

A REFERENCE BOOK
FOR THE MECHANICAL ENGINEER, DESIGNER,
MANUFACTURING ENGINEER, DRAFTSMAN,
TOOLMAKER, AND MACHINIST

Machinery's Handbook

29th Edition

BY ERIK OBERG, FRANKLIN D. JONES,
HOLBROOK L. HORTON, AND HENRY H. RYFFEL

CHRISTOPHER J. McCAULEY, SENIOR EDITOR

2012

INDUSTRIAL PRESS

NEW YORK

COPYRIGHT

COPYRIGHT © 1914, 1924, 1928, 1930, 1931, 1934, 1936, 1937, 1939, 1940, 1941, 1942, 1943, 1944, 1945, 1946, 1948, 1950, 1951, 1952, 1953, 1954, 1955, 1956, 1957, 1959, 1962, 1964, 1966, 1968, 1971, 1974, 1975, 1977, 1979, 1984, 1988, 1992, 1996, 1997, 1998, 2000, 2004, 2008, © 2012 by Industrial Press Inc., New York, NY.

Library of Congress Cataloging-in-Publication Data

Oberg, Erik, 1881—1951

Machinery's Handbook.

2800 p.

Includes index.

I. Mechanical engineering—Handbook, manuals, etc.

I. Jones, Franklin Day, 1879-1967

II. Horton, Holbrook Lynedon, 1907-2001

III. Ryffel, Henry H. 1920-2012 IV. Title.

TJ151.0245 2012 621.8'0212 72-622276

ISBN 978-0-8311-2900-2 (Toolbox Thumb Indexed 11.7 x 17.8 cm)

ISBN 978-0-8311-2901-9 (Large Print Thumb Indexed 17.8 x 25.4 cm)

ISBN 978-0-8311-2902-6 (CD-ROM)

ISBN 978-0-8311-2904-0 (Toolbox Thumb Indexed / CD-ROM Combo 11.7 x 17.8 cm)

ISBN 978-0-8311-2905-7 (Large Print Thumb Indexed / CD-ROM Combo 17.8 x 25.4 cm)

LC card number 72-622276

INDUSTRIAL PRESS, INC.

989 Avenue of the Americas

New York, New York 10018

MACHINERY'S HANDBOOK

29TH EDITION



Production Manager/Art Director: Janet Romano

PREFACE

Machinery's Handbook has served as the principal reference work in metalworking, design and manufacturing facilities, and in technical schools and colleges throughout the world, for nearly 100 years of continuous publication. Throughout this period, the intention of the *Handbook* editors has always been to create a comprehensive and practical tool, combining the most basic and essential aspects of sophisticated manufacturing practice. A tool to be used in much the same way that other tools are used, to make and repair products of high quality, at the lowest cost, and in the shortest time possible.

The essential basics, material that is of proven and everlasting worth, must always be included if the *Handbook* is to continue to provide for the needs of the manufacturing community. But, it remains a difficult task to select suitable material from the almost unlimited supply of data pertaining to the manufacturing and mechanical engineering fields, and to provide for the needs of design and production departments in all sizes of manufacturing plants and workshops, as well as those of job shops, the hobbyist, and students of trade, technical, and engineering schools.

The editors rely to a great extent on conversations and written communications with users of the *Handbook* for guidance on topics to be introduced, revised, lengthened, shortened, or omitted. At the request of users, in 1997 the first ever large-print or "desktop" edition of the *Handbook* was published, followed in 1998 by the publication of the first *Machinery's Handbook CD-ROM* including hundreds of additional pages of material restored from earlier editions. The large-print and CD-ROM editions have since become permanent additions to the growing family of *Machinery's Handbook* products.

Regular users of the *Handbook* will quickly discover some of the many changes embodied in the present edition. One is the combined *Mechanics and Strength of Materials* section, arising out of the two former sections of similar name. The *Plastics* section, formerly a separate thumb tab, has been incorporated into the *Properties of Materials* section. "Old style" numerals, in continuous use in the first twenty-five editions, are now used only in the index for page references, and in cross references throughout the text. The entire text of this edition, including all the tables and equations, has been reset, and a great many of the numerous figures have been redrawn. The current edition has expanded to 2800 pages.

The 29th edition of the *Handbook* contains major revisions of existing content, as well as new material on a variety of topics. The detailed tables of contents located at the beginning of each section have been expanded and fine tuned to simplify locating topics; numerous major sections have been extensively reworked and renovated throughout, including *Mathematics, Mechanics and Strength of Materials, Properties of Materials, Dimensioning, Gaging and Measuring, Machining Operations, Manufacturing Process, Fasteners, Threads and Threading, and Machine Elements*. New and recent material in this edition include a new section on micromachining, expanded material on calculation of hole coordinates, an introduction to metrology, further contributions to the sheet metal and presses section, shaft alignment, taps and tapping, helical coil screw thread inserts, solid geometry, distinguishing between bolts and screws, statistics, calculating thread dimensions, keys and keyways, miniature screws, metric screw threads, and fluid mechanics.

Other subjects in the *Handbook* that are new or have been recently revised, expanded, or updated are lubrication, CNC programming and CNC thread cutting, metric wrench clearances, ANSI and ISO drafting practices, and ISO surface texture.


The metric content of the *Handbook* has been greatly expanded in the 29th edition. Throughout the book, where practical, metric units are shown adjacent to the US customary units in the text. Many formulas are now presented with equivalent metric expressions, and additional metric examples have been added.

The large-print edition is identical to the traditional toolbox edition, only the size is increased by a comfortable 140% for easier reading, making it ideal as a desktop reference. Other than size, there are no differences between the toolbox and large-print editions.

PREFACE

The *Machinery's Handbook 29* CD-ROM contains the complete contents of the printed edition, presented in Adobe PDF format. This popular and well known format allows viewing and printing of pages that are identical to those of the printed book, permits rapid searching of the entire *Handbook*, and includes the ability to magnify the view of any page. Navigation aids in the form of thousands of clickable bookmarks, page cross references, and index entries take you quickly to any page referenced.

New and revised *Handbook* topics often requires cutting or removal of some older topics to gain space for the new. Those topics removed from the print book are generally added to the CD, which also contains much other material not available in the print editions. Included are extensive indexes of materials and standards referenced in the *Handbook*, numerous mathematical tables including trig, logarithms, and sine-bar tables, material on cement and concrete, adhesives and sealants, recipes for coloring and etching metals, forge shop equipment, silent chain, worm gearing and other material on gears, keys and keyways, numerous other topics, new and old, and more than five hundred additional pages.

Also found on the CD are numerous interactive math problems. The math solutions are accessed directly from the CD by clicking an icon, located in the page margin adjacent to a covered problem, (see figure shown here). An internet connection is required to use these problems. A list of currently available interactive math solutions, arranged by topic, can be found in the *Index of Interactive Equations* on *Machinery's Handbook 29 CD*. A single click on a page number in the index takes you to the page containing the topic of interest and the icon to access the solution. Additional interactive solutions are added from time to time as the need arises. 

Those users involved in aspects of machining and grinding will be interested in the topics Micromachining, Machining Econometrics and Grinding Feeds and Speeds, presented in the *Machining* section. The core of all manufacturing methods start with the cutting edge and the metal removal process. Improving the control of the machining process is a major component necessary to achieve a **Lean chain** of manufacturing events. These sections describe the means that are necessary to get metal cutting processes under control and how to properly evaluate the decision making.

A major goal of the editors is to make the *Handbook* easier to use. The 29th edition of the *Handbook* continues to incorporate the timesaving thumb tabs, much requested by users in the past. The table of contents pages beginning each major section, first introduced for the 25th edition, have proven very useful to readers. Consequently, the number of contents pages has been increased to several pages each for many of the larger sections, to thoroughly reflect the contents of these sections.

The editors are greatly indebted to readers who call attention to possible errors and defects in the *Handbook*, who offer suggestions concerning the omission of some matter that is considered to be of general value, or who have technical questions concerning the solution of difficult or troublesome *Handbook* problems. Such dialog is often invaluable and helps to identify topics that require additional clarification or are the source of reader confusion. Queries involving *Handbook* material usually entail an in depth review of the topic in question, and may result in the addition of new material to the *Handbook* intended to resolve or clarify the issue. The material on the mass moment of inertia of hollow circular rings, page 244, and on the effect of temperature on the radius of thin circular rings, page 378, are good examples.

Our goal is to increase the usefulness of the *Handbook* as much as possible. All criticisms and suggestions about revisions, omissions or inclusion of new material, and requests for assistance with manufacturing problems encountered in the shop are welcome.

Christopher J. McCauley
Senior Editor

TABLE OF CONTENTS

LICENSE AND LIMITED WARRANTY AGREEMENT	ii
PREFACE	v
TABLE OF CONTENTS	vii
ACKNOWLEDGMENTS	ix
MATHEMATICS	1
• NUMBERS, FRACTIONS, AND DECIMALS • ALGEBRA AND EQUATIONS • GEOMETRY • SOLUTION OF TRIANGLES	
• MATRICES • MANUFACTURING DATA ANALYSIS • ENGINEERING ECONOMICS	
MECHANICS AND STRENGTH OF MATERIALS	147
• MECHANICS • VELOCITY, ACCELERATION, WORK, AND ENERGY	
• STRENGTH OF MATERIALS • PROPERTIES OF BODIES • BEAMS	
• COLUMNS • PLATES, SHELLS, AND CYLINDERS • SHAFTS	
• SPRINGS • DISC SPRINGS • FLUID MECHANICS	
PROPERTIES, TREATMENT, AND TESTING OF MATERIALS	369
• THE ELEMENTS, HEAT, MASS, AND WEIGHT • PROPERTIES OF WOOD, CERAMICS, PLASTICS, METALS • STANDARD STEELS	
• TOOL STEELS • HARDENING, TEMPERING, AND ANNEALING	
• NONFERROUS ALLOYS • PLASTICS	
DIMENSIONING, GAGING, AND MEASURING	608
• DRAFTING PRACTICES • ALLOWANCES AND TOLERANCES FOR FITS • MEASURING, INSTRUMENTS, AND INSPECTION METHODS	
• SURFACE TEXTURE	
TOOLING AND TOOLMAKING	754
• CUTTING TOOLS • CEMENTED CARBIDES • FORMING TOOLS	
• MILLING CUTTERS • REAMERS • TWIST DRILLS AND COUNTERBORES • TAPS • STANDARD TAPERS • ARBORS, CHUCKS, AND SPINDLES • BROACHES AND BROACHING • FILES AND BURS • KNURLS AND KNURLING • TOOL WEAR AND SHARPENING	
MACHINING OPERATIONS	1004
• CUTTING SPEEDS AND FEEDS • SPEED AND FEED TABLES	
• ESTIMATING SPEEDS AND MACHINING POWER	
• MICROMACHINING • MACHINING ECONOMETRICS • SCREW MACHINES, BAND SAWS, CUTTING FLUIDS • MACHINING NONFERROUS METALS AND NON-METALLIC MATERIALS • GRINDING FEEDS AND SPEEDS • GRINDING AND OTHER ABRASIVE PROCESSES • CNC NUMERICAL CONTROL PROGRAMMING	
MANUFACTURING PROCESSES	1328
• SHEET METAL WORKING AND PRESSES • ELECTRICAL DISCHARGE MACHINING • IRON AND STEEL CASTINGS	
• SOLDERING AND BRAZING • WELDING • LASERS • FINISHING OPERATIONS	

Each section has a detailed Table of Contents or Index located on the page indicated

TABLE OF CONTENTS

FASTENERS	1517
• TORQUE AND TENSION IN FASTENERS • INCH THREADED FASTENERS • METRIC THREADED FASTENERS • HELICAL COIL SCREW THREAD INSERTS • BRITISH FASTENERS • MACHINE SCREWS AND NUTS • CAP AND SET SCREWS • SELF-THREADING SCREWS • T-SLOTS, BOLTS, AND NUTS • RIVETS AND RIVETED JOINTS • PINS AND STUDS • RETAINING RINGS • WING NUTS, WING SCREWS, AND THUMB SCREWS • NAILS, SPIKES, AND WOOD SCREWS	
THREADS AND THREADING	1802
• SCREW THREAD SYSTEMS • UNIFIED SCREW THREADS • CALCULATING THREAD DIMENSIONS • METRIC SCREW THREADS • ACME SCREW THREADS • BUTTRESS THREADS • WHITWORTH THREADS • PIPE AND HOSE THREADS • OTHER THREADS • MEASURING SCREW THREADS • TAPPING AND THREAD CUTTING • THREAD ROLLING • THREAD GRINDING • THREAD MILLING • SIMPLE, COMPOUND, DIFFERENTIAL, AND BLOCK INDEXING	
GEARS, SPLINES, AND CAMS	2122
• GEARS AND GEARING • HYPOID AND BEVEL GEARING • WORM GEARING • HELICAL GEARING • OTHER GEAR TYPES • CHECKING GEAR SIZES • GEAR MATERIALS • SPLINES AND SERRATIONS • CAMS AND CAM DESIGN	
MACHINE ELEMENTS	2310
• PLAIN BEARINGS • BALL, ROLLER, AND NEEDLE BEARINGS • LUBRICATION • COUPLINGS, CLUTCHES, BRAKES • KEYS AND KEYSEATS • FLEXIBLE BELTS AND SHEAVES • TRANSMISSION CHAINS • BALL AND ACME LEADSCREWS • ELECTRIC MOTORS • ADHESIVES AND SEALANTS • O-RINGS • ROLLED STEEL, WIRE, SHEET-METAL, WIRE ROPE • SHAFT ALIGNMENT	
MEASURING UNITS	2651
• SYMBOLS AND ABBREVIATIONS • MEASURING UNITS • U.S. SYSTEM AND METRIC SYSTEM CONVERSIONS	
INDEX	2701
INDEX OF STANDARDS	2789
INDEX OF INTERACTIVE EQUATIONS	2801
INDEX OF MATERIALS	2807
INDEX OF ADDITIONAL CONTENT ON THE CD	2854
ADDITIONAL ONLY ON THE CD	2865
• MATHEMATICS • MECHANICS AND STRENGTH OF MATERIALS • PROPERTIES, TREATMENT, TESTING OF MATERIALS • DIMENSIONING, GAGING, MEASURING, INSPECTION • TOOLING AND TOOL MAKING • MACHINING OPERATIONS • MANUFACTURING PROCESS • FASTENERS • THREADS AND THREADING • GEARS, SPLINES, AND CAMS • MACHINE ELEMENTS • ADDITIONAL	

Each section has a detailed Table of Contents or Index starting at the page indicated

TABLE OF CONTENTS

MATHEMATICS

NUMBERS, FRACTIONS, AND DECIMALS	GEOMETRY
3 Fractional Inch, Decimal, Millimeter Conversion	37 Arithmetical & Geometrical Progression
4 Numbers	40 Analytical Geometry
4 Positive and Negative Numbers	40 Straight Line
5 Sequence of Operations	43 Coordinate Systems
5 Ratio and Proportion	46 Circle
7 Percentage	48 Ellipse
8 Fractions	51 Spherical Areas and Volumes
8 Common Fractions	54 Parabola
8 Reciprocals	54 Hyperbola
9 Addition, Subtraction, Multiplication, Division	66 Areas and Volumes
10 Decimal Fractions	66 The Prismoidal Formula
11 Continued Fractions	66 Pappus or Guldinus Rules
12 Conjugate Fractions	67 Area of Revolution Surface
13 Using Continued Fraction	67 Area of Irregular Plane Surface
14 Powers and Roots	68 Areas of Cycloidal Curves
14 Powers of Ten Notation	68 Contents of Cylindrical Tanks
15 Converting to Power of Ten	70 Areas and Dimensions of Figures
15 Multiplication	76 Formulas for Regular Polygons
16 Division	77 Circular Segments
16 Constants Frequently Used in Mathematical Expressions	80 Circles and Squares of Equal Area
17 Logarithms	81 Diagonals of Squares & Hexagons
17 Natural Logarithms	82 Volumes of Solids
18 Imaginary and Complex Numbers	88 Circles in Circles and Rectangles
19 Factorial	93 Circles within Rectangles
19 Permutations	94 Rollers on a Shaft
19 Combinations	
20 Prime Numbers and Factors	
	SOLUTION OF TRIANGLES
ALGEBRA AND EQUATIONS	95 Functions of Angles
30 Rearrangement of Formulas	96 Laws of Sines and Cosines
31 Principle Algebraic Expressions	96 Trigonometric Identities
32 Solving First Degree Equations	98 Right-angled Triangles
32 Solving Quadratic Equations	101 Obtuse-angled Triangles
33 Factoring a Quadratic Expression	103 Degree-radian Conversion
34 Cubic Equations	105 Functions of Angles, Graphic
34 Solving Numerical Equations	106 Trig Function Tables
35 Series	110 Versed Sine and Versed Cosine
35 Derivatives and Integrals	110 Sevolute and Involute Functions
	111 Involute Functions Tables
	115 Spherical Trigonometry
	115 Right Spherical Trigonometry
	117 Oblique Spherical Trigonometry
	119 Compound Angles
	121 Interpolation

TABLE OF CONTENTS

MATHEMATICS

MATRICES	ENGINEERING ECONOMICS
122 Matrix Operations	134 Interest
122 Matrix Addition and Subtraction	134 Simple and Compound Interest
122 Matrix Multiplication	135 Nominal vs. Effective Interest Rates
123 Transpose of a Matrix	136 Cash Flow and Equivalence
123 Determinant of a Square Matrix	137 Cash Flow Diagrams
124 Minors and Cofactors	139 Depreciation
124 Adjoint of a Matrix	139 Straight Line Depreciation
125 Singularity and Rank of a Matrix	139 Sum of the Years Digits
125 Inverse of a Matrix	139 Double Declining Balance
125 Simultaneous Equations	139 Statutory Depreciation System
MANUFACTURING DATA ANALYSIS	140 Evaluating Alternatives
128 Statistics Theory	140 Net Present Value
128 Statistical Distribution Curves	141 Capitalized Cost
128 Normal Distribution Curve	142 Equivalent Uniform Annual Cost
128 Statistical Analysis	143 Rate of Return
130 Applying Statistics	143 Benefit-cost Ratio
130 Minimum Number of Tests	143 Payback Period
130 Comparing Average Performance	143 Break-even Analysis
132 Examples	146 Overhead Expenses
133 Machinability and Hardness	

NUMBERS, FRACTIONS, AND DECIMALS

Table 1. Fractional and Decimal Inch to Millimeter, Exact^a Values

Fractional Inch	Decimal Inch	Millimeters	Fractional Inch	Decimal Inch	Millimeters
1/64	0.015625	0.396875		0.511811024	13
1/32	0.03125	0.79375	33/64	0.515625	13.096875
	0.039370079	1	17/32	0.53125	13.49375
3/64	0.046875	1.190625	35/64	0.546875	13.890625
1/16	0.0625	1.5875		0.551181102	14
5/64	0.078125	1.984375	9/16	0.5625	14.2875
	0.078740157	2	37/64	0.578125	14.684375
1/12	0.0833 ^b	2.1166	7/12	0.5833	14.8166
3/32	0.09375	2.38125		0.590551181	15
7/64	0.109375	2.778125	19/32	0.59375	15.08125
	0.118110236	3	39/64	0.609375	15.478125
1/8	0.125	3.175	5/8	0.625	15.875
9/64	0.140625	3.571875		0.62992126	16
5/32	0.15625	3.96875	41/64	0.640625	16.271875
	0.157480315	4	21/32	0.65625	16.66875
1/6	0.166	4.233	2/3	0.66	16.933
11/64	0.171875	4.365625		0.669291339	17
3/16	0.1875	4.7625	43/64	0.671875	17.065625
	0.196850394	5	11/16	0.6875	17.4625
13/64	0.203125	5.159375	45/64	0.703125	17.859375
7/32	0.21875	5.55625		0.708661417	18
15/64	0.234375	5.953125	23/32	0.71875	18.25625
	0.236220472	6	47/64	0.734375	18.653125
1/4	0.25	6.35		0.748031496	19
17/64	0.265625	6.746875	3/4	0.75	19.05
	0.275590551	7	49/64	0.765625	19.446875
9/32	0.28125	7.14375	25/32	0.78125	19.84375
19/64	0.296875	7.540625		0.787401575	20
5/16	0.3125	7.9375	51/64	0.796875	20.240625
	0.31496063	8	13/16	0.8125	20.6375
21/64	0.328125	8.334375		0.826771654	21
1/3	0.33	8.466	53/64	0.828125	21.034375
11/32	0.34375	8.73125	27/32	0.84375	21.43125
	0.354330709	9	55/64	0.859375	21.828125
23/64	0.359375	9.128125		0.866141732	22
3/8	0.375	9.525	7/8	0.875	22.225
25/64	0.390625	9.921875	57/64	0.890625	22.621875
	0.393700787	10		0.905511811	23
13/32	0.40625	10.31875	29/32	0.90625	23.01875
5/12	0.4166	10.5833	11/12	0.9166	23.2833
27/64	0.421875	10.715625	59/64	0.921875	23.415625
	0.433070866	11	15/16	0.9375	23.8125
7/16	0.4375	11.1125		0.94488189	24
29/64	0.453125	11.509375	61/64	0.953125	24.209375
15/32	0.46875	11.90625	31/32	0.96875	24.60625
	0.472440945	12		0.984251969	25
31/64	0.484375	12.303125	63/64	0.984375	25.003125
1/2	0.5	12.7			

^a Table data are based on 1 inch = 25.4 mm, exactly. Inch to millimeter conversion values are exact. Whole number millimeter to inch conversions are rounded to 9 decimal places.

^b Numbers with an overbar, repeat indefinitely after the last figure, for example $0.08\overline{33} = 0.08333\dots$

Numbers

Numbers are the basic instrumentation of computation. Calculations are made by operations of numbers. The whole numbers greater than zero are called natural numbers. The first ten numbers 0, 1, 2, 3, 4, 5, 6, 7, 8, 9 are called numerals. Numbers follow certain formulas. The following properties hold true:

Associative law: $x + (y + z) = (x + y) + z$, $x(yz) = (xy)z$

Distributive law: $x(y + z) = xy + xz$

Commutative law: $x + y = y + x$

Identity law: $0 + x = x$, $1x = x$

Inverse law: $x - x = 0$, $x/x = 1$

Positive and Negative Numbers.—The degrees on a thermometer scale extending upward from the zero point may be called *positive* and may be preceded by a plus sign; thus +5 degrees means 5 degrees above zero. The degrees below zero may be called *negative* and may be preceded by a minus sign; thus, -5 degrees means 5 degrees below zero. In the same way, the ordinary numbers 1, 2, 3, etc., which are larger than 0, are called positive numbers; but numbers can be conceived of as extending in the other direction from 0, numbers that, in fact, are less than 0, and these are called negative. As these numbers must be expressed by the same figures as the positive numbers they are designated by a minus sign placed before them, thus: (-3). A negative number should always be enclosed within parentheses whenever it is written in line with other numbers; for example: $17 + (-13) - 3 \times (-0.76)$.

Negative numbers are most commonly met with in the use of logarithms and natural trigonometric functions. The following rules govern calculations with negative numbers.

A negative number can be added to a positive number by subtracting its numerical value from the positive number.

Example: $4 + (-3) = 4 - 3 = 1$

A negative number can be subtracted from a positive number by adding its numerical value to the positive number.

Example: $4 - (-3) = 4 + 3 = 7$

A negative number can be added to a negative number by adding the numerical values and making the sum negative.

Example: $(-4) + (-3) = -7$

A negative number can be subtracted from a larger negative number by subtracting the numerical values and making the difference negative.

Example: $(-4) - (-3) = -1$

A negative number can be subtracted from a smaller negative number by subtracting the numerical values and making the difference positive.

Example: $(-3) - (-4) = 1$

If in a subtraction the number to be subtracted is larger than the number from which it is to be subtracted, the calculation can be carried out by subtracting the smaller number from the larger, and indicating that the remainder is negative.

Example: $3 - 5 = -(5 - 3) = -2$

When a positive number is to be multiplied or divided by a negative numbers, multiply or divide the numerical values as usual; the product or quotient, respectively, is negative. The same rule is true if a negative number is multiplied or divided by a positive number.

Examples: $4 \times (-3) = -12$ $(-4) \times 3 = -12$

$15 \div (-3) = -5$ $(-15) \div 3 = -5$

When two negative numbers are to be multiplied by each other, the product is positive. When a negative number is divided by a negative number, the quotient is positive.

Examples: $(-4) \times (-3) = 12$; $(-4) \div (-3) = 1.333$

The two last rules are often expressed for memorizing as follows: "Equal signs make plus, unequal signs make minus."

Sequence of Performing Arithmetic Operations.—When several numbers or quantities in a formula are connected by signs indicating that additions, subtractions, multiplications, and divisions are to be made, the multiplications and divisions should be carried out first, in the sequence in which they appear, before the additions or subtractions are performed.

Example:

$$10 + 26 \times 7 - 2 = 10 + 182 - 2 = 190$$

$$18 \div 6 + 15 \times 3 = 3 + 45 = 48$$

$$12 + 14 \div 2 - 4 = 12 + 7 - 4 = 15$$

When it is required that certain additions and subtractions should precede multiplications and divisions, use is made of parentheses () and brackets []. These signs indicate that the calculation inside the parentheses or brackets should be carried out completely by itself before the remaining calculations are commenced. If one bracket is placed inside another, the one inside is first calculated.

Example:

$$(6 - 2) \times 5 + 8 = 4 \times 5 + 8 = 20 + 8 = 28$$

$$6 \times (4 + 7) \div 22 = 6 \times 11 \div 22 = 66 \div 22 = 3$$

$$2 + [10 \times 6(8 + 2) - 4] \times 2 = 2 + [10 \times 6 \times 10 - 4] \times 2$$

$$= 2 + [600 - 4] \times 2 = 2 + 596 \times 2 = 2 + 1192 = 1194$$

The parentheses are considered as a sign of multiplication; for example:

$$6(8 + 2) = 6 \times (8 + 2).$$

The line or bar between the numerator and denominator in a fractional expression is to be considered as a division sign. For example,

$$\frac{12 + 16 + 22}{10} = (12 + 16 + 22) \div 10 = 50 \div 10 = 5$$

In formulas, the multiplication sign (\times) is often left out between symbols or letters, the values of which are to be multiplied. Thus,

$$AB = A \times B \quad \text{and} \quad \frac{ABC}{D} = (A \times B \times C) \div D$$

Ratio and Proportion.—The *ratio* between two quantities is the quotient obtained by dividing the first quantity by the second. For example, the ratio between 3 and 12 is $\frac{1}{4}$, and the ratio between 12 and 3 is 4. Ratio is generally indicated by the sign (:); thus, 12 : 3 indicates the ratio of 12 to 3.

A *reciprocal*, or *inverse* ratio, is the opposite of the original ratio. Thus, the inverse ratio of 5 : 7 is 7 : 5.

In a *compound* ratio, each term is the product of the corresponding terms in two or more simple ratios. Thus, when

$$8:2 = 4 \quad 9:3 = 3 \quad 10:5 = 2$$

then the compound ratio is

$$8 \times 9 \times 10 : 2 \times 3 \times 5 = 4 \times 3 \times 2$$

$$720:30 = 24$$

Proportion is the equality of ratios. Thus,

$$6:3 = 10:5 \quad \text{or} \quad 6:3::10:5$$

The first and last terms in a proportion are called the *extremes*; the second and third, the *means*. The product of the extremes is equal to the product of the means. Thus,

$$25:2 = 100:8 \quad \text{and} \quad 25 \times 8 = 2 \times 100$$

If three terms in a proportion are known, the remaining term may be found by the following rules:

The first term is equal to the product of the second and third terms, divided by the fourth.

The second term is equal to the product of the first and fourth terms, divided by the third.

The third term is equal to the product of the first and fourth terms, divided by the second.

The fourth term is equal to the product of the second and third terms, divided by the first.

Example: Let x be the term to be found, then,

$$x : 12 = 3.5 : 21$$

$$x = \frac{12 \times 3.5}{21} = \frac{42}{21} = 2$$

$$\frac{1}{4} : x = 14 : 42$$

$$x = \frac{\frac{1}{4} \times 42}{14} = \frac{1}{4} \times 3 = \frac{3}{4}$$

$$5 : 9 = x : 63$$

$$x = \frac{5 \times 63}{9} = \frac{315}{9} = 35$$

$$\frac{1}{4} : \frac{7}{8} = 4 : x$$

$$x = \frac{\frac{7}{8} \times 4}{\frac{1}{4}} = \frac{3\frac{1}{2}}{\frac{1}{4}} = 14$$

If the second and third terms are the same, that number is the *mean proportional* between the other two. Thus, $8 : 4 = 4 : 2$, and 4 is the mean proportional between 8 and 2. The mean proportional between two numbers may be found by multiplying the numbers together and extracting the square root of the product. Thus, the mean proportional between 3 and 12 is found as follows:

$$3 \times 12 = 36 \quad \text{and} \quad \sqrt{36} = 6$$

which is the mean proportional.

Practical Examples Involving Simple Proportion: If it takes 18 days to assemble 4 lathes, how long would it take to assemble 14 lathes?

Let the number of days to be found be x . Then write out the proportion as follows:

$$4:18 = 14:x$$

$$(\text{lathes} : \text{days} = \text{lathes} : \text{days})$$

Now find the fourth term by the rule given:

$$x = \frac{18 \times 14}{4} = 63 \text{ days}$$

Ten linear meters (32.81 feet) of bar stock are required as blanks for 100 clamping bolts. What total length x of stock would be required for 912 bolts?

$$10:100 = x:912$$

$$32.81:100 = x:912$$

$$(\text{meters}:\text{bolts} = \text{meters}:\text{bolts})$$

or

$$(\text{feet}:\text{bolts} = \text{feet}:\text{bolts})$$

$$x = \frac{10 \times 912}{100} = 91.2 \text{ m}$$

$$x = \frac{32.81 \times 912}{100} = 299.2 \text{ ft}$$

Inverse Proportion: In an inverse proportion, as one of the items involved *increases*, the corresponding item in the proportion *decreases*, or vice versa. For example, a factory employing 270 men completes a given number of typewriters weekly, the number of working hours being 44 per week. How many men would be required for the same production if the working hours were reduced to 40 per week?

The time per week is in an inverse proportion to the number of men employed; the shorter the time, the more men. The inverse proportion is written:

$$270 : x = 40 : 44$$

(men, 44-hour basis: men, 40-hour basis = time, 40-hour basis: time, 44-hour basis)

Thus

$$\frac{270}{x} = \frac{40}{44} \quad \text{and} \quad x = \frac{270 \times 44}{40} = 297 \text{ men}$$

Problems Involving Both Simple and Inverse Proportions: If two groups of data are related both by direct (simple) and inverse proportions among the various quantities, then a simple mathematical relation that may be used in solving problems is as follows:

$$\frac{\text{Product of all directly proportional items in first group}}{\text{Product of all inversely proportional items in first group}} = \frac{\text{Product of all directly proportional items in second group}}{\text{Product of all inversely proportional items in second group}}$$

Example: If a man capable of turning 65 studs in a day of 10 hours is paid \$6.50 per hour, how much per hour ought a man be paid who turns 72 studs in a 9-hour day, if compensated in the same proportion?

The first group of data in this problem consists of the number of hours worked by the first man, his hourly wage, and the number of studs which he produces per day; the second group contains similar data for the second man except for his unknown hourly wage, which may be indicated by x .

The labor cost per stud, as may be seen, is directly proportional to the number of hours worked and the hourly wage. These quantities, therefore, are used in the numerators of the fractions in the formula. The labor cost per stud is inversely proportional to the number of studs produced per day. (The greater the number of studs produced in a given time the less the cost per stud.) The numbers of studs per day, therefore, are placed in the denominators of the fractions in the formula. Thus,

$$\frac{10 \times 6.50}{65} = \frac{9 \times x}{72}$$

$$x = \frac{10 \times 6.50 \times 72}{65 \times 9} = \$8.00 \text{ per hour}$$

Percentage.—If out of 100 pieces made, 12 do not pass inspection, it is said that 12 per cent (12 of the hundred) are rejected. If a quantity of steel is bought for \$100 and sold for \$140, the profit is 28.6 per cent of the selling price.

The per cent of gain or loss is found by dividing the amount of gain or loss by the *original* number of which the percentage is wanted, and multiplying the quotient by 100.

Example: Out of a total output of 280 castings a day, 30 castings are, on an average, rejected. What is the percentage of bad castings?

$$\frac{30}{280} \times 100 = 10.7 \text{ per cent}$$

If by a new process 100 pieces can be made in the same time as 60 could formerly be made, what is the gain in output of the new process over the old, expressed in per cent?

Original number, 60; gain $100 - 60 = 40$. Hence,

$$\frac{40}{60} \times 100 = 66.7 \text{ per cent}$$

Care should be taken always to use the original number, or the number of which the percentage is wanted, as the divisor in all percentage calculations. In the example just given, it

is the percentage of gain over the old output 60 that is wanted and not the percentage with relation to the new output too. Mistakes are often made by overlooking this important point.

Fractions

Common Fractions.— Common fractions consist of two basic parts, a denominator, or bottom number, and a numerator, or top number. The denominator shows how many parts the whole unit has been divided into. The numerator indicates the number of parts of the whole that are being considered. A fraction having a value of $\frac{5}{32}$, means the whole unit has been divided into 32 equal parts and 5 of these parts are considered in the value of the fraction.

The following are the basic facts, rules, and definitions concerning common fractions.

A common fraction having the same numerator and denominator is equal to 1. For example, $\frac{2}{2}$, $\frac{4}{4}$, $\frac{8}{8}$, $\frac{16}{16}$, $\frac{32}{32}$, and $\frac{64}{64}$ all equal 1.

Proper Fraction: A proper fraction is a common fraction having a numerator smaller than its denominator, such as $\frac{1}{4}$, $\frac{1}{2}$, and $\frac{47}{64}$.

Improper Fraction: An improper fraction is a common fraction having a numerator larger than its denominator. For example, $\frac{3}{2}$, $\frac{5}{4}$, and $\frac{10}{8}$. To convert a whole number to an improper fraction place the whole number over 1, as in $4 = \frac{4}{1}$ and $3 = \frac{3}{1}$.

Reducible Fraction: A reducible fraction is a common fraction that can be reduced to lower terms. For example, $\frac{2}{4}$ can be reduced to $\frac{1}{2}$, and $\frac{28}{32}$ can be reduced to $\frac{7}{8}$. To reduce a common fraction to lower terms, divide both the numerator and the denominator by the same number. For example, $\frac{24}{32} \div \frac{8}{8} = \frac{3}{4}$ and $\frac{6}{8} \div \frac{2}{2} = \frac{3}{4}$.

Least Common Denominator: A least common denominator is the smallest denominator value that is evenly divisible by the other denominator values in the problem. For example, given the following numbers, $\frac{1}{2}$, $\frac{1}{4}$, and $\frac{3}{8}$, the least common denominator is 8.

Mixed Number: A mixed number is a combination of a whole number and a common fraction, such as $2\frac{1}{2}$, $1\frac{7}{8}$, $3\frac{15}{16}$ and $1\frac{9}{32}$.

To convert mixed numbers to improper fractions, multiply the whole number by the denominator and add the numerator to obtain the new numerator. The denominator remains the same. For example,

$$2\frac{1}{2} = \frac{2 \times 2 + 1}{2} = \frac{5}{2}$$

$$3\frac{7}{16} = \frac{3 \times 16 + 7}{16} = \frac{55}{16}$$

To convert an improper fraction to a mixed number, divide the numerator by the denominator and reduce the remaining fraction to its lowest terms. For example,

$$1\frac{7}{8} = 17 \div 8 = 2\frac{1}{8} \text{ and } \frac{26}{16} = 26 \div 16 = 1\frac{10}{16} = 1\frac{5}{8}$$

A fraction may be converted to higher terms by multiplying the numerator and denominator by the same number. For example, $\frac{1}{4}$ in 16ths = $\frac{1}{4} \times \frac{4}{4} = \frac{4}{16}$ and $\frac{3}{8}$ in 32nds = $\frac{3}{8} \times \frac{4}{4} = \frac{12}{32}$.

To change a whole number to a common fraction with a specific denominator value, convert the whole number to a fraction and multiply the numerator and denominator by the desired denominator value.

Example: 4 in 16ths = $\frac{4}{1} \times \frac{16}{16} = \frac{64}{16}$ and 3 in 32nds = $\frac{3}{1} \times \frac{32}{32} = \frac{96}{32}$

Reciprocals.—The *reciprocal* R of a number N is obtained by dividing 1 by the number; $R = 1/N$. Reciprocals are useful in some calculations because they avoid the use of negative characteristics as in calculations with logarithms and in trigonometry. In trigonometry, the

values *cosecant*, *secant*, and *cotangent* are often used for convenience and are the reciprocals of the *sine*, *cosine*, and *tangent*, respectively (see page 95). The reciprocal of a fraction, for instance $\frac{3}{4}$, is the fraction inverted, since $1 \div \frac{3}{4} = 1 \times \frac{4}{3} = \frac{4}{3}$.

Adding Fractions and Mixed Numbers

To Add Common Fractions: 1) Find and convert to the least common denominator; 2) Add the numerators; 3) Convert the answer to a mixed number, if necessary; and 4) Reduce the fraction to its lowest terms.

To Add Mixed Numbers: 1) Find and convert to the least common denominator; 2) Add the numerators; 3) Add the whole numbers; and 4) Reduce the answer to its lowest terms.

Example, Addition of Common Fractions:

$$\begin{aligned}\frac{1}{4} + \frac{3}{16} + \frac{7}{8} &= \\ \frac{1}{4}\left(\frac{4}{4}\right) + \frac{3}{16} + \frac{7}{8}\left(\frac{2}{2}\right) &= \\ \frac{4}{16} + \frac{3}{16} + \frac{14}{16} &= \frac{21}{16}\end{aligned}$$

Example, Addition of Mixed Numbers:

$$\begin{aligned}2\frac{1}{2} + 4\frac{1}{4} + 1\frac{15}{32} &= \\ 2\frac{1}{2}\left(\frac{16}{16}\right) + 4\frac{1}{4}\left(\frac{8}{8}\right) + 1\frac{15}{32} &= \\ 2\frac{16}{32} + 4\frac{8}{32} + 1\frac{15}{32} &= 7\frac{39}{32} = 8\frac{7}{32}\end{aligned}$$

Subtracting Fractions and Mixed Numbers

To Subtract Common Fractions: 1) Convert to the least common denominator; 2) Subtract the numerators; and 3) Reduce the answer to its lowest terms.

To Subtract Mixed Numbers: 1) Convert to the least common denominator; 2) Subtract the numerators; 3) Subtract the whole numbers; and 4) Reduce the answer to its lowest terms.

Example, Subtraction of Common Fractions:

$$\begin{aligned}\frac{15}{16} - \frac{7}{32} &= \\ \frac{15}{16}\left(\frac{2}{2}\right) - \frac{7}{32} &= \\ \frac{30}{32} - \frac{7}{32} &= \frac{23}{32}\end{aligned}$$

Example, Subtraction of Mixed Numbers:

$$\begin{aligned}2\frac{3}{8} - 1\frac{1}{16} &= \\ 2\frac{3}{8}\left(\frac{2}{2}\right) - 1\frac{1}{16} &= \\ 2\frac{6}{16} - 1\frac{1}{16} &= 1\frac{5}{16}\end{aligned}$$

Multiplying Fractions and Mixed Numbers

To Multiply Common Fractions: 1) Multiply the numerators; 2) Multiply the denominators; and 3) Convert improper fractions to mixed numbers, if necessary.

To Multiply Mixed Numbers: 1) Convert the mixed numbers to improper fractions; 2) Multiply the numerators; 3) Multiply the denominators; and 4) Convert improper fractions to mixed numbers, if necessary.

Example, Multiplication of Common Fractions:

$$\frac{3}{4} \times \frac{7}{16} = \frac{3 \times 7}{4 \times 16} = \frac{21}{64}$$

Example, Multiplication of Mixed Numbers:

$$2\frac{1}{4} \times 3\frac{1}{2} = \frac{9 \times 7}{4 \times 2} = \frac{63}{8} = 7\frac{7}{8}$$

Dividing Fractions and Mixed Numbers

To Divide Common Fractions: 1) Write the fractions to be divided; 2) Invert (switch) the numerator and denominator in the dividing fraction; 3) Multiply the numerators and denominators; and 4) Convert improper fractions to mixed numbers, if necessary.

To Divide Mixed Numbers: 1) Convert the mixed numbers to improper fractions; 2) Write the improper fraction to be divided; 3) Invert (switch) the numerator and denominator in the dividing fraction; 4) Multiplying numerators and denominators; and 5) Convert improper fractions to mixed numbers, if necessary.

Example, Division of Common Fractions:

$$\frac{3}{4} \div \frac{1}{2} = \frac{3 \times 2}{4 \times 1} = \frac{6}{4} = 1\frac{1}{2}$$

Example, Division of Mixed Numbers:

$$2\frac{1}{2} \div 1\frac{7}{8} = \frac{5 \times 8}{2 \times 15} = \frac{40}{30} = 1\frac{1}{3}$$

Decimal Fractions.—Decimal fractions are fractional parts of a whole unit, which have implied denominators that are multiples of 10. A decimal fraction of 0.1 has a value of 1/10th, 0.01 has a value of 1/100th, and 0.001 has a value of 1/1000th. As the number of decimal place values increases, the value of the decimal number changes by a multiple of 10. A single number placed to the right of a decimal point has a value expressed in tenths; two numbers to the right of a decimal point have a value expressed in hundredths; three numbers to the right have a value expressed in thousandths; and four numbers are expressed in ten-thousandths. Since the denominator is implied, the number of decimal places in the numerator indicates the value of the decimal fraction. So a decimal fraction expressed as a 0.125 means the whole unit has been divided into 1000 parts and 125 of these parts are considered in the value of the decimal fraction.

In industry, most decimal fractions are expressed in terms of thousandths rather than tenths or hundredths. So a decimal fraction of 0.2 is expressed as 200 thousandths, not 2 tenths, and a value of 0.75 is expressed as 750 thousandths, rather than 75 hundredths. In the case of four place decimals, the values are expressed in terms of ten-thousandths. So a value of 0.1875 is expressed as 1 thousand 8 hundred and 75 ten-thousandths. When whole numbers and decimal fractions are used together, whole units are shown to the left of a decimal point, while fractional parts of a whole unit are shown to the right.

Example:

10.125	
Whole Units	Fraction Units

Adding Decimal Fractions: 1) Write the problem with all decimal points aligned vertically; 2) Add the numbers as whole number values; and 3) Insert the decimal point in the same vertical column in the answer.

Subtracting Decimal Fractions: 1) Write the problem with all decimal points aligned vertically; 2) Subtract the numbers as whole number values; and 3) Insert the decimal point in the same vertical column in the answer.

Multiplying Decimal Fractions: 1) Write the problem with the decimal points aligned; 2) Multiply the values as whole numbers; 3) Count the number of decimal places in both multiplied values; and 4) Counting from right to left in the answer, insert the decimal point so the number of decimal places in the answer equals the total number of decimal places in the numbers multiplied.

Example, Adding Decimal Fractions:

$$\begin{array}{r} 0.125 \\ 1.0625 \\ 2.50 \\ \hline 0.1875 \\ 3.8750 \end{array} \quad \text{or} \quad \begin{array}{r} 1.750 \\ 0.875 \\ 0.125 \\ \hline 2.0005 \\ 4.7505 \end{array}$$

Example, Subtracting Decimal Fractions:

$$\begin{array}{r} 1.750 \\ -0.250 \\ \hline 1.500 \end{array} \quad \text{or} \quad \begin{array}{r} 2.625 \\ -1.125 \\ \hline 1.500 \end{array}$$

Example, Multiplying Decimal Fractions:

0.75		1.625	
<u>0.25</u>		<u>0.033</u>	
375	(four decimal places)	4875	(six decimal places)
<u>150</u>		<u>4875</u>	
0.1875		0.053625	

Continued Fractions.—In dealing with a cumbersome fraction, or one which does not have satisfactory factors, it may be possible to substitute some other, approximately equal, fraction which is simpler or which can be factored satisfactorily. Continued fractions provide a means of computing a series of fractions each of which is a closer approximation to the original fraction than the one preceding it in the series.

A continued fraction is a proper fraction (one whose numerator is smaller than its denominator) expressed in the form shown at the left below; or, it may be convenient to write the left expression as shown at the right below.

$$\frac{N}{D} = \frac{1}{D_1 + \frac{1}{D_2 + \frac{1}{D_3 + \dots}}}$$

$$\frac{N}{D} = \frac{1}{D_1} + \frac{1}{D_2} + \frac{1}{D_3} + \frac{1}{D_4} + \dots$$

The continued fraction is produced from a proper fraction N/D by dividing the numerator N both into itself and into the denominator D . Dividing the numerator into itself gives a result of 1; dividing the numerator into the denominator gives a whole number D_1 plus a remainder fraction R_1 . The process is then repeated on the remainder fraction R_1 to obtain D_2 and R_2 ; then D_3, R_3 , etc., until a remainder of zero results. As an example, using $N/D = 2153/9277$,

$$\frac{2153}{9277} = \frac{2153 \div 2153}{9277 \div 2153} = \frac{1}{4 + \frac{665}{2153}} = \frac{1}{D_1 + R_1}$$

$$R_1 = \frac{665}{2153} = \frac{1}{3 + \frac{158}{665}} = \frac{1}{D_2 + R_2} \text{ etc.}$$

from which it may be seen that $D_1 = 4, R_1 = 665/2153; D_2 = 3, R_2 = 158/665$; and, continuing as was explained previously, it would be found that: $D_3 = 4, R_3 = 33/158; \dots; D_9 = 2, R_9 = 0$. The complete set of continued fraction elements representing $2153/9277$ may then be written as

$$\frac{2153}{9277} = \frac{1}{4 + \frac{1}{3 + \frac{1}{4 + \frac{1}{4 + \frac{1}{1 + \frac{1}{3 + \frac{1}{1 + \frac{1}{2 + \frac{1}{2}}}}}}}}}$$

$D_1 \dots \dots \dots D_5 \dots \dots \dots D_9$

By following a simple procedure, together with a table organized similar to the one below for the fraction $2153/9277$, the denominators D_1, D_2, \dots of the elements of a continued fraction may be used to calculate a series of fractions, each of which is a successively closer approximation, called a *convergent*, to the original fraction N/D .

1) The first row of the table contains column numbers numbered from 1 through 2 plus the number of elements, $2 + 9 = 11$ in this example.

2) The second row contains the denominators of the continued fraction elements in sequence but beginning in column 3 instead of column 1 because columns 1 and 2 must be blank in this procedure.

3) The third row contains the convergents to the original fraction as they are calculated and entered. Note that the fractions 1/0 and 0/1 have been inserted into columns 1 and 2. These are two arbitrary convergents, the first equal to infinity, the second to zero, which are used to facilitate the calculations.

4) The convergent in column 3 is now calculated. To find the numerator, multiply the denominator in column 3 by the numerator of the convergent in column 2 and add the numerator of the convergent in column 1. Thus, $4 \times 0 + 1 = 1$.

5) The denominator of the convergent in column 3 is found by multiplying the denominator in column 3 by the denominator of the convergent in column 2 and adding the denominator of the convergent in column 1. Thus, $4 \times 1 + 0 = 4$, and the convergent in column 3 is then $\frac{1}{4}$ as shown in the table.

6) Finding the remaining successive convergents can be reduced to using the simple equation

$$\text{CONVERGENT}_n = \frac{(D_n)(\text{NUM}_{n-1}) + \text{NUM}_{n-2}}{(D_n)(\text{DEN}_{n-1}) + \text{DEN}_{n-2}}$$

in which n = column number in the table; D_n = denominator in column n ; NUM_{n-1} and NUM_{n-2} are numerators and DEN_{n-1} and DEN_{n-2} are denominators of the convergents in the columns indicated by their subscripts; and CONVERGENT_n is the convergent in column n .

Convergents of the Continued Fraction for 2153/9277

Column Number, n	1	2	3	4	5	6	7	8	9	10	11
Denominator, D_n	—	—	4	3	4	4	1	3	1	2	2
Convergent, n	$\frac{1}{0}$	$\frac{0}{1}$	$\frac{1}{4}$	$\frac{3}{13}$	$\frac{13}{56}$	$\frac{55}{237}$	$\frac{68}{293}$	$\frac{259}{1116}$	$\frac{327}{1409}$	$\frac{913}{3934}$	$\frac{2153}{9277}$

Notes: The decimal values of the successive convergents in the table are alternately larger and smaller than the value of the original fraction 2153/9277. If the last convergent in the table has the same value as the original fraction 2153/9277, then *all* of the other calculated convergents are correct.

Conjugate Fractions.—In addition to finding approximate ratios by the use of continued fractions and logarithms of ratios, conjugate fractions may be used for the same purpose, independently, or in combination with the other methods.

Two fractions a/b and c/d are said to be conjugate if $ad - bc = \pm 1$. Examples of such pairs are: 0/1 and 1/1; 1/2 and 1/1; and 9/10 and 8/9. Also, *every successive pair of the convergents of a continued fraction are conjugate*. Conjugate fractions have certain properties that are useful for solving ratio problems:

1) No fraction between two conjugate fractions a/b and c/d can have a denominator smaller than either b or d .

2) A new fraction, e/f , conjugate to both fractions of a given pair of conjugate fractions, a/b and c/d , and lying between them, may be created by adding respective numerators, $a + c$, and denominators, $b + d$, so that $e/f = (a + c)/(b + d)$.

3) The denominator $f = b + d$ of the new fraction e/f is the smallest of any possible fraction lying between a/b and c/d . Thus, 17/19 is conjugate to both 8/9 and 9/10 and no fraction with denominator smaller than 19 lies between them. This property is important if it is desired to minimize the size of the factors of the ratio to be found.

The following example shows the steps to approximate a ratio for a set of gears to any desired degree of accuracy within the limits established for the allowable size of the factors in the ratio.

Example: Find a set of four change gears, ab/cd , to approximate the ratio 2.105399 accurate to within ± 0.0001 ; no gear is to have more than 120 teeth.

Step 1. Convert the given ratio R to a number r between 0 and 1 by taking its reciprocal: $1/R = 1/2.105399 = 0.4749693 = r$.

Step 2. Select a pair of conjugate fractions a/b and c/d that bracket r . The pair $a/b = 0/1$ and $c/d = 1/1$, for example, will bracket 0.4749693.

Step 3. Add the respective numerators and denominators of the conjugates $0/1$ and $1/1$ to create a new conjugate e/f between 0 and 1: $e/f = (a + c)/(b + d) = (0 + 1)/(1 + 1) = 1/2$.

Step 4. Since 0.4749693 lies between $0/1$ and $1/2$, e/f must also be between $0/1$ and $1/2$: $e/f = (0 + 1)/(1 + 2) = 1/3$.

Step 5. Since 0.4749693 now lies between $1/3$ and $1/2$, e/f must also be between $1/3$ and $1/2$: $e/f = (1 + 1)/(3 + 2) = 2/5$.

Step 6. Continuing as above to obtain successively closer approximations of e/f to 0.4749693, and using a handheld calculator and a scratch pad to facilitate the process, the fractions below, each of which has factors less than 120, were determined:

Fraction	Numerator Factors	Denominator Factors	Error
19/40	19	$2 \times 2 \times 2 \times 5$	+ .000031
28/59	$2 \times 2 \times 7$	59	- .00039
47/99	47	$3 \times 3 \times 11$	- .00022
104/219	$2 \times 2 \times 2 \times 13$	3×73	- .000083
123/259	3×41	7×37	- .000066
142/299	2×71	13×23	- .000053
161/339	7×23	3×113	- .000043
218/459	2×109	$3 \times 3 \times 3 \times 17$	- .000024
256/539	$2 \times 2 \times 2 \times 2 \times 2 \times 2 \times 2 \times 2$	$7 \times 7 \times 11$	- .000016
370/779	$2 \times 5 \times 37$	19×41	- .0000014
759/1598	$3 \times 11 \times 23$	$2 \times 17 \times 47$	- .00000059

Factors for the numerators and denominators of the fractions shown above were found with the aid of the Prime Numbers and Factors tables beginning on page 21. Since in Step 1 the desired ratio of 2.105399 was converted to its reciprocal 0.4749693, all of the above fractions should be inverted. Note also that the last fraction, 759/1598, when inverted to become 1598/759, is in error from the desired value by approximately one-half the amount obtained by trial and error using earlier methods.

Using Continued Fraction Convergents as Conjugates.—Since successive convergents of a continued fraction are also conjugate, they may be used to find a series of additional fractions in between themselves. As an example, the successive convergents 55/237 and 68/293 from the table of convergents for 2153/9277 on page 12 will be used to demonstrate the process for finding the first few in-between ratios.

Desired Fraction $N/D = 2153/9277 = 0.2320793$

	a/b	e/f	c/d
(1)	55/237 = .2320675	^a 123/530 = .2320755 error = -.0000039	68/293 = .2320819
(2)	123/530 = .2320755	191/823 = .2320778 error = -.0000016	68/293 = .2320819
(3)	191/823 = .2320778	^a 259/1116 = .2320789 error = -.0000005	68/293 = .2320819
(4)	259/1116 = .2320789	327/1409 = .2320795 error = +.0000002	68/293 = .2320819
(5)	259/1116 = .2320789	586/2525 = .2320792 error = -.0000001	327/1409 = .2320795
(6)	586/2525 = .2320792	913/3934 = .2320793 error = -.0000000	327/1409 = .2320795

^aOnly these ratios had suitable factors below 120.

Step 1. Check the convergents for conjugateness: $55 \times 293 - 237 \times 68 = 16115 - 16116 = -1$ proving the pair to be conjugate.

Step 2. Set up a table as shown above. The leftmost column of line (1) contains the convergent of lowest value, a/b ; the rightmost the higher value, c/d ; and the center column the derived value e/f found by adding the respective numerators and denominators of a/b and c/d . The error or difference between e/f and the desired value N/D , $\text{error} = N/D - e/f$, is also shown.

Step 3. On line (2), the process used on line (1) is repeated with the e/f value from line (1) becoming the new value of a/b while the c/d value remains unchanged. Had the error in e/f been + instead of -, then e/f would have been the new c/d value and a/b would be unchanged.

Step 4. The process is continued until, as seen on line (4), the error changes sign to + from the previous -. When this occurs, the e/f value becomes the c/d value on the next line instead of a/b as previously and the a/b value remains unchanged.

Powers and Roots

The *square* of a number (or quantity) is the product of that number multiplied by itself. Thus, the square of 9 is $9 \times 9 = 81$. The square of a number is indicated by the *exponent* (2), thus: $9^2 = 9 \times 9 = 81$.

The *cube* or *third power* of a number is the product obtained by using that number as a factor three times. Thus, the cube of 4 is $4 \times 4 \times 4 = 64$, and is written 4^3 .

If a number is used as a factor four or five times, respectively, the product is the fourth or fifth power. Thus, $3^4 = 3 \times 3 \times 3 \times 3 = 81$, and $2^5 = 2 \times 2 \times 2 \times 2 \times 2 = 32$. A number can be raised to any power by using it as a factor the required number of times.

The *square root* of a given number is that number which, when multiplied by itself, will give a product equal to the given number. The square root of 16 (written $\sqrt{16}$) equals 4, because $4 \times 4 = 16$.

The *cube root* of a given number is that number which, when used as a factor three times, will give a product equal to the given number. Thus, the cube root of 64 (written $\sqrt[3]{64}$) equals 4, because $4 \times 4 \times 4 = 64$.

The fourth, fifth, etc., roots of a given number are those numbers which when used as factors four, five, etc., times, will give as a product the given number. Thus, $\sqrt[4]{16} = 2$, because $2 \times 2 \times 2 \times 2 = 16$.

In some formulas, there may be such expressions as $(a^2)^3$ and $a^{3/2}$. The first of these, $(a^2)^3$, means that the number a is first to be squared, a^2 , and the result then cubed to give a^6 . Thus, $(a^2)^3$ is equivalent to a^6 which is obtained by *multiplying* the exponents 2 and 3. Similarly, $a^{3/2}$ may be interpreted as the cube of the square root of a , $(\sqrt{a})^3$, or $(a^{1/2})^3$, so that, for example, $16^{3/2} = (\sqrt{16})^3 = 64$.

The multiplications required for raising numbers to powers and the extracting of roots are greatly facilitated by the use of logarithms. Extracting the square root and cube root by the regular arithmetical methods is a slow and cumbersome operation, and any roots can be more rapidly found by using logarithms.

When the power to which a number is to be raised is not an integer, say 1.62, the use of either logarithms or a scientific calculator becomes the only practical means of solution.

Powers of Ten Notation.—Powers of ten notation is used to simplify calculations and ensure accuracy, particularly with respect to the position of decimal points, and also simplifies the expression of numbers which are so large or so small as to be unwieldy. For example, the metric (SI) pressure unit pascal is equivalent to 0.00000986923 atmosphere or 0.0001450377 pound/inch². In powers of ten notation, these figures are 9.86923×10^{-6}

atmosphere and 1.450377×10^{-4} pound/inch². The notation also facilitates adaptation of numbers for electronic data processing and computer readout.

Expressing Numbers in Powers of Ten Notation.—In this system of notation, every number is expressed by two factors, one of which is some integer from 1 to 9 followed by a decimal and the other is some power of 10.

Thus, 10,000 is expressed as 1.0000×10^4 and 10,463 as 1.0463×10^4 . The number 43 is expressed as 4.3×10 and 568 is expressed as 5.68×10^2 .

In the case of decimals, the number 0.0001, which as a fraction is $\frac{1}{10,000}$ and is expressed as 1×10^{-4} and 0.0001463 is expressed as 1.463×10^{-4} . The decimal 0.498 is expressed as 4.98×10^{-1} and 0.03146 is expressed as 3.146×10^{-2} .

Rules for Converting Any Number to Powers of Ten Notation.—Any number can be converted to the powers of ten notation by means of one of two rules.

Rule 1: If the number is a whole number or a whole number and a decimal so that it has digits to the left of the decimal point, the decimal point is moved a sufficient number of places to the *left* to bring it to the immediate right of the first digit. With the decimal point shifted to this position, the number so written comprises the *first* factor when written in powers of ten notation.

The number of places that the decimal point is moved to the left to bring it immediately to the right of the first digit is the *positive* index or power of 10 that comprises the *second* factor when written in powers of ten notation.

Thus, to write 4639 in this notation, the decimal point is moved three places to the left giving the two factors: 4.639×10^3 . Similarly,

$$431.412 = 4.31412 \times 10^2 \quad 986388 = 9.86388 \times 10^5$$

Rule 2: If the number is a decimal, i.e., it has digits entirely to the right of the decimal point, then the decimal point is moved a sufficient number of places to the *right* to bring it immediately to the right of the first digit. With the decimal point shifted to this position, the number so written comprises the *first* factor when written in powers of ten notation.

The number of places that the decimal point is moved to the *right* to bring it immediately to the right of the first digit is the *negative* index or power of 10 that follows the number when written in powers of ten notation.

Thus, to bring the decimal point in 0.005721 to the immediate right of the first digit, which is 5, it must be moved *three* places to the right, giving the two factors: 5.721×10^{-3} . Similarly,

$$0.469 = 4.69 \times 10^{-1} \quad 0.0000516 = 5.16 \times 10^{-5}$$

Multiplying Numbers Written in Powers of Ten Notation.—When multiplying two numbers written in the powers of ten notation together, the procedure is as follows:

1) Multiply the first factor of one number by the first factor of the other to obtain the first factor of the product.

2) Add the index of the second factor (which is some power of 10) of one number to the index of the second factor of the other number to obtain the index of the second factor (which is some power of 10) in the product. Thus:

$$(4.31 \times 10^{-2}) \times (9.0125 \times 10) = (4.31 \times 9.0125) \times 10^{-2+1} = 38.844 \times 10^{-1}$$

$$(5.986 \times 10^4) \times (4.375 \times 10^3) = (5.986 \times 4.375) \times 10^{4+3} = 26.189 \times 10^7$$

In the preceding calculations, neither of the results shown are in the conventional powers of ten form since the first factor in each has two digits. In the conventional powers of ten notation, the results would be

$38.844 \times 10^{-1} = 3.884 \times 10^0 = 3.884$, since $10^0 = 1$, and $26.189 \times 10^7 = 2.619 \times 10^8$ in each case rounding off the first factor to three decimal places.

When multiplying several numbers written in this notation together, the procedure is the same. All of the first factors are multiplied together to get the first factor of the product and all of the indices of the respective powers of ten are added together, taking into account their respective signs, to get the index of the second factor of the product. Thus, $(4.02 \times 10^{-3}) \times (3.987 \times 10) \times (4.863 \times 10^5) = (4.02 \times 3.987 \times 4.863) \times 10^{(-3+1+5)} = 77.94 \times 10^3 = 7.79 \times 10^4$ rounding off the first factor to two decimal places.

Dividing Numbers Written in Powers of Ten Notation.—When dividing one number by another when both are written in this notation, the procedure is as follows:

1) Divide the first factor of the dividend by the first factor of the divisor to get the first factor of the quotient.

2) Subtract the index of the second factor of the divisor from the index of the second factor of the dividend, taking into account their respective signs, to get the index of the second factor of the quotient. Thus:

$$(4.31 \times 10^{-2}) \div (9.0125 \times 10) = \\ (4.31 \div 9.0125) \times (10^{-2-1}) = 0.4782 \times 10^{-3} = 4.782 \times 10^{-4}$$

It can be seen that this system of notation is helpful where several numbers of different magnitudes are to be multiplied and divided.

Example: Find the quotient of $\frac{250 \times 4698 \times 0.00039}{43678 \times 0.002 \times 0.0147}$

Solution: Changing all these numbers to powers of ten notation and performing the operations indicated:

$$\frac{(2.5 \times 10^2) \times (4.698 \times 10^3) \times (3.9 \times 10^{-4})}{(4.3678 \times 10^4) \times (2 \times 10^{-3}) \times (1.47 \times 10^{-2})} = \\ = \frac{(2.5 \times 4.698 \times 3.9)(10^{2+3-4})}{(4.3678 \times 2 \times 1.47)(10^{4-3-2})} = \frac{45.8055 \times 10}{12.8413 \times 10^{-1}} \\ = 3.5670 \times 10^{1-(-1)} = 3.5670 \times 10^2 = 356.70$$

Constants Frequently Used in Mathematical Expressions

$0.00872665 = \frac{\pi}{360}$	$0.8660254 = \frac{\sqrt{3}}{2}$	$2.0943951 = \frac{2\pi}{3}$	$4.712389 = \frac{3\pi}{2}$
$0.01745329 = \frac{\pi}{180}$	$1.0471975 = \frac{\pi}{3}$	$2.3561945 = \frac{3\pi}{4}$	$5.2359878 = \frac{5\pi}{3}$
$0.26179939 = \frac{\pi}{12}$	$1.1547005 = \frac{2\sqrt{3}}{3}$	$2.5980762 = \frac{3\sqrt{3}}{2}$	$5.4977871 = \frac{7\pi}{4}$
$0.39269908 = \frac{\pi}{8}$	$1.2247449 = \frac{\sqrt{3}}{\sqrt{2}}$	$2.6179939 = \frac{5\pi}{6}$	$5.7595865 = \frac{11\pi}{6}$
$0.52359878 = \frac{\pi}{6}$	$1.4142136 = \sqrt{2}$	$3.1415927 = \pi$	$6.2831853 = 2\pi$
$0.57735027 = \frac{\sqrt{3}}{3}$	$1.5707963 = \frac{\pi}{2}$	$3.6651914 = \frac{7\pi}{6}$	$9.8696044 = \pi^2$
$0.62035049 = \sqrt[3]{\frac{3}{4\pi}}$	$1.7320508 = \sqrt{3}$	$3.9269908 = \frac{5\pi}{4}$	$9.424778 = 3\pi$
$0.78539816 = \frac{\pi}{4}$	$2.4674011 = \frac{\pi^2}{4}$	$4.1887902 = \frac{4\pi}{3}$	$12.566371 = 4\pi$
			$57.29578 = \frac{180}{\pi}$
			$114.59156 = \frac{360}{\pi}$

Logarithms

Logarithms have long been used to facilitate and shorten calculations involving multiplication, division, the extraction of roots, and obtaining powers of numbers; however, since the advent of hand-held calculators logarithms are rarely used for multiplication and division problems. Logarithms still come up in other problems, and the following properties of logarithms are useful:

$$\begin{aligned} \log_c c &= 1 & \log_c c^p &= p & \log_c 1 &= 0 \\ \log_c(a \times b) &= \log_c a + \log_c b & \log_c(a \div b) &= \log_c a - \log_c b \\ \log_c(a^p) &= p \log_c a & \log_c(\sqrt[p]{a}) &= 1/p \log_c a \end{aligned}$$

The logarithm of a number is defined as the exponent of a base number raised to a power. For example, $\log_{10} 3.162277 = 0.500$ means the logarithm of 3.162277 is equal to 0.500. Another way of expressing the same relationship is $10^{0.500} = 3.162277$, where 10 is the base number and the exponent 0.500 is the logarithm of 3.162277. A common example of a logarithmic expression $10^2 = 100$ means that the base 10 logarithm of 100 is 2, that is, $\log_{10} 100 = 2.00$. There are two standard systems of logarithms in use: the “common” system (base 10) and the so-called “natural” system (base $e = 2.71828\dots$). Logarithms to base e are frequently written using “ln” instead of “ \log_e ” such as $\ln 6.1 = 1.808289$. Logarithms of a number can be converted between the natural- and common-based systems as follows: $\ln_e A = 2.3026 \times \log_{10} A$ and $\log_{10} A = 0.43430 \times \ln_e A$.

A logarithm consists of two parts, a whole number and a decimal. The whole number, which may be positive, negative, or zero, is called the characteristic; the decimal is called the mantissa. As a rule, only the decimal or mantissa is given in tables of common logarithms; tables of natural logarithms give both the characteristic and mantissa. Abbreviated tables of logarithms and examples are given in *MATHEMATICS* in the *ADDITIONAL* material on *Machinery’s Handbook 29 CD*.

Natural Logarithms.—In certain formulas and in some branches of mathematical analysis, use is made of logarithms (formerly also called Napierian or hyperbolic logarithms). As previously mentioned, the base of this system, $e = 2.7182818284\dots$, is the limit of certain mathematical series. The logarithm of a number A to the base e is usually written $\log_e A$ or $\ln A$. Tables of natural logarithms for numbers ranging from 1 to 10 and 1.00 to 1.01 are given in this Handbook after the table of common logarithms. To obtain natural logs of numbers less than 1 or greater than 10, proceed as in the following examples: $\log_e 0.239 = \log_e 2.39 - \log_e 10$; $\log_e 0.0239 = \log_e 2.39 - 2 \log_e 10$; $\log_e 239 = \log_e 2.39 + 2 \log_e 10$; $\log_e 2390 = \log_e 2.39 + 3 \log_e 10$, etc.

Using Calculators to Find Logarithms.—A scientific calculator is usually the quickest and most accurate method of finding logarithms and numbers corresponding to given logarithms. On most scientific calculators, the key labeled **log** is used to find common logarithms (base 10) and the key labeled **ln** is used for finding natural logarithms (base e). The keystrokes to find a logarithm will vary slightly from one calculator to another, so specific instructions are not given. To find the number corresponding to a given logarithm: use the key labeled **10^x** if a common logarithm is given or use the key labeled **e^x** if a natural logarithm is given; calculators without the **10^x** or **e^x** keys may have a key labeled **x^y** that can be used by substituting 10 or e (2.718281...), as required, for x and substituting the logarithm whose corresponding number is sought for y . On some other calculators, the **log** and **ln** keys are used to find common and natural logarithms, and the same keys in combination with the **INV**, or inverse, key are used to find the number corresponding to a given logarithm.

Imaginary and Complex Numbers

Complex or Imaginary Numbers.—Complex or imaginary numbers represent a class of mathematical objects that are used to simplify certain problems, such as the solution of polynomial equations. The basis of the complex number system is the unit imaginary number i that satisfies the following relations:

$$i^2 = (-i)^2 = -1 \quad i = \sqrt{-1} \quad -i = -\sqrt{-1}$$

In electrical engineering and other fields, the unit imaginary number is often represented by j rather than i . However, the meaning of the two terms is identical.

Rectangular or Trigonometric Form: Every complex number, Z , can be written as the sum of a real number and an imaginary number. When expressed as a sum, $Z = a + bi$, the complex number is said to be in rectangular or trigonometric form. The real part of the number is a , and the imaginary portion is bi because it has the imaginary unit assigned to it.

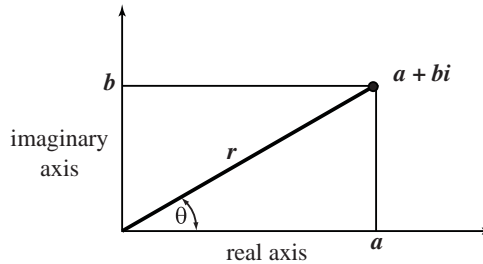
Polar Form: A complex number $Z = a + bi$ can also be expressed in polar form, also known as phasor form. In polar form, the complex number Z is represented by a magnitude r and an angle θ as follows:

$$Z = r \angle \theta$$

$\angle \theta$ = a direction, the angle whose tangent is $b \div a$, thus $\theta = \text{atan} \frac{b}{a}$ and

$$r = \sqrt{a^2 + b^2} \text{ is the magnitude}$$

A complex number can be plotted on a real-imaginary coordinate system known as the complex plane. The figure below illustrates the relationship between the rectangular coordinates a and b , and the polar coordinates r and θ .



Complex Number in the Complex Plane

The rectangular form can be determined from r and θ as follows:

$$a = r \cos \theta \quad b = r \sin \theta \quad a + bi = r \cos \theta + ir \sin \theta = r(\cos \theta + i \sin \theta)$$

The rectangular form can also be written using Euler's Formula:

$$e^{\pm i\theta} = \cos \theta \pm i \sin \theta \quad \sin \theta = \frac{e^{i\theta} - e^{-i\theta}}{2i} \quad \cos \theta = \frac{e^{i\theta} + e^{-i\theta}}{2}$$

Complex Conjugate: Complex numbers commonly arise in finding the solution of polynomials. A polynomial of n^{th} degree has n solutions, an even number of which are complex and the rest are real. The complex solutions always appear as complex conjugate pairs in the form $a + bi$ and $a - bi$. The product of these two conjugates, $(a + bi) \times (a - bi) = a^2 + b^2$, is the square of the magnitude r illustrated in the previous figure.

Operations on Complex Numbers

Example 1, Addition: When adding two complex numbers, the real parts and imaginary parts are added separately, the real parts added to real parts and the imaginary to imaginary parts. Thus,

$$(a_1 + ib_1) + (a_2 + ib_2) = (a_1 + a_2) + i(b_1 + b_2)$$

$$(a_1 + ib_1) - (a_2 + ib_2) = (a_1 - a_2) + i(b_1 - b_2)$$

$$(3 + 4i) + (2 + i) = (3 + 2) + (4 + 1)i = 5 + 5i$$

Example 2, Multiplication: Multiplication of two complex numbers requires the use of the imaginary unit, $i^2 = -1$ and the algebraic distributive law. ✦

$$\begin{aligned} (a_1 + ib_1)(a_2 + ib_2) &= a_1a_2 + ia_1b_2 + ia_2b_1 + i^2b_1b_2 \\ &= a_1a_2 + ia_1b_2 + ia_2b_1 - b_1b_2 \end{aligned}$$

$$\begin{aligned} (7 + 2i) \times (5 - 3i) &= (7)(5) - (7)(3i) + (2i)(5) - (2i)(3i) \\ &= 35 - 21i + 10i - 6i^2 \\ &= 35 - 21i + 10i - (6)(-1) = 41 - 11i \end{aligned}$$

Multiplication of two complex numbers, $Z_1 = r_1(\cos\theta_1 + i\sin\theta_1)$ and $Z_2 = r_2(\cos\theta_2 + i\sin\theta_2)$, results in the following:

$$Z_1 \times Z_2 = r_1(\cos\theta_1 + i\sin\theta_1) \times r_2(\cos\theta_2 + i\sin\theta_2) = r_1r_2[\cos(\theta_1 + \theta_2) + i\sin(\theta_1 + \theta_2)]$$

Example 3, Division: Divide the following two complex numbers, $2 + 3i$ and $4 - 5i$. Dividing complex numbers makes use of the complex conjugate. ✦

$$\frac{2 + 3i}{4 - 5i} = \frac{(2 + 3i)(4 + 5i)}{(4 - 5i)(4 + 5i)} = \frac{8 + 12i + 10i + 15i^2}{16 + 20i - 20i - 25i^2} = \frac{-7 + 22i}{16 + 25} = \left(\frac{-7}{41}\right) + i\left(\frac{22}{41}\right)$$

Example 4: Convert the complex number $8 + 6i$ into phasor form.

First find the magnitude of the phasor vector and then the direction.

$$\text{magnitude} = \sqrt{8^2 + 6^2} = 10 \quad \text{direction} = \text{atan}\frac{6}{8} = 36.87^\circ$$

$$\text{phasor} = 10 \angle 36.87^\circ$$

Factorial.—A factorial is a mathematical shortcut denoted by the symbol ! following a number (for example, $3!$ is three factorial). A factorial is found by multiplying together all the integers greater than zero and less than or equal to the factorial number wanted, except for zero factorial ($0!$), which is defined as 1. For example: $3! = 1 \times 2 \times 3 = 6$; $4! = 1 \times 2 \times 3 \times 4 = 24$; $7! = 1 \times 2 \times 3 \times 4 \times 5 \times 6 \times 7 = 5040$; etc. ✦

Example: How many ways can the letters X, Y, and Z be arranged?

Solution: The numbers of possible arrangements for the three letters are $3! = 3 \times 2 \times 1 = 6$.

Permutations.—The number of ways r objects may be arranged from a set of n elements is given by ${}^n P_r = \frac{n!}{(n-r)!}$

Example: There are 10 people are participating in the final run. In how many different ways can these people come in first, second and third.

Solution: Here r is 3 and n is 10. So the possible numbers of winning number will be

$${}^{10} P_3 = \frac{10!}{(10-3)!} = \frac{10!}{7!} = 10 \times 9 \times 8 = 720$$

Combinations.—The number of ways r distinct objects may be chosen from a set of n elements is given by ${}^n C_r = \frac{n!}{(n-r)!r!}$

Example: How many possible sets of 6 winning numbers can be picked from 52 numbers.

Solution: Here r is 6 and n is 52. So the possible number of winning combinations will be

$${}^{52}C_6 = \frac{52!}{(52-6)!6!} = \frac{52!}{46!6!} = \frac{52 \times 51 \times 50 \times 49 \times 48 \times 47}{1 \times 2 \times 3 \times 4 \times 5 \times 6} = 20358520$$

Prime Numbers and Factors of Numbers

The *factors* of a given number are those numbers which when multiplied together give a product equal to that number; thus, 2 and 3 are factors of 6; and 5 and 7 are factors of 35.

A *prime number* is one which has no factors except itself and 1. Thus, 2, 3, 5, 7, 11, etc., are prime numbers. A factor which is a prime number is called a *prime factor*.

The accompanying “Prime Number and Factor Tables,” starting on page 21, give the smallest prime factor of all odd numbers from 1 to 9600, and can be used for finding all the factors for numbers up to this limit. For example, find the factors of 931. In the column headed “900” and in the line indicated by “31” in the left-hand column, the smallest prime factor is found to be 7. As this leaves another factor 133 (since $931 \div 7 = 133$), find the smallest prime factor of this number. In the column headed “100” and in the line “33”, this is found to be 7, leaving a factor 19. This latter is a prime number; hence, the factors of 931 are $7 \times 7 \times 19$. Where no factor is given for a number in the factor table, it indicates that the number is a prime number.

The last page of the tables lists all prime numbers from 9551 through 18691; and can be used to identify quickly all unfactorable numbers in that range.

For factoring, the following general rules will be found useful:

2 is a factor of any number the right-hand figure of which is an even number or 0. Thus, $28 = 2 \times 14$, and $210 = 2 \times 105$.

3 is a factor of any number the sum of the figures of which is evenly divisible by 3. Thus, 3 is a factor of 1869, because $1 + 8 + 6 + 9 = 24 \div 3 = 8$.

4 is a factor of any number the two right-hand figures of which, considered as one number, are evenly divisible by 4. Thus, 1844 has a factor 4, because $44 \div 4 = 11$.

5 is a factor of any number the right-hand figure of which is 0 or 5. Thus, $85 = 5 \times 17$; $70 = 5 \times 14$.

Tables of prime numbers and factors of numbers are particularly useful for calculations involving change-gear ratios for compound gearing, dividing heads, gear-generating machines, and mechanical designs having gear trains.

Example 1: A set of four gears is required in a mechanical design to provide an overall gear ratio of $4104 \div 1200$. Furthermore, no gear in the set is to have more than 120 teeth or less than 24 teeth. Determine the tooth numbers.

First, as explained previously, the factors of 4104 are determined to be: $2 \times 2 \times 2 \times 3 \times 3 \times 57 = 4104$. Next, the factors of 1200 are determined: $2 \times 2 \times 2 \times 2 \times 5 \times 5 \times 3 = 1200$.

Therefore $\frac{4104}{1200} = \frac{2 \times 2 \times 2 \times 3 \times 3 \times 57}{2 \times 2 \times 2 \times 2 \times 5 \times 5 \times 3} = \frac{72 \times 57}{24 \times 50}$. If the factors had been com-

bined differently, say, to give $\frac{72 \times 57}{16 \times 75}$, then the 16-tooth gear in the denominator would not satisfy the requirement of no less than 24 teeth.

Example 2: Factor the number 25078 into two numbers neither of which is larger than 200.

The first factor of 25078 is obviously 2, leaving $25078 \div 2 = 12539$ to be factored further. However, from the last table, *Prime Numbers from 9551 to 18691*, it is seen that 12539 is a prime number; therefore, no solution exists.

Prime Number and Factor Table for 1 to 1199

From To	0 100	100 200	200 300	300 400	400 500	500 600	600 700	700 800	800 900	900 1000	1000 1100	1100 1200
1	P	P	3	7	P	3	P	P	3	17	7	3
2	P	2	2	2	2	2	2	2	2	2	2	2
3	P	P	7	3	13	P	3	19	11	3	17	P
5	P	3	5	5	3	5	5	3	5	5	3	5
7	P	P	3	P	11	3	P	7	3	P	19	3
9	3	P	11	3	P	P	3	P	P	3	P	P
11	P	3	P	P	3	7	13	3	P	P	3	11
13	P	P	3	P	7	3	P	23	3	11	P	3
15	3	5	5	3	5	5	3	5	5	3	5	5
17	P	3	7	P	3	11	P	3	19	7	3	P
19	P	7	3	11	P	3	P	P	3	P	P	3
21	3	11	13	3	P	P	3	7	P	3	P	19
23	P	3	P	17	3	P	7	3	P	13	3	P
25	5	5	3	5	5	3	5	5	3	5	5	3
27	3	P	P	3	7	17	3	P	P	3	13	7
29	P	3	P	7	3	23	17	3	P	P	3	P
31	P	P	3	P	P	3	P	17	3	7	P	3
33	3	7	P	3	P	13	3	P	7	3	P	11
35	5	3	5	5	3	5	5	3	5	5	3	5
37	P	P	3	P	19	3	7	11	3	P	17	3
39	3	P	P	3	P	7	3	P	P	3	P	17
41	P	3	P	11	3	P	P	3	29	P	3	7
43	P	11	3	7	P	3	P	P	3	23	7	3
45	3	5	5	3	5	5	3	5	5	3	5	5
47	P	3	13	P	3	P	P	3	7	P	3	31
49	7	P	3	P	P	3	11	7	3	13	P	3
51	3	P	P	3	11	19	3	P	23	3	P	P
53	P	3	11	P	3	7	P	3	P	P	3	P
55	5	5	3	5	5	3	5	5	3	5	5	3
57	3	P	P	3	P	P	3	P	P	3	7	13
59	P	3	7	P	3	13	P	3	P	7	3	19
61	P	7	3	19	P	3	P	P	3	31	P	3
63	3	P	P	3	P	P	3	7	P	3	P	P
65	5	3	5	5	3	5	5	3	5	5	3	5
67	P	P	3	P	P	3	23	13	3	P	11	3
69	3	13	P	3	7	P	3	P	11	3	P	7
71	P	3	P	7	3	P	11	3	13	P	3	P
73	P	P	3	P	11	3	P	P	3	7	29	3
75	3	5	5	3	5	5	3	5	5	3	5	5
77	7	3	P	13	3	P	P	3	P	P	3	11
79	P	P	3	P	P	3	7	19	3	11	13	3
81	3	P	P	3	13	7	3	11	P	3	23	P
83	P	3	P	P	3	11	P	3	P	P	3	7
85	5	5	3	5	5	3	5	5	3	5	5	3
87	3	11	7	3	P	P	3	P	P	3	P	P
89	P	3	17	P	3	19	13	3	7	23	3	29
91	7	P	3	17	P	3	P	7	3	P	P	3
93	3	P	P	3	17	P	3	13	19	3	P	P
95	5	3	5	5	3	5	5	3	5	5	3	5
97	P	P	3	P	7	3	17	P	3	P	P	3
99	3	P	13	3	P	P	3	17	29	3	7	11

Prime Number and Factor Table for 1201 to 2399

From To	1200 1300	1300 1400	1400 1500	1500 1600	1600 1700	1700 1800	1800 1900	1900 2000	2000 2100	2100 2200	2200 2300	2300 2400
1	P	P	3	19	P	3	P	P	3	11	31	3
3	3	P	23	3	7	13	3	11	P	3	P	7
5	5	3	5	5	3	5	5	3	5	5	3	5
7	17	P	3	11	P	3	13	P	3	7	P	3
9	3	7	P	3	P	P	3	23	7	3	47	P
11	7	3	17	P	3	29	P	3	P	P	3	P
13	P	13	3	17	P	3	7	P	3	P	P	3
15	3	5	5	3	5	5	3	5	5	3	5	5
17	P	3	13	37	3	17	23	3	P	29	3	7
19	23	P	3	7	P	3	17	19	3	13	7	3
21	3	P	7	3	P	P	3	17	43	3	P	11
23	P	3	P	P	3	P	P	3	7	11	3	23
25	5	5	3	5	5	3	5	5	3	5	5	3
27	3	P	P	3	P	11	3	41	P	3	17	13
29	P	3	P	11	3	7	31	3	P	P	3	17
31	P	11	3	P	7	3	P	P	3	P	23	3
33	3	31	P	3	23	P	3	P	19	3	7	P
35	5	3	5	5	3	5	5	3	5	5	3	5
37	P	7	3	29	P	3	11	13	3	P	P	3
39	3	13	P	3	11	37	3	7	P	3	P	P
41	17	3	11	23	3	P	7	3	13	P	3	P
43	11	17	3	P	31	3	19	29	3	P	P	3
45	3	5	5	3	5	5	3	5	5	3	5	5
47	29	3	P	7	3	P	P	3	23	19	3	P
49	P	19	3	P	17	3	43	P	3	7	13	3
51	3	7	P	3	13	17	3	P	7	3	P	P
53	7	3	P	P	3	P	17	3	P	P	3	13
55	5	5	3	5	5	3	5	5	3	5	5	3
57	3	23	31	3	P	7	3	19	11	3	37	P
59	P	3	P	P	3	P	11	3	29	17	3	7
61	13	P	3	7	11	3	P	37	3	P	7	3
63	3	29	7	3	P	41	3	13	P	3	31	17
65	5	3	5	5	3	5	5	3	5	5	3	5
67	7	P	3	P	P	3	P	7	3	11	P	3
69	3	37	13	3	P	29	3	11	P	3	P	23
71	31	3	P	P	3	7	P	3	19	13	3	P
73	19	P	3	11	7	3	P	P	3	41	P	3
75	3	5	5	3	5	5	3	5	5	3	5	5
77	P	3	7	19	3	P	P	3	31	7	3	P
79	P	7	3	P	23	3	P	P	3	P	43	3
81	3	P	P	3	41	13	3	7	P	3	P	P
83	P	3	P	P	3	P	7	3	P	37	3	P
85	5	5	3	5	5	3	5	5	3	5	5	3
87	3	19	P	3	7	P	3	P	P	3	P	7
89	P	3	P	7	3	P	P	3	P	11	3	P
91	P	13	3	37	19	3	31	11	3	7	29	3
93	3	7	P	3	P	11	3	P	7	3	P	P
95	5	3	5	5	3	5	5	3	5	5	3	5
97	P	11	3	P	P	3	7	P	3	13	P	3
99	3	P	P	3	P	7	3	P	P	3	11	P

Prime Number and Factor Table for 2401 to 3599

From To	2400 2500	2500 2600	2600 2700	2700 2800	2800 2900	2900 3000	3000 3100	3100 3200	3200 3300	3300 3400	3400 3500	3500 3600
1	7	41	3	37	P	3	P	7	3	P	19	3
3	3	P	19	3	P	P	3	29	P	3	41	31
5	5	3	5	5	3	5	5	3	5	5	3	5
7	29	23	3	P	7	3	31	13	3	P	P	3
9	3	13	P	3	53	P	3	P	P	3	7	11
11	P	3	7	P	3	41	P	3	13	7	3	P
13	19	7	3	P	29	3	23	11	3	P	P	3
15	3	5	5	3	5	5	3	5	5	3	5	5
17	P	3	P	11	3	P	7	3	P	31	3	P
19	41	11	3	P	P	3	P	P	3	P	13	3
21	3	P	P	3	7	23	3	P	P	3	11	7
23	P	3	43	7	3	37	P	3	11	P	3	13
25	5	5	3	5	5	3	5	5	3	5	5	3
27	3	7	37	3	11	P	3	53	7	3	23	P
29	7	3	11	P	3	29	13	3	P	P	3	P
31	11	P	3	P	19	3	7	31	3	P	47	3
33	3	17	P	3	P	7	3	13	53	3	P	P
35	5	3	5	5	3	5	5	3	5	5	3	5
37	P	43	3	7	P	3	P	P	3	47	7	3
39	3	P	7	3	17	P	3	43	41	3	19	P
41	P	3	19	P	3	17	P	3	7	13	3	P
43	7	P	3	13	P	3	17	7	3	P	11	3
45	3	5	5	3	5	5	3	5	5	3	5	5
47	P	3	P	41	3	7	11	3	17	P	3	P
49	31	P	3	P	7	3	P	47	3	17	P	3
51	3	P	11	3	P	13	3	23	P	3	7	53
53	11	3	7	P	3	P	43	3	P	7	3	11
55	5	5	3	5	5	3	5	5	3	5	5	3
57	3	P	P	3	P	P	3	7	P	3	P	P
59	P	3	P	31	3	11	7	3	P	P	3	P
61	23	13	3	11	P	3	P	29	3	P	P	3
63	3	11	P	3	7	P	3	P	13	3	P	7
65	5	3	5	5	3	5	5	3	5	5	3	5
67	P	17	3	P	47	3	P	P	3	7	P	3
69	3	7	17	3	19	P	3	P	7	3	P	43
71	7	3	P	17	3	P	37	3	P	P	3	P
73	P	31	3	47	13	3	7	19	3	P	23	3
75	3	5	5	3	5	5	3	5	5	3	5	5
77	P	3	P	P	3	13	17	3	29	11	3	7
79	37	P	3	7	P	3	P	11	3	31	7	3
81	3	29	7	3	43	11	3	P	17	3	59	P
83	13	3	P	11	3	19	P	3	7	17	3	P
85	5	5	3	5	5	3	5	5	3	5	5	3
87	3	13	P	3	P	29	3	P	19	3	11	17
89	19	3	P	P	3	7	P	3	11	P	3	37
91	47	P	3	P	7	3	11	P	3	P	P	3
93	3	P	P	3	11	41	3	31	37	3	7	P
95	5	3	5	5	3	5	5	3	5	5	3	5
97	11	7	3	P	P	3	19	23	3	43	13	3
99	3	23	P	3	13	P	3	7	P	3	P	59

Prime Number and Factor Table for 3601 to 4799

From To	3600 3700	3700 3800	3800 3900	3900 4000	4000 4100	4100 4200	4200 4300	4300 4400	4400 4500	4500 4600	4600 4700	4700 4800
1	13	P	3	47	P	3	P	11	3	7	43	3
3	3	7	P	3	P	11	3	13	7	3	P	P
5	5	3	5	5	3	5	5	3	5	5	3	5
7	P	11	3	P	P	3	7	59	3	P	17	3
9	3	P	13	3	19	7	3	31	P	3	11	17
11	23	3	37	P	3	P	P	3	11	13	3	7
13	P	47	3	7	P	3	11	19	3	P	7	3
15	3	5	5	3	5	5	3	5	5	3	5	5
17	P	3	11	P	3	23	P	3	7	P	3	53
19	7	P	3	P	P	3	P	7	3	P	31	3
21	3	61	P	3	P	13	3	29	P	3	P	P
23	P	3	P	P	3	7	41	3	P	P	3	P
25	5	5	3	5	5	3	5	5	3	5	5	3
27	3	P	43	3	P	P	3	P	19	3	7	29
29	19	3	7	P	3	P	P	3	43	7	3	P
31	P	7	3	P	29	3	P	61	3	23	11	3
33	3	P	P	3	37	P	3	7	11	3	41	P
35	5	3	5	5	3	5	5	3	5	5	3	5
37	P	37	3	31	11	3	19	P	3	13	P	3
39	3	P	11	3	7	P	3	P	23	3	P	7
41	11	3	23	7	3	41	P	3	P	19	3	11
43	P	19	3	P	13	3	P	43	3	7	P	3
45	3	5	5	3	5	5	3	5	5	3	5	5
47	7	3	P	P	3	11	31	3	P	P	3	47
49	41	23	3	11	P	3	7	P	3	P	P	3
51	3	11	P	3	P	7	3	19	P	3	P	P
53	13	3	P	59	3	P	P	3	61	29	3	7
55	5	5	3	5	5	3	5	5	3	5	5	3
57	3	13	7	3	P	P	3	P	P	3	P	67
59	P	3	17	37	3	P	P	3	7	47	3	P
61	7	P	3	17	31	3	P	7	3	P	59	3
63	3	53	P	3	17	23	3	P	P	3	P	11
65	5	3	5	5	3	5	5	3	5	5	3	5
67	19	P	3	P	7	3	17	11	3	P	13	3
69	3	P	53	3	13	11	3	17	41	3	7	19
71	P	3	7	11	3	43	P	3	17	7	3	13
73	P	7	3	29	P	3	P	P	3	17	P	3
75	3	5	5	3	5	5	3	5	5	3	5	5
77	P	3	P	41	3	P	7	3	11	23	3	17
79	13	P	3	23	P	3	11	29	3	19	P	3
81	3	19	P	3	7	37	3	13	P	3	31	7
83	29	3	11	7	3	47	P	3	P	P	3	P
85	5	5	3	5	5	3	5	5	3	5	5	3
87	3	7	13	3	61	53	3	41	7	3	43	P
89	7	3	P	P	3	59	P	3	67	13	3	P
91	P	17	3	13	P	3	7	P	3	P	P	3
93	3	P	17	3	P	7	3	23	P	3	13	P
95	5	3	5	5	3	5	5	3	5	5	3	5
97	P	P	3	7	17	3	P	P	3	P	7	3
99	3	29	7	3	P	13	3	53	11	3	37	P

Prime Number and Factor Table for 4801 to 5999

From To	4800 4900	4900 5000	5000 5100	5100 5200	5200 5300	5300 5400	5400 5500	5500 5600	5600 5700	5700 5800	5800 5900	5900 6000
1	P	13	3	P	7	3	11	P	3	P	P	3
3	3	P	P	3	11	P	3	P	13	3	7	P
5	5	3	5	5	3	5	5	3	5	5	3	5
7	11	7	3	P	41	3	P	P	3	13	P	3
9	3	P	P	3	P	P	3	7	71	3	37	19
11	17	3	P	19	3	47	7	3	31	P	3	23
13	P	17	3	P	13	3	P	37	3	29	P	3
15	3	5	5	3	5	5	3	5	5	3	5	5
17	P	3	29	7	3	13	P	3	41	P	3	61
19	61	P	3	P	17	3	P	P	3	7	11	3
21	3	7	P	3	23	17	3	P	7	3	P	31
23	7	3	P	47	3	P	11	3	P	59	3	P
25	5	5	3	5	5	3	5	5	3	5	5	3
27	3	13	11	3	P	7	3	P	17	3	P	P
29	11	3	47	23	3	73	61	3	13	17	3	7
31	P	P	3	7	P	3	P	P	3	11	7	3
33	3	P	7	3	P	P	3	11	43	3	19	17
35	5	3	5	5	3	5	5	3	5	5	3	5
37	7	P	3	11	P	3	P	7	3	P	13	3
39	3	11	P	3	13	19	3	29	P	3	P	P
41	47	3	71	53	3	7	P	3	P	P	3	13
43	29	P	3	37	7	3	P	23	3	P	P	3
45	3	5	5	3	5	5	3	5	5	3	5	5
47	37	3	7	P	3	P	13	3	P	7	3	19
49	13	7	3	19	29	3	P	31	3	P	P	3
51	3	P	P	3	59	P	3	7	P	3	P	11
53	23	3	31	P	3	53	7	3	P	11	3	P
55	5	5	3	5	5	3	5	5	3	5	5	3
57	3	P	13	3	7	11	3	P	P	3	P	7
59	43	3	P	7	3	23	53	3	P	13	3	59
61	P	11	3	13	P	3	43	67	3	7	P	3
63	3	7	61	3	19	31	3	P	7	3	11	67
65	5	3	5	5	3	5	5	3	5	5	3	5
67	31	P	3	P	23	3	7	19	3	73	P	3
69	3	P	37	3	11	7	3	P	P	3	P	47
71	P	3	11	P	3	41	P	3	53	29	3	7
73	11	P	3	7	P	3	13	P	3	23	7	3
75	3	5	5	3	5	5	3	5	5	3	5	5
77	P	3	P	31	3	19	P	3	7	53	3	43
79	7	13	3	P	P	3	P	7	3	P	P	3
81	3	17	P	3	P	P	3	P	13	3	P	P
83	19	3	13	71	3	7	P	3	P	P	3	31
85	5	5	3	5	5	3	5	5	3	5	5	3
87	3	P	P	3	17	P	3	37	11	3	7	P
89	P	3	7	P	3	17	11	3	P	7	3	53
91	67	7	3	29	11	3	17	P	3	P	43	3
93	3	P	11	3	67	P	3	7	P	3	71	13
95	5	3	5	5	3	5	5	3	5	5	3	5
97	59	19	3	P	P	3	23	29	3	11	P	3
99	3	P	P	3	7	P	3	11	41	3	17	7

Prime Number and Factor Table for 6001 to 7199

From To	6000 6100	6100 6200	6200 6300	6300 6400	6400 6500	6500 6600	6600 6700	6700 6800	6800 6900	6900 7000	7000 7100	7100 7200
1	17	P	3	P	37	3	7	P	3	67	P	3
3	3	17	P	3	19	7	3	P	P	3	47	P
5	5	3	5	5	3	5	5	3	5	5	3	5
7	P	31	3	7	43	3	P	19	3	P	7	3
9	3	41	7	3	13	23	3	P	11	3	43	P
11	P	3	P	P	3	17	11	3	7	P	3	13
13	7	P	3	59	11	3	17	7	3	31	P	3
15	3	5	5	3	5	5	3	5	5	3	5	5
17	11	3	P	P	3	7	13	3	17	P	3	11
19	13	29	3	71	7	3	P	P	3	11	P	3
21	3	P	P	3	P	P	3	11	19	3	7	P
23	19	3	7	P	3	11	37	3	P	7	3	17
25	5	5	3	5	5	3	5	5	3	5	5	3
27	3	11	13	3	P	61	3	7	P	3	P	P
29	P	3	P	P	3	P	7	3	P	13	3	P
31	37	P	3	13	59	3	19	53	3	29	79	3
33	3	P	23	3	7	47	3	P	P	3	13	7
35	5	3	5	5	3	5	5	3	5	5	3	5
37	P	17	3	P	41	3	P	P	3	7	31	3
39	3	7	17	3	47	13	3	23	7	3	P	11
41	7	3	79	17	3	31	29	3	P	11	3	37
43	P	P	3	P	17	3	7	11	3	53	P	3
45	3	5	5	3	5	5	3	5	5	3	5	5
47	P	3	P	11	3	P	17	3	41	P	3	7
49	23	11	3	7	P	3	61	17	3	P	7	3
51	3	P	7	3	P	P	3	43	13	3	11	P
53	P	3	13	P	3	P	P	3	7	17	3	23
55	5	5	3	5	5	3	5	5	3	5	5	3
57	3	47	P	3	11	79	3	29	P	3	P	17
59	73	3	11	P	3	7	P	3	19	P	3	P
61	11	61	3	P	7	3	P	P	3	P	23	3
63	3	P	P	3	23	P	3	P	P	3	7	13
65	5	3	5	5	3	5	5	3	5	5	3	5
67	P	7	3	P	29	3	59	67	3	P	37	3
69	3	31	P	3	P	P	3	7	P	3	P	67
71	13	3	P	23	3	P	7	3	P	P	3	71
73	P	P	3	P	P	3	P	13	3	19	11	3
75	3	5	5	3	5	5	3	5	5	3	5	5
77	59	3	P	7	3	P	11	3	13	P	3	P
79	P	37	3	P	11	3	P	P	3	7	P	3
81	3	7	11	3	P	P	3	P	7	3	73	43
83	7	3	61	13	3	29	41	3	P	P	3	11
85	5	5	3	5	5	3	5	5	3	5	5	3
87	3	23	P	3	13	7	3	11	71	3	19	P
89	P	3	19	P	3	11	P	3	83	29	3	7
91	P	41	3	7	P	3	P	P	3	P	7	3
93	3	11	7	3	43	19	3	P	61	3	41	P
95	5	3	5	5	3	5	5	3	5	5	3	5
97	7	P	3	P	73	3	37	7	3	P	47	3
99	3	P	P	3	67	P	3	13	P	3	31	23

Prime Number and Factor Table for 7201 to 8399

From To	7200 7300	7300 7400	7400 7500	7500 7600	7600 7700	7700 7800	7800 7900	7900 8000	8000 8100	8100 8200	8200 8300	8300 8400
1	19	7	3	13	11	3	29	P	3	P	59	3
3	3	67	11	3	P	P	3	7	53	3	13	19
5	5	3	5	5	3	5	5	3	5	5	3	5
7	P	P	3	P	P	3	37	P	3	11	29	3
9	3	P	31	3	7	13	3	11	P	3	P	7
11	P	3	P	7	3	11	73	3	P	P	3	P
13	P	71	3	11	23	3	13	41	3	7	43	3
15	3	5	5	3	5	5	3	5	5	3	5	5
17	7	3	P	P	3	P	P	3	P	P	3	P
19	P	13	3	73	19	3	7	P	3	23	P	3
21	3	P	41	3	P	7	3	89	13	3	P	53
23	31	3	13	P	3	P	P	3	71	P	3	7
25	5	5	3	5	5	3	5	5	3	5	5	3
27	3	17	7	3	29	P	3	P	23	3	19	11
29	P	3	17	P	3	59	P	3	7	11	3	P
31	7	P	3	17	13	3	41	7	3	47	P	3
33	3	P	P	3	17	11	3	P	29	3	P	13
35	5	3	5	5	3	5	5	3	5	5	3	5
37	P	11	3	P	7	3	17	P	3	79	P	3
39	3	41	43	3	P	71	3	17	P	3	7	31
41	13	3	7	P	3	P	P	3	11	7	3	19
43	P	7	3	19	P	3	11	13	3	17	P	3
45	3	5	5	3	5	5	3	5	5	3	5	5
47	P	3	11	P	3	61	7	3	13	P	3	17
49	11	P	3	P	P	3	47	P	3	29	73	3
51	3	P	P	3	7	23	3	P	83	3	37	7
53	P	3	29	7	3	P	P	3	P	31	3	P
55	5	5	3	5	5	3	5	5	3	5	5	3
57	3	7	P	3	13	P	3	73	7	3	23	61
59	7	3	P	P	3	P	29	3	P	41	3	13
61	53	17	3	P	47	3	7	19	3	P	11	3
63	3	37	17	3	79	7	3	P	11	3	P	P
65	5	3	5	5	3	5	5	3	5	5	3	5
67	13	53	3	7	11	3	P	31	3	P	7	3
69	3	P	7	3	P	17	3	13	P	3	P	P
71	11	3	31	67	3	19	17	3	7	P	3	11
73	7	73	3	P	P	3	P	7	3	11	P	3
75	3	5	5	3	5	5	3	5	5	3	5	5
77	19	3	P	P	3	7	P	3	41	13	3	P
79	29	47	3	11	7	3	P	79	3	P	17	3
81	3	11	P	3	P	31	3	23	P	3	7	17
83	P	3	7	P	3	43	P	3	59	7	3	83
85	5	5	3	5	5	3	5	5	3	5	5	3
87	3	83	P	3	P	13	3	7	P	3	P	P
89	37	3	P	P	3	P	7	3	P	19	3	P
91	23	19	3	P	P	3	13	61	3	P	P	3
93	3	P	59	3	7	P	3	P	P	3	P	7
95	5	3	5	5	3	5	5	3	5	5	3	5
97	P	13	3	71	43	3	53	11	3	7	P	3
99	3	7	P	3	P	11	3	19	7	3	43	37

Prime Number and Factor Table for 8401 to 9599

From To	8400 8500	8500 8600	8600 8700	8700 8800	8800 8900	8900 9000	9000 9100	9100 9200	9200 9300	9300 9400	9400 9500	9500 9600
1	31	P	3	7	13	3	P	19	3	71	7	3
3	3	11	7	3	P	29	3	P	P	3	P	13
5	5	3	5	5	3	5	5	3	5	5	3	5
7	7	47	3	P	P	3	P	7	3	41	23	3
9	3	67	P	3	23	59	3	P	P	3	97	37
11	13	3	79	31	3	7	P	3	61	P	3	P
13	47	P	3	P	7	3	P	13	3	67	P	3
15	3	5	5	3	5	5	3	5	5	3	5	5
17	19	3	7	23	3	37	71	3	13	7	3	31
19	P	7	3	P	P	3	29	11	3	P	P	3
21	3	P	37	3	P	11	3	7	P	3	P	P
23	P	3	P	11	3	P	7	3	23	P	3	89
25	5	5	3	5	5	3	5	5	3	5	5	3
27	3	P	P	3	7	79	3	P	P	3	11	7
29	P	3	P	7	3	P	P	3	11	19	3	13
31	P	19	3	P	P	3	11	23	3	7	P	3
33	3	7	89	3	11	P	3	P	7	3	P	P
35	5	3	5	5	3	5	5	3	5	5	3	5
37	11	P	3	P	P	3	7	P	3	P	P	3
39	3	P	53	3	P	7	3	13	P	3	P	P
41	23	3	P	P	3	P	P	3	P	P	3	7
43	P	P	3	7	37	3	P	41	3	P	7	3
45	3	5	5	3	5	5	3	5	5	3	5	5
47	P	3	P	P	3	23	83	3	7	13	3	P
49	7	83	3	13	P	3	P	7	3	P	11	3
51	3	17	41	3	53	P	3	P	11	3	13	P
53	79	3	17	P	3	7	11	3	19	47	3	41
55	5	5	3	5	5	3	5	5	3	5	5	3
57	3	43	11	3	17	13	3	P	P	3	7	19
59	11	3	7	19	3	17	P	3	47	7	3	11
61	P	7	3	P	P	3	13	P	3	11	P	3
63	3	P	P	3	P	P	3	7	59	3	P	73
65	5	3	5	5	3	5	5	3	5	5	3	5
67	P	13	3	11	P	3	P	89	3	17	P	3
69	3	11	P	3	7	P	3	53	13	3	17	7
71	43	3	13	7	3	P	47	3	73	P	3	17
73	37	P	3	31	19	3	43	P	3	7	P	3
75	3	5	5	3	5	5	3	5	5	3	5	5
77	7	3	P	67	3	47	29	3	P	P	3	61
79	61	23	3	P	13	3	7	67	3	83	P	3
81	3	P	P	3	83	7	3	P	P	3	19	11
83	17	3	19	P	3	13	31	3	P	11	3	7
85	5	5	3	5	5	3	5	5	3	5	5	3
87	3	31	7	3	P	11	3	P	37	3	53	P
89	13	3	P	11	3	89	61	3	7	41	3	43
91	7	11	3	59	17	3	P	7	3	P	P	3
93	3	13	P	3	P	17	3	29	P	3	11	53
95	5	3	5	5	3	5	5	3	5	5	3	5
97	29	P	3	19	7	3	11	17	3	P	P	3
99	3	P	P	3	11	P	3	P	17	3	7	29

Prime Numbers from 9551 to 18691

9551	10181	10853	11497	12157	12763	13417	14071	14747	15361	16001	16693	17387	18043
9587	10193	10859	11503	12161	12781	13421	14081	14753	15373	16007	16699	17389	18047
9601	10211	10861	11519	12163	12791	13441	14083	14759	15377	16033	16703	17393	18049
9613	10223	10867	11527	12197	12799	13451	14087	14767	15383	16057	16729	17401	18059
9619	10243	10883	11549	12203	12809	13457	14107	14771	15391	16061	16741	17417	18061
9623	10247	10889	11551	12211	12821	13463	14143	14779	15401	16063	16747	17419	18077
9629	10253	10891	11579	12227	12823	13469	14149	14783	15413	16067	16759	17431	18089
9631	10259	10903	11587	12239	12829	13477	14153	14797	15427	16069	16763	17443	18097
9643	10267	10909	11593	12241	12841	13487	14159	14813	15439	16073	16787	17449	18119
9649	10271	10937	11597	12251	12853	13499	14173	14821	15443	16087	16811	17467	18121
9661	10273	10939	11617	12253	12889	13513	14177	14827	15451	16091	16823	17471	18127
9677	10289	10949	11621	12263	12893	13523	14197	14831	15461	16097	16829	17477	18131
9679	10301	10957	11633	12269	12899	13537	14207	14843	15467	16103	16831	17483	18133
9689	10303	10973	11657	12277	12907	13553	14221	14851	15473	16111	16843	17489	18143
9697	10313	10979	11677	12281	12911	13567	14243	14867	15493	16127	16871	17491	18149
9719	10321	10987	11681	12289	12917	13577	14249	14869	15497	16139	16879	17497	18169
9721	10331	10993	11689	12301	12919	13591	14251	14879	15511	16141	16883	17509	18181
9733	10333	11003	11699	12323	12923	13597	14281	14887	15527	16183	16889	17519	18191
9739	10337	11027	11701	12329	12941	13613	14293	14891	15541	16187	16901	17539	18199
9743	10343	11047	11717	12343	12953	13619	14303	14897	15551	16189	16903	17551	18211
9749	10357	11057	11719	12347	12959	13627	14321	14923	15559	16193	16921	17569	18217
9767	10369	11059	11731	12373	12967	13633	14323	14929	15569	16217	16927	17573	18223
9769	10391	11069	11743	12377	12973	13649	14327	14939	15581	16223	16931	17579	18229
9781	10399	11071	11777	12379	12979	13669	14341	14947	15583	16229	16937	17581	18233
9787	10427	11083	11779	12391	12983	13679	14347	14951	15601	16231	16943	17597	18251
9791	10429	11087	11783	12401	13001	13681	14369	14957	15607	16249	16963	17599	18253
9803	10433	11093	11789	12409	13003	13687	14387	14969	15619	16253	16979	17609	18257
9811	10453	11113	11801	12413	13007	13691	14389	14983	15629	16267	16981	17623	18269
9817	10457	11117	11807	12421	13009	13693	14401	15013	15641	16273	16987	17627	18287
9829	10459	11119	11813	12433	13033	13697	14407	15017	15643	16301	16993	17657	18289
9833	10463	11131	11821	12437	13037	13709	14411	15031	15647	16319	17011	17659	18301
9839	10477	11149	11827	12451	13043	13711	14419	15053	15649	16333	17021	17669	18307
9851	10487	11159	11831	12457	13049	13721	14423	15061	15661	16339	17027	17681	18311
9857	10499	11161	11833	12473	13063	13723	14431	15073	15667	16349	17029	17683	18313
9859	10501	11171	11839	12479	13093	13729	14437	15077	15671	16361	17033	17707	18329
9871	10513	11173	11863	12487	13099	13751	14447	15083	15679	16363	17041	17713	18341
9883	10529	11177	11867	12491	13103	13757	14449	15091	15683	16369	17047	17729	18353
9887	10531	11197	11887	12497	13109	13759	14461	15101	15727	16381	17053	17737	18367
9901	10559	11213	11897	12503	13121	13763	14479	15107	15731	16411	17077	17747	18371
9907	10567	11239	11903	12511	13127	13781	14489	15121	15733	16417	17093	17749	18379
9923	10589	11243	11909	12517	13147	13789	14503	15131	15737	16421	17099	17761	18397
9929	10597	11251	11923	12527	13151	13799	14519	15137	15739	16427	17107	17783	18401
9931	10601	11257	11927	12539	13159	13807	14533	15139	15749	16433	17117	17789	18413
9941	10607	11261	11933	12541	13163	13829	14537	15149	15761	16447	17123	17791	18427
9949	10613	11273	11939	12547	13171	13831	14543	15161	15767	16451	17137	17807	18433
9967	10627	11279	11941	12553	13177	13841	14549	15173	15773	16453	17159	17827	18439
9973	10631	11287	11953	12569	13183	13859	14551	15187	15787	16477	17167	17837	18443
10007	10639	11299	11959	12577	13187	13873	14557	15193	15791	16481	17183	17839	18451
10009	10651	11311	11969	12583	13217	13877	14561	15199	15797	16487	17189	17851	18457
10037	10657	11317	11971	12589	13219	13879	14563	15217	15803	16493	17191	17863	18461
10039	10663	11321	11981	12601	13229	13883	14591	15227	15809	16519	17203	17881	18481
10061	10667	11329	11987	12611	13241	13901	14593	15233	15817	16529	17207	17891	18493
10067	10687	11351	12007	12613	13249	13903	14621	15241	15823	16547	17209	17903	18503
10069	10691	11353	12011	12619	13259	13907	14627	15259	15859	16553	17231	17909	18517
10079	10709	11369	12037	12637	13267	13913	14629	15263	15877	16561	17239	17911	18521
10091	10711	11383	12041	12641	13291	13921	14633	15269	15881	16567	17257	17921	18523
10093	10723	11393	12043	12647	13297	13931	14639	15271	15887	16573	17291	17923	18539
10099	10729	11399	12049	12653	13309	13933	14653	15277	15889	16603	17293	17929	18541
10103	10733	11411	12071	12659	13313	13963	14657	15287	15901	16607	17299	17939	18553
10111	10739	11423	12073	12671	13327	13967	14669	15289	15907	16619	17317	17957	18583
10133	10753	11437	12097	12689	13331	13997	14683	15299	15913	16631	17321	17959	18587
10139	10771	11443	12101	12697	13337	13999	14699	15307	15919	16633	17327	17971	18593
10141	10781	11447	12107	12703	13339	14009	14713	15313	15923	16649	17333	17977	18617
10151	10789	11467	12109	12713	13367	14011	14717	15319	15937	16651	17341	17981	18637
10159	10799	11471	12113	12721	13381	14029	14723	15329	15959	16657	17351	17987	18661
10163	10831	11483	12119	12739	13397	14033	14731	15331	15971	16661	17359	17989	18671
10169	10837	11489	12143	12743	13399	14051	14737	15349	15973	16673	17377	18013	18679
10177	10847	11491	12149	12757	13411	14057	14741	15359	15991	16691	17383	18041	18691

ALGEBRA AND EQUATIONS

An unknown number can be represented by a symbol or a letter which can be manipulated like an ordinary numeral within an arithmetic expression. The rules of arithmetic are also applicable in algebra.

Rearrangement and Transposition of Terms in Formulas

A formula is a rule for a calculation expressed by using letters and signs instead of writing out the rule in words; by this means, it is possible to condense, in a very small space, the essentials of long and cumbersome rules. The letters used in formulas simply stand in place of the figures that are to be substituted when solving a specific problem.

As an example, the formula for the horsepower transmitted by belting may be written

$$P = \frac{SVW}{33,000}$$

where P = horsepower transmitted; S = working stress of belt per inch of width in pounds; V = velocity of belt in feet per minute; and, W = width of belt in inches.

If the working stress S , the velocity V , and the width W are known, the horsepower can be found directly from this formula by inserting the given values. Assume $S = 33$; $V = 600$; and $W = 5$. Then

$$P = \frac{33 \times 600 \times 5}{33,000} = 3$$

Assume that the horsepower P , the stress S , and the velocity V are known, and that the width of belt, W , is to be found. The formula must then be rearranged so that the symbol W will be on one side of the equals sign and all the known quantities on the other. The rearranged formula is as follows:

$$\frac{P \times 33,000}{SV} = W$$

The quantities (S and V) that were in the numerator on the right side of the equals sign are moved to the denominator on the left side, and “33,000,” which was in the denominator on the right side of the equals sign, is moved to the numerator on the other side. Symbols that are not part of a fraction, like “ P ” in the formula first given, are to be considered as being numerators (having the denominator 1).

Thus, any formula of the form $A = B/C$ can be rearranged as follows:

$$A \times C = B \quad \text{and} \quad C = \frac{B}{A}$$

Suppose a formula to be of the form $A = \frac{B \times C}{D}$

$$\text{Then} \quad D = \frac{B \times C}{A} \quad \frac{A \times D}{C} = B \quad \frac{A \times D}{B} = C$$

The method given is only directly applicable when all the quantities in the numerator or denominator are standing independently or are *factors of a product*. If connected by + or – signs, the entire numerator or denominator must be moved as a unit, thus,

$$\text{Given:} \quad \frac{B + C}{A} = \frac{D + E}{F}$$

$$\text{To solve for } F, \text{ rearrange in two steps as follows:} \quad \frac{F}{A} = \frac{D + E}{B + C} \quad \text{and} \quad F = \frac{A(D + E)}{B + C}$$

A quantity preceded by a + or – sign can be transposed to the opposite side of the equals sign by changing its sign; if the sign is +, change it to – on the other side; if it is –, change it to +. This process is called *transposition* of terms.

Example: $B + C = A - D$ then $A = B + C + D$
 $B = A - D - C$
 $C = A - D - B$

Principal Algebraic Expressions and Formulas

$$\begin{aligned} a \times a &= aa = a^2 & \frac{a^3}{b^3} &= \left(\frac{a}{b}\right)^3 \\ a \times a \times a &= aaa = a^3 & \frac{1}{a^3} &= \left(\frac{1}{a}\right)^3 = a^{-3} \\ a \times b &= ab & (a^2)^3 &= a^{2 \times 3} = (a^3)^2 = a^6 \\ a^2 b^2 &= (ab)^2 & a^3 + b^3 &= (a + b)(a^2 - ab + b^2) \\ a^2 a^3 &= a^{2+3} = a^5 & a^3 - b^3 &= (a - b)(a^2 + ab + b^2) \\ a^4 \div a^3 &= a^{4-3} = a & (a + b)^3 &= a^3 + 3a^2b + 3ab^2 + b^3 \\ a^0 &= 1 & (a - b)^3 &= a^3 - 3a^2b + 3ab^2 - b^3 \\ a^2 - b^2 &= (a + b)(a - b) & a^3 + b^3 &= (a + b)^3 - 3ab(a + b) \\ (a + b)^2 &= a^2 + 2ab + b^2 & a^3 - b^3 &= (a - b)^3 + 3ab(a - b) \\ (a - b)^2 &= a^2 - 2ab + b^2 \\ ab &= \left(\frac{a+b}{2}\right)^2 - \left(\frac{a-b}{2}\right)^2 \end{aligned}$$

$$\begin{aligned} \sqrt{a} \times \sqrt{a} &= a & \sqrt[3]{ab} &= \sqrt[3]{a} \times \sqrt[3]{b} \\ \sqrt[3]{a} \times \sqrt[3]{a} \times \sqrt[3]{a} &= a & \sqrt[3]{\frac{a}{b}} &= \frac{\sqrt[3]{a}}{\sqrt[3]{b}} \\ (\sqrt[3]{a})^3 &= a & \sqrt[3]{\frac{1}{a}} &= \frac{1}{\sqrt[3]{a}} = a^{-1/3} \\ \sqrt[3]{a^2} &= (\sqrt[3]{a})^2 = a^{2/3} \\ \sqrt[4]{\sqrt[3]{a}} &= 4 \times \sqrt[3]{a} = \sqrt[3]{4\sqrt{a}} \\ \sqrt{a} + \sqrt{b} &= \sqrt{a + b + 2\sqrt{ab}} \end{aligned}$$

When	$a \times b = x$	then	$\log a + \log b = \log x$
	$a \div b = x$	then	$\log a - \log b = \log x$
	$a^3 = x$	then	$3 \log a = \log x$
	$\sqrt[3]{a} = x$	then	$\frac{\log a}{3} = \log x$

Equation Solving

An equation is a statement of equality between two expressions, as $5x = 105$. The unknown quantity in an equation is frequently designated by the letter such as x . If there is more than one unknown quantity, the others are designated by letters also usually selected from the end of the alphabet, as y, z, u, t , etc.

An equation of the first degree is one which contains the unknown quantity only in the first power, as in $3x = 9$. A quadratic equation is one which contains the unknown quantity in the second, but no higher, power, as in $x^2 + 3x = 10$.

Solving Equations of the First Degree with One Unknown.—Transpose all the terms containing the unknown x to one side of the equals sign, and all the other terms to the other side. Combine and simplify the expressions as far as possible, and divide both sides by the coefficient of the unknown x . (See the rules given for transposition of formulas.)

$$\begin{aligned} \text{Example:} \quad & 22x - 11 = 15x + 10 \\ & 22x - 15x = 10 + 11 \\ & 7x = 21 \\ & x = 3 \end{aligned}$$

✧ **Solution of Equations of the First Degree with Two Unknowns.**—The form of the simplified equations is

$$\begin{aligned} a_1x + b_1y &= c_1 \\ a_2x + b_2y &= c_2 \end{aligned}$$

Then,

$$x = \frac{c_1b_2 - c_2b_1}{a_1b_2 - a_2b_1} \qquad y = \frac{a_1c_2 - a_2c_1}{a_1b_2 - a_2b_1}$$

Example:

$$\begin{aligned} 3x + 4y &= 17 \\ 5x - 2y &= 11 \\ x &= \frac{17 \times (-2) - 11 \times 4}{3 \times (-2) - 5 \times 4} = \frac{-34 - 44}{-6 - 20} = \frac{-78}{-26} = 3 \end{aligned}$$

The value of y can now be most easily found by inserting the value of x in one of the equations:

$$5 \times 3 - 2y = 11 \qquad 2y = 15 - 11 = 4 \qquad y = 2$$

✧ **Solution of Quadratic Equations with One Unknown.**—If the form of the equation is $ax^2 + bx + c = 0$, then

$$x = \frac{-b \pm \sqrt{b^2 - 4ac}}{2a}$$

Example: Given the equation, $1x^2 + 6x + 5 = 0$, then $a = 1$, $b = 6$, and $c = 5$.

$$x = \frac{-6 \pm \sqrt{6^2 - 4 \times 1 \times 5}}{2 \times 1} = \frac{(-6) + 4}{2} = -1 \quad \text{or} \quad \frac{(-6) - 4}{2} = -5$$

If the form of the equation is $ax^2 + bx = c$, then

$$x = \frac{-b \pm \sqrt{b^2 + 4ac}}{2a}$$

Example: A right-angle triangle has a hypotenuse 5 cm long and one side which is one cm longer than the other; find the lengths of the two sides.

Let $x =$ one side and $x + 1 =$ other side; then $x^2 + (x + 1)^2 = 5^2$ or $x^2 + x^2 + 2x + 1 = 25$; or $2x^2 + 2x = 24$; or $x^2 + x = 12$. Now referring to the basic formula, $ax^2 + bx = c$, we find that $a = 1$, $b = 1$, and $c = 12$; hence,

$$x = \frac{-1 \pm \sqrt{1 + 4 \times 1 \times 12}}{2 \times 1} = \frac{(-1) + 7}{2} = 3 \quad \text{or} \quad x = \frac{(-1) - 7}{2} = -4$$

Since the positive value (3) would apply in this case, the lengths of the two sides are $x = 3$ cm and $x + 1 = 4$ cm.

Factoring a Quadratic Expression.—The method described below is useful in determining factors of the quadratic equation in the form $ax^2 + bx + c = 0$. First, obtain the product ac from the coefficients a and c , and then determine two numbers, f_1 and f_2 , such that $f_1 \times f_2 = |ac|$, and $f_1 + f_2 = b$ if ac is positive, or $f_1 - f_2 = b$ if ac is negative.

The numbers f_1 and f_2 are used to modify or rearrange the bx term to simplify factoring the quadratic expression. The roots of the quadratic equation can be easily obtained from the factors.

Example: Factor $8x^2 + 22x + 5 = 0$ and find the values of x that satisfy the equation.

Solution: In this example, $a = 8$, $b = 22$, and $c = 5$. Therefore, $ac = 8 \times 5 = 40$, and ac is positive, so we are looking for two factors of ac , f_1 and f_2 , such that $f_1 \times f_2 = 40$, and $f_1 + f_2 = 22$.

The ac term can be written as $2 \times 2 \times 2 \times 5 = 40$, and the possible combination of numbers for f_1 and f_2 are (20 and 2), (8 and 5), (4 and 10) and (40 and 1). The requirements for f_1 and f_2 are satisfied by $f_1 = 20$ and $f_2 = 2$, i.e., $20 \times 2 = 40$ and $20 + 2 = 22$. Using f_1 and f_2 , the original quadratic expression is rewritten and factored as follows:

$$\begin{aligned} 8x^2 + 22x + 5 &= 0 \\ 8x^2 + 20x + 2x + 5 &= 0 \\ 4x(2x + 5) + 1(2x + 5) &= 0 \\ (2x + 5)(4x + 1) &= 0 \end{aligned}$$

If the product of the two factors equals zero, then each of the factors equals zero, thus, $2x + 5 = 0$ and $4x + 1 = 0$. Rearranging and solving, $x = -\frac{5}{2}$ and $x = -\frac{1}{4}$.

Example: Factor $8x^2 + 3x - 5 = 0$ and find the solutions for x .

Solution: Here $a = 8$, $b = 3$, $c = -5$, and $ac = 8 \times (-5) = -40$. Because ac is negative, the required numbers, f_1 and f_2 , must satisfy $f_1 \times f_2 = |ac| = 40$ and $f_1 - f_2 = 3$.

As in the previous example, the possible combinations for f_1 and f_2 are (20 and 2), (8 and 5), (4 and 10) and (40 and 1). The numbers $f_1 = 8$ and $f_2 = 5$ satisfy the requirements because $8 \times 5 = 40$ and $8 - 5 = 3$. In the second line below, $5x$ is both added to and subtracted from the original equation, making it possible to rearrange and simplify the expression.

$$\begin{aligned} 8x^2 + 3x - 5 &= 0 \\ 8x^2 + 8x - 5x - 5 &= 0 \\ 8x(x + 1) - 5(x + 1) &= 0 \\ (x + 1)(8x - 5) &= 0 \end{aligned}$$

Solving, for $x + 1 = 0$, $x = -1$; and, for $8x - 5 = 0$, $x = \frac{5}{8}$.

Cubic Equations.—If the given equation has the form: $x^3 + ax + b = 0$ then

$$x = \left(-\frac{b}{2} + \sqrt{\frac{a^3}{27} + \frac{b^2}{4}}\right)^{1/3} + \left(-\frac{b}{2} - \sqrt{\frac{a^3}{27} + \frac{b^2}{4}}\right)^{1/3}$$

The equation $x^3 + px^2 + qx + r = 0$, may be reduced to the form $x_1^3 + ax_1 + b = 0$ by substituting $x_1 = x - \frac{p}{3}$ for x in the given equation.

Solving Numerical Equations Having One Unknown.—The Newton-Raphson method is a procedure for solving various kinds of numerical algebraic and transcendental equations in one unknown. The steps in the procedure are simple and can be used with either a handheld calculator or as a subroutine in a computer program.

Examples of types of equations that can be solved to any desired degree of accuracy by this method are

$$f(x) = x^2 - 101 = 0, \quad f(x) = x^3 - 2x^2 - 5 = 0$$

$$\text{and } f(x) = 2.9x - \cos x - 1 = 0$$

The procedure begins with an estimate, r_1 , of the root satisfying the given equation. This estimate is obtained by judgment, inspection, or plotting a rough graph of the equation and observing the value r_1 where the curve crosses the x axis. This value is then used to calculate values r_2, r_3, \dots, r_n progressively closer to the exact value.

Before continuing, it is necessary to calculate the first derivative, $f'(x)$, of the function. In the above examples, $f'(x)$ is, respectively, $2x$, $3x^2 - 4x$, and $2.9 + \sin x$. These values were found by the methods described in *Derivatives and Integrals of Functions* on page 35.

In the steps that follow,

r_1 is the first estimate of the value of the root of $f(x) = 0$;

$f(r_1)$ is the value of $f(x)$ for $x = r_1$;

$f'(x)$ is the first derivative of $f(x)$;

$f'(r_1)$ is the value of $f'(x)$ for $x = r_1$.

The second approximation of the root of $f(x) = 0$, r_2 , is calculated from

$$r_2 = r_1 - [f(r_1)/f'(r_1)]$$

and, to continue further approximations,

$$r_n = r_{n-1} - [f(r_{n-1})/f'(r_{n-1})]$$

Example: Find the square root of 101 using the Newton-Raphson method. This problem can be restated as an equation to be solved, i.e., $f(x) = x^2 - 101 = 0$

Step 1. By inspection, it is evident that $r_1 = 10$ may be taken as the first approximation of the root of this equation. Then, $f(r_1) = f(10) = 10^2 - 101 = -1$

Step 2. The first derivative, $f'(x)$, of $x^2 - 101$ is $2x$ as stated previously, so that

$$f'(10) = 2(10) = 20.$$

Then, $r_2 = r_1 - f(r_1)/f'(r_1) = 10 - (-1)/20 = 10 + 0.05 = 10.05$

$$\text{Check: } 10.05^2 = 101.0025; \text{ error} = 0.0025$$

Step 3. The next, better approximation is

$$r_3 = r_2 - [f(r_2)/f'(r_2)] = 10.05 - [f(10.05)/f'(10.05)]$$

$$= 10.05 - [(10.05^2 - 101)/2(10.05)] = 10.049875$$

$$\text{Check: } 10.049875^2 = 100.9999875; \text{ error} = 0.0000125$$

Series.—Some hand calculations, as well as computer programs of certain types of mathematical problems, may be facilitated by the use of an appropriate series. For example, in some gear problems, the angle corresponding to a given or calculated involute function is found by using a series together with an iterative procedure such as the Newton-Raphson method described on page 34. The following are those series most commonly used for such purposes. In the series for trigonometric functions, the angles x are in radians (1 radian = $180/\pi$ degrees). The expression $\exp(-x^2)$ means that the base e of the natural logarithm system is raised to the $-x^2$ power; $e = 2.7182818$.

- (1) $\sin x = x - x^3/3! + x^5/5! - x^7/7! + \dots$ for all values of x .
- (2) $\cos x = 1 - x^2/2! + x^4/4! - x^6/6! + \dots$ for all values of x .
- (3) $\tan x = x + x^3/3 + 2x^5/15 + 17x^7/315 + 62x^9/2835 + \dots$ for $|x| < \pi/2$.
- (4) $\arcsin x = x + x^3/6 + 1 \cdot 3 \cdot x^5/(2 \cdot 4 \cdot 5) + 1 \cdot 3 \cdot 5 \cdot x^7/(2 \cdot 4 \cdot 6 \cdot 7) + \dots$ for $|x| \leq 1$.
- (5) $\arccos x = \pi/2 - \arcsin x$
- (6) $\arctan x = x - x^3/3 + x^5/5 - x^7/7 + \dots$ for $|x| \leq 1$.
- (7) $\pi/4 = 1 - 1/3 + 1/5 - 1/7 + 1/9 \dots \pm 1/(2x - 1) \mp \dots$ for all values of x .
- (8) $e = 1 + 1/1! + 2/2! + 1/3! + \dots$ for all values of x .
- (9) $e^x = 1 + x + x^2/2! + x^3/3! + \dots$ for all values of x .
- (10) $\exp(-x^2) = 1 - x^2 + x^4/2! - x^6/3! + \dots$ for all values of x .
- (11) $a^x = 1 + x \log_e a + (x \log_e a)^2/2! + (x \log_e a)^3/3! + \dots$ for all values of x .
- (12) $1/(1+x) = 1 - x + x^2 - x^3 + x^4 - \dots$ for $|x| < 1$.
- (13) $1/(1-x) = 1 + x + x^2 + x^3 + x^4 + \dots$ for $|x| < 1$.
- (14) $1/(1+x)^2 = 1 - 2x + 3x^2 - 4x^3 + 5x^4 - \dots$ for $|x| < 1$.
- (15) $1/(1-x)^2 = 1 + 2x + 3x^2 + 4x^3 + 5x^4 + \dots$ for $|x| < 1$.
- (16) $\sqrt{1+x} = 1 + x/2 - x^2/(2 \cdot 4) + 1 \cdot 3 \cdot x^3/(2 \cdot 4 \cdot 6) - 1 \cdot 3 \cdot 5 \cdot x^4/(2 \cdot 4 \cdot 6 \cdot 8) - \dots$ for $|x| < 1$.
- (17) $1/(\sqrt{1+x}) = 1 - x/2 + 1 \cdot 3 \cdot x^2/(2 \cdot 4) - 1 \cdot 3 \cdot 5 \cdot x^3/(2 \cdot 4 \cdot 6) + \dots$ for $|x| < 1$.
- (18) $(a+x)^n = a^n + na^{n-1}x + n(n-1)a^{n-2}x^2/2! + n(n-1)(n-2)a^{n-3}x^3/3! + \dots$ for $x^2 < a^2$.

Derivatives and Integrals of Functions.—The following are formulas for obtaining the derivatives and integrals of basic mathematical functions. In these formulas, the letters a and c denotes constants; the letter x denotes a variable; and the letters u and v denote functions of the variable x . The expression d/dx means the derivative with respect to x , and as such applies to whatever expression in parentheses follows it. Thus, $d/dx(ax)$ means the derivative with respect to x of the product (ax) of the constant a and the variable x .

Formulas for Differential and Integral Calculus

Derivative	Value	Integral	Value
$\frac{d}{dx}(c)$	0	$\int c dx$	cx
$\frac{d}{dx}(x)$	1	$\int 1 dx$	x
$\frac{d}{dx}(x^n)$	nx^{n-1}	$\int x^n dx$	$\frac{x^{n+1}}{n+1}$
$\frac{d}{dx}(g(u))$	$\frac{d}{du}g(u) \frac{du}{dx}$	$\int \frac{dx}{ax+b}$	$\frac{1}{a} \ln ax+b $
$\frac{d}{dx}(u(x) + v(x))$	$\frac{d}{dx}u(x) + \frac{d}{dx}v(x)$	$\int (u(x) \pm v(x)) dx$	$\int u(x) dx \pm \int v(x) dx$
$\frac{d}{dx}(u(x) \times v(x))$	$u(x) \frac{d}{dx}v(x) + v(x) \frac{d}{dx}u(x)$	$\int u(x)v(x) dx$	$u(x)v(x) - \int v(x) du(x)$

Formulas for Differential and Integral Calculus (Continued)

Derivative	Value	Integral	Value
$\frac{d}{dx}\left(\frac{u(x)}{v(x)}\right)$	$\frac{v(x)\frac{d}{dx}u(x) - u(x)\frac{d}{dx}v(x)}{v(x)^2}$	$\int \frac{dx}{\sqrt{x}}$	$2\sqrt{x}$
$\frac{d}{dx}(\sin x)$	$\cos x$	$\int \cos x dx$	$\sin x$
$\frac{d}{dx}(\cos x)$	$-\sin x$	$\int \sin x dx$	$-\cos x$
$\frac{d}{dx}(\tan x)$	$\sec^2 x$	$\int \tan x dx$	$-\log \cos x$
$\frac{d}{dx}(\cot x)$	$-\operatorname{cosec}^2 x$	$\int \cot x dx$	$\log \sin x$
$\frac{d}{dx}(\sec x)$	$\sec x \tan x$	$\int \sin^2 x dx$	$\left(-\frac{1}{4}\right) \sin(2x) + \frac{1}{2}x$
$\frac{d}{dx}(\csc x)$	$-\csc x \cot x$	$\int \cos^2 x dx$	$\frac{1}{4} \sin(2x) + \frac{1}{2}x$
$\frac{d}{dx}(e^x)$	e^x	$\int e^x dx$	e^x
$\frac{d}{dx}(\log x)$	$\frac{1}{x}$	$\int \frac{1}{x} dx$	$\log x$
$\frac{d}{dx}(a^x)$	$a^x \log a$	$\int a^x dx$	$\frac{a^x}{\log a}$
$\frac{d}{dx}(\operatorname{asin} x)$	$\frac{1}{\sqrt{1-x^2}}$	$\int \frac{dx}{\sqrt{b^2-x^2}}$	$\operatorname{asin} \frac{x}{b}$
$\frac{d}{dx}(\operatorname{acos} x)$	$\frac{-1}{\sqrt{1-x^2}}$	$\int \frac{dx}{\sqrt{x^2-b^2}}$	$\operatorname{acosh} \frac{x}{b} = \log(x + \sqrt{x^2-b^2})$
$\frac{d}{dx}(\operatorname{atan} x)$	$\frac{1}{1+x^2}$	$\int \frac{dx}{b^2+x^2}$	$\frac{1}{b} \operatorname{atan} \frac{x}{b}$
$\frac{d}{dx}(\operatorname{acot} x)$	$\frac{-1}{1+x^2}$	$\int \frac{dx}{b^2-x^2}$	$\frac{1}{b} \operatorname{atanh} \frac{x}{b} = \frac{-1}{2b} \log \left(\frac{ x-b }{ x+b } \right)$
$\frac{d}{dx}(\operatorname{asec} x)$	$\frac{1}{x\sqrt{x^2-1}}$	$\int \frac{dx}{x^2-b^2}$	$\frac{1}{b} \operatorname{acoth} \frac{x}{b} = \frac{1}{2b} \log \left(\frac{ x-b }{ x+b } \right)$
$\frac{d}{dx}(\operatorname{acsc} x)$	$\frac{-1}{x\sqrt{x^2-1}}$	$\int \frac{dx}{ax^2+bx+c}$	$\frac{2}{\sqrt{4ac-b^2}} \operatorname{atan} \frac{(2ax+b)}{\sqrt{4ac-b^2}}$
$\frac{d}{dx}(\log \sin x)$	$\cot x$	$\int e^{ax} \sin bx dx$	$\frac{(\operatorname{asin} bx - b \cos bx) e^{ax}}{a^2+b^2}$
$\frac{d}{dx}(\log \cos x)$	$-\tan x$	$\int e^{ax} \cos bx dx$	$\frac{(\operatorname{acos} bx + b \sin bx) e^{ax}}{a^2+b^2}$
$\frac{d}{dx}(\log \tan x)$	$\frac{2}{\sin 2x}$	$\int \frac{1}{\sin x} dx$	$\log \tan \frac{x}{2}$
$\frac{d}{dx}(\log \cot x)$	$\frac{-2}{\sin 2x}$	$\int \frac{1}{\cos x} dx$	$\log \tan \left(\frac{\pi}{4} + \frac{x}{2} \right)$
$\frac{d}{dx}(\sqrt{x})$	$\frac{1}{2\sqrt{x}}$	$\int \frac{1}{1+\cos x} dx$	$\tan \frac{x}{2}$
$\frac{d}{dx}(\log_{10} x)$	$\frac{\log_{10} e}{x}$	$\int \log x dx$	$x \log x - x$

GEOMETRY

Arithmetical Progression

An arithmetical progression is a series of numbers in which each consecutive term differs from the preceding one by a fixed amount called the *common difference*, d . Thus, 1, 3, 5, 7, etc., is an arithmetical progression where the difference d is 2. The difference here is *added* to the preceding term, and the progression is called increasing. In the series 13, 10, 7, 4, etc., the difference is (-3) , and the progression is called decreasing. In any arithmetical progression (or part of progression), let

a = first term considered

l = last term considered

n = number of terms

d = common difference

S = sum of n terms

Then the general formulas are $l = a + (n - 1)d$ and $S = \frac{a + l}{2} \times n$

In these formulas, d is positive in an increasing and negative in a decreasing progression. When any three of the preceding five quantities are given, the other two can be found by the formulas in the accompanying table of arithmetical progression.

Example: In an arithmetical progression, the first term equals 5, and the last term 40. The difference is 7. Find the sum of the progression.

$$S = \frac{a + l}{2d}(l + d - a) = \frac{5 + 40}{2 \times 7}(40 + 7 - 5) = 135$$

Geometrical Progression

A geometrical progression or a geometrical series is a series in which each term is derived by multiplying the preceding term by a constant multiplier called the *ratio*. When the ratio is greater than 1, the progression is increasing; when less than 1, it is decreasing. Thus, 2, 6, 18, 54, etc., is an increasing geometrical progression with a ratio of 3, and 24, 12, 6, etc., is a decreasing progression with a ratio of $1/2$.

In any geometrical progression (or part of progression), let

a = first term

l = last (or n th) term

n = number of terms

r = ratio of the progression

S = sum of n terms

Then the general formulas are $l = ar^{n-1}$ and $S = \frac{rl - a}{r - 1}$

When any three of the preceding five quantities are given, the other two can be found by the formulas in the accompanying table. For instance, geometrical progressions are used for finding the successive speeds in machine tool drives, and in interest calculations.

Example: The lowest speed of a lathe is 20 rpm. The highest speed is 225 rpm. There are 18 speeds. Find the ratio between successive speeds.

$$\text{Ratio } r = \sqrt[n-1]{\frac{l}{a}} = \sqrt[17]{\frac{225}{20}} = \sqrt[17]{11.25} = 1.153$$

Formulas for Arithmetical Progression

To Find	Given	Use Equation
a	$d \quad l \quad n$	$a = l - (n - 1)d$
	$d \quad n \quad S$	$a = \frac{S}{n} - \frac{n-1}{2} \times d$
	$d \quad l \quad S$	$a = \frac{d \pm \frac{1}{2} \sqrt{(2l+d)^2 - 8dS}}{2}$
	$l \quad n \quad S$	$a = \frac{2S}{n} - l$
d	$a \quad l \quad n$	$d = \frac{l-a}{n-1}$
	$a \quad n \quad S$	$d = \frac{2S-2an}{n(n-1)}$
	$a \quad l \quad S$	$d = \frac{l^2-a^2}{2S-l-a}$
	$l \quad n \quad S$	$d = \frac{2nl-2S}{n(n-1)}$
l	$a \quad d \quad n$	$l = a + (n-1)d$
	$a \quad d \quad S$	$l = -\frac{d}{2} \pm \frac{1}{2} \sqrt{8dS + (2a-d)^2}$
	$a \quad n \quad S$	$l = \frac{2S}{n} - a$
	$d \quad n \quad S$	$l = \frac{S}{n} + \frac{n-1}{2} \times d$
n	$a \quad d \quad l$	$n = 1 + \frac{l-a}{d}$
	$a \quad d \quad S$	$n = \frac{d-2a}{2d} \pm \frac{1}{2d} \sqrt{8dS + (2a-d)^2}$
	$a \quad l \quad S$	$n = \frac{2S}{a+l}$
	$d \quad l \quad S$	$n = \frac{2l+d}{2d} \pm \frac{1}{2d} \sqrt{(2l+d)^2 - 8dS}$
S	$a \quad d \quad n$	$S = \frac{n}{2}[2a + (n-1)d]$
	$a \quad d \quad l$	$S = \frac{a+l}{2} + \frac{l^2-a^2}{2d} = \frac{a+l}{2d}(l+d-a)$
	$a \quad l \quad n$	$S = \frac{n}{2}(a+l)$
	$d \quad l \quad n$	$S = \frac{n}{2}[2l - (n-1)d]$

Formulas for Geometrical Progression

To Find	Given	Use Equation
a	$l \quad n \quad r$	$a = \frac{l}{r^{n-1}}$
	$n \quad r \quad S$	$a = \frac{(r-1)S}{r^n - 1}$
	$l \quad r \quad S$	$a = lr - (r-1)S$
	$l \quad n \quad S$	$a(S-a)^{n-1} = l(S-l)^{n-1}$
l	$a \quad n \quad r$	$l = ar^{n-1}$
	$a \quad r \quad S$	$l = \frac{1}{r}[a + (r-1)S]$
	$a \quad n \quad S$	$l(S-l)^{n-1} = a(S-a)^{n-1}$
	$n \quad r \quad S$	$l = \frac{S(r-1)r^{n-1}}{r^n - 1}$
n	$a \quad l \quad r$	$n = \frac{\log l - \log a}{\log r} + 1$
	$a \quad r \quad S$	$n = \frac{\log[a + (r-1)S] - \log a}{\log r}$
	$a \quad l \quad S$	$n = \frac{\log l - \log a}{\log(S-a) - \log(S-l)} + 1$
	$l \quad r \quad S$	$n = \frac{\log l - \log[lr - (r-1)S]}{\log r} + 1$
r	$a \quad l \quad n$	$r = \sqrt[n-1]{\frac{l}{a}}$
	$a \quad n \quad S$	$r^n = \frac{Sr}{a} + \frac{a-S}{a}$
	$a \quad l \quad S$	$r = \frac{S-a}{S-l}$
	$l \quad n \quad S$	$r^n = \frac{Sr^{n-1}}{S-l} - \frac{l}{S-l}$
S	$a \quad n \quad r$	$S = \frac{a(r^n - 1)}{r - 1}$
	$a \quad l \quad r$	$S = \frac{lr - a}{r - 1}$
	$a \quad l \quad n$	$S = \frac{n-1\sqrt[n]{l} - n-1\sqrt[n]{a^n}}{n-1\sqrt[n]{l} - n-1\sqrt[n]{a}}$
	$l \quad n \quad r$	$S = \frac{l(r^n - 1)}{(r-1)r^{n-1}}$

Analytical Geometry

Straight Line.—A straight line is a line between two points with the minimum distance.

Coordinate System: It is possible to locate any point on a plane by a pair of numbers called the coordinates of the point. If P is a point on a plane, and perpendiculars are drawn from P to the coordinate axes, one perpendicular meets the X-axis at the x-coordinate of P and the other meets the Y-axis at the y-coordinate of P. The pair of numbers (x_1, y_1) , in that order, is called the coordinates or coordinate pair for P.

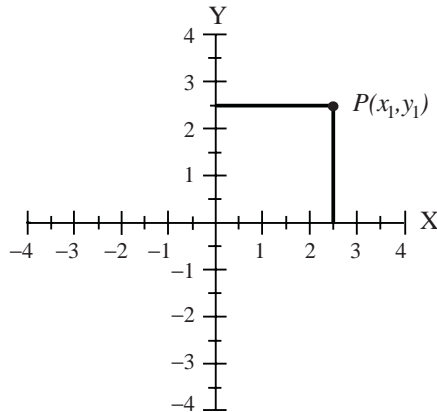


Fig. 1. Coordinate Plan

✦ *Distance Between Two Points:* The distance d between two points $P_1(x_1, y_1)$ and $P_2(x_2, y_2)$ is given by the formula:

$$d(P_1, P_2) = \sqrt{(x_2 - x_1)^2 + (y_2 - y_1)^2}$$

Example 1: What is the distance AB between points A(4,5) and B(7,8)?

Solution: The length of line AB is

$$d = \sqrt{(7 - 4)^2 + (8 - 5)^2} = \sqrt{3^2 + 3^2} = \sqrt{18} = 3\sqrt{2}$$

Intermediate Point: An intermediate point, P(x, y) on a line between two points, $P_1(x_1, y_1)$ and $P_2(x_2, y_2)$, Fig. 2, can be obtained by linear interpolation as follows,

$$x = \frac{r_1 x_1 + r_2 x_2}{r_1 + r_2} \quad \text{and} \quad y = \frac{r_1 y_1 + r_2 y_2}{r_1 + r_2}$$

where r_1 is the ratio of the distance of P_1 to P to the distance of P_1 to P_2 , and r_2 is the ratio of the distance of P_2 to P to the distance of P_1 to P_2 . If the desired point is the midpoint of line $P_1 P_2$, then $r_1 = r_2 = 1$, and the coordinates of P are:

$$x = \frac{x_1 + x_2}{2} \quad \text{and} \quad y = \frac{y_1 + y_2}{2}$$

Example 2: What is the coordinate of point P(x,y), if P divides the line defined by points A(0,0) and B(8,6) at the ratio of 5:3.

Solution: $x = \frac{5 \times 0 + 3 \times 8}{5 + 3} = \frac{24}{8} = 3$ $y = \frac{5 \times 0 + 3 \times 6}{5 + 3} = \frac{18}{8} = 2.25$

External Point: A point, $Q(x, y)$ on the line P_1P_2 , and beyond the two points, $P_1(x_1, y_1)$ and $P_2(x_2, y_2)$, can be obtained by external interpolation as follows,

$$x = \frac{r_1x_1 - r_2x_2}{r_1 - r_2} \quad \text{and} \quad y = \frac{r_1y_1 - r_2y_2}{r_1 - r_2}$$

where r_1 is the ratio of the distance of P_1 to Q to the distance of P_1 to P_2 , and r_2 is the ratio of the distance of P_2 to Q to the distance of P_1 to P_2 .

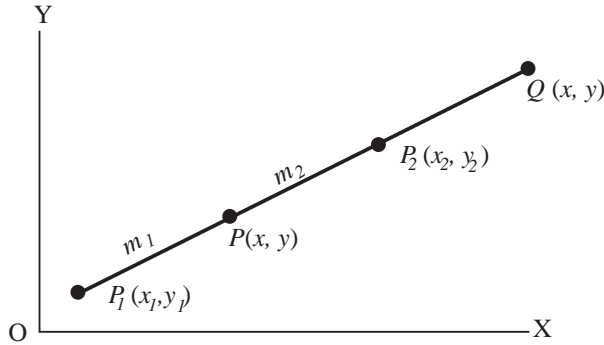


Fig. 2. Finding Intermediate and External Points on a Line

Equation of a line P_1P_2 : The general equation of a line passing through points $P_1(x_1, y_1)$ and $P_2(x_2, y_2)$ is $\frac{y - y_1}{y_1 - y_2} = \frac{x - x_1}{x_1 - x_2}$.

The previous equation is frequently written in the form $y - y_1 = \frac{y_1 - y_2}{x_1 - x_2}(x - x_1)$

where $\frac{y_1 - y_2}{x_1 - x_2}$ is the slope of the line, m , and thus becomes $y - y_1 = m(x - x_1)$ where y_1 is the coordinate of the y -intercept $(0, y_1)$ and x_1 is the coordinate of the x -intercept $(x_1, 0)$. If the line passes through point $(0,0)$, then $x_1 = y_1 = 0$ and the equation becomes $y = mx$. The y -intercept is the y -coordinate of the point at which a line intersects the Y -axis at $x = 0$. The x -intercept is the x -coordinate of the point at which a line intersects the X -axis at $y = 0$.

If a line AB intersects the X -axis at point $A(a,0)$ and the Y -axis at point $B(0,b)$ then the equation of line AB is

$$\frac{x}{a} + \frac{y}{b} = 1$$

Slope: The equation of a line in a Cartesian coordinate system is $y = mx + b$, where x and y are coordinates of a point on a line, m is the slope of the line, and b is the y -intercept. The slope is the rate at which the x coordinates are increasing or decreasing relative to the y coordinates.

Another form of the equation of a line is the point-slope form $(y - y_1) = m(x - x_1)$. The slope, m , is defined as a ratio of the change in the y coordinates, $y_2 - y_1$, to the change in the x coordinates, $x_2 - x_1$,

$$m = \frac{\Delta y}{\Delta x} = \frac{y_2 - y_1}{x_2 - x_1}$$

Example 3: What is the equation of a line AB between points A(4,5) and B(7,8)?

Solution:

$$\begin{aligned}\frac{y - y_1}{y_1 - y_2} &= \frac{x - x_1}{x_1 - x_2} \\ \frac{y - 5}{5 - 8} &= \frac{x - 4}{4 - 7} \\ y - 5 &= x - 4 \\ y - x &= 1\end{aligned}$$

Example 4: Find the general equation of a line passing through the points (3, 2) and (5, 6), and its intersection point with the y-axis.

First, find the slope using the equation above

$$m = \frac{\Delta y}{\Delta x} = \frac{6 - 2}{5 - 3} = \frac{4}{2} = 2$$

The line has a general form of $y = 2x + b$, and the value of the constant b can be determined by substituting the coordinates of a point on the line into the general form. Using point (3,2), $2 = 2 \times 3 + b$ and rearranging, $b = 2 - 6 = -4$. As a check, using another point on the line, (5,6), yields equivalent results, $y = 6 = 2 \times 5 + b$ and $b = 6 - 10 = -4$.

The equation of the line, therefore, is $y = 2x - 4$, indicating that line $y = 2x - 4$ intersects the y-axis at point (0,-4), the y-intercept.

Example 5: Use the point-slope form to find the equation of the line passing through the point (3,2) and having a slope of 2.

$$\begin{aligned}(y - 2) &= 2(x - 3) \\ y &= 2x - 6 + 2 \\ y &= 2x - 4\end{aligned}$$

The slope of this line is positive and crosses the y-axis at the y-intercept, point (0,-4).

Parallel Lines: The two lines, P_1P_2 and Q_1Q_2 , are parallel if both lines have the same slope, that is, if $m_1 = m_2$.

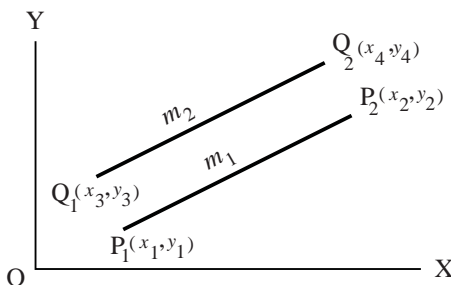


Fig. 3. Parallel Lines

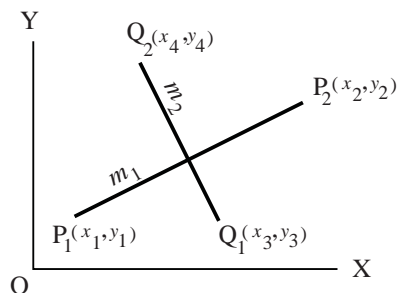


Fig. 4. Perpendicular Lines

Perpendicular Lines: The two lines P_1P_2 and Q_1Q_2 are perpendicular if the product of their slopes equal -1 , that is, $m_1 m_2 = -1$.

Example 6: Find an equation of a line that passes through the point (3,4) and is (a) parallel to and (b) perpendicular to the line $2x - 3y = 16$?

Solution (a): Line $2x - 3y = 16$ in standard form is $y = \frac{2}{3}x - \frac{16}{3}$, and the equation of a line passing through (3,4) is $y - 4 = m(x - 3)$.

If the lines are parallel, their slopes are equal. Thus, $y - 4 = \frac{2}{3}(x - 3)$ is parallel to line $2x - 3y = -6$ and passes through point (3,4).

Solution (b): As illustrated in part (a), line $2x - 3y = -6$ has a slope of $\frac{2}{3}$. The product of the slopes of perpendicular lines is -1 , thus the slope m of a line passing through point (4,3) and perpendicular to $2x - 3y = -6$ must satisfy the following:

$$m = \frac{-1}{m_1} = \frac{-1}{\frac{2}{3}} = -\frac{3}{2}$$

The equation of a line passing through point (4,3) and perpendicular to the line $2x - 3y = 16$ is $y - 4 = -\frac{3}{2}(x - 3)$, which rewritten is $3x + 2y = 17$.

Angle Between Two Lines: For two non-perpendicular lines with slopes m_1 and m_2 , the angle between the two lines is given by

$$\tan \theta = \left| \frac{m_1 - m_2}{1 + m_1 m_2} \right|$$

Note: The straight brackets surrounding a symbol or number, as in $|x|$, stands for absolute value and means use the positive value of the bracketed quantity, irrespective of its sign.

Example 7: Find the angle between the following two lines: $2x - y = 4$ and $3x + 4y = 12$

Solution: The slopes are 2 and $-\frac{3}{4}$, respectively. The angle between two lines is given by

$$\begin{aligned} \tan \theta &= \left| \frac{m_1 - m_2}{1 + m_1 m_2} \right| = \left| \frac{2 - \left(-\frac{3}{4}\right)}{1 + 2\left(-\frac{3}{4}\right)} \right| = \left| \frac{2 + \frac{3}{4}}{1 - \frac{6}{4}} \right| = \left| \frac{\frac{8 + 3}{4}}{\frac{4 - 6}{4}} \right| = \left| \frac{11}{-2} \right| = \frac{11}{2} \\ \theta &= \text{atan} \frac{11}{2} = 79.70^\circ \end{aligned}$$

Distance Between a Point and a Line: The distance between a point (x_1, y_1) and a line given by $Ax + By + C = 0$ is

$$d = \frac{|Ax_1 + By_1 + C|}{\sqrt{A^2 + B^2}}$$

Example 8: Find the distance between the point (4,6) and the line $2x + 3y - 9 = 0$.

Solution: The distance between a point and the line is

$$d = \frac{|Ax_1 + By_1 + C|}{\sqrt{A^2 + B^2}} = \frac{|2 \times 4 + 3 \times 6 - 9|}{\sqrt{2^2 + 3^2}} = \frac{|8 + 18 - 9|}{\sqrt{4 + 9}} = \frac{17}{\sqrt{13}}$$

Coordinate Systems.—*Rectangular, Cartesian Coordinates:* In a Cartesian coordinate system the coordinate axes are perpendicular to one another, and the same unit of length is chosen on the two axes. This rectangular coordinate system is used in the majority of cases.

Polar Coordinates: Another coordinate system is determined by a fixed point O, the origin or pole, and a zero direction or axis through it, on which positive lengths can be laid off and measured, as a number line. A point P can be fixed to the zero direction line at a distance r away and then rotated in a positive sense at an angle θ . The angle, θ , in polar coordinates can take on values from 0° to 360° . A point in polar coordinates takes the form of (r, θ) .

Changing Coordinate Systems: For simplicity it may be assumed that the origin on a Cartesian coordinate system coincides with the pole on a polar coordinate system, and its axis with the x-axis. Then, if point P has polar coordinates of (r, θ) and Cartesian coordinates of (x, y) , by trigonometry $x = r \times \cos(\theta)$ and $y = r \times \sin(\theta)$. By the Pythagorean theorem and trigonometry

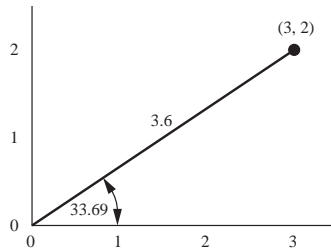
$$r = \sqrt{x^2 + y^2} \quad \theta = \operatorname{atan} \frac{y}{x}$$

✧ *Example 1:* Convert the Cartesian coordinate $(3, 2)$ into polar coordinates.

$$r = \sqrt{3^2 + 2^2} = \sqrt{9 + 4} = \sqrt{13} = 3.6 \quad \theta = \operatorname{atan} \frac{2}{3} = 33.69^\circ$$

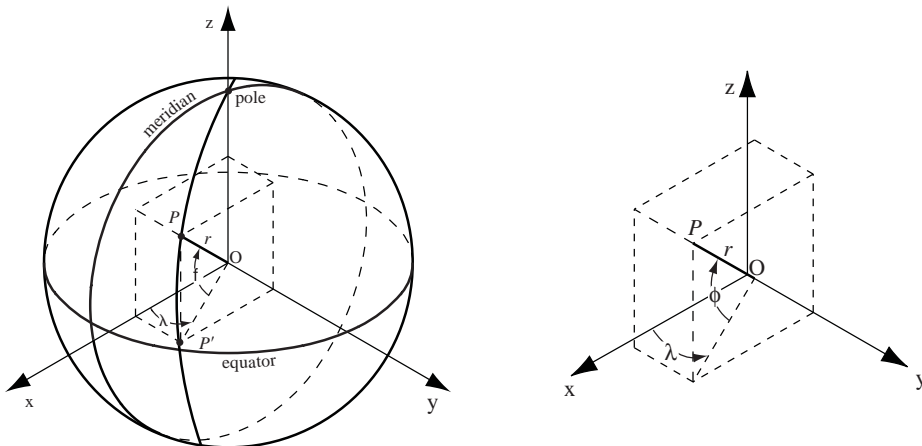
Therefore the point $(3.6, 33.69)$ is the polar form of the Cartesian point $(3, 2)$.

Graphically, the polar and Cartesian coordinates are related in the following figure



✧ *Example 2:* Convert the polar form $(5, 608)$ to Cartesian coordinates. By trigonometry, $x = r \times \cos(\theta)$ and $y = r \times \sin(\theta)$. Then $x = 5 \cos(608) = -1.873$ and $y = 5 \sin(608) = -4.636$. Therefore, the Cartesian point equivalent is $(-1.873, -4.636)$.

Spherical Coordinates: It is convenient in certain problems, for example, those concerned with spherical surfaces, to introduce non-parallel coordinates. An arbitrary point P in space can be expressed in terms of the distance r between point P and the origin O , the angle ϕ that OP' makes with the x - y plane, and the angle λ that the projection OP' (of the segment OP onto the x - y plane) makes with the positive x -axis.



The rectangular coordinates of a point in space can therefore be calculated by the formulas in the following table.

Relationship Between Spherical and Rectangular Coordinates

Spherical to Rectangular	Rectangular to Spherical
$x = r \cos \phi \cos \lambda$ $y = r \cos \phi \sin \lambda$ $z = r \sin \phi$	$r = \sqrt{x^2 + y^2 + z^2}$
	$\phi = \operatorname{atan} \frac{z}{\sqrt{x^2 + y^2}}$ (for $x^2 + y^2 \neq 0$)
	$\lambda = \operatorname{atan} \frac{y}{x}$ (for $x > 0, y > 0$)
	$\lambda = \pi + \operatorname{atan} \frac{y}{x}$ (for $x < 0$)
	$\lambda = 2\pi + \operatorname{atan} \frac{y}{x}$ (for $x > 0, y < 0$)

Example 3: What are the spherical coordinates of the point $P(3, -4, -12)$?

$$r = \sqrt{3^2 + (-4)^2 + (-12)^2} = 13$$

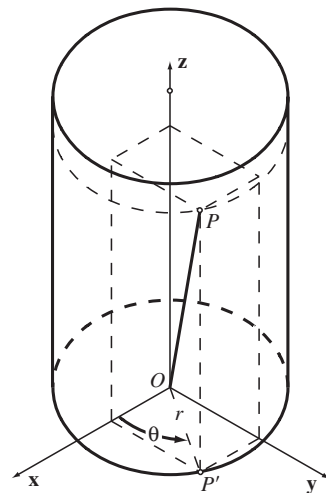
$$\phi = \operatorname{atan} \frac{-12}{\sqrt{3^2 + (-4)^2}} = \operatorname{atan} -\frac{12}{5} = -67.38^\circ$$

$$\lambda = 360^\circ + \operatorname{atan} -\frac{4}{3} = 360^\circ - 53.13^\circ = 306.87^\circ$$

The spherical coordinates of P are therefore $r = 13$, $\phi = -67.38^\circ$, and $\lambda = 306.87^\circ$.

Cylindrical Coordinates: For problems on the surface of a cylinder it is convenient to use cylindrical coordinates. The cylindrical coordinates r, θ, z , of P coincide with the polar coordinates of the point P' in the x - y plane and the rectangular z -coordinate of P . This gives the conversion formula. Those for θ hold only if $x^2 + y^2 \neq 0$; θ is undetermined if $x = y = 0$.

Cylindrical to Rectangular	Rectangular to Cylindrical
$x = r \cos \theta$ $y = r \sin \theta$ $z = z$	$r = \frac{1}{\sqrt{x^2 + y^2}}$
	$\cos \theta = \frac{x}{\sqrt{x^2 + y^2}}$
	$\sin \theta = \frac{y}{\sqrt{x^2 + y^2}}$
	$z = z$



Example 4: Given the cylindrical coordinates of a point P , $r = 3$, $\theta = -30^\circ$, $z = 51$, find the rectangular coordinates. Using the above formulas $x = 3 \cos (-30^\circ) = 3 \cos (30^\circ) = 2.598$; $y = 3 \sin (-30^\circ) = -3 \sin (30^\circ) = -1.5$; and $z = 51$. Therefore, the rectangular coordinates of point P are $x = 2.598$, $y = -1.5$, and $z = 51$.

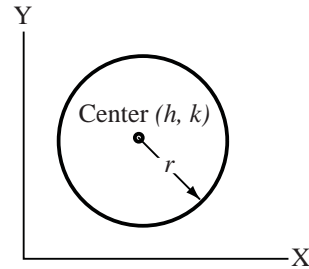
Circle.—The general form for the equation of a circle is $x^2 + y^2 + 2gx + 2fy + c = 0$, where $-g$ and $-f$ are the coordinates of the center and the radius is $r = \sqrt{g^2 + f^2 - c}$.

The center radius form of the circle equation is

$$(x - h)^2 + (y - k)^2 = r^2$$

where r = radius and point (h, k) is the center.

When the center of circle is at point $(0,0)$, the equation of circle reduces to $x^2 + y^2 = r^2$ or $r = \sqrt{x^2 + y^2}$



Example: Point $(4,6)$ lies on a circle whose center is at $(-2,3)$. Find the circle equation?

Solution: The radius is the distance between the center $(-2,3)$ and point $(4,6)$, found using the method of **Example 1** on page 40.

$$r = \sqrt{[4 - (-2)]^2 + (6 - 3)^2} = \sqrt{6^2 + 3^2} = \sqrt{45}$$

The equation of the circle is

$$(x - h)^2 + (y - k)^2 = r^2$$

$$(x + 2)^2 + (y - 3)^2 = x^2 + 4x + 4 + y^2 - 6y + 9 = 45$$

$$x^2 + y^2 + 4x - 6y - 32 = 0$$

Additional Formulas: Listed below are additional formulas for determining the geometry of plane circles and arcs. Although trigonometry and circular measure are related, they both deal with angles in entirely different ways.

$L = \text{perimeter of circle} = \pi D = 2\pi R$

$R = \text{radius} = \frac{\sqrt{N}}{\pi} = \sqrt{X^2 + Y^2}$

$D = \text{diameter of circle} = 2R = \frac{L}{\pi}$

$N = \text{total area of a circle} = \pi R^2$

$X = \sqrt{R^2 - Y^2} \quad Y = \sqrt{R^2 - X^2}$

$M = \text{area of complement section} = R^2 - \frac{\pi R^2}{4} = 0.2146R^2$

$I = \text{distance from center to start of section } T$

$H = \text{height of section } T$

$Q = \text{chord length for segment } S$

$T + S = \text{area of segment} = R^2 \times \sin^{-1}\left(\frac{P}{2R}\right) - \frac{IP}{2}$

Fig. 1a.

Example 1: Find the area of a circular section with included angle of 30° and radius of 7 cm.

Solution: Referring to **Fig. 1b**, $K = \left(\frac{\phi^\circ}{360}\right)\pi R^2 = \left(\frac{30}{360}\right)\pi 7^2 = 12.83 \text{ cm}^2$

Areas K and S

$$L = \text{perimeter of } \phi \text{ degrees} = \left(\frac{\phi^\circ}{360}\right) \times 2\pi R$$

$$R = \text{radius} = \frac{180L}{\pi \phi} = \frac{2K}{L} = \frac{E^2 + 4F^2}{8F}$$

$$S = \text{area of segment} = \frac{R \times L}{2} - \frac{E(R-F)}{2}$$

$$E = \text{chord length} = 2 \times \sqrt{F \times (2R - F)} = D \times \sin\left(\frac{\phi}{2}\right)$$

$$F = \text{chord height} = R - \frac{\sqrt{4R^2 - E^2}}{2} = R \times \left(1 - \cos\left(\frac{\phi}{2}\right)\right)$$

$$\phi = \text{angle at center of circle} = \frac{180L}{\pi \phi}$$

$$K = \text{area of section} = \left(\frac{\phi^\circ}{360}\right) \times \pi \times R^2 = \frac{R \times L}{2}$$

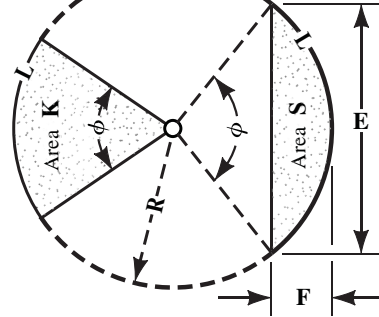


Fig. 1b.

Donut

R_1 = radius of outer circle of donut

R_2 = radius of inner circle of donut

$$U = \text{area of segment of donut} = \frac{\phi}{360} \times \pi \times (R_1^2 - R_2^2)$$

$$W = \text{total area of donut} = \pi(R_1^2 - R_2^2)$$

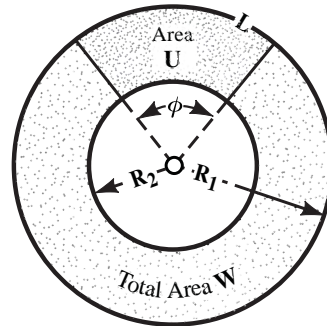


Fig. 1c.

Example 2: Find the chord length E of a circular segment (Fig. 1b), with a depth of 2 cm at the center, that is formed in a circle whose radius 12 cm.

$$\begin{aligned} \text{Solution: The chord length is } E &= 2\sqrt{F(2R - F)} = 2\sqrt{2(2 \times 12 - 2)} \\ &= 4\sqrt{11} = 13.27 \text{ cm} \end{aligned}$$

Example 3: Find the area S of the circular segment from Example 2.

Solution: First determine angle ϕ , then find the perimeter L of the segment, and then solve for area S , as follows:

$$\tan\left(\frac{\phi}{2}\right) = \frac{E/2}{R-F} = \frac{13.27/2}{12-2} = 0.6635 \quad \frac{\phi}{2} = 33.56^\circ \quad \phi = 67.13^\circ$$

$$L = \frac{\phi}{360} (2\pi R) = \frac{67.13}{360} \times (24\pi) = 14.06 \text{ cm}$$

$$\text{Area } S = \frac{R \times L}{2} - \frac{E(R-F)}{2} = \frac{12(14.06)}{2} - \frac{13.27(10)}{2} = 84.36 - 66.35 = 18.01 \text{ cm}^2$$

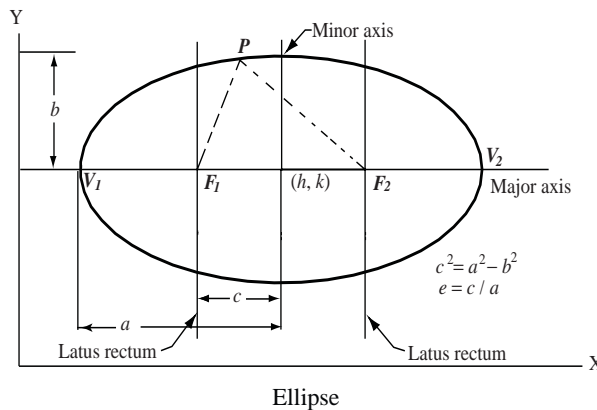
Another way to find angle ϕ is divide one half of the chord length by the radius to obtain

$$\sin\frac{\phi}{2} = \frac{\text{chord}}{2R} = \frac{E}{2R} = \frac{13.27}{2(12)} = 0.5529 \quad \frac{\phi}{2} = 33.5662^\circ \quad \phi = 67.13^\circ$$

Ellipse.—The ellipse with eccentricity e , focus F and a directrix L is the set of all points P such that the distance PF is e times the distance from P to the line L . The general equation of an ellipse is

$$Ax^2 + Cy^2 + Dx + Ey + F = 0 \Big|_{AC > 0 \text{ and } A \neq C}$$

The ellipse has two foci separated along the major axis by a distance $2c$. The line passing through the focus perpendicular to the major axis is called the latus rectum. The line passing through the center, perpendicular to the major axis, is called the minor axis. The distances $2a$ and $2b$ are the major distance, and the minor distance. The ellipse is the locus of points such that the sum of the distances from the two foci to a point on the ellipse is $2a$, thus, $PF_1 + PF_2 = 2a$



If (h, k) are the center, the general equation of an ellipse is $\frac{(x-h)^2}{a^2} + \frac{(y-k)^2}{b^2} = 1$

The eccentricity of the ellipse, $e = \frac{\sqrt{a^2 - b^2}}{a}$, is always less than 1.

The distance between the two foci is $2c = 2\sqrt{a^2 - b^2}$.

The aspect ratio of the ellipse is a/b .

The equation of an ellipse centered at $(0, 0)$ with foci at $(\pm c, 0)$ is $\frac{x^2}{a^2} + \frac{y^2}{b^2} = 1$, and the

ellipse is symmetric about both coordinate axes. Its x -intercepts are $(\pm a, 0)$ and y -intercepts are $(0, \pm b)$. The line joining $(0, b)$ and $(0, -b)$ is called the minor axis. The vertices of the ellipse are $(\pm a, 0)$, and the line joining vertices is the major axis of the ellipse.

Example: Determine the values of h, k, a, b, c , and e of the ellipse

$$3x^2 + 5y^2 - 12x + 30y + 42 = 0$$

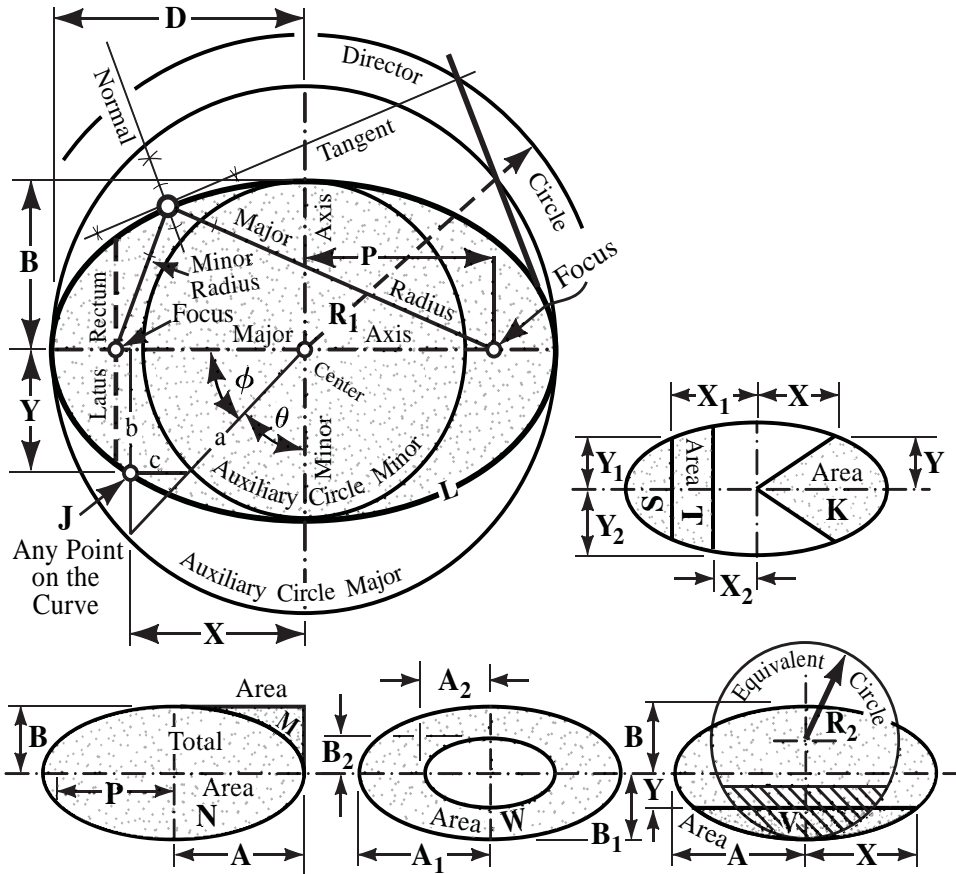
Solution: Rearrange the ellipse equation into the general form as follows:

$$\begin{aligned} 3x^2 + 5y^2 - 12x + 30y + 42 &= 3x^2 - 12x + 5y^2 + 30y + 42 = 0 \\ 3(x^2 - 4x + 2^2) + 5(y^2 + 6y + 3^2) &= 15 \\ \frac{3(x-2)^2}{15} + \frac{5(y+3)^2}{15} &= \frac{(x-2)^2}{(\sqrt{5})^2} + \frac{(y+3)^2}{(\sqrt{3})^2} = 1 \end{aligned}$$

Comparing to the general form, $\frac{(x-h)^2}{a^2} + \frac{(y-k)^2}{b^2} = 1$, and solving for c and e gives:

$$h = 2 \quad k = -3 \quad a = \sqrt{5} \quad b = \sqrt{3} \quad c = \sqrt{2} \quad e = \frac{\sqrt{2}}{\sqrt{5}}$$

Additional Formulas: An ellipse is the locus of points the sum of whose distances from two fixed points, called focus, is a constant. An ellipse can be represented parametrically by the equations $x = a\cos\theta$ and $y = b\sin\theta$, where x and y are the rectangular coordinates of any point on the ellipse, and the parameter θ is the angle at the center measured from the x -axis anticlockwise.



$$R_1 = \text{radius of director circle} = \sqrt{A^2 + B^2}$$

$$A = \text{major radius} = \sqrt{B^2 + P^2}$$

$$R_2 = \text{radius of equivalent circle} = \sqrt{AB}$$

$$B = \text{minor radius} = \sqrt{A^2 - P^2}$$

$$P = \text{center to focus distance} = \sqrt{A^2 - B^2}$$

$$\text{distance, origin to latus rectum} = \frac{2B^2}{A}$$

$$J = \text{any point } (X, Y) \text{ on curve where } X = A \sin \theta = A \cos \phi \text{ and } Y = B \cos \theta = B \sin \phi$$

$$\phi = \text{angle with major axis} = \sin^{-1}\left(\frac{Y}{B}\right) = \cos^{-1}\left(\frac{X}{A}\right) \quad \theta = \text{angle with minor axis} = 90^\circ - \phi$$

$$L = \text{total perimeter (approximate)} = A \left[1.2 \left(\frac{B}{A} \right)^2 + 1.1 \left(\frac{B}{A} \right) + 4 \right]$$

$$L = \text{perimeter (sections)} = \left(\frac{\pi}{180} \right) \times 2\phi \sqrt{AB}$$

Area Calculations

$$N = \text{total surface area of ellipse} = \pi AB$$

$$W = \text{sectional area between outer and inner ellipse} = \pi(A_1B_1 - A_2B_2)$$

$$M = \text{area of complement section} = AB - \frac{\pi AB}{4}$$

$$S = \text{area of section} = AB \times \cos^{-1} \left(\frac{X_1}{A} \right) - X_1 Y_1$$

$$T+S = \text{combined area of sections } T + S = AB \times \cos^{-1} \left(\frac{X_2}{A} \right) - X_2 Y_2$$

$$V = \text{area of section} = R_2^2 \times \sin^{-1} \left(\frac{X}{A} \right) - XY$$

$$K = \text{area of section} = AB \times \cos^{-1} \left(\frac{X}{A} \right)$$

Example 4: Find area of section K , and complement area M , given the major radius of ellipse is 10 cm, minor radius of ellipse is 7 cm, dimension $X = 8.2266$ cm.

Solution: The sectional area K

$$\text{Area } K = AB \times \cos^{-1} \left(\frac{X_1}{A} \right) = 10 \times 7 \times \cos^{-1} \left(\frac{8.2266}{10} \right) = 70 \times 0.6047 = 42.33 \text{ cm}^2$$

Solution: Complement area M

$$\text{Area } M = AB - \frac{\pi AB}{4} = 10 \times 7 - \frac{\pi \times 10 \times 7}{4} = 15.0221 \text{ cm}^2$$

Example 5: Find the area of elliptical section S , $T + S$, provided that major radius of ellipse is 10 cm, minor radius of ellipse is 7 cm, dimension $X_1 = 8.2266$ cm, dimension $Y_1 = 4.4717$ cm, and dimension $X_2 = 6.0041$ cm.

Solution: The sectional area S

$$S = AB \times \cos^{-1} \left(\frac{X_1}{A} \right) - X_1 Y_1 = 10 \times 7 \times \cos^{-1} \left(\frac{8.2266}{10} \right) - 8.2266 \times 4.4717 = 5.5437 \text{ cm}^2$$

Solution: Sectional area $T + S$

$$\phi = \cos^{-1} \left(\frac{X_2}{A} \right) = 53.1007^\circ \quad Y_2 = B \sin \phi = 7 \sin(53.1007^\circ) = 5.5978$$

$$\begin{aligned} T + S &= AB \times \cos^{-1} \left(\frac{X_2}{A} \right) - X_2 Y_2 = 10 \times 7 \times 0.9268 - (6.0041 \times 5.5978) \\ &= 64.876 - 33.6097 = 31.266 \text{ cm}^2 \end{aligned}$$

Example 6: Find the area of elliptical section V , if the major radius of ellipse is 4 inches, minor radius of ellipse is 3 inches, dimension $X = 2.3688$ inches, dimension $Y = 2.4231$ inches.

Solution: Sectional area V

$$R_2 = \sqrt{AB} \quad R_2^2 = AB = 3 \times 4 = 12$$

$$V = R_2^2 \times \sin^{-1}\left(\frac{X}{A}\right) - XY = 12 \times \sin^{-1}\left(\frac{2.3688}{4}\right) - (2.3688 \times 2.4231)$$

$$= 7.6048 - 5.7398 = 1.865 \text{ in}^2$$

Four-Arc Oval that Approximates an Ellipse*.—The method of constructing an approximate ellipse by circular arcs, described on page 64, fails when the ratio of the major to minor diameter equals four or greater. Additionally, it is reported that the method always draws a somewhat larger minor axes than intended. The method described below presents an alternative.

An oval that approximates an ellipse, illustrated in Fig. 2, can be constructed from the following equations:

$$r = \frac{B^2}{2A} \left(\frac{A}{B}\right)^{0.38} \tag{1}$$

where A and B are dimensions of the major and minor axis, respectively, and r is the radius of the curve at the long ends.

The radius R and its location are found from Equations (2) and (3):

$$X = \frac{\frac{A^2}{4} - Ar + Br - \frac{B^2}{4}}{B - 2r} \tag{2} \quad R = \frac{B}{2} + X \tag{3}$$

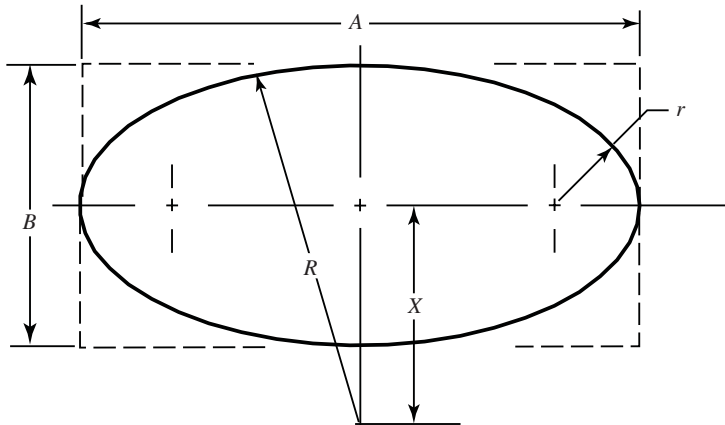


Fig. 2. Four Arc Oval Ellipse

To make an oval thinner or fatter than that given, select a smaller or larger radius r than calculated by Equation (1) and then find X and R using Equations (2) and (3).

Spheres.—The standard form for the equation of a sphere with radius R and centered at point (h, k, l) can be expressed by the equation:

$$(x - h)^2 + (y - k)^2 + (z - l)^2 = R^2$$

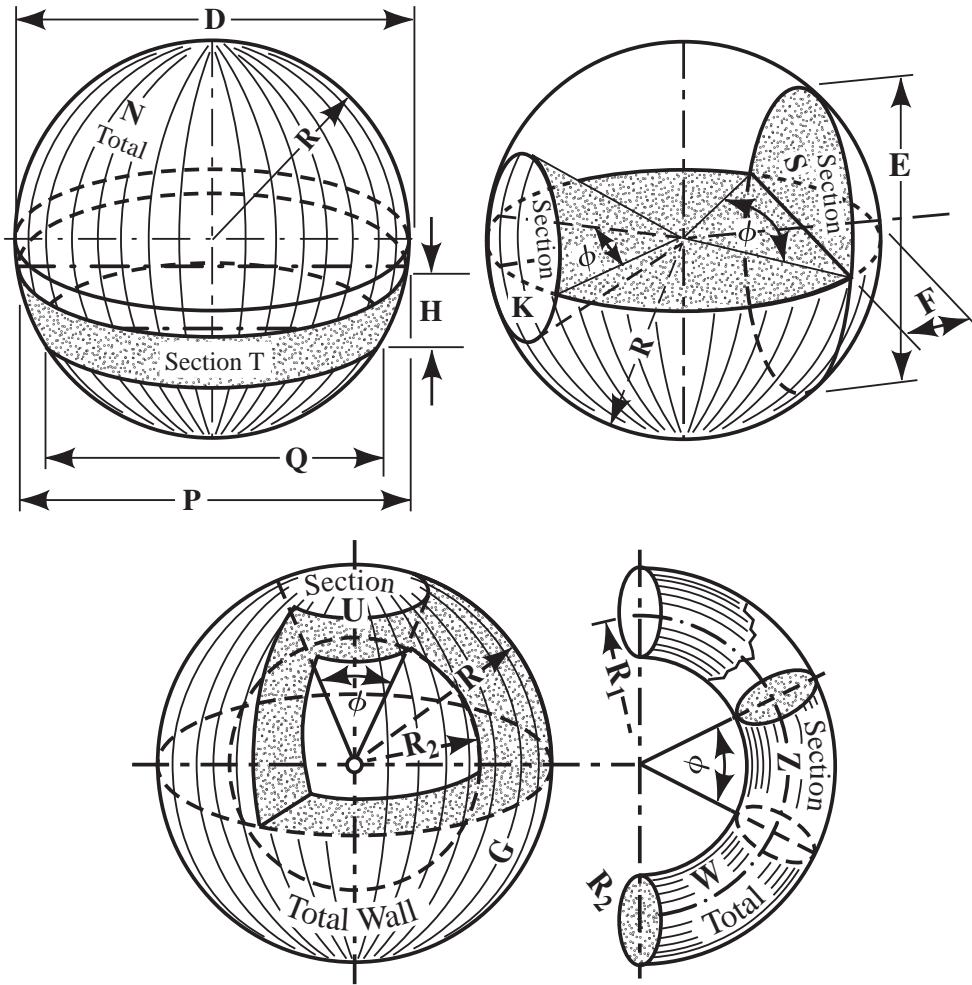
The general form for the equation of a sphere can be written as follows, where A cannot be zero.

$$Ax^2 + Ay^2 + Az^2 + Bx + Cy + Dz + E = 0$$

The general and standard forms of the sphere equations are related as follows:

* *Four-Arc Oval* material contributed by Manfred K. Brueckner

$$h = \frac{-B}{2A} \quad k = \frac{-C}{2A} \quad l = \frac{-D}{2A} \quad R = \sqrt{\frac{B^2 + C^2 + D^2}{4A^2} - \frac{E}{A}}$$



R = radius of sphere D = diameter of sphere
 N_s = total surface area of sphere N_v = total volume of sphere
 R_1 = radius of outer sphere R_2 = radius of inner sphere
 $G_a, K_a, S_a, T_a, U_a, W_a, Z_a$ = sectional surface areas
 $G_v, K_v, S_v, T_v, U_v, W_v, Z_v$ = sectional volumes

Formulas for Spherical Areas and Volumes

To Find	Formula	To Find	Formula
Radius of sphere from volume N_v	$R_N = \sqrt[3]{\frac{3N_v}{4\pi}}$	Radius of Section T	$R_T = \sqrt{\left(\frac{P^2 - Q^2 - 4H^2}{8H}\right)^2 + \frac{P^2}{4}}$
Section	Area		Volume
Entire Sphere	$N_a = 4\pi R^2$	Volume	$N_v = \frac{\pi}{6} \times D^3 = \frac{4\pi}{3} \times R^3$

Formulas for Spherical Areas and Volumes (Continued)

To Find	Formula	To Find	Formula
Section G	$G_a = 4\pi R_1^2 + 4\pi R_2^2$	Volume	$G_v = \frac{4\pi}{3}(R_1^3 - R_2^3)$
Section K	$K_a = 2\pi R^2 \left(1 - \cos \frac{\phi}{2}\right)$	Volume	$K_v = \frac{2\pi R^2 F}{3}$
Section S	$S_a = \pi \times \left(F^2 + \frac{E^2}{4}\right)$	Volume	$S_v = \pi \times F \times \left(\frac{E^2}{8} + \frac{F^2}{6}\right)$
Section T	$T_a = 2\pi RH$	Volume	$T_v = H \times \frac{\pi}{6} \left(H^2 + \frac{3Q^2}{4} + \frac{3P^2}{4}\right)$
Section U	$U_a = 2\pi(R_1^2 + R_2^2) \left(1 - \cos \frac{\phi}{2}\right)$	Volume	$U_v = 2\pi(R_1^3 - R_2^3) \left(1 - \cos \frac{\phi}{2}\right)$
Section W	$W_a = 4\pi^2 \times R_1 \times R_2$	Volume	$W_v = 2\pi^2 \times R_1 \times R_2^2$
Section Z	$Z_a = (4\pi^2 \times R_1 \times R_2) \frac{\phi}{360}$	Volume	$Z_v = (2\pi^2 \times R_1 \times R_2^2) \frac{\phi}{360}$

Example 7: Find the inside and outside surface area G_a and volume G_v of wall G , provided that R_1 is 12.5 cm and R_2 is 10.0 cm.

Solution: Sectional area G_a and sectional volume G_v

$$G_a = 4\pi R_1^2 + 4\pi R_2^2 = 4\pi(12.5)^2 + 4\pi(10)^2 = 3220.13 \text{ cm}^2$$

$$G_v = \frac{4\pi}{3}(R_1^3 - R_2^3) = \frac{4\pi}{3}(12.5^3 - 10^3) = 3992.44 \text{ cm}^3$$

Example 8: Find the surface area K_a and volume K_v of section K of a sphere of radius 15.0 cm, if included angle $\phi = 90^\circ$ and depth $F = 5.0$ cm.

Solution: Sectional area K_a and sectional volume K_v

$$K_a = 2\pi R^2 \left(1 - \cos \frac{\phi}{2}\right) = 2\pi(15)^2 \left(1 - \cos \frac{90^\circ}{2}\right) = 414.07 \text{ cm}^2$$

$$K_v = \frac{2\pi R^2 F}{3} = \frac{2\pi(15)^2(5)}{3} = 2356.19 \text{ cm}^3$$

Example 9: Find the outside surface area S_a and sectional volume S_v of section S of a sphere if $E = 20.0$ cm and $F = 5.0$ cm.

Solution: Sectional area S_a and sectional volume S_v

$$S_a = \pi \times \left(F^2 + \frac{E^2}{4}\right) = \pi \times \left(5^2 + \frac{20^2}{4}\right) = 392.70 \text{ cm}^2$$

$$S_v = \pi \times F \times \left(\frac{E^2}{8} + \frac{F^2}{6}\right) = \pi \times 5 \times \left(\frac{20^2}{8} + \frac{5^2}{6}\right) = 850.85 \text{ cm}^3$$

Example 10: Find the outside and inside surface area U_a and volume U_v of section U of a sphere, if $R_1 = 5.00$ inches, $R_2 = 4.0$ inches, and included angle $\phi = 30^\circ$.

Solution: Sectional area U_a and sectional volume U_v

$$U_a = 2\pi(R_1^2 + R_2^2)\left(1 - \cos\frac{\phi}{2}\right) = 2\pi \times (5^2 + 4^2)\left(1 - \cos\frac{30^\circ}{2}\right) = 8.78 \text{ in}^2$$

$$U_v = 2\pi(R_1^3 - R_2^3)\left(1 - \cos\frac{\phi}{2}\right) = 2\pi \times (5^3 - 4^3)\left(1 - \cos\frac{30^\circ}{2}\right) = 13.06 \text{ in}^3$$

Example 11: Find the total surface area W_a and volume W_v of ring W , if $R_1 = 5.00$ inches and $R_2 = 4.0$ inches.

Solution: Sectional area W_a and sectional volume W_v

$$W_a = 4\pi^2 \times R_1 \times R_2 = 4\pi^2 \times 5 \times 4 = 789.56 \text{ in}^2$$

$$W_v = 2\pi^2 \times R_1 \times R_2^2 = 2\pi^2 \times 5 \times 4^2 = 1579.13 \text{ in}^3$$

Parabola.—A parabola is the set of all points P in the plane that are equidistant from focus F and a line called the directrix. A parabola is symmetric with respect to its parabolic axis. The line perpendicular to the parabolic axis which passing through the focus is known as latus rectum.

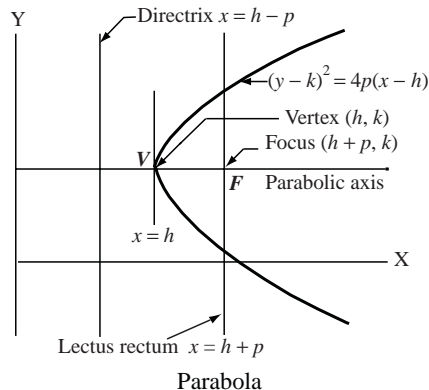
The general equation of a parabola is given by $(y - k)^2 = 4p(x - h)$, where the vertex is located at point (h, k) , the focus F is located at point $(h + p, k)$, the directrix is located at $x = h - p$, and the latus rectum is located at $x = h + p$.

Example: Determine the focus, directrix, axis, vertex, and latus rectum of the parabola

$$4y^2 - 8x - 12y + 1 = 0$$

Solution: Format the equation into the general form of a parabolic equation

$$\begin{aligned} 4y^2 - 8x - 12y + 1 &= 0 \\ 4y^2 - 12y &= 8x - 1 \\ y^2 - 3y &= 2x - \frac{1}{4} \\ y^2 - 2y\frac{3}{2} + \left(\frac{3}{2}\right)^2 &= 2x - \frac{1}{4} + \frac{9}{4} \\ \left(y - \frac{3}{2}\right)^2 &= 2\left(x + 1\right) \end{aligned}$$



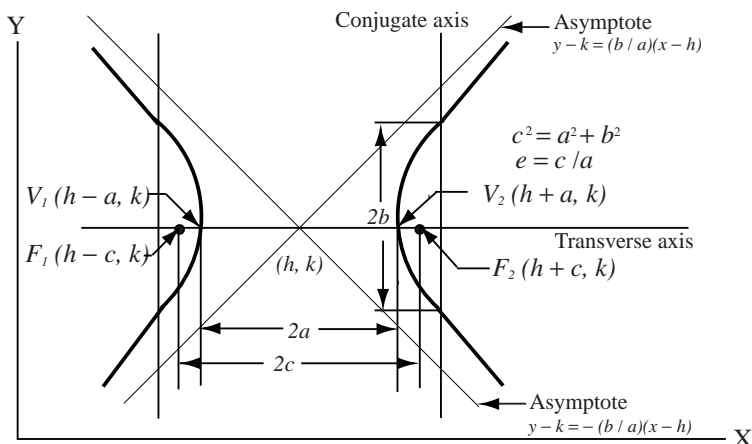
Thus, $k = \frac{3}{2}$, $h = -1$ and $p = \frac{1}{2}$. Focus F is located at point $(h + p, k) = (\frac{1}{2}, \frac{3}{2})$; the directrix is located at $x = h - p = -1 - \frac{1}{2} = -\frac{3}{2}$; the parabolic axis is the horizontal line $y = \frac{3}{2}$; the vertex $V(h, k)$ is located at point $(-1, \frac{3}{2})$; and the latus rectum is located at $x = h + p = -\frac{1}{2}$.

Hyperbola.—The hyperbola with eccentricity e , focus F and a directrix L is the set of all points P such that the distance PF is e times the distance from P to the line L . The general equation of an hyperbola is

$$Ax^2 + Cy^2 + Dx + Ey + F = 0 \Big|_{AC < 0 \text{ and } AC \neq 0}$$

The hyperbola has two foci separated along the transverse axis by a distance $2c$. Lines perpendicular to the transverse axis passing through the foci are the conjugate axis. The distance between two vertices is $2a$. The distance along a conjugate axis between two points on the hyperbola is $2b$. The hyperbola is the locus of points such that the difference of the distances from the two foci is $2a$, thus, $PF_2 - PF_1 = 2a$

If point (h,k) is the center, the general equation of an ellipse is $\frac{(x-h)^2}{a^2} - \frac{(y-k)^2}{b^2} = 1$



Hyperbola

The eccentricity of hyperbola, $e = \frac{\sqrt{a^2 + b^2}}{a}$ is always less than 1.

The distance between the two foci is $2c = 2\sqrt{a^2 + b^2}$.

The equation of a hyperbola with center at $(0, 0)$ and focus at $(\pm c, 0)$ is $\frac{x^2}{a^2} - \frac{y^2}{b^2} = 1$.

Example: Determine the values of $h, k, a, b, c,$ and e of the hyperbola

$$9x^2 - 4y^2 - 36x + 8y - 4 = 0$$

Solution: Convert the hyperbola equation into the general form

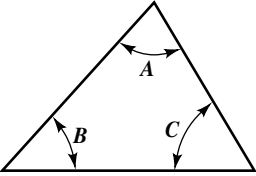
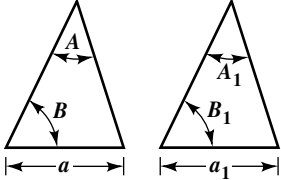
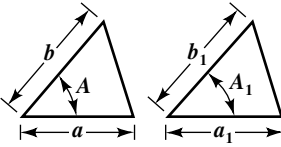
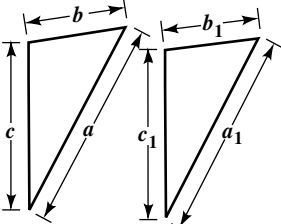
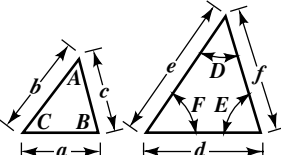
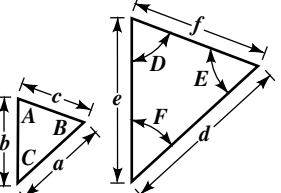
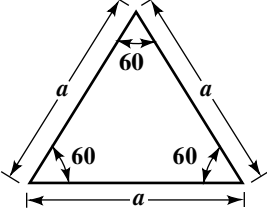
$$\begin{aligned} 9x^2 - 4y^2 - 36x + 8y - 4 &= (9x^2 - 36x) - (4y^2 - 8y) - 4 = 0 \\ 9(x^2 - 4x + 4) - 4(y^2 - 2y + 1) &= 36 \\ 9\frac{(x-2)^2}{36} - 4\frac{(y-1)^2}{36} &= \frac{(x-2)^2}{2^2} - \frac{(y-1)^2}{3^2} = 1 \end{aligned}$$

Comparing the results above with the general form $\frac{(x-h)^2}{a^2} - \frac{(y-k)^2}{b^2} = 1$ and calcu-

lating the eccentricity from $e = \frac{\sqrt{a^2 + b^2}}{a}$ and c from $c = \sqrt{a^2 + b^2}$ gives

$$h = 2 \quad k = 1 \quad a = 2 \quad b = 3 \quad c = \sqrt{13} \quad e = \frac{\sqrt{13}}{2}$$

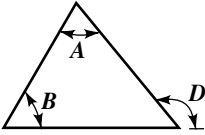
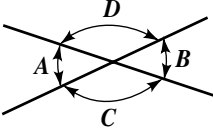
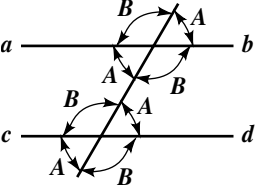
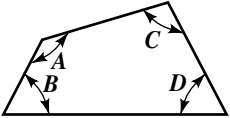
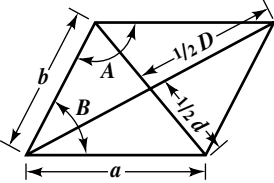
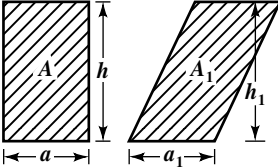
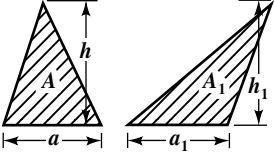
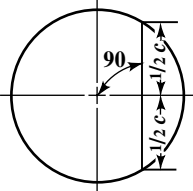
Geometrical Propositions

	<p>The sum of the three angles in a triangle always equals 180 degrees. Hence, if two angles are known, the third angle can always be found.</p> $A + B + C = 180^\circ \quad A = 180^\circ - (B + C)$ $B = 180^\circ - (A + C) \quad C = 180^\circ - (A + B)$
	<p>If one side and two angles in one triangle are equal to one side and similarly located angles in another triangle, then the remaining two sides and angle also are equal.</p> <p>If $a = a_1$, $A = A_1$, and $B = B_1$, then the two other sides and the remaining angle also are equal.</p>
	<p>If two sides and the angle between them in one triangle are equal to two sides and a similarly located angle in another triangle, then the remaining side and angles also are equal.</p> <p>If $a = a_1$, $b = b_1$, and $A = A_1$, then the remaining side and angles also are equal.</p>
	<p>If the three sides in one triangle are equal to the three sides of another triangle, then the angles in the two triangles also are equal.</p> <p>If $a = a_1$, $b = b_1$, and $c = c_1$, then the angles between the respective sides also are equal.</p>
	<p>If the three sides of one triangle are proportional to corresponding sides in another triangle, then the triangles are called <i>similar</i>, and the angles in the one are equal to the angles in the other.</p> <p>If $a : b : c = d : e : f$, then $A = D$, $B = E$, and $C = F$.</p>
	<p>If the angles in one triangle are equal to the angles in another triangle, then the triangles are similar and their corresponding sides are proportional.</p> <p>If $A = D$, $B = E$, and $C = F$, then $a : b : c = d : e : f$.</p>
	<p>If the three sides in a triangle are equal—that is, if the triangle is <i>equilateral</i>—then the three angles also are equal.</p> <p>Each of the three equal angles in an equilateral triangle is 60 degrees.</p> <p>If the three angles in a triangle are equal, then the three sides also are equal.</p>

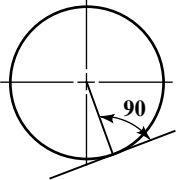
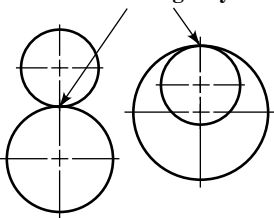
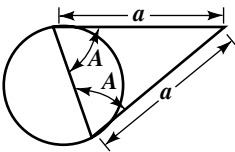
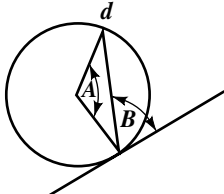
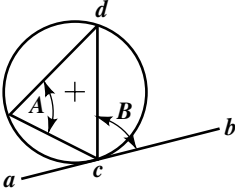
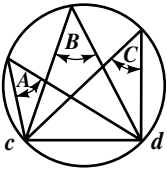
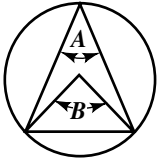
Geometrical Propositions

	<p>A line in an equilateral triangle that bisects or divides any of the angles into two equal parts also bisects the side opposite the angle and is at right angles to it.</p> <p>If line AB divides angle CAD into two equal parts, it also divides line CD into two equal parts and is at right angles to it.</p>
	<p>If two sides in a triangle are equal—that is, if the triangle is an <i>isosceles</i> triangle—then the angles opposite these sides also are equal.</p> <p>If side a equals side b, then angle A equals angle B.</p>
	<p>If two angles in a triangle are equal, the sides opposite these angles also are equal.</p> <p>If angles A and B are equal, then side a equals side b.</p>
	<p>In an isosceles triangle, if a straight line is drawn from the point where the two equal sides meet, so that it bisects the third side or base of the triangle, then it also bisects the angle between the equal sides and is perpendicular to the base.</p>
	<p>In every triangle, that angle is greater that is opposite a longer side. In every triangle, that side is greater which is opposite a greater angle.</p> <p>If a is longer than b, then angle A is greater than B. If angle A is greater than B, then side a is longer than b.</p>
	<p>In every triangle, the sum of the lengths of two sides is always greater than the length of the third.</p> <p>Side a + side b is always greater than side c.</p>
	<p>In a right-angle triangle, the square of the hypotenuse or the side opposite the right angle is equal to the sum of the squares on the two sides that form the right angle.</p> $a^2 = b^2 + c^2$

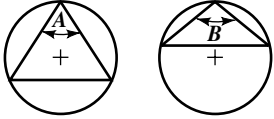
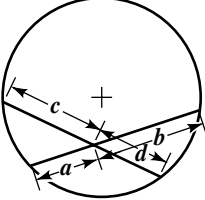
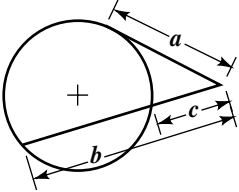
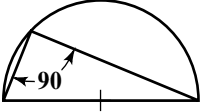
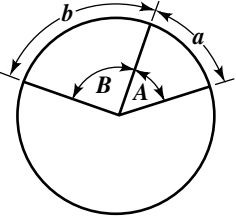
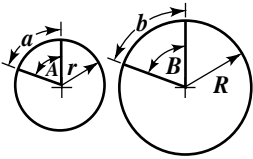
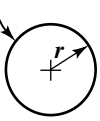
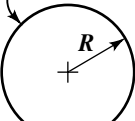
Geometrical Propositions

	<p>If one side of a triangle is produced, then the exterior angle is equal to the sum of the two interior opposite angles.</p> <p style="text-align: center;">Angle D = angle A + angle B</p>
	<p>If two lines intersect, then the opposite angles formed by the intersecting lines are equal.</p> <p style="text-align: center;">Angle A = angle B Angle C = angle D</p>
	<p>If a line intersects two parallel lines, then the corresponding angles formed by the intersecting line and the parallel lines are equal.</p> <p style="text-align: center;">Lines ab and cd are parallel. Then all the angles designated A are equal, and all those designated B are equal.</p>
	<p>In any figure having four sides, the sum of the interior angles equals 360 degrees.</p> <p style="text-align: center;">$A + B + C + D = 360$ degrees</p>
	<p>The sides that are opposite each other in a parallelogram are equal; the angles that are opposite each other are equal; the diagonal divides it into two equal parts. If two diagonals are drawn, they bisect each other.</p>
	<p>The areas of two parallelograms that have equal base and equal height are equal.</p> <p style="text-align: center;">If $a = a_1$ and $h = h_1$, then Area A = area A_1</p>
	<p>The areas of triangles having equal base and equal height are equal.</p> <p style="text-align: center;">If $a = a_1$ and $h = h_1$, then Area A = area A_1</p>
	<p>If a diameter of a circle is at right angles to a chord, then it bisects or divides the chord into two equal parts.</p>

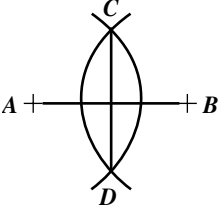
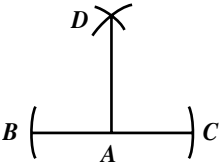
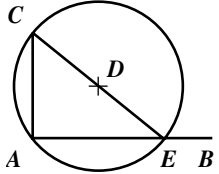
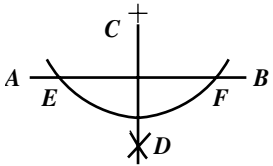
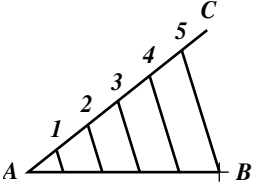
Geometrical Propositions

	<p>If a line is tangent to a circle, then it is also at right angles to a line drawn from the center of the circle to the point of tangency—that is, to a radial line through the point of tangency.</p>
<p>Point of Tangency</p> 	<p>If two circles are tangent to each other, then the straight line that passes through the centers of the two circles must also pass through the point of tangency.</p>
	<p>If from a point outside a circle, tangents are drawn to a circle, the two tangents are equal and make equal angles with the chord joining the points of tangency.</p>
	<p>The angle between a tangent and a chord drawn from the point of tangency equals one-half the angle at the center subtended by the chord.</p> $\text{Angle } B = \frac{1}{2} \text{ angle } A$
	<p>The angle between a tangent and a chord drawn from the point of tangency equals the angle at the periphery subtended by the chord.</p> <p>Angle <i>B</i>, between tangent <i>ab</i> and chord <i>cd</i>, equals angle <i>A</i> subtended at the periphery by chord <i>cd</i>.</p>
	<p>All angles having their vertex at the periphery of a circle and subtended by the same chord are equal.</p> <p>Angles <i>A</i>, <i>B</i>, and <i>C</i>, all subtended by chord <i>cd</i>, are equal.</p>
	<p>If an angle at the circumference of a circle, between two chords, is subtended by the same arc as the angle at the center, between two radii, then the angle at the circumference is equal to one-half of the angle at the center.</p> $\text{Angle } A = \frac{1}{2} \text{ angle } B$

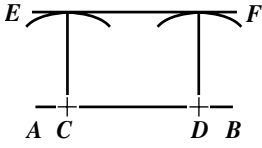
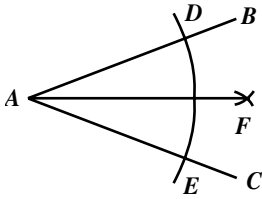
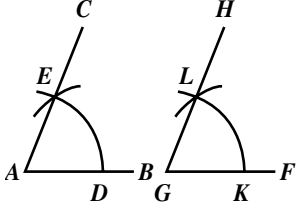
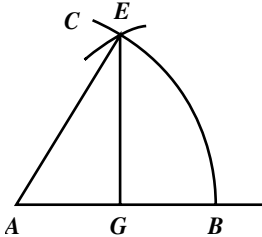
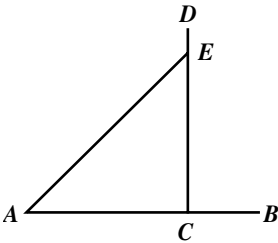
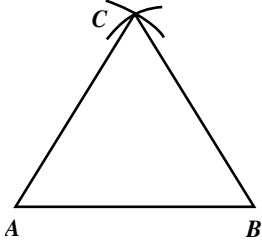
Geometrical Propositions

<p>A = Less than 90 B = More than 90</p> 	<p>An angle subtended by a chord in a circular segment larger than one-half the circle is an acute angle—an angle less than 90 degrees. An angle subtended by a chord in a circular segment less than one-half the circle is an obtuse angle—an angle greater than 90 degrees.</p>
	<p>If two chords intersect each other in a circle, then the rectangle of the segments of the one equals the rectangle of the segments of the other.</p> $a \times b = c \times d$
	<p>If from a point outside a circle two lines are drawn, one of which intersects the circle and the other is tangent to it, then the rectangle contained by the total length of the intersecting line, and that part of it that is between the outside point and the periphery, equals the square of the tangent.</p> $a^2 = b \times c$
	<p>If a triangle is inscribed in a semicircle, the angle opposite the diameter is a right (90-degree) angle.</p> <p>All angles at the periphery of a circle, subtended by the diameter, are right (90-degree) angles.</p>
	<p>The lengths of circular arcs of the same circle are proportional to the corresponding angles at the center.</p> $A : B = a : b$
	<p>The lengths of circular arcs having the same center angle are proportional to the lengths of the radii.</p> <p>If $A = B$, then $a : b = r : R$.</p>
<p>{ Circumf. = c Area = a</p>  <p>{ Circumf. = C Area = A</p> 	<p>The circumferences of two circles are proportional to their radii.</p> <p>The areas of two circles are proportional to the squares of their radii.</p> $c : C = r : R$ $a : A = r^2 : R^2$

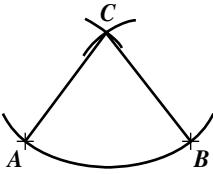
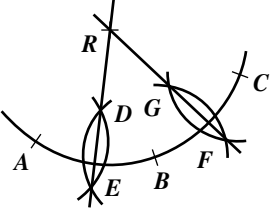
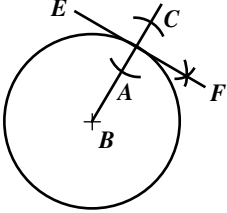
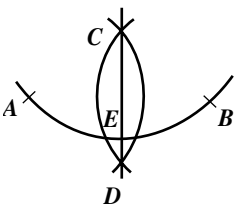
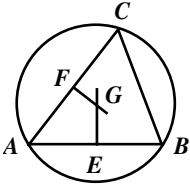
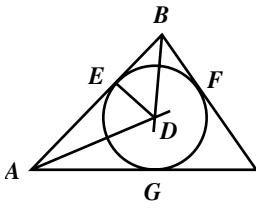
Geometrical Constructions

	<p>To divide a line AB into two equal parts:</p> <p>With the ends A and B as centers and a radius greater than one-half the line, draw circular arcs. Through the intersections C and D, draw line CD. This line divides AB into two equal parts and is also perpendicular to AB.</p>
	<p>To draw a perpendicular to a straight line from a point A on that line:</p> <p>With A as a center and with any radius, draw circular arcs intersecting the given line at B and C. Then, with B and C as centers and a radius longer than AB, draw circular arcs intersecting at D. Line DA is perpendicular to BC at A.</p>
	<p>To draw a perpendicular line from a point A at the end of a line AB:</p> <p>With any point D, outside of the line AB, as a center, and with AD as a radius, draw a circular arc intersecting AB at E. Draw a line through E and D intersecting the arc at C; then join AC. This line is the required perpendicular.</p>
	<p>To draw a perpendicular to a line AB from a point C at a distance from it:</p> <p>With C as a center, draw a circular arc intersecting the given line at E and F. With E and F as centers, draw circular arcs with a radius longer than one-half the distance between E and F. These arcs intersect at D. Line CD is the required perpendicular.</p>
	<p>To divide a straight line AB into a number of equal parts:</p> <p>Let it be required to divide AB into five equal parts. Draw line AC at an angle with AB. Set off on AC five equal parts of any convenient length. Draw $B-5$ and then draw lines parallel with $B-5$ through the other division points on AC. The points where these lines intersect AB are the required division points.</p>

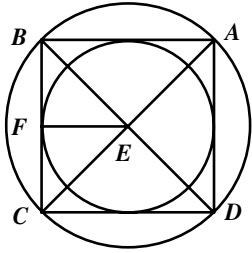
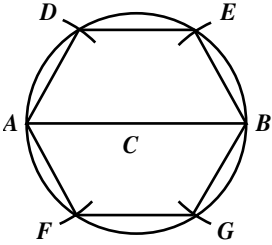
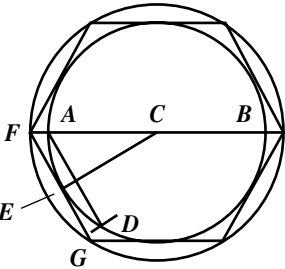
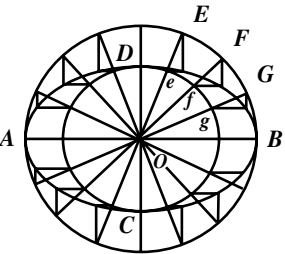
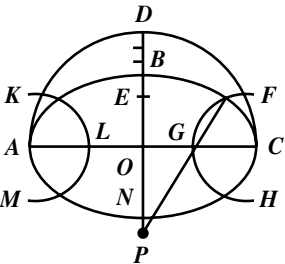
Geometrical Constructions

	<p>To draw a straight line parallel to a given line AB, at a given distance from it:</p> <p>With any points C and D on AB as centers, draw circular arcs with the given distance as radius. Line EF, drawn to touch the circular arcs, is the required parallel line.</p>
	<p>To bisect or divide an angle BAC into two equal parts:</p> <p>With A as a center and any radius, draw arc DE. With D and E as centers and a radius greater than one-half DE, draw circular arcs intersecting at F. Line AF divides the angle into two equal parts.</p>
	<p>To draw an angle upon a line AB, equal to a given angle FGH:</p> <p>With point G as a center and with any radius, draw arc KL. With A as a center and with the same radius, draw arc DE. Make arc DE equal to KL and draw AC through E. Angle BAC then equals angle FGH.</p>
	<p>To lay out a 60-degree angle:</p> <p>With A as a center and any radius, draw an arc BC. With point B as a center and AB as a radius, draw an arc intersecting at E the arc just drawn. EAB is a 60-degree angle.</p> <p>A 30-degree angle may be obtained either by dividing a 60-degree angle into two equal parts or by drawing a line EG perpendicular to AB. Angle AEG is then 30 degrees.</p>
	<p>To draw a 45-degree angle:</p> <p>From point A on line AB, set off a distance AC. Draw the perpendicular DC and set off a distance CE equal to AC. Draw AE. Angle EAC is a 45-degree angle.</p>
	<p>To draw an equilateral triangle, the length of the sides of which equals AB:</p> <p>With A and B as centers and AB as radius, draw circular arcs intersecting at C. Draw AC and BC. Then ABC is an equilateral triangle.</p>

Geometrical Constructions

	<p>To draw a circular arc with a given radius through two given points A and B:</p> <p>With A and B as centers, and the given radius as radius, draw circular arcs intersecting at C. With C as a center, and the same radius, draw a circular arc through A and B.</p>
	<p>To find the center of a circle or of an arc of a circle:</p> <p>Select three points on the periphery of the circle, as A, B, and C. With each of these points as a center and the same radius, describe arcs intersecting each other. Through the points of intersection, draw lines DE and FG. Point H, where these lines intersect, is the center of the circle.</p>
	<p>To draw a tangent to a circle from a given point on the circumference:</p> <p>Through the point of tangency A, draw a radial line BC. At point A, draw a line EF at right angles to BC. This line is the required tangent.</p>
	<p>To divide a circular arc AB into two equal parts:</p> <p>With A and B as centers, and a radius larger than half the distance between A and B, draw circular arcs intersecting at C and D. Line CD divides arc AB into two equal parts at E.</p>
	<p>To describe a circle about a triangle:</p> <p>Divide the sides AB and AC into two equal parts, and from the division points E and F, draw lines at right angles to the sides. These lines intersect at G. With G as a center and GA as a radius, draw circle ABC.</p>
	<p>To inscribe a circle in a triangle:</p> <p>Bisect two of the angles, A and B, by lines intersecting at D. From D, draw a line DE perpendicular to one of the sides, and with DE as a radius, draw circle EFG.</p>

Geometrical Constructions

	<p>To describe a circle about a square and to inscribe a circle in a square:</p> <p>The centers of both the circumscribed and inscribed circles are located at the point E, where the two diagonals of the square intersect. The radius of the circumscribed circle is AE, and of the inscribed circle, EF.</p>
	<p>To inscribe a hexagon in a circle:</p> <p>Draw a diameter AB. With A and B as centers and with the radius of the circle as radius, describe circular arcs intersecting the given circle at D, E, F, and G. Draw lines AD, DE, etc., forming the required hexagon.</p>
	<p>To describe a hexagon about a circle:</p> <p>Draw a diameter AB, and with A as a center and the radius of the circle as radius, cut the circumference of the given circle at D. Join AD and bisect it with radius CE. Through E, draw FG parallel to AD and intersecting line AB at F. With C as a center and CF as radius, draw a circle. Within this circle, inscribe the hexagon as in the preceding problem.</p>
	<p>To describe an ellipse with the given axes AB and CD:</p> <p>Describe circles with O as a center and AB and CD as diameters. From a number of points, E, F, G, etc., on the outer circle, draw radii intersecting the inner circle at e, f, and g. From E, F, and G, draw lines perpendicular to AB, and from e, f, and g, draw lines parallel to AB. The intersections of these perpendicular and parallel lines are points on the curve of the ellipse.</p>
	<p>To construct an approximate ellipse by circular arcs:</p> <p>Let AC be the major axis and BN the minor. Draw half circle ADC with O as a center. Divide BD into three equal parts and set off BE equal to one of these parts. With A and C as centers and OE as radius, describe circular arcs KLM and FGH; with G and L as centers, and the same radius, describe arcs FCH and KAM. Through F and G, drawn line FP, and with P as a center, draw the arc FBK. Arc HNM is drawn in the same manner.</p>

Geometrical Constructions

	<p>To construct a parabola:</p> <p>Divide line AB into a number of equal parts and divide BC into the same number of parts. From the division points on AB, draw horizontal lines. From the division points on BC, draw lines to point A. The points of intersection between lines drawn from points numbered alike are points on the parabola.</p>
	<p>To construct a hyperbola:</p> <p>From focus F, lay off a distance FD equal to the transverse axis, or the distance AB between the two branches of the curve. With F as a center and any distance FE greater than FB as a radius, describe a circular arc. Then with F_1 as a center and DE as a radius, describe arcs intersecting at C and G the arc just described. C and G are points on the hyperbola. Any number of points can be found in a similar manner.</p>
	<p>To construct an involute:</p> <p>Divide the circumference of the base circle ABC into a number of equal parts. Through the division points 1, 2, 3, etc., draw tangents to the circle and make the lengths $D-1$, $E-2$, $F-3$, etc., of these tangents equal to the actual length of the arcs $A-1$, $A-2$, $A-3$, etc.</p>
	<p>To construct a helix:</p> <p>Divide half the circumference of the cylinder, on the surface of which the helix is to be described, into a number of equal parts. Divide half the lead of the helix into the same number of equal parts. From the division points on the circle representing the cylinder, draw vertical lines, and from the division points on the lead, draw horizontal lines as shown. The intersections between lines numbered alike are points on the helix.</p>

Areas and Volumes

✧ **The Prismoidal Formula.**—The prismoidal formula is a general formula by which the volume of any prism, pyramid, or frustum of a pyramid may be found.

A_1 = area at one end of the body

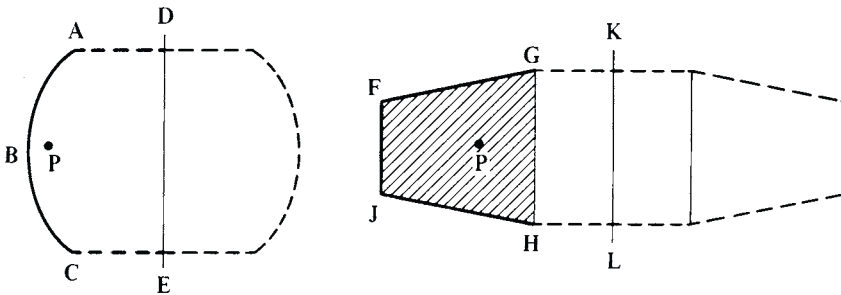
A_2 = area at the other end

A_m = area of middle section between the two end surfaces

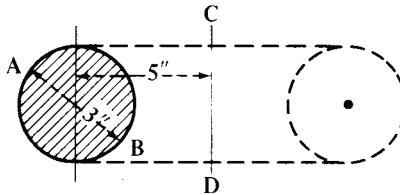
h = height of body

Then, volume V of the body is $V = \frac{h}{6}(A_1 + 4A_m + A_2)$

Pappus or Guldinus Rules.—By means of these rules the area of any surface of revolution and the volume of any solid of revolution may be found. The area of the surface swept out by the revolution of a line ABC (see illustration) about the axis DE equals the length of the line multiplied by the length of the path of its center of gravity, P . If the line is of such a shape that it is difficult to determine its center of gravity, then the line may be divided into a number of short sections, each of which may be considered as a straight line, and the areas swept out by these different sections, as computed by the rule given, may be added to find the total area. The line must lie wholly on one side of the axis of revolution and must be in the same plane.



The volume of a solid body formed by the revolution of a surface $FGHJ$ about axis KL equals the area of the surface multiplied by the length of the path of its center of gravity. The surface must lie wholly on one side of the axis of revolution and in the same plane.



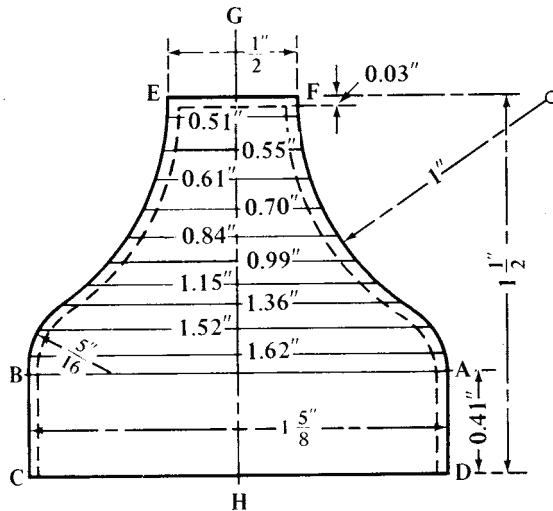
Example: By means of these rules, the area and volume of a cylindrical ring or torus may be found. The torus is formed by a circle AB being rotated about axis CD . The center of gravity of the circle is at its center. Hence, with the dimensions given in the illustration, the length of the path of the center of gravity of the circle is $3.1416 \times 10 = 31.416$ inches. Multiplying by the length of the circumference of the circle, which is $3.1416 \times 3 = 9.4248$ inches, gives $31.416 \times 9.4248 = 296.089$ square inches which is the area of the torus.

The volume equals the area of the circle, which is $0.7854 \times 9 = 7.0686$ square inches, multiplied by the path of the center of gravity, which is 31.416, as before; hence,

$$\text{Volume} = 7.0686 \times 31.416 = 222.067 \text{ cubic inches}$$

Approximate Method for Finding the Area of a Surface of Revolution.—The accompanying illustration is shown in order to give an example of the approximate method based on Guldinus' rule, that can be used for finding the area of a symmetrical body. In the illustration, the dimensions in common fractions are the known dimensions; those in decimals are found by actual measurements on a figure drawn to scale.

The method for finding the area is as follows: First, separate such areas as are cylindrical, conical, or spherical, as these can be found by exact formulas. In the illustration *ABCD* is a cylinder, the area of the surface of which can be easily found. The top area *EF* is simply a circular area, and can thus be computed separately. The remainder of the surface generated by rotating line *AF* about the axis *GH* is found by the approximate method explained in the previous section. From point *A*, set off equal distances on line *AF*. In the illustration, each division indicated is $\frac{1}{8}$ inch long. From the central or middle point of each of these parts draw a line at right angles to the axis of rotation *GH*, measure the length of these lines or diameters (the length of each is given in decimals), add all these lengths together and multiply the sum by the length of one division set off on line *AF* (in this case, $\frac{1}{8}$ inch), and multiply this product by π to find the approximate area of the surface of revolution.



In setting off divisions $\frac{1}{8}$ inch long along line *AF*, the last division does not reach exactly to point *F*, but only to a point 0.03 inch below it. The part 0.03 inch high at the top of the cup can be considered as a cylinder of $\frac{1}{2}$ inch diameter and 0.03 inch height, the area of the cylindrical surface of which is easily computed. By adding the various surfaces together, the total surface of the cup is found as follows:

Cylinder, $1 \frac{5}{8}$ inch diameter, 0.41 inch high	2.093 square inches
Circle, $\frac{1}{2}$ inch diameter	0.196 square inch
Cylinder, $\frac{1}{2}$ inch diameter, 0.03 inch high	0.047 square inch
Irregular surface	<u>3.868 square inches</u>
Total	6.204 square inches

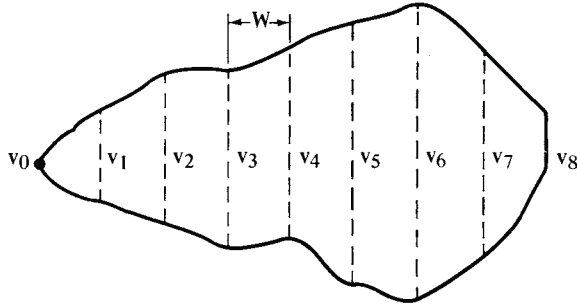
Area of Plane Surfaces of Irregular Outline.—One of the most useful and accurate methods for determining the approximate area of a plane figure or irregular outline is known as *Simpson's Rule*. In applying Simpson's Rule to find an area the work is done in four steps:

- 1) Divide the area into an *even* number, *N*, of parallel strips of equal width *W*; for example, in the accompanying diagram, the area has been divided into 8 strips of equal width.
- 2) Label the sides of the strips V_0, V_1, V_2, \dots , up to V_N .
- 3) Measure the heights $V_0, V_1, V_2, \dots, V_N$ of the sides of the strips.
- 4) Substitute the heights V_0, V_1, \dots , in the following formula to find the area *A* of the figure:

$$A = \frac{W}{3} [(V_0 + V_N) + 4(V_1 + V_3 + \dots + V_{N-1}) + 2(V_2 + V_4 + \dots + V_{N-2})]$$

Example: The area of the accompanying figure was divided into 8 strips on a full-size drawing and the following data obtained. Calculate the area using Simpson's Rule.

- $W = 1$ cm
- $V_0 = 0$ cm
- $V_1 = 1.91$ cm
- $V_2 = 3.18$ cm
- $V_3 = 3.81$ cm
- $V_4 = 4.13$ cm
- $V_5 = 5.27$ cm
- $V_6 = 6.35$ cm
- $V_7 = 4.45$ cm
- $V_8 = 1.27$ cm



Substituting the given data in the Simpson's formula,

$$A = \frac{1}{3} [(0 + 1.27) + 4(1.91 + 3.81 + 5.27 + 4.45) + 2(3.18 + 4.13 + 6.35)]$$

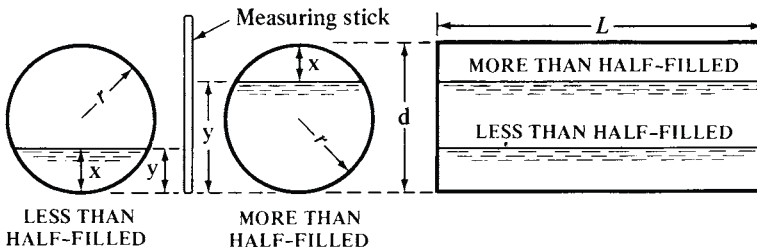
$$= \frac{1}{3} [1.27 + 4(15.44) + 2(13.66)] = 30.12 \text{ cm}^2$$

In applying Simpson's Rule, it should be noted that the larger the number of strips into which the area is divided the more accurate the results obtained.

Areas Enclosed by Cycloidal Curves.—The area between a cycloid and the straight line upon which the generating circle rolls, equals three times the area of the generating circle (see diagram, page 73). The areas between epicycloidal and hypocycloidal curves and the “fixed circle” upon which the generating circle is rolled, may be determined by the following formulas, in which a = radius of the fixed circle upon which the generating circle rolls; b = radius of the generating circle; A = the area for the epicycloidal curve; and A_1 = the area for the hypocycloidal curve.

$$A = \frac{3.1416b^2(3a + 2b)}{a} \qquad A_1 = \frac{3.1416b^2(3a - 2b)}{a}$$

Find the Contents of Cylindrical Tanks at Different Levels.—In conjunction with the table *Segments of Circles for Radius = 1* starting on page 78, the following relations can give a close approximation of the liquid contents, at any level, in a cylindrical tank.



A long measuring rule calibrated in length units or simply a plain stick can be used for measuring contents at a particular level. In turn, the rule or stick can be graduated to serve as a volume gauge for the tank in question. The only requirements are that the cross-section of the tank is circular; the tank's dimensions are known; the gauge rod is inserted vertically through the top center of the tank so that it rests on the exact bottom of the tank; and that consistent metric or English units are used throughout the calculations.

$$K = Cr^2L = \text{Tank Constant (remains the same for any given tank)} \quad (1)$$

$$V_T = \pi K, \text{ for a tank that is completely full} \quad (2)$$

$$V_s = KA \quad (3)$$

$$V = V_s \text{ when tank is less than half full} \quad (4)$$

$$V = V_T - V_s = V_T - KA, \text{ when tank is more than half full} \quad (5)$$

where C = liquid volume conversion factor, the exact value of which depends on the length and liquid volume units being used during measurement: 0.00433 U.S. gal/in³; 7.48 U.S. gal/ft³; 0.00360 U.K. gal/in³; 6.23 U.K. gal/ft³; 0.001 liter/cm³; or 1000 liters/m³

V_T = total volume of liquid tank can hold

V_s = volume formed by segment of circle having depth = x in given tank (see diagram)

V = volume of liquid at particular level in tank

d = diameter of tank; L = length of tank; r = radius of tank (= $\frac{1}{2}$ diameter)

A = segment area of a corresponding unit circle taken from the table starting on page 78

y = actual depth of contents in tank as shown on a gauge rod or stick

x = depth of the segment of a circle to be considered in given tank. As can be seen in above diagram, x is the actual depth of contents (y) when the tank is less than half full, and is the depth of the void ($d - y$) above the contents when the tank is more than half full. From pages 78 and 81 it can also be seen that h , the height of a segment of a corresponding unit circle, is x/r

Example: A tank is 20 feet long and 6 feet in diameter. Convert a long inch-stick into a gauge that is graduated at 1000 and 3000 U.S. gallons. ✦

$$L = 20 \times 12 = 240 \text{ in.} \quad r = \frac{6}{2} \times 12 = 36 \text{ in.}$$

From **Formula (1)**: $K = 0.00433(36)^2(240) = 1346.80$

From **Formula (2)**: $V_T = 3.1416 \times 1347 = 4231.1 \text{ US gal.}$

The 72-inch mark from the bottom on the inch-stick can be graduated for the rounded full volume "4230"; and the halfway point 36" for 4230/2 or "2115." It can be seen that the 1000-gal mark would be below the halfway mark. From **Formulas (3) and (4)**:

$$A_{1000} = \frac{1000}{1347} = 0.7424 \text{ from the table starting on page 78, } h \text{ can be interpolated as}$$

0.5724; and $x = y = 36 \times 0.5724 = 20.61$. If the desired level of accuracy permits, interpolation can be omitted by choosing h directly from the table on page 78 for the value of A nearest that calculated above.

Therefore, the 1000-gal mark is graduated 20 $\frac{5}{8}$ " from bottom of rod.

It can be seen that the 3000 mark would be above the halfway mark. Therefore, the circular segment considered is the cross-section of the void space at the top of the tank. From **Formulas (3) and (5)**:

$$A_{3000} = \frac{4230 - 3000}{1347} = 0.9131; h = 0.6648; x = 36 \times 0.6648 = 23.93''$$

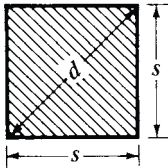
Therefore, the 3000-gal mark is 72.00 - 23.93 = 48.07, or at the 48 $\frac{1}{16}$ " mark from the bottom.

Areas and Dimensions of Plane Figures

In the following tables are given formulas for the areas of plane figures, together with other formulas relating to their dimensions and properties; the surfaces of solids; and the volumes of solids. The notation used in the formulas is, as far as possible, given in the illustration accompanying them; where this has not been possible, it is given at the beginning of each set of formulas.

Examples are given with each entry, some in English and some in metric units, showing the use of the preceding formula.

Square:



$$\begin{aligned}\text{Area} = A &= s^2 = \frac{1}{2}d^2 \\ s &= 0.7071d = \sqrt{A} \\ d &= 1.414s = 1.414\sqrt{A}\end{aligned}$$

Example: Assume that the side s of a square is 15 inches. Find the area and the length of the diagonal.

$$\text{Area} = A = s^2 = 15^2 = 225 \text{ square inches}$$

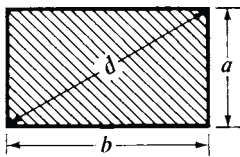
$$\text{Diagonal} = d = 1.414s = 1.414 \times 15 = 21.21 \text{ inches}$$

Example: The area of a square is 625 cm². Find the length of the side s and the diagonal d .

$$s = \sqrt{A} = \sqrt{625} = 25 \text{ cm}$$

$$d = 1.414\sqrt{A} = 1.414 \times 25 = 35.35 \text{ cm}$$

Rectangle:



$$\begin{aligned}\text{Area} = A &= ab = a\sqrt{d^2 - a^2} = b\sqrt{d^2 - b^2} \\ d &= \sqrt{a^2 + b^2} \\ a &= \sqrt{d^2 - b^2} = A \div b \\ b &= \sqrt{d^2 - a^2} = A \div a\end{aligned}$$

Example: The side a of a rectangle is 12 centimeters, and the area 70.5 square centimeters. Find the length of the side b , and the diagonal d .

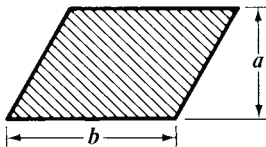
$$b = A \div a = 70.5 \div 12 = 5.875 \text{ centimeters}$$

$$d = \sqrt{a^2 + b^2} = \sqrt{12^2 + 5.875^2} = \sqrt{178.516} = 13.361 \text{ centimeters}$$

Example: The sides of a rectangle are 30.5 and 11 centimeters long. Find the area.

$$\text{Area} = A = a \times b = 30.5 \times 11 = 335.5 \text{ square centimeters}$$

Parallelogram:



$$\begin{aligned}\text{Area} = A &= ab \\ a &= A \div b \\ b &= A \div a\end{aligned}$$

Note: The dimension a is measured at right angles to line b .

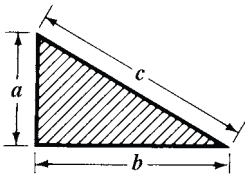
Example: The base b of a parallelogram is 16 feet. The height a is 5.5 feet. Find the area.

$$\text{Area} = A = a \times b = 5.5 \times 16 = 88 \text{ square feet}$$

Example: The area of a parallelogram is 12 square inches. The height is 1.5 inches. Find the length of the base b .

$$b = A \div a = 12 \div 1.5 = 8 \text{ inches}$$

Right-Angled Triangle:



$$\begin{aligned} \text{Area} = A &= \frac{ab}{2} \\ c &= \sqrt{a^2 + b^2} \\ a &= \sqrt{c^2 - b^2} \\ b &= \sqrt{c^2 - a^2} \end{aligned}$$

Example: The sides a and b in a right-angled triangle are 6 and 8 inches. Find side c and the area A :

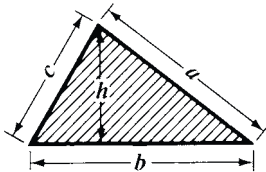
$$\begin{aligned} c &= \sqrt{a^2 + b^2} = \sqrt{6^2 + 8^2} = \sqrt{36 + 64} = \sqrt{100} = 10 \text{ inches} \\ A &= \frac{a \times b}{2} = \frac{6 \times 8}{2} = \frac{48}{2} = 24 \text{ square inches} \end{aligned}$$

Example: If $c = 10$ and $a = 6$ had been known, but not b , the latter would have been found as follows:

$$b = \sqrt{c^2 - a^2} = \sqrt{10^2 - 6^2} = \sqrt{100 - 36} = \sqrt{64} = 8 \text{ inches}$$



Acute-Angled Triangle:



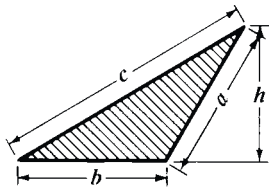
$$\begin{aligned} \text{Area} = A &= \frac{bh}{2} = \frac{b}{2} \sqrt{a^2 - \left(\frac{a^2 + b^2 - c^2}{2b}\right)^2} \\ \text{If } S &= \frac{1}{2}(a + b + c), \text{ then} \\ A &= \sqrt{S(S-a)(S-b)(S-c)} \end{aligned}$$

Example: If $a = 10$, $b = 9$, and $c = 8$ centimeters, what is the area of the triangle?

$$\begin{aligned} A &= \frac{b}{2} \sqrt{a^2 - \left(\frac{a^2 + b^2 - c^2}{2b}\right)^2} = \frac{9}{2} \sqrt{10^2 - \left(\frac{10^2 + 9^2 - 8^2}{2 \times 9}\right)^2} = 4.5 \sqrt{100 - \left(\frac{117}{18}\right)^2} \\ &= 4.5 \sqrt{100 - 42.25} = 4.5 \sqrt{57.75} = 4.5 \times 7.60 = 34.20 \text{ square centimeters} \end{aligned}$$



Obtuse-Angled Triangle:



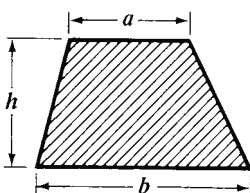
$$\begin{aligned} \text{Area} = A &= \frac{bh}{2} = \frac{b}{2} \sqrt{a^2 - \left(\frac{c^2 - a^2 - b^2}{2b}\right)^2} \\ \text{If } S &= \frac{1}{2}(a + b + c), \text{ then} \\ A &= \sqrt{S(S-a)(S-b)(S-c)} \end{aligned}$$

Example: The side $a = 5$, side $b = 4$, and side $c = 8$ inches. Find the area.

$$\begin{aligned} S &= \frac{1}{2}(a + b + c) = \frac{1}{2}(5 + 4 + 8) = \frac{1}{2} \times 17 = 8.5 \\ A &= \sqrt{S(S-a)(S-b)(S-c)} = \sqrt{8.5(8.5-5)(8.5-4)(8.5-8)} \\ &= \sqrt{8.5 \times 3.5 \times 4.5 \times 0.5} = \sqrt{66.937} = 8.18 \text{ square inches} \end{aligned}$$



Trapezoid:



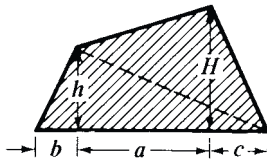
$$\text{Area} = A = \frac{(a+b)h}{2}$$

Note: In Britain, this figure is called a *trapezium* and the one below it is known as a *trapezoid*, the terms being reversed.

Example: Side $a = 23$ meters, side $b = 32$ meters, and height $h = 12$ meters. Find the area.

$$A = \frac{(a+b)h}{2} = \frac{(23+32)12}{2} = \frac{55 \times 12}{2} = 330 \text{ square meters}$$



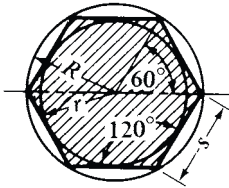
Trapezium:

$$\text{Area} = A = \frac{(H+h)a + bh + cH}{2}$$

A trapezium can also be divided into two triangles as indicated by the dashed line. The area of each of these triangles is computed, and the results added to find the area of the trapezium.

Example: Let $a = 10$, $b = 2$, $c = 3$, $h = 8$, and $H = 12$ inches. Find the area.

$$\begin{aligned} A &= \frac{(H+h)a + bh + cH}{2} = \frac{(12+8)10 + 2 \times 8 + 3 \times 12}{2} \\ &= \frac{20 \times 10 + 16 + 36}{2} = \frac{252}{2} = 126 \text{ square inches} \end{aligned}$$

Regular Hexagon:

$$A = 2.598s^2 = 2.598R^2 = 3.464r^2$$

$$R = s = \text{radius of circumscribed circle} = 1.155r$$

$$r = \text{radius of inscribed circle} = 0.866s = 0.866R$$

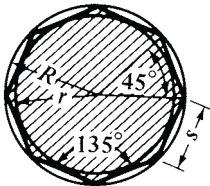
$$s = R = 1.155r$$

Example: The side s of a regular hexagon is 40 millimeters. Find the area and the radius r of the inscribed circle.

$$A = 2.598s^2 = 2.598 \times 40^2 = 2.598 \times 1600 = 4156.8 \text{ square millimeters}$$

$$r = 0.866s = 0.866 \times 40 = 34.64 \text{ millimeters}$$

Example: What is the length of the side of a hexagon that is drawn around a circle of 50 millimeters radius? — Here $r = 50$. Hence, $s = 1.155r = 1.155 \times 50 = 57.75$ millimeters

Regular Octagon:

$$A = \text{area} = 4.828s^2 = 2.828R^2 = 3.314r^2$$

$$R = \text{radius of circumscribed circle} = 1.307s = 1.082r$$

$$r = \text{radius of inscribed circle} = 1.207s = 0.924R$$

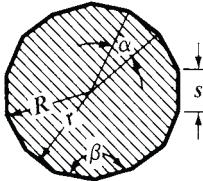
$$s = 0.765R = 0.828r$$

Example: Find the area and the length of the side of an octagon that is inscribed in a circle of 12 inches diameter.

Diameter of circumscribed circle = 12 inches; hence, $R = 6$ inches.

$$A = 2.828R^2 = 2.828 \times 6^2 = 2.828 \times 36 = 101.81 \text{ square inches}$$

$$s = 0.765R = 0.765 \times 6 = 4.590 \text{ inches}$$

Regular Polygon:

$$A = \text{area} \quad n = \text{number of sides}$$

$$\alpha = 360^\circ \div n \quad \beta = 180^\circ - \alpha$$

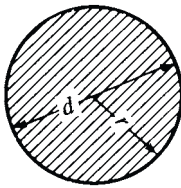
$$A = \frac{nsr}{2} = \frac{ns}{2} \sqrt{R^2 - \frac{s^2}{4}}$$

$$R = \sqrt{r^2 + \frac{s^2}{4}} \quad r = \sqrt{R^2 - \frac{s^2}{4}} \quad s = 2\sqrt{R^2 - r^2}$$

Example: Find the area of a polygon having 12 sides, inscribed in a circle of 8 centimeters radius. The length of the side s is 4.141 centimeters.

$$\begin{aligned} A &= \frac{ns}{2} \sqrt{R^2 - \frac{s^2}{4}} = \frac{12 \times 4.141}{2} \sqrt{8^2 - \frac{4.141^2}{4}} = 24.846 \sqrt{59.713} \\ &= 24.846 \times 7.727 = 191.98 \text{ square centimeters} \end{aligned}$$

Circle:



$$\begin{aligned} \text{Area} = A &= \pi r^2 = 3.1416r^2 = 0.7854d^2 \\ \text{Circumference} = C &= 2\pi r = 6.2832r = 3.1416d \\ r &= C \div 6.2832 = \sqrt{A \div 3.1416} = 0.564\sqrt{A} \\ d &= C \div 3.1416 = \sqrt{A \div 0.7854} = 1.128\sqrt{A} \\ \text{Length of arc for center angle of } 1^\circ &= 0.008727d \\ \text{Length of arc for center angle of } n^\circ &= 0.008727nd \end{aligned}$$

Example: Find the area A and circumference C of a circle with a diameter of $2\frac{3}{4}$ inches.

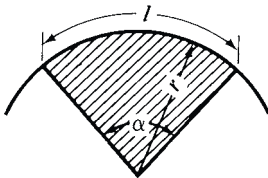
$$A = 0.7854d^2 = 0.7854 \times 2.75^2 = 0.7854 \times 2.75 \times 2.75 = 5.9396 \text{ square inches}$$

$$C = 3.1416d = 3.1416 \times 2.75 = 8.6394 \text{ inches}$$

Example: The area of a circle is 16.8 square inches. Find its diameter.

$$d = 1.128\sqrt{A} = 1.128\sqrt{16.8} = 1.128 \times 4.099 = 4.624 \text{ inches}$$

Circular Sector:



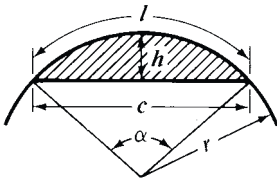
$$\begin{aligned} \text{Length of arc} = l &= \frac{r \times \alpha \times 3.1416}{180} = 0.01745r\alpha = \frac{2A}{r} \\ \text{Area} = A &= \frac{1}{2}rl = 0.008727\alpha r^2 \\ \text{Angle, in degrees} = \alpha &= \frac{57.296 l}{r} \quad r = \frac{2A}{l} = \frac{57.296 l}{\alpha} \end{aligned}$$

Example: The radius of a circle is 35 millimeters, and angle α of a sector of the circle is 60 degrees. Find the area of the sector and the length of arc l .

$$A = 0.008727\alpha r^2 = 0.008727 \times 60 \times 35^2 = 641.41 \text{ mm}^2 = 6.41 \text{ cm}^2$$

$$l = 0.01745r\alpha = 0.01745 \times 35 \times 60 = 36.645 \text{ millimeters}$$

Circular Segment:



$$\begin{aligned} A &= \text{area} \quad l = \text{length of arc} \quad \alpha = \text{angle, in degrees} \\ c &= 2\sqrt{h(2r-h)} \quad A = \frac{1}{2}[rl - c(r-h)] \\ r &= \frac{c^2 + 4h^2}{8h} \quad l = 0.01745r\alpha \\ h &= r - \frac{1}{2}\sqrt{4r^2 - c^2} = r[1 - \cos(\alpha/2)] \quad \alpha = \frac{57.296 l}{r} \end{aligned}$$

See also, *Circular Segments* starting on page 77.

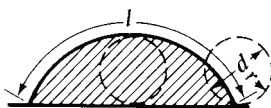
Example: The radius r is 60 inches and the height h is 8 inches. Find the length of the chord c .

$$c = 2\sqrt{h(2r-h)} = 2\sqrt{8 \times (2 \times 60 - 8)} = 2\sqrt{896} = 2 \times 29.93 = 59.86 \text{ inches}$$

Example: If $c = 16$, and $h = 6$ inches, what is the radius of the circle of which the segment is a part?

$$r = \frac{c^2 + 4h^2}{8h} = \frac{16^2 + 4 \times 6^2}{8 \times 6} = \frac{256 + 144}{48} = \frac{400}{48} = 8\frac{1}{3} \text{ inches}$$

Cycloid:

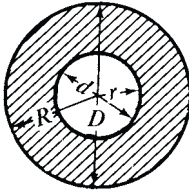


$$\begin{aligned} \text{Area} = A &= 3\pi r^2 = 9.4248r^2 = 2.3562d^2 \\ &= 3 \times \text{area of generating circle} \\ \text{Length of cycloid} = l &= 8r = 4d \end{aligned}$$

See also, *Areas Enclosed by Cycloidal Curves* on page 68.

Example: The diameter of the generating circle of a cycloid is 6 inches. Find the length l of the cycloidal curve, and the area enclosed between the curve and the base line.

$$l = 4d = 4 \times 6 = 24 \text{ inches} \quad A = 2.3562d^2 = 2.3562 \times 6^2 = 84.82 \text{ square inches}$$

Circular Ring:

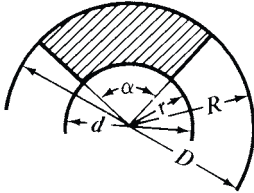
$$\begin{aligned} \text{Area} = A &= \pi(R^2 - r^2) = 3.1416(R^2 - r^2) \\ &= 3.1416(R + r)(R - r) \\ &= 0.7854(D^2 - d^2) = 0.7854(D + d)(D - d) \end{aligned}$$

Example: Let the outside diameter $D = 12$ centimeters and the inside diameter $d = 8$ centimeters. Find the area of the ring.

$$\begin{aligned} A &= 0.7854(D^2 - d^2) = 0.7854(12^2 - 8^2) = 0.7854(144 - 64) = 0.7854 \times 80 \\ &= 62.83 \text{ square centimeters} \end{aligned}$$

By the alternative formula:

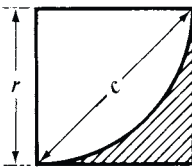
$$\begin{aligned} A &= 0.7854(D + d)(D - d) = 0.7854(12 + 8)(12 - 8) = 0.7854 \times 20 \times 4 \\ &= 62.83 \text{ square centimeters} \end{aligned}$$

Circular Ring Sector:

$$\begin{aligned} A &= \text{area} \quad \alpha = \text{angle, in degrees} \\ A &= \frac{\alpha\pi}{360}(R^2 - r^2) = 0.00873\alpha(R^2 - r^2) \\ &= \frac{\alpha\pi}{4 \times 360}(D^2 - d^2) = 0.00218\alpha(D^2 - d^2) \end{aligned}$$

Example: Find the area, if the outside radius $R = 5$ inches, the inside radius $r = 2$ inches, and $\alpha = 72$ degrees.

$$\begin{aligned} A &= 0.00873\alpha(R^2 - r^2) = 0.00873 \times 72(5^2 - 2^2) \\ &= 0.6286(25 - 4) = 0.6286 \times 21 = 13.2 \text{ square inches} \end{aligned}$$

Spandrel or Fillet:

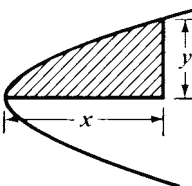
$$\text{Area} = A = r^2 - \frac{\pi r^2}{4} = 0.215r^2 = 0.1075c^2$$

Example: Find the area of a spandrel, the radius of which is 0.7 inch.

$$A = 0.215r^2 = 0.215 \times 0.7^2 = 0.105 \text{ square inch}$$

Example: If chord c were given as 2.2 inches, what would be the area?

$$A = 0.1075c^2 = 0.1075 \times 2.2^2 = 0.520 \text{ square inch}$$

Parabola:

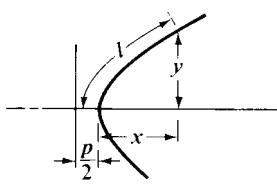
$$\text{Area} = A = \frac{2}{3}xy$$

(The area is equal to two-thirds of a rectangle which has x for its base and y for its height.)

Example: Let x in the illustration be 15 centimeters, and y , 9 centimeters. Find the area of the shaded portion of the parabola.

$$A = \frac{2}{3} \times xy = \frac{2}{3} \times 15 \times 9 = 10 \times 9 = 90 \text{ square centimeters}$$

Parabola:



$$l = \text{length of arc} = \frac{p}{2} \left[\sqrt{\frac{2x}{p} \left(1 + \frac{2x}{p} \right)} + \ln \left(\sqrt{\frac{2x}{p}} + \sqrt{1 + \frac{2x}{p}} \right) \right]$$

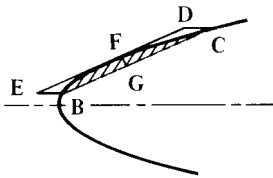
When x is small in proportion to y , the following is a close approximation:

$$l = y \left[1 + \frac{2}{3} \left(\frac{x}{y} \right)^2 - \frac{2}{5} \left(\frac{x}{y} \right)^4 \right] \text{ or } l = \sqrt{y^2 + \frac{4}{3}x^2}$$

Example: If $x = 2$ and $y = 24$ feet, what is the approximate length l of the parabolic curve?

$$\begin{aligned} l &= y \left[1 + \frac{2}{3} \left(\frac{x}{y} \right)^2 - \frac{2}{5} \left(\frac{x}{y} \right)^4 \right] = 24 \left[1 + \frac{2}{3} \left(\frac{2}{24} \right)^2 - \frac{2}{5} \left(\frac{2}{24} \right)^4 \right] \\ &= 24 \left[1 + \frac{2}{3} \times \frac{1}{144} - \frac{2}{5} \times \frac{1}{20,736} \right] = 24 \times 1.0046 = 24.11 \text{ feet} \end{aligned}$$

Segment of Parabola:



$$\text{Area BFC} = A = \frac{2}{3} \text{ area of parallelogram BCDE}$$

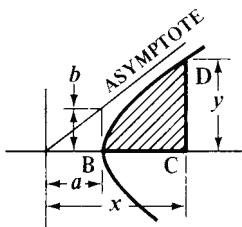
If FG is the height of the segment, measured at right angles to BC , then:

$$\text{Area of segment BFC} = \frac{2}{3} BC \times FG$$

Example: The length of the chord $BC = 19.5$ inches. The distance between lines BC and DE , measured at right angles to BC , is 2.25 inches. This is the height of the segment. Find the area.

$$\text{Area} = A = \frac{2}{3} BC \times FG = \frac{2}{3} \times 19.5 \times 2.25 = 29.25 \text{ square inches}$$

Hyperbola:



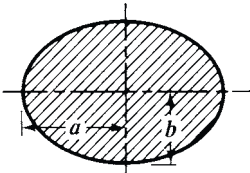
$$\text{Area BCD} = A = \frac{xy}{2} - \frac{ab}{2} \ln \left(\frac{x}{a} + \frac{y}{b} \right)$$

Example: The half-axes a and b are 3 and 2 inches, respectively. Find the area shown shaded in the illustration for $x = 8$ and $y = 5$.

Inserting the known values in the formula:

$$\begin{aligned} A &= \frac{8 \times 5}{2} - \frac{3 \times 2}{2} \times \ln \left(\frac{8}{3} + \frac{5}{2} \right) = 20 - 3 \times \ln 5.167 \\ &= 20 - 3 \times 1.6423 = 20 - 4.927 = 15.073 \text{ square inches} \end{aligned}$$

Ellipse:



$$\text{Area} = A = \pi ab = 3.1416ab$$

An approximate formula for the perimeter is

$$\text{Perimeter} = P = 3.1416 \sqrt{2(a^2 + b^2)}$$

$$\text{A closer approximation is } P = 3.1416 \sqrt{2(a^2 + b^2) - \frac{(a-b)^2}{2.2}}$$

Example: The larger or major axis is 200 millimeters. The smaller or minor axis is 150 millimeters. Find the area and the approximate circumference. Here, then, $a = 100$, and $b = 75$.

$$A = 3.1416ab = 3.1416 \times 100 \times 75 = 23,562 \text{ square millimeters} = 235.62 \text{ square centimeters}$$

$$P = 3.1416 \sqrt{2(a^2 + b^2)} = 3.1416 \sqrt{2(100^2 + 75^2)} = 3.1416 \sqrt{2 \times 15,625}$$

$$= 3.1416 \sqrt{31,250} = 3.1416 \times 176.78 = 555.37 \text{ millimeters} = (55.537 \text{ centimeters})$$

Formulas and Table for Regular Polygons.—The following formulas and table can be used to calculate the area, length of side, and radii of the inscribed and circumscribed circles of regular polygons (equal sided).

$$A = NS^2 \cot \alpha \div 4 = NR^2 \sin \alpha \cos \alpha = Nr^2 \tan \alpha$$

$$r = R \cos \alpha = (S \cot \alpha) \div 2 = \sqrt{(A \times \cot \alpha) \div N}$$

$$R = S \div (2 \sin \alpha) = r \div \cos \alpha = \sqrt{A \div (N \sin \alpha \cos \alpha)}$$

$$S = 2R \sin \alpha = 2r \tan \alpha = 2\sqrt{(A \times \tan \alpha) \div N}$$

where N = number of sides; S = length of side; R = radius of circumscribed circle; r = radius of inscribed circle; A = area of polygon; α , δ , $\alpha = 180^\circ \div N$ = one-half center angle of one side. See also *Regular Polygon* on page 72.

Area, Length of Side, and Inscribed and Circumscribed Radii of Regular Polygons

No. of Sides	$\frac{A}{S^2}$	$\frac{A}{R^2}$	$\frac{A}{r^2}$	$\frac{R}{S}$	$\frac{R}{r}$	$\frac{S}{R}$	$\frac{S}{r}$	$\frac{r}{R}$	$\frac{r}{S}$
3	0.4330	1.2990	5.1962	0.5774	2.0000	1.7321	3.4641	0.5000	0.2887
4	1.0000	2.0000	4.0000	0.7071	1.4142	1.4142	2.0000	0.7071	0.5000
5	1.7205	2.3776	3.6327	0.8507	1.2361	1.1756	1.4531	0.8090	0.6882
6	2.5981	2.5981	3.4641	1.0000	1.1547	1.0000	1.1547	0.8660	0.8660
7	3.6339	2.7364	3.3710	1.1524	1.1099	0.8678	0.9631	0.9010	1.0383
8	4.8284	2.8284	3.3137	1.3066	1.0824	0.7654	0.8284	0.9239	1.2071
9	6.1818	2.8925	3.2757	1.4619	1.0642	0.6840	0.7279	0.9397	1.3737
10	7.6942	2.9389	3.2492	1.6180	1.0515	0.6180	0.6498	0.9511	1.5388
12	11.196	3.0000	3.2154	1.9319	1.0353	0.5176	0.5359	0.9659	1.8660
16	20.109	3.0615	3.1826	2.5629	1.0196	0.3902	0.3978	0.9808	2.5137
20	31.569	3.0902	3.1677	3.1962	1.0125	0.3129	0.3168	0.9877	3.1569
24	45.575	3.1058	3.1597	3.8306	1.0086	0.2611	0.2633	0.9914	3.7979
32	81.225	3.1214	3.1517	5.1011	1.0048	0.1960	0.1970	0.9952	5.0766
48	183.08	3.1326	3.1461	7.6449	1.0021	0.1308	0.1311	0.9979	7.6285
64	325.69	3.1365	3.1441	10.190	1.0012	0.0981	0.0983	0.9988	10.178

Example 1: A regular hexagon is inscribed in a circle of 6 inches diameter. Find the area and the radius of an inscribed circle. Here $R = 3$. From the table, area $A = 2.5981R^2 = 2.5981 \times 9 = 23.3829$ square inches. Radius of inscribed circle, $r = 0.866R = 0.866 \times 3 = 2.598$ inches.

Example 2: An octagon is inscribed in a circle of 100 millimeters diameter. Thus $R = 50$. Find the area and radius of an inscribed circle. $A = 2.8284R^2 = 2.8284 \times 2500 = 7071 \text{ mm}^2 = 70.7 \text{ cm}^2$. Radius of inscribed circle, $r = 0.9239R = 0.9239 \times 50 = 46.195 \text{ mm}$.

Example 3: Thirty-two bolts are to be equally spaced on the periphery of a bolt-circle, 16 inches in diameter. Find the chordal distance between the bolts. Chordal distance equals the side S of a polygon with 32 sides. $R = 8$. Hence, $S = 0.196R = 0.196 \times 8 = 1.568$ inch.

Example 4: Sixteen bolts are to be equally spaced on the periphery of a bolt-circle, 250 millimeters diameter. Find the chordal distance between the bolts. Chordal distance equals the side S of a polygon with 16 sides. $R = 125$. Thus, $S = 0.3902R = 0.3902 \times 125 = 48.775$ millimeters.

Circular Segments.—The table that follows gives the principle formulas for dimensions of circular segments. The dimensions are illustrated in the figures on pages 73 and 78. When two of the dimensions found together in the first column are known, the other dimensions are found by using the formulas in the corresponding row. For example, if radius r and chord c are known, solve for angle α using Equation (13), then use Equations (14) and (15) to solve for h and l , respectively. In these formulas, the value of α is in degrees between 0 and 180°.

Formulas for Circular Segments

Given	Formulas		
α, r	$c = 2r \sin \frac{\alpha}{2}$ (1)	$h = r \left(1 - \cos \frac{\alpha}{2}\right)$ (2)	$l = \frac{\pi r \alpha}{180}$ (3)
α, c	$r = \frac{c}{2 \sin \frac{\alpha}{2}}$ (4)	$h = -\frac{c}{2} \tan \frac{\alpha}{4}$ (5)	$l = \frac{\pi c \alpha}{360 \sin \frac{\alpha}{2}}$ (6)
α, h	$r = \frac{h}{1 - \cos \frac{\alpha}{2}}$ (7)	$c = \frac{2h}{\tan \frac{\alpha}{4}}$ (8)	$l = \frac{\pi h \alpha}{180 \left(1 - \cos \frac{\alpha}{2}\right)}$ (9)
α, l	$r = \frac{180 l}{\pi \alpha}$ (10)	$c = \frac{360 l \sin \frac{\alpha}{2}}{\pi \alpha}$ (11)	$h = \frac{180 l \left(1 - \cos \frac{\alpha}{2}\right)}{\pi \alpha}$ (12)
r, c	$\alpha = \arccos \left(1 - \frac{c^2}{2r^2}\right)$ (13)	$h = r - \frac{\sqrt{4r^2 - c^2}}{2}$ (14)	$l = \frac{\pi}{90} r \arcsin \left(\frac{c}{2r}\right)$ (15)
r, h	$\alpha = 2 \arccos \left(1 - \frac{h}{r}\right)$ (16)	$c = 2 \sqrt{h(2r - h)}$ (17)	$l = \frac{\pi}{90} r \arccos \left(1 - \frac{h}{r}\right)$ (18)
r, l	$\alpha = \frac{180 l}{\pi r}$ (19)	$c = 2r \sin \frac{90l}{\pi R}$ (20)	$h = r \left(1 - \cos \frac{90l}{\pi r}\right)$ (21)
c, h	$\alpha = 4 \operatorname{atan} \frac{2h}{c}$ (22)	$r = \frac{c^2 + 4h^2}{8h}$ (23)	$l = \pi \left(\frac{c^2 + 4h^2}{360h}\right) \operatorname{atan} \frac{2h}{c}$ (24)

Given	Formula To Find	Given	Formula To Find
c, l	$\frac{360 l}{\pi c} = \frac{\alpha}{\sin \frac{\alpha}{2}}$ (25) Solve Equation (25) for α by iteration ^a , then $r = \text{Equation (10)}$ $h = \text{Equation (5)}$	h, l	$\frac{180 l}{\pi h} = \frac{\alpha}{1 - \cos \frac{\alpha}{2}}$ (26) Solve Equation (26) for α by iteration ^a , then $r = \text{Equation (10)}$ $c = \text{Equation (11)}$

^aEquations (25) and (26) can not be easily solved by ordinary means. To solve these equations, test various values of α until the left side of the equation equals the right side. For example, if given $c = 4$ and $l = 5$, the left side of Equation (25) equals 143.24, and by testing various values of α it will be found that the right side equals 143.24 when $\alpha = 129.62^\circ$.

Angle α is in degrees, $0 < \alpha < 180$

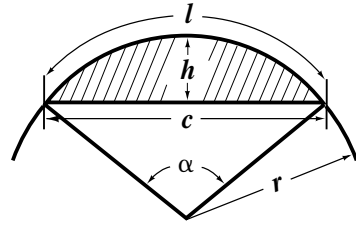
Formulas for Circular Segments contributed by Manfred Brueckner

Segments of Circles for Radius = 1.—Formulas for segments of circles are given on pages 73 and 77. When the central angle α and radius r are known, the following table can be used to find the length of arc l , height of segment h , chord length c , and segment area A . Column A/π is the ratio of segment area A to the area of a circle with radius $r = 1$, in percent.

When angle α and radius r are not known, but segment height h and chord length c are known, ratio h/c can be used to find α , l , and A by linear interpolation. Radius r is found by the formula on page 73 or 77. The value of l is then multiplied by the radius r and the area A by r^2 .

Angle α can be found thus with an accuracy of about 0.001 degree; arc length l with an error of about 0.02 per cent; and area A with an error ranging from about 0.02 per cent for the highest entry value of h/c to about 1 per cent for values of h/c of about 0.050. For lower values of h/c , and where greater accuracy is required, area A should be found by the formula on page 73.

Example: A 3-foot diameter cylindrical tank, mounted horizontally, contains fuel. What is the fuel depth, in inches, when the tank is 20% full? Locate 20% in table column $A/\pi\%$. The depth equals h multiplied by the radius: $h \times r = 0.50758 \times 1.5 \times 12 = 9.14$ inches



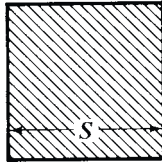
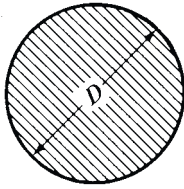
Segments of Circles for Radius = 1 (English or metric units)

α , Deg.	l	h	c	Area A	A/π %	h/c	α , Deg.	l	h	c	Area A	A/π %	h/c
1	0.01745	0.00004	0.01745	0.0000	0.0	0.00218	41	0.71558	0.06333	0.70041	0.0298	0.9	0.09041
2	0.03491	0.00015	0.03490	0.0000	0.0	0.00436	42	0.73304	0.06642	0.71674	0.0320	1.0	0.09267
3	0.05236	0.00034	0.05235	0.0000	0.0	0.00655	43	0.75049	0.06958	0.73300	0.0342	1.1	0.09493
4	0.06981	0.00061	0.06980	0.0000	0.0	0.00873	44	0.76794	0.07282	0.74921	0.0366	1.2	0.09719
5	0.08727	0.00095	0.08724	0.0001	0.0	0.01091	45	0.78540	0.07612	0.76537	0.0391	1.2	0.09946
6	0.10472	0.00137	0.10467	0.0001	0.0	0.01309	46	0.80285	0.07950	0.78146	0.0418	1.3	0.10173
7	0.12217	0.00187	0.12210	0.0002	0.0	0.01528	47	0.82030	0.08294	0.79750	0.0445	1.4	0.10400
8	0.13963	0.00244	0.13951	0.0002	0.0	0.01746	48	0.83776	0.08645	0.81347	0.0473	1.5	0.10628
9	0.15708	0.00308	0.15692	0.0003	0.0	0.01965	49	0.85521	0.09004	0.82939	0.0503	1.6	0.10856
10	0.17453	0.00381	0.17431	0.0004	0.0	0.02183	50	0.87266	0.09369	0.84524	0.0533	1.7	0.11085
11	0.19199	0.00460	0.19169	0.0006	0.0	0.02402	51	0.89012	0.09741	0.86102	0.0565	1.8	0.11314
12	0.20944	0.00548	0.20906	0.0008	0.0	0.02620	52	0.90757	0.10121	0.87674	0.0598	1.9	0.11543
13	0.22689	0.00643	0.22641	0.0010	0.0	0.02839	53	0.92502	0.10507	0.89240	0.0632	2.0	0.11773
14	0.24435	0.00745	0.24374	0.0012	0.0	0.03058	54	0.94248	0.10899	0.90798	0.0667	2.1	0.12004
15	0.26180	0.00856	0.26105	0.0015	0.0	0.03277	55	0.95993	0.11299	0.92350	0.0704	2.2	0.12235
16	0.27925	0.00973	0.27835	0.0018	0.1	0.03496	56	0.97738	0.11705	0.93894	0.0742	2.4	0.12466
17	0.29671	0.01098	0.29562	0.0022	0.1	0.03716	57	0.99484	0.12118	0.95432	0.0781	2.5	0.12698
18	0.31416	0.01231	0.31287	0.0026	0.1	0.03935	58	1.01229	0.12538	0.96962	0.0821	2.6	0.12931
19	0.33161	0.01371	0.33010	0.0030	0.1	0.04155	59	1.02974	0.12964	0.98485	0.0863	2.7	0.13164
20	0.34907	0.01519	0.34730	0.0035	0.1	0.04374	60	1.04720	0.13397	1.00000	0.0906	2.9	0.13397
21	0.36652	0.01675	0.36447	0.0041	0.1	0.04594	61	1.06465	0.13837	1.01508	0.0950	3.0	0.13632
22	0.38397	0.01837	0.38162	0.0047	0.1	0.04814	62	1.08210	0.14283	1.03008	0.0996	3.2	0.13866
23	0.40143	0.02008	0.39874	0.0053	0.2	0.05035	63	1.09956	0.14736	1.04500	0.1043	3.3	0.14101
24	0.41888	0.02185	0.41582	0.0061	0.2	0.05255	64	1.11701	0.15195	1.05984	0.1091	3.5	0.14337
25	0.43633	0.02370	0.43288	0.0069	0.2	0.05476	65	1.13446	0.15661	1.07460	0.1141	3.6	0.14574
26	0.45379	0.02563	0.44990	0.0077	0.2	0.05697	66	1.15192	0.16133	1.08928	0.1192	3.8	0.14811
27	0.47124	0.02763	0.46689	0.0086	0.3	0.05918	67	1.16937	0.16611	1.10387	0.1244	4.0	0.15048
28	0.48869	0.02970	0.48384	0.0096	0.3	0.06139	68	1.18682	0.17096	1.11839	0.1298	4.1	0.15287
29	0.50615	0.03185	0.50076	0.0107	0.3	0.06361	69	1.20428	0.17587	1.13281	0.1353	4.3	0.15525
30	0.52360	0.03407	0.51764	0.0118	0.4	0.06583	70	1.22173	0.18085	1.14715	0.1410	4.5	0.15765
31	0.54105	0.03637	0.53448	0.0130	0.4	0.06805	71	1.23918	0.18588	1.16141	0.1468	4.7	0.16005
32	0.55851	0.03874	0.55127	0.0143	0.5	0.07027	72	1.25664	0.19098	1.17557	0.1528	4.9	0.16246
33	0.57596	0.04118	0.56803	0.0157	0.5	0.07250	73	1.27409	0.19614	1.18965	0.1589	5.1	0.16488
34	0.59341	0.04370	0.58474	0.0171	0.5	0.07473	74	1.29154	0.20136	1.20363	0.1651	5.3	0.16730
35	0.61087	0.04628	0.60141	0.0186	0.6	0.07696	75	1.30900	0.20665	1.21752	0.1715	5.5	0.16973
36	0.62832	0.04894	0.61803	0.0203	0.6	0.07919	76	1.32645	0.21199	1.23132	0.1781	5.7	0.17216
37	0.64577	0.05168	0.63461	0.0220	0.7	0.08143	77	1.34390	0.21739	1.24503	0.1848	5.9	0.17461
38	0.66323	0.05448	0.65114	0.0238	0.8	0.08367	78	1.36136	0.22285	1.25864	0.1916	6.1	0.17706
39	0.68068	0.05736	0.66761	0.0257	0.8	0.08592	79	1.37881	0.22838	1.27216	0.1986	6.3	0.17952
40	0.69813	0.06031	0.68404	0.0277	0.9	0.08816	80	1.39626	0.23396	1.28558	0.2057	6.5	0.18199

Segments of Circles for Radius = 1 (English or metric units) (Continued)

α , Deg.	l	h	c	Area A	$\frac{A}{\pi}$ %	h/c	α , Deg.	l	h	c	Area A	$\frac{A}{\pi}$ %	h/c
81	1.41372	0.23959	1.29890	0.2130	6.8	0.18446	131	2.28638	0.58531	1.81992	0.7658	24.4	0.32161
82	1.43117	0.24529	1.31212	0.2205	7.0	0.18694	132	2.30383	0.59326	1.82709	0.7803	24.8	0.32470
83	1.44862	0.25104	1.32524	0.2280	7.3	0.18943	133	2.32129	0.60125	1.83412	0.7950	25.3	0.32781
84	1.46608	0.25686	1.33826	0.2358	7.5	0.19193	134	2.33874	0.60927	1.84101	0.8097	25.8	0.33094
85	1.48353	0.26272	1.35118	0.2437	7.8	0.19444	135	2.35619	0.61732	1.84776	0.8245	26.2	0.33409
86	1.50098	0.26865	1.36400	0.2517	8.0	0.19696	136	2.37365	0.62539	1.85437	0.8395	26.7	0.33725
87	1.51844	0.27463	1.37671	0.2599	8.3	0.19948	137	2.39110	0.63350	1.86084	0.8546	27.2	0.34044
88	1.53589	0.28066	1.38932	0.2682	8.5	0.20201	138	2.40855	0.64163	1.86716	0.8697	27.7	0.34364
89	1.55334	0.28675	1.40182	0.2767	8.8	0.20456	139	2.42601	0.64979	1.87334	0.8850	28.2	0.34686
90	1.57080	0.29289	1.41421	0.2854	9.1	0.20711	140	2.44346	0.65798	1.87939	0.9003	28.7	0.35010
91	1.58825	0.29909	1.42650	0.2942	9.4	0.20967	141	2.46091	0.66619	1.88528	0.9158	29.2	0.35337
92	1.60570	0.30534	1.43868	0.3032	9.7	0.21224	142	2.47837	0.67443	1.89104	0.9314	29.6	0.35665
93	1.62316	0.31165	1.45075	0.3123	9.9	0.21482	143	2.49582	0.68270	1.89665	0.9470	30.1	0.35995
94	1.64061	0.31800	1.46271	0.3215	10.2	0.21741	144	2.51327	0.69098	1.90211	0.9627	30.6	0.36327
95	1.65806	0.32441	1.47455	0.3309	10.5	0.22001	145	2.53073	0.69929	1.90743	0.9786	31.1	0.36662
96	1.67552	0.33087	1.48629	0.3405	10.8	0.22261	146	2.54818	0.70763	1.91261	0.9945	31.7	0.36998
97	1.69297	0.33738	1.49791	0.3502	11.1	0.22523	147	2.56563	0.71598	1.91764	1.0105	32.2	0.37337
98	1.71042	0.34394	1.50942	0.3601	11.5	0.22786	148	2.58309	0.72436	1.92252	1.0266	32.7	0.37678
99	1.72788	0.35055	1.52081	0.3701	11.8	0.23050	149	2.60054	0.73276	1.92726	1.0428	33.2	0.38021
100	1.74533	0.35721	1.53209	0.3803	12.1	0.23315	150	2.61799	0.74118	1.93185	1.0590	33.7	0.38366
101	1.76278	0.36392	1.54325	0.3906	12.4	0.23582	151	2.63545	0.74962	1.93630	1.0753	34.2	0.38714
102	1.78024	0.37068	1.55429	0.4010	12.8	0.23849	152	2.65290	0.75808	1.94059	1.0917	34.7	0.39064
103	1.79769	0.37749	1.56522	0.4117	13.1	0.24117	153	2.67035	0.76655	1.94474	1.1082	35.3	0.39417
104	1.81514	0.38434	1.57602	0.4224	13.4	0.24387	154	2.68781	0.77505	1.94874	1.1247	35.8	0.39772
105	1.83260	0.39124	1.58671	0.4333	13.8	0.24657	155	2.70526	0.78356	1.95259	1.1413	36.3	0.40129
106	1.85005	0.39818	1.59727	0.4444	14.1	0.24929	156	2.72271	0.79209	1.95630	1.1580	36.9	0.40489
107	1.86750	0.40518	1.60771	0.4556	14.5	0.25202	157	2.74017	0.80063	1.95985	1.1747	37.4	0.40852
108	1.88496	0.41221	1.61803	0.4669	14.9	0.25476	158	2.75762	0.80919	1.96325	1.1915	37.9	0.41217
109	1.90241	0.41930	1.62823	0.4784	15.2	0.25752	159	2.77507	0.81776	1.96651	1.2084	38.5	0.41585
110	1.91986	0.42642	1.63830	0.4901	15.6	0.26028	160	2.79253	0.82635	1.96962	1.2253	39.0	0.41955
111	1.93732	0.43359	1.64825	0.5019	16.0	0.26306	161	2.80998	0.83495	1.97257	1.2422	39.5	0.42328
112	1.95477	0.44081	1.65808	0.5138	16.4	0.26585	162	2.82743	0.84357	1.97538	1.2592	40.1	0.42704
113	1.97222	0.44806	1.66777	0.5259	16.7	0.26866	163	2.84489	0.85219	1.97803	1.2763	40.6	0.43083
114	1.98968	0.45536	1.67734	0.5381	17.1	0.27148	164	2.86234	0.86083	1.98054	1.2934	41.2	0.43464
115	2.00713	0.46270	1.68678	0.5504	17.5	0.27431	165	2.87979	0.86947	1.98289	1.3105	41.7	0.43849
116	2.02458	0.47008	1.69610	0.5629	17.9	0.27715	166	2.89725	0.87813	1.98509	1.3277	42.3	0.44236
117	2.04204	0.47750	1.70528	0.5755	18.3	0.28001	167	2.91470	0.88680	1.98714	1.3449	42.8	0.44627
118	2.05949	0.48496	1.71433	0.5883	18.7	0.28289	168	2.93215	0.89547	1.98904	1.3621	43.4	0.45020
119	2.07694	0.49246	1.72326	0.6012	19.1	0.28577	169	2.94961	0.90415	1.99079	1.3794	43.9	0.45417
120	2.09440	0.50000	1.73205	0.6142	19.6	0.28868	170	2.96706	0.91284	1.99239	1.3967	44.5	0.45817
121	2.11185	0.50758	1.74071	0.6273	20.0	0.29159	171	2.98451	0.92154	1.99383	1.4140	45.0	0.46220
122	2.12930	0.51519	1.74924	0.6406	20.4	0.29452	172	3.00197	0.93024	1.99513	1.4314	45.6	0.46626
123	2.14675	0.52284	1.75763	0.6540	20.8	0.29747	173	3.01942	0.93895	1.99627	1.4488	46.1	0.47035
124	2.16421	0.53053	1.76590	0.6676	21.3	0.30043	174	3.03687	0.94766	1.99726	1.4662	46.7	0.47448
125	2.18166	0.53825	1.77402	0.6813	21.7	0.30341	175	3.05433	0.95638	1.99810	1.4836	47.2	0.47865
126	2.19911	0.54601	1.78201	0.6950	22.1	0.30640	176	3.07178	0.96510	1.99878	1.5010	47.8	0.48284
127	2.21657	0.55380	1.78987	0.7090	22.6	0.30941	177	3.08923	0.97382	1.99931	1.5184	48.3	0.48708
128	2.23402	0.56163	1.79759	0.7230	23.0	0.31243	178	3.10669	0.98255	1.99970	1.5359	48.9	0.49135
129	2.25147	0.56949	1.80517	0.7372	23.5	0.31548	179	3.12414	0.99127	1.99992	1.5533	49.4	0.49566
130	2.26893	0.57738	1.81262	0.7514	23.9	0.31854	180	3.14159	1.00000	2.00000	1.5708	50.0	0.50000

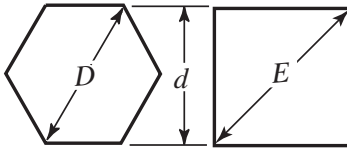
Diameters of Circles and Sides of Squares of Equal Area (English or metric units)



The table below will be found useful for determining the diameter of a circle of an area equal to that of a square, the side of which is known, or for determining the side of a square which has an area equal to that of a circle, the area or diameter of which is known. For example, if the diameter of a circle is $17\frac{1}{2}$ inches, it is found from the table that the side of a square of the same area is 15.51 inches.

Dia. of Circle, D	Side of Square, S	Area of Circle or Square	Dia. of Circle, D	Side of Square, S	Area of Circle or Square	Dia. of Circle, D	Side of Square, S	Area of Circle or Square
$\frac{1}{2}$	0.44	0.196	$20\frac{1}{2}$	18.17	330.06	$40\frac{1}{2}$	35.89	1288.25
1	0.89	0.785	21	18.61	346.36	41	36.34	1320.25
$1\frac{1}{2}$	1.33	1.767	$21\frac{1}{2}$	19.05	363.05	$41\frac{1}{2}$	36.78	1352.65
2	1.77	3.142	22	19.50	380.13	42	37.22	1385.44
$2\frac{1}{2}$	2.22	4.909	$22\frac{1}{2}$	19.94	397.61	$42\frac{1}{2}$	37.66	1418.63
3	2.66	7.069	23	20.38	415.48	43	38.11	1452.20
$3\frac{1}{2}$	3.10	9.621	$23\frac{1}{2}$	20.83	433.74	$43\frac{1}{2}$	38.55	1486.17
4	3.54	12.566	24	21.27	452.39	44	38.99	1520.53
$4\frac{1}{2}$	3.99	15.904	$24\frac{1}{2}$	21.71	471.44	$44\frac{1}{2}$	39.44	1555.28
5	4.43	19.635	25	22.16	490.87	45	39.88	1590.43
$5\frac{1}{2}$	4.87	23.758	$25\frac{1}{2}$	22.60	510.71	$45\frac{1}{2}$	40.32	1625.97
6	5.32	28.274	26	23.04	530.93	46	40.77	1661.90
$6\frac{1}{2}$	5.76	33.183	$26\frac{1}{2}$	23.49	551.55	$46\frac{1}{2}$	41.21	1698.23
7	6.20	38.485	27	23.93	572.56	47	41.65	1734.94
$7\frac{1}{2}$	6.65	44.179	$27\frac{1}{2}$	24.37	593.96	$47\frac{1}{2}$	42.10	1772.05
8	7.09	50.265	28	24.81	615.75	48	42.54	1809.56
$8\frac{1}{2}$	7.53	56.745	$28\frac{1}{2}$	25.26	637.94	$48\frac{1}{2}$	42.98	1847.45
9	7.98	63.617	29	25.70	660.52	49	43.43	1885.74
$9\frac{1}{2}$	8.42	70.882	$29\frac{1}{2}$	26.14	683.49	$49\frac{1}{2}$	43.87	1924.42
10	8.86	78.540	30	26.59	706.86	50	44.31	1963.50
$10\frac{1}{2}$	9.31	86.590	$30\frac{1}{2}$	27.03	730.62	$50\frac{1}{2}$	44.75	2002.96
11	9.75	95.033	31	27.47	754.77	51	45.20	2042.82
$11\frac{1}{2}$	10.19	103.87	$31\frac{1}{2}$	27.92	779.31	$51\frac{1}{2}$	45.64	2083.07
12	10.63	113.10	32	28.36	804.25	52	46.08	2123.72
$12\frac{1}{2}$	11.08	122.72	$32\frac{1}{2}$	28.80	829.58	$52\frac{1}{2}$	46.53	2164.75
13	11.52	132.73	33	29.25	855.30	53	46.97	2206.18
$13\frac{1}{2}$	11.96	143.14	$33\frac{1}{2}$	29.69	881.41	$53\frac{1}{2}$	47.41	2248.01
14	12.41	153.94	34	30.13	907.92	54	47.86	2290.22
$14\frac{1}{2}$	12.85	165.13	$34\frac{1}{2}$	30.57	934.82	$54\frac{1}{2}$	48.30	2332.83
15	13.29	176.71	35	31.02	962.11	55	48.74	2375.83
$15\frac{1}{2}$	13.74	188.69	$35\frac{1}{2}$	31.46	989.80	$55\frac{1}{2}$	49.19	2419.22
16	14.18	201.06	36	31.90	1017.88	56	49.63	2463.01
$16\frac{1}{2}$	14.62	213.82	$36\frac{1}{2}$	32.35	1046.35	$56\frac{1}{2}$	50.07	2507.19
17	15.07	226.98	37	32.79	1075.21	57	50.51	2551.76
$17\frac{1}{2}$	15.51	240.53	$37\frac{1}{2}$	33.23	1104.47	$57\frac{1}{2}$	50.96	2596.72
18	15.95	254.47	38	33.68	1134.11	58	51.40	2642.08
$18\frac{1}{2}$	16.40	268.80	$38\frac{1}{2}$	34.12	1164.16	$58\frac{1}{2}$	51.84	2687.83
19	16.84	283.53	39	34.56	1194.59	59	52.29	2733.97
$19\frac{1}{2}$	17.28	298.65	$39\frac{1}{2}$	35.01	1225.42	$59\frac{1}{2}$	52.73	2780.51
20	17.72	314.16	40	35.45	1256.64	60	53.17	2827.43

Distance Across Corners of Squares and Hexagons.—The table below gives values of dimensions D and E described in the figures and equations that follow.



$$D = \frac{2\sqrt{3}}{3}d = 1.154701d$$

$$E = d\sqrt{2} = 1.414214d$$

A desired value not given directly in the table can be obtained directly from the equations above, or by the simple addition of two or more values taken directly from the table. Further values can be obtained by shifting the decimal point.

Example 1: Find D when $d = 2 \frac{5}{16}$ inches. From the table, for $d = 2$, $D = 2.3094$, and for $d = \frac{5}{16}$, $D = 0.3608$. Therefore, $D = 2.3094 + 0.3608 = 2.6702$ inches.

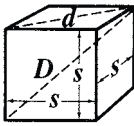
Example 2: Find E when $d = 20.25$ millimeters. From the table, for $d = 20$, $E = 28.2843$; for $d = 0.2$, $E = 0.2828$; and $d = 0.05$, $E = 0.0707$ (obtained by shifting the decimal point one place to the left at $d = 0.5$). Thus, $E = 28.2843 + 0.2828 + 0.0707 = 28.6378$ millimeters.

Distance Across Corners of Squares and Hexagons (English or metric units)

d	D	E	d	D	E	d	D	E	d	D	E
$\frac{1}{32}$	0.0361	0.0442	0.9	1.0392	1.2728	32	36.9504	45.2548	67	77.3650	94.7523
$\frac{1}{16}$	0.0722	0.0884	$\frac{29}{32}$	1.0464	1.2816	33	38.1051	46.6691	68	78.5197	96.1666
$\frac{3}{32}$	0.1083	0.1326	$\frac{15}{16}$	1.0825	1.3258	34	39.2598	48.0833	69	79.6744	97.5808
0.1	0.1155	0.1414	$\frac{31}{32}$	1.1186	1.3700	35	40.4145	49.4975	70	80.8291	98.9950
$\frac{1}{8}$	0.1443	0.1768	1.0	1.1547	1.4142	36	41.5692	50.9117	71	81.9838	100.409
$\frac{5}{32}$	0.1804	0.2210	2.0	2.3094	2.8284	37	42.7239	52.3259	72	83.1385	101.823
$\frac{3}{16}$	0.2165	0.2652	3.0	3.4641	4.2426	38	43.8786	53.7401	73	84.2932	103.238
0.2	0.2309	0.2828	4.0	4.6188	5.6569	39	45.0333	55.1543	74	85.4479	104.652
$\frac{7}{32}$	0.2526	0.3094	5.0	5.7735	7.0711	40	46.1880	56.5686	75	86.6026	106.066
$\frac{1}{4}$	0.2887	0.3536	6.0	6.9282	8.4853	41	47.3427	57.9828	76	87.7573	107.480
$\frac{9}{32}$	0.3248	0.3977	7.0	8.0829	9.8995	42	48.4974	59.3970	77	88.9120	108.894
0.3	0.3464	0.4243	8.0	9.2376	11.3137	43	49.6521	60.8112	78	90.0667	110.309
$\frac{5}{16}$	0.3608	0.4419	9.0	10.3923	12.7279	44	50.8068	62.2254	79	91.2214	111.723
$\frac{11}{32}$	0.3969	0.4861	10	11.5470	14.1421	45	51.9615	63.6396	80	92.3761	113.137
$\frac{3}{8}$	0.4330	0.5303	11	12.7017	15.5564	46	53.1162	65.0538	81	93.5308	114.551
0.4	0.4619	0.5657	12	13.8564	16.9706	47	54.2709	66.4681	82	94.6855	115.966
$\frac{13}{32}$	0.4691	0.5745	13	15.0111	18.3848	48	55.4256	67.8823	83	95.8402	117.380
$\frac{7}{16}$	0.5052	0.6187	14	16.1658	19.7990	49	56.5803	69.2965	84	96.9949	118.794
$\frac{15}{32}$	0.5413	0.6629	15	17.3205	21.2132	50	57.7351	70.7107	85	98.1496	120.208
0.5	0.5774	0.7071	16	18.4752	22.6274	51	58.8898	72.1249	86	99.3043	121.622
$\frac{17}{32}$	0.6134	0.7513	17	19.6299	24.0416	52	60.0445	73.5391	87	100.459	123.037
$\frac{9}{16}$	0.6495	0.7955	18	20.7846	25.4559	53	61.1992	74.9533	88	101.614	124.451
$\frac{19}{32}$	0.6856	0.8397	19	21.9393	26.8701	54	62.3539	76.3676	89	102.768	125.865
0.6	0.6928	0.8485	20	23.0940	28.2843	55	63.5086	77.7818	90	103.923	127.279
$\frac{5}{8}$	0.7217	0.8839	21	24.2487	29.6985	56	64.6633	79.1960	91	105.078	128.693
$\frac{21}{32}$	0.7578	0.9281	22	25.4034	31.1127	57	65.8180	80.6102	92	106.232	130.108
$\frac{11}{16}$	0.7939	0.9723	23	26.5581	32.5269	58	66.9727	82.0244	93	107.387	131.522
0.7	0.8083	0.9899	24	27.7128	33.9411	59	68.1274	83.4386	94	108.542	132.936
$\frac{23}{32}$	0.8299	1.0165	25	28.8675	35.3554	60	69.2821	84.8528	95	109.697	134.350
$\frac{3}{4}$	0.8660	1.0607	26	30.0222	36.7696	61	70.4368	86.2671	96	110.851	135.765
$\frac{25}{32}$	0.9021	1.1049	27	31.1769	38.1838	62	71.5915	87.6813	97	112.006	137.179
0.8	0.9238	1.1314	28	32.3316	39.5980	63	72.7462	89.0955	98	113.161	138.593
$\frac{13}{16}$	0.9382	1.1490	29	33.4863	41.0122	64	73.9009	90.5097	99	114.315	140.007
$\frac{27}{32}$	0.9743	1.1932	30	34.6410	42.4264	65	75.0556	91.9239	100	115.470	141.421
$\frac{7}{8}$	1.0104	1.2374	31	35.7957	43.8406	66	76.2103	93.3381

Volumes of Solids

Cube:



$$\text{Diagonal of cube face} = d = s\sqrt{2}$$

$$\text{Diagonal of cube} = D = \sqrt{\frac{3d^2}{2}} = s\sqrt{3} = 1.732s$$

$$\text{Volume} = V = s^3$$

$$s = \sqrt[3]{V}$$

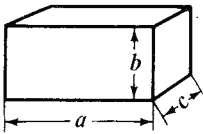
Example: The side of a cube equals 9.5 centimeters. Find its volume.

$$\text{Volume} = V = s^3 = 9.5^3 = 9.5 \times 9.5 \times 9.5 = 857.375 \text{ cubic centimeters}$$

Example: The volume of a cube is 231 cubic centimeters. What is the length of the side?

$$s = \sqrt[3]{V} = \sqrt[3]{231} = 6.136 \text{ centimeters}$$

Square Prism:



$$\text{Volume} = V = abc$$

$$a = \frac{V}{bc} \quad b = \frac{V}{ac} \quad c = \frac{V}{ab}$$

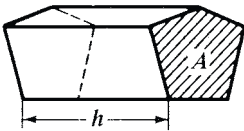
Example: In a square prism, $a = 6$, $b = 5$, $c = 4$. Find the volume.

$$V = a \times b \times c = 6 \times 5 \times 4 = 120 \text{ cubic inches}$$

Example: How high should a box be made to contain 25 cubic feet, if it is 4 feet long and $2\frac{1}{2}$ feet wide? Here, $a = 4$, $c = 2.5$, and $V = 25$. Then,

$$b = \text{depth} = \frac{V}{ac} = \frac{25}{4 \times 2.5} = \frac{25}{10} = 2.5 \text{ feet}$$

Prism:



$V = \text{volume}$

$A = \text{area of end surface}$

$$V = h \times A$$

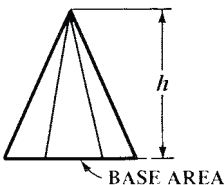
The area A of the end surface is found by the formulas for areas of plane figures on the preceding pages. Height h must be measured perpendicular to the end surface.

Example: A prism, having for its base a regular hexagon with a side s of 7.5 centimeters, is 25 centimeters high. Find the volume.

$$\text{Area of hexagon} = A = 2.598s^2 = 2.598 \times 56.25 = 146.14 \text{ square centimeters}$$

$$\text{Volume of prism} = h \times A = 25 \times 146.14 = 3653.5 \text{ cubic centimeters}$$

Pyramid:



$$\text{Volume} = V = \frac{1}{3}h \times \text{area of base}$$

If the base is a regular polygon with n sides, and $s = \text{length of side}$, $r = \text{radius of inscribed circle}$, and $R = \text{radius of circumscribed circle}$, then:

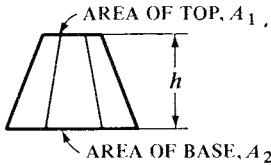
$$V = \frac{nsrh}{6} = \frac{ns}{6}h \sqrt{R^2 - \frac{s^2}{4}}$$

Example: A pyramid, having a height of 9 feet, has a base formed by a rectangle, the sides of which are 2 and 3 feet, respectively. Find the volume.

$$\text{Area of base} = 2 \times 3 = 6 \text{ square feet; } h = 9 \text{ feet}$$

$$\text{Volume} = V = \frac{1}{3}h \times \text{area of base} = \frac{1}{3} \times 9 \times 6 = 18 \text{ cubic feet}$$

Frustum of Pyramid:



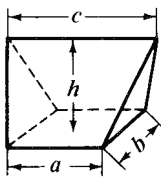
$$\text{Volume} = V = \frac{h}{3}(A_1 + A_2 + \sqrt{A_1 \times A_2})$$

Example: The pyramid in the previous example is cut off $4\frac{1}{2}$ feet from the base, the upper part being removed. The sides of the rectangle forming the top surface of the frustum are, then, 1 and $1\frac{1}{2}$ feet long, respectively. Find the volume of the frustum.

$$\text{Area of top} = A_1 = 1 \times 1\frac{1}{2} = 1\frac{1}{2} \text{ sq. ft.} \quad \text{Area of base} = A_2 = 2 \times 3 = 6 \text{ sq. ft.}$$

$$V = \frac{4.5}{3}(1.5 + 6 + \sqrt{1.5 \times 6}) = 1.5(7.5 + \sqrt{9}) = 1.5 \times 10.5 = 15.75 \text{ cubic feet}$$

Wedge:

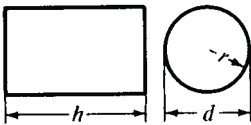


$$\text{Volume} = V = \frac{(2a + c)bh}{6}$$

Example: Let $a = 4$ inches, $b = 3$ inches, and $c = 5$ inches. The height $h = 4.5$ inches. Find the volume.

$$V = \frac{(2a + c)bh}{6} = \frac{(2 \times 4 + 5) \times 3 \times 4.5}{6} = \frac{(8 + 5) \times 13.5}{6} = \frac{175.5}{6} = 29.25 \text{ cubic inches}$$

Cylinder:



$$\text{Volume} = V = 3.1416r^2h = 0.7854d^2h$$

$$\text{Area of cylindrical surface} = S = 6.2832rh = 3.1416dh$$

Total area A of cylindrical surface and end surfaces:

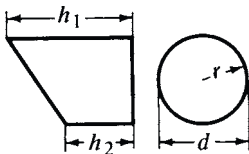
$$A = 6.2832r(r + h) = 3.1416d(\frac{1}{2}d + h)$$

Example: The diameter of a cylinder is 2.5 inches. The length or height is 20 inches. Find the volume and the area of the cylindrical surface S .

$$V = 0.7854d^2h = 0.7854 \times 2.5^2 \times 20 = 0.7854 \times 6.25 \times 20 = 98.17 \text{ cubic inches}$$

$$S = 3.1416dh = 3.1416 \times 2.5 \times 20 = 157.08 \text{ square inches}$$

Portion of Cylinder:



$$\text{Volume} = V = 1.5708r^2(h_1 + h_2)$$

$$= 0.3927d^2(h_1 + h_2)$$

$$\text{Cylindrical surface area} = S = 3.1416r(h_1 + h_2)$$

$$= 1.5708d(h_1 + h_2)$$

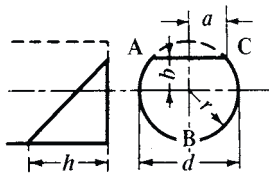
Example: A cylinder 125 millimeters in diameter is cut off at an angle, as shown in the illustration. Dimension $h_1 = 150$, and $h_2 = 100$ mm. Find the volume and the area S of the cylindrical surface.

$$V = 0.3927d^2(h_1 + h_2) = 0.3927 \times 125^2 \times (150 + 100)$$

$$= 0.3927 \times 15,625 \times 250 = 1,533,984 \text{ cubic millimeters} = 1534 \text{ cm}^3$$

$$S = 1.5708d(h_1 + h_2) = 1.5708 \times 125 \times 250$$

$$= 49,087.5 \text{ square millimeters} = 490.9 \text{ square centimeters}$$

Portion of Cylinder:

$$\text{Volume} = V = \left(\frac{2}{3}a^3 \pm b \times \text{area } ABC\right) \frac{h}{r \pm b}$$

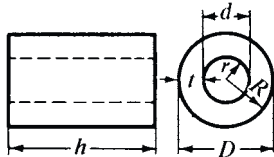
$$\text{Cylindrical surface area} = S = (ad \pm b \times \text{length of arc } ABC) \frac{h}{r \pm b}$$

Use + when base area is larger, and – when base area is less than one-half the base circle.

Example: Find the volume of a cylinder so cut off that line AC passes through the center of the base circle — that is, the base area is a half-circle. The diameter of the cylinder = 5 inches, and the height $h = 2$ inches.

In this case, $a = 2.5$; $b = 0$; $\text{area } ABC = 0.5 \times 0.7854 \times 5^2 = 9.82$; $r = 2.5$.

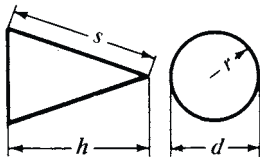
$$V = \left(\frac{2}{3} \times 2.5^3 + 0 \times 9.82\right) \frac{2}{2.5 + 0} = \frac{2}{3} \times 15.625 \times 0.8 = 8.33 \text{ cubic inches}$$

Hollow Cylinder:

$$\begin{aligned} \text{Volume} = V &= 3.1416h(R^2 - r^2) = 0.7854h(D^2 - d^2) \\ &= 3.1416ht(2R - t) = 3.1416ht(D - t) \\ &= 3.1416ht(2r + t) = 3.1416ht(d + t) \\ &= 3.1416ht(R + r) = 1.5708ht(D + d) \end{aligned}$$

Example: A cylindrical shell, 28 centimeters high, is 36 centimeters in outside diameter, and 4 centimeters thick. Find its volume.

$$\begin{aligned} V &= 3.1416ht(D - t) = 3.1416 \times 28 \times 4(36 - 4) = 3.1416 \times 28 \times 4 \times 32 \\ &= 11,259.5 \text{ cubic centimeters} \end{aligned}$$

Cone:

$$\text{Volume} = V = \frac{3.1416r^2h}{3} = 1.0472r^2h = 0.2618d^2h$$

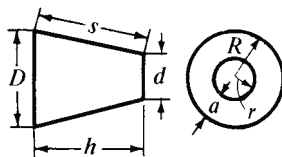
$$\begin{aligned} \text{Conical surface area} = A &= 3.1416r\sqrt{r^2 + h^2} = 3.1416rs \\ &= 1.5708ds \end{aligned}$$

$$s = \sqrt{r^2 + h^2} = \sqrt{\frac{d^2}{4} + h^2}$$

Example: Find the volume and area of the conical surface of a cone, the base of which is a circle of 6 inches diameter, and the height of which is 4 inches.

$$V = 0.2618d^2h = 0.2618 \times 6^2 \times 4 = 0.2618 \times 36 \times 4 = 37.7 \text{ cubic inches}$$

$$\begin{aligned} A &= 3.1416r\sqrt{r^2 + h^2} = 3.1416 \times 3 \times \sqrt{3^2 + 4^2} = 9.4248 \times \sqrt{25} \\ &= 47.124 \text{ square inches} \end{aligned}$$

Frustum of Cone:

$$V = \text{volume} \quad A = \text{area of conical surface}$$

$$V = 1.0472h(R^2 + Rr + r^2) = 0.2618h(D^2 + Dd + d^2)$$

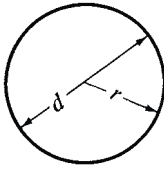
$$A = 3.1416s(R + r) = 1.5708s(D + d)$$

$$a = R - r \quad s = \sqrt{a^2 + h^2} = \sqrt{(R - r)^2 + h^2}$$

Example: Find the volume of a frustum of a cone of the following dimensions: $D = 8$ centimeters; $d = 4$ centimeters; $h = 5$ centimeters.

$$\begin{aligned} V &= 0.2618 \times 5(8^2 + 8 \times 4 + 4^2) = 0.2618 \times 5(64 + 32 + 16) \\ &= 0.2618 \times 5 \times 112 = 146.61 \text{ cubic centimeters} \end{aligned}$$

Sphere:



$$\text{Volume} = V = \frac{4\pi r^3}{3} = \frac{\pi d^3}{6} = 4.1888r^3 = 0.5236d^3$$

$$\text{Surface area} = A = 4\pi r^2 = \pi d^2 = 12.5664r^2 = 3.1416d^2$$

$$r = \sqrt[3]{\frac{3V}{4\pi}} = 0.6204\sqrt[3]{V}$$

Example: Find the volume and the surface of a sphere 6.5 centimeters diameter.

$$V = 0.5236d^3 = 0.5236 \times 6.5^3 = 0.5236 \times 6.5 \times 6.5 \times 6.5 = 143.79 \text{ cm}^3$$

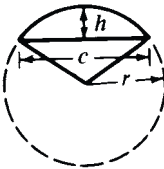
$$A = 3.1416d^2 = 3.1416 \times 6.5^2 = 3.1416 \times 6.5 \times 6.5 = 132.73 \text{ cm}^2$$

Example: The volume of a sphere is 64 cubic centimeters. Find its radius.

$$r = 0.6204\sqrt[3]{64} = 0.6204 \times 4 = 2.4816 \text{ centimeters}$$



Spherical Sector:



$$V = \frac{2\pi r^2 h}{3} = 2.0944r^2 h = \text{Volume}$$

$$A = 3.1416r(2h + \frac{1}{2}c)$$

= total area of conical and spherical surface

$$c = 2\sqrt{h(2r - h)}$$

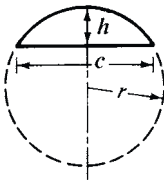
Example: Find the volume of a sector of a sphere 6 inches in diameter, the height h of the sector being 1.5 inch. Also find the length of chord c . Here $r = 3$ and $h = 1.5$.

$$V = 2.0944r^2 h = 2.0944 \times 3^2 \times 1.5 = 2.0944 \times 9 \times 1.5 = 28.27 \text{ cubic inches}$$

$$c = 2\sqrt{h(2r - h)} = 2\sqrt{1.5(2 \times 3 - 1.5)} = 2\sqrt{6.75} = 2 \times 2.598 = 5.196 \text{ inches}$$



Spherical Segment:



$V = \text{volume}$ $A = \text{area of spherical surface}$

$$V = 3.1416h^2\left(r - \frac{h}{3}\right) = 3.1416h\left(\frac{c^2}{8} + \frac{h^2}{6}\right)$$

$$A = 2\pi rh = 6.2832rh = 3.1416\left(\frac{c^2}{4} + h^2\right)$$

$$c = 2\sqrt{h(2r - h)}; \quad r = \frac{c^2 + 4h^2}{8h}$$

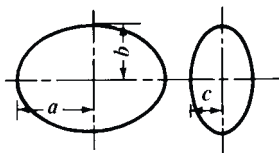
Example: A segment of a sphere has the following dimensions: $h = 50$ millimeters; $c = 125$ millimeters. Find the volume V and the radius of the sphere of which the segment is a part.

$$V = 3.1416 \times 50 \times \left(\frac{125^2}{8} + \frac{50^2}{6}\right) = 157.08 \times \left(\frac{15,625}{8} + \frac{2500}{6}\right) = 372,247 \text{ mm}^3 = 372 \text{ cm}^3$$

$$r = \frac{125^2 + 4 \times 50^2}{8 \times 50} = \frac{15,625 + 10,000}{400} = \frac{25,625}{400} = 64 \text{ millimeters}$$



Ellipsoid:



$$\text{Volume} = V = \frac{4\pi}{3} abc = 4.1888abc$$

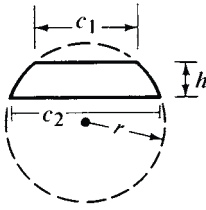
In an ellipsoid of revolution, or spheroid, where $c = b$:

$$V = 4.1888ab^2$$

Example: Find the volume of a spheroid in which $a = 5$, and $b = c = 1.5$ inches.

$$V = 4.1888 \times 5 \times 1.5^2 = 47.124 \text{ cubic inches}$$



Spherical Zone:

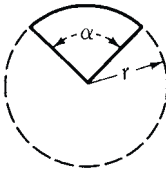
$$\text{Volume} = V = 0.5236h \left(\frac{3c_1^2}{4} + \frac{3c_2^2}{4} + h^2 \right)$$

$$A = 2\pi rh = 6.2832rh = \text{area of spherical surface}$$

$$r = \sqrt{\frac{c_2^2}{4} + \left(\frac{c_2^2 - c_1^2 - 4h^2}{8h} \right)^2}$$

Example: In a spherical zone, let $c_1 = 3$; $c_2 = 4$; and $h = 1.5$ inch. Find the volume.

$$V = 0.5236 \times 1.5 \times \left(\frac{3 \times 3^2}{4} + \frac{3 \times 4^2}{4} + 1.5^2 \right) = 0.5236 \times 1.5 \times \left(\frac{27}{4} + \frac{48}{4} + 2.25 \right) = 16.493 \text{ in}^3$$

Spherical Wedge:

$V = \text{volume}$ $A = \text{area of spherical surface}$

$\alpha = \text{center angle in degrees}$

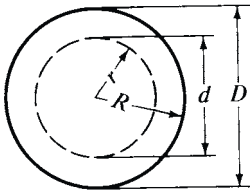
$$V = \frac{\alpha}{360} \times \frac{4\pi r^3}{3} = 0.0116\alpha r^3$$

$$A = \frac{\alpha}{360} \times 4\pi r^2 = 0.0349\alpha r^2$$

Example: Find the area of the spherical surface and the volume of a wedge of a sphere. The diameter of the sphere is 100 millimeters, and the center angle α is 45 degrees.

$$V = 0.0116 \times 45 \times 50^3 = 0.0116 \times 45 \times 125,000 = 65,250 \text{ mm}^3 = 65.25 \text{ cm}^3$$

$$A = 0.0349 \times 45 \times 50^2 = 3926.25 \text{ square millimeters} = 39.26 \text{ cm}^2$$

Hollow Sphere:

$V = \text{volume of material used}$
to make a hollow sphere

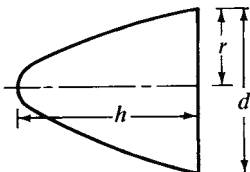
$$V = \frac{4\pi}{3}(R^3 - r^3) = 4.1888(R^3 - r^3)$$

$$= \frac{\pi}{6}(D^3 - d^3) = 0.5236(D^3 - d^3)$$

Example: Find the volume of a hollow sphere, 8 inches in outside diameter, with a thickness of material of 1.5 inch.

Here $R = 4$; $r = 4 - 1.5 = 2.5$.

$$V = 4.1888(4^3 - 2.5^3) = 4.1888(64 - 15.625) = 4.1888 \times 48.375 = 202.63 \text{ cubic inches}$$

Paraboloid:

$$\text{Volume} = V = \frac{1}{2}\pi r^2 h = 0.3927d^2 h$$

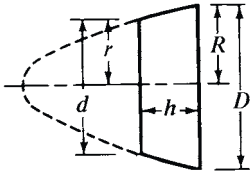
$$\text{Area} = A = \frac{2\pi}{3p} \left[\sqrt{\left(\frac{d^2}{4} + p^2 \right)^3} - p^3 \right]$$

$$\text{in which } p = \frac{d^2}{8h}$$

Example: Find the volume of a paraboloid in which $h = 300$ millimeters and $d = 125$ millimeters.

$$V = 0.3927d^2 h = 0.3927 \times 125^2 \times 300 = 1,840,781 \text{ mm}^3 = 1,840.8 \text{ cm}^3$$

Paraboloidal Segment:



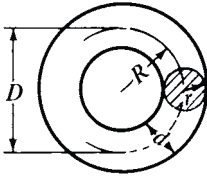
$$\begin{aligned} \text{Volume} = V &= \frac{\pi}{2}h(R^2 + r^2) = 1.5708h(R^2 + r^2) \\ &= \frac{\pi}{8}h(D^2 + d^2) = 0.3927h(D^2 + d^2) \end{aligned}$$

Example: Find the volume of a segment of a paraboloid in which $D = 5$ inches, $d = 3$ inches, and $h = 6$ inches.

$$\begin{aligned} V &= 0.3927h(D^2 + d^2) = 0.3927 \times 6 \times (5^2 + 3^2) \\ &= 0.3927 \times 6 \times 34 = 80.11 \text{ cubic inches} \end{aligned}$$



Torus:



$$\begin{aligned} \text{Volume} = V &= 2\pi^2 Rr^2 = 19.739Rr^2 \\ &= \frac{\pi^2}{4}Dd^2 = 2.4674Dd^2 \end{aligned}$$

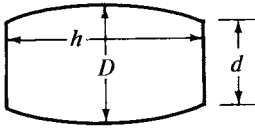
$$\begin{aligned} \text{Area of surface} = A &= 4\pi^2 Rr = 39.478Rr \\ &= \pi^2 Dd = 9.8696Dd \end{aligned}$$

Example: Find the volume and area of surface of a torus in which $d = 1.5$ and $D = 5$ inches.

$$\begin{aligned} V &= 2.4674 \times 5 \times 1.5^2 = 2.4674 \times 5 \times 2.25 = 27.76 \text{ cubic inches} \\ A &= 9.8696 \times 5 \times 1.5 = 74.022 \text{ square inches} \end{aligned}$$



Barrel:



$V =$ approximate volume.

If the sides are bent to the arc of a circle:

$$V = \frac{1}{12}\pi h(2D^2 + d^2) = 0.262h(2D^2 + d^2)$$

If the sides are bent to the arc of a parabola:

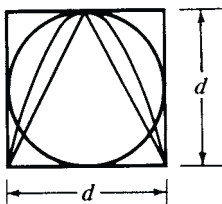
$$V = 0.209h(2D^2 + Dd + \frac{3}{4}d^2)$$

Example: Find the approximate contents of a barrel, the inside dimensions of which are $D = 60$ centimeters, $d = 50$ centimeters; $h = 120$ centimeters.

$$\begin{aligned} V &= 0.262h(2D^2 + d^2) = 0.262 \times 120 \times (2 \times 60^2 + 50^2) \\ &= 0.262 \times 120 \times (7200 + 2500) = 0.262 \times 120 \times 9700 \\ &= 304,968 \text{ cubic centimeters} = 0.305 \text{ cubic meter} \end{aligned}$$



Ratio of Volumes:



If $d =$ base diameter and height of a cone, a paraboloid and a cylinder, and the diameter of a sphere, then the volumes of these bodies are to each other as follows:

$$\text{Cone:paraboloid:sphere:cylinder} = \frac{1}{3} : \frac{1}{2} : \frac{2}{3} : 1$$

Example: Assume, as an example, that the diameter of the base of a cone, paraboloid, and cylinder is 2 inches, that the height is 2 inches, and that the diameter of a sphere is 2 inches. Then the volumes, written in formula form, are as follows:

$$\frac{3.1416 \times 2^2 \times 2}{12} : \frac{3.1416 \times (2p)^2 \times 2}{8} : \frac{3.1416 \times 2^3}{6} : \frac{3.1416 \times 2^2 \times 2}{4} = \frac{1}{3} : \frac{1}{2} : \frac{2}{3} : 1$$



Packing Circles in Circles and Rectangles

Diameter of Circle Enclosing a Given Number of Smaller Circles.—Four of many possible compact arrangements of circles within a circle are shown at A, B, C, and D in Fig. 1. To determine the diameter of the smallest enclosing circle for a particular number of enclosed circles all of the same size, three factors that influence the size of the enclosing circle should be considered. These are discussed in the paragraphs that follow, which are based on the article “How Many Wires Can Be Packed into a Circular Conduit,” by Jacques Dutka, *Machinery*, October 1956.

1) *Arrangement of Center or Core Circles:* The four most common arrangements of center or core circles are shown cross-sectioned in Fig. 1. It may seem, offhand, that the “A” pattern would require the smallest enclosing circle for a given number of enclosed circles but this is not always the case since the most compact arrangement will, in part, depend on the number of circles to be enclosed.

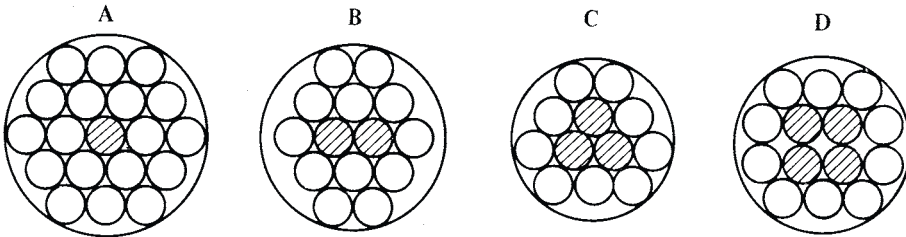


Fig. 1. Arrangements of Circles within a Circle

2) *Diameter of Enclosing Circle When Outer Layer of Circles Is Complete:* Successive, complete “layers” of circles may be placed around each of the central cores, Fig. 1, of 1, 2, 3, or 4 circles as the case may be. The number of circles contained in arrangements of complete “layers” around a central core of circles, as well as the diameter of the enclosing circle, may be obtained using the data in Table 1. Thus, for example, the “A” pattern in Fig. 1 shows, by actual count, a total of 19 circles arranged in two complete “layers” around a central core consisting of one circle; this agrees with the data shown in the left half of Table 1 for $n = 2$.

To determine the diameter of the enclosing circle, the data in the right half of Table 1 is used. Thus, for $n = 2$ and an “A” pattern, the diameter D is 5 times the diameter d of the enclosed circles.

3) *Diameter of Enclosing Circle When Outer Layer of Circles Is Not Complete:* In most cases, it is possible to reduce the size of the enclosing circle from that required if the outer layer were complete. Thus, for example, the “B” pattern in Fig. 1 shows that the central core consisting of 2 circles is surrounded by 1 complete layer of 8 circles and 1 partial, outer layer of 4 circles, so that the total number of circles enclosed is 14. If the outer layer were complete, then (from Table 1) the total number of enclosed circles would be 24 and the diameter of the enclosing circle would be $6d$; however, since the outer layer is composed of only 4 circles out of a possible 14 for a complete second layer, a smaller diameter of enclosing circle may be used. Table 2 shows that for a total of 14 enclosed circles arranged in a “B” pattern with the outer layer of circles incomplete, the diameter for the enclosing circle is $4.606d$.

Table 2 can be used to determine the smallest enclosing circle for a given number of circles to be enclosed by direct comparison of the “A,” “B,” and “C” columns. For data outside the range of Table 2, use the formulas in Dr. Dutka’s article.

Table 1. Number of Circles Contained in Complete Layers of Circles and Diameter of Enclosing Circle (English or metric units)



No. Complete Layers Over Core, <i>n</i>	Number of Circles in Center Pattern							
	1	2	3	4	1	2	3	4
	Arrangement of Circles in Center Pattern (see Fig. 1)							
	“A”	“B”	“C”	“D”	“A”	“B”	“C”	“D”
Number of Circles, <i>N</i> , Enclosed				Diameter, <i>D</i> , of Enclosing Circle ^a				
0	1	2	3	4	<i>d</i>	2 <i>d</i>	2.155 <i>d</i>	2.414 <i>d</i>
1	7	10	12	14	3 <i>d</i>	4 <i>d</i>	4.055 <i>d</i>	4.386 <i>d</i>
2	19	24	27	30	5 <i>d</i>	6 <i>d</i>	6.033 <i>d</i>	6.379 <i>d</i>
3	37	44	48	52	7 <i>d</i>	8 <i>d</i>	8.024 <i>d</i>	8.375 <i>d</i>
4	61	70	75	80	9 <i>d</i>	10 <i>d</i>	10.018 <i>d</i>	10.373 <i>d</i>
5	91	102	108	114	11 <i>d</i>	12 <i>d</i>	12.015 <i>d</i>	12.372 <i>d</i>
<i>n</i>	<i>b</i>	<i>b</i>	<i>b</i>	<i>b</i>	<i>b</i>	<i>b</i>	<i>b</i>	<i>b</i>

^aDiameter *D* is given in terms of *d*, the diameter of the enclosed circles.

^bFor *n* complete layers over core, the number of enclosed circles *N* for the “A” center pattern is $3n^2 + 3n + 1$; for “B,” $3n^2 + 5n + 2$; for “C,” $3n^2 + 6n + 3$; for “D,” $3n^2 + 7n + 4$. The diameter *D* of the enclosing circle for “A” center pattern is $(2n + 1)d$; for “B,” $(2n + 2)d$; for “C,” $(1 + 2\sqrt{n^2 + n + \frac{1}{2}})d$ and for “D,” $(1 + \sqrt{4n^2 + 5.644n + 2})d$.

Table 2. Factors for Determining Diameter, *D*, of Smallest Enclosing Circle for Various Numbers, *N*, of Enclosed Circles (English or metric units)

No. <i>N</i>	Center Circle Pattern			No. <i>N</i>	Center Circle Pattern			No. <i>N</i>	Center Circle Pattern		
	“A”	“B”	“C”		“A”	“B”	“C”		“A”	“B”	“C”
	Diameter Factor <i>K</i>				Diameter Factor <i>K</i>				Diameter Factor <i>K</i>		
2	3	2	...	34	7.001	7.083	7.111	66	9.718	9.545	9.327
3	3	2.733	2.155	35	7.001	7.245	7.111	67	9.718	9.545	9.327
4	3	2.733	3.310	36	7.001	7.245	7.111	68	9.718	9.545	9.327
5	3	3.646	3.310	37	7.001	7.245	7.430	69	9.718	9.661	9.327
6	3	3.646	3.310	38	7.929	7.245	7.430	70	9.718	9.661	10.019
7	3	3.646	4.056	39	7.929	7.558	7.430	71	9.718	9.889	10.019
8	4.465	3.646	4.056	40	7.929	7.558	7.430	72	9.718	9.889	10.019
9	4.465	4	4.056	41	7.929	7.558	7.430	73	9.718	9.889	10.019
10	4.465	4	4.056	42	7.929	7.558	7.430	74	10.166	9.889	10.019
11	4.465	4.606	4.056	43	7.929	8.001	8.024	75	10.166	10	10.019
12	4.465	4.606	4.056	44	8.212	8.001	8.024	76	10.166	10	10.238
13	4.465	4.606	5.164	45	8.212	8.001	8.024	77	10.166	10.540	10.238
14	5	4.606	5.164	46	8.212	8.001	8.024	78	10.166	10.540	10.238
15	5	5.359	5.164	47	8.212	8.001	8.024	79	10.166	10.540	10.452
16	5	5.359	5.164	48	8.212	8.001	8.024	80	10.166	10.540	10.452
17	5	5.359	5.164	49	8.212	8.550	8.572	81	10.166	10.540	10.452
18	5	5.359	5.164	50	8.212	8.550	8.572	82	10.166	10.540	10.452
19	5	5.583	5.619	51	8.212	8.550	8.572	83	10.166	10.540	10.452
20	6.292	5.583	5.619	52	8.212	8.550	8.572	84	10.166	10.540	10.452
21	6.292	5.583	5.619	53	8.212	8.811	8.572	85	10.166	10.644	10.866
22	6.292	5.583	6.034	54	8.212	8.811	8.572	86	11	10.644	10.866
23	6.292	6.001	6.034	55	8.212	8.811	9.083	87	11	10.644	10.866
24	6.292	6.001	6.034	56	9.001	8.811	9.083	88	11	10.644	10.866
25	6.292	6.197	6.034	57	9.001	8.938	9.083	89	11	10.849	10.866
26	6.292	6.197	6.034	58	9.001	8.938	9.083	90	11	10.849	10.866
27	6.292	6.568	6.034	59	9.001	8.938	9.083	91	11	10.849	11.067
28	6.292	6.568	6.774	60	9.001	8.938	9.083	92	11.393	10.849	11.067
29	6.292	6.568	6.774	61	9.001	9.186	9.083	93	11.393	11.149	11.067
30	6.292	6.568	6.774	62	9.718	9.186	9.083	94	11.393	11.149	11.067
31	6.292	7.083	7.111	63	9.718	9.186	9.083	95	11.393	11.149	11.067
32	7.001	7.083	7.111	64	9.718	9.186	9.327	96	11.393	11.149	11.067
33	7.001	7.083	7.111	65	9.718	9.545	9.327	97	11.393	11.441	11.264

Table 2. (Continued) Factors for Determining Diameter, D , of Smallest Enclosing Circle for Various Numbers, N , of Enclosed Circles (English or metric units)

No. N	Center Circle Pattern			No. N	Center Circle Pattern			No. N	Center Circle Pattern		
	"A"	"B"	"C"		"A"	"B"	"C"		"A"	"B"	"C"
	Diameter Factor K				Diameter Factor K				Diameter Factor K		
98	11.584	11.441	11.264	153	14.115	14	14.013	208	16.100	16	16.144
99	11.584	11.441	11.264	154	14.115	14	14.013	209	16.100	16.133	16.144
100	11.584	11.441	11.264	155	14.115	14.077	14.013	210	16.100	16.133	16.144
101	11.584	11.536	11.264	156	14.115	14.077	14.013	211	16.100	16.133	16.144
102	11.584	11.536	11.264	157	14.115	14.077	14.317	212	16.621	16.133	16.144
103	11.584	11.536	12.016	158	14.115	14.077	14.317	213	16.621	16.395	16.144
104	11.584	11.536	12.016	159	14.115	14.229	14.317	214	16.621	16.395	16.276
105	11.584	11.817	12.016	160	14.115	14.229	14.317	215	16.621	16.395	16.276
106	11.584	11.817	12.016	161	14.115	14.229	14.317	216	16.621	16.395	16.276
107	11.584	11.817	12.016	162	14.115	14.229	14.317	217	16.621	16.525	16.276
108	11.584	11.817	12.016	163	14.115	14.454	14.317	218	16.621	16.525	16.276
109	11.584	12	12.016	164	14.857	14.454	14.317	219	16.621	16.525	16.276
110	12.136	12	12.016	165	14.857	14.454	14.317	220	16.621	16.525	16.535
111	12.136	12.270	12.016	166	14.857	14.454	14.317	221	16.621	16.589	16.535
112	12.136	12.270	12.016	167	14.857	14.528	14.317	222	16.621	16.589	16.535
113	12.136	12.270	12.016	168	14.857	14.528	14.317	223	16.621	16.716	16.535
114	12.136	12.270	12.016	169	14.857	14.528	14.614	224	16.875	16.716	16.535
115	12.136	12.358	12.373	170	15	14.528	14.614	225	16.875	16.716	16.535
116	12.136	12.358	12.373	171	15	14.748	14.614	226	16.875	16.716	17.042
117	12.136	12.358	12.373	172	15	14.748	14.614	227	16.875	16.716	17.042
118	12.136	12.358	12.373	173	15	14.748	14.614	228	16.875	16.716	17.042
119	12.136	12.533	12.373	174	15	14.748	14.614	229	16.875	16.716	17.042
120	12.136	12.533	12.373	175	15	14.893	15.048	230	16.875	16.716	17.042
121	12.136	12.533	12.548	176	15	14.893	15.048	231	16.875	17.094	17.042
122	13	12.533	12.548	177	15	14.893	15.048	232	16.875	17.094	17.166
123	13	12.533	12.548	178	15	14.893	15.048	233	16.875	17.094	17.166
124	13	12.533	12.719	179	15	15.107	15.048	234	16.875	17.094	17.166
125	13	12.533	12.719	180	15	15.107	15.048	235	16.875	17.094	17.166
126	13	12.533	12.719	181	15	15.107	15.190	236	17	17.094	17.166
127	13	12.790	12.719	182	15	15.107	15.190	237	17	17.094	17.166
128	13.166	12.790	12.719	183	15	15.178	15.190	238	17	17.094	17.166
129	13.166	12.790	12.719	184	15	15.178	15.190	239	17	17.463	17.166
130	13.166	12.790	13.056	185	15	15.178	15.190	240	17	17.463	17.166
131	13.166	13.125	13.056	186	15	15.178	15.190	241	17	17.463	17.290
132	13.166	13.125	13.056	187	15	15.526	15.469	242	17.371	17.463	17.290
133	13.166	13.125	13.056	188	15.423	15.526	15.469	243	17.371	17.523	17.290
134	13.166	13.125	13.056	189	15.423	15.526	15.469	244	17.371	17.523	17.290
135	13.166	13.125	13.056	190	15.423	15.526	15.469	245	17.371	17.523	17.290
136	13.166	13.125	13.221	191	15.423	15.731	15.469	246	17.371	17.523	17.290
137	13.166	13.289	13.221	192	15.423	15.731	15.469	247	17.371	17.523	17.654
138	13.166	13.289	13.221	193	15.423	15.731	15.743	248	17.371	17.523	17.654
139	13.166	13.289	13.221	194	15.423	15.731	15.743	249	17.371	17.523	17.654
140	13.490	13.289	13.221	195	15.423	15.731	15.743	250	17.371	17.523	17.654
141	13.490	13.530	13.221	196	15.423	15.731	15.743	251	17.371	17.644	17.654
142	13.490	13.530	13.702	197	15.423	15.731	15.743	252	17.371	17.644	17.654
143	13.490	13.530	13.702	198	15.423	15.731	15.743	253	17.371	17.644	17.773
144	13.490	13.530	13.702	199	15.423	15.799	16.012	254	18.089	17.644	17.773
145	13.490	13.768	13.859	200	16.100	15.799	16.012	255	18.089	17.704	17.773
146	13.490	13.768	13.859	201	16.100	15.799	16.012	256	18.089	17.704	17.773
147	13.490	13.768	13.859	202	16.100	15.799	16.012	257	18.089	17.704	17.773
148	13.490	13.768	13.859	203	16.100	15.934	16.012	258	18.089	17.704	17.773
149	13.490	14	13.859	204	16.100	15.934	16.012	259	18.089	17.823	18.010
150	13.490	14	13.859	205	16.100	15.934	16.012	260	18.089	17.823	18.010
151	13.490	14	14.013	206	16.100	15.934	16.012	261	18.089	17.823	18.010
152	14.115	14	14.013	207	16.100	16	16.012	262	18.089	17.823	18.010

The diameter D of the enclosing circle is equal to the diameter factor, K , multiplied by d , the diameter of the enclosed circles, or $D = K \times d$. For example, if the number of circles to be enclosed, N , is 12, and the center circle arrangement is "C," then for $d = 1\frac{1}{2}$ inches, $D = 4.056 \times 1\frac{1}{2} = 6.084$ inches. If $d = 50$ millimeters, then $D = 4.056 \times 50 = 202.9$ millimeters.

Approximate Formula When Number of Enclosed Circles Is Large: When a large number of circles are to be enclosed, the arrangement of the center circles has little effect on the diameter of the enclosing circle. For numbers of circles greater than 10,000, the diameter of the enclosing circle may be calculated within 2 per cent from the formula $D = d(1 + \sqrt{N \div 0.907})$. In this formula, D = diameter of the enclosing circle; d = diameter of the enclosed circles; and N is the number of enclosed circles.

An alternative approach relates the area of each of the same-sized circles to be enclosed to the area of the enclosing circle (or container), as shown in Figs. 1 through 27. The table shows efficient ways for packing various numbers of circles N , from 2 up to 97.

In the table, D = the diameter of each circle to be enclosed, d = the diameter of the enclosing circle or container, and $\Phi = Nd^2/D^2$ = ratio of the area of the N circles to the area of the enclosing circle or container, which is the packing efficiency. Cross-hatching in the diagrams indicates loose circles that may need packing constraints.

Data for Numbers of Circles in Circles

N	D/d	Φ	Fig.	N	D/d	Φ	Fig.
2	2.0000	0.500	1	17	4.7920	0.740	15
3	2.1547	0.646	2	18	4.8637	0.761	16
4	2.4142	0.686	3	19	4.8637	0.803	16
5	2.7013	0.685	4	20	5.1223	0.762	17
6	3.0000	0.667	5	21	5.2523	0.761	18
7	3.0000	0.778	5	22	5.4397	0.743	19
8	3.3048	0.733	6	23	5.5452	0.748	20
9	3.6131	0.689	7	24	5.6517	0.751	21
10	3.8130	0.688	8	25	5.7608	0.753	22
11	3.9238	0.714	9	31	6.2915	0.783	23
12	4.0296	0.739	10	37	6.7588	0.810	24
13	4.2361	0.724	11	55	8.2111	0.816	25
14	4.3284	0.747	12	61	8.6613	0.813	26
15	4.5214	0.734	13	97	11.1587	0.779	27
16	4.6154	0.751	14

Packing of large numbers of circles, such as the 97 in Fig. 27, may be approached by drawing a triangular pattern of circles, as shown in Fig. 28, which represents three circles near the center of the array. The point of a compass is then placed at A , B , or C , or anywhere within triangle ABC , and the radius of the compass is gradually enlarged until it encompasses the number of circles to be enclosed. As a first approximation of the diameter, $D = 1.14d\sqrt{N}$ may be tried.

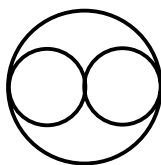


Fig. 1. $N = 2$

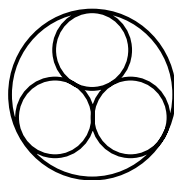


Fig. 2. $N = 3$

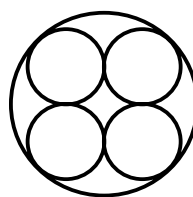


Fig. 3. $N = 4$

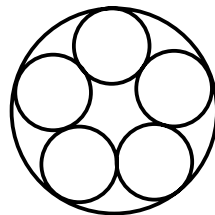


Fig. 4. $N = 5$

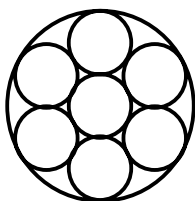


Fig. 5. $N=7$

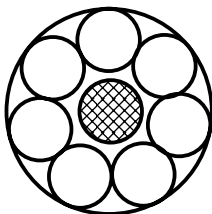


Fig. 6. $N=8$

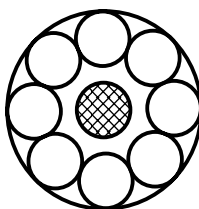


Fig. 7. $N=9$

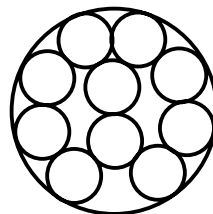


Fig. 8. $N=10$

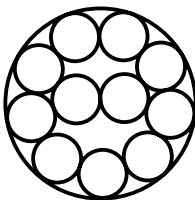


Fig. 9. $N=11$

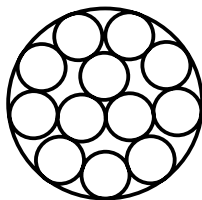


Fig. 10. $N=12$

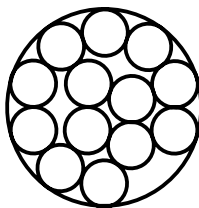


Fig. 11. $N=13$

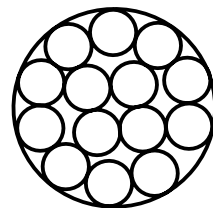


Fig. 12. $N=14$

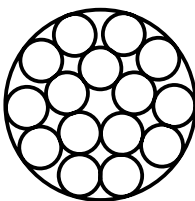


Fig. 13. $N=15$

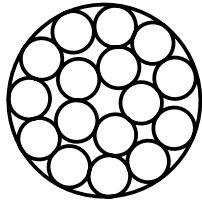


Fig. 14. $N=16$

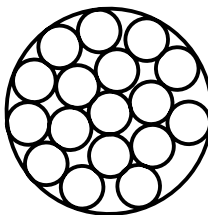


Fig. 15. $N=17$

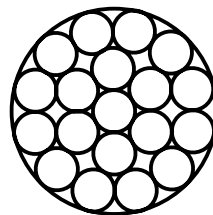


Fig. 16. $N=19$

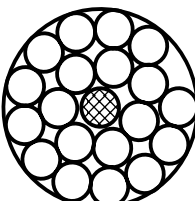


Fig. 17. $N=20$

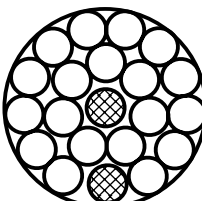


Fig. 18. $N=21$

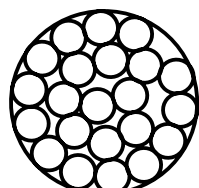


Fig. 19. $N=22$

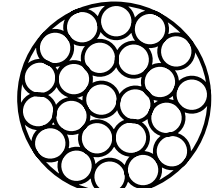


Fig. 20. $N=23$

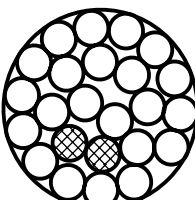


Fig. 21. $N=24$

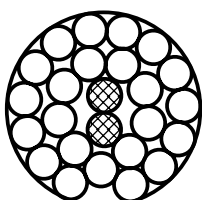


Fig. 22. $N=25$

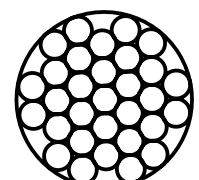


Fig. 23. $N=31$

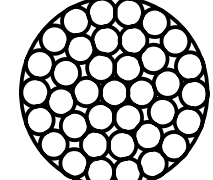


Fig. 24. $N=37$

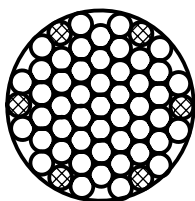


Fig. 25. $N=55$

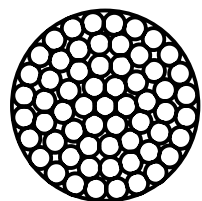


Fig. 26. $N=61$

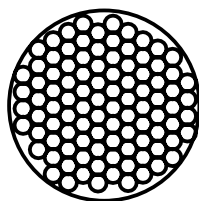


Fig. 27. $N=97$

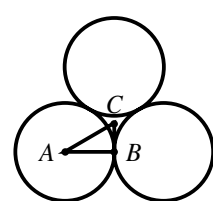


Fig. 28.

Circles within Rectangles.—For small numbers N of circles, packing (for instance, of cans) is less vital than for larger numbers and the number will usually govern the decision whether to use a rectangular or a triangular pattern, examples of which are seen in Figs. 29 and 30.

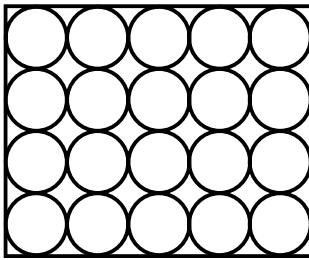


Fig. 29. Rectangular Pattern ($r = 4, c = 5$)

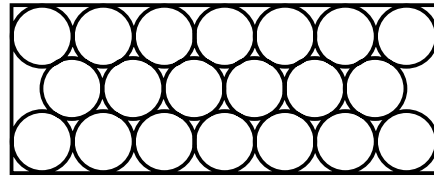


Fig. 30. Triangular Pattern ($r = 3, c = 7$)

If D is the can diameter and H its height, the arrangement in Fig. 29 will hold 20 circles or cans in a volume of $5D \times 4D \times H = 20D^2 H$. The arrangement in Fig. 30 will pack the same 20 cans into a volume of $7D \times 2.732D \times H = 19.124D^2 H$, a reduction of 4.4 per cent. When the ratio of H/D is less than 1.196:1, the rectangular pattern requires less surface area (therefore less material) for the six sides of the box, but for greater ratios, the triangular pattern is better. Some numbers, such as 19, can be accommodated only in a triangular pattern.

The following table shows possible patterns for 3 to 25 cans, where N = number of circles, P = pattern (R rectangular or T triangular), and r and c = numbers of rows and columns, respectively. The final table column shows the most economical application, where V = best volume, S = best surface area (sometimes followed by a condition on H/D). For the rectangular pattern, the area of the container is $rD \times cD$, and for the triangular pattern, the area is $cD \times [1 + (r - 1)\sqrt{3}/2]D$, or $cD^2[1 + 0.866(r - 1)]$.

Numbers of Circles in Rectangular Arrangements

N	P	r	c	Application	N	P	r	c	Application
3	T	2	2	V, S	15	R	3	5	$(S, H/D > 0.038)$
						T	2	8	$V, (S, H/D < 0.038)$
4	R	2	2	V, S	16	R	4	4	V, S
5	T	3	2	V, S	17	T	3	6	V, S
6	R	2	3	V, S	18	T	5	4	V, S
7	T	2	4	V, S	19	T	2	10	V, S
8	R	4	2	$V, (S, H/D < 0.732)$	20	R	4	5	$(S, H/D > 1.196)$
	T	3	3	$(S, H/D > 0.732)$		T	3	7	$V, (S, H/D < 1.196)$
9	R	3	3	V, S	21	R	3	7	$(S, 0.165 < H/D < 0.479)$
10	R	5	2	$V, (S, H/D > 1.976)$		T	6	4	$(S, H/D > 0.479)$
	T	4	3	$(S, H/D > 1.976)$	T	2	11	$V, (S, H/D < 0.165)$	
11	T	3	4	V, S	22	T	4	6	V, S
12	R	3	4	V, S	23	T	5	5	$(S, H/D > 0.366)$
13	T	5	3	$(S, H/D > 0.236)$		T	3	8	$V, (S, H/D < 0.366)$
	T	2	7	$V, (S, H/D < 0.236)$	24	R	4	6	V, S
14	T	4	4	$(S, H/D > 5.464)$	25	R	5	5	$(S, H/D > 1.10)$
	T	3	5	$V, (S, H/D < 5.464)$		T	7	4	$(S, 0.113 < H/D < 1.10)$
						T	2	13	$V, (S, H/D < 0.133)$

Rollers on a Shaft*.—The following formulas illustrate the geometry of rollers on a shaft. In Fig. 31, D is the diameter of the center line of the roller circle, d is the diameter of a roller, $D_S = D - d$ is the shaft diameter, and C is the clearance between two rollers, as indicated below. In the equations that follow, N is the number of rollers, and $N \geq 3$.

Equation (1a) applies when the clearance $C = 0$

$$D = \frac{d}{\sin\left(\frac{180}{N}\right)} \quad (1a)$$

Equation (1b) applies when clearance $C > 0$ then

$$C = D \sin\left(180^\circ - (N - 1) \sin\left(\frac{d}{D}\right)\right) - d \quad (1b)$$

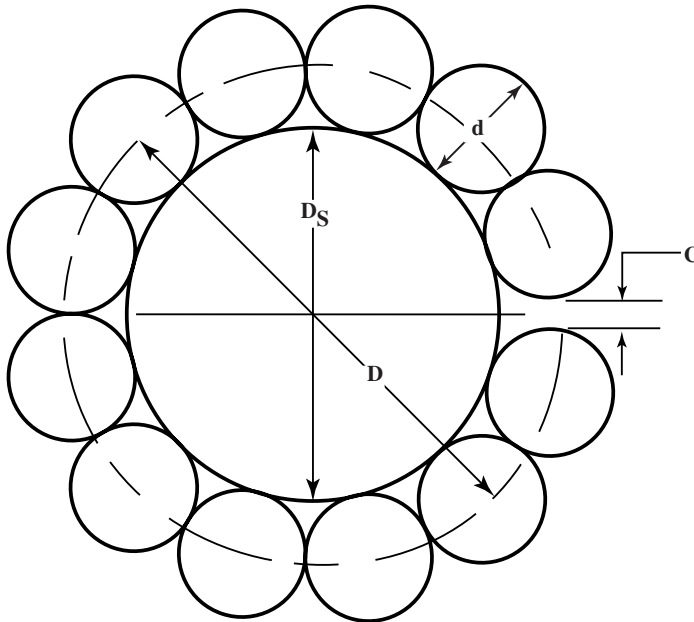


Fig. 31.

Example: Forty bearings are to be placed around a 3-inch diameter shaft with no clearance. What diameter bearings are needed?

Solution: Rearrange Equation (1a), and substitute in the value of N . Use the result to eliminate d , using $D_S = D - d$. Finally, solve for D and d .

$$d = D \sin\left(\frac{180}{N}\right) = D \sin\left(\frac{180}{40}\right) = 0.078459D$$

$$D = D_S + d = 3 + 0.078459D$$

$$D = \frac{3}{0.92154} = 3.2554$$

$$d = D - D_S = 0.2554$$

* *Rollers on a Shaft* contributed by Manfred K. Brueckner.

SOLUTION OF TRIANGLES

Any figure bounded by three straight lines is called a triangle. Any one of the three lines may be called the base, and the line drawn from the angle opposite the base at right angles to it is called the height or altitude of the triangle.

If all three sides of a triangle are of equal length, the triangle is called *equilateral*. Each of the three angles in an equilateral triangle equals 60 degrees. If two sides are of equal length, the triangle is an *isosceles* triangle. If one angle is a right or 90-degree angle, the triangle is a *right* or *right-angled* triangle. The side opposite the right angle is called the *hypotenuse*.

If all the angles are less than 90 degrees, the triangle is called an *acute* or *acute-angled* triangle. If one of the angles is larger than 90 degrees, the triangle is called an *obtuse-angled* triangle. Both acute and obtuse-angled triangles are known under the common name of *oblique-angled* triangles. The sum of the three angles in every triangle is 180 degrees.

The sides and angles of any triangle that are not known can be found when: 1) all the three sides; 2) two sides and one angle; and 3) one side and two angles are given.

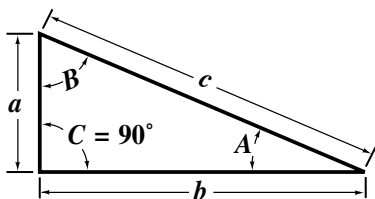
In other words, if a triangle is considered as consisting of six parts, three angles and three sides, the unknown parts can be determined when any three parts are given, provided at least one of the given parts is a side.

Functions of Angles

For every right triangle, a set of six ratios is defined; each is the length of one side of the triangle divided by the length of another side. The six ratios are the trigonometric (trig) functions sine, cosine, tangent, cosecant, secant, and cotangent (abbreviated sin, cos, tan, csc, sec, and cot). Trig functions are usually expressed in terms of an angle in degree or radian measure, as in $\cos 60^\circ = 0.5$. "Arc" in front of a trig function name, as in arcsin or arccos, means find the angle whose function value is given. For example, $\arcsin 0.5 = 30^\circ$ means that 30° is the angle whose sin is equal to 0.5. Electronic calculators frequently use \sin^{-1} , \cos^{-1} , and \tan^{-1} to represent the arc functions.

Example: $\tan 53.1^\circ = 1.332$; $\arctan 1.332 = \tan^{-1} 1.332 = 53.1^\circ = 53^\circ 6'$

The *sine* of an angle equals the opposite side divided by the hypotenuse. Hence, $\sin B = b \div c$, and $\sin A = a \div c$.



The *cosine* of an angle equals the adjacent side divided by the hypotenuse. Hence, $\cos B = a \div c$, and $\cos A = b \div c$.

The *tangent* of an angle equals the opposite side divided by the adjacent side. Hence, $\tan B = b \div a$, and $\tan A = a \div b$.

The *cotangent* of an angle equals the adjacent side divided by the opposite side. Hence, $\cot B = a \div b$, and

$\cot A = b \div a$.

The *secant* of an angle equals the hypotenuse divided by the adjacent side. Hence, $\sec B = c \div a$, and $\sec A = c \div b$.

The *cosecant* of an angle equals the hypotenuse divided by the opposite side. Hence, $\csc B = c \div b$, and $\csc A = c \div a$.

It should be noted that the functions of the angles can be found in this manner only when the triangle is right-angled.

If in a right-angled triangle (see preceding illustration), the lengths of the three sides are represented by a , b , and c , and the angles opposite each of these sides by A , B , and C , then the side c opposite the right angle is the hypotenuse; side b is called the *side adjacent* to angle A and is also the *side opposite* to angle B ; side a is the side adjacent to angle B and the

side opposite to angle A . The meanings of the various functions of angles can be explained with the aid of a right-angled triangle. Note that the cosecant, secant, and cotangent are the reciprocals of, respectively, the sine, cosine, and tangent.

The following relation exists between the angular functions of the two acute angles in a right-angled triangle: The sine of angle B equals the cosine of angle A ; the tangent of angle B equals the cotangent of angle A , and *vice versa*. The sum of the two acute angles in a right-angled triangle always equals 90 degrees; hence, when one angle is known, the other can easily be found. When any two angles together make 90 degrees, one is called the *complement* of the other, and the sine of the one angle equals the cosine of the other, and the tangent of the one equals the cotangent of the other.

The Law of Sines.—In any triangle, any side is to the sine of the angle opposite that side as any other side is to the sine of the angle opposite that side. If a , b , and c are the sides, and A , B , and C their opposite angles, respectively, then:

$$\frac{a}{\sin A} = \frac{b}{\sin B} = \frac{c}{\sin C}, \quad \text{so that:}$$

$$a = \frac{b \sin A}{\sin B} \quad \text{or} \quad a = \frac{c \sin A}{\sin C}$$

$$b = \frac{a \sin B}{\sin A} \quad \text{or} \quad b = \frac{c \sin B}{\sin C}$$

$$c = \frac{a \sin C}{\sin A} \quad \text{or} \quad c = \frac{b \sin C}{\sin B}$$

The Law of Cosines.—In any triangle, the square of any side is equal to the sum of the squares of the other two sides minus twice their product times the cosine of the included angle; or if a , b and c are the sides and A , B , and C are the opposite angles, respectively, then:

$$a^2 = b^2 + c^2 - 2bc \cos A$$

$$b^2 = a^2 + c^2 - 2ac \cos B$$

$$c^2 = a^2 + b^2 - 2ab \cos C$$

These two laws, together with the proposition that the sum of the three angles equals 180 degrees, are the basis of all formulas relating to the solution of triangles.

Formulas for the solution of right-angled and oblique-angled triangles, arranged in tabular form, are given on the following pages.

Signs of Trigonometric Functions.—The diagram, Fig. 1 on page 105, shows the proper sign (+ or -) for the trigonometric functions of angles in each of the four quadrants, 0 to 90, 90 to 180, 180 to 270, and 270 to 360 degrees. Thus, the cosine of an angle between 90 and 180 degrees is negative; the sine of the same angle is positive.

Trigonometric Identities.—Trigonometric identities are formulas that show the relationship between different trigonometric functions. They may be used to change the form of some trigonometric expressions to simplify calculations. For example, if a formula has a term, $2\sin A \cos A$, the equivalent but simpler term $\sin 2A$ may be substituted. The identities that follow may themselves be combined or rearranged in various ways to form new identities.

Basic

$$\tan A = \frac{\sin A}{\cos A} = \frac{1}{\cot A} \quad \sec A = \frac{1}{\cos A} \quad \csc A = \frac{1}{\sin A}$$

Negative Angle

$$\sin(-A) = -\sin A \quad \cos(-A) = \cos A \quad \tan(-A) = -\tan A$$

Pythagorean

$$\sin^2 A + \cos^2 A = 1 \quad 1 + \tan^2 A = \sec^2 A \quad 1 + \cot^2 A = \csc^2 A$$

Sum and Difference of Angles

$$\tan(A + B) = \frac{\tan A + \tan B}{1 - \tan A \tan B} \quad \tan(A - B) = \frac{\tan A - \tan B}{1 + \tan A \tan B}$$

$$\cot(A + B) = \frac{\cot A \cot B - 1}{\cot B + \cot A} \quad \cot(A - B) = \frac{\cot A \cot B + 1}{\cot B - \cot A}$$

$$\sin(A + B) = \sin A \cos B + \cos A \sin B \quad \sin(A - B) = \sin A \cos B - \cos A \sin B$$

$$\cos(A + B) = \cos A \cos B - \sin A \sin B \quad \cos(A - B) = \cos A \cos B + \sin A \sin B$$

Double-Angle

$$\cos 2A = \cos^2 A - \sin^2 A = 2 \cos^2 A - 1 = 1 - 2 \sin^2 A$$

$$\sin 2A = 2 \sin A \cos A \quad \tan 2A = \frac{2 \tan A}{1 - \tan^2 A} = \frac{2}{\cot A - \tan A}$$

Half-Angle

$$\sin \frac{1}{2}A = \sqrt{\frac{1 - \cos A}{2}} \quad \cos \frac{1}{2}A = \sqrt{\frac{1 + \cos A}{2}}$$

$$\tan \frac{1}{2}A = \sqrt{\frac{1 - \cos A}{1 + \cos A}} = \frac{1 - \cos A}{\sin A} = \frac{\sin A}{1 + \cos A}$$

Product-to-Sum

$$\sin A \cos B = \frac{1}{2}[\sin(A + B) + \sin(A - B)]$$

$$\cos A \cos B = \frac{1}{2}[\cos(A + B) + \cos(A - B)]$$

$$\sin A \sin B = \frac{1}{2}[\cos(A - B) - \cos(A + B)]$$

$$\tan A \tan B = \frac{\tan A + \tan B}{\cot A + \cot B}$$

Sum and Difference of Functions

$$\sin A + \sin B = 2[\sin \frac{1}{2}(A + B) \cos \frac{1}{2}(A - B)]$$

$$\sin A - \sin B = 2[\sin \frac{1}{2}(A - B) \cos \frac{1}{2}(A + B)]$$

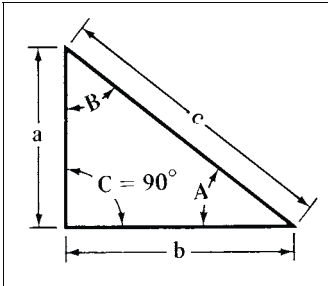
$$\cos A + \cos B = 2[\cos \frac{1}{2}(A + B) \cos \frac{1}{2}(A - B)]$$

$$\cos A - \cos B = -2[\sin \frac{1}{2}(A + B) \sin \frac{1}{2}(A - B)]$$

$$\tan A + \tan B = \frac{\sin(A + B)}{\cos A \cos B} \quad \tan A - \tan B = \frac{\sin(A - B)}{\cos A \cos B}$$

$$\cot A + \cot B = \frac{\sin(B + A)}{\sin A \sin B} \quad \cot A - \cot B = \frac{\sin(B - A)}{\sin A \sin B}$$

Solution of Right-Angled Triangles



As shown in the illustration, the sides of the right-angled triangle are designated a and b and the hypotenuse, c . The angles opposite each of these sides are designated A and B , respectively.

Angle C , opposite the hypotenuse c is the right angle, and is therefore always one of the known quantities.

Sides and Angles Known	Formulas for Sides and Angles to be Found		
Side a ; side b	$c = \sqrt{a^2 + b^2}$	$\tan A = \frac{a}{b}$	$B = 90^\circ - A$
Side a ; hypotenuse c	$b = \sqrt{c^2 - a^2}$	$\sin A = \frac{a}{c}$	$B = 90^\circ - A$
Side b ; hypotenuse c	$a = \sqrt{c^2 - b^2}$	$\sin B = \frac{b}{c}$	$A = 90^\circ - B$
Hypotenuse c ; angle B	$b = c \times \sin B$	$a = c \times \cos B$	$A = 90^\circ - B$
Hypotenuse c ; angle A	$b = c \times \cos A$	$a = c \times \sin A$	$B = 90^\circ - A$
Side b ; angle B	$c = \frac{b}{\sin B}$	$a = b \times \cot B$	$A = 90^\circ - B$
Side b ; angle A	$c = \frac{b}{\cos A}$	$a = b \times \tan A$	$B = 90^\circ - A$
Side a ; angle B	$c = \frac{a}{\cos B}$	$b = a \times \tan B$	$A = 90^\circ - B$
Side a ; angle A	$c = \frac{a}{\sin A}$	$b = a \times \cot A$	$B = 90^\circ - A$

Trig Functions Values for Common Angles

$\sin 0^\circ = 0$	$\cos 0^\circ = 1$	$\tan 0^\circ = 0$
$\sin 30^\circ = \sin \frac{\pi}{6} = 0.5$	$\cos 30^\circ = \cos \frac{\pi}{6} = 0.8660254$	$\tan 30^\circ = \tan \frac{\pi}{6} = 0.57735027$
$\sin 45^\circ = \sin \frac{\pi}{4} = 0.70710678$	$\cos 45^\circ = \cos \frac{\pi}{4} = 0.70710678$	$\tan 45^\circ = \tan \frac{\pi}{4} = 1$
$\sin 60^\circ = \sin \frac{\pi}{3} = 0.8660254$	$\cos 60^\circ = \cos \frac{\pi}{3} = 0.5$	$\tan 60^\circ = \tan \frac{\pi}{3} = 1.7320508$
$\sin 90^\circ = \sin \frac{\pi}{2} = 1$	$\cos 90^\circ = \cos \frac{\pi}{2} = 0$	$\tan 90^\circ = \tan \frac{\pi}{2} = \infty$

Examples of the Solution of Right-Angled Triangles (English or metric units)

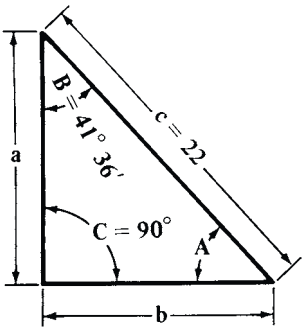
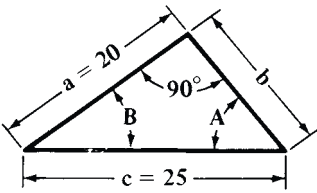
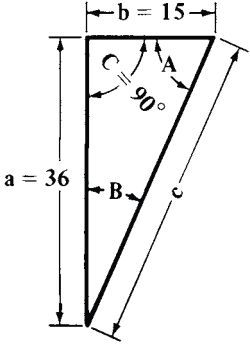
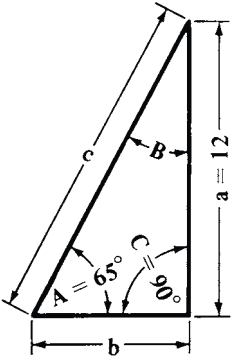
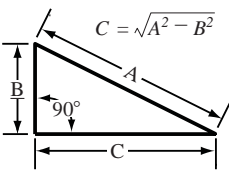
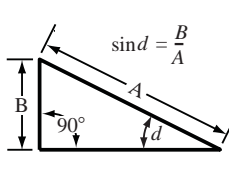
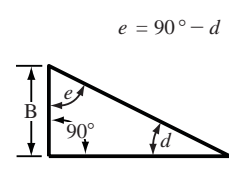
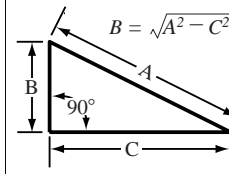
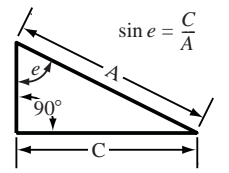
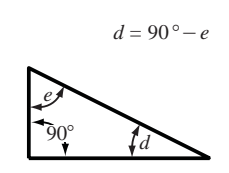
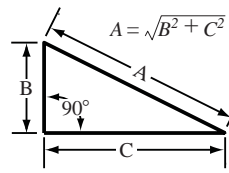
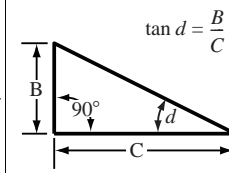
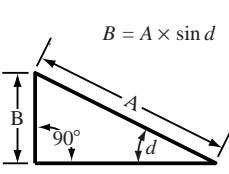
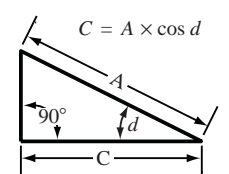
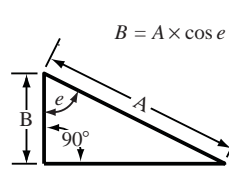
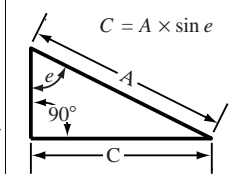
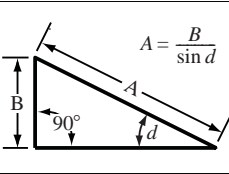
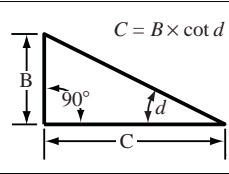
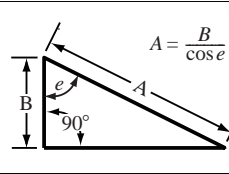
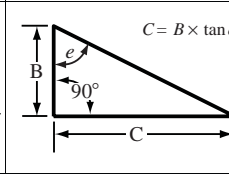
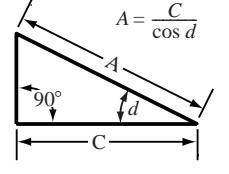
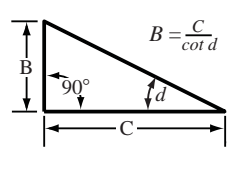
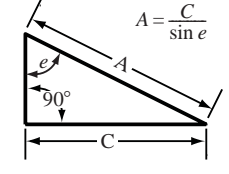
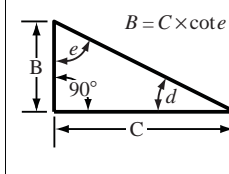
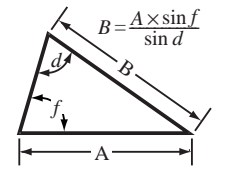
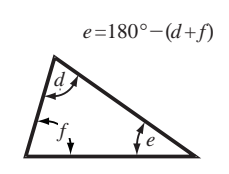
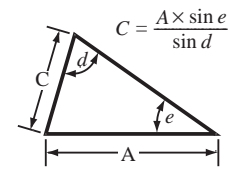
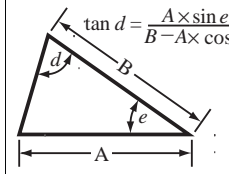
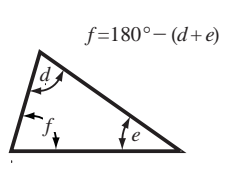
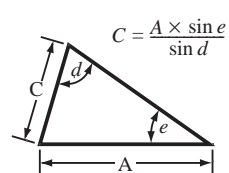
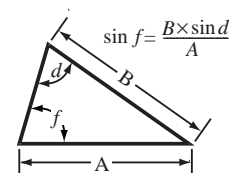
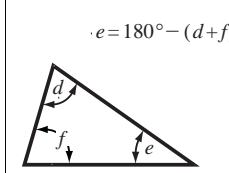
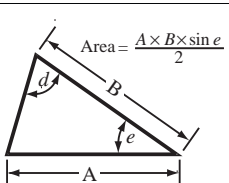
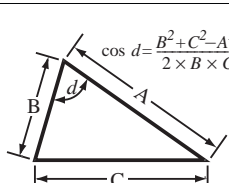
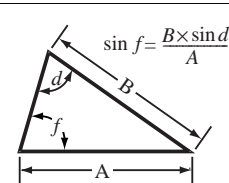
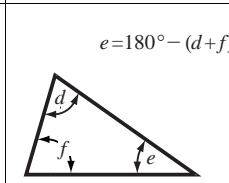
 <p>Hypotenuse and One Angle Known</p>	<p>$c = 22$ inches; $B = 41^\circ 36'$.</p> $a = c \times \cos B = 22 \times \cos 41^\circ 36' = 22 \times 0.74780 = 16.4516 \text{ inches}$ $b = c \times \sin B = 22 \times \sin 41^\circ 36' = 22 \times 0.66393 = 14.6065 \text{ inches}$ $A = 90^\circ - B = 90^\circ - 41^\circ 36' = 48^\circ 24'$
 <p>Hypotenuse and One Side Known</p>	<p>$c = 25$ centimeters; $a = 20$ centimeters.</p> $b = \sqrt{c^2 - a^2} = \sqrt{25^2 - 20^2} = \sqrt{625 - 400} = \sqrt{225} = 15 \text{ centimeters}$ $\sin A = \frac{a}{c} = \frac{20}{25} = 0.8$ <p>Hence, $A = 53^\circ 8'$ $B = 90^\circ - A = 90^\circ - 53^\circ 8' = 36^\circ 52'$</p>
 <p>Two Sides Known</p>	<p>$a = 36$ mm; $b = 15$ mm.</p> $c = \sqrt{a^2 + b^2} = \sqrt{36^2 + 15^2} = \sqrt{1296 + 225} = \sqrt{1521} = 39 \text{ mm}$ $\tan A = \frac{a}{b} = \frac{36}{15} = 2.4$ <p>Hence, $A = 67^\circ 23'$ $B = 90^\circ - A = 90^\circ - 67^\circ 23' = 22^\circ 37'$</p>
 <p>One Side and One Angle Known</p>	<p>$a = 12$ meters; $A = 65^\circ$.</p> $c = \frac{a}{\sin A} = \frac{12}{\sin 65^\circ} = \frac{12}{0.90631} = 13.2405 \text{ meters}$ $b = a \times \cot A = 12 \times \cot 65^\circ = 12 \times 0.46631 = 5.5957 \text{ meters}$ $B = 90^\circ - A = 90^\circ - 65^\circ = 25^\circ$

Chart For The Rapid Solution of Right-Angle and Oblique-Angle Triangles

 $C = \sqrt{A^2 - B^2}$	 $\sin d = \frac{B}{A}$	 $e = 90^\circ - d$	 $B = \sqrt{A^2 - C^2}$
 $\sin e = \frac{C}{A}$	 $d = 90^\circ - e$	 $A = \sqrt{B^2 + C^2}$	 $\tan d = \frac{B}{C}$
 $B = A \times \sin d$	 $C = A \times \cos d$	 $B = A \times \cos e$	 $C = A \times \sin e$
 $A = \frac{B}{\sin d}$	 $C = B \times \cot d$	 $A = \frac{B}{\cos e}$	 $C = B \times \tan e$
 $A = \frac{C}{\cos d}$	 $B = \frac{C}{\cot d}$	 $A = \frac{C}{\sin e}$	 $B = C \times \cot e$
 $B = \frac{A \times \sin f}{\sin d}$	 $e = 180^\circ - (d + f)$	 $C = \frac{A \times \sin e}{\sin d}$	 $\tan d = \frac{A \times \sin e}{B - A \times \cos e}$
 $f = 180^\circ - (d + e)$	 $C = \frac{A \times \sin e}{\sin d}$	 $\sin f = \frac{B \times \sin d}{A}$	 $e = 180^\circ - (d + f)$
 $\text{Area} = \frac{A \times B \times \sin e}{2}$	 $\cos d = \frac{B^2 + C^2 - A^2}{2 \times B \times C}$	 $\sin f = \frac{B \times \sin d}{A}$	 $e = 180^\circ - (d + f)$

Solution of Oblique-Angled Triangles

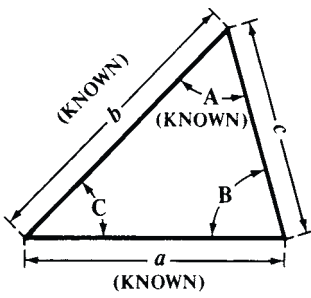
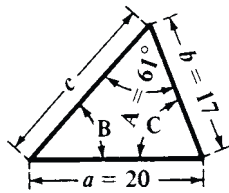
One Side and Two Angles Known (Law of Sines):

<p>One Side and Two Angles Known</p>	<p>Call the known side a, the angle opposite it A, and the other known angle B. Then, $C = 180^\circ - (A + B)$. If angles B and C are given, but not A, then $A = 180^\circ - (B + C)$.</p> $C = 180^\circ - (A + B)$ $b = \frac{a \times \sin B}{\sin A} \quad c = \frac{a \times \sin C}{\sin A}$ $\text{Area} = \frac{a \times b \times \sin C}{2}$
<p>Side and Angles Known</p>	<p>$a = 5$ centimeters; $A = 80^\circ$; $B = 62^\circ$</p> $C = 180^\circ - (80^\circ + 62^\circ) = 180^\circ - 142^\circ = 38^\circ$ $b = \frac{a \times \sin B}{\sin A} = \frac{5 \times \sin 62^\circ}{\sin 80^\circ} = \frac{5 \times 0.88295}{0.98481}$ $= 4.483 \text{ centimeters}$ $c = \frac{a \times \sin C}{\sin A} = \frac{5 \times \sin 38^\circ}{\sin 80^\circ} = \frac{5 \times 0.61566}{0.98481}$ $= 3.126 \text{ centimeters}$

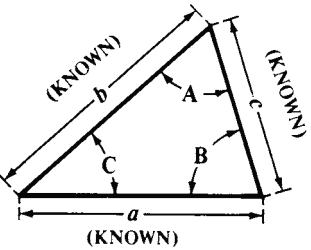
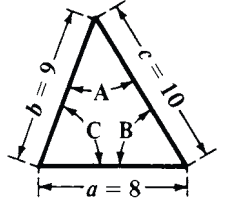
Two Sides and the Angle Between Them Known:

<p>Two Sides and the Angle Between Them Known</p>	<p>Call the known sides a and b, and the known angle between them C. Then,</p> $\tan A = \frac{a \times \sin C}{b - (a \times \cos C)}$ $B = 180^\circ - (A + C) \quad c = \frac{a \times \sin C}{\sin A}$ <p>Side c may also be found directly as below:</p> $c = \sqrt{a^2 + b^2 - (2ab \times \cos C)}$ $\text{Area} = \frac{a \times b \times \sin C}{2}$
<p>Sides and Angle Known</p>	<p>$a = 9$ inches; $b = 8$ inches; $C = 35^\circ$.</p> $\tan A = \frac{a \times \sin C}{b - (a \times \cos C)} = \frac{9 \times \sin 35^\circ}{8 - (9 \times \cos 35^\circ)}$ $= \frac{9 \times 0.57358}{8 - (9 \times 0.81915)} = \frac{5.16222}{0.62765} = 8.22468$ <p>Hence, $A = 83^\circ 4'$</p> $B = 180^\circ - (A + C) = 180^\circ - 118^\circ 4' = 61^\circ 56'$ $c = \frac{a \times \sin C}{\sin A} = \frac{9 \times 0.57358}{0.99269} = 5.2 \text{ inches}$

Two Sides and the Angle Opposite One of the Sides Known:

 <p>Two Sides and the Angle Opposite One of the Sides Known</p>	<p>Call the known angle A, the side opposite it a, and the other known side b. Then,</p> $\sin B = \frac{b \times \sin A}{a} \quad C = 180^\circ - (A + B)$ $c = \frac{a \times \sin C}{\sin A} \quad \text{Area} = \frac{a \times b \times \sin C}{2}$ <p>If, in the above, angle $B >$ angle A but $< 90^\circ$, then a second solution B_2, C_2, c_2 exists for which: $B_2 = 180^\circ - B$; $C_2 = 180^\circ - (A + B_2)$; $c_2 = (a \times \sin C_2) \div \sin A$; area = $(a \times b \times \sin C_2) \div 2$. If $a \geq b$, then the first solution only exists. If $a < b \times \sin A$, then no solution exists.</p>
 <p>Sides and Angle Known</p>	<p>$a = 20$ centimeters; $b = 17$ centimeters; $A = 61^\circ$.</p> $\sin B = \frac{b \times \sin A}{a} = \frac{17 \times \sin 61^\circ}{20}$ $= \frac{17 \times 0.87462}{20} = 0.74343$ <p>Hence, $B = 48^\circ 1'$</p> $C = 180^\circ - (A + B) = 180^\circ - 109^\circ 1' = 70^\circ 59'$ $c = \frac{a \times \sin C}{\sin A} = \frac{20 \times \sin 70^\circ 59'}{\sin 61^\circ} = \frac{20 \times 0.94542}{0.87462}$ $= 21.62 \text{ centimeters}$

All Three Sides are Known:

 <p>All Three Sides Known</p>	<p>Call the sides a, b, and c, and the angles opposite them, A, B, and C. Then,</p> $\cos A = \frac{b^2 + c^2 - a^2}{2bc} \quad \sin B = \frac{b \times \sin A}{a}$ $C = 180^\circ - (A + B) \quad \text{Area} = \frac{a \times b \times \sin C}{2}$
 <p>Sides and Angle Known</p>	<p>$a = 8$ inches; $b = 9$ inches; $c = 10$ inches.</p> $\cos A = \frac{b^2 + c^2 - a^2}{2bc} = \frac{9^2 + 10^2 - 8^2}{2 \times 9 \times 10}$ $= \frac{81 + 100 - 64}{180} = \frac{117}{180} = 0.65000$ <p>Hence, $A = 49^\circ 27'$</p> $\sin B = \frac{b \times \sin A}{a} = \frac{9 \times 0.75984}{8} = 0.85482$ <p>Hence, $B = 58^\circ 44'$</p> $C = 180^\circ - (A + B) = 180^\circ - 108^\circ 11' = 71^\circ 49'$

Conversion Tables of Angular Measure.—The accompanying tables of degrees, minutes, and seconds into radians; radians into degrees, minutes, and seconds; radians into degrees and decimals of a degree; and minutes and seconds into decimals of a degree and vice versa facilitate the conversion of measurements.

Example 1: The Degrees, Minutes, and Seconds into Radians table is used to find the number of radians in 324 degrees, 25 minutes, 13 seconds as follows:

300 degrees	=	5.235988 radians
20 degrees	=	0.349066 radian
4 degrees	=	0.069813 radian
25 minutes	=	0.007272 radian
13 seconds	=	0.000063 radian
324°25'13"	=	5.662202 radians

Example 2: The Radians into Degrees and Decimals of a Degree, and Radians into Degrees, Minutes and Seconds tables are used to find the number of decimal degrees or degrees, minutes and seconds in 0.734 radian as follows:

0.7 radian = 40.1070 degrees	0.7 radian = 40° 6' 25"
0.03 radian = 1.7189 degrees	0.03 radian = 1° 43' 8"
0.004 radian = 0.2292 degree	0.004 radian = 0° 13' 45"
0.734 radian = 42.0551 degrees	0.734 radian = 41° 62' 78" or 42° 3' 18"

Degrees, Minutes, and Seconds into Radians (Based on 180 degrees = π radians)

Degrees into Radians													
Deg.	Rad.	Deg.	Rad.	Deg.	Rad.	Deg.	Rad.	Deg.	Rad.	Deg.	Rad.	Deg.	Rad.
1000	17.453293	100	1.745329	10	0.174533	1	0.017453	0.1	0.001745	0.01	0.000175		
2000	34.906585	200	3.490659	20	0.349066	2	0.034907	0.2	0.003491	0.02	0.000349		
3000	52.359878	300	5.235988	30	0.523599	3	0.052360	0.3	0.005236	0.03	0.000524		
4000	69.813170	400	6.981317	40	0.698132	4	0.069813	0.4	0.006981	0.04	0.000698		
5000	87.266463	500	8.726646	50	0.872665	5	0.087266	0.5	0.008727	0.05	0.000873		
6000	104.719755	600	10.471976	60	1.047198	6	0.104720	0.6	0.010472	0.06	0.001047		
7000	122.173048	700	12.217305	70	1.221730	7	0.122173	0.7	0.012217	0.07	0.001222		
8000	139.626340	800	13.962634	80	1.396263	8	0.139626	0.8	0.013963	0.08	0.001396		
9000	157.079633	900	15.707963	90	1.570796	9	0.157080	0.9	0.015708	0.09	0.001571		
10000	174.532925	1000	17.453293	100	1.745329	10	0.174533	1.0	0.017453	0.10	0.001745		
Minutes into Radians													
Min.	Rad.	Min.	Rad.	Min.	Rad.	Min.	Rad.	Min.	Rad.	Min.	Rad.	Min.	Rad.
1	0.000291	11	0.003200	21	0.006109	31	0.009018	41	0.011926	51	0.014835		
2	0.000582	12	0.003491	22	0.006400	32	0.009308	42	0.012217	52	0.015126		
3	0.000873	13	0.003782	23	0.006690	33	0.009599	43	0.012508	53	0.015417		
4	0.001164	14	0.004072	24	0.006981	34	0.009890	44	0.012799	54	0.015708		
5	0.001454	15	0.004363	25	0.007272	35	0.010181	45	0.013090	55	0.015999		
6	0.001745	16	0.004654	26	0.007563	36	0.010472	46	0.013381	56	0.016290		
7	0.002036	17	0.004945	27	0.007854	37	0.010763	47	0.013672	57	0.016581		
8	0.002327	18	0.005236	28	0.008145	38	0.011054	48	0.013963	58	0.016872		
9	0.002618	19	0.005527	29	0.008436	39	0.011345	49	0.014254	59	0.017162		
10	0.002909	20	0.005818	30	0.008727	40	0.011636	50	0.014544	60	0.017453		
Seconds into Radians													
Sec.	Rad.	Sec.	Rad.	Sec.	Rad.	Sec.	Rad.	Sec.	Rad.	Sec.	Rad.	Sec.	Rad.
1	0.000005	11	0.000053	21	0.000102	31	0.000150	41	0.000199	51	0.000247		
2	0.000010	12	0.000058	22	0.000107	32	0.000155	42	0.000204	52	0.000252		
3	0.000015	13	0.000063	23	0.000112	33	0.000160	43	0.000208	53	0.000257		
4	0.000019	14	0.000068	24	0.000116	34	0.000165	44	0.000213	54	0.000262		
5	0.000024	15	0.000073	25	0.000121	35	0.000170	45	0.000218	55	0.000267		
6	0.000029	16	0.000078	26	0.000126	36	0.000175	46	0.000223	56	0.000271		
7	0.000034	17	0.000082	27	0.000131	37	0.000179	47	0.000228	57	0.000276		
8	0.000039	18	0.000087	28	0.000136	38	0.000184	48	0.000233	58	0.000281		
9	0.000044	19	0.000092	29	0.000141	39	0.000189	49	0.000238	59	0.000286		
10	0.000048	20	0.000097	30	0.000145	40	0.000194	50	0.000242	60	0.000291		

**Radians into Degrees and Decimals of a Degree
(Based on π radians = 180 degrees)**


Rad.	Deg.	Rad.	Deg.	Rad.	Deg.	Rad.	Deg.	Rad.	Deg.	Rad.	Deg.
10	572.9578	1	57.2958	0.1	5.7296	0.01	0.5730	0.001	0.0573	0.0001	0.0057
20	1145.9156	2	114.5916	0.2	11.4592	0.02	1.1459	0.002	0.1146	0.0002	0.0115
30	1718.8734	3	171.8873	0.3	17.1887	0.03	1.7189	0.003	0.1719	0.0003	0.0172
40	2291.8312	4	229.1831	0.4	22.9183	0.04	2.2918	0.004	0.2292	0.0004	0.0229
50	2864.7890	5	286.4789	0.5	28.6479	0.05	2.8648	0.005	0.2865	0.0005	0.0286
60	3437.7468	6	343.7747	0.6	34.3775	0.06	3.4377	0.006	0.3438	0.0006	0.0344
70	4010.7046	7	401.0705	0.7	40.1070	0.07	4.0107	0.007	0.4011	0.0007	0.0401
80	4583.6624	8	458.3662	0.8	45.8366	0.08	4.5837	0.008	0.4584	0.0008	0.0458
90	5156.6202	9	515.6620	0.9	51.5662	0.09	5.1566	0.009	0.5157	0.0009	0.0516
100	5729.5780	10	572.9578	1.0	57.2958	0.10	5.7296	0.010	0.5730	0.0010	0.0573


**Radians into Degrees, Minutes, and Seconds
(Based on π radians = 180 degrees)**

Rad.	Angle	Rad.	Angle	Rad.	Angle	Rad.	Angle	Rad.	Angle	Rad.	Angle
10	572°57'28"	1	57°17'45"	0.1	5°43'46"	0.01	0°34'23"	0.001	0°3'26"	0.0001	0°0'21"
20	1145°54'56"	2	114°35'30"	0.2	11°27'33"	0.02	1°8'45"	0.002	0°6'53"	0.0002	0°0'41"
30	1718°52'24"	3	171°53'14"	0.3	17°11'19"	0.03	1°43'8"	0.003	0°10'19"	0.0003	0°1'2"
40	2291°49'52"	4	229°10'59"	0.4	22°55'6"	0.04	2°17'31"	0.004	0°13'45"	0.0004	0°1'23"
50	2864°47'20"	5	286°28'44"	0.5	28°38'52"	0.05	2°51'53"	0.005	0°17'11"	0.0005	0°1'43"
60	3437°44'48"	6	343°46'29"	0.6	34°22'39"	0.06	3°26'16"	0.006	0°20'38"	0.0006	0°2'4"
70	4010°42'16"	7	401°4'14"	0.7	40°6'25"	0.07	4°0'39"	0.007	0°24'4"	0.0007	0°2'24"
80	4583°39'44"	8	458°21'58"	0.8	45°50'12"	0.08	4°35'1"	0.008	0°27'30"	0.0008	0°2'45"
90	5156°37'13"	9	515°39'43"	0.9	51°33'58"	0.09	5°9'24"	0.009	0°30'56"	0.0009	0°3'6"
100	5729°34'41"	10	572°57'28"	1.0	57°17'45"	0.10	5°43'46"	0.010	0°34'23"	0.0010	0°3'26"

**Minutes and Seconds into Decimal of a Degree and Vice Versa
(Based on 1 second = 0.00027778 degree)**

Minutes into Decimals of a Degree						Seconds into Decimals of a Degree					
Min.	Deg.	Min.	Deg.	Min.	Deg.	Sec.	Deg.	Sec.	Deg.	Sec.	Deg.
1	0.0167	21	0.3500	41	0.6833	1	0.0003	21	0.0058	41	0.0114
2	0.0333	22	0.3667	42	0.7000	2	0.0006	22	0.0061	42	0.0117
3	0.0500	23	0.3833	43	0.7167	3	0.0008	23	0.0064	43	0.0119
4	0.0667	24	0.4000	44	0.7333	4	0.0011	24	0.0067	44	0.0122
5	0.0833	25	0.4167	45	0.7500	5	0.0014	25	0.0069	45	0.0125
6	0.1000	26	0.4333	46	0.7667	6	0.0017	26	0.0072	46	0.0128
7	0.1167	27	0.4500	47	0.7833	7	0.0019	27	0.0075	47	0.0131
8	0.1333	28	0.4667	48	0.8000	8	0.0022	28	0.0078	48	0.0133
9	0.1500	29	0.4833	49	0.8167	9	0.0025	29	0.0081	49	0.0136
10	0.1667	30	0.5000	50	0.8333	10	0.0028	30	0.0083	50	0.0139
11	0.1833	31	0.5167	51	0.8500	11	0.0031	31	0.0086	51	0.0142
12	0.2000	32	0.5333	52	0.8667	12	0.0033	32	0.0089	52	0.0144
13	0.2167	33	0.5500	53	0.8833	13	0.0036	33	0.0092	53	0.0147
14	0.2333	34	0.5667	54	0.9000	14	0.0039	34	0.0094	54	0.0150
15	0.2500	35	0.5833	55	0.9167	15	0.0042	35	0.0097	55	0.0153
16	0.2667	36	0.6000	56	0.9333	16	0.0044	36	0.0100	56	0.0156
17	0.2833	37	0.6167	57	0.9500	17	0.0047	37	0.0103	57	0.0158
18	0.3000	38	0.6333	58	0.9667	18	0.0050	38	0.0106	58	0.0161
19	0.3167	39	0.6500	59	0.9833	19	0.0053	39	0.0108	59	0.0164
20	0.3333	40	0.6667	60	1.0000	20	0.0056	40	0.0111	60	0.0167

 *Example 3:* Convert 11'37" to decimals of a degree. From the left table, 11' = 0.1833 degree. From the right table, 37" = 0.0103 degree. Adding, 11'37" = 0.1833 + 0.0103 = 0.1936 degree.

 *Example 4:* Convert 0.1234 degree to minutes and seconds. From the left table, 0.1167 degree = 7'. Subtracting 0.1167 from 0.1234 gives 0.0067. From the right table, 0.0067 = 24" so that 0.1234 = 7'24".

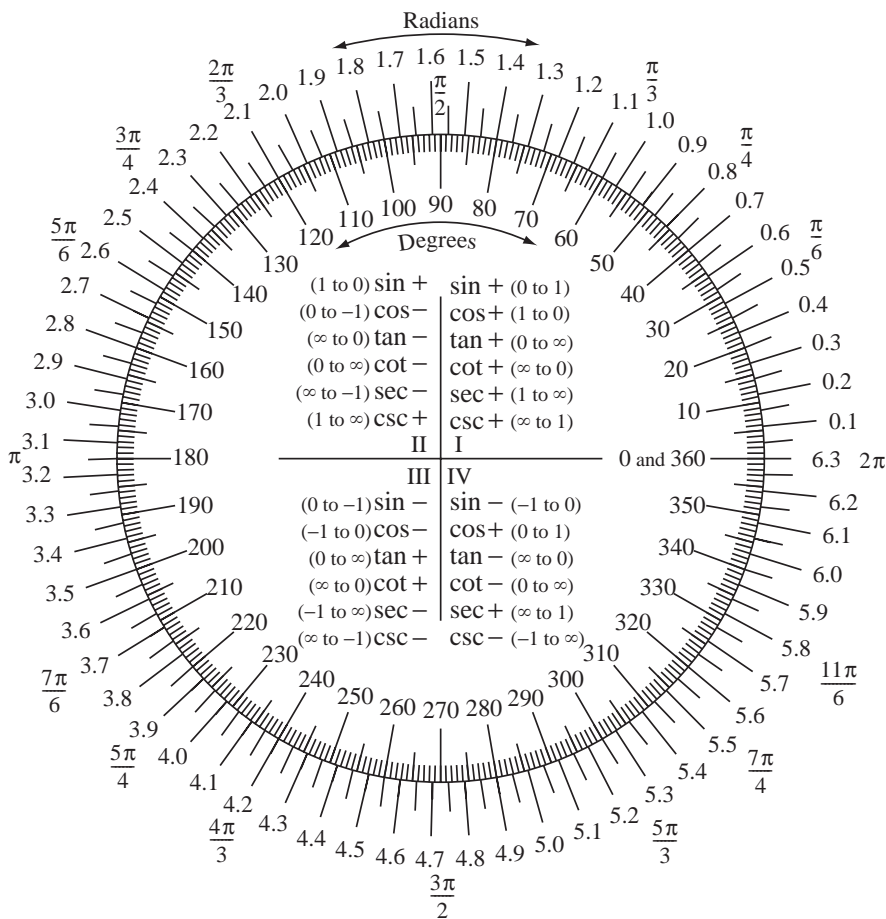


Fig. 1. Signs of Trigonometric Functions, Fractions of π , and Degree-Radian Conversion

Graphic Illustrations of the Functions of Angles.—Fig. 1 shows the sign (+ or -) and the limits between which the numerical values of trigonometric functions vary for angles in each of the four quadrants, 0 to 90, 90 to 180, 180 to 270, and 270 to 360 degrees. The chart indicates, for example, that all the functions are positive for angles between 0 and 90 degrees. In the same way, the cotangent of an angle between 180 and 270 degrees is positive and has a value between infinity and 0; in other words, the cotangent for 180 degrees is infinitely large and then the cotangent gradually decreases for increasing angles, so that the cotangent for 270 degrees equals 0. The cosine, tangent and cotangent for angles between 90 and 180 degrees are negative, although they have the same numerical values as for angles from 0 to 90 degrees. Negative values should be preceded by a minus sign; thus, $\tan 123^\circ 20' = -1.5204$. The chart also illustrates the relationship between degrees, radian, and fractions of pi (π).

In Fig. 2, illustrating the functions of angles, it is assumed that all distances measured in the horizontal direction to the right of line AB are positive. Those measured horizontally to the left of AB are negative. All distances measured vertically, are positive above line CD and negative below it. It can then be readily seen that the sine is positive for all angles less than 180 degrees. For angles larger than 180 degrees, the sine would be measured below CD , and is negative. The cosine is positive up to 90 degrees, but for angles larger than 90 and less than 270 degrees, the cosine is measured to the left of line AB and is negative.

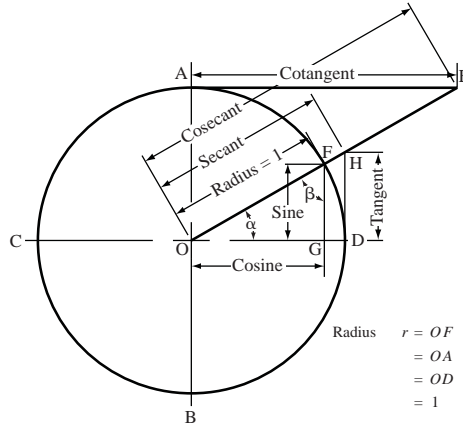


Fig. 2. Graphic Illustration of the Functions of Angles

✦ **Tables of Trigonometric Functions.**—The trigonometric (trig) tables on the following pages give numerical values for sine, cosine, tangent, and cotangent functions of angles from 0 to 90 degrees. Function values for all other angles can be obtained from the tables by applying the rules for signs of trigonometric functions and the useful relationships among angles given in the following. Secant and cosecant functions can be found from $\sec A = 1/\cos A$ and $\csc A = 1/\sin A$.

The trig tables are divided by a double line. The body of each half table consists of four labeled columns of data between columns listing angles. The angles listed to the left of the data increase moving down the table, and angles listed to the right of the data increase moving up the table. Labels above the data identify the trig functions corresponding to angles listed in the left column of each half table. Labels below the data correspond to angles listed in the right column of each half table. To find the value of a function for a particular angle, first locate the angle in the table, then find the appropriate function label across the top or bottom row of the table, and find the function value at the intersection of the angle row and label column. Angles opposite each other are complementary angles (i.e., their sum equals 90°) and related. For example, $\sin 10^\circ = \cos 80^\circ$ and $\cos 10^\circ = \sin 80^\circ$. Expanded trig tables are also available on *Machinery's Handbook CD*.

All trig functions of angles between 0° and 90° have positive values. For other angles, consult Fig. 1 to find the sign of the function in the quadrant where the angle is located. To determine trig functions of angles greater than 90° subtract 90, 180, 270, or 360 from the angle to get an angle less than 90° and use Table 1, *Useful Relationships Among Angles*, to find the equivalent first-quadrant function and angle to look up in the trig tables.

Table 1. Useful Relationships Among Angles

Angle Function	θ	$-\theta$	$90^\circ \pm \theta$	$180^\circ \pm \theta$	$270^\circ \pm \theta$	$360^\circ \pm \theta$
sin	$\sin \theta$	$-\sin \theta$	$+\cos \theta$	$\mp \sin \theta$	$-\cos \theta$	$\pm \sin \theta$
cos	$\cos \theta$	$+\cos \theta$	$\mp \sin \theta$	$-\cos \theta$	$\pm \sin \theta$	$+\cos \theta$
tan	$\tan \theta$	$-\tan \theta$	$\mp \cot \theta$	$\pm \tan \theta$	$\mp \cot \theta$	$\pm \tan \theta$
cot	$\cot \theta$	$-\cot \theta$	$\mp \tan \theta$	$\pm \cot \theta$	$\mp \tan \theta$	$\pm \cot \theta$
sec	$\sec \theta$	$+\sec \theta$	$\mp \csc \theta$	$-\sec \theta$	$\pm \csc \theta$	$+\sec \theta$
csc	$\csc \theta$	$-\csc \theta$	$+\sec \theta$	$\mp \csc \theta$	$-\sec \theta$	$\pm \csc \theta$

Examples: $\cos (270^\circ - \theta) = -\sin \theta$; $\tan (90^\circ + \theta) = -\cot \theta$.

Example: Find the cosine of $336^\circ 40'$. The diagram Fig. 1 shows that the cosine of every angle in Quadrant IV (270° to 360°) is positive. To find the angle and trig function to use when entering the trig table, subtract 270 from 336 to get $\cos 336^\circ 40' = \cos (270^\circ + 66^\circ 40')$ and then find the intersection of the cos row and the $270 \pm \theta$ column in Table 1. Because $\cos (270 \pm \theta)$ in the fourth quadrant is equal to $\pm \sin \theta$ in the first quadrant, find $\sin 66^\circ 40'$ in the trig table. Therefore, $\cos 336^\circ 40' = \sin 66^\circ 40' = 0.918216$.

Trigonometric Functions of Angles from 0° to 15° and 75° to 90°

Angle	sin	cos	tan	cot		Angle	sin	cos	tan	cot	
0° 0'	0.000000	1.000000	0.000000	—	90° 0'	7° 30'	0.130526	0.991445	0.131652	7.595754	82° 30'
10	0.002909	0.999996	0.002909	343.7737	50	40	0.133410	0.991061	0.134613	7.428706	20
20	0.005818	0.999983	0.005818	171.8854	40	50	0.136292	0.990669	0.137576	7.268725	10
30	0.008727	0.999962	0.008727	114.5887	30	8° 0'	0.139173	0.990268	0.140541	7.115370	82° 0'
40	0.011635	0.999932	0.011636	85.93979	20	10	0.142053	0.989859	0.143508	6.968234	50
50	0.014544	0.999894	0.014545	68.75009	10	20	0.144932	0.989442	0.146478	6.826944	40
1° 0'	0.017452	0.999848	0.017455	57.28996	89° 0'	30	0.147809	0.989016	0.149451	6.691156	30
10	0.020361	0.999793	0.020365	49.10388	50	40	0.150686	0.988582	0.152426	6.560554	20
20	0.023269	0.999729	0.023275	42.96408	40	50	0.153561	0.988139	0.155404	6.434843	10
30	0.026177	0.999657	0.026186	38.18846	30	9° 0'	0.156434	0.987688	0.158384	6.313752	81° 0'
40	0.029085	0.999577	0.029097	34.36777	20	10	0.159307	0.987229	0.161368	6.197028	50
50	0.031992	0.999488	0.032009	31.24158	10	20	0.162178	0.986762	0.164354	6.084438	40
2° 0'	0.034899	0.999391	0.034921	28.63625	88° 0'	30	0.165048	0.986286	0.167343	5.975764	30
10	0.037806	0.999285	0.037834	26.43160	50	40	0.167916	0.985801	0.170334	5.870804	20
20	0.040713	0.999171	0.040747	24.54176	40	50	0.170783	0.985309	0.173329	5.769369	10
30	0.043619	0.999048	0.043661	22.90377	30	10° 0'	0.173648	0.984808	0.176327	5.671282	80° 0'
40	0.046525	0.998917	0.046576	21.47040	20	10	0.176512	0.984298	0.179328	5.576379	50
50	0.049431	0.998778	0.049491	20.20555	10	20	0.179375	0.983781	0.182332	5.484505	40
3° 0'	0.052336	0.998630	0.052408	19.08114	87° 0'	30	0.182236	0.983255	0.185339	5.395517	30
10	0.055241	0.998473	0.055325	18.07498	50	40	0.185095	0.982721	0.188349	5.309279	20
20	0.058145	0.998308	0.058243	17.16934	40	50	0.187953	0.982178	0.191363	5.225665	10
30	0.061049	0.998135	0.061163	16.34986	30	11° 0'	0.190809	0.981627	0.194380	5.144554	79° 0'
40	0.063952	0.997953	0.064083	15.60478	20	10	0.193664	0.981068	0.197401	5.065835	50
50	0.066854	0.997763	0.067004	14.92442	10	20	0.196517	0.980500	0.200425	4.989403	40
4° 0'	0.069756	0.997564	0.069927	14.30067	86° 0'	30	0.199368	0.979925	0.203452	4.915157	30
10	0.072658	0.997357	0.072851	13.72674	50	40	0.202218	0.979341	0.206483	4.843005	20
20	0.075559	0.997141	0.075775	13.19688	40	50	0.205065	0.978748	0.209518	4.772857	10
30	0.078459	0.996917	0.078702	12.70621	30	12° 0'	0.207912	0.978148	0.212557	4.704630	78° 0'
40	0.081359	0.996685	0.081629	12.25051	20	10	0.210756	0.977539	0.215599	4.638246	50
50	0.084258	0.996444	0.084558	11.82617	10	20	0.213599	0.976921	0.218645	4.573629	40
5° 0'	0.087156	0.996195	0.087489	11.43005	85° 0'	30	0.216440	0.976296	0.221695	4.510709	30
10	0.090053	0.995937	0.090421	11.05943	50	40	0.219279	0.975662	0.224748	4.449418	20
20	0.092950	0.995671	0.093354	10.71191	40	50	0.222116	0.975020	0.227806	4.389694	10
30	0.095846	0.995396	0.096289	10.38540	30	13° 0'	0.224951	0.974370	0.230868	4.331476	77° 0'
40	0.098741	0.995113	0.099226	10.07803	20	10	0.227784	0.973712	0.233934	4.274707	50
50	0.101635	0.994822	0.102164	9.788173	10	20	0.230616	0.973045	0.237004	4.219332	40
6° 0'	0.104528	0.994522	0.105104	9.514364	84° 0'	30	0.233445	0.972370	0.240079	4.165300	30
10	0.107421	0.994214	0.108046	9.255304	50	40	0.236273	0.971687	0.243157	4.112561	20
20	0.110313	0.993897	0.110990	9.009826	40	50	0.239098	0.970995	0.246241	4.061070	10
30	0.113203	0.993572	0.113936	8.776887	30	14° 0'	0.241922	0.970296	0.249328	4.010781	76° 0'
40	0.116093	0.993238	0.116883	8.555547	20	10	0.244743	0.969588	0.252420	3.961652	50
50	0.118982	0.992896	0.119833	8.344956	10	20	0.247563	0.968872	0.255516	3.913642	40
7° 0'	0.121869	0.992546	0.122785	8.144346	83° 0'	30	0.250380	0.968148	0.258618	3.866713	30
10	0.124756	0.992187	0.125738	7.953022	50	40	0.253195	0.967415	0.261723	3.820828	20
20	0.127642	0.991820	0.128694	7.770351	40	50	0.256008	0.966675	0.264834	3.775952	10
7° 30'	0.130526	0.991445	0.131652	7.595754	82° 30'	15° 0'	0.258819	0.965926	0.267949	3.732051	75° 0'
	cos	sin	cot	tan	Angle		cos	sin	cot	tan	Angle

For angles 0° to 15° 0' (angles found in a column to the left of the data), use the column labels at the top of the table; for angles 75° to 90° 0' (angles found in a column to the right of the data), use the column labels at the bottom of the table.

Trigonometric Functions of Angles from 15° to 30° and 60° to 75°

Angle	sin	cos	tan	cot		Angle	sin	cos	tan	cot	
15° 0'	0.258819	0.965926	0.267949	3.732051	75° 0'	22° 30'	0.382683	0.923880	0.414214	2.414214	67° 30'
10	0.261628	0.965169	0.271069	3.689093	50	40	0.385369	0.922762	0.417626	2.394489	20
20	0.264434	0.964404	0.274194	3.647047	40	50	0.388052	0.921638	0.421046	2.375037	10
30	0.267238	0.963630	0.277325	3.605884	30	23° 0'	0.390731	0.920505	0.424475	2.355852	67° 0'
40	0.270040	0.962849	0.280460	3.565575	20	10	0.393407	0.919364	0.427912	2.336929	50
50	0.272840	0.962059	0.283600	3.526094	10	20	0.396080	0.918216	0.431358	2.318261	40
16° 0'	0.275637	0.961262	0.286745	3.487414	74° 0'	30	0.398749	0.917060	0.434812	2.299843	30
10	0.278432	0.960456	0.289896	3.449512	50	40	0.401415	0.915896	0.438276	2.281669	20
20	0.281225	0.959642	0.293052	3.412363	40	50	0.404078	0.914725	0.441748	2.263736	10
30	0.284015	0.958820	0.296213	3.375943	30	24° 0'	0.406737	0.913545	0.445229	2.246037	66° 0'
40	0.286803	0.957990	0.299380	3.340233	20	10	0.409392	0.912358	0.448719	2.228568	50
50	0.289589	0.957151	0.302553	3.305209	10	20	0.412045	0.911164	0.452218	2.211323	40
17° 0'	0.292372	0.956305	0.305731	3.270853	73° 0'	30	0.414693	0.909961	0.455726	2.194300	30
10	0.295152	0.955450	0.308914	3.237144	50	40	0.417338	0.908751	0.459244	2.177492	20
20	0.297930	0.954588	0.312104	3.204064	40	50	0.419980	0.907533	0.462771	2.160896	10
30	0.300706	0.953717	0.315299	3.171595	30	25° 0'	0.422618	0.906308	0.466308	2.144507	65° 0'
40	0.303479	0.952838	0.318500	3.139719	20	10	0.425253	0.905075	0.469854	2.128321	50
50	0.306249	0.951951	0.321707	3.108421	10	20	0.427884	0.903834	0.473410	2.112335	40
18° 0'	0.309017	0.951057	0.324920	3.077684	72° 0'	30	0.430511	0.902585	0.476976	2.096544	30
10	0.311782	0.950154	0.328139	3.047492	50	40	0.433135	0.901329	0.480551	2.080944	20
20	0.314545	0.949243	0.331364	3.017830	40	50	0.435755	0.900065	0.484137	2.065532	10
30	0.317305	0.948324	0.334595	2.988685	30	26° 0'	0.438371	0.898794	0.487733	2.050304	64° 0'
40	0.320062	0.947397	0.337833	2.960042	20	10	0.440984	0.897515	0.491339	2.035256	50
50	0.322816	0.946462	0.341077	2.931888	10	20	0.443593	0.896229	0.494955	2.020386	40
19° 0'	0.325568	0.945519	0.344328	2.904211	71° 0'	30	0.446198	0.894934	0.498582	2.005690	30
10	0.328317	0.944568	0.347585	2.876997	50	40	0.448799	0.893633	0.502219	1.991164	20
20	0.331063	0.943609	0.350848	2.850235	40	50	0.451397	0.892323	0.505867	1.976805	10
30	0.333807	0.942641	0.354119	2.823913	30	27° 0'	0.453990	0.891007	0.509525	1.962611	63° 0'
40	0.336547	0.941666	0.357396	2.798020	20	10	0.456580	0.889682	0.513195	1.948577	50
50	0.339285	0.940684	0.360679	2.772545	10	20	0.459166	0.888350	0.516875	1.934702	40
20° 0'	0.342020	0.939693	0.363970	2.747477	70° 0'	30	0.461749	0.887011	0.520567	1.920982	30
10	0.344752	0.938694	0.367268	2.722808	50	40	0.464327	0.885664	0.524270	1.907415	20
20	0.347481	0.937687	0.370573	2.698525	40	50	0.466901	0.884309	0.527984	1.893997	10
30	0.350207	0.936672	0.373885	2.674621	30	28° 0'	0.469472	0.882948	0.531709	1.880726	62° 0'
40	0.352931	0.935650	0.377204	2.651087	20	10	0.472038	0.881578	0.535446	1.867600	50
50	0.355651	0.934619	0.380530	2.627912	10	20	0.474600	0.880201	0.539195	1.854616	40
21° 0'	0.358368	0.933580	0.383864	2.605089	69° 0'	30	0.477159	0.878817	0.542956	1.841771	30
10	0.361082	0.932534	0.387205	2.582609	50	40	0.479713	0.877425	0.546728	1.829063	20
20	0.363793	0.931480	0.390554	2.560465	40	50	0.482263	0.876026	0.550513	1.816489	10
30	0.366501	0.930418	0.393910	2.538648	30	29° 0'	0.484810	0.874620	0.554309	1.804048	61° 0'
40	0.369206	0.929348	0.397275	2.517151	20	10	0.487352	0.873206	0.558118	1.791736	50
50	0.371908	0.928270	0.400646	2.495966	10	20	0.489890	0.871784	0.561939	1.779552	40
22° 0'	0.374607	0.927184	0.404026	2.475087	68° 0'	30	0.492424	0.870356	0.565773	1.767494	30
10	0.377302	0.926090	0.407414	2.454506	50	40	0.494953	0.868920	0.569619	1.755559	20
20	0.379994	0.924989	0.410810	2.434217	40	50	0.497479	0.867476	0.573478	1.743745	10
22° 30'	0.382683	0.923880	0.414214	2.414214	67° 30'	30° 0'	0.500000	0.866025	0.577350	1.732051	60° 0'
	cos	sin	cot	tan	Angle		cos	sin	cot	tan	Angle

For angles 15° to 30° 0' (angles found in a column to the left of the data), use the column labels at the top of the table; for angles 60° to 75° 0' (angles found in a column to the right of the data), use the column labels at the bottom of the table.

Trigonometric Functions of Angles from 30° to 60°

Angle	sin	cos	tan	cot		Angle	sin	cos	tan	cot	
30° 0'	0.500000	0.866025	0.577350	1.732051	60° 0'	37° 30'	0.608761	0.793353	0.767327	1.303225	52° 30'
10	0.502517	0.864567	0.581235	1.720474	50	40	0.611067	0.791579	0.771959	1.295406	20
20	0.505030	0.863102	0.585134	1.709012	40	50	0.613367	0.789798	0.776612	1.287645	10
30	0.507538	0.861629	0.589045	1.697663	30	38° 0'	0.615661	0.788011	0.781286	1.279942	52° 0'
40	0.510043	0.860149	0.592970	1.686426	20	10	0.617951	0.786217	0.785981	1.272296	50
50	0.512543	0.858662	0.596908	1.675299	10	20	0.620235	0.784416	0.790697	1.264706	40
31° 0'	0.515038	0.857167	0.600861	1.664279	59° 0'	30	0.622515	0.782608	0.795436	1.257172	30
10	0.517529	0.855665	0.604827	1.653366	50	40	0.624789	0.780794	0.800196	1.249693	20
20	0.520016	0.854156	0.608807	1.642558	40	50	0.627057	0.778973	0.804979	1.242268	10
30	0.522499	0.852640	0.612801	1.631852	30	39° 0'	0.629320	0.777146	0.809784	1.234897	51° 0'
40	0.524977	0.851117	0.616809	1.621247	20	10	0.631578	0.775312	0.814612	1.227579	50
50	0.527450	0.849586	0.620832	1.610742	10	20	0.633831	0.773472	0.819463	1.220312	40
32° 0'	0.529919	0.848048	0.624869	1.600335	58° 0'	30	0.636078	0.771625	0.824336	1.213097	30
10	0.532384	0.846503	0.628921	1.590024	50	40	0.638320	0.769771	0.829234	1.205933	20
20	0.534844	0.844951	0.632988	1.579808	40	50	0.640557	0.767911	0.834155	1.198818	10
30	0.537300	0.843391	0.637070	1.569686	30	40° 0'	0.642788	0.766044	0.839100	1.191754	50° 0'
40	0.539751	0.841825	0.641167	1.559655	20	10	0.645013	0.764171	0.844069	1.184738	50
50	0.542197	0.840251	0.645280	1.549715	10	20	0.647233	0.762292	0.849062	1.177770	40
33° 0'	0.544639	0.838671	0.649408	1.539865	57° 0'	30	0.649448	0.760406	0.854081	1.170850	30
10	0.547076	0.837083	0.653551	1.530102	50	40	0.651657	0.758514	0.859124	1.163976	20
20	0.549509	0.835488	0.657710	1.520426	40	50	0.653861	0.756615	0.864193	1.157149	10
30	0.551937	0.833886	0.661886	1.510835	30	41° 0'	0.656059	0.754710	0.869287	1.150368	49° 0'
40	0.554360	0.832277	0.666077	1.501328	20	10	0.658252	0.752798	0.874407	1.143633	50
50	0.556779	0.830661	0.670284	1.491904	10	20	0.660439	0.750880	0.879553	1.136941	40
34° 0'	0.559193	0.829038	0.674509	1.482561	56° 0'	30	0.662620	0.748956	0.884725	1.130294	30
10	0.561602	0.827407	0.678749	1.473298	50	40	0.664796	0.747025	0.889924	1.123691	20
20	0.564007	0.825770	0.683007	1.464115	40	50	0.666966	0.745088	0.895151	1.117130	10
30	0.566406	0.824126	0.687281	1.455009	30	42° 0'	0.669131	0.743145	0.900404	1.110613	48° 0'
40	0.568801	0.822475	0.691572	1.445980	20	10	0.671289	0.741195	0.905685	1.104137	50
50	0.571191	0.820817	0.695881	1.437027	10	20	0.673443	0.739239	0.910994	1.097702	40
35° 0'	0.573576	0.819152	0.700208	1.428148	55° 0'	30	0.675590	0.737277	0.916331	1.091309	30
10	0.575957	0.817480	0.704551	1.419343	50	40	0.677732	0.735309	0.921697	1.084955	20
20	0.578332	0.815801	0.708913	1.410610	40	50	0.679868	0.733334	0.927091	1.078642	10
30	0.580703	0.814116	0.713293	1.401948	30	43° 0'	0.681998	0.731354	0.932515	1.072369	47° 0'
40	0.583069	0.812423	0.717691	1.393357	20	10	0.684123	0.729367	0.937968	1.066134	50
50	0.585429	0.810723	0.722108	1.384835	10	20	0.686242	0.727374	0.943451	1.059938	40
36° 0'	0.587785	0.809017	0.726543	1.376382	54° 0'	30	0.688355	0.725374	0.948965	1.053780	30
10	0.590136	0.807304	0.730996	1.367996	50	40	0.690462	0.723369	0.954508	1.047660	20
20	0.592482	0.805584	0.735469	1.359676	40	50	0.692563	0.721357	0.960083	1.041577	10
30	0.594823	0.803857	0.739961	1.351422	30	44° 0'	0.694658	0.719340	0.965689	1.035530	46° 0'
40	0.597159	0.802123	0.744472	1.343233	20	10	0.696748	0.717316	0.971326	1.029520	50
50	0.599489	0.800383	0.749003	1.335108	10	20	0.698832	0.715286	0.976996	1.023546	40
37° 0'	0.601815	0.798636	0.753554	1.327045	53° 0'	30	0.700909	0.713250	0.982697	1.017607	30
10	0.604136	0.796882	0.758125	1.319044	50	40	0.702981	0.711209	0.988432	1.011704	20
20	0.606451	0.795121	0.762716	1.311105	40	50	0.705047	0.709161	0.994199	1.005835	10
37° 30'	0.608761	0.793353	0.767327	1.303225	52° 30'	45° 0'	0.707107	0.707107	1.000000	1.000000	45° 0'
	cos	sin	cot	tan	Angle		cos	sin	cot	tan	Angle

For angles 30° to 45° 0' (angles found in a column to the left of the data), use the column labels at the top of the table; for angles 45° to 60° 0' (angles found in a column to the right of the data), use the column labels at the bottom of the table.

Using a Calculator to Find Trig Functions.—A scientific calculator is quicker and more accurate than tables for finding trig functions and angles corresponding to trig functions. On scientific calculators, the keys labeled **sin**, **cos**, and **tan** are used to find the common trig functions. The other functions can be found by using the same keys and the **1/x** key, noting that $\csc A = 1/\sin A$, $\sec A = 1/\cos A$, and $\cot A = 1/\tan A$. The specific keystrokes used will vary slightly from one calculator to another. To find the angle corresponding to a given trig function use the keys labeled **sin⁻¹**, **cos⁻¹**, and **tan⁻¹**. On some other calculators, the **sin**, **cos**, and **tan** are used in combination with the **INV**, or inverse, key to find the number corresponding to a given trig function.

If a scientific calculator or computer is not available, tables are the easiest way to find trig values. However, trig function values can be calculated very accurately without a scientific calculator by using the following formulas:

$$\begin{aligned}\sin A &= A - \frac{A^3}{3!} + \frac{A^5}{5!} - \frac{A^7}{7!} \pm \dots & \cos A &= 1 - \frac{A^2}{2!} + \frac{A^4}{4!} - \frac{A^6}{6!} \pm \dots \\ \sin^{-1} A &= \frac{1}{2} \times \frac{A^3}{3} + \frac{1}{2} \times \frac{3}{4} \times \frac{A^5}{5} + \dots & \tan^{-1} A &= A - \frac{A^3}{3} + \frac{A^5}{5} - \frac{A^7}{7} \pm \dots\end{aligned}$$

where the angle A is expressed in radians (convert degrees to radians by multiplying degrees by $\pi/180 = 0.0174533$). The three dots at the ends of the formulas indicate that the expression continues with more terms following the sequence established by the first few terms. Generally, calculating just three or four terms of the expression is sufficient for accuracy. In these formulas, a number followed by the symbol **!** is called a factorial (for example, $3!$ is three factorial). Except for $0!$, which is defined as 1, a factorial is found by multiplying together all the integers greater than zero and less than or equal to the factorial number wanted. For example: $3! = 1 \times 2 \times 3 = 6$; $4! = 1 \times 2 \times 3 \times 4 = 24$; $7! = 1 \times 2 \times 3 \times 4 \times 5 \times 6 \times 7 = 5040$; etc.

Versed Sine and Versed Cosine.—These functions are sometimes used in formulas for segments of a circle and may be obtained using the relationships:



$$\text{versed } \sin \theta = 1 - \cos \theta; \text{ versed } \cos \theta = 1 - \sin \theta.$$

Sevolute Functions.—Sevolute functions are used in calculating the form diameter of involute splines. They are computed by subtracting the involute function of an angle from the secant of the angle ($1/\cosine = \text{secant}$). Thus, sevolute of 20 degrees = secant of 20 degrees – involute function of 20 degrees = $1.064178 - 0.014904 = 1.049274$.



Involute Functions.—Involute functions are used in certain formulas relating to the design and measurement of gear teeth as well as measurement of threads over wires. See, for example, pages 1997 through 2000, 2207, and 2271.

The tables on the following pages provide values of involute functions for angles from 14 to 51 degrees in increments of 1 minute. These involute functions were calculated from the following formulas: Involute of $\theta = \tan \theta - \theta$, for θ in radians, and involute of $\theta = \tan \theta - \pi \times \theta/180$, for θ in degrees.

Example: For an angle of 14 degrees and 10 minutes, the involute function is found as follows: 10 minutes = $10/60 = 0.166666$ degrees, $14 + 0.166666 = 14.166666$ degree, so that the involute of 14.166666 degrees = $\tan 14.166666 - \pi \times 14.166666/180 = 0.252420 - 0.247255 = 0.005165$. This value is the same as that in the table *Involute Functions for Angles from 14 to 23 Degrees* for 14 degrees and 10 minutes. The same result would be obtained from using the conversion tables beginning on page 103 to convert 14 degrees and 10 minutes to radians and then applying the first of the formulas given above.

Involute Functions for Angles from 14 to 23 Degrees

Minutes	Degrees								
	14	15	16	17	18	19	20	21	22
	Involute Functions								
0	0.004982	0.006150	0.007493	0.009025	0.010760	0.012715	0.014904	0.017345	0.020054
1	0.005000	0.006171	0.007517	0.009052	0.010791	0.012750	0.014943	0.017388	0.020101
2	0.005018	0.006192	0.007541	0.009079	0.010822	0.012784	0.014982	0.017431	0.020149
3	0.005036	0.006213	0.007565	0.009107	0.010853	0.012819	0.015020	0.017474	0.020197
4	0.005055	0.006234	0.007589	0.009134	0.010884	0.012854	0.015059	0.017517	0.020244
5	0.005073	0.006255	0.007613	0.009161	0.010915	0.012888	0.015098	0.017560	0.020292
6	0.005091	0.006276	0.007637	0.009189	0.010946	0.012923	0.015137	0.017603	0.020340
7	0.005110	0.006297	0.007661	0.009216	0.010977	0.012958	0.015176	0.017647	0.020388
8	0.005128	0.006318	0.007686	0.009244	0.011008	0.012993	0.015215	0.017690	0.020436
9	0.005146	0.006340	0.007710	0.009272	0.011039	0.013028	0.015254	0.017734	0.020484
10	0.005165	0.006361	0.007735	0.009299	0.011071	0.013063	0.015293	0.017777	0.020533
11	0.005184	0.006382	0.007759	0.009327	0.011102	0.013098	0.015333	0.017821	0.020581
12	0.005202	0.006404	0.007784	0.009355	0.011133	0.013134	0.015372	0.017865	0.020629
13	0.005221	0.006425	0.007808	0.009383	0.011165	0.013169	0.015411	0.017908	0.020678
14	0.005239	0.006447	0.007833	0.009411	0.011196	0.013204	0.015451	0.017952	0.020726
15	0.005258	0.006469	0.007857	0.009439	0.011228	0.013240	0.015490	0.017996	0.020775
16	0.005277	0.006490	0.007882	0.009467	0.011260	0.013275	0.015530	0.018040	0.020824
17	0.005296	0.006512	0.007907	0.009495	0.011291	0.013311	0.015570	0.018084	0.020873
18	0.005315	0.006534	0.007932	0.009523	0.011323	0.013346	0.015609	0.018129	0.020921
19	0.005334	0.006555	0.007957	0.009552	0.011355	0.013382	0.015649	0.018173	0.020970
20	0.005353	0.006577	0.007982	0.009580	0.011387	0.013418	0.015689	0.018217	0.021019
21	0.005372	0.006599	0.008007	0.009608	0.011419	0.013454	0.015729	0.018262	0.021069
22	0.005391	0.006621	0.008032	0.009637	0.011451	0.013490	0.015769	0.018306	0.021118
23	0.005410	0.006643	0.008057	0.009665	0.011483	0.013526	0.015809	0.018351	0.021167
24	0.005429	0.006665	0.008082	0.009694	0.011515	0.013562	0.015850	0.018395	0.021217
25	0.005448	0.006687	0.008107	0.009722	0.011547	0.013598	0.015890	0.018440	0.021266
26	0.005467	0.006709	0.008133	0.009751	0.011580	0.013634	0.015930	0.018485	0.021316
27	0.005487	0.006732	0.008158	0.009780	0.011612	0.013670	0.015971	0.018530	0.021365
28	0.005506	0.006754	0.008183	0.009808	0.011644	0.013707	0.016011	0.018575	0.021415
29	0.005525	0.006776	0.008209	0.009837	0.011677	0.013743	0.016052	0.018620	0.021465
30	0.005545	0.006799	0.008234	0.009866	0.011709	0.013779	0.016092	0.018665	0.021514
31	0.005564	0.006821	0.008260	0.009895	0.011742	0.013816	0.016133	0.018710	0.021564
32	0.005584	0.006843	0.008285	0.009924	0.011775	0.013852	0.016174	0.018755	0.021614
33	0.005603	0.006866	0.008311	0.009953	0.011807	0.013889	0.016215	0.018800	0.021665
34	0.005623	0.006888	0.008337	0.009982	0.011840	0.013926	0.016255	0.018846	0.021715
35	0.005643	0.006911	0.008362	0.010011	0.011873	0.013963	0.016296	0.018891	0.021765
36	0.005662	0.006934	0.008388	0.010041	0.011906	0.013999	0.016337	0.018937	0.021815
37	0.005682	0.006956	0.008414	0.010070	0.011939	0.014036	0.016379	0.018983	0.021866
38	0.005702	0.006979	0.008440	0.010099	0.011972	0.014073	0.016420	0.019028	0.021916
39	0.005722	0.007002	0.008466	0.010129	0.012005	0.014110	0.016461	0.019074	0.021967
40	0.005742	0.007025	0.008492	0.010158	0.012038	0.014148	0.016502	0.019120	0.022018
41	0.005762	0.007048	0.008518	0.010188	0.012071	0.014185	0.016544	0.019166	0.022068
42	0.005782	0.007071	0.008544	0.010217	0.012105	0.014222	0.016585	0.019212	0.022119
43	0.005802	0.007094	0.008571	0.010247	0.012138	0.014259	0.016627	0.019258	0.022170
44	0.005822	0.007117	0.008597	0.010277	0.012172	0.014297	0.016669	0.019304	0.022221
45	0.005842	0.007140	0.008623	0.010307	0.012205	0.014334	0.016710	0.019350	0.022272
46	0.005862	0.007163	0.008650	0.010336	0.012239	0.014372	0.016752	0.019397	0.022324
47	0.005882	0.007186	0.008676	0.010366	0.012272	0.014409	0.016794	0.019443	0.022375
48	0.005903	0.007209	0.008702	0.010396	0.012306	0.014447	0.016836	0.019490	0.022426
49	0.005923	0.007233	0.008729	0.010426	0.012340	0.014485	0.016878	0.019536	0.022478
50	0.005943	0.007256	0.008756	0.010456	0.012373	0.014523	0.016920	0.019583	0.022529
51	0.005964	0.007280	0.008782	0.010486	0.012407	0.014560	0.016962	0.019630	0.022581
52	0.005984	0.007303	0.008809	0.010517	0.012441	0.014598	0.017004	0.019676	0.022633
53	0.006005	0.007327	0.008836	0.010547	0.012475	0.014636	0.017047	0.019723	0.022684
54	0.006025	0.007350	0.008863	0.010577	0.012509	0.014674	0.017089	0.019770	0.022736
55	0.006046	0.007374	0.008889	0.010608	0.012543	0.014713	0.017132	0.019817	0.022788
56	0.006067	0.007397	0.008916	0.010638	0.012578	0.014751	0.017174	0.019864	0.022840
57	0.006087	0.007421	0.008943	0.010669	0.012612	0.014789	0.017217	0.019912	0.022892
58	0.006108	0.007445	0.008970	0.010699	0.012646	0.014827	0.017259	0.019959	0.022944
59	0.006129	0.007469	0.008998	0.010730	0.012681	0.014866	0.017302	0.020006	0.022997
60	0.006150	0.007493	0.009025	0.010760	0.012715	0.014904	0.017345	0.020054	0.023049

Involute Functions for Angles from 23 to 32 Degrees

Minutes	Degrees								
	23	24	25	26	27	28	29	30	31
	Involute Functions								
0	0.023049	0.026350	0.029975	0.033947	0.038287	0.043017	0.048164	0.053752	0.059809
1	0.023102	0.026407	0.030039	0.034016	0.038362	0.043100	0.048253	0.053849	0.059914
2	0.023154	0.026465	0.030102	0.034086	0.038438	0.043182	0.048343	0.053946	0.060019
3	0.023207	0.026523	0.030166	0.034155	0.038514	0.043264	0.048432	0.054043	0.060124
4	0.023259	0.026581	0.030229	0.034225	0.038590	0.043347	0.048522	0.054140	0.060230
5	0.023312	0.026639	0.030293	0.034294	0.038666	0.043430	0.048612	0.054238	0.060335
6	0.023365	0.026697	0.030357	0.034364	0.038742	0.043513	0.048702	0.054336	0.060441
7	0.023418	0.026756	0.030420	0.034434	0.038818	0.043596	0.048792	0.054433	0.060547
8	0.023471	0.026814	0.030484	0.034504	0.038894	0.043679	0.048883	0.054531	0.060653
9	0.023524	0.026872	0.030549	0.034574	0.038971	0.043762	0.048973	0.054629	0.060759
10	0.023577	0.026931	0.030613	0.034644	0.039047	0.043845	0.049064	0.054728	0.060866
11	0.023631	0.026989	0.030677	0.034714	0.039124	0.043929	0.049154	0.054826	0.060972
12	0.023684	0.027048	0.030741	0.034785	0.039201	0.044012	0.049245	0.054924	0.061079
13	0.023738	0.027107	0.030806	0.034855	0.039278	0.044096	0.049336	0.055023	0.061186
14	0.023791	0.027166	0.030870	0.034926	0.039355	0.044180	0.049427	0.055122	0.061292
15	0.023845	0.027225	0.030935	0.034997	0.039432	0.044264	0.049518	0.055221	0.061400
16	0.023899	0.027284	0.031000	0.035067	0.039509	0.044348	0.049609	0.055320	0.061507
17	0.023952	0.027343	0.031065	0.035138	0.039586	0.044432	0.049701	0.055419	0.061614
18	0.024006	0.027402	0.031130	0.035209	0.039664	0.044516	0.049792	0.055518	0.061721
19	0.024060	0.027462	0.031195	0.035280	0.039741	0.044601	0.049884	0.055617	0.061829
20	0.024114	0.027521	0.031260	0.035352	0.039819	0.044685	0.049976	0.055717	0.061937
21	0.024169	0.027581	0.031325	0.035423	0.039897	0.044770	0.050068	0.055817	0.062045
22	0.024223	0.027640	0.031390	0.035494	0.039974	0.044855	0.050160	0.055916	0.062153
23	0.024277	0.027700	0.031456	0.035566	0.040052	0.044940	0.050252	0.056016	0.062261
24	0.024332	0.027760	0.031521	0.035637	0.040131	0.045024	0.050344	0.056116	0.062369
25	0.024386	0.027820	0.031587	0.035709	0.040209	0.045110	0.050437	0.056217	0.062478
26	0.024441	0.027880	0.031653	0.035781	0.040287	0.045195	0.050529	0.056317	0.062586
27	0.024495	0.027940	0.031718	0.035853	0.040366	0.045280	0.050622	0.056417	0.062695
28	0.024550	0.028000	0.031784	0.035925	0.040444	0.045366	0.050715	0.056518	0.062804
29	0.024605	0.028060	0.031850	0.035997	0.040523	0.045451	0.050808	0.056619	0.062913
30	0.024660	0.028121	0.031917	0.036069	0.040602	0.045537	0.050901	0.056720	0.063022
31	0.024715	0.028181	0.031983	0.036142	0.040680	0.045623	0.050994	0.056821	0.063131
32	0.024770	0.028242	0.032049	0.036214	0.040759	0.045709	0.051087	0.056922	0.063241
33	0.024825	0.028302	0.032116	0.036287	0.040839	0.045795	0.051181	0.057023	0.063350
34	0.024881	0.028363	0.032182	0.036359	0.040918	0.045881	0.051274	0.057124	0.063460
35	0.024936	0.028424	0.032249	0.036432	0.040997	0.045967	0.051368	0.057226	0.063570
36	0.024992	0.028485	0.032315	0.036505	0.041077	0.046054	0.051462	0.057328	0.063680
37	0.025047	0.028546	0.032382	0.036578	0.041156	0.046140	0.051556	0.057429	0.063790
38	0.025103	0.028607	0.032449	0.036651	0.041236	0.046227	0.051650	0.057531	0.063901
39	0.025159	0.028668	0.032516	0.036724	0.041316	0.046313	0.051744	0.057633	0.064011
40	0.025214	0.028729	0.032583	0.036798	0.041395	0.046400	0.051838	0.057736	0.064122
41	0.025270	0.028791	0.032651	0.036871	0.041475	0.046487	0.051933	0.057838	0.064232
42	0.025326	0.028852	0.032718	0.036945	0.041556	0.046575	0.052027	0.057940	0.064343
43	0.025382	0.028914	0.032785	0.037018	0.041636	0.046662	0.052122	0.058043	0.064454
44	0.025439	0.028976	0.032853	0.037092	0.041716	0.046749	0.052217	0.058146	0.064565
45	0.025495	0.029037	0.032920	0.037166	0.041797	0.046837	0.052312	0.058249	0.064677
46	0.025551	0.029099	0.032988	0.037240	0.041877	0.046924	0.052407	0.058352	0.064788
47	0.025608	0.029161	0.033056	0.037314	0.041958	0.047012	0.052502	0.058455	0.064900
48	0.025664	0.029223	0.033124	0.037388	0.042039	0.047100	0.052597	0.058558	0.065012
49	0.025721	0.029285	0.033192	0.037462	0.042120	0.047188	0.052693	0.058662	0.065123
50	0.025778	0.029348	0.033260	0.037537	0.042201	0.047276	0.052788	0.058765	0.065236
51	0.025834	0.029410	0.033328	0.037611	0.042282	0.047364	0.052884	0.058869	0.065348
52	0.025891	0.029472	0.033397	0.037686	0.042363	0.047452	0.052980	0.058973	0.065460
53	0.025948	0.029535	0.033465	0.037761	0.042444	0.047541	0.053076	0.059077	0.065573
54	0.026005	0.029598	0.033534	0.037835	0.042526	0.047630	0.053172	0.059181	0.065685
55	0.026062	0.029660	0.033602	0.037910	0.042608	0.047718	0.053268	0.059285	0.065798
56	0.026120	0.029723	0.033671	0.037985	0.042689	0.047807	0.053365	0.059390	0.065911
57	0.026177	0.029786	0.033740	0.038060	0.042771	0.047896	0.053461	0.059494	0.066024
58	0.026235	0.029849	0.033809	0.038136	0.042853	0.047985	0.053558	0.059599	0.066137
59	0.026292	0.029912	0.033878	0.038211	0.042935	0.048074	0.053655	0.059704	0.066251
60	0.026350	0.029975	0.033947	0.038287	0.043017	0.048164	0.053752	0.059809	0.066364

Involute Functions for Angles from 32 to 41 Degrees

Minutes	Degrees								
	32	33	34	35	36	37	38	39	40
	Involute Functions								
0	0.066364	0.073449	0.081097	0.089342	0.098224	0.107782	0.118061	0.129106	0.140968
1	0.066478	0.073572	0.081229	0.089485	0.098378	0.107948	0.118238	0.129297	0.141173
2	0.066591	0.073695	0.081362	0.089628	0.098532	0.108113	0.118416	0.129488	0.141378
3	0.066705	0.073818	0.081494	0.089771	0.098686	0.108279	0.118594	0.129679	0.141584
4	0.066820	0.073941	0.081627	0.089914	0.098840	0.108445	0.118773	0.129870	0.141789
5	0.066934	0.074064	0.081760	0.090058	0.098994	0.108611	0.118951	0.130062	0.141995
6	0.067048	0.074188	0.081894	0.090201	0.099149	0.108777	0.119130	0.130254	0.142201
7	0.067163	0.074312	0.082027	0.090345	0.099303	0.108943	0.119309	0.130446	0.142408
8	0.067277	0.074435	0.082161	0.090489	0.099458	0.109110	0.119488	0.130639	0.142614
9	0.067392	0.074559	0.082294	0.090633	0.099614	0.109277	0.119667	0.130832	0.142821
10	0.067507	0.074684	0.082428	0.090777	0.099769	0.109444	0.119847	0.131025	0.143028
11	0.067622	0.074808	0.082562	0.090922	0.099924	0.109611	0.120027	0.131218	0.143236
12	0.067738	0.074932	0.082697	0.091067	0.100080	0.109779	0.120207	0.131411	0.143443
13	0.067853	0.075057	0.082831	0.091211	0.100236	0.109947	0.120387	0.131605	0.143651
14	0.067969	0.075182	0.082966	0.091356	0.100392	0.110114	0.120567	0.131799	0.143859
15	0.068084	0.075307	0.083101	0.091502	0.100549	0.110283	0.120748	0.131993	0.144068
16	0.068200	0.075432	0.083235	0.091647	0.100705	0.110451	0.120929	0.132187	0.144276
17	0.068316	0.075557	0.083371	0.091793	0.100862	0.110619	0.121110	0.132381	0.144485
18	0.068432	0.075683	0.083506	0.091938	0.101019	0.110788	0.121291	0.132576	0.144694
19	0.068549	0.075808	0.083641	0.092084	0.101176	0.110957	0.121473	0.132771	0.144903
20	0.068665	0.075934	0.083777	0.092230	0.101333	0.111126	0.121655	0.132966	0.145113
21	0.068782	0.076060	0.083913	0.092377	0.101490	0.111295	0.121837	0.133162	0.145323
22	0.068899	0.076186	0.084049	0.092523	0.101648	0.111465	0.122019	0.133358	0.145533
23	0.069016	0.076312	0.084185	0.092670	0.101806	0.111635	0.122201	0.133553	0.145743
24	0.069133	0.076439	0.084321	0.092816	0.101964	0.111805	0.122384	0.133750	0.145954
25	0.069250	0.076565	0.084458	0.092963	0.102122	0.111975	0.122567	0.133946	0.146165
26	0.069367	0.076692	0.084594	0.093111	0.102280	0.112145	0.122750	0.134143	0.146376
27	0.069485	0.076819	0.084731	0.093258	0.102439	0.112316	0.122933	0.134339	0.146587
28	0.069602	0.076946	0.084868	0.093406	0.102598	0.112486	0.123117	0.134537	0.146799
29	0.069720	0.077073	0.085005	0.093553	0.102757	0.112657	0.123300	0.134734	0.147010
30	0.069838	0.077200	0.085142	0.093701	0.102916	0.112829	0.123484	0.134931	0.147222
31	0.069956	0.077328	0.085280	0.093849	0.103075	0.113000	0.123668	0.135129	0.147435
32	0.070075	0.077455	0.085418	0.093998	0.103235	0.113172	0.123853	0.135327	0.147647
33	0.070193	0.077583	0.085555	0.094146	0.103395	0.113343	0.124037	0.135525	0.147860
34	0.070312	0.077711	0.085693	0.094295	0.103555	0.113515	0.124222	0.135724	0.148073
35	0.070430	0.077839	0.085832	0.094443	0.103715	0.113688	0.124407	0.135923	0.148286
36	0.070549	0.077968	0.085970	0.094593	0.103875	0.113860	0.124592	0.136122	0.148500
37	0.070668	0.078096	0.086108	0.094742	0.104036	0.114033	0.124778	0.136321	0.148714
38	0.070788	0.078225	0.086247	0.094891	0.104196	0.114205	0.124964	0.136520	0.148928
39	0.070907	0.078354	0.086386	0.095041	0.104357	0.114378	0.125150	0.136720	0.149142
40	0.071026	0.078483	0.086525	0.095190	0.104518	0.114552	0.125336	0.136920	0.149357
41	0.071146	0.078612	0.086664	0.095340	0.104680	0.114725	0.125522	0.137120	0.149572
42	0.071266	0.078741	0.086804	0.095490	0.104841	0.114899	0.125709	0.137320	0.149787
43	0.071386	0.078871	0.086943	0.095641	0.105003	0.115073	0.125896	0.137521	0.150002
44	0.071506	0.079000	0.087083	0.095791	0.105165	0.115247	0.126083	0.137722	0.150218
45	0.071626	0.079130	0.087223	0.095942	0.105327	0.115421	0.126270	0.137923	0.150434
46	0.071747	0.079260	0.087363	0.096093	0.105489	0.115595	0.126457	0.138124	0.150650
47	0.071867	0.079390	0.087503	0.096244	0.105652	0.115770	0.126645	0.138326	0.150866
48	0.071988	0.079520	0.087644	0.096395	0.105814	0.115945	0.126833	0.138528	0.151083
49	0.072109	0.079651	0.087784	0.096546	0.105977	0.116120	0.127021	0.138730	0.151299
50	0.072230	0.079781	0.087925	0.096698	0.106140	0.116296	0.127209	0.138932	0.151517
51	0.072351	0.079912	0.088066	0.096850	0.106304	0.116471	0.127398	0.139134	0.151734
52	0.072473	0.080043	0.088207	0.097002	0.106467	0.116647	0.127587	0.139337	0.151952
53	0.072594	0.080174	0.088348	0.097154	0.106631	0.116823	0.127776	0.139540	0.152169
54	0.072716	0.080306	0.088490	0.097306	0.106795	0.116999	0.127965	0.139743	0.152388
55	0.072838	0.080437	0.088631	0.097459	0.106959	0.117175	0.128155	0.139947	0.152606
56	0.072960	0.080569	0.088773	0.097611	0.107123	0.117352	0.128344	0.140151	0.152825
57	0.073082	0.080700	0.088915	0.097764	0.107288	0.117529	0.128534	0.140355	0.153044
58	0.073204	0.080832	0.089057	0.097917	0.107452	0.117706	0.128725	0.140559	0.153263
59	0.073326	0.080964	0.089200	0.098071	0.107617	0.117883	0.128915	0.140763	0.153482
60	0.073449	0.081097	0.089342	0.098224	0.107782	0.118061	0.129106	0.140968	0.153702

Involute Functions for Angles from 41 to 50 Degrees

Minutes	Degrees								
	41	42	43	44	45	46	47	48	49
	Involute Functions								
0	0.153702	0.167366	0.182024	0.197744	0.214602	0.232679	0.252064	0.272855	0.295157
1	0.153922	0.167602	0.182277	0.198015	0.214893	0.232991	0.252399	0.273214	0.295542
2	0.154142	0.167838	0.182530	0.198287	0.215184	0.233304	0.252734	0.273573	0.295928
3	0.154362	0.168075	0.182784	0.198559	0.215476	0.233616	0.253069	0.273933	0.296314
4	0.154583	0.168311	0.183038	0.198832	0.215768	0.233930	0.253405	0.274293	0.296701
5	0.154804	0.168548	0.183292	0.199104	0.216061	0.234243	0.253742	0.274654	0.297088
6	0.155025	0.168786	0.183547	0.199377	0.216353	0.234557	0.254078	0.275015	0.297475
7	0.155247	0.169023	0.183801	0.199651	0.216646	0.234871	0.254415	0.275376	0.297863
8	0.155469	0.169261	0.184057	0.199924	0.216940	0.235186	0.254753	0.275738	0.298251
9	0.155691	0.169500	0.184312	0.200198	0.217234	0.235501	0.255091	0.276101	0.298640
10	0.155913	0.169738	0.184568	0.200473	0.217528	0.235816	0.255429	0.276464	0.299029
11	0.156135	0.169977	0.184824	0.200747	0.217822	0.236132	0.255767	0.276827	0.299419
12	0.156358	0.170216	0.185080	0.201022	0.218117	0.236448	0.256106	0.277191	0.299809
13	0.156581	0.170455	0.185337	0.201297	0.218412	0.236765	0.256446	0.277555	0.300200
14	0.156805	0.170695	0.185594	0.201573	0.218708	0.237082	0.256786	0.277919	0.300591
15	0.157028	0.170935	0.185851	0.201849	0.219004	0.237399	0.257126	0.278284	0.300983
16	0.157252	0.171175	0.186109	0.202125	0.219300	0.237717	0.257467	0.278649	0.301375
17	0.157476	0.171415	0.186367	0.202401	0.219596	0.238035	0.257808	0.279015	0.301767
18	0.157701	0.171656	0.186625	0.202678	0.219893	0.238353	0.258149	0.279381	0.302160
19	0.157925	0.171897	0.186883	0.202956	0.220190	0.238672	0.258491	0.279748	0.302553
20	0.158150	0.172138	0.187142	0.203233	0.220488	0.238991	0.258833	0.280115	0.302947
21	0.158375	0.172380	0.187401	0.203511	0.220786	0.239310	0.259176	0.280483	0.303342
22	0.158601	0.172621	0.187661	0.203789	0.221084	0.239630	0.259519	0.280851	0.303736
23	0.158826	0.172864	0.187920	0.204067	0.221383	0.239950	0.259862	0.281219	0.304132
24	0.159052	0.173106	0.188180	0.204346	0.221682	0.240271	0.260206	0.281588	0.304527
25	0.159279	0.173349	0.188440	0.204625	0.221981	0.240592	0.260550	0.281957	0.304924
26	0.159505	0.173592	0.188701	0.204905	0.222281	0.240913	0.260895	0.282327	0.305320
27	0.159732	0.173835	0.188962	0.205185	0.222581	0.241235	0.261240	0.282697	0.305718
28	0.159959	0.174078	0.189223	0.205465	0.222881	0.241557	0.261585	0.283067	0.306115
29	0.160186	0.174322	0.189485	0.205745	0.223182	0.241879	0.261931	0.283438	0.306513
30	0.160414	0.174566	0.189746	0.206026	0.223483	0.242202	0.262277	0.283810	0.306912
31	0.160642	0.174811	0.190009	0.206307	0.223784	0.242525	0.262624	0.284182	0.307311
32	0.160870	0.175055	0.190271	0.206588	0.224086	0.242849	0.262971	0.284554	0.307710
33	0.161098	0.175300	0.190534	0.206870	0.224388	0.243173	0.263318	0.284927	0.308110
34	0.161327	0.175546	0.190797	0.207152	0.224690	0.243497	0.263666	0.285300	0.308511
35	0.161555	0.175791	0.191060	0.207434	0.224993	0.243822	0.264014	0.285673	0.308911
36	0.161785	0.176037	0.191324	0.207717	0.225296	0.244147	0.264363	0.286047	0.309313
37	0.162014	0.176283	0.191588	0.208000	0.225600	0.244472	0.264712	0.286422	0.309715
38	0.162244	0.176529	0.191852	0.208284	0.225904	0.244798	0.265062	0.286797	0.310117
39	0.162474	0.176776	0.192116	0.208567	0.226208	0.245125	0.265412	0.287172	0.310520
40	0.162704	0.177023	0.192381	0.208851	0.226512	0.245451	0.265762	0.287548	0.310923
41	0.162934	0.177270	0.192646	0.209136	0.226817	0.245778	0.266113	0.287924	0.311327
42	0.163165	0.177518	0.192912	0.209420	0.227123	0.246106	0.266464	0.288301	0.311731
43	0.163396	0.177766	0.193178	0.209705	0.227428	0.246433	0.266815	0.288678	0.312136
44	0.163628	0.178014	0.193444	0.209991	0.227734	0.246761	0.267167	0.289056	0.312541
45	0.163859	0.178262	0.193710	0.210276	0.228041	0.247090	0.267520	0.289434	0.312947
46	0.164091	0.178511	0.193977	0.210562	0.228347	0.247419	0.267872	0.289812	0.313353
47	0.164323	0.178760	0.194244	0.210849	0.228654	0.247748	0.268225	0.290191	0.313759
48	0.164556	0.179009	0.194511	0.211136	0.228962	0.248078	0.268579	0.290570	0.314166
49	0.164788	0.179259	0.194779	0.211423	0.229270	0.248408	0.268933	0.290950	0.314574
50	0.165021	0.179509	0.195047	0.211710	0.229578	0.248738	0.269287	0.291330	0.314982
51	0.165254	0.179759	0.195315	0.211998	0.229886	0.249069	0.269642	0.291711	0.315391
52	0.165488	0.180009	0.195584	0.212286	0.230195	0.249400	0.269998	0.292092	0.315800
53	0.165722	0.180260	0.195853	0.212574	0.230504	0.249732	0.270353	0.292474	0.316209
54	0.165956	0.180511	0.196122	0.212863	0.230814	0.250064	0.270709	0.292856	0.316619
55	0.166190	0.180763	0.196392	0.213152	0.231124	0.250396	0.271066	0.293238	0.317029
56	0.166425	0.181014	0.196661	0.213441	0.231434	0.250729	0.271423	0.293621	0.317440
57	0.166660	0.181266	0.196932	0.213731	0.231745	0.251062	0.271780	0.294004	0.317852
58	0.166895	0.181518	0.197202	0.214021	0.232056	0.251396	0.272138	0.294388	0.318264
59	0.167130	0.181771	0.197473	0.214311	0.232367	0.251730	0.272496	0.294772	0.318676
60	0.167366	0.182024	0.197744	0.214602	0.232679	0.252064	0.272855	0.295157	0.319089

Spherical Trigonometry

Spherical trigonometry deals with the measurement of triangles that are on the surface of spheres. The sides of a spherical triangle curve across the surface of the sphere, and unlike a plane triangle, the angles at the three corners of the triangle total 180 degrees or more.

Right-Angle Spherical Trigonometry.—The heavy black lines A, B, and C of Fig. 1 represent a right spherical triangle. The lines J and K are radii of the sphere as they extend from the center of the sphere to the corners of the triangle. The several plane triangles, indicated by the various broken lines are formed from the radii and corner points of the spherical triangle. Note in Fig. 1 that both J and K are radii and thus have the same value.

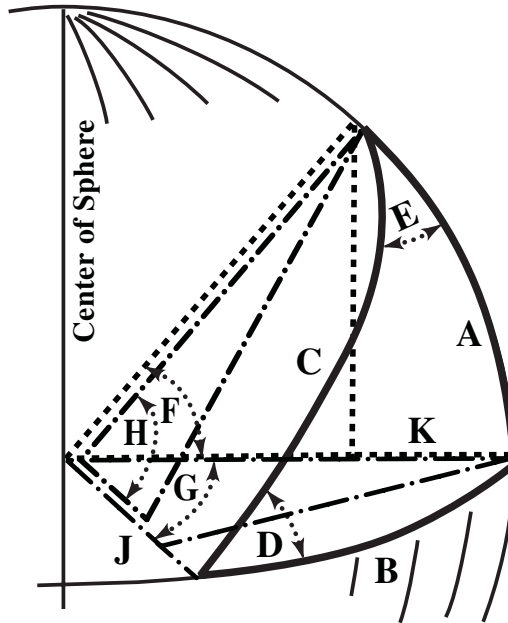


Fig. 1. Right-angle Spherical Triangle

Formulas for Right-angle Spherical Triangles

Formulas for Lengths	
$A = K \times \frac{\pi}{180} \times F^\circ \quad B = J \times \frac{\pi}{180} \times G^\circ \quad C = J \times \frac{\pi}{180} \times H^\circ \quad J = \frac{180}{\pi} \times \frac{B}{G^\circ} \quad K = \frac{180}{\pi} \times \frac{A}{F^\circ}$	
Formulas for Angles	
$F^\circ = \frac{180}{\pi} \times \frac{A}{K} \quad G^\circ = \frac{180}{\pi} \times \frac{B}{J} \quad H^\circ = \frac{180}{\pi} \times \frac{C}{J}$	
Angle	Angular Relationships
D	$\sin(D) = \sin(F) \times \text{cosec}(H) \quad \cos(D) = \tan(G) \times \cot(H) \quad \tan(D) = \tan(F) \times \text{cosec}(G)$
E	$\cos(E) = \cos(G) \times \sin(D) \quad \tan(E) = \tan(G) \times \text{cosec}(F)$
F	$\sin(F) = \tan(G) \times \cot(E) \quad \cos(F) = \sec(G) \times \cos(H) \quad \tan(F) = \tan(D) \times \sin(G)$
G	$\cos(G) = \cos(H) \times \sec(F) \quad \tan(G) = \sin(F) \times \tan(E)$
H	$\cos(H) = \cos(G) \times \cos(F) \quad \cos(H) = \cot(D) \times \cot(E)$
Area Formula	
$\text{Area} = K^2 \times \frac{\pi}{180} (D^\circ + E^\circ + 90^\circ - 180^\circ) = K^2 \times \frac{\pi}{180} (D^\circ + E^\circ - 90^\circ)$	

Example 1: Find the length of arc A of a right-angle spherical triangle on the surface of a sphere where radius $K = 30.00$ inches and angle $F = 10^\circ$.

Solution:
$$A = K \times \frac{\pi}{180}(F) = 30 \times \frac{\pi}{180}(10) = 5.2359 \text{ in}$$

Example 2: Find the length of arc B , on a sphere of radius $J = 11.20$ inches if angle $G = 10^\circ$.

Solution:
$$B = J \times \frac{\pi}{180}(G) = 11.20 \times \frac{\pi}{180}(10) = 1.9547 \text{ in}$$

Example 3: A right spherical triangle is to be constructed on the surface of a sphere 22.400 inches in diameter. Side A is 7.125 inches and angle E is $57^\circ 59' 19''$. Determine the lengths of sides B and C , and angle D , and the area of the triangle.

Solution: The radius of the sphere, $J = K = 11.200$, and the length of side A is used to find the value of angle F . Angle E is converted to decimal degree format for simplicity, then angles E and F are used to solve the equation for angle $\tan(G)$. Side B and angle D can then be found. Angle H can be calculated using either of the two equations given for $\cos(H)$, and finally the length of side C can be found. Notice that the sum of angles $D + E + 90^\circ$ is not equal to 180° , but 194.98° . Calculation details are as follows:

$$F^\circ = \frac{180}{\pi} \times \frac{A}{K} = \frac{180}{\pi} \frac{7.125}{11.200} = 36.449324^\circ$$

$$E = 57^\circ 59' 19'' = 57 + \frac{59}{60} + \frac{19}{3600} = 57.988611^\circ$$

$$\tan(G) = \sin(F) \times \tan(E) = \sin(36.449324^\circ) \times \tan(57.988611^\circ) = 0.950357$$

$$G = \text{atan}0.950357 = 43.541944^\circ$$

$$B = J \times \frac{\pi}{180} \times G^\circ = 11.200 \times \frac{\pi}{180} \times 43.541944 = 8.511443$$

$$\tan(D) = \tan(F) \times \text{cosec}(G) = \tan(36.449324^\circ) \times \text{cosec}(43.541944^\circ) = 1.0721569$$

$$D = \frac{180}{\pi} \times \text{atan}(1.0721569) = 46.994354^\circ$$

$$\cos(H) = \cos(G) \times \cos(F) = \cos(43.541944^\circ) \times \cos(36.449324^\circ) = 0.58307306$$

$$H = \frac{180}{\pi} \times \text{acos}(0.58307306) = 54.333023^\circ$$

$$C = J \times \frac{\pi}{180} \times H^\circ = 11.200 \times \frac{\pi}{180} \times 54.333023^\circ = 10.62085$$

$$\text{Angles}(D + E + 90^\circ) = 46.994354^\circ + 57.988611^\circ + 90^\circ = 194.98297^\circ$$

$$\text{Area} = 11.200^2 \times (194.98297 - 180) = 50.142591 \text{ in}^2$$

Example 4: A right spherical triangle on a 20mm diameter sphere has two 90° angles, and the distance B between the 90° angles is $\frac{1}{3}$ of the circumference of the sphere. Find angle E , the area of the triangle, and check using the conventional formula for area of a sphere.

Solution: By inspection, angle G is $360^\circ/3 = 120^\circ$. Because angles D and G are known, angle E can be calculated using $\cos(E) = \cos(G) \times \sin(D)$. Therefore,

$$\cos(E) = \cos(G) \times \sin(D) = \cos(120^\circ) \times \sin(90^\circ) = -0.5$$

$$E = \text{acos}(-0.5) = 120^\circ$$

$$\text{Area} = 10^2 \times \frac{\pi}{180}(120^\circ + 90^\circ + 90^\circ - 180^\circ) = 100 \times 2.0943951 = 209.4 \text{ mm}^2$$

$$\text{Check: Total area of 20 mm dia. sphere}/6 = \frac{4\pi R^2}{6} = \frac{4\pi(100)}{6} = 209.4 \text{ mm}^2$$

Oblique-Angle Spherical Trigonometry.—The heavy black lines *B*, *C*, and *S* of Fig. 1 represent a right spherical triangle. The lines *J* and *L* are radii of the sphere as they extend from the center of the sphere to the corners of the triangle. The several plane triangles, indicated by the various broken lines are formed from the radii and corner points of the spherical triangle. Note in Fig. 1 that both *J* and *L* are radii and thus have the same value.

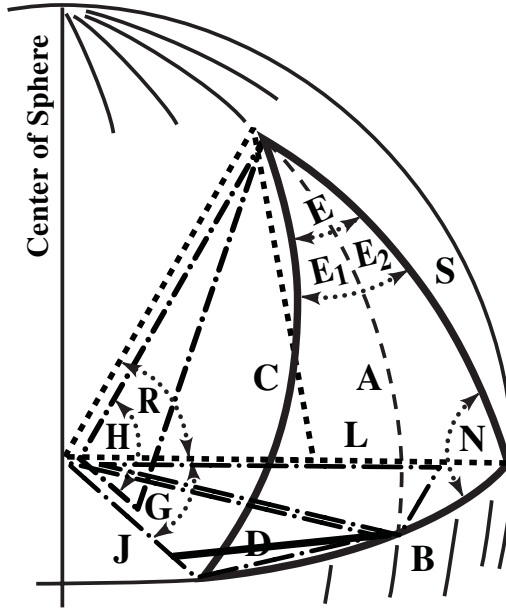


Fig. 2. Oblique-angle Spherical Triangle

Formulas for Oblique Spherical Triangles

Formulas for Lengths				
$B = J \times \frac{\pi}{180} \times G^\circ$	$C = J \times \frac{\pi}{180} \times H^\circ$	$S = L \times \frac{\pi}{180} \times R^\circ$	$J = \frac{180}{\pi} \times \frac{B}{G^\circ}$	$L = \frac{180}{\pi} \times \frac{S}{R^\circ}$
Formulas for Angles				
$G^\circ = \frac{180}{\pi} \times \frac{B}{J}$	$H^\circ = \frac{180}{\pi} \times \frac{C}{J}$	$R^\circ = \frac{180}{\pi} \times \frac{S}{L}$		
Angular Relationships				
Angle	Relationships	Angle	Relationships	
<i>D</i>	$\sin(D) = \sin(R) \times \sin(E) \times \operatorname{cosec}(G)$	<i>E</i>	$\sin(E) = \sin(D) \times \sin(G) \times \operatorname{cosec}(R)$	
<i>G</i>	$\sin(G) = \sin(R) \times \sin(E) \times \operatorname{cosec}(D)$	<i>E</i> ₁	$\cot(E_1) = \tan(D) \times \cos(H)$	
<i>N</i>	$\cos(N) = \cos(D) \times \operatorname{cosec}(E_1) \times \sin(E_2)$	<i>E</i> ₂	$\cot(E_2) = \tan(N) \times \cos(R)$	
<i>N</i>	$\cot\left(\frac{N}{2}\right) = \frac{\sin\left(\frac{R+G}{2}\right)}{\sin\left(\frac{R-G}{2}\right)} \times \tan\left(\frac{D-E}{2}\right)$	<i>H</i>	$\tan\left(\frac{H}{2}\right) = \frac{\sin\left(\frac{D+E}{2}\right)}{\sin\left(\frac{D-E}{2}\right)} \times \tan\left(\frac{R-G}{2}\right)$	
<i>R</i>	$\sin R = \sin D \times \sin G \times \csc E$			
Area of Oblique Spherical Triangle Formula				
$\text{Area} = L^2 \times \frac{\pi}{180} (D + E + N - 180^\circ)$				

Example 1: An oblique spherical triangle is to be constructed on the surface of a sphere of unknown size. The length of side S will be 5.470 inches; the spherical angle of arc S must be $51^\circ 17' 31''$ (angle R in Fig. 2). Angle D must be $59^\circ 55' 10''$, and angle E must be $85^\circ 36' 32''$. Find the size of the sphere, lengths of sides B and C , and the value of angle N .

Solution: Convert known angles to decimal degrees format to simplify calculations:

$$R = 51^\circ + \frac{17}{60} + \frac{31}{3600} = 51.291944^\circ$$

$$D = 59^\circ + \frac{55}{60} + \frac{10}{3600} = 59.919444^\circ$$

$$E = 85^\circ + \frac{36}{60} + \frac{32}{3600} = 85.608889^\circ$$

Find the radius of the sphere:

$$L = \frac{180}{\pi} \times \frac{S}{R^\circ} = \frac{180}{\pi} \times \frac{5.470}{51.291944^\circ} = 6.11 \text{ inches}$$

Find value of angles of G and H in order to get length of sides B and C . Then solve for the value of angle N , and finally the area. Remember that both J and L are radii, thus $J = L$.

$$\begin{aligned} \sin(G) &= \sin(R) \times \sin(E) \times \operatorname{cosec}(D) = 0.780342 \cdot (0.997065) \cdot 1.15564 \\ &= 0.899148 \end{aligned}$$

$$G = \operatorname{asin}(0.899148) = 64.046301^\circ$$

$$B = J = L \times \frac{\pi}{180} \times G^\circ = 6.11 \cdot \frac{\pi}{180} \cdot 64.046301^\circ = 6.829873 \text{ inches}$$

$$\tan\left(\frac{H}{2}\right) = \frac{\sin\left(\frac{D+E}{2}\right)}{\sin\left(\frac{D-E}{2}\right)} \times \tan\left(\frac{R-G}{2}\right) = \frac{\sin(72.76417)}{\sin(-12.844723)} \times \tan(-6.377185)$$

$$= \frac{0.955093}{-0.222310} (-0.111765) = 0.480167$$

$$\frac{H}{2} = \operatorname{atan}(0.480167) = 25.648772^\circ \quad H = 51.297543^\circ$$

$$C = J = L \times \frac{\pi}{180} \times H^\circ = 6.11 \times \frac{\pi}{180} \times 51.297543^\circ = 5.470350 \text{ inches}$$

$$\cot\left(\frac{N}{2}\right) = \frac{\sin\left(\frac{R+G}{2}\right)}{\sin\left(\frac{R-G}{2}\right)} \times \tan\left(\frac{D-E}{2}\right) = \frac{\sin(57.669123)}{\sin(-6.377185)} \times \tan(-12.844723)$$

$$= \frac{0.844974}{-0.111073} (-0.228015) = 1.7345957$$

$$\frac{N}{2} = \operatorname{acot}(1.7345957) = 29.963587^\circ \quad N = 59.927175^\circ$$

$$\text{Area} = L^2 \times \frac{\pi}{180} (D + E + N - 180^\circ) = 16.585 \text{ in}^2$$

The triangle is an isosceles spherical triangle with legs B and S each being 5.470 inches.

Any problem of oblique spherical triangles can also be solved as two right spherical triangles if a value is known for E_1 or E_2 ; in that case, the equations for right spherical triangles are used.

Compound Angles

Three types of compound angles are illustrated by Figs. 1 through 6. The first type is shown in Figs. 1, 2, and 3; the second in Fig. 4; and the third in Figs. 5 and 6.

In Fig. 1 is shown what might be considered as a thread-cutting tool without front clearance. A is a known angle in plane $y-y$ of the top surface. C is the corresponding angle in plane $x-x$ that is at some given angle B with plane $y-y$. Thus, angles A and B are components of the compound angle C .

Example Problem Referring to Fig. 1: Angle $2A$ in plane $y-y$ is known, as is also angle B between planes $x-x$ and $y-y$. It is required to find compound angle $2C$ in plane $x-x$.

Solution: Let $2A = 60$ and $B = 15$

Then

$$\begin{aligned} \tan C &= \tan A \cos B = \tan 30 \cos 15 \\ \tan C &= 0.57735 \times 0.96592 = 0.55767 \\ C &= 29^\circ 8.8' & 2C &= 58^\circ 17.6' \end{aligned}$$

Fig. 2 shows a thread-cutting tool with front clearance angle B . Angle A equals one-half the angle between the cutting edges in plane $y-y$ of the top surface and compound angle C is one-half the angle between the cutting edges in a plane $x-x$ at right angles to the inclined front edge of the tool. The angle between planes $y-y$ and $x-x$ is, therefore, equal to clearance angle B .

Example Problem Referring to Fig. 2: Find the angle $2C$ between the front faces of a thread-cutting tool having a known clearance angle B , which will permit the grinding of these faces so that their top edges will form the desired angle $2A$ for cutting the thread.

Solution: Let $2A = 60$ and $B = 15$

Then

$$\begin{aligned} \tan C &= \frac{\tan A}{\cos B} = \frac{\tan 30^\circ}{\cos 15^\circ} = \frac{0.57735}{0.96592} \\ \tan C &= 0.59772 \\ C &= 30^\circ 52' & 2C &= 61^\circ 44' \end{aligned}$$

In Fig. 3 is shown a form-cutting tool in which the angle A is one-half the angle between the cutting edges in plane $y-y$ of the top surface; B is the front clearance angle; and C is one-half the angle between the cutting edges in plane $x-x$ at right angles to the front edges of the tool. The formula for finding angle C when angles A and B are known is the same as that for Fig. 2.

Example Problem Referring to Fig. 3: Find the angle $2C$ between the front faces of a form-cutting tool having a known clearance angle B that will permit the grinding of these faces so that their top edges will form the desired angle $2A$ for form cutting.

Solution: Let $2A = 46$ and $B = 12$

Then

$$\begin{aligned} \tan C &= \frac{\tan A}{\cos B} = \frac{\tan 23^\circ}{\cos 12^\circ} = \frac{0.42447}{0.97815} \\ \tan C &= 0.43395 \\ C &= 23^\circ 27.5' & 2C &= 46^\circ 55' \end{aligned}$$

In Fig. 4 is shown a wedge-shaped block, the top surface of which is inclined at compound angle C with the base in a plane at right angles with the base and at angle R with the front edge. Angle A in the vertical plane of the front of the plate and angle B in the vertical plane of one side that is at right angles to the front are components of angle C .

Example Problem Referring to Fig. 4: Find the compound angle C of a wedge-shaped block having known component angles A and B in sides at right angles to each other.

Formulas for Compound Angles

<p>Fig. 1. Fig. 2. Fig. 3.</p>	<p>For given angles A and B, find the resultant angle C in plane $x-x$. Angle B is measured in vertical plane $y-y$ of midsection.</p> <p>(Fig. 1) $\tan C = \tan A \times \cos B$</p> <p>(Fig. 2) $\tan C = \frac{\tan A}{\cos B}$</p> <p>(Fig. 3) (Same formula as for Fig. 2)</p>
<p>Fig. 4.</p>	<p>Fig. 4. In machining plate to angles A and B, it is held at angle C in plane $x-x$. Angle of rotation R in plane parallel to base (or complement of R) is for locating plate so that plane $x-x$ is perpendicular to axis of pivot on angle-plate or work-holding vise.</p> $\tan R = \frac{\tan B}{\tan A}; \quad \tan C = \frac{\tan A}{\cos R}$
<p>Fig. 5.</p>	<p>Fig. 5. Angle R in horizontal plane parallel to base is angle from plane $x-x$ to side having angle A.</p> $\tan R = \frac{\tan A}{\tan B}$ <p>$\tan C = \tan A \cos R = \tan B \sin R$</p> <p>Compound angle C is angle in plane $x-x$ from base to corner formed by intersection of planes inclined to angles A and B. This formula for C may be used to find cot of complement of C_1, Fig. 6.</p>
<p>Fig. 6.</p>	<p>Fig. 6. Angles A_1 and B_1 are measured in vertical planes of front and side elevations. Plane $x-x$ is located by angle R from centerline or from plane of angle B_1.</p> $\tan R = \frac{\tan A_1}{\tan B_1}$ $\tan C_1 = \frac{\tan A_1}{\sin R} = \frac{\tan B_1}{\cos R}$ <p>The resultant angle C_1 would be required in drilling hole for pin.</p>

C = compound angle in plane $x-x$ and is the resultant of angles A and B

Solution: Let $A = 47^{\circ}14'$ and $B = 38^{\circ}10'$

$$\begin{aligned} \text{Then } \tan R &= \frac{\tan B}{\tan A} = \frac{\tan 38^{\circ}10'}{\tan 47^{\circ}14'} = \frac{0.78598}{1.0812} = 0.72695 & R &= 36^{\circ}0.9' \\ \tan C &= \frac{\tan A}{\cos R} = \frac{\tan 47^{\circ}14'}{\cos 36^{\circ}0.9'} = \frac{1.0812}{0.80887} = 1.3367 & C &= 53^{\circ}12' \end{aligned}$$

In Fig. 5 is shown a four-sided block, two sides of which are at right angles to each other and to the base of the block. The other two sides are inclined at an oblique angle with the base. Angle C is a compound angle formed by the intersection of these two inclined sides and the intersection of a vertical plane passing through $x-x$, and the base of the block. The components of angle C are angles A and B and angle R is the angle in the base plane of the block between the plane of angle C and the plane of angle A .

Example Problem Referring to Fig. 5: Find the angles C and R in the block shown in Fig. 5 when angles A and B are known.

Solution: Let angle $A = 27^{\circ}$ and $B = 36^{\circ}$

$$\begin{aligned} \text{Then } \cot C &= \sqrt{\cot^2 A + \cot^2 B} = \sqrt{1.9626^2 + 1.3764^2} = \sqrt{5.74627572} = 2.3971 \\ C &= 22^{\circ}38.6' \\ \tan R &= \frac{\cot B}{\cot A} = \frac{\cot 36^{\circ}}{\cot 27^{\circ}} = \frac{1.3764}{1.9626} = 0.70131 & R &= 35^{\circ}2.5' \end{aligned}$$

Example Problem Referring to Fig. 6: A rod or pipe is inserted into a rectangular block at an angle. Angle C_1 is the compound angle of inclination (measured from the vertical) in a plane passing through the center line of the rod or pipe and at right angles to the top surface of the block. Angles A_1 and B_1 are the angles of inclination of the rod or pipe when viewed respectively in the front and side planes of the block. Angle R is the angle between the plane of angle C_1 and the plane of angle B_1 . Find angles C_1 and R when a rod or pipe is inclined at known angles A_1 and B_1 .

Solution: Let $A_1 = 39^{\circ}$ and $B_1 = 34^{\circ}$

$$\begin{aligned} \text{Then } \tan C_1 &= \sqrt{\tan^2 A_1 + \tan^2 B_1} = \sqrt{0.80978^2 + 0.67451^2} = 1.0539 \\ C_1 &= 46^{\circ}30.2' \\ \tan R &= \frac{\tan A_1}{\tan B_1} = \frac{0.80978}{0.67451} = 1.2005 & R &= 50^{\circ}12.4' \end{aligned}$$

Interpolation.—In mathematics, interpolation is the process of finding a value in a table or in a mathematical expression which falls between two given tabulated or known values. In engineering handbooks, the values of trigonometric functions are usually given to degrees and minutes; hence, if the given angle is to degrees, minutes and seconds, the value of the function is determined from the nearest given values, by interpolation.

Interpolation to Find Functions of an Angle: Assume that the sine of $14^{\circ}22'26''$ is to be determined. It is evident that this value lies between the sine of $14^{\circ}22'$ and the sine of $14^{\circ}23'$. Sine $14^{\circ}23' = 0.24841$ and sine $14^{\circ}22' = 0.24813$. The difference $= 0.24841 - 0.24813 = 0.00028$. Consider this difference as a whole number (28) and multiply it by a fraction having as its numerator the number of seconds (26) in the given angle, and as its denominator 60 (number of seconds in one minute). Thus $\frac{26}{60} \times 28 = 12$ nearly; hence, by adding 0.00012 to sine of $14^{\circ}22'$ we find that sine $14^{\circ}22'26'' = 0.24813 + 0.00012 = 0.24825$. The correction value (represented in this example by 0.00012) is *added* to the function of the *smaller* angle nearest the given angle in dealing with *sines* or *tangents* but this correction value is *subtracted* in dealing with *cosines* or *cotangents*.

MATRICES

A matrix is a set of real numbers arranged in rows and columns to form a rectangular array. A matrix with m rows and n columns is an $m \times n$ matrix (m by n) and may be written as

$$A_{mn} = \begin{bmatrix} a_{11} & a_{12} & \cdots & a_{1n} \\ a_{21} & a_{22} & \cdots & a_{2n} \\ \cdots & \cdots & \cdots & \cdots \\ a_{m1} & a_{m2} & \cdots & a_{mn} \end{bmatrix}$$

The a_{ij} terms are called the entries or elements of the matrix. The first subscript i identifies the row position of an entry, and the second subscript j identifies the column position in the matrix.

Some common matrix types have special names, as follows:

Column Matrix: A matrix that has only one column ($m \times 1$).

Diagonal Matrix: A square matrix in which all values are zero except for those on one of the diagonals. If the diagonal entries are all 1, the matrix is an *identity* matrix.

Identity Matrix: A diagonal matrix in which the diagonal entries are all 1.

Row Matrix: A matrix that has only one row ($1 \times n$).

Square Matrix: A matrix in which the number of rows and columns are equal, i.e., $m = n$.

Zero Matrix: A matrix in which all the entries of the matrix are zero. The zero matrix is also called the *null* matrix.

Matrix Operations

Matrix Addition and Subtraction.—Matrices can be added or subtracted if they have the same shape, that is, if number of columns in each matrix is the same, and the number of rows in each matrix is the same. The sum or difference of the matrices are determined by adding or subtracting the corresponding elements of each matrix. Thus, each element in the resultant matrix is formed using $c_{ij} = a_{ij} \pm b_{ij}$ as illustrated below:

$$\begin{bmatrix} c_{11} & c_{12} & c_{13} \\ c_{21} & c_{22} & c_{23} \\ c_{31} & c_{32} & c_{33} \end{bmatrix} = \begin{bmatrix} a_{11} & a_{12} & a_{13} \\ a_{21} & a_{22} & a_{23} \\ a_{31} & a_{32} & a_{33} \end{bmatrix} \pm \begin{bmatrix} b_{11} & b_{12} & b_{13} \\ b_{21} & b_{22} & b_{23} \\ b_{31} & b_{32} & b_{33} \end{bmatrix} = \begin{bmatrix} (a_{11} \pm b_{11}) & (a_{12} \pm b_{12}) & (a_{13} \pm b_{13}) \\ (a_{21} \pm b_{21}) & (a_{22} \pm b_{22}) & (a_{23} \pm b_{23}) \\ (a_{31} \pm b_{31}) & (a_{32} \pm b_{32}) & (a_{33} \pm b_{33}) \end{bmatrix}$$

Example 1

$$\begin{bmatrix} 4 & 6 & -5 \\ 5 & -7 & 8 \\ -8 & 6 & -7 \end{bmatrix} + \begin{bmatrix} 8 & -2 & 6 \\ -6 & 9 & 5 \\ 9 & -2 & 2 \end{bmatrix} = \begin{bmatrix} (4+8) & (6-2) & (-5+6) \\ (5-6) & (-7+9) & (8+5) \\ (-8+9) & (6-2) & (-7+2) \end{bmatrix} = \begin{bmatrix} 12 & 4 & 1 \\ -1 & 2 & 13 \\ 1 & 4 & -5 \end{bmatrix}$$

Matrix Multiplication.—Two matrices can be multiplied *only* when the number of columns in the first matrix is equal to the number of rows of the second matrix. Matrix multiplication is not commutative, thus, $A \times B$ is not necessarily equal to $B \times A$.

Each resulting entry c_{ij} in the product matrix, $C = A \times B$, is the sum of the products of each element in the i^{th} row of matrix A multiplied by the corresponding element in the j^{th} column of matrix B , as illustrated in the following:

$$\begin{bmatrix} a_{11} & a_{12} & a_{13} \\ a_{21} & a_{22} & a_{23} \\ a_{31} & a_{32} & a_{33} \end{bmatrix} \times \begin{bmatrix} b_{11} & b_{12} & b_{13} \\ b_{21} & b_{22} & b_{23} \\ b_{31} & b_{32} & b_{33} \end{bmatrix}$$

$$= \begin{bmatrix} (a_{11}b_{11} + a_{12}b_{21} + a_{13}b_{31}) & (a_{11}b_{12} + a_{12}b_{22} + a_{13}b_{32}) & (a_{11}b_{13} + a_{12}b_{23} + a_{13}b_{33}) \\ (a_{21}b_{11} + a_{22}b_{21} + a_{23}b_{31}) & (a_{21}b_{12} + a_{22}b_{22} + a_{23}b_{32}) & (a_{21}b_{13} + a_{22}b_{23} + a_{23}b_{33}) \\ (a_{31}b_{11} + a_{32}b_{21} + a_{33}b_{31}) & (a_{31}b_{12} + a_{32}b_{22} + a_{33}b_{32}) & (a_{31}b_{13} + a_{32}b_{23} + a_{33}b_{33}) \end{bmatrix}$$

Example 2

$$\begin{bmatrix} 1 & 2 & 3 \\ 4 & 5 & 6 \\ 3 & 2 & 1 \end{bmatrix} \times \begin{bmatrix} 7 & 8 & 9 \\ 1 & 2 & 3 \\ 4 & 5 & 7 \end{bmatrix} = \begin{bmatrix} (1 \cdot 7 + 2 \cdot 1 + 3 \cdot 4) & (1 \cdot 8 + 2 \cdot 2 + 3 \cdot 5) & (1 \cdot 9 + 2 \cdot 3 + 3 \cdot 7) \\ (4 \cdot 7 + 5 \cdot 1 + 6 \cdot 4) & (4 \cdot 8 + 5 \cdot 2 + 6 \cdot 5) & (4 \cdot 9 + 5 \cdot 3 + 6 \cdot 7) \\ (3 \cdot 7 + 2 \cdot 1 + 1 \cdot 4) & (3 \cdot 8 + 2 \cdot 2 + 1 \cdot 5) & (3 \cdot 9 + 2 \cdot 3 + 1 \cdot 7) \end{bmatrix}$$

$$= \begin{bmatrix} (7 + 2 + 12) & (8 + 4 + 15) & (9 + 6 + 21) \\ (28 + 5 + 24) & (32 + 10 + 30) & (36 + 15 + 42) \\ (21 + 2 + 4) & (24 + 4 + 5) & (27 + 6 + 7) \end{bmatrix} = \begin{bmatrix} 21 & 27 & 36 \\ 57 & 72 & 93 \\ 27 & 33 & 40 \end{bmatrix}$$

Transpose of a Matrix.—If the rows of a matrix A_{mn} are interchanged with its columns, the new matrix is called the transpose of matrix A , or A^T_{nm} . The first row of the matrix becomes the first column in the transposed matrix, the second row of the matrix becomes second column, and the third row of the matrix becomes third column.

Example 3:

$$A = \begin{bmatrix} 21 & 27 & 36 \\ 57 & 72 & 93 \\ 27 & 33 & 40 \end{bmatrix} \quad A^T = \begin{bmatrix} 21 & 57 & 27 \\ 27 & 72 & 33 \\ 36 & 93 & 40 \end{bmatrix}$$

Determinant of a Square Matrix.— Every square matrix A is associated with a real number, its determinant, which may be written $\det(A)$ or $|A|$.

For $A = \begin{bmatrix} a_{11} & a_{12} \\ a_{21} & a_{22} \end{bmatrix}$, the determinant of A is

$$\det(A) = |A| = \begin{vmatrix} a_{11} & a_{12} \\ a_{21} & a_{22} \end{vmatrix} = a_{11}a_{22} - a_{12}a_{21}$$

For a 3×3 matrix B , the determinant is

$$\det(B) = \begin{vmatrix} b_{11} & b_{12} & b_{13} \\ b_{21} & b_{22} & b_{23} \\ b_{31} & b_{32} & b_{33} \end{vmatrix}$$

$$= (b_{11}b_{22}b_{33} - b_{11}b_{23}b_{32}) - (b_{12}b_{21}b_{33} - b_{12}b_{23}b_{31}) + (b_{13}b_{21}b_{32} - b_{13}b_{22}b_{31})$$

$$= b_{11}(b_{22}b_{33} - b_{23}b_{32}) - b_{12}(b_{21}b_{33} - b_{23}b_{31}) + b_{13}(b_{21}b_{32} - b_{22}b_{31})$$

The determinant of an $n \times n$ matrix results in n successive terms with alternating signs (+ or -). The troublesome task of keeping track of the proper sign for each term can be avoided by multiplying each term by $(-1)^{i+j}$ and adding all the terms. For example, using this rule, the last line of the previous equation can be rewritten as follows:

$$= (-1)^{(1+1)}b_{11}(b_{22}b_{33} - b_{23}b_{32}) + (-1)^{(1+2)}b_{12}(b_{21}b_{33} - b_{23}b_{31}) + (-1)^{(1+3)}b_{13}(b_{21}b_{32} - b_{22}b_{31})$$

Example 4: Find the determinant of the following matrix.

$$A = \begin{bmatrix} 5 & 6 & 7 \\ 1 & 2 & 3 \\ 4 & 5 & 6 \end{bmatrix}$$

Solution:

$$\begin{aligned} \det(A) &= (-1)^{(1+1)} \cdot 5 \cdot [(2 \times 6) - (5 \times 3)] \\ &\quad + (-1)^{(1+2)} \cdot 6 \cdot [(1 \times 6) - (4 \times 3)] \\ &\quad + (-1)^{(1+3)} \cdot 7 \cdot [(1 \times 5) - (2 \times 4)] \\ \det(A) &= 5(12 - 15) - 6(6 - 12) + 7(5 - 8) \\ &= 5(-3) - 6(-6) + 7(-3) = -15 + 36 - 21 = 0 \end{aligned}$$

Minors and Cofactors.— The minor M_{ij} of a matrix A is the determinant of a submatrix resulting from the elimination of row i and of column j . If A is a square matrix, the minor M_{ij} of the entry a_{ij} is the determinant of the matrix obtained by deleting the i^{th} row and j^{th} column of A .

The cofactor C_{ij} of the entry a_{ij} is given by $C_{ij} = (-1)^{(i+j)}M_{ij}$. When the matrix is formed by the cofactors, then it is called a cofactors matrix.

Example 5: Find the minors and cofactors of

$$A = \begin{bmatrix} 1 & 2 & 3 \\ 4 & 5 & 6 \\ 3 & 2 & 1 \end{bmatrix}$$

Solution: To determine the minor M_{11} , delete the first row and first column of A and find the determinant of the resulting matrix.

$$M_{11} = \begin{vmatrix} 5 & 6 \\ 2 & 1 \end{vmatrix} = (5 \times 1) - (6 \times 2) = 5 - 12 = -7$$

Similarly to find M_{12} , delete the first row and second column of A and find the determinant of the resulting matrix.

$$M_{12} = \begin{vmatrix} 4 & 6 \\ 3 & 1 \end{vmatrix} = (4 \times 1) - (6 \times 3) = 4 - 18 = -14$$

Continuing this way, we obtain the following minors:

$$\begin{array}{lll} M_{11} = -7 & M_{12} = -14 & M_{13} = -7 \\ M_{21} = -4 & M_{22} = -8 & M_{23} = -4 \\ M_{31} = -3 & M_{32} = -6 & M_{33} = -3 \end{array}$$

To find the cofactor $C_{ij} = (-1)^{(i+j)} \times M_{ij}$, thus $C_{11} = (-1)^{(1+1)} \times M_{11} = 1 \times (-7) = -7$

Similarly $C_{12} = (-1)^{(1+2)} \times M_{12} = -1 \times -14 = 14$, and continuing this way we obtain the following cofactors

$$\begin{array}{lll} C_{11} = -7 & C_{12} = 14 & C_{13} = -7 \\ C_{21} = 4 & C_{22} = -8 & C_{23} = 4 \\ C_{31} = -3 & C_{32} = 6 & C_{33} = -3 \end{array}$$

Adjoint of a Matrix.—The transpose of cofactor matrix is called the adjoint matrix. First determine the cofactor matrix and then transpose it to obtain the adjoint matrix.

Example 6: Find the adjoint matrix of A

$$A = \begin{bmatrix} 1 & 2 & 3 \\ 4 & 5 & 6 \\ 3 & 2 & 1 \end{bmatrix}$$

Solution: The cofactor matrix from the above example is shown below at the left, and the adjoint matrix on the right.

$$\text{Cofactor}(A) = \begin{bmatrix} -7 & 14 & -7 \\ 4 & -8 & 4 \\ -3 & 6 & -3 \end{bmatrix} \quad \text{Adjoint}(A) = \begin{bmatrix} -7 & 14 & -7 \\ 4 & -8 & 4 \\ -3 & 6 & -3 \end{bmatrix}^T = \begin{bmatrix} -7 & 4 & -3 \\ 14 & -8 & 6 \\ -7 & 4 & -3 \end{bmatrix}$$

Singularity and Rank of a Matrix.— A singular matrix is one whose determinant is zero. The rank of a matrix is the maximum number of linearly independent row or column vectors.

Inverse of a Matrix.— A square non-singular matrix A has an inverse A^{-1} such that the product of matrix A and inverse matrix A^{-1} , is the identity matrix I . Thus, $AA^{-1} = I$. The inverse is the ratio of adjoint of the matrix and the determinant of that matrix.

$$A^{-1} = \frac{\text{Adjoint}(A)}{|A|}$$

Example 7: What is the inverse of the following matrix?

$$A = \begin{bmatrix} 2 & 3 & 5 \\ 4 & 1 & 6 \\ 1 & 4 & 0 \end{bmatrix}$$

Solution: The basic formula of an inverse of a matrix is

$$A^{-1} = \frac{\text{Adjoint}(A)}{|A|}$$

The determinant of A is

$$\begin{aligned} |A| &= 2(1 \times 0 - 4 \times 6) - 3(4 \times 0 - 1 \times 6) + 5(4 \times 4 - 1 \times 1) \\ &= 2(0 - 24) - 3(0 - 6) + 5(16 - 1) \\ &= -48 + 18 + 75 = 45 \end{aligned}$$

The cofactors are

$$\begin{aligned} a_{11} &= (-1)^{1+1} \begin{vmatrix} 1 & 6 \\ 4 & 0 \end{vmatrix} = -24 & a_{12} &= (-1)^{1+2} \begin{vmatrix} 4 & 6 \\ 1 & 0 \end{vmatrix} = 6 & a_{13} &= (-1)^{1+3} \begin{vmatrix} 4 & 1 \\ 1 & 4 \end{vmatrix} = 15 \\ a_{21} &= (-1)^{2+1} \begin{vmatrix} 3 & 5 \\ 4 & 0 \end{vmatrix} = 20 & a_{22} &= (-1)^{2+2} \begin{vmatrix} 2 & 5 \\ 1 & 0 \end{vmatrix} = -5 & a_{23} &= (-1)^{2+3} \begin{vmatrix} 2 & 3 \\ 1 & 4 \end{vmatrix} = -5 \\ a_{31} &= (-1)^{3+1} \begin{vmatrix} 3 & 5 \\ 1 & 6 \end{vmatrix} = 13 & a_{32} &= (-1)^{3+2} \begin{vmatrix} 2 & 5 \\ 4 & 6 \end{vmatrix} = 8 & a_{33} &= (-1)^{3+3} \begin{vmatrix} 2 & 3 \\ 4 & 1 \end{vmatrix} = -10 \end{aligned}$$

The matrix of cofactors is $\begin{bmatrix} -24 & 6 & 15 \\ 20 & -5 & -5 \\ 13 & 8 & -10 \end{bmatrix}$ and the adjoint matrix is $\begin{bmatrix} -24 & 20 & 13 \\ 6 & -5 & 8 \\ 15 & -5 & -10 \end{bmatrix}$

Then the inverse of matrix A is

$$A^{-1} = \frac{\text{Adjoint}(A)}{|A|} = \frac{1}{45} \begin{bmatrix} -24 & 20 & 13 \\ 6 & -5 & 8 \\ 15 & -5 & -10 \end{bmatrix}$$

Simultaneous Equations.— Matrices can be used to solve systems of simultaneous equations with a large number of unknowns. Generally, this method is less cumbersome than using substitution methods. The coefficients of the equations are placed in matrix form. The matrix is then manipulated into the Identity matrix, see below, to yield a solution.

$$\begin{bmatrix} 1 & 0 & 0 \\ 0 & 1 & 0 \\ 0 & 0 & 1 \end{bmatrix}$$

Identity Matrix

✧ *Example 8:* Solve the three simultaneous equations using matrix operations.

$$-4x_1 + 8x_2 + 12x_3 = 16$$

$$3x_1 - x_2 + 2x_3 = 5$$

$$x_1 + 7x_2 + 6x_3 = 10$$

Solution: First, place the equation coefficients and constants into matrix form. The object is to transform the coefficient matrix into the form shown below, thereby obtaining a solution to the system of equations.

$$\begin{bmatrix} -4 & 8 & 12 & 16 \\ 3 & -1 & 2 & 5 \\ 1 & 7 & 6 & 10 \end{bmatrix} \Leftrightarrow \begin{bmatrix} 1 & 0 & 0 & x_1 \\ 0 & 1 & 0 & x_2 \\ 0 & 0 & 1 & x_3 \end{bmatrix}$$

Transform the coefficient matrix so that element c_{11} is 1 and all other elements in the first column are 0, as follows: a) Divide *Row 1* (R_1) by -4 ; b) multiply new R_1 by -3 , then add to R_2 ; and c) multiply R_1 by -1 , then add to R_3 .

$$\begin{bmatrix} -\frac{4}{-4} & \frac{8}{-4} & \frac{12}{-4} & \frac{16}{-4} \\ 3 & -1 & 2 & 5 \\ 1 & 7 & 6 & 10 \end{bmatrix} \Rightarrow \begin{bmatrix} 1 & -2 & -3 & -4 \\ (3-3) & (-1+6) & (2+9) & (5+12) \\ (1-1) & (7+2) & (6+3) & (10+4) \end{bmatrix} \Rightarrow \begin{bmatrix} 1 & -2 & -3 & -4 \\ 0 & 5 & 11 & 17 \\ 0 & 9 & 9 & 14 \end{bmatrix}$$

Transform the resulting matrix so that element c_{22} is 1 and all other elements in the second column are 0, as follows: a) Divide R_2 by 9; b) multiply new R_2 by -5 , then add to R_1 ; c) multiply R_2 by 2, then add to R_3 ; and d) swap R_2 and R_3 .

$$\begin{bmatrix} 1 & -2 & -3 & -4 \\ 0 & 5 & 11 & 17 \\ 0 & 9 & 9 & 14 \\ 0 & 9 & 9 & 14 \end{bmatrix} \Rightarrow \begin{bmatrix} 1 & (-2+2) & (-3+2) & (-4+\frac{28}{9}) \\ 0 & (5-5) & (11-5) & (17-\frac{70}{9}) \\ 0 & 1 & 1 & \frac{14}{9} \end{bmatrix} \Rightarrow \begin{bmatrix} 1 & 0 & -1 & -\frac{8}{9} \\ 0 & 0 & 6 & \frac{83}{9} \\ 0 & 1 & 1 & \frac{14}{9} \end{bmatrix} \Rightarrow \begin{bmatrix} 1 & 0 & -1 & -\frac{8}{9} \\ 0 & 1 & 1 & \frac{14}{9} \\ 0 & 0 & 6 & \frac{83}{9} \end{bmatrix}$$

Transform the resulting matrix so that element c_{33} is 1 and all other elements in the third column are 0, as follows: a) Divide R_3 by 6; b) multiply new R_3 by -1 , then add to R_2 ; and c) add R_3 to R_1 .

$$\begin{bmatrix} 1 & 0 & -1 & -\frac{8}{9} \\ 0 & 1 & 1 & \frac{14}{9} \\ 0 & 0 & \frac{6}{6} & \frac{83}{9(6)} \end{bmatrix} \Rightarrow \begin{bmatrix} 1 & 0 & (-1+1) & (-\frac{8}{9} + \frac{83}{54}) \\ 0 & 1 & (1-1) & (\frac{14}{9} - \frac{83}{54}) \\ 0 & 0 & 1 & \frac{83}{54} \end{bmatrix} \Rightarrow \begin{bmatrix} 1 & 0 & 0 & \frac{35}{54} \\ 0 & 1 & 0 & \frac{1}{54} \\ 0 & 0 & 1 & \frac{83}{54} \end{bmatrix}$$

Finally, when the identity matrix has been formed, the last column contains the values of x_1 , x_2 , and x_3 that satisfy the original equations.

$$x_1 = \frac{35}{54} \quad x_2 = \frac{1}{54} \quad x_3 = \frac{83}{54}$$

Checking the solutions:

$$\begin{aligned} -4x_1 + 8x_2 + 12x_3 &= 16 & 3x_1 - x_2 + 2x_3 &= 5 & x_1 + 7x_2 + 6x_3 &= 10 \\ 16 &= 16 & 5 &= 5 & 10 &= 10 \end{aligned}$$

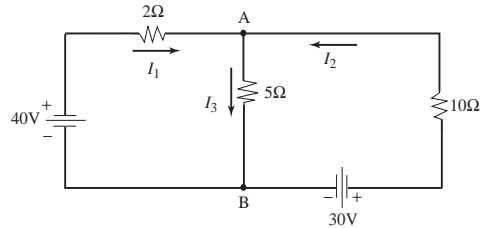
Example 9: Use matrix operations to find the currents (I_1, I_2, I_3) in the following electrical network.

By Kirchoff's Current Law:

$$\begin{aligned} I_1 + I_2 &= I_3 \\ I_1 + I_2 - I_3 &= 0 \end{aligned}$$

By Kirchoff's Voltage Law, and Ohm's Law:

$$\begin{aligned} 2I_1 + 5I_3 - 40 &= 0 \\ 10I_2 + 5I_3 - 30 &= 0 \end{aligned}$$



By combining all the above equations, a linear system of three independent equations is formed. Solve the system for the currents I_1, I_2 , and I_3 .

$$\begin{aligned} I_1 + I_2 - I_3 &= 0 \\ 2I_1 + 5I_3 &= 40 \\ 10I_2 + 5I_3 &= 30 \end{aligned}$$

Solution: If A is the matrix of coefficients of the currents, B is the matrix of currents (variables), and C be the matrix of constants from the right side of the equations, then the problem can be written in the following form: $AB = C$, and $B = A^{-1}C$, where A^{-1} is the inverse of matrix A .

Thus,

$$A = \begin{bmatrix} 1 & 1 & -1 \\ 2 & 0 & 5 \\ 0 & 10 & 5 \end{bmatrix} \quad B = \begin{bmatrix} I_1 \\ I_2 \\ I_3 \end{bmatrix} \quad C = \begin{bmatrix} 0 \\ 40 \\ 30 \end{bmatrix} \quad \text{and} \quad \begin{bmatrix} I_1 \\ I_2 \\ I_3 \end{bmatrix} = \begin{bmatrix} 1 & 1 & -1 \\ 2 & 0 & 5 \\ 0 & 10 & 5 \end{bmatrix}^{-1} \begin{bmatrix} 0 \\ 40 \\ 30 \end{bmatrix}$$

Using the method of [Example 7](#), the inverse of matrix A is

$$A^{-1} = \begin{bmatrix} 1 & 1 & -1 \\ 2 & 0 & 5 \\ 0 & 10 & 5 \end{bmatrix}^{-1} = -\frac{1}{80} \begin{bmatrix} 50 & 15 & -5 \\ 10 & -5 & 7 \\ -20 & 10 & 2 \end{bmatrix} = \begin{bmatrix} \frac{5}{8} & \frac{3}{16} & -\frac{1}{16} \\ \frac{1}{8} & -\frac{1}{16} & \frac{7}{80} \\ -\frac{1}{4} & \frac{1}{8} & \frac{1}{40} \end{bmatrix}$$

and finally, matrix B can be found as follows:

$$B = A^{-1}C = \begin{bmatrix} \frac{5}{8} & \frac{3}{16} & -\frac{1}{16} \\ \frac{1}{8} & -\frac{1}{16} & \frac{7}{80} \\ -\frac{1}{4} & \frac{1}{8} & \frac{1}{40} \end{bmatrix} \begin{bmatrix} 0 \\ 40 \\ 30 \end{bmatrix} = \begin{bmatrix} 5.625 \\ 0.125 \\ 5.75 \end{bmatrix}$$

Thus, $I_1 = 5.625$ amps, $I_2 = 0.125$ amps, and $I_3 = 5.75$ amps.

STATISTICAL ANALYSIS OF MANUFACTURING DATA

Statistics Theory

High volume manufacturing production, unlike prototype design work, typically involves repeating the same machining operations and processes hundreds, thousands, or millions of times during a given product's or product family's production run. Understanding the failure mechanisms in a product's tooling and improving the efficiency of these operations by adjusting manufacturing parameters can save on: tool wear of indexable inserts, milling cutters, reamers, twist drills; improve speed, feeds, and power consumption profiles; reduce machine tool accuracy drift; and reduce lubrication and other maintenance related failures. Improving these and other related process, by even a tiny amount, can result in huge cost savings in large production run environments.

The first step is to take measurements and test the values of production processes so that patterns can be found. Most testing procedures include the collection and tabulation of experimental data. Without mathematical statistical analysis and interpretation it would be impossible to know whether or not the testing was comprehensive enough to offer valid experimental conclusions that can then be used to make manufacturing process changes.

Statistical Distribution Curves.—Statistical analysis depends on the type of statistical distributions that apply to various properties of the data being examined.

There are six statistical distributions: 1) Normal; 2) Log Normal; 3) Exponential; 4) Binomial; 5) Weibull; and 6) Poisson.

Normal Distribution Curve.—The *normal* distribution is the most widely used and best-understood statistical distribution. It is used to model mechanical, physical, electrical, and chemical properties which scatter randomly about a well-defined mean value without either positive or negative bias. This curve is frequently called a bell curve. The following describes the characteristics of the *normal* distribution curve.

Statistical Analysis.—Statistically analyzing data is a very important scientific and engineering tool which defines the characteristics of samples (limited number of observations, trials, data points, etc.). If a sample of data is randomly selected from the population, its statistical characteristics converge towards the statistical characteristics of the population as the sample size increases. Because economic constraints, such as testing time and cost, prevent a large number of repeat tests, it is important to understand how a sample of data represents an approximation of the real population of data. The following parameters must be calculated to evaluate the sample of data with respect to the population of data:

\bar{X} = Sample mean S = Sample standard deviation V = Coefficient of variation

A_x = Absolute error of the sample mean

R_x = Relative error of the sample mean

t = Critical value of *t-distribution* (or *Student's Distribution*)

μ = Population mean

$\bar{X} \pm t \times A_x$ = Confidence interval for the population mean

Sample Mean, (\bar{X}): The *sample mean*, sometimes called the measure of average, is a value about which the data is "centered around." There are several types of such "average" measures, the most common of which is the arithmetic mean, or the sample mean. The sample mean \bar{X} is calculated as:

$$\bar{X} = \frac{1}{n} \sum_{i=1}^n x_i \quad (1)$$

where x_i = individual data point

n = number of data points

Sample Standard Deviation, (S) is a measure of the dispersion of data about its standard mean \bar{X} . The sample standard deviation is calculated by the formula:

$$S = \sqrt{\frac{\sum_{i=1}^n (x_i - \bar{X})^2}{n-1}} \quad (2)$$

where $n-1$ = the number of *degrees of freedom (d.f.)*

Degrees of freedom, (d.f.) can be defined as the number of observations made in excess of the minimum needed to estimate a statistical parameter or quantity. For example, only one measurement is required to identify the width of an indexable insert's flank wear that occurred while machining a workpiece. If the measurements are repeated seven times, then the sample variance of flank wear measurement has six degrees of freedom.

Coefficient of Variation, (V) is used to evaluate or control the variability in data points. The coefficient of variation is calculated by dividing the sample standard deviation S by the sample mean \bar{X} and expressing the result in per cent:

$$V = \frac{S}{\bar{X}} 100\% \quad (3)$$

Absolute Error of the Sample Mean, (A_x) is calculated by dividing the sample standard deviation by the square root of the number of data points. The result is expressed in the same unit of measure as the sample standard deviation and the sample mean:

$$A_x = \frac{S}{\sqrt{n}} \quad (4)$$

Relative Error of the Sample Mean, (R_x) is calculated by dividing the absolute error of the sample mean by the sample mean and expressing the result in per cent:

$$R_x = \frac{A_x}{\bar{X}} 100\% \quad (5)$$

Critical Value of "t-Distribution" (Student distribution): The "t-Distribution" was discovered in 1908 by W. S. Gosset, who wrote under the name "Student". The critical value of t depends on the number of degrees of freedom and the probability of error. If a 95% two-sided confidence is used for statistical analysis, then the probability of error is 5% or 2.5% per side. A 5% probability of error provides practical accuracy, which is commonly acceptable in various engineering calculations.

For a 5% probability of error, the critical value of *t-Distribution* can be determined from [Table 1](#), page 131, at the intersection of the column under the heading $t_{0.025}$ and the row corresponding to the number of degrees of freedom shown in the column heading *d.f.*

Population Mean (μ): The normal distribution has two parameters: the population mean μ and the population standard deviation S . The sample mean \bar{X} is an estimate of the population mean ($\mu = \bar{X}$), and the sample standard deviation is an estimate of the population standard deviation ($\sigma = S$). A graph of the normal distribution is symmetric about its mean μ . Virtually, all of the area (99.74%) under the graph is contained within the interval:

$$\mu - 3\sigma, \mu + 3\sigma$$

Thus, almost all of the probability associated with a normal distribution falls within \pm three standard deviations of the population mean μ . Also, 95.44% of the area falls within \pm two standard deviations of μ , and 68.26% within \pm one standard deviation.

Confidence Interval for the Population Mean: The degree of confidence associated with a confidence interval or limit is known as its confidence level. Confidence levels of 90%, 95%, and 99% are commonly used. For example, a 95% confidence limit for the unknown population mean, estimated by use of the sample mean and sample standard deviation, pro-

vides a value above which the unknown population mean is expected to lie with 95% confidence.

Equations (1) through (5) describe a sample mean that is only an estimate of the true (population) mean. Therefore, it is important to define a confidence interval that determines a range within which the population mean lies. Such an interval depends on the sample mean, \bar{X} , absolute error of the sample mean, A_x , and *t-distribution* (Student's) value. A confidence interval for the population mean satisfies the inequality:

$$\bar{X} - A_x \times t \leq \mu \leq \bar{X} + A_x \times t \quad (6)$$

Applying Statistics

Minimum Numbers of Tests, or Data Points.—Minimum numbers of the data points, which represent the sample size can be determined through the formulas for the coefficient of variation V , Equation (3), the absolute error of the sample mean A_x , Equation (4), and the relative error of the sample mean R_x , Equation (5).

According to Equation (4), the absolute error of the sample mean is:

$$A_x = \frac{S}{\sqrt{n}}$$

The other expression for the absolute error of the sample mean from Equation (5) is:

$$A_x = \bar{X} \times R_x \quad (7)$$

Because the values to the left from the equal sign in Equations (4) and (7) are equal, the values to the right from the equal sign are also equal and, therefore:

$$\frac{S}{\sqrt{n}} = \bar{X} \times R_x \quad (8)$$

Solving for \sqrt{n} in Equation (8) produces:

$$\sqrt{n} = \frac{S}{\bar{X} \times R_x} \quad (9)$$

Because S/\bar{X} is the coefficient of variation V , see Equation (3), then:

$$\sqrt{n} = \frac{V}{R_x} \quad \text{and} \quad n = \frac{V^2}{R_x^2} \quad (10)$$

The coefficient of variation of the sample mean must be known or selected according to previously collected data of a similar kind, or, if necessary, preliminary tests should be conducted to estimate its value. Based on numerous studies of cutting tool performance and publications on mechanical properties of cutting tool materials, the values of the coefficient of variation within 25 to 45% are considered as typical. The relative error of the sample mean between 6 and 12% is also considered typical. The coefficient of variation and the relative error are used to estimate how many tests are required. For example, if $V = 30\%$ and $R_x = 8\%$, then the numbers of tests required are $n = 30^2/8^2 = 14$.

Comparing Products with Respect to Average Performance.—Lab and field tests are usually conducted to compare the average performance of two or more products. The term “average performance” is a quantitative value, which can be any mechanical, physical, or chemical characteristics of a product. For example, the average tool life of drills and indexable cutting inserts, the average hardness of cemented carbide grades, etc. The products may differ in manufacturing procedure (CVD or PVD coatings), in chemical composition (alloying elements and their amount), and in other parameters. Data collected during the experiments must be statistically treated to determine whether the products have the same

performance characteristics or not. For example, is there a difference in the sample means or not?

Statistical treatment of data obtained from experiments with two products, includes the following steps:

- a) Calculation of the samples mean \bar{X}_1 and \bar{X}_2 using Equation (1)
- b) Calculation of the samples standard deviation S_1 and S_2 using Equation (2)
- c) Calculation of a weighted, or pooled standard deviation using the following formula:

$$S_p = \sqrt{\frac{(n_1 - 1) \times S_1^2 + (n_2 - 1) \times S_2^2}{(n_1 - 1) + (n_2 - 1)}} \tag{11}$$

where n_1 and n_2 the number of data points for products 1 and 2 respectively.

d) Selection of a confidence level. A 95% two-sided confidence level is recommended. At this confidence level, the probability of error is $\pm 2.5\%$ per side. The values of *t-Distribution* versus *degrees of freedom (d.f.)* are provided in Table 1, and for a 95% confidence level are located in the column under the heading “ $t_{0.025}$ ” with respect to given degrees of freedom ($d.f. = n_1 + n_2 - 2$).

- e) Calculation of *Decision Criterion (d.c.)* using the following formula:

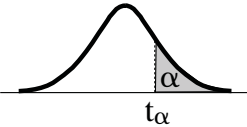
$$d.c. = t_{0.025} \times S_p \sqrt{\frac{n_1 + n_2}{n_1 \times n_2}} \tag{12}$$

f) Comparison of the value of *Decision Criterion* with the difference of the samples mean: take $\bar{X}_1 - \bar{X}_2$ if $\bar{X}_1 > \bar{X}_2$, or $\bar{X}_2 - \bar{X}_1$ if $\bar{X}_2 > \bar{X}_1$

The products average performance is statistically significant if the difference in the two sample means is greater than *Decision Criterion*, i.e.

$$\bar{X}_1 - \bar{X}_2 > d.c. \quad \text{or} \quad \bar{X}_2 - \bar{X}_1 > d.c.$$

Table 1. Critical Values of *t-Distribution*

													
<i>d.f.</i>	$t_{0.100}$	$t_{0.050}$	$t_{0.025}$	$t_{0.010}$	$t_{0.005}$	<i>d.f.</i>	$t_{0.100}$	$t_{0.050}$	$t_{0.025}$	$t_{0.010}$	$t_{0.005}$	<i>d.f.</i>	<i>d.f.</i>
1	3.078	6.314	12.706	31.821	63.657	1	16	1.337	1.746	2.120	2.583	2.921	16
2	1.886	2.920	4.303	6.965	9.925	2	17	1.333	1.740	2.110	2.567	2.898	17
3	1.638	2.353	3.182	4.541	5.841	3	18	1.330	1.734	2.101	2.552	2.878	18
4	1.533	2.132	2.776	3.747	4.604	4	19	1.328	1.729	2.093	2.539	2.861	19
5	1.476	2.015	2.571	3.365	4.032	5	20	1.325	1.725	2.086	2.528	2.845	20
6	1.440	1.943	2.447	3.143	3.707	6	21	1.323	1.721	2.080	2.518	2.831	21
7	1.415	1.895	2.365	2.998	3.499	7	22	1.321	1.717	2.074	2.508	2.819	22
8	1.397	1.860	2.306	2.896	3.355	8	23	1.319	1.714	2.069	2.500	2.807	23
9	1.383	1.833	2.262	2.821	3.250	9	24	1.318	1.711	2.064	2.492	2.797	24
10	1.372	1.812	2.228	2.764	3.169	10	25	1.316	1.708	2.060	2.485	2.787	25
11	1.363	1.796	2.201	2.718	3.106	11	26	1.315	1.706	2.056	2.479	2.779	26
12	1.356	1.782	2.179	2.681	3.055	12	27	1.314	1.703	2.052	2.473	2.771	27
13	1.350	1.771	2.160	2.650	3.012	13	28	1.313	1.701	2.048	2.467	2.763	28
14	1.345	1.761	2.145	2.624	2.977	14	29	1.311	1.699	2.045	2.462	2.756	29
15	1.341	1.753	2.131	2.602	2.947	15	Inf.	1.282	1.645	1.960	2.326	2.576	Inf.

Example 1:

Tool Life Tests of CNMG-432 Indexable Inserts Made of Two Different Carbide Grades (A and B)

Carbide Grade A				Carbide Grades		
Test Number	Data, x_i minutes	Treatment of Data		Characteristics of Normal Distribution	A	B
		$x_i - \bar{X}$	$(x_i - \bar{X})^2$			
1	15.0	-2.1	4.41	Number of data points, n	7	7
2	19.0	1.9	3.61	Number of degrees of freedom, $n - 1$	6	6
3	16.9	-0.2	0.04	Sample mean (s.m.), Equation (1)	17.1	14.8
4	16.6	-0.5	0.25	Sample standard deviation, Equation (2)	1.6	2.1
5	16.6	-0.5	0.25	Coefficient of variation, Equation (3)	9.4%	14.2%
6	16.1	-1.0	1.00	Absolute error of the s.m., Equation (4)	0.6	0.8
7	19.4	2.3	5.29	Relative error of the s.m., Equation (5)	3.5%	5.4%
$n = 7$		$\bar{X} = 17.1$		t -value at 95% confidence level at given degrees of freedom, d.f. = 6, Table 1	2.447	2.447
$\sum x_i = 119.6$		$\sum (x_i - \bar{X})^2 = 14.85$		Population mean is greater than:	15.6	12.8
				Population mean is less than:	18.6	16.8

Carbide Grade B				Comparison of Grades A and B	
Test Number	Data, x_i minutes	Treatment of Data			
		$x_i - \bar{X}$	$(x_i - \bar{X})^2$		
1	14.6	-0.2	0.04	Pooled standard deviation, Equation (11)	1.9
2	13.5	-1.3	1.69	t -value at 95% confidence level at given degrees of freedom, d.f. = 6 + 6 = 12, Table 1	2.179
3	15.6	0.8	0.64	Decision Criterion, Equation (12)	2.2
4	12.4	-2.4	5.76	The difference between the two sample means	2.3
5	14.6	-0.2	0.04		
6	13.8	-1.0	1.00		
7	19.1	4.3	18.49		
$n = 7$		$\bar{X} = 14.8$			
$\sum x_i = 103.6$		$\sum (x_i - \bar{X})^2 = 27.66$			

Conclusion:

Sample means of the tool life of carbide grades A and B are statistically *significant* at the 95% confidence level, since the difference of the sample means (17.1 – 14.8 = 2.3 min.) is **greater** than the *Decision Criterion* (2.2 min.).

Note: $n_i = i^{\text{th}}$ test or data point, $x_i = i^{\text{th}}$ value of the data point

Example 2:

Tensile Strength of Carbon Steel Specimens Versus Heat Treatment

Carbon Steel Sample A				Samples		
Test Number	Data, x_i MPa	Treatment of Data		Characteristics of Normal Distribution	A	B
		$x_i - \bar{X}$	$(x_i - \bar{X})^2$			
1	522.0	6.9	47.61	Number of data points, n	5	5
2	511.0	-4.1	16.81	Number of degrees of freedom, $n - 1$	4	4
3	488.9	-26.2	686.44	Sample mean (s.m.), Equation (1)	515.1	504.7
4	553.7	38.6	1490.00	Sample standard deviation, Equation (2)	24.8	11.1
5	499.9	-15.1	228.01	Coefficient of variation, Equation (3)	4.8%	2.2%
$n = 5$		$\bar{X} = 515.1$		Absolute error of the s.m., Equation (4)	11.1	5.0
$\sum x_i = 2575.5$		$\sum (x_i - \bar{X})^2 = 2468.9$		Relative error of the s.m., Equation (5)	2.2%	1.0%
				t -value at 95% confidence level at given degrees of freedom, d.f. = 4, Table 1	2.776	2.776
				Population mean is greater than:	484.3	490.8
				Population mean is less than:	545.9	518.6

Carbon Steel Sample B				Comparison of Samples A and B	
Test Number	Data, x_i MPa	Treatment of Data			
		$x_i - \bar{X}$	$(x_i - \bar{X})^2$		
1	517.1	12.4	153.76	Pooled standard deviation, Equation (11)	19.2
2	490.2	-14.5	210.25	t -value at 95% confidence level at given degrees of freedom, d.f. = 4 + 4 = 8, Table 1	2.306
3	499.1	-5.6	31.36	Decision Criterion, Equation (12)	28.0
4	514.4	9.7	94.09	The difference between the two sample means	10.4
5	502.6	-2.1	4.41		
$n = 5$		$\bar{X} = 504.7$			
$\sum x_i = 2523.4$		$\sum (x_i - \bar{X})^2 = 493.87$			

Conclusion:

Sample means of the tensile strength of samples A and B are statistically *insignificant* at the 95% confidence level, since the difference of the sample means (515.1 – 504.7 = 10.4 MPa) is **less** than the *Decision Criterion* (28.0 MPa).

Note: $n_i = i^{\text{th}}$ test or data point, $x_i = i^{\text{th}}$ value of the data point

Example 3:

Tool Life Tests of 6.0 mm Diameter Drills with Different Web Thickness

Drills with 2.0 mm Web, Group A				Drill Groups		
Test Number	Data, x_i minutes	Treatment of Data		Characteristics of Normal Distribution		
		$x_i - \bar{X}$	$(x_i - \bar{X})^2$	A	B	
1	15.68	-11.06	122.3236	Number of data points, n	14	16
2	18.88	-7.86	61.7796	Number of degrees of freedom, $n - 1$	13	15
3	19.20	-7.54	56.8516	Sample mean (s.m.), Equation (1)	26.74	15.01
4	22.56	-4.18	17.4724	Sample standard deviation, Equation (2)	6.94	7.30
5	23.20	-3.54	12.5316	Coefficient of variation, Equation (3)	26.0%	48.6%
6	24.40	-2.34	5.4756	Absolute error of the s.m., Equation (4)	1.85	1.83
7	24.64	-2.10	4.4100	Relative error of the s.m., Equation (5)	6.9%	12.2%
8	26.56	0.18	0.0324	t -value at 95% confidence level at given degrees of freedom, Table 1	2.160	2.131
9	27.20	0.46	0.2116		d.f.=13	d.f.=15
10	30.24	3.50	12.2500	Population mean is greater than:	22.74	11.11
11	32.16	5.42	29.3764	Population mean is less than:	30.74	18.91
12	33.60	6.86	47.0596	Comparison of Grades A and B		
13	36.80	10.06	101.2036	Pooled standard deviation, Equation (11)	7.14	
14	39.20	12.46	155.2516	t -value at 95% confidence level at given degrees of freedom, d.f. = 13 + 15 = 28, Table 1	2.048	
$n = 14$		$\bar{X} = 26.74$		Decision Criterion, Equation (12)	5.35	
$\sum x_i = 374.32$		$\sum (x_i - \bar{X})^2 = 626.2296$		The difference between the two sample means	11.73	

Drills with 0.9 mm Web, Group B

Test Number	Data, x_i minutes	Treatment of Data		Test Number	Data, x_i minutes	Treatment of Data	
		$x_i - \bar{X}$	$(x_i - \bar{X})^2$			$x_i - \bar{X}$	$(x_i - \bar{X})^2$
1	5.04	-9.97	99.4009	7	12.16	-2.85	8.1225
2	6.48	-8.53	72.7609	8	14.24	-0.77	0.5929
3	7.12	-7.89	62.2521	9	15.68	0.67	0.4489
4	7.20	-7.81	60.9961	10	16.32	1.31	1.7161
5	9.44	-5.57	31.0249	11	17.84	2.83	8.0089
6	11.36	-3.65	13.3225	12	18.00	2.99	8.9401
				13	21.28	6.27	39.3129
				14	23.04	8.03	64.4809
				15	24.60	9.59	91.9681
				16	30.40	15.39	236.8521
$n = 14$				$n = 16$			
$\sum x_i = 374.32$				$\sum x_i = 240.20$			
$\bar{X} = 26.74$				$\bar{X} = 15.01$			
$\sum (x_i - \bar{X})^2 = 626.2296$				$\sum (x_i - \bar{X})^2 = 800.2008$			

Conclusion:

Sample means of the tool life of the drills in Group A and B are statistically *significant* at the 95% confidence level, since the difference of the sample means (26.74 - 15.01 = 11.73 min.) is **greater** than the *Decision Criterion* (5.35 min.). Note: $n_i = i^{\text{th}}$ test or data point, $x_i = i^{\text{th}}$ value of the data point

Machinability and Hardness.—In cutting steels, the allowable cutting speed for a given tool life between grindings is, as a general rule, inversely proportional to the hardness of a given steel. To illustrate, tests in turning an alloy steel with a high-speed steel tool showed a cutting speed of 70 feet per minute (21.3 meter per minute) when the hardness of the steel was 180 Brinell; the cutting speed had to be reduced to about 35 feet per minute (10.7 meter per minute) when the hardness was increased to 360 Brinell, the life between tool grindings for these tests being 20 minutes in each case. The machinability of other steels of the same hardness might vary. For example, the tests just referred to showed more or less variation in the cutting speeds for steels of the same hardness, but having different compositions or properties. Thus, while there is a constant relationship between the hardness of a steel and its tensile strength, there is not the same constant relationship between steel hardness and machinability as applied to different steels.

ENGINEERING ECONOMICS

Engineers, managers, purchasing agents, and others are often required to plan and evaluate project alternatives, and make economic decisions that may greatly affect the success or failure of a project.

The goals of a project, such as reducing manufacturing cost or increasing production, selection of machine tool alternatives, or reduction of tooling, labor and other costs, determine which of the available alternatives may bring the most attractive economic return.

Various cost analysis techniques that may be used to obtain the desired outcome are discussed in the material that follows.

Interest

Interest is money paid for the use of money lent for a certain time. *Simple* interest is the interest paid on the principal (money lent) only. When simple interest that is due is not paid, and its amount is added to the interest-bearing principal, the interest calculated on this new principal is called *compound* interest. The compounding of the interest into the principal may take place yearly or more often, according to circumstances.

Interest Formulas.—The symbols used in the formulas to calculate various types of interest are:

P = principal or amount of money lent

I = nominal annual interest rate stated as a percentage, i.e., 10 per cent per annum

I_e = effective annual interest rate when interest is compounded more often than once a year (see *Nominal vs. Effective Interest Rates*)

i = nominal annual interest rate per cent expressed as a decimal, i.e., if $I = 12$ per cent, then $i = 12/100 = 0.12$

n = number of annual interest periods

m = number of interest compounding periods in one year

F = a sum of money at the end of n interest periods from the present date that is equivalent to P with added interest i

A = the payment at the end of each period in a uniform series of payments continuing for n periods, the entire series equivalent to P at interest rate i

Note: The exact amount of interest for one day is $1/365$ of the interest for one year. Banks, however, customarily take the year as composed of 12 months of 30 days, making a total of 360 days to a year. This method is also used for home-mortgage-type payments, so that the interest rate per month is $30/360 = 1/12$ of the annual interest rate. For example, if I is a 12 per cent per annum nominal interest rate, then for a 30-day period, the interest rate is $(12 \times 1/12) = 1.0$ per cent per month. The decimal rate per month is then $1.0/100 = 0.01$.

Simple Interest.—The formulas for simple interest are:

$$\text{Interest for } n \text{ years} = P \times i \times n$$

$$\text{Total amount after } n \text{ years, } S = P + P \times i \times n$$

Example: For \$250 that has been lent for three years at 6 per cent simple interest: $P = 250$; $I = 6$; $i = I/100 = 0.06$; $n = 3$.

$$F = 250 + (250 \times 0.06 \times 3) = 250 + 45 = \$295$$

Compound Interest.—The following formulas apply when compound interest is to be computed and assuming that the interest is compounded annually.

$$F = P(1 + i)^n$$

$$P = F/(1 + i)^n$$

$$i = (F/P)^{1/n} - 1$$

$$n = (\log F - \log P)/\log(1 + i)$$

Example: At 10 per cent interest compounded annually for 10 years, a principal amount P of \$1000 becomes a sum F of

$$F = 1000(1 + 10/100)^{10} = \$2,593.74$$

If a sum $F = \$2593.74$ is to be accumulated, beginning with a principal $P = \$1,000$ over a period $n = 10$ years, the interest rate i to accomplish this would have to be $i = (2593.74/1000)^{1/10} - 1 = 0.09999$, which rounds to 0.1, or 10 per cent.

For a principal $P = \$500$ to become $F = \$1,000$ at 6 per cent interest compounded annually, the number of years n would have to be

$$\begin{aligned} n &= (\log 1000 - \log 500)/\log(1 + 0.06) \\ &= (3 - 2.69897)/0.025306 = 11.9 \text{ years} \end{aligned}$$

To triple the principal $P = \$500$ to become $F = \$1,500$, the number of years would have to be

$$\begin{aligned} n &= (\log 1500 - \log 500)/\log(1 + 0.06) \\ &= (3.17609 - 2.69897)/0.025306 = 18.85 \text{ years} \end{aligned}$$

Interest Compounded More Often Than Annually.—If interest is payable m times a year, it will be computed m times during each year, or nm times during n years. The rate for each compounding period will be i/m if i is the nominal annual decimal interest rate. Therefore, at the end of n years, the amount F will be: $F = P(1 + i/m)^{nm}$.

As an example, if $P = \$1,000$; n is 5 years, the interest payable quarterly, and the annual rate is 6 per cent, then $n = 5$; $m = 4$; $i = 0.06$; $i/m = 0.06/4 = 0.015$; and $nm = 5 \times 4 = 20$, so that

$$F = 1000(1 + 0.015)^{20} = \$1,346.86$$

Nominal vs. Effective Interest Rates.—Deposits in savings banks, automobile loans, interest on bonds, and many other transactions of this type involve computation of interest due and payable more often than once a year. For such instances, there is a difference between the *nominal* annual interest rate stated to be the cost of borrowed money and the *effective* rate that is actually charged.

For example, a loan with interest charged at 1 per cent per month is described as having an interest rate of 12 per cent per annum. To be precise, this rate should be stated as being a *nominal* 12 per cent per annum compounded monthly; the actual or *effective* rate for monthly payments is 12.7 per cent. For quarterly compounding, the effective rate would be 12.6 per cent:

$$I_e = (1 + I/m)^m - 1$$

In this formula, I_e is the effective annual rate, I is the nominal annual rate, and m is the number of times per year the money is compounded.

Example: For a nominal per annum rate of 12 per cent, with monthly compounding, the effective per annum rate is

$$I_e = (1 + 0.12/12)^{12} - 1 = 0.1268 = 12.7 \text{ per cent effective per annum rate}$$

Example: Same as before but with quarterly compounding:

$$I_e = (1 + 0.12/4)^4 - 1 = 0.1255 = 12.6 \text{ per cent effective per annum rate}$$

Finding Unknown Interest Rates.—If a single payment of P dollars is to produce a sum of F dollars after n annual compounding periods, the per annum decimal interest rate is found using:

$$i = \sqrt[n]{\frac{F}{P}} - 1$$

Cash Flow and Equivalence

The sum of money receipts or disbursement in a project's financial report are called cash flows. Due to the time value of money, the timing of cash flows over the project life plays a vital role in project success. Engineering economy problems involve the following four patterns of cash flow, both separately and in combination. Two cash flow patterns are said to be equivalent if they have the same value at a particular time.

Present Value and Discount.—The present value or present worth P of a given amount F is the amount P that, when placed at interest i for a given time n , will produce the given amount F .

$$\text{At simple interest, } P = F/(1 + ni)$$

$$\text{At compound interest, } P = F/(1 + i)^n$$

The *true discount* D is the difference between F and P : $D = F - P$.

These formulas are for an annual interest rate. If interest is payable other than annually, modify the formulas as indicated in the formulas in the section *Interest Compounded More Often Than Annually* on page 135.

Example: Find the present value and discount of \$500 due in six months at 6 per cent simple interest. Here, $F = 500$; $n = 6/12 = 0.5$ year; $i = 0.06$. Then, $P = 500/(1 + 0.5 \times 0.06) = \485.44 .

Example: Find the sum that, placed at 5 per cent compound interest, will in three years produce \$5,000. Here, $F = 5000$; $i = 0.05$; $n = 3$. Then,

$$P = 5000/(1 + 0.05)^3 = \$4,319.19$$

Annuities.—An annuity is a fixed sum paid at regular intervals. In the formulas that follow, yearly payments are assumed. It is customary to calculate annuities on the basis of compound interest. If an annuity A is to be paid out for n consecutive years, the interest rate being i , then the present value P of the annuity is

$$P = A \frac{(1 + i)^n - 1}{i(1 + i)^n}$$

If at the *beginning* of each year a sum A is set aside at an interest rate i , the total value F of the sum set aside, with interest, at the end of n years, will be

$$F = A \frac{(1 + i)[(1 + i)^n - 1]}{i}$$

If at the *end* of each year a sum A is set aside at an interest rate i , then the total value F of the principal, with interest, at the end of n years will be

$$F = A \frac{(1 + i)^n - 1}{i}$$

If a principal P is increased or decreased by a sum A at the end of each year, then the value of the principal after n years will be

$$F = P(1 + i)^n \pm A \frac{(1 + i)^n - 1}{i}$$

If the sum A by which the principal P is decreased each year is greater than the total yearly interest on the principal, then the principal, with the accumulated interest, will be entirely used up in n years:

$$n = \frac{\log A - \log(A - iP)}{\log(1 + i)}$$

Example: If an annuity of \$200 is to be paid for 10 years, what is the present amount of money that needs to be deposited if the interest is 5 per cent. Here, $A = 200$; $i = 0.05$; $n = 10$:

$$P = 200 \frac{(1 + 0.05)^{10} - 1}{0.05(1 + 0.05)^{10}} = \$1,544.35$$

The annuity a principal P drawing interest at the rate i will give for a period of n years is

$$A = P \frac{i(1 + i)^n}{(1 + i)^n - 1}$$

Example: A sum of \$10,000 is placed at 4 per cent. What is the amount of the annuity payable for 20 years out of this sum: Here, $P = 10000$; $i = 0.04$; $n = 20$:

$$A = 10,000 \frac{0.04(1 + 0.04)^{20}}{(1 + 0.04)^{20} - 1} = \$735.82$$

Sinking Funds.—Amortization is “the extinction of debt, usually by means of a sinking fund.” The sinking fund is created by a fixed investment A placed each year at compound interest for a term of years n , and is therefore an annuity of sufficient size to produce at the end of the term of years the amount F necessary for the repayment of the principal of the debt, or to provide a definite sum for other purposes. Then,

$$F = A \frac{(1 + i)^n - 1}{i} \quad \text{and} \quad A = F \frac{i}{(1 + i)^n - 1}$$

Example: If \$2,000 is invested annually for 10 years at 4 per cent compound interest, as a sinking fund, what would be the total amount of the fund at the expiration of the term? Here, $A = 2000$; $n = 10$; $i = 0.04$:

$$F = 2000 \frac{(1 + 0.04)^{10} - 1}{0.04} = \$24,012.21$$

Cash Flow Diagrams.—The following conventions are used to standardize cash flow diagrams. The horizontal (time) axis is marked off in equal increments, one per period, up to the duration of the project. Receipts are represented by arrows directed upwards and disbursements are represented by arrows directed downwards. The arrow length is proportional to the magnitude of cash flow. In the following, i = interest rate, and n = number of payments or periods.

Table 1. Cash Flow Patterns

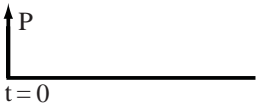
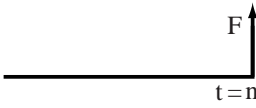
<p>P-pattern P = present value</p>	<p>A single amount P occurring at the beginning of n years. P represents “Present” amount.</p>	
<p>F-pattern F = future value</p>	<p>A single amount F occurring at the end of n years. F represents “Future” amount.</p>	

Table 1. (Continued) Cash Flow Patterns

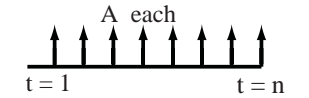
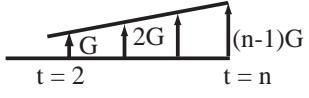
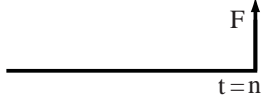
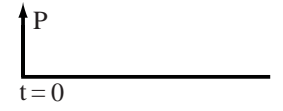
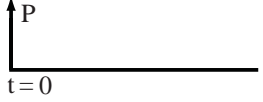
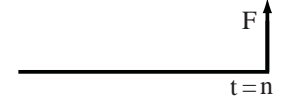
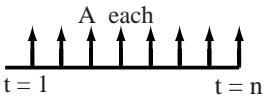
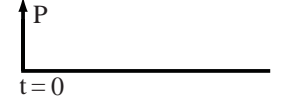
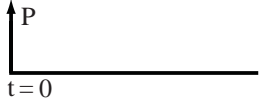
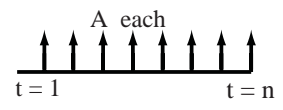
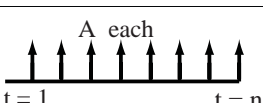
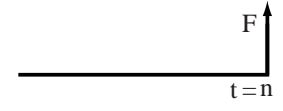
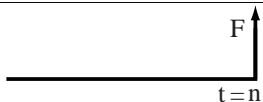
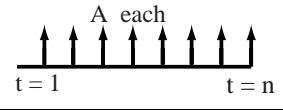

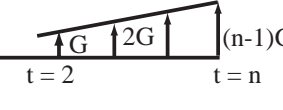
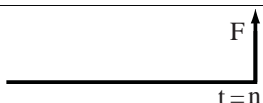
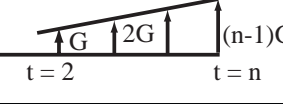
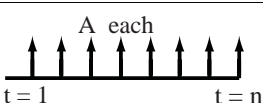
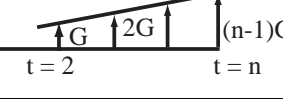
<p>A-pattern A = annual value</p>	<p>Equal amounts A occurring at the end of each of n years. A represents "annual" amount.</p>	
<p>G-pattern G = uniform gradient of expense</p>	<p>G is increasing by an equal amount over the period of life n. G represents "Gradient" amount.</p>	

Table 2. Standard Cash Flow Factors

Symbol	To Find	Formula	Given	Symbol
	F	$(F/P, i\%, n)$ $F = P(1 + i)^n$	P	
	P	$(P/F, i\%, n)$ $P = \frac{F}{(1 + i)^n}$	F	
	A	$(A/P, i\%, n)$ $A = P \frac{i(1 + i)^n}{(1 + i)^n - 1}$	P	
	P	$(P/A, i\%, n)$ $P = A \frac{(1 + i)^n - 1}{i(1 + i)^n}$	A	
	A	$(A/F, i\%, n)$ $A = F \frac{i}{(1 + i)^n - 1}$	F	
	F	$(F/A, i\%, n)$ $F = A \left[\frac{(1 + i)^n - 1}{i} \right]$	A	
	P	$(P/G, i\%, n)$ $P = G \frac{1}{i} \left[\frac{(1 + i)^n - 1}{i(1 + i)^n} - \frac{n}{(1 + i)^n} \right]$	G	
	F	$(F/G, i\%, n)$ $F = G \frac{1}{i} \left[\frac{(1 + i)^n - 1}{i} - n \right]$	G	
	A	$(A/G, i\%, n)$ $A = G \left[\frac{1}{i} - \frac{n}{(1 + i)^n - 1} \right]$	G	

Example: A rental property pays \$2000/month with a \$10 per month increase starting the second year. Based on 10 year period and 8% annual interest, compute the unified average annuity, considering the gradient.

Solution:

$$\begin{aligned} \text{Average rental} &= G \left[\frac{1}{i} - \frac{n}{(1+i)^n - 1} \right] + A \\ &= 10 \left[\frac{1}{(8/1200)} - \frac{120}{(1 + 8/1200)^{120} - 1} \right] + 2000 \\ &= 516 + 2000 = \$2516 \end{aligned}$$

Depreciation

Depreciation is the allocation of the cost of an asset over its depreciable life. A machine may decline in value because it is wearing out and no longer performing its function as well as when it is new. Depreciation is a economical technique that spreads the purchase price of an asset or other property over a number of years. Tax regulations do not allow the cost of an asset to be treated as a deductible expense in the year of purchase. Portions of the expense must be allocated to each of the years of the asset’s depreciation period. The amount that is allocated each year is called the depreciation.

Straight Line Depreciation.—Straight line depreciation is a constant depreciation charge over the period of life. If P is the principal value, L is the salvage value and n is the period of life. The depreciation will be

$$\begin{aligned} \text{Depreciation at xth year} \quad D_x &= \frac{P-L}{n} \\ \text{Book Value after x years} \quad BV_x &= \frac{(P-L)(n-x) + L}{n} \\ \text{After Tax Depreciation Recovery} \quad ATDR &= TR \left(\frac{P-L}{n} \right) \left(\frac{(1+i)^n - 1}{i(1+i)^n} \right) \end{aligned}$$

Sum of the Years Digits.—Another method for allocating the cost of an asset minus salvage value over its useful life is called sum of the years digits depreciation. This method results in larger than straight line depreciation charges during the early years of an asset and smaller charges near the end period.

$$\begin{aligned} \text{Depreciation at xth year} \quad D_x &= \frac{2(P-L)(n-x+1)}{n(n+1)} \\ \text{Book Value after x years} \quad BV_x &= P - (P-L)(2n-x+1) \frac{x}{n(n+1)} \end{aligned}$$

Double Declining Balance Method.—A constant depreciation is applied to the book value of the property.

$$\begin{aligned} \text{Depreciation at xth year} \quad D_x &= 2 \left(\frac{P}{n} \right) \left(\frac{n-2}{n} \right)^{(x-1)} \\ \text{Book Value after x years} \quad BV_x &= P \left(\frac{n-2}{n} \right)^x \end{aligned}$$

Statutory Depreciation System.— The latest depreciation method is used in U.S. income tax purpose is called accelerated cost recovery system (ACRS) depreciation. The first step in ACRS is to determine the property class of the asset being depreciated. All personal property falls into one of six classes.

$$\text{Depreciation at xth year} \quad D_x = P \times \text{Factor}$$

Table 3. Property Class and Factor

ACRS Classes of Depreciable Property		Depreciation Rate for Recovery Period (n)				
Property Class	Personal Property	Year (x)	3 Years	5 Years	7 Years	10 Years
3	Handling device for food and beverage manufacture, plastic products, fabricated metal products	1	33.33%	20.00%	14.29%	10.00%
		2	44.45%	32.00%	24.49%	18.00%
		3	14.81%	19.20%	17.49%	14.40%
5	Automobiles, trucks, computer, aircraft, petroleum drilling equipment, research and experimentation equip.	4	7.41%	11.52%	12.49%	11.52%
		5		11.52%	8.93%	9.22%
7	Office furniture, fixtures, and equip.	6		5.76%	8.92%	7.37%
10	Railroad cars, manufacture of tobacco products	7			8.93%	6.55%
		8			4.46%	6.55%
15	Telephone distribution line, municipal sewers plant	9				6.56%
		10				6.55%
20	Municipal sewers	11				3.28%

Evaluating Alternatives

Two or more mutually exclusive investments compete for limited funds. There are a number of ways for selecting the superior alternative from a group of proposals. This section concerns strategies for selecting alternatives in such a way that net value is maximized.

Net Present Value.—One of the easiest way to compare mutually exclusive alternatives is to resolve their consequences to the present time. It is most frequently used to determine the present value of future money receipts and disbursements. There are three economic criteria for present worth analysis described in the table that follows. If investment cost is same, consider only the output money. If the output result is known, then minimize the investment cost. If neither input nor output is fixed, then maximize the output minus the input. This method is widely applied when alternatives have the same period of time.

With uniform annual expense before tax
$$NPV = -P + (AR - AE) \left(\frac{(1+i)^n - 1}{i(1+i)^n} \right) + \frac{L}{(1+i)^n}$$

With uniform gradient on annual expense before tax
$$NPV = -P + (AR - AE - (A/G, i, n)G) \left(\frac{(1+i)^n - 1}{i(1+i)^n} \right) + \frac{L}{(1+i)^n}$$

With uniform annual expense after tax
$$NPV = -P + (AR - AE)(1 - TR) \left(\frac{(1+i)^n - 1}{i(1+i)^n} \right) + \frac{L}{(1+i)^n}$$

With uniform gradient on annual expense after tax
$$NPV = -P + (AR - AE - (A/G, i, n)G)(1 - TR) \left(\frac{(1+i)^n - 1}{i(1+i)^n} \right) + \frac{L}{(1+i)^n}$$

The symbol used in this table are defined as follows:

- P = Present value NPV = Net present value AR = Annual revenue
- AE = Annual expense G = Uniform gradient of expense TR = Tax rate as percentage
- i = Interest rate n = Number of payments or periods L = Salvage value

The previous formulas do not consider depreciation. To include depreciation, the after tax depreciation recovery (ATDR) must be added to get the net present value.

Example : A pharmaceutical company produces a product from different chemical compositions. Two mixing processes, batch and continuous, are available.

Process	Continuous	Batch
Initial cost	\$75000	\$35000
Lifetime (years)	10	10
Maintenance (per year)	\$5000	\$8000
Capacity (units/year)	25000	20000

The company uses straight line depreciation, pays 40% of its net income as income tax, and has an after tax minimum attractive rate of return of 15%. The company can sell the product at \$1.00 per unit. Which manufacturing process should the company invest in?

Solution: Because the lifetimes are equal, we can make a comparison using the present worth method by applying the formulas for *NPV* and also for *ATDR*.

$$\begin{aligned}
 NPV_{Continuous} &= -P + (AR - AE)(1 - TR) \left(\frac{(1+i)^n - 1}{i(1+i)^n} \right) + TR \left(\frac{P-L}{n} \right) \left(\frac{(1+i)^n - 1}{i(1+i)^n} \right) \\
 &= -75000 + (25000 \times 1 - 5000)(1 - 0.40) \left(\frac{\left(1 + \frac{15}{100}\right)^{10} - 1}{\left(\frac{15}{100}\right)\left(1 + \frac{15}{100}\right)^{10}} \right) + 0.40 \left(\frac{75000}{10} \right) \left(\frac{\left(1 + \frac{15}{100}\right)^{10} - 1}{\left(\frac{15}{100}\right)\left(1 + \frac{15}{100}\right)^{10}} \right) \\
 &= -14775 + 15056 = 281
 \end{aligned}$$

$$\begin{aligned}
 NPV_{Batch} &= -P + (AR - AE)(1 - TR) \left(\frac{(1+i)^n - 1}{i(1+i)^n} \right) + TR \left(\frac{P-L}{n} \right) \left(\frac{(1+i)^n - 1}{i(1+i)^n} \right) \\
 &= -35000 + ([20000 \times 1] - 8000)(1 - 0.40) \left(\frac{\left(1 + \frac{15}{100}\right)^{10} - 1}{\left(\frac{15}{100}\right)\left(1 + \frac{15}{100}\right)^{10}} \right) + 0.40 \left(\frac{35000}{10} \right) \left(\frac{\left(1 + \frac{15}{100}\right)^{10} - 1}{\left(\frac{15}{100}\right)\left(1 + \frac{15}{100}\right)^{10}} \right) \\
 &= 1135 + 7026 = 8161
 \end{aligned}$$

Based on above calculations, the batch production process is selected because it gives a greater net present value (*NPV*) than the continuous process.

Capitalized Cost.—In governmental analyses, there are some circumstances where a service is required for an infinite period of time such as with roads, dams, pipelines, etc. Present worth of a project with an infinite life is known as capitalized cost. Capitalized cost is the amount of money at $n = 0$ needed to perpetually support the projection the earned interest only. Capitalized cost is the present sum of money that would need to be set aside now, at some interest rate, to yield the funds required to provide the service.

$$CC = P + A(P/A, i\%, n) - L(P/F, i\%, n) + G(P/G, i\%, n)$$

Without Periodical Replacement	$CC = P + \frac{A}{i}$
With 100% Periodical Replacement	$CC = P + \frac{P-L}{(1+i)^n - 1} + \frac{A}{i}$
With Periodical Renovation Cost	$CC = P + \frac{RC}{(1+i)^n - 1} + \frac{A}{i}$

where CC = capitalized cost; P = initial cost; L = salvage value; A = annual cost; RC = renovation cost; i = interest rate; and, n = effective period of time.

Equivalent Uniform Annual Cost.—This method is applied when the alternatives have unequal periods of life. To avoid unequal periods of time, the present value and future value is converted to an annual value. The alternatives must be mutually exclusive and repeatedly renewed up to the duration of the longest lived alternative.

$$A = P(A/P, i\%, n) - L(A/F, i\%, n) + G(A/G, i\%, n) + AE$$

$$\begin{array}{l} \text{With Sinking Fund} \\ \text{Depreciation} \end{array} \quad A = (P - L) \frac{i(1+i)^n}{(1+i)^n - 1} + Li + AE$$

$$\begin{array}{l} \text{With Sinking Fund} \\ \text{Depreciation and} \\ \text{Uniform Gradient } G \end{array} \quad A = (P - L) \frac{i(1+i)^n}{(1+i)^n - 1} + Li + AE + G \left(\frac{1}{i} - \frac{n}{(1+i)^n - 1} \right)$$

$$\begin{array}{l} \text{Straight Line} \\ \text{Depreciation} \end{array} \quad A = \frac{P-L}{n} + Li + AE + \frac{(P-L)(n+1)i}{2n}$$

Example: An investment of \$15,000 is being considered to reduce labor and labor-associated costs in a materials handling operation from \$8,200 a year to \$3,300. This operation is expected to be used for 10 years before being changed or discontinued entirely. In addition to the initial investment of \$15,000 and the annual cost of \$3,300 for labor, there are additional annual costs for power, maintenance, insurance, and property taxes of \$1,800 associated with the revised operation. Based on comparisons of annual costs, should the \$15,000 investment be made or the present operation continued?

The present annual cost of the operation is \$8,200 for labor and labor-associated costs. The proposed operation has an annual cost of \$3,300 for labor and labor extras plus \$1,800 for additional power, maintenance, insurance, and taxes, plus the annual cost of recovering the initial investment of \$15,000 at some interest rate (minimum acceptable rate of return).

Assuming that 10 per cent would be an acceptable rate of return on this investment over a period of 10 years, the annual amount to be recovered on the initial investment would be \$15,000 multiplied by the capital recovery factor.

Putting this value into $(A/P, i\%, n)$ yields:

$$A = \frac{i(1+i)^n}{(1+i)^n - 1} P + AE = \frac{(10/100)(1+10/100)^{10}}{(1+10/100)^{10} - 1} 15000 + 5100 = 7541.18$$

Adding this amount to the \$5,100 annual cost associated with the investment (\$3,300 + \$1,800 = \$5,100) gives a total annual cost of \$7,542, which is less than the present annual cost of \$8,200. Thus, the investment is justified unless there are other considerations such as the effects of income taxes, salvage values, expected life, uncertainty about the required rate of return, changes in the cost of borrowed funds, and others.

A tabulation of annual costs of alternative plans A, B, C, etc., is a good way to compare costs item by item. For this example:

	Item	Plan A	Plan B
1	Labor and labor extras	\$8,200.00	\$3,300.00
2	Annual cost of \$15,000 investment		2,442.00
3	Power		400.00
4	Maintenance		1,100.00
5	Property taxes and insurance		300.00
	Total annual cost	\$8,200.00	\$7,542.00

Example, (Annual Cost Considering Salvage Value): If in the previous example the salvage value of the equipment installed was \$5,000 at the end of 10 years, what effect does this have on the annual cost of the proposed investment of \$15,000?

The only item in the annual cost of the previous example that will be affected is the capital recovery amount of \$2,442. The following formula gives the amount of annual capital recovery when salvage value is considered:

$$A = (P - L) \frac{i(1+i)^n}{(1+i)^n - 1} + Li + AE$$

$$= (15000 - 5000) \frac{\left(\frac{10}{100}\right) \left(1 + \frac{10}{100}\right)^{10}}{\left(1 + \frac{10}{100}\right)^{10} - 1} + 5000 \left(\frac{10}{100}\right) + 5100 = 7227.45$$

Adding this amount to the \$5,100 annual cost determined previously gives a total annual cost of \$7,227, which is \$315 less than the previous annual cost of \$7,542 for the proposed investment.

Rate of Return.—The estimated interest rate produced by an investment. Rate of return (*ROR*) is the interest rate at which the benefits are equivalent to the costs. It is defined as the interest rate paid on the unpaid balance of a loan such that the payment schedule makes the unpaid loan balance equal to zero when the final payment is made. It may be computed by finding the interest rate in such a way that the estimated expenditures are equal to the capital gain. *Net Present Worth = 0*, or *PW of benefits – PW of costs = 0*

$$\frac{((1 + ROR)^n - 1)}{ROR(1 + ROR)^n} (AR - AE) + \frac{L}{(1 + ROR)^n} = P$$

The rate of return can only be calculated by trial and error solution. To find out the present worth, select a reasonable interest rate, calculate the present worth. Choose another rate, calculate the present worth. Interpolate or extrapolate the value of *ROR* to find the zero value of present worth.

Benefit-Cost Ratio.—It is the ratio of present worth of benefit and present worth of cost. This method is applied to municipal project evaluations where benefits (*B*) and costs (*C*) accrue to different segments of the community. The project is considered acceptable if the ratio equals or exceeds 1. For fixed input maximize the $B/C \geq 1$ and for fixed output maximize the $B/C \geq 1$ and if neither input nor output is fixed, to compute the incremental benefit cost ratio ($\Delta B/\Delta C$), choose $\Delta B/\Delta C \geq 1$.

Example: To build a bridge over a river costs \$1,200,000, benefits of \$2,000,000, and disbenefits of \$500,000. (a) What is the benefit cost ratio? (b) What is the excess of benefits over costs?

$$\text{Solution: The benefit cost ratio is } B/C = \frac{B - D}{C} = \frac{2,000,000 - 500,000}{1,200,000} = 3$$

The excess of benefits over cost equal $2,000,000 - 1,200,000 - 500,000 = 300,000$.

Payback Period.—This is the period of time required for the profit or other benefits of an investment to equal the cost of investment. The criterion in all situations is to minimize the payback period.

Break-Even Analysis.—Break-even analysis is a method of comparing two or more alternatives to determine which works best. Frequently, cost is the basis of the comparison, with the least expensive alternative being the most desirable. Break-even analysis can be applied in situations such as: to determine if it is more efficient and cost effective to use HSS, carbide, or ceramic tooling; to compare coated versus uncoated carbide tooling; to decide which of several machines should be used to produce a part; or to decide whether to

buy a new machine for a particular job or to continue to use an older machine. The techniques used to solve any of these problems are the same; however, the details will be different, depending on the type of comparison being made. The remainder of this section deals with break-even analysis based on comparing the costs of manufacturing a product using different machines.

Choosing a Manufacturing Method: The object of this analysis is to decide which of several machines can produce parts at the lowest cost. In order to compare the cost of producing a part, all the costs involved in making that part must be considered. The cost of manufacturing any number of parts can be expressed as the sum: $C_T = C_F + n \times C_V$, where C_T is the total cost of manufacturing one part, C_F is the sum of the fixed costs of making the parts, n is the number of parts made, and C_V is the total variable costs per piece made.

Fixed costs are manufacturing costs that have to be paid whatever number of parts are produced and usually before any parts can be produced. They include the cost of drafting and CNC part programs, the cost of special tools and equipment required to make the part, and the cost of setting up the machine for the job. Fixed costs are generally one-time charges that occur at the beginning of a job or are recurrent charges that do not depend on the number of pieces made, such as those that might occur each time a job is run again.

Variable costs depend on the number of parts produced and are expressed as the cost per part made. The variable costs include the cost of materials, the cost of machine time, the cost of the labor directly involved in making the part, and the portion of the overhead that is attributable to production of the part. Variable costs can be expressed as: $C_V = \text{material cost} + \text{machine cost} + \text{labor cost} + \text{overhead cost}$. When comparing alternatives, if the same cost is incurred by each alternative, then that cost can be eliminated from the analysis without affecting the result. For example, the cost of material is frequently omitted from a manufacturing analysis if each machine is going to make parts from the same stock and if there is not going to be a significant difference in the amount of scrap produced by each method. The time to produce one part is needed to determine the machine, labor, and overhead costs. The total time expressed in hours per part is $t_T = t_f + t_s$, where t_f equals the floor-to-floor production time for one part and t_s the setup time per part. The setup time, t_s , is the time spent setting up the machine and periodically reconditioning tooling, divided by the number of parts made per setup.

Material cost equals the cost of the materials divided by the number of parts made.

Machine cost is the portion of a machine's total cost that is charged toward the production of each part. It is found by multiplying the machine rate (cost of the machine per hour) by the machine time per part, t_f . The machine hourly rate is calculated by dividing the lifetime costs (including purchase price, insurance, maintenance, etc.) by the estimated lifetime hours of operation of the machine. The total operating hours may be difficult to determine but a reasonable number can be based on experience and dealer information.

Labor costs are the wages paid to people who are directly involved in the manufacture of the part. The labor cost per part is the labor rate per hour multiplied by the time needed to manufacture each part, t_T . Indirect labor, which supports but is not directly involved in the manufacture of the part, is charged as overhead.

Overhead cost is the cost of producing an item that is not directly related to the cost of manufacture. Overhead includes the cost of management and other support personnel, building costs, heating and cooling, and similar expenses. Often, overhead is estimated as a percentage of the largest component cost of producing a part. For example, if direct labor is the largest expense in producing a part, the overhead can be estimated as a percentage of the direct labor costs. On the other hand, if equipment costs are higher, the overhead would be based on a percentage of the machine cost. Depending on the company, typical overhead charges range from about 150 to 800 per cent of the highest variable cost.

Most of the time, the decision to use one machine or another for making parts depends on how many pieces are needed. For example, given three machines *A*, *B*, and *C*, if only a few parts need to be produced, then, in terms of cost, machine *A* might be the best; if hundreds of parts are needed, then machine *B* might be best; and, if thousands of components are to be manufactured, then machine *C* may result in the lowest cost per part. Break-even analysis reveals how many components need to be produced before a particular machine becomes more cost effective than another.

To use break-even analysis, the cost of operating each machine needs to be established. The costs are plotted on a graph as a function of the number of components to be manufactured to learn which machine can make the required parts for the least cost. The following graph is a plot of the fixed and variable costs of producing a quantity of parts on two different machines, *Machine 1* and *Machine 2*. Fixed costs for each machine are plotted on the vertical *cost* axis. Variable costs for each machine are plotted as a line that intersects the cost axis at the fixed cost for each respective machine. The variable cost line is constructed with a slope that is equal to the cost per part, that is, for each part made, the line rises by an amount equal to the cost per part. If the calculations necessary to produce the graph are done carefully, the total cost of producing any quantity of parts can be found from the data plotted on the graph.

As an example, the graph shown in Fig. 7 is a comparison of the cost of manufacturing a quantity of a small part on a manually operated milling machine (*Machine 1*) and on a CNC machining center (*Machine 2*). The fixed costs (fixed costs = lead time \times lead time rate + setup time \times setup rate) for the manual machine are \$190 and the fixed costs for the CNC machine are higher at \$600. The fixed cost for each machine is the starting point of the line representing the cost of manufacturing a quantity of parts with that machine. The variable costs plotted are: \$18 per piece for the manual machine and \$5 per piece for the CNC mill.

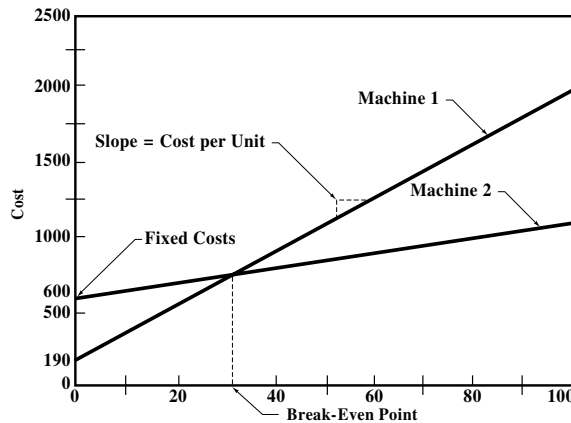


Fig. 7. Quantity of Parts

The variable costs are calculated using the machine, labor, and overhead costs. The cost of materials is not included because it is assumed that materials cost will be the same for parts made on either machine and there will be no appreciable difference in the amount of scrap generated. The original cost of *Machine 1* (the manual milling machine) is \$19,000 with an estimated operating life of 16,000 hours, so the hourly operating cost is $19,000/16,000 = \$1.20$ per hour. The labor rate is \$17 per hour and the overhead is estimated as 1.6 times the labor rate, or $17 \times 1.6 = \$27.20$ per hour. The time, t_p , needed to complete each part on *Machine 1* is estimated as 24 minutes (0.4 hour). Therefore, by using *Machine 1*, the variable cost per part excluding material is $(1.20 + 17.00 + 27.20) \$/h \times 0.4 \text{ h/part} = \18 per part. For *Machine 2* (the CNC machining center), the machine cost is calculated at \$3 per hour, which is based on a \$60,000 initial cost (including installation, maintenance, insurance, etc.) and 20,000 hours of estimated lifetime. The cost of labor is \$15 per hour for

Machine 2 and the overhead is again calculated at 1.6 times the labor rate, or \$24 per hour. Each part is estimated to take 7.2 minutes (0.12 h) to make, so the variable cost per part made on *Machine 2* is $(3 + 15 + 24) \text{ \$/h} \times 0.12 \text{ h/part} = \5 per part.

The lines representing the variable cost of operating each machine intersect at only one point on the graph. The intersection point corresponds to a quantity of parts that can be made by either the CNC or manual machine for the same cost, which is the break-even point. In the figure, the break-even point is 31.5 parts and the cost of those parts is \$757, or about \$24 apiece, excluding materials. The graph shows that if fewer than 32 parts need to be made, the total cost will be lowest if the manual machine is used because the line representing *Machine 1* is lower (representing lower cost) than the line representing *Machine 2*. On the other hand, if more than 31 parts are going to be made, the CNC machine will produce them for a lower cost. It is easy to see that the per piece cost of manufacturing is lower on the CNC machine because the line for *Machine 2* rises at a slower rate than the line for *Machine 1*. For producing only a few parts, the manual machine will make them less expensively than the CNC because the fixed costs are lower, but once the CNC part program has been written, the CNC can also run small batches efficiently because very little setup work is required.

The quantity of parts corresponding to the break-even point is known as the break-even quantity Q_b . The break-even quantity can be found without the use of the graph by using the following break-even equation: $Q_b = (C_{F1} - C_{F2}) / (C_{V2} - C_{V1})$. In this equation, the C_{F1} and C_{F2} are the fixed costs for *Machine 1* and *Machine 2*, respectively; C_{V1} and C_{V2} are the variable costs for *Machine 1* and *Machine 2*, respectively.

Break-even analysis techniques are also useful for comparing performance of more than two machines. Plot the manufacturing costs for each machine on a graph as before and then compare the costs of the machines in pairs using the techniques described. For example, if an automatic machine such as a rotary transfer machine is included as *Machine 3* in the preceding analysis, then three lines representing the costs of operating each machine would be plotted on the graph. The equation to find the break-even quantities is applied three times in succession, for *Machines 1* and *2*, for *Machines 1* and *3*, and again for *Machines 2* and *3*. The result of this analysis will show the region (range of quantities) within which each machine is most profitable.

Overhead Expenses.—Machine-Hour Distribution: The machine-hour rate method consists of distributing all the manufacturing expenses of an establishment by a charge to each job of the overhead cost of operating the machines and other facilities used on that job. This overhead charge is not an average for the whole plant or department, but is, as nearly as possible, the actual overhead cost of maintaining and operating each of the machines, group of machines, benches, etc., which are found in the plant. By the proper use of this method it is possible to show the difference between the expense cost of a boring mill and a lathe, a gear-cutter and a splining machine, etc.

Man-Hour Distribution: The man-hour method of distributing overhead has for its base the number of hours spent on a job instead of the amount of wages paid. The assumption is made that the overhead expenses have a fixed ratio to the number of hours of time spent on a job. Certain items of expense bear a direct relation to the number of hours worked, and include the expenses of the payroll, compensation, insurance, and supervision.

Man-Rate Distribution: The man-rate method of distributing overhead costs is the one in most general use because of its simplicity. To use this method, find the ratio of total expenses to total labor for a given business, and to apply this ratio to the labor cost of each job. For a factory making one kind of product, this method of distributing overhead is quite satisfactory, but where the product itself is varied and the tools used are different for each of the products, this method is incorrect and misleading as to final results.

TABLE OF CONTENTS
MECHANICS AND STRENGTH OF MATERIALS

MECHANICS	STRENGTH OF MATERIALS
149 Terms and Definitions	199 Properties of Materials
153 Force Systems	200 Yield Point, Elastic Modulus and Poission's Ratio
153 Scalar and Vector Quantities	201 Compressive, Shear Properties
153 Graphical Resolution of Forces	201 Creep
155 Couples and Forces	203 Fatigue Failure
156 Resolution of Force Systems	204 Stress
157 Subtraction and Addition of Force	204 Factors of Safety
161 Forces in Two or More Planes	204 Working Stress
162 Parallel Forces	205 Stress Concentration Factors
163 Nonparallel Forces	209 Simple Stresses
165 Friction	210 Deflections
165 Laws of Friction	211 Combined Stresses
166 Coefficients of Friction	211 Tables of Combined Stresses
167 Mechanisms	212 Formulas for Combined Stresses
167 Levers	215 Three-dimensional Stress
169 Inclined Plane, Wedge	217 Sample Calculations
170 Wheels and Pulleys	219 Stresses in a Loaded Ring
171 Screw	220 Strength of Taper Pins
171 Geneva Wheel	
172 Toggle Joint	
173 Pendulums	
	PROPERTIES OF BODIES
	221 Center of Gravity
	228 Radius of Gyration
	231 Center and Radius of Oscillation
	231 Center of Percussion
	232 Moment of Inertia
	233 Calculating For Built-up Sections
	234 Area Moments of Inertia, Section Moduli and Radius of Gyration
	244 Polar Area Moment of Inertia and Section Modulus
	244 Mass Moment of Inertia
	246 Polar Mass Moments of Inertia
	249 Tables for Rectangles and Shafts
	BEAMS
	256 Beam Calculations
	257 Stress and Deflection Beam Table
	268 Rectangular Solid Beams
	269 Round Solid Beams
	273 Deflection as Limiting Factor
	274 Curved Beams
	277 Size of Rail to Carry Load
	277 American Railway Formulas
	278 Stresses Produced by Shocks
	278 Beam Stresses Due to Shock
	279 Stresses in Helical Springs
	280 Fatigue Stresses
VELOCITY, ACCELERATION, WORK, AND ENERGY	
175 Velocity and Acceleration	
175 Newton's Laws of Motion	
175 Constant Velocity	
175 Constant Acceleration	
176 Angular Velocity	
177 Linear Velocity of Rotating Body	
177 Rotary Motion with Acceleration	
179 Force, Work, Energy, Momentum	
179 Acceleration by Forces	
180 Torque and Angular Acceleration	
181 Energy	
182 Work Performed by Forces	
182 Work and Energy	
183 Force of a Blow	
184 Impulse and Momentum	
186 Work and Power	
187 Centrifugal Force	
188 Centrifugal Casting	
191 Balancing Rotating Parts	
191 Static and Dynamic Balancing	
192 Masses in Same Plane	
194 Masses in Two or More Planes	
195 Balancing Lathe Fixtures	
197 Critical Speeds	

TABLE OF CONTENTS
MECHANICS AND STRENGTH OF MATERIALS

COLUMNS	SPRINGS	
281 Strength of Columns or Struts	(Continued)	
281 Rankine or Gordon Formula	327 Bending Stress	
281 Straight-line Formula	327 Extension Spring Design	
281 American Railway Formulas	329 Tolerances for Springs	
282 Euler Formula	331 Torsion Spring Design	
282 Eccentrically Loaded Columns	338 Torsion Spring Characteristics	
285 AISC Formulas	343 Torsion Spring Tolerances	
PLATES, SHELLS, AND CYLINDERS		
288 Square Flat Plates	344 Miscellaneous Springs	
290 Circular Flat Plates	344 Flat Springs Formula	
290 Cylinders, Internal Pressure	345 Moduli of Elasticity	
291 Spherical Shells, Internal Pressure	345 Heat Treatment of Springs	
293 Cylinders, External Pressure	348 Spring Failure	
SHAFTS		
295 Shaft Calculations	348 Causes of Spring Failure	
295 Torsional Strength of Shafting	349 Music Wire	
297 Torsional Deflections	DISC SPRINGS	
298 Linear Deflections	350 Performance of Disc Springs	
299 Design of Transmission Shafting	350 Introduction	
301 Effect of Keyways	350 Nomenclature	
301 Brittle Materials	350 Group Classifications	
302 Critical Speeds	351 Contact Surfaces	
302 Shaft Couplings	351 Materials	
303 Hollow and Solid Shafts	352 Stacking of Disc Springs	
SPRINGS		
304 Introduction to Spring Design	354 Disc Spring Forces and Stresses	
304 Notation	354 Springs Without Contact Surfaces	
305 Spring Materials	357 Springs Without Contact Surfaces	
305 High-Carbon Spring Steels	357 Functional Stresses	
306 Alloy Spring Steels	357 Fatigue Life	
306 Stainless Spring Steels	361 Dimensional Ratios	
307 Copper-Base Spring Alloys	361 Example Applications	
308 Nickel-Base Spring Alloys	FLUID MECHANICS	
309 Spring Stresses	365 Properties of Fluids	
309 Working Stresses	365 Fluids	
314 Endurance Limit	365 Viscosity	
315 Working Stresses at Elevated Temperatures	366 Statics	
316 Spring Design Data	366 Pressure	
316 Spring Characteristics	367 Hydrostatic Pressure on Surfaces	
316 Compression Spring Design	367 Pressure on Horizontal Surfaces	
317 Formulas for Compression Spring	367 Pressure on Vertical Surfaces	
320 Spring Characteristics	367 Pressure on Inclined Surfaces	
325 Extension Springs	368 Forces on Curved Surfaces	

MECHANICS

Throughout this section in this Handbook, both English and metric SI data and formulas are given to cover the requirements of working in either system of measurement. Except for the passage entitled *The Use of the Metric SI System in Mechanics Calculations*, formulas and text relating exclusively to SI are given in bold face type.

Terms and Definitions

Definitions.—The science of mechanics deals with the effects of forces in causing or preventing motion. *Statics* is the branch of mechanics that deals with bodies in equilibrium, i.e., the forces acting on them cause them to remain at rest or to move with uniform velocity. *Dynamics* is the branch of mechanics that deals with bodies not in equilibrium, i.e., the forces acting on them cause them to move with non-uniform velocity. *Kinetics* is the branch of dynamics that deals with both the forces acting on bodies and the motions that they cause. *Kinematics* is the branch of dynamics that deals only with the motions of bodies without reference to the forces that cause them.

Definitions of certain terms and quantities as used in mechanics follow:

Force may be defined simply as a push or a pull; the push or pull may result from the force of contact between bodies or from a force, such as magnetism or gravitation, in which no direct contact takes place.

Matter is any substance that occupies space; gases, liquids, solids, electrons, atoms, molecules, etc., all fit this definition.

Inertia is the property of matter that causes it to resist any change in its motion or state of rest.

Mass is a measure of the inertia of a body.

Work, in mechanics, is the product of force times distance and is expressed by a combination of units of force and distance, as foot-pounds, inch-pounds, meter-kilograms, etc. **The metric SI unit of work is the joule, which is the work done when the point of application of a force of one newton is displaced through a distance of one meter in the direction of the force.**

Power, in mechanics, is the product of force times distance divided by time; it measures the performance of a given amount of work in a given time. It is the rate of doing work and as such is expressed in foot-pounds per minute, foot-pounds per second, kilogram-meters per second, etc. **The metric SI unit is the watt, which is one joule per second.**

Horsepower is the unit of power that has been adopted for engineering work. One horsepower is equal to 33,000 foot-pounds per minute or 550 foot-pounds per second. The *kilowatt*, used in electrical work, equals 1.34 horsepower; or 1 horsepower equals 0.746 kilowatt. **However, in the metric SI, the term horsepower is not used, and the basic unit of power is the watt. This unit, and the derived units milliwatt and kilowatt, for example, are the same as those used in electrical work.**

Torque or moment of a force is a measure of the tendency of the force to rotate the body upon which it acts about an axis. The magnitude of the moment due to a force acting in a plane perpendicular to some axis is obtained by multiplying the force by the perpendicular distance from the axis to the line of action of the force. (If the axis of rotation is not perpendicular to the plane of the force, then the components of the force in a plane perpendicular to the axis of rotation are used to find the resultant moment of the force by finding the moment of each component and adding these component moments algebraically.) Moment or torque is commonly expressed in pound-feet, pound-inches, kilogram-meters, etc. **The metric SI unit is the newton-meter ($N \cdot m$).**

Velocity is the time-rate of change of distance and is expressed as distance divided by time, that is, feet per second, miles per hour, centimeters per second, meters per second, etc.

Acceleration is defined as the time-rate of change of velocity and is expressed as velocity divided by time or as distance divided by time squared, that is, in feet per second, per second or feet per second squared; inches per second, per second or inches per second squared; centimeters per second, per second or centimeters per second squared; etc. **The metric SI unit is the meter per second squared.**

Unit Systems.—In mechanics calculations, both *absolute* and *gravitational* systems of units are employed. The fundamental units in absolute systems are *length*, *time*, and *mass*, and from these units, the dimension of force is derived. Two absolute systems which have been in use for many years are the cgs (centimeter-gram-second) and the MKS (meter-kilogram-second) systems. Another system, known as MKSA (meter-kilogram-second-ampere), links the MKS system of units of mechanics with electro magnetic units.

The Conference General des Poids et Mesures (CGPM), which is the body responsible for all international matters concerning the metric system, adopted in 1954 a rationalized and coherent system of units based on the four MKSA units and including the kelvin as the unit of temperature, and the candela as the unit of luminous intensity. In 1960, the CGPM formally named this system the ‘Systeme International d’Unites,’ for which the abbreviation is SI in all languages. In 1971, the 14th CGPM adopted a seventh base unit, the mole, which is the unit of quantity (“amount of substance”). Further details of the SI are given in the section *MEASURING UNITS* starting on page 2656, and its application in mechanics calculations, contrasted with the use of the English system, is considered on page 150.

The fundamental units in gravitational systems are *length*, *time*, and *force*, and from these units, the dimension of mass is derived. In the gravitational system most widely used in English measure countries, the units of length, time, and force are, respectively, the foot, the second, and the pound. The corresponding unit of mass, commonly called the *slug*, is equal to 1 pound second² per foot and is derived from the formula, $M = W \div g$ in which M = mass in slugs, W = weight in pounds, and g = acceleration due to gravity, commonly taken as 32.16 feet per second². A body that weighs 32.16 lbs. on the surface of the earth has, therefore, a mass of one slug.

Many engineering calculations utilize a system of units consisting of the inch, the second, and the pound. The corresponding units of mass are pounds second² per inch and the value of g is taken as 386 inches per second².

In a gravitational system that has been widely used in metric countries, the units of length, time, and force are, respectively, the meter, the second, and the kilogram. The corresponding units of mass are kilograms second² per meter and the value of g is taken as 9.81 meters per second².

Acceleration of Gravity g Used in Mechanics Formulas.—The acceleration of a freely falling body has been found to vary according to location on the earth’s surface as well as with height, the value at the equator being 32.09 feet per second, per second while at the poles it is 32.26 ft/sec². In the United States it is customary to regard 32.16 as satisfactory for most practical purposes in engineering calculations.

Standard Pound Force: For use in defining the magnitude of a standard unit of force, known as the *pound force*, a fixed value of 32.1740 ft/sec², designated by the symbol g_0 , has been adopted by international agreement. As a result of this agreement, whenever the term mass, M , appears in a mechanics formula and the substitution $M = W/g$ is made, use of the standard value $g_0 = 32.1740$ ft/sec² is implied although as stated previously, it is customary to use approximate values for g except where extreme accuracy is required.

The Use of the Metric SI System in Mechanics Calculations.—The SI system is a development of the traditional metric system based on decimal arithmetic; fractions are avoided. For each physical quantity, units of different sizes are formed by multiplying or dividing a single base value by powers of 10. Thus, changes can be made very simply by

adding zeros or shifting decimal points. For example, the meter is the basic unit of length; the kilometer is a multiple (1,000 meters); and the millimeter is a sub-multiple (one-thousandth of a meter).

In the older metric system, the simplicity of a series of units linked by powers of 10 is an advantage for plain quantities such as length, but this simplicity is lost as soon as more complex units are encountered. For example, in different branches of science and engineering, energy may appear as the erg, the calorie, the kilogram-meter, the liter-atmosphere, or the horsepower-hour. In contrast, the SI provides only one basic unit for each physical quantity, and universality is thus achieved.

There are seven base-units, and in mechanics calculations three are used, which are for the basic quantities of length, mass, and time, expressed as the meter (m), the kilogram (kg), and the second (s). The other four base-units are the ampere (A) for electric current, the kelvin (K) for thermodynamic temperature, the candela (cd) for luminous intensity, and the mole (mol) for amount of substance.

The SI is a coherent system. A system of units is said to be coherent if the product or quotient of any two unit quantities in the system is the unit of the resultant quantity. For example, in a coherent system in which the foot is a unit of length, the square foot is the unit of area, whereas the acre is not. Further details of the SI, and definitions of the units, are given in the section *MEASURING UNITS* starting on page 2656, near the end of the book.

Other physical quantities are derived from the base-units. For example, the unit of velocity is the meter per second (m/s), which is a combination of the base-units of length and time. The unit of acceleration is the meter per second squared (m/s²). By applying Newton's second law of motion — force is proportional to mass multiplied by acceleration — the unit of force is obtained, which is the kg · m/s². This unit is known as the newton, or N. Work, or force times distance, is the kg · m²/s², which is the joule, (1 joule = 1 newton-meter) and energy is also expressed in these terms. The abbreviation for joule is J. Power, or work per unit time, is the kg · m²/s³, which is the watt (1 watt = 1 joule per second = 1 newton-meter per second). The abbreviation for watt is W.

More information on Newton's laws may be found in the section *Newton's Laws of Motion* on page 175.

The coherence of SI units has two important advantages. The first, that of uniqueness and therefore universality, has been explained. The second is that it greatly simplifies technical calculations. Equations representing physical principles can be applied without introducing such numbers as 550 in power calculations, which, in the English system of measurement have to be used to convert units. Thus conversion factors largely disappear from calculations carried out in SI units, with a great saving in time and labor.

Mass, Weight, Force, Load: SI is an absolute system (see *Unit Systems* on page 150), and consequently it is necessary to make a clear distinction between mass and weight. The *mass* of a body is a measure of its inertia, whereas the *weight* of a body is the *force* exerted on it by gravity. In a fixed gravitational field, weight is directly proportional to mass, and the distinction between the two can be easily overlooked. However, if a body is moved to a different gravitational field, for example, that of the moon, its weight alters, but its mass remains unchanged. Since the gravitational field on earth varies from place to place by only a small amount, and weight is proportional to mass, it is practical to use the weight of unit mass as a unit of force, and this procedure is adopted in both the English and older metric systems of measurement. In common usage, they are given the same names, and we say that a mass of 1 pound has a weight of 1 pound. In the former case the pound is being used as a unit of mass, and in the latter case, as a unit of force. This procedure is convenient in some branches of engineering, but leads to confusion in others.

As mentioned earlier, Newton's second law of motion states that force is proportional to mass times acceleration. Because an unsupported body on the earth's surface falls with acceleration g (32 ft/s² approximately), the pound (force) is that force which will impart an

acceleration of $g \text{ ft/s}^2$ to a pound (mass). Similarly, the kilogram (force) is that force which will impart an acceleration of g (9.8 meters per second² approximately), to a mass of one kilogram. In the SI, the *newton* is that force which will impart unit acceleration (1 m/s^2) to a mass of one kilogram. It is therefore smaller than the kilogram (force) in the ratio 1: g (about 1:9.8). This fact has important consequences in engineering calculations. The factor g now disappears from a wide range of formulas in dynamics, but appears in many formulas in statics where it was formerly absent. It is however not quite the same g , for reasons which will now be explained.

In the article on page 179, the mass of a body is referred to as M , but it is immediately replaced in subsequent formulas by W/g , where W is the weight in pounds (force), which leads to familiar expressions such as $WV^2/2g$ for kinetic energy. In this treatment, the M which appears briefly is really expressed in terms of the slug (page 150), a unit normally used only in aeronautical engineering. In everyday engineers' language, weight and mass are regarded as synonymous and expressions such as $WV^2/2g$ are used without pondering the distinction. Nevertheless, on reflection it seems odd that g should appear in a formula which has nothing to do with gravity at all. In fact the g used here is not the true, local value of the acceleration due to gravity, but an arbitrary standard value which has been chosen as part of the definition of the pound (force) and is more properly designated g_0 (page 150). Its function is not to indicate the strength of the local gravitational field, but to convert from one unit to another.

In the SI the unit of mass is the *kilogram*, and the unit of force (and therefore weight) is the *newton*.

The following are typical statements in dynamics expressed in SI units:

A force of R newtons acting on a mass of M kilograms produces an acceleration of R/M meters per second². The kinetic energy of a mass of M kg moving with velocity V m/s is $\frac{1}{2}MV^2$ kg (m/s)² or $\frac{1}{2}MV^2$ joules. The work done by a force of R newtons moving a distance L meters is RL Nm, or RL joules. If this work were converted entirely into kinetic energy we could write $RL = \frac{1}{2}MV^2$ and it is instructive to consider the units. Remembering that the N is the same as the $\text{kg} \cdot \text{m/s}^2$, we have $(\text{kg} \cdot \text{m/s}^2) \times \text{m} = \text{kg} (\text{m/s})^2$, which is obviously correct. It will be noted that g does not appear anywhere in these statements.

In contrast, in many branches of engineering where the weight of a body is important, rather than its mass, using SI units, g does appear where formerly it was absent. Thus, if a rope hangs vertically supporting a mass of M kilograms the tension in the rope is Mg N. Here g is the acceleration due to gravity, and its units are m/s^2 . The ordinary numerical value of 9.81 will be sufficiently accurate for most purposes on earth. The expression is still valid elsewhere, for example, on the moon, provided the proper value of g is used. The maximum tension the rope can safely withstand (and other similar properties) will also be specified in terms of the newton, so that direct comparison may be made with the tension predicted.

Words like load and weight have to be used with greater care. In everyday language we might say "a lift carries a load of five people of average weight 70 kg," but in precise technical language we say that if the average mass is 70 kg, then the average weight is $70g$ N, and the total load (that is force) on the lift is $350g$ N.

If the lift starts to rise with acceleration $a \cdot \text{m/s}^2$, the load becomes $350(g + a)$ N; both g and a have units of m/s^2 , the mass is in kg, so the load is in terms of $\text{kg} \cdot \text{m/s}^2$, which is the same as the newton.

Pressure and stress: These quantities are expressed in terms of force per unit area. In the SI the unit is the pascal (Pa), which expressed in terms of SI derived and base units is the newton per meter squared (N/m^2). The pascal is very small—it is only equivalent to $0.15 \times 10^{-3} \text{ lb/in}^2$ —hence the kilopascal ($\text{kPa} = 1000$ pascals), and the megapascal ($\text{MPa} = 10^6$

pascals) may be more convenient multiples in practice. Thus, note: 1 newton per millimeter squared = 1 meganewton per meter squared = 1 megapascal.

In addition to the pascal, the bar, a non-SI unit, is in use in the field of pressure measurement in some countries, including England. Thus, in view of existing practice, the International Committee of Weights and Measures (CIPM) decided in 1969 to retain this unit for a limited time for use with those of SI. The bar = 10^5 pascals and the hectobar = 10^7 pascals.

Force Systems

Scalar and Vector Quantities.—The quantities dealt with in mechanics are of two kinds according to whether magnitude alone or direction as well as magnitude must be known in order to completely specify them. Quantities such as time, volume and density are completely specified when their magnitude is known. Such quantities are called *scalar* quantities. Quantities such as force, velocity, acceleration, moment, and displacement which must, in order to be specified completely, have a specific direction as well as magnitude, are called *vector* quantities.

Graphical Representation of Forces.—A force has three characteristics which, when known, determine it. They are *direction*, *point of application*, and *magnitude*. The direction of a force is the direction in which it tends to move the body upon which it acts. The point of application is the place on the line of action where the force is applied. Forces may conveniently be represented by straight lines and arrow heads. The arrow head indicates the direction of the force, and the length of the line, its magnitude to any suitable scale. The point of application may be at any point on the line, but it is generally convenient to assume it to be at one end. In the accompanying illustration, a force is supposed to act along line *AB* in a direction from left to right. The length of line *AB* shows the magnitude of the force. If point *A* is the point of application, the force is exerted as a pull, but if point *B* be assumed to be the point of application, it would indicate that the force is exerted as a push.



Vector

Velocities, moments, displacements, etc. may similarly be represented and manipulated graphically because they are all of the same class of quantities called vectors. (See *Scalar and Vector Quantities*.)

Addition and Subtraction of Forces: The resultant of two forces applied at the same point and acting in the same direction, as in Fig. 1, is equal to the sum of the forces. For example, if the two forces *AB* and *AC*, one equal to two and the other equal to three pounds, are applied at point *A*, then their resultant *AD* equals the sum of these forces, or five pounds.

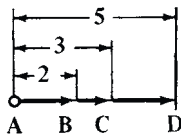


Fig. 1.

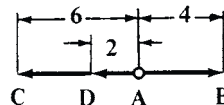


Fig. 2.

If two forces act in opposite directions, as in Fig. 2, then their resultant is equal to their difference, and the direction of the resultant is the same as the direction of the greater of the two forces. For example, *AB* and *AC* are both applied at point *A*; then, if *AB* equals four and *AC* equals six newtons, the resultant *AD* equals two newtons and acts in the direction of *AC*.

Parallelogram of Forces: If two forces applied at a point are represented in magnitude and direction by the adjacent sides of a parallelogram (AB and AC in Fig. 3), their resultant will be represented in magnitude and direction by the diagonal AR drawn from the intersection of the two component forces.

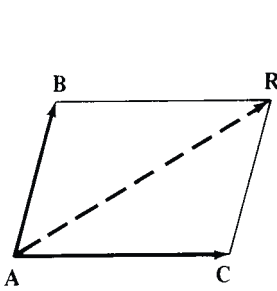


Fig. 3.

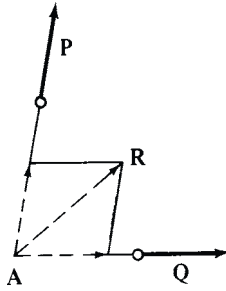


Fig. 4.

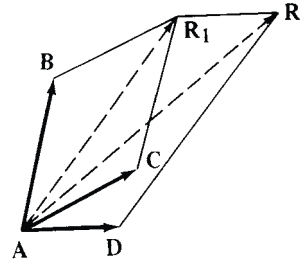


Fig. 5.

If two forces P and Q do not have the same point of application, as in Fig. 4, but the lines indicating their directions intersect, the forces may be imagined as applied at the point of intersection between the lines (as at A), and the resultant of the two forces may be found by constructing the parallelogram of forces. Line AR shows the direction and magnitude of the resultant, the point of application of which may be assumed to be at any point on line AR or its extension.

If the resultant of three or more forces having the same point of application is to be found, as in Fig. 5, first find the resultant of any two of the forces (AB and AC) and then find the resultant of the resultant just found (AR_1) and the third force (AD). If there are more than three forces, continue in this manner until the resultant of all the forces has been found.

Parallel Forces: If two forces are parallel and act in the same direction, as in Fig. 6, then their resultant is parallel to both lines, is located between them, and is equal to the sum of the two components. The point of application of the resultant divides the line joining the points of application of the components inversely as the magnitude of the components. Thus,

$$AB : CE = CD : AD$$

The resultant of two parallel and unequal forces acting in opposite directions, Fig. 7, is parallel to both lines, is located outside of them on the side of the greater of the components, has the same direction as the greater component, and is equal in magnitude to the difference between the two components. The point of application on the line AC produced is found from the proportion:

$$AB : CD = CE : AE$$

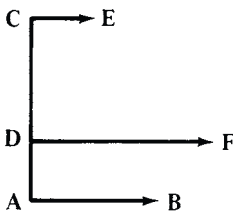


Fig. 6.

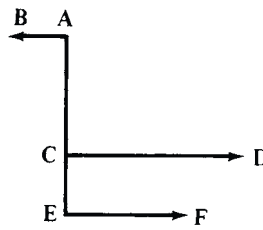


Fig. 7.

Polygon of Forces: When several forces are applied at a point and act in a single plane, Fig. 8, their resultant may be found more simply than by the method just described, as follows: From the extreme end of the line representing the first force, draw a line representing the second force, parallel to it and of the same length and in the direction of the second force. Then through the extreme end of this line draw a line parallel to, and of the same

length and direction as the third force, and continue this until all the forces have been thus represented. Then draw a line from the point of application of the forces (as A) to the extreme point (as 5_1) of the line last drawn. This line ($A 5_1$) is the resultant of the forces.

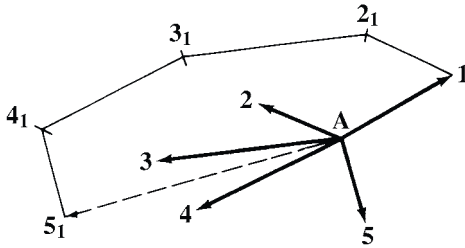


Fig. 8.

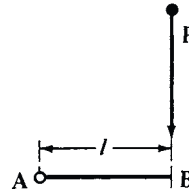
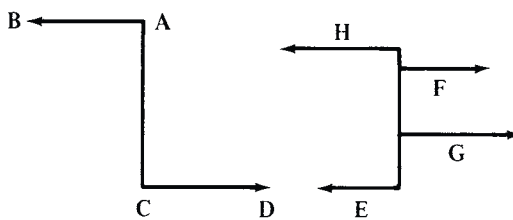


Fig. 9.

Moment of a Force: The moment of a force with respect to a point is the product of the force multiplied by the perpendicular distance from the given point to the direction of the force. In Fig. 9, the moment of the force P with relation to point A is $P \times AB$. The perpendicular distance AB is called the lever-arm of the force. The moment is the measure of the tendency of the force to produce rotation about the given point, which is termed the center of moments. If the force is measured in pounds and the distance in inches, the moment is expressed in inch-pounds. **In metric SI units, the moment is expressed in newton-meters ($N \cdot m$), or newton-millimeters ($N \cdot mm$).**

The moment of the resultant of any number of forces acting together in the same plane is equal to the algebraic sum of the moments of the separate forces.

Couples.—If the forces AB and CD are equal and parallel but act in opposite directions, then the resultant equals 0, or, in other words, the two forces have no resultant and are called a couple. A couple tends to produce rotation. The measure of this tendency is called the moment of the couple and is the product of one of the forces multiplied by the distance between the two.



Two Examples of Couples

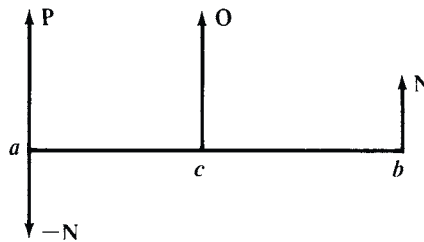
As a couple has no resultant, no single force can balance or counteract the tendency of the couple to produce rotation. To prevent the rotation of a body acted upon by a couple, two other forces are therefore required, forming a second couple. In the illustration, E and F form one couple and G and H are the balancing couple. The body on which they act is in equilibrium if the moments of the two couples are equal and tend to rotate the body in opposite directions. A couple may also be represented by a vector in the direction of the axis about which the couple acts. The length of the vector, to some scale, represents the magnitude of the couple, and the direction of the vector is that in which a right-hand screw would advance if it were to be rotated by the couple.

Composition of a Single Force and Couple.—A single force and a couple in the same plane or in parallel planes may be replaced by another single force equal and parallel to the first force, at a distance from it equal to the moment of the couple divided by the magnitude of the force. The new single force is located so that the moment of the resultant about the point of application of the original force is of the same sign as the moment of the couple.

In the next figure, with the couple $N - N$ in the position shown, the resultant of P , $-N$, and N is O (which equals P) acting on a line through point c so that $(P - N) \times ac = N \times bc$.

Thus, it follows that,

$$ac = \frac{N(ac + bc)}{P} = \frac{\text{Moment of Couple}}{P}$$



Single Force and Couple Composition

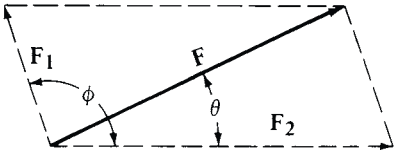
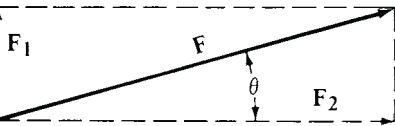
Algebraic Composition and Resolution of Force Systems.—The graphical methods given beginning on page 153 are convenient for solving problems involving force systems in which all of the forces lie in the same plane and only a few forces are involved. If many forces are involved, however, or the forces do not lie in the same plane, it is better to use algebraic methods to avoid complicated space diagrams. Systematic procedures for solving force problems by algebraic methods are outlined beginning on page 156. In connection with the use of these procedures, it is necessary to define several terms applicable to force systems in general.

The single force which produces the same effect upon a body as two or more forces acting together is called their *resultant*. The separate forces which can be so combined are called the *components*. Finding the resultant of two or more forces is called the *composition of forces*, and finding two or more components of a given force, the *resolution of forces*. Forces are said to be *concurrent* when their lines of action can be extended to meet at a common point; forces that are *parallel* are, of course, *nonconcurrent*. Two forces having the same line of action are said to be *collinear*. Two forces equal in magnitude, parallel, and in opposite directions constitute a *couple*. Forces all in the same plane are said to be *coplanar*; if not in the same plane, they are called *noncoplanar* forces.

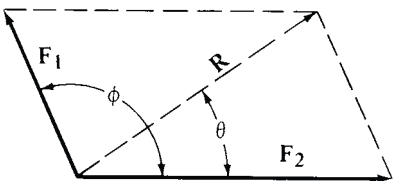
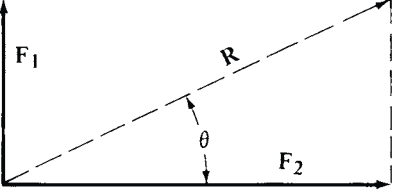
The *resultant* of a system of forces is the simplest equivalent system that can be determined. It may be a single force, a couple, or a noncoplanar force and a couple. This last type of resultant, a noncoplanar force and a couple, may be replaced, if desired, by two *skewed* forces (forces that are nonconcurrent, nonparallel, and noncoplanar). When the resultant of a system of forces is zero, the system is in equilibrium, that is, the body on which the force system acts remains at rest or continues to move with uniform velocity.

Algebraic Solution of Force Systems—All Forces in the Same Plane

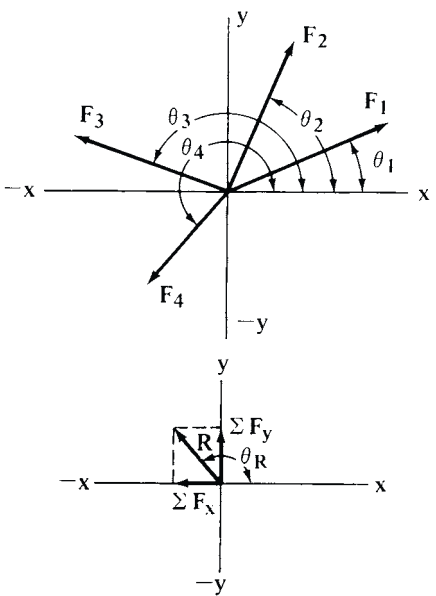
Finding Two Concurrent Components of a Single Force:

	<p>Case I: To find two components F_1 and F_2 at angles θ and ϕ, ϕ not being 90°.</p> $F_1 = \frac{F \sin \theta}{\sin \phi}$ $F_2 = \frac{F \sin(\phi - \theta)}{\sin \phi}$
	<p>Case II: Components F_1 and F_2 form 90° angle.</p> $F_1 = F \sin \theta$ $F_2 = F \cos \theta$

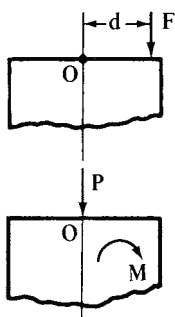
Finding the Resultant of Two Concurrent Forces:

	<p>Case I: Forces F_1 and F_2 do not form 90° angle.</p> $R = \frac{F_1 \sin \phi}{\sin \theta} \text{ or } R = \frac{F_2 \sin \phi}{\sin(\phi - \theta)} \text{ or}$ $R = \sqrt{F_1^2 + F_2^2 + 2F_1F_2 \cos \phi}$ $\tan \theta = \frac{F_1 \sin \phi}{F_1 \cos \phi + F_2}$
	<p>Case II: Forces F_1 and F_2 form 90° angle.</p> $R = \frac{F_2}{\cos \theta} \text{ or } R = \frac{F_1}{\sin \theta} \text{ or}$ $R = \sqrt{F_1^2 + F_2^2}$ $\tan \theta = \frac{F_1}{F_2}$

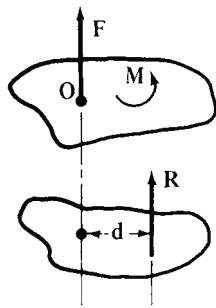
Finding the Resultant of Three or More Concurrent Forces:

	<p>To determine resultant of forces F_1, F_2, F_3, etc. making angles, respectively, of $\theta_1, \theta_2, \theta_3$, etc. with the x axis, find the x and y components F_x and F_y of each force and arrange in a table similar to that shown below for a system of three forces. Find the algebraic sum of the F_x and F_y components ($\sum F_x$ and $\sum F_y$) and use these to determine resultant R.</p> <table border="1" data-bbox="655 1362 1159 1535"> <thead> <tr> <th>Force</th> <th>F_x</th> <th>F_y</th> </tr> </thead> <tbody> <tr> <td>F_1</td> <td>$F_1 \cos \theta_1$</td> <td>$F_1 \sin \theta_1$</td> </tr> <tr> <td>F_2</td> <td>$F_2 \cos \theta_2$</td> <td>$F_2 \sin \theta_2$</td> </tr> <tr> <td>F_3</td> <td>$F_3 \cos \theta_3$</td> <td>$F_3 \sin \theta_3$</td> </tr> <tr> <td></td> <td>$\sum F_x$</td> <td>$\sum F_y$</td> </tr> </tbody> </table> $R = \sqrt{(\sum F_x)^2 + (\sum F_y)^2}$ $\cos \theta_R = \frac{\sum F_x}{R}$ <p>or $\tan \theta_R = \frac{\sum F_y}{\sum F_x}$</p>	Force	F_x	F_y	F_1	$F_1 \cos \theta_1$	$F_1 \sin \theta_1$	F_2	$F_2 \cos \theta_2$	$F_2 \sin \theta_2$	F_3	$F_3 \cos \theta_3$	$F_3 \sin \theta_3$		$\sum F_x$	$\sum F_y$
Force	F_x	F_y														
F_1	$F_1 \cos \theta_1$	$F_1 \sin \theta_1$														
F_2	$F_2 \cos \theta_2$	$F_2 \sin \theta_2$														
F_3	$F_3 \cos \theta_3$	$F_3 \sin \theta_3$														
	$\sum F_x$	$\sum F_y$														

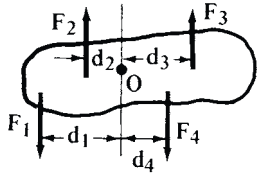
Finding a Force and a Couple Which Together are Equivalent to a Single Force:

	<p>To resolve a single force F into a couple of moment M and a force P passing through any chosen point O at a distance d from the original force F, use the relations</p> $P = F$ $M = F \times d$ <p>The moment M must, of course, tend to produce rotation about O in the same direction as the original force. Thus, as seen in the diagram, F tends to produce clockwise rotation; hence M is shown clockwise.</p>
---	---

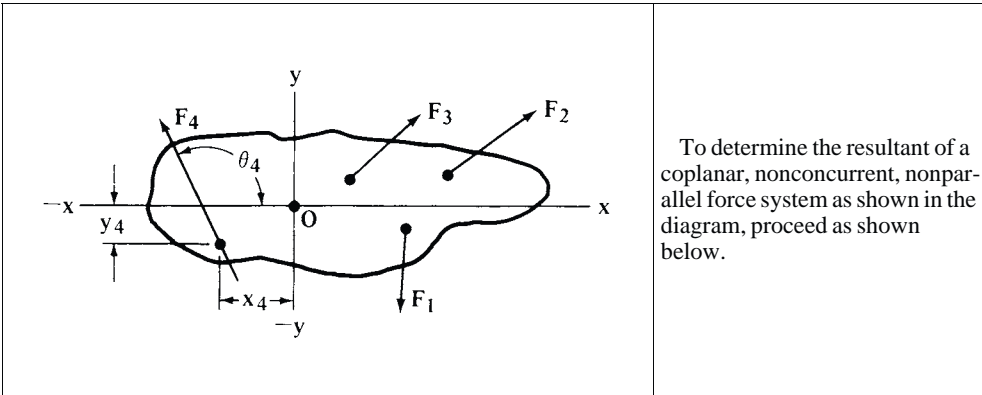
Finding the Resultant of a Single Force and a Couple:

	<p>The resultant of a single force F and a couple M is a single force R equal in magnitude and direction to F and parallel to it at a distance d to the left or right of F.</p> $R = F$ $d = M \div R$ <p>Resultant R is placed to the left or right of point of application O of the original force F depending on which position will give R the same direction of moment about O as the original couple M.</p>
---	---

Finding the Resultant of a System of Parallel Forces:

	<p>To find the resultant of a system of coplanar parallel forces, proceed as indicated below.</p>
<ol style="list-style-type: none"> 1) Select any convenient point O from which perpendicular distances d_1, d_2, d_3, etc. to parallel forces F_1, F_2, F_3, etc. can be specified or calculated. 2) Find the algebraic sum of all the forces; this will give the magnitude of the resultant of the system. $R = \Sigma F = F_1 + F_2 + F_3 + \dots$ 3) Find the algebraic sum of the moments of the forces about O; clockwise moments may be taken as negative and counterclockwise moments as positive: $\Sigma M_O = F_1 d_1 + F_2 d_2 + \dots$ 4) Calculate the distance d from O to the line of action of resultant R: $d = \Sigma M_O \div R$ <p>This distance is measured to the left or right from O depending on which position will give the moment of R the same direction of rotation about O as the couple ΣM_O, that is, if ΣM_O is negative, then d is left or right of O depending on which direction will make $R \times d$ negative.</p> <p><i>Note Concerning Interpretation of Results:</i> If $R = 0$, then the resultant of the system is a couple ΣM_O; if $\Sigma M_O = 0$ then the resultant is a single force R; if both R and $\Sigma M_O = 0$, then the system is in equilibrium.</p>	

Finding the Resultant of Forces Not Intersecting at a Common Point:



To determine the resultant of a coplanar, nonconcurrent, nonparallel force system as shown in the diagram, proceed as shown below.

- 1) Draw a set of x and y coordinate axes through any convenient point O in the plane of the forces as shown in the diagram.
- 2) Determine the x and y coordinates of any convenient point on the line of action of each force and the angle θ , measured in a counterclockwise direction, that each line of action makes with the positive x axis. For example, in the diagram, coordinates x_4, y_4 , and θ_4 are shown for F_4 . Similar data should be known for each of the forces of the system.
- 3) Calculate the x and y components (F_x, F_y) of each force and the moment of each component about O . Counterclockwise moments are considered positive and clockwise moments are negative. Tabulate all results in a manner similar to that shown below for a system of three forces and find $\Sigma F_x, \Sigma F_y, \Sigma M_O$ by algebraic addition.

Force F	Coordinates of F			Components of F		Moment of F about O
	x	y	θ	F_x	F_y	$M_O = xF_y - yF_x$
F_1	x_1	y_1	θ_1	$F_1 \cos \theta_1$	$F_1 \sin \theta_1$	$x_1 F_1 \sin \theta_1 - y_1 F_1 \cos \theta_1$
F_2	x_2	y_2	θ_2	$F_2 \cos \theta_2$	$F_2 \sin \theta_2$	$x_2 F_2 \sin \theta_2 - y_2 F_2 \cos \theta_2$
F_3	x_3	y_3	θ_3	$F_3 \cos \theta_3$	$F_3 \sin \theta_3$	$x_3 F_3 \sin \theta_3 - y_3 F_3 \cos \theta_3$
				ΣF_x	ΣF_y	ΣM_O

4. Compute the resultant of the system and the angle θ_R it makes with the x axis by using the formulas:

$$R = \sqrt{(\Sigma F_x)^2 + (\Sigma F_y)^2}$$

$$\cos \theta_R = \Sigma F_x \div R \text{ or } \tan \theta_R = \Sigma F_y \div \Sigma F_x$$

5. Calculate the distance d from O to the line of action of the resultant R :

$$d = \Sigma M_O \div R$$

Distance d is in such direction from O as will make the moment of R about O have the same sign as ΣM_O .

Note Concerning Interpretation of Results: If $R = 0$, then the resultant is a couple ΣM_O ; if $\Sigma M_O = 0$, then R passes through O ; if both $R = 0$ and $\Sigma M_O = 0$, then the system is in equilibrium.

Example: Find the resultant of three coplanar nonconcurrent forces for which the following data are given.

$$F_1 = 10 \text{ lbs; } x_1 = 5 \text{ in.; } y_1 = -1 \text{ in.; } \theta_1 = 270^\circ$$

$$F_2 = 20 \text{ lbs; } x_2 = 4 \text{ in.; } y_2 = 1.5 \text{ in.; } \theta_2 = 50^\circ$$

$$F_3 = 30 \text{ lbs; } x_3 = 2 \text{ in.; } y_3 = 2 \text{ in.; } \theta_3 = 60^\circ$$

$$F_{x_1} = 10 \cos 270^\circ = 10 \times 0 = 0 \text{ lbs.}$$

$$F_{x_2} = 20 \cos 50^\circ = 20 \times 0.64279 = 12.86 \text{ lbs.}$$

$$F_{x_3} = 30 \cos 60^\circ = 30 \times 0.5000 = 15.00 \text{ lbs.}$$

$$F_{y_1} = 10 \times \sin 270^\circ = 10 \times (-1) = -10.00 \text{ lbs.}$$

$$F_{y_2} = 20 \times \sin 50^\circ = 20 \times 0.76604 = 15.32 \text{ lbs.}$$

$$F_{y_3} = 30 \times \sin 60^\circ = 30 \times 0.86603 = 25.98 \text{ lbs.}$$

$$M_{o_1} = 5 \times (-10) - (-1) \times 0 = -50 \text{ in. lbs.}$$

$$M_{o_2} = 4 \times 15.32 - 1.5 \times 12.86 = 41.99 \text{ in. lbs.}$$

$$M_{o_3} = 2 \times 25.98 - 2 \times 15 = 21.96 \text{ in. lbs.}$$

Note: When working in metric SI units, pounds are replaced by newtons (N); inches by meters or millimeters, and inch-pounds by newton-meters (N · m) or newton-millimeters (N · mm).

Force F	Coordinates of F			Components of F		Moment of F about O
	x	y	θ	F_x	F_y	
$F_1 = 10$	5	-1	270°	0	-10.00	-50.00
$F_2 = 20$	4	1.5	50°	12.86	15.32	41.99
$F_3 = 30$	2	2	60°	15.00	25.98	21.96
				$\Sigma F_x = 27.86$	$\Sigma F_y = 31.30$	$\Sigma M_O = 13.95$

$$R = \sqrt{(27.86)^2 + (31.30)^2}$$

$$= 41.90 \text{ lbs.}$$

$$\tan \theta_R = \frac{31.30}{27.86} = 1.1235$$

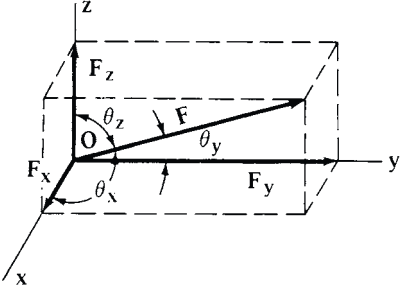
$$\theta_R = 48^\circ 20'$$

$$d = \frac{13.95}{41.90} = 0.33 \text{ inches}$$

measured as shown on the diagram.

Algebraic Solution of Force Systems — Forces Not in Same Plane

Resolving a Single Force Into Its Three Rectangular Components:

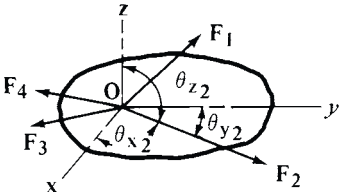


$F_x = F \cos \theta_x$
 $F_y = F \cos \theta_y$
 $F_z = F \cos \theta_z$
 $F = \sqrt{F_x^2 + F_y^2 + F_z^2}$

The diagram shows how a force F may be resolved at any point O on its line of action into three concurrent components each of which is perpendicular to the other two.

The x, y, z components F_x, F_y, F_z of force F are determined from the accompanying relations in which $\theta_x, \theta_y, \theta_z$ are the angles that the force F makes with the x, y, z axes.

Finding the Resultant of Any Number of Concurrent Forces:



To find the resultant of any number of noncoplanar concurrent forces F_1, F_2, F_3 , etc., use the procedure outlined below.

1) Draw a set of x, y, z axes at O , the point of concurrency of the forces. The angles each force makes measured counterclockwise from the positive x, y , and z coordinate axes must be known in addition to the magnitudes of the forces. For force F_2 , for example, the angles are $\theta_{x2}, \theta_{y2}, \theta_{z2}$ as indicated on the diagram.

2) Apply the first three formulas given under the heading “Resolving a Single Force Into Its Three Rectangular Components” to each force to find its x, y , and z components. Tabulate these calculations as shown below for a system of three forces. Algebraically add the calculated components to find $\Sigma F_x, \Sigma F_y$, and ΣF_z which are the components of the resultant.

Force F	Angles			Components of Forces		
	θ_x	θ_y	θ_z	F_x	F_y	F_z
F_1	θ_{x1}	θ_{y1}	θ_{z1}	$F_1 \cos \theta_{x1}$	$F_1 \cos \theta_{y1}$	$F_1 \cos \theta_{z1}$
F_2	θ_{x2}	θ_{y2}	θ_{z2}	$F_2 \cos \theta_{x2}$	$F_2 \cos \theta_{y2}$	$F_2 \cos \theta_{z2}$
F_3	θ_{x3}	θ_{y3}	θ_{z3}	$F_3 \cos \theta_{x3}$	$F_3 \cos \theta_{y3}$	$F_3 \cos \theta_{z3}$
				ΣF_x	ΣF_y	ΣF_z

3. Find the resultant of the system from the formula $R = \sqrt{(\Sigma F_x)^2 + (\Sigma F_y)^2 + (\Sigma F_z)^2}$

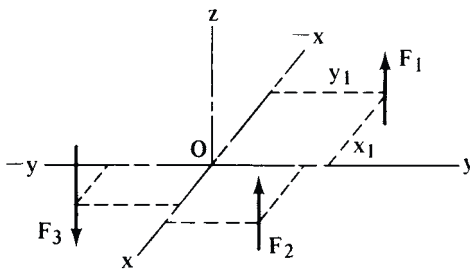
4. Calculate the angles θ_{xR}, θ_{yR} , and θ_{zR} that the resultant R makes with the respective coordinate axes:

$$\cos \theta_{xR} = \frac{\Sigma F_x}{R}$$

$$\cos \theta_{yR} = \frac{\Sigma F_y}{R}$$

$$\cos \theta_{zR} = \frac{\Sigma F_z}{R}$$

Finding the Resultant of Parallel Forces Not in the Same Plane:



In the diagram, forces $F_1, F_2,$ etc. represent a system of noncoplanar parallel forces. To find the resultant of such systems, use the procedure shown below.

1) Draw a set of $x, y,$ and z coordinate axes through any point O in such a way that one of these axes, say the z axis, is parallel to the lines of action of the forces. The x and y axes then will be perpendicular to the forces.

2) Set the distances of each force from the x and y axes in a table as shown below. For example, x_1 and y_1 are the x and y distances for F_1 shown in the diagram.

3) Calculate the moment of each force about the x and y axes and set the results in the table as shown for a system consisting of three forces. The algebraic sums of the moments $\sum M_x$ and $\sum M_y$ are then obtained. (In taking moments about the x and y axes, assign counterclockwise moments a plus (+) sign and clockwise moments a minus (-) sign. In deciding whether a moment is counterclockwise or clockwise, look from the positive side of the axis in question toward the negative side.)

Force	Coordinates of Force F		Moments M_x and M_y due to F	
	x	y	M_x	M_y
F_1	x_1	y_1	$F_1 y_1$	$F_1 x_1$
F_2	x_2	y_2	$F_2 y_2$	$F_2 x_2$
F_3	x_3	y_3	$F_3 y_3$	$F_3 x_3$
ΣF			ΣM_x	ΣM_y

4. Find the algebraic sum ΣF of all the forces; this will be the resultant R of the system.

$$R = \Sigma F = F_1 + F_2 + \dots$$

5. Calculate x_R and y_R , the moment arms of the resultant:

$$x_R = \Sigma M_y \div R$$

$$y_R = \Sigma M_x \div R$$

These moment arms are measured in such direction along the x and y axes as will give the resultant a moment of the same direction of rotation as ΣM_x and ΣM_y .

Note Concerning Interpretation of Results: If ΣM_x and ΣM_y are both 0, then the resultant is a single force R along the z axis; if R is also 0, then the system is in equilibrium. If R is 0 but ΣM_x and ΣM_y are not both 0, then the resultant is a couple

$$M_R = \sqrt{(\Sigma M_x)^2 + (\Sigma M_y)^2}$$

that lies in a plane parallel to the z axis and making an angle θ_R measured in a counterclockwise direction from the positive x axis and calculated from the following formula:

$$\sin \theta_R = \frac{\Sigma M_x}{M_R}$$

Finding the Resultant of Nonparallel Forces Not Meeting at a Common Point:

The diagram shows a system of noncoplanar, nonparallel, nonconcurrent forces F_1, F_2 , etc. for which the resultant is to be determined. Generally speaking, the resultant will be a noncoplanar force and a couple which may be further combined, if desired, into two forces that are skewed.

This is the most general force system that can be devised, so each of the other systems so far described represents a special, simpler case of this general force system. The method of solution described below for a system of three forces applies for any number of forces.

- 1) Select a set of coordinate x, y , and z axes at any desired point O in the body as shown in the diagram.
- 2) Determine the x, y , and z coordinates of any convenient point on the line of action of each force as shown for F_2 . Also determine the angles, $\theta_x, \theta_y, \theta_z$ that each force makes with each coordinate axis. These angles are measured counterclockwise from the positive direction of the x, y , and z axes. The data is tabulated, as shown in the table accompanying Step 3, for convenient use in subsequent calculations.
- 3) Calculate the x, y , and z components of each force using the formulas given in the accompanying table. Add these components algebraically to get $\Sigma F_x, \Sigma F_y$, and ΣF_z which are the components of the resultant, R , given by the formula,

$$R = \sqrt{(\Sigma F_x)^2 + (\Sigma F_y)^2 + (\Sigma F_z)^2}$$

Force	Coordinates of Force F						Components of F		
	x	y	z	θ_x	θ_y	θ_z	F_x	F_y	F_z
F_1	x_1	y_1	z_1	θ_{x1}	θ_{y1}	θ_{z1}	$F_1 \cos \theta_{x1}$	$F_1 \cos \theta_{y1}$	$F_1 \cos \theta_{z1}$
F_2	x_2	y_2	z_2	θ_{x2}	θ_{y2}	θ_{z2}	$F_2 \cos \theta_{x2}$	$F_2 \cos \theta_{y2}$	$F_2 \cos \theta_{z2}$
F_3	x_3	y_3	z_3	θ_{x3}	θ_{y3}	θ_{z3}	$F_3 \cos \theta_{x3}$	$F_3 \cos \theta_{y3}$	$F_3 \cos \theta_{z3}$
							ΣF_x	ΣF_y	ΣF_z

The resultant force R makes angles of θ_{xR}, θ_{yR} , and θ_{zR} with the x, y , and z axes, respectively, and passes through the selected point O . These angles are determined from the formulas,

$$\begin{aligned} \cos \theta_{xR} &= \Sigma F_x \div R \\ \cos \theta_{yR} &= \Sigma F_y \div R \\ \cos \theta_{zR} &= \Sigma F_z \div R \end{aligned}$$

4. Calculate the moments M_x, M_y, M_z about $x, y,$ and z axes, respectively, due to the $F_x, F_y,$ and F_z components of each force and set them in tabular form. The formulas to use are given in the accompanying table.

In interpreting moments about the $x, y,$ and z axes, consider counterclockwise moments a plus (+) sign and clockwise moments a minus (-) sign. In deciding whether a moment is counterclockwise or clockwise, look from the positive side of the axis in question toward the negative side.

Force	Moments of Components of $F (F_x, F_y, F_z)$ about x, y, z axes		
F	$M_x = yF_z - zF_y$	$M_y = zF_x - xF_z$	$M_z = xF_y - yF_x$
F_1	$M_{x1} = y_1F_{z1} - z_1F_{y1}$	$M_{y1} = z_1F_{x1} - x_1F_{z1}$	$M_{z1} = x_1F_{y1} - y_1F_{x1}$
F_2	$M_{x2} = y_2F_{z2} - z_2F_{y2}$	$M_{y2} = z_2F_{x2} - x_2F_{z2}$	$M_{z2} = x_2F_{y2} - y_2F_{x2}$
F_3	$M_{x3} = y_3F_{z3} - z_3F_{y3}$	$M_{y3} = z_3F_{x3} - x_3F_{z3}$	$M_{z3} = x_3F_{y3} - y_3F_{x3}$
	ΣM_x	ΣM_y	ΣM_z

5. Add the component moments algebraically to get $\Sigma M_x, \Sigma M_y$ and ΣM_z which are the components of the resultant couple, M , given by the formula,

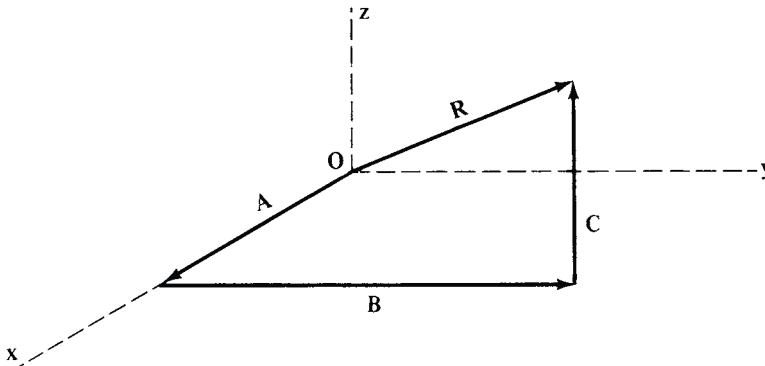
$$M = \sqrt{(\Sigma M_x)^2 + (\Sigma M_y)^2 + (\Sigma M_z)^2}$$

The resultant couple M will tend to produce rotation about an axis making angles of $\beta_x, \beta_y,$ and β_z with the x, y, z axes, respectively. These angles are determined from the formulas,

$$\cos \beta_x = \frac{\Sigma M_x}{M} \quad \cos \beta_y = \frac{\Sigma M_y}{M} \quad \cos \beta_z = \frac{\Sigma M_z}{M}$$

General Method of Locating Resultant When Its Components are Known: To determine the position of the resultant force of a system of forces, proceed as follows:

From the origin, point O , of a set of coordinate axes x, y, z , lay off on the x axis a length A representing the algebraic sum ΣF_x of the x components of all the forces. From the end of line A lay off a line B representing ΣF_y , the algebraic sum of the y components; this line B is drawn in a direction parallel to the y axis. From the end of line B lay off a line C representing ΣF_z . Finally, draw a line R from O to the end of C ; R will be the resultant of the system.



Friction

Properties of Friction.—Friction is the resistance to motion that takes place when one body is moved upon another, and is generally defined as “that force which acts between two bodies at their surface of contact, so as to resist their sliding on each other.” According to the conditions under which sliding occurs, the force of friction, F , bears a certain relation to the force between the two bodies called the normal force N . The relation between force of friction and normal force is given by the *coefficient of friction*, generally denoted by the Greek letter μ . Thus:

$$F = \mu \times N \quad \text{and} \quad \mu = \frac{F}{N}$$

Example: A body weighing 28 pounds rests on a horizontal surface. The force required to keep it in motion along the surface is 7 pounds. Find the coefficient of friction.

$$\mu = \frac{F}{N} = \frac{7}{28} = 0.25$$

If a body is placed on an inclined plane, the friction between the body and the plane will prevent it from sliding down the inclined surface, provided the angle of the plane with the horizontal is not too great. There will be a certain angle, however, at which the body will just barely be able to remain stationary, the frictional resistance being very nearly overcome by the tendency of the body to slide down. This angle is termed the angle of repose, and the tangent of this angle equals the coefficient of friction. The angle of repose is frequently denoted by the Greek letter θ . Thus, $\mu = \tan \theta$.

A greater force is required to start a body moving from a state of rest than to merely keep it in motion, because the *friction of rest* is greater than the *friction of motion*.

Laws of Friction.—*Unlubricated or Dry Surfaces:*

1) For low pressures (normal force per unit area) the friction is directly proportional to the normal force between the two surfaces. As the pressure increases, the friction does not rise proportionally; but when the pressure becomes abnormally high, the friction increases at a rapid rate until seizing takes place.

2) The friction both in its total amount and its coefficient is independent of the areas in contact, so long as the normal force remains the same. This is true for moderate pressures only. For high pressures, this law is modified in the same way as in the first case.

3) At very low velocities the friction is independent of the velocity of rubbing. As the velocities increase, the friction decreases.

Lubricated Surfaces: For well lubricated surfaces, the laws of friction are considerably different from those governing dry or poorly lubricated surfaces.

1) The frictional resistance is almost independent of the pressure (normal force per unit area) if the surfaces are flooded with oil.

2) The friction varies directly as the speed, at low pressures; but for high pressures the friction is very great at low velocities, approaching a minimum at about two feet per second (0.61 meter per second), linear velocity, and afterwards increasing approximately as the square root of the speed.

3) For well lubricated surfaces the frictional resistance depends, to a very great extent, on the temperature, partly because of the change in the viscosity of the oil and partly because, for a journal bearing, the diameter of the bearing increases with the rise of temperature more rapidly than the diameter of the shaft, thus relieving the bearing of side pressure.

4) If the bearing surfaces are flooded with oil, the friction is almost independent of the nature of the material of the surfaces in contact. As the lubrication becomes less ample, the coefficient of friction becomes more dependent upon the material of the surfaces.

Influence of Friction on the Efficiency of Small Machine Elements.—Friction between machine parts lowers the efficiency of a machine. Average values of the efficiency, in per cent, of the most common machine elements when carefully made are ordi-

nary bearings, 95 to 98; roller bearings, 98; ball bearings, 99; spur gears with cut teeth, including bearings, 99; bevel gears with cut teeth, including bearings, 98; belting, from 96 to 98; high-class silent power transmission chain, 97 to 99; roller chains, 95 to 97.

Coefficients of Friction.—Tables 1 and 2 provide representative values of static friction for various combinations of materials with dry (clean, unlubricated) and lubricated surfaces. The values for static or breakaway friction shown in these tables will generally be higher than the subsequent or sliding friction. Typically, the steel-on-steel static coefficient of 0.8 unlubricated will drop to 0.4 when sliding has been initiated; with oil lubrication, the value will drop from 0.16 to 0.03.

Many factors affect friction, and even slight deviations from normal or test conditions can produce wide variations. Accordingly, when using friction coefficients in design calculations, due allowance or factors of safety should be considered, and in critical applications, specific tests conducted to provide specific coefficients for material, geometry, and/or lubricant combinations.

Table 1. Coefficients of Static Friction for Steel on Various Materials

Material	Coefficient of Friction, μ		Material	Coefficient of Friction, μ	
	Clean	Lubricated		Clean	Lubricated
Steel	0.8	0.16	Hard carbon	0.14	0.11-0.14
Copper-lead alloy	0.22		Graphite	0.1	0.1
Phosphor-bronze	0.35		Tungsten carbide	0.4-0.6	0.1-0.2
Aluminum-bronze	0.45		Plexiglas	0.4-0.5	0.4-0.5
Brass	0.35	0.19	Polystyrene	0.3-0.35	0.3-0.35
Cast iron	0.4	0.21	Polythene	0.2	0.2
Bronze		0.16	Teflon	0.04	0.04
Sintered bronze		0.13			

Tables 1 and 2 used with permission from *The Friction and Lubrication of Solids*, Vol. 1, by Bowden and Tabor, Clarendon Press, Oxford, 1950.

Table 2. Coefficients of Static Friction for Various Materials Combinations

Material Combination	Coefficient of Friction, μ		Material Combination	Coefficient of Friction, μ	
	Clean	Lubricated		Clean	Lubricated
Aluminum-aluminum	1.35	0.30	Tungsten carbide-tungsten carbide	0.2-0.25	0.12
Cadmium-cadmium	0.5	0.05	Plexiglas-Plexiglas	0.8	0.8
Chromium-chromium	0.41	0.34	Polystyrene-polystyrene	0.5	0.5
Copper-copper	1.0	0.08	Teflon-Teflon	0.04	0.04
Iron-iron	1.0	0.15-0.20	Nylon-nylon	0.15-0.25	
Magnesium-magnesium	0.6	0.08	Solids on rubber	1-4	
Nickel-nickel	0.7	0.28	Wood on wood (clean)	0.25-0.5	
Platinum-platinum	1.2	0.25	Wood on wood (wet)	0.2	
Silver-silver	1.4	0.55	Wood on metals (clean)	0.2-0.6	
Zinc-zinc	0.6	0.04	Wood on metals (wet)	0.2	
Glass-glass	0.9-1.0	0.1-0.6	Brick on wood	0.6	
Glass-metal	0.5-0.7	0.2-0.3	Leather on wood	0.3-0.4	
Diamond-diamond	0.1	0.05-0.1	Leather on metal (clean)	0.6	
Diamond-metal	0.1-0.15	0.1	Leather on metal (wet)	0.4	
Sapphire-sapphire	0.2	0.2	Leather on metal (greasy)	0.2	
Hard carbon on carbon	0.16	0.12-0.14	Brake material on cast iron	0.4	
Graphite-graphite (in vacuum)	0.5-0.8		Brake material on cast iron (wet)	0.2	
Graphite-graphite	0.1	0.1			

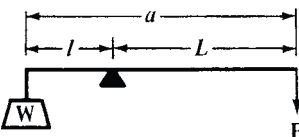
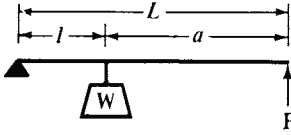
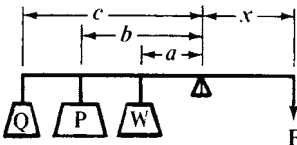
Rolling Friction.—When a body rolls on a surface, the force resisting the motion is termed *rolling friction* or *rolling resistance*. Let W = total weight of rolling body or load on wheel, in pounds (newtons); r = radius of wheel, in inches (centimeters); f = coefficient of rolling resistance, in inches (centimeters). Then, resistance to rolling, in pounds (newtons) equals $(W \times f) \div r$.

Coefficient of rolling resistance varies with conditions. For wood on wood 0.06 inch (0.152 cm) may be used; for iron on iron, 0.02 inch (0.051 cm); iron on granite, 0.085 inch (0.216 cm); iron on asphalt, 0.15 inch (0.381 cm); and iron on wood, 0.22 inch (0.559 cm).

The coefficient of rolling resistance, f , is in inches (or centimeters) and is not the same as the sliding or static coefficient of friction given in **Tables 1** and **2**, which is a dimensionless ratio between frictional resistance and normal load. Various investigators are not in close agreement on the true values for these coefficients and the foregoing values should only be used for the approximate calculation of rolling resistance.

Mechanisms

Levers

Types of Levers	Examples
 <p> $F:W = l:L$ </p> $F = \frac{W \times l}{L}$ $L = \frac{W \times a}{W + F} = \frac{W \times l}{F}$ <p> $F \times L = W \times l$ </p> $W = \frac{F \times L}{l}$ $l = \frac{F \times a}{W + F} = \frac{F \times L}{W}$	<p>A pull of 80 pounds is exerted at the end of the lever, at W; $l = 12$ inches and $L = 32$ inches. Find the value of force F required to balance the lever.</p> $F = \frac{80 \times 12}{32} = \frac{960}{32} = 30 \text{ pounds}$ <p>If $F = 20$; $W = 180$; and $l = 3$; how long must L be made to secure equilibrium?</p> $L = \frac{180 \times 3}{20} = 27$
 <p> $F:W = l:L$ </p> $F = \frac{W \times l}{L}$ $L = \frac{W \times a}{W - F} = \frac{W \times l}{F}$ <p> $F \times L = W \times l$ </p> $W = \frac{F \times L}{l}$ $l = \frac{F \times a}{W - F} = \frac{F \times L}{W}$	<p>Total length L of a lever is 25 centimeters. A weight of 400 newtons supported at W; l is 10 centimeters. Find the value of F.</p> $F = \frac{400 \times 10}{25} = 160 \text{ newtons}$ <p>If $F = 400$ newtons, $W = 9000$ pounds, and $a = 1.5$ m, what should L equal to secure equilibrium?</p> $L = \frac{9000 \times 1.5}{9000 - 400(100)} = 5.24 \text{ feet}$
 <p>When three or more forces act on lever:</p> $F \times x = W \times a + P \times b + Q \times c$ $x = \frac{W \times a + P \times b + Q \times c}{F}$ $F = \frac{W \times a + P \times b + Q \times c}{x}$	<p>Let $W = 20$, $P = 30$, and $Q = 15$ pounds; $a = 4$, $b = 7$, and $c = 10$ inches. If $x = 6$ inches, find F.</p> $F = \frac{20 \times 4 + 30 \times 7 + 15 \times 10}{6} = 73\frac{1}{3} \text{ lbs}$ <p>Assuming $F = 20$ pounds in the example above, how long must lever arm x be made?</p> $x = \frac{20 \times 4 + 30 \times 7 + 15 \times 10}{20} = 22 \text{ inches}$

The above formulas are valid using metric SI units, with forces expressed in newtons, and lengths in meters. However, it should be noted that the weight of a mass W kilograms is equal to

a force of Wg newtons, where g is approximately 9.81 m/s^2 . Thus, supposing that in the first example $l = 0.4 \text{ m}$, $L = 1.2 \text{ m}$, and $W = 30 \text{ kg}$, then the weight of W is $30g$ newtons, so that the force F required to balance the lever is $F = \frac{30g \times 0.4}{1.2} = 10g = 98.1$ newtons.

This force could be produced by suspending a mass of 10 kg at F .

Table of Forces on Inclined Planes

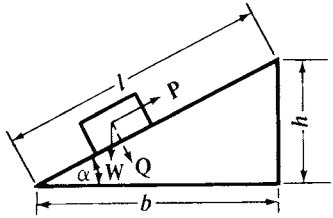
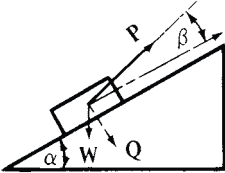
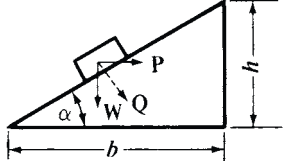
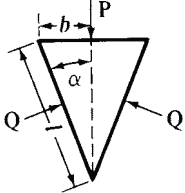
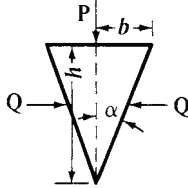
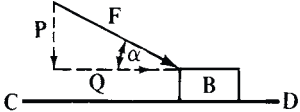
The table below makes it possible to find the force required for moving a body on an inclined plane. The friction on the plane is not taken into account. The column headed "Tension P in Cable per Ton of 2000 Pounds" gives the pull in pounds required for moving one ton along the inclined surface. The fourth column gives the perpendicular or normal pressure. If the coefficient of friction is known, the added pull required to overcome friction is thus easily determined:

$$Q \times \text{coefficient of friction} = \text{additional pull required.}$$

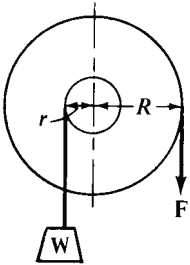
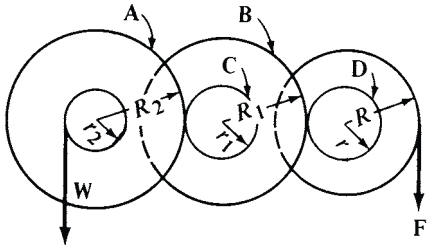
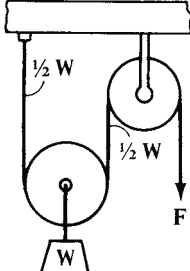
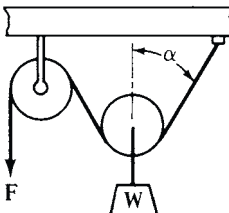
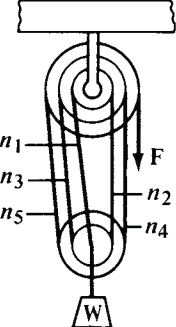
Per Cent of Grade. Rise, Ft. per 100 Ft.	Angle α	Tension P in Cable per Ton of 2000 Lbs.	Perpendicular Pressure Q on Plane per Ton of 2000 Lbs.	Per Cent of Grade. Rise, Ft. per 100 Ft.	Angle α	Tension P in Cable per Ton of 2000 Lbs.	Perpendicular Pressure Q on Plane per Ton of 2000 Lbs.
1	0.57	20.00	1999.90	51	27.02	908.65	1781.67
2	1.15	39.99	1999.60	52	27.47	922.71	1774.43
3	1.72	59.97	1999.10	53	27.92	936.59	1767.15
4	2.29	79.94	1998.40	54	28.37	950.30	1759.81
5	2.86	99.88	1997.50	55	28.81	963.84	1752.43
6	3.43	119.78	1996.41	56	29.25	977.21	1745.01
7	4.00	139.66	1995.12	57	29.68	990.41	1737.55
8	4.57	159.49	1993.63	58	30.11	1003.44	1730.06
9	5.14	179.28	1991.95	59	30.54	1016.30	1722.54
10	5.71	199.01	1990.07	60	30.96	1028.99	1714.99
11	6.28	218.68	1988.01	61	31.38	1041.52	1707.41
12	6.84	238.29	1985.75	62	31.80	1053.88	1699.81
13	7.41	257.83	1983.31	63	32.21	1066.08	1692.18
14	7.97	277.30	1980.68	64	32.62	1078.11	1684.54
15	8.53	296.68	1977.87	65	33.02	1089.98	1676.89
16	9.09	315.98	1974.88	66	33.42	1101.68	1669.22
17	9.65	335.19	1971.71	67	33.82	1113.23	1661.54
18	10.20	354.31	1968.37	68	34.22	1124.62	1653.85
19	10.76	373.32	1964.85	69	34.61	1135.85	1646.16
20	11.31	392.23	1961.16	70	34.99	1146.92	1638.46
21	11.86	411.03	1957.31	71	35.37	1157.84	1630.77
22	12.41	429.72	1953.29	72	35.75	1168.61	1623.07
23	12.95	448.30	1949.11	73	36.13	1179.22	1615.37
24	13.50	466.75	1944.77	74	36.50	1189.69	1607.68
25	14.04	485.07	1940.29	75	36.87	1200.00	1600.00
26	14.57	503.27	1935.65	76	37.23	1210.17	1592.32
27	15.11	521.33	1930.86	77	37.60	1220.19	1584.66
28	15.64	539.26	1925.93	78	37.95	1230.06	1577.00
29	16.17	557.05	1920.86	79	38.31	1239.80	1569.36
30	16.70	574.70	1915.65	80	38.66	1249.39	1561.74
31	17.22	592.20	1910.31	81	39.01	1258.84	1554.13
32	17.74	609.55	1904.85	82	39.35	1268.16	1546.54
33	18.26	626.76	1899.26	83	39.69	1277.34	1538.96
34	18.78	643.81	1893.55	84	40.03	1286.38	1531.41
35	19.29	660.70	1887.72	85	40.36	1295.30	1523.88
36	19.80	677.44	1881.77	86	40.70	1304.08	1516.37
37	20.30	694.02	1875.72	87	41.02	1312.73	1508.89
38	20.81	710.44	1869.57	88	41.35	1321.26	1501.43
39	21.31	726.69	1863.31	89	41.67	1329.65	1493.99
40	21.80	742.78	1856.95	90	41.99	1337.93	1486.59
41	22.29	758.71	1850.50	91	42.30	1346.08	1479.21
42	22.78	774.47	1843.96	92	42.61	1354.11	1471.86
43	23.27	790.06	1837.34	93	42.92	1362.03	1464.54
44	23.75	805.48	1830.63	94	43.23	1369.82	1457.26
45	24.23	820.73	1823.84	95	43.53	1377.50	1450.00
46	24.70	835.81	1816.98	96	43.83	1385.06	1442.77
47	25.17	850.72	1810.05	97	44.13	1392.52	1435.58
48	25.64	865.46	1803.05	98	44.42	1399.86	1428.43
49	26.10	880.03	1795.98	99	44.71	1407.09	1421.30
50	26.57	894.43	1788.85	100	45.00	1414.21	1414.21

Tensions and pressures in pounds.

Inclined Plane—Wedge

<p>W = weight of body</p>  <p>Neglecting friction:</p> $P = W \times \frac{h}{l} = W \times \sin \alpha$ $W = P \times \frac{l}{h} = \frac{P}{\sin \alpha} = P \times \operatorname{cosec} \alpha$ $Q = W \times \frac{b}{l} = W \times \cos \alpha$	<p>If friction is taken into account, then</p> <p>Force P to pull body up is:</p> $P = W(\mu \cos \alpha + \sin \alpha)$ <p>Force P_1 to pull body down is:</p> $P_1 = W(\mu \cos \alpha - \sin \alpha)$ <p>Force P_2 to hold body stationary:</p> $P_2 = W(\sin \alpha - \mu \cos \alpha)$ <p>in which μ is the coefficient of friction.</p>
<p>W = weight of body</p>  <p>Neglecting friction:</p> $P = W \times \frac{\sin \alpha}{\cos \beta}$ $W = P \times \frac{\cos \beta}{\sin \alpha}$ $Q = W \times \frac{\cos(\alpha + \beta)}{\cos \beta}$ <p>With friction: Coefficient of friction = $\mu = \tan \phi$</p> $P = W \times \frac{\sin(\alpha + \phi)}{\cos(\beta - \phi)}$	<p>W = weight of body</p>  <p>Neglecting friction:</p> $P = W \times \frac{h}{b} = W \times \tan \alpha$ $W = P \times \frac{b}{h} = P \times \cot \alpha$ $Q = \frac{W}{\cos \alpha} = W \times \sec \alpha$ <p>With friction: Coefficient of friction = $\mu = \tan \phi$</p> $P = W \tan(\alpha + \phi)$
 <p>Neglecting friction:</p> $P = 2Q \times \frac{b}{l} = 2Q \times \sin \alpha$ $Q = P \times \frac{l}{2b} = \frac{1}{2} P \times \operatorname{cosec} \alpha$ <p>With friction: Coefficient of friction = μ.</p> $P = 2Q(\mu \cos \alpha + \sin \alpha)$	 <p>Neglecting friction:</p> $P = 2Q \times \frac{b}{h} = 2Q \times \tan \alpha$ $Q = P \times \frac{h}{2b} = \frac{1}{2} P \times \cot \alpha$ <p>With friction: Coefficient of friction = $\mu = \tan \phi$.</p> $P = 2Q \tan(\alpha + \phi)$
	<p>Force Moving Body on Horizontal Plane.—F tends to move B along line CD; Q is the component which actually moves B; P is the pressure, due to F, of the body on CD.</p> $Q = F \times \cos \alpha \quad P = \sqrt{F^2 - Q^2}$

Wheels and Pulleys

 <p style="text-align: center;">$F:W = r:R$</p> <p style="text-align: center;">$F \times R = W \times r$</p> <p style="text-align: center;">$F = \frac{W \times r}{R}$</p> <p style="text-align: center;">$W = \frac{F \times R}{r}$</p> <p style="text-align: center;">$R = \frac{W \times r}{F}$</p> <p style="text-align: center;">$r = \frac{F \times R}{W}$</p>	<p>The radius of a drum on which is wound the lifting rope of a windlass is 2 inches. What force will be exerted at the periphery of a gear of 24 inches diameter, mounted on the same shaft as the drum and transmitting power to it, if one ton (2000 pounds) is to be lifted? Here $W = 2000$; $R = 12$; $r = 2$.</p> $F = \frac{2000 \times 2}{12} = 333 \text{ pounds}$
 <p>A, B, C and D are the pitch circles of gears.</p> $F = \frac{W \times r \times r_1 \times r_2}{R \times R_1 \times R_2}$ $W = \frac{F \times R \times R_1 \times R_2}{r \times r_1 \times r_2}$	<p>Let the pitch diameters of gears A, B, C and D be 30, 28, 12 and 10 inches, respectively. Then $R_2 = 15$; $R_1 = 14$; $r_1 = 6$; and $r = 5$. Let $R = 12$, and $r_2 = 4$. Then the force F required to lift a weight W of 2000 pounds, friction being neglected, is:</p> $F = \frac{2000 \times 5 \times 6 \times 4}{12 \times 14 \times 15} = 95 \text{ pounds}$
 <p style="text-align: center;">$F = \frac{1}{2}W$</p> <p>The velocity with which weight W will be raised equals one-half the velocity of the force applied at F.</p>	 <p style="text-align: center;">$F:W = \sec \alpha:2$</p> <p style="text-align: center;">$F = \frac{W \times \sec \alpha}{2}$</p> <p style="text-align: center;">$W = 2F \times \cos \alpha$</p>
 <p style="text-align: center;">$n = \text{number of strands or parts of rope } (n_1, n_2, \text{ etc.}).$</p> <p style="text-align: center;">$F = \frac{1}{n} \times W$</p> <p>The velocity with which W will be raised equals $\frac{1}{n}$ of the velocity of the force applied at F.</p>	<p>In the illustration is shown a combination of a double and triple block. The pulleys each turn freely on a pin as axis, and are drawn with different diameters, to show the parts of the rope more clearly. There are 5 parts of rope. Therefore, if 200 pounds is to be lifted, the force F required at the end of the rope is:</p> $F = \frac{1}{5} \times 200 = 40 \text{ pounds}$

Note: The above formulas are valid using metric SI units, with forces expressed in newtons, and lengths in meters or millimeters. (See note on page 167 concerning weight and mass.)

Differential Pulley

	<p>In the differential pulley a chain must be used, engaging sprockets, so as to prevent the chain from slipping over the pulley faces.</p> $P \times R = \frac{1}{2}W(R - r)$ $P = \frac{W(R - r)}{2R}$ $W = \frac{2PR}{R - r}$
<p style="text-align: center;">Chinese Windlass</p>	<p>The Chinese windlass is of the differential motion principle, in that the resultant motion is the difference between two original motions. The hoisting rope is arranged to unwind from one part of a drum or pulley onto another part differing somewhat in diameter. The distance that the load or hook moves for one revolution of the compound hoisting drum is equal to half the difference between the circumferences of the two drum sections.</p>

Screw

	<p>F = force at end of handle or wrench; R = lever-arm of F; r = pitch radius of screw; p = lead of thread; Q = load. Then, neglecting friction:</p> $F = Q \times \frac{p}{6.2832R} \quad Q = F \times \frac{6.2832R}{p}$ <p>If μ is the coefficient of friction, then: For motion in direction of load Q which <i>assists</i> it:</p> $F = Q \times \frac{6.2832\mu r - p}{6.2832r + \mu p} \times \frac{r}{R}$ <p>For motion opposite load Q which <i>resists</i> it:</p> $F = Q \times \frac{p + 6.2832\mu r}{6.2832r - \mu p} \times \frac{r}{R}$
--	--

Geneva Wheel

	<p>Geneva wheels are frequently used on machine tools for indexing or rotating some part of the machine through a fractional part of a revolution.</p> <p>The driven wheel shown in the illustration has four radial slots located 90 degrees apart, and the driver carries a roller k which engages one of these slots each time it makes a revolution, thus turning the driven wheel one-quarter revolution. The concentric surface b engages the concave surface c between each pair of slots before the driving roller is disengaged from the driven wheel, which prevents the latter from rotating while the roller is moving around to engage the next successive slot. The circular boss b on the driver is cut away at d to provide a clearance space for the projecting arms of the driven wheel. In designing gearing of the general type illustrated, it is advisable to so proportion the driving and driven members that the angle a will be approximately 90 degrees.</p> <p>The radial slots in the driven part will then be tangent to the circular path of the driving roller at the time the roller enters and leaves the slot. When the gearing is designed in this way, the driven wheel is started gradually from a state of rest and the motion is also gradually checked.</p>
--	--

Toggle Joint

A link mechanism commonly known as a toggle joint is applied to machines of different types, such as drawing and embossing presses, stone crushers, etc., for securing great pressure. The principle of the toggle joint is shown by Fig. 10. There are two links, *b* and *c*, which are connected at the center. Link *b* is free to swivel about a fixed pin or bearing at *d*, and link *c* is connected to a sliding member *e*. Rod *f* joins links *b* and *c* at the central connection. When force is applied to rod *f* in a direction at right angles to center-line *xx*, along which the driven member *e* moves, this force is greatly multiplied at *e*, because a movement at the joint *g* produces a relatively slight movement at *e*. As the angle α becomes less, motion at *e* decreases and the force increases until the links are in line. If *R* = the resistance at *e*, *P* = the applied power or force, and α = the angle between each link, and a line *x-x* passing through the axes of the pins, then:

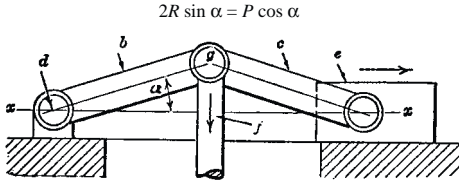


Fig. 10. Toggle Joint Principle

If arms *ED* and *EH* are of unequal length then

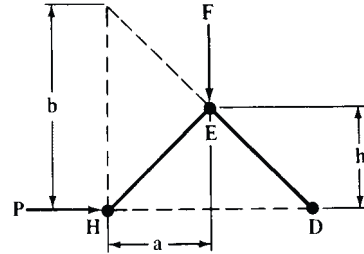
$$P = (F \times a) \div b$$

The relation between *P* and *F* changes constantly as *F* moves downward.

If arms *ED* and *EH* are equal, then

$$P = (F \times a) + 2h$$

A double toggle-joint does not increase the pressure exerted so long as the relative distances moved by *F* and *P* remain the same.



Toggle-joints with Equal Arms

				$2P \sin \alpha = F \cos \alpha$ $\frac{P}{F} = \frac{\cos \alpha}{2 \sin \alpha} = \text{coefficient}$ $P = F \times \text{coefficient}$ <p>where F = force applied; P = resistance; α = given angle.</p> <p>Equivalent expressions (see diagram):</p> $P = \frac{FS}{4h} \quad P = \frac{Fs}{H}$ <p>To use the table, measure angle α, and find the coefficient in the table corresponding to the angle found. The coefficient is the ratio of the resistance to the force applied, and multiplying the force applied by the coefficient gives the resistance, neglecting friction.</p>			
Angle °	Coefficient	Angle °	Coefficient	Angle °	Coefficient	Angle °	Coefficient
0.01	2864.79	1.00	28.64	5.25	5.44	23	1.18
0.02	1432.39	1.10	26.04	5.50	5.19	24	1.12
0.03	954.93	1.20	23.87	5.75	4.97	25	1.07
0.04	716.20	1.30	22.03	6.00	4.76	26	1.03
0.05	572.96	1.40	20.46	6.50	4.39	27	0.98
0.10	286.48	1.50	19.09	7.00	4.07	28	0.94
0.15	190.99	1.60	17.90	7.50	3.80	29	0.90
0.20	143.24	1.70	16.85	8.00	3.56	30	0.87
0.25	114.59	1.80	15.91	8.50	3.35	31	0.83
0.30	95.49	1.90	15.07	9.00	3.16	32	0.80
0.35	81.85	2.00	14.32	10.00	2.84	33	0.77
0.40	71.62	2.25	12.73	11.00	2.57	34	0.74
0.45	63.66	2.50	11.45	12.00	2.35	35	0.71
0.50	57.29	2.75	10.41	13.00	2.17	36	0.69
0.55	52.09	3.00	9.54	14.00	2.01	37	0.66
0.60	47.74	3.25	8.81	15.00	1.87	38	0.64
0.65	44.07	3.50	8.17	16.00	1.74	39	0.62
0.70	40.92	3.75	7.63	17.00	1.64	40	0.60
0.75	38.20	4.00	7.15	18.00	1.54	41	0.58
0.80	35.81	4.25	6.73	19.00	1.45	42	0.56
0.85	33.70	4.50	6.35	20.00	1.37	43	0.54
0.90	31.83	4.75	6.02	21.00	1.30	44	0.52
0.95	30.15	5.00	5.72	22.00	1.24	45	0.50

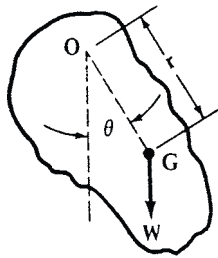
Pendulums

A *compound* or *physical* pendulum consists of any rigid body suspended from a fixed horizontal axis about which the body may oscillate in a vertical plane due to the action of gravity.

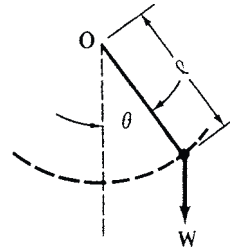
A *simple* or *mathematical* pendulum is similar to a compound pendulum except that the mass of the body is concentrated at a single point which is suspended from a fixed horizontal axis by a weightless cord. Actually, a simple pendulum cannot be constructed since it is impossible to have either a weightless cord or a body whose mass is entirely concentrated at one point. A good approximation, however, consists of a small, heavy bob suspended by a light, fine wire. If these conditions are not met by the pendulum, it should be considered as a compound pendulum.

A *conical* pendulum is similar to a simple pendulum except that the weight suspended by the cord moves at a uniform speed around the circumference of a circle in a horizontal plane instead of oscillating back and forth in a vertical plane. The principle of the conical pendulum is employed in the Watt fly-ball governor.

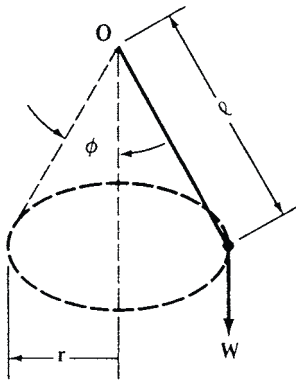
Four Types of Pendulum



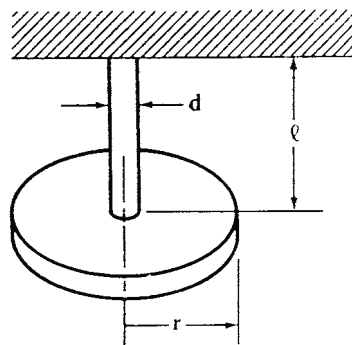
Physical Pendulum



Simple Pendulum



Conical Pendulum



Torsional Pendulum

W = Weight of Disk

A *torsional* pendulum in its simplest form consists of a disk fixed to a slender rod, the other end of which is fastened to a fixed frame. When the disc is twisted through some angle and released, it will then oscillate back and forth about the axis of the rod because of the torque exerted by the rod.

Pendulum Formulas.—From the formulas that follow, the period of vibration or time required for one complete cycle back and forth may be determined for the types of pendulums shown in the accompanying diagram.

For a *simple* pendulum,

$$T = 2\pi \sqrt{\frac{l}{g}} \quad (1)$$

where T = period in seconds for one complete cycle; g = acceleration due to gravity = 32.17 feet per second per second (approximately); and l is the length of the pendulum in feet as shown on the accompanying diagram.

For a *physical* or *compound* pendulum,

$$T = 2\pi \sqrt{\frac{k_0^2}{gr}} \quad (2)$$

where k_0 = radius of gyration of the pendulum about the axis of rotation, in feet, and r is the distance from the axis of rotation to the center of gravity, in feet.

The metric SI units that can be used in the two above formulas are T = time in seconds; g = approximately 9.81 meters per second squared, which is the value for acceleration due to gravity; l = the length of the pendulum in meters; k_0 = the radius of gyration in meters, and r = the distance from the axis of rotation to the center of gravity, in meters.

Formulas (1) and (2) are accurate when the angle of oscillation θ shown in the diagram is very small. For θ equal to 22 degrees, these formulas give results that are too small by 1 per cent; for θ equal to 32 degrees, by 2 per cent.

For a *conical* pendulum, the time in seconds for one revolution is:

$$T = 2\pi \sqrt{\frac{l \cos \phi}{g}} \quad (3a) \quad \text{or} \quad T = 2\pi \sqrt{\frac{r \cot \phi}{g}} \quad (3b)$$

For a *torsional* pendulum consisting of a thin rod and a disk as shown in the figure

$$T = \frac{2}{3} \sqrt{\frac{\pi W r^2 l}{g d^4 G}} \quad (4)$$

where W = weight of disk in pounds; r = radius of disk in feet; l = length of rod in feet; d = diameter of rod in feet; and G = modulus of elasticity in shear of the rod material in pounds per square inch.

The formula using metric SI units is:

$$T = 8 \sqrt{\frac{\pi M r^2 l}{d^4 G}}$$

where T = time in seconds for one complete oscillation; M = mass in kilograms; r = radius in meters; l = length of rod in meters; d = diameter of rod in meters; G = modulus of elasticity in shear of the rod material in pascals (newtons per meter squared). The same formula can be applied using millimeters, providing dimensions are expressed in millimeters throughout, and the modulus of elasticity in megapascals (newtons per millimeter squared).

Harmonic.—A harmonic is any component of a periodic quantity which is an integral multiple of the fundamental frequency. For example, a component the frequency of which is twice the fundamental frequency is called the second harmonic.

A harmonic, in electricity, is an alternating-current electromotive force wave of higher frequency than the fundamental, and superimposed on the same so as to distort it from a true sine-wave shape. It is caused by the slots, the shape of the pole pieces, and the pulsation of the armature reaction. The third and the fifth harmonics, i.e., with a frequency three and five times the fundamental, are generally the predominating ones in three-phase machines.

VELOCITY, ACCELERATION, WORK, AND ENERGY

Velocity and Acceleration

Motion is a progressive change of position of a body. Velocity is the rate of motion, that is, the rate of change of position. When the velocity of a body is the same at every moment during which the motion takes place, the latter is called *uniform* motion. When the velocity is variable and constantly increasing, the rate at which it changes is called *acceleration*. Acceleration is the rate at which the velocity of a body changes in a unit of time, as the change in feet or meters per second, in one second. When the motion is decreasing instead of increasing, it is called *retarded* motion, and the rate at which the motion is retarded is frequently called the *deceleration*. If the acceleration is uniform, the motion is called *uniformly accelerated* motion. An example of such motion is found in that of falling bodies.

Newton's Laws of Motion.—The first clear statement of the fundamental relations existing between force and motion was made in the seventeenth century by Sir Isaac Newton, the English mathematician and physicist. It was put in the form of three laws, which are given as originally stated by Newton:

- 1) Every body continues in its state of rest, or uniform motion in a straight line, except in so far as it may be compelled by force to change that state.
- 2) Change of motion is proportional to the force applied and takes place in the direction in which that force acts.
- 3) To every action there is always an equal reaction; or, the mutual actions of two bodies are always equal and oppositely directed.

Motion with Constant Velocity.—In the formulas that follow, S = distance moved; V = velocity; t = time of motion, θ = angle of rotation, and ω = angular velocity; the usual units for these quantities in the US Customary System are, respectively, feet, feet per second, seconds, radians, and radians per second. The usual metric units are meters, meters per second, seconds, radians, and radians per second. Any consistent set of units may be employed.

$$\text{Constant Linear Velocity: } S = V \times t \quad V = S \div t \quad t = S \div V$$

$$\text{Constant Angular Velocity: } \theta = \omega t \quad \omega = \theta \div t \quad t = \theta \div \omega$$

Relation between Angular Motion and Linear Motion: The relation between the angular velocity of a rotating body and the linear velocity of a point at a distance r from the center of rotation is:

$$V(\text{ft/s}) = r(\text{ft}) \times \omega(\text{radians/s}) \quad V(\text{m/s}) = r(\text{m}) \times \omega(\text{radians/s})$$

Similarly, the distance moved by the point during rotation through angle θ is:

$$S(\text{ft}) = r(\text{ft}) \times \theta(\text{radians}) \quad S(\text{m}) = r(\text{m}) \times \theta(\text{radians})$$

Linear Motion with Constant Acceleration.—The relations between distance, velocity, and time for linear motion with constant or uniform acceleration are given by the formulas in the accompanying [Table 1](#). In these formulas, the acceleration is assumed to be in the same direction as the initial velocity; hence, if the acceleration in a particular problem should happen to be in a direction opposite that of the initial velocity, then a should be replaced by $-a$. Thus, for example, the formula $V_f = V_o + at$ becomes $V_f = V_o - at$ when a and V_o are opposite in direction.

Example: A car is moving at 100 kmph when the brakes are suddenly locked and the car begins to skid. If it takes 2 seconds to slow the car to 50 kmph, at what rate is it being decelerated, how long is it before the car comes to a halt, and how far will it have traveled?

The initial velocity V_o of the car is 100 kmph or 27.78 m/sec and the acceleration a due to braking is opposite in direction to V_o , since the car is slowed to 50 kmph or 13.89 m/sec.

Table 1. Linear Motion with Constant Acceleration

To Find	Known	Formula	To Find	Known	Formula
Motion Uniformly Accelerated From Rest ($V_o = 0$)					
S	a, t	$S = \frac{1}{2}at^2$	t	S, V_f	$t = 2S \div V_f$
	V_f, t	$S = \frac{1}{2}V_f t$		S, a	$t = \sqrt{2S \div a}$
	V_f, a	$S = V_f^2 \div 2a$		a, V_f	$t = V_f \div a$
V_f	a, t	$V_f = at$	a	S, t	$a = 2S \div t^2$
	S, t	$V_f = 2S \div t$		S, V	$a = V_f^2 \div 2S$
	a, S	$V_f = \sqrt{2aS}$		V_f, t	$a = V_f \div t$
Motion Uniformly Accelerated From Initial Velocity V_o					
S	a, t, V_o	$S = V_o t + \frac{1}{2}at^2$	t	V_o, V_f, a	$t = (V_f - V_o) \div a$
	V_o, V_f, t	$S = (V_f + V_o)t \div 2$		V_o, V_f, S	$t = 2S \div (V_f + V_o)$
	V_o, V_f, a	$S = (V_f^2 - V_o^2) \div 2a$	a	V_o, V_f, S	$a = (V_f^2 - V_o^2) \div 2S$
	V_f, a, t	$S = V_f t - \frac{1}{2}at^2$		V_o, V_f, t	$a = (V_f - V_o) \div t$
V_f	V_o, a, t	$V_f = V_o + at$	V_o, S, t	$a = 2(S - V_o t) \div t^2$	
	V_o, S, t	$V_f = (2S \div t) - V_o$	V_f, S, t	$a = 2(V_f t - S) \div t^2$	
	V_o, a, S	$V_f = \sqrt{V_o^2 + 2aS}$	<i>Meanings of Symbols</i>		
	S, a, t	$V_f = (S \div t) + \frac{1}{2}at$	S = distance moved in feet or meters V_f = final velocity, feet or meters per second V_o = initial velocity, feet or meters per second a = acceleration, feet or meters per second per second t = time of acceleration in seconds		
V_o	V_f, a, S	$V_o = \sqrt{V_f^2 - 2aS}$			
	V_f, S, t	$V_o = (2S \div t) - V_f$			
	V_f, a, t	$V_o = V_f - at$			
	S, a, t	$V_o = (S \div t) - \frac{1}{2}at$			

Since V_o, V_f and t are known, a can be determined from the formula

$$a = (V_f - V_o) \div t = (13.89 - 27.78) \div 2 = -6.95 \text{ m/sec}^2$$

The time required to stop the car can be determined from the formula

$$t = (V_f - V_o) \div a = (0 - 27.78) \div (-6.95) = 4 \text{ seconds}$$

The distance traveled by the car is obtained from the formula

$$S = V_o t + \frac{1}{2}at^2 = (27.78 \times 4) + \left(\frac{1}{2}(-6.95) \times 4^2\right) = (111.12 - 55.6) = 55.52 \text{ meters}$$

Angular Velocity of Rotating Bodies.—The angular velocity of a rotating body is the angle through which the body turns in a unit of time. Angular velocity is commonly expressed in terms of revolutions per minute, but in certain engineering applications it is necessary to express it as radians per second. By definition there are 2π radians in 360 degrees, or one revolution, so that one radian = $360 \div 2\pi = 57.3$ degrees. To convert angular velocity in revolutions per minute, n , to angular velocity in radians per second, ω , multiply by π and divide by 30:

$$\omega = \frac{\pi n}{30} \tag{1}$$

The following **Table 2** may be used to obtain angular velocity in radians per second for all numbers of revolutions per minute from 1 to 239.

**Table 2. Angular Velocity in Revolutions per Minute
Converted to Radians per Second**

R.P.M.	Angular Velocity in Radians per Second									
	0	1	2	3	4	5	6	7	8	9
0	0.00	0.10	0.21	0.31	0.42	0.52	0.63	0.73	0.84	0.94
10	1.05	1.15	1.26	1.36	1.47	1.57	1.67	1.78	1.88	1.99
20	2.09	2.20	2.30	2.41	2.51	2.62	2.72	2.83	2.93	3.04
30	3.14	3.25	3.35	3.46	3.56	3.66	3.77	3.87	3.98	4.08
40	4.19	4.29	4.40	4.50	4.61	4.71	4.82	4.92	5.03	5.13
50	5.24	5.34	5.44	5.55	5.65	5.76	5.86	5.97	6.07	6.18
60	6.28	6.39	6.49	6.60	6.70	6.81	6.91	7.02	7.12	7.23
70	7.33	7.43	7.54	7.64	7.75	7.85	7.96	8.06	8.17	8.27
80	8.38	8.48	8.59	8.69	8.80	8.90	9.01	9.11	9.21	9.32
90	9.42	9.53	9.63	9.74	9.84	9.95	10.05	10.16	10.26	10.37
100	10.47	10.58	10.68	10.79	10.89	11.00	11.10	11.20	11.31	11.41
110	11.52	11.62	11.73	11.83	11.94	12.04	12.15	12.25	12.36	12.46
120	12.57	12.67	12.78	12.88	12.98	13.09	13.19	13.30	13.40	13.51
130	13.61	13.72	13.82	13.93	14.03	14.14	14.24	14.35	14.45	14.56
140	14.66	14.76	14.87	14.97	15.08	15.18	15.29	15.39	15.50	15.60
150	15.71	15.81	15.92	16.02	16.13	16.23	16.34	16.44	16.55	16.65
160	16.75	16.86	16.96	17.07	17.17	17.28	17.38	17.49	17.59	17.70
170	17.80	17.91	18.01	18.12	18.22	18.33	18.43	18.53	18.64	18.74
180	18.85	18.95	19.06	19.16	19.27	19.37	19.48	19.58	19.69	19.79
190	19.90	20.00	20.11	20.21	20.32	20.42	20.52	20.63	20.73	20.84
200	20.94	21.05	21.15	21.26	21.36	21.47	21.57	21.68	21.78	21.89
210	21.99	22.10	22.20	22.30	22.41	22.51	22.62	22.72	22.83	22.93
220	23.04	23.14	23.25	23.35	23.46	23.56	23.67	23.77	23.88	23.98
230	24.09	24.19	24.29	24.40	24.50	24.61	24.71	24.82	24.92	25.03

Example: To find the angular velocity in radians per second of a flywheel making 97 revolutions per minute, locate 90 in the left-hand column and 7 at the top of the columns; at the intersection of the two lines, the angular velocity is read off as equal to 10.16 radians per second.

Linear Velocity of Points on a Rotating Body.—The linear velocity, v , of any point on a rotating body expressed in feet per second may be found by multiplying the angular velocity of the body in radians per second, ω , by the radius, r , in feet from the center of rotation to the point:

$$v = \omega r \tag{2}$$

The metric SI units are v = meters per second; ω = radians per second, r = meters.

Rotary Motion with Constant Acceleration.—The relations among angle of rotation, angular velocity, and time for rotation with constant or uniform acceleration are given in the accompanying **Table 3**.

In these formulas, the acceleration is assumed to be in the same direction as the initial angular velocity; hence, if the acceleration in a particular problem should happen to be in a direction opposite that of the initial angular velocity, then α should be replaced by $-\alpha$. Thus, for example, the formula $\omega_f = \omega_o + \alpha t$ becomes $\omega_f = \omega_o - \alpha t$ when α and ω_o are opposite in direction.

Linear Acceleration of a Point on a Rotating Body: A point on a body rotating about a fixed axis has a linear acceleration a that is the resultant of two component accelerations. The first component is the centripetal or normal acceleration which is directed from the point P toward the axis of rotation; its magnitude is $r\omega^2$ where r is the radius from the axis to the point P and ω is the angular velocity of the body at the time acceleration a is to be

Table 3. Rotary Motion with Constant Acceleration

To Find	Known	Formula	To Find	Known	Formula
Motion Uniformly Accelerated From Rest ($\omega_o = 0$)					
θ	α, t	$\theta = \frac{1}{2}\alpha t^2$	t	θ, ω_f	$t = 2\theta \div \omega_f$
	ω_f, t	$\theta = \frac{1}{2}\omega_f t$		θ, α	$t = \sqrt{2\theta \div \alpha}$
	ω_f, α	$\theta = \omega_f^2 \div 2\alpha$		α, ω_f	$t = \omega_f \div \alpha$
ω_f	α, t	$\omega_f = \alpha t$	α	θ, t	$\alpha = 2\theta \div t^2$
	θ, t	$\omega_f = 2\theta \div t$		θ, ω_f	$\alpha = \omega_f^2 \div 2\theta$
	α, θ	$\omega_f = \sqrt{2\alpha\theta}$		ω_f, t	$\alpha = \omega_f \div t$
Motion Uniformly Accelerated From Initial Velocity ω_o					
θ	α, t, ω_o	$\theta = \omega_o t + \frac{1}{2}\alpha t^2$	α	$\omega_o, \omega_f, \theta$	$\alpha = (\omega_f^2 - \omega_o^2) \div 2\theta$
	ω_o, ω_f, t	$\theta = (\omega_f + \omega_o)t \div 2$		ω_o, ω_f, t	$\alpha = (\omega_f - \omega_o) \div t$
	$\omega_o, \omega_f, \alpha$	$\theta = (\omega_f^2 - \omega_o^2) \div 2\alpha$		ω_o, θ, t	$\alpha = 2(\theta - \omega_o t) \div t^2$
	ω_f, α, t	$\theta = \omega_f t - \frac{1}{2}\alpha t^2$		ω_f, θ, t	$\alpha = 2(\omega_f t - \theta) \div t^2$
ω_f	ω_o, α, t	$\omega_f = \omega_o + \alpha t$	<i>Meanings of Symbols</i> θ = angle of rotation, radians ω_f = final angular velocity, radians per second ω_o = initial angular velocity, radians per second α = angular acceleration, radians per second, per second t = time in seconds 1 degree = 0.01745 radians (See conversion table on page 103)		
	ω_o, θ, t	$\omega_f = (2\theta \div t) - \omega_o$			
	ω_o, α, θ	$\omega_f = \sqrt{\omega_o^2 + 2\alpha\theta}$			
ω_o	ω_f, α, θ	$\omega_o = \sqrt{\omega_f^2 - 2\alpha\theta}$			
	ω_f, θ, t	$\omega_o = (2\theta \div t) - \omega_f$			
	ω_f, α, t	$\omega_o = \omega_f - \alpha t$			
	θ, α, t	$\omega_o = (\theta \div t) - \frac{1}{2}\alpha t$			
t	$\omega_o, \omega_f, \alpha$	$t = (\omega_f - \omega_o) \div \alpha$			
	$\omega_o, \omega_f, \theta$	$t = 2\theta \div (\omega_f + \omega_o)$			

determined. The second component of a is the tangential acceleration which is equal to $r\alpha$ where α is the angular acceleration of the body.

The acceleration of point P is the resultant of $r\omega^2$ and $r\alpha$ and is given by the formula

$$a = \sqrt{(r\omega^2)^2 + (r\alpha)^2}$$

When $\alpha = 0$, this formula reduces to: $a = r\omega^2$

Example: A flywheel on a press rotating at 120 rpm is slowed to 102 rpm during a punching operation that requires $\frac{3}{4}$ second for the punching portion of the cycle. What angular deceleration does the flywheel experience?

From the table on page 177, the angular velocities corresponding to 120 rpm and 102 rpm, respectively, are 12.57 and 10.68 radians per second. Therefore, using the formula

$$\begin{aligned} \alpha &= (\omega_f - \omega_o) \div t \\ \alpha &= (10.68 - 12.57) \div \frac{3}{4} = -1.89 \div \frac{3}{4} \\ \alpha &= -2.52 \text{ radians per second per second} \end{aligned}$$

which is, from the table on page 177, -24 rpm per second. The minus sign in the answer indicates that the acceleration α acts to slow the flywheel, that is, the flywheel is being decelerated.

Force, Work, Energy, and Momentum

Accelerations Resulting from Unbalanced Forces.—In the section describing the resolution and composition of forces it was stated that when the resultant of a system of forces is zero, the system is in equilibrium, that is, the body on which the force system acts remains at rest or continues to move with uniform velocity. If, however, the resultant of a system of forces is not zero, the body on which the forces act will be accelerated in the direction of the unbalanced force. To determine the relation between the unbalanced force and the resulting acceleration, Newton's laws of motion must be applied. These laws may be stated as follows:

First Law: Every body continues in a state of rest or in uniform motion in a straight line, until it is compelled by a force to change its state of rest or motion.

Second Law: Change of motion is proportional to the force applied, and takes place along the straight line in which the force acts. The “force applied” represents the resultant of *all* the forces acting on the body. This law is sometimes worded: An unbalanced force acting on a body causes an acceleration of the body in the direction of the force and of magnitude proportional to the force and inversely proportional to the mass of the body. Stated as a formula, $R = Ma$ where R is the resultant of *all* the forces acting on the body, M is the mass of the body (mass = weight W divided by acceleration due to gravity g), and a is the acceleration of the body resulting from application of force R .

Third Law: To every action there is always an equal reaction, or, in other words, if a force acts to change the state of motion of a body, the body offers a resistance equal and directly opposite to the force.

Newton's second law may be used to calculate linear and angular accelerations of a body produced by unbalanced forces and torques acting on the body; however, it is necessary first to use the methods described under *Algebraic Composition and Resolution of Force Systems* starting on page 156 to determine the magnitude and direction of the resultant of *all* forces acting on the body. Then, for a body moving with pure translation,

$$R = Ma = \frac{W}{g}a$$

where R is the resultant force in pounds acting on a body weighing W pounds; g is the gravitational constant, usually taken as 32.16 ft/sec², approximately; and a is the resulting acceleration in ft/sec² of the body due to R and in the same direction as R .

Using metric SI units, the formula is $R = Ma$, where R = force in newtons (N), M = mass in kilograms, and a = acceleration in meters/second squared. It should be noted that the weight of a body of mass M kg is Mg newtons, where g is approximately 9.81 m/s².

Free Body Diagram: In order to correctly determine the effect of forces on the motion of a body it is necessary to resort to what is known as a *free body diagram*. This diagram shows 1) the body removed or isolated from contact with all other bodies that exert force on the body; and 2) *all* the forces acting on the body.

Thus, for example, in Fig. 1a the block being pulled up the plane is acted upon by certain forces; the free body diagram of this block is shown at Fig. 1b. Note that all forces acting on the block are indicated. These forces include: 1) the force of gravity (weight); 2) the pull of the cable, P ; 3) the normal component, $W \cos \phi$, of the force exerted on the block by the plane; and 4) the friction force, $\mu W \cos \phi$, of the plane on the block.

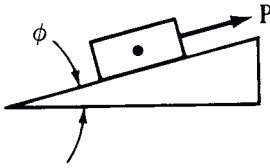


Fig. 1a.

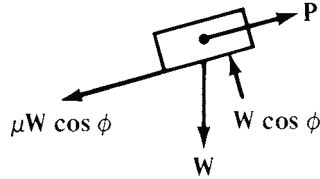


Fig. 1b.

In preparing a free body diagram, it is important to realize that only those forces exerted *on* the body being considered are shown; forces exerted by the body on other bodies are disregarded. This feature makes the free body diagram an invaluable aid in the solution of problems in mechanics.

Example: A 100-pound body is being hoisted by a winch, the tension in the hoisting cable being kept constant at 110 pounds. At what rate is the body accelerated?

Two forces are acting on the body, its weight, 100 pounds downward, and the pull of the cable, 110 pounds upward. The resultant force R , from a free body diagram, is therefore $110 - 100$. Thus, applying Newton's second law,

$$110 - 100 = \frac{100}{32.16} a$$

$$a = \frac{32.16 \times 10}{100} = 3.216 \text{ ft/sec}^2 \text{ upward}$$

It should be noted that since in this problem the resultant force R was positive ($110 - 100 = +10$), the acceleration a is also positive, that is, a is in the same direction as R , which is in accord with Newton's second law.

Example using SI metric units: A body of mass 50 kilograms is being hoisted by a winch, and the tension in the cable is 600 newtons. What is the acceleration? The weight of the 50 kg body is $50g$ newtons, where $g =$ approximately 9.81 m/s^2 (see *Note* on page 187). Applying the formula $R = Ma$, the calculation is: $(600 - 50g) = 50a$. Thus,

$$a = \frac{600 - 50g}{50} = \frac{600 - (50 \times 9.81)}{50} = 2.19 \text{ m/s}^2$$

Formulas Relating Torque and Angular Acceleration: For a body rotating about a fixed axis the relation between the unbalanced torque acting to produce rotation and the resulting angular acceleration may be determined from any one of the following formulas, each based on Newton's second law:

$$T_o = J_M \alpha$$

$$T_o = M k_o^2 \alpha$$

$$T_o = \frac{W k_o^2 \alpha}{g} = \frac{W k_o^2 \alpha}{32.16}$$

where T_o is the unbalanced torque in pounds-feet; J_M in ft-lbs-sec^2 is the moment of inertia of the body about the axis of rotation; k_o in feet is the radius of gyration of the body with respect to the axis of rotation, and α in radians per second, per second is the angular acceleration of the body.

Example: A flywheel has a diameter of 3 feet and weighs 1000 pounds. What torque must be applied, neglecting bearing friction, to accelerate the flywheel at the rate of 100 revolutions per minute, per second?

From page 246 the moment of inertia of a solid cylinder with respect to a gravity axis at right angles to the circular cross-section is given as $\frac{1}{2}Mr^2$. From page 177, 100 rpm = 10.47 radians per second, hence an acceleration of 100 rpm per second = 10.47 radians per second, per second. Therefore, using the first of the preceding formulas,

$$T_o = J_M\alpha = \left(\frac{1}{2}\right)\frac{1000}{32.16}\left(\frac{3}{2}\right)^2 \times 10.47 = 366 \text{ ft-lbs}$$

Using metric SI units, the formulas are: $T_o = J_M\alpha = Mk_o^2\alpha$, where T_o = torque in newton-meters; J_M = the moment of inertia in $\text{kg} \cdot \text{m}^2$, and α = the angular acceleration in radians per second squared.

Example: A flywheel has a diameter of 1.5 m, and a mass of 800 kg. What torque is needed to produce an angular acceleration of 100 revolutions per minute, per second? As in the preceding example, $\alpha = 10.47 \text{ rad/s}^2$. Thus:

$$J_M = \frac{1}{2}Mr^2 = \frac{1}{2} \times 800 \times 0.75^2 = 225 \text{ kg} \cdot \text{m}^2$$

Therefore: $T_o = J_M\alpha = 225 \times 10.47 = 2356 \text{ N} \cdot \text{m}$.

Energy.—A body is said to possess energy when it is capable of doing work or overcoming resistance. The energy may be either mechanical or non-mechanical, the latter including chemical, electrical, thermal, and atomic energy.

Mechanical energy includes *kinetic energy* (energy possessed by a body because of its motion) and *potential energy* (energy possessed by a body because of its position in a field of force and/or its elastic deformation).

Kinetic Energy: The motion of a body may be one of pure translation, pure rotation, or a combination of rotation and translation. By translation is meant motion in which every line in the body remains parallel to its original position throughout the motion, that is, no rotation is associated with the motion of the body.

The kinetic energy of a translating body is given by the formula

$$\text{Kinetic Energy in ft-lbs due to translation} = E_{KT} = \frac{1}{2}MV^2 = \frac{WV^2}{2g} \quad (3a)$$

where M = mass of body ($= W \div g$); V = velocity of the center of gravity of the body in feet per second; W = weight of body in pounds; and g = acceleration due to gravity = 32.16 feet per second, per second.

The kinetic energy of a body rotating about a fixed axis O is expressed by the formula:

$$\text{Kinetic Energy in ft-lbs due to rotation} = E_{KR} = \frac{1}{2}J_{MO}\omega^2 \quad (3b)$$

where J_{MO} is the moment of inertia of the body about the fixed axis O in pounds-feet-seconds², and ω = angular velocity in radians per second.

For a body that is moving with both translation and rotation, the total kinetic energy is given by the following formula as the sum of the kinetic energy due to translation of the center of gravity and the kinetic energy due to rotation about the center of gravity:

$$\begin{aligned} \text{Total Kinetic Energy in ft-lbs} &= E_T = \frac{1}{2}MV^2 + \frac{1}{2}J_{MG}\omega^2 \\ &= \frac{WV^2}{2g} + \frac{1}{2}J_{MG}\omega^2 = \frac{WV^2}{2g} + \frac{1}{2}\frac{Wk^2\omega^2}{g} = \frac{W}{2g}(V^2 + k^2\omega^2) \end{aligned} \quad (3c)$$

where J_{MG} is the moment of inertia of the body about its gravity axis in pounds-feet-seconds², k is the radius of gyration in feet with respect to an axis through the center of gravity, and the other quantities are as previously defined.

In the metric SI system, energy is expressed as the joule (J). One joule = 1 newton-meter. The kinetic energy of a translating body is given by the formula $E_{KT} = \frac{1}{2}MV^2$,

where M = mass in kilograms, and V = velocity in meters per second. Kinetic energy due to rotation is expressed by the formula $E_{KR} = \frac{1}{2}J_{MO}\omega^2$, where J_{MO} = moment of inertia in $\text{kg} \cdot \text{m}^2$, and ω = the angular velocity in radians per second. Total kinetic energy $ET = \frac{1}{2}MV^2 + \frac{1}{2}J_{MO}\omega^2$ joules = $\frac{1}{2}M(V^2 + k^2\omega^2)$ joules, where k = radius of gyration in meters.

Potential Energy: The most common example of a body having potential energy because of its position in a field of force is that of a body elevated to some height above the earth. Here the field of force is the gravitational field of the earth and the potential energy E_{PF} of a body weighing W pounds elevated to some height S in feet above the surface of the earth is WS foot-pounds. If the body is permitted to drop from this height its potential energy E_{PF} will be converted to kinetic energy. Thus, after falling through height S the kinetic energy of the body will be WS ft-lbs.

In metric SI units, the potential energy E_{PF} of a body of mass M kilograms elevated to a height of S meters, is MgS joules. After it has fallen a distance S , the kinetic energy gained will thus be MgS joules.

Another type of potential energy is elastic potential energy, such as possessed by a spring that has been compressed or extended. The amount of work in ft lbs done in compressing the spring S feet is equal to $KS^2/2$, where K is the spring constant in pounds per foot. Thus, when the spring is released to act against some resistance, it can perform $KS^2/2$ ft-lbs of work which is the amount of elastic potential energy E_{PE} stored in the spring.

Using metric SI units, the amount of work done in compressing the spring a distance S meters is $KS^2/2$ joules, where K is the spring constant in newtons per meter.

Work Performed by Forces and Couples.—The work U done by a force F in moving an object along some path is the product of the distance S the body is moved and the component $F \cos \alpha$ of the force F in the direction of S .

$$U = FS \cos \alpha$$

where U = work in ft-lbs; S = distance moved in feet; F = force in lbs; and α = angle between line of action of force and the path of S .

If the force is in the same direction as the motion, then $\cos \alpha = \cos 0 = 1$ and this formula reduces to:

$$U = FS$$

Similarly, the work done by a couple T turning an object through an angle θ is:

$$U = T\theta$$

where T = torque of couple in pounds-feet and θ = the angular rotation in radians.

The above formulas can be used with metric SI units: U is in joules; S is in meters; F is in newtons, and T is in newton-meters.

Relation between Work and Energy.—Theoretically, when work is performed on a body and there are no energy losses (such as due to friction, air resistance, etc.), the energy acquired by the body is equal to the work performed on the body; this energy may be either potential, kinetic, or a combination of both.

In actual situations, however, there may be energy losses that must be taken into account. Thus, the relation between work done on a body, energy losses, and the energy acquired by the body can be stated as:

$$\text{Work Performed} - \text{Losses} = \text{Energy Acquired}$$

$$U - \text{Losses} = E_T$$

Example 1: A 12-inch cube of steel weighing 490 pounds is being moved on a horizontal conveyor belt at a speed of 6 miles per hour (8.8 feet per second). What is the kinetic energy of the cube?

Since the block is not rotating, **Formula (3a)** for the kinetic energy of a body moving with pure translation applies:

$$\text{Kinetic Energy} = \frac{WV^2}{2g} = \frac{490 \times (8.8)^2}{2 \times 32.16} = 590 \text{ ft-lbs}$$

A similar example using metric SI units is as follows: If a cube of mass 200 kg is being moved on a conveyor belt at a speed of 3 meters per second, what is the kinetic energy of the cube? It is:

$$\text{Kinetic Energy} = \frac{1}{2}MV^2 = \frac{1}{2} \times 200 \times 3^2 = 900 \text{ joules}$$

Example 2: If the conveyor in **Example 1** is brought to an abrupt stop, how long would it take for the steel block to come to a stop and how far along the belt would it slide before stopping if the coefficient of friction μ between the block and the conveyor belt is 0.2 and the block slides without tipping over?

The only force acting to slow the motion of the block is the friction force between the block and the belt. This force F is equal to the weight of the block, W , multiplied by the coefficient of friction; $F = \mu W = 0.2 \times 490 = 98$ lbs.

The time required to bring the block to a stop can be determined from the impulse-momentum **Formula (4c)** on page 184.

$$R \times t = \frac{W}{g}(V_f - V_o) = (-98)t = \frac{490}{32.16} \times (0 - 8.8)$$

$$t = \frac{490 \times 8.8}{98 \times 32.16} = 1.37 \text{ seconds}$$

The distance the block slides before stopping can be determined by equating the kinetic energy of the block and the work done by friction in stopping it:

$$\begin{aligned} \text{Kinetic energy of block} (WV^2/2g) &= \text{Work done by friction} (F \times S) \\ 590 &= 98 \times S \\ S &= \frac{590}{98} = 6.0 \text{ feet} \end{aligned}$$

If metric SI units are used, the calculation is as follows (for the cube of 200 kg mass): The friction force = μ multiplied by the weight Mg where $g =$ approximately 9.81 m/s^2 . Thus, $\mu Mg = 0.2 \times 200g = 392.4$ newtons. The time t required to bring the block to a stop is $(-392.4)t = 200(0 - 3)$. Therefore,

$$t = \frac{200 \times 3}{392.4} = 1.53 \text{ seconds}$$

The kinetic energy of the block is equal to the work done by friction, that is $392.4 \times S = 900$ joules. Thus, the distance S which the block moves before stopping is

$$S = \frac{900}{392.4} = 2.29 \text{ meters}$$

Force of a Blow.—A body that weighs W pounds and falls S feet from an initial position of rest is capable of doing WS foot-pounds of work. The work performed during its fall may be, for example, that necessary to drive a pile a distance d into the ground. Neglecting losses in the form of dissipated heat and strain energy, the work done in driving the pile is equal to the product of the impact force acting on the pile and the distance d which the pile is driven. Since the impact force is not accurately known, an average value, called the

“average force of the blow,” may be assumed. Equating the work done on the pile and the work done by the falling body, which in this case is a pile driver:

$$\text{Average force of blow} \times d = WS$$

or,

$$\text{Average force of blow} = \frac{WS}{d}$$

where, S = total height in feet through which the driver falls, including the distance d that the pile is driven

W = weight of driver in pounds

d = distance in feet which pile is driven

When using metric SI units, it should be noted that a body of mass M kilograms has a weight of Mg newtons, where g = approximately 9.81 m/s^2 . If the body falls a distance S meters, it can do work equal to MgS joules. The average force of the blow is MgS/d newtons, where d is the distance in meters that the pile is driven.

Example: A pile driver weighing 200 pounds strikes the top of the pile after having fallen from a height of 20 feet. It forces the pile into the ground a distance of $\frac{1}{2}$ foot. Before the ram is brought to rest, it will $200 \times (20 + \frac{1}{2}) = 4100$ foot-pounds of work, and as this energy is expended in a distance of one-half foot, the average force of the blow equals $4100 \div \frac{1}{2} = 8200$ pounds.

A similar example using metric SI units is as follows: A pile driver of mass 100 kilograms falls 10 meters and moves the pile a distance of 0.3 meters. The work done = $100g(10 + 0.3)$ joules, and it is expended in 0.3 meters. Thus, the average force is

$$\frac{100g \times 10.3}{0.3} = 33680 \text{ newtons or } 33.68 \text{ kN}$$

Impulse and Momentum.—The *linear momentum* of a body is defined as the product of the mass M of the body and the velocity V of the center of gravity of the body:

$$\text{Linear momentum} = MV \text{ or since } M = W \div g$$

$$\text{Linear momentum} = \frac{WV}{g} \quad (4a)$$

It should be noted that linear momentum is a vector quantity, the momentum being in the same direction as V .

Linear impulse is defined as the product of the resultant R of *all* the forces acting on a body and the time t that the resultant acts:

$$\text{Linear Impulse} = Rt \quad (4b)$$

The change in the linear momentum of a body is numerically equal to the linear impulse that causes the change in momentum:

$$\text{Linear Impulse} = \text{change in Linear Momentum}$$

$$Rt = \frac{W}{g}V_f - \frac{W}{g}V_o = \frac{W}{g}(V_f - V_o) \quad (4c)$$

where V_f the final velocity of the body after time t , and V_o , the initial velocity of the body, are both in the same direction as the applied force R . If V_o , and V_f are in opposite directions, then the minus sign in the formula becomes a plus sign.

In metric SI units, the formulas are: Linear Momentum = MV kg · m/s, where M = mass in kg, and V = velocity in meters per second; and Linear Impulse = Rt newton-seconds, where R = force in newtons, and t = time in seconds. In **Formula (4c) above, W/g is replaced by M when SI units are used.**

Example: A 1000-pound block is pulled up a 2-degree incline by a cable exerting a constant force F of 600 pounds. If the coefficient of friction μ between the block and the plane is 0.5, how fast will the block be moving up the plane 10 seconds after the pull is applied?

The resultant force R causing the body to be accelerated up the plane is the difference between F , the force acting up the plane, and P , the force acting to resist motion up the plane. This latter force for a body on a plane is given by the formula at the top of page 169 as $P = W(\mu \cos \alpha + \sin \alpha)$ where α is the angle of the incline.

$$\begin{aligned} \text{Thus, } R &= F - P = F - W(\mu \cos \alpha + \sin \alpha) \\ &= 600 - 1000(0.5 \cos 2^\circ + \sin 2^\circ) = 600 - 1000(0.5 \times 0.99939 + 0.03490) \\ R &= 600 - 535 = 65 \text{ pounds.} \end{aligned}$$

Formula (4c) can now be applied to determine the speed at which the body will be moving up the plane after 10 seconds.

$$\begin{aligned} Rt &= \frac{W}{g} V_f - \frac{W}{g} V_o \\ 65 \times 10 &= \frac{1000}{32.2} V_f - \frac{1000}{32.2} \times 0 \\ V_f &= \frac{65 \times 10 \times 32.2}{1000} = 20.9 \text{ ft per sec} = 14.3 \text{ miles per hour} \end{aligned}$$

A similar example using metric SI units is as follows: A 500 kg block is pulled up a 2 degree incline by a constant force F of 4 kN. The coefficient of friction μ between the block and the plane is 0.5. How fast will the block be moving 10 seconds after the pull is applied?

The resultant force R is:

$$\begin{aligned} R &= F - Mg(\mu \cos \alpha + \sin \alpha) \\ &= 4000 - 500 \times 9.81(0.5 \times 0.99939 + 0.03490) = 1378\text{N or } 1.378 \text{ kN} \end{aligned}$$

Formula (4c) can now be applied to determine the speed at which the body will be moving up the plane after 10 seconds. Replacing W/g by M in the formula, the calculation is:

$$\begin{aligned} Rt &= MV_f - MV_o \\ 1378 \times 10 &= 500(V_f - 0) \\ V_f &= \frac{1378 \times 10}{500} = 27.6 \text{ m/s} \end{aligned}$$

Angular Impulse and Momentum: In a manner similar to that for linear impulse and moment, the formulas for angular impulse and momentum for a body rotating about a fixed axis are:

$$\text{Angular momentum} = J_M \omega \tag{5a}$$

$$\text{Angular impulse} = T_o t \tag{5b}$$

where J_M is the moment of inertia of the body about the axis of rotation in pounds-feet-seconds², ω is the angular velocity in radians per second, T_o , is the torque in pounds-feet about the axis of rotation, and t is the time in seconds that T_o , acts.

The change in angular momentum of a body is numerically equal to the angular impulse that causes the change in angular momentum:

$$\begin{aligned} \text{Angular Impulse} &= \text{Change in Angular Momentum} \\ T_o t &= J_M \omega_f - J_M \omega_o = J_M(\omega_f - \omega_o) \end{aligned} \tag{5c}$$

where ω_f and ω_o are the final and initial angular velocities, respectively.

Example: A flywheel having a moment of inertia of 25 lbs-ft-sec² is revolving with an angular velocity of 10 radians per second when a constant torque of 20 lbs-ft is applied to reverse its direction of rotation. For what length of time must this constant torque act to stop the flywheel and bring it up to a reverse speed of 5 radians per second?

Applying **Formula (5c)**,

$$T_o t = J_M(\omega_f - \omega_o)$$

$$20t = 25(10 - [-5]) = 250 + 125$$

$$t = 375 \div 20 = 18.8 \text{ seconds}$$

A similar example using metric SI units is as follows: A flywheel with a moment of inertia of 20 kilogram-meters² is revolving with an angular velocity of 10 radians per second when a constant torque of 30 newton-meters is applied to reverse its direction of rotation. For what length of time must this constant torque act to stop the flywheel and bring it up to a reverse speed of 5 radians per second? Applying **Formula (5c)**, the calculation is:

$$T_o t = J_M(\omega_f - \omega_o),$$

$$30t = 20(10 - [-5]).$$

Thus, $t = \frac{20 \times 15}{30} = 10 \text{ seconds}$

Formulas for Work and Power.—The formulas in the accompanying **Table 4** may be used to determine work and power in terms of the applied force and the velocity at the point of application of the force.

Table 4. Formulas^a for Work and Power

To Find	Known	Formula	To Find	Known	Formula
S	P, t, F	$S = P \times t \div F$	K	F, S	$K = F \times S$
	K, F	$S = K \div F$		P, t	$K = P \times t$
	t, F, hp	$S = 550 \times t \times hp \div F$		F, V, t	$K = F \times V \times t$
V	P, F	$V = P \div F$	t, hp	$K = 550 \times t \times hp$	
	K, F, t	$V = K \div (F \times t)$	hp	F, S, t	$hp = F \times S \div (550 \times t)$
	F, hp	$V = 550 \times hp \div F$		P	$hp = P \div 550$
t	F, S, P	$t = F \times S \div P$		F, V	$hp = F \times V \div 550$
	K, F, V	$t = K \div (F \times V)$	K, t	$hp = K \div (550 \times t)$	
	F, S, hp	$t = F \times S \div (550 \times hp)$	Meanings of Symbols: (metric units see note ^a) S = distance in feet V = constant or average velocity in feet per second t = time in seconds F = constant or average force in pounds P = power in foot-pounds per second hp = horsepower K = work in foot-pounds		
F	P, V	$F = P \div V$			
	K, S	$F = K \div S$			
	K, V, t	$F = K \div (V \times t)$			
P	V, hp	$F = 550 \times hp \div V$			
	F, V	$P = F \times V$			
	F, S, t	$P = F \times S \div t$			
K	K, t	$P = K \div t$			
	hp	$P = 550 \times hp$			

^a *Note:* The metric SI unit of work is the joule (one joule = 1 newton-meter), and the unit of power is the watt (one watt = 1 joule per second = 1 N · m/s). The term horsepower is not used. Thus, those formulas above that involve horsepower and the factor 550 are not applicable when working in SI units. The remaining formulas can be used, and the units are: S = distance in meters; V = constant or average velocity in meters per second; t = time in seconds; F = force in newtons; P = power in watts; K = work in joules.

Example: A casting weighing 300 pounds is to be lifted by means of an overhead crane. The casting is lifted 10 feet in 12 seconds. What is the horsepower developed? Here $F = 300$; $S = 10$; $t = 12$.

$$\text{hp} = \frac{F \times S}{550t} = \frac{300 \times 10}{550 \times 12} = 0.45$$

A similar example using metric SI units is as follows: A casting of mass 150 kg is lifted 4 meters in 15 seconds by means of a crane. What is the power? Here $F = 150g$ N, $S = 4$ m, and $t = 15$ s. Thus:

$$\text{Power} = \frac{FS}{t} = \frac{150g \times 4}{15} = \frac{150 \times 9.81 \times 4}{15} = 392 \text{ watts or } 0.392 \text{ kW}$$

Centrifugal Force

Centrifugal Force.—When a body rotates about any axis other than one at its center of mass, it exerts an outward radial force called centrifugal force upon the axis or any arm or cord from the axis that restrains it from moving in a straight (tangential) line. In the following formulas:

F = centrifugal force in pounds

W = weight of revolving body in pounds

v = velocity at radius R on body in feet per second

n = number of revolutions per minute

g = acceleration due to gravity = 32.16 feet per second per second

R = perpendicular distance in feet from axis of rotation to center of mass, or for practical use, to center of gravity of revolving body

Note: If a body rotates about its own center of mass, R equals zero and v equals zero. This means that the *resultant* of the centrifugal forces of all the elements of the body is equal to zero or, in other words, no centrifugal force is exerted on the axis of rotation. The centrifugal force of any part or element of such a body is found by the equations given below, where R is the radius to the center of gravity of the part or element. In a flywheel rim, R is the mean radius of the rim because it is the radius to the center of gravity of a thin radial section.

$$F = \frac{Wv^2}{gR} = \frac{Wv^2}{32.16R} = \frac{4WR\pi^2n^2}{60 \times 60g} = \frac{WRn^2}{2933} = 0.000341 WRn^2$$

$$W = \frac{FRg}{v^2} = \frac{2933F}{Rn^2} \qquad v = \sqrt{\frac{FRg}{W}}$$

$$R = \frac{Wv^2}{Fg} = \frac{2933F}{Wn^2} \qquad n = \sqrt{\frac{2933F}{WR}}$$

(If n is the number of revolutions per second instead of per minute, then $F = 1227WRn^2$.)

If metric SI units are used in the foregoing formulas, W/g is replaced by M , which is the mass in kilograms; F = centrifugal force in newtons; v = velocity in meters per second; n = number of revolutions per minute; and R = the radius in meters. Thus:

$$F = Mv^2/R = \frac{Mn^2(2\pi R^2)}{60^2 R} = 0.01097 MRn^2$$

If the rate of rotation is expressed as $n_1 =$ revolutions per second, then $F = 39.48 MRn_1^2$; if it is expressed as ω radians per second, then $F = MR\omega^2$.

Calculating Centrifugal Force.—In the ordinary formula for centrifugal force, $F = 0.000341 WRn^2$; the mean radius R of the flywheel or pulley rim is given in feet. For small dimensions, it is more convenient to have the formula in the form:

$$F = 0.2842 \times 10^{-4} W r n^2$$

in which F = centrifugal force, in pounds; W = weight of rim, in pounds; r = mean radius of rim, in inches; n = number of revolutions per minute.

In this formula let $C = 0.00028416n^2$. This, then, is the centrifugal force of one pound, one inch from the axis. The formula can now be written in the form,

$$F = W r C$$

C is calculated for various values of the revolutions per minute n , and the calculated values of C are given in **Table 5**. To find the centrifugal force in any given case, simply find the value of C in the table and multiply it by the product of W and r , the four multiplications in the original formula given thus having been reduced to two.

Example: A cast-iron flywheel with a mean rim radius of 9 inches, is rotated at a speed of 800 revolutions per minute. If the weight of the rim is 20 pounds, what is the centrifugal force?

From **Table 5**, for $n = 800$ revolutions per minute, the value of C is 18.1862.

Thus,

$$F = W r C = 20 \times 9 \times 18.1862 = 3273.52 \text{ pounds}$$

Using metric SI units, $0.01097n^2$ is the centrifugal force acting on a body of 1 kilogram mass rotating at n revolutions per minute at a distance of 1 meter from the axis. If this value is designated C_1 , then the centrifugal force of mass M kilograms rotating at this speed at a distance from the axis of R meters, is $C_1 MR$ newtons. To simplify calculations, values for C_1 are given in **Table 6**. If it is required to work in terms of millimeters, the force is $0.001 C_1 MR_1$ newtons, where R_1 is the radius in millimeters.

Example: A steel pulley with a mean rim radius of 120 millimeters is rotated at a speed of 1100 revolutions per minute. If the mass of the rim is 5 kilograms, what is the centrifugal force?

From **Table 6**, for $n = 1100$ revolutions per minute, the value of C_1 is 13,269.1.

Thus,

$$F = 0.001 C_1 MR_1 = 0.001 \times 13,269.1 \times 5 \times 120 = 7961.50 \text{ newtons}$$

Centrifugal Casting.—The centrifugal casting of metals is an old art. This process has become important in such work as the manufacture of paper-mill rolls, railroad car wheels, and cast-iron pipe. The centrifugal casting process has been successfully applied in the production of non-metallic tubes, such as concrete pipe, in the production of solid castings by locating the molds around the rim of a spinning wheel, and to a limited extent in the production of solid ingots by a largely similar process. Hollow objects such as cast-iron pipe are cast by introducing molten metal into a spinning mold. If the chilling of the metal is extremely rapid, for example in casting cast-iron pipe against a water-cooled chilled mold, it is imperative to use a movable spout. The particular feature that determines the field of application of hot-mold centrifugal casting is the ability to produce long cast shapes of comparatively thin metal.

Table 5. Factors C for Calculating Centrifugal Force (English units)

n	C	n	C	n	C	n	C
50	0.07104	100	0.28416	470	6.2770	5200	768.369
51	0.07391	101	0.28987	480	6.5470	5300	798.205
52	0.07684	102	0.29564	490	6.8227	5400	828.611
53	0.07982	103	0.30147	500	7.1040	5500	859.584
54	0.08286	104	0.30735	600	10.2298	5600	891.126
55	0.08596	105	0.31328	700	13.9238	5700	923.236
56	0.08911	106	0.31928	800	18.1862	5800	955.914
57	0.09232	107	0.32533	900	23.0170	5900	989.161
58	0.09559	108	0.33144	1000	28.4160	6000	1022.980
59	0.09892	109	0.33761	1100	34.3834	6100	1057.360
60	0.10230	110	0.34383	1200	40.9190	6200	1092.310
61	0.10573	115	0.37580	1300	48.0230	6300	1127.830
62	0.10923	120	0.40921	1400	55.6954	6400	1163.920
63	0.11278	125	0.44400	1500	63.9360	6500	1200.580
64	0.11639	130	0.48023	1600	72.7450	6600	1237.800
65	0.12006	135	0.51788	1700	82.1222	6700	1275.590
66	0.12378	140	0.55695	1800	92.0678	6800	1313.960
67	0.12756	145	0.59744	1900	102.5820	6900	1352.890
68	0.13140	150	0.63936	2000	113.6640	7000	1392.380
69	0.13529	160	0.72745	2100	125.3150	7100	1432.450
70	0.13924	170	0.82122	2200	137.5330	7200	1473.090
71	0.14325	180	0.92067	2300	150.3210	7300	1514.290
72	0.14731	190	1.02590	2400	163.6760	7400	1556.060
73	0.15143	200	1.1367	2500	177.6000	7500	1598.400
74	0.15561	210	1.2531	2600	192.0920	7600	1641.310
75	0.15984	220	1.3753	2700	207.1530	7700	1684.780
76	0.16413	230	1.5032	2800	222.7810	7800	1728.830
77	0.16848	240	1.6358	2900	238.9790	7900	1773.440
78	0.17288	250	1.7760	3000	255.7400	8000	1818.620
79	0.17734	260	1.9209	3100	273.0780	8100	1864.370
80	0.18186	270	2.0715	3200	290.9800	8200	1910.690
81	0.18644	280	2.2278	3300	309.4500	8300	1957.580
82	0.19107	290	2.3898	3400	328.4890	8400	2005.030
83	0.19576	300	2.5574	3500	348.0960	8500	2053.060
84	0.20050	310	2.7308	3600	368.2710	8600	2101.650
85	0.20530	320	2.9098	3700	389.0150	8700	2150.810
86	0.21016	330	3.0945	3800	410.3270	8800	2200.540
87	0.21508	340	3.2849	3900	432.2070	8900	2250.830
88	0.22005	350	3.4809	4000	454.6560	9000	2301.700
89	0.22508	360	3.6823	4100	477.6730	9100	2353.130
90	0.23017	370	3.8901	4200	501.2580	9200	2405.130
91	0.23531	380	4.1032	4300	525.4120	9300	2457.700
92	0.24051	390	4.3220	4400	550.1340	9400	2510.840
93	0.24577	400	4.5466	4500	575.4240	9500	2564.540
94	0.25108	410	4.7767	4600	601.2830	9600	2618.820
95	0.25645	420	5.0126	4700	627.7090	9700	2673.660
96	0.26188	430	5.2541	4800	654.7050	9800	2729.070
97	0.26737	440	5.5013	4900	682.2680	9900	2785.050
98	0.27291	450	5.7542	5000	710.4000	10000	2841.600
99	0.27851	460	6.0128	5100	739.1000		

Table 6. Factors C_1 for Calculating Centrifugal Force (Metric SI units)

n	C_1	n	C_1	n	C_1	n	C_1
50	27.4156	100	109.662	470	2,422.44	5200	296,527
51	28.5232	101	111.867	480	2,526.62	5300	308,041
52	29.6527	102	114.093	490	2,632.99	5400	319,775
53	30.8041	103	116.341	500	2,741.56	5500	331,728
54	31.9775	104	118.611	600	3,947.84	5600	343,901
55	33.1728	105	120.903	700	5,373.45	5700	356,293
56	34.3901	106	123.217	800	7,018.39	5800	368,904
57	35.6293	107	125.552	900	8,882.64	5900	381,734
58	36.8904	108	127.910	1000	10,966.2	6000	394,784
59	38.1734	109	130.290	1100	13,269.1	6100	408,053
60	39.4784	110	132.691	1200	15,791.4	6200	421,542
61	40.8053	115	145.028	1300	18,532.9	6300	435,250
62	42.1542	120	157.914	1400	21,493.8	6400	449,177
63	43.5250	125	171.347	1500	24,674.0	6500	463,323
64	44.9177	130	185.329	1600	28,073.5	6600	477,689
65	46.3323	135	199.860	1700	31,692.4	6700	492,274
66	47.7689	140	214.938	1800	35,530.6	6800	507,078
67	49.2274	145	230.565	1900	39,588.1	6900	522,102
68	50.7078	150	246.740	2000	43,864.9	7000	537,345
69	52.2102	160	280.735	2100	48,361.1	7100	552,808
70	53.7345	170	316.924	2200	53,076.5	7200	568,489
71	55.2808	180	355.306	2300	58,011.3	7300	584,390
72	56.8489	190	395.881	2400	63,165.5	7400	600,511
73	58.4390	200	438.649	2500	68,538.9	7500	616,850
74	60.0511	210	483.611	2600	74,131.7	7600	633,409
75	61.6850	220	530.765	2700	79,943.8	7700	650,188
76	63.3409	230	580.113	2800	85,975.2	7800	667,185
77	65.0188	240	631.655	2900	92,226.0	7900	684,402
78	66.7185	250	685.389	3000	98,696.0	8000	701,839
79	68.4402	260	741.317	3100	105,385	8100	719,494
80	70.1839	270	799.438	3200	112,294	8200	737,369
81	71.9494	280	859.752	3300	119,422	8300	755,463
82	73.7369	290	922.260	3400	126,770	8400	773,777
83	75.5463	300	986.960	3500	134,336	8500	792,310
84	77.3777	310	1,053.85	3600	142,122	8600	811,062
85	79.2310	320	1,122.94	3700	150,128	8700	830,034
86	81.1062	330	1,194.22	3800	158,352	8800	849,225
87	83.0034	340	1,267.70	3900	166,796	8900	868,635
88	84.9225	350	1,343.36	4000	175,460	9000	888,264
89	86.8635	360	1,421.22	4100	184,342	9100	908,113
90	88.8264	370	1,501.28	4200	193,444	9200	928,182
91	90.8113	380	1,583.52	4300	202,766	9300	948,469
92	92.8182	390	1,667.96	4400	212,306	9400	968,976
93	94.8469	400	1,754.60	4500	222,066	9500	989,702
94	96.8976	410	1,843.42	4600	232,045	9600	1,010,650
95	98.9702	420	1,934.44	4700	242,244	9700	1,031,810
96	101.065	430	2,027.66	4800	252,662	9800	1,053,200
97	103.181	440	2,123.06	4900	263,299	9900	1,074,800
98	105.320	450	2,220.66	5000	274,156	10000	1,096,620
99	107.480	460	2,320.45	5100	285,232		

Balancing Rotating Parts

Static Balancing.—There are several methods of testing the standing or static balance of a rotating part. A simple method that is sometimes used for flywheels, etc., is illustrated by the diagram, Fig. 1. An accurate shaft is inserted through the bore of the finished wheel, which is then mounted on carefully leveled “parallels” A. If the wheel is in an unbalanced state, it will turn until the heavy side is downward. When it will stand in any position as the result of counterbalancing and reducing the heavy portions, it is said to be in standing or static balance. Another test which is used for disk-shaped parts is shown in Fig. 2. The disk D is mounted on a vertical arbor attached to an adjustable cross-slide B. The latter is carried by a table C, which is supported by a knife-edged bearing. A pendulum having an adjustable screw-weight W at the lower end is suspended from cross-slide B. To test the static balance of disk D, slide B is adjusted until pointer E of the pendulum coincides with the center of a stationary scale F. Disk D is then turned halfway around without moving the slide, and if the indicator remains stationary, it shows that the disk is in balance for this particular position. The test is then repeated for ten or twelve other positions, and the heavy sides are reduced, usually by drilling out the required amount of metal. Several other devices for testing static balance are designed on this same principle.

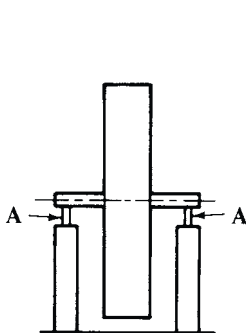


Fig. 1.

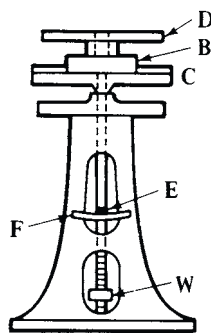


Fig. 2.

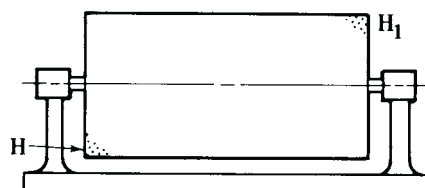


Fig. 3.

Running or Dynamic Balance.—A cylindrical body may be in perfect static balance and not be in a balanced state when rotating at high speed. If the part is in the form of a thin disk, static balancing, if carefully done, may be accurate enough for high speeds, but if the rotating part is long in proportion to its diameter, and the unbalanced portions are at opposite ends or in different planes, the balancing must be done so as to counteract the centrifugal force of these heavy parts when they are rotating rapidly. This process is known as a running balance or dynamic balancing. To illustrate, if a heavy section is located at H (Fig. 3), and another correspondingly heavy section at H_1 , one may exactly counterbalance the other when the cylinder is stationary, and this static balance may be sufficient for a part rigidly mounted and rotating at a comparatively slow speed; but when the speed is very high, as in turbine rotors, etc., the heavy masses H and H_1 , being in different planes, are in an unbalanced state owing to the effect of centrifugal force, which results in excessive strains and injurious vibrations. Theoretically, to obtain a perfect running balance, the exact positions of the heavy sections should be located and the balancing effected either by reducing their weight or by adding counterweights opposite each section and in the same plane at the proper radius; but if the rotating part is rigidly mounted on a stiff shaft, a running balance that is sufficiently accurate for practical purposes can be obtained by means of comparatively few counterbalancing weights located with reference to the unbalanced parts.

Balancing Calculations.—As indicated previously, centrifugal forces caused by an unbalanced mass or masses in a rotating machine member cause additional loads on the bearings which are transmitted to the housing or frame and to other machine members. Such dynamically unbalanced conditions can occur even though static balance (balance at

zero speed) exists. Dynamic balance can be achieved by the addition of one or two masses rotating about the same axis and at the same speed as the unbalanced masses. A single unbalanced mass can be balanced by one counterbalancing mass located 180 degrees opposite and in the same plane of rotation as the unbalanced mass, if the product of their respective radii and masses are equal; i.e., $M_1r_1 = M_2r_2$. Two or more unbalanced masses rotating in the same plane can be balanced by a single mass rotating in the same plane, or by two masses rotating about the same axis in two separate planes. Likewise, two or more unbalanced masses rotating in different planes about a common axis can be balanced by two masses rotating about the same axis in separate planes. When the unbalanced masses are in separate planes they may be in static balance but not in dynamic balance; i.e., they may be balanced when not rotating but unbalanced when rotating. If a system is in dynamic balance, it will remain in balance at all speeds, although this is not strictly true at the critical speed of the system. (See *Critical Speeds* on page 197.)

In all the equations that follow, the symbol M denotes either mass in kilograms or in slugs, or weight in pounds. Either mass or weight units may be used and the equations may be used with metric or with customary English units without change; however, in a given problem the units must be all metric or all customary English.

Counterbalancing Several Masses Located in a Single Plane.—In all balancing problems, it is the product of counterbalancing mass (or weight) and its radius that is calculated; it is thus necessary to select either the mass or the radius and then calculate the other value from the product of the two quantities. Design considerations usually make this decision self-evident. The angular position of the counterbalancing mass must also be calculated. Referring to Fig. 4:

$$M_B r_B = \sqrt{(\sum M r \cos \theta)^2 + (\sum M r \sin \theta)^2} \quad (1)$$

$$\tan \theta_B = \frac{-\sum M r \sin \theta}{-\sum M r \cos \theta} = \frac{y}{x} \quad (2)$$

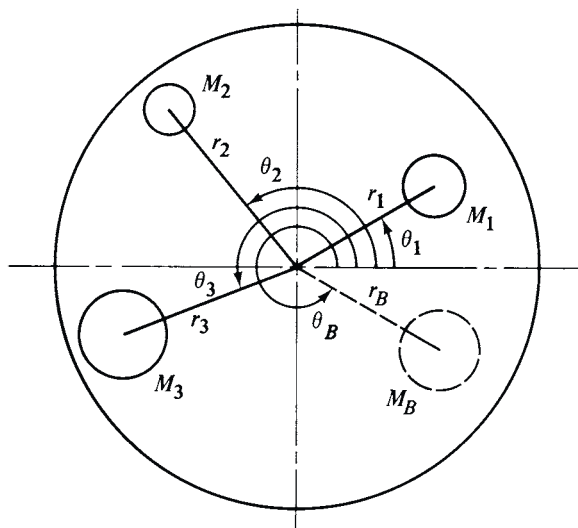
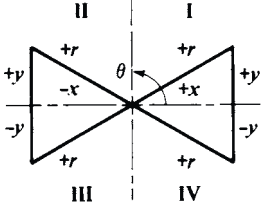


Fig. 4.

Table 1. Relationship of the Signs of the Functions of the Angle with Respect to the Quadrant in Which They Occur

	Angle θ				
		0° to 90°	90° to 180°	180° to 270°	270° to 360°
	Signs of the Functions				
	tan	$\frac{+y}{+x}$	$\frac{+y}{-x}$	$\frac{-y}{-x}$	$\frac{-y}{+x}$
sine	$\frac{+y}{+r}$	$\frac{+y}{+r}$	$\frac{-y}{+r}$	$\frac{-y}{+r}$	
cosine	$\frac{+x}{+r}$	$\frac{-x}{+r}$	$\frac{-x}{+r}$	$\frac{+x}{+r}$	

where:

$M_1, M_2, M_3, \dots M_n$ = any unbalanced mass or weight, kg or lb

M_B = counterbalancing mass or weight, kg or lb

r = radius to center of gravity of any unbalanced mass or weight, mm or inch

r_B = radius to center of gravity of counterbalancing mass or weight, mm or inch

θ = angular position of r of any unbalanced mass or weight, degrees

θ_B = angular position of r_B of counterbalancing mass or weight, degrees

x and y = see **Table 1**

Table 1 is helpful in finding the angular position of the counterbalancing mass or weight. It indicates the range of the angles within which this angular position occurs by noting the plus and minus signs of the numerator and the denominator of the terms in **Equation (2)**. In a like manner, **Table 1** is helpful in determining the *sign* of the sine or cosine functions for angles ranging from 0 to 360 degrees. Balancing problems are usually solved most conveniently by arranging the arithmetical calculations in a tabular form.

Example: Referring to **Fig. 4**, the particular values of the unbalanced weights have been entered in the table below. Calculate the magnitude of the counterbalancing weight if its radius is to be 10 inches.

M		r in.	θ deg.	cos θ	sin θ	$Mr \cos \theta$	$Mr \sin \theta$
No.	lb.						
1	10	10	30	0.8660	0.5000	86.6	50.0
2	5	20	120	-0.5000	0.8660	-50.0	86.6
3	15	15	200	-0.9397	-0.3420	-211.4	-77.0
						-174.8 = $\sum Mr \cos \theta$	59.6 = $\sum Mr \sin \theta$

$$M_B = \frac{\sqrt{(\sum Mr \cos \theta)^2 + (\sum Mr \sin \theta)^2}}{r_B} = \frac{\sqrt{(-174.8)^2 + (59.6)^2}}{10}$$

$$M_B = 18.5 \text{ lb}$$

$$\tan \theta_B = \frac{-(\sum Mr \sin \theta)}{-(\sum Mr \cos \theta)} = \frac{-(59.6)}{-(-174.8)} = \frac{-y}{+x}; \theta_B = 341^\circ 10'$$

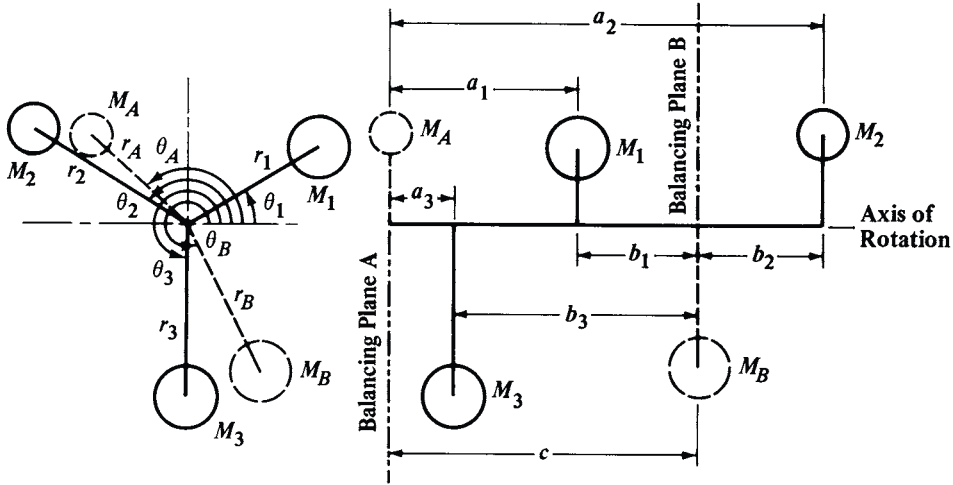


Fig. 5.

Counterbalancing Masses Located in Two or More Planes.—Unbalanced masses or weights rotating about a common axis in two separate planes of rotation form a couple, which must be counterbalanced by masses or weights, also located in two separate planes, call them planes A and B, and rotating about the same common axis (see *Couples* on page 155). In addition, they must be balanced in the direction perpendicular to the axis, as before. Since two counterbalancing masses are required, two separate equations are required to calculate the product of each mass or weight and its radius, and two additional equations are required to calculate the angular positions. The planes A and B selected as balancing planes may be any two planes separated by any convenient distance c , along the axis of rotation. In Fig. 5:

For balancing plane A:

$$M_A r_A = \frac{\sqrt{(\sum M r b \cos \theta)^2 + (\sum M r b \sin \theta)^2}}{c} \tag{3}$$

$$\tan \theta_A = \frac{-(\sum M r b \sin \theta)}{-(\sum M r b \cos \theta)} = \frac{y}{x} \tag{4}$$

For balancing plane B:

$$M_B r_B = \frac{\sqrt{(\sum M r a \cos \theta)^2 + (\sum M r a \sin \theta)^2}}{c} \tag{5}$$

$$\tan \theta_B = \frac{-(\sum M r a \sin \theta)}{-(\sum M r a \cos \theta)} = \frac{y}{x} \tag{6}$$

Where: M_A and M_B are the mass or weight of the counterbalancing masses in the balancing planes A and B, respectively; r_A and r_B are the radii; and θ_A and θ_B are the angular positions of the balancing masses in these planes. M , r , and θ are the mass or weight, radius, and angular positions of the unbalanced masses, with the subscripts defining the particular mass to which the values are assigned. The length c , the distance between the balancing planes, is always a positive value. The axial dimensions, a and b , may be either positive or negative, depending upon their position relative to the balancing plane; for example, in Fig. 5, the dimension b_2 would be negative.

Example: Referring to Fig. 5, a set of values for the masses and dimensions has been selected and put into convenient table form below. The separation of balancing planes, c , is assumed as being 15 inches. If in balancing plane A, the radius of the counterbalancing

weight is selected to be 10 inches; calculate the magnitude of the counterbalancing mass and its position. If in balancing plane *B*, the counterbalancing mass is selected to be 10 lb; calculate its radius and position.

For balancing plane *A*:

Plane	<i>M</i> lb	<i>r</i> in.	θ deg.	Balancing Plane <i>A</i>			
				<i>b</i> in.	<i>Mrb</i>	<i>Mrb</i> cos θ	<i>Mrb</i> sin θ
1	10	8	30	6	480	415.7	240.0
2	8	10	135	-6	-480	339.4	-339.4
3	12	9	270	12	1296	0.0	-1296.0
<i>A</i>	?	10	?	15 ^a		755.1	-1395.4
<i>B</i>	10	?	?	0		= $\sum Mrb$ cos θ	= $\sum Mrb$ sin θ

^a 15 inches = distance *c* between planes *A* and *B*.

$$M_A = \frac{\sqrt{(\sum Mrb \cos \theta)^2 + (\sum Mrb \sin \theta)^2}}{r_A c} = \frac{\sqrt{(755.1)^2 + (-1395.4)^2}}{10(15)}$$

$$M_A = 10.6 \text{ lb}$$

$$\tan \theta_A = \frac{-\sum Mrb \sin \theta}{-\sum Mrb \cos \theta} = \frac{-(-1395.4)}{-(755.1)} = \frac{+y}{-x}$$

$$\theta_A = 118^\circ 25'$$

For balancing plane *B*:

Plane	<i>M</i> lb	<i>r</i> in.	θ deg.	Balancing Plane <i>B</i>			
				<i>a</i> in.	<i>Mra</i>	<i>Mra</i> cos θ	<i>Mra</i> sin θ
1	10	8	30	9	720	623.5	360.0
2	8	10	135	21	1680	-1187.9	1187.9
3	12	9	270	3	324	0.0	-324.0
<i>A</i>	?	10	?	0		-564.4	1223.9
<i>B</i>	10	?	?	15 ^a		= $\sum Mra$ cos θ	= $\sum Mra$ sin θ

^a 15 inches = distance *c* between planes *A* and *B*.

$$r_B = \frac{\sqrt{(\sum Mra \cos \theta)^2 + (\sum Mra \sin \theta)^2}}{M_B c} = \frac{\sqrt{(-564.4)^2 + (1223.9)^2}}{10(15)}$$

$$= 8.985 \text{ in.}$$

$$\tan \theta_B = \frac{-\sum Mra \sin \theta}{-\sum Mra \cos \theta} = \frac{-(1223.9)}{-(-564.4)} = \frac{-y}{+x}$$

$$\theta_B = 294^\circ 45'$$

Balancing Lathe Fixtures.—Lathe fixtures rotating at a high speed require balancing. Often it is assumed that the center of gravity of the workpiece and fixture, and of the counterbalancing masses are in the same plane; however, this is not usually the case. Counterbalancing masses are required in two separate planes to prevent excessive vibration or bearing loads at high speeds.

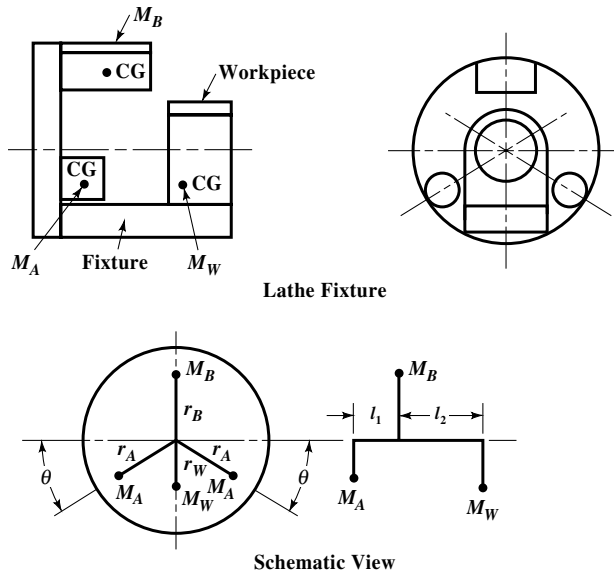


Fig. 6.

Usually a single counterbalancing mass is placed in one plane selected to be 180 degrees directly opposite the combined center of gravity of the workpiece and the fixture. Two equal counterbalancing masses are then placed in the second counterbalancing plane, equally spaced on each side of the fixture. Referring to Fig. 6, the two counterbalancing masses M_A and the two angles θ are equal. For the design in this illustration, the following formulas can be used to calculate the magnitude of the counterbalancing masses. Since their angular positions are fixed by the design, they are not calculated.

$$M_B = \frac{M_w r_w (l_1 + l_2)}{r_B l_1} \quad (7)$$

$$M_A = \frac{M_B r_B - M_w r_w}{2 r_A \sin \theta} \quad (8)$$

In these formulas M_w and r_w denote the mass or weight and the radius of the combined center of gravity of the workpiece and the fixture.

Example: In Fig. 6 the combined weight of the workpiece and the fixture is 18.5 lb. The following dimensions were determined from the layout of the fixture and by calculating the centers of gravity: $r_w = 2$ in.; $r_A = 6.25$ in.; $r_B = 6$ in.; $l_1 = 3$ in.; $l_2 = 5$ in.; and $\theta = 30^\circ$. Calculate the weights of the counterbalancing masses.

$$M_B = \frac{M_w r_w (l_1 + l_2)}{r_B l_1} = \frac{18.5 \times 2 \times 8}{6 \times 3} = 16.44 \text{ lb}$$

$$M_A = \frac{M_B r_B - M_w r_w}{2 r_A \sin \theta} = \frac{(16.44 \times 6) - (18.5 \times 2)}{(2 \times 6.25) \sin 30^\circ} = 9.86 \text{ lb (each weight)}$$

Critical Speeds

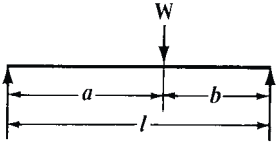
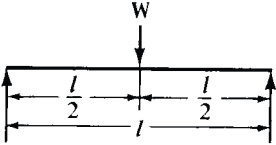
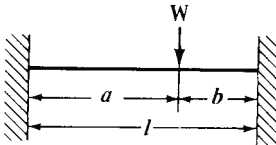
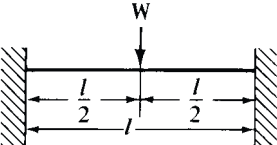
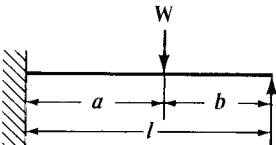
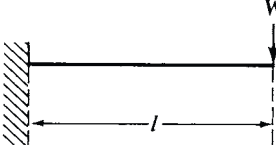
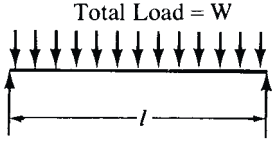
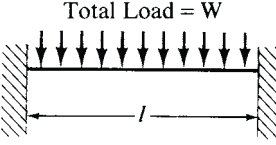
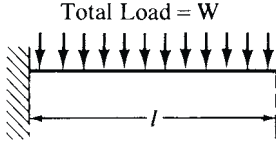
Critical Speeds of Rotating Bodies and Shafts.—If a body or disk mounted upon a shaft rotates about it, the center of gravity of the body or disk must be at the center of the shaft, if a perfect running balance is to be obtained. In most cases, however, the center of gravity of the disk will be slightly removed from the center of the shaft, owing to the difficulty of perfect balancing. Now, if the shaft and disk be rotated, the centrifugal force generated by the heavier side will be greater than that generated by the lighter side geometrically opposite to it, and the shaft will deflect toward the heavier side, causing the center of the disk to rotate in a small circle. A rotating shaft without a body or disk mounted on it can also become dynamically unstable, and the resulting vibrations and deflections can result in damage not only to the shaft but to the machine of which it is a part. These conditions hold true up to a comparatively high speed; but a point is eventually reached (at several thousand revolutions per minute) when momentarily there will be excessive vibration, and then the parts will run quietly again. The speed at which this occurs is called the *critical speed* of the wheel or shaft, and the phenomenon itself for the shaft-mounted disk or body is called the *settling* of the wheel. The explanation of the settling is that at this speed the axis of rotation changes, and the wheel and shaft, instead of rotating about their geometrical center, begin to rotate about an axis through their center of gravity. The shaft itself is then deflected so that for every revolution its geometrical center traces a circle around the center of gravity of the rotating mass.

Critical speeds depend upon the magnitude or location of the load or loads carried by the shaft, the length of the shaft, its diameter and the kind of supporting bearings. The normal operating speed of a machine may or may not be higher than the critical speed. For instance, some steam turbines exceed the critical speed, although they do not run long enough at the critical speed for the vibrations to build up to an excessive amplitude. The practice of the General Electric Co. at Schenectady is to keep below the critical speeds. It is assumed that the maximum speed of a machine may be within 20 per cent high or low of the critical speed without vibration troubles. Thus, in a design of steam turbine sets, critical speed is a factor that determines the size of the shafts for both the generators and turbines. Although a machine may run very close to the critical speed, the alignment and play of the bearings, the balance and construction generally, will require extra care, resulting in a more expensive machine; moreover, while such a machine may run smoothly for a considerable time, any looseness or play that may develop later, causing a slight imbalance, will immediately set up excessive vibrations.

The formulas commonly used to determine critical speeds are sufficiently accurate for general purposes. There are cases, however, where the torque applied to a shaft has an important effect on its critical speed. Investigations have shown that the critical speeds of a uniform shaft are decreased as the applied torque is increased, and that there exist critical torques which will reduce the corresponding critical speed of the shaft to zero. A detailed analysis of the effects of applied torques on critical speeds may be found in a paper, "Critical Speeds of Uniform Shafts under Axial Torque," by Golumb and Rosenberg, presented at the First U.S. National Congress of Applied Mechanics in 1951.

Formulas for Critical Speeds.—The critical speed formulas given in the accompanying table (from the paper on Critical Speed Calculation presented before the ASME by S. H. Weaver) apply to (1) shafts with single concentrated loads and (2) shafts carrying uniformly distributed loads. These formulas also cover different conditions as regards bearings. If the bearings are self-aligning or very short, the shaft is considered supported at the ends; whereas, if the bearings are long and rigid, the shaft is considered fixed. These formulas, for both concentrated and distributed loads, apply to vertical shafts as well as horizontal shafts, the critical speeds having the same value in both cases. The data required for the solution of critical speed problems are the same as for shaft deflection. As the shaft is usually of variable diameter and its stiffness is increased by a long hub, an ideal shaft of uniform diameter and equal stiffness must be assumed.

Critical Speed Formulas

Formulas for Single Concentrated Load		
 $N = 387,000 \frac{d^2}{ab} \sqrt{\frac{l}{W}}$ <p>Bearings supported</p>	 $N = 1,550,500 \frac{d^2}{l\sqrt{Wl}}$ <p>Bearings supported</p>	 $N = 387,000 \frac{d^2 l}{ab} \sqrt{\frac{l}{Wab}}$ <p>Bearings fixed</p>
 $N = 3,100,850 \frac{d^2}{l\sqrt{Wl}}$ <p>Bearings fixed</p>	 $N = 775,200 \frac{d^2 l}{ab} \sqrt{\frac{l}{Wa(3l+b)}}$ <p>One-fixed — One supported</p>	 $N = 387,000 \frac{d^2}{l\sqrt{Wl}}$ <p>One fixed — One free end</p>
Formulas for Distributed Loads—First Critical Speed		
 $N = 2,232,500 \frac{d^2}{l\sqrt{Wl}}$ $N_1 = 4,760,000 \frac{d}{l^2}$ <p>Bearings supported</p>	 $N = 4,979,250 \frac{d^2}{l\sqrt{Wl}}$ $N_1 = 10,616,740 \frac{d}{l^2}$ <p>Bearings fixed</p>	 $N = 795,200 \frac{d^2}{l\sqrt{Wl}}$ $N_1 = 1,695,500 \frac{d}{l^2}$ <p>One fixed—One free end</p>

N = critical speed, RPM

N_1 = critical speed of shaft alone

d = diameter of shaft, in inches

W = load applied to shaft, in pounds

l = distance between centers of bearings, in inches

a and b = distances from bearings to load

In calculating critical speeds, the weight of the shaft is either neglected or, say, one-half to two-thirds of the weight is added to the concentrated load. The formulas apply to steel shafts having a modulus of elasticity $E = 29,000,000$. Although a shaft carrying a number of loads or a distributed load may have an infinite number of critical speeds, ordinarily it is the first critical speed that is of importance in engineering work. The first critical speed is obtained by the formulas given in the distributed loads portion of the table *Critical Speed Formulas*.

STRENGTH OF MATERIALS

Introduction

Strength of materials deals with the relations between the external forces applied to elastic bodies and the resulting deformations and stresses. In the design of structures and machines, the application of the principles of strength of materials is necessary if satisfactory materials are to be utilized and adequate proportions obtained to resist functional forces.

Forces are produced by the action of gravity, by accelerations and impacts of moving parts, by gasses and fluids under pressure, by the transmission of mechanical power, etc. In order to analyze the stresses and deflections of a body, the magnitudes, directions and points of application of forces acting on the body must be known. Information given in the Mechanics section provides the basis for evaluating force systems.

The time element in the application of a force on a body is an important consideration. Thus a force may be static or change so slowly that its maximum value can be treated as if it were static; it may be suddenly applied, as with an impact; or it may have a repetitive or cyclic behavior.

The environment in which forces act on a machine or part is also important. Such factors as high and low temperatures; the presence of corrosive gases, vapors and liquids; radiation, etc. may have a marked effect on how well parts are able to resist stresses.

Throughout the Strength of Materials section in this Handbook, both English and metric SI data and formulas are given to cover the requirements of working in either system of measurement. Formulas and text relating exclusively to SI units are given in bold-face type.

Mechanical Properties of Materials.—Many mechanical properties of materials are determined from tests, some of which give relationships between stresses and strains as shown by the curves in the accompanying figures.

Stress is force per unit area and is usually expressed in pounds per square inch. If the stress tends to stretch or lengthen the material, it is called *tensile* stress; if to compress or shorten the material, a *compressive* stress; and if to shear the material, a *shearing* stress. Tensile and compressive stresses always act at right-angles to (normal to) the area being considered; shearing stresses are always in the plane of the area (at right-angles to compressive or tensile stresses).

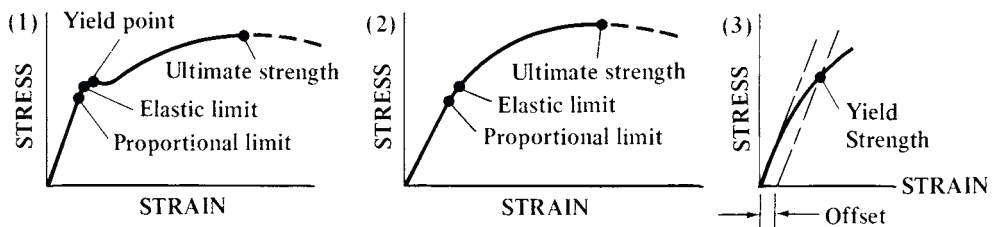


Fig. 1. Stress-strain curves

In the SI, the unit of stress is the pascal (Pa), the newton per meter squared (N/m²). The megapascal (newtons per millimeter squared) is often an appropriate sub-multiple for use in practice.

Unit strain is the amount by which a dimension of a body changes when the body is subjected to a load, divided by the original value of the dimension. The simpler term *strain* is often used instead of unit strain.

Proportional limit is the point on a stress-strain curve at which it begins to deviate from the straight-line relationship between stress and strain.

Elastic limit is the maximum stress to which a test specimen may be subjected and still return to its original length upon release of the load. A material is said to be stressed within the *elastic region* when the working stress does not exceed the elastic limit, and to be stressed in the *plastic region* when the working stress does exceed the elastic limit. The elastic limit for steel is for all practical purposes the same as its proportional limit.

Yield point is a point on the stress-strain curve at which there is a sudden increase in strain without a corresponding increase in stress. Not all materials have a yield point. Some representative values of the yield point (in ksi and MPa) are as follows:

Material	Yield Point		Material	Yield Point	
	ksi	MPa		ksi	MPa
Aluminum, wrought, 2014-T6	60	414	Titanium, pure	55-70	379-483
Aluminum, wrought, 6061-T6	35	241	Titanium, alloy, 5Al, 2.5Sn	110	758
Beryllium copper	140	965	Steel for bridges and buildings, ASTM A7-61T, all shapes	33	227
Brass, naval	25-50	172-345	Steel, castings, high strength, for structural purposes, ASTM A148.60 (seven grades)	40-145	276-1000
Cast iron, malleable	32-45	221-310	Steel, stainless (0.08-0.2C, 17Cr, 7Ni) ¼ hard	78	538
Cast iron, nodular	45-65	311-448			
Magnesium, AZ80A-T5	38	262			

Yield strength, S_y , is the maximum stress that can be applied without permanent deformation of the test specimen. This is the value of the stress at the elastic limit for materials for which there is an elastic limit. Because of the difficulty in determining the elastic limit, and because many materials do not have an elastic region, yield strength is often determined by the offset method as illustrated by the accompanying figure at (3). Yield strength in such a case is the stress value on the stress-strain curve corresponding to a definite amount of permanent set or strain, usually 0.1 or 0.2 per cent of the original dimension. Yield strength data for various materials are given in tables starting on pages 391, 393, 421, 422, 424, 426, 430, 513, 515, 519, 528, 529, 534, 534, 539, 547, 549, 550, and elsewhere.

Ultimate strength, S_u , (also called *tensile strength*) is the maximum stress value obtained on a stress-strain curve.

Modulus of elasticity, E , (also called *Young's modulus*) is the ratio of unit stress to unit strain within the proportional limit of a material in tension or compression. Some representative values of Young's modulus in both US Customary and metric units are as follows:

Material	Young's Modulus		Material	Young's Modulus	
	10 ⁶ psi	10 ⁹ Pa		10 ⁶ psi	10 ⁹ Pa
Aluminum, cast, pure	9	62.1	Magnesium, AZ80A-T5	6.5	44.8
Aluminum, wrought, 2014-T6	10.6	73.1	Titanium, pure	15.5	106.9
Beryllium copper	19	131	Titanium, alloy, 5 Al, 2.5 Sn	17	117.2
Brass, naval	15	103.4	Steel for bridges and buildings, ASTM A7-61T, all shapes	29	199.9
Bronze, phosphor, ASTM B159	15	103.4	Steel, castings, high strength, for structural purposes, ASTM A148-60	29	199.9
Cast iron, malleable	26	179.3			
Cast iron, nodular	23.5	162			

Modulus of elasticity in shear, G , is the ratio of unit stress to unit strain within the proportional limit of a material in shear.

Poisson's ratio, μ , is the ratio of lateral strain to longitudinal strain for a given material subjected to uniform longitudinal stresses within the proportional limit. The term is found in certain equations associated with strength of materials. Values of Poisson's ratio for common materials are as follows:

Aluminum	0.334	Nickel silver	0.322
Beryllium copper	0.285	Phosphor bronze	0.349
Brass	0.340	Rubber	0.500
Cast iron, gray	0.211	Steel, cast	0.265
Copper	0.340	high carbon	0.295
Inconel	0.290	mild	0.303
Lead	0.431	nickel	0.291
Magnesium	0.350	Wrought iron	0.278
Monel metal	0.320	Zinc	0.331

Compressive Properties.—From compression tests, *compressive yield strength*, S_{cy} , and *compressive ultimate strength*, S_{cu} , are determined. Ductile materials under compression loading merely swell or buckle without fracture, hence do not have a compressive ultimate strength.

Shear Properties.—The properties of *shear yield strength*, S_{sy} , *shear ultimate strength*, S_{su} , and the *modulus of rigidity*, G , are determined by direct shear and torsional tests. The modulus of rigidity is also known as the modulus of elasticity in shear. It is the ratio of the shear stress, τ , to the shear strain, γ , in radians, within the proportional limit: $G = \tau/\gamma$.

Creep.—Continuing changes in dimensions of a stressed material over time is called creep, and it varies with different materials and periods under stress, also with temperature. Creep tests may take some time as it is necessary to apply a constant tensile load to a specimen under a selected temperature. Measurements are taken to record the resulting elongation at time periods sufficiently long for a relationship to be established. The data are then plotted as elongation against time. The load is applied to the specimen only after it has reached the testing temperature, and causes an initial elastic elongation that includes some plastic deformation if the load is above the proportional limit for the material.

Some combinations of stress and temperature may cause failure of the specimen. Others show initial high rates of deformation, followed by decreasing, then constant, rates over long periods. Generally testing times to arrive at the constant rate of deformation are over 1000 hours.

Creep Rupture.—Tests for creep rupture are similar to creep tests but are prolonged until the specimen fails. Further data to be obtained from these tests include time to rupture, amount of elongation, and reduction of area. Stress-rupture tests are performed without measuring the elongation, so that no strain data are recorded, time to failure, elongation and reduction of area being sufficient. Sometimes, a V-notch is cut in the specimen to allow measurement of notch sensitivity under the testing conditions.

Stress Analysis.—Stresses, deflections, strains, and loads may be determined by application of strain gages or lacquers to the surface of a part, then applying loads simulating those to be encountered in service. Strain gages are commercially available in a variety of configurations and are usually cemented to the part surface. The strain gages are then calibrated by application of a known moment, load, torque, or pressure. The electrical characteristics of the strain gages change in proportion to the amount of strain, and the magnitude of changes in these characteristics under loads to be applied in service indicate changes caused by stress in the shape of the components being tested.

Lacquers are compounded especially for stress analysis and are applied to the entire part surface. When the part is loaded, and the lacquer is viewed under light of specific wavelength, stresses are indicated by color shading in the lacquer. The presence and intensity of the strains can then be identified and measured on the part(s) or on photographs of the set-up. From such images, it is possible to determine the need for thicker walls, strengthening ribs and other modifications to component design that will enable the part to withstand stresses in service.

Most of these tests have been standardized by the American Society for Testing and Materials (ASTM), and are published in their *Book of Standards* in separate sections for metals, plastics, rubber, and wood. Many of the test methods are also adopted by the American National Standards Institute (ANSI).

Fatigue Properties.—When a material is subjected to many cycles of stress reversal or fluctuation (variation in magnitude without reversal), failure may occur, even though the maximum stress at any cycle is considerably less than the value at which failure would occur if the stress were constant. Fatigue properties are determined by subjecting test specimens to stress cycles and counting the number of cycles to failure. From a series of such tests in which maximum stress values are progressively reduced, S-N diagrams can be

plotted as illustrated by the accompanying figures. The S-N diagram Fig. 2a shows the behavior of a material for which there is an *endurance limit*, S_{en} . Endurance limit is the stress value at which the number of cycles to failure is infinite. Steels have endurance limits that vary according to hardness, composition, and quality; but many non-ferrous metals do not. The S-N diagram Fig. 2b does not have an endurance limit. For a metal that does not have an endurance limit, it is standard practice to specify fatigue strength as the stress value corresponding to a specific number of stress reversals, usually 100,000,000 or 500,000,000.

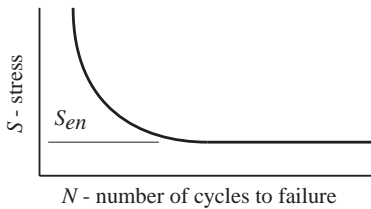


Fig. 2a. S-N endurance limit

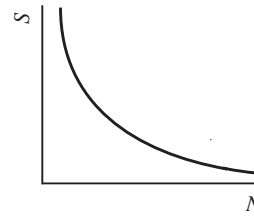


Fig. 2b. S-N no endurance limit

The Influence of Mean Stress on Fatigue.—Most published data on the fatigue properties of metals are for completely reversed alternating stresses, that is, the mean stress of the cycle is equal to zero. However, if a structure is subjected to stresses that fluctuate between different values of tension and compression, then the mean stress is not zero.

When fatigue data for a specified mean stress and design life are not available for a material, the influence of nonzero mean stress can be estimated from empirical relationships that relate failure at a given life, under zero mean stress, to failure at the same life under zero mean cyclic stress. One widely used formula is Goodman's linear relationship,

$$S_a = S(1 - S_m/S_u)$$

where S_a is the alternating stress associated with some nonzero mean stress, S_m . S is the alternating fatigue strength at zero mean stress. S_u is the ultimate tensile strength.

Goodman's linear relationship is usually represented graphically on a so-called *Goodman Diagram*, shown in Fig. 3a. The alternating fatigue strength or the alternating stress for a given number of endurance cycles is plotted on the ordinate (y-axis) and the static tensile strength is plotted on the abscissa (x-axis). The straight line joining the alternating fatigue strength, S , and the tensile strength, S_u , is the Goodman line.

The value of an alternating stress S_{ax} at a known value of mean stress S_{mx} is determined as shown by the dashed lines on the diagram.

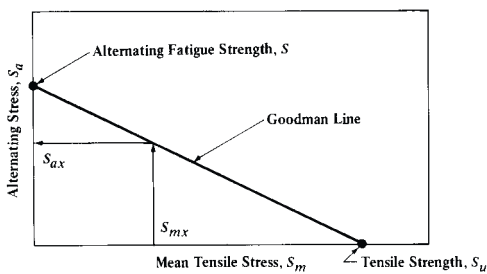


Fig. 3a. Goodman Diagram

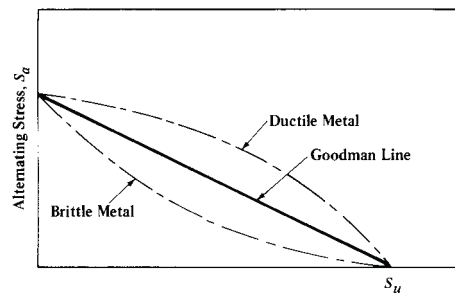


Fig. 3b. Mean Tensile Stress

For ductile materials, the Goodman law is usually conservative, since approximately 90 per cent of actual test data for most ferrous and nonferrous alloys fall above the Goodman line, even at low endurance values where the yield strength is exceeded. For many brittle

materials, however, actual test values can fall below the Goodman line, as illustrated in Fig. 3b

As a rule of thumb, materials having an elongation of less than 5 per cent in a tensile test may be regarded as brittle. Those having an elongation of 5 per cent or more may be regarded as ductile.

Cumulative Fatigue Damage.—Most data are determined from tests at a constant stress amplitude. This is easy to do experimentally, and the data can be presented in a straightforward manner. In actual engineering applications, however, the alternating stress amplitude usually changes in some way during service operation. Such changes, referred to as “spectrum loading,” make the direct use of standard S-N fatigue curves inappropriate. A problem exists, therefore, in predicting the fatigue life under varying stress amplitude from conventional, constant-amplitude S-N fatigue data.

The assumption in predicting spectrum loading effects is that operation at a given stress amplitude and number of cycles will produce a certain amount of permanent fatigue damage and that subsequent operation at different stress amplitude and number of cycles will produce additional fatigue damage and a sequential accumulation of total damage, which at a critical value will cause fatigue failure. Although the assumption appears simple, the amount of damage incurred at any stress amplitude and number of cycles has proven difficult to determine, and several “cumulative damage” theories have been advanced.

One of the first and simplest methods for evaluating cumulative damage is known as Miner's law or the linear damage rule, where it is assumed that n_1 cycles at a stress of S_1 , for which the average number of cycles to failure is N_1 , cause an amount of damage n_1/N_1 . Failure is predicted to occur when

$$\Sigma n/N = 1$$

The term n/N is known as the “cycle ratio” or the damage fraction.

The greatest advantages of the Miner rule are its simplicity and prediction reliability, which approximates that of more complex theories. For these reasons the rule is widely used. It should be noted, however, that it does not account for all influences, and errors are to be expected in failure prediction ability.

Modes of Fatigue Failure.—Several modes of fatigue failure are:

Low/High-Cycle Fatigue: This fatigue process covers cyclic loading in two significantly different domains, with different physical mechanisms of failure. One domain is characterized by relatively low cyclic loads, strain cycles confined largely to the elastic range, and long lives or a high number of cycles to failure; traditionally, this has been called “high-cycle fatigue.” The other domain has cyclic loads that are relatively high, significant amounts of plastic strain induced during each cycle, and short lives or a low number of cycles to failure. This domain has commonly been called “low-cycle fatigue” or cyclic strain-controlled fatigue.

The transition from low- to high-cycle fatigue behavior occurs in the range from approximately 10,000 to 100,000 cycles. Many define low-cycle fatigue as failure that occurs in 50,000 cycles or less.

Thermal Fatigue: Cyclic temperature changes in a machine part will produce cyclic stresses and strains if natural thermal expansions and contractions are either wholly or partially constrained. These cyclic strains produce fatigue failure just as though they were produced by external mechanical loading. When strain cycling is produced by a fluctuating temperature field, the failure process is termed “thermal fatigue.”

While thermal fatigue and mechanical fatigue phenomena are very similar, and can be mathematically expressed by the same types of equations, the use of mechanical fatigue results to predict thermal fatigue performance must be done with care. For equal values of plastic strain range, the number of cycles to failure is usually up to 2.5 times lower for thermally cycled than for mechanically cycled samples.

Corrosion Fatigue: Corrosion fatigue is a failure mode where cyclic stresses and a corrosion-producing environment combine to initiate and propagate cracks in fewer stress cycles and at lower stress amplitudes than would be required in a more inert environment. The corrosion process forms pits and surface discontinuities that act as stress raisers to accelerate fatigue cracking. The cyclic loads may also cause cracking and flaking of the corrosion layer, baring fresh metal to the corrosive environment. Each process accelerates the other, making the cumulative result more serious.

Surface or Contact Fatigue: Surface fatigue failure is usually associated with rolling surfaces in contact, and results in pitting, cracking, and spalling of the contacting surfaces from cyclic Hertz contact stresses that cause the maximum values of cyclic shear stresses to be slightly below the surface. The cyclic subsurface shear stresses generate cracks that propagate to the contacting surface, dislodging particles in the process.

Combined Creep and Fatigue: In this failure mode, all of the conditions for both creep failure and fatigue failure exist simultaneously. Each process influences the other in producing failure, but this interaction is not well understood.

Factors of Safety.—There is always a risk that the working stress to which a member is subjected will exceed the strength of its material. The purpose of a factor of safety is to minimize this risk.

Factors of safety can be incorporated into design calculations in many ways. For most calculations the following equation is used:

$$s_w = S_m / f_s \quad (1)$$

where f_s is the factor of safety, S_m is the strength of the material in pounds per square inch, and s_w is the allowable working stress, also in pounds per square inch. Since the factor of safety is greater than 1, the allowable working stress will be less than the strength of the material.

In general, S_m is based on yield strength for ductile materials, ultimate strength for brittle materials, and fatigue strength for parts subjected to cyclic stressing. Most strength values are obtained by testing standard specimens at 68°F. in normal atmospheres. If, however, the character of the stress or environment differs significantly from that used in obtaining standard strength data, then special data must be obtained. If special data are not available, standard data must be suitably modified.

General recommendations for values of factors of safety are given in the following list.

f_s	Application
1.3-1.5	For use with highly reliable materials where loading and environmental conditions are not severe, and where weight is an important consideration.
1.5-2	For applications using reliable materials where loading and environmental conditions are not severe.
2-2.5	For use with ordinary materials where loading and environmental conditions are not severe.
2.5-3	For less tried and for brittle materials where loading and environmental conditions are not severe.
3-4	For applications in which material properties are not reliable and where loading and environmental conditions are not severe, or where reliable materials are to be used under difficult loading and environmental conditions.

Working Stress.—Calculated working stresses are the products of calculated nominal stress values and stress concentration factors. Calculated nominal stress values are based on the assumption of idealized stress distributions. Such nominal stresses may be simple stresses, combined stresses, or cyclic stresses. Depending on the nature of the nominal stress, one of the following equations applies:

$$s_w = K\sigma \quad (2)$$

$$s_w = K\tau \quad (3)$$

$$s_w = K\sigma' \quad (4)$$

$$s_w = K\tau' \quad (5)$$

$$s_w = K\sigma_{cy} \quad (6)$$

$$s_w = K\tau_{cy} \quad (7)$$

where K is a stress concentration factor; σ and τ are, respectively, simple normal (tensile or compressive) and shear stresses; σ' and τ' are combined normal and shear stresses; σ_{cy} and τ_{cy} are cyclic normal and shear stresses.

Where there is uneven stress distribution, as illustrated in the table (on page 209) of simple stresses for Cases 3, 4 and 6, the maximum stress is the one to which the stress concentration factor is applied in computing working stresses. The location of the maximum stress in each case is discussed under the section *Simple Stresses* and the formulas for these maximum stresses are given in the *Table of Simple Stresses* on page 209.

Stress Concentration Factors.—Stress concentration is related to type of material, the nature of the stress, environmental conditions, and the geometry of parts. When stress concentration factors that specifically match all of the foregoing conditions are not available, the following equation may be used:

$$K = 1 + q(K_t - 1) \quad (8)$$

K_t is a theoretical stress concentration factor that is a function only of the geometry of a part and the nature of the stress; q is the *index of sensitivity* of the material. If the geometry is such as to provide no theoretical stress concentration, $K_t = 1$.

Curves for evaluating K_t are on pages 205 through 208. For constant stresses in cast iron and in ductile materials, $q = 0$ (hence $K = 1$). For constant stresses in brittle materials such as hardened steel, q may be taken as 0.15; for very brittle materials such as steels that have been quenched but not drawn, q may be taken as 0.25. When stresses are suddenly applied (impact stresses) q ranges from 0.4 to 0.6 for ductile materials; for cast iron it is taken as 0.5; and, for brittle materials, 1.

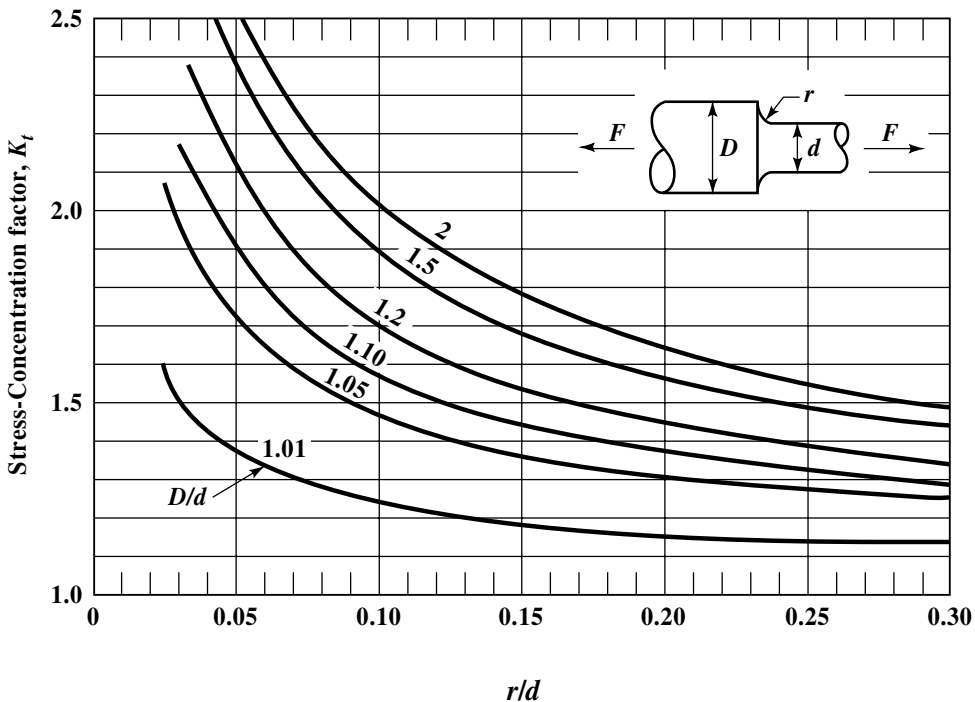


Fig. 4. Stress-concentration factor, K_t , for a filleted shaft in tension

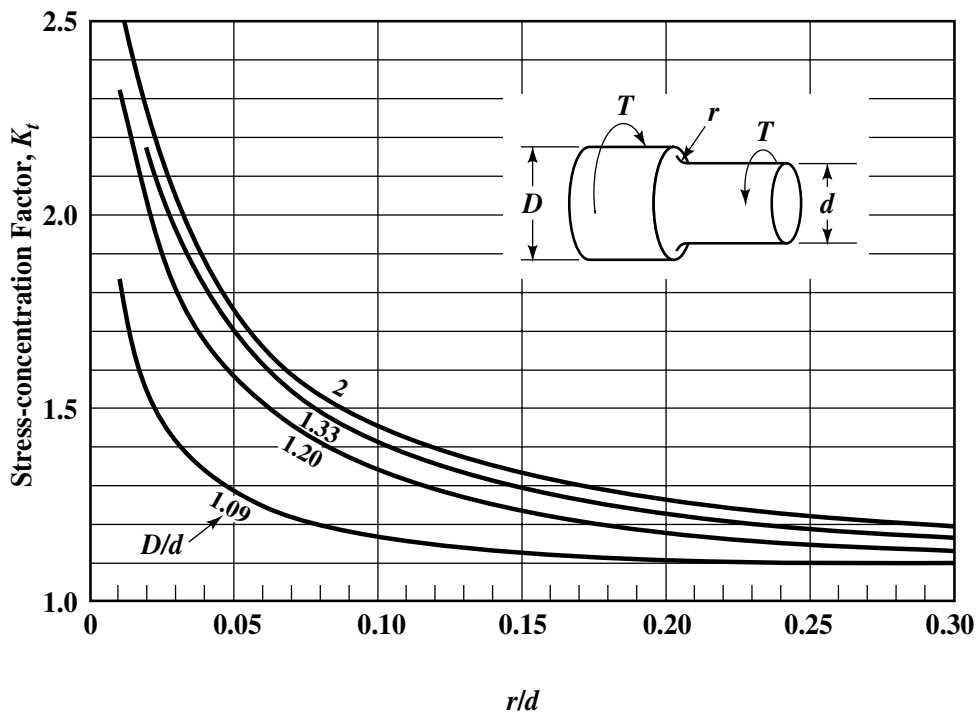


Fig. 5. Stress-concentration factor, K_t , for a filleted shaft in torsion^a

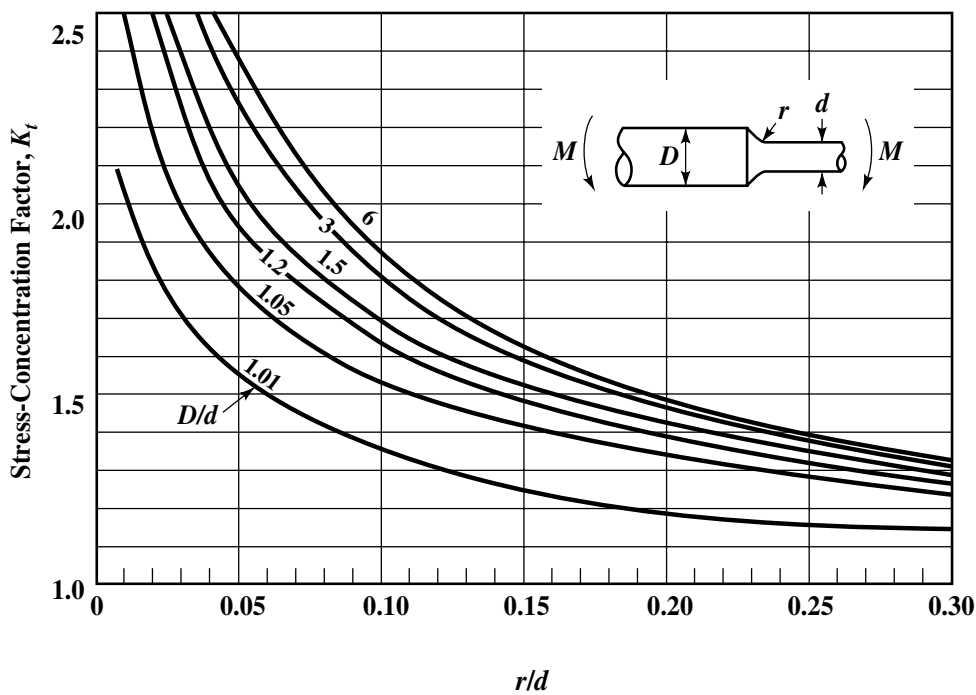


Fig. 6. Stress-concentration factor, K_t , for a shaft with shoulder fillet in bending^a

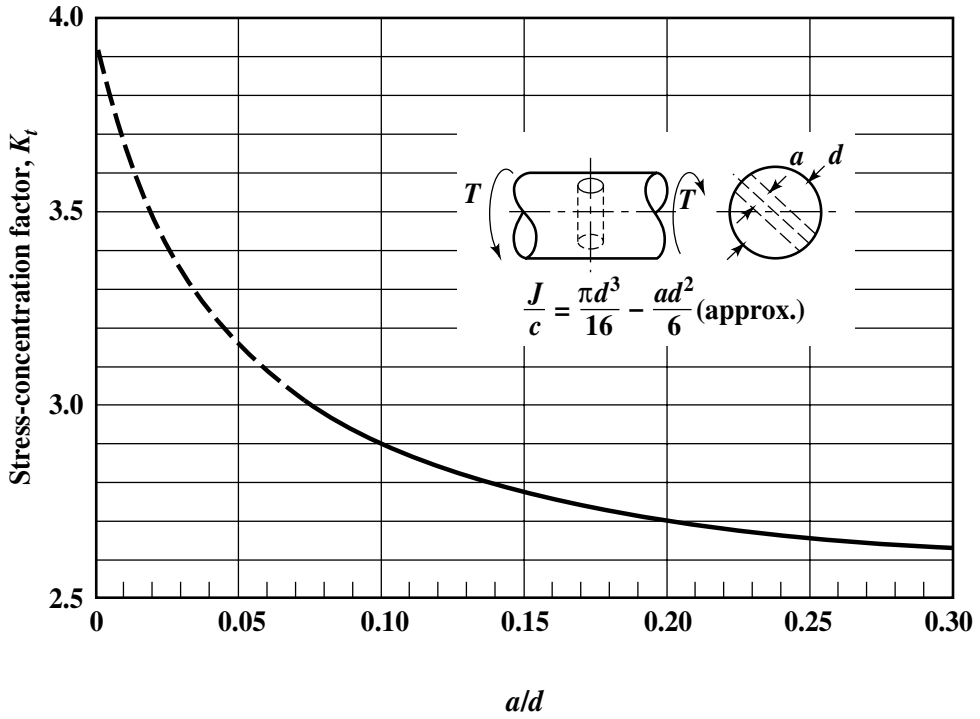


Fig. 7. Stress-concentration factor, K_t , for a shaft, with a transverse hole, in torsion^a

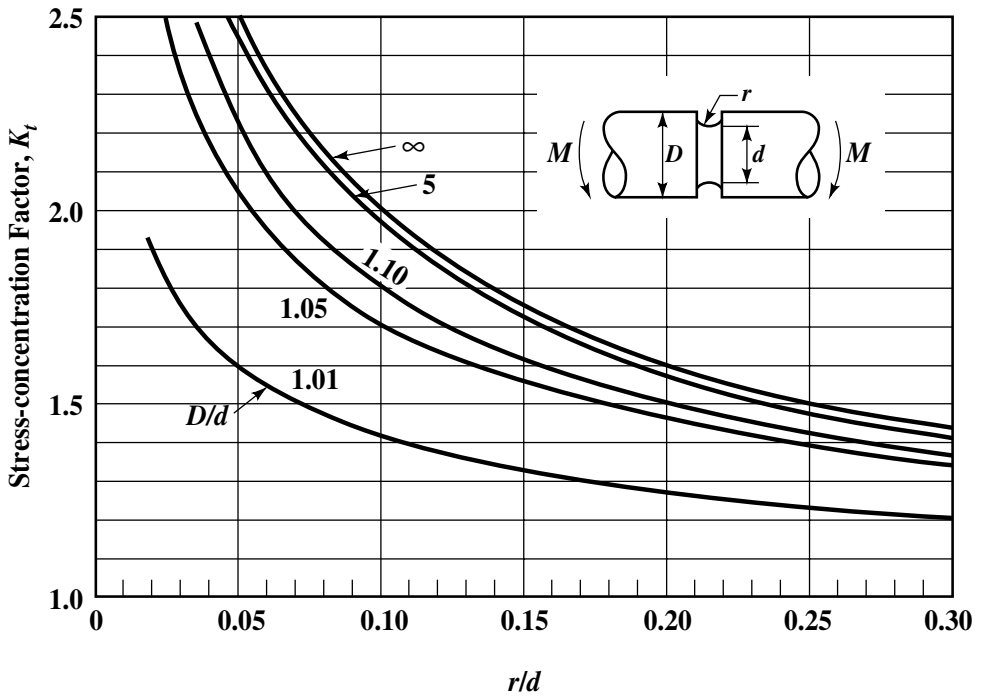


Fig. 8. Stress-concentration factor, K_t , for a grooved shaft in bending^a

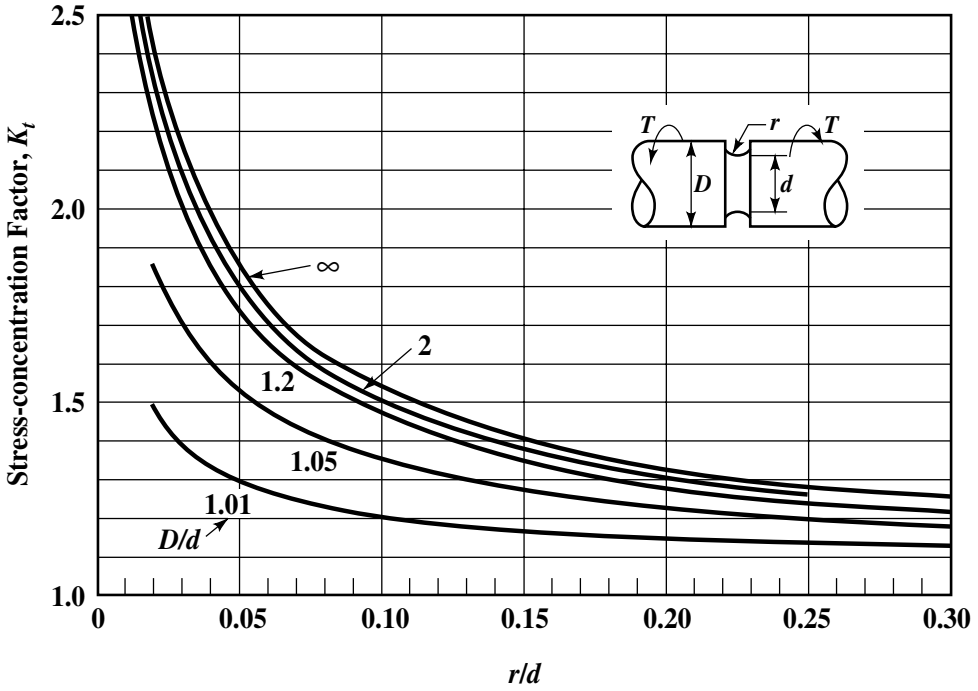


Fig. 9. Stress-concentration factor, K_t , for a grooved shaft in torsion^a

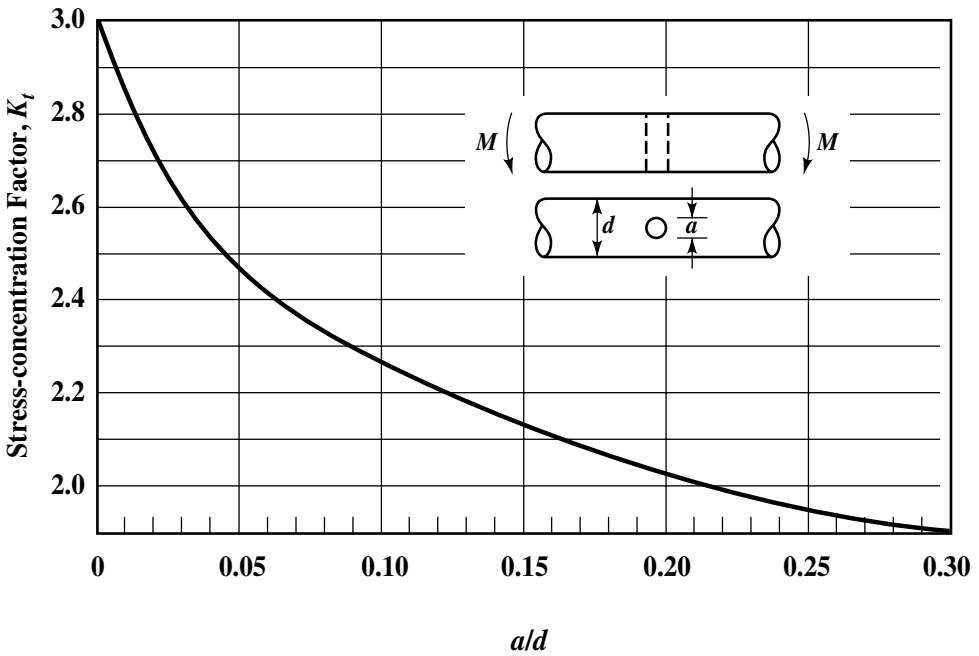
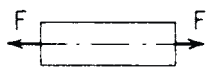
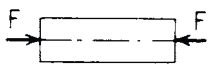
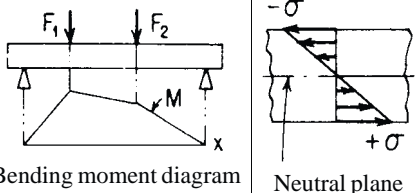
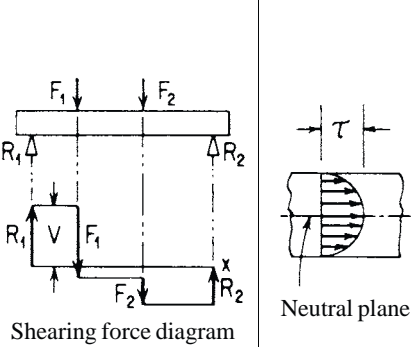
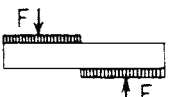

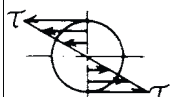


Fig. 10. Stress-concentration factor, K_t , for a shaft, with a transverse hole, in bending^a

^a Source: R. E. Peterson, Design Factors for Stress Concentration, *Machine Design*, vol. 23, 1951. For other stress concentration charts, see Lipson and Juvinall, *The Handbook of Stress and Strength*, The Macmillan Co., 1963.

Simple Stresses.—Simple stresses are produced by constant conditions of loading on elements that can be represented as beams, rods, or bars. The table on page 209 summarizes information pertaining to the calculation of simple stresses. Following is an explanation of the symbols used in simple stress formulae: σ = simple normal (tensile or compressive) stress in pounds per square inch; τ = simple shear stress in pounds per square inch; F = external force in pounds; V = shearing force in pounds; M = bending moment in inch-pounds; T = torsional moment in inch-pounds; A = cross-sectional area in square inches; Z = section modulus in inches³; Z_p = polar section modulus in inches³; I = moment of inertia in inches⁴; J = polar moment of inertia in inches⁴; a = area of the web of wide flange and I beams in square inches; y = perpendicular distance from axis through center of gravity of cross-sectional area to stressed fiber in inches; c = radial distance from center of gravity to stressed fiber in inches.

Table 2. Table of Simple Stresses

Case	Type of Loading	Illustration	Stress Distribution	Stress Equations
1	Direct tension		Uniform	$\sigma = \frac{F}{A}$ (9)
2	Direct compression		Uniform	$\sigma = -\frac{F}{A}$ (10)
3	Bending		Neutral plane	$\sigma = \pm \frac{M}{Z} = \pm \frac{My}{I}$ (11)
4	Shear		Neutral plane	For beams of rectangular cross-section: $\tau = \frac{3V}{2A}$ (12) For beams of solid circular cross-section: $\tau = \frac{4V}{3A}$ (13) For wide flange and I beams (approximately): $\tau = \frac{V}{a}$ (14)
5	Direct shear		Uniform	$\tau = \frac{F}{A}$ (15)
6	Torsion			$\tau = \frac{T}{Z_p} = \frac{Tc}{J}$ (16)

SI metric units can be applied in the calculations in place of the English units of measurement without changes to the formulas. The SI units are the newton (N), which is the unit of force; the meter; the meter squared; the pascal (Pa) which is the

newton per meter squared (N/M^2); and the newton-meter ($\text{N} \cdot \text{m}$) for moment of force. Often in design work using the metric system, the millimeter is employed rather than the meter. In such instances, the dimensions can be converted to meters before the stress calculations are begun. Alternatively, the same formulas can be applied using millimeters in place of the meter, providing the treatment is consistent throughout. In such instances, stress and strength properties must be expressed in megapascals (MPa), which is the same as newtons per millimeter squared (N/mm^2), and moments in newton-millimeters ($\text{N} \cdot \text{mm}^2$). *Note:* $1 \text{ N}/\text{mm}^2 = 1 \text{ N}/10^{-6}\text{m}^2 = 10^6 \text{ N}/\text{m}^2 = 1 \text{ meganewton}/\text{m}^2 = 1 \text{ megapascal}$.

For direct tension and direct compression loading, Cases 1 and 2 in the table on page 209, the force F must act along a line through the center of gravity of the section at which the stress is calculated. The equation for direct compression loading applies only to members for which the ratio of length to least radius of gyration is relatively small, approximately 20, otherwise the member must be treated as a column.

The table *Stresses and Deflections in Beams* starting on page 257 give equations for calculating stresses due to bending for common types of beams and conditions of loading. Where these tables are not applicable, stress may be calculated using Equation (11) in the table on page 209. In using this equation it is necessary to determine the value of the bending moment at the point where the stress is to be calculated. For beams of constant cross-section, stress is ordinarily calculated at the point coinciding with the maximum value of bending moment. Bending loading results in the characteristic stress distribution shown in the table for Case 3. It will be noted that the maximum stress values are at the surfaces farthest from the neutral plane. One of the surfaces is stressed in tension and the other in compression. It is for this reason that the \pm sign is used in Equation (11). Numerous tables for evaluating section moduli are given in the section starting on page 232.

Shear stresses caused by bending have maximum values at neutral planes and zero values at the surfaces farthest from the neutral axis, as indicated by the stress distribution diagram shown for Case 4 in the *Table of Simple Stresses*. Values for V in Equations (12), (13) and (14) can be determined from shearing force diagrams. The shearing force diagram shown in Case 4 corresponds to the bending moment diagram for Case 3. As shown in this diagram, the value taken for V is represented by the greatest vertical distance from the x axis. The shear stress caused by direct shear loading, Case 5, has a uniform distribution. However, the shear stress caused by torsion loading, Case 6, has a zero value at the axis and a maximum value at the surface farthest from the axis.

Deflections.—For direct tension and direct compression loading on members with uniform cross sections, deflection can be calculated using Equation (17). For direct tension loading, e is an elongation; for direct compression loading, e is a contraction. Deflection is in inches when the load F is in pounds, the length L over which deflection occurs is in inches, the cross-sectional area A is in square inches, and the modulus of elasticity E is in pounds per square inch. The angular deflection of members with uniform circular cross sections subject to torsion loading can be calculated with Equation (18).

$$e = FL/AE \qquad (17) \qquad \theta = TL/GJ \qquad (18)$$

The angular deflection θ is in radians when the torsional moment T is in inch-pounds, the length L over which the member is twisted is in inches, the modulus of rigidity G is in pounds per square inch, and the polar moment of inertia J is in inches⁴.

Metric SI units can be used in Equations (17) and (18), where F = force in newtons (N); L = length over which deflection or twisting occurs in meters; A = cross-sectional area in meters squared; E = the modulus of elasticity in (newtons per meter squared); θ = radians; T = the torsional moment in newton-meters (N·m); G = modulus of rigidity, in pascals; and J = the polar moment of inertia in meters⁴. If the load (F) is applied as a weight, it should be noted that the weight of a mass M kilograms is Mg newtons,

where $g = 9.81 \text{ m/s}^2$. Millimeters can be used in the calculations in place of meters, providing the treatment is consistent throughout.

Combined Stresses.—A member may be loaded in such a way that a combination of simple stresses acts at a point. Three general cases occur, examples of which are shown in the accompanying illustration Fig. 11.

Superposition of Stresses: Fig. 11 at (1) illustrates a common situation that results in simple stresses combining by superposition at points **a** and **b**. The equal and opposite forces F_1 will cause a compressive stress $\sigma_1 = -F_1/A$. Force F_2 will cause a bending moment M to exist in the plane of points **a** and **b**. The resulting stress $\sigma_2 = \pm M/Z$. The combined stress at point **a**,

$$\sigma'_a = -\frac{F_1}{A} - \frac{M}{Z} \quad (19) \quad \text{and at } \mathbf{b}, \quad \sigma'_b = -\frac{F_1}{A} + \frac{M}{Z} \quad (20)$$

where the minus sign indicates a compressive stress and the plus sign a tensile stress. Thus, the stress at **a** will be compressive and at **b** either tensile or compressive depending on which term in the equation for σ'_b has the greatest value.

Normal Stresses at Right Angles: This is shown in Fig. 11 at (2). This combination of stresses occurs, for example, in tanks subjected to internal or external pressure. The principle normal stresses are $\sigma_x = F_1/A_1$, $\sigma_y = F_2/A_2$, and $\sigma_z = 0$ in this plane stress problem. Determine the values of these three stresses with their signs, order them algebraically, and then calculate the maximum shear stress:

$$\tau = (\sigma_{\text{largest}} - \sigma_{\text{smallest}})/2 \quad (21)$$

Normal and Shear Stresses: The example in Fig. 11 at (3) shows a member subjected to a torsional shear stress, $\tau = T/Z_p$, and a direct compressive stress, $\sigma = -F/A$. At some point **a** on the member the principal normal stresses are calculated using the equation,

$$\sigma' = \frac{\sigma}{2} \pm \sqrt{\left(\frac{\sigma}{2}\right)^2 + \tau^2} \quad (22)$$

The maximum shear stress is calculated by using the equation,

$$\tau' = \sqrt{\left(\frac{\sigma}{2}\right)^2 + \tau^2} \quad (23)$$

The point **a** should ordinarily be selected where stress is a maximum value. For the example shown in the figure at (3), the point **a** can be anywhere on the cylindrical surface because the combined stress has the same value anywhere on that surface.

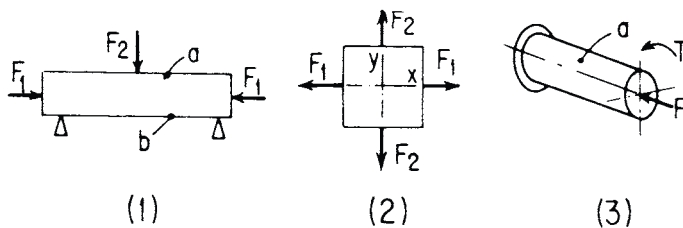


Fig. 11. Types of Combined Loading

Tables of Combined Stresses.—Beginning on page 212, these tables list equations for maximum nominal tensile or compressive (normal) stresses, and maximum nominal shear stresses for common machine elements. These equations were derived using general Equations (19), (20), (22), and (23). The equations apply to the critical points indicated on the

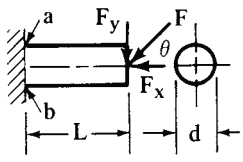
figures. Cases 1, 2, 3, and 4 are cantilever beams. These may be loaded with a combination of a vertical and horizontal force, or by a single oblique force. If the single oblique force F and the angle θ are given, then horizontal and vertical forces can be calculated using the equations $F_x = F \cos \theta$ and $F_y = F \sin \theta$. In cases 9 and 10 of the table, the equations for σ'_a can give a tensile and a compressive stress because of the \pm sign in front of the radical. Equations involving direct compression are valid only if machine elements have relatively short lengths with respect to their sections, otherwise column equations apply.

Calculation of Worst Stress Condition: Stress failure can occur at any critical point if either the tensile, compressive, or shear stress properties of the material are exceeded by the corresponding working stress. It is necessary to evaluate the factor of safety for each possible failure condition.

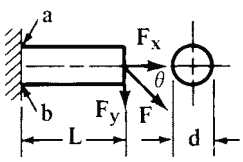
The following rules apply to calculations using equations in the *Table of Simple Stresses* on page 209, and to calculations based on Equations (19) and (20). *Rule 1:* For every calculated normal stress there is a corresponding induced shear stress; the value of the shear stress is equal to half that of the normal stress. *Rule 2:* For every calculated shear stress there is a corresponding induced normal stress; the value of the normal stress is equal to that of the shear stress. The tables of combined stress formulas, below, include equations for calculating both maximum nominal tensile or compressive stresses, and maximum nominal shear stresses.

Formulas for Combined Stresses

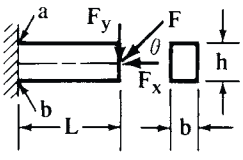
(1) Circular Cantilever Beam in Direct Compression and Bending:

Type of Beam and Loading	Maximum Nominal Tensile or Compressive Stress	Maximum Nominal Shear Stress
	$\sigma'_a = \frac{1.273}{d^2} \left(\frac{8LF_y}{d} - F_x \right)$ $\sigma'_b = -\frac{1.273}{d^2} \left(\frac{8LF_y}{d} + F_x \right)$	$\tau'_a = 0.5\sigma'_a$ $\tau'_b = 0.5\sigma'_b$

(2) Circular Cantilever Beam in Direct Tension and Bending:

Type of Beam and Loading	Maximum Nominal Tensile or Compressive Stress	Maximum Nominal Shear Stress
	$\sigma'_a = \frac{1.273}{d^2} \left(F_x + \frac{8LF_y}{d} \right)$ $\sigma'_b = \frac{1.273}{d^2} \left(F_x - \frac{8LF_y}{d} \right)$	$\tau'_a = 0.5\sigma'_a$ $\tau'_b = 0.5\sigma'_b$

(3) Rectangular Cantilever Beam in Direct Compression and Bending:

Type of Beam and Loading	Maximum Nominal Tensile or Compressive Stress	Maximum Nominal Shear Stress
	$\sigma'_a = \frac{1}{bh} \left(\frac{6LF_y}{h} - F_x \right)$ $\sigma'_b = -\frac{1}{bh} \left(\frac{6LF_y}{h} + F_x \right)$	$\tau'_a = 0.5\sigma'_a$ $\tau'_b = 0.5\sigma'_b$

(4) Rectangular Cantilever Beam in Direct Tension and Bending:

Type of Beam and Loading	Maximum Nominal Tensile or Compressive Stress	Maximum Nominal Shear Stress
	$\sigma'_a = \frac{1}{bh} \left(F_x + \frac{6LF_y}{h} \right)$ $\sigma'_b = \frac{1}{bh} \left(F_x - \frac{6LF_y}{h} \right)$	$\tau'_a = 0.5\sigma'_a$ $\tau'_b = 0.5\sigma'_b$

(5) Circular Beam or Shaft in Direct Compression and Bending:

Type of Beam and Loading	Maximum Nominal Tensile or Compressive Stress	Maximum Nominal Shear Stress
	$\sigma'_a = -\frac{1.273}{d^2} \left(\frac{2LF_y}{d} + F_x \right)$ $\sigma'_b = \frac{1.273}{d^2} \left(\frac{2LF_y}{d} - F_x \right)$	$\tau'_a = 0.5\sigma'_a$ $\tau'_b = 0.5\sigma'_b$

(6) Circular Beam or Shaft in Direct Tension and Bending:

Type of Beam and Loading	Maximum Nominal Tensile or Compressive Stress	Maximum Nominal Shear Stress
	$\sigma'_a = \frac{1.273}{d^2} \left(F_x - \frac{2LF_y}{d} \right)$ $\sigma'_b = \frac{1.273}{d^2} \left(F_x + \frac{2LF_y}{d} \right)$	$\tau'_a = 0.5\sigma'_a$ $\tau'_b = 0.5\sigma'_b$

(7) Rectangular Beam or Shaft in Direct Compression and Bending:

Type of Beam and Loading	Maximum Nominal Tensile or Compressive Stress	Maximum Nominal Shear Stress
	$\sigma'_a = -\frac{1}{bh} \left(\frac{3LF_y}{2h} + F_x \right)$ $\sigma'_b = \frac{1}{bh} \left(-\frac{3LF_y}{2h} - F_x \right)$	$\tau'_a = 0.5\sigma'_a$ $\tau'_b = 0.5\sigma'_b$

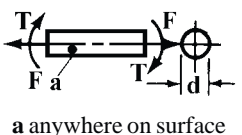
(8) Rectangular Beam or Shaft in Direct Tension and Bending:

Type of Beam and Loading	Maximum Nominal Tensile or Compressive Stress	Maximum Nominal Shear Stress
	$\sigma'_a = \frac{1}{bh} \left(F_x - \frac{3LF_y}{2h} \right)$ $\sigma'_b = \frac{1}{bh} \left(F_x + \frac{3LF_y}{2h} \right)$	$\tau'_a = 0.5\sigma'_a$ $\tau'_b = 0.5\sigma'_b$

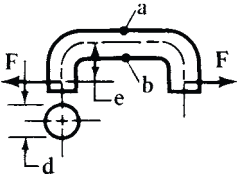
(9) Circular Shaft in Direct Compression and Torsion:

Type of Beam and Loading	Maximum Nominal Tensile or Compressive Stress	Maximum Nominal Shear Stress
<p>a anywhere on surface</p>	$\sigma'_a = -\frac{0.637}{d^2} \left[F_x \pm \sqrt{F_y^2 + \left(\frac{8T}{d} \right)^2} \right]$	$\tau'_a = -\frac{0.637}{d^2} \sqrt{F_y^2 + \left(\frac{8T}{d} \right)^2}$

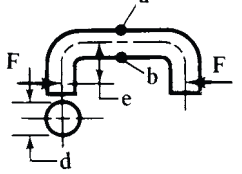
(10) Circular Shaft in Direct Tension and Torsion:

Type of Beam and Loading	Maximum Nominal Tensile or Compressive Stress	Maximum Nominal Shear Stress
 <p>a anywhere on surface</p>	$\sigma'_a = \frac{0.637}{d^2} \left[F \pm \sqrt{F^2 + \left(\frac{8T}{d} \right)^2} \right]$	$\tau'_a = \frac{0.637}{d^2} \sqrt{F^2 + \left(\frac{8T}{d} \right)^2}$

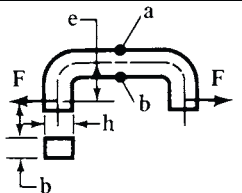
(11) Offset Link, Circular Cross Section, in Direct Tension:

Type of Beam and Loading	Maximum Nominal Tensile or Compressive Stress	Maximum Nominal Shear Stress
	$\sigma'_a = \frac{1.273F}{d^2} \left(1 - \frac{8e}{d} \right)$ $\sigma'_b = \frac{1.273F}{d^2} \left(1 + \frac{8e}{d} \right)$	$\tau'_a = 0.5\sigma'_a$ $\tau'_b = 0.5\sigma'_b$

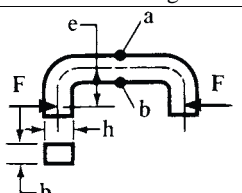
(12) Offset Link, Circular Cross Section, in Direct Compression:

Type of Beam and Loading	Maximum Nominal Tensile or Compressive Stress	Maximum Nominal Shear Stress
	$\sigma'_a = \frac{1.273F}{d^2} \left(\frac{8e}{d} - 1 \right)$ $\sigma'_b = -\frac{1.273F}{d^2} \left(\frac{8e}{d} + 1 \right)$	$\tau'_a = 0.5\sigma'_a$ $\tau'_b = 0.5\sigma'_b$

(13) Offset Link, Rectangular Section, in Direct Tension:

Type of Beam and Loading	Maximum Nominal Tensile or Compressive Stress	Maximum Nominal Shear Stress
	$\sigma'_a = \frac{F}{bh} \left(1 - \frac{6e}{h} \right)$ $\sigma'_b = \frac{F}{bh} \left(1 + \frac{6e}{h} \right)$	$\tau'_a = 0.5\sigma'_a$ $\tau'_b = 0.5\sigma'_b$

(14) Offset Link, Rectangular Section, in Direct Compression:

Type of Beam and Loading	Maximum Nominal Tensile or Compressive Stress	Maximum Nominal Shear Stress
	$\sigma'_a = \frac{F}{bh} \left(\frac{6e}{h} - 1 \right)$ $\sigma'_b = -\frac{F}{bh} \left(\frac{6e}{h} + 1 \right)$	$\tau'_a = 0.5\sigma'_a$ $\tau'_b = 0.5\sigma'_b$

Formulas from the simple and combined stress tables, as well as tension and shear factors, can be applied without change in calculations using metric SI units. Stresses are given in newtons per meter squared (N/m²) or in N/mm².

Three-Dimensional Stress.—Three-dimensional or triaxial stress occurs in assemblies such as a shaft press-fitted into a gear bore or in pipes and cylinders subjected to internal or external fluid pressure. Triaxial stress also occurs in two-dimensional stress problems if the loads produce normal stresses that are either both tensile or both compressive. In either case the calculated maximum shear stress, based on the corresponding two-dimensional theory, will be less than the true maximum value because of three-dimensional effects. Therefore, if the stress analysis is to be based on the maximum-shear-stress theory of failure, the triaxial stress cubic equation should first be used to calculate the three principal stresses and from these the true maximum shear stress. The following procedure provides the principal maximum normal tensile and compressive stresses and the true maximum shear stress at any point on a body subjected to any combination of loads.

The basis for the procedure is the stress cubic equation

$$S^3 - AS^2 + BS - C = 0$$

in which:

$$A = S_x + S_y + S_z$$

$$B = S_x S_y + S_y S_z + S_z S_x - S_{xy}^2 - S_{yz}^2 - S_{zx}^2$$

$$C = S_x S_y S_z + 2S_{xy} S_{yz} S_{zx} - S_x S_{yz}^2 - S_y S_{zx}^2 - S_z S_{xy}^2$$

and $S_x, S_y,$ etc., are as shown in Fig. 12.

The coordinate system XYZ in Fig. 12 shows the positive directions of the normal and shear stress components on an elementary cube of material. Only six of the nine components shown are needed for the calculations: the normal stresses $S_x, S_y,$ and S_z on three of the faces of the cube; and the three shear stresses $S_{xy}, S_{yz},$ and S_{zx} . The remaining three shear stresses are known because $S_{yx} = S_{xy}, S_{zy} = S_{yz},$ and $S_{xz} = S_{zx}$. The normal stresses $S_x, S_y,$ and S_z are shown as positive (tensile) stresses; the opposite direction is negative (compressive). The first subscript of each shear stress identifies the coordinate axis perpendicular to the plane of the shear stress; the second subscript identifies the axis to which the stress is parallel. Thus, S_{xy} , is the shear stress in the YZ plane to which the X axis is perpendicular, and the stress is parallel to the Y axis.

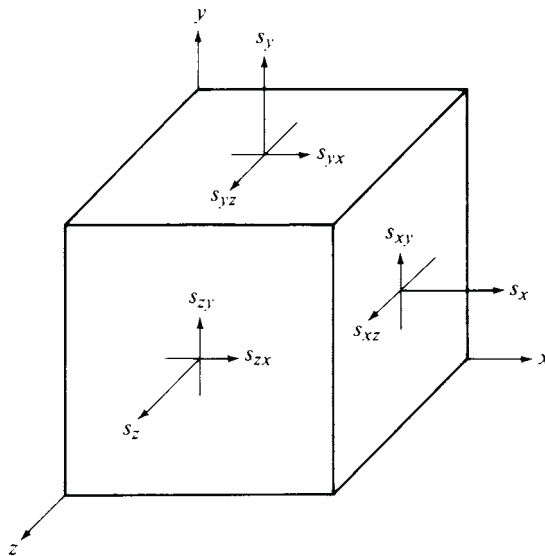


Fig. 12. XYZ Coordinate System Showing Positive Directions of Stresses

Step 1. Draw a diagram of the hardware to be analyzed, such as the shaft shown in Fig. 13, and show the applied loads $P, T,$ and any others.

Step 2. For any point at which the stresses are to be analyzed, draw a coordinate diagram similar to Fig. 12 and show the magnitudes of the stresses resulting from the applied loads (these stresses may be calculated by using standard basic equations from strength of materials, and should include any stress concentration factors).

Step 3. Substitute the values of the six stresses S_x , S_y , S_z , S_{xy} , S_{yz} , and S_{zx} , including zero values, into the formulas for the quantities A through K . The quantities I , J , and K represent the principal normal stresses at the point analyzed. As a check, if the algebraic sum $I + J + K$ equals A , within rounding errors, then the calculations up to this point should be correct.

$$D = A^2/3 - B \quad E = A \times B/3 - C - 2 \times A^3/27$$

$$F = \sqrt{(D^3/27)} \quad G = \arccos(-E/(2 \times F))$$

$$H = \sqrt{(D/3)} \quad I = 2 \times H \times \cos(G/3) + A/3$$

$$J = 2 \times H \times [\cos(G/3 + 120^\circ)] + A/3 \quad K = 2 \times H \times [\cos(G/3 + 240^\circ)] + A/3$$

Step 4. Calculate the true maximum shear stress, $S_{s(\max)}$ using the formula

$$S_{s(\max)} = 0.5 \times (S_{\text{large}} - S_{\text{small}})$$

in which S_{large} is equal to the algebraically largest of the calculated principal stresses I , J , or K and S_{small} is algebraically the smallest.

The maximum principal normal stresses and the maximum true shear stress calculated above may be used with any of the various theories of failure.

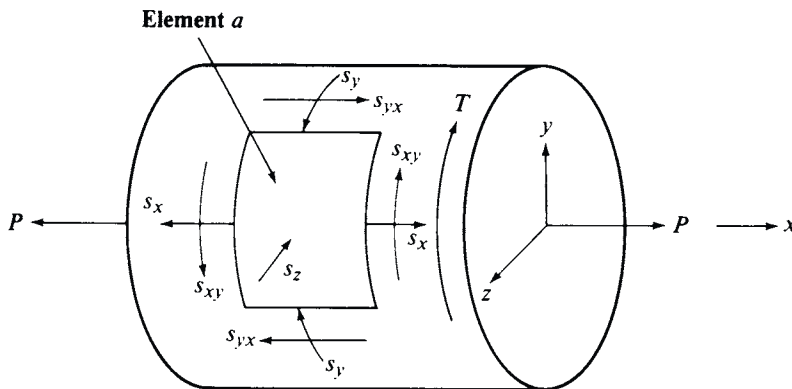


Fig. 13. Example of Triaxial Stress on an Element a of Shaft Surface Caused by Load P , Torque T , and 5000 psi Hydraulic Pressure

Example: A torque T on the shaft in Fig. 13 causes a shearing stress S_{xy} of 8000 psi in the outer fibers of the shaft; and the loads P at the ends of the shaft produce a tensile stress S_x of 4000 psi. The shaft passes through a hydraulic cylinder so that the shaft circumference is subjected to the hydraulic pressure of 5000 psi in the cylinder, causing compressive stresses S_y and S_z of -5000 psi on the surface of the shaft. Find the maximum shear stress at any point A on the surface of the shaft.

From the statement of the problem $S_x = +4000$ psi, $S_y = -5000$ psi, $S_z = -5000$ psi, $S_{xy} = +8000$ psi, $S_{yz} = 0$ psi, and $S_{zx} = 0$ psi.

$$A = 4000 - 5000 - 5000 = -6000$$

$$B = (4000 \times -5000) + (-5000 \times -5000) + (-5000 \times 4000) - 8000^2 - 0^2 - 0^2 = -7.9 \times 10^7$$

$$C = (4000 \times -5000 \times -5000) + 2 \times 8000 \times 0 \times 0 - (4000 \times 0^2) - (-5000 \times 0^2) - (-5000 \times 8000^2) = 4.2 \times 10^{11}$$

$$D = A^2/3 - B = 9.1 \times 10^7 \quad E = A \times B/3 - C - 2 \times A^3/27 = -2.46 \times 10^{11}$$

$$F = \sqrt{(D^3/27)} = 1.6706 \times 10^{11} \quad G = \arccos(-E/(2 \times F)) = 42.586 \text{ degrees}$$

$$H = \sqrt{(D/3)} = 5507.57 \quad I = 2 \times H \times \cos(G/3 + A/3 = 8678.8, \text{ say, } 8680 \text{ psi}$$

$$J = 2 \times H \times [\cos(G/3 + 120^\circ)] + A/3 = -9678.78, \text{ say, } -9680 \text{ psi}$$

$$K = 2 \times H [\cos(G/3 + 240^\circ)] + A/3 = -5000 \text{ psi}$$

Check: $8680 + (-9680) + (-5000) = -6000$ within rounding error.

$$S_{s(\max)} = 0.5 \times (8680 - (-9680)) = 9180 \text{ psi}$$

Sample Calculations.—The following examples illustrate some typical strength of materials calculations, using both English and metric SI units of measurement.

Example 1(a): A round bar made from SAE 1025 low carbon steel is to support a direct tension load of 50,000 pounds. Using a factor of safety of 4, and assuming that the stress concentration factor $K = 1$, a suitable standard diameter is to be determined. Calculations are to be based on a yield strength of 40,000 psi.

Because the factor of safety and strength of the material are known, the allowable working stress s_w may be calculated using Equation (1): $40,000/4 = 10,000$ psi. The relationship between working stress s_w and nominal stress σ is given by Equation (2). Since $K = 1$, $\sigma = 10,000$ psi. Applying Equation (9) in the *Table of Simple Stresses*, the area of the bar can be solved for: $A = 50,000/10,000$ or 5 square inches. The next largest standard diameter corresponding to this area is $2\frac{9}{16}$ inches.

Example 1(b): A similar example to that given in 1(a), using metric SI units is as follows. A round steel bar of 300 meganewtons/meter² yield strength, is to withstand a direct tension of 200 kilonewtons. Using a safety factor of 4, and assuming that the stress concentration factor $K = 1$, a suitable diameter is to be determined.

Because the factor of safety and the strength of the material are known, the allowable working stress s_w may be calculated using Equation (1): $300/4 = 75$ mega-newtons/meter². The relationship between working stress and nominal stress σ is given by Equation (2). Since $K = 1$, $\sigma = 75$ MN/m². Applying Equation (9) in the *Table of Simple Stresses* on page 209, the area of the bar can be determined from:

$$A = \frac{200 \text{ kN}}{75 \text{ MN/m}^2} = \frac{200,000 \text{ N}}{75,000,000 \text{ N/m}^2} = 0.00267 \text{ m}^2$$

The diameter corresponding to this area is 0.058 meters, or approximately 0.06 m.

Millimeters can be employed in the calculations in place of meters, providing the treatment is consistent throughout. In this instance the diameter would be 60 mm.

Note: If the tension in the bar is produced by hanging a mass of M kilograms from its end, the value is Mg newtons, where g = approximately 9.81 meters per second².

Example 2(a): What would the total elongation of the bar in Example 1(a) be if its length were 60 inches? Applying Equation (17),

$$e = \frac{50,000 \times 60}{5.157 \times 30,000,000} = 0.019 \text{ inch}$$

Example 2(b): What would be the total elongation of the bar in Example 1(b) if its length were 1.5 meters? The problem is solved by applying Equation (17) in which $F = 200$ kilonewtons; $L = 1.5$ meters; $A = \pi 0.06^2/4 = 0.00283$ m². Assuming a modulus of elasticity E of 200 giganewtons/meter², then the calculation is:

$$e = \frac{200,000 \times 1.5}{0.00283 \times 200,000,000,000} = 0.000530 \text{ m}$$

The calculation is less unwieldy if carried out using millimeters in place of meters; then $F = 200$ kN; $L = 1500$ mm; $A = 2830$ mm², and $E = 200,000$ N/mm². Thus:

$$e = \frac{200,000 \times 1500}{2830 \times 200,000} = 0.530 \text{ mm}$$

Example 3(a): Determine the size for the section of a square bar which is to be held firmly at one end and is to support a load of 3000 pounds at the outer end. The bar is to be 30 inches long and is to be made from SAE 1045 medium carbon steel with a yield point of 60,000 psi. A factor of safety of 3 and a stress concentration factor of 1.3 are to be used.

From **Equation (1)** the allowable working stress $s_w = 60,000/3 = 20,000$ psi. The applicable equation relating working stress and nominal stress is **Equation (2)**; hence, $\sigma = 20,000/1.3 = 15,400$ psi. The member must be treated as a cantilever beam subject to a bending moment of 30×3000 or 90,000 inch-pounds. Solving **Equation (11)** in the *Table of Simple Stresses* for section modulus: $Z = 90,000/15,400 = 5.85$ inch³. The section modulus for a square section with neutral axis equidistant from either side is $a^3/6$, where a is the dimension of the square, so $a = \sqrt[3]{35.1} = 3.27$ inches. The bar size can be $3\frac{5}{16}$ inches.

Example 3(b): A similar example to that given in **Example 3(a)**, using metric SI units is as follows. Determine the size for the section of a square bar which is to be held firmly at one end and is to support a load of 1600 kilograms at the outer end. The bar is to be 1 meter long, and is to be made from steel with a yield strength of 500 newtons/mm². A factor of safety of 3, and a stress concentration factor of 1.3 are to be used. The calculation can be performed using millimeters throughout.

From **Equation (1)** the allowable working stress $s_w = 500 \text{ N/mm}^2/3 = 167 \text{ N/mm}^2$. The formula relating working stress and nominal stress is **Equation (2)**; hence $\sigma = 167/1.3 = 128 \text{ N/mm}^2$. Since a mass of 1600 kg equals a weight of 1600 g newtons, where $g = 9.81$ meters/second², the force acting on the bar is 15,700 newtons. The bending moment on the bar, which must be treated as a cantilever beam, is thus $1000 \text{ mm} \times 15,700 \text{ N} = 15,700,000 \text{ N} \cdot \text{mm}$. Solving **Equation (11)** in the *Table of Simple Stresses* for section modulus: $Z = M/\sigma = 15,700,000/128 = 123,000 \text{ mm}^3$. Since the section modulus for a square section with neutral axis equidistant from either side is $a^3/6$, where a is the dimension of the square,

$$a = \sqrt[3]{6 \times 123,000} = 90.4 \text{ mm}$$

Example 4(a): Find the working stress in a 2-inch diameter shaft through which a transverse hole $\frac{1}{4}$ inch in diameter has been drilled. The shaft is subject to a torsional moment of 80,000 inch-pounds and is made from hardened steel so that the index of sensitivity $q = 0.2$.

The polar section modulus is calculated using the equation shown in the stress concentration curve for a Round Shaft in Torsion with Transverse Hole, **Fig. 7**, page 207.

$$\frac{J}{c} = Z_p = \frac{\pi \times 2^3}{16} - \frac{2^2}{4 \times 6} = 1.4 \text{ inches}^3$$

The nominal shear stress due to torsion loading is computed using **Equation (16)** in the *Table of Simple Stresses*: $\tau = 80,000/1.4 = 57,200$ psi

Referring to the previously mentioned stress concentration curve on page 207, K_t is 2.82 since d/D is 0.125. The stress concentration factor may now be calculated by means of **Equation (8)**: $K = 1 + 0.2(2.82 - 1) = 1.36$. Working stress calculated with **Equation (3)** is $s_w = 1.36 \times 57,200 = 77,800$ psi.

Example 4(b): A similar example to that given in **4(a)**, using metric SI units is as follows. Find the working stress in a 50 mm diameter shaft through which a transverse hole 6 mm in diameter has been drilled. The shaft is subject to a torsional moment of 8000 newton-meters, and has an index of sensitivity of $q = 0.2$. If the calculation is made in millimeters, the torsional moment is 8,000,000 N · mm.

The polar section modulus is calculated using the equation shown in the stress concentration curve for a Round Shaft in Torsion with Transverse Hole, **Fig. 7**, page 207:

$$\frac{J}{c} = Z_p = \frac{\pi \times 50^3}{16} - \frac{6 \times 50^2}{6} = 24,544 - 2500 = 22,044 \text{ mm}^3$$

The nominal shear stress due to torsion loading is computed using **Equation (16)** in the *Table of Simple Stresses*:

$$\tau = 8,000,000/22,000 = 363 \text{ N/mm}^2 = 363 \text{ megapascals}$$

Referring to the previously mentioned stress concentration curve on page 207, K_t is 2.85, since $ad = 6/50 = 0.12$. The stress concentration factor may now be calculated by means of **Equation (8)**: $K = 1 + 0.2(2.85 - 1) = 1.37$. From **Equation (3)**, working stress $s_w = 1.37 \times 363 = 497 \text{ N/mm}^2 = 497 \text{ megapascals}$.

Example 5(a): For Case 3 in the *Tables of Combined Stresses*, calculate the least factor of safety for a 5052-H32 aluminum beam is 10 inches long, one inch wide, and 2 inches high. Yield strengths are 23,000 psi tension; 21,000 psi compression; 13,000 psi shear. The stress concentration factor is 1.5; F_y is 600 lbs; F_x 500 lbs.

From *Tables of Combined Stresses*, Case 3:

$$\sigma_b' = -\frac{1}{1 \times 2} \left(\frac{6 \times 10 \times 600}{2} + 500 \right) = -9250 \text{ psi (in compression)}$$

The other formulas for Case 3 give $\sigma_a' = 8750 \text{ psi}$ (in tension); $\tau_a' = 4375 \text{ psi}$, and $\tau_b' = 4625 \text{ psi}$. Using **Equation (4)** for the nominal compressive stress of 9250 psi: $S_w = 1.5 \times 9250 = 13,900 \text{ psi}$. From **Equation (1)** $f_s = 21,000/13,900 = 1.51$. Applying **Equations (1)**, **(4)** and **(5)** in appropriate fashion to the other calculated nominal stress values for tension and shear will show that the factor of safety of 1.51, governed by the compressive stress at b on the beam, is minimum.

Example 5(b): What maximum F can be applied in Case 3 if the aluminum beam is 200 mm long; 20 mm wide; 40 mm high; $\theta = 30^\circ$; $f_s = 2$, governing for compression, $K = 1.5$, and $S_m = 144 \text{ N/mm}^2$ for compression.

From **Equation (1)** $S_w = -144 \text{ N/mm}^2$. Therefore, from **Equation (4)**, $\sigma_b' = -72/1.5 = -48 \text{ N/mm}^2$. Since $F_x = F \cos 30^\circ = 0.866F$, and $F_y = F \sin 30^\circ = 0.5F$:

$$-48 = -\frac{1}{20 \times 40} \left(0.866F + \frac{6 \times 200 \times 0.5F}{40} \right) \quad F = 2420 \text{ N}$$

Stresses and Deflections in a Loaded Ring.—For *thin* rings, that is, rings in which the dimension d shown in the accompanying diagram is small compared with D , the maximum stress in the ring is due primarily to bending moments produced by the forces P . The maximum stress due to bending is:

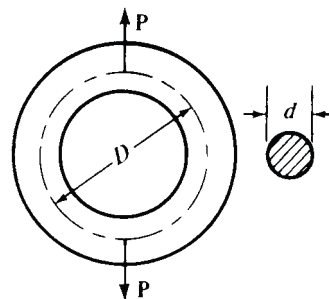
$$S = \frac{PDd}{4\pi I} \tag{24}$$

For a ring of circular cross section where d is the diameter of the bar from which the ring is made,

$$S = \frac{1.621PD}{d^3} \quad \text{or} \quad P = \frac{0.617Sd^3}{D} \tag{25}$$

The increase in the vertical diameter of the ring due to load P is:

$$\text{Increase in vertical diameter} = \frac{0.0186PD^3}{EI} \text{ inches} \tag{26}$$



The *decrease* in the horizontal diameter will be about 92% of the increase in the vertical diameter given by **Formula (26)**. In the above formulas, P = load on ring in pounds; D = mean diameter of ring in inches; S = tensile stress in pounds per square inch, I = moment of inertia of section in inches⁴; and E = modulus of elasticity of material in pounds per square inch.

Strength of Taper Pins.—The mean diameter of taper pin required to safely transmit a known torque, may be found from the formulas:

$$d = 1.13 \sqrt{\frac{T}{DS}} \quad (27) \quad \text{and} \quad d = 283 \sqrt{\frac{HP}{NDS}} \quad (28a)$$

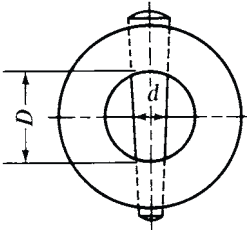
in which formulas T = torque in inch-pounds; S = safe unit stress in pounds per square inch; HP = horsepower transmitted; N = number of revolutions per minute; and d and D denote dimensions shown in the figure.

Formula (27) can be used with metric SI units where d and D denote dimensions shown in the figure in millimeters; T = torque in newton-millimeters ($N \cdot \text{mm}$); and S = safe unit stress in newtons per millimeter² (N/mm^2). **Formula (28a)** is replaced by:

$$d = 110.3 \sqrt{\frac{\text{Power}}{NDS}} \quad (28b)$$

where d and D denote dimensions shown in the figure in millimeters; S = safe unit stress in N/mm^2 ; N = number of revolutions per minute, and Power = power transmitted in watts.

Example 6(a): A lever secured to a 2-inch round shaft by a steel tapered pin (dimension $d = \frac{3}{8}$ inch) has a pull of 50 pounds at a 30-inch radius from shaft center. Find S , the unit working stress on the pin. By rearranging **Formula (27)**:



$$S = \frac{1.27T}{Dd^2} = \frac{1.27 \times 50 \times 30}{2 \times \left(\frac{3}{8}\right)^2} \cong 6770 \text{ psi}$$

6770 pounds per square inch is a safe unit working stress for machine steel in shear.

Let $P = 50$ pounds, $R = 30$ inches, $D = 2$ inches, and $S = 6000$ pounds unit working stress. Using **Formula (27)** to find d :

$$d = 1.13 \sqrt{\frac{T}{DS}} = 1.13 \sqrt{\frac{50 \times 30}{2 \times 6000}} = 1.13 \sqrt{\frac{1}{8}} = 0.4 \text{ inch}$$

Example 6(b): A similar example using SI units is as follows: A lever secured to a 50 mm round shaft by a steel tapered pin ($d = 10$ mm) has a pull of 200 newtons at a radius of 800 mm. Find S , the working stress on the pin. By rearranging **Formula (27)**:

$$S = \frac{1.27T}{Dd^2} = \frac{1.27 \times 200 \times 800}{50 \times 10^2} = 40.6 \text{ N/mm}^2 = 40.6 \text{ megapascals}$$

If a shaft of 50 mm diameter is to transmit power of 12 kilowatts at a speed of 500 rpm, find the mean diameter of the pin for a material having a safe unit stress of 40 N/mm^2 . Using **Equation (28b)**:

$$\begin{aligned} d &= 110.3 \sqrt{\frac{\text{Power}}{NDS}} & \text{then } d &= 110.3 \sqrt{\frac{12,000}{500 \times 50 \times 40}} \\ &= 110.3 \times 0.1096 = 12.09 \text{ mm} \end{aligned}$$

PROPERTIES OF BODIES

Center of Gravity

Center of Gravity.—The center of gravity of a body, volume, area, or line is that point at which if the body, volume, area, or line were suspended it would be perfectly balanced in all positions. For symmetrical bodies of uniform material it is at the geometric center. The center of gravity of a uniform round rod, for example, is at the center of its diameter half-way along its length; the center of gravity of a sphere is at the center of the sphere. For solids, areas, and arcs that are not symmetrical, the determination of the center of gravity may be made experimentally or may be calculated by the use of formulas.

The tables that follow give such formulas for some of the more important shapes. For more complicated and unsymmetrical shapes the methods outlined on page 227 may be used.

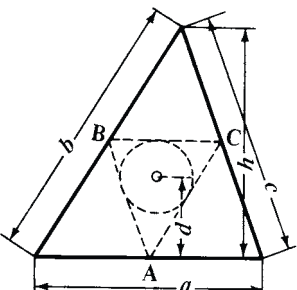
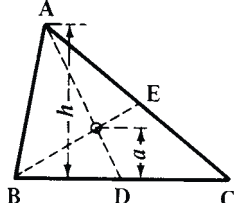
Example: A piece of wire is bent into the form of a semi-circular arc of 10-inch (25.4 cm) radius. How far from the center of the arc is the center of gravity located?

Accompanying the *Circular Arc* diagram on page 222 is a formula for the distance from the center of gravity of an arc to the center of the arc: $a = 2r \div \pi$. Therefore,

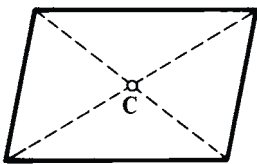
$$a = \frac{2 \times 10}{3.1416} = 6.366 \text{ inches} \qquad a = \frac{2 \times 25.4}{3.1416} = 16.17 \text{ cm}$$

Formulas for Center of Gravity

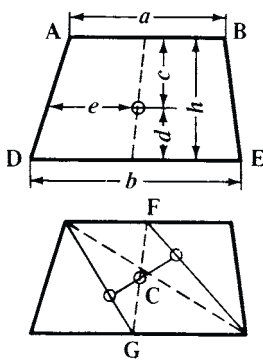
Triangle:

	<p><i>Perimeter</i></p> <p>If <i>A</i>, <i>B</i> and <i>C</i> are the middle points of the sides of the triangle, then the center of gravity is at the center of the circle that can be inscribed in triangle <i>ABC</i>. The distance <i>d</i> of the center of gravity from side <i>a</i> is:</p> $d = \frac{h(b+c)}{2(a+b+c)}$ <p>where <i>h</i> is the height perpendicular to <i>a</i>.</p>
	<p><i>Area</i></p> <p>The center of gravity is at the intersection of lines <i>AD</i> and <i>BE</i>, which bisect the sides <i>BC</i> and <i>AC</i>. The perpendicular distance from the center of gravity to any one of the sides is equal to one-third the height perpendicular to that side. Hence, $a = h \div 3$.</p>

Perimeter or Area of a Parallelogram :

	<p>The center of gravity is at the intersection of the diagonals.</p>
---	---

Area of Trapezoid:



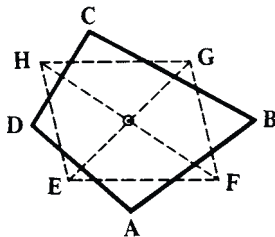
The center of gravity is on the line joining the middle points of parallel lines AB and DE.

$$c = \frac{h(a+2b)}{3(a+b)} \quad d = \frac{h(2a+b)}{3(a+b)}$$

$$e = \frac{a^2 + ab + b^2}{3(a+b)}$$

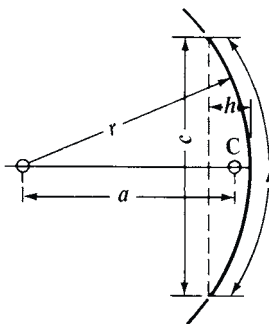
The trapezoid can also be divided into two triangles. The center of gravity is at the intersection of the line joining the centers of gravity of the triangles, and the middle line FG.

Any Four-sided Figure :



Two cases are possible, as shown in the illustration. To find the center of gravity of the four-sided figure ABCD, each of the sides is divided into three equal parts. A line is then drawn through each pair of division points next to the points of intersection A, B, C, and D of the sides of the figure. These lines form a parallelogram EFGH; the intersection of the diagonals EG and FH locates center of gravity.

Circular Arc:



The center of gravity is on the line that bisects the arc, at a distance $a = \frac{r \times c}{l} = \frac{c(c^2 + 4h^2)}{8lh}$ from the center of the circle.

For an arc equal to one-half the periphery:

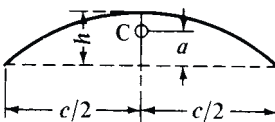
$$a = 2r \div \pi = 0.6366r$$

For an arc equal to one-quarter of the periphery:

$$a = 2r\sqrt{2} \div \pi = 0.9003r$$

For an arc equal to one-sixth of the periphery:

$$a = 3r \div \pi = 0.9549r$$

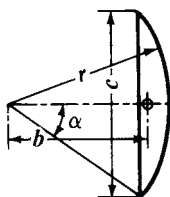


An approximate formula is very nearly exact for all arcs less than one-quarter of the periphery is:

$$a = \frac{2}{3}h$$

The error is only about one per cent for a quarter circle, and decreases for smaller arcs.

Circle Segment :

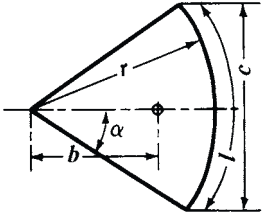


The distance of the center of gravity from the center of the circle is:

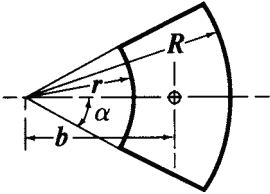
$$b = \frac{c^3}{12A} = \frac{2}{3} \times \frac{r^3 \sin^3 \alpha}{A}$$

in which A = area of segment.

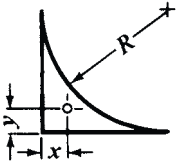
Circle Sector :

	<p>Distance b from center of gravity to center of circle is:</p> $b = \frac{2rc}{3l} = \frac{r^2c}{3A} = 38.197 \frac{r \sin \alpha}{\alpha}$ <p>in which A = area of sector, and α is expressed in degrees.</p> <p>For the area of a half-circle:</p> $b = 4r + 3\pi = 0.4244r$ <p>For the area of a quarter circle:</p> $b = 4\sqrt{2} \times r + 3\pi = 0.6002r$ <p>For the area of a sixth of a circle:</p> $b = 2r + \pi = 0.6366r$
---	--

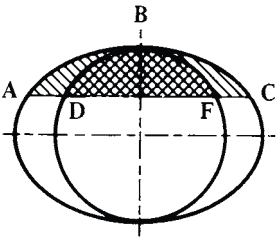
Part of Circle Ring :

	<p>Distance b from center of gravity to center of circle is:</p> $b = 38.197 \frac{(R^3 - r^3) \sin \alpha}{(R^2 - r^2) \alpha}$ <p>Angle α is expressed in degrees.</p>
---	---

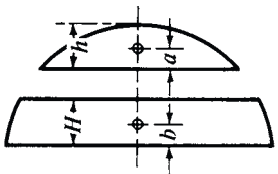
Spandrel or Fillet :

	<p>Area = $0.2146R^2$ $x = 0.2234R$ $y = 0.2234R$</p>
---	--

Segment of an Ellipse :

	<p>The center of gravity of an elliptic segment ABC, symmetrical about one of the axes, coincides with the center of gravity of the segment DBF of a circle, the diameter of which is equal to that axis of the ellipse about which the elliptic segment is symmetrical.</p>
---	--

Spherical Surface of Segments and Zones of Spheres :

	<p>Distances a and b which determine the center of gravity, are:</p> $a = \frac{h}{2} \quad b = \frac{H}{2}$
---	--

Area of a Parabola :

	<p>For the complete parabolic area, the center of gravity is on the center line or axis, and</p> $a = \frac{3h}{5}$ <p>For one-half of the parabola:</p> $a = \frac{3h}{5} \text{ and } b = \frac{3w}{8}$ <p>For the complement area ABC:</p> $c = 0.3h \text{ and } d = 0.75w$
--	---

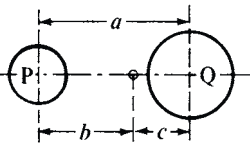
Cylinder :

	<p>The center of gravity of a solid cylinder (or prism) with parallel end surfaces, is located at the middle of the line that joins the centers of gravity of the end surfaces.</p> <p>The center of gravity of a cylindrical surface or shell, with the base or end surface in one end, is found from:</p> $a = \frac{2h^2}{4h + d}$ <p>The center of gravity of a cylinder cut off by an inclined plane is located by:</p> $a = \frac{h}{2} + \frac{r^2 \tan^2 \alpha}{8h} \quad b = \frac{r^2 \tan \alpha}{4h}$ <p>where α is the angle between the obliquely cut off surface and the base surface.</p>
--	--

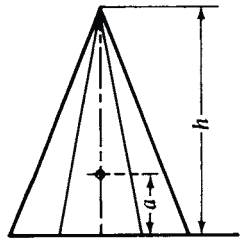
Portion of Cylinder :

	<p>For a solid portion of a cylinder, as shown, the center of gravity is determined by:</p> $a = \frac{3}{16} \times 3.1416r \quad b = \frac{3}{32} \times 3.1416h$ <p>For the cylindrical surface only:</p> $a = \frac{1}{4} \times 3.1416r \quad b = \frac{1}{8} \times 3.1416h$ <p>If the cylinder is hollow, the center of gravity of the solid shell is found by:</p> $a = \frac{3}{16} \times 3.1416 \frac{R^4 - r^4}{R^3 - r^3}$ $b = \frac{3}{32} \times 3.1416 \frac{H^4 - h^4}{H^3 - h^3}$
--	--

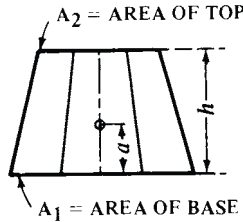
Center of Gravity of Two Bodies :

	<p>If the weights of the bodies are P and Q, and the distance between their centers of gravity is a, then:</p> $b = \frac{Qa}{P+Q} \quad c = \frac{Pa}{P+Q}$
---	---

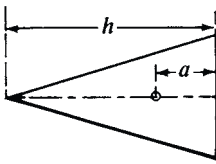
Pyramid :

	<p>In a solid pyramid the center of gravity is located on the line joining the apex with the center of gravity of the base surface, at a distance from the base equal to one-quarter of the height; or $a = \frac{1}{4}h$.</p> <p>The center of gravity of the triangular surfaces forming the pyramid is located on the line joining the apex with the center of gravity of the base surface, at a distance from the base equal to one-third of the height; or $a = \frac{1}{3}h$.</p>
---	---

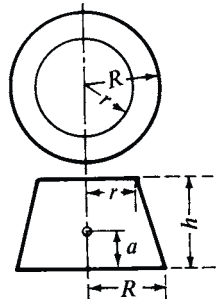
Frustum of Pyramid :

	<p>The center of gravity is located on the line that joins the centers of gravity of the end surfaces. If A_1 = area of base surface, and A_2 area of top surface,</p> $a = \frac{h(A_1 + 2\sqrt{A_1 \times A_2} + 3A_2)}{4(A_1 + \sqrt{A_1 \times A_2} + A_2)}$
---	--

Cone :

	<p>The same rules apply as for the pyramid. For the solid cone:</p> $a = \frac{1}{4}h$ <p>For the conical surface:</p> $a = \frac{1}{3}h$
---	---

Frustum of Cone :

	<p>The same rules apply as for the frustum of a pyramid. For a solid frustum of a circular cone the formula below is also used:</p> $a = \frac{h(R^2 + 2Rr + 3r^2)}{4(R^2 + Rr + r^2)}$ <p>The location of the center of gravity of the conical surface of a frustum of a cone is determined by:</p> $a = \frac{h(R + 2r)}{3(R + r)}$
---	---

Wedge :

	<p>The center of gravity is on the line joining the center of gravity of the base with the middle point of the edge, and is located at:</p> $a = \frac{h(b+c)}{2(2b+c)}$
--	--

Paraboloid :

	<p>The center of gravity of a solid paraboloid of rotation is at:</p> $a = \frac{1}{3}h$
--	--

Half of a Hollow Sphere :

	<p>The center of gravity is located at:</p> $a = \frac{3(R^4 - r^4)}{8(R^3 - r^3)}$
--	---

Spherical Segment :

	<p>The center of gravity of a solid segment is determined by:</p> $a = \frac{3(2r-h)^2}{4(3r-h)}$ $b = \frac{h(4r-h)}{4(3r-h)}$ <p>For a half-sphere, $a = b = \frac{3}{8}r$</p>
--	---

Spherical Sector :

	<p>The center of gravity of a solid sector is at:</p> $a = \frac{3}{8}(1 + \cos \alpha)r = \frac{3}{8}(2r - h)$
--	---

Segment of Ellipsoid or Spheroid :

	<p>The center of gravity of a solid segment ABC, symmetrical about the axis of rotation, coincides with the center of gravity of the segment DBF of a sphere, the diameter of which is equal to the axis of rotation of the spheroid.</p>
--	---

Center of Gravity of Figures of any Outline.—If the figure is symmetrical about a center line, as in Fig. 1, the center of gravity will be located on that line. To find the exact location on that line, the simplest method is by taking moments with reference to any convenient axis at right angles to this center line. Divide the area into geometrical figures, the centers of gravity of which can be easily found. In the example shown, divide the figure into three rectangles KLMN, EFGH and OPRS. Call the areas of these rectangles *A*, *B* and *C*, respectively, and find the center of gravity of each. Then select any convenient axis, as X-X, at right angles to the center line Y-Y, and determine distances *a*, *b* and *c*. The distance *y* of the center of gravity of the complete figure from the axis X-X is then found from the equation:

$$y = \frac{Aa + Bb + Cc}{A + B + C}$$

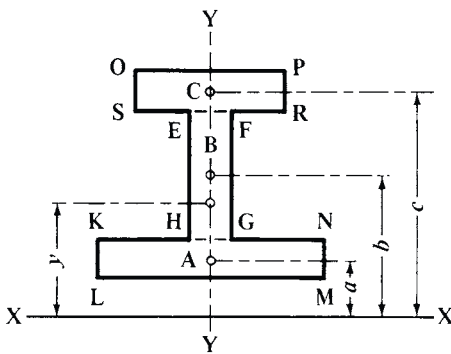


Fig. 1.

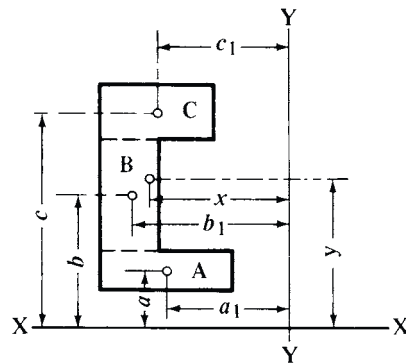


Fig. 2.

Example 1: Assume that the area *A* is 24 square inches, *B*, 14 square inches, and *C*, 16 square inches, and that *a* = 3 inches, *b* = 7.5 inches, and *c* = 12 inches. Then:

$$y = \frac{24 \times 3 + 14 \times 7.5 + 16 \times 12}{24 + 14 + 16} = \frac{369}{54} = 6.83 \text{ inches}$$

If the figure, the center of gravity of which is to be found, is not symmetrical about any axis, as in Fig. 2, then moments must be taken with relation to two axes X-X and Y-Y, centers of gravity of which can be easily found, the same as before. The center of gravity is determined by the equations:

$$x = \frac{Aa_1 + Bb_1 + Cc_1}{A + B + C} \quad y = \frac{Aa + Bb + Cc}{A + B + C}$$

Example 2: In Fig. 2, let *A* = 14 cm², *B* = 18 cm², and *C* = 20 cm². Let *a* = 3 cm, *b* = 7 cm, and *c* = 11.5 cm. Let *a*₁ = 6.5 cm, *b*₁ = 8.5 cm, and *c*₁ = 7 cm. Then:

$$x = \frac{14 \times 6.5 + 18 \times 8.5 + 20 \times 7}{14 + 18 + 20} = \frac{384}{52} = 7.38 \text{ cm}$$

$$y = \frac{14 \times 3 + 18 \times 7 + 20 \times 11.5}{14 + 18 + 20} = \frac{398}{52} = 7.65 \text{ cm}$$

In other words, the center of gravity is located at a distance of 7.65 cm from the axis X-X and 7.38 cm from the axis Y-Y.

Radius of Gyration

The radius of gyration with reference to an axis is that distance from the axis at which the entire mass of a body may be considered as concentrated, the moment of inertia, meanwhile, remaining unchanged. If W is the weight of a body; J_M , its moment of inertia with respect to some axis; and k_o , the radius of gyration with respect to the same axis, then:

$$k_o = \sqrt{\frac{J_M g}{W}} \quad \text{and} \quad J_M = \frac{W k_o^2}{g}$$

When using metric SI units, the formulas are:

$$k_o = \sqrt{\frac{J_M}{M}} \quad \text{and} \quad J_M = M k_o^2$$

where k_o = the radius of gyration in meters, J_M = moment of inertia in kilogram-meter², and M = mass in kilograms.

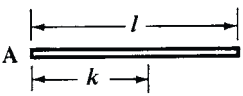
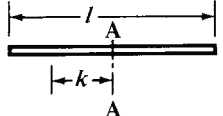
To find the radius of gyration of an area, such as for the cross-section of a beam, divide the moment of inertia of the area by the area and extract the square root.

When the axis, the reference to which the radius of gyration is taken, passes through the center of gravity, the radius of gyration is the least possible and is called the *principal* radius of gyration. If k is the radius of gyration with respect to such an axis passing through the center of gravity of a body, then the radius of gyration, k_o , with respect to a parallel axis at a distance d from the gravity axis is given by: $k_o = \sqrt{k^2 + d^2}$

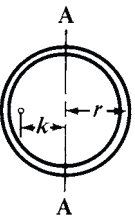
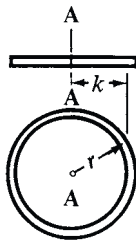
Tables of radii of gyration for various bodies and axes follows.

Formulas for Radius of Gyration

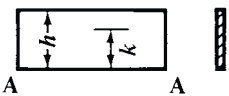
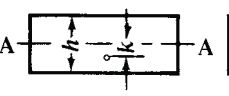
Bar of Small Diameter:

 $k = 0.5773l$ $k^2 = \frac{1}{3}l^2$ <p>Axis at end</p>	 $k = 0.2886l$ $k^2 = \frac{1}{12}l^2$ <p>Axis at center</p>
---	---

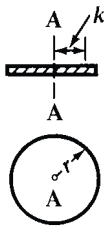
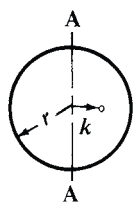
Bar of Small Diameter Bent to Circular Shape:

 $k = 0.7071r$ $k^2 = \frac{1}{2}r^2$ <p>Axis, a diameter of the ring</p>	 $k = r$ $k^2 = r^2$ <p>Axis through center of ring</p>
--	--

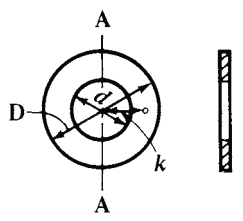
Parallelogram (Thin Flat Plate):

 $k = 0.5773h$ $k^2 = \frac{1}{3}h^2$ <p>Axis at base</p>	 $k = 0.2886h$ $k^2 = \frac{1}{12}h^2$ <p>Axis at mid-height</p>
--	---

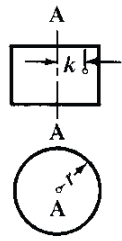
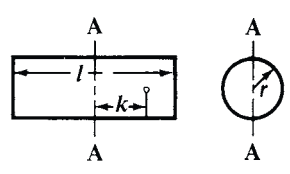
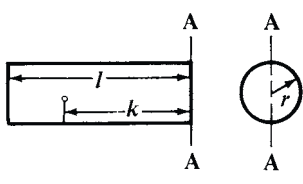
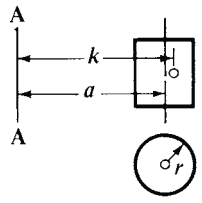
Thin Circular Disk:

 <p>Axis through center</p>	$k = 0.7071r$ $k^2 = \frac{1}{2}r^2$
 <p>Axis its diameter</p>	$k = \frac{1}{2}r$ $k^2 = \frac{1}{4}r^2$

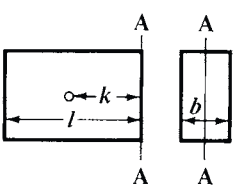
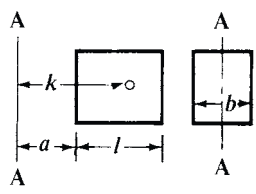
Thin, Flat, Circular Ring :

 <p>Axis its diameter</p>	$k = \frac{1}{4}\sqrt{D^2 + d^2}$ $k^2 = \frac{D^2 + d^2}{16}$
--	--

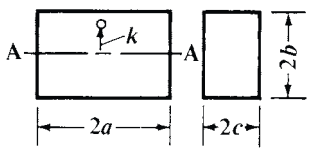
Cylinder:

 <p>Axis through center</p>	$k = \frac{r}{\sqrt{2}}$ $k^2 = \frac{1}{2}r^2$
 <p>Axis, diameter at mid-length</p>	$k = \frac{\sqrt{l^2 + 3r^2}}{\sqrt{12}}$ $k^2 = \frac{l^2}{12} + \frac{r^2}{4}$
 <p>Axis, diameter at end</p>	$k = \frac{\sqrt{4l^2 + 3r^2}}{\sqrt{12}}$ $k^2 = \frac{l^2}{3} + \frac{r^2}{4}$
 <p>Axis at a distance</p>	$k = \sqrt{a^2 + \frac{1}{2}r^2}$ $k^2 = a^2 + \frac{1}{2}r^2$

Parallelepiped:

 <p>Axis at one end, central</p>	$k = \frac{\sqrt{4l^2 + b^2}}{\sqrt{12}}$ $k^2 = \frac{4l^2 + b^2}{12}$
 <p>Axis at distance from end</p>	$k = \sqrt{\frac{4l^2 + b^2}{12} + a^2 + al}$

Rectangular Prism:

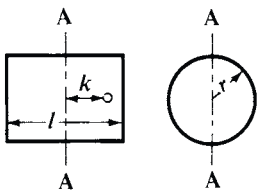


Axis through center

$$k = 0.577\sqrt{b^2 + c^2}$$

$$k^2 = \frac{1}{3}(b^2 + c^2)$$

Thin Hollow Cylinder:

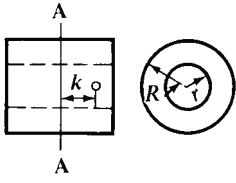


Axis, diameter at mid-length

$$k = 0.289\sqrt{l^2 + 6r^2}$$

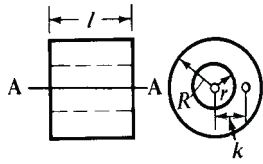
$$k^2 = \frac{l^2}{12} + \frac{r^2}{2}$$

Hollow Cylinder:



Axis, diameter at mid-length

$$k = \frac{\sqrt{l^2 + 3(R^2 + r^2)}}{\sqrt{12}}$$

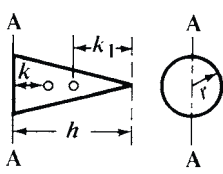
$$k^2 = \frac{l^2}{12} + \frac{R^2 + r^2}{4}$$


Longitudinal Axis

$$k = \frac{\sqrt{R^2 + r^2}}{\sqrt{2}}$$

$$k^2 = \frac{1}{2}(R^2 + r^2)$$

Cone:



Axis at base

$$k = \sqrt{\frac{2h^2 + 3r^2}{20}}$$

Axis at apex

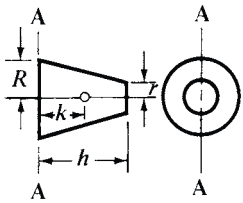
$$k_1 = \sqrt{\frac{12h^2 + 3r^2}{20}}$$


Axis through its center line

$$k = 0.5477r$$

$$k^2 = 0.3r^2$$

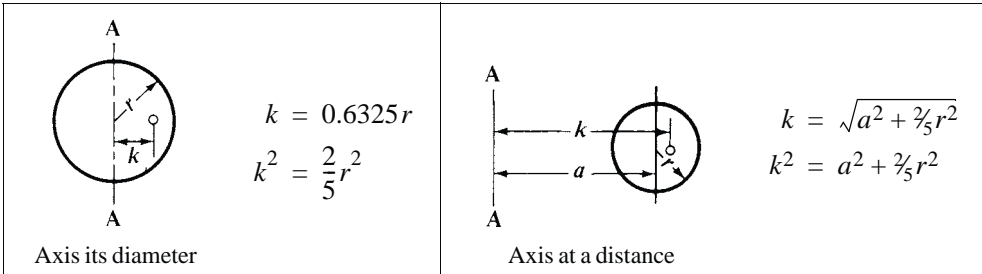
Frustum of Cone:



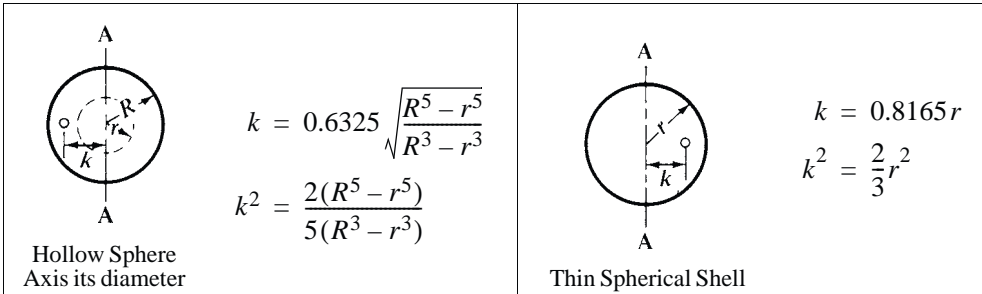
Axis at large end

$$k = \sqrt{\frac{h^2}{10} \left(\frac{R^2 + 3Rr + 6r^2}{R^2 + Rr + r^2} \right) + \frac{3}{20} \left(\frac{R^5 - r^5}{R^3 - r^3} \right)}$$

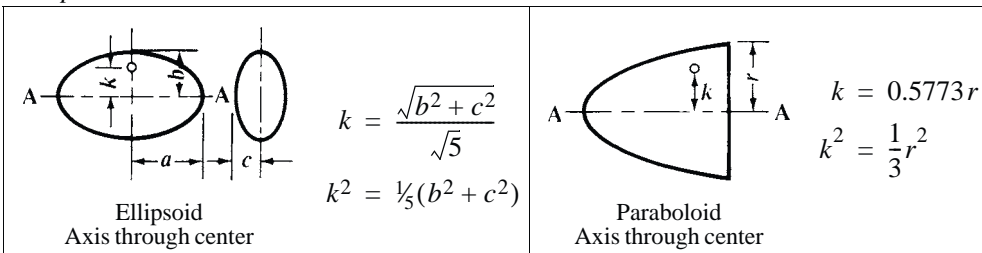
Sphere:



Hollow Sphere and Thin Spherical Shell:



Ellipsoid and Paraboloid:



Center and Radius of Oscillation.—If a body oscillates about a horizontal axis which does not pass through its center of gravity, there will be a point on the line drawn from the center of gravity, perpendicular to the axis, the motion of which will be the same as if the whole mass were concentrated at that point. This point is called the *center of oscillation*. The *radius of oscillation* is the distance between the center of oscillation and the point of suspension. In a straight line, or in a bar of small diameter, suspended at one end and oscillating about it, the center of oscillation is at two-thirds the length of the rod from the end by which it is suspended.

When the vibrations are perpendicular to the plane of the figure, and the figure is suspended by the vertex of an angle or its uppermost point, the radius of oscillation of an isosceles triangle is equal to $\frac{3}{4}$ of the height of the triangle; of a circle, $\frac{5}{8}$ of the diameter; of a parabola, $\frac{5}{7}$ of the height.

If the vibrations are in the plane of the figure, then the radius of oscillation of a circle equals $\frac{3}{4}$ of the diameter; of a rectangle, suspended at the vertex of one angle, $\frac{2}{3}$ of the diagonal.

Center of Percussion.—For a body that moves without rotation, the resultant of all the forces acting on the body passes through the center of gravity. On the other hand, for a body that rotates about some *fixed axis*, the resultant of all the forces acting on it does not pass through the center of gravity of the body but through a point called the *center of percus-*

sion. The center of percussion is useful in determining the position of the resultant in mechanics problems involving angular acceleration of bodies about a fixed axis.

Finding the Center of Percussion when the Radius of Gyration and the Location of the Center of Gravity are Known: The center of percussion lies on a line drawn through the center of rotation and the center of gravity. The distance from the axis of rotation to the center of percussion may be calculated from the following formula

$$q = k_o^2 \div r$$

in which q = distance from the axis of rotation to the center of percussion; k_o = the radius of gyration of the body with respect to the axis of rotation; and r = the distance from the axis of rotation to the center of gravity of the body.

Moment of Inertia

An important property of areas and solid bodies is the moment of inertia. Standard formulas are derived by multiplying elementary particles of area or mass by the squares of their distances from reference axes. Moments of inertia, therefore, depend on the location of reference axes. Values are minimum when these axes pass through the centers of gravity.

Three kinds of moments of inertia occur in engineering formulas:

1) *Moments of inertia of plane area, I* , in which the axis is in the plane of the area, are found in formulas for calculating deflections and stresses in beams. When dimensions are given in inches, the units of I are inches⁴. A table of formulas for calculating the I of common areas can be found beginning on page 234.

2) *Polar moments of inertia of plane areas, J* , in which the axis is at right angles to the plane of the area, occur in formulas for the torsional strength of shafting. When dimensions are given in inches, the units of J are inches⁴. If moments of inertia, I , are known for a plane area with respect to both x and y axes, then the polar moment for the z axis may be calculated using the equation, $J_z = I_x + I_y$

A table of formulas for calculating J for common areas can be found on page 245 in this section.

When metric SI units are used, the formulas referred to in (1) and (2) above, are valid if the dimensions are given consistently in meters or millimeters. If meters are used, the units of I and J are in meters⁴; if millimeters are used, these units are in millimeters⁴.

3) *Polar moments of inertia of masses, J_M^** , appear in dynamics equations involving rotational motion. J_M bears the same relationship to angular acceleration as mass does to linear acceleration. If units are in the foot-pound-second system, the units of J_M are ft-lbs-sec² or slug-ft². (1 slug = 1 pound second² per foot.) If units are in the inch-pound-second system, the units of J_M are inch-lbs-sec².

If metric SI values are used, the units of J_M are kilogram-meter squared. Formulas for calculating J_M for various bodies are given beginning on page 246. If the polar moment of inertia J is known for the area of a body of constant cross section, J_M may be calculated using the equation,

$$J_M = \frac{\rho L}{g} J$$

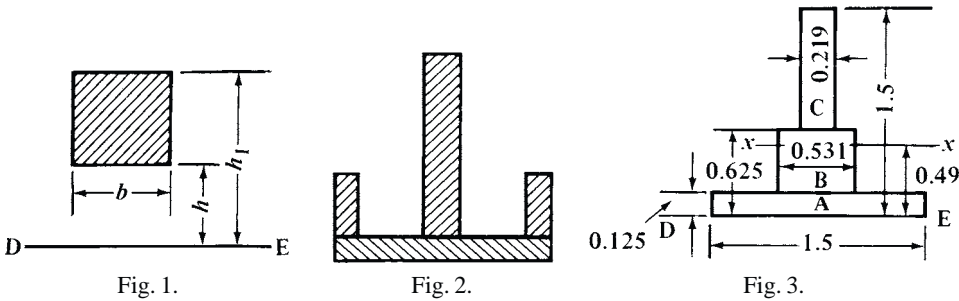
where ρ is the density of the material, L the length of the part, and g the gravitational constant. If dimensions are in the foot-pound-second system, ρ is in lbs per ft³, L is in ft, g is

* In some books the symbol I denotes the polar moment of inertia of masses; J_M is used in this handbook to avoid confusion with moments of inertia of plane areas.

32.16 ft per sec², and J is in ft⁴. If dimensions are in the inch-pound-second system, ρ is in lbs per in³, L is in inches, g is 386 inches per sec², and J is in inches⁴.

Using metric SI units, the above formula becomes $J_M = \rho L J$, where ρ = the density in kilograms/meter³, L = the length in meters, and J = the polar moment of inertia in meters⁴. The units of J_M are kg · m².

Moment of Inertia of Built-up Sections.—The usual method of calculating the moment of inertia of a built-up section involves the calculations of the moment of inertia for each element of the section about its own neutral axis, and the transferring of this moment of inertia to the previously found neutral axis of the whole built-up section. A much simpler method that can be used in the case of any section which can be divided into rectangular elements bounded by lines parallel and perpendicular to the neutral axis is the so-called tabular method based upon the formula: $I = b(h_1^3 - h^3)/3$ in which I = the moment of inertia about axis DE , Fig. 1, and b , h and h_1 are dimensions as given in the same illustration.



Example: The method may be illustrated by applying it to the section shown in Fig. 2, and for simplicity of calculation shown “massed” in Fig. 3. The calculation may then be tabulated as shown in the accompanying table. The distance from the axis DE to the neutral axis xx (which will be designated as d) is found by dividing the sum of the geometrical moments by the area. The moment of inertia about the neutral axis is then found in the usual way by subtracting the area multiplied by d^2 from the moment of inertia about the axis DE .

Tabulated Calculation of Moment of Inertia

Section	Breadth b	Height h_1	Area $b(h_1 - h)$	h_1^2	Moment $\frac{b(h_1^3 - h^3)}{2}$	h_1^3	I about axis DE $\frac{b(h_1^3 - h^3)}{3}$
A	1.500	0.125	0.187	0.016	0.012	0.002	0.001
B	0.531	0.625	0.266	0.391	0.100	0.244	0.043
C	0.219	1.500	0.191	2.250	0.203	3.375	0.228
			$\Sigma A = 0.644$		$\Sigma M = 0.315$		$\Sigma I_{DE} = 0.272$

The distance d from DE , the axis at the base of the configuration, to the neutral axis xx is:

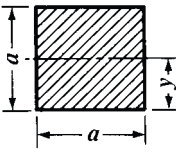
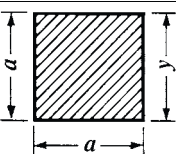
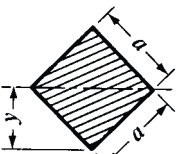
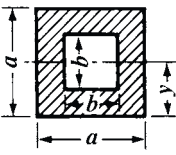
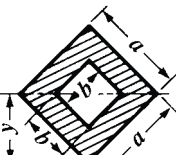
$$d = \frac{M}{A} = \frac{0.315}{0.644} = 0.49$$

The moment of inertia of the entire section with reference to the neutral axis xx is:

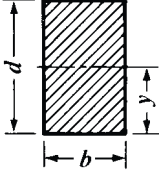
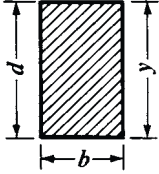
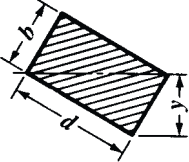
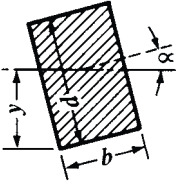
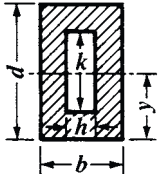
$$\begin{aligned} I_N &= I_{DE} - A d^2 \\ &= 0.272 - 0.644 \times 0.49^2 \\ &= 0.117 \end{aligned}$$

Formulas for Moments of Inertia, Section Moduli, etc.—On the following pages are given formulas for the moments of inertia and other properties of forty-two different cross-sections. The formulas give the area of the section A , and the distance y from the neutral axis to the extreme fiber, for each example. Where the formulas for the section modulus and radius of gyration are very lengthy, the formula for the section modulus, for example, has been simply given as $I \div y$. The radius of gyration is sometimes given as $\sqrt{I \div A}$ to save space.

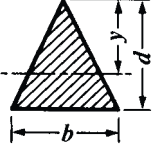
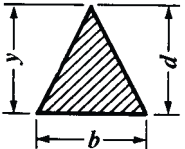
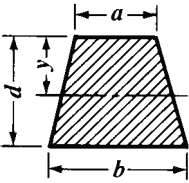

Moments of Inertia, Section Moduli, and Radii of Gyration

Section $A = \text{area}$ $y = \text{distance from axis to extreme fiber}$	Moment of Inertia I	Section Modulus $Z = \frac{I}{y}$	Radius of Gyration $k = \sqrt{\frac{I}{A}}$
Square and Rectangular Sections			
 $A = a^2 \quad y = \frac{a}{2}$	$\frac{a^4}{12}$	$\frac{a^3}{6}$	$\frac{a}{\sqrt{12}} = 0.289a$
 $A = a^2 \quad y = a$	$\frac{a^4}{3}$	$\frac{a^3}{3}$	$\frac{a}{\sqrt{3}} = 0.577a$
 $A = a^2$ $y = \frac{a}{\sqrt{2}} = 0.707a$	$\frac{a^4}{12}$	$\frac{a^3}{6\sqrt{2}} = 0.118a^3$	$\frac{a}{\sqrt{12}} = 0.289a$
 $A = a^2 - b^2 \quad y = \frac{a}{2}$	$\frac{a^4 - b^4}{12}$	$\frac{a^4 - b^4}{6a}$	$\sqrt{\frac{a^2 + b^2}{12}}$ $= 0.289\sqrt{a^2 + b^2}$
 $A = a^2 - b^2 \quad y = \frac{a}{\sqrt{2}}$	$\frac{a^4 - b^4}{12}$	$\frac{\sqrt{2}(a^4 - b^4)}{12a}$ $= 0.118\frac{a^4 - b^4}{a}$	$\sqrt{\frac{a^2 + b^2}{12}}$ $= 0.289\sqrt{a^2 + b^2}$

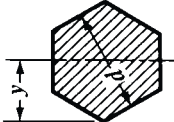
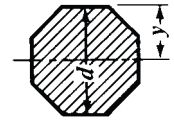
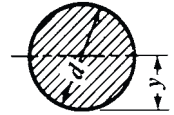
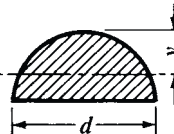
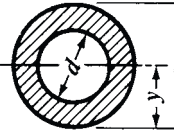
Moments of Inertia, Section Moduli, and Radii of Gyration

Section $A = \text{area}$ $y = \text{distance from axis to extreme fiber}$	Moment of Inertia I	Section Modulus $Z = \frac{I}{y}$	Radius of Gyration $k = \sqrt{\frac{I}{A}}$
Square and Rectangular Sections			
 <p>$A = bd \quad y = \frac{d}{2}$</p>	$\frac{bd^3}{12}$	$\frac{bd^2}{6}$	$\frac{d}{\sqrt{12}} = 0.289d$
 <p>$A = bd \quad y = d$</p>	$\frac{bd^3}{3}$	$\frac{bd^2}{3}$	$\frac{d}{\sqrt{3}} = 0.577d$
 <p>$A = bd$ $y = \frac{bd}{\sqrt{b^2 + d^2}}$</p>	$\frac{b^3 d^3}{6(b^2 + d^2)}$	$\frac{b^2 d^2}{6\sqrt{b^2 + d^2}}$	$\frac{bd}{\sqrt{6(b^2 + d^2)}}$ $= 0.408 \frac{bd}{\sqrt{b^2 + d^2}}$
 <p>$A = bd$ $y = \frac{1}{2}(d \cos \alpha + b \sin \alpha)$</p>	$\frac{bd}{12}(d^2 \cos^2 \alpha + b^2 \sin^2 \alpha)$	$\frac{bd}{6} \times \frac{(d^2 \cos^2 \alpha + b^2 \sin^2 \alpha)}{(d \cos \alpha + b \sin \alpha)}$	$\sqrt{\frac{d^2 \cos^2 \alpha + b^2 \sin^2 \alpha}{12}}$ $= 0.289 \times \sqrt{d^2 \cos^2 \alpha + b^2 \sin^2 \alpha}$
 <p>$A = bd - hk$ $y = \frac{d}{2}$</p>	$\frac{bd^3 - hk^3}{12}$	$\frac{bd^3 - hk^3}{6d}$	$\sqrt{\frac{bd^3 - hk^3}{12(bd - hk)}}$ $= 0.289 \sqrt{\frac{bd^3 - hk^3}{bd - hk}}$

Moments of Inertia, Section Moduli, and Radii of Gyration (Continued)

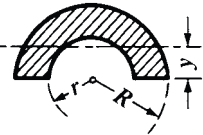
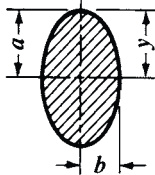
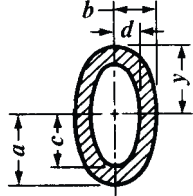
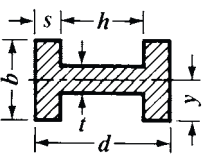
Section	Area of Section, <i>A</i>	Distance from Neutral Axis to Extreme Fiber, <i>y</i>	Moment of Inertia, <i>I</i>	Section Modulus, <i>Z = I/y</i>	Radius of Gyration, $k = \sqrt{I/A}$
Triangular Sections					
	$\frac{1}{2}bd$	$\frac{2}{3}d$	$\frac{bd^3}{36}$	$\frac{bd^2}{24}$	$\frac{d}{\sqrt{18}} = 0.236d$
	$\frac{1}{2}bd$	d	$\frac{bd^3}{12}$	$\frac{bd^2}{12}$	$\frac{d}{\sqrt{6}} = 0.408d$
Polygon Sections					
	$\frac{d(a+b)}{2}$	$\frac{d(a+2b)}{3(a+b)}$	$\frac{d^3(a^2+4ab+b^2)}{36(a+b)}$	$\frac{d^2(a^2+4ab+b^2)}{12(a+b)}$	$\sqrt{\frac{d^2(a^2+4ab+b^2)}{18(a+b)^2}}$
	$\frac{3d^2 \tan 30^\circ}{2}$ $= 0.866d^2$	$\frac{d}{2}$	$\frac{A}{12} \left[\frac{d^2(1+2\cos^2 30^\circ)}{4\cos^2 30^\circ} \right]$ $= 0.06d^4$	$\frac{A}{6} \left[\frac{d(1+2\cos^2 30^\circ)}{4\cos^2 30^\circ} \right]$ $= 0.12d^3$	$\sqrt{\frac{d^2(1+2\cos^2 30^\circ)}{48\cos^2 30^\circ}}$ $= 0.264d$

Moments of Inertia, Section Moduli, and Radii of Gyration (Continued)

Section	Area of Section, A	Distance from Neutral Axis to Extreme Fiber, y	Moment of Inertia, I	Section Modulus, $Z = I/y$	Radius of Gyration, $k = \sqrt{I/A}$
	$\frac{3d^2 \tan 30^\circ}{2}$ $= 0.866d^2$	$\frac{d}{2 \cos 30^\circ} = 0.577d$	$\frac{A}{12} \left[\frac{d^2(1 + 2 \cos^2 30^\circ)}{4 \cos^2 30^\circ} \right]$ $= 0.06d^4$	$\frac{A}{6.9} \left[\frac{d(1 + 2 \cos^2 30^\circ)}{4 \cos^2 30^\circ} \right]$ $= 0.104d^3$	$\sqrt{\frac{d^2(1 + 2 \cos^2 30^\circ)}{48 \cos^2 30^\circ}}$ $= 0.264d$
	$2d^2 \tan 22\frac{1}{2}^\circ = 0.828d^2$	$\frac{d}{2}$	$\frac{A}{12} \left[\frac{d^2(1 + 2 \cos^2 22\frac{1}{2}^\circ)}{4 \cos^2 22\frac{1}{2}^\circ} \right]$ $= 0.055d^4$	$\frac{A}{6} \left[\frac{d(1 + 2 \cos^2 22\frac{1}{2}^\circ)}{4 \cos^2 22\frac{1}{2}^\circ} \right]$ $= 0.109d^3$	$\sqrt{\frac{d^2(1 + 2 \cos^2 22\frac{1}{2}^\circ)}{48 \cos^2 22\frac{1}{2}^\circ}}$ $= 0.257d$
Circular, Elliptical, and Circular Arc Sections					
	$\frac{\pi d^2}{4} = 0.7854d^2$	$\frac{d}{2}$	$\frac{\pi d^4}{64} = 0.049d^4$	$\frac{\pi d^3}{32} = 0.098d^3$	$\frac{d}{4}$
	$\frac{\pi d^2}{8} = 0.393d^2$	$\frac{(3\pi - 4)d}{6\pi}$ $= 0.288d$	$\frac{(9\pi^2 - 64)d^4}{1152\pi}$ $= 0.007d^4$	$\frac{(9\pi^2 - 64)d^3}{192(3\pi - 4)}$ $= 0.024d^3$	$\frac{\sqrt{(9\pi^2 - 64)d^2}}{12\pi}$ $= 0.132d$
	$\frac{\pi(D^2 - d^2)}{4}$ $= 0.7854(D^2 - d^2)$	$\frac{D}{2}$	$\frac{\pi(D^4 - d^4)}{64}$ $= 0.049(D^4 - d^4)$	$\frac{\pi(D^4 - d^4)}{32D}$ $= 0.098 \frac{D^4 - d^4}{D}$	$\frac{\sqrt{D^2 + d^2}}{4}$

✧ MOMENT OF INERTIA, SECTION MODULUS, AND RADIUS OF GYRATION ✧ 237

Moments of Inertia, Section Moduli, and Radii of Gyration (Continued)

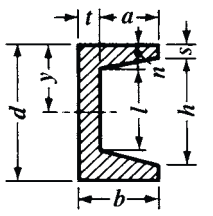
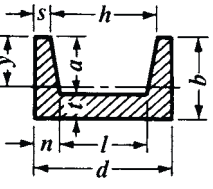
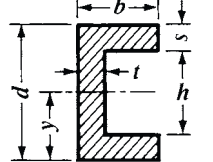
Section	Area of Section, A	Distance from Neutral Axis to Extreme Fiber, y	Moment of Inertia, I	Section Modulus, $Z = I/y$	Radius of Gyration, $k = \sqrt{I/A}$
	$\frac{\pi(R^2 - r^2)}{2}$ $= 1.5708(R^2 - r^2)$	$\frac{4(R^3 - r^3)}{3\pi(R^2 - r^2)}$ $= 0.424\frac{R^3 - r^3}{R^2 - r^2}$	$0.1098(R^4 - r^4)$ $\frac{0.283R^2r^2(R - r)}{R + r}$	$\frac{I}{y}$	$\sqrt{\frac{I}{A}}$
	$\pi ab = 3.1416ab$	a	$\frac{\pi a^3 b}{4} = 0.7854a^3 b$	$\frac{\pi a^2 b}{4} = 0.7854a^2 b$	$\frac{a}{2}$
	$\pi(ab - cd)$ $= 3.1416(ab - cd)$	a	$\frac{\pi}{4}(a^3 b - c^3 d)$ $= 0.7854(a^3 b - c^3 d)$	$\frac{\pi(a^3 b - c^3 d)}{4a}$ $= 0.7854\frac{a^3 b - c^3 d}{a}$	$\frac{1}{2}\sqrt{\frac{a^3 b - c^3 d}{ab - cd}}$
I-Sections					
	$bd - h(b - t)$	$\frac{b}{2}$	$\frac{2sb^3 + ht^3}{12}$	$\frac{2sb^3 + ht^3}{6b}$	$\sqrt{\frac{2sb^3 + ht^3}{12[bd - h(b - t)]}}$

Moments of Inertia, Section Moduli, and Radii of Gyration (Continued)

Section	Area of Section, A	Distance from Neutral Axis to Extreme Fiber, y	Moment of Inertia, I	Section Modulus, $Z = I/y$	Radius of Gyration, $k = \sqrt{I/A}$
	$dt + 2a(s + n)$	$\frac{d}{2}$	$\frac{1}{12} \left[bd^3 - \frac{1}{4g} (h^4 - t^4) \right]$ in which $g = \text{slope of flange} = \frac{(h - l)}{(b - t)} = \frac{100}{6}$ for standard I-beams.	$\frac{1}{6d} \left[bd^3 - \frac{1}{4g} (h^4 - t^4) \right]$	$\sqrt{\frac{\frac{1}{12} \left[bd^3 - \frac{1}{4g} (h^4 - t^4) \right]}{dt + 2a(s + n)}}$
	$bd - h(b - t)$	$\frac{d}{2}$	$\frac{bd^3 - h^3(b - t)}{12}$	$\frac{bd^3 - h^3(b - t)}{6d}$	$\sqrt{\frac{bd^3 - h^3(b - t)}{12[bd - h(b - t)]}}$
	$dt + 2a(s + n)$	$\frac{b}{2}$	$\frac{1}{12} \left[b^3(d - h) + lt^3 + \frac{g}{4}(b^4 - t^4) \right]$ in which $g = \text{slope of flange} = \frac{(h - l)}{(b - t)} = \frac{1}{6}$ for standard I-beams.	$\frac{1}{6b} \left[b^3(d - h) + lt^3 + \frac{g}{4}(b^4 - t^4) \right]$	$\sqrt{\frac{I}{A}}$
	$bs + ht + as$	$\frac{d - [td^2 + s^2(b - t) + s(a - t)(2d - s)]}{2A}$	$\frac{1}{3} [b(d - y)^3 + ay^3 - (b - t)(d - y - s)^3 - (a - t)(y - s)^3]$	$\frac{I}{y}$	$\sqrt{\frac{I}{A}}$

MOMENT OF INERTIA, SECTION MODULUS

Moments of Inertia, Section Moduli, and Radii of Gyration (Continued)

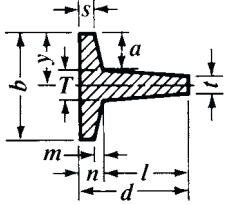
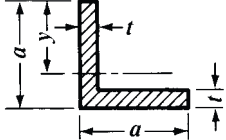
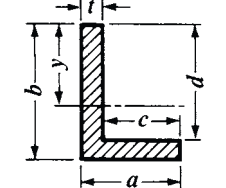
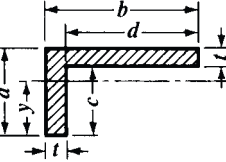
Section	Area of Section, A	Distance from Neutral Axis to Extreme Fiber, y	Moment of Inertia, I	Section Modulus, $Z = I/y$	Radius of Gyration, $k = \sqrt{I/A}$
C-Sections					
	$dt + a(s + n)$	$\frac{d}{2}$	$\frac{1}{12} \left[bd^3 - \frac{1}{8g}(h^4 - l^4) \right]$ $g = \text{slope of flange}$ $= \frac{h-l}{2(b-t)} = \frac{1}{6}$ for standard channels.	$\frac{1}{6d} \left[bd^3 - \frac{1}{8g}(h^4 - l^4) \right]$	$\sqrt{\frac{\frac{1}{12} \left[bd^3 - \frac{1}{8g}(h^4 - l^4) \right]}{dt + a(s + n)}}$
	$dt + a(s + n)$	$b - \left[b^2 s + \frac{ht^2}{2} + \frac{g}{3}(b-t)^2 \times (b+2t) \right] \div A$ $g = \text{slope of flange}$ $= \frac{h-l}{2(b-t)}$	$\frac{1}{3} \left[2sb^3 + lt^3 + \frac{g}{2}(b^4 - t^4) \right] - A(b-y)^2$ $g = \text{slope of flange}$ $= \frac{h-l}{2(b-t)} = \frac{1}{6}$ for standard channels.	$\frac{I}{y}$	$\sqrt{\frac{I}{A}}$
	$bd - h(b-t)$	$\frac{d}{2}$	$\frac{bd^3 - h^3(b-t)}{12}$	$\frac{bd^3 - h^3(b-t)}{6d}$	$\sqrt{\frac{bd^3 - h^3(b-t)}{12[bd - h(b-t)]}}$

Moments of Inertia, Section Moduli, and Radii of Gyration (Continued)

Section	Area of Section, A	Distance from Neutral Axis to Extreme Fiber, y	Moment of Inertia, I	Section Modulus, $Z = I/y$	Radius of Gyration, $k = \sqrt{I/A}$
	$bd - h(b - t)$	$b - \frac{2b^2s + ht^2}{2bd - 2h(b - t)}$	$\frac{2sb^3 + ht^3}{3} - A(b - y)^2$	$\frac{I}{y}$	$\sqrt{\frac{I}{A}}$
T-Sections					
	$bs + ht$	$d - \frac{d^2t + s^2(b - t)}{2(bs + ht)}$	$\frac{1}{3}[ty^3 + b(d - y)^3 - (b - t)(d - y - s)^3]$	$\frac{I}{y}$	$\frac{\sqrt{\frac{1}{3(bs + ht)[ty^3 + b(d - y)^3 - (b - t)(d - y - s)^3]}}}{-(b - t)(d - y - s)^3}$
	$\frac{l(T + t)}{2} + Tn + a(s + n)$	$d - [3s^2(b - T) + 2am(m + 3s) + 3Td^2 - l(T - t)(3d - l)] \div 6A$	$\frac{1}{12}[l^3(T + 3t) + 4bn^3 - 2am^3] - A(d - y - n)^2$	$\frac{I}{y}$	$\sqrt{\frac{I}{A}}$
	$bs + \frac{h(T + t)}{2}$	$d - [3bs^2 + 3ht(d + s) + h(T - t)(h + 3s)] \div 6A$	$\frac{1}{12}[4bs^3 + h^3(3t + T)] - A(d - y - s)^2$	$\frac{I}{y}$	$\sqrt{\frac{I}{A}}$

* MOMENT OF INERTIA, SECTION MODULUS * 241

Moments of Inertia, Section Moduli, and Radii of Gyration (Continued)

Section	Area of Section, A	Distance from Neutral Axis to Extreme Fiber, y	Moment of Inertia, I	Section Modulus, $Z = I/y$	Radius of Gyration, $k = \sqrt{I/A}$
	$\frac{l(T+t)}{2} + Tn + a(s+n)$	$\frac{b}{2}$	$\frac{sb^3 + mT^3 + lt^3}{12} + \frac{am[2a^2 + (2a + 3T)^2]}{36} + \frac{l(T-t)[(T-t)^2 + 2(T+2t)^2]}{144}$	$\frac{I}{y}$	$\sqrt{\frac{I}{A}}$
L-, Z-, and X-Sections					
	$t(2a - t)$	$a - \frac{a^2 + at - t^2}{2(2a - t)}$	$\frac{1}{3}[ty^3 + a(a - y)^3 - (a - t)(a - y - t)^3]$	$\frac{I}{y}$	$\sqrt{\frac{I}{A}}$
	$t(a + b - t)$	$b - \frac{t(2d + a) + d^2}{2(d + a)}$	$\frac{1}{3}[ty^3 + a(b - y)^3 - (a - t)(b - y - t)^3]$	$\frac{I}{y}$	$\sqrt{\frac{1}{3t(a + b - t)}[ty^3 + a(b - y)^3 - (a - t)(b - y - t)^3]}$
	$t(a + b - t)$	$a - \frac{t(2c + b) + c^2}{2(c + b)}$	$\frac{1}{3}[ty^3 + b(a - y)^3 - (b - t)(a - y - t)^3]$	$\frac{I}{y}$	$\sqrt{\frac{1}{3t(a + b - t)}[ty^3 + b(a - y)^3 - (b - t)(a - y - t)^3]}$

Moments of Inertia, Section Moduli, and Radii of Gyration (Continued)

Section	Area of Section, A	Distance from Neutral Axis to Extreme Fiber, y	Moment of Inertia, I	Section Modulus, $Z = I/y$	Radius of Gyration, $k = \sqrt{I/A}$
	$t(2a - t)$	$\frac{a^2 + at - t^2}{2(2a - t) \cos 45^\circ}$	$\frac{A}{12} [7(a^2 + b^2) - 12y^2]$ $-2ab^2(a - b)$ in which $b = (a - t)$	$\frac{I}{y}$	$\sqrt{\frac{I}{A}}$
	$t[b + 2(a - t)]$	$\frac{b}{2}$	$\frac{ab^3 - c(b - 2t)^3}{12}$	$\frac{ab^3 - c(b - 2t)^3}{6b}$	$\sqrt{\frac{ab^3 - c(b - 2t)^3}{12t[b + 2(a - t)]}}$
	$t[b + 2(a - t)]$	$\frac{2a - t}{2}$	$\frac{b(a + c)^3 - 2c^3d - 6a^2cd}{12}$	$\frac{b(a + c)^3 - 2c^3d - 6a^2cd}{6(2a - t)}$	$\sqrt{\frac{b(a + c)^3 - 2c^3d - 6a^2cd}{12t[b + 2(a - t)]}}$
	$dt + s(b - t)$	$\frac{d}{2}$	$\frac{td^3 + s^3(b - t)}{12}$	$\frac{td^3 - s^3(b - t)}{6d}$	$\sqrt{\frac{td^3 + s^3(b - t)}{12[td + s(b - t)]}}$

❖ MOMENT ❖
 ❖ NERTIA, SEC ❖
 ❖ N MODULUS ❖

Polar Area Moment of Inertia and Section Modulus.—The *polar moment of inertia*, J , of a cross-section with respect to a polar axis, that is, an axis at right angles to the plane of the cross-section, is defined as the moment of inertia of the cross-section with respect to the point of intersection of the axis and the plane. The polar moment of inertia may be found by taking the sum of the moments of inertia about two perpendicular axes lying in the plane of the cross-section and passing through this point. Thus, for example, the polar moment of inertia of a circular or a square area with respect to a polar axis through the center of gravity is equal to two times the moment of inertia with respect to an axis lying in the plane of the cross-section and passing through the center of gravity.

The polar moment of inertia with respect to a polar axis through the center of gravity is required for problems involving the torsional strength of shafts since this axis is usually the axis about which twisting of the shaft takes place.

The *polar section modulus* (also called section modulus of torsion), Z_p , for *circular* sections may be found by dividing the polar moment of inertia, J , by the distance c from the center of gravity to the most remote fiber. This method may be used to find the *approximate* value of the polar section modulus of sections that are *nearly* round. For other than circular cross-sections, however, the polar section modulus *does not* equal the polar moment of inertia divided by the distance c .

The accompanying table *Polar Moment of Inertia and Polar Section Modulus* on page 245 gives formulas for the polar section modulus for several different cross-sections. The polar section modulus multiplied by the allowable torsional shearing stress gives the allowable twisting moment to which a shaft may be subjected, see [Formula \(7\)](#) on page 296.

Mass Moments of Inertia*, J_M .—Starting on page 246, formulas for mass moment of inertia of various solids are given in a series of tables. The example that follows illustrates the derivation of J_M for one of the bodies given on page 246.

Example, Polar Mass Moment of Inertia of a Hollow Circular Section: Referring to the figure *Hollow Cylinder* on page 246, consider a strip of width dr on a hollow circular section, whose inner radius is r and outer radius is R .

The mass of the strip = $2\pi r dr \rho$, where ρ is the density of material. In order to get the mass of an individual section, integrate the mass of the strip from r to R .

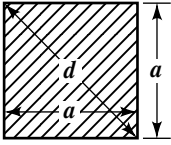
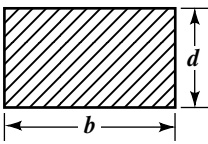
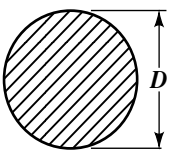
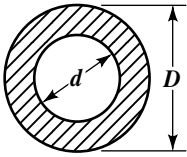
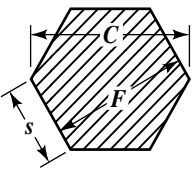
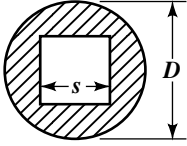
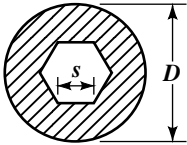
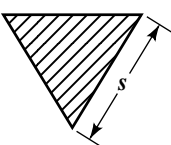
$$\begin{aligned} M &= \int_r^R 2\pi r(dr)\rho = 2\pi\rho \int_r^R r(dr) = 2\pi\rho \left[\frac{r^2}{2} \right]_r^R \\ &= 2\pi\rho \left(\frac{R^2}{2} - \frac{r^2}{2} \right) = \pi\rho(R^2 - r^2) \end{aligned}$$

The 2nd moment of the strip about the AA axis = $2\pi r dr \rho r^2$. To find the polar moment of inertia about the AA axis, integrate the 2nd moment from r to R .

$$\begin{aligned} J_M &= \int_r^R 2\pi r(dr)\rho r^2 = 2\pi\rho \int_r^R r^3(dr) = 2\pi\rho \left[\frac{r^4}{4} \right]_r^R \\ &= 2\pi\rho \left(\frac{R^4}{4} - \frac{r^4}{4} \right) = \frac{\pi\rho}{2} (R^2 - r^2)(R^2 + r^2) \\ &= \pi\rho(R^2 - r^2) \frac{(R^2 + r^2)}{2} = \frac{M(R^2 + r^2)}{2} \end{aligned}$$

* In some books the symbol I denotes the polar moment of inertia of masses; J_M is used in this handbook to avoid confusion with moments of inertia of plane areas.

Polar Moment of Inertia and Polar Section Modulus

Section	Polar Moment of Inertia, J	Polar Section Modulus, Z_p
	$\frac{a^4}{6} = 0.1667a^4$	$0.208a^3 = 0.074d^3$
	$\frac{bd(b^2 + d^2)}{12}$	$\frac{bd^2}{3 + 1.8\frac{d}{b}}$ (d is the shorter side)
	$\frac{\pi D^4}{32} = 0.098D^4$ (see also footnote, page 250)	$\frac{\pi D^3}{16} = 0.196D^3$ (see also footnote, page 250)
	$\frac{\pi}{32}(D^4 - d^4)$ $= 0.098(D^4 - d^4)$	$\frac{\pi}{16}\left(\frac{D^4 - d^4}{D}\right)$ $= 0.196\left(\frac{D^4 - d^4}{D}\right)$
	$\frac{5\sqrt{3}}{8}s^4 = 1.0825s^4$ $= 0.12F^4$	$0.20F^3$
	$\frac{\pi D^4}{32} - \frac{s^4}{6}$ $= 0.098D^4 - 0.167s^4$	$\frac{\pi D^3}{16} - \frac{s^4}{3D}$ $= 0.196D^3 - 0.333\frac{s^4}{D}$
	$\frac{\pi D^4}{32} - \frac{5\sqrt{3}}{8}s^4$ $= 0.098D^4 - 1.0825s^4$	$\frac{\pi D^3}{16} - \frac{5\sqrt{3}}{4D}s^4$ $= 0.196D^3 - 2.165\frac{s^4}{D}$
	$\frac{\sqrt{3}}{48}s^4 = 0.036s^4$	$\frac{s^3}{20} = 0.05s^3$

Formulas for Polar Moment of Inertia of Masses, J_M

Prism:

	<p>With reference to axis A - A: $J_M = \frac{M}{12}(h^2 + b^2)$</p> <p>With reference to axis B - B: $J_M = M\left(\frac{l^2}{3} + \frac{h^2}{12}\right)$</p>
--	--

Cylinder:

	<p>With reference to axis A - A: $J_M = \frac{1}{2}Mr^2$</p> <p>With reference to axis B - B: $J_M = M\left(\frac{l^2}{3} + \frac{r^2}{4}\right)$</p>
--	---

Hollow Cylinder:

	<p>With reference to axis A - A: $J_M = \frac{1}{2}M(R^2 + r^2)$</p> <p>With reference to axis B - B:</p> $J_M = M\left(\frac{l^2}{3} + \frac{R^2 + r^2}{4}\right)$
--	--

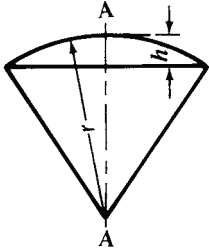
Pyramid, Rectangular Base:

	<p>With reference to axis A - A: $J_M = \frac{M}{20}(a^2 + b^2)$</p> <p>With reference to axis B - B (through the center of gravity):</p> $J_M = M\left(\frac{3}{80}h^2 + \frac{b^2}{20}\right)$
--	---

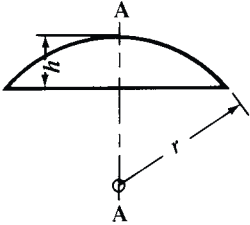
Sphere:

	<p>With reference to any axis through the center:</p> $J_M = \frac{2}{5}Mr^2$
--	---

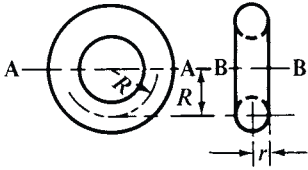
Spherical Sector:

	<p>With reference to axis A - A: $J_M = \frac{M}{5}(3rh - h^2)$</p>
---	--

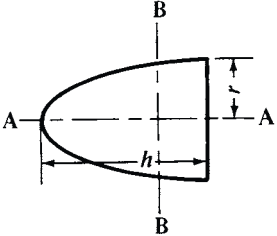
Spherical Segment:

	<p><i>Spherical Segment:</i> With reference to axis A - A:</p> $J_M = M \left(r^2 - \frac{3rh}{4} + \frac{3h^2}{20} \right) \frac{2h}{3r - h}$
---	---

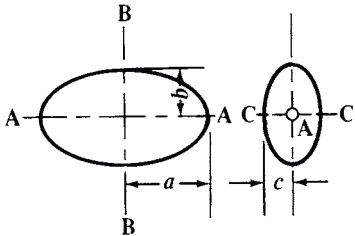
Torus:

	<p>With reference to axis A - A: $J_M = M \left(\frac{R^2}{2} + \frac{5r^2}{8} \right)$</p> <p>With reference to axis B - B: $J_M = M(R^2 + \frac{3}{4}r^2)$</p>
--	---

Paraboloid:

	<p>With reference to axis A - A: $J_M = \frac{1}{3}Mr^2$</p> <p>With reference to axis B - B (through the center of gravity):</p> $J_M = M \left(\frac{r^2}{6} + \frac{h^2}{18} \right)$
---	--

Ellipsoid:

	<p>With reference to axis A - A: $J_M = \frac{M}{5}(b^2 + c^2)$</p> <p>With reference to axis B - B: $J_M = \frac{M}{5}(a^2 + c^2)$</p> <p>With reference to axis C - C: $J_M = \frac{M}{5}(a^2 + b^2)$</p>
---	--

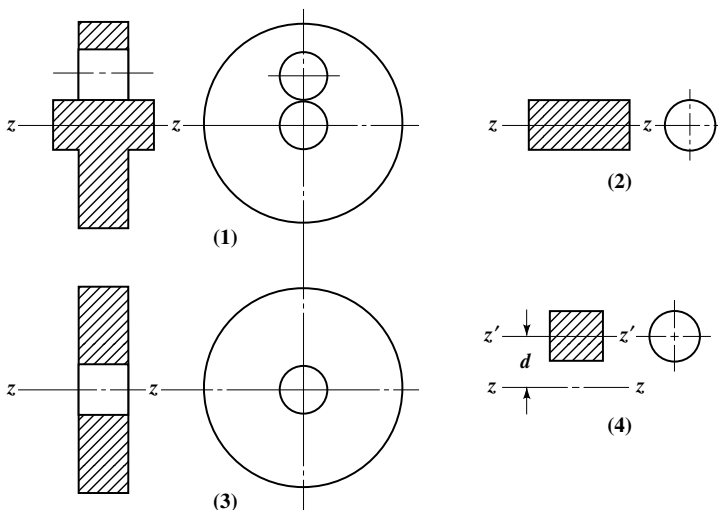
Cone:

	<p>With reference to axis A - A: $J_M = \frac{3M}{10}r^2$</p> <p>With reference to axis B - B (through the center of gravity):</p> $J_M = \frac{3M}{20}\left(r^2 + \frac{h^2}{4}\right)$
--	---

Frustrum of Cone:

	<p>With reference to axis A - A: $J_M = \frac{3M(R^5 - r^5)}{10(R^3 - r^3)}$</p>
--	---

Moments of Inertia of Complex Areas and Masses may be evaluated by the addition and subtraction of elementary areas and masses. For example, the accompanying figure shows a complex mass at (1); its mass polar moment of inertia can be determined by adding together the moments of inertia of the bodies shown at (2) and (3), and subtracting that at (4). Thus, $J_{M1} = J_{M2} + J_{M3} - J_{M4}$. All of these moments of inertia are with respect to the axis of rotation $z - z$. Formulas for J_{M2} and J_{M3} can be obtained from the tables beginning on page 246. The moment of inertia for the body at (4) can be evaluated by using the following transfer-axis equation: $J_{M4} = J_{M4}' + d^2M$. The term J_{M4}' is the moment of inertia with respect to axis $z' - z'$; it may be evaluated using the same equation that applies to J_{M2} where d is the distance between the $z - z$ and the $z' - z'$ axes, and M is the mass of the body (= weight in lbs \div g).

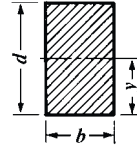


Moments of Inertia of Complex Masses

Similar calculations can be made when calculating I and J for complex areas using the appropriate transfer-axis equations are $I = I' + d^2A$ and $J = J' + d^2A$. The primed term, I' or J' , is with respect to the center of gravity of the corresponding area A ; d is the distance between the axis through the center of gravity and the axis to which I or J is referred.

**Moments of Inertia and Section Moduli
for Rectangles and Round Shafts**

Moments of inertia and section modulus values shown here are for rectangles 1 millimeter wide (*b*). To obtain moment of inertia or section modulus for rectangle of given side length (*d*), multiply appropriate table value by given width. (See the text starting on page 234 for basic formulas.)



**Moments of Inertia and Section Moduli for Rectangles
(Metric Units)**

Length of Side (mm)	Moment of Inertia	Section Modulus	Length of Side (mm)	Moment of Inertia	Section Modulus	Length of Side (mm)	Moment of Inertia	Section Modulus
5	10.4167	4.16667	56	14634.7	522.667	107	102087	1908.17
6	18.0000	6.00000	57	15432.8	541.500	108	104976	1944.00
7	28.5833	8.16667	58	16259.3	560.667	109	107919	1980.17
8	42.6667	10.6667	59	17114.9	580.167	110	110917	2016.67
9	60.7500	13.5000	60	18000.0	600.000	111	113969	2053.50
10	83.3333	16.6667	61	18915.1	620.167	112	117077	2090.67
11	110.917	20.1667	62	19860.7	640.667	113	120241	2128.17
12	144.000	24.0000	63	20837.3	661.500	114	123462	2166.00
13	183.083	28.1667	64	21845.3	682.667	115	126740	2204.17
14	228.667	32.6667	65	22885.4	704.167	116	130075	2242.67
15	281.250	37.5000	66	23958.0	726.000	117	133468	2281.50
16	341.333	42.6667	67	25063.6	748.167	118	136919	2320.67
17	409.417	48.1667	68	26202.7	770.667	119	140430	2360.17
18	486.000	54.0000	69	27375.8	793.500	120	144000	2400.00
19	571.583	60.1667	70	28583.3	816.667	121	147630	2440.17
20	666.667	66.6667	71	29825.9	840.167	122	151321	2480.67
21	771.750	73.5000	72	31104.0	864.000	123	155072	2521.50
22	887.333	80.6667	73	32418.1	888.167	124	158885	2562.67
23	1013.92	88.1667	74	33768.7	912.667	125	162760	2604.17
24	1152.00	96.0000	75	35156.3	937.500	126	166698	2646.00
25	1302.08	104.1667	76	36581.3	962.667	127	170699	2688.17
26	1464.67	112.6667	77	38044.4	988.167	128	174763	2730.67
27	1640.25	121.5000	78	39546.0	1014.00	130	183083	2816.67
28	1829.33	130.6667	79	41086.6	1040.17	132	191664	2904.00
29	2032.42	140.167	80	42666.7	1066.67	135	205031	3037.50
30	2250.00	150.000	81	44286.8	1093.50	138	219006	3174.00
31	2482.58	160.167	82	45947.3	1120.67	140	228667	3266.67
32	2730.67	170.667	83	47648.9	1148.17	143	243684	3408.17
33	2994.75	181.500	84	49392.0	1176.00	147	264710	3601.50
34	3275.33	192.667	85	51177.1	1204.17	150	281250	3750.00
35	3572.92	204.167	86	53004.7	1232.67	155	310323	4004.17
36	3888.00	216.000	87	54875.3	1261.50	160	341333	4266.67
37	4221.08	228.167	88	56789.3	1290.67	165	374344	4537.50
38	4572.67	240.667	89	58747.4	1320.17	170	409417	4816.67
39	4943.25	253.500	90	60750.0	1350.00	175	446615	5104.17
40	5333.33	266.667	91	62797.6	1380.17	180	486000	5400.00
41	5743.42	280.167	92	64890.7	1410.67	185	527635	5704.17
42	6174.00	294.000	93	67029.8	1441.50	190	571583	6016.67
43	6625.58	308.167	94	69215.3	1472.67	195	617906	6337.50
44	7098.67	322.667	95	71447.9	1504.17	200	666667	6666.67
45	7593.75	337.500	96	73728.0	1536.00	210	771750	7350.00
46	8111.33	352.667	97	76056.1	1568.17	220	887333	8066.67
47	8651.92	368.167	98	78432.7	1600.67	230	1013917	8816.67
48	9216.00	384.000	99	80858.3	1633.50	240	1152000	9600.00
49	9804.08	400.167	100	83333.3	1666.67	250	1302083	10416.7
50	10416.7	416.667	101	85858.4	1700.17	260	1464667	11266.7
51	11054.3	433.500	102	88434.0	1734.00	270	1640250	12150.0
52	11717.3	450.667	103	91060.6	1768.17	280	1829333	13066.7
53	12406.4	468.167	104	93738.7	1802.67	290	2032417	14016.7
54	13122.0	486.000	105	96468.8	1837.50	300	2250000	15000.0
55	13864.6	504.167	106	99251.3	1872.67

Section Moduli for Rectangles

Length of Side	Section Modulus	Length of Side	Section Modulus	Length of Side	Section Modulus	Length of Side	Section Modulus
1/8	0.0026	2 3/4	1.26	12	24.00	25	104.2
3/16	0.0059	3	1.50	12 1/2	26.04	26	112.7
1/4	0.0104	3 1/4	1.76	13	28.17	27	121.5
5/16	0.0163	3 1/2	2.04	13 1/2	30.38	28	130.7
3/8	0.0234	3 3/4	2.34	14	32.67	29	140.2
7/16	0.032	4	2.67	14 1/2	35.04	30	150.0
1/2	0.042	4 1/2	3.38	15	37.5	32	170.7
5/8	0.065	5	4.17	15 1/2	40.0	34	192.7
3/4	0.094	5 1/2	5.04	16	42.7	36	216.0
7/8	0.128	6	6.00	16 1/2	45.4	38	240.7
1	0.167	6 1/2	7.04	17	48.2	40	266.7
1 1/8	0.211	7	8.17	17 1/2	51.0	42	294.0
1 1/4	0.260	7 1/2	9.38	18	54.0	44	322.7
1 3/8	0.315	8	10.67	18 1/2	57.0	46	352.7
1 1/2	0.375	8 1/2	12.04	19	60.2	48	384.0
1 5/8	0.440	9	13.50	19 1/2	63.4	50	416.7
1 3/4	0.510	9 1/2	15.04	20	66.7	52	450.7
1 7/8	0.586	10	16.67	21	73.5	54	486.0
2	0.67	10 1/2	18.38	22	80.7	56	522.7
2 1/4	0.84	11	20.17	23	88.2	58	560.7
2 1/2	1.04	11 1/2	22.04	24	96.0	60	600.0

Section modulus values are shown for rectangles 1 inch wide. To obtain section modulus for rectangle of given side length, multiply value in table by given width.

Section Moduli and Moments of Inertia for Round Shafts

Dia.	Section Modulus	Moment of Inertia	Dia.	Section Modulus	Moment of Inertia	Dia.	Section Modulus	Moment of Inertia
1/8	0.00019	0.00001	27/64	0.00737	0.00155	23/32	0.03645	0.01310
9/64	0.00027	0.00002	7/16	0.00822	0.00180	47/64	0.03888	0.01428
5/32	0.00037	0.00003	29/64	0.00913	0.00207	3/4	0.04142	0.01553
11/64	0.00050	0.00004	15/32	0.01011	0.00237	49/64	0.04406	0.01687
3/16	0.00065	0.00006	31/64	0.01116	0.00270	25/32	0.04681	0.01829
13/64	0.00082	0.00008	1/2	0.01227	0.00307	51/64	0.04968	0.01979
7/32	0.00103	0.00011	33/64	0.01346	0.00347	13/16	0.05266	0.02139
15/64	0.00126	0.00015	17/32	0.01472	0.00391	53/64	0.05576	0.02309
1/4	0.00153	0.00019	35/64	0.01606	0.00439	27/32	0.05897	0.02488
17/64	0.00184	0.00024	9/16	0.01747	0.00491	55/64	0.06231	0.02677
9/32	0.00218	0.00031	37/64	0.01897	0.00548	7/8	0.06577	0.02877
19/64	0.00257	0.00038	19/32	0.02055	0.00610	57/64	0.06936	0.03089
5/16	0.00300	0.00047	39/64	0.02222	0.00677	29/32	0.07307	0.03311
21/64	0.00347	0.00057	5/8	0.02397	0.00749	59/64	0.07692	0.03545
11/32	0.00399	0.00069	41/64	0.02581	0.00827	15/16	0.08089	0.03792
23/64	0.00456	0.00082	21/32	0.02775	0.00910	61/64	0.08501	0.04051
3/8	0.00518	0.00097	43/64	0.02978	0.01000	31/32	0.08926	0.04323
25/64	0.00585	0.00114	11/16	0.03190	0.01097	63/64	0.09364	0.04609
13/32	0.00658	0.00134	45/64	0.03413	0.01200

In this and succeeding tables, the *Polar Section Modulus* for a shaft of given diameter can be obtained by multiplying its section modulus by 2. Similarly, its *Polar Moment of Inertia* can be obtained by multiplying its moment of inertia by 2.

Section Moduli and Moments of Inertia for Round Shafts (English or Metric Units)

Dia.	Section Modulus	Moment of Inertia	Dia.	Section Modulus	Moment of Inertia	Dia.	Section Modulus	Moment of Inertia
1.00	0.0982	0.0491	1.50	0.3313	0.2485	2.00	0.7854	0.7854
1.01	0.1011	0.0511	1.51	0.3380	0.2552	2.01	0.7972	0.8012
1.02	0.1042	0.0531	1.52	0.3448	0.2620	2.02	0.8092	0.8173
1.03	0.1073	0.0552	1.53	0.3516	0.2690	2.03	0.8213	0.8336
1.04	0.1104	0.0574	1.54	0.3586	0.2761	2.04	0.8335	0.8501
1.05	0.1136	0.0597	1.55	0.3656	0.2833	2.05	0.8458	0.8669
1.06	0.1169	0.0620	1.56	0.3727	0.2907	2.06	0.8582	0.8840
1.07	0.1203	0.0643	1.57	0.3799	0.2982	2.07	0.8708	0.9013
1.08	0.1237	0.0668	1.58	0.3872	0.3059	2.08	0.8835	0.9188
1.09	0.1271	0.0693	1.59	0.3946	0.3137	2.09	0.8963	0.9366
1.10	0.1307	0.0719	1.60	0.4021	0.3217	2.10	0.9092	0.9547
1.11	0.1343	0.0745	1.61	0.4097	0.3298	2.11	0.9222	0.9730
1.12	0.1379	0.0772	1.62	0.4174	0.3381	2.12	0.9354	0.9915
1.13	0.1417	0.0800	1.63	0.4252	0.3465	2.13	0.9487	1.0104
1.14	0.1455	0.0829	1.64	0.4330	0.3551	2.14	0.9621	1.0295
1.15	0.1493	0.0859	1.65	0.4410	0.3638	2.15	0.9757	1.0489
1.16	0.1532	0.0889	1.66	0.4491	0.3727	2.16	0.9894	1.0685
1.17	0.1572	0.0920	1.67	0.4572	0.3818	2.17	1.0032	1.0885
1.18	0.1613	0.0952	1.68	0.4655	0.3910	2.18	1.0171	1.1087
1.19	0.1654	0.0984	1.69	0.4739	0.4004	2.19	1.0312	1.1291
1.20	0.1696	0.1018	1.70	0.4823	0.4100	2.20	1.0454	1.1499
1.21	0.1739	0.1052	1.71	0.4909	0.4197	2.21	1.0597	1.1710
1.22	0.1783	0.1087	1.72	0.4996	0.4296	2.22	1.0741	1.1923
1.23	0.1827	0.1124	1.73	0.5083	0.4397	2.23	1.0887	1.2139
1.24	0.1872	0.1161	1.74	0.5172	0.4500	2.24	1.1034	1.2358
1.25	0.1917	0.1198	1.75	0.5262	0.4604	2.25	1.1183	1.2581
1.26	0.1964	0.1237	1.76	0.5352	0.4710	2.26	1.1332	1.2806
1.27	0.2011	0.1277	1.77	0.5444	0.4818	2.27	1.1484	1.3034
1.28	0.2059	0.1318	1.78	0.5537	0.4928	2.28	1.1636	1.3265
1.29	0.2108	0.1359	1.79	0.5631	0.5039	2.29	1.1790	1.3499
1.30	0.2157	0.1402	1.80	0.5726	0.5153	2.30	1.1945	1.3737
1.31	0.2207	0.1446	1.81	0.5822	0.5268	2.31	1.2101	1.3977
1.32	0.2258	0.1490	1.82	0.5919	0.5386	2.32	1.2259	1.4221
1.33	0.2310	0.1536	1.83	0.6017	0.5505	2.33	1.2418	1.4468
1.34	0.2362	0.1583	1.84	0.6116	0.5627	2.34	1.2579	1.4717
1.35	0.2415	0.1630	1.85	0.6216	0.5750	2.35	1.2741	1.4971
1.36	0.2470	0.1679	1.86	0.6317	0.5875	2.36	1.2904	1.5227
1.37	0.2524	0.1729	1.87	0.6420	0.6003	2.37	1.3069	1.5487
1.38	0.2580	0.1780	1.88	0.6523	0.6132	2.38	1.3235	1.5750
1.39	0.2637	0.1832	1.89	0.6628	0.6264	2.39	1.3403	1.6016
1.40	0.2694	0.1886	1.90	0.6734	0.6397	2.40	1.3572	1.6286
1.41	0.2752	0.1940	1.91	0.6841	0.6533	2.41	1.3742	1.6559
1.42	0.2811	0.1996	1.92	0.6949	0.6671	2.42	1.3914	1.6836
1.43	0.2871	0.2053	1.93	0.7058	0.6811	2.43	1.4087	1.7116
1.44	0.2931	0.2111	1.94	0.7168	0.6953	2.44	1.4262	1.7399
1.45	0.2993	0.2170	1.95	0.7280	0.7098	2.45	1.4438	1.7686
1.46	0.3055	0.2230	1.96	0.7392	0.7244	2.46	1.4615	1.7977
1.47	0.3119	0.2292	1.97	0.7506	0.7393	2.47	1.4794	1.8271
1.48	0.3183	0.2355	1.98	0.7621	0.7545	2.48	1.4975	1.8568
1.49	0.3248	0.2419	1.99	0.7737	0.7698	2.49	1.5156	1.8870

Section Moduli and Moments of Inertia for Round Shafts (English or Metric Units)

Dia.	Section Modulus	Moment of Inertia	Dia.	Section Modulus	Moment of Inertia	Dia.	Section Modulus	Moment of Inertia
2.50	1.5340	1.9175	3.00	2.6507	3.9761	3.50	4.2092	7.3662
2.51	1.5525	1.9483	3.01	2.6773	4.0294	3.51	4.2454	7.4507
2.52	1.5711	1.9796	3.02	2.7041	4.0832	3.52	4.2818	7.5360
2.53	1.5899	2.0112	3.03	2.7310	4.1375	3.53	4.3184	7.6220
2.54	1.6088	2.0432	3.04	2.7582	4.1924	3.54	4.3552	7.7087
2.55	1.6279	2.0755	3.05	2.7855	4.2479	3.55	4.3922	7.7962
2.56	1.6471	2.1083	3.06	2.8130	4.3038	3.56	4.4295	7.8844
2.57	1.6665	2.1414	3.07	2.8406	4.3604	3.57	4.4669	7.9734
2.58	1.6860	2.1749	3.08	2.8685	4.4175	3.58	4.5054	8.0631
2.59	1.7057	2.2089	3.09	2.8965	4.4751	3.59	4.5424	8.1536
2.60	1.7255	2.2432	3.10	2.9247	4.5333	3.60	4.5804	8.2248
2.61	1.7455	2.2779	3.11	2.9531	4.5921	3.61	4.6187	8.3368
2.62	1.7656	2.3130	3.12	2.9817	4.6514	3.62	4.6572	8.4295
2.63	1.7859	2.3485	3.13	3.0105	4.7114	3.63	4.6959	8.5231
2.64	1.8064	2.3844	3.14	3.0394	4.7719	3.64	4.7348	8.6174
2.65	1.8270	2.4208	3.15	3.0685	4.8329	3.65	4.7740	8.7125
2.66	1.8478	2.4575	3.16	3.0979	4.8946	3.66	4.8133	8.8083
2.67	1.8687	2.4947	3.17	3.1274	4.9569	3.67	4.8529	8.9050
2.68	1.8897	2.5323	3.18	3.1570	5.0197	3.68	4.8926	9.0025
2.69	1.9110	2.5703	3.19	3.1869	5.0831	3.69	4.9326	9.1007
2.70	1.9324	2.6087	3.20	3.2170	5.1472	3.70	4.9728	9.1998
2.71	1.9539	2.6476	3.21	3.2472	5.2118	3.71	5.0133	9.2996
2.72	1.9756	2.6869	3.22	3.2777	5.2771	3.72	5.0539	9.4003
2.73	1.9975	2.7266	3.23	3.3083	5.3429	3.73	5.0948	9.5018
2.74	2.0195	2.7668	3.24	3.3391	5.4094	3.74	5.1359	9.6041
2.75	2.0417	2.8074	3.25	3.3702	5.4765	3.75	5.1772	9.7072
2.76	2.0641	2.8484	3.26	3.4014	5.5442	3.76	5.2187	9.8112
2.77	2.0866	2.8899	3.27	3.4328	5.6126	3.77	5.2605	9.9160
2.78	2.1093	2.9319	3.28	3.4643	5.6815	3.78	5.3024	10.0216
2.79	2.1321	2.9743	3.29	3.4961	5.7511	3.79	5.3446	10.1281
2.80	2.1551	3.0172	3.30	3.5281	5.8214	3.80	5.3870	10.2354
2.81	2.1783	3.0605	3.31	3.5603	5.8923	3.81	5.4297	10.3436
2.82	2.2016	3.1043	3.32	3.5926	5.9638	3.82	5.4726	10.4526
2.83	2.2251	3.1486	3.33	3.6252	6.0360	3.83	5.5156	10.5625
2.84	2.2488	3.1933	3.34	3.6580	6.1088	3.84	5.5590	10.6732
2.85	2.2727	3.2385	3.35	3.6909	6.1823	3.85	5.6025	10.7848
2.86	2.2967	3.2842	3.36	3.7241	6.2564	3.86	5.6463	10.8973
2.87	2.3208	3.3304	3.37	3.7574	6.3313	3.87	5.6903	11.0107
2.88	2.3452	3.3771	3.38	3.7910	6.4067	3.88	5.7345	11.1249
2.89	2.3697	3.4242	3.39	3.8247	6.4829	3.89	5.7789	11.2401
2.90	2.3944	3.4719	3.40	3.8587	6.5597	3.90	5.8236	11.3561
2.91	2.4192	3.5200	3.41	3.8928	6.6372	3.91	5.8685	11.4730
2.92	2.4443	3.5686	3.42	3.9272	6.7154	3.92	5.9137	11.5908
2.93	2.4695	3.6178	3.43	3.9617	6.7943	3.93	5.9591	11.7095
2.94	2.4948	3.6674	3.44	3.9965	6.8739	3.94	6.0047	11.8292
2.95	2.5204	3.7176	3.45	4.0314	6.9542	3.95	6.0505	11.9497
2.96	2.5461	3.7682	3.46	4.0666	7.0352	3.96	6.0966	12.0712
2.97	2.5720	3.8194	3.47	4.1019	7.1168	3.97	6.1429	12.1936
2.98	2.5981	3.8711	3.48	4.1375	7.1992	3.98	6.1894	12.3169
2.99	2.6243	3.9233	3.49	4.1733	7.2824	3.99	6.2362	12.4412

Section Moduli and Moments of Inertia for Round Shafts (English or Metric Units)

Dia.	Section Modulus	Moment of Inertia	Dia.	Section Modulus	Moment of Inertia	Dia.	Section Modulus	Moment of Inertia
4.00	6.2832	12.566	4.50	8.946	20.129	5.00	12.272	30.680
4.01	6.3304	12.693	4.51	9.006	20.308	5.01	12.346	30.926
4.02	6.3779	12.820	4.52	9.066	20.489	5.02	12.420	31.173
4.03	6.4256	12.948	4.53	9.126	20.671	5.03	12.494	31.423
4.04	6.4736	13.077	4.54	9.187	20.854	5.04	12.569	31.673
4.05	6.5218	13.207	4.55	9.248	21.039	5.05	12.644	31.925
4.06	6.5702	13.337	4.56	9.309	21.224	5.06	12.719	32.179
4.07	6.6189	13.469	4.57	9.370	21.411	5.07	12.795	32.434
4.08	6.6678	13.602	4.58	9.432	21.599	5.08	12.870	32.691
4.09	6.7169	13.736	4.59	9.494	21.788	5.09	12.947	32.949
4.10	6.7663	13.871	4.60	9.556	21.979	5.10	13.023	33.209
4.11	6.8159	14.007	4.61	9.618	22.170	5.11	13.100	33.470
4.12	6.8658	14.144	4.62	9.681	22.363	5.12	13.177	33.733
4.13	6.9159	14.281	4.63	9.744	22.558	5.13	13.254	33.997
4.14	6.9663	14.420	4.64	9.807	22.753	5.14	13.332	34.263
4.15	7.0169	14.560	4.65	9.871	22.950	5.15	13.410	34.530
4.16	7.0677	14.701	4.66	9.935	23.148	5.16	13.488	34.799
4.17	7.1188	14.843	4.67	9.999	23.347	5.17	13.567	35.070
4.18	7.1702	14.986	4.68	10.063	23.548	5.18	13.645	35.342
4.19	7.2217	15.130	4.69	10.128	23.750	5.19	13.725	35.616
4.20	7.2736	15.275	4.70	10.193	23.953	5.20	13.804	35.891
4.21	7.3257	15.420	4.71	10.258	24.158	5.21	13.884	36.168
4.22	7.3780	15.568	4.72	10.323	24.363	5.22	13.964	36.446
4.23	7.4306	15.716	4.73	10.389	24.571	5.23	14.044	36.726
4.24	7.4834	15.865	4.74	10.455	24.779	5.24	14.125	37.008
4.25	7.5364	16.015	4.75	10.522	24.989	5.25	14.206	37.291
4.26	7.5898	16.166	4.76	10.588	25.200	5.26	14.288	37.576
4.27	7.6433	16.319	4.77	10.655	25.412	5.27	14.369	37.863
4.28	7.6972	16.472	4.78	10.722	25.626	5.28	14.451	38.151
4.29	7.7513	16.626	4.79	10.790	25.841	5.29	14.533	38.441
4.30	7.8056	16.782	4.80	10.857	26.058	5.30	14.616	38.732
4.31	7.8602	16.939	4.81	10.925	26.275	5.31	14.699	39.025
4.32	7.9150	17.096	4.82	10.994	26.495	5.32	14.782	39.320
4.33	7.9701	17.255	4.83	11.062	26.715	5.33	14.866	39.617
4.34	8.0254	17.415	4.84	11.131	26.937	5.34	14.949	39.915
4.35	8.0810	17.576	4.85	11.200	27.160	5.35	15.034	40.215
4.36	8.1369	17.738	4.86	11.270	27.385	5.36	15.118	40.516
4.37	8.1930	17.902	4.87	11.339	27.611	5.37	15.203	40.819
4.38	8.2494	18.066	4.88	11.409	27.839	5.38	15.288	41.124
4.39	8.3060	18.232	4.89	11.480	28.068	5.39	15.373	41.431
4.40	8.3629	18.398	4.90	11.550	28.298	5.40	15.459	41.739
4.41	8.4201	18.566	4.91	11.621	28.530	5.41	15.545	42.049
4.42	8.4775	18.735	4.92	11.692	28.763	5.42	15.631	42.361
4.43	8.5351	18.905	4.93	11.764	28.997	5.43	15.718	42.675
4.44	8.5931	19.077	4.94	11.835	29.233	5.44	15.805	42.990
4.45	8.6513	19.249	4.95	11.907	29.471	5.45	15.892	43.307
4.46	8.7097	19.423	4.96	11.980	29.710	5.46	15.980	43.626
4.47	8.7684	19.597	4.97	12.052	29.950	5.47	16.068	43.946
4.48	8.8274	19.773	4.98	12.125	30.192	5.48	16.156	44.268
4.49	8.8867	19.951	4.99	12.198	30.435	5.49	16.245	44.592

Section Moduli and Moments of Inertia for Round Shafts (English or Metric Units)

Dia.	Section Modulus	Moment of Inertia	Dia.	Section Modulus	Moment of Inertia	Dia.	Section Modulus	Moment of Inertia
5.5	16.3338	44.9180	30	2650.72	39760.8	54.5	15892.4	433068
6	21.2058	63.6173	30.5	2785.48	42478.5	55	16333.8	449180
6.5	26.9612	87.6241	31	2924.72	45333.2	55.5	16783.4	465738
7	33.6739	117.859	31.5	3068.54	48329.5	56	17241.1	482750
7.5	41.4175	155.316	32	3216.99	51471.9	56.5	17707.0	500223
8	50.2655	201.062	32.5	3370.16	54765.0	57	18181.3	518166
8.5	60.2916	256.239	33	3528.11	58213.8	57.5	18663.9	536588
9	71.5694	322.062	33.5	3690.92	61822.9	58	19155.1	555497
9.5	84.1726	399.820	34	3858.66	65597.2	58.5	19654.7	574901
10	98.1748	490.874	34.5	4031.41	69541.9	59	20163.0	594810
10.5	113.650	596.660	35	4209.24	73661.8	59.5	20680.0	615230
11	130.671	718.688	35.5	4392.23	77962.1	60	21205.8	636173
11.5	149.312	858.541	36	4580.44	82448.0	60.5	21740.3	657645
12	169.646	1017.88	36.5	4773.96	87124.7	61	22283.8	679656
12.5	191.748	1198.42	37	4972.85	91997.7	61.5	22836.3	702215
13	215.690	1401.98	37.5	5177.19	97072.2	62	23397.8	725332
13.5	241.547	1630.44	38	5387.05	102354	62.5	23968.4	749014
14	269.392	1885.74	38.5	5602.50	107848	63	24548.3	773272
14.5	299.298	2169.91	39	5823.63	113561	63.5	25137.4	798114
15	331.340	2485.05	39.5	6050.50	119497	64	25735.9	823550
15.5	365.591	2833.33	40	6283.19	125664	64.5	26343.8	849589
16	402.124	3216.99	40.5	6521.76	132066	65	26961.2	876241
16.5	441.013	3638.36	41	6766.30	138709	65.5	27588.2	903514
17	482.333	4099.83	41.5	7016.88	145600	66	28224.9	931420
17.5	526.155	4603.86	42	7273.57	152745	66.5	28871.2	959967
18	572.555	5153.00	42.5	7536.45	160150	67	29527.3	989166
18.5	621.606	5749.85	43	7805.58	167820	67.5	30193.3	1019025
19	673.381	6397.12	43.5	8081.05	175763	68	30869.3	1049556
19.5	727.954	7097.55	44	8362.92	183984	68.5	31555.2	1080767
20	785.398	7853.98	44.5	8651.27	192491	69	32251.3	1112670
20.5	845.788	8669.33	45	8946.18	201289	69.5	32957.5	1145273
21	909.197	9546.56	45.5	9247.71	210385	70	33673.9	1178588
21.5	975.698	10488.8	46	9555.94	219787	70.5	34400.7	1212625
22	1045.36	11499.0	46.5	9870.95	229499	71	35137.8	1247393
22.5	1118.27	12580.6	47	10192.8	239531	71.5	35885.4	1282904
23	1194.49	13736.7	47.5	10521.6	249887	72	36643.5	1319167
23.5	1274.10	14970.7	48	10857.3	260576	72.5	37412.3	1356194
24	1357.17	16286.0	48.5	11200.2	271604	73	38191.7	1393995
24.5	1443.77	17686.2	49	11550.2	282979	73.5	38981.8	1432581
25	1533.98	19174.8	49.5	11907.4	294707	74	39782.8	1471963
25.5	1627.87	20755.4	50	12271.8	306796	74.5	40594.6	1512150
26	1725.52	22431.8	50.5	12643.7	319253	75	41417.5	1553156
26.5	1827.00	24207.7	51	13023.0	332086	75.5	42251.4	1594989
27	1932.37	26087.0	51.5	13409.8	345302	76	43096.4	1637662
27.5	2041.73	28073.8	52	13804.2	358908	76.5	43952.6	1681186
28	2155.13	30171.9	52.5	14206.2	372913	77	44820.0	1725571
28.5	2272.66	32385.4	53	14616.0	387323	77.5	45698.8	1770829
29	2394.38	34718.6	53.5	15033.5	402147	78	46589.0	1816972
29.5	2520.38	37175.6	54	15459.0	417393	78.5	47490.7	1864011

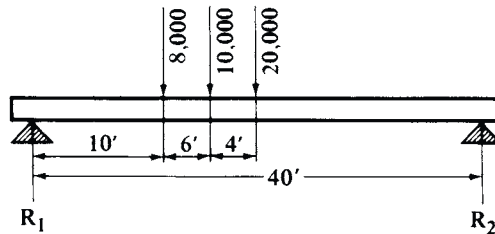
Section Moduli and Moments of Inertia for Round Shafts (English or Metric Units)

Dia.	Section Modulus	Moment of Inertia	Dia.	Section Modulus	Moment of Inertia	Dia.	Section Modulus	Moment of Inertia
79	48404.0	1911958	103.5	108848	5632890	128	205887	13176795
79.5	49328.9	1960823	104	110433	5742530	128.5	208310	13383892
80	50265.5	2010619	104.5	112034	5853762	129	210751	13593420
80.5	51213.9	2061358	105	113650	5966602	129.5	213211	13805399
81	52174.1	2113051	105.5	115281	6081066	130	215690	14019848
81.5	53146.3	2165710	106	116928	6197169	130.5	218188	14236786
82	54130.4	2219347	106.5	118590	6314927	131	220706	14456231
82.5	55126.7	2273975	107	120268	6434355	131.5	223243	14678204
83	56135.1	2329605	107.5	121962	6555469	132	225799	14902723
83.5	57155.7	2386249	108	123672	6678285	132.5	228374	15129808
84	58188.6	2443920	108.5	125398	6802818	133	230970	15359478
84.5	59233.9	2502631	109	127139	6929085	133.5	233584	15591754
85	60291.6	2562392	109.5	128897	7057102	134	236219	15826653
85.5	61361.8	2623218	110	130671	7186884	134.5	238873	16064198
86	62444.7	2685120	110.5	132461	7318448	135	241547	16304406
86.5	63540.1	2748111	111	134267	7451811	135.5	244241	16547298
87	64648.4	2812205	111.5	136089	7586987	136	246954	16792893
87.5	65769.4	2877412	112	137928	7723995	136.5	249688	17041213
88	66903.4	2943748	112.5	139784	7862850	137	252442	17292276
88.5	68050.2	3011223	113	141656	8003569	137.5	255216	17546104
89	69210.2	3079853	113.5	143545	8146168	138	258010	17802715
89.5	70383.2	3149648	114	145450	8290664	138.5	260825	18062131
90	71569.4	3220623	114.5	147372	8437074	139	263660	18324372
90.5	72768.9	3292791	115	149312	8585414	139.5	266516	18589458
91	73981.7	3366166	115.5	151268	8735703	140	269392	18857410
91.5	75207.9	3440759	116	153241	8887955	140.5	272288	19128248
92	76447.5	3516586	116.5	155231	9042189	141	275206	19401993
92.5	77700.7	3593659	117	157238	9198422	141.5	278144	19678666
93	78967.6	3671992	117.5	159262	9356671	142	281103	19958288
93.5	80248.1	3751598	118	161304	9516953	142.5	284083	20240878
94	81542.4	3832492	118.5	163363	9679286	143	287083	20526460
94.5	82850.5	3914688	119	165440	9843686	143.5	290105	20815052
95	84172.6	3998198	119.5	167534	10010172	144	293148	21106677
95.5	85508.6	4083038	120	169646	10178760	144.5	296213	21401356
96	86858.8	4169220	120.5	171775	10349469	145	299298	21699109
96.5	88223.0	4256760	121	173923	10522317	145.5	302405	21999959
97	89601.5	4345671	121.5	176088	10697321	146	305533	22303926
97.5	90994.2	4435968	122	178270	10874498	146.5	308683	22611033
98	92401.3	4527664	122.5	180471	11053867	147	311854	22921300
98.5	93822.8	4620775	123	182690	11235447	147.5	315047	23234749
99	95258.9	4715315	123.5	184927	11419254	148	318262	23551402
99.5	96709.5	4811298	124	187182	11605307	148.5	321499	23871280
100	98174.8	4908739	124.5	189456	11793625	149	324757	24194406
100.5	99654.8	5007652	125	191748	11984225	149.5	328037	24520802
101	101150	5108053	125.5	194058	12177126	150	331340	24850489
101.5	102659	5209956	126	196386	12372347
102	104184	5313376	126.5	198734	12569905
102.5	105723	5418329	127	201100	12769820
103	107278	5524828	127.5	203484	12972110

BEAMS

Beam Calculations

Reaction at the Supports.—When a beam is loaded by vertical loads or forces, the sum of the reactions at the supports equals the sum of the loads. In a simple beam, when the loads are symmetrically placed with reference to the supports, or when the load is uniformly distributed, the reaction at each end will equal one-half of the sum of the loads. When the loads are not symmetrically placed, the reaction at each support may be ascertained from the fact that the algebraic sum of the moments must equal zero. In the accompanying illustration, if moments are taken about the support to the left, then: $R_2 \times 40 - 8000 \times 10 - 10,000 \times 16 - 20,000 \times 20 = 0$; $R_2 = 16,000$ pounds. In the same way, moments taken about the support at the right give $R_1 = 22,000$ pounds.



The sum of the reactions equals 38,000 pounds, which is also the sum of the loads. If part of the load is uniformly distributed over the beam, this part is first equally divided between the two supports, or the uniform load may be considered as concentrated at its center of gravity.

If metric SI units are used for the calculations, distances may be expressed in meters or millimeters, providing the treatment is consistent, and loads in newtons. Note: If the load is given in kilograms, the value referred to is the mass. A mass of M kilograms has a weight (applies a force) of Mg newtons, where $g =$ approximately 9.81 meters per second².

Stresses and Deflections in Beams.—On the following pages [Table 1](#) gives an extensive list of formulas for stresses and deflections in beams, shafts, etc. It is assumed that all the dimensions are in inches, all loads in pounds, and all stresses in pounds per square inch. **The formulas are also valid using metric SI units, with all dimensions in millimeters, all loads in newtons, and stresses and moduli in newtons per millimeter² (N/mm²).** *Note: A load due to the weight of a mass of M kilograms is Mg newtons, where $g =$ approximately 9.81 meters per second².* In the tables:

E = modulus of elasticity of the material

I = moment of inertia of the cross-section of the beam

Z = section modulus of the cross-section of the beam = $I \div$ distance from neutral axis to extreme fiber

W = load on beam

s = stress in extreme fiber, or maximum stress in the cross-section considered, due to load W . A positive value of s denotes tension in the upper fibers and compression in the lower ones (as in a cantilever). A negative value of s denotes the reverse (as in a beam supported at the ends). The greatest safe load is that value of W which causes a maximum stress equal to, but not exceeding, the greatest safe value of s

y = deflection measured from the position occupied if the load causing the deflection were removed. A positive value of y denotes deflection below this position; a negative value, deflection upward

u, v, w, x = variable distances along the beam from a given support to any point

Table 1. Stresses and Deflections in Beams

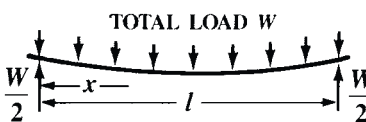
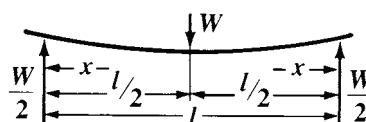
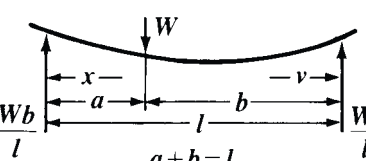
Type of Beam	Stresses		Deflections	
	General Formula for Stress at any Point	Stresses at Critical Points	General Formula for Deflection at any Point ^a	Deflections at Critical Points ^a
Case 1. — Supported at Both Ends, Uniform Load				
 <p style="text-align: center;">TOTAL LOAD W</p>	$s = -\frac{W}{2ZI}x(l-x)$	Stress at center, $-\frac{Wl}{8Z}$ If cross-section is constant, this is the maximum stress.	$y = \frac{Wx(l-x)}{24EI}[l^2 + x(l-x)]$	Maximum deflection, at center, $\frac{5}{384} \frac{Wl^3}{EI}$
Case 2. — Supported at Both Ends, Load at Center				
	Between each support and load, $s = -\frac{Wx}{2Z}$	Stress at center, $-\frac{Wl}{4Z}$ If cross-section is constant, this is the maximum stress.	Between each support and load, $y = \frac{Wx}{48EI}(3l^2 - 4x^2)$	Maximum deflection, at load, $\frac{Wl^3}{48EI}$
Case 3. — Supported at Both Ends, Load at any Point				
 <p style="text-align: center;">$a + b = l$</p>	For segment of length a , $s = -\frac{Wbx}{ZI}$ For segment of length b , $s = -\frac{Wav}{ZI}$	Stress at load, $-\frac{Wab}{ZI}$ If cross-section is constant, this is the maximum stress.	For segment of length a , $y = \frac{Wbx}{6EI}(l^2 - x^2 - b^2)$ For segment of length b , $y = \frac{Wav}{6EI}(l^2 - v^2 - a^2)$	Deflection at load, $\frac{Wa^2b^2}{3EI}$ Let a be the length of the shorter segment and b of the longer one. The maximum deflection $\frac{Wav_1^3}{3EI}$ is in the longer segment, at $v = b\sqrt{\frac{1}{3} + \frac{2a}{3b}} = v_1$

Table 1. (Continued) Stresses and Deflections in Beams

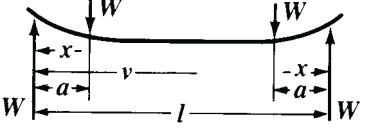
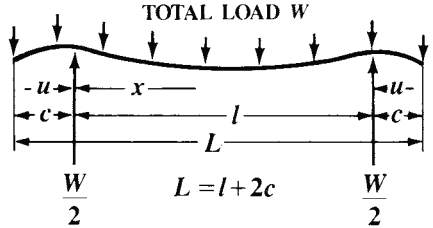
Type of Beam	Stresses		Deflections	
	General Formula for Stress at any Point	Stresses at Critical Points	General Formula for Deflection at any Point ^a	Deflections at Critical Points ^a
Case 4. — Supported at Both Ends, Two Symmetrical Loads				
	Between each support and adjacent load, $s = -\frac{Wx}{Z}$ Between loads, $s = -\frac{Wa}{Z}$	Stress at each load, and at all points between, $-\frac{Wa}{Z}$	Between each support and adjacent load, $y = \frac{Wx}{6EI}[3a(l-a) - x^2]$ Between loads, $y = \frac{Wa}{6EI}[3v(l-v) - a^2]$	Maximum deflection at center, $\frac{Wa}{24EI}(3l^2 - 4a^2)$ Deflection at loads $\frac{Wa^2}{6EI}(3l - 4a)$
Case 5. — Both Ends Overhanging Supports Symmetrically, Uniform Load				
	Between each support and adjacent end, $s = \frac{W}{2Zl}(c-u)^2$ Between supports, $s = \frac{W}{2ZL}[c^2 - x(l-x)]$	Stress at each support, $\frac{wc^2}{2ZL}$ Stress at center, $\frac{W}{2ZL}(c^2 - \frac{1}{4}l^2)$ If cross-section is constant, the greater of these is the maximum stress. If l is greater than $2c$, the stress is zero at points $\sqrt{\frac{1}{4}l^2 - c^2}$ on both sides of the center. If cross-section is constant and if $l = 2.828c$, the stresses at supports and center are equal and opposite, and are $\pm \frac{WL}{46.62Z}$	Between each support and adjacent end, $y = \frac{Wu}{24EIL}[6c^2(l+u) - u^2(4c-u) - l^3]$ Between supports, $y = \frac{Wx(l-x)}{24EIL}[x(l-x) + l^2 - 6c^2]$	Deflection at ends, $\frac{Wc}{24EIL}[3c^2(c+2l) - l^3]$ Deflection at center, $\frac{Wl^2}{384EIL}(5l^2 - 24c^2)$ If l is between $2c$ and $2.449c$, there are maximum upward deflections at points $\sqrt{3(\frac{1}{4}l^2 - c^2)}$ on both sides of the center, which are, $-\frac{W}{96EIL}(6c^2 - l^2)^2$

Table 1. (Continued) Stresses and Deflections in Beams

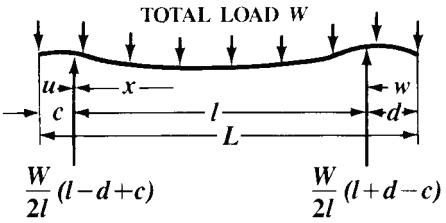
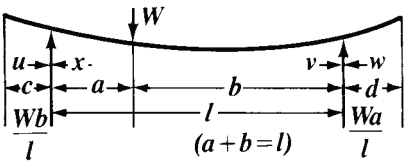
Type of Beam	Stresses		Deflections	
	General Formula for Stress at any Point	Stresses at Critical Points	General Formula for Deflection at any Point ^a	Deflections at Critical Points ^a
Case 6. — Both Ends Overhanging Supports Unsymmetrically, Uniform Load				
	<p>For overhanging end of length c,</p> $s = \frac{W}{2ZL}(c - u)^2$ <p>Between supports,</p> $s = \frac{W}{2ZL} \left\{ c^2 \left(\frac{l-x}{l} \right) + d^2 \frac{x}{l} - x(l-x) \right\}$ <p>For overhanging end of length d,</p> $s = \frac{W}{2ZL}(d - w)^2$	<p>Stress at support next to end of length c, $\frac{Wc^2}{2ZL}$</p> <p>Critical stress between supports is at</p> $x = \frac{l^2 + c^2 - d^2}{2l} = x_1$ <p>and is $\frac{W}{2ZL}(c^2 - x_1^2)$</p> <p>Stress at support next to end of length d, $\frac{Wd^2}{2ZL}$</p> <p>If cross-section is constant, the greatest of these three is the maximum stress.</p> <p>If $x_1 > c$, the stress is zero at points $\sqrt{x_1^2 - c^2}$ on both sides of $x = x_1$.</p>	<p>For overhanging end of length c,</p> $y = \frac{Wu}{24EIL} [2l(d^2 + 2c^2) + 6c^2u - u^2(4c - u) - l^3]$ <p>Between supports,</p> $y = \frac{Wx(l-x)}{24EIL} \{ x(l-x) + l^2 - 2(d^2 + c^2) - \frac{2}{l}[d^2x + c^2(l-x)] \}$ <p>For overhanging end of length d,</p> $y = \frac{Ww}{24EIL} [2l(c^2 + 2d^2) + 6d^2w - w^2(4d - w) - l^3]$	<p>Deflection at end c,</p> $\frac{Wc}{24EIL} [2l(d^2 + 2c^2) + 3c^3 - l^3]$ <p>Deflection at end d,</p> $\frac{Wd}{24EIL} [2l(c^2 + 2d^2) + 3d^3 - l^3]$ <p>This case is so complicated that convenient general expressions for the critical deflections between supports cannot be obtained.</p>
Case 7. — Both Ends Overhanging Supports, Load at any Point Between				
	<p>Between supports:</p> <p>For segment of length a,</p> $s = \frac{Wbx}{Zl}$ <p>For segment of length b,</p> $s = \frac{Wav}{Zl}$ <p>Beyond supports $s = 0$.</p>	<p>Stress at load,</p> $\frac{Wab}{Zl}$ <p>If cross-section is constant, this is the maximum stress.</p>	<p>Between supports, same as Case 3.</p> <p>For overhanging end of length c,</p> $y = -\frac{Wabu}{6EIl}(l + b)$ <p>For overhanging end of length d,</p> $y = -\frac{Wabw}{6EIl}(l + a)$	<p>Between supports, same as Case 3.</p> <p>Deflection at end c,</p> $-\frac{Wabc}{6EIl}(l + b)$ <p>Deflection at end d,</p> $-\frac{Wabd}{6EIl}(l + a)$

Table 1. (Continued) Stresses and Deflections in Beams

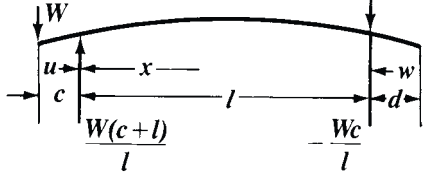
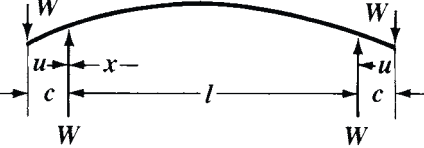
Type of Beam	Stresses		Deflections	
	General Formula for Stress at any Point	Stresses at Critical Points	General Formula for Deflection at any Point ^a	Deflections at Critical Points ^a
Case 8. — Both Ends Overhanging Supports, Single Overhanging Load				
	<p>Between load and adjacent support,</p> $s = \frac{W}{Z}(c - u)$ <p>Between supports,</p> $s = \frac{Wc}{Zl}(l - x)$ <p>Between unloaded end and adjacent supports, $s = 0$.</p>	<p>Stress at support adjacent to load,</p> $\frac{Wc}{Z}$ <p>If cross-section is constant, this is the maximum stress. Stress is zero at other support.</p>	<p>Between load and adjacent support,</p> $y = \frac{Wu}{6EI}(3cu - u^2 + 2cl)$ <p>Between supports,</p> $y = -\frac{Wcx}{6EI}(l - x)(2l - x)$ <p>Between unloaded end and adjacent support, $y = \frac{Wclw}{6EI}$</p>	<p>Deflection at load,</p> $\frac{Wc^2}{3EI}(c + l)$ <p>Maximum upward deflection is at $x = .42265l$, and is $-\frac{Wcl^2}{15.55EI}$</p> <p>Deflection at unloaded end,</p> $\frac{Wcld}{6EI}$
Case 9. — Both Ends Overhanging Supports, Symmetrical Overhanging Loads				
	<p>Between each load and adjacent support,</p> $s = \frac{W}{Z}(c - u)$ <p>Between supports,</p> $s = \frac{Wc}{Z}$	<p>Stress at supports and at all points between,</p> $\frac{Wc}{Z}$ <p>If cross-section is constant, this is the maximum stress.</p>	<p>Between each load and adjacent support,</p> $y = \frac{Wu}{6EI}[3c(l + u) - u^2]$ <p>Between supports,</p> $y = -\frac{Wcx}{2EI}(l - x)$	<p>Deflections at loads,</p> $\frac{Wc^2}{6EI}(2c + 3l)$ <p>Deflection at center,</p> $\frac{Wcl^2}{8EI}$
<p>The above expressions involve the usual approximations of the theory of flexure, and hold only for small deflections. Exact expressions for deflections of any magnitude are as follows:</p> <p>Between supports the curve is a circle of radius $r = \frac{EI}{Wc}$</p> <p>Deflection at any point x between supports</p> $y = \sqrt{r^2 - \frac{1}{4}l^2} - \sqrt{r^2 - (\frac{1}{2}l - x)^2}$ <p>Deflection at center, $\sqrt{r^2 - \frac{1}{4}l^2} - r$</p>				

Table 1. (Continued) Stresses and Deflections in Beams

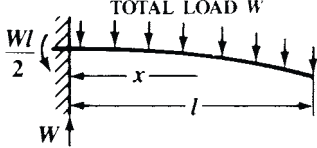
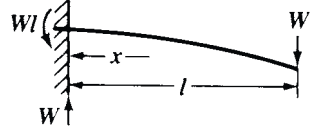
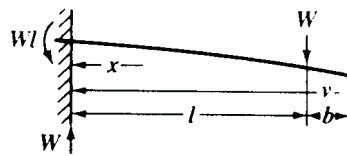
Type of Beam	Stresses		Deflections	
	General Formula for Stress at any Point	Stresses at Critical Points	General Formula for Deflection at any Point ^a	Deflections at Critical Points ^a
Case 10. — Fixed at One End, Uniform Load				
	$s = \frac{W}{2Zl}(l-x)^2$	Stress at support, $\frac{Wl}{2Z}$ If cross-section is constant, this is the maximum stress.	$y = \frac{Wx^2}{24EI}[2l^2 + (2l-x)^2]$	Maximum deflection, at end, $\frac{Wl^3}{8EI}$
Case 11. — Fixed at One End, Load at Other				
	$s = \frac{W}{Z}(l-x)$	Stress at support, $\frac{Wl}{Z}$ If cross-section is constant, this is the maximum stress.	$y = \frac{Wx^2}{6EI}(3l-x)$	Maximum deflection, at end, $\frac{Wl^3}{3EI}$
Case 12. — Fixed at One End, Intermediate Load				
	Between support and load, $s = \frac{W}{Z}(l-x)$ Beyond load, $s = 0$.	Stress at support, $\frac{Wl}{Z}$ If cross-section is constant, this is the maximum stress.	Between support and load, $y = \frac{Wx^2}{6EI}(3l-x)$ Beyond load, $y = \frac{Wl^2}{6EI}(3v-l)$	Deflection at load, $\frac{Wl^3}{3EI}$ Maximum deflection, at end, $\frac{Wl^2}{6EI}(2l+3v)$

Table 1. (Continued) Stresses and Deflections in Beams

Type of Beam	Stresses		Deflections	
	General Formula for Stress at any Point	Stresses at Critical Points	General Formula for Deflection at any Point ^a	Deflections at Critical Points ^a
Case 13. — Fixed at One End, Supported at the Other, Load at Center				
	<p>Between point of fixture and load,</p> $s = \frac{W}{16Z}(3l - 11x)$ <p>Between support and load,</p> $s = -\frac{5}{16} \frac{Wv}{Z}$	<p>Maximum stress at point of fixture, $\frac{3}{16} \frac{Wl}{Z}$</p> <p>Stress is zero at $x = \frac{3}{11}l$</p> <p>Greatest negative stress at center, $-\frac{5}{32} \frac{Wl}{Z}$</p>	<p>Between point of fixture and load,</p> $y = \frac{Wx^2}{96EI}(9l - 11x)$ <p>Between support and load,</p> $y = \frac{Wv}{96EI}(3l^2 - 5v^2)$	<p>Maximum deflection is at $v = 0.4472l$, and is $\frac{WL^3}{107.33EI}$</p> <p>Deflection at load,</p> $\frac{7}{768} \frac{WL^3}{EI}$
Case 14. — Fixed at One End, Supported at the Other, Load at any Point				
<p> $m = (l + a)(l + b) + al$ $n = al(l + b)$ </p>	<p>Between point of fixture and load,</p> $s = \frac{Wb}{2Zl^3}(n - mx)$ <p>Between support and load,</p> $s = -\frac{Wa^2v}{2Zl^3}(3l - a)$	<p>Greatest positive stress, at point of fixture,</p> $\frac{Wab}{2Zl^2}(l + b)$ <p>Greatest negative stress, at load,</p> $-\frac{Wa^2b}{2Zl^3}(3l - a)$ <p>If $a < 0.5858l$, the first is the maximum stress. If $a = 0.5858l$, the two are equal and are $\pm \frac{Wl}{5.83Z}$. If $a > 0.5858l$, the second is the maximum stress.</p> <p>Stress is zero at $x = \frac{n}{m}$</p>	<p>Between point of fixture and load,</p> $y = \frac{Wx^2b}{12EI l^3}(3n - mx)$ <p>Between support and load,</p> $y = \frac{Wa^2v}{12EI l^3}[3l^2b - v^2(3l - a)]$	<p>Deflection at load,</p> $\frac{Wa^3b^2}{12EI l^3}(3l + b)$ <p>If $a < 0.5858l$, maximum deflection is $\frac{Wa^2b}{6EI} \sqrt{\frac{b}{2l + b}}$ and located between load and support, at $v = l \sqrt{\frac{b}{2l + b}}$</p> <p>If $a = 0.5858l$, maximum deflection is at load and is $\frac{Wl^3}{101.9EI}$</p> <p>If $a > 0.5858l$, maximum deflection is $\frac{Wbn^3}{3EI m^2 l^3}$ and located between load and point of fixture, at $x = \frac{2n}{m}$</p>

Table 1. (Continued) Stresses and Deflections in Beams

Type of Beam	Stresses		Deflections	
	General Formula for Stress at any Point	Stresses at Critical Points	General Formula for Deflection at any Point ^a	Deflections at Critical Points ^a
Case 15. — Fixed at One End, Supported at the Other, Uniform Load				
	$s = \frac{W(l-x)}{2Zl} (\frac{1}{4}l - x)$	Maximum stress at point of fixture, $\frac{Wl}{8Z}$ Stress is zero at $x = \frac{1}{4}l$. Greatest negative stress is at $x = \frac{5}{8}l$ and is $-\frac{9}{128} \frac{Wl}{Z}$	$y = \frac{Wx^2(l-x)}{48EI} (3l - 2x)$	Maximum deflection is at $x = 0.5785l$, and is $\frac{Wl^3}{185EI}$ Deflection at center, $\frac{Wl^3}{192EI}$ Deflection at point of greatest negative stress, at $x = \frac{5}{8}l$ is $\frac{Wl^3}{187EI}$
Case 16. — Fixed at One End, Free but Guided at the Other, Uniform Load				
	$s = \frac{Wl}{Z} \left\{ \frac{1}{3} - \frac{x}{l} + \frac{1}{2} \left(\frac{x}{l} \right)^2 \right\}$	Maximum stress, at support, $\frac{Wl}{3Z}$ Stress is zero at $x = 0.4227l$ Greatest negative stress, at free end, $-\frac{Wl}{6Z}$	$y = \frac{Wx^2}{24EI} (2l - x)^2$	Maximum deflection, at free end, $\frac{Wl^3}{24EI}$
Case 17. — Fixed at One End, Free but Guided at the Other, with Load				
	$s = \frac{W}{Z} (\frac{1}{2}l - x)$	Stress at support, $\frac{Wl}{2Z}$ Stress at free end $-\frac{Wl}{2Z}$ These are the maximum stresses and are equal and opposite. Stress is zero at center.	$y = \frac{Wx^2}{12EI} (3l - 2x)$	Maximum deflection, at free end, $\frac{Wl^3}{12EI}$

Table 1. (Continued) Stresses and Deflections in Beams

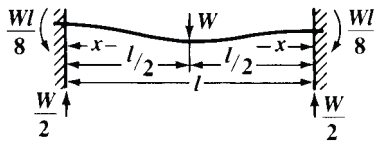
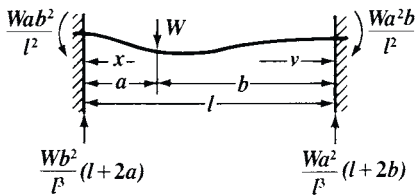
Type of Beam	Stresses		Deflections	
	General Formula for Stress at any Point	Stresses at Critical Points	General Formula for Deflection at any Point ^a	Deflections at Critical Points ^a
Case 18. — Fixed at Both Ends, Load at Center				
	<p>Between each end and load,</p> $s = \frac{W}{2Z}(\frac{1}{4}l - x)$	<p>Stress at ends $\frac{Wl}{8Z}$</p> <p>Stress at load $-\frac{Wl}{8Z}$</p> <p>These are the maximum stresses and are equal and opposite.</p> <p>Stress is zero at $x = \frac{1}{4}l$</p>	$y = \frac{Wx^2}{48EI}(3l - 4x)$	<p>Maximum deflection, at load,</p> $\frac{Wl^3}{192EI}$
Case 19. — Fixed at Both Ends, Load at any Point				
	<p>For segment of length a,</p> $s = \frac{Wb^2}{Zl^3}[al - x(l + 2a)]$ <p>For segment of length b,</p> $s = \frac{Wa^2}{Zl^3}[bl - v(l + 2b)]$	<p>Stress at end next to segment of length a, $\frac{Wab^2}{Zl^2}$</p> <p>Stress at end next to segment of length b, $\frac{Wa^2b}{Zl^2}$</p> <p>Maximum stress is at end next to shorter segment.</p> <p>Stress is zero at</p> $x = \frac{al}{l + 2a}$ <p>and</p> $v = \frac{bl}{l + 2b}$ <p>Greatest negative stress, at load, $-\frac{2Wa^2b^2}{Zl^3}$</p>	<p>For segment of length a,</p> $y = \frac{Wx^2b^2}{6EI^3}[2a(l - x) + l(a - x)]$ <p>For segment of length b,</p> $y = \frac{Wv^2a^2}{6EI^3}[2b(l - v) + l(b - v)]$	<p>Deflection at load, $\frac{Wa^3b^3}{3EI^3}$</p> <p>Let b be the length of the longer segment and a of the shorter one. The maximum deflection is in the longer segment, at</p> $v = \frac{2bl}{l + 2b}$ <p>and is</p> $\frac{2Wa^2b^3}{3EI(l + 2b)^2}$

Table 1. (Continued) Stresses and Deflections in Beams

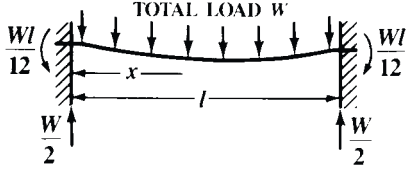
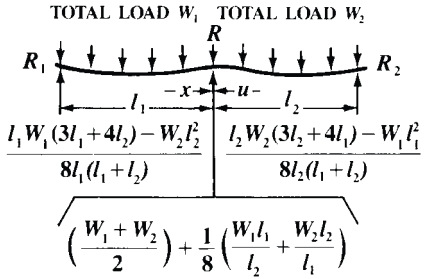
Type of Beam	Stresses		Deflections	
	General Formula for Stress at any Point	Stresses at Critical Points	General Formula for Deflection at any Point ^a	Deflections at Critical Points ^a
Case 20. — Fixed at Both Ends, Uniform Load				
	$s = \frac{Wl}{2Z} \left[\frac{1}{6} - \frac{x}{l} + \left(\frac{x}{l} \right)^2 \right]$	Maximum stress, at ends, $\frac{Wl}{12Z}$ Stress is zero at $x = 0.7887l$ and at $x = 0.2113l$ Greatest negative stress, at center, $-\frac{Wl}{24Z}$	$y = \frac{Wx^2}{24EI}(l-x)^2$	Maximum deflection, at center, $\frac{Wl^3}{384EI}$
Case 21. — Continuous Beam, with Two Unequal Spans, Unequal, Uniform Loads				
	Between R_1 and R , $s = \frac{l_1 - x}{Z} \left\{ \frac{(l_1 - x)W_1}{2l_1} - R_1 \right\}$ Between R_2 and R , $s = \frac{l_2 - u}{Z} \left\{ \frac{(l_2 - u)W_2}{2l_2} - R_2 \right\}$	Stress at support R , $\frac{W_1 l_1^2 + W_2 l_2^2}{8Z(l_1 + l_2)}$ Greatest stress in the first span is at $x = \frac{l_1}{W_1}(W_1 - R_1)$ and is $-\frac{R_1^2 l_1}{2ZW_1}$ Greatest stress in the second span is at $u = \frac{l_2}{W_2}(W_2 - R_2)$ and is, $-\frac{R_2^2 l_2}{2ZW_2}$	Between R_1 and R , $y = \frac{x(l_1 - x)}{24EI} \left\{ (2l_1 - x)(4R_1 - W_1) - \frac{W_1(l_1 - x)^2}{l_1} \right\}$ Between R_2 and R , $y = \frac{u(l_2 - u)}{24EI} \left\{ (2l_2 - u)(4R_2 - W_2) - \frac{W_2(l_2 - u)^2}{l_2} \right\}$	This case is so complicated that convenient general expressions for the critical deflections cannot be obtained.

Table 1. (Continued) Stresses and Deflections in Beams

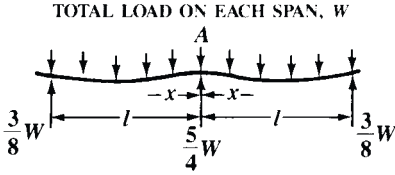
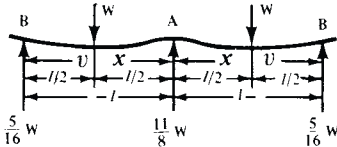
Type of Beam	Stresses		Deflections	
	General Formula for Stress at any Point	Stresses at Critical Points	General Formula for Deflection at any Point ^a	Deflections at Critical Points ^a
Case 22. — Continuous Beam, with Two Equal Spans, Uniform Load				
 <p>TOTAL LOAD ON EACH SPAN, W</p>	$s = \frac{W(l-x)}{2Zl}(\frac{1}{4}l - x)$	Maximum stress at point A, $\frac{Wl}{8Z}$ Stress is zero at $x = \frac{1}{2}l$ Greatest negative stress is at $x = \frac{3}{8}l$ and is, $-\frac{9}{128} \frac{Wl}{Z}$	$y = \frac{Wx^2(l-x)}{48EI}(3l - 2x)$	Maximum deflection is at $x = 0.5785l$, and is $\frac{Wl^3}{185EI}$ Deflection at center of span, $\frac{Wl^3}{192EI}$ Deflection at point of greatest negative stress, at $x = \frac{3}{8}l$ is $\frac{Wl^3}{187EI}$
Case 23. — Continuous Beam, with Two Equal Spans, Equal Loads at Center of Each				
	Between point A and load, $s = \frac{W}{16Z}(3l - 11x)$ Between point B and load, $s = -\frac{5}{16} \frac{Wv}{Z}$	Maximum stress at point A, $\frac{3}{16} \frac{Wl}{Z}$ Stress is zero at $x = \frac{3}{11}l$ Greatest negative stress at center of span, $-\frac{5}{32} \frac{Wl}{Z}$	Between point A and load, $y = \frac{Wx^2}{96EI}(9l - 11x)$ Between point B and load, $y = \frac{Wv}{96EI}(3l^2 - 5v^2)$	Maximum deflection is at $v = 0.4472l$, and is $\frac{Wl^3}{107.33EI}$ Deflection at load, $\frac{7}{768} \frac{Wl^3}{EI}$

Table 1. (Continued) Stresses and Deflections in Beams

Type of Beam	Stresses		Deflections	
	General Formula for Stress at any Point	Stresses at Critical Points	General Formula for Deflection at any Point ^a	Deflections at Critical Points ^a
Case 24. — Continuous Beam, with Two Unequal Spans, Unequal Loads at any Point of Each				
<div style="display: flex; align-items: center;"> <div style="margin-right: 20px;"> $m = \frac{1}{2(l_1 + l_2)} \left(\frac{W_1 a_1 b_1}{l_1} (l_1 + a_1) + \frac{W_2 a_2 b_2}{l_2} (l_2 + a_2) \right)$ </div> <div> $\frac{W_1 b_1 - m}{l_1} = r_1$ $\frac{\sqrt{W_1 a_1 + m}}{l_1} + \frac{\sqrt{W_2 a_2 + m}}{l_2} = r$ $\frac{W_2 b_2 - m}{l_2} = r_2$ </div> </div>	<p>Between R_1 and W_1,</p> $s = -\frac{wr_1}{Z}$ <p>Between R and W_1, $s =$</p> $\frac{1}{l_1 Z} [m(l_1 - u) - W_1 a_1 u]$ <p>Between R and W_2, $s =$</p> $\frac{1}{l_2 Z} [m(l_2 - x) - W_2 a_2 x]$ <p>Between R_2 and W_2,</p> $s = -\frac{vr_2}{Z}$	<p>Stress at load W_1,</p> $-\frac{a_1 r_1}{Z}$ <p>Stress at support R,</p> $\frac{m}{Z}$ <p>Stress at load W_2,</p> $-\frac{a_2 r_2}{Z}$ <p>The greatest of these is the maximum stress.</p>	<p>Between R_1 and W_1,</p> $y = \frac{w}{6EI} \left\{ (l_1 - w)(l_1 + w)r_1 - \frac{W_1 b_1^3}{l_1} \right\}$ <p>Between R and W_1,</p> $y = \frac{u}{6EI l_1} [W_1 a_1 b_1 (l_1 + a_1) - W_1 a_1 u^2 - m(2l_1 - u)(l_1 - u)]$ <p>Between R and W_2,</p> $y = \frac{x}{6EI l_2} [W_2 a_2 b_2 (l_2 + a_2) - W_2 a_2 x^2 - m(2l_2 - x)(l_2 - x)]$ <p>Between R_2 and W_2,</p> $y = \frac{v}{6EI} \left\{ (l_2 - v)(l_2 + v)r_2 - \frac{W_2 b_2^3}{l_2} \right\}$	<p>Deflection at load W_1,</p> $\frac{a_1 b_1}{6EI l_1} [2a_1 b_1 W_1 - m(l_1 + a_1)]$ <p>Deflection at load W_2,</p> $\frac{a_2 b_2}{6EI l_2} [2a_2 b_2 W_2 - m(l_2 + a_2)]$ <p>This case is so complicated that convenient general expressions for the maximum deflections cannot be obtained.</p>

^a The deflections apply only to cases where the cross section of the beam is constant for its entire length.

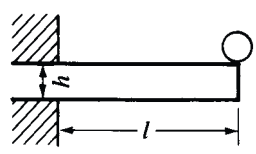
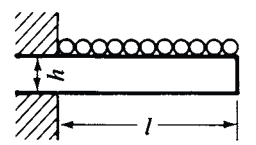
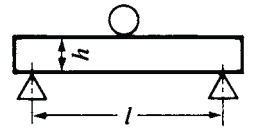
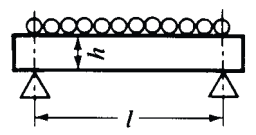
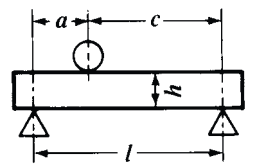
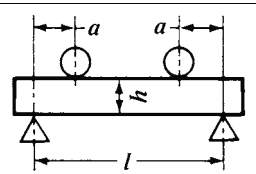
In the diagrammatical illustrations of the beams and their loading, the values indicated near, but below, the supports are the “reactions” or upward forces at the supports. For Cases 1 to 12, inclusive, the reactions, as well as the formulas for the stresses, are the same whether the beam is of constant or variable cross-section. For the other cases, the reactions and the stresses given are for constant cross-section beams only.

The bending moment at any point in inch-pounds (newton-meters if metric units are used) is $s \times Z$ and can be found by omitting the divisor Z in the formula for the stress given in the tables. A positive value of the bending moment denotes tension in the upper fibers and compression in the lower ones. A negative value denotes the reverse. The value of W corresponding to a given stress is found by transposition of the formula. For example, in Case 1, the stress at the critical point is $s = -Wl \div 8Z$. From this formula we find $W = -8Zs \div l$. Of course, the negative sign of W may be ignored.

In **Table 1**, if there are several kinds of loads, as, for instance, a uniform load and a load at any point, or separate loads at different points, the total stress and the total deflection at any point is found by adding together the various stresses or deflections at the point considered due to each load acting by itself. If the stress or deflection due to any one of the loads is negative, it must be subtracted instead of added.

Tables 2a and **2b** give expressions for determining dimensions of rectangular and round beams in terms of beam stresses and load.

Table 2a. Rectangular Solid Beams

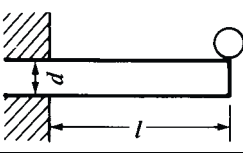
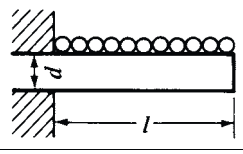
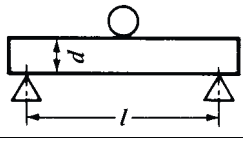
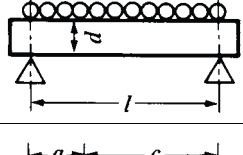
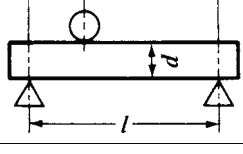
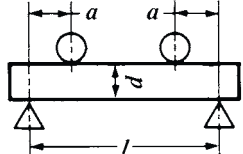
Style of Loading and Support	Breadth of Beam, <i>b</i> inch (mm)	Beam Height, <i>h</i> inch (mm)	Stress in Extreme Fibers, <i>f</i> lb/in ² (N/mm ²)	Beam Length, <i>l</i> inch (mm)	Total Load, <i>W</i> lb (N)
Beam fixed at one end, loaded at the other					
	$\frac{6lW}{fh^2} = b$	$\sqrt{\frac{6lW}{bf}} = h$	$\frac{6lW}{bh^2} = f$	$\frac{bfh^2}{6W} = l$	$\frac{bfh^2}{6l} = W$
Beam fixed at one end, uniformly loaded					
	$\frac{3lW}{fh^2} = b$	$\sqrt{\frac{3lW}{bf}} = h$	$\frac{3lW}{bh^2} = f$	$\frac{bfh^2}{3W} = l$	$\frac{bfh^2}{3l} = W$
Beam supported at both ends, single load in middle					
	$\frac{3lW}{2fh^2} = b$	$\sqrt{\frac{3lW}{2bf}} = h$	$\frac{3lW}{2bh^2} = f$	$\frac{2bfh^2}{3W} = l$	$\frac{2bfh^2}{3l} = W$
Beam supported at both ends, uniformly loaded					
	$\frac{3lW}{4fh^2} = b$	$\sqrt{\frac{3lW}{4bf}} = h$	$\frac{3lW}{4bh^2} = f$	$\frac{4bfh^2}{3W} = l$	$\frac{4bfh^2}{3l} = W$
Beam supported at both ends, single unsymmetrical load					
	$\frac{6Wac}{fh^2l} = b$	$\sqrt{\frac{6Wac}{bfl}} = h$	$\frac{6Wac}{bh^2l} = f$	$a + c = l$	$\frac{bh^2fl}{6ac} = W$
Beam supported at both ends, two symmetrical loads					
	$\frac{3Wa}{fh^2} = b$	$\sqrt{\frac{3Wa}{bf}} = h$	$\frac{3Wa}{bh^2} = f$	$l, \text{ any length}$ $\frac{bh^2f}{3W} = a$	$\frac{bh^2f}{3a} = W$

Deflection of Beam Uniformly Loaded for Part of Its Length.—In the following formulas, lengths are in inches, weights in pounds. *W* = total load; *L* = total length between supports; *E* = modulus of elasticity; *I* = moment of inertia of beam section; *a* = fraction of length of beam at each end, that is not loaded = $b \div L$; and *f* = deflection.

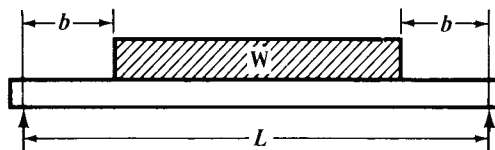
$$f = \frac{WL^3}{384EI(1 - 2a)}(5 - 24a^2 + 16a^4)$$

The expression for maximum bending moment is: $M_{\max} = \frac{1}{8}WL(1 + 2a)$.

Table 2b. Round Solid Beams

Style of Loading and Support	Diameter of Beam, d inch (mm)	Stress in Extreme Fibers, f lb/in ² (N/mm ²)	Beam Length, l inch (mm)	Total Load, W lb (N)
Beam fixed at one end, loaded at the other				
	$\sqrt[3]{\frac{10.18lW}{f}} = d$	$\frac{10.18lW}{d^3} = f$	$\frac{d^3f}{10.18W} = l$	$\frac{d^3f}{10.18l} = W$
Beam fixed at one end, uniformly loaded				
	$\sqrt[3]{\frac{5.092Wl}{f}} = d$	$\frac{5.092Wl}{d^3} = f$	$\frac{d^3f}{5.092W} = l$	$\frac{d^3f}{5.092l} = W$
Beam supported at both ends, single load in middle				
	$\sqrt[3]{\frac{2.546Wl}{f}} = d$	$\frac{2.546Wl}{d^3} = f$	$\frac{d^3f}{2.546W} = l$	$\frac{d^3f}{2.546l} = W$
Beam supported at both ends, uniformly loaded				
	$\sqrt[3]{\frac{1.273Wl}{f}} = d$	$\frac{1.273Wl}{d^3} = f$	$\frac{d^3f}{1.273W} = l$	$\frac{d^3f}{1.273l} = W$
Beam supported at both ends, single unsymmetrical load				
	$\sqrt[3]{\frac{10.18Wac}{fl}} = d$	$\frac{10.18Wac}{d^3l} = f$	$a + c = l$	$\frac{d^3fl}{10.18ac} = W$
Beam supported at both ends, two symmetrical loads				
	$\sqrt[3]{\frac{5.092Wa}{f}} = d$	$\frac{5.092Wa}{d^3} = f$	l , any length $\frac{d^3f}{5.092W} = a$	$\frac{d^3f}{5.092a} = W$

These formulas apply to simple beams resting on supports at the ends.

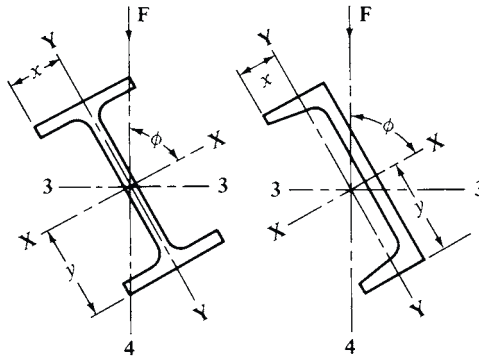


If the formulas are used with metric SI units, W = total load in newtons; L = total length between supports in millimeters; E = modulus of elasticity in newtons per millimeter²; I = moment of inertia of beam section in millimeters⁴; a = fraction of length of beam at each end, that is not loaded = $b \div L$; and f = deflection in millimeters. The bending moment M_{\max} is in newton-millimeters (N · mm).

Note: A load due to the weight of a mass of M kilograms is Mg newtons, where g = approximately 9.81 meters per second².

Bending Stress Due to an Oblique Transverse Force.—The following illustration shows a beam and a channel being subjected to a transverse force acting at an angle ϕ to the center of gravity. To find the bending stress, the moments of inertia I around axes 3-3 and 4-4 are computed from the following equations: $I_3 = I_x \sin^2 \phi + I_y \cos^2 \phi$, and $I_4 = I_x \cos^2 \phi + I_y \sin^2 \phi$.

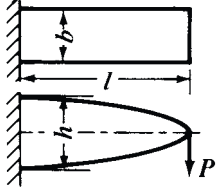
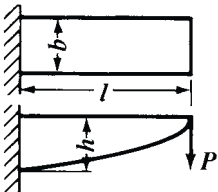
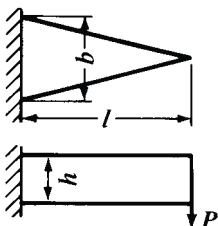
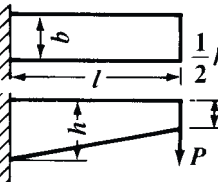
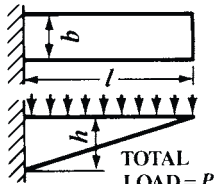
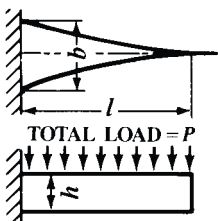
The computed bending stress f_b is then found from $f_b = M \left(\frac{y}{I_x} \sin \phi + \frac{x}{I_y} \cos \phi \right)$ where M is the bending moment due to force F .



Beams of Uniform Strength Throughout Their Length.—The bending moment in a beam is generally not uniform throughout its length, but varies. Therefore, a beam of uniform cross-section which is made strong enough at its most strained section, will have an excess of material at every other section. Sometimes it may be desirable to have the cross-section uniform, but at other times the metal can be more advantageously distributed if the beam is so designed that its cross-section varies from point to point, so that it is at every point just great enough to take care of the bending stresses at that point. **Tables 3a** and **3b** are given showing beams in which the load is applied in different ways and which are supported by different methods, and the shape of the beam required for uniform strength is indicated. It should be noted that the shape given is the theoretical shape required to resist bending only. It is apparent that sufficient cross-section of beam must also be added either at the points of support (in beams supported at both ends), or at the point of application of the load (in beams loaded at one end), to take care of the vertical shear.

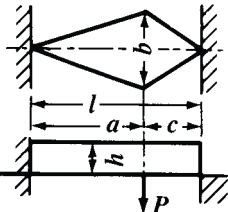
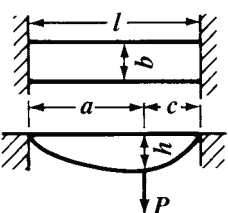
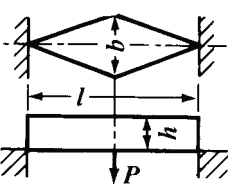
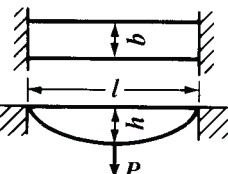
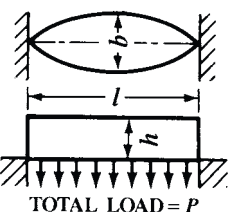
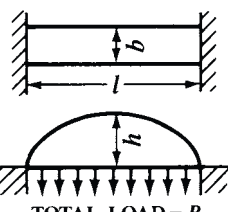
It should be noted that the theoretical shapes of the beams given in the two tables that follow are based on the stated assumptions of uniformity of width or depth of cross-section, and unless these are observed in the design, the theoretical outlines do not apply without modifications. For example, in a cantilever with the load at one end, the outline is a parabola only when the width of the beam is uniform. It is not correct to use a strictly parabolic shape when the thickness is not uniform, as, for instance, when the beam is made of an I- or T-section. In such cases, some modification may be necessary; but it is evident that whatever the shape adopted, the correct depth of the section can be obtained by an investigation of the bending moment and the shearing load at a number of points, and then a line can be drawn through the points thus ascertained, which will provide for a beam of practically uniform strength whether the cross-section be of uniform width or not.

Table 3a. Beams of Uniform Strength Throughout Their Length

Type of Beam	Description	Formula ^a
	<p>Load at one end. Width of beam uniform. Depth of beam decreasing towards loaded end. Outline of beam-shape, parabola with vertex at loaded end.</p>	$P = \frac{Sbh^2}{6l}$
	<p>Load at one end. Width of beam uniform. Depth of beam decreasing towards loaded end. Outline of beam, one-half of a parabola with vertex at loaded end. Beam may be reversed so that upper edge is parabolic.</p>	$P = \frac{Sbh^2}{6l}$
	<p>Load at one end. Depth of beam uniform. Width of beam decreasing towards loaded end. Outline of beam triangular, with apex at loaded end.</p>	$P = \frac{Sbh^2}{6l}$
	<p>Beam of <i>approximately</i> uniform strength. Load at one end. Width of beam uniform. Depth of beam decreasing towards loaded end, but not tapering to a sharp point.</p>	$P = \frac{Sbh^2}{6l}$
	<p>Uniformly distributed load. Width of beam uniform. Depth of beam decreasing towards outer end. Outline of beam, right-angled triangle.</p>	$P = \frac{Sbh^2}{3l}$
	<p>Uniformly distributed load. Depth of beam uniform. Width of beam gradually decreasing towards outer end. Outline of beam is formed by two parabolas which tangent each other at their vertexes at the outer end of the beam.</p>	$P = \frac{Sbh^2}{3l}$

^aIn the formulas, P = load in pounds; S = safe stress in pounds per square inch; and $a, b, c, h,$ and l are in inches. **If metric SI units are used, P is in newtons; S = safe stress in N/mm^2 ; and $a, b, c, h,$ and l are in millimeters.**

Table 3b. Beams of Uniform Strength Throughout Their Length

Type of Beam	Description	Formula ^a
	<p>Beam supported at both ends. Load concentrated at any point. Depth of beam uniform. Width of beam maximum at point of loading. Outline of beam, two triangles with apexes at points of support.</p>	$P = \frac{Sbh^2l}{6ac}$
	<p>Beam supported at both ends. Load concentrated at any point. Width of beam uniform. Depth of beam maximum at point of loading. Outline of beam is formed by two parabolas with their vertices at points of support.</p>	$P = \frac{Sbh^2l}{6ac}$
	<p>Beam supported at both ends. Load concentrated in the middle. Depth of beam uniform. Width of beam maximum at point of loading. Outline of beam, two triangles with apexes at points of support.</p>	$P = \frac{2Sbh^2}{3l}$
	<p>Beam supported at both ends. Load concentrated at center. Width of beam uniform. Depth of beam maximum at point of loading. Outline of beam, two parabolas with vertices at points of support.</p>	$P = \frac{2Sbh^2}{3l}$
 <p>TOTAL LOAD = P</p>	<p>Beam supported at both ends. Load uniformly distributed. Depth of beam uniform. Width of beam maximum at center. Outline of beam, two parabolas with vertexes at middle of beam.</p>	$P = \frac{4Sbh^2}{3l}$
 <p>TOTAL LOAD = P</p>	<p>Beam supported at both ends. Load uniformly distributed. Width of beam uniform. Depth of beam maximum at center. Outline of beam one-half of an ellipse.</p>	$P = \frac{4Sbh^2}{3l}$

^a For details of English and metric SI units used in the formulas, see footnote on page 271.

Deflection as a Limiting Factor in Beam Design.—For some applications, a beam must be stronger than required by the maximum load it is to support, in order to prevent excessive deflection. Maximum allowable deflections vary widely for different classes of service, so a general formula for determining them cannot be given. When exceptionally stiff girders are required, one rule is to limit the deflection to 1 inch per 100 feet of span; hence, if l = length of span in inches, deflection = $l \div 1200$. According to another formula, deflection limit = $l \div 360$ where beams are adjacent to materials like plaster which would be broken by excessive beam deflection. Some machine parts of the beam type must be very rigid to maintain alignment under load. For example, the deflection of a punch press column may be limited to 0.010 inch or less. These examples merely illustrate variations in practice. It is impracticable to give general formulas for determining the allowable deflection in any specific application, because the allowable amount depends on the conditions governing each class of work.

Procedure in Designing for Deflection: Assume that a deflection equal to $l \div 1200$ is to be the limiting factor in selecting a wide-flange (W-shape) beam having a span length of 144 inches. Supports are at both ends and load at center is 15,000 pounds. Deflection y is to be limited to $144 \div 1200 = 0.12$ inch. According to the formula on page 257 (Case 2), in which W = load on beam in pounds, l = length of span in inches, E = modulus of elasticity of material, I = moment of inertia of cross section:

$$\text{Deflection } y = \frac{Wl^3}{48EI} \quad \text{hence, } I = \frac{Wl^3}{48yE} = \frac{15,000 \times 144^3}{48 \times 0.12 \times 29,000,000} = 268.1$$

A structural wide-flange beam, see *Steel Wide-Flange Sections* on page 2596, having a depth of 12 inches and weighing 35 pounds per foot has a moment of inertia I of 285 and a section modulus (Z or S) of 45.6. Checking now for maximum stress s (Case 2, page 257):

$$s = \frac{Wl}{4Z} = \frac{15,000 \times 144}{4 \times 46.0} = 11,842 \text{ lbs/in}^2$$

Although deflection is the limiting factor in this case, the maximum stress is checked to make sure that it is within the allowable limit. As the limiting deflection is decreased, for a given load and length of span, the beam strength and rigidity must be increased, and, consequently, the maximum stress is decreased. Thus, in the preceding example, if the maximum deflection is 0.08 inch instead of 0.12 inch, then the calculated value for the moment of inertia I will be 402; hence a W 12 \times 53 beam having an I value of 426 could be used (nearest value above 402). The maximum stress then would be reduced to 7640 pounds per square inch and the calculated deflection is 0.076 inch.

A similar example using metric SI units is as follows. Assume that a deflection equal to $l \div 1000$ millimeters is to be the limiting factor in selecting a W-beam having a span length of 5 meters. Supports are at both ends and the load at the center is 30 kilonewtons. Deflection y is to be limited to $5000 \div 1000 = 5$ millimeters. The formula on page 257 (Case 2) is applied, and W = load on beam in newtons; l = length of span in mm; E = modulus of elasticity (assume 200,000 N/mm² in this example); and I = moment of inertia of cross-section in millimeters⁴. Thus,

$$\text{Deflection } y = \frac{Wl^3}{48EI}$$

hence

$$I = \frac{Wl^3}{48yE} = \frac{30,000 \times 5000^3}{48 \times 5 \times 200,000} = 78,125,000 \text{ mm}^4$$

Although deflection is the limiting factor in this case, the maximum stress is checked to make sure that it is within the allowable limit, using the formula from page 257 (Case 2):

$$s = \frac{Wl}{4Z}$$

The units of s are newtons per square millimeter; W is the load in newtons; l is the length in mm; and $Z =$ section modulus of the cross-section of the beam $= I \div$ distance in mm from neutral axis to extreme fiber.

Curved Beams.—The formula $S = Mc/I$ used to compute stresses due to bending of beams is based on the assumption that the beams are straight before any loads are applied. In beams having initial curvature, however, the stresses may be considerably higher than predicted by the ordinary straight-beam formula because the effect of initial curvature is to shift the neutral axis of a curved member in from the gravity axis toward the center of curvature (the concave side of the beam). This shift in the position of the neutral axis causes an increase in the stress on the concave side of the beam and decreases the stress at the outside fibers.

Hooks, press frames, and other machine members which as a rule have a rather pronounced initial curvature may have a maximum stress at the inside fibers of up to about $3\frac{1}{2}$ times that predicted by the ordinary straight-beam formula.

Stress Correction Factors for Curved Beams: A simple method for determining the maximum fiber stress due to bending of curved members consists of 1) calculating the maximum stress using the straight-beam formula $S = Mc/I$; and; and 2) multiplying the calculated stress by a stress correction factor. **Table 4** on page 275 gives stress correction factors for some of the common cross-sections and proportions used in the design of curved members.

An example in the application of the method using English units of measurement is given at the bottom of the table. **A similar example using metric SI units is as follows: The fiber stresses of a curved rectangular beam are calculated as 40 newtons per millimeter², using the straight beam formula, $S = Mc/I$. If the beam is 150 mm deep and its radius of curvature is 300 mm, what are the true stresses? $R/c = 300/75 = 4$. From **Table 4** on page 275, the K factors corresponding to $R/c = 4$ are 1.20 and 0.85. Thus, the inside fiber stress is $40 \times 1.20 = 48 \text{ N/mm}^2 = 48$ megapascals; and the outside fiber stress is $40 \times 0.85 = 34 \text{ N/mm}^2 = 34$ megapascals.**

Approximate Formula for Stress Correction Factor: The stress correction factors given in **Table 4** on page 275 were determined by Wilson and Quereau and published in the University of Illinois Engineering Experiment Station Circular No. 16, "A Simple Method of Determining Stress in Curved Flexural Members." In this same publication the authors indicate that the following empirical formula may be used to calculate the value of the stress correction factor for the *inside* fibers of sections not covered by the tabular data to within 5 per cent accuracy except in triangular sections where up to 10 per cent deviation may be expected. However, for most engineering calculations, this formula should prove satisfactory for general use in determining the factor for the inside fibers.

$$K = 1.00 + 0.5 \frac{I}{bc^2} \left[\frac{1}{R-c} + \frac{1}{R} \right]$$

(Use 1.05 instead of 0.5 in this formula for circular and elliptical sections.)

$I =$ Moment of inertia of section about centroidal axis

$b =$ maximum width of section

$c =$ distance from centroidal axis to inside fiber, i.e., to the extreme fiber nearest the center of curvature

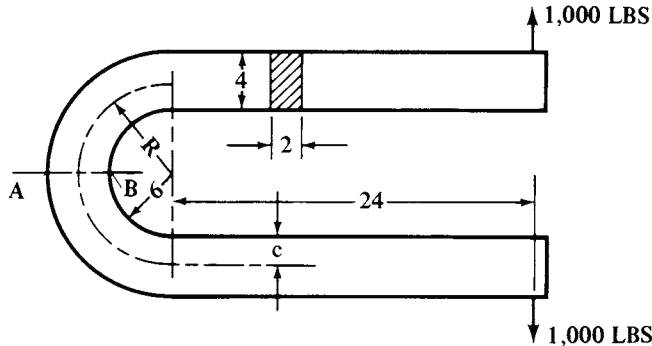
$R =$ radius of curvature of centroidal axis of beam

Table 4. Values of Stress Correction Factor K for Various Curved Beam Sections

Section	R/c	Factor K		y_0^a	Section	R/c	Factor K		y_0^a
		Inside Fiber	Outside Fiber				Inside Fiber	Outside Fiber	
	1.2	3.41	.54	.224R		1.2	3.63	.58	.418R
	1.4	2.40	.60	.151R		1.4	2.54	.63	.299R
	1.6	1.96	.65	.108R		1.6	2.14	.67	.229R
	1.8	1.75	.68	.084R		1.8	1.89	.70	.183R
	2.0	1.62	.71	.069R		2.0	1.73	.72	.149R
	3.0	1.33	.79	.030R		3.0	1.41	.79	.069R
	4.0	1.23	.84	.016R		4.0	1.29	.83	.040R
	6.0	1.14	.89	.0070R		6.0	1.18	.88	.018R
	8.0	1.10	.91	.0039R		8.0	1.13	.91	.010R
	10.0	1.08	.93	.0025R		10.0	1.10	.92	.0065R
	1.2	2.89	.57	.305R		1.2	3.55	.67	.409R
	1.4	2.13	.63	.204R		1.4	2.48	.72	.292R
	1.6	1.79	.67	.149R		1.6	2.07	.76	.224R
	1.8	1.63	.70	.112R		1.8	1.83	.78	.178R
	2.0	1.52	.73	.090R		2.0	1.69	.80	.144R
	3.0	1.30	.81	.041R		3.0	1.38	.86	.067R
	4.0	1.20	.85	.021R		4.0	1.26	.89	.038R
	6.0	1.12	.90	.0093R		6.0	1.15	.92	.018R
	8.0	1.09	.92	.0052R		8.0	1.10	.94	.010R
	10.0	1.07	.94	.0033R		10.0	1.08	.95	.0065R
	1.2	3.01	.54	.336R		1.2	2.52	.67	.408R
	1.4	2.18	.60	.229R		1.4	1.90	.71	.285R
	1.6	1.87	.65	.168R		1.6	1.63	.75	.208R
	1.8	1.69	.68	.128R		1.8	1.50	.77	.160R
	2.0	1.58	.71	.102R		2.0	1.41	.79	.127R
	3.0	1.33	.80	.046R		3.0	1.23	.86	.058R
	4.0	1.23	.84	.024R		4.0	1.16	.89	.030R
	6.0	1.13	.88	.011R		6.0	1.10	.92	.013R
	8.0	1.10	.91	.0060R		8.0	1.07	.94	.0076R
	10.0	1.08	.93	.0039R		10.0	1.05	.95	.0048R
	1.2	3.09	.56	.336R		1.2	3.28	.58	.269R
	1.4	2.25	.62	.229R		1.4	2.31	.64	.182R
	1.6	1.91	.66	.168R		1.6	1.89	.68	.134R
	1.8	1.73	.70	.128R		1.8	1.70	.71	.104R
	2.0	1.61	.73	.102R		2.0	1.57	.73	.083R
	3.0	1.37	.81	.046R		3.0	1.31	.81	.038R
	4.0	1.26	.86	.024R		4.0	1.21	.85	.020R
	6.0	1.17	.91	.011R		6.0	1.13	.90	.0087R
	8.0	1.13	.94	.0060R		8.0	1.10	.92	.0049R
	10.0	1.11	.95	.0039R		10.0	1.07	.93	.0031R
	1.2	3.14	.52	.352R		1.2	2.63	.68	.399R
	1.4	2.29	.54	.243R		1.4	1.97	.73	.280R
	1.6	1.93	.62	.179R		1.6	1.66	.76	.205R
	1.8	1.74	.65	.138R		1.8	1.51	.78	.159R
	2.0	1.61	.68	.110R		2.0	1.43	.80	.127R
	3.0	1.34	.76	.050R		3.0	1.23	.86	.058R
	4.0	1.24	.82	.028R		4.0	1.15	.89	.031R
	6.0	1.15	.87	.012R		6.0	1.09	.92	.014R
	8.0	1.12	.91	.0060R		8.0	1.07	.94	.0076R
	10.0	1.10	.93	.0039R		10.0	1.06	.95	.0048R
	1.2	3.26	.44	.361R	<p><i>Example:</i> The fiber stresses of a curved rectangular beam are calculated as 5000 psi using the straight beam formula, $S = Mc/I$. If the beam is 8 inches deep and its radius of curvature is 12 inches, what are the true stresses? $R/c = 12/4 = 3$. The factors in the table corresponding to $R/c = 3$ are 0.81 and 1.30. Outside fiber stress = $5000 \times 0.81 = 4050$ psi; inside fiber stress = $5000 \times 1.30 = 6500$ psi.</p>				
	1.4	2.39	.50	.251R					
	1.6	1.99	.54	.186R					
	1.8	1.78	.57	.144R					
	2.0	1.66	.60	.116R					
	3.0	1.37	.70	.052R					
	4.0	1.27	.75	.029R					
	6.0	1.16	.82	.013R					
	8.0	1.12	.86	.0060R					
	10.0	1.09	.88	.0039R					

^a y_0 is the distance from the centroidal axis to the neutral axis of curved beams subjected to pure bending and is measured from the centroidal axis toward the center of curvature.

Example: The accompanying diagram shows the dimensions of a clamp frame of rectangular cross-section. Determine the maximum stress at points *A* and *B* due to a clamping force of 1000 pounds.



The cross-sectional area = $2 \times 4 = 8$ square inches; the bending moment at section *AB* is $1000(24 + 6 + 2) = 32,000$ inch pounds; the distance from the center of gravity of the section at *AB* to point *B* is $c = 2$ inches; and using the formula on page 235, the moment of inertia of the section is $2 \times (4)^3 \div 12 = 10.667$ inches⁴.

Using the straight-beam formula, page 274, the stress at points *A* and *B* due to the bending moment is:

$$S = \frac{Mc}{I} = \frac{32,000 \times 2}{10.667} = 6000 \text{ psi}$$

The stress at *A* is a compressive stress of 6000 psi and that at *B* is a tensile stress of 6000 psi.

These values must be corrected to account for the curvature effect. In Table 4 on page 275 for $R/c = (6 + 2)/(2) = 4$, the value of *K* is found to be 1.20 and 0.85 for points *B* and *A* respectively. Thus, the actual stress due to bending at point *B* is $1.20 \times 6000 = 7200$ psi in tension and the stress at point *A* is $0.85 \times 6000 = 5100$ psi in compression.

To these stresses at *A* and *B* must be added, algebraically, the direct stress at section *AB* due to the 1000-pound clamping force. The direct stress on section *AB* will be a tensile stress equal to the clamping force divided by the section area. Thus $1000 \div 8 = 125$ psi in tension.

The maximum unit stress at *A* is, therefore, $5100 - 125 = 4975$ psi in compression and the maximum unit stress at *B* is $7200 + 125 = 7325$ psi in tension.

The following is a similar calculation using metric SI units, assuming that it is required to determine the maximum stress at points *A* and *B* due to clamping force of 4 kilonewtons acting on the frame. The frame cross-section is 50 by 100 millimeters, the radius $R = 200$ mm, and the length of the straight portions is 600 mm. Thus, the cross-sectional area = $50 \times 100 = 5000$ mm²; the bending moment at *AB* is $4000(600 + 200) = 3,200,000$ newton-millimeters; the distance from the center of gravity of the section at *AB* to point *B* is $c = 50$ mm; and the moment of inertia of the section is, using the formula on page 235, $50 \times (100)^3 / 12 = 4,170,000$ mm⁴.

Using the straight-beam formula, page 274, the stress at points *A* and *B* due to the bending moment is:

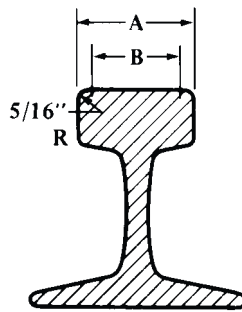
$$\begin{aligned} s &= \frac{Mc}{I} = \frac{3,200,000 \times 50}{4,170,000} \\ &= 38.4 \text{ newtons per millimeter}^2 = 38.4 \text{ megapascals} \end{aligned}$$

The stress at *A* is a compressive stress of 38.4 N/mm², while that at *B* is a tensile stress of 38.4 N/mm². These values must be corrected to account for the curvature

effect. From the table on page 275, the K factors are 1.20 and 0.85 for points A and B respectively, derived from $R/c = 200/50 = 4$. Thus, the actual stress due to bending at point B is $1.20 \times 38.4 = 46.1 \text{ N/mm}^2$ (46.1 megapascals) in tension; and the stress at point A is $0.85 \times 38.4 = 32.6 \text{ N/mm}^2$ (32.6 megapascals) in compression.

To these stresses at A and B must be added, algebraically, the direct stress at section AB due to the 4 kN clamping force. The direct stress on section AB will be a tensile stress equal to the clamping force divided by the section area. Thus, $4000/5000 = 0.8 \text{ N/mm}^2$. The maximum unit stress at A is, therefore, $32.61 - 0.8 = 31.8 \text{ N/mm}^2$ (31.8 megapascals) in compression, and the maximum unit stress at B is $46.1 + 0.8 = 46.9 \text{ N/mm}^2$ (46.9 megapascals) in tension.

Size of Rail Necessary to Carry a Given Load.—The following formulas may be employed for determining the size of rail and wheel suitable for carrying a given load. Let, A = the width of the head of the rail in inches; B = width of the tread of the rail in inches; C = the wheel-load in pounds; D = the diameter of the wheel in inches.



Then the width of the tread of the rail in inches is found from the formula:

$$B = \frac{C}{1250D} \tag{1}$$

The width A of the head equals $B + \frac{5}{8}$ inch. The diameter D of the smallest track wheel that will safely carry the load is found from the formula:

$$D = \frac{C}{A \times K} \tag{2}$$

in which $K = 600$ to 800 for steel castings; $K = 300$ to 400 for cast iron.

As an example, assume that the wheel-load is 10,000 pounds; the diameter of the wheel is 20 inches; and the material is cast steel. Determine the size of rail necessary to carry this load. From **Formula (1)**:

$$B = \frac{10,000}{1250 \times 20} = 0.4 \text{ inch}$$

The width of the rail required equals $0.4 + \frac{5}{8} \text{ inch} = 1.025 \text{ inch}$. Determine also whether a wheel 20 inches in diameter is large enough to safely carry the load. From **Formula (2)**:

$$D = \frac{10,000}{1.025 \times 600} = 16\frac{1}{4} \text{ inches}$$

This is the smallest diameter of track wheel that will safely carry the load; hence a 20-inch wheel is ample.

American Railway Engineering Association Formulas.—The American Railway Engineering Association recommends for safe operation of steel cylinders rolling on steel plates that the allowable load p in pounds per inch of length of the cylinder should not exceed the value calculated from the formula

$$p = \frac{y.s. - 13,000}{20,000} 600d \text{ for diameter } d \text{ less than 25 inches}$$

This formula is based on steel having a yield strength, y.s., of 32,000 pounds per square inch. For roller or wheel diameters of up to 25 inches, the Hertz stress (contact stress) resulting from the calculated load p will be approximately 76,000 pounds per square inch.

For a 10-inch diameter roller the safe load per inch of roller length is

$$p = \frac{32,000 - 13,000}{20,000} 600 \times 10 = 5700 \text{ lbs per inch of length}$$

Therefore, to support a 10,000 pound load the roller or wheel would need to be $10,000/5700 = 1.75$ inches wide.

Stresses Produced by Shocks

Stresses in Beams Produced by Shocks.—Any elastic structure subjected to a shock will deflect until the product of the average resistance, developed by the deflection, and the distance through which it has been overcome, has reached a value equal to the energy of the shock. It follows that for a given shock, the average resisting stresses are inversely proportional to the deflection. If the structure were perfectly rigid, the deflection would be zero, and the stress infinite. The effect of a shock is, therefore, to a great extent dependent upon the elastic property (the springiness) of the structure subjected to the impact.

The energy of a body in motion, such as a falling body, may be spent in each of four ways:

- 1) In deforming the body struck as a whole.
- 2) In deforming the falling body as a whole.
- 3) In partial deformation of both bodies on the surface of contact (most of this energy will be transformed into heat).
- 4) Part of the energy will be taken up by the supports, if these are not perfectly rigid and inelastic.

How much energy is spent in the last three ways it is usually difficult to determine, and for this reason it is safest to figure as if the whole amount were spent as in Case 1. If a reliable judgment is possible as to what percentage of the energy is spent in other ways than the first, a corresponding fraction of the total energy can be assumed as developing stresses in the body subjected to shocks.

One investigation into the stresses produced by shocks led to the following conclusions:

- 1) A suddenly applied load will produce the same deflection, and, therefore, the same stress as a static load twice as great; and 2) The unit stress p (see formulas in [Table 1](#), "*Stresses Produced in Beams by Shocks*") for a given load producing a shock, varies directly as the square root of the modulus of elasticity E , and inversely as the square root of the length L of the beam and the area of the section.

Thus, for instance, if the sectional area of a beam is increased by four times, the unit stress will diminish only by half. This result is entirely different from those produced by static loads where the stress would vary inversely with the area, and within certain limits be practically independent of the modulus of elasticity.

In [Table 1](#), the expression for the approximate value of p , which is applicable whenever the deflection of the beam is small as compared with the total height h through which the body producing the shock is dropped, is always the same for beams supported at both ends and subjected to shock at *any* point between the supports. In the formulas all dimensions are in inches and weights in pounds.

Table 1. Stresses Produced in Beams by Shocks

Method of Support and Point Struck by Falling Body	Fiber (Unit) Stress p produced by Weight Q Dropped Through a Distance h	Approximate Value of p
Supported at both ends; struck in center.	$p = \frac{QaL}{4I} \left(1 + \sqrt{1 + \frac{96hEI}{QL^3}} \right)$	$p = a \sqrt{\frac{6QhE}{LI}}$
Fixed at one end; struck at the other.	$p = \frac{QaL}{I} \left(1 + \sqrt{1 + \frac{6hEI}{QL^3}} \right)$	$p = a \sqrt{\frac{6QhE}{LI}}$
Fixed at both ends; struck in center.	$p = \frac{QaL}{8I} \left(1 + \sqrt{1 + \frac{384hEI}{QL^3}} \right)$	$p = a \sqrt{\frac{6QhE}{LI}}$

I = moment of inertia of section; a = distance of extreme fiber from neutral axis; L = length of beam; E = modulus of elasticity.

If metric SI units are used, p is in newtons per square millimeter; Q is in newtons; E = modulus of elasticity in N/mm²; I = moment of inertia of section in millimeters⁴; and h , a , and L in millimeters. Note: If Q is given in kilograms, the value referred to is mass. The weight Q of a mass M kilograms is Mg newtons, where g = approximately 9.81 meters per second².

Examples of How Formulas for Stresses Produced by Shocks are Derived: The general formula from which specific formulas for shock stresses in beams, springs, and other machine and structural members are derived is:

$$p = p_s \left(1 + \sqrt{1 + \frac{2h}{y}} \right) \tag{1}$$

In this formula, p = stress in pounds per square inch due to shock caused by impact of a moving load; p_s = stress in pounds per square inch resulting when moving load is applied statically; h = distance in inches that load falls before striking beam, spring, or other member; y = deflection, in inches, resulting from static load.

As an example of how **Formula (1)** may be used to obtain a formula for a specific application, suppose that the load W shown applied to the beam in Case 2 on page 257 were dropped on the beam from a height of h inches instead of being gradually applied (static loading). The maximum stress p_s due to load W for Case 2 is given as $Wl \div 4Z$ and the maximum deflection y is given as $Wl^3 \div 48EI$. Substituting these values in **Formula (1)**,

$$p = \frac{Wl}{4Z} \left(1 + \sqrt{1 + \frac{2h}{Wl^3 \div 48EI}} \right) = \frac{Wl}{4Z} \left(1 + \sqrt{1 + \frac{96hEI}{Wl^3}} \right) \tag{2}$$

If in **Formula (2)** the letter Q is used in place of W and if Z , the section modulus, is replaced by its equivalent, $I \div a$ distance a from neutral axis to extreme fiber of beam, then **Formula (2)** becomes the first formula given in the accompanying **Table 1, Stresses Produced in Beams by Shocks**

Stresses in Helical Springs Produced by Shocks.—A load suddenly applied on a spring will produce the same deflection, and, therefore, also the same unit stress, as a static load twice as great. When the load drops from a height h , the stresses are as given in the accompanying **Table 2**. The approximate values are applicable when the deflection is small as compared with the height h . The formulas show that the fiber stress for a given shock will be greater in a spring made from a square bar than in one made from a round bar, if the diameter of coil be the same and the side of the square bar equals the diameter of the round

bar. It is, therefore, more economical to use round stock for springs which must withstand shocks, due to the fact that the deflection for the same fiber stress for a square bar spring is smaller than that for a round bar spring, the ratio being as 4 to 5. The round bar spring is therefore capable of storing more energy than a square bar spring for the same stress.

Table 2. Stresses Produced in Springs by Shocks

Form of Bar from Which Spring is Made	Fiber (Unit) Stress f Produced by Weight Q Dropped a Height h on a Helical Spring	Approximate Value of f
Round	$f = \frac{8QD}{\pi d^3} \left(1 + \sqrt{1 + \frac{Ghd^4}{4QD^3n}} \right)$	$f = 1.27 \sqrt{\frac{QhG}{Dd^2n}}$
Square	$f = \frac{9QD}{4d^3} \left(1 + \sqrt{1 + \frac{Ghd^4}{0.9\pi QD^3n}} \right)$	$f = 1.34 \sqrt{\frac{QhG}{Dd^2n}}$

G = modulus of elasticity for torsion; d = diameter or side of bar; D = mean diameter of spring; n = number of coils in spring.

Shocks from Bodies in Motion.—The formulas given can be applied, in general, to shocks from bodies in motion. A body of weight W moving horizontally with the velocity of v feet per second, has a stored-up energy:

$$E_K = \frac{1}{2} \times \frac{Wv^2}{g} \text{ foot-pounds} \quad \text{or} \quad \frac{6Wv^2}{g} \text{ inch-pounds}$$

This expression may be substituted for Qh in the tables in the equations for unit stresses containing this quantity, and the stresses produced by the energy of the moving body thereby determined.

The formulas in the tables give the maximum value of the stresses, providing the designer with some definitive guidance even where there may be justification for assuming that only a part of the energy of the shock is taken up by the member under stress.

The formulas can also be applied using metric SI units. The stored-up energy of a body of mass M kilograms moving horizontally with the velocity of v meters per second is:

$$E_K = \frac{1}{2}Mv^2 \text{ newton-meters}$$

This expression may be substituted for Qh in the appropriate equations in the tables. For calculation in millimeters, $Qh = 1000 E_K$ newton-millimeters.

Fatigue Stresses.—So-called "fatigue ruptures" occur in parts that are subjected to continually repeated shocks or stresses of small magnitude. Machine parts that are subjected to continual stresses in varying directions, or to repeated shocks, even if of comparatively small magnitude, may fail ultimately if designed, from a mere knowledge of the behavior of the material under a steady stress, such as is imposed upon it by ordinary tensile stress testing machines. Examinations of numerous cases of machine parts, broken under actual working conditions, indicate that at least 80 per cent of these ruptures are caused by fatigue stresses. Most fatigue ruptures are caused by bending stresses, and frequently by a revolving bending stress. Hence, to test materials for this class of stress, the tests should be made to stress the material in a manner similar to that in which it will be stressed under actual working conditions. See *Fatigue Properties* on page 201 for more on this topic.

COLUMNS

Strength of Columns or Struts

Structural members which are subject to compression may be so long in proportion to the diameter or lateral dimensions that failure may be the result 1) of both compression and bending; and 2) of bending or buckling to such a degree that compression stress may be ignored.

In such cases, the *slenderness ratio* is important. This ratio equals the length l of the column in inches or millimeters, according to the unit system in use, divided by the least radius of gyration r of the cross-section. Various formulas have been used for designing columns which are too slender to be designed for compression only.

Rankine or Gordon Formula.—This formula is generally applied when slenderness ratios range between 20 and 100, and sometimes for ratios up to 120. The notation, in English and metric SI units of measurement, is given on page 283.

$$p = \frac{S}{1 + K\left(\frac{l}{r}\right)^2} = \text{ultimate load, } \frac{\text{lb}}{\text{in}^2} \text{ or } \frac{\text{N}}{\text{mm}^2}$$

Factor K may be established by tests with a given material and end condition, and for the probable range of l/r . If determined by calculation, $K = S/C\pi^2E$. Factor C equals 1 for either rounded or pivoted column ends, 4 for fixed ends, and 1 to 4 for square flat ends. The factors 25,000, 12,500, etc., in the Rankine formulas, arranged as on page 283, equal $1/K$, and have been used extensively.

Straight-line Formula.—This general type of formula is often used in designing compression members for buildings, bridges, or similar structural work. It is convenient especially in designing a number of columns that are made of the same material but vary in size, assuming that factor B is known. This factor is determined by tests.

$$p = S_y - B\left(\frac{l}{r}\right) = \text{ultimate load, lbs. per sq. in.}$$

S_y equals yield point, lbs. per square inch, and factor B ranges from 50 to 100. Safe unit stress = $p \div$ factor of safety.

Formulas of American Railway Engineering Association.—The formulas that follow apply to structural steel having an ultimate strength of 60,000 to 72,000 pounds per square inch.

For building columns having l/r ratios not greater than 120, allowable unit stress = $17,000 - 0.485 l^2/r^2$. For columns having l/r ratios greater than 120, allowable unit stress

$$\text{allowable unit stress} = \frac{18,000}{1 + l^2/18,000r^2}$$

For bridge compression members centrally loaded and with values of l/r not greater than 140:

$$\text{Allowable unit stress, riveted ends} = 15,000 - \frac{1}{4} \frac{l^2}{r^2}$$

$$\text{Allowable unit stress, pin ends} = 15,000 - \frac{1}{3} \frac{l^2}{r^2}$$

Euler Formula.—This formula is for columns that are so slender that bending or buckling action predominates and compressive stresses are not taken into account.

$$P = \frac{C\pi^2IE}{l^2} = \text{total ultimate load, in pounds or newtons}$$

The notation, in English and metric SI units of measurement, is given in the table *Rankine's and Euler's Formulas for Columns* on page 283. Factors C for different end conditions are included in the Euler formulas at the bottom of the table. According to a series of experiments, Euler formulas should be used if the values of l/r exceed the following ratios: Structural steel and flat ends, 195; hinged ends, 155; round ends, 120; cast iron with flat ends, 120; hinged ends, 100; round ends, 75; oak with flat ends, 130. The *critical slenderness ratio*, which marks the dividing line between the shorter columns and those slender enough to warrant using the Euler formula, depends upon the column material and its end conditions. If the Euler formula is applied when the slenderness ratio is too small, the *calculated* ultimate strength will exceed the yield point of the material and, obviously, will be incorrect.

Eccentrically Loaded Columns.—In the application of the column formulas previously referred to, it is assumed that the action of the load coincides with the axis of the column. If the load is offset relative to the column axis, the column is said to be eccentrically loaded, and its strength is then calculated by using a modification of the Rankine formula, the quantity cz/r^2 being added to the denominator, as shown in the table on the next page. This modified formula is applicable to columns having a slenderness ratio varying from 20 or 30 to about 100.

Machine Elements Subjected to Compressive Loads.—As in structural compression members, an unbraced machine member that is relatively slender (i.e., its length is more than, say, six times the least dimension perpendicular to its longitudinal axis) is usually designed as a column, because failure due to overloading (assuming a compressive load centrally applied in an axial direction) may occur by buckling or a combination of buckling and compression rather than by direct compression alone. In the design of unbraced steel machine “columns” which are to carry compressive loads applied along their longitudinal axes, two formulas are in general use:

$$\text{(Euler)} \quad P_{cr} = \frac{S_y A r^2}{Q} \quad (1)$$

$$\text{(J. B. Johnson)} \quad P_{cr} = AS_y \left(1 - \frac{Q}{4r^2}\right) \quad (2) \quad \text{where} \quad Q = \frac{S_y l^2}{n\pi^2 E} \quad (3)$$

In these formulas, P_{cr} = critical load in pounds that would result in failure of the column; A = cross-sectional area, square inches; S_y = yield point of material, pounds per square inch; r = least radius of gyration of cross-section, inches; E = modulus of elasticity, pounds per square inch; l = column length, inches; and n = coefficient for end conditions. For both ends fixed, $n = 4$; for one end fixed, one end free, $n = 0.25$; for one end fixed and the other end free but guided, $n = 2$; for round or pinned ends, free but guided, $n = 1$; and for flat ends, $n = 1$ to 4. It should be noted that these values of n represent ideal conditions that are seldom attained in practice; for example, for both ends fixed, a value of $n = 3$ to 3.5 may be more realistic than $n = 4$.

If metric SI units are used in these formulas, P_{cr} = critical load in newtons that would result in failure of the column; A = cross-sectional area, square millimeters; S_y = yield point of the material, newtons per square mm; r = least radius of gyration of cross-section, mm; E = modulus of elasticity, newtons per square mm; l = column length, mm; and n = a coefficient for end conditions. The coefficients given are valid for calculations in metric units.

Rankine's and Euler's Formulas for Columns

Symbol	Quantity	English Unit	Metric SI Units
p	Ultimate unit load	Lbs./sq. in.	Newtons/sq. mm.
P	Total ultimate load	Pounds	Newtons
S	Ultimate compressive strength of material	Lbs./sq. in.	Newtons/sq. mm.
l	Length of column or strut	Inches	Millimeters
r	Least radius of gyration	Inches	Millimeters
I	Least moment of inertia	Inches ⁴	Millimeters ⁴
r^2	Moment of inertia/area of section	Inches ²	Millimeters ²
E	Modulus of elasticity of material	Lbs./sq. in.	Newtons/sq. mm.
c	Distance from neutral axis of cross-section to side under compression	Inches	Millimeters
z	Distance from axis of load to axis coinciding with center of gravity of cross-section	Inches	Millimeters

Rankine's Formulas

Material	Both Ends of Column Fixed	One End Fixed and One End Rounded	Both Ends Rounded
Steel	$p = \frac{S}{1 + \frac{l^2}{25,000r^2}}$	$p = \frac{S}{1 + \frac{l^2}{12,500r^2}}$	$p = \frac{S}{1 + \frac{l^2}{6250r^2}}$
Cast Iron	$p = \frac{S}{1 + \frac{l^2}{5000r^2}}$	$p = \frac{S}{1 + \frac{l^2}{2500r^2}}$	$p = \frac{S}{1 + \frac{l^2}{1250r^2}}$
Wrought Iron	$p = \frac{S}{1 + \frac{l^2}{35,000r^2}}$	$p = \frac{S}{1 + \frac{l^2}{17,500r^2}}$	$p = \frac{S}{1 + \frac{l^2}{8750r^2}}$
Timber	$p = \frac{S}{1 + \frac{l^2}{3000r^2}}$	$p = \frac{S}{1 + \frac{l^2}{1500r^2}}$	$p = \frac{S}{1 + \frac{l^2}{750r^2}}$

Formulas Modified for Eccentrically Loaded Columns

Material	Both Ends of Column Fixed	One End Fixed and One End Rounded	Both Ends Rounded
Steel	$p = \frac{S}{1 + \frac{l^2}{25,000r^2} + \frac{cz}{r^2}}$	$p = \frac{S}{1 + \frac{l^2}{12,500r^2} + \frac{cz}{r^2}}$	$p = \frac{S}{1 + \frac{l^2}{6250r^2} + \frac{cz}{r^2}}$

For materials other than steel, such as cast iron, use the Rankine formulas given in the upper table and add to the denominator the quantity cz/r^2

Euler's Formulas for Slender Columns

Both Ends of Column Fixed	One End Fixed and One End Rounded	Both Ends Rounded	One End Fixed and One End Free
$P = \frac{4\pi^2IE}{l^2}$	$P = \frac{2\pi^2IE}{l^2}$	$P = \frac{\pi^2IE}{l^2}$	$P = \frac{\pi^2IE}{4l^2}$

Allowable Working Loads for Columns: To find the total allowable working load for a given section, divide the total ultimate load P (or $p \times$ area), as found by the appropriate formula above, by a suitable factor of safety.

Factor of Safety for Machine Columns: When the conditions of loading and the physical qualities of the material used are accurately known, a factor of safety as low as 1.25 is sometimes used when minimum weight is important. Usually, however, a factor of safety of 2 to 2.5 is applied for steady loads. The factor of safety represents the ratio of the critical load P_{cr} to the working load.

Application of Euler and Johnson Formulas: To determine whether the Euler or Johnson formula is applicable in any particular case, it is necessary to determine the value of the quantity $Q \div r^2$. If $Q \div r^2$ is greater than 2, then the Euler Formula (1) should be used; if $Q \div r^2$ is less than 2, then the J. B. Johnson formula is applicable. Most compression members in machine design are in the range of proportions covered by the Johnson formula. For this reason a good procedure is to design machine elements on the basis of the Johnson formula and then as a check calculate $Q \div r^2$ to determine whether the Johnson formula applies or the Euler formula should have been used.

✦ *Example 1, Compression Member Design:* A rectangular machine member 24 inches long and $\frac{1}{2} \times 1$ inch in cross-section is to carry a compressive load of 4000 pounds along its axis. What is the factor of safety for this load if the material is machinery steel having a yield point of 40,000 pounds per square inch, the load is steady, and each end of the rod has a ball connection so that $n = 1$?

From Formula (3)

$$Q = \frac{40,000 \times 24 \times 24}{1 \times 3.1416 \times 3.1416 \times 30,000,000} = 0.0778$$

(The values 40,000 and 30,000,000 were obtained from the table *Strength Data for Iron and Steel* on page 432.)

The radius of gyration r for a rectangular section (page 235) is $0.289 \times$ the dimension in the direction of bending. In columns, bending is most apt to occur in the direction in which the section is the weakest, the $\frac{1}{2}$ -inch dimension in this example. Hence, least radius of gyration $r = 0.289 \times \frac{1}{2} = 0.145$ inch.

$$\frac{Q}{r^2} = \frac{0.0778}{(0.145)^2} = 3.70$$

which is more than 2 so that the Euler formula will be used.

$$\begin{aligned} P_{cr} &= \frac{s_y A r^2}{Q} = \frac{40,000 \times \frac{1}{2} \times 1}{3.70} \\ &= 5400 \text{ pounds so that the factor of safety is } 5400 \div 4000 = 1.35 \end{aligned}$$

✦ *Example 2, Compression Member Design:* In the preceding example, the column formulas were used to check the adequacy of a column of known dimensions. The more usual problem involves determining what the dimensions should be to resist a specified load. For example,;

A 24-inch long bar of rectangular cross-section with width w twice its depth d is to carry a load of 4000 pounds. What must the width and depth be if a factor of safety of 1.35 is to be used?

First determine the critical load P_{cr} :

$$\begin{aligned} P_{cr} &= \text{working load} \times \text{factor of safety} \\ &= 4000 \times 1.35 = 5400 \text{ pounds} \end{aligned}$$

Next determine Q which, as in **Example 1**, will be 0.0778.

Assume **Formula (2)** applies:

$$P_{cr} = A_s y \left(1 - \frac{Q}{4r^2}\right)$$

$$5400 = w \times d \times 40,000 \left(1 - \frac{0.0778}{4r^2}\right)$$

$$= 2d^2 \times 40,000 \left(1 - \frac{0.01945}{r^2}\right)$$

$$\frac{5400}{40,000 \times 2} = d^2 \left(1 - \frac{0.01945}{r^2}\right)$$

As mentioned in **Example 1** the least radius of gyration r of a rectangle is equal to 0.289 times the least dimension, d , in this case. Therefore, substituting for d the value $r \div 0.289$,

$$\frac{5400}{40,000 \times 2} = \left(\frac{r}{0.289}\right)^2 \left(1 - \frac{0.01945}{r^2}\right)$$

$$\frac{5400 \times 0.289 \times 0.289}{40,000 \times 2} = r^2 - 0.01945$$

$$0.005638 = r^2 - 0.01945$$

$$r^2 = 0.0251$$

Checking to determine if $Q \div r^2$ is greater or less than 2,

$$\frac{Q}{r^2} = \frac{0.0778}{0.0251} = 3.1$$

therefore **Formula (1)** should have been used to determine r and dimensions w and d . Using **Formula (1)**,

$$5400 = \frac{40,000 \times 2d^2 \times r^2}{Q} = \frac{40,000 \times 2 \times \left(\frac{r}{0.289}\right)^2 r^2}{0.0778}$$

$$r^4 = \frac{5400 \times 0.0778 \times 0.289 \times 0.289}{40,000 \times 2} = 0.0004386$$

$$d = \frac{0.145}{0.289} = 0.50 \text{ inch}$$

and $w = 2d = 1$ inch as in the previous example.

American Institute of Steel Construction.—For main or secondary compression members with l/r ratios up to 120, safe unit stress = $17,000 - 0.485l^2/r^2$. For columns and bracing or other secondary members with l/r ratios above 120,

Safe unit stress, psi = $\frac{18,000}{1 + l^2/18,000r^2}$ for bracing and secondary members. For main

members, safe unit stress, psi = $\frac{18,000}{1 + l^2/18,000r^2} \times \left(1.6 - \frac{l/r}{200}\right)$

Pipe Columns: Allowable concentric loads for steel pipe columns based on the above formulas are given in the table on page 286.

Allowable Concentric Loads for Steel Pipe Columns

STANDARD STEEL PIPE								
Nominal Diameter, Inches	12	10	8	6	5	4	3½	3
Wall Thickness, Inch	0.375	0.365	0.322	0.280	0.258	0.237	0.226	0.216
Weight per Foot, Pounds	49.56	40.48	28.55	18.97	14.62	10.79	9.11	7.58
Effective Length (<i>KL</i>), Feet ^a	Allowable Concentric Loads in Thousands of Pounds							
6	303	246	171	110	83	59	48	38
7	301	243	168	108	81	57	46	36
8	299	241	166	106	78	54	44	34
9	296	238	163	103	76	52	41	31
10	293	235	161	101	73	49	38	28
11	291	232	158	98	71	46	35	25
12	288	229	155	95	68	43	32	22
13	285	226	152	92	65	40	29	19
14	282	223	149	89	61	36	25	16
15	278	220	145	86	58	33	22	14
16	275	216	142	82	55	29	19	12
17	272	213	138	79	51	26	17	11
18	268	209	135	75	47	23	15	10
19	265	205	131	71	43	21	14	9
20	261	201	127	67	39	19	12	
22	254	193	119	59	32	15	10	
24	246	185	111	51	27	13		
25	242	180	106	47	25	12		
26	238	176	102	43	23			
EXTRA STRONG STEEL PIPE								
Nominal Diameter, Inches	12	10	8	6	5	4	3½	3
Wall Thickness, Inch	0.500	0.500	0.500	0.432	0.375	0.337	0.318	0.300
Weight per Foot, Pounds	65.42	54.74	43.39	28.57	20.78	14.98	12.50	10.25
Effective Length (<i>KL</i>), Feet ^a	Allowable Concentric Loads in Thousands of Pounds							
6	400	332	259	166	118	81	66	52
7	397	328	255	162	114	78	63	48
8	394	325	251	159	111	75	59	45
9	390	321	247	155	107	71	55	41
10	387	318	243	151	103	67	51	37
11	383	314	239	146	99	63	47	33
12	379	309	234	142	95	59	43	28
13	375	305	229	137	91	54	38	24
14	371	301	224	132	86	49	33	21
15	367	296	219	127	81	44	29	18
16	363	291	214	122	76	39	25	16
18	353	281	203	111	65	31	20	12
19	349	276	197	105	59	28	18	11
20	344	271	191	99	54	25	16	
21	337	265	185	92	48	22	14	
22	334	260	179	86	44	21		
24	323	248	166	73	37	17		
26	312	236	152	62	32			
28	301	224	137	54	27			

^aWith respect to radius of gyration. The effective length (*KL*) is the actual unbraced length, *L*, in feet, multiplied by the effective length factor (*K*) which is dependent upon the restraint at the ends of the unbraced length and the means available to resist lateral movements. *K* may be determined by referring to the last portion of this table.

Allowable Concentric Loads for Steel Pipe Columns (Continued)

DOUBLE-EXTRA STRONG STEEL PIPE					
Nominal Diameter, Inches	8	6	5	4	3
Wall Thickness, Inch	0.875	0.864	0.750	0.674	0.600
Weight per Foot, Pounds	72.42	53.16	38.55	27.54	18.58
Effective Length (KL), Feet ^a	Allowable Concentric Loads in Thousands of Pounds				
6	431	306	216	147	91
7	424	299	209	140	84
8	417	292	202	133	77
9	410	284	195	126	69
10	403	275	187	118	60
11	395	266	178	109	51
12	387	257	170	100	43
13	378	247	160	91	37
14	369	237	151	81	32
15	360	227	141	70	28
16	351	216	130	62	24
17	341	205	119	55	22
18	331	193	108	49	
19	321	181	97	44	
20	310	168	87	40	
22	288	142	72	33	
24	264	119	61		
26	240	102	52		
28	213	88	44		

EFFECTIVE LENGTH FACTORS (K) FOR VARIOUS COLUMN CONFIGURATIONS						
	(a)	(b)	(c)	(d)	(e)	(f)
Buckled shape of column is shown by dashed line						
Theoretical K value	0.5	0.7	1.0	1.0	2.0	2.0
Recommended design value when ideal conditions are approximated	0.65	0.80	1.2	1.0	2.10	2.0
End condition code						
			Rotation fixed and translation fixed	Rotation free and translation fixed	Rotation fixed and translation free	Rotation free and translation free

Load tables are given for 36 ksi yield stress steel. No load values are given below the heavy horizontal lines, because the Kl/r ratios (where l is the actual unbraced length in inches and r is the governing radius of gyration in inches) would exceed 200.

Data from "Manual of Steel Construction," 8th ed., 1980, with permission of the American Institute of Steel Construction.

PLATES, SHELLS, AND CYLINDERS

Flat Stayed Surfaces.—Large flat areas are often held against pressure by stays distributed at regular intervals over the surface. In boiler work, these stays are usually screwed into the plate and the projecting end riveted over to insure steam tightness. The U.S. Board of Supervising Inspectors and the American Boiler Makers Association rules give the following formula for flat stayed surfaces:

$$P = \frac{C \times t^2}{S^2}$$

in which P = pressure in pounds per square inch

C = a constant, which equals

112 for plates $\frac{7}{16}$ inch and under

120, for plates over $\frac{7}{16}$ inch thick

140, for plates with stays having a nut and bolt on the inside and outside

160, for plates with stays having washers of at least one-half the thickness of the plate, and with a diameter at least one-half of the greatest pitch

t = thickness of plate in 16ths of an inch (thickness = $\frac{7}{16}$, $t = 7$)

S = greatest pitch of stays in inches

Strength and Deflection of Flat Plates.—Generally, the formulas used to determine stresses and deflections in flat plates are based on certain assumptions that can be closely approximated in practice. These assumptions are:

- 1) the thickness of the plate is not greater than one-quarter the least width of the plate;
- 2) the greatest deflection when the plate is loaded is less than one-half the plate thickness;
- 3) the maximum tensile stress resulting from the load does not exceed the elastic limit of the material; and
- 4) all loads are perpendicular to the plane of the plate.

Plates of ductile materials fail when the maximum stress resulting from deflection under load exceeds the yield strength; for brittle materials, failure occurs when the maximum stress reaches the ultimate tensile strength of the material involved.

Square and Rectangular Flat Plates.—The formulas that follow give the maximum stress and deflection of flat steel plates supported in various ways and subjected to the loading indicated. These formulas are based upon a modulus of elasticity for steel of 30,000,000 pounds per square inch and a value of Poisson's ratio of 0.3. If the formulas for maximum stress, S , are applied without modification to other materials such as cast iron, aluminum, and brass for which the range of Poisson's ratio is about 0.26 to 0.34, the maximum stress calculations will be in error by not more than about 3 per cent. The deflection formulas may also be applied to materials other than steel by substituting in these formulas the appropriate value for E , the modulus of elasticity of the material (see pages 432 and 513). The deflections thus obtained will not be in error by more than about 3 per cent.

In the stress and deflection formulas that follow,

p = uniformly distributed load acting on plate, pounds per square inch

W = total load on plate, pounds; $W = p \times$ area of plate

L = distance between supports (length of plate), inches. For rectangular plates, L = long side, l = short side

t = thickness of plate, inches

S = maximum tensile stress in plate, pounds per square inch

d = maximum deflection of plate, inches

E = modulus of elasticity in tension. $E = 30,000,000$ pounds per square inch for steel

If metric SI units are used in the formulas, then,

W = total load on plate, newtons

L = distance between supports (length of plate), millimeters. For rectangular plates, L = long side, l = short side

t = thickness of plate, millimeters

S = maximum tensile stress in plate, newtons per mm squared

d = maximum deflection of plate, mm

E = modulus of elasticity, newtons per mm squared

a) Square flat plate supported at top and bottom of all four edges and a uniformly distributed load over the surface of the plate.

$$S = \frac{0.29 W}{t^2} \quad (1)$$

$$d = \frac{0.0443 WL^2}{Et^3} \quad (2)$$

b) Square flat plate supported at the bottom only of all four edges and a uniformly distributed load over the surface of the plate.

$$S = \frac{0.28 W}{t^2} \quad (3)$$

$$d = \frac{0.0443 WL^2}{Et^3} \quad (4)$$

c) Square flat plate with all edges firmly fixed and a uniformly distributed load over the surface of the plate.

$$S = \frac{0.31 W}{t^2} \quad (5)$$

$$d = \frac{0.0138 WL^2}{Et^3} \quad (6)$$

d) Square flat plate with all edges firmly fixed and a uniform load over small circular area at the center. In Equations (7) and (9), r_0 = radius of area to which load is applied. If $r_0 <$

$1.7t$, use r_s where $r_s = \sqrt{1.6r_0^2 + t^2} - 0.675t$.

$$S = \frac{0.62 W}{t^2} \log_e \left(\frac{L}{2r_0} \right) \quad (7)$$

$$d = \frac{0.0568 WL^2}{Et^3} \quad (8)$$

e) Square flat plate with all edges supported above and below, or below only, and a concentrated load at the center. (See Item d), above, for definition of r_0).

$$S = \frac{0.62 W}{t^2} \left[\log_e \left(\frac{L}{2r_0} \right) + 0.577 \right] \quad (9)$$

$$d = \frac{0.1266 WL^2}{Et^3} \quad (10)$$

f) Rectangular plate with all edges supported at top and bottom and a uniformly distributed load over the surface of the plate.

$$S = \frac{0.75 W}{t^2 \left(\frac{L}{l} + 1.61 \frac{l^2}{L^2} \right)} \quad (11)$$

$$d = \frac{0.1422 W}{Et^3 \left(\frac{L}{l^3} + \frac{2.21}{L^2} \right)} \quad (12)$$

g) Rectangular plate with all edges fixed and a uniformly distributed load over the surface of the plate.

$$S = \frac{0.5 W}{t^2 \left(\frac{L}{l} + \frac{0.623 l^5}{L^5} \right)} \quad (13)$$

$$d = \frac{0.0284 W}{Et^3 \left(\frac{L}{l^3} + \frac{1.056 l^2}{L^4} \right)} \quad (14)$$

Circular Flat Plates.—In the following formulas, R = radius of plate to supporting edge in inches; W = total load in pounds; and other symbols are the same as used for square and rectangular plates.

If metric SI units are used, R = radius of plate to supporting edge in millimeters, and the values of other symbols are the same as those used for square and rectangular plates.

a) Edge supported around the circumference and a uniformly distributed load over the surface of the plate.

$$S = \frac{0.39W}{t^2} \quad (15) \quad d = \frac{0.221WR^2}{Et^3} \quad (16)$$

b) Edge fixed around circumference and a uniformly distributed load over the surface of the plate.

$$S = \frac{0.24W}{t^2} \quad (17) \quad d = \frac{0.0543WR^2}{Et^3} \quad (18)$$

c) Edge supported around the circumference and a concentrated load at the center.

$$S = \frac{0.48W}{t^2} \left[1 + 1.31 \log_e \frac{R}{0.325t} - 0.0185 \frac{t^2}{R^2} \right] \quad (19) \quad d = \frac{0.55WR^2}{Et^3} \quad (20)$$

d) Edge fixed around circumference and a concentrated load at the center.

$$S = \frac{0.62W}{t^2} \left[\log_e \frac{R}{0.325t} + 0.0264 \frac{t^2}{R^2} \right] \quad (21) \quad d = \frac{0.22WR^2}{Et^3} \quad (22)$$

Strength of Cylinders Subjected to Internal Pressure.—In designing a cylinder to withstand internal pressure, the choice of formula to be used depends on 1) the kind of material of which the cylinder is made (whether brittle or ductile); 2) the construction of the cylinder ends (whether open or closed); and 3) whether the cylinder is classed as a thin- or a thick-walled cylinder.

A cylinder is considered to be thin-walled when the ratio of wall thickness to inside diameter is 0.1 or less and thick-walled when this ratio is greater than 0.1. Materials such as cast iron, hard steel, cast aluminum are considered to be brittle materials; low-carbon steel, brass, bronze, etc. are considered to be ductile.

In the formulas that follow, p = internal pressure, pounds per square inch; D = inside diameter of cylinder, inches; t = wall thickness of cylinder, inches; μ = Poisson's ratio, = 0.3 for steel, 0.26 for cast iron, 0.34 for aluminum and brass; and S = allowable tensile stress, pounds per square inch.

Metric SI units can be used in Formulas (23), (25), (26), and (27), where p = internal pressure in newtons per square millimeter; D = inside diameter of cylinder, millimeters; t = wall thickness, mm; μ = Poisson's ratio, = 0.3 for steel, 0.26 for cast iron, and 0.34 for aluminum and brass; and S = allowable tensile stress, N/mm². For the use of metric SI units in Formula (24), see below.

Thin-walled Cylinders:
$$t = \frac{Dp}{2S} \quad (23)$$

For low-pressure cylinders of cast iron such as are used for certain engine and press applications, a formula in common use is

$$t = \frac{Dp}{2500} + 0.3 \quad (24)$$

This formula is based on allowable stress of 1250 pounds per square inch and will give a wall thickness 0.3 inch greater than **Formula (23)** to allow for variations in metal thickness that may result from the casting process.

If metric SI units are used in **Formula (24), t = cylinder wall thickness in millimeters; D = inside diameter of cylinder, mm; and the allowable stress is in newtons per square millimeter. The value of 0.3 inches additional wall thickness is 7.62 mm, and the next highest number in preferred metric basic sizes is 8 mm.**

Thick-walled Cylinders of Brittle Material, Ends Open or Closed: Lamé's equation is used when cylinders of this type are subjected to internal pressure. ✦

$$t = \frac{D}{2} \left(\sqrt{\frac{S+p}{S-p}} - 1 \right) \tag{25}$$

The table *Ratio of Outside Radius to Inside Radius, Thick Cylinders* on page 292 is for convenience in calculating the dimensions of cylinders under high internal pressure without the use of **Formula (25)**.

Example, Use of the Table: Assume that a cylinder of 10 inches inside diameter is to withstand a pressure of 2500 pounds per square inch; the material is cast iron and the allowable stress is 6000 pounds per square inch. To solve the problem, locate the allowable stress per square inch in the left-hand column of the table and the working pressure at the top of the columns. Then find the ratio between the outside and inside radii in the body of the table. In this example, the ratio is 1.558, and hence the outside diameter of the cylinder should be 10×1.558 , or about $15\frac{5}{8}$ inches. The thickness of the cylinder wall will therefore be $(15.58 - 10)/2 = 2.79$ inches.

Unless very high-grade material is used and sound castings assured, cast iron should not be used for pressures exceeding 2000 pounds psi (13.75 N/mm^2). It is well to leave more metal in the bottom of a hydraulic cylinder than is indicated by the results of calculations, because a hole of some size must be cored in the bottom to permit the entrance of a boring bar when finishing the cylinder, and when this hole is subsequently tapped and plugged it often gives trouble if there is too little thickness.

For steady or gradually applied stresses, the maximum allowable fiber stress S may be assumed to be from 3500 to 4000 psi ($24\text{-}27 \text{ N/mm}^2$) for cast iron; from 6000 to 7000 psi ($41\text{-}48 \text{ N/mm}^2$) for brass; and 12,000 psi (82 N/mm^2) for steel castings. For intermittent stresses, such as in cylinders for steam and hydraulic work, 3000 psi (20 N/mm^2) for cast iron; 5000 psi (34 N/mm^2) for brass; and 10,000 psi (69 N/mm^2) for steel castings, is ordinarily used. These values give ample factors of safety.

Note: In metric SI units, 1000 pounds per square inch equals 6.895 newtons per square millimeter. Also, one newtons per square millimeter equals one megapascal ($1 \text{ N/mm}^2 = 1 \text{ MPa}$).

Thick-walled Cylinders of Ductile Material, Closed Ends: Clavarino's equation is used: ✦

$$t = \frac{D}{2} \left[\sqrt{\frac{S + (1 - 2\mu)p}{S - (1 + \mu)p}} - 1 \right] \tag{26}$$

Thick-walled Cylinders of Ductile Material, Open Ends: Birnie's equation is used: ✦

$$t = \frac{D}{2} \left[\sqrt{\frac{S + (1 - \mu)p}{S - (1 + \mu)p}} - 1 \right] \tag{27}$$

Spherical Shells Subjected to Internal Pressure.—Let:

D = internal diameter of shell in inches

p = internal pressure in pounds per square inch

S = safe tensile stress per square inch

t = thickness of metal in the shell, in inches. Then, $t = pD \div 4S$ (28)

Ratio of Outside Radius to Inside Radius, Thick Cylinders

Allowable Stress per Sq. In. of Section	Working Pressure in Cylinder, Pounds per Square Inch												
	1000	1500	2000	2500	3000	3500	4000	4500	5000	5500	6000	6500	7000
2000	1.732
2500	1.528	2.000
3000	1.414	1.732	2.236
3500	1.342	1.581	1.915	2.449
4000	1.291	1.483	1.732	2.082	2.646
4500	1.254	1.414	1.612	1.871	2.236	2.828
5000	1.225	1.363	1.528	1.732	2.000	2.380	3.000
5500	1.202	1.323	1.464	1.633	1.844	2.121	2.517	3.162
6000	1.183	1.291	1.414	1.558	1.732	1.949	2.236	2.646	3.317
6500	...	1.265	1.374	1.500	1.648	1.826	2.049	2.345	2.769	3.464
7000	...	1.243	1.342	1.453	1.581	1.732	1.915	2.145	2.449	2.887	3.606
7500	...	1.225	1.314	1.414	1.528	1.658	1.813	2.000	2.236	2.550	3.000	3.742	...
8000	...	1.209	1.291	1.382	1.483	1.599	1.732	1.890	2.082	2.324	2.646	3.109	3.873
8500	...	1.195	1.271	1.354	1.446	1.549	1.667	1.803	1.964	2.160	2.408	2.739	3.215
9000	...	1.183	1.254	1.330	1.414	1.508	1.612	1.732	1.871	2.035	2.236	2.490	2.828
9500	1.238	1.309	1.387	1.472	1.567	1.673	1.795	1.936	2.104	2.309	2.569
10,000	1.225	1.291	1.363	1.441	1.528	1.624	1.732	1.856	2.000	2.171	2.380
10,500	1.213	1.275	1.342	1.414	1.494	1.581	1.679	1.789	1.915	2.062	2.236
11,000	1.202	1.260	1.323	1.390	1.464	1.544	1.633	1.732	1.844	1.972	2.121
11,500	1.192	1.247	1.306	1.369	1.438	1.512	1.593	1.683	1.784	1.897	2.028
12,000	1.183	1.235	1.291	1.350	1.414	1.483	1.558	1.641	1.732	1.834	1.949
12,500	1.225	1.277	1.333	1.393	1.458	1.528	1.604	1.687	1.780	1.883
13,000	1.215	1.265	1.318	1.374	1.435	1.500	1.571	1.648	1.732	1.826
13,500	1.206	1.254	1.304	1.357	1.414	1.475	1.541	1.612	1.690	1.776
14,000	1.198	1.243	1.291	1.342	1.395	1.453	1.515	1.581	1.653	1.732
14,500	1.190	1.234	1.279	1.327	1.378	1.433	1.491	1.553	1.620	1.693
15,000	1.183	1.225	1.268	1.314	1.363	1.414	1.469	1.528	1.590	1.658
16,000	1.171	1.209	1.249	1.291	1.335	1.382	1.431	1.483	1.539	1.599

Formula (28) also applies to hemi-spherical shells, such as the hemi-spherical head of a cylindrical container subjected to internal pressure, etc.

If metric SI units are used, then:

D = internal diameter of shell in millimeters

p = internal pressure in newtons per square millimeter

S = safe tensile stress in newtons per square millimeter

t = thickness of metal in the shell, in millimeters. Use Formula (28).

Meters can be used in the formula in place of millimeters, providing the treatment is consistent throughout.

Example: Find the thickness of metal required in the hemi-spherical end of a cylindrical vessel, 2 feet in diameter, subjected to an internal pressure of 500 pounds per square inch. The material is mild steel and a tensile stress of 10,000 pounds per square inch is allowable.

$$t = \frac{500 \times 2 \times 12}{4 \times 10,000} = 0.3 \text{ inch}$$

Example: A similar example using metric SI units is as follows: find the thickness of metal required in the hemi-spherical end of a cylindrical vessel, 750 mm in diameter, subjected to an internal pressure of 3 newtons/mm². The material is mild steel and a tensile stress of 70 newtons/mm² is allowable.

$$t = \frac{3 \times 750}{4 \times 70} = 8.04 \text{ mm}$$

If the radius of curvature of the domed head of a boiler or container subjected to internal pressure is made equal to the diameter of the boiler, the thickness of the cylindrical shell and of the spherical head should be made the same. For example, if a boiler is 3 feet in diameter, the radius of curvature of its head should also be 3 feet, if material of the same thickness is to be used and the stresses are to be equal in both the head and cylindrical portion.

Collapsing Pressure of Cylinders and Tubes Subjected to External Pressures.—The following formulas may be used for finding the collapsing pressures of lap-welded Bessemer steel tubes:

$$P = 86,670 \frac{t}{D} - 1386 \quad (29)$$

$$P = 50,210,000 \left(\frac{t}{D} \right)^3 \quad (30)$$

in which P = collapsing pressure in pounds per square inch; D = outside diameter of tube or cylinder in inches; t = thickness of wall in inches.

Formula (29) is for values of P greater than 580 pounds per square inch, and **Formula (30)** is for values of P less than 580 pounds per square inch. These formulas are substantially correct for all lengths of pipe greater than six diameters between transverse joints that tend to hold the pipe to a circular form. The pressure P found is the actual collapsing pressure, and a suitable factor of safety must be used. Ordinarily, a factor of safety of 5 is sufficient. In cases where there are repeated fluctuations of the pressure, vibration, shocks and other stresses, a factor of safety of from 6 to 12 should be used.

If metric SI units are used the formulas are:

$$P = 597.6 \frac{t}{D} - 9.556 \quad (31)$$

$$P = 346,200 \left(\frac{t}{D} \right)^3 \quad (32)$$

where P = collapsing pressure in newtons per square millimeter; D = outside diameter of tube or cylinder in millimeters; and t = thickness of wall in millimeters. **Formula (31)** is for values of P greater than 4 N/mm², and **Formula (32)** is for values of P less than 4 N/mm².

The table *Tubes Subjected to External Pressure* is based upon the requirements of the Steam Boat Inspection Service of the Department of Commerce and Labor and gives the permissible working pressures and corresponding minimum wall thickness for long, plain, lap-welded and seamless steel flues subjected to external pressure only. The table thicknesses have been calculated from the formula:

$$t = \frac{[(F \times p) + 1386]D}{86,670}$$

in which D = outside diameter of flue or tube in inches; t = thickness of wall in inches; p = working pressure in pounds per square inch; F = factor of safety. The formula is applicable to working pressures greater than 100 pounds per square inch, to outside diameters from 7 to 18 inches, and to temperatures less than 650°F.

The preceding **Formulas (29)** and **(30)** were determined by Prof. R. T. Stewart, Dean of the Mechanical Engineering Department of the University of Pittsburgh, in a series of experiments carried out at the plant of the National Tube Co., McKeesport, Pa.

The apparent fiber stress under which the different tubes failed varied from about 7000 pounds per square inch for the relatively thinnest to 35,000 pounds per square inch for the relatively thickest walls. The average yield point of the material tested was 37,000 pounds and the tensile strength 58,000 pounds per square inch, so it is evident that the strength of a tube subjected to external fluid collapsing pressure is not dependent alone upon the elastic limit or ultimate strength of the material from which it is made.

Tubes Subjected to External Pressure

Outside Diameter of Tube, Inches	Working Pressure in Pounds per Square Inch						
	100	120	140	160	180	200	220
	Thickness of Tube in Inches. Safety Factor, 5						
7	0.152	0.160	0.168	0.177	0.185	0.193	0.201
8	0.174	0.183	0.193	0.202	0.211	0.220	0.229
9	0.196	0.206	0.217	0.227	0.237	0.248	0.258
10	0.218	0.229	0.241	0.252	0.264	0.275	0.287
11	0.239	0.252	0.265	0.277	0.290	0.303	0.316
12	0.261	0.275	0.289	0.303	0.317	0.330	0.344
13	0.283	0.298	0.313	0.328	0.343	0.358	0.373
14	0.301	0.320	0.337	0.353	0.369	0.385	0.402
15	0.323	0.343	0.361	0.378	0.396	0.413	0.430
16	0.344	0.366	0.385	0.404	0.422	0.440	0.459
16	0.366	0.389	0.409	0.429	0.448	0.468	0.488
18	0.387	0.412	0.433	0.454	0.475	0.496	0.516

Dimensions and Maximum Allowable Pressure of Tubes Subjected to External Pressure

Outside Dia., Inches	Thick-ness of Material, Inches	Max. Pressure Allowed, psi	Outside Dia., Inches	Thick-ness of Material, Inches	Max. Pressure Allowed, psi	Outside Dia., Inches	Thick-ness of Material, Inches	Max. Pressure Allowed, psi
2	0.095	427	3	0.109	327	4	0.134	303
2¼	0.095	380	3¼	0.120	332	4½	0.134	238
2½	0.109	392	3½	0.120	308	5	0.148	235
2¾	0.109	356	3¾	0.120	282	6	0.165	199

SHAFTS

Shaft Calculations

Torsional Strength of Shafting.—In the formulas that follow,

α = angular deflection of shaft in degrees

c = distance from center of gravity to extreme fiber

D = diameter of shaft in inches

G = torsional modulus of elasticity = 11,500,000 pounds per square inch for steel

J = polar moment of inertia of shaft cross-section (see table)

l = length of shaft in inches

N = angular velocity of shaft in revolutions per minute

P = power transmitted in horsepower

S_s = allowable torsional shearing stress in pounds per square inch

T = torsional or twisting moment in inch-pounds

Z_p = polar section modulus (see table page 245)

The allowable twisting moment for a shaft of any cross-section such as circular, square, etc., is:

$$T = S_s \times Z_p \quad (1)$$

For a shaft delivering P horsepower at N revolutions per minute the twisting moment T being transmitted is:

$$T = \frac{63,000P}{N} \quad (2)$$

The twisting moment T as determined by **Formula (2)** should be less than the value determined by using **Formula (1)** if the maximum allowable stress S_s is not to be exceeded.

The diameter of a solid circular shaft required to transmit a given torque T is:

$$D = \sqrt[3]{\frac{5.1T}{S_s}} \quad (3a) \quad \text{or} \quad D = \sqrt[3]{\frac{321,000P}{NS_s}} \quad (3b)$$

The allowable stresses that are generally used in practice are: 4000 pounds per square inch for main power-transmitting shafts; 6000 pounds per square inch for lineshafts carrying pulleys; and 8500 pounds per square inch for small, short shafts, countershafts, etc. Using these allowable stresses, the horsepower P transmitted by a shaft of diameter D , or the diameter D of a shaft to transmit a given horsepower P may be determined from the following formulas:

For main power-transmitting shafts:

$$P = \frac{D^3 N}{80} \quad (4a) \quad \text{or} \quad D = \sqrt[3]{\frac{80P}{N}} \quad (4b)$$

For lineshafts carrying pulleys:

$$P = \frac{D^3 N}{53.5} \quad (5a) \quad \text{or} \quad D = \sqrt[3]{\frac{53.5P}{N}} \quad (5b)$$

For small, short shafts:

$$P = \frac{D^3 N}{38} \quad (6a) \quad \text{or} \quad D = \sqrt[3]{\frac{38P}{N}} \quad (6b)$$

Shafts that are subjected to shocks, such as sudden starting and stopping, should be given a greater factor of safety resulting in the use of lower allowable stresses than those just mentioned.

Example: What should be the diameter of a lineshaft to transmit 10 horsepower if the shaft is to make 150 revolutions per minute? Using [Formula \(5b\)](#),

$$D = \sqrt[3]{\frac{53.5 \times 10}{150}} = 1.53 \text{ or, say, } 1\frac{1}{16} \text{ inches}$$

Example: What horsepower would be transmitted by a short shaft, 2 inches in diameter, carrying two pulleys close to the bearings, if the shaft makes 300 revolutions per minute? Using [Formula \(6a\)](#),

$$P = \frac{2^3 \times 300}{38} = 63 \text{ horsepower}$$

Torsional Strength of Shafting, Calculations in Metric SI Units.—The allowable twisting moment for a shaft of any cross-section such as circular, square, etc., can be calculated from:

$$T = S_s \times Z_p \quad (7)$$

where T = torsional or twisting moment in newton-millimeters; S_s = allowable torsional shearing stress in newtons per square millimeter; and Z_p = polar section modulus in millimeters³.

✦ For a shaft delivering power of P kilowatts at N revolutions per minute, the twisting moment T being transmitted is:

$$T = \frac{9.55 \times 10^6 P}{N} \quad (8) \quad \text{or} \quad T = \frac{10^6 P}{\omega} \quad (8a)$$

where T is in newton-millimeters, and ω = angular velocity in radians per second.

The diameter D of a solid circular shaft required to transmit a given torque T is:

$$D = \sqrt[3]{\frac{5.1T}{S_s}} \quad (9a) \quad \text{or} \quad D = \sqrt[3]{\frac{48.7 \times 10^6 P}{NS_s}} \quad (9b)$$

$$\text{or} \quad D = \sqrt[3]{\frac{5.1 \times 10^6 P}{\omega S_s}} \quad (9c)$$

where D is in millimeters; T is in newton-millimeters; P is power in kilowatts; N = revolutions per minute; S_s = allowable torsional shearing stress in newtons per square millimeter, and ω = angular velocity in radians per second.

If 28 newtons/mm² and 59 newtons/mm² are taken as the generally allowed stresses for main power-transmitting shafts and small short shafts, respectively, then using these allowable stresses, the power P transmitted by a shaft of diameter D , or the diameter D of a shaft to transmit a given power P may be determined from the following formulas:

For main power-transmitting shafts:

$$P = \frac{D^3 N}{1.77 \times 10^6} \quad (10a)$$

or

$$D = \sqrt[3]{\frac{1.77 \times 10^6 P}{N}} \quad (10b)$$

For small, short shafts:

$$P = \frac{D^3 N}{0.83 \times 10^6} \quad (11a)$$

or

$$D = \sqrt[3]{\frac{0.83 \times 10^6 P}{N}} \quad (11b)$$

where P is in kilowatts, D is in millimeters, and N = revolutions per minute.

Example: What should be the diameter of a power-transmitting shaft to transmit 150 kW at 500 rpm?

$$D = \sqrt[3]{\frac{1.77 \times 10^6 \times 150}{500}} = 81 \text{ millimeters}$$

Example: What power would a short shaft, 50 millimeters in diameter, transmit at 400 rpm?

$$P = \frac{50^3 \times 400}{0.83 \times 10^6} = 60 \text{ kilowatts}$$

Torsional Deflection of Circular Shafts.—Shafting must often be proportioned not only to provide the strength required to transmit a given torque, but also to prevent torsional deflection (twisting) through a greater angle than has been found satisfactory for a given type of service.

For a solid circular shaft the torsional deflection in degrees is given by:

$$\alpha = \frac{584 T l}{D^4 G} \quad (12)$$

Example: Find the torsional deflection for a solid steel shaft 4 inches in diameter and 48 inches long, subjected to a twisting moment of 24,000 inch-pounds. By **Formula (12)**,

$$\alpha = \frac{584 \times 24,000 \times 48}{4^4 \times 11,500,000} = 0.23 \text{ degree}$$

Formula (12) can be used with metric SI units, where α = angular deflection of shaft in degrees; T = torsional moment in newton-millimeters; l = length of shaft in millimeters; D = diameter of shaft in millimeters; and G = torsional modulus of elasticity in newtons per square millimeter.

Example: Find the torsional deflection of a solid steel shaft, 100 mm in diameter and 1300 mm long, subjected to a twisting moment of 3×10^6 newton-millimeters. The torsional modulus of elasticity is 80,000 newtons/mm². By **Formula (12)**

$$\alpha = \frac{584 \times 3 \times 10^6 \times 1300}{100^4 \times 80,000} = 0.285 \text{ degree}$$

The diameter of a shaft that is to have a maximum torsional deflection α is given by:

$$D = 4.9 \times \sqrt[4]{\frac{T l}{G \alpha}} \quad (13)$$

Formula (13) can be used with metric SI units, where D = diameter of shaft in millimeters; T = torsional moment in newton-millimeters; l = length of shaft in millime-

ters; G = torsional modulus of elasticity in newtons per square millimeter; and α = angular deflection of shaft in degrees.

According to some authorities, the allowable twist in steel transmission shafting should not exceed 0.08 degree per foot length of the shaft. The diameter D of a shaft that will permit a maximum angular deflection of 0.08 degree per foot of length for a given torque T or for a given horsepower P can be determined from the formulas:

$$D = 0.29\sqrt[4]{T} \quad (14a) \quad \text{or} \quad D = 4.6 \times \sqrt[4]{\frac{P}{N}} \quad (14b)$$

Using metric SI units and assuming an allowable twist in steel transmission shafting of 0.26 degree per meter length, **Formulas (14a) and (14b) become:**

$$D = 2.26\sqrt[4]{T} \quad \text{or} \quad D = 125.7 \times \sqrt[4]{\frac{P}{N}}$$

where D = diameter of shaft in millimeters; T = torsional moment in newton-millimeters; P = power in kilowatts; and N = revolutions per minute.

Another rule that has been generally used in mill practice limits the deflection to 1 degree in a length equal to 20 times the shaft diameter. For a given torque or horsepower, the diameter of a shaft having this maximum deflection is given by:

$$D = 0.1\sqrt[3]{T} \quad (15a) \quad \text{or} \quad D = 4.0 \times \sqrt[3]{\frac{P}{N}} \quad (15b)$$

Example: Find the diameter of a steel lineshaft to transmit 10 horsepower at 150 revolutions per minute with a torsional deflection not exceeding 0.08 degree per foot of length. By **Formula (14b)**,

$$D = 4.6 \times \sqrt[4]{\frac{10}{150}} = 2.35 \text{ inches}$$

This diameter is larger than that obtained for the same horsepower and rpm in the example given for **Formula (5b)** in which the diameter was calculated for strength considerations only. The usual procedure in the design of shafting which is to have a specified maximum angular deflection is to compute the diameter first by means of **Formulas (13), (14a), (14b), (15a), or (15b)** and then by means of **Formulas (3a), (3b), (4b), (5b), or (6b)**, using the larger of the two diameters thus found.

Linear Deflection of Shafting.—For steel line shafting, it is considered good practice to limit the linear deflection to a maximum of 0.010 inch per foot of length. The maximum distance in feet between bearings, for average conditions, in order to avoid excessive linear deflection, is determined by the formulas:

$$L = 8.95\sqrt[3]{D^2} \text{ for shafting subject to no bending action except its own weight}$$

$$L = 5.2\sqrt[3]{D^2} \text{ for shafting subject to bending action of pulleys, etc.}$$

in which D = diameter of shaft in inches and L = maximum distance between bearings in feet. Pulleys should be placed as close to the bearings as possible.

In general, shafting up to three inches in diameter is almost always made from cold-rolled steel. This shafting is true and straight and needs no turning, but if keyways are cut in the shaft, it must usually be straightened afterwards, as the cutting of the keyways relieves the tension on the surface of the shaft produced by the cold-rolling process. Sizes of shafting from three to five inches in diameter may be either cold-rolled or turned, more frequently the latter, and all larger sizes of shafting must be turned because cold-rolled shafting is not available in diameters larger than 5 inches.

Diameters of Finished Shafting (former American Standard ASA B17.1)

Diameters, Inches		Minus Tolerances, Inches ^a	Diameters, Inches		Minus Tolerances, Inches ^a	Diameters, Inches		Minus Tolerances, Inches ^a
Transmission Shafting	Machinery Shafting		Transmission Shafting	Machinery Shafting		Transmission Shafting	Machinery Shafting	
	1/2	0.002		1 13/16	0.003		3 3/4	0.004
	9/16	0.002		1 7/8	0.003		3 7/8	0.004
	5/8	0.002	1 15/16	1 5/8	0.003	3 15/16	4	0.004
	11/16	0.002		2	0.003		4 1/4	0.005
	3/4	0.002		2 1/16	0.004	4 7/16	4 1/2	0.005
	13/16	0.002		2 1/8	0.004		4 3/4	0.005
	7/8	0.002	2 3/16	2 3/16	0.004	4 15/16	5	0.005
15/16	15/16	0.002		2 1/4	0.004		5 1/4	0.005
	1	0.002		2 5/16	0.004	5 7/16	5 1/2	0.005
	1 1/16	0.003		2 3/8	0.004		5 3/4	0.005
	1 1/8	0.003	2 7/16	2 7/16	0.004	5 5/16	6	0.005
1 3/16	1 3/16	0.003		2 1/2	0.004		6 1/4	0.006
	1 1/4	0.003		2 5/8	0.004	6 1/2	6 1/2	0.006
	1 5/16	0.003		2 3/4	0.004		6 3/4	0.006
	1 3/8	0.003	2 15/16	2 7/8	0.004	7	7	0.006
1 7/16	1 7/16	0.003		3	0.004		7 1/4	0.006
	1 1/2	0.003		3 1/8	0.004	7 1/2	7 1/2	0.006
	1 1/6	0.003		3 1/4	0.004		7 3/4	0.006
	1 5/8	0.003		3 3/8	0.004	8	8	0.006
1 11/16	1 11/16	0.003	3 7/16	3 1/2	0.004
	1 3/4	0.003		3 5/8	0.004

^a *Note*.—These tolerances are *negative* or minus and represent the maximum allowable variation *below* the exact nominal size. For instance the maximum diameter of the 1 15/16 inch shaft is 1.938 inch and its minimum allowable diameter is 1.935 inch. Stock lengths of finished transmission shafting shall be: 16, 20 and 24 feet.

Design of Transmission Shafting.—The following guidelines for the design of shafting for transmitting a given amount of power under various conditions of loading are based upon formulas given in the former American Standard ASA B17c Code for the Design of Transmission Shafting. These formulas are based on the *maximum-shear theory* of failure which assumes that the elastic limit of a *ductile* ferrous material in shear is practically one-half its elastic limit in tension. This theory agrees, very nearly, with the results of tests on ductile materials and has gained wide acceptance in practice.

The formulas given apply in all shaft designs including shafts for special machinery. The limitation of these formulas is that they provide only for the strength of shafting and are not concerned with the torsional or lineal deformations which may, in shafts used in machine design, be the controlling factor (see *Torsional Deflection of Circular Shafts* on page 297 and *Linear Deflection of Shafting* on page 298 for deflection considerations). In the formulas that follow,

$$B = \sqrt[3]{1 \div (1 - K^4)} \text{ (see Table 3)}$$

D = outside diameter of shaft in inches

D_1 = inside diameter of a hollow shaft in inches

K_m = shock and fatigue factor to be applied in every case to the computed bending moment (see Table 1)

K_t = combined shock and fatigue factor to be applied in every case to the computed torsional moment (see Table 1)

M = maximum bending moment in inch-pounds

N = revolutions per minute

P = maximum power to be transmitted by the shaft in horsepower

p_t = maximum allowable shearing stress under combined loading conditions in pounds per square inch (see **Table 2**)

S = maximum allowable flexural (bending) stress, in either tension or compression in pounds per square inch (see **Table 2**)

S_s = maximum allowable torsional shearing stress in pounds per square inch (see **Table 2**)

T = maximum torsional moment in inch-pounds

V = maximum transverse shearing load in pounds

For shafts subjected to pure torsional loads only,

$$D = B \sqrt[3]{\frac{5.1 K_t T}{S_s}} \quad (16a) \quad \text{or} \quad D = B \sqrt[3]{\frac{321,000 K_t P}{S_s N}} \quad (16b)$$

For stationary shafts subjected to bending only,

$$D = B \sqrt[3]{\frac{10.2 K_m M}{S}} \quad (17)$$

For shafts subjected to combined torsion and bending,

$$D = B \sqrt[3]{\frac{5.1}{p_t} \sqrt{(K_m M)^2 + (K_t T)^2}} \quad (18a)$$

or

$$D = B \times \sqrt[3]{\frac{5.1}{p_t} \sqrt{(K_m M)^2 + \left(\frac{63,000 K_t P}{N}\right)^2}} \quad (18b)$$

Formulas (16a) to (18b) may be used for solid shafts or for hollow shafts. For solid shafts the factor B is equal to 1, whereas for hollow shafts the value of B depends on the value of K which, in turn, depends on the ratio of the inside diameter of the shaft to the outside diameter ($D_1 \div D = K$). **Table 3** gives values of B corresponding to various values of K .

For short solid shafts subjected only to heavy transverse shear, the diameter of shaft required is:

$$D = \sqrt{\frac{1.7V}{S_s}} \quad (19)$$

✦ **Formulas (16a), (17), (18a) and (19), can be used unchanged with metric SI units. Formula (16b) becomes:**

$$D = B \sqrt[3]{\frac{48.7 K_t P}{S_s N}} \quad \text{and Formula (18b) becomes:}$$

$$D = B \sqrt[3]{\frac{5.1}{p_t} \sqrt{(K_m M)^2 + \left(\frac{9.55 K_t P}{N}\right)^2}}$$

Throughout the formulas, D = outside diameter of shaft in millimeters; T = maximum torsional moment in newton-millimeters; S_s = maximum allowable torsional shearing stress in newtons per millimeter squared (see **Table 2**); P = maximum power to be transmitted in milliwatts; N = revolutions per minute; M = maximum bending moment in newton-millimeters; S = maximum allowable flexural (bending) stress, either in tension or compression in newtons per millimeter squared (see **Table 2**); p_t = maximum allowable shearing stress under combined loading conditions in newtons per millimeter squared; and V = maximum transverse shearing load in kilograms.

The factors K_m , K_t , and B are unchanged, and D_1 = the inside diameter of a hollow shaft in millimeters.

Table 1. Recommended Values of the Combined Shock and Fatigue Factors for Various Types of Load

Type of Load	Stationary Shafts		Rotating Shafts	
	K_m	K_t	K_m	K_t
Gradually applied and steady	1.0	1.0	1.5	1.0
Suddenly applied, minor shocks only	1.5-2.0	1.5-2.0	1.5-2.0	1.0-1.5
Suddenly applied, heavy shocks	2.0-3.0	1.5-3.0

Table 2. Recommended Maximum Allowable Working Stresses for Shafts Under Various Types of Load

Material	Type of Load		
	Simple Bending	Pure Torsion	Combined Stress
“Commercial Steel” shafting without keyways	$S = 16,000$	$S_s = 8000$	$p_t = 8000$
“Commercial Steel” shafting with keyways	$S = 12,000$	$S_s = 6000$	$p_t = 6000$
Steel purchased under definite physical specs.	(See note ^a)	(See note ^b)	(See note ^b)

^a $S = 60$ per cent of the elastic limit in tension but not more than 36 per cent of the ultimate tensile strength.

^b S_s and $p_t = 30$ per cent of the elastic limit in tension but not more than 18 per cent of the ultimate tensile strength.

If the values in the Table are converted to metric SI units, note that 1000 pounds per square inch = 6.895 newtons per square millimeter.

Table 3. Values of the Factor B Corresponding to Various Values of K for Hollow Shafts

$K = \frac{D_1}{D} =$	0.95	0.90	0.85	0.80	0.75	0.70	0.65	0.60	0.55	0.50
$B = \sqrt[3]{1 \div (1 - K^4)}$	1.75	1.43	1.28	1.19	1.14	1.10	1.07	1.05	1.03	1.02

For solid shafts, $B = 1$ because $K = 0$, as follows: $B = \sqrt[3]{1 \div (1 - K^4)} = \sqrt[3]{1 \div (1 - 0)} = 1$

Effect of Keyways on Shaft Strength.—Keyways cut into a shaft reduce its load carrying ability, particularly when impact loads or stress reversals are involved. To ensure an adequate factor of safety in the design of a shaft with standard keyway (width, one-quarter, and depth, one-eighth of shaft diameter), the former Code for Transmission Shafting tentatively recommended that shafts with keyways be designed on the basis of a solid circular shaft using not more than 75 per cent of the working stress recommended for the solid shaft. See also page 2460.

Formula for Shafts of Brittle Materials.—The preceding formulas are applicable to ductile materials and are based on the maximum-shear theory of failure which assumes that the elastic limit of a ductile material in shear is one-half its elastic limit in tension.

Brittle materials are generally stronger in shear than in tension; therefore, the maximum-shear theory is not applicable. The *maximum-normal-stress theory* of failure is now generally accepted for the design of shafts made from brittle materials. A material may be considered to be brittle if its elongation in a 2-inch gage length is less than 5 per cent. Materials such as cast iron, hardened tool steel, hard bronze, etc., conform to this rule. The diameter of a shaft made of a brittle material may be determined from the following formula which is based on the maximum-normal-stress theory of failure:

$$D = B \sqrt[3]{\frac{5.1}{S_t} [(K_m M) + \sqrt{(K_m M)^2 + (K_t T)^2}]}$$

where S_t is the maximum allowable tensile stress in pounds per square inch and the other quantities are as previously defined.

The formula can be used unchanged with metric SI units, where D = outside diameter of shaft in millimeters; S_t = the maximum allowable tensile stress in newtons per millimeter squared; M = maximum bending moment in newton-millimeters; and T = maximum torsional moment in newton-millimeters. The factors K_m , K_t , and B are unchanged.

Critical Speed of Rotating Shafts.—At certain speeds, a rotating shaft will become dynamically unstable and the resulting vibrations and deflections can result in damage not only to the shaft but to the machine of which it is a part. The speeds at which such dynamic instability occurs are called the critical speeds of the shaft. On page 198 are given formulas for the critical speeds of shafts subject to various conditions of loading and support. A shaft may be safely operated either above or below its critical speed, good practice indicating that the operating speed be at least 20 per cent above or below the critical.

The formulas commonly used to determine critical speeds are sufficiently accurate for general purposes. However, the torque applied to a shaft has an important effect on its critical speed. Investigations have shown that the critical speeds of a uniform shaft are decreased as the applied torque is increased, and that there exist critical torques which will reduce the corresponding critical speed of the shaft to zero. A detailed analysis of the effects of applied torques on critical speeds may be found in a paper, "Critical Speeds of Uniform Shafts under Axial Torque," by Golomb and Rosenberg presented at the First U.S. National Congress of Applied Mechanics in 1951.

Shaft Couplings.—A shaft coupling is a device for fastening together the ends of two shafts, so that the rotary motion of one causes rotary motion of the other. One of the most simple and common forms of coupling is the flange coupling Figs. 1a and 1b. It consists of two flanged sleeves or hubs, each of which is keyed to the end of one of the two shafts to be connected. The sleeves are held together and prevented from rotating relative to each other by bolts through the flanges as indicated.

Flange Coupling

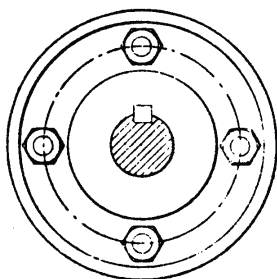


Fig. 1a.

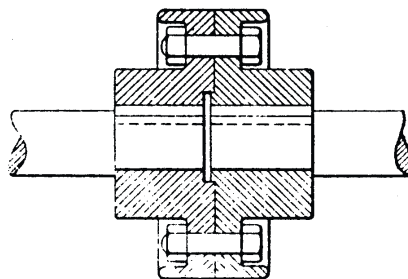


Fig. 1b.

Flexible Couplings: Flexible couplings are the most common mechanical means of compensating for unavoidable errors in alignment of shafts and shafting. When correctly applied, they are highly efficient for joining lengths of shafting without causing loss of power from bearing friction due to misalignment, and for use in direct motor drives for all kinds of machinery. Flexible couplings are not intended to be used for connecting a driven shaft and a driving shaft that are purposely placed in different planes or at an angle but are intended simply to overcome slight unavoidable errors in alignment that develop in service. There is a wide variety of flexible coupling designs; most of them consist essentially of two flanged members or hubs, fastened to the shafts and connected by some yielding arrangement. Balance is an important factor in coupling selection or design; it is not suffi-

cient that the coupling be perfectly balanced when installed, but it must remain in balance after wear has taken place.

Comparison of Hollow and Solid Shafting with Same Outside Diameter.—Table 4 that follows gives the per cent decrease in strength and weight of a hollow shaft relative to the strength and weight of a solid shaft of the same diameter. The upper figures in each line give the per cent decrease in strength and the lower figures give the per cent decrease in weight.

Example: A 4-inch shaft, with a 2-inch hole through it, has a weight 25 per cent less than a solid 4-inch shaft, but its strength is decreased only 6.25 per cent.

Table 4. Comparative Torsional Strengths and Weights of Hollow and Solid Shafting with Same Outside Diameter

Dia. of Solid and Hollow Shaft, Inches	Diameter of Axial Hole in Hollow Shaft, Inches									
	1	1¼	1½	1¾	2	2½	3	3½	4	4½
1½	19.76	48.23
	44.44	69.44
1¾	10.67	26.04	53.98
	32.66	51.02	73.49
2	6.25	15.26	31.65	58.62
	25.00	39.07	56.25	76.54
2¼	3.91	9.53	19.76	36.60	62.43
	19.75	30.87	44.44	60.49	79.00
2½	2.56	6.25	12.96	24.01	40.96
	16.00	25.00	36.00	49.00	64.00
2¾	1.75	4.28	8.86	16.40	27.98	68.30
	13.22	20.66	29.74	40.48	52.89	82.63
3	1.24	3.01	6.25	11.58	19.76	48.23
	11.11	17.36	25.00	34.01	44.44	69.44
3¼	0.87	2.19	4.54	8.41	14.35	35.02	72.61
	9.46	14.80	21.30	29.00	37.87	59.17	85.22
3½	0.67	1.63	3.38	6.25	10.67	26.04	53.98
	8.16	12.76	18.36	25.00	32.66	51.02	73.49
3¾	0.51	1.24	2.56	4.75	8.09	19.76	40.96	75.89
	7.11	11.11	16.00	21.77	28.45	44.44	64.00	87.10
4	0.40	0.96	1.98	3.68	6.25	15.26	31.65	58.62
	6.25	9.77	14.06	19.14	25.00	39.07	56.25	76.56
4¼	0.31	0.74	1.56	2.89	4.91	11.99	24.83	46.00	78.47	...
	5.54	8.65	12.45	16.95	22.15	34.61	49.85	67.83	88.59	...
4½	0.25	0.70	1.24	2.29	3.91	9.53	19.76	36.60	62.43	...
	4.94	7.72	11.11	15.12	19.75	30.87	44.44	60.49	79.00	...
4¾	0.20	0.50	1.00	1.85	3.15	7.68	15.92	29.48	50.29	80.56
	4.43	6.93	9.97	13.57	17.73	27.70	39.90	54.29	70.91	89.75
5	0.16	0.40	0.81	1.51	2.56	6.25	12.96	24.01	40.96	65.61
	4.00	6.25	8.10	12.25	16.00	25.00	36.00	49.00	64.00	81.00
5½	0.11	0.27	0.55	1.03	1.75	4.27	8.86	16.40	27.98	44.82
	3.30	5.17	7.43	10.12	13.22	20.66	29.76	40.48	52.89	66.94
6	0.09	0.19	0.40	0.73	1.24	3.02	6.25	11.58	19.76	31.65
	2.77	4.34	6.25	8.50	11.11	17.36	25.00	34.02	44.44	56.25
6½	0.06	0.14	0.29	0.59	0.90	2.19	4.54	8.41	14.35	23.98
	2.36	3.70	5.32	7.24	9.47	14.79	21.30	28.99	37.87	47.93
7	0.05	0.11	0.22	0.40	0.67	1.63	3.38	6.25	10.67	17.08
	2.04	3.19	4.59	6.25	8.16	12.76	18.36	25.00	32.66	41.33
7½	0.04	0.08	0.16	0.30	0.51	1.24	2.56	4.75	8.09	12.96
	1.77	2.77	4.00	5.44	7.11	11.11	16.00	21.77	28.45	36.00
8	0.03	0.06	0.13	0.23	0.40	0.96	1.98	3.68	6.25	10.02
	1.56	2.44	3.51	4.78	6.25	9.77	14.06	19.14	25.00	31.64

The upper figures in each line give number of per cent decrease in strength; the lower figures give per cent decrease in weight.

SPRINGS

Introduction to Spring Design

Many advances have been made in the spring industry in recent years. For example: developments in materials permit longer fatigue life at higher stresses; simplified design procedures reduce the complexities of design, and improved methods of manufacture help to speed up some of the complicated fabricating procedures and increase production. New types of testing instruments and revised tolerances also permit higher standards of accuracy. Designers should also consider the possibility of using standard springs now available from stock. They can be obtained from spring manufacturing companies located in different areas, and small shipments usually can be made quickly.

Designers of springs require information in the following order of precedence to simplify design procedures.

- 1) Spring materials and their applications
- 2) Allowable spring stresses
- 3) Spring design data with tables of spring characteristics, tables of formulas, and tolerances.

Only the more commonly used types of springs are covered in detail here. Special types and designs rarely used such as torsion bars, volute springs, Belleville washers, constant force, ring and spiral springs and those made from rectangular wire are only described briefly. Belleville and disc springs are discussed in the section *DISC SPRINGS* starting on page 350

Notation.—The following symbols are used in spring equations:

- AC = Active coils
- b = Widest width of rectangular wire, inches
- CL = Compressed length, inches
- D = Mean coil diameter, inches = $OD - d$
- d = Diameter of wire or side of square, inches
- E = Modulus of elasticity in tension, pounds per square inch
- F = Deflection, for N coils, inches
- F° = Deflection, for N coils, rotary, degrees
- f = Deflection, for one active coil
- FL = Free length, unloaded spring, inches
- G = Modulus of elasticity in torsion, pounds per square inch
- IT = Initial tension, pounds
- K = Curvature stress correction factor
- L = Active length subject to deflection, inches
- N = Number of active coils, total
- P = Load, pounds
- p = pitch, inches
- R = Distance from load to central axis, inches
- S or S_t = Stress, torsional, pounds per square inch
- S_b = Stress, bending, pounds per square inch
- SH = Solid height
- S_{it} = Stress, torsional, due to initial tension, pounds per square inch
- T = Torque = $P \times R$, pound-inches
- TC = Total coils
- t = Thickness, inches
- U = Number of revolutions = $F^\circ/360^\circ$

Spring Materials

The spring materials most commonly used include high-carbon spring steels, alloy spring steels, stainless spring steels, copper-base spring alloys, and nickel-base spring alloys.

High-Carbon Spring Steels in Wire Form.—These spring steels are the most commonly used of all spring materials because they are the least expensive, are easily worked, and are readily available. However, they are not satisfactory for springs operating at high or low temperatures or for shock or impact loading. The following wire forms are available:

Music Wire, ASTM A228 : (0.80-0.95 per cent carbon) This is the most widely used of all spring materials for small springs operating at temperatures up to about 250 degrees F. It is tough, has a high tensile strength, and can withstand high stresses under repeated loading. The material is readily available in round form in diameters ranging from 0.005 to 0.125 inch and in some larger sizes up to $\frac{3}{16}$ inch. It is not available with high tensile strengths in square or rectangular sections. Music wire can be plated easily and is obtainable pretinned or preplated with cadmium, but plating after spring manufacture is usually preferred for maximum corrosion resistance.

Oil-Tempered MB Grade, ASTM A229 : (0.60-0.70 per cent carbon) This general-purpose spring steel is commonly used for many types of coil springs where the cost of music wire is prohibitive and in sizes larger than are available in music wire. It is readily available in diameters ranging from 0.125 to 0.500 inch, but both smaller and larger sizes may be obtained. The material should not be used under shock and impact loading conditions, at temperatures above 350 degrees F., or at temperatures in the sub-zero range. Square and rectangular sections of wire are obtainable in fractional sizes. Annealed stock also can be obtained for hardening and tempering after coiling. This material has a heat-treating scale that must be removed before plating.

Oil-Tempered HB Grade, SAE 1080 : (0.75-0.85 per cent carbon) This material is similar to the MB Grade except that it has a higher carbon content and a higher tensile strength. It is obtainable in the same sizes and is used for more accurate requirements than the MB Grade, but is not so readily available. In lieu of using this material it may be better to use an alloy spring steel, particularly if a long fatigue life or high endurance properties are needed. Round and square sections are obtainable in the oil-tempered or annealed conditions.

Hard-Drawn MB Grade, ASTM A227 : (0.60-0.70 per cent carbon) This grade is used for general-purpose springs where cost is the most important factor. Although increased use in recent years has resulted in improved quality, it is best not to use it where long life and accuracy of loads and deflections are important. It is available in diameters ranging from 0.031 to 0.500 inch and in some smaller and larger sizes also. The material is available in square sections but at reduced tensile strengths. It is readily plated. Applications should be limited to those in the temperature range of 0 to 250 degrees F.

High-Carbon Spring Steels in Flat Strip Form.—Two types of thin, flat, high-carbon spring steel strip are most widely used although several other types are obtainable for specific applications in watches, clocks, and certain instruments. These two compositions are used for over 95 per cent of all such applications. Thin sections of these materials under 0.015 inch having a carbon content of over 0.85 per cent and a hardness of over 47 on the Rockwell C scale are susceptible to hydrogen-embrittlement even though special plating and heating operations are employed. The two types are described as follows:

Cold-Rolled Spring Steel, Blue-Tempered or Annealed, SAE 1074, also 1064, and 1070 : (0.60 to 0.80 per cent carbon) This very popular spring steel is available in thicknesses ranging from 0.005 to 0.062 inch and in some thinner and thicker sections. The material is available in the annealed condition for forming in 4-slide machines and in presses, and can

readily be hardened and tempered after forming. It is also available in the heat-treated or blue-tempered condition. The steel is obtainable in several finishes such as straw color, blue color, black, or plain. Hardnesses ranging from 42 to 46 Rockwell C are recommended for spring applications. Uses include spring clips, flat springs, clock springs, and motor, power, and spiral springs.

Cold-Rolled Spring Steel, Blue-Tempered Clock Steel, SAE 1095 : (0.90 to 1.05 per cent carbon) This popular type should be used principally in the blue-tempered condition. Although obtainable in the annealed condition, it does not always harden properly during heat-treatment as it is a "shallow" hardening type. It is used principally in clocks and motor springs. End sections of springs made from this steel are annealed for bending or piercing operations. Hardnesses usually range from 47 to 51 Rockwell C.

Other materials available in strip form and used for flat springs are brass, phosphor-bronze, beryllium-copper, stainless steels, and nickel alloys.

Alloy Spring Steels.—These spring steels are used for conditions of high stress, and shock or impact loadings. They can withstand both higher and lower temperatures than the high-carbon steels and are obtainable in either the annealed or pretempered conditions.

Chromium Vanadium, ASTM A231: This very popular spring steel is used under conditions involving higher stresses than those for which the high-carbon spring steels are recommended and is also used where good fatigue strength and endurance are needed. It behaves well under shock and impact loading. The material is available in diameters ranging from 0.031 to 0.500 inch and in some larger sizes also. In square sections it is available in fractional sizes. Both the annealed and pretempered types are available in round, square, and rectangular sections. It is used extensively in aircraft-engine valve springs and for springs operating at temperatures up to 425 degrees F.

Silicon Manganese: This alloy steel is quite popular in Great Britain. It is less expensive than chromium-vanadium steel and is available in round, square, and rectangular sections in both annealed and pretempered conditions in sizes ranging from 0.031 to 0.500 inch. It was formerly used for knee-action springs in automobiles. It is used in flat leaf springs for trucks and as a substitute for more expensive spring steels.

Chromium Silicon, ASTM A401: This alloy is used for highly stressed springs that require long life and are subjected to shock loading. It can be heat-treated to higher hardnesses than other spring steels so that high tensile strengths are obtainable. The most popular sizes range from 0.031 to 0.500 inch in diameter. Very rarely are square, flat, or rectangular sections used. Hardnesses ranging from 50 to 53 Rockwell C are quite common and the alloy may be used at temperatures up to 475 degrees F. This material is usually ordered specially for each job.

Stainless Spring Steels.—The use of stainless spring steels has increased and several compositions are available all of which may be used for temperatures up to 550 degrees F. They are all corrosion resistant. Only the stainless 18-8 compositions should be used at sub-zero temperatures.

Stainless Type 302, ASTM A313 : (18 per cent chromium, 8 per cent nickel) This stainless spring steel is very popular because it has the highest tensile strength and quite uniform properties. It is cold-drawn to obtain its mechanical properties and cannot be hardened by heat treatment. This material is nonmagnetic only when fully annealed and becomes slightly magnetic due to the cold-working performed to produce spring properties. It is suitable for use at temperatures up to 550 degrees F. and for sub-zero temperatures. It is very corrosion resistant. The material best exhibits its desirable mechanical properties in diameters ranging from 0.005 to 0.1875 inch although some larger diameters are available. It is also available as hard-rolled flat strip. Square and rectangular sections are available but are infrequently used.

Stainless Type 304, ASTM A313 : (18 per cent chromium, 8 per cent nickel) This material is quite similar to Type 302, but has better bending properties and about 5 per cent lower tensile strength. It is a little easier to draw, due to the slightly lower carbon content.

Stainless Type 316, ASTM A313 : (18 per cent chromium, 12 per cent nickel, 2 per cent molybdenum) This material is quite similar to Type 302 but is slightly more corrosion resistant because of its higher nickel content. Its tensile strength is 10 to 15 per cent lower than Type 302. It is used for aircraft springs.

Stainless Type 17-7 PH ASTM A313 : (17 per cent chromium, 7 per cent nickel) This alloy, which also contains small amounts of aluminum and titanium, is formed in a moderately hard state and then precipitation hardened at relatively low temperatures for several hours to produce tensile strengths nearly comparable to music wire. This material is not readily available in all sizes, and has limited applications due to its high manufacturing cost.

Stainless Type 414, SAE 51414 : (12 per cent chromium, 2 per cent nickel) This alloy has tensile strengths about 15 per cent lower than Type 302 and can be hardened by heat-treatment. For best corrosion resistance it should be highly polished or kept clean. It can be obtained hard drawn in diameters up to 0.1875 inch and is commonly used in flat cold-rolled strip for stampings. The material is not satisfactory for use at low temperatures.

Stainless Type 420, SAE 51420 : (13 per cent chromium) This is the best stainless steel for use in large diameters above 0.1875 inch and is frequently used in smaller sizes. It is formed in the annealed condition and then hardened and tempered. It does not exhibit its stainless properties until after it is hardened. Clean bright surfaces provide the best corrosion resistance, therefore the heat-treating scale must be removed. Bright hardening methods are preferred.

Stainless Type 431, SAE 51431 : (16 per cent chromium, 2 per cent nickel) This spring alloy acquires high tensile properties (nearly the same as music wire) by a combination of heat-treatment to harden the wire plus cold-drawing after heat-treatment. Its corrosion resistance is not equal to Type 302.

Copper-Base Spring Alloys.—Copper-base alloys are important spring materials because of their good electrical properties combined with their good resistance to corrosion. Although these materials are more expensive than the high-carbon and the alloy steels, they nevertheless are frequently used in electrical components and in sub-zero temperatures.

Spring Brass, ASTM B 134 : (70 per cent copper, 30 per cent zinc) This material is the least expensive and has the highest electrical conductivity of the copper-base alloys. It has a low tensile strength and poor spring qualities, but is extensively used in flat stampings and where sharp bends are needed. It cannot be hardened by heat-treatment and should not be used at temperatures above 150 degrees F., but is especially good at sub-zero temperatures. Available in round sections and flat strips, this hard-drawn material is usually used in the "spring hard" temper.

Phosphor Bronze, ASTM B 159 : (95 per cent copper, 5 per cent tin) This alloy is the most popular of this group because it combines the best qualities of tensile strength, hardness, electrical conductivity, and corrosion resistance with the least cost. It is more expensive than brass, but can withstand stresses 50 per cent higher. The material cannot be hardened by heat-treatment. It can be used at temperatures up to 212 degrees F. and at sub-zero temperatures. It is available in round sections and flat strip, usually in the "extra-hard" or "spring hard" tempers. It is frequently used for contact fingers in switches because of its low arcing properties. An 8 per cent tin composition is used for flat springs and a superfine grain composition called "Duraflex," has good endurance properties.

Beryllium Copper, ASTM B 197 : (98 per cent copper, 2 per cent beryllium) This alloy can be formed in the annealed condition and then precipitation hardened after forming at

temperatures around 600 degrees F, for 2 to 3 hours. This treatment produces a high hardness combined with a high tensile strength. After hardening, the material becomes quite brittle and can withstand very little or no forming. It is the most expensive alloy in the group and heat-treating is expensive due to the need for holding the parts in fixtures to prevent distortion. The principal use of this alloy is for carrying electric current in switches and in electrical components. Flat strip is frequently used for contact fingers.

Nickel-Base Spring Alloys.—Nickel-base alloys are corrosion resistant, withstand both elevated and sub-zero temperatures, and their non-magnetic characteristic makes them useful for such applications as gyroscopes, chronoscopes, and indicating instruments. These materials have a high electrical resistance and therefore should not be used for conductors of electrical current.

*Monel**: (67 per cent nickel, 30 per cent copper) This material is the least expensive of the nickel-base alloys. It also has the lowest tensile strength but is useful due to its resistance to the corrosive effects of sea water and because it is nearly non-magnetic. The alloy can be subjected to stresses slightly higher than phosphor bronze and nearly as high as beryllium copper. Its high tensile strength and hardness are obtained as a result of cold-drawing and cold-rolling only, since it can not be hardened by heat-treatment. It can be used at temperatures ranging from -100 to +425 degrees F. at normal operating stresses and is available in round wires up to $\frac{3}{16}$ inch in diameter with quite high tensile strengths. Larger diameters and flat strip are available with lower tensile strengths.

*"K" Monel**: (66 per cent nickel, 29 per cent copper, 3 per cent aluminum) This material is quite similar to Monel except that the addition of the aluminum makes it a precipitation-hardening alloy. It may be formed in the soft or fairly hard condition and then hardened by a long-time age-hardening heat-treatment to obtain a tensile strength and hardness above Monel and nearly as high as stainless steel. It is used in sizes larger than those usually used with Monel, is non-magnetic and can be used in temperatures ranging from -100 to +450 degrees F. at normal working stresses under 45,000 pounds per square inch.

*Inconel**: (78 per cent nickel, 14 per cent chromium, 7 per cent iron) This is one of the most popular of the non-magnetic nickel-base alloys because of its corrosion resistance and because it can be used at temperatures up to 700 degrees F. It is more expensive than stainless steel but less expensive than beryllium copper. Its hardness and tensile strength is higher than that of "K" Monel and is obtained as a result of cold-drawing and cold-rolling only. It cannot be hardened by heat treatment. Wire diameters up to $\frac{1}{4}$ inch have the best tensile properties. It is often used in steam valves, regulating valves, and for springs in boilers, compressors, turbines, and jet engines.

*Inconel "X"**: (70 per cent nickel, 16 per cent chromium, 7 per cent iron) This material is quite similar to Inconel but the small amounts of titanium, columbium and aluminum in its composition make it a precipitation-hardening alloy. It can be formed in the soft or partially hard condition and then hardened by holding it at 1200 degrees F. for 4 hours. It is non-magnetic and is used in larger sections than Inconel. This alloy is used at temperatures up to 850 degrees F. and at stresses up to 55,000 pounds per square inch.

*Duranickel** ("*Z*" Nickel): (98 per cent nickel) This alloy is non-magnetic, corrosion resistant, has a high tensile strength and is hardenable by precipitation hardening at 900 degrees F. for 6 hours. It may be used at the same stresses as Inconel but should not be used at temperatures above 500 degrees F.

Nickel-Base Spring Alloys with Constant Moduli of Elasticity.—Some special nickel alloys have a constant modulus of elasticity over a wide temperature range. These materials are especially useful where springs undergo temperature changes and must exhibit uniform spring characteristics. These materials have a low or zero thermo-elastic coefficient

* Trade name of the International Nickel Company.

and therefore do not undergo variations in spring stiffness because of modulus changes due to temperature differentials. They also have low hysteresis and creep values which makes them preferred for use in food-weighing scales, precision instruments, gyroscopes, measuring devices, recording instruments and computing scales where the temperature ranges from -50 to $+150$ degrees F. These materials are expensive, none being regularly stocked in a wide variety of sizes. They should not be specified without prior discussion with spring manufacturers because some suppliers may not fabricate springs from these alloys due to the special manufacturing processes required. All of these alloys are used in small wire diameters and in thin strip only and are covered by U.S. patents. They are more specifically described as follows:

Elinvar^{*}: (nickel, iron, chromium) This alloy, the first constant-modulus alloy used for hairsprings in watches, is an austenitic alloy hardened only by cold-drawing and cold-rolling. Additions of titanium, tungsten, molybdenum and other alloying elements have brought about improved characteristics and precipitation-hardening abilities. These improved alloys are known by the following trade names: Elinvar Extra, Durinval, Modulvar and Nivarox.

Ni-Span C^{*}: (nickel, iron, chromium, titanium) This very popular constant-modulus alloy is usually formed in the 50 per cent cold-worked condition and precipitation-hardened at 900 degrees F. for 8 hours, although heating up to 1250 degrees F. for 3 hours produces hardnesses of 40 to 44 Rockwell C, permitting safe torsional stresses of 60,000 to 80,000 pounds per square inch. This material is ferromagnetic up to 400 degrees F; above that temperature it becomes non-magnetic.

Iso-Elastic[†]: (nickel, iron, chromium, molybdenum) This popular alloy is relatively easy to fabricate and is used at safe torsional stresses of 40,000 to 60,000 pounds per square inch and hardnesses of 30 to 36 Rockwell C. It is used principally in dynamometers, instruments, and food-weighing scales.

Elgiloy[‡]: (nickel, iron, chromium, cobalt) This alloy, also known by the trade names 8J Alloy, Durapower, and Cobenium, is a non-magnetic alloy suitable for sub-zero temperatures and temperatures up to about 1000 degrees F., provided that torsional stresses are kept under 75,000 pounds per square inch. It is precipitation-hardened at 900 degrees F. for 8 hours to produce hardnesses of 48 to 50 Rockwell C. The alloy is used in watch and instrument springs.

Dynavar^{**}: (nickel, iron, chromium, cobalt) This alloy is a non-magnetic, corrosion-resistant material suitable for sub-zero temperatures and temperatures up to about 750 degrees F., provided that torsional stresses are kept below 75,000 pounds per square inch. It is precipitation-hardened to produce hardnesses of 48 to 50 Rockwell C and is used in watch and instrument springs.

Spring Stresses

Allowable Working Stresses for Springs.—The safe working stress for any particular spring depends to a large extent on the following items:

- 1) Type of spring — whether compression, extension, torsion, etc.
- 2) Size of spring — small or large, long or short
- 3) Spring material
- 4) Size of spring material
- 5) Type of service — light, average, or severe
- 6) Stress range — low, average, or high

* Trade name of Soc. Anon. de Commentry Fourchambault et Decazeville, Paris, France.

† Trade name of John Chatillon & Sons.

‡ Trade name of Elgin National Watch Company.

** Trade name of Hamilton Watch Company.

- 7) Loading — static, dynamic, or shock
- 8) Operating temperature
- 9) Design of spring — spring index, sharp bends, hooks.

Consideration should also be given to other factors that affect spring life: corrosion, buckling, friction, and hydrogen embrittlement decrease spring life; manufacturing operations such as high-heat stress-equalizing, presetting, and shot-peening increase spring life.

Item 5, the type of service to which a spring is subjected, is a major factor in determining a safe working stress once consideration has been given to type of spring, kind and size of material, temperature, type of loading, and so on. The types of service are:

Light Service: This includes springs subjected to static loads or small deflections and seldom-used springs such as those in bomb fuses, projectiles, and safety devices. This service is for 1,000 to 10,000 deflections.

Average Service: This includes springs in general use in machine tools, mechanical products, and electrical components. Normal frequency of deflections not exceeding 18,000 per hour permit such springs to withstand 100,000 to 1,000,000 deflections.

Severe Service: This includes springs subjected to rapid deflections over long periods of time and to shock loading such as in pneumatic hammers, hydraulic controls and valves. This service is for 1,000,000 deflections, and above. Lowering the values 10 per cent permits 10,000,000 deflections.

Figs. 1 through 6 show curves that relate the three types of service conditions to allowable working stresses and wire sizes for compression and extension springs, and safe values are provided. Figs. 7 through 10 provide similar information for helical torsion springs. In each chart, the values obtained from the curves may be increased by 20 per cent (but not beyond the top curves on the charts if permanent set is to be avoided) for springs that are baked, and shot-peened, and compression springs that are pressed. Springs stressed slightly above the Light Service curves will take a permanent set.

A curvature correction factor is included in all curves, and is used in spring design calculations (see examples beginning page 317). The curves may be used for materials other than those designated in Figs. 1 through 10, by applying multiplication factors as given in Table 1.

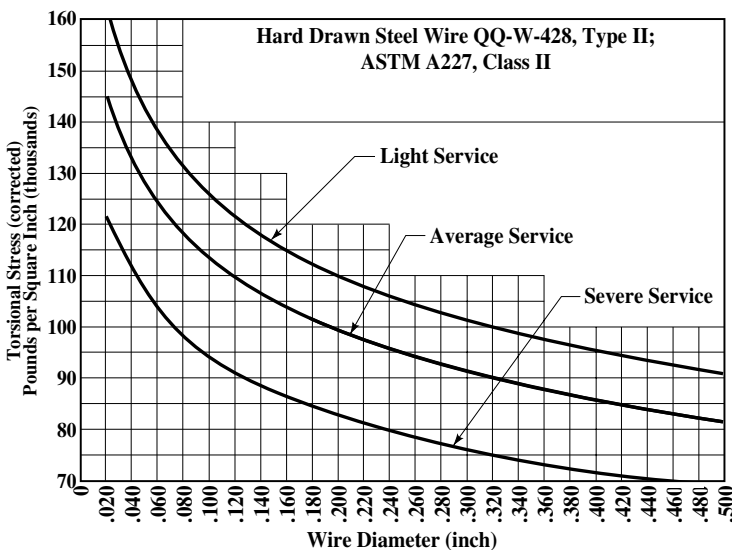


Fig. 1. Allowable Working Stresses for Compression Springs — Hard Drawn Steel Wire^a

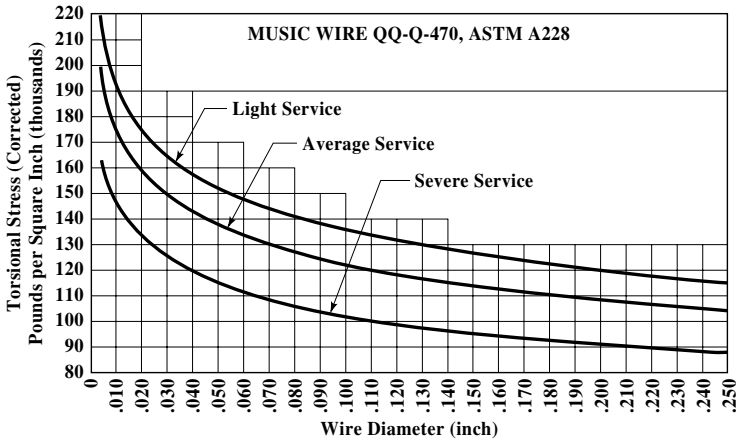


Fig. 2. Allowable Working Stresses for Compression Springs — Music Wire^a

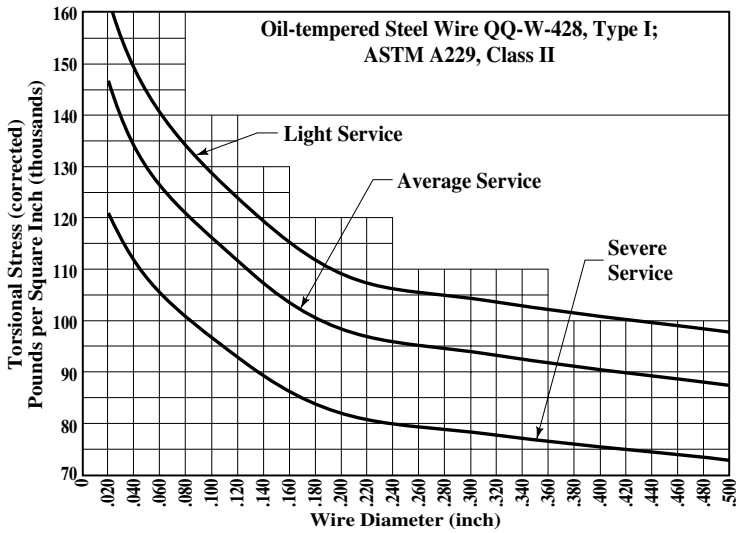


Fig. 3. Allowable Working Stresses for Compression Springs — Oil-Tempered^a

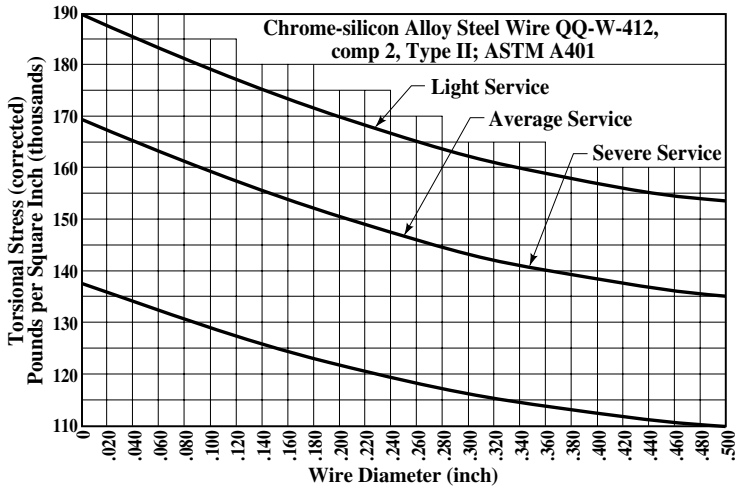


Fig. 4. Allowable Working Stresses for Compression Springs — Chrome-Silicon Alloy Steel Wire^a

STRESSES IN SPRINGS

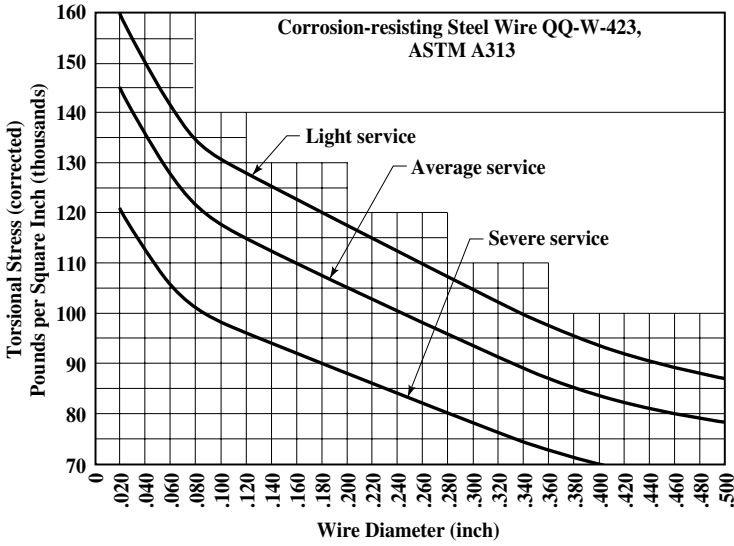


Fig. 5. Allowable Working Stresses for Compression Springs — Corrosion-Resisting Steel Wire^a

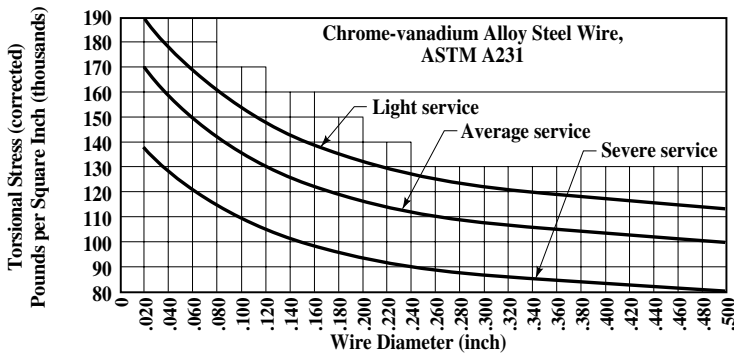


Fig. 6. Allowable Working Stresses for Compression Springs — Chrome-Vanadium Alloy Steel Wire^a

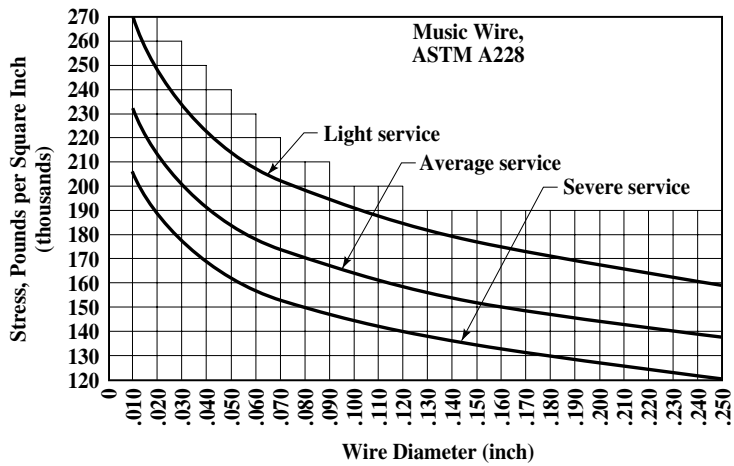


Fig. 7. Recommended Design Stresses in Bending for Helical Torsion Springs — Round Music Wire

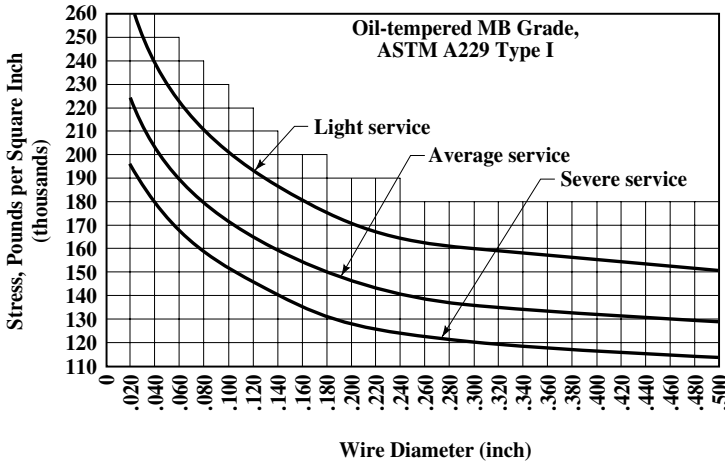


Fig. 8. Recommended Design Stresses in Bending for Helical Torsion Springs — Oil-Tempered MB Round Wire

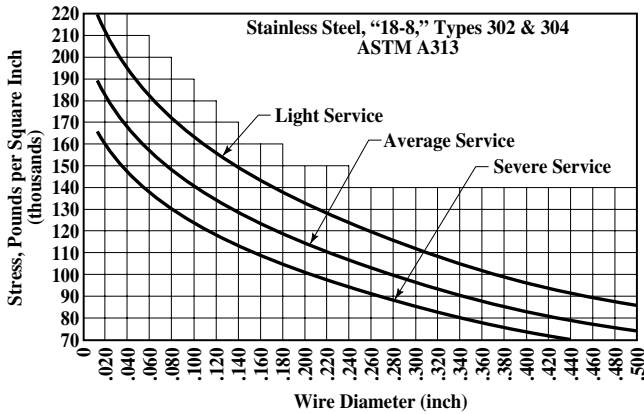


Fig. 9. Recommended Design Stresses in Bending for Helical Torsion Springs — Stainless Steel Round Wire

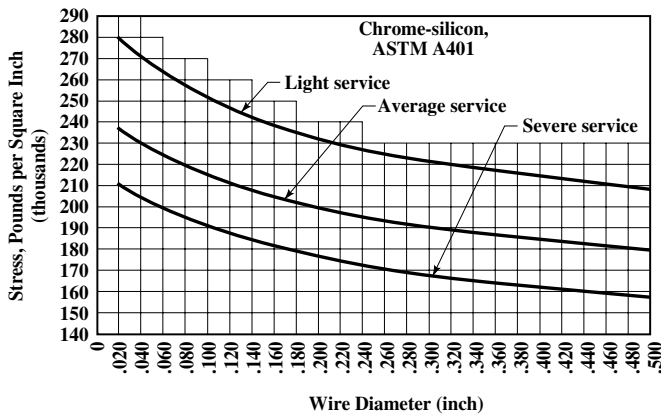


Fig. 10. Recommended Design Stresses in Bending for Helical Torsion Springs — Chrome-Silicon Round Wire

^a Although Figs. 1 through 6 are for compression springs, they may also be used for extension springs; for extension springs, *reduce* the values obtained from the curves by 10 to 15 per cent.

Table 1. Correction Factors for Other Materials

Compression and Tension Springs			
Material	Factor	Material	Factor
Silicon-manganese	Multiply the values in the chromium-vanadium curves (Fig. 6) by 0.90	Stainless Steel, 316	Multiply the values in the corrosion-resisting steel curves (Fig. 5) by 0.90
Valve-spring quality wire	Use the values in the chromium-vanadium curves (Fig. 6)		
Stainless Steel, 304 and 420	Multiply the values in the corrosion-resisting steel curves (Fig. 5) by 0.95	Stainless Steel, 431 and 17-7PH	Multiply the values in the music wire curves (Fig. 2) by 0.90

Helical Torsion Springs			
Material	Factor ^a	Material	Factor ^a
Hard Drawn MB	0.70	Stainless Steel, 431	
Stainless Steel, 316		Up to 1/32 inch diameter	0.80
Up to 1/32 inch diameter	0.75	Over 1/32 to 1/16 inch	0.85
Over 1/32 to 3/16 inch	0.70	Over 1/16 to 1/8 inch	0.95
Over 3/16 to 1/4 inch	0.65	Over 1/8 inch	1.00
Over 1/4 inch	0.50	Chromium-Vanadium	
Stainless Steel, 17-7 PH		Up to 1/16 inch diameter	1.05
Up to 1/8 inch diameter	1.00	Over 1/16 inch	1.10
Over 1/8 to 3/16 inch	1.07	Phosphor Bronze	
Over 3/16 inch	1.12	Up to 1/8 inch diameter	0.45
Stainless Steel, 420		Over 1/8 inch	0.55
Up to 1/32 inch diameter	0.70	Beryllium Copper ^b	
Over 1/32 to 1/16 inch	0.75	Up to 1/32 inch diameter	0.55
Over 1/16 to 1/8 inch	0.80	Over 1/32 to 1/16 inch	0.60
Over 1/8 to 3/16 inch	0.90	Over 1/16 to 1/8 inch	0.70
Over 3/16 inch	1.00	Over 1/8 inch	0.80

^a Multiply the values in the curves for oil-tempered MB grade ASTM A229 Type 1 steel (Fig. 8) by these factors to obtain required values.

^b Hard drawn and heat treated after coiling.

For use with design stress curves shown in Figs. 2, 5, 6, and 8.

Endurance Limit for Spring Materials.—When a spring is deflected continually it will become “tired” and fail at a stress far below its elastic limit. This type of failure is called *fatigue failure* and usually occurs without warning. *Endurance limit* is the highest stress, or range of stress, in pounds per square inch that can be repeated indefinitely without failure of the spring. Usually ten million cycles of deflection is called “infinite life” and is satisfactory for determining this limit.

For severely worked springs of long life, such as those used in automobile or aircraft engines and in similar applications, it is best to determine the allowable working stresses by referring to the endurance limit curves seen in Fig. 11. These curves are based principally upon the range or difference between the stress caused by the first or initial load and the stress caused by the final load. Experience with springs designed to stresses within the limits of these curves indicates that they should have infinite or unlimited fatigue life. All values include Wahl curvature correction factor. The stress ranges shown may be increased 20 to 30 per cent for springs that have been properly heated, pressed to remove set, and then shot peened, provided that the increased values are lower than the torsional elastic limit by at least 10 per cent.

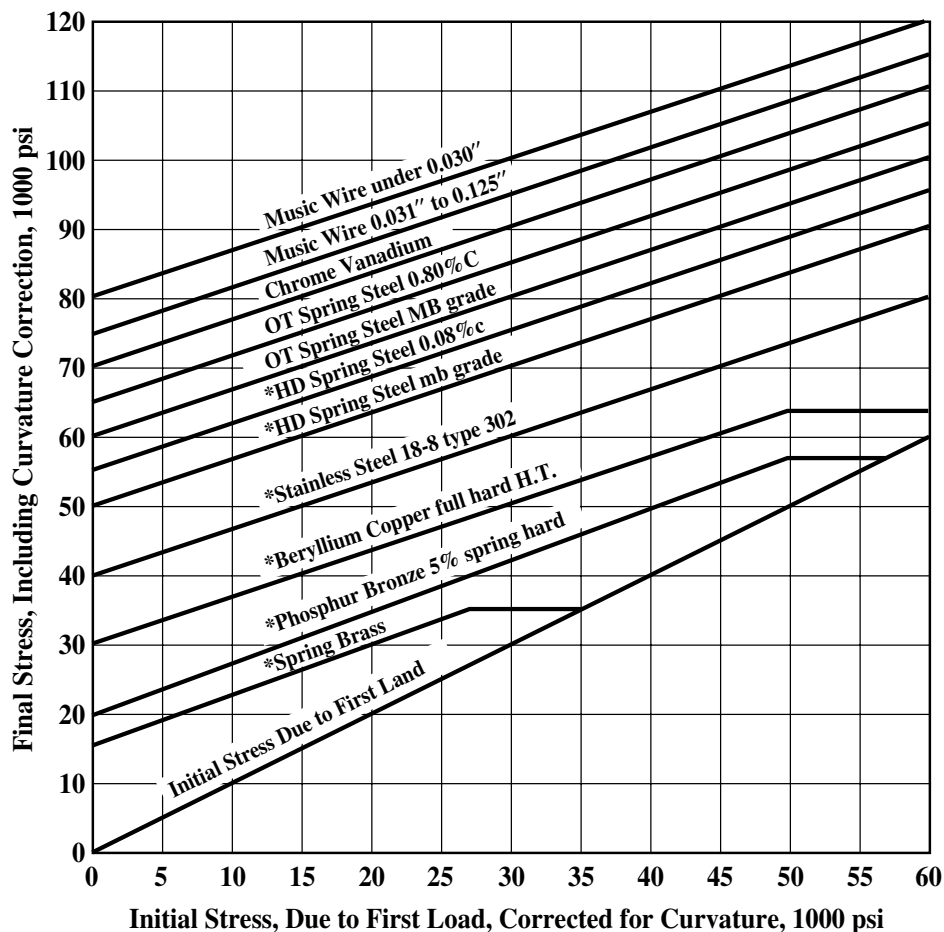


Fig. 11. Endurance Limit Curves for Compression Springs

Notes: For commercial spring materials with wire diameters up to $\frac{1}{4}$ inch except as noted. Stress ranges may be increased by approximately 30 per cent for properly heated, preset, shot-peened springs.

Materials preceded by * are not ordinarily recommended for long continued service under severe operating conditions.

Working Stresses at Elevated Temperatures.—Since modulus of elasticity decreases with increase in temperature, springs used at high temperatures exert less load and have larger deflections under load than at room temperature. The torsional modulus of elasticity for steel may be 11,200,000 pounds per square inch at room temperature, but it will drop to 10,600,000 pounds per square inch at 400°F. and will be only 10,000,000 pounds per square inch at 600°F. Also, the elastic limit is reduced, thereby lowering the permissible working stress.

Design stresses should be as low as possible for all springs used at elevated temperatures. In addition, corrosive conditions that usually exist at high temperatures, especially with steam, may require the use of corrosion-resistant material. Table 2 shows the permissible elevated temperatures at which various spring materials may be operated, together with the maximum recommended working stresses at these temperatures. The loss in load at the temperatures shown is less than 5 per cent in 48 hours; however, if the temperatures listed are increased by 20 to 40 degrees, the loss of load may be nearer 10 per cent. Maximum stresses shown in the table are for compression and extension springs and may be increased

by 75 per cent for torsion and flat springs. In using the data in Table 2 it should be noted that the values given are for materials in the heat-treated or spring temper condition.

Table 2. Recommended Maximum Working Temperatures and Corresponding Maximum Working Stresses for Springs

Spring Material	Max. Working Temp., °F	Max. Working Stress, psi	Spring Material	Max. Working Temp., °F	Max. Working Stress, psi
Brass Spring Wire	150	30,000	Permanickel ^a	500	50,000
Phosphor Bronze	225	35,000	Stainless Steel 18-8	550	55,000
Music Wire	250	75,000	Stainless Chromium 431	600	50,000
Beryllium-Copper	300	40,000	Inconel	700	50,000
Hard Drawn Steel Wire	325	50,000	High Speed Steel	775	70,000
Carbon Spring Steels	375	55,000	Inconel X	850	55,000
Alloy Spring Steels	400	65,000	Chromium-Molybdenum-Vanadium	900	55,000
Monel	425	40,000	Cobanium, Elgiloy	1000	75,000
K-Monel	450	45,000			

^a Formerly called Z-Nickel, Type B.

Loss of load at temperatures shown is less than 5 per cent in 48 hours.

Spring Design Data

Spring Characteristics.—This section provides tables of spring characteristics, tables of principal formulas, and other information of a practical nature for designing the more commonly used types of springs.

Standard wire gages for springs: Information on wire gages is given in the section beginning on page 2604, and gages in decimals of an inch are given in the table on page 2605. It should be noted that the range in this table extends from Number 7/0 through Number 80. However, in spring design, the range most commonly used extends only from Gage Number 4/0 through Number 40. When selecting wire use Steel Wire Gage or Washburn and Moen gage for all carbon steels and alloy steels except music wire; use Brown & Sharpe gage for brass and phosphor bronze wire; use Birmingham gage for flat spring steels, and cold rolled strip; and use piano or music wire gage for music wire.

Spring index: The spring index is the ratio of the mean coil diameter of a spring to the wire diameter (D/d). This ratio is one of the most important considerations in spring design because the deflection, stress, number of coils, and selection of either annealed or tempered material depend to a considerable extent on this ratio. The best proportioned springs have an index of 7 through 9. Indexes of 4 through 7, and 9 through 16 are often used. Springs with values larger than 16 require tolerances wider than standard for manufacturing; those with values less than 5 are difficult to coil on automatic coiling machines.

Direction of helix: Unless functional requirements call for a definite hand, the helix of compression and extension springs should be specified as optional. When springs are designed to operate, one inside the other, the helices should be opposite hand to prevent intermeshing. For the same reason, a spring that is to operate freely over a threaded member should have a helix of opposite hand to that of the thread. When a spring is to engage with a screw or bolt, it should, of course, have the same helix as that of the thread.

Helical Compression Spring Design.—After selecting a suitable material and a safe stress value for a given spring, designers should next determine the type of end coil formation best suited for the particular application. Springs with unground ends are less expensive but they do not stand perfectly upright; if this requirement has to be met, closed ground ends are used. Helical compression springs with different types of ends are shown in Fig. 12.

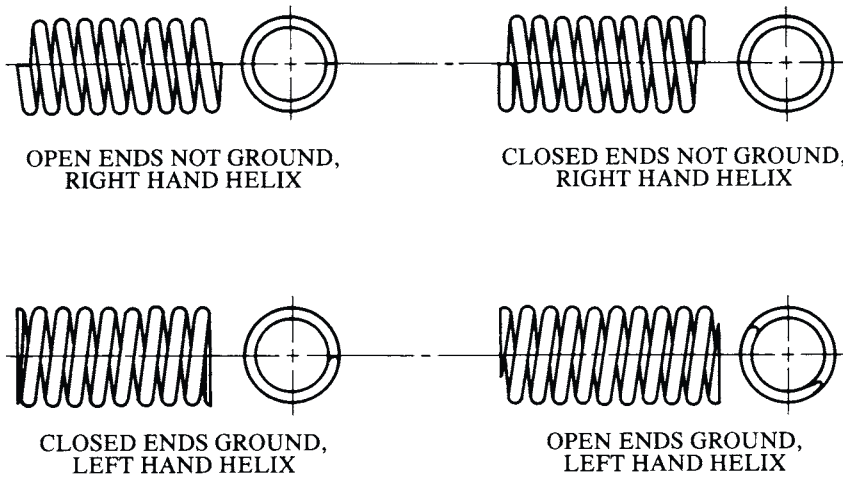


Fig. 12. Types of Helical Compression Spring Ends

Spring design formulas: **Table 3** gives formulas for compression spring dimensional characteristics, and **Table 4** gives design formulas for compression and extension springs.

Curvature correction: In addition to the stress obtained from the formulas for load or deflection, there is a direct shearing stress and an increased stress on the inside of the section due to curvature. Therefore, the stress obtained by the usual formulas should be multiplied by a factor K taken from the curve in **Fig. 13**. The corrected stress thus obtained is used only for comparison with the allowable working stress (fatigue strength) curves to determine if it is a safe stress and should not be used in formulas for deflection. The curvature correction factor K is for compression and extension springs made from round wire. For square wire reduce the K value by approximately 4 per cent.

Design procedure: The limiting dimensions of a spring are often determined by the available space in the product or assembly in which it is to be used. The loads and deflections on a spring may also be known or can be estimated, but the wire size and number of coils are usually unknown. Design can be carried out with the aid of the tabular data that appears later in this section (see **Table 5**, which is a simple method, or by calculation alone using the formulas in **Tables 3** and **4**).

Example: A compression spring with closed and ground ends is to be made from ASTM A229 high carbon steel wire, as shown in **Fig. 14**. Determine the wire size and number of coils.

Method 1, using table: Referring to **Table 5**, starting on page 321, locate the spring outside diameter ($1\frac{3}{16}$ inches, from **Fig. 14** on page 319) in the left-hand column. Note from the drawing that the spring load is 36 pounds. Move to the right in the table to the figure nearest this value, which is 41.7 pounds. This is somewhat above the required value but safe. Immediately above the load value, the deflection f is given, which in this instance is 0.1594 inch. This is the deflection of one coil under a load of 41.7 pounds with an uncorrected torsional stress S of 100,000 pounds per square inch for ASTM A229 oil-tempered MB steel. For other spring materials, see the footnotes to **Table 5**. Moving vertically in **Table 5** from the load entry, the wire diameter is found to be 0.0915 inch.

The remaining spring design calculations are completed as follows:

Step 1: The stress with a load of 36 pounds is obtained by proportion, as follows: The 36 pound load is 86.3 per cent of the 41.7 pound load; therefore, the stress S at 36 pounds = $0.863 \times 100,000 = 86,300$ pounds per square inch.

Table 3. Formulas for Compression Springs

Feature	Type of End			
	Open or Plain (not ground)	Open or Plain (with ends ground)	Squared or Closed (not ground)	Closed and Ground
	Formula ^a			
Pitch (p)	$\frac{FL-d}{N}$	$\frac{FL}{TC}$	$\frac{FL-3d}{N}$	$\frac{FL-2d}{N}$
Solid Height (SH)	$(TC+1)d$	$TC \times d$	$(TC+1)d$	$TC \times d$
Number of Active Coils (N)	$N = TC$ $= \frac{FL-d}{p}$	$N = TC - 1$ $= \frac{FL}{p} - 1$	$N = TC - 2$ $= \frac{FL-3d}{p}$	$N = TC - 2$ $= \frac{FL-2d}{p}$
Total Coils (TC)	$\frac{FL-d}{p}$	$\frac{FL}{p}$	$\frac{FL-3d}{p} + 2$	$\frac{FL-2d}{p} + 2$
Free Length (FL)	$(p \times TC) + d$	$p \times TC$	$(p \times N) + 3d$	$(p \times N) + 2d$

^aThe symbol notation is given on page 304.

Table 4. Formulas for Compression and Extension Springs

Feature	Formula ^{a, b}	
	Springs made from round wire	Springs made from square wire
Load, P Pounds	$P = \frac{0.393Sd^3}{D} = \frac{Gd^4F}{8ND^3}$	$P = \frac{0.416Sd^3}{D} = \frac{Gd^4F}{5.58ND^3}$
Stress, Torsional, S Pounds per square inch	$S = \frac{GdF}{\pi ND^2} = \frac{PD}{0.393d^3}$	$S = \frac{GdF}{2.32ND^2} = P \frac{D}{0.416d^3}$
Deflection, F Inch	$F = \frac{8PND^3}{Gd^4} = \frac{\pi SND^2}{Gd}$	$F = \frac{5.58PND^3}{Gd^4} = \frac{2.32SND^2}{Gd}$
Number of Active Coils, N	$N = \frac{Gd^4F}{8PD^3} = \frac{GdF}{\pi SD^2}$	$N = \frac{Gd^4F}{5.58PD^3} = \frac{GdF}{2.32SD^2}$
Wire Diameter, d Inch	$d = \frac{\pi SND^2}{GF} = \sqrt[3]{\frac{2.55PD}{S}}$	$d = \frac{2.32SND^2}{GF} = \sqrt[3]{\frac{PD}{0.416S}}$
Stress due to Initial Tension, S_{it}	$S_{it} = \frac{S}{P} \times IT$	$S_{it} = \frac{S}{P} \times IT$

^aThe symbol notation is given on page 304.

^bTwo formulas are given for each feature, and designers can use the one found to be appropriate for a given design. The end result from either of any two formulas is the same.

Step 2: The 86.3 per cent figure is also used to determine the deflection per coil f at 36 pounds load: $0.863 \times 0.1594 = 0.1375$ inch.

Step 3: The number of active coils $AC = \frac{F}{f} = \frac{1.25}{0.1375} = 9.1$

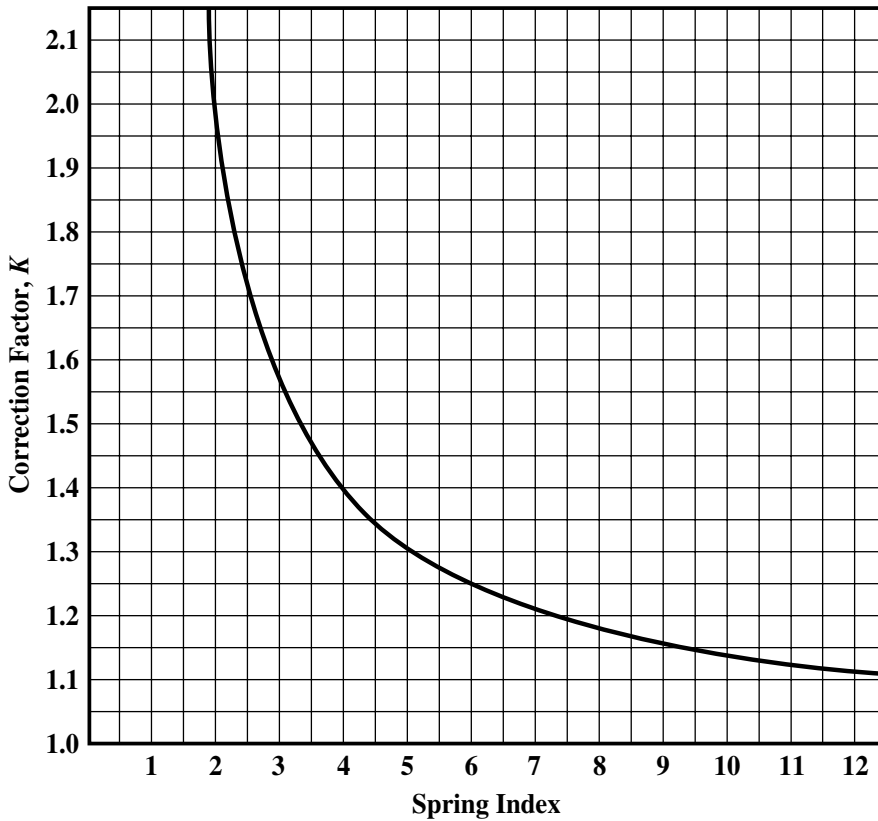


Fig. 13. Compression and Extension Spring-Stress Correction for Curvature^a

^aFor springs made from round wire. For springs made from square wire, reduce the *K* factor values by approximately 4 per cent.

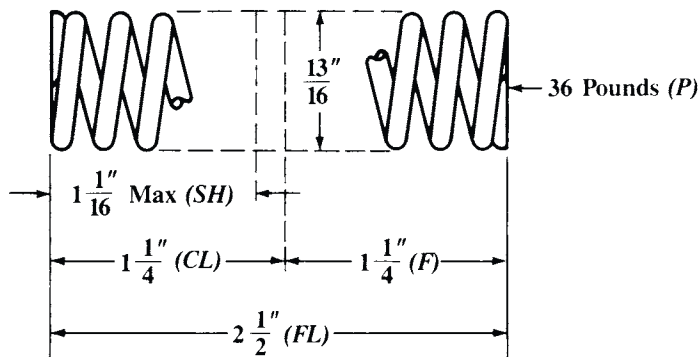


Fig. 14. Compression Spring Design Example

Step 4: Total Coils $TC = AC + 2$ (Table 3) = $9 + 2 = 11$
 Therefore, a quick answer is: 11 coils of 0.0915 inch diameter wire. However, the design procedure should be completed by carrying out these remaining steps:

Step 5: From Table 3, Solid Height = $SH = TC \times d = 11 \times 0.0915 \cong 1$ inch

Therefore, Total Deflection = $FL - SH = 1.5$ inches

$$\text{Step 6: Stress Solid} = \frac{86,300}{1.25} \times 1.5 = 103,500 \text{ pounds per square inch}$$

$$\text{Step 7: Spring Index} = \frac{O.D.}{d} - 1 = \frac{0.8125}{0.0915} - 1 = 7.9$$

Step 8: From Fig. 13 on page 319, the curvature correction factor $K = 1.185$

Step 9: Total Stress at 36 pounds load = $S \times K = 86,300 \times 1.185 = 102,300$ pounds per square inch. This stress is below the 117,000 pounds per square inch permitted for 0.0915 inch wire shown on the middle curve in Fig. 3 on page 311, so it is a safe working stress.

Step 10: Total Stress at Solid = $103,500 \times 1.185 = 122,800$ pounds per square inch. This stress is also safe, as it is below the 131,000 pounds per square inch shown on the top curve of Fig. 3, and therefore the spring will not set.

Method 2, using formulas: The procedure for design using formulas is as follows (the design example is the same as in Method 1, and the spring is shown in Fig. 14):

Step 1: Select a safe stress S below the middle fatigue strength curve Fig. 3 on page 311 for ASTM A229 steel wire, say 90,000 pounds per square inch. Assume a mean diameter D slightly below the $\frac{13}{16}$ -inch $O.D.$, say 0.7 inch. Note that the value of G is 11,200,000 pounds per square inch (Table 20 on page 346).

Step 2: A trial wire diameter d and other values are found by formulas from Table 4 as follows:

$$\begin{aligned} d &= \sqrt[3]{\frac{2.55PD}{S}} = \sqrt[3]{\frac{2.55 \times 36 \times 0.7}{90,000}} \\ &= \sqrt[3]{0.000714} = 0.0894 \text{ inch} \end{aligned}$$

Note: Table 21 on page 347 can be used to avoid solving the cube root.

Step 3: From Table 21 (also see the table on page 2605), select the nearest wire gauge size, which is 0.0915 inch diameter. Using this value, the mean diameter $D = \frac{13}{16}$ inch - 0.0915 = 0.721 inch.

$$\text{Step 4: The stress } S = \frac{PD}{0.393d^3} = \frac{36 \times 0.721}{0.393 \times 0.0915^3} = 86,300 \text{ lb/in}^2$$

Step 5: The number of active coils is

$$N = \frac{GdF}{\pi SD^2} = \frac{11,200,000 \times 0.0915 \times 1.25}{3.1416 \times 86,300 \times 0.721^2} = 9.1 \text{ (say 9)}$$

The answer is the same as before, which is to use 11 total coils of 0.0915-inch diameter wire. The total coils, solid height, etc., are determined in the same manner as in Method 1.

Table of Spring Characteristics.—Table 5 gives characteristics for compression and extension springs made from ASTM A229 oil-tempered MB spring steel having a torsional modulus of elasticity G of 11,200,000 pounds per square inch, and an uncorrected torsional stress S of 100,000 pounds per square inch. The deflection f for one coil under a load P is shown in the body of the table. The method of using these data is explained in the problems for compression and extension spring design. The table may be used for other materials by applying factors to f . The factors are given in a footnote to the table.

Table 5. Compression and Extension Spring Deflections^a

Spring Outside Dia.		Wire Size or Washburn and Moen Gauge, and Decimal Equivalent ^b																							
		.10	.12	.14	.16	.18	.20	.22	.24	.26	.28	.30	.32	.34	.36	.38	.041	.0475	.054	.0625					
Nom.	Dec.	Deflection <i>f</i> (inch) per coil, at Load <i>P</i> (pounds) ^c																							
7/64	.1094	.0277	.0222	.01824	.01529	.01302	.01121	.00974	.00853	.00751	.00664	.00589					
		.395	.697	1.130	1.722	2.51	3.52	4.79	6.36	8.28	10.59	13.35				
1/8	.125	.0371	.0299	.0247	.0208	.01784	.01548	.01353	.01192	.01058	.00943	.00844	.00758	.00683	.00617					
		.342	.600	.971	1.475	2.14	2.99	4.06	5.37	6.97	8.89	11.16	13.83	16.95	20.6				
9/64	.1406	.0478	.0387	.0321	.0272	.0234	.0204	.01794	.01590	.01417	.01271	.01144	.01034	.00937	.00852	.00777				
		.301	.528	.852	1.291	1.868	2.61	3.53	4.65	6.02	7.66	9.58	11.84	14.47	17.51	21.0			
5/32	.1563	.0600	.0487	.0406	.0345	.0298	.0261	.0230	.0205	.01832	0.1649	.01491	.01354	.01234	.01128	.01033	.00909			
		.268	.470	.758	1.146	1.656	2.31	3.11	4.10	5.30	6.72	8.39	10.35	12.62	15.23	18.22	23.5		
11/64	.1719	.0735	.0598	.0500	.0426	.0369	.0324	.0287	.0256	.0230	.0208	.01883	.01716	.01569	.01439	.01324	.01172	.00914		
		.243	.424	.683	1.031	1.488	2.07	2.79	3.67	4.73	5.99	7.47	9.19	11.19	13.48	16.09	21.8	33.8	
3/16	.1875	.0884	.0720	.0603	.0516	.0448	.0394	.0349	.0313	.0281	.0255	.0232	.0212	.01944	.01788	.01650	.01468	.01157	.00926	
		.221	.387	.621	.938	1.351	1.876	2.53	3.32	4.27	5.40	6.73	8.27	10.05	12.09	14.41	18.47	30.07	46.3
13/64	.2031	.1046	.0854	.0717	.0614	.0534	.0470	.0418	.0375	.0338	.0307	.0280	.0257	.0236	.0218	.0201	.01798	.01430	.01155
		.203	.355	.570	.859	1.237	1.716	2.31	3.03	3.90	4.92	6.12	7.52	9.13	10.96	13.05	16.69	27.1	41.5
7/32	.21881000	.0841	.0721	.0628	.0555	.0494	.0444	.0401	.0365	.0333	.0306	.0282	.0260	.0241	.0216	.01733	.01411	.01096
	328	.526	.793	1.140	1.580	2.13	2.79	3.58	4.52	5.61	6.88	8.35	10.02	11.92	15.22	24.6	37.5	61.3
15/64	.23441156	.0974	.0836	.0730	.0645	.0575	.0518	.0469	.0427	.0391	.0359	.0331	.0307	.0285	.0256	.0206	.01690	.01326
	305	.489	.736	1.058	1.465	1.969	2.58	3.21	4.18	5.19	6.35	7.70	9.23	10.97	13.99	22.5	34.3	55.8
1/4	.2501116	.0960	.0839	.0742	.0663	.0597	.0541	.0494	.0453	.0417	.0385	.0357	.0332	.0299	.0242	.01996	.01578
	457	.687	.987	1.366	1.834	2.40	3.08	3.88	4.82	5.90	7.14	8.56	10.17	12.95	20.8	31.6	51.1
9/32	.28131432	.1234	.1080	.0958	.0857	.0774	.0703	.0643	.0591	.0545	.0505	.0469	.0437	.0395	.0323	.0268	.0215
	403	.606	.870	1.202	1.613	2.11	2.70	3.40	4.22	5.16	6.24	7.47	8.86	11.26	18.01	27.2	43.8
5/16	.31251541	.1351	.1200	.1076	.0973	.0886	.0811	.0746	.0690	.0640	.0596	.0556	.0504	.0415	.0347	.0281
	542	.778	1.074	1.440	1.881	2.41	3.03	3.75	4.58	5.54	6.63	7.85	9.97	15.89	23.9	38.3
11/32	.34381633	.1470	.1321	.1196	.1090	.0999	.0921	.0852	.0792	.0733	.0690	.0627	.0518	.0436	.0355
	703	.970	1.300	1.697	2.17	2.73	3.38	4.12	4.98	5.95	7.05	8.94	14.21	21.3	34.1
3/8	.3751768	.1589	.1440	.1314	.1206	.1113	.1031	.0960	.0895	.0839	.0764	.0634	.0535	.0438
	885	1.185	1.546	1.978	2.48	3.07	3.75	4.53	5.40	6.40	8.10	12.85	19.27	30.7

SPRING DESIGN

^a This table is for ASTM A229 oil tempered spring steel with a torsional modulus *G* of 11,200,000 psi, and an uncorrected torsional stress of 100,000 psi. For other materials use the following factors: stainless steel, multiply *f* by 1.067; spring brass, multiply *f* by 2.24; phosphor bronze, multiply *f* by 1.867; Monel metal, multiply *f* by 1.244; beryllium copper, multiply *f* by 1.725; Inconel (non-magnetic), multiply *f* by 1.045.

^b Round wire. For square wire, multiply *f* by 0.707, and *p*, by 1.2

^c The upper figure is the deflection and the lower figure the load as read against each spring size. *Note:* Intermediate values can be obtained within reasonable accuracy by interpolation.

Table 5. (Continued) Compression and Extension Spring Deflections^a

Spring Outside Dia.		Wire Size or Washburn and Moen Gauge, and Decimal Equivalent																	
		.026	.028	.030	.032	.034	.036	.038	.041	.0475	.054	.0625	.072	.080	.0915	$\frac{3}{32}$.12	.11	$\frac{1}{8}$
Nom.	Dec.	Deflection f (inch) per coil, at Load P (pounds)																	
$\frac{13}{32}$.4063	.1560	.1434	.1324	.1228	.1143	.1068	.1001	.0913	.0760	.0645	.0531	.0436	.0373	.0304	.0292	.0241
		1.815	2.28	2.82	3.44	4.15	4.95	5.85	7.41	11.73	17.56	27.9	43.9	61.6	95.6	103.7	153.3
$\frac{7}{16}$.4375	.1827	.1680	.1553	.1441	.1343	.1256	.1178	.1075	.0898	.0764	.0631	.0521	.0448	.0367	.0353	.0293	.0234	.0219
		1.678	2.11	2.60	3.17	3.82	4.56	5.39	6.82	10.79	16.13	25.6	40.1	56.3	86.9	94.3	138.9	217.	245.
$\frac{15}{32}$.4688	.212	.1947	.1800	.1673	.1560	.1459	.1370	.1252	.1048	.0894	.0741	.0614	.0530	.0437	.0420	.0351	.0282	.0265
		1.559	1.956	2.42	2.94	3.55	4.23	5.00	6.33	9.99	14.91	23.6	37.0	51.7	79.7	86.4	126.9	197.3	223.
$\frac{1}{2}$.500	.243	.223	.207	.1920	.1792	.1678	.1575	.1441	.1209	.1033	.0859	.0714	.0619	.0512	.0494	.0414	.0335	.0316
		1.456	1.826	2.26	2.75	3.31	3.95	4.67	5.90	9.30	13.87	21.9	34.3	47.9	73.6	80.0	116.9	181.1	205.
$\frac{17}{32}$.5313	.276	.254	.235	.219	.204	.1911	.1796	.1645	.1382	.1183	.0987	.0822	.0714	.0593	.0572	.0482	.0393	.0371
		1.366	1.713	2.12	2.58	3.10	3.70	4.37	5.52	8.70	12.96	20.5	31.9	44.6	68.4	74.1	108.3	167.3	188.8
$\frac{9}{16}$.5625286	.265	.247	.230	.216	.203	.1861	.1566	.1343	.1122	.0937	.0816	.0680	.0657	.0555	.0455	.0430
		...	1.613	1.991	2.42	2.92	3.48	4.11	5.19	8.18	12.16	19.17	29.9	41.7	63.9	69.1	100.9	155.5	175.3
$\frac{19}{32}$.5938297	.277	.259	.242	.228	.209	.1762	.1514	.1267	.1061	.0926	.0774	.0748	.0634	.0522	.0493
		1.880	2.29	2.76	3.28	3.88	4.90	7.71	11.46	18.04	28.1	39.1	60.0	64.8	94.4	145.2	163.6
$\frac{5}{8}$.625331	.308	.288	.270	.254	.233	.1969	.1693	.1420	.1191	.1041	.0873	.0844	.0718	.0593	.0561
		1.782	2.17	2.61	3.11	3.67	4.63	7.29	10.83	17.04	26.5	36.9	56.4	61.0	88.7	136.2	153.4
$\frac{21}{32}$.6563342	.320	.300	.282	.259	.219	.1884	.1582	.1330	.1164	.0978	.0946	.0807	.0668	.0634
		2.06	2.48	2.95	3.49	4.40	6.92	10.27	16.14	25.1	34.9	53.3	57.6	83.7	128.3	144.3
$\frac{11}{16}$.6875352	.331	.311	.286	.242	.208	.1753	.1476	.1294	.1089	.1054	.0901	.0748	.0710
		2.36	2.81	3.32	4.19	6.58	9.76	15.34	23.8	33.1	50.5	54.6	79.2	121.2	136.3
$\frac{23}{32}$.7188363	.342	.314	.266	.230	.1933	.1630	.1431	.1206	.1168	.1000	.0833	.0791
		2.68	3.17	3.99	6.27	9.31	14.61	22.7	31.5	48.0	51.9	75.2	114.9	129.2
$\frac{3}{4}$.750374	.344	.291	.252	.212	.1791	.1574	.1329	.1288	.1105	.0923	.0877
		3.03	3.82	5.99	8.89	13.94	21.6	30.0	45.7	49.4	71.5	109.2	122.7
$\frac{25}{32}$.7813375	.318	.275	.232	.1960	.1724	.1459	.1413	.1214	.1017	.0967
		3.66	5.74	8.50	13.34	20.7	28.7	43.6	47.1	68.2	104.0	116.9
$\frac{13}{16}$.8125407	.346	.299	.253	.214	.1881	.1594	.1545	.1329	.1115	.1061
		3.51	5.50	8.15	12.78	19.80	27.5	41.7	45.1	65.2	99.3	111.5

^a This table is for ASTM A229 oil tempered spring steel with a torsional modulus G of 11,200,000 psi, and an uncorrected torsional stress of 100,000 psi. For other materials, and other important footnotes, see page 321.

Table 5. (Continued) Compression and Extension Spring Deflections ^a

Spring Outside Dia.		Wire Size or Washburn and Moen Gauge, and Decimal Equivalent																
		15	14	13	$\frac{3}{32}$	12	11	$\frac{1}{8}$	10	9	$\frac{5}{32}$	8	7	$\frac{3}{16}$	6	5	$\frac{7}{32}$	4
Nom. Dec.		.072	.080	.0915	.0938	.1055	.1205	.125	.135	.1483	.1563	.162	.177	.1875	.192	.207	.2188	.2253
		Deflection <i>f</i> (inch) per coil, at Load <i>P</i> (pounds)																
$\frac{7}{8}$.875	.251	.222	.1882	.1825	.1574	.1325	.1262	.1138	.0999	.0928	.0880	.0772	.0707	.0682	.0605	.0552	.0526
		18.26	25.3	39.4	41.5	59.9	91.1	102.3	130.5	176.3	209.	234.	312.	377.	407.	521.	626.	691.
$\frac{29}{32}$.9063	.271	.239	.204	.1974	.1705	.1438	.1370	.1236	.1087	.1010	.0959	.0843	.0772	.0746	.0663	.0606	.0577
		17.57	24.3	36.9	39.9	57.6	87.5	98.2	125.2	169.0	199.9	224.	299.	360.	389.	498.	598.	660.
$\frac{15}{16}$.9375	.292	.258	.219	.213	.1841	.1554	.1479	.1338	.1178	.1096	.1041	.0917	.0842	.0812	.0723	.0662	.0632
		16.94	23.5	35.6	38.4	55.4	84.1	94.4	120.4	162.3	191.9	215.	286.	345.	373.	477.	572.	631.
$\frac{31}{32}$.9688	.313	.277	.236	.229	.1982	.1675	.1598	.1445	.1273	.1183	.1127	.0994	.0913	.0882	.0786	.0721	.0688
		16.35	22.6	34.3	37.0	53.4	81.0	90.9	115.9	156.1	184.5	207.	275.	332.	358.	457.	548.	604.
1	1.000	.336	.297	.253	.246	.213	.1801	.1718	.1555	.1372	.1278	.1216	.1074	.0986	.0954	.0852	.0783	.0747
		15.80	21.9	33.1	35.8	51.5	78.1	87.6	111.7	150.4	177.6	198.8	264.	319.	344.	439.	526.	580.
$1\frac{1}{32}$	1.031	.359	.317	.271	.263	.228	.1931	.1843	.1669	.1474	.1374	.1308	.1157	.1065	.1029	.0921	.0845	.0809
		15.28	21.1	32.0	34.6	49.8	75.5	84.6	107.8	145.1	171.3	191.6	255.	307.	331.	423.	506.	557.
$1\frac{1}{16}$	1.063	.382	.338	.289	.281	.244	.207	.1972	.1788	.1580	.1474	.1404	.1243	.1145	.1107	.0993	.0913	.0873
		14.80	20.5	31.0	33.5	48.2	73.0	81.8	104.2	140.1	165.4	185.0	246.	296.	319.	407.	487.	537.
$1\frac{1}{32}$	1.094	.407	.360	.308	.299	.260	.221	.211	.1910	.1691	.1578	.1503	.1332	.1229	.1188	.1066	.0982	.0939
		14.34	19.83	30.0	32.4	46.7	70.6	79.2	100.8	135.5	159.9	178.8	238.	286.	308.	393.	470.	517.
$1\frac{1}{8}$	1.125	.432	.383	.328	.318	.277	.235	.224	.204	.1804	.1685	.1604	.1424	.1315	.1272	.1142	.1053	.1008
		13.92	19.24	29.1	31.4	45.2	68.4	76.7	97.6	131.2	154.7	173.0	230.	276.	298.	379.	454.	499.
$1\frac{3}{16}$	1.188	.485	.431	.368	.358	.311	.265	.254	.231	.204	.1908	.1812	.1620	.1496	.1448	.1303	.1203	.1153
		13.14	18.15	27.5	29.6	42.6	64.4	72.1	91.7	123.3	145.4	162.4	215.	259.	279.	355.	424.	467.
$1\frac{1}{4}$	1.250	.541	.480	.412	.400	.349	.297	.284	.258	.230	.215	.205	.1824	.1690	.1635	.1474	.1363	.1308
		12.44	17.19	26.0	28.0	40.3	60.8	68.2	86.6	116.2	137.0	153.1	203.	244.	263.	334.	399.	438.
$1\frac{5}{16}$	1.313	.600	.533	.457	.444	.387	.331	.317	.288	.256	.240	.229	.205	.1894	.1836	.1657	.1535	.1472
		11.81	16.31	24.6	26.6	38.2	57.7	64.6	82.0	110.1	129.7	144.7	191.6	230.	248.	315.	376.	413.
$1\frac{3}{8}$	1.375	.662	.588	.506	.491	.429	.367	.351	.320	.285	.267	.255	.227	.211	.204	.1848	.1713	.1650
		11.25	15.53	23.4	25.3	36.3	54.8	61.4	77.9	104.4	123.0	137.3	181.7	218.	235.	298.	356.	391.
$1\frac{7}{16}$	1.438	.727	.647	.556	.540	.472	.404	.387	.353	.314	.295	.282	.252	.234	.227	.205	.1905	.1829
		10.73	14.81	22.3	24.1	34.6	52.2	58.4	74.1	99.4	117.0	130.6	172.6	207.	223.	283.	337.	371.

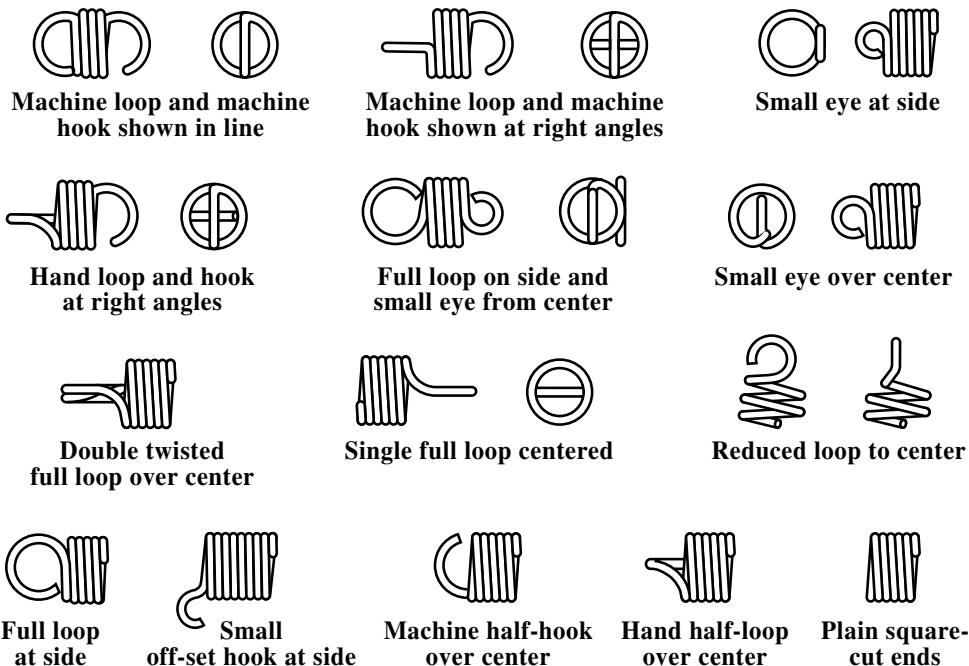
^aThis table is for ASTM A229 oil tempered spring steel with a torsional modulus *G* of 11,200,000 psi, and an uncorrected torsional stress of 100,000 psi. For other materials, and other important footnotes, see page 321.

Table 5. (Continued) Compression and Extension Spring Deflections ^a

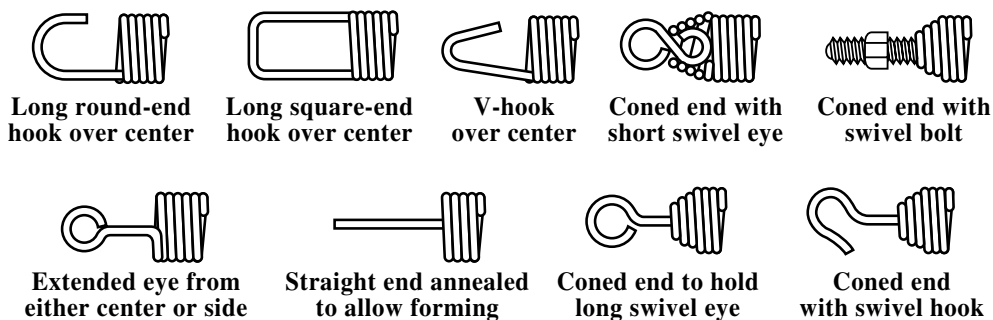
Spring Outside Dia.		Wire Size or Washburn and Moen Gauge, and Decimal Equivalent																	
		11	1/8	10	9	5/32	8	7	3/16	6	5	7/32	4	3	1/4	2	5/32	0	5/16
Nom. Dec.		.1205	.125	.135	.1483	.1563	.162	.177	.1875	.192	.207	.2188	.2253	.2437	.250	.2625	.2813	.3065	.3125
		Deflection <i>f</i> (inch) per coil, at Load <i>P</i> (pounds)																	
1 1/2	1.500	.443	.424	.387	.350	.324	.310	.277	.258	.250	.227	.210	.202	.1815	.1754	.1612	.1482	.1305	.1267
		49.8	55.8	70.8	94.8	111.5	124.5	164.6	197.1	213.	269.	321.	352.	452.	499.	574.	717.	947.	1008.
1 5/8	1.625	.527	.505	.461	.413	.387	.370	.332	.309	.300	.273	.254	.244	.220	.212	.1986	.1801	.1592	.1547
		45.7	51.1	64.8	86.7	102.0	113.9	150.3	180.0	193.9	246.	292.	321.	411.	446.	521.	650.	858.	912.
1 3/4	1.750	.619	.593	.542	.485	.456	.437	.392	.366	.355	.323	.301	.290	.261	.253	.237	.215	.1908	.1856
		42.2	47.2	59.8	80.0	94.0	104.9	138.5	165.6	178.4	226.	269.	295.	377.	409.	477.	595.	783.	833.
1 7/8	1.875	.717	.687	.629	.564	.530	.508	.457	.426	.414	.377	.351	.339	.306	.296	.278	.253	.225	.219
		39.2	43.8	55.5	74.2	87.2	97.3	128.2	153.4	165.1	209.	248.	272.	348.	378.	440.	548.	721.	767.
1 5/16	1.938	.769	.738	.676	.605	.569	.546	.492	.458	.446	.405	.379	.365	.331	.320	.300	.273	.243	.237
		37.8	42.3	53.6	71.6	84.2	93.8	123.6	147.9	159.2	201.	239.	262.	335.	364.	425.	528.	693.	737.
2	2.000	.823	.789	.723	.649	.610	.585	.527	.492	.478	.436	.407	.392	.355	.344	.323	.295	.263	.256
		36.6	40.9	51.8	69.2	81.3	90.6	119.4	142.8	153.7	194.3	231.	253.	324.	351.	409.	509.	668.	710.
2 1/16	2.063	.878	.843	.768	.693	.652	.626	.564	.526	.512	.467	.436	.421	.381	.369	.346	.316	.282	.275
		35.4	39.6	50.1	66.9	78.7	87.6	115.4	138.1	148.5	187.7	223.	245.	312.	339.	395.	491.	644.	685.
2 1/8	2.125	.936	.898	.823	.739	.696	.667	.602	.562	.546	.499	.466	.449	.407	.395	.371	.339	.303	.295
		34.3	38.3	48.5	64.8	76.1	84.9	111.8	133.6	143.8	181.6	216.	236.	302.	327.	381.	474.	622.	661.
2 3/16	2.188	.995	.955	.876	.786	.740	.711	.641	.598	.582	.532	.497	.479	.435	.421	.396	.362	.324	.316
		33.3	37.2	47.1	62.8	73.8	82.2	108.3	129.5	139.2	175.8	209.	229.	292.	317.	369.	459.	601.	639.
2 1/4	2.250	1.056	1.013	.930	.835	.787	.755	.681	.637	.619	.566	.529	.511	.463	.449	.423	.387	.346	.337
		32.3	36.1	45.7	60.9	71.6	79.8	105.7	125.5	135.0	170.5	202.	222.	283.	307.	357.	444.	582.	618.
2 5/16	2.313	1.119	1.074	.986	.886	.834	.801	.723	.676	.657	.601	.562	.542	.493	.478	.449	.411	.368	.359
		31.4	35.1	44.4	59.2	69.5	77.5	101.9	121.8	131.0	165.4	196.3	215.	275.	298.	347.	430.	564.	599.
2 3/8	2.375	1.184	1.136	1.043	.938	.884	.848	.763	.716	.696	.637	.596	.576	.523	.507	.477	.437	.392	.382
		30.5	34.1	43.1	57.5	67.6	75.3	99.1	118.3	127.3	160.7	190.7	209.	267.	289.	336.	417.	547.	581.
2 7/16	2.438	...	1.201	1.102	.991	.934	.897	.810	.757	.737	.674	.631	.609	.554	.537	.506	.464	.416	.405
		...	33.2	42.0	56.0	65.7	73.2	96.3	115.1	123.7	156.1	185.3	203.	259.	281.	327.	405.	531.	564.
2 1/2	2.500	...	1.266	1.162	1.046	.986	.946	.855	.800	.778	.713	.667	.644	.586	.568	.536	.491	.441	.430
		...	32.3	40.9	54.5	64.0	71.3	93.7	111.6	120.4	151.9	180.2	197.5	252.	273.	317.	394.	516.	548.

^a This table is for ASTM A229 oil tempered spring steel with a torsional modulus *G* of 11,200,000 psi, and an uncorrected torsional stress of 100,000 psi. For other materials, and other important footnotes, see page 321.

Extension Springs.—About 10 per cent of all springs made by many companies are of this type, and they frequently cause trouble because insufficient consideration is given to stress due to initial tension, stress and deflection of hooks, special manufacturing methods, secondary operations and overstretching at assembly. Fig. 15 shows types of ends used on these springs.



All the Above Ends are Standard Types for Which No Special Tools are Required



This Group of Special Ends Requires Special Tools

Fig. 15. Types of Helical Extension Spring Ends

Initial tension: In the spring industry, the term “Initial tension” is used to define a force or load, measurable in pounds or ounces, which presses the coils of a close wound extension spring against one another. This force must be overcome before the coils of a spring begin to open up.

Initial tension is wound into extension springs by bending each coil as it is wound away from its normal plane, thereby producing a slight twist in the wire which causes the coil to spring back tightly against the adjacent coil. Initial tension can be wound into cold-coiled

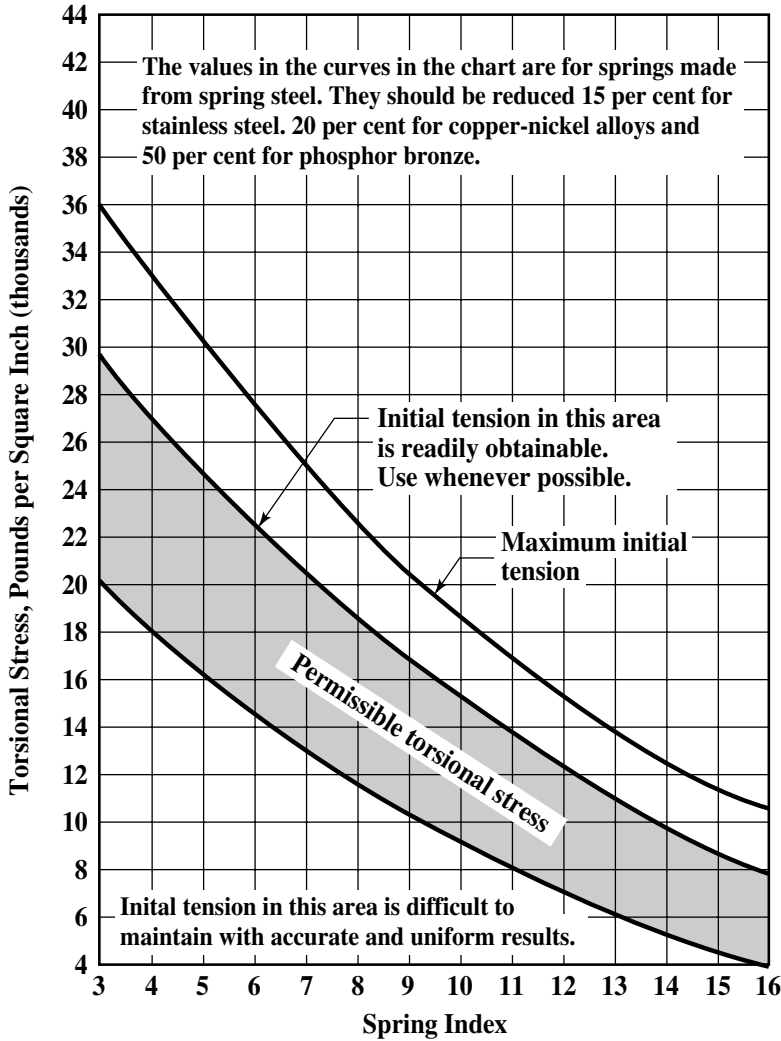


Fig. 16. Permissible Torsional Stress Caused by Initial Tension in Coiled Extension Springs for Different Spring Indexes

extension springs only. Hot-wound springs and springs made from annealed steel are hardened and tempered after coiling, and therefore initial tension cannot be produced. It is possible to make a spring having initial tension only when a high tensile strength, obtained by cold drawing or by heat-treatment, is possessed by the material as it is being wound into springs. Materials that possess the required characteristics for the manufacture of such springs include hard-drawn wire, music wire, pre-tempered wire, 18-8 stainless steel, phosphor-bronze, and many of the hard-drawn copper-nickel, and nonferrous alloys. Permissible torsional stresses resulting from initial tension for different spring indexes are shown in Fig. 16.

Hook failure: The great majority of breakages in extension springs occurs in the hooks. Hooks are subjected to both bending and torsional stresses and have higher stresses than the coils in the spring.

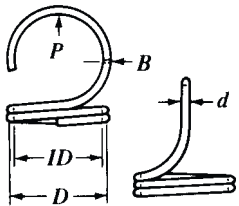
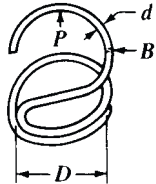
Stresses in regular hooks: The calculations for the stresses in hooks are quite complicated and lengthy. Also, the radii of the bends are difficult to determine and frequently vary between specifications and actual production samples. However, regular hooks are more highly stressed than the coils in the body and are subjected to a bending stress at section B

(see Table 6.) The bending stress S_b at section B should be compared with allowable stresses for torsion springs and with the elastic limit of the material in tension (See Figs. 7 through 10.)

Stresses in cross over hooks: Results of tests on springs having a normal average index show that the cross over hooks last longer than regular hooks. These results may not occur on springs of small index or if the cross over bend is made too sharply.

In as much as both types of hooks have the same bending stress, it would appear that the fatigue life would be the same. However, the large bend radius of the regular hooks causes some torsional stresses to coincide with the bending stresses, thus explaining the earlier breakages. If sharper bends were made on the regular hooks, the life should then be the same as for cross over hooks.

Table 6. Formula for Bending Stress at Section B

Type of Hook	Stress in Bending
 <p style="text-align: center;">Regular Hook</p>	$S_b = \frac{5PD^2}{I.D. \cdot d^3}$
 <p style="text-align: center;">Cross-over Hook</p>	

Stresses in half hooks: The formulas for regular hooks can also be used for half hooks, because the smaller bend radius allows for the increase in stress. It will therefore be observed that half hooks have the same stress in bending as regular hooks.

Frequently overlooked facts by many designers are that one full hook deflects an amount equal to one half a coil and each half hook deflects an amount equal to one tenth of a coil. Allowances for these deflections should be made when designing springs. Thus, an extension spring, with regular full hooks and having 10 coils, will have a deflection equal to 11 coils, or 10 per cent more than the calculated deflection.

Extension Spring Design.—The available space in a product or assembly usually determines the limiting dimensions of a spring, but the wire size, number of coils, and initial tension are often unknown.

Example: An extension spring is to be made from spring steel ASTM A229, with regular hooks as shown in Fig. 17. Calculate the wire size, number of coils and initial tension.

Note: Allow about 20 to 25 per cent of the 9 pound load for initial tension, say 2 pounds, and then design for a 7 pound load (not 9 pounds) at $\frac{5}{8}$ inch deflection. Also use lower stresses than for a compression spring to allow for overstretching during assembly and to obtain a safe stress on the hooks. Proceed as for compression springs, but locate a load in the tables somewhat higher than the 9 pound load.

Method 1, using table: From Table 5 locate $\frac{3}{4}$ inch outside diameter in the left column and move to the right to locate a load P of 13.94 pounds. A deflection f of 0.212 inch appears above this figure. Moving vertically from this position to the top of the column a suitable wire diameter of 0.0625 inch is found.

The remaining design calculations are completed as follows:

Step 1: The stress with a load of 7 pounds is obtained as follows:

The 7 pound load is 50.2 per cent of the 13.94 pound load. Therefore, the stress S at 7 pounds = 0.502 per cent \times 100,000 = 50,200 pounds per square inch.

Step 2: The 50.2 per cent figure is also used to determine the deflection per coil f : 0.502 per cent \times 0.212 = 0.1062 inch.

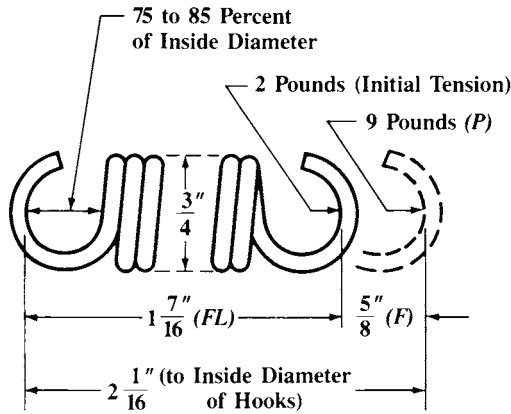


Fig. 17. Extension Spring Design Example

Step 3: The number of active coils. (say 6)

$$AC = \frac{F}{f} = \frac{0.625}{0.1062} = 5.86$$

This result should be reduced by 1 to allow for deflection of 2 hooks (see notes 1 and 2 that follow these calculations.) Therefore, a quick answer is: 5 coils of 0.0625 inch diameter wire. However, the design procedure should be completed by carrying out the following steps:

Step 4: The body length = $(TC + 1) \times d = (5 + 1) \times 0.0625 = 3/8$ inch.

Step 5: The length from the body to inside hook

$$= \frac{FL - \text{Body}}{2} = \frac{1.4375 - 0.375}{2} = 0.531 \text{ inch}$$

$$\text{Percentage of I.D.} = \frac{0.531}{\text{I.D.}} = \frac{0.531}{0.625} = 85 \text{ per cent}$$

This length is satisfactory, see Note 3 following this procedure.

Step 6:

$$\text{The spring index} = \frac{\text{O.D.}}{d} - 1 = \frac{0.75}{0.0625} - 1 = 11$$

Step 7: The initial tension stress is

$$S_{it} = \frac{S \times IT}{P} = \frac{50,200 \times 2}{7} = 14,340 \text{ pounds per square inch}$$

This stress is satisfactory, as checked against curve in Fig. 16.

Step 8: The curvature correction factor $K = 1.12$ (Fig. 13).

Step 9: The total stress = $(50,200 + 14,340) \times 1.12 = 72,285$ pounds per square inch

This result is less than 106,250 pounds per square inch permitted by the middle curve for 0.0625 inch wire in Fig. 3 and therefore is a safe working stress that permits some additional deflection that is usually necessary for assembly purposes.

Step 10: The large majority of hook breakage is due to high stress in bending and should be checked as follows:

From **Table 6**, stress on hook in bending is:

$$S_b = \frac{5PD^2}{I.D.d^3} = \frac{5 \times 9 \times 0.6875^2}{0.625 \times 0.0625^3} = 139,200 \text{ pounds per square inch}$$

This result is less than the top curve value, **Fig. 8**, for 0.0625 inch diameter wire, and is therefore safe. Also see Note 5 that follows.

Notes: The following points should be noted when designing extension springs:

- 1) All coils are active and thus $AC = TC$.
- 2) Each full hook deflection is approximately equal to $\frac{1}{2}$ coil. Therefore for 2 hooks, reduce the total coils by 1. (Each half hook deflection is nearly equal to $\frac{1}{10}$ of a coil.)
- 3) The distance from the body to the inside of a regular full hook equals 75 to 85 per cent (90 per cent maximum) of the I.D. For a cross over center hook, this distance equals the I.D.
- 4) Some initial tension should usually be used to hold the spring together. Try not to exceed the maximum curve shown on **Fig. 16**. Without initial tension, a long spring with many coils will have a different length in the horizontal position than it will when hung vertically.
- 5) The hooks are stressed in bending, therefore their stress should be less than the maximum bending stress as used for torsion springs — use top fatigue strength curves **Figs. 7** through **10**.

Method 2, using formulas: The sequence of steps for designing extension springs by formulas is similar to that for compression springs. The formulas for this method are given in **Table 3**.

Tolerances for Compression and Extension Springs.—Tolerances for coil diameter, free length, squareness, load, and the angle between loop planes for compression and extension springs are given in **Tables 7** through **12**. To meet the requirements of load, rate, free length, and solid height, it is necessary to vary the number of coils for compression springs by ± 5 per cent. For extension springs, the tolerances on the numbers of coils are: for 3 to 5 coils, ± 20 per cent; for 6 to 8 coils, ± 30 per cent; for 9 to 12 coils, ± 40 per cent. For each additional coil, a further $1\frac{1}{2}$ per cent tolerance is added to the extension spring values. Closer tolerances on the number of coils for either type of spring lead to the need for trimming after coiling, and manufacturing time and cost are increased. **Fig. 18** shows deviations allowed on the ends of extension springs, and variations in end alignments.

Table 7. Compression and Extension Spring Coil Diameter Tolerances

Wire Diameter, Inch	Spring Index						
	4	6	8	10	12	14	16
	Tolerance, \pm inch						
0.015	0.002	0.002	0.003	0.004	0.005	0.006	0.007
0.023	0.002	0.003	0.004	0.006	0.007	0.008	0.010
0.035	0.002	0.004	0.006	0.007	0.009	0.011	0.013
0.051	0.003	0.005	0.007	0.010	0.012	0.015	0.017
0.076	0.004	0.007	0.010	0.013	0.016	0.019	0.022
0.114	0.006	0.009	0.013	0.018	0.021	0.025	0.029
0.171	0.008	0.012	0.017	0.023	0.028	0.033	0.038
0.250	0.011	0.015	0.021	0.028	0.035	0.042	0.049
0.375	0.016	0.020	0.026	0.037	0.046	0.054	0.064
0.500	0.021	0.030	0.040	0.062	0.080	0.100	0.125

Courtesy of the Spring Manufacturers Institute

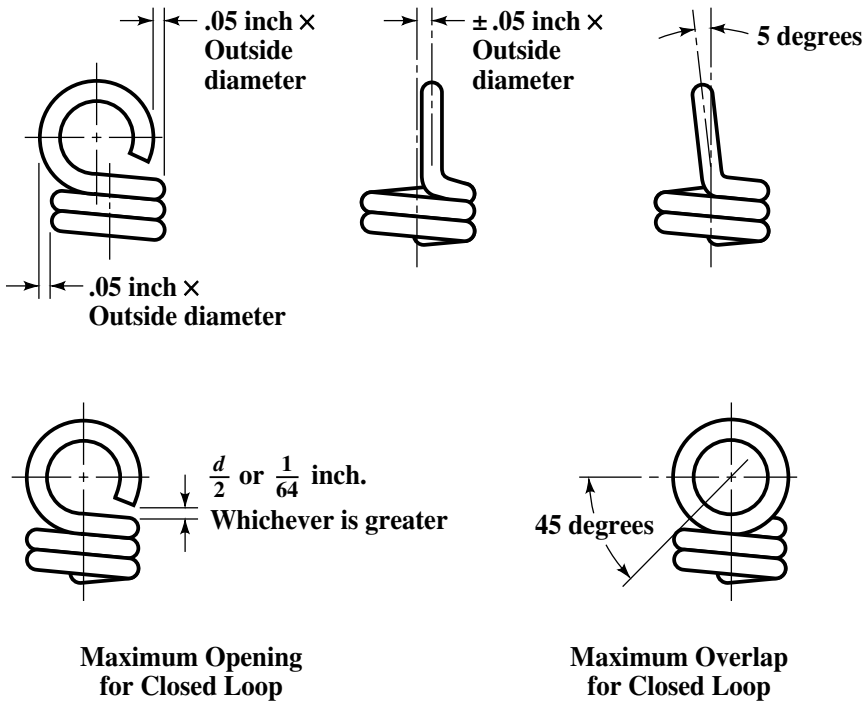


Fig. 18. Maximum Deviations Allowed on Ends and Variation in Alignment of Ends (Loops) for Extension Springs

Table 8. Compression Spring Normal Free-Length Tolerances, Squared and Ground Ends

Number of Active Coils per Inch	Spring Index						
	4	6	8	10	12	14	16
	Tolerance, ± Inch per Inch of Free Length ^a						
0.5	0.010	0.011	0.012	0.013	0.015	0.016	0.016
1	0.011	0.013	0.015	0.016	0.017	0.018	0.019
2	0.013	0.015	0.017	0.019	0.020	0.022	0.023
4	0.016	0.018	0.021	0.023	0.024	0.026	0.027
8	0.019	0.022	0.024	0.026	0.028	0.030	0.032
12	0.021	0.024	0.027	0.030	0.032	0.034	0.036
16	0.022	0.026	0.029	0.032	0.034	0.036	0.038
20	0.023	0.027	0.031	0.034	0.036	0.038	0.040

^a For springs less than 0.5 inch long, use the tolerances for 0.5 inch long springs. For springs with unground closed ends, multiply the tolerances by 1.7.

Courtesy of the Spring Manufacturers Institute

Table 9. Extension Spring Normal Free-Length and End Tolerances

Free-Length Tolerances		End Tolerances		Free-Length Tolerances		End Tolerances	
Spring Free Length (inch)	Tolerance (inch)	Total Number of Coils	Angle Between Loop Planes	Spring Free Length (inch)	Tolerance (inch)	Total Number of Coils	Angle Between Loop Planes
Up to 0.5	±0.020	3 to 6	±25°	Over 4.0 to 8.0	±0.093	13 to 16	±60°
Over 0.5 to 1.0	±0.030			Over 8.0 to 16.0	±0.156	Over 16	Random
Over 1.0 to 2.0	±0.040	7 to 9	±35°	Over 16.0 to 24.0	±0.218		
Over 2.0 to 4.0	±0.060	10 to 12	±45°				

Courtesy of the Spring Manufacturers Institute

Table 10. Compression Spring Squareness Tolerances

Slenderness Ratio FL/D^a	Spring Index						
	4	6	8	10	12	14	16
	Squareness Tolerances (\pm degrees)						
0.5	3.0	3.0	3.5	3.5	3.5	3.5	4.0
1.0	2.5	3.0	3.0	3.0	3.0	3.5	3.5
1.5	2.5	2.5	2.5	3.0	3.0	3.0	3.0
2.0	2.5	2.5	2.5	2.5	3.0	3.0	3.0
3.0	2.0	2.5	2.5	2.5	2.5	2.5	3.0
4.0	2.0	2.0	2.5	2.5	2.5	2.5	2.5
6.0	2.0	2.0	2.0	2.5	2.5	2.5	2.5
8.0	2.0	2.0	2.0	2.0	2.5	2.5	2.5
10.0	2.0	2.0	2.0	2.0	2.0	2.5	2.5
12.0	2.0	2.0	2.0	2.0	2.0	2.0	2.5

^a Slenderness Ratio = $FL \div D$

Springs with closed and ground ends, in the free position. Squareness tolerances closer than those shown require special process techniques which increase cost. Springs made from fine wire sizes, and with high spring indices, irregular shapes or long free lengths, require special attention in determining appropriate tolerance and feasibility of grinding ends.

Table 11. Compression Spring Normal Load Tolerances

Length Tolerance, \pm inch	Deflection (inch) ^a														
	0.05	0.10	0.15	0.20	0.25	0.30	0.40	0.50	0.75	1.00	1.50	2.00	3.00	4.00	6.00
	Tolerance, \pm Per Cent of Load														
0.005	12	7	6	5
0.010	...	12	8.5	7	6.5	5.5	5
0.020	...	22	15.5	12	10	8.5	7	6	5
0.030	22	17	14	12	9.5	8	6	5
0.040	22	18	15.5	12	10	7.5	6	5
0.050	22	19	14.5	12	9	7	5.5
0.060	25	22	17	14	10	8	6	5
0.070	25	19.5	16	11	9	6.5	5.5
0.080	22	18	12.5	10	7.5	6	5
0.090	25	20	14	11	8	6	5
0.100	22	15.5	12	8.5	7	5.5
0.200	22	15.5	12	8.5	7	5.5
0.300	22	17	12	9.5	7
0.400	21	15	12	8.5
0.500	25	18.5	14.5	10.5

^a From free length to loaded position.

Torsion Spring Design.—Fig. 19 shows the types of ends most commonly used on torsion springs. To produce them requires only limited tooling. The straight torsion end is the least expensive and should be used whenever possible. After determining the spring load or torque required and selecting the end formations, the designer usually estimates suitable space or size limitations. However, the space should be considered approximate until the wire size and number of coils have been determined. The wire size is dependent principally upon the torque. Design data can be developed with the aid of the tabular data, which is a simple method, or by calculation alone, as shown in the following sections. Many other factors affecting the design and operation of torsion springs are also covered in the section, *Torsion Spring Design Recommendations* on page 337. Design formulas are shown in Table 13.

Curvature correction: In addition to the stress obtained from the formulas for load or deflection, there is a direct shearing stress on the inside of the section due to curvature. Therefore, the stress obtained by the usual formulas should be multiplied by the factor K

Table 12. Extension Spring Normal Load Tolerances

Spring Index	$\frac{FL}{F}$	Wire Diameter (inch)										
		0.015	0.022	0.032	0.044	0.062	0.092	0.125	0.187	0.250	0.375	0.437
		Tolerance, \pm Per Cent of Load										
4	12	20.0	18.5	17.6	16.9	16.2	15.5	15.0	14.3	13.8	13.0	12.6
	8	18.5	17.5	16.7	15.8	15.0	14.5	14.0	13.2	12.5	11.5	11.0
	6	16.8	16.1	15.5	14.7	13.8	13.2	12.7	11.8	11.2	9.9	9.4
	4.5	15.0	14.7	14.1	13.5	12.6	12.0	11.5	10.3	9.7	8.4	7.9
	2.5	13.1	12.4	12.1	11.8	10.6	10.0	9.1	8.5	8.0	6.8	6.2
	1.5	10.2	9.9	9.3	8.9	8.0	7.5	7.0	6.5	6.1	5.3	4.8
	0.5	6.2	5.4	4.8	4.6	4.3	4.1	4.0	3.8	3.6	3.3	3.2
6	12	17.0	15.5	14.6	14.1	13.5	13.1	12.7	12.0	11.5	11.2	10.7
	8	16.2	14.7	13.9	13.4	12.6	12.2	11.7	11.0	10.5	10.0	9.5
	6	15.2	14.0	12.9	12.3	11.6	10.9	10.7	10.0	9.4	8.8	8.3
	4.5	13.7	12.4	11.5	11.0	10.5	10.0	9.6	9.0	8.3	7.6	7.1
	2.5	11.9	10.8	10.2	9.8	9.4	9.0	8.5	7.9	7.2	6.2	6.0
	1.5	9.9	9.0	8.3	7.7	7.3	7.0	6.7	6.4	6.0	4.9	4.7
	0.5	6.3	5.5	4.9	4.7	4.5	4.3	4.1	4.0	3.7	3.5	3.4
8	12	15.8	14.3	13.1	13.0	12.1	12.0	11.5	10.8	10.2	10.0	9.5
	8	15.0	13.7	12.5	12.1	11.4	11.0	10.6	10.1	9.4	9.0	8.6
	6	14.2	13.0	11.7	11.2	10.6	10.0	9.7	9.3	8.6	8.1	7.6
	4.5	12.8	11.7	10.7	10.1	9.7	9.0	8.7	8.3	7.8	7.2	6.6
	2.5	11.2	10.2	9.5	8.8	8.3	7.9	7.7	7.4	6.9	6.1	5.6
	1.5	9.5	8.6	7.8	7.1	6.9	6.7	6.5	6.2	5.8	4.9	4.5
	0.5	6.3	5.6	5.0	4.8	4.5	4.4	4.2	4.1	3.9	3.6	3.5
10	12	14.8	13.3	12.0	11.9	11.1	10.9	10.5	9.9	9.3	9.2	8.8
	8	14.2	12.8	11.6	11.2	10.5	10.2	9.7	9.2	8.6	8.3	8.0
	6	13.4	12.1	10.8	10.5	9.8	9.3	8.9	8.6	8.0	7.6	7.2
	4.5	12.3	10.8	10.0	9.5	9.0	8.5	8.1	7.8	7.3	6.8	6.4
	2.5	10.8	9.6	9.0	8.4	8.0	7.7	7.3	7.0	6.5	5.9	5.5
	1.5	9.2	8.3	7.5	6.9	6.7	6.5	6.3	6.0	5.6	5.0	4.6
	0.5	6.4	5.7	5.1	4.9	4.7	4.5	4.3	4.2	4.0	3.8	3.7
12	12	14.0	12.3	11.1	10.8	10.1	9.8	9.5	9.0	8.5	8.2	7.9
	8	13.2	11.8	10.7	10.2	9.6	9.3	8.9	8.4	7.9	7.5	7.2
	6	12.6	11.2	10.2	9.7	9.0	8.5	8.2	7.9	7.4	6.9	6.4
	4.5	11.7	10.2	9.4	9.0	8.4	8.0	7.6	7.2	6.8	6.3	5.8
	2.5	10.5	9.2	8.5	8.0	7.8	7.4	7.0	6.6	6.1	5.6	5.2
	1.5	8.9	8.0	7.2	6.8	6.5	6.3	6.1	5.7	5.4	4.8	4.5
	0.5	6.5	5.8	5.3	5.1	4.9	4.7	4.5	4.3	4.2	4.0	3.3
14	12	13.1	11.3	10.2	9.7	9.1	8.8	8.4	8.1	7.6	7.2	7.0
	8	12.4	10.9	9.8	9.2	8.7	8.3	8.0	7.6	7.2	6.8	6.4
	6	11.8	10.4	9.3	8.8	8.3	7.7	7.5	7.2	6.8	6.3	5.9
	4.5	11.1	9.7	8.7	8.2	7.8	7.2	7.0	6.7	6.3	5.8	5.4
	2.5	10.1	8.8	8.1	7.6	7.1	6.7	6.5	6.2	5.7	5.2	5.0
	1.5	8.6	7.7	7.0	6.7	6.3	6.0	5.8	5.5	5.2	4.7	4.5
	0.5	6.6	5.9	5.4	5.2	5.0	4.8	4.6	4.4	4.3	4.2	4.0
16	12	12.3	10.3	9.2	8.6	8.1	7.7	7.4	7.2	6.8	6.3	6.1
	8	11.7	10.0	8.9	8.3	7.8	7.4	7.2	6.8	6.5	6.0	5.7
	6	11.0	9.6	8.5	8.0	7.5	7.1	6.9	6.5	6.2	5.7	5.4
	4.5	10.5	9.1	8.1	7.5	7.2	6.8	6.5	6.2	5.8	5.3	5.1
	2.5	9.7	8.4	7.6	7.0	6.7	6.3	6.1	5.7	5.4	4.9	4.7
	1.5	8.3	7.4	6.6	6.2	6.0	5.8	5.6	5.3	5.1	4.6	4.4
	0.5	6.7	5.9	5.5	5.3	5.1	5.0	4.8	4.6	4.5	4.3	4.1

FL/F = the ratio of the spring free length FL to the deflection F .

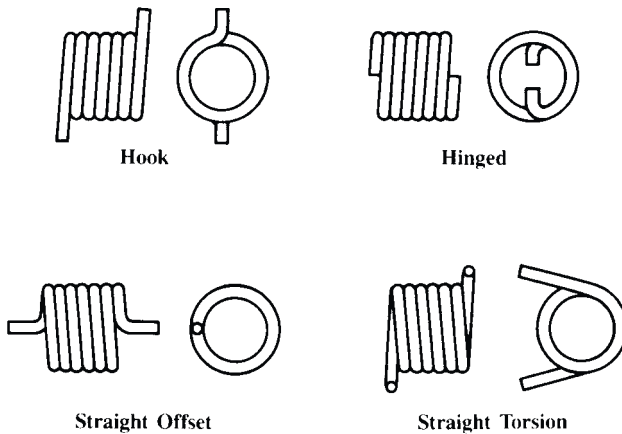


Fig. 19. The Most Commonly Used Types of Ends for Torsion Springs

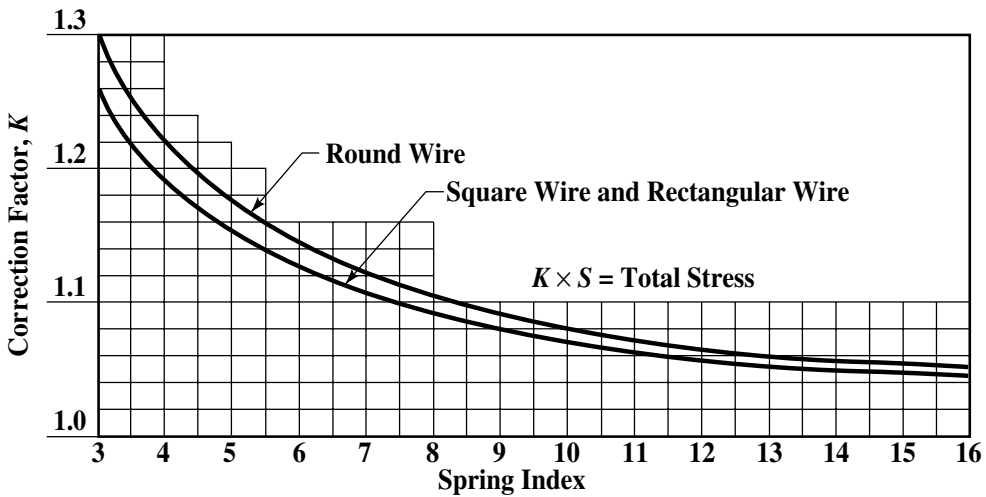


Fig. 20. Torsion Spring Stress Correction for Curvature obtained from the curve in Fig. 20. The corrected stress thus obtained is used only for comparison with the allowable working stress (fatigue strength) curves to determine if it is a safe value, and should not be used in the formulas for deflection.

Torque: Torque is a force applied to a moment arm and tends to produce rotation. Torsion springs exert torque in a circular arc and the arms are rotated about the central axis. It should be noted that the stress produced is in bending, not in torsion. In the spring industry it is customary to specify torque in conjunction with the deflection or with the arms of a spring at a definite position. Formulas for torque are expressed in pound-inches. If ounce-inches are specified, it is necessary to divide this value by 16 in order to use the formulas.

When a load is specified at a distance from a centerline, the torque is, of course, equal to the load multiplied by the distance. The load can be in pounds or ounces with the distances in inches or the load can be in grams or kilograms with the distance in centimeters or millimeters, but to use the design formulas, all values must be converted to pounds and inches. Design formulas for torque are based on the tangent to the arc of rotation and presume that a rod is used to support the spring. The stress in bending caused by the moment $P \times R$ is identical in magnitude to the torque T , provided a rod is used.

Theoretically, it makes no difference how or where the load is applied to the arms of torsion springs. Thus, in Fig. 21, the loads shown multiplied by their respective distances produce the same torque; i.e., $20 \times 0.5 = 10$ pound-inches; $10 \times 1 = 10$ pound-inches; and 5×2

Table 13. Formulas for Torsion Springs

Feature	Springs made from round wire	Springs made from square wire
	Formula ^{a,b}	
$d =$ Wire diameter, Inches	$\sqrt[3]{\frac{10.18T}{S_b}}$	$\sqrt[3]{\frac{6T}{S_b}}$
	$\sqrt[4]{\frac{4000TND}{EF^\circ}}$	$\sqrt[4]{\frac{2375TND}{EF^\circ}}$
$S_b =$ Stress, bending pounds per square inch	$\frac{10.18T}{d^3}$	$\frac{6T}{d^3}$
	$\frac{EdF^\circ}{392ND}$	$\frac{EdF^\circ}{392ND}$
$N =$ Active Coils	$\frac{EdF^\circ}{392S_bD}$	$\frac{EdF^\circ}{392S_bD}$
	$\frac{Ed^4F^\circ}{4000TD}$	$\frac{Ed^4F^\circ}{2375TD}$
$F^\circ =$ Deflection	$\frac{392S_bND}{Ed}$	$\frac{392S_bND}{Ed}$
	$\frac{4000TND}{Ed^4}$	$\frac{2375TND}{Ed^4}$
$T =$ Torque Inch lbs. (Also = $P \times R$)	$0.0982S_b d^3$	$0.1666S_b d^3$
	$\frac{Ed^4F^\circ}{4000ND}$	$\frac{Ed^4F^\circ}{2375ND}$
$ID_1 =$ Inside Diameter After Deflection, Inches	$\frac{N(ID \text{ free})}{N + \frac{F^\circ}{360}}$	$\frac{N(ID \text{ free})}{N + \frac{F^\circ}{360}}$

^a Where two formulas are given for one feature, the designer should use the one found to be appropriate for the given design. The end result from either of any two formulas is the same.

^b The symbol notation is given on page 304.

= 10 pound-inches. To further simplify the understanding of torsion spring torque, observe in both Fig. 22 and Fig. 23 that although the turning force is in a circular arc the torque is not equal to P times the radius. The torque in both designs equals $P \times R$ because the spring rests against the support rod at point a .

Design Procedure: Torsion spring designs require more effort than other kinds because consideration has to be given to more details such as the proper size of a supporting rod, reduction of the inside diameter, increase in length, deflection of arms, allowance for friction, and method of testing.

Example: What music wire diameter and how many coils are required for the torsion spring shown in Fig. 24, which is to withstand at least 1000 cycles? Determine the corrected stress and the reduced inside diameter after deflection.

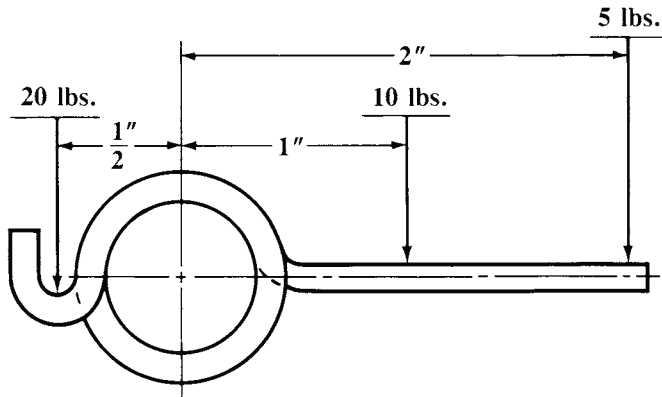


Fig. 21. Right-Hand Torsion Spring

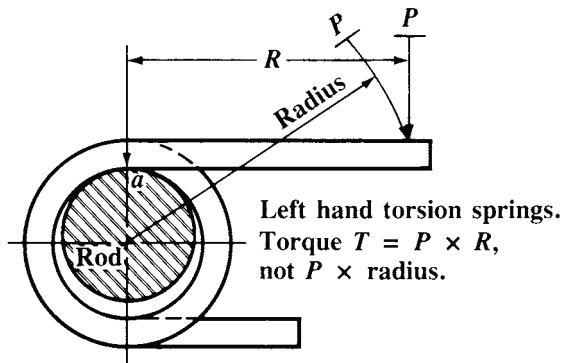


Fig. 22. Left-Hand Torsion Spring

The Torque is $T = P \times R$, Not $P \times \text{Radius}$, because the Spring is Resting Against the Support Rod at Point a

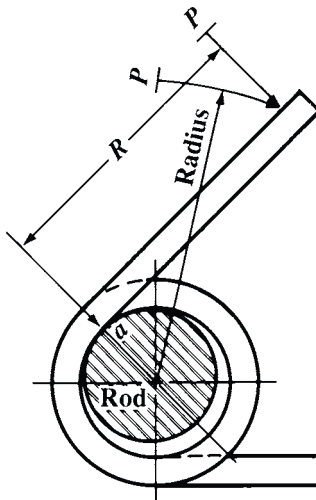


Fig. 23. Left-Hand Torsion Spring

As with the Spring in Fig. 22, the Torque is $T = P \times R$, Not $P \times \text{Radius}$, Because the Support Point Is at a

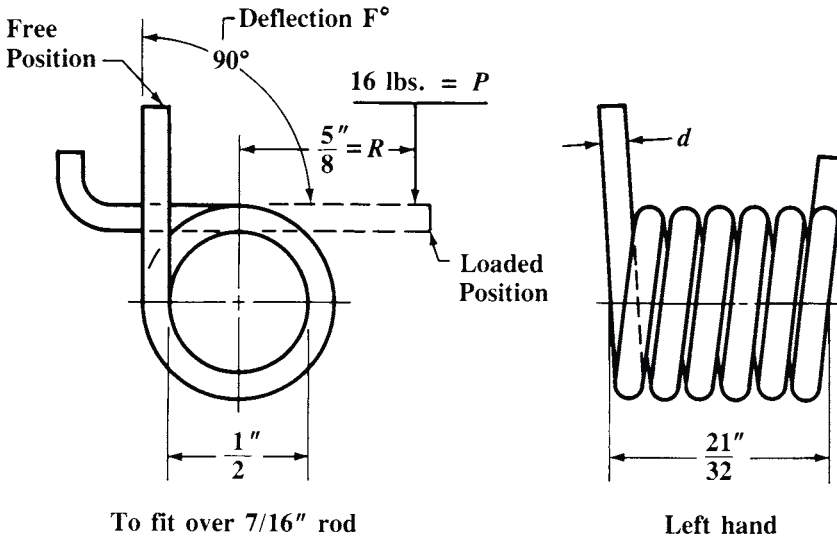


Fig. 24. Torsion Spring Design Example. The Spring Is to be Assembled on a $\frac{7}{16}$ -Inch Support Rod
Method 1, using table: From **Table 14**, page 339, locate the $\frac{1}{2}$ inch inside diameter for the spring in the left-hand column. Move to the right and then vertically to locate a torque value nearest to the required 10 pound-inches, which is 10.07 pound-inches. At the top of the same column, the music wire diameter is found, which is Number 31 gauge (0.085 inch). At the bottom of the same column the deflection for one coil is found, which is 15.81 degrees. As a 90-degree deflection is required, the number of coils needed is $\frac{90}{15.81} = 5.69$ (say $5\frac{3}{4}$ coils).

The spring index $\frac{D}{d} = \frac{0.500 + 0.085}{0.085} = 6.88$ and thus the curvature correction factor *K* from **Fig. 20** = 1.13. Therefore the corrected stress equals $167,000 \times 1.13 = 188,700$ pounds per square inch which is below the Light Service curve (**Fig. 7**) and therefore should provide a fatigue life of over 1,000 cycles. The reduced inside diameter due to deflection is found from the formula in **Table 13**:

$$ID_1 = \frac{N(ID \text{ free})}{N + \frac{F}{360}} = \frac{5.75 \times 0.500}{5.75 + \frac{90}{360}} = 0.479 \text{ in.}$$

This reduced diameter easily clears a suggested $\frac{7}{16}$ inch diameter supporting rod: $0.479 - 0.4375 = 0.041$ inch clearance, and it also allows for the standard tolerance. The overall length of the spring equals the total number of coils plus one, times the wire diameter. Thus, $6\frac{3}{4} \times 0.085 = 0.574$ inch. If a small space of about $\frac{1}{64}$ in. is allowed between the coils to eliminate coil friction, an overall length of $\frac{21}{32}$ inch results.

Although this completes the design calculations, other tolerances should be applied in accordance with the Torsion Spring Tolerance **Tables 16** through **17** shown at the end of this section.

Longer fatigue life: If a longer fatigue life is desired, use a slightly larger wire diameter. Usually the next larger gage size is satisfactory. The larger wire will reduce the stress and still exert the same torque, but will require more coils and a longer overall length.

Percentage method for calculating longer life: The spring design can be easily adjusted for longer life as follows:

1) Select the next larger gage size, which is Number 32 (0.090 inch) from Table 14. The torque is 11.88 pound-inches, the design stress is 166,000 pounds per square inch, and the deflection is 14.9 degrees per coil. As a percentage the torque is $10/11.88 \times 100 = 84$ per cent.

2) The new stress is $0.84 \times 166,000 = 139,440$ pounds per square inch. This value is under the bottom or Severe Service curve, Fig. 7, and thus assures longer life.

3) The new deflection per coil is $0.84 \times 14.97 = 12.57$ degrees. Therefore, the total number of coils required = $90/12.57 = 7.16$ (say $7 \frac{1}{8}$). The new overall length = $8 \frac{1}{8} \times 0.090 = 0.73$ inch (say $\frac{3}{4}$ inch). A slight increase in the overall length and new arm location are thus necessary.

Method 2, using formulas: When using this method, it is often necessary to solve the formulas several times because assumptions must be made initially either for the stress or for a wire size. The procedure for design using formulas is as follows (the design example is the same as in Method 1, and the spring is shown in Fig. 24):

Step 1: Note from Table 13, page 334 that the wire diameter formula is:

$$d = \sqrt[3]{\frac{10.18T}{S_b}}$$

Step 2: Referring to Fig. 7, select a trial stress, say 150,000 pounds per square inch.

Step 3: Apply the trial stress, and the 10 pound-inches torque value in the wire diameter formula:

$$d = \sqrt[3]{\frac{10.18T}{S_b}} = \sqrt[3]{\frac{10.18 \times 10}{150,000}} = \sqrt[3]{0.000679} = 0.0879 \text{ inch}$$

The nearest gauge sizes are 0.085 and 0.090 inch diameter. *Note:* Table 21, page 347, can be used to avoid solving the cube root.

Step 4: Select 0.085 inch wire diameter and solve the equation for the actual stress:

$$S_b = \frac{10.18T}{d^3} = \frac{10.18 \times 10}{0.085^3} = 165,764 \text{ pounds per square inch}$$

Step 5: Calculate the number of coils from the equation, Table 13:

$$N = \frac{EdF^\circ}{392S_bD} = \frac{28,500,000 \times 0.085 \times 90}{392 \times 165,764 \times 0.585} = 5.73 \text{ (say } 5 \frac{3}{4}\text{)}$$

Step 6: Calculate the total stress. The spring index is 6.88, and the correction factor *K* is 1.13, therefore total stress = $165,764 \times 1.13 = 187,313$ pounds per square inch. *Note:* The corrected stress should not be used in any of the formulas as it does not determine the torque or the deflection.

Torsion Spring Design Recommendations.—The following recommendations should be taken into account when designing torsion springs:

Hand: The hand or direction of coiling should be specified and the spring designed so deflection causes the spring to wind up and to have more coils. This increase in coils and overall length should be allowed for during design. Deflecting the spring in an unwinding direction produces higher stresses and may cause early failure. When a spring is sighted down the longitudinal axis, it is “right hand” when the direction of the wire into the spring takes a clockwise direction or if the angle of the coils follows an angle similar to the threads of a standard bolt or screw, otherwise it is “left hand.” A spring must be coiled right-handed to engage the threads of a standard machine screw.

Rods: Torsion springs should be supported by a rod running through the center whenever possible. If unsupported, or if held by clamps or lugs, the spring will buckle and the torque will be reduced or unusual stresses may occur.

Diameter Reduction: The inside diameter reduces during deflection. This reduction should be computed and proper clearance provided over the supporting rod. Also, allowances should be considered for normal spring diameter tolerances.

Winding: The coils of a spring may be closely or loosely wound, but they seldom should be wound with the coils pressed tightly together. Tightly wound springs with initial tension on the coils do not deflect uniformly and are difficult to test accurately. A small space between the coils of about 20 to 25 per cent of the wire thickness is desirable. Square and rectangular wire sections should be avoided whenever possible as they are difficult to wind, expensive, and are not always readily available.

Arm Length: All the wire in a torsion spring is active between the points where the loads are applied. Deflection of long extended arms can be calculated by allowing one third of the arm length, from the point of load contact to the body of the spring, to be converted into coils. However, if the length of arm is equal to or less than one-half the length of one coil, it can be safely neglected in most applications.

Total Coils: Torsion springs having less than three coils frequently buckle and are difficult to test accurately. When thirty or more coils are used, light loads will not deflect all the coils simultaneously due to friction with the supporting rod. To facilitate manufacturing it is usually preferable to specify the total number of coils to the nearest fraction in eighths or quarters such as $5 \frac{1}{8}$, $5 \frac{1}{4}$, $5 \frac{1}{2}$, etc.

Double Torsion: This design consists of one left-hand-wound series of coils and one series of right-hand-wound coils connected at the center. These springs are difficult to manufacture and are expensive, so it often is better to use two separate springs. For torque and stress calculations, each series is calculated separately as individual springs; then the torque values are added together, but the deflections are not added.

Bends: Arms should be kept as straight as possible. Bends are difficult to produce and often are made by secondary operations, so they are therefore expensive. Sharp bends raise stresses that cause early failure. Bend radii should be as large as practicable. Hooks tend to open during deflection; their stresses can be calculated by the same procedure as that for tension springs.

Spring Index: The spring index must be used with caution. In design formulas it is D/d . For shop measurement it is O.D./ d . For arbor design it is I.D./ d . Conversions are easily performed by either adding or subtracting 1 from D/d .

Proportions: A spring index between 4 and 14 provides the best proportions. Larger ratios may require more than average tolerances. Ratios of 3 or less, often cannot be coiled on automatic spring coiling machines because of arbor breakage. Also, springs with smaller or larger spring indexes often do not give the same results as are obtained using the design formulas.

Table of Torsion Spring Characteristics.—Table 14 shows design characteristics for the most commonly used torsion springs made from wire of standard gauge sizes. The deflection for one coil at a specified torque and stress is shown in the body of the table. The figures are based on music wire (ASTM A228) and oil-tempered MB grade (ASTM A229), and can be used for several other materials which have similar values for the modulus of elasticity E . However, the design stress may be too high or too low, and the design stress, torque, and deflection per coil should each be multiplied by the appropriate correction factor in Table 15 when using any of the materials given in that table.

Table 14. Torsion Spring Deflections

AMW Wire Gauge Decimal Equivalent ^a	1 .010	2 .011	3 .012	4 .013	5 .014	6 .016	7 .018	8 .020	9 .022	10 .024	11 .026	12 .029	13 .031	14 .033	15 .035	16 .037	
Design Stress, kpsi	232	229	226	224	221	217	214	210	207	205	202	199	197	196	194	192	
Torque, pound-inch	.0228	.0299	.0383	.0483	.0596	.0873	.1226	.1650	.2164	.2783	.3486	.4766	.5763	.6917	.8168	.9550	
Inside Diameter, inch	Deflection, degrees per coil																
1/16	0.0625	22.35	20.33	18.64	17.29	16.05	14.15	18.72	11.51	10.56	9.818	9.137	8.343	7.896
5/64	0.078125	27.17	24.66	22.55	20.86	19.32	16.96	15.19	13.69	12.52	11.59	10.75	9.768	9.215
3/32	0.09375	31.98	28.98	26.47	24.44	22.60	19.78	17.65	15.87	14.47	13.36	12.36	11.19	10.53	10.18	9.646	9.171
7/64	0.109375	36.80	33.30	30.38	28.02	25.88	22.60	20.12	18.05	16.43	15.14	13.98	12.62	11.85	11.43	10.82	10.27
1/8	0.125	41.62	37.62	34.29	31.60	29.16	25.41	22.59	20.23	18.38	16.91	15.59	14.04	13.17	12.68	11.99	11.36
9/64	0.140625	46.44	41.94	38.20	35.17	32.43	28.23	25.06	22.41	20.33	18.69	17.20	15.47	14.49	13.94	13.16	12.46
5/32	0.15625	51.25	46.27	42.11	38.75	35.71	31.04	27.53	24.59	22.29	20.46	18.82	16.89	15.81	15.19	14.33	13.56
3/16	0.1875	60.89	54.91	49.93	45.91	42.27	36.67	32.47	28.95	26.19	24.01	22.04	19.74	18.45	17.70	16.67	15.75
7/32	0.21875	70.52	63.56	57.75	53.06	48.82	42.31	37.40	33.31	30.10	27.55	25.27	22.59	21.09	20.21	19.01	17.94
1/4	0.250	80.15	72.20	65.57	60.22	55.38	47.94	42.34	37.67	34.01	31.10	28.49	25.44	23.73	22.72	21.35	20.13
AMW Wire Gauge Decimal Equivalent ^a	17 .039	18 .041	19 .043	20 .045	21 .047	22 .049	23 .051	24 .055	25 .059	26 .063	27 .067	28 .071	29 .075	30 .080	31 .085		
Design Stress, kpsi	190	188	187	185	184	183	182	180	178	176	174	173	171	169	167		
Torque, pound-inch	1.107	1.272	1.460	1.655	1.876	2.114	2.371	2.941	3.590	4.322	5.139	6.080	7.084	8.497	10.07		
Inside Diameter, inch	Deflection, degrees per coil																
1/8	0.125	10.80	10.29	9.876	9.447	9.102	8.784	
9/64	0.140625	11.83	11.26	10.79	10.32	9.929	9.572	9.244	8.654	8.141	
5/32	0.15625	12.86	12.23	11.71	11.18	10.76	10.36	9.997	9.345	8.778	8.279	7.975	
3/16	0.1875	14.92	14.16	13.55	12.92	12.41	11.94	11.50	10.73	10.05	9.459	9.091	8.663	8.232	7.772	7.364	
7/32	0.21875	16.97	16.10	15.39	14.66	14.06	13.52	13.01	12.11	11.33	10.64	10.21	9.711	9.212	8.680	8.208	
1/4	0.250	19.03	18.04	17.22	16.39	15.72	15.09	14.52	13.49	12.60	11.82	11.32	10.76	10.19	9.588	9.053	

^aFor sizes up to 13 gauge, the table values are for music wire with a modulus *E* of 29,000,000 psi; and for sizes from 27 to 31 gauge, the values are for oil-tempered MB with a modulus of 28,500,000 psi.

Table 14. (Continued) Torsion Spring Deflections

AMW Wire Gauge Decimal Equivalent ^a	8 .020	9 .022	10 .024	11 .026	12 .029	13 .031	14 .033	15 .035	16 .037	17 .039	18 .041	19 .043	20 .045	21 .047	22 .049	23 .051	
Design Stress, kpsi	210	207	205	202	199	197	196	194	192	190	188	187	185	184	183	182	
Torque, pound-inch	.1650	.2164	.2783	.3486	.4766	.5763	.6917	.8168	.9550	1.107	1.272	1.460	1.655	1.876	2.114	2.371	
Inside Diameter, inch	Deflection, degrees per coil																
$\frac{1}{32}$	0.28125	42.03	37.92	34.65	31.72	28.29	26.37	25.23	23.69	22.32	21.09	19.97	19.06	18.13	17.37	16.67	16.03
$\frac{5}{16}$	0.3125	46.39	41.82	38.19	34.95	31.14	29.01	27.74	26.04	24.51	23.15	21.91	20.90	19.87	19.02	18.25	17.53
$\frac{11}{32}$	0.34375	50.75	45.73	41.74	38.17	33.99	31.65	30.25	28.38	26.71	25.21	23.85	22.73	21.60	20.68	19.83	19.04
$\frac{3}{8}$	0.375	55.11	49.64	45.29	41.40	36.84	34.28	32.76	30.72	28.90	27.26	25.78	24.57	23.34	22.33	21.40	20.55
$\frac{13}{32}$	0.40625	59.47	53.54	48.85	44.63	39.69	36.92	35.26	33.06	31.09	29.32	27.72	26.41	25.08	23.99	22.98	22.06
$\frac{7}{16}$	0.4375	63.83	57.45	52.38	47.85	42.54	39.56	37.77	35.40	33.28	31.38	29.66	28.25	26.81	25.64	24.56	23.56
$\frac{15}{32}$	0.46875	68.19	61.36	55.93	51.00	45.39	42.20	40.28	37.74	35.47	33.44	31.59	30.08	28.55	27.29	26.14	25.07
$\frac{1}{2}$	0.500	72.55	65.27	59.48	54.30	48.24	44.84	42.79	40.08	37.67	35.49	33.53	31.92	30.29	28.95	27.71	26.58
AMW Wire Gauge Decimal Equivalent ^a	24 .055	25 .059	26 .063	27 .067	28 .071	29 .075	30 .080	31 .085	32 .090	33 .095	34 .100	35 .106	36 .112	37 .118	$\frac{1}{8}$ 125		
Design Stress, kpsi	180	178	176	174	173	171	169	167	166	164	163	161	160	158	156		
Torque, pound-inch	2.941	3.590	4.322	5.139	6.080	7.084	8.497	10.07	11.88	13.81	16.00	18.83	22.07	25.49	29.92		
Inside Diameter, inch	Deflection, degrees per coil																
$\frac{1}{32}$	0.28125	14.88	13.88	13.00	12.44	11.81	11.17	10.50	9.897	9.418	8.934	8.547	8.090	7.727	7.353	6.973	
$\frac{5}{16}$	0.3125	16.26	15.15	14.18	13.56	12.85	12.15	11.40	10.74	10.21	9.676	9.248	8.743	8.341	7.929	7.510	
$\frac{11}{32}$	0.34375	17.64	16.42	15.36	14.67	13.90	13.13	12.31	11.59	11.00	10.42	9.948	9.396	8.955	8.504	8.046	
$\frac{3}{8}$	0.375	19.02	17.70	16.54	15.79	14.95	14.11	13.22	12.43	11.80	11.16	10.65	10.05	9.569	9.080	8.583	
$\frac{13}{32}$	0.40625	20.40	18.97	17.72	16.90	15.99	15.09	14.13	13.28	12.59	11.90	11.35	10.70	10.18	9.655	9.119	
$\frac{7}{16}$	0.4375	21.79	20.25	18.90	18.02	17.04	16.07	15.04	14.12	13.38	12.64	12.05	11.35	10.80	10.23	9.655	
$\frac{15}{32}$	0.46875	23.17	21.52	20.08	19.14	18.09	17.05	15.94	14.96	14.17	13.39	12.75	12.01	11.41	10.81	10.19	
$\frac{1}{2}$	0.500	24.55	22.80	21.26	20.25	19.14	18.03	16.85	15.81	14.97	14.13	13.45	12.66	12.03	11.38	10.73	

^a For sizes up to 13 gauge, the table values are for music wire with a modulus E of 29,000,000 psi; and for sizes from 27 to 31 gauge, the values are for oil-tempered MB with a modulus of 28,500,000 psi.

Table 14. (Continued) Torsion Spring Deflections

AMW Wire Gauge Decimal Equivalent ^a	16 .037	17 .039	18 .041	19 .043	20 .045	21 .047	22 .049	23 .051	24 .055	25 .059	26 .063	27 .067	28 .071	29 .075	30 .080		
Design Stress, kpsi	192	190	188	187	185	184	183	182	180	178	176	174	173	171	169		
Torque, pound-inch	.9550	1.107	1.272	1.460	1.655	1.876	2.114	2.371	2.941	3.590	4.322	5.139	6.080	7.084	8.497		
Inside Diameter, inch	Deflection, degrees per coil																
$\frac{1}{32}$	0.53125	39.86	37.55	35.47	33.76	32.02	30.60	29.29	28.09	25.93	24.07	22.44	21.37	20.18	19.01	17.76	
$\frac{1}{16}$	0.5625	42.05	39.61	37.40	35.59	33.76	32.25	30.87	29.59	27.32	25.35	23.62	22.49	21.23	19.99	18.67	
$\frac{3}{32}$	0.59375	44.24	41.67	39.34	37.43	35.50	33.91	32.45	31.10	28.70	26.62	24.80	23.60	22.28	20.97	19.58	
$\frac{5}{8}$	0.625	46.43	43.73	41.28	39.27	37.23	35.56	34.02	32.61	30.08	27.89	25.98	24.72	23.33	21.95	20.48	
$\frac{2}{32}$	0.65625	48.63	45.78	43.22	41.10	38.97	37.22	35.60	34.12	31.46	29.17	27.16	25.83	24.37	22.93	21.39	
$\frac{1}{16}$	0.6875	50.82	47.84	45.15	42.94	40.71	38.87	37.18	35.62	32.85	30.44	28.34	26.95	25.42	23.91	22.30	
$\frac{3}{32}$	0.71875	53.01	49.90	47.09	44.78	42.44	40.52	38.76	37.13	34.23	31.72	29.52	28.07	26.47	24.89	23.21	
$\frac{3}{4}$	0.750	55.20	51.96	49.03	46.62	44.18	42.18	40.33	38.64	35.61	32.99	30.70	29.18	27.52	25.87	24.12	
Wire Gauge ^{ab} or Size and Decimal Equivalent	31 .085	32 .090	33 .095	34 .100	35 .106	36 .112	37 .118	$\frac{1}{8}$.125	10 .135	9 .1483	$\frac{5}{32}$.1563	8 .162	7 .177	$\frac{3}{16}$.1875	6 .192	5 .207	
Design Stress, kpsi	167	166	164	163	161	160	158	156	161	158	156	154	150	149	146	143	
Torque, pound-inch	10.07	11.88	13.81	16.00	18.83	22.07	25.49	29.92	38.90	50.60	58.44	64.30	81.68	96.45	101.5	124.6	
Inside Diameter, inch	Deflection, degrees per coil																
$\frac{1}{32}$	0.53125	16.65	15.76	14.87	14.15	13.31	12.64	11.96	11.26	10.93	9.958	9.441	9.064	8.256	7.856	7.565	7.015
$\frac{1}{16}$	0.5625	17.50	16.55	15.61	14.85	13.97	13.25	12.53	11.80	11.44	10.42	9.870	9.473	8.620	8.198	7.891	7.312
$\frac{3}{32}$	0.59375	18.34	17.35	16.35	15.55	14.62	13.87	13.11	12.34	11.95	10.87	10.30	9.882	8.984	8.539	8.218	7.609
$\frac{5}{8}$	0.625	19.19	18.14	17.10	16.25	15.27	14.48	13.68	12.87	12.47	11.33	10.73	10.29	9.348	8.881	8.545	7.906
$\frac{2}{32}$	0.65625	20.03	18.93	17.84	16.95	15.92	15.10	14.26	13.41	12.98	11.79	11.16	10.70	9.713	9.222	8.872	8.202
$\frac{1}{16}$	0.6875	20.88	19.72	18.58	17.65	16.58	15.71	14.83	13.95	13.49	12.25	11.59	11.11	10.08	9.564	9.199	8.499
$\frac{3}{32}$	0.71875	21.72	20.52	19.32	18.36	17.23	16.32	15.41	14.48	14.00	12.71	12.02	11.52	10.44	9.905	9.526	8.796
$\frac{3}{4}$	0.750	22.56	21.31	20.06	19.06	17.88	16.94	15.99	15.02	14.52	13.16	12.44	11.92	10.81	10.25	9.852	9.093

^a For sizes up to 26 gauge, the table values are for music wire with a modulus E of 29,500,000 psi; for sizes from 27 to $\frac{1}{8}$ inch diameter the table values are for music wire with a modulus of 28,500,000 psi; for sizes from 10 gauge to $\frac{1}{8}$ inch diameter, the values are for oil-tempered MB with a modulus of 28,500,000 psi.

^b Gauges 31 through 37 are AMW gauges. Gauges 10 through 5 are Washburn and Moen.

Table 14. (Continued) Torsion Spring Deflections

AMW Wire Gauge Decimal Equivalent ^a	24 .055	25 .059	26 .063	27 .067	28 .071	29 .075	30 .080	31 .085	32 .090	33 .095	34 .100	35 .106	36 .112	37 .118	1/8 .125		
Design Stress, kpsi	180	178	176	174	173	171	169	167	166	164	163	161	160	158	156		
Torque, pound-inch	2.941	3.590	4.322	5.139	6.080	7.084	8.497	10.07	11.88	13.81	16.00	18.83	22.07	25.49	29.92		
Inside Diameter, inch	Deflection, degrees per coil																
3/16	0.8125	38.38	35.54	33.06	31.42	29.61	27.83	25.93	24.25	22.90	21.55	20.46	19.19	18.17	17.14	16.09	
7/8	0.875	41.14	38.09	35.42	33.65	31.70	29.79	27.75	25.94	24.58	23.03	21.86	20.49	19.39	18.29	17.17	
5/16	0.9375	43.91	40.64	37.78	35.88	33.80	31.75	29.56	27.63	26.07	24.52	23.26	21.80	20.62	19.44	18.24	
1	1.000	46.67	43.19	40.14	38.11	35.89	33.71	31.38	29.32	27.65	26.00	24.66	23.11	21.85	20.59	19.31	
1 1/16	1.0625	49.44	45.74	42.50	40.35	37.99	35.67	33.20	31.01	29.24	27.48	26.06	24.41	23.08	21.74	20.38	
1 1/8	1.125	52.20	48.28	44.86	42.58	40.08	37.63	35.01	32.70	30.82	28.97	27.46	25.72	24.31	22.89	21.46	
1 3/16	1.1875	54.97	50.83	47.22	44.81	42.18	39.59	36.83	34.39	32.41	30.45	28.86	27.02	25.53	24.04	22.53	
1 1/4	1.250	57.73	53.38	49.58	47.04	44.27	41.55	38.64	36.08	33.99	31.94	30.27	28.33	26.76	25.19	23.60	
Washburn and Moen Gauge or Size and Decimal Equivalent ^a	10 .135	9 .1483	7/32 .1563	8 .162	7 .177	3/16 .1875	6 .192	5 .207	7/32 .2188	4 .2253	3 .2437	1/4 .250	5/32 .2813	3/16 .3125	11/32 .3438	3/8 .375	
Design Stress, kpsi	161	158	156	154	150	149	146	143	142	141	140	139	138	137	136	135	
Torque, pound-inch	38.90	50.60	58.44	64.30	81.68	96.45	101.5	124.6	146.0	158.3	199.0	213.3	301.5	410.6	542.5	700.0	
Inside Diameter, inch	Deflection, degrees per coil																
3/16	0.8125	15.54	14.08	13.30	12.74	11.53	10.93	10.51	9.687	9.208	8.933	8.346	8.125	7.382	6.784	6.292	5.880
7/8	0.875	16.57	15.00	14.16	13.56	12.26	11.61	11.16	10.28	9.766	9.471	8.840	8.603	7.803	7.161	6.632	6.189
5/16	0.9375	17.59	15.91	15.02	14.38	12.99	12.30	11.81	10.87	10.32	10.01	9.333	9.081	8.225	7.537	6.972	6.499
1	1.000	18.62	16.83	15.88	15.19	13.72	12.98	12.47	11.47	10.88	10.55	9.827	9.559	8.647	7.914	7.312	6.808
1 1/16	1.0625	19.64	17.74	16.74	16.01	14.45	13.66	13.12	12.06	11.44	11.09	10.32	10.04	9.069	8.291	7.652	7.118
1 1/8	1.125	20.67	18.66	17.59	16.83	15.18	14.35	13.77	12.66	12.00	11.62	10.81	10.52	9.491	8.668	7.993	7.427
1 3/16	1.1875	21.69	19.57	18.45	17.64	15.90	15.03	14.43	13.25	12.56	12.16	11.31	10.99	9.912	9.045	8.333	7.737
1 1/4	1.250	22.72	20.49	19.31	18.46	16.63	15.71	15.08	13.84	13.11	12.70	11.80	11.47	10.33	9.422	8.673	8.046

^a For sizes up to 26 gauge, the table values are for music wire with a modulus *E* of 29,500,000 psi; for sizes from 27 to 1/8 inch diameter the table values are for music wire with a modulus of 28,500,000 psi; for sizes from 10 gauge to 1/8 inch diameter, the values are for oil-tempered MB with a modulus of 28,500,000 psi.

For an example in the use of the table, see the example starting on page 334. Note: Intermediate values may be interpolated within reasonable accuracy.

Table 15. Correction Factors for Other Materials

Material ^a	Factor	Material ^a	Factor
Hard Drawn MB	0.75	Stainless 316	
Chrome-vanadium	1.10	Up to 1/8 inch diameter	0.75
Chrome-silicon	1.20	Over 1/8 to 1/4 inch diameter	0.65
Stainless 302 and 304		Over 1/4 inch diameter	0.65
Up to 1/8 inch diameter	0.85	Stainless 17-7 PH	
Over 1/8 to 1/4 inch diameter	0.75	Up to 1/8 inch diameter	1.00
Over 1/4 inch diameter	0.65	Over 1/8 to 3/16 inch diameter	1.07
Stainless 431	0.80	Over 3/16 inch diameter	1.12
Stainless 420	0.85

^aFor use with values in Table 14. Note: The figures in Table 14 are for music wire (ASTM A228) and oil-tempered MB grade (ASTM A229) and can be used for several other materials that have a similar modulus of elasticity *E*. However, the design stress may be too high or too low, and therefore the design stress, torque, and deflection per coil should each be multiplied by the appropriate correction factor when using any of the materials given in this table (Table 15).

Torsion Spring Tolerances.—Torsion springs are coiled in a different manner from other types of coiled springs and therefore different tolerances apply. The commercial tolerance on loads is ± 10 per cent and is specified with reference to the angular deflection. For example: 100 pound-inches ± 10 per cent at 45 degrees deflection. One load specified usually suffices. If two loads and two deflections are specified, the manufacturing and testing times are increased. Tolerances smaller than ± 10 per cent require each spring to be individually tested and adjusted, which adds considerably to manufacturing time and cost. Tables 16, 17, and 18 give, respectively, free angle tolerances, tolerances on the number of coils, and coil diameter tolerances.

Table 16. Torsion Spring Tolerances for Angular Relationship of Ends

Number of Coils (<i>N</i>)	Spring Index								
	4	6	8	10	12	14	16	18	20
	Free Angle Tolerance, ± degrees								
1	2	3	3.5	4	4.5	5	5.5	5.5	6
2	4	5	6	7	8	8.5	9	9.5	10
3	5.5	7	8	9.5	10.5	11	12	13	14
4	7	9	10	12	14	15	16	16.5	17
5	8	10	12	14	16	18	20	20.5	21
6	9.5	12	14.5	16	19	20.5	21	22.5	24
8	12	15	18	20.5	23	25	27	28	29
10	14	19	21	24	27	29	31.5	32.5	34
15	20	25	28	31	34	36	38	40	42
20	25	30	34	37	41	44	47	49	51
25	29	35	40	44	48	52	56	60	63
30	32	38	44	50	55	60	65	68	70
50	45	55	63	70	77	84	90	95	100

Table 17. Torsion Spring Tolerance on Number of Coils

Number of Coils	Tolerance	Number of Coils	Tolerance
up to 5	±5°	over 10 to 20	±15°
over 5 to 10	±10°	over 20 to 40	±30°

Table 18. Torsion Spring Coil Diameter Tolerances

Wire Diameter, Inch	Spring Index						
	4	6	8	10	12	14	16
	Coil Diameter Tolerance, ± inch						
0.015	0.002	0.002	0.002	0.002	0.003	0.003	0.004
0.023	0.002	0.002	0.002	0.003	0.004	0.005	0.006
0.035	0.002	0.002	0.003	0.004	0.006	0.007	0.009
0.051	0.002	0.003	0.005	0.007	0.008	0.010	0.012
0.076	0.003	0.005	0.007	0.009	0.012	0.015	0.018
0.114	0.004	0.007	0.010	0.013	0.018	0.022	0.028
0.172	0.006	0.010	0.013	0.020	0.027	0.034	0.042
0.250	0.008	0.014	0.022	0.030	0.040	0.050	0.060

Miscellaneous Springs.—This section provides information on various springs, some in common use, some less commonly used.

Conical compression: These springs taper from top to bottom and are useful where an increasing (instead of a constant) load rate is needed, where solid height must be small, and where vibration must be damped. Conical springs with a uniform pitch are easiest to coil. Load and deflection formulas for compression springs can be used - using the average mean coil diameter, and providing the deflection does not cause the largest active coil to lie against the bottom coil. When this happens, each coil must be calculated separately, using the standard formulas for compression springs.

Constant force springs: Those springs are made from flat spring steel and are finding more applications each year. Complicated design procedures can be eliminated by selecting a standard design from thousands now available from several spring manufacturers.

Spiral, clock, and motor springs: Although often used in wind-up type motors for toys and other products, these springs are difficult to design and results cannot be calculated with precise accuracy. However, many useful designs have been developed and are available from spring manufacturing companies.

Flat springs: These springs are often used to overcome operating space limitations in various products such as electric switches and relays. Table 19 lists formulas for designing flat springs. The formulas are based on standard beam formulas where the deflection is small.

Table 19. Formulas for Flat Springs

Feature				
Deflect., y Inches	$y = \frac{PL^3}{4Ebt^3}$ $= \frac{S_b L^2}{6Et}$	$y = \frac{4PL^3}{Ebt^3}$ $= \frac{2S_b L^2}{3Et}$	$y = \frac{6PL^3}{Ebt^3}$ $= \frac{S_b L^2}{Et}$	$y = \frac{5.22PL^3}{Ebt^3}$ $= \frac{0.87S_b L^2}{Et}$
Load, P Pounds	$P = \frac{2S_b bt^2}{3L}$ $= \frac{4Ebt^3 y}{L^3}$	$P = \frac{S_b bt^2}{6L}$ $= \frac{Ebt^3 y}{4L^3}$	$P = \frac{S_b bt^2}{6L}$ $= \frac{Ebt^3 y}{6L^3}$	$P = \frac{S_b bt^2}{6L}$ $= \frac{Ebt^3 y}{5.22L^3}$

Table 19. (Continued) Formulas for Flat Springs

Feature				
Stress, S_b Bending psi	$S_b = \frac{3PL}{2bt^2}$ $= \frac{6Ety}{L^2}$	$S_b = \frac{6PL}{bt^2}$ $= \frac{3Ety}{2L^2}$	$S_b = \frac{6PL}{bt^2}$ $= \frac{Ety}{L^2}$	$S_b = \frac{6PL}{bt^2}$ $= \frac{Ety}{0.87L^2}$
Thickness, t Inches	$t = \frac{S_b L^2}{6Ey}$ $= \sqrt[3]{\frac{PL^3}{4Eby}}$	$t = \frac{2S_b L^2}{3Ey}$ $= \sqrt[3]{\frac{4PL^3}{Eby}}$	$t = \frac{S_b L^2}{Ey}$ $= \sqrt[3]{\frac{6PL^3}{Eby}}$	$t = \frac{0.87S_b L^2}{Ey}$ $= \sqrt[3]{\frac{5.22PL^3}{Eby}}$

Based on standard beam formulas where the deflection is small.

y is deflection, see page 304 for other notation.

Note: Where two formulas are given for one feature, the designer should use the one found to be appropriate for the given design. The result from either of any two formulas is the same.

Belleville washers or disc springs: These washer type springs can sustain relatively large loads with small deflections, and the loads and deflections can be increased by stacking the springs.

Information on springs of this type is given in the section *DISC SPRINGS* starting on page 350.

Volute springs: These springs are often used on army tanks and heavy field artillery, and seldom find additional uses because of their high cost, long production time, difficulties in manufacture, and unavailability of a wide range of materials and sizes. Small volute springs are often replaced with standard compression springs.

Torsion bars: Although the more simple types are often used on motor cars, the more complicated types with specially forged ends are finding fewer applications as time goes.

Moduli of Elasticity of Spring Materials.—The modulus of elasticity in tension, denoted by the letter E , and the modulus of elasticity in torsion, denoted by the letter G , are used in formulas relating to spring design. Values of these moduli for various ferrous and nonferrous spring materials are given in **Table 20**.

General Heat Treating Information for Springs.—The following is general information on the heat treatment of springs, and is applicable to pre-tempered or hard-drawn spring materials only.

Compression springs are baked after coiling (before setting) to relieve residual stresses and thus permit larger deflections before taking a permanent set.

Extension springs also are baked, but heat removes some of the initial tension. Allowance should be made for this loss. Baking at 500 degrees F for 30 minutes removes approximately 50 per cent of the initial tension. The shrinkage in diameter however, will slightly increase the load and rate.

Outside diameters shrink when springs of music wire, pretempered MB, and other carbon or alloy steels are baked. Baking also slightly increases the free length and these changes produce a little stronger load and increase the rate.

Outside diameters expand when springs of stainless steel (18-8) are baked. The free length is also reduced slightly and these changes result in a little lighter load and a decrease the spring rate.

Inconel, Monel, and nickel alloys do not change much when baked.

Beryllium-copper shrinks and deforms when heated. Such springs usually are baked in fixtures or supported on arbors or rods during heating.

Brass and phosphor bronze springs should be given a light heat only. Baking above 450 degrees F will soften the material. Do not heat in salt pots.

Torsion springs do not require baking because coiling causes residual stresses in a direction that is helpful, but such springs frequently are baked so that jarring or handling will not cause them to lose the position of their ends.

Table 20. Moduli of Elasticity in Torsion and Tension of Spring Materials

Ferrous Materials			Nonferrous Materials		
Material (Commercial Name)	Modulus of Elasticity ^a , psi		Material (Commercial Name)	Modulus of Elasticity ^a , psi	
	In Torsion, <i>G</i>	In Tension, <i>E</i>		In Torsion, <i>G</i>	In Tension, <i>E</i>
Hard Drawn MB			Spring Brass		
Up to 0.032 inch	11,700,000	28,800,000	Type 70-30	5,000,000	15,000,000
0.033 to 0.063 inch	11,600,000	28,700,000	Phosphor Bronze		
0.064 to 0.125 inch	11,500,000	28,600,000	5 per cent tin	6,000,000	15,000,000
0.126 to 0.625 inch	11,400,000	28,500,000	Beryllium-Copper		
Music Wire			Cold Drawn 4 Nos.	7,000,000	17,000,000
Up to 0.032 inch	12,000,000	29,500,000	Pretempered, fully hard	7,250,000	19,000,000
0.033 to 0.063 inch	11,850,000	29,000,000	Inconel ^b 600	10,500,000	31,000,000 ^c
0.064 to 0.125 inch	11,750,000	28,500,000	Inconel ^b X 750	10,500,000	31,000,000 ^c
0.126 to 0.250 inch	11,600,000	28,000,000	Monel ^b 400	9,500,000	26,000,000
Oil-Tempered MB	11,200,000	28,500,000	Monel ^b K 500	9,500,000	26,000,000
Chrome-Vanadium	11,200,000	28,500,000	Duranickel ^b 300	11,000,000	30,000,000
Chrome-Silicon	11,200,000	29,500,000	Permanickel ^b	11,000,000	30,000,000
Silicon-Manganese	10,750,000	29,000,000	Ni Span ^b C 902	10,000,000	27,500,000
Stainless Steel			Elgiloy ^d	12,000,000	29,500,000
Types 302, 304, 316	10,000,000	28,000,000 ^c	Iso-Elastic ^e	9,200,000	26,000,000
Type 17-7 PH	10,500,000	29,500,000			
Type 420	11,000,000	29,000,000			
Type 431	11,400,000	29,500,000			

^a *Note:* Modulus *G* (shear modulus) is used for compression and extension springs; modulus *E* (Young's modulus) is used for torsion, flat, and spiral springs.

^b Trade name of International Nickel Company.

^c May be 2,000,000 pounds per square inch less if material is not fully hard.

^d Trade name of Hamilton Watch Company.

^e Trade name of John Chatillon & Sons.

Spring brass and phosphor bronze springs that are not very highly stressed and are not subject to severe operating use may be stress relieved after coiling by immersing them in boiling water for a period of 1 hour.

Positions of loops will change with heat. Parallel hooks may change as much as 45 degrees during baking. Torsion spring arms will alter position considerably. These changes should be allowed for during looping or forming.

Quick heating after coiling either in a high-temperature salt pot or by passing a spring through a gas flame is not good practice. Samples heated in this way will not conform with production runs that are properly baked. A small, controlled-temperature oven should be used for samples and for small lot orders.

Plated springs should always be baked before plating to relieve coiling stresses and again after plating to relieve hydrogen embrittlement.

Hardness values fall with high heat—but music wire, hard drawn, and stainless steel will increase 2 to 4 points Rockwell C.

Table 21. Squares, Cubes, and Fourth Powers of Wire Diameters

Steel Wire Gage (U.S.)	Music or Piano Wire Gage	Diameter		Section Area	Square	Cube	Fourth Power
		Inch					
7-0	...	0.4900	0.1886	0.24010	0.11765	0.05765	
6-0	...	0.4615	0.1673	0.21298	0.09829	0.04536	
5-0	...	0.4305	0.1456	0.18533	0.07978	0.03435	
4-0	...	0.3938	0.1218	0.15508	0.06107	0.02405	
3-0	...	0.3625	0.1032	0.13141	0.04763	0.01727	
2-0	...	0.331	0.0860	0.10956	0.03626	0.01200	
1-0	...	0.3065	0.0738	0.09394	0.02879	0.008825	
1	...	0.283	0.0629	0.08009	0.02267	0.006414	
2	...	0.2625	0.0541	0.06891	0.01809	0.004748	
3	...	0.2437	0.0466	0.05939	0.01447	0.003527	
4	...	0.2253	0.0399	0.05076	0.01144	0.002577	
5	...	0.207	0.0337	0.04285	0.00887	0.001836	
6	...	0.192	0.0290	0.03686	0.00708	0.001359	
...	45	0.180	0.0254	0.03240	0.00583	0.001050	
7	...	0.177	0.0246	0.03133	0.00555	0.000982	
...	44	0.170	0.0227	0.02890	0.00491	0.000835	
8	43	0.162	0.0206	0.02624	0.00425	0.000689	
...	42	0.154	0.0186	0.02372	0.00365	0.000563	
9	...	0.1483	0.0173	0.02199	0.00326	0.000484	
...	41	0.146	0.0167	0.02132	0.00311	0.000455	
...	40	0.138	0.0150	0.01904	0.00263	0.000363	
10	...	0.135	0.0143	0.01822	0.00246	0.000332	
...	39	0.130	0.0133	0.01690	0.00220	0.000286	
...	38	0.124	0.0121	0.01538	0.00191	0.000237	
11	...	0.1205	0.0114	0.01452	0.00175	0.000211	
...	37	0.118	0.0109	0.01392	0.00164	0.000194	
...	36	0.112	0.0099	0.01254	0.00140	0.000157	
...	35	0.106	0.0088	0.01124	0.00119	0.000126	
12	...	0.1055	0.0087	0.01113	0.001174	0.0001239	
...	34	0.100	0.0078	0.0100	0.001000	0.0001000	
...	33	0.095	0.0071	0.00902	0.000857	0.0000815	
13	...	0.0915	0.0066	0.00837	0.000766	0.0000701	
...	32	0.090	0.0064	0.00810	0.000729	0.0000656	
...	31	0.085	0.0057	0.00722	0.000614	0.0000522	
14	...	0.080	0.0050	0.0064	0.000512	0.0000410	
...	29	0.075	0.0044	0.00562	0.000422	0.0000316	
15	...	0.072	0.0041	0.00518	0.000373	0.0000269	
...	28	0.071	0.0040	0.00504	0.000358	0.0000254	
...	27	0.067	0.0035	0.00449	0.000301	0.0000202	
...	26	0.063	0.0031	0.00397	0.000250	0.0000158	
16	...	0.0625	0.0031	0.00391	0.000244	0.0000153	
...	25	0.059	0.0027	0.00348	0.000205	0.0000121	
...	24	0.055	0.0024	0.00302	0.000166	0.00000915	
17	...	0.054	0.0023	0.00292	0.000157	0.00000850	
...	23	0.051	0.0020	0.00260	0.000133	0.00000677	
...	22	0.049	0.00189	0.00240	0.000118	0.00000576	
18	...	0.0475	0.00177	0.00226	0.000107	0.00000509	
...	21	0.047	0.00173	0.00221	0.000104	0.00000488	
...	20	0.045	0.00159	0.00202	0.000091	0.00000410	
...	19	0.043	0.00145	0.00185	0.0000795	0.00000342	
19	18	0.041	0.00132	0.00168	0.0000689	0.00000283	
...	17	0.039	0.00119	0.00152	0.0000593	0.00000231	
...	16	0.037	0.00108	0.00137	0.0000507	0.00000187	
...	15	0.035	0.00096	0.00122	0.0000429	0.00000150	
20	...	0.0348	0.00095	0.00121	0.0000421	0.00000147	
...	14	0.033	0.00086	0.00109	0.0000359	0.00000119	
21	...	0.0317	0.00079	0.00100	0.0000319	0.00000101	
...	13	0.031	0.00075	0.00096	0.0000298	0.000000924	
...	12	0.029	0.00066	0.00084	0.0000244	0.000000707	
22	...	0.0286	0.00064	0.00082	0.0000234	0.000000669	
...	11	0.026	0.00053	0.00068	0.0000176	0.000000457	
23	...	0.0258	0.00052	0.00067	0.0000172	0.000000443	
...	10	0.024	0.00045	0.00058	0.0000138	0.000000332	
24	...	0.023	0.00042	0.00053	0.0000122	0.000000280	
...	9	0.022	0.00038	0.00048	0.0000106	0.000000234	

Spring Failure.—Spring failure may be breakage, high permanent set, or loss of load. The causes are listed in groups in Table 22. Group 1 covers causes that occur most frequently; Group 2 covers causes that are less frequent; and Group 3 lists causes that occur occasionally.

Table 22. Causes of Spring Failure

	Cause	Comments and Recommendations
Group 1	High stress	The majority of spring failures are due to high stresses caused by large deflections and high loads. High stresses should be used only for statically loaded springs. Low stresses lengthen fatigue life.
	Hydrogen embrittlement	Improper electroplating methods and acid cleaning of springs, without proper baking treatment, cause spring steels to become brittle, and are a frequent cause of failure. Nonferrous springs are immune.
	Sharp bends and holes	Sharp bends on extension, torsion, and flat springs, and holes or notches in flat springs, cause high concentrations of stress, resulting in failure. Bend radii should be as large as possible, and tool marks avoided.
	Fatigue	Repeated deflections of springs, especially above 1,000,000 cycles, even with medium stresses, may cause failure. Low stresses should be used if a spring is to be subjected to a very high number of operating cycles.
Group 2	Shock loading	Impact, shock, and rapid loading cause far higher stresses than those computed by the regular spring formulas. High-carbon spring steels do not withstand shock loading as well as do alloy steels.
	Corrosion	Slight rusting or pitting caused by acids, alkalis, galvanic corrosion, stress corrosion cracking, or corrosive atmosphere weakens the material and causes higher stresses in the corroded area.
	Faulty heat treatment	Keeping spring materials at the hardening temperature for longer periods than necessary causes an undesirable growth in grain structure, resulting in brittleness, even though the hardness may be correct.
	Faulty material	Poor material containing inclusions, seams, slivers, and flat material with rough, slit, or torn edges is a cause of early failure. Overdrawn wire, improper hardness, and poor grain structure also cause early failure.
Group 3	High temperature	High operating temperatures reduce spring temper (or hardness) and lower the modulus of elasticity, thereby causing lower loads, reducing the elastic limit, and increasing corrosion. Corrosion-resisting or nickel alloys should be used.
	Low temperature	Temperatures below -40 degrees F reduce the ability of carbon steels to withstand shock loads. Carbon steels become brittle at -70 degrees F. Corrosion-resisting, nickel, or nonferrous alloys should be used.
	Friction	Close fits on rods or in holes result in a wearing away of material and occasional failure. The outside diameters of compression springs expand during deflection but they become smaller on torsion springs.
	Other causes	Enlarged hooks on extension springs increase the stress at the bends. Carrying too much electrical current will cause failure. Welding and soldering frequently destroy the spring temper. Tool marks, nicks, and cuts often raise stresses. Deflecting torsion springs outwardly causes high stresses and winding them tightly causes binding on supporting rods. High speed of deflection, vibration, and surging due to operation near natural periods of vibration or their harmonics cause increased stresses.

Table 23. Arbor Diameters for Springs Made from Music Wire

Wire Dia. (inch)	Spring Outside Diameter (inch)												
	$\frac{1}{16}$	$\frac{3}{32}$	$\frac{1}{8}$	$\frac{5}{32}$	$\frac{3}{16}$	$\frac{7}{32}$	$\frac{1}{4}$	$\frac{9}{32}$	$\frac{5}{16}$	$\frac{11}{32}$	$\frac{3}{8}$	$\frac{7}{16}$	$\frac{1}{2}$
	Arbor Diameter (inch)												
0.008	0.039	0.060	0.078	0.093	0.107	0.119	0.129
0.010	0.037	0.060	0.080	0.099	0.115	0.129	0.142	0.154	0.164
0.012	0.034	0.059	0.081	0.101	0.119	0.135	0.150	0.163	0.177	0.189	0.200
0.014	0.031	0.057	0.081	0.102	0.121	0.140	0.156	0.172	0.187	0.200	0.213	0.234	...
0.016	0.028	0.055	0.079	0.102	0.123	0.142	0.161	0.178	0.194	0.209	0.224	0.250	0.271
0.018	...	0.053	0.077	0.101	0.124	0.144	0.161	0.182	0.200	0.215	0.231	0.259	0.284
0.020	...	0.049	0.075	0.096	0.123	0.144	0.165	0.184	0.203	0.220	0.237	0.268	0.296
0.022	...	0.046	0.072	0.097	0.122	0.145	0.165	0.186	0.206	0.224	0.242	0.275	0.305
0.024	...	0.043	0.070	0.095	0.120	0.144	0.166	0.187	0.207	0.226	0.245	0.280	0.312
0.026	0.067	0.093	0.118	0.143	0.166	0.187	0.208	0.228	0.248	0.285	0.318
0.028	0.064	0.091	0.115	0.141	0.165	0.187	0.208	0.229	0.250	0.288	0.323
0.030	0.061	0.088	0.113	0.138	0.163	0.187	0.209	0.229	0.251	0.291	0.328
0.032	0.057	0.085	0.111	0.136	0.161	0.185	0.209	0.229	0.251	0.292	0.331
0.034	0.082	0.109	0.134	0.159	0.184	0.208	0.229	0.251	0.292	0.333
0.036	0.078	0.106	0.131	0.156	0.182	0.206	0.229	0.250	0.294	0.333
0.038	0.075	0.103	0.129	0.154	0.179	0.205	0.227	0.251	0.293	0.335
0.041	0.098	0.125	0.151	0.176	0.201	0.226	0.250	0.294	0.336
0.0475	0.087	0.115	0.142	0.168	0.194	0.220	0.244	0.293	0.337
0.054	0.103	0.132	0.160	0.187	0.212	0.245	0.287	0.336
0.0625	0.108	0.146	0.169	0.201	0.228	0.280	0.330
0.072	0.129	0.158	0.186	0.214	0.268	0.319
0.080	0.144	0.173	0.201	0.256	0.308
0.0915	0.181	0.238	0.293
0.1055	0.215	0.271
0.1205	0.215
0.125	0.239

Wire Dia. (inch)	Spring Outside Diameter (inches)													
	$\frac{9}{16}$	$\frac{5}{8}$	$1\frac{1}{16}$	$\frac{3}{4}$	$1\frac{1}{16}$	$\frac{7}{8}$	$1\frac{5}{16}$	1	$1\frac{1}{8}$	$1\frac{1}{4}$	$1\frac{3}{8}$	$1\frac{1}{2}$	$1\frac{3}{4}$	2
	Arbor Diameter (inches)													
0.022	0.332	0.357	0.380
0.024	0.341	0.367	0.393	0.415
0.026	0.350	0.380	0.406	0.430
0.028	0.356	0.387	0.416	0.442	0.467
0.030	0.362	0.395	0.426	0.453	0.481	0.506
0.032	0.367	0.400	0.432	0.462	0.490	0.516	0.540
0.034	0.370	0.404	0.437	0.469	0.498	0.526	0.552	0.557
0.036	0.372	0.407	0.442	0.474	0.506	0.536	0.562	0.589
0.038	0.375	0.412	0.448	0.481	0.512	0.543	0.572	0.600	0.650
0.041	0.378	0.416	0.456	0.489	0.522	0.554	0.586	0.615	0.670	0.718
0.0475	0.380	0.422	0.464	0.504	0.541	0.576	0.610	0.643	0.706	0.763	0.812
0.054	0.381	0.425	0.467	0.509	0.550	0.589	0.625	0.661	0.727	0.792	0.850	0.906
0.0625	0.379	0.426	0.468	0.512	0.556	0.597	0.639	0.678	0.753	0.822	0.889	0.951	1.06	1.17
0.072	0.370	0.418	0.466	0.512	0.555	0.599	0.641	0.682	0.765	0.840	0.911	0.980	1.11	1.22
0.080	0.360	0.411	0.461	0.509	0.554	0.599	0.641	0.685	0.772	0.851	0.930	1.00	1.13	1.26
0.0915	0.347	0.398	0.448	0.500	0.547	0.597	0.640	0.685	0.776	0.860	0.942	1.02	1.16	1.30
0.1055	0.327	0.381	0.433	0.485	0.535	0.586	0.630	0.683	0.775	0.865	0.952	1.04	1.20	1.35
0.1205	0.303	0.358	0.414	0.468	0.520	0.571	0.622	0.673	0.772	0.864	0.955	1.04	1.22	1.38
0.125	0.295	0.351	0.406	0.461	0.515	0.567	0.617	0.671	0.770	0.864	0.955	1.05	1.23	1.39

DISC SPRINGS

Performance of Disc Springs

Introduction.—Disc springs, also known as Belleville springs, are conically formed from washers and have rectangular cross section. The disc spring concept was invented by a Frenchman Louis Belleville in 1865. His springs were relatively thick and had a small amount of cone height or “dish”, which determined axial deflection. At that time, these springs were used in the buffer parts of railway rolling stock, for recoil mechanisms of guns, and some other applications. The use of disc springs will be advantageous when space is limited and high force is required, as these conditions cannot be satisfied by using coil springs. Load-deflection characteristics of disc springs are linear and regressive depending on their dimensions and the type of stacking. A large number of standard sizes are available from disc spring manufacturers and distributors, so that custom sizes may not be required. Therefore, disc springs are widely used today in virtually all branches of engineering with possibilities of new applications.

Disc Spring Nomenclature.—Disc spring manufacturers assign their own part number for each disc spring, but the catalog numbers for disc springs are similar, so each item can often be identified regardless of the manufacturer. The disc spring identification number is a numerical code that provides basic dimensions in millimeters. Identification numbers representing the primary dimensions of the disc spring and consist of one, two, or three numbers separated from each other by dash marks or spaces. Disc spring manufacturers in the United States also provide dimensions in inches. Dimensions of several typical disc springs are shown in the following table. Basic nomenclature is illustrated in Fig. 1.

Catalog Number (mm)	Outside Diameter D (mm)	Inside Diameter d (mm)	Thickness t (mm)	Equivalent Catalog Number (inch)
8-4.2-0.4	8	4.2	0.4	0.315-0.165-0.0157
50-25.4-2	50	25.4	2	1.97-1.00-0.0787
200-102-12	200	102	12	7.87-4.02-0.472

Additional dimensions shown in catalogs are cone (dish) height h at unloaded condition, and overall height $H = h + t$, that combines the cone height and the thickness of a disc spring.

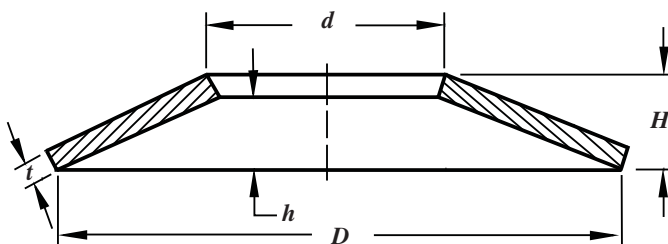


Fig. 1. Disc Spring Nomenclature

Disc Spring Group Classification.—Forces and stresses generated by compression depend on disc spring thickness much more than on any other dimensions. Standard DIN 2093 divides all disc springs into three groups in accordance with their thickness:

Group 1 includes all disc springs with thickness less than 1.25 mm (0.0492 inch).

Group 2 includes all disc springs with thickness between 1.25 mm and 6.0 mm (0.0492 inch and 0.2362 inch).

Group 3 includes disc springs with thickness greater than 6.0 mm (0.2362 inch).

There are 87 standard disc spring items, which are manufactured in accordance with Standard DIN 2093 specifications for dimensions and quality requirements. There are 30 standard disc spring items in *Group 1*. The smallest and the largest disc springs in this group are 8-4.2-0.2 and 40-20.4-1 respectively. *Group 2* has 45 standard disc spring items.

The smallest and the largest disc springs are 22.5-11.2-1.25 and 200-102-5.5 respectfully. *Group 3* includes 12 standard disc spring items. The smallest and the largest disc springs of this group are 125-64-8 and 250-127-14 respectively.

Summary of Disc Spring Sizes Specified in DIN 2093

Classification	OD		ID		Thickness	
	Min.	Max	Min.	Max	Min.	Max
<i>Group 1</i>	6 mm (0.236 in)	40 mm (1.575 in)	3.2 mm (0.126 in)	20.4 mm (0.803 in)	0.2 mm (0.008 in)	1.2 mm (0.047 in)
<i>Group 2</i>	20 mm (0.787 in)	225 mm (8.858 in)	10.2 mm (0.402 in)	112 mm (4.409 in)	1.25 mm (0.049 in)	6 mm (0.236 in)
<i>Group 3</i>	125 mm (4.921 in)	250 mm (9.843 in)	61 mm (2.402 in)	127 mm (5.000 in)	6.5 mm (0.256 in)	16 mm (0.630 in)

The number of catalog items by disc spring dimensions depends on the manufacturer. Currently, the smallest disc spring is 6-3.2-0.3 and the largest is 250-127-16. One of the U.S. disc spring manufacturers, Key Bellevilles, Inc. offers 190 catalog items. The greatest number of disc spring items can be found in Christian Bauer GmbH + Co. catalog. There are 291 disc spring catalog items in all three groups.

Disc Spring Contact Surfaces.—Disc springs are manufactured with and without contact (also called load-bearing) surfaces. Contact surfaces are small flats at points 1 and 3 in Fig. 2, adjacent to the corner radii of the spring. The width of the contact surfaces w depends on the outside diameter D of the spring, and its value is approximately $w = D/150$.

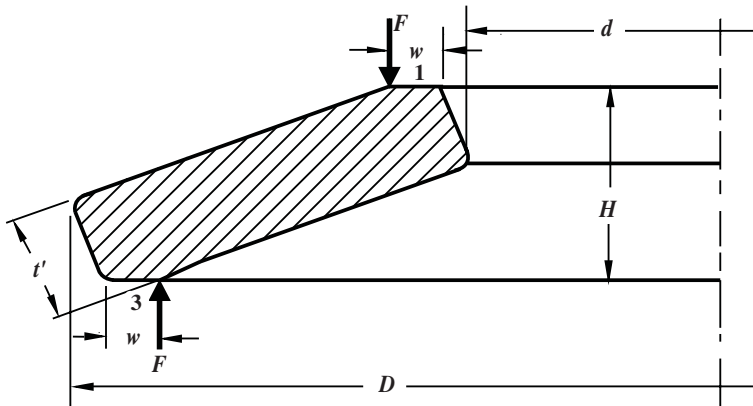


Fig. 2. Disc Spring with Contact Surfaces

Disc springs of *Group 1* and *Group 2*, that are contained in the DIN 2093 Standard, do not have contact surfaces, although some *Group 2* disc springs not included in DIN 2093 are manufactured with contact surfaces. All disc springs of *Group 3* (standard and nonstandard) are manufactured with contact surfaces. Almost all disc springs with contact surfaces are manufactured with reduced thickness.

Disc springs without contact surfaces have a corner radii r whose value depends on the spring thickness, t . One disc spring manufacturer recommends the following relationship:

$$r = t/6$$

Disc Spring Materials.—A wide variety of materials are available for disc springs, but selection of the material depends mainly on application. High-carbon steels are used only for *Group 1* disc springs. AISI 1070 and AISI 1095 carbon steels are used in the U.S. Similar high-carbon steels such as DIN 1.1231 and DIN 1.1238 (Germany), and BS 060 A67 and BS 060 A78 (Great Britain) are used in other countries. The most common materials for *Groups 2* and *3* springs operating under normal conditions are chromium-vanadium alloy steels such as AISI 6150 used in the U.S. Similar alloys such as DIN 1.8159 and DIN 1.7701 (Germany) and BS 735 A50 (Great Britain) are used in foreign countries. Some

disc spring manufacturers in the U.S. also use chromium alloy steel AISI 5160. The hardness of disc springs in *Groups 2* and *3* should be 42 to 52 HRC. The hardness of disc springs in *Group 1* tested by the Vickers method should be 412 to 544 HV.

If disc springs must withstand corrosion and high temperatures, stainless steels and heat-resistant alloys are used. Most commonly used stainless steels in the United States are AISI types 301, 316, and 631, which are similar to foreign material numbers DIN 1.4310, DIN 1.4401, and DIN 1.4568, respectively. The operating temperature range for 631 stainless steel is -330 to 660°F (-200 to 350°C). Among heat-resistant alloys, Inconel 718 and Inconel X750 (similar to DIN 2.4668 and DIN 2.4669, respectively) are the most popular. Operating temperature range for Inconel 718 is -440 to 1290°F (-260 to 700°C).

When disc springs are stacked in large numbers and their total weight becomes a major concern, titanium α - β alloys can be used to reduce weight. In such cases, Ti-6Al-4V alloy is used.

If nonmagnetic and corrosion resistant properties are required and material strength is not an issue, phosphor bronzes and beryllium-coppers are the most popular copper alloys for disc springs. Phosphor bronze C52100, which is similar to DIN material number 2.1030, is used at the ordinary temperature range. Beryllium-coppers C17000 and C17200, similar to material numbers DIN 2.1245 and DIN 2.1247 respectively, works well at very low temperatures.

Strength properties of disc spring materials are characterized by moduli of elasticity and Poisson's ratios. These are summarized in [Table 1](#).

Table 1. Strength Characteristics of Disc Spring Materials

Material	Modulus of Elasticity		Poisson's Ratio
	10^6 psi	N/mm ²	
All Steels	28-31	193,000-213,700	0.30
Heat-resistant Alloys			0.28-0.29
α - β Titanium Alloys (Ti-6Al-4V)	17	117,200	0.32
Phosphor Bronze (C52100)	16	110,300	0.35
Beryllium-copper (C17000)	17	117,200	0.30
Beryllium-copper (C17200)	18	124,100	0.30

Stacking of Disc Springs.—Individual disc springs can be arranged in series and parallel stacks. Disc springs in series stacking, [Fig. 3](#), provide larger deflection S_{total} under the same load F as a single disc spring would generate. Disc springs in parallel stacking, [Fig. 4](#), generate higher loads F_{total} with the same deflection s , that a single disc spring would have.

n = number of disc springs in stack

s = deflection of single spring

S_{total} = total deflection of stack of n springs

F = load generated by a single spring

F_{total} = total load generated by springs in stack

L_0 = length of unloaded spring stack

Series: For n disc springs arranged in series, [Fig. 3](#), the following equations are applied:

$$F_{total} = F$$

$$S_{total} = s \times n$$

$$L_0 = H \times n = (t + h) \times n \quad (1)$$

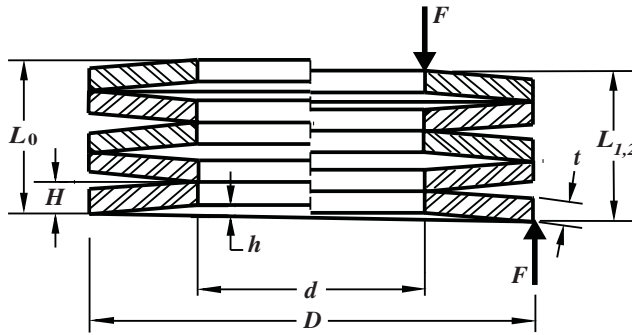


Fig. 3. Disc Springs in Series Stacking
 $L_{1,2}$ indices indicate length of spring stack under minimum and maximum load

Parallel: Parallel stacking generates a force that is directly proportional to number of springs arranged in parallel. Two springs in parallel will double the force, three springs in parallel will triple the force, and so on. However, it is a common practice to use two springs in parallel in order to keep the frictional forces between the springs as low as possible. Otherwise, the actual spring force cannot be accurately determined due to deviation from its theoretical value.

For n disc springs arranged in parallel as in Fig. 4, the following equations are applied:

$$F_{total} = F \times n$$

$$S_{total} = s$$

$$L_0 = H + t(n - 1) = (h + t) + tn - t = h + tn \tag{2}$$

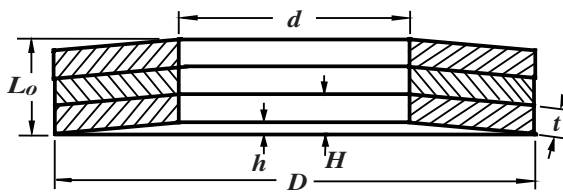


Fig. 4. Disc Springs in Parallel Stacking

Parallel-Series: When both higher force and greater deflection are required, disc springs must be arranged in a combined parallel-series stacking as illustrated in Fig. 5.

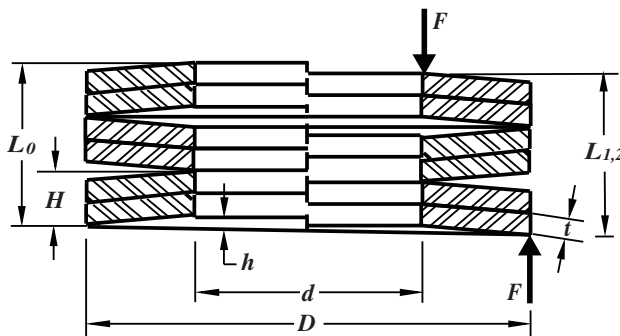


Fig. 5. Disc Springs in Parallel-Series Stacking

Normally, two springs in parallel are nested in series stacking. Two springs in parallel, called a pair, double the force, and the number of pairs, n_p , determines the total deflection, S_{total} .

For n_p disc spring pairs arranged in series, the following equations are applied:

$$\begin{aligned} F_{total} &= 2 \times F \\ S_{total} &= s \times n_p \\ L_0 &= H \times n_p = (2t + h) \times n_p \end{aligned} \quad (3)$$

Disc Spring Forces and Stresses

Several methods of calculating forces and stresses for given disc spring configurations exist, some very complicated, others of limited accuracy. The theory which is widely used today for force and stress calculations was developed more than 65 years ago by Almen and Laszlo.

The theory is based on the following assumptions: cross sections are rectangular without radii, over the entire range of spring deflection; no stresses occur in the radial direction; disc springs are always under elastic deformation during deflection; and due to small cone angles of unloaded disc springs (between 3.5° and 8.6°), mathematical simplifications are applied.

The theory provides accurate results for disc springs with the following ratios: outside-to-inside diameter, $D/d = 1.3$ to 2.5 ; and cone height-to-thickness, h/t is up to 1.5 .

Force Generated by Disc Springs Without Contact Surfaces.—Disc springs in *Group 1* and most of disc springs in *Group 2* are manufactured without contact (load-bearing) surfaces, but have corner radii.

A single disc spring force applied to points 1 and 3 in Fig. 6 can be found from Equation (4) in which corner radii are not considered:

$$F = \frac{4 \cdot E \cdot s}{(1 - \mu^2) \cdot K_1 \cdot D^2} \left[\left(h - \frac{s}{2} \right) \cdot (h - s) \cdot t + t^3 \right] \quad (4)$$

where F = disc spring force; E = modulus of elasticity of spring material; μ = Poisson's ratio of spring material; K_1 = constant depending on outside-to-inside diameter ratio; D = disc spring nominal outside diameter; h = cone (dish) height; s = disc spring deflection; and, t = disc spring thickness.

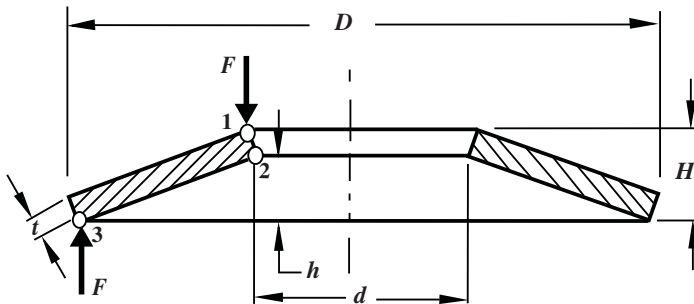


Fig. 6. Schematic of Applied Forces

It has been found that the theoretical forces calculated using Equation (4) are lower than the actual (measured) spring forces, as illustrated in Fig. 7. The difference between theoretical (trace 1) and measured force values (trace 3) was significantly reduced (trace 2) when the actual outside diameter of the spring in loaded condition was used in the calculations.

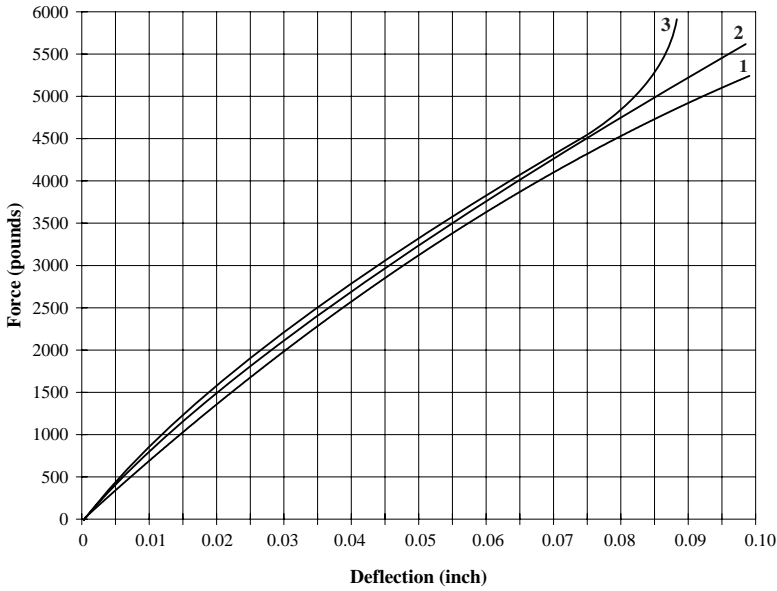


Fig. 7. Force-Deflection Relationships (80-36-3.6 Disc Springs)
 1 - Theoretical Force Calculated by Equation (4)
 2 - Theoretical Force Calculated by Equation (10)
 3 - Measured Force

The actual outside diameter D_a of a disc spring contact circle is smaller than the nominal outside diameter D due to cone angle α and corner radius r , as shown in Fig. 8. Diameter D_a cannot be measured, but can be calculated by Equation (9) developed by the author.

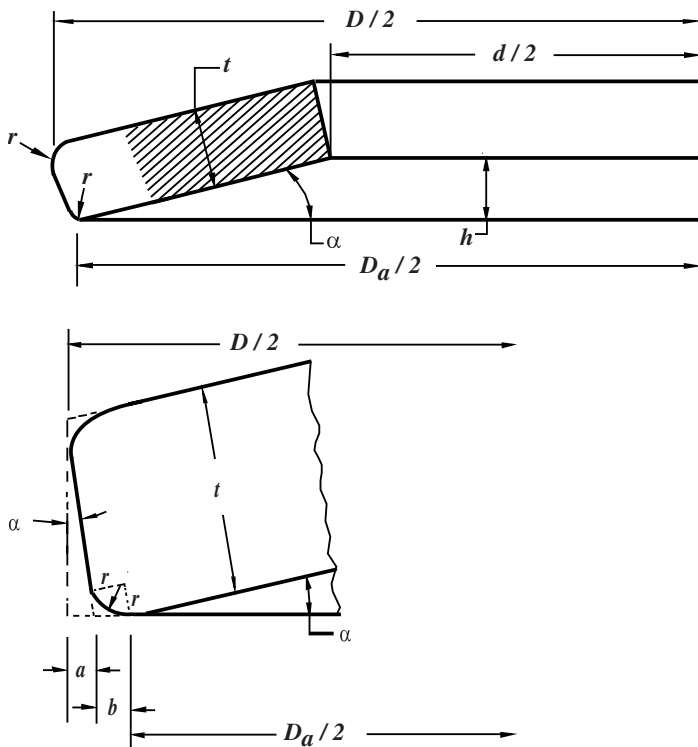


Fig. 8. Conventional Shape of Disc Spring

From Fig. 8,

$$\frac{D_a}{2} = \frac{D}{2} - (a + b) \quad (5)$$

where $a = t \times \sin \alpha$ and $b = r \times \cos \alpha$. Substitution of a and b values into Equation (5) gives:

$$\frac{D_a}{2} = \frac{D}{2} - (t \sin \alpha + r \cos \alpha) \quad (6)$$

The cone angle α is found from:

$$\tan \alpha = \frac{h}{\frac{D}{2} - \frac{d}{2}} = \frac{2h}{D-d} \quad \alpha = \text{atan}\left(\frac{2h}{D-d}\right) \quad (7)$$

Substituting α from Equation (7) and $r = t/6$ into Equation (6) gives:

$$\frac{D_a}{2} = \frac{D}{2} - t \left\{ \sin \left[\text{atan}\left(\frac{2h}{D-d}\right) \right] + \frac{1}{6} \cos \left[\text{atan}\left(\frac{2h}{D-d}\right) \right] \right\} \quad (8)$$

Finally,

$$D_a = D - 2t \left\{ \sin \left[\text{atan}\left(\frac{2h}{D-d}\right) \right] + \frac{1}{6} \cos \left[\text{atan}\left(\frac{2h}{D-d}\right) \right] \right\} \quad (9)$$

Substituting D_a from Equation (9) for D in Equation (4) yields Equation (10), that provides better accuracy for calculating disc spring forces.

$$F = \frac{4 \cdot E \cdot s}{(1 - \mu^2) \cdot K_1 \cdot D_a^2} \left[\left(h - \frac{s}{2} \right) \cdot (h - s) \cdot t + t^3 \right] \quad (10)$$

The constant K_1 depends on disc spring outside diameter D , inside diameter d , and their ratio $\delta = D/d$:

$$K_1 = \frac{\left(\frac{\delta - 1}{\delta} \right)^2}{\pi \cdot \left(\frac{\delta + 1}{\delta - 1} - \frac{2}{\ln \delta} \right)} \quad (11)$$

Table 2 compares the spring force of a series of disc springs deflected by 75% of their cone height, i.e., $s = 0.75h$, as determined from manufacturers catalogs calculated in accordance with Equation (4), calculated forces by use of Equation (10), and measured forces.

Table 2. Comparison Between Calculated and Measured Disc Spring Forces

Disc Spring Catalog Item	Schnorr Handbook for Disc Springs	Christian Bauer Disc Spring Handbook	Key Bellevilles Disc Spring Catalog	Spring Force Calculated by Equation (10)	Measured Disc Spring Force
50 - 22.4 - 2.5 $S = 1.05$ mm	8510 N 1913 lbf	8510 N 1913 lbf	8616 N 1937 lbf	9020 N 2028 lbf	9563 N 2150 lbf
60 - 30.5 - 2.5 $S = 1.35$ mm	8340 N 1875 lbf	8342 N 1875 lbf	8465 N 1903 lbf	8794 N 1977 lbf	8896 N 2000 lbf
60 - 30.5 - 3 $S = 1.275$ mm	13200 N 2967 lbf	13270 N 2983 lbf	13416 N 3016 lbf	14052 N 3159 lbf	13985 N 3144 lbf
70 - 35.5 - 3 $S = 1.575$ mm	12300 N 2765 lbf	12320 N 2770 lbf	12397 N 2787 lbf	12971 N 2916 lbf	13287 N 2987 lbf
70 - 35.5 - 3.5 $S = 1.35$ mm		16180 N 3637 lbf		17170 N 3860 lbf	17304 N 3890 lbf

Comparison made at 75% deflection, in Newtons (N) and pounds (lbf)

The difference between disc spring forces calculated by Equation (10) and the measured forces varies from -5.7% (maximum) to +0.5% (minimum). Disc spring forces calculated by Equation (4) and shown in manufacturers catalogs are less than measured forces by -11% (maximum) to -6% (minimum).

Force Generated by Disc Spring with Contact Surfaces.—Some of disc springs in Group 2 and all disc springs in Group 3 are manufactured with small contact (load-bearing) surfaces or flats in addition to the corner radii. These flats provide better contact between disc springs, but, at the same time, they reduce the springs outside diameter and generate higher spring force because in Equation (4) force F is inversely proportional to the square of outside diameter D^2 . To compensate for the undesired force increase, the disc spring thickness is reduced from t to t' . Thickness reduction factors t'/t are approximately 0.94 for disc spring series A and B, and approximately 0.96 for series C springs. With such reduction factors, the disc spring force at 75% deflection is the same as for equivalent disc spring without contact surfaces. Equation (12), which is similar to Equation (10), has an additional constant K_4 that correlates the increase in spring force due to contact surfaces. If disc springs do not have contact surfaces, then $K_4^2 = K_4 = 1$.

$$F = \frac{4 \cdot E \cdot K_4^2 \cdot s}{(1 - \mu^2) \cdot K_1 \cdot D_a^2} \left[K_4^2 \cdot \left(h' - \frac{s}{2} \right) \cdot (h' - s) \cdot t' + (t')^3 \right] \tag{12}$$

where t' = reduced thickness of a disc spring

h' = cone height adjusted to reduced thickness: $h' = H - t'$ ($h' > h$)

K_4 = constant applied to disc springs with contact surfaces.

K_4^2 can be calculated as follows:

$$K_4^2 = \frac{-b + \sqrt{b^2 - 4ac}}{2a} \tag{13}$$

where $a = t'(H - 4t' + 3t)(5H - 8t' + 3t)$; $b = 32(t')^3$; and, $c = -t[5(H - t)^2 + 32t^2]$.

Disc Spring Functional Stresses.—Disc springs are designed for both static and dynamic load applications. In static load applications, disc springs may be under constant or fluctuating load conditions that change up to 5,000 or 10,000 cycles over long time intervals. Dynamic loads occur when disc springs are under continuously changing deflection between pre-load (approximately 15% to 20% of the cone height) and the maximum deflection values over short time intervals. Both static and dynamic loads cause compressive and tensile stresses. The position of critical stress points on a disc spring cross section are shown in Fig. 9.

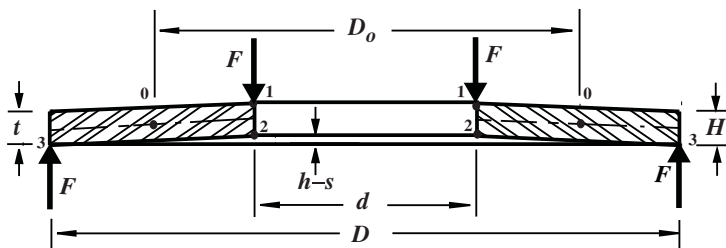


Fig. 9. Critical Stress Points

s is deflection of spring by force F ; $h - s$ is a cone height of loaded disc spring

Compressive stresses are acting at points 0 and 1, that are located on the top surface of the disc spring. Point 0 is located on the cross-sectional mid-point diameter, and point 1 is located on the top inside diameter. Tensile stresses are acting at points 2 and 3, which are located on the bottom surface of the disc spring. Point 2 is on the bottom inside diameter, and point 3 is on the bottom outside diameter. The following equations are used to calcu-

late stresses. The minus sign “-” indicates that compressive stresses are acting in a direction opposite to the tensile stresses.

$$\text{Point 0: } \sigma_0 = -\frac{3}{\pi} \cdot \frac{4E \cdot t \cdot s \cdot K_4}{(1 - \mu^2) \cdot K_1 \cdot D_a^2} \quad (14)$$

$$\text{Point 1: } \sigma_1 = -\frac{4E \cdot K_4 \cdot s \cdot \left[K_4 \cdot K_2 \cdot \left(h - \frac{s}{2} \right) + K_3 \cdot t \right]}{(1 - \mu^2) \cdot K_1 \cdot D_a^2} \quad (15)$$

$$\text{Point 2: } \sigma_2 = \frac{4E \cdot K_4 \cdot s \cdot \left[K_3 \cdot t - K_2 \cdot K_4 \cdot \left(h - \frac{s}{2} \right) \right]}{(1 - \mu^2) \cdot K_1 \cdot D_a^2} \quad (16)$$

$$\text{Point 3: } \sigma_3 = \frac{4E \cdot K_4 \cdot s \cdot \left[K_4 \cdot (2K_3 - K_2) \cdot \left(h - \frac{s}{2} \right) + K_3 \cdot t \right]}{(1 - \mu^2) \cdot K_1 \cdot D_a^2 \cdot \delta} \quad (17)$$

K_2 and K_3 are disc spring dimensional constants, defined as follows:

$$K_2 = \frac{6 \left(\frac{\delta - 1}{\ln \delta} - 1 \right)}{\pi \cdot \ln \delta} \quad (18) \quad K_3 = \frac{3 \cdot (\delta - 1)}{\pi \cdot \ln \delta} \quad (19)$$

where $\delta = D/d$ is the outside-to-inside diameter ratio.

In static application, if disc springs are fully flattened (100% deflection), compressive stress at point 0 should not exceed the tensile strength of disc spring materials. For most spring steels, the permissible value is $\sigma_0 \leq 1600 \text{ N/mm}^2$ or 232,000 psi.

In dynamic applications, certain limitations on tensile stress values are recommended to obtain controlled fatigue life of disc springs utilized in various stacking. Maximum tensile stresses at points 2 and 3 depend on the *Group* number of the disc springs. Stresses σ_2 and σ_3 should not exceed the following values:

	Group 1	Group 2	Group 3
Maximum allowable tensile stresses at points 2 and 3	1300 N/mm ² (188,000 psi)	1250 N/mm ² (181,000 psi)	1200 N/mm ² (174,000 psi)

Fatigue Life of Disc Springs.—Fatigue life is measured in terms of the maximum number of cycles that dynamically loaded disc springs can sustain prior to failure. Dynamically loaded disc springs are divided into two groups: disc springs with unlimited fatigue life, which exceeds 2×10^6 cycles without failure, and disc springs with limited fatigue life between 10^4 cycles and less than 2×10^6 cycles.

Typically, fatigue life is estimated from three diagrams, each representing one of the three Groups of disc springs (Figs. 10, 11, and 12). Fatigue life is found at the intersection of the vertical line representing minimum tensile stress σ_{\min} with the horizontal line, which represents maximum tensile stress σ_{\max} . The point of intersection of these two lines defines fatigue life expressed in number of cycles N that can be sustained prior to failure.

Example: For *Group 2* springs in Fig. 11, the intersection point of the $\sigma_{\min} = 500 \text{ N/mm}^2$ line with the $\sigma_{\max} = 1200 \text{ N/mm}^2$ line, is located on the $N = 10^5$ cycles line. The estimated fatigue life is 10^5 cycles.

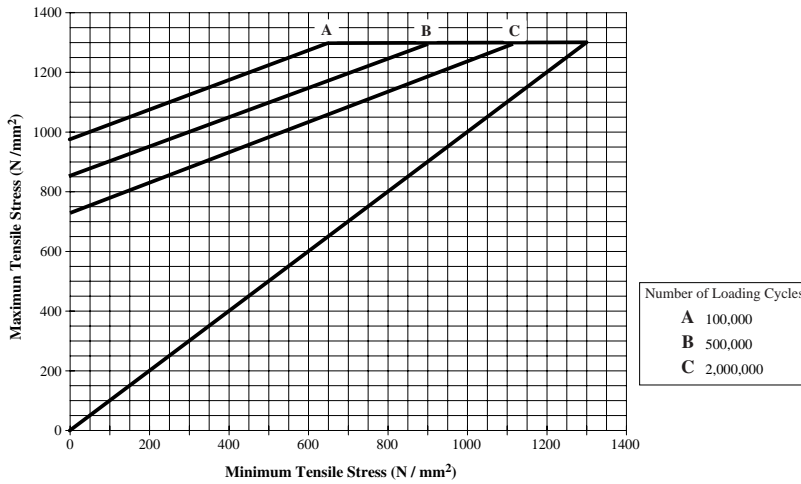


Fig. 10. *Group 1* Diagram for Estimating Fatigue Life of Disc Springs ($0.2 \leq t < 1.25$ mm)

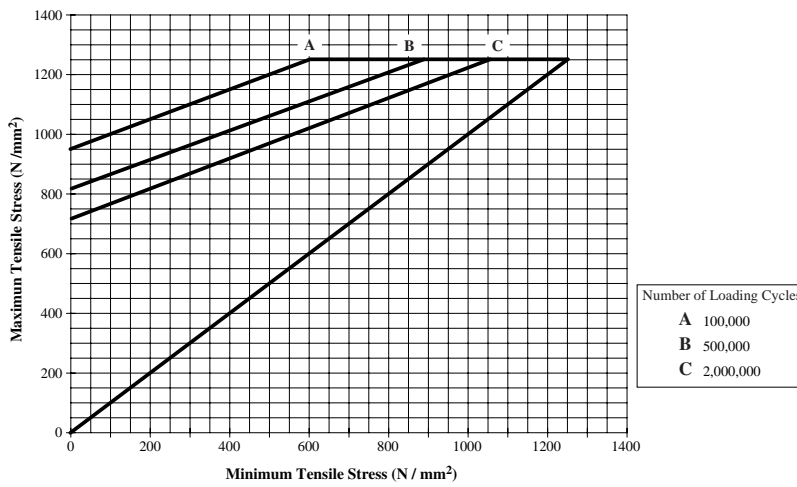


Fig. 11. *Group 2* Diagram for Estimating Fatigue Life of Disc Springs ($1.25 \leq t \leq 6$ mm)

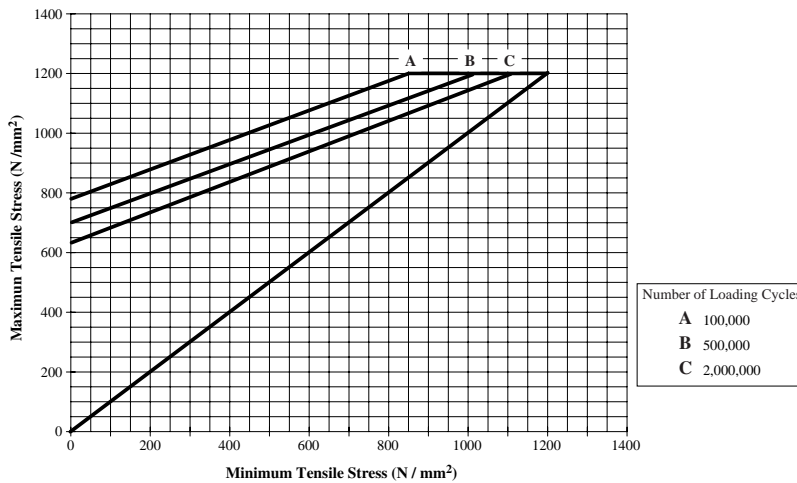


Fig. 12. *Group 3* Diagram for Estimating Fatigue Life of Disc Springs ($6 < t \leq 16$ mm)

When the intersection points of the minimum and maximum stress lines fall inside the areas of each cycle line, only the approximate fatigue life can be estimated by extrapolating the distance from the point of intersection to the nearest cycle line. The extrapolation cannot provide accurate values of fatigue life, because the distance between the cycle lines is expressed in logarithmic scale, and the distance between tensile strength values is expressed in linear scale (Figs. 10, 11, and 12), therefore linear-to-logarithmic scales ratio is not applicable.

When intersection points of minimum and maximum stress lines fall outside the cycle lines area, especially outside the $N = 10^5$ cycles line, the fatigue life cannot be estimated.

Thus, the use of the fatigue life diagrams should be limited to such cases when the minimum and maximum tensile stress lines intersect exactly with each of the cycle lines.

To calculate fatigue life of disc springs without the diagrams, the following equations developed by the author can be used.

$$\text{Disc Springs in Group 1} \quad N = 10^{10.29085532 - 0.00542096(\sigma_{max} - 0.5\sigma_{min})} \quad (20)$$

$$\text{Disc Springs in Group 2} \quad N = 10^{10.10734911 - 0.00537616(\sigma_{max} - 0.5\sigma_{min})} \quad (21)$$

$$\text{Disc Springs in Group 3} \quad N = 10^{13.23985664 - 0.01084192(\sigma_{max} - 0.5\sigma_{min})} \quad (22)$$

As can be seen from Equations (20), (21), and (22), the maximum and minimum tensile stress range affects the fatigue life of disc springs. Since tensile stresses at Points 2 and 3 have different values, see Equations (16) and (17), it is necessary to determine at which critical point the minimum and maximum stresses should be used for calculating fatigue life. The general method is based on the diagram, Fig. 9, from which Point 2 or Point 3 can be found in relationship with disc spring outside-to-inside diameters ratio D_o/D_i and disc spring cone height-to-thickness ratio h/r . This method requires intermediate calculations of D_o/D_i and h/r ratios and is applicable only to disc springs without contact surfaces. The method is not valid for Group 3 disc springs or for disc springs in Group 2 that have contact surfaces and reduced thickness.

A simple and accurate method, that is valid for all disc springs, is based on the following statements:

if $(\sigma_{2max} - 0.5\sigma_{2min}) > (\sigma_{3max} - 0.5\sigma_{3min})$, then Point 2 is used, otherwise

if $(\sigma_{3max} - 0.5\sigma_{3min}) > (\sigma_{2max} - 0.5\sigma_{2min})$, then Point 3 is used

The maximum and minimum tensile stress range for disc springs in Groups 1, 2, and 3 is found from the following equations.

For disc springs in Group 1:

$$\sigma_{max} - 0.5\sigma_{min} = \frac{10.29085532 - \log N}{0.00542096} \quad (23)$$

For disc springs in Group 2:

$$\sigma_{max} - 0.5\sigma_{min} = \frac{10.10734911 - \log N}{0.00537616} \quad (24)$$

For disc springs in Group 3:

$$\sigma_{max} - 0.5\sigma_{min} = \frac{13.23985664 - \log N}{0.01084192} \quad (25)$$

Thus, Equations (23), (24), and (25) can be used to design any spring stack that provides required fatigue life. The following example illustrates how a maximum-minimum stress range is calculated in relationship with fatigue life of a given disc spring stack.

Example: A dynamically loaded stack, which utilizes disc springs in *Group 2*, must have the fatigue life of 5×10^5 cycles. The maximum allowable tensile stress at Points 2 or 3 is 1250 N/mm^2 . Find the minimum tensile stress value to sustain $N = 5 \times 10^5$ cycles.

Solution: Substitution of $\sigma_{\max} = 1250$ and $N = 5 \times 10^5$ in Equation (24) gives:

$$1250 - 0.5\sigma_{\min} = \frac{10.10734911 - \log(5 \times 10^5)}{0.00537616} = \frac{10.10734911 - 5.69897}{0.00537616} = 820$$

$$\text{from which } \sigma_{\min} = \frac{1250 - 820}{0.5} = 860 \text{ N/mm}^2 \text{ (124,700 psi)}$$

Recommended Dimensional Characteristics of Disc Springs.—Dimensions of disc springs play a very important role in their performance. It is imperative to check selected disc springs for dimensional ratios, that should fall within the following ranges:

- 1) Diameters ratio, $\delta = D/d = 1.7$ to 2.5 .
- 2) Cone height-to-thickness ratio, $h/t = 0.4$ to 1.3 .
- 3) Outside diameter-to-thickness ratio, $D/t = 18$ to 40 .

Small values of δ correspond with small values of the other two ratios. The h/t ratio determines the shape of force-deflection characteristic graphs, that may be nearly linear or strongly curved. If $h/t = 0.4$ the graph is almost linear during deflection of a disc spring up to its flat position. If $h/t = 1.6$ the graph is strongly curved and its maximum point is at 75% deflection. Disc spring deflection from 75% to 100% slightly reduces spring force. Within the $h/t = 0.4 - 1.3$ range, disc spring forces increase with the increase in deflection and reach maximum values at 100% deflection. In a stack of disc springs with a ratio $h/t > 1.3$ deflection of individual springs may be unequal, and only one disc spring should be used if possible.

Example Applications of Disc Springs

Example 1, Disc Springs in Group 2 (no contact surfaces): A mechanical device that works under dynamic loads must sustain a minimum of 1,000,000 cycles. The applied load varies from its minimum to maximum value every 30 seconds. The maximum load is approximately 20,000N (4,500 lbf). A 40-mm diameter guide rod is a receptacle for the disc springs. The rod is located inside a hollow cylinder. Deflection of the disc springs under minimum load should not exceed 5.5 mm (0.217 inch) including a 20 per cent pre-load deflection. Under maximum load, the deflection is limited to 8 mm (0.315 inch) maximum. Available space for the disc spring stack inside the cylinder is 35 to 40 mm (1.38 to 1.57 inch) in length and 80 to 85 mm (3.15 to 3.54 inch) in diameter.

Select the disc spring catalog item, determine the number of springs in the stack, the spring forces, the stresses at minimum and maximum deflection, and actual disc spring fatigue life.

Solution: 1) Disc spring standard inside diameter is 41 mm (1.61 inch) to fit the guide rod. The outside standard diameter is 80 mm (3.15 in) to fit the cylinder inside diameter. Disc springs with such diameters are available in various thickness: 2.25, 3.0, 4.0, and 5.0 mm (0.089, 0.118, 0.157, and 0.197 inch). The 2.25- and 3.0-mm thick springs do not fit the applied loads, since the maximum force values for disc springs with such thickness are 7,200N and 13,400N (1,600 lbf and 3,000 lbf) respectively. A 5.0-mm thick disc spring should not be used because its D/t ratio, $80/5 = 16$, is less than 18 and is considered as unfavorable. Disc spring selection is narrowed to an 80-41-4 catalog item.

2) Checking 80 - 41 - 4 disc spring for dimensional ratios:

$$\delta = D/d = 80/41 = 1.95 \quad h/t = 22/4 = 0.55 \quad D/t = 80/4 = 20$$

Because the dimensional ratios are favorable, the 80-41-4 disc springs are selected.

3) The number of springs in the stack is found from Equation (1):

$$n = L_o / (t + h) = 40 / (4 + 2.2) = 40/6.2 = 6.45.$$

Rounding n to the nearest integer gives $n = 6$. The actual length of unloaded spring stack is $L_o = 6.2 \times 6 = 37.2$ mm (1.465 inch) and it satisfies the $L_o < 40$ mm condition.

4) Calculating the cone angle α from Equation (7) and actual outside diameter D_a from Equation (9) gives:

$$\alpha = \text{atan}\left(\frac{2 \times 2.2}{80 - 41}\right) = \text{atan}(0.11282) = 6.4^\circ$$

$$D_a = 80 - 2 \times 4 \left(\sin[\text{atan}(0.11282)] + \frac{1}{6} \cos[\text{atan}(0.11282)] \right)$$

$$D_a = 77.78 \text{ mm (3.062 in)}$$

5) Calculating constant K_1 from Equation (11):

$$\delta = \frac{D}{d} = 1.95122$$

$$K_1 = \frac{\left(\frac{1.95122 - 1}{1.95122}\right)^2}{\pi \cdot \left[\frac{1.95122 + 1}{1.95122 - 1} - \frac{2}{\ln(1.95122)}\right]} = 0.6841$$

6) Calculating minimum and maximum forces, F_{min} and F_{max} from Equation (10):

Based on the design requirements, the disc spring stack is deflecting by 5.5 mm (0.217 in) under minimum load, and each individual disc spring is deflecting by $5.5/6 \cong 0.92$ mm (0.036 in). A single disc spring deflection $s_{min} = 0.9$ mm (0.035 in) is used to calculate F_{min} . Under maximum load, the disc spring stack is permitted maximum deflection of 8 mm (0.315 in), and each individual disc spring deflects by $8/6 \cong 1.33$ mm (0.0524 in). A disc spring deflection $s_{max} = 1.32$ mm (0.052 in) will be used to calculate F_{max} . If disc springs are made of AISI 6150 alloy steel, then modulus of elasticity $E = 206,000$ N/mm² (30×10^6 psi) and Poisson's ratio $\mu = 0.3$.

$$F_{min} = \frac{4 \cdot 206000}{(1 - 0.3^2)(0.6841)(77.78)^2} \left[\left(2.2 - \frac{0.9}{2}\right) \cdot (2.2 - 0.9) \cdot 4 + 4^3 \right] 0.9$$

$$F_{min} = 14390 \text{ N (3235 lbf)}$$

$$F_{max} = \frac{4 \cdot 206000}{(1 - 0.3^2)(0.6841)(77.78)^2} \left[\left(2.2 - \frac{1.32}{2}\right) \cdot (2.2 - 1.32) \cdot 4 + 4^3 \right] 1.32$$

$$F_{max} = 20050 \text{ N (4510 lbf)}$$

7) Calculating constant K_2 , Equation (18):

$$\delta = \frac{D}{d} = \frac{80}{41} = 1.95122$$

$$K_2 = \frac{6 \left(\frac{\delta - 1}{\ln \delta} - 1 \right)}{\pi \cdot \ln \delta} = \frac{6 \left(\frac{1.95122 - 1}{\ln(1.95122)} - 1 \right)}{\pi \cdot \ln(1.95122)} = 1.2086$$

8) Calculating constant K_3 (Equation (19)):

$$K_3 = \frac{3 \cdot (\delta - 1)}{\pi \cdot \ln \delta} = \frac{3 \cdot (1.95122 - 1)}{\pi \cdot \ln(1.95122)} = 1.3589$$

9) Compressive stress σ_0 at point 0 due to maximum deflection, Equation (14):

$$\sigma_0 = -\frac{3}{\pi} \cdot \frac{4E \cdot t \cdot s \cdot K_4}{(1 - \mu^2) \cdot K_1 \cdot D_a^2} = -\frac{3}{\pi} \cdot \frac{4 \cdot 206000 \cdot 4 \cdot 1.32 \cdot 1}{(1 - 0.3^2) \cdot 0.6841 \cdot 77.78^2}$$

$$\sigma_0 = 1103 \text{ N/mm}^2 = 160000 \text{ psi}$$

Because the compressive stress at point 0 does not exceed 1600 N/mm², its current value satisfies the design requirement.

10) Tensile stress σ_2 at point 2 due to minimum deflection $s = 0.9$ mm, Equation (16):

$$\sigma_{2min} = \frac{4E \cdot K_4 \cdot s \cdot \left[K_3 \cdot t - K_2 \cdot K_4 \cdot \left(h - \frac{s}{2} \right) \right]}{(1 - \mu^2) \cdot K_1 \cdot D_a^2} =$$

$$\frac{4 \cdot 206000 \cdot 1 \cdot 0.9 \cdot \left[1.3589 \cdot 4 - 1.2086 \cdot 1 \cdot \left(2.2 - \frac{0.9}{2} \right) \right]}{(1 - 0.3^2) \cdot 0.6841 \cdot 77.78^2} = 654 \text{ N/mm}^2$$

11) Tensile stress σ_2 at point 2 due to maximum deflection $s = 1.32$ mm, Equation (16):

$$\sigma_{2max} = \frac{4E \cdot K_4 \cdot s \cdot \left[K_3 \cdot t - K_2 \cdot K_4 \cdot \left(h - \frac{s}{2} \right) \right]}{(1 - \mu^2) \cdot K_1 \cdot D_a^2} =$$

$$\frac{4 \cdot 206000 \cdot 1 \cdot 1.32 \cdot \left[1.3589 \cdot 4 - 1.2086 \cdot 1 \cdot \left(2.2 - \frac{1.32}{2} \right) \right]}{(1 - 0.3^2) \cdot 0.6841 \cdot 77.78^2} = 1032 \text{ N/mm}^2$$

Thus, $\sigma_{2min} = 654 \text{ N/mm}^2$ (94,850 psi) and $\sigma_{2max} = 1032 \text{ N/mm}^2$ (149,700 psi).

12) Tensile stress σ_3 at point 3 due to minimum deflection $s = 0.9$ mm, Equation (17):

$$\sigma_{3min} = \frac{4E \cdot K_4 \cdot s \cdot \left[K_4 \cdot (2K_3 - K_2) \cdot \left(h - \frac{s}{2} \right) + K_3 \cdot t \right]}{(1 - \mu^2) \cdot K_1 \cdot D_a^2 \cdot \delta} =$$

$$\frac{4 \cdot 206000 \cdot 1 \cdot 0.9 \cdot \left[1 \cdot (2 \cdot 1.3589 - 1.2086) \cdot \left(2.2 - \frac{0.9}{2} \right) + 1.3589 \cdot 4 \right]}{(1 - 0.3^2) \cdot 0.6841 \cdot 77.78^2 \cdot 1.95122} = 815 \text{ N/mm}^2$$

13) Tensile stress σ_3 at point 3 due to maximum deflection $s = 1.32$ mm, Equation (17):

$$\sigma_{3max} = \frac{4E \cdot K_4 \cdot s \cdot \left[K_4 \cdot (2K_3 - K_2) \cdot \left(h - \frac{s}{2} \right) + K_3 \cdot t \right]}{(1 - \mu^2) \cdot K_1 \cdot D_a^2 \cdot \delta} =$$

$$\frac{4 \cdot 206000 \cdot 1 \cdot 1.32 \cdot \left[1 \cdot (2 \cdot 1.3589 - 1.2086) \cdot \left(2.2 - \frac{1.32}{2} \right) + 1.3589 \cdot 4 \right]}{(1 - 0.3^2) \cdot 0.6841 \cdot 77.78^2 \cdot 1.95122} = 1149 \text{ N/mm}^2$$

Thus, $\sigma_{3min} = 815 \text{ N/mm}^2$ (118,200 psi) and $\sigma_{3max} = 1149 \text{ N/mm}^2$ (166,600 psi).

14) Functional tensile stress range at critical points 2 and 3.

$$\text{Point 2: } \sigma_{2max} - 0.5\sigma_{2min} = 1032 - 0.5 \times 654 = 705 \text{ N/mm}^2$$

$$\text{Point 3: } \sigma_{3max} - 0.5\sigma_{3min} = 1149 - 0.5 \times 815 = 741.5 \text{ N/mm}^2$$

Because $\sigma_{3max} - 0.5\sigma_{3min} > \sigma_{2max} - 0.5\sigma_{2min}$, the tensile stresses at point 3 are used for fatigue life calculations.

15) Fatigue life of selected disc springs, **Equation (21)**:

$$N = 10^{[10.10734911 - 0.00537616(1149 - 0.5 \times 815)]} = 10^{10.10734911 - 3.98642264} = 10^{6.12092647}$$

$N = 1,321,000$ cycles. Thus, the calculated actual fatigue life exceeds required minimum number of cycles by 32%.

In conclusion, the six 80-41-4 disc springs arranged in series stacking, satisfy the requirements and will provide a 32 % longer fatigue life than required by the design criteria.

Example 2: A company wishes to use *Group 3* disc springs with contact surfaces on couplings to absorb bumping impacts between railway cars.

Given:

$D = 200$ mm, disc spring outside diameter

$d = 102$ mm, disc spring inside diameter

$t = 14$ mm, spring standard thickness

$t' = 13.1$ mm, spring reduced thickness

$h = 4.2$ mm, cone height of unloaded spring

$n = 22$, number of springs in series stacking

$S_i = 33.9$ mm, initial deflection of the pack

$S_a = 36.0$ mm, additional deflection of the pack

Find the fatigue life in cycles and determine if the selected springs are suitable for the application.

The calculations are performed in the following sequence:

1) Determine the minimum s_{min} and maximum s_{max} deflections of a single disc spring:

$$s_{max} = \frac{(S_i + S_a)}{n} = \frac{(33.9 + 36)}{22} = 3.18 \text{ mm}$$

$$s_{min} = \frac{S_i}{n} = \frac{33.9}{22} = 1.54 \text{ mm}$$

2) Use **Equations (16)** and **(17)** to calculate tensile stresses σ_2 and σ_3 at s_{min} and s_{max} deflections:

$$\sigma_{2min} = 674 \text{ N/mm}^2, \sigma_{2max} = 1513 \text{ N/mm}^2, \sigma_{3min} = 707 \text{ N/mm}^2, \sigma_{3max} = 1379 \text{ N/mm}^2$$

3) Determine critical stress points:

$$\sigma_{2max} - 0.5\sigma_{2min} = 1513 - 0.5 \times 674 = 1176 \text{ N/mm}^2$$

$$\sigma_{3max} - 0.5\sigma_{3min} = 1379 - 0.5 \times 707 = 1025.5 \text{ N/mm}^2$$

Because $(\sigma_{2max} - 0.5\sigma_{2min}) > (\sigma_{3max} - 0.5\sigma_{3min})$, then tensile stresses at Point 2 are used to calculate fatigue life.

4) Fatigue life N is calculated using **Equation (22)**:

$$N = 10^{[13.23985664 - (0.01084192 \times 1176)]} = 10^{0.49} = 3 \text{ cycles}$$

The selected disc springs at the above-mentioned minimum and maximum deflection values will not sustain any number of cycles. It is imperative to check the selected disc springs for dimensional ratios:

Outside-to-inside diameters ratio, $200/102 = 1.96$; within recommended range.

Cone height-to-thickness ratio is $4.2/13.1 = 0.3$; out of range, the minimum ratio is 0.4.

Outside diameter-to-thickness ratio is $200/13.1 = 15$; out of range, the minimum ratio is 18. Thus, only one of the dimensional ratios satisfies the requirements for the best disc spring performance.

FLUID MECHANICS

Properties of Fluids

Fluids.—A fluid is a substance, which deforms continuously when subjected to a shear stress. A small amount of shear force can cause fluids to move, but a solid needs a certain amount of shear stress to yield. The difference in behavior between solid and liquids is due to their molecular structure. In solids, the position of molecules is fixed in space; the molecules are close to each other and have strong molecular attraction. However, in fluids the molecules can move and change their position instantly and only relatively weak molecular forces exist between them. Every flowing fluid has a shear stress, but a stagnant fluid does not have a shear force.

Compressibility is another distinguishing factor that separates fluids from gases. Liquids are relatively incompressible, but gases are strongly compressible and expand indefinitely when all external forces are removed.

The pressure at a point in a fluid is the same in all directions. Pressure exerted by a fluid on a solid surface is always normal (perpendicular) to the surface.

Viscosity.—Viscosity is a property of fluids that determines the resistance of the fluid to shearing stresses. Viscosity of a fluids is due to cohesion and interaction between fluids. An ideal fluid has no viscosity. Viscosity is dependent on temperature, but independent of pressure. A Saybolt viscosimeter is used to measure the viscosity of a fluid.

$$\tau = \frac{F}{A} = \frac{\mu}{\frac{du}{dy}}$$

The effect of viscosity on a fluid is usually expressed in terms of a non-dimensional parameter called the *Reynolds Number* R_e . It is a dimensionless number that represents the ratio of inertia force to viscous force.

$$R_e = \frac{\rho v D}{\mu g} \quad (\text{For U.S. units})$$

$$R_e = \frac{\rho v D}{\mu} \quad (\text{For SI units})$$

$$R_e = \frac{v D}{\nu} \quad (\text{applying kinematic viscosity})$$

R_n = Reynolds number

v = velocity; ft/s, m/s

D = diameter; ft, m

ρ, γ = density; lb/ft³, kg/m³ (for water 62.4 lb/ft³, 1000 kg/m³)

g = gravity acceleration; ft/s², m/s² ($g = 32.2$ ft/s² or $g = 9.81$ m/s²)

μ = absolute viscosity; lbf-sec/ft², N-s/m² (1 lbf-sec/ft² = 47.88 N-s/m² = 47.88 Pa)

ν = kinematic viscosity; ft²/s, m²/s (1 ft²/s = 0.0929 m²/s)

Kinematic Viscosity: It is the ratio of absolute viscosity to mass density. It is usually expressed by ν . The unit is ft²/sec or m²/sec.

(SI) (US)

$$\nu = \frac{\mu}{\rho} \qquad \nu = \frac{\mu g_c}{\rho}$$

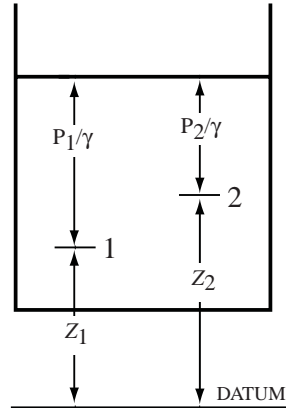
Statics

Pressure.— Pressure is defined as the average force per unit area. Mathematically if dF represents *infinitesimal force* applied over an *infinitesimal area*, dA , the pressure is

$$p = \frac{dF}{dA}$$

Considering an incompressible fluid, p_1 is the pressure and z_1 is the elevation at point 1, and p_2 is the pressure and z_2 is the elevation at point 2. At the datum the pressure is equal. Pressure increases as elevation decreases, and pressure reduces as elevation increases.

At point 1 the pressure will be $\frac{p_1}{\gamma} + z_1$ and at point 2 the pressure will be $\frac{p_2}{\gamma} + z_2$.



Because the pressure is equal at the datum,

$$\frac{p_1}{\gamma} + z_1 = \frac{p_2}{\gamma} + z_2$$

$$\frac{p_1}{\gamma} - \frac{p_2}{\gamma} = z_2 - z_1$$

$$p_1 - p_2 = \gamma(z_2 - z_1)$$

If p_2 is the pressure of the open liquid surface, then p_2 is the pressure of the atmosphere. In order to determine the gauge pressure, we can treat $p_2 = 0$. If the elevation change from point 1 to point 2 is h , then

$$p_1 - p_2 = \gamma h$$

$$p_1 = \gamma h$$

The pressure at any point is equal to the height times density of the fluid.

$$h \text{ (in ft of H}_2\text{O)} = \frac{p}{\gamma} = \frac{\text{psi} \times 144}{62.4} = 2.308 \times \text{psi}$$

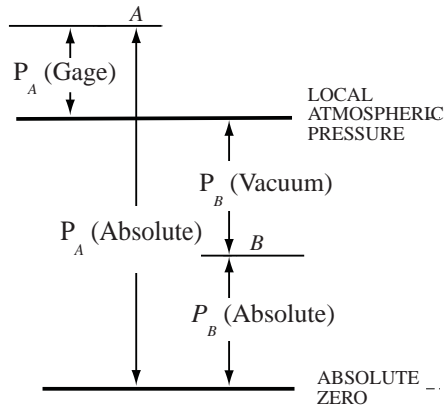
$$h \text{ (in m of H}_2\text{O)} = \frac{p}{\gamma} = \frac{\frac{\text{kN}}{\text{m}^2}}{9.81} = 0.102 \times \frac{\text{kN}}{\text{m}^2}$$

If the pressure is measured relative to the absolute zero pressure, it is called the absolute pressure; when pressure is measured relative to the atmospheric pressure as a base, it is called gage pressure. When measuring gage pressure, atmospheric pressure is not included. Pressure gages show zero at atmosphere pressure.

If the gage pressure is below atmospheric pressure, the pressure is called vacuum. A perfect vacuum indicates absolute zero pressure.

$$P_{\text{absolute}} = P_{\text{gage}} + P_{\text{atmosphere}}$$

$$P_{\text{absolute}} = P_{\text{atmosphere}} - P_{\text{vacuum}}$$



Hydrostatic Pressure on Surfaces

The hydrostatic force on a surface is the resultant force of a horizontal component of force and a vertical component of force.

Pressure on Horizontal Plane Surfaces.—The pressure on a horizontal plane surface is uniform over the surface and acts through the center of the surface. The horizontal component of the total pressure on a curved surface is equal to the total pressure on the projection of the surface on the vertical plane. The point of application of the horizontal component is at the center of the projected area. The total horizontal force on a vertical surface is the pressure times the surface area.

$$P = \rho gh$$

$$P = \gamma h$$

$$F_h = PA_v = \gamma hA_v$$

Pressure on Vertical Plane Surfaces.—The pressure on a vertical plane surface increases linearly with depth. The pressure distribution will be triangular. The vertical component of the total pressure on a curved surface is equal to the weight of the liquid extending from the curved surface to the free surface of the liquid. The center of pressure will pass through the center of gravity of the curved surface. The center of pressure is located at $\frac{2}{3}$ of the depth.

$$F_v = P_{avg}A = \frac{1}{2}(P_1 + P_2)A = \frac{1}{2}(0 + \rho gh)A = \frac{1}{2}\rho ghA = \frac{1}{2}\gamma hA$$

Pressure on Inclined Plane Surfaces.—The average pressure on an inclined plate is

$$P_{avg} = \frac{1}{2}\rho g(h_1 + h_2)$$

$$F = P_{avg} \times A$$

The resultant center of pressure

$$h_r = h_c + \frac{I_c}{Ah_c}$$

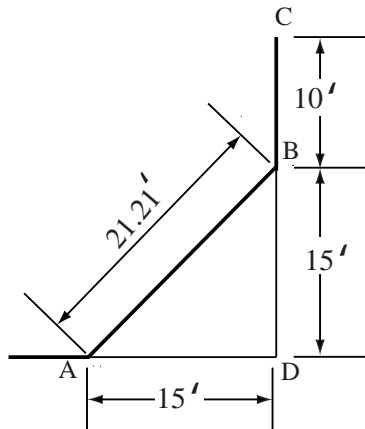
where h_r = the distance (slant distance) measured on the plane area from the free surface to the center of pressure

h_c = the distance (straight distance) measured on the plane area from the free surface to the center of pressure

I_c = second moment of the area about a horizontal axis through the centroid and in the plane of the area

A = the total surface area

Example: The tank shown is filled with diesel fuel ($\rho = 49.92 \text{ lbm/ft}^3$); What is the force on a 1 ft long section of the wall.



Solution: The average depth is $(0+25)/2 = 12.5 \text{ ft}$.

The average horizontal force on a 1 ft section of a wall ABC is equal to the horizontal force on section CBD

$$\begin{aligned} P_h &= \gamma A h_c \\ &= 49.92(25 \times 1) \times (12.5) \\ &= 15600 \text{ lbf} \end{aligned}$$

The vertical component of force on the inclined surface is equal to the weight of the liquid above it.

$$\begin{aligned} P_v &= \text{weight of the diesel above AB} \\ &= \left((15 \times 10) + \frac{1}{2} \times (15 \times 15) \right) \times 1 \times 49.92 \\ &= 13104 \text{ lb} \end{aligned}$$

Forces on Curved and Compound Surfaces.— The horizontal force on a curved surface is equal to the horizontal force on a vertical projection plane from the inclined plane.

The vertical force on a curved surface is equal to the weight of the fluid column above it. The resultant of horizontal and vertical component of force will give the resultant force and the direction in which the force is acting.

$$\begin{aligned} F &= \sqrt{F_h^2 + F_v^2} \\ \tan \theta &= \frac{F_v}{F_h} \end{aligned}$$

TABLE OF CONTENTS
PROPERTIES, TREATMENT, AND TESTING OF MATERIALS

<p style="text-align: center;">THE ELEMENTS, HEAT, MASS, AND WEIGHT</p> <p>371 The Elements</p> <p>372 Latent Heat</p> <p>372 Specific Heat</p> <p>375 Coefficient of Thermal Expansion</p> <p>376 Ignition Temperatures</p> <p>376 Thermal Properties of Metals</p> <p>378 Adjusting Length for Temperature</p> <p>380 Density</p> <p>380 Specific Gravity</p> <p>382 Weight of Natural Piles</p> <p>384 Molecular Weight</p> <p>384 Mol</p> <p>384 Air</p> <p>384 Alligation</p> <p>384 Earth or Soil Weight</p>	<p style="text-align: center;">STANDARD STEELS</p> <p><i>(Continued)</i></p> <p>410 Carbon Steels</p> <p>413 Carburizing Grade Alloy Steels</p> <p>414 Hardenable Grade Alloy Steels</p> <p>415 Characteristics of Stainless Steels</p> <p>418 Chromium-Nickel Austenitic Steels</p> <p>420 High-Strength, Low-Alloy Steels</p> <p>422 Mechanical Properties of Steels</p>
<p style="text-align: center;">PROPERTIES OF WOOD, CERAMICS, PLASTICS, METALS</p> <p>385 Properties of Wood</p> <p>385 Mechanical Properties</p> <p>386 Weight of Wood</p> <p>387 Density of Wood</p> <p>387 Machinability of Wood</p> <p>389 Properties of</p> <p>389 Ceramics</p> <p>390 Plastics</p> <p>391 Investment Casting Alloys</p> <p>393 Powdered Metals</p> <p>394 Elastic Properties of Materials</p> <p>395 Tensile Strength of Spring Wire</p> <p>395 Temperature Effects on Strength</p>	<p style="text-align: center;">TOOL STEELS</p> <p>433 Overview</p> <p>433 Properties of Tool Steels</p> <p>436 Tool Faults, Failures and Cures</p> <p>437 Tool Steel Properties</p> <p>439 Classification</p> <p>443 Tool Steel Selection</p> <p>446 High-Speed Tool Steels</p> <p>446 Molybdenum-Type</p> <p>448 Tungsten-Type</p> <p>449 Hot-Work Tool Steels</p> <p>451 Tungsten-Types</p> <p>451 Molybdenum-Types</p> <p>452 Cold-Work Tool Steels</p> <p>452 Oil-Hardening Types</p> <p>453 Air-Hardening Types</p> <p>455 Shock-Resisting Tool Steels</p> <p>455 Mold Steels</p> <p>457 Special-Purpose Tool Steels</p> <p>457 Water-Hardening Tool Steels</p> <p>459 Forms of Tool Steel</p> <p>460 Tolerances of Dimensions</p> <p>460 Allowances for Machining</p> <p>460 Decarburization Limits</p>
<p style="text-align: center;">STANDARD STEELS</p> <p>396 Property, Composition, Application</p> <p>396 Standard Steel Classification</p> <p>398 Numbering Systems</p> <p>398 Unified Numbering System</p> <p>399 Standard Steel Numbering System</p> <p>399 Binary, Ternary and Quarternary</p> <p>399 Damascus Steel</p> <p>400 AISI-SAE Numbers for Steels</p> <p>401 AISI-SAE Designation System</p> <p>402 Composition of Carbon Steels</p> <p>404 Composition of Alloy Steels</p> <p>406 Composition of Stainless Steels</p> <p>407 Thermal Treatments of Steel</p> <p>408 Applications of Steels</p>	<p style="text-align: center;">HARDENING, TEMPERING, AND ANNEALING</p> <p>461 Heat Treatment Of Standard Steels</p> <p>461 Heat-Treating Definitions</p> <p>465 Hardness and Hardenability</p> <p>467 Case Hardening</p> <p>469 Slow Cooling</p> <p>469 Rapid Cooling or Quenching</p> <p>470 Heat-Treating Furnaces</p> <p>471 Physical Properties</p> <p>471 Hardening</p> <p>473 Hardening Temperatures</p> <p>474 Heating Steel in Liquid Baths</p> <p>474 Salt Baths</p>

TABLE OF CONTENTS
PROPERTIES, TREATMENT, AND TESTING OF MATERIALS

HARDENING, TEMPERING, AND ANNEALING

(Continued)

475	Quenching Baths
475	Hardening or Quenching Baths
476	Quenching in Water
476	Quenching in Molten Salt Bath
477	Tanks for Quenching Baths
479	Tempering
480	Color as Temperature Indicator
484	Case Hardening
484	Carburization
485	Pack-Hardening
485	Cyanide Hardening
485	Nitriding Process
487	Flame Hardening
487	Induction Hardening
490	Typical Heat Treatments
490	SAE Carbon Steels
491	SAE Alloy Steels
492	Metallography
494	Chromium-Ni Austenitic Steels
495	Stainless Chromium Steels
496	Heat Treating High-Speed Steels
496	Tungsten High-Speed Steels
499	Molybdenum High-Speed Steels
501	Nitriding High-Speed Steel
502	Subzero Treatment of Steel
505	Testing the Hardness of Metals
505	Brinell Hardness Test
506	Rockwell Hardness Test
506	Shore's Scleroscope
506	Vickers Hardness Test
507	Knoop Hardness Numbers
507	Monotron Hardness Indicator
507	Keep's Test
508	Comparative Hardness Scales

NONFERROUS ALLOYS

513	Strength of Nonferrous Metals
514	Copper and Copper Alloys
514	Cast Copper Alloys
519	Wrought Copper Alloys
528	Cu -Silicon, -Beryllium Alloys
530	Aluminum and Aluminum Alloys
531	Temper Designations
534	Alloy Designation Systems
534	Casting Alloys
537	Wrought Alloys
543	Clad Aluminum Alloys

NONFERROUS ALLOYS

(Continued)

543	Principal Alloy Groups
544	Type Metal
545	Magnesium Alloys
548	Nickel and Nickel Alloys
548	Titanium and Titanium Alloys
550	Mechanical Properties Table

PLASTICS

551	Properties of Plastics
551	Characteristics of Plastics
552	Plastics Materials
554	Application Properties
559	Stress and Strain in Plastics
566	Strength and Modulus
570	Thermal Properties
572	Electrical Properties
575	Chemical Resistance
575	Mechanical Properties
575	Design Analysis
575	Structural Analysis
577	Design Stresses
578	Thermal Stresses
579	Designing for Stiffness
579	Manufacture of Plastics Products
581	Sheet Thermoforming
581	Blow Molding
581	Processing of Thermosets
583	Polyurethanes
583	Reinforced Plastics
584	Injection Molding
588	Load-Bearing Parts
592	Melt Flow in the Mold
593	Design for Assembly
597	Assembly with Fasteners
598	Machining Plastics
604	Plastics Gearing
607	Bakelite

THE ELEMENTS, HEAT, MASS, AND WEIGHT

Table 1. The Elements — Symbols, Atomic Numbers and Weights, Melting Points

Name of Element	Sym bol	Atomic		Melting Point, °C	Name of Element	Sym bol	Atomic		Melting Point, °C
		Num.	Weight				Num.	Weight	
Actinium	Ac	89	227.028	1050	Neon	Ne	10	20.1179	-248.67
Aluminum	Al	13	26.9815	660.37	Neptunium	Np	93	237.048	640 ± 1
Americium	Am	95	(243)	994 ± 4	Nickel	Ni	28	58.69	1453
Antimony	Sb	51	121.75	630.74	Niobium	Nb	41	92.9064	2468 ± 10
Argon	A	18	39.948	-189.2	Nitrogen	N	7	14.0067	-209.86
Arsenic	As	33	74.9216	817 ^a	Nobelium	No	102	(259)	...
Astatine	At	85	(210)	302	Osmium	Os	76	190.2	3045 ± 30
Barium	Ba	56	137.33	725	Oxygen	O	8	15.9994	-218.4
Berkelium	Bk	97	(247)	...	Palladium	Pd	46	106.42	1554
Beryllium	Be	4	9.01218	1278 ± 5	Phosphorus	P	15	30.9738	44.1
Bismuth	Bi	83	208.980	271.3	Platinum	Pt	78	195.08	1772
Boron	B	5	10.81	2079	Plutonium	Pu	94	(244)	641
Bromine	Br	35	79.904	-7.2	Polonium	Po	84	(209)	254
Cadmium	Cd	48	112.41	320.9	Potassium	K	19	39.0938	63.25
Calcium	Ca	20	40.08	839 ± 2	Praseodymium	Pr	59	140.908	931 ± 4
Californium	Cf	98	(251)	...	Promethium	Pm	61	(145)	1080 ^b
Carbon	C	6	12.011	3652 ^c	Protactinium	Pa	91	231.0359	1600
Cerium	Ce	58	140.12	798 ± 2	Radium	Ra	88	226.025	700
Cesium	Cs	55	132.9054	28.4 ± 0.01	Radon	Rn	86	(222)	-71
Chlorine	Cl	17	35.453	-100.98	Rhenium	Re	75	186.207	3180
Chromium	Cr	24	51.996	1857 ± 20	Rhodium	Rh	45	102.906	1965 ± 3
Cobalt	Co	27	58.9332	1495	Rubidium	Rb	37	85.4678	38.89
Copper	Cu	29	63.546	1083.4 ± 0.2	Ruthenium	Ru	44	101.07	2310
Curium	Cm	96	(247)	1340 ± 40	Samarium	Sm	62	150.36	1072 ± 5
Dysprosium	Dy	66	162.5	1409	Scandium	Sc	21	44.9559	1539
Einsteinium	Es	99	(252)	...	Selenium	Se	34	78.96	217
Erbium	Er	68	167.26	1522	Silicon	Si	14	28.0855	1410
Europium	Eu	63	151.96	822 ± 5	Silver	Ag	47	107.868	961.93
Fermium	Fm	100	(257)	...	Sodium	Na	11	22.9898	97.81 ± 0.03
Fluorine	F	9	18.9984	-219.62	Strontium	Sr	38	87.62	769
Francium	Fr	87	(223)	27 ^b	Sulfur	S	16	32.06	112.8
Gadolinium	Gd	64	157.25	1311 ± 1	Tantalum	Ta	73	180.9479	2996
Gallium	Ga	31	69.72	29.78	Technetium	Tc	43	(98)	2172
Germanium	Ge	32	72.59	937.4	Tellurium	Te	52	127.60	449.5 ± 0.3
Gold	Au	79	196.967	1064.434	Terbium	Tb	65	158.925	1360 ± 4
Hafnium	Hf	72	178.49	2227 ± 20	Thallium	Tl	81	204.383	303.5
Helium	He	2	4.00260	-272.2 ^d	Thorium	Th	90	232.038	1750
Holmium	Ho	67	164.930	1470	Thulium	Tm	69	168.934	1545 ± 15
Hydrogen	H	1	1.00794	-259.14	Tin	Sn	50	118.71	231.9681
Indium	In	49	114.82	156.61	Titanium	Ti	22	47.88	1660 ± 10
Iodine	I	53	126.905	113.5	Tungsten	W	74	183.85	3410 ± 20
Iridium	Ir	77	192.22	2410	Unnilhexium	Unh	106	(266)	...
Iron	Fe	26	55.847	1535	Unnilnonium	Unn	109	(266)	...
Krypton	Kr	36	83.80	-156.6	Unniloctium	Uno	108	(265)	...
Lanthanum	La	57	138.906	920 ± 5	Unnilpentium	Unp	105	(262)	...
Lawrencium	Lw	103	(260)	...	Unnilquadium	Unq	104	(261)	...
Lead	Pb	82	207.2	327.502	Unnilseptium	Uns	107	(261)	...
Lithium	Li	3	6.941	180.54	Uranium	U	92	238.029	1132 ± 0.8
Lutetium	Lu	71	174.967	1656 ± 5	Vanadium	V	23	50.9415	1890 ± 10
Magnesium	Mg	12	24.305	648.8 ± 0.5	Xenon	Xe	54	131.29	-111.9
Manganese	Mn	25	54.9380	1244 ± 2	Ytterbium	Yb	70	173.04	824 ± 5
Mendelevium	Md	101	(258)	...	Yttrium	Y	39	88.9059	1523 ± 8
Mercury	Hg	80	200.59	-38.87	Zinc	Zn	30	65.39	419.58
Molybdenum	Mo	42	95.94	2617	Zirconium	Zr	40	91.224	1852 ± 2
Neodymium	Nd	60	144.24	1010					

^a At 28 atm (2.837 MPa).

^b Approximate.

^c Sublimates.

^d At 26 atm (2.635 MPa).

Notes: Values in parentheses are atomic weights of the most stable known isotopes. Melting points at standard pressure except as noted.

Heat and Combustion Related Properties

Latent Heat.—When a body changes from the solid to the liquid state or from the liquid to the gaseous state, a certain amount of heat is used to accomplish this change. This heat does not raise the temperature of the body and is called latent heat. When the body changes again from the gaseous to the liquid, or from the liquid to the solid state, it gives out this quantity of heat. The *latent heat of fusion* is the heat supplied to a solid body at the melting point; this heat is absorbed by the body although its temperature remains nearly stationary during the whole operation of melting. The *latent heat of evaporation* is the heat that must be supplied to a liquid at the boiling point to transform the liquid into a vapor. The latent heat is generally given in British thermal units per pound, or kilojoules per kilogram. The latent heat of evaporation of water is 966.6 Btu/pound, or 2248 kJ/kg. This means that it takes 966.6 Btu to evaporate 1 pound, or 2248 kJ to evaporate 1 kilogram, of water after it has been raised to the boiling point, 212°F or 100°C.

When a body changes from the solid to the gaseous state without passing through the liquid stage, as solid carbon dioxide does, the process is called *sublimation*.

Table 2. Latent Heat of Fusion

Substance	Btu per Pound	kJ/kg	Substance	Btu per Pound	kJ/kg	Substance	Btu per Pound	kJ/kg
Bismuth	22.75	52.92	Paraffine	63.27	147.17	Sulfur	16.86	39.22
Beeswax	76.14	177.10	Phosphorus	9.06	21.07	Tin	25.65	59.66
Cast iron, gray	41.40	96.30	Lead	10.00	23.26	Zinc	50.63	117.77
Cast iron, white	59.40	138.16	Silver	37.92	88.20	Ice	144.00	334.94

Table 3. Latent Heat of Evaporation

Liquid	Btu per Pound	kJ/kg	Liquid	Btu per Pound	kJ/kg	Liquid	Btu per Pound	kJ/kg
Alcohol, ethyl	371.0	863	Carbon bisulfide	160.0	372	Turpentine	133.0	309
Alcohol, methyl	481.0	1119	Ether	162.8	379	Water	966.6	2248
Ammonia	529.0	1230	Sulfur dioxide	164.0	381			

Table 4. Boiling Points of Various Substances at Atmospheric Pressure

Substance	Boiling Point		Substance	Boiling Point		Substance	Boiling Point	
	°F	°C		°F	°C		°F	°C
Aniline	363	183.9	Chloroform	140	60.0	Saturated brine	226	107.8
Alcohol	173	78.3	Ether	100	37.8	Sulfur	833	445.0
Ammonia	-28	-33.3	Linseed oil	597	313.9	Sulfuric acid	590	310.0
Benzine	176	80.0	Mercury	676	357.8	Water, pure	212	100.0
Bromine	145	62.8	Napthaline	428	220.0	Water, sea	2132	100.7
Carbon bisulfide	118	47.8	Nitric acid	248	120.0	Wood alcohol	150	65.6
			Oil of turpentine	315	157.2			

Specific Heat.—The specific heat of a substance is the ratio of the heat required to raise the temperature of a certain weight of the given substance 1°F, to the heat required to raise the temperature of the same weight of water 1°F. As the specific heat is not constant at all temperatures, it is generally assumed that it is determined by raising the temperature from 62 to 63°F. For most substances, however, specific heat is practically constant for temperatures up to 212°F.

In metric units, specific heat is defined as the ratio of the heat needed to raise the temperature of a mass by 1°C, to the heat needed to raise the temperature of the same mass of water by 1°C. In the metric system, heat is measured in joules (J), mass is in grams (g), and measurements usually taken at 15°C.

Because specific heat is a dimensionless ratio, the values given in [Tables 5 and 5](#) that follow are valid in both the US system and the metric system.

Table 5. Average Specific Heats of Various Substances

Substance	Specific Heat	Substance	Specific Heat
Alcohol (absolute)	0.700	Lead	0.031
Alcohol (density 0.8)	0.622	Lead (fluid)	0.037
Aluminum	0.214	Limestone	0.217
Antimony	0.051	Magnesia	0.222
Benzine	0.450	Marble	0.210
Brass	0.094	Masonry, brick	0.200
Brickwork	0.200	Mercury	0.033
Cadmium	0.057	Naphtha	0.310
Carbon	0.204	Nickel	0.109
Charcoal	0.200	Oil, machine	0.400
Chalk	0.215	Oil, olive	0.350
Coal	0.240	Paper	0.32
Coke	0.203	Phosphorus	0.189
Copper, 32° to 212°F (0-100°C)	0.094	Platinum	0.032
Copper, 32° to 572°F (0-100°C)	0.101	Quartz	0.188
Corundum	0.198	Sand	0.195
Ether	0.503	Silica	0.191
Fusel oil	0.564	Silver	0.056
Glass	0.194	Soda	0.231
Gold	0.031	Steel, high carbon	0.117
Graphite	0.201	Steel, mild	0.116
Ice	0.504	Stone (generally)	0.200
Iron, cast	0.130	Sulfur	0.178
Iron, wrought, 32° to 212°F (0-100°C)	0.110	Sulfuric acid	0.330
32° to 392°F (0-200°C)	0.115	Tin (solid)	0.056
32° to 572°F (0-300°C)	0.122	Tin (fluid)	0.064
32° to 662°F (0-350°C)	0.126	Turpentine	0.472
Iron, at high temperatures:		Water	1.000
1382° to 1832°F (750-1000°C)	0.213	Wood, fir	0.650
1750° to 1840°F (954-1004°C)	0.218	Wood, oak	0.570
1920° to 2190°F (1049-1199°C)	0.199	Wood, pine	0.467
Kerosene	0.500	Zinc	0.095

Table 6. Specific Heat of Gases

Gas	Constant Pressure	Constant Volume	Gas	Constant Pressure	Constant Volume
Acetic acid	0.412	...	Chloroform	0.157	...
Air	0.238	0.168	Ethylene	0.404	0.332
Alcohol	0.453	0.399	Hydrogen	3.409	2.412
Ammonia	0.508	0.399	Nitrogen	0.244	0.173
Carbonic acid	0.217	0.171	Oxygen	0.217	0.155
Carbonic oxide	0.245	0.176	Steam	0.480	0.346
Chlorine	0.121	...			

Heat Loss from Uncovered Steam Pipes.—The loss of heat from a bare steam or hot-water pipe varies with the temperature difference of the inside the pipe and that of the surrounding air. The loss is 2.15 Btu per hour, per square foot of pipe surface, per degree F of temperature difference when the latter is 100 degrees; for a difference of 200 degrees, the loss is 2.66 Btu; for 300 degrees, 3.26 Btu; for 400 degrees, 4.03 Btu; for 500 degrees, 5.18 Btu. Thus, if the pipe area is 1.18 square feet per foot of length, and the temperature difference 300°F, the loss per hour per foot of length = $1.18 \times 300 \times 3.26 = 1154$ Btu.

Table 7. Values of Thermal Conductivity (k) and of Conductance (C) of Common Building and Insulating Materials

Type of Material	Thick-ness, in.	k or C^a	Type of Material	Thick-ness, in.	k or C^a	Max. Temp., °F	Density, lb per cu. ft.	k^a
BUILDING			BUILDING (Continued)					
Batt:	Siding:
Mineral Fiber	2-2 $\frac{3}{4}$	0.14	Metal ^b	Avg.	1.61
Mineral Fiber	3-3 $\frac{1}{2}$	0.09	Wood, Med. Density	$\frac{7}{16}$	1.49
Mineral Fiber	3 $\frac{1}{2}$ -6 $\frac{1}{2}$	0.05	Stone:
Mineral Fiber	6-7	0.04	Lime or Sand	1	12.50
Mineral Fiber	8 $\frac{1}{2}$	0.03	Wall Tile:
Block:	Hollow Clay, 1-Cell	4	0.9
Cinder	4	0.90	Hollow Clay, 2-Cell	8	0.54
Cinder	8	0.58	Hollow Clay, 3-Cell	12	0.40
Cinder	12	0.53	Hollow Gypsum	Avg.	0.7
Block:	INSULATING					
Concrete	4	1.40	Blanket, Mineral Fiber:
Concrete	8	0.90	Felt	400	3 to 8	0.26
Concrete	12	0.78	Rock or Slag	1200	6 to 12	0.26 ^c
Board:	Glass	350	0.65	0.33
Asbestos Cement	$\frac{1}{4}$	16.5	Textile	350	0.65	0.31
Plaster	$\frac{1}{2}$	2.22	Blanket, Hairfelt	180	10	0.29
Plywood	$\frac{3}{4}$	1.07	Board, Block and Pipe
Brick:	Insulation:
Common	1	5.0	Amosite	1500	15 to 18	0.32 ^c
Face	1	9.0	Asbestos Paper	700	30	0.40 ^c
Concrete (poured)	1	12.0	Glass or Slag (for Pipe)	350	3 to 4	0.23
Floor:	Glass or Slag (for Pipe)	1000	10 to 15	0.33 ^c
Wood Subfloor	$\frac{3}{4}$	1.06	Glass, Cellular	800	9	0.40
Hardwood Finish	$\frac{3}{4}$	1.47	Magnesia (85%)	600	11 to 12	0.35 ^c
Tile	Avg.	20.0	Mineral Fiber	100	15	0.29
Glass:	Polystyrene, Beaded	170	1	0.28
Architectural	...	10.00	Polystyrene, Rigid	170	1.8	0.25
Mortar:	Rubber, Rigid Foam	150	4.5	0.22
Cement	1	5.0	Wood Felt	180	20	0.31
Plaster:	Loose Fill:
Sand	$\frac{3}{8}$	13.30	Cellulose	2.5 to 3	0.27
Sand and Gypsum	$\frac{1}{2}$	11.10	Mineral Fiber	2 to 5	0.28
Stucco	1	5.0	Perlite	5 to 8	0.37
Roofing:	Silica Aerogel	7.6	0.17
Asphalt Roll	Avg.	6.50	Vermiculite	7 to 8.2	0.47
Shingle, asb. cem.	Avg.	4.76	Mineral Fiber Cement:
Shingle, asphalt	Avg.	2.27	Clay Binder	1800	24 to 30	0.49 ^c
Shingle, wood	Avg.	1.06	Hydraulic Binder	1200	30 to 40	0.75 ^c

^a Units are in Btu/hr-ft²-°F. Where thickness is given as 1 inch, the value given is thermal conductivity (k); for other thicknesses the value given is thermal conductance (C). All values are for a test mean temperature of 75°F, except those designated with ^c, which are for 100°F.

^b Over hollowback sheathing.

^c Test mean temperature 100°F, see footnote ^a.

Source: American Society of Heating, Refrigerating and Air-Conditioning Engineers, Inc.: *Handbook of Fundamentals*.

Table 8. Typical Values of Coefficient of Linear Thermal Expansion for Thermoplastics and Other Commonly Used Materials

Material ^a	in/in/deg F × 10 ⁻⁵	cm/cm/deg C × 10 ⁻⁵	Material ^a	in/in/deg F × 10 ⁻⁵	cm/cm/deg C × 10 ⁻⁵
Liquid Crystal—GR	0.3	0.6	ABS—GR	1.7	3.1
Glass	0.4	0.7	Polypropylene—GR	1.8	3.2
Steel	0.6	1.1	Epoxy—GR	2.0	3.6
Concrete	0.8	1.4	Polyphenylene sulfide—GR	2.0	3.6
Copper	0.9	1.6	Acetal—GR	2.2	4.0
Bronze	1.0	1.8	Epoxy	3.0	5.4
Brass	1.0	1.8	Polycarbonate	3.6	6.5
Aluminum	1.2	2.2	Acrylic	3.8	6.8
Polycarbonate—GR	1.2	2.2	ABS	4.0	7.2
Nylon—GR	1.3	2.3	Nylon	4.5	8.1
TP polyester—GR	1.4	2.5	Acetal	4.8	8.5
Magnesium	1.4	2.5	Polypropylene	4.8	8.6
Zinc	1.7	3.1	TP Polyester	6.9	12.4
ABS—GR	1.7	3.1	Polyethylene	7.2	13.0

^aGR = Typical glass fiber-reinforced material. Other plastics materials shown are unfilled.

**Table 9. Linear Expansion of Various Substances between 32 and 212°F
Expansion of Volume = 3 × Linear Expansion**

Substance	Linear Expansion		Substance	Linear Expansion	
	for 1°F	for 1°C		for 1°F	for 1°C
Brick	0.0000030	0.0000054	Masonry, brick from	0.0000026	0.0000047
Cement, Portland	0.0000060	0.0000108	to	0.0000050	0.0000090
Concrete	0.0000080	0.0000144	Plaster	0.0000092	0.0000166
Ebonite	0.0000428	0.0000770	Porcelain	0.0000020	0.0000036
Glass, thermometer	0.0000050	0.0000090	Quartz, from	0.0000043	0.0000077
Glass, hard	0.0000040	0.0000072	to	0.0000079	0.0000142
Granite	0.0000044	0.0000079	Slate	0.0000058	0.0000104
Marble, from	0.0000031	0.0000056	Sandstone	0.0000065	0.0000117
to	0.0000079	0.0000142	Wood, pine	0.0000028	0.0000050

Table 10. Coefficients of Heat Transmission

Metal	Btu per Second	Metal	Btu per Second	Metal	Btu per Second
Aluminum	0.00203	German silver	0.00050	Steel, soft	0.00062
Antimony	0.00022	Iron	0.00089	Silver	0.00610
Brass, yellow	0.00142	Lead	0.00045	Tin	0.00084
Brass, red	0.00157	Mercury	0.00011	Zinc	0.00170
Copper	0.00404	Steel, hard	0.00034

Heat transmitted, in British thermal units, per second, through metal 1 inch thick, per square inch of surface, for a temperature difference of 1°F

Table 11. Coefficients of Heat Radiation

Surface	Btu per Hour	Surface	Btu per Hour
Cast-iron, new	0.6480	Sawdust	0.7215
Cast-iron, rusted	0.6868	Sand, fine	0.7400
Copper, polished	0.0327	Silver, polished	0.0266
Glass	0.5948	Tin, polished	0.0439
Iron, ordinary	0.5662	Tinned iron, polished	0.0858
Iron, sheet-, polished	0.0920	Water	1.0853
Oil	1.4800

Heat radiated, in British thermal units, per square foot of surface per hour, for a temperature difference of 1°F

Table 12. Freezing Mixtures

Mixture	Temperature Change, °F		Temperature Change, °C	
	From	To	From	To
Common salt (NaCl), 1 part; snow, 3 parts	32	±0	0	-17.8
Common salt (NaCl), 1 part; snow, 1 part	32	-0.4	0	-18
Calcium chloride (CaCl ₂), 3 parts; snow, 2 parts	32	-27	0	-32.8
Calcium chloride (CaCl ₂), 2 parts; snow, 1 part	32	-44	0	-42.2
Sal ammoniac (NH ₄ Cl), 5 parts; saltpeter (KNO ₃), 5 parts; water, 16 parts	50	+10	10	-12.2
Sal ammoniac (NH ₄ Cl), 1 part; saltpeter (KNO ₃), 1 part; water, 1 part	46	-11	7.8	-23.9
Ammonium nitrate (NH ₄ NO ₃), 1 part; water, 1 part	50	+3	10	-16.1
Potassium hydrate (KOH), 4 parts; snow, 3 parts	32	-35	0	-37.2

Ignition Temperatures.—The following temperatures are required to ignite the different substances specified: Phosphorus, transparent, 120°F (49°C); bisulfide of carbon, 300°F (149°C); gun cotton, 430°F (221°C); nitro-glycerine, 490°F (254°C); phosphorus, amorphous, 500°F (260°C); rifle powder, 550°F (288°C); charcoal, 660°F (349°C); dry pine wood, 800°F (427°C); dry oak wood, 900°F (482°C).

Table 13. Typical Thermal Properties of Various Metals

Material and Alloy Designation ^a	Density, ρ		Melting Point, °F		Conductivity, <i>k</i> Btu/hr-ft-°F	Specific Heat, <i>C</i> Btu/lb-°F	Coeff. of Expansion, α	
	lb/in ³	g/cc	solidus	liquidus			μin/in-°F	μm/m-°C
Aluminum Alloys								
2011	0.102	2.823	995	1190	82.5	0.23	12.8	23.0
2017	0.101	2.796	995	1185	99.4	0.22	13.1	23.6
2024	0.100	2.768	995	1180	109.2	0.22	12.9	23.2
3003	0.099	2.740	1190	1210	111	0.22	12.9	23.2
5052	0.097	2.685	1100	1200	80	0.22	13.2	23.8
5086	0.096	2.657	1085	1185	73	0.23	13.2	23.8
6061	0.098	2.713	1080	1200	104	0.23	13.0	23.4
7075	0.101	2.796	890	1180	70	0.23	13.1	23.6
Copper-Base Alloys								
Manganese Bronze	0.302	8.359	1590	1630	61	0.09	11.8	21.2
C11000 (Electrolytic tough pitch)	0.321	8.885	1941	1981	226	0.09	9.8	17.6
C14500 (Free machining Cu)	0.323	8.941	1924	1967	205	0.09	9.9	17.8
C17200, C17300 (Beryllium Cu)	0.298	8.249	1590	1800	62	0.10	9.9	17.8
C18200 (Chromium Cu)	0.321	8.885	1958	1967	187	0.09	9.8	17.6
C18700 (Leaded Cu)	0.323	8.941	1750	1975	218	0.09	9.8	17.6
C22000 (Commercial bronze, 90%)	0.318	8.802	1870	1910	109	0.09	10.2	18.4
C23000 (Red brass, 85%)	0.316	8.747	1810	1880	92	0.09	10.4	18.7
C26000 (Cartridge brass, 70%)	0.313	8.664	1680	1750	70	0.09	11.1	20.0
C27000 (Yellow brass)	0.306	8.470	1660	1710	67	0.09	11.3	20.3
C28000 (Muntz metal, 60%)	0.303	8.387	1650	1660	71	0.09	11.6	20.9
C33000 (Low-leaded brass tube)	0.310	8.581	1660	1720	67	0.09	11.2	20.2
C35300 (High-leaded brass)	0.306	8.470	1630	1670	67	0.09	11.3	20.3
C35600 (Extra-high-leaded brass)	0.307	8.498	1630	1660	67	0.09	11.4	20.5
C36000 (Free machining brass)	0.307	8.498	1630	1650	67	0.09	11.4	20.5
C36500 (Leaded Muntz metal)	0.304	8.415	1630	1650	71	0.09	11.6	20.9
C46400 (Naval brass)	0.304	8.415	1630	1650	67	0.09	11.8	21.2
C51000 (Phosphor bronze, 5% A)	0.320	8.858	1750	1920	40	0.09	9.9	17.8
C54400 (Free cutting phos. bronze)	0.321	8.885	1700	1830	50	0.09	9.6	17.3
C62300 (Aluminum bronze, 9%)	0.276	7.640	1905	1915	31.4	0.09	9.0	16.2
C62400 (Aluminum bronze, 11%)	0.269	7.446	1880	1900	33.9	0.09	9.2	16.6
C63000 (Ni-Al bronze)	0.274	7.584	1895	1930	21.8	0.09	9.0	16.2
Nickel-Silver	0.314	8.691	1870	2030	17	0.09	9.0	16.2

Table 13. Typical Thermal Properties of Various Metals (Continued)

Material and Alloy Designation ^a	Density, ρ		Melting Point, °F		Conductivity, k	Specific Heat, C	Coeff. of Expansion, α	
	lb/in ³	g/cc	solidus	liquidus	Btu/hr-ft-°F	Btu/lb/°F	μin/in-°F	μm/m-°C
Nickel-Base Alloys								
Nickel 200, 201, 205	0.321	8.885	2615	2635	43.3	0.11	8.5	15.3
Hastelloy C-22	0.314	8.691	2475	2550	7.5	0.10	6.9	12.4
Hastelloy C-276	0.321	8.885	2415	2500	7.5	0.10	6.2	11.2
Inconel 718	0.296	8.193	2300	2437	6.5	0.10	7.2	13.0
Monel	0.305	8.442	2370	2460	10	0.10	8.7	15.7
Monel 400	0.319	8.830	2370	2460	12.6	0.10	7.7	13.9
Monel K500	0.306	8.470	2400	2460	10.1	0.10	7.6	13.7
Monel R405	0.319	8.830	2370	2460	10.1	0.10	7.6	13.7
Stainless Steels								
S30100	0.290	8.027	2550	2590	9.4	0.12	9.4	16.9
S30200, S30300, S30323	0.290	8.027	2550	2590	9.4	0.12	9.6	17.3
S30215	0.290	8.027	2500	2550	9.2	0.12	9.0	16.2
S30400, S30500	0.290	8.027	2550	2650	9.4	0.12	9.6	17.3
S30430	0.290	8.027	2550	2650	6.5	0.12	9.6	17.3
S30800	0.290	8.027	2550	2650	8.8	0.12	9.6	17.3
S30900, S30908	0.290	8.027	2550	2650	9.0	0.12	8.3	14.9
S31000, S31008	0.290	8.027	2550	2650	8.2	0.12	8.8	15.8
S31600, S31700	0.290	8.027	2500	2550	9.4	0.12	8.8	15.8
S31703	0.290	8.027	2500	2550	8.3	0.12	9.2	16.6
S32100	0.290	8.027	2550	2600	9.3	0.12	9.2	16.6
S34700	0.290	8.027	2550	2650	9.3	0.12	9.2	16.6
S34800	0.290	8.027	2550	2650	9.3	0.12	9.3	16.7
S38400	0.290	8.027	2550	2650	9.4	0.12	9.6	17.3
S40300, S41000, S41600, S41623	0.280	7.750	2700	2790	14.4	0.11	5.5	9.9
S40500	0.280	7.750	2700	2790	15.6	0.12	6.0	10.8
S41400	0.280	7.750	2600	2700	14.4	0.11	5.8	10.4
S42000, S42020	0.280	7.750	2650	2750	14.4	0.11	5.7	10.3
S42200	0.280	7.750	2675	2700	13.8	0.11	6.2	11.2
S42900	0.280	7.750	2650	2750	14.8	0.11	5.7	10.3
S43000, S43020, S43023	0.280	7.750	2600	2750	15.1	0.11	5.8	10.4
S43600	0.280	7.750	2600	2750	13.8	0.11	5.2	9.4
S44002, S44004	0.280	7.750	2500	2700	14.0	0.11	5.7	10.3
S44003	0.280	7.750	2500	2750	14.0	0.11	5.6	10.1
S44600	0.270	7.474	2600	2750	12.1	0.12	5.8	10.4
S50100, S50200	0.280	7.750	2700	2800	21.2	0.11	6.2	11.2
Cast Iron and Steel								
Malleable Iron, A220 (50005, 60004, 80002)	0.265	7.335			29.5	0.12	7.5	13.5
Grey Cast Iron	0.25	6.920			28.0	0.25	5.8	10.4
Ductile Iron, A536 (120–90–02)	0.25	6.920	liquidus approximately, 2100 to 2200, depending on composition		20.0	0.16	5.9–6.2	10.6–11.16
Ductile Iron, A536 (100–70–03)	0.25	6.920			18.0	0.15	5.9–6.2	10.6–11.16
Ductile Iron, A536 (80–55–06)	0.25	6.920			20.8	0.15	5.9–6.2	10.6–11.16
Ductile Iron, A536 (65–45–120)	0.25	6.920				0.12	5.9–6.2	10.6–11.16
Ductile Iron, A536 (60–40–18)	0.25	6.920						
Cast Steel, 3%C	0.25	6.920	liquidus, 2640		28.0	0.12	7.0	12.6
Titanium Alloys								
Commercially Pure	0.163	4.512	3000	3040	9.0	0.12	5.1	9.2
Ti-5Al-2.5Sn	0.162	4.484	2820	3000	4.5	0.13	5.3	9.5
Ti-8Mn	0.171	4.733	2730	2970	6.3	0.19	6.0	10.8

^a Alloy designations correspond to the Aluminum Association numbers for aluminum alloys and to the unified numbering system (UNS) for copper and stainless steel alloys. A220 and A536 are ASTM specified irons.

Adjusting Lengths for Reference Temperature.—The standard reference temperature for industrial length measurements is 20 degrees Celsius (68 degrees Fahrenheit). For other temperatures, corrections should be made in accordance with the difference in thermal expansion for the two parts, especially when the gage is made of a different material than the part to be inspected.

✦ *Example:* An aluminum part is to be measured with a steel gage when the room temperature is 30 °C. The aluminum part has a coefficient of linear thermal expansion, $\alpha_{Part} = 24.7 \times 10^{-6}$ mm/mm-°C, and for the steel gage, $\alpha_{Gage} = 10.8 \times 10^{-6}$ mm/mm-°C.

At the reference temperature, the specified length of the aluminum part is 20.021 mm. What is the length of the part at the measuring (room) temperature?

ΔL , the change in the measured length due to temperature, is given by:

$$\begin{aligned}\Delta L &= L(T_R - T_0)(\alpha_{Part} - \alpha_{Gage}) \\ &= 20.021(30 - 20)(24.7 - 10.8) \times 10^{-6} \text{ mm} \\ &= 2782.919 \times 10^{-6} \approx 0.003 \text{ mm}\end{aligned}$$

where L = length of part at reference temperature; T_R = room temperature (temperature of part and gage); and, T_0 = reference temperature.

Thus, the temperature corrected length at 30°C is $L + \Delta L = 20.021 + 0.003 = 20.024$ mm.

Length Change Due to Temperature.—Table 14 gives changes in length for variations from the standard reference temperature of 68°F (20°C) for materials of known coefficients of expansion, α . Coefficients of expansion are given in tables on pages 375, 376, 389, 390, and elsewhere.

Example: In Table 14, for coefficients between those listed, add appropriate listed values. For example, a length change for a coefficient of 7 is the sum of values in the 5 and 2 columns. Fractional interpolation also is possible. Thus, in a steel bar with a coefficient of thermal expansion of $6.3 \times 10^{-6} = 0.0000063$ in/in = 6.3 $\mu\text{in/in}$ of length/°F, the increase in length at 73°F is $25 + 5 + 1.5 = 31.5$ $\mu\text{in/in}$ of length. For a steel with the same coefficient of expansion, the change in length, measured in degrees C, is expressed in microns (micrometers)/meter ($\mu\text{m/m}$) of length.

Alternatively, and for temperatures beyond the scope of the table, the length difference due to a temperature change is equal to the coefficient of expansion multiplied by the change in temperature, i.e., $\Delta L = \alpha \Delta T$. Thus, for the previous example, $\Delta L = 6.3 \times (73 - 68) = 6.3 \times 5 = 31.5$ $\mu\text{in/in}$.

✦ **Change in Radius of Thin Circular Ring with Temperature.**—Consider a circular ring of initial radius r , that undergoes a temperature change ΔT . Initially, the circumference of the ring is $c = 2\pi r$. If the coefficient of expansion of the ring material is α , the change in circumference due to the temperature change is $\Delta c = 2\pi r \alpha \Delta T$

The new circumference of the ring will be: $c_n = c + \Delta c = 2\pi r + 2\pi r \alpha \Delta T = 2\pi r(1 + \alpha \Delta T)$

Note: An increase in temperature causes Δc to be positive, and a decrease in temperature causes Δc to be negative.

As the circumference increases, the radius of the circle also increases. If the new radius is R , the new circumference $2\pi R$. For a given change in temperature, ΔT , the change in radius of the ring is found as follows:

$$c_n = 2\pi R = 2\pi r(1 + \alpha \Delta T) \quad R = r + r\alpha \Delta T \quad \Delta r = R - r = r\alpha \Delta T$$

Table 14. Differences in Length in Microinches/Inch (Microns/Meter) for Changes from the Standard Temperature of 68°F (20°C)

Temperature Deg.		Coefficient of Thermal Expansion of Material per Degree F (C) × 10 ⁶									
		1	2	3	4	5	10	15	20	25	30
F	C	Total Change in Length from Standard Temperature {									
		for °F in microinches/inch of length (μin/in)					for °C or °K in microns/meter of length (μm/m)				
38	-10	-30	-60	-90	-120	-150	-300	-450	-600	-750	-900
39	-9	-29	-58	-87	-116	-145	-290	-435	-580	-725	-870
40	-8	-28	-56	-84	-112	-140	-280	-420	-560	-700	-840
41	-7	-27	-54	-81	-108	-135	-270	-405	-540	-675	-810
42	-6	-26	-52	-78	-104	-130	-260	-390	-520	-650	-780
43	-5	-25	-50	-75	-100	-125	-250	-375	-500	-625	-750
44	-4	-24	-48	-72	-96	-120	-240	-360	-480	-600	-720
45	-3	-23	-46	-69	-92	-115	-230	-345	-460	-575	-690
46	-2	-22	-44	-66	-88	-110	-220	-330	-440	-550	-660
47	-1	-21	-42	-63	-84	-105	-210	-315	-420	-525	-630
48	0	-20	-40	-60	-80	-100	-200	-300	-400	-500	-600
49	1	-19	-38	-57	-76	-95	-190	-285	-380	-475	-570
50	2	-18	-36	-54	-72	-90	-180	-270	-360	-450	-540
51	3	-17	-34	-51	-68	-85	-170	-255	-340	-425	-510
52	4	-16	-32	-48	-64	-80	-160	-240	-320	-400	-480
53	5	-15	-30	-45	-60	-75	-150	-225	-300	-375	-450
54	6	-14	-28	-42	-56	-70	-140	-210	-280	-350	-420
55	7	-13	-26	-39	-52	-65	-130	-195	-260	-325	-390
56	8	-12	-24	-36	-48	-60	-120	-180	-240	-300	-360
57	9	-11	-22	-33	-44	-55	-110	-165	-220	-275	-330
58	10	-10	-20	-30	-40	-50	-100	-150	-200	-250	-300
59	11	-9	-18	-27	-36	-45	-90	-135	-180	-225	-270
60	12	-8	-16	-24	-32	-40	-80	-120	-160	-200	-240
61	13	-7	-14	-21	-28	-35	-70	-105	-140	-175	-210
62	14	-6	-12	-18	-24	-30	-60	-90	-120	-150	-180
63	15	-5	-10	-15	-20	-25	-50	-75	-100	-125	-150
64	16	-4	-8	-12	-16	-20	-40	-60	-80	-100	-120
65	17	-3	-6	-9	-12	-15	-30	-45	-60	-75	-90
66	18	-2	-4	-6	-8	-10	-20	-30	-40	-50	-60
67	19	-1	-2	-3	-4	-5	-10	-15	-20	-25	-30
68	20	0	0	0	0	0	0	0	0	0	0
69	21	1	2	3	4	5	10	15	20	25	30
70	22	2	4	6	8	10	20	30	40	50	60
71	23	3	6	9	12	15	30	45	60	75	90
72	24	4	8	12	16	20	40	60	80	100	120
73	25	5	10	15	20	25	50	75	100	125	150
74	26	6	12	18	24	30	60	90	120	150	180
75	27	7	14	21	28	35	70	105	140	175	210
76	28	8	16	24	32	40	80	120	160	200	240
77	29	9	18	27	36	45	90	135	180	225	270
78	30	10	20	30	40	50	100	150	200	250	300
79	31	11	22	33	44	55	110	165	220	275	330
80	32	12	24	36	48	60	120	180	240	300	360
81	33	13	26	39	52	65	130	195	260	325	390
82	34	14	28	42	56	70	140	210	280	350	420
83	35	15	30	45	60	75	150	225	300	375	450
84	36	16	32	48	64	80	160	240	320	400	480
85	37	17	34	51	68	85	170	255	340	425	510
86	38	18	36	54	72	90	180	270	360	450	540
87	39	19	38	57	76	95	190	285	380	475	570
88	40	20	40	60	80	100	200	300	400	500	600
89	41	21	42	63	84	105	210	315	420	525	630
90	42	22	44	66	88	110	220	330	440	550	660
91	43	23	46	69	92	115	230	345	460	575	690
92	44	24	48	72	96	120	240	360	480	600	720
93	45	25	50	75	100	125	250	375	500	625	750
94	46	26	52	78	104	130	260	390	520	650	780
95	47	27	54	81	108	135	270	405	540	675	810
96	48	28	56	84	112	140	280	420	560	700	840
97	49	29	58	87	116	145	290	435	580	725	870
98	50	30	60	90	120	150	300	450	600	750	900



Properties of Mass and Weight

Density.—The density of any solid, fluid or gaseous substance is the mass of that substance per unit volume. If weight is used in the ordinary sense as being equivalent to mass, then density may be defined as the weight per unit volume. The density depends upon the unit in which the mass or weight is expressed, and upon the unit of volume used. In engineering and scientific work, density is generally expressed in grams per cubic centimeter, without naming the units, because the density will be equal to the specific gravity.

Specific Gravity.—Specific gravity is a number indicating how many times a volume of material is heavier than an equal volume of water. Density of water varies slightly at different temperatures. In exacting scientific studies a reference temperature of 4°C (39.2°F) is often used, and the weight of 1 cubic meter of pure water at 4°C is 1000 kg. In engineering practice the usual custom is to measure specific gravity at water temperature of 60 or 62°F (15.5 or 16.6°C); 1 cubic foot of pure water at 62°F weighs 62.355 pounds.

Given	Rule to find density	Given	Rule to find specific gravity
Specific Gravity (S.G.)	$\text{weight/cm}^3 = \text{S.G.}$	weight/cm^3	$\text{S.G.} = \text{weight/cm}^3$
	$\text{weight/m}^3 = \text{S.G.} \times 1000$	weight/m^3	$\text{S.G.} = \text{weight/m}^3 \div 1000$
	$\text{weight/in}^3 = \text{S.G.} \times 0.0361$	weight/in^3	$\text{S.G.} = \text{weight/in}^3 \div 0.0361$
	$\text{weight/ft}^3 = \text{S.G.} \div 0.01604$	weight/ft^3	$\text{S.G.} = \text{weight/ft}^3 \times 0.01604$

When specific gravity is known, the weight per cubic centimeter is equal to its specific gravity. The weight per cubic meter equals the specific gravity \times 1000. The weight per cubic inch equals the specific gravity \times 0.0361. The weight of a cubic foot equals the specific gravity divided by 0.01604.

When weight per cubic centimeter is known, the specific gravity is equal to the weight per cubic centimeter. If weight per cubic meter is known, the specific gravity equals this weight divided by 1000. If density is given in lb/in³, specific gravity may be determined by dividing the density by 0.0361. If weight per cubic foot is known, specific gravity equals this weight multiplied by 0.01604.

Examples: The specific gravity of cast iron is 7.2. The weight of 80 cm³ of cast iron = $7.2 \times 80 = 5.6$ kg. The weight of 5 in³ of cast iron = $7.2 \times 0.0361 \times 5 = 1.2996$ pounds.

Examples: The weight of a cubic centimeter of gold is 19.31 grams. The specific gravity of gold = weight of a cubic centimeter of gold = 19.31. A cubic inch of gold weighs 0.697 pound. The specific gravity of gold = $0.697 \div 0.0361 = 19.31$

Table 15. Average Specific Gravity of Various Substances

Substance	Specific Gravity	^a Weight		Substance	Specific Gravity	^a Weight		Substance	Specific Gravity	^a Weight	
		lb/ft ³	kg/m ³			lb/ft ³	kg/m ³			lb/ft ³	kg/m ³
ABS	1.05	66	1057	Glass	2.6	162	2595	Platinum	21.5	1342	21497
Acrylic	1.19	74	1185	Glass, crushed	...	74	1185	Polycarbonate	1.19	74	1185
Aluminum bronze	7.8	486	7785	Gold, 22 carat fine	17.5	1091	17476	Polyethylene	0.97	60	961
Aluminum, cast	2.6	160	2563	Gold, pure	19.3	1204	19286	Polypropylene	0.91	57	913
Aluminum, wrought	2.7	167	2675	Granite	2.7	168	2691	Polyurethane	1.05	66	1057
Asbestos	2.4	150	2403	Gravel	...	109	1746	Quartz	2.6	162	2595
Asphaltum	1.4	87	1394	Gypsum	2.4	150	2403	Salt, common	...	48	769
Borax	1.8	112	1794	Ice	0.9	56	897	Sand, dry	...	100	1602
Brick, common	1.8	112	1794	Iron, cast	7.2	447	7160	Sand, wet	...	125	2002
Brick, fire	2.3	143	2291	Iron, wrought	7.7	479	7673	Sandstone	2.3	143	2291
Brick, hard	2.0	125	2002	Iron slag	2.7	168	2691	Silver	10.5	656	10508
Brick, pressed	2.2	137	2195	Lead	11.4	711	11389	Slate	2.8	175	2803
Brickwork, in cement	1.8	112	1794	Limestone	2.6	162	2595	Soapstone	2.7	168	2691
Brickwork, in mortar	1.6	100	1602	Marble	2.7	168	2691	Steel	7.9	491	7865
CPVC	1.55	97	1554	Masonry	2.4	150	2403	Sulfur	2.0	125	2002
Cement, Portland (set)	3.1	193	3092	Mercury	13.56	845.3	13540	Tar, bituminous	1.2	75	1201
Chalk	2.3	143	2291	Mica	2.8	175	2803	Tile	1.8	112	1794
Charcoal	0.4	25	400	Mortar	1.5	94	1506	Trap rock	3.0	187	2995
Coal, anthracite	1.5	94	1506	Nickel, cast	8.3	517	8282	Water at 4°C	1.0	62.43	1000
Coal, bituminous	1.3	81	1297	Nickel, rolled	8.7	542	8682	Water at 62°F	1.0	62.355	1000
Concrete	2.2	137	2195	Nylon 6, Cast	1.16	73	1169	White metal	7.3	457	7320
Earth, loose	...	75	1201	PTFE	2.19	137	2195	Zinc, cast	6.9	429	6872
Earth, rammed	...	100	1602	Phosphorus	1.8	112	1794	Zinc, sheet	7.2	450	7208
Emery	4.0	249	3989	Plaster of Paris	1.8	112	1794

^aThe weight per cubic foot, or per cubic meter, is calculated on the basis of the specific gravity except for those substances that occur in bulk, heaped, or loose form. In these instances, only the weights per cubic foot and per cubic meter are given because the voids present in representative samples make the values of the specific gravities inaccurate.

Average Weights and Volumes of Solid Fuels

Material	lb/ft ³	ft ³ /ton (2240 lb)	kg/m ³	lb/bushel	m ³ /t
Anthracite coal	55–65	34–41	881–1041	67 (80 ^a)	0.96–1.14
Bituminous coal	50–55	41–45	801–881	78–86 (80 ^a)	1.14–1.25
Charcoal	18–18.5	121–124	288–296	22–23 (20 ^a)	3.37–3.47
Coke	28	80	449	35 (40 ^a)	2.23

^aLegal commodities weight/bushel defined by statute in some states.

Note: t = metric ton = 1000 kg; ton = US ton of 2000 lbs; a gross or long ton = 2240 lbs.

Specific Gravity of Gases.—The specific gravity of gases is the number that indicates their weight in comparison with that of an equal volume of air. The specific gravity of air is 1, and the comparison is made at 32°F (0°C). Values are given in [Table 16](#).

Table 16. Specific Gravity of Gases At 32°F (0°C)

Gas	Sp. Gr.	Gas	Sp. Gr.	Gas	Sp. Gr.
Air ^a	1.000	Ether vapor	2.586	Marsh gas	0.555
Acetylene	0.920	Ethylene	0.967	Nitrogen	0.971
Alcohol vapor	1.601	Hydrofluoric acid	2.370	Nitric oxide	1.039
Ammonia	0.592	Hydrochloric acid	1.261	Nitrous oxide	1.527
Carbon dioxide	1.520	Hydrogen	0.069	Oxygen	1.106
Carbon monoxide	0.967	Illuminating gas	0.400	Sulfur dioxide	2.250
Chlorine	2.423	Mercury vapor	6.940	Water vapor	0.623

^a 1 cubic foot of air at 32°F and atmospheric pressure weighs 0.0807 pound. 1 cubic meter of air at 0°C and atmospheric pressure weighs 1.29 kg.

Specific Gravity of Liquids.—The specific gravity of liquids is the number that indicates how much a certain volume of the liquid weighs compared with an equal volume of water, the same as with solid bodies. Specific gravity of various liquids is given in [Table 17](#).

The density of liquid is often expressed in degrees on the hydrometer, an instrument for determining the density of liquids, provided with graduations made to an arbitrary scale. The hydrometer consists of a glass tube with a bulb at one end containing air, and arranged with a weight at the bottom so as to float in an upright position in the liquid, the density of which is to be measured. The depth to which the hydrometer sinks in the liquid is read off on the graduated scale. The most commonly used hydrometer is the Baumé, see [Table 18](#). The value of the degrees of the Baumé scale differs according to whether the liquid is heavier or lighter than water. The specific gravity for liquids heavier than water equals $145 \div (145 - \text{degrees Baumé})$. For liquids lighter than water, the specific gravity equals $140 \div (130 + \text{degrees Baumé})$.

Table 17. Specific Gravity of Liquids

Liquid	Sp. Gr.	Liquid	Sp. Gr.	Liquid	Sp. Gr.	Liquid	Sp. Gr.
Acetic acid	1.06	Cotton-seed oil	0.93	Naphtha	0.76	Tar	1.00
Alcohol, commercial	0.83	Ether, sulfuric	0.72	Nitric acid	1.50	Turpentine oil	0.87
Alcohol, pure	0.79	Fluoric acid	1.50	Olive oil	0.92	Vinegar	1.08
Ammonia	0.89	Gasoline	0.70	Palm oil	0.97	Water	1.00
Benzine	0.69	Kerosene	0.80	Petroleum oil	0.82	Water, sea	1.03
Bromine	2.97	Linseed oil	0.94	Phosphoric acid	1.78	Whale oil	0.92
Carbolic acid	0.96	Mineral oil	0.92	Rape oil	0.92		
Carbon disulfide	1.26	Muriatic acid	1.20	Sulfuric acid	1.84		

Table 18. Degrees on Baumé's Hydrometer Converted to Specific Gravity

Deg. Baumé	Specific Gravity for Liquids		Deg. Baumé	Specific Gravity for Liquids		Deg. Baumé	Specific Gravity for Liquids	
	Heavier than Water	Lighter than Water		Heavier than Water	Lighter than Water		Heavier than Water	Lighter than Water
0	1.000	...	27	1.229	0.892	54	1.593	0.761
1	1.007	...	28	1.239	0.886	55	1.611	0.757
2	1.014	...	29	1.250	0.881	56	1.629	0.753
3	1.021	...	30	1.261	0.875	57	1.648	0.749
4	1.028	...	31	1.272	0.870	58	1.667	0.745
5	1.036	...	32	1.283	0.864	59	1.686	0.741
6	1.043	...	33	1.295	0.859	60	1.706	0.737
7	1.051	...	34	1.306	0.854	61	1.726	0.733
8	1.058	...	35	1.318	0.849	62	1.747	0.729
9	1.066	...	36	1.330	0.843	63	1.768	0.725
10	1.074	1.000	37	1.343	0.838	64	1.790	0.721
11	1.082	0.993	38	1.355	0.833	65	1.813	0.718
12	1.090	0.986	39	1.368	0.828	66	1.836	0.714
13	1.099	0.979	40	1.381	0.824	67	1.859	0.710
14	1.107	0.972	41	1.394	0.819	68	1.883	0.707
15	1.115	0.966	42	1.408	0.814	69	1.908	0.704
16	1.124	0.959	43	1.422	0.809	70	1.933	0.700
17	1.133	0.952	44	1.436	0.805	71	1.959	0.696
18	1.142	0.946	45	1.450	0.800	72	1.986	0.693
19	1.151	0.940	46	1.465	0.796	73	2.014	0.689
20	1.160	0.933	47	1.480	0.791	74	2.042	0.686
21	1.169	0.927	48	1.495	0.787	75	2.071	0.683
22	1.179	0.921	49	1.510	0.782	76	2.101	0.679
23	1.189	0.915	50	1.526	0.778	77	2.132	0.676
24	1.198	0.909	51	1.542	0.773	78	2.164	0.673
25	1.208	0.903	52	1.559	0.769	79	2.197	0.669
26	1.219	0.897	53	1.576	0.765	80	2.230	0.666

How to Estimate the Weight of Natural Piles.—To calculate the upper and lower limits of weight of a substance piled naturally on a plate, use the following:

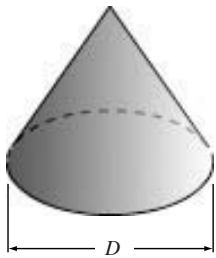


Fig. 1a. Conical Pile

For a substance piled naturally on a circular plate, forming a cone of material,

$$W = MD^3 \tag{1}$$

where W = weight, lb (kg); D = diameter of plate in Fig. 1a, in feet (meters); and, M = a materials factor, whose upper and lower limits are given in Table 19b.

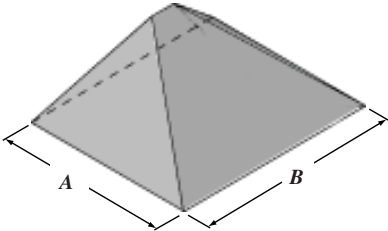


Fig. 1b. Rectangular Pile

For a substance piled naturally on a rectangular plate,

$$W = MRA^3 \tag{2}$$

where W = weight, lb (kg); A and B = the length and width in feet (meters), respectively, of the rectangular plate in Fig. 1b, with $B \leq A$; M = a materials factor, whose upper and lower limits are given in Table 19b; and, R = is a factor given in Table 19a as a function of the ratio B/A .

Example: Find the upper and lower limits of the weight of dry ashes piled naturally on a plate 10 ft. in diameter.

Using Equation (1), $M = 4.58$ from Table 19b, the lower limit $W = 4.58 \times 10^3 = 4,580$ lb. For $M = 5.89$, the upper limit $W = 5.89 \times 10^3 = 5,890$ lb.

Example: What weight of dry ashes rests on a rectangular plate 10 ft. by 5 ft.?

For $B/A = 5/10 = 0.5$, $R = 0.39789$ from Table 19a. Using Equation (2), for $M = 4.58$, the lower limit $W = 4.58 \times 0.39789 \times 10^3 = 1,822$ lb. For $M = 5.89$, the upper limit $W = 5.89 \times 0.39789 \times 10^3 = 2,344$ lb.

Example: What is the weight of a pile of cast iron chips resting on a rectangular plate 4 m by 2 m? For $B/A = 2/4$, $R = 0.39789$ from Table 19a. Using Equation (2), for $M = 17.02$, the lower limit $W = 17.02 \times 0.39789 \times 4^3 = 433$ kg. For $M = 26.18$, the upper limit $W = 26.18 \times 0.39789 \times 4^3 = 667$ kg.

Table 19a. Factor R as a function of B/A (B ≤ A)

B/A	R	B/A	R	B/A	R	B/A	R	B/A	R	B/A	R
0.01	0.00019	0.18	0.05817	0.35	0.20666	0.52	0.42691	0.69	0.70015	0.86	1.00761
0.02	0.00076	0.19	0.06458	0.36	0.21782	0.53	0.44170	0.70	0.71747	0.87	1.02636
0.03	0.00170	0.20	0.07130	0.37	0.22921	0.54	0.45667	0.71	0.73491	0.88	1.04516
0.04	0.00302	0.21	0.07833	0.38	0.24085	0.55	0.47182	0.72	0.75245	0.89	1.06400
0.05	0.00470	0.22	0.08566	0.39	0.25273	0.56	0.48713	0.73	0.77011	0.90	1.08289
0.06	0.00674	0.23	0.09329	0.40	0.26483	0.57	0.50262	0.74	0.78787	0.91	1.10182
0.07	0.00914	0.24	0.10121	0.41	0.27717	0.58	0.51826	0.75	0.80572	0.92	1.12078
0.08	0.01190	0.25	0.10942	0.42	0.28973	0.59	0.53407	0.76	0.82367	0.93	1.13977
0.09	0.01501	0.26	0.11792	0.43	0.30252	0.60	0.55004	0.77	0.84172	0.94	1.15879
0.10	0.01846	0.27	0.12670	0.44	0.31552	0.61	0.56616	0.78	0.85985	0.95	1.17783
0.11	0.02226	0.28	0.13576	0.45	0.32873	0.62	0.58243	0.79	0.87807	0.96	1.19689
0.12	0.02640	0.29	0.14509	0.46	0.34216	0.63	0.59884	0.80	0.89636	0.97	1.21596
0.13	0.03088	0.30	0.15470	0.47	0.35579	0.64	0.61539	0.81	0.91473	0.98	1.23505
0.14	0.03569	0.31	0.16457	0.48	0.36963	0.65	0.63208	0.82	0.93318	0.99	1.25414
0.15	0.04082	0.32	0.17471	0.49	0.38366	0.66	0.64891	0.83	0.95169	1.00	1.27324
0.16	0.04628	0.33	0.18511	0.50	0.39789	0.67	0.66586	0.84	0.97027
0.17	0.05207	0.34	0.19576	0.51	0.41231	0.68	0.68295	0.85	0.98891

Table 19b. Limits of Factor M for Various Materials

Material	Factor M	Material	Factor M	Material	Factor M
Almonds, whole	2.12-3.93	Coffee, ground	1.89-3.27	Peanuts, unshelled	1.13-3.14
Aluminum chips	0.92-1.96	Coke, pulverized	2.21	Peanuts, shelled	2.65-5.89
Aluminum silicate	3.7-6.41	Copper oxide, powdered	20.87	Peas, dry	2.75-3.05
Ammonium chloride	3.93-6.81	Cork, granulated	1.57-1.96	Potassium carbonate	3.85-6.68
Asbestos, shred	2.62-3.27	Corn on cob	1.29-1.33	Potassium sulphate	5.5-6.28
Ashes, dry	4.58-5.89	Corn sugar	2.34-4.06	Pumice	5.24-5.89
Ashes, damp	6.24-7.80	Cottonseed, dry, de-linted	1.66-5.24	Rice, bran	1.51-2.75
Asphalt, crushed	3.4-5.89	Diatomaceous earth	0.83-1.83	Rubber, scrap, ground	2.11-4.58
Bakelite, powdered	3.93-5.24	Dicalcium phosphate	5.63	Salt, dry, coarse	3.02-8.38
Baking powder	3.1-5.37	Ebonite, crushed	4.91-9.16	Salt, dry, fine	5.29-10.47
Barium carbonate	9.42	Epsom salts	3.02-6.54	Saltpeper	6.05-10.47
Bauxite, mine run	5.9-6.69	Feldspar, ground	8.51-9.16	Salt rock, crushed	4.58
Beans, navy, dry	3.63	Fish scrap	5.24-6.54	Sand, very fine	7.36-9
Beets, sugar, shredded	0.47-0.55	Flour	5.61-10.43	Sawdust, dry	0.95-2.85
Bicarbonate of soda	3.10	Flue dust	2.65-3.40	Sesame seed	2.04-4.84
Borax	3.78-9.16	Flourspar (Flourite)	10.73-14.40	Shellac, powdered	2.34-4.06
Boric acid	4.16-7.20	Graphite, flake	3.02-5.24	Slag, furnace, granular	4.53-8.51
Bronze chips	3.93-6.54	Gravel	6.8-13.18	Soap powder	1.51-3.27
Buckwheat	2.8-3.17	Gypsum, calcined	6.04-6.59	Sodium nitrate	3.96-4.66
Calcium lactate	3.4-3.8	Hominy	2.8-6.54	Sodium sulphite	10.54
Calcium oxide (lime)	3.30	Hops, dry	4.58	Sodium sulphate	6.92
Carbon, ground	2.51	Kaolin clay	12.32-21.34	Soybeans	3.48-6.28
Casein	2.72-4.71	Lead silicate, granulated	25.26	Steel chips, crushed	7.56-19.63
Cashew nuts	4.19-4.84	Lead sulphate, pulverized	24.09	Sugar, refined	3.78-7.2
Cast iron chips	17.02-26.18	Lime ground	7.85	Sulphur	4.5-6.95
Cement, Portland	6.8-13.09	Limestone, crushed	6.42-11.78	Talcum powder	4.37-5.9
Cinders, coal	3.02-5.24	Magnesium chloride	4.32	Tin oxide, ground	9.17
Clay, blended for tile	5.89	Malt, dry, ground	1.66-2.88	Tobacco stems	1.96-3.27
Coal, anthracite, chestnut	2.43	Manganese sulphate	5.29-9.16	Trisodium phosphate	4.53-7.85
Coal, bituminous, sized	2.64-4.48	Marble, crushed	6.8-12.44	Walnut shells, crushed	2.65-5.24
Coal, ground	2.90	Mica, ground	1.24-1.43	Wood chips, fir	2.49-2.88
Cocoa, powdered	3.93-4.58	Milk, whole, powdered	2.62	Zinc sulphate	8.85-11.12
Coconut, shredded	2.62-2.88	Oats	1.74-2.86
Coffee beans	2.42-5.89	Orange peel, dry	1.96

Molecular Weight.—The smallest mass of a chemical combination which can be conceived of as existing and yet preserving its chemical properties is known as a *molecule*. The molecular weight of a chemical compound is equal to the sum of the atomic weights of the atoms contained in the molecule, and are calculated from the atomic weights, when the symbol of the compound is known. See [Table 1](#) on page 371 for atomic weights. The atomic weight of silver is 107.88; of nitrogen, 14.01; and of oxygen, 16; hence, the molecular weight of silver-nitrate, the chemical formula of which is AgNO_3 equals $107.88 + 14.01 + (3 \times 16) = 169.89$.

Mol.—The term “mol” is used as a designation of quantity in electro-chemistry to indicate the number of grams of a substance equal to its molecular weight. For example, one mol of silver-nitrate equals 169.89 grams, the molecular weight of silver-nitrate being 169.89.

Air.—Air is a mechanical mixture composed of 78 per cent, by volume, of nitrogen, 21 per cent of oxygen, and 1 per cent of argon. The weight of pure air at 32 °F (0 °C), and an atmospheric pressure of 29.92 inches of mercury (760 mm mercury or 760 torr) or 14.70 pounds per square inch, is 0.08073 pound per cubic foot. The volume of a pound of air at the same temperature and pressure is 12.387 cubic feet. The weight of air, in pounds per cubic foot, at any other temperature or pressure may be determined by first multiplying the barometer reading (atmospheric pressure in inches of mercury) by 1.325 and then dividing the product by the absolute temperature in degrees F. The absolute zero from which all temperatures must be derived in dealing with the weight and volume of gases, is assumed to be minus 459.67 °F (273.15 °C). Hence, to obtain the absolute temperature, add to the temperature observed on a regular Fahrenheit thermometer the value 459.67.

Alligation.—Alligation or "the rule of mixtures" are names applied to several rules of arithmetical processes for determining the relation between proportions and prices of the ingredients of a mixture and the cost of the mixture per unit of weight or volume. For example, if an alloy is composed of several metals varying in price, the price per pound of the alloy can be found as in the following example: An alloy is composed of 50 pounds of copper at \$1.70 a pound, 10 pounds of tin at \$4.05 a pound, 20 pounds of zinc at \$0.99 a pound, and 5 pounds of lead at \$1.10 cents a pound. What is the cost of the alloy per pound, no account being taken of the cost of mixing it? Multiply the number of pounds of each of the ingredients by its price per pound, add these products together, and divide the sum by the total weight of all the ingredients. The quotient is the price per pound of the alloy.

Example: The foregoing example would be worked out numerically as follows:

Total cost of materials: $50 \times 1.70 + 10 \times 4.05 + 20 \times 0.99 + 5 \times 1.10 = \150.80

Total weight of metal in alloy: $50 + 10 + 20 + 5 = 85$ lbs.

Price per pound of alloy = $150.80 \div 85 = \$1.77$, approximately.

Earth or Soil Weight.—Loose earth has a weight of approximately 75 lb/ft³ (1200 kg/m³) and rammed earth, 100 lb/ft³ (1600 kg/m³).

Composition of Earth Crust: The solid crust of the earth, according to an estimate, is composed approximately of the following elements: oxygen, 44.0 to 48.7%; silicon, 22.8 to 36.2%; aluminum, 6.1 to 9.9%; iron, 2.4 to 9.9%; calcium, 0.9 to 6.6%; magnesium, 0.1 to 2.7%; sodium, 2.4 to 2.5%; potassium, 1.7 to 3.1%.

Loads on Soils and Rocks: The bearing capacities of soils and rocks is useful in structural engineering, and also of value under certain conditions in connection with the installation of very heavy machinery requiring foundations. The ultimate resistance of various soils and rocks will be given in tons per square foot: natural earth that is solid and dry, 4 to 6 tons; thick beds of absolutely dry clay, 4 tons; thick beds of moderately dry clay, 2 tons; soft clay, 1 ton; gravel that is dry, coarse, and well packed, 6 to 8 tons; soft, friable rock and shales, 5 to 10 tons; sand that is compact, dry, and well cemented, 4 tons; natural sand in a clean dry condition, 2 to 4 tons; compact bed-rock, northern red sandstone, 20 tons; compact bed-rock, northern sound limestone, 25 tons; compact bed-rock granite, 30 tons.

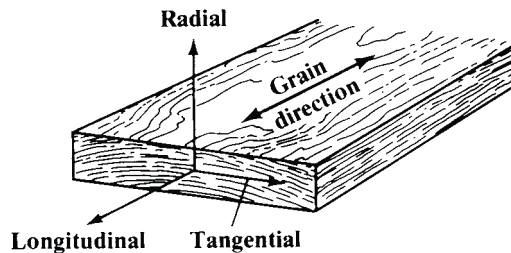
PROPERTIES OF WOOD, CERAMICS, PLASTICS, METALS

Properties of Wood

Mechanical Properties of Wood.—Wood is composed of cellulose, lignin, ash-forming minerals, and extractives formed into a cellular structure. (Extractives are substances that can be removed from wood by extraction with such solvents as water, alcohol, acetone, benzene, and ether.) Variations in the characteristics and volumes of the four components and differences in the cellular structure result in some woods being heavy and some light, some stiff and some flexible, and some hard and some soft. For a single species, the properties are relatively constant within limits; therefore, selection of wood by species alone may sometimes be adequate. However, to use wood most effectively in engineering applications, the effects of physical properties or specific characteristics must be considered.

The mechanical properties listed in the accompanying **Table 1** were obtained from tests on small pieces of wood termed “clear” and “straight grained” because they did not contain such characteristics as knots, cross grain, checks, and splits. However, these test pieces did contain such characteristics as growth rings that occur in consistent patterns within the piece. Since wood products may contain knots, cross grain, etc., these characteristics must be taken into account when assessing actual properties or when estimating actual performance. In addition, the methods of data collection and analysis have changed over the years during which the data in **Table 1** have been collected; therefore, the appropriateness of the data should be reviewed when used for critical applications such as stress grades of lumber.

Wood is an orthotropic material; that is, its mechanical properties are unique and independent in three mutually perpendicular directions—longitudinal, radial, and tangential. These directions are illustrated in the following figure.



Modulus of Rupture: The modulus of rupture in bending reflects the maximum load-carrying capacity of a member and is proportional to the maximum moment borne by the member. The modulus is an accepted criterion of strength, although it is not a true stress because the formula used to calculate it is valid only to the proportional limit.

Work to Maximum Load in Bending: The work to maximum load in bending represents the ability to absorb shock with some permanent deformation and more or less injury to a specimen; it is a measure of the combined strength and toughness of the wood under bending stress.

Maximum Crushing Strength: The maximum crushing strength is the maximum stress sustained by a compression parallel-to-grain specimen having a ratio of length to least diameter of less than 11.

Compression Perpendicular to Grain: Strength in compression perpendicular to grain is reported as the stress at the proportional limit because there is no clearly defined ultimate stress for this property.

Shear Strength Parallel to Grain: Shear strength is a measure of the ability to resist internal slipping of one part upon another along the grain. The values listed in the table are averages of the radial and tangential shears.

Tensile Strength Perpendicular to Grain: The tensile strength perpendicular to the grain is a measure of the resistance of wood to forces acting across the grain that tend to split the material. Averages of radial and tangential measurements are listed.

Table 1. Mechanical Properties of Commercially Important U.S. Grown Woods

Use the first number in each column for GREEN wood; use the second number for DRY wood.	Static Bending				Maximum Crushing Strength (10 ³ psi)	Compression Strength Perpendicular to Grain (psi)	Shear Strength Parallel to Grain (psi)	Tensile Strength Perp. to Grain (psi)				
	Modulus of Rupture (10 ³ psi)		Work to Max Load (in.-lb/in. ³)									
Basswood, American	5.0	8.7	5.3	7.2	2.22	4.73	170	370	600	990	280	350
Cedar, N. white	4.2	6.5	5.7	4.8	1.90	3.96	230	310	620	850	240	240
Cedar, W. red	5.2	7.5	5.0	5.8	2.77	4.56	240	460	770	990	230	220
Douglas Fir, coast ^a	7.7	12.4	7.6	9.9	3.78	7.23	380	800	900	1,130	300	340
Douglas Fir, interior W.	7.7	12.6	7.2	10.6	3.87	7.43	420	760	940	1,290	290	350
Douglas Fir, interior N.	7.4	13.1	8.1	10.5	3.47	6.90	360	770	950	1,400	340	390
Douglas Fir, interior S.	6.8	11.9	8.0	9.0	3.11	6.23	340	740	950	1,510	250	330
Fir, balsam	5.5	9.2	4.7	5.1	2.63	5.28	190	404	662	944	180	180
Hemlock, Eastern	6.4	8.9	6.7	6.8	3.08	5.41	360	650	850	1,060	230	...
Hemlock, Mountain	6.3	11.5	11.0	10.4	2.88	6.44	370	860	930	1,540	330	...
Hemlock, Western	6.6	11.3	6.9	8.3	3.36	7.20	280	550	860	1,290	290	340
Pine, E. white	4.9	9.9	5.2	8.3	2.44	5.66	220	580	680	1,170	250	420
Pine, Virginia	7.3	13.0	10.9	13.7	3.42	6.71	390	910	890	1,350	400	380
Pine, W. white	4.7	9.7	5.0	8.8	2.43	5.04	190	470	680	1,040	260	...
Redwood, old-growth	7.5	10.0	7.4	6.9	4.20	6.15	420	700	800	940	260	240
Redwood, young-growth	5.9	7.9	5.7	5.2	3.11	5.22	270	520	890	1,110	300	250
Spruce, Engelmann	4.7	9.3	5.1	6.4	2.18	4.48	200	410	640	1,200	240	350
Spruce, red	6.0	10.8	6.9	8.4	2.72	5.54	260	550	750	1,290	220	350
Spruce, white	5.0	9.4	6.0	7.7	2.35	5.18	210	430	640	970	220	360

^aCoast: grows west of the summit of the Cascade Mountains in OR and WA. Interior west: grows in CA and all counties in OR and WA east of but adjacent to the Cascade summit. Interior north: grows in remainder of OR and WA and ID, MT, and WY. Interior south: grows in UT, CO, AZ, and NM.

Results of tests on small, clear, straight-grained specimens. Data for dry specimens are from tests of seasoned material adjusted to a moisture content of 12%.

Source: U.S. Department of Agriculture: *Wood Handbook*.

Weight of Wood.—The weight of seasoned wood per cord is approximately as follows, assuming about 70 cubic feet of *solid wood* per cord: beech, 3300 pounds; chestnut, 2600 pounds; elm, 2900 pounds; maple, 3100 pounds; poplar, 2200 pounds; white pine, 2200 pounds; red oak, 3300 pounds; white oak, 3500 pounds. For additional weights of green and dry woods, see [Table 2](#).

Weight per Foot of Wood, Board Measure.—The following is the weight in pounds of various kinds of woods, commercially known as dry timber, per foot board measure: white oak, 4.16; white pine, 1.98; Douglas fir, 2.65; short-leaf yellow pine, 2.65; red pine, 2.60; hemlock, 2.08; spruce, 2.08; cypress, 2.39; cedar, 1.93; chestnut, 3.43; Georgia yellow pine, 3.17; California spruce, 2.08. For other woods, divide the weight/ft³ from [Table 2](#) by 12 to obtain the approximate weight per board foot.

Effect of Pressure Treatment on Mechanical Properties of Wood.—The strength of wood preserved with creosote, coal-tar, creosote-coal-tar mixtures, creosote-petroleum mixtures, or pentachlorophenol dissolved in petroleum oil is not reduced. However, water-borne salt preservatives contain chemicals such as copper, arsenic, chromium, and ammonia, which have the potential of affecting mechanical properties of treated wood and

causing mechanical fasteners to corrode. Preservative salt-retention levels required for marine protection may reduce bending strength by 10 per cent or more.

Density of Wood.—The following formula can be used to find the density of wood in lb/ft³ as a function of its moisture content.

$$\rho = 62.4 \left(\frac{G}{1 + G \times 0.009 \times M} \right) \left(1 + \frac{M}{100} \right)$$

where ρ is the density, G is the specific gravity of wood, and M is the moisture content expressed in per cent.

Table 2. Weights of American Woods, in Pounds per Cubic Foot

Species	Green	Air-dry	Species	Green	Air-dry	Species	Green	Air-dry
Alder, red	46	28	Douglas fir, Rocky Mt. region	35	30	Oak, red	64	44
Ash, black	52	34	Elm, American	54	35	Oak, white	63	47
Ash, commercial white	48	41	Elm, rock	53	44	Pine, lodgepole	39	29
Ash, Oregon	46	38	Elm, slippery	56	37	Pine, northern white	36	25
Aspen	43	26	Fir, balsam	45	25	Pine, Norway	42	34
Basswood	42	26	Fir, commercial white	46	27	Pine, ponderosa	45	28
Beech	54	45	Gum, black	45	35	Pines, southern yellow:		
Birch	57	44	Gum, red	50	34	Pine, loblolly	53	36
Birch, paper	50	38	Hemlock, eastern	50	28	Pine, longleaf	55	41
Cedar, Alaska	36	31	Hemlock, western	41	29	Pine, shortleaf	52	36
Cedar, eastern red	37	33	Hickory, pecan	62	45	Pine, sugar	52	25
Cedar, northern white	28	22	Hickory, true	63	51	Pine, western white	35	27
Cedar, southern white	26	23	Honeylocust	61	...	Poplar, yellow	38	28
Cedar, western red	27	23	Larch, western	48	36	Redwood	50	28
Cherry, black	45	35	Locust, black	58	48	Spruce, eastern	34	28
Chestnut	55	30	Maple, bigleaf	47	34	Spruce, Engelmann	39	23
Cottonwood, eastern	49	28	Maple, black	54	40	Spruce, Sitka	33	28
Cottonwood, northern black	46	24	Maple, red	50	38	Sycamore	52	34
Cypress, southern	51	32	Maple, silver	45	33	Tamarack	47	37
Douglas fir, coast region	38	34	Maple, sugar	56	44	Walnut, black	58	38

Source: United States Department of Agriculture

Machinability of Wood.—The ease of working wood with hand tools generally varies directly with the specific gravity of the wood; the lower the specific gravity, the easier the wood is to cut with a sharp tool. A rough idea of the specific gravity of various woods can be obtained from the preceding table by dividing the weight of wood in lb/ft³ by 62.355.

A wood species that is easy to cut does not necessarily develop a smooth surface when it is machined. Three major factors, other than specific gravity, influence the smoothness of the surface obtained by machining: interlocked and variable grain, hard deposits in the grain, and reaction wood. Interlocked and variable grain is a characteristic of many tropical and some domestic species; this type of grain structure causes difficulty in planing quarter sawn boards unless careful attention is paid to feed rates, cutting angles, and sharpness of the knives. Hard deposits of calcium carbonate, silica, and other minerals in the grain tend to dull cutting edges quickly, especially in wood that has been dried to the usual in service moisture content. Reaction wood results from growth under some physical stress such as occurs in leaning trunks and crooked branches. Generally, reaction wood occurs as tension wood in hardwoods and as compression wood in softwoods. Tension wood is particularly troublesome, often resulting in fibrous and fuzzy surfaces, especially in woods of lower density. Reaction wood may also be responsible for pinching saw blades, resulting in burning and dulling of teeth.

The Table 3 rates the suitability of various domestic hardwoods for machining. The data for each species represent the percentage of pieces machined that successfully met the listed quality requirement for the processes. For example, 62 per cent of the black walnut

pieces planed came out perfect, but only 34 per cent of the pieces run on the shaper achieved good to excellent results.

Table 3. Machinability and Related Properties of Various Domestic Hardwoods

Type of Wood	Planing	Shaping	Turning	Boring	Mortising	Sanding
	Quality Required					
	Perfect	Good to Excellent	Fair to Excellent	Good to Excellent	Fair to Excellent	Good to Excellent
Alder, red	61	20	88	64	52	...
Ash	75	55	79	94	58	75
Aspen	26	7	65	78	60	...
Basswood	64	10	68	76	51	17
Beech	83	24	90	99	92	49
Birch	63	57	80	97	97	34
Birch, paper	47	22
Cherry, black	80	80	88	100	100	...
Chestnut	74	28	87	91	70	64
Cottonwood	21	3	70	70	52	19
Elm, soft	33	13	65	94	75	66
Hackberry	74	10	77	99	72	...
Hickory	76	20	84	100	98	80
Magnolia	65	27	79	71	32	37
Maple, bigleaf	52	56	8	100	80	...
Maple, hard	54	72	82	99	95	38
Maple, soft	41	25	76	80	34	37
Oak, red	91	28	84	99	95	81
Oak, white	87	35	85	95	99	83
Pecan	88	40	89	100	98	...
Sweetgum	51	28	86	92	53	23
Sycamore	22	12	85	98	96	21
Tanoak	80	39	81	100	100	...
Tupelo, black	48	32	75	82	24	21
Tupelo, water	55	52	79	62	33	34
Walnut, black	62	34	91	100	98	...
Willow	52	5	58	71	24	24
Yellow-poplar	70	13	81	87	63	19

The data above represent the percentage of pieces attempted that meet the quality requirement listed.

Nominal and Minimum Sizes of Sawn Lumber

Type of Lumber	Thickness (inches)			Face Widths (inches)		
	Nominal, T_n	Dry	Green	Nominal, W_n	Dry	Green
Boards	1	$\frac{3}{4}$	$\frac{25}{32}$	2 to 4	$W_n - \frac{1}{2}$	$W_n - \frac{7}{16}$
	$1\frac{1}{4}$	1	$1\frac{1}{32}$	5 to 7	$W_n - \frac{1}{2}$	$W_n - \frac{3}{8}$
	$1\frac{1}{2}$	$1\frac{1}{4}$	$1\frac{1}{32}$	8 to 16	$W_n - \frac{3}{4}$	$W_n - \frac{1}{2}$
Dimension Lumber	2	$1\frac{1}{2}$	$1\frac{1}{16}$	2 to 4	$W_n - \frac{1}{2}$	$W_n - \frac{7}{16}$
	$2\frac{1}{2}$	2	$2\frac{1}{16}$	5 to 6	$W_n - \frac{1}{2}$	$W_n - \frac{3}{8}$
	3	$2\frac{1}{2}$	$2\frac{1}{16}$	8 to 16	$W_n - \frac{3}{4}$	$W_n - \frac{1}{2}$
	$3\frac{1}{2}$	3	$3\frac{1}{16}$
	4	$3\frac{1}{2}$	$3\frac{1}{16}$
Timbers	$4\frac{1}{2}$	4	$4\frac{1}{16}$
	5 and up	...	$T_n - \frac{1}{2}$	5 and up	...	$W_n - \frac{1}{2}$

Source: National Forest Products Association: *Design Values for Wood Construction*. Moisture content: dry lumber $\leq 19\%$; green lumber $> 19\%$. Dimension lumber refers to lumber 2 to 4 inches thick (nominal) and 2 inches or greater in width. Timbers refers to lumber of approximately square cross-section, 5 \times 5 inches or larger, and a width no more than 2 inches greater than the thickness.

Tabulated Properties of Ceramics, Plastics, and Metals

Typical Properties of Ceramics Materials

Material	Density ^a		Dielectric Strength (V/mil)	Coeff. of Expansion ^b		Flexural Strength (10 ³ psi)	Mohs's Hardness ^c	Operating Temp. (°F)	Tensile Strength		Compressive Strength (10 ³ psi)	Thermal Conductivity ^d		
	lb/in ³	g/cm ³		10 ⁻⁶ in/in-°F	10 ⁻⁶ m/m-°C				10 ³ psi	MPa		(Btu-ft/hr-ft ² -°F)	W/(m-k)	
Machinable Glass Ceramic	0.09	2.49	1000	4.1-7.0	7.38-12.6		48 Ra	1472	50	0.85	1.47	
	0.11	3.04	400	6	10.8	15	5.5	700	40	0.24	0.42	
	0.10	2.77	380	5.2	9.4	14	5.0	1100	32	0.34	0.59	
Glass-Mica	Machining Grades	0.09-0.10	2.49-2.77	400	10.5-11.2	18.9-20.2	12.5-13	90 Rh	750	6	41	40-45	0.24-0.29	0.41-0.50
		0.10	2.77	380	9.4	16.9	11	90 Rh	1100	5	34	32	0.34	0.59
	Molding Grades	0.13-0.17	3.60-4.70	300-325	11-11.5	19.8-20.7	9-10	90 Rh	700-750	6-6.5	41-45	33-35	0.29-0.31	0.50-0.54
		0.14	3.88	350	10.3	18.5	9	90 Rh	1300	6	41	30	0.3	0.52
Aluminum Silicate		0.10	2.77	80	2.5	4.5	4.5	1-2	1000	12	0.92	1.59
		0.08	2.21	100	2.9	5.2	10	6.0	2100	25	0.75	1.30
Alumina Silicate		0.08	2.21	70	2370	0.38	0.66
Silica Foam		0.03	0.83	80	0.3	0.5	0.4	NA	2000	1.4	0.10	0.17
TiO ₂ (Titania)		0.14	3.88	100	4.61	8.3	20	8	1800	7.5	52	100
Lava (Grade A)		0.08	2.21	80	1.83	3.3	9	6	2000	2.5	17	40	0.92	1.59
Zirconium Phosphate		0.11	3.04	NA	0.5	0.9	7.5	NA	2800	30	0.4 (approx.)	0.69
ZrO ₂		0.21	5.81	...	6.1	11.0	102	1300 V	261	1.69	2.92
ZrO ₂ -SiO ₂ (Zircon)		0.11	3.04	220	1.94	3.5	16	7.5	1825	10	69	90
2MgO-SiO ₂ (Forsterite)		0.11	3.04	240	5.56	10.0	20	7.5	1825	10	69	85	4.58	7.93
MgO-SiO ₂ (Steatite)		0.09-0.10	2.49-2.77	210-240	3.83-5.44	6.89-9.79	18-21	7.5	1825	8.5-10	59-69	80-90	3.17-3.42	5.49-5.92
2MgO-2Al ₂ O ₃ -5SiO ₂ (Cordierite)		0.06	1.66	60	0.33	0.6	3.4	6.5	2000	2.5	17	18.5	1.00	1.73
		0.08	2.21	100-172	1.22-1.28	2.20-2.30	8-12	7-7.5	2000	3.5-3.7	24-25	30-40	1.00	1.73
		0.09	2.49	200	1.33	2.4	15	8	2000	4	28	50	1.83	3.17
Al ₂ O ₃ (Alumina)	94%	0.13	3.60	210	3.33	6.0	44	9	2700	20	138	315	16.00	27.69
	96%	0.13-0.14	3.60-3.88	210	3.5-3.7	6.3-6.6	48-60	9	2600-2800	25	172	375	20.3-20.7	35.13-35.8
	99.5%	0.14	3.88	200	3.72	6.7	70	9	2700	28	193	380	21.25	36.78
	99.9%	0.14	3.88	...	3.75	6.8	72	9	2900	400

^a Obtain specific gravity by dividing density in lb/in³ by 0.0361; for density in lb/ft³, multiply lb/in.³ by 1728; for kg/m³, multiply density in lb/in³ by 27,679.9.

^b To convert coefficient of expansion to 10⁻⁶ in/in-°C, multiply table value by 1.8.

^c Mohs's Hardness scale is used unless otherwise indicated as follows: Ra and Rh for Rockwell A and H scales, respectively; V for Vickers hardness.

^d To convert conductivity from Btu-ft/hr-ft²-°F to cal-cm/sec-cm²-°C, divide by 241.9.

Typical Properties of Plastics Materials

Material	Density ^a		Specific Gravity	Dielectric Strength		Coeff. of Expansion ^b		Tensile Modulus		Izod Impact		Flexural Modulus		% Elongation	Hardness ^c	Max. Operating Temp.	
	lb/in ³	g/cm ³		V/mil	MV/m	10 ⁻⁶ in/in-°F	10 ⁻⁶ m/m-°C	10 ³ psi	MPa	ft-lb/in of notch	J/m of notch	ksi at 73°F	MPa at 23°C			°F	°C
ABS, Extrusion Grade	0.038	1.052	1.05	53.0	95.4	275	1896	7	373.65	300	2068	...	105 Rr	200	93
ABS, High Impact	0.037	1.024	1.03	200	1379	330	2275	...	105 Rr
Acetal, 20% Glass	0.056	1.550	1.55	1000	6895	0.9	48.04	715	4930	...	94 Rm
Acetal, Copolymer	0.051	1.412	1.41	380	14.96	47.0	84.6	437	3013	2	106.76	400	2758	13	94 Rm
Acetyl, Homopolymer	0.051	1.412	1.41	58.0	104.4	310	2137	320	2206	...	94 Rm	200	93
Acrylic	0.043	1.190	1.19	500	19.69	35.0	63.0	400	2758	0.5	26.69	400	2758	2.7	94 Rm	180	82
Azdel	0.043	1.190	1.19	500	19.69	15.0	27.0	750	5171	14	747.30	800	5516	2.1	94 Rm	311	155
CPVC	0.056	1.550	1.55	34.0	61.2	400	2758	3	160.14	400	2758	4	...	212	100
Fiber Glass Sheet	0.067	1.855	1.87	11.1	20.0	8	427.03	1	7	...	101 Rm	260	127
Nylon 6, 30% Glass	0.050	1.384	1.39	1350	9308	2.8	149.46	1400	9653	...	119 Rr
Nylon 6, Cast	0.042	1.163	1.16	295	11.61	45.0	81.0	380	2620	1.4	74.73	450	3103	20	100 Rr	210	99
Nylon 6/6, Cast	0.047	1.301	1.30
Nylon 6/6, Extruded	0.041	1.135	1.14	600	23.62	45.0	81.0	390	2689	1	53.38	240	118 Rr	230	110
Nylon 60L, Cast	0.042	1.163	1.16	2.2	117.43
PET, unfilled	0.049	1.356	1.36	1300	51.18	39.0	70.2	500	3447	0.5	26.69	400	2758	70	...	230	110
PTFE (Teflon)	0.079	2.187	2.19	480	18.90	50.0	90.0	225	1551	3	160.14	80	552	350
PVC	0.050	1.384	1.39	500	19.69	29.5	53.1	550	3792	0.8	42.70	400	2758	31-40	110 Rr	170	77
PVDF	0.064	1.772	1.77	260	10.24	60.0	108.0	320	2206	3	160.14	200	1379	80	100 Rr	180	82
Phenolics	0.050	1.384	1.38	11.1	20.0	2.4	128.11	1000	6895	...	100 Rm	248	120
Polycarbonate	0.043	1.190	1.19	380	14.96	37.5	67.5	345	2379	14	747.30	340	2344	110	74 Rm	290	143
Polyetherimide	0.046	1.273	1.27	480	18.90	430	2965	1.1	58.72	480	3309
Polyethylene, HD	0.035	0.969	0.97	475	18.70	20.0	36.0	156	1076	6	320.27	160	1103	900	...	180	82
Polyethylene, UHMW	0.034	0.941	0.94	710	27.95	19.0	34.2	110	758	No Break	...	130	896	450	64 Rr	176	80
Polymethylpentene	0.030	0.830	0.83	220	1517	2.5	133.45
Polymid, unfilled	0.051	1.412	1.41	560	22.05	300	2068	1.5	80.07
Polyphenylene Sul-fide	0.047	1.301	1.30	380	14.96	0.5	26.69	550	3792
Polypropylene	0.033	0.913	0.91	600	23.62	96.0	172.8	155	1069	0.75	40.03	200	1379	120	92 Rr	150	66
Poly sulfone	0.045	1.246	1.25	425	16.73	31.0	55.8	360	2482	1.2	64.05	390	2689	50	120 Rr	325	163
Polyurethane	0.038	1.052	1.05	465-520

^a To obtain specific gravity, divide density in lb/in³ by 0.0361; for density in lb/ft³, multiply lb/in³ by 1728; for kg/m³, multiply density in lb/in³ by 27,679.9.

^b To convert coefficient of expansion to 10⁻⁶ in/in-°C, multiply table value by 1.8.

^c Hardness value scales are as follows: Rm for Rockwell M scale; Rr for Rockwell R scale.

Mechanical Properties of Various Investment Casting Alloys

Alloy Designation	Material Condition	Tensile Strength (10 ³ psi)	0.2% Yield Strength ^a (10 ³ psi)	% Elongation	Hardness
Aluminum					
356	As Cast	32-40	22-30	3-7	...
A356	As Cast	38-40	28-36	3-10	...
A357	As Cast	33-50	27-40	3-9	...
355, C355	As Cast	35-50	28-39	1-8	...
D712 (40E)	As Cast	34-40	25-32	4-8	...
A354	As Cast	47-55	36-45	2-5	...
RR-350	As Cast	32-45	24-38	1.5-5	...
Precedent 71	As Cast	35-55	25-45	2-5	...
KO-1	As Cast	56-60	48-55	3-5	...
Copper-Base Alloys^a					
Al Bronze C (954)	As Cast	75-85	30-40	10-20	80-85 Rb
	Heat-Treated	90-105	45-55	6-10	91-96 Rb
Al Bronze D (955)	As Cast	90-100	40-50	6-10	91-96 Rb
	Heat-Treated	110-120	60-70	5-8	93-98 Rb
Manganese Bronze, A	...	65-75	25-40	16-24	60-65 Rb
Manganese Bronze, C	...	110-120	60-70	8-16	95-100 Rb
Silicon Bronze	...	45	18	20	...
Tin Bronze	...	40-50	18-30	20-35	40-50 Rb
Lead, Yellow Brass (854)	...	30-50	11-20	15-25	...
Red Brass	...	30-40	14-25	20-30	30-35 Rb
Silicon Brass	...	70	32	24	...
Pure Copper	...	20-30	...	4-50	35-42 Rb
Beryllium Cu 10C (820)	As Cast	45-50	40-45	15-20	50-55 Rb
	Hardened	90-100	90-130	3-8	90-95 Rb
Beryllium Cu 165C (824)	...	70-155	40-140	1-15	60 Rb-38 Rc
Beryllium Cu 20C (825)	As Cast	70-80	50-55	18-23	75-80 Rb
	Hardened	110-160	...	1-4	25-44 Rc
Beryllium Cu 275C (828)	As Cast	80-90	...	15-20	80-85 Rb
Chrome Copper	...	33-50	20-40	20-30	70-78 Rb
Carbon and Low-Alloy Steels and Iron					
IC 1010	Annealed	50-60	30-35	30-35	50-55 Rb
IC 1020	Annealed	60-70	40-45	25-40	80 Rb
IC 1030	Annealed	65-75	45-50	20-30	75 Rb
	Hardened	85-150	60-150	0-15	20-50 Rc
IC 1035	Annealed	70-80	45-55	20-30	80 Rb
	Hardened	90-150	85-150	0-15	25-52 Rc
IC 1045	Annealed	80-90	50-60	20-25	100 Rb
	Hardened	100-180	90-180	0-10	25-57 Rc
IC 1050	Annealed	90-110	50-65	20-25	100 Rb
	Hardened	125-180	100-180	0-10	30-60 Rc
IC 1060	Annealed	100-120	55-70	5-10	25 Rc
	Hardened	120-200	100-180	0-3	30-60 Rc
IC 1090	Annealed	110-150	70-80	12-20	30 Rc
	Hardened	130-180	130-180	0-3	37-50 Rc
IC 2345	Hardened	130-200	110-180	5-10	30-58 Rc
IC 4130	Hardened	130-170	100-130	5-20	23-49 Rc
IC 4140	Hardened	130-200	100-155	5-20	29-57 Rc
IC 4150	Hardened	140-200	120-180	5-10	25-58 Rc
IC 4330	Hardened	130-190	100-175	5-20	25-48 Rc
IC 4340	Hardened	130-200	100-180	5-20	20-55 Rc
IC 4620	Hardened	110-150	90-130	10-20	20-32 Rc
IC 6150, IC 8740	Hardened	140-200	120-180	5-10	30-60 Rc
IC 8620	Hardened	100-130	80-110	10-20	20-45 Rc
IC 8630	Hardened	120-170	100-130	7-20	25-50 Rc
IC 8640	Hardened	130-200	100-180	5-20	30-60 Rc

Mechanical Properties of Various Investment Casting Alloys (Continued)

Alloy Designation	Material Condition	Tensile Strength (10 ³ psi)	0.2% Yield Strength ^a (10 ³ psi)	% Elongation	Hardness
Carbon and Low-Alloy Steels and Iron (Continued)					
IC 8665	Hardened	170-220	140-200	0-10	...
IC 8730	Hardened	120-170	110-150	7-20	...
IC 52100	Hardened	180-230	140-180	1-7	30-65 Rc
IC 1722AS	Hardened	130-170	100-140	6-12	25-48 Rc
1.2% Si Iron	...	50-60	37-43	30-35	55 Rb
Ductile Iron, Ferritic	Annealed	60-80	40-50	18-24	143-200 Bhn
Ductile Iron, Pearlitic	Normalized	100-120	70-80	3-10	243-303 Bhn
Hardenable Stainless Steel					
CA-15	Hardened	95-200	75-160	5-12	94 Rb-45 Rc
IC 416	Hardened	95-200	75-160	3-8	94 Rb-45 Rc
CA-40	Hardened	200-225	130-210	0-5	30-52 Rc
IC 431	Hardened	110-160	75-105	5-20	20-40 Rc
IC 17-4	Hardened	150-190	140-160	6-20	34-44 Rc
Am-355	Hardened	200-220	150-165	6-12	...
IC 15-5	Hardened	135-170	110-145	5-15	26-38 Rc
CD-4M Cu	Annealed	100-115	75-85	20-30	94-100 Rb
	Hardened	135-145	100-120	10-25	28-32 Rc
Austenitic Stainless Steels					
CF-3, CF-3M, CF-8, CF-8M, IC 316F	Annealed	70-85	40-50	35-50	90 Rb (max)
CF-8C	Annealed	70-85	32-36	30-40	90 Rb (max)
CF-16F	Annealed	65-75	30-35	35-45	90 Rb (max)
CF-20	Annealed	65-75	30-45	35-60	90 Rb (max)
CH-20	Annealed	70-80	30-40	30-45	90 Rb (max)
CN-7M	Annealed	65-75	25-35	35-45	90 Rb (max)
IC 321, CK-20	Annealed	65-75	30-40	35-45	90 Rb (max)
Nickel-Base Alloys					
Alloy B	Annealed	75-85	50-60	8-12	90-100 Rb
Alloy C	As Cast	80-95	45-55	8-12	90-100 Rb
	Annealed	75-95	45-55	8-12	90 Rb-25 Rc
Alloy X ^b	AC to 24°C	63-70	41-45	10-15	85-96 Rb
	AC to 816°C	35-45	...	12-20	...
Invar (Fe-Ni alloy)	As Cast	50-60	25-30	30-40	50-60 Rb
In 600 (Inconel)	As Cast	65-75	35-40	10-20	80-90 Rb
In 625 (Inconel)	Annealed	80-100	40-55	15-30	10-20 Rc
Monel 410	As Cast	65-75	32-38	25-35	65-75 Rb
S Monel	Annealed	100-110	55-65	5-10	20-28 Rc
	Hardened	120-140	85-100	0	32-38 Rc
RH Monel	As Cast	100-110	60-80	10-20	20-30 Rc
Monel E	As Cast	65-80	33-40	25-35	67-78 Rb
M-35 Monel	As Cast	65-80	25-35	25-40	65-85 Rb
Cobalt-Base Alloys					
Cobalt 21	As Cast	95-130	65-95	8-20	24-32 Rc
Cobalt 25	As Cast	90-120	60-75	15-25	20-25 Rc
Cobalt 31	As Cast	105-130	75-90	6-10	20-30 Rc
Cobalt 36	As Cast	90-105	60-70	15-20	30-36 Rc
F75	As Cast	95-110	70-80	8-15	25-34 Rc
N-155	Sol. Anneal	90-100	50-60	15-30	90-100 Rb

^a For copper alloys, yield strength is determined by 0.5% extension under load or 0.2% offset method. A number in parentheses following a copper alloy indicates the UNS designation of that alloy (for example, Al Bronze C (954) identifies the alloy as UNS C95400).

^b AC = air cooled to temperature indicated.

Source: Investment Casting Institute. Mechanical properties are average values of separately cast test bars, and are for reference only. Items marked ... indicates data are not available. Alloys identified by IC followed by an SAE designation number (IC 1010 steel, for example) are generally similar to the SAE material although properties and chemical composition may be different.

Typical Properties of Compressed and Sintered Powdered Metal Alloys

Alloy Number ^a and Nominal Composition (%)		Density (g/cc)	Hardness	Strength (10 ³ psi)			% Elongation
				Transverse Rupture	Ultimate Tensile	Yield	
Copper Base							
...	100Cu	7.7-7.9	81-82 Rh	54-68	24-34	...	10-26
CZP-3002	70Cu, 1.5Pb, Bal. Zn	8	75 Rh	...	33.9	...	24
CNZ-1818	63Cu, 17.5Ni, Bal. Zn	7.9	90 Rh	73	34	20	11
CTG-1004	10Sn, 4.4C, Bal. Cu	7	67 Rh	20	9.4	6.5	6
CTG-1001	10Sn, 1C, Bal. Cu	6.5	45 Rh	25.8	15.1	9.6	9.7
Iron Base (Balance of composition, Fe)							
FC-2015	23.5Cu, 1.5C	6.5	65 Rb	80	52.4	48.5	0
FC-0800	8Cu, 0.4C	6.3-6.8	39-55 Rb	75-100	38-54	32-47	1 or less
FX-2008	20Cu, 1C	7.3	93 Rb	164.2	72.3	57.7	2
FN-0408	4Ni, 1-2Cu, 0.75C	6.3-7	64-84 Rb	70-107	37-63	30-47	1-1.6
F-0000	100Fe	6.5	26 Rf	37.7	15.7	11	5.7
FN-0005	0.45C, 0.50 MnS	6.4-6.8	66-78 Rf	44-61
F-0000	0.02C, 0.45P	6.6-7.2	35-50 Rb	90-125	...	29-38	3.9-5.5
F-0008	0.6-0.9C	6.2-7	50-70 Rb	61-100	35-57	30-40	<0.5 to 1
FC-0508	0.6-0.9C, 4-6Cu	5.9-6.8	60-80 Rb	100-145	58-82	50-70	<0.5 to 1
FN-0405	4Ni, 0.5C	6.6-7.0	73-82 Rb	90-100	47-50	38-40	<1
FN-0208	2Ni, 0.8C	6.6-7.0	50-70 Rb	70-108	47-58	35-51	<1
FN-0205	2Ni, 0.5C	6.6-7.0	51-61 Rb	72-93	35-45	27-31	2.0-2.5
FN-0200	2Ni, 0.25C	6.6	29 Rb	57.5	25.8	19.0	1.3
FC-0208	2Cu, 0.75C	6.5-6.7	68-72 Rb	95-107	56-61	51-54	up to 1
FC-2008	20Cu, 1C	6.2	45 Rb	79.5	47.8	40.0	1.3
...	4Ni, 0.6C, 1.6Cu, 0.55Mo	7.0	92 Rb	190.0	100.0	65.0	2.5
FL-4605	1.8Ni, 0.6C, 1.6Cu, 0.55Mo	7.0	87 Rb	170.0	80.0	55.0	2.5
FL-4605	1.8Ni, 0.6C, 0.55Mo	7.0	80 Rb	150.0
SS-316L	17Cr, 13Ni, 2.2Mo, 0.9Si	6.5	65 Rb	94.0	45.0	30.0	6.0
...	17Cr, 13Ni, 2.2Mo, 0.9Si, 15-20Cu	7.3	66 Rb	108.6	59.2	49.7	4.3
SS-410	13Cr, 0.8Si, 0.8Mn	6.2	15 Rc	85.0	66.7	56.9	0
FL-4608	2Cu, 3.8Ni, 0.9C, 0.75Mo	6.8	24 Rc	107.3	55.8	46.5	1.5
SS-303N1	18Cr, 11Ni, 1Mn	6.4	62 Rb	86.0	39.0	32.0	0.5
SS-304N1	19Cr, 10Ni, 1Mn	6.4	61 Rb	112.0	43.0	38.0	0.5
Tungsten Base							
90W, 6Ni, 4Cu		17.0	24 Rc	...	110	80	6
90W, 7Ni, 3Cu		17.0	25 Rc	...	120	88	10
92.5W, 5.25Ni, 2.25Cu		17.5	26 Rc	...	114	84	7
92.5W, Bal. Ni, Fe, and Mo		17.6	30 Rc	...	120	90	4
93W, Bal. Ni, Fe, and Mo		17.7	32 Rc	...	125	95	4
95W, 3.5Ni, 1.5Cu		18.0	27 Rc	...	110	85	7
95W, 3.5Ni, 1.5Fe		18.0	27 Rc	...	120	90	7
97W, 2.1Ni, 0.9Fe		18.5	28 Rc	...	123	85	5

^a Copper- and iron-base alloy designations are Metal Powder Industries Federation (MPIF) alloy numbers.

Typical Elastic Properties of Materials

Material	Modulus of Elasticity		Shear Modulus		Bulk Modulus		Poisson's Ratio
	10 ⁶ psi	GPa	10 ⁶ psi	GPa	10 ⁶ psi	GPa	
Aluminum, var. alloys	9.9-10.3	68-71	3.7-3.9	26-27	9.9-10.2	68-70	0.330-0.334
Aluminum, 6061-T6	10	70	3.8	26	0.35
Aluminum, 2024-T4	10.6	73	4	28	0.32
Beryllium copper	18	124	7	48	0.29
Brass, 70-30	15.9	110	6	41	15.7	108	0.331
Brass, cast	14.5	100	5.3	37	16.8	116	0.357
Bronze	14.9	103	6.5	45	0.14
Copper	15.6	108	5.8	40	17.9	123	0.355
Glass	6.7	46	2.7	19	0.24
Glass ceramic (machinable)	9.7	67	3.7	26	0.29
Inconel	31	214	11	76	0.27-0.38
Iron, cast	13.5-21.0	93-145	5.2-8.2	36-57	8.4-15.5	58-107	0.221-0.299
Iron, ductile	23.8-25.2	164-174	9.1-9.6	63-66	0.26-0.31
Iron, grey cast	14.5	100	6	41	0.211
Iron, malleable	23.6	163	9.3	64	17.2	119	0.271
Lead	5.3	37	1.9	13	0.43
Magnesium	6.5	45	2.4	17	0.35
Magnesium alloy	6.3	43	2.5	17	4.8	33	0.281
Molybdenum	48	331	17	117	0.307
Monel metal	25	172	9.5	66	22.5	155	0.315
Nickel silver	18.5	128	7	48	0.322
Nickel steel	30	207	11.5	79	0.291
Phosphor bronze	13.8	95	5.1	35	16.3	112	0.359
Stainless steel 18-8	27.6	190	10.6	73	23.6	163	0.305
Steel, cast	28.5	197	11.3	78	20.2	139	0.265
Steel, cold-rolled	29.5	203	11.5	79	23.1	159	0.287
Steel, all others	28.6-30.0	197-207	11.0-11.9	76-82	22.6-24.0	156-165	0.283-0.292
Titanium (99.0 Ti)	15-16	103-110	6.5	45	0.24
Titanium (Ti-8Al-1Mo-1V)	18	124	6.8	47	0.32
Zinc, cast alloys	10.9-12.4	75-85	0.33
Zinc, wrought alloys	6.2-14	43-97	0.33
Z-nickel	30	207	11	76	0.36

Data represent typical values, but material properties may vary widely, depending on exact composition, material condition, and processing. Symbol ... indicates no data available.

Average Ultimate Strength of Common Materials other than Metals

Material	Compression		Tension		Material	Compression		Tension	
	psi	kPa	psi	kPa		psi	kPa	psi	kPa
Bricks, best hard	12,000	82737	400	2758	Concrete, Portland	1,000	6895	200	1379
Bricks, light red	1,000	6895	40	276	Concrete, Portland, 1 year old	2,000	13790	400	2758
Brickwork, common	1,000	6895	50	345	Granite	19,000	131000	700	4826
Brickwork, best	2,000	13790	300	2068	Limestone and sandstone	9,000	62053	300	2068
Cement, Portland, 1 month old	2,000	13790	400	2758	Trap rock	20,000	137895	800	5516
Cement, Portland, 1 year old	3,000	20684	500	3447	Slate	14,000	96527	500	3447
					Vulcanized fiber	39,000	268896	13,000	89632

Minimum Tensile Strength of Spring Wire by Diameter

Wire Dia.		Wire Type													
		Music Wire		Hard-Drawn MB		Oil Temp. MB		Stainless Steel 18-8		Cr-V Alloy		Phosphor Bronze		Chrome Silicon	
inch	mm	kpsi	MPa	kpsi	MPa	kpsi	MPa	kpsi	MPa	kpsi	MPa	kpsi	MPa	kpsi	MPa
0.004	0.10	439	3027	325	2241	140	965
0.008	0.20	399	2751	325	2241	140	965
0.012	0.30	377	2599	316	2179
0.020	0.51	350	2413	283	1951	288	1986	300	2068
0.028	0.71	333	2296	271	1868	281	1937	284	1958
0.032	0.81	327	2255	265	1827	275	1896	278	1917	281	1937	300	2068
0.035	0.89	322	2220	261	1800	268	1848	274	1889	276	1903	298	2055
0.041	1.04	314	2165	255	1758	261	1800	270	1862	270	1862	135	931	298	2055
0.047	1.19	307	2117	248	1710	254	1751	262	1806	263	1813	292	2013
0.054	1.37	301	2075	243	1675	248	1710	258	1779	257	1772	292	2013
0.063	1.60	293	2020	237	1634	242	1669	251	1731	251	1731	130	896	290	1999
0.072	1.83	287	1979	232	1600	236	1627	245	1689	245	1689	288	1986
0.080	2.03	282	1944	227	1565	230	1586	240	1655	240	1655	285	1965
0.092	2.34	275	1896	220	1517	225	1551	233	1606	235	1620	280	1931
0.105	2.67	269	1855	216	1489	220	1517	227	1565	229	1579	125	862	275	1896
0.120	3.05	263	1813	210	1448	215	1482	221	1524	222	1531	275	1896
0.135	3.43	258	1779	206	1420	210	1448	213	1469	219	1510	270	1862
0.148	3.76	253	1744	203	1400	205	1413	207	1427	215	1482	268	1848
0.162	4.11	249	1717	200	1379	200	1379	200	1379	212	1462	162	1117
0.177	4.50	245	1689	195	1344	195	1344	195	1344	210	1448	260	1793
0.192	4.88	241	1662	192	1324	190	1310	189	1303	206	1420	260	1793
0.207	5.26	238	1641	190	1310	185	1276	185	1276	204	1407	260	1793
0.225	5.72	225	1551	186	1282	183	1262	180	1241	200	1379	120	827	255	1758
0.250	6.35	220	1517	182	1255	180	1241	174	1200	196	1351	250	1724
0.312	7.92	174	1200	178	1227	160	1103	189	1303	110	758	245	1689
0.375	9.53	167	1151	175	1207	187	1289	240	1655
0.437	11.10	165	1138	170	1172	186	1282	235	1620
0.500	12.70	156	1076	165	1138	185	1276	100	689	230	1586

For allowable working stresses and recommended design stresses in bending, related to severity of service, refer to Fig. 1 through Fig. 10 on pages 310 through 313, and for endurance limits for compression springs made from these materials refer to Fig. 11 on page 315 in the section on spring stresses.

Effect of Temperature on Strength and Elasticity of Metals.—Most ferrous metals have a maximum strength at approximately 400°F (204°C), whereas the strength of non-ferrous alloys is a maximum at about room temperature. The table on page 395 gives general data for variation in metal strength with temperature.

The modulus of elasticity of metals decreases regularly with increasing temperatures above room temperature until at some elevated temperature it falls off rapidly and reaches zero at the melting point.

Influence of Temperature on the Strength of Metals

Material	210°F (99°C)	400°F (204°C)	570°F (299°C)	750°F (399°C)	930°F (499°C)	1100°F (593°C)	1300°F (704°C)	1475°F (802°C)
	Strength in Per Cent of Strength at 70°F (21°C)							
Wrought iron	104	112	116	96	76	42	25	15
Cast iron	...	100	99	92	76	42
Steel castings	109	125	121	97	57
Structural steel	103	132	122	86	49	28
Copper	95	85	73	59	42
Bronze	101	94	57	26	18

STANDARD STEELS

Properties, Compositions, and Applications

Steel is the generic term for a large family of iron-carbon alloys, which are malleable, within some temperature range, immediately after solidification from the molten state. The principal raw materials used in steelmaking are iron ore, coal, and limestone. These materials are converted in a blast furnace into a product known as “pig iron,” which contains considerable amounts of carbon, manganese, sulfur, phosphorus, and silicon. Pig iron is hard, brittle, and unsuitable for direct processing into wrought forms. Steelmaking is the process of refining pig iron as well as iron and steel scrap by removing undesirable elements from the melt and then adding desirable elements in predetermined amounts. A primary reaction in most steelmaking is the combination of carbon with oxygen to form a gas. If dissolved oxygen is not removed from the melt prior to or during pouring, the gaseous products continue to evolve during solidification. If the steel is strongly deoxidized by the addition of deoxidizing elements, no gas is evolved, and the steel is called “killed” because it lies quietly in the molds. Increasing degrees of gas evolution (decreased deoxidation) characterize steels called “semikilled”, “capped,” or “rimmed.” The degree of deoxidation affects some of the properties of the steel. In addition to oxygen, liquid steel contains measurable amounts of dissolved hydrogen and nitrogen. For some critical steel applications, special deoxidation practices as well as vacuum treatments may be used to reduce and control dissolved gases.

The carbon content of common steel grades ranges from a few hundredths of a per cent to about 1 per cent. All steels also contain varying amounts of other elements, principally manganese, which acts as a deoxidizer and facilitates hot working. Silicon, phosphorus, and sulfur are also always present, if only in trace amounts. Other elements may be present, either as residuals that are not intentionally added, but result from the raw materials or steelmaking practice, or as alloying elements added to effect changes in the properties of the steel.

Steels can be cast to shape, or the cast ingot or strand can be reheated and hot worked by rolling, forging, extrusion, or other processes into a wrought mill shape. Wrought steels are the most widely used of engineering materials, offering a multitude of forms, finishes, strengths, and usable temperature ranges. No other material offers comparable versatility for product design.

Standard Steel Classification.—Wrought steels may be classified systematically into groups based on some common characteristic, such as chemical composition, deoxidation practice, finishing method, or product form. Chemical composition is the most often used basis for identifying and assigning standard designations to wrought steels. Although carbon is the principal hardening and strengthening element in steel, no single element controls the steel’s characteristics. The combined effect of several elements influences response to heat treatment, hardness, strength, microstructure, corrosion resistance, and formability. The standard steels can be divided broadly into three main groups: carbon steels, alloy steels, and stainless steels.

Carbon Steels: A steel qualifies as a carbon steel when its manganese content is limited to 1.65 per cent (max), silicon to 0.60 per cent (max), and copper to 0.60 per cent (max). With the exception of deoxidizers and boron when specified, no other alloying elements are added intentionally, but they may be present as residuals. If any of these incidental elements are considered detrimental for special applications, maximum acceptable limits may be specified. In contrast to most alloy steels, carbon steels are most often used without a final heat treatment; however, they may be annealed, normalized, case hardened, or quenched and tempered to enhance fabrication or mechanical properties. Carbon steels may be killed, semikilled, capped, or rimmed, and, when necessary, the method of deoxidation may be specified.

Alloy Steels: Alloy steels comprise not only those grades that exceed the element content limits for carbon steel, but also any grade to which different elements than used for carbon steel are added, within specific ranges or specific minimums, to enhance mechanical properties, fabricating characteristics, or any other attribute of the steel. By this definition, alloy steels encompass all steels other than carbon steels; however, by convention, steels containing over 3.99 per cent chromium are considered “special types” of alloy steel, which include the stainless steels and many of the tool steels.

In a technical sense, the term alloy steel is reserved for those steels that contain a modest amount of alloying elements (about 1-4 per cent) and generally depend on thermal treatments to develop specific mechanical properties. Alloy steels are always killed, but special deoxidation or melting practices, including vacuum, may be specified for special critical applications. Alloy steels generally require additional care throughout their manufacture, because they are more sensitive to thermal and mechanical operations.

Stainless Steels: Stainless steels are high-alloy steels and have superior corrosion resistance to the carbon and conventional low-alloy steels because they contain relatively large amounts of chromium. Although other elements may also increase corrosion resistance, their usefulness in this respect is limited.

Stainless steels generally contain at least 10 per cent chromium, with or without other elements. It has been customary in the United States, however, to include in the stainless steel classification those steels that contain as little as 4 per cent chromium. Together, these steels form a family known as the stainless and heat-resisting steels, some of which possess very high strength and oxidation resistance. Few, however, contain more than 30 per cent chromium or less than 50 per cent iron.

In the broadest sense, the standard stainless steels can be divided into three groups based on their structures: austenitic, ferritic, and martensitic. In each of the three groups, there is one composition that represents the basic, general-purpose alloy. All other compositions are derived from the basic alloy, with specific variations in composition being made to obtain very specific properties.

The *austenitic grades* are nonmagnetic in the annealed condition, although some may become slightly magnetic after cold working. They can be hardened only by cold working, and not by heat treatment, and combine outstanding corrosion and heat resistance with good mechanical properties over a wide temperature range. The austenitic grades are further classified into two subgroups: the chromium-nickel types and the less frequently used chromium-manganese-low-nickel types. The basic composition in the chromium-nickel group is widely known as 18-8 (Cr-Ni) and is the general-purpose austenitic grade. This grade is the basis for over 20 modifications that can be characterized as follows: the chromium-nickel ratio has been modified to change the forming characteristics; the carbon content has been decreased to prevent intergranular corrosion; the elements niobium or titanium have been added to stabilize the structure; or molybdenum has been added or the chromium and nickel contents have been increased to improve corrosion or oxidation resistance.

The standard *ferritic grades* are always magnetic and contain chromium but no nickel. They can be hardened to some extent by cold working, but not by heat treatment, and they combine corrosion and heat resistance with moderate mechanical properties and decorative appeal. The ferritic grades generally are restricted to a narrower range of corrosive conditions than the austenitic grades. The basic ferritic grade contains 17 per cent chromium. In this series, there are free-machining modifications and grades with increased chromium content to improve scaling resistance. Also in this ferritic group is a 12 per cent chromium steel (the basic composition of the martensitic group) with other elements, such as aluminum or titanium, added to prevent hardening.

The standard *martensitic grades* are magnetic and can be hardened by quenching and tempering. They contain chromium and, with two exceptions, no nickel. The basic martensitic grade normally contains 12 per cent chromium. There are more than 10 standard com-

positions in the martensitic series; some are modified to improve machinability and others have small additions of nickel or other elements to improve the mechanical properties or their response to heat treatment. Still others have greatly increased carbon content, in the tool steel range, and are hardenable to the highest levels of all the stainless steels. The martensitic grades are excellent for service in mild environments such as the atmosphere, freshwater, steam, and weak acids, but are not resistant to severely corrosive solutions.

Numbering Systems for Metals and Alloys.—Several different numbering systems have been developed for metals and alloys by various trade associations, professional engineering societies, standards organizations, and by private industries for their own use. The numerical code used to identify the metal or alloy may or may not be related to a specification, which is a statement of the technical and commercial requirements that the product must meet. Numbering systems in use include those developed by the American Iron and Steel Institute (AISI), Society of Automotive Engineers (SAE), American Society for Testing and Materials (ASTM), American National Standards Institute (ANSI), Steel Founders Society of America, American Society of Mechanical Engineers (ASME), American Welding Society (AWS), Aluminum Association, Copper Development Association, U.S. Department of Defense (Military Specifications), and the General Accounting Office (Federal Specifications).

The Unified Numbering System (UNS) was developed through a joint effort of the ASTM and the SAE to provide a means of correlating the different numbering systems for metals and alloys that have a commercial standing. This system avoids the confusion caused when more than one identification number is used to specify the same material, or when the same number is assigned to two entirely different materials. It is important to understand that a UNS number is not a specification; it is an identification number for metals and alloys for which detailed specifications are provided elsewhere. UNS numbers are shown in [Table 1](#); each number consists of a letter prefix followed by five digits. In some, the letter is suggestive of the family of metals identified by the series, such as A for aluminum and C for copper. Whenever possible, the numbers in the UNS groups contain numbering sequences taken directly from other systems to facilitate identification of the material; e.g., the corresponding UNS number for AISI 1020 steel is G10200. The UNS numbers corresponding to the commonly used AISI-SAE numbers that are used to identify plain carbon, alloy, and tool steels are given in [Table 2](#).

Table 1. Unified Numbering System (UNS) for Metals and Alloys

UNS Series	Metal
A00001 to A99999	Aluminum and aluminum alloys
C00001 to C99999	Copper and copper alloys
D00001 to D99999	Specified mechanical property steels
E00001 to E99999	Rare earth and rare earthlike metals and alloys
F00001 to F99999	Cast irons
G00001 to G99999	AISI and SAE carbon and alloy steels (except tool steels)
H00001 to H99999	AISI and SAE H-steels
J00001 to J99999	Cast steels (except tool steels)
K00001 to K99999	Miscellaneous steels and ferrous alloys
L00001 to L99999	Low-melting metals and alloys
M00001 to M99999	Miscellaneous nonferrous metals and alloys
N00001 to N99999	Nickel and nickel alloys
P00001 to P99999	Precious metals and alloys
R00001 to R99999	Reactive and refractory metals and alloys
S00001 to S99999	Heat and corrosion resistant (stainless) steels
T00001 to T99999	Tool steels, wrought and cast
W00001 to W99999	Welding filler metals
Z00001 to Z99999	Zinc and zinc alloys

Identifying Metals.—When it is necessary to sort materials, several rough methods may be used without elaborate chemical analysis. The most obvious of these is by using a magnet to pick out those materials that contain magnetic elements. To differentiate various levels of carbon and other elements in a steel bar, hold the bar in contact with a grinding wheel and observe the sparks. With high levels of carbon, for instance, sparks are produced that appear to split into several bright tracers. Patterns produced by several other elements, including small amounts of aluminum and titanium, for instance, can be identified with the aid of Data Sheet 13, issued by the American Society for Metals (ASM), Metals Park, OH.

Standard Steel Numbering System.—The most widely used systems for identifying wrought carbon, low-alloy, and stainless steels are based on chemical composition, and are those of the American Iron and Steel Institute (AISI) and the Society of Automotive Engineers (SAE). These systems are almost identical, but they are carefully coordinated. The standard steels so designated have been developed cooperatively by producers and users and have been found through long experience to cover most of the wrought ferrous metals used in automotive vehicles and related equipment. These designations, however, are not specifications, and should not be used for purchasing unless accompanied by supplementary information necessary to describe commercially the product desired. Engineering societies, associations, and institutes whose members make, specify, or purchase steel products publish standard specifications, many of which have become well known and respected. The most comprehensive and widely used specifications are those published by the American Society for Testing and Materials (ASTM). The U.S. government and various companies also publish their own specification for steel products to serve their own special procurement needs. The Unified Numbering System (UNS) for metals and alloys is also used to designate steels (see pages 398 and 400).

The numerical designation system used by both AISI and SAE for wrought carbon, alloy, and stainless steels is summarized in Table 3. In Table 4 is given the compositions of the standard carbon steels; Table 5 lists the standard low-alloy steel compositions; and Table 6 includes the typical compositions of the standard stainless steels.

Binary Alloy.—An alloy containing two elements. When the term is used in regard to iron or steel, it refers to a material that has one alloying element in addition to iron. Since carbon is always present in steel, plain carbon steel is the typical binary iron alloy.

Ternary Alloy.—This is an alloy consisting of three elements. When the term refers to steel, it denotes a steel which contains two alloying elements in addition to iron; since carbon is always present, it is one of these elements. The third element may be nickel, chromium, manganese, tungsten, molybdenum, titanium, or any other element that is alloyed to give the steel some special property.

Quarternary Alloy.—A quarternary alloy is an alloy consisting of four elements. When applied to steel, such an alloy contains, in addition to iron, three alloying elements. Carbon is one of these, and the other two may be chromium and nickel, silicon and manganese, etc.

Damascus Steel.—A characteristic feature of Damascus steel is its surface patterns which vary with the carbon content and are either in the form of wavy parallel stripes or mottled patterns. This steel represents an early development in steel making, as it was imported during the Middle Ages to Western Europe through Syria and Palestine, and is known also as Indian steel and bulat. The old Indian method of producing real damascene steel consists in using a pure ore and the best grade of charcoal. The Persian practice is to use soft iron bars and charcoal and plumbago (black lead or graphite) to supply the carbon; and a third method consists of a certain heat-treatment which resembles a prolonged tempering. One investigator has concluded that the carbon, irregularly dispersed in the metal and forming two distinct combinations, is what causes the damask or characteristic pattern and that the slower the cooling the larger the veins will be.

An imitation of Damascus steel can be obtained by etching the surface of the steel blade with acids, the parts which are not to be attacked by the acid being protected by a “resist.”

Table 2. AISI and SAE Numbers and Their Corresponding UNS Numbers for Plain Carbon, Alloy, and Tool Steels

AISI-SAE Numbers	UNS Numbers	AISI-SAE Numbers	UNS Numbers	AISI-SAE Numbers	UNS Numbers	AISI-SAE Numbers	UNS Numbers
Plain Carbon Steels							
1005	G10050	1030	G10300	1070	G10700	1566	G15660
1006	G10060	1035	G10350	1078	G10780	1110	G11100
1008	G10080	1037	G10370	1080	G10800	1117	G11170
1010	G10100	1038	G10380	1084	G10840	1118	G11180
1012	G10120	1039	G10390	1086	G10860	1137	G11370
1015	G10150	1040	G10400	1090	G10900	1139	G11390
1016	G10160	1042	G10420	1095	G10950	1140	G11400
1017	G10170	1043	G10430	1513	G15130	1141	G11410
1018	G10180	1044	G10440	1522	G15220	1144	G11440
1019	G10190	1045	G10450	1524	G15240	1146	G11460
1020	G10200	1046	G10460	1526	G15260	1151	G11510
1021	G10210	1049	G10490	1527	G15270	1211	G12110
1022	G10220	1050	G10500	1541	G15410	1212	G12120
1023	G10230	1053	G10530	1548	G15480	1213	G12130
1025	G10250	1055	G10550	1551	G15510	1215	G12150
1026	G10260	1059	G10590	1552	G15520	12L14	G12144
1029	G10290	1060	G10600	1561	G15610
Alloy Steels							
1330	G13300	4150	G41500	5140	G51400	8642	G86420
1335	G13350	4161	G41610	5150	G51500	8645	G86450
1340	G13400	4320	G43200	5155	G51550	8655	G86550
1345	G13450	4340	G43400	5160	G51600	8720	G87200
4023	G40230	E4340	G43406	E51100	G51986	8740	G87400
4024	G40240	4615	G46150	E52100	G52986	8822	G88220
4027	G40270	4620	G46200	6118	G61180	9260	G92600
4028	G40280	4626	G46260	6150	G61500	50B44	G50441
4037	G40370	4720	G47200	8615	G86150	50B46	G50461
4047	G40470	4815	G48150	8617	G86170	50B50	G50501
4118	G41180	4817	G48170	8620	G86200	50B60	G50601
4130	G41300	4820	G48200	8622	G86220	51B60	G51601
4137	G41370	5117	G51170	8625	G86250	81B45	G81451
4140	G41400	5120	G51200	8627	G86270	94B17	G94171
4142	G41420	5130	G51300	8630	G86300	94B30	G94301
4145	G41450	5132	G51320	8637	G86370
4147	G41470	5135	G51350	8640	G86400
Tool Steels (AISI and UNS Only)							
M1	T11301	T6	T12006	A6	T30106	P4	T51604
M2	T11302	T8	T12008	A7	T30107	P5	T51605
M4	T11304	T15	T12015	A8	T30108	P6	T51606
M6	T11306	H10	T20810	A9	T30109	P20	T51620
M7	T11307	H11	T20811	A10	T30110	P21	T51621
M10	T11310	H12	T20812	D2	T30402	F1	T60601
M3-1	T11313	H13	T20813	D3	T30403	F2	T60602
M3-2	T11323	H14	T20814	D4	T30404	L2	T61202
M30	T11330	H19	T20819	D5	T30405	L3	T61203
M33	T11333	H21	T20821	D7	T30407	L6	T61206
M34	T11334	H22	T20822	O1	T31501	W1	T72301
M36	T11336	H23	T20823	O2	T31502	W2	T72302
M41	T11341	H24	T20824	O6	T31506	W5	T72305
M42	T11342	H25	T20825	O7	T31507	CA2	T90102
M43	T11343	H26	T20826	S1	T41901	CD2	T90402
M44	T11344	H41	T20841	S2	T41902	CD5	T90405
M46	T11346	H42	T20842	S4	T41904	CH12	T90812
M47	T11347	H43	T20843	S5	T41905	CH13	T90813
T1	T12001	A2	T30102	S6	T41906	CO1	T91501
T2	T12002	A3	T30103	S7	T41907	CS5	T91905
T4	T12004	A4	T30104	P2	T51602
T5	T12005	A5	T30105	P3	T51603

Table 3. AISI-SAE System of Designating Carbon and Alloy Steels

AISI-SAE Designation ^a		Type of Steel and Nominal Alloy Content (%)
		Carbon Steels
	10xx	Plain Carbon (Mn 1.00% max.)
	11xx	Resulfurized
	12xx	Resulfurized and Rephosphorized
	15xx	Plain Carbon (Max. Mn range 1.00 to 1.65%)
		Manganese Steels
	13xx	Mn 1.75
		Nickel Steels
	23xx	Ni 3.50
	25xx	Ni 5.00
		Nickel-Chromium Steels
	31xx	Ni 1.25; Cr 0.65 and 0.80
	32xx	Ni 1.75; Cr 1.07
	33xx	Ni 3.50; Cr 1.50 and 1.57
	34xx	Ni 3.00; Cr 0.77
		Molybdenum Steels
	40xx	Mo 0.20 and 0.25
	44xx	Mo 0.40 and 0.52
		Chromium-Molybdenum Steels
	41xx	Cr 0.50, 0.80, and 0.95; Mo 0.12, 0.20, 0.25, and 0.30
		Nickel-Chromium-Molybdenum Steels
	43xx	Ni 1.82; Cr 0.50 and 0.80; Mo 0.25
	43BVxx	Ni 1.82; Cr 0.50; Mo 0.12 and 0.35; V 0.03 min.
	47xx	Ni 1.05; Cr 0.45; Mo 0.20 and 0.35
	81xx	Ni 0.30; Cr 0.40; Mo 0.12
	86xx	Ni 0.55; Cr 0.50; Mo 0.20
	87xx	Ni 0.55; Cr 0.50; Mo 0.25
	88xx	Ni 0.55; Cr 0.50; Mo 0.35
	93xx	Ni 3.25; Cr 1.20; Mo 0.12
	94xx	Ni 0.45; Cr 0.40; Mo 0.12
	97xx	Ni 0.55; Cr 0.20; Mo 0.20
	98xx	Ni 1.00; Cr 0.80; Mo 0.25
		Nickel-Molybdenum Steels
	46xx	Ni 0.85 and 1.82; Mo 0.20 and 0.25
	48xx	Ni 3.50; Mo 0.25
		Chromium Steels
	50xx	Cr 0.27, 0.40, 0.50, and 0.65
	51xx	Cr 0.80, 0.87, 0.92, 0.95, 1.00, and 1.05
	50xxx	Cr 0.50; C 1.00 min.
	51xxx	Cr 1.02; C 1.00 min.
	52xxx	Cr 1.45; C 1.00 min.
		Chromium-Vanadium Steels
	61xx	Cr 0.60, 0.80, and 0.95; V 0.10 and 0.15 min
		Tungsten-Chromium Steels
	72xx	W 1.75; Cr 0.75
		Silicon-Manganese Steels
	92xx	Si 1.40 and 2.00; Mn 0.65, 0.82, and 0.85; Cr 0.00 and 0.65
		High-Strength Low-Alloy Steels
	9xx	Various SAE grades
	xxBxx	B denotes boron steels
	xxLxx	L denotes leaded steels
AISI	SAE	Stainless Steels
2xx	302xx	Chromium-Manganese-Nickel Steels
3xx	303xx	Chromium-Nickel Steels
4xx	514xx	Chromium Steels
5xx	515xx	Chromium Steels

^a xx in the last two digits of the carbon and low-alloy designations (but not the stainless steels) indicates that the carbon content (in hundredths of a per cent) is to be inserted.

Table 4. Composition of AISI-SAE Standard Carbon Steels

AISI-SAE No.	UNS No.	Composition(%) ^a			
		C	Mn	P(max) ^b	S(max) ^b
Nonresulfurized Grades — 1 per cent Mn (max)					
1005 ^c	G10050	0.06 max	0.35 max	0.040	0.050
1006 ^c	G10060	0.08 max	0.25-0.40	0.040	0.050
1008	G10080	0.10 max	0.30-0.50	0.040	0.050
1010	G10100	0.08-0.13	0.30-0.60	0.040	0.050
1012	G10120	0.10-0.15	0.30-0.60	0.040	0.050
1015	G10150	0.13-0.18	0.30-0.60	0.040	0.050
1016	G10160	0.13-0.18	0.60-0.90	0.040	0.050
1017	G10170	0.15-0.20	0.30-0.60	0.040	0.050
1018	G10180	0.15-0.20	0.60-0.90	0.040	0.050
1019	G10190	0.15-0.20	0.70-1.00	0.040	0.050
1020	G10200	0.18-0.23	0.30-0.60	0.040	0.050
1021	G10210	0.18-0.23	0.60-0.90	0.040	0.050
1022	G10220	0.18-0.23	0.70-1.00	0.040	0.050
1023	G10230	0.20-0.25	0.30-0.60	0.040	0.050
1025	G10250	0.22-0.28	0.30-0.60	0.040	0.050
1026	G10260	0.22-0.28	0.60-0.90	0.040	0.050
1029	G10290	0.25-0.31	0.60-0.90	0.040	0.050
1030	G10300	0.28-0.34	0.60-0.90	0.040	0.050
1035	G10350	0.32-0.38	0.60-0.90	0.040	0.050
1037	G10370	0.32-0.38	0.70-1.00	0.040	0.050
1038	G10380	0.35-0.42	0.60-0.90	0.040	0.050
1039	G10390	0.37-0.44	0.70-1.00	0.040	0.050
1040	G10400	0.37-0.44	0.60-0.90	0.040	0.050
1042	G10420	0.40-0.47	0.60-0.90	0.040	0.050
1043	G10430	0.40-0.47	0.70-1.00	0.040	0.050
1044	G10440	0.43-0.50	0.30-0.60	0.040	0.050
1045	G10450	0.43-0.50	0.60-0.90	0.040	0.050
1046	G10460	0.43-0.50	0.70-1.00	0.040	0.050
1049	G10490	0.46-0.53	0.60-0.90	0.040	0.050
1050	G10500	0.48-0.55	0.60-0.90	0.040	0.050
1053	G10530	0.48-0.55	0.70-1.00	0.040	0.050
1055	G10550	0.50-0.60	0.60-0.90	0.040	0.050
1059 ^c	G10590	0.55-0.65	0.50-0.80	0.040	0.050
1060	G10600	0.55-0.65	0.60-0.90	0.040	0.050
1064 ^c	G10640	0.60-0.70	0.50-0.80	0.040	0.050
1065 ^c	G10650	0.60-0.70	0.60-0.90	0.040	0.050
1069 ^c	G10690	0.65-0.75	0.40-0.70	0.040	0.050
1070	G10700	0.65-0.75	0.60-0.90	0.040	0.050
1078	G10780	0.72-0.85	0.30-0.60	0.040	0.050
1080	G10800	0.75-0.88	0.60-0.90	0.040	0.050
1084	G10840	0.80-0.93	0.60-0.90	0.040	0.050
1086 ^c	G10860	0.80-0.93	0.30-0.50	0.040	0.050
1090	G10900	0.85-0.98	0.60-0.90	0.040	0.050
1095	G10950	0.90-1.03	0.30-0.50	0.040	0.050

Table 4. (Continued) Composition of AISI-SAE Standard Carbon Steels

AISI-SAE No.	UNS No.	Composition(%) ^a			
		C	Mn	P(max) ^b	S(max) ^b
Nonresulfurized Grades — Over 1 per cent Mn					
1513	G15130	0.10-0.16	1.10-1.40	0.040	0.050
1522	G15220	0.18-0.24	1.10-1.40	0.040	0.050
1524	G15240	0.19-0.25	1.35-1.65	0.040	0.050
1526	G15260	0.22-0.29	1.10-1.40	0.040	0.050
1527	G15270	0.22-0.29	1.20-1.50	0.040	0.050
1541	G15410	0.36-0.44	1.35-1.65	0.040	0.050
1548	G15480	0.44-0.52	1.10-1.40	0.040	0.050
1551	G15510	0.45-0.56	0.85-1.15	0.040	0.050
1552	G15520	0.47-0.55	1.20-1.50	0.040	0.050
1561	G15610	0.55-0.65	0.75-1.05	0.040	0.050
1566	G15660	0.60-0.71	0.85-1.15	0.040	0.050
Free-Machining Grades — Resulfurized					
1110	G11100	0.08-0.13	0.30-0.60	0.040	0.08-0.13
1117	G11170	0.14-0.20	1.00-1.30	0.040	0.08-0.13
1118	G11180	0.14-0.20	1.30-1.60	0.040	0.08-0.13
1137	G11370	0.32-0.39	1.35-1.65	0.040	0.08-0.13
1139	G11390	0.35-0.43	1.35-1.65	0.040	0.13-0.20
1140	G11400	0.37-0.44	0.70-1.00	0.040	0.08-0.13
1141	G11410	0.37-0.45	1.35-1.65	0.040	0.08-0.13
1144	G11440	0.40-0.48	1.35-1.65	0.040	0.24-0.33
1146	G11460	0.42-0.49	0.70-1.00	0.040	0.08-0.13
1151	G11510	0.48-0.55	0.70-1.00	0.040	0.08-0.13
Free-Machining Grades — Resulfurized and Rephosphorized					
1211	G12110	0.13 max	0.60-0.90	0.07-0.12	0.10-0.15
1212	G12120	0.13 max	0.70-1.00	0.07-0.12	0.16-0.23
1213	G12130	0.13 max	0.70-1.00	0.07-0.12	0.24-0.33
1215	G12150	0.09 max	0.75-1.05	0.04-0.09	0.26-0.35
12L14 ^d	G12144	0.15 max	0.85-1.15	0.04-0.09	0.26-0.35

^aThe following notes refer to boron, copper, lead, and silicon additions: Boron: Standard killed carbon steels, which are generally fine grain, may be produced with a boron treatment addition to improve hardenability. Such steels are produced to a range of 0.0005-0.003 per cent B. These steels are identified by inserting the letter "B" between the second and third numerals of the AISI or SAE number, e.g., 10B46. Copper: When copper is required, 0.20 per cent (min) is generally specified. Lead: Standard carbon steels can be produced with a lead range of 0.15-0.35 per cent to improve machinability. Such steels are identified by inserting the letter "L" between the second and third numerals of the AISI or SAE number, e.g., 12L15 and 10L45. Silicon: It is not common practice to produce the 12XX series of resulfurized and rephosphorized steels to specified limits for silicon because of its adverse effect on machinability. When silicon ranges or limits are required for resulfurized or nonresulfurized steels, however, these values apply: a range of 0.08 per cent Si for Si max up to 0.15 per cent inclusive, a range of 0.10 per cent Si for Si max over 0.15 to 0.20 per cent inclusive, a range of 0.15 per cent Si for Si max over 0.20 to 0.30 per cent inclusive, and a range of 0.20 per cent Si for Si max over 0.30 to 0.60 per cent inclusive. Example: Si max is 0.25 per cent, range is 0.10-0.25 per cent.

^b Values given are maximum percentages, except where a range of values is given.

^c Standard grades for wire rods and wire only.

^d 0.15-0.35 per cent Pb.

Table 5. Compositions of AISI-SAE Standard Alloy Steels

AISI-SAE No.	UNS No.	Composition (%) ^{a,b}							
		C	Mn	P (max)	S (max)	Si	Ni	Cr	Mo
1330	G13300	0.28-0.33	1.60-1.90	0.035	0.040	0.15-0.35
1335	G13350	0.33-0.38	1.60-1.90	0.035	0.040	0.15-0.35
1340	G13400	0.38-0.43	1.60-1.90	0.035	0.040	0.15-0.35
1345	G13450	0.43-0.48	1.60-1.90	0.035	0.040	0.15-0.35
4023	G40230	0.20-0.25	0.70-0.90	0.035	0.040	0.15-0.35	0.20-0.30
4024	G40240	0.20-0.25	0.70-0.90	0.035	0.035-0.050	0.15-0.35	0.20-0.30
4027	G40270	0.25-0.30	0.70-0.90	0.035	0.040	0.15-0.35	0.20-0.30
4028	G40280	0.25-0.30	0.70-0.90	0.035	0.035-0.050	0.15-0.35	0.20-0.30
4037	G40370	0.35-0.40	0.70-0.90	0.035	0.040	0.15-0.35	0.20-0.30
4047	G40470	0.45-0.50	0.70-0.90	0.035	0.040	0.15-0.35	0.20-0.30
4118	G41180	0.18-0.23	0.70-0.90	0.035	0.040	0.15-0.35	...	0.40-0.60	0.08-0.15
4130	G41300	0.28-0.33	0.40-0.60	0.035	0.040	0.15-0.35	...	0.80-1.10	0.15-0.25
4137	G41370	0.35-0.40	0.70-0.90	0.035	0.040	0.15-0.35	...	0.80-1.10	0.15-0.25
4140	G41400	0.38-0.43	0.75-1.00	0.035	0.040	0.15-0.35	...	0.80-1.10	0.15-0.25
4142	G41420	0.40-0.45	0.75-1.00	0.035	0.040	0.15-0.35	...	0.80-1.10	0.15-0.25
4145	G41450	0.43-0.48	0.75-1.00	0.035	0.040	0.15-0.35	...	0.80-1.10	0.15-0.25
4147	G41470	0.45-0.50	0.75-1.00	0.035	0.040	0.15-0.35	...	0.80-1.10	0.15-0.25
4150	G41500	0.48-0.53	0.75-1.00	0.035	0.040	0.15-0.35	...	0.80-1.10	0.15-0.25
4161	G41610	0.56-0.64	0.75-1.00	0.035	0.040	0.15-0.35	...	0.70-0.90	0.25-0.35
4320	G43200	0.17-0.22	0.45-0.65	0.035	0.040	0.15-0.35	1.65-2.00	0.40-0.60	0.20-0.30
4340	G43400	0.38-0.43	0.60-0.80	0.035	0.040	0.15-0.35	1.65-2.00	0.70-0.90	0.20-0.30
E4340 ^c	G43406	0.38-0.43	0.65-0.85	0.025	0.025	0.15-0.35	1.65-2.00	0.70-0.90	0.20-0.30
4615	G46150	0.13-0.18	0.45-0.65	0.035	0.040	0.15-0.35	1.65-2.00	...	0.20-0.30
4620	G46200	0.17-0.22	0.45-0.65	0.035	0.040	0.15-0.35	1.65-2.00	...	0.20-0.30
4626	G46260	0.24-0.29	0.45-0.65	0.035	0.040	0.15-0.35	0.70-1.00	...	0.15-0.25
4720	G47200	0.17-0.22	0.50-0.70	0.035	0.040	0.15-0.35	0.90-1.20	0.35-0.55	0.15-0.25
4815	G48150	0.13-0.18	0.40-0.60	0.035	0.040	0.15-0.35	3.25-3.75	...	0.20-0.30
4817	G48170	0.15-0.20	0.40-0.60	0.035	0.040	0.15-0.35	3.25-3.75	...	0.20-0.30
4820	G48200	0.18-0.23	0.50-0.70	0.035	0.040	0.15-0.35	3.25-3.75	...	0.20-0.30
5117	G51170	0.15-0.20	0.70-0.90	0.035	0.040	0.15-0.35	...	0.70-0.90	...
5120	G51200	0.17-0.22	0.70-0.90	0.035	0.040	0.15-0.35	...	0.70-0.90	...
5130	G51300	0.28-0.33	0.70-0.90	0.035	0.040	0.15-0.35	...	0.80-1.10	...
5132	G51320	0.30-0.35	0.60-0.80	0.035	0.040	0.15-0.35	...	0.75-1.00	...
5135	G51350	0.33-0.38	0.60-0.80	0.035	0.040	0.15-0.35	...	0.80-1.05	...
5140	G51400	0.38-0.43	0.70-0.90	0.035	0.040	0.15-0.35	...	0.70-0.90	...
5150	G51500	0.48-0.53	0.70-0.90	0.035	0.040	0.15-0.35	...	0.70-0.90	...
5155	G51550	0.51-0.59	0.70-0.90	0.035	0.040	0.15-0.35	...	0.70-0.90	...
5160	G51600	0.56-0.64	0.75-1.00	0.035	0.040	0.15-0.35	...	0.70-0.90	...

Table 5. (Continued) Compositions of AISI-SAE Standard Alloy Steels

AISI-SAE No.	UNS No.	Composition (%) ^{a,b}							
		C	Mn	P (max)	S (max)	Si	Ni	Cr	Mo
E51100 ^c	G51986	0.98-1.10	0.25-0.45	0.025	0.025	0.15-0.35	...	0.90-1.15	...
E52100 ^c	G52986	0.98-1.10	0.25-0.45	0.025	0.025	0.15-0.35	...	1.30-1.60	...
6118	G61180	0.16-0.21	0.50-0.70	0.035	0.040	0.15-0.35	...	0.50-0.70	0.10-0.15 V
6150	G61500	0.48-0.53	0.70-0.90	0.035	0.040	0.15-0.35	...	0.80-1.10	0.15 V min
8615	G86150	0.13-0.18	0.70-0.90	0.035	0.040	0.15-0.35	0.40-0.70	0.40-0.60	0.15-0.25
8617	G86170	0.15-0.20	0.70-0.90	0.035	0.040	0.15-0.35	0.40-0.70	0.40-0.60	0.15-0.25
8620	G86200	0.18-0.23	0.70-0.90	0.035	0.040	0.15-0.35	0.40-0.70	0.40-0.60	0.15-0.25
8622	G86220	0.20-0.25	0.70-0.90	0.035	0.040	0.15-0.35	0.40-0.70	0.40-0.60	0.15-0.25
8625	G86250	0.23-0.28	0.70-0.90	0.035	0.040	0.15-0.35	0.40-0.70	0.40-0.60	0.15-0.25
8627	G86270	0.25-0.30	0.70-0.90	0.035	0.040	0.15-0.35	0.40-0.70	0.40-0.60	0.15-0.25
8630	G86300	0.28-0.33	0.70-0.90	0.035	0.040	0.15-0.35	0.40-0.70	0.40-0.60	0.15-0.25
8637	G86370	0.35-0.40	0.75-1.00	0.035	0.040	0.15-0.35	0.40-0.70	0.40-0.60	0.15-0.25
8640	G86400	0.38-0.43	0.75-1.00	0.035	0.040	0.15-0.35	0.40-0.70	0.40-0.60	0.15-0.25
8642	G86420	0.40-0.45	0.75-1.00	0.035	0.040	0.15-0.35	0.40-0.70	0.40-0.60	0.15-0.25
8645	G86450	0.43-0.48	0.75-1.00	0.035	0.040	0.15-0.35	0.40-0.70	0.40-0.60	0.15-0.25
8655	G86550	0.51-0.59	0.75-1.00	0.035	0.040	0.15-0.35	0.40-0.70	0.40-0.60	0.15-0.25
8720	G87200	0.18-0.23	0.70-0.90	0.035	0.040	0.15-0.35	0.40-0.70	0.40-0.60	0.20-0.30
8740	G87400	0.38-0.43	0.75-1.00	0.035	0.040	0.15-0.35	0.40-0.70	0.40-0.60	0.20-0.30
8822	G88220	0.20-0.25	0.75-1.00	0.035	0.040	0.15-0.35	0.40-0.70	0.40-0.60	0.30-0.40
9260	G92600	0.56-0.64	0.75-1.00	0.035	0.040	1.80-2.20
Standard Boron Grades ^d									
50B44	G50441	0.43-0.48	0.75-1.00	0.035	0.040	0.15-0.35	...	0.40-0.60	...
50B46	G50461	0.44-0.49	0.75-1.00	0.035	0.040	0.15-0.35	...	0.20-0.35	...
50B50	G50501	0.48-0.53	0.75-1.00	0.035	0.040	0.15-0.35	...	0.40-0.60	...
50B60	G50601	0.56-0.64	0.75-1.00	0.035	0.040	0.15-0.35	...	0.40-0.60	...
51B60	G51601	0.56-0.64	0.75-1.00	0.035	0.040	0.15-0.35	...	0.70-0.90	...
81B45	G81451	0.43-0.48	0.75-1.00	0.035	0.040	0.15-0.35	0.20-0.40	0.35-0.55	0.08-0.15
94B17	G94171	0.15-0.20	0.75-1.00	0.035	0.040	0.15-0.35	0.30-0.60	0.30-0.50	0.08-0.15
94B30	G94301	0.28-0.33	0.75-1.00	0.035	0.040	0.15-0.35	0.30-0.60	0.30-0.50	0.08-0.15

^a Small quantities of certain elements are present that are not specified or required. These incidental elements may be present to the following maximum amounts: Cu, 0.35 per cent; Ni, 0.25 per cent; Cr, 0.20 per cent; and Mo, 0.06 per cent.

^b Standard alloy steels can also be produced with a lead range of 0.15-0.35 per cent. Such steels are identified by inserting the letter "L" between the second and third numerals of the AISI or SAE number, e.g., 41L40.

^c Electric furnace steel.

^d 0.0005-0.003 per cent B.

Source: American Iron and Steel Institute: *Steel Products Manual*.

Table 6. Standard Stainless Steels — Typical Compositions

AISI Type (UNS)	Typical Composition (%)	AISI Type (UNS)	Typical Composition (%)
Austenitic			
201 (S20100)	16-18 Cr, 3.5-5.5 Ni, 0.15 C, 5.5-7.5 Mn, 0.75 Si, 0.060 P, 0.030 S, 0.25 N	310 (S31000)	24-26 Cr, 19-22 Ni, 0.25 C, 2.0 Mn, 1.5 Si, 0.045 P, 0.030 S
202 (S20200)	17-19 Cr, 4-6 Ni, 0.15 C, 7.5-10.0 Mn, 0.75 Si, 0.060 P, 0.030 S, 0.25 N	310S (S31008)	24-26 Cr, 19-22 Ni, 0.08 C, 2.0 Mn, 1.5 Si, 0.045 P, 0.30 S
205 (S20500)	16.5-18 Cr, 1-1.75 Ni, 0.12-0.25 C, 14-15.5 Mn, 0.75 Si, 0.060 P, 0.030 S, 0.32-0.40 N	314 (S31400)	23-26 Cr, 19-22 Ni, 0.25 C, 2.0 Mn, 1.5-3.0 Si, 0.045 P, 0.030 S
301 (S30100)	16-18 Cr, 6-8 Ni, 0.15 C, 2.0 Mn, 0.75 Si, 0.045 P, 0.030 S	316 (S31600)	16-18 Cr, 10-14 Ni, 0.08 C, 2.0 Mn, 0.75 Si, 0.045 P, 0.030 S, 2.0-3.0 Mo, 0.10 N
302 (S30200)	17-19 Cr, 8-10 Ni, 0.15 C, 2.0 Mn, 0.75 Si, 0.045 P, 0.030 S, 0.10 N	316L (S31603)	16-18 Cr, 10-14 Ni, 0.03 C, 2.0 Mn, 0.75 Si, 0.045 P, 0.030 S, 2.0-3.0 Mo, 0.10 N
302B (S30215)	17-19 Cr, 8-10 Ni, 0.15 C, 2.0 Mn, 2.0-3.0 Si, 0.045 P, 0.030 S	316F (S31620)	16-18 Cr, 10-14 Ni, 0.08 C, 2.0 Mn, 1.0 Si, 0.20 P, 0.10 S min, 1.75-2.50 Mo
303 (S30300)	17-19 Cr, 8-10 Ni, 0.15 C, 2.0 Mn, 1.0 Si, 0.20 P, 0.015 S min, 0.60 Mo (optional)	316N (S31651)	16-18 Cr, 10-14 Ni, 0.08 C, 2.0 Mn, 0.75 Si, 0.045 P, 0.030 S, 2-3 Mo, 0.10-0.16 N
303Se (S30323)	17-19 Cr, 8-10 Ni, 0.15 C, 2.0 Mn, 1.0 Si, 0.20 P, 0.060 S, 0.15 Se min	317 (S31700)	18-20 Cr, 11-15 Ni, 0.08 C, 2.0 Mn, 0.75 Si, 0.045 P, 0.030 S, 3.0-4.0 Mo, 0.10 N max
304 (S30400)	18-20 Cr, 8-10.5 Ni, 0.08 C, 2.0 Mn, 0.75 Si, 0.045 P, 0.030 S, 0.10 N	317L (S31703)	18-20 Cr, 11-15 Ni, 0.03 C, 2.0 Mn, 0.75 Si, 0.045 P, 0.030 S, 3-4 Mo, 0.10 N max
304L (S30403)	18-20 Cr, 8-12 Ni, 0.03 C, 2.0 Mn, 0.75 Si, 0.045 P, 0.030 S, 0.10 N	321 (S32100)	17-19 Cr, 9-12 Ni, 0.08 C, 2.0 Mn, 0.75 Si, 0.045 P, 0.030 S [Ti, 5(C + N) min, 0.70 max], 0.10 max
304 Cu (S30430)	17-19 Cr, 8-10 Ni, 0.08 C, 2.0 Mn, 0.75 Si, 0.045 P, 0.030 S, 3-4 Cu	329 (S32900)	23-28 Cr, 2.5-5 Ni, 0.08 C, 2.0 Mn, 0.75 Si, 0.040 P, 0.030 S, 1-2 Mo
304N (S30451)	18-20 Cr, 8-10.5 Ni, 0.08 C, 2.0 Mn, 0.75 Si, 0.045 P, 0.030 S, 0.10-0.16 N	330 (N08330)	17-20 Cr, 34-37 Ni, 0.08 C, 2.0 Mn, 0.75-1.50 Si, 0.040 P, 0.030 S
305 (S30500)	17-19 Cr, 10.50-13 Ni, 0.12 C, 2.0 Mn, 0.75 Si, 0.045 P, 0.030 S	347 (S34700)	17-19 Cr, 9-13 Ni, 0.08 C, 2.0 Mn, 0.75 Si, 0.045 P, 0.030 S (Nb + Ta, 10 × C min, 1 max)
308 (S30800)	19-21 Cr, 10-12 Ni, 0.08 C, 2.0 Mn, 1.0 Si, 0.045 P, 0.030 S	348 (S34800)	17-19 Cr, 9-13 Ni, 0.08 C, 2.0 Mn, 0.75 Si, 0.045 P, 0.030 S (Nb + Ta, 10 × C min, 1 max, but 0.10 Ta max), 0.20 Ca
309 (S30900)	22-24 Cr, 12-15 Ni, 0.20 C, 2.0 Mn, 1.0 Si, 0.045 P, 0.030 S	384 (S38400)	15-17 Cr, 17-19 Ni, 0.08 C, 2.0 Mn, 1.0 Si, 0.045 P, 0.030 S
309S (S30908)	22-24 Cr, 12-15 Ni, 0.08 C, 2.0 Mn, 1.0 Si, 0.045 P, 0.030 S
Ferritic			
405 (S40500)	11.5-14.5 Cr, 0.08 C, 1.0 Mn, 1.0 Si, 0.040 P, 0.030 S, 0.1-0.3 Al, 0.60 max	430FSe (S43023)	16-18 Cr, 0.12 C, 1.25 Mn, 1.0 Si, 0.060 P, 0.060 S, 0.15 Se min
409 (S40900)	10.5-11.75 Cr, 0.08 C, 1.0 Mn, 1.0 Si, 0.045 P, 0.030 S, 0.05 Ni (Ti 6 × C, but with 0.75 max)	434 (S43400)	16-18 Cr, 0.12 C, 1.0 Mn, 1.0 Si, 0.040 P, 0.030 S, 0.75-1.25 Mo
429 (S42900)	14-16 Cr, 0.12 C, 1.0 Mn, 1.0 Si, 0.040 P, 0.30 S, 0.75 Ni	436 (S43600)	16-18 Cr, 0.12 C, 1.0 Mn, 1.0 Si, 0.040 P, 0.030 S, 0.75-1.25 Mo (Nb + Ta 5 × C min, 0.70 max)
430 (S43000)	16-18 Cr, 0.12 C, 1.0 Mn, 1.0 Si, 0.040 P, 0.30 S, 0.75 Ni	442 (S44200)	18-23 Cr, 0.20 C, 1.0 Mn, 1.0 Si, 0.040 P, 0.030 S
430F (S43020)	16-18 Cr, 0.12 C, 1.25 Mn, 1.0 Si, 0.060 P, 0.15 S min, 0.60 Mo (optional)	446 (S44600)	23-27 Cr, 0.20 C, 1.5 Mn, 1.0 Si, 0.040 P, 0.030 S, 0.025 N

Table 6. (Continued) Standard Stainless Steels — Typical Compositions

AISI Type (UNS)	Typical Composition (%)	AISI Type (UNS)	Typical Composition (%)
Martensitic			
403 (S40300)	11.5-13.0 Cr, 1.15 C, 1.0 Mn, 0.5 Si, 0.040 P, 0.030 S, 0.60 Ni	420F (S42020)	12-14 Cr, over 0.15 C, 1.25 Mn, 1.0 Si, 0.060 P, 0.15 S min, 0.60 Mo max (optional)
410 (S41000)	11.5-13.5 Cr, 0.15 C, 1.0 Mn, 1.0 Si, 0.040 P, 0.030 S, 0.75 Ni	422 (S42200)	11-12.50 Cr, 0.50-1.0 Ni, 0.20- 0.25 C, 0.50-1.0 Mn, 0.50 Si, 0.025 P, 0.025 S, 0.90-1.25 Mo, 0.20-0.30 V, 0.90-1.25 W
414 (S41400)	11.5-13.5 Cr, 1.25-2.50 Ni, 0.15 C, 1.0 Mn, 1.0 Si, 0.040 P, 0.030 S, 1.25-2.50 Ni	431 (S41623)	15-17 Cr, 1.25-2.50 Ni, 0.20 C, 1.0 Mn, 1.0 Si, 0.040 P, 0.030 S
416 (S41600)	12-14 Cr, 0.15 C, 1.25 Mn, 1.0 Si, 0.060 P, 0.15 S min, 0.060 Mo (optional)	440A (S44002)	16-18 Cr, 0.60-0.75 C, 1.0 Mn, 1.0 Si, 0.040 P, 0.030 S, 0.75 Mo
416Se (S41623)	12-14 Cr, 0.15 C, 1.25 Mn, 1.0 Si, 0.060 P, 0.060 S, 0.15 Se min	440B (S44003)	16-18 Cr, 0.75-0.95 C, 1.0 Mn, 1.0 Si, 0.040 P, 0.030 S, 0.75 Mo
420 (S42000)	12-14 Cr, 0.15 C min, 1.0 Mn, 1.0 Si, 0.040 P, 0.030 S	440C (S44004)	16-18 Cr, 0.95-1.20 C, 1.0 Mn, 1.0 Si, 0.040 P, 0.030 S, 0.75 Mo
Heat-Resisting			
501 (S50100)	4-6 Cr, 0.10 C min, 1.0 Mn, 1.0 Si, 0.040 P, 0.030 S, 0.40-0.65 Mo	502 (S50200)	4-6 Cr, 0.10 C, 1.0 Mn, 1.0 Si, 0.040 P, 0.030 S, 0.40-0.65 Mo

Thermal Treatments of Steel.—Steel’s versatility is due to its response to thermal treatment. Although most steel products are used in the as-rolled or un-heat-treated condition, thermal treatment greatly increases the number of properties that can be obtained, because at certain “critical temperatures” iron changes from one type of crystal structure to another. This structural change, known as an allotropic transformation, is spontaneous and reversible and can be made to occur by simply changing the temperature of the metal.

In steel, the transformation in crystal structure occurs over a range of temperatures, bounded by lower and upper critical points. When heated, most carbon and low-alloy steels have a critical temperature range between 1300 and 1600°F (700 and 870°C). Steel above this temperature, but below the melting range, has a crystalline structure known as austenite, in which the carbon and alloying elements are dissolved in a solid solution. Below this critical range, the crystal structure changes to a phase known as ferrite, which is capable of maintaining only a very small percentage of carbon in solid solution. The remaining carbon exists in the form of carbides, which are compounds of carbon and iron and certain of the other alloying elements. Depending primarily on cooling rate, the carbides may be present as thin plates alternating with the ferrite (pearlite); as spheroidal globular particles at ferrite grain boundaries or dispersed throughout the ferrite; or as a uniform distribution of extremely fine particles throughout a “ferritelike” phase, which has an acicular (needle-like) appearance, named martensite. In some of the highly alloyed stainless steels the addition of certain elements stabilizes the austenite structure so that it persists even at very low temperatures (austenitic grades). Other alloying elements can prevent the formation of austenite entirely up to the melting point (ferritic grades).

Fundamentally, all steel heat treatments are intended to either harden or soften the metal. They involve one or a series of operations in which the solid metal is heated and cooled under specified conditions to develop a required structure and properties. In general, there are five major forms of heat treatment for the standard steels that modify properties to suit either fabrication or end use.

Quenching and Tempering: The primary hardening treatment for steel, quenching and tempering, usually consists of three successive operations: heating the steel above the critical range and holding it at these temperatures for a sufficient time to approach a uniform solid solution (austenitizing); cooling the steel rapidly by quenching in oil, water, brine,

salt or air to form a hard, usually brittle, metastable structure known as untempered or white martensite; tempering the steel by reheating it to a temperature below the critical range in order to obtain the required combination of hardness, strength, ductility, toughness, and structural stability (tempered martensite).

Two well-known modifications of conventional quenching and tempering are “austempering” and “martempering.” They involve interrupted quenching techniques (two or more quenching media) that can be utilized for some steels to obtain desired structures and properties while minimizing distortion and cracking problems that may occur in conventional hardening.

Normalizing: The steel is heated to a temperature above the critical range, after which it is cooled in still air to produce a generally fine pearlite structure. The purpose is to promote uniformity of structure and properties after a hot-working operation such as forging or extrusion. Steels may be placed in service in the normalized condition, or they may be subjected to additional thermal treatment after subsequent machining or other operations.

Annealing: The steel is heated to a temperature above or within the critical range, then cooled at a predetermined slow rate (usually in a furnace) to produce a coarse pearlite structure. This treatment is used to soften the steel for improved machinability; to improve or restore ductility for subsequent forming operations; or to eliminate the residual stresses and microstructural effects of cold working.

Spheroidize Annealing: This is a special form of annealing that requires prolonged heating at an appropriate temperature followed by slow cooling in order to produce globular carbides, a structure desirable for machining, cold forming, or cold drawing, or for the effect it will have on subsequent heat treatment.

Stress Relieving: This process reduces internal stresses, caused by machining, cold working, or welding, by heating the steel to a temperature below the critical range and holding it there long enough to equalize the temperature throughout the piece.

See the sections *HARDENING, TEMPERING, AND ANNEALING* on page 461 and *Heat Treating High-Speed Steels* on page 496 for more information about the heat treatment of steels.

Applications.—Many factors enter into the selection of a steel for a particular application. These factors include the mechanical and physical properties needed to satisfy the design requirements and service environment; the cost and availability of the material; the cost of processing (machining, heat treatment, welding, etc.); and the suitability of available processing equipment or the cost of any new equipment required.

These steel selection considerations require input from designers, metallurgists, manufacturing engineers, service engineers, and procurement specialists, and can be considered proper or optimum when the part is made from the lowest cost material consistent with satisfying engineering and service requirements. The factors in selection can vary widely among different organizations, so that several different steels may be used successfully for similar applications. The best choice of a steel for any application most often results from a balance or trade-offs among the various selection considerations.

The AISI/SAE designated “standard steels” provide a convenient way for engineers and metallurgists to state briefly but clearly the chemical composition and, in some instances, some of the properties desired, and they are widely recognized and used in the United States and in many other countries. There are, however, numerous nonstandard carbon, alloy, and stainless steel grades that are widely used for special applications.

The following sections and tables illustrate the general characteristics and typical applications of most of the standard carbon, alloy, and stainless steel grades.

General Application of SAE Steels: These applications are intended as a general guide only since the selection may depend on the exact character of the service, cost of material, machinability when machining is required, or other factors. When more than one steel is

recommended for a given application, information on the characteristics of each steel listed will be found in the section *Carbon Steels* starting on page 410.

- Adapters, 1145
- Agricultural steel, 1070, 1080
- Aircraft forgings, 4140
- Axles front or rear, 1040, 4140
- Axle shafts, 1045, 2340, 2345, 3135, 3140, 3141, 4063, 4340
- Ball-bearing races, 52100
- Balls for ball bearings, 52100
- Body stock for cars, rimmed*
- Bolts and screws, 1035
- Bolts
 - anchor, 1040
 - cold-headed, 4042
 - connecting-rod, 3130
 - heat-treated, 2330
 - heavy-duty, 4815, 4820
 - steering-arm, 3130
- Brake levers, 1030, 1040
- Bumper bars, 1085
- Cams free-wheeling, 4615, 4620
- Camshafts, 1020, 1040
- Carburized parts, 1020, 1022, 1024, 1117, 1118, 1320, 2317, 2515, 3310, 3115, 3120, 4023, 4032
- Chain pins transmission, 4320, 4815, 4820
- Chains transmission, 3135, 3140
- Clutch disks, 1060, 1070, 1085
- Clutch springs, 1060
- Coil springs, 4063
- Cold-headed bolts, 4042
- Cold-heading
 - steel, 30905, 1070
 - wire or rod, rimmed*, 1035
- Cold-rolled steel, 1070
- Connecting-rods, 1040, 3141
- Connecting-rod bolts, 3130
- Corrosion resisting, 51710, 30805
- Covers transmission, rimmed*
- Crankshafts, 1045, 1145, 3135, 3140, 3141
- Crankshafts Diesel engine, 4340
- Cushion springs, 1060
- Cutlery stainless, 51335
- Cylinder studs, 3130
- Deep-drawing steel, rimmed*, 30905
- Differential gears, 4023
- Disks clutch, 1070, 1060
- Ductile steel, 30905
- Fan blades, 1020
- Fatigue resisting 4340, 4640
- Fender stock for cars, rimmed*
- Forgings
 - aircraft, 4140
 - carbon steel, 1040, 1045
 - heat-treated, 3240, 5140, 6150
 - high-duty, 6150
 - small or medium, 1035
 - large, 1036
- Free-cutting steel
 - carbon, 1111, 1113
 - chromium-nickel steel, 30615
 - manganese steel, 1132, 1137
- Gears
 - carburized, 1320, 2317, 3115, 3120, 3310, 4119, 4125, 4320, 4615, 4620, 4815, 4820
 - heat-treated, 2345
 - car and truck, 4027, 4032
 - cyanide-hardening, 5140
 - differential, 4023
 - high duty, 4640, 6150
 - oil-hardening, 3145, 3150, 4340, 5150
 - ring, 1045, 3115, 3120, 4119
 - transmission, 3115, 3120, 4119
 - truck and bus, 3310, 4320
- Gear shift levers, 1030
- Harrow disks, 1080
- Hay-rake teeth, 1095
- Key stock, 1030, 2330, 3130
- Leaf springs, 1085, 9260
- Levers
 - brake, 1030, 1040
 - gear shift, 1030
 - heat-treated, 2330
- Lock washers, 1060
- Mower knives, 1085
- Mower sections, 1070
- Music wire, 1085
- Nuts, 3130
 - heat-treated, 2330
- Oil pans automobile, rimmed*
- Pinions carburized, 3115, 3120, 4320
- Piston pins, 3115, 3120
- Plow
 - beams, 1070
 - disks, 1080
 - shares, 1080

* The "rimmed" and "killed" steels listed are in the SAE 1008, 1010, and 1015 group. See general description of these steels.

- Propeller shafts, 2340, 2345, 4140
- Races ball-bearing, 52100
- Ring gears, 3115, 3120, 4119
- Rings snap, 1060, 1070, 1090
- Rivets, rimmed*
- Rod and wire, killed*
- Rod cold-heading, 1035
- Roller bearings, 4815
- Rollers for bearings, 52100
- Screws and bolts, 1035
- Screw stock
 - Bessemer, 1111, 1112, 1113
 - open-hearth, 1115
- Screws heat-treated, 2330
- Seat springs, 10956
- Shafts
 - axle, 1045
 - cyanide-hardening, 5140
 - heavy-duty, 4340, 6150, 4615, 4620
 - oil-hardening, 5150
 - propeller, 2340, 2345, 4140
 - transmission, 4140
- Sheets and strips, rimmed*
- Snap rings, 1060, 1070, 1090
- Spline shafts, 1045, 1320, 2340, 2345, 3115, 3120, 3135, 3140, 4023
- Spring clips, 1060
- Springs
 - coil, 1095, 4063, 6150
 - clutch, 1060
 - cushion, 1060
 - hard-drawn coiled, 1066
 - leaf, 1085, 1095, 4063, 4068, 9260, 6150
 - oil-hardening, 5150
 - oil-tempered wire, 1066
 - seat, 1095
 - valve, 1060
- Spring wire, 1045
 - hard-drawn, 1055
 - oil-tempered, 1055
- Stainless irons, 51210, 51710
- Steel
 - cold-rolled, 1070
 - cold-heading, 30905
 - free-cutting carbon, 1111, 1113
 - free-cutting chrome-nickel, 30615
 - free-cutting manganese, 1132
 - minimum distortion, 4615, 4620, 4640
 - soft ductile, 30905
- Steering arms, 4042
- Steering-arm bolts, 3130
- Steering knuckles, 3141
- Steering-knuckle pins, 4815, 4820
- Tacks, rimmed*
- Thrust washers, 1060
 - oil-hardened, 5150
- Transmission shafts, 4140
- Tubing, 1040
 - front axle, 4140
 - seamless, 1030
 - welded, 1020
- Universal joints, 1145
- Valve springs, 1060
- Washers lock, 1060
- Welded structures, 30705
- Wire and rod, killed*
- Wire
 - cold-heading, rimmed*
 - hard-drawn spring, 1045, 1055
 - music, 1085
 - oil-tempered spring, 1055
- Wrist-pins automobile, 1020
- Yokes, 1145

Carbon Steels.—*SAE Steels 1006, 1008, 1010, 1015*: These steels are the lowest carbon steels of the plain carbon type, and are selected where cold formability is the primary requisite of the user. They are produced both as rimmed and killed steels. Rimmed steel is used for sheet, strip, rod, and wire where excellent surface finish or good drawing qualities are required, such as body and fender stock, hoods, lamps, oil pans, and other deep-drawn and -formed products. This steel is also used for cold-heading wire for tacks, and rivets and low carbon wire products. Killed steel (usually aluminum killed or special killed) is used for difficult stampings, or where nonaging properties are needed. Killed steels (usually silicon killed) should be used in preference to rimmed steel for forging or heat-treating applications.

These steels have relatively low tensile values and should not be selected where much strength is desired. Within the carbon range of the group, strength and hardness will rise with increases in carbon and/or with cold work, but such increases in strength are at the sacrifice of ductility or the ability to withstand cold deformation. Where cold rolled strip is used, the proper temper designation should be specified to obtain the desired properties.

With less than 0.15 carbon, the steels are susceptible to serious grain growth, causing brittleness, which may occur as the result of a combination of critical strain (from cold work) followed by heating to certain elevated temperatures. If cold-worked parts formed from these steels are to be later heated to temperatures in excess of 1100°F (590°C), the user should exercise care to avoid or reduce cold working. When this condition develops, it can be overcome by heating the parts to a temperature well in excess of the upper critical point, or at least 1750°F (955°C).

Steels in this group, being nearly pure iron or ferritic in structure, do not machine freely and should be avoided for cut screws and operations requiring broaching or smooth finish on turning. The machinability of bar, rod, and wire products is improved by cold drawing. Steels in this group are readily welded.

SAE 1016, 1017, 1018, 1019, 1020, 1021, 1022, 1023, 1024, 1025, 1026, 1027, 1030:

Steels in this group, due to the carbon range covered, have increased strength and hardness, and reduced cold formability compared to the lowest carbon group. For heat-treating purposes, they are known as carburizing or case hardening grades. When uniform response to heat treatment is required, or for forgings, killed steel is preferred; for other uses, semi-killed or rimmed steel may be indicated, depending on the combination of properties desired. Rimmed steels can ordinarily be supplied up to 0.25 carbon.

Selection of one of these steels for carburizing applications depends on the nature of the part, the properties desired, and the processing practice preferred. Increases in carbon give greater core hardness with a given quench, or permit the use of thicker sections. Increases in manganese improve the hardenability of both the core and case; in carbon steels this is the only change in composition that will increase case hardenability. The higher manganese variants also machine much better. For carburizing applications, SAE 1016, 1018, and 1019 are widely used for thin sections or water-quenched parts. SAE 1022 and 1024 are used for heavier sections or where oil quenching is desired, and SAE 1024 is sometimes used for such parts as transmission and rear axle gears. SAE 1027 is used for parts given a light case to obtain satisfactory core properties without drastic quenching. SAE 1025 and 1030, although not usually regarded as carburizing types, are sometimes used in this manner for larger sections or where greater core hardness is needed.

For cold-formed or -headed parts, the lowest manganese grades (SAE 1017, 1020, and 1025) offer the best formability at their carbon level. SAE 1020 is used for fan blades and some frame members, and SAE 1020 and 1025 are widely used for low-strength bolts. The next higher manganese types (SAE 1018, 1021, and 1026) provide increased strength.

All steels listed may be readily welded or brazed by the common commercial methods. SAE 1020 is frequently used for welded tubing. These steels are used for numerous forged parts, the lower-carbon grades where high strength is not essential. Forgings from the lower-carbon steels usually machine better in the as-forged condition without annealing, or after normalizing.

SAE 1030, 1033, 1034, 1035, 1036, 1038, 1039, 1040, 1041, 1042, 1043, 1045, 1046, 1049, 1050, 1052: These steels, of the medium-carbon type, are selected for uses where higher mechanical properties are needed and are frequently further hardened and strengthened by heat treatment or by cold work. These grades are ordinarily produced as killed steels.

Steels in this group are suitable for a wide variety of automotive-type applications. The particular carbon and manganese level selected is affected by a number of factors. Increases in the mechanical properties required in section thickness, or in depth of hardening, ordinarily indicate either higher carbon or manganese or both. The heat-treating practice preferred, particularly the quenching medium, has a great effect on the steel selected. In general, any of the grades over 0.30 carbon may be selectively hardened by induction or flame methods.

The lower-carbon and manganese steels in this group find usage for certain types of cold-formed parts. SAE 1030 is used for shift and brake levers. SAE 1034 and 1035 are used in the form of wire and rod for cold upsetting such as bolts, and SAE 1038 for bolts and studs. The parts cold-formed from these steels are usually heat-treated prior to use. Stampings are generally limited to flat parts or simple bends. The higher-carbon SAE 1038, 1040, and 1042 are frequently cold drawn to specified physical properties for use without heat treatment for some applications such as cylinder head studs.

Any of this group of steels may be used for forgings, the selection being governed by the section size and the physical properties desired after heat treatment. Thus, SAE 1030 and 1035 are used for shifter forks and many small forgings where moderate properties are desired, but the deeper-hardening SAE 1036 is used for more critical parts where a higher strength level and more uniformity are essential, such as some front suspension parts. Forgings such as connecting rods, steering arms, truck front axles, axle shafts, and tractor wheels are commonly made from the SAE 1038 to 1045 group. Larger forgings at similar strength levels need more carbon and perhaps more manganese. Examples are crankshafts made from SAE 1046 and 1052. These steels are also used for small forgings where high hardness after oil quenching is desired. Suitable heat treatment is necessary on forgings from this group to provide machinability. These steels are also widely used for parts machined from bar stock, the selection following an identical pattern to that described for forgings. They are used both with and without heat treatment, depending on the application and the level of properties needed. As a class, they are considered good for normal machining operations. It is also possible to weld these steels by most commercial methods, but precautions should be taken to avoid cracking from too rapid cooling.

SAE 1055, 1060, 1062, 1064, 1065, 1066, 1070, 1074, 1078, 1080, 1085, 1086, 1090, 1095: Steels in this group are of the high-carbon type, having more carbon than is required to achieve maximum as quenched hardness. They are used for applications where the higher carbon is needed to improve wear characteristics for cutting edges, to make springs, and for special purposes. Selection of a particular grade is affected by the nature of the part, its end use, and the manufacturing methods available.

In general, cold-forming methods are not practical on this group of steels, being limited to flat stampings and springs coiled from small-diameter wire. Practically all parts from these steels are heat treated before use, with some variations in heat-treating methods to obtain optimum properties for the particular use to which the steel is to be put.

Uses in the spring industry include SAE 1065 for pretempered wire and SAE 1066 for cushion springs of hard-drawn wire, SAE 1064 may be used for small washers and thin stamped parts, SAE 1074 for light flat springs formed from annealed stock, and SAE 1080 and 1085 for thicker flat springs. SAE 1085 is also used for heavier coil springs. Valve spring wire and music wire are special products.

Due to good wear properties when properly heat-treated, the high-carbon steels find wide usage in the farm implement industry. SAE 1070 has been used for plow beams, SAE 1074 for plow shares, and SAE 1078 for such parts as rake teeth, scrapers, cultivator shovels, and plow shares. SAE 1085 has been used for scraper blades, disks, and for spring tooth harrows. SAE 1086 and 1090 find use as mower and binder sections, twine holders, and knotter disks.

SAE 1111, 1112, 1113: This class of steels is intended for those uses where easy machining is the primary requirement. They are characterized by a higher sulfur content than comparable carbon steels. This composition results in some sacrifice of cold-forming properties, weldability, and forging characteristics. In general, the uses are similar to those for carbon steels of similar carbon and manganese content.

These steels are commonly known as Bessemer screw stock, and are considered the best machining steels available, machinability improving within the group as sulfur increases. They are used for a wide variety of machined parts. Although of excellent strength in the

cold-drawn condition, they have an unfavorable property of cold shortness and are not commonly used for vital parts. These steels may be cyanided or carburized, but when uniform response to heat-treating is necessary, open-hearth steels are recommended.

SAE 1109, 1114, 1115, 1116, 1117, 1118, 1119, 1120, 1126: Steels in this group are used where a combination of good machinability and more uniform response to heat treatment is needed. The lower-carbon varieties are used for small parts that are to be cyanided or carbonitrided. SAE 1116, 1117, 1118, and 1119 carry more manganese for better hardenability, permitting oil quenching after case-hardening heat treatments in many instances. The higher-carbon SAE 1120 and 1126 provide more core hardness when this is needed.

SAE 1132, 1137, 1138, 1140, 1141, 1144, 1145, 1146, 1151: This group of steels has characteristics comparable to carbon steels of the same carbon level, except for changes due to higher sulfur as noted previously. They are widely used for parts where large amounts of machining are necessary, or where threads, splines, or other contours present special problems with tooling. SAE 1137, for example, is widely used for nuts and bolts and studs with machined threads. The higher-manganese SAE 1132, 1137, 1141, and 1144 offer greater hardenability, the higher-carbon types being suitable for oil quenching for many parts. All these steels may be selectively hardened by induction or flame heating if desired.

Carburizing Grades of Alloy Steels.—*Properties of the Case:* The properties of carburized and hardened cases (surface layers) depend on the carbon and alloy content, the structure of the case, and the degree and distribution of residual stresses. The carbon content of the case depends on the details of the carburizing process, and the response of iron and the alloying elements present, to carburization. The original carbon content of the steel has little or no effect on the carbon content produced in the case. The hardenability of the case, therefore, depends on the alloy content of the steel and the final carbon content produced by carburizing, but not on the initial carbon content of the steel.

With complete carbide solution, the effect of alloying elements on the hardenability of the case is about the same as the effect of these elements on the hardenability of the core. As an exception to this statement, any element that inhibits carburizing may reduce the hardenability of the case. Some elements that raise the hardenability of the core may tend to produce more retained austenite and consequently somewhat lower hardness in the case.

Alloy steels are frequently used for case hardening because the required surface hardness can be obtained by moderate speeds of quenching. Slower quenching may mean less distortion than would be encountered with water quenching. It is usually desirable to select a steel that will attain a minimum surface hardness of 58 or 60 Rockwell C after carburizing and oil quenching. Where section sizes are large, a high-hardenability alloy steel may be necessary, whereas for medium and light sections, low-hardenability steels will suffice.

In general, the case-hardening alloy steels may be divided into two classes as far as the hardenability of the case is concerned. Only the general type of steel (SAE 3300-4100, etc.) is discussed. The original carbon content of the steel has no effect on the carbon content of the case, so the last two digits in the specification numbers are not meaningful as far as the case is concerned.

a) High-Hardenability Case: SAE 2500, 3300, 4300, 4800, 9300

As these are high-alloy steels, both the case and the core have high hardenability. They are used particularly for carburized parts having thick sections, such as bevel drive pinions and heavy gears. Good case properties can be obtained by oil quenching. These steels are likely to have retained austenite in the case after carburizing and quenching; consequently, special precautions or treatments, such as refrigeration, may be required.

b) Medium-Hardenability Case: SAE 1300, 2300, 4000, 4100, 4600, 5100, 8600, 8700

Carburized cases of these steels have medium hardenability, which means that their hardenability is intermediate between that of plain carbon steel and the higher-alloy car-

burizing steels discussed earlier. In general, these steels can be used for average-size case-hardened automotive parts such as gears, pinions, piston pins, ball studs, universal joint crosses, crankshafts, etc. Satisfactory case hardness is usually produced by oil quenching.

Core Properties: The core properties of case-hardened steels depend on both carbon and alloy content of the steel. Each of the general types of alloy case-hardening steel is usually made with two or more carbon contents to permit different hardenability in the core.

The most desirable hardness for the core depends on the design and functioning of the individual part. In general, where high compressive loads are encountered, relatively high core hardness is beneficial in supporting the case. Low core hardnesses may be desirable where great toughness is essential.

The case-hardening steels may be divided into three general classes, depending on hardenability of the core.

- a) Low-Hardenability Core: SAE 4017, 4023, 4024, 4027*, 4028*, 4608, 4615, 4617*, 8615*, 8617*
- b) Medium-Hardenability Core: SAE 1320, 2317, 2512, 2515*, 3115, 3120, 4032, 4119, 4317, 4620, 4621, 4812, 4815*, 5115, 5120, 8620, 8622, 8720, 9420
- c) High-Hardenability Core: SAE 2517, 3310, 3316, 4320, 4817, 4820, 9310, 9315, 9317

Heat Treatments: In general, all the alloy carburizing steels are made with fine grain and most are suitable for direct quenching from the carburizing temperature. Several other types of heat treatment involving single and double quenching are also used for most of these steels. See [Table 4a](#) on page 490 and [Table 4b](#) on page 491.

Directly Hardenable Grades of Alloy Steels.—These steels may be considered in five groups on the basis of approximate mean carbon content of the SAE specification. In general, the last two figures of the specification agree with the mean carbon content. Consequently the heading *0.30-0.37 Mean Carbon Content of SAE Specification* includes steels such as SAE 1330, 3135, and 4137.

It is necessary to deviate from the above plan in the classification of the carbon molybdenum steels. When carbon molybdenum steels are used, it is customary to specify higher carbon content for any given application than would be specified for other alloy steels, due to the low alloy content of these steels. For example, SAE 4063 is used for the same applications as SAE 4140, 4145, and 5150. Consequently, in the following discussion, the carbon molybdenum steels have been shown in the groups where they belong on the basis of applications rather than carbon content.

Mean Carbon Content of SAE Specification	Common Applications
(a) 0.30-0.37 per cent	Heat-treated parts requiring moderate strength and great toughness.
(b) 0.40-0.42 per cent	Heat-treated parts requiring higher strength and good toughness.
(c) 0.45-0.50 per cent	Heat-treated parts requiring fairly high hardness and strength with moderate toughness.
(d) 0.50-0.62 per cent	Springs and hand tools.
(e) 1.02 per cent	Ball and roller bearings.

For the present discussion, steels of each carbon content are divided into two or three groups on the basis of hardenability. Transformation ranges and consequently heat-treating practices vary somewhat with different alloying elements even though the hardenability is not changed.

0.30-0.37 Mean Carbon Content of SAE Specification: These steels are frequently used for water-quenched parts of moderate section size and for oil-quenched parts of small section size. Typical applications of these steels are connecting rods, steering arms and steering knuckles, axle shafts, bolts, studs, screws, and other parts requiring strength and

* Borderline classifications might be considered in the next higher hardenability group.

toughness where section size is small enough to permit the desired physical properties to be obtained with the customary heat treatment.

Steels falling in this classification may be subdivided into two groups on the basis of hardenability:

- a) Low Hardenability: SAE 1330, 1335, 4037, 4042, 4130, 5130, 5132, 8630
- b) Medium Hardenability: SAE 2330, 3130, 3135, 4137, 5135, 8632, 8635, 8637, 8735, 9437

0.40-0.42 Mean Carbon Content of SAE Specification: In general, these steels are used for medium and large size parts requiring high degree of strength and toughness. The choice of the proper steel depends on the section size and the mechanical properties that must be produced. The low and medium hardenability steels are used for average size automotive parts such as steering knuckles, axle shafts, propeller shafts, etc. The high hardenability steels are used particularly for large axles and shafts for large aircraft parts.

These steels are usually considered as oil quenching steels, although some large parts made of the low and medium hardenability classifications may be quenched in water under properly controlled conditions.

These steels may be divided into three groups on the basis of hardenability:

- a) Low Hardenability: SAE 1340, 4047, 5140, 9440
- b) Medium Hardenability: SAE 2340, 3140, 3141, 4053, 4063, 4140, 4640, 8640, 8641, 8642, 8740, 8742, 9442
- c) High Hardenability: SAE 4340, 9840

0.45-0.50 Mean Carbon Content of SAE Specification: These steels are used primarily for gears and other parts requiring fairly high hardness as well as strength and toughness. Such parts are usually oil-quenched and a minimum of 90 per cent martensite in the as-quenched condition is desirable.

- a) Low Hardenability: SAE 5045, 5046, 5145, 9747, 9763
- b) Medium Hardenability: SAE 2345, 3145, 3150, 4145, 5147, 5150, 8645, 8647, 8650, 8745, 8747, 8750, 9445, 9845
- c) High Hardenability: SAE 4150, 9850

0.50-0.63 Mean Carbon Content of SAE Specification: These steels are used primarily for springs and hand tools. The hardenability necessary depends on the thickness of the material and the quenching practice.

- a) Medium hardenability: SAE 4068, 5150, 5152, 6150, 8650, 9254, 9255, 9260, 9261
- b) High Hardenability: SAE 8653, 8655, 8660, 9262

1.02 Mean Carbon Content of SAE Specification—SAE 50100, 51100, 52100: These straight chromium electric furnace steels are used primarily for the races and balls or rollers of antifriction bearings. They are also used for other parts requiring high hardness and wear resistance. The compositions of the three steels are identical, except for a variation in chromium, with a corresponding variation in hardenability.

- a) Low Hardenability: SAE 50100
- b) Medium Hardenability: SAE 51100, 52100

Resulfurized Steel: Some of the alloy steels, SAE 4024, 4028, and 8641, are made resulfurized so as to give better machinability at a relatively high hardness. In general, increased sulfur results in decreased transverse ductility, notched impact toughness, and weldability.

Characteristics and Typical Applications of Standard Stainless Steels.—Typical applications of various stainless steel alloys are given in the following. The first number given is the AISI designation followed by the UNS number in parenthesis. (See also *Numbering Systems for Metals and Alloys* on page 398)

201 (S20100): High work-hardening rate; low-nickel equivalent of type 301. Flatware; automobile wheel covers, trim.

202 (S20200): General-purpose low-nickel equivalent of type 302. Kitchen equipment; hub caps; milk handling.

205 (S20500): Lower work-hardening rate than type 202; used for spinning and special drawing operations. Nonmagnetic and cryogenic parts.

301 (S30100): High work-hardening rate; used for structural applications where high strength plus high ductility are required. Railroad cars; trailer bodies; aircraft structurals; fasteners; automobile wheel covers, trim; pole line hardware.

302 (S30200): General-purpose austenitic stainless steel. Trim; food-handling equipment; aircraft cowlings; antennas; springs; cookware; building exteriors; tanks; hospital, household appliances; jewelry; oil refining equipment; signs.

302B (S30215): More resistant to scale than type 302. Furnace parts; still liners; heating elements; annealing covers; burner sections.

303 (S30300): Free-machining modification of type 302, for heavier cuts. Screw machine products; shafts; valves; bolts; bushings; nuts.

303Se (S30323): Free-machining modification of type 302, for lighter cuts; used where hot working or cold heading may be involved. Aircraft fittings; bolts; nuts; rivets; screws; studs.

304 (S30400): Low-carbon modification of type 302 for restriction of carbide precipitation during welding. Chemical and food processing equipment; brewing equipment; cryogenic vessels; gutters; downspouts; flashings.

304L (S30403): Extra-low-carbon modification of type 304 for further restriction of carbide precipitation during welding. Coal hopper linings; tanks for liquid fertilizer and tomato paste.

304Cu (S30430): Lower work-hardening rate than type 304. Severe cold-heading applications.

304N (S30451): Higher nitrogen than type 304 to increase strength with minimum effect on ductility and corrosion resistance, more resistant to increased magnetic permeability. Type 304 applications requiring higher strength.

305 (S30500): Low work-hardening rate; used for spin forming, severe drawing, cold heading, and forming. Coffee urn tops; mixing bowls; reflectors.

308 (S30800): Higher-alloy steel having high corrosion and heat resistance. Welding filler metals to compensate for alloy loss in welding; industrial furnaces.

309 (S30900): High-temperature strength and scale resistance. Aircraft heaters; heat-treating equipment; annealing covers; furnace parts; heat exchangers; heat-treating trays; oven linings; pump parts.

309S (S30908): Low-carbon modification of type 309. Welded constructions; assemblies subject to moist corrosion conditions.

310 (S31000): Higher elevated temperature strength and scale resistance than type 309. Heat exchangers; furnace parts; combustion chambers; welding filler metals; gas-turbine parts; incinerators; recuperators; rolls for roller hearth furnaces.

310S (S31008): Low-carbon modification of type 310. Welded constructions; jet engine rings.

314 (S31400): More resistant to scale than type 310. Severe cold-heading or -forming applications. Annealing and carburizing boxes; heat-treating fixtures; radiant tubes.

316 (S31600): Higher corrosion resistance than types 302 and 304; high creep strength. Chemical and pulp handling equipment; photographic equipment; brandy vats; fertilizer parts; ketchup cooking kettles; yeast tubs.

316L (S31603): Extra-low-carbon modification of type 316. Welded construction where intergranular carbide precipitation must be avoided. Type 316 applications requiring extensive welding.

316F (S31620): Higher phosphorus and sulfur than type 316 to improve machining and nonseizing characteristics. Automatic screw machine parts.

316N (S31651): Higher nitrogen than type 316 to increase strength with minimum effect on ductility and corrosion resistance. Type 316 applications requiring extra strength.

317 (S31700): Higher corrosion and creep resistance than type 316. Dyeing and ink manufacturing equipment.

317L (S31703): Extra-low-carbon modification of type 317 for restriction of carbide precipitation during welding. Welded assemblies.

321 (S32100): Stabilized for weldments under severe corrosive conditions, and service from 800–1650°F (425–900°C). Aircraft exhaust manifolds; boiler shells; process equipment; expansion joints; cabin heaters; fire walls; flexible couplings; pressure vessels.

329 (S32900): Austenitic-ferritic type with general corrosion resistance similar to type 316 but with better resistance to stress-corrosion cracking; capable of age hardening. Valves; valve fittings; piping; pump parts.

330 (N08330): Good resistance to carburization and oxidation and to thermal shock. Heat-treating fixtures.

347 (S34700): Similar to type 321 with higher creep strength. Airplane exhaust stacks; welded tank cars for chemicals; jet engine parts.

348 (S34800): Similar to type 321; low retentivity. Tubes and pipes for radioactive systems; nuclear energy uses.

384 (S38400): Suitable for severe cold heading or cold forming; lower cold-work-hardening rate than type 305. Bolts; rivets; screws; instrument parts.

403 (S40300): “Turbine quality” grade. Steam turbine blading and other highly stressed parts including jet engine rings.

405 (S40500): Nonhardenable grade for assemblies where air-hardening types such as 410 or 403 are objectionable. Annealing boxes; quenching racks; oxidation-resistant partitions.

409 (S40900): General-purpose construction stainless. Automotive exhaust systems; transformer and capacitor cases; dry fertilizer spreaders; tanks for agricultural sprays.

410 (S41000): General-purpose heat-treatable type. Machine parts; pump shafts; bolts; bushings; coal chutes; cutlery; hardware; jet engine parts; mining machinery; rifle barrels; screws; valves.

414 (41400): High hardenability steel. Springs; tempered rules; machine parts, bolts; mining machinery; scissors; ships’ bells; spindles; valve seats.

416 (S41600): Free-machining modification of type 410, for heavier cuts. Aircraft fittings; bolts; nuts; fire extinguisher inserts; rivets; screws.

416Se (S41623): Free-machining modification of type 410, for lighter cuts. Machined parts requiring hot working or cold heading.

420 (S42000): Higher carbon modification of type 410. Cutlery; surgical instruments; valves; wear-resisting parts; glass molds; hand tools; vegetable choppers.

420F (S42020): Free-machining modification of type 420. Applications similar to those for type 420 requiring better machinability.

422 (S42200): High strength and toughness at service temperatures up to 1200°F (650°C). Steam turbine blades; fasteners.

429 (S42900): Improved weldability as compared to type 430. Nitric acid and nitrogen-fixation equipment.

430 (S43000): General-purpose nonhardenable chromium type. Decorative trim; nitric acid tanks; annealing baskets; combustion chambers; dishwashers; heaters; mufflers; range hoods; recuperators; restaurant equipment.

430F (S43020): Free-machining modification of type 430, for heavier cuts. Screw machine parts.

430FSe (S43023): Free-machining modification of type 430, for lighter cuts. Machined parts requiring light cold heading or forming.

431 (S43100): Special-purpose hardenable steel used where particularly high mechanical properties are required. Aircraft fittings; beater bars; paper machinery; bolts.

434 (S43400): Modification of type 430 designed to resist atmospheric corrosion in the presence of winter road conditioning and dust-laying compounds. Automotive trim and fasteners.

436 (S43600): Similar to types 430 and 434. Used where low “roping” or “ridging” required. General corrosion and heat-resistant applications such as automobile trim.

440A (S44002): Hardenable to higher hardness than type 420 with good corrosion resistance. Cutlery; bearings; surgical tools.

440B (S44003): Cutlery grade. Cutlery, valve parts; instrument bearings.

440C (S44004): Yields highest hardnesses of hardenable stainless steels. Balls; bearings; races; nozzles; balls and seats for oil well pumps; valve parts.

442 (S44200): High-chromium steel, principally for parts that must resist high service temperatures without scaling. Furnace parts; nozzles; combustion chambers.

446 (S44600): High-resistance to corrosion and scaling at high temperatures, especially for intermittent service; often used in sulfur-bearing atmosphere. Annealing boxes; combustion chambers; glass molds; heaters; pyrometer tubes; recuperators; stirring rods; valves.

501 (S50100): Heat resistance; good mechanical properties at moderately elevated temperatures. Heat exchangers; petroleum refining equipment.

502 (S50200): More ductility and less strength than type 501. Heat exchangers; petroleum refining equipment; gaskets.

Chromium-Nickel Austenitic Steels. — (Not capable of heat treatment) *SAE 30201*:

This steel is an austenitic chromium-nickel-manganese stainless steel usually required in flat products. In the annealed condition, it exhibits higher strength values than the corresponding chromium-nickel stainless steel (SAE 30301). It is nonmagnetic in the annealed condition, but may be magnetic when cold-worked. SAE 30201 is used to obtain high strength by work-hardening and is well suited for corrosion-resistant structural members requiring high strength with low weight. It has excellent resistance to a wide variety of corrosive media, showing behavior comparable to stainless grade SAE 30301. It has high ductility and excellent forming properties. Owing to this steel's work-hardening rate and yield strength, tools for forming must be designed to allow for a higher springback or recovery rate. It is used for automotive trim, automotive wheel covers, railroad passenger car bodies and structural members, and truck trailer bodies.

SAE 30202: Like chromium-nickel stainless steel SAE 30302, this is a general-purpose stainless steel. It has excellent corrosion resistance and deep drawing qualities. It is non-hardenable by thermal treatments, but may be cold worked to high tensile strengths. In the annealed condition, it is nonmagnetic but slightly magnetic when cold-worked. Applications for this stainless steel are hub cap, railcar and truck trailer bodies, and spring wire.

SAE 30301: Capable of attaining high tensile strength and ductility by moderate or severe cold working. It is used largely in the cold-rolled or cold-drawn condition in the form of sheet, strip, and wire. Its corrosion resistance is good but not equal to SAE 30302.

SAE 30302: The most widely used of the general-purpose austenitic chromium-nickel stainless steels. It is used for deep drawing largely in the annealed condition. It can be worked to high tensile strengths but with slightly lower ductility than SAE 30301.

SAE 30303F: A free-machining steel recommended for the manufacture of parts produced on automatic screw machines. Caution must be used in forging this steel.

SAE 30304: Similar to SAE 30302 but somewhat superior in corrosion resistance and having superior welding properties for certain types of equipment.

SAE 30305: Similar to SAE 30304 but capable of lower hardness. Has greater ductility with slower work-hardening tendency.

SAE 30309: A steel with high heat-resisting qualities which is resistant to oxidation at temperatures up to about 1800°F (980°C).

SAE 30310: This steel has the highest heat-resisting properties of the chromium nickel steels listed here and will resist oxidation at temperatures up to about 1900°F (1040°C).

SAE 30316: Recommended for use in parts where unusual resistance to chemical or salt water corrosion is necessary. It has superior creep strength at elevated temperatures.

SAE 30317: Similar to SAE 30316 but has the highest corrosion resistance of all these alloys in many environments.

SAE 30321: Recommended for use in the manufacture of welded structures where heat treatment after welding is not feasible. It is also recommended for use where temperatures up to 1600°F (870°C) are encountered in service.

SAE 30325: Used for such parts as heat control shafts.

SAE 30347: This steel is similar to SAE 30321. This niobium alloy is sometimes preferred to titanium because niobium is less likely to be lost in welding operations.

Stainless Chromium Irons and Steels.—*SAE 51409*: An 11 per cent chromium alloy developed, especially for automotive mufflers and tailpipes. Resistance to corrosion and oxidation is very similar to SAE 51410. It is nonhardenable and has good forming and welding characteristics. This alloy is recommended for mildly corrosive applications where surface appearance is not critical.

SAE 51410: A general-purpose stainless steel capable of heat treatment to show good physical properties. It is used for general stainless applications, both in the heat-treated and annealed condition but is not as resistant to corrosion as SAE 51430 in either the annealed or heat-treated condition.

SAE 51414: A corrosion and heat-resisting nickel-bearing chromium steel with somewhat better corrosion resistance than SAE 51410. It will attain slightly higher mechanical properties when heat-treated than SAE 51410. It is used in the form of tempered strip or wire, and in bars and forgings for heat-treated parts.

SAE 51416F: A free-machining grade for the manufacture of parts produced in automatic screw machines.

SAE 51420: This steel heat-treatable to a relatively high hardness. It will harden to a maximum of approximately 500 Brinell. Maximum corrosion resisting qualities exist only in the fully hardened condition. It is used for cutlery, hardened pump shafts, etc.

SAE 51420F: This is similar to SAE 51420 except for its free-machining properties.

SAE 51430: This high-chromium steel is not capable of heat treatment and is recommended for use in shallow parts requiring moderate draw. Corrosion and heat resistance are superior to SAE 51410.

SAE 51430F: This steel is similar to SAE 51430 except for its free-machining properties.

SAE 51431: This nickel-bearing chromium steel is designed for heat treatment to high mechanical properties. Its corrosion resistance is superior to other hardenable steels.

SAE 51440A: A hardenable chromium steel with greater quenched hardness than SAE 51420 and greater toughness than SAE 51440B and 51440C. Maximum corrosion resistance is obtained in the fully hardened and polished condition.

SAE 51440B: A hardenable chromium steel with greater quenched hardness than SAE 51440A. Maximum corrosion resistance is obtained in the fully hardened and polished condition. Capable of hardening to 50-60 Rockwell C depending on carbon content.

SAE 51440C: This steel has the greatest quenched hardness and wear resistance on heat treatment of any corrosion- or heat-resistant steel.

SAE 51440F: The same as SAE 51440C, except for its free-machining characteristics.

SAE 51442: A corrosion- and heat-resisting chromium steel with corrosion-resisting properties slightly better than SAE 51430 and with good scale resistance up to 1600°F (870°C).

SAE 51446: A corrosion- and heat-resisting steel with maximum amount of chromium consistent with commercial malleability. Used principally for parts that must resist high temperatures in service without scaling. Resists oxidation up to 2000°F (1095°C).

SAE 51501: Used for its heat and corrosion resistance and good mechanical properties at temperatures up to approximately 1000°F (540°C).

High-Strength, Low-Alloy Steels.—High-strength, low-alloy (HSLA) steel represents a specific group of steels in which enhanced mechanical properties and, sometimes, resistance to atmospheric corrosion are obtained by the addition of moderate amounts of one or more alloying elements other than carbon. Different types are available, some of which are carbon-manganese steels and others contain further alloy additions, governed by special requirements for weldability, formability, toughness, strength, and economics. These steels may be obtained in the form of sheet, strip, plates, structural shapes, bars, and bar size sections.

HSLA steels are especially characterized by their mechanical properties, obtained in the as-rolled condition. They are not intended for quenching and tempering. For certain applications, they are sometimes annealed, normalized, or stress relieved with some influence on mechanical properties.

Where these steels are used for fabrication by welding, care must be exercised in selection of grade and in the details of the welding process. Certain grades may be welded without preheat or postheat.

Because of their high strength-to-weight ratio, abrasion resistance, and, in certain compositions, improved atmospheric corrosion resistance, these steels are adapted particularly for use in mobile equipment and other structures where substantial weight savings are generally desirable. Typical applications are truck bodies, frames, structural members, scrapers, truck wheels, cranes, shovels, booms, chutes, and conveyors.

Grade 942X: A niobium- or vanadium-treated carbon-manganese high-strength steel similar to 945X and 945C except for somewhat improved welding and forming properties.

Grade 945A: A HSLA steel with excellent welding characteristics, both arc and resistance, and the best formability, weldability, and low-temperature notch toughness of the high-strength steels. It is generally used in sheets, strip, and light plate thicknesses.

Grade 945C: A carbon-manganese high-strength steel with satisfactory arc welding properties if adequate precautions are observed. It is similar to grade 950C, except that lower carbon and manganese improve arc welding characteristics, formability, and low-temperature notch toughness at some sacrifice in strength.

Grade 945X: A niobium- or vanadium-treated carbon-manganese high-strength steel similar to 945C, except for somewhat improved welding and forming properties.

Grade 950A: A HSLA steel with good weldability, both arc and resistance, with good low-temperature notch toughness, and good formability. It is generally used in sheet, strip, and light plate thicknesses.

Grade 950B: A HSLA steel with satisfactory arc welding properties and fairly good low-temperature notch toughness and formability.

Grade 950C: A carbon-manganese high-strength steel that can be arc welded with special precautions, but is unsuitable for resistance welding. The formability and toughness are fair.

Grade 950D: A HSLA steel with good weldability, both arc and resistance, and fairly good formability. Where low-temperature properties are important, the effect of phosphorus in conjunction with other elements present should be considered.

Grade 950X: A niobium- or vanadium-treated carbon-manganese high-strength steel similar to 950C, except for somewhat improved welding and forming properties.

Grades 955X, 960X, 965X, 970X, 980X: These are steels similar to 945X and 950X with higher strength obtained by increased amounts of strengthening elements, such as carbon or manganese, or by the addition of nitrogen up to about 0.015 per cent. This increased strength involves reduced formability and usually decreased weldability. Toughness will vary considerably with composition and mill practice.

The formability, composition, and minimum mechanical properties of the HSLA steel grades are shown in [Tables 7](#) through [Table 9](#) on page [421](#).

Table 7. HSLA Steel Grades in Approximate Order of Increasing Excellence

Weldability	Formability	Toughness
980X	980X	980X
970X	970X	970X
965X	965X	965X
960X	960X	960X
955X, 950C, 942X	955X	955X
945C	950C	945C, 950C, 942X
950B, 950X	950D	945X, 950X
945X	950B, 950X, 942X	950D
950D	945C, 945X	950B
950A	950A	950A
945A	945A	945A

Source: SAE Handbook, 1990. Reprinted with permission. Copyright © 1990. Society of Automotive Engineers, Inc. All rights reserved.

Table 8. Chemical Composition Ladle Analysis of HSLA Steels (max. per cent)

Grade	C	Mn	P	Grade	C	Mn	P
942X	0.21	1.35	0.04	950D	0.15	1.00	0.15
945A	0.15	1.00	0.04	950X	0.23	1.35	0.04
945C	0.23	1.40	0.04	955X	0.25	1.35	0.04
945X	0.22	1.35	0.04	960X	0.26	1.45	0.04
950A	0.15	1.30	0.04	965X	0.26	1.45	0.04
950B	0.22	1.30	0.04	970X	0.26	1.65	0.04
950C	0.25	1.60	0.04	980X	0.26	1.65	0.04

Sulfur, 0.05 per cent max; silicon, 0.90 per cent max.

Source: SAE Handbook, 1990. Reprinted with permission. Copyright © 1990. Society of Automotive Engineers, Inc. All rights reserved.

Table 9. Minimum Mechanical Properties of High-strength Low-alloy Steels

Grade	Form	Strength ^a (psi)		% Elongation		Grade	Form	Strength ^a (psi)		% Elongation	
		Yield	Tensile	2 in.	8 in.			Yield	Tensile	2 in.	8 in.
942X	Plates, shapes, bars to 4 in. incl.	42,000	60,000	24	20	955X	Sheet and strip	55,000	70,000	20	...
945A, C	Sheet and strip	45,000	60,000	22	...	960X	Plates, shapes, bars To 1½ in. incl.	55,000	70,000	...	17
	Plates, shapes, bars To ½ in. incl.	45,000	65,000	22	18		Sheet and strip	60,000	75,000	18	...
	½-1½ in. incl.	42,000	62,000	24	19		Plates, shapes, bars To 1½ in. incl.	60,000	75,000	...	16
945X	1½-3 in. incl.	40,000	62,000	24	19	965X	Sheet and strip	65,000	80,000	16	...
	Sheet and strip	45,000	60,000	25	...		Plates, shapes, bars To ¾ in. incl.	65,000	80,000	...	15
	Plates, shapes, bars To 1½ in. incl.	45,000	60,000	22	19		970X	Sheet and strip	70,000	85,000	14
950A, B, C, D	Sheet and strip	50,000	70,000	22	...	Plates, shapes, bars To ¾ in. incl.		70,000	85,000	...	14
	Plates, shapes, bars To ½ in. incl.	50,000	70,000	22	18	980X		Sheet and strip	80,000	95,000	12
	½-1½ in. incl.	45,000	67,000	24	19		Plates to ¾ in. incl.	80,000	95,000	...	10
1½-3 in. incl.	42,000	63,000	24	19							
950X	Sheet and strip	50,000	65,000	22	...						
	Plates, shapes, bars To 1½ in. incl.	50,000	65,000	...	18						

^a Yield strength to be measured at 0.2 per cent offset. Mechanical properties to be determined in accordance with ASTM A 370.

Source: SAE Handbook, 1990. Reprinted with permission. Copyright © 1990. Society of Automotive Engineers, Inc. All rights reserved.

Typical Mechanical Properties of Steel.—Tables 10 through 13 provide expected minimum and/or typical mechanical properties of selected standard carbon and alloy steels and stainless steels.

Table 10. Expected Minimum Mechanical Properties of Cold-Drawn Carbon-Steel Rounds, Squares, and Hexagons

Size, in.	As Cold-Drawn					Cold-Drawn Followed by Low-Temperature Stress Relief					Cold-Drawn Followed by High-Temperature Stress Relief				
	Strength		Elongation in 2 inches, Per cent	Reduction in Area, Per cent	Hardness, Bhn	Strength		Elongation in 2 inches, Per cent	Reduction in Area, Per cent	Hardness, Bhn	Strength		Elongation in 2 inches, Per cent	Reduction in Area, Per cent	Hardness, Bhn
	Tensile	Yield				Tensile	Yield				Tensile	Yield			
	1000 lb/in ²					1000 lb/in ²					1000 lb/in ²				
AISI 1018 and 1025 Steels															
5/8-7/8	70	60	18	40	143	65	45	20	45	131
Over 7/8-1 1/4	65	55	16	40	131	60	45	20	45	121
Over 1 1/4-2	60	50	15	35	121	55	45	16	40	111
Over 2-3	55	45	15	35	111	50	40	15	40	101
AISI 1117 and 1118 Steels															
5/8-7/8	75	65	15	40	149	80	70	15	40	163	70	50	18	45	143
Over 7/8-1 1/4	70	60	15	40	143	75	65	15	40	149	65	50	16	45	131
Over 1 1/4-2	65	55	13	35	131	70	60	13	35	143	60	50	15	40	121
Over 2-3	60	50	12	30	121	65	55	12	35	131	55	45	15	40	111
AISI 1035 Steel															
5/8-7/8	85	75	13	35	170	90	80	13	35	179	80	60	16	45	163
Over 7/8-1 1/4	80	70	12	35	163	85	75	12	35	170	75	60	15	45	149
Over 1 1/4-2	75	65	12	35	149	80	70	12	35	163	70	60	15	40	143
Over 2-3	70	60	10	30	143	75	65	10	30	149	65	55	12	35	131
AISI 1040 and 1140 Steels															
5/8-7/8	90	80	12	35	179	95	85	12	35	187	85	65	15	45	170
Over 7/8-1 1/4	85	75	12	35	170	90	80	12	35	179	80	65	15	45	163
Over 1 1/4-2	80	70	10	30	163	85	75	10	30	170	75	60	15	40	149
Over 2-3	75	65	10	30	149	80	70	10	30	163	70	55	12	35	143

Table 10. (Continued) Expected Minimum Mechanical Properties of Cold-Drawn Carbon-Steel Rounds, Squares, and Hexagons

Size, in.	As Cold-Drawn					Cold-Drawn Followed by Low-Temperature Stress Relief					Cold-Drawn Followed by High-Temperature Stress Relief				
	Strength		Elongation in 2 inches, Per cent	Reduction in Area, Per cent	Hardness, Bhn	Strength		Elongation in 2 inches, Per cent	Reduction in Area, Per cent	Hardness, Bhn	Strength		Elongation in 2 inches, Per cent	Reduction in Area, Per cent	Hardness, Bhn
	Tensile	Yield				Tensile	Yield				Tensile	Yield			
	1000 lb/in ²					1000 lb/in ²					1000 lb/in ²				
AISI 1045, 1145, and 1146 Steels															
5/8-7/8	95	85	12	35	187	100	90	12	35	197	90	70	15	45	179
Over 7/8-1 1/4	90	80	11	30	179	95	85	11	30	187	85	70	15	45	170
Over 1 1/4-2	85	75	10	30	170	90	80	10	30	179	80	65	15	40	163
Over 2-3	80	70	10	30	163	85	75	10	25	170	75	60	12	35	149
AISI 1050, 1137, and 1151 Steels															
5/8-7/8	100	90	11	35	197	105	95	11	35	212	95	75	15	45	187
Over 7/8-1 1/4	95	85	11	30	187	100	90	11	30	197	90	75	15	40	179
Over 1 1/4-2	90	80	10	30	179	95	85	10	30	187	85	70	15	40	170
Over 2-3	85	75	10	30	170	90	80	10	25	179	80	65	12	35	163
AISI 1141 Steel															
5/8-7/8	105	95	11	30	212	110	100	11	30	223	100	80	15	40	197
Over 7/8-1 1/4	100	90	10	30	197	105	95	10	30	212	95	80	15	40	187
Over 1 1/4-2	95	85	10	30	187	100	90	10	25	197	90	75	15	40	179
Over 2-3	90	80	10	20	179	95	85	10	20	187	85	70	12	30	170
AISI 1144 Steel															
5/8-7/8	110	100	10	30	223	115	105	10	30	229	105	85	15	40	212
Over 7/8-1 1/4	105	95	10	30	212	110	100	10	30	223	100	85	15	40	197
Over 1 1/4-2	100	90	10	25	197	105	95	10	25	212	95	80	15	35	187
Over 2-3	95	85	10	20	187	100	90	10	20	197	90	75	12	30	179

Source: AISI Committee of Hot-Rolled and Cold-Finished Bar Producers and published in 1974 DATABOOK issue of the American Society for Metals' *METAL PROGRESS* magazine and used with its permission.

Table 11a. Typical Mechanical Properties of Selected Carbon and Alloy Steels (Hot Rolled, Normalized, and Annealed)

AISI No. ^a	Treatment	Strength		Elongation, Per cent	Reduction in Area, Per cent	Hardness, Bhn	Impact Strength (Izod), ft-lb
		Tensile	Yield				
		lb/in. ²					
1015	As-rolled	61,000	45,500	39.0	61.0	126	81.5
	Normalized (1700 F)	61,500	47,000	37.0	69.6	121	85.2
	Annealed (1600 F)	56,000	41,250	37.0	69.7	111	84.8
1020	As-rolled	65,000	48,000	36.0	59.0	143	64.0
	Normalized (1600 F)	64,000	50,250	35.8	67.9	131	86.8
	Annealed (1600 F)	57,250	42,750	36.5	66.0	111	91.0
1022	As-rolled	73,000	52,000	35.0	67.0	149	60.0
	Normalized (1700 F)	70,000	52,000	34.0	67.5	143	86.5
	Annealed (1600 F)	65,250	46,000	35.0	63.6	137	89.0
1030	As-rolled	80,000	50,000	32.0	57.0	179	55.0
	Normalized (1700 F)	75,000	50,000	32.0	60.8	149	69.0
	Annealed (1550 F)	67,250	49,500	31.2	57.9	126	51.2
1040	As-rolled	90,000	60,000	25.0	50.0	201	36.0
	Normalized (1650 F)	85,500	54,250	28.0	54.9	170	48.0
	Annealed (1450 F)	75,250	51,250	30.2	57.2	149	32.7
1050	As-rolled	105,000	60,000	20.0	40.0	229	23.0
	Normalized (1650 F)	108,500	62,000	20.0	39.4	217	20.0
	Annealed (1450 F)	92,250	53,000	23.7	39.9	187	12.5
1060	As-rolled	118,000	70,000	17.0	34.0	241	13.0
	Normalized (1650 F)	112,500	61,000	18.0	37.2	229	9.7
	Annealed (1450 F)	90,750	54,000	22.5	38.2	179	8.3
1080	As-rolled	140,000	85,000	12.0	17.0	293	5.0
	Normalized (1650 F)	146,500	76,000	11.0	20.6	293	5.0
	Annealed (1450 F)	89,250	54,500	24.7	45.0	174	4.5
1095	As-rolled	140,000	83,000	9.0	18.0	293	3.0
	Normalized (1650 F)	147,000	72,500	9.5	13.5	293	4.0
	Annealed (1450 F)	95,250	55,000	13.0	20.6	192	2.0
1117	As-rolled	70,600	44,300	33.0	63.0	143	60.0
	Normalized (1650 F)	67,750	44,000	33.5	63.8	137	62.8
	Annealed (1575 F)	62,250	40,500	32.8	58.0	121	69.0
1118	As-rolled	75,600	45,900	32.0	70.0	149	80.0
	Normalized (1700 F)	69,250	46,250	33.5	65.9	143	76.3
	Annealed (1450 F)	65,250	41,250	34.5	66.8	131	78.5
1137	As-rolled	91,000	55,000	28.0	61.0	192	61.0
	Normalized (1650 F)	97,000	57,500	22.5	48.5	197	47.0
	Annealed (1450 F)	84,750	50,000	26.8	53.9	174	36.8
1141	As-rolled	98,000	52,000	22.0	38.0	192	8.2
	Normalized (1650 F)	102,500	58,750	22.7	55.5	201	38.8
	Annealed (1500 F)	86,800	51,200	25.5	49.3	163	25.3
1144	As-rolled	102,000	61,000	21.0	41.0	212	39.0
	Normalized (1650 F)	96,750	58,000	21.0	40.4	197	32.0
	Annealed (1450 F)	84,750	50,250	24.8	41.3	167	48.0

Table 11a. (Continued) Typical Mechanical Properties of Selected Carbon and Alloy Steels (Hot Rolled, Normalized, and Annealed)

AISI No. ^a	Treatment	Strength		Elongation, Per cent	Reduction in Area, Per cent	Hardness, Bhn	Impact Strength (Izod), ft-lb
		Tensile	Yield				
		lb/in. ²					
1340	Normalized (1600 F)	121,250	81,000	22.0	62.9	248	68.2
	Annealed (1475 F)	102,000	63,250	25.5	57.3	207	52.0
3140	Normalized (1600 F)	129,250	87,000	19.7	57.3	262	39.5
	Annealed (1500 F)	100,000	61,250	24.5	50.8	197	34.2
4130	Normalized (1600 F)	97,000	63,250	25.5	59.5	197	63.7
	Annealed (1585 F)	81,250	52,250	28.2	55.6	156	45.5
4140	Normalized (1600 F)	148,000	95,000	17.7	46.8	302	16.7
	Annealed (1500 F)	95,000	60,500	25.7	56.9	197	40.2
4150	Normalized (1600 F)	167,500	106,500	11.7	30.8	321	8.5
	Annealed (1500 F)	105,750	55,000	20.2	40.2	197	18.2
4320	Normalized (1640 F)	115,000	67,250	20.8	50.7	235	53.8
	Annealed (1560 F)	84,000	61,625	29.0	58.4	163	81.0
4340	Normalized (1600 F)	185,500	125,000	12.2	36.3	363	11.7
	Annealed (1490 F)	108,000	68,500	22.0	49.9	217	37.7
4620	Normalized (1650 F)	83,250	53,125	29.0	66.7	174	98.0
	Annealed (1575 F)	74,250	54,000	31.3	60.3	149	69.0
4820	Normalized (1580 F)	109,500	70,250	24.0	59.2	229	81.0
	Annealed (1500 F)	98,750	67,250	22.3	58.8	197	68.5
5140	Normalized (1600 F)	115,000	68,500	22.7	59.2	229	28.0
	Annealed (1525 F)	83,000	42,500	28.6	57.3	167	30.0
5150	Normalized (1600 F)	126,250	76,750	20.7	58.7	255	23.2
	Annealed (1520 F)	98,000	51,750	22.0	43.7	197	18.5
5160	Normalized (1575 F)	138,750	77,000	17.5	44.8	269	8.0
	Annealed (1495 F)	104,750	40,000	17.2	30.6	197	7.4
6150	Normalized (1600 F)	136,250	89,250	21.8	61.0	269	26.2
	Annealed (1500 F)	96,750	59,750	23.0	48.4	197	20.2
8620	Normalized (1675 F)	91,750	51,750	26.3	59.7	183	73.5
	Annealed (1600 F)	77,750	55,875	31.3	62.1	149	82.8
8630	Normalized (1600 F)	94,250	62,250	23.5	53.5	187	69.8
	Annealed (1550 F)	81,750	54,000	29.0	58.9	156	70.2
8650	Normalized (1600 F)	148,500	99,750	14.0	40.4	302	10.0
	Annealed (1465 F)	103,750	56,000	22.5	46.4	212	21.7
8740	Normalized (1600 F)	134,750	88,000	16.0	47.9	269	13.0
	Annealed (1500 F)	100,750	60,250	22.2	46.4	201	29.5
9255	Normalized (1650 F)	135,250	84,000	19.7	43.4	269	10.0
	Annealed (1550 F)	112,250	70,500	21.7	41.1	229	6.5
9310	Normalized (1630 F)	131,500	82,750	18.8	58.1	269	88.0
	Annealed (1550 F)	119,000	63,750	17.3	42.1	241	58.0

^a All grades are fine-grained except those in the 1100 series that are coarse-grained. Austenitizing temperatures are given in parentheses. Heat-treated specimens were oil-quenched unless otherwise indicated.

Source: Bethlehem Steel Corp. and Republic Steel Corp. as published in 1974 DATABOOK issue of the American Society for Metals' METAL PROGRESS magazine and used with its permission.

Table 11b. Typical Mechanical Properties of Selected Carbon and Alloy Steels (Hot Rolled, Normalized, and Annealed)

AISI No. ^a	Tempering Temperature, °F	Strength		Elongation, Per cent	Reduction in Area, Per cent	Hardness, Bhn
		Tensile	Yield			
		1000 lb/in. ²				
1030 ^b	400	123	94	17	47	495
	600	116	90	19	53	401
	800	106	84	23	60	302
	1000	97	75	28	65	255
	1200	85	64	32	70	207
1040 ^b	400	130	96	16	45	514
	600	129	94	18	52	444
	800	122	92	21	57	352
	1000	113	86	23	61	269
	1200	97	72	28	68	201
1040	400	113	86	19	48	262
	600	113	86	20	53	255
	800	110	80	21	54	241
	1000	104	71	26	57	212
	1200	92	63	29	65	192
1050 ^b	400	163	117	9	27	514
	600	158	115	13	36	444
	800	145	110	19	48	375
	1000	125	95	23	58	293
	1200	104	78	28	65	235
1050	400
	600	142	105	14	47	321
	800	136	95	20	50	277
	1000	127	84	23	53	262
	1200	107	68	29	60	223
1060	400	160	113	13	40	321
	600	160	113	13	40	321
	800	156	111	14	41	311
	1000	140	97	17	45	277
	1200	116	76	23	54	229
1080	400	190	142	12	35	388
	600	189	142	12	35	388
	800	187	138	13	36	375
	1000	164	117	16	40	321
	1200	129	87	21	50	255
1095 ^b	400	216	152	10	31	601
	600	212	150	11	33	534
	800	199	139	13	35	388
	1000	165	110	15	40	293
	1200	122	85	20	47	235
1095	400	187	120	10	30	401
	600	183	118	10	30	375
	800	176	112	12	32	363
	1000	158	98	15	37	321
	1200	130	80	21	47	269
1137	400	157	136	5	22	352
	600	143	122	10	33	285
	800	127	106	15	48	262
	1000	110	88	24	62	229
	1200	95	70	28	69	197

Table 11b. (Continued) Typical Mechanical Properties of Selected Carbon and Alloy Steels (Hot Rolled, Normalized, and Annealed)

AISI No. ^a	Tempering Temperature, °F	Strength		Elongation, Per cent	Reduction in Area, Per cent	Hardness, Bhn
		Tensile	Yield			
		1000 lb/in. ²				
1137 ^b	400	217	169	5	17	415
	600	199	163	9	25	375
	800	160	143	14	40	311
	1000	120	105	19	60	262
	1200	94	77	25	69	187
1141	400	237	176	6	17	461
	600	212	186	9	32	415
	800	169	150	12	47	331
	1000	130	111	18	57	262
	1200	103	86	23	62	217
1144	400	127	91	17	36	277
	600	126	90	17	40	262
	800	123	88	18	42	248
	1000	117	83	20	46	235
	1200	105	73	23	55	217
1330 ^b	400	232	211	9	39	459
	600	207	186	9	44	402
	800	168	150	15	53	335
	1000	127	112	18	60	263
	1200	106	83	23	63	216
1340	400	262	231	11	35	505
	600	230	206	12	43	453
	800	183	167	14	51	375
	1000	140	120	17	58	295
	1200	116	90	22	66	252
4037	400	149	110	6	38	310
	600	138	111	14	53	295
	800	127	106	20	60	270
	1000	115	95	23	63	247
	1200	101	61	29	60	220
4042	400	261	241	12	37	516
	600	234	211	13	42	455
	800	187	170	15	51	380
	1000	143	128	20	59	300
	1200	115	100	28	66	238
4130 ^b	400	236	212	10	41	467
	600	217	200	11	43	435
	800	186	173	13	49	380
	1000	150	132	17	57	315
	1200	118	102	22	64	245
4140	400	257	238	8	38	510
	600	225	208	9	43	445
	800	181	165	13	49	370
	1000	138	121	18	58	285
	1200	110	95	22	63	230
4150	400	280	250	10	39	530
	600	256	231	10	40	495
	800	220	200	12	45	440
	1000	175	160	15	52	370
	1200	139	122	19	60	290
4340	400	272	243	10	38	520
	600	250	230	10	40	486
	800	213	198	10	44	430
	1000	170	156	13	51	360
	1200	140	124	19	60	280

Table 11b. (Continued) Typical Mechanical Properties of Selected Carbon and Alloy Steels (Hot Rolled, Normalized, and Annealed)

AISI No. ^a	Tempering Temperature, °F	Strength		Elongation, Per cent	Reduction in Area, Per cent	Hardness, Bhn
		Tensile	Yield			
		1000 lb/in. ²				
5046	400	253	204	9	25	482
	600	205	168	10	37	401
	800	165	135	13	50	336
	1000	136	111	18	61	282
	1200	114	95	24	66	235
50B46	400	560
	600	258	235	10	37	505
	800	202	181	13	47	405
	1000	157	142	17	51	322
	1200	128	115	22	60	273
50B60	400	600
	600	273	257	8	32	525
	800	219	201	11	34	435
	1000	163	145	15	38	350
	1200	130	113	19	50	290
5130	400	234	220	10	40	475
	600	217	204	10	46	440
	800	185	175	12	51	379
	1000	150	136	15	56	305
	1200	115	100	20	63	245
5140	400	260	238	9	38	490
	600	229	210	10	43	450
	800	190	170	13	50	365
	1000	145	125	17	58	280
	1200	110	96	25	66	235
5150	400	282	251	5	37	525
	600	252	230	6	40	475
	800	210	190	9	47	410
	1000	163	150	15	54	340
	1200	117	118	20	60	270
5160	400	322	260	4	10	627
	600	290	257	9	30	555
	800	233	212	10	37	461
	1000	169	151	12	47	341
	1200	130	116	20	56	269
51B60	400	600
	600	540
	800	237	216	11	36	460
	1000	175	160	15	44	355
	1200	140	126	20	47	290
6150	400	280	245	8	38	538
	600	250	228	8	39	483
	800	208	193	10	43	420
	1000	168	155	13	50	345
	1200	137	122	17	58	282
81B45	400	295	250	10	33	550
	600	256	228	8	42	475
	800	204	190	11	48	405
	1000	160	149	16	53	338
	1200	130	115	20	55	280

Table 11b. (Continued) Typical Mechanical Properties of Selected Carbon and Alloy Steels (Hot Rolled, Normalized, and Annealed)

AISI No. ^a	Tempering Temperature, °F	Strength		Elongation, Per cent	Reduction in Area, Per cent	Hardness, Bhn
		Tensile	Yield			
		1000 lb/in. ²				
8630	400	238	218	9	38	465
	600	215	202	10	42	430
	800	185	170	13	47	375
	1000	150	130	17	54	310
	1200	112	100	23	63	240
8640	400	270	242	10	40	505
	600	240	220	10	41	460
	800	200	188	12	45	400
	1000	160	150	16	54	340
86B45	400	287	238	9	31	525
	600	246	225	9	40	475
	800	200	191	11	41	395
	1000	160	150	15	49	335
8650	400	281	243	10	38	525
	600	250	225	10	40	490
	800	210	192	12	45	420
	1000	170	153	15	51	340
8660	400	140	120	20	58	280
	600	580
	800	535
	1000	237	225	13	37	460
	1200	190	176	17	46	370
8740	400	155	138	20	53	315
	600	290	240	10	41	578
	800	249	225	11	46	495
	1000	208	197	13	50	415
	1200	175	165	15	55	363
9255	400	143	131	20	60	302
	600	305	297	1	3	601
	800	281	260	4	10	578
	1000	233	216	8	22	477
	1200	182	160	15	32	352
9260	400	144	118	20	42	285
	600	600
	800	540
	1000	255	218	8	24	470
	1200	192	164	12	30	390
94B30	400	142	118	20	43	295
	600	250	225	12	46	475
	800	232	206	12	49	445
	1000	195	175	13	57	382
	1200	145	135	16	65	307
	400	120	105	21	69	250

^a All grades are fine-grained except those in the 1100 series that are coarse-grained. Austenitizing temperatures are given in parentheses. Heat-treated specimens were oil-quenched unless otherwise indicated.

^b Water quenched.

Source: Bethlehem Steel Corp. and Republic Steel Corp. as published in 1974 DATABOOK issue of the American Society for Metals' *METAL PROGRESS* magazine and used with its permission.

Table 12. Nominal Mechanical Properties of Standard Stainless Steels

Grade	Condition	Tensile Strength (psi)	0.2 Per Cent Yield Strength (psi)	Elongation in 2 in. (%)	Reduction of Area (%)	Hardness	
						Rockwell	Bhn
Austenitic Steels							
201	Annealed	115,000	55,000	55	...	B90	...
	1/4-hard	125,000 ^a	75,000 ^a	20 ^a	...	C25	...
	1/2-hard	150,000 ^a	110,000 ^a	10 ^a	...	C32	...
	3/4-hard	175,000 ^a	135,000 ^a	5 ^a	...	C37	...
	Full-hard	185,000 ^a	140,000 ^a	4 ^a	...	C41	...
202	Annealed	105,000	55,000	55	...	B90	...
	1/4-hard	125,000 ^a	75,000 ^a	12 ^a	...	C27	...
301	Annealed	110,000	40,000	60	...	B85	165
	1/4-hard	125,000 ^a	75,000 ^a	25 ^a	...	C25	...
	1/2-hard	150,000 ^a	110,000 ^a	15 ^a	...	C32	...
	3/4-hard	175,000 ^a	135,000 ^a	12 ^a	...	C37	...
	Full-hard	185,000	140,000 ^a	8 ^a	...	C41	...
302	Annealed	90,000	37,000	55	65	B82	155
	1/4-hard (sheet, strip)	125,000 ^a	75,000 ^a	12 ^a	...	C25	...
	Cold-drawn (bar, wire) ^b	To 350,000
302B	Annealed	95,000	40,000	50	65	B85	165
303, 303Se	Annealed	90,000	35,000	50	55	B84	160
304	Annealed	85,000	35,000	55	65	B80	150
304L	Annealed	80,000	30,000	55	65	B76	140
305	Annealed	85,000	37,000	55	70	B82	156
308	Annealed	85,000	35,000	55	65	B80	150
309, 309S	Annealed	90,000	40,000	45	65	B85	165
310, 310S	Annealed	95,000	40,000	45	65	B87	170
314	Annealed	100,000	50,000	45	60	B87	170
316	Annealed	85,000	35,000	55	70	B80	150
	Cold-drawn (bar, wire) ^b	To 300,000
316L	Annealed	78,000	30,000	55	65	B76	145
317	Annealed	90,000	40,000	50	55	B85	160
321	Annealed	87,000	35,000	55	65	B80	150
347, 348	Annealed	92,000	35,000	50	65	B84	160
Martensitic Steels							
403, 410, 416, 416Se	Annealed	75,000	40,000	30	65	B82	155
	Hardened ^c	C43	410
	Tempered at						
	400°F	190,000	145,000	15	55	C41	390
	600°F	180,000	140,000	15	55	C39	375
	800°F	195,000	150,000	17	55	C41	390
	1000°F	145,000	115,000	20	65	C31	300
	1200°F	110,000	85,000	23	65	B97	225
	1400°F	90,000	60,000	30	70	B89	180

Table 12. (Continued) Nominal Mechanical Properties of Standard Stainless Steels

Grade	Condition	Tensile Strength (psi)	0.2 Per Cent Yield Strength (psi)	Elongation in 2 in. (%)	Reduction of Area (%)	Hardness		
						Rockwell	Bhn	
Martensitic Steels (Continued)								
414	Annealed	120,000	95,000	17	55	C22	235	
	Hardened ^c	C44	426	
	Tempered at							
	400°F	200,000	150,000	15	55	C43	415	
	600°F	190,000	145,000	15	55	C41	400	
	800°F	200,000	150,000	16	58	C43	415	
	1000°F	145,000	120,000	20	60	C34	325	
420, 420F	1200°F	120,000	105,000	20	65	C24	260	
	Annealed	95,000	50,000	25	55	B92	195	
	Hardened ^d	C54	540	
	Tempered at							
	600°F	230,000	195,000	8	25	C50	500	
	431	Annealed	125,000	95,000	20	60	C24	260
		Hardened ^d	C45	440
Tempered at								
400°F		205,000	155,000	15	55	C43	415	
600°F		195,000	150,000	15	55	C41	400	
800°F		205,000	155,000	15	60	C43	415	
1000°F		150,000	130,000	18	60	C34	325	
440A	1200°F	125,000	95,000	20	60	C24	260	
	Annealed	105,000	60,000	20	45	B95	215	
	Hardened ^d	C56	570	
	Tempered							
	600°F	260,000	240,000	5	20	C51	510	
	440B	Annealed	107,000	62,000	18	35	B96	220
		Hardened ^d	C58	590
Tempered								
600°F		280,000	270,000	3	15	C55	555	
440C, 440F		Annealed	110,000	65,000	13	25	B97	230
		Hardened ^d	C60	610
		Tempered						
	600°F	285,000	275,000	2	10	C57	580	
	501	Annealed	70,000	30,000	28	65	...	160
		Annealed	70,000	30,000	30	75	B80	150
	Ferritic Steels							
405	Annealed	70,000	40,000	30	60	B80	150	
430	Annealed	75,000	45,000	30	60	B82	155	
430F, 430FSe	Annealed	80,000	55,000	25	60	B86	170	
446	Annealed	80,000	50,000	23	50	B86	170	

^a Minimum.^b Depending on size and amount of cold reduction.^c Hardening temperature 1800°F (982°C), 1-in.-diam. bars.^d Hardening temperature 1900°F (1038°C), 1-in.-diam. bars.Source: *Metals Handbook*, 8th edition, Volume 1.

Table 13. Strength Data for Iron and Steel

Material	Ultimate Strength			Yield Point, Thousands of Pounds per Square Inch	Modulus of Elasticity	
	Tension, Thousands of Pounds per Square Inch, T	Compression, in terms of T	Shear, in terms of T		Tension, Millions of psi, E	Shear, ^a in terms of E
Cast iron, gray, class 20	20 ^b	3.6 T to 4.4 T	1.6 T	...	11.6	0.40 E
class 25	25 ^b	3.6 T to 4.4 T	1.4 T	...	14.2	0.40 E
class 30	30 ^b	3.7 T	1.4 T	...	14.5	0.40 E
class 35	35 ^b	3.2 T to 3.9 T	1.4 T	...	16.0	0.40 E
class 40	40 ^b	3.1 T to 3.4 T	1.3 T	...	17	0.40 E
class 50	50 ^b	3.0 T to 3.4 T	1.3 T	...	18	0.40 E
class 60	60 ^b	2.8 T	1.0 T	...	19.9	0.40 E
malleable	40 to 100 ^c	30 to 80 ^c	25	0.43 E
nodular (ductile iron)	60 to 120 ^d	40 to 90 ^d	23	...
Cast steel, carbon	60 to 100	T	0.75 T	30 to 70	30	0.38 E
low-alloy	70 to 200	T	0.75 T	45 to 170	30	0.38 E
Steel, SAE 950 (low-alloy)	65 to 70	T	0.75 T	45 to 50	30	0.38 E
1025 (low-carbon)	60 to 103	T	0.75 T	40 to 90	30	0.38 E
1045 (medium-carbon)	80 to 182	T	0.75 T	50 to 162	30	0.38 E
1095 (high-carbon)	90 to 213	T	0.75 T	20 to 150	30	0.39 E
1112 (free-cutting)*	60 to 100	T	0.75 T	30 to 95	30	0.38 E
1212 (free-cutting)	57 to 80	T	0.75 T	25 to 72	30	0.38 E
1330 (alloy)	90 to 162	T	0.75 T	27 to 149	30	0.38 E
2517 (alloy) ^e	88 to 190	T	0.75 T	60 to 155	30	0.38 E
3140 (alloy)	93 to 188	T	0.75 T	62 to 162	30	0.38 E
3310 (alloy) ^e	104 to 172	T	0.75 T	56 to 142	30	0.38 E
4023 (alloy) ^e	105 to 170	T	0.75 T	60 to 114	30	0.38 E
4130 (alloy)	81 to 179	T	0.75 T	46 to 161	30	0.38 E
4340 (alloy)	109 to 220	T	0.75 T	68 to 200	30	0.38 E
4640 (alloy)	98 to 192	T	0.75 T	62 to 169	30	0.38 E
4820 (alloy) ^e	98 to 209	T	0.75 T	68 to 184	30	0.38 E
5150 (alloy)	98 to 210	T	0.75 T	51 to 190	30	0.38 E
52100 (alloy)	100 to 238	T	0.75 T	81 to 228	30	0.38 E
6150 (alloy)	96 to 228	T	0.75 T	59 to 210	30	0.38 E
8650 (alloy)	110 to 228	T	0.75 T	69 to 206	30	0.38 E
8740 (alloy)	100 to 179	T	0.75 T	60 to 165	30	0.38 E
9310 (alloy) ^e	117 to 187	T	0.75 T	63 to 162	30	0.38 E
9840 (alloy)	120 to 285	T	0.75 T	45 to 50	30	0.38 E
Steel, stainless, SAE						
30302 ^f	85 to 125	T	...	35 to 95	28	0.45 E
30321 ^f	85 to 95	T	...	30 to 60	28	...
30347 ^f	90 to 100	T	...	35 to 65	28	...
51420 ^g	95 to 230	T	...	50 to 195	29	0.40 E
51430 ^h	75 to 85	T	...	40 to 70	29	...
51446 ^h	80 to 85	T	...	50 to 70	29	...
51501 ^g	70 to 175	T	...	30 to 135	29	...
Steel, structural						
common	60 to 75	T	0.75 T	33 ^b	29	0.41 E
rivet	52 to 62	T	0.75 T	28 ^b	29	...
rivet, high-strength	68 to 82	T	0.75 T	38 ^b	29	...
Wrought iron	34 to 54	T	0.83 T	23 to 32	28	...

^a Synonymous in other literature to the modulus of elasticity in torsion and the modulus of rigidity, G .

^b Minimum specified value of the American Society for Testing and Materials. The specifications for the various materials are as follows: Cast iron, ASTM A48; structural steel for bridges and structures, ASTM A7; structural rivet steel, ASTM A141; high-strength structural rivet steel, ASTM A195.

^c Range of minimum specified values of the ASTM (ASTM A47, A197, and A220).

^d Range of minimum specified values of the ASTM (ASTM A339) and the Munitions Board Standards Agency (MIL-I-17166A and MIL-I-11466).

^e Carburizing grades of steel.

^f Nonhardenable nickel-chromium and Chromium-nickel-manganese steel (austenitic).

^g Hardenable chromium steel (martensitic).

^h Nonhardenable chromium steel (ferritic).

TOOL STEELS

Overview

As the designation implies, tool steels serve primarily for making tools used in manufacturing and in the trades for the working and forming of metals, wood, plastics, and other industrial materials. Tools must withstand high specific loads, often concentrated at exposed areas, may have to operate at elevated or rapidly changing temperatures and in continual contact with abrasive types of work materials, and are often subjected to shocks, or may have to perform under other varieties of adverse conditions. Nevertheless, when employed under circumstances that are regarded as normal operating conditions, the tool should not suffer major damage, untimely wear resulting in the dulling of the edges, or be susceptible to detrimental metallurgical changes.

Tools for less demanding uses, such as ordinary handtools, including hammers, chisels, files, mining bits, etc., are often made of standard AISI steels that are not considered as belonging to any of the tool steel categories.

The steel for most types of tools must be used in a heat-treated state, generally hardened and tempered, to provide the properties needed for the particular application. The adaptability to heat treatment with a minimum of harmful effects, which dependably results in the intended beneficial changes in material properties, is still another requirement that tool steels must satisfy.

To meet such varied requirements, steel types of different chemical composition, often produced by special metallurgical processes, have been developed. Due to the large number of tool steel types produced by the steel mills, which generally are made available with proprietary designations, it is rather difficult for the user to select those types that are most suitable for any specific application, unless the recommendations of a particular steel producer or producers are obtained.

Substantial clarification has resulted from the development of a classification system that is now widely accepted throughout the industry, on the part of both the producers and the users of tool steels. That system is used in the following as a base for providing concise information on tool steel types, their properties, and methods of tool steel selection.

The tool steel classification system establishes seven basic categories of tool and die steels. These categories are associated with the predominant applicational characteristics of the tool steel types they comprise. A few of these categories are composed of several groups to distinguish between families of steel types that, while serving the same general purpose, differ with regard to one or more dominant characteristics.

To provide an easily applicable guide for the selection of tool steel types best suited for a particular application, the subsequent discussions and tables are based on the previously mentioned application-related categories. As an introduction to the detailed surveys, a concise discussion is presented of the principal tool steel characteristics that govern the suitability for varying service purposes and operational conditions. A brief review of the major steel alloying elements and of the effect of these constituents on the significant characteristics of tool steels is also given in the following sections.

The Properties of Tool Steels.—Tool steels must possess certain properties to a higher than ordinary degree to make them adaptable for uses that require the ability to sustain heavy loads and perform dependably even under adverse conditions.

The extent and the types of loads, the characteristics of the operating conditions, and the expected performance with regard to both the duration and the level of consistency are the principal considerations, in combination with the aspects of cost, that govern the selection of tool steels for specific applications.

Although it is not possible to define and apply exact parameters for measuring significant tool steel characteristics, certain properties can be determined that may greatly assist in appraising the suitability of various types of tool steels for specific uses.

Because tool steels are generally heat-treated to make them adaptable to the intended use by enhancing the desirable properties, *the behavior of the steel during heat treatment* is of prime importance. The behavior of the steel comprises, in this respect, both the resistance to harmful effects and the attainment of the desirable properties. The following are considered the major properties related to heat treatment:

Safety in Hardening: This designation expresses the ability of the steel to withstand the harmful effects of exposure to very high heat and particularly to the sudden temperature changes during quenching, without harmful effects. One way of obtaining this property is by adding alloying elements to reduce the critical speed at which quenching must be carried out, thus permitting the use of milder quenching media such as oil, salt, or just still air.

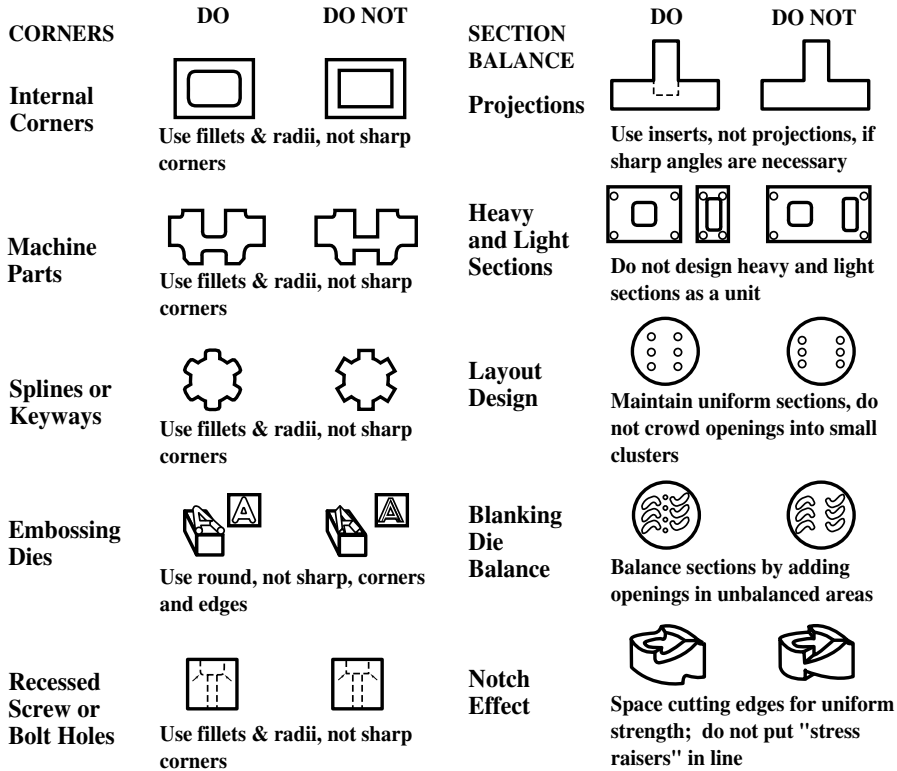


Fig. 1. Tool and die design tips to reduce breakage in heat treatment.
Courtesy of Society of Automotive Engineers, Inc.

The most common harm parts made of tool steel suffer from during heat treatment is the development of cracks. In addition to the composition of the steel and the applied heat-treating process, the configuration of the part can also affect the sensitivity to cracking. The preceding figure illustrates a few design characteristics related to cracking and warpage in heat treatment; the observation of these design tips, which call for generous filleting, avoidance of sharp angles, and major changes without transition in the cross-section, is particularly advisable when using tool steel types with a low index value for safety in hardening.

In current practice, the previously mentioned property of tool steels is rated in the order of decreasing safety (i.e., increasing sensitivity) as Highest, Very High, High, Medium, and Low safety, expressed in Tables 6 through 11 by the letters A, B, C, D, and E.

Distortions in Heat Treating: In parts made from tool steels, distortions are often a consequence of inadequate design (See Fig. 1.) or improper heat treatment (e.g., lack of stress relieving). However, certain types of tool steels display different degrees of sensitivity to

distortion. Steels that are less stable require safer design of the parts for which they are used, more careful heat treatment, including the proper support for long and slender parts, or thin sections, and possibly greater grinding allowance to permit subsequent correction of the distorted shape. Some parts made of a type of steel generally sensitive to distortions can be heat-treated with very little damage when the requirements of the part call for a relatively shallow hardened layer over a soft core. However, for intricate shapes and large tools, steel types should be selected that possess superior nondeforming properties. The ratings used in **Tables 6** through **11** express the nondeforming properties (stability of shape in heat treatment) of the steel types and start with the lowest distortion (the best stability) designated as A; the greatest susceptibility to distortion is designated as E.

Depth of Hardening: Hardening depth is indicated by a relative rating based on how deep the phase transformation penetrates from the surface and thus produces a hardened layer. Because of the effect of the heat-treating process, and particularly of the applied quenching medium, on the depth of hardness, reference is made in **Tables 6** through **11** to the quench that results in the listed relative hardenability values. These values are designated by letters A, B, and C, expressing deep, medium, and shallow depth, respectively.

Resistance to Decarburization: Higher or lower sensitivity to losing a part of the carbon content of the surface exposed to heat depends on the chemistry of the steel. The sensitivity can be balanced partially by appropriate heat-treating equipment and processes. Also, the amount of material to be removed from the surface after heat treatment, usually by grinding, should be specified in such a manner as to avoid the retention of a decarburized layer on functional surfaces. The relative resistance of individual tool steel types to decarburization during heat treatment is rated in **Tables 6** through **11** from High to Low, expressed by the letters A, B, and C.

Tool steels must be workable with generally available means, without requiring highly specialized processes. The tools made from these steels must, of course, perform adequately, often under adverse environmental and burdensome operational conditions. The ability of the individual types of tool steels to satisfy, to different degrees, such applicational requirements can also be appraised on the basis of significant properties, such as the following.

Machinability: Tools are precision products whose final shape and dimensions must be produced by machining, a process to which not all tool steel types lend themselves equally well. The difference in machinability is particularly evident in tool steels that, depending on their chemical composition, may contain substantial amounts of metallic carbides, beneficial to increased wear resistance, yet detrimental to the service life of tools with which the steel has to be worked. The microstructure of the steel type can also affect the ease of machining and, in some types, certain phase conditions, such as those due to low carbon content, may cause difficulties in achieving a fine surface finish. Certain types of tool steels have their machinability improved by the addition of small amounts of sulfur or lead.

Machinability affects the cost of making the tool, particularly for intricate tool shapes, and must be considered in selection of the steel to be used. The ratings in **Tables 6** through **11**, starting with A for the greatest ease of machining to E for the lowest machinability, refer to working of the steel in an unhardened condition. Machinability is not necessarily identical with grindability, which expresses how well the steel is adapted to grinding after heat treating. The ease of grinding, however, may become an important consideration in tool steel selection, particularly for cutting tools and dies, which require regular sharpening involving extensive grinding. AVCO Bay State Abrasives Company compiled information on the relative grindability of frequently used types of tool steels. A simplified version of that information is presented in **Table 1**, which assigns the listed tool steel types to one of the following grindability grades: High (A), Medium (B), Low (C), and Very Low (D), expressing decreasing ratios of volume of metal removed to wheel wear.

Table 1. Relative Grindability of Selected Types of Frequently Used Tool Steels

AISI Tool Steel Type	H41	H42	H43	Other H	D2	D3	D5	D7	A Types	O Types	L Types	F Types					
Relative Grindability Index	B	B	B	A	B	B	B	C	A	A	A	B					
High-Speed Tool Steel Type	M1	M2	M3 (1)	M3 (2)	M4	M7	M8	M10	M15	M36	M43	T1	T2	T3	T5	T6	T15
Relative Grindability Index	A	B	C	C	D	B	A	B	D	B	B	A	B	C	B	B	D

Hot Hardness: This property designates the steel's resistance to the softening effect of elevated temperature. This characteristic is related to the tempering temperature of the type of steel, which is controlled by various alloying elements such as tungsten, molybdenum, vanadium, cobalt, and chromium.

Hot hardness is a necessary property of tools used for hot work, like forging, casting, and hot extrusion. Hot hardness is also important in cutting tools operated at high-speed, which generate sufficient heat to raise their temperature well above the level where ordinary steels lose their hardness; hence the designation *high-speed steels*, which refers to a family of tool steels developed for use at high cutting speeds. Frequently it is the degree of the tool steel's resistance to softening at elevated temperature that governs important process data, such as the applicable cutting speed. In the ratings of [Tables 6](#) through [11](#), tool steel types having the highest hot hardness are marked with A, subsequent letters expressing gradually decreasing capacity to endure elevated temperature without losing hardness.

Wear Resistance: The gradual erosion of the tool's operating surface, most conspicuously occurring at the exposed edges, is known as wear. Resistance to wear prolongs the useful life of the tool by delaying the degradation of its surface through abrasive contact with the work at regular operating temperatures; these temperatures vary according to the type of process. Wear resistance is observable experimentally and measurable by comparison. Certain types of metallic carbides embedded into the steel matrix are considered to be the prime contributing factors to wear resistance, besides the hardness of the heat-treated steel material. The ratings of [Tables 6](#) through [11](#), starting with A for the best to E for poor, are based on conditions thought to be normal in operations for which various types of tool materials are primarily used.

Toughness: In tool steels, this property expresses ability to sustain shocks, suddenly applied and relieved loads, or major impacts, without breaking. Steels used for making tools must also be able to absorb such forces with only a minimum of elastic deformation and without permanent deformation to any extent that would interfere with the proper functioning of the tool. Certain types of tool steels, particularly those with high carbon content and without the presence of beneficial alloying constituents, tend to be the most sensitive to shocks, although they can also be made to act tougher when used for tools that permit a hardened case to be supported by a soft core. Tempering improves toughness, while generally reducing hardness. The rating indexes in [Tables 6](#) through [11](#), A for the highest toughness through E for the types most sensitive to shocks, apply to tools heat treated to hardness values normally used for the particular type of tool steel.

Common Tool Faults and Failures.—The proper selection of the steel grade used for any particular type of tool is of great importance, but it should be recognized that many of the failures experienced in common practice originate from causes other than those related to the tool material.

To permit a better appraisal of the actual causes of failure and possible corrective action, a general, although not complete, list of common tool faults, resulting failures, and corrective actions is shown in [Tables 2a](#) through [2d](#). In this list, the potential failure causes are grouped into four categories. The possibility of more than a single cause being responsible for the experienced failure should not be excluded.

Note: Examples of tool failures from causes such as listed above may be found in “The Tool Steel Trouble Shooter” handbook, published by Bethlehem Steel Corporation.

Finally, it must be remembered that the proper usage of tools is indispensable for obtaining satisfactory performance and tool life. Using the tools properly involves, for example, the avoidance of damage to the tool; overloading; excessive speeds and feeds; the application of adequate coolant when called for; a rigid setup; proper alignment; and firm tool and work holding.

Table 2a. Common Tool Faults, Failures, and Cures
Improper Tool Design

Fault Description	Probable Failure	Possible Cure
Drastic section changes—widely different thicknesses of adjacent wall sections or protruding elements	In liquid quenching, the thin section will cool and then harden more rapidly than the adjacent thicker section, setting up stresses that may exceed the strength of the steel.	Make such parts of two pieces or use an air-hardening tool steel that avoids the harsh action of a liquid quench.
Sharp corners on shoulders or in square holes	Cracking can occur, particularly in liquid quenching, due to stress concentrations.	Apply fillets to the corners and/or use an air-hardening tool steel.
Sharp cornered keyways	Failure may arise during service, and is usually considered to be caused by fatigue.	The use of round keyways should be preferred when the general configuration of the part makes it prone to failure due to square keyways.
Abrupt section changes in battering tools	Due to impact in service, pneumatic tools are particularly sensitive to stress concentrations that lead to fatigue failures.	Use taper transitions, which are better than even generous fillets.
Functional inadequacy of tool design—e.g., insufficient guidance for a punch	Excessive wear or breakage in service may occur.	Assure solid support, avoid unnecessary play, adapt travel length to operational conditions (e.g., punch to penetrate to four-fifths of thickness in hard work material).
Improper tool clearance, such as in blanking and punching tools	Deformed and burred parts may be produced, excessive tool wear or breakage can result.	Adapt clearances to material conditions and dimensions to reduce tool load and to obtain clean sheared surfaces.

The Effect of Alloying Elements on Tool Steel Properties.—*Carbon (C):* The presence of carbon, usually in excess of 0.60 per cent for nonalloyed types, is essential for raising the hardenability of steels to the levels needed for tools. Raising the carbon content by different amounts up to a maximum of about 1.3 per cent increases the hardness slightly and the wear resistance considerably. The amount of carbon in tool steels is designed to attain certain properties (such as in the water-hardening category where higher carbon content may be chosen to improve wear resistance, although to the detriment of toughness) or, in the alloyed types of tool steels, in conformance with the other constituents to produce well-balanced metallurgical and performance properties.

Manganese (Mn): In small amounts, to about 0.60 per cent, manganese is added to reduce brittleness and to improve forgeability. Larger amounts of manganese improve hardenability, permitting oil quenching for nonalloyed carbon steels, thus reducing deformation, although with regard to several other properties, manganese is not an equivalent replacement for the regular alloying elements.

Silicon (Si): In itself, silicon may not be considered an alloying element of tool steels, but it is needed as a deoxidizer and improves the hot-forming properties of the steel. In combination with certain alloying elements, the silicon content is sometimes raised to about 2 per cent to increase the strength and toughness of steels used for tools that have to sustain shock loads.

Table 2b. Common Tool Faults, Failures, and Cures
 Faulty Condition or Inadequate Grade of Tool Steel

Fault Description	Probable Failure	Possible Cure
Improper tool steel grade selection	Typical failures: Chipping—insufficient toughness. Wear—poor abrasion resistance. Softening—inadequate “red hardness.”	Choose the tool steel grade by following recommendations and improve selection when needed, guided by property ratings.
Material defects—voids, streaks, tears, flakes, surface cooling cracks, etc.	When not recognized during material inspection, tools made of defective steel often prove to be useless.	Obtain tool steels from reliable sources and inspect tool material for detectable defects.
Decarburized surface layer (“bark”) in rolled tool steel bars	Cracking may originate from the decarburized layer or it will not harden (“soft skin”).	Provide allowance for stock to be removed from all surfaces of hot-rolled tool steel. Recommended amounts are listed in tool steel catalogs and vary according to section size, generally about 10 per cent for smaller and 5 per cent for larger diameters.
Brittleness caused by poor carbide distribution in high-alloy tool steels	Excessive brittleness can cause chipping or breakage during service.	Bars with large diameter (above about 4 inches or 10 cm) tend to be prone to nonuniform carbide distribution. Choose upset forged discs instead of large-diameter bars.
Unfavorable grain flow	Improper grain flow of the steel used for milling cutters and similar tools can cause teeth to break out.	Upset forged discs made with an upset ratio of about 2 to 1 (starting to upset thickness) display radial grain flow. Highly stressed tools, such as gear-shaper cutters, may require the cross forging of blanks.

Tungsten (W): Tungsten is one of the important alloying elements of tool steels, particularly because of two valuable properties: it improves “hot hardness,” that is, the resistance of the steel to the softening effect of elevated temperature, and it forms hard, abrasion-resistant carbides, thus improving the wear properties of tool steels.

Vanadium (V): Vanadium contributes to the refinement of the carbide structure and thus improves the forgeability of alloy tool steels. Vanadium has a very strong tendency to form a hard carbide, which improves both the hardness and the wear properties of tool steels. However, a large amount of vanadium carbide makes the grinding of the tool very difficult (causing low grindability).

Molybdenum (Mo): In small amounts, molybdenum improves certain metallurgical properties of alloy steels such as deep hardening and toughness. It is used often in larger amounts in certain high-speed tool steels to replace tungsten, primarily for economic reasons, often with nearly equivalent results.

Cobalt (Co): As an alloying element of tool steels, cobalt increases hot hardness and is used in applications where that property is needed. Substantial addition of cobalt, however, raises the critical quenching temperature of the steel with a tendency to increase the decarburization of the surface, and reduces toughness.

Chromium (Cr): This element is added in amounts of several per cent to high-alloy tool steels, and up to 12 per cent to types in which chromium is the major alloying element. Chromium improves hardenability and, together with high carbon, provides both wear resistance and toughness, a combination valuable in certain tool applications. However, high chromium raises the hardening temperature of the tool steel, and thus can make it prone to hardening deformations. A high percentage of chromium also affects the grindability of the tool steel.

Nickel (Ni): Generally in combination with other alloying elements, particularly chromium, nickel is used to improve the toughness and, to some extent, the wear resistance of tool steels.

Table 2c. Common Tool Faults, Failures, and Cures
Heat-Treatment Faults

Fault Description	Probable Failure	Possible Cure
Improper preparation for heat treatment. Certain tools may require stress relieving or annealing, and often preheating, too	Tools highly stressed during machining or forming, unless stress relieved, may aggravate the thermal stresses of heat treatment, thus causing cracks. Excessive temperature gradients developed in nonpreheated tools with different section thicknesses can cause warpage.	Stress relieve, when needed, before hardening. Anneal prior to heavy machining or cold forming (e.g., hobbing). Preheat tools (a) having substantial section thickness variations or (b) requiring high quenching temperatures, as those made of high-speed tool steels.
Overheating during hardening; quenching from too high a temperature	Causes grain coarsening and a sensitivity to cracking that is more pronounced in tools with drastic section changes.	Overheated tools have a characteristic microstructure that aids recognition of the cause of failure and indicates the need for improved temperature control.
Low hardening temperature	The tool may not harden at all, or in its outer portion only, thereby setting up stresses that can lead to cracks.	Controlling both the temperature of the furnace and the time of holding the tool at quenching temperature will prevent this not too frequent deficiency.
Inadequate composition or condition of the quenching media	Water-hardening tool steels are particularly sensitive to inadequate quenching media, which can cause soft spots or even violent cracking.	For water-hardening tool steels, use water free of dissolved air and contaminants, also assure sufficient quantity and proper agitation of the quench.
Improper handling during and after quenching	Cracking, particularly of tools with sharp corners, during the heat treatment can result from holding the part too long in the quench or incorrectly applied tempering.	Following the steel producer's specifications is a safe way to assure proper heat-treatment handling. In general, the tool should be left in the quench until it reaches a temperature of 150–200°F (66–93°C), and should then be transferred promptly into a warm tempering furnace.
Insufficient tempering	Omission of double tempering for steel types that require it may cause early failure by heat checking in hot-work steels or make the tool abnormally sensitive to grinding checks.	Double temper highly alloyed tool steel of the high-speed, hot-work, and high-chromium categories, to remove stresses caused by martensite formed during the first tempering phase. Second temper also increases hardness of most high-speed steels.
Decarburization and carburization	Unless hardened in a neutral atmosphere the original carbon content of the tool surface may be changed: Reduced carbon (decarburization) causes a soft layer that wears rapidly. Increased carbon (carburization) when excessive may cause brittleness.	Heating in neutral atmosphere or well-maintained salt bath and controlling the furnace temperature and the time during which the tool is subjected to heating can usually keep the carbon imbalance within acceptable limits.

The addition of more than one element to a steel often produces what is called a synergistic effect. Thus, the combined effects of two or more alloy elements may be greater than the sum of the individual effects of each element.

Classification of Tool Steels.—Steels for tools must satisfy a number of different, often conflicting requirements. The need for specific steel properties arising from widely varying applications has led to the development of many compositions of tool steels, each intended to meet a particular combination of applicational requirements. The diversity of tool steels, their number being continually expanded by the addition of new developments, makes it extremely difficult for the user to select the type best suited to his needs, or to find equivalent alternatives for specific types available from particular sources.

As a cooperative industrial effort under the sponsorship of AISI and SAE, a tool classification system has been developed in which the commonly used tool steels are grouped into seven major categories. These categories, several of which contain more than a single group, are listed in [Table 3](#) with the letter symbols used for their identification. The individual types of tool steels within each category are identified by suffix numbers following the letter symbols.

Table 2d. Common Tool Faults, Failures, and Cures
Grinding Damages

Fault Description	Probable Failure	Possible Cure
Grinding Damages		
Excessive stock removal rate causing heating of the part surface beyond the applied tempering temperature	Scorched tool surface displaying temper colors varying from yellow to purple, depending on the degree of heat, causes softening of the ground surface. When coolant is used, a local rehardening can take place, often resulting in cracks.	Prevention: by reducing speed and feed, or using coarser, softer, more open-structured grinding wheel, with ample coolant. Correction: eliminate the discolored layer by subsequent light stock removal. Not always a cure, because the effects of abusive grinding may not be corrected.
Improper grinding wheel specifications; grain too fine or bond too hard	Intense localized heating during grinding may set up surface stresses causing grinding cracks. These cracks are either parallel but at right angles to the direction of grinding or, when more advanced, form a network. May need cold etch or magnetic particle testing to become recognizable.	Prevention: by correcting the grinding wheel specifications. Correction: in shallow (0.002–0.004-inch, or 0.05–0.1 mm) cracks, by removing the damaged layer, when permitted by the design of the tool, using very light grinding passes.
Incorrectly dressed or loaded grinding wheel	Heating of the work surface can cause scorching or cracking. Incorrect dressing can also cause a poor finish of the ground work surface.	Dress wheel with sharper diamond and faster diamond advance to produce coarser wheel surface. Alternate dressing methods, like crush-dressing, can improve wheel surface conditions. Dress wheel regularly to avoid loading or glazing of the wheel surface.
Inadequate coolant, with regard to composition, amount, distribution, and cleanliness	Introducing into the tool surface heat that is not adequately dissipated or absorbed by the coolant can cause softening, or even the development of cracks.	Improve coolant supply and quality, or reduce stock removal rate to reduce generation of heat in grinding.
Damage caused by abusive abrasive cutoff	The intensive heat developed during this process can cause a hardening of the steel surface, or may even result in cracks.	Reduce rate of advance; adopt wheel specifications better suited for the job. Use ample coolant or, when harmful effect not eliminated, replace abrasive cutoff by some cooler-acting stock separation method (e.g., sawing or lathe cutoff) unless damaged surface is being removed by subsequent machining.

Table 3. Classification of Tool Steels

Category Designation	Letter Symbol	Group Designation
High-Speed Tool Steels	M	Molybdenum types
Hot-Work Tool Steels	T	Tungsten types
	H1-H19	Chromium types
	H20-H39	Tungsten types
Cold-Work Tool Steels	H40-H59	Molybdenum types
	D	High-carbon, high-chromium types
	A	Medium-alloy, air-hardening types
Shock-Resisting Tool Steels	O	Oil-hardening types
Mold Steels	S	...
Special-Purpose Tool Steels	P	...
Water-Hardening Tool Steels	L	Low-alloy types
	F	Carbon-tungsten types
	W	...

The following detailed discussion of tool steels will be in agreement with these categories, showing for each type the percentages of the major alloying elements. However, these values are for identification only; elements in tool steels of different producers in the mean analysis of the individual types may deviate from the listed percentages.

Table 4. Classification, Approximate Compositions, and Properties Affecting Selection of Tool and Die Steels
(From SAE Recommended Practice)

Type of Tool Steel	Chemical Composition ^a								Non-warping Prop.	Safety in Hardening	Toughness	Depth of Hardening	Wear Resistance
	C	Mn	Si	Cr	V	W	Mo	Co					
Water Hardening													
0.80 Carbon	70-0.85	b	b	b	Poor	Fair	Good ^c	Shallow	Fair
0.90 Carbon	0.85-0.95	b	b	b	Poor	Fair	Good ^c	Shallow	Fair
1.00 Carbon	0.95-1.10	b	b	b	Poor	Fair	Good ^c	Shallow	Good
1.20 Carbon	1.10-1.30	b	b	b	Poor	Fair	Good ^c	Shallow	Good
0.90 Carbon-V	0.85-0.95	b	b	b	0.15-0.35	Poor	Fair	Good	Shallow	Fair
1.00 Carbon-V	0.95-1.10	b	b	b	0.15-0.35	Poor	Fair	Good	Shallow	Good
1.00 Carbon-VV	0.90-1.10	b	b	b	0.35-0.50	Poor	Fair	Good	Shallow	Good
Oil Hardening													
Low Manganese	0.90	1.20	0.25	0.50	0.20 ^d	0.50	Good	Good	Fair	Deep	Good
High Manganese	0.90	1.60	0.25	0.35 ^d	0.20 ^d	...	0.30 ^d	...	Good	Good	Fair	Deep	Good
High-Carbon, High-Chromium ^e	2.15	0.35	0.35	12.00	0.80 ^d	0.75 ^d	0.80 ^d	...	Good	Good	Poor	Through	Best
Chromium	1.00	0.35	0.25	1.40	0.40	...	Fair	Good	Fair	Deep	Good
Molybdenum Graphitic	1.45	0.75	1.00	0.25	...	Fair	Good	Fair	Deep	Good
Nickel-Chromium ^f	0.75	0.70	0.25	0.85	0.25 ^d	...	0.50 ^d	...	Fair	Good	Fair	Deep	Fair
Air Hardening													
High-Carbon, High-Chromium	1.50	0.40	0.40	12.00	0.80 ^d	...	0.90	0.60 ^d	Best	Best	Fair	Through	Best
5 Per Cent Chromium	1.00	0.60	0.25	5.25	0.40 ^d	...	1.10	...	Best	Best	Fair	Through	Good
High-Carbon, High-Chromium-Cobalt	1.50	0.40	0.40	12.00	0.80 ^d	...	0.90	3.10	Best	Best	Fair	Through	Best
Shock-Resisting													
Chromium-Tungsten	0.50	0.25	0.35	1.40	0.20	2.25	0.40 ^d	...	Fair	Good	Good	Deep	Fair
Silicon-Molybdenum	0.50	0.40	1.00	...	0.25 ^d	...	0.50	...	Poor ^g	Poor ^h	Best	Deep	Fair
Silicon-Manganese	0.55	0.80	2.00	0.30 ^d	0.25 ^d	...	0.40 ^d	...	Poor ^g	Poor ^h	Best	Deep	Fair
Hot Work													
Chromium-Molybdenum-Tungsten	0.35	0.30	1.00	5.00	0.25 ^d	1.25	1.50	...	Good	Good	Good	Through	Fair
Chromium-Molybdenum-V	0.35	0.30	1.00	5.00	0.40	...	1.50	...	Good	Good	Good	Through	Fair
Chromium-Molybdenum-VV	0.35	0.30	1.00	5.00	0.90	...	1.50	...	Good	Good	Good	Through	Fair
Tungsten	0.32	0.30	0.20	3.25	0.40	9.00	Good	Good	Good	Through	Fair

Table 4. (Continued) Classification, Approximate Compositions, and Properties Affecting Selection of Tool and Die Steels
(From SAE Recommended Practice)

Type of Tool Steel	Chemical Composition ^a								Non-warping Prop.	Safety in Hardening	Toughness	Depth of Hardening	Wear Resistance
	C	Mn	Si	Cr	V	W	Mo	Co					
High Speed													
Tungsten, 18-4-1	0.70	0.30	0.30	4.10	1.10	18.00	Good	Good	Poor	Through	Good
Tungsten, 18-4-2	0.80	0.30	0.30	4.10	2.10	18.50	0.80	...	Good	Good	Poor	Through	Good
Tungsten, 18-4-3	1.05	0.30	0.30	4.10	3.25	18.50	0.70	...	Good	Good	Poor	Through	Best
Cobalt-Tungsten, 14-4-2-5	0.80	0.30	0.30	4.10	2.00	14.00	0.80	5.00	Good	Fair	Poor	Through	Good
Cobalt-Tungsten, 18-4-1-5	0.75	0.30	0.30	4.10	1.00	18.00	0.80	5.00	Good	Fair	Poor	Through	Good
Cobalt-Tungsten, 18-4-2-8	0.80	0.30	0.30	4.10	1.75	18.50	0.80	8.00	Good	Fair	Poor	Through	Good
Cobalt-Tungsten, 18-4-2-12	0.80	0.30	0.30	4.10	1.75	20.00	0.80	12.00	Good	Fair	Poor	Through	Good
Molybdenum, 8-2-1	0.80	0.30	0.30	4.00	1.15	1.50	8.50	...	Good	Fair	Poor	Through	Good
Molybdenum-Tungsten, 6-6-2	0.83	0.30	0.30	4.10	1.90	6.25	5.00	...	Good	Fair	Poor	Through	Good
Molybdenum-Tungsten, 6-6-3	1.15	0.30	0.30	4.10	3.25	5.75	5.25	...	Good	Fair	Poor	Through	Best
Molybdenum-Tungsten, 6-6-4	1.30	0.30	0.30	4.25	4.25	5.75	5.25	...	Good	Fair	Poor	Through	Best
Cobalt-Molybdenum-Tungsten, 6-6-2-8	0.85	0.30	0.30	4.10	2.00	6.00	5.00	8.00	Good	Fair	Poor	Through	Good

^aC = carbon; Mn = manganese; Si = silicon; Cr = chromium; V = vanadium; W = tungsten; Mo = molybdenum; Co = cobalt.

^bCarbon tool steels are usually available in four grades or qualities: *Special (Grade 1)*—The highest quality water-hardening carbon tool steel, controlled for hardenability, chemistry held to closest limits, and subject to rigid tests to ensure maximum uniformity in performance; *Extra (Grade 2)*—A high-quality water-hardening carbon tool steel, controlled for hardenability, subject to tests to ensure good service; *Standard (Grade 3)*—A good-quality water-hardening carbon tool steel, not controlled for hardenability, recommended for application where some latitude with respect to uniformity is permissible; *Commercial (Grade 4)*—A commercial-quality water-hardening carbon tool steel, not controlled for hardenability, not subject to special tests. On *special* and *extra* grades, limits on manganese, silicon, and chromium are not generally required if Shepherd hardenability limits are specified. For *standard* and *commercial* grades, limits are 0.35 max. each for Mn and Si; 0.15 max. Cr for standard; 0.20 max. Cr for commercial.

^cToughness decreases somewhat when increasing depth of hardening.

^dOptional element. Steels have found satisfactory application either with or without the element present. In silicon-manganese steel listed under Shock-Resisting Steels, if chromium, vanadium, and molybdenum are not present, then hardenability will be affected.

^eThis steel may have 0.50 per cent nickel as an optional element. The steel has been found to give satisfactory application either with or without the element present.

^fApproximate nickel content of this steel is 1.50 per cent.

^gPoor when water quenched, fair when oil quenched.

^hPoor when water quenched, good when oil quenched.

The Selection of Tool Steels for Particular Applications.—Although the advice of the specialized steel producer is often sought as a reliable source of information, the engineer is still faced with the task of selecting the tool steel. It must be realized that frequently the designation of the tool or of the process will not define the particular tool steel type best suited for the job. For that reason, tool steel selection tables naming a single type for each listed application cannot take into consideration such often conflicting work factors as ease of tool fabrication and maintenance (resharpening), productivity, product quality, and tooling cost.

When data related to past experience with tool steels for identical or similar applications are not available, a tool steel selection procedure may be followed, based on information in this Handbook section as follows:

Identify the AISI category that contains the sought type of steel by consulting the Quick Reference Table, **Table 5**, starting on page 444. Within the defined category:

- a) find from the listed applications of the most frequently used types of tool steels the particular type that corresponds to the job on hand; or
- b) evaluate from the table of property ratings the best compromise between any conflicting properties (e.g., compromising on wear resistance to obtain better toughness).

For those willing to refine even further the first choice or to improve on it when there is not entirely satisfactory experience in one or more meaningful respects, the identifying analyses of the different types of tool steels within each general category may provide additional guidance. In this procedure, the general discussion of the effects of different alloying elements on the properties of tool steels, in a previous section, will probably be found useful.

The following two examples illustrate the procedure for refining an original choice with the purpose of adopting a tool steel grade best suited to a particular set of conditions:

Example 1, Workpiece—Trimming Dies: For the manufacture of a type of trimming die, the first choice was grade A2, because for the planned medium rate of production, the lower material cost was considered an advantage.

A subsequent rise in the production rate indicated the use of a higher-alloy tool steel, such as D2, whose increased abrasion resistance would permit longer runs between regrinds.

A still further increase in the abrasion-resistant properties was then sought, which led to the use of D7, the high carbon and high chromium content of which provided excellent edge retainment, although at the cost of greatly reduced grindability. Finally, it became a matter of economic appraisal, whether the somewhat shorter tool regrind intervals (for D2) or the more expensive tool sharpening (for D7) constituted the lesser burden.

Example 2, Workpiece—Circular form cutter made of high-speed tool steel for use on multiple-spindle automatic turning machines: The first choice from the **Table 5** may be the classical tungsten-base high-speed tool steel T1, because of its good performance and ease of heat treatment, or its alternate in the molybdenum high-speed tool steel category, the type M2.

In practice, neither of these grades provided a tool that could hold its edge and profile over the economical tool change time, because of the abrasive properties of the work material and the high cutting speeds applied in the cycle. An overrating of the problem resulted in reaching for the top of the scale, making the tool from T15, a high-alloy high-speed tool steel (high vanadium and high cobalt).

Although the performance of the tools made of T15 was excellent, the cost of this steel type was rather high, and the grinding of the tool, both for making it and in the regularly needed resharpening, proved to be very time-consuming and expensive. Therefore, an intermediate tool steel type was tried, the M3 that provided added abrasion resistance (due to increased carbon and vanadium content), and was less expensive and much easier to grind than the T15.

Table 5. Quick Reference Guide for Tool Steel Selection

Application Areas	Tool Steel Categories and AISI Letter Symbol						
	High-Speed Tool Steels, M and T	Hot-Work Tool Steels, H	Cold-Work Tool Steels, D, A, and O	Shock-Resisting Tool Steels, S	Mold Steels, P	Special-Purpose Tool Steels, L and F	Water-Hardening Tool Steels, W
Examples of Typical Applications							
Cutting Tools Single-point types (lathe, planer, boring) Milling cutters Drills Reamers Taps Threading dies Form cutters	General-purpose production tools: M2, T1 For increased abrasion resistance: M3, M4, and M10 Heavy-duty work calling for high hot hardness: T5, T15 Heavy-duty work calling for high abrasion resistance: M42, M44		Tools with keen edges (knives, razors) Tools for operations where no high-speed is involved, yet stability in heat treatment and substantial abrasion resistance are needed	Pipe cutter wheels			Uses that do not require hot hardness or high abrasion resistance. Examples with carbon content of applicable group: Taps (1.05/1.10% C) Reamers (1.10/1.15% C) Twist drills (1.20/1.25% C) Files (1.35/1.40% C)
Hot Forging Tools and Dies Dies and inserts Forging machine plungers and pierces	For combining hot hardness with high abrasion resistance: M2, T1	Dies for presses and hammers: H20, H21 For severe conditions over extended service periods: H22 to H26, also H43	Hot trimming dies: D2	Hot trimming dies Blacksmith tools Hot swaging dies			Smith's tools (1.65/0.70% C) Hot chisels (0.70/0.75% C) Drop forging dies (0.90/1.00% C) Applications limited to short-run production
Hot Extrusion Tools and Dies Extrusion dies and mandrels, Dummy blocks Valve extrusion tools	Brass extrusion dies: T1	Extrusion dies and dummy blocks: H20 to H26 For tools that are exposed to less heat: H10 to H19		Compression molding: S1			

Table 5. (Continued) Quick Reference Guide for Tool Steel Selection

Application Areas	Tool Steel Categories and AISI Letter Symbol						
	High-Speed Tool Steels, M and T	Hot-Work Tool Steels, H	Cold-Work Tool Steels, D, A, and O	Shock-Resisting Tool Steels, S	Mold Steels, P	Special-Purpose Tool Steels, L and F	Water-Hardening Tool Steels, W
Examples of Typical Applications							
Cold-Forming Dies Bending, forming, drawing, and deep drawing dies and punches	Burnishing tools: M1, T1	Cold heading: die casting dies: H13	Drawing dies: O1 Coining tools: O1, D2 Forming and bending dies: A2 Thread rolling dies: D2	Hobbing and short-run applications: S1, S7 Rivet sets and rivet busters		Blanking, forming, and trimmer dies when toughness has precedence over abrasion resistance: L6	Cold-heading dies: W1 or W2 (C ≅ 1.00%) Bending dies: W1 (C ≅ 1.00%)
Shearing Tools Dies for piercing, punching, and trimming Shear blades	Special dies for cold and hot work: T1 For work requiring high abrasion resistance: M2, M3	For shearing knives: H11, H12 For severe hot shearing applications: M21, M25	Dies for medium runs: A2, A6 also O1 and O4 Dies for long runs: D2, D3 Trimming dies (also for hot trimming): A2	Cold and hot shear blades Hot punching and piercing tools Boilermaker's tools		Knives for work requiring high toughness: L6	Trimming dies (0.90/0.95% C) Cold blanking and punching dies (1.00% C)
Die Casting Dies and Plastics Molds		For zinc and lead: H11 For aluminum: H13 For brass: H21	A2 and A6 O1		Plastics molds: P2 to P4, and P20		
Structural Parts for Severe Service Conditions	Roller bearings for high-temperature environment: T1 Lathe centers: M2 and T1	For aircraft components (landing gear, arrester hooks, rocket cases): H11	Lathe centers: D2, D3 Arbors: O1 Bushings: A4 Gages: D2	Pawls Clutch parts		Spindles, clutch parts (where high toughness is needed): L6	Spring steel (1.10/1.15% C)
Battering Tools for Hand and Power Tool Use				Pneumatic chisels for cold work: S5 For higher performance: S7			For intermittent use: W1 (0.80% C)

High-Speed Tool Steels

The primary application of high-speed steels is to tools used for the working of metals at high cutting speeds. Cutting metal at high speed generates heat, the penetration of the cutting tool edge into the work material requires great hardness and strength, and the continued frictional contact of the tool with both the parent material and the detached chips can only be sustained by an abrasion-resistant tool edge.

Accordingly, the dominant properties of high-speed steel are a) resistance to the softening effect of elevated temperature; b) great hardness penetrating to substantial depth from the surface; and c) excellent abrasion resistance.

High-speed tool steels are listed in the AISI specifications in two groups: molybdenum types and tungsten types, these designations expressing the dominant alloying element of the respective group.

Molybdenum-Type High-Speed Tool Steels.—Unlike the traditional tungsten-base high-speed steels, the tool steels listed in this category are considered to have molybdenum as the principal alloying constituent, this element also being used in the designation of the group. Other significant elements like tungsten and cobalt might be present in equal, or even greater amounts in several types listed in this category. The available range of types also includes high-speed tool steels with higher than usual carbon and vanadium content. Amounts of these alloying elements have been increased to obtain better abrasion resistance although such a change in composition may adversely affect the machinability and the grindability of the steel. The series in whose AISI identification numbers the number 4 is the first digit was developed to attain exceptionally high hardness in heat treatment that, for these types, usually requires triple tempering rather than the double tempering generally applied for high-speed tool steels.

Frequently Used Molybdenum Types: AISI M1: This alloy was developed as a substitute for the classical T1 to save on the alloying element tungsten by replacing most of it with molybdenum. In most uses, this steel is an acceptable substitute, although it requires greater care or more advanced equipment for its heat treatment than the tungsten alloyed type it replaces. The steel is often selected for cutting tools like drills, taps, milling cutters, reamers, lathe tools used for lighter cuts, and for shearing dies.

AISI M2: Similar to M1, yet with substantial tungsten content replacing a part of the molybdenum. This is one of the general-purpose high-speed tool steels, combining the economic advantages of the molybdenum-type steels with greater ease of hardening, excellent wear resistance, and improved toughness. It is a preferred steel type for the manufacture of general-purpose lathe tools; of most categories of multiple-edge cutting tools, like milling cutters, taps, dies, reamers, and for form tools in lathe operations.

AISI M3: A high-speed tool steel with increased vanadium content for improved wear resistance, yet still below the level where vanadium would interfere with the ease of grinding. This steel is preferred for cutting tools requiring improved wear resistance, like broaches, form tools, milling cutters, chasers, and reamers.

AISI M7: The chemical composition of this type is similar to that of M1, except for the higher carbon and vanadium content that raises the cutting efficiency without materially reducing the toughness. Because of sensitivity to decarburization, heat treatment in a salt bath or a controlled atmosphere is advisable. Used for blanking and trimming dies, shear blades, lathe tools, and thread rolling dies.

AISI M10: Although the relatively high vanadium content assures excellent wear and cutting properties, the only slightly increased carbon does not cause brittleness to an extent that is harmful in many applications. Form cutters and single-point lathe tools, broaches, planer tools, punches, blanking dies, and shear blades are examples of typical uses.

AISI M42: In applications where high hardness both at regular and at elevated temperatures is needed, this type of high-speed steel with high cobalt content can provide excellent service. Typical applications are tool bits, form tools, shaving tools, fly cutters, roll turning

Table 6. Molybdenum High-Speed Steels

Identifying Chemical Composition and Typical Heat-Treatment Data																					
Identifying Chemical Elements in Per Cent	AISI Type		M1	M2	M3 Cl. 1	M3 Cl. 2	M4	M6	M7	M10	M30	M33	M34	M36	M41	M42	M43	M44	M46	M47	
	C		0.80	0.85; 1.00	1.05	1.20	1.30	0.80	1.00	0.85; 1.00	0.80	0.90	0.90	0.80	1.10	1.10	1.20	1.15	1.25	1.10	
	W		1.50	6.00	6.00	6.00	5.50	4.00	1.75	...	2.00	1.50	2.00	6.00	6.75	1.50	2.75	5.25	2.00	1.50	
	Mo		8.00	5.00	5.00	5.00	4.50	5.00	8.75	8.00	8.00	9.50	8.00	5.00	3.75	9.50	8.00	6.25	8.25	9.50	
	Cr		4.00	4.00	4.00	4.00	4.00	4.00	4.00	4.00	4.00	4.00	4.00	4.00	4.25	3.75	3.75	4.25	4.00	3.75	
	V		1.00	2.00	2.40	3.00	4.00	1.50	2.00	2.00	1.25	1.15	2.00	2.00	2.00	1.15	1.60	2.25	3.20	1.25	
	Co		12.00	5.00	8.00	8.00	8.00	5.00	8.00	8.25	12.00	8.25	5.00	
Heat-Treat. Data	Hardening Temperature Range		°F	2150–2225	2175–2225	2200–2250	2200–2250	2200–2250	2150–2200	2150–2225	2150–2225	2200–2250	2200–2250	2225–2275	2175–2220	2175–2210	2175–2220	2190–2240	2175–2225	2150–2200	
			°C	1177–1218	1191–1218	1204–1232	1204–1232	1204–1232	1177–1204	1177–1218	1177–1218	1204–1232	1204–1232	1204–1232	1204–1232	1218–1246	1191–1216	1191–1210	1191–1216	1199–1227	1191–1218
	Tempering Temperature Range		°F	1000–1100	1000–1160	1000–1100	1000–1100	1000–1100	1000–1100	1000–1100	1000–1100	1000–1100	1000–1100	1000–1100	1000–1100	1000–1100	950–1100	950–1100	1000–1160	975–1050	975–1100
			°C	538–593	538–627	538–593	538–593	538–593	538–593	538–593	538–593	538–593	538–593	538–593	538–593	538–593	538–593	510–593	510–593	538–627	524–566
	Approx. Tempered Hardness, Rc		65–60	65–60	66–61	66–61	66–61	66–61	66–61	65–60	65–60	65–60	65–60	65–60	65–60	70–65	70–65	70–65	70–62	69–67	70–65
Relative Ratings of Properties (A = greatest to E = least)																					
Characteristics in Heat Treatment	Safety in Hardening		D	D	D	D	D	D	D	D	D	D	D	D	D	D	D	D	D	D	
	Depth of Hardening		A	A	A	A	A	A	A	A	A	A	A	A	A	A	A	A	A	A	A
	Resistance to Decarburization		C	B	B	B	B	C	C	C	C	C	C	C	C	C	C	C	C	C	C
	Stability of Shape in Heat Treatment	Quenching Medium	Air or Salt	C	C	C	C	C	C	C	C	C	C	C	C	C	C	C	C	C	C
Oil			D	D	D	D	D	D	D	D	D	D	D	D	D	D	D	D	D	D	D
Service Properties	Machinability		D	D	D	D/E	D	D	D	D	D	D	D	D	D	D	D	D	D	D	
	Hot Hardness		B	B	B	B	B	A	B	B	A	A	A	A	A	A	A	A	A	A	A
	Wear Resistance		B	B	B	B	A	B	B	B	B	B	B	B	B	B	B	B	B	B	B
	Toughness		E	E	E	E	E	E	E	E	E	E	E	E	E	E	E	E	E	E	E

tools, and thread rolling dies. Important uses are found for M42, and for other types of the “M40” group in the working of “difficult-to-machine” alloys.

Tungsten-Type High-Speed Tool Steels.—For several decades following their introduction, the tungsten-base high-speed steels were the only types available for cutting operations involving the generation of substantial heat, and are still preferred by users who do not have the kind of advanced heat-treating equipment that efficient hardening of the molybdenum-type high-speed tool steels requires. Most tungsten high-speed steels display excellent resistance to decarburization and can be brought to good hardness by simple heat treatment. However, even with tungsten-type high-speed steels, heat treatment using modern methods and furnaces can appreciably improve the metallurgical qualities of the hardened material and the performance of the cutting tools made from these steels.

Table 7. Tungsten High-Speed Tool Steels—Identifying Chemical Composition and Typical Heat-Treatment Data

AISI Type			T1	T2	T4	T5	T6	T8	T15
Identifying Chemical Elements in Per Cent									
C			0.75	0.80	0.75	0.80	0.80	0.75	1.50
W			18.00	18.00	18.00	18.00	20.00	14.00	12.00
Cr			4.00	4.00	4.00	4.00	4.50	4.00	4.00
V			1.00	2.00	1.00	2.00	1.50	2.00	5.00
Co			5.00	5.00	5.00
Heat-Treatment Data									
Hardening Temperature Range		°F	2300–2375	2300–2375	2300–2375	2325–2375	2325–2375	2300–2375	2200–2300
		°C	1260–1302	1260–1302	1260–1302	1274–1302	1274–1302	1260–1302	1204–1260
Tempering Temperature Range		°F	1000–1100	1000–1100	1000–1100	1000–1100	1000–1100	1000–1100	1000–1200
		°C	538–593	538–593	538–593	538–593	538–593	538–593	538–649
Approx. Tempered Hardness, R _c			65–60	66–61	66–62	65–60	65–60	65–60	68–63
Characteristics in Heat Treatment ^a									
Safety in Hardening			C	C	D	D	D	D	D
Depth of Hardening			A	A	A	A	A	A	A
Resistance to Decarburization			A	A	B	C	C	B	B
Stability of Shape in Heat Treatment	Quenching Medium	Air or Salt	C	C	C	C	C	C	C
		Oil	D	D	D	D	D	D	D
Service Properties									
Machinability			D	D	D	D	D/E	D	D/E
Hot Hardness			B	B	A	A	A	A	A
Wear Resistance			B	B	B	B	B	B	A
Toughness			E	E	E	E	E	E	E

^aRelative Ratings of Properties (A = greatest to E = least)

Frequently Used Tungsten Types: AISI T1: Also mentioned as the 18-4-1 type with reference to the nominal percentage of its principal alloying elements (W-Cr-V), it is considered to be the classical type of high-speed tool steel. The chemical composition of T1 was developed in the early 1900s, and has changed very little since. T1 is still considered to be perhaps the best general-purpose high-speed tool steel because of the comparative ease of its machining and heat treatment. It combines a high degree of cutting ability with relative toughness. T1 steel is used for all types of multiple-edge cutting tools like drills, reamers, milling cutters, threading taps and dies, light- and medium-duty lathe tools, and is also used for punches, dies, and machine knives, as well as for structural parts that are subjected to elevated temperatures, like lathe centers, and certain types of antifriction bearings.

AISI T2: Similar to T1 except for somewhat higher carbon content and twice the vanadium contained in the former grade. Its handling ease, both in machining and heat treating, is comparable to that of T1, although it should be held at the quenching temperature slightly longer, particularly when the heating is carried out in a controlled atmosphere furnace. The applications are similar to that of T1, however, because of its increased wear

resistance T2 is preferred for tools required for finer cuts, and where the form or size retention of the tool is particularly important, such as for form and finishing tools.

AISI T5: The essential characteristic of this type of high-speed steel, its superior red hardness, stems from its substantial cobalt content that, combined with the relatively high amount of vanadium, provides this steel with excellent wear resistance. In heat treatment, the tendency for decarburization must be considered, and heating in a controlled, slightly reducing atmosphere is recommended. This type of high-speed tool steel is mainly used for single-point tools and inserts; it is well adapted for working at high-speeds and feeds, for cutting hard materials and those that produce discontinuous chips, also for nonferrous metals and, for all kinds of tools needed for hogging (removing great bulks of material).

AISI T15: The performance qualities of this high-alloy tool steel surpass most of those found in other grades of high-speed tool steels. The high vanadium content, supported by uncommonly high carbon assures superior cutting ability and wear resistance. The addition of high cobalt increases the "hot hardness," and therefore tools made of T15 can sustain cutting speeds in excess of those commonly applicable to tools made of steel. The machining and heat treatment of T15 does not cause extraordinary problems, although for best results, heating to high temperature is often applied in its heat treatment, and double or even triple tempering is recommended. On the other hand, T15 is rather difficult to grind because of the presence of large amounts of very hard metallic carbides; therefore, it is considered to have a very low "grindability" index. The main uses are in the field of high-speed cutting and the working of hard metallic materials, T15 being often considered to represent in its application a transition from the regular high-speed tool steels to cemented carbides. Lathe tool bits, form cutters, and solid and inserted blade milling cutters are examples of uses of this steel type for cutting tools; excellent results may also be obtained with such tools as cold-work dies, punches, blanking, and forming dies, etc. The low toughness rating of the T15 steel excludes its application for operations that involve shock or sudden variations in load.

Hot-Work Tool Steels

A family of special tool steels has been developed for tools that in their regular service are in contact with hot metals over a shorter or longer period of time, with or without cooling being applied, and are known as hot-work steels. The essential property of these steels is their capability to sustain elevated temperature without seriously affecting the usefulness of the tools made from them. Depending on the purpose of the tools for which they were developed, the particular types of hot-work tool steels have different dominant properties and are assigned to one of three groups, based primarily on their principal alloying elements.

Hot-Work Tool Steels, Chromium Types.—As referred to in the group designation, the chromium content is considered the characteristic element of these tool steels. Their predominant properties are high hardenability, excellent toughness, and great ductility, even at the cost of wear resistance. Some members of this family are made with the addition of tungsten, and in one type, cobalt as well. These alloying elements improve the resistance to the softening effect of elevated temperatures, but reduce ductility.

Frequently Used Chromium Types: AISI H11: This hot-work tool steel of the Chromium-molybdenum-vanadium type has excellent ductility, can be machined easily, and retains its strength at temperatures up to 1000°F (538°C).

These properties, combined with relatively good abrasion and shock resistance, account for the varied fields of application of H11, which include the following typical uses: a) structural applications where high strength is needed at elevated operating temperatures, as for gas turbine engine components; and b) hot-work tools, particularly of the kind whose service involves shocks and drastic cooling of the tool, such as in extrusion tools, pierce and draw punches, bolt header dies, etc.

Table 8. Hot-Work Tool Steels

Identifying Chemical Composition and Typical Heat-Treatment Data																		
AISI	Group		Chromium Types					Tungsten Types					Molybdenum Types					
	Type		H10	H11	H12	H13	H14	H19	H21	H22	H23	H24	H25	H26	H41	H42	H43	
Identifying Chemical Elements in Per Cent	C		0.40	0.35	0.35	0.35	0.40	0.40	0.35	0.35	0.35	0.45	0.25	0.50	0.65	0.60	0.55	
	W		1.50	...	5.00	4.25	9.00	11.00	12.00	15.00	15.00	18.00	1.50	6.00	...	
	Mo		2.50	1.50	1.50	1.50	8.00	5.00	8.00	
	Cr		3.25	5.00	5.00	5.00	5.00	4.25	3.50	2.00	12.00	3.00	4.00	4.00	4.00	4.00	4.00	
	V		0.40	0.40	0.40	1.00	...	2.00	1.00	1.00	2.00	2.00	
	Co		4.25	
Heat-Treat. Data	Hardening Temperature Range		°F	1850–1900	1825–1875	1825–1875	1825–1900	1850–1950	2000–2200	2000–2200	2000–2200	2000–2300	2000–2250	2100–2300	2150–2300	2000–2175	2050–2225	2000–2175
			°C	1010–1038	996–1024	996–1024	996–1038	1010–1066	1093–1204	1093–1204	1093–1204	1093–1260	1093–1232	1149–1260	1177–1260	1093–1191	1121–1218	1093–1191
	Tempering Temperature Range		°F	1000–1200	1000–1200	1000–1200	1000–1200	1100–1200	1000–1300	1100–1250	1100–1250	1200–1500	1050–1200	1050–1250	1050–1250	1050–1200	1050–1200	1050–1200
			°C	538–649	538–649	538–649	538–649	593–649	538–704	593–677	593–677	649–816	566–649	566–677	566–677	566–649	566–649	566–649
	Approx. Tempered Hardness, Rc		56–39	54–38	55–38	53–38	47–40	59–40	54–36	52–39	47–30	55–45	44–35	58–43	60–50	60–50	58–45	
Relative Ratings of Properties (A = greatest to D = least)																		
Characteristics in Heat Treatment	Safety in Hardening		A	A	A	A	A	B	B	B	B	B	B	B	C	C	C	
	Depth of Hardening		A	A	A	A	A	A	A	A	A	A	A	A	A	A	A	
	Resistance to Decarburization		B	B	B	B	B	B	B	B	B	B	B	B	B	C	B	C
	Stability of Shape in Heat Treatment	Quenching Medium	Air or Salt	B	B	B	B	C	C	C	C	...	C	C	C	C	C	C
			Oil	D	D	D	D	D	D	D	D	D	D
Service Properties	Machinability		C/D	C/D	C/D	C/D	D	D	D	D	D	D	D	D	D	D	D	
	Hot Hardness		C	C	C	C	C	C	C	C	B	B	B	B	B	B	B	
	Wear Resistance		D	D	D	D	D	C/D	C/D	C/D	C/D	C	D	C	C	C	C	
	Toughness		C	B	B	B	C	C	C	C	D	D	C	D	D	D	D	

AISI H12: The properties of this type of steel are comparable to those of H11, with increased abrasion resistance and hot hardness, resulting from the addition of tungsten, yet in an amount that does not affect the good toughness of this steel type. The applications, based on these properties, are hot-work tools that often have to withstand severe impact, such as various punches, bolt header dies, trimmer dies, and hot shear blades. H12 is also used to make aluminum extrusion dies and die-casting dies.

AISI H13: This type of tool steel differs from the preceding ones particularly in properties related to the addition of about 1 per cent vanadium, which contributes to increased hot hardness, abrasion resistance, and reduced sensitivity to heat checking. Such properties are needed in die casting, particularly of aluminum, where the tools are subjected to drastic heating and cooling at high operating temperatures. Besides die-casting dies, H13 is also widely used for extrusion dies, trimmer dies, hot gripper and header dies, and hot shear blades.

AISI H19: This high-alloyed hot-work tool steel, containing chromium, tungsten, cobalt, and vanadium, has excellent resistance to abrasion and shocks at elevated temperatures. It is particularly well adapted to severe hot-work uses where the tool, to retain its size and shape, must withstand wear and the washing-out effect of molten work material. Typical applications include brass extrusion dies and dummy blocks, inserts for forging and valve extrusion dies, press forging dies, and hot punches.

Hot-Work Tool Steels, Tungsten Types.—Substantial amounts of tungsten, yet very low-carbon content characterize the hot-work tool steels of this group. These tool steels have been developed for applications where the tool is in contact with the hot-work material over extended periods of time; therefore, the resistance of the steel to the softening effect of elevated temperatures is of prime importance, even to the extent of accepting a lower degree of toughness.

Frequently Used Tungsten Types: AISI H21: This medium-tungsten alloyed hot-work tool steel has substantially increased abrasion resistance over the chromium alloyed types, yet possesses a degree of toughness that represents a transition between the chromium and the higher-alloyed tungsten-steel types. The principal applications are for tools subjected to continued abrasion, yet to only a limited amount of shock loads, like tools for the extrusion of brass, both dies and dummy blocks, pierces for forging machines, inserts for forging tools, and hot nut tools. Another typical application is dies for the hot extrusion of automobile valves.

AISI H24: The comparatively high tungsten content (about 14 per cent) of this steel results in good hardness, great compression strength, and excellent abrasion resistance, but makes it sensitive to shock loads. By taking these properties into account, the principal applications include extrusion dies for brass in long-run operations, hot-forming and gripper dies with shallow impressions, punches that are subjected to great wear yet only to moderate shocks, and hot shear blades.

AISI H20: The composition of this high-alloyed tungsten-type hot-work steel resembles the tungsten-type high-speed steel AISI T1, except for the somewhat lower carbon content for improved toughness. The high amount of tungsten provides the maximum resistance to the softening effect of elevated temperature and assures excellent wear-resistant properties, including withstanding the washing-out effect of certain processes. However, this steel is less resistant to thermal shocks than the chromium hot-work steels. Typical applications comprise extrusion dies for long production runs, extrusion mandrels operated without cooling, hot piercing punches, hot forging dies and inserts. It is also used as special structural steel for springs operating at elevated temperatures.

Hot-Work Tool Steels, Molybdenum Types.—These steels are closely related to certain types of molybdenum high-speed steels and possess excellent resistance to the softening effect of elevated temperature but their ductility is rather low. These steel types are generally available on special orders only.

Frequently Used Molybdenum Types: AISI H43: The principal constituents of this hot-work steel, chromium, molybdenum, and vanadium, provide excellent abrasion- and wear-resistant properties at elevated temperatures. H43 has a good resistance to the development of heat checks and a toughness adequate for many different purposes. Applications include tools and operations that tend to cause surface wear in high-temperature work, like hot headers, punch and die inserts, hot heading and hot nut dies, as well as different kinds of punches operating at high temperature in service involving considerable wear.

Cold-Work Tool Steels

Tool steels of the cold-working category are primarily intended for die work, although their use is by no means restricted to that general field. Cold-work tool steels are extensively used for tools whose regular service does not involve elevated temperatures. They are available in chemical compositions adjusted to the varying requirements of a wide range of different applications. According to their predominant properties, characterized either by the chemical composition or by the quenching medium in heat treatment, the cold-work tool steels are assigned to three different groups, as discussed in what follows.

Cold-Work Tool Steels, High-Carbon, High-Chromium Types.—The chemical composition of tool steels of this family is characterized by the very high chromium content, to the order of 12 to 13 per cent, and the uncommonly high carbon content, in the range of about 1.50 to 2.30 per cent. Additional alloying elements that are present in different amounts in some of the steel types of this group are vanadium, molybdenum, and cobalt, each of which contributes desirable properties.

The predominant properties of the whole group are: 1) excellent dimensional stability in heat treatment, where, with one exception, air quench is used; 2) great wear resistance, particularly in the types with the highest carbon content; and 3) rather good machinability.

Frequently Used High-Carbon, High-Chromium Types: AISI D2: An air-hardening die steel with high-carbon, high-chromium content having several desirable tool steel properties, such as abrasion resistance, high hardness, and nondeforming characteristics. The carbon content of this type, although relatively high, is not particularly detrimental to its machining. The ease of working can be further improved by selecting the same basic type with the addition of sulfur. Several steel producers supply the sulfurized version of D2, in which the uniformly distributed sulfide particles substantially improve the machinability and the resulting surface finish. The applications comprise primarily cold-working press tools for shearing (blanking and stamping dies, punches, shear blades), for forming (bending, seaming), also for thread rolling dies, solid gages, and wear-resistant structural parts. Dies for hot trimming of forgings are also made of D2 which is then heated treated to a lower hardness for the purpose of increasing toughness.

AISI D3: The high carbon content of this high-chromium tool steel type results in excellent resistance to wear and abrasion and provides superior compressive strength as long as the pressure is applied gradually, without exerting sudden shocks. In hardening, an oil quench is used, without affecting the excellent nondeforming properties of this type. Its deep-hardening properties make it particularly suitable for tools that require repeated regrinding during their service life, such as different types of dies and punches. The more important applications comprise blanking, stamping, and trimming dies and punches for long production runs; forming, bending and drawing tools; and structural elements like plug and ring gages, and lathe centers, in applications where high wear resistance is important.

Cold-Work Tool Steels, Oil-Hardening Types.—With a relatively low percentage of alloying elements, yet with a substantial amount of manganese, these less expensive types of tool steels attain good depth of hardness in an oil quench, although at the cost of reduced resistance to deformation. Their good machinability supports general-purpose applica-

tions, yet because of relatively low wear resistance, they are mostly selected for comparatively short-run work.

Frequently Used Oil-Hardening Types: AISI O1: A low-alloy tool steel that is hardened in oil and exhibits only a low tendency to shrinking or warping. It is used for cutting tools, the operation of which does not generate high heat, such as taps and threading dies, reamers, and broaches, and for press tools like blanking, trimming, and forming dies in short- or medium-run operations.

AISI O2: Manganese is the dominant alloying element in this type of oil-hardening tool steel that has good nondeforming properties, can be machined easily, and performs satisfactorily in low-volume production. The low hardening temperature results in good safety in hardening, both with regard to form stability and freedom from cracking. The combination of handling ease, including free-machining properties, with good wear resistance, makes this type of tool steel adaptable to a wide range of common applications such as cutting tools for low- and medium-speed operations; forming tools including thread rolling dies; structural parts such as bushings and fixed gages, and for plastics molds.

AISI O6: This oil-hardening type of tool steel belongs to a group often designated as graphitic because of the presence of small particles of graphitic carbon that are uniformly dispersed throughout the steel. Usually, about one-third of the total carbon is present as free graphite in nodular form, which contributes to the uncommon ease of machining. In the service of parts made of this type of steel, the free graphite acts like a lubricant, reducing wear and galling. The ease of hardening is also excellent, requiring only a comparatively low quenching temperature. Deep hardness penetration is produced and the oil quench causes very little dimensional change. The principal applications of the O6 tool steel are in the field of structural parts, like arbors, bushings, bodies for inserted tool cutters, and shanks for cutting tools, jigs, and machine parts, and fixed gages like plugs, rings, and snap gages. It is also used for blanking, forming, and trimming dies and punches, in applications where the stability of the tool material is more important than high wear resistance.

Cold-Work Tool Steels, Medium-Alloy, Air-Hardening Types.—The desirable nondeforming properties of the high-chromium types are approached by the members of this family, with substantially lower alloy content that, however, is sufficient to permit hardening by air quenching. The machinability is good, and the comparatively low wear resistance is balanced by relatively high toughness, a property that, in certain applications, may be considered of prime importance.

Frequently Used Medium-Alloy, Air-Hardening Types: AISI A2: The lower chromium content, about 5 per cent, makes this air-hardening tool steel less expensive than the high-chromium types, without affecting its nondeforming properties. The somewhat reduced wear resistance is balanced by greater toughness, making this type suitable for press work where the process calls for tough tool materials. The machinability is improved by the addition of about 0.12 percent sulfur, offered as a variety of the basic composition by several steel producers. The prime uses of this tool steel type are punches for blanking and forming, cold and hot trimming dies (the latter heat treated to a lower hardness), thread rolling dies, and plastics molds.

AISI A6: The composition of this type of tool steel makes it adaptable to air hardening from a relatively low temperature, comparable to that of oil-hardening types, yet offering improved stability in heat treating. Its reduced tendency to heat-treatment distortions makes this tool steel type well adapted for die work, forming tools, and gages, which do not require the highest degree of wear resistance.

Shock-Resisting, Mold, and Special-Purpose Tool Steels

There are fields of tool application in which specific properties of the tool steels have dominant significance, determining to a great extent the performance and the service life of tools made of these materials. To meet these requirements, special types of tool steels

Table 9. Cold-Work Tool Steels

Identifying Chemical Composition and Typical Heat-Treatment Data																			
AISI	Group		High-Carbon, High-Chromium Types					Medium-Alloy, Air-Hardening Types							Oil-Hardening Types				
	Types	D2	D3	D4	D5	D7	A2	A3	A4	A6	A7	A8	A9	A10	O1	O2	O6	O7	
Identifying Chemical Elements in Per Cent	C	1.50	2.25	2.25	1.50	2.35	1.00	1.25	1.00	0.70	2.25	0.55	0.50	1.35	0.90	0.90	1.45	1.20	
	Mn	2.00	2.00	1.80	1.00	1.60	
	Si	1.25	1.00	...	
	W	1.00	1.25	0.50	1.75	
	Mo	1.00	...	1.00	1.00	1.00	1.00	1.00	1.00	1.25	1.00	1.25	1.40	1.50	0.25	...	
	Cr	12.00	12.00	12.00	12.00	12.00	5.00	5.00	1.00	1.00	5.25	5.00	5.00	...	0.50	0.75	
	V	1.00	4.00	...	1.00	4.75	...	1.00	
Co	3.00		
Heat-Treatment Data	Ni	1.50	1.80	
	Hardening Temperature Range	°F	1800–1875	1700–1800	1775–1850	1800–1875	1850–1950	1700–1800	1750–1850	1500–1600	1525–1600	1750–1800	1800–1850	1800–1875	1450–1500	1450–1500	1400–1475	1450–1500	1550–1525
		°C	982–1024	927–982	968–1010	982–1024	1010–1066	927–982	954–1010	816–871	829–871	954–982	982–1010	982–1024	788–816	788–816	760–802	788–816	843–829
	Quenching Medium		Air	Oil	Air	Air	Air	Air	Air	Air	Air	Air	Air	Air	Air	Oil	Oil	Oil	Oil
	Tempering Temperature Range	°F	400–1000	400–1000	400–1000	400–1000	300–1000	350–1000	350–1000	350–800	300–800	300–1000	350–1100	950–1150	350–800	350–500	350–500	350–600	350–550
		°C	204–538	204–538	204–538	204–538	149–538	177–538	177–538	177–427	149–427	149–538	177–593	510–621	177–427	177–260	177–260	177–316	177–288
Approx. Tempered Hardness, Rc		61–54	61–54	61–54	61–54	65–58	62–57	65–57	62–54	60–54	67–57	60–50	56–35	62–55	62–57	62–57	63–58	64–58	
Relative Ratings of Properties (A = greatest to E = least)																			
Characteristics in Heat Treatment	Safety in Hardening	A	C	A	A	A	A	A	A	A	A	A	A	A	B	B	B	B	
	Depth of Hardening	A	A	A	A	A	A	A	A	A	A	A	A	A	B	B	B	B	
	Resistance to Decarburization	B	B	B	B	B	B	B	A/B	A/B	B	B	B	A/B	A	A	A	A	
	Stability of Shape in Heat Treatment	A	B	A	A	A	A	A	A	A	A	A	A	A	B	B	B	B	
Service Properties	Machinability	E	E	E	E	E	D	D	D/E	D/E	E	D	D	C/D	C	C	B	C	
	Hot Hardness	C	C	C	C	C	C	C	D	D	C	C	C	D	E	E	E	E	
	Wear Resistance	B/C	B	B	B/C	A	C	B	C/D	C/D	A	C/D	C/D	C	D	D	D	D	
	Toughness	E	E	E	E	E	D	D	D	D	E	C	C	D	D	D	D	C	

have been developed. These individual types grew into families with members that, while similar in their major characteristics, provide related properties to different degrees. Originally developed for a specific use, the resulting particular properties of some of these tool steels made them desirable for other uses as well. In the tool steel classification system, they are shown in three groups, as discussed in what follows.

Shock-Resisting Tool Steels.—These steels are made with low-carbon content for increased toughness, even at the expense of wear resistance, which is generally low. Each member of this group also contains alloying elements, different in composition and amount, selected to provide properties particularly adjusted to specific applications. Such varying properties are the degree of toughness (generally, high in all members), hot hardness, abrasion resistance, and machinability.

Properties and Applications of Frequently Used Shock-Resisting Types: AISI S1: This Chromium-tungsten alloyed tool steel combines, in its hardened state, great toughness with high hardness and strength. Although it has a low-carbon content for reasons of good toughness, the carbon-forming alloys contribute to deep hardenability and abrasion resistance. When high wear resistance is also required, this property can be improved by carburizing the surface of the tool while still retaining its shock-resistant characteristics. Primary uses are for battering tools, including hand and pneumatic chisels. The chemical composition, particularly the silicon and tungsten content, provides good hot hardness, too, up to operating temperatures of about 1050°F (566°C), making this tool steel type also adaptable for such hot-work tool applications involving shock loads, as headers, pierces, forming tools, drop forge die inserts, and heavy shear blades.

AISI S2: This steel type serves primarily for hand chisels and pneumatic tools, although it also has limited applications for hot work. Although its wear-resistance properties are only moderate, S2 is sometimes used for forming and thread rolling applications, when the resistance to rupturing is more important than extended service life. For hot-work applications, this steel requires heat treatment in a neutral atmosphere to avoid either carburization or decarburization of the surface. Such conditions make this tool steel type particularly susceptible to failure in hot-work uses.

AISI S5: This composition is essentially a Silicon-manganese type tool steel with small additions of chromium, molybdenum, and vanadium for the purpose of improved deep hardening and refinement of the grain structure. The most important properties of this steel are its high elastic limit and good ductility, resulting in excellent shock-resisting characteristics, when used at atmospheric temperatures. Its recommended quenching medium is oil, although a water quench may also be applied as long as the design of the tools avoids sharp corners or drastic sectional changes. Typical applications include pneumatic tools in severe service, like chipping chisels, also shear blades, heavy-duty punches, and bending rolls. Occasionally, this steel is also used for structural applications, like shanks for carbide tools and machine parts subject to shocks.

Mold Steels.—These materials differ from all other types of tool steels by their very low-carbon content, generally requiring carburizing to obtain a hard operating surface. A special property of most steel types in this group is the adaptability to shaping by impression (hobbing) instead of by conventional machining. They also have high resistance to decarburization in heat treatment and dimensional stability, characteristics that obviate the need for grinding following heat treatment. Molding dies for plastics materials require an excellent surface finish, even to the degree of high luster; the generally high-chromium content of these types of tool steels greatly aids in meeting this requirement.

Properties and Applications of Frequently Used Mold Steel Types: AISI P3 and P4:

Essentially, both types of tool steels were developed for the same special purpose, that is, the making of plastics molds. The application conditions of plastics molds require high core strength, good wear resistance at elevated temperature, and excellent surface finish. Both types are carburizing steels that possess good dimensional stability. Because hob-

Table 10. Shock-Resisting, Mold, and Special-Purpose Tool Steels

Identifying Chemical Composition and Typical Heat-Treatment Data																			
AISI	Category		Shock-Resisting Tool Steels				Mold Steels						Special-Purpose Tool Steels						
	Types		S1	S2	S5	S7	P2	P3	P4	P5	P6	P20	P21 ^a	L2 ^b	L3 ^b	L6	F1	F2	
Identifying Elements in Per Cent	C		0.50	0.50	0.55	0.50	0.07	0.10	0.07	0.10	0.10	0.35	0.20	0.50/1.10	1.00	0.70	1.00	1.25	
	Mn		0.80	
	Si		...	1.00	2.00	
	W		2.50	1.25	3.50	
	Mo		...	0.50	0.40	1.40	0.20	...	0.75	0.40	0.25	
	Cr		1.50	3.25	2.00	0.60	5.00	2.25	1.50	1.25	...	1.00	1.50	0.75	
	V		0.20	0.20	
Ni		0.50	1.25	3.50	...	4.00	1.50		
Heat-Treat. Data	Hardening Temperature		°F	1650–1750	1550–1650	1600–1700	1700–1750	1525–1550 ^c	1475–1525 ^c	1775–1825 ^c	1550–1600 ^c	1450–1500 ^c	1500–1600 ^c	Soln. treat.	1550–1700	1500–1600	1450–1550	1450–1600	1450–1600
			°C	899–954	843–899	871–927	927–955	829–843c	802–829c	968–996c	843–871c	788–816c	816–871c	Soln. treat.	843–927	816–871	788–843	788–871	788–871
	Tempering Temp. Range		°F	400–1200	350–800	350–800	400–1150	350–500	350–500	350–900	350–500	350–450	900–1100	Aged	350–1000	350–600	350–1000	350–500	350–500
			°C	204–649	177–427	177–427	204–621	177–260	177–260	177–482	177–260	177–232	482–593	Aged	177–538	177–316	177–538	177–260	177–260
	Approx. Tempered Hardness, Rc			58–40	60–50	60–50	57–45	64–58 ^d	64–58 ^d	64–58 ^d	64–58 ^d	61–58 ^d	37–28 ^d	40–30	63–45	63–56	62–45	64–60	65–62
Relative Ratings of Properties (A = greatest to E = least)																			
Characteristics in Heat Treatment	Safety in Hardening		C	E	C	B/C	C	C	C	C	C	A	D	D	C	E	E		
	Depth of Hardening		B	B	B	A	B ^e	B ^e	C	C	C	A ^e	B	A	B	B	C	C	
	Resist. to Decarb.		B	C	C	B	A	A	A	A	A	A	A	A	A	A	A	A	
	Stability of Shape in Heat Treatment	Quench. Med.	Air	A	B	...	B	C	A	
			Oil	D	...	D	C	C	C	...	C	C	...	A	D	D	C	...	
Water ^f		...	E	E	E	E	...	E	E		
Service Properties	Machinability		D	C/D	C/D	D	C/D	D	D/E	D	D	C/D	D	C	C	D	C	D	
	Hot Hardness		D	E	E	C	E	E	D	E	E	E	D	E	E	E	E	E	
	Wear Resistance		D/E	D/E	D/E	D/E	D	D	C	D	D	D/E	D	D/E	D	D	D	B/C	
	Toughness		B	A	A	B	C	C	C	C	C	C	D	B	D	B	E	E	

^a Contains also about 1.20 per cent A1. Solution treated in hardening.

^b Quenched in oil.

^c After carburizing.

^d Carburized case.

^e Core hardenability.

^f Sometimes brine is used.

bing, that is, sinking the cavity by pressing a punch representing the inverse replica of the cavity into the tool material, is the process by which many plastics mold cavities are produced, good “hobbability” of the tool steels used for this purpose is an important requirement. The different chemistry of these two types of mold steels is responsible for the high core hardness of the P4, which makes it better suited for applications requiring high strength at elevated temperature.

AISI P6: This nickel-chromium-type plastics mold steel has exceptional core strength and develops a deep carburized case. Due to the high nickel-chromium content, the cavities of molds made of this steel type are produced by machining rather than by hobbing. An outstanding characteristic of this steel type is the high luster that is produced by polishing of the hard case surface.

AISI P20: This general-type mold steel is adaptable to both through hardening and carburized case hardening. In through hardening, an oil quench is used and a relatively lower, yet deeply penetrating hardness is obtained, such as is needed for zinc die-casting dies and injection molds for plastics. After the direct quenching and tempering, carburizing produces a very hard case and comparatively high core hardness. When thus heat treated, this steel is particularly well adapted for making compression, transfer, and plunger-type plastics molds.

Special-Purpose Tool Steels.—These steels include several low-alloy types of tool steels that were developed to provide transitional types between the more commonly used basic types of tool steels, and thereby contribute to the balancing of certain conflicting properties such as wear resistance and toughness; to offer intermediate depth of hardening; and to be less expensive than the higher-alloyed types of tool steels.

Properties and Applications of Frequently Used Special-Purpose Types: *AISI L6:* This material is a low-alloy-type special-purpose tool steel. The comparatively safe hardening and the fair nondeforming properties, combined with the service advantage of good toughness in comparison to most other oil-hardening types, explains the acceptance of this steel with a rather special chemical composition. The uses of L6 are for tools whose toughness requirements prevail over abrasion-resistant properties, such as forming rolls and forming and trimmer dies in applications where combinations of moderate shock- and wear-resistant properties are sought. The areas of use also include structural parts, like clutch members, pawls, and knuckle pins, that must withstand shock loads and still display good wear properties.

AISI F2: This carbon-tungsten type is one of the most abrasion-resistant of all water-hardening tool steels. However, it is sensitive to thermal changes, such as are involved in heat treatment and it is also susceptible to distortions. Consequently, its use is limited to tools of simple shape in order to avoid cracking in hardening. The shallow hardening characteristics of F2 result in a tough core and are desirable properties for certain tool types that, at the same time, require excellent wear-resistant properties.

Water-Hardening Tool Steels.—Steel types in this category are made without, or with only a minimum amount of alloying elements and, their heat treatment needs the harsh quenching action of water or brine, hence the general designation of the category.

Water-hardening steels are usually available with different percentages of carbon, to provide properties required for different applications; the classification system lists a carbon range of 0.60 to 1.40 per cent. In practice, however, the steel mills produce these steels in a few varieties of differing carbon content, often giving proprietary designations to each particular group. Typical carbon content limits of frequently used water-hardening tool steels are 0.70-0.90, 0.90-1.10, 1.05-1.20, and 1.20-1.30 per cent. The appropriate group should be chosen according to the intended use, as indicated in the steel selection guide for this category, keeping in mind that whereas higher carbon content results in deeper hardness penetration, it also reduces toughness.

The general system distinguishes the following four grades, listed in the order of decreasing quality: 1) special; 2) extra; 3) standard; and 4) commercial.

The differences between these grades, which are not offered by all steel mills, are defined in principle only. The distinguishing characteristics are purity and consistency, resulting from different degrees of process refinement and inspection steps applied in making the steel. Higher qualities are selected for assuring dependable uniformity and performance of the tools made from the steel.

The groups with higher carbon content are more sensitive to heat-treatment defects and are generally used for the more demanding applications, so the better grades are usually chosen for the high-carbon types and the lower grades for applications where steels with lower carbon content only are needed.

Water-hardening tool steels, although the least expensive, have several drawbacks, but these are quite acceptable in many types of applications. Some limiting properties are the tendency to deformation in heat treatment due to harsh effects of the applied quenching medium, the sensitivity to heat during the use of the tools made of these steels, the only fair degree of toughness, and the shallow penetration of hardness. However, this last-mentioned property may prove a desirable characteristic in certain applications, such as cold-heading dies, because the relatively shallow hard case is supported by the tough, although softer core.

The AISI designation for water-hardening tool steels is W, followed by a numeral indicating the type, primarily defined by the chemical composition, as shown in **Table 11**.

Table 11. Water-Hardening Tool Steels—Identifying Chemical Composition and Heat-Treatment Data

Chemical Composition in Per Cent				AISI Types				
				W1		W2		W5
C				0.60–1.40		0.60–1.40		1.10
V				Varying carbon content may be available				
Cr				...		0.25		...
Mn				These elements are adjusted to satisfy the hardening requirements				0.50
Si								
Heat-Treatment Data								
Hardening Temperature Ranges Varying with Carbon Content		0.60–0.80%		1450–1500°F (788–816°C)				
		0.85–1.05%		1425–1550°F (774–843°C)				
		1.10–1.40%		1400–1525°F (760–829°C)				
Quenching Medium				Brine or Water				
Tempering Temperature Range				350–650°F (177–343°C)				
Approx. Tempered Hardness, Rc				64–50				
Relative Ratings of Properties (A = greatest to E = least)								
Characteristics in Heat Treatment				Service Properties				
Safety in Hardening	Depth of Hardening	Resistance to Decarburization	Stability of Shape in Heat Treatment	Machinability	Hot Hardness	Wear Resistance	Toughness	
D	C	A	E	A	E	D/E	C/D	

Water-Hardening Type W1 (Plain Carbon) Tool Steels, Recommended Applications:

Group I (C-0.70 to 0.90%): This group is relatively tough and therefore preferred for tools that are subjected to shocks or abusive treatment. Used for such applications as: hand tools, chisels, screwdriver blades, cold punches, and nail sets, and fixture elements, vise jaws, anvil faces, and chuck jaws.

Group II (C-0.90 to 1.10%): This group combines greater hardness with fair toughness, resulting in improved cutting capacity and moderate ability to sustain shock loads. Used for such applications as: hand tools, knives, center punches, pneumatic chisels, cutting tools, reamers, hand taps, and threading dies, wood augers; die parts, drawing and heading dies, shear knives, cutting and forming dies; and fixture elements, drill bushings, lathe centers, collets, and fixed gages.

Group III (C-1.05 to 1.20%): The higher carbon content of this group increases the depth of hardness penetrations, yet reduces toughness, thus the resistance to shock loads. Preferred for applications where wear resistance and cutting ability are the prime considerations. Used for such applications as: hand tools, woodworking chisels, paper knives, cutting tools (for low-speed applications), milling cutters, reamers, planer tools, thread chasers, center drills, die parts, cold blanking, coining, bending dies.

Group IV (C-1.20 to 1-30%): The high carbon content of this group produces a hard case of considerable depth with improved wear resistance yet sensitive to shock and concentrated stresses. Selected for applications where the capacity to withstand abrasive wear is needed, and where the retention of a keen edge or the original shape of the tool is important. Used for such applications as: cutting tools for finishing work, like cutters and reamers, and for cutting chilled cast iron and forming tools, for ferrous and nonferrous metals, and burnishing tools.

By adding small amounts of alloying elements to W-steel types 2 and 5, certain characteristics that are desirable for specific applications are improved. The vanadium in type 2 contributes to retaining a greater degree of fine-grain structure after heat treating. Chromium in type 5 improves the deep-hardening characteristics of the steel, a property needed for large sections, and assists in maintaining the keen cutting edge that is desirable in cutting tools like broaches, reamers, threading taps, and dies.

Mill Production Forms of Tool Steels

Tool steels are produced in many different forms, but not all those listed in the following are always readily available; certain forms and shapes are made for special orders only.

Hot-Finished Bars and Cold-Finished Bars: These bars are the most commonly produced forms of tool steels. Bars can be furnished in many different cross-sections, the round shape being the most common. Sizes can vary over a wide range, with a more limited number of standard stock sizes. Various conditions may also be available, however, technological limitations prevent all conditions applying to every size, shape, or type of steel. Tool steel bars may be supplied in one of the following conditions and surface finishes:

Conditions: Hot-rolled or forged (natural); hot-rolled or forged and annealed; hot-rolled or forged and heat-treated; cold- or hot-drawn (as drawn); and cold- or hot-drawn and annealed.

Finishes: Hot-rolled finish (scale not removed); pickled or blast-cleaned; cold-drawn; turned or machined; rough ground; centerless ground or precision flat ground; and polished (rounds only).

Other forms in which tool steels are supplied are the following:

Rolled or Forged Special Shapes: These shapes are usually produced on special orders only, for the purpose of reducing material loss and machining time in the large-volume manufacture of certain frequently used types of tools.

Forgings: All types of tool steels may be supplied in the form of forgings, that are usually specified for special shapes and for dimensions that are beyond the range covered by bars.

Wires: Tool steel wires are produced either by hot or cold drawing and are specified when special shapes, controlled dimensional accuracy, improved surface finish, or special mechanical properties are required. Round wire is commonly produced within an approximate size range of 0.015 to 0.500 inch (0.38 to 12.7 mm), and these dimensions also indicate the limits within which other shapes of tool steel wires, like oval, square, or rectangular, may be produced.

Drill Rods: Rods are produced in round, rectangular, square, hexagonal, and octagonal shapes, usually with tight dimensional tolerances to eliminate subsequent machining, thereby offering manufacturing economies for the users.

Hot-Rolled Plates and Sheets, and Cold-Rolled Strips: Such forms of tool steel are generally specified for the high-volume production of specific tool types.

Tool Bits: These pieces are semifinished tools and are used by clamping in a tool holder or shank in a manner permitting ready replacement. Tool bits are commonly made of high-speed types of tool steels, mostly in square, but also in round, rectangular, and other shapes. Tool bits are made of hot rolled bars and are commonly, yet not exclusively, supplied in hardened and ground form, ready for use after the appropriate cutting edges are ground, usually in the user's plant.

Hollow Bars: These bars are generally produced by trepanning, boring, or drilling of solid round rods and are used for making tools or structural parts of annular shapes, like rolls, ring gages, bushings, etc.

Tolerances of Dimensions.—Such tolerances have been developed and published by the American Iron and Steel Institute (AISI) as a compilation of available industry experience that, however, does not exclude the establishment of closer tolerances, particularly for hot rolled products manufactured in large quantities. The tolerances differ for various categories of production processes (e.g., forged, hot-rolled, cold-drawn, centerless ground) and of general shapes.

Allowances for Machining.—These allowances provide freedom from soft spots and defects of the tool surface, thereby preventing failures in heat treatment or in service. After a layer of specific thickness, known as the allowance, has been removed, the bar or other form of tool steel material should have a surface without decarburization and other surface defects, such as scale marks or seams. The industry wide accepted machining allowance values for tool steels in different conditions, shapes, and size ranges are spelled out in AISI specifications and are generally also listed in the tool steel catalogs of the producer companies.

Decarburization Limits.—Heating of steel for production operation causes the oxidation of the exposed surfaces resulting in the loss of carbon. That condition, called decarburization, penetrates to a certain depth from the surface, depending on the applied process, the shape and the dimensions of the product. Values of tolerance for decarburization must be considered as one of the factors for defining the machining allowances, which must also compensate for expected variations of size and shape, the dimensional effects of heat treatment, and so forth. Decarburization can be present not only in hot-rolled and forged, but also in rough turned and cold-drawn conditions.

Advances in Tool Steel Making Technology.—Significant advances in processes for tool steel production have been made that offer more homogeneous materials of greater density and higher purity for applications where such extremely high quality is required. Two of these methods of tool steel production are of particular interest.

Vacuum-melted tool steels: These steels are produced by the consumable electrode method, which involves remelting of the steel originally produced by conventional processes. Inside a vacuum-tight shell that has been evacuated, the electrode cast of tool steel of the desired chemical analysis is lowered into a water-cooled copper mold where it strikes a low-voltage, high-amperage arc causing the electrode to be consumed by gradual melting. The undesirable gases and volatiles are drawn off by the vacuum, and the inclusions float on the surface of the pool, accumulating on the top of the produced ingot, to be removed later by cropping. In the field of tool steels, the consumable-electrode vacuum-melting (CVM) process is applied primarily to the production of special grades of hot-work and high-speed tool steels.

High-speed tool steels produced by powder metallurgy: The steel produced by conventional methods is reduced to a fine powder by a gas atomization process. The powder is compacted by a hot isostatic method with pressures in the range of 15,000 to 17,000 psi (103 to 117 MPa). The compacted billets are hot-rolled to the final bar size, yielding a tool-steel material which has 100 per cent theoretical density. High-speed tool steels produced by the P/M method offer a tool material providing increased tool wear life and high impact strength, of particular advantage in interrupted cuts.

HARDENING, TEMPERING, AND ANNEALING

Heat Treatment Of Standard Steels

Heat-Treating Definitions.—This glossary of heat-treating terms has been adopted by the American Foundrymen's Association, the American Society for Metals, the American Society for Testing and Materials, and the Society of Automotive Engineers. Since it is not intended to be a specification but is strictly a set of definitions, temperatures have purposely been omitted.

Aging: Describes a time-temperature-dependent change in the properties of certain alloys. Except for strain aging and age softening, it is the result of precipitation from a solid solution of one or more compounds whose solubility decreases with decreasing temperature. For each alloy susceptible to aging, there is a unique range of time-temperature combinations to which it will respond.

Annealing: A term denoting a treatment, consisting of heating to and holding at a suitable temperature followed by cooling at a suitable rate, used primarily to soften but also to simultaneously produce desired changes in other properties or in microstructure. The purpose of such changes may be, but is not confined to, improvement of machinability; facilitation of cold working; improvement of mechanical or electrical properties; or increase in stability of dimensions. The time-temperature cycles used vary widely both in maximum temperature attained and in cooling rate employed, depending on the composition of the material, its condition, and the results desired. When applicable, the following more specific process names should be used: Black Annealing, Blue Annealing, Box Annealing, Bright Annealing, Cycle Annealing, Flame Annealing, Full Annealing, Graphitizing, Intermediate Annealing, Isothermal Annealing, Process Annealing, Quench Annealing, and Spheroidizing. When the term is used without qualification, full annealing is implied. When applied only for the relief of stress, the process is properly called stress relieving.

Black Annealing: Box annealing or pot annealing, used mainly for sheet, strip, or wire.

Blue Annealing: Heating hot-rolled sheet in an open furnace to a temperature within the transformation range and then cooling in air, to soften the metal. The formation of a bluish oxide on the surface is incidental.

Box Annealing: Annealing in a sealed container under conditions that minimize oxidation. In box annealing, the charge is usually heated slowly to a temperature below the transformation range, but sometimes above or within it, and is then cooled slowly; this process is also called "close annealing" or "pot annealing."

Bright Annealing: Annealing in a protective medium to prevent discoloration of the bright surface.

Cycle Annealing: An annealing process employing a predetermined and closely controlled time-temperature cycle to produce specific properties or microstructure.

Flame Annealing: Annealing in which the heat is applied directly by a flame.

Full Annealing: Austenitizing and then cooling at a rate such that the hardness of the product approaches a minimum.

Graphitizing: Annealing in such a way that some or all of the carbon is precipitated as graphite.

Intermediate Annealing: Annealing at one or more stages during manufacture and before final thermal treatment.

Isothermal Annealing: Austenitizing and then cooling to and holding at a temperature at which austenite transforms to a relatively soft ferrite-carbide aggregate.

Process Annealing: An imprecise term used to denote various treatments that improve workability. For the term to be meaningful, the condition of the material and the time-temperature cycle used must be stated.

Quench Annealing: Annealing an austenitic alloy by *Solution Heat Treatment*.

Spheroidizing: Heating and cooling in a cycle designed to produce a spheroidal or globular form of carbide.

Austempering: Quenching from a temperature above the transformation range, in a medium having a rate of heat abstraction high enough to prevent the formation of high-temperature transformation products, and then holding the alloy, until transformation is complete, at a temperature below that of pearlite formation and above that of martensite formation.

Austenitizing: Forming austenite by heating into the transformation range (partial austenitizing) or above the transformation range (complete austenitizing). When used without qualification, the term implies complete austenitizing.

Baking: Heating to a low temperature in order to remove entrained gases.

Bluing: A treatment of the surface of iron-base alloys, usually in the form of sheet or strip, on which, by the action of air or steam at a suitable temperature, a thin blue oxide film is formed on the initially scale-free surface, as a means of improving appearance and resistance to corrosion. This term is also used to denote a heat treatment of springs after fabrication, to reduce the internal stress created by coiling and forming.

Carbon Potential: A measure of the ability of an environment containing active carbon to alter or maintain, under prescribed conditions, the carbon content of the steel exposed to it. In any particular environment, the carbon level attained will depend on such factors as temperature, time, and steel composition.

Carbon Restoration: Replacing the carbon lost in the surface layer from previous processing by carburizing this layer to substantially the original carbon level.

Carbonitriding: A case-hardening process in which a suitable ferrous material is heated above the lower transformation temperature in a gaseous atmosphere of such composition as to cause simultaneous absorption of carbon and nitrogen by the surface and, by diffusion, create a concentration gradient. The process is completed by cooling at a rate that produces the desired properties in the workpiece.

Carburizing: A process in which carbon is introduced into a solid iron-base alloy by heating above the transformation temperature range while in contact with a carbonaceous material that may be a solid, liquid, or gas. Carburizing is frequently followed by quenching to produce a hardened case.

Case: 1) The surface layer of an iron-base alloy that has been suitably altered in composition and can be made substantially harder than the interior or core by a process of case hardening; and 2) the term case is also used to designate the hardened surface layer of a piece of steel that is large enough to have a distinctly softer core or center.

Cementation: The process of introducing elements into the outer layer of metal objects by means of high-temperature diffusion.

Cold Treatment: Exposing to suitable subzero temperatures for the purpose of obtaining desired conditions or properties, such as dimensional or microstructural stability. When the treatment involves the transformation of retained austenite, it is usually followed by a tempering treatment.

Conditioning Heat Treatment: A preliminary heat treatment used to prepare a material for a desired reaction to a subsequent heat treatment. For the term to be meaningful, the treatment used must be specified.

Controlled Cooling: A term used to describe a process by which a steel object is cooled from an elevated temperature, usually from the final hot-forming operation in a predetermined manner of cooling to avoid hardening, cracking, or internal damage.

Core: 1) The interior portion of an iron-base alloy that after case hardening is substantially softer than the surface layer or case; and 2) the term core is also used to designate the relatively soft central portion of certain hardened tool steels.

Critical Range or Critical Temperature Range: Synonymous with *Transformation Range*, which is preferred.

Cyaniding: A process of case hardening an iron-base alloy by the simultaneous absorption of carbon and nitrogen by heating in a cyanide salt. Cyaniding is usually followed by quenching to produce a hard case.

Decarburization: The loss of carbon from the surface of an iron-base alloy as the result of heating in a medium that reacts with the carbon.

Drawing: Drawing, or drawing the temper, is synonymous with *Tempering*, which is preferable.

Eutectic Alloy: The alloy composition that freezes at constant temperature similar to a pure metal. The lowest melting (or freezing) combination of two or more metals. The alloy structure (homogeneous) of two or more solid phases formed from the liquid eutectically.

Hardenability: In a ferrous alloy, the property that determines the depth and distribution of hardness induced by quenching.

Hardening: Any process of increasing hardness of metal by suitable treatment, usually involving heating and cooling. See also *Aging*.

Hardening, Case: A process of surface hardening involving a change in the composition of the outer layer of an iron-base alloy followed by appropriate thermal treatment. Typical case-hardening processes are *Carburizing*, *Cyaniding*, *Carbonitriding*, and *Nitriding*.

Hardening, Flame: A process of heating the surface layer of an iron-base alloy above the transformation temperature range by means of a high-temperature flame, followed by quenching.

Hardening, Precipitation: A process of hardening an alloy in which a constituent precipitates from a supersaturated solid solution. See also *Aging*.

Hardening, Secondary: An increase in hardness following the normal softening that occurs during the tempering of certain alloy steels.

Heating, Differential: A heating process by which the temperature is made to vary throughout the object being heated so that on cooling, different portions may have such different physical properties as may be desired.

Heating, Induction: A process of local heating by electrical induction.

Heat Treatment: A combination of heating and cooling operations applied to a metal or alloy in the solid state to obtain desired conditions or properties. Heating for the sole purpose of hot working is excluded from the meaning of this definition.

Heat Treatment, Solution: A treatment in which an alloy is heated to a suitable temperature and held at this temperature for a sufficient length of time to allow a desired constituent to enter into solid solution, followed by rapid cooling to hold the constituent in solution. The material is then in a supersaturated, unstable state, and may subsequently exhibit *Age Hardening*.

Homogenizing: A high-temperature heat-treatment process intended to eliminate or to decrease chemical segregation by diffusion.

Isothermal Transformation: A change in phase at constant temperature.

Malleablizing: A process of annealing white cast iron in which the combined carbon is wholly or in part transformed to graphitic or free carbon and, in some cases, part of the carbon is removed completely. See *Temper Carbon*.

Maraging: A precipitation hardening treatment applied to a special group of iron-base alloys to precipitate one or more intermetallic compounds in a matrix of essentially carbon-free martensite.

Martempering: A hardening procedure in which an austenitized ferrous workpiece is quenched into an appropriate medium whose temperature is maintained substantially at the M_s of the workpiece, held in the medium until its temperature is uniform throughout but not long enough to permit bainite to form, and then cooled in air. The treatment is followed by tempering.

Nitriding: A process of case hardening in which an iron-base alloy of special composition is heated in an atmosphere of ammonia or in contact with nitrogenous material. Surface hardening is produced by the absorption of nitrogen without quenching.

Normalizing: A process in which an iron-base alloy is heated to a temperature above the transformation range and subsequently cooled in still air at room temperature.

Overheated: A metal is said to have been overheated if, after exposure to an unduly high temperature, it develops an undesirably coarse grain structure but is not permanently damaged. The structure damaged by overheating can be corrected by suitable heat treatment or by mechanical work or by a combination of the two. In this respect it differs from a Burnt structure.

Patenting: A process of heat treatment applied to medium- or high-carbon steel in wire making prior to the wire drawing or between drafts. It consists in heating to a temperature above the transformation range, followed by cooling to a temperature below that range in air or in a bath of molten lead or salt maintained at a temperature appropriate to the carbon content of the steel and the properties required of the finished product.

Preheating: Heating to an appropriate temperature immediately prior to austenitizing when hardening high-hardenability constructional steels, many of the tool steels, and heavy sections.

Quenching: Rapid cooling. When applicable, the following more specific terms should be used: Direct Quenching, Fog Quenching, Hot Quenching, Interrupted Quenching, Selective Quenching, Slack Quenching, Spray Quenching, and Time Quenching.

Direct Quenching: Quenching carburized parts directly from the carburizing operation.

Fog Quenching: Quenching in a mist.

Hot Quenching: An imprecise term used to cover a variety of quenching procedures in which a quenching medium is maintained at a prescribed temperature above 160°F (71°C).

Interrupted Quenching: A quenching procedure in which the workpiece is removed from the first quench at a temperature substantially higher than that of the quenchant and is then subjected to a second quenching system having a different cooling rate than the first.

Selective Quenching: Quenching only certain portions of a workpiece.

Slack Quenching: The incomplete hardening of steel due to quenching from the austenitizing temperature at a rate slower than the critical cooling rate for the particular steel, resulting in the formation of one or more transformation products in addition to martensite.

Spray Quenching: Quenching in a spray of liquid.

Time Quenching: Interrupted quenching in which the duration of holding in the quenching medium is controlled.

Soaking: Prolonged heating of a metal at a selected temperature.

Stabilizing Treatment: A treatment applied to stabilize the dimensions of a workpiece or the structure of a material such as 1) before finishing to final dimensions, heating a workpiece to or somewhat beyond its operating temperature and then cooling to room temperature a sufficient number of times to ensure stability of dimensions in service; 2) transforming retained austenite in those materials that retain substantial amounts when quench hardened (see cold treatment); and 3) heating a solution-treated austenitic stainless steel that contains controlled amounts of titanium or niobium plus tantalum to a temperature below the solution heat-treating temperature to cause precipitation of finely divided, uniformly distributed carbides of those elements, thereby substantially reducing the amount of carbon available for the formation of chromium carbides in the grain boundaries on subsequent exposure to temperatures in the sensitizing range.

Stress Relieving: A process to reduce internal residual stresses in a metal object by heating the object to a suitable temperature and holding for a proper time at that temperature. This treatment may be applied to relieve stresses induced by casting, quenching, normalizing, machining, cold working, or welding.

Temper Carbon: The free or graphitic carbon that comes out of solution usually in the form of rounded nodules in the structure during *Graphitizing* or *Malleablizing*.

Tempering: Heating a quench-hardened or normalized ferrous alloy to a temperature below the transformation range to produce desired changes in properties.

Double Tempering: A treatment in which quench hardened steel is given two complete tempering cycles at substantially the same temperature for the purpose of ensuring completion of the tempering reaction and promoting stability of the resulting microstructure.

Snap Temper: A precautionary interim stress-relieving treatment applied to high hardenability steels immediately after quenching to prevent cracking because of delay in tempering them at the prescribed higher temperature.

Temper Brittleness: Brittleness that results when certain steels are held within, or are cooled slowly through, a certain range of temperatures below the transformation range. The brittleness is revealed by notched-bar impact tests at or below room temperature.

Transformation Ranges or Transformation Temperature Ranges: Those ranges of temperature within which austenite forms during heating and transforms during cooling. The two ranges are distinct, sometimes overlapping but never coinciding. The limiting temperatures of the ranges depend on the composition of the alloy and on the rate of change of temperature, particularly during cooling.

Transformation Temperature: The temperature at which a change in phase occurs. The term is sometimes used to denote the limiting temperature of a transformation range. The following symbols are used for iron and steels:

A_{cm} = In hypereutectoid steel, the temperature at which the solution of cementite in austenite is completed during heating

A_{c1} = The temperature at which austenite begins to form during heating

A_{c3} = The temperature at which transformation of ferrite to austenite is completed during heating

A_{c4} = The temperature at which austenite transforms to delta ferrite during heating

$A_{e1}, A_{e3}, A_{e_{cm}}, A_{e4}$ = The temperatures of phase changes at equilibrium

$A_{r_{cm}}$ = In hypereutectoid steel, the temperature at which precipitation of cementite starts during cooling

A_{r1} = The temperature at which transformation of austenite to ferrite or to ferrite plus cementite is completed during cooling

A_{r3} = The temperature at which austenite begins to transform to ferrite during cooling

A_{r4} = The temperature at which delta ferrite transforms to austenite during cooling

M_s = The temperature at which transformation of austenite to martensite starts during cooling

M_f = The temperature, during cooling, at which transformation of austenite to martensite is substantially completed

All these changes except the formation of martensite occur at lower temperatures during cooling than during heating, and depend on the rate of change of temperature.

Hardness and Hardenability.—Hardenability is the property of steel that determines the *depth and distribution of hardness* induced by quenching from the austenitizing temperature. Hardenability should not be confused with hardness as such or with maximum hardness. Hardness is a measure of the ability of a metal to resist penetration as determined by any one of a number of standard tests (Brinell, Rockwell, Vickers, etc). The maximum attainable hardness of any steel depends solely on carbon content and is not significantly affected by alloy content. Maximum hardness is realized only when the cooling rate in quenching is rapid enough to ensure full transformation to martensite.

The as-quenched surface hardness of a steel part is dependent on carbon content and cooling rate, but the *depth* to which a certain hardness level is maintained with given quenching conditions is a function of its hardenability. Hardenability is largely determined by the percentage of alloying elements in the steel; however, austenite grain size, time and temperature during austenitizing, and prior microstructure also significantly affect the hardness depth. The hardenability required for a particular part depends on size, design, and service stresses. For highly stressed parts, the best combination of strength and toughness is obtained by through hardening to a martensitic structure followed by adequate tempering. There are applications, however, where through hardening is not necessary or even

desirable. For parts that are stressed principally at or near the surface, or in which wear resistance or resistance to shock loading is anticipated, a shallow hardening steel with a moderately soft core may be appropriate.

For through hardening of thin sections, carbon steels may be adequate; but as section size increases, alloy steels of increasing hardenability are required. The usual practice is to select the most economical grade that can meet the desired properties consistently. It is not good practice to utilize a higher alloy grade than necessary, because excessive use of alloying elements adds little to the properties and can sometimes induce susceptibility to quenching cracks.

Quenching Media: The choice of quenching media is often a critical factor in the selection of steel of the proper hardenability for a particular application. Quenching severity can be varied by selection of quenching medium, agitation control, and additives that improve the cooling capability of the quenchant. Increasing the quenching severity permits the use of less expensive steels of lower hardenability; however, consideration must also be given to the amount of distortion that can be tolerated and the susceptibility to quench cracking. In general, the more severe the quenchant and the less symmetrical the part being quenched, the greater are the size and shape changes that result from quenching and the greater is the risk of quench cracking. Consequently, although water quenching is less costly than oil quenching, and water quenching steels are less expensive than those requiring oil quenching, it is important to know that the parts being hardened can withstand the resulting distortion and the possibility of cracking.

Oil, salt, and synthetic water-polymer quenchant are also used, but they often require steels of higher alloy content and hardenability. A general rule for the selection of steel and quenchant for a particular part is that the steel should have a hardenability not exceeding that required by the severity of the quenchant selected. The carbon content of the steel should also not exceed that required to meet specified hardness and strength, because quench cracking susceptibility increases with carbon content.

The choice of quenching media is important in hardening, but another factor is agitation of the quenching bath. The more rapidly the bath is agitated, the more rapidly heat is removed from the steel and the more effective is the quench.

Hardenability Test Methods: The most commonly used method for determining hardenability is the end-quench test developed by Jominy and Boegehold, and described in detail in both SAE J406 and ASTM A255. In this test a normalized 1-inch-round (25.4 mm), approximately 4-inch-long (102 mm) specimen of the steel to be evaluated is heated uniformly to its austenitizing temperature. The specimen is then removed from the furnace, placed in a jig, and immediately end quenched by a jet of room-temperature water. The water is played on the end face of the specimen, without touching the sides, until the entire specimen has cooled. Longitudinal flat surfaces are ground on opposite sides of the piece and Rockwell C scale hardness readings are taken at $\frac{1}{16}$ -inch (1.6 mm) intervals from the quenched end. The resulting data are plotted on graph paper with the hardness values as ordinates (y -axis) and distances from the quenched end as abscissas (x -axis). Representative data have been accumulated for a variety of standard steel grades and are published by SAE and AISI as "H-bands." These data show graphically and in tabular form the high and low limits applicable to each grade. The suffix H following the standard AISI/SAE numerical designation indicates that the steel has been produced to specific hardenability limits.

Experiments have confirmed that the cooling rate at a given point along the Jominy bar corresponds closely to the cooling rate at various locations in round bars of various sizes. In general, when end-quench curves for different steels coincide approximately, similar treatments will produce similar properties in sections of the same size. On occasion it is necessary to predict the end-quench hardenability of a steel not available for testing, and reasonably accurate means of calculating hardness for any Jominy location on a section of steel of known analysis and grain size have been developed.

Tempering: As-quenched steels are in a highly stressed condition and are seldom used without tempering. Tempering imparts plasticity or toughness to the steel, and is inevitably accompanied by a loss in hardness and strength. The loss in strength, however, is only incidental to the very important increase in toughness, which is due to the relief of residual stresses induced during quenching and to precipitation, coalescence, and spheroidization of iron and alloy carbides resulting in a microstructure of greater plasticity.

Alloying slows the tempering rate, so that alloy steel requires a higher tempering temperature to obtain a given hardness than carbon steel of the same carbon content. The higher tempering temperature for a given hardness permits a greater relaxation of residual stress and thereby improves the steel's mechanical properties. Tempering is done in furnaces or in oil or salt baths at temperatures varying from 300 to 1200°F (149 to 649°C). With most grades of alloy steel, the range between 500 and 700°F (260 to 371°C) is avoided because of a phenomenon known as "blue brittleness," which reduces impact properties. Tempering the martensitic stainless steels in the range of 800-1100°F (427 to 593°C) is not recommended because of the low and erratic impact properties and reduced corrosion resistance that result. Maximum toughness is achieved at higher temperatures. It is important to temper parts as soon as possible after quenching, because any delay greatly increases the risk of cracking resulting from the high-stress condition in the as-quenched part.

Surface Hardening Treatment (Case Hardening).—Many applications require high hardness or strength primarily at the surface, and complex service stresses frequently require not only a hard, wear-resistant surface, but also core strength and toughness to withstand impact stress.

To achieve these different properties, two general processes are used: 1) The chemical composition of the surface is altered, prior to or after quenching and tempering; the processes used include carburizing, nitriding, cyaniding, and carbonitriding; and 2) Only the surface layer is hardened by the heating and quenching process; the most common processes used for surface hardening are flame hardening and induction hardening.

Carburizing: Carbon is diffused into the part's surface to a controlled depth by heating the part in a carbonaceous medium. The resulting depth of carburization, commonly referred to as case depth, depends on the carbon potential of the medium used and the time and temperature of the carburizing treatment. The steels most suitable for carburizing to enhance toughness are those with sufficiently low carbon contents, usually below 0.3 per cent. Carburizing temperatures range from 1550 to 1750°F (843 to 954°C), with the temperature and time at temperature adjusted to obtain various case depths. Steel selection, hardenability, and type of quench are determined by section size, desired core hardness, and service requirements.

Three types of carburizing are most often used: 1) *Liquid carburizing* involves heating the steel in molten barium cyanide or sodium cyanide. The case absorbs some nitrogen in addition to carbon, thus enhancing surface hardness; 2) *Gas carburizing* involves heating the steel in a gas of controlled carbon content. When used, the carbon level in the case can be closely controlled; and 3) *Pack carburizing*, which involves sealing both the steel and solid carbonaceous material in a gas-tight container, then heating this combination.

With any of these methods, the part may be either quenched after the carburizing cycle without reheating or air cooled followed by reheating to the austenitizing temperature prior to quenching. The case depth may be varied to suit the conditions of loading in service. However, service characteristics frequently require that only selective areas of a part have to be case hardened. Covering the areas not to be cased, with copper plating or a layer of commercial paste, allows the carbon to penetrate only the exposed areas. Another method involves carburizing the entire part, then removing the case in selected areas by machining, prior to quench hardening.

Nitriding: The steel part is heated to a temperature of 900-1150°F (482 to 621°C) in an atmosphere of ammonia gas and dissociated ammonia for an extended period of time that

depends on the case depth desired. A thin, very hard case results from the formation of nitrides. Strong nitride-forming elements (chromium and molybdenum) are required to be present in the steel, and often special nonstandard grades containing aluminum (a strong nitride former) are used. The major advantage of this process is that parts can be quenched and tempered, then machined, prior to nitriding, because only a little distortion occurs during nitriding.

Cyaniding: This process involves heating the part in a bath of sodium cyanide to a temperature slightly above the transformation range, followed by quenching, to obtain a thin case of high hardness.

Carbonitriding: This process is similar to cyaniding except that the absorption of carbon and nitrogen is accomplished by heating the part in a gaseous atmosphere containing hydrocarbons and ammonia. Temperatures of 1425-1625°F (774 to 885°C) are used for parts to be quenched, and lower temperatures, 1200-1450°F (649 to 788°C), may be used where a liquid quench is not required.

Flame Hardening: This process involves rapid heating with a direct high-temperature gas flame, such that the surface layer of the part is heated above the transformation range, followed by cooling at a rate that causes the desired hardening. Steels for flame hardening are usually in the range of 0.30-0.60 per cent carbon, with hardenability appropriate for the case depth desired and the quenchant used. The quenchant is usually sprayed on the surface a short distance behind the heating flame. Immediate tempering is required and may be done in a conventional furnace or by a flame-tempering process, depending on part size and costs.

Induction Hardening: This process is similar in many respects to flame hardening except that the heating is caused by a high-frequency electric current sent through a coil or inductor surrounding the part. The depth of heating depends on the frequency, the rate of heat conduction from the surface, and the length of the heating cycle. Quenching is usually accomplished with a water spray introduced at the proper time through jets in or near the inductor block or coil. In some instances, however, parts are oil-quenched by immersing them in a bath of oil after they reach the hardening temperature.

Structure of Fully Annealed Carbon Steel.—In carbon steel that has been fully annealed, there are normally present, apart from such impurities as phosphorus and sulfur, two constituents: the element iron in a form metallurgically known as *ferrite* and the chemical compound iron carbide in the form metallurgically known as *cementite*. This latter constituent consists of 6.67 per cent carbon and 93.33 per cent iron. A certain proportion of these two constituents will be present as a mechanical mixture. This mechanical mixture, the amount of which depends on the carbon content of the steel, consists of alternate bands or layers of ferrite and cementite. Under the microscope, the matrix frequently has the appearance of mother-of-pearl and hence has been named *pearlite*. Pearlite contains about 0.85 per cent carbon and 99.15 per cent iron, neglecting impurities. A fully annealed steel containing 0.85 per cent carbon would consist entirely of pearlite. Such a steel is known as *eutectoid* steel and has a laminated structure characteristic of a eutectic alloy. Steel that has less than 0.85 per cent carbon (*hypoeutectoid* steel) has an excess of ferrite above that required to mix with the cementite present to form pearlite; hence, both ferrite and pearlite are present in the fully annealed state. Steel having a carbon content greater than 0.85 per cent (*hypereutectoid* steel) has an excess of cementite over that required to mix with the ferrite to form pearlite; hence, both cementite and pearlite are present in the fully annealed state. The structural constitution of carbon steel in terms of ferrite, cementite, pearlite and austenite for different carbon contents and at different temperatures is shown by the accompanying figure, *Phase Diagram of Carbon Steel*.

Effect of Heating Fully Annealed Carbon Steel.—When carbon steel in the fully annealed state is heated above the lower critical point, which is some temperature in the range of 1335 to 1355°F (724 to 735°C) depending on the carbon content, the alternate

bands or layers of ferrite and cementite that make up the pearlite begin to merge into each other. This process continues until the pearlite is thoroughly “dissolved,” forming what is known as *austenite*. If the temperature of the steel continues to rise and there is present, in addition to the pearlite, any excess ferrite or cementite, this also will begin to dissolve into the austenite until finally only austenite will be present. The temperature at which the excess ferrite or cementite is completely dissolved in the austenite is called the *upper critical point*. This temperature varies with the carbon content of the steel much more widely than the lower critical point (see Fig. 1).

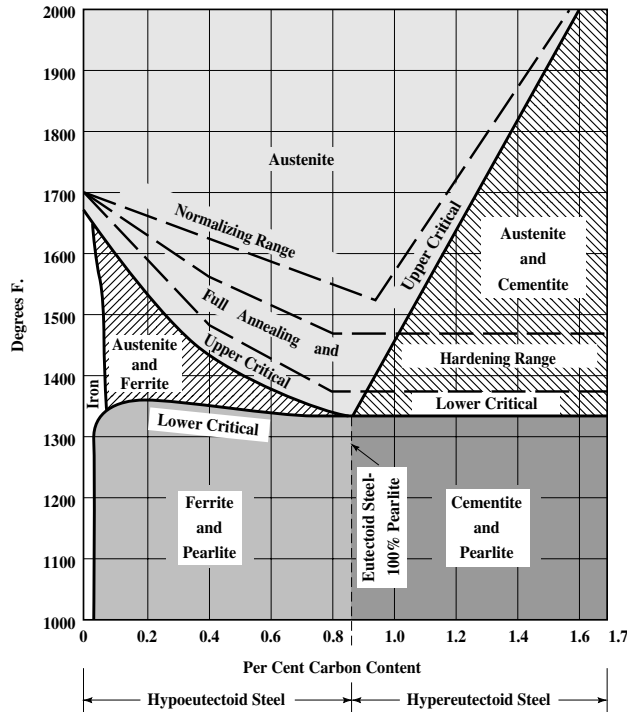


Fig. 1. Phase Diagram of Carbon Steel

Effect of Slow Cooling on Carbon Steel.—If carbon steel that has been heated to the point where it consists entirely of austenite is slowly cooled, the process of transformation that took place during the heating will be reversed, but the upper and lower critical points will occur at somewhat lower temperatures than they do on heating. Assuming that the steel was originally fully annealed, its structure on returning to atmospheric temperature after slow cooling will be the same as before in terms of the proportions of ferrite or cementite and pearlite present. The austenite will have entirely disappeared.

Effect of Rapid Cooling or Quenching on Carbon Steel.—Observations have shown that as the rate at which carbon steel is cooled from an austenitic state is increased, the temperature at which the austenite begins to change into pearlite drops more and more below the slow cooling transformation temperature of about 1300°F (704°C). For example, a 0.80 per cent carbon steel that is cooled at such a rate that the temperature drops 500°F (278°C drop) in one second will show transformation of austenite beginning at 930°F (500°C). As the cooling rate is increased, the laminations of the pearlite formed by the transformation of the austenite become finer and finer up to the point where they cannot be detected under a high-power microscope, while the steel itself increases in hardness and tensile strength. As the rate of cooling is still further increased, this transformation temperature suddenly drops to around 500°F (260°C) or lower, depending on the carbon content of the steel. The cooling rate at which this sudden drop in transformation temperature takes place is called the *critical cooling rate*. When a piece of carbon steel is quenched at this rate

or faster, a new structure is formed. The austenite is transformed into *martensite*, which is characterized by an angular needlelike structure and a very high hardness.

If carbon steel is subjected to a severe quench or to extremely rapid cooling, a small percentage of the austenite, instead of being transformed into martensite during the quenching operation, may be retained. Over a period of time, however, this remaining austenite tends to be gradually transformed into martensite even though the steel is not subjected to further heating or cooling. Martensite has a lower density than austenite, and such a change, or "aging" as it is called, often results in an appreciable increase in volume or "growth" and the setting up of new internal stresses in the steel.

Steel Heat-Treating Furnaces.—Various types of furnaces heated by gas, oil, or electricity are used for the heat treatment of steel. These furnaces include the oven or box type in various modifications for "in-and-out" or for continuous loading and unloading; the retort type; the pit type; the pot type; and the salt-bath electrode type.

Oven or Box Furnaces: This type of furnace has a box or oven-shaped heating chamber. The "in-and-out" oven furnaces are loaded by hand or by a track-mounted car that, when rolled into the furnace, forms the bottom of the heating chamber. The car type is used where heavy or bulky pieces must be handled. Some oven-type furnaces are provided with a full muffle or a semimuffle, which is an enclosed refractory chamber into which the parts to be heated are placed. The full-muffle, being fully enclosed, prevents any flames or burning gases from coming in contact with the work and permits a special atmosphere to be used to protect or condition the work. The semimuffle, which is open at the top, protects the work from direct impingement of the flame although it does not shut off the work from the hot gases. In the direct-heat-type oven furnace, the work is open to the flame. In the electric oven furnace, a retort is provided when gas atmospheres are to be employed to confine the gas and prevent it from attacking the heating elements. Where muffles are used, they must be replaced periodically, and a greater amount of fuel is required than in a direct-heat type of oven furnace.

For continuous loading and unloading, there are several types of furnaces such as rotary hearth car; roller-, furnace belt-, walking-beam, or pusher-conveyor; and a continuous-kiln-type through which track-mounted cars are run. In the continuous type of furnace, the work may pass through several zones that are maintained at different temperatures for pre-heating, heating, soaking, and cooling.

Retort Furnace: This is a vertical type of furnace provided with a cylindrical metal retort into which the parts to be heat-treated are suspended either individually, if large enough, or in a container of some sort. The use of a retort permits special gas atmospheres to be employed for carburizing, nitriding, etc.

Pit-Type Furnace: This is a vertical furnace arranged for the loading of parts in a metal basket. The parts within the basket are heated by convection, and when the basket is lowered into place, it fits into the furnace chamber in such a way as to provide a dead-air space to prevent direct heating.

Pot-Type Furnace: This furnace is used for the immersion method of heat treating small parts. A cast-alloy pot is employed to hold a bath of molten lead or salt in which the parts are placed for heating.

Salt Bath Electrode Furnace: In this type of electric furnace, heating is accomplished by means of electrodes suspended directly in the salt bath. The patented grouping and design of electrodes provide an electromagnetic action that results in an automatic stirring action. This stirring tends to produce an even temperature throughout the bath.

Vacuum Furnace: Vacuum heat treatment is a relatively new development in metallurgical processing, with a vacuum substituting for the more commonly used protective gas atmospheres. The most often used furnace is the "cold wall" type, consisting of a water-cooled vessel that is maintained near ambient temperature during operation. During quenching, the chamber is backfilled up to or above atmospheric pressure with an inert gas,

which is circulated by an internal fan. When even faster cooling rates are needed, furnaces are available with capability for liquid quenching, performed in an isolated chamber.

Fluidized-Bed Furnace: Fluidized-bed techniques are not new; however, new furnace designs have extended the technology into the temperature ranges required for most common heat treatments. In fluidization, a bed of dry, finely divided particles, typically aluminum oxide, is made to behave like a liquid by feeding gas upward through the bed. An important characteristic of the bed is high-efficiency heat transfer. Applications include continuous or batch-type units for all general heat treatments.

Physical Properties of Heat-Treated Steels.—Steels that have been “fully hardened” to the same hardness when quenched will have about the same tensile and yield strengths regardless of composition and alloying elements. When the hardness of such a steel is known, it is also possible to predict its reduction of area and tempering temperature. The accompanying figures illustrating these relationships have been prepared by the Society of Automotive Engineers.

Fig. 2 gives the range of Brinell hardnesses that could be expected for any particular tensile strength or it may be used to determine the range of tensile strengths that would correspond to any particular hardness. Fig. 3 shows the relationship between the tensile strength or hardness and the yield point. The solid line is the normal-expectancy curve. The dotted-line curves give the range of the variation of scatter of the plotted data. Fig. 4 shows the relationship that exists between the tensile strength (or hardness) and the reduction of area. The curve to the left represents the alloy steels and that on the right the carbon steels. Both are normal-expectancy curves and the extremities of the perpendicular lines that intersect them represent the variations from the normal-expectancy curves that may be caused by quality differences and by the magnitude of parasitic stresses induced by quenching. Fig. 5 shows the relationship between the hardness (or approximately equivalent tensile strength) and the tempering temperature. Three curves are given, one for fully hardened steels with a carbon content between 0.40 and 0.55 per cent, one for fully hardened steels with a carbon content between 0.30 and 0.40 per cent, and one for steels that are not fully hardened.

From Fig. 2, it can be seen that for a tensile strength of, say, 200,000 pounds per square inch (1379 MPa), the Brinell hardness could range between 375 and 425. By taking 400 as the mean hardness value and using Fig. 5, it can be seen that the tempering temperature of fully hardened steels of 0.40 to 0.55 per cent carbon content would be 990°F (532°C) and that of fully hardened steels of 0.30 to 0.40 per cent carbon would be 870°F (466°C). This chart also shows that the tempering temperature for a steel not fully hardened would approach 520°F (271°C). A yield point of $0.9 \times 200,000$, or 180,000 pounds per square inch (1241 MPa) is indicated (Fig. 3) for the fully hardened steel with a tensile strength of 200,000 pounds per square inch. Most alloy steels of 200,000 pounds per square inch tensile strength would probably have a reduction in area of close to 44 per cent (Fig. 4) but some would have values in the range of 35 to 53 per cent. Carbon steels of the same tensile strength would probably have a reduction in area of close to 24 per cent but could possibly range from 17 to 31 per cent.

Figs. 3 and 4 represent steel in the quenched and tempered condition and Fig. 2 represents steel in the hardened and tempered, as-rolled, annealed, and normalized conditions. These charts give a good general indication of mechanical properties; however, more exact information when required should be obtained from tests on samples of the individual heats of steel under consideration.

Hardening

Basic Steps in Hardening.—The operation of hardening steel consists fundamentally of two steps. The first step is to heat the steel to some temperature above its transformation point (usually at least 100°F or 56°C above) so that it becomes entirely austenitic in struc-

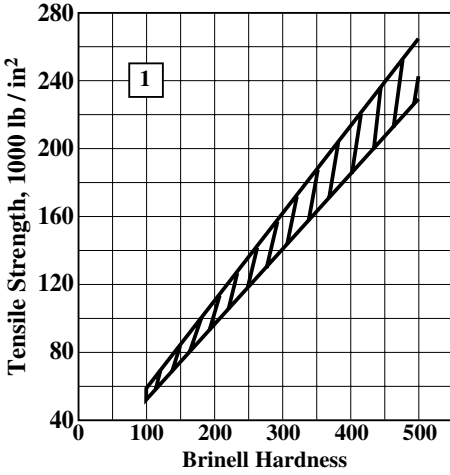


Fig. 2.

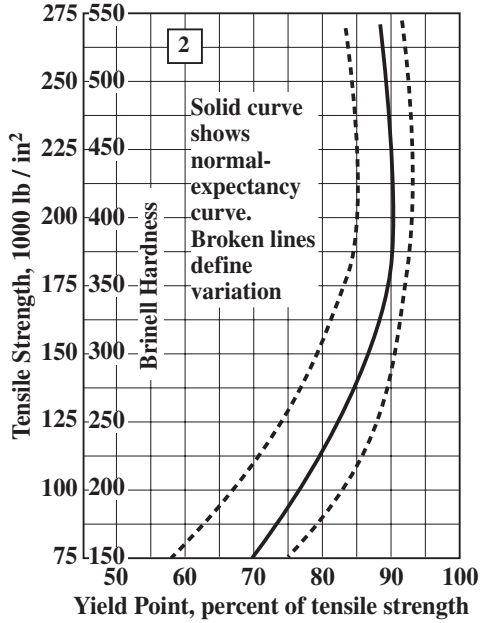


Fig. 3.

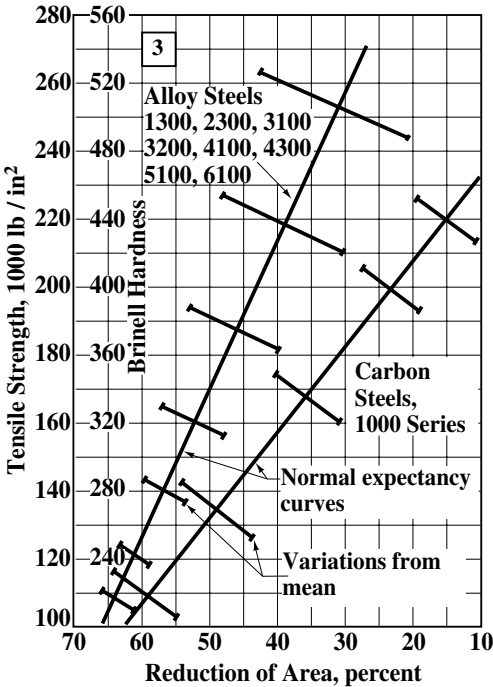


Fig. 4.

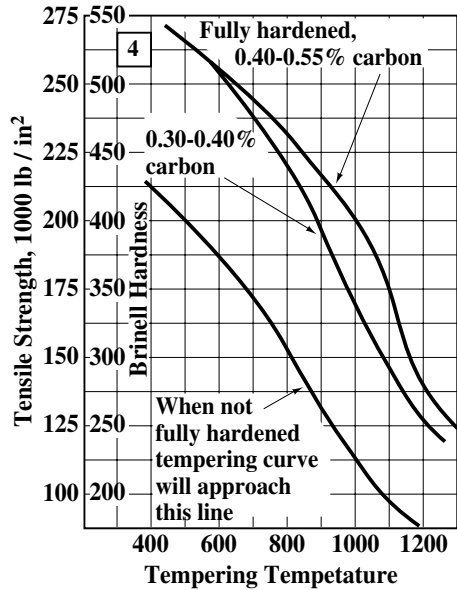


Fig. 5.

ture. The second step is to quench the steel at some rate faster than the critical rate (which depends on the carbon content, the amounts of alloying elements present other than carbon, and the grain size of the austenite) to produce a martensitic structure. The hardness of a martensitic steel depends on its carbon content and ranges from about 460 Brinell at 0.20 per cent carbon to about 710 Brinell above 0.50 carbon. In comparison, ferrite has a hardness of about 90 Brinell, pearlite about 240 Brinell, and cementite around 550 Brinell.

Critical Points of Decalescence and Recalescence.—The critical or transformation point at which pearlite is transformed into austenite as it is being heated is also called the *decalescence point*. If the temperature of the steel was observed as it passed through the

decalescence point, it would be noted that it would continue to absorb heat without appreciably rising in temperature, although the immediate surroundings were hotter than the steel. Similarly, the critical or transformation point at which austenite is transformed back into pearlite on cooling is called the *recalescence point*. When this point is reached, the steel will give out heat so that its temperature instead of continuing to fall, will momentarily increase.

The recalescence point is lower than the decalcescence point by anywhere from 85 to 215°F (47 to 119°C lower), and the lower of these points does not manifest itself unless the higher one has first been fully passed. These critical points have a direct relation to the hardening of steel. Unless a temperature sufficient to reach the decalcescence point is obtained, so that the pearlite is changed into austenite, no hardening action can take place; and unless the steel is cooled suddenly before it reaches the recalescence point, thus preventing the changing back again from austenite to pearlite, no hardening can take place. The critical points vary for different kinds of steel and must be determined by tests. The variation in the critical points makes it necessary to heat different steels to different temperatures when hardening.

Hardening Temperatures.—The maximum temperature to which a steel is heated before quenching to harden it is called the hardening temperature. Hardening temperatures vary for different steels and different classes of service, although, in general, it may be said that the hardening temperature for any given steel is above the lower critical point of that steel.

Just how far above this point the hardening temperature lies for any particular steel depends on three factors: 1) the chemical composition of the steel; 2) the amount of excess ferrite (if the steel has less than 0.85 per cent carbon content) or the amount of excess cementite (if the steel has more than 0.85 per cent carbon content) that is to be dissolved in the austenite; and 3) the maximum grain size permitted, if desired.

The general range of full-hardening temperatures for carbon steels is shown by the diagram. This range is merely indicative of general practice and is not intended to represent absolute hardening temperature limits. It can be seen that for steels of less than 0.85 per cent carbon content, the hardening range is above the upper critical point — that is, above the temperature at which all the excess ferrite has been dissolved in the austenite. On the other hand, for steels of more than 0.85 per cent carbon content, the hardening range lies somewhat below the upper critical point. This indicates that in this hardening range, some of the excess cementite still remains undissolved in the austenite. If steel of more than 0.85 per cent carbon content were heated above the upper critical point and then quenched, the resulting grain size would be excessively large.

At one time, it was considered desirable to heat steel only to the minimum temperature at which it would fully harden, one of the reasons being to avoid grain growth that takes place at higher temperature. It is now realized that no such rule as this can be applied generally since there are factors other than hardness that must be taken into consideration. For example, in many cases, toughness can be impaired by too low a temperature just as much as by too high a temperature. It is true, however, that too high hardening temperatures result in warpage, distortion, increased scale, and decarburization.

Hardening Temperatures for Carbon Tool Steels.—The best hardening temperatures for any given tool steel are dependent on the type of tool and the intended class of service. Wherever possible, the specific recommendations of the tool steel manufacturer should be followed. General recommendations for hardening temperatures of carbon tool steels based on carbon content are as follows: For steel of 0.65 to 0.80 per cent carbon content, 1450 to 1550°F (788 to 843°C); for steel of 0.80 to 0.95 per cent carbon content, 1410 to 1460°F (766 to 793°C); for steel of 0.95 to 1.10 per cent carbon content, 1390 to 1430°F (754 to 777°C); and for steels of 1.10 per cent and over carbon content, 1380 to 1420°F (749 to 771°C). For a given hardening temperature range, the higher temperatures tend to produce deeper hardness penetration and increased compressional strength, whereas the

lower temperatures tend to result in shallower hardness penetration but increased resistance to splitting or bursting stresses.

Determining Hardening Temperatures.—A hardening temperature can be specified directly or it may be specified indirectly as a certain temperature rise above the lower critical point of the steel. Where the temperature is specified directly, a pyrometer of the type that indicates the furnace temperature or a pyrometer of the type that indicates the work temperature may be employed. If the pyrometer shows furnace temperature, care must be taken to allow sufficient time for the work to reach the furnace temperature after the pyrometer indicates that the required hardening temperature has been attained. If the pyrometer indicates work temperature, then, where the workpiece is large, time must be allowed for the interior of the work to reach the temperature of the surface, which is the temperature indicated by the pyrometer.

Where the hardening temperature is specified as a given temperature rise above the critical point of the steel, a pyrometer that indicates the temperature of the work should be used. The critical point, as well as the given temperature rise, can be more accurately determined with this type of pyrometer. As the work is heated, its temperature, as indicated by the pyrometer, rises steadily until the lower critical or decalescence point of the steel is reached. At this point, the temperature of the work ceases to rise and the pyrometer indicating or recording point remains stationary or fluctuates slightly. After a certain elapsed period, depending on the heat input rate, the internal changes in structure of the steel that take place at the lower critical point are completed and the temperature of the work again begins to rise. A small fluctuations in temperature may occur in the interval during which structural changes are taking place, so for uniform practice, the critical point may be considered as the temperature at which the pointer first becomes stationary.

Heating Steel in Liquid Baths.—The liquid bath commonly used for heating steel tools preparatory to hardening are molten lead, sodium cyanide, barium chloride, a mixture of barium and potassium chloride, and other metallic salts. The molten substance is retained in a crucible or pot and the heat required may be obtained from gas, oil, or electricity. The principal advantages of heating baths are as follows: No part of the work can be heated to a temperature above that of the bath; the temperature can be easily maintained at whatever degree has proved, in practice, to give the best results; the submerged steel can be heated uniformly, and the finished surfaces are protected against oxidation.

Salt Baths.—Molten baths of various salt mixtures or compounds are used extensively for heat-treating operations such as hardening and tempering; they are also utilized for annealing ferrous and nonferrous metals. Commercial salt-bath mixtures are available that meet a wide range of temperature and other metallurgical requirements. For example, there are neutral baths for heating tool and die steels without carburizing the surfaces; baths for carburizing the surfaces of low-carbon steel parts; baths adapted for the usual tempering temperatures of, say, 300 to 1100°F (approx. 150 to 595°C); and baths that may be heated to temperatures up to approximately 2400°F (1315°C) for hardening high-speed steels. Salt baths are also adapted for local or selective hardening, the type of bath being selected to suit the requirements. For example, a neutral bath may be used for annealing the ends of tubing or other parts, or an activated cyanide bath for carburizing the ends of shafts or other parts. Surfaces that are not to be carburized are protected by copper plating. When the work is immersed, the unplated surfaces are subjected to the carburizing action.

Baths may consist of a mixture of sodium, potassium, barium, and calcium chlorides or nitrates of sodium, potassium, barium, and calcium in varying proportions, to which sodium carbonate and sodium cyanide are sometimes added to prevent decarburization. Various proportions of these salts provide baths of different properties. Potassium cyanide is seldom used as sodium cyanide costs less. The specific gravity of a salt bath is not as high as that of a lead bath; consequently, the work may be suspended in a salt bath and does not have to be held below the surface as in a lead bath.

The Lead Bath.—The lead bath is extensively used, but is not adapted to the high temperatures required for hardening high-speed steel, as it begins to vaporize at about 1190°F (645°C). As the temperature increases, the lead volatilizes and gives off poisonous vapors; hence, lead furnaces should be equipped with hoods to carry away the fumes. Lead baths are generally used for temperatures below 1500 or 1600°F (815 or 870°C). They are often employed for heating small pieces that must be hardened in quantities. It is important to use pure lead that is free from sulfur. The work should be preheated before plunging it into the molten lead.

Defects in Hardening.—Uneven heating is the cause of most of the defects in hardening. Cracks of a circular form, from the corners or edges of a tool, indicate uneven heating in hardening. Cracks of a vertical nature and dark-colored fissures indicate that the steel has been burned and should be put on the scrap heap. Tools that have hard and soft places have been either unevenly heated, unevenly cooled, or “soaked,” a term used to indicate prolonged heating. A tool not thoroughly moved about in the hardening fluid will show hard and soft places, and have a tendency to crack. Tools that are hardened by dropping them to the bottom of the tank sometimes have soft places, owing to contact with the floor or sides.

Scale on Hardened Steel.—The formation of scale on the surface of hardened steel is due to the contact of oxygen with the heated steel; hence, to prevent scale, the heated steel must not be exposed to the action of the air. When using an oven heating furnace, the flame should be so regulated that it is not visible in the heating chamber. The heated steel should be exposed to the air as little as possible, when transferring it from the furnace to the quenching bath. An old method of preventing scale and retaining a fine finish on dies used in jewelry manufacture, small taps, etc., is as follows: Fill the die impression with powdered boracic acid and place near the fire until the acid melts; then add a little more acid to ensure covering all the surfaces. The die is then hardened in the usual way. If the boracic acid does not come off entirely in the quenching bath, immerse the work in boiling water. Dies hardened by this method are said to be as durable as those heated without the acid.

Hardening or Quenching Baths.—The purpose of a quenching bath is to remove heat from the steel being hardened at a rate that is faster than the critical cooling rate. Generally speaking, the more rapid the rate of heat extraction above the cooling rate, the higher will be the resulting hardness. To obtain the different rates of cooling required by different classes of work, baths of various kinds are used. These include plain or fresh water, brine, caustic soda solutions, oils of various classes, oil-water emulsions, baths of molten salt or lead for high-speed steels, and air cooling for some high-speed steel tools when a slow rate of cooling is required. To minimize distortion and cracking where such tendencies are present, without sacrificing depth-of-hardness penetration, a quenching medium should be selected that will cool rapidly at the higher temperatures and more slowly at the lower temperatures, that is below 750°F (400°C). Oil quenches in general meet this requirement.

Oil Quenching Baths: Oil is used very extensively as a quenching medium as it results in a good proportion of hardness, toughness, and freedom from warpage when used with standard steels. Oil baths are used extensively for alloy steels. Various kinds of oils are employed, such as prepared mineral oils and vegetable, animal, and fish oils, either singly or in combination. Prepared mineral quenching oils are widely used because they have good quenching characteristics, are chemically stable, do not have an objectionable odor, and are relatively inexpensive. Special compounded oils of the soluble type are used in many plants instead of such oils as fish oil, linseed oil, cottonseed oil, etc. The soluble properties enable the oil to form an emulsion with water.

Oil cools steel at a slower rate than water, but the rate is fast enough for alloy steel. Oils have different cooling rates, however, and this rate may vary through the initial and final stages of the quenching operation. Faster cooling in the initial stage and slower cooling at lower temperatures are preferable because there is less danger of cracking the steel. The temperature of quenching oil baths should range ordinarily between 90 and 130°F (32 and

55°C). A fairly constant temperature may be maintained either by circulating the oil through cooling coils or by using a tank provided with a cold-water jacket.

A good quenching oil should possess a flash and fire point sufficiently high to be safe under the conditions used and 350°F (175°C) should be about the minimum point. The specific heat of the oil regulates the hardness and toughness of the quenched steel; and the greater the specific heat, the higher will be the hardness produced. Specific heats of quenching oils vary from 0.20 to 0.75, the specific heats of fish, animal, and vegetable oils usually being from 0.2 to 0.4, and of soluble and mineral oils from 0.5 to 0.7. The efficient temperature range for quenching oil is from 90 to 140°F (32 to 60°C).

Quenching in Water.—Many carbon tool steels are hardened by immersing them in a bath of fresh water, but water is not an ideal quenching medium. Contact between the water and work and the cooling of the hot steel are impaired by the formation of gas bubbles or an insulating vapor film especially in holes, cavities, or pockets. The result is uneven cooling and sometimes excessive strains which may cause the tool to crack; in fact, there is greater danger of cracking in a fresh-water bath than in one containing salt water or brine.

In order to secure more even cooling and reduce danger of cracking, either rock salt (8 or 9 per cent) or caustic soda (3 to 5 per cent) may be added to the bath to eliminate or prevent the formation of a vapor film or gas pockets, thus promoting rapid early cooling. Brine is commonly used and $\frac{3}{4}$ pound of rock salt per gallon (90 gm per liter) of water is equivalent to about 8 per cent of salt. Brine is not inherently a more severe or drastic quenching medium than plain water, although it may seem to be because the brine makes better contact with the heated steel and, consequently, cooling is more effective. In still-bath quenching, a slow up-and-down movement of the tool is preferable to a violent swishing around.

The temperature of water-base quenching baths should preferably be kept around 70°F (21°C), but up to 90 or 100°F (32 to 38°C) is a safe range. The temperature of the hardening bath has a great deal to do with the hardness obtained. The higher the temperature of the quenching water, the more nearly does its effect approach that of oil; and if boiling water is used for quenching, it will have an effect even more gentle than that of oil — in fact, it would leave the steel nearly soft. Parts of irregular shape are sometimes quenched in a water bath that has been warmed somewhat to prevent sudden cooling and cracking.

When water is used, it should be “soft” because unsatisfactory results will be obtained with “hard” water. Any contamination of water-base quenching liquids by soap tends to decrease their rate of cooling. A water bath having 1 or 2 inches (2.5 to 5 cm) of oil on the top is sometimes employed to advantage for quenching tools made of high-carbon steel as the oil through which the work first passes reduces the sudden quenching action of the water.

The bath should be amply large to dissipate the heat rapidly and the temperature should be kept about constant so that successive pieces will be cooled at the same rate. Irregularly shaped parts should be immersed so that the heaviest or thickest section enters the bath first. After immersion, the part to be hardened should be agitated in the bath; the agitation reduces the tendency of the formation of a vapor coating on certain surfaces, and a more uniform rate of cooling is obtained. The work should never be dropped to the bottom of the bath until quite cool.

Flush or Local Quenching by Pressure-Spraying: When dies for cold heading, drawing, extruding, etc., or other tools, require a hard working surface and a relatively soft but tough body, the quenching may be done by spraying water under pressure against the interior or other surfaces to be hardened. Special spraying fixtures are used to hold the tool and apply the spray where the hardening is required. The pressure spray prevents the formation of gas pockets previously referred to in connection with the fresh-water quenching bath; hence, fresh water is effective for flush quenching and there is no advantage in using brine.

Quenching in Molten Salt Bath.—A molten salt bath may be used in preference to oil for quenching high-speed steel. The object in using a liquid salt bath for quenching (instead of

an oil bath) is to obtain maximum hardness with minimum cooling stresses and distortion that might result in cracking expensive tools, especially if there are irregular sections. The temperature of the quenching bath may be around 1100 or 1200°F (595 to 650°C). Quenching is followed by cooling to room temperature and then the tool is tempered or drawn in a bath having a temperature range of 950 to 1100°F (510 to 593°C). In many cases, the tempering temperature is about 1050°F (566°C).

Tanks for Quenching Baths.—The main point to be considered in a quenching bath is to keep it at a uniform temperature, so that successive pieces quenched will be subjected to the same heat treatment. The next consideration is to keep the bath agitated, so that it will not be of different temperatures in different places; if thoroughly agitated and kept in motion, as the case with the bath shown in Fig. 1, it is not even necessary to keep the pieces in motion in the bath, as steam will not be likely to form around the pieces quenched. Experience has proved that if a piece is held still in a thoroughly agitated bath, it will come out much straighter than if it has been moved around in an unagitated bath, an important consideration, especially when hardening long pieces. It is, besides, no easy matter to keep heavy and long pieces in motion unless it be done by mechanical means.

In Fig. 1 is shown a water or brine tank for quenching baths. Water is forced by a pump or other means through the supply pipe into the intermediate space between the outer and inner tank. From the intermediate space, it is forced into the inner tank through holes as indicated. The water returns to the storage tank by overflowing from the inner tank into the outer one and then through the overflow pipe as indicated. In Fig. 3 is shown another water or brine tank of a more common type. In this case, the water or brine is pumped from the storage tank and continuously returned to it. If the storage tank contains a large volume of water, there is no need for a special means for cooling. Otherwise, arrangements must be made for cooling the water after it has passed through the tank. The bath is agitated by the force with which the water is pumped into it. The holes at A are drilled at an angle, so as to throw the water toward the center of the tank. In Fig. 2 is shown an oil-quenching tank in which water is circulated in an outer surrounding tank to keep the oil bath cool. Air is forced into the oil bath to keep it agitated. Fig. 4 shows the ordinary type of quenching tank cooled by water forced through a coil of pipe. This arrangement can be used for oil, water, or brine. Fig. 5 shows a similar type of quenching tank, but with two coils of pipe. Water flows through one of these and steam through the other. By these means, it is possible to keep the bath at a constant temperature.

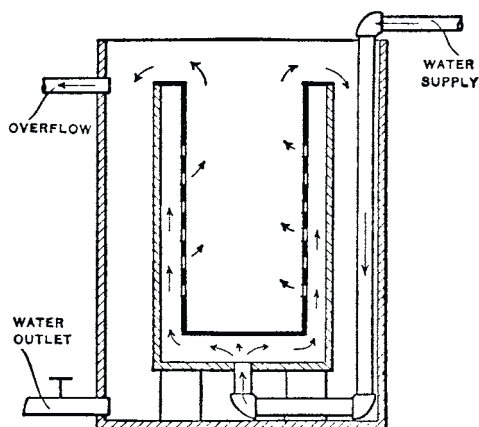


Fig. 1.

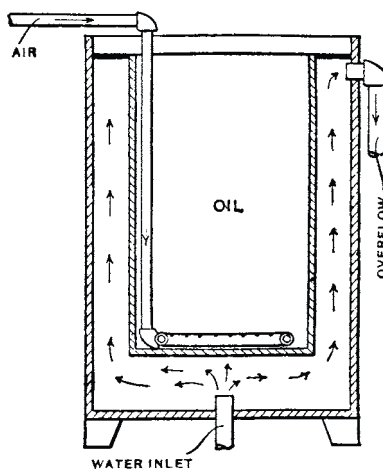


Fig. 2.

Interrupted Quenching.—*Austempering, martempering, and isothermal quenching* are three methods of interrupted quenching that have been developed to obtain greater tough-

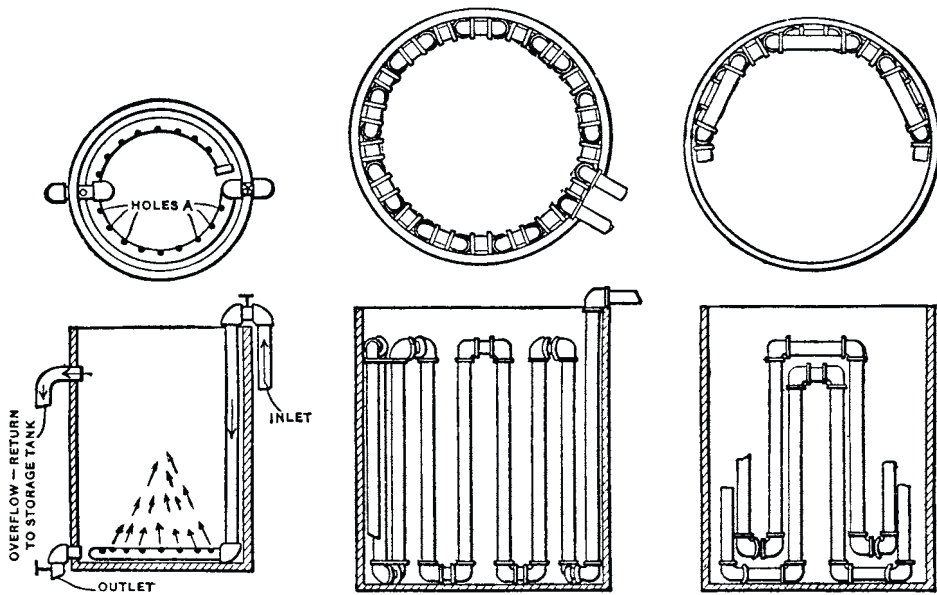


Fig. 3.

Fig. 4.

Fig. 5.

ness and ductility for given hardnesses and to avoid the difficulties of quench cracks, internal stresses, and warpage, frequently experienced when the conventional method of quenching steel directly and rapidly from above the transformation point to atmospheric temperature is employed. In each of these three methods, quenching is begun when the work has reached some temperature above the transformation point and is conducted at a rate faster than the critical rate. The rapid cooling of the steel is interrupted, however, at some temperature above that at which martensite begins to form. The three methods differ in the temperature range at which interruption of the rapid quench takes place, the length of time that the steel is held at this temperature, and whether the subsequent cooling to atmospheric temperature is rapid or slow, and is or is not preceded by a tempering operation.

One of the reasons for maintaining the steel at a constant temperature for a definite period of time is to permit the inside sections of the piece to reach the same temperature as the outer sections so that when transformation of the structure does take place, it will occur at about the same rate and period of time throughout the piece. In order to maintain the constant temperature required in interrupted quenching, a quenching arrangement for absorbing and dissipating a large quantity of heat without increase in temperature is needed. Molten salt baths equipped for water spray or air cooling around the exterior of the bath container have been used for this purpose.

Austempering: This is a heat-treating process in which steels are quenched in a bath maintained at some constant temperature in the range of 350 to 800°F (177 to 427°C), depending on the analysis of the steel and the characteristics to be obtained. On immersion in the quenching bath, the steel is cooled more rapidly than the critical quenching rate. When the temperature of the steel reaches that of the bath, however, the quenching action is interrupted. If the steel is now held at this temperature for a predetermined length of time, say, from 10 to 60 minutes, the austenitic structure of the steel is gradually changed into a new structure, called *bainite*. The structure of bainite is acicular (needlelike) and resembles that of tempered martensite such as is usually obtained by quenching in the usual manner to atmospheric temperature and tempering at 400°F (204°C) or higher.

Hardnesses ranging up to 60 Rockwell C, depending on the carbon and alloy content of the steel, are obtainable and compare favorably with those obtained for the respective steels by a conventional quench and tempering to above 400°F (204°C). Much greater

toughness and ductility are obtained in an austempered piece, however, as compared with a similar piece quenched and tempered in the usual manner.

Two factors are important in austempering. First, the steel must be quenched rapidly enough to the specified subtransformation temperature to avoid any formation of pearlite, and, second, it must be held at this temperature until the transformation from austenite to bainite is completed. Time and temperature transformation curves (called S-curves because of their shape) have been developed for different steels and these curves provide important data governing the conduct of austempering, as well as the other interrupted quenching methods.

Austempering has been applied chiefly to steels having 0.60 per cent or more carbon content with or without additional low-alloy content, and to pieces of small diameter or section, usually under 1 inch (2.5 cm), but varying with the composition of the steel. Case-hardened parts may also be austempered.

Martempering: In this process the steel is first rapidly quenched from some temperature above the transformation point down to some temperature (usually about 400°F or 204°C) just above that at which martensite begins to form. It is then held at this temperature for a length of time sufficient to equalize the temperature throughout the part, after which it is removed and cooled in air. As the temperature of the steel drops below the transformation point, martensite begins to form in a matrix of austenite at a fairly uniform rate throughout the piece. The soft austenite acts as a cushion to absorb some of the stresses which develop as the martensite is formed. The difficulties presented by quench cracks, internal stresses, and dimensional changes are largely avoided, thus a structure of high hardness can be obtained. If greater toughness and ductility are required, conventional tempering may follow. In general, heavier sections can be hardened more easily by the martempering process than by the austempering process. The martempering process is especially suited to the higher-alloyed steels.

Isothermal Quenching: This process resembles austempering in that the steel is first rapidly quenched from above the transformation point down to a temperature that is above that at which martensite begins to form and is held at this temperature until the austenite is completely transformed into bainite. The constant temperature to which the piece is quenched and then maintained is usually 450°F (232°C) or above. The process differs from austempering in that after transformation to a bainite structure has been completed, the steel is immersed in another bath and is brought up to some higher temperature, depending on the characteristics desired, and is maintained at this temperature for a definite period of time, followed by cooling in air. Thus, tempering to obtain the desired toughness or ductility takes place immediately after the structure of the steel has changed to bainite and before it is cooled to atmospheric temperature.

Laser and Electron-Beam Surface Hardening.—Industrial lasers and electron-beam equipment are now available for surface hardening of steels. The laser and electron beams can generate very intense energy fluxes and steep temperature profiles in the workpiece, so that external quench media are not needed. This self-quenching is due to a cold interior with sufficient mass acting as a large heat sink to rapidly cool the hot surface by conducting heat to the interior of a part. The laser beam is a beam of light and does not require a vacuum for operation. The electron beam is a stream of electrons and processing usually takes place in a vacuum chamber or envelope. Both processes may normally be applied to finished machined or ground surfaces, because little distortion results.

Tempering

The object of *tempering* or *drawing* is to reduce the brittleness in hardened steel and to remove the internal strains caused by the sudden cooling in the quenching bath. The tempering process consists in heating the steel by various means to a certain temperature and then cooling it. When steel is in a fully hardened condition, its structure consists largely of

martensite. On reheating to a temperature of about 300 to 750°F (150 to 400°C), a softer and tougher structure known as *troostite* is formed. If the steel is reheated to a temperature of 750 to 1290°F (400 to 700°C), a structure known as *sorbite* is formed that has somewhat less strength than troostite but much greater ductility.

Tempering Temperatures.—If steel is heated in an oxidizing atmosphere, a film of oxide forms on the surface that changes color as the temperature increases. These oxide colors (see [Table 1](#)) have been used extensively in the past as a means of gaging the correct amount of temper; but since these colors are affected to some extent by the composition of the metal, the method is not dependable.

Table 1. Temperatures as Indicated by the Color of Plain Carbon Steel

Degrees		Color of Steel	Degrees		Color of Steel
Fahrenheit	Centigrade		Fahrenheit	Centigrade	
430	221.1	Very pale yellow	510	265.6	Spotted red-brown
440	226.7	Light yellow	520	271.1	Brown-purple
450	232.2	Pale straw-yellow	530	276.7	Light purple
460	237.8	Straw-yellow	540	282.2	Full purple
470	243.3	Deep straw-yellow	550	287.8	Dark purple
480	248.9	Dark yellow	560	293.3	Full blue
490	254.4	Yellow-brown	570	298.9	Dark blue
500	260.0	Brown-yellow	640	337.8	Light blue

The availability of reliable pyrometers in combination with tempering baths of oil, salt, or lead make it possible to heat the work uniformly and to a given temperature within close limits.

Suggested temperatures for tempering various tools are given in [Table 2](#).

Table 2. Tempering Temperatures for Various Plain Carbon Steel Tools

Degrees F	Degrees C	Class of Tool
495 to 500	257 to 260	Taps, ½ inch (1.27 cm) or over, for use on automatic screw machines
495 to 500	257 to 260	Nut taps ½ inch (1.27 cm) and under
515 to 520	268 to 271	Taps, ¼ inch (0.635 cm) and under, for use on automatic screw machines
525 to 530	274 to 277	Thread dies to cut thread close to shoulder
500 to 510	260 to 266	Thread dies for general work
495	257	Thread dies for tool steel or steel tube
525 to 540	274 to 282	Dies for bolt threader threading to shoulder
460 to 470	238 to 243	Thread rolling dies
430 to 435	221 to 224	Hollow mills (solid type) for roughing on automatic screw machines
485	252	Knurls
450	232	Twist drills for hard service
450	232	Centering tools for automatic screw machines
430	221	Forming tools for automatic screw machines
430 to 435	221 to 224	Cut-off tools for automatic screw machines
440 to 450	227 to 232	Profile cutters for milling machines
430	221	Formed milling cutters
435 to 440	224 to 227	Milling cutters
430 to 440	221 to 227	Reamers
460	238	Counterbores and countersinks
480	249	Cutters for tube- or pipe-cutting machines
460 to 520	238 to 271	Snaps for pneumatic hammers — harden full length, temper to 460°F (238°C), then bring point to 520°F (271°C)

Tempering in Oil.—Oil baths are extensively used for tempering tools (especially in quantity), the work being immersed in oil heated to the required temperature, which is indicated by a thermometer. It is important that the oil have a uniform temperature throughout and that the work be immersed long enough to acquire this temperature. Cold steel should not be plunged into a bath heated for tempering, owing to the danger of cracking. The steel should either be preheated to about 300°F (150°C), before placing it in the bath, or the latter should be at a comparatively low temperature before immersing the steel, and then be heated to the required degree. A temperature of from 650 to 700°F (343 to 371°C) can be obtained with heavy tempering oils; for higher temperatures, either a bath of nitrate salts or a lead bath may be used.

In tempering, the best method is to immerse the pieces to be tempered before starting to heat the oil, so that they are heated with the oil. After the pieces tempered are taken out of the oil bath, they should be immediately dipped in a tank of caustic soda, and after that in a tank of hot water. This will remove all oil that might adhere to the tools. The following tempering oil has given satisfactory results: mineral oil, 94 per cent; saponifiable oil, 6 per cent; specific gravity, 0.920; flash point, 550°F (288°C); fire test, 625°F (329°C).

Tempering in Salt Baths.—Molten salt baths may be used for tempering or drawing operations. Nitrate baths are particularly adapted for the usual drawing temperature range of, say, 300 to 1100°F (150 to 595°C). Tempering in an oil bath usually is limited to temperatures of 500 to 600°F (260 to 315°C), and some heat-treating specialists recommend the use of a salt bath for temperatures above 350 or 400°F (175 or 205°C), as it is considered more efficient and economical. Tempering in a bath (salt or oil) has several advantages, such as ease in controlling the temperature range and maintenance of a uniform temperature. The work is also heated much more rapidly in a molten bath. A gas- or oil-fired muffle or semimuffle furnace may be used for tempering, but a salt bath or oil bath is preferable. A salt bath is recommended for tempering high-speed steel, although furnaces may also be used. The bath or furnace temperature should be increased gradually, say, from 300 to 400°F (150 to 205°C) up to the tempering temperature, which may range from 1050 to 1150°F (565 to 620°C) for high-speed steel.

Tempering in a Lead Bath.—The lead bath is commonly used for heating steel in connection with tempering, as well as for hardening. The bath is first heated to the temperature at which the steel should be tempered; the preheated work is then placed in the bath long enough to acquire this temperature, after which it is removed and cooled. As the melting temperature of pure lead is about 620°F (327°C), tin is commonly added to it to lower the temperature sufficiently for tempering. Reductions in temperature can be obtained by varying the proportions of lead and tin, as shown in [Table 3](#).

Table 3. Temperatures of Lead Bath Alloys

Parts Lead	Parts Tin	Melting Temp.,		Parts Lead	Parts Tin	Melting Temp.,		Parts Lead	Parts Tin	Melting Temp.,	
		Deg. F	Deg. C			Deg. F	Deg. C			Deg. F	Deg. C
200	8	560	293	39	8	510	266	19	8	460	238
100	8	550	288	33	8	500	260	17	8	450	232
75	8	540	282	28	8	490	254	16	8	440	227
60	8	530	277	24	8	480	249	15	8	430	221
48	8	520	271	21	8	470	243	14	8	420	216

To Prevent Lead from Sticking to Steel.—To prevent hot lead from sticking to parts heated in it, mix common whiting with wood alcohol, and paint the part that is to be heated. Water can be used instead of alcohol, but in that case, the paint must be thoroughly dry, as otherwise the moisture will cause the lead to “fly.” Another method is to make a thick paste according to the following formula: pulverized charred leather, 1 pound; fine wheat flour, 1½ pounds; fine table salt, 2 pounds. Coat the tool with this paste and heat slowly until dry,

then proceed to harden. Still another method is to heat the work to a blue color, or about 600°F (316°C), and then dip it in a strong solution of salt water, prior to heating in the lead bath. The lead is sometimes removed from parts having fine projections or teeth, by using a stiff brush just before immersing in the cooling bath. Removal of lead is necessary to prevent the formation of soft spots.

Tempering in Sand.—The sand bath is used for tempering certain classes of work. One method is to deposit the sand on an iron plate or in a shallow box that has burners beneath it. With this method of tempering, tools such as boiler punches, etc., can be given a varying temper by placing them endwise in the sand. As the temperature of the sand bath is higher toward the bottom, a tool can be so placed that the color of the lower end will become a deep dark blue when the middle portion is a very dark straw, and the working end or top a light straw color, the hardness gradually increasing from the bottom up.

Double Tempering.—In tempering high-speed steel tools, it is common practice to repeat the tempering operation or “double temper” the steel. Double tempering is done by heating the steel to tempering temperature, say 1050°F (566°C), and holding it at that temperature for two hours. It is then cooled to room temperature, reheated to the same temperature for another two-hour period, and again cooled to room temperature. After the first tempering operation, some untempered martensite remains in the steel. This martensite is not only tempered by a second tempering operation but is relieved of internal stresses, thus improving the steel for service conditions. The hardening temperature for the higher-alloy steels may affect the hardness after tempering. For example, molybdenum high-speed steel heated to 2100°F (1149°C) had a hardness of 61 Rockwell C after tempering, whereas a temperature of 2250°F (1232°C) resulted in hardness of 64.5 Rockwell C after tempering.

Annealing, Spheroidizing, and Normalizing

Annealing of steel is a heat-treating process in which the steel is heated to some elevated temperature, usually in or near the critical range, is held at this temperature for some period of time, and is then cooled, usually at a slow rate. Spheroidizing and normalizing may be considered as special cases of annealing.

The *full annealing* of carbon steel consists in heating it slightly above the *upper* critical point for hypoeutectoid steels (steels of less than 0.85 per cent carbon content) and slightly above the *lower* critical point for hypereutectoid steels (steels of more than 0.85 per cent carbon content), holding it at this temperature until it is uniformly heated and then slowly cooling it to 1000°F (538°C) or below. The resulting structure is layerlike, or lamellar, in character due to the pearlite that is formed during the slow cooling.

Annealing is employed 1) to soften steel for machining, cutting, stamping, etc., or for some particular service; 2) to alter ductility, toughness, electrical or magnetic characteristics or other physical properties; 3) to refine the crystal structure; 4) to produce grain reorientation; and 5) to relieve stresses and hardness resulting from cold working.

The *spheroidizing* of steel, according to the American Society of Metals, is “any process of heating and cooling that produces a rounded or globular form of carbide.” High-carbon steels are spheroidized to improve their machinability especially in continuous cutting operations such as are performed by lathes and screw machines. In low-carbon steels, spheroidizing may be employed to meet certain strength requirements before subsequent heat treatment. Spheroidizing also tends to increase resistance to abrasion.

The *normalizing* of steel consists in heating it to some temperature above that used for annealing, usually about 100°F (56°C) above the upper critical range, and then cooling it in still air at room temperature. Normalizing is intended to put the steel into a uniform, unstressed condition of proper grain size and refinement so that it will properly respond to further heat treatments. It is particularly important in the case of forgings that are to be later heat treated. Normalizing may or may not (depending on the composition) leave steel in a sufficiently soft state for machining with available tools. Annealing for machinability is

often preceded by normalizing and the combined treatment — frequently called a *double anneal* — produces a better result than a simple anneal.

Annealing Practice.—For carbon steels, the following annealing temperatures are recommended by the American Society for Testing and Materials:

Per cent carbon	Annealing Temperature	
	°F	°C
less than 0.12%	1600 to 1700	871 to 927
0.12 to 0.29%	1550 to 1600	843 to 871
0.30 to 0.49%	1500 to 1550	816 to 843
0.50 to 1.00%	1450 to 1500	788 to 816

Slightly lower temperatures are satisfactory for steels having more than 0.75 per cent manganese content. Heating should be uniform to avoid the formation of additional stresses. In the case of large workpieces, the heating should be slow enough so that the temperature of the interior does not lag too far behind that of the surface.

It has been found that in annealing steel, the higher the temperature to which it is heated to produce an austenitic structure, the greater the tendency of the structure to become lamellar (pearlitic) in cooling. On the other hand, the closer the austenitizing temperature to the critical temperature, the greater is the tendency of the annealed steel to become spheroidal.

Rate of Cooling: After heating the steel to some temperature within the annealing range, it should be cooled slowly enough to permit the development of the desired softness and ductility. In general, the slower the cooling rate, the greater the resulting softness and ductility. Steel of a high-carbon content should be cooled more slowly than steel of a low-carbon content; and the higher the alloy content, the slower is the cooling rate usually required. Where extreme softness and ductility are not required, the steel may be cooled in the annealing furnace to some temperature well below the critical point, say, to about 1000°F (538°C) and then removed and cooled in air.

Annealing by Constant-Temperature Transformation.—It has been found that steel that has been heated above the critical point so that it has an austenitic structure can be transformed into a lamellar (pearlitic) or a spheroidal structure by holding it for a definite period of time at some constant subcritical temperature. In other words, it is feasible to anneal steel by means of a constant-temperature transformation as well as by the conventional continuous cooling method. When the constant-temperature transformation method is employed, the steel, after being heated to some temperature above the critical and held at this temperature until it is austenitized, is cooled as rapidly as feasible to some relatively high subcritical transformation temperature. This temperature selection is governed by the desired microstructure and hardness required and is taken from a transformation time and temperature curve (often called a TTT curve). As drawn for a particular steel, such a curve shows the length of time required to transform that steel from an austenitic state at various subcritical temperatures. After being held at the selected sub-critical temperature for the required length of time, the steel is cooled to room temperature — again, as rapidly as feasible. This rapid cooling down to the selected transformation temperature and then down to room temperature has a negligible effect on the structure of the steel and often produces a considerable time saving over the conventional slow cooling method of annealing.

The softest condition in steel can be developed by heating it to a temperature usually less than 100°F (56°C) above the lower critical point and then cooling it to some temperature, usually less than 100 degrees (56°C), below the critical point, where it is held until the transformation is completed. Certain steels require a very lengthy period of time for transformation of the austenite when held at a constant temperature within this range. For such steels, a practical procedure is to allow most of the transformation to take place in this temperature range where a soft product is formed and then to finish the transformation at a lower temperature where the time for the completion of the transformation is short.

Spheroidizing Practice.—A common method of spheroidizing steel consists in heating it to or slightly below the lower critical point, holding it at this temperature for a period of time, and then cooling it slowly to about 1000°F (538°C) or below. The length of time for which the steel is held at the spheroidizing temperature largely governs the degree of spheroidization. High-carbon steel may be spheroidized by subjecting it to a temperature that alternately rises and falls between a point within and a point without the critical range. Tool steel may be spheroidized by heating to a temperature slightly above the critical range and then, after being held at this temperature for a period of time, cooling without removal from the furnace.

Normalizing Practice.—When using the lower-carbon steels, simple normalizing is often sufficient to place the steel in its best condition for machining and will lessen distortion in carburizing or hardening. In the medium- and higher-carbon steels, combined normalizing and annealing constitutes the best practice. For unimportant parts, the normalizing may be omitted entirely or annealing may be practiced only when the steel is otherwise difficult to machine. Both processes are recommended in the following heat treatments (for SAE steels) as representing the best metallurgical practice. The temperatures recommended for normalizing and annealing have been made indefinite in many instances because of the many different types of furnaces used in various plants and the difference in results desired.

Case Hardening

In order to harden low-carbon steel, it is necessary to increase the carbon content of the surface of the steel so that a thin outer “case” can be hardened by heating the steel to the hardening temperature and then quenching it. The process, therefore, involves two separate operations. The first is the *carburizing* operation for impregnating the outer surface with sufficient carbon, and the second operation is that of heat treating the carburized parts so as to obtain a hard outer case and, at the same time, give the “core” the required physical properties. The term “case hardening” is ordinarily used to indicate the complete process of carburizing and hardening.

Carburization.—Carburization is the result of heating iron or steel to a temperature below its melting point in the presence of a solid, liquid, or gaseous material that decomposes so as to liberate carbon when heated to the temperature used. In this way, it is possible to obtain by the gradual penetration, diffusion, or absorption of the carbon by the steel, a “zone” or “case” of higher-carbon content at the outer surfaces than that of the original object. When a carburized object is rapidly cooled or quenched in water, oil, brine, etc., from the proper temperature, this case becomes hard, leaving the inside of the piece soft, but of great toughness.

Use of Carbonaceous Mixtures.—When carburizing materials of the solid class are used, the case-hardening process consists in packing steel articles in metal boxes or pots, with a carbonaceous compound surrounding the steel objects. The boxes or pots are sealed and placed in a carburizing oven or furnace maintained usually at a temperature of from about 1650 to 1700°F (899 to 927°C) for a length of time depending on the extent of the carburizing action desired. The carbon from the carburizing compound will then be absorbed by the steel on the surfaces desired, and the low-carbon steel is converted into high-carbon steel at these portions. The internal sections and the insulated parts of the object retain practically their original low-carbon content. The result is a steel of a dual structure, a high-carbon and a low-carbon steel in the same piece. The carburized steel may now be heat treated by heating and quenching, in much the same way as high-carbon steel is hardened, in order to develop the properties of hardness and toughness; but as the steel is, in reality, two steels in one, one high-carbon and one low-carbon, the correct heat treatment after carburizing includes two distinct processes, one suitable for the high-carbon portion or the “case,” as it is generally called, and one suitable for the low-carbon portion or core. The method of heat treatment varies according to the kind of steel used. Usually, an

initial heating and slow cooling is followed by reheating to 1400-1450°F (760 to 788°C), quenching in oil or water, and a final tempering. More definite information is given in the following section on SAE steels.

Carburizers: There are many commercial carburizers on the market in which the materials used as the generator may be hard and soft wood charcoal, animal charcoal, coke, coal, beans and nuts, bone and leather, or various combinations of these. The energizers may be barium, cyanogen, and ammonium compounds, various salts, soda ash, or lime and oil hydrocarbons.

Pack-Hardening.—When cutting tools, gages, and other parts made from high-carbon steels are heated for hardening while packed in some carbonaceous material in order to protect delicate edges, corners, or finished surfaces, the process usually is known as pack-hardening. Thus, the purpose is to protect the work, prevent scale formation, ensure uniform heating, and minimize the danger of cracking and warpage. The work is packed, as in carburizing, and in the same type of receptacle. Common hardwood charcoal often is used, especially if it has had an initial heating to eliminate shrinkage and discharge its more impure gases. The lowest temperature required for hardening should be employed for pack-hardening — usually 1400 to 1450°F (760 to 788°C) for carbon steels. Pack-hardening has also been applied to high-speed steels, but modern developments in heat-treating salts have made it possible to harden high-speed steel without decarburization, injury to sharp edges, or marring the finished surfaces. See *Salt Baths* on page 474.

Cyanide Hardening.—When low-carbon steel requires a very hard outer surface but does not need high shock-resisting qualities, the cyanide-hardening process may be employed to produce what is known as superficial hardness. This superficial hardening is the result of carburizing a very thin outer skin (which may be only a few thousandths inch thick) by immersing the steel in a bath containing sodium cyanide. The temperatures usually vary from 1450 to 1650°F (788 to 899°C) and the percentage of sodium cyanide in the bath extends over a wide range, depending on the steel used and properties required.

Nitriding Process.—Nitriding is a process for surface hardening certain alloy steels by heating the steel in an atmosphere of nitrogen (ammonia gas) at approximately 950°F (510°C). The steel is then cooled slowly. Finish machined surfaces hardened by nitriding are subject to minimum distortion. The physical properties, such as toughness, high impact strength, etc., can be imparted to the core by previous heat treatments and are unaffected by drawing temperatures up to 950°F (510°C). The “Nitralloy” steels suitable for this process may be readily machined in the heat-treated as well as in the annealed state, and they forge as easily as alloy steels of the same carbon content. Certain heat treatments must be applied prior to nitriding, the first being annealing to relieve rolling, forging, or machining strains. Parts or sections not requiring heat treating should be machined or ground to the exact dimensions required. Close tolerances must be maintained in finish machining, but allowances for growth due to adsorption of nitrogen should be made, and this usually amounts to about 0.0005 inch (0.0127 mm) for a case depth of 0.02 inch (0.508 mm). Parts requiring heat treatment for definite physical properties are forged or cut from annealed stock, heat treated for the desired physical properties, rough machined, normalized, and finish machined. If quenched and drawn parts are normalized afterwards, the drawing and normalizing temperatures should be alike. The normalizing temperature may be below but should never be above the drawing temperature.

Ion Nitriding.—Ion nitriding, also referred to as glow discharge nitriding, is a process for case hardening of steel parts such as tool spindles, cutting tools, extrusion equipment, forging dies, gears, and crankshafts. An electrical potential ionizes low-pressure nitrogen gas, and the ions produced are accelerated to and impinge on the workpiece, heating it to the appropriate temperature for diffusion to take place. Therefore, there is no requirement for a supplemental heat source. The inward diffusion of the nitrogen ions forms the iron and

alloy nitrides in the case. White layer formation, familiar in conventional gas nitriding, is readily controlled by this process.

Liquid Carburizing.—Activated liquid salt baths are now used extensively for carburizing. Sodium cyanide and other salt baths are used. The salt bath is heated by electrodes immersed in it, the bath itself acting as the conductor and resistor. One or more groups of electrodes, with two or more electrodes per group, may be used. The heating is accompanied by a stirring action to ensure uniform temperature and carburizing activity throughout the bath. The temperature may be controlled by a thermocouple immersed in the bath and connecting with a pyrometer designed to provide automatic regulation. The advantages of liquid baths include rapid action; uniform carburization; minimum distortion; and elimination of the packing and unpacking required when carbonaceous mixtures are used. In selective carburizing, the portions of the work that are not to be carburized are copper-plated and the entire piece is then immersed in an activated cyanide bath. The copper inhibits any carburizing action on the plated parts, and this method offers a practical solution for selectively carburizing any portion of a steel part.

Gas Carburizing.—When carburizing gases are used, the mixture varies with the type of case and quality of product desired. The gaseous hydrocarbons most widely used are methane (natural gas), propane, and butane. These carbon-bearing gases are mixed with air, with manufactured gases of several types, with flue gas, or with other specially prepared “diluent” gases. It is necessary to maintain a continuous fresh stream of carburizing gases to the carburizing retort or muffle, as well as to remove the spent gases from the muffle continuously, in order to obtain the correct mixture of gases inside the muffle. A slight pressure is maintained on the muffle to exclude unwanted gases.

The horizontal rotary type of gas carburizing furnace has a retort or muffle that revolves slowly. This type of furnace is adapted to small parts such as ball and roller bearings, chain links, small axles, bolts, etc. With this type of furnace, very large pieces such as gears, for example, may be injured by successive shocks due to tumbling within the rotor.

The vertical pit type of gas carburizer has a stationary workholder that is placed vertically in a pit. The work, instead of circulating in the gases as with the rotary type, is stationary and the gases circulate around it. This type is applicable to long large shafts or other parts or shapes that cannot be rolled in a rotary type of furnace.

There are three types of continuous gas furnaces that may be designated as

- 1) direct quench and manually operated
- 2) direct quench and mechanically operated
- 3) cooling-zone type

Where production does not warrant using a large continuous-type furnace, a horizontal muffle furnace of the batch type may be used, especially if the quantities of work are varied and the production not continuous.

Vacuum Carburizing.—Vacuum carburizing is a high-temperature gas carburizing process that is performed at pressures below atmospheric. The furnace atmosphere usually consists solely of an enriching gas, such as natural gas, pure methane, or propane; nitrogen is sometimes used as a carrier gas. Vacuum carburizing offers several advantages such as combining of processing operations and reduced total processing time.

Carburizing Steels.—A low-carbon steel containing, say, from 0.10 to 0.20 per cent of carbon is suitable for carburized case hardening. In addition to straight-carbon steels, the low-carbon alloy steels are employed. The alloys add to case-hardened parts the same advantageous properties that they give to other classes of steel. Various steels suitable for case hardening will be found in the section on SAE steels.

To Clean Work after Case Hardening.—To clean work, especially if knurled, or if dirt is likely to stick into crevices after case hardening, wash it in caustic soda (1 part soda to 10 parts water). In making the solution, the soda should be put into hot water gradually, and the mixture stirred until the soda is thoroughly dissolved. A still more effective method of

cleaning is to dip the work into a mixture of 1 part sulfuric acid and 2 parts water. Leave the pieces in this mixture about three minutes; then wash them immediately in a soda solution.

Flame Hardening.—This method of hardening is especially applicable to the selective hardening of large steel forgings or castings that must be finish-machined prior to heat-treatment, or that because of size or shape cannot be heat treated by using a furnace or bath. An oxyacetylene torch is used to heat quickly the surface to be hardened; this surface is then quenched to secure a hardened layer that may vary in depth from a mere skin to $\frac{1}{4}$ inch (6.35 mm) and with hardness ranging from 400 to 700 Brinell. A multiflame torchhead may be equipped with quenching holes or a spray nozzle back of the flame. This is not a carburizing or a case-hardening process as the torch is only a heating medium. Most authorities recommend tempering or drawing of the hardened surface at temperatures between 200 and 350°F (93 and 177°C). This treatment may be done in a standard furnace, an oil bath, or with a gas flame. It should follow the hardening process as closely as possible. Medium-carbon and many low-alloy steels are suitable for flame hardening. Plain carbon steels ranging from 0.35 to 0.60 per cent carbon will give hardnesses of from 400 to 700 Brinell. Steels in the 0.40 to 0.45 per cent carbon range are preferred, as they have excellent core properties and produce hardnesses of from 400 to 500 Brinell without checking or cracking. Higher-carbon steels will give greater hardnesses, but extreme care must be taken to prevent cracking. Careful control of the quenching operation is required.

Spinning Method of Flame Hardening: This method is employed on circular objects that can be rotated or spun past a stationary flame. It may be subdivided according to the speed of rotation, as where the part is rotated slowly in front of a stationary flame and the quench is applied immediately after the flame. This method is used on large circular pieces such as track wheels and bearing surfaces. There will be a narrow band of material with lower hardness between adjacent torches if more than one path of the flame is required to harden the surface. There will also be an area of lower hardness where the flame is extinguished. A second method is applicable to small rollers or pinions. The work is spun at a speed of 50 to 150 rpm in front of the flame until the entire piece has reached the proper temperature; then it is quenched as a unit by a cooling spray or by ejecting it into a cooling bath.

The Progressive Method: In this method the torch travels along the face of the work and the work remains stationary. It is used to harden lathe ways, gear teeth, and track rails.

The Stationary or Spot-hardening Method: When this method is employed, the work and torch are both stationary. When the spot to be hardened reaches the quenching temperature, the flame is removed and the quench applied.

The Combination Method: This approach is a combination of the spinning and progressive methods, and is used for long bearing surfaces. The work rotates slowly past the torch as the torch travels longitudinally across the face of the work at the rate of the torch width per revolution of the work.

Equipment for the stationary method of flame hardening consists merely of an acetylene torch, an oxyacetylene supply, and a suitable means of quenching; but when the other methods are employed, work-handling tools are essential and specialty designed torches are desirable. A lathe is ideally suited for the spinning or combination hardening method, whereas a planer is easily adapted for progressive hardening. Production jobs, such as the hardening of gears, require specially designed machines. These machines reduce handling and hardening time, as well as assuring consistent results.

Induction Hardening.—The hardening of steel by means of induction heating and subsequent quenching in either liquid or air is particularly applicable to parts that require localized hardening or controlled depth of hardening and to irregularly shaped parts, such as cams that require uniform surface hardening around their contour.

Advantages offered by induction hardening are: 1) a short heating cycle that may range from a fraction of a second to several seconds; heat energy can be induced in a piece of steel

at the rate of 100 to 250 Btu/in²/min (165 to 410 J/mm²/min) by induction heating, as compared with a rate of 3 Btu/in²/min (5 J/mm²/min) for the same material at room temperature when placed in a furnace with a wall temperature of 2000°F (1093°C); 2) absence of tendency to produce oxidation or decarburization; 3) exact control of depth and area of hardening; 4) close regulation of degree of hardness obtained by automatic timing of heating and quenching cycles; 5) minimum amount of warpage or distortion; and 6) possibility of substituting carbon steels for higher-cost alloy steels.

The principal advantage of induction hardening to the designer lies in its application to localized zones. Thus, specific areas in a given part can be heat treated separately to the respective hardnesses required. Parts can be designed so that the stresses at any given point in the finished piece can be relieved by local heating. Parts can be designed in which welded or brazed assemblies are built up prior to heat treating with only internal surfaces or projections requiring hardening.

Types of Induction Heating Equipment.—Induction heating is secured by placing the metal part inside or close to an “applicator” coil of one or more turns, through which alternating current is passed. The coil, formed to suit the general class of work to be heated, is usually made of copper tubing through which water is passed to prevent overheating of the coil itself. The workpiece is held either in a fixed position or is rotated slowly within or close to the applicator coil. Where the length of work is too great to permit heating in a fixed position, progressive heating may be employed. Thus, a rod or tube of steel may be fed through an applicator coil of one or more turns so that the heating zone travels progressively along the entire length of the workpiece.

The frequency of the alternating current used and the type of generator employed to supply this current to the applicator coil depend on the character of the work to be done.

There are three types of commercial equipment used to produce high-frequency current for induction heating: 1) motor generator sets that deliver current at frequencies of approximately 1000, 2000, 3000, and 10,000 cycles; 2) spark gap oscillator units that produce frequencies ranging from 80,000 to 300,000 cycles; and 3) vacuum tube oscillator sets, which produce currents at frequencies ranging from 350,000 to 15,000,000 cycles or more.

Depth of Heat Penetration.—Generally speaking, the higher the frequency used, the shallower the depth of heat penetration. For heating clear through, for deep hardening, and for large workpieces, low power concentrations and low frequencies are usually used. For very shallow and closely controlled depths of heating, as in surface hardening, and in localized heat treating of small workpieces, currents at high frequencies are used.

For example, a ½-inch (12.7 mm) round bar of hardenable steel will be heated through its entire structure quite rapidly by an induced current of 2000 cycles. After quenching, the bar would show through hardness with a decrease in hardness from surface to center. The same piece of steel could be readily heated and surface hardened to a depth of 0.100 inch (2.5 mm) with current at 9600 cycles, and to an even shallower depth with current at 100,000 cycles. A ¼-inch (6.35 mm) bar, however, would not reach a sufficiently high temperature at 2000 cycles to permit hardening, but at 9600 cycles through hardening would be accomplished. Current at over 100,000 cycles would be needed for surface hardening such a bar.

Types of Steel for Induction Hardening.—Most of the standard types of steels can be hardened by induction heating, providing the carbon content is sufficient to produce the desired degree of hardness by quenching. Thus, low-carbon steels with a carburized case, medium- and high-carbon steels (both plain and alloy), and cast iron with a portion of the carbon in combined form, may be used for this purpose. Induction heating of alloy steels should be limited primarily to the shallow hardening type, that is those of low alloy content, otherwise the severe quench usually required may result in a highly stressed surface with consequent reduced load-carrying capacity and danger of cracking.

Through Hardening, Annealing, and Normalizing by Induction.—For through hardening, annealing, and normalizing by induction, low power concentrations are desirable to prevent too great a temperature differential between the surface and the interior of the work. A satisfactory rate of heating is obtained when the total power input to the work is slightly greater than the radiation losses at the desired temperature. If possible, as low a frequency should be used as is consistent with good electrical coupling. A number of applicator coils may be connected in a series so that several workpieces can be heated simultaneously, thus reducing the power input to each. Widening the spacing between work and applicator coil also will reduce the amount of power delivered to the work.

Induction Surface Hardening.—As indicated on page 488 in “*Depth of Heat Penetration*” currents at much higher frequencies are required in induction surface hardening than in through hardening by induction. In general, the smaller the workpiece, the thinner the section, or the shallower the depth to be hardened, the higher will be the frequency required. High power concentrations are also needed to make possible a short heating period so that an undue amount of heat will not be conducted to adjacent or interior areas, where a change in hardness is not desired. Generators of large capacity and applicator coils of but a few turns, or even a single turn, provide the necessary concentration of power in the localized area to be hardened.

Induction heating of internal surfaces, such as the interior of a hollow cylindrical part or the inside of a hole, can be accomplished readily with applicator coils shaped to match the cross-section of the opening, which may be round, square, elliptical or other form. If the internal surface is of short length, a multiturn applicator coil extending along its entire length may be employed. Where the power available is insufficient to heat the entire internal surface at once, progressive heating is used. For this purpose, an applicator coil of few turns — often but a single turn — is employed, and either coil or work is moved so that the heated zone passes progressively from one end of the hole or opening to the other. For bores of small diameter, a hairpin-shaped applicator, extending the entire length of the hole, may be used and the work rotated about the axis of the hole to ensure even heating.

Quenching After Induction Heating.—After induction heating, quenching may be by immersion in a liquid bath (usually oil), by liquid spray (usually water), or by self-quenching. The term “self-quenching” is used when there is no quenching medium and hardening of the heated section is due chiefly to rapid absorption of heat by the mass of cool metal adjacent to it. Quenching by immersion offers the advantage of even cooling and is particularly satisfactory for through heated parts. Spray quenching may be arranged so that the quenching ring and applicator coil are in the same or adjacent units, permitting the quenching cycle to follow the heating cycle immediately without removal of the work from the holding fixture. Automatic timing to a fraction of a second may also be employed for both heating and quenching with this arrangement to secure the exact degree of hardness desired. Self-quenching is applicable only in thin-surface hardening where the mass of adjacent cool metal in the part is great enough to conduct the heat rapidly out of the surface layer that is being hardened. It has been recommended that for adequate self-quenching, the mass of the unheated section should be at least ten times that of the heated shell. It has been found difficult to use the self-quenching technique to produce hardened shells of much more than about 0.060 inch (1.52 mm) thickness. Close to this limit, self-quenching can only be accomplished with the easily hardenable steels. By using a combination of self-quench and liquid quench, however, it is possible to produce hardened shells on work too thin to self-quench completely. In general, self-quenching is confined chiefly to relatively small parts and simple shapes.

Induction Hardening of Gear Teeth.—Several advantages are claimed for the induction hardening of gear teeth. One advantage is that the gear teeth can be completely machined, including shaving, when in the soft-annealed or normalized condition, and then hardened, because when induction heating is used, distortion is held to a minimum. Another advantage claimed is that bushings and inserts can be assembled in the gears before hardening. A

wide latitude in choice of built-up webs and easily machined hubs is afforded because the hardness of neither web nor hub is affected by the induction-hardening operation although slight dimensional changes may occur in certain designs. Regular carbon steels can be used in place of alloy steels for a wide variety of gears, and steel with a higher carbon content can frequently be substituted for a carburizing steel so that the carburizing operation can be eliminated. Another saving in time is the elimination of cleaning after hardening.

In heating spur gear teeth by induction, the gear is usually placed inside a circular unit that combines the applicator coil and quenching ring. An automatic timing device controls both the heating and quenching cycles. During the heating cycle, the gear is rotated at 25 to 35 rpm to ensure uniform heating.

In hardening bevel gears, the applicator coil is wound to conform to the face angle of the gear. In some spiral-bevel gears, there is a tendency to obtain more heat on one side of the tooth than on the other. In some sizes of spiral-bevel gears, this tendency can be overcome by applying slightly more heat to ensure hardening of the concave side. In some forms of spiral-bevel gears, it has been the practice to carburize that part of the gear surface which is to be hardened, after the teeth have been rough-cut. Carburizing is followed by the finish-cutting operation, after which the teeth can be induction heated, using a long enough period to heat the entire tooth. When the gear is quenched, only the carburized surface will become hardened.

Table 4a. Typical Heat Treatments for SAE Carbon Steels (Carburizing Grades)

SAE No.	Normalize, Deg. F	Carburize		Cool ^a	Reheat		Cool ^a	2nd Reheat, Deg. F	Cool ^a	Temper. ^b		
		Deg. F	Deg. C		Deg. F	Deg. C				Deg. F	Deg. C	
1010 to 1022	{	...	1650–1700	899–927	A	250–400	121– 204	
		...	1650–1700	899–927	B	1400–1450	760–788	A	...	250–400	121– 204	
		...	1650–1700	899–927	C	1400–1450	760–788	A	...	250–400	121– 204	
		...	1650–1700	899–927	C	1650–1700	899–927	B	1400–1450	A	250–400	121– 204
		...	1500–1650 ^{c,d}	816–899 ^{c,d}	B	Optional	Optional
...	1350–1575 ^{e,d}	732–857 ^{e,d}	D	Optional	Optional		
1024	{	1650–1750 ^f	1650–1700	899–927	E	250–400	121– 204	
		...	1350–1575 ^{e,d}	732–857 ^{e,d}	D	Optional	Optional	
1025 to 1026	{	...	1650–1700	899–927	A	250–400	121– 204	
		...	1500–1650 ^{c,d}	816–899 ^{c,d}	B	Optional	Optional	
1027	{	...	1350–1575 ^{e,d}	732–857 ^{e,d}	D	Optional	Optional	
1030	{	...	1500–1650 ^{c,d}	816–899 ^{c,d}	B	Optional	Optional	
		...	1350–1575 ^{e,d}	732–857 ^{e,d}	D	Optional	Optional	
1111 to 1113	{	...	1500–1650 ^{c,d}	816–899 ^{c,d}	B	Optional	Optional	
		...	1350–1575 ^{e,d}	732–857 ^{e,d}	D	Optional	Optional	
1109 to 1120	{	...	1650–1700	899–927	A	250–400	121– 204	
		...	1650–1700	899–927	B	1400–1450	760–788	A	...	250–400	121– 204	
		...	1650–1700	899–927	C	1400–1450	760–788	A	...	250–400	121– 204	
		...	1650–1700	899–927	C	1650–1700	899–927	B	1400–1450	A	250–400	121– 204
		...	1500–1650 ^{c,d}	816–899 ^{c,d}	B	Optional	Optional
...	1350–1575 ^{e,d}	732–857 ^{e,d}	D	Optional	Optional		
1126	{	...	1500–1650 ^{c,d}	816–899 ^{c,d}	B	Optional	Optional	
		...	1350–1575 ^{e,d}	732–857 ^{e,d}	D	Optional	Optional	

^a Symbols: A = water or brine; B = water or oil; C = cool slowly; D = air or oil; E = oil; F = water, brine, or oil.

^b Even where tempering temperatures are shown, tempering is not mandatory in many applications. Tempering is usually employed for partial stress relief and improves resistance to grinding cracks.

^c Activated or cyanide baths.

^d May be given refining heat as in other processes.

^e Carbonitriding atmospheres.

^f Normalizing temperatures at least 50°F (28°C) above the carburizing temperature are sometimes recommended where minimum heat-treatment distortion is of vital importance.

Table 4b. Typical Heat Treatments for SAE Carbon Steels (Heat-Treating Grades)

SAE Number	Normalize, Deg. F	Anneal, Deg. F	Harden, Deg. F	Quench ^a	Temper, Deg. F
1025 & 1030	1575–1650	A	To Desired Hardness
1033 to 1035	1525–1575	B	
1036	{ 1600–1700	...	1525–1575	B	
	1525–1575	B	
1038 to 1040	{ 1600–1700	...	1525–1575	B	
	1525–1575	B	
1041	1600–1700	and/or 1400–1500	1475–1550	E	
1042 to 1050	1600–1700	...	1475–1550	B	
1052 & 1055	1550–1650	and/or 1400–1500	1475–1550	E	
1060 to 1074	1550–1650	and/or 1400–1500	1475–1550	E	
1078	...	1400–1500 ^a	1450–1500	A	
1080 to 1090	1550–1650	and/or 1400–1500 ^a	1450–1500	E ^b	
1095	{ ...	1400–1500 ^a	1450–1500	F	
	...	1400–1500 ^a	1500–1600	E	
1132 & 1137	1600–1700	and/or 1400–1500	1525–1575	B	
1138 & 1140	{	1500–1550	B	
	1600–1700	...	1500–1550	B	
1141 & 1144	{ ...	1400–1500	1475–1550	E	
	1600–1700	1400–1500	1475–1550	E	
1145 to 1151	{	1475–1550	B	
	1600–1700	...	1475–1550	B	

^a Slow cooling produces a spheroidal structure in these high-carbon steels that is sometimes required for machining purposes.

^b May be water- or brine-quenched by special techniques such as partial immersion or time quenched; otherwise they are subject to quench cracking.

Table 5a. Typical Heat Treatments for SAE Alloy Steels (Carburizing Grades)

SAE No.	Normalize ^a	Cycle Anneal ^b	Carburized		Cool ^c	Reheat		Cool ^c	Temper, ^d	
			Deg. F	Deg. C		Deg. F	Deg. C		Deg. F	Deg. C
1320	{ yes	...	1650–1700	899–927	E	1400–1450 ^e	760–788 ^e	E	250–350	121–177
	yes	...	1650–1700	899–927	E	1475–1525 ^f	802–829 ^f	E	250–350	121–177
	yes	...	1650–1700	899–927	C	1400–1450 ^e	760–788 ^e	E	250–350	121–177
	yes	...	1650–1700	899–927	C	1500–1550 ^f	816–843 ^f	E	250–350	121–177
	yes	...	1650–1700	899–927	E ^g	250–350	121–177
	yes	...	1500–1650 ^h	816–899 ^h	E	250–350	121–177
2317	{ yes	yes	1650–1700	899–927	E	1375–1425 ^e	746–774 ^e	E	250–350	121–177
	yes	yes	1650–1700	899–927	E	1450–1500 ^f	788–816 ^f	E	250–350	121–177
	yes	yes	1650–1700	899–927	C	1375–1425 ^e	746–774 ^e	E	250–350	121–177
	yes	yes	1650–1700	899–927	C	1475–1525 ^f	802–829 ^f	E	250–350	121–177
	yes	yes	1650–1700	899–927	E ^g	250–350	121–177
	yes	yes	1450–1650 ^h	788–899 ^h	E	250–350	121–177
2512 to 2517	{ yes ⁱ	...	1650–1700	899–927	C	1325–1375 ^e	718–746 ^e	E	250–350	121–177
	yes ⁱ	...	1650–1700	899–927	C	1425–1475 ^f	774–802 ^f	E	250–350	121–177
3115 & 3120	{ yes	...	1650–1700	899–927	E	1400–1450 ^e	760–788 ^e	E	250–350	121–177
	yes	...	1650–1700	899–927	E	1475–1525 ^f	802–829 ^f	E	250–350	121–177
	yes	...	1650–1700	899–927	C	1400–1450 ^e	760–788 ^e	E	250–350	121–177
	yes	...	1650–1700	899–927	C	1500–1550 ^f	816–843 ^f	E	250–350	121–177
	yes	...	1650–1700	899–927	E ^g	250–350	121–177
	yes	1500–1650 ^h	816–899 ^h	E	250–350	121–177
3310 & 3316	{ yes ⁱ	...	1650–1700	899–927	E	1400–1450 ^e	760–788 ^e	E	250–350	121–177
	yes ⁱ	...	1650–1700	899–927	C	1475–1500 ^f	802–816 ^f	E	250–350	121–177
4017 to 4032	yes	yes	1650–1700	899–927	E ^g	250–350	121–177
4119 & 4125	yes	...	1650–1700	899–927	E ^g	250–350	121–177

Table 5a. (Continued) Typical Heat Treatments for SAE Alloy Steels (Carburizing Grades)

SAE No.	Normalize ^a	Cycle Anneal ^b	Carburized		Cool ^c	Reheat		Cool ^c	Temper. ^d	
			Deg. F	Deg. C		Deg. F	Deg. C		Deg. F	Deg. C
4317 & 4320 4608 to 4621	yes	yes	1650–1700	899–927	E	1425–1475 ^e	774–802 ^e	E	250–350	121–177
	yes	yes	1650–1700	899–927	E	1475–1527 ^f	802–831 ^f	E	250–350	121–177
	yes	yes	1650–1700	899–927	C	1425–1475 ^e	774–802 ^e	E	250–350	121–177
	yes	yes	1650–1700	899–927	C	1475–1525 ^f	802–829 ^f	E	250–350	121–177
	yes	yes	1650–1700	899–927	E ^g	250–350	121–177
	yes	yes	1650–1700	899–927	E ^g	250–350	121–177
	yes	...	1500–1650 ^h	816–899 ^h	E	250–350	121–177
4812 to 4820	yes ⁱ	yes	1650–1700	899–927	E	1375–1425 ^e	746–774 ^e	E	250–350	121–177
	yes ⁱ	yes	1650–1700	899–927	E	1450–1500 ^f	788–816 ^f	E	250–350	121–177
	yes ⁱ	yes	1650–1700	899–927	C	1375–1425 ^e	746–774 ^e	E	250–350	121–177
	yes ⁱ	yes	1650–1700	899–927	C	1450–1500 ^f	788–816 ^f	E	250–350	121–177
	1650–1700	899–927	E ^g	250–350	121–177
5115 & 5120	yes	...	1650–1700	899–927	E	1425–1475 ^e	774–802 ^e	E	250–350	121–177
	yes	...	1650–1700	899–927	E	1500–1550 ^f	816–843 ^f	E	250–350	121–177
	yes	...	1650–1700	899–927	C	1425–1475 ^e	774–802 ^e	E	250–350	121–177
	yes	...	1650–1700	899–927	C	1500–1550 ^f	816–843 ^f	E	250–350	121–177
	yes	...	1500–1650 ^h	816–899 ^h	E	250–350	121–177
8615 to 8625 8720	yes	yes	1650–1700	899–927	E	1475–1525 ^e	802–829 ^e	E	250–350	121–177
	yes	yes	1650–1700	899–927	E	1525–1575 ^f	829–857 ^f	E	250–350	121–177
	yes	yes	1650–1700	899–927	C	1475–1525 ^e	802–829 ^e	E	250–350	121–177
	yes	yes	1650–1700	899–927	C	1525–1575 ^f	829–857 ^f	E	250–350	121–177
	yes	yes	1650–1700	899–927	E ^g	250–350	121–177
	yes	yes	1500–1650 ^h	816–899 ^h	E	250–350	121–177
9310 to 9317	yes ⁱ	...	1650–1700	899–927	E	1400–1450 ^e	760–788 ^e	E	250–350	121–177
	yes ⁱ	...	1650–1700	899–927	C	1500–1525	816–829	E	250–350	121–177

^a Normalizing temperatures should be not less than 50°F (28°C) higher than the carburizing temperature. Follow by air cooling.

^b For cycle annealing, heat to normalizing temperature—hold for uniformity—cool rapidly to 1000–1250°F (538–677°C); hold 1 to 3 hours, then air or furnace cool to obtain a structure suitable for machining and finishing.

^c Symbols: C = cool slowly; E = oil.

^d Tempering treatment is optional and is generally employed for partial stress relief and improved resistance to cracking from grinding operations.

^e For use when case hardness only is paramount.

^f For use when higher core hardness is desired.

^g Treatment is for fine-grained steels only, when a second reheat is often unnecessary.

^h Treatment is for activated or cyanide baths. Parts may be given refining heats as indicated for other heat-treating processes.

ⁱ After normalizing, reheat to temperatures of 1000–1200°F (538–649°C) and hold approximately 4 hours.

Metallography.—The science or study of the microstructure of metal is known by most metallurgists as “metallography” or sometimes “crystallography”. The examination of metals and metal alloys by the aid of the microscope is one of the most effective methods of studying their properties, and is also a valuable means of controlling the quality of manufactured metallic articles and of testing the finished product. In preparing the specimen, a flat surface is first formed by filing or grinding, and then given a high polish, which is later etched in order to reveal clearly the internal structure under the microscope. This process shows clearly to an experienced observer the effect of variation in composition, heat-treatment, etc., and in many cases it has proved a correct means of determining certain properties of industrial products that a chemical analysis has failed to reveal.

Table 5b. Typical Heat Treatments for SAE Alloy Steels (Directly Hardenable Grades)

SAE No.	Normalize, °F		Anneal, °F	Harden, °F	Quench ^a	Temper, °F	
1330	{ ... 1600-1700	and/or	...	1525-1575	B	{ To desired hardness	
1335 & 1340	{ ... 1600-1700	and/or	...	1500-1550 1525-1575	E E		
2330	{ ... 1600-1700	and/or	...	1450-1500 1450-1500	E E		
2340 & 2345	{ ... 1600-1700	and/or	...	1425-1475 1425-1475	E E		
3130	1600-1700		...	1500-1550	B		
3135 to 3141	{ ... 1600-1700	and/or	...	1500-1550 1500-1550	E E		
3145 & 3150	{ ... 1600-1700	and/or	...	1500-1550 1500-1550	E E		
4037 & 4042	...		1525-1575	1500-1575	E		{ Gears, 350-450 To desired hardness
4047 & 4053 4063 & 4068 4130 4137 & 4140 4145 & 4150 4340 1600-1700 1600-1700 1600-1700 1600-1700	and/or and/or and/or and draw	1450-1550 1450-1550 1450-1550 1450-1550 1100-1225	1500-1575 1475-1550 1600-1650 1550-1600 1500-1600 1475-1525	E E B E E E		{ To desired hardness
4640	{ 1600-1700 1600-1700	and/or and/or	1450-1550 1450-1500	1450-1500 1450-1500	E E		To desired hardness Gears, 350-450
5045 & 5046 5130 & 5132	1600-1700 1650-1750	and/or and/or	1450-1550 1450-1550	1475-1500 1500-1550	E G	250-300 To desired hardness	
5135 to 5145	1650-1750	and/or	1450-1550	1500-1550	E	{ To desired hardness Gears, 350-400	
5147 to 5152	1650-1750	and/or	1450-1550	1475-1550	E	{ To desired hardness Gears, 350-400	
50100 51100 52100	{		1350-1450 1350-1450	1425-1475 1500-1600	H E	To desired hardness	
6150 9254 to 9262 8627 to 8632 8635 to 8641 8642 to 8653 8655 & 8660 8735 & 8740 8745 & 8750 9437 & 9440 9442 to 9747 9840 9845 & 9850	1650-1750 ... 1600-1700 1600-1700 1600-1700 1650-1750 1600-1700 1600-1700 1600-1700 1600-1700 1600-1700 1600-1700 1600-1700	and/or and/or and/or and/or and/or and/or and/or and/or and/or and/or and/or and/or	1550-1650 ... 1450-1550 1450-1550 1450-1550 1450-1550 1450-1550 1450-1500 1450-1550 1450-1550 1450-1550	1600-1650 1500-1650 1550-1650 1525-1575 1500-1550 1475-1550 1525-1575 1500-1550 1550-1600 1500-1600 1500-1550	E E B E E E E E E E E E	{ To desired hardness	

^aSymbols: B = water or oil; E = oil; G = water, caustic solution, or oil; H = water.

Table 5c. Typical Heat Treatments for SAE Alloy Steels (Heat-Treating Grades—Chromium–Nickel Austenitic Steels)

SAE No.	Normalize	Anneal, ^a		Harden °F (°C)	Quenching Medium	Temper
		Deg. F	Deg. C			
30301 to 30347	...	1800–2100	982–1149	...	Water or Air	...

^aQuench to produce full austenitic structure using water or air in accordance with thickness of section. Annealing temperatures given cover process and full annealing as used by industry, the lower end of the range being used for process annealing.

Table 5d. Typical Heat Treatments for SAE Alloy Steels
(Heat-Treating Grades—Stainless Chromium Irons and Steels)

SAE No. ^a	Normalize	Sub-critical Anneal		Full Anneal		Harden		Quenching Medium	Temper
		Deg. F	Deg. C	Deg. F	Deg. C	Deg. F	Deg. C		
51410	...	1300–1350 ^b	704–732 ^b	1550–1650 ^c	843–899 ^c	Oil or air	To desired hardness
	1750–1850	954–1010		
51414	...	1200–1250 ^b	649–677 ^b	Oil or air	To desired hardness
	1750–1850	954–1010		
51416	...	1300–1350 ^b	704–732 ^b	1550–1650 ^c	843–899 ^c	Oil or air	To desired hardness
	1750–1850	954–1010		
51420	...	1350–1450 ^b	732–788 ^b	1550–1650 ^c	843–899 ^c	Oil or air	To desired hardness
51420F	1800–1850	982–1010		
51430	...	1400–1500 ^d	760–816 ^d
51430F	...	1250–1500 ^d	677–816 ^d
51431	...	1150–1225 ^b	621–663 ^b	1800–1900	982–1038	Oil or air	To desired hardness
51440A 51440B 51440C 51440F	...	1350–1440 ^b	732–782 ^b	1550–1650 ^c	843–899 ^c	1850–1950	1010–1066	Oil or air	To desired hardness
51442	...	1400–1500 ^d	760–816 ^d
51446	...	1500–1650 ^d	816–899 ^d
51501	...	1325–1375 ^b	718–746 ^b	1525–1600 ^c	829–871 ^c	1600–1700	871–927	Oil or air	To desired hardness

^a Suffixes A, B, and C denote steels differing in carbon content only. Suffix F denotes a free-machining steel.

^b Usually air cooled, but may be furnace cooled.

^c Cool slowly in furnace.

^d Cool rapidly in air.

Table 6. Typical SAE Heat Treatments for Grades of Chromium-Nickel Austenitic Steels Not Hardenable by Thermal Treatment

SAE Steels	AISI No.	Annealing ^a Temperature		Quenching Medium
		(degrees F)	(degrees C)	
30201	201	1850-2050	1010-1120	Air
30202	202	1850-2050	1010-1120	Air
30301	301	1850-2050	1010-1120	Air
30302	302	1850-2050	1010-1120	Air
30303	303	1850-2050	1010-1120	Air
30304	304	1850-2050	1010-1120	Air
30305	305	1850-2050	1010-1120	Air
30309	309	1900-2050	1040-1120	Air
30310	310	1900-2100	1040-1150	Air
30316	316	1850-2050	1010-1120	Air
30317	317	1850-2050	1010-1120	Air
30321	321	1750-2050	955-1120	Air
30325	325	1800-2100	980-1150	Air
30330	...	1950-2150	1065-1175	Air
30347	347	1850-2050	1010-1120	Air

^a Quench to produce full austenitic structure in accordance with the thickness of the section. Annealing temperatures given cover process and full annealing as already established and used by industry, the lower end of the range being used for process annealing.

Source: SAE Handbook, 1990. Reprinted with permission. Copyright © 1990. Society of Automotive Engineers, Inc. All rights reserved.

Table 7. Typical SAE Heat Treatments for Stainless Chromium Steels

SAE Steels	AISI No.	Normalizing Temperature	Subcritical Annealing Temperature		Full Annealing ^a Temperature		Hardening Temperature (degrees F)		Quenching Medium	Temper
			degrees F	degrees C	degrees F	degrees C	degrees F	degrees C		
51409	1625	885	Air	...
51410	410	...	1300–1350 ^b	705–730 ^b	1500–1650	845–900	1700–1850	925–1010	Oil or air	To desired hardness
51414	414	...	1200–1250 ^b	650–675 ^b	1800–1900	980–1040	Oil or air	To desired hardness
51416	416	...	1300–1350 ^c	705–730 ^c	1500–1650	845–900	1700–1850	925–1010	Oil or air	To desired hardness
51420	420	...	1350–1450 ^b	730–790 ^b	1550–1650	845–900	1800–1900	980–1040	Oil or air	To desired hardness
51420F ^d	1350–1450 ^b	730–790 ^b	1550–1650	845–900	1800–1900	980–1040	Oil or air	To desired hardness
51430	430	...	1400–1500 ^c	760–815 ^c
51430F ^d	1250–1400 ^c	675–760 ^c
51431	431	...	1150–1225 ^b	620–665 ^b	1800–1950	980–1065	Oil or air	To desired hardness
51434	1400–1600 ^c	760–870 ^c
51436	1400–1600 ^c	760–870 ^c
51440A ^d	440A ^d	...	1350–1440 ^b	730–780 ^b	1550–1650	845–900	1850–1950	1010–1065	Oil or air	To desired hardness
51440B ^d	440B ^d									
51440C ^d	440C ^d									
51440F ^d	...									
51442	442	...	1350–1500 ^c	730–815 ^c
51446	446	...	1450–1600 ^b	790–870 ^b
51501	501	...	1325–1375 ^c	720–745 ^c	1525–1600	829–871	1600–1700	871–927	Oil or air	To desired hardness

^a Cool slowly in furnace.

^b Usually air cooled but may be furnace cooled.

^c Cool rapidly in air.

^d Suffixes A, B, and C denote three types of steel differing only in carbon content. Suffix F denotes a free-machining steel.

Source: SAE Handbook, 1990. Reprinted with permission. Copyright © 1990. Society of Automotive Engineers, Inc. All rights reserved.

Heat Treating High-Speed Steels

Cobaltcrom Steel.—A tungstenless alloy steel or high-speed steel that contains approximately 1.5 per cent carbon, 12.5 per cent chromium, and 3.5 per cent cobalt. Tools such as dies and milling cutters, made from cobaltcrom steel can be cast to shape in suitable molds, the teeth of cutters being formed so that it is necessary only to grind them.

Before the blanks can be machined, they must be annealed; this operation is performed by pack annealing at the temperature of 1800°F (982°C), for a period of from three to six hours, according to the size of the castings being annealed. The following directions are given for the hardening of blanking and trimming dies, milling cutters, and similar tools made from cobaltcrom steel: Heat slowly in a hardening furnace to about 1830°F (999°C), and hold at this temperature until the tools are thoroughly soaked. Reduce the temperature about 50°F (28°C), withdraw the tools from the furnace, and allow them to cool in the atmosphere. As soon as the red color disappears from the cooling tool, place it in quenching oil until cold. The slight drop of 50°F (28°C) in temperature while the tool is still in the hardening furnace is highly important to obtain proper results. The steel will be injured if the tool is heated above 1860°F (1016°C). In cooling milling cutters or other rotary tools, it is suggested that they be suspended on a wire to ensure a uniform rate of cooling.

Tools that are to be subjected to shocks or vibration, such as pneumatic rivet sets, shear blades, etc., should be heated slowly to 1650°F (899°C), after which the temperature should be reduced to about 1610°F (877°C), at which point the tool should be removed from the furnace and permitted to cool in the atmosphere. No appreciable scaling occurs in the hardening of cobaltcrom steel tools.

Preheating Tungsten High-Speed Steel.—Tungsten high-speed steel must be hardened at a very high temperature; consequently, tools made from such steel are seldom hardened without at least one preheating stage to avoid internal strain. This requirement applies especially to milling cutters, taps, and other tools having thin teeth and thick bodies and to forming tools of irregular shape and section. The tools should be heated slowly and carefully to a temperature somewhat below the critical point of the steel, usually in the range of 1500 to 1600°F (816 to 871°C). Limiting the preheating temperature prevents the operation from being unduly sensitive, and the tool may be safely left in the furnace until it reaches a uniform temperature throughout its length and cross-section.

A single stage of preheating is customary for tools of simple form that are not more than from 1 to 1½ inches (25 to 38 mm) in thickness. For large, intricate tools, two stages of preheating are frequently used. The first brings the tool up to a temperature of about 1100 to 1200°F (593 to 649°C), and the second raises its temperature to 1550 to 1600°F (843 to 649°C). A preheating time of 5 minutes for each ¼ inch (6.4 mm) in tool thickness has been recommended for a furnace temperature of 1600°F (871°C). This is where a single stage of preheating is used and the furnace capacity should be sufficient to maintain practically constant temperature when the tools are changed. To prevent undue chilling, it is common practice to insert a single tool or a small lot in the hardening furnace whenever a tool or lot is removed, rather than to insert a full charge of cold metal at one time.

Preheating is usually done in a simple type of oven furnace heated by gas, electricity, or oil. Atmospheric control is seldom used, although for 18-4-1 steel a slightly reducing atmosphere (2 to 6 per cent carbon monoxide) has been found to produce the least amount of scale and will result in a better surface after final hardening.

Hardening of Tungsten High-Speed Steel.—All tungsten high-speed steels must be heated to a temperature close to their fusion point to develop their maximum efficiency as metal-cutting tools. Hardening temperatures ranging from 2200 to 2500°F (1204 to 1371°C) may be needed. The effects of changes in the hardening temperature on the cutting efficiency of several of the more common high-speed steels are shown in [Table 1](#). The figures given are ratios, the value 1.00 for each steel being assigned to the highest observed cutting speed for that steel. The figures for different steels, therefore, cannot be directly

compared with each other, except to note changes in the point of maximum cutting efficiency.

Table 1. Relation of Hardening Temperature to Cutting Efficiency

Hardening Temperature		Typical Analyses of High-Speed Steels			
Deg. F	Deg. C	18-4-1	14-4-2	18-4-1 Cobalt	14-4-2 Cobalt
2200	1204	0.86	0.83	0.84	0.85
2250	1232	0.88	0.88	0.86	0.88
2300	1260	0.90	0.93	0.90	0.91
2350	1288	0.95	0.98	0.94	0.94
2400	1316	0.99	0.98	0.98	0.98
2450	1343	1.00	...	0.99	1.00
2500	1371	0.98	...	1.00	0.97

The figures in the table refer to tools heated in an oven-type furnace in which a neutral atmosphere is maintained. The available data indicate that a steel reaches its best cutting qualities at a temperature approximately 50°F (28°C) lower than the figures in the table if it is hardened in a bath-type furnace. It is, however, desirable to use a hardening temperature approximately 50°F (28°C) lower than that giving maximum cutting qualities, to avoid the possibility of overheating the tool.

Length of Time for Heating: The cutting efficiency of a tool is affected by the time that it is kept at the hardening temperature, almost as much as by the hardening temperature itself. It has been common practice to heat a tool for hardening until a “sweat” appeared on its surface. This sweat is presumably a melting of the oxide film on the surface of a tool heated in an oxidizing atmosphere. It does not appear when the tool is heated in an inert atmosphere. This method of determining the proper heating time is at best an approximation and indicates only the temperature on the outside of the tool rather than the condition of the interior. As such, it cannot be relied upon to give consistent results.

The only safe method is to heat the tool for a definite predetermined time, based on the size and the thickness of metal that the heat must penetrate to reach the interior. The values given in **Table 2** are based on a series of experiments to determine the relative cutting efficiency of a group of tools hardened in an identical manner, except for variations in the time the tools were kept at the hardening temperature. The time given is based on that required to harden throughout a tool resting on a conducting hearth; the tool receives heat freely from three sides, on its large top surface and its smaller side surfaces. (The table does not apply to a disk lying flat on the hearth.) For a tool having a projecting cutting edge, such as a tap, the thickness or depth of the projecting portion on which the cutting edge is formed should be used when referring to the table.

Table 2. Length of Heating Time for Through Hardening

High-Speed Steel Tool Thickness		Time in Furnace at High Heat, Minutes	High-Speed Steel Tool Thickness		Time in Furnace at High Heat, Minutes	High-Speed Steel Tool Thickness		Time in Furnace at High Heat, Minutes
Inch	Centimeter		Inch	Centimeter		Inch	Centimeter	
¼	0.635	2	½	3.81	7	5	12.7	18
½	1.27	3	2	5.08	8	6	15.24	20
¾	1.905	4	3	7.62	12	8	20.32	25
1	2.54	5	4	10.16	15	10	25.4	30

The time periods given in **Table 2** are based on complete penetration of the hardening effect. For very thick tools, the practical procedure is to harden to a depth sufficient to produce an adequate cutting edge, leaving the interior of the tool relatively soft.

Where atmosphere control is not provided, it often will be found impracticable to use both the temperature for maximum cutting efficiency, given in **Table 1**, and the heating time, given in **Table 2**, because abnormal scaling, grain growth, and surface decarburization of the tool will result. The principal value of an accurate control of the furnace atmosphere appears to lie in the fact that its use makes possible the particular heat treatment that produces the best structure in the tool without destruction of the tool surface or grain.

Quenching Tungsten High-Speed Steel.—High-speed steel is usually quenched in oil. The oil bath offers a convenient quench; it calls for no unusual care in handling and brings about a uniform and satisfactory rate of cooling, which does not vary appreciably with the temperature of the oil. Some authorities believe it desirable to withdraw the tool from the oil bath for a few seconds after it has reached a dull red. It is also believed desirable to move the tool around in the quenching oil, particularly immediately after it has been placed in it, to prevent the formation of a gas film on the tool. Such a film is usually a poor conductor of heat and slows the rate of cooling.

Salt Bath: Quenching in a lead or salt bath at from 1000 to 1200°F (538 to 649°C) has the advantage that cooling of the tool from hardening to room temperature is accomplished in two stages, thus reducing the possibility of setting up internal strains that may tend to crack the tool. The quenching temperature is sufficiently below the lower critical point for a tool so quenched to be allowed to cool to room temperature in still air. This type of quench is particularly advantageous for tools of complicated section that would easily develop hardening cracks. The salt quench has the advantage that the tool sinks and requires only a support, whereas the same tool will float in the lead bath and must be held under the surface. It is believed that the lead quench gives a somewhat higher matrix hardness, and is of advantage for tools that tend to fail by nose abrasion. Tools treated as described are brittle unless given a regular tempering treatment, because the 1000°F (538°C) quenching temperature is not a substitute for later tempering at the same temperature, after the tool has cooled to room temperature.

Air Cooling: Many high-speed steel tools are quenched in air, either in a stream of dry compressed air or in still air. Small sections harden satisfactorily in still air, but heavier sections should be subjected to air under pressure. One advantage of air cooling is that the tool can be kept straight and free from distortion, although it is likely that there will be more scale on a tool thus quenched than when oil, lead, or salt is used. Cooling between steel plates may help to keep thin flat tools straight and flat.

Straightening High-Speed Tools when Quenching.—The final straightness required in a tool must be considered when it is quenched. When several similar tools are to be hardened, a jig can be used to advantage for holding the tools while quenching. When long slender tools are quenched without holders, they frequently warp and must be straightened later. The best time for this straightening is during the first few minutes after the tools have been quenched, as the steel is then quite pliable and may be straightened without difficulty. The straightening must be done at once, as the tools become hard in a few minutes.

Anneal Before Rehardening.—Tools that are too soft after hardening must be annealed before rehardening. A quick anneal, such as previously described, is all that is required to put such a tool into the proper condition for rehardening. This treatment is absolutely essential. For milling cutters and forming tools of irregular section, a full anneal should be used.

Tempering or Drawing Tungsten High-Speed Steel.—The tempering or drawing temperature for high-speed steel tools usually varies from 900 to 1200°F (482 to 649°C). This temperature is higher for turning and planing tools than for such tools as milling cutters, forming tools, etc. If the temperature is below 800°F (427°C), the tool is likely to be too brittle. The general idea is to temper tools at the highest temperature likely to occur in service. Because this temperature ordinarily is unknown, the general practice is to temper at whatever temperature experience with that particular steel and tool has proved to be the

best. The furnace used for tempering usually is kept at a temperature of from 1000 to 1100°F (538 to 593°C) for ordinary high-speed steels and from 1200 to 1300°F (649 to 704°C) for steels of the cobalt type. These furnace temperatures apply to tools of the class used on lathes and planers. Such tools, in service, frequently heat to the point of visible redness. Milling cutters, forming tools, or any other tools for lighter duty may be tempered as low as 850 or 900°F (454 to 482°C). When the tool has reached the temperature of the furnace, it should be held at this temperature for from one to several hours until it has been heated evenly throughout. It should then be allowed to cool gradually in the air and in a place that is dry and free from air drafts. In tempering, the tool should not be quenched, because quenching tends to produce strains that may result later in cracks.

Annealing Tungsten High-Speed Steel.—The following method of annealing high-speed steel has been used extensively. Use an iron box or pipe of sufficient size to allow at least ½ inch (12.7 mm) of packing between the pieces of steel to be annealed and the sides of the box or pipe. It is not necessary that each piece of steel be kept separate from every other piece, but only that the steel be prevented from touching the sides of the annealing pipe or box. Pack carefully with powdered charcoal, fine dry lime, or mica (preferably charcoal), and cover with an airtight cap or lute with fire clay; heat slowly to 1600 to 1650°F (871 to 899°C) and keep at this heat from 2 to 8 hours, depending on the size of the pieces to be annealed. A piece measuring 2×1×8 inches (5×2.5×20.3 cm) requires about 3 hours. Cool as slowly as possible, and do not expose to the air until cold, because cooling in air is likely to cause partial hardening. A good method is to allow the box or pipe to remain in the furnace until cold.

Hardening Molybdenum High-Speed Steels.—Table 3 gives the compositions of several molybdenum high-speed steels that are widely used for general commercial tool applications. The general method of hardening molybdenum high-speed steels resembles that used for 18-4-1 tungsten high-speed steel except that the hardening temperatures are lower and more precautions must be taken to avoid decarburization, especially on tools made from Type I or Type II steels, when the surface is not ground after hardening. Either salt baths or atmosphere-controlled furnaces are recommended for hardening molybdenum high-speed steels.

Table 3. Compositions of Molybdenum High-Speed Steels

Element	Molybdenum-Tungsten		Molybdenum-Vanadium	Tungsten-Molybdenum
	Type Ia (Per Cent)	Type Ib ^a (Per Cent)	Type II (Per Cent)	Type III (Per Cent)
Carbon	0.70-0.85	0.76-0.82	0.70-0.90	0.75-0.90
Tungsten	1.25-2.00	1.60-2.30	...	5.00-6.00
Chromium	3.00-5.00	3.70-4.20	3.00-5.00	3.50-5.00
Vanadium	0.90-1.50	1.05-1.35	1.50-2.25	1.25-1.75
Molybdenum	8.00-9.50	8.00-9.00	7.50-9.50	3.50-5.50
Cobalt	See footnote	4.50-5.50	See footnote	See footnote

^a Cobalt may be used in any of these steels in varying amounts up to 9 per cent, and the vanadium content may be as high as 2.25 percent. When cobalt is used in Type III steel, the vanadium content may be as high as 2.25 per cent. When cobalt is used in Type III steel, this steel becomes susceptible to decarburization. As an illustration of the use of cobalt, Type Ib steel is included. This is steel T10 in the U.S. Navy Specification 46S37, dated November 1, 1939.

The usual method is to preheat uniformly in a separate furnace to 1250 to 1550°F (677 to 843°C) then transfer to a high-heat furnace maintained within the hardening temperature range given in Table 4. Single-point cutting tools, in general, should be hardened at the upper end of the temperature range indicated by Table 4. Slight grain coarsening is not objectionable in such tools when they are properly supported in service and are not subjected to chattering; however, when these tools are used for intermittent cuts, it is better to

use the middle of the temperature range. All other cutting tools, such as drills, countersinks, taps, milling cutters, reamers, broaches, and form tools, should be hardened in the middle of the range shown. For certain tools, such as slender taps, cold punches, and blanking and trimming dies, where greater toughness to resist shocks is required, the lower end of the hardening temperature range should be used.

Table 4. Heat Treatment of Molybdenum High-Speed Steels

Heat-Treating Operation	Molybdenum–Tungsten		Molybdenum–Vanadium		Tungsten–Molybdenum	
	Types Ia and Ib ^a Temp.		Type II Temp.		Type III Temp.	
	Deg. F	Deg. C	Deg. F	Deg. C	Deg. F	Deg. C
Forging	1850–2000	1010–1093	1850–2000	1010–1093	1900–2050	1038–1121
Not below	1600	871	1600	871	1600	871
Annealing	1450–1550	788–843	1450–1550	788–843	1450–1550	788–843
Strain relief	1150–1350	621–732	1150–1350	621–732	1150–1350	621–732
Preheating	1250–1500	677–816	1250–1500	677–816	1250–1550	677–843
Hardening ^b	2150–2250 ^a	1177–1232 ^a	2150–2250	1177–1232	2175–2275	1191–1246
Salt	2150–2225	1177–1218	2150–2225	1177–1218	2150–2250	1177–1232
Tempering	950–1100	510–593	950–1100	510–593	950–1100	510–593

^a For similar working conditions, Type Ib steel requires slightly higher hardening heat than Type Ia.

^b The higher side of the hardening range should be used for large sections, and the lower side for small sections.

Molybdenum high-speed steels can be pack-hardened following the same practice as is used for tungsten high-speed steels, but keeping on the lower side of the hardening range (approximately 1850°F or 1010°C). Special surface treatments such as nitriding by immersion in molten cyanide that are used for tungsten high-speed steels are also applicable to molybdenum high-speed tools.

When heated in an open fire or in furnaces without atmosphere control, these steels do not sweat like 18-4-1 steels; consequently, determining the proper time in the high-heat chamber is a matter of experience. This time approximates that used with 18-4-1 steels, although it may be slightly longer when the lower part of the hardening range is used. Much can be learned by preliminary hardening of test pieces and checking on the hardness fracture and structure. It is difficult to give the exact heating time, because it is affected by temperature, type of furnace, size and shape, and furnace atmosphere. Rate of heat transfer is most rapid in salt baths, and slowest in controlled-atmosphere furnaces with high carbon monoxide content.

Quenching and Tempering of Molybdenum High-Speed Tools.—Quenching may be done in oil, air, or molten bath. To reduce the possibility of breakage and undue distortion of intricately shaped tools, it is advisable to quench in a molten bath at approximately 1100°F (593°C). The tool also may be quenched in oil and removed while still red, or at approximately 1100°F (593°C). The tool is then cooled in air to room temperature, and tempered immediately to avoid cracking.

When straightening is necessary, it should be done after quenching and before cooling to room temperature prior to tempering.

To temper, the tools should be reheated slowly and uniformly to 950 to 1100°F (510 to 593°C). For general work, 1050°F (566°C) is most common. The tools should be held at this temperature at least 1 hour. Two hours is a safer minimum, and 4 hours is maximum. The time and temperature depend on the hardness and toughness required. Where tools are subjected to more or less shock, multiple temperings are suggested.

Protective Coatings for Molybdenum Steels.—To protect the surface from oxidation during heat treatment, borax may be applied by sprinkling it lightly over the steel when the latter is heated in a furnace to a low temperature, 1200 to 1400°F (649 to 760°C). Small tools may be rolled in a box of borax before heating. Another method more suitable for finished tools is to apply the borax or boric acid in the form of a supersaturated water solution.

The tools are then immersed in the solution at 180 to 212°F (82 to 100°C), or the solution may be applied with a brush or spray. Pieces so treated are heated as usual, taking care in handling to ensure good adherence of the coating. Special protective coatings or paints, when properly applied, have been found extremely useful. These materials do not fuse or run at the temperatures used, and therefore do not affect the furnace hearth. When applying these coatings, it is necessary to have a surface free from scale or grease to ensure good adherence. Coatings may be sprayed or brushed on, and usually one thin coat is sufficient. Heavy coats tend to pit the surface of the tool and are difficult to remove. Tools covered with these coatings should be allowed to dry before they are charged into the preheat furnace. After hardening and tempering, the coating can be easily removed by light blasting with sand or steel shot. When tools are lightly ground, these coatings come off immediately. Protection may also be obtained by wrapping pieces in stainless steel foil.

Nitriding High-Speed Steel Tools.—Nitriding is applied to high-speed steel for the purpose of increasing tool life by producing a very hard skin or case, the thickness of which ordinarily is from 0.001 to 0.002 inch (0.025 to 0.05 mm). Nitriding is done after the tool has been fully heat treated and finish-ground. (The process differs entirely from that which is applied to surface harden certain alloy steels by heating in an atmosphere of nitrogen or ammonia gas.) The temperature of the high-speed steel nitriding bath, which is a mixture of sodium and potassium cyanides, is equal to or slightly lower than the tempering temperature. For ordinary tools, this temperature usually varies from about 1025 to 1050°F (552 to 566°C); but if the tools are exceptionally fragile, the range may be reduced to 950 or 1000°F (510 to 538°C). Accurate temperature control is essential to prevent exceeding the final tempering temperature. The nitriding time may vary from 10 or 15 minutes to 30 minutes or longer, and should be determined by experiment. The shorter periods are applied to tools for iron or steel, or any shock-resisting tools, and the longer periods are for tools used in machining nonferrous metals and plastics. This nitriding process is applied to tools such as hobs, reamers, taps, box tools, form tools, and milling cutters. Nitriding may increase tool life 50 to 200 per cent, or more, but it should always be preceded by correct heat treatment.

Nitriding Bath Mixtures and Temperatures: A mixture of 60 per cent sodium cyanide and 40 per cent potassium cyanide is commonly used for nitriding. This mixture has a melting point of 925°F (496°C), which is gradually reduced to 800°F (427°C) as the cyanate content of the bath increases. A more economical mixture of 70 per cent sodium cyanide and 30 per cent potassium cyanide may be used if the bath temperature is only 1050°F (566°C). Nitriding bath temperatures should not exceed 1100°F (593°C) because higher temperatures accelerate the formation of carbonate at the expense of the essential cyanide. A third mixture used for nitriding consists of 55 per cent sodium cyanide, 25 per cent potassium chloride, and 20 per cent sodium carbonate. This mixture melts at 930°F (499°C).

Equipment for Hardening High-Speed Steel.—Equipment for hardening high-speed steel consists of a hardening furnace capable of maintaining a temperature of 2350 to 2450°F (1288 to 1343°C); a preheating furnace capable of maintaining a temperature of 1700 to 1800°F (927 to 982°C), and of sufficient size to hold a number of pieces of the work; a tempering (drawing) furnace capable of maintaining a temperature of 1000 to 1200°F (538 to 649°C) as a general rule; and a water-cooled tank of quenching oil.

High-speed steels usually are heated for hardening either in some type of electric furnace or in a gas-fired furnace of the muffle type. The small furnaces used for high-speed steel seldom are oil-fired. It is desirable to use automatic temperature control and, where an oven type of furnace is employed, a controlled atmosphere is advisable because of the variations in cutting qualities caused by hardening under uncontrolled conditions. Some furnaces of both electric and fuel-fired types are equipped with a salt bath suitable for high-speed steel hardening temperatures. Salt baths have the advantage of providing protection against the atmosphere during the heating period. A type of salt developed for commercial use is water-soluble, so that all deposits from the hardening bath may be removed by

immersion in water after quenching in oil or salt, or after air cooling. One type of electric furnace heats the salt bath internally by electrodes immersed in it. The same type of furnace is also applied to various heat-treating operations, such as cyanide hardening, liquid carburizing, tempering, and annealing.

An open-forge fire has many disadvantages, especially in hardening cutters or other tools that cannot be ground all over after hardening. The air blast decarburizes the steel and lack of temperature control makes it impossible to obtain uniform results. Electric and gas furnaces provide continuous uniform heat, and the temperature may be regulated accurately, especially when pyrometers are used. In shops equipped with only one furnace for carbon steel and one for high-speed steel, the tempering can be done in the furnace used for hardening carbon steel after the preheating is finished and the steel has been removed for hardening.

Heating High-Speed Steel for Forging.—Care should be taken not to heat high-speed steel for forging too abruptly. In winter, the steel may be extremely cold when brought into the forge shop. If the steel is put directly into the hot forge fire, it is likely to develop cracks that will show up later in the finished tool. The steel, therefore, should be warmed gradually before heating for forging.

Subzero Treatment of Steel

Subzero treatment consists of subjecting the steel, after hardening and either before or after tempering, to a subzero temperature, (that usually ranges from -100 to -120°F (-73 to -84°C), and for a period of time varying with the size or volume of the tool, gage, or other part. Commercial equipment is available for obtaining these low temperatures.

The subzero treatment is employed by most gage manufacturers to stabilize precision gages and prevent subsequent changes in size or form. Subzero treatment is also applied to some high-speed steel cutting tools. The object here is to increase the durability or life of the tools; however, up to the present time, the results of tests by metallurgists and tool engineers often differ considerably and in some instances are contradictory. Methods of procedure also vary, especially with regard to the order and number of operations in the complete heat-treating and cooling cycle.

Changes Resulting From Subzero Treatment.—When steel is at the hardening temperature it contains a solid solution of carbon and iron known as *austenite*. When the steel is hardened by sudden cooling, most of the austenite, which is relatively soft, tough, and ductile even at room temperatures, is transformed into martensite, a hard and strong constituent. If all the austenite were changed to martensite upon reaching room temperature, this process would be an ideal hardening operation, but many steels retain some austenite. In general, the higher the carbon and alloy contents and the higher the hardening temperature, the greater the tendency to retain austenite. When steel is cooled to subzero temperatures, the stability of the retained austenite is reduced so that it is more readily transformed. To obtain more complete transformation, the subzero treatment may be repeated. The ultimate transformation of austenite to martensite may take place in carbon steel without the aid of subzero treatment, but this natural transformation might require 6 months or longer, whereas by refrigeration this change occurs in a few hours.

The thorough, uniform heating that is always recommended in heat-treating operations should be accompanied by thorough, uniform cooling when the subzero treatment is applied. To ensure uniform cooling, the subzero cooling period should be increased for the larger tools and it may range from 2 to 6 hours. The tool or other part is sometimes surrounded by one or more layers of heavy wrapping or asbestos paper to delay the cooling somewhat and ensure uniformity. After the cooling cycle is started, it should continue without interruption.

Subzero treatment may sometimes cause cracking. Normally, the austenite in steel provides a cushioning effect that may prevent cracking or breakage resulting from treatments

involving temperature and dimensional changes; but if this cushioning effect is removed, particularly at very low temperatures as in subzero treatments, there may be danger of cracking, especially with tools having large or irregular sections and sharp corners offering relatively low resistance to stresses. This effect is one reason why subzero treatments may differ in regard to the cooling and tempering cycle.

Stabilizing Dimensions of Gages or Precision Parts by Subzero Cooling.—Transformation of austenite into martensite is accompanied by an increase in volume; consequently, the transformation of austenite, that may occur naturally over a period of months or years, tends to change the dimensions and form of steel parts, and such changes may be serious in the case of precision gages, close-fitting machine parts, etc. To prevent such changes, the subzero treatment has proved effective. Gage-blocks, for example, may be stabilized by hardening followed by repeated cycles of chilling and tempering, to transform a large percentage of the austenite into martensite.

Order of Operations for Stabilizing Precision Gages: If precision gages and sine-bars, are heat-treated in the ordinary manner and then are finished without some stabilizing treatment, dimensional changes and warpage are liable to occur. Sub-zero cooling provides a practical and fairly rapid method of obtaining the necessary stabilization by transforming the austenite into martensite. In stabilization treatments of this kind, tempering is the final operation. One series of treatments that has been recommended after hardening and rough-grinding is as follows:

a) Cool to -120°F (-84°C). This cooling period may require from one to six hours, depending on the size and form of the gage.

b) Place gage in boiling water for two hours (oil or salt bath may also be used).

Note: Steps **Item a)** and **Item b)** may be repeated from two to six times, depending on the size and form of the gage. These repeated cycles will eventually transform practically all the austenite into martensite. Two or three cooling and drawing operations usually are sufficient for such work as thread gages and gage-blocks.

c) Follow with regular tempering or drawing operation and finish gage by lapping.

Series of Stabilizing Treatments for Chromium Steel: The following series of treatments has proved successful in stabilizing precision gage-blocks made from SAE 52100 chromium steel.

a) Preheat to 600°F (316°C), then heat to 1575°F (857°C) for a period of four minutes.

b) Quench in oil at 85°F (29°C). Uniform quenching is essential.

c) Temper at 275°F (135°C) for one hour.

d) Cool in tempering furnace to room temperature.

e) Continue cooling in atmosphere of industrial refrigerator for six hours with temperature of atmosphere at -120°F (-84°C).

f) Allow gage-blocks to return to room temperature and again temper.

Note: The complete treatment consists of six subzero cooling periods, each followed by a tempering operation. The transformation to martensite is believed to be complete even after the fifth cooling period. The hardness is about 66 Rockwell C. Transformation is checked by magnetic tests based upon the magnetism of martensite and the nonmagnetic qualities of austenite.

Stabilizing Dimensions of Close-Fitting Machine Parts.—Subzero treatment will always cause an increase in size. Machine parts subjected to repeated and perhaps drastic changes in temperature, as in aircraft, may eventually cause trouble due to growth or warpage as the austenite gradually changes to martensite. In some instances, the sizes of close-fitting moving parts have increased sufficiently to cause seizure. Such treatment, for example, may be applied to precision bearings made from SAE 52100 or alloy carburizing steels for stabilizing or aging them. *Time* aging of 52100 steels after hardening has been found to cause changes as large as 0.0025 inch (0.064 mm) in medium size sections. A

practical remedy is to apply the subzero treatment before the final grinding or other machining operation.

Subzero Treatment of Carburized Parts to Improve Physical Properties.—The subzero treatment has been applied to carburized machine parts. For example, the amount of retained austenite in carburized gears may be sufficient to reduce the life of the gears. In one component, the Rockwell hardness was increased from 55 C to 65 C without loss of impact resistance qualities; in fact, impact and fatigue resistance may be increased in some examples.

Application of Subzero Treatments to High-Speed Steel.—The subzero treatment has been applied to such tools as milling cutters, hobs, taps, broaches, and drills. It is applicable to different classes of high-speed steels, such as the 18-4-1 tungsten, 18-4-14 cobalt, and the molybdenum high-speed steels. This *cold* treatment is applied preferably in conjunction with the heat treatment, both being combined in a continuous cycle of operations. The general procedure is either to harden the steel, cool it to a subzero temperature, and then temper; or, especially if there is more than one tempering operation, the first one may *precede* subzero cooling. The cooling and tempering cycle may be repeated two or more times. The number and order of the operations, or the complete cycle, may be varied to suit the class of work and, to minimize the danger of cracking, particularly if the tool has large or irregular sections, sharp corners or edges, or a high cobalt content. A subzero treatment of some kind with a final tempering operation for stress relief, is intended to increase strength and toughness without much loss in hardness; consequently, if there is greater strength at a given hardness, tools subjected to subzero treatment can operate with a higher degree of hardness than those heat treated in the ordinary manner, or, if greater toughness is preferred, it can be obtained by tempering to the original degree of hardness.

Order of Cooling and Tempering Periods for High-speed Steel.—The order or cycle for the cooling and tempering periods has not been standardized. The methods that follow have been applied to high-speed steel tools. They are given as examples of procedure and are subject to possible changes due to subsequent developments. The usual ranges of preheating and hardening temperatures are given; but for a particular steel, the recommended temperatures should be obtained from the manufacturer.

1) *Double Subzero Treatment:* (For rugged simple tool forms without irregular sections, sharp corners or edges where cracks might develop during the subzero treatment).

- a) Preheat between 1400 and 1600°F (760 and 871°C). Double preheating is preferable, the first preheating ranging from 700 to 1000°F (371 to 538°C).
- b) Heat to the hardening temperature. *Note:* Tests indicate that the effect of subzero treatment on high-speed steel may be influenced decidedly by the hardening temperature. If this temperature is near the lower part of the range, the results are unsatisfactory. Effective temperatures for ordinary high-speed steels appear to range from 2300 to 2350°F (1260 to 1288°C).
- c) Quench in oil, salt, lead, or air, down to a workpiece temperature of 150–200°F (66–93°C). *Note:* One method is to quench in oil; a second method is to quench in oil to about 200–225°F (93–107°C) and then air cool; a third method is to quench in salt bath at 1050–1100°F (566–593°C) and then air cool.
- d) Cool in refrigerating unit to temperature of –100 to –120°F (–73 to –84°C) *right after quenching.* *Note:* Tests have shown that a delay of one hour has a detrimental effect, and in ten hours the efficiency of the subzero treatment is reduced 50 per cent. This is because the austenite becomes more and more stabilized when the subzero treatment is delayed; consequently, the austenite is more difficult to transform into martensite.) The refrigerating period usually varies from two to six hours, depending on the size of the tool. Remove the tool from the refrigerating unit and allow it to return to room temperature.
- e) Temper to required hardness for a period of two and one-half to three hours. The tempering temperature usually varies from a minimum of 1000 to 1100°F (538 to 593°C)

for ordinary high-speed steels. Tests indicate that if this first tempering is less than two and one-half hours at 1050°F (566°C), there will not be sufficient precipitation of carbides at the tempering temperature to allow complete transformation of the retained austenite on cooling, whereas more than three hours causes some loss in room temperature hardness, hot hardness, strength, and toughness.

- f) Repeat subzero treatment, step **Item d**).
- g) Repeat the tempering operation, **Item e**). *Note:* The time for the second tempering operation is sometimes reduced to about $\frac{1}{2}$ the time required for the first tempering.
- 2) *Single Subzero Treatment:* This treatment is the same as procedure **Item 1**) except that a second subzero cooling is omitted; hence, the cycle consists of hardening, subzero cooling, and double tempering. Procedure **Item 3**), which follows, also has one subzero cooling period in the cycle, but this *follows* the first tempering operation.
- 3) *Tempering Followed by Subzero Treatment:* This treatment is for tools having irregular sections, sharp corners, or edges where cracks might develop if the hardening operation were followed immediately by subzero cooling.
 - a) Preheat and heat for hardening.
 - b) Preheat and heat for hardening.
 - c) Quench as described under procedure **Item 1**).
 - d) Temper to required hardness.
 - e) Cool to subzero temperature -100 to -120°F (-73 to -84°C) and then allow the tool to return to room temperature.
 - f) Repeat tempering operation.

Testing the Hardness of Metals

Brinell Hardness Test.—The Brinell test for determining the hardness of metallic materials consists in applying a known load to the surface of the material to be tested through a hardened steel ball of known diameter. The diameter of the resulting permanent impression in the metal is measured and the Brinell Hardness Number (BHN) is then calculated from the following formula in which D = diameter of ball in millimeters, d = measured diameter at the rim of the impression in millimeters, and P = applied load in kilograms.

$$\text{BHN} = \frac{\text{load on indenting tool in kilograms}}{\text{surface area of indentation in sq. mm.}} = \frac{P}{\frac{\pi D}{2}(D - \sqrt{D^2 - d^2})}$$

If the steel ball were not deformed under the applied load and if the impression were truly spherical, then the preceding formula would be a general one, and any combination of applied load and size of ball could be used. The impression, however, is not quite a spherical surface because there must always be some deformation of the steel ball and some recovery of form of the metal in the impression; hence, for a standard Brinell test, the size and characteristics of the ball and the magnitude of the applied load must be standardized. In the standard Brinell test, a ball 10 millimeters in diameter and a load of 3000, 1500, or 500 kilograms is used. It is desirable, although not mandatory, that the test load be of such magnitude that the diameter of the impression be in the range of 2.50 to 4.75 millimeters. The following test loads and approximate Brinell numbers for this range of impression diameters are: 3000 kg, 160 to 600 BHN; 1500 kg, 80 to 300 BHN; 500 kg, 26 to 100 BHN. In making a Brinell test, the load should be applied steadily and without a jerk for at least 15 seconds for iron and steel, and at least 30 seconds in testing other metals. A minimum period of 2 minutes, for example, has been recommended for magnesium and magnesium alloys. (For the softer metals, loads of 250, 125, or 100 kg are sometimes used.)

According to the American Society for Testing and Materials Standard E10-66, a steel ball may be used on material having a BHN not over 450, a Hultgren ball on material not over 500, or a carbide ball on material not over 630. The Brinell hardness test is not recommended for material having a BHN over 630.

Rockwell Hardness Test.—The Rockwell hardness tester is essentially a machine that measures hardness by determining the depth of penetration of a penetrator into the specimen under certain fixed conditions of test. The penetrator may be either a steel ball or a diamond spheroconical penetrator. The hardness number is related to the depth of indentation and the number is higher the harder the material. A minor load of 10 kg is first applied, causing an initial penetration; the dial is set at zero on the black-figure scale, and the major load is applied. This major load is customarily 60 or 100 kg when a steel ball is used as a penetrator, but other loads may be used when necessary. The ball penetrator is $\frac{1}{16}$ inch in diameter normally, but other penetrators of larger diameter, such as $\frac{1}{8}$ inch, may be employed for soft metals. When a diamond spheroconical penetrator is employed, the load usually is 150 kg. Experience decides the best combination of load and penetrator for use. After the major load is applied and removed, according to standard procedure, the reading is taken while the minor load is still applied.

The Rockwell Hardness Scales.—The various Rockwell scales and their applications are shown in the following table. The type of penetrator and load used with each are shown in [Tables 1](#) and [2](#), which give comparative hardness values for different hardness scales.

Scale	Testing Application
A	For tungsten carbide and other extremely hard materials. Also for thin, hard sheets.
B	For materials of medium hardness such as low- and medium-carbon steels in the annealed condition.
C	For materials harder than Rockwell B-100.
D	Where a somewhat lighter load is desired than on the C scale, as on case-hardened pieces.
E	For very soft materials such as bearing metals.
F	Same as the E scale but using a $\frac{1}{16}$ -inch ball.
G	For metals harder than tested on the B scale.
H & K	For softer metals.
15-N; 30-N; 45-N	Where a shallow impression or a small area is desired. For hardened steel and hard alloys.
15-T; 30-T; 45-T	Where a shallow impression or a small area is desired for materials softer than hardened steel.

Shore's Scleroscope.—The scleroscope is an instrument that measures the hardness of the work in terms of elasticity. A diamond-tipped hammer is allowed to drop from a known height on the metal to be tested. As this hammer strikes the metal, it rebounds, and the harder the metal, the greater the rebound. The extreme height of the rebound is recorded, and an average of a number of readings taken on a single piece will give a good indication of the hardness of the work. The surface smoothness of the work affects the reading of the instrument. The readings are also affected by the contour and mass of the work and the depth of the case, in carburized work, the soft core of light-depth carburizing, pack-hardening, or cyanide hardening, absorbing the force of the hammer fall and decreasing the rebound. The hammer weighs about 40 grains, the height of the rebound of hardened steel is in the neighborhood of 100 on the scale, or about $6\frac{1}{4}$ inches (158.8 mm), and the total fall is about 10 inches or 255 millimeters.

Vickers Hardness Test.—The Vickers test is similar in principle to the Brinell test. The standard Vickers penetrator is a square-based diamond pyramid having an included point angle of 136 degrees. The numerical value of the hardness number equals the applied load in kilograms divided by the area of the pyramidal impression: A smooth, firmly supported, flat surface is required. The load, which usually is applied for 30 seconds, may be 5, 10, 20, 30, 50, or 120 kilograms. The 50-kilogram load is the most usual. The hardness number is based upon the diagonal length of the square impression. The Vickers test is considered to be very accurate, and may be applied to thin sheets as well as to larger sections with proper load regulation.

Knoop Hardness Numbers.—The Knoop hardness test is applicable to extremely thin metal, plated surfaces, exceptionally hard and brittle materials, very shallow carburized or nitrided surfaces, or whenever the applied load must be kept below 3600 grams. The Knoop indenter is a diamond ground to an elongated pyramidal form and it produces an indentation having long and short diagonals with a ratio of approximately 7 to 1. The longitudinal angle of the indenter is 172 degrees, 30 minutes, and the transverse angle 130 degrees. The Tukon Tester in which the Knoop indenter is used is fully automatic under electronic control. The Knoop hardness number equals the load in kilograms divided by the projected area of indentation in square millimeters. The indentation number corresponding to the long diagonal and for a given load may be determined from a table computed for a theoretically perfect indenter. The load, which may be varied from 25 to 3600 grams, is applied for a definite period and always normal to the surface tested. Lapped plane surfaces free from scratches are required.

Monotron Hardness Indicator.—With this instrument, a diamond-ball impressor point $\frac{3}{4}$ mm in diameter is forced into the material to a depth of $\frac{1}{5000}$ inch and the pressure required to produce this constant impression indicates the hardness. One of two dials shows the pressure in kilograms and pounds, and the other shows the depth of the impression in millimeters and inches. Readings in Brinell numbers may be obtained by means of a scale designated as *M-1*.

Keep's Test.—With this apparatus, a standard steel drill is caused to make a definite number of revolutions while it is pressed with standard force against the specimen to be tested. The hardness is automatically recorded on a diagram on which a dead soft material gives a horizontal line, and a material as hard as the drill itself gives a vertical line, intermediate hardness being represented by the corresponding angle between 0 and 90 degrees.

Comparison of Hardness Scales.—Tables 1, 2, and 3 show comparisons of various hardness scales. All such tables are based on the assumption that the metal tested is homogeneous to a depth several times that of the indentation. To the extent that the metal being tested is not homogeneous, errors are introduced because different loads and different shapes of penetrators meet the resistance of metal of varying hardness, depending on the depth of indentation. Another source of error is introduced in comparing the hardness of different materials as measured on different hardness scales. This error arises from the fact that in any hardness test, metal that is severely cold-worked actually supports the penetrator, and different metals, different alloys, and different analyses of the same type of alloy have different cold-working properties. In spite of the possible inaccuracies introduced by such factors, it is of considerable value to be able to compare hardness values in a general way.

The data shown in Table 1 are based on extensive tests on carbon and alloy steels mostly in the heat-treated condition, but have been found to be reliable on constructional alloy steels and tool steels in the as-forged, annealed, normalized, quenched, and tempered conditions, providing they are homogeneous. These hardness comparisons are not as accurate for special alloys such as high manganese steel, 18-8 stainless steel and other austenitic steels, nickel-base alloys, constructional alloy steels, and nickel-base alloys in the cold-worked condition.

The data shown in Table 2 are for hardness measurements of unhardened steel, steel of soft temper, grey and malleable cast iron, and most nonferrous metals. Again these hardness comparisons are not as accurate for annealed metals of high Rockwell B hardness such as austenitic stainless steel, nickel and high nickel alloys, and cold-worked metals of low B-scale hardness such as aluminum and the softer alloys.

Table 3 is intended to provide a general numerical comparison of the various Rockwell hardness scales, however, it should not be used for conversion between the various scales.

Table 1. Comparative Hardness Scales for Steel

Rockwell C-Scale Hardness Number	Diamond Pyramid Hardness Number Vickers	Brinell Hardness Number 10-mm Ball, 3000-kgf Load			Rockwell Hardness Number		Rockwell Superficial Hardness Number Superficial Diamond Indenter			Shore Scleroscope Hardness Number
		Standard Ball	Hultgren Ball	Tungsten Carbide Ball	A-Scale 60-kgf Load Diamond Indenter	D-Scale 100-kgf Load Diamond Indenter	15-N Scale 15-kgf Load	30-N Scale 30-kgf Load	45-N Scale 45-kgf Load	
68	940	85.6	76.9	93.2	84.4	75.4	97
67	900	85.0	76.1	92.9	83.6	74.2	95
66	865	84.5	75.4	92.5	82.8	73.3	92
65	832	(739)	83.9	74.5	92.2	81.9	72.0	91
64	800	(722)	83.4	73.8	91.8	81.1	71.0	88
63	772	(705)	82.8	73.0	91.4	80.1	69.9	87
62	746	(688)	82.3	72.2	91.1	79.3	68.8	85
61	720	(670)	81.8	71.5	90.7	78.4	67.7	83
60	697	...	(613)	(654)	81.2	70.7	90.2	77.5	66.6	81
59	674	...	(599)	(634)	80.7	69.9	89.8	76.6	65.5	80
58	653	...	(587)	615	80.1	69.2	89.3	75.7	64.3	78
57	633	...	(575)	595	79.6	68.5	88.9	74.8	63.2	76
56	613	...	(561)	577	79.0	67.7	88.3	73.9	62.0	75
55	595	...	(546)	560	78.5	66.9	87.9	73.0	60.9	74
54	577	...	(534)	543	78.0	66.1	87.4	72.0	59.8	72
53	560	...	(519)	525	77.4	65.4	86.9	71.2	58.6	71
52	544	(500)	(508)	512	76.8	64.6	86.4	70.2	57.4	69
51	528	(487)	(494)	496	76.3	63.8	85.9	69.4	56.1	68
50	513	(475)	(481)	481	75.9	63.1	85.5	68.5	55.0	67
49	498	(464)	(469)	469	75.2	62.1	85.0	67.6	53.8	66
48	484	(451)	(455)	455	74.7	61.4	84.5	66.7	52.5	64
47	471	442	443	443	74.1	60.8	83.9	65.8	51.4	63
46	458	432	432	432	73.6	60.0	83.5	64.8	50.3	62
45	446	421	421	421	73.1	59.2	83.0	64.0	49.0	60
44	434	409	409	409	72.5	58.5	82.5	63.1	47.8	58
43	423	400	400	400	72.0	57.7	82.0	62.2	46.7	57
42	412	390	390	390	71.5	56.9	81.5	61.3	45.5	56
41	402	381	381	381	70.9	56.2	80.9	60.4	44.3	55
40	392	371	371	371	70.4	55.4	80.4	59.5	43.1	54
39	382	362	362	362	69.9	54.6	79.9	58.6	41.9	52
38	372	353	353	353	69.4	53.8	79.4	57.7	40.8	51
37	363	344	344	344	68.9	53.1	78.8	56.8	39.6	50
36	354	336	336	336	68.4	52.3	78.3	55.9	38.4	49
35	345	327	327	327	67.9	51.5	77.7	55.0	37.2	48
34	336	319	319	319	67.4	50.8	77.2	54.2	36.1	47
33	327	311	311	311	66.8	50.0	76.6	53.3	34.9	46
32	318	301	301	301	66.3	49.2	76.1	52.1	33.7	44
31	310	294	294	294	65.8	48.4	75.6	51.3	32.5	43
30	302	286	286	286	65.3	47.7	75.0	50.4	31.3	42
29	294	279	279	279	64.7	47.0	74.5	49.5	30.1	41
28	286	271	271	271	64.3	46.1	73.9	48.6	28.9	41
27	279	264	264	264	63.8	45.2	73.3	47.7	27.8	40
26	272	258	258	258	63.3	44.6	72.8	46.8	26.7	38
25	266	253	253	253	62.8	43.8	72.2	45.9	25.5	38
24	260	247	247	247	62.4	43.1	71.6	45.0	24.3	37
23	254	243	243	243	62.0	42.1	71.0	44.0	23.1	36
22	248	237	237	237	61.5	41.6	70.5	43.2	22.0	35

Table 1. (Continued) Comparative Hardness Scales for Steel

Rockwell C-Scale Hardness Number	Diamond Pyramid Hardness Number Vickers	Brinell Hardness Number 10-mm Ball, 3000-kgf Load			Rockwell Hardness Number		Rockwell Superficial Hardness Number Superficial Diamond Indenter			Shore Scleroscope Hardness Number
		Standard Ball	Hultgren Ball	Tungsten Carbide Ball	A-Scale 60-kgf Load Diamond Indenter	D-Scale 100-kgf Load Diamond Indenter	15-N Scale 15-kgf Load	30-N Scale 30-kgf Load	45-N Scale 45-kgf Load	
21	243	231	231	231	61.0	40.9	69.9	42.3	20.7	35
20	238	226	226	226	60.5	40.1	69.4	41.5	19.6	34
(18)	230	219	219	219	33
(16)	222	212	212	212	32
(14)	213	203	203	203	31
(12)	204	194	194	194	29
(10)	196	187	187	187	28
(8)	188	179	179	179	27
(6)	180	171	171	171	26
(4)	173	165	165	165	25
(2)	166	158	158	158	24
(0)	160	152	152	152	24

Note: The values in this table shown in **boldface** type correspond to those shown in American Society for Testing and Materials Specification E140-67.

Values in () are beyond the normal range and are given for information only.

Turner’s Sclerometer.—In making this test a weighted diamond point is drawn, once forward and once backward, over the smooth surface of the material to be tested. The hardness number is the weight in grams required to produce a standard scratch.

Mohs’s Hardness Scale.—Hardness, in general, is determined by what is known as Mohs’s scale, a standard for hardness that is applied mainly to nonmetallic elements and minerals. In this hardness scale, there are ten degrees or steps, each designated by a mineral, the difference in hardness of the different steps being determined by the fact that any member in the series will scratch any of the preceding members. This scale is as follows:

- 1) talc; 2) gypsum; 3) calcite; 4) fluor spar; 5) apatite; 6) orthoclase; 7) quartz;
- 8) topaz; 9) sapphire or corundum; and 10) diamond.

These minerals, arbitrarily selected as standards, are successively harder, from talc, the softest of all minerals, to diamond, the hardest. This scale, which is now universally used for nonmetallic minerals, is not applied to metals.

Relation Between Hardness and Tensile Strength.—The approximate relationship between the hardness and tensile strength is shown by the following formula:

$$\text{Tensile strength} = Bhn \times 515 \text{ (for Brinell numbers up to 175).}$$

$$\text{Tensile strength} = Bhn \times 490 \text{ (for Brinell numbers larger than 175).}$$

The above formulas give the tensile strength in pounds per square inch for steels. These approximate relationships between hardness and tensile strength do not apply to nonferrous metals with the possible exception of certain aluminum alloys.

Durometer Tests.—The durometer is a portable hardness tester for measuring hardness of rubber, plastics, and some soft metals. The instrument is designed to apply pressure to the specimen and the hardness is read from a scale while the pressure is maintained. Various scales can be used by changing the indenter and the load applied.

Table 2. Comparative Hardness Scales for Unhardened Steel, Soft-Temper Steel, Grey and Malleable Cast Iron, and Nonferrous Alloys

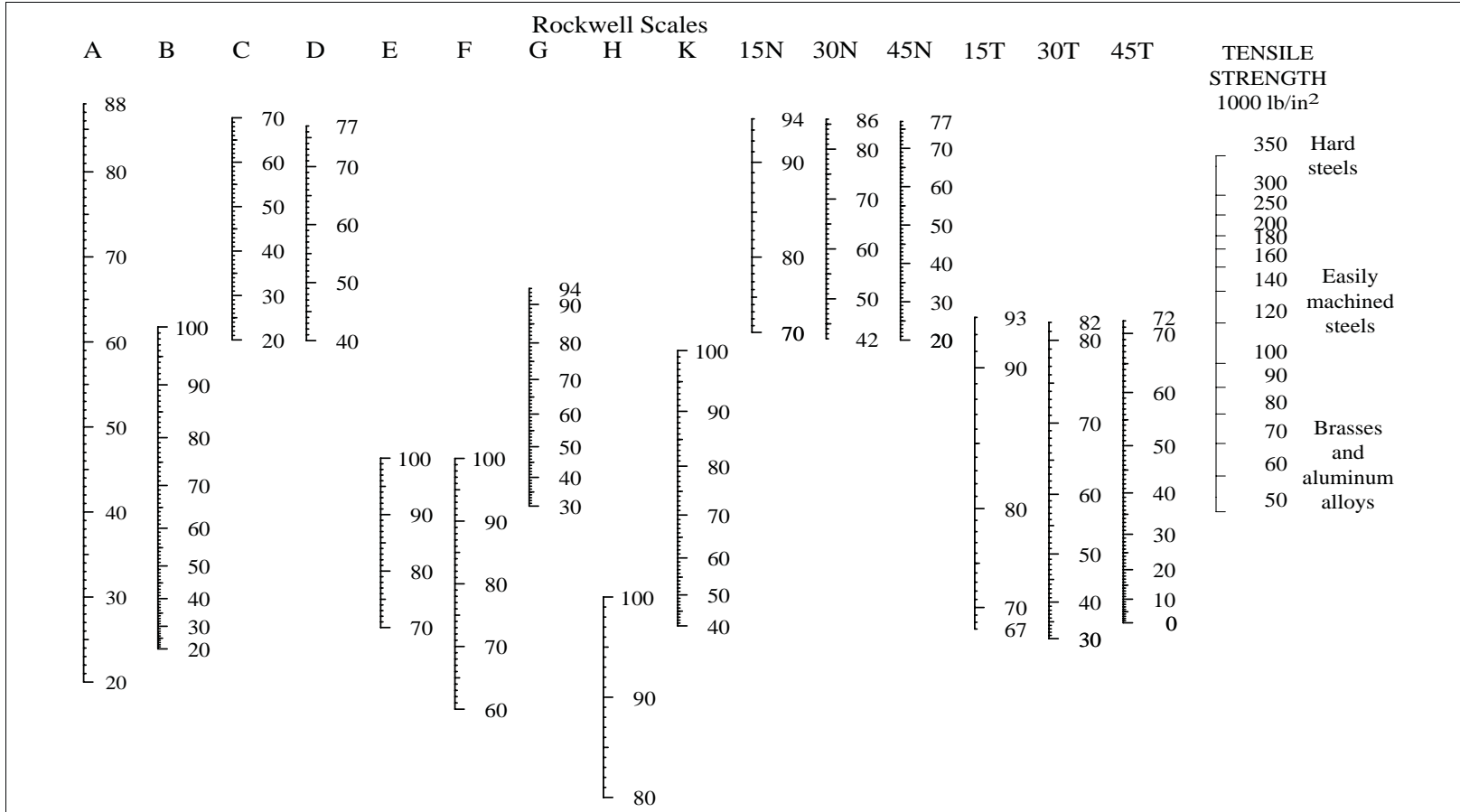
Rockwell Hardness Number			Rockwell Superficial Hardness Number			Rockwell Hardness Number			Brinell Hardness Number		
$\frac{1}{16}$ " Ball Indenter			$\frac{1}{16}$ " Ball Indenter			$\frac{1}{8}$ " Ball Indenter			"Brale" Indenter	10-mm Standard Ball	
B scale 100-kg Load	F scale 60-kg Load	G scale 150-kg Load	15-T scale 15-kg Load	30-T scale 30-kg Load	45-T scale 45-kg Load	E scale 100-kg Load	H scale 60-kg Load	K scale 150-kg Load	A scale 60-kg Load	500-kg Load	3000-kg Load
100	...	82.5	93.0	82.0	72.0	61.5	201	240
99	...	81.0	92.5	81.5	71.0	61.0	195	234
98	...	79.0	...	81.0	70.0	60.0	189	228
97	...	77.5	92.0	80.5	69.0	59.5	184	222
96	...	76.0	...	80.0	68.0	59.0	179	216
95	...	74.0	91.5	79.0	67.0	58.0	175	210
94	...	72.5	...	78.5	66.0	57.5	171	205
93	...	71.0	91.0	78.0	65.5	57.0	167	200
92	...	69.0	90.5	77.5	64.5	100	56.5	163	195
91	...	67.5	...	77.0	63.5	99.5	56.0	160	190
90	...	66.0	90.0	76.0	62.5	98.5	55.5	157	185
89	...	64.0	89.5	75.5	61.5	98.0	55.0	154	180
88	...	62.5	...	75.0	60.5	97.0	54.0	151	176
87	...	61.0	89.0	74.5	59.5	96.5	53.5	148	172
86	...	59.0	88.5	74.0	58.5	95.5	53.0	145	169
85	...	57.5	...	73.5	58.0	94.5	52.5	142	165
84	...	56.0	88.0	73.0	57.0	94.0	52.0	140	162
83	...	54.0	87.5	72.0	56.0	93.0	51.0	137	159
82	...	52.5	...	71.5	55.0	92.0	50.5	135	156
81	...	51.0	87.0	71.0	54.0	91.0	50.0	133	153
80	...	49.0	86.5	70.0	53.0	90.5	49.5	130	150
79	...	47.5	...	69.5	52.0	89.5	49.0	128	147
78	...	46.0	86.0	69.0	51.0	88.5	48.5	126	144
77	...	44.0	85.5	68.0	50.0	88.0	48.0	124	141
76	...	42.5	...	67.5	49.0	87.0	47.0	122	139
75	99.5	41.0	85.0	67.0	48.5	86.0	46.5	120	137
74	99.0	39.0	...	66.0	47.5	85.0	46.0	118	135
73	98.5	37.5	84.5	65.5	46.5	84.5	45.5	116	132
72	98.0	36.0	84.0	65.0	45.5	83.5	45.0	114	130
71	97.5	34.5	...	64.0	44.5	100	...	82.5	44.5	112	127
70	97.0	32.5	83.5	63.5	43.5	99.5	...	81.5	44.0	110	125
69	96.0	31.0	83.0	62.5	42.5	99.0	...	81.0	43.5	109	123
68	95.5	29.5	...	62.0	41.5	98.0	...	80.0	43.0	107	121
67	95.0	28.0	82.5	61.5	40.5	97.5	...	79.0	42.5	106	119
66	94.5	26.5	82.0	60.5	39.5	97.0	...	78.0	42.0	104	117
65	94.0	25.0	...	60.0	38.5	96.0	...	77.5	...	102	116
64	93.5	23.5	81.5	59.5	37.5	95.5	...	76.5	41.5	101	114
63	93.0	22.0	81.0	58.5	36.5	95.0	...	75.5	41.0	99	112
62	92.0	20.5	...	58.0	35.5	94.5	...	74.5	40.5	98	110
61	91.5	19.0	80.5	57.0	34.5	93.5	...	74.0	40.0	96	108
60	91.0	17.5	...	56.5	33.5	93.0	...	73.0	39.5	95	107
59	90.5	16.0	80.0	56.0	32.0	92.5	...	72.0	39.0	94	106
58	90.0	14.5	79.5	55.0	31.0	92.0	...	71.0	38.5	92	104
57	89.5	13.0	...	54.5	30.0	91.0	...	70.5	38.0	91	103
56	89.0	11.5	79.0	54.0	29.0	90.5	...	69.5	...	90	101
55	88.0	10.0	78.5	53.0	28.0	90.0	...	68.5	37.5	89	100
54	87.5	8.5	...	52.5	27.0	89.5	...	68.0	37.0	87	...
53	87.0	7.0	78.0	51.5	26.0	89.0	...	67.0	36.5	86	...
52	86.5	5.5	77.5	51.0	25.0	88.0	...	66.0	36.0	85	...
51	86.0	4.0	...	50.5	24.0	87.5	...	65.0	35.5	84	...
50	85.5	2.5	77.0	49.5	23.0	87.0	...	64.5	35.0	83	...
49	85.0	1.0	76.5	49.0	22.0	86.5	...	63.5	...	82	...

Table 2. (Continued) Comparative Hardness Scales for Unhardened Steel, Soft-Temper Steel, Grey and Malleable Cast Iron, and Nonferrous Alloys

Rockwell Hardness Number			Rockwell Superficial Hardness Number			Rockwell Hardness Number			Brinell Hardness Number		
1/16" Ball Indenter			1/16" Ball Indenter			1/8" Ball Indenter			"Brale" Indenter	10-mm Standard Ball	
B scale 100-kg Load	F scale 60-kg Load	G scale 150-kg Load	15-T scale 15-kg Load	30-T scale 30-kg Load	45-T scale 45-kg Load	E scale 100-kg Load	H scale 60-kg Load	K scale 150-kg Load	A scale 60-kg Load	500-kg Load	3000-kg Load
48	84.5	48.5	20.5	85.5	...	62.5	34.5	81	...
47	84.0	...	76.0	47.5	19.5	85.0	...	61.5	34.0	80	...
46	83.0	...	75.5	47.0	18.5	84.5	...	61.0	33.5
45	82.5	46.0	17.5	84.0	...	60.0	33.0	79	...
44	82.0	...	75.0	45.5	16.5	83.5	...	59.0	32.5	78	...
43	81.5	...	74.5	45.0	15.5	82.5	...	58.0	32.0	77	...
42	81.0	44.0	14.5	82.0	...	57.5	31.5	76	...
41	80.5	...	74.0	43.5	13.5	81.5	...	56.5	31.0	75	...
40	79.5	...	73.5	43.0	12.5	81.0	...	55.5
39	79.0	42.0	11.0	80.0	...	54.5	30.5	74	...
38	78.5	...	73.0	41.5	10.0	79.5	...	54.0	30.0	73	...
37	78.0	...	72.5	40.5	9.0	79.0	...	53.0	29.5	72	...
36	77.5	40.0	8.0	78.5	100	52.0	29.0
35	77.0	...	72.0	39.5	7.0	78.0	99.5	51.5	28.5	71	...
34	76.5	...	71.5	38.5	6.0	77.0	99.0	50.5	28.0	70	...
33	75.5	38.0	5.0	76.5	...	49.5	...	69	...
32	75.0	...	71.0	37.5	4.0	76.0	98.5	48.5	27.5
31	74.5	36.5	3.0	75.5	98.0	48.0	27.0	68	...
30	74.0	...	70.5	36.0	2.0	75.0	...	47.0	26.5	67	...
29	73.5	...	70.0	35.5	1.0	74.0	97.5	46.0	26.0
28	73.0	34.5	...	73.5	97.0	45.0	25.5	66	...
27	72.5	...	69.5	34.0	...	73.0	96.5	44.5	25.0
26	72.0	...	69.0	33.0	...	72.5	...	43.5	24.5	65	...
25	71.0	32.5	...	72.0	96.0	42.5	...	64	...
24	70.5	...	68.5	32.0	...	71.0	95.5	41.5	24.0
23	70.0	...	68.0	31.0	...	70.5	...	41.0	23.5	63	...
22	69.5	30.5	...	70.0	95.0	40.0	23.0
21	69.0	...	67.5	29.5	...	69.5	94.5	39.0	22.5	62	...
20	68.5	29.0	...	68.5	...	38.0	22.0
19	68.0	...	67.0	28.5	...	68.0	94.0	37.5	21.5	61	...
18	67.0	...	66.5	27.5	...	67.5	93.5	36.5
17	66.5	27.0	...	67.0	93.0	35.5	21.0	60	...
16	66.0	...	66.0	26.0	...	66.5	...	35.0	20.5
15	65.5	...	65.5	25.5	...	65.5	92.5	34.0	20.0	59	...
14	65.0	25.0	...	65.0	92.0	33.0
13	64.5	...	65.0	24.0	...	64.5	...	32.0	...	58	...
12	64.0	...	64.5	23.5	...	64.0	91.5	31.5
11	63.5	23.0	...	63.5	91.0	30.5
10	63.0	...	64.0	22.0	...	62.5	90.5	29.5	...	57	...
9	62.0	21.5	...	62.0	...	29.0
8	61.5	...	63.5	20.5	...	61.5	90.0	28.0
7	61.0	...	63.0	20.0	...	61.0	89.5	27.0	...	56	...
6	60.5	19.5	...	60.5	...	26.0
5	60.0	...	62.5	18.5	...	60.0	89.0	25.5	...	55	...
4	59.5	...	62.0	18.0	...	59.0	88.5	24.5
3	59.0	17.0	...	58.5	88.0	23.5
2	58.0	...	61.5	16.5	...	58.0	...	23.0	...	54	...
1	57.5	...	61.0	16.0	...	57.5	87.5	22.0
0	57.0	15.0	...	57.0	87.0	21.0	...	53	...

Not applicable to annealed metals of high B-scale hardness such as austenitic stainless steels, nickel and high-nickel alloys nor to cold-worked metals of low B-scale hardness such as aluminum and the softer alloys. (Compiled by Wilson Mechanical Instrument Co.)

Table 3. Graphical Comparison of Rockwell Hardness Scales



Source: George Dorian of GPDorian Co. Note: This chart is for the general comparison of Rockwell scales only.

NONFERROUS ALLOYS

Strength Data for Nonferrous Metals

The ultimate tensile, shear, and yield strengths and moduli of elasticity of many nonferrous metals are given in Table 1. Values for the most part are given in ranges rather than as single values because of differences in composition, forms, sizes, and shapes for the aluminum alloys plus differences in heat treatments undergone for the other nonferrous metals. The values in the table are meant to serve as a guide, not as specifications. More specific data should be obtained from the supplier.

Table 1. Strength Data for Nonferrous Metals

Material	Ultimate Strength				Yield Strength (0.2% offset)		Modulus of Elasticity			
	in Tension		in Shear		ksi	MPa	in Tension, E		in Shear, G	
	ksi	MPa	ksi	MPa			10^6 psi	10^3 MPa	10^6 psi	10^3 MPa
Aluminum alloys, cast,										
sand-cast	19–35	131–241	14–26	97–179	8–25	55–172	10.3	71
heat-treated	20–48	138–331	20 t–34	138–234	16–40	110–276	10.3	71
permanent-mold-cast,	23–35	159–241	16–27	110–186	9–24	62–165	10.3	71
heat-treated	23–48	159–331	15–36	103–248	8.5–43	59–296	10.3	71
die-cast	30–46	207–317	19–29	131–200	16–27	110–186	10.3	71
Aluminum alloys,										
wrought,										
annealed	10–42	69–290	7–26	48–179	4–22	28–152	10.0–10.6	68.9–73
cold-worked	12–63	83–434	8–34	55–234	11–59	76–407	10.0–10.3	68.9–71
heat-treated	22–83	152–572	14–48	97–331	13–73	90–503	10.0–11.4	68.9–78.6
Aluminum bronze, cast,	62–90	428–621	25–37	172–255	15–18	103.4–124.1
heat-treated	80–110	552–758	32–65	221–448	15–18	103.4–124.1
Aluminum bronze,										
wrought,										
annealed	55–80	379–552	20–40	138–276	16–19	110.3–131
cold-worked	71–110	490–758	62–66	427–455	16–19	110.3–131
heat-treated	101–151	696–1041	48–94	331–648	16–19	110.3–131
Brasses, leaded, cast	32–40	221–276	29–31	200–214	12–15	83–103	12–14	82.7–96.5
flat products, wrought	46–85	317–586	31–45	214–310	14–62	97–427	14–17	96.5–117.2	5.3–6.4	36.5–44.1
wire, wrought	50–88	345–607	34–46	234–317	15	103.4	5.6	38.6
Brasses, nonleaded,										
flat products, wrought	34–99	234–683	28–48	193–331	10–65	69–448	15–17	103.4–117.2	5.6–6.4	38.6–44.1
wire, wrought	40–130	276–896	29–60	200–414	15–17	103.4–117.2	5.6–6.4	38.6–44.1
Copper, wrought,										
flat products	32–57	221–393	22–29	152–200	10–53	69–365	17	117.2	6.4	44.1
wire	35–66	241–455	24–33	165–228	17	117.2	6.4	44.1
Inconel, cast	70–95	483–655	30–45	207–310	23	158.6
flat products, wrought	80–170	552–1172	30–160	207–1103	31	213.7	11	75.8
wire, wrought	80–185	552–1276	25–175	172–1207	31	213.7	11	75.8
Lead	2.2–4.9	15–34	0.8–2.0	5.5–13.8
Magnesium, cast,										
sand & permanent mold	22–40	152–276	17–22	117–152	12–23	83–159	6.5	44.8	2.4	16.5
die-cast	33	228	20	138	22	152	6.5	44.8	2.4	16.5
Magnesium, wrought										
sheet and plate	35–42	241–290	21–23	145–159	20–32	138–221	6.5	44.8	2.4	16.5
bars, rods, and shapes	37–55	255–379	19–27	131–186	26–44	179–303	6.5	44.8	2.4	16.5
Monel, cast	65–90	448–621	32–40	221–276	19	131
flat products, wrought	70–140	483–965	25–130	172–896	26	179.3	9.5	65.5
wire, wrought	70–170	483–1172	25–160	172–1103	26	179.3	9.5	65.5
Nickel, cast,	45–60	310–414	20–30	138–207	21.5	148.2
flat products, wrought	55–130	379–896	15–115	103–793	30	206.8	11	75.8
wire, wrought	50–165	345–1138	10–155	69–1069	30	206.8	11	75.8
Nickel silver, cast	40–50	276–345	24–25	165–172
flat products, wrought	49–115	338–793	41–59	283–407	18–90	124–621	17.5–18	120.7–124.1	6.6–6.8	45.5–46.9
wire, wrought	50–145	345–1000	25–90	172–621	17.5–18	120.7–124.1	6.6–6.8	45.5–46.9
Phosphor bronze, wrought										
flat products	40–128	276–883	14–80	97–552	15–17	103.4–117.2	5.6–6.4	38.6–44.1
wire	50–147	345–1014	20–80	138–552	16–17	110.3–117.2	6–6.4	41.4–44.1
Silicon bronze, wrought,										
flat products	56–110	386–758	42–63	290–434	21–62	145–427	15	103.4	5.6	38.6
wire	50–145	345–1000	36–70	248–483	25–70	172–483	15–17	103.4–117.2	5.6–6.4	38.6–44.1
Tin bronze, leaded, cast	21–38	145–262	23–43	159–296	15–18	103–124	10–14.5	68.9–100
Titanium	50–135	345–931	40–120	276–827	15.0–16.5	103.4–113.8
Zinc, commercial rolled	19.5–31	134–214
Zirconium	22–83	152–572	9–14.5	62.1–100	4.8	33.1

Consult the index for data on metals not listed and for more data on metals listed.

Copper and Copper Alloys

Pure copper is a reddish, highly malleable metal, and was one of the first to be found and utilized. Copper and its alloys are widely used because of their excellent electrical and thermal conductivities, outstanding resistance to corrosion, ease of fabrication, and broad ranges of obtainable strengths and special properties. Almost 400 commercial copper and copper-alloy compositions are available from mills as wrought products (rod, plate, sheet, strip, tube, pipe, extrusions, foil, forgings, and wire) and from foundries as castings.

Copper alloys are grouped into several general categories according to composition:

- coppers and high-copper alloys
- brasses
- bronzes
- copper nickels
- copper-nickel-zinc alloys (nickel silvers)
- lead coppers
- special alloys

The designation system originally developed by the U.S. copper and brass industry for identifying copper alloys used a three-digit number preceded by the letters CA. These designations have now been made part of the Unified Numbering System (UNS) simply by expanding the numbers to five digits preceded by the letter C. Because the old numbers are embedded in the new UNS numbers, no confusion results. UNS C10000 to C79999 are assigned to wrought compositions, and UNS C80000 to C99999 are assigned to castings. The designation system is not a specification, but a method for identifying the composition of mill and foundry products. The precise technical and quality assurance requirements to be satisfied are defined in relevant standard specifications issued by the federal government, the military, and the ASTM.

Classification of Copper and Copper Alloys

Family	Principal Alloying Element	UNS Numbers ^a
Coppers, high-copper alloys		C1xxxx
Brasses	Zn	C2xxxx, C3xxxx, C4xxxx, C66400 to C69800
Phosphor bronzes	Sn	C5xxxx
Aluminum bronzes	Al	C60600 to C64200
Silicon bronzes	Si	C64700 to C66100
Copper nickels, nickel silvers	Ni	C7xxxx

^aWrought alloys.

Cast Copper Alloys.—Generally, casting permits greater latitude in the use of alloying elements than in the fabrication of wrought products, which requires either hot or cold working. The cast compositions of coppers and high-copper alloys have a designated minimum copper content and may include other elements to impart special properties. The cast brasses comprise copper-zinc-tin alloys (red, semired, and yellow brasses); manganese bronze alloys (high-strength yellow brasses); leaded manganese bronze alloys (leaded high-strength yellow brasses); and copper-zinc-silicon alloys (silicon brasses and bronzes).

The cast bronze alloys have four main families: copper-tin alloys (tin bronzes); copper-tin-lead alloys (leaded and high leaded tin bronzes); copper-tin-nickel alloys (nickel-tin bronzes); and copper-aluminum alloys (aluminum bronzes).

The cast copper-nickel alloys contain nickel as the principal alloying element. The leaded coppers are cast alloys containing 20 per cent or more lead.

Table 2 lists the properties and applications of common cast copper alloys.

Table 2. Properties and Applications of Cast Coppers and Copper Alloys

UNS Designation	Nominal Composition (%)	Typical Mechanical Properties, as Cast or Heat Treated ^a				Typical Applications
		Tensile Strength (ksi)	Yield Strength (ksi)	Elongation in 2 in. (%)	Machinability Rating ^b	
Copper Alloys						
C80100	99.95 Cu + Ag min, 0.05 others max	25	9	40	10	Electrical and thermal conductors; corrosion and oxidation-resistant applications.
C80300	99.95 Cu + Ag min, 0.034 Ag min, 0.05 others max	25	9	40	10	Electrical and thermal conductors; corrosion and oxidation-resistant applications.
C80500	99.75 Cu + Ag min, 0.034 Ag min, 0.02 B max, 0.23 others max	25	9	40	10	Electrical and thermal conductors; corrosion and oxidation-resistant applications.
C80700	99.75 Cu + Ag min, 0.02 B max, 0.23 others max	25	9	40	10	Electrical and thermal conductors; corrosion and oxidation-resistant applications.
C80900	99.70 Cu + Ag min, 0.034 Ag min, 0.30 others max	25	9	40	10	Electrical and thermal conductors; corrosion and oxidation-resistant applications.
C81100	99.70 Cu + Ag min, 0.30 others max	25	9	40	10	Electrical and thermal conductors; corrosion and oxidation resistant applications.
High-Copper Alloys						
C81300	98.5 Cu min, 0.06 Be, 0.80 Co, 0.40 others max	(53)	(36)	(11)	20	Higher hardness electrical and thermal conductors.
C81400	98.5 Cu min, 0.06 Be, 0.80 Cr, 0.40 others max	(53)	(36)	(11)	20	Higher hardness electrical and thermal conductors.
C81500	98.0 Cu min, 1.0 Cr, 0.50 others max	(51)	(40)	(17)	20	Electrical and/or thermal conductors used as structural members where strength and hardness greater than that of C80100-81100 are required.
C81700	94.2 Cu min, 1.0 Ag, 0.4 Be, 0.9 Co, 0.9 Ni	(92)	(68)	(8)	30	Electrical and/or thermal conductors used as structural members where strength and hardness greater than that of C80100-81100 are required. Also used in place of C81500 where electrical and/or thermal conductivities can be sacrificed for hardness and strength.
C81800	95.6 Cu min, 1.0 Ag, 0.4 Be, 1.6 Co	50 (102)	25 (75)	20 (8)	20	Resistance-welding electrodes, dies.
C82000	96.8 Cu, 0.6 Be, 2.6 Co	50 (100)	20 (75)	20 (8)	20	Current-carrying parts, contact and switch blades, bushings and bearings, and soldering iron and resistance-welding tips.
C82100	97.7 Cu, 0.5 Be, 0.9 Co, 0.9 Ni	(92)	(68)	(8)	30	Electrical and/or thermal conductors used as structural members where strength and hardness greater than that of C80100-81100 are required. Also used in place of C81500 where electrical and/or thermal conductivities can be sacrificed for hardness and strength.
C82200	96.5 Cu min, 0.6 Be, 1.5 Ni	57 (95)	30 (75)	20 (8)	20	Clutch rings, brake drums, seam-welder electrodes, projection welding dies, spot-welding tips, beam-welder shapes, bushings, water-cooled holders.
C82400	96.4 Cu min, 1.70 Be, 0.25 Co	72 (150)	37 (140)	20 (1)	20	Safety tools, molds for plastic parts, cams, bushings, bearings, valves, pump parts, gears.
C82500	97.2 Cu, 2.0 Be, 0.5 Co, 0.25 Si	80 (160)	45	20 (1)	20	Safety tools, molds for plastic parts, cams, bushings, bearings, valves, pump parts.
C82600	95.2 Cu min, 2.3 Be, 0.5 Co, 0.25 Si	82 (165)	47 (155)	20 (1)	20	Bearings and molds for plastic parts.
C82700	96.3 Cu, 2.45 Be, 1.25 Ni	(155)	(130)	(0)	20	Bearings and molds for plastic parts.
C82800	96.6 Cu, 2.6 Be, 0.5 Co, 0.25 Si	97 (165)	55 (145)	20 (1)	10	Molds for plastic parts, cams, bushings, bearings, valves, pump parts, sleeves.

Table 2. (Continued) Properties and Applications of Cast Coppers and Copper Alloys

UNS Designation	Nominal Composition (%)	Typical Mechanical Properties, as Cast or Heat Treated ^a				Typical Applications
		Tensile Strength (ksi)	Yield Strength (ksi)	Elongation in 2 in. (%)	Machinability Rating ^b	
Red Brasses and Leaded Red Brasses						
C83300	93 Cu, 1.5 Sn, 1.5 Pb, 4 Zn	32	10	35	35	Terminal ends for electrical cables.
C83400	90 Cu, 10 Zn	35	10	30	60	Moderate strength, moderate conductivity castings; rotating bands.
C83600	85 Cu, 5 Sn, 5 Pb, 5 Zn	37	17	30	84	Valves, flanges, pipe fittings, plumbing goods, pump castings, water pump impellers and housings, ornamental fixtures, small gears.
C83800	83 Cu, 4 Sn, 6 Pb, 7 Zn	35	16	25	90	Low-pressure valves and fittings, plumbing supplies and fittings, general hardware, air-gas-water fittings, pump components, railroad catenary fittings.
Semired Brasses and Leaded Semired Brasses						
C84200	80 Cu, 5 Sn, 2.5 Pb, 12.5 Zn	35	14	27	80	Pipe fittings, elbows, T's, couplings, bushings, locknuts, plugs, unions.
C84400	81 Cu, 3 Sn, 7 Pb, 9 Zn	34	15	26	90	General hardware, ornamental castings, plumbing supplies and fixtures, low-pressure valves and fittings.
C84500	78 Cu, 3 Sn, 7 Pb, 12 Zn	35	14	28	90	Plumbing fixtures, cocks, faucets, stops, waste, air and gas fittings, low-pressure valve fittings.
C84800	76 Cu, 3 Sn, 6 Pb, 15 Zn	36	14	30	90	Plumbing fixtures, cocks, faucets, stops, waste, air, and gas, general hardware, and low-pressure valve fittings.
Yellow Brasses and Leaded Yellow Brasses						
C85200	72 Cu, 1 Sn, 3 Pb, 24 Zn	38	13	35	80	Plumbing fittings and fixtures, ferrules, valves, hardware, ornamental brass, chandeliers, and irons.
C85400	67 Cu, 1 Sn, 3 Pb, 29 Zn	34	12	35	80	General-purpose yellow casting alloy not subject to high internal pressure. Furniture hardware, ornamental castings, radiator fittings, ship trimmings, battery clamps, valves, and fittings.
C85500	61 Cu, 0.8 Al, bal Zn	60	23	40	80	Ornamental castings.
C85700	63 Cu, 1 Sn, 1 Pb, 34.7 Zn, 0.3 Al	50	18	40	80	Bushings, hardware fittings, ornamental castings.
C85800	58 Cu, 1 Sn, 1 Pb, 40 Zn	55	30	15	80	General-purpose die-casting alloy having moderate strength.
Manganese and Leaded Manganese Bronze Alloys						
C86100	67 Cu, 21 Zn, 3 Fe, 5 Al, 4 Mn	95	50	20	30	Marine castings, gears, gun mounts, bushings and bearings, marine racing propellers.
C86200	64 Cu, 26 Zn, 3 Fe, 4 Al, 3 Mn	95	48	20	30	Marine castings, gears, gun mounts, bushings and bearings.
C86300	63 Cu, 25 Zn, 3 Fe, 6 Al, 3 Mn	115	83	15	8	Extra-heavy duty, high-strength alloy. Large valve stems, gears, cams, slow-speed heavy-load bearings, screwdown nuts, hydraulic cylinder-parts.
C86400	59 Cu, 1 Pb, 40 Zn	65	25	20	65	Free-machining manganese bronze. Valve stems, marine fittings, lever arms, brackets, light-duty gears.
C86500	58 Cu, 0.5 Sn, 39.5 Zn, 1 Fe, 1 Al	71	28	30	26	Machinery parts requiring strength and toughness, lever arms, valve stems, gears.
C86700	58 Cu, 1 Pb, 41 Zn	85	42	20	55	High strength, free-machining manganese bronze. Valve stems.
C86800	55 Cu, 37 Zn, 3 Ni, 2 Fe, 3 Mn	82	38	22	30	Marine fittings, marine propellers.
Silicon Bronzes and Silicon Brasses						
C87200	89 Cu min, 4 Si	55	25	30	40	Bearings, bells, impellers, pump and valve components, marine fittings, corrosion-resistant castings.
C87400	83 Cu, 14 Zn, 3 Si	55	24	30	50	Bearings, gears, impellers, rocker arms, valve stems, clamps.

Table 2. (Continued) Properties and Applications of Cast Coppers and Copper Alloys

UNS Designation	Nominal Composition (%)	Typical Mechanical Properties, as Cast or Heat Treated ^a				Typical Applications
		Tensile Strength (ksi)	Yield Strength (ksi)	Elongation in 2 in. (%)	Machinability Rating ^b	
C87500	82 Cu, 14 Zn, 4 Si	67	30	21	50	Bearings, gears, impellers, rocker arms, valve stems, small boat proellers.
C87600	90 Cu, 5.5 Zn, 4.5 Si	66	32	20	40	Valve stems.
C87800	82 Cu, 14 Zn, 4 Si	85	50	25	40	High-strength, thin-wall die castings; brush holders, lever arms, brackets, clamps, hexagonal nuts.
C87900	65 Cu, 34 Zn, 1 Si	70	35	25	80	General-purpose die-casting alloy having moderate strength.
Tin Bronzes						
C90200	93 Cu, 7 Sn	38	16	30	20	Bearings and bushings.
C90300	88 Cu, 8 Sn, 4 Zn	45	21	30	30	Bearings, bushings, pump impellers, piston rings, valve components, seal rings, steam fittings, gears.
C90500	88 Cu, 10 Sn, 2 Zn	45	22	25	30	Bearings, bushings, pump impellers, piston rings, valve components, steam fittings, gears.
C90700	89 Cu, 11 Sn	44 (55)	22 (30)	20 (16)	20	Gears, bearings, bushings.
C90900	87 Cu, 13 Sn	40	20	15	20	Bearings and bushings.
C91000	85 Cu, 14 Sn, 1 Zn	32	25	2	20	Piston rings and bearings.
C91100	84 Cu, 16 Sn	35	25	2	10	Piston rings, bearings, bushings, bridge plates.
C91300	81 Cu, 19 Sn	35	30	0.5	10	Piston rings, bearings, bushings, bridge plates, bells.
C91600	88 Cu, 10.5 Sn, 1.5 Ni	44 (60)	22 (32)	16 (16)	20	Gears.
C91700	86.5 Cu, 12 Sn, 1.5 Ni	44 (60)	22 (32)	16 (16)	20	Gears.
Leaded Tin Bronzes						
C92200	88 Cu, 6 Sn, 1.5 Pb, 4.5 Zn	40	20	30	42	Valves, fittings, and pressure-containing parts for use up to 550°F.
C92300	87 Cu, 8 Sn, 4 Zn	40	20	25	42	Valves, pipe fittings, and high-pressure steam castings. Superior machinability to C90300.
C92500	87 Cu, 11 Sn, 1 Pb, 1 Ni	44	20	20	30	Gears, automotive synchronizer rings.
C92600	87 Cu, 10 Sn, 1 Pb, 2 Zn	44	20	30	40	Bearings, bushings, pump impellers, piston rings, valve components, steam fittings, and gears. Superior machinability to C90500.
C92700	88 Cu, 10 Sn, 2 Pb	42	21	20	45	Bearings, bushings, pump impellers, piston rings, and gears. Superior machinability to C90500.
C92800	79 Cu, 16 Sn, 5 Pb	40	30	1	70	Piston rings.
C92900	82 Cu min, 9 Sn min, 2 Pb min, 2.8 Ni min	47 (47)	26 (26)	20 (20)	40	Gears, wear plates, guides, cams, parts requiring machinability superior to that of C91600 or 91700.
High-Leaded Tin Bronzes						
C93200	83 Cu, 6.3 Sn min, 7 Pb, 3 Zn	35	18	20	70	General-utility bearings and bushings.
C93400	84 Cu, 8 Sn, 8 Pb	32	16	20	70	Bearings and bushings.
C93500	85 Cu, 5 Sn, 9 Pb	32	16	20	70	Small bearings and bushings, bronze backing for babbitt-lined automotive bearings.
C93700	80 Cu, 10 Sn, 10 Pb	35	18	20	80	Bearings for high speed and heavy pressures, pumps, impellers, corrosion-resistant applications, pressure tight castings.
C93800	78 Cu, 7 Sn, 15 Pb	30	16	18	80	Bearings for general service and moderate pressure, pump impellers, and bodies for use in acid mine water.
C93900	79 Cu, 6 Sn, 15 Pb	32	22	7	80	Continuous castings only. Bearings for general service, pump bodies, and impellers for mine waters.
C94300	70 Cu, 5 Sn, 25 Pb	27	13	15	80	High-speed bearings for light loads.
C94400	81 Cu, 8 Sn, 11 Pb, 0.35 P	32	16	18	80	General-utility alloy for bushings and bearings.
C94500	73 Cu, 7 Sn, 20 Pb	25	12	12	80	Locomotive wearing parts; high-low, low-speed bearings.

Table 2. (Continued) Properties and Applications of Cast Coppers and Copper Alloys

UNS Designation	Nominal Composition (%)	Typical Mechanical Properties, as Cast or Heat Treated ^a				Typical Applications
		Tensile Strength (ksi)	Yield Strength (ksi)	Elongation in 2 in. (%)	Machinability Rating ^b	
Nickel-Tin Bronzes						
C94700	88 Cu, 5 Sn, 2 Zn, 5 Ni	50 (85)	23 (60)	35 (10)	30 (20)	Valve stems and bodies, bearings, wear guides, shift forks, feeding mechanisms, circuit breaker parts, gears, piston cylinders, nozzles.
C94800	87 Cu, 5 Sn, 5 Ni	45 (60)	23 (30)	35 (8)	50 (40)	Structural castings, gear components, motion-translation devices, machinery parts, bearings.
Aluminum Bronzes						
C95200	88 Cu, 3 Fe, 9 Al	80	27	35	50	Acid-resisting pumps, bearing, gears, valve seats, guides, plungers, pump rods, bushings.
C95300	89 Cu, 1 Fe, 10 Al	75 (85)	27 (42)	25 (15)	55	Pickling baskets, nuts, gears, steel mill slippers, marine equipment, welding jaws.
C95400	85 Cu, 4 Fe, 11 Al	85 (105)	35 (54)	18 (8)	60	Bearings, gears, worms, bushings, valve seats and guides, pickling hooks.
C95500	81 Cu, 4 Ni, 4 Fe, 11 Al	100 (120)	44 (68)	12 (10)	50	Valve guides and seats in aircraft engines, corrosion-resistant parts, bushings, gears, worms, pickling hooks and baskets, agitators.
C95600	91 Cu, 7 Al, 2 Si	75	34	18	60	Cable connectors, terminals, valve stems, marine hardware, gears, worms, pole-line hardware.
C95700	75 Cu, 2 Ni, 3 Fe, 8 Al, 12 Mn	95	45	26	50	Propellers, impellers, stator clamp segments, safety tools, welding rods, valves, pump casings.
C95800	81 Cu, 5 Ni, 4 Fe, 9 Al, 1 Mn	95	38	25	50	Propeller hubs, blades, and other parts in contact with salt water.
Copper-Nickels						
C96200	88.6 Cu, 10 Ni, 1.4 Fe	45 min	25 min	20 min	10	Components of items being used for seawater corrosion resistance.
C96300	79.3 Cu, 20 Ni, 0.7 Fe	75 min	55 min	10 min	15	Centrifugally cast tailshaft sleeves.
C96400	69.1 Cu, 30 Ni, 0.9 Fe	68	37	28	20	Valves, pump bodies, flanges, elbows used for seawater corrosion resistance.
C96600	68.5 Cu, 30 Ni, 1 Fe, 0.5 Be	(110)	(70)	(7)	20	High-strength constructional parts for seawater corrosion resistance.
Nickel Silvers						
C97300	56 Cu, 2 Sn, 10 Pb, 12 Ni, 20 Zn	35	17	20	70	Hardware fittings, valves and valve trim, statuary, ornamental castings.
C97400	59 Cu, 3 Sn, 5 Pb, 17 Ni, 16 Zn	38	17	20	60	Valves, hardware, fittings, ornamental castings.
C97600	64 Cu, 4 Sn, 4 Pb, 20 Ni, 8 Zn	45	24	20	70	Marine castings, sanitary fittings, ornamental hardware, valves, pumps.
C97800	66 Cu, 5 Sn, 2 Pb, 25 Ni, 2 Zn	55	30	15	60	Ornamental and sanitary castings, valves and valve seats, musical instrument components.
Special Alloys						
C99300	71.8 Cu, 15 Ni, 0.7 Fe, 11 Al, 1.5 Co	95	55	2	20	Glass-making molds, plate glass rolls, marine hardware.
C99400	90.4 Cu, 2.2 Ni, 2.0 Fe, 1.2 Al, 1.2 Si, 3.0 Zn	66 (79)	34 (54)	25	50	Valve stems, marine and other uses requiring resistance to dezincification and dealuminification, propeller wheels, electrical parts, mining equipment gears.
C99500	87.9 Cu, 4.5 Ni, 4.0 Fe, 1.2 Al, 1.2 Si, 1.2 Zn	70 min	40 min	12 min	50	Same as C99400, but where higher yield strength is required.
C99700	56.5 Cu, Al, 1.5 Pb, 12 Mn, 5 Ni, 24 Zn	55	25	25	80	
C99750	58 Cu, 1 Al, 1 Pb, 20 Mn, 20 Zn	65 (75)	32 (40)	30 (20)		

^a Values in parentheses are for heat-treated condition.

^b Free cutting brass = 100.

Source: Copper Development Association, New York.

Wrought Copper Alloys.—Wrought copper alloys can be utilized in the annealed, cold-worked, stress-relieved, or hardened-by-heat-treatment conditions, depending on composition and end use. The “temper designation” for copper alloys is defined in ASTM Standard Recommended Practice B601, which is applicable to all product forms.

Wrought copper and high-copper alloys, like cast alloys, have a designated minimum copper content and may include other elements to impart special properties. Wrought brasses have zinc as the principal alloying element and may have other designated elements. They comprise the copper-zinc alloys; copper-zinc-lead alloys (leaded brasses); and copper-zinc-tin alloys (tin brasses).

Wrought bronzes comprise four main groups; copper-tin-phosphorus alloys (phosphor bronze); copper-tin-lead-phosphorus alloys (leaded phosphor bronze); copper-aluminum alloys (aluminum bronzes); and copper-silicon alloys (silicon bronze).

Wrought copper-nickel alloys, like the cast alloys, have nickel as the principal alloying element. The wrought copper-nickel-zinc alloys are known as “nickel silvers” because of their color.

Table 3 lists the nominal composition, properties, and applications of common wrought copper alloys.

Table 3. Properties and Applications of Wrought Coppers and Copper Alloys

Name and Number	Nominal Composition (%)	Strength (ksi)		Elongation in 2 in. (%)	Machinability Rating ^a	Fabricating Characteristics and Typical Applications
		Tensile	Yield			
C10100 Oxygen-free electronic	99.99 Cu	32 -66	10 -53	55	20	Excellent hot and cold workability; good forgeability. Fabricated by blanking, coining, copper-smithing, drawing and upsetting, hot forging and pressing, spinning, swaging, stamping. Uses: busbars, bus conductors, waveguides, hollow conductors, lead-in wires and anodes for vacuum tubes, vacuum seals, transistor components, glass to metal seals, coaxial cables and tubes, klystrons, microwave tubes, rectifiers.
C10200 Oxygen-free copper	99.95 Cu	32-66	10-53	55	20	Fabricating characteristics same as C10100. Uses: busbars, waveguides.
C10300 Oxygen-free, extra-low phosphorus	99.95 Cu, 0.003 P	32-55	10-50	50	20	Fabricating characteristics same as C10100. Uses: busbars, electrical conductors, tubular bus, and applications requiring good conductivity and welding or brazing properties.
C10400, C10500, C10700 Oxygen-free, silver-bearing	99.95 Cu	32-66	10-53	55	20	Fabricating characteristics same as C10100. Uses: auto gaskets, radiators, busbars, conductivity wire, contacts, radio parts, winding, switches, terminals, commutator segments; chemical process equipment; printing rolls, clad metals, printed-circuit foil.
C10800 Oxygen-free, low phosphorus	99.95 Cu, 0.009 P	32-55	10-50	50	20	Fabricating characteristics same as C10100. Uses: refrigerators, air conditioners, gas and heater lines, oil burner tubes, plumbing pipe and tube, brewery tubes, condenser and heat-exchanger tubes, dairy and distiller tubes, pulp and paper lines, tanks; air, gasoline, and hydraulic lines.
C11000 Electrolytic tough pitch copper	99.90 Cu, 0.04 O	32-66	10-53	55	20	Fabricating characteristics same as C10100. Uses: downspouts, gutters, roofing, gaskets, auto radiators, busbars, nails, printing rolls, rivets, radio parts.
C11000 Electrolytic tough pitch, anneal-resistant	99.90 Cu, 0.04 O, 0.01 Cd	66			20	Fabricated by drawing and stranding, stamping. Uses: electrical power transmission where resistance to softening under overloads is desired.
C11300, C11400, C11500, C11600 Silver-bearing tough pitch copper	99.90 Cu, 0.04 O, Ag	32-66	10-53	55	20	Fabricating characteristics same as C10100. Uses: gaskets, radiators, busbars, windings, switches, chemical process equipment, clad metals, printed-circuit foil.

Table 3. (Continued) Properties and Applications of Wrought Coppers and Copper Alloys

Name and Number	Nominal Composition (%)	Strength (ksi)		Elongation in 2 in. (%)	Machinability Rating ^a	Fabricating Characteristics and Typical Applications
		Tensile	Yield			
C12000, C12100 Phosphorus deoxidized, low residual phosphorus	99.9 Cu	32-57	10-53	55	20	Fabricating characteristics same as C10100. Uses: busbars, electrical conductors, tubular bus, and applications requiring welding or brazing.
C12200, C12210 Phosphorus deoxidized copper, high residual phosphorus	99.90 Cu, 0.02 P	32-55	10-53	55	20	Fabricating characteristics same as C10100. Uses: gas and heater lines; oil burner tubing; plumbing pipe and tubing; condenser, evaporator, heat exchanger, dairy, and distiller tubing; steam and water lines; air, gasoline, and hydraulic lines.
C12500, C12700, C12800, C12900, C13000 Fire-refined tough pitch with silver	99.88 Cu	32-66	10-53	55	20	Fabricating characteristics same as C10100. Uses: same as C11000, Electrolytic tough pitch copper.
C14200 Phosphorus deoxidized, arsenical	99.68 Cu, 0.3 As, 0.02 P	32-55	10-50	45	20	Fabricating characteristics same as C10100. Uses: staybolts, heat-exchanger and condenser tubes.
C14300, C14310 Cadmium copper, deoxidized	99.9 Cu, 0.1 Cd	32-58	11-56	42	20	Fabricating characteristics same as C10100. Uses: anneal-resistant electrical applications requiring thermal softening and embrittlement resistance, lead frames, contacts, terminals, solder-coated and solder-fabricated parts, furnace-brazed assemblies and welded components, cable wrap.
C14500, C14510, C14520 Tellurium bearing	99.5 Cu, 0.50 Te, 0.008 P	32-56	10-51	50	85	Fabricating characteristics same as C10100. Uses: Forgings and screw-machine products, and parts requiring high conductivity, extensive machining, corrosion resistance, copper color, or a combination of these; electrical connectors, motor and switch parts, plumbing fittings, soldering coppers, welding torch tips, transistor bases, and furnace-brazed articles.
C14700, C14710, C14720 Sulfur bearing	99.6 Cu, 0.40 S	32-57	10-55	52	85	Fabricating characteristics same as C10100. Uses: screw-machine products and parts requiring high conductivity, extensive machining, corrosion resistance, copper color, or a combination of these; electrical connectors, motor and switch components, plumbing fittings, cold-headed and machined parts, cold forgings, furnace-brazed articles, screws, soldering coppers, rivets and welding torch tips.
C15000 Zirconium copper	99.8 Cu, 0.15 Zr	29-76	6-72	54	20	Fabricating characteristics same as C10100. Uses: switches, high-temperature circuit breakers, commutators, stud bases for power transmitters, rectifiers, soldering welding tips.
C15500	99.75 Cu, 0.06 P, 0.11 Mg, Ag	40-80	18-72	40	20	Fabricating characteristics same as C10100. Uses: high-conductivity light-duty springs, electrical contacts, fittings, clamps, connectors, diaphragms, electronic components, resistance-welding electrodes.
C15715	99.6 Cu, 0.13 Al ₂ O ₃	52-88	44-84	27	20	Excellent cold workability. Fabricated by extrusion, drawing, rolling, heading, swaging, machining, blanking, roll threading. Uses: integrated-circuit lead frames, diode leads; vacuum, microwave, and x-ray tube components; electrical components; brush springs; commutators, electric generator and motor components.
C15720	99.5 Cu, 0.18 Al ₂ O ₃	64-98	54-96	25		Excellent cold workability. Fabricated by extrusion, drawing, rolling, heading, swaging, machining, blanking. Uses: relay and switch springs, lead frames, contact supports, heat sinks, circuit breaker parts, rotor bars, resistance-welding electrodes and wheels, connectors, soldering gun tips.

Table 3. (Continued) Properties and Applications of Wrought Coppers and Copper Alloys

Name and Number	Nominal Composition (%)	Strength (ksi)		Elongation in 2 in. (%)	Machinability Rating ^a	Fabricating Characteristics and Typical Applications
		Tensile	Yield			
C15760	98.8 Cu, 0.58 Al ₂ O ₃	70-90	65-87	22		Excellent cold workability. Fabricated by extrusion and drawing. Uses: resistance-welding electrodes, soldering gun tips, MIG welding contact tips, continuous-casting molds.
C16200, C16210 Cadmium copper	99.0 Cu, 1.0 Cd	35-100	7-69	57	20	Excellent cold workability; good hot formability. Uses: trolley wires, heating pads, electric-blanket elements, spring contacts, railbands, high-strength transmission lines, connectors, cable wrap, switch-gear components, and waveguide cavities.
C16500	98.6 Cu, 0.8 Cd, 0.6 Sn	40-95	14-71	53	20	Fabricating characteristics same as C16200. Uses: electrical springs and contacts, trolley wire, clips, flat cable, resistance-welding electrodes.
C17000 Beryllium copper	98.3 Cu, 1.7 Be, 0.20 Co	70-190	32-170	45	20	Fabricating characteristics same as C16200. Commonly fabricated by blanking, forming and bending, turning, drilling, tapping. Uses: bellows, Bourdon tubing, diaphragms, fuse clips, fasteners, lock-washers, springs, switch parts, roll pins, valves, welding equipment.
C17200 Beryllium copper	98.1 Cu, 1.9 Be, 0.20 Co	68-212	25-195	48	20	Similar to C17000, particularly for its nonsparking characteristics.
C17300 Beryllium copper	98.1 Cu, 1.9 Be, 0.40 Pb	68-212	25-195	48	50	Combines superior machinability with good fabricating characteristics of C17200.
C17500, C17510 Beryllium copper	96.9 Cu, 2.5 Co, 0.6 Be	45-115	25-110	28		Fabricating characteristics same as C16200. Uses: fuse clips, fasteners, springs, switch and relay parts, electrical conductors, welding equipment.
C18200, C18400, C18500 Chromium copper	99.2 Cu	34-86	14-77	40	20	Excellent cold workability, good hot workability. Uses: resistance-welding electrodes, seam-welding wheels, switch gear, electrode holder jaws, cable connectors, current-carrying arms and shafts, circuit-breaker parts, molds, spot-welding tips, flash-welding electrodes, electrical and thermal conductors requiring strength, switch contacts.
C18700 Leaded copper	99.0 Cu, 1.0 Pb	32-55	10-50	45	85	Good cold workability; poor hot formability. Uses: connectors, motor and switch parts, screw-machine parts requiring high conductivity.
C18900	98.7 Cu, 0.8 Sn, 0.3 Si, 0.20 Mn	38-95	9-52	48	20	Fabricating characteristics same as C10100. Uses: welding rod and wire for inert gas tungsten arc and metal arc welding and oxyacetylene welding of copper.
C19000 Copper-nickel-phosphorus alloy	98.6 Cu, 1.1 Ni, 0.3 P	38-115	20-81	50	30	Fabricating characteristics same as C10100. Uses: springs, clips, electrical connectors, power tube and electron tube components, high-strength electrical conductors, bolts, nails, screws, cotter pins, and parts requiring some combination of high strength, high electrical or thermal conductivity, high resistance to fatigue and creep, and good workability.
C19100 Copper-nickel-phosphorus-tellurium alloy	98.2 Cu, 1.1 Ni, 0.5 Te, 0.2 P	36-104	10-92	27	75	Good hot and cold workability. Uses: forgings and screw-machine parts requiring high strength, hardenability, extensive machining, corrosion resistance, copper color, good conductivity, or a combination of these; bolts, bushings, electrical connectors, gears, marine hardware, nuts, pinions, tie rods, turnbuckle barrels, welding torch tips.
C19200	99 Cu, 1.0 Fe, 0.03 P	37-77	11-74	40	20	Excellent hot and cold workability. Uses: automotive hydraulic brake lines, flexible hose, electrical terminals, fuse clips, gaskets, gift hollow ware, applications requiring resistance to softening and stress corrosion, air-conditioning and heat-exchanger tubing.

Table 3. (Continued) Properties and Applications of Wrought Coppers and Copper Alloys

Name and Number	Nominal Composition (%)	Strength (ksi)		Elongation in 2 in. (%)	Machinability Rating ^a	Fabricating Characteristics and Typical Applications
		Tensile	Yield			
C19400	97.4 Cu, 2.4 Fe, 0.13 Zn, 0.04 P	45-76	24-73	32	20	Excellent hot and cold workability. Uses: circuit-breaker components, contact springs, electrical clamps, electrical springs, electrical terminals, flexible hose, fuse clips, gaskets, gift hollow ware, plug contacts, rivets, and welded condenser tubes.
C19500	97.0 Cu, 1.5 Fe, 0.6 Sn, 0.10 P, 0.80 Co	80-97	65-95	15	20	Excellent hot and cold workability. Uses: electrical springs, sockets, terminals, connectors, clips, and other current-carrying parts requiring strength.
C21000 Gilding, 95%	95.0 Cu, 5.0 Zn	34-64	10-58	45	20	Excellent cold workability, good hot workability for blanking, coining, drawing, piercing and punching, shearing, spinning, squeezing and swaging, stamping. Uses: coins, medals, bullet jackets, fuse caps, primers, plaques, jewelry base for gold plate.
C22000 Commercial bronze, 90%	90.0 Cu, 10.0 Zn	37-72	10-62	50	20	Fabricating characteristics same as C21000, plus heading and up-setting, roll threading and knurling, hot forging and pressing. Uses: etching bronze, grillwork, screen cloth, weatherstripping, lipstick cases, compacts, marine hardware, screws, rivets.
C22600 Jewelry bronze, 87.5%	87.5 Cu, 12.5 Zn	39-97	11-62	46	30	Fabricating characteristics same as C21000, plus heading and up-setting, roll threading and knurling. Uses: angles, channels, chain, fasteners, costume jewelry, lipstick cases, powder compacts, base for gold plate.
C23000 Red brass, 85%	85.0 Cu, 15.0 Zn	39-105	10-63	55	30	Excellent cold workability; good hot formability. Uses: weather-stripping, conduit, sockets, fasteners, fire extinguishers, condenser and heat-exchanger tubing, plumbing pipe, radiator cores.
C24000 Low brass, 80%	80.0 Cu, 20.0 Zn	42-125	12-65	55	30	Excellent cold workability. Fabricating characteristics same as C23000. Uses: battery caps, bellows, musical instruments, clock dials, pump lines, flexible hose.
C26000, C26100, C26130, C26200 Cartridge brass, 70%	70.0 Cu, 30.0 Zn	44-130	11-65	66		Excellent cold workability. Uses: radiator cores and tanks, flashlight shells, lamp fixtures, fasteners, screws, springs, grillwork, stencils, plumbing accessories, plumbing brass goods, locks, hinges, ammunition components, plumbing accessories, pins, rivets.
C26800, C27000 Yellow brass	65.0 Cu, 35.0 Zn	46-128	14-62	65	30	Excellent cold workability. Fabricating characteristics same as C23000. Uses: same as C26000 except not used for ammunition.
C28000 Muntz metal, 60%	60.0 Cu, 40.0 Zn	54-74	21-55	52	40	Excellent hot formability and forgeability for blanking, forming and bending, hot forging and pressing, hot heading and upsetting, shearing. Uses: architectural, large nuts and bolts, brazing rod, condenser plates, heat-exchanger and condenser tubing, hot forgings.
C31400 Leaded commercial bronze	89.0 Cu, 1.9 Pb, 0.1 Zn	37-60	12-55	45	80	Excellent machinability. Uses: screws, machine parts, pickling crates.
C31600 Leaded commercial bronze, nickel-bearing	89.0 Cu, 1.9 Pb, 1.0 Ni, 8.1 Zn	37-67	12-59	45	80	Good cold workability; poor hot formability. Uses: electrical connectors, fasteners, hardware, nuts, screws, screw-machine parts.
C33000 Low-leaded brass tube	66.0 Cu, 0.5 Pb, 33.5 Zn	47-75	15-60	60	60	Combines good machinability and excellent cold workability. Fabricated by forming and bending, machining, piercing and punching. Uses: pump and power cylinders and liners, ammunition primers, plumbing accessories.

Table 3. (Continued) Properties and Applications of Wrought Coppers and Copper Alloys

Name and Number	Nominal Composition (%)	Strength (ksi)		Elongation in 2 in. (%)	Machinability Rating ^a	Fabricating Characteristics and Typical Applications
		Tensile	Yield			
C33200 High-leaded brass tube	66.0 Cu, 2.0 Pb, 32.0 Zn	47-75	15-60	50	80	Excellent machinability. Fabricated by piercing, punching, and machining. Uses: general-purpose screw-machine parts.
C33500 Low-leaded brass	63.5 Cu, 0.5 Pb, 36 Zn	46-74	14-60	65	60	Similar to C33200. Commonly fabricated by blanking, drawing, machining, piercing and punching, stamping. Uses: butts, hinges, watch backs.
C34000 Medium-leaded brass	63.5 Cu, 1.0 Pb, 35.5 Zn	47-88	15-60	60	70	Similar to C33200. Fabricated by blanking, heading and upsetting, machining, piercing and punching, roll threading and knurling, stamping. Uses: butts, gears, nuts, rivets, screws, dials, engravings, instrument plates.
C34200 High-leaded brass	63.5 Cu, 2.0 Pb, 34.5 Zn	49-85	17-62	52	90	Combines excellent machinability with moderate cold workability. Uses: clock plates and nuts, clock and watch backs, gears, wheels and channel plate.
C35000 Medium-leaded brass	62.5 Cu, 1.1 Pb, 36.4 Zn	45-95	13-70	66	70	Fair cold workability; poor hot formability. Uses: bearing cages, book dies, clock plates, gears, hinges, hose couplings, keys, lock parts, lock tumblers, meter parts, nuts, sink strainers, strike plates, templates, type characters, washers, wear plates.
C35300 High-leaded brass	61.5 Cu, 2.8 Pb, 36.5 Zn	49-85	17-62	52	90	Similar to C34200.
C35600 Extra-high-leaded brass	61.5 Cu, 2.5 Pb, 36 Zn	47-97	17-87	60	100	Excellent machinability. Fabricated by blanking, machining, piercing and punching, stamping. Uses: clock plates and nuts, clock and watch backs, gears, wheels, and channel plate.
C36000 Free-cutting brass	61.5 Cu, 3.1 Pb, 35.4 Zn	49-68	18-45	53	100	Excellent machinability. Fabricated by machining, roll threading, and knurling. Uses: gears, pinions, automatic high-speed screw-machine parts.
C36500 to C36800 Leaded Muntz metal	59.5 Cu, 0.5 Pb, 40.0 Zn	54 (As hot rolled)	20	45	60	Combines good machinability with excellent hot formability. Uses: condenser-tube plates.
C37000 Free-cutting Muntz metal	60.0 Cu, 1.0 Pb, 39.0 Zn	54-80	20-60	40	70	Fabricating characteristics similar to C36500 to 36800. Uses: automatic screw-machine parts.
C37700 Forging brass	59.5 Cu, 2.0 Pb, 38.0 Zn	52 (As extruded)	20	45	80	Excellent hot workability. Fabricated by heading and upsetting, hot forging and pressing, hot heading and upsetting, machining. Uses: forgings and pressings of all kinds.
C38500 Architectural bronze	57.0 Cu, 3.0 Pb, 40.0 Zn	60 (As extruded)	20	30	90	Excellent machinability and hot workability. Fabricated by hot forging and pressing, forming, bending, and machining. Uses: architectural extrusions, store fronts, thresholds, trim, butts, hinges, lock bodies, and forgings.
C40500	95 Cu, 1 Sn, 4 Zn	39-78	12-70	49	20	Excellent cold workability. Fabricated by blanking, forming, and drawing. Uses: meter clips, terminals, fuse clips, contact and relay springs, washers.
C40800	95 Cu, 2 Sn, 3 Zn	42-79	13-75	43	20	Excellent cold workability. Fabricated by blanking, stamping, and shearing. Uses: electrical connectors.
C41100	91 Cu, 0.5 Sn, 8.5 Zn	39-106	11-72	43	20	Excellent cold workability, good hot formability. Fabricated by blanking, forming and bending, drawing, piercing and punching, shearing, spinning, and stamping. Uses: bushings, bearing sleeves, thrust washers, flexible metal hose.
C41300	90.0 Cu, 1.0 Sn, 9.0 Zn	41-105	12-82	45	20	Excellent cold workability; good hot formability. Uses: plater bar for jewelry products, flat springs for electrical switchgear.

Table 3. (Continued) Properties and Applications of Wrought Coppers and Copper Alloys

Name and Number	Nominal Composition (%)	Strength (ksi)		Elongation in 2 in. (%)	Machinability Rating ^a	Fabricating Characteristics and Typical Applications
		Tensile	Yield			
C41500	91 Cu, 1.8 Sn, 7.2 Zn	46-81	17-75	44	30	Excellent cold workability. Fabricated by blanking, drawing, bending, forming, shearing, and stamping. Uses: spring applications for electrical switches.
C42200	87.5 Cu, 1.1 Sn, 11.4 Zn	43-88	15-75	46	30	Excellent cold workability; good hot formability. Fabricated by blanking, piercing, forming, and drawing. Uses: sash chains, fuse clips, terminals, spring washers, contact springs, electrical connectors.
C42500	88.5 Cu, 2.0 Sn, 9.5 Zn	45-92	18-76	49	30	Excellent cold workability. Fabricated by blanking, piercing, forming, and drawing. Uses: electrical switches, springs, terminals, connectors, fuse clips, pen clips, weather stripping.
C43000	87.0 Cu, 2.2 Sn, 10.8 Zn	46-94	18-73	55	30	Excellent cold workability; good hot formability. Fabricated by blanking, coining, drawing, forming, bending, heading, and upsetting. Uses: same as C42500.
C43400	85.0 Cu, 0.7 Sn, 14.3 Zn	45-90	15-75	49	30	Excellent cold workability. Fabricated by blanking, drawing, bonding, forming, stamping, and shearing. Uses: electrical switch parts, blades, relay springs, contacts.
C43500	81.0 Cu, 0.9 Sn, 18.1 Zn	46-80	16-68	46	30	Excellent cold workability for fabrication by forming and bending. Uses: Bourdon tubing and musical instruments.
C44300, C44400, C44500 Inhibited admiralty	71.0 Cu, 28.0 Zn, 1.0 Sn	48-55	18-22	65	30	Excellent cold workability for forming and bending. Uses: condenser, evaporator and heat-exchanger tubing, condenser tubing plates, distiller tubing, ferrules.
C46400 to C46700 Naval brass	60.0 Cu, 39.2 Zn, 0.8 Sn	55-88	25-66	50	30	Excellent hot workability and hot forgeability. Fabricated by blanking, drawing, bending, heading and upsetting, hot forging, pressing. Uses: aircraft turnbuckle barrels, balls, bolts, marine hardware, nuts, propeller shafts, rivets, valve stems, condenser plates, welding rod.
C48200 Naval brass, medium- leaded	60.5 Cu, 0.7 Pb, 0.8 Sn, 38.0 Zn	56-75	25-53	43	50	Good hot workability for hot forging, pressing, and machining operations. Uses: marine hardware, screw-machine products, valve stems.
C48500 Leaded naval brass	60.0 Cu, 1.8 Pb, 37.5 Zn, 0.7 Sn	57-75	25-53	40	70	Combines good hot forgeability and machinability. Fabricated by hot forging and pressing, machining. Uses: marine hardware, screw-machine parts, valve stems.
C50500 Phosphor bronze, 1.25% E	98.7 Cu, 1.3 Sn, trace P	40-79	14-50	48	20	Excellent cold workability; good hot formability. Fabricated by blanking, bending, heading and upsetting, shearing and swaging. Uses: electrical contacts, flexible hose, pole-line hardware.
C51000 Phosphor bronze, 5% A	94.8 Cu, 5.0 Sn, trace P	47-140	19-80	64	20	Excellent cold workability. Fabricated by blanking, drawing, bending, heading and upsetting, roll threading and knurling, shearing, stamping. Uses: bellows, Bourdon tubing, clutch discs, cotter pins, diaphragms, fasteners, lock washers, wire brushes, chemical hardware, textile machinery, welding rod.
C51100	95.6 Cu, 4.2 Sn, 0.2 P	46-103	50-80	48	20	Excellent cold workability. Uses: bridge bearing plates, locator bars, fuse clips, sleeve bushings, springs, switch parts, truss wire, wire brushes, chemical hardware, perforated sheets, textile machinery.

Table 3. (Continued) Properties and Applications of Wrought Coppers and Copper Alloys

Name and Number	Nominal Composition (%)	Strength (ksi)		Elongation in 2 in. (%)	Machinability Rating ^a	Fabricating Characteristics and Typical Applications
		Tensile	Yield			
C52100 Phosphor bronze, 8% C	92.0 Cu, 8.0 Sn, trace P	55-140	24-80	70	20	Good cold workability for blanking, drawing, forming and bending, shearing, stamping. Uses: generally for more severe service conditions than C51000.
C52400 Phosphor bronze, 10% D	90.0 Cu, 10.0 Sn, trace P	66-147	28	70	20	Good cold workability for blanking, forming and bending, shearing. Uses: heavy bars and plates for severe compression, bridge and expansion plates and fittings, articles requiring good spring qualities, resilience, fatigue resistance, good wear and corrosion resistance.
C54400	88.0 Cu, 4.0 Pb, 4.0 Zn, 4.0 Sn	44-75	19-63	50	80	Excellent machinability; good cold workability. Fabricated by blanking, drawing, bending, machining, shearing, stamping. Uses: bearings, bushings, gears, pinions, shafts, thrust washers, valve parts.
C60800	95.0 Cu, 5.0 Al	60	27	55	20	Good cold workability; fair hot formability. Uses: condenser, evaporator and heat-exchanger tubes, distiller tubes, ferrules.
C61000	92.0 Cu, 8.0 Al	52-60	17-27	45	20	Good hot and cold workability. Uses: bolts, pump parts, shafts, tie rods, overlay on steel for wearing surfaces.
C61300	90.3 Cu, 0.35 Sn, 6.8 Al, 0.35 Sn	70-85	30-58	42	30	Good hot and cold formability. Uses: nuts, bolts, corrosion resistant vessels and tanks, structural components, machine parts, condenser tube and piping systems, marine protective sheathing and fasteners, munitions mixing troughs and blending chambers.
C61400 Aluminum bronze, D	91.0 Cu, 7.0 Al, 2.0 Fe	76-89	33-60	45	20	Similar to C61300.
C61500	90.0 Cu, 8.0 Al, 2.0 Ni	70-145	22-140	55	30	Good hot and cold workability. Fabricating characteristics similar to C52100. Uses: hardware, decorative metal trim, interior furnishings and other articles requiring high tarnish resistance.
C61800	89.0 Cu, 1.0 Fe, 10.0 Al	80-85	39-42.5	28	40	Fabricated by hot forging and hot pressing. Uses: bushings, bearings, corrosion-resistant applications, welding rods.
C61900	86.5 Cu, 4.0 Fe, 9.5 Al	92-152	49-145	30		Excellent hot formability for fabricating by blanking, forming, bending, shearing, and stamping. Uses: springs, contacts, and switch components.
C62300	87.0 Cu, 3.0 Fe, 10.0 Al	75-98	35-52	35	50	Good hot and cold formability. Fabricated by bending, hot forging, hot pressing, forming, and welding. Uses: bearings, bushings, valve guides, gears, valve seats, nuts, bolts, pump rods, worm gears, and cams.
C62400	86.0 Cu, 3.0 Fe, 11.0 Al	90-105	40-52	18	50	Excellent hot formability for fabrication by hot forging and hot bending. Uses: bushings, gears, cams, wear strips, nuts, drift pins, tie rods.
C62500	82.7 Cu, 4.3 Fe, 13.0 Al	100 (As extruded)	55	1	20	Excellent hot formability for fabrication by hot forging and machining. Uses: guide bushings, wear strips, cams, dies, forming rolls.
C63000	82.0 Cu, 3.0 Fe, 10.0 Al, 5.0 Ni	90-118	50-75	20	30	Good hot formability. Fabricated by hot forming and forging. Uses: nuts, bolts, valve seats, plunger tips, marine shafts, valve guides, aircraft parts, pump shafts, structural members.
C63200	82.0 Cu, 4.0 Fe, 9.0 Al, 5.0 Ni	90-105	45-53	25	30	Good hot formability. Fabricated by hot forming and welding. Uses: nuts, bolts, structural pump parts, shafting requiring corrosion resistance.

Table 3. (Continued) Properties and Applications of Wrought Coppers and Copper Alloys

Name and Number	Nominal Composition (%)	Strength (ksi)		Elongation in 2 in. (%)	Machinability Rating ^a	Fabricating Characteristics and Typical Applications
		Tensile	Yield			
C63600	95.5 Cu, 3.5 Al, 1.0 Si	60-84		64	40	Excellent cold workability; fair hot formability. Fabricated by cold heading. Uses: components for pole-line hardware, cold-headed nuts for wire and cable connectors, bolts and screw products.
C63800	95.0 Cu, 2.8 Al, 1.8 Si, 0.40 Co	82-130	54-114	36		Excellent cold workability and hot formability. Uses: springs, switch parts, contacts, relay springs, glass sealing, and porcelain enameling.
C64200	91.2 Cu, 7.0 Al, 1.8 Si	75-102	35-68	32	60	Excellent hot formability. Fabricated by hot forming, forging, machining. Uses: valve stems, gears, marine hardware, pole-line hardware, bolts, nuts, valve bodies, and components.
C65100 Low-silicon bronze, B	98.5 Cu, 1.5 Si	40-105	15-71	55	30	Excellent hot and cold workability. Fabricated by forming and bending, heading and upsetting, hot forging and pressing, roll threading and knurling, squeezing and swaging. Uses: hydraulic pressure lines, anchor screws, bolts, cable clamps, cap screws, machine screws, marine hardware, nuts, pole-line hardware, rivets, U-bolts, electrical conduits, heat-exchanger tubing, welding rod.
C65500 High-silicon bronze, A	97.0 Cu, 3.0 Si	56-145	21-71	63	30	Excellent hot and cold workability. Fabricated by blanking, drawing, forming and bending, heading and upsetting, hot forging and pressing, roll threading and knurling, shearing, squeezing and swaging. Uses: similar to C65100 including propeller shafts.
C66700 Manganese brass	70.0 Cu, 28.8 Zn, 1.2 Mn	45.8-100	12-92.5	60	30	Excellent cold formability. Fabricated by blanking, bending, forming, stamping, welding. Uses: brass products resistance welded by spot, seam, and butt welding.
C67400	58.5 Cu, 36.5 Zn, 1.2 Al, 2.8 Mn, 1.0 Sn	70-92	34-55	28	25	Excellent hot formability. Fabricated by hot forging and pressing, machining. Uses: bushings, gears, connecting rods, shafts, wear plates.
C67500 Manganese bronze, A	58.5 Cu, 1.4 Fe, 39.0 Zn, 1.0 Sn, 0.1 Mn	65-84	30-60	33	30	Excellent hot workability. Fabricated by hot forging and pressing, hot heading and upsetting. Uses: clutch discs, pump rods, shafting, balls, valve stems and bodies.
C68700 Aluminum brass, arsenical	77.5 Cu, 20.5 Zn, 2.0 Al, trace As	60	27	55	30	Excellent cold workability for forming and bending. Uses: condenser, evaporator- and heat-exchanger tubing, condenser tubing plates, distiller tubing, ferrules.
C68800	73.5 Cu, 22.7 Zn, 3.4 Al, 0.40 Co	82-129	55-114	36		Excellent hot and cold formability. Fabricated by blanking, drawing, forming and bending, shearing and stamping. Uses: springs, switches, contacts, relays, drawn parts.
C69000	73.3 Cu, 3.4 Al, 0.6 Ni, 22.7 Zn	82-130	52-117	35		Fabricating characteristics same as C68800. Uses: contacts, relays, switches, springs, drawn parts.
C69400 Silicon red brass	81.5 Cu, 14.5 Zn, 4.0 Si	80-100	40-57	25	30	Excellent hot formability for fabrication by forging, screw-machine operations. Uses: valve stems where corrosion resistance and high strength are critical.
C70400 Copper nickel, 5%	92.4 Cu, 1.5 Fe, 5.5 Ni, 0.6 Mn	38-77	40-76	46	20	Excellent cold workability; good hot formability. Fabricated by forming, bending, and welding. Uses: condensers, evaporators, heat exchangers, ferrules, salt water piping, lithium bromide absorption tubing, shipboard condenser intake systems.

Table 3. (Continued) Properties and Applications of Wrought Coppers and Copper Alloys

Name and Number	Nominal Composition (%)	Strength (ksi)		Elongation in 2 in. (%)	Machinability Rating ^a	Fabricating Characteristics and Typical Applications
		Tensile	Yield			
C70600 Copper nickel, 10%	88.6 Cu, 1.4 Fe, 10.0 Ni	44-60	16-57	42	20	Good hot and cold workability. Fabricated by forming and bending, welding. Uses: condensers, condenser plates, distiller tubing, evaporator and heat-exchanger tubing, ferrules.
C71000 Copper nickel, 20%	79.0 Cu, 21.0 Ni	49-95	13-85	40	20	Good hot and cold formability. Fabricated by blanking, forming and bending, welding. Uses: communication relays, condensers, condenser plates, electrical springs, evaporator and heat-exchanger tubes, ferrules, resistors.
C71500 Copper nickel, 30%	69.5 Cu, 30.0 Ni, 0.5 Fe	54-75	20-70	45	20	Similar to C70600.
C72200	82.2 Cu, 16.5 Ni, 0.8 Fe, 0.5 Cr	46-70	18-66	46		Good hot and cold formability. Fabricated by forming, bending, and welding. Uses: condenser tubing, heat-exchanger tubing, salt water piping.
C72500	88.2 Cu, 9.5 Ni, 2.3 Sn	55-120	22-108	35	20	Excellent cold and hot formability. Fabricated by blanking, brazing, coining, drawing, etching, forming and bending, heading and upsetting, roll threading and knurling, shearing, spinning, squeezing, stamping, and swaging. Uses: relay and switch springs, connectors, brazing alloy, lead frames, control and sensing bellows.
C73500	72.0 Cu, 10.0 Zn, 18.0 Ni	50-100	15-84	37	20	Fabricating characteristics same as C74500. Uses: hollow ware, medallions, jewelry, base for silver plate, cosmetic cases, musical instruments, name plates, contacts.
C74500 Nickel silver, 65-10	65.0 Cu, 25.0 Zn, 10.0 Ni	49-130	18-76	50	20	Excellent cold workability. Fabricated by blanking, drawing, etching, forming and bending, heading and upsetting, roll threading and knurling, shearing, spinning, squeezing, and swaging. Uses: rivets, screws, slide fasteners, optical parts, etching stock, hollow ware, nameplates, platers' bars.
C75200 Nickel silver, 65-18	65.0 Cu, 17.0 Zn, 18.0 Ni	56-103	25-90	45	20	Fabricating characteristics similar to C74500. Uses: rivets, screws, table flatware, truss wire, zippers, bows, camera parts, core bars, temples, base for silver plate, costume jewelry, etching stock, hollow ware, nameplates, radio dials.
C75400 Nickel silver, 65-15	65.0 Cu, 20.0 Zn, 15.0 Ni	53-92	18-79	43	20	Fabricating characteristics similar to C74500. Uses: camera parts, optical equipment, etching stock, jewelry.
C75700 Nickel silver, 65-12	65.0 Cu, 23.0 Zn, 12.0 Ni	52-93	18-79	48	20	Fabricating characteristics similar to C74500. Uses: slide fasteners, camera parts, optical parts, etching stock, name plates.
C76390	61 Cu, 13 Zn, 24.5 Ni, 1 Pb, 0.5 Sn	90	85	6	40	Fabricated by machining, roll threading, and knurling. Uses: hardware, fasteners, connectors for electronic applications.
C77000 Nickel silver, 55-18	55.0 Cu, 27.0 Zn, 18.0 Ni	60-145	27-90	40	30	Good cold workability. Fabricated by blanking, forming and bending, and shearing. Uses: optical goods, springs, and resistance wire.
C78200	65.0 Cu, 2.0 Pb, 25.0 Zn, 8.0 Ni	53-91	23-76	40	60	Good cold formability. Fabricated by blanking, milling, and drilling. Uses: key blanks, watch plates, watch parts.

^aFree-cutting brass = 100.

Source: Copper Development Association, New York.

Strength of Copper-Zinc-Tin Alloys (U.S. Government Tests)

Percentage of			Tensile Strength		Percentage of			Tensile Strength		Percentage of			Tensile Strength	
Copper	Zinc	Tin	lb/in ²	MPa	Copper	Zinc	Tin	lb/in ²	MPa	Copper	Zinc	Tin	lb/in ²	MPa
45	50	5	15,000	103.4	60	20	20	10,000	68.9	75	20	5	45,000	310.3
50	45	5	50,000	344.7	65	30	5	50,000	344.7	75	15	10	45,000	310.3
50	40	10	15,000	103.4	65	25	10	42,000	289.6	75	10	15	43,000	296.5
55	43	2	65,000	488.2	65	20	15	30,000	206.8	75	5	20	41,000	282.7
55	40	5	62,000	427.5	65	15	20	18,000	124.1	80	15	5	45,000	310.3
55	35	10	32,500	224.0	65	10	25	12,000	82.7	80	10	10	45,000	310.3
55	30	15	15,000	103.4	70	25	5	45,000	310.3	80	5	15	47,500	327.5
60	37	3	60,000	413.7	70	20	10	44,000	303.4	85	10	5	43,500	299.9
60	35	5	52,500	362.0	70	15	15	37,000	255.1	85	5	10	46,500	320.6
60	30	10	40,000	275.8	70	10	20	30,000	206.8	90	5	5	42,000	289.6

Copper-Silicon and Copper-Beryllium Alloys

Everdur.—This copper-silicon alloy is available in five slightly different nominal compositions for applications that require high strength, good fabricating and fusing qualities, immunity to rust, free-machining and a corrosion resistance equivalent to copper. The following table gives the nominal compositions and tensile strengths, yield strengths, and per cent elongations for various tempers and forms.

Table 4. Nominal Composition and Properties of Everdur

Desig. No.	Nominal Composition					Temper ^a	Strength				Elongation (%)
							Tensile		Yield		
	Cu	Si	Mn	Pb	Al		ksi	MPa	ksi	MPa	
655	95.80	3.10	1.10			A	52	359	15	103	35 ^b
						HRA	50	345	18	124	40
						CRA	52	359	18	124	35
						CRHH	71	490	40	276	10
						CRH	87	600	60	414	3
					H	70–85	483–586	38–50	262–345	17 to 8 ^b	
651	98.25	1.50	0.25			AP	38	262	10	69	35
						HP	50	345	40	276	7
						XHB	75–85	517–586	45–55	310–379	8 to 6 ^b
661	95.60	3.00	1.00	0.40		A	52	359	15	103	35 ^b
						H	85	586	50	345	13 to 8 ^b
6552	94.90	4.00	1.10			AC	45	310			15
637	90.75	2.00			7.25	A	75–90	517–621	37.5–45	259–310	12 to 9 ^b

^a Symbols used are: HRA for hot-rolled and annealed tank plates; CRA for cold-rolled sheets and strips; CRHH for cold-rolled half hard strips; abd CRH for cold-rolled hard strips. For round, square, hexagonal, and octagonal rods: A for annealed; H for hard; and XHB for extra-hard bolt temper (in coils for cold-heading). For pipe and tube: AP for annealed; and HP for hard. For castings: AC for as cast.

^b Per cent elongation in 4 times the diameter or thickness of the specimen. All other values are per cent elongation in 2 inches.

Designation numbers are those of the American Brass Co.

The values given for the tensile strength, yield strength, and elongation are all minimum values. Where ranges are shown, the first values given are for the largest diameter or largest size specimens. Yield strength values were determined at 0.50 per cent elongation under load.

Copper-Beryllium Alloys.—Alloys of copper and beryllium present health hazards. Particles produced by machining may be absorbed into the body through the skin, the mouth, the nose, or an open wound, resulting in a condition requiring immediate medical attention. Working of these alloys requires protective clothing or other shielding in a monitored environment. Copper-beryllium alloys involved in a fire give off profuse toxic fumes that must not be inhaled.

These alloys contain copper, beryllium, cobalt, and silver, and fall into two groups. One group whose beryllium content is greater than one per cent is characterized by its high strength and hardness and the other, whose beryllium content is less than one per cent, by its high electrical and thermal conductivity. The alloys have many applications in the electrical and aircraft industries or wherever strength, corrosion resistance, conductivity, non-magnetic and nonsparking properties are essential. Beryllium copper is obtainable in the form of strips, rods and bars, wire, platers, bars, billets, tubes, and casting ingots.

Composition and Properties: Table 5 lists some of the more common wrought alloys and gives some of their mechanical properties.

Table 5. Wrought Copper–Beryllium Properties

Alloy ^a	Form	Temper ^b	Heat Treatment	Tensile Strength		Yield Strength 0.2% Offset		Elongation % in 2 inch (5.08 cm)
				ksi	MPa	ksi	MPa	
25	Rod, Bar, and Plate	A	3 hr at 600°F (316°C) or mill heat treated	60–85	414–586	20–30	138–207	35–60
		½ H or H		85–130	586–896	75–105	517–724	10–20
		AT		165–190	1138–1310	145–175	1000–1207	3–10
		½ HT or HT		175–215	1207–1482	150–200	1034–1379	2–5
	Wire	A	3 hr at 600°F (316°C)	58–78	400–538	20–35	138–241	35–55
		¼ H		90–115	621–793	70–95	483–655	10–35
		½ H		110–135	758–931	90–110	621–758	5–10
		¾ H		130–155	896–1069	110–135	758–931	2–8
		AT		165–190	1138–1310	145–175	1000–1207	3–8
		¼ HT		175–205	1207–1413	160–190	1103–1310	2–5
		½ HT		190–215	1310–1482	175–200	1207–1379	1–3
		¾ HT		195–220	1344–1517	180–205	1241–1413	1–3
		XHT		115–165	793–1138	95–145	655–1000	2–8
		165		Rod, Bar, and Plate	A	3 hr at 650°F (343°C) or mill heat treated	60–85	414–586
½ H or H	85–130		586–896		75–105		517–724	10–20
AT	150–180		1034–1241		125–155		862–1069	4–10
10	Rod, Bar, and Plate	½ HT or HT	2 hr at 650°F (343°C) or mill heat treated	165–200	1138–1379	135–165	931–1138	2–5
		A	3 hr at 900°F (482°C) or mill heat treated	35–55	241–379	20–30	138–207	20–35
		½ H or H		65–80	448–552	55–75	379–517	10–15
AT	100–120	689–827		80–100	552–689	10–25		
50	Rod, Bar, and Plate	½ HT or HT	2 hr at 900°F (482°C) or mill heat treated	110–130	758–896	100–120	689–827	8–20
		A	3 hr at 900°F (482°C) or mill heat treated	35–55	241–379	20–30	138–207	20–35
		½ H or H		65–80	448–552	55–75	379–517	10–15
AT	100–120	689–827		80–100	552–689	10–25		
35	Rod, Bar, and Plate	½ HT or HT	2 hr at 900°F (482°C) or mill heat treated	110–130	758–896	100–120	689–827	8–20
		A	3 hr at 900°F (482°C) or mill heat treated	35–55	241–379	20–30	138–207	20–35
		½ H or H		65–80	448–552	55–75	379–517	10–15
AT	100–120	689–827		80–100	552–689	10–25		

^a Composition (in per cent) of alloys is as follows: alloy 25: 1.80–2.05 Be, 0.20–0.35 Co, balance Cu; alloy 165: 1.6–1.8 Be, 0.20–0.35 Co, balance Cu; alloy 10: 0.4–0.7 Be, 2.35–2.70 Co, balance Cu; alloy 50, 0.25–0.50 Be, 1.4–1.7 Co, 0.9–1.1 Ag, balance Cu; alloy 35, 0.25–0.50 Be, 1.4–1.6 Ni, balance Cu.

^b Temper symbol designations: A, solution annealed; H, hard; HT, heat-treated from hard; At, heat-treated from solution annealed.

Aluminum and Aluminum Alloys

Pure aluminum is a silver-white metal characterized by a slightly bluish cast. It has a specific gravity of 2.70, resists the corrosive effects of many chemicals, and has a malleability approaching that of gold. When alloyed with other metals, numerous properties are obtained that make these alloys useful over a wide range of applications.

Aluminum alloys are light in weight compared with steel, brass, nickel, or copper; can be fabricated by all common processes; are available in a wide range of sizes, shapes, and forms; resist corrosion; readily accept a wide range of surface finishes; have good electrical and thermal conductivities; and are highly reflective to both heat and light.

Characteristics of Aluminum and Aluminum Alloys.—Aluminum and its alloys lose part of their strength at elevated temperatures, although some alloys retain good strength at temperatures from 400 to 500°F (204 to 260°C). At subzero temperatures, however, their strength increases without loss of ductility so that aluminum is a particularly useful metal for low-temperature applications.

When aluminum surfaces are exposed to the atmosphere, a thin invisible oxide skin forms immediately that protects the metal from further oxidation. This self-protecting characteristic gives aluminum its high resistance to corrosion. Unless exposed to some substance or condition that destroys this protective oxide coating, the metal remains protected against corrosion. Aluminum is highly resistant to weathering, even in industrial atmospheres. It is also corrosion resistant to many acids. Alkalis are among the few substances that attack the oxide skin and therefore are corrosive to aluminum. Although the metal can safely be used in the presence of certain mild alkalis with the aid of inhibitors, in general, direct contact with alkaline substances should be avoided. Direct contact with certain other metals should be avoided in the presence of an electrolyte; otherwise, galvanic corrosion of the aluminum may take place in the contact area. Where other metals must be fastened to aluminum, the use of a bituminous paint coating or insulating tape is recommended.

Aluminum is one of the two common metals having an electrical conductivity high enough for use as an electric conductor. The conductivity of electric-conductor (EC) grade is about 62 per cent that of the International Annealed Copper Standard. Because aluminum has less than one-third the specific gravity of copper, however, a pound of aluminum will go almost twice as far as a pound of copper when used as a conductor. Alloying lowers the conductivity somewhat so that wherever possible the EC grade is used in electric conductor applications. However, aluminum takes a set, which often results in loosening of screwed connectors, leading to arcing and fires. Special clamping designs are therefore required when aluminum is used for electrical wiring, especially in buildings.

Aluminum has nonsparking and nonmagnetic characteristics that make the metal useful for electrical shielding purposes such as in bus bar housings or enclosures for other electrical equipment and for use around inflammable or explosive substances.

Aluminum can be cast by any method known. It can be rolled to any desired thickness down to foil thinner than paper and in sheet form can be stamped, drawn, spun, or roll-formed. The metal also may be hammered or forged. Aluminum wire, drawn from rolled rod, may be stranded into cable of any desired size and type. The metal may be extruded into a variety of shapes. It may be turned, milled, bored, or otherwise machined in equipment often operating at their maximum speeds. Aluminum rod and bar may readily be employed in the high-speed manufacture of parts made on automatic screw-machine.

Almost any method of joining is applicable to aluminum—riveting, welding, or brazing. A wide variety of mechanical aluminum fasteners simplifies the assembly of many products. Resin bonding of aluminum parts has been successfully employed, particularly in aircraft components.

For the majority of applications, aluminum needs no protective coating. Mechanical finishes such as polishing, sandblasting, or wire brushing meet the majority of needs. When

additional protection is desired, chemical, electrochemical, and paint finishes are all used. Vitreous enamels have been developed for aluminum, and the metal may also be electroplated.

Temper Designations for Aluminum Alloys.—The temper designation system adopted by the Aluminum Association and used in industry pertains to all forms of wrought and cast aluminum and aluminum alloys except ingot. It is based on the sequences of basic treatments used to produce the various tempers. The temper designation follows the alloy designation, being separated by a dash.

Basic temper designations consist of letters. Subdivisions of the basic tempers, where required, are indicated by one or more digits following the letter. These digits designate specific sequences of basic treatments, but only operations recognized as significantly influencing the characteristics of the product are indicated. Should some other variation of the same sequence of basic operations be applied to the same alloy, resulting in different characteristics, then additional digits are added.

The basic temper designations and subdivisions are as follows:

-F, as fabricated: Applies to products that acquire some temper from shaping processes not having special control over the amount of strain-hardening or thermal treatment. For wrought products, there are no mechanical property limits.

-O, annealed, recrystallized (wrought products only): Applies to the softest temper of wrought products.

-H, strain-hardened (wrought products only): Applies to products that have their strength increased by strain-hardening with or without supplementary thermal treatments to produce partial softening.

The -H is always followed by two or more digits. The first digit indicates the specific combination of basic operations, as follows:

-H1, strain-hardened only: Applies to products that are strain-hardened to obtain the desired mechanical properties without supplementary thermal treatment. The number following this designation indicates the degree of strain-hardening.

-H2, strain-hardened and then partially annealed: Applies to products that are strain-hardened more than the desired final amount and then reduced in strength to the desired level by partial annealing. For alloys that age-soften at room temperature, the -H2 tempers have approximately the same ultimate strength as the corresponding -H3 tempers. For other alloys, the -H2 tempers have approximately the same ultimate strengths as the corresponding -H1 tempers and slightly higher elongations. The number following this designation indicates the degree of strain-hardening remaining after the product has been partially annealed.

-H3, strain-hardened and then stabilized: Applies to products which are strain-hardened and then stabilized by a low-temperature heating to slightly lower their strength and increase ductility. This designation applies only to the magnesium-containing alloys that, unless stabilized, gradually age-soften at room temperature. The number following this designation indicates the degree of strain-hardening remaining after the product has been strain-hardened a specific amount and then stabilized.

The second digit following the designations -H1, -H2, and -H3 indicates the final degree of strain-hardening. Numeral 8 has been assigned to indicate tempers having a final degree of strain-hardening equivalent to that resulting from approximately 75 per cent reduction of area. Tempers between -O (annealed) and 8 (full hard) are designated by numerals 1 through 7. Material having an ultimate strength about midway between that of the -O temper and that of the 8 temper is designated by the numeral 4 (half hard); between -O and 4 by the numeral 2 (quarter hard); and between 4 and 8 by the numeral 6 (three-quarter hard). (*Note:* For two-digit -H tempers whose second figure is odd, the standard limits for ultimate strength are exactly midway between those for the adjacent two-digit -H tempers whose second figures are even.) Numeral 9 designates extra-hard tempers.

The third digit, when used, indicates a variation of a two-digit -H temper, and is used when the degree of control of temper or the mechanical properties are different from but close to those for the two-digit -H temper designation to which it is added. (*Note:* The minimum ultimate strength of a three-digit -H temper is at least as close to that of the corresponding two-digit -H temper as it is to the adjacent two-digit -H tempers.) Numerals 1 through 9 may be arbitrarily assigned and registered with the Aluminum Association for an alloy and product to indicate a specific degree of control of temper or specific mechanical property limits. Zero has been assigned to indicate degrees of control of temper or mechanical property limits negotiated between the manufacturer and purchaser that are not used widely enough to justify registration with the Aluminum Association.

The following three-digit -H temper designations have been assigned for wrought products in all alloys:

-H111: Applies to products that are strain-hardened less than the amount required for a controlled H11 temper.

-H112: Applies to products that acquire some temper from shaping processes not having special control over the amount of strain-hardening or thermal treatment, but for which there are mechanical property limits, or mechanical property testing is required.

The following three-digit H temper designations have been assigned for wrought products in alloys containing more than a normal 4 per cent magnesium.

-H311: Applies to products that are strain-hardened less than the amount required for a controlled H31 temper.

-H321: Applies to products that are strain-hardened less than the amount required for a controlled H32 temper.

-H323: Applies to products that are specially fabricated to have acceptable resistance to stress-corrosion cracking.

-H343: Applies to products that are specially fabricated to have acceptable resistance to stress-corrosion cracking.

The following three-digit -H temper designations have been assigned for

Patterned or Embossed Sheet	Fabricated Form
-H114	-O temper
-H124, -H224, -H324	-H11, -H21, -H31 temper, respectively
-H134, -H234, -H334	-H12, -H22, -H32 temper, respectively
-H144, -H244, -H344	-H13, -H23, -H33 temper, respectively
-H154, -H254, -H354	-H14, -H24, -H34 temper, respectively
-H164, -H264, -H364	-H15, -H25, -H35 temper, respectively
-H174, -H274, -H374	-H16, -H26, -H36 temper, respectively
-H184, -H284, -H384	-H17, -H27, -H37 temper, respectively
-H194, -H294, -H394	-H18, -H28, -H38 temper, respectively
-H195, -H395	-H19, -H39 temper, respectively

-W, solution heat-treated: An unstable temper applicable only to alloys that spontaneously age at room temperature after solution heat treatment. This designation is specific only when the period of natural aging is indicated.

-T, thermally treated to produce stable tempers other than -F, -O, or -H: Applies to products that are thermally treated, with or without supplementary strain-hardening, to produce stable tempers. The -T is always followed by one or more digits. Numerals 2 through 10 have been assigned to indicate specific sequences of basic treatments, as follows:

-T1, naturally aged to a substantially stable condition: Applies to products for which the rate of cooling from an elevated temperature-shaping process, such as casting or extrusion, is such that their strength is increased by room-temperature aging.

-T2, annealed (cast products only): Designates a type of annealing treatment used to improve ductility and increase dimensional stability of castings.

-T3, solution heat-treated and then cold-worked: Applies to products that are cold-worked to improve strength, or in which the effect of cold work in flattening or straightening is recognized in applicable specifications.

-T4, solution heat-treated and naturally aged to a substantially stable condition: Applies to products that are not cold-worked after solution heat treatment, or in which the effect of cold work in flattening or straightening may not be recognized in applicable specifications.

-T5, artificially aged only: Applies to products that are artificially aged after an elevated-temperature rapid-cool fabrication process, such as casting or extrusion, to improve mechanical properties or dimensional stability, or both.

-T6, solution heat-treated and then artificially aged: Applies to products that are not cold-worked after solution heat-treatment, or in which the effect of cold work in flattening or straightening may not be recognized in applicable specifications.

-T7, solution heat-treated and then stabilized: Applies to products that are stabilized to carry them beyond the point of maximum hardness, providing control of growth or residual stress or both.

-T8, solution heat-treated, cold-worked, and then artificially aged: Applies to products that are cold-worked to improve strength, or in which the effect of cold work in flattening or straightening is recognized in applicable specifications.

-T9, solution heat-treated, artificially aged, and then cold-worked: Applies to products that are cold-worked to improve strength.

-T10, artificially aged and then cold-worked: Applies to products that are artificially aged after an elevated-temperature rapid-cool fabrication process, such as casting or extrusion, and then cold-worked to improve strength.

Additional digits may be added to designations -T1 through -T10 to indicate a variation in treatment that significantly alters the characteristics of the product. These may be arbitrarily assigned and registered with The Aluminum Association for an alloy and product to indicate a specific treatment or specific mechanical property limits.

These additional digits have been assigned for wrought products in all alloys:

-T__51, stress-relieved by stretching: Applies to products that are stress-relieved by stretching the following amounts after solution heat-treatment:

Plate	1½ to 3 per cent permanent set
Rod, Bar and Shapes	1 to 3 per cent permanent set
Drawn tube	0.5 to 3 per cent permanent set

Applies directly to plate and rolled or cold-finished rod and bar.

These products receive no further straightening after stretching.

Applies to extruded rod and bar shapes and tube when designated as follows:

-T__510: Products that receive no further straightening after stretching.

-T__511: Products that receive minor straightening after stretching to comply with standard tolerances.

-T__52, stress-relieved by compressing: Applies to products that are stress-relieved by compressing after solution heat-treatment, to produce a nominal permanent set of 2½ per cent.

-T__54, stress-relieved by combined stretching and compressing: Applies to die forgings that are stress-relieved by restriking cold in the finish die.

The following two-digit -T temper designations have been assigned for wrought products in all alloys:

-T42: Applies to products solution heat-treated and naturally aged that attain mechanical properties different from those of the -T4 temper.

-T62: Applies to products solution heat-treated and artificially aged that attain mechanical properties different from those of the -T6 temper.

Aluminum Alloy Designation Systems.—Aluminum casting alloys are listed in many specifications of various standardizing agencies. The numbering systems used by each differ and are not always correlatable. Casting alloys are available from producers who use a commercial numbering system and this numbering system is the one used in the tables of aluminum casting alloys given in this section.

Table 6a lists the nominal composition of commonly used aluminum casting alloys, and Tables 6b and 6c list the typical tensile properties of separately cast bars.

Table 6a. Nominal Compositions (in per cent) of Common Aluminum Casting Alloys (AA/ANSI)

Alloy	Product ^a	Si	Fe	Cu	Mn	Mg	Cr	Ni	Zn	Ti	Others	
											Each	Total
201.0	S	0.10	0.15	4.0-5.2	0.20-0.50	0.15-0.55				0.15-0.35	0.05 ^b	0.10
204.0	S&P	0.20	0.35	4.2-5.0	0.10	0.15-0.35		0.05	0.10	0.15-0.30	0.05 ^c	0.15
208.0	S&P	2.5-3.5	1.2	3.5-4.5	0.50	0.10		0.35	1.0	0.25		0.50
222.0	S&P	2.0	1.5	9.2-10.7	0.50	0.15-0.35		0.50	0.8	0.25		0.35
242.0	S&P	0.7	1.0	3.5-4.5	0.35	1.2-1.8	0.25	1.7-2.3	0.35	0.25	0.05	0.15
295.0	S	0.7-1.5	1.0	4.0-5.0	0.35	0.03			0.35	0.25	0.05	0.15
308.0	P	5.0-6.0	1.0	4.0-5.0	0.50	0.10			1.0	0.25		0.50
319.0	S&P	5.5-6.5	1.0	3.0-4.0	0.50	0.10		0.35	1.0	0.25		0.50
328.0	S	7.5-8.5	1.0	1.0-2.0	0.20-0.6	0.20-0.6	0.35	0.25	1.5	0.25		0.50
332.0	P	8.5-10.5	1.2	2.0-4.0	0.50	0.50-1.5		0.50	1.0	0.25		0.50
333.0	P	8.0-10.0	1.0	3.0-4.0	0.50	0.05-0.50		0.50	1.0	0.25		0.50
336.0	P	11.0-13.0	1.2	0.50-1.5	0.35	0.7-1.3		2.0-3.0	0.35	0.25	0.05	
355.0	S&P	4.5-5.5	0.6 ^d	1.0-1.5	0.50 ^d	0.40-0.6	0.25		0.35	0.25	0.05	0.15
C355.0	S&P	4.5-5.5	0.20	1.0-1.5	0.10	0.40-0.6			0.10	0.20	0.05	0.15
356.0	S&P	6.5-7.5	0.6 ^d	0.25	0.35 ^d	0.20-0.45			0.35	0.25	0.05	0.15
356.0	S&P	6.5-7.5	0.20	0.20	0.10	0.25-0.45			0.10	0.20	0.05	0.15
357.0	S&P	6.5-7.5	0.15	0.05	0.03	0.45-0.6			0.05	0.20	0.05	0.15
A357.0	S&P	6.5-7.5	0.20	0.20	0.10	0.40-0.7			0.10	0.04-0.20	0.05 ^e	0.15
443.0	S&P	4.5-6.0	0.8	0.6	0.50	0.05	0.25		0.50	0.25		0.35
B443.0	S&P	4.5-6.0	0.8	0.15	0.35	0.05			0.35	0.25	0.05	0.15
A444.0	P	6.5-7.5	0.20	0.10	0.10	0.05			0.10	0.20	0.05	0.15
512.0	S	1.4-2.2	0.6	0.35	0.8	3.5-4.5	0.25		0.35	0.25	0.05	0.15
513.0	P	0.30	0.40	0.10	0.30	3.5-4.5			1.4-2.2	0.20	0.05	0.15
514.0	S	0.35	0.50	0.15	0.35	3.5-4.5			0.15	0.25	0.05	0.15
520.0	S	0.25	0.30	0.25	0.15	9.5-10.6			0.15	0.25	0.05	0.15
705.0	S&P	0.20	0.8	0.20	0.40-0.6	1.4-1.8	0.20-0.40		2.7-3.3	0.25	0.05	0.15
707.0	S&P	0.20	0.8	0.20	0.40-0.6	1.8-2.4	0.20-0.40		4.0-4.5	0.25	0.05	0.15
710.0	S	0.15	0.50	0.35-0.65	0.05	0.6-0.8			6.0-7.0	0.25	0.05	0.15
711.0	P	0.30	0.7-1.4	0.35-0.65	0.05	0.25-0.45			6.0-7.0	0.20	0.05	0.15
712.0	S	0.30	0.50	0.25	0.10	0.50-0.65	0.40-0.6		5.0-6.5	0.15-0.25	0.05	0.20
850.0	S&P	0.7	0.7	0.7-1.3	0.10	0.10		0.7-1.3		0.20	— ^f	0.30
851.0	S&P	2.0-3.0	0.7	0.7-1.3	0.10	0.10		0.3-0.7		0.20	— ^f	0.30

^a S = sand cast; P = permanent mold cast. The sum of those "Others" metallic elements 0.010 per cent or more each, expressed to the second decimal before determining the sum. *Source: Standards for Aluminum Sand and Permanent Mold Castings*, courtesy of the Aluminum Association.

^b Also contains 0.40-1.0 per cent silver.

^c Also contains 0.05 max. per cent tin.

^d If iron exceeds 0.45 per cent, manganese content should not be less than one-half the iron content.

^e Also contains 0.04-0.07 per cent beryllium.

^f Also contains 5.5-7.0 per cent tin.

Table 6b. Mechanical Property Limits for Separately Cast Test Bars of Commonly Used Aluminum Sand Casting Alloys

Alloy	Temper ^a	Minimum Properties			Typical Brinell Hardness (500 kgf load, 10-mm ball)
		Tensile Strength (ksi)		Elongation In 2 inches (%)	
		Ultimate	Yield		
201.0	T7	60.0	50.0	3.0	110-140
204.0	T4	45.0	28.0	6.0	
208.0	F	19.0	12.0	1.5	40-70
222.0	O	23.0			65-95
222.0	T61	30.0			100-130
242.0	O	23.0			55-85
242.0	T571	29.0			70-100
242.0	T61	32.0	20.0		90-120
242.0	T77	24.0	13.0	1.0	60-90
295.0	T4	29.0	13.0	6.0	45-75
295.0	T6	32.0	20.0	3.0	60-90
295.0	T62	36.0	28.0		80-110
295.0	T7	29.0	16.0	3.0	55-85
319.0	F	23.0	13.0	1.5	55-85
319.0	T5	25.0			65-95
319.0	T6	31.0	20.0	1.5	65-95
328.0	F	25.0	14.0	1.0	45-75
328.0	T6	34.0	21.0	1.0	65-95
354.0	b				
355.0	T51	25.0	18.0		50-80
355.0	T6	32.0	20.0	2.0	70-105
355.0	T7	35.0			70-100
355.0	T71	30.0	22.0		60-95
C355.0	T6	36.0	25.0	2.5	75-105
356.0	F	19.0		2.0	40-70
356.0	T51	23.0	16.0		45-75
356.0	T6	30.0	20.0	3.0	55-90
356.0	T7	31.0	29.0		60-90
356.0	T71	25.0	18.0	3.0	45-75
A356.0	T6	34.0	24.0	3.5	70-105
443.0	F	17.0	7.0	3.0	25-55
B443.0	F	17.0	6.0	3.0	25-55
512.0	F	17.0	10.0		35-65
514.0	F	22.0	9.0	6.0	35-65
520.0	T4 ^c	42.0	22.0	12.0	60-90
535.0	F or T5	35.0	18.0	9.0	60-90
705.0	F or T5	30.0	17.0	5.0	50-80
707.0	T5	33.0	22.0	2.0	70-100
707.0	T7	37.0	30.0	1.0	65-95
710.0	F or T5	32.0	20.0	2.0	60-90
712.0	F or T5	34.0	25.0	4.0	60-90
713.0	F or T5	32.0	22.0	3.0	60-90
771.0	T5	42.0	38.0	1.5	85-115
771.0	T51	32.0	27.0	3.0	70-100
771.0	T52	36.0	30.0	1.5	70-100
771.0	T53	36.0	27.0	1.5	
771.0	T6	42.0	35.0	5.0	75-105
771.0	T71	48.0	45.0	2.0	105-135
850.0	T5	16.0		5.0	30-60
851.0	T5	17.0		3.0	30-60
852.0	T5	24.0	18.0		45-75

Source: Standards for Aluminum Sand and Permanent Mold Castings, courtesy of the Aluminum Association.

^aF indicates "as cast" condition.

^bMechanical properties for these alloys depend on the casting process. For further information consult the individual foundries.

^cThe T4 temper of Alloy 520.0 is unstable; significant room temperature aging occurs within life expectancy of most castings. Elongation may decrease by as much as 80 percent.

Table 6c. Mechanical Property Limits for Separately Cast Test Bars of Commonly Used Aluminum Permanent Mold Casting Alloys

Alloy	Temper ^a	Minimum Properties			Typical Brinell Hardness (500 kgf load, 10-mm ball)
		Tensile Strength (ksi)		Elongation In 2 inches (%)	
		Ultimate	Yield		
204.0	T4	48.0	29.0	8.0	
208.0	T4	33.0	15.0	4.5	60-90
208.0	T6	35.0	22.0	2.0	75-105
208.0	T7	33.0	16.0	3.0	65-95
222.0	T551	30.0			100-130
222.0	T65	40.0			125-155
242.0	T571	34.0			90-120
242.0	T61	40.0			95-125
296.0	T6	35.0		2.0	75-105
308.0	F	24.0			55-85
319.0	F	28.0	14.0	1.5	70-100
319.0	T6	34.0		2.0	75-105
332.0	T5	31.0			90-120
333.0	F	28.0			65-100
333.0	T5	30.0			70-105
333.0	T6	35.0			85-115
333.0	T7	31.0			75-105
336.0	T551	31.0			90-120
336.0	T65	40.0			110-140
354.0	T61	48.0	37.0	3.0	
354.0	T62	52.0	42.0	2.0	
355.0	T51	27.0			60-90
355.0	T6	37.0		1.5	75-105
355.0	T62	42.0			90-120
355.0	T7	36.0			70-100
355.0	T71	34.0	27.0		65-95
C355.0	T61	40.0	30.0	3.0	75-105
356.0	F	21.0		3.0	40-70
356.0	T51	25.0			55-85
356.0	T6	33.0	22.0	3.0	65-95
356.0	T7	25.0		3.0	60-90
356.0	T71	25.0		3.0	60-90
A356.0	T61	37.0	26.0	5.0	70-100
357.0	T6	45.0		3.0	75-105
A357.0	T61	45.0	36.0	3.0	85-115
359.0	T61	45.0	34.0	4.0	75-105
359.0	T62	47.0	38.0	3.0	85-115
443.0	F	21.0	7.0	2.0	30-60
B443.0	F	21.0	6.0	2.5	30-60
A444.0	T4	20.0		20.0	
513.0	F	22.0	12.0	2.5	45-75
535.0	F	35.0	18.0	8.0	60-90
705.0	T5	37.0	17.0	10.0	55-85
707.0	T7	45.0	35.0	3.0	80-110
711.0	T1	28.0	18.0	7.0	55-85
713.0	T5	32.0	22.0	4.0	60-90
850.0	T5	18.0		8.0	30-60
851.0	T5	17.0		3.0	30-60
851.0	T6	18.0		8.0	
852.0	T5	27.0		3.0	55-85

Source: Standards for Aluminum Sand and Permanent Mold Castings. Courtesy of the Aluminum Association.

^aF indicates "as cast" condition.

A system of four-digit numerical designations for wrought aluminum and wrought aluminum alloys was adopted by the Aluminum Association in 1954. This system is used by the commercial producers and is similar to the one used by the SAE; the difference being the addition of two prefix letters.

The first digit of the designation identifies the alloy type: 1) indicating an aluminum of 99.00 per cent or greater purity; 2) copper; 3) manganese; 4) silicon; 5) magnesium; 6) magnesium and silicon; 7) zinc; 8) some element other than those aforementioned; and 9) unused (not assigned at present).

If the second digit in the designation is zero, it indicates that there is no special control on individual impurities; integers 1 through 9 indicate special control on one or more individual impurities.

In the 1000 series group for aluminum of 99.00 per cent or greater purity, the last two of the four digits indicate to the nearest hundredth the amount of aluminum above 99.00 per cent. Thus designation 1030 indicates 99.30 per cent minimum aluminum. In the 2000 to 8000 series groups the last two of the four digits have no significance but are used to identify different alloys in the group. At the time of adoption of this designation system most of the existing commercial designation numbers were used for these last two digits, as for example, 14S became 2014, 3S became 3003, and 75S became 7075. When new alloys are developed and are commercially used these last two digits are assigned consecutively beginning with -01, skipping any numbers previously assigned at the time of initial adoption.

Experimental alloys are also designated in accordance with this system but they are indicated by the prefix X. The prefix is dropped upon standardization.

Table 7a shows the product forms and nominal compositions of common wrought aluminum alloys, and Table 7b lists typical mechanical properties of wrought aluminum alloys.

Table 7a. Nominal Compositions of Common Wrought Aluminum Alloys

Alloy	Alloying Elements — Aluminum and Normal Impurities Constitute Remainder												
	Si	Cu	Mn	Mg	Cr	Ni	Zn	Ti	Pb	Bi	V	Z	Fe
1050			99.50 per cent minimum aluminum										
1060			99.60 per cent minimum aluminum										
1100		0.12	99.00 per cent minimum aluminum										
1145			99.45 per cent minimum aluminum										
1175			99.75 per cent minimum aluminum										
1200			99.00 per cent minimum aluminum										
1230			99.30 per cent minimum aluminum										
1235			99.35 per cent minimum aluminum										
1345			99.45 per cent minimum aluminum										
1350 ^a			99.50 per cent minimum aluminum										
2011		5.5							0.4	0.4			
2014	0.8	4.4	0.8	0.50									
2017	0.50	4.0	0.7	0.6									
2018		4.0		0.7		2.0							
2024		4.4	0.6	1.5									
2025	0.8	4.4	0.8										
2036		2.6	0.25	0.45									
2117		2.6		0.35									
2124		4.4	0.6	1.5									
2218		4.0		1.5		2.0							
2219		6.3	0.30					0.06			0.10	0.18	
2319		6.3	0.30					0.15			0.10	0.18	
2618	0.18	2.3		1.6		1.0		0.07					1.1

Table 7a. (Continued) Nominal Compositions of Common Wrought Aluminum Alloys

Alloy	Alloying Elements — Aluminum and Normal Impurities Constitute Remainder												
	Si	Cu	Mn	Mg	Cr	Ni	Zn	Ti	Pb	Bi	V	Z	Fe
3003		0.12	1.2										
3004			1.2	1.0									
3005			1.2	0.40									
4032	12.2	0.9		1.0		0.9							
4043	5.2												
4045	10.0												
4047	12.0												
4145	10.0	4.0											
5005				0.8									
5050				1.4									
5052				2.5	0.25								
5056			0.12	5.0	0.12								
5083			0.7	4.4	0.15								
5086			0.45	4.0	0.15								
5183			0.8	4.8	0.15								
5252				2.5									
5254				3.5	0.25								
5356			0.12	5.0	0.12			0.13					
5456			0.8	5.1	0.12								
5457			0.30	1.0									
5554			0.8	2.7	0.12								
5556			0.8	5.1	0.12								
5652				2.5	0.25								
5654				3.5	0.25			0.10					
6003	0.7			1.2									
6005	0.8			0.50									
6053	0.7			1.2	0.25								
6061	0.6	0.28		1.0	0.20								
6066	1.4	1.0	0.8	1.1									
6070	1.4	0.28	0.7	0.8									
6101	0.50			0.6									
6105	0.8			0.62									
6151	0.9			0.6	0.25								
6201	0.7			0.8									
6253	0.7			1.2	0.25		2.0						
6262	0.6	0.28		1.0	0.09				0.6	0.6			
6351	1.0		0.6	0.6									
6463	0.40			0.7									
7005			0.45	1.4	0.13		4.5	0.04				0.14	
7008				1.0	0.18		5.0						
7049		1.6		2.4	0.16		7.7						
7050		2.3		2.2	6.2							0.12	
7072							1.0						
7075		1.6		2.5	0.23		5.6						
7108				1.0			5.0					0.18	
7178		2.0		2.8	0.23		6.8						
8017		0.15		0.03									0.7
8030 ^b		0.22											
8177				0.08									0.35

^a Formerly designated EC.^b Boron 0.02 per cent.

Source: Aluminum Standards and Data. Courtesy of the Aluminum Association.

Table 7b. Typical Mechanical Properties of Wrought Aluminum Alloys

Alloy and Temper	Tension				Brinell Hardness Number 500 kg load, 10-mm ball	Ultimate Shearing Strength (ksi)	Endurance Limit ^a (ksi)
	Strength (ksi)		Elongation in 2 inches (%)				
	Ultimate	Yield	1/16-inch Thick Specimen	1/2-inch Diameter Specimen			
1060-O	10	4	43		19	7	3
1060-H12	12	11	16		23	8	4
1060-H14	14	13	12		26	9	5
1060-H16	16	15	8		30	10	6.5
1060-H18	19	18	6		35	11	6.5
1100-O	13	5	35	45	23	9	5
1100-H12	16	15	12	25	28	10	6
1100-H14	18	17	9	20	32	11	7
1100-H16	21	20	6	17	38	12	9
1100-H18	24	22	5	15	44	13	9
1350-O	12	4		b		8	
1350-H12	14	12				9	
1350-H14	16	14				10	
1350-H16	18	16				11	
1350-H19	27	24		c		15	7
2011-T3	55	43		15	95	32	18
2011-T8	59	45		12	100	35	18
2014-O	27	14		18	45	18	13
2014-T4, T451	62	42		20	105	38	20
2014-T6, T651	70	60		13	135	42	18
Alclad 2014-O	25	10	21			18	
Alclad 2014-T3	63	40	20			37	
Alclad 2014-T4, T451	61	37	22			37	
Alclad 2014-T6, T651	68	60	10			41	
2017-O	26	10		22	45	18	13
2017-T4, T451	62	40		22	105	38	18
2018-T61	61	46		12	120	39	17
2024-O	27	11	20	22	47	18	13
2024-T3	70	50	18		120	41	20
2024-T4, T351	68	47	20	19	120	41	20
2024-T361 ^d	72	57	13		130	42	18
Alclad 2024-O	26	11	20			18	
Alclad 2024-T3	65	45	18			40	
Alclad 2024-T4, T351	64	42	19			40	
Alclad 2024-T361 ^d	67	53	11			41	
Alclad 2024-T81, T851	65	60	6			40	
Alclad 2024-T861 ^d	70	66	6			42	
2025-T6	58	37		19	110	35	18
2036-T4	49	28	24				18 ^e
2117-T4	43	24		27	70	28	14
2218-T72	48	37		11	95	30	
2219-O	25	11	18				
2219-T42	52	27	20				
2219-T31, T351	52	36	17				
2219-T37	57	46	11				
2219-T62	60	42	10				15
2219-T81, T851	66	51	10				15
2219-T87	69	57	10				15

Table 7b. (Continued) Typical Mechanical Properties of Wrought Aluminum Alloys

Alloy and Temper	Tension				Brinell Hardness Number 500 kg load, 10-mm ball	Ultimate Shearing Strength (ksi)	Endurance Limit ^a (ksi)
	Strength (ksi)		Elongation in 2 inches (%)				
	Ultimate	Yield	1/16-inch Thick Specimen	1/2-inch Diameter Specimen			
3003-O	16	6	30	40	28	11	7
3003-H12	19	18	10	20	35	12	8
3003-H14	22	21	8	16	40	14	9
3003-H16	26	25	5	14	47	15	10
3003-H18	29	27	4	10	55	16	10
Alclad 3003-O	16	6	30	40		11	
Alclad 3003-H12	19	18	10	20		12	
Alclad 3003-H14	22	21	8	16		14	
Alclad 3003-H16	26	25	5	14		15	
Alclad 3003-H18	29	27	4	10		16	
3004-O	26	10	20	25	45	16	14
3004-H32	31	25	10	17	52	17	15
3004-H34	35	29	9	12	63	18	15
3004-H36	38	33	5	9	70	20	16
3004-H38	41	36	5	6	77	21	16
Alclad 3004-O	26	10	20	25		16	
Alclad 3004-H32	31	25	10	17		17	
Alclad 3004-H34	35	29	9	12		18	
Alclad 3004-H36	38	33	5	9		20	
Alclad 3004-H38	41	36	5	6		21	
3105-O	17	8	24			12	
3105-H12	22	19	7			14	
3105-H14	25	22	5			15	
3105-H16	28	25	4			16	
3105-H18	31	28	3			17	
3105-H25	26	23	8			15	
4032-T6	55	46		9	120	38	16
5005-O	18	6	25		28	11	
5005-H12	20	19	10			14	
5005-H14	23	22	6			14	
5005-H16	26	25	5			15	
5005-H18	29	28	4			16	
5005-H32	20	17	11		36	14	
5005-H34	23	20	8		41	14	
5005-H36	26	24	6		46	15	
5005-H38	29	27	5		51	16	
5050-O	21	8	24		36	15	12
5050-H32	25	21	9		46	17	13
5050-H34	28	24	8		53	18	13
5050-H36	30	26	7		58	19	14
5050-H38	32	29	6		63	20	14
5052-O	28	13	25	30	47	18	16
5052-H32	33	28	12	18	60	20	17
5052-H34	38	31	10	14	68	21	18
5052-H36	40	35	8	10	73	23	19
5052-H38	42	37	7	8	77	24	20
5056-O	42	22		35	65	26	20
5056-H18	63	59		10	105	34	22
5056-H38	60	50		15	100	32	22
5083-O	42	21		22		25	
5083-H321, H116	46	33		16			23

Table 7b. (Continued) Typical Mechanical Properties of Wrought Aluminum Alloys

Alloy and Temper	Tension				Brinell Hardness Number 500 kg load, 10-mm ball	Ultimate Shearing Strength (ksi)	Endurance Limit ^a (ksi)
	Strength (ksi)		Elongation in 2 inches (%)				
	Ultimate	Yield	$\frac{1}{16}$ -inch Thick Specimen	$\frac{1}{2}$ -inch Diameter Specimen			
5086-O	38	17	22			23	
5086-H32, H116	42	30	12				
5086-H34	47	37	10			27	
5086-H112	39	19	14				
5154-O	35	17	27		58	22	17
5154-H32	39	30	15		67	22	18
5154-H34	42	33	13		73	24	19
5154-H36	45	36	12		78	26	20
5154-H38	48	39	10		80	28	21
5154-H112	35	17	25		63		17
5252-H25	34	25	11		68	21	
5252-H38, H28	41	35	5		75	23	
5254-O	35	17	27		58	22	17
5254-H32	39	30	15		67	22	18
5254-H34	42	33	13		73	24	19
5254-H36	45	36	12		78	26	20
5254-H38	48	39	10		80	28	21
5254-H112	35	17	25		63		17
5454-O	36	17	22		62	23	
5454-H32	40	30	10		73	24	
5454-H34	44	35	10		81	26	
5454-H111	38	26	14		70	23	
5454-H112	36	18	18		62	23	
5456-O	45	23		24			
5456-H112	45	24		22			
5456-H321, H116	51	37		16	90	30	
5457-O	19	7	22		32	12	
5457-H25	26	23	12		48	16	
5457-H38, H28	30	27	6		55	18	
5652-O	28	13	25	30	47	18	16
5652-H32	33	28	12	18	60	20	17
5652-H34	38	31	10	14	68	21	18
5652-H36	40	35	8	10	73	23	19
5652-H38	42	37	7	8	77	24	20
5657-H25	23	20	12		40	14	
5657-H38, H28	28	24	7		50	15	
6061-O	18	8	25	30	30	12	9
6061-T4, T451	35	21	22	25	65	24	14
6061-T6, T651	45	40	12	17	95	30	14
Alclad 6061-O	17	7	25			11	
Alclad 6061-T4, T451	33	19	22			22	
Alclad 6061-T6, T651	42	37	12			27	
6063-O	13	7			25	10	8
6063-T1	22	13	20		42	14	9
6063-T4	25	13	22				
6063-T5	27	21	12		60	17	10
6063-T6	35	31	12		73	22	10
6063-T83	37	35	9		82	22	
6063-T831	30	27	10		70	18	
6063-T832	42	39	12		95	27	

Table 7b. (Continued) Typical Mechanical Properties of Wrought Aluminum Alloys

Alloy and Temper	Tension				Brinell Hardness Number 500 kg load, 10-mm ball	Ultimate Shearing Strength (ksi)	Endurance Limit ^a (ksi)
	Strength (ksi)		Elongation in 2 inches (%)				
	Ultimate	Yield	1/16-inch Thick Specimen	1/2-inch Diameter Specimen			
6066-O	22	12		18	43	14	
6066-T4, T451	52	30		18	90	29	
6066-T6, T651	57	52		12	120	34	16
6070-T6	55	51	10			34	14
6101-H111	14	11					
6101-T6	32	28	15		71	20	
6262-T9	58	55		10	120	35	13
6351-T4	36	22	20				
6351-T6	45	41	14		95	29	13
6463-T1	22	13	20		42	14	10
6463-T5	27	21	12		60	17	10
6463-T6	35	31	12		74	22	10
7049-T73	75	65		12	135	44	
7049-T7352	75	63		11	135	43	
7050-T73510, T73511	72	63		12			
7050-T7451 ^f	76	68		11		44	
7050-T7651	80	71		11		47	
7075-O	33	15	17	16	60	22	
7075-T6, T651	83	73	11	11	150	48	23
Alclad 7075-O	32	14	17			22	
Alclad 7075-T6, T651	76	67	11			46	
7178-O	33	15	15	16			
7178-T6, T651	88	78	10	11			
7178-T76, T7651	83	73		11			
Alclad 7178-O	32	14	16				
Alclad 7178-T6, T651	81	71	10				
8176-H24	17	14	15			10	

^a Based on 500,000,000 cycles of completely reversed stress using the R. R. Moore type of machine and specimen.

^b 1350-O wire should have an elongation of approximately 23 per cent in 10 inches.

^c 1350-H19 wire should have an elongation of approximately 1.5 per cent in 10 inches.

^d Tempers T361 and T861 were formerly designated T36 and T86, respectively.

^e Based on 10^7 cycles using flexural type testing of sheet specimens.

^f T7451, although not previously registered, has appeared in the literature and in some specifications as T73651.

The data given in this table are intended only as a basis for comparing alloys and tempers and should not be specified as engineering requirements or used for design purposes. The indicated typical mechanical properties for all except O temper material are higher than the specified minimum properties. For O temper products, typical ultimate and yield values are slightly lower than specified (maximum) values.

Source: Aluminum Standards and Data. Courtesy of the Aluminum Association.

Heat-treatability of Wrought Aluminum Alloys.—In high-purity form, aluminum is soft and ductile. Most commercial uses, however, require greater strength than pure aluminum affords. This extra strength is achieved in aluminum first by the addition of other elements to produce various alloys, which singly or in combination impart strength to the metal. Further strengthening is possible by means that classify the alloys roughly into two categories, non-heat-treatable and heat-treatable.

Non-heat-treatable alloys: The initial strength of alloys in this group depends upon the hardening effect of elements such as manganese, silicon, iron and magnesium, singly or in

various combinations. The non-heat-treatable alloys are usually designated, therefore, in the 1000, 3000, 4000, or 5000 series. These alloys are work-hardenable, so further strengthening is made possible by various degrees of cold working, denoted by the "H" series of tempers. Alloys containing appreciable amounts of magnesium when supplied in strain-hardened tempers are usually given a final elevated-temperature treatment called *stabilizing* for property stability.

Heat-treatable alloys: The initial strength of alloys in this group is enhanced by the addition of alloying elements such as copper, magnesium, zinc, and silicon. These elements singly or in various combinations show increasing solid solubility in aluminum with increasing temperature, so it is possible to subject them to thermal treatments that will impart pronounced strengthening.

The first step, called *heat-treatment* or *solution heat-treatment*, is an elevated-temperature process designed to put the soluble element in solid solution. This step is followed by rapid quenching, usually in water, which momentarily "freezes" the structure and for a short time renders the alloy very workable. Some fabricators retain this more workable structure by storing the alloys at below freezing temperatures until they can be formed. At room or elevated temperatures the alloys are not stable after quenching, however, and precipitation of the constituents from the supersaturated solution begins. After a period of several days at room temperature, termed *aging* or *room-temperature precipitation*, the alloy is considerably stronger. Many alloys approach a stable condition at room temperature, but some alloys, particularly those containing magnesium and silicon or magnesium and zinc, continue to age-harden for long periods of time at room temperature.

Heating for a controlled time at slightly elevated temperatures provides even further strengthening and properties are stabilized. This process is called *artificial aging* or *precipitation hardening*. By application of the proper combination of solution heat-treatment, quenching, cold working and artificial aging, the highest strengths are obtained.

Clad Aluminum Alloys.—The heat-treatable alloys in which copper or zinc are major alloying constituents are less resistant to corrosive attack than the majority of non-heat-treatable alloys. To increase the corrosion resistance of these alloys in sheet and plate form they are often clad with high-purity aluminum, a low magnesium-silicon alloy, or an alloy containing 1 per cent zinc. The cladding, usually from 2½ to 5 per cent of the total thickness on each side, not only protects the composite due to its own inherently excellent corrosion resistance but also exerts a galvanic effect that further protects the core material.

Special composites may be obtained such as clad non-heat-treatable alloys for extra corrosion protection, for brazing purposes, or for special surface finishes. Some alloys in wire and tubular form are clad for similar reasons and on an experimental basis extrusions also have been clad.

Aluminum Alloys, Wrought, Sheet.—*Physical Properties:* In the form of sheets, the tensile strength varies from 35,000 psi (241 MPa) for soft temper to 62,000 (427 MPa) psi for heat-treated sheets, and the elongation in 2 inches (5.08 cm) from 12 to 18 per cent. The yield strength of a heat-treated sheet is about 40,000 psi (276 MPa) minimum.

Characteristics of Principal Aluminum Alloy Series Groups.—*1000 series:* These alloys are characterized by high corrosion resistance, high thermal and electrical conductivity, low mechanical properties and good workability. Moderate increases in strength may be obtained by strain-hardening. Iron and silicon are the major impurities.

2000 series: Copper is the principal alloying element in this group. These alloys require solution heat-treatment to obtain optimum properties; in the heat-treated condition mechanical properties are similar to, and sometimes exceed, those of mild steel. In some instances artificial aging is employed to further increase the mechanical properties. This treatment materially increases yield strength, with attendant loss in elongation; its effect on tensile (ultimate) strength is not as great. The alloys in the 2000 series do not have as good corrosion resistance as most other aluminum alloys and under certain conditions they

may be subject to intergranular corrosion. Therefore, these alloys in the form of sheet are usually clad with a high-purity alloy or a magnesium-silicon alloy of the 6000 series which provides galvanic protection to the core material and thus greatly increases resistance to corrosion. Alloy 2024 is perhaps the best known and most widely used aircraft alloy.

3000 series: Manganese is the major alloying element of alloys in this group, which are generally non-heat-treatable. Because only a limited percentage of manganese, up to about 1.5 per cent, can be effectively added to aluminum, it is used as a major element in only a few instances. One of these, however, is the popular 3003, used for moderate-strength applications requiring good workability.

4000 series: The major alloying element of this group is silicon, which can be added in sufficient quantities to cause substantial lowering of the melting point without producing brittleness in the resulting alloys. For these reasons aluminum-silicon alloys are used in welding wire and as brazing alloys where a lower melting point than that of the parent metal is required. Most alloys in this series are non-heat-treatable, but when used in welding heat-treatable alloys they will pick up some of the alloying constituents of the latter and so respond to heat-treatment to a limited extent. The alloys containing appreciable amounts of silicon become dark gray when anodic oxide finishes are applied, and hence are in demand for architectural applications.

5000 series: Magnesium is one of the most effective and widely used alloying elements for aluminum. When it is used as the major alloying element or with manganese, the result is a moderate to high strength non-heat-treatable alloy. Magnesium is considerably more effective than manganese as a hardener, about 0.8 per cent magnesium being equal to 1.25 per cent manganese, and it can be added in considerably higher quantities. Alloys in this series possess good welding characteristics and good resistance to corrosion in marine atmospheres. However, certain limitations should be placed on the amount of cold work and the safe operating temperatures permissible for the higher magnesium content alloys (over about 3½ per cent for operating temperatures over about 150°F or 66°C) to avoid susceptibility to stress corrosion.

6000 series: Alloys in this group contain silicon and magnesium in approximate proportions to form magnesium silicide, thus making them capable of being heat-treated. The major alloy in this series is 6061, one of the most versatile of the heat-treatable alloys. Though less strong than most of the 2000 or 7000 alloys, the magnesium-silicon (or magnesium-silicide) alloys possess good formability and corrosion resistance, with medium strength. Alloys in this heat-treatable group may be formed in the -T4 temper (solution heat-treated but not artificially aged) and then reach full -T6 properties by artificial aging.

7000 series: Zinc is the major alloying element in this group, and when coupled with a smaller percentage of magnesium, results in heat-treatable alloys of very high strength. Other elements such as copper and chromium are usually added in small quantities. A notable member of this group is 7075, which is among the highest strength aluminum alloys available and is used in air-frame structures and for highly stressed parts.

Type Metal.—Antimony gives to metals the property of expansion on solidification, and hence, is used in type metal for casting type for the printing trades to insure completely filling the molds. Type metals are generally made with from 5 to 25 per cent of antimony, and with lead, tin and sometimes a small percentage of copper as the other alloying metals.

The compositions of a number of type metal alloys are as follows (figures given are percentages): lead 77.5, tin 6.5, antimony 16; lead 70, tin, 10, antimony 18, copper, 2; lead 63.2, tin 12, antimony 24, copper 0.8; lead 60.5, tin 14.5, antimony 24-25, copper 0.75; lead 60, tin 35, antimony 5; and lead 55.5, tin 40, antimony 4.5.

A high grade of type metal is composed of the following percentages: lead 50; tin 25; and antimony 25.

Magnesium Alloys

Magnesium Alloys.—Magnesium is the lightest of all structural metals. Silver-white in color, pure magnesium is relatively soft, so is rarely used for structural purposes in the pure state. Principal metallurgical uses for pure magnesium are as an alloying element for aluminum and other metals; as a reducing agent in the extraction of such metals as titanium, zirconium, hafnium, and uranium; as a nodularizing agent in the manufacture of ductile iron; and as a sulfur removal agent in steel manufacture. Magnesium alloys are made by alloying up to about 10 per cent of other metals and have low density and an excellent combination of mechanical properties, as shown in [Table 8a](#), resulting in high strength-to-weight ratios.

Magnesium alloys are the easiest of all the structural metals to machine, and these alloys have very high weld efficiencies. Magnesium is readily processed by all the standard casting and fabrication techniques used in metalworking, especially by pressure die casting. Because the metal work hardens rapidly, cold forming is limited to mild deformation, but magnesium alloys have excellent working characteristics at temperatures between 300 and 500°F (149 and 260°C).

These alloys have relatively low elastic moduli, so they will absorb energy with good resistance to dents and high damping capacities. Fatigue strength also is good, particularly in the low-stress, high-cycle range. The alloys can be precipitation hardened, so mechanical properties can be improved by solution heat treatment and aging. Corrosion resistance was greatly improved recently, when methods were found to limit heavy metal impurities to “parts per million.”

Applications of Magnesium Alloys.—Magnesium alloys are used in a wide variety of structural applications including industrial, materials handling, automotive, consumer-durable, and aerospace equipment. In industrial machinery, the alloys are used for parts that operate at high speeds, which must have light weight to allow rapid acceleration and minimize inertial forces. Materials handling equipment applications include hand trucks, dockboards, grain shovels, and gravity conveyors. Automotive applications include wheels, gearboxes, clutch housings, valve covers, and brake pedal and other brackets. Consumer durables include luggage, softball bats, tennis rackets, and housings for cameras and projectors. Their high strength-to-weight ratio suits magnesium alloys to use in a variety of aircraft structures, particularly helicopters. Very intricate shapes that are uneconomical to produce in other materials are often cast in magnesium, sometimes without draft. Wrought magnesium alloys are made in the form of bars, forgings, extrusions, wire, sheet, and plate.

Alloy and Temper Designation.—Magnesium alloys are designated by a standard four-part system established by the ASTM, and now also used by the SAE, that indicates both chemical composition and temper. Designations begin with two letters representing the two alloying elements that are specified in the greatest amount; these letters are arranged in order of decreasing percentage of alloying elements or alphabetically if they are present in equal amounts. The letters are followed by digits representing the respective composition percentages, rounded off to whole numbers, and then by a serial letter indicating some variation in composition of minor constituents. The final part, separated by a hyphen, consists of a letter followed by a number, indicating the temper condition. The letters that designate the more common alloying elements are A, aluminum; E, rare earths; H, thorium; K, zirconium; M, manganese; Q, silver; S, silicon; T, tin; Z, zinc.

The letters and numbers that indicate the temper designation are: F, as fabricated; O, annealed; H10, H11, strain hardened; H23, H24, H26, strain hardened and annealed; T4, solution heat treated; T5, artificially aged; T6, solution heat treated and artificially aged; and T8, solution heat treated, cold-worked, and artificially aged.

The nominal composition and typical properties of magnesium alloys are listed in [Tables 8a](#) and [8b](#).

Table 8a. Nominal Compositions of Magnesium Alloys

Alloy	Al	Zn	Mn ^a	Si	Zr	Ag	Th	Y	Rare Earth
Sand and Permanent Mold (Gravity Die) Castings									
AM100A-T61	10.0		0.10						
AZ63A-T6	6.0	3.0	0.15						
AZ81A-T4	7.6	0.7	0.13						
AZ91C-T6	8.7	0.7	0.13						
AZ91E-T6 ^b	8.7	0.7	0.17						
AZ92A-T6	9.0	2.0	0.10						
EZ33A-T5		2.6			0.8				3.3
HK31A-T6		0.3			0.7		3.3		
HZ32A-T6		2.1			0.8		3.3		0.1
K1A-F					0.7				
QE22A-T6					0.7	2.5			2.2
QH21A-T6		0.2			0.7		1.1		1.1
ZE41A-T5		4.3	0.15		0.7				1.3
ZE63A-T6		5.8			0.7				2.6
ZH62A-T5		5.7			0.8		1.8		
ZK51A-T5		4.6			0.8				
ZK61A-T6		6.0			0.8				
WE54A-F					0.5			5.3	3.5
Pressure Die Castings									
AZ91A-F	9.0	0.7	0.13						
AZ91B-F ^c	9.0	0.7	0.13						
AZ91D-F ^b	9.0	0.7	0.15						
AM60A-F	6.0		0.13						
AM60B-F ^b	6.0		0.25						
AS41A-F ^d	4.3		0.35	1.0					
Extruded Bars and Shapes									
AZ10A-F	1.3	0.4	0.20						
AZ31B-F	3.0	1.0	0.20						
AZ31C-F	3.0	1.0	0.15						
AZ61A-F	6.5	1.0	0.15						
AZ80A-T5	8.5	0.5	0.12						
HM31A-F			1.20				3.0		
M1A-F			1.20						
ZK40A-T5		4.0			0.45				
ZK60A-F		5.5			0.45				
Sheet and Plate									
AZ31B-H24	3.0	1.0	0.20						
AZ31C-H24	3.0	1.0	0.15						
HK31A-H24					0.7		3.3		
HM21A-T8			0.80				2.0		

^a All manganese values are minimum.

^b High-purity alloy, Ni, Fe, and Cu severely restricted.

^c 0.30 per cent maximum residual copper is allowed.

^d For battery applications.

Source: *Metals Handbook*, 9th edition, Vol. 2, American Society for Metals.

Table 8b. Typical Room-Temperature Mechanical Properties of Magnesium Alloys

Alloy	Tensile Strength (ksi)	Yield Strength			Elongation in 2 in. (%)	Shear Strength (ksi)	Hardness Rockwell B ^a
		Tensile (ksi)	Compressive (ksi)	Bearing (ksi)			
Sand and Permanent Mold (Gravity Die) Castings							
AM100A-T61	40	22	22	68	1		69
AZ63A-T6	40	14	14	44	12	18	55
AZ81A-T4	40	12	12	35	15	21	55
AZ91C-T6	40	21	21	52	6	21	70
AZ91E-T6 ^b	40	21	21	52	6	21	70
AZ92A-T6	40	22	22	65	3	21	81
EZ33A-T5	23	16	16	40	3	20	50
HK31A-T6	32	15	15	40	8	21	55
HZ32A-T6	27	13	13	37	4	20	55
K1A-F	26	8	8	18	19	8	
QE22A-T6	38	28	28		3		80
QH21A-T6	40	30	30		4	22	
ZE41A-T5	30	20	20	51	4	23	62
ZE63A-T6	44	28	28		10		60-85
ZH62A-T5	35	22	22	49	4	23	70
ZK51A-T5	30	20	20	51	4	22	62
ZK61A-T6	45	28	28		10		
WE54A-F	40	29	29		4		
Pressure Die Castings							
AZ91A-F	34	23	23		3	20	63
AZ91B-FAZ91B-F ^c	34	23	23		3	20	63
AZ91D-F ^b	34	23	23		3	20	63
AM60A-F	32	19	19		8		
AM60B-F ^b	32	19	19		8		
AS41A-F ^d	31	20	20		6		
Extruded Bars and Shapes							
AZ10A-F	35	21	10		10		
AZ31B-F	38	29	14	33	15	19	49
AZ31C-F	38	29	14	33	15	19	49
AZ61A-F	45	33	19	41	16	20	60
AZ80A-T5	55	40	35		7	24	82
HM31A-F	42	33	27	50	10	22	
M1A-F	37	26	12	28	12	18	44
ZK40A-T5	40	37	20		4		
ZK60A-F	51	41	36	59	11	26	88
Sheet and Plate							
AZ31B-H24	42	32	26	47	15	23	73
AZ31C-H24	42	32	26	47	15	23	73
HK31A-H24	38	30	23	41	9		68
HM21A-T8	34	25	19	39	11	18	

^a 500 kg load, 10-mm ball.

^b High-purity alloy, Ni, Fe, and Cu severely restricted.

^c 0.30 per cent maximum residual copper is allowed.

^d For battery applications.

Source: *Metals Handbook*, 9th edition, Vol. 2, American Society for Metals.

Nickel and Nickel Alloys

Characteristics of Nickel and Nickel Alloys.—Nickel is a white metal, similar in some respects to iron but with good oxidation and corrosion resistances. Nickel and its alloys are used in a variety of applications, usually requiring specific corrosion resistance or high strength at high temperature. Some nickel alloys exhibit very high toughness; others have very high strength, high proportional limits, and high moduli compared with steel. Commercially, pure nickel has good electrical, magnetic, and magnetostrictive properties. Nickel alloys are strong, tough, and ductile at cryogenic temperatures, and several of the nickel-based superalloys have good strength at temperatures up to 2000°F (1095°C).

Most wrought nickel alloys can be hot and cold-worked, machined, and welded successfully; an exception is the most highly alloyed nickel compound—forged nickel-based superalloys—in which these operations are more difficult. The casting alloys can be machined or ground, and many can be welded and brazed.

There are five categories into which the common nickel-based metals and alloys can be separated: the pure nickel and high nickel (over 94 per cent Ni) alloys; the nickel-molybdenum and nickel-molybdenum-chromium superalloys, which are specifically for corrosive or high-temperature, high-strength service; the nickel-molybdenum-chromium-copper alloys, which are also specified for corrosion applications; the nickel-copper (Monel) alloys, which are used in actively corrosive environments; and the nickel-chromium and nickel-chromium-iron superalloys, which are noted for their strength and corrosion resistance at high temperatures.

Descriptions and compositions of some commonly used nickel and high nickel alloys are shown in [Table 9](#).

Titanium and Titanium Alloys

Titanium is a gray, light metal with a better strength-to-weight ratio than any other metal at room temperature, and is used in corrosive environments or in applications that take advantage of its light weight, good strength, and nonmagnetic properties. Titanium is available commercially in many alloys, but multiple requirements can be met by a single grade of the commercially pure metal. The alloys of titanium are of three metallurgical types: alpha, alpha-beta, and beta, with these designations referring to the predominant phases present in the microstructure.

Titanium has a strong affinity for hydrogen, oxygen, and nitrogen gases, which tend to embrittle the material; carbon is another embrittling agent. Titanium is outstanding in its resistance to strongly oxidizing acids, aqueous chloride solutions, moist chlorine gas, sodium hypochlorite, and seawater and brine solutions. Nearly all nonaircraft applications take advantage of this corrosion resistance. Its uses in aircraft engine compressors and in airframe structures are based on both its high corrosion resistance and high strength-to-weight ratio.

Procedures for forming titanium are similar to those for forming stainless steel. Titanium and its alloys can be machined and abrasive ground; however, sharp tools and continuous feed are required to prevent work hardening. Tapping is difficult because the metal galls.

Titanium castings can be produced by investment or graphite mold methods; however, because of the highly reactive nature of the metal in the presence of oxygen, casting must be done in a vacuum.

Generally, titanium is welded by gas-tungsten arc or plasma arc techniques, and the key to successful welding lies in proper cleaning and shielding. The alpha-beta titanium alloys can be heat treated for higher strength, but they are not easily welded. Beta and alpha-beta alloys are designed for formability; they are formed in the soft state, and then heat treated for high strength.

The properties of some wrought titanium alloys are shown in [Table 10](#).

Table 9. Common Cast and Wrought Nickel and High Nickel Alloys — Designations, Compositions, Typical Properties, and Uses

UNS Designation	Description and Common Name	Nominal Composition (Weight %)	Typical Room-Temperature Properties			Form	Typical Uses
			Tensile (ksi)	0.2% Yield (ksi)	Elong. (%)		
N02200	Commercially pure Ni (Nickel 200)	99.5 Ni	67	22	47	Wrought	Food processing and chemical equipment.
N04400	Nickel-copper alloy (Monel 400)	65 Ni, 32 Cu, 2 Fe	79	30	48	Wrought	Valves, pumps, shafts, marine fixtures and fasteners, electrical and petroleum refining equipment.
N05500	Age-hardened Ni-Cu alloy (Monel K 500)	65 Ni, 30 Cu, 2 Fe, 3 Al + Ti	160	111	24	Wrought	Pump shafts, impellers, springs, fasteners, and electronic and oil well components.
N06002	Ni-Cr Alloy (Hastelloy X)	60 Ni, 22 Cr, 19 Fe, 9 Mo, 0.6 W	114	52	43	Wrought	Turbine and furnace parts, petrochemical equipment.
N06003	Ni-Cr alloy (Nichrome V)	80 Ni, 20 Cr	100	60	30	Wrought	Heating elements, resistors, electronic parts.
N06333	Ni-Cr alloy (RA 333)	48 Ni, 25 Cr, 18 Fe, 3 Mo, 3 W, 3 Co	100	50	50	Wrought	Turbine and furnace parts.
N06600	Ni-Cr alloy (Inconel 600)	75 Ni, 15 Cr, 10 Fe	90	36	47	Wrought	Chemical, electronic, food processing and heat treating equipment; nuclear steam generator tubing.
N06625	Ni-Cr alloy (Inconel 625)	61 Ni, 21 Cr, 2 Fe, 9 Mo, 4 Nb	142	86	42	Wrought	Turbine parts, marine and chemical equipment.
N07001	Age-hardened Ni-Cr alloy (Waspalloy)	58 Ni, 20 Cr, 14 Co, 4 Mo, 3 Al, 1.3 Ti, B, Zr	185	115	25	Wrought	Turbine parts.
N07500	Age-hardened Ni-Cr alloy (Udimet 500)	52 Ni, 18 Cr, 19 Co, 4 Mo, 3 Al, 3 Ti, B, Zr	176	110	16	Wrought & Cast	Turbine parts.
N07750	Age-hardened Ni-Cr alloy (Inconel X-750)	73 Ni, 16 Cr, 7 Fe, 2.5 Ti, 1 Al, 1 Nb	185	130	20	Wrought	Turbine parts, nuclear reactor springs, bolts, extrusion dies, forming tools.
N08800	Ni-Cr-Fe alloy (Incoloy 800)	32 Ni, 21 Cr, 46 Fe, 0.4 Ti, 0.4 Al	87	42	44	Wrought	Heat exchangers, furnace parts, chemical and power plant piping.
N08825	Ni-Cr-Fe alloy (Incoloy 825)	42 Ni, 22 Cr, 30 Fe, 3 Mo, 2 Cu, 1 Ti, Al	91	35	50	Wrought	Heat treating and chemical handling equipment.
N09901	Age-hardened Ni-Cr-Fe alloy (Incoloy 901)	43 Ni, 12 Cr, 36 Fe, 6 Mo, 3 Ti + Al, B	175	130	14	Wrought	Turbine parts.
N10001	Ni-Mo alloy (Hastelloy B)	67 Ni, 28 Mo, 5 Fe	121	57	63	Wrought	Chemical handling equipment.
N10004	Ni-Cr-Mo alloy (Hastelloy W)	59 Ni, 5 Cr, 25 Mo, 5 Fe, 0.6 V	123	53	55	Wrought	Weld wire for joining dissimilar metals, engine repair and maintenance.
N10276	Ni-Cr-Mo alloy (Hastelloy C-276)	57 Ni, 15 Cr, 16 Mo, 5 Fe, 4 W, 2 Co	116	52	60	Wrought	Chemical handling equipment.
N13100	Ni-Co alloy (IN 100)	60 Ni, 10 Cr, 15 Co, 3 Mo, 5.5 Al, 5 Ti, 1 V, B, Zr	147	123	9	Cast	Turbine parts.

For strength in MPa, multiply strength in ksi by 6.8947572

Table 10. Mechanical Properties of Wrought Titanium Alloys

Nominal Composition (%)	Condition	Tensile Strength (ksi)	Room Temperature		Reduction in Area (%)
			Yield Strength (ksi)	Elongation (%)	
Commercially Pure					
99.5 Ti	Annealed	48	35	30	55
99.2 Ti	Annealed	63	50	28	50
99.1 Ti	Annealed	75	65	25	45
99.0 Ti	Annealed	96	85	20	40
99.2 Ti ^a	Annealed	63	50	28	50
98.9 Ti ^b	Annealed	75	65	25	42
Alpha Alloys					
5 Al, 2.5 Sn	Annealed	125	117	16	40
5 Al, 2.5 Sn (low O ₂)	Annealed	117	108	16	
Near Alpha Alloys					
8 Al, 1 Mo, 1 V	Duplex annealed	145	138	15	28
11 Sn, 1 Mo, 2.25 Al, 5.0 Zr, 1 Mo, 0.2 Si	Duplex annealed	160	144	15	35
6 Al, 2 Sn, 4 Zr, 2 Mo	Duplex annealed	142	130	15	35
5 Al, 5 Sn, 2 Zr, 2 Mo, 0.25 Si	975°C (1785°F) (½ h), AC 595°C (1100°F)(2 h), AC	152	140	13	
6 Al, 2 Nb, 1 Ta, 1 Mo	As rolled 2.5 cm (1 in.) plate	124	110	13	34
6 Al, 2 Sn, 1.5 Zr, 1 Mo, 0.35 Bi, 0.1 Si	Beta forge + duplex anneal	147	137	11	
Alpha-Beta Alloys					
8 Mn	Annealed	137	125	15	32
3 Al, 2.5 V	Annealed	100	85	20	
6 Al, 4 V	Annealed	144	134	14	30
	Solution + age	170	160	10	25
6 Al, 4 V (low O ₂)	Annealed	130	120	15	35
6 Al, 6 V, 2 Sn	Annealed	155	145	14	30
	Solution + age	185	170	10	20
7 Al, 4 Mo	Solution + age	160	150	16	22
6 Al, 2 Sn, 4 Zr, 6 Mo	Solution + age	184	170	10	23
6 Al, 2 Sn, 2 Zr, 2 Mo, 2 Cr, 0.25 Si	Solution + age	185	165	11	33
10 V, 2 Fe, 3 Al	Solution + age	185	174	10	19
Beta Alloys					
13 V, 11 Cr, 3 Al	Solution + age	177	170	8	
	Solution + age	185	175	8	
8 Mo, 8 V, 2 Fe, 3 Al	Solution + age	190	180	8	
3 Al, 8 V, 6 Cr, 4 Mo, 4 Zr	Solution + age	210	200	7	
	Annealed	128	121	15	
11.5 Mo, 6 Zr, 4.5 Sn	Solution + age	201	191	11	

^a Also contains 0.2 Pd.

^b Also contains 0.8 Ni and 0.3 Mo.

Source: Titanium Metals Corp. of America and RMI Co.

For strength in MPa, multiply strength in ksi by 6.8947572

PLASTICS

Properties of Plastics

Characteristics of Important Plastics Families

ABS (acrylonitrile-butadiene-styrene)	Rigid, low-cost thermoplastic, easily machined and thermo-formed.
Acetal	Engineering thermoplastic with good strength, wear resistance, and dimensional stability. More dimensionally stable than nylon under wet and humid conditions.
Acrylic	Clear, transparent, strong, break-resistant thermoplastic with excellent chemical resistance and weatherability.
CPVC (chlorinated PVC)	Thermoplastic with properties similar to PVC, but operates to a 40-60°F (14-16°C) higher temperature.
Fiberglass	Thermosetting composite with high strength-to-weight ratio, excellent dielectric properties, and unaffected by corrosion.
Nylon	Thermoplastic with excellent impact resistance, ideal for wear applications such as bearings and gears, self-lubricating under some circumstances.
PEEK (polyetheretherketone)	Engineering thermoplastic, excellent temperature resistance, suitable for continuous use above 500°F (260°C), excellent flexural and tensile properties.
PET (polyethylene-terephthalate)	Dimensionally stable thermoplastic with superior machining characteristics compared to acetal.
Phenolic	Thermosetting family of plastics with minimal thermal expansion, high compressive strength, excellent wear and abrasion resistance, and a low coefficient of friction. Used for bearing applications and molded parts.
Polycarbonate	Transparent tough thermoplastic with high impact strength, excellent chemical resistance and electrical properties, and good dimensional stability.
Polypropylene	Good chemical resistance combined with low moisture absorption and excellent electrical properties, retains strength up to 250°F (120°C).
Polysulfone	Durable thermoplastic, good electrical properties, operates at temperatures in excess of 300°F (150°C).
Polyurethane	Thermoplastic, excellent impact and abrasion resistance, resists sunlight and weathering.
PTFE (polytetrafluoroethylene)	Thermoplastic, low coefficient of friction, withstands up to 500°F (260°C), inert to chemicals and solvents, self-lubricating with a low thermal-expansion rate.
PVC (polyvinyl chloride)	Thermoplastic, resists corrosive solutions and gases both acid and alkaline, good stiffness.
PVDF (polyvinylidene-fluoride)	Thermoplastic, outstanding chemical resistance, excellent substitute for PVC or polypropylene. Good mechanical strength and dielectric properties.

Plastics Materials.—Plastics encompass a wide range of materials that consist of long chains of carbon atoms with attached atoms of other elements, mainly hydrogen, and small, repeating chemical functional groups that influence the plastics' properties. Some other elements found in plastics are oxygen, nitrogen, chlorine, sulfur, and fluorine. A special class, the *silicones*, have chains of alternating silicon and oxygen atoms with small carbon-based side groups. These repeating chain segments are called *mers*, giving the term *polymers* for these materials. The pure (*neat*) materials are also known as *resins*. Commercial plastics are resins containing additives in amounts ranging from trace quantities to 50 per cent or more. In any sample of resin, molecular chain lengths will generally vary widely but the average must exceed several thousand mer units if the resin is to possess good mechanical properties. There are two main classes of resin: *thermoplastics* (which includes *elastomers*) and *thermosets*.

Thermoplastics: Plastics that soften when heated are called thermoplastics. These plastics can be repeatedly melted and then solidified by cooling. This reversible change may actually be repeated several times until a final product is made. For example, freshly polymerized polypropylene is a fine powder that is converted into conveniently processible pellets by extrusion. The extruder compacts and melts the powder and pumps it through a strand die, where the emerging strands are water-chilled and sliced into $\frac{3}{16}$ -inch (10mm) BB-sized pellets. A sheet maker may then reprocess the pellets in an extruder to produce long rolls of thin sheet or short slabs of thicker sheet. These are transported to a thermoformer, which again heat-softens the sheet and pulls it down over a chilled mold to make packages from the thin sheet or wastebaskets from the thicker ones. Some examples of commodity thermoplastic families are polystyrenes (PS), polyethylenes (PE), acrylics (PMMA), cellulose (e.g., cellulose acetate butyrate, CAB), and polyvinyls—from soft and flexible to hard and stiff. *Engineering Thermoplastics*, such as the nylon family, acetal resins, polycarbonate, and others listed in the preceding table generally have superior strength, toughness and resistance to heat and chemicals. Thermoplasticity makes it easy to recycle these resins. Although the heating/cooling cycle can be repeated, recycling reduces mechanical properties and appearance.

Thermosets: Thermosetting plastics, such as amino, epoxy, phenolic, and unsaturated polyesters come to the final processor as partially polymerized mixtures of chemically active, long-chain molecules. When they are heated during molding, the mixture components react to form chemical bonds, called *cross-links*, between the original chains forming huge three-dimensional molecules. Such products generally have good heat resistance. However, if heated above their molding temperatures, they do not melt, but instead decompose. They cannot be reprocessed, so opportunities for salvaging scrap for recycling are limited. Many rubbers that are processed by vulcanizing, such as butyl, latex, neoprene, nitrile, polyurethane, and silicone, also are classified as thermosets.

Elastomers and Rubbers: Raw natural or synthetic rubber, initially thermoplastic, is mixed with finely divided carbon and sulfur. During molding these materials undergo cross-linking by sulfur, a process called *vulcanizing*. Elastomers typically have low elastic moduli (stiffness) but high elasticity (stretch). Many if stretched to twice their length (or much more) and then released, will snap back resiliently to their original length and shape. Thermoplastic elastomers are often used in place of rubber, and may also be used as additives for improving impact strength of rigid thermoplastics.

Thermoplastic Structures.—Thermoplastics can be classified by their structures into three categories:

Amorphous: These randomly structured materials are sometimes called *noncrystalline*. Such thermoplastics include acrylates, polycarbonate (PC), polystyrene, acrylonitrile-butadiene-styrene (ABS), styrene acrylonitrile (SAN), and polyvinylchloride (PVC) and its acetate copolymers.

Crystalline: Half or even more of the chains in crystalline thermoplastics are organized into tiny regular regions called *crystallites*. Representative members are nylons, acetals, polyethylene (PE), polypropylene (PP), and polyethylene terephthalate (PET). The crystallites are linked by amorphous zones; the resulting microstructures make these materials stronger and stiffer than similar materials without crystallinity. They are generally higher melting, with more sharply defined melting ranges than amorphous resins.

Liquid-Crystalline Polymers (LCP): These contain crystal-like structures even in the melted resin. They have highly ordered, rod-like microstructures with good mechanical properties and high melting temperatures. They have the lowest shrinkage and warpage of the three types of thermoplastics.

Copolymers, Blends, Additives, and Reinforcements.—Plastics can be manipulated to modify mechanical, chemical, electrical, and cost characteristics.

Copolymers: Combining two or more different polymers can create a new material with properties that are completely different from those of the individual polymers (*homopolymers*) from which they are made. The copolymers are alloyed: mechanically blended from the two or more different polymers, often with special additives to make them compatible. These “alloys” are compounded so as to retain the most desirable characteristics of each constituent, especially impact strength and flame resistance. The properties usually are intermediate between those of the constituent homopolymer materials.

Copolymers such as SAN and ABS have long been commercially available. Newer blends and alloys are not always readily available in sheets or in standard industry stock shapes supplied for machining.

Additives and Fillers: Plastics compounds with desired sets of properties are produced from “neat” resins by adding many types of other chemicals and materials. Antioxidants, lubricants, pigments and dyes, fire retardants, and ultraviolet protectants in small percentages usually do not significantly alter mechanical and physical properties. *Larger* quantities of particulate fillers such as wood flour (used with thermosets), silica powder, glass or phenolic microballoons, carbon and metal powders do affect density, thermal and electrical conductivity, mechanical properties, and unit cost. The use of such additives makes available many grades of a given plastic type from each commercial plastics manufacturer.

Plasticizers: Plasticizers soften and toughen the base resins with which they are compounded. While they are used in several resin families to some extent, polyvinyl chloride resins (PVC) and related plastics use plasticizers and many other additives in high percentages. These modified resins produce a myriad of grades of PVC from the familiar rigid pipe material (the dominant consumer of PVC) to wire coatings, flooring, and elastomerics used in footwear.

Fibers: Plastics, which have much lower moduli and strengths than glass and metals, can be made stiffer and stronger by incorporating glass, graphite or other fibers. Short chopped fibers in fractions up to about 40 per cent, randomly oriented in molding compounds, provide substantial increases in stiffness and strength. But more dramatic improvements are obtained by incorporating longer fibers in carefully chosen directions, as in fishing rods and golf club shafts, where content of glass or carbon fiber may be more than 50 per cent by weight. Historically, sturdy composites have been and are still made by compression molding multilayer canvas, paper, or cotton-felt sheets impregnated with phenolic or other thermosetting resins. (See also *Plastics Gearing* on page 604.) A relatively recent reinforcement material is *oriented aramid* (aromatic polyamide, Kevlar), whose strength and modulus rival those of metals. Its most familiar use has been in “bullet-proof” vests for law-enforcement and military personnel.

Cellular Plastics.—Many rigid and flexible, thermoplastic and thermosetting resins families are available as foamed plastics in the form of sheets, boards, bars, and cylinders as well as molded shapes. The internal structure of plastic foam consists of tiny gas-filled cells bounded by shared membranes of the resin.

In *closed cell* foams, each cell is a tiny polyhedral cavity adjacent to, but not opening into, other cells. Foamed polystyrene hot liquid beverage cups are an example of closed cell foams. In *open cell* foams the cells are not completely closed but instead form continuous connecting tunnels with other cells in all directions throughout the object. Kitchen sponges are open cell foams.

Densities of plastics foams range from 90 per cent of the resin's unfoamed density down to just a few per cent. Foaming may be accomplished physically by injection of a gas or volatile solvent during extrusion or molding, or by mixing a chemical blowing agent with the resin. When the mix is processed, the unstable blowing agent decomposes in the melt, generating bubbles. Foams have many uses: low-cost space filling, cushioning, thermal and electrical insulation, and as the interlayer member of sandwich materials. Polystyrene, polyethylene, and polyurethane (rigid and flexible) are important foam families.

Application and Physical Properties.—Selecting a plastic for a specific application requires knowledge of many different kinds of properties of candidate materials. Density and mechanical properties will be important considerations in most cases. The plastics must bear tensile, compressive or bending loads, resist or allow twisting or stretching, survive impacts, withstand thousands or even millions of repeated stress cycles, and resist abrasion. Special service environments—extremely low or high temperatures, humidities, outdoor exposure, and the presence of active solvents and chemicals—will modify the selection criteria. Thermal or electrical properties such as coefficients of thermal expansion, thermal or electrical conductivity, heat capacity (specific heat), dielectric strength, and dielectric-loss factor may sometimes be important.

Over many years Committee D-20 of ASTM (formerly American Society for Testing Materials) has developed thousands of characterization and test methods for plastics and their products. ASTM Standards, Section 8, "Plastics," is updated and reissued annually by ASTM. All leading U.S. resin makers and many compounders can furnish the product designer with the results of batteries of tests made on their materials according to numbered ASTM standards. For example, ASTM Test D638, Tensile Properties, prescribes the preparation and dimensions of specimens to be tested by pulling from both ends. Several useful mechanical-property values are obtained from this test: tensile modulus yield strength, tensile strength at break, and elongation (per cent stretching) at break. Most plastics products are made by molding from a molten or pre-polymer condition by processes such as extrusion or injection- or compression-molding. Products so made are apt to have a somewhat different microstructure close to the surfaces than are found in their interiors. In theory, the behavior of a simple test bar in bending should be calculable from the straight tensile-test modulus E , as it is with metals. However, because of the "skin effects" found in molded plastics such predictions are not very reliable. For this reason ASTM Committee D-20 developed Method D790 for flexural properties. Flexural moduli, theoretically the same as E , actually tend to be somewhat higher in molded thermoplastics, as are their flexural strengths.

Even with homogeneous plastics, whose properties are expected to be about the same in all principal directions, certain processing conditions, such as stretching while the heat-softened plastic is cooling, can cause alignment *orientation* of the long polymer chains or crystallites in the stretching direction. This will increase tensile strength in that direction but with some reduction in the perpendicular cross directions. Even more striking anisotropic effects are achieved with long-fiber reinforcements.

Suppliers of unreinforced sheet, bar, and rod stock for machining usually relieve stress by controlled annealing of any residual stresses developed in processing, thereby preventing distortions related to the relief of residual strains during machining.

Some of the more important application properties are defined here.

Density and Specific Gravity: These are closely linked properties. *Density* is the mass (or weight) per unit volume of a material, used mainly to calculate the mass of material

required to make a part whose volume has been calculated from its dimensions. In the plastics industry commonly used units are lb/in^3 or g/cm^3 . *Specific gravity* is the ratio of a material's density to that of water, both being measured at the same temperature, at 23°C (73.4°F) for plastics. Since the density of water at typical room temperatures is very close to 1.00 gm/cm^3 , specific gravity and density measured in metric units are numerically almost equal. In the U.S. Customary System units, water density equals 0.0361 lb/in^3 . Specific gravities of neat resins range from 0.83 for polymethylpentene to 2.20 for polytetrafluoroethylene (PTFE - Teflon). Because specific gravity is a ratio of densities of like units, it is dimensionless. See also *Specific Gravity* on page 380.

Unlike specific gravity, *specific volume* is not dimensionless, but is defined as the reciprocal of density, in^3/lb or cm^3/g .

Shrinkage: This is the difference in measurement between a linear dimension of a mold and the corresponding dimension of a plastic article made in the mold, divided by the mold dimension, and expressed in/in, mils/in, or per cent. The dominant material property here is the *coefficient of linear thermal expansion* since the shrinkage is mainly due to cooling from the high temperature of the melt as it solidifies under pressure in the mold to room temperature after its removal from the mold. Expansion coefficients of plastics are much larger than those of metals and ceramics, ranging from 30 to over $100 \text{ in/in } ^\circ\text{C}$ ($\text{cm/cm } ^\circ\text{C}$). For type-66 nylon, which freezes at 260°C (500°F), shrinkage may be as much as 20 mils/in (0.02 cm/cm), i.e., 2 per cent. Shrinkage can also be affected by other molding conditions and by additive content. Amorphous and liquid-crystalline thermoplastics have lower shrinkages than crystalline materials. Glass- or carbon-reinforced and mineral-filled compounds have lower shrinkage than their neat resins. For accurate assessment of shrinkage, test moldings are advised before mold-cavity dimensions are finalized.

Water Absorption: The increase in weight of a test specimen due to absorption of water, expressed as a percentage of the original dry weight. Standard test specimens (ASTM Method D570) are first dried for 24 hours, then weighed before and after immersion in water at 23°C (73.4°F) for a specified time. Absorption of water affects not only the dimensions of plastics parts but also mechanical and electrical properties. Parts made from materials with low water absorption tend to have greater dimensional stability.

Transparency: A measure of the percentage of incident light that is transmitted through a test specimen. It is quantified as *luminous transmittance*, the ratio of transmitted to incident light. *Haze* measures the percentage of light entering a specimen that is scattered more than 2.5 degrees from the incident beam.

Elasticity: An *elastic* material is one that can be deformed to an extent less than its *elastic limit* such that when the deforming stress is removed, it will recover its original shape and dimensions. A more precisely formulated definition of "elastic", which few plastics obey, is "A material that obeys Hooke's law of proportionality of strain to stress up to its proportional limit" (see page 562.) The *modulus of elasticity* is Hooke's law constant E , the quotient of stress divided by strain in the proportional region. In a tensile test, strain is the fractional amount of elongation reached under a given stress. Because plastics generally deviate from strict linearity, even at very low stresses, the moduli reported are usually "one per cent moduli," that is the quotient of stress and strain at one per cent strain. For most materials the limit of recoverable strain is a few per cent or less. For rubbers and a handful of thermoplastic elastomers, maximum recoverable strain may be as high as 100 per cent or more. Stress and strain in relation to plastics part design is discussed on page 559.

Plasticity: The deformation behavior exhibited when materials are stressed beyond their elastic limits without breaking, i.e., when stress exceeds the *yield point*. In this mode there can be considerable flow among the microstructural elements of the material, and permanent changes in the dimensions and shape of the deformed article occur. Plastic deformation continues with small increases in stress until finally there is rupture. Plasticity is exhibited to some degree by most unreinforced plastics. While parts are normally designed

to operate in their material's elastic ranges, and plastic deformation may render a part useless for its designed function, plastic deformation *can* sometimes prevent catastrophic failure. A few plastics have such compliant plasticity that they can be cold-formed by metal-working methods—rolled, stretched, or even forged into final products. This property in metals is called *ductility*.

Toughness: This is a complex property that relates to the ability of a material to absorb mechanical energy without cracking or breaking. Often it depends on the rate at which the specimen is deformed. In a standard tensile test (ASTM D638), the strain rate is fairly low—from 0.15 to 15 (in/in)/min. In a tensile-impact test (ASTM D1822) the specimen is abruptly stretched to failure in milliseconds at a strain rate of about 20,000 (in/in)/min. The tensile tester of D638 generates a graph of stress (psi) vs. strain (in/in). The area under this curve is the energy in ft-lb_f/in³ absorbed by the gage volume as it is stretched and finally broken. The impact tester, on the other hand, directly determines how many foot-pounds of energy are needed to stretch and break the specimen. That value, too, can be converted to energy per unit of specimen volume, but the number will be very different from the other. A widely used test of toughness for plastics is the Izod impact test (ASTM D256), in which a falling pendulum strikes and breaks off the upper half of a cantilever test bar whose leading face has a 0.1-inch (2.54 mm) deep, V-shaped notch across it just above the clamping point. This test (the oldest in ASTM's Plastics list, first published in 1926) involves not only toughness but also the *notch-sensitivity* of the plastic. The test result is expressed in ft-lb_f/in of notch width. Izod-test values for 1/8-inch (3.2 mm) wide specimens of neat thermoplastics range from 0.4 for crystal polystyrene or wood-flour-filled phenolics to 14 for polycarbonate and phenolics with a high content of glass fiber. Particulate fillers may increase or decrease Izod impact strength; fibrous reinforcements usually increase it. Thus, applying tabulated toughness values to plastics part design is not a simple task.

Brittleness: Lack of toughness, characterized in plastics by Izod impact test values below 1.0 ft-lb_f/in (53 J/m) or by abrupt fracture with little or no yield in tensile tests.

Notch Sensitivity: A measure of the ease with which a crack progresses through a material from an existing notch, crack, or sharp corner.

Hardness: The ability of a material to resist dents and scratches; it is related to *abrasion resistance* and general durability. Several ASTM test methods are in use for plastics, Rockwell (ASTM D785) being a popular one. One of three hardened steel balls is pressed into the test specimen, first with a low force, then a much higher one, while a micrometer indicates the increase in depth of impression. Five scales are available for plastics: R, L, M, E, and K, in order of increasing hardness, requiring progressively smaller balls and stronger forces. The scale *must* be identified in the report of Rockwell hardness numbers. When an article is expected to suffer abrasion in service, the abrasion loss of candidate plastics may be experimentally determined with an abrasion machine (ASTM D1242).

Homogeneous plastics have the same composition throughout a part down to the microstructural level, but not to the molecular level as in simple chemical compounds. A 3/16-inch (5 mm) BB-sized pellet of a neat resin contains many long-chain molecules of various chain lengths. However, even compounds containing several additives, pigments, and powdery fillers behave in molded articles as if they were homogeneous.

Heterogeneous (inhomogeneous) plastics vary in composition and structure. A compound reinforced with centimeter-long, randomly oriented, chopped glass fibers will not look homogeneous under 50× magnification, yet it may be safely treated as such in the design of parts that are larger than the test samples whose properties have been measured.

Isotropy and Anisotropy: These properties are related to homogeneous and heterogeneous plastics properties. In isotropic materials, measured properties are equal in all directions. Cast metals and plastics tend to be isotropic. Processing effects such as flow orientation that do not change homogeneity can create substantial directional differences

in properties. This effect is called anisotropy. In plastic films made by extruding molten resin onto chilled rolls, the films are usually stronger in the “machine” direction, weaker in the lateral or cross direction. Laminates made of laid-up reinforcing fibers or woven cloths can be nearly biaxially isotropic in the laminate plane, but their interlaminar shear is low because no fibers cross through the plane. Extremely anisotropic are unidirectional laminates where all the fibers are parallel, as in golf club shafts reinforced with graphite fibers.

Wood, see page 385, is a natural anisotropic material, strong and stiff in the grain (growth) direction, less so in the perpendicular and tangential directions. Commercially important fibers, both natural and synthetic, are also highly anisotropic with their greatest strength and moduli aligned with length.

As the degree of anisotropy increases, the number of physical constants (moduli) required to define a material’s stress-strain behavior also increases, up to a maximum of 21. Absence of such complete information on complex laminates and the inadequacy of simple analysis methods point to the need for extensive end-use testing of plastics parts before approval of a particular application design. Computer modeling using finite element analysis (FEA) techniques can help in the successful implementation of these materials. Detailed properties data are required for reliable and accurate modeling.

In addition to mechanical properties, isotropy and anisotropy can affect molding shrinkage. Anisotropic shrinkage caused by patterns of flow in the mold is important in molding crystalline and fiber-reinforced plastics, for which different shrinkage values are experienced in the flow and cross-flow directions. These values are of most concern to the tool designer and molder; however, the existence and severity of anisotropic shrinkage must be considered when a material is chosen for a part having tight tolerances.

Coefficient of Friction: This property comes into play in plastics gears and bearings and other applications where low dynamic (kinetic) friction is desired between moving surfaces in contact. When a weighted block of a plastic is dragged at a steady velocity along a horizontal slab of the same or different material and the contact surfaces are smooth, the coefficient of friction is defined as the ratio of the horizontal drag force to the total weight of the block, called the normal force. In general, the observed coefficients will be different for different pairs of materials, so a test report must identify both materials. While some coefficients were (long ago) determined in this basic manner, ASTM D3028 now prescribes a sophisticated machine (“frictionometer”) for measuring the property. Coefficients of friction change with temperature. Materials such as 66-nylon, acetal resin, and polytetrafluoroethylene containing molybdenum disulfide, which have low self-coefficients, typically enjoy long operating life in unlubricated gears and bearings.

Significance of Elasticity, Homogeneity, and Isotropy in Plastics: In the section *The Basics of Stress and Strain in Plastics* on page 559, formulas for stress and strain in a wide variety of structural geometries are based on the assumption that: 1) the materials are perfectly isotropic and elastic, obeying Hooke’s law in tension, compression, and shear; and 2) the only mechanical properties needed are the elastic modulus E , the shear modulus G , and, occasionally, Poisson’s ratio ν . See pages 561 and 562.

The structural material low-carbon steel obeys these assumptions at temperatures below dull red heat. For this metal, $E = 30,000$ kpsi (206.8 GPa), $G = 11,400$ kpsi (78.6 GPa), and Poisson’s ratio $\nu = 0.32$. The elastic limit is about 40 kpsi (276 MPa), which indicates that its elongation in tension at that limit is only 0.13 per cent. Its stress-strain graph up to the elastic limit is a straight line. If it is loaded up to half its elastic limit, and maintained at that load for a couple of decades, then the loading is removed, the 0.065 per cent elongation will be instantly and completely recovered. Rate of loading in the normal applications does not affect properties.

Plastics, in contrast, are *viscoelastic* materials. They are complex aggregates of many different elastic and fluid elements and therefore display properties between those of crystalline metals and very viscous fluids. Their stress-strain graphs tend not to be linear, even

at low stresses, they are sensitive to rate of loading and to temperature, as shown generically in Fig. 1. Curves A and B identify brittle materials, whereas curves C through E display increasing ductility.

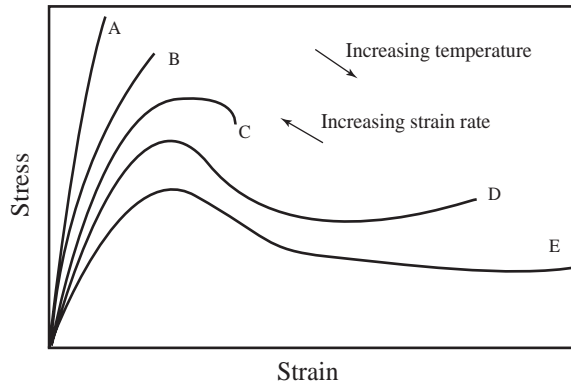


Fig. 1. Generic Tensile-Test Graphs for Plastics, Showing Typical Range of Behavior from Brittle to Highly Ductile

Structural analysis during design of components uses two independent constants, Young's modulus (E) and Poisson's ratio (ν), but two constants are sufficient only for elastic, isotropic materials that respond linearly to loads (when load is proportional to deformation). Designers often use the same values for these constants everywhere in the structure, which is correct only if the structure is homogeneous.

Assumptions of linear elasticity, isotropy, and homogeneity are reasonable for many analyses and are a good starting point, but use of these assumptions can lead to significant design errors with plastics, particularly with glass-reinforced and liquid crystalline polymers, which are highly anisotropic. In this discussion plastics are assumed to be linearly elastic, homogeneous, and isotropic to allow a simpler presentation of mechanical properties in line with the data provided in plastics manufacturers' marketing data sheets. The standard equations of structural analysis (bending, torsion, pressure in a pipe, etc.) also require these assumptions.

Creep: When plastics are subjected to sustained high loads, they *creep*. That is, they tend to slowly deform (flow), exhibiting the viscous side of their nature. If the load is removed, the stressed object will usually not return completely to its original shape and dimensions. Creep is more rapid at higher temperatures, even at temperatures expected in normal service. Laboratory stress-strain curves obtained according to ASTM D638 at moderate strain rates and 23°C (73.4°F) or other temperatures will resemble those in Fig. 2. Most plastics have no true proportional limits, instead exhibiting curved dependence of stress-vs-strain at the lowest strains. Tangent moduli from D638 therefore tend to be subjective and inaccurate when used for predicting deformation. The isometric diagram of Fig. 2 shows the dependence of stress in Styron 475, a rigid modified polystyrene, at various strains and times. Note the logarithmic time scale (0.01 h = 36 s, 10,000 h = 1.14 yr). The curve on the left panel, for 0.01 h, is the stress-strain graph one might obtain at one of the slower testing rates of ASTM D638. The stress ordinate at the left edge, front, i.e., 600 psi (4.1 MPa) for a strain of 0.15 per cent, corresponds to a short-time modulus for this resin of 400 kpsi (2.8 MPa), in agreement with values reported elsewhere. When this small strain was maintained for 1000 hours (6 weeks), the stress had decayed along the first curve (left rear to right front) to about 400 psi (2.8 MPa), two-thirds of its initial value.

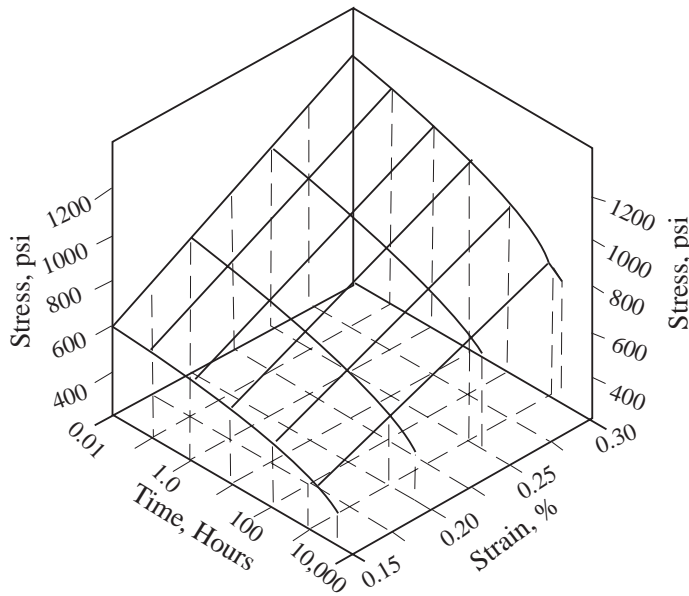


Fig. 2. Isometric Plot for High-impact Polystyrene Showing Stress Response to Imposed Strains Over Three Decades of Time

Some hygroscopic resins can absorb water from the air, with stress-strain behavior ranging from curve B or C of Fig. 1 when very dry to curve D or E at high moisture contents. Polyamides (nylons), classified as engineering resins with superior properties, exemplify this moisture dependence, picking up about 0.3 per cent in very dry climates, 2.5 per cent or more in very humid ones.

One must not use modulus and strength values reported from ASTM D638 testing in the design of plastics products that must sustain loads over long times. Still, the values from the standard tests do provide information aiding in the preliminary selection of materials. Fig. 3 compares the short-time tensile moduli and breaking strengths of some common rigid plastics. Properties for these and other plastics are included in the plastics properties table on page 390.

The Basics of Stress and Strain in Plastics.—The mechanical behavior of plastics are similar in many ways to metals but there are important differences that must be kept in mind in the design of plastics products and parts.

Stress: A three-dimensional body having a balanced system of external forces F_1 through F_5 acting on it such that the body is at rest is shown in Fig. 4. Such a body develops internal forces to transfer and distribute the external loads. If the body is cut at an arbitrary cross-section and one part is removed, as shown at the right in Fig. 4, a new system of forces acting on the cut surface is developed to balance the remaining external forces. Similar forces (stresses) exist within the uncut body.

Stresses must be defined by both magnitude and direction. The stress S acting in the direction shown in Fig. 4 on the point P of the cut surface has two stress components. One of these components, σ , acts perpendicular to the surface and is called a *normal or direct stress*. The other stress, τ , acts parallel to the surface and is called a *shear stress*.

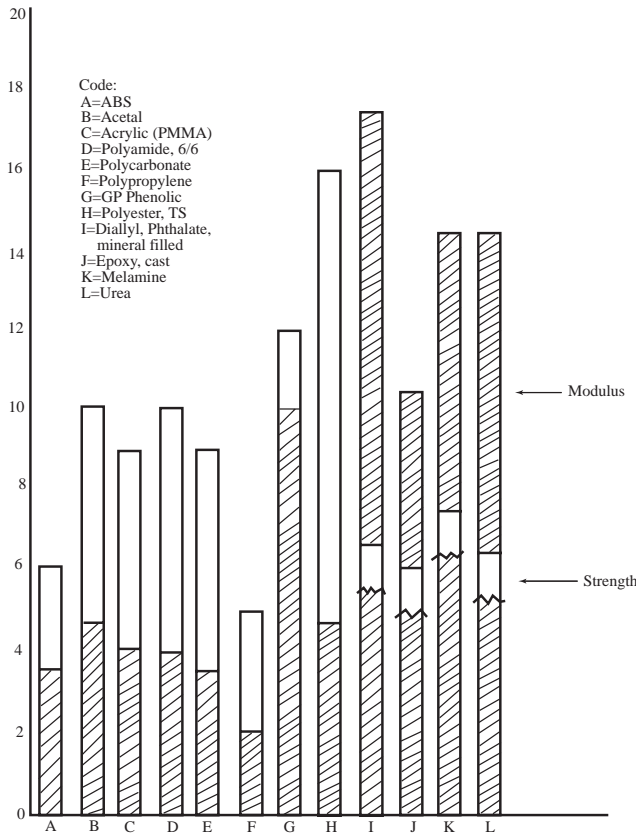


Fig. 3. Comparison of Tensile Moduli and Strengths for Five Thermoplastics and Five Thermosets of Interest to Designers of Plastics Products

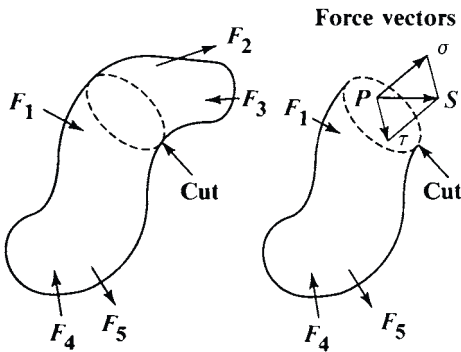


Fig. 4. Internal Forces and Stresses in a Body

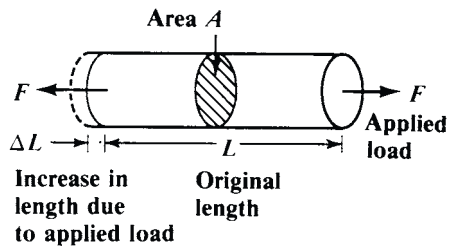


Fig. 5. Simple Tension Load

Normal stress (σ) is illustrated by the simple tension test shown in Fig. 5, where the direct stress is the ratio of applied load to the original cross-sectional area in lb_f/in^2 . In the Système International (SI or metric system, see page 2656, and Table 39 on page 2688) the stress σ is expressed in newtons/meter² (N/m^2).

$$\text{Stress} = \frac{\text{Load}}{\text{Area}} \quad \text{or} \quad \sigma = \frac{F}{A} \quad (1)$$

If the load is applied as shown in Fig. 5, the test piece is in tension, and if reversed, it is in compression.

Normal strain (ϵ) is also illustrated by the diagram in Fig. 5, where the load or stress applied to the test piece causes it to change its length. If the bar has an original length L and changes its length by ΔL , the strain, ϵ , is defined as

$$\text{Strain} = \frac{\text{Change of Length}}{\text{Original Length}} \quad \text{or} \quad \epsilon = \frac{\Delta L}{L} \quad (2)$$

Strain is the ratio between the amount of deformation of the material and its original length. It is a dimensionless quantity. Extensions of most materials under load are generally very small. Strain ($\mu\epsilon$ or microstrain in most metals) is measured and expressed in microinches (millionths of an inch) per inch, or 10^{-6} in/in (10^{-6} cm/cm). Alternatively, strain is expressed as a percentage. The three methods compare as follows:

$$1000\mu\epsilon = 0.001 = 0.1 \text{ per cent strain}$$

$$10000\mu\epsilon = 0.010 = 1 \text{ per cent strain}$$

Modulus of Elasticity E: Most metals and plastics have deformations that are proportional to the imposed loads over a range of loads. Stress is proportional to load and strain is proportional to deformation, so stress is proportional to strain and is expressed by Hooke's law:

$$\frac{\text{Stress}}{\text{Strain}} = \text{Constant} = E \quad (3)$$

The constant E is called by various names: the *modulus of elasticity*, *Young's modulus*, or, in the plastics industry, *tensile modulus*. Referring to Fig. 5, tensile modulus is given by the formula:

$$E = \frac{\sigma}{\epsilon} = \frac{F/A}{\Delta L/L} = \frac{FL}{A\Delta L} \quad (4)$$

Thus, the modulus is the slope of the initial portion of the stress-strain curve. An elastic material does not necessarily obey Hooke's law, since it is possible for a material to return to its original shape without the stress being proportional to the strain. If a material does obey Hooke's law, however, it is elastic.

The straight portion of the stress-strain curve for many plastics is difficult to locate, and it is necessary to construct a straight line tangent to the initial portion of the curve to use as a modulus. The shape of a line so obtained is called the *initial modulus*. In some plastics the initial modulus can be misleading, owing to the nonlinear elasticity of the material. Some suppliers therefore provide the so-called 1 per cent secant modulus, which is the ratio of stress to strain at 1 per cent strain on the stress-strain curve. In the illustration of typical stress-strain curves in Fig. 6, the secant modulus at the point E is the slope of the line OE .

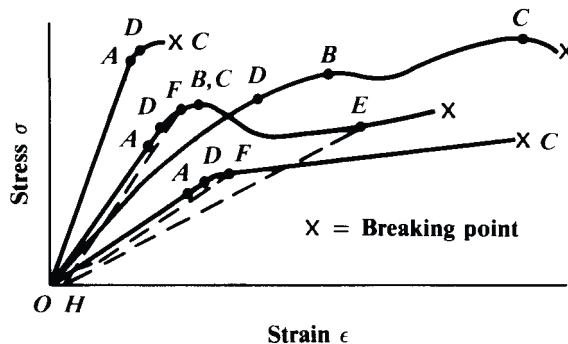


Fig. 6. Typical Stress-Strain Curves

For metals, Young's modulus is expressed in terms of $10^6 \text{ lb}_f/\text{in}^2$, N/m^2 , or Pa, as convenient (see *Units of Pressure and Stress* starting on page 2686.)

Secant modulus is the ratio of stress to corresponding strain at any point on the stress-strain curve (see *Modulus of Elasticity E*).

Proportional limit is the greatest stress at which a material is capable of sustaining the applied load without losing the proportionality of stress to strain. This limit is the point on the stress-strain curve where the slope begins to change, as shown at A on each of the curves in Fig. 6. Proportional limit is expressed in lb_f/in^2 (MPa or GPa).

Yield point is the first point on the stress-strain curve where an increase in strain occurs without an increase in stress, and is indicated by B on some of the curves in Fig. 6. The slope of the curve is zero at this point; however, some materials do not have a yield point.

Ultimate strength is the maximum stress a material withstands when subjected to a load, and is indicated by C in Fig. 6. Ultimate strength is expressed in lb_f/in^2 (MPa or GPa).

Elastic limit is indicated by the point D on the stress-strain curve in Fig. 6 and is the level beyond which a material is permanently deformed when the load is removed.

Although many materials can be loaded beyond their proportional limit and still return to zero strain when the load is removed, some plastics have no proportional limit in that no region exists where the stress is proportional to strain (i.e., where the material obeys Hooke's law).

Yield strength is the stress at which a material shows a specified deviation from stress to strain proportionality. Some materials do not show a yield strength clearly, and it may be desirable to choose an arbitrary stress level beyond the elastic limit, especially with plastics that have a very high strain at the yield point, to establish a realistic yield strength. Such a point is seen at F on some of the curves in Fig. 6 and is defined by constructing a line parallel to OA at a specified offset strain H. The stress at the intersection of the line with the stress-strain curve at F would be the yield strength at H offset. If H were at 2 per cent strain, F would be described as the yield strength at a 2 per cent strain offset.

Poisson's Ratio ν is the ratio of the lateral contraction to longitudinal elongation. Under a tensile load, a rectangular bar of length L with sides of widths b and d lengthens by an amount ΔL , producing a longitudinal strain of

$$\epsilon = \frac{\Delta L}{L} \quad (5)$$

The bar is reduced in its lateral dimensions and the associated lateral strains will be opposite in sign, resulting in

$$\epsilon = -\frac{\Delta b}{b} = -\frac{\Delta d}{d} \quad (6)$$

If the deformation is within the elastic range, Poisson's ratio of the lateral to the longitudinal strains will be constant. The formula is:

$$\nu = \frac{\text{Lateral Strain}}{\text{Longitudinal Strain}} = \frac{\Delta d/d}{\Delta L/L} \quad (7)$$

When a bar like that in Fig. 5 is stretched in tension, mass must be conserved so if there is no change in diameter the average density would diminish inversely as the strain increases. If the area decreased in percentage as much as length increased in percentage, the stretched volume would equal the original volume and density would be preserved. In fact most real materials do contract laterally when stretched, but not enough to preserve constant density, so density does usually does diminish with elongation.

Values of ν for most engineering materials lie between 0.20 and 0.40, and these values hold for unfilled rigid thermoplastics. Values of ν for filled or reinforced rigid thermoplastics fall between 0.10 and 0.40 and for structural foam between 0.30 and 0.40. Rigid ther-

moset plastics have Poisson's ratios between 0.20 and 0.40, whether filled or unfilled, and elastomers can approach 0.5.

Table 1 lists values of ν determined at 23 °C for some plastics by measuring of lateral contraction and longitudinal elongation in tensile tests.

Table 1. Poisson's Ratio at 23 °C for Resins and Compounds

Plastic	Poisson's Ratio, ν	Plastic	Poisson's Ratio, ν
ABS, unfilled	0.35	PCTFE	0.33
Acetal	0.35	Polyester, thermoplastic, gfr ^a	0.35-0.41
Acrylic (PMMA)	0.35-0.40	Polyester, thermoset, gfr ^a	0.24
Alkyd, mineral filled	0.17	Polyetherimide	0.36
Diallyl phthalate	0.27	Polyethylene, HD	0.45
FEP resin	0.48	Polyphenylene ether	0.35
Phenolic, cellulose-filled	0.24	Polyphenylene oxide	0.27-0.38
Phenolic, gfr ^a	0.20	Polystyrene, cross-linked	0.35
Polyamide 6, dry, gfr ^a	0.36	Polyethersulfone	0.40
Polyamide 6/6, dry, gfr ^a	0.32	PTFE	0.46
Polyamide, min-filled, gfr ^a	0.32	PVF	0.40
Polycarbonate	0.37	PVDF	0.34
PC, gfr ^a	0.38		

^a gfr = glass-fiber reinforced, 30 or 33%

Mineral fillers and glass-fiber reinforcements in plastics reduce Poisson's ratio. In anisotropic structures such as uni- and bi-directional laminates Poisson's ratio may be different in orthogonal (i.e., perpendicular) directions. Usually, the value perpendicular to the reinforcing fibers will be the one most likely to be relevant. Vulcanized gum rubber has exceptional behavior, its Poisson ratio = 0.5 and it conserves density. This must be kept in mind in designing items to be compressed, such as rubber cushions and bumpers. When a rubber specimen is compressed it is shortened and its sides must be free to bulge out, otherwise the incompressibility of the rubber would not allow it to deform at all.

Shear stress is described on page 211. Any block of material is subject to a set of equal and opposite shearing forces Q . If the block is envisaged as an infinite number of infinitesimally thin layers as shown diagrammatically in Fig. 7, it is easy to imagine a tendency for one layer subject to a force to slide over the next layer, producing a shear form of deformation or failure. The shear stress τ is defined as

$$\tau = \frac{\text{Shear Load}}{\text{Area Resisting Load}} = \frac{Q}{A} \quad (8)$$

Shear stress is always tangential to the area on which it acts. Shearing strain is the angle of deformation γ and is measured in radians.

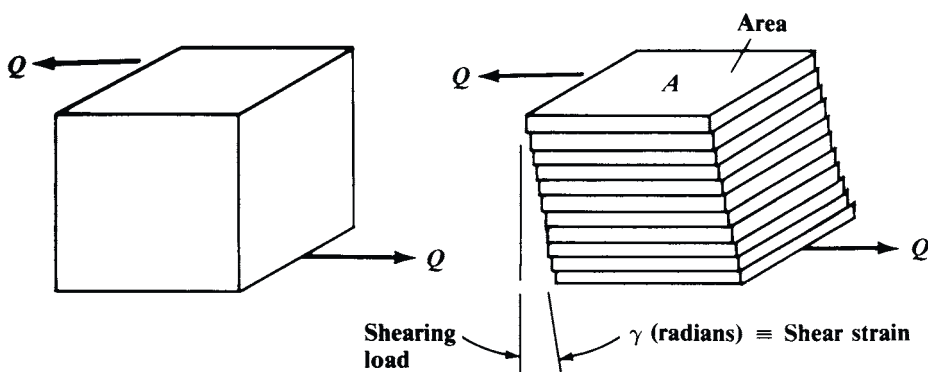


Fig. 7. Shear Stress Is Visualized as a Force Q Causing Infinitely Thin Layers of a Component to Slide Past Each Other, Producing a Shear Form of Failure

Example: In Fig. 8a, shear stress in the overlapped zone equals the tensile force F divided by the contact area of the adhesive. That is, $\tau = F/(WL)$. As F is increased, the joint will finally fail in shear, either in the adhesive layer or in the material of one of the bars, depending on which material has the greater shear strength.

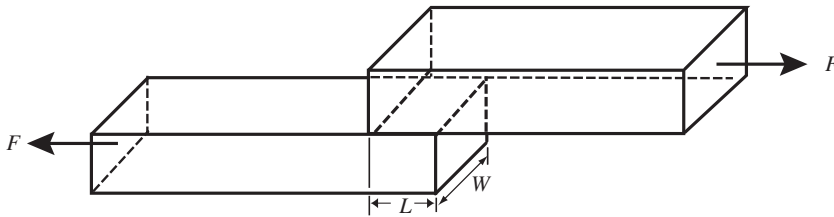


Fig. 8a. Adhesive Lap Joint

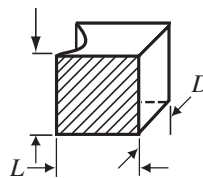
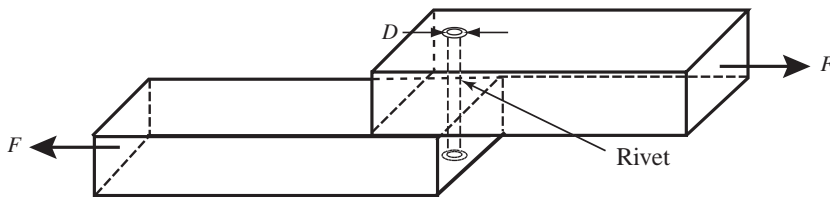


Fig. 8b. Riveted Lap Joint

In Fig. 8b, a similar lap joint is joined with a rivet of diameter D . In this case, the shear area in the rivet is $\pi D^2/4$, a much smaller area. But what if the rivet were aluminum and much stronger than the plastic being joined? A second, very different shear area comes into play, shown as a free body in the lower portion of Fig. 8b, the small bar-end volume adjacent to the rivet. The area shown shaded is equal to $L \times t$ and is $1/2$ of the shear area, so the total shear area equals $2Lt$. Thus, the shear stress τ exerted by the rivet and trying to push that plug out of each bar end is $F/(2Lt)$. As the force F is increased, the mode of failure in the rivet or the bar end will be decided by which of these shear stresses first exceeds the shear strength of the material in which it is acting.

Geometries like those in Figs. 8a and 8b are not useful for determining shear *modulus* because there is very little recordable shear deformation prior to failure at the shear strength. However, the very simple shear geometry shown in Fig. 9 is used in ASTM D732 test to measure the shear strengths of plastics. The washer-shaped test sample has an outer diameter of 2 inches (50.8 mm) and a central hole of about 9/16 inch (14.3 mm) to allow the half-inch (12.7 mm) bolt to pass freely through the specimen. The thickness may be any measured value between 0.05 and 0.5 inch (1.27 and 12.7 mm). In this test the shear area is given by $\pi \times$ punch diameter \times disk thickness. The results of such tests are often described in manufacturers' marketing data sheets as the shear strength of the material. The shear strength reported from such a test is not a pure shear strength because a considerable part of the load is transferred by bending or compressing, or both, rather than by pure shear, and results can be affected by the susceptibility of the material to the sharpness of the load faces in the test apparatus. Thus, the test cannot be used to develop shear stress-strain curves or to determine the shear modulus. Shear strengths reported from this test have coefficients of variation of about 4 per cent.

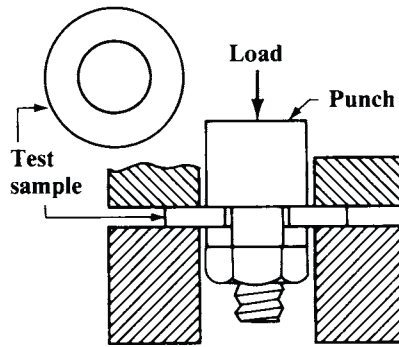


Fig. 9. Setup for Testing Shear Strength of Plastics in ASTM Test D732.
Specimen may be Molded or Cut from Sheet

When analyzing plastics in a pure shear situation or when the maximum shear stress is calculated in a complex stress environment, designers often use a shear strength value of about half the tensile strength, or the direct shear strength obtained from the test referred to above, whichever is least.

Shear modulus G is a constant otherwise called the *modulus of rigidity*, and, for materials that behave according to Hooke's law, it is directly comparable to the modulus of elasticity used in direct stress calculations. The constant is derived from

$$G = \frac{\text{Shear Stress}}{\text{Shear Strain}} = \frac{\tau}{\gamma} \quad (9)$$

For isotropic materials in their Hooke's-law range at low deformations it may be assumed that the modulus in compression is equal to E . Then a simple theoretical relationship links the tensile and shear moduli with Poisson's ratio.

$$G = \frac{E}{2(1 + \nu)} \quad (10)$$

ASTM D1043 provides a method for determining the shear modulus G of plastic specimens at various temperatures by a torsion test. Material suppliers can furnish values of G for their compounds.

Relating Material Constants: Although only two material constants are required to characterize a material that is linearly elastic, homogeneous, and isotropic, three such constants have been introduced here. These three constants are tensile modulus E , Poisson's ratio ν , and shear modulus G , and they are related by Equation (10) or rewritten in the following form, based on elasticity principles:

$$\frac{E}{G} = 2(1 + \nu) \quad (11)$$

This relationship holds for most metals and is generally applicable to injection-moldable thermoplastics. It must be remembered, however, that most plastics, and particularly fiber-reinforced and liquid crystalline materials, are inherently either nonlinear, anisotropic, or both.

Bulk Modulus B : When a sample of material is subjected to high pressure from all sides its volume diminishes with a corresponding increase in density. Bulk modulus B is defined as the increase in pressure divided by the fractional decrease in specific volume:

$$B = \frac{\Delta P}{(\Delta V)/V} \rightarrow \frac{dP}{d \ln V} \quad (12)$$

Since $\rho = \frac{1}{V}$, it follows that

$$\frac{1}{B} = \frac{(\Delta\rho)/\rho}{\Delta P} \rightarrow \frac{d\ln\rho}{dP} \quad (13)$$

The dimensions of B are pressure per unit of fractional volume contraction. In English units B is in Mpsi/(in³/in³), or just Mpsi; and the SI units for B are GPa/(cm³/cm³) or just GPa. The last equation indicates that what happens to volume (and specific volume) also happens in the same degree to density, but with the opposite sign, i.e., as the volume increases, the density decreases and vice versa.

For isotropic elastic materials it has been shown that bulk modulus is linked to Young's modulus and Poisson's ratio by the equation

$$B = \frac{E}{3(1 - 2\nu)} \quad (14)$$

Thus, all three moduli, E , G , and B are linked through Poisson's ratio.

True stress and true strain are terms not in frequent use. In Fig. 5 the stress, sometimes called the *engineering stress*, is calculated from an increasing load F , acting over a constant area A . Because the cross-sectional area is reduced with most materials, use of that smaller cross-sectional area in the calculation yields what is called the "true stress." In addition, the direct strain referred to earlier, that is, the total change in length divided by the original length, is often called the "engineering strain." The true strain would be the instantaneous deformation divided by the instantaneous length. Therefore, the shape of such a stress-strain curve would not be the same as a simple stress-strain curve. Modulus values and stress-strain curves are almost universally based on engineering stress and strain.

Other Measures of Strength and Modulus.—Tensile and compression properties of many engineering materials, which are treated as linearly elastic, homogeneous, and isotropic, are often considered to be identical so as to eliminate the need to measure properties in compression. Also, if tension and compression properties are identical, under standard beam bending theory, there is no need to measure the properties in bending. In a concession to the nonlinear, anisotropic nature of most plastics, these properties, particularly flexural properties, are often reported on manufacturers' marketing data sheets.

Compression Strength and Modulus: Because of the relative simplicity of testing in tension the elastic modulus of a material is usually measured and reported as a tension value. For design purposes it often is necessary to know the stress-strain relationship for compression loading. With most elastic materials at low stress levels, the tensile and compressive stress-strain curves are nearly equivalent. At higher stress levels, the compressive strain is less than the tensile strain. Unlike tensile loading, which usually results in a clear-cut failure, stressing in compression produces a slow and indefinite yielding that seldom leads to failure. Because of this phenomenon, compressive strength is customarily expressed as the amount of stress in lb_f/in² (or Pa) required to deform a standard plastics test specimen to a certain strain. Compression modulus is not always reported, because defining a stress at a given strain is equivalent to reporting a secant modulus. If a compression modulus is given, it is usually an initial modulus.

Bending Strength and Modulus: When a beam of rectangular cross-section is bent under a vertical load midway between the beam supports, the bottom surface is stretched in tension while the top surface is compressed. Extending from end to end along the vertical center of the beam is a plane of zero stress called the *neutral axis*. Whatever the shape of the cross-section—constant along the beam—the neutral axis is located at the center of gravity (centroid) of that cross-sectional area. The theory of bending for simple beams makes the following assumptions: that the beam is initially straight, unstressed, and symmetric; the material is linearly elastic, homogeneous, and isotropic; the proportional limit is not exceeded; Young's modulus for the material is the same in tension and compression; and all deflections are small so that cross-sections remain planar during bending.

For a beam of length L with a rectangular section of width b and depth h carrying a central load F the formula for the maximum bending stress σ at the bottom surface is

$$\sigma = \frac{3FL}{2bh^2} \quad (15)$$

and the formula for the maximum deflection at the center of the beam is

$$y = \frac{FL^3}{4Ebh^3} \quad (16)$$

Note that, if the deflection equation is solved for E , Young's modulus, the modulus can be estimated by measuring the deflection of a beam under a known central force:

$$E = \frac{FL^3}{4ybh^3} \quad (17)$$

This is the basis for ASTM Test D790 for the flexural modulus and strength of plastics. The flexural modulus reported is usually the initial modulus from the load/deflection curve. Most plastics parts undergo bending, so use of flexural values, which tend to be higher than tensile values for many molded plastics, should give more conservative and hence trustworthy results in product design.

Rate Dependence of Mechanical Properties: Tensile and flexural data in manufacturers' literature are measured at specific displacement rates. These rates are usually not consistent with the loading environment encountered in use of the product. The same plastics material, under differing rates or in other environmental conditions, can produce different stress-strain curves. Designers should be aware of the loading rates in specific applications and request the appropriate data. End-use testing must always be considered, particularly when adequate data are not available.

Time-Related Mechanical Properties.—Mechanical properties discussed previously were related to loads applied gradually and applied for short periods. Long-term and very short-term loading may give somewhat different results. With high-performance thermoplastics it is important to consider creep, impact, fatigue, and related issues. Even the best laboratory test methods do not always predict structural response of production parts accurately, and other factors may also affect results.

Creep is defined as increasing strain over time at constant stress. The rate of creep for a given material depends on applied stress, temperature, and time.

Creep behavior of a material is an important, even crucial, issue with plastics where parts are to be subjected to loads for extended periods and where the maximum allowable deflection is critical. To determine creep behavior, test samples may be loaded in tension, compression, or flexure in a constant-temperature environment. Under constant loads, deflection is recorded at regular intervals over suitable periods. Results are generally obtained for four or more stress levels and recorded as creep curves of strain versus logarithmically scaled time. In general, crystalline materials have lower creep rates than amorphous plastics. Glass reinforcement substantially improves the creep resistance. Fig. 10 shows the great differences in creep-rupture behavior that exist among different plastics at several temperatures.

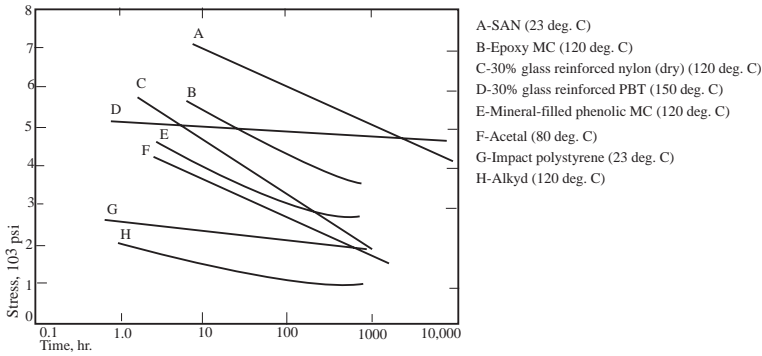


Fig. 10. Plots Showing Diminishing Strengths of Several Plastics as Creep Period Is Extended. (Curves are Steeper at Higher Temperatures, Except Curve D for Glass-fiber-reinforced Polybutylene Terephthalate)

Apparent or Creep Modulus: If the deflection of a part subjected to continuous loading is calculated using the short-test modulus of elasticity E results are likely to be disappointing or even disastrous because the effects of creep have not been considered. If the stress level and temperature are known and creep curves are available for the temperature in question, an apparent, or creep, modulus E_{app} can be calculated from the creep curves by the formula: $E_{app} = \sigma / \epsilon_c$ where σ is the calculated stress level and ϵ_c is the strain from the creep curve at the expected time and temperature. This value E_{app} can be used instead of E in predicting the maximum beam deflection from the traditional equation given earlier.

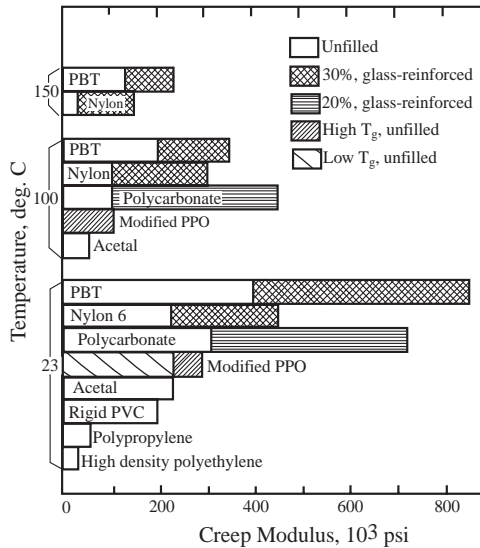


Fig. 11. 1000-hour Creep Moduli of Several Plastics at Room Temperature and Higher

Manufacturers' data often include curves of creep modulus (or log creep modulus) versus log time at either constant stress or constant strain derived from creep data. The bar graphs of Fig. 11 show 1000-h creep moduli for several engineering resins at 23 and 100 °C. This kind of information may also be provided as tables of values at constant stress and temperature for various time periods.

Creep rupture data are obtained in the same manner as creep data except that higher stresses are used and time is measured to failure. Such failures may be brittle or ductile

with some degree of necking. Results are generally plotted as log stress versus log time to failure.

Stress relaxation occurs when plastics parts are assembled into a permanent deflected condition, as in a press fit, a bolted assembly, or some plastics springs. Under constant strain over a period of time the stress level decreases due to the same internal molecular movement that produces creep. Stress relaxation is important with such applications as bolt preloading and springs, where loading must be maintained. The relaxation can be assessed by applying a fixed strain to a sample and measuring the load over time. A relaxation modulus similar to the creep modulus can be derived from the relaxation data. Relaxation data are not as readily available as creep data, but the decrease in load due to stress relaxation can be approximated by using the creep modulus E_{app} calculated from the creep curves.

Plastics parts often fail due to imposition of excessive fixed strains over extended periods of time, for example, a plastics tube that is a press fit over a steel shaft. No relaxation rupture equivalent to creep rupture exists, so for initial design purposes a strain limit of 20 per cent of the strain at the yield point or yield strength is suggested for high-elongation plastics. For low-elongation brittle plastics that have no yield point, 20 per cent of the elongation at break is also recommended. These figures should be regarded only as guidelines for development of initial design concepts; prototype parts should be thoroughly tested under end-use conditions to confirm the suitability of the design. Higher or lower property limits may also be indicated in manufacturers' data on specific materials.

Extrapolating creep and relaxation data must be done with caution. When creep and relaxation data are plotted as log property against log time, the curves are generally less pronounced, facilitating extrapolation. This procedure is common practice, particularly with creep modulus and creep rupture data. Extrapolation should not exceed one unit of log time, and the strain limit of 20 per cent of the yield or ultimate strength mentioned above should not be exceeded.

Impact loading describes a situation in which a load is applied extremely rapidly. Any moving body has kinetic energy and when the motion is stopped by a collision, the energy is dissipated. Ability of a plastic part to absorb energy is determined by the shape, size, thickness, and type of material. Impact-testing methods now available do not provide designers with information that can be used analytically. The tests can be used for comparing relative notch sensitivity or relative impact resistance, and so can be useful in choosing a series of materials to be evaluated for an application or in grading materials within a series. Impact testing by the Izod and Charpy (ASTM Method D6110) methods, in which a pendulum arm is swung from a certain height to impact a notched test specimen, is the most widely used for measuring impact strength. Impact with the test specimen reduces the energy remaining in the arm, and this energy loss is recorded in ft-lb_f (J). The value of such tests is that they permit comparison of the relative notch toughness of two or more materials under specific conditions.

The tensile impact test mentioned earlier aids ranking materials because it represents more realistically conditions that are encountered by actual parts in certain applications.

Fatigue tests measure the ability of plastics materials to withstand repeated stresses or other cyclic phenomena. Example applications are: a snap-action or snap-fit latch that is frequently opened and closed, a gear tooth, a bearing, and a structural component subject to vibration or to repeated impacts. Cyclic loading can cause mechanical deterioration and progressive fracture, leading to failure in service. Typical fatigue tests are carried out on machines designed to subject a cantilever test piece to reversing flexural loading cycles at different stress levels. ASTM Test D671 is of this type, with a cycle rate of 30 Hz. The number of cycles to failure is recorded for each stress level. Data are normally presented in plots of stress versus log cycles called S-N curves for specific cycle rates and environmental temperatures.

Tensile impact tests mount the test specimen on the swinging arm. Attached to the test specimen is a cross-piece that is arrested by a notched anvil as the bar swings down, allowing the energy stored in the arm to break the specimen under tension as it passes through the notch. Another impact test used for plastics allows a weighted, round-ended cylindrical “dart” to fall on a flat disk of the plastics to be tested. This test is good for ranking materials because it represents conditions encountered by actual parts in certain applications.

Thermal Properties.—Melting temperatures of highly crystalline thermoplastics are sharp and clearly defined, but amorphous and liquid-crystalline materials soften and become more fluid over wider temperature ranges. Melting points have greater significance in molding and assembly operations than in product design, which usually deals with the product’s service temperatures, well beneath the melting range.

Glass transition is a reversible change that occurs in an amorphous polymer or in amorphous regions of a partly crystalline polymer when it is heated from a very low temperature into a certain range, peculiar to each polymer, characterized by a rather sudden change from a hard, glassy, or brittle condition to a flexible or rubbery condition. Physical properties such as coefficient of thermal expansion, specific heat, and density usually undergo distinct changes in their temperature derivatives at the same time. The symbol for the glass-transition temperature is T_g .

Vicat Softening Point is the temperature at which a small, circular, lightly gravity-loaded, heated probe penetrates a specific distance into a thermoplastics test specimen. This test (ASTM D1525) measures the ability of a thermoplastics material to withstand short-term contact with a heated surface, and is most useful for crystalline plastics. Amorphous thermoplastics tend to creep during the test, which reduces its usefulness for such materials.

Deflection Temperature Under Load (DTUL) is the temperature at which a test bar of 0.5 inch (12.7 mm) thickness, loaded to a specified bending stress, will deflect by 0.010 inch (0.25 mm). This ASTM test (D648) is run at bending stresses of 66 lb_f/in² (0.455 MPa) or 264 lb_f/in² (1.82 MPa) or both. The value obtained was once referred to as the *heat distortion temperature* and is an indication of the ability of the material to perform at elevated temperatures under load. Both stress and deflection for a specific design of test bar are given so the test may be regarded as establishing the temperature at which the flexural modulus is reduced to particular values—35,200 psi (242.7 MPa) at 66 psi stress, and 140,000 psi (965.3 MPa) at 264 psi stress.

Linear Thermal Expansion: Like metals, thermoplastic materials expand when heated and contract when cooled. For a given temperature range, most plastics change dimensions much more than metals. The coefficient of linear thermal expansion (α) is the ratio of the fractional change in a linear dimension for a unit change of temperature and is expressed as in/in-F), or cm/cm-C. Typical average values for common materials and selected plastics are shown in . ASTM Method D696 directs that if samples should be prepared so as to give a minimum of anisotropy, but if anisotropy is suspected, specimens shall be cut so as to measure α along the principal axes of anisotropy. The values in [Table 8](#), page 375 may be presumed to have been measured according to those instructions.

Thermal Conductivity is the rate at which a material conducts heat energy along its length or through its thickness. For example, if a tightly covered plastic insulated cooler at 32°F (0°C) is filled with ice and chilled beverage cans and the outside is 80°F (27°C), heat from the surrounding warm air passes slowly through the box wall, melting the ice inside. The low thermal conductivity of the wall resists this heat flow. The property is defined by *Fourier’s law of heat conduction* as follows:

$$Q_x = k \frac{\Delta T}{x}$$

where Q_x = flux, i.e., the rate of heat flow per unit area of the wall surface,

k = thermal conductivity of the box-wall material,
 ΔT = temperature difference from the hot side to the cold side, and
 x = wall thickness.

English units for k are Btu/h-in² (°F/in); SI units are J/s-m²(K/m).

In sharp contrast to metals, plastics are poor heat conductors, therefore excellent insulators, plastic foams even more so. Plastics are also good electrical insulators. These insulating properties are valuable in many applications. Conductivities can be enhanced where needed by loading the plastics with copper or aluminum powder. In anisotropic materials thermal conductivity may differ along major axes. Thermal conductivities for plastics are listed in the table (see *Typical Properties of Plastics Materials* on page 390).

Aging at elevated temperatures may affect physical, mechanical, electrical, or thermal properties of plastics materials. Data from tests on specimens stored at specific temperatures for suitable periods are presented as plots of properties versus aging time at various temperatures, and may be used as an indication of thermal stability of the material.

Temperature index is a rating by Underwriters Laboratories (UL) of electrical and mechanical properties (with and without effects of impacts) of plastics materials used in electrical equipment for certain continuous operating conditions.

Flammability ratings also are produced by Underwriters Laboratories. UL tests measure the ability to continue burning after a flame is removed, and the percentage of oxygen needed for the material to continue burning. Other tests measure combustibility, ignition temperatures, and smoke generation. The importance of flammability testing for plastics is reflected by ASTM's listing of ten different tests under the index subject "Flammability—Plastics." The high carbon and hydrogen content of plastics means they are usually flammable. Some exceptions are fluorocarbons and chlorofluoroplastics which are not flammable. Silicones and rigid PVC won't sustain fire by themselves. Compounders can significantly reduce any plastic's flammability by judiciously choosing from among hundred of available fire-retarding additives.

Effect of Temperature on Mechanical Properties.—The equivalence of high strain rates and low temperatures (and vice versa) must be kept in mind when designing with plastics materials. Stress-strain curves for tests performed with one strain rate at several temperatures are similar to those for tests with one temperature and several strain rates. That is, very high strain rates and very low temperatures produce similar responses in materials. Conversely, the effects of very low strain rates, that is, creep effects, can be determined more quickly by testing at elevated temperatures and employing time-temperature superposition methods to estimate creep at lower temperatures and longer times. End-use testing at temperatures near or above the highest values expected in everyday use of a product helps the designer estimate long-term performance of components.

Strength, modulus, and elongation behavior are similar for tensile, compressive, flexural, and shear properties. Generally, strength and modulus decrease with increasing temperature. The effect of temperature increase is shown by the curves in Fig. 12 for crystalline and amorphous materials, where a gradual drop in modulus is seen as the glass-transition temperature T_g is approached. The deflection temperature marks a flexural modulus of 35,200 psi (242.7 MPa) at a test stress of 66 psi (455 kPa), giving rise to the horizontal dashed line in Fig. 12. Above the glass-transition temperature amorphous materials suffer rapid diminution of modulus, and even with glass-fiber reinforcement modulus drops rapidly above T_g . Some crystalline resins maintain usable moduli at temperatures approaching the crystalline melting point (T_m). Glass-fiber reinforcement can substantially improve the modulus of crystalline materials between the glass-transition and melting temperatures. Generally, strength-versus-temperature curves exhibit shapes like modulus curves while, as expected, elongations increase with rising temperatures.

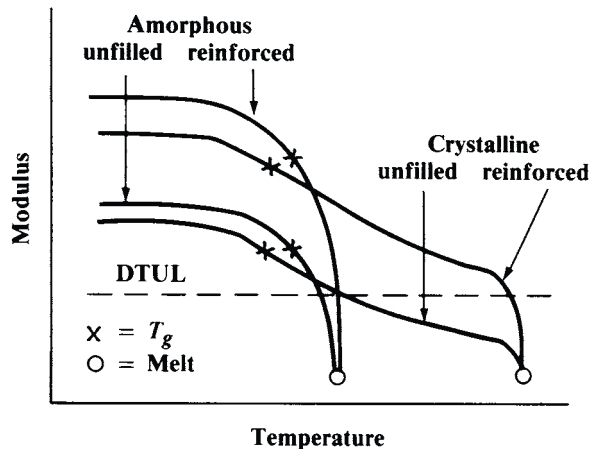


Fig. 12. Schematic of Modulus Behavior of Crystalline and Amorphous Plastics Showing T_g and T_m and the Beneficial Effect of Reinforcement on Deflection Temperature Under Load (DTUL)

As temperatures drop significantly below normal ambient values, most plastics materials become brittle and lose much of their room-temperature impact strength, although a few materials show only a gradual decrease. Concern over failures at low temperatures led to the development of ASTM D746, Brittleness Temperature of Plastics, in 1943. In this test, small, unnotched test bars are set up as cantilever beams in groups of five or more, brought to a preset low temperature, and struck by a weighted, blunt-nosed bar falling at 2 m/s. The experiment is repeated at other temperatures, higher and lower, and the fraction of breaks is plotted vs temperature on normal-probability graph paper. From the plot the temperature at which half the bars break is estimated and reported as the brittleness temperature. Plastics reinforced with long glass fibers have relatively high impact values, both notched and unnotched, at room temperature. They retain much of these values at lower temperatures.

Electrical Properties.—The most notable electrical property of plastics is that they are good insulators, but there are many other electrical properties that must be considered in plastics part design.

Conductivity in solids depends on the availability and mobility of movable charge carriers within the material. Metals are good conductors because the metal atom has a loosely held, outermost electron, and the close proximity of the atoms allows these outer electrons to break free and move within the lattice structure. These free electrons give metals the ability to conduct large currents, even at low voltages. Outer electrons in materials such as glass, porcelain, and plastics are tightly bound to the atoms or molecules so there are no free electrons. Electrical current cannot be conducted and the materials act as insulators.

Volume resistivity is the electrical resistance of a material when a steady electromotive force (emf) difference is applied to a sample of the material that is made part of an electric circuit. Ohm's law governs the flow of direct current:

$$I = \frac{V}{R}$$

where I = current, amperes (A)

V = emf difference across the test element, volts (V)

R = its resistance, ohms (Ω)

R is determined by the element's dimensions and the material's electrical resistivity:

$$R = \rho \frac{L}{A}$$

where L = length of the element, cm

A = its cross-sectional area perpendicular to the current direction, cm^2

ρ = resistivity of the conductor material, ohm-cm

Materials having resistivities above 10^8 ohm-cm are considered insulators, and materials with values between 10^8 and 10^3 ohm-cm are considered partial conductors. Most plastics have volume resistivities in the range of 10^{12} to 10^{18} ohm-cm.

Surface resistivity is a measure of the susceptibility of an electrical insulating material to surface contamination, particularly moisture, which makes it electrically conductive. The tests use parallel electrodes that are placed on the same surface of the material. Measured resistance is multiplied by the width of the electrodes and divided by the distance between them and reported as ohms per square. Methods for determining both volume and surface resistivities of insulating materials are spelled out in ASTM D257.

The results of such measurements are sometimes reported in terms of their reciprocals, *volume conductivity* (siemens/cm) and *surface conductivity* (siemens). The unit siemens is the reciprocal of resistance, $1/R$ (with units $1/\Omega$.) The siemens was formerly known as the mho.

Dielectric strength is a measure of the voltage required to cause an insulator to break down and allow an electric current to pass through the resulting conductive path. It may be measured (ASTM Test D149) at any or several frequencies from 0 Hz (direct current) to 800 Hz; the results are expressed in volts per mil (0.001 inch, or 0.0254 mm) of thickness. High values of this property are desired in capacitor films and wire coverings. Variables that may affect test results include temperature, frequency, sample contamination, internal voids, rate of voltage increase, and duration of test. Although the use of volts/mil units in test results suggests that the same dielectric strength value should apply to different film thicknesses, tests show that thinner films fail at lower V/mil than thicker ones.

Dielectric Constant or Permittivity is a dimensionless constant that indicates how easily a material can become polarized by imposition of an electrical field on an insulator. Polarization occurs because of charge-carrying atoms or functional groups (dipoles) in materials. When the field is applied these groups try to align their positive and negative ends with the field. Reversal of the direction of the electric field results in reversal of the polarization. The dielectric constant is the ratio of the permittivity of the material in normal ambient conditions to the permittivity of a vacuum. Permittivity is important when plastics are used as insulating materials in capacitors and high-frequency electrical apparatus. Changes in temperature, humidity, electrical frequency, and part thickness may affect the dielectric constant. Dielectric constants for a dozen various engineering thermoplastics are listed in the [Table 2](#). Many others are included in the main table of plastics properties, *Typical Properties of Plastics Materials* on page 390.

Heat Dissipation Factor: If a polar material is subjected to an alternating electric field, its dipoles reverse their orientation twice per cycle. This movement encounters frictional resistance at the molecular level, and at high frequencies that friction can generate considerable heat, as detected by the electrical phase angle between voltage and current. This effect is called the *heat dissipation factor*. The heat dissipation factor is a measure of heat energy dissipated by rapidly repeated reversals of polarization, as with an alternating current. The dissipation factor can also be thought of as the ratio of electrical energy lost to that transmitted at a representative frequency, such as 1 MHz (10^6 cycles/s). This high-frequency heat generation, undesired in many insulation uses, can be used to preheat thermo-setting materials just before molding. It is also the basis for electronic heat-sealing, widely used in the fabrication of articles from plasticized-PVC films. Some heat dissipation factor values are shown in [Table 2](#).

Table 2. Typical Values of Dielectric Constants and Heat Dissipation Factors for Several Thermoplastics at Room Temperature

Material	Dielectric Constant	Heat Dissipation Factor	Material	Dielectric Constant	Heat Dissipation Factor
Acetal	3.7-3.9	0.001-0.007	Polypropylene	2.3-2.9	0.003-0.014
Acrylic	2.1-3.9	0.001-0.060	Polysulfone	2.7-3.8	0.0008-0.009
ABS	2.9-3.4	0.006-0.021	Modified PPO	2.4-3.1	0.0002-0.005
Nylon 6/6	3.1-8.3	0.006-0.190	Polyphenylene sulfide	2.9-4.5	0.001-0.002
Polycarbonate	2.9-3.8	0.0006-0.026	Polyarylate	2.6-3.1	0.001-0.022
TP Polyester	3.0-4.5	0.0012-0.022	Liquid crystal	3.7-10	0.010-0.060

Arc Resistance as determined by ASTM D495 is the length of time (seconds) required for an electric arc applied on the surface of an insulating material to develop a conductive path. Materials that resist such a development are preferred for parts of switchgear and other high-voltage apparatus. This test is used mostly for thermosetting materials because, unlike thermoplastics which tend to melt in the arc, thermosets decompose and do produce conductive paths.

Comparative Tracking Index (CTI) is a UL test with an ASTM counterpart (D3638) that is similar to the arc resistance test except that the surface to be tested is precoated with an ammonium chloride electrolyte. The test measures the voltage required to cause a conductive path to form between the electrodes and indicates the arc resistance of a contaminated surface, a condition often found in electrical and electronic equipment.

End-Use Environmental Considerations.—The environment that will be encountered by the product is a prime consideration at the design stage. Problems with cracking, crazing, discoloration, loss of properties, melting, or dissolving can be encountered in the presence of high or low temperatures, chemical substances, energy sources, and radiation. Plastics components also are often subjected to processing, assembly, finishing, and cleaning operations before reaching their ultimate environment.

The stress level in the plastics product greatly affects performance. Generally, increased stress levels resulting from injection molding, forming, assembly work, and end-use forces reduce resistance to environmental factors. Although many plastics are hygroscopic and absorption of water results in dimensional and property changes, plastics are widely accepted because of their relative compatibility with the environment compared with metals. Some chemicals attack the polymer chain directly by reaction, resulting in a progressive lowering of the molecular weight of the polymer and changes in the short-term mechanical properties; others dissolve the material, although high-molecular-weight plastics dissolve very slowly. Swelling, changes in weight and dimensions, and loss of properties are evidence of solvation.

Plasticization may result if the chemical is miscible with the polymer, resulting in loss of strength, stiffness, and creep resistance, and increased impact resistance. The material may swell and warp due to relaxation of molded-in stresses. Environmental stress cracking may cause catastrophic failure when plastics are stressed, even when the product appears to be unaffected by exposure to a chemical.

Chemical compatibility data are obtained from standard test bars exposed to or placed in the chemical of study and tested as previously described for such properties as tensile strength, flexural modulus, dimensional change, weight, and discoloration. Chemical resistances from some commonly used thermoplastics materials are shown in [Table 3](#), but are only general guidelines and cannot substitute for values derived from tests on the end product. More extensive tests expose samples to a chemical in the presence of fixed stress

or fixed strain distribution along its length, followed by examination for the stress or strain location at which damage begins.

While the preceding tests may provide useful data about chemical compatibility, they do not generate reliable information on performance properties for design purposes. The only tests that provide such information are the creep modulus and rupture tests, conducted at appropriate temperatures in the environment that will be encountered by the product, preferably on prototype parts. Many plastics are slowly degraded to varying degrees by ultraviolet light (UV), which causes fading, chalking, and embrittlement. Acrylics and a few others are not damaged by UV. However, hundreds of additives are available that, when compounded into neat resins, will give compounds that are resistant to heat, burning, UV, staining, etc.

Mechanical Properties.—Almost all end-use applications involve some degree of loading, so mechanical properties are of prime importance in designing with plastics. Material selection is usually based on manufacturers' marketing data sheets listing tensile strength, modulus of elasticity (E), elongation, impact strength, stress and strain behavior, and shear strength. Suppliers' data often are generated under standard test conditions, so they may not be directly transferable to the components produced. Because of the somewhat lower modulus of elasticity of plastics materials (10^5 lb_f/in² for plastics compared with 10^6 lb_f/in² for metals, in metric units 100 MPa compared with 1000 MPa), different units of measure are used to express the results.

Determination of the true meaning of mechanical properties and their relation to end-use requirements is of vital importance in design. In practical applications materials are seldom subjected to steady deformation without the influence of other factors such as environment and temperature. A thorough understanding of mechanical properties and tests used to determine such properties, and the effects of adverse or beneficial conditions on mechanical properties over long time periods, is extremely important. Some manufacturers offer design and technical advice to customers who need additional design assistance.

Design Analysis

Structural Analysis.—Plastics parts may be subjected to stresses caused by assembly, handling, temperature variations, and other environmental effects. Simple analysis using information in *Moment of Inertia* on page 232 and *Beam Calculations* on page 256 can be used to make sure that newly designed parts can withstand these stresses. These methods may also be used for product improvement, cost reduction, and failure analysis of existing parts.

Safety Factors: In setting safety factors for plastics parts there are no hard and fast rules. The most important consideration is the consequence of failure. For example, a little extra deflection in an outside wall or a crack in one of six internal screw bosses may not cause much concern, but the failure of a pressure vessel or water valve might have serious safety or product liability implications. Tests should be run on actual parts at the most extreme operating conditions that could possibly be encountered during product life. For example, maximum working load should be applied at the maximum temperature and in the presence of any chemicals that might be encountered in service. Loads, temperatures, and chemicals to which a product may be exposed prior to its end use also should be investigated. Impact loading tests should be performed at the lowest temperature expected, including during assembly and shipping. Effects of variations in resin lots and molding conditions must also be considered.

Failures in testing of preproduction lots often can be corrected by increasing the wall thickness, using ribs or gussets, and eliminating stress concentrations. Changing the material to another grade of the same resin or to a different plastics with more suitable mechanical properties is another possible solution. Reviews of product data and discussions with experienced engineers suggest the design stresses shown in [Table 4](#) are suitable for use

Table 3. Chemical Resistance of Various Materials by Chemical Classes

Polyarylate										d	d	d	d	d	d	d	d	d	Polycarbonate
Polyphenylene Sulfide*										d	d	d	d	d	d	d	d	d	Polysulfone*
Liquid Crystal Polymer*										d	d	d	d	d	d	d	d	d	Modified Polyphenylene Oxide
Polyester Elastomer										d	d	d	d	d	d	d	d	d	Polypropylene
Thermoplastic Polyester (PET)										d	d	d	d	d	d	d	d	d	ABS
Thermoplastic Polyester (PBT)										d	d	d	d	d	d	d	d	d	316 Stainless Steel
Nylon 6/6										d	d	d	d	d	d	d	d	d	Carbon Steel
Acetal Homopolymer										d	d	d	d	d	d	d	d	d	Aluminum
Acetal Copolymer										d	d	d	d	d	d	d	d	d	
ACIDS AND BASES																			
Acids, weak	A	B	C	A	A	A	A	A	A	A	B	A	A	A	A	A	C	Dilute mineral acids	
Acids, strong	C	C	C	B	—	C	B	A	—	C	C	—	A	A	B	C	C	Concentrated mineral acids	
Bases, weak	A	C	A	B	B	A	B	A	—	C	A	A	A	A	A	B	C	Dilute sodium hydroxide	
Bases, strong	A	C	C	—	—	B	C	A	—	C	A	—	A	A	B	B	C	Concentrated sodium hydroxide	
Acids, organic, weak	A	B	C	A	A	A	A	A	A	A	B	A	A	A	A	C	C	Acetic acid, vinegar	
Acids, organic, strong	C	C	C	B	—	C	B	A	—	C	C	A	A	A	B	C	C	Trichloroacetic acid	
AUTOMOTIVE																			
Automotive, fuel	A	A	A	A	A	A	A	A	C	C	A	C	C	A	A	A	A		
Automotive, lubricants	A	A	A	A	A	A	A	A	C	C	A	A	A	A	A	B	A		
Automotive, hydraulic	A	A	—	A	A	—	A	A	C	C	C	A	A	A	—	—	—		
SOLVENTS																			
Aliphatic hydrocarbons	A	A	A	A	A	A	A	A	A	A	B	C	A	A	A	A	A	Heptane, hexane	
Aliphatic hydrocarbons, halo-genated	A	B	C	B	B	A	A	A	C	C	C	—	—	—	B	B	B	Ethylene chloride, chloroform	
Alcohols	A	A	B	A	A	A	A	A	A	A	A	A	A	A	A	A	B	Ethanol, cyclohexanol	
Aldehydes	A	A	A	A	B	B	A	A	—	C	B	—	A	—	A	B	A	Acetaldehyde, formaldehyde	
Amines	—	—	—	—	—	—	C	B	—	C	C	—	A	—	A	B	B	Aniline, triethanolamine	
Aromatic hydrocarbons	A	B	A	A	B	B	A	A	C	C	C	C	C	C	A	A	A	Toluene, xylene, naphtha	
Aromatic hydrocarbons, halo-genated	—	—	—	—	—	C	—	A	C	C	C	—	—	—	A	A	A	Chlorobenzene	
Aromatic, hydroxy	C	C	C	C	—	C	A	A	—	C	C	—	A	—	B	C	A	Phenol	
Esters	B	B	A	B	B	B	A	A	C	C	C	—	C	—	B	B	B	Ethyl acetate, dioctyl phthalate	
Ethers	B	—	A	A	—	—	A	—	A	B	—	C	—	A	A	A	A	Butyl ether, diethyl ether	
Ketones	B	B	A	B	B	B	A	A	C	C	C	—	B	C	A	A	A	Methyl ethyl ketone, acetone	
MISCELLANEOUS																			
Detergents	A	—	A	—	B	—	—	A	A	A	—	B	A	—	A	A	B	Laundry and dishwashing detergents, soaps	
Inorganic salts	B	B	B	—	A	—	—	A	—	A	—	—	A	A	B	B	B	Zinc chloride, cupric sulfate	
Oxidizing agents, strong	C	C	C	—	C	—	B	B	—	C	—	—	A	—	C	C	C	30% hydrogen peroxide, bromine (wet)	
Oxidizing agents, weak	C	C	C	A	—	A	A	A	—	A	—	A	A	A	B	C	A	Sodium hypochlorite solution	
Water, ambient	A	A	B	A	A	A	A	A	A	A	A	A	A	—	A	C	B		
Water, hot	B	C	B	C	C	B	A	A	—	C	—	A	C	—	A	C	B		
Water, steam	C	C	C	C	C	C	B	A	—	C	—	—	C	—	A	C	—		

A—minimal effect; B—some effect; C—generally not recommended.

This information is presented for instructional purposes and is not intended for design. The data were extracted from numerous sources making consistent rating assignments difficult. Furthermore, the response of any given material to specific chemicals in any one class can vary significantly. Indeed, during the preparation of the table, the effect on one plastics of various chemicals in the same category ranged from essentially no effect to total dissolution. Therefore, an "A" rating for a particular plastics exposed to a particular class of chemicals should not be interpreted as applying to all chemicals in that class. The rating simply means that for the chemicals in that class found in the literature reviewed, the rating was generally an "A." There may be other chemicals in the same class for which the rating would be "C." Finally, the typical chemicals listed do not necessarily correspond to the ones on which the individual ratings are based.

Room temperature except for hot water, steam, and materials marked with a * \equiv 200°F (93.3°C). Generally, extended exposure (more than a week) data were used.

with the structural analysis information indicated above and the equations presented here, for preliminary design analysis, and for evaluating general product dimensions. Products designed under these guidelines must be thoroughly tested before being marketed.

Table 4. Design Stresses for Preliminary Part Designs Expressed as a Percentage of Manufacturers' Data Sheet Strength Values

	Failure Not Critical	Failure Critical
Intermittent (nonfatigue) loading	25-50	10-25
Continuous loading	10-25	5-10

Failure Criteria: Setting of failure criteria is beyond the scope of this section, which is intended to give only basic general information on plastics. Designers who wish to rationalize complex stress states and analyses might investigate the maximum shear theory of failure (otherwise known as Coulomb or Tresca theory). It is further suggested that the shear strength be taken as the manufacturer's published shear strength, or half the tensile strength, whichever is lower. Better still, use half the stress at the elastic limit, if known.

Pressure Vessels: The most common plastic pressure vessel is a cylindrical tube with internal pressure. In selecting a wall thickness for the tube it is convenient to use the thin-wall hoop stress equation:

$$\text{hoop stress } \sigma = \frac{Pd_i}{2t} \tag{18}$$

where P = uniform internal pressure in the tube, d_i = inside diameter of the tube, and t = tube-wall thickness. This equation is reasonably accurate for tubes where the wall thickness is less than $0.1 \times d$. Also, it is easy to solve for the wall thickness t required to support an internal pressure P with an allowable hoop stress σ . For wall thicknesses greater than $0.1d$, the maximum hoop stress on the wall surface inside the tube can be calculated from

hoop stress

$$\sigma = P \frac{d_o^2 + d_i^2}{d_o^2 - d_i^2} \quad \text{or} \quad \sigma = P \frac{1 + R}{1 - R} \tag{19}$$

where d_i and d_o are the inside and outside diameters of the tube, and $R = (d_i/d_o)^2$.

By substituting $d_o = d_i + t$ into the left equation one can solve it for the required wall thickness t to provide a working equation for design. The result is

$$t = \frac{d_i}{2} \left(\sqrt{\frac{\sigma + P}{\sigma - P}} - 1 \right) \tag{20}$$

In the above equations all units must be consistent.

Press Fits: Press fits are used widely in assembly work for speed and convenience, although they sometimes are unsatisfactory with thermoplastics parts. Common applications are to a plastics hub or boss accepting a plastics or metal shaft or pin. Forcing the pin into the hole expands the hub, creating a tensile or hoop stress.

If the interference is too great, very high strain and stress develop and the plastics part will: a) fail immediately by developing a crack parallel to the hub axis to relieve the stress, a typical hoop stress failure; b) survive assembly but fail prematurely due to creep rupture caused by the high induced-stress levels; and c) undergo stress relaxation sufficient to reduce the stress to a level that can be sustained.

For a typical press fit, the allowable design stress depends on the particular plastics material, temperature, and other environmental considerations. Hoop stress equations for such a design make use of a geometry factor γ :

$$\gamma = \frac{1 + (d_s/d_o)^2}{1 - (d_s/d_o)^2} \quad (21)$$

where d_s = diameter of the pin to be inserted and d_o = outside diameter of the boss.

When both the shaft and the hub are of the same or essentially the same materials, the hoop stress σ given the diametral interference $i = d_s - d_i$ is

$$\sigma = \frac{i}{d_s} E_p \frac{\gamma}{\gamma + 1} \quad (22)$$

and the allowable interference i_a given the permissible design stress σ_a is

$$i_a = d_s \frac{\sigma_a}{E_p} \frac{\gamma + 1}{\gamma} \quad (23)$$

When the shaft is metal and the hub is plastics, the hoop stress given i is obtained from

$$\sigma = \frac{i}{d_s} E_p \frac{\gamma}{(\gamma + \nu_p)} \quad (24)$$

and the allowable interference i_a given the permissible design stress for plastics σ_a is

$$i_a = d_s \frac{\sigma_a}{E_p} \frac{\gamma + \nu_p}{\gamma} \quad (25)$$

where E_p = modulus of elasticity of plastics and ν_p = Poisson's ratio for plastics.

Pipe Threads: Pipe threads on plastics pipes and other parts used in plastics plumbing and pneumatic assemblies require only hand tight assembly to effect a good seat, especially if a compatible sealant tape or compound is used. Assembling a tapered male pipe thread into a mating female thread in a plastics part is analogous to driving a cone into a round hole and may result in a split boss. Sometimes straight threads and an O-ring seal can avoid the need for pipe threads. When pipe threads must be used, torque control is essential.

When mating metal to plastics pipe threads, the threaded plastics component should be the male member, so that the plastics are in compression. If torque can be controlled during assembly, fluoroplastics tape should be used on female plastics pipe threads. If torque cannot be controlled, an external hoop ring, either pressed on or molded in, should be considered. Flats should not be designed into plastics parts for assembly purposes because they will encourage overtightening. If some provision for improved gripping must be made, wings or a textured surface may be used. An approximate formula for the hoop stress σ produced in a plastics boss with internal pipe threads is

$$\sigma = \frac{3T}{tdL} \quad (26)$$

where T = torque in in-lb, t = wall thickness of the plastics boss in inches, d = pipe outside diameter in inches, and L = length of thread engagement in inches.

Equation (26) assumes certain geometric relationships and a coefficient of friction of 0.15. If compatible thread lubricants are used during assembly, the torque must be reduced. To ensure safety and reliability, all threaded assemblies must be subjected to long-term testing under operating pressures, temperatures, and stresses caused by installation procedures exceeding those likely to be encountered in service.

Thermal Stresses.—When materials with different coefficients of thermal expansion are bolted, riveted, bonded, crimped, pressed, welded, or fastened by any method that prevents relative movement between the parts, there is potential for thermal stress to exist. Typical examples are joining of nonreinforced thermoplastics parts with materials such as metals,

glass, or ceramics which usually have much lower coefficients of thermal expansion than plastics. The basic relationship for thermal expansion is

$$\Delta L = \alpha L \Delta T \quad (27)$$

where ΔL = change in length, α = coefficient of thermal expansion (see Table 8, page 375), L = linear dimension under consideration (including hole diameters), and ΔT = temperature change.

If the plastics component is constrained so that it cannot expand or contract, the strain ϵ_T , induced by a temperature change, is calculated by

$$\epsilon_T = \frac{\Delta L}{L} = \alpha \Delta T \quad (28)$$

The stress can then be calculated by multiplying the strain ϵ_T by the tensile modulus of the material at the temperature involved. A typical example is of a plastics part to be mounted to a metal part, such as a window in a housing. Both components expand with changes in temperature. The plastics imposes insignificant load to the metal but considerable stress is generated in the plastics. For such an example, the approximate thermal stress σ_T in the plastics is given by

$$\sigma_T = (\alpha_m - \alpha_p) E_p \Delta T \quad (29)$$

where α_m = coefficient of thermal expansion of the metal, α_p = coefficient of thermal expansion of the plastics, and E_p = tensile modulus of the plastics at the temperature involved. Other equations for thermal expansion in various situations are shown in Fig. 13.

Most plastics expand more than metals with temperature increase and their modulus drops. The result is a compressive load in the plastics that often results in buckling. Conversely, as the temperature drops, the plastics shrinks more than the metal and develops an increased tensile modulus. These conditions can cause tensile rupture of the plastics part. Clearances around fasteners, warpage, creep, or failure, or yield of adhesives tend to relieve the thermal stress. Allowances must be made for temperature changes, especially with large parts subjected to wide variations. Provision is often made for relative motion ΔL_{rel} between two materials, as illustrated in Fig. 13:

$$\Delta L_{rel} = (\alpha_p - \alpha_m) L \Delta T \quad (30)$$

Designing for Stiffness.—The designer must take full advantage of the ability of plastics to be easily formed into a desired shape, in contrast to woods where every shape must be machined or assembled from planks or blocks. To a lesser degree, the same is often true of metals, although die-castable metals have a considerable shape versatility. Though the modulus of elasticity is much less in plastics than in metals, *stiffness* is a property not of the material but of the *structure* that can be made from it. When the product must support bending loads, as in a bookshelf, a simple beam of rectangular cross section would be the logical approach if the shelf material were pine or mahogany. If the material is plastic, other cross sections of higher stiffness per unit weight can be considered. Fig. 14 shows some alternatives to the traditional rectangular cross section that achieve greater stiffness with less material.

Manufacture of Plastics Products

The main processes for manufacturing large quantities of plastics products are extrusion, injection molding, blow molding, and sheet thermoforming for thermoplastic materials; compression molding, transfer molding, prepreg molding, and pultrusion for thermosetting materials.

More tonnage of thermoplastics pass through extrusion machines than any type of plastics forming machines. The dominant type of extruder is the single-screw extruder. A feed

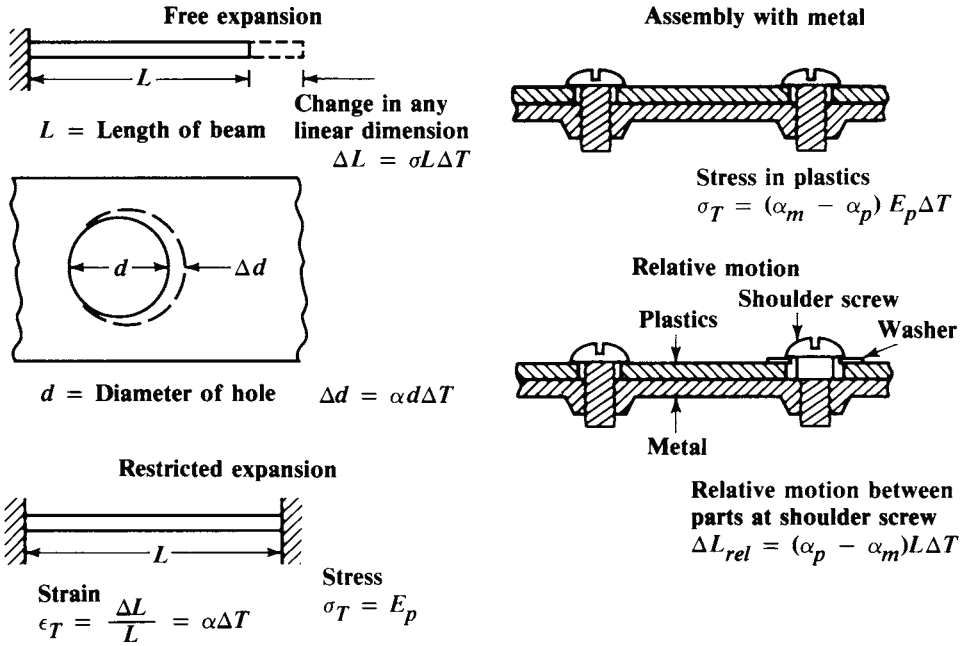


Fig. 13. Thermal Expansion Equations for Various Combinations of Materials and Situations

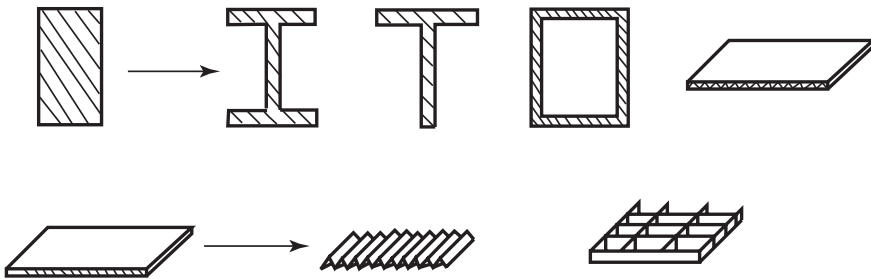


Fig. 14. Placing Most of the Material Far From the Centroid Achieves Far Higher Bending Stiffness per Unit Weight of Plastics

hopper supplies small plastic granules to a thick-barreled, heated cylinder insidewhich turns a sturdy, precisely contoured screw. A powerful variable-speed motor drive turns the screw at 50 to 500 rpm. At the delivery end is attached a die, a block of metal with a specially shaped orifice. The screw has two main jobs: one, to melt by friction and thoroughly mix the feed, transforming it from cold, solid particles into a homogeneous hot, viscous melt; two, to develop the very high pressure (2,000-8,000 psi, or 14-55 MPa) needed to pump the melt through the die. This produces a continuous length of product whose cross-section resembles but is not identical to that of the die opening. Extruders are widely employed in intermediate processing of material in the plastics industry. Some final consumer products made by this process are pipes, sheets and films, garden hoses, electrical wires, netting, fishing lines and leaders, and house sidings. Many extruded products are parts of other industrial or consumer products. For example, huge quantities of ABS sheet and flexible vinyl gasketing go into refrigerators and freezers each year. Mop handles are extruded tubing cut to the length needed. Produce bags are made from extruded tubular blown polyethylene film that is laid flat, printed, heat-sealed across and perforated for tear-

off at intervals, then wound on roll cores for delivery to the supermarkets. An important class of extruded products are rods, bars, and tubes from which machinists fabricate smaller quantities of objects, such as prototypes for testing prior to mass production.

The extrusion process can determine a product's cross-sectional shape and size but not its third dimension (length).

Sheet Thermoforming.—Also known as vacuum forming, this widely used molding process operates at pressures of 100 psi (689.5 kPa) or less, usually at 14.7 psia (atmospheric pressure) i.e. 101.35 kPa. The process begins with a sheet of plastic from which a single product or sometimes up to several dozen small products are to be made per operating cycle. Mounted in a frame, the sheet to be formed is preheated in an oven or slid between paired radiant heaters at the thermoforming press until it begins to sag. The temperature is still well below that at which the same resin would be injection molded. The sheet is then positioned over the mold, which, in the original and simplest variant of the process, is a female mold made porous by drilling many small holes through it. The mold is enclosed in a chamber (vacuum box) so that a vacuum can be drawn from below. The softened sheet is clamped to the mold around its edges, vacuum is applied, and atmospheric pressure presses the sheet against the mold surface. Cooling and solidification of the part is done with fans, water mist, or cooling channels in the mold. The unclamped molding is then indexed to a die-cutting table where the edges are trimmed and multiple parts cut out. Trim scrap, which may be as much as 20 per cent of the sheet area, is recycled to the sheet extruder.

Because the vacuum-drawn sheet contacts the upper areas of the mold early in the mold cycle and the bottom last, the wall thickness of the finished part is thinner at the bottom than the upper areas. Often, at least average thickness is needed in the bottom areas to satisfy the design service and service life requirements. Over the years, techniques have been developed that permit draw depths of more than twice the clamping width with much more uniform wall thickness. Polystyrene cups for cold drinks are now made in this way. **Fig. 15** shows the steps in a more sophisticated variant vacuum air-cushion forming, in which a male mold component provides plug assistance without actually touching the softened plastic membrane. Clearly, though, thermoforming cannot match the tight tolerances of injection molding. Nor can it produce intricate shapes nor parts that require substantial or abrupt variations in wall thickness. Because of the low pressure, molds do not require the elaborate design planning and massive construction of injection molds. They can be made much more cheaply of aluminum – even plaster for short runs – and usually do not need the extensive polishing and hard-chrome plating typical with injection molds. Also, thermoforming machines are much less massive for equal part sizes than injection machines. Production efficiency is higher in multi-station machines but requires a higher financial investment.

Blow Molding.— In its most common form, blow molding couples an extruder with a chilled aluminum mold to make a hollow object such as a two-liter soda bottle. A cross-head die attached to the extruder extrudes a tube of hot melt (*parison*) downward between the mold halves, as in **Fig. 16**. The parison-inflating air injection at stage 4 is done through a needle that penetrates the pinched-off melt at the inverted top of the bottle. Bottles with capacities from 2 ml to 10 gallons (38 liters) and myriad other hollow objects are produced by this process. Close tolerances are maintained on the threaded closures where the mold halves meet; elsewhere they are looser, comparable to those of sheet thermoforming. As in thermoforming, when a particular product, e.g., a half-gallon or 2-liter bottle, warrants very high production rate, highly automated, multi-station machines are economical.

Processing of Thermosets.—While some thermosetting materials have been adapted to injection molding processes, most are still processed by compression molding, transfer molding, prepreg molding, sprayup, and hand layup. Commonly used *compression molding* is a process in which precompounded and catalyzed resins, still thermoplastically formable, are preformed into buns or bricks of known weight. One or more bricks are pre-

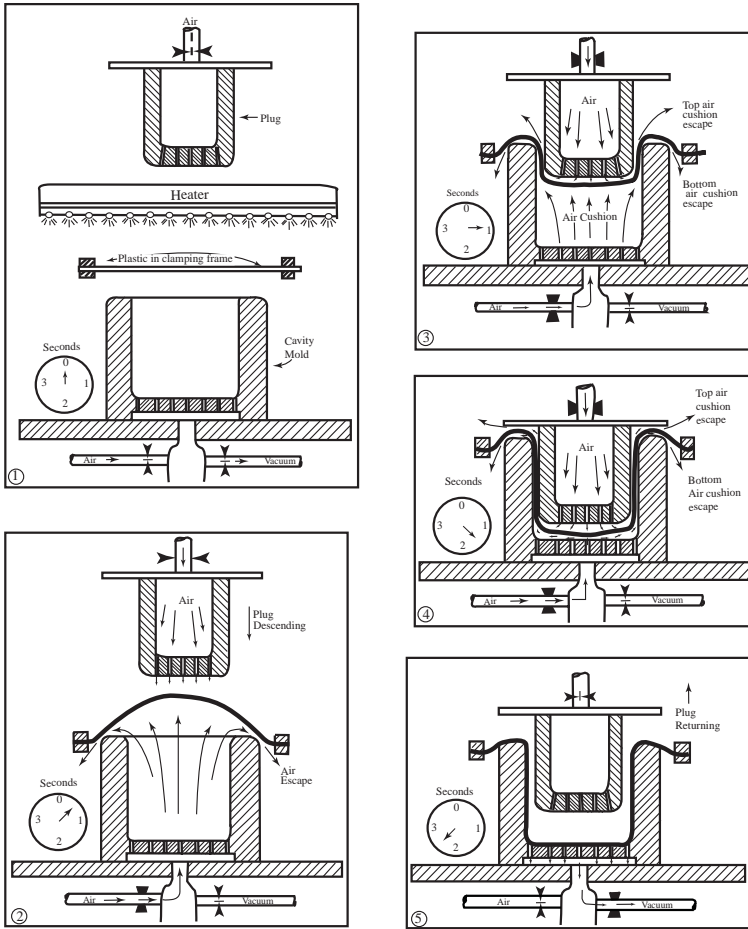


Fig. 15. Five Stages in the Cycle of Air-cushion Vacuum Forming. Balancing the Air Pressures at Stages 3 and 4 Can Be Tricky. Removal and Trimming Follows Stage 5.

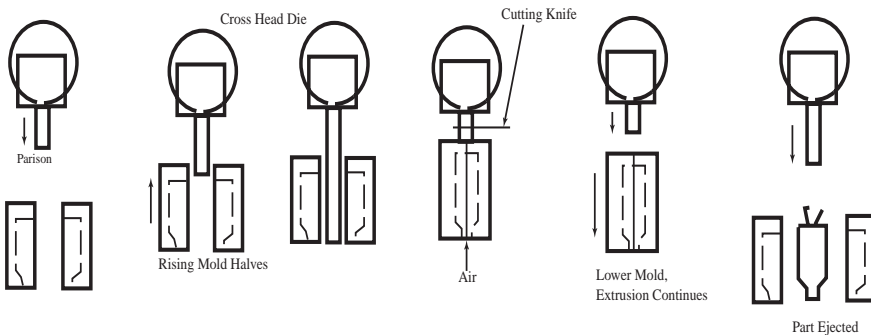


Fig. 16. Six Stages of Extrusion/Blow Molding are Shown in this Schematic of Process

heated in convection or electronic ovens and quickly positioned in the female half of a horizontal mold. It and the hovering male half are at the molding temperature. The mold is closed and brought to high pressure, squeezing the softened bricks, which, ideally, flow into all parts of the mold cavity. Pressure is maintained for the time required to complete the chemical cross-linking reaction and the molding to solidify, after which it is ejected

from the mold, any slight leakage at the parting line (*flash*) is trimmed, and it is set aside to cool. With the correct choice and dose of catalyst, time in the mold need not be long. As with injection molding, the high pressures dictate massive molds and presses.

Compression molding is also an efficient way of processing unsaturated polyesters, perhaps the most versatile and user-friendly resins available for reinforced plastics processing. When reinforced with chopped glass and mixed to a dough-like consistency, these compounds, known as premix or “gunk,” have been widely used in the automotive and boat industries. Compression molding is also used with sheet-molding compounds. Glass-fiber cloths are preimpregnated with resin and need only heat and pressure to cure them into finished products.

With a mold provided with both heating and cooling, thermoplastics, too, may be compression molded, an obviously slow process, but sometimes convenient for making prototypes and test pieces.

In *transfer molding*, also called *plunger molding*, the thermosetting compound is preheated in a separate cylinder (the pot) until it is fully fluid, then forced by a plunger through a runner into the final mold. This process is capable of molding complex parts that cannot be made by compression molding, and also offers closer dimensional tolerances and glossier surfaces than the latter. Multi-cavity molds are feasible. Transfer molding has been used widely in the electronics industry.

Another popular method of processing thermosets into unidirectionally reinforced products is *pultrusion*, in which continuous glass roving or mat is pulled through a resin bath or impregnator and then into a preforming fixture where the cross-section is partly shaped. The preliminary profile continues through dies where curing mechanisms are applied, and finally to a cut-off saw to produce shapes such as channels, rods, and tubes. Ladder rails, fishing rods, tool handles, tent poles, and numerous other parts are made by this process.

Polyurethanes.—Polyurethanes (PUR) are among the most versatile of polymers, both as thermoplastic and thermosetting, as well as being the most ubiquitous in every day products. For example, the flexible thermoplastic members of the family are mainly elastomers that are favorites for athletic shoes, while the rigid, transparent thermoplastics are vying with polycarbonate for the high-value market in eyeglass lenses.

The thermosets are formed by linking two reactive components, an isocyanate and a polyol. Toluene diisocyanate and diphenylmethane diisocyanate are the most used isocyanates, while a variety of polyols are commonly used. The short-chain, low-molecular-weight types result in rigid plastics, and longer-chain types form flexible materials. About 70 per cent of all PURs worldwide go into automotive, building and construction, mattresses, and furniture including frame members produced by reaction injection molding. Densities of rigid PUR foams range from 1 to 8 lb/ft³ (16–128 kg/m³) and much higher in furniture members. Flexible PUR foams range from near that of the parent plastic down to 1 lb/ft³ (16 kg/m³). Since the reactive components must be mixed instantly and thoroughly at the moment of application, a special industry of PUR processing machinery has developed to deal with that requirement.

Cast rigid PUR is available in rod, tube, and bar stock form.

Reinforced Plastics.—Mentioned previously were compression molding of premixes and pultrusion for unidirectionally reinforced structures. For superior strength and modulus, many items are reinforced with cloths of various fibers and weaves. Felted mats are often cross-layered and then impregnated with liquid resin (e.g., polyester or epoxy) prior to being cured to make final products. Some of these products, if not too large, can be compression molded. But with judicious catalysis, the resin can be cured at room temperature, facilitating manufacture at low pressure, with or without heat, of large structures such as boats and storage tanks for liquids. With layup one can handily distribute the reinforcing web in accordance with the stress distribution expected when the product is placed in service. **Fig. 17** shows four increasingly positive (and more costly) ways of curing hand

layouts. Also, many laminates are produced in sheets, typically 4 ft by 8 ft (122 by 244 cm), for subsequent fabrication into final products. The familiar decorative laminates (Formica), for example, are produced in large presses with multiple steam-heated platens interleaved between laminates, permitting production of dozens of sheets in one pressing. Properties of some reinforced plastics available in sheet form are given in Table 5.

Table 5. General Properties of Reinforced Plastics (ASTM Test Procedures)

Material	Specific Gravity	Tensile		Compressive Strength 10 ³ psi	Flexural Strength 10 ³ psi	Izod Impact Strength ft-lb/in notch	Heat Resistance Continuous °F	Arc Resistance seconds
		Strength 10 ³ psi	Modulus 10 ⁶ psi					
Polyester								
Glass cloth	1.5-2.1	30-70	1-3	25-50	40-90	5-30	300-350	60-120
Glass mat	1.3-2.3	20-25	0.5-2	15-50	25-40	2-10	300-350	120-180
Asbestos	1.6-1.9	30-60	1-3	30-50	50-70	2-8	300-450	100-140
Paper	1.2-1.5	6-14	0.5-1.5	20-25	13-28	1-2	220-250	28-75
Cotton cloth	1.2-1.4	7-9	0.5-1.5	23-24	13-18	1-4	230-250	70-85
Epoxy								
Glass cloth	1.9-2.0	20-60	2-4	50-70	70-100	11-26	330-500	100-110
Glass mat	1.8-2.0	14-30	1-3	30-38	20-26	8-15	330-500	110-125
Paper	1.4-1.5	10-19	0.5-1	20-28	19-24	0.5-1	260-300	30-100
Phenolic								
Glass cloth	1.8-2.0	40-60	1-3	35-40	65-95	10-35	350-500	20-130
Glass mat	1.7-1.9	5-20		17-26	10-60	8-16	350-500	40-150
Asbestos	1.7-1.9	40-65	2-5	45-55	50-90	1-6	350-600	120-200
Paper	1.3-1.4	8-20	1-2	20-40	10-30	0.3-1	225-250	Tracks
Cotton cloth	1.3-1.4	7-16	0.5-1.5	30-44	14-30	0.5-3	225-250	Tracks
Nylon cloth	1.1-1.2	5-10	0.3-0.5	28-36	9-22	2-4	150-165	Tracks
Silicone								
Glass cloth	1.6-1.9	10-35	1-2	25-46	10-38	5-13	400-700	150-250
Asbestos cloth	1.7-1.8	10-25	1-2	40-50	12-20	6-9	450-730	150-300

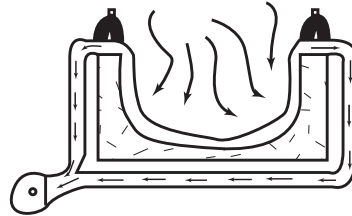
Injection Molding.— This process produces the majority of plastics consumer and industrial products. The modern injection molding machine consists of an extruder, much like the one described previously, but with the added feature that the screw can be slid forward to quickly inject the stored-up hot melt into the second main part, the mold. A nozzle at the end of the extruder presses tightly into a recess (*sprue*) in the stationary half of the mold. The two halves of the mold, with a vertical parting surface, are made from heavy steel and mounted on thick steel tie-bars. Within the mold is a network of *runners* distributing melt from the sprue to the mold cavities that determine the dimensions of the molded product. The mold halves are clamped together with high pressure by hydraulic piston. Coolant channels passing near the cavities keep the mold cold, well below the freezing range of the plastic. The screw moves forward, forcing the melt through the runners and into the cavities and maintains melt pressure (5,000-15,000 psi, 34-103 MPa) while the moldings cool and freeze. Then the far half of the mold is withdrawn, activating ejection pins that push the moldings and runners out of the mold. Meanwhile the extruder has retracted and generates more hot melt. Typically the process is highly automated with computer controls. Injection machines are rated by their melting capacity, shot size, and clamping force. They range from machines shooting two ounces of melt into a family mold that makes the parts for a hobbyist's model airplane, to machines that mold 40-gallon (151 liter) trash cans in molds with two cavities—one for the can, the other for its lid.

Injection molding is capable of making identical items with very close tolerances on dimensions, so it is ideal for the production of interchangeable industrial parts destined for complex assemblies. Undercut shapes can be molded with the aid of side-draw mold sections. For example, millions of bottle caps are molded in automatic unscrewing molds. Producing mold cavities and their male halves in fine tool steels is costly, so one should be quite certain that the part design is accurate before finishing the mold cavities. Successful



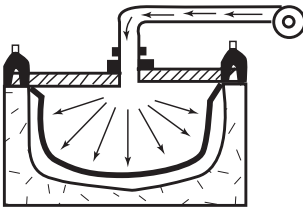
Contact Molding

Resin in contact with air. Layup normally cures at room temperature, heat may accelerate cure. A smoother exposed side may be achieved by wiping on cellophane.



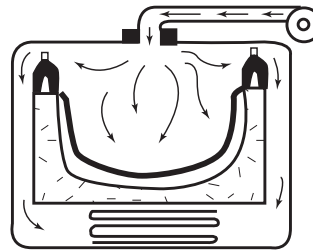
Vacuum Bag

Cellophane or polyvinyl acetate is placed over the layup. Joints are sealed with plastic; vacuum is drawn. Resultant atmospheric pressure eliminates voids and forces out entrapped air and excess resin.



Pressure Bag

Tailored bag - normally rubber sheeting - is placed against layup. Air or steam pressure up to 50 psi (345 kPa) is applied between pressure plate and bag.



Autoclave

Modification of the pressure bag method; after layup, the entire assembly is placed in steam autoclave at 50–100 psi (345–690 kPa). Additional pressure achieves higher glass loadings and improved removal of air.

Fig. 17. Variants of Hand-layup Method of Reinforced Plastics Molding with Cloth or Mat Provide Improved Control of Final Product Qualities

production requires the inputs of all persons connected with the project: the product designer, the mold designer, the mold maker, the molder and the customer. Because of the high investment in the mold, injection molding is seldom considered for short runs. However, inexpensive molds that may serve to make a few hundred parts have been made from metal-filled epoxy casting compounds.

Historically, injection molding was limited to thermoplastics. Now, however, special temperature-control techniques in molds have opened the process to thermosets too.

Design for Injection Molding.—Product analysis is a good starting point in the design process for plastics molding. Make a detailed checklist of the functions the new part will have to perform and the operating conditions it will encounter. If the part will replace an older design that required fabrication from other materials and, perhaps, subassembly with fasteners or adhesives, the new design may be able to take advantage of injection molding's versatility to meld the several functions into a single new part design.

Properties Checklist: Identify potential candidate materials that can fulfill required functions. Preliminary analysis using relevant properties should reduce the list to a few materials that can do the job and the volume (in³ or cm³) of each that is required.

Considerations and questions to ask in this phase of the project are:

- 1) Strength, structural stiffness, impact loading, exposure to chemicals, operating temperature range (and possible overheating and cooling), electrical factors, and other relevant material factors.
- 2) Will building codes or other government regulations be involved?
- 3) Must the design be approved by clients or in-house managers?
- 4) Has the marketing group determined the anticipated production run?
- 5) Input from the prospective mold builder and molder (often not the same) should be sought before the design is made final.
- 6) The cost for each part produced of the plastics to be used.

Relative Plastics Costs: The list of some unit comparative unit costs in Table 6 should serve to narrow materials choices, but current quantity quotations from various suppliers must be obtained. For injection molding of a large production run, a crude estimate of part cost is double the material cost.

Table 6. Volumetric Costs of Plastics, Dollars per Cubic Inch and per Cubic Meter

Material	Price		Material	Price	
	\$/in ³	\$/m ³		\$/in ³	\$/m ³
ABS	0.032	1953	Polyester (PET)	0.055	3356
Acetal	0.074	4516	Polyester, thermosetting	0.043	2624
Acrylic	0.034	2075	Polyetherether ketone	1.72	104961
Alkyd	0.068	4150	Polyetherimide	0.25	15256
Cellulosics	0.075	4577	Polyethylene, low-density	0.014	854
Diallyl phthalate	0.154	9398	Polyethylene, high-density	0.01	610
Epoxy	0.081	4943	Polyphenylene ether	0.05	3051
Fluoropolymers	0.48	29291	Polyphenylene oxide	0.05	3051
Liquid-crystal polymer	0.43	26240	Polyphenylene sulfide	0.119	7262
Melamine	0.049	2990	Polypropylene	0.01	610
Phenolic, GP	0.038	2319	Polystyrene	0.015	915
Polyamide (6 or 6/6)	0.058	3539	Polysulfone	0.20	12205
Polyamideimide	0.95	57973	Polyurethane, thermoplastic	0.074	4516
Polycarbonate	0.073	4455	Polyurethane, thermosetting	0.062	3783
Polycarbonate-ABS alloy	0.078	4760	Urea	0.053	3234

Use the formula $\$/in^3 = 0.0361 \times \text{specific gravity} \times \$/lb$ to convert suppliers dollars-per-pound prices to dollars per in³.

Based on 1999 market prices.

Wall Thicknesses: Wall thicknesses throughout the part are often of great importance. Nominal dimensions and tolerances should be calculated and should be decided before the mold is made, since modifications are costly. In general, wall thicknesses should be kept as thin as needed to meet the part's design requirements, and as uniform as possible. Ideally, the flow of molten plastic should be arranged to flow through thicker sections into thinner ones rather than the reverse. This is accomplished—in consultation with the mold builder—by gating cavities at the edges of thick sections. The mold builder will help, too, with the decisions on how many cavities are needed, how to arrange them in the mold for optimal temperature control, the best runner layout and sizing, and what size mold and injection machine will be economical for the production desired. Most injection-molded plastics parts have wall thicknesses in the range from 0.03 to 0.25 inch (0.8 to 6 mm). For compounds containing half-inch (12.7 mm) and longer glass fibers, and thermoplastic polyurethanes, the range shifts upward by about a factor of 3.

When the plastics selection for the part has been finalized, the suppliers of that plastic type can provide recommendations of grades and wall thicknesses appropriate to those grades. Table 7 shows typical nominal wall thicknesses for various thermoplastics.

Table 7. Typical Nominal Wall Thicknesses for Various Classes of Thermoplastics

Thermoplastics Group	Typical Working Range		Thermoplastics Group	Typical Working Range	
	inch	mm		inch	mm
Acrylonitrile-butadiene-styrene (ABS)	0.045–0.140	1.14–3.56	Polyester elastomer	0.025–0.125	0.64–3.18
Acetal	0.030–0.120	0.76–3.05	Polyethylene	0.030–0.200	0.76–5.08
Acrylic	0.025–0.150	0.64–3.81	Polyphenylene sulfide	0.020–0.180	0.51–4.57
Liquid-crystal polymer	0.008–0.120	0.20–3.05	Polypropylene	0.025–0.150	0.64–3.81
Long-fiber-reinforced plastics	0.075–1.000	1.91–25.4	Polystyrene	0.035–0.150	0.89–3.81
Modified polyphenylene ether	0.045–0.140	1.14–3.56	Polysulfone	0.050–0.150	1.27–3.81
Nylon	0.010–0.115	0.25–2.92	Polyurethane	0.080–0.750	2.03–19.05
Polyarylate	0.045–0.150	1.14–3.81	Polyvinyl chloride (PVC)	0.040–0.150	1.02–3.81
Polycarbonate	0.040–0.150	1.02–3.81	Styrene-acrylonitrile (SAN)	0.035–0.150	0.89–3.81
Polyester	0.025–0.125	0.64–3.18

If the plastics part is to carry loads, load-bearing areas should be analyzed for stress and deflection. When stress or deflection is too high, solutions are to use ribs or contours to increase section modulus; to use a higher-strength, higher-modulus (fiber-reinforced) material; or to increase the wall thickness if it is not already too thick. Where space allows, adding or thickening ribs can increase structural integrity without thickening walls.

Equations (15), (16), and (17) on page 567 can be related to formulas using the section modulus and moment of inertia on page 257, where for Case 2, stress at the beam center is given by $\sigma = -Wl/4Z$.

On page 256, note that $Z = I \div$ distance from neutral axis to extreme fiber ($h \div 2$ in the plastics example). The rectangular beam section diagrammed on page 235 gives the equivalent of $I = bh^3/12$ for the rectangular section in the plastics example. Therefore,

$$Z = \frac{I}{h/2} = \frac{bh^3}{12} \times \frac{2}{h} = \frac{bh^2}{6}$$

In $\sigma = -Wl/4Z$, the (–) sign indicates that the beam is supported at the ends, so that the upper fibers are in compression and the lower fibers are in tension. Also, $W = F$ and $l = L$ in the respective equations, so that stress, $\sigma = FL/4(bh^2)/6$, and $\sigma = 3FL/2bh^2$.

To calculate the maximum deflection y at load, equate Equation (16) from page 567 and $Y = Wl^3/48EI$ from page 257, where $W = F$, $l = L$, $E = E$, and $I = bh^3/12$. Therefore,

$$y = \frac{FL^3}{48E(bh^3/12)} = \frac{FL^3}{4Ebh^3}$$

Example: Assume that a beam (see Figs. 19a and 19b) as described in connection with Equations (15), (16), and (17) on page 567 is 0.75 inch wide with a constant wall thickness of 0.080 inch, so that the cross-sectional area is 0.060 in², and there is a central load W of 5 lb. Based on a bending or flexural modulus of 300,000 lb/in², the maximum stress is calculated at 6250 lb/in² and the maximum deflection at 0.694 inch. Both the stress and the deflection are too high, so a decision is made to add a rib measuring 0.040 inch thick by 0.400 inch deep, with a small draft of 1/2 degree per side to reinforce the structure.

The equations on page 257, the drawing on page 241 representing the ribbed section (neglecting radii), and the accompanying formulas permit calculation of the maximum stress and deflection for the ribbed section.

With the new cross-sectional area only slightly larger at 0.0746 in², the calculated stress is reduced to 2270 lb/in², and the deflection goes down to 0.026 inch, which is acceptable for both the material and the application. To achieve the same result from a heavier beam would require a thickness of 0.239 inch, tripling the weight of the beam and increasing molding difficulties. The rib adds only 24.3 per cent to the total section weight.

Use of ribs allows the structural characteristics of a part to be tailored to suit its function, but ribs can cause warping and appearance problems, so are best avoided if they are not

structurally necessary. If the first parts produced require strengthening, ribs can be added or thickened without high cost after the tool is finished because the work consists only of removing steel from the mold. In general, ribs should have a base thickness of about half the thickness of the adjacent wall, and be kept as thin as possible where they are positioned near faces that need to have a good appearance.

Where structural strength is more important than appearance, or when materials are used that have low shrinkage, ribs can be made 75 or 100 per cent of the wall thickness. However, where the rib base joins the main molding there is an increase in thickness forming a heavy mass of material. Shrinkage of this mass can produce a cavity or void, a hollow area or sink, or can distort the molding. If the mass is very large, cooling time may be prolonged, leading to low output from the machine. Large masses of material in other parts of a molding are also best avoided. These problems can usually be addressed by good mold design.

Ribs need not be of constant height or width and are often varied in proportions to suit the stress distribution in the part. All ribs should have a minimum of $\frac{1}{2}$ degree of draft per side for ease of removal from the mold and a minimum radius of 0.005 inch (0.127 mm) at the base to avoid stress-raising corners. Draft and thickness requirements will usually limit the height of the rib, which can be from 1.5 to 5 times the base thickness, and several evenly spaced ribs are generally preferred to a single large one. Smooth transitions should be made to other structural features such as bosses, walls, and pads.

Other ways to improve section properties include use of top-hat and corrugated sections, crowning or doming of some areas, and reinforcement with metal or other inserts that are placed in the mold before it is closed. To keep molded parts uniform in wall thickness, cores or projections may be provided in the mold to prevent a space being filled with molding material. Blind holes can be cored by pins that are supported on only one side of the mold and through holes by pins that pass through both sides. The length-to-width ratio should be kept as low as possible to prevent bending or breakage under the high pressures used in the injection molding process.

Agency approvals for resistance to flammability or heat, electrical properties, or other characteristics are usually based on specific wall thicknesses. These restrictions sometimes necessitate thicker walls than are required for structural strength purposes.

When determining wall thickness, design engineers must also have some knowledge of mold design and should consider the ability of plastics to flow into the narrow mold channels. The degree and rate of flow depends on temperature and pressure to some extent, but varies for different materials, as shown in Fig. 18.

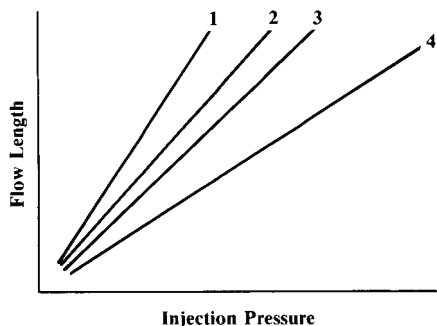


Fig. 18. Typical Spiral-Flow Curves for (1) Nylon 6/6, (2) Polyester Thermoplastics PBT, Liquid-Crystal-Glass-Reinforced, and Polyphenylene-Sulfide-Glass-Reinforced, (3) Acetal Copolymer, and (4) PBT-Glass-Reinforced Plastics Materials

Stresses and Deflections in Load-Bearing Parts.—If the plastic part is to carry loads, load-bearing areas should be analyzed for stress and deflection according to the principles presented earlier. If stress or deflection is found to be too high, solutions are to use ribs or contours to increase section modulus; or to use a higher-strength or higher-modulus (i.e.,

fiber-reinforced) material; or to increase the wall thickness if it is not already excessive. Where space allows, adding or thickening ribs can increase structural integrity without making walls thicker.

Formulas given in *Beam Calculations* starting on page 256, which presume elastic behavior, can be used if care is taken to use moduli and strengths related to anticipated service times and temperatures.

Example: Consider a simple case of a beam with rectangular cross section b wide and h deep, of length l centrally loaded and freely supported at its ends. This is an example of case 2 on page 257 with a beam cross-section depicted generically in the first diagram of *Moments of Inertia, Section Moduli, and Radii of Gyration* on page 235. Applicable formulas for the moment of inertia I of the beam cross-section, the section modulus Z , and the maximum tensile stress s beneath the central load are

$$I = \frac{bh^3}{12} \quad Z = \frac{I}{(h/2)} = \frac{bh^2}{6} \quad \sigma = \frac{Wl}{4Z} = \frac{6Wl}{4bh^2}$$

From the last box for Case 2, the maximum deflection at the beam center is given by

$$y = \frac{Wl^3}{48EI} = \frac{Wl^3}{4Ebh^3}$$

We can now exercise these equations in an example of a small beam whose width = 19 mm, depth (wall thickness) = 2.0 mm, and length between supports = 102 mm. The beam is to support a central load of 22.24 N (5 lb). This beam's cross-section is depicted in Fig. 19a. It has very little depth, hence a low sectional modulus, so may not handle the job. The plastic's flex modulus is 2068.5 MPa (300,000 psi). Using the formulas above, the four quantities to be calculated are

$$I = \frac{19(2^3)}{12} = 12.666667 \text{ mm}^4$$

$$Z = \frac{(12.666667)2}{2} = 12.666667 \text{ mm}^3$$

$$\sigma = \frac{6(22.24)102}{4(19)^2} = 44.77 \text{ MPa}$$

$$y = \frac{(22.24)(102^3)}{(4)(2068.5)(19)(2^3)} = 18.77 \text{ mm}$$

Both the stress and the deflection are too high. The wall thickness could be increased, but instead a rib will be added that will run along the underside and center of the beam, changing its cross section to that shown in Fig. 19b. The rib will be 10 mm deep but only 1.0 mm thick, with a slight draft of 0.5 degree per side. Following the formulas given in the table *Moments of Inertia, Section Moduli, and Radii of Gyration* starting on page 234, see third row of the T-sections for the T-section with the tapered rib, the new cross-sectional area is 47.125 mm² and the location of the neutral axis is 9.84 mm above the most extreme fiber at the bottom of the rib. The new cross-sectional moment of inertia I is 353.60 mm⁴, 28 times greater than the original I . The section modulus $Z = 353.60/9.84 = 35.94 \text{ mm}^3$. The recomputed extreme stress is 15.8 MPa, and the maximum deflection is 0.67 mm, acceptable for both the material and the application. To achieve the same result from a heavier rectangular-section beam would require a thickness (depth) of 6.1 mm, tripling the beam's weight and increasing molding difficulties. The new rib adds only 24 percent to the total section weight.

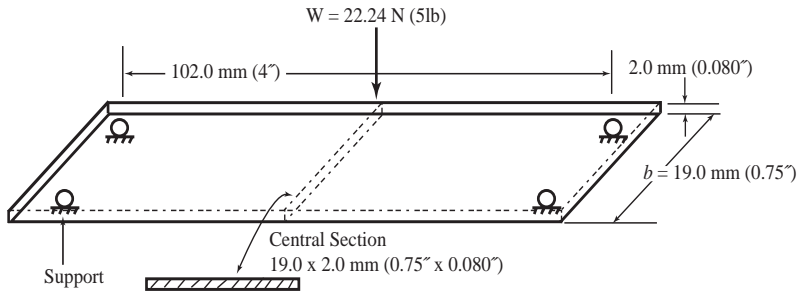


Fig. 19a. Original Beam (Dimensions in parenthesis are for Example on page 587)

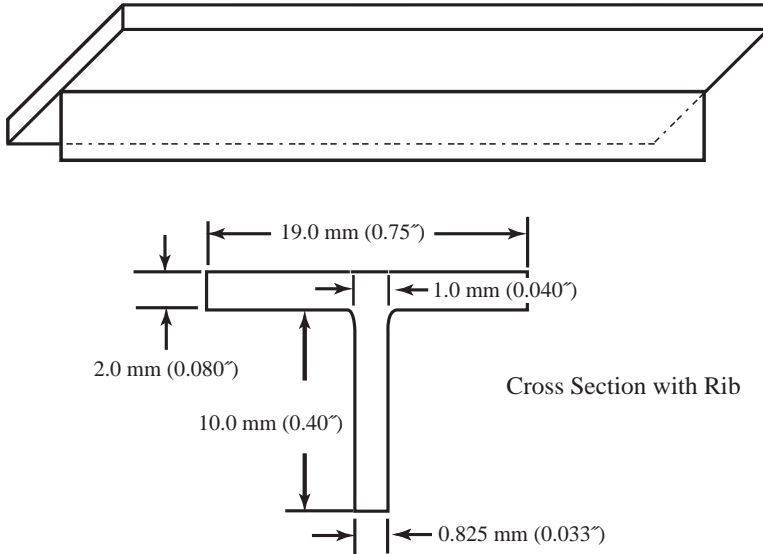


Fig. 19b. Beam with Small Rib (Dimensions in parenthesis are for Example on page 587)

Use of ribs allows the structural needs of a part to be tailored to suit its function, but ribs can cause warping and appearance problems, so are best avoided if they are not structurally necessary. If the first parts produced require strengthening, ribs can be added or thickened without high cost after the tool is finished because the work consists only of removing steel from the mold. In general, ribs should have a base thickness of about half the thickness of the adjacent wall, and should be kept as thin as possible where they are positioned near faces that need to have a good appearance.

Where structural strength is more important than appearance, or when materials are used that have low shrinkage, ribs can be made 75 to 100 per cent of the wall thickness. However, where the rib base joins the main molding there is an increase in thickness forming a heavier local mass of material. Shrinkage of this mass can produce a depression or void, a hollow area called a *sink*, or it can distort the molding. If the mass is very large, cooling time may be prolonged, leading to reduced output from the machine. Large masses in other parts of a molding are also best avoided. These problems can usually be prevented by thoughtful design of parts and molds.

Ribs need not be of constant height or width, and are often varied in proportions to suit the stress distribution in the part. All ribs should have a minimum of 0.5 degrees of draft per side for ease of removal from the mold, and a radius of at least 0.005 inch (0.127 mm) at the base to avoid stress-raising corners. Draft and thickness requirements will usually limit the height of the rib, which can be from 1.5 to 5 times the base thickness, and several evenly spaced ribs are generally preferred to a single large one. Smooth transitions should be made to other structural features such as bosses, walls, and pads.

Other ways to improve section properties include use of top-hat and corrugated sections, crowning or doming of some areas, and reinforcement with metal or other inserts that are placed in the mold before it is closed.

Agency approvals for resistance to flammability or heat, electrical properties, or other characteristics are usually based on specific wall thicknesses. These restrictions sometimes necessitate thicker walls than are required for structural strength purposes.

Draft: Most molded parts have features that must be cut into the mold perpendicular to the parting line. Removal of these parts from the mold is easier if they are tapered in the direction of mold opening. This taper is called *draft* in the line of draw or mold movement, and it allows the part to break free of the mold by creating a clearance as soon as the mold starts to open. The drawing of Fig. 20 defines draft and the dimensions associated with it. Plastics materials shrink as they cool, so they grip mold projections very tightly and ejection can be difficult without sufficient draft. A draft of $\frac{1}{2}$ degree on each side of a projection on the part is generally considered the minimum, although up to 3 degrees per side is often used.

The exact relationship between the draft angle α and the dimensional difference from the top to the bottom of the draw depth D is given by

$$d = D \tan \alpha \quad (31)$$

where \tan is the tangent of the draft angle. An excellent approximation is

$$d = 0.0175 \alpha D \quad (32)$$

This is accurate to the nearest 0.001 inch (0.025 mm) for draft angles up to 5 degrees and draw depths up to 10 inches (254 mm).

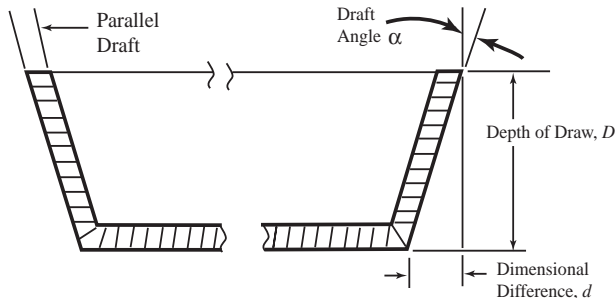


Fig. 20. Defining Dimensions Related to Draft and Draft Angle

Where minimal variation in wall thickness is needed to produce sidewalls that are perpendicular to the direction of draw, the mold sometimes can be designed to produce parallel draft, as indicated at the left in Fig. 20. The amount of draft also depends on the surface finish of the mold walls. Any texturing of the surface will increase the draft requirement by at least 1 degree per side for every 0.001 inch (0.025 mm) of texture depth.

Most plastics parts are so designed that they can be ejected parallel with the direction of mold parting. Complex parts with undercuts may require mold designs with cavity-forming projections that must move at an angle to the direction of opening. Between these two extremes lie such items as “windows,” or simple openings in the side of a molding, which can be produced by the normal interaction of the two main parts of the mold.

Fillets, Radii, and Undercuts: Sharp corners are always to be avoided in injection-molded part designs because they represent points of stress concentration. Sharp corners in metal parts often are less important because the stresses are low compared with the strength of the material or because local yielding redistributes the loads. Sharp inside corners are particularly to be avoided in moldings because severe molded-in stresses are generated as the material shrinks onto the mold corner. Sharp corners also cause poor material flow patterns, reduced mechanical properties, and increased tool wear. Therefore, inside

corner radii should be equal to half the nominal wall thickness with a minimum of 0.020 inch (0.51 mm) for parts subject to stress, and 0.005 inch (0.127 mm) radius for stress-free parts. Outside corner radius should equal the inside corner radius plus the wall thickness.

With an inside radius of half the wall thickness, a stress concentration of 1.5 is a reasonable assumption, and for radii down to 0.1 times the wall thickness, a stress concentration of 3 is likely. More information on stress concentrations is found in *Working Stress* on page 204. A suitable value for q in Equation (8) on page 205, for plastics materials, is 1. That is, the actual stress-concentration factor equals the theoretical value.

Impact Resistance: The impact resistance of a plastics part is directly related to its ability to absorb mechanical energy without fracture or deformation, and this ability depends on the material properties and the part geometry. Increasing wall thickness may improve the impact resistance but may also hurt impact resistance by making the part too stiff so that it is unable to deflect and distribute the force.

Melt Flow in the Mold.—The designer of plastics products needs to have a basic appreciation of what goes on during injection molding and the special properties of plastics that affect molding. Some of these, such as thermal properties, have been previously described. It is the flow properties of molten plastics that dominate mold filling. Foremost are the very high viscosities of thermoplastic melts—thousands to hundreds of thousands times that of room-temperature water—requiring pressures (P) of 5,000–15,000 psi (35–103 MPa) to move the melt quickly through the short distance from the injection cylinder through the mold runners and into the cavities. Second is the strong dependence of viscosity on temperature, so the transfer to the chilled mold must be nearly instantaneous to obtain fully filled cavities and accurately dimensioned products. Because of the high viscosities and rapid flow, frictional heat is dissipated within the melt, helping to keep it warm during its travel. Another property, also helpful, is more subtle: plastic melts have non-Newtonian physical properties. That is, viscosity depends not only on temperature, as with ordinary liquids, but also on the flow rate (or pressure drop ΔP). Doubling ΔP may triple or quadruple the flow rate through the mold passages, but the pressure itself squeezes molecules closer together and tends to increase viscosity and freezing point. In an injection machine one can only raise ΔP by raising P . Unpredictable results can be obtained if the melt temperature is near the freezing range.

If the product designer is calling for thin wall sections, *Flow Rate (FR)*, formerly known as *Melt Flow Index (MFI)*, can be used as a selection property characteristic among grades of candidate plastics. The higher the flow rate, the easier it will likely be to fill thin sections during molding. Flow rate values are obtained by testing (ASTM Test D 1238) in a simple extrusion plastometer. In this device, a small sample of resin is loaded into a 9.55-mm diameter well in a heated cylinder and brought to a test temperature above the plastic's melting range. At the bottom of the well is a die 2.1 mm in bore diameter and 8 mm long.

A weighted piston drives the melt through the die while a timer runs. Extrudate is collected and weighed and the flow rate is reported in grams per 10-minute interval. To accommodate the wide range of plastics flow behaviors, 36 standard conditions specifying both the melt temperature in °C and the total piston weight in kg have been adopted. *FR* values are meaningless without the condition numbers. Most polypropylenes (PP), for example, are tested at condition 230/2.16, meaning a PP resin reported to have an *FR* of 8 (230/2.16 assumed) would be one that at 230 °C under a piston weighing 2.16 kg_f, produced a flow rate of 8 g/10 min. Resin and compound suppliers can supply the *FR* values for their grades. Product designer should obtain all three numbers.

A somewhat more practical way of judging resin flows under actual molding conditions uses a spiral-flow mold. This injection mold and variants were in common use by the early 1950s. A similar mold is the basis for testing the flow of transfer-molding compounds (ASTM D 3123). A half-round or shallow-trapezoidal groove, 1/8 inch (3.2 mm) wide and beginning at the center, circles outward with the spiral radius increasing about 3/8 inch (9.5

mm) per turn, to a total channel length of 70 to 100 inches (178 to 254 cm). Inch numerals and 0.1-inch marks are engraved in the flat upper half of the mold. The injection nozzle fills the mold from its center and, under specified melt and mold temperatures and injection pressure, holds pressure until flow stops. The mold is opened and the flow distance is read off the molded spiral and recorded. With careful control of molding conditions flow distances of 40 inches (102 cm) and more can be closely reproduced in repeated shots. Many resin suppliers have spiral-flow data available for product designers and processors.

Design for Assembly.—An advantage of the flexibility of plastics parts compared to other materials, is that they can often be designed for assembly by means of molded-in snap-fit, press-fit, pop-on, and thread fasteners. With careful design no additional fasteners, adhesives, solvents, or special equipment is required, significantly reducing assembly time and costs. Improper assembly can be minimized, but tooling is often made more complex and disassembly may be difficult with these methods.

Mechanical fasteners designed for metals are generally usable with plastics, and there are many other fasteners designed specifically for plastics. Typical are bolts, self-tapping and thread-forming screws, rivets, threaded inserts, and spring clips. Care must be taken to avoid overstressing the parts. Creep can result in loss of preload in poorly designed systems.

Snap-fit designs are widely used, a typical application being to battery compartment covers. All snap-fit designs have a molded part that must flex like a spring, usually past a designed-in interference, then return to its unflexed position to hold the parts together. The design must have sufficient holding power without exceeding the elastic or fatigue limits of the material. With the typical snap-fit designs in Fig. 21 beam equations can be used to calculate the maximum strain during assembly. If the stress is kept below the yield point of the material, the flexing finger returns to its original position.

With some materials the calculated bending stress can exceed the yield point stress considerably if the movement is done rapidly. In other words, the flexing finger passes through its maximum deflection or strain and the material does not respond as it should if the yield stress has been greatly exceeded. It is common to evaluate snap-ins by calculating the strain instead of stress.

Dynamic strain ϵ for the straight beam, is calculated from $\epsilon = \frac{3Yh_0}{2L^2}$ and for the tapered beam, from $\epsilon = \frac{3Yh_0}{2L^2K}$.

The derived values should be compared with the permissible dynamic strain limits for the material in question, if known. A tapered finger provides more uniform stress distribution and is recommended where possible. Sharp corners or structural discontinuities that will cause stress concentrations on fingers such as those shown must be avoided.

Snap-in arrangements usually require undercuts produced by a sliding core in the mold as shown in Fig. 22a. Sometimes the snap finger can be simply popped off when the mold is opened. An alternative to the sliding core is shown in Fig. 22b, which requires an opening in the molding at the base of the flexing finger. Other snap-in assembly techniques that take advantage of the flexibility of plastics are shown in Fig. 23.

Molded-in threads in holes usually are formed by cores that require some type of unscrewing or collapsing mechanism leading to tooling complications. External threads can often be molded by positioning them across the parting plane of the mold. Molding of threads finer than 28 threads per inch (0.9 mm pitch) is generally not practical.

Chemical Bonding. Chemical bonding is suited to applications that must be leak-tight or where stresses due to assembly must be minimized. However, adhesives and solvents can be hazardous and their preparation and cure times can be prolonged. Properly applied

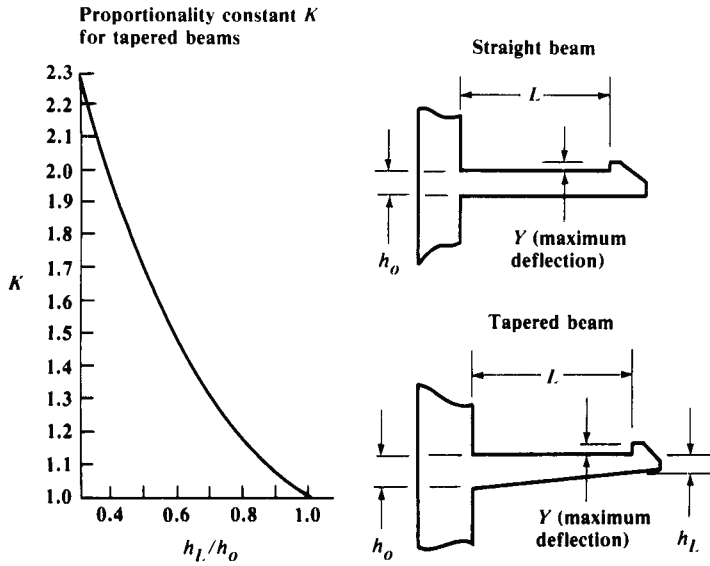


Fig. 21. Snap-fit Designs for Cantilever Beams with Rectangular Cross Sections

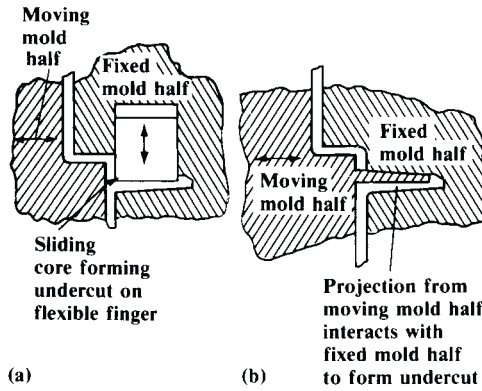


Fig. 22. (a) Arrangement for Molding an Undercut on the End of a Flexible Finger Using a Sliding Core; (b) With the Undercut Formed by a Mold Projection, the Sliding Core is Eliminated

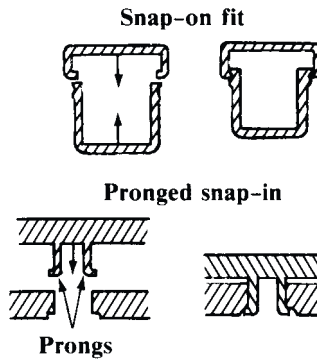


Fig. 23. Examples of Snap-In and Snap-On Arrangements

cyanoacrylate adhesives achieve moderate strength in seconds or minutes and work well with assemblies that can be brought together very quickly after applying the bonding agent.

Chemical bonding may use solvents, or solvents bodied with resin or so-called “100% solids” adhesives, such as epoxies and cyanoacrylates. Use of solvents is limited to compatible materials that can be dissolved by the same solvent. Because most of the solvent must gradually diffuse out of the joint, solvent cementing is used mostly where a very thin film of the solvent can be applied to the accurately mating surface(s) to be joined, followed by rapid assembly, usually with clamping. Bodied solvent cements permit more flexibility in such operations. Safety precautions must be observed in handling the solvents to protect workers and in solvent recovery.

Adhesives that set up or cure with little or no loss of volatiles include epoxies, acrylics, polyurethanes, phenolics, rubbers, polyesters, and vinyls. Cyanoacrylates are often used because of their rapid setting with many materials, both similar and dissimilar, and because they are naturally catalyzed by atmospheric humidity. Their downside is the very short working time they allow for assembly.

Recommendations of both plastics suppliers and adhesives suppliers should be sought because many adhesives contain active components that can partly dissolve the plastics' surfaces, giving improved adhesion. However, some adhesives attack certain plastics, causing crazing and even joint failure. The main disadvantages of adhesives is that their bonds require time to reach full strength, they may need long clamp times, may require fixtures and may involve special ovens or curing conditions. Also, surface preparation may be difficult because of the presence of grease or mold-release compounds; even a fingerprint can spoil a bond. Some adhesion-resistant materials such as polyolefins, nylons, and fluorocarbons usually need pretreatment with surface-activating primers prior to applying an adhesive. Some materials may need mechanical roughening to improve joint strength.

Welding Plastics: Plastics welding techniques include ultrasonic, hot-plate, spin, induction, and microwave energy, melt-bead sealing, and hot-gas welding. Thermal methods are also used for staking, swaging, and other post-thermoforming procedures. Materials must be melt-compatible and have similar melting temperatures.

Plastics welding encompasses a variety of processes in which a film melt is created at the surfaces to be joined. *Ultrasonic welding* is frequently used for joining small- and medium-sized parts of a single material or melt-compatible materials that share the same melting-temperature range. High-frequency (20- to 40-kHz) acoustic vibrational energy is briefly applied to the surfaces to be joined, creating localized molecular excitation that causes a thin layer to melt. The surfaces are pressed and held together while the melt freezes. With proper joint designs, welds can be made in only two seconds, and which on cooling are as strong as the base resins. The lower part of the assembly is supported in a rigid nest fixture and the upper part is aligned, usually by the joint design. This upper part has the freedom to couple acoustically when it is in contact with the horn through which the ultrasonic energy is transmitted. Fig. 24 shows a couple of typical joint designs for this process. The example on the left in Fig. 24 shows a simple butt-type, energy-director design that works well with amorphous materials. The inverted-cone projection, known as an *energy director*, concentrates the energy in a small area on both faces of the joint. This area melts quickly and the material flows as the parts are pressed together. At the right in Fig. 24 is shown a shear-interference joint. Melting of both components starts in the small initial contact area and flow continues along the near-vertical wall as the parts are pressed together, creating a continuous, leakproof joint with a strength that can exceed that of the parts joined.

With hygroscopic plastics, welding should be done as soon as possible after molding because even small amounts of moisture can weaken bonds. Drying immediately before welding may be advisable. Drawbacks of ultrasonic welding are the following: design, quality control, equipment maintenance, and settings are of critical importance for consis-

tent, high-strength welds; the equipment is costly; the process uses large amounts of electric power especially with large parts; and parts to be joined must be of the same or compatible plastics. Filled and fiber-reinforced materials are more difficult to weld.

Although horn frequencies in ultrasonic welding are not audible to the ear, sounds that cause discomfort may be generated when plastics parts vibrate at lower frequencies, necessitating sound-proofing.

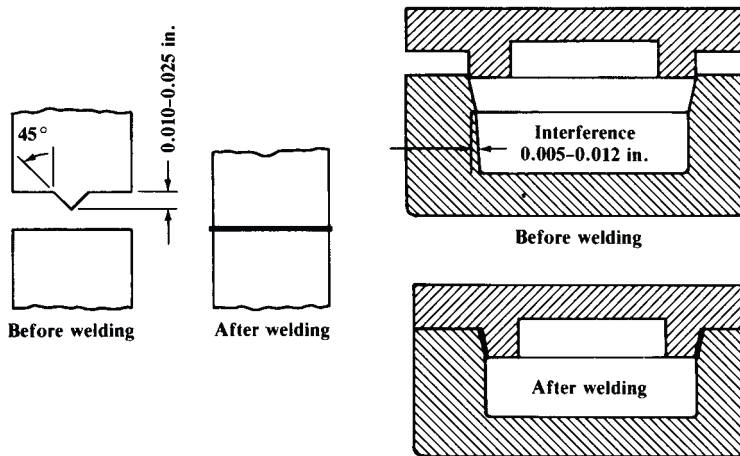


Fig. 24. (left) Energy-director Type of Ultrasonic Weld Joint for Molded-part Assembly, and (right) Typical Shear-interference Joint

Vibration Welding: Vibration welding resembles ultrasonic welding except that the parts to be joined are rubbed together to produce frictional heat that melts the faces. The energy is transferred in the form of high-amplitude, low-frequency, reciprocating motion. After a short period of vibration, the weld area cools and solidifies while the parts are held in the alignment provided by the welding fixture. Typical frequencies used are 120 to 240 Hz and amplitudes range between 0.10 and 0.20 inch (2.54–5.08 mm). When the geometry or assembly design prevents linear movement, vibration-welding equipment can be designed to produce angular displacement of parts. Like ultrasonic welding, vibration welding produces high-strength joints and is better suited to large parts and irregular joint faces. Moisture in hygroscopic materials such as nylon appears to affect joint strength less.

Spin Welding: Spin welding like vibration welding, uses frictional heat to melt the faces of circular joint surfaces. It is a rapid and economical method of joining melt-compatible parts. The process is completed in about three seconds and is easily automated. The frictional heat is generated by rotating one part against its mate (usually fixed) with a controlled pressure. When rotation is stopped, pressure is maintained during cooling and solidification of the joint. Simple equipment such as a drill press can serve for this process.

Hot-Gas Welding: Hot-gas welding is a process resembling acetylene brazing and welding of metals. Used mostly with polyolefins, which do not accept adhesives, the hot-gas welding equipment consists of an electric hot-gas “gun” that provides, through any of several interchangeable nozzles, a stream of hot air or preferably hot nitrogen at a temperature above the melting range of the plastic to be worked. A welding rod of the same material provides the melt that forms the joint to be made between two parts. The parts to be joined are set up in their final orientation in a jig. A groove will usually be machined in one or both to accept the molten plastic. The operator directs the hot gas stream along the joint surfaces while feeding and melting the welding rod into the joint. The welded structure is then allowed to cool several hours. Some huge tanks have been fabricated from thick polyethylene sheets by this technique. It is also useful for repairing broken polyolefin parts. Hot-gas

welding can produce joints with 85 per cent of the strength of the parent material. Hot-gas welding is not recommended for use with substrates less than $\frac{1}{16}$ inch (1.6 mm) thick.

Dielectric Welding: Dielectric welding is also known as *radio-frequency welding*. This process utilizes the dielectric loss that occurs in many plastics when they are placed in a rapidly reversing electric field. It is widely used with flexible thermoplastics films and sheets of materials—typically plasticized PVC and polyurethane—and for joining some injection-molded parts. The parts to be joined are brought together between two electrodes that also supply joining pressure. The field passes through the material, generating heat throughout the volume between the electrodes until it reaches melting range. The field is then turned off and pressure is maintained until the joined parts freeze. Polyolefins and some other plastics are so nonpolar that their dielectric loss is too small to permit welding them by this method.

Electromagnetic or Induction Welding: This form of welding uses inductive heating to generate fusion temperatures in thermoplastics as shown at the top in Fig. 25. Fine iron particles embedded in a gasket, preform, filament, ribbon, adhesive, or molded part are excited by the rapidly alternating magnetic field, generating eddy currents that, through resistive loss, cause distributed local heating. The heated parts are pressed together and, as the temperature rises, the material of the particle carrier flows under pressure through the joint interface, filling voids and cavities and becoming an integral part of the weld. Ideally, the melted material should be contained and subjected to internal pressure by the surrounding component surfaces. Proper joint design is essential to successful induction welding.

Requirements of the preform often add cost to this welding method but the cost is offset by low reject rates resulting from good reliability of the welds. Structural, hermetic welds can be produced in most thermoplastics materials and automation can be used for large-volume production. The process also offers great latitude in joint size, configuration, tolerance requirements, and ability to bond some dissimilar materials. A limitation is that no ferrous metal can be near the joint line during the energizing of the inductor coil. All components of an assembly (except the weld medium) to be induction-welded must therefore be nonferrous, or ferrous components must be placed where they will not be subjected to the high-frequency field from the inductor.

Assembly with Fasteners.—Metal fasteners of high strength can overstress plastics parts, so torque-controlled tightening or special design provisions are needed. Examples of poor and preferred designs are shown in Fig. 26. The shoulder of the metal screw shown in the lower right portion of Fig. 26 meets the metal component when it is tightened, sparing the plastic part from over-compression. Where force cannot be satisfactorily controlled, even with a shoulder screw, various types of washers can be used to spread the compression force over wider areas.

Metal inserts are available in a wide range of shapes and sizes for permanent installation of metal threads or bushings in plastics parts. Inserts are typically installed in molded bosses, designed with holes to suit the insert to be used. Some inserts are pressed into place and others are installed by methods designed to limit stress and increase strength. Generally, the outside of the insert is knurled or otherwise provided with projections of various configurations that penetrate the plastics and prevent movement under normal torques exerted during assembly. “Helicoil” inserts have large standard threads on the outside and receive a smaller standard screw inside, thus lowering the assembly torque on the plastic by diluting it to the larger outside contact area. Inserts can also be installed with equipment similar to that used for ultrasonic welding, the plastics being melted to enhance contact with the metal and reduce insertion stresses.

Thread-cutting and -forming screws are widely used with plastics parts. Information on standard self-threading screws is found in *SELF-THREADING SCREWS* starting on page 1701. Thread-forming screws must be used carefully with high-modulus, low-creep plastics, as high hoop stresses can be generated during insertion. Screws with multiple lobes

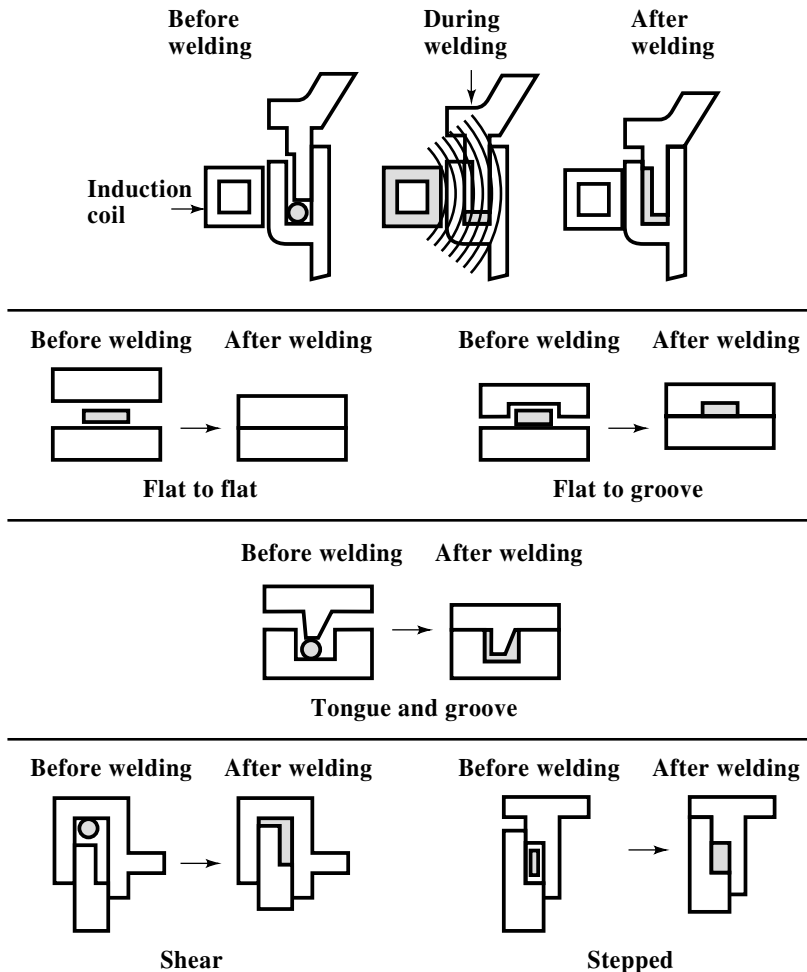


Fig. 25. Typical Joint Designs Used in Induction-welding Plastics Assembly

and screws with alternating low and high threads have excellent holding power in plastics. Molded holes must have sufficient depth to prevent bottoming, and boss walls must be thick enough to resist stresses. As a general rule of thumb, the outside diameter of the boss should be double the major diameter of the screw.

Hollow aluminum or other metal rivets are often used in plastics assembly, as are stamped sheet-metal components, especially push-on or -in designs. Molded plastics fasteners are also frequently used.

Machining Plastics.—Plastics can be molded into complex shapes and so do not usually need to be machined. However, machining is sometimes more cost-effective than making a complex tool, especially when requirements are for prototype development, low-volume production, undercuts, angular holes, or other openings that are difficult to produce in a mold. Special methods for development of prototypes are discussed later. All machining of plastics requires dust control, adequate ventilation, safety guards, and eye protection.

Like some metals, plastics may need to be annealed before machining to avoid warpage. Some commercially available bar and rod stock are sold already annealed. If annealing is necessary, instructions can be obtained from plastics suppliers. Plastics moduli are small fractions—2 to 10 per cent—of those of metals and this lower stiffness permits much greater deflection of the work material during cutting. Thermoplastics materials must be

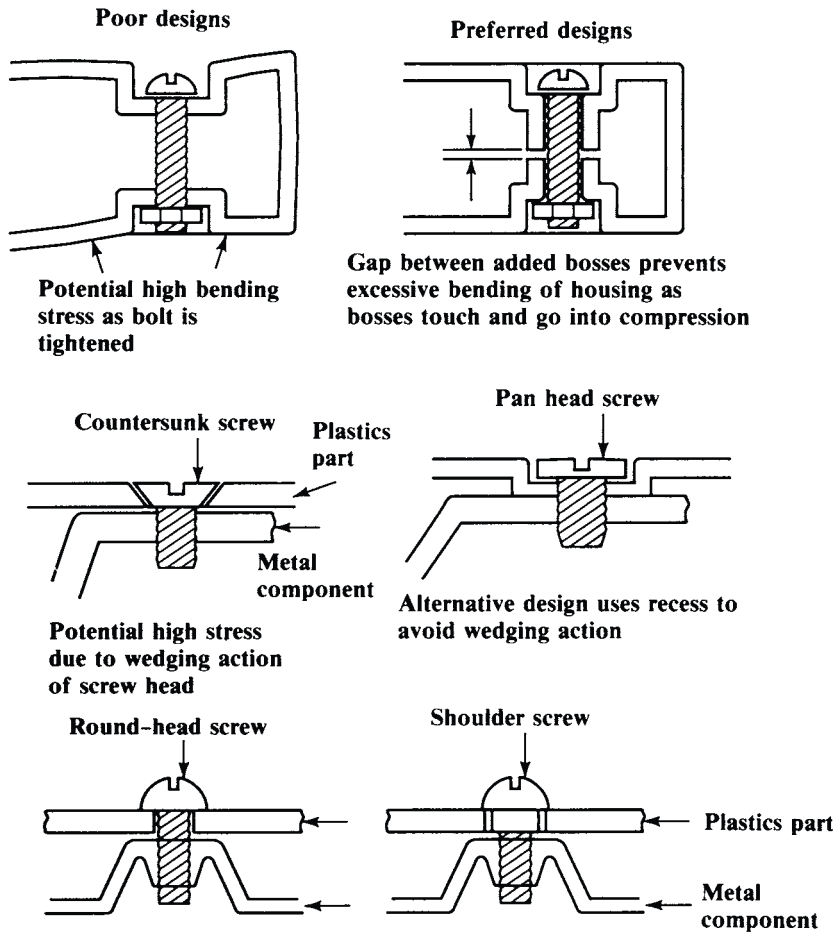


Fig. 26. Examples of Bad and Good Designs in Assembling Plastics with Metal Fasteners

held and supported firmly to prevent distortion, and sharp tools are essential to minimize normal forces.

Plastics recover elastically during and after machining so that drilled or tapped holes often end up tapered or of smaller diameter than the tool. Turned diameters also can end up larger or smaller than the dimensions measured immediately after the finishing cut. The low thermal conductivity of plastics causes most of the heat generated in cutting to be absorbed by the tool. Heat in the plastics tends to stay at the surface. The heat must be removed by an air blast or a liquid coolant for reliable results in machining.

Plastics have thermal expansion coefficients some 10 times higher than those of metals so that even though actual heat generation during machining may be less than with metals there can easily be more expansion. Adequate tool clearances must be provided to minimize heating. Compared with most structural metals, temperatures at which plastics soften, deform and degrade are quite low. Allowing frictional heat to build up causes gumming, discoloration, poor tolerance control, and rough finishes. These effects are more pronounced with plastics such as polystyrene and polyvinyl chloride that have low melting points than with plastics that have higher melting points, such as nylons, fluoroplastics, and polyphenylene sulfide. Sufficient clearances must be provided on cutting tools to prevent rubbing contact between the tool and the work. Tool surfaces that will come into con-

tact with plastics during machining should be polished to reduce frictional drag and resulting temperature increases. Proper rake angles depend on depth of cut, cutting speed, and the type of plastic being cut. Large rake angles should be used to produce continuous-type cuttings, but they should not be so large as to cause brittle fracture of the work and resulting discontinuous chips.

Turning and Cutting Off: High speed steel and carbide tools are commonly used with cutting speeds of 200-500 and 500-800 ft/min (61-152 and 152-244 m/min), respectively. Water-soluble coolants can be used to keep down temperatures at the shear zone and improve the finish, except when they react with the work material. Chatter may result from the low modulus of elasticity and can be reduced by close chucking and follow rests. Box tools are good for long, thin parts. Tools for cutting off plastics require greater front and side clearances than are needed for metal. Cutting speeds should be about half those used for turning operations.

Drilling: This is the most common machining operation because small-diameter holes are more easily drilled than molded. However, plastics are rather difficult to drill without some damage. Many difficulties not encountered in drilling metals, such as gumming, burning in the drilled hole, cracks around the edges or growth of cracks after drilling, can occur. Two reasons for these difficulties are: swarf flow (chip removal) in drilling is poor, and cutting speeds vary from the center to the periphery of the drill, so that drilling imposes severe loading on the workpiece. Some drill types used with plastics are shown in Fig. 27.

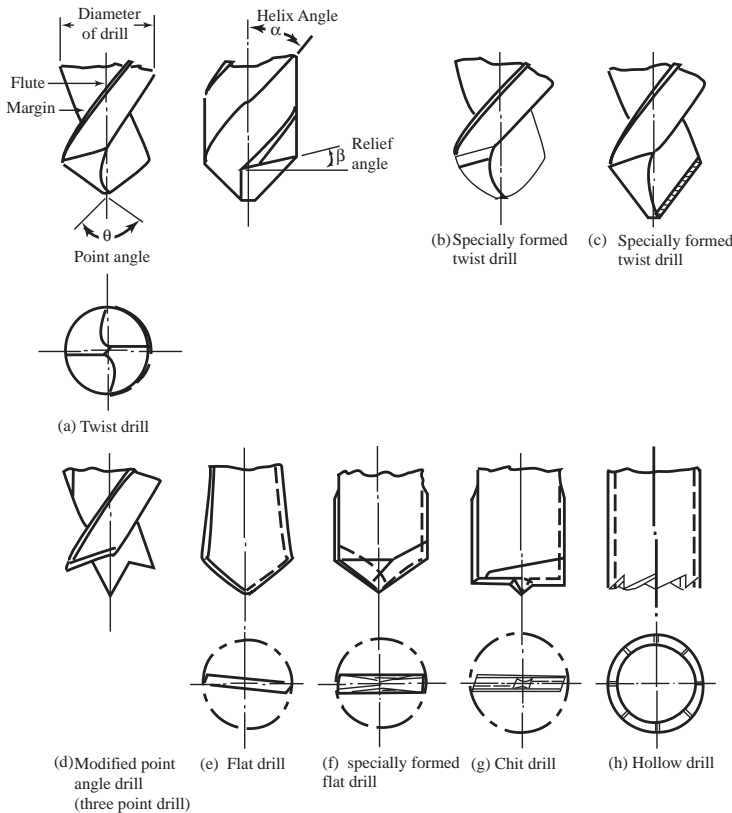


Fig. 27. Drill Designs Used for Drilling Plastics

Drills of high-speed steel or premium high-speed steel (T15, M33, or M41-M47) are recommended, with low helix angles, point angles of 70–120 degrees, and wide, highly polished flutes to ease chip exit. Normal feed rates are in the range of 0.001–0.012 in/rev (0.025–0.3 mm/rev) for holes of 1/16 to 2 inch (1.6–51 mm) diameter, and speeds of 100–

250 ft/min (30.5–76.2 m/min), and with lower speeds used for deep and blind holes. Point angles of 60 to 90 degrees (included) are used for many plastics, but an angle of 120 degrees should be used for rigid polyvinyl chloride and acrylic (polymethyl methacrylate).

Clearance angles of 9 to 15 degrees are usually sufficient to prevent the drill flanks from rubbing in the bottom of the hole, but acrylic materials require angles of 12–20 degrees. Tests may be needed to determine the drill diameter for accurately sized holes, allowing for thermal expansion and elastic recovery. Reaming may be used to size holes accurately, but even those diameters produced may also be affected by thermal expansion of the plastics. Close-fitting bushings in drill jigs may increase friction on the drill and cause swarf to plug up the drill flutes. For positioning accuracy, removable templates may be used to spot the hole position, then set aside for the drilling to be completed. Pilot holes are not necessary, except when the hole is to be reamed or counterbored. Frequent pull-out (peck drilling) to remove chips and compressed air cooling may be needed, especially for deep holes.

Drilling and reaming speed and feed suggestions for various materials are shown in Table 8. These speeds and feeds can be increased where there is no melting, burning, discoloration, or poor surface finish. Drilling is best done with commercially available drills designed for plastics (Fig. 27), usually having large helix angles, narrow lands, and highly polished or chromium-plated flutes to expel swarf rapidly and minimize frictional heating. Circle cutters are often preferred for holes in thin materials. Drills must be kept sharp and cool, and carbide tools may be needed in high production, especially with glass-reinforced materials. They must be cooled with clean compressed air to avoid contamination. Aqueous solutions are used for deep drilling because metal cutting fluids and oils may degrade or attack the plastics and may cause a cleaning problem. Plastics parts must be held firmly during drilling to counter the tendency for the tooling to grab and spin the work.

Table 8. Speeds and Feeds for Drilling Holes of 0.25 to 0.375 inch (6.3–9.5 mm) Diameter in Various Thermoplastics

Material	Speed (rpm)	Feed ^a	Comments
Polyethylene	1,000–2,000	H	Easy to machine
Polyvinyl chloride	1,000–2,000	M	Tends to become gummy
Acrylic	500–1,500	M-H	Easy to drill with lubricant
Polystyrene	500–1,500	H	Must have coolant
ABS	500–1,000	M-H	
Polytetrafluoroethylene	1,000	L-M	Easy to drill
Nylon 6/6	1,000	H	Easy to drill
Polycarbonate	500–1,500	M-H	Easy to drill, some gumming
Acetal	1,000–2,000	H	Easy to drill
Polypropylene	1,000–2,000	H	Easy to drill
Polyester	1,000–1,500	H	Easy to drill

^aH = high; M = medium; L = low.

Tapping and Threading of Plastics: Many different threaded fasteners can be used with plastics, including thread-tapping and -forming screws, threaded metal inserts, and molded-in threads, but threads must sometimes be machined after molding. For tapping of through-holes in thin cast, molded, or extruded thermoplastics and thermosets, a speed of 50 ft/min (15.2 m/min) is appropriate. Tapping of filled materials is done at 25 ft/min (7.6 m/min). These speeds should be reduced for deep or blind holes and when the percentage of thread is greater than 65–75 per cent. Taps should be of M10, M7, or M1, molybdenum high-speed steel, with finish-ground and -polished flutes. Two-flute taps are recommended for holes up to 0.125 inch (3.2 mm) diameter. Oversize taps may be required to

make up for elastic recovery of the plastics. The danger of retapping on the return stroke can be reduced by blunting the withdrawal edges of the tool.

Sawing Thermoset Cast or Molded Plastics: Circular or band saws may be used for sawing. Circular saws provide smoother cut faces than band saws, but band saws run cooler so are often preferred even for straight cuts. Projection of the circular saw above the table should be minimized. Saws should have skip teeth or buttress teeth with zero front rake and a raker set. Precision-tooth saw blades should be used for thicknesses up to 1 inch (25.4 mm), and saws with buttress teeth are recommended for thicknesses above 1 inch (25.4 mm). Dull edges to the teeth cause chipping of the plastics and may cause breakage of the saw. Sawing speeds and other recommendations for using blades of high-carbon steel are shown in Table 9.

Table 9. Speeds and Numbers of Teeth for Sawing Plastics Materials with High-Carbon Steel Saw Blades

Material Thickness		Number of Teeth on Blade	Peripheral Speed			
			Thermoset Cast or Molded Plastics		Thermoplastics (and Epoxy, Melamine, Phenolic and Allyl Thermosets)	
(inch)	(mm)		(ft/min)	(m/min)	(ft/min)	(m/min)
0–0.5	0–13	8–14	2000–3000	607–914	4000–5000	1219–1524
0.5–1	13–25	6–8	1800–2200	549–671	3500–4300	1067–1311
1–3	25–76	3	1500–2200	475–671	3000–3500	914–1067
>3	>76	>3	1200–1800	366–549	2500–3000	762–914

Milling of Plastics: Peripheral cutting with end mills is used for edge preparation, slotting and similar milling operations, and end cutting can also be used for facing operations. Speeds for milling range from 800 to 1400 ft/min (244–427 m/min) for peripheral end milling of many thermoplastics and from 400 to 800 ft/min (122–244 m/min) for many thermosets. However, slower speeds are generally used for other milling operations, with some thermoplastics being machined at 300–500 ft/min (91–152 m/min), and some thermosets at 150–300 ft/min (46–91 m/min). Adequate support and suitable feed rates are very important. A table feed that is too low will generate excessive heat and cause surface cracks, loss of dimensional accuracy, and poor surface finish. Too high a feed rate will produce a rough surface. High-speed steel tools (M2, M3, M7, or T15) are generally used, but for glass-reinforced nylon, silicone, polyimide, and allyl, carbide (C2) is recommended.

Other Machining Techniques: Lasers can be used for machining plastics, especially sheet laminates, although their use may generate internal stresses. Ultrasonic machining has no thermal, chemical, or electrical reaction with the workpiece and can produce holes down to 0.003-inch (0.0762 mm) diameter; tight tolerances, 0.0005 inch (0.0127 mm); and very smooth finishes, 0.15 μ inch (0.381 μ m) with No. 600 boron carbide abrasive powder. Water-jet cutting using pressures up to 60,000 lb/inch² (414 N/mm²) is widely used for plastics and does not introduce stresses into the material. Tolerances of \pm 0.004 inch (\pm 0.102 mm) can be held, depending on the equipment available. Process variables, pressures, feed rates, and the nozzle diameter depend on the material being cut. This method does not work with hollow parts unless they can be filled with a solid core.

Machining Hard Rubber: Hard rubber, or ebonite, is the oldest rigid manmade plastic, and has been used since the 1840s. The base material is a highly vulcanized natural or, today, synthetic rubber, empirical formula C5H8S, containing 32 per cent sulfur. A range of compositions containing various amounts of fillers is available. Unfilled ebonite has a specific gravity = 1.18, tensile strength = 9,000 psi (62 N/mm²), elongation = 3 per cent, and Izod impact strength = 0.5 ft-lb_p/in (26.7 J/m) of notch. Its continued use is due to its good insulating characteristics, good chemical resistance, and ease of machining. Tools suitable for steel, high-speed steel, or tungsten carbide may be used with hard rubber with no top or side rake angles and 10 to 20 degrees clearance angles.

Without coolant, surface speeds of 200 ft/min (60 m/min) are recommended for turning, boring and facing; they may be increased to 300 surface ft/min (90 m/min) with coolant.

Drilling of hard rubber requires high-speed steel drills of 35 to 40 degrees helix angle to obtain maximum cutting speeds and drill life. Feed rates for drilling range up to 0.015 in/rev (0.38 mm/rev). Deep-fluted taps are best for threading hard rubber and should be 0.002 to 0.005 inch (0.05-0.13 mm) oversize if close tolerances are to be held. Machine oil is used as the lubricant. Hard rubber may be sawed with band saws having 5 to 10 teeth per inch, running at about 3000 ft/min (915 m/min), or it may be cut with abrasive wheels. Use of coolant in grinding ebonite gives a smoother finish.

Piercing and blanking of hard-rubber sheet is best performed with the rubber and dies warmed. Straightening of the often-distorted blanks may be accomplished by dropping them into a pan of hot water.

Development of Plastics Prototypes.—Model prototypes are made for testing of properties, such as stress and fatigue resistance to find ways to improve quality and reliability, to improve tooling design, and to reduce time to market. Prototyping may answer questions about finish, sink marks that result from contraction, witness lines from mold joints, ejector pin marks, knit or weld lines, texturing, moldability, shrinkage, mechanical strength, insert pull-out resistance electrical properties, and problems of mating with other parts.

Prototypes of moldings are made in five major steps including design; refining the design; making a model (physical or computer); making a mold; and producing parts. The model may be made from wood, plaster, plastics (by machining), or metal. Some 90 per cent of prototypes are made by CAD/CAM methods that allow holding of dimensional tolerances to 2-3 per cent of drawing specifications.

Prototypes can also be made by a process called *stereolithography* which uses a tank of photosensitive liquid polymer, an *x-y* scanning, ultraviolet laser with a beam diameter of 0.010 inch (0.254 mm), a *z*-axis elevator platform, and a controlling computer. The platform height is adjusted so that a suitable thickness of liquid polymer covers its surface. The laser beam is focused on the liquid surface and hardens the polymer at this point by heating.

The CAD representation of the prototype is described by a model in which thin 0.005-0.020 inch (0.13-0.51 mm) cross-sections can be isolated. Data representing the lowest level of the prototype are used to move the platform so that a layer of the polymer corresponding to the lowest "slice" is hardened. The platform is then lowered, the liquid polymer flows over the hardened layer, and the platform is again raised, less an amount equal to the next "slice." The process is repeated for successive "slices" of the prototype, which is thus built up gradually to form a hollow, three-dimensional shape corresponding to the model in the CAD program. The part thus produced is fairly brittle but can be used for visual examination, design verification, and marketing evaluation, and can be replicated from other materials such as plastics or metals by casting or other methods.

Finishing and Decorating methods used for plastics parts include spray painting, vacuum metallizing, hot stamping, silk screening, and plating. Conductive coatings may be applied to inside surfaces, usually by flame- or arc-spraying, to dissipate static electricity and provide electromagnetic shielding. Thorough cleaning is essential. Materials such as polyethylene, polypropylene, and acetal have waxlike surfaces that may not be painted easily or may need pretreatment or special primers. Many amorphous plastics are easy to paint. Suitable coatings include polyurethane-, epoxy-, acrylic-, alkyd-, and vinyl-based paints. Oven curing must be carried out at temperatures well below the deflection temperatures of the plastics in order to avoid distortion of parts. See *Deflection Temperature Under Load (DTUL)* on page 570.

Vacuum Metallizing and Sputter Coating require application of a special base lacquer and protective clear top coat before and after treatment. Resistance heating or an electron beam can be used to melt the coating metals such as aluminum, silver, copper, and gold, which usually are pure elements. Wires of the coating metal are hung from tungsten heat-

ing elements in an array that gives them direct views of the surfaces to be coated. Sputter plating uses a plasma to produce the metallic vapor, also requires line-of-sight setup, and can use brass as well as the other metals mentioned. The appearance of gold or brass is often simulated with vacuum-metallized aluminum by tinting the overcoating lacquer. Chromium plating requires etched surfaces to ensure good adhesion.

Polishing: Plastics may be polished by buffing methods similar to those used on metals, but experiments to determine the effect of frictional heat are recommended. Surfaces can be heated to 300-400°F (150-205°C) by buffing, and some plastics soften and melt at these temperatures. Heating sometimes causes plastics to give off toxic gases, so masks should be worn to filter out such gases and dust. Parting lines, imperfections, scratches, saw lines, and scars resulting from fabrication can be treated with abrasives prior to buffing. Wet or dry abrasives such as silicon carbide or aluminum oxide are generally used in grain sizes of 60 to as fine as 320. Some buffing compounds are ineffective on plastics. Scratch lines should be presented at a slight angle to the buff surface for best results. Light, tallow-free grease will help keep the abrasive surface free from buildup, and speeds of 5,000 to 6,000 surface feet per minute (1525-1830 m/min) are recommended.

For low-melting point plastics, soft cotton buffs are best, with surface speeds of 4,000 to 5,000 feet per minute (1220-1525 m/min) using a wet or greasy tripoli or silica compound. For finishing, rouge alone may be needed for a satisfactory finish. If a cleaning solvent is used it should be checked to see that it does not dissolve the plastics, and it should be used only in a well-ventilated area. Acrylics such as Acrylite or Plexiglass may also be “flame polished” under advice from the materials supplier.

Plastics Gearing.—Plastics gears may be cut from blanks, as are metal gears, or molded to shape in an injection-molding machine for lower production costs, though tooling may cost more. Cut plastics gears may be of similar design to their metal counterparts, but molded gears are usually of modified form to suit material characteristics. Plastics materials also may be preferred for gears because of superior sliding properties with reduced noise and less need for lubrication, chemical or electrical properties, or resistance to wear. However, plastics gear teeth slide more smoothly and easily against metal teeth than do plastics against plastics, and wear is less. For power transmission, plastics gear teeth are usually of involute form. See also *Non-metallic Gearing* on page 2245.

Most plastics gears are made from nylons and acetals, although acrylonitrile-butadiene-styrenes (ABS), polycarbonates, polysulfones, phenylene oxides, polyurethanes, and thermoplastic polyesters have also been used. Additives used in plastics for gears include glass and carbon fiber for added strength and stiffness, and fibers, beads, and powders for reduced thermal expansion and better dimensional stability. Other materials, such as molybdenum disulfide, polytetrafluoroethylene powder (PTFE), and silicones may be incorporated as integral lubricants to reduce friction and wear.

Choice of plastics gear material depends on requirements for size and nature of loads to be transmitted, designated speeds, required life, working environment, type of cooling, lubrication, and operating precision. Because of cost plastics gears are sometimes not enclosed in sealed housings, so are often given only a single coating of lubricant grease. Overloading of lubricated plastics gear teeth will usually cause tooth fracture, and unlubricated teeth often suffer excessive wear. Thermoplastics strength varies with temperature, with higher temperatures reducing root stress and permitting tooth deformation. In calculating power to be transmitted by spur, helical, and straight bevel gearing, the following formulas should be used with the factors given in [Tables 10, 11, and 12](#).

	US Customary Units		Metric Units
Internal and External Spur Gears	$HP = \frac{S_s F Y V}{55(600 + V) P C_s} \quad (33a)$	$KW = \frac{F Y m S_s V}{327(3.05 + V) C_s} \quad (33b)$	

$$\begin{array}{l}
 \text{Internal and} \\
 \text{External} \\
 \text{Helical Gears}
 \end{array}
 \begin{array}{l}
 \text{US Customary Units} \\
 HP = \frac{S_s F Y V}{423(78 + \sqrt{V}) P_n C_s} \quad (34a)
 \end{array}
 \begin{array}{l}
 \text{Metric Units} \\
 KW = \frac{F Y m S_s V}{179(5.56 + \sqrt{V}) C_s} \quad (34b)
 \end{array}$$

$$\begin{array}{l}
 \text{Straight Bevel} \\
 \text{Gears}
 \end{array}
 \begin{array}{l}
 HP = \frac{S_s F Y V (C - F)}{55(600 + V) P C C_s} \quad (35a)
 \end{array}
 \begin{array}{l}
 KW = \frac{F Y m S_s V (C - F)}{327(3.05 + V) C_s} \quad (35b)
 \end{array}$$

S_s = safe stress in bending (from Table 11); F = face width in inches (mm); Y = tooth form factor (from Table 10); m = module, mm; C = pitch cone distance in inches (mm); C_s = service factor (from Table 12); P = diametral pitch; P_n = normal diametral pitch; and V = velocity at pitch circle diameter in ft/min (m/s).

Table 10. Tooth Form Factors Y for Plastics Gears

Number of Teeth	14½-deg Involute or Cycloidal	20-deg Full Depth Involute	20-deg Stub Tooth Involute	20-deg Internal Full Depth	
				Pinion	Gear
12	0.210	0.245	0.311	0.327	...
13	0.220	0.261	0.324	0.327	...
14	0.226	0.276	0.339	0.330	...
15	0.236	0.289	0.348	0.330	...
16	0.242	0.259	0.361	0.333	...
17	0.251	0.302	0.367	0.342	...
18	0.261	0.308	0.377	0.349	...
19	0.273	0.314	0.386	0.358	...
20	0.283	0.320	0.393	0.364	...
21	0.289	0.327	0.399	0.371	...
22	0.292	0.330	0.405	0.374	...
24	0.298	0.336	0.415	0.383	...
26	0.307	0.346	0.424	0.393	...
28	0.314	0.352	0.430	0.399	0.691
30	0.320	0.358	0.437	0.405	0.679
34	0.327	0.371	0.446	0.415	0.660
38	0.336	0.383	0.456	0.424	0.644
43	0.346	0.396	0.462	0.430	0.628
50	0.352	0.480	0.474	0.437	0.613
60	0.358	0.421	0.484	0.446	0.597
75	0.364	0.434	0.496	0.452	0.581
100	0.371	0.446	0.506	0.462	0.565
150	0.377	0.459	0.518	0.468	0.550
300	0.383	0.471	0.534	0.478	0.534
Rack	0.390	0.484	0.550

These values assume a moderate temperature increase and some initial lubrication. With bevel gearing, divide the number of teeth by the cosine of the pitch angle and use the data in the table. For example, if a 20-deg PA bevel gear has 40 teeth and a pitch angle of 58 deg, 40 divided by the cosine of 58 deg = 40 ÷ 0.529919 ≈ 75, and $Y = 0.434$.

Table 11. Safe Bending Stress Values for Plastics Gears

Plastics Type	Safe Stress			
	Unfilled		Glass-filled	
	(lb/in ²)	(MPa)	(lb/in ²)	(MPa)
ABS	3,000	20.68	6,000	41.37
Acetal	5,000	34.47	7,000	48.26
Nylon	6,000	41.37	12,000	82.74
Polycarbonate	6,000	41.37	9,000	62.05
Polyester	3,500	24.13	8,000	55.16
Polyurethane	2,500	17.24

Table 12. Service Factors for Plastics Gears

Type of Load	8-10 hr/day	24 hr/day	Intermittent, 3 hr/day	Occasional, ½ hr/day
Steady	1.00	1.25	0.80	0.50
Light shock	1.25	1.5	1.00	0.80
Medium shock	1.5	1.75	1.25	1.00
Heavy shock	1.75	2.00	1.5	1.25

Example: As an example, assume that a material is to be selected for a spur gear that must transmit ½ hp at 350 rpm for 8 hrs/day under a steady load. The gear is to have 75 teeth, 32 diametral pitch, 20-deg pressure angle, 0.375-inch face width, and a pitch diameter of 2.3438 inches. Using Equation (33a),

$$HP = \frac{S_s FYV}{55(600 + V)PC_s} \quad \text{or} \quad S_s = \frac{55(600 + V)PC_s HP}{FYV}$$

$$HP = 0.125, \quad Y = 0.434 \quad \text{and}$$

$$V = \frac{rpm \times \pi \times D}{12} = \frac{350 \times 3.1416 \times 2.3438}{12} = 215 \text{ ft/min}$$

therefore,

$$S_s = \frac{55(600 + 215)32 \times 1.00 \times 0.125}{0.375 \times 0.434 \times 215} = 5,124 \text{ lb/in}^2$$

From Table 11 it is apparent that the gear could be molded from several materials. Available physical and chemical characteristics must now be considered in relation to the operating environment for the gear. Strengths of plastics materials decrease with increasing temperatures, and not all plastics resist the effects of some liquids, including some lubricants. Some plastics deteriorate when in sunlight for long periods; some are more dimensionally stable than others; and wear resistance varies from one to another. Manufacturers' data sheets will answer some of these questions.

Backlash: Plastics gears should be so dimensioned that they will provide sufficient backlash at the highest temperatures likely to be encountered in service. Dimensional allowances must also be made for gears made of hygroscopic plastics that may be exposed to damp service conditions. Teeth of heavily loaded gears usually have tip relief to reduce effects of deflection, and have full fillet radii to reduce stress concentrations. Such modifications to tooth form are also desirable in plastics gears. If the pinion in a pair of gears has a small number of teeth, undercutting may result. Undercutting weakens teeth, causes undue wear, and may affect continuity of action. The undercutting can be reduced by using the long-short addendum system, which involves increasing the addendum of the pinion

teeth and reducing that of the gear teeth. The modified addendum method will also reduce the amount of initial wear that takes place during initial stages of contact between the teeth.

Accuracy: The Gear Handbook, AGMA 390-03a-1980, Part 2, Gear Classification, provides a system whereby results of gear accuracy measurements are expressed in terms of maximum tooth-to-tooth and composite tolerances. This system uses AGMA quality numbers related to maximum tolerances, by pitch and diameter, and is equally applicable to plastics gears as to metal gears. AGMA quality numbers must be chosen for a pair of mating gears early in the design process, and the finished gears must be inspected by being run in close mesh with a master gear in a center-distance measuring instrument to make sure that the errors do not exceed the specified tolerances.

To prevent failure from fatigue and wear caused by excessive flexing of the teeth, plastics gears must be made to the same standards of accuracy as metal gears. Solidification shrinkage of plastics requires that dimensions of molds for gears be larger than the dimensions of the parts to be produced from them. The amount of the shrinkage is usually added to the mold dimension (with the mold at operating temperature). However, this procedure cannot be followed for the tooth profile as it would introduce large errors in the pressure angle. Increases in pressure angle cause gear teeth to become wider at the root and more pointed. Sliding conditions are improved and the teeth are stronger, so that higher loading values can be used.

Shrinkage allowances have the greatest effect on the accuracy of the molded gears, so tooth profiles must be calculated extremely carefully in terms of mold profile. If a tooth is merely made larger by using a standard hobbing cutter to cut the tool, whereby the teeth in the mold are electroeroded, differential shrinkage caused by the molded tooth being thicker at the root than at the tip will distort the shape of the molded tooth, making it thinner at the tip and thicker at the root. With two mating gears these faulty shapes will affect the pressure angle resulting in binding, wear, and general malfunction. If the tooth thickness limits for a molded gear are to be held to +0.000 inch, -0.001 inch (-0.025 mm), the outside diameter must be permitted to vary up to 0.0027 inch (0.069 mm) for 20-deg and 0.0039 inch (0.099 mm) for 14½-deg pressure angle gears. All high-accuracy gears should be specified with AGMA quality numbers and inspected with center-distance measuring machines if the required accuracy is to be achieved.

Bakelite.—Phenolic resinoid plastics (commonly designated by the trade name “Bakelite”) were invented in 1907 by Dr. L. H. Baekeland. Like most products of creative chemistry, phenol resinoid bears no resemblance to the raw materials from which it is made. Principal among these raw materials are phenol or “carbolic acid,” a white crystalline solid, and formaldehyde, a gas, which when dissolved in water is commonly known as formalin. Both are highly reactive substances. Under certain definite, controlled conditions they may be caused to combine chemically, forming a distinctly new and highly useful product, a product which is resin-like but superior in its properties to any natural resin. In its raw, or primary state, phenol resinoid is quickly softened by moderate heat, and is soluble in certain solvents, notably alcohol. Further heating, however, causes it to harden, after which it cannot again be softened at any temperature. Furthermore, the solvents which served to dissolve it in its primary state now have little or no effect on it. This property of being first fusible and soluble, and then, under the influence of heat, becoming infusible and insoluble—of becoming, in fact, a material of pronounced hardness, strength, and resistance to deteriorating agents generally, has made phenol resinoid outstanding among organic plastic materials. It is called a resinoid to distinguish it from natural resinous substances. Bakelite plastics may be classified generally in the following groups: molding materials, coating materials, impregnating materials, cements, bonding resins, cast resinoids, resinoid varnishes for the production of laminated materials.

TABLE OF CONTENTS
DIMENSIONING, GAGING, AND MEASURING

<p style="text-align: center;">DRAFTING PRACTICES</p> <p>609 ANSI and ISO Drafting Practices</p> <p>609 Sizes of Drawing Sheets</p> <p>609 Line Conventions and Drawings</p> <p>611 Symbols for Section Lining</p> <p>612 ANSI and ISO Symbols</p> <p>613 Surface Texture Symbols</p> <p>613 GD&T</p> <p>615 Y14.5 and ISO Drafting Definitions</p> <p>619 Datum Referencing</p> <p>620 Positional Tolerance</p> <p>623 GD&T and CAD Models</p> <p>624 Digital Product Definitions</p> <p>625 Checking Designs and Drawings</p> <p>625 Design Parameters</p>	<p style="text-align: center;">MEASURING, INSTRUMENTS, AND INSPECTION METHODS</p> <p>675 Verniers and Micrometers</p> <p>678 Sine-bar</p> <p>680 Using Sine-bar Tables</p> <p>681 Measuring Tapers with V-block</p> <p>681 Dimensioning Tapers</p> <p>682 Angles and Tapers</p> <p>682 Measuring Dovetail Slides</p> <p>683 Taper per Foot</p> <p>684 Figuring Tapers</p> <p>686 Measurement over Pins and Rolls</p> <p>686 Checking a V-shaped Groove</p> <p>687 Checking Radius of Arc</p> <p>688 Checking Shaft Conditions</p> <p>692 Coordinates for Hole Circles</p> <p>694 Adapting Equations to Geometry</p> <p>695 Lengths of Chords</p> <p>696 Hole Coordinate Tables</p> <p>705 Gage Blocks</p> <p>707 Gage Block Sets</p> <p>708 Surface Plates</p> <p>708 Materials and Grades</p> <p>711 Calibration of Surface Plates</p> <p>716 Parallel Bars</p> <p>720 Calibration</p> <p>723 Right Angle Plates</p> <p>723 Grades</p> <p>726 Types</p> <p>728 Calibration and Maintenance</p> <p>731 Measurements Using Light</p> <p>732 Interferometer</p>
<p style="text-align: center;">ALLOWANCES AND TOLERANCES FOR FITS</p> <p>628 Basic Size</p> <p>628 Tolerances</p> <p>630 Force fits</p> <p>631 Expansion and Shrinkage Fits</p> <p>632 Temperatures for Shrinkage Fits</p> <p>634 ANSI Standard Limits and Fits</p> <p>634 Definitions</p> <p>635 Preferred Basic Sizes</p> <p>635 Standard Tolerances</p> <p>635 ANSI Standard Fits</p> <p>639 Modified Standard Fits</p> <p>641 Running and Sliding Fits</p> <p>643 Clearance Locational Fits</p> <p>645 Transition Locational Fits</p> <p>648 ANSI Metric Limits and Fits</p> <p>648 Definitions</p> <p>649 Tolerances Designation</p> <p>650 Preferred Metric Fits</p> <p>653 Hole Basis Fits</p> <p>653 Clearance Fits</p> <p>655 Transition and Interference Fits</p> <p>657 Shaft Basis Fits</p> <p>657 Clearance Fits</p> <p>659 Transition and Interference Fits</p> <p>661 Gagemakers Tolerances</p> <p>662 ISO Metric Limits and Fits</p> <p>663 Definitions</p> <p>663 Calculated Limits of Tolerance</p> <p>666 Selected Fits</p> <p>668 Deviations for Shafts and Holes</p> <p>672 Preferred Numbers and Sizes</p>	<p style="text-align: center;">SURFACE TEXTURE</p> <p>733 ANSI Surface Texture</p> <p>736 Sampling Lengths</p> <p>737 Roughness Parameters</p> <p>738 Waviness Parameters</p> <p>739 Instruments for Measurement</p> <p>740 Roughness Measurements</p> <p>740 Surface Texture Symbols</p> <p>743 Roughness Average Values</p> <p>744 Lay Symbols</p> <p>744 Surface Texture of Castings</p> <p>747 ISO Surface Finish Standards</p> <p>747 Surface Finish Symbolology</p> <p>750 ISO Profiles</p>

DRAFTING PRACTICES

While there are many national standards-based drafting practices throughout the world, three sets of standards practices predominate internationally. These sets of practice include: the American National Standards Institute (ANSI); those modeled on standards developed by the International Organization for Standardization (ISO); and to a lesser extent, those based on Japanese Industry Standards (JIS). However since JIS has committed to adopting ISO practices, coverage will be limited to ANSI practice and select ISO practices where appropriate. In general, there are several ANSI Standards for use in preparing engineering drawings and related documents.

ANSI and ISO Drafting Practices

Sizes of Drawing Sheets.—Recommended trimmed sheet sizes are shown in [Table 1](#). Customary inch sizes are documented in American National Standard ASME Y14.1-2005 and are based on commercial letterhead paper (8 × 11) and are in general use throughout the United States. Each successive size beginning with 8 × 11 in. (A), is double the size of the previous (except size F). Using sizes based on commercial letterhead paper size, and its multiples, permits filing small prints and folded larger prints in the same commercial standard letter files. For drawings requiring trimmed metric sheets, sizes are based on ASME Y14.1M-2005 in the United States and ISO 5457 outside of the U.S. Metric sizes are harmonized across the U.S. and the ISO standards. As with the customary inch sheet sizes, each successive metric size sheet beginning with commercial letterhead paper size A4, is double the previous size also for ease of folding and filing.

Metric sizes are based on the width-to-length ratio of 1 to $\sqrt{2}$. Note that the metric size designators increase as the paper decreases in area. Virtually all CAD systems include both inch and metric size paper templates. Most countries outside of the United States use metric paper sizes, so for foreign correspondence it is recommended that the metric sheet sizes be used. For additional sizes and details see the respective standards.

Table 1. Drawing Sheet Sizes

U.S. Customary Size, inches (ASME Y14.1-2005)			Metric Size, millimeters (ASME Y14.1M-2005)				
A	8½ × 11	D	22 × 34	A4	210 × 297	A1	594 × 841
B	11 × 17	E	34 × 44	A3	297 × 420	A0	841 × 1189
C	17 × 22	F	28 × 40	A2	420 × 594		

Line Conventions and Drawings.—American National Standard ANSI/ASME Y14.2M establishes line and lettering practices for engineering drawings. The line conventions and the symbols for section lining are as shown on pages [Table 2](#) and [Table 3](#).

Approximate width of THICK lines for metric drawings are 0.6 mm, and for inch drawings, 0.032 inch. Approximate width of THIN lines for metric drawings are 0.3 mm, and for inch drawings, 0.016 inch. These approximate line widths are intended to differentiate between THICK and THIN lines and are not values influencing acceptance or rejection of drawings. Basic line conventions in ISO are established in ISO 128-20: 1996. Lines intended to comply with ISO standards use widths of: 0.13 mm, 0.18 mm, 0.25 mm, 0.35 mm, 0.5 mm, 0.7 mm, 1 mm, 1.4 mm and 2 mm, but again may deviate as long as lines are consistent in width and it is possible to differentiate “unambiguously” between two adjacent lines with different widths.

Table 2. American National Standard for Engineering Drawings
ANSI/ASME Y14.2M-1992 (R2008)





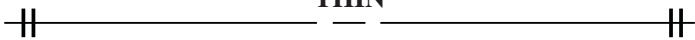
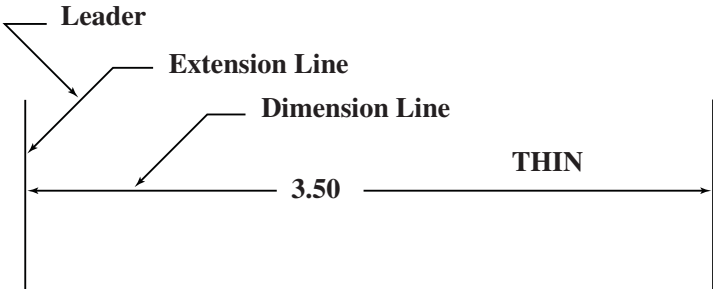








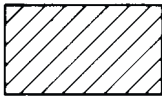
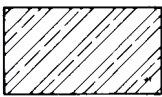
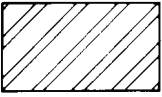
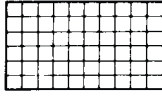
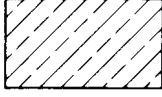
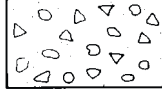

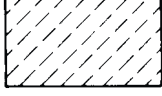


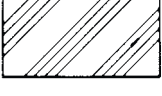




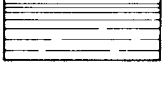
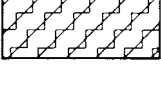
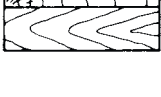
Visible Line	THICK 
Hidden Line	THIN 
Section Line	THIN 
Center Line	THIN 
Symmetry Line	THIN 
Dimension Line Extension Line and Leader	
Cutting-Plane Line or Viewing-Plane Line	THICK  THICK 
Break Line	THICK  Short Breaks THIN  Long Breaks
Phantom Line	THIN 
Stitch Line	THIN  THIN 
Chain Line	THICK 

Table 3. American National Standard Symbols for Section Lining
ANSI Y14.2M-1979 (R1987)^a

	Cast and Malleable iron (Also for general use of all materials)		Titanium and refractory material
	Steel		Electric windings, electromagnets, resistance, etc.
	Bronze, brass, copper, and compositions		Concrete
	White metal, zinc, lead, babbitt, and alloys		Marble, slate, glass, porcelain, etc.
	Magnesium, aluminum, and aluminum alloys		Earth
	Rubber, plastic electrical insulation		Rock
	Cork, felt, fabric, leather, fiber		Sand
	Sound insulation		Water and other liquids
	Thermal insulation		Wood-across grain Wood-with grain

^aThis table has been removed from the current version of standard and is retained here for reference.

Table 4. Comparison of ANSI and ISO Geometric Symbols ASME Y14.5-2009

Symbol for	ASME Y14.5	ISO	Symbol for	ANSI Y14.5	ISO	Symbol for	ASME Y14.5M	ISO
Straightness			Circular Runout (arrowheads may be filled or not)			Feature Control Frame		
Flatness			Total Runout (arrowheads may be filled or not)			Datum Feature (triangle may be filled or not)		
Circularity			At Maximum Material Condition At Maximum Material Boundary ^a			All Around - Profile		
						All Over - Profile		NONE
Cylindricity			At Least Material Condition At Maximum Material Boundary ^a			Conical Taper		
Profile of a Line			Regardless of Feature Size	NONE	NONE	Slope		
Profile of a Surface			Projected Tolerance Zone			Counterbore		NONE
						Spotface		NONE
Angularity			Diameter			Countersink		NONE
Perpendicularity			Basic Dimension			Depth/Deep		NONE
Parallelism			Reference Dimension			Square (Shape)		
Position			Datum Target			Dimension Not to Scale		
Concentricity Coaxiality			Target Point			Number of Times/Places		
Symmetry			Dimension Origin			Arc Length		
Radius	R	R	Spherical Radius	SR	SR	Spherical Diameter	S∅	S∅
Between (filled or not filled)			Controlled Radius	CR	NONE	Statistical Tolerance		NONE
						Continuous Feature		NONE

Symbols of additional tolerance modifiers are shown in Fig. 12, page 621.

^aThe ISO system does not include a symbol for Maximum Material Boundary or for Least Material Boundary.

Surface Texture Symbols.—A detailed explanation of the use of surface-texture symbols from American National Standard ANSI/ASME Y14.36M begins on page 740 while ISO surface-texture techniques, standardized in ISO 1302, are explained beginning on page 747.

Geometric Dimensioning and Tolerancing (GD&T).—ANSI/ASME Y14.5-2009 “Dimensioning and Tolerancing”, covers dimensioning, tolerancing, and similar practices for engineering drawings and related documentation. The mathematical definitions of dimensioning and tolerancing principles are given in the standard ANSI/ASME Y14.5.1M-1994 (R2004). ISO standards ISO 8015, ISO 1101 and ISO 26921 contain a detailed explanation of ISO geometric dimensioning and tolerancing practices. Those ISO practices involving GD&T and other selected ISO standard practices are shown in contrast to ANSI practices where applicable.

Geometric dimensioning and tolerancing provides a comprehensive system for symbolically defining the geometrical tolerance zone within which features must be contained. It provides an accurate transmission of design specifications among the three primary users of engineering drawings; design, manufacturing, and quality assurance groups. Some techniques introduced in ASME Y14.5-2009 have been accepted by ISO. These techniques include projected tolerance zone, the three-plane datum concept, total runout tolerance, multiple datums, and datum targets. Although Y14.5 follows ISO practice closely, there are still differences between ISO and U.S. practice. (A comparison of symbols used in ISO standards and Y14.5 is given in Table 4.)

One major area of disagreement is the ISO “principle of independency” versus the “Taylor principle.” Y14.5 and standard U.S. practice both follow the Taylor principle, in which a geometric tolerancing zone may not extend beyond the boundary (or envelope) of perfect form at MMC (maximum material condition). This boundary is prescribed to control variations as well as the size of individual features. The U.S. definition of independency further defines features of size as being independent and not required to maintain a perfect relationship with other features. The “envelope principle” is optional in treatment of these principles. A summary of the application of ASME geometric control symbols and their use with basic dimensions and modifiers is given in Table 5.

ASME Y14.5 features metric SI units (the International System of Units), but customary units may be used without violating any principles. On drawings where all dimensions are either in millimeters or in inches, individual identification of linear units is not required. However, the drawing should contain a note stating “*Unless otherwise specified, all dimensions are in millimeters*” (or *in inches*, as applicable). According to Y14.5, all dimensions are applicable at a temperature of 20°C (68°F) unless otherwise specified. Compensation may be made for measurements taken at other temperatures.

Angular units are expressed in degrees and decimals of a degree (35.4) or in degrees (°), minutes (′), and seconds (″), as in 35° 25′ 10″. Where decimal degrees less than one are specified, a zero shall precede the decimal value. A 90-degree angle is implied where center lines and depicting features are shown on a drawing at right angles and no angle is specified. A 90-degree BASIC angle applies where center lines of features in a pattern or surface shown at right angles on a drawing are located or defined by basic dimensions and no angle is specified.

Basic to all U.S. practice is that orthographic drawing views are arranged in 3rd angle projection while Europe and Asia generally follow ISO practices which default to 1st angle projection. In 1st angle projection the orientation of the views is reversed from U.S. practice. See Fig. 1a for 3rd angle projection and Fig. 1b for 1st angle projection. Note the graphical symbol at the bottom of each which indicates projection system in use for the drawing. Both ANSI and ISO practice allow the other projection system, but the use of non-default practice must be declared by use of the graphical symbol.

Table 5. ASME Y14.5 Geometric Control Symbols

Type ^a	Geometric Characteristics		Pertains To	Basic Dimensions	Feature Modifier	Datum Modifier
Form		Straightness	Only individual feature	Not applicable	See Table Note 1	No datum
		Circularity				
		Flatness				
		Cylindricity				
Profile		Profile (Line)	Individual or related	Yes if related	Modifier not applicable	See Table Note 1
		Profile (Surface)				
Orientation		Angularity	Always related feature(s)	Yes	See Table Note 1	See Table Note 1
		Perpendicularity		Not applicable		
		Parallelism		Yes		
Location		Position	Always related feature(s)	Yes	Only RFS	See Table Note 1
		Concentricity				
		Symmetry				
Runout		Circular Runout	Always related feature(s)	Not applicable	Only RFS	See Table Note 1
		Total Runout ^b				

Note 1: Default RFS unless MMC or LMC explicitly stated.

^a Five types of geometric control, when datums are indicated, when basic dimensions are required, and when MMC and LMC modifiers may be used.

^b Arrowheads may be filled in.

ANSI and ISO Orthographic Projections

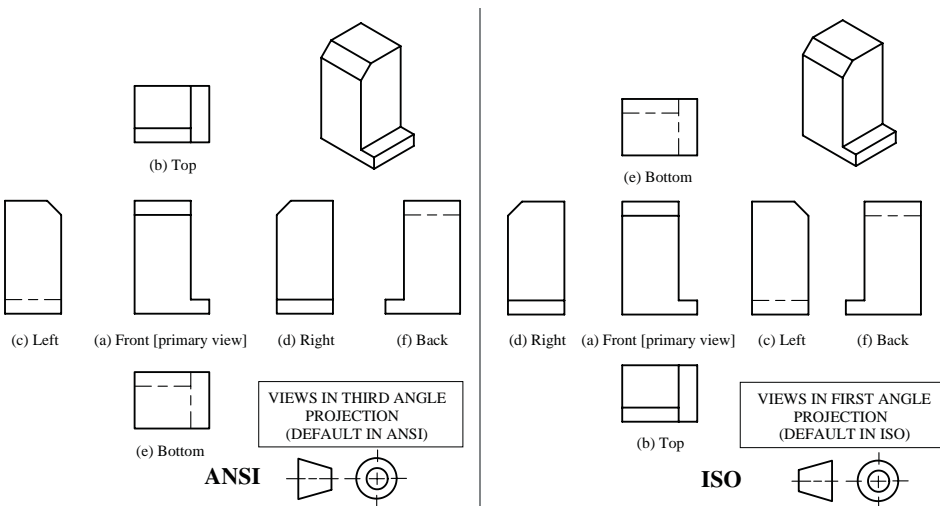


Fig. 1a. ANSI - Orthographic Projection Following Third Angle Projection.

Fig. 1b. ISO - Orthographic Projection Following First Angle Projection.

U.S. ASME Y14.5-2009 and ISO practice use a preceding 0 before millimeter dimension values less than 1. Unlike, U.S. practice, ISO requires a comma as a decimal placeholder where U.S. practice would use a decimal point, Figs. 2a and 2c. For decimal inch dimensioning, a zero is NOT used before the decimal for values less than 1 inch, Fig. 2b.



Fig. 2a. US Practice,
Metric Dimensions



Fig. 2b. US Practice,
Inch Dimensions



Fig. 2c. ISO Practice

When dimensioning per U.S. default practice, unless otherwise specified, dimension lines are broken and dimension text remains horizontal, hence read from the bottom of the drawing, see Fig. 3a. ISO dimensioning practices default to aligned text with dimensions placed above an unbroken dimension line, see Fig. 3b.

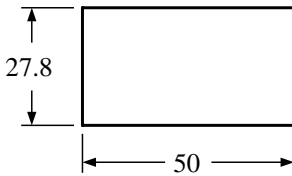


Fig. 3a. Default U.S. Practice.

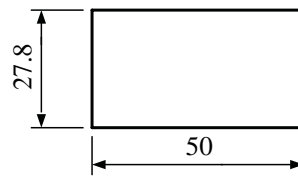


Fig. 3b. Default ISO Practice.

Y14.5 and ISO Drafting Definitions

Definitions.—The following terms are defined as their use applies to ASME Y14.5. Where ISO practice in actual use differs the definitions are expanded to clarify the contrasting practices.

Datum Feature: The feature of a part that is used to establish a datum, identified with either a datum feature or datum target symbols, see Fig. 4.

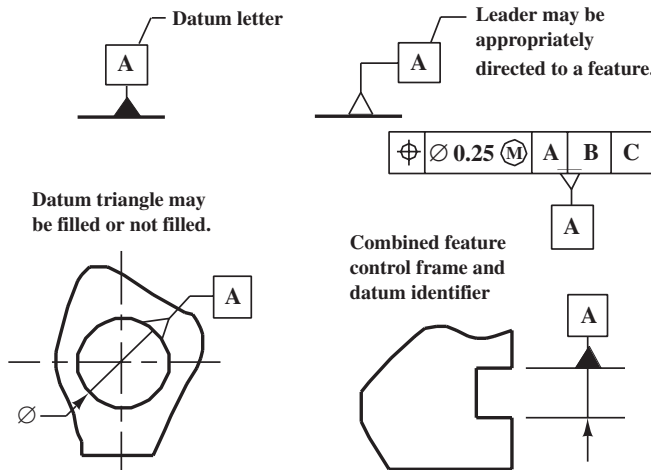


Fig. 4. Datum Feature Symbol

Datum Identifier: The graphic symbol on a drawing used to indicate the datum feature.

Specified Datum Feature: A datum is the origin from which the location or other geometric characteristics of features of a part are established.

Datum Reference Frame: Sufficient features on a part are chosen to position the part in relationship to as many as three planes. The three planes are mutually perpendicular and together are called the datum reference frame. The planes follow an order of precedence and allow the part to be immobilized. This immobilization in turn creates measurable relationships among features.

Datum Simulator: Formed by the datum feature contacting a precision surface such as a surface plate, gage surface or by a mandrel contacting the datum. Thus, the plane formed by contact restricts motion and constitutes the specific reference surface from which measurements are taken and dimensions verified. The datum simulator is the practical embodiment of the datum feature during manufacturing and quality assurance.

Datum Target: A specified point, line, or area on a part, used to establish a datum; see page 619.

Degrees of Freedom: The six directions of movement or translation are called degrees of freedom in a three-dimensional environment. They are up-down, left-right, fore-aft, roll, pitch, and yaw, see Fig. 5.

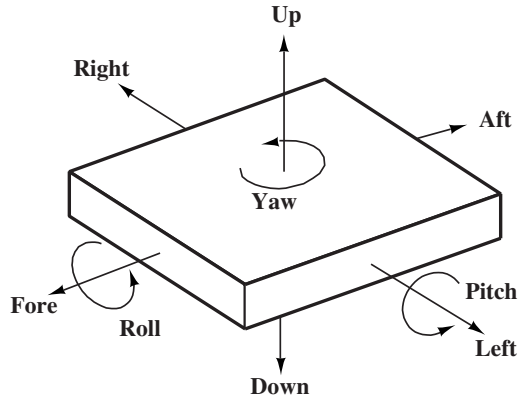


Fig. 5. Degrees of Freedom (Movement) That Must be Controlled, Depending on the Design Requirements.

Dimension, Basic: A numerical value used to describe the theoretically exact size, orientation, location, or optionally, the profile, of a feature or datum or datum target. Basic dimensions are indicated by a rectangle around the dimension and are not toleranced directly or by default, see Fig. 6. The specific dimensional limits are determined by the permissible variations as established by the tolerance zone specified in the feature control frame. A dimension is only considered basic for the geometric control to which it is related.

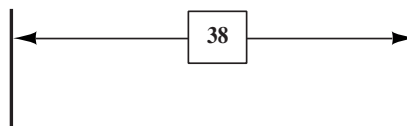


Fig. 6. Basic Dimensions

Dimension, Origin: A symbol used to indicate the origin and direction of a dimension between two features. The dimension originates from the symbol with the dimension tolerance zone being applied at the other feature, see Fig. 7.

Dimension, Reference: A dimension, usually without tolerance, used for information purposes only. Considered to be auxiliary information and not governing production or inspection operations. A reference dimension is a repeat of a dimension or is derived from a calculation or combination of other values shown on the drawing or on related drawings.

Feature Control Frame [Tolerance Frame]: Specification on a drawing that indicates the type of geometric control for the feature, the tolerance for the control, and the related datums, if applicable, see Fig. 8.

Feature: The general term applied to a physical portion of a part, such as a surface, hole, pin, tab, or slot. In ISO practice, depending on how the tolerance frame leader line is attached to the feature, different interpretations may be invoked as to whether the reference is to a line or surface, or an axis or median planer.

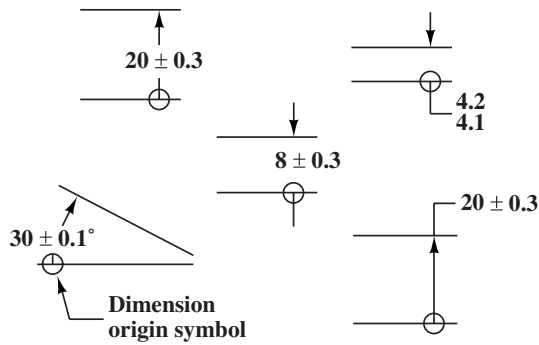


Fig. 7. Dimension Origin Symbol

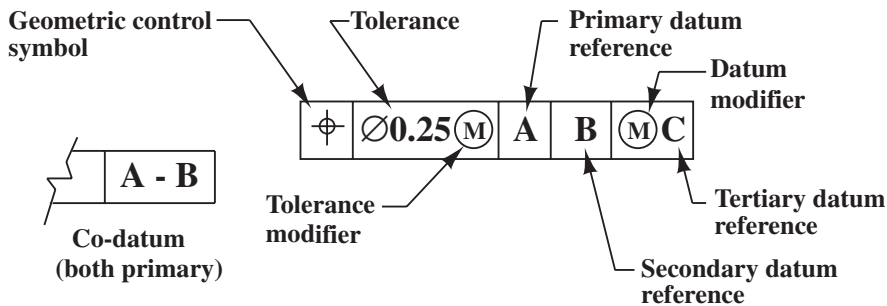


Fig. 8. Feature Control Frame and Datum Order of Precedence

When an ISO tolerance frame leader line terminates on the outline of the feature, it indicates that the control is a line or the surface itself (Fig. 9a.) When an ISO tolerance frame leader line terminates on a dimension, the axis or medium plane of the dimensioned feature is being controlled. Either inside or outside dimension lines may be used (Fig. 9b.)

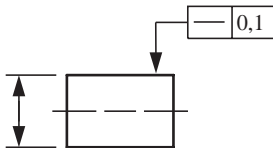


Fig. 9a. ISO Tolerance Frame Leader Line Terminating on the Outline of the Feature.

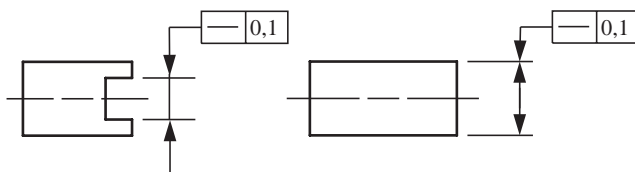


Fig. 9b. ISO Tolerance Frame Leader Line Terminating on a Dimension.

Feature of Size, Regular: One cylindrical or spherical surface, a circular element, and a set of two opposed parallel elements or opposed parallel surfaces, each of which is associated with a directly toleranced dimension.

Feature of Size, Irregular: A directly toleranced feature or collection of features that may contain or be contained by an actual mating envelope that is: a) a sphere, cylinder, or pair of parallel planes; or, b) other than a sphere, cylinder, or pair of parallel planes.

Least Material Boundary (LMB): The limit defined by a tolerance or combination of tolerances that exist on or inside the material of a feature or features.

Least Material Condition (LMC): The condition in which a feature of size contains the least amount of material within the stated limits of size, for example, upper limit or maximum hole diameter and lower limit or minimum shaft diameter.

Limits, Upper and Lower (UL and LL): The arithmetic values representing the maximum and minimum size allowable for a dimension or tolerance. The upper limit represents the maximum size allowable. The lower limit represents the minimum size allowable.

Maximum Material Boundary (MMB): The limit defined by a tolerance or combination of tolerances that exist on or outside the material of a feature or features.

Maximum Material Condition (MMC): The condition in which a feature of size contains the maximum amount of material within the stated limits of size. For example, the lower limit of a hole is the minimum hole diameter. The upper limit of a shaft is the maximum shaft diameter.

Position: Formerly called true position, position is the theoretically exact location of a feature established by basic dimensions. In ISO practice a basic dimension is called a theoretically exact dimension (TED). A positional tolerance is indicated by the position symbol, a tolerance value, applicable material condition modifiers, and appropriate datum references placed in a feature control frame.

Regardless of Feature Size (RFS): The term used to indicate that a geometric tolerance or datum reference applies at any increment of size of the feature within its tolerance limits. RFS is the default condition unless MMC or LMC is specified. The concept is now the default in ASME Y14.5-2009, unless specifically stated otherwise. Thus the symbol for RFS is no longer supported in ASME Y14.5-2009.

Regardless of Material Boundary (RMB) indicates that a datum feature simulator progresses from MMB toward LMB until it makes maximum contact with the extremities of a feature(s). See *Datum Simulator* on page 616.

Size, Actual: The term indicating the size of a feature as produced.

Tolerance Zone Symmetry: In geometric tolerancing, the tolerance value stated in the feature control frame is always a single value. Unless otherwise specified, it is assumed that boundaries created by the stated tolerance are bilateral and equidistant about the perfect form control specified. See Fig. 10a for default zone. If desired, the tolerance may be specified as unilateral or unequally bilateral. See Figs. 10b and 10c for external and internal unilateral zones, and Fig. 10d for an example of a bilateral asymmetrical zone.

Tolerance Zone Symmetry Examples

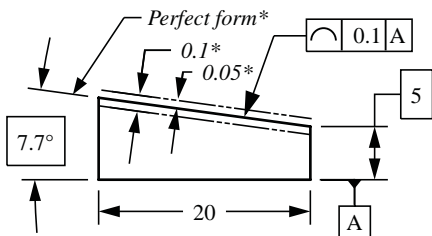


Fig. 10a. Default Symmetrical Tolerance Zone About Perfect Form.

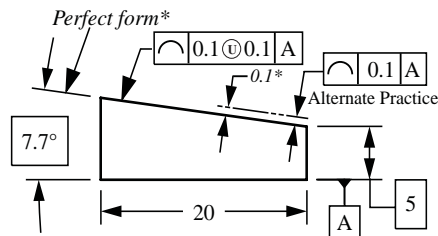


Fig. 10b. External Unilateral Tolerance Zone About Perfect Form.

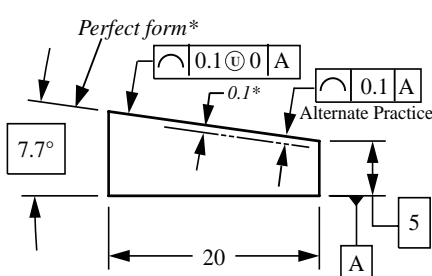


Fig. 10c. Internal Unilateral Tolerance Zone About Perfect Form.

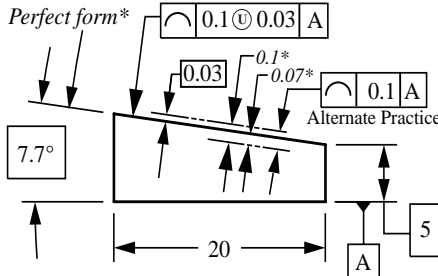


Fig. 10d. Bilateral Asymmetrical Tolerance Zone About Perfect Form.

* Added for clarification and is not part of the specification.

Tolerance, Bilateral: A tolerance where variation is permitted in both directions from the specified dimension. Bilateral tolerances may be equal or unequal.

Tolerance, Geometric: The general term applied to the category of tolerances used to control form, profile, orientation, location, and runout.

Tolerance, Unilateral: A tolerance where variation is permitted in only one direction from the specified dimension.

True Geometric Counterpart: Theoretically perfect plane of a specified datum feature.

Virtual Condition: A constant boundary generated by the collective effects of the feature size, its specified MMC or LMC material condition, and the geometric tolerance for that condition.

Datum Referencing.—A datum indicates the origin of a dimensional relationship between a toleranced feature and a designated feature or features on a part. The designated feature serves as a datum feature, whereas its true geometric counterpart establishes the datum plane. Because measurements cannot be made from a true geometric counterpart, which is theoretical, a datum is assumed to exist in and be simulated by the associated processing equipment.

For example, machine tables and surface plates, although not true planes, are of such quality that they are used to simulate the datums from which measurements are taken and dimensions are verified. When magnified, flat surfaces of manufactured parts are seen to have irregularities, so that contact is made with a datum plane formed at a number of surface extremities or high points. Sufficient datum features, those most important to the design of the part, are chosen to position the part in relation to a set of three mutually perpendicular planes, the datum reference frame. This reference frame exists only in theory and not on the part. Therefore, it is necessary to establish a method for simulating the theoretical reference frame from existing features of the part. This simulation is accomplished by positioning the part on appropriate datum features to adequately relate the part to the reference frame and to restrict the degrees of freedom of the part in relation to it.

These reference frame planes are simulated in a mutually perpendicular relationship to provide direction as well as the origin for related dimensions and measurements. Thus, when the part is positioned on the datum reference frame (by physical contact between each datum feature and its counterpart in the associated processing equipment), dimensions related to the datum reference frame by a feature control frame are thereby mutually perpendicular. This theoretical reference frame constitutes the three-plane dimensioning system used for datum referencing.

Depending on the degrees of freedom that must be controlled, a simple reference frame may suffice. At other times, additional datum reference frames may be necessary where physical separation occurs or the functional relationship of features require that datum reference frames be applied at specific locations on the part. Each feature control frame must contain the datum feature references that are applicable.

Datum Targets: Datum targets are used to establish a datum plane. They may be points, lines or surface areas. Datum targets are used when the datum feature contains irregularities, other features block the surface or the entire surface cannot be used. Examples where datum targets may be indicated include uneven surfaces, forgings and castings, weldments, non-planar surfaces or surfaces subject to warping or distortion. The datum target symbol is located outside the part outline with a leader directed to the target point, area or line. The targets are dimensionally located on the part using basic or toleranced dimensions. If basic dimensions are used, established tooling or gaging tolerances apply.

A solid leader line from the symbol to the target is used for visible or near side locations with a dashed leader line used for hidden or far side locations. The datum target symbol is divided horizontally into two halves. The top half contains the target point area if applicable; the bottom half contains a datum feature identifying letter and target number. Target numbers indicate the quantity required to define a primary, secondary, or tertiary datum. If indicating a target point or target line, the top half is left blank. Datum targets and datum features may be combined to form the datum reference frame, see [Fig. 11](#).

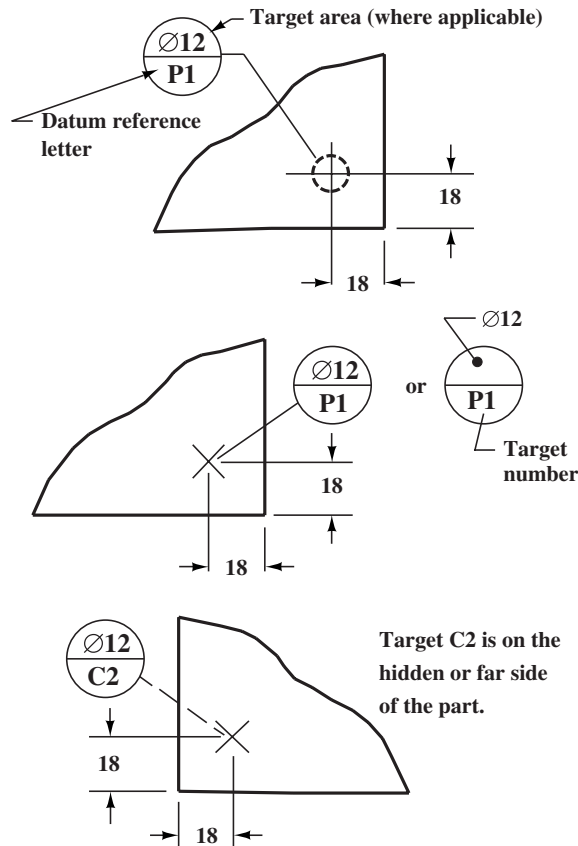


Fig. 11. Datum Target Symbols.

Datum Target Points: A datum target point is indicated by the symbol “X,” which is dimensionally located on a direct view of the surface. Where there is no direct view, the point location is dimensioned on multiple views.

Datum Target Lines: A datum target line is dimensionally located on an edge view of the surface using a phantom line on the direct view. Where there is no direct view, the location is dimensioned on multiple views. Where the length of the datum target line must be controlled, its length and location are dimensioned.

Datum Target Areas: Where it is determined that an area, or areas, of flat contact are necessary to ensure establishment of the datum, and where spherical or pointed pins would be inadequate, a target area of the desired shape is specified. Examples include the need to span holes, finishing irregularities, or rough surface conditions. The datum target area may be indicated with the “X” symbol as with a datum point, but the area of contact is specified in the upper half of the datum target symbol. Datum target areas may additionally be specified by defining controlling dimensions and drawing the contact area on the feature with section lines inside a phantom outline of the desired shape.

Positional Tolerance.—A positional tolerance defines a zone within which the center, axis, or center plane of a feature of size is permitted to vary from true (theoretically exact) position. Basic dimensions establish the true position from specified datum features and between interrelated features. A positional tolerance is indicated by the position symbol, a tolerance, and appropriate datum references placed in a feature control frame.

Modifiers: In certain geometric tolerances, modifiers in the form of additional symbols may be used to further refine the level of control. The use of the MMC and LMC modifiers

has been common practice for many years. Several new modifiers introduced with the 1994 U.S. standard include free state, tangent plane and statistical tolerancing, see Fig. 12. New modifiers introduced in the 2009 standard include MMB, LMB, and RMB.

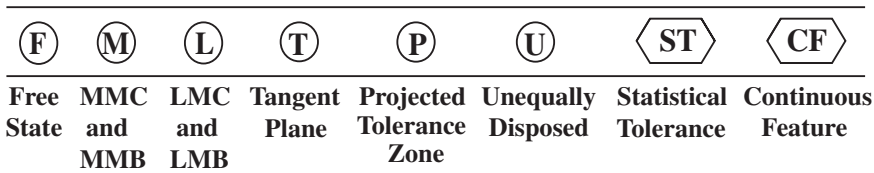


Fig. 12. Tolerance Modifiers.

Projected Tolerance Zone: Application of this concept is recommended where any variation in perpendicularity of the threaded or press-fit holes could cause fasteners such as screws, studs, or pins to interfere with mating parts. An interference with subsequent parts can occur even though the hole axes are inclined within allowable limits. This interference occurs because without a projected tolerance zone, a positional tolerance is applied solely to the depth of threaded or press-fit holes. Unlike the floating fastener application involving clearance holes only, the attitude of a fixed fastener is restrained by the inclination of the produced hole into which it assembles.

With a projected tolerance zone equal to the thickness of the mating part, the inclinational error is accounted for in both parts. In other words the projected zone is an extension of the tolerance zone begun inside the hole and projected out, in this case 14 mm, on the same axis within the specified tolerance of location. The minimum extent and direction of the projected tolerance zone is shown as a value in the feature control frame. The zone may be shown in a drawing view as a dimensioned value with a heavy chain line drawn closely adjacent to an extension of the center line of the hole, see Fig. 13.

It has been noted that the projected tolerance zone illustration shown here differs slightly from that shown in ASME Y14.5-2009. However it is believed that the illustration shown here is a more realistic portrayal of the intent of the text in the standard.

Statistical Tolerance: The statistical tolerancing symbol is a modifier that may be used to indicate that a tolerance is controlled statistically as opposed to being controlled arithmetically. With arithmetic control, assembly tolerances are typically divided arithmetically among the individual components of the assembly. This division results in the assumption that assemblies based on “worst case” conditions would be guaranteed to fit because the worst case set of parts fit — so that anything better would fit as well. When this technique is restrictive, statistical tolerancing, via the symbol, may be specified in the feature control frame as a method of increasing tolerances for individual parts. This procedure may reduce manufacturing costs because its use changes the assumption that statistical process control may make a statistically significant quantity of parts fit, but not absolutely all. The technique should only be used when sound statistical methods are employed.

Tangent Plane: When it is desirable to control the surface of a feature by the contacting or high points of the surface, a tangent plane symbol is added as a modifier to the tolerance in the feature control frame, see Fig. 14.

Free State: The free state modifier symbol is used when the geometric tolerance applies to the feature in its “free state,” or after removal of any forces used in the manufacturing process. With removal of forces the part may distort due to gravity, flexibility, spring back, or other release of internal stresses developed during fabrication. Typical applications include parts with extremely thin walls and non-rigid parts made of rubber or plastics. The modifier is placed in the tolerance portion of the feature control frame and follows any other modifier.

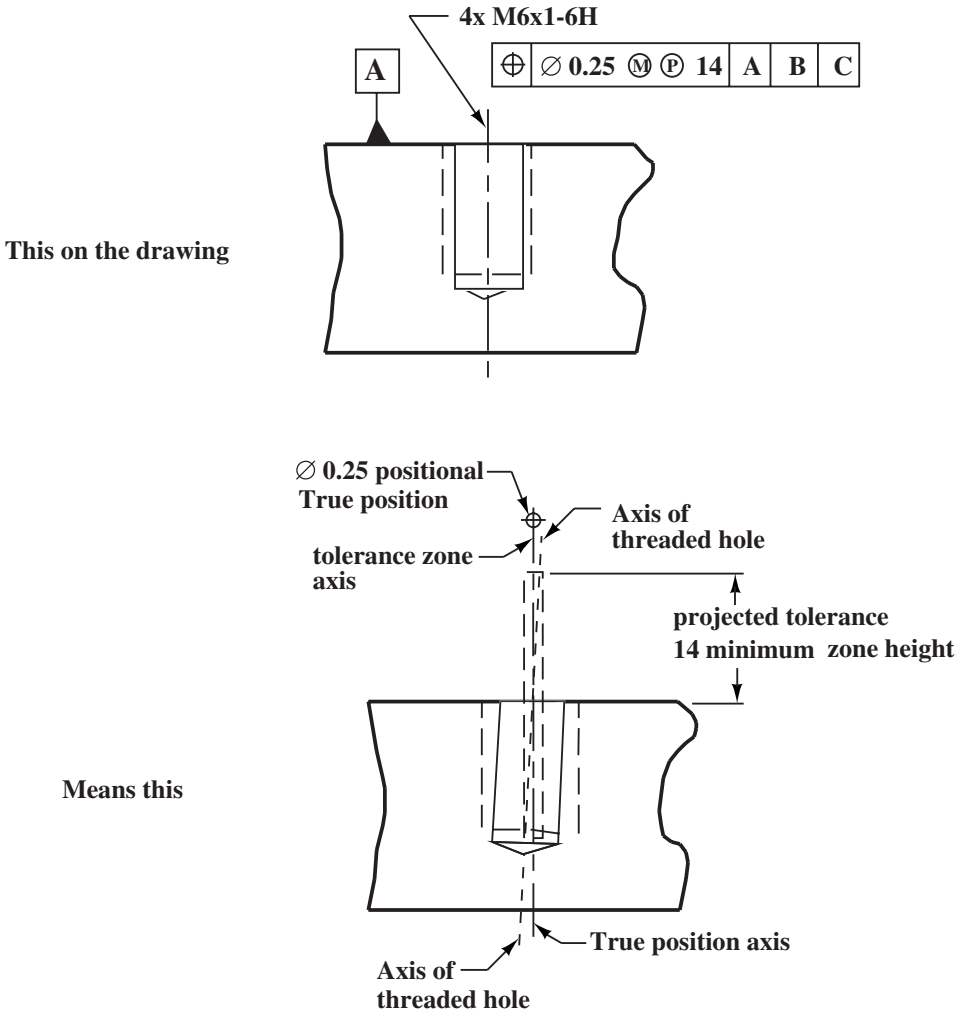


Fig. 13. Projected Tolerance Zone Application.

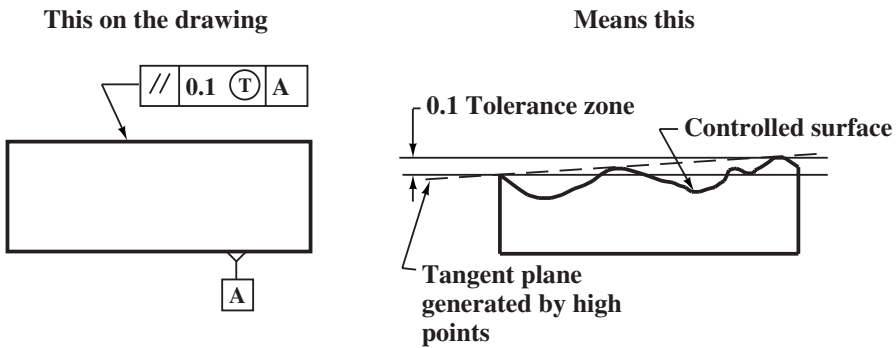


Fig. 14. Tangent Plane Modifier.

The above examples are just a few of the numerous concepts and related symbols covered by ASME Y14.5-2009. Refer to the standard for a complete discussion with further examples of the application of geometric dimensioning and tolerancing principles.

GD&T and CAD Models.—ASME Y14.5-2009 and all earlier editions are usable on modern CAD systems. However the primary concepts are still communicated visually among design, manufacturing and quality stakeholders via annotation applied to engineering drawings, be they on paper or depicted on a computer monitor. Effectively there is no difference between specifications communicated manually on paper using a pencil, and those applied to a drawing on a CAD system, the latter being for all practical purposes, an electronic drawing board. As such, utilization of the tolerancing information still requires that a person read the specifications, interpret them and manually apply the information in manufacturing and/or quality systems. That manual process has begun to change with the introduction of ANSI/ASME Y14.41-2003, Digital Production Definition Data Practices, and its international version ISO 16792:2006, Digital Production Definition Data Practices.

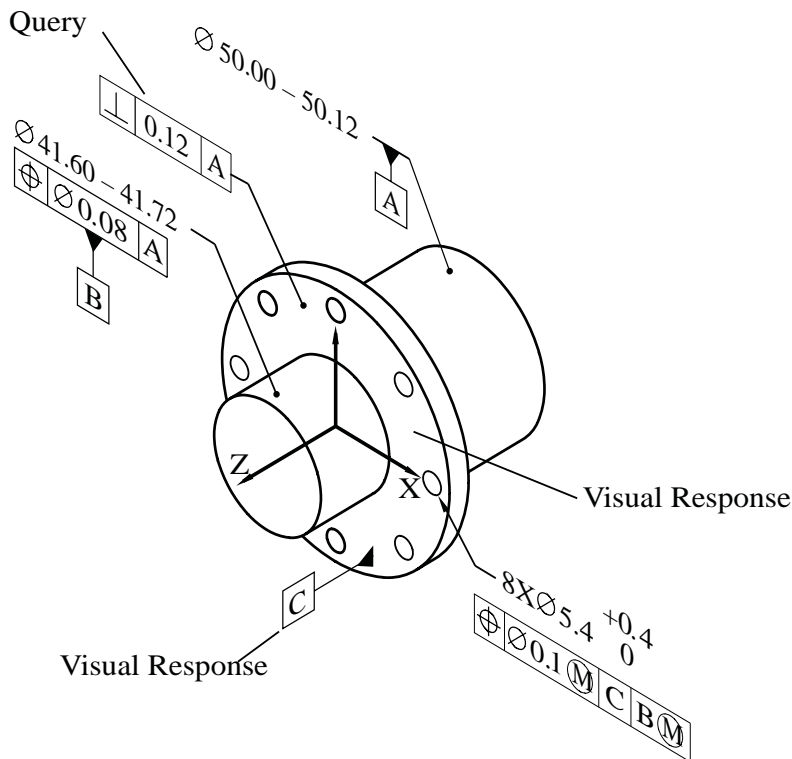


Fig. 15. Visual Response to a Tolerance Query on a 3D CAD System Compliant with ANSI/ASME Y14.41-2003.

These standards define use of ASME GD&T practices, and ISO GD&T practices respectively in a digital environment where specifications are embedded directly into the product definition data set as part of product lifecycle management (PLM). Embedded GD&T is generally called “eGD&T” (electronic geometric dimensioning & tolerancing). Once incorporated into the data set, the specifications can be selectively queried for visual display as needed on a computer screen or an engineering drawing, see Fig. 15. Perhaps more importantly the embedded tolerancing information can be directly accessed by software for tolerance analysis, process planning, or any other applications designed to utilize the geometric and tolerancing information as part of product lifecycle management. As these standards are adopted by CAD vendors and fully implemented, their promise is for a more expedient, more accurate design and analysis process.

Both standards define how current GD&T concepts are applied to digital models. Both standards also explain where rules have changed to account for differing requirements between 2D-based annotation and 3D annotations.

Digital Product Definition Data Practices Terms.—The following terms are defined in both ANSI/ASME Y14.41 and ISO 16792. In ISO 16792, rules are modified to recognize ISO drawing practices where those practices differ from predominately U.S. practice as illustrated in ANSI/ASME Y14.41-2003. Rules in both standards cover not only data sets with models only, but also those data sets with models and drawings. See the respective standards for complete rules and definitions.

Annotation: Dimensions, tolerances, notes, text, or symbols visible without any manual or external manipulation.

Attribute: A dimension, tolerance, note, text, or symbol required to complete the product definition or feature of the product that is not visible but available upon interrogating the model.

Design Model: The portion of the data set that contains model and supplemental geometry.

Geometric Element: A graphic entity used in a data set. For example: point, line, plane, surface, solid, model coordinate system or crosshatching.

Management Data: The data required for the release, control, and storage of product definition data as well as other relevant engineering data.

Model: A combination of design model, annotation and attributes that describes a product, see Fig. 16.

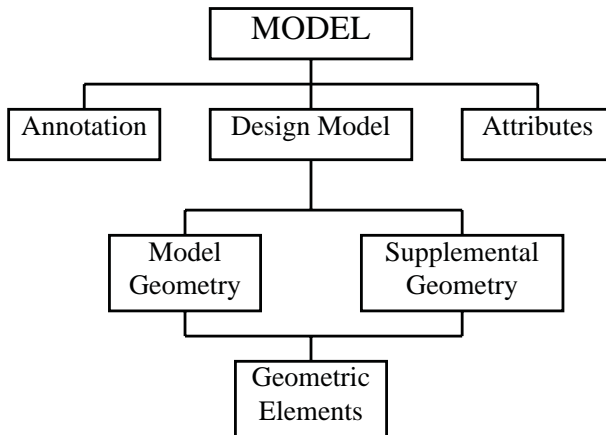


Fig. 16. Content of a Digital Model (ANSI Y14.41-2003).

Model Value: The numerical value derived by interrogating the model that quantifies the form and spatial relationships of the geometry composing a design model or assembly of models to the precision (number of decimal places) of the computer system.

Model Geometry: Geometric elements in product definition data which represent a designed product.

Product Definition Data: Data elements required to completely define a product.

Product Definition Data Set: A collection of one or more computer file(s) that discloses (directly or by reference), by means of graphic or textual presentations, or combinations of both, the physical and functional requirements of an item, see Fig. 17.

Query: A means of interrogating a digital element or the relationship between digital elements, see Fig. 17.

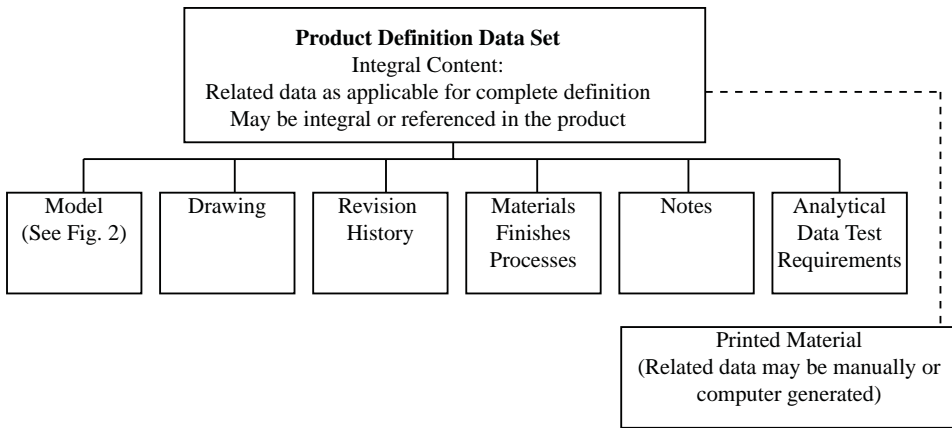


Fig. 17. Product Definition Data Set (ANSI Y14.41-2003).

Supplemental Geometry: Geometric elements included in product definition data to communicate design requirements but not intended to represent a portion of the manufactured product.

Checking Designs and Drawings.—In order for production designs to be maintained at the highest level of consistency, a set of suggestions for checking models and drawings is provided below. The suggestions first concentrate on a review of the design parameters in a global sense, then secondly a detailed review of the drawings and/or model itself. It is recommended that these suggestions be followed in parts based on responsibility, by engineers, checkers, designers, detailers and any others involved in producing, reviewing and approving engineering models and drawings.

Design Parameters.—*Inspecting a New Design:* When a new design is involved, first carefully inspect the general design and its parts in relationship to the assemblies as a whole, ascertaining that parts function correctly and assemble under all material conditions. Additionally, determine if the parts have the proper relative proportions, that the general design satisfies constraints for strength, rigidity, bearing areas, appearance, manufacturability, ergonomics of assembly, direction of motion, no unnecessary interferences, etc. Generate a digital simulation physical rapid prototype if necessary. If the design appears to be unsatisfactory in any aspect, or improvements appear to be possible, notify the person responsible for that aspect of the design.

Checking for Strength: Physically inspect the design for strength, rigidity, and appearance. Compare it with other designs used in similar service whenever possible, giving preference to the known working designs in such a comparison, unless the known designs are examples of unsatisfactory parts. If there is any question, perform applicable analysis on the model or if required, manually compute the stresses and deformations. If the new design is for a larger version of an existing device, ascertain that any standard parts necessarily increased in size, will continue to be sufficiently strong to bear increased service loads.

Materials Specified: For the design, consider the material specification in relationship to the various manufacturing process options available, such as molding, forging, a weldment, or other method with which to form the rough shape. Then consider the machining operations to see whether changes in form or design will reduce the number of operations or reduce the machining cost. Parts should be designed with reference to the economical use of material, and whenever possible, utilize standard stock sizes and material readily obtainable from local sources. In the case of alloy steel, special bronze, and similar or exotic materials, confirm that the material can be obtained in the required size.

Checking Casting Designs: In checking castings, the form of the pattern is studied, the methods of molding, the method of supporting and venting the cores, and the effect of draft and rough molding on clearances. Undue metal thickness should be avoided, as well as extreme differences between thick and thin sections in the same casting.

All metal thicknesses should be specified, so that appropriate chaplets can be selected for supporting cores. Ample fillets and rounds should be provided, and properly dimensioned directly or by note. Cores should be designed so that they can be secured in the mold without crushing or causing interference.

Allowances should be made for swelling, shrinkage, or misalignment of cores to ensure adequate machineability. Material should be added to surfaces destined to be finished.

On large castings, sufficient extra material should be provided for finishing to permit “clean up” to net size in case of warpage.

Checking Drawings.—The following are some rules-of-thumb and general guidelines to keep in mind when creating and reviewing engineering drawings and data models.

Checking the Technique Used in Making Drawing: Inspect the drawing to see that all regular, auxiliary and sections are made in such a way as to illustrate the most descriptive views of the form of the piece and its relationship to other parts. Selection of type and quantity of views on a drawing serve as both a carrier of the dimensional values and to represent accurately the visual nature of the part. Ultimately, drawings must communicate design intent, both numerically and visually.

Checking Dimensions in General: In general all dimensions should be checked for correctness. If manually drawn, dimensions should also be scaled to determine if the drawing is to scale. Where any dimension is “not-to-scale,” it is indicated by underlining the offending dimension. This is the standard technique for indicating not-to-scale. While most CAD systems automatically indicate not-to-scale dimensions, some do not. Not-to-scale dimensions are problematic on CAD drawings and models as they are indicative of dimension values not matching the geometry. In the case of a CAD drawing dimension being not-to-scale, it too should be underlined. However, this may be a serious concern, and may demand immediate correction. More and more, CAD geometry drives downstream applications such as numerical control or tolerance analysis. Hence errors in CAD geometry cannot be tolerated if accurate downstream results are expected.

ANSI and ISO Drawing Checklists.—The following checklists represents questions based on industry practice and standards for engineering drawings and unless noted, applies to both inch and metric drawings and models and both ASME Y14.5 and ISO methodology.

Model Checklist: Are features built within dimensional limits and to appropriate material conditions (MMC, LMC, nominal)?

Are features built to sufficient numerical accuracy?

Are fillets and rounds added to all non-finished corners of castings and forgings?

On as-cast models, is machining allowance added to surfaces destined to be finished?

Has allowance for wrench clearance been built into locations of bolts and other fasteners requiring tools?

Drawing Checklist: Are all dimensions indicated, only once to avoid potentially misinterpreted redundant dimensioning?

Are all auxiliary and section views labeled?

Are general notes added to address default conditions such as fillets & rounds, numerical significance, default tolerances?

Are all finish marks indicated where appropriate?

Are clearance hole diameters clearly specified, to avoid potential look-up errors?

Are there sufficient views so that no assumptions need be made about any feature or dimension?

If following U.S. practice, are all dimensions, notes and other text readable from the bottom of the drawing?

If following ISO practice, is all dimensional text aligned with each dimension on the drawing?

When dimensioning in metric, are preceding 0s shown for values less than 1, and trailing 0s not shown for integers? (e.g. 0.11 and 10)

When heat-treatment is required, the heat-treatment should be specified.

When dimension in inches, are preceding 0s not shown for values less than 1, and trailing 0s added for consistent significant digits? (e.g. 11 and 10.00)

If dimensioning symbols are used, such as depth, diameter, radius, etc., are the symbols placed before the dimensional value?

Are quantities specified for all dimensions or features occurring in multiple locations (via 2X or TWO TIMES)?

Are threaded holes specified by tap drill and thread specifications to avoid potential look-up errors?

Are all occurrences of dimensional and non-dimensional text to consistent size or per company policy?

Are dimensions to hidden lines and those directly to object lines minimized unless impossible to avoid?

Are dimensions shown in a view depicting the true shape projection of the feature?

Do all dimensions account for tolerance, either directly or indirectly via note or block tolerance?

Does the selection of paper size match the complexity of the part, to avoid over-crowding via a size too small or wasted space via a size too large?

Are dimensions shown in a form which minimizes unnecessary calculations by readers of the drawing?

Are views aligned left-to-right and bottom-to-top, and arranged properly for 3rd angle projection (or 1st angle projection)?

Is the primary view the most descriptive view possible?

Is chain dimensioning minimized to avoid "stacking" of tolerances?

Are holes and other round features and parts located by their centers?

Are witness lines (extension lines) used with dimensions rather than dimensioning directly to features?

Is the drawing title correct and the drawing number or file name in the correct format?

ALLOWANCES AND TOLERANCES FOR FITS

Limits and Fits

Fits between cylindrical parts, i.e., cylindrical fits, govern the proper assembly and performance of many mechanisms. Clearance fits permit relative freedom of motion between a shaft and a hole—axially, radially, or both. Interference fits secure a certain amount of tightness between parts, whether these are meant to remain permanently assembled or to be taken apart from time to time. Or again, two parts may be required to fit together snugly—without apparent tightness or looseness. The designer's problem is to specify these different types of fits in such a way that the shop can produce them. Establishing the specifications requires the adoption of two manufacturing limits for the hole and two for the shaft, and, hence, the adoption of a manufacturing tolerance on each part.

In selecting and specifying limits and fits for various applications, it is essential in the interests of interchangeable manufacturing that 1) standard definitions of terms relating to limits and fits be used; 2) preferred basic sizes be selected wherever possible to reduce material and tooling costs; 3) limits be based upon a series of preferred tolerances and allowances; and 4) a uniform system of applying tolerances (preferably unilateral) be used. These principles have been incorporated in both the American and British standards for limits and fits. Information about these standards is given beginning on page 634.

Basic Size.—The basic size of a screw thread or machine part is the theoretical or nominal standard size from which variations are made. For example, a shaft may have a *basic* diameter of 2 inches, but a maximum variation of minus 0.010 inch may be permitted. The minimum hole should be of basic size wherever the use of standard tools represents the greatest economy. The maximum shaft should be of basic size wherever the use of standard purchased material, without further machining, represents the greatest economy, even though special tools are required to machine the mating part.

Tolerances.—Tolerance is the amount of variation permitted on dimensions or surfaces of machine parts. The tolerance is equal to the difference between the maximum and minimum limits of any specified dimension. For example, if the maximum limit for the diameter of a shaft is 2.000 inches and its minimum limit 1.990 inches, the tolerance for this diameter is 0.010 inch. The extent of these tolerances is established by determining the maximum and minimum clearances required on operating surfaces. As applied to the fitting of machine parts, the word tolerance means the amount that duplicate parts are allowed to vary in size in connection with manufacturing operations, owing to unavoidable imperfections of workmanship. Tolerance may also be defined as the amount that duplicate parts are permitted to vary in size to secure sufficient accuracy without unnecessary refinement. The terms “tolerance” and “allowance” are often used interchangeably, but, according to common usage, *allowance* is a difference in dimensions prescribed to secure various classes of fits between different parts.

Unilateral and Bilateral Tolerances.—The term “unilateral tolerance” means that the total tolerance, as related to a basic dimension, is in *one* direction only. For example, if the basic dimension were 1 inch and the tolerance were expressed as 1.000 – 0.002, or as 1.000 + 0.002, these would be unilateral tolerances because the total tolerance in each is in one direction. On the contrary, if the tolerance were divided, so as to be partly plus and partly minus, it would be classed as “bilateral.”

Thus, $1.000 \begin{matrix} +0.001 \\ -0.001 \end{matrix}$

is an example of bilateral tolerance, because the total tolerance of 0.002 is given in two directions—plus and minus.

When unilateral tolerances are used, one of the three following methods should be used to express them:

- 1) Specify, limiting dimensions only as
 Diameter of hole: 2.250, 2.252
 Diameter of shaft: 2.249, 2.247
- 2) One limiting size may be specified with its tolerances as
 Diameter of hole: $2.250 + 0.002, -0.000$
 Diameter of shaft: $2.249 + 0.000, -0.002$
- 3) The nominal size may be specified for both parts, with a notation showing both allowance and tolerance, as
 Diameter of hole: $2\frac{1}{4} + 0.002, -0.000$
 Diameter of shaft: $2\frac{1}{4} - 0.001, -0.003$

Bilateral tolerances should be specified as such, usually with plus and minus tolerances of equal amount. An example of the expression of bilateral tolerances is

$$2 \pm 0.001 \quad \text{or} \quad 2 \begin{array}{l} +0.001 \\ -0.001 \end{array}$$

Application of Tolerances.—According to common practice, tolerances are applied in such a way as to show the permissible amount of dimensional variation in the direction that is less dangerous. When a variation in either direction is equally dangerous, a bilateral tolerance should be given. When a variation in one direction is more dangerous than a variation in another, a unilateral tolerance should be given in the less dangerous direction.

For nonmating surfaces, or atmospheric fits, the tolerances may be bilateral, or unilateral, depending entirely upon the nature of the variations that develop in manufacture. On mating surfaces, with few exceptions, the tolerances should be unilateral.

Where tolerances are required on the distances between holes, usually they should be bilateral, as variation in either direction is normally equally dangerous. The variation in the distance between shafts carrying gears, however, should always be unilateral and plus; otherwise, the gears might run too tight. A slight increase in the backlash between gears is seldom of much importance.

One exception to the use of unilateral tolerances on mating surfaces occurs when tapers are involved; either bilateral or unilateral tolerances may then prove advisable, depending upon conditions. These tolerances should be determined in the same manner as the tolerances on the distances between holes. When a variation either in or out of the position of the mating taper surfaces is equally dangerous, the tolerances should be bilateral. When a variation in one direction is of less danger than a variation in the opposite direction, the tolerance should be unilateral and in the less dangerous direction.

Locating Tolerance Dimensions.—Only one dimension in the same straight line can be controlled within fixed limits. That dimension is the distance between the cutting surface of the tool and the locating or registering surface of the part being machined. Therefore, it is incorrect to locate any point or surface with tolerances from more than one point in the same straight line.

Every part of a mechanism must be located in each plane. Every operating part must be located with proper operating allowances. After such requirements of location are met, all other surfaces should have liberal clearances. Dimensions should be given between those points or surfaces that it is essential to hold in a specific relation to each other. This restriction applies particularly to those surfaces in each plane that control the location of other component parts. Many dimensions are relatively unimportant in this respect. It is good practice to establish a common locating point in each plane and give, as far as possible, all such dimensions from these common locating points. The locating points on the drawing, the locating or registering points used for machining the surfaces and the locating points for measuring should all be identical.

The initial dimensions placed on component drawings should be the exact dimensions that would be used if it were possible to work without tolerances. Tolerances should be

given in that direction in which variations will cause the least harm or danger. When a variation in either direction is equally dangerous, the tolerances should be of equal amount in both directions, or bilateral. The initial clearance, or allowance, between operating parts should be as small as the operation of the mechanism will permit. The maximum clearance should be as great as the proper functioning of the mechanism will permit.

Direction of Tolerances on Gages.—The extreme sizes for all plain limit gages shall not exceed the extreme limits of the part to be gaged. All variations in the gages, whatever their cause or purpose, shall bring these gages within these extreme limits.

The data for gage tolerances on page 661 cover gages to inspect workpieces held to tolerances in the American National Standard ANSI B4.4M-1981.

Allowance for Forced Fits.—The allowance per inch of diameter usually ranges from 0.001 inch to 0.0025 inch (0.0254-0.0635 mm), 0.0015 inch (0.0381 mm) being a fair average. Ordinarily the allowance per inch decreases as the diameter increases; thus the total allowance for a diameter of 2 inches (50.8 mm) might be 0.004 inch (0.102 mm), whereas for a diameter of 8 inches (203.2 mm) the total allowance might not be over 0.009 or 0.010 inch (0.23 or 0.25 mm). The parts to be assembled by forced fits are usually made cylindrical, although sometimes they are slightly tapered. Advantages of the taper form are: the possibility of abrasion of the fitted surfaces is reduced; less pressure is required in assembling; and parts are more readily separated when renewal is required. On the other hand, the taper fit is less reliable, because if it loosens, the entire fit is free with but little axial movement. Some lubricant, such as white lead and lard oil mixed to the consistency of paint, should be applied to the pin and bore before assembling, to reduce the tendency toward abrasion.

Pressure for Forced Fits.—The pressure required for assembling cylindrical parts depends not only upon the allowance for the fit, but also upon the area of the fitted surfaces, the pressure increasing in proportion to the distance that the inner member is forced in. The approximate ultimate pressure in tons can be determined by the use of the following formula in conjunction with the accompanying table of *Pressure Factors for Forced Fits*. Assuming that A = area of surface in contact in “fit”; a = total allowance in inches; P = ultimate pressure required, in tons; F = pressure factor based upon assumption that the diameter of the hub is twice the diameter of the bore, that the shaft is of machine steel, and that the hub is of cast iron:

$$P = \frac{A \times a \times F}{2}$$

Pressure Factors for Forced Fits

Diameter, Inches	Pressure Factor	Diameter, Inches	Pressure Factor	Diameter, Inches	Pressure Factor	Diameter, Inches	Pressure Factor	Diameter, Inches	Pressure Factor
1	500	3½	132	6	75	9	48.7	14	30.5
1¼	395	3¾	123	6¼	72	9½	46.0	14½	29.4
1½	325	4	115	6½	69	10	43.5	15	28.3
1¾	276	4¼	108	6¾	66	10½	41.3	15½	27.4
2	240	4½	101	7	64	11	39.3	16	26.5
2¼	212	4¾	96	7¼	61	11½	37.5	16½	25.6
2½	189	5	91	7½	59	12	35.9	17	24.8
2¾	171	5¼	86	7¾	57	12½	34.4	17½	24.1
3	156	5½	82	8	55	13	33.0	18	23.4
3¼	143	5¾	78	8½	52	13½	31.7

Allowance for Given Pressure.—By transposing the preceding formula, the approximate allowance for a required ultimate tonnage can be determined. Thus, $a = \frac{2P}{AF}$. The

average ultimate pressure in tons commonly used ranges from 7 to 10 times the diameter in inches.

Expansion Fits.—In assembling certain classes of work requiring a very tight fit, the inner member is contracted by sub-zero cooling to permit insertion into the outer member and a tight fit is obtained as the temperature rises and the inner part expands. To obtain the sub-zero temperature, solid carbon dioxide or “dry ice” has been used but its temperature of about -109°F (-78°C) below zero will not contract some parts sufficiently to permit insertion in holes or recesses. Greater contraction may be obtained by using high purity liquid nitrogen which has a temperature of about -320°F (-196°C) below zero. During a temperature reduction from 75 degrees F. to -321°F (-196°C), the shrinkage per inch of diameter varies from about 0.002 to 0.003 inch for steel; 0.0042 inch for aluminum alloys; 0.0046 inch for magnesium alloys; 0.0033 inch for copper alloys; 0.0023 inch for monel metal; and 0.0017 inch for cast iron (not alloyed). The cooling equipment may vary from an insulated bucket to a special automatic unit, depending upon the kind and quantity of work. One type of unit is so arranged that parts are precooled by vapors from the liquid nitrogen before immersion. With another type, cooling is entirely by the vapor method.

Shrinkage Fits.—General practice seems to favor a smaller allowance for shrinkage fits than for forced fits, although in many shops the allowances are practically the same for each, and for some classes of work, shrinkage allowances exceed those for forced fits. The shrinkage allowance also varies to a great extent with the form and construction of the part that has to be shrunk into place. The thickness or amount of metal around the hole is the most important factor. The way in which the metal is distributed also has an influence on the results. Shrinkage allowances for locomotive driving wheel tires adopted by the American Railway Master Mechanics Association are as follows:

Center diameter, inches	38	44	50	56	62	66
Allowances, inches	0.040	0.047	0.053	0.060	0.066	0.070

Whether parts are to be assembled by forced or shrinkage fits depends upon conditions. For example, to press a tire over its wheel center, without heating, would ordinarily be a rather difficult job. On the other hand, pins, etc., are easily and quickly forced into place with a hydraulic press and there is the additional advantage of knowing the exact pressure required in assembling, whereas there is more or less uncertainty connected with a shrinkage fit, unless the stresses are calculated. Tests to determine the difference in the quality of shrinkage and forced fits showed that the resistance of a shrinkage fit to slippage for an axial pull was 3.66 times greater than that of a forced fit, and in rotation or torsion, 3.2 times greater. In each comparative test, dimensions and allowances were equal.

Allowances for Shrinkage Fits.—The most important point to consider when calculating shrinkage fits is the stress in the hub at the bore, which depends chiefly upon the shrinkage allowance. If the allowance is excessive, the elastic limit of the material will be exceeded and permanent set will occur, or, in extreme conditions, the ultimate strength of the metal will be exceeded and the hub will burst. The intensity of the grip of the fit and the resistance to slippage depends mainly upon the thickness of the hub; the greater the thickness, the stronger the grip, and *vice versa*. Assuming the modulus of elasticity for steel to be 30,000,000 (206.8×10^{-6} MPa), and for cast iron, 15,000,000 (103.4×10^{-6} MPa), the shrinkage allowance per inch (mm) of nominal diameter can be determined by the following formula, in which *A* = allowance per inch (mm) of diameter; *T* = true tangential tensile stress at inner surface of outer member, psi (MPa); *C* = factor taken from one of the accompanying [Tables 1, 2, and 3](#).

For a cast-iron hub and steel shaft:

$$\text{US} \quad A = \frac{T(2 + C)}{30,000,000} \quad (1a) \quad \text{metric} \quad A = 25.4 \frac{T(2 + C)}{206.843 \times 10^9} \quad (1b)$$

When both hub and shaft are of steel:

$$\text{US} \quad A = \frac{T(1+C)}{30,000,000} \quad (2a) \quad \text{metric} \quad A = 25.4 \frac{T(1+C)}{206.843 \times 10^9} \quad (2b)$$

If the shaft is solid, the factor C is taken from **Table 1**; if it is hollow and the hub is of steel, factor C is taken from **Table 2**; if it is hollow and the hub is of cast iron, the factor is taken from **Table 3**.

Table 1. Factors for Calculating Shrinkage Fit Allowances for Steel Shafts and Steel or Cast Iron Hubs

Ratio of Diameters $\frac{D_2}{D_1}$	Steel Hub	Cast-iron Hub	Ratio of Diameters $\frac{D_2}{D_1}$	Steel Hub	Cast-iron Hub
	C			C	
1.5	0.227	0.234	2.8	0.410	0.432
1.6	0.255	0.263	3.0	0.421	0.444
1.8	0.299	0.311	3.2	0.430	0.455
2.0	0.333	0.348	3.4	0.438	0.463
2.2	0.359	0.377	3.6	0.444	0.471
2.4	0.380	0.399	3.8	0.450	0.477
2.6	0.397	0.417	4.0	0.455	0.482

Values of factor C for solid steel shafts of nominal diameter D_1 , and hubs of steel or cast iron of nominal external and internal diameters D_2 and D_1 , respectively.

Example 1: A steel crank web 375 mm outside diameter is to be shrunk on a 250 mm solid steel shaft. Required is the allowance per mm of shaft diameter to produce a maximum tensile stress in the crank of 170 MPa, assuming the stresses in the crank to be equivalent to those in a ring of the diameter given.

The ratio of the external to the internal diameters equals $375 \div 250 = 1.5$; $T = 170$ MPa; from **Table 1**, $C = 0.227$. Substituting in **Formula (2b)**:

$$A = 25.4 \frac{170 \times (1 + 0.227)}{206843} = 0.026 \text{ mm}$$

Example 2: Find the allowance per mm of diameter for a 250 mm shaft having a 125 mm axial through hole, other conditions being the same as in **Example 1**.

The ratio of external to internal diameters of the hub equals $375 \div 250 = 1.5$, as before, and the ratio of external to internal diameters of the shaft equals $250 \div 125 = 2$. From **Table 2**, we find that factor $C = 0.455$; $T = 170$ MPa. Substituting these values in **Formula (2b)**:

$$A = 25.4 \frac{170(1 + 0.455)}{206843} = 0.030 \text{ mm}$$

The allowance is increased, as compared with **Example 1**, because the hollow shaft is more compressible.

Example 3: If the crank web in **Example 1** is of cast iron and 28 MPa is the maximum tensile stress in the hub, what is the allowance per mm of diameter?

$$\frac{D_2}{D_1} = 1.5 \quad T = 28$$

In **Table 1**, we find that $C = 0.234$. Substituting in **Formula (1b)**, for cast-iron hubs, $A = 0.0076$ mm, which, owing to the lower tensile strength of cast iron, is about one-third the shrinkage allowance in **Example 1**, although the stress is two-thirds of the elastic limit.

Temperatures for Shrinkage Fits.—The temperature to which the outer member in a shrinkage fit should be heated for clearance in assembling the parts depends on the total

Table 2. Factors for Calculating Shrinkage Fit Allowances for Hollow Steel Shafts and Steel Hubs

$\frac{D_2}{D_1}$	$\frac{D_1}{D_0}$	C^a	$\frac{D_2}{D_1}$	$\frac{D_1}{D_0}$	C^a	$\frac{D_2}{D_1}$	$\frac{D_1}{D_0}$	C^a
1.5	2.0	0.455	2.4	2.0	0.760	3.4	2.0	0.876
	2.5	0.357		2.5	0.597		2.5	0.689
	3.0	0.313		3.0	0.523		3.0	0.602
	3.5	0.288		3.5	0.481		3.5	0.555
1.6	2.0	0.509	2.6	2.0	0.793	3.6	2.0	0.888
	2.5	0.400		2.5	0.624		2.5	0.698
	3.0	0.350		3.0	0.546		3.0	0.611
	3.5	0.322		3.5	0.502		3.5	0.562
1.8	2.0	0.599	2.8	2.0	0.820	3.8	2.0	0.900
	2.5	0.471		2.5	0.645		2.5	0.707
	3.0	0.412		3.0	0.564		3.0	0.619
	3.5	0.379		3.5	0.519		3.5	0.570
2.0	2.0	0.667	3.0	2.0	0.842	4.0	2.0	0.909
	2.5	0.524		2.5	0.662		2.5	0.715
	3.0	0.459		3.0	0.580		3.0	0.625
	3.5	0.422		3.5	0.533		3.5	0.576
2.2	2.0	0.718	3.2	2.0	0.860
	2.5	0.565		2.5	0.676
	3.0	0.494		3.0	0.591
	3.5	0.455		3.5	0.544

^a Values of factor C for hollow steel shafts of external and internal diameters D_1 and D_0 , respectively, and steel hubs of nominal external diameter D_2 .

Table 3. Factors for Calculating Shrinkage Fit Allowances for Hollow Steel Shafts and Cast-iron Hubs

$\frac{D_2}{D_1}$	$\frac{D_1}{D_0}$	C^a	$\frac{D_2}{D_1}$	$\frac{D_1}{D_0}$	C^a	$\frac{D_2}{D_1}$	$\frac{D_1}{D_0}$	C^a
1.5	2.0	0.468	2.4	2.0	0.798	3.4	2.0	0.926
	2.5	0.368		2.5	0.628		2.5	0.728
	3.0	0.322		3.0	0.549		3.0	0.637
	3.5	0.296		3.5	0.506		3.5	0.587
1.6	2.0	0.527	2.6	2.0	0.834	3.6	2.0	0.941
	2.5	0.414		2.5	0.656		2.5	0.740
	3.0	0.362		3.0	0.574		3.0	0.647
	3.5	0.333		3.5	0.528		3.5	0.596
1.8	2.0	0.621	2.8	2.0	0.864	3.8	2.0	0.953
	2.5	0.488		2.5	0.679		2.5	0.749
	3.0	0.427		3.0	0.594		3.0	0.656
	3.5	0.393		3.5	0.547		3.5	0.603
2.0	2.0	0.696	3.0	2.0	0.888	4.0	2.0	0.964
	2.5	0.547		2.5	0.698		2.5	0.758
	3.0	0.479		3.0	0.611		3.0	0.663
	3.5	0.441		3.5	0.562		3.5	0.610
2.2	2.0	0.753	3.2	2.0	0.909
	2.5	0.592		2.5	0.715
	3.0	0.518		3.0	0.625
	3.5	0.477		3.5	0.576

^a Values of factor C for hollow steel shafts and cast-iron hubs. Notation as in [Table 2](#).

expansion required and on the coefficient α of linear expansion of the metal (i.e., the increase in length of any section of the metal in any direction for an increase in temperature of 1 degree F). The total expansion in diameter that is required consists of the total allowance for shrinkage and an added amount for clearance. The value of the coefficient α is, for nickel-steel, 0.000007; for steel in general, 0.0000065; for cast iron, 0.0000062. As an example, take an outer member of steel to be expanded 0.005 inch per inch of internal diameter, 0.001 being the shrinkage allowance and the remainder for clearance. Then

$$\alpha \times t^{\circ} = 0.005$$

$$t = \frac{0.005}{0.0000065} = 769 \text{ degrees F}$$

The value t is the number of degrees F that the temperature of the member must be raised above that of the room temperature.

ANSI Standard Limits and Fits

This American National Standard for Preferred Limits and Fits for Cylindrical Parts, ANSI B4.1-1967 (R2009), presents definitions of terms applying to fits between plain (non threaded) cylindrical parts and makes recommendations on preferred sizes, allowances, tolerances, and fits for use wherever they are applicable. This standard is in accord with the recommendations of American-British-Canadian (ABC) conferences up to a diameter of 20 inches. Experimental work is being carried on with the objective of reaching agreement in the range above 20 inches. The recommendations in the standard are presented for guidance and for use where they might serve to improve and simplify products, practices, and facilities. They should have application for a wide range of products.

As revised in 1967, and reaffirmed in 2009, the definitions in ANSI B4.1 have been expanded and some of the limits in certain classes have been changed.

Factors Affecting Selection of Fits.—Many factors, such as length of engagement, bearing load, speed, lubrication, temperature, humidity, and materials must be taken into consideration in the selection of fits for a particular application, and modifications in the ANSI recommendations may be required to satisfy extreme conditions. Subsequent adjustments may also be found desirable as a result of experience in a particular application to suit critical functional requirements or to permit optimum manufacturing economy.

Definitions.—The following terms are defined in this standard:

Nominal Size: The nominal size is the designation used for the purpose of general identification.

Dimension: A dimension is a geometrical characteristic such as diameter, length, angle, or center distance.

Size: Size is a designation of magnitude. When a value is assigned to a dimension, it is referred to as the size of that dimension. (It is recognized that the words “dimension” and “size” are both used at times to convey the meaning of magnitude.)

Allowance: An allowance is a prescribed difference between the maximum material limits of mating parts. (See definition of *Fit*). It is a minimum clearance (positive allowance) or maximum interference (negative allowance) between such parts.

Tolerance: A tolerance is the total permissible variation of a size. The tolerance is the difference between the limits of size.

Basic Size: The basic size is that size from which the limits of size are derived by the application of allowances and tolerances.

Design Size: The design size is the basic size with allowance applied, from which the limits of size are derived by the application of tolerances. Where there is no allowance, the design size is the same as the basic size.

Actual Size: An actual size is a measured size.

Limits of Size: The limits of size are the applicable maximum and minimum sizes.

Maximum Material Limit: A maximum material limit is that limit of size that provides the maximum amount of material for the part. Normally it is the maximum limit of size of an external dimension or the minimum limit of size of an internal dimension.*

Minimum Material Limit: A minimum material limit is that limit of size that provides the minimum amount of material for the part. Normally it is the minimum limit of size of an external dimension or the maximum limit of size of an internal dimension.*

Tolerance Limit: A tolerance limit is the variation, positive or negative, by which a size is permitted to depart from the design size.

Unilateral Tolerance: A unilateral tolerance is a tolerance in which variation is permitted in only one direction from the design size.

Bilateral Tolerance: A bilateral tolerance is a tolerance in which variation is permitted in both directions from the design size.

Unilateral Tolerance System: A design plan that uses only unilateral tolerances is known as a Unilateral Tolerance System.

Bilateral Tolerance System: A design plan that uses only bilateral tolerances is known as a Bilateral Tolerance System.

Fits.—Fit: Fit is the general term used to signify the range of tightness that may result from the application of a specific combination of allowances and tolerances in the design of mating parts.

Actual Fit: The actual fit between two mating parts is the relation existing between them with respect to the amount of clearance or interference that is present when they are assembled. (Fits are of three general types: clearance, transition, and interference.)

Clearance Fit: A clearance fit is one having limits of size so specified that a clearance always results when mating parts are assembled.

Interference Fit: An interference fit is one having limits of size so specified that an interference always results when mating parts are assembled.

Transition Fit: A transition fit is one having limits of size so specified that either a clearance or an interference may result when mating parts are assembled.

Basic Hole System: A basic hole system is a system of fits in which the design size of the hole is the basic size and the allowance, if any, is applied to the shaft.

Basic Shaft System: A basic shaft system is a system of fits in which the design size of the shaft is the basic size and the allowance, if any, is applied to the hole.

Preferred Basic Sizes.—In specifying fits, the basic size of mating parts shall be chosen from the decimal series or the fractional series in [Table 4](#).

Preferred Series for Tolerances and Allowances.—All fundamental tolerances and allowances of all shafts and holes have been taken from the series given in [Table 5](#).

Standard Tolerances.—The series of standard tolerances shown in [Table 6](#) are so arranged that for any one grade they represent approximately similar production difficulties throughout the range of sizes. This table provides a suitable range from which appropriate tolerances for holes and shafts can be selected and enables standard gages to be used. The tolerances shown in [Table 6](#) have been used in the succeeding tables for different classes of fits.

[Table 7](#) graphically illustrates the range of tolerance grades that various machining processes may produce under normal conditions.

ANSI Standard Fits.—[Tables 8a](#) through [12](#) inclusive show a series of standard types and classes of fits on a unilateral hole basis, such that the fit produced by mating parts in any one class will produce approximately similar performance throughout the range of sizes. These tables prescribe the fit for any given size, or type of fit; they also prescribe the

* An example of exceptions: an exterior corner radius where the maximum radius is the minimum material limit and the minimum radius is the maximum material limit.

Table 4. Preferred Basic Sizes ANSI B4.1-1967 (R2009)

Decimal ^a			Fractional ^a					
0.010	2.00	8.50	$\frac{1}{64}$	0.015625	$2\frac{1}{4}$	2.2500	$9\frac{1}{2}$	9.5000
0.012	2.20	9.00	$\frac{1}{32}$	0.03125	$2\frac{1}{2}$	2.5000	10	10.0000
0.016	2.40	9.50	$\frac{1}{16}$	0.0625	$2\frac{3}{4}$	2.7500	$10\frac{1}{2}$	10.5000
0.020	2.60	10.00	$\frac{3}{32}$	0.09375	3	3.0000	11	11.0000
0.025	2.80	10.50	$\frac{1}{8}$	0.1250	$3\frac{1}{4}$	3.2500	$11\frac{1}{2}$	11.5000
0.032	3.00	11.00	$\frac{5}{32}$	0.15625	$3\frac{1}{2}$	3.5000	12	12.0000
0.040	3.20	11.50	$\frac{3}{16}$	0.1875	$3\frac{3}{4}$	3.7500	$12\frac{1}{2}$	12.5000
0.05	3.40	12.00	$\frac{1}{4}$	0.2500	4	4.0000	13	13.0000
0.06	3.60	12.50	$\frac{5}{16}$	0.3125	$4\frac{1}{4}$	4.2500	$13\frac{1}{2}$	13.5000
0.08	3.80	13.00	$\frac{3}{8}$	0.3750	$4\frac{1}{2}$	4.5000	14	14.0000
0.10	4.00	13.50	$\frac{7}{16}$	0.4375	$4\frac{3}{4}$	4.7500	$14\frac{1}{2}$	14.5000
0.12	4.20	14.00	$\frac{1}{2}$	0.5000	5	5.0000	15	15.0000
0.16	4.40	14.50	$\frac{9}{16}$	0.5625	$5\frac{1}{4}$	5.2500	$15\frac{1}{2}$	15.5000
0.20	4.60	15.00	$\frac{5}{8}$	0.6250	$5\frac{1}{2}$	5.5000	16	16.0000
0.24	4.80	15.50	$1\frac{1}{16}$	0.6875	$5\frac{3}{4}$	5.7500	$16\frac{1}{2}$	16.5000
0.30	5.00	16.00	$\frac{3}{4}$	0.7500	6	6.0000	17	17.0000
0.40	5.20	16.50	$\frac{7}{8}$	0.8750	$6\frac{1}{2}$	6.5000	$17\frac{1}{2}$	17.5000
0.50	5.40	17.00	1	1.0000	7	7.0000	18	18.0000
0.60	5.60	17.50	$1\frac{1}{4}$	1.2500	$7\frac{1}{2}$	7.5000	$18\frac{1}{2}$	18.5000
0.80	5.80	18.00	$1\frac{1}{2}$	1.5000	8	8.0000	19	19.0000
1.00	6.00	18.50	$1\frac{3}{4}$	1.7500	$8\frac{1}{2}$	8.5000	$19\frac{1}{2}$	19.5000
1.20	6.50	19.00	2	2.0000	9	9.0000	20	20.0000
1.40	7.00	19.50
1.60	7.50	20.00
1.80	8.00

^a All dimensions are in inches.

Table 5. Preferred Series of Tolerances and Allowances^a ANSI B4.1-1967 (R2009)

0.1	1	10	100	0.3	3	30	...
...	1.2	12	125	...	3.5	35	...
0.15	1.4	14	...	0.4	4	40	...
...	1.6	16	160	...	4.5	45	...
...	1.8	18	...	0.5	5	50	...
0.2	2	20	200	0.6	6	60	...
...	2.2	22	...	0.7	7	70	...
0.25	2.5	25	250	0.8	8	80	...
...	2.8	28	...	0.9	9

^a All values in thousandths of an inch standard limits for the mating parts that will produce the fit. The fits listed in these tables contain all those that appear in the approved American-British-Canadian proposal.

Selection of Fits: In selecting limits of size for any application, the type of fit is determined first, based on the use or service required from the equipment being designed; then the limits of size of the mating parts are established, to insure that the desired fit will be produced.

Theoretically, an infinite number of fits could be chosen, but the number of standard fits shown in the accompanying tables should cover most applications.

Designation of Standard Fits: Standard fits are designated by means of the following symbols which, facilitate reference to classes of fit for educational purposes. The symbols are not intended to be shown on manufacturing drawings; instead, sizes should be specified on drawings.

Table 6. ANSI Standard Tolerances ANSI B4.1-1967 (R2009)

Nominal Size, Inches		Grade									
		4	5	6	7	8	9	10	11	12	13
Over	To	Tolerances in thousandths of an inch ^a									
0	0.12	0.12	0.15	0.25	0.4	0.6	1.0	1.6	2.5	4	6
0.12	0.24	0.15	0.20	0.3	0.5	0.7	1.2	1.8	3.0	5	7
0.24	0.40	0.15	0.25	0.4	0.6	0.9	1.4	2.2	3.5	6	9
0.40	0.71	0.2	0.3	0.4	0.7	1.0	1.6	2.8	4.0	7	10
0.71	1.19	0.25	0.4	0.5	0.8	1.2	2.0	3.5	5.0	8	12
1.19	1.97	0.3	0.4	0.6	1.0	1.6	2.5	4.0	6	10	16
1.97	3.15	0.3	0.5	0.7	1.2	1.8	3.0	4.5	7	12	18
3.15	4.73	0.4	0.6	0.9	1.4	2.2	3.5	5	9	14	22
4.73	7.09	0.5	0.7	1.0	1.6	2.5	4.0	6	10	16	25
7.09	9.85	0.6	0.8	1.2	1.8	2.8	4.5	7	12	18	28
9.85	12.41	0.6	0.9	1.2	2.0	3.0	5.0	8	12	20	30
12.41	15.75	0.7	1.0	1.4	2.2	3.5	6	9	14	22	35
15.75	19.69	0.8	1.0	1.6	2.5	4	6	10	16	25	40
19.69	30.09	0.9	1.2	2.0	3	5	8	12	20	30	50
30.09	41.49	1.0	1.6	2.5	4	6	10	16	25	40	60
41.49	56.19	1.2	2.0	3	5	8	12	20	30	50	80
56.19	76.39	1.6	2.5	4	6	10	16	25	40	60	100
76.39	100.9	2.0	3	5	8	12	20	30	50	80	125
100.9	131.9	2.5	4	6	10	16	25	40	60	100	160
131.9	171.9	3	5	8	12	20	30	50	80	125	200
171.9	200	4	6	10	16	25	40	60	100	160	250

^a All tolerances above heavy line are in accordance with American-British-Canadian (ABC) agreements.

Table 7. Relation of Machining Processes to Tolerance Grades ANSI B4.1-1967 (R2009)

	MACHINING OPERATION	TOLERANCE GRADES										
		4	5	6	7	8	9	10	11	12	13	
This chart may be used as a general guide to determine the machining processes that will under normal conditions, produce work within the tolerance grades indicated. (See also <i>Relation of Surface Roughness to Tolerances</i> starting on page 738.	Lapping & Honing	█										
	Cylindrical Grinding	█	█									
	Surface Grinding	█	█	█								
	Diamond Turning	█	█	█	█							
	Diamond Boring	█	█	█	█	█						
	Broaching	█	█	█	█	█	█					
	Reaming	█	█	█	█	█	█	█				
	Turning	█	█	█	█	█	█	█	█	█		
	Boring	█	█	█	█	█	█	█	█	█	█	
	Milling	█	█	█	█	█	█	█	█	█	█	█
	Planing & Shaping	█	█	█	█	█	█	█	█	█	█	█
	Drilling	█	█	█	█	█	█	█	█	█	█	█

The letter symbols used to designate standard fits are as follows:

RC = Running or Sliding Clearance Fit *LC* = Locational Clearance Fit

LT = Transition Clearance or Interference Fit

LN = Locational Interference Fit

FN = Force or Shrink Fit

These letter symbols are used in conjunction with numbers representing the class of fit; thus FN 4 represents a Class 4, force fit.

Each of these symbols (two letters and a number) represents a complete fit for which the minimum and maximum clearance or interference and the limits of size for the mating parts are given directly in the tables.

Description of Fits.—The classes of fits are arranged in three general groups: running and sliding fits, locational fits, and force fits.

Running and Sliding Fits (RC): Running and sliding fits, for which limits of clearance are given in [Table 8a](#), are intended to provide a similar running performance, with suitable lubrication allowance, throughout the range of sizes. The clearances for the first two classes, used chiefly as slide fits, increase more slowly with the diameter than for the other classes, so that accurate location is maintained even at the expense of free relative motion.

These fits may be described as follows:

RC 1 *Close sliding fits* are intended for the accurate location of parts that must assemble without perceptible play.

RC 2 *Sliding fits* are intended for accurate location, but with greater maximum clearance than class RC 1. Parts made to this fit move and turn easily but are not intended to run freely, and in the larger sizes may seize with small temperature changes.

RC 3 *Precision running fits* are about the closest fits that can be expected to run freely, and are intended for precision work at slow speeds and light journal pressures, but are not suitable where appreciable temperature differences are likely to be encountered.

RC 4 *Close running fits* are intended chiefly for running fits on accurate machinery with moderate surface speeds and journal pressures, where accurate location and minimum play are desired.

RC 5 and RC 6 *Medium running fits* are intended for higher running speeds, or heavy journal pressures, or both.

RC 7 *Free running fits* are intended for use where accuracy is not essential, or where large temperature variations are likely to be encountered, or under both these conditions.

RC 8 and RC 9 *Loose running fits* are intended for use where wide commercial tolerances may be necessary, together with an allowance, on the external member.

Locational Fits (LC, LT, and LN): Locational fits are fits intended to determine only the location of the mating parts; they may provide rigid or accurate location, as with interference fits, or provide some freedom of location, as with clearance fits. Accordingly, they are divided into three groups: clearance fits (LC), transition fits (LT), and interference fits (LN).

These are described as follows:

LC *Locational clearance fits* are intended for parts which are normally stationary, but that can be freely assembled or disassembled. They range from snug fits for parts requiring accuracy of location, through the medium clearance fits for parts such as spigots, to the looser fastener fits where freedom of assembly is of prime importance.

LT *Locational transition fits* are a compromise between clearance and interference fits, for applications where accuracy of location is important, but either a small amount of clearance or interference is permissible.

LN *Locational interference fits* are used where accuracy of location is of prime importance, and for parts requiring rigidity and alignment with no special requirements for bore pressure. Such fits are not intended for parts designed to transmit frictional loads from one part to another by virtue of the tightness of fit. These conditions are covered by force fits.

Force Fits: (FN): Force or shrink fits constitute a special type of interference fit, normally characterized by maintenance of constant bore pressures throughout the range of sizes. The interference therefore varies almost directly with diameter, and the difference

between its minimum and maximum value is small, to maintain the resulting pressures within reasonable limits.

These fits are described as follows:

FN 1 *Light drive fits* are those requiring light assembly pressures, and produce more or less permanent assemblies. They are suitable for thin sections or long fits, or in cast-iron external members.

FN 2 *Medium drive fits* are suitable for ordinary steel parts, or for shrink fits on light sections. They are about the tightest fits that can be used with high-grade cast-iron external members.

FN 3 *Heavy drive fits* are suitable for heavier steel parts or for shrink fits in medium sections.

FN 4 and FN 5 *Force fits* are suitable for parts that can be highly stressed, or for shrink fits where the heavy pressing forces required are impractical.

Graphical Representation of Limits and Fits.—A visual comparison of the hole and shaft tolerances and the clearances or interferences provided by the various types and classes of fits can be obtained from the diagrams on page 640. These diagrams have been drawn to scale for a nominal diameter of 1 inch.

Use of Standard Fit Tables.—*Example 1:* A Class RC 1 fit is to be used in assembling a mating hole and shaft of 2-inch nominal diameter. This class of fit was selected because the application required accurate location of the parts with no perceptible play (see *Description of Fits*, RC 1 close sliding fits). From the data in Table 8a, establish the limits of size and clearance of the hole and shaft.

Maximum hole = $2 + 0.0005 = 2.0005$; minimum hole = 2 inches

Maximum shaft = $2 - 0.0004 = 1.9996$; minimum shaft = $2 - 0.0007 = 1.9993$ inches

Minimum clearance = 0.0004; maximum clearance = 0.0012 inch

Modified Standard Fits.—Fits having the same limits of clearance or interference as those shown in Tables 8a to 12 may sometimes have to be produced by using holes or shafts having limits of size other than those shown in these tables. These modifications may be accomplished by using either a *Bilateral Hole System (Symbol B)* or a *Basic Shaft System (Symbol S)*. Both methods will result in nonstandard holes and shafts.

Bilateral Hole Fits (Symbol B): The common situation is where holes are produced with fixed tools such as drills or reamers; to provide a longer wear life for such tools, a bilateral tolerance is desired.

The symbols used for these fits are identical with those used for standard fits except that they are followed by the letter B. Thus, LC 4B is a clearance locational fit, Class 4, except that it is produced with a bilateral hole.

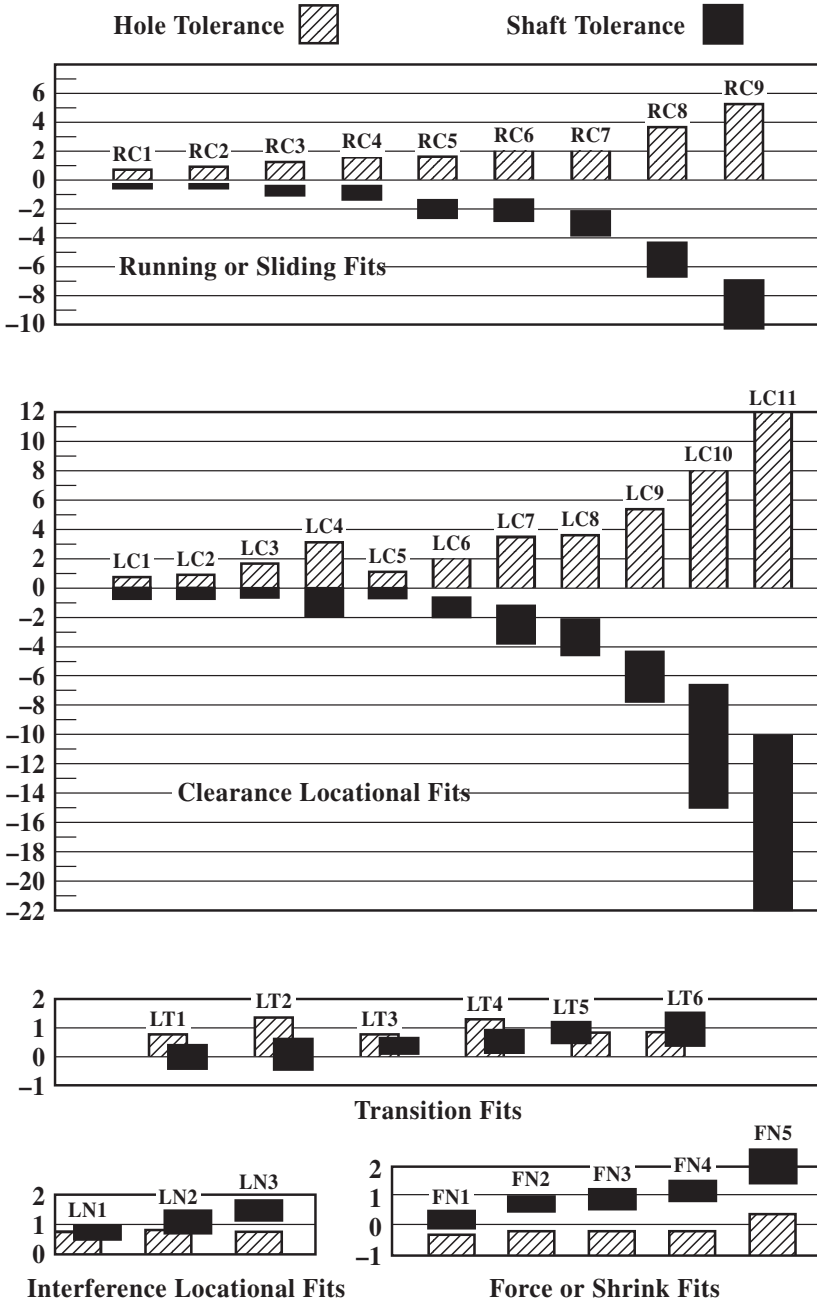
The limits of clearance or interference are identical with those shown in Tables 8a to 12 for the corresponding fits.

The hole tolerance, however, is changed so that the plus limit is that for one grade finer than the value shown in the tables and the minus limit equals the amount by which the plus limit was lowered. The shaft limits are both lowered by the same amount as the lower limit of size of the hole. The finer grade of tolerance required to make these modifications may be obtained from Table 6. For example, an LC 4B fit for a 6-inch diameter hole would have tolerance limits of +4.0, -2.0 (+0.0040 inch, -0.0020 inch); the shaft would have tolerance limits of -2.0, -6.0 (-0.0020 inch, -0.0060 inch).

Basic Shaft Fits (Symbol S): For these fits, the maximum size of the shaft is basic. The limits of clearance or interference are identical with those shown in Tables 8a to 12 for the corresponding fits and the symbols used for these fits are identical with those used for standard fits except that they are followed by the letter S. Thus, LC 4S is a clearance locational fit, Class 4, except that it is produced on a basic shaft basis.

The limits for hole and shaft as given in Tables 8a to 12 are increased for clearance fits (*decreased* for transition or interference fits) by the value of the upper shaft limit; that is, by the amount required to change the maximum shaft to the basic size.

Graphical Representation of ANSI Standard Limits and Fits
ANSI B4.1-1967 (R2009)



Diagrams show disposition of hole and shaft tolerances (in thousandths of an inch) with respect to basic size (0) for a diameter of 1 inch.

Table 8a. American National Standard Running and Sliding Fits ANSI B4.1-1967 (R2009)

Nominal Size Range, Inches	Class RC 1			Class RC 2			Class RC 3			Class RC 4		
	Clearance ^a	Standard Tolerance Limits		Clearance ^a	Standard Tolerance Limits		Clearance ^a	Standard Tolerance Limits		Clearance ^a	Standard Tolerance Limits	
		Hole H5	Shaft g4		Hole H6	Shaft g5		Hole H7	Shaft f6		Hole H8	Shaft f7
Over To	Values shown below are in thousandths of an inch											
0 - 0.12	0.1	+0.2	-0.1	0.1	+0.25	-0.1	0.3	+0.4	-0.3	0.3	+0.6	-0.3
	0.45	0	-0.25	0.55	0	-0.3	0.95	0	-0.55	1.3	0	-0.7
0.12 - 0.24	0.15	+0.2	-0.15	0.15	+0.3	-0.15	0.4	+0.5	-0.4	0.4	+0.7	-0.4
	0.5	0	-0.3	0.65	0	-0.35	1.2	0	-0.7	1.6	0	-0.9
0.24 - 0.40	0.2	+0.25	-0.2	0.2	+0.4	-0.2	0.5	+0.6	-0.5	0.5	+0.9	-0.5
	0.6	0	-0.35	0.85	0	-0.45	1.5	0	-0.9	2.0	0	-1.1
0.40 - 0.71	0.25	+0.3	-0.25	0.25	+0.4	-0.25	0.6	+0.7	-0.6	0.6	+1.0	-0.6
	0.75	0	-0.45	0.95	0	-0.55	1.7	0	-1.0	2.3	0	-1.3
0.71 - 1.19	0.3	+0.4	-0.3	0.3	+0.5	-0.3	0.8	+0.8	-0.8	0.8	+1.2	-0.8
	0.95	0	-0.55	1.2	0	-0.7	2.1	0	-1.3	2.8	0	-1.6
1.19 - 1.97	0.4	+0.4	-0.4	0.4	+0.6	-0.4	1.0	+1.0	-1.0	1.0	+1.6	-1.0
	1.1	0	-0.7	1.4	0	-0.8	2.6	0	-1.6	3.6	0	-2.0
1.97 - 3.15	0.4	+0.5	-0.4	0.4	+0.7	-0.4	1.2	+1.2	-1.2	1.2	+1.8	-1.2
	1.2	0	-0.7	1.6	0	-0.9	3.1	0	-1.9	4.2	0	-2.4
3.15 - 4.73	0.5	+0.6	-0.5	0.5	+0.9	-0.5	1.4	+1.4	-1.4	1.4	+2.2	-1.4
	1.5	0	-0.9	2.0	0	-1.1	3.7	0	-2.3	5.0	0	-2.8
4.73 - 7.09	0.6	+0.7	-0.6	0.6	+1.0	-0.6	1.6	+1.6	-1.6	1.6	+2.5	-1.6
	1.8	0	-1.1	2.3	0	-1.3	4.2	0	-2.6	5.7	0	-3.2
7.09 - 9.85	0.6	+0.8	-0.6	0.6	+1.2	-0.6	2.0	+1.8	-2.0	2.0	+2.8	-2.0
	2.0	0	-1.2	2.6	0	-1.4	5.0	0	-3.2	6.6	0	-3.8
9.85 - 12.41	0.8	+0.9	-0.8	0.8	+1.2	-0.8	2.5	+2.0	-2.5	2.5	+3.0	-2.5
	2.3	0	-1.4	2.9	0	-1.7	5.7	0	-3.7	7.5	0	-4.5
12.41 - 15.75	1.0	+1.0	-1.0	1.0	+1.4	-1.0	3.0	+2.2	-3.0	3.0	+3.5	-3.0
	2.7	0	-1.7	3.4	0	-2.0	6.6	0	-4.4	8.7	0	-5.2
15.75 - 19.69	1.2	+1.0	-1.2	1.2	+1.6	-1.2	4.0	+2.5	-4.0	4.0	+4.0	-4.0
	3.0	0	-2.0	3.8	0	-2.2	8.1	0	-5.6	10.5	0	-6.5

Table 8b. American National Standard Running and Sliding Fits ANSI B4.1-1967 (R2009)

Nominal Size Range, Inches Over To	Class RC 5			Class RC 6			Class RC 7			Class RC 8			Class RC 9		
	Clear-ance ^a	Standard Tolerance Limits		Clear-ance ^a	Standard Tolerance Limits		Clear-ance ^a	Standard Tolerance Limits		Clear-ance ^a	Standard Tolerance Limits		Clear-ance ^a	Standard Tolerance Limits	
		Hole H8	Shaft e7		Hole H9	Shaft e8		Hole H9	Shaft d8		Hole H10	Shaft c9		Hole H11	Shaft
Values shown below are in thousandths of an inch															
0 - 0.12	0.6 1.6	+0.6 0	- 0.6 - 1.0	0.6 2.2	+1.0 0	- 0.6 - 1.2	1.0 2.6	+1.0 0	- 1.0 - 1.6	2.5 5.1	+1.6 0	- 2.5 - 3.5	4.0 8.1	+2.5 0	- 4.0 - 5.6
0.12 - 0.24	0.8 2.0	+0.7 0	- 0.8 - 1.3	0.8 2.7	+1.2 0	- 0.8 - 1.5	1.2 3.1	+1.2 0	- 1.2 - 1.9	2.8 5.8	+1.8 0	- 2.8 - 4.0	4.5 9.0	+3.0 0	- 4.5 - 6.0
0.24 - 0.40	1.0 2.5	+0.9 0	- 1.0 - 1.6	1.0 3.3	+1.4 0	- 1.0 - 1.9	1.6 3.9	+1.4 0	- 1.6 - 2.5	3.0 6.6	+2.2 0	- 3.0 - 4.4	5.0 10.7	+3.5 0	- 5.0 - 7.2
0.40 - 0.71	1.2 2.9	+1.0 0	- 1.2 - 1.9	1.2 3.8	+1.6 0	- 1.2 - 2.2	2.0 4.6	+1.6 0	- 2.0 - 3.0	3.5 7.9	+2.8 0	- 3.5 - 5.1	6.0 12.8	+4.0 0	- 6.0 - 8.8
0.71 - 1.19	1.6 3.6	+1.2 0	- 1.6 - 2.4	1.6 4.8	+2.0 0	- 1.6 - 2.8	2.5 5.7	+2.0 0	- 2.5 - 3.7	4.5 10.0	+3.5 0	- 4.5 - 6.5	7.0 15.5	+5.0 0	- 7.0 -10.5
1.19 - 1.97	2.0 4.6	+1.6 0	- 2.0 - 3.0	2.0 6.1	+2.5 0	- 2.0 - 3.6	3.0 7.1	+2.5 0	- 3.0 - 4.6	5.0 11.5	+4.0 0	- 5.0 - 7.5	8.0 18.0	+6.0 0	- 8.0 -12.0
1.97 - 3.15	2.5 5.5	+1.8 0	- 2.5 - 3.7	2.5 7.3	+3.0 0	- 2.5 - 4.3	4.0 8.8	+3.0 0	- 4.0 - 5.8	6.0 13.5	+4.5 0	- 6.0 - 9.0	9.0 20.5	+7.0 0	- 9.0 -13.5
3.15 - 4.73	3.0 6.6	+2.2 0	- 3.0 - 4.4	3.0 8.7	+3.5 0	- 3.0 - 5.2	5.0 10.7	+3.5 0	- 5.0 - 7.2	7.0 15.5	+5.0 0	- 7.0 -10.5	10.0 24.0	+9.0 0	-10.0 -15.0
4.73 - 7.09	3.5 7.6	+2.5 0	- 3.5 - 5.1	3.5 10.0	+4.0 0	- 3.5 - 6.0	6.0 12.5	+4.0 0	- 6.0 - 8.5	8.0 18.0	+6.0 0	- 8.0 -12.0	12.0 28.0	+10.0 0	-12.0 -18.0
7.09 - 9.85	4.0 8.6	+2.8 0	- 4.0 - 5.8	4.0 11.3	+4.5 0	- 4.0 - 6.8	7.0 14.3	+4.5 0	- 7.0 - 9.8	10.0 21.5	+7.0 0	-10.0 -14.5	15.0 34.0	+12.0 0	-15.0 -22.0
9.85 - 12.41	5.0 10.0	+3.0 0	- 5.0 - 7.0	5.0 13.0	+5.0 0	- 5.0 - 8.0	8.0 16.0	+5.0 0	- 8.0 -11.0	12.0 25.0	+8.0 0	-12.0 -17.0	18.0 38.0	+12.0 0	-18.0 -26.0
12.41 - 15.75	6.0 11.7	+3.5 0	- 6.0 - 8.2	6.0 15.5	+6.0 0	- 6.0 - 9.5	10.0 19.5	+6.0 0	-10.0 -13.5	14.0 29.0	+9.0 0	-14.0 -20.0	22.0 45.0	+14.0 0	-22.0 -31.0
15.75 - 19.69	8.0 14.5	+4.0 0	- 8.0 -10.5	8.0 18.0	+6.0 0	- 8.0 -12.0	12.0 22.0	+6.0 0	-12.0 -16.0	16.0 32.0	+10.0 0	-16.0 -22.0	25.0 51.0	+16.0 0	-25.0 -35.0

^aPairs of values shown represent minimum and maximum amounts of clearance resulting from application of standard tolerance limits.

Tolerance limits given in body of table are added to or subtracted from basic size (as indicated by + or - sign) to obtain maximum and minimum sizes of mating parts. All data above heavy lines are in accord with ABC agreements. Symbols H5, g4, etc. are hole and shaft designations in ABC system. Limits for sizes above 19.69 inches are also given in the ANSI Standard.

Table 9a. American National Standard Clearance Locational Fits ANSI B4.1-1967 (R2009)

Nominal Size Range, Inches	Class LC 1			Class LC 2			Class LC 3			Class LC 4			Class LC 5		
	Clear- ance ^a	Standard Tolerance Limits		Clear- ance ^a	Standard Tolerance Limits		Clear- ance ^a	Standard Tolerance Limits		Clear- ance ^a	Standard Tolerance Limits		Clear- ance ^a	Standard Tolerance Limits	
		Hole H6	Shaft h5		Hole H7	Shaft h6		Hole H8	Shaft h7		Hole H10	Shaft h9		Hole H7	Shaft g6
Over To	Values shown below are in thousandths of an inch														
0- 0.12	0 0.45	+0.25 0	0 -0.2	0 0.65	+0.4 0	0 -0.25	0 1	+0.6 0	0 -0.4	0 2.6	+1.6 0	0 -1.0	0.1 0.75	+0.4 0	-0.1 -0.35
0.12- 0.24	0 0.5	+0.3 0	0 -0.2	0 0.8	+0.5 0	0 -0.3	0 1.2	+0.7 0	0 -0.5	0 3.0	+1.8 0	0 -1.2	0.15 0.95	+0.5 0	-0.15 -0.45
0.24- 0.40	0 0.65	+0.4 0	0 -0.25	0 1.0	+0.6 0	0 -0.4	0 1.5	+0.9 0	0 -0.6	0 3.6	+2.2 0	0 -1.4	0.2 1.2	+0.6 0	-0.2 -0.6
0.40- 0.71	0 0.7	+0.4 0	0 -0.3	0 1.1	+0.7 0	0 -0.4	0 1.7	+1.0 0	0 -0.7	0 4.4	+2.8 0	0 -1.6	0.25 1.35	+0.7 0	-0.25 -0.65
0.71- 1.19	0 0.9	+0.5 0	0 -0.4	0 1.3	+0.8 0	0 -0.5	0 2	+1.2 0	0 -0.8	0 5.5	+3.5 0	0 -2.0	0.3 1.6	+0.8 0	-0.3 -0.8
1.19- 1.97	0 1.0	+0.6 0	0 -0.4	0 1.6	+1.0 0	0 -0.6	0 2.6	+1.6 0	0 -1	0 6.5	+4.0 0	0 -2.5	0.4 2.0	+1.0 0	-0.4 -1.0
1.97- 3.15	0 1.2	+0.7 0	0 -0.5	0 1.9	+1.2 0	0 -0.7	0 3	+1.8 0	0 -1.2	0 7.5	+4.5 0	0 -3	0.4 2.3	+1.2 0	-0.4 -1.1
3.15- 4.73	0 1.5	+0.9 0	0 -0.6	0 2.3	+1.4 0	0 -0.9	0 3.6	+2.2 0	0 -1.4	0 8.5	+5.0 0	0 -3.5	0.5 2.8	+1.4 0	-0.5 -1.4
4.73- 7.09	0 1.7	+1.0 0	0 -0.7	0 2.6	+1.6 0	0 -1.0	0 4.1	+2.5 0	0 -1.6	0 10.0	+6.0 0	0 -4	0.6 3.2	+1.6 0	-0.6 -1.6
7.09- 9.85	0 2.0	+1.2 0	0 -0.8	0 3.0	+1.8 0	0 -1.2	0 4.6	+2.8 0	0 -1.8	0 11.5	+7.0 0	0 -4.5	0.6 3.6	+1.8 0	-0.6 -1.8
9.85- 12.41	0 2.1	+1.2 0	0 -0.9	0 3.2	+2.0 0	0 -1.2	0 5	+3.0 0	0 -2.0	0 13.0	+8.0 0	0 -5	0.7 3.9	+2.0 0	-0.7 -1.9
12.41- 15.75	0 2.4	+1.4 0	0 -1.0	0 3.6	+2.2 0	0 -1.4	0 5.7	+3.5 0	0 -2.2	0 15.0	+9.0 0	0 -6	0.7 4.3	+2.2 0	-0.7 -2.1
15.75- 19.69	0 2.6	+1.6 0	0 -1.0	0 4.1	+2.5 0	0 -1.6	0 6.5	+4 0	0 -2.5	0 16.0	+10.0 0	0 -6	0.8 4.9	+2.5 0	-0.8 -2.4

Tolerance limits given in body of table are added or subtracted to basic size (as indicated by + or - sign) to obtain maximum and minimum sizes of mating parts. All data above heavy lines are in accordance with American-British-Canadian (ABC) agreements. Symbols H6, H7, s6, etc. are hole and shaft designations in ABC system. Limits for sizes above 19.69 inches are not covered by ABC agreements but are given in the ANSI Standard.

Table 9b. American National Standard Clearance Locational Fits ANSI B4.1-1967 (R2009)

Nominal Size Range, Inches Over To	Class LC 6			Class LC 7			Class LC 8			Class LC 9			Class LC 10			Class LC 11		
	Clearance ^a	Std. Tolerance Limits		Clearance ^a	Std. Tolerance Limits		Clearance ^a	Std. Tolerance Limits		Clearance ^a	Std. Tolerance Limits		Clearance ^a	Std. Tolerance Limits		Clearance ^a	Std. Tolerance Limits	
		Hole H9	Shaft f8		Hole H10	Shaft e9		Hole H10	Shaft d9		Hole H11	Shaft c10		Hole H12	Shaft		Hole H13	Shaft
Values shown below are in thousandths of an inch																		
0 - 0.12	0.3 1.9	+1.0 0	-0.3 -0.9	0.6 3.2	+1.6 0	- 0.6 - 1.6	1.0 2.0	+1.6 0	- 1.0 - 2.0	2.5 6.6	+2.5 0	- 2.5 - 4.1	4 12	+4 0	- 4 - 8	5 17	+6 0	- 5 - 11
0.12 - 0.24	0.4 2.3	+1.2 0	-0.4 -1.1	0.8 3.8	+1.8 0	- 0.8 - 2.0	1.2 4.2	+1.8 0	- 1.2 - 2.4	2.8 7.6	+3.0 0	- 2.8 - 4.6	4.5 14.5	+5 0	- 4.5 - 9.5	6 20	+7 0	- 6 - 13
0.24 - 0.40	0.5 2.8	+1.4 0	-0.5 -1.4	1.0 4.6	+2.2 0	- 1.0 - 2.4	1.6 5.2	+2.2 0	- 1.6 - 3.0	3.0 8.7	+3.5 0	- 3.0 - 5.2	5 17	+6 0	- 5 - 11	7 25	+9 0	- 7 - 16
0.40 - 0.71	0.6 3.2	+1.6 0	-0.6 -1.6	1.2 5.6	+2.8 0	- 1.2 - 2.8	2.0 6.4	+2.8 0	- 2.0 - 3.6	3.5 10.3	+4.0 0	- 3.5 - 6.3	6 20	+7 0	- 6 - 13	8 28	+10 0	- 8 - 18
0.71 - 1.19	0.8 4.0	+2.0 0	-0.8 -2.0	1.6 7.1	+3.5 0	- 1.6 - 3.6	2.5 8.0	+3.5 0	- 2.5 - 4.5	4.5 13.0	+5.0 0	- 4.5 - 8.0	7 23	+8 0	- 7 - 15	10 34	+12 0	- 10 - 22
1.19 - 1.97	1.0 5.1	+2.5 0	-1.0 -2.6	2.0 8.5	+4.0 0	- 2.0 - 4.5	3.6 9.5	+4.0 0	- 3.0 - 5.5	5.0 15.0	+6 0	- 5.0 - 9.0	8 28	+10 0	- 8 - 18	12 44	+16 0	- 12 - 28
1.97 - 3.15	1.2 6.0	+3.0 0	-1.0 -3.0	2.5 10.0	+4.5 0	- 2.5 - 5.5	4.0 11.5	+4.5 0	- 4.0 - 7.0	6.0 17.5	+7 0	- 6.0 - 10.5	10 34	+12 0	- 10 - 22	14 50	+18 0	- 14 - 32
3.15 - 4.73	1.4 7.1	+3.5 0	-1.4 -3.6	3.0 11.5	+5.0 0	- 3.0 - 6.5	5.0 13.5	+5.0 0	- 5.0 - 8.5	7 21	+9 0	- 7 - 12	11 39	+14 0	- 11 - 25	16 60	+22 0	- 16 - 38
4.73 - 7.09	1.6 8.1	+4.0 0	-1.6 -4.1	3.5 13.5	+6.0 0	- 3.5 - 7.5	6 16	+6 0	- 6 - 10	8 24	+10 0	- 8 - 14	12 44	+16 0	- 12 - 28	18 68	+25 0	- 18 - 43
7.09 - 9.85	2.0 9.3	+4.5 0	-2.0 -4.8	4.0 15.5	+7.0 0	- 4.0 - 8.5	7 18.5	+7 0	- 7 - 11.5	10 29	+12 0	- 10 - 17	16 52	+18 0	- 16 - 34	22 78	+28 0	- 22 - 50
9.85 - 12.41	2.2 10.2	+5.0 0	-2.2 -5.2	4.5 17.5	+8.0 0	- 4.5 - 9.5	7 20	+8 0	- 7 - 12	12 32	+12 0	- 12 - 20	20 60	+20 0	- 20 - 40	28 88	+30 0	- 28 - 58
12.41 - 15.75	2.5 12.0	+6.0 0	-2.5 -6.0	5.0 20.0	+9.0 0	- 5 - 11	8 23	+9 0	- 8 - 14	14 37	+14 0	- 14 - 23	22 66	+22 0	- 22 - 44	30 100	+35 0	- 30 - 65
15.75- 19.69	2.8 12.8	+6.0 0	-2.8 -6.8	5.0 21.0	+10.0 0	- 5 - 11	9 25	+10 0	- 9 - 15	16 42	+16 0	- 16 - 26	25 75	+25 0	- 25 - 50	35 115	+40 0	- 35 - 75

^aPairs of values shown represent minimum and maximum amounts of interference resulting from application of standard tolerance limits.

Table 10. ANSI Standard Transition Locational Fits ANSI B4.1-1967 (R2009)

Nominal Size Range, Inches	Class LT 1			Class LT 2			Class LT 3			Class LT 4			Class LT 5			Class LT 6			
	Fit ^a	Std. Tolerance Limits		Fit ^a	Std. Tolerance Limits		Fit ^a	Std. Tolerance Limits		Fit ^a	Std. Tolerance Limits		Fit ^a	Std. Tolerance Limits		Fit ^a	Std. Tolerance Limits		
		Hole H7	Shaft js6		Hole H8	Shaft js7		Hole H7	Shaft k6		Hole H8	Shaft k7		Hole H7	Shaft n6		Hole H7	Shaft n7	
Over To	Values shown below are in thousandths of an inch																		
0 - 0.12	-0.12 +0.52	+0.4 0	+0.12 -0.12	-0.2 +0.8	+0.6 0	+0.2 -0.2								-0.5 +0.15	+0.4 0	+0.5 +0.25	-0.65 +0.15	+0.4 0	+0.65 +0.25
0.12 - 0.24	-0.15 +0.65	+0.5 0	+0.15 -0.15	-0.25 +0.95	+0.7 0	+0.25 -0.25								-0.6 +0.2	+0.5 0	+0.6 +0.3	-0.8 +0.2	+0.5 0	+0.8 +0.3
0.24 - 0.40	-0.2 +0.8	+0.6 0	+0.2 -0.2	-0.3 +1.2	+0.9 0	+0.3 -0.3	-0.5 +0.5	+0.6 0	+0.5 +0.1	-0.7 +0.8	+0.9 0	+0.7 +0.1		-0.8 +0.2	+0.6 0	+0.8 +0.4	-1.0 +0.2	+0.6 0	+1.0 +0.4
0.40 - 0.71	-0.2 +0.9	+0.7 0	+0.2 -0.2	-0.35 +1.35	+1.0 0	+0.35 -0.35	-0.5 +0.6	+0.7 0	+0.5 +0.1	-0.8 +0.9	+1.0 0	+0.8 +0.1		-0.9 +0.2	+0.7 0	+0.9 +0.5	-1.2 +0.2	+0.7 0	+1.2 +0.5
0.71 - 1.19	-0.25 +1.05	+0.8 0	+0.25 -0.25	-0.4 +1.6	+1.2 0	+0.4 -0.4	-0.6 +0.7	+0.8 0	+0.6 +0.1	-0.9 +1.1	+1.2 0	+0.9 +0.1		-1.1 +0.2	+0.8 0	+1.1 +0.6	-1.4 +0.2	+0.8 0	+1.4 +0.6
1.19 - 1.97	-0.3 +1.3	+1.0 0	+0.3 -0.3	-0.5 +2.1	+1.6 0	+0.5 -0.5	-0.7 +0.9	+1.0 0	+0.7 +0.1	-1.1 +1.5	+1.6 0	+1.1 +0.1		-1.3 +0.3	+1.0 0	+1.3 +0.7	-1.7 +0.3	+1.0 0	+1.7 +0.7
1.97 - 3.15	-0.3 +1.5	+1.2 0	+0.3 -0.3	-0.6 +2.4	+1.8 0	+0.6 -0.6	-0.8 +1.1	+1.2 0	+0.8 +0.1	-1.3 +1.7	+1.8 0	+1.3 +0.1		-1.5 +0.4	+1.2 0	+1.5 +0.8	-2.0 +0.4	+1.2 0	+2.0 +0.8
3.15 - 4.73	-0.4 +1.8	+1.4 0	+0.4 -0.4	-0.7 +2.9	+2.2 0	+0.7 -0.7	-1.0 +1.3	+1.4 0	+1.0 +0.1	-1.5 +2.1	+2.2 0	+1.5 +0.1		-1.9 +0.4	+1.4 0	+1.9 +1.0	-2.4 +0.4	+1.4 0	+2.4 +1.0
4.73 - 7.09	-0.5 +2.1	+1.6 0	+0.5 -0.5	-0.8 +3.3	+2.5 0	+0.8 -0.8	-1.1 +1.5	+1.6 0	+1.1 +0.1	-1.7 +2.4	+2.5 0	+1.7 +0.1		-2.2 +0.4	+1.6 0	+2.2 +1.2	-2.8 +0.4	+1.6 0	+2.8 +1.2
7.09 - 9.85	-0.6 +2.4	+1.8 0	+0.6 -0.6	-0.9 +3.7	+2.8 0	+0.9 -0.9	-1.4 +1.6	+1.8 0	+1.4 +0.2	-2.0 +2.6	+2.8 0	+2.0 +0.2		-2.6 +0.4	+1.8 0	+2.6 +1.4	-3.2 +0.4	+1.8 0	+3.2 +1.4
9.85 - 12.41	-0.6 +2.6	+2.0 0	+0.6 -0.6	-1.0 +4.0	+3.0 0	+1.0 -1.0	-1.4 +1.8	+2.0 0	+1.4 +0.2	-2.2 +2.8	+3.0 0	+2.2 +0.2		-2.6 +0.6	+2.0 0	+2.6 +1.4	-3.4 +0.6	+2.0 0	+3.4 +1.4
12.41 - 15.75	-0.7 +2.9	+2.2 0	+0.7 -0.7	-1.0 +4.5	+3.5 0	+1.0 -1.0	-1.6 +2.0	+2.2 0	+1.6 +0.2	-2.4 +3.3	+3.5 0	+2.4 +0.2		-3.0 +0.6	+2.2 0	+3.0 +1.6	-3.8 +0.6	+2.2 0	+3.8 +1.6
15.75 - 19.69	-0.8 +3.3	+2.5 0	+0.8 -0.8	-1.2 +5.2	+4.0 0	+1.2 -1.2	-1.8 +2.3	+2.5 0	+1.8 +0.2	-2.7 +3.8	+4.0 0	+2.7 +0.2		-3.4 +0.7	+2.5 0	+3.4 +1.8	-4.3 +0.7	+2.5 0	+4.3 +1.8

^aPairs of values shown represent maximum amount of interference (-) and maximum amount of clearance (+) resulting from application of standard tolerance limits. All data above heavy lines are in accord with ABC agreements. Symbols H7, js6, etc., are hole and shaft designations in the ABC system.

Table 11. ANSI Standard Force and Shrink Fits ANSI B4.1-1967 (R2009)

Nominal Size Range, Inches	Class FN 1			Class FN 2			Class FN 3			Class FN 4			Class FN 5		
	Interference ^a	Standard Tolerance Limits		Interference ^a	Standard Tolerance Limits		Interference ^a	Standard Tolerance Limits		Interference ^a	Standard Tolerance Limits		Interference ^a	Standard Tolerance Limits	
		Hole H6	Shaft		Hole H7	Shaft s6		Hole H7	Shaft t6		Hole H7	Shaft u6		Hole H8	Shaft x7
Over To	Values shown below are in thousandths of an inch														
0- 0.12	0.05 0.5	+0.25 0	+0.5 +0.3	0.2 0.85	+0.4 0	+0.85 +0.6				0.3 0.95	+0.4 0	+0.95 +0.7	0.3 1.3	+0.6 0	+1.3 +0.9
0.12- 0.24	0.1 0.6	+0.3 0	+0.6 +0.4	0.2 1.0	+0.5 0	+1.0 +0.7				0.4 1.2	+0.5 0	+1.2 +0.9	0.5 1.7	+0.7 0	+1.7 +1.2
0.24- 0.40	0.1 0.75	+0.4 0	+0.75 +0.5	0.4 1.4	+0.6 0	+1.4 +1.0				0.6 1.6	+0.6 0	+1.6 +1.2	0.5 2.0	+0.9 0	+2.0 +1.4
0.40- 0.56	0.1 0.8	+0.4 0	+0.8 +0.5	0.5 1.6	+0.7 0	+1.6 +1.2				0.7 1.8	+0.7 0	+1.8 +1.4	0.6 2.3	+1.0 0	+2.3 +1.6
0.56- 0.71	0.2 0.9	+0.4 0	+0.9 +0.6	0.5 1.6	+0.7 0	+1.6 +1.2				0.7 1.8	+0.7 0	+1.8 +1.4	0.8 2.5	+1.0 0	+2.5 +1.8
0.71- 0.95	0.2 1.1	+0.5 0	+1.1 +0.7	0.6 1.9	+0.8 0	+1.9 +1.4				0.8 2.1	+0.8 0	+2.1 +1.6	1.0 3.0	+1.2 0	+3.0 +2.2
0.95- 1.19	0.3 1.2	+0.5 0	+1.2 +0.8	0.6 1.9	+0.8 0	+1.9 +1.4	0.8 2.1	+0.8 0	+2.1 +1.6	+1.0 2.3	+0.8 0	+2.3 +1.8	1.3 3.3	+1.2 0	+3.3 +2.5
1.19- 1.58	0.3 1.3	+0.6 0	+1.3 +0.9	0.8 2.4	+1.0 0	+2.4 +1.8	1.0 2.6	+1.0 0	+2.6 +2.0	1.5 3.1	+1.0 0	+3.1 +2.5	1.4 4.0	+1.6 0	+4.0 +3.0
1.58- 1.97	0.4 1.4	+0.6 0	+1.4 +1.0	0.8 2.4	+1.0 0	+2.4 +1.8	1.2 2.8	+1.0 0	+2.8 +2.2	1.8 3.4	+1.0 0	+3.4 +2.8	2.4 5.0	+1.6 0	+5.0 +4.0
1.97- 2.56	0.6 1.8	+0.7 0	+1.8 +1.3	0.8 2.7	+1.2 0	+2.7 +2.0	1.3 3.2	+1.2 0	+3.2 +2.5	2.3 4.2	+1.2 0	+4.2 +3.5	3.2 6.2	+1.8 0	+6.2 +5.0
2.56- 3.15	0.7 1.9	+0.7 0	+1.9 +1.4	1.0 2.9	+1.2 0	+2.9 +2.2	1.8 3.7	+1.2 0	+3.7 +3.0	2.8 4.7	+1.2 0	+4.7 +4.0	4.2 7.2	+1.8 0	+7.2 +6.0
3.15- 3.94	0.9 2.4	+0.9 0	+2.4 +1.8	1.4 3.7	+1.4 0	+3.7 +2.8	2.1 4.4	+1.4 0	+4.4 +3.5	3.6 5.9	+1.4 0	+5.9 +5.0	4.8 8.4	+2.2 0	+8.4 +7.0
3.94- 4.73	1.1 2.6	+0.9 0	+2.6 +2.0	1.6 3.9	+1.4 0	+3.9 +3.0	2.6 4.9	+1.4 0	+4.9 +4.0	4.6 6.9	+1.4 0	+6.9 +6.0	5.8 9.4	+2.2 0	+9.4 +8.0
4.73- 5.52	1.2 2.9	+1.0 0	+2.9 +2.2	1.9 4.5	+1.6 0	+4.5 +3.5	3.4 6.0	+1.6 0	+6.0 +5.0	5.4 8.0	+1.6 0	+8.0 +7.0	7.5 11.6	+2.5 0	+11.6 +10.0

Table 11. ANSI Standard Force and Shrink Fits ANSI B4.1-1967 (R2009)

Nominal Size Range, Inches Over To		Class FN 1			Class FN 2			Class FN 3			Class FN 4			Class FN 5		
		Standard Tolerance Limits			Standard Tolerance Limits			Standard Tolerance Limits			Standard Tolerance Limits			Standard Tolerance Limits		
		Interference ^a	Hole H6	Shaft	Interference ^a	Hole H7	Shaft s6	Interference ^a	Hole H7	Shaft t6	Interference ^a	Hole H7	Shaft u6	Interference ^a	Hole H8	Shaft x7
Values shown below are in thousandths of an inch																
5.52-	6.30	1.5	+1.0	+3.2	2.4	+1.6	+5.0	3.4	+1.6	+6.0	5.4	+1.6	+8.0	9.5	+2.5	+13.6
		3.2	0	+2.5	5.0	0	+4.0	6.0	0	+5.0	8.0	0	+7.0	13.6	0	+12.0
6.30-	7.09	1.8	+1.0	+3.5	2.9	+1.6	+5.5	4.4	+1.6	+7.0	6.4	+1.6	+9.0	9.5	+2.5	+13.6
		3.5	0	+2.8	5.5	0	+4.5	7.0	0	+6.0	9.0	0	+8.0	13.6	0	+12.0
7.09-	7.88	1.8	+1.2	+3.8	3.2	+1.8	+6.2	5.2	+1.8	+8.2	7.2	+1.8	+10.2	11.2	+2.8	+15.8
		3.8	0	+3.0	6.2	0	+5.0	8.2	0	+7.0	10.2	0	+9.0	15.8	0	+14.0
7.88-	8.86	2.3	+1.2	+4.3	3.2	+1.8	+6.2	5.2	+1.8	+8.2	8.2	+1.8	+11.2	13.2	+2.8	+17.8
		4.3	0	+3.5	6.2	0	+5.0	8.2	0	+7.0	11.2	0	+10.0	17.8	0	+16.0
8.86-	9.85	2.3	+1.2	+4.3	4.2	+1.8	+7.2	6.2	+1.8	+9.2	10.2	+1.8	+13.2	13.2	+2.8	+17.8
		4.3	0	+3.5	7.2	0	+6.0	9.2	0	+8.0	13.2	0	+12.0	17.8	0	+16.0
9.85-	11.03	2.8	+1.2	+4.9	4.0	+2.0	+7.2	7.0	+2.0	+10.2	10.0	+2.0	+13.2	15.0	+3.0	+20.0
		4.9	0	+4.0	7.2	0	+6.0	10.2	0	+9.0	13.2	0	+12.0	20.0	0	+18.0
11.03-	12.41	2.8	+1.2	+4.9	5.0	+2.0	+8.2	7.0	+2.0	+10.2	12.0	+2.0	+15.2	17.0	+3.0	+22.0
		4.9	0	+4.0	8.2	0	+7.0	10.2	0	+9.0	15.2	0	+14.0	22.0	0	+20.0
12.41-	13.98	3.1	+1.4	+5.5	5.8	+2.2	+9.4	7.8	+2.2	+11.4	13.8	+2.2	+17.4	18.5	+3.5	+24.2
		5.5	0	+4.5	9.4	0	+8.0	11.4	0	+10.0	17.4	0	+16.0	24.2	0	+22.0
13.98-	15.75	3.6	+1.4	+6.1	5.8	+2.2	+9.4	9.8	+2.2	+13.4	15.8	+2.2	+19.4	21.5	+3.5	+27.2
		6.1	0	+5.0	9.4	0	+8.0	13.4	0	+12.0	19.4	0	+18.0	27.2	0	+25.0
15.75-	17.72	4.4	+1.6	+7.0	6.5	+2.5	+10.6	+9.5	+2.5	+13.6	17.5	+2.5	+21.6	24.0	+4.0	+30.5
		7.0	0	+6.0	10.6	0	+9.0	13.6	0	+12.0	21.6	0	+20.0	30.5	0	+28.0
17.72-	19.69	4.4	+1.6	+7.0	7.5	+2.5	+11.6	11.5	+2.5	+15.6	19.5	+2.5	+23.6	26.0	+4.0	+32.5
		7.0	0	+6.0	11.6	0	+10.0	15.6	0	+14.0	23.6	0	+22.0	32.5	0	+30.0

^aPairs of values shown represent minimum and maximum amounts of interference resulting from application of standard tolerance limits.

All data above heavy lines are in accordance with American-British-Canadian (ABC) agreements. Symbols H6, H7, s6, etc., are hole and shaft designations in the ABC system. Limits for sizes above 19.69 inches are not covered by ABC agreements but are given in the ANSI standard.

Table 12. ANSI Standard Interference Location Fits ANSI B4.1-1967 (R2009)

Nominal Size Range, Inches	Class LN 1			Class LN 2			Class LN 3		
	Limits of Inter- ference	Standard Limits		Limits of Inter- ference	Standard Limits		Limits of Inter- ference	Standard Limits	
		Hole H6	Shaft h5		Hole H7	Shaft p6		Hole H7	Shaft r6
Over To	Values shown below are given in thousandths of an inch								
0- 0.12	0 0.45	+0.25 0	+0.45 +0.25	0 0.65	+0.4 0	+0.65 +0.4	0.1 0.75	+0.4 0	+0.75 +0.5
0.12- 0.24	0 0.5	+0.3 0	+0.5 +0.3	0 0.8	+0.5 0	+0.8 +0.5	0.1 0.9	+0.5 0	+0.9 +0.6
0.24- 0.40	0 0.65	+0.4 0	+0.65 +0.4	0 1.0	+0.6 0	+1.0 +0.6	0.2 1.2	+0.6 0	+1.2 +0.8
0.40- 0.71	0 0.8	+0.4 0	+0.8 +0.4	0 1.1	+0.7 0	+1.1 +0.7	0.3 1.4	+0.7 0	+1.4 +1.0
0.71- 1.19	0 1.0	+0.5 0	+1.0 +0.5	0 1.3	+0.8 0	+1.3 +0.8	0.4 1.7	+0.8 0	+1.7 +1.2
1.19- 1.97	0 1.1	+0.6 0	+1.1 +0.6	0 1.6	+1.0 0	+1.6 +1.0	0.4 2.0	+1.0 0	+2.0 +1.4
1.97- 3.15	0.1 1.3	+0.7 0	+1.3 +0.8	0.2 2.1	+1.2 0	+2.1 +1.4	0.4 2.3	+1.2 0	+2.3 +1.6
3.15- 4.73	0.1 1.6	+0.9 0	+1.6 +1.0	0.2 2.5	+1.4 0	+2.5 +1.6	0.6 2.9	+1.4 0	+2.9 +2.0
4.73- 7.09	0.2 1.9	+1.0 0	+1.9 +1.2	0.2 2.8	+1.6 0	+2.8 +1.8	0.9 3.5	+1.6 0	+3.5 +2.5
7.09- 9.85	0.2 2.2	+1.2 0	+2.2 +1.4	0.2 3.2	+1.8 0	+3.2 +2.0	1.2 4.2	+1.8 0	+4.2 +3.0
9.85- 12.41	0.2 2.3	+1.2 0	+2.3 +1.4	0.2 3.4	+2.0 0	+3.4 +2.2	1.5 4.7	+2.0 0	+4.7 +3.5
12.41- 15.75	0.2 2.6	+1.4 0	+2.6 +1.6	0.3 3.9	+2.2 0	+3.9 +2.5	2.3 5.9	+2.2 0	+5.9 +4.5
15.75- 19.69	0.2 2.8	+1.6 0	+2.8 +1.8	0.3 4.4	+2.5 0	+4.4 +2.8	2.5 6.6	+2.5 0	+6.6 +5.0

All data in this table are in accordance with American-British-Canadian (ABC) agreements.

Limits for sizes above 19.69 inches are not covered by ABC agreements but are given in the ANSI Standard.

Symbols H7, p6, etc., are hole and shaft designations in the ABC system.

Tolerance limits given in body of table are added or subtracted to basic size (as indicated by + or - sign) to obtain maximum and minimum sizes of mating parts.

American National Standard Preferred Metric Limits and Fits

This standard ANSI B4.2-1978 (R2009) describes the ISO system of metric limits and fits for mating parts as approved for general engineering usage in the United States.

It establishes: 1) the designation symbols used to define dimensional limits on drawings, material stock, related tools, gages, etc.; 2) the preferred basic sizes (first and second choices); 3) the preferred tolerance zones (first, second, and third choices); 4) the preferred limits and fits for sizes (first choice only) up to and including 500 millimeters; and 5) the definitions of related terms.

The general terms "hole" and "shaft" can also be taken to refer to the space containing or contained by two parallel faces of any part, such as the width of a slot, or the thickness of a key.

Definitions.—The most important terms relating to limits and fits are shown in Fig. 1 and are defined as follows:

Basic Size: The size to which limits of deviation are assigned. The basic size is the same for both members of a fit. For example, it is designated by the numbers 40 in 40H7.

Deviation: The algebraic difference between a size and the corresponding basic size.

Upper Deviation: The algebraic difference between the maximum limit of size and the corresponding basic size.

Lower Deviation: The algebraic difference between the minimum limit of size and the corresponding basic size.

Fundamental Deviation: That one of the two deviations closest to the basic size. For example, it is designated by the letter H in 40H7.

Tolerance: The difference between the maximum and minimum size limits on a part.

Tolerance Zone: A zone representing the tolerance and its position in relation to the basic size.

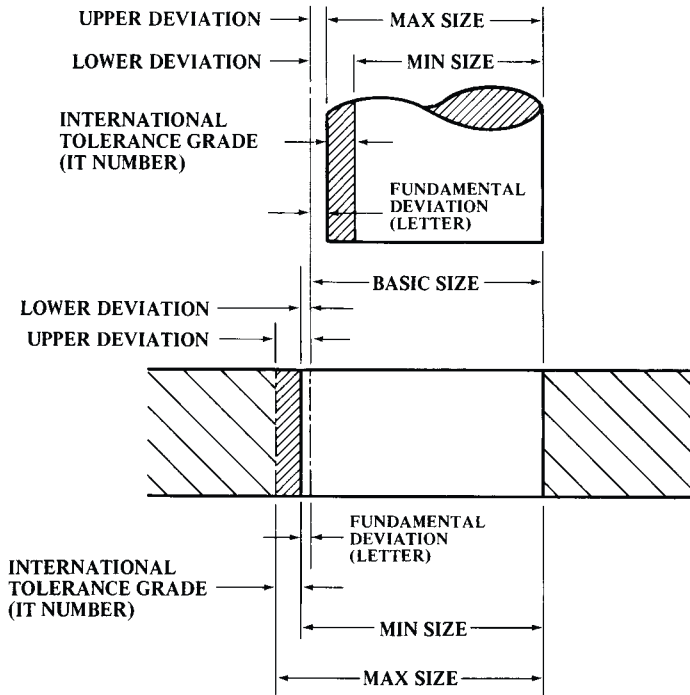


Fig. 1. Illustration of Definitions

International Tolerance Grade: (IT): A group of tolerances that vary depending on the basic size, but that provide the same relative level of accuracy within a given grade. For example, it is designated by the number 7 in 40H7 or as IT7.

Hole Basis: The system of fits where the minimum hole size is basic. The fundamental deviation for a hole basis system is H.

Shaft Basis: The system of fits where the maximum shaft size is basic. The fundamental deviation for a shaft basis system is h.

Clearance Fit: The relationship between assembled parts when clearance occurs under all tolerance conditions.

Interference Fit: The relationship between assembled parts when interference occurs under all tolerance conditions.

Transition Fit: The relationship between assembled parts when either a clearance or an interference fit can result, depending on the tolerance conditions of the mating parts.

Tolerances Designation.—An “International Tolerance grade” establishes the magnitude of the tolerance zone or the amount of part size variation allowed for external and internal dimensions alike (see Fig. 1). Tolerances are expressed in grade numbers that are consistent with International Tolerance grades identified by the prefix IT, such as IT6, IT11, etc. A smaller grade number provides a smaller tolerance zone.

A fundamental deviation establishes the position of the tolerance zone with respect to the basic size (see Fig. 1). Fundamental deviations are expressed by tolerance position letters. Capital letters are used for internal dimensions and lowercase or small letters for external dimensions.

Symbols.—By combining the IT grade number and the tolerance position letter, the tolerance symbol is established that identifies the actual maximum and minimum limits of the part. The toleranced size is thus defined by the basic size of the part followed by a symbol composed of a letter and a number, such as 40H7, 40f7, etc.

A fit is indicated by the basic size common to both components, followed by a symbol corresponding to each component, the internal part symbol preceding the external part symbol, such as 40H8/f7.

Some methods of designating tolerances on drawings are:

$$40H8 \qquad 40H8 \begin{pmatrix} 40.039 \\ 40.000 \end{pmatrix} \qquad \begin{pmatrix} 40.039 \\ 40.000 \end{pmatrix} 40H8$$

The values in parentheses indicate reference only.

Preferred Metric Fits.—First-choice tolerance zones are used to establish preferred fits in ANSI B4.2, *Preferred Metric Limits and Fits*, as shown in Figs. 2 and 3. A complete listing of first-, second-, and third- choice tolerance zones is given in the Standard.

Hole basis fits have a fundamental deviation of H on the hole, and shaft basis fits have a fundamental deviation of *h* on the shaft and are shown in Fig. 2 for hole basis and Fig. 3 for shaft basis fits. A description of both types of fits, that have the same relative fit condition, is given in Table 1. Normally, the hole basis system is preferred; however, when a common shaft mates with several holes, the shaft basis system should be used.

The hole basis and shaft basis fits shown in the table *Description of Preferred Fits* on page 652 are combined with the first-choice preferred metric sizes from Table 1, page 673 to form Tables 2, 3, 4, and 5, in which specific limits as well as the resultant fits are tabulated.

If the required size is not found tabulated in Tables 2 through 5 then the preferred fit can be calculated from numerical values given in an appendix of ANSI B4.2-1978 (R2009). It is anticipated that other fit conditions may be necessary to meet special requirements, and a preferred fit can be loosened or tightened simply by selecting a standard tolerance zone as given in the Standard. Information on how to calculate limit dimensions, clearances, and interferences, for nonpreferred fits and sizes can be found in an appendix of this Standard.

Conversion of Fits: It may sometimes be necessary or desirable to modify the tolerance zone on one or both of two mating parts, yet still keep the total tolerance and fit condition the same. Examples of this appear in Table 1 on page 652 when converting from a hole basis fit to a shaft basis fit. The corresponding fits are identical yet the individual tolerance zones are different.

To convert from one type of fit to another, reverse the fundamental deviations between the shaft and hole keeping the IT grade the same on each individual part. The examples below represent preferred fits from Table 1 for a 60-mm basic size. These fits have the same maximum clearance (0.520) and the same minimum clearance (0.140).

Hole basis, loose running fit, values from Table 2

$$\text{Hole } 60H11 \begin{pmatrix} 60.190 \\ 60.000 \end{pmatrix} \qquad \text{Shaft } 60c11 \begin{pmatrix} 59.860 \\ 59.670 \end{pmatrix} \qquad \text{Fit } 60H11/c11 \begin{pmatrix} 0.520 \\ 0.140 \end{pmatrix}$$

Hole basis, loose running fit, values from Table 4

$$\text{Hole } 60C11 \begin{pmatrix} 60.330 \\ 60.140 \end{pmatrix} \qquad \text{Shaft } 60h11 \begin{pmatrix} 60.000 \\ 59.810 \end{pmatrix} \qquad \text{Fit } 60C11/h11 \begin{pmatrix} 0.520 \\ 0.140 \end{pmatrix}$$

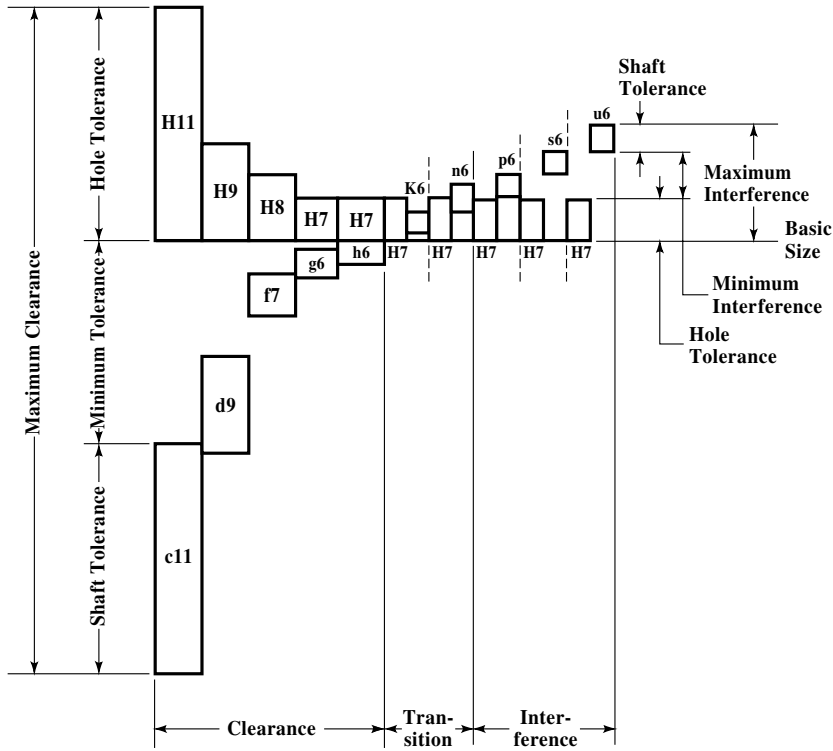


Fig. 2. Preferred Hole Basis Fits

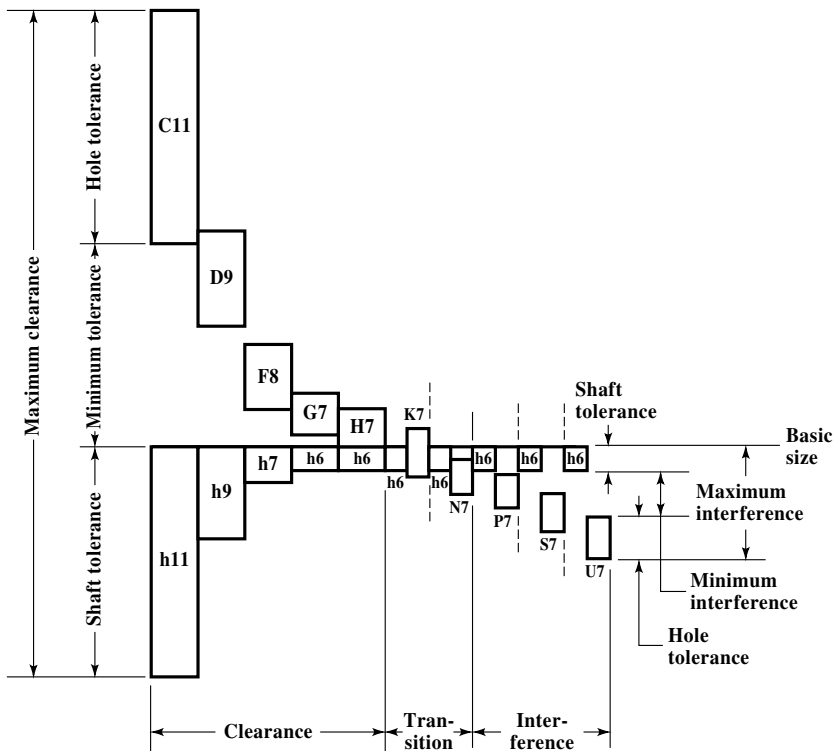


Fig. 3. Preferred Shaft Basis Fits

Table 1. Description of Preferred Fits

	ISO SYMBOL		DESCRIPTION	
	Hole Basis	Shaft Basis		
Clearance Fits	H11/c11	C11/h11	<u>Loose running</u> fit for wide commercial tolerances or allowances on external members.	↑ More Clearance
	H9/d9	D9/h9	<u>Free running</u> fit not for use where accuracy is essential, but good for large temperature variations, high running speeds, or heavy journal pressures.	
	H8/f7	F8/h7	<u>Close Running</u> fit for running on accurate machines and for accurate moderate speeds and journal pressures.	
	H7/g6	G7/h6	<u>Sliding fit</u> not intended to run freely, but to move and turn freely and locate accurately.	
	H7/h6	H7/h6	<u>Locational clearance</u> fit provides snug fit for locating stationary parts; but can be freely assembled and disassembled.	
Transition Fits	H7/k6	K7/h6	<u>Locational transition</u> fit for accurate location, a compromise between clearance and Interference.	↓ More Interference
	H7/n6	N7/h6	<u>Locational transition</u> fit for more accurate location where greater interference is permissible.	
Interference Fits	H7/p6 ^a	P7/h6	<u>Locational interference</u> fit for parts requiring rigidity and alignment with prime accuracy of location but without special bore pressure requirements.	
	H7/s6	S7/h6	<u>Medium drive</u> fit for ordinary steel parts or shrink fits on light sections, the tightest fit usable with cast iron.	
	H7/u6	U7/h6	<u>Force</u> fit suitable for parts which can be highly stressed or for shrink fits where the heavy pressing forces required are impractical.	

^a Transition fit for basic sizes in range from 0 through 3 mm.

Table 2. American National Standard Preferred Hole Basis Metric Clearance Fits ANSI B4.2-1978 (R2009)

Basic Size ^a		Loose Running			Free Running			Close Running			Sliding			Locational Clearance		
		Hole H11	Shaft c11	Fit ^b	Hole H9	Shaft d9	Fit ^b	Hole H8	Shaft f7	Fit ^b	Hole H7	Shaft g6	Fit ^b	Hole H7	Shaft h6	Fit ^b
1	Max	1.060	0.940	0.180	1.025	0.980	0.070	1.014	0.994	0.030	1.010	0.998	0.018	1.010	1.000	0.016
	Min	1.000	0.880	0.060	1.000	0.995	0.020	1.000	0.984	0.006	1.000	0.992	0.002	1.000	0.994	0.000
1.2	Max	1.260	1.140	0.180	1.225	1.180	0.070	1.214	1.194	0.030	1.210	1.198	0.018	1.210	1.200	0.016
	Min	1.200	1.080	0.060	1.200	1.155	0.020	1.200	1.184	0.006	1.200	1.192	0.002	1.200	1.194	0.000
1.6	Max	1.660	1.540	0.180	1.625	1.580	0.070	1.614	1.594	0.030	1.610	1.598	0.018	1.610	1.600	0.016
	Min	1.600	1.480	0.060	1.600	1.555	0.020	1.600	1.584	0.006	1.600	1.592	0.002	1.600	1.594	0.000
2	Max	2.060	1.940	0.180	2.025	1.980	0.070	2.014	1.994	0.030	2.010	1.998	0.018	2.010	2.000	0.016
	Min	2.000	1.880	0.060	2.000	1.955	0.020	2.000	1.984	0.006	2.000	1.992	0.002	2.000	1.994	0.000
2.5	Max	2.560	2.440	0.180	2.525	2.480	0.070	2.514	2.494	0.030	2.510	2.498	0.018	2.510	2.500	0.016
	Min	2.500	2.380	0.060	2.500	2.455	0.020	2.500	2.484	0.006	2.500	2.492	0.002	2.500	2.494	0.000
3	Max	3.060	2.940	0.180	3.025	2.980	0.070	3.014	2.994	0.030	3.010	2.998	0.018	3.010	3.000	0.016
	Min	3.000	2.880	0.060	3.000	2.955	0.020	3.000	2.984	0.006	3.000	2.992	0.002	3.000	2.994	0.000
4	Max	4.075	3.930	0.220	4.030	3.970	0.090	4.018	3.990	0.040	4.012	3.996	0.024	4.012	4.000	0.020
	Min	4.000	3.855	0.070	4.000	3.940	0.030	4.000	3.978	0.010	4.000	3.988	0.004	4.000	3.992	0.000
5	Max	5.075	4.930	0.220	5.030	4.970	0.090	5.018	4.990	0.040	5.012	4.996	0.024	5.012	5.000	0.020
	Min	5.000	4.855	0.070	5.000	4.940	0.030	5.000	4.978	0.010	5.000	4.988	0.004	5.000	4.992	0.000
6	Max	6.075	5.930	0.220	6.030	5.970	0.090	6.018	5.990	0.040	6.012	5.996	0.024	6.012	6.000	0.020
	Min	6.000	5.855	0.070	6.000	5.940	0.030	6.000	5.978	0.010	6.000	5.988	0.004	6.000	5.992	0.000
8	Max	8.090	7.920	0.260	8.036	7.960	0.112	8.022	7.987	0.050	8.015	7.995	0.029	8.015	8.000	0.024
	Min	8.000	7.830	0.080	8.000	7.924	0.040	8.000	7.972	0.013	8.000	7.986	0.005	8.000	7.991	0.000
10	Max	10.090	9.920	0.260	10.036	9.960	0.112	10.022	9.987	0.050	10.015	9.995	0.029	10.015	10.000	0.024
	Min	10.000	9.830	0.080	10.000	9.924	0.040	10.000	9.972	0.013	10.000	9.986	0.005	10.000	9.991	0.000
12	Max	12.110	11.905	0.315	12.043	11.956	0.136	12.027	11.984	0.061	12.018	11.994	0.035	12.018	12.000	0.029
	Min	12.000	11.795	0.095	12.000	11.907	0.050	12.000	11.966	0.016	12.000	11.983	0.006	12.000	11.989	0.000
16	Max	16.110	15.905	0.315	16.043	15.950	0.136	16.027	15.984	0.061	16.018	15.994	0.035	16.018	16.000	0.029
	Min	16.000	15.795	0.095	16.000	15.907	0.050	16.000	15.966	0.016	16.000	15.983	0.006	16.000	15.989	0.000
20	Max	20.130	19.890	0.370	20.052	19.935	0.169	20.033	19.980	0.074	20.021	19.993	0.041	20.021	20.000	0.034
	Min	20.000	19.760	0.110	20.000	19.883	0.065	20.000	19.959	0.020	20.000	19.980	0.007	20.000	19.987	0.000
25	Max	25.130	24.890	0.370	25.052	24.935	0.169	25.033	24.980	0.074	25.021	24.993	0.041	25.021	25.000	0.034
	Min	25.000	24.760	0.110	25.000	24.883	0.065	25.000	24.959	0.020	25.000	24.980	0.007	25.000	24.987	0.000

Table 2. American National Standard Preferred Hole Basis Metric Clearance Fits ANSI B4.2-1978 (R2009)

Basic Size ^a		Loose Running			Free Running			Close Running			Sliding			Locational Clearance		
		Hole H11	Shaft c11	Fit ^b	Hole H9	Shaft d9	Fit ^b	Hole H8	Shaft f7	Fit ^b	Hole H7	Shaft g6	Fit ^b	Hole H7	Shaft h6	Fit ^b
30	Max	30.130	29.890	0.370	30.052	29.935	0.169	30.033	29.980	0.074	30.021	29.993	0.041	30.021	30.000	0.034
	Min	30.000	29.760	0.110	30.000	29.883	0.065	30.000	29.959	0.020	30.000	29.980	0.007	30.000	29.987	0.000
40	Max	40.160	39.880	0.440	40.062	39.920	0.204	40.039	39.975	0.089	40.025	39.991	0.050	40.025	40.000	0.041
	Min	40.000	39.720	0.120	40.000	39.858	0.080	40.000	39.950	0.025	40.000	39.975	0.009	40.000	39.984	0.000
50	Max	50.160	49.870	0.450	50.062	49.920	0.204	50.039	49.975	0.089	50.025	49.991	0.050	50.025	50.000	0.041
	Min	50.000	49.710	0.130	50.000	49.858	0.080	50.000	49.950	0.025	50.000	49.975	0.009	50.000	49.984	0.000
60	Max	60.190	59.860	0.520	60.074	59.900	0.248	60.046	59.970	0.106	60.030	59.990	0.059	60.030	60.000	0.049
	Min	60.000	59.670	0.140	60.000	59.826	0.100	60.000	59.940	0.030	60.000	59.971	0.010	60.000	59.981	0.000
80	Max	80.190	79.850	0.530	80.074	79.900	0.248	80.046	79.970	0.106	80.030	79.990	0.059	80.030	80.000	0.049
	Min	80.000	79.660	0.150	80.000	79.826	0.100	80.000	79.940	0.030	80.000	79.971	0.010	80.000	79.981	0.000
100	Max	100.220	99.830	0.610	100.087	99.880	0.294	100.054	99.964	0.125	100.035	99.988	0.069	100.035	100.000	0.057
	Min	100.000	99.610	0.170	100.000	99.793	0.120	100.000	99.929	0.036	100.000	99.966	0.012	100.000	99.978	0.000
120	Max	120.220	119.820	0.620	120.087	119.880	0.294	120.054	119.964	0.125	120.035	119.988	0.069	120.035	120.000	0.057
	Min	120.000	119.600	0.180	120.000	119.793	0.120	120.000	119.929	0.036	120.000	119.966	0.012	120.000	119.978	0.000
160	Max	160.250	159.790	0.710	160.100	159.855	0.345	160.063	159.957	0.146	160.040	159.986	0.079	160.040	160.000	0.065
	Min	160.000	159.540	0.210	160.000	159.755	0.145	160.000	159.917	0.043	160.000	159.961	0.014	160.000	159.975	0.000
200	Max	200.290	199.760	0.820	200.115	199.830	0.400	200.072	199.950	0.168	200.046	199.985	0.090	200.046	200.000	0.075
	Min	200.000	199.470	0.240	200.000	199.715	0.170	200.000	199.904	0.050	200.000	199.956	0.015	200.000	199.971	0.000
250	Max	250.290	249.720	0.860	250.115	249.830	0.400	250.072	249.950	0.168	250.046	249.985	0.090	250.046	250.000	0.075
	Min	250.000	249.430	0.280	250.000	249.715	0.170	250.000	249.904	0.050	250.000	249.956	0.015	250.000	249.971	0.000
300	Max	300.320	299.670	0.970	300.130	299.810	0.450	300.081	299.944	0.189	300.052	299.983	0.101	300.052	300.000	0.084
	Min	300.000	299.350	0.330	300.000	299.680	0.190	300.000	299.892	0.056	300.000	299.951	0.017	300.000	299.968	0.000
400	Max	400.360	399.600	1.120	400.140	399.790	0.490	400.089	399.938	0.208	400.057	399.982	0.111	400.057	400.000	0.093
	Min	400.000	399.240	0.400	400.000	399.650	0.210	400.000	399.881	0.062	400.000	399.946	0.018	400.000	399.964	0.000
500	Max	500.400	499.520	1.280	500.155	499.770	0.540	500.097	499.932	0.228	500.063	499.980	0.123	500.063	500.000	0.103
	Min	500.000	499.120	0.480	500.000	499.615	0.230	500.000	499.869	0.068	500.000	499.940	0.020	500.000	499.960	0.000

^aThe sizes shown are first-choice basic sizes (see Table 1, page 673). Preferred fits for other sizes can be calculated from data given in ANSI B4.2-1978 (R2009).

^bAll fits shown in this table have clearance.

All dimensions are in millimeters.

Table 3. American National Standard Preferred Hole Basis Metric Transition and Interference Fits ANSI B4.2-1978 (R2009)

Basic Size ^a		Locational Transition			Locational Transition			Locational Interference			Medium Drive			Force		
		Hole H7	Shaft k6	Fit ^b	Hole H7	Shaft n6	Fit ^b	Hole H7	Shaft p6	Fit ^b	Hole H7	Shaft s6	Fit ^b	Hole H7	Shaft u6	Fit ^b
1	Max	1.010	1.006	+0.010	1.010	1.010	+0.006	1.010	1.012	+0.004	1.010	1.020	-0.004	1.010	1.024	-0.008
	Min	1.000	1.000	-0.006	1.000	1.004	-0.010	1.000	1.006	-0.012	1.000	1.014	-0.020	1.000	1.018	-0.024
1.2	Max	1.210	1.206	+0.010	1.210	1.210	+0.006	1.210	1.212	+0.004	1.210	1.220	-0.004	1.210	1.224	-0.008
	Min	1.200	1.200	-0.006	1.200	1.204	-0.010	1.200	1.206	-0.012	1.200	1.214	-0.020	1.200	1.218	-0.024
1.6	Max	1.610	1.606	+0.010	1.610	1.610	+0.006	1.610	1.612	+0.004	1.610	1.620	-0.004	1.610	1.624	-0.008
	Min	1.600	1.600	-0.006	1.600	1.604	-0.010	1.600	1.606	-0.012	1.600	1.614	-0.020	1.600	1.618	-0.024
2	Max	2.010	2.006	+0.010	2.010	2.010	+0.006	2.010	2.012	+0.004	2.010	2.020	-0.004	2.010	2.024	-0.008
	Min	2.000	2.000	-0.006	2.000	2.004	-0.010	2.000	2.006	-0.012	2.000	2.014	-0.020	2.000	2.018	-0.024
2.5	Max	2.510	2.506	+0.010	2.510	2.510	+0.006	2.510	2.512	+0.004	2.510	2.520	-0.004	2.510	2.524	-0.008
	Min	2.500	2.500	-0.006	2.500	2.504	-0.010	2.500	2.506	-0.012	2.500	2.514	-0.020	2.500	2.518	-0.024
3	Max	3.010	3.006	+0.010	3.010	3.010	+0.006	3.010	3.012	+0.004	3.010	3.020	-0.004	3.010	3.024	-0.008
	Min	3.000	3.000	-0.006	3.000	3.004	-0.010	3.000	3.006	-0.012	3.000	3.014	-0.020	3.000	3.018	-0.024
4	Max	4.012	4.009	+0.011	4.012	4.016	+0.004	4.012	4.020	0.000	4.012	4.027	-0.007	4.012	4.031	-0.011
	Min	4.000	4.001	-0.009	4.000	4.008	-0.016	4.000	4.012	-0.020	4.000	4.019	-0.027	4.000	4.023	-0.031
5	Max	5.012	5.009	+0.011	5.012	5.016	+0.004	5.012	5.020	0.000	5.012	5.027	-0.007	5.012	5.031	-0.011
	Min	5.000	5.001	-0.009	5.000	5.008	-0.016	5.000	5.012	-0.020	5.000	5.019	-0.027	5.000	5.023	-0.031
6	Max	6.012	6.009	+0.011	6.012	6.016	+0.004	6.012	6.020	0.000	6.012	6.027	-0.007	6.012	6.031	-0.011
	Min	6.000	6.001	-0.009	6.000	6.008	-0.016	6.000	6.012	-0.020	6.000	6.019	-0.027	6.000	6.023	-0.031
8	Max	8.015	8.010	+0.014	8.015	8.019	+0.005	8.015	8.024	0.000	8.015	8.032	-0.008	8.015	8.037	-0.013
	Min	8.000	8.001	-0.010	8.000	8.010	-0.019	8.000	8.015	-0.024	8.000	8.023	-0.032	8.000	8.028	-0.037
10	Max	10.015	10.010	+0.014	10.015	10.019	+0.005	10.015	10.024	0.000	10.015	10.032	-0.008	10.015	10.034	-0.013
	Min	10.000	10.001	-0.010	10.000	10.010	-0.019	10.000	10.015	-0.024	10.000	10.023	-0.032	10.000	10.028	-0.037
12	Max	12.018	12.012	+0.017	12.018	12.023	+0.006	12.018	12.029	0.000	12.018	12.039	-0.010	12.018	12.044	-0.015
	Min	12.000	12.001	-0.012	12.000	12.012	-0.023	12.000	12.018	-0.029	12.000	12.028	-0.039	12.000	12.033	-0.044
16	Max	16.018	16.012	+0.017	16.018	16.023	+0.006	16.018	16.029	0.000	16.018	16.039	-0.010	16.018	16.044	-0.015
	Min	16.000	16.001	-0.012	16.000	16.012	-0.023	16.000	16.018	-0.029	16.000	16.028	-0.039	16.000	16.033	-0.044
20	Max	20.021	20.015	+0.019	20.021	20.028	+0.006	20.021	20.035	-0.001	20.021	20.048	-0.014	20.021	20.054	-0.020
	Min	20.000	20.002	-0.015	20.000	20.015	-0.028	20.000	20.022	-0.035	20.000	20.035	-0.048	20.000	20.041	-0.054
25	Max	25.021	25.015	+0.019	25.021	25.028	+0.006	25.021	25.035	-0.001	25.021	25.048	-0.014	25.021	25.061	-0.027
	Min	25.000	25.002	-0.015	25.000	25.015	-0.028	25.000	25.022	-0.035	25.000	25.035	-0.048	25.000	25.048	-0.061

Table 3. American National Standard Preferred Hole Basis Metric Transition and Interference Fits ANSI B4.2-1978 (R2009)

Basic Size ^a		Locational Transition			Locational Transition			Locational Interference			Medium Drive			Force		
		Hole H7	Shaft k6	Fit ^b	Hole H7	Shaft n6	Fit ^b	Hole H7	Shaft p6	Fit ^b	Hole H7	Shaft s6	Fit ^b	Hole H7	Shaft u6	Fit ^b
30	Max	30.021	30.015	+0.019	30.021	30.028	+0.006	30.021	30.035	-0.001	30.021	30.048	-0.014	30.021	30.061	-0.027
	Min	30.000	30.002	-0.015	30.000	30.015	-0.028	30.000	30.022	-0.035	30.000	30.035	-0.048	30.000	30.048	-0.061
40	Max	40.025	40.018	+0.023	40.025	40.033	+0.008	40.025	40.042	-0.001	40.025	40.059	-0.018	40.025	40.076	-0.035
	Min	40.000	40.002	-0.018	40.000	40.017	-0.033	40.000	40.026	-0.042	40.000	40.043	-0.059	40.000	40.060	-0.076
50	Max	50.025	50.018	+0.023	50.025	50.033	+0.008	50.025	50.042	-0.001	50.025	50.059	-0.018	50.025	50.086	-0.045
	Min	50.000	50.002	-0.018	50.000	50.017	-0.033	50.000	50.026	-0.042	50.000	50.043	-0.059	50.000	50.070	-0.086
60	Max	60.030	60.021	+0.028	60.030	60.039	+0.010	60.030	60.051	-0.002	60.030	60.072	-0.023	60.030	60.106	-0.057
	Min	60.000	60.002	-0.021	60.000	60.020	-0.039	60.000	60.032	-0.051	60.000	60.053	-0.072	60.000	60.087	-0.106
80	Max	80.030	80.021	+0.028	80.030	80.039	+0.010	80.030	80.051	-0.002	80.030	80.078	-0.029	80.030	80.121	-0.072
	Min	80.000	80.002	-0.021	80.000	80.020	-0.039	80.000	80.032	-0.051	80.000	80.059	-0.078	80.000	80.102	-0.121
100	Max	100.035	100.025	+0.032	100.035	100.045	+0.012	100.035	100.059	-0.002	100.035	100.093	-0.036	100.035	100.146	-0.089
	Min	100.000	100.003	-0.025	100.000	100.023	-0.045	100.000	100.037	-0.059	100.000	100.071	-0.093	100.000	100.124	-0.146
120	Max	120.035	120.025	+0.032	120.035	120.045	+0.012	120.035	120.059	-0.002	120.035	120.101	-0.044	120.035	120.166	-0.109
	Min	120.000	120.003	-0.025	120.000	120.023	-0.045	120.000	120.037	-0.059	120.000	120.079	-0.101	120.000	120.144	-0.166
160	Max	160.040	160.028	+0.037	160.040	160.052	+0.013	160.040	160.068	-0.003	160.040	160.125	-0.060	160.040	160.215	-0.150
	Min	160.000	160.003	-0.028	160.000	160.027	-0.052	160.000	160.043	-0.068	160.000	160.100	-0.125	160.000	160.190	-0.215
200	Max	200.046	200.033	+0.042	200.046	200.060	+0.015	200.046	200.079	-0.004	200.046	200.151	-0.076	200.046	200.265	-0.190
	Min	200.000	200.004	-0.033	200.000	200.031	-0.060	200.000	200.050	-0.079	200.000	200.122	-0.151	200.000	200.236	-0.265
250	Max	250.046	250.033	+0.042	250.046	250.060	+0.015	250.046	250.079	-0.004	250.046	250.169	-0.094	250.046	250.313	-0.238
	Min	250.000	250.004	-0.033	250.000	250.031	-0.060	250.000	250.050	-0.079	250.000	250.140	-0.169	250.000	250.284	-0.313
300	Max	300.052	300.036	+0.048	300.052	300.066	+0.018	300.052	300.088	-0.004	300.052	300.202	-0.118	300.052	300.382	-0.298
	Min	300.000	300.004	-0.036	300.000	300.034	-0.066	300.000	300.056	-0.088	300.000	300.170	-0.202	300.000	300.350	-0.382
400	Max	400.057	400.040	+0.053	400.057	400.073	+0.020	400.057	400.098	-0.005	400.057	400.244	-0.151	400.057	400.471	-0.378
	Min	400.000	400.004	-0.040	400.000	400.037	-0.073	400.000	400.062	-0.098	400.000	400.208	-0.244	400.000	400.435	-0.471
500	Max	500.063	500.045	+0.058	500.063	500.080	+0.023	500.063	500.108	-0.005	500.063	500.292	-0.189	500.063	500.580	-0.477
	Min	500.000	500.005	-0.045	500.000	500.040	-0.080	500.000	500.068	-0.108	500.000	500.252	-0.292	500.000	500.540	-0.580

^aThe sizes shown are first-choice basic sizes (see Table 1, page 673). Preferred fits for other sizes can be calculated from data given in ANSI B4.2-1978 (R2009).

^bA plus sign indicates clearance; a minus sign indicates interference.

All dimensions are in millimeters.

Table 4. American National Standard Preferred Shaft Basis Metric Clearance Fits ANSI B4.2-1978 (R2009)

Basic Size ^a		Loose Running			Free Running			Close Running			Sliding			Locational Clearance		
		Hole C11	Shaft h11	Fit ^b	Hole D9	Shaft h9	Fit ^b	Hole F8	Shaft h7	Fit ^b	Hole G7	Shaft h6	Fit ^b	Hole H7	Shaft h6	Fit ^b
1	Max	1.120	1.000	0.180	1.045	1.000	0.070	1.020	1.000	0.030	1.012	1.000	0.018	1.010	1.000	0.016
	Min	1.060	0.940	0.060	1.020	0.975	0.020	1.006	0.990	0.006	1.002	0.994	0.002	1.000	0.994	0.000
1.2	Max	1.320	1.200	0.180	1.245	1.200	0.070	1.220	1.200	0.030	1.212	1.200	0.018	1.210	1.200	0.016
	Min	1.260	1.140	0.060	1.220	1.175	0.020	1.206	1.190	0.006	1.202	1.194	0.002	1.200	1.194	0.000
1.6	Max	1.720	1.600	0.180	1.645	1.600	0.070	1.620	1.600	0.030	1.612	1.600	0.018	1.610	1.600	0.016
	Min	1.660	1.540	0.060	1.620	1.575	0.020	1.606	1.590	0.006	1.602	1.594	0.002	1.600	1.594	0.000
2	Max	2.120	2.000	0.180	2.045	2.000	0.070	2.020	2.000	0.030	2.012	2.000	0.018	2.010	2.000	0.016
	Min	2.060	1.940	0.060	2.020	1.975	0.020	2.006	1.990	0.006	2.002	1.994	0.002	2.000	1.994	0.000
2.5	Max	2.620	2.500	0.180	2.545	2.500	0.070	2.520	2.500	0.030	2.512	2.500	0.018	2.510	2.500	0.016
	Min	2.560	2.440	0.060	2.520	2.475	0.020	2.506	2.490	0.006	2.502	2.494	0.002	2.500	2.494	0.000
3	Max	3.120	3.000	0.180	3.045	3.000	0.070	3.020	3.000	0.030	3.012	3.000	0.018	3.010	3.000	0.016
	Min	3.060	2.940	0.060	3.020	2.975	0.020	3.006	2.990	0.006	3.002	2.994	0.002	3.000	2.994	0.000
4	Max	4.145	4.000	0.220	4.060	4.000	0.090	4.028	4.000	0.040	4.016	4.000	0.024	4.012	4.000	0.020
	Min	4.070	3.925	0.070	4.030	3.970	0.030	4.010	3.988	0.010	4.004	3.992	0.004	4.000	3.992	0.000
5	Max	5.145	5.000	0.220	5.060	5.000	0.090	5.028	5.000	0.040	5.016	5.000	0.024	5.012	5.000	0.020
	Min	5.070	4.925	0.070	5.030	4.970	0.030	5.010	4.988	0.010	5.004	4.992	0.004	5.000	4.992	0.000
6	Max	6.145	6.000	0.220	6.060	6.000	0.090	6.028	6.000	0.040	6.016	6.000	0.024	6.012	6.000	0.020
	Min	6.070	5.925	0.070	6.030	5.970	0.030	6.010	5.988	0.010	6.004	5.992	0.004	6.000	5.992	0.000
8	Max	8.170	8.000	0.260	8.076	8.000	0.112	8.035	8.000	0.050	8.020	8.000	0.029	8.015	8.000	0.024
	Min	8.080	7.910	0.080	8.040	7.964	0.040	8.013	7.985	0.013	8.005	7.991	0.005	8.000	7.991	0.000
10	Max	10.170	10.000	0.260	10.076	10.000	0.112	10.035	10.000	0.050	10.020	10.000	0.029	10.015	10.000	0.024
	Min	10.080	9.910	0.080	10.040	9.964	0.040	10.013	9.985	0.013	10.005	9.991	0.005	10.000	9.991	0.000
12	Max	12.205	12.000	0.315	12.093	12.000	0.136	12.043	12.000	0.061	12.024	12.000	0.035	12.018	12.000	0.029
	Min	12.095	11.890	0.095	12.050	11.957	0.050	12.016	11.982	0.016	12.006	11.989	0.006	12.000	11.989	0.000
16	Max	16.205	16.000	0.315	16.093	16.000	0.136	16.043	16.000	0.061	16.024	16.000	0.035	16.018	16.000	0.029
	Min	16.095	15.890	0.095	16.050	15.957	0.050	16.016	15.982	0.016	16.006	15.989	0.006	16.000	15.989	0.000
20	Max	20.240	20.000	0.370	20.117	20.000	0.169	20.053	20.000	0.074	20.028	20.000	0.041	20.021	20.000	0.034
	Min	20.110	19.870	0.110	20.065	19.948	0.065	20.020	19.979	0.020	20.007	19.987	0.007	20.000	19.987	0.000
25	Max	25.240	25.000	0.370	25.117	25.000	0.169	25.053	25.000	0.074	25.028	25.000	0.041	25.021	25.000	0.034
	Min	25.110	24.870	0.110	25.065	24.948	0.065	25.020	24.979	0.020	25.007	24.987	0.007	25.000	24.987	0.000

SHAFT BASIS METRIC CLEARANCE FITS

Table 4. American National Standard Preferred Shaft Basis Metric Clearance Fits ANSI B4.2-1978 (R2009)

Basic Size ^a		Loose Running			Free Running			Close Running			Sliding			Locational Clearance		
		Hole C11	Shaft h11	Fit ^b	Hole D9	Shaft h9	Fit ^b	Hole F8	Shaft h7	Fit ^b	Hole G7	Shaft h6	Fit ^b	Hole H7	Shaft h6	Fit ^b
30	Max	30.240	30.000	0.370	30.117	30.000	0.169	30.053	30.000	0.074	30.028	30.000	0.041	30.021	30.000	0.034
	Min	30.110	29.870	0.110	30.065	29.948	0.065	30.020	29.979	0.020	30.007	29.987	0.007	30.000	29.987	0.000
40	Max	40.280	40.000	0.440	40.142	40.000	0.204	40.064	40.000	0.089	40.034	40.000	0.050	40.025	40.000	0.041
	Min	40.120	39.840	0.120	40.080	39.938	0.080	40.025	39.975	0.025	40.009	39.984	0.009	40.000	39.984	0.000
50	Max	50.290	50.000	0.450	50.142	50.000	0.204	50.064	50.000	0.089	50.034	50.000	0.050	50.025	50.000	0.041
	Min	50.130	49.840	0.130	50.080	49.938	0.080	50.025	49.975	0.025	50.009	49.984	0.009	50.000	49.984	0.000
60	Max	60.330	60.000	0.520	60.174	60.000	0.248	60.076	60.000	0.106	60.040	60.000	0.059	60.030	60.000	0.049
	Min	60.140	59.810	0.140	60.100	59.926	0.100	60.030	59.970	0.030	60.010	59.981	0.010	60.000	59.981	0.000
80	Max	80.340	80.000	0.530	80.174	80.000	0.248	80.076	80.000	0.106	80.040	80.000	0.059	80.030	80.000	0.049
	Min	80.150	79.810	0.150	80.100	79.926	0.100	80.030	79.970	0.030	80.010	79.981	0.010	80.000	79.981	0.000
100	Max	100.390	100.000	0.610	100.207	100.000	0.294	100.090	100.000	0.125	100.047	100.000	0.069	100.035	100.000	0.057
	Min	100.170	99.780	0.170	100.120	99.913	0.120	100.036	99.965	0.036	100.012	99.978	0.012	100.000	99.978	0.000
120	Max	120.400	120.000	0.620	120.207	120.000	0.294	120.090	120.000	0.125	120.047	120.000	0.069	120.035	120.000	0.057
	Min	120.180	119.780	0.180	120.120	119.913	0.120	120.036	119.965	0.036	120.012	119.978	0.012	120.000	119.978	0.000
160	Max	160.460	160.000	0.710	160.245	160.000	0.345	160.106	160.000	0.146	160.054	160.000	0.079	160.040	160.000	0.065
	Min	160.210	159.750	0.210	160.145	159.900	0.145	160.043	159.960	0.043	160.014	159.975	0.014	160.000	159.975	0.000
200	Max	200.530	200.000	0.820	200.285	200.000	0.400	200.122	200.000	0.168	200.061	200.000	0.090	200.046	200.000	0.075
	Min	200.240	199.710	0.240	200.170	199.885	0.170	200.050	199.954	0.050	200.015	199.971	0.015	200.000	199.971	0.000
250	Max	250.570	250.000	0.860	250.285	250.000	0.400	250.122	250.000	0.168	250.061	250.000	0.090	250.046	250.000	0.075
	Min	250.280	249.710	0.280	250.170	249.885	0.170	250.050	249.954	0.050	250.015	249.971	0.015	250.000	249.971	0.000
300	Max	300.650	300.000	0.970	300.320	300.000	0.450	300.137	300.000	0.189	300.069	300.000	0.101	300.052	300.000	0.084
	Min	300.330	299.680	0.330	300.190	299.870	0.190	300.056	299.948	0.056	300.017	299.968	0.017	300.000	299.968	0.000
400	Max	400.760	400.000	1.120	400.350	400.000	0.490	400.151	400.000	0.208	400.075	400.000	0.111	400.057	400.000	0.093
	Min	400.400	399.640	0.400	400.210	399.860	0.210	400.062	399.943	0.062	400.018	399.964	0.018	400.000	399.964	0.000
500	Max	500.880	500.000	1.280	500.385	500.000	0.540	500.165	500.000	0.228	500.083	500.000	0.123	500.063	500.000	0.103
	Min	500.480	499.600	0.480	500.230	499.845	0.230	500.068	499.937	0.068	500.020	499.960	0.020	500.000	499.960	0.000

^aThe sizes shown are first-choice basic sizes (see Table 1, page 673). Preferred fits for other sizes can be calculated from data given in ANSI B4.2-1978 (R2009).

^bAll fits shown in this table have clearance.

All dimensions are in millimeters.

Table 5. American National Standard Preferred Shaft Basis Metric Transition and Interference Fits ANSI B4.2-1978 (R2009)

Basic Size ^a		Locational Transition			Locational Transition			Locational Interference			Medium Drive			Force		
		Hole K7	Shaft h6	Fit ^b	Hole N7	Shaft h6	Fit ^b	Hole P7	Shaft h6	Fit ^b	Hole S7	Shaft h6	Fit ^b	Hole U7	Shaft h6	Fit ^b
1	Max	1.000	1.000	+0.006	0.996	1.000	+0.002	0.994	1.000	0.000	0.986	1.000	-0.008	0.982	1.000	-0.012
	Min	0.990	0.994	-0.010	0.986	0.994	-0.014	0.984	0.994	-0.016	0.976	0.994	-0.024	0.972	0.994	-0.028
1.2	Max	1.200	1.200	+0.006	1.196	1.200	+0.002	1.194	1.200	0.000	1.186	1.200	-0.008	1.182	1.200	-0.012
	Min	1.190	1.194	-0.010	1.186	1.194	-0.014	1.184	1.194	-0.016	1.176	1.194	-0.024	1.172	1.194	-0.028
1.6	Max	1.600	1.600	+0.006	1.596	1.600	+0.002	1.594	1.600	0.000	1.586	1.600	-0.008	1.582	1.600	-0.012
	Min	1.590	1.594	-0.010	1.586	1.594	-0.014	1.584	1.594	-0.016	1.576	1.594	-0.024	1.572	1.594	-0.028
2	Max	2.000	2.000	+0.006	1.996	2.000	+0.002	1.994	2.000	0.000	1.986	2.000	-0.008	1.982	2.000	-0.012
	Min	1.990	1.994	-0.010	1.986	1.994	-0.014	1.984	1.994	-0.016	1.976	1.994	-0.024	1.972	1.994	-0.028
2.5	Max	2.500	2.500	+0.006	2.496	2.500	+0.002	2.494	2.500	0.000	2.486	2.500	-0.008	2.482	2.500	-0.012
	Min	2.490	2.494	-0.010	2.486	2.494	-0.014	2.484	2.494	-0.016	2.476	2.494	-0.024	2.472	2.494	-0.028
3	Max	3.000	3.000	+0.006	2.996	3.000	+0.002	2.994	3.000	0.000	2.986	3.000	-0.008	2.982	3.000	-0.012
	Min	2.990	2.994	-0.010	2.986	2.994	-0.014	2.984	2.994	-0.016	2.976	2.994	-0.024	2.972	2.994	-0.028
4	Max	4.003	4.000	+0.011	3.996	4.000	+0.004	3.992	4.000	0.000	3.985	4.000	-0.007	3.981	4.000	-0.011
	Min	3.991	3.992	-0.009	3.984	3.992	-0.016	3.980	3.992	-0.020	3.973	3.992	-0.027	3.969	3.992	-0.031
5	Max	5.003	5.000	+0.011	4.996	5.000	+0.004	4.992	5.000	0.000	4.985	5.000	-0.007	4.981	5.000	-0.011
	Min	4.991	4.992	-0.009	4.984	4.992	-0.016	4.980	4.992	-0.020	4.973	4.992	-0.027	4.969	4.992	-0.031
6	Max	6.003	6.000	+0.011	5.996	6.000	+0.004	5.992	6.000	0.000	5.985	6.000	-0.007	5.981	6.000	-0.011
	Min	5.991	5.992	-0.009	5.984	5.992	-0.016	5.980	5.992	-0.020	5.973	5.992	-0.027	5.969	5.992	-0.031
8	Max	8.005	8.000	+0.014	7.996	8.000	+0.005	7.991	8.000	0.000	7.983	8.000	-0.008	7.978	8.000	-0.013
	Min	7.990	7.991	-0.010	7.981	7.991	-0.019	7.976	7.991	-0.024	7.968	7.991	-0.032	7.963	7.991	-0.037
10	Max	10.005	10.000	+0.014	9.996	10.000	+0.005	9.991	10.000	0.000	9.983	10.000	-0.008	9.978	10.000	-0.013
	Min	9.990	9.991	-0.010	9.981	9.991	-0.019	9.976	9.991	-0.024	9.968	9.991	-0.032	9.963	9.991	-0.037
12	Max	12.006	12.000	+0.017	11.995	12.000	+0.006	11.989	12.000	0.000	11.979	12.000	-0.010	11.974	12.000	-0.015
	Min	11.988	11.989	-0.012	11.977	11.989	-0.023	11.971	11.989	-0.029	11.961	11.989	-0.039	11.956	11.989	-0.044
16	Max	16.006	16.000	+0.017	15.995	16.000	+0.006	15.989	16.000	0.000	15.979	16.000	-0.010	15.974	16.000	-0.015
	Min	15.988	15.989	-0.012	15.977	15.989	-0.023	15.971	15.989	-0.029	15.961	15.989	-0.039	15.956	15.989	-0.044
20	Max	20.006	20.000	+0.019	19.993	20.000	+0.006	19.986	20.000	-0.001	19.973	20.000	-0.014	19.967	20.000	-0.020
	Min	19.985	19.987	-0.015	19.972	19.987	-0.028	19.965	19.987	-0.035	19.952	19.987	-0.048	19.946	19.987	-0.054
25	Max	25.006	25.000	+0.019	24.993	25.000	+0.006	24.986	25.000	-0.001	24.973	25.000	-0.014	24.966	25.000	-0.027
	Min	24.985	24.987	-0.015	24.972	24.987	-0.028	24.965	24.987	-0.035	24.952	24.987	-0.048	24.939	24.987	-0.061

Table 5. American National Standard Preferred Shaft Basis Metric Transition and Interference Fits ANSI B4.2-1978 (R2009)

Basic Size ^a		Locational Transition			Locational Transition			Locational Interference			Medium Drive			Force		
		Hole K7	Shaft h6	Fit ^b	Hole N7	Shaft h6	Fit ^b	Hole P7	Shaft h6	Fit ^b	Hole S7	Shaft h6	Fit ^b	Hole U7	Shaft h6	Fit ^b
30	Max	30.006	30.000	+0.019	29.993	30.000	+0.006	29.986	30.000	-0.001	29.973	30.000	-0.014	29.960	30.000	-0.027
	Min	29.985	29.987	-0.015	29.972	29.987	-0.028	29.965	29.987	-0.035	29.952	29.987	-0.048	29.939	29.987	-0.061
40	Max	40.007	40.000	+0.023	39.992	40.000	+0.008	39.983	40.000	-0.001	39.966	40.000	-0.018	39.949	40.000	-0.035
	Min	39.982	39.984	-0.018	39.967	39.984	-0.033	39.958	39.984	-0.042	39.941	39.984	-0.059	39.924	39.984	-0.076
50	Max	50.007	50.000	+0.023	49.992	50.000	+0.008	49.983	50.000	-0.001	49.966	50.000	-0.018	49.939	50.000	-0.045
	Min	49.982	49.984	-0.018	49.967	49.984	-0.033	49.958	49.984	-0.042	49.941	49.984	-0.059	49.914	49.984	-0.086
60	Max	60.009	60.000	+0.028	59.991	60.000	+0.010	59.979	60.000	-0.002	59.958	60.000	-0.023	59.924	60.000	-0.087
	Min	59.979	59.981	-0.021	59.961	59.981	-0.039	59.949	59.981	-0.051	59.928	59.981	-0.072	59.894	59.981	-0.106
80	Max	80.009	80.000	+0.028	79.991	80.000	+0.010	79.979	80.000	-0.002	79.952	80.000	-0.029	79.909	80.000	-0.072
	Min	79.979	79.981	-0.021	79.961	79.981	-0.039	79.949	79.981	-0.051	79.922	79.981	-0.078	79.879	79.981	-0.121
100	Max	100.010	100.000	+0.032	99.990	100.000	+0.012	99.976	100.000	-0.002	99.942	100.000	-0.036	99.889	100.000	-0.089
	Min	99.975	99.978	-0.025	99.955	99.978	-0.045	99.941	99.978	-0.059	99.907	99.978	-0.093	99.854	99.978	-0.146
120	Max	120.010	120.000	+0.032	119.990	120.000	+0.012	119.976	120.000	-0.002	119.934	120.000	-0.044	119.869	120.000	-0.109
	Min	119.975	119.978	-0.025	119.955	119.978	-0.045	119.941	119.978	-0.059	119.899	119.978	-0.101	119.834	119.978	-0.166
160	Max	160.012	160.000	+0.037	159.988	160.000	+0.013	159.972	160.000	-0.003	159.915	160.000	-0.060	159.825	160.000	-0.150
	Min	159.972	159.975	-0.028	159.948	159.975	-0.052	159.932	159.975	-0.068	159.875	159.975	-0.125	159.785	159.975	-0.215
200	Max	200.013	200.000	+0.042	199.986	200.000	+0.015	199.967	200.000	-0.004	199.895	200.000	-0.076	199.781	200.000	-0.190
	Min	199.967	199.971	-0.033	199.940	199.971	-0.060	199.921	199.971	-0.079	199.849	199.971	-0.151	199.735	199.971	-0.265
250	Max	250.013	250.000	+0.042	249.986	250.000	+0.015	249.967	250.000	-0.004	249.877	250.000	-0.094	249.733	250.000	-0.238
	Min	249.967	249.971	-0.033	249.940	249.971	-0.060	249.921	249.971	-0.079	249.831	249.971	-0.169	249.687	249.971	-0.313
300	Max	300.016	300.000	+0.048	299.986	300.000	+0.018	299.964	300.000	-0.004	299.850	300.000	-0.118	299.670	300.000	-0.298
	Min	299.964	299.968	-0.036	299.934	299.968	-0.066	299.912	299.968	-0.088	299.798	299.968	-0.202	299.618	299.968	-0.382
400	Max	400.017	400.000	+0.053	399.984	400.000	+0.020	399.959	400.000	-0.005	399.813	400.000	-0.151	399.586	400.000	-0.378
	Min	399.960	399.964	-0.040	399.927	399.964	-0.073	399.902	399.964	-0.098	399.756	399.964	-0.244	399.529	399.964	-0.471
500	Max	500.018	500.000	+0.058	499.983	500.000	+0.023	499.955	500.000	-0.005	499.771	500.000	-0.189	499.483	500.000	-0.477
	Min	499.955	499.960	-0.045	499.920	499.960	-0.080	499.892	499.960	-0.108	499.708	499.960	-0.292	499.420	499.960	-0.580

^aThe sizes shown are first-choice basic sizes (see Table 1, page 673). Preferred fits for other sizes can be calculated from data given in ANSI B4.2-1978 (R2009).

^bA plus sign indicates clearance; a minus sign indicates interference.

All dimensions are in millimeters.

**Table 6. American National Standard Gagemakers Tolerances
ANSI B4.4M-1981 (R1994)**

Gagemakers Tolerance		Workpiece Tolerance		
Class	ISO Symbol ^a	IT Grade	Recommended Gage Usage	
Rejection of Good Parts Increase ↑	ZM	0.05 IT11	IT11	Low-precision gages recommended to be used to inspect workpieces held to internal (hole) tolerances C11 and H11 and to external (shaft) tolerances c11 and h11.
	YM	0.05 IT9	IT9	Gages recommended to be used to inspect workpieces held to internal (hole) tolerances D9 and H9 and to external (shaft) tolerances d9 and h9.
	XM	0.05 IT8	IT8	Precision gages recommended to be used to inspect workpieces held to internal (hole) tolerances F8 and H8.
Gage Cost Increase ↓	XXM	0.05 IT7	IT7	Recommended to be used for gages to inspect workpieces held to internal (hole) tolerances G7, H7, K7, N7, P7, S7, and U7, and to external (shaft) tolerances f7 and h7.
	XXXM	0.05 IT6	IT6	High-precision gages recommended to be used to inspect workpieces held to external (shaft) tolerances g6, h6, k6, n6, p6, s6, and u6.

^a Gagemakers tolerance is equal to 5 per cent of workpiece tolerance or 5 per cent of applicable IT grade value. See Table 7.

For workpiece tolerance class values, see previous Tables 2 through 5, inclusive.

**Table 7. American National Standard Gagemakers Tolerances
ANSI B4.4M-1981 (R1994)**

Basic Size		Class ZM	Class YM	Class XM	Class XXM	Class XXXM
Over	To	0.05 IT11	0.05 IT9	0.05 IT8	0.05 IT7	0.05 IT6
0	3	0.0030	0.0012	0.0007	0.0005	0.0003
3	6	0.0037	0.0015	0.0009	0.0006	0.0004
6	10	0.0045	0.0018	0.0011	0.0007	0.0005
10	18	0.0055	0.0021	0.0013	0.0009	0.0006
18	30	0.0065	0.0026	0.0016	0.0010	0.0007
30	50	0.0080	0.0031	0.0019	0.0012	0.0008
50	80	0.0095	0.0037	0.0023	0.0015	0.0010
80	120	0.0110	0.0043	0.0027	0.0017	0.0011
120	180	0.0125	0.0050	0.0031	0.0020	0.0013
180	250	0.0145	0.0057	0.0036	0.0023	0.0015
250	315	0.0160	0.0065	0.0040	0.0026	0.0016
315	400	0.0180	0.0070	0.0044	0.0028	0.0018
400	500	0.0200	0.0077	0.0048	0.0031	0.0020

All dimensions are in millimeters. For closer gagemakers tolerance classes than Class XXXM, specify 5 per cent of IT5, IT4, or IT3 and use the designation 0.05 IT5, 0.05 IT4, etc.

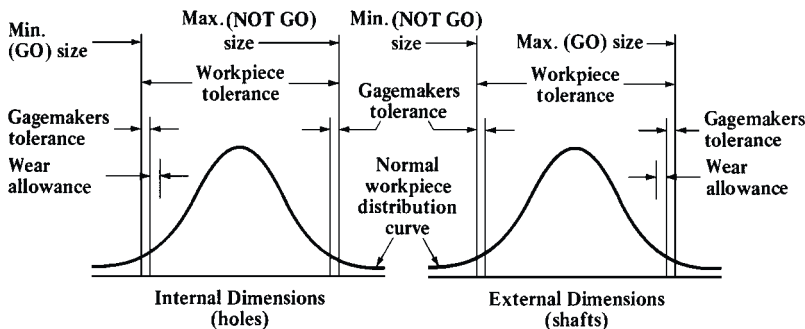


Fig. 4. Relationship between Gagemakers Tolerance, Wear Allowance and Workpiece Tolerance

recommendations apply equally well to other sections, and the general term *hole* or *shaft* can be taken to mean the space contained by or containing two parallel faces or tangent planes of any part, such as the width of a slot, or the thickness of a key. It is also strongly emphasized that the grades series of tolerances are intended for the most general application, and should be used wherever possible whether the features of the component involved are members of a fit or not.

Definitions.—The definitions given in the Standard include the following:

Limits of Size: The maximum and minimum sizes permitted for a feature.

Basic Size: The reference size to which the limits of size are fixed. The basic size is the same for both members of a fit.

Upper Deviation: The algebraic difference between the maximum limit of size and the corresponding basic size. It is designated as “ES” for a hole, and as “es” for a shaft, which stands for the French term *écart supérieur*.

Lower Deviation: The algebraic difference between the minimum limit of size and the corresponding basic size. It is designated as “EI” for a hole, and as “ei” for a shaft, which stands for the French term *écart inférieur*.

Zero Line: In a graphical representation of limits and fits, the straight line to which the deviations are referred. The zero line is the line of zero deviation and represents the basic size.

Tolerance: The difference between the maximum limit of size and the minimum limit of size. It is an absolute value without sign.

Tolerance Zone: In a graphical representation of tolerances, the zone comprised between the two lines representing the limits of tolerance and defined by its magnitude (tolerance) and by its position in relation to the zero line.

Fundamental Deviation: That one of the two deviations, being the one nearest to the zero line, which is conventionally chosen to define the position of the tolerance zone in relation to the zero line.

Shaft-Basis System of Fits: A system of fits in which the different clearances and interferences are obtained by associating various holes with a single shaft. In the ISO system, the basic shaft is the shaft the upper deviation of which is zero.

Hole-Basis System of Fits: A system of fits in which the different clearances and interferences are obtained by associating various shafts with a single hole. In the ISO system, the basic hole is the hole the lower deviation of which is zero.

Selected Limits of Tolerance, and Fits.—The number of fit combinations that can be built up with the ISO system is very large. However, experience shows that the majority of fits required for usual engineering products can be provided by a limited selection of tolerances. Limits of tolerance for selected holes are shown in [Table 1](#), and for shafts, in [Table 2](#). Selected fits, based on combinations of the selected hole and shaft tolerances, are given in [Table 3](#).

Tolerances and Fundamental Deviations.—There are 18 tolerance grades intended to meet the requirements of different classes of work, and they are designated IT01, IT0, and IT1 to IT16. (IT stands for ISO series of tolerances.) [Table 4](#) shows the standardized numerical values for the 18 tolerance grades, which are known as standard tolerances. The system provides 27 fundamental deviations for sizes up to and including 500 mm, and [Tables 5a](#) and [5b](#) contain the values for shafts and [Tables 6a](#) and [6b](#) for holes. Uppercase (capital) letters designate hole deviations, and the same letters in lower case designate shaft deviations. The deviation j_s (J_s for holes) is provided to meet the need for symmetrical bilateral tolerances. In this instance, there is no fundamental deviation, and the tolerance zone, of whatever magnitude, is equally disposed about the zero line.

Calculated Limits of Tolerance.—The deviations and fundamental tolerances provided by the ISO system can be combined in any way that appears necessary to give a required fit. Thus, for example, the deviations H (basic hole) and f (clearance shaft) could be associ-

ated, and with each of these deviations any one of the tolerance grades IT01 to IT16 could be used. All the limits of tolerance that the system is capable of providing for sizes up to and including 500 mm can be calculated from the standard tolerances given in **Table 4**, and the fundamental deviations given in **Tables 5a, 5b, 6a** and **6b**. The range includes limits of tolerance for shafts and holes used in small high-precision work and horology.

The system provides for the use of either hole-basis or shaft-basis fits, and the Standard includes details of procedures for converting from one type of fit to the other.

The limits of tolerance for a shaft or hole are designated by the appropriate letter indicating the fundamental deviation, followed by a suffix number denoting the tolerance grade. This suffix number is the numerical part of the tolerance grade designation. Thus, a hole tolerance with deviation H and tolerance grade IT7 is designated H7. Likewise, a shaft with deviation p and tolerance grade IT6 is designated p6. The limits of size of a component feature are defined by the basic size, say, 45 mm, followed by the appropriate tolerance designation, for example, 45 H7 or 45 p6. A fit is indicated by combining the basic size common to both features with the designation appropriate to each of them, for example, 45 H7-p6 or 45 H7/p6.

When calculating the limits of size for a shaft, the upper deviation e_s , or the lower deviation e_i , is first obtained from **Tables 5a** or **5b**, depending on the particular letter designation, and nominal dimension. If an upper deviation has been determined, the lower deviation $e_i = e_s - IT$. The IT value is obtained from **Table 4** for the particular tolerance grade being applied. If a lower deviation has been obtained from **Tables 5a** or **5b**, the upper deviation $e_s = e_i + IT$. When the upper deviation ES has been determined for a hole from **Tables 6a** or **6b**, the lower deviation EI = ES - IT. If a lower deviation EI has been obtained from **Table 6a**, then the upper deviation ES = EI + IT.

The upper deviations for holes K, M, and N with tolerance grades up to and including IT8, and for holes P to ZC with tolerance grades up to and including IT7 must be calculated by adding the delta (Δ) values given in **Table 6b** as indicated.

Example 1: The limits of size for a part of 133 mm basic size with a tolerance designation g9 are derived as follows:

From **Table 5a**, the upper deviation (e_s) is -0.014 mm. From **Table 4**, the tolerance grade (IT9) is 0.100 mm. The lower deviation (e_i) = $e_s - IT = 0.114$ mm, and the limits of size are thus 132.986 and 132.886 mm.

Example 2: The limits of size for a part 20 mm in size, with tolerance designation D3, are derived as follows: From **Table 6a**, the lower deviation (EI) is $+0.065$ mm. From **Table 4**, the tolerance grade (IT3) is 0.004 mm. The upper deviation (ES) = EI + IT = 0.069 mm, and thus the limits of size for the part are 20.069 and 20.065 mm.

Example 3: The limits of size for a part 32 mm in size, with tolerance designation M5, which involves a delta value, are obtained as follows: From **Table 6a**, the upper deviation ES is -0.009 mm + $\Delta = -0.005$ mm. (The delta value given at the end of **Table 6b** for this size and grade IT5 is 0.004 mm.) From **Table 4**, the tolerance grade (IT5) is 0.011 mm. The lower deviation (EI) = ES - IT = -0.016 mm, and thus the limits of size for the part are 31.995 and 31.984 mm.

Where the designations h and H or j_s and J_s are used, it is only necessary to refer to **Table 4**. For h and H, the fundamental deviation is always zero, and the disposition of the tolerance is always negative (−) for a shaft, and positive (+) for a hole.

Example 4: The limits for a part 40 mm in size, designated h8 are derived as follows: From **Table 4**, the tolerance grade (IT8) is 0.039 mm, and the limits are therefore 40.000 and 39.961 mm.

Example 5: The limits for a part 60 mm in size, designated j_s7 or J_s7 are derived as follows: From **Table 4**, the tolerance grade (IT7) is 0.030 mm, and this value is divided equally about the basic size to give limits of 60.015 and 59.985 mm.

**Table 1. British Standard Limits of Tolerance for Selected Holes
(Upper and Lower Deviations) BS 4500:1969**

Nominal Sizes, mm		H7		H8		H9		H11	
Over	Up to and Including	ES +	EI	ES +	EI	ES +	EI	ES +	EI
...	3	10	0	14	0	25	0	60	0
3	6	12	0	18	0	30	0	75	0
6	10	15	0	22	0	36	0	90	0
10	18	18	0	27	0	43	0	110	0
18	30	21	0	33	0	52	0	130	0
30	50	25	0	39	0	62	0	160	0
50	80	30	0	46	0	74	0	190	0
80	120	35	0	54	0	87	0	220	0
120	180	40	0	63	0	100	0	250	0
180	250	46	0	72	0	115	0	290	0
250	315	52	0	81	0	130	0	320	0
315	400	57	0	89	0	140	0	360	0
400	500	63	0	97	0	155	0	400	0

ES = Upper deviation, EI = Lower deviation.

The dimensions are given in 0.001 mm, except for the nominal sizes, which are in millimeters.

**Table 2. British Standard Limits of Tolerance for Selected Shafts
(Upper and Lower Deviations) BS 4500:1969**

Nominal Sizes, mm		c11		d10		e9		f7		g6		h6		k6		n6		p6		s6	
Over	Up to and Incl.	es -	ei -	es -	ei -	es -	ei -	es -	ei -	es -	ei -	es -	ei -	es +	ei +	es +	ei +	es +	ei +	es +	ei +
...	3	60	120	20	60	14	39	6	16	2	8	0	6	6	0	10	4	12	6	20	14
3	6	70	145	30	78	20	50	10	22	4	12	0	8	9	1	16	8	20	12	27	19
6	10	80	170	40	98	25	61	13	28	5	14	0	9	10	1	19	10	24	15	32	23
10	18	95	205	50	120	32	75	16	34	6	17	0	11	12	1	23	12	29	18	39	28
18	30	110	240	65	149	40	92	20	41	7	20	0	13	15	2	28	15	35	22	48	35
30	40	120	280	80	180	50	112	25	50	9	25	0	16	18	2	33	17	42	26	59	43
40	50	130	290	80	180	50	112	25	50	9	25	0	16	18	2	33	17	42	26	59	43
50	65	140	330	100	220	60	134	30	60	10	29	0	19	21	2	39	20	51	32	72	53
65	80	150	340	100	220	60	134	30	60	10	29	0	19	21	2	39	20	51	32	78	59
80	100	170	390	120	260	72	159	36	71	12	34	0	22	25	3	45	23	59	37	93	71
100	120	180	400	120	260	72	159	36	71	12	34	0	22	25	3	45	23	59	37	101	79
120	140	200	450	145	305	85	185	43	83	14	39	0	25	28	3	52	27	68	43	117	92
140	160	210	460	145	305	85	185	43	83	14	39	0	25	28	3	52	27	68	43	125	100
160	180	230	480	145	305	85	185	43	83	14	39	0	25	28	3	52	27	68	43	133	108
180	200	240	530	170	355	100	215	50	96	15	44	0	29	33	4	60	31	79	50	151	122
200	225	260	550	170	355	100	215	50	96	15	44	0	29	33	4	60	31	79	50	159	130
225	250	280	570	170	355	100	215	50	96	15	44	0	29	33	4	60	31	79	50	169	140
250	280	300	620	190	400	110	240	56	108	17	49	0	32	36	4	66	34	88	56	190	158
280	315	330	650	190	400	110	240	56	108	17	49	0	32	36	4	66	34	88	56	202	170
315	355	360	720	210	440	125	265	62	119	18	54	0	36	40	4	73	37	98	62	226	190
355	400	400	760	210	440	125	265	62	119	18	54	0	36	40	4	73	37	98	62	244	208
400	450	440	840	230	480	135	290	68	131	20	60	0	40	45	5	80	40	108	68	272	232
450	500	480	880	230	480	135	290	68	131	20	60	0	40	45	5	80	40	108	68	292	252

es = Upper deviation, ei = Lower deviation.

The dimensions are given in 0.001 mm, except for the nominal sizes, which are in millimeters.

Table 3. British Standard Selected Fits, Minimum and Maximum Clearances BS 4500:1969

Nominal Sizes, mm		H11—c11		H9—d10		H9—e9		H8—f7		H7—g6		H7—h6		H7—k6		H7—n6		H7—p6		H7—s6	
Over	Up to and Including	Min	Max	Min	Max	Min	Max	Min	Max	Min	Max	Min	Max	Min	Max	Min	Max	Min	Max	Min	Max
...	3	60	180	20	85	14	64	6	30	2	18	0	16	-6	+10	-10	+6	-12	+4	-20	-4
3	6	70	220	30	108	20	80	10	40	4	24	0	20	-9	+11	-16	+4	-20	0	-27	-7
6	10	80	260	40	134	25	97	13	50	5	29	0	24	-10	+14	-19	+5	-24	0	-32	-8
10	18	95	315	50	163	32	118	16	61	6	35	0	29	-12	+17	-23	+6	-29	0	-39	-10
18	30	110	370	65	201	40	144	20	74	7	41	0	34	-15	+19	-28	+6	-35	-1	-48	-14
30	40	120	440	80	242	50	174	25	89	9	50	0	41	-18	+23	-33	+8	-42	-1	-59	-18
40	50	130	450	80	242	50	174	25	89	9	50	0	41	-18	+23	-33	+8	-42	-1	-59	-18
50	65	140	520	100	294	60	208	30	106	10	59	0	49	-21	+28	-39	+10	-51	-2	-72	-23
65	80	150	530	100	294	60	208	30	106	10	59	0	49	-21	+28	-39	+10	-51	-2	-78	-29
80	100	170	610	120	347	72	246	36	125	12	69	0	57	-25	+32	-45	+12	-59	-2	-93	-36
100	120	180	620	120	347	72	246	36	125	12	69	0	57	-25	+32	-45	+12	-59	-2	-101	-44
120	140	200	700	145	405	85	285	43	146	14	79	0	65	-28	+37	-52	+13	-68	-3	-117	-52
140	160	210	710	145	405	85	285	43	146	14	79	0	65	-28	+37	-52	+13	-68	-3	-125	-60
160	180	230	730	145	405	85	285	43	146	14	79	0	65	-28	+37	-52	+13	-68	-3	-133	-68
180	200	240	820	170	470	100	330	50	168	15	90	0	75	-33	+42	-60	+15	-79	-4	-151	-76
200	225	260	840	170	470	100	330	50	168	15	90	0	75	-33	+42	-60	+15	-79	-4	-159	-84
225	250	280	860	170	470	100	330	50	168	15	90	0	75	-33	+42	-60	+15	-79	-4	-169	-94
250	280	300	940	190	530	110	370	56	189	17	101	0	84	-36	+48	-66	+18	-88	-4	-190	-126
280	315	330	970	190	530	110	370	56	189	17	101	0	84	-36	+48	-66	+18	-88	-4	-202	-112
315	355	360	1080	210	580	125	405	62	208	18	111	0	93	-40	-53	-73	+20	-98	-5	-226	-133
355	400	400	1120	210	580	125	405	62	208	18	111	0	93	-40	-53	-73	+20	-98	-5	-244	-151
400	450	440	1240	230	635	135	445	68	228	20	123	0	103	-45	+58	-80	+23	-108	-5	-272	-169
450	500	480	1280	230	635	135	445	68	228	20	123	0	103	-45	+58	-80	+23	-108	-5	-292	-189

The dimensions are given in 0.001 mm, except for the nominal sizes, which are in millimeters.

Minus (-) sign indicates negative clearance, i.e., interference.

Table 4. British Standard Limits and Fits BS 4500:1969

Nominal Sizes, mm		Tolerance Grades																	
Over	To	IT 01	IT 0	IT 1	IT 2	IT 3	IT 4	IT 5	IT 6	IT 7	IT 8	IT 9	IT 10	IT 11	IT 12	IT 13	IT 14 ^a	IT 15 ^a	IT 16 ^a
...	3	0.3	0.5	0.8	1.2	2	3	4	6	10	14	25	40	60	100	140	250	400	600
3	6	0.4	0.6	1	1.5	2.5	4	5	8	12	18	30	48	75	120	180	300	480	750
6	10	0.4	0.6	1	1.5	2.5	4	6	9	15	22	36	58	90	150	220	360	580	900
10	18	0.5	0.8	1.2	2	3	5	8	11	18	27	43	70	110	180	270	430	700	1100
18	30	0.6	1	1.5	2.5	4	6	9	13	21	33	52	84	130	210	330	520	840	1300
30	50	0.6	1	1.5	2.5	4	7	11	16	25	39	62	100	160	250	390	620	1000	1600
50	80	0.8	1.2	2	3	5	8	13	19	30	46	74	120	190	300	460	740	1200	1900
80	120	1	1.5	2.5	4	6	10	15	22	35	54	87	140	220	350	540	870	1400	2200
120	180	1.2	2	3.5	5	8	12	18	25	40	63	100	160	250	400	630	1000	1600	2500
180	250	2	3	4.5	7	10	14	20	29	46	72	115	185	290	460	720	1150	1850	2900
250	315	2.5	4	6	8	12	16	23	32	52	81	130	210	320	520	810	1300	2100	3200
315	400	3	5	7	9	13	18	25	36	57	89	140	230	360	570	890	1400	2300	3600
400	500	4	6	8	10	15	20	27	40	63	97	155	250	400	630	970	1550	2500	4000

^aNot applicable to sizes below 1 mm.

The dimensions are given in 0.001 mm, except for the nominal sizes which are in millimeters.

Table 5a. British Standard Fundamental Deviations for Shafts BS 4500:1969

Nominal Sizes, mm		Grade																
		01 to 16											5-6	7	8	4-7	≤3 >7	
		Fundamental (Upper) Deviation es											Fundamental (Lower) Deviation ei					
Over	To	a ^a	b ^a	c	cd	d	e	ef	f	fg	g	h	js ^b	j			k	
...	3	-270	-140	-60	-34	-20	-14	-10	-6	-4	-2	0	±IT/2	-2	-4	-6	0	0
3	6	-270	-140	-70	-46	-30	-20	-14	-10	-6	-4	0		-2	-4	...	+1	0
6	10	-280	-150	-80	-56	-40	-25	-18	-13	-8	-5	0		-2	-5	...	+1	0
10	14	-290	-150	-95	...	-50	-32	...	-16	...	-6	0		-3	-6	...	+1	0
14	18	-290	-150	-95	...	-50	-32	...	-16	...	-6	0		-3	-6	...	+1	0
18	24	-300	-160	-110	...	-65	-40	...	-20	...	-7	0		-4	-8	...	+2	0
24	30	-300	-160	-110	...	-65	-40	...	-20	...	-7	0		-4	-8	...	+2	0
30	40	-310	-170	-120	...	-80	-50	...	-25	...	-9	0		-5	-10	...	+2	0
40	50	-320	-180	-130	...	-80	-50	...	-25	...	-9	0		-5	-10	...	+2	0
50	65	-340	-190	-140	...	-100	-60	...	-30	...	-10	0		-7	-12	...	+2	0
65	80	-360	-200	-150	...	-100	-60	...	-30	...	-10	0		-7	-12	...	+2	0
80	100	-380	-220	-170	...	-120	-72	...	-36	...	-12	0		-9	-15	...	+3	0
100	120	-410	-240	-180	...	-120	-72	...	-36	...	-12	0		-9	-15	...	+3	0
120	140	-460	-260	-200	...	-145	-85	...	-43	...	-14	0		-11	-18	...	+3	0
140	160	-520	-280	-210	...	-145	-85	...	-43	...	-14	0		-11	-18	...	+3	0
160	180	-580	-310	-230	...	-145	-85	...	-43	...	-14	0		-11	-18	...	+3	0
180	200	-660	-340	-240	...	-170	-100	...	-50	...	-15	0		-13	-21	...	+4	0
200	225	-740	-380	-260	...	-170	-100	...	-50	...	-15	0		-13	-21	...	+4	0
225	250	-820	-420	-280	...	-170	-100	...	-50	...	-15	0		-13	-21	...	+4	0
250	280	-920	-480	-300	...	-190	-110	...	-56	...	-17	0		-16	-26	...	+4	0
280	315	-1050	-540	-330	...	-190	-110	...	-56	...	-17	0	-16	-26	...	+4	0	
315	355	-1200	-600	-360	...	-210	-125	...	-62	...	-18	0	-18	-28	...	+4	0	
355	400	-1350	-680	-400	...	-210	-125	...	-62	...	-18	0	-18	-28	...	+4	0	
400	450	-1500	-760	-440	...	-230	-135	...	-68	...	-20	0	-20	-32	...	+5	0	
450	500	-1650	-840	-480	...	-230	-135	...	-68	...	-20	0	-20	-32	...	+5	0	

^aNot applicable to sizes up to 1 mm.

^bIn grades 7 to 11, the two symmetrical deviations ±IT/2 should be rounded if the IT value in micrometers is an odd value by replacing it with the even value immediately below. For example, if IT = 175, replace it by 174.

Table 5b. British Standard Fundamental Deviations for Shafts BS 4500:1969

Nominal Sizes, mm		Grade													
		01 to 16													
		Fundamental (Lower) Deviation e_i													
Over	To	m	n	p	r	s	t	u	v	x	y	z	za	zb	zc
...	3	+2	+4	+6	+10	+14	...	+18	...	+20	...	+26	+32	+40	+60
3	6	+4	+8	+12	+15	+19	...	+23	...	+28	...	+35	+42	+50	+80
6	10	+6	+10	+15	+19	+23	...	+28	...	+34	...	+42	+52	+67	+97
10	14	+7	+12	+18	+23	+28	...	+33	...	+40	...	+50	+64	+90	+130
14	18	+7	+12	+18	+23	+28	...	+33	+39	+45	...	+60	+77	+108	+150
18	24	+8	+15	+22	+28	+35	...	+41	+47	+54	+63	+73	+98	+136	+188
24	30	+8	+15	+22	+28	+35	+41	+48	+55	+64	+75	+88	+118	+160	+218
30	40	+9	+17	+26	+34	+43	+48	+60	+68	+80	+94	+112	+148	+200	+274
40	50	+9	+17	+26	+34	+43	+54	+70	+81	+97	+114	+136	+180	+242	+325
50	65	+11	+20	+32	+41	+53	+66	+87	+102	+122	+144	+172	+226	+300	+405
65	80	+11	+20	+32	+43	+59	+75	+102	+120	+146	+174	+210	+274	+360	+480
80	100	+13	+23	+37	+51	+71	+91	+124	+146	+178	+214	+258	+335	+445	+585
100	120	+13	+23	+37	+54	+79	+104	+144	+172	+210	+254	+310	+400	+525	+690
120	140	+15	+27	+43	+63	+92	+122	+170	+202	+248	+300	+365	+470	+620	+800
140	160	+15	+27	+43	+65	+100	+134	+190	+228	+280	+340	+415	+535	+700	+900
160	180	+15	+27	+43	+68	+108	+146	+210	+252	+310	+380	+465	+600	+780	+1000
180	200	+17	+31	+50	+77	+122	+166	+236	+284	+350	+425	+520	+670	+880	+1150
200	225	+17	+31	+50	+80	+130	+180	+258	+310	+385	+470	+575	+740	+960	+1250
225	250	+17	+31	+50	+84	+140	+196	+284	+340	+425	+520	+640	+820	+1050	+1350
250	280	+20	+34	+56	+94	+158	+218	+315	+385	+475	+580	+710	+920	+1200	+1550
280	315	+20	+34	+56	+98	+170	+240	+350	+425	+525	+650	+790	+1000	+1300	+1700
315	355	+21	+37	+62	+108	+190	+268	+390	+475	+590	+730	+900	+1150	+1500	+1900
355	400	+21	+37	+62	+114	+208	+294	+435	+530	+660	+820	+1000	+1300	+1650	+2100
400	450	+23	+40	+68	+126	+232	+330	+490	+595	+740	+920	+1100	+1450	+1850	+2400
450	500	+23	+40	+68	+132	+252	+360	+540	+660	+820	+1000	+1250	+1600	+2100	+2600

The dimensions are in 0.001 mm, except the nominal sizes, which are in millimeters.

Table 6a. British Standard Fundamental Deviations for Holes BS 4500:1969

Nominal Sizes, mm		Grade																				
		01 to 16												6	7	8	≤8	>8	≤8 ^a	>8	≤8	>8 ^b
		Fundamental (Lower) Deviation EI												Fundamental (Upper) Deviation ES								
Over	To	A ^b	B ^b	C	CD	D	E	EF	F	FG	G	H	Js ^c	J			K ^d		M ^d		N ^d	
...	3	+270	+140	+60	+34	+20	+14	+10	+6	+4	+2	0		+2	+4	+6	0	0	-2	-2	-4	-4
3	6	+270	+140	+70	+46	+30	+20	+14	+10	+6	+4	0		+5	+6	+10	-1+Δ	...	-4+Δ	-4	-8+Δ	0
6	10	+280	+150	+80	+56	+40	+25	+18	+13	+8	+5	0		+5	+8	+12	-1+Δ	...	-6+Δ	-6	-10+Δ	0
10	14	+290	+150	+95	...	+50	+32	...	+16	...	+6	0		+6	+10	+15	-1+Δ	...	-7+Δ	-7	-12+Δ	0
14	18	+290	+150	+95	...	+50	+32	...	+16	...	+6	0		+6	+10	+15	-1+Δ	...	-7+Δ	-7	-12+Δ	0
18	24	+300	+160	+110	...	+65	+40	...	+20	...	+7	0		+8	+12	+20	-2+Δ	...	-8+Δ	-8	-15+Δ	0
24	30	+300	+160	+110	...	+65	+40	...	+20	...	+7	0		+8	+12	+20	-2+Δ	...	-8+Δ	-8	-15+Δ	0
30	40	+310	+170	+120	...	+80	+50	...	+25	...	+9	0		+10	+14	+24	-2+Δ	...	-9+Δ	-9	-17+Δ	0
40	50	+320	+180	+130	...	+80	+50	...	+25	...	+9	0		+10	+14	+24	-2+Δ	...	-9+Δ	-9	-17+Δ	0
50	65	+340	+190	+140	...	+100	+60	...	+30	...	+10	0		+13	+18	+28	-2+Δ	...	-11+Δ	-11	-20+Δ	0
65	80	+360	+200	+150	...	+100	+60	...	+30	...	+10	0		+13	+18	+28	-2+Δ	...	-11+Δ	-11	-20+Δ	0
80	100	+380	+220	+170	...	+120	+72	...	+36	...	+12	0		+16	+22	+34	-3+Δ	...	-13+Δ	-13	-23+Δ	0
100	120	+410	+240	+180	...	+120	+72	...	+36	...	+12	0	±IT/2	+16	+22	+34	-3+Δ	...	-13+Δ	-13	-23+Δ	0
120	140	+460	+260	+200	...	+145	+85	...	+43	...	+14	0		+18	+26	+41	-3+Δ	...	-15+Δ	-15	-27+Δ	0
140	160	+520	+280	+210	...	+145	+85	...	+43	...	+14	0		+18	+26	+41	-3+Δ	...	-15+Δ	-15	-27+Δ	0
160	180	+580	+310	+230	...	+145	+85	...	+43	...	+14	0		+18	+26	+41	-3+Δ	...	-15+Δ	-15	-27+Δ	0
180	200	+660	+340	+240	...	+170	+100	...	+50	...	+15	0		+22	+30	+47	-4+Δ	...	-17+Δ	-17	-31+Δ	0
200	225	+740	+380	+260	...	+170	+100	...	+50	...	+15	0		+22	+30	+47	-4+Δ	...	-17+Δ	-17	-31+Δ	0
225	250	+820	+420	+280	...	+170	+100	...	+50	...	+15	0		+22	+30	+47	-4+Δ	...	-17+Δ	-17	-31+Δ	0
250	280	+920	+480	+300	...	+190	+110	...	+56	...	+17	0		+25	+36	+55	-4+Δ	...	-20+Δ	-20	-34+Δ	0
280	315	+1050	+540	+330	...	+190	+110	...	+56	...	+17	0		+25	+36	+55	-4+Δ	...	-20+Δ	-20	-34+Δ	0
315	355	+1200	+600	+360	...	+210	+125	...	+62	...	+18	0		+29	+39	+60	-4+Δ	...	-21+Δ	-21	-37+Δ	0
355	400	+1350	+680	+400	...	+210	+125	...	+62	...	+18	0		+29	+39	+60	-4+Δ	...	-21+Δ	-21	-37+Δ	0
400	450	+1500	+760	+440	...	+230	+135	...	+68	...	+20	0		+33	+43	+66	-5+Δ	...	-23+Δ	-23	-40+Δ	0
450	500	+1650	+840	+480	...	+230	+135	...	+68	...	+20	0		+33	+43	+66	-5+Δ	...	-23+Δ	-23	-40+Δ	0

^a Special case: for M6, ES = -9 for sizes from 250 to 315 mm, instead of -11.

^b Not applicable to sizes up to 1 mm.

^c In grades 7 to 11, the two symmetrical deviations ±IT/2 should be rounded if the IT value in micrometers is an odd value, by replacing it with the even value below. For example, if IT = 175, replace it by 174.

^d When calculating deviations for holes K, M, and N with tolerance grades up to and including IT8, and holes P to ZC with tolerance grades up to and including IT7, the delta (Δ) values are added to the upper deviation ES. For example, for 25 P7, ES = -0.022 + 0.008 = -0.014 mm.

Table 6b. British Standard Fundamental Deviations for Holes BS 4500:1969

Nominal Sizes, mm		Grade													Values for delta (Δ) ^d					
		≤ 7	> 7																	
		Over	To	Fundamental (Upper) Deviation ES												Grade				
		P to ZC	P	R	S	T	U	V	X	Y	Z	ZA	ZB	ZC	3	4	5	6	7	8
...	3	Same deviation as for grades above 7 increased by Δ	-6	-10	-14	...	-18	...	-20	...	-26	-32	-40	-60	0	0	0	0	0	0
3	6		-12	-15	-19	...	-23	...	-28	...	-35	-42	-50	-80	1	1.5	1	3	4	6
6	10		-15	-19	-23	...	-28	...	-34	...	-42	-52	-67	-97	1	1.5	2	3	6	7
10	14		-18	-23	-28	...	-33	...	-40	...	-50	-64	-90	-130	1	2	3	3	7	9
14	18		-18	-23	-28	...	-33	-39	-45	...	-60	-77	-108	-150	1	2	3	3	7	9
18	24		-22	-28	-35	...	-41	-47	-54	-63	-73	-98	-136	-188	1.5	2	3	4	8	12
24	30		-22	-28	-35	-41	-48	-55	-64	-75	-88	-118	-160	-218	1.5	2	3	4	8	12
30	40		-26	-34	-43	-48	-60	-68	-80	-94	-112	-148	-200	-274	1.5	3	4	5	9	14
40	50		-26	-34	-43	-54	-70	-81	-97	-114	-136	-180	-242	-325	1.5	3	4	5	9	14
50	65		-32	-41	-53	-66	-87	-102	-122	-144	-172	-226	-300	-405	2	3	5	6	11	16
65	80		-32	-43	-59	-75	-102	-120	-146	-174	-210	-274	-360	-480	2	3	5	6	11	16
80	100		-37	-51	-71	-91	-124	-146	-178	-214	-258	-335	-445	-585	2	4	5	7	13	19
100	120		-37	-54	-79	-104	-144	-172	-210	-254	-310	-400	-525	-690	2	4	5	7	13	19
120	140		-43	-63	-92	-122	-170	-202	-248	-300	-365	-470	-620	-800	3	4	6	7	15	23
140	160		-43	-65	-100	-134	-190	-228	-280	-340	-415	-535	-700	-900	3	4	6	7	15	23
160	180		-43	-68	-108	-146	-210	-252	-310	-380	-465	-600	-780	-1000	3	4	6	7	15	23
180	200		-50	-77	-122	-166	-226	-284	-350	-425	-520	-670	-880	-1150	3	4	6	9	17	26
200	225		-50	-80	-130	-180	-258	-310	-385	-470	-575	-740	-960	-1250	3	4	6	9	17	26
225	250		-50	-84	-140	-196	-284	-340	-425	-520	-640	-820	-1050	-1350	3	4	6	9	17	26
250	280		-56	-94	-158	-218	-315	-385	-475	-580	-710	-920	-1200	-1550	4	4	7	9	20	29
280	315	-56	-98	-170	-240	-350	-425	-525	-650	-790	-1000	-1300	-1700	4	4	7	9	20	29	
315	355	-62	-108	-190	-268	-390	-475	-590	-730	-900	-1150	-1500	-1800	4	5	7	11	21	32	
355	400	-62	-114	-208	-294	-435	-530	-660	-820	-1000	-1300	-1650	-2100	4	5	7	11	21	32	
400	450	-68	-126	-232	-330	-490	-595	-740	-920	-1100	-1450	-1850	-2400	5	5	7	13	23	34	
450	500	-68	-132	-252	-360	-540	-660	-820	-1000	-1250	-1600	-2100	-2600	5	5	7	13	23	34	

The dimensions are given in 0.001 mm, except the nominal sizes, which are in millimeters.

Preferred Numbers

Preferred numbers are series of numbers selected to be used for standardization purposes in preference to any other numbers. Their use will lead to simplified practice and they should be employed whenever possible for individual standard sizes and ratings, or for a series, in applications similar to the following:

- 1) Important or characteristic linear dimensions, such as diameters and lengths, areas, volume, weights, capacities.
- 2) Ratings of machinery and apparatus in horsepower, kilowatts, kilovolt-amperes, volt-ages, currents, speeds, power-factors, pressures, heat units, temperatures, gas or liquid-flow units, weight-handling capacities, etc.
- 3) Characteristic ratios of figures for all kinds of units.

American National Standard for Preferred Numbers.—ANSI Standard Z17.1-1973 covers basic series of preferred numbers which are independent of any measurement system and therefore can be used with metric or customary units. This standard has been withdrawn with no superceding standard specified.

The numbers are rounded values of the following five geometric series of numbers: $10^{N/5}$, $10^{N/10}$, $10^{N/20}$, $10^{N/40}$, and $10^{N/80}$, where N is an integer in the series 0, 1, 2, 3, etc. The designations used for the five series are respectively R5, R10, R20, R40, and R80, where R stands for Renard (Charles Renard, originator of the first preferred number system) and the number indicates the root of 10 on which the particular series is based.

The R5 series gives 5 numbers approximately 60 per cent apart, the R10 series gives 10 numbers approximately 25 per cent apart, the R20 series gives 20 numbers approximately 12 per cent apart, the R40 series gives 40 numbers approximately 6 per cent apart, and the R80 series gives 80 numbers approximately 3 per cent apart. The number of sizes for a given purpose can be minimized by using first the R5 series and adding sizes from the R10 and R20 series as needed. The R40 and R80 series are used principally for expressing tolerances in sizes based on preferred numbers. Preferred numbers below 1 are formed by dividing the given numbers by 10, 100, etc., and numbers above 10 are obtained by multiplying the given numbers by 10, 100, etc. Sizes graded according to the system may not be exactly proportional to one another due to the fact that preferred numbers may differ from calculated values by +1.26 per cent to -1.01 per cent. Deviations from preferred numbers are used in some instances — for example, where whole numbers are needed, such as 32 instead of 31.5 for the number of teeth in a gear.

Basic Series of Preferred Numbers ANSI Z17.1-1973

Series Designation								
R5	R10	R20	R40	R40	R80	R80	R80	R80
Preferred Numbers								
1.00	1.00	1.00	1.00	3.15	1.00	1.80	3.15	5.60
1.60	1.25	1.12	1.06	3.35	1.03	1.85	3.25	5.80
2.50	1.60	1.25	1.12	3.55	1.06	1.90	3.35	6.00
4.00	2.00	1.40	1.18	3.75	1.09	1.95	3.45	6.15
6.30	2.50	1.60	1.25	4.00	1.12	2.00	3.55	6.30
...	3.15	1.80	1.32	4.25	1.15	2.06	3.65	6.50
...	4.00	2.00	1.40	4.50	1.18	2.12	3.75	6.70
...	5.00	2.24	1.50	4.75	1.22	2.18	3.87	6.90
...	6.30	2.50	1.60	5.00	1.25	2.24	4.00	7.10
...	8.00	2.80	1.70	5.30	1.28	2.30	4.12	7.30
...	...	3.15	1.80	5.60	1.32	2.36	4.25	7.50
...	...	3.55	1.90	6.00	1.36	2.43	4.37	7.75
...	...	4.00	2.00	6.30	1.40	2.50	4.50	8.00
...	...	4.50	2.12	6.70	1.45	2.58	4.62	8.25
...	...	5.00	2.24	7.10	1.50	2.65	4.75	8.50
...	...	5.60	2.36	7.50	1.55	2.72	4.87	8.75
...	...	6.30	2.50	8.00	1.60	2.80	5.00	9.00
...	...	7.10	2.65	8.50	1.65	2.90	5.15	9.25
...	...	8.00	2.80	9.00	1.70	3.00	5.20	9.50
...	...	9.00	3.00	9.50	1.75	3.07	5.45	9.75

Preferred Metric Sizes.—American National Standard ANSI B32.4M-1980 (R1994), presents series of preferred metric sizes for round, square, rectangular, and hexagonal metal products. **Table 1** gives preferred metric diameters from 1 to 320 millimeters for round metal products. Wherever possible, sizes should be selected from the Preferred Series shown in the table. A Second Preference series is also shown. A Third Preference Series not shown in the table is: 1.3, 2.1, 2.4, 2.6, 3.2, 3.8, 4.2, 4.8, 7.5, 8.5, 9.5, 36, 85, and 95. This standard has now been consolidated into ASME B32.100-2005, see *Metric Sizes for Flat Metal Products* on page 2610.

ANSI B4.2-1978, R2009 states that the basic size of mating parts should be chosen from the first choice sizes listed in **Table 1**. Most of the Preferred Series of sizes are derived from the American National Standard “10 series” of preferred numbers (see *American National Standard for Preferred Numbers* on page 672). Most of the Second Preference Series are derived from the “20 series” of preferred numbers. Third Preference sizes are generally from the “40 series” of preferred numbers.

For preferred metric diameters less than 1 millimeter, preferred across flat metric sizes of square and hexagon metal products, preferred across flat metric sizes of rectangular metal products, and preferred metric lengths of metal products, reference should be made to the Standard.

Table 1. American National Standard Preferred Metric Sizes
ANSI B4.2-1978 (R2009)

Basic Size, mm		Basic Size, mm		Basic Size, mm		Basic Size, mm	
1st Choice	2nd Choice	1st Choice	2nd Choice	1st Choice	2nd Choice	1st Choice	2nd Choice
1	...	6	...	40	...	250	...
...	1.1	...	7	...	45	...	280
1.2	...	8	...	50	...	300	...
...	1.4	...	9	...	55	...	350
1.6	...	10	...	60	...	400	...
...	1.8	...	11	...	70	...	450
2	...	12	...	80	...	500	...
...	2.2	...	14	...	90	...	550
2.5	...	16	...	100	...	600	...
...	2.8	...	18	...	110	...	700
3	...	20	...	120	...	800	...
...	3.5	...	22	...	140	...	900
4	...	25	...	160	...	1000	...
...	4.5	...	28	...	180
5	...	30	...	200
...	5.5	...	35	...	220

Preferred Metric Sizes for Metal Products.—See *Metric Sizes for Flat Metal Products* on page 2610

British Standard Preferred Numbers and Preferred Sizes.—This British Standard, PD 6481:1977 1983, gives recommendations for the use of preferred numbers and preferred sizes for functional characteristics and dimensions of various products.

The preferred number system is internationally standardized in ISO 3. It is also referred to as the Renard, or R, series (see *American National Standard for Preferred Numbers*, on page 672).

The series in the preferred number system are geometric series, that is, there is a constant ratio between each figure and the succeeding one, within a decimal framework. Thus, the R5 series has five steps between 1 and 10, the R10 series has 10 steps between 1 and 10, the R20 series, 20 steps, and the R40 series, 40 steps, giving increases between steps of approximately 60, 25, 12, and 6 per cent, respectively.

The preferred size series have been developed from the preferred number series by rounding off the inconvenient numbers in the basic series and adjusting for linear measurement in millimeters. These series are shown in Table 2.

After taking all normal considerations into account, it is recommended that (a) for ranges of values of the primary *functional* characteristics (outputs and capacities) of a series of products, the preferred number series R5 to R40 (see page 672) should be used, and (b) whenever linear sizes are concerned, the preferred sizes as given in the following table should be used. The presentation of preferred sizes gives designers and users a logical selection and the benefits of rational variety reduction.

The second-choice size given should only be used when it is not possible to use the first choice, and the third choice should be applied only if a size from the second choice cannot be selected. With this procedure, common usage will tend to be concentrated on a limited range of sizes, and a contribution is thus made to variety reduction. However, the decision to use a particular size cannot be taken on the basis that one is first choice and the other not. Account must be taken of the effect on the design, the availability of tools, and other relevant factors.

Table 2. British Standard Preferred Sizes, PD 6481: 1977 (1983)

Choice			Choice			Choice			Choice			Choice			Choice		
1st	2nd	3rd	1st	2nd	3rd	1st	2nd	3rd	1st	2nd	3rd	1st	2nd	3rd	1st	2nd	3rd
1				5.2		23		65					122				188
	1.1			5.5		24				66			125		190		
1.2				5.8	25				68				128			195	192
		1.3	6			26		70		72		130					
		1.4		6.2		28							132				198
		1.5		6.5	30					74			135		200		
1.6				6.8		32			75				138				205
		1.7		7		34				76	140				210		
		1.8		7.5	35				78				142				215
		1.9	8			36		80					145		220		
2				8.5		38				82			148				225
		2.1		9		40				85		150				230	
		2.2		9.5		42				88			152				235
		2.4	10			44		90					155		240		
2.5				11		45				92			158				245
		2.6	12			46				95		160				250	
2.8				13		48				98			162				255
3				14		50		100					165		260		
		3.2		15		52				102			168				265
		3.5	16			54		105				170				270	
		3.8		17	55					108			172				275
4				18		56		110					175		280		
		4.2		19		58				112			178				285
		4.5	20			60				115		180				290	
		4.8		21		62				118			182				295
5				22		64		120					185		300		

For dimensions above 300, each series continues in a similar manner, i.e., the intervals between each series number are the same as between 200 and 300.

MEASURING, INSTRUMENTS, AND INSPECTION METHODS

Verniers and Micrometers

Reading a Vernier.—A general rule for taking readings with a vernier scale is as follows: Note the number of inches and sub-divisions of an inch that the zero mark of the vernier scale has moved along the true scale, and then add to this reading as many thousandths, or hundredths, or whatever fractional part of an inch the vernier reads to, as there are spaces between the vernier zero and that line on the vernier which coincides with one on the true scale. For example, if the zero line of a vernier which reads to thousandths is slightly beyond the 0.5 inch division on the main or true scale, as shown in Fig. 1, and graduation line 10 on the vernier exactly coincides with one on the true scale, the reading is $0.5 + 0.010$ or 0.510 inch. In order to determine the reading or fractional part of an inch that can be obtained by a vernier, multiply the denominator of the finest sub-division given on the true scale by the total number of divisions on the vernier. For example, if one inch on the true scale is divided into 40 parts or fortieths (as in Fig. 1), and the vernier into twenty-five parts, the vernier will read to thousandths of an inch, as $25 \times 40 = 1000$. Similarly, if there are sixteen divisions to the inch on the true scale and a total of eight on the vernier, the latter will enable readings to be taken within $\frac{1}{128}$ of an inch, as $8 \times 16 = 128$.

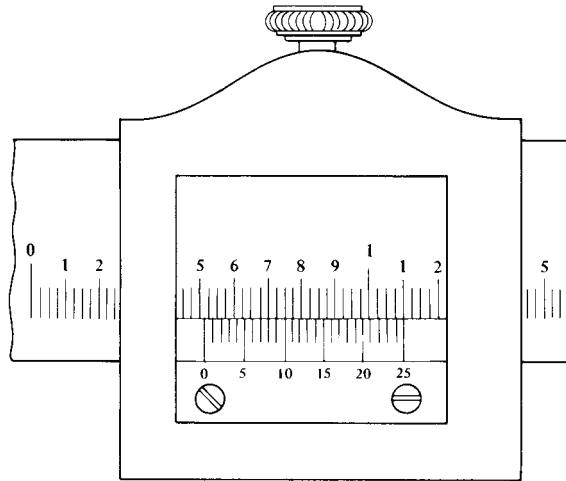


Fig. 1.

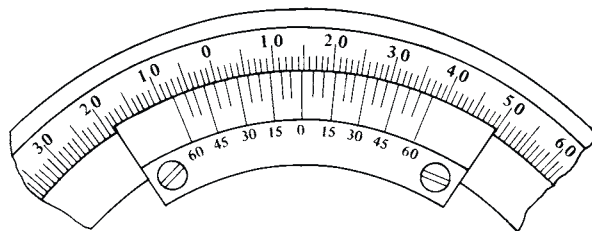


Fig. 2.

If the vernier is on a protractor, note the whole number of degrees passed by the vernier zero mark and then count the spaces between the vernier zero and that line which coincides with a graduation on the protractor scale. If the vernier indicates angles within five minutes or one-twelfth degree (as in Fig. 2), the number of spaces multiplied by 5 will, of course, give the number of minutes to be added to the whole number of degrees. The reading of the protractor set as illustrated would be 14 whole degrees (the number passed by the zero mark on the vernier) plus 30 minutes, as the graduation 30 on the vernier is the only one to the right of the vernier zero which exactly coincides with a line on the protractor scale. It

will be noted that there are duplicate scales on the vernier, one being to the right and the other to the left of zero. The left-hand scale is used when the vernier zero is moved to the left of the zero of the protractor scale, whereas the right-hand graduations are used when the movement is to the right.

Reading a Metric Vernier.—The smallest graduation on the bar (true or main scale) of the metric vernier gage shown in Fig. 1, is 0.5 millimeter. The scale is numbered at each twentieth division, and thus increments of 10, 20, 30, 40 millimeters, etc., are indicated. There are 25 divisions on the vernier scale, occupying the same length as 24 divisions on the bar, which is 12 millimeters. Therefore, one division on the vernier scale equals one twenty-fifth of 12 millimeters = $0.04 \times 12 = 0.48$ millimeter. Thus, the difference between one bar division (0.50 mm) and one vernier division (0.48 mm) is $0.50 - 0.48 = 0.02$ millimeter, which is the minimum measuring increment that the gage provides. To permit direct readings, the vernier scale has graduations to represent tenths of a millimeter (0.1 mm) and fiftieths of a millimeter (0.02 mm).

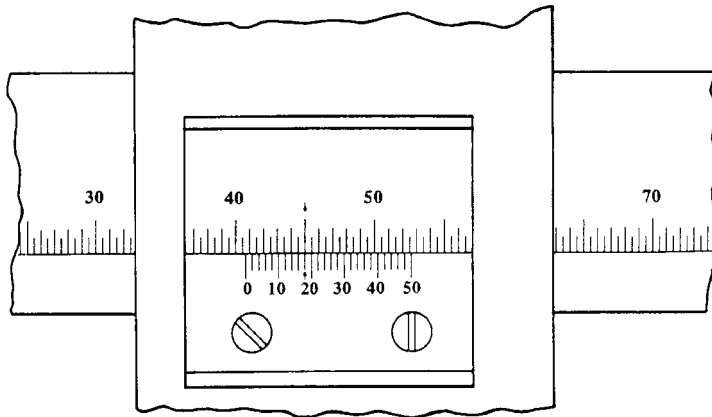


Fig. 1.

To read a vernier gage, first note how many millimeters the zero line on the vernier is from the zero line on the bar. Next, find the graduation on the vernier scale which exactly coincides with a graduation line on the bar, and note the value of the vernier scale graduation. This value is added to the value obtained from the bar, and the result is the total reading.

In the example shown in Fig. 1, the vernier zero is just past the 40.5 millimeters graduation on the bar. The 0.18 millimeter line on the vernier coincides with a line on the bar, and the total reading is therefore $40.5 + 0.18 = 40.68$ mm.

Dual Metric-Inch Vernier.—The vernier gage shown in Fig. 2 has separate metric and inch 50-division vernier scales to permit measurements in either system.

A 50-division vernier has more widely spaced graduations than the 25-division vernier shown on the previous pages, and is thus easier to read. On the bar, the smallest metric graduation is 1 millimeter, and the 50 divisions of the vernier occupy the same length as 49 divisions on the bar, which is 49 mm. Therefore, one division on the vernier scale equals one-fiftieth of 49 millimeters = $0.02 \times 49 = 0.98$ mm. Thus, the difference between one bar division (1.0 mm) and one vernier division (0.98 mm) is 0.02 mm, which is the minimum measuring increment the gage provides.

The vernier scale is graduated for direct reading to 0.02 mm. In the figure, the vernier zero is just past the 27 mm graduation on the bar, and the 0.42 mm graduation on the vernier coincides with a line on the bar. The total reading is therefore 27.42 mm.

The smallest inch graduation on the bar is 0.05 inch, and the 50 vernier divisions occupy the same length as 49 bar divisions, which is 2.45 inches. Therefore, one vernier division equals one-fiftieth of 2.45 inches = $0.02 \times 2.45 = 0.049$ inch. Thus, the difference between

the length of a bar division and a vernier division is $0.050 - 0.049 = 0.001$ inch. The vernier scale is graduated for direct reading to 0.001 inch. In the example, the vernier zero is past the 1.05 graduation on the bar, and the 0.029 graduation on the vernier coincides with a line on the bar. Thus, the total reading is 1.079 inches.

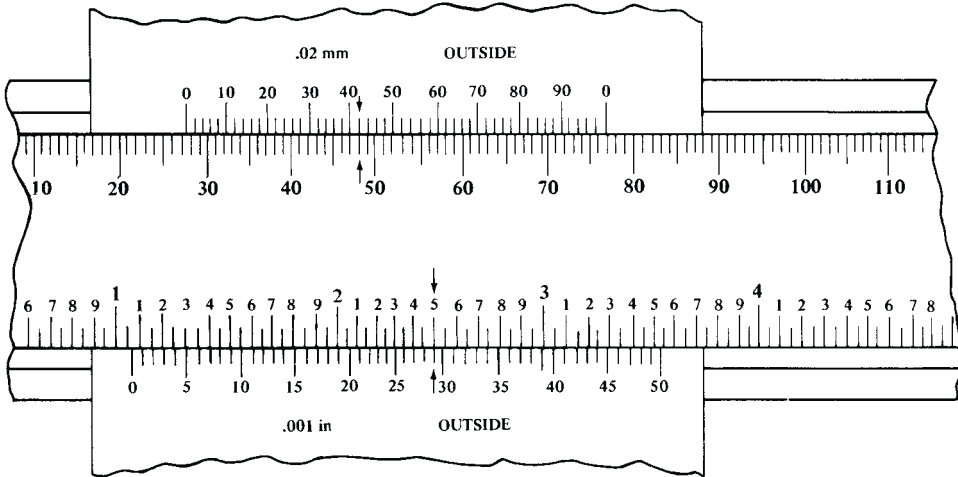


Fig. 2.

Reading a Micrometer.—The spindle of an inch-system micrometer has 40 threads per inch, so that one turn moves the spindle axially 0.025 inch ($1 \div 40 = 0.025$), equal to the distance between two graduations on the frame. The 25 graduations on the thimble allow the 0.025 inch to be further divided, so that turning the thimble through one division moves the spindle axially 0.001 inch ($0.025 \div 25 = 0.001$). To read a micrometer, count the number of whole divisions that are visible on the scale of the frame, multiply this number by 25 (the number of thousandths of an inch that each division represents) and add to the product the number of that division on the thimble which coincides with the axial zero line on the frame. The result will be the diameter expressed in thousandths of an inch. As the numbers 1, 2, 3, etc., opposite every fourth sub-division on the frame, indicate hundreds of thousandths, the reading can easily be taken mentally. Suppose the thimble were screwed out so that graduation 2, and three additional sub-divisions, were visible (as shown in Fig. 3), and that graduation 10 on the thimble coincided with the axial line on the frame. The reading then would be $0.200 + 0.075 + 0.010$, or 0.285 inch.

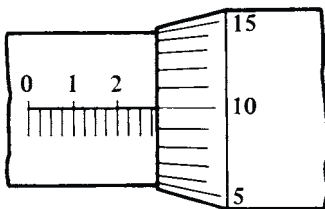


Fig. 3. Inch Micrometer

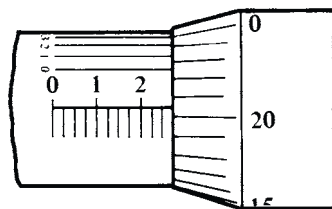


Fig. 4. Inch Micrometer with Vernier

Some micrometers have a vernier scale on the frame in addition to the regular graduations, so that measurements within 0.0001 part of an inch can be taken. Micrometers of this type are read as follows: First determine the number of thousandths, as with an ordinary micrometer, and then find a line on the vernier scale that exactly coincides with one on the thimble; the number of this line represents the number of ten-thousandths to be added to the number of thousandths obtained by the regular graduations. The reading shown in the illustration, Fig. 4, is $0.270 + 0.0003 = 0.2703$ inch.

Micrometers graduated according to the English system of measurement ordinarily have a table of decimal equivalents stamped on the sides of the frame, so that fractions such as sixty-fourths, thirty-seconds, etc., can readily be converted into decimals.

Reading a Metric Micrometer.—The spindle of an ordinary metric micrometer has 2 threads per millimeter, and thus one complete revolution moves the spindle through a distance of 0.5 millimeter. The longitudinal line on the frame is graduated with 1 millimeter divisions and 0.5 millimeter sub-divisions. The thimble has 50 graduations, each being 0.01 millimeter (one-hundredth of a millimeter).

To read a metric micrometer, note the number of millimeter divisions visible on the scale of the sleeve, and add the total to the particular division on the thimble which coincides with the axial line on the sleeve. Suppose that the thimble were screwed out so that graduation 5, and one additional 0.5 sub-division were visible (as shown in Fig. 5), and that graduation 28 on the thimble coincided with the axial line on the sleeve. The reading then would be $5.00 + 0.5 + 0.28 = 5.78$ mm.

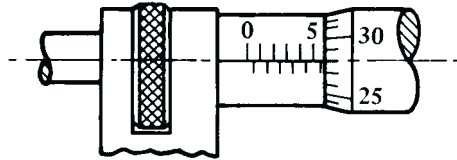


Fig. 5. Metric Micrometer

Some micrometers are provided with a vernier scale on the sleeve in addition to the regular graduations to permit measurements within 0.002 millimeter to be made. Micrometers of this type are read as follows: First determine the number of whole millimeters (if any) and the number of hundredths of a millimeter, as with an ordinary micrometer, and then find a line on the sleeve vernier scale which exactly coincides with one on the thimble. The number of this coinciding vernier line represents the number of two-thousandths of a millimeter to be added to the reading already obtained. Thus, for example, a measurement of 2.958 millimeters would be obtained by reading 2.5 millimeters on the sleeve, adding 0.45 millimeter read from the thimble, and then adding 0.008 millimeter as determined by the vernier.

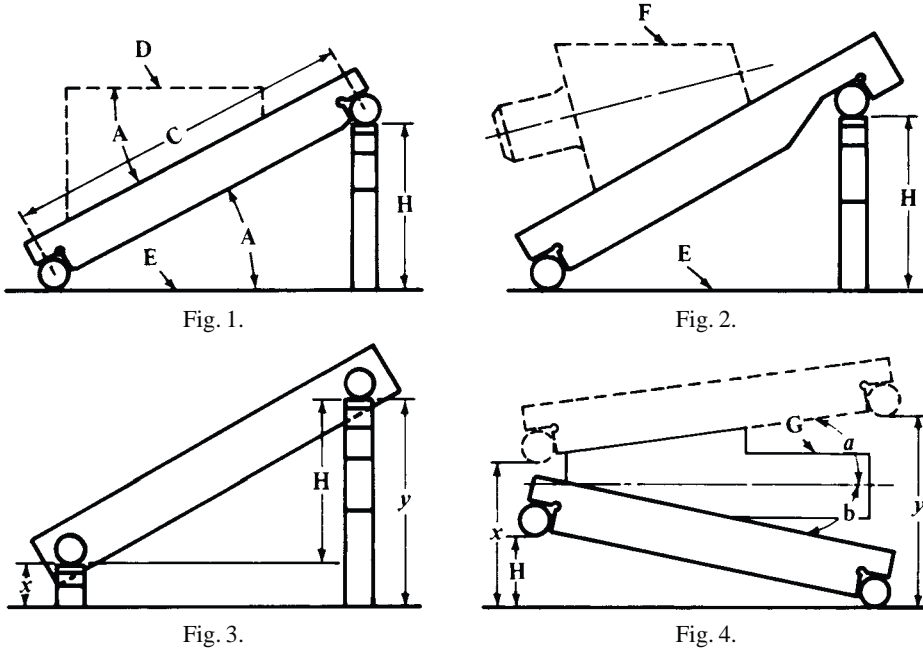
Note: 0.01 millimeter = 0.000393 inch, and 0.002 millimeter = 0.000078 inch (78 millionths). Therefore, metric micrometers provide smaller measuring increments than comparable inch unit micrometers—the smallest graduation of an ordinary inch reading micrometer is 0.001 inch; the vernier type has graduations down to 0.0001 inch. When using either a metric or inch micrometer, without a vernier, smaller readings than those graduated may of course be obtained by visual interpolation between graduations.

Sine-bar

The sine-bar is used either for very accurate angular measurements or for locating work at a given angle as, for example, in surface grinding templets, gages, etc. The sine-bar is especially useful in measuring or checking angles when the limit of accuracy is 5 minutes or less. Some bevel protractors are equipped with verniers which read to 5 minutes but the setting depends upon the alignment of graduations whereas a sine-bar usually is located by positive contact with precision gage-blocks selected for whatever dimension is required for obtaining a given angle.

Types of Sine-bars.—A sine-bar consists of a hardened, ground and lapped steel bar with very accurate cylindrical plugs of equal diameter attached to or near each end. The form illustrated by Fig. 1 has notched ends for receiving the cylindrical plugs so that they are held firmly against both faces of the notch. The standard center-to-center distance *C* between the plugs is either 5 or 10 inches. The upper and lower sides of sine-bars are parallel to the center line of the plugs within very close limits. The body of the sine-bar ordi-

narily has several through holes to reduce the weight. In the making of the sine-bar shown in Fig. 2, if too much material is removed from one locating notch, regrinding the shoulder at the opposite end would make it possible to obtain the correct center distance. That is the reason for this change in form. The type of sine-bar illustrated by Fig. 3 has the cylindrical disks or plugs attached to one side. These differences in form or arrangement do not, of course, affect the principle governing the use of the sine-bar. An accurate surface plate or master flat is always used in conjunction with a sine-bar in order to form the base from which the vertical measurements are made.



Setting a Sine-bar to a Given Angle.—To find the vertical distance H , for setting a sine-bar to the required angle, convert the angle to decimal form on a pocket calculator, take the sine of that angle, and multiply by the distance between the cylinders. For example, if an angle of 31 degrees, 30 minutes is required, the equivalent angle is 31 degrees plus $\frac{30}{60} = 31 + 0.5$, or 31.5 degrees. (For conversions from minutes and seconds to decimals of degrees and vice versa, see page 103). The sine of 31.5 degrees is 0.5225 and multiplying this value by the sine-bar length gives 2.613 in. for the height H , Fig. 1 and 3, of the gage blocks.

Finding Angle when Height H of Sine-bar is Known.—To find the angle equivalent to a given height H , reverse the above procedure. Thus, if the height H is 1.4061 in., dividing by 5 gives a sine of 0.28122, which corresponds to an angle of 16.333 degrees, or 16 degrees 20 minutes.

Checking Angle of Templet or Gage by Using Sine-bar.—Place templet or gage on sine-bar as indicated by dotted lines, Fig. 1. Clamps may be used to hold work in place. Place upper end of sine-bar on gage blocks having total height H corresponding to the required angle. If upper edge D of work is parallel with surface plate E , then angle A of work equals angle A to which sine-bar is set. Parallelism between edge D and surface plate may be tested by checking the height at each end with a dial gage or some type of indicating comparator.

Measuring Angle of Templet or Gage with Sine-bar.—To measure such an angle, adjust height of gage blocks and sine-bar until edge D , Fig. 1, is parallel with surface plate E ; then find angle corresponding to height H , of gage blocks. For example, if height H is

2.5939 inches when D and E are parallel, the calculator will show that the angle A of the work is 31 degrees, 15 minutes.

Checking Taper per Foot with Sine-bar.—As an example, assume that the plug gage in Fig. 2 is supposed to have a taper of $6\frac{1}{8}$ inches per foot and taper is to be checked by using a 5-inch sine-bar. The table of *Tapers per Foot and Corresponding Angles* on page 683 shows that the included angle for a taper of $6\frac{1}{8}$ inches per foot is 28 degrees 38 minutes 1 second, or 28.6336 degrees from the calculator. For a 5-inch sine-bar, the calculator gives a value of 2.396 inch for the height H of the gage blocks. Using this height, if the upper surface F of the plug gage is parallel to the surface plate the angle corresponds to a taper of $6\frac{1}{8}$ inches per foot.

Setting Sine-bar having Plugs Attached to Side.—If the lower plug does not rest directly on the surface plate, as in Fig. 3, the height H for the sine-bar is the difference between heights x and y , or the difference between the heights of the plugs; otherwise, the procedure in setting the sine-bar and checking angles is the same as previously described.

Checking Templets Having Two Angles.—Assume that angle a of templet, Fig. 4, is 9 degrees, angle b 12 degrees, and that edge G is parallel to the surface plate. For an angle b of 12 degrees, the calculator shows that the height H is 1.03956 inches. For an angle a of 9 degrees, the difference between measurements x and y when the sine-bar is in contact with the upper edge of the templet is 0.78217 inch.

Sine-bar Tables to Set Sine-bars to Given Angle.—*Machinery's Handbook CD* contains tables that give constants for sine-bars of 2.5 to 10 inches and 75 to 150 mm length. These constants represent the vertical height H for setting a sine-bar of the corresponding length to the required angle.

Using Sine-bar Tables with Sine-bars of Other Lengths.—A sine-bar may sometimes be preferred that is longer (or shorter) than that given in available tables because of its longer working surface or because the longer center distance is conducive to greater precision. To use the sine-bar tables with a sine-bar of another length to obtain the vertical distances H , multiply the value obtained from the table by the fraction (length of sine-bar used \div length of sine-bar specified in table).

Example: Use the 5-inch sine-bar table to obtain the vertical height H for setting a 10-inch sine-bar to an angle of 39° . The sine of 39 degrees is 0.62932, hence the vertical height H for setting a 10-inch sine-bar is 6.2932 inches.

Solution: The height H given for 39° in the 5-inch sine-bar table (*Constants for 5-inch Sine-Bar* in the *ADDITIONAL* material on *Machinery's Handbook 29 CD*) is 3.14660. The corresponding height for a 10-inch sine-bar is $10/5 \times 3.14660 = 6.2932$ inches.

Using a Calculator to Determine Sine-bar Constants for a Given Angle.—The constant required to set a given angle for a sine-bar of any length can be quickly determined by using a scientific calculator. The required formulas are as follows:

- a) angle A given in degrees and calculator is set to measure angles in radian or a) angle A is given in radian, or
 b) angle A is given in degrees and calculator is set to measure angles in degrees

$$H = L \times \sin\left(A \times \frac{\pi}{180}\right)$$

$$H = L \times \sin(A)$$

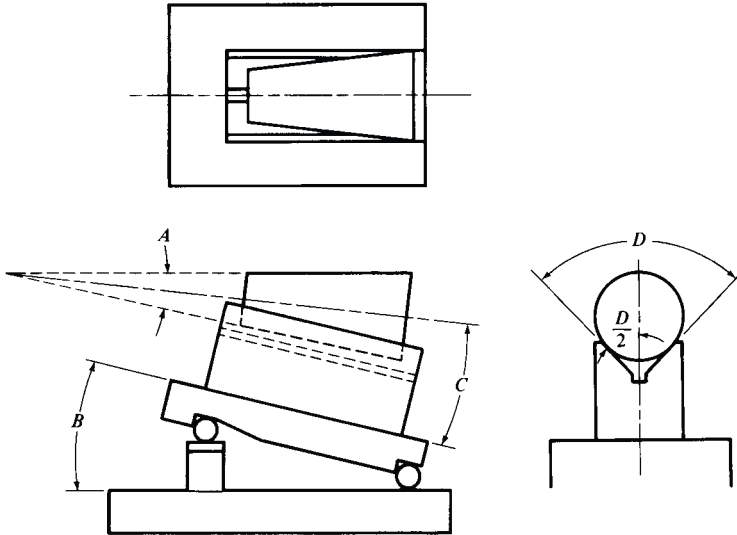
where L = length of the sine-bar A = angle to which the sine-bar is to be set

H = vertical height to which one end of sine-bar must be set to obtain angle A

$\pi = 3.141592654$

In the previous formulas, the height H and length L must be given in the same units, but may be in either metric or US units. Thus, if L is given in mm, then H is in mm; and, if L is given in inches, then H is in inches.

Measuring Tapers with Vee-block and Sine-bar.—The taper on a conical part may be checked or found by placing the part in a vee-block which rests on the surface of a sine-plate or sine-bar as shown in the accompanying diagram. The advantage of this method is that the axis of the vee-block may be aligned with the sides of the sine-bar. Thus when the tapered part is placed in the vee-block it will be aligned perpendicular to the transverse axis of the sine-bar.



The sine-bar is set to angle $B = (C + A/2)$ where $A/2$ is one-half the included angle of the tapered part. If D is the included angle of the precision vee-block, the angle C is calculated from the formula:

$$\sin C = \frac{\sin(A/2)}{\sin(D/2)}$$

If dial indicator readings show no change across all points along the top of the taper surface, then this checks that the angle A of the taper is correct.

If the indicator readings vary, proceed as follows to find the actual angle of taper: 1) Adjust the angle of the sine-bar until the indicator reading is constant. Then find the new angle B' as explained in the paragraph *Measuring Angle of Temple or Gage with Sine-bar* on page 679; and 2) Using the angle B' calculate the actual half-angle $A'/2$ of the taper from the formula:

$$\tan \frac{A'}{2} = \frac{\sin B'}{\csc \frac{D}{2} + \cos B'}$$

The taper per foot corresponding to certain half-angles of taper may be found in the table on page 683.

Dimensioning Tapers.—At least three methods of dimensioning tapers are in use.

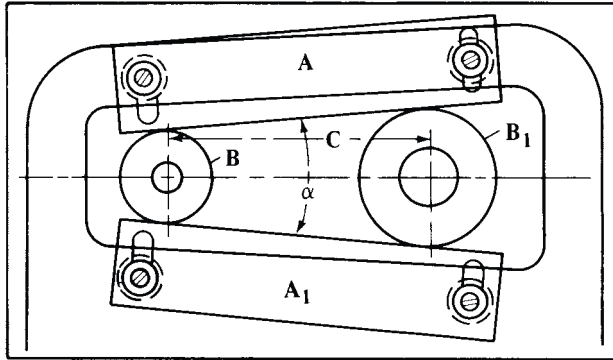
Standard Tapers: Give one diameter or width, the length, and insert note on drawing designating the taper by number.

Special Tapers: In dimensioning a taper when the slope is specified, the length and only one diameter should be given or the diameters at both ends of the taper should be given and length omitted.

Precision Work: In certain cases where very precise measurements are necessary the taper surface, either external or internal, is specified by giving a diameter at a certain distance from a surface and the slope of the taper.

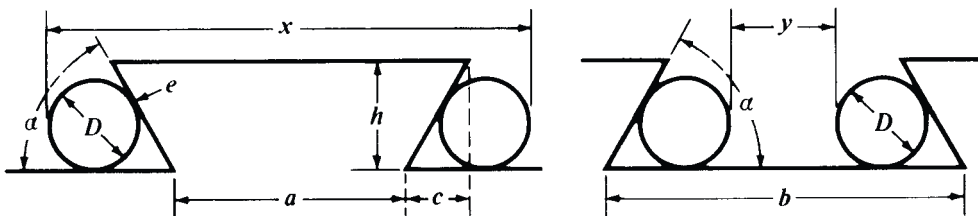
Accurate Measurement of Angles and Tapers

When great accuracy is required in the measurement of angles, or when originating tapers, disks are commonly used. The principle of the disk method of taper measurement is that if two disks of unequal diameters are placed either in contact or a certain distance apart, lines tangent to their peripheries will represent an angle or taper, the degree of which depends upon the diameters of the two disks and the distance between them.



The gage shown in the accompanying illustration, which is a form commonly used for originating tapers or measuring angles accurately, is set by means of disks. This gage consists of two adjustable straight edges *A* and *A*₁, which are in contact with disks *B* and *B*₁. The angle α or the taper between the straight edges depends, of course, upon the diameters of the disks and the center distance *C*, and as these three dimensions can be measured accurately, it is possible to set the gage to a given angle within very close limits. Moreover, if a record of the three dimensions is kept, the exact setting of the gage can be reproduced quickly at any time. The following rules may be used for adjusting a gage of this type, and cover all problems likely to arise in practice. Disks are also occasionally used for the setting of parts in angular positions when they are to be machined accurately to a given angle; the rules are applicable to these conditions also.

Measuring Dovetail Slides.—Dovetail slides that must be machined accurately to a given width are commonly gaged by using pieces of cylindrical rod or wire and measuring as indicated by the dimensions *x* and *y* of the accompanying illustrations.



The rod or wire used should be small enough so that the point of contact *e* is somewhat below the corner or edge of the dovetail.

✦ To obtain dimension *x* for measuring male dovetails, add 1 to the cotangent of one-half the dovetail angle α , multiply by diameter *D* of the rods used, and add the product to dimension *a*.

$$\text{✦ } x = D(1 + \cot \frac{1}{2}\alpha) + a \qquad c = h \times \cot \alpha$$

To obtain dimension *y* for measuring a female dovetail, add 1 to the cotangent of one-half the dovetail angle α , multiply by diameter *D* of the rod used, and subtract the result from dimension *b*. Expressing these rules as formulas:

$$\text{✦ } y = b - D(1 + \cot \frac{1}{2}\alpha)$$

Tapers per Foot and Corresponding Angles

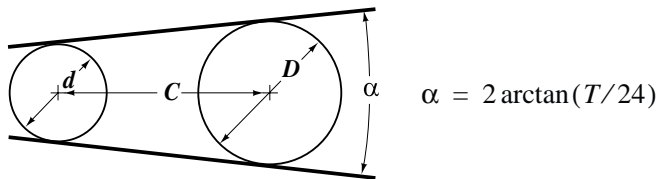
Taper per Foot	Included Angle		Angle with Center Line		Taper per Foot	Included Angle		Angle with Center Line	
1/64	0.074604°	0° 4' 29"	0° 2' 14"	1 1/8	8.934318°	8° 56' 4"	4° 28' 2"		
1/32	0.149208°	0 8 57	0 4 29	1 15/16	9.230863°	9 13 51	4 36 56		
1/16	0.298415	0 17 54	0 8 57	2	9.527283	9 31 38	4 45 49		
3/32	0.447621	0 26 51	0 13 26	2 1/8	10.119738	10 7 11	5 3 36		
1/8	0.596826	0 35 49	0 17 54	2 1/4	10.711650	10 42 42	5 21 21		
5/32	0.746028	0 44 46	0 22 23	2 3/8	11.302990	11 18 11	5 39 5		
3/16	0.895228	0 53 43	0 26 51	2 1/2	11.893726	11 53 37	5 56 49		
7/32	1.044425	1 2 40	0 31 20	2 5/8	12.483829	12 29 2	6 14 31		
1/4	1.193619	1 11 37	0 35 49	2 3/4	13.073267	13 4 24	6 32 12		
9/32	1.342808	1 20 34	0 40 17	2 7/8	13.662012	13 39 43	6 49 52		
5/16	1.491993	1 29 31	0 44 46	3	14.250033	14 15 0	7 7 30		
11/32	1.641173	1 38 28	0 49 14	3 1/8	14.837300	14 50 14	7 25 7		
3/8	1.790347	1 47 25	0 53 43	3 1/4	15.423785	15 25 26	7 42 43		
13/32	1.939516	1 56 22	0 58 11	3 3/8	16.009458	16 0 34	8 0 17		
7/16	2.088677	2 5 19	1 2 40	3 1/2	16.594290	16 35 39	8 17 50		
15/32	2.237832	2 14 16	1 7 8	3 5/8	17.178253	17 10 42	8 35 21		
1/2	2.386979	2 23 13	1 11 37	3 3/4	17.761318	17 45 41	8 52 50		
17/32	2.536118	2 32 10	1 16 5	3 7/8	18.343458	18 20 36	9 10 18		
9/16	2.685248	2 41 7	1 20 33	4	18.924644	18 55 29	9 27 44		
19/32	2.834369	2 50 4	1 25 2	4 1/8	19.504850	19 30 17	9 45 9		
5/8	2.983481	2 59 1	1 29 30	4 1/4	20.084047	20 5 3	10 2 31		
21/32	3.132582	3 7 57	1 33 59	4 3/8	20.662210	20 39 44	10 19 52		
11/16	3.281673	3 16 54	1 38 27	4 1/2	21.239311	21 14 22	10 37 11		
23/32	3.430753	3 25 51	1 42 55	4 5/8	21.815324	21 48 55	10 54 28		
3/4	3.579821	3 34 47	1 47 24	4 3/4	22.390223	22 23 25	11 11 42		
25/32	3.728877	3 43 44	1 51 52	4 7/8	22.963983	22 57 50	11 28 55		
13/16	3.877921	3 52 41	1 56 20	5	23.536578	23 32 12	11 46 6		
27/32	4.026951	4 1 37	2 0 49	5 1/8	24.107983	24 6 29	12 3 14		
7/8	4.175968	4 10 33	2 5 17	5 1/4	24.678175	24 40 41	12 20 21		
29/32	4.324970	4 19 30	2 9 45	5 3/8	25.247127	25 14 50	12 37 25		
15/16	4.473958	4 28 26	2 14 13	5 1/2	25.814817	25 48 53	12 54 27		
31/32	4.622931	4 37 23	2 18 41	5 5/8	26.381221	26 22 52	13 11 26		
1	4.771888	4 46 19	2 23 9	5 3/4	26.946316	26 56 47	13 28 23		
1 1/16	5.069753	5 4 11	2 32 6	5 7/8	27.510079	27 30 36	13 45 18		
1 1/8	5.367550	5 22 3	2 41 2	6	28.072487	28 4 21	14 2 10		
1 3/16	5.665275	5 39 55	2 49 57	6 1/8	28.633518	28 38 1	14 19 0		
1 1/4	5.962922	5 57 47	2 58 53	6 1/4	29.193151	29 11 35	14 35 48		
1 5/16	6.260490	6 15 38	3 7 49	6 3/8	29.751364	29 45 5	14 52 32		
1 3/8	6.557973	6 33 29	3 16 44	6 1/2	30.308136	30 18 29	15 9 15		
1 7/16	6.855367	6 51 19	3 25 40	6 5/8	30.863447	30 51 48	15 25 54		
1 1/2	7.152669	7 9 10	3 34 35	6 3/4	31.417276	31 25 2	15 42 31		
1 9/16	7.449874	7 27 0	3 43 30	6 7/8	31.969603	31 58 11	15 59 5		
1 5/8	7.746979	7 44 49	3 52 25	7	32.520409	32 31 13	16 15 37		
1 11/16	8.043980	8 2 38	4 1 19	7 1/8	33.069676	33 4 11	16 32 5		
1 3/4	8.340873	8 20 27	4 10 14	7 1/4	33.617383	33 37 3	16 48 31		
1 13/16	8.637654	8 38 16	4 19 8	7 3/8	34.163514	34 9 49	17 4 54		

Taper per foot represents inches of taper per foot of length. For conversions into decimal degrees and radians see *Conversion Tables of Angular Measure* on page 103.

Rules for Figuring Tapers

Given	To Find	Rule
The taper per foot.	The taper per inch.	Divide the taper per foot by 12.
The taper per inch.	The taper per foot.	Multiply the taper per inch by 12.
End diameters and length of taper in inches.	The taper per foot.	Subtract small diameter from large; divide by length of taper; and multiply quotient by 12.
Large diameter and length of taper in inches, and taper per foot.	Diameter at small end in inches	Divide taper per foot by 12; multiply by length of taper; and subtract result from large diameter.
Small diameter and length of taper in inches, and taper per foot.	Diameter at large end in inches.	Divide taper per foot by 12; multiply by length of taper; and add result to small diameter.
The taper per foot and two diameters in inches.	Distance between two given diameters in inches.	Subtract small diameter from large; divide remainder by taper per foot; and multiply quotient by 12.
The taper per foot.	Amount of taper in a certain length in inches.	Divide taper per foot by 12; multiply by given length of tapered part.

To find angle α for given taper T in inches per foot.—



Example: What angle α is equivalent to a taper of 1.5 inches per foot?

$$\alpha = 2 \times \arctan(1.5/24) = 7.153^\circ$$

To find taper per foot T given angle α in degrees.—

$$T = 24 \tan(\alpha/2) \text{ inches per foot}$$

Example: What taper T is equivalent to an angle of 7.153° ?

$$T = 24 \tan(7.153/2) = 1.5 \text{ inches per foot}$$

To find angle α given dimensions D , d , and C .— Let K be the difference in the disk diameters divided by twice the center distance. $K = (D - d)/(2C)$, then $\alpha = 2 \arcsin K$

Example: If the disk diameters d and D are 1 and 1.5 inches, respectively, and the center distance C is 5 inches, find the included angle α .

$$K = (1.5 - 1)/(2 \times 5) = 0.05 \quad \alpha = 2 \times \arcsin 0.05 = 5.732^\circ$$

To find taper T measured at right angles to a line through the disk centers given dimensions D , d , and distance C .— Find K using the formula in the previous example,

then $T = 24K/\sqrt{1 - K^2}$ inches per foot

Example: If disk diameters d and D are 1 and 1.5 inches, respectively, and the center distance C is 5 inches, find the taper per foot.

$$K = (1.5 - 1)/(2 \times 5) = 0.05 \quad T = \frac{24 \times 0.05}{\sqrt{1 - (0.05)^2}} = 1.2015 \text{ inches per foot}$$

To find center distance C for a given taper T in inches per foot.—

$$C = \frac{D-d}{2} \times \frac{\sqrt{1+(T/24)^2}}{T/24} \text{ inches}$$

Example: Gage is to be set to $\frac{3}{4}$ inch per foot, and disk diameters are 1.25 and 1.5 inches, respectively. Find the required center distance for the disks.

$$C = \frac{1.5 - 1.25}{2} \times \frac{\sqrt{1+(0.75/24)^2}}{0.75/24} = 4.002 \text{ inches}$$

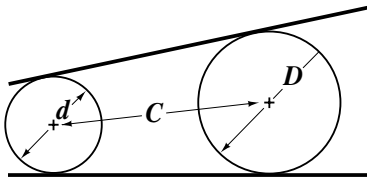
To find center distance C for a given angle α and dimensions D and d .—

$$C = (D - d)/2 \sin(\alpha/2) \text{ inches}$$

Example: If an angle α of 20° is required, and the disks are 1 and 3 inches in diameter, respectively, find the required center distance C .

$$C = (3 - 1)/(2 \times \sin 10^\circ) = 5.759 \text{ inches}$$

To find taper T measured at right angles to one side .—When one side is taken as a base line and the taper is measured at right angles to that side, calculate K as explained above and use the following formula for determining the taper T :



$$T = 24K \frac{\sqrt{1-K^2}}{1-2K^2} \text{ inches per foot}$$

Example: If the disk diameters are 2 and 3 inches, respectively, and the center distance is 5 inches, what is the taper per foot measured at right angles to one side?

$$K = \frac{3-2}{2 \times 5} = 0.1 \quad T = 24 \times 0.1 \times \frac{\sqrt{1-(0.1)^2}}{1-[2 \times (0.1)^2]} = 2.4367 \text{ in. per ft.}$$

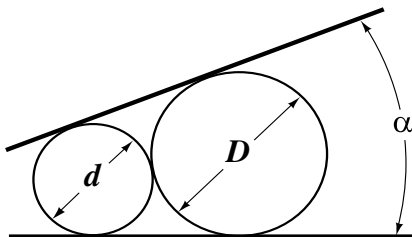
To find center distance C when taper T is measured from one side.—

$$C = \frac{D-d}{\sqrt{2-2/\sqrt{1+(T/12)^2}}} \text{ inches}$$

Example: If the taper measured at right angles to one side is 6.9 inches per foot, and the disks are 2 and 5 inches in diameter, respectively, what is center distance C ?

$$C = \frac{5-2}{\sqrt{2-2/\sqrt{1+(6.9/12)^2}}} = 5.815 \text{ inches.}$$

To find diameter D of a large disk in contact with a small disk of diameter d given angle α .—



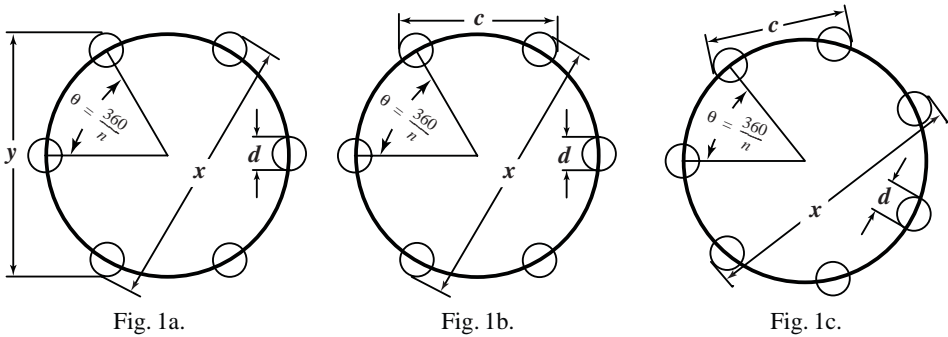
$$D = d \times \frac{1 + \sin(\alpha/2)}{1 - \sin(\alpha/2)} \text{ inches}$$

Example: The required angle α is 15° . Find diameter D of a large disk that is in contact with a standard 1-inch reference disk.

$$D = 1 \times \frac{1 + \sin 7.5^\circ}{1 - \sin 7.5^\circ} = 1.3002 \text{ inches}$$

Measurement over Pins and Rolls

Measurement over Pins.—When the distance across a bolt circle is too large to measure using ordinary measuring tools, then the required distance may be found from the distance across adjacent or alternate holes using one of the methods that follow:



Even Number of Holes in Circle: To measure the unknown distance x over opposite plugs in a bolt circle of n holes (n is even and greater than 4), as shown in Fig. 1a, where y is the distance over alternate plugs, d is the diameter of the holes, and $\theta = 360/n$ is the angle between adjacent holes, use the following general equation for obtaining x :

$$x = \frac{y - d}{\sin \theta} + d$$

✦ *Example:* In a die that has six 3/4-inch diameter holes equally spaced on a circle, where the distance y over alternate holes is 4 1/2 inches, and the angle θ between adjacent holes is 60, then

$$x = \frac{4.500 - 0.7500}{\sin 60^\circ} + 0.7500 = 5.0801$$

In a similar problem, the distance c over adjacent plugs is given, as shown in Fig. 1b. If the number of holes is even and greater than 4, the distance x over opposite plugs is given in the following formula:

✦
$$x = 2(c - d) \left(\frac{\sin \left(\frac{180 - \theta}{2} \right)}{\sin \theta} \right) + d$$

where d and θ are as defined above.

Odd Number of Holes in Circle: In a circle as shown in Fig. 1c, where the number of holes n is odd and greater than 3, and the distance c over adjacent holes is given, then θ equals $360/n$ and the distance x across the most widely spaced holes is given by:

✦
$$x = \frac{c - d}{\sin \frac{\theta}{4}} + d$$

✦ **Checking a V-shaped Groove by Measurement Over Pins.**—In checking a groove of the shape shown in Fig. 2, it is necessary to measure the dimension X over the pins of radius R . If values for the radius R , dimension Z , and the angles α and β are known, the problem is

to determine the distance Y , to arrive at the required overall dimension for X . If a line AC is drawn from the bottom of the V to the center of the pin at the left in Fig. 2, and a line CB from the center of this pin to its point of tangency with the side of the V , a right-angled triangle is formed in which one side, CB , is known and one angle CAB , can be determined. A line drawn from the center of a circle to the point of intersection of two tangents to the circle bisects the angle made by the tangent lines, and angle CAB therefore equals $\frac{1}{2}(\alpha + \beta)$. The length AC and the angle DAC can now be found, and with AC known in the right-angled triangle ADC , AD , which is equal to Y can be found.

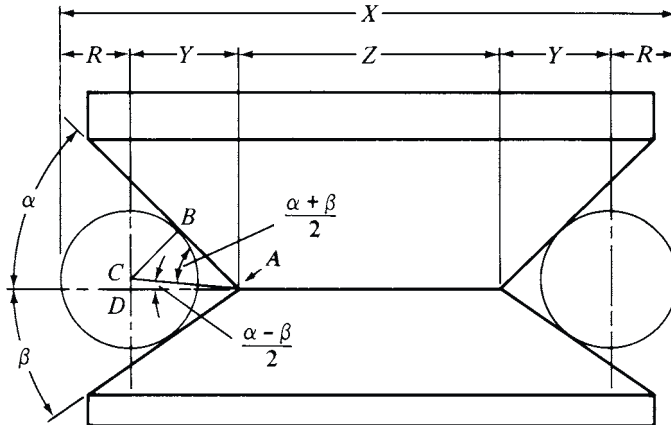


Fig. 2.

The value for X can be obtained from the formula

$$X = Z + 2R \left(\csc \frac{\alpha + \beta}{2} \cos \frac{\alpha - \beta}{2} + 1 \right)$$

For example, if $R = 0.500$, $Z = 1.824$, $\alpha = 45$ degrees, and $\beta = 35$ degrees,

$$X = 1.824 + (2 \times 0.5) \left(\csc \frac{45^\circ + 35^\circ}{2} \cos \frac{45^\circ - 35^\circ}{2} + 1 \right)$$

$$X = 1.824 + \csc 40^\circ \cos 5^\circ + 1$$

$$X = 1.824 + 1.5557 \times 0.99619 + 1$$

$$X = 1.824 + 1.550 + 1 = 4.374$$

Checking Radius of Arc by Measurement Over Rolls.—The radius R of large-radius concave and convex gages of the type shown in Figs. 3a, 3b and 3c can be checked by measurement L over two rolls with the gage resting on the rolls as shown. If the diameter of the rolls D , the length L , and the height H of the top of the arc above the surface plate (for the concave gage, Fig. 3a) are known or can be measured, the radius R of the workpiece to be checked can be calculated trigonometrically, as follows.

Referring to Fig. 3a for the concave gage, if L and D are known, cb can be found, and if H and D are known, ce can be found. With cb and ce known, ab can be found by means of a diagram as shown in Fig. 3c.

In diagram Fig. 3c, cb and ce are shown at right angles as in Fig. 3a. A line is drawn connecting points b and e and line ce is extended to the right. A line is now drawn from point b perpendicular to be and intersecting the extension of ce at point f . A semicircle can now be drawn through points b , e , and f with point a as the center. Triangles bce and bcf are similar and have a common side. Thus $ce:bc::bc:cf$. With ce and bc known, cf can be found from this proportion and hence ef which is the diameter of the semicircle and radius ab . Then $R = ab + D/2$.

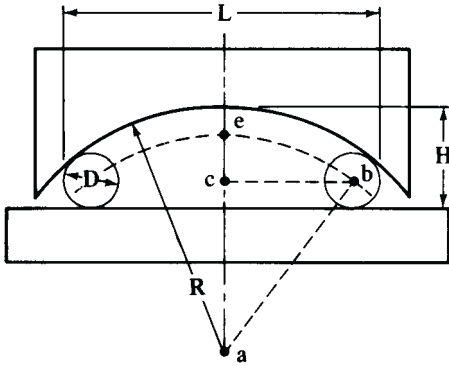


Fig. 3a.

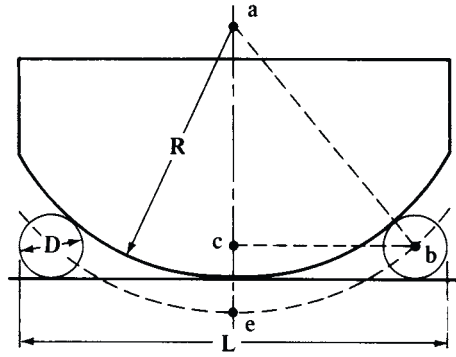


Fig. 3b.

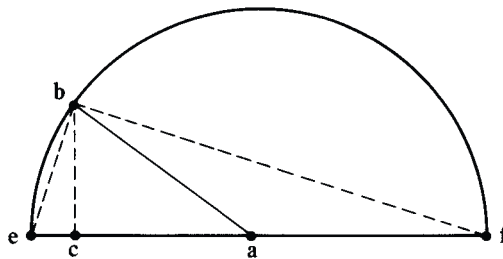


Fig. 3c.

The procedure for the convex gage is similar. The distances *cb* and *ce* are readily found and from these two distances *ab* is computed on the basis of similar triangles as before. Radius *R* is then readily found.

The derived formulas for concave and convex gages are as follows:

Formulas:

$$R = \frac{(L - D)^2}{8(H - D)} + \frac{H}{2} \quad (\text{Concave gage Fig. 3a})$$

$$R = \frac{(L - D)^2}{8D} \quad (\text{Convex gage Fig. 3b})$$

For example: For Fig. 3a, let $L = 17.8$, $D = 3.20$, and $H = 5.72$, then

$$R = \frac{(17.8 - 3.20)^2}{8(5.72 - 3.20)} + \frac{5.72}{2} = \frac{(14.60)^2}{8 \times 2.52} + 2.86$$

$$R = \frac{213.16}{20.16} + 2.86 = 13.43$$

For Fig. 3b, let $L = 22.28$ and $D = 3.40$, then

$$R = \frac{(22.28 - 3.40)^2}{8 \times 3.40} = \frac{356.45}{27.20} = 13.1$$

Checking Shaft Conditions

Checking for Various Shaft Conditions.—An indicating height gage, together with V-blocks can be used to check shafts for ovality, taper, straightness (bending or curving), and concentricity of features (as shown exaggerated in Fig. 4). If a shaft on which work has

been completed shows lack of concentricity. it may be due to the shaft having become bent or bowed because of mishandling or oval or tapered due to poor machine conditions. In checking for concentricity, the first step is to check for ovality, or out-of-roundness, as in Fig. 4a. The shaft is supported in a suitable V-block on a surface table and the dial indicator plunger is placed over the workpiece, which is then rotated beneath the plunger to obtain readings of the amount of eccentricity.

This procedure (sometimes called clocking, owing to the resemblance of the dial indicator to a clock face) is repeated for other shaft diameters as necessary, and, in addition to making a written record of the measurements, the positions of extreme conditions should be marked on the workpiece for later reference.

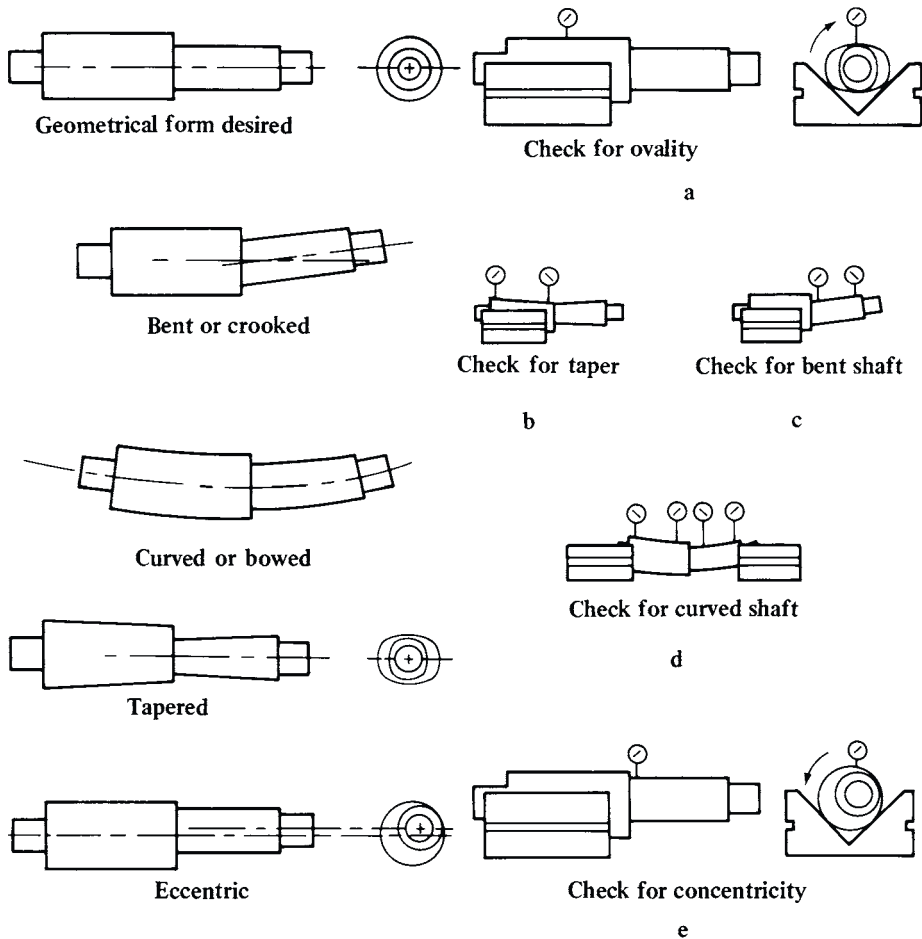


Fig. 4.

To check for taper, the shaft is supported in the V-block and the dial indicator is used to measure the maximum height over the shaft at various positions along its length, as shown in Fig. 4b, without turning the workpiece. Again, the shaft should be marked with the reading positions and values, also the direction of the taper, and a written record should be made of the amount and direction of any taper discovered.

Checking for a bent shaft requires that the shaft be clocked at the shoulder and at the farther end, as shown in Fig. 4c. For a second check the shaft is rotated only 90° or a quarter turn. When the recorded readings are compared with those from the ovality and taper checks, the three conditions can be distinguished.

To detect a curved or bowed condition, the shaft should be suspended in two V-blocks with only about $\frac{1}{8}$ inch of each end in each vee. Alternatively, the shaft can be placed between centers. The shaft is then clocked at several points, as shown in Fig. 4d, but preferably not at those locations used for the ovality, taper, or crookedness checks. If the single element due to curvature is to be distinguished from the effects of ovality, taper, and crookedness, and its value assessed, great care must be taken to differentiate between the conditions detected by the measurements.

Finally, the amount of eccentricity between one shaft diameter and another may be tested by the setup shown in Fig. 4e. With the indicator plunger in contact with the smaller diameter, close to the shoulder, the shaft is rotated in the V-block and the indicator needle position is monitored to find the maximum and minimum readings.

Curvature, ovality, or crookedness conditions may tend to cancel each other, as shown in Fig. 5, and one or more of these degrees of defectiveness may add themselves to the true eccentricity readings, depending on their angular positions. Fig. 5a shows, for instance, how crookedness and ovality tend to cancel each other, and also shows their effect in falsifying the reading for eccentricity. As the same shaft is turned in the V-block to the position shown in Fig. 5b, the maximum curvature reading could tend to cancel or reduce the maximum eccentricity reading. Where maximum readings for ovality, curvature, or crookedness occur at the same angular position, their values should be subtracted from the eccentricity reading to arrive at a true picture of the shaft condition. Confirmation of eccentricity readings may be obtained by reversing the shaft in the V-block, as shown in Fig. 5c, and clocking the larger diameter of the shaft.

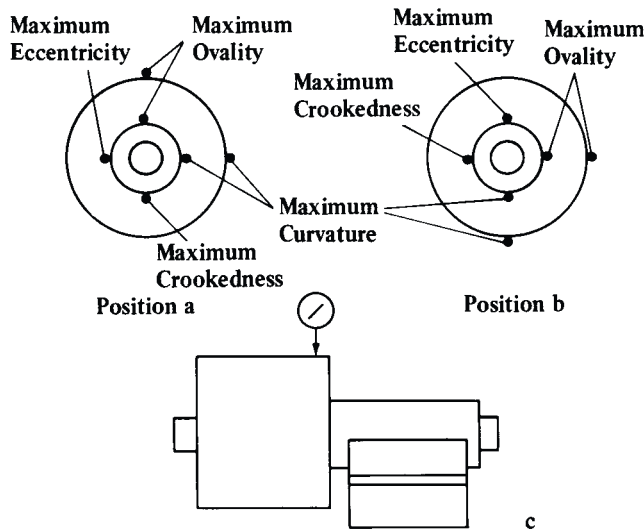


Fig. 5.

Out-of-Roundness—Lobing.—With the imposition of finer tolerances and the development of improved measurement methods, it has become apparent that no hole, cylinder, or sphere can be produced with a perfectly symmetrical round shape. Some of the conditions are diagrammed in Fig. 6, where Fig. 6a shows simple ovality and Fig. 6b shows ovality occurring in two directions. From the observation of such conditions have come the terms lobe and lobing. Fig. 6c shows the three-lobed shape common with centerless-ground components, and Fig. 6d is typical of multi-lobed shapes. In Fig. 6e are shown surface waviness, surface roughness, and out-of-roundness, which often are combined with lobing.

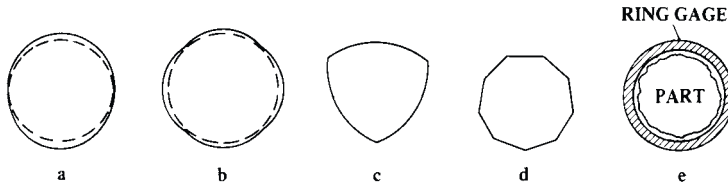


Fig. 6.

In Figs. 6a through 6d, the cylinder (or hole) diameters are shown at full size but the lobes are magnified some 10,000 times to make them visible. In precision parts, the deviation from the round condition is usually only in the range of millionths of an inch, although it occasionally can be 0.0001 inch, 0.0002 inch, or more. For instance, a 3-inch-diameter part may have a lobing condition amounting to an inaccuracy of only 30 millionths (0.000030 inch). Even if the distortion (ovality, waviness, roughness) is small, it may cause hum, vibration, heat buildup, and wear, possibly leading to eventual failure of the component or assembly.

Plain elliptical out-of-roundness (two lobes), or any even number of lobes, can be detected by rotating the part on a surface plate under a dial indicator of adequate resolution, or by using an indicating caliper or snap gage. However, supporting such a part in a V-block during measurement will tend to conceal roundness errors. Ovality in a hole can be detected by a dial-type bore gage or internal measuring machine. Parts with odd numbers of lobes require an instrument that can measure the envelope or complete circumference. Plug and ring gages will tell whether a shaft can be assembled into a bearing, but not whether there will be a good fit, as illustrated in Fig. 6e.

A standard, 90-degree included-angle V-block can be used to detect and count the number of lobes, but to measure the exact amount of lobing indicated by $R-r$ in Fig. 7 requires a V-block with an angle α , which is related to the number of lobes. This angle α can be calculated from the formula $2\alpha = 180^\circ - 360^\circ/N$, where N is the number of lobes. Thus, for a three-lobe form, α becomes 30 degrees, and the V-block used should have a 60-degree included angle. The distance M , which is obtained by rotating the part under the comparator plunger, is converted to a value for the radial variation in cylinder contour by the formula $M = (R - r)(1 + \csc \alpha)$.

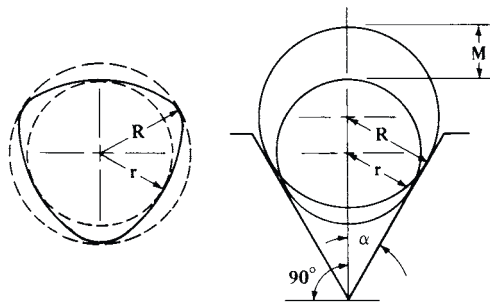


Fig. 7.

Using a V-block (even of appropriate angle) for parts with odd numbers of lobes will give exaggerated readings when the distance $R - r$ (Fig. 7) is used as the measure of the amount of out-of-roundness. The accompanying table shows the appropriate V-block angles for various odd numbers of lobes, and the factors $(1 + \csc \alpha)$ by which the readings are increased over the actual out-of-roundness values.

Table of Lobes, V-block Angles and Exaggeration Factors in Measuring Out-of-round Conditions in Shafts

Number of Lobes	Included Angle of V-block (deg)	Exaggeration Factor (1 + csc α)
3	60	3.00
5	108	2.24
7	128.57	2.11
9	140	2.06

Measurement of a complete circumference requires special equipment, often incorporating a precision spindle running true within two millionths (0.000002) inch. A stylus attached to the spindle is caused to traverse the internal or external cylinder being inspected, and its divergences are processed electronically to produce a polar chart similar to the wavy outline in Fig. 6e. The electronic circuits provide for the variations due to surface effects to be separated from those of lobing and other departures from the “true” cylinder traced out by the spindle.

Coordinates for Hole Circles

Type “A” Hole Circles.—Type “A” hole circles can be identified by hole number 1 at the top of the hole circle, as shown in Figs. 1a and 1b. The *x*, *y* coordinates for hole circles of from 3 to 33 holes corresponding to the geometry of Fig. 1a are given in Table 1a, and corresponding to the geometry of Fig. 1b in Table 1b. Holes are numbered in a counterclockwise direction as shown. Coordinates given are based upon a hole circle of (1) unit diameter. For other diameters, multiply the *x* and *y* coordinates from the table by the hole circle diameter. For example, for a 3-inch or 3-centimeter hole circle diameter, multiply table values by 3. Coordinates are valid in any unit system.

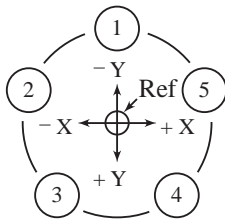


Fig. 1a. Type “A” Circle

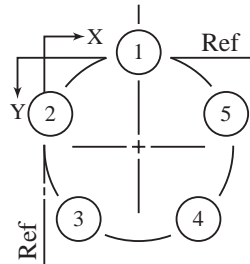


Fig. 1b. Type “A” Circle

The origin of the coordinate system in Fig. 1a, marked “Ref”, is at the center of the hole circle at position $x = 0, y = 0$. The equations for calculating hole coordinates for type “A” circles with the coordinate system origin at the center of the hole circle are as follows:

$$\theta = \frac{360}{n} = \frac{2\pi}{n} \quad x_H = -\frac{D}{2} \sin((H-1)\theta) \quad y_H = -\frac{D}{2} \cos((H-1)\theta) \quad (1a)$$

where n = number of holes in circle; D = diameter of hole circle; θ = angle between adjacent holes in circle; H = number (from 1 to n) of the current hole; x_H = x coordinate at position of hole number H ; and, y_H = y coordinate at position of hole number H .

Example 1(a): Calculate the hole coordinates for the 5-hole circle shown in Fig. 1a when circle diameter = 1. Compare the results to the data tabulated in Table 1a.

Hole	$\theta = 360/5 = 72^\circ$	$D = 1$
1	$x_H = x_1 = -\frac{1}{2} \times \sin(0) = 0.00000$	$y_1 = -\frac{1}{2} \times \cos(0) = -0.50000$
2	$x_2 = -\frac{1}{2} \times \sin(72) = -0.47553$	$y_2 = -\frac{1}{2} \times \cos(72) = -0.15451$
3	$x_3 = -\frac{1}{2} \times \sin(144) = -0.29389$	$y_3 = -\frac{1}{2} \times \cos(144) = 0.40451$
4	$x_4 = -\frac{1}{2} \times \sin(216) = 0.29389$	$y_4 = -\frac{1}{2} \times \cos(216) = 0.40451$
5	$x_5 = -\frac{1}{2} \times \sin(288) = 0.47553$	$y_5 = -\frac{1}{2} \times \cos(288) = -0.15451$

In Fig. 1b, the origin of the coordinate system (point 0,0) is located at the top left of the figure at the intersection of the two lines labeled “Ref.” The center of the hole circle is offset from the coordinate system origin by distance X_O in the $+x$ direction, and by distance Y_O in the $+y$ direction. In practice the origin of the coordinate system can be located at any convenient distance from the center of the hole circle. In Fig. 1b it can be determined by inspection that the distances $X_O = Y_O = D/2$. The equations for calculating hole positions of type “A” circles of the Fig. 1b type are almost the same as in Equation (1a), but with the addition of X_O and Y_O terms, as follows:

$$\theta = \frac{360}{n} = \frac{2\pi}{n} \quad x_H = -\frac{D}{2} \sin((H-1)\theta) + X_O \quad y_H = -\frac{D}{2} \cos((H-1)\theta) + Y_O \quad (1b)$$

Example 1(b): Use results of Example 1(a) to determine hole coordinates of Fig. 1b for circle diameter = 1, and compare results with Table 1b.

Hole	$\theta = 360/5 = 72^\circ$	$D = 1$	$X_O = D/2 = 0.50000$	$Y_O = D/2 = 0.50000$
1	$x_1 = 0.00000 + X_O = 0.50000$			$y_1 = -0.50000 + Y_O = 0.00000$
2	$x_2 = -0.47553 + X_O = 0.02447$			$y_2 = -0.15451 + Y_O = 0.34549$
3	$x_3 = -0.29389 + X_O = 0.20611$			$y_3 = 0.40451 + Y_O = 0.90451$
4	$x_4 = 0.29389 + X_O = 0.79389$			$y_4 = 0.40451 + Y_O = 0.90451$
5	$x_5 = 0.47553 + X_O = 0.97553$			$y_5 = -0.15451 + Y_O = 0.34549$

Type “B” Hole Circles.—Compared to type “A” hole circles, type “B” hole circles, Figs. 2a and 2b, are arranged such that the circle of holes is rotated about the center of the circle by $\frac{\theta}{2}$ degrees, that is, $\frac{1}{2}$ of the angle between adjacent holes. The x,y coordinates for type “B” hole circles of from 3 to 33 holes are given in Table 2a for geometry corresponding to Fig. 2a, and in Table 2b for geometry corresponding to Fig. 2b. Holes are numbered in a counterclockwise direction as shown. Coordinates given are based upon a hole circle of (1) unit diameter. For other diameters, multiply the x and y coordinates from the table by the hole circle diameter. For example, for a 3-inch or 3-centimeter hole circle diameter, multiply table values by 3. Coordinates are valid in any unit system.

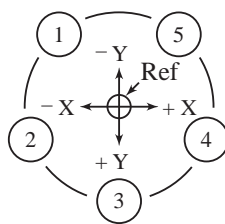


Fig. 2a. Type “B” Circle

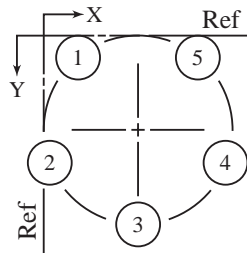


Fig. 2b. Type “B” Circle

In Fig. 2a the coordinate system origin, marked “Ref”, is at the center of the hole circle at position $x = 0, y = 0$. Equations for calculating hole coordinates for type “B” circles with the coordinate system origin at the center of the hole circle as in Fig. 2a are as follows:

$$\theta = \frac{360}{n} = \frac{2\pi}{n} \quad x_H = -\frac{D}{2} \sin\left((H-1)\theta + \frac{\theta}{2}\right) \quad y_H = -\frac{D}{2} \cos\left((H-1)\theta + \frac{\theta}{2}\right) \quad (2a)$$

where n = number of holes in circle; D = diameter of hole circle; θ = angle between adjacent holes; x_H = x coordinate at position of hole number H ; and, y_H = y coordinate at position of hole number H .

Example 2(a): Calculate the hole coordinates for the 5-hole circle shown in Fig. 2a when circle diameter = 1. Compare the results to the data in Table 2a.

Hole	$\theta = 360/5 = 72^\circ$	$\theta/2 = 36^\circ$	$D = 1$
1	$x_1 = -\frac{1}{2} \times \sin(36) = -0.29389$		$y_1 = -\frac{1}{2} \times \cos(36) = -0.40451$
2	$x_2 = -\frac{1}{2} \times \sin(108) = -0.47553$		$y_2 = -\frac{1}{2} \times \cos(108) = 0.15451$
3	$x_3 = -\frac{1}{2} \times \sin(180) = 0.00000$		$y_3 = -\frac{1}{2} \times \cos(180) = 0.50000$
4	$x_4 = -\frac{1}{2} \times \sin(252) = 0.47553$		$y_4 = -\frac{1}{2} \times \cos(252) = 0.15451$
5	$x_5 = -\frac{1}{2} \times \sin(324) = 0.29389$		$y_5 = -\frac{1}{2} \times \cos(324) = -0.40451$

In Fig. 2b the origin of the coordinate system (point 0,0) is located at the top left of the figure at the intersection of the two lines labeled “Ref.” The center of the hole circle is offset from the coordinate system origin by distance X_0 in the +x direction, and by distance Y_0 in the +y direction. In practice the origin of the coordinate system can be chosen at any convenient distance from the hole circle origin. In Fig. 2b it can be determined by inspection that distance $X_0 = Y_0 = D/2$. The equations for calculating hole positions of type “B” circles of the Fig. 2b type are the same as in Equation (2a), but with the addition of X_0 and Y_0 terms, as follows:

$$\theta = \frac{360}{n} = \frac{2\pi}{n} \quad x_H = -\frac{D}{2} \sin\left((H-1)\theta + \frac{\theta}{2}\right) + X_0 \quad y_H = -\frac{D}{2} \cos\left((H-1)\theta + \frac{\theta}{2}\right) + Y_0 \quad (2b)$$

✦ *Example 2(b):* Use the coordinates obtained in Example 2(a) to determine the hole coordinates of a 5-hole circle shown in Fig. 1b with circle diameter = 1. Compare the results to the data in Table 2b.

Hole	$\theta = 360/5 = 72^\circ$	$\theta/2 = 36^\circ$	$D = 1$	$X_0 = D/2 = 0.50000$	$Y_0 = D/2 = 0.50000$
1	$x_1 = -\frac{1}{2} \times \sin(36) + 0.50000 = 0.20611$				$y_1 = -\frac{1}{2} \times \cos(36) + 0.50000 = 0.09549$
2	$x_2 = -\frac{1}{2} \times \sin(108) + 0.50000 = 0.02447$				$y_2 = -\frac{1}{2} \times \cos(108) + 0.50000 = 0.65451$
3	$x_3 = -\frac{1}{2} \times \sin(180) + 0.50000 = 0.50000$				$y_3 = -\frac{1}{2} \times \cos(180) + 0.50000 = 1.00000$
4	$x_4 = -\frac{1}{2} \times \sin(252) + 0.50000 = 0.97553$				$y_4 = -\frac{1}{2} \times \cos(252) + 0.50000 = 0.65451$
5	$x_5 = -\frac{1}{2} \times \sin(324) + 0.50000 = 0.79389$				$y_5 = -\frac{1}{2} \times \cos(324) + 0.50000 = 0.09549$

Adapting Hole Coordinate Equations for Different Geometry.—Hole coordinate values in Tables 1a through 2b are obtained using the equations given previously, along with the geometry of the corresponding figures. If the geometry does not match that given in one of the previous figures, hole coordinate values from the tables or equations will be incorrect. Fig. 3 illustrates such a case. Fig. 3 resembles a type “A” hole circle (Fig. 1b) with hole number 2 at the top, and it also resembles a type “B” hole circle (Fig. 2b) in which all holes have been rotated 90° clockwise. A closer look also reveals that the positive y direction in Fig. 3 is opposite that used in Figs. 1b and 2b. Therefore, to determine the hole coordinates of Fig. 3 it is necessary to create new equations that match the given geometry, or modify the previous equations to match the Fig. 3 geometry.

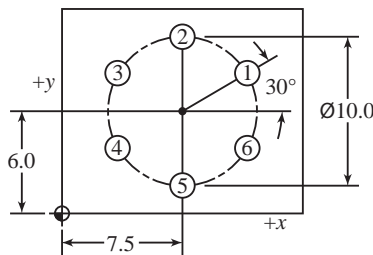


Fig. 3.

Example 3(a), Determining Hole Coordinates for Fig. 3: Write equations for the coordinates of holes 1, 2, and 3 of Fig. 3.

$$\begin{aligned} x_1 &= 7.5 + 5\cos(30^\circ) = 11.8301 & y_1 &= 6.0 + 5\sin(30^\circ) = 8.5000 \\ x_2 &= 7.5 + 5\cos(30^\circ + 60^\circ) = 7.5 & y_2 &= 6.0 + 5\sin(30^\circ + 60^\circ) = 11.0000 \\ x_3 &= 7.5 + 5\cos(30^\circ + 120^\circ) = 3.1699 & y_3 &= 6.0 + 5\sin(30^\circ + 120^\circ) = 8.5000 \end{aligned}$$

Example 3(b), Modify Equation (2b) for Fig. 3: In Fig. 3, hole numbering is rotated 90° ($\pi/2$ radian) in the clockwise (negative) direction relative to Fig. 2b, and the direction of the +y coordinate axis is the reverse, or negative of that given in Fig. 2b. Equations for Fig. 3 can be obtained from Equation (2b) by

- 1) subtracting 90° from the angle of each hole in the x and y equations of Equation (2b)
- 2) multiplying the y_H equation by -1 to reverse the orientation of the y axis

$$x_H = -\frac{D}{2} \sin\left((H-1)\theta + \frac{\theta}{2} - 90\right) + X_0 \quad y_H = -\left(-\frac{D}{2} \cos\left((H-1)\theta + \frac{\theta}{2} - 90\right) + Y_0\right)$$

In Fig. 3, $\theta = 360/n = 60^\circ$ for 6 holes, $X_0 = 7.5$, and $Y_0 = -6.0$.

$$\begin{aligned} x_1 &= -5\sin(30 - 90) + 7.5 = 11.8301 & y_1 &= 5\cos(30 - 90) + 6 = 8.5000 \\ x_2 &= -5\sin(60^\circ + 30^\circ - 90^\circ) + 7.5 = 7.5 & y_2 &= 5\cos(60^\circ + 30^\circ - 90^\circ) + 6 = 11.0000 \\ x_3 &= -5\sin(120^\circ + 30^\circ - 90^\circ) + 7.5 = 3.1699 & y_3 &= 5\cos(120^\circ + 30^\circ - 90^\circ) + 6 = 8.5000 \end{aligned}$$

Lengths of Chords on Hole Circle Circumference.— Table 3 on page 704 gives the lengths of chords for spacing off the circumferences of circles. The object of this table is to make possible the division of the periphery into a number of equal parts without trials with the dividers. Table 3 is calculated for circles having a diameter equal to 1. For circles of other diameters, the length of chord given in the table should be multiplied by the diameter of the circle. Table 3 may be used by toolmakers when setting “buttons” in circular formation, and may be used with inch or metric dimensions. See *Coordinates for Hole Circles* on page 692 for more information on this topic.

Example: Assume that it is required to divide the periphery of a circle of 20 inches diameter into thirty-two equal parts.

Solution: From the table the length of the chord is found to be 0.098017 inch, if the diameter of the circle were 1 inch. With a diameter of 20 inches the length of the chord for one division would be $20 \times 0.098017 = 1.9603$ inches. Another example in metric units: For a 100 millimeter diameter requiring 5 equal divisions, the length of the chord for one division would be $100 \times 0.587785 = 58.7785$ millimeters.

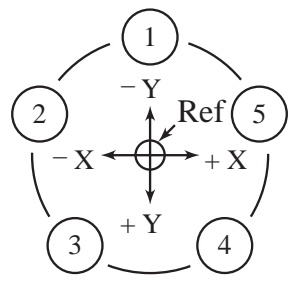
Example: Assume that it is required to divide a circle of $6\frac{1}{2}$ millimeter diameter into seven equal parts. Find the length of the chord required for spacing off the circumference.

Solution: In Table 3, the length of the chord for dividing a circle of 1 millimeter diameter into 7 equal parts is 0.433884 mm. The length of chord for a circle of $6\frac{1}{2}$ mm diameter is $6\frac{1}{2} \times 0.433884 = 2.820246$ mm.

Example: Assume that it is required to divide a circle having a diameter of $9\frac{23}{32}$ inches into 15 equal divisions.

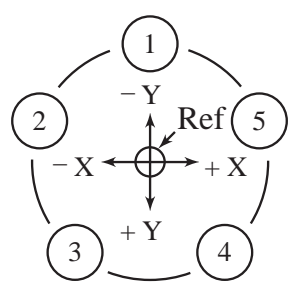
Solution: In Table 3, the length of the chord for dividing a circle of 1 inch diameter into 15 equal parts is 0.207912 inch. The length of chord for a circle of 9 inches diameter is $9\frac{23}{32} \times 0.207912 = 2.020645$ inches.

Table 1a. Hole Coordinate Dimension Factors for Type "A" Hole Circles



10 holes			13 holes (Continued)			16 holes			18 holes (Continued)			20 holes (Continued)			22 holes (Continued)		
#	x	y	#	x	y	#	x	y	#	x	y	#	x	y	#	x	y
1	0.00000	-0.50000	6	-0.33156	0.37426	1	0.00000	-0.50000	8	-0.32139	0.38302	11	0.00000	0.50000	10	-0.27032	0.42063
2	-0.29389	-0.40451	7	-0.11966	0.48547	2	-0.19134	-0.46194	9	-0.17101	0.46985	12	0.15451	0.47553	11	-0.14087	0.47975
3	-0.47553	-0.15451	8	0.11966	0.48547	3	-0.35355	-0.35355	10	0.00000	0.50000	13	0.29389	0.40451	12	0.00000	0.50000
4	-0.47553	0.15451	9	0.33156	0.37426	4	-0.46194	-0.19134	11	0.17101	0.46985	14	0.40451	0.29389	13	0.14087	0.47975
5	-0.29389	0.40451	10	0.46751	0.17730	5	-0.50000	0.00000	12	0.32139	0.38302	15	0.47553	0.15451	14	0.27032	0.42063
6	0.00000	0.50000	11	0.49635	-0.06027	6	-0.46194	0.19134	13	0.43301	0.25000	16	0.50000	0.00000	15	0.37787	0.32743
7	0.29389	0.40451	12	0.41149	-0.28403	7	-0.35355	0.35355	14	0.49240	0.08682	17	0.47553	-0.15451	16	0.45482	0.20771
8	0.47553	0.15451	13	0.23236	-0.44273	8	-0.19134	0.46194	15	0.49240	-0.08682	18	0.40451	-0.29389	17	0.49491	0.07116
9	0.47553	-0.15451				9	0.00000	0.50000	16	0.43301	-0.25000	19	0.29389	-0.40451	18	0.49491	-0.07116
10	0.29389	-0.40451				10	0.19134	0.46194	17	0.32139	-0.38302	20	0.15451	-0.47553	19	0.45482	-0.20771
11 holes			14 holes			17 holes			19 holes			21 holes			23 holes		
#	x	y	#	x	y	#	x	y	#	x	y	#	x	y	#	x	y
1	0.00000	-0.50000	1	0.00000	-0.50000	1	0.00000	-0.50000	1	0.00000	-0.50000	1	0.00000	-0.50000	1	0.00000	-0.50000
2	-0.27032	-0.42063	2	-0.21694	-0.45048	2	-0.18062	-0.46624	2	-0.16235	-0.47291	2	-0.14738	-0.47779	2	-0.13490	-0.48146
3	-0.45482	-0.20771	3	-0.39092	-0.31174	3	-0.3685	-0.36950	3	-0.30711	-0.39457	3	-0.28166	-0.41312	3	-0.28166	-0.41312
4	-0.49491	0.07116	4	-0.48746	-0.11126	4	-0.47589	0.20085	4	-0.40711	-0.39902	4	-0.39092	-0.31174	4	-0.39092	-0.31174
5	-0.37787	0.32743	5	-0.37787	0.32743	5	-0.49787	-0.04613	5	-0.48858	-0.27347	5	-0.46544	-0.18267	5	-0.46544	-0.18267
6	-0.14087	0.47975	6	0.00000	0.50000	6	-0.48091	0.13683	6	-0.48470	-0.12274	6	-0.49860	-0.03737	6	-0.49860	-0.03737
7	0.14087	0.47975	7	0.21694	0.45048	7	-0.49787	-0.04613	7	-0.49829	0.04129	7	-0.48746	0.11126	7	-0.48746	0.11126
8	0.37787	0.32743	8	0.39092	0.31174	8	-0.47589	0.20085	8	-0.43301	0.25000	8	-0.43301	0.25000	8	-0.43301	0.25000
9	0.49491	0.07116	9	0.48746	0.11126	9	-0.47589	0.20085	9	-0.36786	0.33864	9	-0.34009	0.36653	9	-0.34009	0.36653
10	0.45482	-0.20771	10	0.48746	-0.11126	10	-0.44758	-0.22287	10	-0.23797	0.43974	10	-0.21694	0.45048	10	-0.21694	0.45048
11	0.27032	-0.42063	11	0.39092	-0.31174	11	-0.49787	-0.04613	11	-0.08230	0.49318	11	-0.07452	0.49442	11	-0.07452	0.49442
			12	0.21694	-0.45048	12	-0.48091	0.13683	12	0.08230	0.49318	12	0.07452	0.49442	12	0.07452	0.49442
12 holes			15 holes			18 holes			20 holes			22 holes			24 holes		
#	x	y	#	x	y	#	x	y	#	x	y	#	x	y	#	x	y
1	0.00000	-0.50000	1	0.00000	-0.50000	1	0.00000	-0.50000	1	0.00000	-0.50000	1	0.00000	-0.50000	1	0.00000	-0.50000
2	-0.35355	-0.35355	2	-0.25000	-0.43301	2	-0.20337	-0.45677	2	-0.15451	-0.47553	2	-0.14087	-0.47975	2	-0.12941	-0.48296
3	-0.50000	0.00000	3	-0.43301	-0.25000	3	-0.37157	-0.33457	3	-0.32139	-0.38302	3	-0.29389	-0.40451	3	-0.27032	-0.42063
4	-0.35355	0.35355	4	-0.50000	0.00000	4	-0.47553	-0.15451	4	-0.46194	-0.19134	4	-0.40451	-0.29389	4	-0.37787	-0.32743
5	0.00000	0.50000	5	-0.43301	0.25000	5	-0.49726	0.05226	5	-0.43301	0.25000	5	-0.45482	-0.20771	5	-0.45482	-0.20771
6	0.29389	0.40451	6	-0.25000	0.43301	6	-0.43301	0.25000	6	-0.43301	0.25000	6	-0.50000	0.00000	6	-0.49491	-0.07116
7	0.47553	-0.15451	7	0.00000	0.50000	7	-0.29389	0.40451	7	-0.44758	-0.22287	7	-0.47553	0.15451	7	-0.49491	-0.07116
			8	0.25000	0.43301	8	-0.10396	0.48907	8	0.33685	-0.36950	8	-0.40451	0.29389	8	-0.45482	0.20771
			9	0.43301	0.25000	9	0.10396	0.48907	9	0.18062	-0.46624	9	-0.15451	-0.47553	9	-0.37787	0.32743
			10	0.50000	0.00000	10	0.29389	0.40451	10	0.18062	-0.46624	10	-0.15451	-0.47553	10	-0.15451	-0.47553
			11	0.43301	-0.25000	11	0.43301	0.25000	11	0.18062	-0.46624	11	-0.15451	-0.47553	11	-0.15451	-0.47553
			12	0.25000	-0.43301	12	0.49726	0.05226	12	0.18062	-0.46624	12	-0.15451	-0.47553	12	-0.15451	-0.47553
13 holes			16 holes			19 holes			21 holes			23 holes			25 holes		
#	x	y	#	x	y	#	x	y	#	x	y	#	x	y	#	x	y
1	0.00000	-0.50000	1	0.00000	-0.50000	1	0.00000	-0.50000	1	0.00000	-0.50000	1	0.00000	-0.50000	1	0.00000	-0.50000
2	-0.23236	-0.44273	2	-0.23236	-0.44273	2	-0.23236	-0.44273	2	-0.23236	-0.44273	2	-0.23236	-0.44273	2	-0.23236	-0.44273
3	-0.41149	-0.28403	3	-0.41149	-0.28403	3	-0.41149	-0.28403	3	-0.41149	-0.28403	3	-0.41149	-0.28403	3	-0.41149	-0.28403
4	-0.49635	-0.06027	4	-0.49635	-0.06027	4	-0.49635	-0.06027	4	-0.49635	-0.06027	4	-0.49635	-0.06027	4	-0.49635	-0.06027
5	-0.46751	0.17730	5	-0.46751	0.17730	5	-0.46751	0.17730	5	-0.46751	0.17730	5	-0.46751	0.17730	5	-0.46751	0.17730

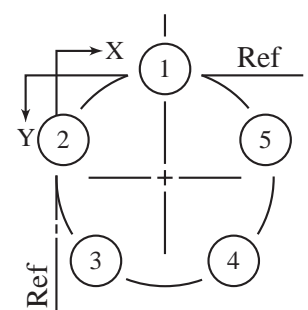
Table 1a. (Continued) Hole Coordinate Dimension Factors for Type "A" Hole Circles



24 holes (Continued)			25 holes (Continued)			26 holes (Continued)			27 holes (Continued)			29 holes (Continued)			30 holes (Continued)			32 holes			33 holes (Continued)		
#	x	y	#	x	y	#	x	y	#	x	y	#	x	y	#	x	y	#	x	y	#	x	y
5	-0.43301	-0.25000	7	-0.49901	-0.03140	8	-0.49635	0.06027	24	0.40106	-0.29858	9	-0.49341	0.08089	22	0.47553	0.15451	1	0.00000	-0.50000	11	-0.47250	0.16353
6	-0.48296	-0.12941	8	-0.49114	0.09369	9	-0.46751	0.17730	25	0.32139	-0.38302	10	-0.46449	0.18507	23	0.49726	0.05226	2	-0.09755	-0.49039	12	-0.43301	0.25000
7	-0.50000	0.00000	9	-0.45241	0.21289	10	-0.41149	0.28403	26	0.22440	-0.44682	11	-0.41384	0.28059	24	0.49726	-0.05226	3	-0.19134	-0.46194	13	-0.37787	0.32743
8	-0.48296	0.12941	10	-0.38526	0.31871	11	-0.33156	0.37426	27	0.11531	-0.48652	12	-0.34385	0.36300	25	0.47553	-0.15451	4	-0.27779	-0.41573	14	-0.30908	0.39303
9	-0.43301	0.25000	11	-0.29389	0.40451	12	-0.23236	0.44273	28 holes			13	-0.25778	0.42843	26	0.43301	-0.25000	5	-0.35355	-0.35355	15	-0.22911	0.44442
10	-0.35355	0.35355	12	-0.18406	0.46489	13	-0.11966	0.48547	#	x	y	14	-0.15965	0.47383	27	0.37157	-0.33457	6	-0.41573	-0.27779	16	-0.14087	0.47975
11	-0.25000	0.43301	13	-0.06267	0.49606	14	0.00000	0.50000	1	0.00000	-0.50000	15	-0.05406	0.49707	28	0.29389	-0.40451	7	-0.46194	-0.19134	17	-0.04753	0.49774
12	-0.12941	0.48296	14	0.06267	0.49606	15	0.11966	0.48547	2	-0.11126	-0.48746	16	0.05406	0.49707	29	0.20337	-0.45677	8	-0.49039	-0.09755	18	0.04753	0.49774
13	0.00000	0.50000	15	0.18406	0.46489	16	0.23236	0.44273	3	-0.21694	-0.45048	17	0.15965	0.47383	30	0.10396	-0.48907	9	-0.50000	0.00000	19	0.14087	0.47975
14	0.12941	0.48296	16	0.29389	0.40451	17	0.33156	0.37426	4	-0.31174	-0.39092	18	0.25778	0.42843	31 holes			10	-0.49039	0.09755	20	0.22911	0.44442
15	0.25000	0.43301	17	0.38526	0.31871	18	0.41149	-0.28403	5	-0.39092	-0.31174	19	0.34385	0.36300	#	x	y	11	-0.46194	0.19134	21	0.30908	0.39303
16	0.35355	0.35355	18	0.45241	0.21289	19	0.46751	0.17730	6	-0.45048	-0.21694	20	0.41384	0.28059	1	0.00000	-0.50000	12	-0.41573	0.27779	22	0.37787	0.32743
17	0.43301	0.25000	19	0.49114	0.09369	20	0.49635	0.06027	7	-0.48746	-0.11126	21	0.46449	0.18507	2	-0.10065	-0.48976	13	-0.35355	0.35355	23	0.43301	0.25000
18	0.48296	0.12941	20	0.49901	-0.03140	21	0.49635	-0.06027	8	-0.50000	0.00000	22	0.49341	0.08089	3	-0.19718	-0.45948	14	-0.27779	0.41573	24	0.47250	0.16353
19	0.50000	0.00000	21	0.47553	-0.15451	22	0.46751	-0.17730	9	-0.48746	0.11126	23	0.49927	-0.02707	4	-0.28563	-0.41038	15	-0.19134	0.46194	25	0.49491	0.07116
20	0.48296	-0.12941	22	0.42216	-0.26791	23	0.41149	-0.28403	10	-0.45048	0.21694	24	0.48177	-0.13376	5	-0.36240	-0.34448	16	-0.09755	0.49039	26	0.49943	-0.02379
21	0.43301	-0.25000	23	0.34227	-0.36448	24	0.33156	-0.37426	11	-0.39092	0.31174	25	0.44176	-0.23420	6	-0.42432	-0.26448	17	0.00000	0.50000	27	0.48591	-0.11788
22	0.35355	-0.35355	24	0.24088	-0.43815	25	0.23236	-0.44273	12	-0.31174	0.39092	26	0.38108	-0.32369	7	-0.46888	-0.17365	18	0.09755	0.49039	28	0.45482	-0.20771
23	0.25000	-0.43301	25	0.12434	-0.48429	26	0.11966	-0.48547	13	-0.21694	0.45048	27	0.30259	-0.39805	8	-0.49423	-0.07571	19	0.19134	0.46194	29	0.40729	-0.29003
24	0.12941	-0.48296	26 holes			14	-0.05805	0.49662	14	-0.11126	0.48746	28	0.20994	-0.45379	9	-0.49936	0.02532	20	0.27779	0.41573	30	0.34504	-0.36187
25 holes			#	x	y	15	0.05805	0.49662	15	0.00000	0.50000	29	0.10749	-0.48831	10	-0.48404	0.12533	21	0.35355	0.35355	31	0.27032	-0.42063
1	0.00000	-0.50000	1	0.00000	-0.50000	16	0.17101	0.46985	16	0.11126	0.48746	30 holes			11	-0.44890	0.22020	22	0.41573	0.27779	32	0.18583	-0.46418
2	-0.12434	-0.48429	2	-0.11966	-0.48547	17	0.27475	0.41774	17	0.21694	0.45048	#	x	y	12	-0.39539	0.30605	23	0.46194	0.19134	33	0.09463	-0.49096
3	-0.24088	-0.43815	3	-0.23236	-0.44273	18	0.36369	0.34312	18	0.31174	0.39092	1	0.00000	-0.50000	13	-0.32569	0.37938	24	0.49039	0.09755			
4	-0.34227	-0.36448	4	-0.33156	-0.37426	19	0.43301	0.25000	19	0.39092	0.31174	2	-0.10396	-0.48907	14	-0.24265	0.43717	25	0.50000	0.00000			
5	-0.42216	-0.26791	5	-0.41149	-0.28403	20	0.47899	0.14340	20	0.45048	0.21694	3	-0.20337	-0.45677	15	-0.14968	0.47707	26	0.49039	-0.09755			
6	-0.44273	0.06027	6	-0.42940	-0.08682	21	0.49915	0.02907	21	0.48746	0.11126	4	-0.29389	-0.40451	16	-0.05058	0.49743	27	0.46194	-0.19134			
7	-0.47553	-0.15451	7	-0.49240	-0.08682	22	-0.49915	0.02907	22	0.50000	0.00000	5	-0.37157	-0.33457	17	0.05058	0.49743	28	0.41573	-0.27779			
						23	-0.49915	0.02907	23	0.48746	-0.11126	6	-0.43301	-0.25000	18	0.14968	0.47707	29	0.35355	-0.35355			
						24	-0.47899	0.14340	24	0.45048	-0.21694	7	-0.47553	-0.15451	19	0.24265	0.43717	30	0.27779	-0.41573			
						25	-0.43301	0.25000	25	0.39092	-0.31174	8	-0.49726	-0.05226	20	0.32569	0.37938	31	0.19134	-0.46194			
						26	-0.36369	0.34312	26	0.31174	-0.39092	9	-0.49726	0.05226	21	0.39539	0.30605	32	0.09755	-0.49039			
						27	-0.27475	0.41774	27	0.21694	-0.45048	10	-0.47553	0.15451	22	0.44890	0.22020	33 holes					
						28	-0.17101	0.46985	28	0.11126	-0.48746	11	-0.43301	0.25000	23	0.48404	0.12533	#	x	y			
						29	-0.05805	0.49662	29 holes			12	-0.37157	0.33457	24	0.49936	0.02532	1	0.00000	-0.50000			
						30	0.05805	0.49662	#	x	y	13	-0.29389	0.40451	25	0.49423	-0.07571	2	-0.09463	-0.49096			
						31	0.17101	0.46985	1	0.00000	-0.50000	14	-0.20337	0.45677	26	0.46888	-0.17365	3	-0.18583	-0.46418			
						32	0.27475	0.41774	2	-0.10749	-0.48831	15	-0.10396	0.48907	27	0.42432	-0.26448	4	-0.27032	-0.42063			
						33	0.36369	0.34312	3	-0.20994	-0.45379	16	0.00000	0.50000	28	0.36240	-0.34448	5	-0.34504	-0.36187			
						34	0.43301	0.25000	4	-0.30259	-0.39805	17	0.10396	0.48907	29	0.28563	-0.41038	6	-0.40729	-0.29003			
						35	0.47899	0.14340	5	-0.38108	-0.32369	18	0.20337	0.45677	30	0.19718	-0.45948	7	-0.45482	-0.20771			
						36	0.49915	0.02907	6	-0.44176	-0.23420	19	0.29389	0.40451	31	0.10065	-0.48976	8	-0.48591	-0.11788			
						37	0.49240	-0.08682	7	-0.48177	-0.13376	20	0.37157	0.33457				9	-0.49943	-0.02379			
						38	0.45911	-0.19804	8	-0.49927	-0.02707	21	0.43301	0.25000				10	-0.49491	0.07116			

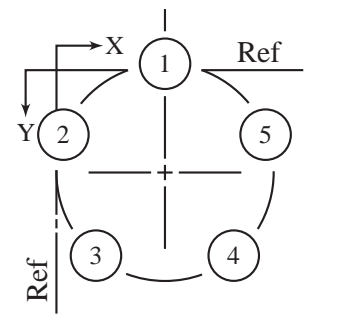
HOLE CIRCLE COORDINATES

Table 1b. Hole Coordinate Dimension Factors for Type "A" Hole Circles



10 holes			13 holes (Continued)			16 holes			18 holes (Continued)			20 holes (Continued)			22 holes (Continued)		
#	x	y	#	x	y	#	x	y	#	x	y	#	x	y	#	x	y
1	0.50000	0.00000	6	0.16844	0.87426	1	0.50000	0.00000	8	0.17861	0.88302	11	0.50000	1.00000	10	0.22968	0.92063
2	0.20611	0.09549	7	0.38034	0.98547	2	0.30866	0.03806	9	0.32899	0.96985	12	0.65451	0.97553	11	0.35913	0.97975
3	0.02447	0.34549	8	0.61966	0.98547	3	0.14645	0.14645	10	0.50000	1.00000	13	0.79389	0.90451	12	0.50000	1.00000
4	0.02447	0.65451	9	0.83156	0.87426	4	0.03806	0.30866	11	0.67101	0.96985	14	0.90451	0.79389	13	0.64087	0.97975
5	0.20611	0.90451	10	0.96751	0.67730	5	0.00000	0.50000	12	0.82139	0.88302	15	0.97553	0.65451	14	0.77032	0.92063
6	0.50000	1.00000	11	0.99635	0.43973	6	0.03806	0.69134	13	0.93301	0.75000	16	1.00000	0.50000	15	0.87787	0.82743
7	0.79389	0.90451	12	0.91149	0.21597	7	0.14645	0.85355	14	0.99240	0.58682	17	0.97553	0.34549	16	0.95482	0.70771
8	0.97553	0.65451	13	0.73236	0.05727	8	0.30866	0.96194	15	0.99240	0.41318	18	0.90451	0.20611	17	0.99491	0.57116
9	0.97553	0.34549				9	0.50000	1.00000	16	0.93301	0.25000	19	0.79389	0.09549	18	0.99491	0.42884
10	0.79389	0.09549				10	0.69134	0.96194	17	0.82139	0.11698	20	0.65451	0.02447	19	0.95482	0.29229
11 holes			14 holes			17 holes			19 holes			21 holes			23 holes		
#	x	y	#	x	y	#	x	y	#	x	y	#	x	y	#	x	y
1	0.50000	0.00000	1	0.50000	0.00000	1	0.50000	0.00000	1	0.50000	0.00000	1	0.50000	0.00000	1	0.50000	0.00000
2	0.22968	0.07937	2	0.28306	0.04952	2	0.31938	0.03376	2	0.35262	0.02221	2	0.35262	0.02221	2	0.35262	0.02221
3	0.04518	0.29229	3	0.10908	0.18826	3	0.16315	0.13050	3	0.21834	0.08688	3	0.21834	0.08688	3	0.21834	0.08688
4	0.00509	0.57116	4	0.01254	0.61126	4	0.05242	0.27713	4	0.10908	0.18826	4	0.10908	0.18826	4	0.10908	0.18826
5	0.12213	0.82743	5	0.01254	0.61126	5	0.00213	0.45387	5	0.03456	0.31733	5	0.03456	0.31733	5	0.03456	0.31733
6	0.35913	0.97975	6	0.10908	0.81174	6	0.01909	0.63683	6	0.00171	0.54129	6	0.00140	0.46263	6	0.00140	0.46263
7	0.64087	0.97975	7	0.28306	0.95048	7	0.10099	0.80132	7	0.04211	0.70085	7	0.01124	0.61126	7	0.01124	0.61126
8	0.87787	0.82743	8	0.50000	1.00000	8	0.23678	0.92511	8	0.13214	0.83864	8	0.15991	0.86653	8	0.15991	0.86653
9	0.99491	0.57116	9	0.71694	0.95048	9	0.40813	0.99149	9	0.26203	0.93974	9	0.28306	0.95048	9	0.28306	0.95048
10	0.95482	0.29229	10	0.89092	0.81174	10	0.59187	0.99149	10	0.41770	0.99318	10	0.42548	0.99442	10	0.42548	0.99442
11	0.77032	0.07937	11	0.98746	0.61126	11	0.76322	0.92511	11	0.58230	0.99318	11	0.57452	0.99442	11	0.57452	0.99442
12 holes			15 holes			18 holes			20 holes			22 holes			24 holes		
#	x	y	#	x	y	#	x	y	#	x	y	#	x	y	#	x	y
1	0.50000	0.00000	1	0.50000	0.00000	1	0.50000	0.00000	1	0.50000	0.00000	1	0.50000	0.00000	1	0.50000	0.00000
2	0.14645	0.14645	2	0.25000	0.06699	2	0.29663	0.04323	2	0.34549	0.02447	2	0.35913	0.02025	2	0.35913	0.02025
3	0.00000	0.50000	3	0.06699	0.25000	3	0.12843	0.16543	3	0.20611	0.09549	3	0.22968	0.07937	3	0.22968	0.07937
4	0.14645	0.85355	4	0.00000	0.50000	4	0.02447	0.34549	4	0.09549	0.20611	4	0.12213	0.17257	4	0.12213	0.17257
5	0.50000	1.00000	5	0.06699	0.75000	5	0.00274	0.55226	5	0.17861	0.11698	5	0.00000	0.50000	5	0.04518	0.29229
6	0.85355	0.85355	6	0.25000	0.93301	6	0.06699	0.75000	6	0.06699	0.25000	6	0.00509	0.42884	6	0.00509	0.42884
7	1.00000	0.50000	7	0.50000	1.00000	7	0.45387	0.53870	7	0.09549	0.20611	7	0.00509	0.75000	7	0.00509	0.75000
8	0.85355	0.14645	8	0.75000	0.93301	8	0.20611	0.90451	8	0.17861	0.11698	8	0.00509	1.00000	8	0.00509	1.00000
9	0.50000	0.00000	9	0.93301	0.75000	9	0.39604	0.98907	9	0.14645	0.14645	9	0.00509	0.50000	9	0.00509	0.50000
10	0.14645	0.14645	10	1.00000	0.50000	10	0.60396	0.98907	10	0.34549	0.02447	10	0.00509	0.25000	10	0.00509	0.25000
11	0.00000	0.50000	11	0.93301	0.25000	11	0.79389	0.90451	11	0.20611	0.09549	11	0.00509	0.00000	11	0.00509	0.00000
12	0.14645	0.85355	12	0.75000	0.06699	12	0.93301	0.75000	12	0.09549	0.20611	12	0.00509	0.00000	12	0.00509	0.00000
13 holes			16 holes			19 holes			21 holes			23 holes					
#	x	y	#	x	y	#	x	y	#	x	y	#	x	y			
1	0.50000	0.00000	1	0.50000	0.00000	1	0.50000	0.00000	1	0.50000	0.00000	1	0.50000	0.00000			
2	0.26764	0.05727	2	0.26764	0.05727	2	0.32899	0.03015	2	0.32899	0.03015	2	0.32899	0.03015			
3	0.08851	0.21597	3	0.08851	0.21597	3	0.17861	0.11698	3	0.17861	0.11698	3	0.17861	0.11698			
4	0.00365	0.43973	4	0.00365	0.43973	4	0.06699	0.25000	4	0.06699	0.25000	4	0.06699	0.25000			
5	0.03249	0.67730	5	0.03249	0.67730	5	0.00760	0.41318	5	0.00760	0.41318	5	0.00760	0.41318			
6	0.00365	0.43973	6	0.00365	0.43973	6	0.00760	0.58682	6	0.00760	0.58682	6	0.00760	0.58682			
7	0.03249	0.67730	7	0.03249	0.67730	7	0.06699	0.75000	7	0.06699	0.75000	7	0.06699	0.75000			
8	0.00365	0.43973	8	0.00365	0.43973	8	0.06699	1.00000	8	0.06699	1.00000	8	0.06699	1.00000			
9	0.03249	0.67730	9	0.03249	0.67730	9	0.06699	0.75000	9	0.06699	0.75000	9	0.06699	0.75000			

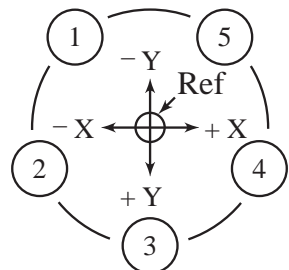
Table 1b. (Continued) Hole Coordinate Dimension Factors for Type "A" Hole Circles



24 holes (Continued)			25 holes (Continued)			26 holes (Continued)		27 holes (Continued)		29 holes (Continued)		30 holes (Continued)		32 holes			33 holes (Continued)						
#	x	y	#	x	y	#	x	y	#	x	y	#	x	y	#	x	y	#	x	y			
5	0.06699	0.25000	7	0.00099	0.46860	8	0.00365	0.56027	24	0.90106	0.20142	22	0.97553	0.65451	1	0.50000	0.00000	11	0.02750	0.66353			
6	0.01704	0.37059	8	0.00886	0.59369	9	0.03249	0.67730	25	0.82139	0.11698	23	0.99726	0.55226	2	0.40245	0.00961	12	0.06699	0.75000			
7	0.00000	0.50000	9	0.04759	0.71289	10	0.08851	0.78403	26	0.72440	0.05318	24	0.99726	0.44774	3	0.30866	0.03806	13	0.12213	0.82743			
8	0.01704	0.62941	10	0.11474	0.81871	11	0.16844	0.87426	27	0.61531	0.01348	25	0.97553	0.34549	4	0.22221	0.08427	14	0.19092	0.89303			
9	0.06699	0.75000	11	0.20611	0.90451	12	0.26764	0.94273	28 holes			26	0.93301	0.25000	5	0.14645	0.14645	15	0.27089	0.94442			
10	0.14645	0.85355	12	0.31594	0.96489	13	0.38034	0.98547	#	x	y	27	0.87157	0.16543	6	0.08427	0.22221	16	0.35913	0.97975			
11	0.25000	0.93301	13	0.43733	0.99606	14	0.50000	1.00000	1	0.50000	0.00000	28	0.79389	0.09549	7	0.03806	0.30866	17	0.45247	0.99774			
12	0.37059	0.98296	14	0.56267	0.99606	15	0.61966	0.98547	2	0.38874	0.01254	16	0.55406	0.99707	8	0.00961	0.40245	18	0.54753	0.99774			
13	0.50000	1.00000	15	0.68406	0.96489	16	0.73236	0.94273	3	0.28306	0.04952	17	0.65965	0.97383	9	0.00000	0.50000	19	0.64087	0.97975			
14	0.62941	0.98296	16	0.79389	0.90451	17	0.83156	0.87426	4	0.18826	0.10908	18	0.75778	0.92843	10	0.00961	0.59755	20	0.72911	0.94442			
15	0.75000	0.93301	17	0.88526	0.81871	18	0.91149	0.78403	5	0.10908	0.18826	19	0.84385	0.86300	11	0.03806	0.69134	21	0.80908	0.89303			
16	0.85355	0.85355	18	0.95241	0.71289	19	0.96751	0.67730	6	0.04952	0.28306	20	0.91384	0.78059	12	0.08427	0.77779	22	0.87787	0.82743			
17	0.93301	0.75000	19	0.99114	0.59369	20	0.99635	0.56027	7	0.01254	0.38874	21	0.96449	0.68507	13	0.14645	0.85355	23	0.93301	0.75000			
18	0.98296	0.62941	20	0.99901	0.46860	21	0.99635	0.43973	8	0.00000	0.50000	22	0.99341	0.58089	14	0.22221	0.91573	24	0.97250	0.66353			
19	1.00000	0.50000	21	0.97553	0.34549	22	0.96751	0.32270	9	0.01254	0.61126	23	0.99927	0.47293	15	0.30866	0.96194	25	0.99491	0.57116			
20	0.98296	0.37059	22	0.92216	0.23209	23	0.91149	0.21597	10	0.04952	0.71694	24	0.98177	0.36624	16	0.40245	0.99039	26	0.99943	0.47621			
21	0.93301	0.25000	23	0.84227	0.13552	24	0.83156	0.12574	11	0.10908	0.81174	25	0.94176	0.26580	17	0.50000	1.00000	27	0.98591	0.38212			
22	0.85355	0.14645	24	0.74088	0.06185	25	0.73236	0.05727	12	0.18826	0.89092	26	0.88108	0.17631	18	0.59755	0.99039	28	0.95482	0.29229			
23	0.75000	0.06699	25	0.62434	0.01571	26	0.61966	0.01453	13	0.28306	0.95048	27	0.80259	0.10195	19	0.69134	0.96194	29	0.90729	0.20997			
24	0.62941	0.01704							14	0.38874	0.98746	28	0.70994	0.04621	20	0.77779	0.91573	30	0.84504	0.13813			
									15	0.50000	1.00000	29	0.60749	0.01169	10	0.01596	0.62533	31	0.77032	0.07937			
									16	0.61126	0.98746				11	0.05110	0.72020	22	0.91573	0.77779	32	0.68583	0.03582
									17	0.71694	0.95048				12	0.10461	0.80605	23	0.96194	0.69134	33	0.59463	0.00904
									18	0.81174	0.89092				13	0.17431	0.87938	24	0.99039	0.59755			
									19	0.89092	0.81174				14	0.25735	0.93717	25	1.00000	0.50000			
									20	0.95048	0.71694				15	0.35032	0.97707	26	0.99039	0.40245			
									21	0.98746	0.61126				16	0.44942	0.99743	27	0.96194	0.30866			
									22	1.00000	0.50000				17	0.55058	0.99743	28	0.91573	0.22221			
									23	0.98746	0.38874				18	0.64968	0.97707	29	0.85355	0.14645			
									24	0.95048	0.28306				19	0.74265	0.93717	30	0.77779	0.08427			
									25	0.89092	0.18826				20	0.82569	0.87938	31	0.69134	0.03806			
									26	0.81174	0.10908				21	0.89539	0.80605	32	0.59755	0.00961			
									27	0.71694	0.04952				22	0.94890	0.72020				33 holes		
									28	0.61126	0.01254				23	0.98404	0.62533	#	x	y			
									29 holes						24	0.99936	0.52532	1	0.50000	0.00000			
									#	x	y				25	0.99423	0.42429	2	0.40537	0.00904			
									1	0.50000	0.00000				26	0.96888	0.32635	3	0.31417	0.03582			
									2	0.39251	0.01169				27	0.92432	0.23552	4	0.22968	0.07937			
									3	0.29006	0.04621				28	0.86240	0.15552	5	0.15496	0.13813			
									4	0.19741	0.01095				29	0.78563	0.08962	6	0.09271	0.20997			
									5	0.11892	0.17631				30	0.69718	0.04052	7	0.04518	0.29229			
									6	0.05824	0.26580				31	0.60065	0.01024	8	0.01409	0.38212			
									7	0.01823	0.36624				10	0.00509	0.57116	9	0.00509	0.47621			
									8	0.00073	0.47293												

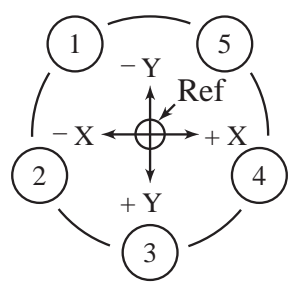
HOLE CIRCLE COORDINATES

Table 2a. Hole Coordinate Dimension Factors for Type "B" Hole Circles



10 holes			13 holes (Continued)			16 holes			18 holes (Continued)			20 holes (Continued)			22 holes (Continued)		
#	x	y	#	x	y	#	x	y	#	x	y	#	x	y	#	x	y
1	-0.15451	-0.47553	6	-0.23236	0.44273	1	-0.09755	-0.49039	8	-0.25000	0.43301	11	0.07822	0.49384	10	-0.20771	0.45482
2	-0.40451	-0.29389	7	0.00000	0.50000	2	-0.27779	-0.41573	9	-0.08682	0.49240	12	0.22700	0.44550	11	-0.07116	0.49491
3	-0.50000	0.00000	8	0.23236	0.44273	3	-0.41573	-0.27779	10	0.08682	0.49240	13	0.35355	0.35355	12	0.07116	0.49491
4	-0.40451	0.29389	9	0.41149	0.28403	4	-0.49039	-0.09755	11	0.25000	0.43301	14	0.44550	0.22700	13	0.20771	0.45482
5	-0.15451	0.47553	10	0.49635	0.06027	5	-0.49039	0.09755	12	0.38302	0.32139	15	0.49384	0.07822	14	0.32743	0.37787
6	0.15451	0.47553	11	0.46751	-0.17730	6	-0.41573	0.27779	13	0.46985	0.17101	16	0.49384	-0.07822	15	0.42063	0.27032
7	0.40451	0.29389	12	0.33156	-0.37426	7	-0.27779	0.41573	14	0.50000	0.00000	17	0.44550	-0.22700	16	0.47975	0.14087
8	0.50000	0.00000	13	0.11966	-0.48547	8	-0.09755	0.49039	15	0.46985	-0.17101	18	0.35355	-0.35355	17	0.50000	0.00000
9	0.40451	-0.29389				9	0.09755	0.49039	16	0.38302	-0.32139	19	0.22700	-0.44550	18	0.47975	-0.14087
10	0.15451	-0.47553				10	0.27779	0.41573	17	0.25000	-0.43301	20	0.07822	-0.49384	19	0.42063	-0.27032
11 holes			14 holes			17 holes			19 holes			21 holes			23 holes		
#	x	y	#	x	y	#	x	y	#	x	y	#	x	y	#	x	y
1	-0.14087	-0.47975	1	-0.11126	-0.48746	1	-0.09187	-0.49149	1	-0.08230	-0.49318	1	-0.07452	-0.49442	1	-0.06808	-0.49534
2	-0.37787	-0.32743	2	-0.31174	-0.39092	2	-0.26322	-0.42511	2	-0.23797	-0.43974	2	-0.21694	-0.45048	2	-0.19920	-0.45861
3	-0.49491	-0.07116	3	-0.45048	-0.21694	3	-0.36786	-0.33864	3	-0.36786	-0.33864	3	-0.34009	-0.36653	3	-0.31554	-0.38786
4	-0.45482	0.20771	4	-0.50000	0.00000	4	-0.45789	-0.20085	4	-0.43301	-0.25000	4	-0.43301	-0.25000	4	-0.40848	-0.28834
5	-0.27032	0.42063	5	-0.45048	0.21694	5	-0.49829	-0.04129	5	-0.48746	-0.11126	5	-0.48746	-0.11126	5	-0.47113	-0.16744
6	0.00000	0.50000	6	-0.11126	0.48746	6	-0.49829	-0.04129	6	-0.49860	0.03737	6	-0.49860	0.03737	6	-0.49883	-0.03412
7	0.27032	0.42063	7	0.11126	0.48746	7	-0.48470	0.12274	7	-0.48470	0.12274	7	-0.46544	0.18267	7	-0.48954	0.10173
8	0.45482	0.20771	8	0.31174	0.39092	8	-0.41858	0.27347	8	-0.41858	0.27347	8	-0.39092	0.31174	8	-0.44394	0.23003
9	0.49491	-0.07116	9	0.45048	0.21694	9	-0.39901	-0.30132	9	-0.30711	0.39457	9	-0.28166	0.41312	9	-0.49883	-0.03412
10	0.37787	-0.32743	10	0.50000	0.00000	10	-0.48091	-0.13683	10	-0.16235	0.47291	10	-0.14738	0.47779	10	-0.48954	0.10173
11	0.14087	-0.47975	11	0.45048	-0.21694	11	-0.49787	0.04613	11	0.00000	0.50000	11	0.00000	0.50000	11	-0.44394	0.23003
			12	0.14087	-0.47975	12	-0.44758	0.22287	12	0.16235	0.47291	12	0.14738	0.47779	12	-0.36542	0.34128
			13	0.11126	-0.48746	13	-0.33685	0.36950	13	0.30711	0.39457	13	0.28166	0.41312	13	-0.25979	0.42721
			14			14	-0.18062	0.46624	14	0.41858	0.27347	14	0.39092	0.31174	14	-0.13490	0.48146
12 holes			15 holes			18 holes			20 holes			22 holes			24 holes		
#	x	y	#	x	y	#	x	y	#	x	y	#	x	y	#	x	y
1	-0.12941	-0.48296	1	-0.10396	-0.48907	1	-0.08682	-0.49240	1	-0.07822	-0.49384	1	-0.07116	-0.49491	1	-0.06526	-0.49572
2	-0.46194	-0.19134	2	-0.35355	-0.35355	2	-0.25000	-0.43301	2	-0.22700	-0.44550	2	-0.20771	-0.45482	2	-0.19134	-0.46194
3	-0.46194	0.19134	3	-0.48296	-0.12941	3	-0.29389	-0.40451	3	-0.35355	-0.35355	3	-0.32743	-0.37787	3	-0.30438	-0.39668
4	-0.19134	0.46194	4	-0.48296	0.12941	4	-0.43301	-0.25000	4	-0.44550	-0.22700	4	-0.42063	-0.07822	4	-0.39668	-0.30438
5	0.19134	0.46194	5	-0.35355	0.35355	5	-0.49726	-0.05226	5	-0.49384	-0.07822	5	-0.47975	-0.14087	5	-0.46985	-0.17101
6	0.46194	0.19134	6	-0.12941	0.48296	6	-0.47553	0.15451	6	-0.49384	0.07822	6	-0.44550	0.22700	6	-0.45000	0.00000
7	0.46194	-0.19134	7	0.12941	0.48296	7	-0.37157	0.33457	7	-0.46985	0.17101	7	-0.44550	0.35355	7	-0.47975	0.14087
8	0.19134	-0.46194	8	0.35355	0.35355	8	-0.20337	0.45677	8	-0.46985	0.17101	8	-0.22700	0.44550	8	-0.42063	0.27032
			9	0.48296	0.12941	9	0.00000	0.50000	9	0.39901	-0.30132	9	-0.32743	-0.37787	9	-0.32743	0.37787
			10	0.48296	-0.12941	10	0.20337	0.45677	10	0.26322	-0.42511						
			11	0.35355	-0.35355	11	0.37157	0.33457	11	0.09187	-0.49149						
			12	0.12941	-0.48296	12	0.47553	0.15451									
13 holes			16 holes			19 holes			21 holes			23 holes					
#	x	y	#	x	y	#	x	y	#	x	y	#	x	y			
1	-0.11966	-0.48547	1	-0.08682	-0.49240	1	-0.07822	-0.49384	1	-0.07116	-0.49491	1	-0.06526	-0.49572			
2	-0.33156	-0.37426	2	-0.25000	-0.43301	2	-0.22700	-0.44550	2	-0.20771	-0.45482	2	-0.19134	-0.46194			
3	-0.46751	-0.17730	3	-0.38302	-0.32139	3	-0.35355	-0.35355	3	-0.32743	-0.37787	3	-0.30438	-0.39668			
4	-0.49635	0.06027	4	-0.46985	0.17101	4	-0.44550	-0.22700	4	-0.42063	-0.07822	4	-0.39668	-0.30438			
5	-0.41149	0.28403	5	-0.50000	0.00000	5	-0.49384	-0.07822	5	-0.47975	-0.14087	5	-0.46985	-0.17101			
6	0.09635	0.06027	6	-0.46985	0.17101	6	-0.49384	0.07822	6	-0.44550	0.22700	6	-0.45000	0.00000			
7	0.46751	-0.17730	7	-0.46985	0.17101	7	-0.44550	0.22700	7	-0.44550	0.35355	7	-0.47975	0.14087			
8	0.46751	-0.17730	8	-0.46985	0.17101	8	-0.44550	0.22700	8	-0.44550	0.35355	8	-0.47975	0.14087			
9	0.40451	0.29389	9	-0.46985	0.17101	9	-0.22700	0.44550	9	-0.42063	0.27032	9	-0.42063	0.27032			
10	0.15451	-0.47553	10	-0.38302	-0.32139	10	-0.07822	0.49384	10	-0.32743	0.37787	10	-0.32743	0.37787			

Table 2a. (Continued) Hole Coordinate Dimension Factors for Type "B" Hole Circles

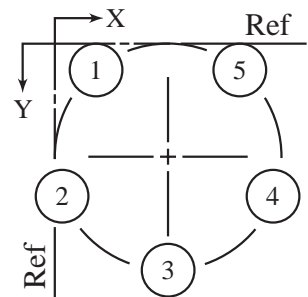


24 holes (Continued)				25 holes (Continued)				
#	x	y	#	x	y			
5	-0.46194	-0.19134	7	-0.49901	0.03140			
6	-0.49572	-0.06526	8	-0.47553	0.15451			
7	-0.49572	0.06526	9	-0.42216	0.26791			
8	-0.46194	0.19134	10	-0.34227	0.36448			
9	-0.39668	0.30438	11	-0.24088	0.43815			
10	-0.30438	0.39668	12	-0.12434	0.48429			
11	-0.19134	0.46194	13	0.00000	0.50000			
12	-0.06526	0.49572	14	0.12434	0.48429			
13	0.06526	0.49572	15	0.24088	0.43815			
14	0.19134	0.46194	16	0.34227	0.36448			
15	0.30438	0.39668	17	0.42216	0.26791			
16	0.39668	0.30438	18	0.47553	0.15451			
17	0.46194	0.19134	19	0.49901	0.03140			
18	0.49572	0.06526	20	0.49114	-0.09369			
19	0.49572	-0.06526	21	0.45241	-0.21289			
20	0.46194	-0.19134	22	0.38526	-0.31871			
21	0.39668	-0.30438	23	0.29389	-0.40451			
22	0.30438	-0.39668	24	0.18406	-0.46489			
23	0.19134	-0.46194	25	0.06267	-0.49606			
24	0.06526	-0.49572						

26 holes (Continued)				27 holes (Continued)				29 holes (Continued)				30 holes (Continued)				32 holes				33 holes (Continued)											
#	x	y	#	x	y	#	x	y	#	x	y	#	x	y	#	x	y	#	x	y	#	x	y	#	x	y					
8	-0.48547	0.11966	24	0.36369	-0.34312	9	-0.48177	0.13376	22	0.48907	0.10396	1	-0.04901	-0.49759	11	-0.45482	0.20771														
9	-0.44273	0.23236	25	0.27475	-0.41774	10	-0.44176	0.23420	23	0.50000	0.00000	2	-0.14514	-0.47847	12	-0.40729	0.29003														
10	-0.37426	0.33156	26	0.17101	-0.46985	11	-0.38108	0.32369	24	0.48907	-0.10396	3	-0.23570	-0.44096	13	-0.34504	0.36187														
11	-0.28403	0.41149	27	0.05805	-0.49662	12	-0.30259	0.39805	25	0.45677	-0.20337	4	-0.31720	-0.38651	14	-0.27032	0.42063														
12	-0.17730	0.46751	28 holes				13	-0.20994	0.45379	26	0.40451	-0.29389	5	-0.38651	-0.31720	15	-0.18583	0.46418													
13	-0.06027	0.49635	#	x	y	14	-0.10749	0.48831	27	0.33457	-0.37157	6	-0.44096	-0.23570	16	-0.09463	0.49096														
14	0.06027	0.49635	1	-0.05598	-0.49686	15	0.00000	0.50000	28	0.25000	-0.43301	7	-0.47847	-0.14514	17	0.00000	0.50000														
15	0.17730	0.46751	2	-0.16514	-0.47194	16	0.10749	0.48831	29	0.15451	-0.47553	8	-0.49759	-0.04901	18	0.09463	0.49096														
16	0.28403	0.41149	3	-0.26602	-0.42336	17	0.20994	0.45379	30	0.05226	-0.49726	9	-0.49759	0.04901	19	0.18583	0.46418														
17	0.37426	0.33156	4	-0.35355	-0.35355	18	0.30259	0.39805	31 holes				10	-0.47847	0.14514	20	0.27032	0.42063													
18	0.44273	0.23236	5	-0.42336	-0.26602	19	0.38108	0.32369	#	x	y	11	-0.44096	0.23570	21	0.34504	0.36187														
19	0.48547	0.11966	6	-0.47194	-0.16514	20	0.44176	0.23420	1	-0.05058	-0.49743	12	-0.38651	0.31720	22	0.40729	0.29003														
20	0.50000	0.00000	7	-0.49686	-0.05598	21	0.48177	0.13376	2	-0.14968	-0.47707	13	-0.31720	0.38651	23	0.45482	0.20771														
21	0.48547	-0.11966	8	-0.49686	0.05598	22	0.49927	0.02707	3	-0.24265	-0.43717	14	-0.23570	0.44096	24	0.48591	0.11788														
22	0.44273	-0.23236	9	-0.47194	0.16514	23	0.49341	-0.08089	4	-0.32569	-0.37938	15	-0.14514	0.47847	25	0.49943	0.02379														
23	0.37426	-0.33156	10	-0.42336	0.26602	24	0.46449	-0.18507	5	-0.39539	-0.30605	16	-0.04901	0.49759	26	0.49491	-0.07116														
24	0.28403	-0.41149	11	-0.35355	0.35355	25	0.41384	-0.28059	6	-0.44890	-0.22020	17	0.04901	0.49759	27	0.47250	-0.16353														
25	0.17730	-0.46751	12	-0.26602	0.42336	26	0.34385	-0.36300	7	-0.48404	-0.12533	18	0.14514	0.47847	28	0.43301	-0.25000														
26	0.06027	-0.49635	13	-0.16514	0.47194	27	0.25778	-0.42843	8	-0.49936	-0.02532	19	0.23570	0.44096	29	0.37787	-0.32743														
				27 holes				28	0.15965	-0.47383	9	-0.49423	0.07571	20	0.31720	0.38651	30	0.30908	-0.39303												
				#	x	y	15	0.05598	0.49686	29	0.05406	-0.49707	10	-0.46888	0.17365	21	0.22911	-0.44442													
				1	-0.05805	-0.49662	16	0.16514	0.47194	30 holes				11	-0.42432	0.26448	22	0.44096	0.23570												
				2	-0.17101	-0.46985	17	0.26602	0.42336	#	x	y	12	-0.36240	0.34448	23	0.47847	0.14514													
				3	-0.27475	-0.41774	18	0.35355	0.35355	1	-0.05226	-0.49726	13	-0.28563	0.41038	24	0.49759	0.04901													
				4	-0.36369	-0.34312	19	0.42336	0.26602	2	-0.15451	-0.47553	14	-0.19718	0.45948	25	0.49759	-0.04901													
				5	-0.43301	-0.25000	20	0.47194	0.16514	3	-0.25000	-0.43301	15	-0.10065	0.48976	26	0.47847	-0.14514													
				6	-0.47899	-0.14340	21	0.49686	0.05598	4	-0.33457	-0.37157	16	0.00000	0.50000	27	0.44096	-0.23570													
				7	-0.49915	-0.02907	22	0.49686	-0.05598	5	-0.40451	-0.29389	17	0.10065	0.48976	28	0.38651	-0.31720													
				8	-0.49240	0.08682	23	0.47194	-0.16514	6	-0.45677	-0.20337	18	0.19718	0.45948	29	0.31720	-0.38651													
				9	-0.45911	0.19804	24	0.42336	-0.26602	7	-0.48907	-0.10396	19	0.28563	0.41038	30	0.23570	-0.44096													
				10	-0.40106	0.29858	25	0.35355	-0.35355	8	-0.50000	0.00000	20	0.36240	0.34448	31	0.14514	-0.47847													
				11	-0.32139	0.38302	26	0.26602	-0.42336	9	-0.48907	0.10396	21	0.42432	0.26448	32	0.04901	-0.49759													
				12	-0.22440	0.44682	27	0.16514	-0.47194	10	-0.45677	0.20337	22	0.46888	0.17365	33 holes															
				13	-0.11531	0.48652	28	0.05598	-0.49686	11	-0.40451	0.29389	23	0.49423	0.07571	#	x	y													
				14	0.00000	0.50000	29 holes				12	-0.33457	0.37157	24	0.49936	-0.02532	1	-0.04753	-0.49774												
				15	0.11531	0.48652	#	x	y	13	-0.25000	0.43301	25	0.48404	-0.12533	2	-0.14087	-0.47975													
				16	0.22440	0.44682	1	-0.05406	-0.49707	14	-0.15451	0.47553	26	0.44890	-0.22020	3	-0.22911	-0.44442													
				17	0.32139	0.38302	2	-0.15965	-0.47383	15	-0.05226	0.49726	27	0.39539	-0.30605	4	-0.30908	-0.39303													
				18	0.40106	0.29858	3	-0.25778	-0.42843	16	0.05226	0.49726	28	0.32569	-0.37938	5	-0.37787	-0.32743													
				19	0.45911	0.19804	4	-0.34385	-0.36300	17	0.15451	0.47553	29	0.24265	-0.43717	6	-0.43301	-0.25000													
				20	0.49240	0.08682	5	-0.41384	-0.28059	18	0.25000	0.43301	30	0.14968	-0.47707	7	-0.47250	-0.16353													
				21	0.49915	-0.02907	6	-0.46449	-0.18507	19	0.33457	0.37157	31	0.05058	-0.49743	8	-0.49491	-0.07116													
				22	0.47899	-0.14340	7	-0.49341	-0.08089	20	0.40451	0.29389					9	-0.49943	0.02379												
				23	0.43301	-0.25000	8	-0.49927	0.02707	21	0.45677	0.20337					10	-0.48591	0.11788												

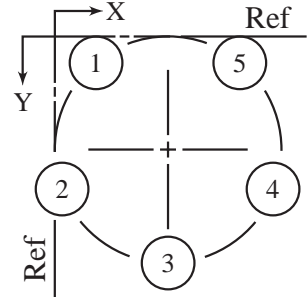
HOLE CIRCLE COORDINATES

Table 2b. Hole Coordinate Dimension Factors for Type "B" Hole Circles



10 holes			13 holes (Continued)			16 holes			18 holes (Continued)			20 holes (Continued)			22 holes (Continued)		
#	x	y	#	x	y	#	x	y	#	x	y	#	x	y	#	x	y
1	0.34549	0.02447	6	0.26764	0.94273	1	0.40245	0.00961	8	0.25000	0.93301	11	0.57822	0.99384	10	0.29229	0.95482
2	0.09549	0.20611	7	0.50000	1.00000	2	0.22221	0.08427	9	0.41318	0.99240	12	0.72700	0.94550	11	0.42884	0.99491
3	0.00000	0.50000	8	0.73236	0.94273	3	0.08427	0.22221	10	0.58682	0.99240	13	0.85355	0.85355	12	0.57116	0.99491
4	0.09549	0.79389	9	0.91149	0.78403	4	0.00961	0.40245	11	0.75000	0.93301	14	0.94550	0.72700	13	0.70771	0.95482
5	0.34549	0.97553	10	0.99635	0.56027	5	0.00961	0.59755	12	0.88302	0.82139	15	0.99384	0.57822	14	0.82743	0.87787
6	0.65451	0.97553	11	0.96751	0.32270	6	0.08427	0.77779	13	0.96985	0.67101	16	0.99384	0.42178	15	0.92063	0.77032
7	0.90451	0.79389	12	0.83156	0.12574	7	0.22221	0.91573	14	1.00000	0.50000	17	0.94550	0.27300	16	0.97975	0.64087
8	1.00000	0.50000	13	0.61966	0.01453	8	0.40245	0.99039	15	0.96985	0.32899	18	0.85355	0.14645	17	1.00000	0.50000
9	0.90451	0.20611				9	0.59755	0.99039	16	0.88302	0.17861	19	0.72700	0.05450	18	0.97975	0.35913
10	0.65451	0.02447				10	0.77779	0.91573	17	0.75000	0.06699	20	0.57822	0.00616	19	0.92063	0.22968
11 holes			14 holes			17 holes			19 holes			21 holes			23 holes		
#	x	y	#	x	y	#	x	y	#	x	y	#	x	y	#	x	y
1	0.35913	0.02025	1	0.38874	0.01254	1	0.40813	0.00851	1	0.42548	0.00558	1	0.43192	0.00466			
2	0.12213	0.17257	2	0.18826	0.10908	2	0.23678	0.07489	2	0.26203	0.06026	2	0.28306	0.04952			
3	0.00509	0.42884	3	0.04952	0.28306	3	0.10099	0.19868	3	0.13214	0.16136	3	0.15991	0.13347			
4	0.04518	0.70771	4	0.00000	0.50000	4	0.00274	0.44774	4	0.04211	0.29915	4	0.06699	0.25000			
5	0.22968	0.92063	5	0.04952	0.71694	5	0.02447	0.65451	5	0.00171	0.45871	5	0.01254	0.29915			
6	0.50000	1.00000	6	0.18826	0.89092	6	0.12843	0.83457	6	0.00140	0.53737	6	0.00140	0.53737			
7	0.89092	0.81174	7	0.38874	0.98746	7	0.29663	0.95677	7	0.03456	0.68267	7	0.03456	0.68267			
8	0.98746	0.38874	8	0.61126	0.98746	8	0.50000	1.00000	8	0.10908	0.81174	8	0.10908	0.81174			
9	0.71694	0.04952	9	0.81174	0.89092	9	0.70337	0.95677	9	0.19289	0.89457	9	0.21834	0.91312			
			10	0.95048	0.71694	10	0.87787	0.17257	10	0.33765	0.97291	10	0.35262	0.97779			
			11	0.99491	0.42884	11	0.64087	0.02025	11	0.50000	1.00000	11	0.50000	1.00000			
			12	0.98746	0.38874	12	0.81174	0.10908	12	0.66235	0.97291	12	0.64738	0.97779			
			13	0.89092	0.81174	13	0.61126	0.01254	13	0.80711	0.89457	13	0.78166	0.91312			
			14	0.85355	0.85355				14	0.91858	0.77347	14	0.89092	0.81174			
									15	0.98470	0.62274	15	0.96544	0.68267			
									16	0.99829	0.45871	16	0.99860	0.53737			
									17	0.95789	0.29915	17	0.98746	0.38874			
									18	0.86786	0.16136	18	0.93301	0.25000			
									19	0.87397	0.06026	19	0.84009	0.13347			
									20	0.58230	0.00682	20	0.71694	0.04952			
									21			21	0.57452	0.00558			
12 holes			15 holes			18 holes			20 holes			22 holes			24 holes		
#	x	y	#	x	y	#	x	y	#	x	y	#	x	y	#	x	y
1	0.30866	0.03806	1	0.37059	0.01704	1	0.41318	0.00760	1	0.42178	0.00616	1	0.42884	0.00509			
2	0.03806	0.30866	2	0.14645	0.14645	2	0.25000	0.06699	2	0.27300	0.05450	2	0.29229	0.04518			
3	0.03806	0.69134	3	0.01704	0.37059	3	0.11698	0.17861	3	0.05450	0.27300	3	0.17257	0.12213			
4	0.30866	0.96194	4	0.01704	0.62941	4	0.03015	0.32899	4	0.00616	0.42178	4	0.07937	0.22968			
5	0.69134	0.96194	5	0.14645	0.85355	5	0.00000	0.50000	5	0.00616	0.57822	5	0.02025	0.35913			
6	0.96194	0.69134	6	0.37059	0.98296	6	0.03015	0.50000	6	0.05450	0.72700	6	0.00000	0.50000			
7	0.96194	0.30866	7	0.62941	0.98296	7	0.03015	0.67101	7	0.14645	0.85355	7	0.02025	0.64087			
8	0.69134	0.03806	8	0.85355	0.85355	8	0.03015	0.82139	8	0.27300	0.94550	8	0.07937	0.77032			
			9	0.98296	0.62941	9	0.11698	0.82139	9	0.42178	0.99384	9	0.17257	0.87787			
			10	0.98296	0.37059												
			11	0.85355	0.14645												
			12	0.62941	0.01704												
13 holes			16 holes			19 holes			21 holes			23 holes			25 holes		
#	x	y	#	x	y	#	x	y	#	x	y	#	x	y	#	x	y
1	0.38034	0.01453	1	0.38034	0.01453	1	0.41318	0.00760	1	0.42178	0.00616	1	0.42884	0.00509	1	0.43474	0.00428
2	0.16844	0.12574	2	0.16844	0.12574	2	0.25000	0.06699	2	0.27300	0.05450	2	0.29229	0.04518	2	0.30866	0.03806
3	0.03249	0.32270	3	0.03249	0.32270	3	0.11698	0.17861	3	0.05450	0.27300	3	0.17257	0.12213	3	0.19562	0.10332
4	0.00365	0.56027	4	0.00365	0.56027	4	0.03015	0.32899	4	0.00616	0.42178	4	0.07937	0.22968	4	0.10332	0.19562
5	0.08851	0.78403	5	0.08851	0.78403	5	0.00000	0.50000	5	0.00616	0.57822	5	0.02025	0.35913			

Table 2b. (Continued) Hole Coordinate Dimension Factors for Type "B" Hole Circles



24 holes (Continued)			25 holes (Continued)			26 holes (Continued)		27 holes (Continued)		29 holes (Continued)		30 holes (Continued)		32 holes			33 holes (Continued)						
#	x	y	#	x	y	#	x	y	#	x	y	#	x	y	#	x	y	#	x	y			
5	0.03806	0.30866	7	0.00099	0.53140	8	0.01453	0.61966	24	0.86369	0.15688	9	0.01823	0.63376	22	0.98907	0.60396	11	0.04518	0.70771			
6	0.00428	0.43474	8	0.02447	0.65451	9	0.05727	0.73236	25	0.77475	0.08226	10	0.05824	0.73420	23	1.00000	0.50000	2	0.35486	0.02153			
7	0.00428	0.56526	9	0.07784	0.76791	10	0.12574	0.83156	26	0.67101	0.03015	11	0.11892	0.82369	24	0.98907	0.39604	3	0.26430	0.05904			
8	0.03806	0.69134	10	0.15773	0.86448	11	0.21597	0.91149	27	0.55805	0.00338	12	0.19741	0.89805	25	0.95677	0.29663	4	0.18280	0.11349			
9	0.10332	0.80438	11	0.25912	0.93815	12	0.32270	0.96751	28 holes			13	0.29006	0.95379	26	0.90451	0.20611	5	0.11349	0.18280			
10	0.19562	0.89668	12	0.37566	0.98429	13	0.43973	0.99635	#	x	y	14	0.39251	0.98831	27	0.83457	0.12843	6	0.05904	0.26430			
11	0.30866	0.96194	13	0.50000	1.00000	14	0.56027	0.99635	1	0.44402	0.00314	15	0.50000	1.00000	28	0.75000	0.06699	7	0.02153	0.35486			
12	0.43474	0.99572	14	0.62434	0.98429	15	0.67730	0.96751	2	0.33486	0.02806	16	0.60749	0.98831	29	0.65451	0.02447	8	0.00241	0.45099			
13	0.56526	0.99572	15	0.74088	0.93815	16	0.78403	0.91149	3	0.23398	0.07664	17	0.70994	0.95379	30	0.55226	0.00274	9	0.00241	0.54901			
14	0.69134	0.96194	16	0.84227	0.86448	17	0.87426	0.83156	4	0.14645	0.14645	18	0.80259	0.89805	10	0.02153	0.64514						
15	0.80438	0.89668	17	0.92216	0.76791	18	0.94273	0.73236	5	0.07664	0.23398	19	0.88108	0.82369	11	0.05904	0.73570						
16	0.89668	0.80438	18	0.97553	0.65451	19	0.98547	0.61966	6	0.02806	0.33486	20	0.94176	0.73420	12	0.11349	0.18720						
17	0.96194	0.69134	19	0.99901	0.53140	20	1.00000	0.50000	7	0.00314	0.44402	21	0.98177	0.63376	13	0.18280	0.88651						
18	0.99572	0.56526	20	0.99114	0.40631	21	0.98547	0.38034	8	0.00314	0.55598	22	0.99927	0.52707	14	0.26430	0.94096						
19	0.99572	0.43474	21	0.95241	0.28711	22	0.94273	0.26764	9	0.02806	0.66514	23	0.99341	0.41911	15	0.35486	0.97847						
20	0.96194	0.30866	22	0.88526	0.18129	23	0.87426	0.16844	10	0.07664	0.76602	24	0.96449	0.31493	16	0.45099	0.99759						
21	0.89668	0.19562	23	0.79389	0.09549	24	0.78403	0.08851	11	0.14645	0.85355	25	0.91384	0.21941	17	0.54901	0.99759						
22	0.80438	0.10332	24	0.68406	0.03511	25	0.67730	0.03249	12	0.23398	0.92336	26	0.84385	0.13700	18	0.64514	0.97847						
23	0.69134	0.03806	25	0.56267	0.00394	26	0.56027	0.00365	13	0.33486	0.97194	27	0.75778	0.07157	19	0.73570	0.94096						
24	0.56526	0.00428							14	0.44402	0.99686	28	0.65965	0.02617	20	0.81720	0.88651						
									15	0.55598	0.99686	29	0.55406	0.00293	21	0.80908	0.10697						
									27 holes			30 holes											
									#	x	y	#	x	y									
									1	0.44195	0.00338	1	0.44774	0.00274									
									2	0.32899	0.03015	2	0.34549	0.02447									
									3	0.22525	0.08226	3	0.25000	0.06699									
									4	0.13631	0.15688	4	0.16543	0.12843									
									5	0.06699	0.25000	5	0.09549	0.20611									
									6	0.02101	0.35660	6	0.04323	0.29663									
									7	0.00085	0.47093	7	0.01093	0.50000									
									8	0.00760	0.58682	8	0.04323	0.70337									
									9	0.04089	0.69804	9	0.01093	0.79389									
									10	0.09894	0.79858	10	0.04323	0.93001									
									11	0.17861	0.88302	11	0.01093	0.97553									
									12	0.27560	0.94682	12	0.16543	0.87157									
									13	0.38469	0.98652	13	0.25000	0.93301									
									14	0.50000	1.00000	14	0.34549	0.97553									
									15	0.61531	0.98652	15	0.44774	0.97226									
									16	0.72440	0.94682	16	0.52226	0.99726									
									17	0.82139	0.88302	17	0.65451	0.97553									
									18	0.90106	0.79858	18	0.75000	0.93301									
									19	0.95911	0.69804	19	0.83457	0.87157									
									20	0.99240	0.58682	20	0.95677	0.70337									
									21	0.99915	0.47093	21	0.98547	0.38034									
									22	0.97899	0.35660	22	0.99341	0.41911									
									23	0.93301	0.25000	23	0.95677	0.70337									

HOLE CIRCLE COORDINATES

Table 3. Lengths of Chords for Spacing Off the Circumferences of Circles with a Diameter Equal to 1 (English or Metric units)

No. of Spaces	Length of Chord	No. of Spaces	Length of Chord	No. of Spaces	Length of Chord	No. of Spaces	Length of Chord
3	0.866025	41	0.076549	79	0.039757	117	0.026848
4	0.707107	42	0.074730	80	0.039260	118	0.026621
5	0.587785	43	0.072995	81	0.038775	119	0.026397
6	0.500000	44	0.071339	82	0.038303	120	0.026177
7	0.433884	45	0.069756	83	0.037841	121	0.025961
8	0.382683	46	0.068242	84	0.037391	122	0.025748
9	0.342020	47	0.066793	85	0.036951	123	0.025539
10	0.309017	48	0.065403	86	0.036522	124	0.025333
11	0.281733	49	0.064070	87	0.036102	125	0.025130
12	0.258819	50	0.062791	88	0.035692	126	0.024931
13	0.239316	51	0.061561	89	0.035291	127	0.024734
14	0.222521	52	0.060378	90	0.034899	128	0.024541
15	0.207912	53	0.059241	91	0.034516	129	0.024351
16	0.195090	54	0.058145	92	0.034141	130	0.024164
17	0.183750	55	0.057089	93	0.033774	131	0.023979
18	0.173648	56	0.056070	94	0.033415	132	0.023798
19	0.164595	57	0.055088	95	0.033063	133	0.023619
20	0.156434	58	0.054139	96	0.032719	134	0.023443
21	0.149042	59	0.053222	97	0.032382	135	0.023269
22	0.142315	60	0.052336	98	0.032052	136	0.023098
23	0.136167	61	0.051479	99	0.031728	137	0.022929
24	0.130526	62	0.050649	100	0.031411	138	0.022763
25	0.125333	63	0.049846	101	0.031100	139	0.022599
26	0.120537	64	0.049068	102	0.030795	140	0.022438
27	0.116093	65	0.048313	103	0.030496	141	0.022279
28	0.111964	66	0.047582	104	0.030203	142	0.022122
29	0.108119	67	0.046872	105	0.029915	143	0.021967
30	0.104528	68	0.046183	106	0.029633	144	0.021815
31	0.101168	69	0.045515	107	0.029356	145	0.021664
32	0.098017	70	0.044865	108	0.029085	146	0.021516
33	0.095056	71	0.044233	109	0.028818	147	0.021370
34	0.092268	72	0.043619	110	0.028556	148	0.021225
35	0.089639	73	0.043022	111	0.028299	149	0.021083
36	0.087156	74	0.042441	112	0.028046	150	0.020942
37	0.084806	75	0.041876	113	0.027798	151	0.020804
38	0.082579	76	0.041325	114	0.027554	152	0.020667
39	0.080467	77	0.040789	115	0.027315	153	0.020532
40	0.078459	78	0.040266	116	0.027079	154	0.020399

For circles of other diameters, multiply length given in table by diameter of circle.

Example: In a drill jig, 8 holes, each $\frac{1}{2}$ inch diameter, were spaced evenly on a 6-inch diameter circle. To test the accuracy of the jig, plugs were placed in adjacent holes, and the distance over the plugs was measured with a micrometer. What should be the micrometer reading?

Solution: The micrometer reading equals the diameter of one plug plus 6 times the chordal distance between adjacent hole centers given in the table above. Thus, the reading should be $\frac{1}{2} + (6 \times 0.382683) = 2.796098$ inches.

Gage Blocks

The primary standard for linear measurement is the *gage block*. Gage blocks were originally called the Jo-Block after its Swedish inventor, Carl Edvard Johansson. These precision lapped blocks are the primary means of establishing measurement traceability to the prime standards located in the national laboratories of every country, which are themselves defined by the distance traveled by light in a vacuum over a fixed time period.

The gage block is very critical in establishing true traceability and measurement assurance in the dimensional discipline. There are several materials and grades of gage blocks to select from. The most common material in use today is steel. However there is also Cro-Bloc, made by Mitutoyo, a thermally stable material with a very low coefficient of thermal expansion, and ceramic blocks, with extremely good wear capabilities. The average life span of a gage block is approximately 3 years. With proper care and cleaning the gage block may last many years longer but will eventually wear beyond the limits of the allowable tolerances and need to be replaced.

The size tolerances applied to gage blocks, defined in the ANSI/ASME B89.1.9-2002, are shown in **Tables 1a** and **1b**, for inch and metric units, respectively. Nearly all gage blocks are manufactured and calibrated to this standard. B89.1.9 establishes the allowable deviations for size variance as well as flatness and parallelism. It is these controlled dimensions that give the gage block the properties necessary for use as a dimensional standard.

Table 1a. Maximum Permitted Deviations of Length at Any Point^a and Tolerance on Variation in Length^b, Inch ANSI/ASME B89.1.9-2002

Nominal Length Range, l_n inches	Calibration Grade K		Grade 00		Grade 0		Grade AS-1		Grade AS-2	
	Limit on Deviations of Length ^a	Tolerance for Variation in Length ^b	Limit on Deviations of Length ^a	Tolerance for Variation in Length ^b	Limit on Deviations of Length ^a	Tolerance for Variation in Length ^b	Limit on Deviations of Length ^a	Tolerance for Variation in Length ^b	Limit on Deviations of Length ^a	Tolerance for Variation in Length ^b
	$\pm t_e$ μ in.	t_v μ in.	$\pm t_e$ μ in.	t_v μ in.	$\pm t_e$ μ in.	t_v μ in.	$\pm t_e$ μ in.	t_v μ in.	$\pm t_e$ μ in.	t_v μ in.
≤ 0.05	12		4		6		12		24	
$0.05 < l_n \leq 0.4$	10		3		5		8		18	
$0.55 < l_n \leq 1$	12	2	3	2	6	4	12	6	24	12
$1 < l_n \leq 2$	16		4		8		16		32	
$2 < l_n \leq 3$	20		5		10		20		40	14
$3 < l_n \leq 4$	24		6		12		24		48	
$4 < l_n \leq 5$	32	3	8	3	16	5	32	8	64	16
$5 < l_n \leq 6$	32		8		16					
$6 < l_n \leq 7$	40		10		20					
$7 < l_n \leq 8$	40	4	10	4	20	6	40	10	80	
$8 < l_n \leq 10$	48		12		24		48		104	18
$10 < l_n \leq 12$	56		14		28	7	56		112	20
$12 < l_n \leq 16$	72	5	18	5	36	8	72	12	144	24
$16 < l_n \leq 20$	88		20		44		88	14	176	
$20 < l_n \leq 24$	104	6	25	6	52	10	104	16	200	28
$24 < l_n \leq 28$	120	7	30	7	60	12	120	18	240	
$28 < l_n \leq 32$	136		34		68		136		260	32
$32 < l_n \leq 36$	152	8	38	8	76	14	152	20	300	36
$36 < l_n \leq 40$	160	10	40	10	80	16	168	24	320	40

^a Maximum permitted deviations of length at any point, $\pm t_e$ μ inch, from nominal length, l_e inches.

^b Tolerance, t_v μ inch, for the variation in length.

Care of Gage Blocks.—Through proper care and handling of gage blocks the functional life span can be maximized and many years of use can be realized from your investment. The basic care and cleaning of gage blocks should follow these simple guidelines.

Table 1b. Maximum Permitted Deviations of Length at Any Point^a and Tolerance on Variation in Length^b, Metric ANSI/ASME B89.1.9-2002

Nominal Length Range, l_n mm	Calibration Grade K		Grade 00		Grade 0		Grade AS-1		Grade AS-2	
	Limit on Deviations of Length ^a	Tolerance for Variation in Length ^b	Limit on Deviations of Length ^a	Tolerance for Variation in Length ^b	Limit on Deviations of Length ^a	Tolerance for Variation in Length ^b	Limit on Deviations of Length ^a	Tolerance for Variation in Length ^b	Limit on Deviations of Length ^a	Tolerance for Variation in Length ^b
	$\pm t_e$ μm	t_v μm	$\pm t_e$ μm	t_v μm	$\pm t_e$ μm	t_v μm	$\pm t_e$ μm	t_v μm	$\pm t_e$ μm	t_v μm
≤ 0.5	0.30		0.10		0.14		0.30		0.60	
$0.5 < l_n \leq 10$	0.20	0.05		0.05	0.12		0.20	0.16	0.45	
$10 < l_n \leq 25$	0.30		0.07		0.14	0.10	0.30		0.60	0.30
$25 < l_n \leq 50$	0.40	0.06	0.10	0.06	0.20		0.40	0.18	0.80	
$50 < l_n \leq 75$	0.50		0.12	0.07	0.25	0.12	0.50		1.00	0.35
$75 < l_n \leq 100$	0.60	0.07	0.15		0.30		0.60	0.20	1.20	
$100 < l_n \leq 150$	0.80	0.08	0.20	0.08	0.40	0.14	0.80		1.60	0.40
$150 < l_n \leq 200$	1.00	0.09	0.25	0.09	0.50		1.00		2.00	
$200 < l_n \leq 250$	1.20		0.30		0.60	0.16	1.20	0.25	2.40	0.45
$250 < l_n \leq 300$	1.40	0.10	0.35	0.10	0.70	0.18	1.40		2.80	
$300 < l_n \leq 400$	1.80	0.12	0.45	0.12	0.90	0.20	1.80	0.30	3.60	0.50
$400 < l_n \leq 500$	2.20	0.14	0.50	0.14	1.10		2.20	0.35	4.40	0.60
$500 < l_n \leq 600$	2.60	0.16	0.65	0.16	1.30	0.25	2.60	0.40	5.00	
$600 < l_n \leq 700$	3.00	0.18	0.75	0.18	1.50		3.00	0.45	6.00	0.70
$700 < l_n \leq 800$	3.40		0.85		1.70	0.30	3.40		6.50	0.80
$800 < l_n \leq 900$	3.80	0.20	0.95	0.20	1.90		3.80	0.50	7.50	0.90
$900 < l_n \leq 1000$	4.20	0.25	1.00	0.25	2.00	0.40	4.20	0.60	8.00	1.00

^a Maximum permitted deviations of length at any point, $\pm t_e$ μm , from nominal length, l_e mm.

^b Tolerance, t_v μm , for the variation in length.

1) Always keep gage blocks clean and well oiled when not in direct use. The use of alcohol is acceptable as a cleaner but it is always advisable to coat the gage block with a rust inhibitor when placing them back in the case. A very light machine oil is recommended.

2) Take great care when removing gage blocks from the case so as not to nick or damage the working surface. Clean with a soft cloth or chamois and isopropanol. Never touch gage blocks with bare hands. Oil from fingers will cause corrosion on the bare metal surface.

3) Always keep the gage blocks over a soft cloth or chamois when handling or wringing them together. Dropping the gage blocks onto a hard surface or other gage blocks will damage the working surface and cause an error beyond the limits of the tolerance. Always handle the gage blocks as highly accurate precision instruments.

4) Should the gage block surface show signs of degradation and the wringing together of blocks become difficult, the surface may need to be deburred. The use of a serrated sintered aluminum oxide deburring stone is recommended to recondition the surface and renew the ability to join the gage blocks through wringing. Caution must be exercised when deburring the surface of the gage blocks so the surface is not damage instead of repaired.

5) Gently place the gage block flat on the serrated block. With two fingers (using gloves), press down firmly, but not hard, on the gage block and slide it lengthwise over the serrations on the block for three or four strokes until the surface feels very smooth. Turn the gage block over and repeat the movement. Remove and clean the gage block thoroughly.

6) It is important that the serrated sintered aluminum oxide deburring stone is cleaned as well, and metal deposits, oils, and dirt are not allowed to build up on the surface. A cotton packing impregnated with a metal solvent will clean the serrated sintered aluminum oxide deburring stone.

Calibration and Verification of Gage Blocks.— The calibration and verification of gage blocks should be completed on a regular basis. This is done to maintain measurement assurance in every good quality program. The quality assurance program will determine the optimal interval for recalibration of the gage block sets to maintain the appropriate

level of measurement assurance. Calibration of the gage blocks should be done by an approved and if necessary certified calibration laboratory that provides impartial third party confirmation of the calibrated features of the gage block set.

Precision Gage Blocks.—Precision gage blocks are usually purchased in sets comprising a specific number of blocks of different sizes. The nominal gage lengths of individual blocks in a set are determined mathematically so that particular desired lengths can be obtained by combining selected blocks. They are made to several different tolerance grades which categorize them as master blocks, calibration blocks, inspection blocks, and workshop blocks. *Master blocks* are employed as basic reference standards; *calibration blocks* are used for high precision gaging work and calibrating inspection blocks; *inspection blocks* are used as toolroom standards and for checking and setting limit and comparator gages, for example. The *workshop blocks* are working gages used as shop standards for direct precision measurements and gaging applications, including sine-bars.

Federal Specification GGG-G-15C, Gage Blocks (see below), lists typical sets, and gives details of materials, design, and manufacturing requirements, and tolerance grades. When there is in a set no single block of the exact size that is wanted, two or more blocks are combined by “wringing” them together. Wringing is achieved by first placing one block crosswise on the other and applying some pressure. Then a swiveling motion is used to twist the blocks to a parallel position, causing them to adhere firmly to one another.

When combining blocks for a given dimension, the object is to use as few blocks as possible to obtain the dimension. The procedure for selecting blocks is based on successively eliminating the right-hand figure of the desired dimension.

Example: Referring to inch size gage block set number 1 below, determine the blocks required to obtain 3.6742 inches. *Step 1:* Eliminate 0.0002 by selecting a 0.1002 block. Subtract 0.1002 from 3.6743 = 3.5740. *Step 2:* Eliminate 0.004 by selecting a 0.124 block. Subtract 0.124 from 3.5740 = 3.450. *Step 3:* Eliminate 0.450 with a block this size. Subtract 0.450 from 3.450 = 3.000. *Step 4:* Select a 3.000 inch block. The combined blocks are $0.1002 + 0.124 + 0.450 + 3.000 = 3.6742$ inches.

Gage Block Sets, Inch Sizes (Federal Specification GGG-G-15C).—*Set Number 1 (81 Blocks):* First Series: 0.0001 Inch Increments (9 Blocks), 0.1001 to 0.1009; Second Series: 0.001 Inch Increments (49 Blocks), 0.101 to 0.149; Third Series: 0.050 Inch Increments (19 Blocks), 0.050 to 0.950; Fourth Series: 1.000 Inch Increments (4 Blocks), 1.000 to 4.000 inch.

Set Numbers 2, 3, and 4: The specification does not list a set 2 or 3. Gage block set number 4 (88 blocks), listed in the Specification, is not given here; it is the same as set number 1 (81 blocks) but contains seven additional blocks measuring 0.0625, 0.078125, 0.093750, 0.100025, 0.100050, 0.100075, and 0.109375 inch.

Set Number 5 (21 Blocks): First Series: 0.0001 Inch Increments (9 Blocks), 0.0101 to 0.0109; Second Series: 0.001 Inch Increments (11 Blocks), 0.010 to 0.020; One Block 0.01005 inch.

Set Number 6 (28 Blocks): First Series: 0.0001 Inch Increments (9 Blocks), 0.0201 to 0.0209; Second Series: 0.001 Inch Increments (9 Blocks), 0.021 to 0.029; Third Series: 0.010 Inch Increments (9 Blocks), 0.010 to 0.090; One Block 0.02005 Inch.

Long Gage Block Set Number 7 (8 Blocks): Whole Inch Series (8 Blocks), 5, 6, 7, 8, 10, 12, 16, 20 inches.

Set Number 8 (36 Blocks): First Series: 0.0001 Inch Increments (9 Blocks), 0.1001 to 0.1009; Second Series: 0.001 Inch Increments (11 Blocks), 0.100 to 0.110; Third Series: 0.010 Inch Increments (8 Blocks), 0.120 to 0.190; Fourth Series: 0.100 Inch Increments (4 Blocks), 0.200 to 0.500; Whole Inch Series (3 Blocks), 1, 2, 4 Inches; One Block 0.050 inch.

Set Number 9 (20 Blocks): First Series: 0.0001 Inch Increments (9 Blocks), 0.0501 to 0.0509; Second Series: 0.001 Inch Increments (10 Blocks), 0.050 to 0.059; One Block 0.05005 inch.

Gage Block Sets, Metric Sizes (Federal Specification GGG-G-15C).—*Set Number 1M (45 Blocks):* First Series: 0.001 Millimeter Increments (9 Blocks), 1.001 to 1.009; Second Series: 0.01 Millimeter Increments (9 Blocks), 1.01 to 1.09; Third Series: 0.10 Millimeter Increments (9 Blocks), 1.10 to 1.90; Fourth Series: 1.0 Millimeter Increments (9 Blocks), 1.0 to 9.0; Fifth Series: 10 Millimeter Increments (9 Blocks), 10 to 90 mm.

Set Number 2M (88 Blocks): First Series: 0.001 Millimeter Increments (9 Blocks), 1.001 to 1.009; Second Series: 0.01 Millimeter Increments (49 Blocks), 1.01 to 1.49; Third Series: 0.50 Millimeter Increments (19 Blocks), 0.5 to 9.5; Fourth Series: 10 Millimeter Increments (10 Blocks), 10 to 100; One Block 1.0005 mm.

Set Number 3M: Gage block set number 3M (112 blocks) is not given here. It is similar to set number 2M (88 blocks), and the chief difference is the inclusion of a larger number of blocks in the 0.5 millimeter increment series up to 24.5 mm.

Set Number 4M (45 Blocks): First Series: 0.001 Millimeter Increments (9 Blocks), 2.001 to 2.009; Second Series: 0.01 Millimeter Increments (9 Blocks), 2.01 to 2.09; Third Series: 0.10 Millimeter Increments (9 Blocks), 2.1 to 2.9; Fourth Series: 1 Millimeter Increments (9 Blocks), 1.0 to 9.0; Fifth Series: 10 Millimeter Increments (9 Blocks), 10 to 90 mm.

Set Numbers 5M, 6M, 7M: Set numbers 5M (88 blocks), 6M (112 blocks), and 7M (17 blocks) are not listed here.

Long Gage Block Set Number 8M (8 Blocks): Whole Millimeter Series (8 Blocks), 125, 150, 175, 200, 250, 300, 400, 500 mm.

Surface Plates

The surface plate is the primary plane from which all vertical measurements are made. The quality and dependability of this surface is one of the most critical elements in dimensional inspection measurement. Originally made from cast iron, the present day granite plate was first developed during WW II as a result of the fact that all the metal was being used in the war effort. Faced with a need to check precision parts, Mr. Wallace Herman, a metal working and monument shop owner, decided to investigate the use of granite as a suitable replacement for the then common cast iron surface plate and manufactured the first granite surface plate in his shop in Dayton, OH.

Although surface plates have changed in their design and materials, the basic concept has remained the same. The stability and precision that can be achieved with granite is actually far superior to cast iron and is much easier to maintain. With the proper care and maintenance, a well made surface plate can last for generations and always remain within the parameters of the grade to which it was originally made, or even better.

Materials and Grades of Surface Plates.—The selection of a surface plate is driven directly by the specific application the plate will be used for. A plate, for instance, that will be used in a very large machining facility would be primarily concerned with the load bearing properties and secondarily in surface flatness accuracy, although both are important concerns. A surface plate that will be used in a metrology laboratory or high precision inspection department with a high volume of work would be concerned with high accuracy and surface wear properties. In each case the material and design would be considered for the application in mind before a selection is made and a purchase initiated.

The material properties of the granite is what makes the difference in the performance of surface plate. The differences in the various types of granite are considered in [Table 1](#), based on Federal Specification GGG-P-463c, Plate, Surface (Granite) (Inch and Metric).

Table 1. Granite Rock-types, Physical Properties, and Mineral Components GGG-P-463c

Rock-type	Natural Color	Texture	Mineral Constituents, Descending Order Of Abundance	Modulus of Elasticity	
				10 ⁶ psi	GPa
Biotite granite	Bluish gray	Fine grained	Orthoclase, smoky quartz ^a , oligoclase, albite, biotite, muscovite, magnetite and zircon	3.5–7.0	24.1–48.2
	Light gray	Medium grained	Oligoclase, orthoclase and microcline, quartz, biotite, apatite and zircon	3.5–7.0	24.1–48.2
	Pink		Orthoclase with a small amount of microcline, plagioclase, quartz ^a , biotite, magnetite, and garnet	5.0–9.0	34.4–62.0
Biotite hornblende granite	Reddish brown	Fine grained	Orthoclase and microcline, quartz ^a , hornblende, biotite, plagioclase and magnetite	6.0–9.0	41.3–62.0
Biotite-muscovite	Light gray	Medium to fine grained	Microcline, quartz, plagioclase, biotite, muscovite and magnetite	5.0–7.0	34.4–48.2
Diabase	Dark gray	Fine grained	Plagioclase, pyroxene and magnetite	9.0–12.0	62.0–82.7
Hypersthene Gabbro			Plagioclase, pyroxene, hornblende, magnetite and biotite	10.0–12.0	68.9–82.7
Muscovite-biotite granite-gneiss	Light gray	Medium grained	Microcline and orthoclase, oligoclase, quartz, rutile, muscovite	3.5–8.0	24.1–55.1

^a28 to 32% quartz by volume. In certain conditions, high quartz content tends to increase wear life.

As indicated in **Table 1**, the fine grained pink granite containing a small amount of quartz has a lower modulus of elasticity and therefore a lower load bearing per square foot capacity. The presence of the large quartz crystals however result in a high degree of wearability by providing an ultra smooth surface finish with increased surface hardness that resists wear on the granite and the precision ground and lapped instruments used on it. Although the load bearing properties are lower than that of the black or dark gray granite this can be compensated for by increasing the thickness of the plate.

As a result of the increased wearability of pink granite the interval between lapping compared to fine grained black granite can be as much as five times as long. This is an important consideration when planning the maintenance costs and downtime involved in maintaining a production schedule.

The precision lapped and calibrated granite surface plate is a high precision piece of equipment and must be maintained as such. Great care should be taken at all time to protect the surface and attention to cleanliness is critical in the life span of the surface plate. It is essential that the surface be protected from the buildup of dirt, grease, airborne grime and oils. The plate should be covered when not in use to avoid accidentally dropping objects on the surface and chipping or cracking the precision finished surface.

All surface plates should be installed and supported according to manufacturers design and recommendations. Plates up to and including 6 × 12 feet are supported in a three point non-distortable support system of hard rubber pads that are installed during manufacturing and remain in place during lapping and finishing. These pads are critical in the correct support of the surface plate and must never be removed or repositioned. Always make sure the surface plate is resting on these pads and never support the plate by its ledges or under the four corners, as this will cause deformation of the surface and introduce errors beyond the tolerance limits.

Surface plates made to meet standard guidelines and accuracy parameters established over the last fifty years and published in documents such as the Federal Specification GGG-P-463c will be manufactured in certain pre-designed sizes. These designs have been analyzed for dimensional stability and dependability and will, with proper care, provide dependable measurement assurance for many years. There are manufacturers that will special order surface plates in a wide variety of sizes and configurations to meet the needs of

specialized applications and these manufacturers have engineering staffs that will design a surface plate to meet those needs. However most applications and manufacturers products fall under the design guidelines of the tables in the GGG-P-463c Federal Specification.

Table 2a. Standard Sizes for Rectangular Granite Surface Plates GGG-P-463c

Inch				Metric			
Width (inch)	Length (inch)	Calculated Diagonal (inch)	Area (ft ²)	Width (mm)	Length (mm)	Calculated Diagonal (mm)	Area (m ²)
12	12	17.0	1	300	300	424	0.090
	18	21.6	1.5		350	541	0.135
18	18	25.5	2.25	450	450	636	0.202
	24	30.0	3		600	750	0.270
24	24	33.9	4	600	600	849	0.360
	36	43.3	6		900	1082	0.540
	48	53.7	8		1200	1342	0.720
36	36	50.9	9	900	900	1273	0.810
	48	60.0	12		1200	1500	1.080
	60	70.0	15		1500	1749	1.350
	72	80.5	18		1800	2012	1.620
48	48	67.9	16	1200	1200	1697	1.440
	60	76.9	20		1500	1921	1.800
	72	86.5	24		1800	2163	2.160
	96	107.3	32		2400	2683	2.880
	120	129.2	40		3000	3231	3.600
60	120	134.2	50	1500	300	3304	4.500
72	96	120.0	48	1800	2400	3000	4.320
	144	161.0	72		3600	4025	6.480

Table 2b. Standard Sizes for Round Granite Surface Plates GGG-P-463c

Inch		Millimeter	
Diameter (inch)	Area (ft ²)	Diameter (mm)	Area (m ²)
12	0.8	300	0.071
18	1.8	450	0.159
24	3.1	600	0.283
36	7.1	900	0.636
48	48	1200	1.131

Thickness: For rectangular and round surface plates, specify thickness only if essential; see Appendix 30 and inch and metric versions of Tables XI and XII of GGG-P-463c.

Surface plate grades are established in the Federal Specifications and are the guidelines by which the plates are calibrated. The flatness tolerances in microinches for standard inch-dimension plates, listed in **Table 3a**., are obtained through the standard formula:

$$\text{Total flatness tolerance for inch-dimension grade AA plates} = 40 + \frac{D^2}{25} \mu\text{in.}$$

where D = diagonal or diameter of the plate in inches. The calculated flatness tolerance for grade AA is rounded to the nearest 25 μ in.

For metric plate sizes, the total flatness tolerance of grade AA plates in micrometers is:

$$\text{Total flatness tolerance for metric grade AA plates} = 1 + 1.62D^2 \times 10^{-6} \mu\text{m}$$

where D = diagonal or diameter of the plate in millimeters.

For both the inch and metric plates, the tolerances of the A and B grades are 2 and 4 times, respectively, those for grade AA.

Tables 3a and **3b**, adapted from Federal Specification GGG-P-463c contains the calculated tolerances for the standard size and grades of rectangular and round surface plates.

Table 3a. Total Flatness Tolerance, Rectangular Surface Plates GGG-P-463c

Rectangular Plates									
Inch Sizes, Tolerances in Microinches					Millimeter Sizes, Tolerances in Micrometers				
Width (inch)	Length (inch)	Grade AA	Grade A	Grade B	Width (mm)	Length (mm)	Grade AA	Grade A	Grade B
12	12	50	100	200	300	300	1.3	2.6	5.2
	18	50	100	200		450	1.5	2.9	5.9
18	18	50	100	200	450	450	1.6	3.3	6.6
	24	75	150	300		600	1.9	3.8	7.6
24	24	75	150	300	600	600	2.2	4.3	8.6
	36	100	200	400		900	2.9	5.7	11.5
	48	150	300	600		1200	3.9	7.8	15.5
36	36	150	300	600	900	900	3.6	7.2	14.4
	48	200	400	800		1200	4.6	9.2	18.4
	60	250	500	1000		1500	5.9	11.8	23.6
	72	300	600	1200		1800	7.5	15.0	29.9
48	48	200	400	800	1200	1200	5.6	11.2	22.4
	60	300	600	1200		1500	6.9	13.8	17.6
	72	350	700	1400		1800	8.5	17.0	33.9
	96	500	1000	2000		2400	12.5	25.0	50.0
60	120	700	1400	2800	1500	3000	17.7	35.4	70.8
	120	750	1500	3000		3000	18.5	36.9	73.9
72	96	600	1200	2400	1800	2400	15.4	30.8	61.6
	144	1100	2200	4400		3600	26.9	53.8	107.7

Table 3b. Total Flatness Tolerance, Round Surface Plates GGG-P-463c

Round Plates							
Inch Sizes, Tolerances in Microinches				Millimeter Sizes, Tolerances in Micrometers			
Diameter (inch)	Grade AA	Grade A	Grade B	Diameter (mm)	Grade AA	Grade A	Grade B
12	50	100	200	300	1.1	2.3	4.6
18	50	100	200	450	1.3	2.5	5.3
24	75	150	300	600	1.6	3.2	6.3
36	100	200	400	900	2.3	4.6	9.2
48	125	250	500	1200	3.3	6.6	13.2

Calibration of Surface Plates.—Surface plates, like other precision instruments, will drift out of tolerance in time and need to be periodically checked and even adjusted to maintain accuracy. For a surface plate this adjustment involves lapping the surface and physically removing material until the entire surface is once again flat to within the limits of the grade that it was made. This is a labor intensive adjustment that should only be attempted by a trained technician with the appropriate tools. An untrained technician, even with the proper lapping tools and compounds, may cause more harm than good when attempting such an adjustment.

However, with proper care and cleaning a surface plate may not need lapping at every calibration. Completing the calibration process will give the quality assurance program the data needed to identify wear patterns on a surface plate and have the proper maintenance completed before an out of tolerance condition occurs, thereby avoiding a costly failure impact analysis and reinspection of parts, or even a recall of finished parts from a customer. The calibration process is a cost effective alternative to these undesirable effects.

Fig. 1 illustrates the “Union Jack” or eight line pattern that is used to analyze the overall flatness of the surface plate working area. Each line is measured independently and the positive and negative elevations are recorded at predetermined intervals. The peak to val-

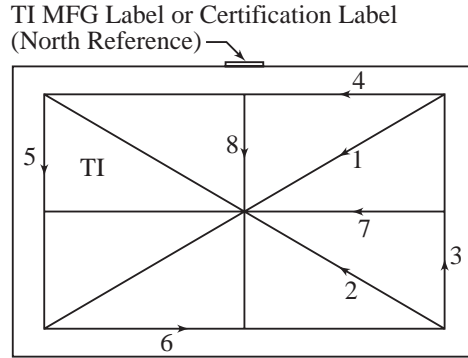


Fig. 1. Union Jack pattern

ley flatness is calculated from the recorded data. This method was developed by JC Moody while working for the Sandia Corp. and the resulting plot of the data points is referred to as a Moody Plot. There are many software packages available that simplify the process of calculating this plot and provide a detailed printout of the data in a graphical format.

Repeat-o-Meter Method (Fed. Spec. GGG-P-463c).—The easiest and quickest method of monitoring for surface plate wear and tolerance adherence is the Repeat-o-Meter method. A *repeat reading gage* similar in design to the one shown in Fig. 2 is used to establish the variation in flatness of the surface plate.

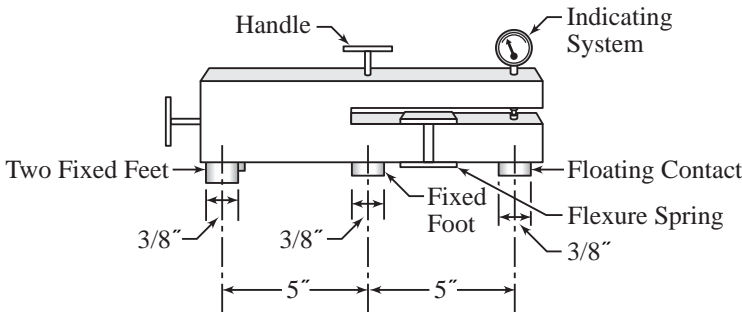


Fig. 2. Repeat Reading Gage from Federal Specification GGG-P-463c

The gage is placed at the center of the surface plate and the indicator is set to zero. The eight line Union Jack pattern, Fig. 1, is then scanned in the sequence defined in the Federal Specification GGG-P-463c. The result of the maximum reading minus the minimum reading shall not exceed the flatness tolerance expressed in Tables 4a and 4b for inch and millimeter sized plates, respectively.

Table 4a. Tolerance for Repeat Reading of Measurement (microinches)

Diagonal / Diameter Range		Grade AA	Grade A	Grade B	Obtained
Over	Thru	Full Indicator Movement (FIM), microinches			
...	30	35	60	110	When not specified
30	60	45	70	120	
60	90	60	80	160	
90	120	75	100	200	
120	150	90	120	240	
150	...	100	140	280	
All Sizes		25	50	100	When specified

Table 4b. Tolerance for Repeat Reading of Measurement (micrometers)

Diagonal / Diameter Range (mm)		Grade AA	Grade A	Grade B	Obtained
Over	Thru	Full Indicator Movement (FIM), micrometers			
...	800	35	60	110	When not specified
800	1500	45	70	120	
1500	2200	60	80	160	
2200	3000	75	100	200	
3000	3800	90	120	240	
3800	...	100	140	280	
All Sizes		0.6	1.3	2.5	When specified

Note for Tables 4a and 4b: If it is intended that small objects be measured on large surface plates, it should be noted that a larger tolerance in flatness over small areas is permitted on larger plates.

All points on the work surface shall be contained between two parallel planes, the roof plane and the base plane. The distance between these planes shall be no greater than that specified in the tolerance table for the respective grades.

Autocollimator Calibration (Ref NAVAIR 17-20MD-14, 1 MAY 1995).—Calibration of a surface plate by autocollimator is one of the most accurate and relatively quickest methods in use today. The method has been in use since the advent of the autocollimator in the 1940s but was refined by JC Moody with the development of the Moody plot analysis method that utilized the data collected on perimeters, diagonals and bisectors. The resulting pattern resembles the “Union Jack” and is referred to as such.

Autocollimators today have been enhanced with the inclusion of CCD devices, digital readouts, computer interfacing, and automatic data collection that calculates the deviations and analyzes the results in a fraction of the time previously required, producing a full color graphical diagram of the surface plate variances.

Figs. 3 and 4 show the positioning of the turning mirrors used when performing the surface plate calibration with an autocollimator.

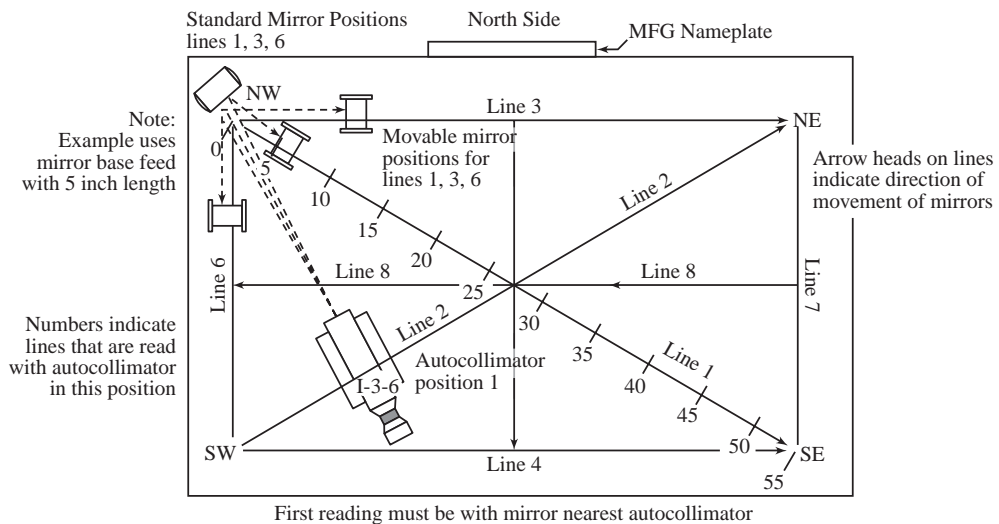


Fig. 3. Placement of the first turning mirror and retroreflector: TO 33K6-4-137-1

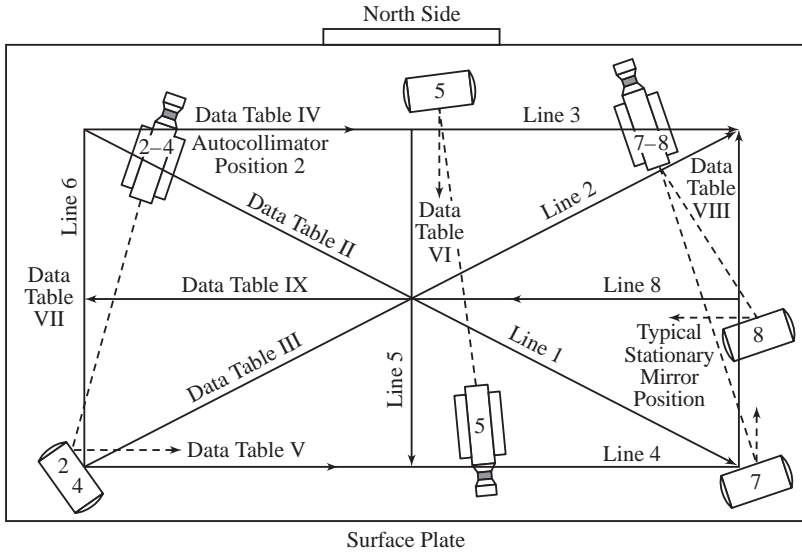


Fig. 4. Turning mirror placement for remaining lines: TO 33K6-4-137-1

Interferometer Calibration (Ref TO 33K6-4-10-1 30 April 2006).—Calibration of a surface plate can also be accomplished using a laser interferometer. The laser offers the absolute lowest uncertainty in the calibration process and although it takes more time than either of the other methods it is sometimes required by some customers that do military or government contract work. There are several models and methods available on the market today. The general process will be covered but familiarity with the particular model being used is necessary to complete the full calibration procedure.

The process is much the same as the autocollimator calibration method using turning mirrors. The laser tripod and laser head are located as close to the line being shot as possible. Move the tripod and realign the laser interferometer for each line during calibration. If available, use the turning mirrors to facilitate the alignment of the beam. As with any high precision physical measurements, air currents and vibrations will affect the indications. Take precautions to minimize these affects. Clean the surface plate twice with surface plate cleaner and once again with ethyl alcohol prior to beginning the calibration process.

Mark the surface with lines as shown in Fig. 5 below. The lines will be either 3 or 4 inches away from the edge of the surface plate depending on the size of the plate. The North side of the plate will always be the side bearing the manufacturers label or the previous calibration label.

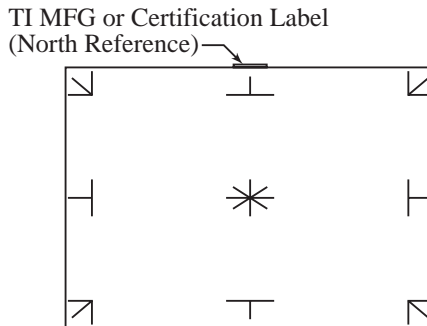


Fig. 5. Reference lines for Union Jack 1

Clamp the straight edge to the surface plate in the position shown in Fig. 6 below. The straightedge will always be offset from the center of the line so that the centerline of the mirror will travel directly above the center of the reference line.

Place the interferometer and retroreflector on the reference line closest to the laser head. Direct the beam through the interferometer optics and using the vertical and horizontal adjustments on the tripod head adjust until the beam returns through the optics and registers a strong beam strength on the beam strength indicator.

Slide the retroreflector to the far end of the reference line and use the rotation adjustment on the tripod head to swing the beam back into alignment with the laser head until once again the beam strength indicator shows a strong beam strength. Using this method of Translate Near / Rotate Far you will be able to align the beam with the path of the reference line. Patience will be required and the manufacturer will also have information regarding the best method for the specific model being used.

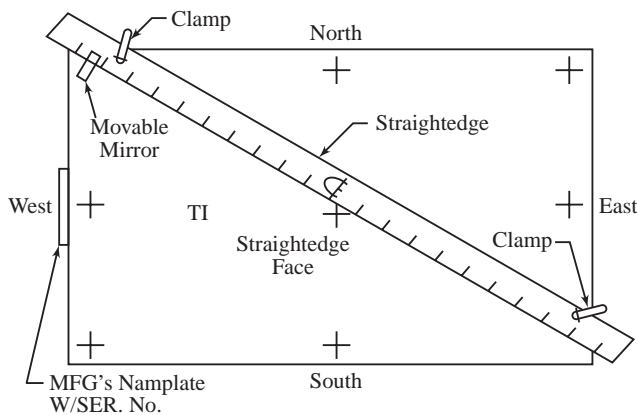


Fig. 6. Placement of the straightedge for measurement of the first reference line

Once the alignment of the first reference line has been completed, take the measurements at the stations recommended by the software calculations. The number of stations will change according to the size of the surface plate and the length of the footpad used for the retroreflector. Record the values at each station along the first reference line then return to the first position and verify that the reading repeats before proceeding to the next line. Great care must be taken to ensure a clean plate and footpad, free of residue or buildup. A very small amount of dirt or dust can cause an out of tolerance condition and result in many wasted hours of failure impact analysis and possibly recall of parts to be reinspected unnecessarily.

When the data from all the reference lines has been collected, the interferometer software will calculate the overall flatness of the plate and make the determination as to whether or not the plate meets the specific grade to which it has been assigned or needs to be lapped to meet tolerance limits. If there is a failure determination, the plate will need to be lapped and reshot to collect the "As Left" data and close the calibration event with an acceptance of the calibration data.

Lapping a surface plate is a very specific skill and should not be attempted by an amateur or enthusiastic technician however good the intentions may be. Lapping requires specialized tools and compounds as well as skill. Attempting to lap a surface plate by an inexperienced technician may well cause more damage than is already present. Always consult an experienced and proven professional in this field.

Parallel Bars

Parallel bars are used for workpiece support during layout, machining, and inspection operations. Parallel bars are made from either steel, cast-iron, or granite, come in a wide range of sizes and are either used alone or in matched pairs. In general, there are four types of parallel bars; Type I, Solid; Type II, Ribbed; Type III, Box; Type IV, Adjustable. Although the parallel bar is a relatively simple tool it is still considered a precision instrument and must be handled with the same attention to care and handling as other precision ground and finished supporting gages. Most precision parallels are made from heat treated steel and hardened to a Rockwell C55 to 60. Generally they have a finish of Ra 8 μin with a fine finish free from all grind marks, chatter, or cracks. Granite parallel bars are also very desirable in an environment where thermal expansion is a consideration or where steel or cast iron would not be acceptable. Granite parallel bars are made to a very high degree of accuracy and can be used in a precision inspection setup.

Type I, Solid .—Type I parallel bars are designed to be used independently as an individual bar to aid in inspection setups. They can be used as a reference surface or to establish a vertical plane perpendicular to a base plane. They can also be used as an extended support plane, when used in matched pairs, to establish an elevated plane that is parallel to the base plane. Type I parallel bars have four finished sides that shall not vary from a true plane by more than 0.0002 inch per foot (0.005mm/300mm). The adjacent sides will be square to each other within 0.0005 inch (0.012mm). Type I parallel bars will appear similar to Fig. 1 and will meet the tolerance specifications stated in Table 1.

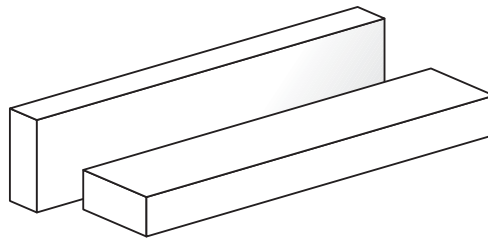


Fig. 1. Parallel Bars, Type 1, Solid

Table 1. Steel and Cast Iron Parallel Bar Tolerances, Inch Sizes

Size ^a	Tolerance Limits			Width/Height Variance Matched Pairs (in.)
	Straightness (in.)	Parallelism (in.)	Width/Height (in.)	
Inch Sizes				
(in.)	(in.)	(in.)	(in.)	(in.)
1/8 to 3/16	0.002	0.0001	0.0002	0.0002
1/4 to 3/4	0.0005	0.0001	0.0002	0.0002
3/4 to 1-1/8	0.0002	0.0001	0.0002	0.0002
1-1/8 to 1-1/2	0.0002	0.00015	0.0003	0.0003
1-1/2 to 3	0.0002	0.0002	0.0004	0.0004
Millimeter Sizes				
(mm)	(mm)	(mm)	(mm)	(mm)
3 to 5	0.0500	0.0025	0.0050	0.0050
6 to 20	0.0130	0.0025	0.0050	0.0050
20 to 25	0.0050	0.0025	0.0050	0.0050
25 to 35	0.0050	0.0040	0.0080	0.0080
35 to 75	0.0050	0.0050	0.0100	0.0100

^a Size as applicable to either width or height dimension specified by the manufacturer

Some common size configurations available from most manufacturers of Type I precision parallel bars appear in Table 2. This is a representation of sizes that are available, however it is possible to have parallel bars custom made to a special order for a particular application. In which case either the tolerance specifications of the engineering drawing or the specifications defined in the Federal Specification GGG-P-61a shall apply. It is at the discretion of the designing engineer which tolerances will apply in this case.

Table 2. Common Sizes of Parallel Bars

Width and Height (in.)	Length ± 0.002 (in.)	Width and Height (in.)	Length ± 0.002 (in.)	Width and Height (in.)	Length ± 0.002 (in.)
$\frac{1}{8} \times 1$	6	$\frac{7}{16} \times \frac{7}{8}$	6	$\frac{1}{2} \times 1\frac{1}{2}$	12
$\frac{1}{8} \times 1\frac{3}{16}$	6	$\frac{1}{2} \times \frac{5}{8}$	6	$\frac{1}{2} \times 2$	12
$\frac{3}{16} \times \frac{7}{8}$	6	$\frac{1}{2} \times \frac{3}{4}$	6	$1\frac{1}{16} \times 1\frac{1}{4}$	12
$\frac{3}{16} \times 1\frac{1}{8}$	6	$\frac{1}{2} \times 1\frac{3}{16}$	6	$\frac{3}{4} \times 1$	12
$\frac{1}{4} \times \frac{3}{8}$	6	$\frac{1}{2} \times 1$	6	$\frac{3}{4} \times 2$	12
$\frac{1}{4} \times \frac{1}{2}$	6	$\frac{1}{4} \times \frac{3}{8}$	9	$1 \times 1\frac{1}{2}$	12
$\frac{1}{4} \times \frac{5}{8}$	6	$\frac{1}{2} \times \frac{5}{8}$	9	1×2	12
$\frac{1}{4} \times \frac{3}{4}$	6	$\frac{1}{2} \times 1$	9	1×3	12
$\frac{1}{4} \times 1$	6	$\frac{1}{2} \times 1\frac{1}{4}$	9	$1\frac{1}{4} \times 1\frac{3}{4}$	12
$\frac{3}{8} \times \frac{1}{2}$	6	$\frac{1}{2} \times 1\frac{1}{2}$	9	$1\frac{1}{4} \times 2\frac{1}{2}$	12
$\frac{3}{8} \times \frac{3}{4}$	6	$\frac{3}{4} \times 1$	9	$1\frac{1}{2} \times 2$	12
$\frac{3}{8} \times \frac{7}{8}$	6	$\frac{3}{4} \times 1\frac{1}{2}$	9	$1\frac{1}{2} \times 3$	12
$\frac{3}{8} \times 1$	6	$\frac{3}{8} \times 1$	12		

Type II, Ribbed.—The Type II parallel bars are rectangular in cross section and made from a cast grey iron. The casting is ribbed to provide lightness while maintaining strength and rigidity. The ribbing on the Type II parallel bar extends to the outer surfaces of the bar and becomes an integral part of the working surface. The working surfaces of the Type II have a fine ground surface that will not exceed a Ra value of 16 μin. All the sharp edges are removed and the surface is free from all machining marks such as grind chatter or burn. The Type II parallel bar is finished on the four sides of its length. The ends not being considered working surfaces are not finished for work applications. The Type II parallel bar is a much more rugged design than the Type I and is designed to support workpieces of larger dimensions. Type II parallel bars are commonly available in sizes up to 4 by 8 inches with a length of 36 inches. Although larger in overall size, the Type II still maintains a very close tolerance in straightness, parallelism, and squareness.

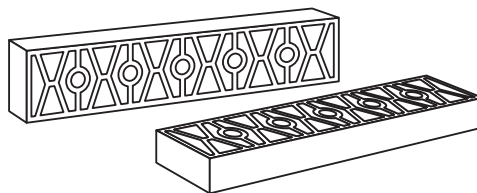


Fig. 2. Parallel Bars, Type II, Ribbed

After each bar is cast and rough ground the bar is subject to a seasoning or aging process. This process can either be natural or artificial. The aging process is necessary to provide long term stability after finish grinding. Once the bar is aged and seasoned the final dimensions will remain stable and not warp or twist for many years. Well made and seasoned castings have been known to be in service for nearly 100 years and still hold their original geometry. Type II parallel bars will appear similar to Fig. 2 and will conform to the toler-

ances defined in **Table 3**. Squareness and parallelism tolerances are Total Indicated Readings (TIR) over the full length of the bar.

The following table shows some common sizes that are readily available from most manufacturers of precision parallel bars. These are representative of the sizes that may be available in the general market and almost any size or combination may be special made for a specific application.

Table 3. Tolerance Limits for Type II - Ribbed Parallel Bars

Size	Tolerance Limits			Width/Height Variance Matched Pairs
	Straightness	Parallelism	Squareness	
Inch Sizes				
(inch)	(inch)	(inch)	(inch)	(inch)
1½ × 3 × 24	0.0002	0.0005	0.0005	0.0005
2 × 4 × 24	0.0002	0.0005	0.0005	0.0005
2½ × 5 × 24	0.0002	0.0005	0.0005	0.0005
3 × 6 × 36	0.0002	0.0005	0.0005	0.0005
4 × 8 × 36	0.0002	0.0005	0.0005	0.0005
Millimeter Sizes				
(mm)	(mm)	(mm)	(mm)	(mm)
35 × 75 × 600	0.005	0.013	0.013	0.013
50 × 100 × 600	0.005	0.013	0.013	0.013
50 × 152 × 600	0.005	0.013	0.013	0.013
75 × 150 × 1000	0.005	0.013	0.013	0.013
100 × 200 × 1000	0.005	0.013	0.013	0.013

Type III, Box Parallel.—The Type III “Box” Parallel are designed to provide a wide working surface. The Type III can either be square or rectangular in cross section. The rectangular design will have a rib running through the middle of the block the entire length. This provides support to the two larger surfaces. The surfaces of all six sides will be finish ground to a Ra average of 16μ inches and all sharp edges will be removed. The ground surfaces will all be free from grind chatter marks and grind burn marks.

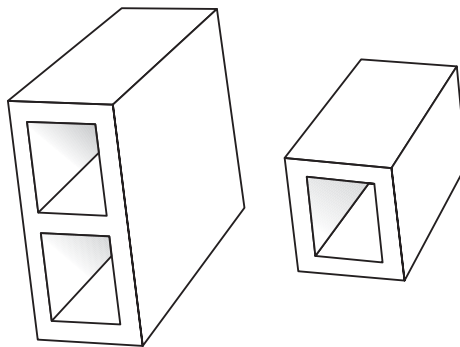


Fig. 3. Type III, Box Parallel

The Type III parallel bar, after casting and rough grinding will be subject to a seasoning or aging process. This process can either be artificial or natural. This aging process insures the stability of the material after the grinding process. The finished Type III parallel bars will have a material hardness of Brinell 180 checked with a 10mm ball and a 3000 Kg load.

Each of the six working surfaces will not vary from a true plane (straightness) by more than 0.0002 inch per foot. The opposite sides and ends will be parallel to each other within 0.0005 inch. All adjacent sides will be square to each other within 0.0005 inch as well. The

size as specified will also be within 0.0005 inch. The Type III box parallel will appear similar to Fig. 3. Tolerances are given in Table 4.

Table 4. Tolerance Limits for Type III Box Parallel

Size (in)	Straightness (in)	Squareness (in)	Parallelism (in)
4 × 4 × 6	0.0001	0.0005	0.0005
4 × 6 × 6	0.0001	0.0005	0.0005
5 × 8 × 12	0.0002	0.0005	0.0005
10 × 10 × 10	0.0001	0.0005	0.0005

Type IV, Adjustable Parallel.—The adjustable parallel is a precision parallel that is adjustable to any height within a specified range. This design allows a flexibility in the use of the parallel that the other designs do not possess. The adjustable parallel is made of close grained, seasoned cast iron. After initial casting and rough machining the members of the parallel are subject to an aging or seasoning process. This process can either be natural or artificial. When complete, the member will have a hardness value of no less than a Rockwell “B” scale 87. The final machining on the adjustable parallel shall have a finish of Ra 16 μin on the working surfaces and a Ra 32 μin on the sides. The sides of the adjustable parallel are not designed to be working surfaces.

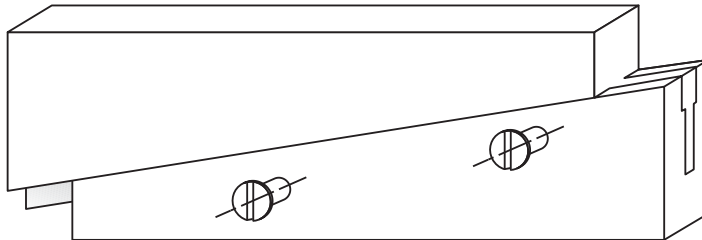


Fig. 4. Type IV, Adjustable Parallel

The adjustable parallel is made of two pieces. One piece is a fixed member machined with a dovetail slot, and the other a sliding member machined with a dovetail that fits into the slot and slides smoothly. It is this feature that gives the adjustable parallel the ability to be adjusted to any height within the range specified. The width of the bearing surface between the two members will be 1/2 the total thickness of the parallel. The two members are held into place and fixed by a locking screw arrangement that secures the two members and prevents them from moving or slipping after they have been set. Adjustable parallels are supplied in either individual pieces or in sets that cover a wide range. The adjustable parallel will conform to the tolerances defined in Table 5 and will appear similar to Fig. 4. A bilateral tolerance will be applied to the parallelism and flatness

Table 5. Tolerance Limits for Type IV - Adjustable Parallel

Size (range) (in)	Length (in)	Thickness (in)	Parallelism (in)	Straightness (flatness) (in)	Lock Screws
0.375 - 0.500	1.750	9/32	0.0005	0.00005	1
0.500 - 0.6875	2.125	9/32	0.0005	0.00005	1
0.6875 - 0.9375	2.6875	9/32	0.0007	0.00007	1
0.9375 - 1.3125	3.5625	9/32	0.0007	0.00009	2
1.3125 - 1.750	4.1875	9/32	0.0009	0.00010	2
1.750 - 2.250	5.0625	9/32	0.0009	0.00012	2

Granite Parallel, High Precision.—The granite parallel is designed for the very high precision applications where thermal or magnetic properties must be taken into consideration. The granite parallel is made with a much tighter tolerance than the cast iron or steel

parallels. The configuration is basically the same as the Type I solid parallel, the only difference is in the material and the tolerance limits. The Granite parallel is supplied in either individual members or matched sets. Granite parallels must meet the tolerances defined in the table below and will appear similar to Fig. 1.

Table 6. Tolerance Limits - Granite Parallel

Size (in)	Grade AA	Grade A	Grade B
	Flatness and Parallelism	Flatness and Parallelism	Flatness and Parallelism
0.5 × 1 × 6	0.000025	0.00005	0.00010
0.750 × 1 × 6	0.00003	0.00006	N/A
0.750 × 1.5 × 9	0.00004	0.00008	0.00010
1 × 2 × 12	0.00006	0.00010	N/A
1.5 × 3 × 18	0.00015	0.00030	N/A
2 × 4 × 24	0.00020	0.00040	N/A
1.5 × 4 × 30	0.00025	0.00040	N/A

Calibration, Precision Parallel Bars, Naval Air Systems and Air Force Metrology.—

It is commonly understood that wear and naturally occurring damage will affect the performance of all precision measuring equipment. Identifying an out of tolerance condition before it can impact a critical measurement is the primary goal of calibration. Parallel bars are no exception to this rule. A precision ground steel or cast iron parallel bar may become worn or even deformed from daily wear or excessive forces applied. A granite parallel can also show evidence of wear, and due to the extremely close tolerances applied to granite parallel bars the monitoring of these instruments is even more critical. It is not extremely difficult to perform the calibration of the parallel bar and it can be achieved in a relatively short period of time in a temperature controlled environment on a clean surface plate with an electronic indicator, a height transfer standard, and a few gage blocks. The features that will be observed are Flatness, Parallelism and Height and Width of matched pairs. The exact height and width of individual parallel bars is not a critical feature but in this status they can only be used independently.

As an additional note, a Pratt & Whitney Supermicrometer can be used to measure the exact height and width of a set of matched parallel bars, but in the absence of this instrument, the same results can be achieved with the instruments listed above. The uncertainty of the measurement is effectively the same and the confidence in the results is just as high with either method.

Flatness (Straightness) Calibration Method.—In any calibration the first steps are to ensure a clean working surface and a proper setup of the standards and measuring instruments. To that end, the first step is to clean the surface plate thoroughly with an approved surface plate cleaner and place the electronic indicator next to the working. The indicator should be powered up and allowed to warm up. The surface plate should be of an accuracy grade to provide a surface flatness deviation no greater than 0.00005" within the working surface that will be used. The *UUT* or *Unit Under Test* should be cleaned and, as a preliminary step to calibration, should be deburred with a clean ultra-fine hard Arkansas stone or gage block deburring stone. Only the edges should be stoned as this is where most burrs will occur. However all edges corners and surfaces should be observed to ensure no damage or burring is present before proceeding.

For precision cast iron or steel parallel bars the UUT will be set up on two gage blocks of the same size and accuracy grade. A 2.000" gage block is recommended as a minimum. This will allow access both sides of the parallel bar when taking data to determine the flatness of each side. It is important that the gage blocks are placed at the correct points to support the UUT without any sagging effect on the bar. These are called *Airy points* and are calculated by a simple formula:

$$\text{Airy point separation distance} = 0.554L, \text{ where } L \text{ is the length of the UUT.}$$

Example: For a 12.00" UUT, the gage blocks should be placed $0.554 \times 12.00 = 6.650$ inches apart and located $(12.00 - 6.650)/2 = 2.675$ inches from each end, as shown in Fig. 5. This distance should be very close to the calculated distance but it does not have to exact. Establishing the distance using a machinists rule within 0.100" is sufficient.

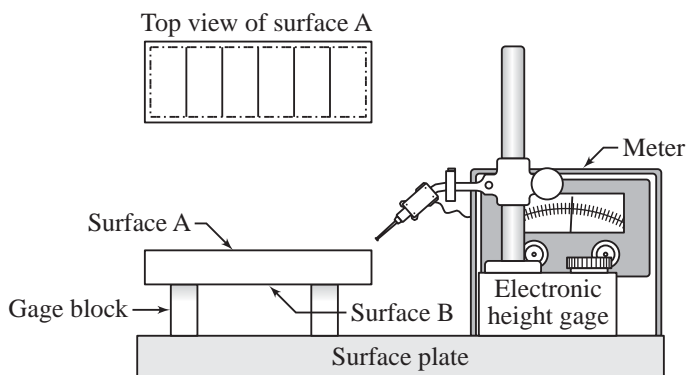


Fig. 5. Parallel Bar Flatness Setup

The UUT will be marked at five points equally spaced along the distance of each surface. The marks should be done with a felt tipped marker or other suitable method. By general convention the largest parallel surfaces are designated A and B. The two smaller surfaces are C and D. The markings A1 through D1 and A2 through D2 should be aligned with one another. A datasheet similar to the one shown in Table 7 should be created to collect the data and aid in the calculations of the deviations.

With the UUT placed on the gage blocks as shown, configure the electronic indicator to measure “over” and set the indicator amplifier range to ± 0.0002 with a resolution of 0.00001". It is recommended however to begin the readings at a slightly higher range and dial the scale in to a more sensitive resolution to determine the magnitude of the error. This will keep the readings on scale. Take the final readings in the highest sensitivity scale.

Place the indicator contact point on the UUT at the A1 position and zero the amplifier. All readings will have the x1 position as the zero point. (A1, B1, C1, D1) All deviations will be from this point.

Sweep the surface of the UUT, recording on the datasheet the deviation as indicated at each of the calibration points. Ensure that each point does not exceed the documented tolerance for the type, style, grade, and size of the UUT.

When Side A has been scanned adjust the electronic indicator contact point for “Under” measurements and place the contact point at the B1 calibration point and zero the indicator amplifier. This measurement is taken from the underside of the UUT and the data collected will be used to calculate the parallelism of the two sides A to B. Once again sweep the surface and record the deviations of the surface at each of the designated calibration points. Verify that all readings for sides A and B are within the tolerance limits assigned to the UUT.

Parallelism will be calculated from the sum of the deviations of each side. Calculate the sum of the deviations at each calibration point for surfaces A and B. The sum of the deviations will reveal the parallelism of the two surfaces. Verify that the values calculated are within the assigned tolerances for the UUT.

Carefully move the UUT to the adjacent sides (C and D) with side C up and repeat the sequence to determine the flatness and parallelism for sides C and D. Once complete and the values have been determined to be within the assigned tolerance limits, remove the UUT from the gage blocks and place on the surface pate. If this is a matched set of parallel

Table 7. Calibration of Parallel Bar and Matched Parallel Bar Sets

Straightness				
Surface A	Nominal	As Found	As Left	Tolerance
Zero Setting (Point 1)				
Cal Point 2				
Cal Point 3				
Cal Point 4				
Cal Point 5				
Surface B (under)	Nominal	As Found	As Left	Tolerance
Zero Setting (Point 1)				
Cal Point 2				
Cal Point 3				
Cal Point 4				
Cal Point 5				
Surface C	Nominal	As Found	As Left	Tolerance
Zero Setting (Point 1)				
Cal Point 2				
Cal Point 3				
Cal Point 4				
Cal Point 5				
Surface D (under)	Nominal	As Found	As Left	Tolerance
Zero Setting (Point 1)				
Cal Point 2				
Cal Point 3				
Cal Point 4				
Cal Point 5				
Parallelism Calculations				
Sum Surfaces A + B	Nominal	As Found	As Left	Tolerance
A2 + B2				
A3 + B3				
A4 + B4				
A5 + B5				
Sum Surfaces C + D	Nominal	As Found	As Left	Tolerance
C2 + D2				
C3 + D3				
C4 + D4				
C5 + D5				

bars place the second member on the gage blocks as for the first member and complete the sequence for the second member.

Height and Width, Matched Sets.—The calibration of height and width of matched sets of steel or cast iron parallel bars is a relatively simple process. Place the two parallel bars side by side on the surface plate in the same orientation. That is with the same side up and the predefined calibration points adjacent to each other. One parallel bar will be designated as “A” and the other as “B”.

Position the height transfer gage next to the parallel bars and dial the transfer gage to the dimension of the side under test. Zero the electronic indicator on the transfer gage. Pull back the indicator probe off the land of the transfer gage and then replace it onto the land and ensure the zero setting repeats. If it does not repeat, re-zero the indicator amplifier and repeat the reading again. Verify the zero setting in this manner until the reading repeats three times in a row with no variation. Then move the indicator probe to the surface of the “A” parallel bar and observe the deviation from zero reading. Sweep the entire surface and verify that all readings fall within the tolerance limits defined for the type and grade under test. Return the indicator probe to the transfer gage land and confirm that the zero point has not shifted before accepting the readings observed. If the zero point has shifted it will be necessary to repeat the zero point setup and take the readings from the parallel bar again. If the readings are acceptable proceed to the “B” parallel bar and verify that the deviation

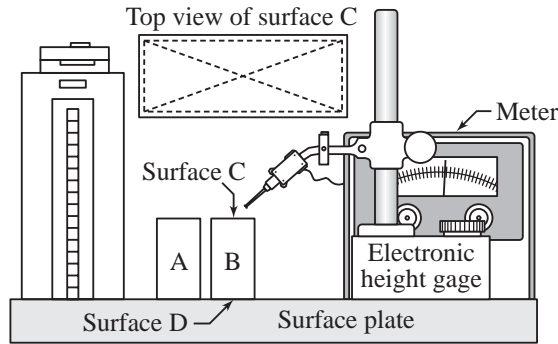


Fig. 6. Parallel Bar Matched Set, Height and Width Calibration

from zero reading is within the tolerance limits defined and the deviation from the “A” block are not beyond the limits for the type and grade under test.

The size limitations for the granite parallel bars are not as rigid for the individual bars. The acceptable limits for size being $\pm 1/32$ inch. However the tolerance for size for the matched sets is the same as for the steel and cast iron. The calibration procedure for the granite parallel bars is the same as for steel and cast iron.

As a final note it should be mentioned that a Pratt & Whitney Supermicrometer can also be used to calibrate the height and width of a parallel bar or a matched set of parallel bars. The Supermicrometer is set up using a gage block or gage block stack to the precise dimension of either the height or width of the parallel bar and zeroed at that point. The gage block is then removed and the parallel bar is set on the elevating table between the anvils of the Supermicrometer and supported by two flatted rounds. The parallel bar is then measured at the first calibration point and the reading compared to the tolerance limits to assure compliance. The bar is then measured at each remaining calibration point, verifying at each point the compliance to the tolerance limits. This same process is then completed for the “B” parallel bar in the matched set and the values obtained in the measurement of the “A” bar are compared to assure the deviations in the matched sizes are within the tolerance limits. This method is very good for smaller parallel bar matched sets if a Supermicrometer is available.

Right Angle Plates

Right angle plates or knees, as they are more generally referred to, are divided into six different types as defined in Federal Specification GGG-P-441A. Right angle plates are used in both machining applications and the setup and inspection of machined parts and assemblies. The plate material is usually high grade, fine grained, controlled process iron or iron alloy castings. These castings are always of uniform quality, free from blow holes, porosity or other material inconsistencies, and defects. All castings after being rough cut are stress relieved to assure dimensional stability and become more stable as they age. With proper care and surface maintenance angle plates can perform for many years. Fine angle plates over 50 years old are still in service.

Right-angle Plate Grades.—Most right angle plates are manufactured to meet the guidelines and tolerances laid out in the GGG-P-441A or IS 2554:1971 (India Standards Bureau). While these two governing documents may differ slightly from each other, they both achieve the goal of establishing dimensional guidelines and tolerances that enable the manufacturer to produce a dependably consistent product with values and accuracies that the customer requires to maintain a high degree of measurement confidence in their quality systems.

Angle plates come in grades according to the surface finish that is applied and the dimensional accuracies that they are manufactured to. The assigned grade is in direct correlation

to the quality and accuracy of the angle plate. Federal Specification GGG-P-441A specifies three *Grades* of surface finish applied to right angle plates. In addition, there are six distinct *Types* of angle plates that have unique properties according to their specifically designed target uses in the manufacturing process.

Grade A angle plates are the highest grade of plates and are used in precise applications where the smallest deviation from square (90°) is required. These plates are used in various industries for clamping and holding work in a vertical position. The scraped surface is beneficial for supporting work in a very precise vertical plane and facilitating the dispersion of lubricants and coolants during the manufacturing process. Grade A plates are required to have working surfaces that are fine precision scraped with relief spots to prevent sticking of gage blocks or precision lapped instruments. These relief spots allow the surface to be controlled to a high degree of flatness. Each square inch of surface on a Grade A plate has 15 to 18 spotting cavities, from 0.0002" to 0.0005" deep, and a bearing surface of 20 to 40%. The bearing area does not deviate from the mean plane by more than 0.0001 inch in over 24 inches, and no more than 0.0002 inch in up to 60 inches, as per **Table 1**. No square inch may vary from the adjacent area by more than 0.0001" per square foot. The adjacent working surfaces on any Grade A angle plate shall not vary from square by more than 0.0001" in every 8". This equates to 2.5 arc seconds. These angle plates make excellent fixturing for high precision shaping, milling, grinding, drilling, or boring operations.

Table 1. Maximum Permissible Deviation of Bearing Area from Main Plane (GGG-P-441A)

Maximum dimension of working surface, inches		Maximum permissible deviation of bearing areas from mean plane, inch	
Above	To and including	Grades A and B	Grade C
2½	12	0.0001	0.0002
12	24		
24	36	0.0002	0.0004
36	48		0.0006
48	60		0.0008

Grade B plates are made to meet requirements of precision inspection and calibration operations. Although the style of the plate can accommodate uses in any of the manufacturing practices, the precision ground surface finish lends itself to inspection applications on the surface plate and use in calibration laboratories, high precision inspection stations, or situations where a fine precision ground finish is desired and the highest degree of accuracy necessary. The Grade B angle plate has a working surface that is precision ground to a roughness average value of not more than 16 microinches for plates less than 64 square inches and 32 microinches for larger plates. The precision ground surface of the Grade B plate is well suited to the applications involved in the inspection process of high accuracy, tight tolerance, precision made parts. The fine ground finish offers a precise surface that does not deviate from the mean plane by more than 0.0001 inch in over 24 inches, and no more than 0.0002 inch in up to 60 inches, as per **Table 1**. No adjacent areas shall vary with each other by more than 0.0001 inch per square foot. The aspect that is most critical about the angle plate is the control of squareness and the ability to pass on the accuracy to the parts being machined or inspected. All adjacent working surfaces will not vary from square by more than 0.0001 inch in every 8 inches. This high degree of accuracy in the Grade A and Grade B angle plates provides the measurement assurance necessary to inspect precision parts and calibrate precision measuring instruments.

Grade C angle plates are the workhorses of the plate grades. Designed to have a smooth machined finish and controlled to not exceed a surface roughness of 32 r.m.s. The bearing area of the working surface shall not exceed a deviation from the mean plane any greater than between 0.0002 to 0.0008 inch depending on the size of the bearing area, as per **Table 1**. Furthermore no adjacent square foot may deviate from another by more than 0.0003 inch

per square foot. This ensures that the bearing surface is tightly controlled in the graduation of allowable error and will not deviate from the mean plane beyond the allowable limits. Deviation beyond the allowable graduation limits will introduce an error in the surface flatness beyond the functional limits. This flatness deviation control enables the surface of the angle plate to support the workpiece in such a manner as to not introduce errors due to nonuniform support beneath the workpiece or squareness errors from the adjacent sides.

IS 2554:1971 Grades: Standard sizes and accuracy of angle plates specified by IS 2554:1971 (India Standards Bureau) are given in **Tables 2a** and **2b**.

Table 2a. Sizes and Accuracy of Slotted Angle Plates Metric Sizes (IS 2554:1971)

Size (mm) <i>L × B × H</i>	Accuracy in Microns, μm			
	Flatness of Working Faces	Squareness of Working Faces over Dimension <i>H</i>	Parallelism of Opposite Faces & Edges over their Total Length	Squareness of End Faces with Respect to Exterior Faces as Measured over Dimension <i>L</i>
Grade 1				
150 × 100 × 125	5	10	13	13
150 × 150 × 150	5	10	13	13
175 × 100 × 125	5	13	15	15
200 × 150 × 125	8	15	18	18
250 × 150 × 175	8	15	18	18
300 × 200 × 225	8	18	20	20
300 × 300 × 300	8	18	20	20
350 × 200 × 250	8	18	20	20
450 × 300 × 350	10	18	20	20
400 × 400 × 400	10	18	20	20
600 × 400 × 450	10	20	23	23
Grade 2				
700 × 420 × 700	50	140	140	140
900 × 600 × 700				
1000 × 700 × 500				

Table 2b. Sizes and Accuracy of Slotted Angle Plates Inch Sizes (IS 2554:1971)

Size (in) <i>L × B × H</i>	Accuracy in Inches			
	Flatness of Working Faces	Squareness of Working Faces over Dimension <i>H</i>	Parallelism of Opposite Faces & Edges over their Total Length	Squareness of End Faces with Respect to Exterior Faces as Measured over Dimension <i>L</i>
Grade 1				
6 × 4 × 5	0.0002	0.0004	0.0005	0.0005
6 × 6 × 6	0.0002	0.0004	0.0005	0.0005
7 × 6 × 5	0.0002	0.0005	0.0006	0.0006
8 × 6 × 5	0.0003	0.0006	0.0007	0.0007
10 × 6 × 7	0.0003	0.0006	0.0007	0.0007
12 × 8 × 9	0.0003	0.0007	0.0008	0.0008
12 × 12 × 12	0.0003	0.0007	0.0008	0.0008
14 × 8 × 10	0.0003	0.0007	0.0008	0.0008
18 × 12 × 14	0.0004	0.0007	0.0008	0.0008
16 × 16 × 16	0.0004	0.0007	0.0008	0.0008
24 × 16 × 18	0.0004	0.0008	0.0009	0.0009
Grade 2				
28 × 16 × 28	0.002	0.0055	0.0055	0.0055
36 × 24 × 28				
24 × 16 × 18				

Angle Plate Types.—The right angle plate is further divided into *Types* and *Classes*, each type having unique characteristics and uses. Types I, II, and III angle plates or knees are intended to be used by craftsmen for ordinary machine shop operations; Types IV, V, and VI are intended to be used principally by toolmakers and for precision type work.

Type I: Class 1-Plain Right-angle Plate and Class 2-Slotted Right-angle Plate: The Type I Class 1 angle plate has two members with the outside surfaces at right angles to each other. Both the working surfaces and the ends are machined square to within the tolerance limits assigned to their grade, (Fig. 1a). Type I Class 2 plates are similar to Class 1 with the vertical and horizontal slots provided on one or both faces, (Fig. 1b).

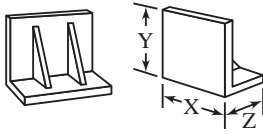


Fig. 1a. Type I Class 1-Plain

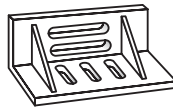


Fig. 1b. Type I Class 2-Slotted

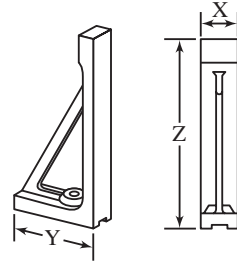


Fig. 1c. Type I Class 3, Measuring-Plain

All the right angle plates of the various types have ribbing of sufficient thickness to assure maximum support for flatness, squareness, and stability. Class 1 plates of approximately 10 to 12 inches will have at least 2 ribs, 16 to 24 inches will have at least 3 ribs, and 36 inches and above will have a minimum of 4 ribs in their design.

Plates weighing over 75 pounds are designed with lifting holes in the ribbing or threaded holes for the placement of lifting eyes.

Type I, Class 3, Measuring Plane Right-angle Plate: The Type I Class 3 angle plate, Fig. 1c, is designed to establish a measuring plane for production or inspection functions. It has two outside working surfaces that are at right angles to each other. The working surfaces are finished according to the grade specified and are the only two faces designed for functional operation. Unless specifically ordered otherwise, the sides and ends will be finish ground only, and these surfaces are not to be used to determine or establish squareness. The rib provides support between the ends of the plate and is cored out to provide good hand gripping surface without sacrificing the stabilizing effect of the rib. The short base member “Y” is provided with a suitable hole so the plate may be bolted to the table of a machine or a tapped hole in a surface plate.

Type II, Inside Right-angle Plate: The Type II right angle plate is an inside right angle that is constructed with the same adherence to squareness and finish as the outside angle plates, Fig. 2. The inside angle plate is an inverted T-shaped casting formed by a base and a perpendicular member of approximately the same thickness. One side of the perpendicular, the adjacent top side of the base, and the bottom of the base are the three working surfaces and are all finished in accordance to the grade specified. The opposite ends and opposite sides are machined parallel and square to their respective working surfaces.

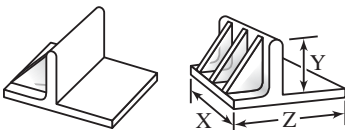


Fig. 2. Type II, Inside Right-angle Plate

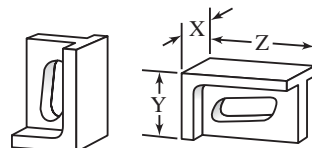


Fig. 3. Type III, Universal Right-angle Plates

Type III, Universal Right-angle Plate: By far the most versatile and useful right angle plate in the machine shop is the Type III universal right angle plate, Fig. 3. The Type III has two outside working surfaces at right angles and all adjacent sides are ground and finished to the same tolerance assigned to the main working surfaces. This provides a full range of positioning capabilities and makes the universal right angle just as accurate on its side as it is resting on its main working surface. All opposite sides are parallel within 0.0002 inch per foot. The universal right angle has a rib located between the ends that is square in configuration and provides support and stability to the main working surfaces while providing additional working surfaces which can be utilized for work support due to the accuracy assigned to the entire plate. The rib is hollowed out to provide good hand grip without sacrificing the stabilizing characteristics.

Type IV: Machinist's Adjustable Angle Plate: The Type IV adjustable angle plate, Fig. 4, is designed to allow rotation of the workpiece through 360°. The workpiece support table is adjustable from zero horizontal to 90° vertical in 10° increments. Basically the Type IV machinist's adjustable angle plate consists of a tilting table mounted on a rotary table base. The base has heavy lugs or bolt slots to accommodate mounting the plate on machine tools. The bottom of the base is machined true flat, parallel to the top plate and square to the vertical axis. The base is the true foundation of the plate and must be manufactured to the tightest of tolerances. All accuracies extend from the craftsmanship that is put into the base work of the Type IV plate. The top of the rotary base is graduated in one degree increments for the full 360° and is marked at least every 10° for a minimum of plus and minus 90° from zero (0°). Most plates are marked around the full 360° in 10° major divisions with 1° minor divisions, permanently engraved or etched on a chrome or brightly finished face for ease of reading and maintenance. The standard rotary accuracy to which all Type IV plates are made is ± 2.5 minutes, noncumulative. This tolerance maintains the accuracy ratio necessary to maintain a good measurement assurance level in your quality system.

The tilting table consists of two plates joined together at one end by a precision hinge and provided with an adjustable and positive locking mechanism. The bottom plate is attached to the base at the vertical axis. This plate will swivel through 360° freely and will also have a positive locking mechanism. The bottom of the plate is marked with a permanent line for accurate positioning in relation to the graduations on the base. The top plate is made in one piece as a casting and has T-slots milled in from the solid plate, as shown in Fig. 4.

The top plate is adjustable up to 90° and the positive locking mechanism is robust enough to secure the workpiece into position during milling, drilling, or boring operations without movement. The top plate is made with a protractor integrated into the design that is marked from 0° (horizontal) to 90° (vertical) with major scale indications at every 10°. Minor scale graduations may be indicated at 1° increments. The noncumulative error between graduations of the protractor is no greater than ± 2.5 minutes which allows for a high level of confidence in the measurements and operations made with this plate.

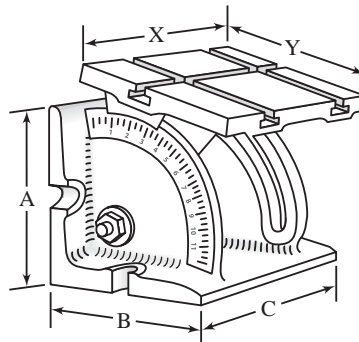
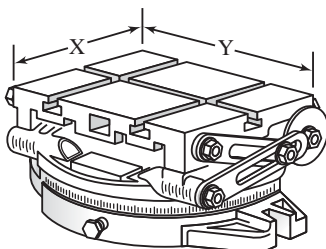


Fig. 4. Type IV, Machinist's Adjustable Angle Plate Fig. 5. Type V, Toolmaker's Adjustable Knee

Type V, Toolmaker's Adjustable Angle Plate: The toolmaker's adjustable knee or adjustable angle plate extends the capabilities of the right angle plate and allows for precise adjustment of the support table or bearing surface from 0° (horizontal) through 90° (vertical), Fig. 5. The same tolerances in regards to flatness and squareness applies to the bearing surface and the base.

The toolmakers adjustable knee is constructed of a plate, finished to the tolerances determined by the class specified, and a right angle iron with two ribs. The right angle iron and the plate are joined together by a precision hinge that has the capability to be secured at any position within the arc from 0° to 90° . The two ribs are of sufficient thickness to provide stability and support enough to withstand the forces applied during boring, milling, drilling, or grinding operations. The locking mechanism must be capable of maintaining its locked position under the same circumstances. The table is provided with T-slots for the mounting of the workpiece.

The adjustable angle plate has a quadrant scale that is divided into 90 divisions and a vernier scale. The vernier scale is graduated into 5 minute divisions from 0 to 60 minutes on either side of the zero index. The 0 (zero index) and every 15 minute index thereafter on both sides of 0 is clearly marked with the corresponding number and the 5 minute divisions are clearly readable. The quadrant scale has 1 degree divisions from 0° to 90° . The zero index and every 10° index following will be clearly marked with the corresponding number. A tolerance not to exceed plus or minus 2 minutes, noncumulative, is given for the error between any two graduations.

Due to their specialized nature the toolmakers adjustable angle plate usually is only manufactures in one size according to the GGG-P-441A Federal Specification.

Type VI: Toolmaker's Non-adjustable Angle Plate: The Type VI toolmaker's nonadjustable right angle plate is different from the other types in that it has two members. These members have two working surfaces at right angle to each other as well as a finished pad on the back of both working surfaces. The design is of sufficient thickness along with the ribbing to insure rigidity and stability in all operations and applications.

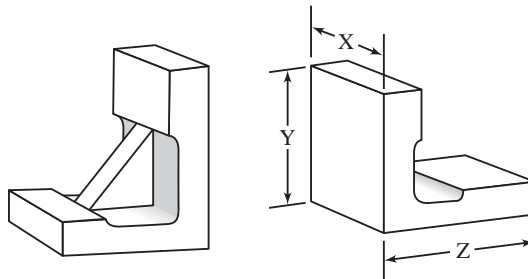


Fig. 6. Type VI, Toolmaker's Non-adjustable Knee

Both front sides and the back side pads are considered functional working surfaces and will be manufactured according to the grade specified. The working surfaces, the opposite sides, and the opposite ends are all machined parallel to each other and square to their respective working surfaces. All machined surfaces will meet the tolerance limits assigned to the specified grade for finish, flatness, squareness, and parallelism. The Type VI toolmaker's nonadjustable right angle plate will appear similar to Fig. 6.

Calibration and Maintenance of Right Angle Plates.—In many machine shops and quality assurance programs, right angle plates are not calibrated and are considered “Calibration Not Required” or “Reference Only” instruments that are not placed into the calibration recall system. Inevitably, this practice may lead to unknown error in a manufacturing operation or inspection procedure. However, calibration of a right angle plate may be an investment in quality if it becomes evident that an angle plate that has worn

out of squareness or flatness is introducing error in a machining operation or inspection process. There are several calibration procedures and methods for verifying the accuracy of the right angle plate.

Flatness Calibration: The first feature that should be calibrated is the flatness of the working surfaces. The tolerances for the calibration of any individual right angle plate is defined by the manufacturer and in their absence the GGG-P-441A shall provide an acceptable calibration tolerance. For Type I, II and VI angle plates, the setup for the flatness calibration will appear similar to Fig. 7.

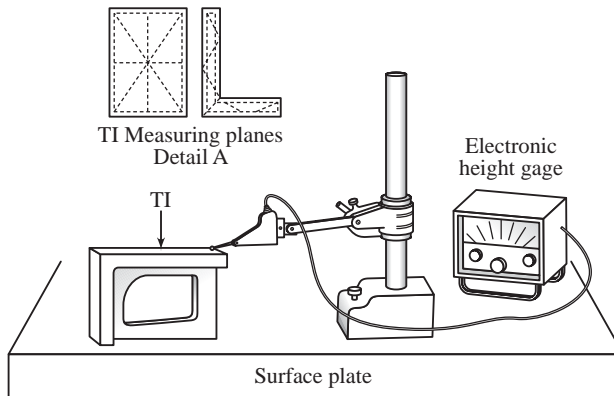


Fig. 7. Calibration of Surface Flatness

Place the angle plate (the *Test Instrument*, or *TI*) on the leveling plate, as shown, and use a jack stand or similar device to support the TI in position. A bubble level can assist in leveling the plate. When the plate has been leveled, use the electronic indicator to measure the surface following the pattern shown in the Detail A of Fig. 7. This pattern is generally called the Union Jack in that it resembles the stripes on the British flag.

Observe the readings and record the *maximum plus* and the *maximum minus* readings overall. Subtract the maximum minus reading from the maximum plus reading and the result is the overall flatness of the surface. This value must meet the manufacturers tolerance limits for the model under test or the tolerances specified in the GGG-P-441A. The same process is performed for the side opposite and the sides of the TI. All readings must meet the tolerances stated by the manufacturer or GGG-P-441A. Flatness is only checked on TIs that require external hardware for support and leveling on the surface plate. On units not requiring external support, such as Type III plates, flatness is checked as a function of the parallelism calibration.

Parallelism Calibration (Type III Right Angle): The Type III universal right angle plate has a parallelism tolerance due to the unique design of this unit. As was discussed previously the Type III is finished on all sides and is square and parallel to all working surfaces and sides opposite.

General Parallelism Tolerances	
Size Range	Total Indicator Reading
> 2.5 to 24 inches	0.0004 inch TIR
> 24 to 36 inches	0.0008 inch TIR
> 36 to 48 inches	0.0012 inch TIR
> 48 to 60 inches	0.0016 inch TIR

Before beginning the calibration process attention must be paid to the surface condition to be certain that no burrs or damage to the edges or surface is present that might affect the outcome of the measurements. A super fine grained “hard Arkansas stone” may be used to

remove any burrs on the edges or surfaces prior to beginning the calibration process. After the right angle plate is clean and free from burrs, the TI is placed on the surface plate as shown in Fig. 8. There is no need for a leveling plate as the side opposite is finished and parallel to the working surface, and the parallelism feature is what is being indicated.

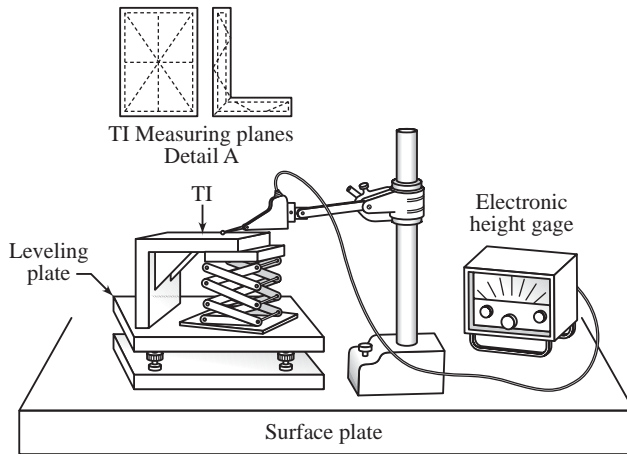


Fig. 8. Measuring Flatness/Parallelism of Type III Right-angle Plate

Using the electronic indicator as before, indicate the surface in the Union Jack pattern and record the maximum plus and the maximum minus readings overall. In general, it is a good idea to zero the electronic indicator in the center of the Union Jack and take the readings from that point. This provides an easily repeated starting point and provides an overall numerical picture of the parallelism of the surface. As before, subtract the minimum reading from the maximum and the result must meet the tolerance limits specified by the manufacturer or GGG-P-441A. Repeat this process for the remaining sides. All results must meet the stated tolerances.

Squareness Calibration (Preferred Method): The simplest method that can be used to verify the squareness of the Type III universal right angle plate, as well as the squareness of the other types, is quite sufficient when done properly to meet the accuracy ratio that is required for a high confidence level measurement. This method provides quantifiable data that can be assigned an uncertainty should the *Quality System* determine this necessary. This method provides a good measurement to verify the squareness value and identify any out of tolerance conditions before the error is passed on into the manufacturing or inspection process.

Place the angle plate (TI) on the surface plate with two 0.1005 inch gage blocks between the face of the angle plate and the face of the granite angle block, as shown in Fig. 9a.

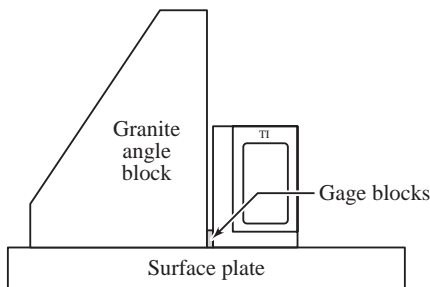


Fig. 9a. Gage Blocks Between TI and Granite Angle Block

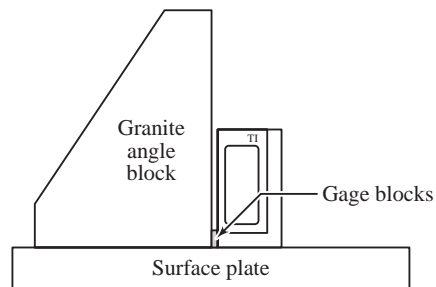


Fig. 9b. Gage Blocks Between Rotated TI and Granite Angle Block

Then, beginning with a 0.1000 inch gage block, gently insert the gage block between the TI and the granite angle block at the top edge of the TI. Continue placing increasingly larger gage blocks between the TI and the granite angle block until the next larger gage block cannot be inserted without moving the TI. A gentle force should be applied to make sure the gage block is in direct contact with the granite surface, and as the gage block slides between the TI and the granite there should be no resistance until reaching the gage block size that is too large to go between without moving the granite. Record the size of this block as Block A. Rotate the TI and place the side opposite against the granite angle block as shown in Fig. 9b. Repeat the gage block sequence as above and record the size of the gage block as Block B.

To calculate the squareness of the working faces of the rotated TI follow the formula:

$$\text{Squareness} = \frac{|A - B|}{2}$$

Example: Block A = 0.1001 inch and Block B = 0.1009 inch.

Solution: The calculation would be 0.1001 minus 0.1009 divided by 2. The result being (-)0.0004 in overall squareness of the working surfaces to a perfect perpendicular plane.

Repeat the sequence for all remaining sides opposite. All results must meet the tolerances specified by the manufacturer or the GGG-P-441A standard. If for any reason the results do not meet the specified tolerances it is possible to have the right angle plates refurbished at a fraction of the cost of a new one. It is also possible that the deviations may be acceptable to the quality system and if the results are discussed with the Quality Engineer the decision may be made to accept the unit "As Is" and annotate the deviation for future reference. The unit may also be downgraded to a less critical operation and the previous application be taken over by a new unit of acceptable condition. These decisions must be made by the quality engineers or quality managers and follow the guidelines of the quality system in place.

Measurements Using Light

Measuring by Light-wave Interference Bands.—Surface variations as small as two millionths (0.000002) inch can be detected by light-wave interference methods, using an optical flat. An optical flat is a transparent block, usually of plate glass, clear fused quartz, or borosilicate glass, the faces of which are finished to extremely fine limits (of the order of 1 to 8 millionths [0.000001 to 0.000008] inch, depending on the application) for flatness. When an optical flat is placed on a "flat" surface, as shown in Fig. 1, any small departure from flatness will result in formation of a wedge-shaped layer of air between the work surface and the underside of the flat.

Light rays reflected from the work surface and underside of the flat either interfere with or reinforce each other. Interference of two reflections results when the air gap measures exactly half a wavelength of the light used, and produces a dark band across the work surface when viewed perpendicularly, under monochromatic helium light. A light band is produced halfway between the dark bands when the rays reinforce each other. With the 0.0000232-inch-wavelength helium light used, the dark bands occur where the optical flat and work surface are separated by 11.6 millionths (0.0000116) inch, or multiples thereof.

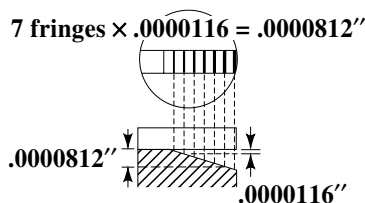


Fig. 1.

For instance, at a distance of seven dark bands from the point of contact, as shown in Fig. 1, the underface of the optical flat is separated from the work surface by a distance of 7×0.0000116 inch or 0.0000812 inch. The bands are separated more widely and the indications become increasingly distorted as the viewing angle departs from the perpendicular. If the bands appear straight, equally spaced and parallel with each other, the work surface is flat. Convex or concave surfaces cause the bands to curve correspondingly, and a cylindrical tendency in the work surface will produce unevenly spaced, straight bands.

Interferometer.—The interferometer is an instrument of great precision for measuring exceedingly small movements, distances, or displacements, by means of the interference of two beams of light. Instruments of this type are used by physicists and by the makers of astronomical instruments requiring great accuracy. Prior to the introduction of the interferometer, the compound microscope had to be used in connection with very delicate measurements of length. The microscope, however, could not be used for objects smaller than one-half a wave length of light. Two physicists (Professors Michelson and Morley) developed an instrument which was named the *interferometer*, for accomplishing in the laboratory what was beyond the range of the compound microscope. This instrument consisted principally of a system of optical mirrors arranged in such a way as to let the waves of light from a suitable source pass between and through them, the waves in the course of their travel being divided and reflected a certain number of times, thus making it possible to measure objects ten times smaller than was possible with the best compound microscope obtainable. Professor C.W. Chamberlain of Denison University invented another instrument known as the *compound interferometer* which is much more sensitive than the one previously referred to; in fact, it is claimed that it will measure a distance as small as one twenty-millionth of an inch. These compound interferometers have been constructed in several different forms.

An important practical application of the interferometer is in measuring precision gages by a fundamental method of measurement. The use of this optical apparatus is a scientific undertaking, requiring considerable time and involving complex calculations. For this reason all commercial methods of checking accuracy must be comparative, and the taking of fundamental measurements is necessarily confined to the basic or primary standards, such as are used to a very limited extent for checking working masters, where the greatest possible degree of accuracy is required. The interferometer is used to assist in determining the number of light waves of known wave length (or color) which at a given instant are between two planes coinciding with the opposite faces of a gage-block or whatever part is to be measured. When this number is known, the thickness can be computed because the lengths of the light waves used have been determined with almost absolute precision. The light, therefore, becomes a scale with divisions — approximately two hundred-thousandths inch apart.

SURFACE TEXTURE

American National Standard Surface Texture (Surface Roughness, Waviness, and Lay)

American National Standard ANSI/ASME B46.1-1995 is concerned with the geometric irregularities of surfaces of solid materials, physical specimens for gaging roughness, and the characteristics of stylus instrumentation for measuring roughness. The standard defines surface texture and its constituents: roughness, waviness, lay, and flaws. A set of symbols for drawings, specifications, and reports is established. To ensure a uniform basis for measurements the standard also provides specifications for Precision Reference Specimens, and Roughness Comparison Specimens, and establishes requirements for stylus-type instruments. The standard is not concerned with luster, appearance, color, corrosion resistance, wear resistance, hardness, subsurface microstructure, surface integrity, and many other characteristics that may be governing considerations in specific applications.

The standard is expressed in SI metric units but U.S. customary units may be used without prejudice. The standard does not define the degrees of surface roughness and waviness or type of lay suitable for specific purposes, nor does it specify the means by which any degree of such irregularities may be obtained or produced. However, criteria for selection of surface qualities and information on instrument techniques and methods of producing, controlling and inspecting surfaces are included in Appendixes attached to the standard. The Appendix sections are not considered a part of the standard: they are included for clarification or information purposes only.

Surfaces, in general, are very complex in character. The standard deals only with the height, width, and direction of surface irregularities because these characteristics are of practical importance in specific applications. Surface texture designations as delineated in this standard may not be a sufficient index to performance. Other part characteristics such as dimensional and geometrical relationships, material, metallurgy, and stress must also be controlled.

Definitions of Terms Relating to the Surfaces of Solid Materials.—The terms and ratings in the standard relate to surfaces produced by such means as abrading, casting, coating, cutting, etching, plastic deformation, sintering, wear, and erosion.

Error of form is considered to be that deviation from the nominal surface caused by errors in machine tool ways, guides, insecure clamping or incorrect alignment of the work-piece or wear, all of which are not included in surface texture. Out-of-roundness and out-of-flatness are examples of errors of form. See ANSI/ASME B89.3.1-1972, R2003 for measurement of out-of-roundness.

Flaws are unintentional, unexpected, and unwanted interruptions in the topography typical of a part surface and are defined as such only when agreed upon by buyer and seller. If flaws are defined, the surface should be inspected specifically to determine whether flaws are present, and rejected or accepted prior to performing final surface roughness measurements. If defined flaws are not present, or if flaws are not defined, then interruptions in the part surface may be included in roughness measurements.

Lay is the direction of the predominant surface pattern, ordinarily determined by the production method used.

Roughness consists of the finer irregularities of the surface texture, usually including those irregularities that result from the inherent action of the production process. These irregularities are considered to include traverse feed marks and other irregularities within the limits of the roughness sampling length.

Surface is the boundary of an object that separates that object from another object, substance or space.

Surface, measured is the real surface obtained by instrumental or other means.

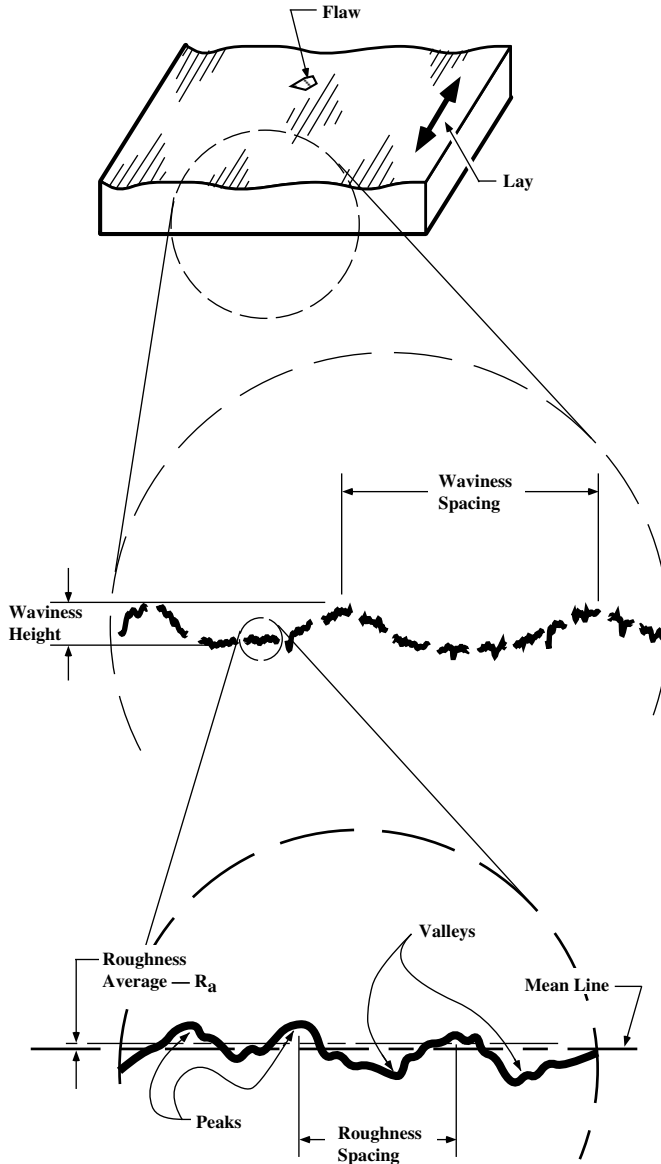


Fig. 1. Pictorial Display of Surface Characteristics

Surface, nominal is the intended surface contour (exclusive of any intended surface roughness), the shape and extent of which is usually shown and dimensioned on a drawing or descriptive specification.

Surface, real is the actual boundary of the object. Manufacturing processes determine its deviation from the nominal surface.

Surface texture is repetitive or random deviations from the real surface that forms the three-dimensional topography of the surface. Surface texture includes roughness, waviness, lay and flaws. Fig. 1 is an example of a unidirectional lay surface. Roughness and waviness parallel to the lay are not represented in the expanded views.

Waviness is the more widely spaced component of surface texture. Unless otherwise noted, waviness includes all irregularities whose spacing is greater than the roughness sampling length and less than the waviness sampling length. Waviness may result from

such factors as machine or work deflections, vibration, chatter, heat-treatment or warping strains. Roughness may be considered as being superposed on a 'wavy' surface.

Definitions of Terms Relating to the Measurement of Surface Texture.—Terms regarding surface texture pertain to the geometric irregularities of surfaces and include roughness, waviness and lay.

Profile is the contour of the surface in a plane measured normal, or perpendicular, to the surface, unless another other angle is specified.

Graphical centerline. See Mean Line.

Height (z) is considered to be those measurements of the profile in a direction normal, or perpendicular, to the nominal profile. For digital instruments, the profile $Z(x)$ is approximated by a set of digitized values. Height parameters are expressed in micrometers (μm).

Height range (z) is the maximum peak-to-valley surface height that can be detected accurately with the instrument. It is measurement normal, or perpendicular, to the nominal profile and is another key specification.

Mean line (M) is the line about which deviations are measured and is a line parallel to the general direction of the profile within the limits of the sampling length. See Fig. 2. The mean line may be determined in one of two ways. The filtered mean line is the centerline established by the selected cutoff and its associated circuitry in an electronic roughness average measuring instrument. The least squares mean line is formed by the nominal profile but by dividing into selected lengths the sum of the squares of the deviations minimizes the deviation from the nominal form. The form of the nominal profile could be a curve or a straight line.

Peak is the point of maximum height on that portion of a profile that lies above the mean line and between two intersections of the profile with the mean line.

Profile measured is a representation of the real profile obtained by instrumental or other means. When the measured profile is a graphical representation, it will usually be distorted through the use of different vertical and horizontal magnifications but shall otherwise be as faithful to the profile as technically possible.

Profile, modified is the measured profile where filter mechanisms (including the instrument datum) are used to minimize certain surface texture characteristics and emphasize others. Instrument users apply profile modifications typically to differentiate surface roughness from surface waviness.

Profile, nominal is the profile of the nominal surface; it is the intended profile (exclusive of any intended roughness profile). Profile is usually drawn in an x-z coordinate system. See Fig. 2.

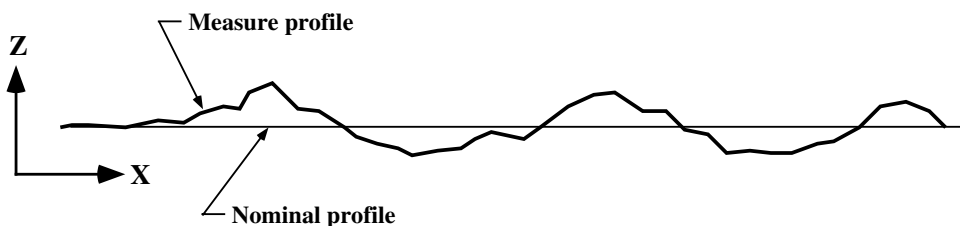


Fig. 2. Nominal and Measured Profiles

Profile, real is the profile of the real surface.

Profile, total is the measured profile where the heights and spacing may be amplified differently but otherwise no filtering takes place.

Roughness profile is obtained by filtering out the longer wavelengths characteristic of waviness.

Roughness spacing is the average spacing between adjacent peaks of the measured profile within the roughness sampling length.

Roughness topography is the modified topography obtained by filtering out the longer wavelengths of waviness and form error.

Sampling length is the nominal spacing within which a surface characteristic is determined. The range of sampling lengths is a key specification of a measuring instrument.

Spacing is the distance between specified points on the profile measured parallel to the nominal profile.

Spatial (x) resolution is the smallest wavelength which can be resolved to 50% of the actual amplitude. This also is a key specification of a measuring instrument.

System height resolution is the minimum height that can be distinguished from background noise of the measurement instrument. Background noise values can be determined by measuring approximate rms roughness of a sample surface where actual roughness is significantly less than the background noise of the measuring instrument. It is a key instrumentation specification.

Topography is the three-dimensional representation of geometric surface irregularities.

Topography, measured is the three-dimensional representation of geometric surface irregularities obtained by measurement.

Topography, modified is the three-dimensional representation of geometric surface irregularities obtained by measurement but filtered to minimize certain surface characteristics and accentuate others.

Valley is the point of maximum depth on that portion of a profile that lies below the mean line and between two intersections of the profile with the mean line.

Waviness, evaluation length (L), is the length within which waviness parameters are determined.

Waviness, long-wavelength cutoff (lcw) the spatial wavelength above which the undulations of waviness profile are removed to identify form parameters. A digital Gaussian filter can be used to separate form error from waviness but its use must be specified.

Waviness profile is obtained by filtering out the shorter roughness wavelengths characteristic of roughness and the longer wavelengths associated with the part form parameters.

Waviness sampling length is a concept no longer used. See waviness long-wavelength cutoff and waviness evaluation length.

Waviness short-wavelength cutoff (lsw) is the spatial wavelength below which roughness parameters are removed by electrical or digital filters.

Waviness topography is the modified topography obtained by filtering out the shorter wavelengths of roughness and the longer wavelengths associated with form error.

Waviness spacing is the average spacing between adjacent peaks of the measured profile within the waviness sampling length.

Sampling Lengths.—Sampling length is the normal interval for a single value of a surface parameter. Generally it is the longest spatial wavelength to be included in the profile measurement. Range of sampling lengths is an important specification for a measuring instrument.

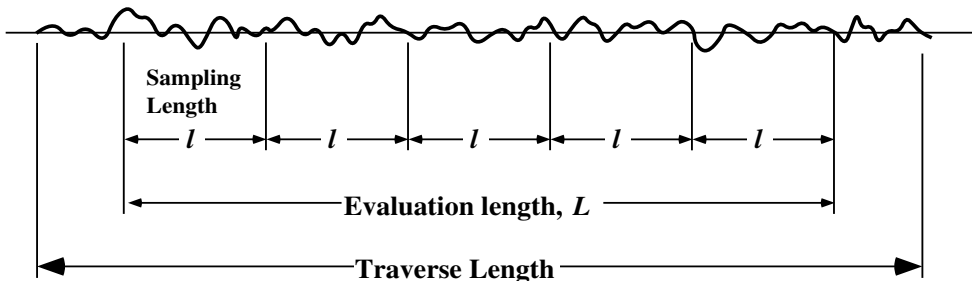


Fig. 3. Traverse Length

Roughness sampling length (l) is the sampling length within which the roughness average is determined. This length is chosen to separate the profile irregularities which are des-

ignated as roughness from those irregularities designated as waviness. It is different from evaluation length (L) and the traversing length. See Fig. 3.

Evaluation length (L) is the length the surface characteristics are evaluated. The evaluation length is a key specification of a measuring instrument.

Traversing length is profile length traversed to establish a representative evaluation length. It is always longer than the evaluation length. See Section 4.4.4 of ANSI/ASME B46.1-1995 for values which should be used for different type measurements.

Cutoff is the electrical response characteristic of the measuring instrument which is selected to limit the spacing of the surface irregularities to be included in the assessment of surface texture. Cutoff is rated in millimeters. In most electrical averaging instruments, the cutoff can be user selected and is a characteristic of the instrument rather than of the surface being measured. In specifying the cutoff, care must be taken to choose a value which will include all the surface irregularities to be assessed.

Waviness sampling length (l) is a concept no longer used. See waviness long-wavelength cutoff and waviness evaluation length.

Roughness Parameters.—Roughness is the fine irregularities of the surface texture resulting from the production process or material condition.

Roughness average (R_a), also known as arithmetic average (AA) is the arithmetic average of the absolute values of the measured profile height deviations divided by the evaluation length, L . This is shown as the shaded area of Fig. 4 and generally includes sampling lengths or cutoffs. For graphical determinations of roughness average, the height deviations are measured normal, or perpendicular, to the chart center line.

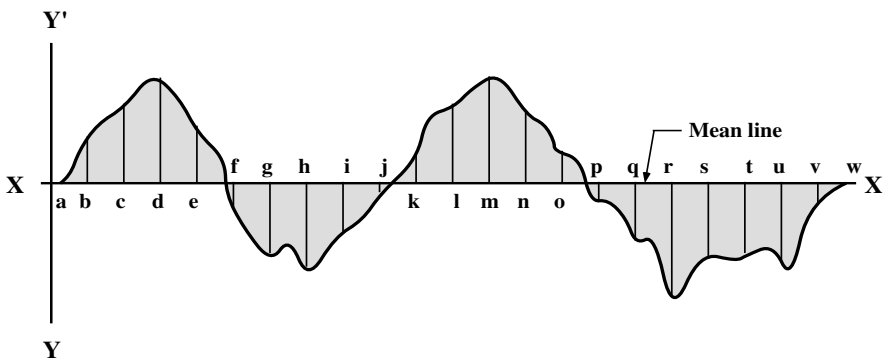


Fig. 4.

Roughness average is expressed in micrometers (μm). A micrometer is one millionth of a meter (0.000001 meter). A microinch (μin) is one millionth of an inch (0.000001 inch). One microinch equals 0.0254 micrometer ($1 \mu\text{in} = 0.0254 \mu\text{m}$).

Roughness Average Value (R_a) From Continuously Averaging Meter Reading may be made of readings from stylus-type instruments of the continuously averaging type. To ensure uniform interpretation, it should be understood that the reading that is considered significant is the mean reading around which the needle tends to dwell or fluctuate with a small amplitude.

Roughness is also indicated by the root-mean-square (rms) average, which is the square root of the average value squared, within the evaluation length and measured from the mean line shown in Fig. 4, expressed in micrometers. A roughness-measuring instrument calibrated for rms average usually reads about 11 per cent higher than an instrument calibrated for arithmetical average. Such instruments usually can be recalibrated to read arithmetical average. Some manufacturers consider the difference between rms and AA to be small enough that rms on a drawing may be read as AA for many purposes.

Roughness evaluation length (L), for statistical purposes should, whenever possible, consist of five sampling lengths (l). Use of other than five sampling lengths must be clearly indicated.

Waviness Parameters.—Waviness is the more widely spaced component of surface texture. Roughness may be thought of as superimposed on waviness.

Waviness height (Wt) is the peak-to-valley height of the modified profile with roughness and part form errors removed by filtering, smoothing or other means. This value is typically three or more times the roughness average. The measurement is taken normal, or perpendicular, to the nominal profile within the limits of the waviness sampling length.

Waviness evaluation length (Lw) is the evaluation length required to determine waviness parameters. For waviness, the sampling length concept is no longer used. Rather, only waviness evaluation length (Lw) and waviness long-wavelength cutoff (lew) are defined. For better statistics, the waviness evaluation length should be several times the waviness long-wavelength cutoff.

Relation of Surface Roughness to Tolerances.—Because the measurement of surface roughness involves the determination of the average linear deviation of the measured surface from the nominal surface, there is a direct relationship between the dimensional tolerance on a part and the permissible surface roughness. It is evident that a requirement for the accurate measurement of a dimension is that the variations introduced by surface roughness should not exceed the dimensional tolerances. If this is not the case, the measurement of the dimension will be subject to an uncertainty greater than the required tolerance, as illustrated in Fig. 5.

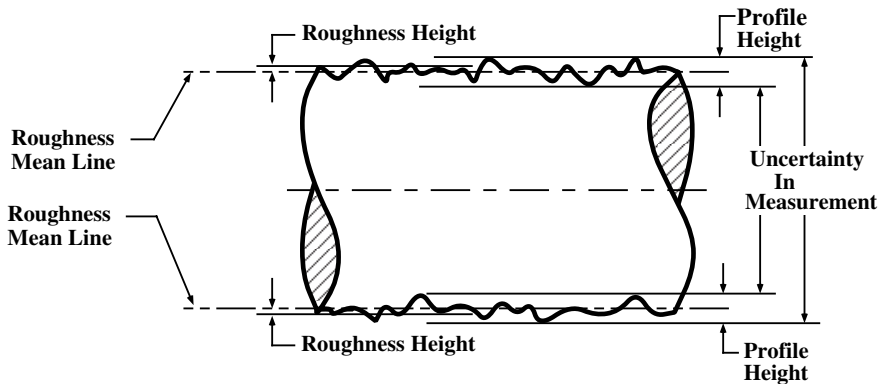


Fig. 5.

The standard method of measuring surface roughness involves the determination of the average deviation from the mean surface. On most surfaces the total profile height of the surface roughness (peak-to-valley height) will be approximately four times (4 \times) the measured average surface roughness. This factor will vary somewhat with the character of the surface under consideration, but the value of four may be used to establish approximate profile heights.



From these considerations it follows that if the arithmetical average value of surface roughness specified on a part exceeds one eighth of the dimensional tolerance, the whole tolerance will be taken up by the roughness height. In most cases, a smaller roughness specification than this will be found; but on parts where very small dimensional tolerances are given, it is necessary to specify a suitably small surface roughness so useful dimensional measurements can be made. The tables on pages 635 and 662 show the relations between machining processes and working tolerances.

Values for surface roughness produced by common processing methods are shown in Table 1. The ability of a processing operation to produce a specific surface roughness depends on many factors. For example, in surface grinding, the final surface depends on the peripheral speed of the wheel, the speed of the traverse, the rate of feed, the grit size, bonding material and state of dress of the wheel, the amount and type of lubrication at the

Table 1. Surface Roughness Produced by Common Production Methods

Process	Roughness Average, R_a - Micrometers μm (Microinches $\mu\text{in.}$)												
	50 (2000)	25 (1000)	12.5 (500)	6.3 (250)	3.2 (125)	1.6 (63)	0.80 (32)	0.40 (16)	0.20 (8)	0.10 (4)	0.05 (2)	0.025 (1)	0.012 (0.5)
Flame Cutting													
Snagging													
Sawing													
Planing, Shaping													
Drilling													
Chemical Milling													
Elect. Discharge Mach.													
Milling													
Broaching													
Reaming													
Electron Beam													
Laser													
Electro-Chemical													
Boring, Turning													
Barrel Finishing													
Electrolytic Grinding													
Roller Burnishing													
Grinding													
Honing													
Electro-Polish													
Polishing													
Lapping													
Superfinishing													
Sand Casting													
Hot Rolling													
Forging													
Perm. Mold Casting													
Investment Casting													
Extruding													
Cold Rolling, Drawing													
Die Casting													

The ranges shown above are typical of the processes listed
 Higher or lower values may be obtained under special conditions

KEY  Average Application
 Less Frequent Application

point of cutting, and the mechanical properties of the piece being ground. A small change in any of the above factors can have a marked effect on the surface produced.

Instrumentation for Surface Texture Measurement.—Instrumentation used for measurement of surface texture, including roughness and waviness generally falls into six types. These include:

Type I, Profiling Contact Skidless Instruments: Used for very smooth to very rough surfaces. Used for roughness and may measure waviness. Can generate filtered or unfiltered profiles and may have a selection of filters and parameters for data analysis. Examples include: 1) skidless stylus-type with LVDT (linear variable differential transformer) vertical transducers; 2) skidless-type using an interferometric transducer; 3) skidless stylus-type using capacitance transducer.

Type II, Profiling Non-contact Instruments: Capable of full profiling or topographical analysis. Non-contact operation may be advantageous for softness but may vary with sample type and reflectivity. Can generate filtered or unfiltered profiles but may have difficulty with steeply inclined surfaces. Examples include: 1) interferometric microscope; 2) optical focus sensing; 3) Nomarski differential profiling; 4) laser triangulation; 5) scanning electron microscope (SEM) stereoscopy; 6) confocal optical microscope.

Type III, Scanned Probe Microscope: Feature high spatial resolution (at or near the atomic scale) but area of measurement may be limited. Examples include: 1) scanning tunneling microscope (STM) and 2) atomic force microscope (AFM).

Type IV, Profiling Contact Skidded Instruments: Uses a skid as a datum to eliminate longer wavelengths; thus cannot be used for waviness or errors of form. May have a selection of filters and parameters and generates an output recording of filtered and skid-modified profiles. Examples include: 1) skidded, stylus-type with LVDT vertical measuring transducer and 2) fringe-field capacitance (FFC) transducer.

Type V, Skidded Instruments with Parameters Only: Uses a skid as a datum to eliminate longer wavelengths; thus cannot be used for waviness or errors of form. Does not generate a profile. Filters are typically 2RC type and generate Ra but other parameters may be available. Examples include: 1) skidded, stylus-type with piezoelectric measuring transducer and 2) skidded, stylus-type with moving coil measuring transducer.

Type VI, Area Averaging Methods: Used to measure averaged parameters over defined areas but do not generate profiles. Examples include: 1) parallel plate capacitance (PPC) method; 2) total integrated scatter (TIS); 3) angle resolved scatter (ARS)/bi-directional reflectance distribution function (BRDF).

Selecting Cutoff for Roughness Measurements.—In general, surfaces will contain irregularities with a large range of widths. Surface texture instruments are designed to respond only to irregularity spacings less than a given value, called cutoff. In some cases, such as surfaces in which actual contact area with a mating surface is important, the largest convenient cutoff will be used. In other cases, such as surfaces subject to fatigue failure only the irregularities of small width will be important, and more significant values will be obtained when a short cutoff is used. In still other cases, such as identifying chatter marks on machined surfaces, information is needed on only the widely spaced irregularities. For such measurements, a large cutoff value and a larger radius stylus should be used.

The effect of variation in cutoff can be understood better by reference to [Fig. 6](#). The profile at the top is the true movement of a stylus on a surface having a roughness spacing of about 1 mm and the profiles below are interpretations of the same surface with cutoff value settings of 0.8 mm, 0.25 mm and 0.08 mm, respectively. It can be seen that the trace based on 0.8 mm cutoff includes most of the coarse irregularities and all of the fine irregularities of the surface. The trace based on 0.25 mm excludes the coarser irregularities but includes the fine and medium fine. The trace based on 0.08 mm cutoff includes only the very fine irregularities. In this example the effect of reducing the cutoff has been to reduce the roughness average indication. However, had the surface been made up only of irregularities as fine as those of the bottom trace, the roughness average values would have been the same for all three cutoff settings.

In other words, all irregularities having a spacing less than the value of the cutoff used are included in a measurement. Obviously, if the cutoff value is too small to include coarser irregularities of a surface, the measurements will not agree with those taken with a larger cutoff. For this reason, care must be taken to choose a cutoff value which will include all of the surface irregularities it is desired to assess.

To become proficient in the use of continuously averaging stylus-type instruments the inspector or machine operator must realize that for uniform interpretation, the reading which is considered significant is the mean reading around which the needle tends to dwell or fluctuate under small amplitude.

Drawing Practices for Surface Texture Symbols.—American National Standard ANSI/ASME Y14.36M-1996, R2008 establishes the method to designate symbolic controls for surface texture of solid materials. It includes methods for controlling roughness, waviness, and lay, and provides a set of symbols for use on drawings, specifications, or other documents. The standard is expressed in SI metric units but U.S. customary units may be used without prejudice. Units used (metric or non-metric) should be consistent with the other units used on the drawing or documents. Approximate non-metric equivalents are shown for reference.

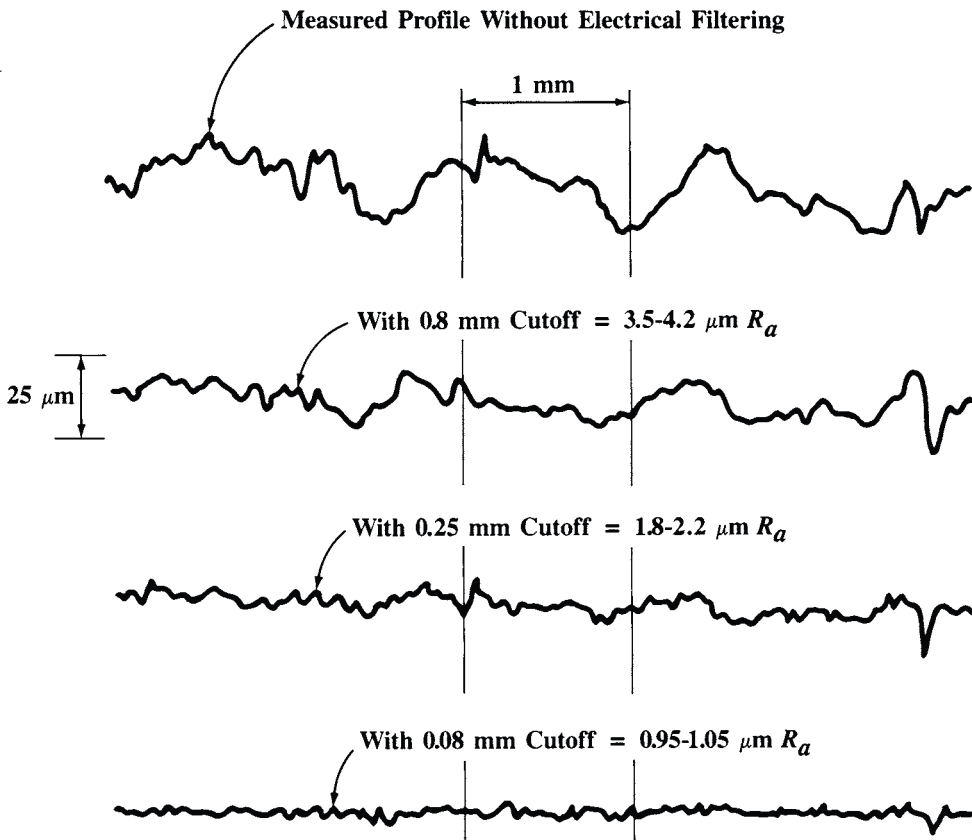


Fig. 6. Effects of Various Cutoff Values

Surface Texture Symbol.—The symbol used to designate control of surface irregularities is shown in Fig. 7b and Fig. 7d. Where surface texture values other than roughness average are specified, the symbol must be drawn with the horizontal extension as shown in Fig. 7f.

Use of Surface Texture Symbols: When required from a functional standpoint, the desired surface characteristics should be specified. Where no surface texture control is specified, the surface produced by normal manufacturing methods is satisfactory provided it is within the limits of size (and form) specified in accordance with ASME Y14.5-2009, Dimensioning and Tolerancing. It is considered good practice to always specify some maximum value, either specifically or by default (for example, in the manner of the note shown in Fig. 8 on page 743).

Material Removal Required or Prohibited: The surface texture symbol is modified when necessary to require or prohibit removal of material. When it is necessary to indicate that a surface must be produced by removal of material by machining, specify the symbol shown in Fig. 7b. When required, the amount of material to be removed is specified as shown in Fig. 7c, in millimeters for metric drawings and in inches for non-metric drawings. Tolerance for material removal may be added to the basic value shown or specified in a general note. When it is necessary to indicate that a surface must be produced without material removal, specify the machining prohibited symbol as shown in Fig. 7d.

Proportions of Surface Texture Symbols: The recommended proportions for drawing the surface texture symbol are shown in Fig. 7f. The letter height and line width should be the same as that for dimensions and dimension lines.

Surface Texture Symbols and Construction






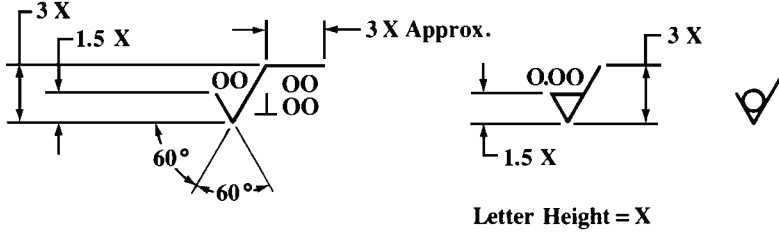
Symbol	Meaning
 Fig. 7a.	Basic Surface Texture Symbol. Surface may be produced by any method except when the bar or circle (Fig. 7b or 7d) is specified.
 Fig. 7b.	Material Removal By Machining Is Required. The horizontal bar indicates that material removal by machining is required to produce the surface and that material must be provided for that purpose.
3.5  Fig. 7c.	Material Removal Allowance. The number indicates the amount of stock to be removed by machining in millimeters (or inches). Tolerances may be added to the basic value shown or in general note.
 Fig. 7d.	Material Removal Prohibited. The circle in the vee indicates that the surface must be produced by processes such as casting, forging, hot finishing, cold finishing, die casting, powder metallurgy or injection molding without subsequent removal of material.
 Fig. 7e.	Surface Texture Symbol. To be used when any surface characteristics are specified above the horizontal line or the right of the symbol. Surface may be produced by any method except when the bar or circle (Fig. 7b and 7d) is specified.
 <p style="text-align: center;">Letter Height = X</p>	

Fig. 7f.

Applying Surface Texture Symbols.—The point of the symbol should be on a line representing the surface, an extension line of the surface, or a leader line directed to the surface, or to an extension line. The symbol may be specified following a diameter dimension. Although ASME Y14.5-2009, “Dimensioning and Tolerancing” specifies that normally all textual dimensions and notes should be read from the bottom of the drawing, the surface texture symbol itself with its textual values may be rotated as required. Regardless, the long leg (and extension) must be to the right as the symbol is read. For parts requiring extensive and uniform surface roughness control, a general note may be added to the drawing which applies to each surface texture symbol specified without values as shown in Fig. 8.

When the symbol is used with a dimension, it affects the entire surface defined by the dimension. Areas of transition, such as chamfers and fillets, shall conform with the roughest adjacent finished area unless otherwise indicated.

Surface texture values, unless otherwise specified, apply to the complete surface. Drawings or specifications for plated or coated parts shall indicate whether the surface texture values apply before plating, after plating, or both before and after plating.

Only those values required to specify and verify the required texture characteristics should be included in the symbol. Values should be in metric units for metric drawing and non-metric units for non-metric drawings. Minority units on dual dimensioned drawings are enclosed in brackets.

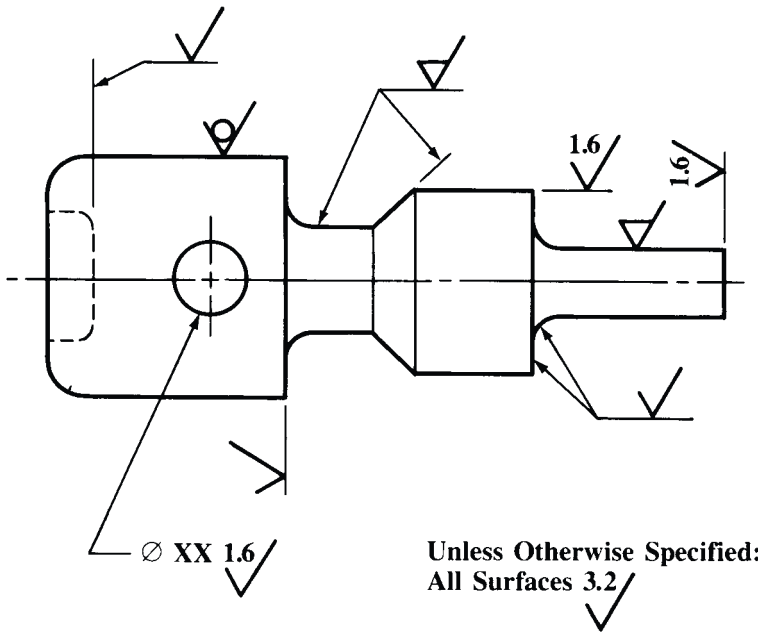


Fig. 8. Application of Surface Texture Symbols

Roughness and waviness measurements, unless otherwise specified, apply in a direction which gives the maximum reading; generally across the lay.

Cutoff or Roughness Sampling Length, (l): Standard values are listed in Table 2. When no value is specified, the value 0.8 mm (0.030 in.) applies.

Table 2. Standard Roughness Sampling Length (Cutoff) Values

mm	in.	mm	in.
0.08	0.003	2.5	0.1
0.25	0.010	8.0	0.3
0.80	0.030	25.0	1.0

Roughness Average (Ra): The preferred series of specified roughness average values is given in Table 3.

Table 3. Preferred Series Roughness Average Values (R_a)

μm	μin	μm	μin	μm	μin
0.012	0.5	0.40 ^a	16 ^a	4.0	160
0.025 ^a	1 ^a	0.50	20	5.0	200
0.050 ^a	2 ^a	0.63	25	6.3 ^a	250 ^a
0.075 ^a	3	0.80 ^a	32 ^a	8.0	320
0.10 ^a	4 ^a	1.00	40	10.0	400
0.125	5	1.25	50	12.5 ^a	500 ^a
0.15	6	1.60 ^a	63 ^a	15	600
0.20 ^a	8 ^a	2.0	80	20	800
0.25	10	2.5	100	25 ^a	1000 ^a
0.32	13	3.2 ^a	125 ^a

^a Recommended

Waviness Height (Wt): The preferred series of maximum waviness height values is listed in **Table 4**. Waviness height is not currently shown in U.S. or ISO Standards. It is included here to follow present industry practice in the United States.

Table 4. Preferred Series Maximum Waviness Height Values

mm	inch	mm	inch	mm	inch
0.0005	0.00002	0.008	0.0003	0.12	0.005
0.0008	0.00003	0.012	0.0005	0.20	0.008
0.0012	0.00005	0.020	0.0008	0.25	0.010
0.0020	0.00008	0.025	0.001	0.38	0.015
0.0025	0.0001	0.05	0.002	0.50	0.020
0.005	0.0002	0.08	0.003	0.80	0.030

Lay: Symbols for designating the direction of lay are shown and interpreted in **Table 5**.

Example Designations.—**Table 6** illustrates examples of designations of roughness, waviness, and lay by insertion of values in appropriate positions relative to the symbol.

Where surface roughness control of several operations is required within a given area, or on a given surface, surface qualities may be designated, as in **Fig. 9a**. If a surface must be produced by one particular process or a series of processes, they should be specified as shown in **Fig. 9b**. Where special requirements are needed on a designated surface, a note should be added at the symbol giving the requirements and the area involved. An example is illustrated in **Fig. 9c**.

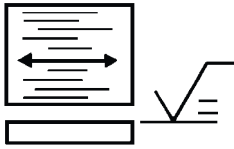
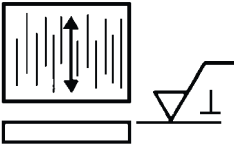
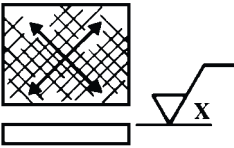

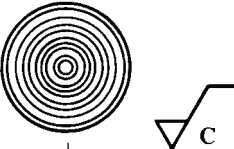

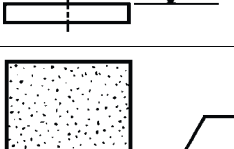
Surface Texture of Castings.—Surface characteristics should not be controlled on a drawing or specification unless such control is essential to functional performance or appearance of the product. Imposition of such restrictions when unnecessary may increase production costs and in any event will serve to lessen the emphasis on the control specified for important surfaces. Surface characteristics of castings should never be considered on the same basis as machined surfaces. Castings are characterized by random distribution of non-directional deviations from the nominal surface.

Surfaces of castings rarely need control beyond that provided by the production method necessary to meet dimensional requirements. Comparison specimens are frequently used for evaluating surfaces having specific functional requirements. Surface texture control should not be specified unless required for appearance or function of the surface. Specification of such requirements may increase cost to the user.

Engineers should recognize that different areas of the same castings may have different surface textures. It is recommended that specifications of the surface be limited to defined areas of the casting. Practicality of and methods of determining that a casting's surface texture meets the specification shall be coordinated with the producer. The Society of Automotive Engineers standard J435 "Automotive Steel Castings" describes methods of evaluating steel casting surface texture used in the automotive and related industries.

Metric Dimensions on Drawings.—The length units of the metric system that are most generally used in connection with any work relating to mechanical engineering are the meter (39.37 inches) and the millimeter (0.03937 inch). One meter equals 1000 millimeters. On mechanical drawings, all dimensions are generally given in millimeters, no matter how large the dimensions may be. In fact, dimensions of such machines as locomotives and large electrical apparatus are given exclusively in millimeters. This practice is adopted to avoid mistakes due to misplacing decimal points, or misreading dimensions as when other units are used as well. When dimensions are given in millimeters, many of them can be given without resorting to decimal points, as a millimeter is only a little more than $\frac{1}{32}$ inch. Only dimensions of precision need be given in decimals of a millimeter; such dimensions are generally given in hundredths of a millimeter—for example, 0.02 millimeter, which is equal to 0.0008 inch. As 0.01 millimeter is equal to 0.0004 inch, dimensions are seldom given with greater accuracy than to hundredths of a millimeter.

Table 5. Lay Symbols

Lay Symbol	Meaning	Example Showing Direction of Tool Marks
=	Lay approximately parallel to the line representing the surface to which the symbol is applied.	
⊥	Lay approximately perpendicular to the line representing the surface to which the symbol is applied.	
X	Lay angular in both directions to line representing the surface to which the symbol is applied.	
M	Lay multidirectional	
C	Lay approximately circular relative to the center of the surface to which the symbol is applied.	
R	Lay approximately radial relative to the center of the surface to which the symbol is applied.	
P	Lay particulate, non-directional, or protuberant	

Scales of Metric Drawings: Drawings made to the metric system are not made to scales of $\frac{1}{2}$, $\frac{1}{4}$, $\frac{1}{8}$, etc., as with drawings made to the English system. If the object cannot be drawn full size, it may be drawn $\frac{1}{2}$, $\frac{1}{5}$, $\frac{1}{10}$, $\frac{1}{20}$, $\frac{1}{50}$, $\frac{1}{100}$, $\frac{1}{200}$, $\frac{1}{500}$, or $\frac{1}{1000}$ size. If the object is too small and has to be drawn larger, it is drawn 2, 5, or 10 times its actual size.

1.6
✓

Table 6. Application of Surface Texture Values to Symbol ANSI B46.1-1978

Roughness average rating is placed at the left of the long leg. The specification of only one rating shall indicate the maximum value and any lesser value shall be acceptable. Specify in microinches (microinch).

Material removal by machining is required to produce the surface. The basic amount of stock provided for material removal is specified at the left of the short leg of the symbol. Specify in millimeters (inch).

1.6
0.8
✓

The specification of maximum and minimum roughness average values indicates permissible range. Specify in microinches (microinch).

Removal of material is prohibited.

0.005-5

Maximum waviness height rating is the first value above the horizontal extension. Any lesser rating shall be acceptable. Specify in millimeters (inch).

Lay designation is indicated by the lay symbol placed at the right of the long leg.

Maximum waviness spacing rating is the second value placed above the horizontal extension and to the right of the waviness height rating. Any lesser rating shall be acceptable. Specify in millimeters (inch).

Roughness sampling length or cutoff rating is placed below the horizontal extension. When no value is shown, 0.80 mm (0.030 inch) applies. Specify in millimeters (inch).

Where required maximum roughness spacing shall be placed at the right of the lay symbol. Any lesser rating shall be acceptable. Specify in millimeters (inch).

ISO Surface Finish Standards

ISO surface finish standards are comprised of numerous individual standards, that taken as a whole, form a set of standards roughly comparable in scope to American National Standard ANSI/ASME Y14.36M.

ISO Surface Finish (ISO 1302).—The primary standard dealing with surface finish, ISO 1302:2002 is concerned with the methods of specifying surface texture symbology and additional indications on engineering drawings. The parameters in ISO surface finish standards relate to surfaces produced by abrading, casting, coating, cutting, etching, plastic deformation, sintering, wear, erosion, and some other methods.

ISO 1302 defines how surface texture and its constituents, roughness, waviness, and lay, are specified on the symbology. Surface defects are specifically excluded from consideration during inspection of surface texture but definitions of flaws and imperfections are discussed in ISO 8785.

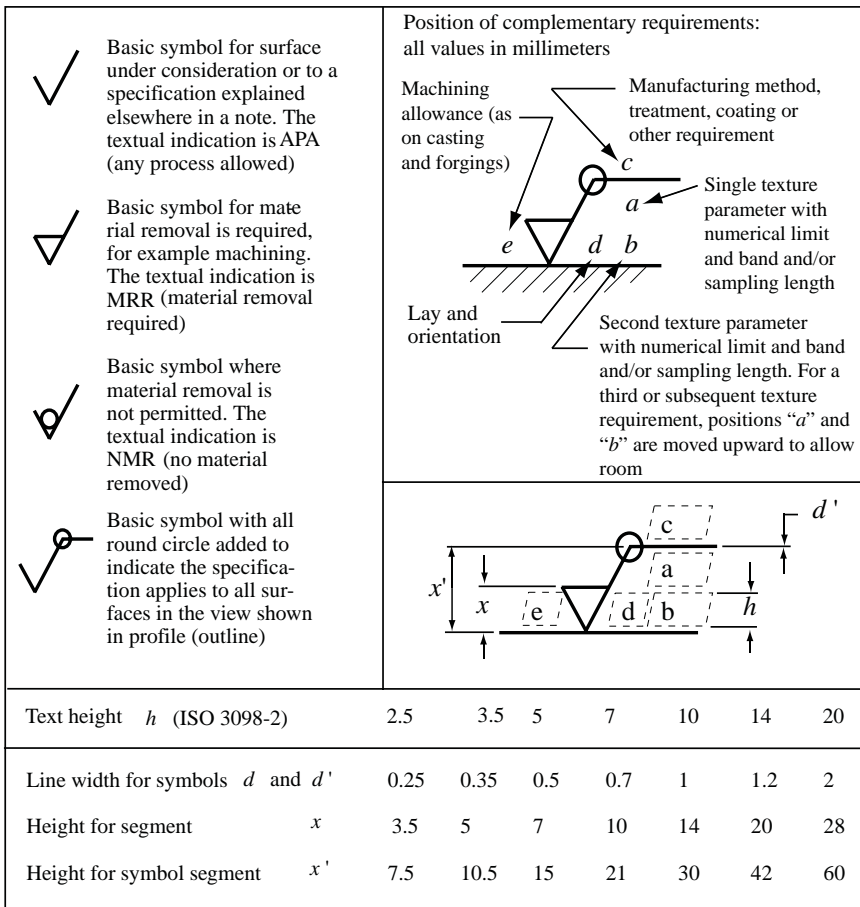


Fig. 1. ISO Surface Finish Symbols.

Differences Between ISO and ANSI Surface Finish Symbology: ISO 1302, like ASME Y14.36M, is not concerned with luster, appearance, color, corrosion resistance, wear resistance, hardness, sub-surface microstructure, surface integrity, and many other characteristics that may govern considerations in specific applications. Visually, ISO 1302 surface finish symbols are similar to the ANSI symbols, however, with the release of the 2002 edition, the indication of some of the parameters have changed when compared to ASME Y14.36M. The proportions of the symbol in relationship to text height differs in each as

well. There is now less harmonization between ASME Y14.36M and ISO 1302 than has been the case previously.

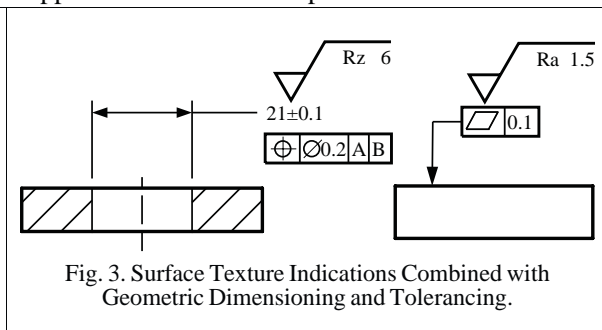
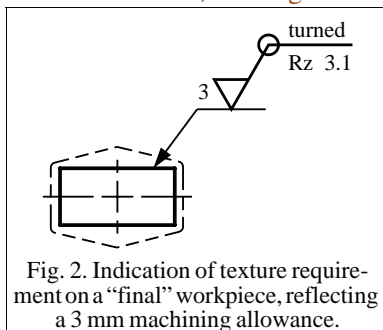
Table 1. Other ISO Standards Related to Surface Finish.

ISO 3274:1996	“Geometrical Product Specifications (GPS) — Surface texture: Profile method — Nominal characteristics of contact (stylus) instruments.”
ISO 4287:1997	“Geometrical Product Specifications (GPS) — Surface texture: Profile method — Terms, definitions and surface texture parameters.”
ISO 4288:1996	“Geometrical Product Specifications (GPS) — Surface texture: Profile method — Rules and procedures for the assessment of surface texture.”
ISO 8785:1998	“Geometrical Product Specifications (GPS) — Surface imperfections — Terms, definitions and parameters.”
ISO 12085:1996	“Geometrical Product Specifications (GPS) — Surface texture: Profile method — Motif parameters.”
ISO 13565-1:1996	“Geometrical Product Specifications (GPS) — Surface texture: Profile method; Surfaces having stratified functional properties — Part 1: Filtering and general measurement conditions.”
ISO 13565-2:1996	“Geometrical Product Specifications (GPS) — Surface texture: Profile method; Surfaces having stratified functional properties — Part 2: Height characterization using the linear material ratio curve.”
ISO 13565-3:1998	“Geometrical Product Specifications (GPS) — Surface texture: Profile method; Surfaces having stratified functional properties — Part 3: Height characterization using the material probability curve.”

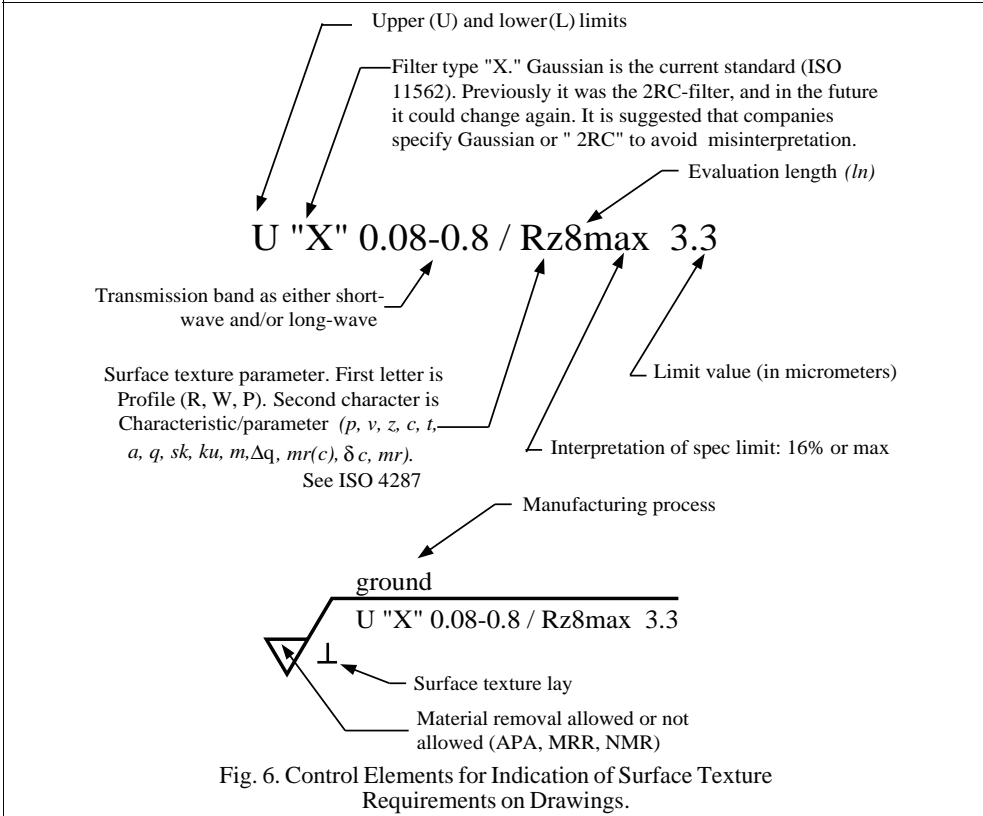
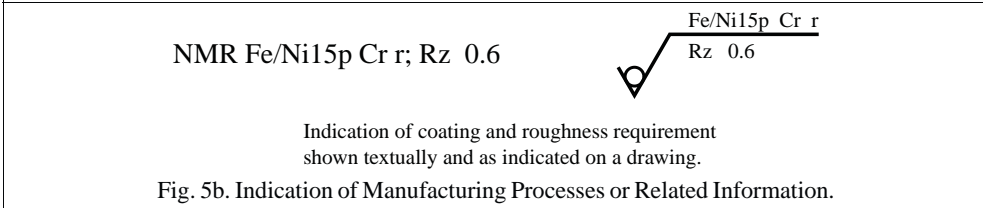
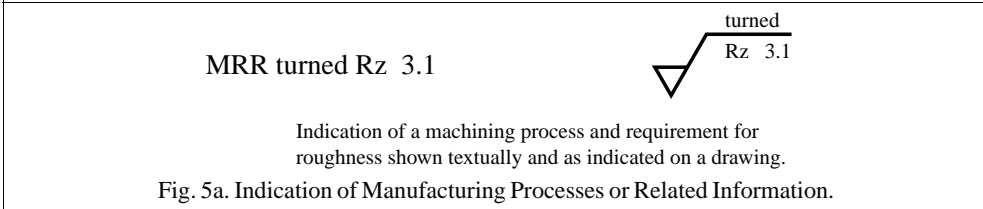
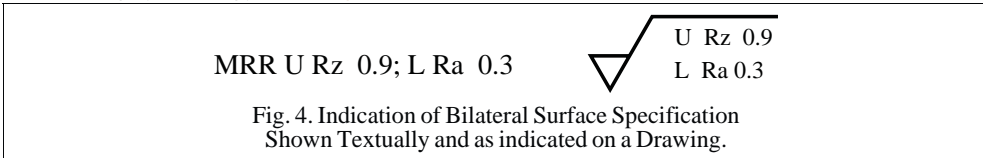
Table 2. ISO Surface Parameter Symbols (ISO 4287:1997)

R_p = max height profile R_v = max profile valley depth R_z^* = max height of the profile R_c = mean height of profile R_t = total height of the profile R_a = arithmetic mean deviation of the profile R_q = root mean square deviation of the profile R_{sk} = skewness of the profile R_{ku} = kurtosis of the profile R_{Sm} = mean width of the profile $R_{\Delta q}$ = root mean square slope of the profile R_{mv} = material ration of the profile	$R\delta_c$ = profile section height difference l_p = sampling length - primary profile l_w = sampling length - waviness profile l_r = sampling length - roughness profile l_n = evaluation length $Z(x)$ = ordinate value dZ/dX = local slope Z_p = profile peak height Z_v = profile valley depth Z_t = profile element height X_s = profile element width ML = material length of profile
--	---

Graphic Symbology Textural Descriptions.—New to this version of ISO 1302:2002 is the ability to add textual descriptions of the graphic symbology used on drawing. This gives specifications writers a consistent means to describe surface texture specification from within a body of text without having to add illustrations. See Fig. 1 for textual application definitions, then Figs. 2- 6 for applications of this concept.



ISO 1302:2002 does not define the degrees of surface roughness and waviness or type of lay for specific purposes, nor does it specify the means by which any degree of such irregularities may be obtained or produced. Also, errors of form such as out-of-roundness and out-of-flatness are not addressed in the ISO surface finish standards. This edition does better illustrate how surface texture indications can be used on castings to reflect machining allowances (Fig. 2) and how symbology can be attached to geometric dimensioning and tolerancing symbology (See Fig. 3).



ISO Profiles.—Profile parameters may be one of three types (ISO 4287). These include:

R-profile: Defined as the evaluation length. The ISO default length l_n consists of five sampling lengths l_r , thus $l_n = 5 \times l_r$.

W-profile: This parameter indicates waviness. There is no default length.

P-profile: Indicates the structure parameters. The default evaluation length is defined in ISO 4288: 1996.

Rules for Comparing Measured Values to Specified Limits.—

Max Rule: When a maximum requirement is specified for a surface finish parameter on a drawing (e.g. $Rz1.5max$), none of the inspected values may extend beyond the upper limit over the entire surface. The term “max” must be added to the parametric symbol in the surface finish symbology on the drawing.

16% Rule: When upper and lower limits are specified, no more than 16% of all measured values of the selected parameter within the evaluation length may exceed the upper limit. No more than 16% of all measured values of the selected parameter within the evaluation length may be less than the lower limit.

Exceptions to the 16% Rule: Where the measured values of roughness profiles being inspected follow a normal distribution, the 16% rule may be overridden. This is allowed when greater than 16% of the measured values exceed the upper limit, but the total roughness profile conforms with the sum of the arithmetic mean and standard deviation ($\mu + \sigma$). Effectively this means that the greater the value of σ , the further μ must be from the upper limit (see Fig. 7).

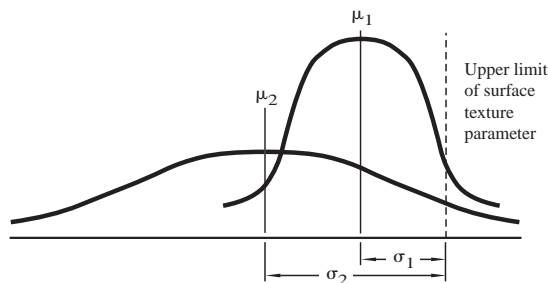
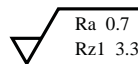


Fig. 7. Roughness Parameter Value Curves Showing Mean and Standard Deviation.

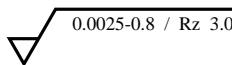
With the "16%-rule" transmission band as default it is shown textually and in drawings as:

MRR Ra 0.7; Rz1 3.3



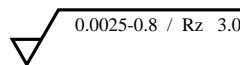
If the "max-rule" transmission band is applied, it is shown textually and in drawings as:

MRR 0.0025-0.8 / Rz 3.0



Transmission band and sampling length are specified when there is no default value. The transmission band is indicated with the cut-off value of the filters in millimeters separated by a hyphen (-) with the short-wave filter first and the long-wave filter second. Again, in textual format and on drawings.

MRR 0.0025-0.8 / Rz 3.0



A specification can indicate only one of the two transmission band filters. If only one is indicated, the hyphen is maintained to indicate whether the indication is the short-wave or the long-wave filter.

0.008- (short-wave filter indication)

-0.25 (long-wave filter indication)

Fig. 8. Indications of Transmission Band and Sampling Length in Textual Format.

Determining Cut-off Wavelength: When the sampling length is specified on the drawing or in documentation, the cut-off wavelength λ_c is equal to the sample length. When no sampling length is specified, the cut-off wavelength is estimated using **Table 3**.

Measurement of Roughness Parameters: For non-periodic roughness the parameter Ra , Rz , $Rz1_{max}$ or RSm are first estimated using visual inspection, comparison to specimens, graphic analysis, etc. The sampling length is then selected from **Table 3**, based on the use of Ra , Rz , $Rz1_{max}$ or RSm . Then with instrumentation, a representative sample is taken using the sampling length chosen above.

The measured values are then compared to the ranges of values in **Table 3** for the particular parameter. If the value is outside the range of values for the estimated sampling length, the measuring instrument is adjusted for the next higher or lower sampling length and the measurement repeated. If the final setting corresponds to **Table 3**, then both the sampling length setting and Ra , Rz , $Rz1_{max}$ or RSm values are correct and a representative measurement of the parameter can be taken.

For periodic roughness, the parameter RSm is estimated graphically and the recommended cut-off values selected using **Table 3**. If the value is outside the range of values for the estimated sampling length, the measuring instrument is adjusted for the next higher or lower sampling length and the measurement repeated. If the final setting corresponds to **Table 3**, then both the sampling length setting and RSm values are correct and a representative measurement of the parameter can be taken.

Table 3. Sampling Lengths

Curves for Non-periodic Profiles such as Ground Surfaces		Curves for Periodic and Non-periodic Profiles	Sampling length, lr (mm)	Evaluation length, ln (mm)
For $Ra, Rq, Rsk, Rku, R\Delta q$	For Rz, Rv, Rp, Rc, Rt	For R -parameters and RSm		
$Ra, \mu m$	$Rz, Rz1_{max}, \mu m$	$RSm, \mu m$		
$(0.006) < Ra \leq 0.02$	$(0.025) < Rz, Rz1_{max} \leq 0.1$	$0.013 < RSm \leq 0.04$	0.08	0.4
$0.02 < Ra \leq 0.1$	$0.1 < Rz, Rz1_{max} \leq 0.5$	$0.04 < RSm \leq 0.13$	0.25	1.25
$0.1 < Ra \leq 2$	$0.5 < Rz, Rz1_{max} \leq 10$	$0.13 < RSm \leq 0.4$	0.8	4
$2 < Ra \leq 10$	$10 < Rz, Rz1_{max} \leq 50$	$0.4 < RSm \leq 1.3$	2.5	12.5
$10 < Ra \leq 80$	$50 < Rz, Rz1_{max} \leq 200$	$1.3 < RSm \leq 4$	8	40

Table 4. Preferred Roughness Values and Roughness Grades

Roughness values, Ra		Previous Grade Number from ISO 1302	Roughness values, Ra		Previous Grade Number from ISO 1302
μm	μin		μm	μin	
50	2000	N12	0.8	32	N6
25	1000	N11	0.4	16	N5
12.5	500	N10	0.2	8	N4
6.3	250	N9	0.1	4	N3
3.2	125	N8	0.05	2	N2
1.6	63	N7	0.025	1	N1

Table 5. Examples of ISO Applications of Surface Texture Symbology

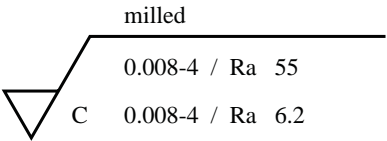
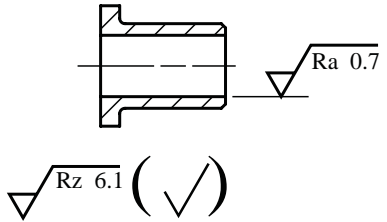
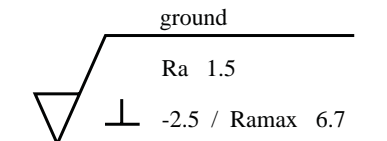
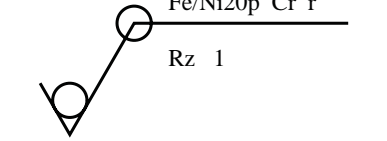
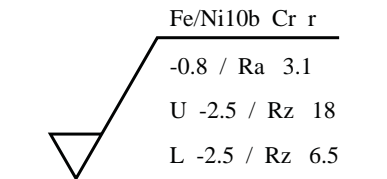
Interpretation	Example
<p><i>Surface roughness</i> is produced by milling with a bilateral tolerance between an upper limit of $Ra = 55 \mu\text{m}$ and a lower limit of $Ra = 6.2 \mu\text{m}$. Both apply the “16%-rule” default (ISO 4288). Both transmission bands are 0.008 - 4 mm, using default evaluation length ($5 \times 4 \text{ mm} = 20 \text{ mm}$) (ISO 4288). The surface lay is circular about the center. U and L are omitted because it is obvious one is upper and one lower. Material removal is allowed.</p>	 <p>milled</p> <p>0.008-4 / Ra 55</p> <p>C 0.008-4 / Ra 6.2</p>
<p>Simplified representation where <i>surface roughness</i> of $Rz = 6.1 \mu\text{m}$ is the default for all surfaces as indicated by the $Rz = 6.1$ specification, plus basic symbol within parentheses. The default the “16%-rule” applies to both as does the default transmission band (ISO 4288 and ISO 3274). Any deviating specification is called out with local notes such as the $Ra = 0.7 \mu\text{m}$ specification. There is no lay requirement and material removal is allowed.</p>	 <p>Ra 0.7</p> <p>Rz 6.1 (✓)</p>
<p><i>Surface roughness</i> is produced by grinding to two upper limit specifications: $Ra = 1.5 \mu\text{m}$ and limited to $Rz = 6.7 \mu\text{m}$ max; The default “16%-rule,” default transmission band and default evaluation length apply to the Ra while the “max-rule,” a -2.5 mm transmission band and default evaluation length apply to the Rz. The surface lay is perpendicular relative to the plane of projection and material removal is allowed.</p>	 <p>ground</p> <p>Ra 1.5</p> <p>⊥ -2.5 / Ramax 6.7</p>
<p><i>Surface treatment</i> is without any material removal allowed, and to a single unilateral upper limit specification of $Rz = 1 \mu\text{m}$. The default “16%-rule,” default transmission band and default evaluation length apply. The surface treatment is nickel-chrome plated to all surfaces shown in profile (outline) in the view where the symbol is applied. There is no lay requirement.</p>	 <p>Fe/Ni20p Cr r</p> <p>Rz 1</p>
<p><i>Surface roughness</i> is produced by any material removal process to one unilateral upper limit and one bilateral specification: the unilateral, $Ra = 3.1$ is to the default “16%-rule,” a transmission band of -0.8 mm and the default evaluation length ($5 \times 0.8 = 4 \text{ mm}$). The bilateral Rz has an upper limit of $Rz = 18 \mu\text{m}$ and a lower limit of $Rz = 6.5 \mu\text{m}$. Both limits are to a transmission band of -2.5 mm with both to the default $5 \times 2.5 = 12.5 \text{ mm}$. The symbol U and L may be indicated even if it is obvious. Surface treatment is nickel/chromium plating. There is no lay requirement.</p>	 <p>Fe/Ni10b Cr r</p> <p>-0.8 / Ra 3.1</p> <p>U -2.5 / Rz 18</p> <p>L -2.5 / Rz 6.5</p>

Table 5. Examples of ISO Applications of Surface Texture Symbology (Continued)

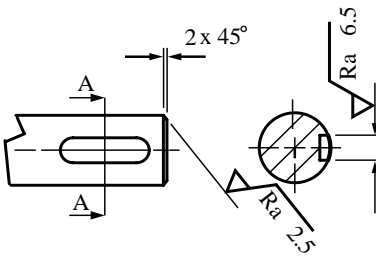
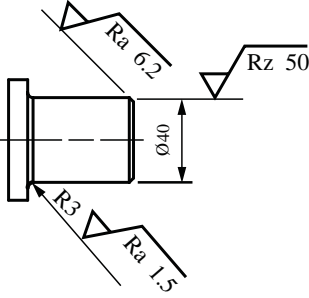
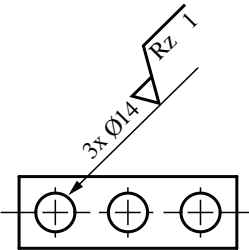
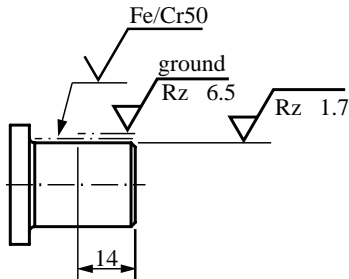
Interpretation	Example
<p>Surface texture symbology may be combined with dimension leaders and witness (extension) lines. Surface roughness for the side surfaces of the key-way is produced by any material removal process to one unilateral upper limit specification, $Ra = 6.5$ m. It is to the default “16%-rule,” default transmission band and default evaluation length ($5 \times \lambda_c$) (ISO 3274). There is no lay requirement.</p> <p>Surface roughness for the chamfer is produced by any material removal process to one unilateral upper limit specification, $Ra = 2.5$ m. It is to the default “16%-rule,” default transmission band and default evaluation length ($5 \times \lambda_c$) (ISO 3274). There is no lay requirement.</p>	
<p>Surface texture symbology may be applied to extended extension lines or on extended projection lines. All feature surface roughness specifications shown are obtainable by any material removal process and are single unilateral upper limit specifications respectively: $Ra = 1.5$ m, $Ra = 6.2$ m and $Rz = 50$ m. All are to “16%-rule” default, default transmission band and default evaluation length ($5 \times \lambda_c$). There is no lay requirement for any of the three.</p>	
<p>Surface texture symbology and dimensions may be combined on leader lines. The feature surface roughness specifications shown is obtainable by any material removal process and is single unilateral upper limit specifications respectively: $Rz = 1$ m, to the default “16%-rule,” default transmission band and default evaluation length ($5 \times \lambda_c$). There is no lay requirement.</p>	
<p>Symbology can be used for <i>dimensional information</i> and <i>surface treatment</i>. This example illustrates three successive step of a manufacturing process.</p> <p>The first step is a single unilateral upper limit $Rz = 1.7$ m to the default “16%-rule,” default evaluation length ($5 \times \lambda_c$) and default transmission band. It is obtainable by any material removal process, with no lay characteristics specified. Step two indicated with a phantom line over the whole length of the cylinder has no surface texture requirement other than chromium plating.</p> <p>The third step is a single unilateral upper limit of $Rz = 6.5$ m applied only to the first 14 mm of the cylinder surface. The default “16%-rule” applies as does default evaluation length ($5 \times \lambda_c$) and default transmission band. Material removal is to be by grinding, with no lay characteristics specified.</p>	

TABLE OF CONTENTS
TOOLING AND TOOLMAKING

CUTTING TOOLS	FORMING TOOLS
757 Terms and Definitions	796 Dovetail Forming Tools
757 Tool Contour	796 Straight Forming Tools
760 Relief Angles	799 Circular Forming Tools
761 Rake Angles	800 Circular Forming Tools Formula
762 Nose Radius	801 Top Rake
763 Chipbreakers	801 Constants for Diameters
764 Planing Tools	801 Corrected Diameters
764 Indexable Inserts	806 Arrangement of Circular Tools
765 Identification System	807 Circular Cut-Off Tools
766 Indexable Insert Tool Holders	
767 Standard Shank Sizes	MILLING CUTTERS
768 Letter Symbols	808 Selection of Milling Cutters
769 Indexable Insert Holders	808 Number of Teeth
772 Sintered Carbide Tools	809 Hand of Milling Cutters
772 Sintered Carbide Blanks	810 Plain Milling Cutters
772 Single Point Tools	811 Side Milling Cutters
772 Single-Point, Sintered-Carbide-Tipped Tools	812 T-Slot Milling Cutters
774 Tool Nose Radii	813 Metal Slitting Saws
775 Tool Angle Tolerances	813 Milling Cutter Terms
775 Carbide Tipped Tools	815 Shell Mills
775 Style A	816 Multiple- and Two-Flute Single-End Helical End Mills
776 Style B	817 Regular-, Long-, and Extra Long-Length, Mills
777 Style C	818 Two-Flute, High Helix, Regular-, Long-, Extra Long-, Mills
777 Style D	819 Roughing, Single-End End Mills
778 Style E	827 Concave, Convex, and Corner-Rounding Arbor-Type Cutters
778 Styles ER and EL	829 Roller Chain Sprocket
779 Style F	831 Keys and Keyways
780 Style G	832 Woodruff Keyseat Cutters
781 Chip Breaker	836 Spline-Shaft Milling Cutter
781 Chipless Machining	836 Cutter Grinding
781 Indexable Insert Holders for NC	837 Wheel Speeds and Feeds
782 Insert Radius Compensation	837 Clearance Angles
784 Threading Tool Insert Radius	838 Rake Angles for Milling Cutters
	838 Eccentric Type Radial Relief
CEMENTED CARBIDES	841 Indicator Drop Method
785 Cemented Carbide	843 Distance to Set Tooth
785 Carbides and Carbonitrides	
786 Properties of Tungsten-Carbide-Based Cutting-Tool	REAMERS
790 ISO Classifications of Hardmetals	844 Hand Reamers
790 Ceramics	845 Irregular Tooth Spacing in Reamers
793 Superhard Materials	845 Threaded-end Hand Reamers
794 Machining Data	845 Fluted & Rose Chucking Reamers
795 Hardmetal Tooling	847 Vertical Adjustment of Tooth-rest
795 Cutting Blades	

TABLE OF CONTENTS
TOOLING AND TOOLMAKING

<p style="text-align: center;">REAMERS</p> <p><i>(Continued)</i></p> <p>847 Reamer Terms and Definitions</p> <p>851 Direction of Rotation and Helix</p> <p>851 Dimensions of Centers</p> <p>852 Reamer Difficulties</p> <p>854 Expansion Chucking Reamers</p> <p>855 Hand Reamers</p> <p>856 Expansion Hand Reamers</p> <p>857 Driving Slots and Lugs</p> <p>858 Chucking Reamers</p> <p>861 Shell Reamers</p> <p>863 Center Reamers</p> <p>864 Taper Pipe Reamers</p> <hr/> <p style="text-align: center;">TWIST DRILLS AND COUNTERBORES</p> <hr/> <p>866 Definitions of Twist Drill Terms</p> <p>867 Types of Drills</p> <p>887 Split-Sleeve Collet Drill Drivers</p> <p>888 Three- and Four-Flute Straight Shank Core Drills</p> <p>889 Twist Drills and Centering Tools</p> <p>890 British Standard Combined Drills</p> <p>890 Drill Drivers</p> <p>890 British Std. Metric Twist Drills</p> <p>891 Gauge and Letter Sizes</p> <p>892 Morse Taper Shank Twist Drills</p> <p>893 Tolerance on Diameter</p> <p>894 Parallel Shank Jobber Twist Drills</p> <p>896 Stub Drills</p> <p>896 Steels for Twist Drills</p> <p>896 Accuracy of Drilled Holes</p> <p>897 Counterboring</p> <p>898 Interchangeable Cutters</p> <p>898 Three Piece Counterbores</p> <p>899 Sintered Carbide Boring Tools</p> <p>899 Style Designations</p> <p>901 Boring Tools</p> <p>901 Square</p> <p>902 Carbide-Tipped Square</p> <p>903 Solid Carbide Round</p> <p>903 Boring Machines, Origin</p> <hr/> <p style="text-align: center;">TAPS</p> <hr/> <p>904 Thread Form, Styles, and Types</p> <p>906 Standard System of Tap Marking</p> <p>906 Unified Inch Screw Taps</p> <p>909 Thread Limits, Ground Thread</p> <p>910 Thread Limits, Cut Thread</p>	<p style="text-align: center;">TAPS</p> <p><i>(Continued)</i></p> <p>911 M Profile Metric Taps</p> <p>911 Thread Limits, Ground Thread</p> <p>912 Tap Terms</p> <p>918 Tap Dimensions, Inch and Metric</p> <p>921 Optional Neck and Thread Length</p> <p>924 Extension Tap Dimensions</p> <p>925 Fine Pitch Tap Dimensions</p> <p>926 Standard Number of Flutes</p> <p>927 Pulley Taps Dimensions</p> <p>928 Straight and Taper Pipe Tap</p> <p>928 Dimensions</p> <p>929 Tolerances</p> <p>929 Runout and Locational Tolerance</p> <p>930 M Profile Tap D Limits (Inch)</p> <p>930 M Profile Tap D Limits (mm)</p> <p>931 Tap Sizes for Class 6H Threads</p> <p>932 Tap Sizes, Unified 2B & 3B</p> <p>933 Unified Threads Taps H Limits</p> <p>938 Straight Pipe Tap Thread Limits</p> <p>940 Taper Pipe Tap Thread Limits</p> <p>941 Screw Thread Insert Tap Limits</p> <p>944 Acme and Square-Threaded Taps</p> <p>944 Acme Threads Taps</p> <p>944 Adjustable Taps</p> <p>944 Proportions</p> <p>944 Drill Hole Sizes for Acme Threads</p> <p>947 Tapping Square Threads</p> <p>947 Collapsible Taps</p> <hr/> <p style="text-align: center;">STANDARD TAPERS</p> <hr/> <p>948 Standard Tapers</p> <p>948 Morse Taper</p> <p>948 Brown & Sharpe Taper</p> <p>949 Jarno Taper</p> <p>956 British Standard Tapers</p> <p>957 Morse Taper Sleeves</p> <p>958 Brown & Sharpe Taper Shank</p> <p>959 Jarno Taper Shanks</p> <p>959 Machine Tool Spindles</p> <p>960 Plug and Ring Gages</p> <p>961 Jacobs Tapers and Threads</p> <p>962 Spindle Noses</p> <p>964 Tool Shanks</p> <p>965 Draw-in Bolt Ends</p> <p>966 Spindle Nose</p> <p>967 V-Flange Tool Shanks</p> <p>968 Retention Knobs</p> <p>968 Collets</p> <p>968 R8 Collet</p>
---	---

TABLE OF CONTENTS
TOOLING AND TOOLMAKING

STANDARD TAPERS	KNURLS AND KNURLING
<i>(Continued)</i>	
969 Collets for Lathes, Mills, Grinders, and Fixtures	991 Knurls and Knurling
971 ER Type Collets	991 ANSI Standard
	991 Preferred Sizes
	991 Specifications
	992 Cylindrical Tools
	993 Flat Tools
	993 Specifications for Flat Dies
	993 Formulas to Knurled Work
	994 Tolerances
	995 Marking on Knurls and Dies
	995 Concave Knurls
ARBORS, CHUCKS, AND SPINDLES	TOOL WEAR AND SHARPENING
972 Portable Tool Spindles	996 Flank Wear
972 Circular Saw Arbors	997 Cratering
972 Spindles for Geared Chucks	997 Cutting Edge Chipping
972 Spindle Sizes	997 Deformation
972 Straight Grinding Wheel Spindles	998 Surface Finish
973 Square Drives for Portable Air	998 Sharpening Twist Drills
974 Threaded and Tapered Spindles	998 Relief Grinding of the Tool Flanks
974 Abrasion Tool Spindles	999 Drill Point Thinning
975 Hex Chucks for Portable Air	1000 Sharpening Carbide Tools
976 Mounted Wheels and Points	1000 Silicon Carbide Wheels
978 Shapes and Sizes	1001 Diamond Wheels
	1001 Diamond Wheel Grit Sizes
	1001 Diamond Wheel Grades
	1001 Diamond Concentration
	1002 Dry Versus Wet Grinding Carbide
	1002 Coolants for Carbide Grinding
	1002 Peripheral vs. Flat Side Grinding
	1003 Lapping Carbide Tools
	1003 Chip Breaker Grinding
	1003 Summary of Miscellaneous Points
BROACHES AND BROACHING	
979 The Broaching Process	
979 Types of Broaches	
980 Pitch of Broach Teeth	
981 Data for Surface Broaches	
982 Depth of Cut per Tooth	
983 Face Angle or Rake	
983 Clearance Angle	
983 Land Width	
983 Depth of Broach Teeth	
983 Radius of Tooth Fillet	
983 Total Length of Broach	
983 Chip Breakers	
984 Shear Angle	
984 Types of Broaching Machines	
984 Ball-Broaching	
985 Broaching Difficulties	
FILES AND BURS	
986 Definitions of File Terms	
987 File Characteristics	
987 Classes of Files	
989 Rotary Files and Burs	
990 Speeds of Rotary Files and Burs	
990 Steel Wool	

CUTTING TOOLS

Terms and Definitions

Tool Contour.—Tools for turning, planing, etc., are made in straight, bent, offset, and other forms to place the cutting edges in convenient positions for operating on differently located surfaces. The contour or shape of the cutting edge may also be varied to suit different classes of work. Tool shapes, however, are not only related to the kind of operation, but, in roughing tools particularly, the contour may have a decided effect upon the cutting efficiency of the tool. To illustrate, an increase in the side cutting-edge angle of a roughing tool, or in the nose radius, tends to permit higher cutting speeds because the chip will be thinner for a given feed rate. Such changes, however, may result in chattering or vibrations unless the work and the machine are rigid; hence, the most desirable contour may be a compromise between the ideal form and one that is needed to meet practical requirements.

Terms and Definitions.—The terms and definitions relating to single-point tools vary somewhat in different plants, but the following are in general use.

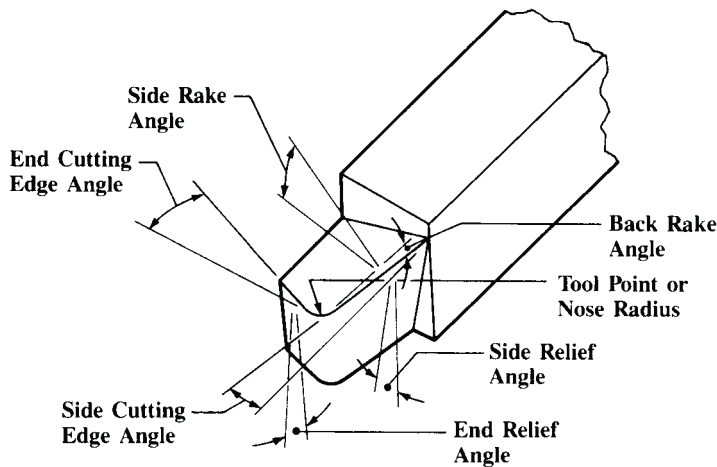


Fig. 1. Terms Applied to Single-point Turning Tools

Single-point Tool: This term is applied to tools for turning, planing, boring, etc., which have a cutting edge at one end. This cutting edge may be formed on one end of a solid piece of steel, or the cutting part of the tool may consist of an insert or tip which is held to the body of the tool by brazing, welding, or mechanical means.

Shank: The shank is the main body of the tool. If the tool is an inserted cutter type, the shank supports the cutter or bit. (See diagram, Fig. 1.)

Nose: A general term sometimes used to designate the cutting end but usually relating more particularly to the rounded tip of the cutting end.

Face: The surface against which the chips bear, as they are severed in turning or planing operations, is called the face.

Flank: The flank is that end surface adjacent to the cutting edge and below it when the tool is in a horizontal position as for turning.

Base: The base is the surface of the tool shank that bears against the supporting tool-holder or block.

Side Cutting Edge: The side cutting edge is the cutting edge on the side of the tool. Tools such as shown in Fig. 1 do the bulk of the cutting with this cutting edge and are, therefore, sometimes called side cutting edge tools.

End Cutting Edge: The end cutting edge is the cutting edge at the end of the tool.

On side cutting edge tools, the end cutting edge can be used for light plunging and facing cuts. Cutoff tools and similar tools have only one cutting edge located on the end. These

tools and other tools that are intended to cut primarily with the end cutting edge are sometimes called end cutting edge tools.

Rake: A metal-cutting tool is said to have rake when the tool face or surface against which the chips bear as they are being severed, is inclined for the purpose of either increasing or diminishing the keenness or bluntness of the edge. The magnitude of the rake is most conveniently measured by two angles called the back rake angle and the side rake angle. The tool shown in Fig. 1 has rake. If the face of the tool did not incline but was parallel to the base, there would be no rake; the rake angles would be zero.

Positive Rake: If the inclination of the tool face is such as to make the cutting edge keener or more acute than when the rake angle is zero, the rake angle is defined as positive.

Negative Rake: If the inclination of the tool face makes the cutting edge less keen or more blunt than when the rake angle is zero, the rake is defined as negative.

Back Rake: The back rake is the inclination of the face toward or away from the end or the end cutting edge of the tool. When the inclination is away from the end cutting edge, as shown in Fig. 1, the back rake is positive. If the inclination is downward toward the end cutting edge the back rake is negative.

Side Rake: The side rake is the inclination of the face toward or away from the side cutting edge. When the inclination is away from the side cutting edge, as shown in Fig. 1, the side rake is positive. If the inclination is toward the side cutting edge the side rake is negative.

Relief: The flanks below the side cutting edge and the end cutting edge must be relieved to allow these cutting edges to penetrate into the workpiece when taking a cut. If the flanks are not provided with relief, the cutting edges will rub against the workpiece and be unable to penetrate in order to form the chip. Relief is also provided below the nose of the tool to allow it to penetrate into the workpiece. The relief at the nose is usually a blend of the side relief and the end relief.

End Relief Angle: The end relief angle is a measure of the relief below the end cutting edge.

Side Relief Angle: The side relief angle is a measure of the relief below the side cutting edge.

Back Rake Angle: The back rake angle is a measure of the back rake. It is measured in a plane that passes through the side cutting edge and is perpendicular to the base. Thus, the back rake angle can be defined by measuring the inclination of the side cutting edge with respect to a line or plane that is parallel to the base. The back rake angle may be positive, negative, or zero depending upon the magnitude and direction of the back rake.

Side Rake Angle: The side rake angle is a measure of the side rake. This angle is always measured in a plane that is perpendicular to the side cutting edge and perpendicular to the base. Thus, the side rake angle is the angle of inclination of the face perpendicular to the side cutting edge with reference to a line or a plane that is parallel to the base.

End Cutting Edge Angle: The end cutting edge angle is the angle made by the end cutting edge with respect to a plane perpendicular to the axis of the tool shank. It is provided to allow the end cutting edge to clear the finish machined surface on the workpiece.

Side Cutting Edge Angle: The side cutting edge angle is the angle made by the side cutting edge and a plane that is parallel to the side of the shank.

Nose Radius: The nose radius is the radius of the nose of the tool. The performance of the tool, in part, is influenced by nose radius so that it must be carefully controlled.

Lead Angle: The lead angle, shown in Fig. 2, is not ground on the tool. It is a tool setting angle which has a great influence on the performance of the tool. The lead angle is bounded by the side cutting edge and a plane perpendicular to the workpiece surface when the tool is in position to cut; or, more exactly, the lead angle is the angle between the side cutting edge and a plane perpendicular to the direction of the feed travel.

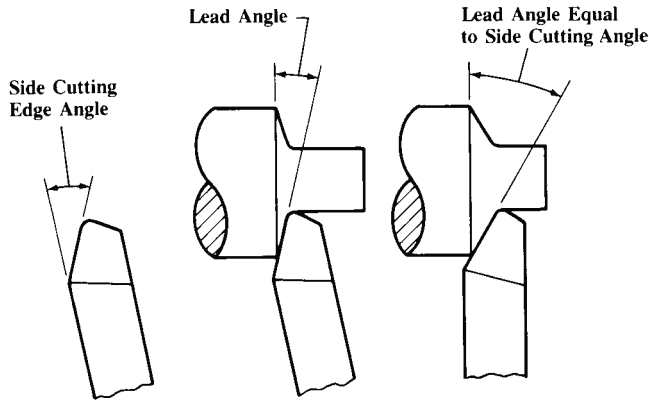


Fig. 2. Lead Angle on Single-point Turning Tool

Solid Tool: A solid tool is a cutting tool made from one piece of tool material.

Brazed Tool: A brazed tool is a cutting tool having a blank of cutting-tool material permanently brazed to a steel shank.

Blank: A blank is an unground piece of cutting-tool material from which a brazed tool is made.

Tool Bit: A tool bit is a relatively small cutting tool that is clamped in a holder in such a way that it can readily be removed and replaced. It is intended primarily to be reground when dull and not indexed.

Tool-bit Blank: The tool-bit blank is an unground piece of cutting-tool material from which a tool bit can be made by grinding. It is available in standard sizes and shapes.

Tool-bit Holder: Usually made from forged steel, the tool-bit holder is used to hold the tool bit, to act as an extended shank for the tool bit, and to provide a means for clamping in the tool post.

Straight-shank Tool-bit Holder: A straight-shank tool-bit holder has a straight shank when viewed from the top. The axis of the tool bit is held parallel to the axis of the shank.

Offset-shank Tool-bit Holder: An offset-shank tool-bit holder has the shank bent to the right or left, as seen in Fig. 3. The axis of the tool bit is held at an angle with respect to the axis of the shank.

Side cutting Tool: A side cutting tool has its major cutting edge on the side of the cutting part of the tool. The major cutting edge may be parallel or at an angle with respect to the axis of the tool.

Indexable Inserts: An indexable insert is a relatively small piece of cutting-tool material that is geometrically shaped to have two or several cutting edges that are used until dull. The insert is then indexed on the holder to apply a sharp cutting edge. When all the cutting edges have been dulled, the insert is discarded. The insert is held in a pocket or against other locating surfaces on an indexable insert holder by means of a mechanical clamping device that can be tightened or loosened easily.

Indexable Insert Holder: Made of steel, an indexable insert holder is used to hold indexable inserts. It is equipped with a mechanical clamping device that holds the inserts firmly in a pocket or against other seating surfaces.

Straight-shank Indexable Insert Holder: A straight-shank indexable insert tool-holder is essentially straight when viewed from the top, although the cutting edge of the insert may be oriented parallel, or at an angle to, the axis of the holder.

Offset-shank Indexable Insert Holder: An offset-shank indexable insert holder has the head end, or the end containing the insert pocket, offset to the right or left, as shown in Fig.

3.

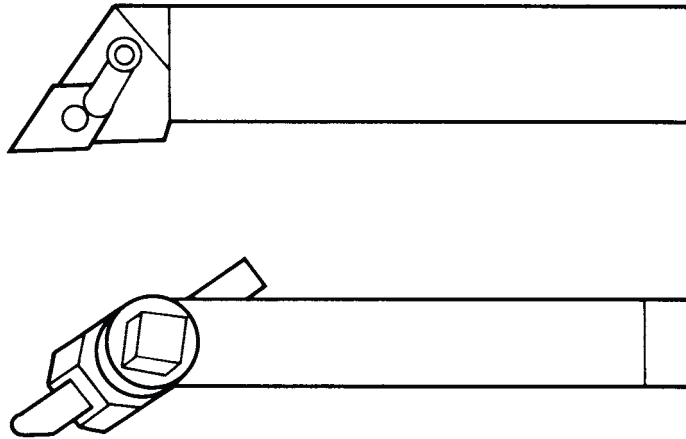


Fig. 3. Top: Right-hand Offset-shank, Indexable Insert Holder
Bottom: Right-hand Offset-shank Tool-bit Holder

End cutting Tool: An end cutting tool has its major cutting edge on the end of the cutting part of the tool. The major cutting edge may be perpendicular or at an angle, with respect to the axis of the tool.

Curved Cutting-edge Tool: A curved cutting-edge tool has a continuously variable side cutting edge angle. The cutting edge is usually in the form of a smooth, continuous curve along its entire length, or along a large portion of its length.

Right-hand Tool: A right-hand tool has the major, or working, cutting edge on the right-hand side when viewed from the cutting end with the face up. As used in a lathe, such a tool is usually fed into the work from right to left, when viewed from the shank end.

Left-hand Tool: A left-hand tool has the major or working cutting edge on the left-hand side when viewed from the cutting end with the face up. As used in a lathe, the tool is usually fed into the work from left to right, when viewed from the shank end.

Neutral-hand Tool: A neutral-hand tool is a tool to cut either left to right or right to left; or the cut may be parallel to the axis of the shank as when plunge cutting.

Chipbreaker: A groove formed in or on a shoulder on the face of a turning tool back of the cutting edge to break up the chips and prevent the formation of long, continuous chips which would be dangerous to the operator and also bulky and cumbersome to handle. A chipbreaker of the shoulder type may be formed directly on the tool face or it may consist of a separate piece that is held either by brazing or by clamping.

Relief Angles.—The end relief angle and the side relief angle on single-point cutting tools are usually, though not invariably, made equal to each other. The relief angle under the nose of the tool is a blend of the side and end relief angles.

The size of the relief angles has a pronounced effect on the performance of the cutting tool. If the relief angles are too large, the cutting edge will be weakened and in danger of breaking when a heavy cutting load is placed on it by a hard and tough material. On finish cuts, rapid wear of the cutting edge may cause problems with size control on the part. Relief angles that are too small will cause the rate of wear on the flank of the tool below the cutting edge to increase, thereby significantly reducing the tool life. In general, when cutting hard and tough materials, the relief angles should be 6 to 8 degrees for high-speed steel tools and 5 to 7 degrees for carbide tools. For medium steels, mild steels, cast iron, and other average work the recommended values of the relief angles are 8 to 12 degrees for high-speed steel tools and 5 to 10 degrees for carbides. Ductile materials having a relatively low modulus of elasticity should be cut using larger relief angles. For example, the relief angles recommended for turning copper, brass, bronze, aluminum, ferritic malleable

iron, and similar metals are 12 to 16 degrees for high-speed steel tools and 8 to 14 degrees for carbides.

Larger relief angles generally tend to produce a better finish on the finish machined surface because less surface of the worn flank of the tool rubs against the workpiece. For this reason, single-point thread-cutting tools should be provided with relief angles that are as large as circumstances will permit. Problems encountered when machining stainless steel may be overcome by increasing the size of the relief angle. The relief angles used should never be smaller than necessary.

Rake Angles.—Machinability tests have confirmed that when the rake angle along which the chip slides, called the true rake angle, is made larger in the positive direction, the cutting force and the cutting temperature will decrease. Also, the tool life for a given cutting speed will increase with increases in the true rake angle up to an optimum value, after which it will decrease again. For turning tools which cut primarily with the side cutting edge, the true rake angle corresponds rather closely with the side rake angle except when taking shallow cuts. Increasing the side rake angle in the positive direction lowers the cutting force and the cutting temperature, while at the same time it results in a longer tool life or a higher permissible cutting speed up to an optimum value of the side rake angle. After the optimum value is exceeded, the cutting force and the cutting temperature will continue to drop; however, the tool life and the permissible cutting speed will decrease.

As an approximation, the magnitude of the cutting force will decrease about one per cent per degree increase in the side rake angle. While not exact, this rule of thumb does correspond approximately to test results and can be used to make rough estimates. Of course, the cutting force also increases about one per cent per degree decrease in the side rake angle. The limiting value of the side rake angle for optimum tool life or cutting speed depends upon the work material and the cutting tool material. In general, lower values can be used for hard and tough work materials. Cemented carbides are harder and more brittle than high-speed steel; therefore, the rake angles usually used for cemented carbides are less positive than for high-speed steel.

Negative rake angles cause the face of the tool to slope in the opposite direction from positive rake angles and, as might be expected, they have an opposite effect. For side cutting edge tools, increasing the side rake angle in a negative direction will result in an increase in the cutting force and an increase in the cutting temperature of approximately one per cent per degree change in rake angle. For example, if the side rake angle is changed from 5 degrees positive to 5 degrees negative, the cutting force will be about 10 per cent larger. Usually the tool life will also decrease when negative side rake angles are used, although the tool life will sometimes increase when the negative rake angle is not too large and when a fast cutting speed is used.

Negative side rake angles are usually used in combination with negative back rake angles on single-point cutting tools. The negative rake angles strengthen the cutting edges enabling them to sustain heavier cutting loads and shock loads. They are recommended for turning very hard materials and for heavy interrupted cuts. There is also an economic advantage in favor of using negative rake indexable inserts and tool holders inasmuch as the cutting edges provided on both the top and bottom of the insert can be used.

On turning tools that cut primarily with the side cutting edge, the effect of the back rake angle alone is much less than the effect of the side rake angle although the direction of the change in cutting force, cutting temperature, and tool life is the same. The effect that the back rake angle has can be ignored unless, of course, extremely large changes in this angle are made. A positive back rake angle does improve the performance of the nose of the tool somewhat and is helpful in taking light finishing cuts. A negative back rake angle strengthens the nose of the tool and is helpful when interrupted cuts are taken. The back rake angle has a very significant effect on the performance of end cutting edge tools, such as cut-off tools. For these tools, the effect of the back rake angle is very similar to the effect of the side rake angle on side cutting edge tools.

Side Cutting Edge and Lead Angles.—These angles are considered together because the side cutting edge angle is usually designed to provide the desired lead angle when the tool is being used. The side cutting edge angle and the lead angle will be equal when the shank of the cutting tool is positioned perpendicular to the workpiece, or, more correctly, perpendicular to the direction of the feed. When the shank is not perpendicular, the lead angle is determined by the side cutting edge and an imaginary line perpendicular to the feed direction.

The flow of the chips over the face of the tool is approximately perpendicular to the side cutting edge except when shallow cuts are taken. The thickness of the undeformed chip is measured perpendicular to the side cutting edge. As the lead angle is increased, the length of chip in contact with the side cutting edge is increased, and the chip will become longer and thinner. This effect is the same as increasing the depth of cut and decreasing the feed, although the actual depth of cut and feed remain the same and the same amount of metal is removed. The effect of lengthening and thinning the chip by increasing the lead angle is very beneficial as it increases the tool life for a given cutting speed or that speed can be increased. Increasing the cutting speed while the feed and the tool life remain the same leads to faster production.

However, an adverse effect must be considered. Chatter can be caused by a cutting edge that is oriented at a high lead angle when turning and sometimes, when turning long and slender shafts, even a small lead angle can cause chatter. In fact, an unsuitable lead angle of the side cutting edge is one of the principal causes of chatter. When chatter occurs, often simply reducing the lead angle will cure it. Sometimes, very long and slender shafts can be turned successfully with a tool having a zero degree lead angle (and having a small nose radius). Boring bars, being usually somewhat long and slender, are also susceptible to chatter if a large lead angle is used. The lead angle for boring bars should be kept small, and for very long and slender boring bars a zero degree lead angle is recommended. It is impossible to provide a rule that will determine when chatter caused by a lead angle will occur and when it will not. In making a judgment, the first consideration is the length to diameter ratio of the part to be turned, or of the boring bar. Then the method of holding the workpiece must be considered — a part that is firmly held is less apt to chatter. Finally, the overall condition and rigidity of the machine must be considered because they may be the real cause of chatter.

Although chatter can be a problem, the advantages gained from high lead angles are such that the lead angle should be as large as possible at all times.

End Cutting Edge Angle.—The size of the end cutting edge angle is important when tool wear by cratering occurs. Frequently, the crater will enlarge until it breaks through the end cutting edge just behind the nose, and tool failure follows shortly. Reducing the size of the end cutting edge angle tends to delay the time of crater breakthrough. When cratering takes place, the recommended end cutting edge angle is 8 to 15 degrees. If there is no cratering, the angle can be made larger. Larger end cutting edge angles may be required to enable profile turning tools to plunge into the work without interference from the end cutting edge.

Nose Radius.—The tool nose is a very critical part of the cutting edge since it cuts the finished surface on the workpiece. If the nose is made to a sharp point, the finish machined surface will usually be unacceptable and the life of the tool will be short. Thus, a nose radius is required to obtain an acceptable surface finish and tool life. The surface finish obtained is determined by the feed rate and by the nose radius if other factors such as the work material, the cutting speed, and cutting fluids are not considered. A large nose radius will give a better surface finish and will permit a faster feed rate to be used.

Machinability tests have demonstrated that increasing the nose radius will also improve the tool life or allow a faster cutting speed to be used. For example, high-speed steel tools were used to turn an alloy steel in one series of tests where complete or catastrophic tool failure was used as a criterion for the end of tool life. The cutting speed for a 60-minute tool

life was found to be 125 fpm (0.635 m/s) when the nose radius was $\frac{1}{16}$ inch (1.59 mm) and 160 fpm (0.8.13 m/s) when the nose radius was $\frac{1}{4}$ inch (6.35 mm).

A very large nose radius can often be used but a limit is sometimes imposed because the tendency for chatter to occur is increased as the nose radius is made larger. A nose radius that is too large can cause chatter and when it does, a smaller nose radius must be used on the tool. It is always good practice to make the nose radius as large as is compatible with the operation being performed.

Chipbreakers.—Many steel turning tools are equipped with chipbreaking devices to prevent the formation of long continuous chips in connection with the turning of steel at the high speeds made possible by high-speed steel and especially cemented carbide tools. Long steel chips are dangerous to the operator, and cumbersome to handle, and they may twist around the tool and cause damage. Broken chips not only occupy less space, but permit a better flow of coolant to the cutting edge. Several different forms of chipbreakers are illustrated in Fig. 4.

Angular Shoulder Type: The angular shoulder type shown at A is one of the commonly used forms. As the enlarged sectional view shows, the chipbreaking shoulder is located back of the cutting edge. The angle a between the shoulder and cutting edge may vary from 6 to 15 degrees or more, 8 degrees being a fair average. The ideal angle, width W and depth G , depend upon the speed and feed, the depth of cut, and the material. As a general rule, width W , at the end of the tool, varies from $\frac{3}{32}$ to $\frac{7}{32}$ inch (2.4-5.6 mm), and the depth G may range from $\frac{1}{64}$ to $\frac{1}{16}$ inch (0.4-1.6 mm). The shoulder radius equals depth G . If the tool has a large nose radius, the corner of the shoulder at the nose end may be beveled off, as illustrated at B, to prevent it from coming into contact with the work. The width K for type B should equal approximately 1.5 times the nose radius.

Parallel Shoulder Type: Diagram C shows a design with a chipbreaking shoulder that is parallel with the cutting edge. With this form, the chips are likely to come off in short curled sections. The parallel form may also be applied to straight tools which do not have a side cutting-edge angle. The tendency with this parallel shoulder form is to force the chips against the work and damage it.

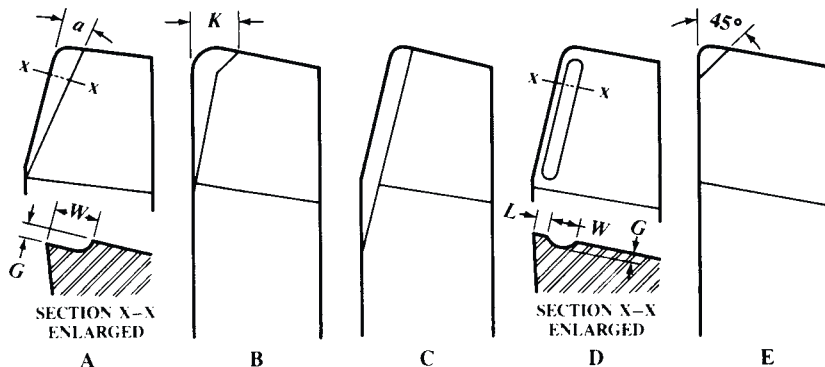


Fig. 4. Different Forms of Chipbreakers for Turning Tools

Groove Type: This type (diagram D) has a groove in the face of the tool produced by grinding. Between the groove and the cutting edge, there is a land L . Under ideal conditions, this width L , the groove width W , and the groove depth G , would be varied to suit the feed, depth of cut and material. For average use, L and G are about $\frac{1}{32}$ inch (0.79 mm), and W , $\frac{1}{16}$ inch (1.59 mm). There are differences of opinion concerning the relative merits of the groove type and the shoulder type. Both types have proved satisfactory when properly proportioned for a given class of work.

Chipbreaker for Light Cuts: Diagram E illustrates a form of chipbreaker that is sometimes used on tools for finishing cuts having a maximum depth of about $\frac{1}{32}$ inch (0.79 mm). This chipbreaker is a shoulder type having an angle of 45 degrees and a maximum width of about $\frac{1}{16}$ inch (1.59 mm). It is important in grinding all chipbreakers to give the chip-bearing surfaces a fine finish, such as would be obtained by honing. This finish greatly increases the life of the tool.

Planing Tools.—Many of the principles which govern the shape of turning tools also apply in the grinding of tools for planing. The amount of rake depends upon the hardness of the material, and the direction of the rake should be away from the *working part* of the cutting edge. The angle of clearance should be about 4 or 5 degrees for planer tools, which is less than for lathe tools. This small clearance is allowable because a planer tool is held about square with the platen, whereas a lathe tool, the height and inclination of which can be varied, may not always be clamped in the same position.

Carbide Tools: Carbide tools for planing usually have negative rake. Round-nose and square-nose end-cutting tools should have a “negative back rake” (or front rake) of 2 or 3 degrees. Side cutting tools may have a negative back rake of 10 degrees, a negative side rake of 5 degrees, and a side cutting-edge angle of 8 degrees.

Indexable Inserts

Introduction.—A large proportion of cemented carbide, single-point cutting tools are indexable inserts and indexable insert tool holders. Dimensional specifications for solid sintered carbide indexable inserts are given in ANSI B212.12-1991 (R2002). Samples of the many insert shapes are shown in [Table 3b](#). Most modern, cemented carbide, face milling cutters are of the indexable insert type. Larger size end milling cutters, side milling or slotting cutters, boring tools, and a wide variety of special tools are made to use indexable inserts. These inserts are primarily made from cemented carbide, although most of the cemented oxide cutting tools are also indexable inserts.

The objective of this type of tooling is to provide an insert with several cutting edges. When an edge is worn, the insert is indexed in the tool holder until all the cutting edges are used up, after which it is discarded. The insert is not intended to be reground. The advantages are that the cutting edges on the tool can be rapidly changed without removing the tool holder from the machine, tool-grinding costs are eliminated, and the cost of the insert is less than the cost of a similar, brazed carbide tool. Of course, the cost of the tool holder must be added to the cost of the insert; however, one tool holder will usually last for a long time before it, too, must be replaced.

Indexable inserts and tool holders are made with a negative rake or with a positive rake. Negative rake inserts have the advantage of having twice as many cutting edges available as comparable positive rake inserts, because the cutting edges on both the top and bottom of negative rake inserts can be used, while only the top cutting edges can be used on positive rake inserts. Positive rake inserts have a distinct advantage when machining long and slender parts, thin-walled parts, or other parts that are subject to bending or chatter when the cutting load is applied to them, because the cutting force is significantly lower as compared to that for negative rake inserts. Indexable inserts can be obtained in the following forms: utility ground, or ground on top and bottom only; precision ground, or ground on all surfaces; prehone to produce a slight rounding of the cutting edge; and precision molded, which are unground. Positive-negative rake inserts also are available. These inserts are held on a negative-rake tool holder and have a chipbreaker groove that is formed to produce an effective positive-rake angle while cutting. Cutting edges may be available on the top surface only, or on both top and bottom surfaces. The positive-rake chipbreaker surface may be ground or precision molded on the insert.

Many materials, such as gray cast iron, form a discontinuous chip. For these materials an insert that has plain faces without chipbreaker grooves should always be used. Steels and

other ductile materials form a continuous chip that must be broken into small segments when machined on lathes and planers having single-point, cemented-carbide and cemented-oxide cutting tools; otherwise, the chips can cause injury to the operator. In this case a chipbreaker must be used. Some inserts are made with chipbreaker grooves molded or ground directly on the insert. When inserts with plain faces are used, a cemented-carbide plate-type chipbreaker is clamped on top of the insert.

Identification System for Indexable Inserts.—The size of indexable inserts is determined by the diameter of an inscribed circle (I.C.), except for rectangular and parallelogram inserts where the length and width are used. To describe an insert in its entirety, a standard ANSI B212.4-2002 identification system is used where each position number designates a feature of the insert. The ANSI Standard includes items now commonly used and facilitates identification of items not in common use. Identification consists of up to ten positions; each position defines a characteristic of the insert as shown below:

1	2	3	4	5	6	7	8 ^a	9 ^a	10 ^a
T	N	M	G	5	4	3			A

^aEighth, Ninth, and Tenth Positions are used only when required.

1) *Shape*: The shape of an insert is designated by a letter: **R** for round; **S**, square; **T**, triangle; **A**, 85° parallelogram; **B**, 82° parallelogram; **C**, 80° diamond; **D**, 55° diamond; **E**, 75° diamond; **H**, hexagon; **K**, 55° parallelogram; **L**, rectangle; **M**, 86° diamond; **O**, octagon; **P**, pentagon; **V**, 35° diamond; and **W**, 80° trigon.

2) *Relief Angle (Clearances)*: The second position is a letter denoting the relief angles: **N** for 0°; **A**, 3°; **B**, 5°; **C**, 7°; **P**, 11°; **D**, 15°; **E**, 20°; **F**, 25°; **G**, 30°; **H**, 0° & 11°*; **J**, 0° & 14°*; **K**, 0° & 17°*; **L**, 0° & 20°*; **M**, 11° & 14°*; **R**, 11° & 17°*; **S**, 11° & 20°*. When mounted on a holder, the actual relief angle may be different from that on the insert.

3) *Tolerances*: The third position is a letter and indicates the tolerances which control the indexability of the insert. Tolerances specified do not imply the method of manufacture.

Symbol	Tolerance (± from nominal)		Symbol	Tolerance (± from nominal)	
	Inscribed Circle, Inch	Thickness, Inch		Inscribed Circle, Inch	Thickness, Inch
A	0.001	0.001	H	0.0005	0.001
B	0.001	0.005	J	0.002–0.005	0.001
C	0.001	0.001	K	0.002–0.005	0.001
D	0.001	0.005	L	0.002–0.005	0.001
E	0.001	0.001	M	0.002–0.004 ^a	0.005
F	0.0005	0.001	U	0.005–0.010 ^a	0.005
G	0.001	0.005	N	0.002–0.004 ^a	0.001

^aExact tolerance is determined by size of insert. See ANSI B212.12.

4) *Type*: The type of insert is designated by a letter. **A**, with hole; **B**, with hole and countersink; **C**, with hole and two countersinks; **F**, chip grooves both surfaces, no hole; **G**, same as **F** but with hole; **H**, with hole, one countersink, and chip groove on one rake surface; **J**, with hole, two countersinks and chip grooves on two rake surfaces; **M**, with hole and chip groove on one rake surface; **N**, without hole; **Q**, with hole and two countersinks; **R**, without hole but with chip groove on one rake surface; **T**, with hole, one countersink, and chip groove on one rake face; **U**, with hole, two countersinks, and chip grooves on two rake faces; and **W**, with hole and one countersink. *Note*: a dash may be used after position 4 to

* Second angle is secondary facet angle, which may vary by ± 1°.

separate the shape-describing portion from the following dimensional description of the insert and is not to be considered a position in the standard description.

5) *Size*: The size of the insert is designated by a one- or a two-digit number. For regular polygons and diamonds, it is the number of eighths of an inch in the nominal size of the inscribed circle, and will be a one- or two-digit number when the number of eighths is a whole number. It will be a two-digit number, including one decimal place, when it is not a whole number. Rectangular and parallelogram inserts require two digits: the first digit indicates the number of eighths of an inch width and the second digit, the number of quarters of an inch length.

6) *Thickness*: The thickness is designated by a one- or two-digit number, which indicates the number of sixteenths of an inch in the thickness of the insert. It is a one-digit number when the number of sixteenths is a whole number; it is a two-digit number carried to one decimal place when the number of sixteenths of an inch is not a whole number.

7) *Cutting Point Configuration*: The cutting point, or nose radius, is designated by a number representing $\frac{1}{64}$ ths of an inch; a flat at the cutting point or nose, is designated by a letter: **0** for sharp corner, 0.002 inch max. radius; **0.2** for 0.004 radius; **0.3 for 0.008 radius**; **1**, $\frac{1}{64}$ inch radius; **2**, $\frac{1}{32}$ inch radius; **3**, $\frac{3}{64}$ inch radius; **4**, $\frac{1}{16}$ inch radius; **5**, $\frac{5}{64}$ inch radius; **6**, $\frac{3}{32}$ inch radius; **7**, $\frac{7}{64}$ inch radius; **8**, $\frac{1}{8}$ inch radius; **X**, any other radius; **A**, square insert with 45° chamfer; **D**, square insert with 30° chamfer; **E**, square insert with 15° chamfer; **F**, square insert with 3° chamfer; **K**, square insert with 30° double chamfer; **L**, square insert with 15° double chamfer; **M**, square insert with 3° double chamfer; **N**, truncated triangle insert; and **P**, flattened corner triangle insert.

8) *Special Cutting Point Definition*: The eighth position, if it follows a letter in the 7th position, is a number indicating the number of $\frac{1}{64}$ ths of an inch in the primary facet length measured parallel to the edge of the facet.

9) *Hand*: **R**, right; **L**, left; to be used when required in ninth position.

10) *Other Conditions*: Position ten defines special conditions (such as edge treatment, surface finish): **A**, honed, 0.0005 to less than 0.003 inch (0.0127 to 0.0762 mm); **B**, honed, 0.003 to less than 0.005 inch (0.0762 to 0.127 mm); **C**, honed, 0.005 to less than 0.007 inch (0.127 to 0.178 mm); **J**, polished, 4 μ inch (0.1016 μ m) arithmetic average (AA) on rake surfaces only; **T**, chamfered, manufacturer's standard negative land, rake face only.

Indexable Insert Tool Holders.—Indexable insert tool holders are made from a good grade of steel which is heat treated to a hardness of 44 to 48 Rc for most normal applications. Accurate pockets that serve to locate the insert in position and to provide surfaces against which the insert can be clamped are machined in the ends of tool holders. A cemented carbide seat usually is provided, and is held in the bottom of the pocket by a screw or by the clamping pin, if one is used. The seat is necessary to provide a flat bearing surface upon which the insert can rest and, in so doing, it adds materially to the ability of the insert to withstand the cutting load. The seating surface of the holder may provide a positive-, negative-, or a neutral-rake orientation to the insert when it is in position on the holder. Holders, therefore, are classified as positive, negative, or neutral rake.

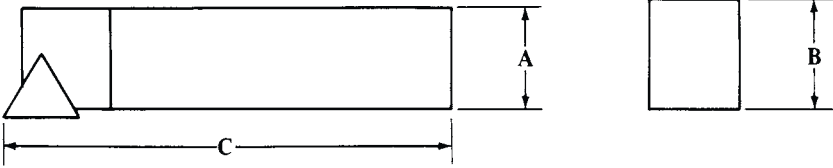
Four basic methods are used to clamp the insert on the holder: 1) Clamping, usually top clamping; 2) Pin-lock clamping; 3) Multiple clamping using a clamp, usually a top clamp, and a pin lock; and 4) Clamping the insert with a machine screw.

All top clamps are actuated by a screw that forces the clamp directly against the insert. When required, a cemented-carbide, plate-type chipbreaker is placed between the clamp and the insert. Pin-lock clamps require an insert having a hole: the pin acts against the walls of the hole to clamp the insert firmly against the seating surfaces of the holder. Multiple or combination clamping, simultaneously using both a pin-lock and a top clamp, is recommended when taking heavier or interrupted cuts. Holders are available on which all the above-mentioned methods of clamping may be used. Other holders are made with only a top clamp or a pin lock. Screw-on type holders use a machine screw to hold the insert in the

pocket. Most standard indexable insert holders are either straight-shank or offset-shank, although special holders are made having a wide variety of configurations.

The common shank sizes of indexable insert tool holders are shown in Table 1. Not all styles are available in every shank size. Positive- and negative-rake tools are also not available in every style or shank size. Some manufacturers provide additional shank sizes for certain tool holder styles. For more complete details the manufacturers' catalogs must be consulted.

Table 1. Standard Shank Sizes for Indexable Insert Holders



Basic Shank Size	Shank Dimensions for Indexable Insert Holders					
	A		B		C ^a	
	inch	mm	inch	mm	inch	mm
1/2 x 1/2 x 4 1/2	0.500	12.70	0.500	12.70	4.500	114.30
5/8 x 5/8 x 4 1/2	0.625	15.87	0.625	15.87	4.500	114.30
5/8 x 1 1/4 x 6	0.625	15.87	1.250	31.75	6.000	152.40
3/4 x 3/4 x 4 1/2	0.750	19.05	0.750	19.05	4.500	114.30
3/4 x 1 x 6	0.750	19.05	1.000	25.40	6.000	152.40
3/4 x 1 1/4 x 6	0.750	19.05	1.250	31.75	6.000	152.40
1 x 1 x 6	1.000	25.40	1.000	25.40	6.000	152.40
1 x 1 1/4 x 6	1.000	25.40	1.250	31.75	6.000	152.40
1 x 1 1/2 x 6	1.000	25.40	1.500	38.10	6.000	152.40
1 1/4 x 1 1/4 x 7	1.250	31.75	1.250	31.75	7.000	177.80
1 1/4 x 1 1/2 x 8	1.250	31.75	1.500	38.10	8.000	203.20
1 3/8 x 2 1/16 x 6 3/8	1.375	34.92	2.062	52.37	6.380	162.05
1 1/2 x 1 1/2 x 7	1.500	38.10	1.500	38.10	7.000	177.80
1 3/4 x 1 3/4 x 9 1/2	1.750	44.45	1.750	44.45	9.500	241.30
2 x 2 x 8	2.000	50.80	2.000	50.80	8.000	203.20

^aHolder length; may vary by manufacturer. Actual shank length depends on holder style.

Identification System for Indexable Insert Holders.—The following identification system conforms to the American National Standard, ANSI B212.5-2002, Metric Holders for Indexable Inserts.

Each position in the system designates a feature of the holder in the following sequence:

1 2 3 4 5 — 6 — 7 — 8^a — 9 — 10^a
C T N A R — 85 — 25 — D — 16 — Q

1) *Method of Holding Horizontally Mounted Insert:* The method of holding or clamping is designated by a letter: **C**, top clamping, insert without hole; **M**, top and hole clamping, insert with hole; **P**, hole clamping, insert with hole; **S**, screw clamping through hole, insert with hole; **W**, wedge clamping.

2) *Insert Shape:* The insert shape is identified by a letter: **H**, hexagonal; **O**, octagonal; **P**, pentagonal; **S**, square; **T**, triangular; **C**, rhombic, 80° included angle; **D**, rhombic, 55° included angle; **E**, rhombic, 75° included angle; **M**, rhombic, 86° included angle; **V**, rhombic, 35° included angle; **W**, hexagonal, 80° included angle; **L**, rectangular; **A**, parallelogram, 85° included angle; **B**, parallelogram, 82° included angle; **K**, parallelogram, 55° included angle; **R**, round. The included angle is always the smaller angle.

3) *Holder Style:* The holder style designates the shank style and the side cutting edge angle, or end cutting edge angle, or the purpose for which the holder is used. It is design-

nated by a letter: **A**, for straight shank with 0° side cutting edge angle; **B**, straight shank with 15° side cutting edge angle; **C**, straight-shank end cutting tool with 0° end cutting edge angle; **D**, straight shank with 45° side cutting edge angle; **E**, straight shank with 30° side cutting edge angle; **F**, offset shank with 0° end cutting edge angle; **G**, offset shank with 0° side cutting edge angle; **J**, offset shank with negative 3° side cutting edge angle; **K**, offset shank with 15° end cutting edge angle; **L**, offset shank with negative 5° side cutting edge angle and 5° end cutting edge angle; **M**, straight shank with 40° side cutting edge angle; **N**, straight shank with 27° side cutting edge angle; **R**, offset shank with 15° side cutting edge angle; **S**, offset shank with 45° side cutting edge angle; **T**, offset shank with 30° side cutting edge angle; **U**, offset shank with negative 3° end cutting edge angle; **V**, straight shank with $17\frac{1}{2}^\circ$ side cutting edge angle; **W**, offset shank with 30° end cutting edge angle; **Y**, offset shank with 5° end cutting edge angle.

4) *Normal Clearances*: The normal clearances of inserts are identified by letters: **A**, 3° ; **B**, 5° ; **C**, 7° ; **D**, 15° ; **E**, 20° ; **F**, 25° ; **G**, 30° ; **N**, 0° ; **P**, 11° .

5) *Hand of tool*: The hand of the tool is designated by a letter: **R** for right-hand; **L**, left-hand; and **N**, neutral, or either hand.

6) *Tool Height for Rectangular Shank Cross Sections*: The tool height for tool holders with a rectangular shank cross section and the height of cutting edge equal to shank height is given as a two-digit number representing this value in millimeters. For example, a height of 32 mm would be encoded as 32; 8 mm would be encoded as 08, where the one-digit value is preceded by a zero.

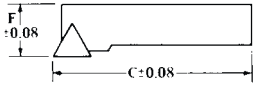
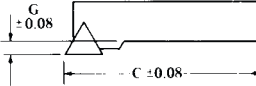
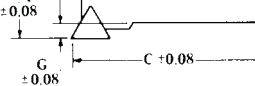
7) *Tool Width for Rectangular Shank Cross Sections*: The tool width for tool holders with a rectangular shank cross section is given as a two-digit number representing this value in millimeters. For example, a width of 25 mm would be encoded as 25; 8 mm would be encoded as 08, where the one-digit value is preceded by a zero.

8) *Tool Length*: The tool length is designated by a letter: **A**, 32 mm; **B**, 40 mm; **C**, 50 mm; **D**, 60 mm; **E**, 70 mm; **F**, 80 mm; **G**, 90 mm; **H**, 100 mm; **J**, 110 mm; **K**, 125 mm; **L**, 140 mm; **M**, 150 mm; **N**, 160 mm; **P**, 170 mm; **Q**, 180 mm; **R**, 200 mm; **S**, 250 mm; **T**, 300 mm; **U**, 350 mm; **V**, 400 mm; **W**, 450 mm; **X**, special length to be specified; **Y**, 500 mm.

9) *Indexable Insert Size*: The size of indexable inserts is encoded as follows: For insert shapes **C**, **D**, **E**, **H**, **M**, **O**, **P**, **R**, **S**, **T**, **V**, the side length (the diameter for **R** inserts) in millimeters is used as a two-digit number, with decimals being disregarded. For example, the symbol for a side length of 16.5 mm is 16. For insert shapes **A**, **B**, **K**, **L**, the length of the main cutting edge or of the longer cutting edge in millimeters is encoded as a two-digit number, disregarding decimals. If the symbol obtained has only one digit, then it should be preceded by a zero. For example, the symbol for a main cutting edge of 19.5 mm is 19; for an edge of 9.5 mm, the symbol is 09.

10) *Special Tolerances*: Special tolerances are indicated by a letter: **Q**, back and end qualified tool; **F**, front and end qualified tool; **B**, back, front, and end qualified tool. A qualified tool is one that has tolerances of ± 0.08 mm for dimensions *F*, *G*, and *C*. (See Table 2.)

Table 2. Letter Symbols for Qualification of Tool Holders
Position 10 ANSI B212.5-2002

Letter Symbol			
	Q F B		
Qualification of Tool Holder	 <p>Back and end qualified tool</p>	 <p>Front and end qualified tool</p>	 <p>Back, front, and end qualified tool</p>

Selecting Indexable Insert Holders.—A guide for selecting indexable insert holders is provided by [Table 3b](#). Some operations such as deep grooving, cut-off, and threading are not given in this table. However, tool holders designed specifically for these operations are available. The boring operations listed in [Table 3b](#) refer primarily to larger holes, into which the holders will fit. Smaller holes are bored using boring bars. An examination of this table shows that several tool-holder styles can be used and frequently are used for each operation. Selection of the best holder for a given job depends largely on the job and there are certain basic facts that should be considered in making the selection.

Rake Angle: A negative-rake insert has twice as many cutting edges available as a comparable positive-rake insert. Sometimes the tool life obtained when using the second face may be less than that obtained on the first face because the tool wear on the cutting edges of the first face may reduce the insert strength. Nevertheless, the advantage of negative-rake inserts and holders is such that they should be considered first in making any choice. Positive-rake holders should be used where lower cutting forces are required, as when machining slender or small-diameter parts, when chatter may occur, and for machining some materials, such as aluminum, copper, and certain grades of stainless steel, when positive-negative rake inserts can sometimes be used to advantage. These inserts are held on negative-rake holders that have their rake surfaces ground or molded to form a positive-rake angle.

Insert Shape: The configuration of the workpiece, the operation to be performed, and the lead angle required often determine the insert shape. When these factors need not be considered, the insert shape should be selected on the basis of insert strength and the maximum number of cutting edges available. Thus, a round insert is the strongest and has a maximum number of available cutting edges. It can be used with heavier feeds while producing a good surface finish. Round inserts are limited by their tendency to cause chatter, which may preclude their use. The square insert is the next most effective shape, providing good corner strength and more cutting edges than all other inserts except the round insert. The only limitation of this insert shape is that it must be used with a lead angle. Therefore, the square insert cannot be used for turning square shoulders or for back-facing. Triangle inserts are the most versatile and can be used to perform more operations than any other insert shape. The 80-degree diamond insert is designed primarily for heavy turning and facing operations, using the 100-degree corners, and for turning and back-facing square shoulders using the 80-degree corners. The 55- and 35-degree diamond inserts are intended primarily for tracing.

Lead Angle: Tool holders should be selected to provide the largest possible lead angle, although limitations are sometimes imposed by the nature of the job. For example, when turning and back-facing a shoulder, a negative lead angle must be used. Slender or small-diameter parts may deflect, causing difficulties in holding size, or chatter when the lead angle is too large.

End Cutting Edge Angle: When tracing or contour turning, the plunge angle is determined by the end cutting edge angle. A 2-deg minimum clearance angle should be provided between the workpiece surface and the end cutting edge of the insert. [Table 3a](#) provides the maximum plunge angle for holders commonly used to plunge when tracing where insert shape identifiers are *S* = square, *T* = triangle, *D* = 55-deg diamond, *V* = 35-deg diamond. When severe cratering cannot be avoided, an insert having a small, end cutting edge angle is desirable to delay the crater breakthrough behind the nose. For very heavy cuts a small, end cutting edge angle will strengthen the corner of the tool. Tool holders for numerical control machines are discussed beginning page [781](#).

Table 3a. Maximum Plunge Angle for Tracing or Contour Turning

Tool Holder Style	Insert Shape	Maximum Plunge Angle	Tool Holder Style	Insert Shape	Maximum Plunge Angle
E	T	58°	J	D	30°
D and S	S	43°	J	V	50°
H	D	71°	N	T	55°
J	T	25°	N	D	58° < 60°

Table 3b. Indexable Insert Holder Application Guide

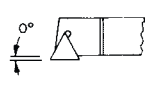
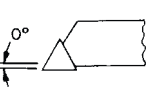
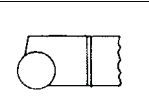
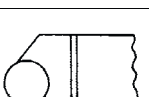
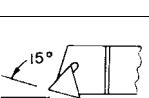
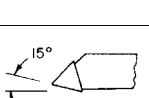
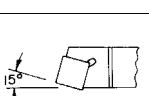
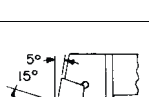

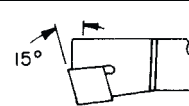
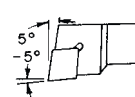
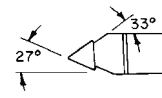
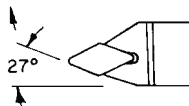
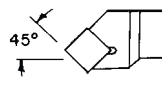
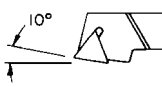
Tool	Tool Holder Style	Insert Shape	N-Negative P-Positive	Application									
				Rake	Turn	Face	Turn and Face	Turn and Backface	Trace	Groove	Chamfer	Bore	Plane
	A	T	N	●	●							●	
			P	●	●							●	
	A	T	N	●	●				●				
			P	●	●				●				
	A	R	N	●	●	●							●
			P										
	A	R	N	●	●	●			●				●
			P										
	B	T	N	●	●							●	
			P	●	●								●
	B	T	N	●	●				●			●	
			P	●	●				●				●
	B	S	N	●	●							●	
			P	●	●								●
	B	C	N	●	●	●						●	●
			P										
	C	T	N	●	●					●	●		
			P	●	●						●	●	

Table 3b. (Continued) Indexable Insert Holder Application Guide

Tool	Tool Holder Style	Insert Shape	N-Negative P-Positive	Application									
				Turn	Face	Turn and Face	Turn and Backface	Trace	Groove	Chamfer	Bore	Plane	
	K	C	N	●	●							●	
	L	C	N			●	●						
	N	T	N	●	●			●					
			P	●	●			●					
	N	D	N	●	●			●					
	S	S	N	●	●	●		●		●	●	●	
			P	●	●	●		●		●	●	●	
	W	S	N	●	●								

Sintered Carbide Blanks and Cutting Tools

Sintered Carbide Blanks.—As shown in Table 4, American National Standard ANSI B212.1-2002 provides standard sizes and designations for eight styles of sintered carbide blanks. These blanks are the unground solid carbide from which either solid or tipped cutting tools are made. Tipped cutting tools are made by brazing a blank onto a shank to produce the cutting tool; these tools differ from carbide *insert* cutting tools which consist of a carbide insert held mechanically in a tool holder. A typical single-point carbide-tipped cutting tool is shown in Fig. 1 on page 774.

Single-Point, Sintered-Carbide-Tipped Tools.—American National Standard ANSI B212.1-2002 covers eight different styles of single-point, carbide-tipped general purpose tools. These styles are designated by the letters A to G inclusive. Styles A, B, F, G, and E with offset point are either right- or left-hand cutting as indicated by the letters R or L. Dimensions of tips and shanks are given in Tables 5 to 12. For dimensions and tolerances not shown, and for the identification system, dimensions, and tolerances of sintered carbide boring tools, see the Standard.

A number follows the letters of the tool style and hand designation and for square shank tools, represents the number of sixteenths of an inch of width, *W*, and height, *H*. With rectangular shanks, the first digit of the number indicates the number of eighths of an inch in the shank width, *W*, and the second digit the number of quarters of an inch in the shank

**Table 4. American National Standard Sizes and Designations for Carbide Blanks
ANSI B212.1-2002 (R2007)**

Blank Dimensions ^a			Style ^b		Blank Dimensions ^a			Style ^b			
			1000	2000				0000	1000	3000	4000
<i>T</i>	<i>W</i>	<i>L</i>	Blank Designation		<i>T</i>	<i>W</i>	<i>L</i>	Blank Designation			
1/16	1/8	5/8	1010	2010	1/4	3/8	3/16	0350	1350	3350	4350
1/16	5/32	1/4	1015	2015	1/4	3/8	3/4	0360	1360	3360	4360
1/16	3/16	1/4	1020	2020	1/4	7/16	5/8	0370	1370	3370	4370
1/16	1/4	1/4	1025	2025	1/4	1/2	3/4	0380	1380	3380	4380
1/16	1/4	5/16	1030	2030	1/4	9/16	1	0390	1390	3390	4390
3/32	1/8	3/4	1035	2035	1/4	5/8	5/8	0400	1400	3400	4400
3/32	3/16	5/16	1040	2040	1/4	3/4	3/4	0405	1405	3405	4405
3/32	3/16	1/2	1050	2050	1/4	3/4	1	0410	1410	3410	4410
3/32	1/4	3/8	1060	2060	1/4	1	1	0415	1415	3415	4415
3/32	1/4	1/2	1070	2070	5/16	7/16	5/8	0420	1420	3420	4420
3/32	5/16	3/8	1080	2080	5/16	7/16	15/16	0430	1430	3430	4430
3/32	3/8	3/8	1090	2090	5/16	1/2	3/4	0440	1440	3440	4440
3/32	3/8	1/2	1100	2100	5/16	1/2	1	0450	1450	3450	4450
3/32	7/16	1/2	1105	2105	5/16	5/8	1	0460	1460	3460	4460
3/32	5/16	3/8	1080	2080	5/16	3/4	3/4	0470	1470	3470	4470
1/8	3/16	3/4	1110	2110	5/16	3/4	1	0475	1475	3475	4475
1/8	1/4	1/2	1120	2120	5/16	3/4	1 1/4	0480	1480	3480	4480
1/8	1/4	5/8	1130	2130	3/8	1/2	3/4	0490	1490	3490	4490
1/8	1/4	3/4	1140	2140	3/8	1/2	1	0500	1500	3500	4500
1/8	5/16	7/16	1150	2150	3/8	5/8	1	0510	1510	3510	4510
1/8	3/16	1/2	1160	2160	3/8	3/8	1 1/4	0515	1515	3515	4515
1/8	3/16	3/4	1110	2110	3/8	3/4	1 1/4	0520	1520	3520	4520
1/8	5/16	5/8	1170	2170	3/8	3/4	1 1/2	0525	1525	3525	4525
1/8	3/8	1/2	1180	2180	1/2	3/4	1	0530	1530	3530	4530
1/8	3/8	3/4	1190	2190	1/2	3/4	1 1/4	0540	1540	3540	4540
1/8	1/2	1/2	1200	2200	3/8	1/2	3/4	0490	1490	3490	4490
1/8	1/2	3/4	1210	2210	1/2	3/4	1 1/2	0550	1550	3550	4550
1/8	3/4	3/4	1215	2215							
5/32	3/8	9/16	1220	2220	<i>T</i>	<i>W</i>	<i>L</i>	<i>F</i>	Style ^b		
5/32	3/8	3/4	1230	2230					5000	6000	70000
5/32	5/8	5/8	1240	2240	1/16	1/4	3/16	...	5030
3/16	3/16	7/16	1250	2250	3/32	1/4	3/8	1/16	7060
3/16	5/16	5/8	1260	2260	3/32	5/16	3/8	...	5080	6080	...
3/16	3/8	1/2	1270	2270	3/32	3/8	1/2	...	5100	6100	...
3/16	3/8	5/8	1280	2280	3/32	7/16	1/2	...	5105
3/16	3/8	3/4	1290	2290	1/8	5/16	5/8	3/32	7170
3/16	7/16	5/8	1300	2300	3/32	1/4	3/8	1/16	7060
3/16	7/16	13/16	1310	2310	1/8	1/2	1/2	...	5200	6200	...
3/16	1/2	1/2	1320	2320	5/32	3/8	3/4	1/8	7230
3/16	1/2	3/4	1330	2330	5/32	5/8	5/8	...	5240	6240	...
3/16	3/4	3/4	1340	2340	3/16	3/4	3/4	...	5340	6340	...
					1/4	1	3/4	...	5410

^a All dimensions are in inches.

^b See Fig. 1 on page 774 for a description of styles.

height, *H*. One exception is the 1 1/2 × 2-inch size which has been arbitrarily assigned the number 90.

A typical single-point carbide tipped cutting tool is shown in Fig. 2. The side rake, side relief, and the clearance angles are normal to the side-cutting edge, rather than the shank, to facilitate its being ground on a tilting-table grinder. The end-relief and clearance angles are normal to the end-cutting edge. The back-rake angle is parallel to the side-cutting edge.

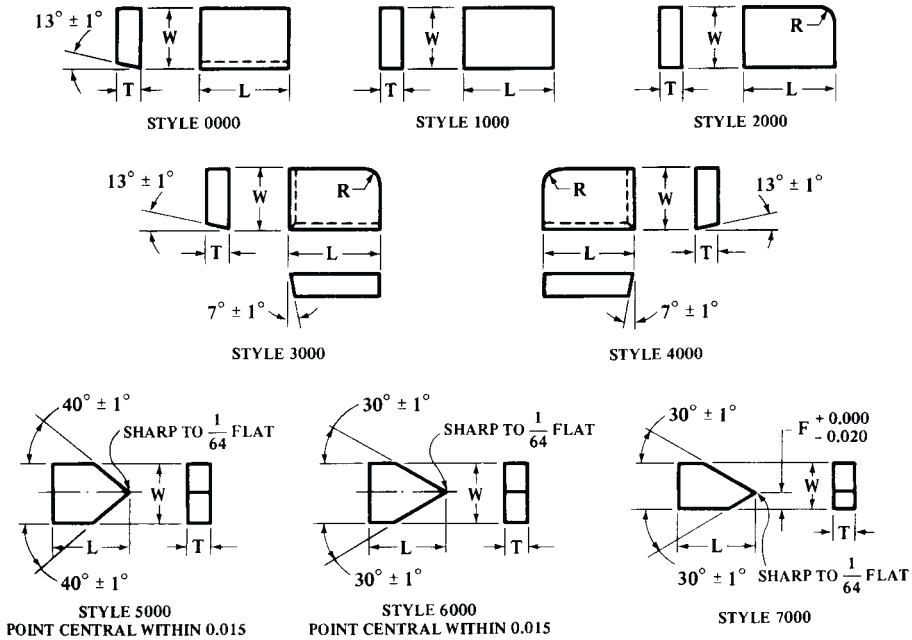


Fig. 1. Eight styles of sintered carbide blanks (see Table 4.)

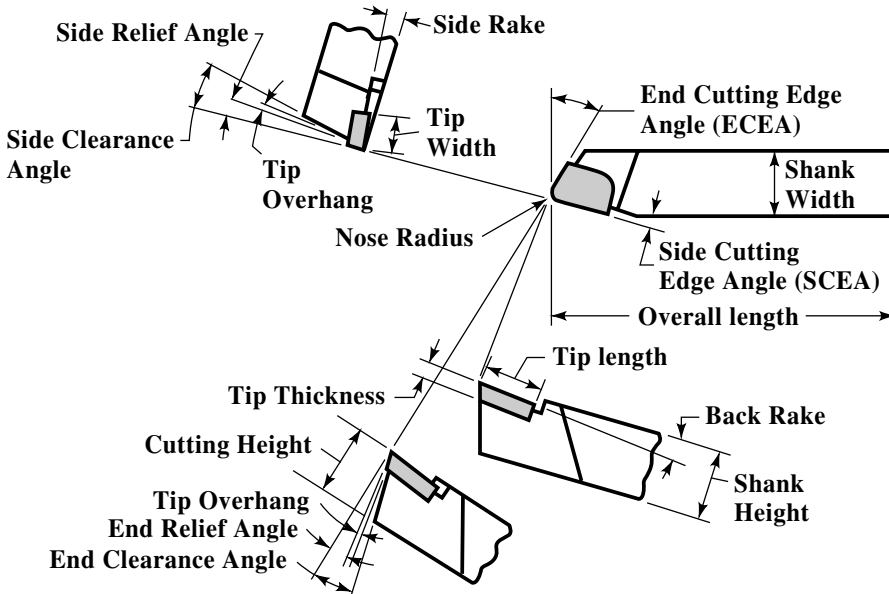


Fig. 2. A typical single-point carbide tipped cutting tool.

The tip of the brazed carbide blank overhangs the shank of the tool by either $\frac{1}{32}$ or $\frac{1}{16}$ inch, depending on the size of the tool. For tools in Tables 5, 6, 7, 8, 11 and 12, the maximum overhang is $\frac{1}{32}$ inch for shank sizes 4, 5, 6, 7, 8, 10, 12 and 44; for other shank sizes in these tables, the maximum overhang is $\frac{1}{16}$ inch. In Tables 9 and 10 all tools have maximum overhang of $\frac{1}{32}$ inch.

Single-point Tool Nose Radii: The tool nose radii recommended in the American National Standard are as follows: For square-shank tools up to and including $\frac{3}{8}$ -inch square

tools, $\frac{1}{64}$ inch; for those over $\frac{3}{8}$ -inch square through $1\frac{1}{4}$ -inches square, $\frac{1}{32}$ inch; and for those above $1\frac{1}{4}$ -inches square, $\frac{1}{16}$ inch. For rectangular-shank tools with shank section of $\frac{1}{2} \times 1$ inch through $1 \times 1\frac{1}{2}$ inches, the nose radii are $\frac{1}{32}$ inch, and for 1×2 and $1\frac{1}{2} \times 2$ inch shanks, the nose radius is $\frac{1}{16}$ inch.

Single-point Tool Angle Tolerances: The tool angles shown on the diagrams in the Tables 5 through 12 are general recommendations. Tolerances applicable to these angles are ± 1 degree on all angles except end and side clearance angles; for these the tolerance is ± 2 degrees.

Table 5. American National Standard Style A Carbide Tipped Tools
ANSI B212.1-2002 (R2007)

Designation		Shank Dimensions			Tip Designation ^a	Tip Dimensions		
Style AR ^a	Style AL ^a	Width A	Height B	Length C		Thickness T	Width W	Length L
Square Shank								
AR 4	AL 4	$\frac{1}{4}$	$\frac{1}{4}$	2	2040	$\frac{3}{32}$	$\frac{3}{16}$	$\frac{5}{16}$
AR 5	AL 5	$\frac{3}{16}$	$\frac{3}{16}$	$2\frac{1}{4}$	2070	$\frac{3}{32}$	$\frac{1}{4}$	$\frac{1}{2}$
AR 6	AL 6	$\frac{3}{8}$	$\frac{3}{8}$	$2\frac{1}{2}$	2070	$\frac{3}{32}$	$\frac{1}{4}$	$\frac{1}{2}$
AR 7	AL 7	$\frac{7}{16}$	$\frac{7}{16}$	3	2070	$\frac{3}{32}$	$\frac{1}{4}$	$\frac{1}{2}$
AR 8	AL 8	$\frac{1}{2}$	$\frac{1}{2}$	$3\frac{1}{2}$	2170	$\frac{1}{8}$	$\frac{5}{16}$	$\frac{5}{8}$
AR 10	AL 10	$\frac{5}{8}$	$\frac{5}{8}$	4	2230	$\frac{5}{32}$	$\frac{3}{8}$	$\frac{3}{4}$
AR 12	AL 12	$\frac{3}{4}$	$\frac{3}{4}$	$4\frac{1}{2}$	2310	$\frac{3}{16}$	$\frac{7}{16}$	$1\frac{3}{16}$
AR 16	AL 16	1	1	6	{ P3390, P4390	$\frac{1}{4}$	$\frac{9}{16}$	1
AR 20	AL 20	$1\frac{1}{4}$	$1\frac{1}{4}$	7	{ P3460, P4460	$\frac{5}{16}$	$\frac{5}{8}$	1
AR 24	AL 24	$1\frac{1}{2}$	$1\frac{1}{2}$	8	{ P3510, P4510	$\frac{3}{8}$	$\frac{5}{8}$	1
Rectangular Shank								
AR 44	AL 44	$\frac{1}{2}$	1	6	P2260	$\frac{3}{16}$	$\frac{5}{16}$	$\frac{5}{8}$
AR 54	AL 54	$\frac{5}{8}$	1	6	{ P3360, P4360	$\frac{1}{4}$	$\frac{3}{8}$	$\frac{3}{4}$
AR 55	AL 55	$\frac{5}{8}$	$1\frac{1}{4}$	7	{ P3360, P4360	$\frac{1}{4}$	$\frac{3}{8}$	$\frac{3}{4}$
AR 64	AL 64	$\frac{3}{4}$	1	6	{ P3380, P4380	$\frac{1}{4}$	$\frac{1}{2}$	$\frac{3}{4}$
AR 66	AL 66	$\frac{3}{4}$	$1\frac{1}{2}$	8	{ P3430, P4430	$\frac{5}{16}$	$\frac{7}{16}$	$1\frac{5}{16}$
AR 85	AL 85	1	$1\frac{1}{4}$	7	{ P3460, P4460	$\frac{5}{16}$	$\frac{5}{8}$	1
AR 86	AL 86	1	$1\frac{1}{2}$	8	{ P3510, P4510	$\frac{3}{8}$	$\frac{5}{8}$	1
AR 88	AL 88	1	2	10	{ P3510, P4510	$\frac{3}{8}$	$\frac{5}{8}$	1
AR 90	AL 90	$1\frac{1}{2}$	2	10	{ P3540, P4540	$\frac{1}{2}$	$\frac{3}{4}$	$1\frac{1}{4}$

^a "A" is straight shank, 0 deg., SCEA (side-cutting-edge angle). "R" is right-cut. "L" is left-cut. Where a pair of tip numbers is shown, the upper number applies to AR tools, the lower to AL tools. All dimensions are in inches.

Table 6. American National Standard Style B Carbide Tipped Tools with 15-degree Side-cutting-edge Angle ANSI B212.1-2002 (R2007)

Designation		Shank Dimensions			Tip Designation ^a	Tip Dimensions		
Style BR	Style BL	Width A	Height B	Length C		Thickness T	Width W	Length L
Square Shank								
BR 4	BL 4	1/4	1/4	2	2015	1/16	5/32	1/4
BR 5	BL 5	5/16	5/16	2 1/4	2040	3/32	3/16	5/16
BR 6	BL 6	3/8	3/8	2 1/2	2070	3/32	1/4	1/2
BR 7	BL 7	7/16	7/16	3	2070	3/32	1/4	1/2
BR 8	BL 8	1/2	1/2	3 1/2	2170	1/8	5/16	3/8
BR 10	BL 10	5/8	5/8	4	2230	5/32	3/8	3/4
BR 12	BL 12	3/4	3/4	4 1/2	2310	3/16	7/16	13/16
BR 16	BL 16	1	1	6	{ 3390, 4390	1/4	9/16	1
BR 20	BL 20	1 1/4	1 1/4	7	{ 3460, 4460	5/16	5/8	1
BR 24	BL 24	1 1/2	1 1/2	8	{ 3510, 4510	3/8	5/8	1
Rectangular Shank								
BR 44	BL 44	1/2	1	6	2260	3/16	5/16	5/8
BR 54	BL 54	5/8	1	6	{ 3360, 4360	1/4	3/8	3/4
BR 55	BL 55	5/8	1 1/4	7	{ 3360, 4360	1/4	3/8	3/4
BR 64	BL 64	3/4	1	6	{ 3380, 4380	1/4	1/2	3/4
BR 66	BL 66	3/4	1 1/2	8	{ 3430, 4430	5/16	7/16	15/16
BR 85	BL 85	1	1 1/4	7	{ 3460, 4460	5/16	5/8	1
BR 86	BL 86	1	1 1/2	8	{ 3510, 4510	3/8	5/8	1
BR 88	BL 88	1	2	10	{ 3510, 4510	3/8	5/8	1
BR 90	BL 90	1 1/2	2	10	{ 3540, 4540	1/2	3/4	1 1/4

^a Where a pair of tip numbers is shown, the upper number applies to BR tools, the lower to BL tools. All dimensions are in inches.

Brazing Carbide Tips to Steel Shanks.—Sintered carbide tips or blanks are attached to steel shanks by brazing. Shanks usually are made of low-alloy steels having carbon contents ranging from 0.40 to 0.60 per cent. *Shank Preparation:* The carbide tip usually is inserted into a milled recess or seat. When a recess is used, the bottom should be flat to provide a firm even support for the tip. The corner radius of the seat should be somewhat smaller than the radius on the tip to avoid contact and insure support along each side of the recess. *Cleaning:* All surfaces to be brazed must be absolutely clean. Surfaces of the tip may be cleaned by grinding lightly or by sand-blasting. *Brazing Materials and Equipment:* The brazing metal may be copper, naval brass such as Tobin bronze, or silver solder. A flux such as borax is used to protect the clean surfaces and prevent oxidation. Heating may be done in a furnace or by oxy-acetylene torch or an oxy-hydrogen torch. Copper brazing usually is done in a furnace, although an oxy-hydrogen torch with excess hydrogen is sometimes used. *Brazing Procedure:* One method using a torch is to place a thin sheet material, such as copper foil, around and beneath the carbide tip, the top of which is covered with flux. The flame is applied to the under side of the tool shank, and, when the materials melt, the tip is pressed firmly into its seat with tongs or with the end of a rod. Brazing material in the form of wire or rod may be used to coat or tin the surfaces of the recess after the flux melts and runs freely. The tip is then inserted, flux is applied to the top, and heating continued until the coatings melt and run freely. The tip, after coating with flux, is placed in the recess and the shank end is heated. Then a small piece of silver solder, having a melting point of 1325°F (718°C), is placed on top of the tip. When this solder melts, it runs over the nickel-coated surfaces while the tip is held firmly into its seat. The brazed tool should be cooled slowly to avoid cracking due to unequal contraction between the steel and carbide.

**Table 7. American National Standard Style C Carbide Tipped Tools
ANSI B212.1-2002 (R2007)**

Designation	Shank Dimensions			Tip Designation	Tip Dimensions		
	Width, A	Height, B	Length, C		Thickness, T	Width, W	Length, L
C 4	1/4	1/4	2	1030	1/16	1/4	5/16
C 5	5/16	5/16	2 1/4	1080	3/32	5/16	3/8
C 6	3/8	3/8	2 1/2	1090	3/32	3/8	3/8
C 7	7/16	7/16	3	1105	3/32	7/16	1/2
C 8	1/2	1/2	3 1/2	1200	1/8	1/2	1/2
C 10	5/8	5/8	4	1240	5/32	5/8	5/8
C 12	3/4	3/4	4 1/2	1340	3/16	3/4	3/4
C 16	1	1	6	1410	1/4	1	3/4
C 20	1 1/4	1 1/4	7	1480	5/16	1 1/4	3/4
C 44	1/2	1	6	1320	3/16	1/2	1/2
C 54	5/8	1	6	1400	1/4	5/8	5/8
C 55	5/8	1 1/4	7	1400	1/4	5/8	5/8
C 64	3/4	1	6	1405	1/4	3/4	3/4
C 66	3/4	1 1/2	8	1470	3/16	3/4	3/4
C 86	1	1 1/2	8	1475	5/16	1	3/4

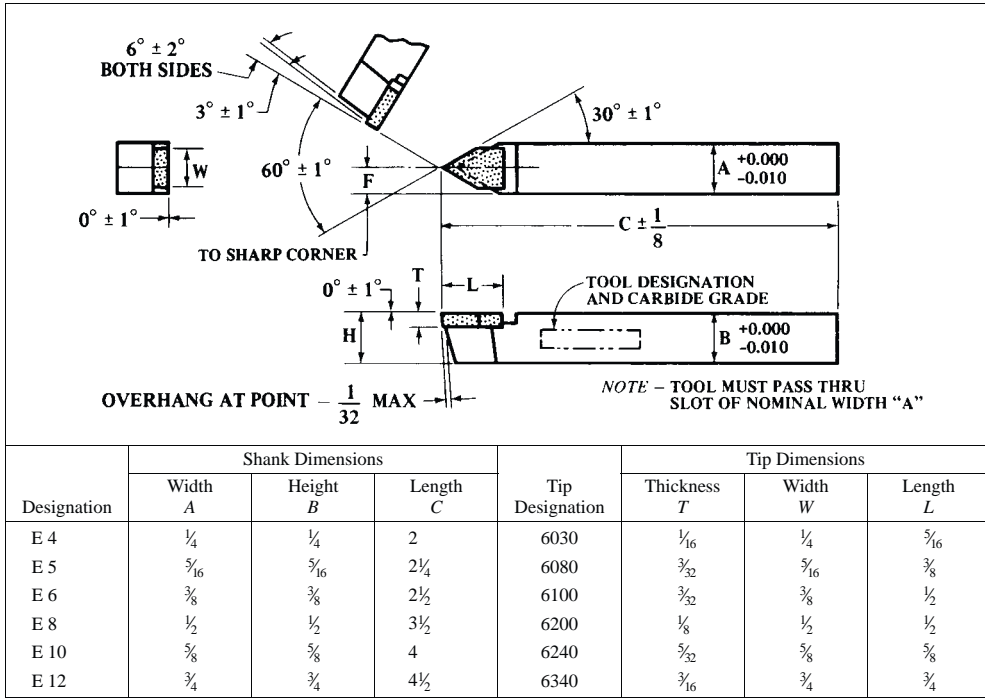
All dimensions are in inches. Square shanks above horizontal line; rectangular below.

**Table 8. American National Standard Style D, 80-degree Nose-angle Carbide Tipped Tools
ANSI B212.1-2002 (R2007)**

Designation	Shank Dimensions			Tip Designation	Tip Dimensions		
	Width, A	Height, B	Length, C		Thickness, T	Width, W	Length, L
D 4	1/4	1/4	2	5030	1/16	1/4	5/16
D 5	5/16	5/16	2 1/4	5080	3/32	5/16	3/8
D 6	3/8	3/8	2 1/2	5100	3/32	3/8	1/2
D 7	7/16	7/16	3	5105	3/32	7/16	1/2
D 8	1/2	1/2	3 1/2	5200	1/8	1/2	1/2
D 10	5/8	5/8	4	5240	5/32	5/8	5/8
D 12	3/4	3/4	4 1/2	5340	3/16	3/4	3/4
D 16	1	1	6	5410	1/4	1	3/4

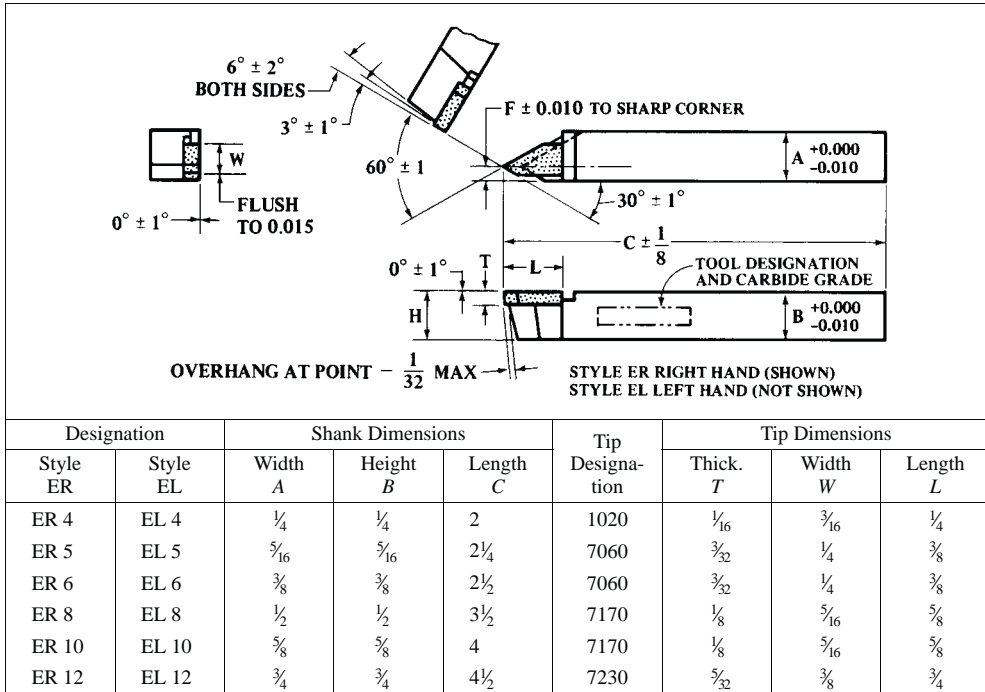
All dimensions are in inches.

Table 9. American National Standard Style E, 60-degree Nose-angle, Carbide Tipped Tools ANSI B212.1-2002 (R2007)



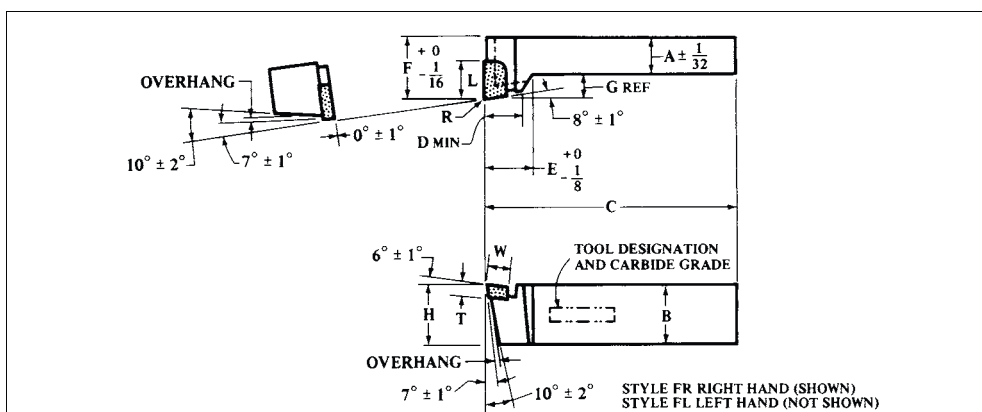
All dimensions are in inches.

Table 10. American National Standard Styles ER and EL, 60-degree Nose-angle, Carbide Tipped Tools with Offset Point ANSI B212.1-2002 (R2007)



All dimensions are in inches.

Table 11. American National Standard Style F, Offset, End-cutting Carbide Tipped Tools ANSI B212.1-2002 (R2007)



Designation		Shank Dimensions					Tip Designation	Tip Dimensions		
Style FR	Style FL	Width A	Height B	Length C	Offset G	Length of Offset E		Thickness T	Width W	Length L
Square Shank										
FR 8	FL 8	1/2	1/2	3 1/2	1/4	3/4	{ P4170, P3170	1/8	5/16	5/8
FR 10	FL 10	3/8	3/8	4	3/8	1	{ P1230, P3230	3/32	3/8	3/4
FR 12	FL 12	3/4	3/4	4 1/2	3/8	1 1/8	{ P4310, P3310	3/16	7/16	13/16
FR 16	FL 16	1	1	6	3/4	1 3/8	{ P4390, P3390	1/4	9/16	1
FR 20	FL 20	1 1/4	1 1/4	7	3/4	1 1/2	{ P4460, P3460	5/16	5/8	1
FR 24	FL 24	1 1/2	1 1/2	8	3/4	1 1/2	{ P4510, P3510	3/8	5/8	1
Rectangular Shank										
FR 44	FL 44	1/2	1	6	1/2	7/8	{ P4260, P1260	3/16	5/16	5/8
FR 55	FL 55	3/8	1 1/4	7	3/8	1 1/8	{ P4360, P3360	1/4	3/8	3/4
FR 64	FL 64	3/4	1	6	3/8	1 3/16	{ P4380, P3380	1/4	1/2	3/4
FR 66	FL 66	3/4	1 1/2	8	3/4	1 1/4	{ P4430, P3430	5/16	7/16	15/16
FR 85	FL 85	1	1 1/4	7	3/4	1 1/2	{ P4460, P3460	5/16	5/8	1
FR 86	FL 86	1	1 1/2	8	3/4	1 1/2	{ P4510, P3510	3/8	5/8	1
FR 90	FL 90	1 1/2	2	10	3/4	1 5/8	{ P4540, P3540	1/2	3/4	1 1/4

All dimensions are in inches. Where a pair of tip numbers is shown, the upper number applies to FR tools, the lower number to FL tools.

Carbide Tools.—Cemented or sintered carbides are used in the machine building and various other industries, chiefly for cutting tools but also for certain other tools or parts subject to considerable abrasion or wear. Carbide cutting tools, when properly selected to obtain the right combination of strength and hardness, are very effective in machining all classes of iron and steel, non-ferrous alloys, non-metallic materials, hard rubber, synthetic resins, slate, marble, and other materials which would quickly dull steel tools either because of hardness or abrasive action. Carbide cutting tools are not only durable, but capable of exceptionally high cutting speeds. See *CEMENTED CARBIDES* starting on page 785 for more on these materials.

Tungsten carbide is used extensively in cutting cast iron, nonferrous metals which form short chips in cutting; plastics and various other non-metallic materials. A grade having a hardness of 87.5 Rockwell A might be used where a strong grade is required, as for roughing cuts, whereas for light high-speed finishing or other cuts, a hardness of about 92 might be preferable. When tungsten carbide is applied to steel, craters or chip cavities are formed

Table 12. American National Standard Style G, Offset, Side-cutting, Carbide Tipped Tools ANSI B212.1-2002 (R2007)

Designation		Shank Dimensions					Tip Designation	Tip Dimensions		
Style GR	Style GL	Width A	Height B	Length C	Offset G	Length of Offset E		Thickness T	Width W	Length L
Square Shank										
GR 8	GL 8	1/2	1/2	3 1/2	1/4	1 1/16	{ P3170, P4170	1/8	5/16	5/8
GR 10	GL 10	5/8	5/8	4	3/8	1 3/8	{ P3230, P4230	5/32	3/8	3/4
GR 12	GL 12	3/4	3/4	4 1/2	3/8	1 1/2	{ P3310, P2310	3/16	7/16	13/16
GR 16	GL 16	1	1	6	1/2	1 11/16	{ P3390, P4390	1/4	9/16	1
GR 20	GL 20	1 1/4	1 1/4	7	3/4	1 13/16	{ P3460, P4460	5/16	5/8	1
GR 24	GL 24	1 1/2	1 1/2	8	3/4	1 13/16	{ P3510, P4510	3/8	5/8	1
Rectangular Shank										
GR 44	GL 44	1/2	1	6	1/4	1 1/16	{ P3260, P4260	3/16	5/16	5/8
GR 55	GL 55	5/8	1 1/4	7	3/8	1 3/8	{ P3360, P4360	1/4	3/8	3/4
GR 64	GL 64	3/4	1	6	1/2	1 7/16	{ P3380, P4380	1/4	1/2	3/4
GR 66	GL 66	3/4	1 1/2	8	1/2	1 5/8	{ P3430, P4430	5/16	7/16	15/16
GR 85	GL 85	1	1 1/4	7	1/2	1 11/16	{ P3460, P4460	5/16	5/8	1
GR 86	GL 86	1	1 1/2	8	1/2	1 11/16	{ P3510, P4510	3/8	5/8	1
GR 90	GL 90	1 1/2	2	10	3/4	2 1/16	{ P3540, P4540	1/2	3/4	1 1/4

All dimensions are in inches. Where a pair of tip numbers is shown, the upper number applies to GR tools, the lower number to GL tools.

back of the cutting edge; hence other carbides have been developed which offer greater resistance to abrasion.

Tungsten-titanium carbide (often called "titanium carbide") is adapted to cutting either heat-treated or unheattreated steels, cast steel, or any tough material which might form chip cavities. It is also applicable to bronzes, monel metal, aluminum alloys, etc.

Tungsten-tantalum carbide or "tantalum carbide" cutting tools are also applicable to steels, bronzes or other tough materials. A hardness of 86.8 Rockwell A is recommended by one manufacturer for roughing steel, whereas a grade for finishing might have a hardness ranging from 88.8 to 91.5 Rockwell A.

Chip Breaker.—The term “chip breaker” indicates a method of forming or grinding turning tools, that will cause the chips to break up into short pieces, thus preventing the formation of long or continuous chips which would occupy considerable space and be difficult to handle. The chip-breaking form of cutting end is especially useful in turning with carbide-tipped steel turning tools because the cutting speeds are high and the chip formation rapid. The chip breaker consists of a shoulder back of the cutting edge. As the chip encounters this shoulder it is bent and broken repeatedly into small pieces. Some tools have attached or “mechanical” chip breakers which serve the same purpose as the shoulder.

Chipless Machining.— Chipless machining is the term applied to methods of cold forming metals to the required finished part shape (or nearly finished shape) without the production of chips (or with a minimum of subsequent machining required). Cold forming of steel has long been performed in such operations as wire-, bar-, and tube-drawing; cold-heading; coining; and conventional stamping and drawing. However, newer methods of plastic deformation with greatly increased degrees of metal displacement have been developed. Among these processes are: the rolling of serrations, splines, and gears; power spinning; internal swaging; radial forging; the cold forming of multiple-diameter shafts; cold extrusion; and high-energy-rate forming, which includes explosive forming. Also, the processes of cold heading, thread rolling and rotary swaging are also considered chipless machining processes.

Indexable Insert Holders for NC.—Indexable insert holders for numerical control lathes are usually made to more precise standards than ordinary holders. Where applicable, reference should be made to American National Standard B212.3-1986, Precision Holders for Indexable Inserts. This standard covers the dimensional specifications, styles, and designations of precision holders for indexable inserts, which are defined as tool holders that locate the gage insert (a combination of shim and insert thicknesses) from the back or front and end surfaces to a specified dimension with a ± 0.003 inch (± 0.08 mm) tolerance. In NC programming, the programmed path is that followed by the center of the tool tip, which is the center of the point, or nose radius, of the insert. The surfaces produced are the result of the path of the nose and the major cutting edge, so it is necessary to compensate for the nose or point radius and the lead angle when writing the program. **Table 1**, from B212.3, gives the compensating dimensions for different holder styles. The reference point is determined by the intersection of extensions from the major and minor cutting edges, which would be the location of the point of a sharp pointed tool. The distances from this point to the nose radius are L_1 and D_1 ; L_2 and D_2 are the distances from the sharp point to the center of the nose radius. Threading tools have sharp corners and do not require a radius compensation. Other dimensions of importance in programming threading tools are also given in **Table 2**; the data were developed by Kennametal, Inc.

The C and F characters are tool holder dimensions other than the shank size. In all instances, the C dimension is parallel to the length of the shank and the F dimension is parallel to the side dimension; actual dimensions must be obtained from the manufacturer. For all K style holders, the C dimension is the distance from the end of the shank to the tangent point of the nose radius and the end cutting edge of the insert. For all other holders, the C dimension is from the end of the shank to a tangent to the nose radius of the insert. The F dimension on all B, D, E, M, P, and V style holders is measured from the back side of the shank to the tangent point of the nose radius and the side cutting edge of the insert. For all A, F, G, J, K, and L style holders, the F dimension is the distance from the back side of the shank to the tangent of the nose radius of the insert. In all these designs, the nose radius is the standard radius corresponding to those given in the paragraph *Cutting Point Configuration* on page 766.

Table 1. Insert Radius Compensation ANSI B212.3-1986

Square Profile						
B Style ^a Also applies to R Style		Turning 15° Lead Angle				
		Rad.	L-1	L-2	D-1	D-2
		1/64	.0035	.0191	.0009	.0110
		1/32	.0070	.0383	.0019	.0221
		3/64	.0105	.0574	.0028	.0331
1/16	.0140	.0765	.0038	.0442		
D Style ^a Also applies to S Style		Turning 45° Lead Angle				
		Rad.	L-1	L-2	D-1	D-2
		1/64	.0065	.0221	.0065	0
		1/32	.0129	.0442	.0129	0
		3/64	.0194	.0663	.0194	0
1/16	.0259	.0884	.0259	0		
K Style ^a		Facing 15° Lead Angle				
		Rad.	L-1	L-2	D-1	D-2
		1/64	.0009	.0110	.0035	.0191
		1/32	.0019	.0221	.0070	.0383
		3/64	.0028	.0331	.0105	.0574
1/16	.0038	.0442	.0140	.0765		
Triangle Profile						
G Style ^a		Turning 0° Lead Angle				
		Rad.	L-1	L-2	D-1	D-2
		1/64	.0114	.0271	0	.0156
		1/32	.0229	.0541	0	.0312
		3/64	.0343	.0812	0	.0469
1/16	.0458	.1082	0	.0625		
B Style ^a Also applies to R Style		Turning and Facing 15° Lead Angle				
		Rad.	L-1	L-2	D-1	D-2
		1/64	.0146	.0302	.0039	.0081
		1/32	.0291	.0604	.0078	.0162
		3/64	.0437	.0906	.0117	.0243
1/16	.0582	.1207	.0156	.0324		
F Style ^a		Facing 90° Lead Angle				
		Rad.	L-1	L-2	D-1	D-2
		1/64	0	.0156	.0114	.0271
		1/32	0	.0312	.0229	.0541
		3/64	0	.0469	.0343	.0812
1/16	0	.0625	.0458	.1082		

Table 1. (Continued) Insert Radius Compensation ANSI B212.3-1986

Triangle Profile (continued)						
J Style ^a		Turning & Facing 3° Lead Angle				
		Rad.	L-1	L-2	D-1	D-2
		1/64	.0106	.0262	.0014	.0170
		1/32	.0212	.0524	.0028	.0340
		3/64	.0318	.0786	.0042	.0511
1/16	.0423	.1048	.0056	.0681		
80° Diamond Profile						
G Style ^a		Turning & Facing 0° Lead Angle				
		Rad.	L-1	L-2	D-1	D-2
		1/64	.0030	.0186	0	.0156
		1/32	.0060	.0312	0	.0312
		3/64	.0090	.0559	0	.0469
1/16	.0120	.0745	0	.0625		
L Style ^a		Turning & Facing 5° Reverse Lead Angle				
		Rad.	L-1	L-2	D-1	D-2
		1/64	.0016	.0172	.0016	.0172
		1/32	.0031	.0344	.0031	.0344
		3/64	.0047	.0516	.0047	.0516
1/16	.0062	.0688	.0062	.0688		
F Style ^a		Facing 0° Lead Angle				
		Rad.	L-1	L-2	D-1	D-2
		1/64	0	.0156	.0030	.0186
		1/32	0	.0312	.0060	.0372
		3/64	0	.0469	.0090	.0559
1/16	0	.0625	.0120	.0745		
R Style ^a		Turning 15° Lead Angle				
		Rad.	L-1	L-2	D-1	D-2
		1/64	.0011	.0167	.0003	.0117
		1/32	.0022	.0384	.0006	.0234
		3/64	.0032	.0501	.0009	.0351
1/16	.0043	.0668	.0012	.0468		
K Style ^a		Facing 15° Lead Angle				
		Rad.	L-1	L-2	D-1	D-2
		1/64	.0003	.0117	.0011	.0167
		1/32	.0006	.0234	.0022	.0334
		3/64	.0009	.0351	.0032	.0501
1/16	.0012	.0468	.0043	.0668		

Table 1. (Continued) Insert Radius Compensation ANSI B212.3-1986

55° Profile						
J Style ^a		Profiling 3° Reverse Lead Angle				
		Rad.	L-1	L-2	D-1	D-2
		1/64	.0135	.0292	.0015	.0172
		1/32	.0271	.0583	.0031	.0343
		3/64	.0406	.0875	.0046	.0519
1/16	.0541	.1166	.0062	.0687		
35° Profile						
J Style ^a Negative rake holders have 6° back rake and 6° side rake		Profiling 3° Reverse Lead Angle				
		Rad.	L-1	L-2	D-1	D-2
		1/64	.0330	.0487	.0026	.0182
		1/32	.0661	.0973	.0051	.0364
		3/64	.0991	.1460	.0077	.0546
1/16	.1322	.1947	.0103	.0728		
L Style ^a		Profiling 5° Lead Angle				
		Rad.	L-1	L-2	D-1	D-2
		1/64	.0324	.0480	.0042	.0198
		1/32	.0648	.0360	.0086	.0398
		3/64	.0971	.1440	.0128	.0597
1/16	.1205	.1920	.0170	.0795		

^a L-1 and D-1 over sharp point to nose radius; and L-2 and D-2 over sharp point to center of nose radius. The D-1 dimension for the B, E, D, M, P, S, T, and V style tools are over the sharp point of insert to a sharp point at the intersection of a line on the lead angle on the cutting edge of the insert and the C dimension. The L-1 dimensions on K style tools are over the sharp point of insert to sharp point intersection of lead angle and F dimensions.

All dimensions are in inches.

Table 2. Threading Tool Insert Radius Compensation for NC Programming

Threading						
Insert Size	T	R	U	Y	X	Z
2	5/32 Wide	.040	.075	.040	.024	.140
3	3/16 Wide	.046	.098	.054	.031	.183
4	1/4 Wide	.053	.128	.054	.049	.239
5	3/8 Wide	.099	.190
Buttress Threading		29° Acme		60° V-Threading		
Z	X	R	Y	U	T	
NTB-B	NTB-A	NA	NTF	NT		

All dimensions are given in inches. Courtesy of Kennametal, Inc.

CEMENTED CARBIDES

Cemented Carbides and Other Hard Materials

Carbides and Carbonitrides.—Though high-speed steel retains its importance for such applications as drilling and broaching, most metal cutting is carried out with carbide tools. For materials that are very difficult to machine, carbide is now being replaced by carbonitrides, ceramics, and superhard materials. Cemented (or sintered) carbides and carbonitrides, known collectively in most parts of the world as hard metals, are a range of very hard, refractory, wear-resistant alloys made by powder metallurgy techniques. The minute carbide or nitride particles are “cemented” by a binder metal that is liquid at the sintering temperature. Compositions and properties of individual hardmetals can be as different as those of brass and high-speed steel.

All hardmetals are *cermets*, combining *ceramic* particles with a *metallic* binder. It is unfortunate that (owing to a mistranslation) the term *cermet* has come to mean either all hardmetals with a titanium carbide (TiC) base or simply cemented titanium carbonitrides. Although no single element other than carbon is present in all hard-metals, it is no accident that the generic term is “tungsten carbide.” The earliest successful grades were based on carbon, as are the majority of those made today, as listed in [Table 1](#).

The outstanding machining capabilities of high-speed steel are due to the presence of very hard carbide particles, notably tungsten carbide, in the iron-rich matrix. Modern methods of making cutting tools from pure tungsten carbide were based on this knowledge. Early pieces of cemented carbide were much too brittle for industrial use, but it was soon found that mixing tungsten carbide powder with up to 10 per cent of metals such as iron, nickel, or cobalt, allowed pressed compacts to be sintered at about 1500°C to give a product with low porosity, very high hardness, and considerable strength. This combination of properties made the materials ideally suitable for use as tools for cutting metal.

Cemented carbides for cutting tools were introduced commercially in 1927, and although the key discoveries were made in Germany, many of the later developments have taken place in the United States, Austria, Sweden, and other countries. Recent years have seen two “revolutions” in carbide cutting tools, one led by the United States and the other by Europe. These were the change from brazed to clamped carbide inserts and the rapid development of coating technology.

When indexable tips were first introduced, it was found that so little carbide was worn away before they were discarded that a minor industry began to develop, regrinding the so-called “throwaway” tips and selling them for reuse in adapted toolholders. Hardmetal consumption, which had grown dramatically when indexable inserts were introduced, leveled off and began to decline. This situation was changed by the advent and rapid acceptance of carbide, nitride, and oxide coatings. Application of an even harder, more wear-resistant surface to a tougher, more shock-resistant substrate allowed production of new generations of longer-lasting inserts. Regrinding destroyed the enhanced properties of the coatings, so was abandoned for coated tooling.

Brazed tools have the advantage that they can be reground over and over again, until almost no carbide is left, but the tools must always be reset after grinding to maintain machining accuracy. However, all brazed tools suffer to some extent from the stresses left by the brazing process, which in unskilled hands or with poor design can shatter the carbide even before it has been used to cut metal. In present conditions it is cheaper to use indexable inserts, which are tool tips of precise size, clamped in similarly precise holders, needing no time-consuming and costly resetting but usable only until each cutting edge or corner has lost its initial sharpness (see [Introduction](#) and related topics starting on page 764 and [Indexable Insert Holders for NC](#) on page 781). The absence of brazing stresses and the “one-use” concept also means that harder, longer-lasting grades can be used.

Table 1. Typical Properties of Tungsten-Carbide-Based Cutting-Tool Hardmetals

ISO Application Code	Composition (%)				Density (g/cm ³)	Hardness (Vickers)	Transverse Rupture Strength (N/mm ²)
	WC	TiC	TaC	Co			
P01	50	35	7	6	8.5	1900	1100
P05	78	16		6	11.4	1820	1300
P10	69	15	8	8	11.5	1740	1400
P15	78	12	3	7	11.7	1660	1500
P20	79	8	5	8	12.1	1580	1600
P25	82	6	4	8	12.9	1530	1700
P30	84	5	2	9	13.3	1490	1850
P40	85	5		10	13.4	1420	1950
P50	78	3	3	16	13.1	1250	2300
M10	85	5	4	6	13.4	1590	1800
M20	82	5	5	8	13.3	1540	1900
M30	86	4		10	13.6	1440	2000
M40	84	4	2	10	14.0	1380	2100
K01	97			3	15.2	1850	1450
K05	95		1	4	15.0	1790	1550
K10	92		2	6	14.9	1730	1700
K20	94			6	14.8	1650	1950
K30	91			9	14.4	1400	2250
K40	89			11	14.1	1320	2500

A complementary development was the introduction of ever-more complex chip-breakers, derived from computer-aided design and pressed and sintered to precise shapes and dimensions. Another advance was the application of hot isostatic pressing (HIP), which has moved hardmetals into applications that were formerly uneconomic. This method allows virtually all residual porosity to be squeezed out of the carbide by means of inert gas at high pressure, applied at about the sintering temperature. Toughness, rupture strength, and shock resistance can be doubled or tripled by this method, and the reject rates of very large sintered components are reduced to a fraction of their previous levels.

Further research has produced a substantial number of excellent cutting-tool materials based on titanium carbonitride. Generally called “cermets,” as noted previously, carbonitride-based cutting inserts offer excellent performance and considerable prospects for the future.

Compositions and Structures: Properties of hardmetals are profoundly influenced by microstructure. The microstructure in turn depends on many factors including basic chemical composition of the carbide and matrix phases; size, shape, and distribution of carbide particles; relative proportions of carbide and matrix phases; degree of intersolubility of carbides; excess or deficiency of carbon; variations in composition and structure caused by diffusion or segregation; production methods generally, but especially milling, carburizing, and sintering methods, and the types of raw materials; post sintering treatments such as hot isostatic pressing; and coatings or diffusion layers applied after initial sintering.

Tungsten Carbide/Cobalt (WC/Co): The first commercially available cemented carbides consisted of fine angular particles of tungsten carbide bonded with metallic cobalt. Intended initially for wire-drawing dies, this composition type is still considered to have the greatest resistance to simple abrasive wear and therefore to have many applications in machining.

For maximum hardness to be obtained from closeness of packing, the tungsten carbide grains should be as small as possible, preferably below 1 μm (0.00004 inch) and considerably less for special purposes. Hardness and abrasion resistance increase as the cobalt content is lowered, provided that a minimum of cobalt is present (2 per cent can be enough, although 3 per cent is the realistic minimum) to ensure complete sintering. In general, as

carbide grain size or cobalt content or both are increased—frequently in unison—tougher and less hard grades are obtained. No porosity should be visible, even under the highest optical magnification.

WC/Co compositions used for cutting tools range from about 2 to 13 per cent cobalt, and from less than 0.5 to more than 5 μm (0.00002-0.0002 in.) in grain size. For stamping tools, swaying dies, and other wear applications for parts subjected to moderate or severe shock, cobalt content can be as much as 30 per cent, and grain size a maximum of about 10 μm (0.0004 in.). In recent years, “micrograin” carbides, combining submicron (less than 0.00004 in.) carbide grains with relatively high cobalt content have found increasing use for machining at low speeds and high feed rates. An early use was in high-speed wood-working cutters such as are used for planing.

For optimum properties, porosity should be at a minimum, carbide grain size as regular as possible, and carbon content of the tungsten carbide phase close to the theoretical (stoichiometric) value. Many tungsten carbide/cobalt compositions are modified by small but important additions—from 0.5 to perhaps 3 per cent of tantalum, niobium, chromium, vanadium, titanium, hafnium, or other carbides. The basic purpose of these additions is generally inhibition of grain growth, so that a consistently fine structure is maintained.

Tungsten - Titanium Carbide/Cobalt (WC/TiC/Co): These grades are used for tools to cut steels and other ferrous alloys, the purpose of the TiC content being to resist the high-temperature diffusive attack that causes chemical breakdown and cratering. Tungsten carbide diffuses readily into the chip surface, but titanium carbide is extremely resistant to such diffusion. A solid solution or “mixed crystal” of WC in TiC retains the anticratering property to a great extent.

Unfortunately, titanium carbide and TiC-based solid solutions are considerably more brittle and less abrasion resistant than tungsten carbide. TiC content, therefore, is kept as low as possible, only sufficient TiC being provided to avoid severe cratering wear. Even 2 or 3 per cent of titanium carbide has a noticeable effect, and as the relative content is substantially increased, the cratering tendency becomes more severe.

In the limiting formulation the carbide is tungsten-free and based entirely on TiC, but generally TiC content extends to no more than about 18 per cent. Above this figure the carbide becomes excessively brittle and is very difficult to braze, although this drawback is not a problem with throwaway inserts.

WC/TiC/Co grades generally have two distinct carbide phases, angular crystals of almost pure WC and rounded TiC/WC mixed crystals. Among progressive manufacturers, although WC/TiC/Co hardmetals are very widely used, in certain important respects they are obsolescent, having been superseded by the WC/TiC/Ta(Nb)C/Co series in the many applications where higher strength combined with crater resistance is an advantage. TiC, TiN, and other coatings on tough substrates have also diminished the attractions of high-TiC grades for high-speed machining of steels and ferrous alloys.

Tungsten-Titanium-Tantalum (-Niobium) Carbide/Cobalt: Except for coated carbides, tungsten-titanium-tantalum (-niobium) grades could be the most popular class of hardmetals. Used mainly for cutting steel, they combine and improve upon most of the best features of the longer-established WC/TiC/Co compositions. These carbides compete directly with carbonitrides and silicon nitride ceramics, and the best cemented carbides of this class can undertake very heavy cuts at high speeds on all types of steels, including austenitic stainless varieties. These tools also operate well on ductile cast irons and nickel-base superalloys, where great heat and high pressures are generated at the cutting edge. However, they do not have the resistance to abrasive wear possessed by micrograin straight tungsten carbide grades nor the good resistance to cratering of coated grades and titanium carbide-based cermets.

Titanium Carbide/Molybdenum/Nickel (TiC/Mo/Ni): The extreme indentation hardness and crater resistance of titanium carbide, allied to the cheapness and availability of its main

raw material (titanium dioxide, TiO_2), provide a strong inducement to use grades based on this carbide alone. Although developed early in the history of hardmetals, these carbides were difficult to braze satisfactorily and consequently were little used until the advent of clamped, throwaway inserts. Moreover, the carbides were notoriously brittle and could take only fine cuts in minimal-shock conditions.

Titanium-carbide-based grades again came into prominence about 1960, when nickel-molybdenum began to be used as a binder instead of nickel. The new grades were able to perform a wider range of tasks including interrupted cutting and cutting under shock conditions.

The very high indentation hardness values recorded for titanium carbide grades are not accompanied by correspondingly greater resistance to abrasive wear, the apparently less hard tungsten carbide being considerably superior in this property. Moreover, carbonitrides, advanced tantalum-containing multicarbides, and coated variants generally provide better all-round cutting performances.

Titanium-Base Carbonitrides: Development of titanium-carbonitride-based cutting-tool materials predates the use of coatings of this type on more conventional hardmetals by many years. Appreciable, though uncontrolled, amounts of carbonitride were often present, if only by accident, when cracked ammonia was used as a less expensive substitute for hydrogen in some stages of the production process in the 1950's and perhaps for two decades earlier.

Much of the recent, more scientific development of this class of materials has taken place in the United States, particularly by Teledyne Firth Sterling with its SD_3 grade and in Japan by several companies. Many of the compositions currently in use are extremely complex, and their structures—even with apparently similar compositions—can vary enormously. For instance, Mitsubishi characterizes its Himet NX series of cermets as $\text{TiC}/\text{WC}/\text{Ta}(\text{Nb})\text{C}/\text{Mo}_2\text{C}/\text{TiN}/\text{Ni}/\text{Co}/\text{Al}$, with a structure comprising both large and medium-size carbide particles (mainly TiC according to the quoted density) in a superalloy-type matrix containing an aluminum-bearing intermetallic compound.

Steel- and Alloy-Bonded Titanium Carbide: The class of material exemplified by Ferro-Tic, as it is known, consists primarily of titanium carbide bonded with heat-treatable steel, but some grades also contain tungsten carbide or are bonded with nickel- or copper-base alloys. These cemented carbides are characterized by high binder contents (typically 50-60 per cent by volume) and lower hardnesses, compared with the more usual hardmetals, and by the great variation in properties obtained by heat treatment.

In the annealed condition, steel-bonded carbides have a relatively soft matrix and can be machined with little difficulty, especially by CBN (superhard cubic boron nitride) tools. After heat treatment, the degree of hardness and wear resistance achieved is considerably greater than that of normal tool steels, although understandably much less than that of traditional sintered carbides. Microstructures are extremely varied, being composed of 40-50 per cent TiC by volume and a matrix appropriate to the alloy composition and the stage of heat treatment. Applications include stamping, blanking and drawing dies, machine components, and similar items where the ability to machine before hardening reduces production costs substantially.

Coating: As a final stage in carbide manufacture, coatings of various kinds are applied mainly to cutting tools, where for cutting steel in particular it is advantageous to give the flank and clearance surfaces characteristics that are quite different from those of the body of the insert. Coatings of titanium carbide, nitride, or carbonitride; of aluminum oxide; and of other refractory compounds are applied to a variety of hardmetal substrates by chemical or physical vapor deposition (CVD or PVD) or by newer plasma methods.

The most recent types of coatings include hafnium, tantalum, and zirconium carbides and nitrides; alumina/titanium oxide; and multiple carbide/carbonitride/nitride/oxide, oxynitride or oxycarbonitride combinations. Greatly improved properties have been

claimed for variants with as many as 13 distinct CVD coatings. A markedly sharper cutting edge compared with other CVD-coated hardmetals is claimed, permitting finer cuts and the successful machining of soft but abrasive alloys.

The keenest edges on coated carbides are achieved by the techniques of physical vapor deposition. In this process, ions are deposited directionally from the electrodes, rather than evenly on all surfaces, so the sharpness of cutting edges is maintained and may even be enhanced. PVD coatings currently available include titanium nitride and carbonitride, their distinctive gold color having become familiar throughout the world on high-speed steel tooling. The high temperatures required for normal CVD tends to soften heat-treated high-speed steel. PVD-coated hardmetals have been produced commercially for several years, especially for precision milling inserts.

Recent developments in extremely hard coatings, generally involving exotic techniques, include boron carbide, cubic boron nitride, and pure diamond. Almost the ultimate in wear resistance, the commercial applications of thin plasma-generated diamond surfaces at present are mainly in manufacture of semiconductors, where other special properties are important.

For cutting tools the substrate is of equal importance to the coating in many respects, its critical properties including fracture toughness (resistance to crack propagation), elastic modulus, resistance to heat and abrasion, and expansion coefficient. Some manufacturers are now producing inserts with graded composition, so that structures and properties are optimized at both surface and interior, and coatings are less likely to crack or break away.

Specifications: Compared with other standardized materials, the world of sintered hardmetals is peculiar. For instance, an engineer who seeks a carbide grade for the finish-machining of a steel component may be told to use *ISO Standard Grade P10 or Industry Code C7*. If the composition and nominal properties of the designated tool material are then requested, the surprising answer is that, in basic composition alone, the tungsten carbide content of P10 (or of the now superseded C7) can vary from zero to about 75, titanium carbide from 8 to 80, cobalt 0 to 10, and nickel 0 to 15 per cent. There are other possible constituents, also, in this so-called standard alloy, and many basic properties can vary as much as the composition. All that these dissimilar materials have in common, and all that the so-called standards mean, is that their suppliers—and sometimes their suppliers alone—consider them suitable for one particular and ill-defined machining application (which for P10 or C7 is the finish machining of steel).

This peculiar situation arose because the production of cemented carbides in occupied Europe during World War II was controlled by the German Hartmetallzentrale, and no factory other than Krupp was permitted to produce more than one grade. By the end of the war, all German-controlled producers were equipped to make the G, S, H, and F series to German standards. In the postwar years, this series of carbides formed the basis of unofficial European standardization. With the advent of the newer multicarbides, the previous identities of grades were gradually lost. The applications relating to the old grades were retained, however, as a new German DIN standard, eventually being adopted, in somewhat modified form, by the International Standards Organization (ISO) and by ANSI in the United States.

The American cemented carbides industry developed under diverse ownership and solid competition. The major companies actively and independently developed new varieties of hardmetals, and there was little or no standardization, although there were many attempts to compile equivalent charts as a substitute for true standardization. Around 1942, the Buick division of GMC produced a simple classification code that arranged nearly 100 grades derived from 10 manufacturers under only 14 symbols (TC-1 to TC-14). In spite of serious deficiencies, this system remained in use for many years as an American industry standard; that is, Buick TC-1 was equivalent to industry code C1. Buick itself went much further, using the tremendous influence, research facilities, and purchasing potential of its parent company to standardize the products of each carbide manufacturer by properties

that could be tested, rather than by the indeterminate recommended applications. Many large-scale carbide users have developed similar systems in attempts to exert some degree of in-house standardization and quality control. Small and medium-sized users, however, still suffer from so-called industry standards, which only provide a starting point for grade selection.

ISO standard 513, summarized in [Table 2](#), divides all machining grades into three color-coded groups: straight tungsten carbide grades (letter K, color red) for cutting gray cast iron, nonferrous metals, and nonmetallics; highly alloyed grades (letter P, color blue) for machining steel; and less alloyed grades (letter M, color yellow, generally with less TiC than the corresponding P series), which are multipurpose and may be used on steels, nickel-base superalloys, ductile cast irons, and so on. Each grade within a group is also given a number to represent its position in a range from maximum hardness to maximum toughness (shock resistance). Typical applications are described for grades at more or less regular numerical intervals. Although coated grades scarcely existed when the ISO standard was prepared, it is easy to classify coated as uncoated carbides—or carbonitrides, ceramics, and superhard materials—according to this system.

In this situation, it is easy to see how one plant will prefer one manufacturer's carbide and a second plant will prefer that of another. Each has found the carbide most nearly ideal for the particular conditions involved. In these circumstances it pays each manufacturer to make grades that differ in hardness, toughness, and crater resistance, so that they can provide a product that is near the optimum for a specific customer's application.

Although not classified as a hard metal, new particle or powder metallurgical methods of manufacture, coupled with new coating technology have led in recent years to something of an upsurge in the use of high speed steel. Lower cost is a big factor, and the development of such coatings as titanium nitride, cubic boron nitride, and pure diamond, has enabled some high speed steel tools to rival tools made from tungsten and other carbides in their ability to maintain cutting accuracy and prolong tool life. Multiple layers may be used to produce optimum properties in the coating, with adhesive strength where there is contact with the substrate, combined with hardness at the cutting surface to resist abrasion. Total thickness of such coating, even with multiple layers, is seldom more than 15 microns (0.000060 in.).

Importance of Correct Grades: A great diversity of hardmetal types is required to cope with all possible combinations of metals and alloys, machining operations, and working conditions. Tough, shock-resistant grades are needed for slow speeds and interrupted cutting, harder grades for high-speed finishing, heat-resisting alloyed grades for machining superalloys, and crater-resistant compositions, including most of the many coated varieties, for machining steels and ductile iron.

Ceramics.—Moving up the hardness scale, ceramics provide increasing competition for cemented carbides, both in performance and in cost-effectiveness, though not yet in reliability. Hardmetals themselves consist of ceramics—nonmetallic refractory compounds, usually carbides or carbonitrides—with a metallic binder of much lower melting point. In such systems, densification generally takes place by liquid-phase sintering. Pure ceramics have no metallic binder, but may contain lower-melting-point compounds or ceramic mixtures that permit liquid-phase sintering to take place. Where this condition is not possible, hot pressing or hot isostatic pressing can often be used to make a strong, relatively pore-free component or cutting insert. This section is restricted to those ceramics that compete directly with hardmetals, mainly in the cutting-tool category as shown in [Table 3](#).

Ceramics are hard, completely nonmetallic substances that resist heat and abrasive wear. Increasingly used as clamped indexable tool inserts, ceramics differ significantly from tool steels, which are completely metallic. Ceramics also differ from cermets such as cemented carbides and carbonitrides, which comprise minute ceramic particles held together by metallic binders.

Table 2. ISO Classifications of Hardmetals (Cemented Carbides and Carbonitrides) by Application

Main Types of Chip Removal		Groups of Applications			Direction of Decrease in Characteristic	
Symbol and Color	Broad Categories of Materials to be Machined	Designation (Grade)	Specific Material to be Machined	Use and Working Conditions	of cut	of carbide
P Blue	Ferrous with long chips	P01	Steel, steel castings	Finish turning and boring; high cutting speeds, small chip sections, accurate dimensions, fine finish, vibration-free operations	↑ speed ↑ wear	
		P10	Steel, steel casting	Turning, copying, threading, milling; high cutting speeds; small or medium chip sections		
		P20	Steel, steel castings, ductile cast iron with long chips	Turning, copying, milling; medium cutting speeds and chip sections, planing with small chip sections		
		P30	Steel, steel castings, ductile cast iron with long chips	Turning, milling, planing; medium or large chip sections, unfavorable machining conditions		
		P40	Steel, steel castings with sand inclusions and cavities	Turning, planing, slotting; low cutting speeds, large chip sections, with possible large cutting angles, unfavorable cutting conditions, and work on automatic machines		
		P50	Steel, steel castings of medium or low tensile strength, with sand inclusions and cavities	Operations demanding very tough carbides; turning, planing, slotting; low cutting speeds, large chip sections, with possible large cutting angles, unfavorable conditions and work on automatic machines		
M Yellow	Ferrous metals with long or short chips, and non ferrous metals	M10	Steel, steel castings, manganese steel, gray cast iron, alloy cast iron	Turning; medium or high cutting speeds, small or medium chip sections		
		M20	Steel, steel castings, austenitic or manganese steel, gray cast iron	Turning, milling; medium cutting speeds and chip sections		
		M30	Steel, steel castings, austenitic steel, gray cast iron, high-temperature-resistant alloys	Turning, milling, planing; medium cutting speeds, medium or large chip sections		
		M40	Mild, free-cutting steel, low-tensile steel, non-ferrous metals and light alloys	Turning, parting off; particularly on automatic machines		
K Red	Ferrous metals with short chips, non-ferrous metals and non-metallic materials	K01	Very hard gray cast iron, chilled castings over 85 Shore, high-silicon aluminum alloys, hardened steel, highly abrasive plastics, hard cardboard, ceramics	Turning, finish turning, boring, milling, scraping		
		K10	Gray cast iron over 220 Brinell, malleable cast iron with short chips, hardened steel, silicon-aluminum and copper alloys, plastics, glass, hard rubber, hard cardboard, porcelain, stone	Turning, milling, drilling, boring, broaching, scraping		
		K20	Gray cast iron up to 220 Brinell, nonferrous metals, copper, brass, aluminum	Turning, milling, planing, boring, broaching, demanding very tough carbide		
		K30	Low-hardness gray cast iron, low-tensile steel, compressed wood	Turning, milling, planing, slotting, unfavorable conditions, and possibility of large cutting angles		
		K40	Softwood or hard wood, nonferrous metals	Turning, milling, planing, slotting, unfavorable conditions, and possibility of large cutting angles		

Table 3. Typical Properties of Cutting Tool Ceramics

Group	Alumina	Alumina/TiC	Silicon Nitride	PCD	PCBN
Typical composition types	Al ₂ O ₃ or Al ₂ O ₃ /ZrO ₂	70/30 Al ₂ O ₃ /TiC	Si ₃ N ₄ /Y ₂ O ₃ plus		
Density (g/cm ³)	4.0	4.25	3.27	3.4	3.1
Transverse rupture strength (N/mm ²)	700	750	800		800
Compressive strength (kN/mm ²)	4.0	4.5	4.0	4.7	3.8
Hardness (HV)	1750	1800	1600		
Hardness HK (kN/mm ²)				50	28
Young's modulus (kN/mm ²)	380	370	300	925	680
Modulus of rigidity (kN/mm ²)	150	160	150	430	280
Poisson's ratio	0.24	0.22	0.20	0.09	0.22
Thermal expansion coefficient (10 ⁻⁶ /K)	8.5	7.8	3.2	3.8	4.9
Thermal conductivity (W/m K)	23	17	22	120	100
Fracture toughness (K _{1c} MN/m ^{3/2})	2.3	3.3	5.0	7.9	10

Alumina-based ceramics were introduced as cutting inserts during World War II, and were for many years considered too brittle for regular machine-shop use. Improved machine tools and finer-grain, tougher compositions incorporating zirconia or silicon carbide “whiskers” now permit their use in a wide range of applications. Silicon nitride, often combined with alumina (aluminum oxide), yttria (yttrium oxide), and other oxides and nitrides, is used for much of the high-speed machining of superalloys, and newer grades have been formulated specifically for cast iron—potentially a far larger market.

In addition to improvements in toolholders, great advances have been made in machine tools, many of which now feature the higher powers and speeds required for the efficient use of ceramic tooling. Brittleness at the cutting edge is no longer a disadvantage, with the improvements made to the ceramics themselves, mainly in toughness, but also in other critical properties.

Although very large numbers of useful ceramic materials are now available, only a few combinations have been found to combine such properties as minimum porosity, hardness, wear resistance, chemical stability, and resistance to shock to the extent necessary for cutting-tool inserts. Most ceramics used for machining are still based on high-purity, fine-grained alumina (aluminum oxide), but embody property-enhancing additions of other ceramics such as zirconia (zirconium oxide), titania (titanium oxide), titanium carbide, tungsten carbide, and titanium nitride. For commercial purposes, those more commonly used are often termed “white” (alumina with or without zirconia) or “black” (roughly 70/30 alumina/titanium carbide). More recent developments are the distinctively green alumina ceramics strengthened with silicon carbide whiskers and the brown-tinged silicon nitride types.

Ceramics benefit from hot isostatic pressing, used to remove the last vestiges of porosity and raise substantially the material's shock resistance, even more than carbide-based hard-metals. Significant improvements are derived by even small parts such as tool inserts, although, in principle, they should not need such treatment if raw materials and manufacturing methods are properly controlled.

Oxide Ceramics: Alumina cutting tips have extreme hardness—more than HV 2000 or HRA 94—and give excellent service in their limited but important range of uses such as the machining of chilled iron rolls and brake drums. A substantial family of alumina-based materials has been developed, and fine-grained alumina-based composites now have sufficient strength for milling cast iron at speeds up to 2500 ft/min (800 m/min). Resistance to cratering when machining steel is exceptional.

Oxide/Carbide Ceramics: A second important class of alumina-based cutting ceramics combines aluminum oxide or alumina-zirconia with a refractory carbide or carbides,

nearly always 30 per cent TiC. The compound is black and normally is hot pressed or hot isostatically pressed (HIPed). As shown in [Table 3](#), the physical and mechanical properties of this material are generally similar to those of the pure alumina ceramics, but strength and shock resistance are generally higher, being comparable with those of higher-toughness simple alumina-zirconia grades. Current commercial grades are even more complex, combining alumina, zirconia, and titanium carbide with the further addition of titanium nitride.

Silicon Nitride Base: One of the most effective ceramic cutting-tool materials developed in the UK is Syalon (from SiAlON or silicon-aluminum-oxynitride) though it incorporates a substantial amount of yttria for efficient liquid-phase sintering). The material combines high strength with hot hardness, shock resistance, and other vital properties. Syalon cutting inserts are made by Kennametal and Sandvik and sold as Kyon 2000 and CC680, respectively. The brown Kyon 200 is suitable for machining high-nickel alloys and cast iron, but a later development, Kyon 3000 has good potential for machining cast iron.

Resistance to thermal stress and thermal shock of Kyon 2000 are comparable to those of sintered carbides. Toughness is substantially less than that of carbides, but roughly twice that of oxide-based cutting-tool materials at temperatures up to 850°C. Syon 200 can cut at high edge temperatures and is harder than carbide and some other ceramics at over 700°C, although softer than most at room temperature.

Whisker-Reinforced Ceramics: To improve toughness, Greenleaf Corp. has reinforced alumina ceramics with silicon carbide single-crystal “whiskers” that impart a distinctive green color to the material, marketed as WG300. Typically as thin as human hairs, the immensely strong whiskers improve tool life under arduous conditions. Whisker-reinforced ceramics and perhaps hardmetals are likely to become increasingly important as cutting and wear-resistant materials. Their only drawback seems to be the carcinogenic nature of the included fibers, which requires stringent precautions during manufacture.

Superhard Materials.—Polycrystalline synthetic diamond (PCD) and cubic boron nitride (PCBN), in the two columns at the right in [Table 3](#), are almost the only cutting-insert materials in the “superhard” category. Both PCD and PCBN are usually made with the highest practicable concentration of the hard constituent, although ceramic or metallic binders can be almost equally important in providing overall strength and optimizing other properties. Variations in grain size are another critical factor in determining cutting characteristics and edge stability. Some manufacturers treat CBN in similar fashion to tungsten carbide, varying the composition and amount of binder within exceptionally wide limits to influence the physical and mechanical properties of the sintered compact.

In comparing these materials, users should note that some inserts comprise solid polycrystalline diamond or CBN and are double-sized to provide twice the number of cutting edges. Others consist of a layer, from 0.020 to 0.040 inch (0.5 to 1 mm) thick, on a tough carbide backing. A third type is produced with a solid superhard material almost surrounded by sintered carbide. A fourth type, used mainly for cutting inserts, comprises solid hard metal with a tiny superhard insert at one or more (usually only one) cutting corners or edges. Superhard cutting inserts are expensive—up to 30 times the cost of equivalent shapes or sizes in ceramic or cemented carbide—but their outstanding properties, exceptional performance and extremely long life can make them by far the most cost-effective for certain applications.

Diamond: Diamond is the hardest material found or made. As harder, more abrasive ceramics and other materials came into widespread use, diamond began to be used for grinding-wheel grits. Cemented carbide tools virtually demanded diamond grinding wheels for fine edge finishing. Solid single-crystal diamond tools were and are used to a small extent for special purposes, such as microtomes, for machining of hard materials, and for exceptionally fine finishes. These diamonds are made from comparatively large, high-quality gem-type diamonds, have isotropic properties, and are very expensive. By comparison, diamond abrasive grits cost only a few dollars a carat.

Synthetic diamonds are produced from graphite using high temperatures and extremely high pressures. The fine diamond particles produced are sintered together in the presence of a metal “catalyst” to produce high-efficiency anisotropic cutting tool inserts. These tools comprise either a solid diamond compact or a layer of sintered diamond on a carbide backing, and are made under conditions similar to, though less severe than, those used in diamond synthesis. Both natural and synthetic diamond can be sintered in this way, although the latter method is the most frequently used.

Polycrystalline diamond (PCD) compacts are immensely hard and can be used to machine many substances, from highly abrasive hardwoods and glass fiber to nonferrous metals, hardmetals, and tough ceramics. Important classes of tools that are also available with cubic boron nitride inserts include brazed-tip drills, single-point turning tools, and face-milling cutters.

Boron Nitride: Polycrystalline diamond has one big limitation: it cannot be used to machine steel or any other ferrous material without rapid chemical breakdown. Boron nitride does not have this limitation. Normally soft and slippery like graphite, the soft hexagonal crystals (HBN) become cubic boron nitride (CBN) when subjected to ultrahigh pressures and temperatures, with a structure similar to and hardness second only to diamond. As a solid insert of polycrystalline cubic boron nitride (PCBN), the compound machines even the hardest steel with relative immunity from chemical breakdown or cratering.

Backed by sintered carbide, inserts of PCBN can readily be brazed, increasing the usefulness of the material and the range of tooling in which it can be used. With great hardness and abrasion resistance, coupled with extreme chemical stability when in contact with ferrous alloys at high temperatures, PCBN has the ability to machine both steels and cast irons at high speeds for long operating cycles. Only its currently high cost in relation to hardmetals prevents its wider use in mass-production machining.

Similar in general properties to PCBN, the recently developed “Wurbon” consists of a mixture of ultrafine (0.02 μm grain size) hexagonal and cubic boron nitride with a “wurtzite” structure, and is produced from soft hexagonal boron nitride in a microsecond by an explosive shock-wave.

Basic Machining Data: Most mass-production metal cutting operations are carried out with carbide-tipped tools but their correct application is not simple. Even apparently similar batches of the same material vary greatly in their machining characteristics and may require different tool settings to attain optimum performance. Depth of cut, feed, surface speed, cutting rate, desired surface finish, and target tool life often need to be modified to suit the requirements of a particular component.

For the same downtime, the life of an insert between indexings can be less than that of an equivalent brazed tool between regrinds, so a much higher rate of metal removal is possible with the indexable or throwaway insert. It is commonplace for the claims for a new coating to include increases in surface-speed rates of 200–300 per cent, and for a new insert design to offer similar improvements. Many operations are run at metal removal rates that are far from optimum for tool life because the rates used maximize productivity and cost-effectiveness.

Thus any recommendations for cutting speeds and feeds must be oversimplified or extremely complex, and must be hedged with many provisos, dependent on the technical and economic conditions in the manufacturing plant concerned. A preliminary grade selection should be made from the ISO-based tables and manufacturers' literature consulted for recommendations on the chosen grades and tool designs. If tool life is much greater than that desired under the suggested conditions, speeds, feeds, or depths of cut may be increased. If tools fail by edge breakage, a tougher (more shock-resistant) grade should be selected, with a numerically higher ISO code.

Alternatively, increasing the surface speed and decreasing the feed may be tried. If tools fail prematurely from what appears to be abrasive wear, a harder grade with numerically lower ISO designation should be tried. If cratering is severe, use a grade with higher titanium carbide content; that is, switch from an ISO K to M or M to P grade, use a P grade with lower numerical value, change to a coated grade, or use a coated grade with a (claimed) more-resistant surface layer.

Built-Up Edge and Cratering: The big problem in cutting steel with carbide tools is associated with the built-up edge and the familiar phenomenon called cratering. Research has shown that the built-up edge is continuous with the chip itself during normal cutting. Additions of titanium, tantalum, and niobium to the basic carbide mixture have a remarkable effect on the nature and degree of cratering, which is related to adhesion between the tool and the chip.

Hardmetal Tooling for Wood and Nonmetallics.—Carbide-tipped circular saws are now conventional for cutting wood, wood products such as chipboard, and plastics, and tipped bandsaws of large size are also gaining in popularity. Tipped handsaws and mechanical equivalents are seldom needed for wood, but they are extremely useful for cutting abrasive building boards, glass-reinforced plastics, and similar material. Like the hardmetal tips used on most other woodworking tools, saw tips generally make use of straight (unalloyed) tungsten carbide/cobalt grades. However, where excessive heat is generated as with the cutting of high-silica hardwoods and particularly abrasive chipboards, the very hard but tough tungsten-titanium-tantalum-niobium carbide solid-solution grades, normally reserved for steel finishing, may be preferred. Saw tips are usually brazed and reground a number of times during service, so coated grades appear to have little immediate potential in this field.

Cutting Blades and Plane Irons: These tools comprise long, thin, comparatively wide slabs of carbide on a minimal-thickness steel backing. Compositions are straight tungsten carbide, preferably micrograin (to maintain a keen cutting edge with an included angle of 30° or less), but with relatively high amounts of cobalt, 11-13 per cent, for toughness. Considerable expertise is necessary to braze and grind these cutters without inducing or failing to relieve the excessive stresses that cause distortion or cracking.

Other Woodworking Cutters: Routers and other cutters are generally similar to those used on metals and include many indexable-insert designs. The main difference with wood is that rotational and surface speeds can be the maximum available on the machine. High-speed routing of aluminum and magnesium alloys was developed largely from machines and techniques originally designed for work on wood.

Cutting Other Materials: The machining of plastics, fiber-reinforced plastics, graphite, asbestos, and other hard and abrasive constructional materials mainly requires abrasion resistance. Cutting pressures and power requirements are generally low. With thermoplastics and some other materials, particular attention must be given to cooling because of softening or degradation of the work material that might be caused by the heat generated in cutting. An important application of cemented carbides is the drilling and routing of printed circuit boards. Solid tungsten carbide drills of extremely small sizes are used for this work.

FORMING TOOLS

When curved surfaces or those of stepped, angular or irregular shape are required in connection with turning operations, especially on turret lathes and “automatics,” forming tools are used. These tools are so made that the contour of the cutting edge corresponds to the shape required and usually they may be ground repeatedly without changing the shape of the cutting edge. There are two general classes of forming tools—the straight type and the circular type. The circular forming tool is generally used on small narrow forms, whereas the straight type is more suitable for wide forming operations. Some straight forming tools are clamped in a horizontal position upon the cut-off slide, whereas the others are held in a vertical position in a special holder. A common form of holder for these vertical tools is one having a dovetail slot in which the forming tool is clamped; hence they are often called “dovetail forming tools.” In many cases, two forming tools are used, especially when a very smooth surface is required, one being employed for roughing and the other for finishing.

There was an American standard for forming tool blanks which covered both straight or dovetailed, and circular forms. The formed part of the finished blanks must be shaped to suit whatever job the tool is to be used for. This former standard includes the important dimensions of holders for both straight and circular forms.

Dimensions of Steps on Straight or Dovetail Forming Tools.—The diagrams at the top of the accompanying **Table 1** illustrate a straight or “dovetail” forming tool. The upper or cutting face lies in the same plane as the center of the work and there is no rake. (Many forming tools have rake to increase the cutting efficiency, and this type will be referred to later.) In making a forming tool, the various steps measured perpendicular to the front face (as at d) must be proportioned so as to obtain the required radial dimensions on the work. For example, if D equals the difference between two radial dimensions on the work, then:

$$\text{Step } d = D \times \text{cosine front clearance angle}$$

Angles on Straight Forming Tools.—In making forming tools to the required shape or contour, any angular surfaces (like the steps referred to in the previous paragraph) are affected by the clearance angle. For example, assume that angle A on the work (see diagram at top of accompanying table) is 20 degrees. The angle on the tool in plane $x-x$, in that case, will be slightly less than 20 degrees. In making the tool, this modified or reduced angle is required because of the convenience in machining and measuring the angle square to the front face of the tool or in the plane $x-x$.

If the angle on the work is measured from a line parallel to the axis (as at A in diagram), then the reduced angle on the tool as measured square to the front face (or in plane $x-x$) is found as follows:

$$\tan \text{ reduced angle on tool} = \tan A \times \cos \text{ front clearance angle}$$

If angle A on the work is larger than, say, 45 degrees, it may be given on the drawing as indicated at B . In this case, the angle is measured from a plane perpendicular to the axis of the work. When the angle is so specified, the angle on the tool in plane $x-x$ may be found as follows:

$$\tan \text{ reduced angle on tool} = \frac{\tan B}{\cos \text{ clearance angle}}$$

Table Giving Step Dimensions and Angles on Straight or Dovetailed Forming Tools.—The accompanying **Table 1** gives the required dimensions and angles within its range, directly without calculation.

Table 1. Dimensions of Steps and Angles on Straight Forming Tools

Radial Depth of Step D	Depth d of step on tool			Radial Depth of Step D	Depth d of step on tool		
	When $C = 10^\circ$	When $C = 15^\circ$	When $C = 20^\circ$		When $C = 10^\circ$	When $C = 15^\circ$	When $C = 20^\circ$
0.001	0.00098	0.00096	0.00094	0.040	0.03939	0.03863	0.03758
0.002	0.00197	0.00193	0.00187	0.050	0.04924	0.04829	0.04698
0.003	0.00295	0.00289	0.00281	0.060	0.05908	0.05795	0.05638
0.004	0.00393	0.00386	0.00375	0.070	0.06893	0.06761	0.06577
0.005	0.00492	0.00483	0.00469	0.080	0.07878	0.07727	0.07517
0.006	0.00590	0.00579	0.00563	0.090	0.08863	0.08693	0.08457
0.007	0.00689	0.00676	0.00657	0.100	0.09848	0.09659	0.09396
0.008	0.00787	0.00772	0.00751	0.200	0.19696	0.19318	0.18793
0.009	0.00886	0.00869	0.00845	0.300	0.29544	0.28977	0.28190
0.010	0.00984	0.00965	0.00939	0.400	0.39392	0.38637	0.37587
0.020	0.01969	0.01931	0.01879	0.500	0.49240	0.48296	0.46984
0.030	0.02954	0.02897	0.02819

Upper section of table gives depth d of step on forming tool for a given dimension D that equals the actual depth of the step on the work, measured radially and along the cutting face of the tool (see diagram at left). First, locate depth D required on work; then find depth d on tool under tool clearance angle C . Depth d is measured perpendicular to front face of tool.

Angle A in Plane of Tool Cutting Face	Angle on tool in plane $x-x$			Angle A in Plane of Tool Cutting Face	Angle on tool in plane $x-x$		
	When $C = 10^\circ$	When $C = 15^\circ$	When $C = 20^\circ$		When $C = 10^\circ$	When $C = 15^\circ$	When $C = 20^\circ$
5°	4° 55'	4° 50'	4° 42'	50°	49° 34'	49° 1'	48° 14'
10	9 51	9 40	9 24	55	54 35	54 4	53 18
15	14 47	14 31	14 8	60	59 37	59 8	58 26
20	19 43	19 22	18 53	65	64 40	64 14	63 36
25	24 40	24 15	23 40	70	69 43	69 21	68 50
30	29 37	29 9	28 29	75	74 47	74 30	74 5
35	34 35	34 4	33 20	80	79 51	79 39	79 22
40	39 34	39 1	38 15	85	84 55	84 49	84 41
45	44 34	44 0	43 13

Lower section of table gives angles as measured in plane $x-x$ perpendicular to front face of forming tool (see diagram on right). Find in first column the angle A required on work; then find reduced angle in plane $x-x$ under given clearance angle C .

To Find Dimensions of Steps: The upper section of **Table 1** is used in determining the dimensions of steps. The radial depth of the step or the actual cutting depth D (see left-hand diagram) is given in the first column of the table. The columns that follow give the corresponding depths d for a front clearance angle of 10, 15, or 20 degrees. To illustrate the use of the table, suppose a tool is required for turning the part shown in **Fig. 1**, which has diameters of 0.75, 1.25, and 1.75 inches, respectively. The difference between the largest and the smallest radius is 0.5 inch, which is the depth of one step. Assume that the clearance angle is 15 degrees. First, locate 0.5 in the column headed "Radial Depth of Step D "; then find depth d in the column headed "when $C = 15^\circ$." As will be seen, this depth is 0.48296

inch. Practically the same procedure is followed in determining the depth of the second step on the tool. The difference in the radii in this case equals 0.25. This value is not given directly in the table, so first find the depth equivalent to 0.200 and add to it the depth equivalent to 0.050. Thus, we have $0.19318 + 0.04829 = 0.24147$. In using **Table 1**, it is assumed that the top face of the tool is set at the height of the work axis.

To Find Angle: The lower section of **Table 1** applies to angles when they are measured relative to the axis of the work. The application of the table will again be illustrated by using the part shown in **Fig. 1**. The angle used here is 40 degrees (which is also the angle in the plane of the cutting face of the tool). If the clearance angle is 15 degrees, the angle measured in plane $x-x$ square to the face of the tool is shown by the table to be $39^{\circ} 1'$ - a reduction of practically 1 degree.

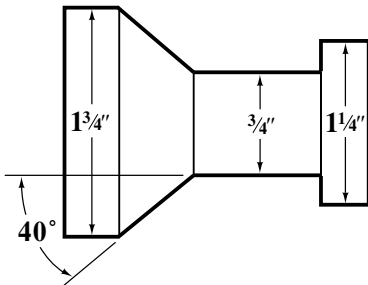


Fig. 1.

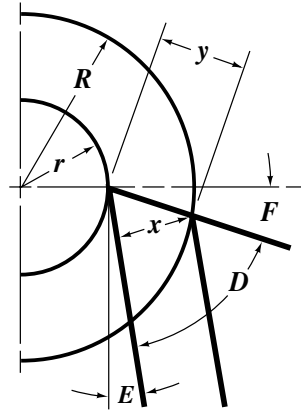


Fig. 2.

If a straight forming tool has rake, the depth x of each step (see **Fig. 2**), measured perpendicular to the front or clearance face, is affected not only by the clearance angle, but by the rake angle F and the radii R and r of the steps on the work. First, it is necessary to find three angles, designated A , B , and C , that are not shown on the drawing.

$$\text{Angle } A = 180^{\circ} - \text{rake angle } F$$

$$\sin B = \frac{r \sin A}{R}$$

$$\text{Angle } C = 180^{\circ} - (A + B)$$

$$y = \frac{R \sin C}{\sin A}$$

$$\text{Angle } D \text{ of tool} = 90^{\circ} - (E + F)$$

$$\text{Depth } x = y \sin D$$

If the work has two or more shoulders, the depth x for other steps on the tool may be determined for each radius r . If the work has curved or angular forms, it is more practical to use a tool without rake because its profile, in the plane of the cutting face, duplicates that of the work.

Example: Assume that radius R equals 16 mm and radius r equals 10 mm so that the step on the work has a radial depth of 6 mm. The tool has a rake angle F of 10 degrees and a clearance angle E of 15 degrees. Then angle $A = 180 - 10 = 170$ degrees.

$$\sin B = \frac{10 \times 0.17365}{16} = 0.10853 \quad \text{Angle } B = 6.23^\circ \text{ nearly.}$$

$$\text{Angle } C = 180 - (170^\circ + 6.23^\circ) = 3.77^\circ$$

$$\text{Dimension } y = \frac{16 \times 0.06575}{0.17365} = 6.0582$$

$$\text{Angle } D = 90^\circ - (15 + 10) = 65 \text{ degrees}$$

$$\text{Depth } x \text{ of step} = 6.0582 \times 0.90631 = 5.490 \text{ mm}$$

Circular Forming Tools.—To provide sufficient peripheral clearance on circular forming tools, the cutting face is offset with relation to the center of the tool a distance C , as shown in Fig. 3. Whenever a circular tool has two or more diameters, the difference in the radii of the steps on the tool will not correspond exactly to the difference in the steps on the work. The form produced with the tool also changes, although the change is very slight, unless the amount of offset C is considerable. Assume that a circular tool is required to produce the piece A having two diameters as shown.

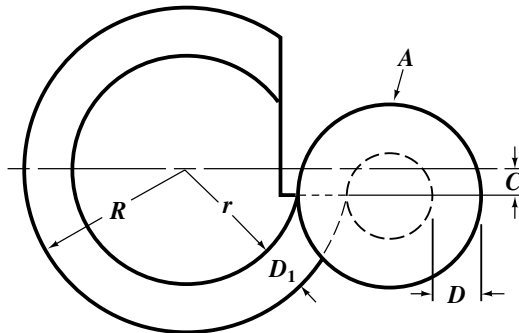


Fig. 3.

If the difference D_1 between the large and small radii of the tool were made equal to dimension D required on the work, D would be a certain amount oversize, depending upon the offset C of the cutting edge. The following formulas can be used to determine the radii of circular forming tools for turning parts to different diameters:

Let R = largest radius of tool in inches; D = difference in radii of steps on work; C = amount cutting edge is offset from center of tool; r = required radius in inches; then

$$r = \sqrt{(\sqrt{R^2 - C^2} - D)^2 + C^2} \quad (1)$$

If the small radius r is given and the large radius R is required, then

$$R = \sqrt{(\sqrt{r^2 - C^2} + D)^2 + C^2} \quad (2)$$

To illustrate, if D (Fig. 3) is to be $\frac{1}{8}$ inch, the large radius R is $1\frac{1}{8}$ inches, and C is $\frac{5}{32}$ inch, what radius r would be required to compensate for the offset C of the cutting edge? Inserting these values in Formula (1):

$$r = \sqrt{(\sqrt{(1\frac{1}{8})^2 - (\frac{5}{32})^2} - \frac{1}{8})^2 + (\frac{5}{32})^2} = 1.0014 \text{ inches}$$

The value of r is thus found to be 1.0014 inches; hence, the diameter = $2 \times 1.0014 = 2.0028$ inches instead of 2 inches, as it would have been if the cutting edge had been exactly on the center line. Formulas for circular tools used on different makes of screw machines can be simplified when the values R and C are constant for each size of machine. The accompanying Table 2, *Formulas for Circular Forming Tools*, gives the standard values

Table 2. Formulas for Circular Forming Tools^a

Make of Machine	Size of Machine	Radius R , Inches	Offset C , Inches	Radius r , Inches
Brown & Sharpe	No. 00	0.875	0.125	$r = \sqrt{(0.8660 - D)^2 + 0.0156}$
	No. 0	1.125	0.15625	$r = \sqrt{(1.1141 - D)^2 + 0.0244}$
	No. 2	1.50	0.250	$r = \sqrt{(1.4790 - D)^2 + 0.0625}$
	No. 6	2.00	0.3125	$r = \sqrt{(1.975 - D)^2 + 0.0976}$
Acme	No. 51	0.75	0.09375	$r = \sqrt{(1.7441 - D)^2 + 0.0088}$
	No. 515	0.75	0.09375	$r = \sqrt{(0.7441 - D)^2 + 0.0088}$
	No. 52	1.0	0.09375	$r = \sqrt{(0.9956 - D)^2 + 0.0088}$
	No. 53	1.1875	0.125	$r = \sqrt{(1.1809 - D)^2 + 0.0156}$
	No. 54	1.250	0.15625	$r = \sqrt{(1.2402 - D)^2 + 0.0244}$
	No. 55	1.250	0.15625	$r = \sqrt{(1.2402 - D)^2 + 0.0244}$
	No. 56	1.50	0.1875	$r = \sqrt{(1.4882 - D)^2 + 0.0352}$
Cleveland	$\frac{1}{4}$ "	0.625	0.03125	$r = \sqrt{(0.6242 - D)^2 + 0.0010}$
	$\frac{3}{8}$ "	0.084375	0.0625	$r = \sqrt{(0.8414 - D)^2 + 0.0039}$
	$\frac{5}{8}$ "	1.15625	0.0625	$r = \sqrt{(1.1546 - D)^2 + 0.0039}$
	$\frac{7}{8}$ "	1.1875	0.0625	$r = \sqrt{(1.1859 - D)^2 + 0.0039}$
	$1\frac{1}{4}$ "	1.375	0.0625	$r = \sqrt{(1.3736 - D)^2 + 0.0039}$
	2"	1.375	0.0625	$r = \sqrt{(1.3736 - D)^2 + 0.0039}$
	$2\frac{1}{4}$ "	1.625	0.125	$r = \sqrt{(1.6202 - D)^2 + 0.0156}$
	$2\frac{3}{4}$ "	1.875	0.15625	$r = \sqrt{(1.8685 - D)^2 + 0.0244}$
	$3\frac{1}{4}$ "	1.875	0.15625	$r = \sqrt{(1.8685 - D)^2 + 0.0244}$
	$4\frac{1}{4}$ "	2.50	0.250	$r = \sqrt{(2.4875 - D)^2 + 0.0625}$
6"	2.625	0.250	$r = \sqrt{(2.6131 - D)^2 + 0.0625}$	

^aFor notation, see Fig. 3

of R and C for circular tools used on different automatics. The formulas for determining the radius r (see column at right-hand side of table) contain a constant that represents the value of the expression $\sqrt{R^2 - C^2}$ in Formula (1).

Table 3, *Constant for Determining Diameters of Circular Forming Tools* has been compiled to facilitate proportioning tools of this type and gives constants for computing the various diameters of forming tools, when the cutting face of the tool is $\frac{1}{8}$, $\frac{3}{16}$, $\frac{1}{4}$, or $\frac{5}{16}$ inch below the horizontal center line. As there is no standard distance for the location of the cutting face, the table has been prepared to correspond with distances commonly used. As an example, suppose the tool is required for a part having three diameters of 1.75, 0.75, and 1.25 inches, respectively, as shown in Fig. 1, and that the largest diameter of the tool is 3

inches and the cutting face is $\frac{1}{4}$ inch below the horizontal center line. The first step would be to determine approximately the respective diameters of the forming tool and then correct the diameters by the use of the table. To produce the three diameters shown in Fig. 1, with a 3-inch forming tool, the tool diameters would be approximately 2, 3, and 2.5 inches, respectively. The first dimension (2 inches) is 1 inch less in diameter than that of the tool, and the necessary correction should be given in the column "Correction for Difference in Diameter"; but as the table is only extended to half-inch differences, it will be necessary to obtain this particular correction in two steps. On the line for 3-inch diameter and under corrections for $\frac{1}{2}$ inch, we find 0.0085; then in line with $2\frac{1}{2}$ and under the same heading, we find 0.0129, hence the total correction would be $0.0085 + 0.0129 = 0.0214$ inch. This correction is added to the approximate diameter, making the exact diameter of the first step $2 + 0.0214 = 2.0214$ inches. The next step would be computed in the same way, by noting on the 3-inch line the correction for $\frac{1}{2}$ inch and adding it to the approximate diameter of the second step, giving an exact diameter of $2.5 + 0.0085 + 2.5085$ inches. Therefore, to produce the part shown in Fig. 1, the tool should have three steps of 3, 2.0214, and 2.5085 inches, respectively, provided the cutting face is $\frac{1}{4}$ inch below the center. All diameters are computed in this way, from the largest diameter of the tool.

Tables 4a, 4b, and 4c, *Corrected Diameters of Circular Forming Tools*, are especially applicable to tools used on Brown & Sharpe automatic screw machines. Directions for using these tables are given on page 801.

Circular Tools Having Top Rake.—Circular forming tools without top rake are satisfactory for brass, but tools for steel or other tough metals cut better when there is a rake angle of 10 or 12 degrees. For such tools, the small radius r (see Fig. 3) for an outside radius R may be found by the formula

$$r = \sqrt{P^2 + R^2 - 2PR \cos \theta}$$

To find the value of P , proceed as follows: $\sin \phi = \text{small radius on work} \times \sin \text{rake angle} \div \text{large radius on work}$. Angle $\beta = \text{rake angle} - \phi$. $P = \text{large radius on work} \times \sin \beta \div \sin \text{rake angle}$. Angle $\theta = \text{rake angle} + \delta$. $\sin \delta = \text{vertical height } C \text{ from center of tool to center of work} \div R$. It is assumed that the tool point is to be set at the same height as the work center.

Using Tables for "Corrected Diameters of Circular Forming Tools".—Tables 4a, 4b, and 4c are especially applicable to Brown & Sharpe automatic screw machines. The maximum diameter D of forming tools for these machines should be as follows: For No. 00 machine, $1\frac{3}{4}$ inches; for No. 0 machine, $2\frac{1}{4}$ inches; for No. 2 machine, 3 inches. To find the other diameters of the tool for any piece to be formed, proceed as follows: Subtract the smallest diameter of the work from the diameter of the work that is to be formed by the required tool diameter; divide the remainder by 2; locate the quotient obtained in the column headed "Length c on Tool," and opposite the figure thus located and in the column headed by the number of the machine used, read off directly the diameter to which the tool is to be made. The quotient obtained, which is located in the column headed "Length c on Tool," is the length c , as shown in Fig. 4.

Example: A piece of work is to be formed on a No. 0 machine to two diameters, one being $\frac{1}{4}$ inch and one 0.550 inch; find the diameters of the tool. The maximum tool diameter is $2\frac{1}{4}$ inches, or the diameter that will cut the $\frac{1}{4}$ -inch diameter of the work. To find the other diameter, proceed according to the rule given: $0.550 - \frac{1}{4} = 0.300$; $0.300 \div 2 = 0.150$. In Table 4b, opposite 0.150, we find that the required tool diameter is 1.9534 inches. These tables are for tools without rakes.

Table 3. Constant for Determining Diameters of Circular Forming Tools

Dia. of Tool	Radius of Tool	Cutting Face $\frac{1}{8}$ Inch Below Center			Cutting Face $\frac{3}{16}$ Inch Below Center			Cutting Face $\frac{1}{4}$ Inch Below Center			Cutting Face $\frac{5}{16}$ Inch Below Center		
		Correction for Difference in Diameter			Correction for Difference in Diameter			Correction for Difference in Diameter			Correction for Difference in Diameter		
		$\frac{1}{8}$ Inch	$\frac{1}{4}$ Inch	$\frac{1}{2}$ Inch	$\frac{1}{8}$ Inch	$\frac{1}{4}$ Inch	$\frac{1}{2}$ Inch	$\frac{1}{8}$ Inch	$\frac{1}{4}$ Inch	$\frac{1}{2}$ Inch	$\frac{1}{8}$ Inch	$\frac{1}{4}$ Inch	$\frac{1}{2}$ Inch
1	0.500
$1\frac{1}{8}$	0.5625	0.0036	0.0086	0.0167	0.0298
$1\frac{1}{4}$	0.625	0.0028	0.0065	...	0.0067	0.0154	...	0.0128	0.0296	...	0.0221	0.0519	...
$1\frac{3}{8}$	0.6875	0.0023	0.0054	0.0102	0.0172
$1\frac{1}{2}$	0.750	0.0019	0.0042	0.0107	0.0045	0.0099	0.0253	0.0083	0.0185	0.0481	0.0138	0.0310	0.0829
$1\frac{5}{8}$	0.8125	0.0016	0.0037	0.0069	0.0114
$1\frac{3}{4}$	0.875	0.0014	0.0030	...	0.0032	0.0069	...	0.0058	0.0128	...	0.0095	0.0210	...
$1\frac{7}{8}$	0.9375	0.0012	0.0027	0.0050	0.0081
2	1.000	0.0010	0.0022	0.0052	0.0024	0.0051	0.0121	0.0044	0.0094	0.0223	0.0070	0.0152	0.0362
$2\frac{1}{8}$	1.0625	0.0009	0.0021	0.0038	0.0061
$2\frac{1}{4}$	1.125	0.0008	0.0017	...	0.0018	0.0040	...	0.0034	0.0072	...	0.0054	0.0116	...
$2\frac{3}{8}$	1.1875	0.0007	0.0016	0.0029	0.0048
$2\frac{1}{2}$	1.250	0.0006	0.0014	0.0031	0.0015	0.0031	0.0071	0.0027	0.0057	0.0129	0.0043	0.0092	0.0208
$2\frac{5}{8}$	1.3125	0.0006	0.0013	0.0024	0.0038
$2\frac{3}{4}$	1.375	0.0005	0.0011	...	0.0012	0.0026	...	0.0022	0.0046	...	0.0035	0.0073	...
$2\frac{7}{8}$	1.4375	0.0005	0.0011	0.0020	0.0032
3	1.500	0.0004	0.0009	0.0021	0.0010	0.0021	0.0047	0.0018	0.0038	0.0085	0.0029	0.0061	0.0135
$3\frac{1}{8}$	1.5625	0.00004	0.0009	0.0017	0.0027
$3\frac{1}{4}$	1.625	0.0003	0.0008	...	0.0008	0.0018	...	0.0015	0.0032	...	0.0024	0.0051	...
$3\frac{3}{8}$	1.6875	0.0003	0.0008	0.0014	0.0023
$3\frac{1}{2}$	1.750	0.0003	0.0007	0.0015	0.0007	0.0015	0.0033	0.0013	0.0028	0.0060	0.0021	0.0044	0.0095
$3\frac{5}{8}$	1.8125	0.0003	0.0007	0.0012	0.0019
$3\frac{3}{4}$	1.875	0.0002	0.0006	...	0.0006	0.0013	...	0.0011	0.0024	...	0.0018	0.0038	...

Table 4a. Corrected Diameters of Circular Forming Tools

Length <i>c</i> on Tool	Number of B. & S. Automatic Screw Machine			Length <i>c</i> on Tool	Number of B. & S. Automatic Screw Machine		
	No. 00	No. 0	No. 2		No. 00	No. 0	No. 2
0.001	1.7480	2.2480	2.9980	0.058	1.6353	2.1352	2.8857
0.002	1.7460	2.2460	2.9961	0.059	1.6333	2.1332	2.8837
0.003	1.7441	2.2441	2.9941	0.060	1.6313	2.1312	2.8818
0.004	1.7421	2.2421	2.9921	0.061	1.6294	2.1293	2.8798
0.005	1.7401	2.2401	2.9901	0.062	1.6274	2.1273	2.8778
0.006	1.7381	2.2381	2.9882	$\frac{1}{16}$	1.6264	2.1263	2.8768
0.007	1.7362	2.2361	2.9862	0.063	1.6254	2.1253	2.8759
0.008	1.7342	2.2341	2.9842	0.064	1.6234	2.1233	2.8739
0.009	1.7322	2.2321	2.9823	0.065	1.6215	2.1213	2.8719
0.010	1.7302	2.2302	2.9803	0.066	1.6195	2.1194	2.8699
0.011	1.7282	2.2282	2.9783	0.067	1.6175	2.1174	2.8680
0.012	1.7263	2.2262	2.9763	0.068	1.6155	2.1154	2.8660
0.013	1.7243	2.2243	2.9744	0.069	1.6136	2.1134	2.8640
0.014	1.7223	2.2222	2.9724	0.070	1.6116	2.1115	2.8621
0.015	1.7203	2.2203	2.9704	0.071	1.6096	2.1095	2.8601
$\frac{1}{64}$	1.7191	2.2191	2.9692	0.072	1.6076	2.1075	2.8581
0.016	1.7184	2.2183	2.9685	0.073	1.6057	2.1055	2.8561
0.017	1.7164	2.2163	2.9665	0.074	1.6037	2.1035	2.8542
0.018	1.7144	2.2143	2.9645	0.075	1.6017	2.1016	2.8522
0.019	1.7124	2.2123	2.9625	0.076	1.5997	2.0996	2.8503
0.020	1.7104	2.2104	2.9606	0.077	1.5978	2.0976	2.8483
0.021	1.7085	2.2084	2.9586	0.078	1.5958	2.0956	2.8463
0.022	1.7065	2.2064	2.9566	$\frac{3}{64}$	1.5955	2.0954	2.8461
0.023	1.7045	2.2045	2.9547	0.079	1.5938	2.0937	2.8443
0.024	1.7025	2.2025	2.9527	0.080	1.5918	2.0917	2.8424
0.025	1.7005	2.2005	2.9507	0.081	1.5899	2.0897	2.8404
0.026	1.6986	2.1985	2.9488	0.082	1.5879	2.0877	2.8384
0.027	1.6966	2.1965	2.9468	0.083	1.5859	2.0857	2.8365
0.028	1.6946	2.1945	2.9448	0.084	1.5839	2.0838	2.8345
0.029	1.6926	2.1925	2.9428	0.085	1.5820	2.0818	2.8325
0.030	1.6907	2.1906	2.9409	0.086	1.5800	2.0798	2.8306
0.031	1.6887	2.1886	2.9389	0.087	1.5780	2.0778	2.8286
$\frac{1}{32}$	1.6882	2.1881	2.9384	0.088	1.5760	2.0759	2.8266
0.032	1.6867	2.1866	2.9369	0.089	1.5740	2.0739	2.8247
0.033	1.6847	2.1847	2.9350	0.090	1.5721	2.0719	2.8227
0.034	1.6827	2.1827	2.9330	0.091	1.5701	2.0699	2.8207
0.035	1.6808	2.1807	2.9310	0.092	1.5681	2.0679	2.8187
0.036	1.6788	2.1787	2.9290	0.093	1.5661	2.0660	2.8168
0.037	1.6768	2.1767	2.9271	$\frac{3}{32}$	1.5647	2.0645	2.8153
0.038	1.6748	2.1747	2.9251	0.094	1.5642	2.0640	2.8148
0.039	1.6729	2.1727	2.9231	0.095	1.5622	2.0620	2.8128
0.040	1.6709	2.1708	2.9211	0.096	1.5602	2.0600	2.8109
0.041	1.6689	2.1688	2.9192	0.097	1.5582	2.0581	2.8089
0.042	1.6669	2.1668	2.9172	0.098	1.5563	2.0561	2.8069
0.043	1.6649	2.1649	2.9152	0.099	1.5543	2.0541	2.8050
0.044	1.6630	2.1629	2.9133	0.100	1.5523	2.0521	2.8030
0.045	1.6610	2.1609	2.9113	0.101	1.5503	2.0502	2.8010
0.046	1.6590	2.1589	2.9093	0.102	1.5484	2.0482	2.7991
$\frac{3}{64}$	1.6573	2.1572	2.9076	0.103	1.5464	2.0462	2.7971
0.047	1.6570	2.1569	2.9073	0.104	1.5444	2.0442	2.7951
0.048	1.6550	2.1549	2.9054	0.105	1.5425	2.0422	2.7932
0.049	1.6531	2.1529	2.9034	0.106	1.5405	2.0403	2.7912
0.050	1.6511	2.1510	2.9014	0.107	1.5385	2.0383	2.7892
0.051	1.6491	2.1490	2.8995	0.108	1.5365	2.0363	2.7873
0.052	1.6471	2.1470	2.8975	0.109	1.5346	2.0343	2.7853
0.053	1.6452	2.1451	2.8955	$\frac{7}{64}$	1.5338	2.0336	2.7846
0.054	1.6432	2.1431	2.8936	0.110	1.5326	2.0324	2.7833
0.055	1.6412	2.1411	2.8916	0.111	1.5306	2.0304	2.7814
0.056	1.6392	2.1391	2.8896	0.112	1.5287	2.0284	2.7794
0.057	1.6373	2.1372	2.8877	0.113	1.5267	2.0264	2.7774

Table 4a. Corrected Diameters of Circular Forming Tools (Continued)

Length <i>c</i> on Tool	Number of B. & S. Automatic Screw Machine			Length <i>c</i> on Tool	Number of B. & S. Automatic Screw Machine		
	No. 00	No. 0	No. 2		No. 00	No. 0	No. 2
0.113	1.5267	2.0264	2.7774	0.171	1.4124	1.9119	2.6634
0.114	1.5247	2.0245	2.7755	$\frac{1}{64}$	1.4107	1.9103	2.6617
0.115	1.5227	2.0225	2.7735	0.172	1.4104	1.9099	2.6614
0.116	1.5208	2.0205	2.7715	0.173	1.4084	1.9080	2.6595
0.117	1.5188	2.0185	2.7696	0.174	1.4065	1.9060	2.6575
0.118	1.5168	2.0166	2.7676	0.175	1.4045	1.9040	2.6556
0.119	1.5148	2.0146	2.7656	0.176	1.4025	1.9021	2.6536
0.120	1.5129	2.0126	2.7637	0.177	1.4006	1.9001	2.6516
0.121	1.5109	2.0106	2.7617	0.178	1.3986	1.8981	2.6497
0.122	1.5089	2.0087	2.7597	0.179	1.3966	1.8961	2.6477
0.123	1.5070	2.0067	2.7578	0.180	1.3947	1.8942	2.6457
0.124	1.5050	2.0047	2.7558	0.181	1.3927	1.8922	2.6438
0.125	1.5030	2.0027	2.7538	0.182	1.3907	1.8902	2.6418
0.126	1.5010	2.0008	2.7519	0.183	1.3888	1.8882	2.6398
0.127	1.4991	1.9988	2.7499	0.184	1.3868	1.8863	2.6379
0.128	1.4971	1.9968	2.7479	0.185	1.3848	1.8843	2.6359
0.129	1.4951	1.9948	2.7460	0.186	1.3829	1.8823	2.6339
0.130	1.4932	1.9929	2.7440	0.187	1.3809	1.8804	2.6320
0.131	1.4912	1.9909	2.7420	$\frac{3}{16}$	1.3799	1.8794	2.6310
0.132	1.4892	1.9889	2.7401	0.188	1.3789	1.8784	2.6300
0.133	1.4872	1.9869	2.7381	0.189	1.3770	1.8764	2.6281
0.134	1.4853	1.9850	2.7361	0.190	1.3750	1.8744	2.6261
0.135	1.4833	1.9830	2.7342	0.191	1.3730	1.8725	2.6241
0.136	1.4813	1.9810	2.7322	0.192	1.3711	1.8705	2.6222
0.137	1.4794	1.9790	2.7302	0.193	1.3691	1.8685	2.6202
0.138	1.4774	1.9771	2.7282	0.194	1.3671	1.8665	2.6182
0.139	1.4754	1.9751	2.7263	0.195	1.3652	1.8646	2.6163
0.140	1.4734	1.9731	2.7243	0.196	1.3632	1.8626	2.6143
$\frac{1}{64}$	1.4722	1.9719	2.7231	0.197	1.3612	1.8606	2.6123
0.141	1.4715	1.9711	2.7224	0.198	1.3592	1.8587	2.6104
0.142	1.4695	1.9692	2.7204	0.199	1.3573	1.8567	2.6084
0.143	1.4675	1.9672	2.7184	0.200	1.3553	1.8547	2.6064
0.144	1.4655	1.9652	2.7165	0.201	...	1.8527	2.6045
0.145	1.4636	1.9632	2.7145	0.202	...	1.8508	2.6025
0.146	1.4616	1.9613	2.7125	0.203	...	1.8488	2.6006
0.147	1.4596	1.9593	2.7106	$\frac{1}{64}$...	1.8468	2.6003
0.148	1.4577	1.9573	2.7086	0.204	...	1.8468	2.5986
0.149	1.4557	1.9553	2.7066	0.205	...	1.8449	2.5966
0.150	1.4537	1.9534	2.7047	0.206	...	1.8429	2.5947
0.151	1.4517	1.9514	2.7027	0.207	...	1.8409	2.5927
0.152	1.4498	1.9494	2.7007	0.208	...	1.8390	2.5908
0.153	1.4478	1.9474	2.6988	0.209	...	1.8370	2.5888
0.154	1.4458	1.9455	2.6968	0.210	...	1.8350	2.5868
0.155	1.4439	1.9435	2.6948	0.211	...	1.8330	2.5849
0.156	1.4419	1.9415	2.6929	0.212	...	1.8311	2.5829
$\frac{5}{32}$	1.4414	1.9410	2.6924	0.213	...	1.8291	2.5809
0.157	1.4399	1.9395	2.6909	0.214	...	1.8271	2.5790
0.158	1.4380	1.9376	2.6889	0.215	...	1.8252	2.5770
0.159	1.4360	1.9356	2.6870	0.216	...	1.8232	2.5751
0.160	1.4340	1.9336	2.6850	0.217	...	1.8212	2.5731
0.161	1.4321	1.9317	2.6830	0.218	...	1.8193	2.5711
0.162	1.4301	1.9297	2.6811	$\frac{7}{32}$...	1.8178	2.5697
0.163	1.4281	1.9277	2.6791	0.219	...	1.8173	2.5692
0.164	1.4262	1.9257	2.6772	0.220	...	1.8153	2.5672
0.165	1.4242	1.9238	2.6752	0.221	...	1.8133	2.5653
0.166	1.4222	1.9218	2.6732	0.222	...	1.8114	2.5633
0.167	1.4203	1.9198	2.6713	0.223	...	1.8094	2.5613
0.168	1.4183	1.9178	2.6693	0.224	...	1.8074	2.5594
0.169	1.4163	1.9159	2.6673	0.225	...	1.8055	2.5574
0.170	1.4144	1.9139	2.6654	0.226	...	1.8035	2.5555

Table 4b. Corrected Diameters of Circular Forming Tools

Length <i>c</i> on Tool	Number of B. & S. Screw Machine		Length <i>c</i> on Tool	Number of B. & S. Screw Machine		Length <i>c</i> on Tool	Number 2 B. & S. Machine
	No. 0	No. 2		No. 0	No. 2		
0.227	1.8015	2.5535	0.284	1.6894	2.4418	0.341	2.3303
0.228	1.7996	2.5515	0.285	1.6874	2.4398	0.342	2.3284
0.229	1.7976	2.5496	0.286	1.6854	2.4378	0.343	2.3264
0.230	1.7956	2.5476	0.287	1.6835	2.4359	$\frac{1}{32}$	2.3250
0.231	1.7936	2.5456	0.288	1.6815	2.4340	0.344	2.3245
0.232	1.7917	2.5437	0.289	1.6795	2.4320	0.345	2.3225
0.233	1.7897	2.5417	0.290	1.6776	2.4300	0.346	2.3206
0.234	1.7877	2.5398	0.291	1.6756	2.4281	0.347	2.3186
$\frac{15}{64}$	1.7870	2.5390	0.292	1.6736	2.4261	0.348	2.3166
0.235	1.7858	2.5378	0.293	1.6717	2.4242	0.349	2.3147
0.236	1.7838	2.5358	0.294	1.6697	2.4222	0.350	2.3127
0.237	1.7818	2.5339	0.295	1.6677	2.4203	0.351	2.3108
0.238	1.7799	2.5319	0.296	1.6658	2.4183	0.352	2.3088
0.239	1.7779	2.5300	$\frac{19}{64}$	1.6641	2.4166	0.353	2.3069
0.240	1.7759	2.5280	0.297	1.6638	2.4163	0.354	2.3049
0.241	1.7739	2.5260	0.298	1.6618	2.4144	0.355	2.3030
0.242	1.7720	2.5241	0.299	1.6599	2.4124	0.356	2.3010
0.243	1.7700	2.5221	0.300	1.6579	2.4105	0.357	2.2991
0.244	1.7680	2.5201	0.301	...	2.4085	0.358	2.2971
0.245	1.7661	2.5182	0.302	...	2.4066	0.359	2.2952
0.246	1.7641	2.5162	0.303	...	2.4046	$\frac{23}{64}$	2.2945
0.247	1.7621	2.5143	0.304	...	2.4026	0.360	2.2932
0.248	1.7602	2.5123	0.305	...	2.4007	0.361	2.2913
0.249	1.7582	2.5104	0.306	...	2.3987	0.362	2.2893
0.250	1.7562	2.5084	0.307	...	2.3968	0.363	2.2874
0.251	1.7543	2.5064	0.308	...	2.3948	0.364	2.2854
0.252	1.7523	2.5045	0.309	...	2.3929	0.365	2.2835
0.253	1.7503	2.5025	0.310	...	2.3909	0.366	2.2815
0.254	1.7484	2.5005	0.311	...	2.3890	0.367	2.2796
0.255	1.7464	2.4986	0.312	...	2.3870	0.368	2.2776
0.256	1.7444	2.4966	$\frac{5}{16}$...	2.3860	0.369	2.2757
0.257	1.7425	2.4947	0.313	...	2.3851	0.370	2.2737
0.258	1.7405	2.4927	0.314	...	2.3831	0.371	2.2718
0.259	1.7385	2.4908	0.315	...	2.3811	0.372	2.2698
0.260	1.7366	2.4888	0.316	...	2.3792	0.373	2.2679
0.261	1.7346	2.4868	0.317	...	2.3772	0.374	2.2659
0.262	1.7326	2.4849	0.318	...	2.3753	0.375	2.2640
0.263	1.7306	2.4829	0.319	...	2.3733	0.376	2.2620
0.264	1.7287	2.4810	0.320	...	2.3714	0.377	2.2601
0.265	1.7267	2.4790	0.321	...	2.3694	0.378	2.2581
$\frac{17}{64}$	1.7255	2.4778	0.322	...	2.3675	0.379	2.2562
0.266	1.7248	2.4770	0.323	...	2.3655	0.380	2.2542
0.267	1.7228	2.4751	0.324	...	2.3636	0.381	2.2523
0.268	1.7208	2.4731	0.325	...	2.3616	0.382	2.2503
0.269	1.7189	2.4712	0.326	...	2.3596	0.383	2.2484
0.270	1.7169	2.4692	0.327	...	2.3577	0.384	2.2464
0.271	1.7149	2.4673	0.328	...	2.3557	0.385	2.2445
0.272	1.7130	2.4653	$\frac{21}{64}$...	2.3555	0.386	2.2425
0.273	1.7110	2.4633	0.329	...	2.3538	0.387	2.2406
0.274	1.7090	2.4614	0.330	...	2.3518	0.388	2.2386
0.275	1.7071	2.4594	0.331	...	2.3499	0.389	2.2367
0.276	1.7051	2.4575	0.332	...	2.3479	0.390	2.2347
0.277	1.7031	2.4555	0.333	...	2.3460	$\frac{25}{64}$	2.2335
0.278	1.7012	2.4535	0.334	...	2.3440	0.391	2.2328
0.279	1.6992	2.4516	0.335	...	2.3421	0.392	2.2308
0.280	1.6972	2.4496	0.336	...	2.3401	0.393	2.2289
0.281	1.6953	2.4477	0.337	...	2.3381	0.394	2.2269
$\frac{9}{32}$	1.6948	2.4472	0.338	...	2.3362	0.395	2.2250
0.282	1.6933	2.4457	0.339	...	2.3342	0.396	2.2230
0.283	1.6913	2.4438	0.340	...	2.3323	0.397	2.2211

Table 4c. Corrected Diameters of Circular Forming Tools

Length <i>c</i> on Tool	Number 2 B. & S. Machine	Length <i>c</i> on Tool	Number 2 B. & S. Machine	Length <i>c</i> on Tool	Number 2 B. & S. Machine	Length <i>c</i> on Tool	Number 2 B. & S. Machine
0.398	2.2191	0.423	2.1704	0.449	2.1199	0.474	2.0713
0.399	2.2172	0.424	2.1685	0.450	2.1179	0.475	2.0694
0.400	2.2152	0.425	2.1666	0.451	2.1160	0.476	2.0674
0.401	2.2133	0.426	2.1646	0.452	2.1140	0.477	2.0655
0.402	2.2113	0.427	2.1627	0.453	2.1121	0.478	2.0636
0.403	2.2094	0.428	2.1607	$\frac{3}{64}$	2.1118	0.479	2.0616
0.404	2.2074	0.429	2.1588	0.454	2.1101	0.480	2.0597
0.405	2.2055	0.430	2.1568	0.455	2.1082	0.481	2.0577
0.406	2.2035	0.431	2.1549	0.456	2.1063	0.482	2.0558
$\frac{13}{32}$	2.2030	0.432	2.1529	0.457	2.1043	0.483	2.0538
0.407	2.2016	0.433	2.1510	0.458	2.1024	0.484	2.0519
0.408	2.1996	0.434	2.1490	0.459	2.1004	0.485	2.0500
0.409	2.1977	0.435	2.1471	0.460	2.0985	0.486	2.0480
0.410	2.1957	0.436	2.1452	0.461	2.0966	0.487	2.0461
0.411	2.1938	0.437	2.1432	0.462	2.0946	0.488	2.0441
0.412	2.1919	$\frac{7}{16}$	2.1422	0.463	2.0927	0.489	2.0422
0.413	2.1899	0.438	2.1413	0.464	2.0907	0.490	2.0403
0.414	2.1880	0.439	2.1393	0.465	2.0888	0.491	2.0383
0.415	2.1860	0.440	2.1374	0.466	2.0868	0.492	2.0364
0.416	2.1841	0.441	2.1354	0.467	2.0849	0.493	2.0344
0.417	2.1821	0.442	2.1335	0.468	2.0830	0.494	2.0325
0.418	2.1802	0.443	2.1315	$\frac{15}{32}$	2.0815	0.495	2.0306
0.419	2.1782	0.444	2.1296	0.469	2.0810	0.496	2.0286
0.420	2.1763	0.445	2.1276	0.470	2.0791	0.497	2.0267
0.421	2.1743	0.446	2.1257	0.471	2.0771	0.498	2.0247
$\frac{27}{64}$	2.1726	0.447	2.1237	0.472	2.0752	0.499	2.0228
0.422	2.1724	0.448	2.1218	0.473	2.0733	0.500	2.0209

Dimensions of Forming Tools for B. & S. Automatic Screw Machines

	No. of Machine	Max. Dia., <i>D</i>	<i>h</i>	<i>T</i>	<i>W</i>
	00	$1\frac{3}{4}$	$\frac{1}{8}$	$\frac{3}{8}$ -16	$\frac{1}{4}$
0	$2\frac{1}{4}$	$\frac{5}{32}$	$\frac{1}{2}$ -14	$\frac{5}{16}$	
2	3	$\frac{1}{4}$	$\frac{5}{8}$ -12	$\frac{3}{8}$	
6	4	$\frac{5}{16}$	$\frac{3}{4}$ -12	$\frac{3}{8}$	

Fig. 4.

Arrangement of Circular Tools.—When applying circular tools to automatic screw machines, their arrangement has an important bearing on the results obtained. The various ways of arranging the circular tools, with relation to the rotation of the spindle, are shown at A, B, C, and D in Fig. 5. These diagrams represent the view obtained when looking toward the chuck. The arrangement shown at A gives good results on long forming operations on brass and steel because the pressure of the cut on the front tool is downward; the support is more rigid than when the forming tool is turned upside down on the front slide, as shown at B; here the stock, turning up toward the tool, has a tendency to lift the cross-slide, causing chattering; therefore, the arrangement shown at A is recommended when a high-quality finish is desired. The arrangement at B works satisfactorily for short steel pieces that do not require a high finish; it allows the chips to drop clear of the work, and is especially advantageous when making screws, when the forming and cut-off tools operate after the die, as no time is lost in reversing the spindle. The arrangement at C is recommended for heavy cutting on large work, when both tools are used for forming the piece; a rigid support is then necessary for both tools and a good supply of oil is also required. The

arrangement at D is objectionable and should be avoided; it is used only when a left-hand thread is cut on the piece and when the cut-off tool is used on the front slide, leaving the heavy cutting to be performed from the rear slide. In all "cross-forming" work, it is essential that the spindle bearings be kept in good condition, and that the collet or chuck has a parallel contact upon the bar that is being formed.

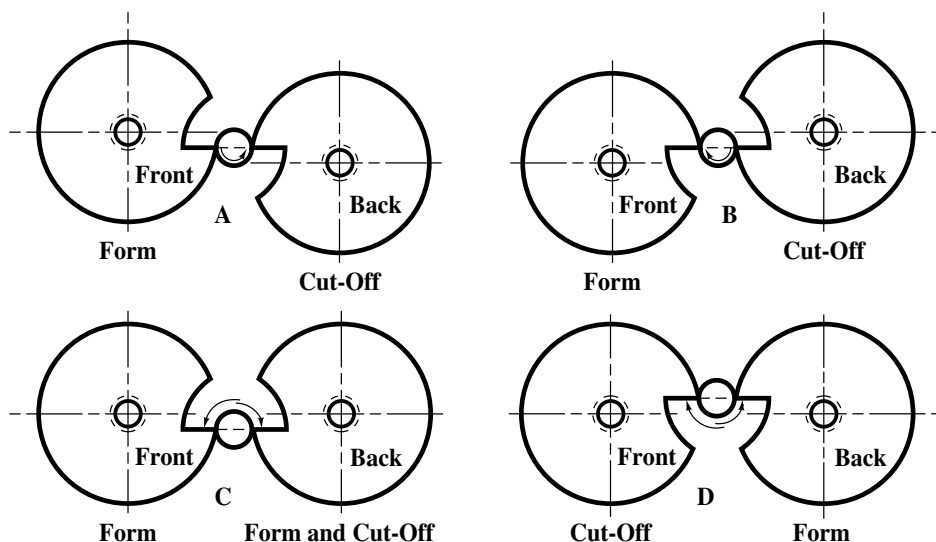


Fig. 5.

Feeds and Speeds for Forming Tools.—Approximate feeds and speeds for forming tools are given in the table beginning on page 1171. The feeds and speeds are average values, and if the job at hand has any features out of the ordinary, the figures given should be altered accordingly.

Dimensions for Circular Cut-Off Tools

	Dia. of Stock	Soft Brass, Copper		Norway Iron, Machine Steel		Drill Rod, Tool Steel	
		$a = 23 \text{ Deg.}$		$a = 15 \text{ Deg.}$		$a = 12 \text{ Deg.}$	
		T	x	T	x	T	x
	1/16	0.031	0.013	0.039	0.010	0.043	0.009
	1/8	0.044	0.019	0.055	0.015	0.062	0.013
	3/16	0.052	0.022	0.068	0.018	0.076	0.016
	1/4	0.062	0.026	0.078	0.021	0.088	0.019
	5/16	0.069	0.029	0.087	0.023	0.098	0.021
	3/8	0.076	0.032	0.095	0.025	0.107	0.023
	7/16	0.082	0.035	0.103	0.028	0.116	0.025
	1/2	0.088	0.037	0.110	0.029	0.124	0.026
	9/16	0.093	0.039	0.117	0.031	0.131	0.028
	5/8	0.098	0.042	0.123	0.033	0.137	0.029
	11/16	0.103	0.044	0.129	0.035	0.145	0.031
	3/4	0.107	0.045	0.134	0.036	0.152	0.032
	13/16	0.112	0.047	0.141	0.038	0.158	0.033
	7/8	0.116	0.049	0.146	0.039	0.164	0.035
	15/16	0.120	0.051	0.151	0.040	0.170	0.036
	1	0.124	0.053	0.156	0.042	0.175	0.037

The length of the blade equals radius of stock $R + x + r + \frac{1}{32}$ inch (for notation, see illustration above); $r = \frac{1}{16}$ inch for $\frac{3}{8}$ - to $\frac{3}{4}$ -inch stock, and $\frac{3}{32}$ inch for $\frac{3}{4}$ - to 1-inch stock.

MILLING CUTTERS

Selection of Milling Cutters

The most suitable type of milling cutter for a particular milling operation depends on such factors as the kind of cut to be made, the material to be cut, the number of parts to be machined, and the type of milling machine available. Solid cutters of small size will usually cost less, initially, than inserted blade types; for long-run production, inserted-blade cutters will probably have a lower overall cost. Depending on either the material to be cut or the amount of production involved, the use of carbide-tipped cutters in preference to high-speed steel or other cutting tool materials may be justified.

Rake angles depend on both the cutter material and the work material. Carbide and cast alloy cutting tool materials generally have smaller rake angles than high-speed steel tool materials because of their lower edge strength and greater abrasion resistance. Soft work materials permit higher radial rake angles than hard materials; thin cutters permit zero or practically zero axial rake angles; and wide cutters operate smoother with high axial rake angles. See *Rake Angles for Milling Cutters* on page 838.

Cutting edge relief or clearance angles are usually from 3 to 6 degrees for hard or tough materials, 4 to 7 degrees for average materials, and 6 to 12 degrees for easily machined materials. See *Clearance Angles for Milling Cutter Teeth* on page 837.

The number of teeth in the milling cutter is also a factor that should be given consideration, as explained in the next paragraph.

Number of Teeth in Milling Cutters.—In determining the number of teeth a milling cutter should have for optimum performance, there is no universal rule.

There are, however, two factors that should be considered in making a choice: 1) The number of teeth should never be so great as to reduce the chip space between the teeth to a point where a free flow of chips is prevented; and 2) The chip space should be smooth and without sharp corners that would cause clogging of the chips in the space.

For milling ductile materials that produce a continuous and curled chip, a cutter with large chip spaces is preferable. Such coarse tooth cutters permit an easier flow of the chips through the chip space than would be obtained with fine tooth cutters, and help to eliminate cutter “chatter.” For cutting operations in thin materials, fine tooth cutters reduce cutter and workpiece vibration and the tendency for the cutter teeth to “straddle” the workpiece and dig in. For slitting copper and other soft nonferrous materials, teeth that are either chamfered or alternately flat and V-shaped are best.

As a general rule, to give satisfactory performance the number of teeth in milling cutters should be such that *no more than two teeth at a time are engaged in the cut*. Based on this rule, the following formulas (valid in both SI and English system of units) are recommended:

For face milling cutters,

$$T = \frac{6.3D}{W} \quad (1)$$

For peripheral milling cutters,

$$T = \frac{12.6D \cos A}{D + 4d} \quad (2)$$

where T = number of teeth in cutter; D = cutter diameter in inches (mm); W = width of cut in inches (mm); d = depth of cut in inches (mm); and A = helix angle of cutter.

To find the number of teeth that a cutter should have when other than two teeth in the cut at the same time is desired, Formulas (1) and (2) should be divided by 2 and the result multiplied by the number of teeth desired in the cut.

Example: Determine the required number of teeth in a face mill where $D = 6$ inches and $W = 4$ inches. Using **Formula (1)**,

$$T = \frac{6.3 \times 6}{4} = 10 \text{ teeth, approximately}$$

Example: Determine the required number of teeth in a plain milling cutter where $D = 4$ inches and $d = \frac{1}{4}$ inch. Using **Formula (2)**,

$$T = \frac{12.6 \times 4 \times \cos 0^\circ}{4 + (4 \times \frac{1}{4})} = 10 \text{ teeth, approximately}$$

In *high speed milling* with sintered carbide, high-speed steel, and cast non-ferrous cutting tool materials, a formula that permits full use of the power available at the cutter but prevents overloading of the motor driving the milling machine is:

$$T = \frac{K \times H}{F \times N \times d \times W} \quad (3)$$

where T = number of cutter teeth; H = horsepower (kilowatts) available at the cutter; F = feed per tooth in inches (mm); N = revolutions per minute of cutter; d = depth of cut in inches (mm); W = width of cut in inches (mm); and K = a constant which may be taken as 0.65 for average steel, 1.5 for cast iron, and 2.5 for aluminum. For metric units, $K = 14278$ for average steel, 32949 for cast iron, and 54915 for aluminum. These values are conservative and take into account dulling of the cutter in service.

Example: Determine the required number of teeth in a sintered carbide tipped face mill for high speed milling of 200 Brinell hardness alloy steel if $H = 7.5$ kilowatt; $F = 0.2032$ mm; $N = 272$ rpm; $d = 3.2$ mm; $W = 152.4$ mm; and K for alloy steel is 14278. Using **Formula (3)**,

$$T = \frac{14278 \times 7.5}{0.2032 \times 272 \times 3.2 \times 152.4} = 4 \text{ teeth, approximately}$$

American National Standard Milling Cutters.—According to American National Standard ANSI/ASME B94.19-1997 milling cutters may be classified in two general ways, which are given as follows:

By Type of Relief on Cutting Edges: Milling cutters may be described on the basis of one of two methods of providing relief for the cutting edges. *Profile sharpened* cutters are those on which relief is obtained and which are resharpened by grinding a narrow land back of the cutting edges. Profile sharpened cutters may produce flat, curved, or irregular surfaces. *Form relieved* cutters are those which are so relieved that by grinding only the faces of the teeth the original form is maintained throughout the life of the cutters. Form relieved cutters may produce flat, curved or irregular surfaces.

By Method of Mounting: Milling cutters may be described by one of two methods used to mount the cutter. *Arbor type* cutters are those which have a hole for mounting on an arbor and usually have a keyway to receive a driving key. These are sometimes called *Shell type*. *Shank type* cutters are those which have a straight or tapered shank to fit the machine tool spindle or adapter.

Explanation of the “Hand” of Milling Cutters.—In the ANSI Standard the terms “right hand” and “left hand” are used to describe hand of rotation, hand of cutter and hand of flute helix.

Hand of Rotation or Hand of Cut is described as either “right hand” if the cutter revolves counterclockwise as it cuts when viewed from a position in front of a horizontal milling machine and facing the spindle or “left hand” if the cutter revolves clockwise as it cuts when viewed from the same position.

American National Standard Plain Milling Cutters
ANSI/ASME B94.19-1997 (R2003)

Cutter Diameter			Range of Face Widths, Nom. ^a	Hole Diameter		
Nom.	Max.	Min.		Nom.	Max.	Min.
Light-duty Cutters ^b						
2½	2.515	2.485	⅜, ¼, ⅝, ⅜, ½, ⅝, ¾, 1, 1½, 2 and 3	1	1.00075	1.0000
3	3.015	2.985	⅜, ¼, ⅝, ⅜, ⅝, ¾, and 1½	1	1.00075	1.0000
3	3.015	2.985	½, ⅝, ¾, 1, 1¼, 1½, 2 and 3	¼	1.2510	1.2500
4	4.015	3.985	¼, ⅝, and ⅜	1	1.00075	1.0000
4	4.015	3.985	⅜, ½, ⅝, ¾, 1, 1½, 2, 3 and 4	¼	1.2510	1.2500
Heavy-duty Cutters ^c						
2½	2.515	2.485	2	1	1.00075	1.0000
2½	2.515	2.485	4	1	1.0010	1.0000
3	3.015	2.985	2, 2½, 3, 4 and 6	¼	1.2510	1.2500
4	4.015	3.985	2, 3, 4 and 6	½	1.5010	1.5000
High-helix Cutters ^d						
3	3.015	2.985	4 and 6	¼	1.2510	1.2500
4	4.015	3.985	8	½	1.5010	1.5000

^a *Tolerances on Face Widths:* Up to 1 inch, inclusive, ± 0.001 inch; over 1 to 2 inches, inclusive, +0.010, -0.000 inch; over 2 inches, +0.020, -0.000 inch.

^b Light-duty plain milling cutters with face widths under ¾ inch have straight teeth. Cutters with ¾-inch face and wider have helix angles of not less than 15 degrees nor greater than 25 degrees.

^c Heavy-duty plain milling cutters have a helix angle of not less than 25 degrees nor greater than 45 degrees.

^d High-helix plain milling cutters have a helix angle of not less than 45 degrees nor greater than 52 degrees.

All dimensions are in inches. All cutters are high-speed steel. Plain milling cutters are of cylindrical shape, having teeth on the peripheral surface only.

Hand of Cutter: Some types of cutters require special consideration when referring to their hand. These are principally cutters with unsymmetrical forms, face type cutters, or cutters with threaded holes. *Symmetrical* cutters may be reversed on the arbor in the same axial position and rotated in the cutting direction without altering the contour produced on the work-piece, and may be considered as either right or left hand. *Unsymmetrical* cutters reverse the contour produced on the work-piece when reversed on the arbor in the same axial position and rotated in the cutting direction. A *single-angle* cutter is considered to be a right-hand cutter if it revolves counterclockwise, or a left-hand cutter if it revolves clockwise, when cutting as viewed from the side of the larger diameter. The *hand of rotation* of a single angle milling cutter need not necessarily be the same as its *hand of cutter*. A *single corner rounding* cutter is considered to be a right-hand cutter if it revolves counterclockwise, or a left-hand cutter if it revolves clockwise, when cutting as viewed from the side of the smaller diameter.

American National Standard Side Milling Cutters
ANSI/ASME B94.19-1997 (R2003)

Cutter Diameter			Range of Face Widths Nom. ^a	Hole Diameter		
Nom.	Max.	Min.		Nom.	Max.	Min.
Side Cutters ^b						
2	2.015	1.985	$\frac{3}{16}, \frac{1}{4}, \frac{3}{8}$	$\frac{5}{8}$	0.62575	0.6250
2½	2.515	2.485	$\frac{1}{4}, \frac{3}{8}, \frac{1}{2}$	$\frac{7}{8}$	0.87575	0.8750
3	3.015	2.985	$\frac{1}{4}, \frac{5}{16}, \frac{3}{8}, \frac{7}{16}, \frac{1}{2}$	1	1.00075	1.0000
4	4.015	3.985	$\frac{1}{4}, \frac{3}{8}, \frac{1}{2}, \frac{5}{8}, \frac{3}{4}, \frac{7}{8}$	1	1.00075	1.0000
4	4.015	3.985	$\frac{1}{2}, \frac{5}{8}, \frac{3}{4}$	1¼	1.2510	1.2500
5	5.015	4.985	$\frac{1}{2}, \frac{5}{8}, \frac{3}{4}$	1	1.00075	1.0000
5	5.015	4.985	$\frac{1}{2}, \frac{5}{8}, \frac{3}{4}, 1$	1¼	1.2510	1.2500
6	6.015	5.985	$\frac{1}{2}$	1	1.00075	1.0000
6	6.015	5.985	$\frac{1}{2}, \frac{5}{8}, \frac{3}{4}, 1$	1¼	1.2510	1.2500
7	7.015	6.985	$\frac{3}{4}$	1¼	1.2510	1.2500
7	7.015	6.985	$\frac{3}{4}$	1½	1.5010	1.5000
8	8.015	7.985	$\frac{3}{4}, 1$	1¼	1.2510	1.2500
8	8.015	7.985	$\frac{3}{4}, 1$	1½	1.5010	1.5000
Staggered-tooth Side Cutters ^c						
2½	2.515	2.485	$\frac{1}{4}, \frac{5}{16}, \frac{3}{8}, \frac{1}{2}$	$\frac{7}{8}$	0.87575	0.8750
3	3.015	2.985	$\frac{3}{16}, \frac{1}{4}, \frac{5}{16}, \frac{3}{8}$	1	1.00075	1.0000
3	3.015	2.985	$\frac{1}{2}, \frac{5}{8}, \frac{3}{4}$	1¼	1.2510	1.2500
4	4.015	3.985	$\frac{1}{4}, \frac{5}{16}, \frac{3}{8}, \frac{7}{16}, \frac{1}{2},$ $\frac{5}{8}, \frac{3}{4}$ and $\frac{7}{8}$	1¼	1.2510	1.2500
5	5.015	4.985	$\frac{1}{2}, \frac{5}{8}, \frac{3}{4}$	1¼	1.2510	1.2500
6	6.015	5.985	$\frac{3}{8}, \frac{1}{2}, \frac{5}{8}, \frac{3}{4}, \frac{7}{8}, 1$	1¼	1.2510	1.2500
8	8.015	7.985	$\frac{3}{8}, \frac{1}{2}, \frac{5}{8}, \frac{3}{4}, 1$	1½	1.5010	1.5000
Half Side Cutters ^d						
4	4.015	3.985	$\frac{3}{4}$	1¼	1.2510	1.2500
5	5.015	4.985	$\frac{3}{4}$	1¼	1.2510	1.2500
6	6.015	5.985	$\frac{3}{4}$	1¼	1.2510	1.2500

^a *Tolerances on Face Widths:* For side cutters, +0.002, -0.001 inch; for staggered-tooth side cutters up to $\frac{3}{4}$ inch face width, inclusive, +0.000 -0.0005 inch, and over $\frac{3}{4}$ to 1 inch, inclusive, +0.000 -0.0010 inch; and for half side cutters, +0.015, -0.000 inch.

^b Side milling cutters have straight peripheral teeth and side teeth on both sides.

^c Staggered-tooth side milling cutters have peripheral teeth of alternate right- and left-hand helix and alternate side teeth.

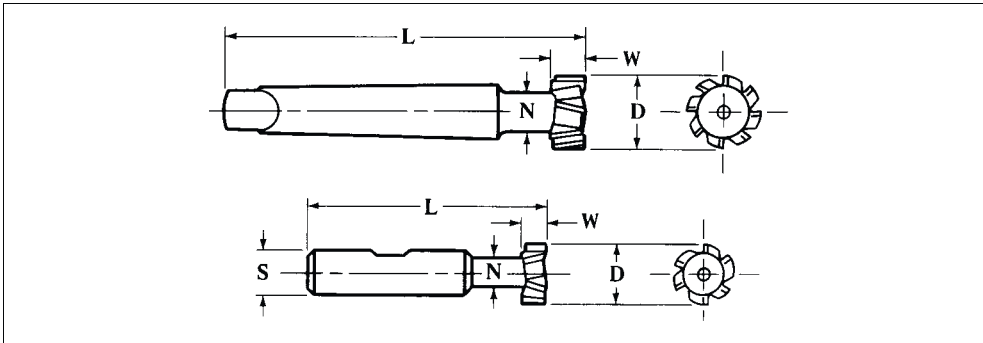
^d Half side milling cutters have side teeth on one side only. The peripheral teeth are helical of the same hand as the cut. Made either with right-hand or left-hand cut.

All dimensions are in inches. All cutters are high-speed steel. Side milling cutters are of cylindrical shape, having teeth on the periphery and on one or both sides.

Hand of Flute Helix: Milling cutters may have *straight flutes* which means that their cutting edges are in planes parallel to the cutter axis. Milling cutters with flute helix in one direction only are described as having a right-hand helix if the flutes twist away from the observer in a clockwise direction when viewed from either end of the cutter or as having a left-hand helix if the flutes twist away from the observer in a counterclockwise direction when viewed from either end of the cutter. *Staggered tooth cutters* are milling cutters with every other flute of opposite (right and left hand) helix.

An illustration describing the various milling cutter elements of both a profile cutter and a form-relieved cutter is given on page 813.

American National Standard Staggered Teeth, T-Slot Milling Cutters with Brown & Sharpe Taper and Weldon Shanks ANSI/ASME B94.19-1997 (R2003)



Bolt Size	Cutter Dia., <i>D</i>	Face Width, <i>W</i>	Neck Dia., <i>N</i>	With B. & S. Taper ^{a,b}		With Weldon Shank	
				Length, <i>L</i>	Taper No.	Length, <i>L</i>	Dia., <i>S</i>
1/4	9/16	15/64	17/64	2 19/32	1/2
5/16	2 1/32	17/64	2 1/64	2 11/16	1/2
3/8	25/32	2 1/64	13/32	3 1/4	3/4
1/2	3 1/32	25/64	17/32	5	7	3 7/16	3/4
5/8	1 1/4	3 1/64	2 1/32	5 1/4	7	3 15/16	1
3/4	1 15/32	5/8	25/32	6 7/8	9	4 7/16	1
1	1 27/32	53/64	1 1/32	7 1/4	9	4 13/16	1 1/4

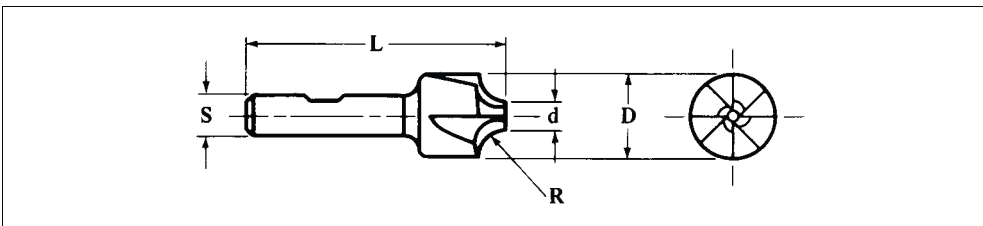
^aFor dimensions of Brown & Sharpe taper shanks, see information given on page 958.

^bBrown & Sharpe taper shanks have been removed from ANSI/ASME B94.19 they are included for reference only.

All dimensions are in inches. All cutters are high-speed steel and only right-hand cutters are standard.

Tolerances: On *D*, +0.000, -0.010 inch; on *W*, +0.000, -0.005 inch; on *N*, +0.000, -0.005 inch; on *L*, ± 1/16 inch; on *S*, -0.0001 to -0.0005 inch.

American National Standard Form Relieved Corner Rounding Cutters with Weldon Shanks ANSI/ASME B94.19-1997 (R2003)



Rad., <i>R</i>	Dia., <i>D</i>	Dia., <i>d</i>	<i>S</i>	<i>L</i>	Rad., <i>R</i>	Dia., <i>D</i>	Dia., <i>d</i>	<i>S</i>	<i>L</i>
1/16	7/16	1/4	3/8	2 1/2	3/8	1 1/4	3/8	1/2	3 1/2
3/32	1/2	1/4	3/8	2 1/2	3/16	7/8	5/16	3/4	3 1/8
1/8	5/8	1/4	1/2	3	1/4	1	3/8	3/4	3 1/4
5/32	3/4	5/16	1/2	3	5/16	1 1/8	3/8	7/8	3 1/2
3/16	7/8	5/16	1/2	3	3/8	1 1/4	3/8	7/8	3 3/4
1/4	1	3/8	1/2	3	7/16	1 3/8	3/8	1	4
3/16	1 1/8	3/8	1/2	3 1/4	1/2	1 1/2	3/8	1	4 1/8

All dimensions are in inches. All cutters are high-speed steel. Right-hand cutters are standard.

Tolerances: On *D*, ±0.010 inch; on diameter of circle, 2*R*, ±0.001 inch for cutters up to and including 1/8-inch radius, +0.002, -0.001 inch for cutters over 1/8-inch radius; on *S*, -0.0001 to -0.0005 inch; and on *L*, ± 1/16 inch.

American National Standard Metal Slitting Saws ANSI/ASME B94.19-1997 (R2003)

Cutter Diameter			Range of Face Widths Nom. ^a	Hole Diameter		
Nom.	Max.	Min.		Nom.	Max.	Min.
Plain Metal Slitting Saws^b						
2½	2.515	2.485	⅜, ¾, ⅜, ⅜, ⅜	⅜	0.87575	0.8750
3	3.015	2.985	⅜, ¾, ⅜, ⅜, ⅜	1	1.00075	1.0000
4	4.015	3.985	⅜, ¾, ⅜, ⅜, ⅜	1	1.00075	1.0000
5	5.015	4.985	⅜, ¾, ⅜, ⅜, ⅜	1	1.00075	1.0000
5	5.015	4.985	⅜, ¾, ⅜, ⅜, ⅜	1¼	1.2510	1.2500
6	6.015	5.985	⅜, ¾, ⅜, ⅜, ⅜	1	1.00075	1.0000
6	6.015	5.985	⅜, ¾, ⅜, ⅜, ⅜	1¼	1.2510	1.2500
8	8.015	7.985	⅜, ¾, ⅜, ⅜, ⅜	1	1.00075	1.0000
8	8.015	7.985	⅜, ¾, ⅜, ⅜, ⅜	1¼	1.2510	1.2500
Metal Slitting Saws with Side Teeth^c						
2½	2.515	2.485	⅜, ¾, ⅜, ⅜, ⅜	⅜	0.87575	0.8750
3	3.015	2.985	⅜, ¾, ⅜, ⅜, ⅜	1	1.00075	1.0000
4	4.015	3.985	⅜, ¾, ⅜, ⅜, ⅜	1	1.00075	1.0000
5	5.015	4.985	⅜, ¾, ⅜, ⅜, ⅜	1	1.00075	1.0000
5	5.015	4.985	⅜, ¾, ⅜, ⅜, ⅜	1¼	1.2510	1.2500
6	6.015	5.985	⅜, ¾, ⅜, ⅜, ⅜	1	1.00075	1.0000
6	6.015	5.985	⅜, ¾, ⅜, ⅜, ⅜	1¼	1.2510	1.2500
8	8.015	7.985	⅜, ¾, ⅜, ⅜, ⅜	1	1.00075	1.0000
8	8.015	7.985	⅜, ¾, ⅜, ⅜, ⅜	1¼	1.2510	1.2500
Metal Slitting Saws with Staggered Peripheral and Side Teeth^d						
3	3.015	2.985	⅜, ¾, ⅜, ⅜, ⅜	1	1.00075	1.0000
4	4.015	3.985	⅜, ¾, ⅜, ⅜, ⅜	1	1.00075	1.0000
5	5.015	4.985	⅜, ¾, ⅜, ⅜, ⅜	1	1.00075	1.0000
6	6.015	5.985	⅜, ¾, ⅜, ⅜, ⅜	1	1.00075	1.0000
6	6.015	5.985	⅜, ¾, ⅜, ⅜, ⅜	1¼	1.2510	1.2500
8	8.015	7.985	⅜, ¾, ⅜, ⅜, ⅜	1¼	1.2510	1.2500
10	10.015	9.985	⅜, ¾, ⅜, ⅜, ⅜	1¼	1.2510	1.2500
12	12.015	11.985	⅜, ¾, ⅜, ⅜, ⅜	1½	1.5010	1.5000

^aTolerances on face widths are plus or minus 0.001 inch.

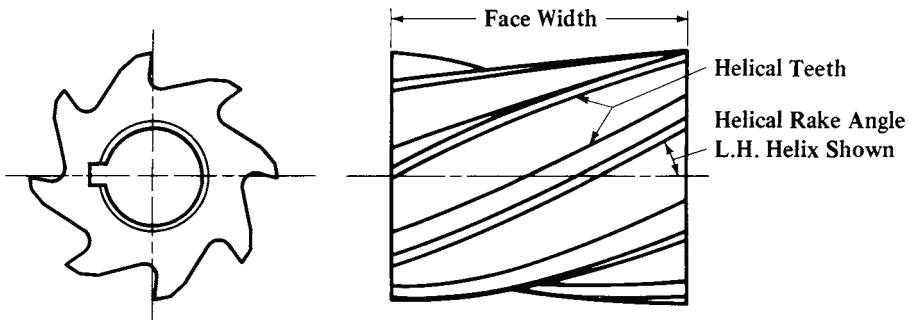
^bPlain metal slitting saws are relatively thin plain milling cutters having peripheral teeth only. They are furnished with or without hub and their sides are concaved to the arbor hole or hub.

^cMetal slitting saws with side teeth are relatively thin side milling cutters having both peripheral and side teeth.

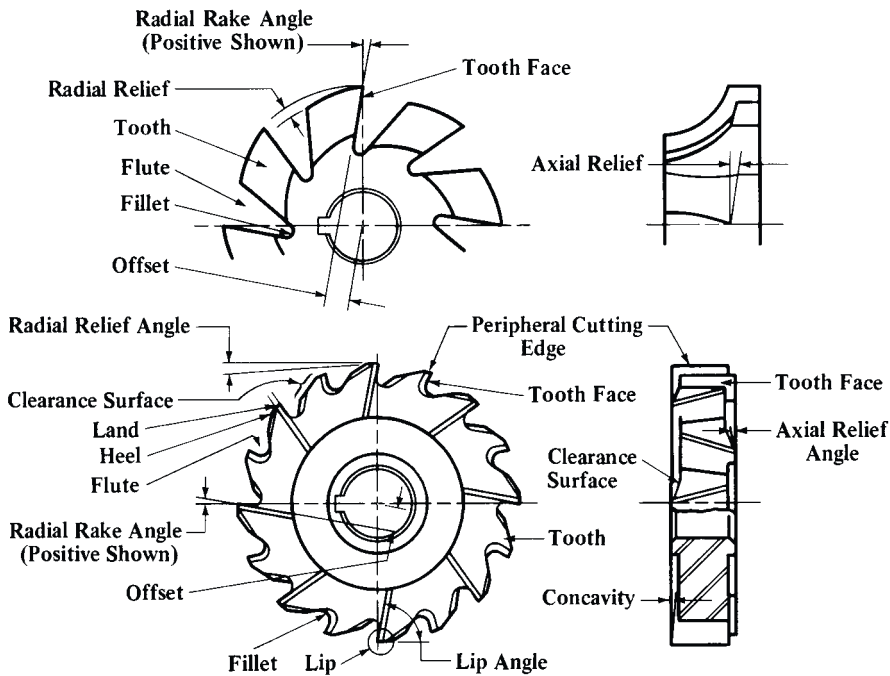
^dMetal slitting saws with staggered peripheral and side teeth are relatively thin staggered tooth milling cutters having peripheral teeth of alternate right- and left-hand helix and alternate side teeth.

All dimensions are in inches. All saws are high-speed steel. Metal slitting saws are similar to plain or side milling cutters but are relatively thin.

Milling Cutter Terms



Milling Cutter Terms (Continued)



**American National Standard Single- and Double-Angle
Milling Cutters ANSI/ASME B94.19-1997 (R2003)**

Cutter Diameter			Nominal Face Width ^a	Hole Diameter		
Nom.	Max.	Min.		Nom.	Max.	Min.
Single-angle Cutters ^b						
^c 1¼	1.265	1.235	⅞	⅜-24 UNF-2B RH ⅜-24 UNF-2B LH		
^c 1⅝	1.640	1.610	⅞	½-20 UNF-2B RH		
2¾	2.765	2.735	½	1	1.00075	1.0000
3	3.015	2.985	½	1¼	1.2510	1.2500
Double-angle Cutters ^d						
2¾	2.765	2.735	½	1	1.00075	1.0000

^a Face width tolerances are plus or minus 0.015 inch.

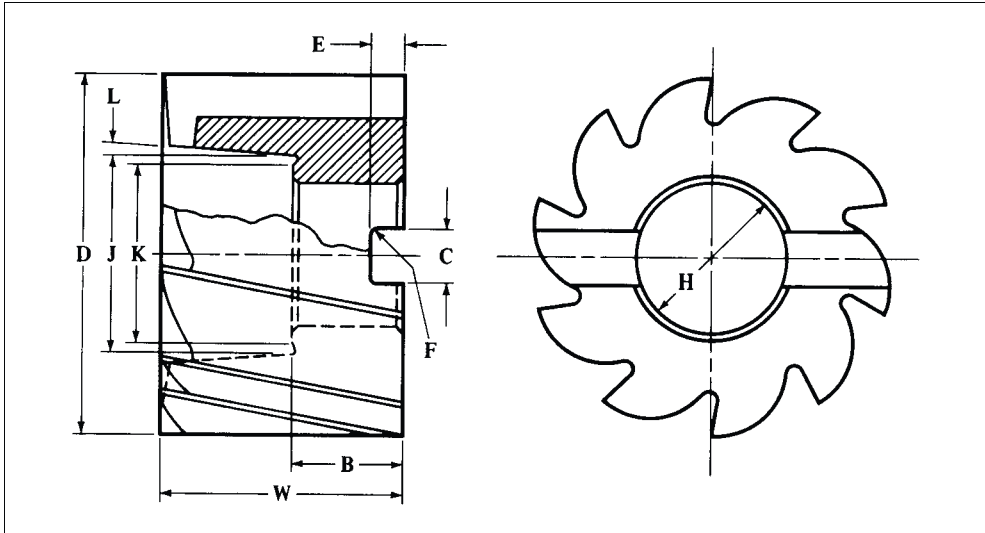
^b Single-angle milling cutters have peripheral teeth, one cutting edge of which lies in a conical surface and the other in the plane perpendicular to the cutter axis. There are two types: one has a plain keywayed hole and has an included tooth angle of either 45 or 60 degrees plus or minus 10 minutes; the other has a threaded hole and has an included tooth angle of 60 degrees plus or minus 10 minutes. Cutters with a right-hand threaded hole have a right-hand hand of rotation and a right-hand hand of cutter. Cutters with a left-hand threaded hole have a left-hand hand of rotation and a left-hand hand of cutter. Cutters with plain keywayed holes are standard as either right-hand or left-hand cutters.

^c These cutters have threaded holes, the sizes of which are given under "Hole Diameter."

^d Double-angle milling cutters have symmetrical peripheral teeth both sides of which lie in conical surfaces. They are designated by the included angle, which may be 45, 60 or 90 degrees. Tolerances are plus or minus 10 minutes for the half angle on each side of the center.

All dimensions are in inches. All cutters are high-speed steel.

American National Standard Shell Mills ANSI/ASME B94.19-1997 (R2003)

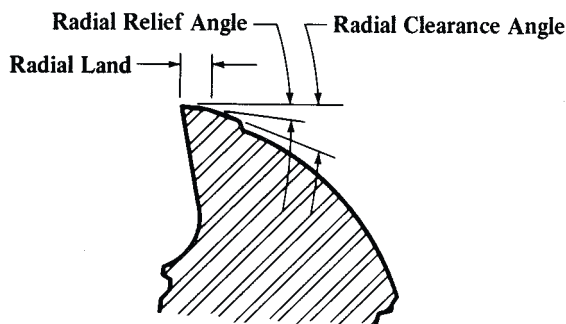


Dia., D	Width, W	Dia., H	Length, B	Width, C	Depth, E	Radius, F	Dia., J	Dia., K	Angle, L
inches	inches	inches	inches	inches	inches	inches	inches	degrees	inches
1 1/4	1	1/2	5/8	1/4	5/32	1/64	11/16	5/8	0
1 1/2	1 1/8	1/2	5/8	1/4	5/32	1/64	11/16	5/8	0
1 3/4	1 1/4	3/4	3/4	5/16	3/16	1/32	15/16	7/8	0
2	1 3/8	3/4	3/4	5/16	3/16	1/32	15/16	7/8	0
2 1/4	1 1/2	1	3/4	3/8	7/32	1/32	1 1/4	13/16	0
2 1/2	1 5/8	1	3/4	3/8	7/32	1/32	1 3/8	13/16	0
2 3/4	1 5/8	1	3/4	3/8	7/32	1/32	1 1/2	13/16	5
3	1 3/4	1 1/4	3/4	1/2	9/32	1/32	1 2/32	1 1/2	5
3 1/2	1 7/8	1 1/4	3/4	1/2	9/32	1/32	1 11/16	1 1/2	5
4	2 1/4	1 1/2	1	5/8	3/8	1/16	2 1/32	1 7/8	5
4 1/2	2 1/4	1 1/2	1	5/8	3/8	1/16	2 1/16	1 7/8	10
5	2 1/4	1 1/2	1	5/8	3/8	1/16	2 9/16	1 7/8	10
6	2 1/4	2	1	3/4	7/16	1/16	2 13/16	2 1/2	15

All cutters are high-speed steel. Right-hand cutters with right-hand helix and square corners are standard.

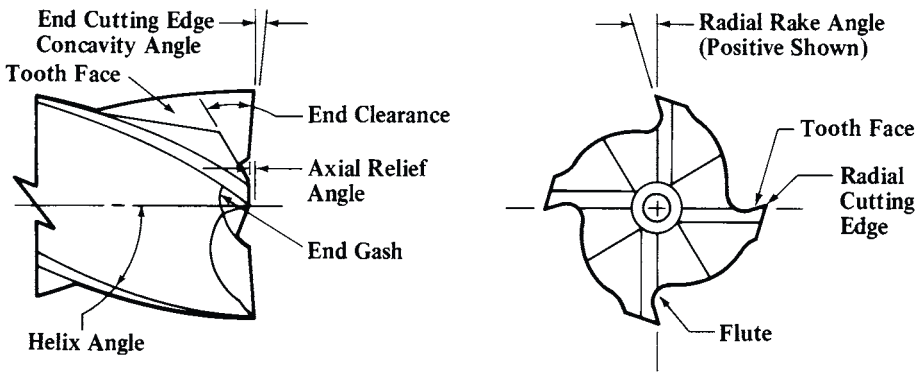
Tolerances: On D, +1/64 inch; on W, ±1/64 inch; on H, +0.0005 inch; on B, +1/64 inch; on C, at least +0.008 but not more than +0.012 inch; on E, +1/64 inch; on J, ±1/64 inch; on K, ±1/64 inch.

End Mill Terms



Enlarged Section of End Mill Tooth

End Mill Terms (Continued)



Enlarged Section of End Mill

American National Standard Multiple- and Two-Flute Single-End Helical End Mills with Plain Straight and Weldon Shanks ANSI/ASME B94.19-1997 (R2003)

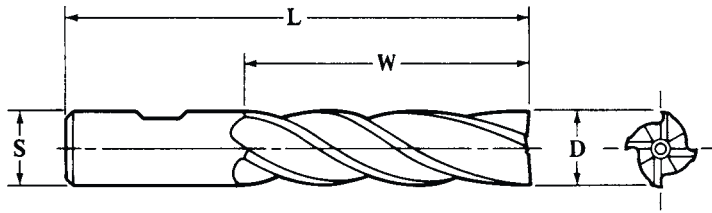
Cutter Diameter, <i>D</i>			Shank Diameter, <i>S</i>		Length of Cut, <i>W</i>	Length Overall, <i>L</i>
Nom.	Max.	Min.	Max.	Min.		
Multiple-flute with Plain Straight Shanks						
1/8	.130	.125	.125	.1245	5/16	1 1/4
3/16	.1925	.1875	.1875	.1870	1/2	1 3/8
1/4	.255	.250	.250	.2495	5/8	1 11/16
3/8	.380	.375	.375	.3745	3/4	1 13/16
1/2	.505	.500	.500	.4995	15/16	2 1/4
3/4	.755	.750	.750	.7495	1 1/4	2 5/8
Two-flute for Keyway Cutting with Weldon Shanks						
1/8	.125	.1235	.375	.3745	3/8	2 5/16
3/16	.1875	.1860	.375	.3745	7/16	2 5/16
1/4	.250	.2485	.375	.3745	1/2	2 5/16
5/16	.3125	.3110	.375	.3745	9/16	2 5/16
3/8	.375	.3735	.375	.3745	9/16	2 5/16
1/2	.500	.4985	.500	.4995	1	3
5/8	.625	.6235	.625	.6245	1 1/16	3 7/16
3/4	.750	.7485	.750	.7495	1 1/16	3 9/16
7/8	.875	.8735	.875	.8745	1 1/2	3 3/4
1	1.000	.9985	1.000	.9995	1 3/8	4 1/8
1 1/4	1.250	1.2485	1.250	1.2495	1 5/8	4 7/8
1 1/2	1.500	1.4985	1.250	1.2495	1 5/8	4 7/8

All dimensions are in inches. All cutters are high-speed steel. Right-hand cutters with right-hand helix are standard.

The helix angle is not less than 10 degrees for multiple-flute cutters with plain straight shanks; the helix angle is optional with the manufacturer for two-flute cutters with Weldon shanks.

Tolerances: On *W*, ±1/32 inch; on *L*, ±1/16 inch.

ANSI Regular-, Long-, and Extra Long-Length, Multiple-Flute Medium Helix Single-End End Mills with Weldon Shanks ANSI/ASME B94.19-1997 (R2003)



As Indicated By The Dimensions Given Below, Shank Diameter S May Be Larger, Smaller, Or The Same As The Cutter Diameter D

Cutter Dia., D	Regular Mills				Long Mills				Extra Long Mills			
	S	W	L	N ^a	S	W	L	N ^a	S	W	L	N ^a
1/8 ^b	3/8	3/8	25/16	4
3/16 ^b	3/8	1/2	23/8	4
1/4 ^b	3/8	5/8	27/16	4	3/8	1 1/4	3 1/16	4	3/8	1 3/4	3 3/16	4
5/16 ^b	3/8	3/4	2 1/2	4	3/8	1 3/8	3 3/8	4	3/8	2	3 3/4	4
3/8 ^b	3/8	3/4	2 1/2	4	3/8	1 1/2	3 1/4	4	3/8	2 1/2	4 1/4	4
7/16	3/8	1	2 11/16	4	1/2	1 3/4	3 3/4	4
1/2	3/8	1	2 11/16	4	1/2	2	4	4	1/2	3	5	4
1/2 ^b	1/2	1 1/4	3 1/4	4
9/16	1/2	1 3/8	3 3/8	4
5/8	1/2	1 3/8	3 3/8	4	5/8	2 1/2	4 5/8	4	5/8	4	6 1/8	4
11/16	1/2	1 5/8	3 5/8	4
3/4	1/2	1 5/8	3 5/8	4	3/4	3	5 1/4	4	3/4	4	6 1/4	4
5/8 ^b	5/8	1 5/8	3 3/4	4
11/16 ^b	5/8	1 5/8	3 3/4	4
3/4 ^b	5/8	1 5/8	3 3/4	4
13/16	5/8	1 7/8	4	6
7/8	5/8	1 7/8	4	6	7/8	3 1/2	5 3/4	4	7/8	5	7 1/4	4
1	5/8	1 7/8	4	6	1	4	6 1/2	4	1	6	8 1/2	4
7/8	7/8	1 7/8	4 1/8	4
1	7/8	1 7/8	4 1/8	4
1 1/8	7/8	2	4 1/4	6	1	4	6 1/2	6
1 1/4	7/8	2	4 1/4	6	1	4	6 1/2	6	1 1/4	6	8 1/2	6
1	1	2	4 1/2	4
1 1/8	1	2	4 1/2	6
1 1/4	1	2	4 1/2	6
1 3/8	1	2	4 1/2	6
1 1/2	1	2	4 1/2	6	1	4	6 1/2	6
1 1/4	1 1/4	2	4 1/2	6	1 1/4	4	6 1/2	6
1 1/2	1 1/4	2	4 1/2	6	1 1/4	4	6 1/2	6	1 1/4	8	10 1/2	6
1 3/4	1 1/4	2	4 1/2	6	1 1/4	4	6 1/2	6
2	1 1/4	2	4 1/2	8	1 1/4	4	6 1/2	8

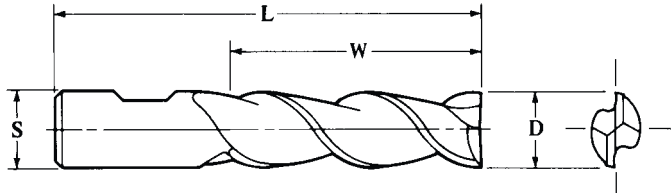
^aN = Number of flutes.

^bIn this size of regular mill a left-hand cutter with left-hand helix is also standard.

All dimensions are in inches. All cutters are high-speed steel. Helix angle is greater than 19 degrees but not more than 39 degrees. Right-hand cutters with right-hand helix are standard.

Tolerances: On D, +0.003 inch; on S, -0.0001 to -0.0005 inch; on W, ±1/32 inch; on L, ±1/16 inch.

ANSI Two-Flute, High Helix, Regular-, Long-, and Extra Long-Length, Single-End End Mills with Weldon Shanks ANSI/ASME B94.19-1997 (R2003)



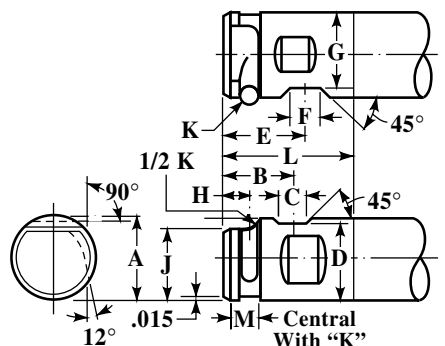
Cutter Dia., <i>D</i>	Regular Mill			Long Mill			Extra Long Mill		
	<i>S</i>	<i>W</i>	<i>L</i>	<i>S</i>	<i>W</i>	<i>L</i>	<i>S</i>	<i>W</i>	<i>L</i>
1/4	3/8	5/8	2 7/16	3/8	1 1/4	3 1/16	3/8	1 3/4	3 3/16
5/16	3/8	3/4	2 1/2	3/8	1 3/8	3 3/8	3/8	2	3 3/4
3/8	3/8	3/4	2 1/2	3/8	1 1/2	3 1/4	3/8	2 1/2	4 1/4
7/16	3/8	1	2 11/16	1/2	1 3/4	3 3/4
1/2	1/2	1 1/4	3 3/4	1/2	2	4	1/2	3	5
5/8	5/8	1 5/8	3 3/4	5/8	2 1/2	4 5/8	5/8	4	6 1/8
3/4	3/4	1 5/8	3 7/8	3/4	3	5 1/4	3/4	4	6 1/4
7/8	7/8	1 7/8	4 1/8
1	1	2	4 1/2	1	4	6 1/2	1	6	8 1/2
1 1/4	1 1/4	2	4 1/2	1 1/4	4	6 1/2	1 1/4	6	8 1/2
1 1/2	1 1/4	2	4 1/2	1 1/4	4	6 1/2	1 1/4	8	10 1/2
2	1 1/4	2	4 1/2	1 1/4	4	6 1/2

All dimensions are in inches. All cutters are high-speed steel. Right-hand cutters with right-hand helix are standard. Helix angle is greater than 39 degrees.

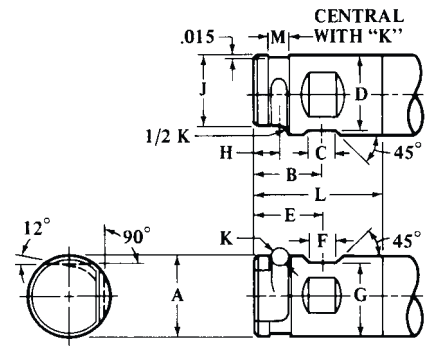
Tolerances: On *D*, +0.003 inch; on *S*, -0.0001 to -0.0005 inch; on *W*, ±1/32 inch; and on *L*, ±1/16 inch.

Combination Shanks for End Mills ANSI/ASME B94.19-1997 (R2003)

Right-hand Cut



Left-hand Cut



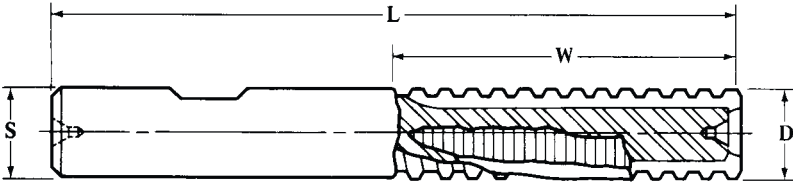
Dia. <i>A</i>	<i>L</i> ^a	<i>B</i>	<i>C</i>	<i>D</i>	<i>E</i>	<i>F</i>	<i>G</i>	<i>H</i>	<i>J</i>	<i>K</i>	<i>M</i>
1 1/2	2 11/16	1 3/16	.515	1.406	1 1/2	.515	1.371	1/16	1.302	.377	7/16
2	3 3/4	1 23/32	.700	1.900	1 3/4	.700	1.809	5/8	1.772	.440	1/2
2 1/2	3 1/2	1 15/16	.700	2.400	2	.700	2.312	3/4	2.245	.503	1/8

^a Length of shank.

All dimensions are in inches.

Modified for use as Weldon or Pin Drive shank.

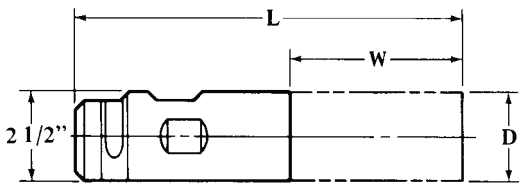
ANSI Roughing, Single-End End Mills with Weldon Shanks, High-Speed Steel ANSI/ASME B94.19-1997 (R2003)



Diameter		Length		Diameter		Length	
Cutter <i>D</i>	Shank <i>S</i>	Cut <i>W</i>	Overall <i>L</i>	Cutter <i>D</i>	Shank <i>S</i>	Cut <i>W</i>	Overall <i>L</i>
1/2	1/2	1	3	2	2	2	5 3/4
1/2	1/2	1 1/4	3 3/4	2	2	3	6 3/4
1/2	1/2	2	4	2	2	4	7 3/4
5/8	5/8	1 1/4	3 3/8	2	2	5	8 3/4
5/8	5/8	1 5/8	3 3/4	2	2	6	9 3/4
5/8	5/8	2 1/2	4 5/8	2	2	7	10 3/4
3/4	3/4	1 1/2	3 3/4	2	2	8	11 3/4
3/4	3/4	1 5/8	3 7/8	2	2	10	13 3/4
3/4	3/4	3	5 1/4	2	2	12	15 3/4
1	1	2	4 1/2	2 1/2	2	4	7 3/4
1	1	4	6 1/2	2 1/2	2	6	9 3/4
1 1/4	1 1/4	2	4 1/2	2 1/2	2	8	11 3/4
1 1/4	1 1/4	4	6 1/2	2 1/2	2	10	13 3/4
1 1/2	1 1/4	2	4 1/2	3	2 1/2	4	7 3/4
1 1/2	1 1/4	4	6 1/2	3	2 1/2	6	9 3/4
1 3/4	1 1/4	2	4 1/2	3	2 1/2	8	11 3/4
1 3/4	1 1/4	4	6 1/2	3	2 1/2	10	13 3/4

All dimensions are in inches. Right-hand cutters with right-hand helix are standard.
 Tolerances: Outside diameter, +0.025, -0.005 inch; length of cut, +1/8, -1/32 inch.

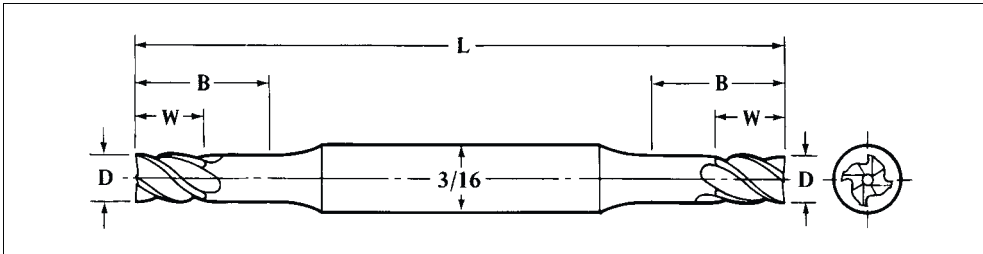
American National Standard Heavy Duty, Medium Helix Single-End End Mills, 2 1/2-inch Combination Shank, High-Speed Steel ANSI/ASME B94.19-1997 (R2003)



Dia. of Cutter, <i>D</i>	No. of Flutes	Length of Cut, <i>W</i>	Length Overall, <i>L</i>	Dia. of Cutter, <i>D</i>	No. of Flutes	Length of Cut, <i>W</i>	Length Overall, <i>L</i>
2 1/2	3	8	12	3	3	4	7 3/4
2 1/2	3	10	14	3	3	6	9 3/4
2 1/2	6	4	8	3	3	8	11 3/4
2 1/2	6	6	10	3	8	4	7 3/4
2 1/2	6	8	12	3	8	6	9 3/4
2 1/2	6	10	14	3	8	8	11 3/4
2 1/2	6	12	16	3	8	10	13 3/4
3	2	4	7 3/4	3	8	12	15 3/4
3	2	6	9 3/4

All dimensions are in inches. For shank dimensions see page 818. Right-hand cutters with right-hand helix are standard. Helix angle is greater than 19 degrees but not more than 39 degrees.
 Tolerances: On *D*, +0.005 inch; on *W*, ±1/32 inch; on *L*, ±1/16 inch.

**ANSI Stub-, Regular-, and Long-Length, Four-Flute, Medium Helix, Plain-End, Double-End Miniature End Mills with $\frac{3}{16}$ -Inch Diameter Straight Shanks
ANSI/ASME B94.19-1997 (R2003)**



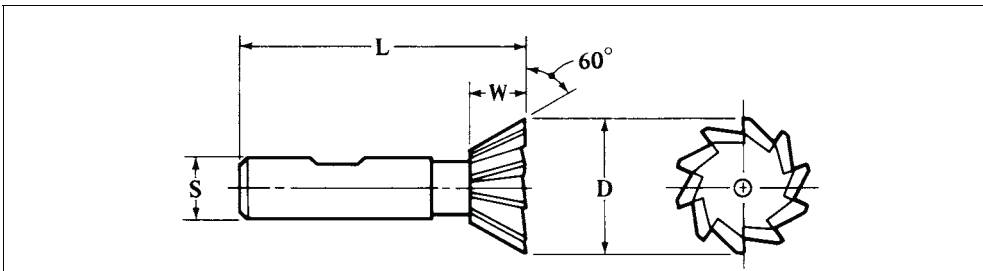
Dia. <i>D</i>	Stub Length		Regular Length	
	<i>W</i>	<i>L</i>	<i>W</i>	<i>L</i>
$\frac{1}{16}$	$\frac{3}{32}$	2	$\frac{3}{16}$	$2\frac{1}{4}$
$\frac{3}{32}$	$\frac{9}{64}$	2	$\frac{9}{32}$	$2\frac{1}{4}$
$\frac{1}{8}$	$\frac{3}{16}$	2	$\frac{3}{8}$	$2\frac{1}{4}$
$\frac{5}{32}$	$\frac{15}{64}$	2	$\frac{7}{16}$	$2\frac{1}{4}$
$\frac{3}{16}$	$\frac{9}{32}$	2	$\frac{1}{2}$	$2\frac{1}{4}$

Dia. <i>D</i>	Long Length		
	<i>B</i>	<i>W</i>	<i>L</i>
$\frac{1}{16}$	$\frac{3}{8}$	$\frac{7}{32}$	$2\frac{1}{2}$
$\frac{3}{32}$	$\frac{1}{2}$	$\frac{9}{32}$	$2\frac{5}{8}$
$\frac{1}{8}$	$\frac{3}{4}$	$\frac{3}{4}$	$3\frac{1}{8}$
$\frac{5}{32}$	$\frac{7}{8}$	$\frac{7}{8}$	$3\frac{1}{4}$
$\frac{3}{16}$	1	1	$3\frac{3}{8}$

All dimensions are in inches. All cutters are high-speed steel. Right-hand cutters with right-hand helix are standard. Helix angle is greater than 19 degrees but not more than 39 degrees.

Tolerances: On *D*, + 0.003 inch (if the shank is the same diameter as the cutting portion, however, then the tolerance on the cutting diameter is - 0.0025 inch.); on *W*, + $\frac{1}{32}$, - $\frac{1}{64}$ inch; and on *L*, $\pm\frac{1}{16}$ inch.

American National Standard 60-Degree Single-Angle Milling Cutters with Weldon Shanks ANSI/ASME B94.19-1997 (R2003)

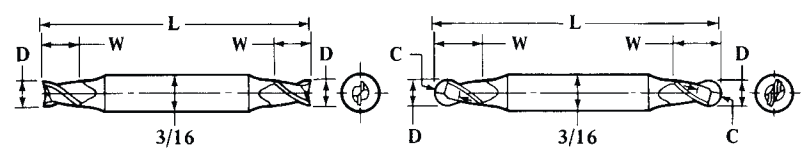


Dia., <i>D</i>	<i>S</i>	<i>W</i>	<i>L</i>	Dia., <i>D</i>	<i>S</i>	<i>W</i>	<i>L</i>
$\frac{3}{4}$	$\frac{3}{8}$	$\frac{5}{16}$	$2\frac{1}{8}$	$1\frac{7}{8}$	$\frac{7}{8}$	$\frac{13}{16}$	$3\frac{1}{4}$
$1\frac{3}{8}$	$\frac{5}{8}$	$\frac{9}{16}$	$2\frac{7}{8}$	$2\frac{1}{4}$	1	$1\frac{1}{16}$	$3\frac{3}{4}$

All dimensions are in inches. All cutters are high-speed steel. Right-hand cutters are standard.

Tolerances: On *D*, ± 0.015 inch; on *S*, - 0.0001 to - 0.0005 inch; on *W*, ± 0.015 inch; and on *L*, $\pm\frac{1}{16}$ inch.

American National Standard Stub-, Regular-, and Long-Length, Two-Flute, Medium Helix, Plain- and Ball-End, Double-End Miniature End Mills with 3/16-Inch Diameter Straight Shanks ANSI/ASME B94.19-1997 (R2003)



Dia., C and D	Stub Length				Regular Length			
	Plain End		Ball End		Plain End		Ball End	
	W	L	W	L	W	L	W	L
1/32	3/64	2	3/32	2 1/4
3/64	1/16	2	9/64	2 1/4
1/16	3/32	2	3/32	2	3/16	2 1/4	3/16	2 1/4
5/64	1/8	2	15/64	2 1/4
3/32	9/64	2	9/64	2	9/32	2 1/4	9/32	2 1/4
7/64	5/32	2	21/64	2 1/4
1/8	3/16	2	3/16	2	3/8	2 1/4	3/8	2 1/4
9/64	7/32	2	13/32	2 1/4
5/32	15/64	2	15/64	2	7/16	2 1/4	7/16	2 1/4
11/64	1/4	2	1/2	2 1/4
3/16	9/32	2	9/32	2	1/2	2 1/4	1/2	2 1/4

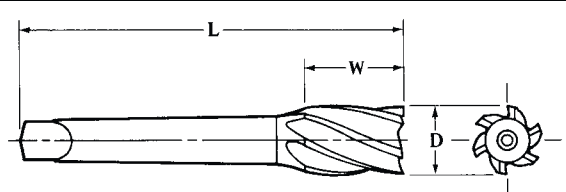
Dia., D	Long Length, Plain End			Dia., D	Long Length, Plain End		
	B ^a	W	L		B ^a	W	L
1/16	3/8	7/32	2 1/2	5/32	7/8	7/8	3 1/4
3/32	1/2	9/32	2 3/8	3/16	1	1	3 3/8
1/8	3/4	3/4	3 1/8				

^aB is the length below the shank.

All dimensions are in inches. All cutters are high-speed steel. Right-hand cutters with right-hand helix are standard. Helix angle is greater than 19 degrees but not more than 39 degrees.

Tolerances: On C and D, -0.0015 inch for stub and regular length; +0.003 inch for long length (if the shank is the same diameter as the cutting portion, however, then the tolerance on the cutting diameter is -0.0025 inch.); on W, + 1/32, - 1/64 inch; and on L, ± 1/16 inch.

American National Standard Multiple Flute, Helical Series End Mills with Brown & Sharpe Taper Shanks



Dia., D	W	L	Taper No.	Dia., D	W	L	Taper No.
1/2	15/16	4 15/16	7	1 1/4	2	7 1/4	9
3/4	1 1/4	5 1/4	7	1 1/2	2 1/4	7 1/2	9
1	1 5/8	5 5/8	7	2	2 3/4	8	9

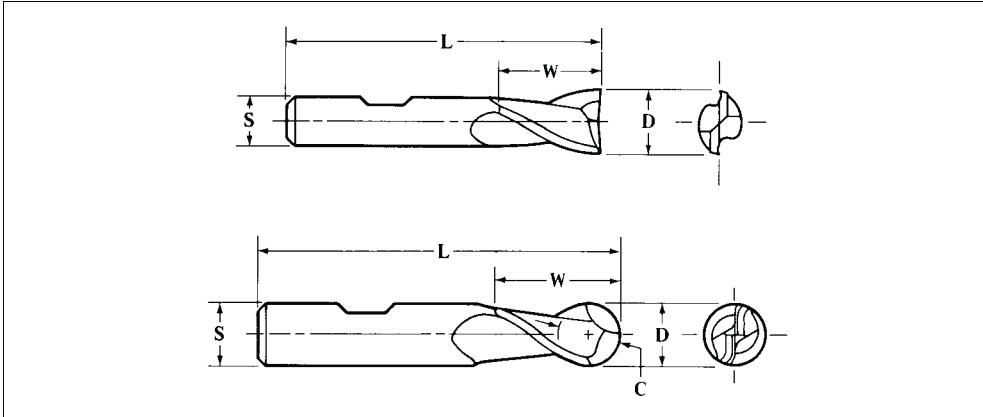
All dimensions are in inches. All cutters are high-speed steel. Right-hand cutters with right-hand helix are standard. Helix angle is not less than 10 degrees.

No. 5 taper is standard without tang; Nos. 7 and 9 are standard with tang only.

Tolerances: On D, +0.005 inch; on W, ± 1/32 inch; and on L ± 1/16 inch.

For dimensions of B & S taper shanks, see information given on page 958.

**American National Standard Stub- and Regular-Length, Two-Flute, Medium Helix, Plain- and Ball-End, Single-End End Mills with Weldon Shanks
ANSI/ASME B94.19-1997 (R2003)**



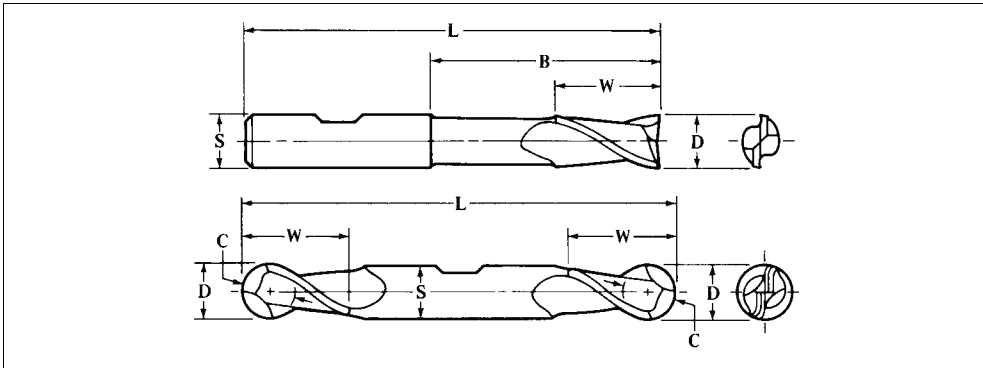
Regular Length — Plain End				Stub Length — Plain End			
Dia., <i>D</i>	<i>S</i>	<i>W</i>	<i>L</i>	Cutter Dia., <i>D</i>	Shank Dia., <i>S</i>	Length of Cut. <i>W</i>	Length Overall. <i>L</i>
1/8	3/8	3/8	2 5/16	1/8	3/8	3/16	2 1/8
3/16	3/8	7/16	2 5/16	3/16	3/8	9/32	2 3/16
1/4	3/8	1/2	2 5/16	1/4	3/8	3/8	2 1/4
5/16	3/8	9/16	2 5/16	Regular Length — Ball End			
3/8	3/8	9/16	2 5/16				
7/16	3/8	13/16	2 1/2	Dia., <i>C</i> and <i>D</i>	Shank Dia., <i>S</i>	Length of Cut. <i>W</i>	Length Overall. <i>L</i>
1/2	3/8	13/16	2 1/2	1/8	3/8	3/8	2 3/16
1/2	1/2	1	3	3/16	3/8	1/2	2 3/8
9/16	1/2	1 1/8	3 1/8	1/4	3/8	5/8	2 7/16
5/8	1/2	1 1/8	3 1/8	5/16	3/8	3/4	2 1/2
11/16	1/2	1 5/16	3 3/16	3/8	3/8	3/4	2 1/2
3/4	1/2	1 5/16	3 5/16	7/16	1/2	1	3
5/8	5/8	1 3/16	3 7/16	1/2	1/2	1	3
11/16	5/8	1 5/16	3 7/16	9/16	1/2	1 1/8	3 1/8
3/4	5/8	1 5/16	3 7/16	5/8	1/2	1 1/8	3 3/8
13/16	5/8	1 1/2	3 3/8	7/8	7/8	2	4 1/4
7/8	5/8	1 1/2	3 3/8	1	1	2 1/4	4 3/4
1	5/8	1 1/2	3 3/8	1 1/8	1	2 1/4	4 3/4
7/8	7/8	1 1/2	3 3/4	1 1/4	1 1/4	2 1/2	5
1	7/8	1 1/2	3 3/4	1 1/2	1 1/4	2 1/2	5
1 1/8	7/8	1 5/8	3 3/8				
1 1/4	7/8	1 5/8	3 7/8				
1	1	1 5/8	4 1/8				
1 1/8	1	1 5/8	4 1/8				
1 1/4	1	1 5/8	4 1/8				
1 3/8	1	1 5/8	4 1/8				
1 1/2	1	1 5/8	4 1/8				
1 1/4	1 1/4	1 5/8	4 1/8				
1 1/2	1 1/4	1 5/8	4 1/8				
1 3/4	1 1/4	1 5/8	4 1/8				
2	1 1/4	1 5/8	4 1/8				

All dimensions are in inches. All cutters are high-speed steel. Right-hand cutters with right-hand helix are standard. Helix angle is greater than 19 degrees but not more than 39 degrees.

Tolerances: On *C* and *D*, -0.0015 inch for stub-length mills, +0.003 inch for regular-length mills; on *S*, -0.0001 to -0.0005 inch; on *W*, ± 1/32 inch; and on *L*, ± 1/16 inch.

The following single-end end mills are available in premium high speed steel: ball end, two flute, with *D* ranging from 1/8 to 1 1/2 inches; ball end, multiple flute, with *D* ranging from 1/8 to 1 inch; and plain end, two flute, with *D* ranging from 1/8 to 1 1/2 inches.

American National Standard Long-Length Single-End and Stub-, and Regular Length, Double-End, Plain- and Ball-End, Medium Helix, Two-Flute End Mills with Weldon Shanks ANSI/ASME B94.19-1997 (R2003)



Single End								
Dia., C and D	Long Length — Plain End				Long Length — Ball End			
	S	B ^a	W	L	S	B ^a	W	L
1/8	3/8	13/16	3/8	2 3/8
3/16	3/8	1 1/8	1/2	2 11/16
1/4	3/8	1 1/2	5/8	3 1/16	3/8	1 1/2	5/8	3 1/16
5/16	3/8	1 3/4	3/4	3 5/16	3/8	1 3/4	3/4	3 5/16
3/8	3/8	1 3/4	3/4	3 3/16	3/8	1 3/4	3/4	3 3/16
7/16	1/2	1 7/8	1	3 1/16
1/2	1/2	2 7/32	1	4	1/2	2 1/4	1	4
5/8	5/8	2 27/32	1 3/8	4 5/8	5/8	2 3/4	1 3/8	4 5/8
3/4	3/4	3 11/32	1 5/8	5 3/8	3/4	3 3/8	1 5/8	5 3/8
1	1	4 31/32	2 1/2	7 1/4	1	5	2 1/2	7 1/4
1 1/4	1 1/4	4 31/32	3	7 1/4

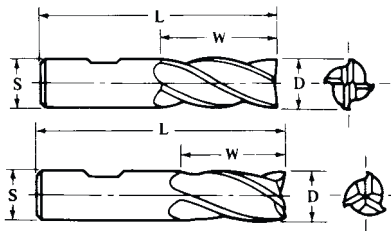
^aB is the length below the shank.

Double End									
Dia., C and D	Stub Length — Plain End			Regular Length — Plain End			Regular Length — Ball End		
	S	W	L	S	W	L	S	W	L
1/8	3/8	3/16	2 3/4	3/8	3/8	3 1/16	3/8	3/8	3 1/16
3/32	3/8	15/64	2 3/4	3/8	7/16	3 1/8
3/16	3/8	9/32	2 3/4	3/8	7/16	3 1/8	3/8	7/16	3 1/8
7/32	3/8	21/64	2 7/8	3/8	1/2	3 3/8
1/4	3/8	3/8	2 7/8	3/8	1/2	3 3/8	3/8	1/2	3 3/8
9/32	3/8	9/16	3 3/8
5/16	3/8	9/16	3 3/8	3/8	9/16	3 3/8
1 1/32	3/8	9/16	3 3/8
3/8	3/8	9/16	3 3/8	3/8	9/16	3 3/8
1 1/32	1/2	13/16	3 3/4
7/16	1/2	13/16	3 3/4	1/2	13/16	3 3/4
1 5/32	1/2	13/16	3 3/4
1/2	1/2	13/16	3 3/4	1/2	13/16	3 3/4
9/16	5/8	1 1/8	4 1/2
5/8	5/8	1 1/8	4 1/2	5/8	1 1/8	4 1/2
1 1/16	3/4	1 5/16	5
3/4	3/4	1 5/16	5	3/4	1 5/16	5
7/8	7/8	1 9/16	5 1/2
1	1	1 3/8	5 7/8	1	1 3/8	5 7/8

All dimensions are in inches. All cutters are high-speed steel. Right-hand cutters with right-hand helix are standard. Helix angle is greater than 19 degrees but not more than 39 degrees.

Tolerances: On C and D, + 0.003 inch for single-end mills, -0.0015 inch for double-end mills; on S, -0.0001 to -0.0005 inch; on W, ± 1/32 inch; and on L, ± 1/16 inch.

American National Standard Regular-, Long-, and Extra Long-Length, Three- and Four-Flute, Medium Helix, Center Cutting, Single-End End Mills with Weldon Shanks ANSI/ASME B94.19-1997 (R2003)



Four Flute									
Dia., <i>D</i>	Regular Length			Long Length			Extra Long Length		
	<i>S</i>	<i>W</i>	<i>L</i>	<i>S</i>	<i>W</i>	<i>L</i>	<i>S</i>	<i>W</i>	<i>L</i>
1/8	3/8	3/8	2 5/16
3/16	3/8	1/2	2 3/8
1/4	3/8	5/8	2 7/16	3/8	1 1/4	3 3/16	3/8	1 3/4	3 3/16
5/16	3/8	3/4	2 1/2	3/8	1 3/8	3 1/8	3/8	2	3 3/4
3/8	3/8	3/4	2 1/2	3/8	1 1/2	3 1/4	3/8	2 1/2	4 1/4
1/2	1/2	1 1/4	3 1/4	1/2	2	4	1/2	3	5
5/8	5/8	1 5/8	3 3/4	5/8	2 1/2	4 5/8	5/8	4	6 1/8
11/16	5/8	1 5/8	3 3/4
3/4	3/4	1 5/8	3 3/8	3/4	3	5 1/4	3/4	4	6 1/4
7/8	7/8	1 7/8	4 1/8	7/8	3 1/2	5 3/4	7/8	5	7 1/4
1	1	2	4 1/2	1	4	6 1/2	1	6	8 1/2
1 1/8	1	2	4 1/2
1 1/4	1 1/4	2	4 1/2	1 1/4	4	6 1/2	1 1/4	6	8 1/2
1 1/2	1 1/4	2	4 1/2

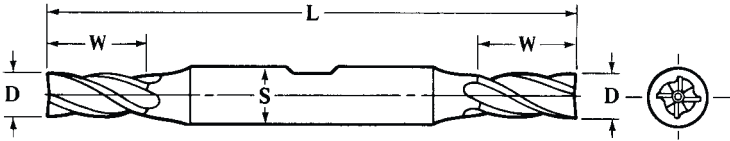
Three Flute							
Dia., <i>D</i>	<i>S</i>	<i>W</i>	<i>L</i>	Dia., <i>D</i>	<i>S</i>	<i>W</i>	<i>L</i>
Regular Length				Regular Length (cont.)			
1/8	3/8	3/8	2 5/16	1 1/8	1	2	4 1/2
3/16	3/8	1/2	2 3/8	1 1/4	1	2	4 1/2
1/4	3/8	5/8	2 7/16	1 1/2	1	2	4 1/2
5/16	3/8	3/4	2 1/2	1 1/4	1 1/4	2	4 1/2
3/8	3/8	3/4	2 1/2	1 1/2	1 1/4	2	4 1/2
7/16	3/8	1	2 11/16	1 3/4	1 1/4	2	4 1/2
1/2	3/8	1	2 11/16	2	1 1/4	2	4 1/2
1/2	1/2	1 1/4	3 1/4	Long Length			
9/16	1/2	1 3/8	3 3/8	1/4	3/8	1 1/4	3 11/16
5/8	1/2	1 3/8	3 3/8	5/16	3/8	1 3/8	3 3/8
3/4	1/2	1 5/8	3 3/8	3/8	3/8	1 1/2	3 1/4
5/8	5/8	1 5/8	3 3/4	7/16	1/2	1 3/4	3 3/4
3/4	5/8	1 5/8	3 3/4	1/2	1/2	2	4
7/8	5/8	1 7/8	4	5/8	5/8	2 1/2	4 5/8
1	5/8	1 7/8	4	3/4	3/4	3	5 1/4
3/4	3/4	1 5/8	3 3/8	1	1	4	6 1/2
7/8	3/4	1 7/8	4 1/8	1 1/4	1 1/4	4	6 1/2
1	3/4	1 7/8	4 1/8	1 1/2	1 1/4	4	6 1/2
1	7/8	1 7/8	4 1/8	1 3/4	1 1/4	4	6 1/2
1	1	2	4 1/2	2	1 1/4	4	6 1/2

All dimensions are in inches. All cutters are high-speed steel. Right-hand cutters with right-hand helix are standard. Helix angle is greater than 19 degrees but not more than 39 degrees.

Tolerances: On *D*, +0.003 inch; on *S*, -0.0001 to -0.0005 inch; on *W*, ±1/32 inch; and on *L*, ±1/16 inch.

The following center-cutting, single-end end mills are available in premium high speed steel: regular length, multiple flute, with *D* ranging from 1/8 to 1 1/2 inches; long length, multiple flute, with *D* ranging from 3/8 to 1 1/4 inches; and extra long-length, multiple flute, with *D* ranging from 3/8 to 1 1/4 inches.

American National Standard Stub- and Regular-length, Four-flute, Medium Helix, Double-end End Mills with Weldon Shanks ANSI/ASME B94.19-1997 (R2003)



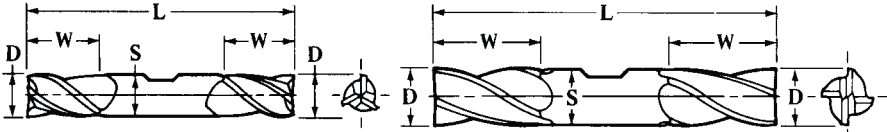
Dia., D	S	W	L	Dia., D	S	W	L	Dia., D	S	W	L
Stub Length											
1/8	3/8	3/16	2 3/4	3/16	3/8	9/32	2 3/4	1/4	3/8	3/8	2 7/8
5/32	3/8	15/64	2 3/4	7/32	3/8	2 1/64	2 7/8
Regular Length											
1/8 ^a	3/8	3/8	3 1/16	11/32	3/8	3/4	3 1/2	5/8 ^a	3/8	1 3/8	5
3/32 ^a	3/8	7/16	3 3/8	3/8 ^a	3/8	3/4	3 1/2	11/16	3/4	1 5/8	5 5/8
3/16 ^a	3/8	1/2	3 1/4	13/32	1/2	1	4 1/8	3/4 ^a	3/4	1 5/8	5 5/8
7/32	3/8	9/16	3 1/4	7/16	1/2	1	4 1/8	13/16	7/8	1 7/8	6 1/8
1/4 ^a	3/8	5/8	3 3/8	15/32	1/2	1	4 1/8	7/8	7/8	1 7/8	6 1/8
9/32	3/8	11/16	3 3/8	1/2 ^a	1/2	1	4 1/8	1	1	1 7/8	6 3/8
3/16 ^a	3/8	3/4	3 1/2	9/16	3/8	1 3/8	5

^a In this size of regular mill a left-hand cutter with a left-hand helix is also standard.

All dimensions are in inches. All cutters are high-speed steel. Right-hand cutters with right-hand helix are standard. Helix angle is greater than 19 degrees but not more than 39 degrees.

Tolerances: On D, +0.003 inch (if the shank is the same diameter as the cutting portion, however, then the tolerance on the cutting diameter is -0.0025 inch); on S, -0.0001 to -0.0005 inch; on W, ±1/32 inch; and on L, ±1/16 inch.

American National Standard Stub- and Regular-Length, Four-Flute, Medium Helix, Double-End End Mills with Weldon Shanks ANSI/ASME B94.19-1997 (R2003)

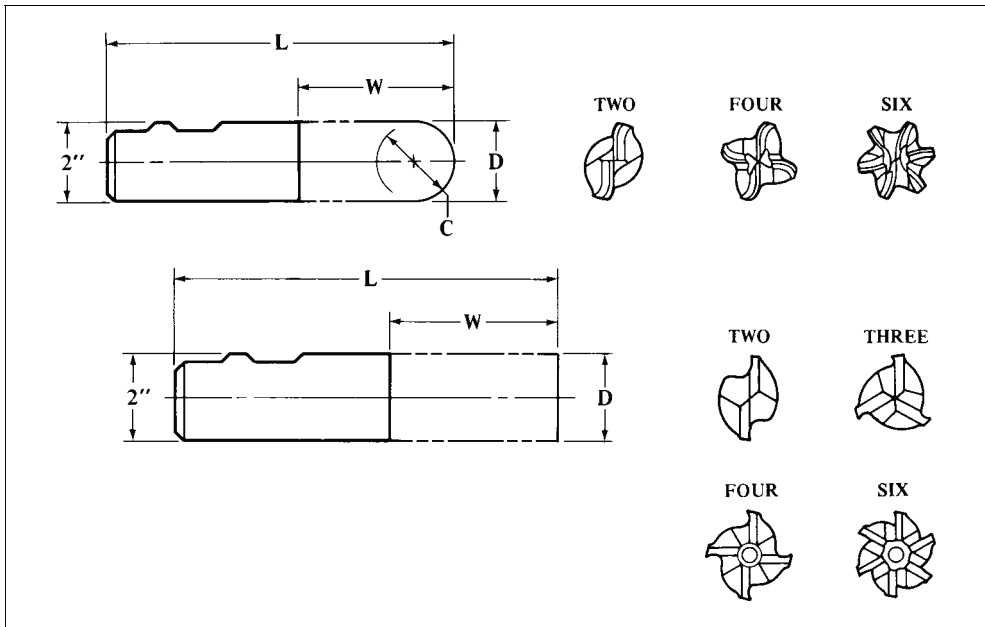


Dia., D	S	W	L	Dia., D	S	W	L
Three Flute				Four Flute			
1/8	3/8	3/8	3 1/16	1/8	3/8	3/8	3 1/16
3/16	3/8	1/2	3 1/4	3/16	3/8	1/2	3 1/4
1/4	3/8	5/8	3 3/8	1/4	3/8	5/8	3 3/8
5/16	3/8	3/4	3 1/2	5/16	3/8	3/4	3 1/2
3/8	3/8	3/4	3 1/2	3/8	3/8	3/4	3 1/2
7/16	1/2	1	4 1/8	1/2	1/2	1	4 1/8
1/2	1/2	1	4 1/8	5/8	3/8	1 3/8	5
9/16	5/8	1 3/8	5	3/4	3/4	1 5/8	5 5/8
5/8	5/8	1 3/8	5	7/8	7/8	1 7/8	6 1/8
3/4	3/4	1 5/8	5 5/8	1	1	1 7/8	6 3/8
1	1	1 7/8	6 3/8

All dimensions are in inches. All cutters are high-speed steel. Right-hand cutters with right-hand helix are standard. Helix angle is greater than 19 degrees but not more than 39 degrees.

Tolerances: On D, +0.0015 inch; on S, -0.0001 to -0.0005 inch; on W, ±1/32 inch; and on L, ±1/16 inch.

American National Standard Plain- and Ball-End, Heavy Duty, Medium Helix, Single-End End Mills with 2-Inch Diameter Shanks ANSI/ASME B94.19-1997 (R2003)



Dia., C and D	Plain End			Ball End		
	W	L	No. of Flutes	W	L	No. of Flutes
2	2	5¾	2, 4, 6
2	3	6¾	2, 3
2	4	7¾	2, 3, 4, 6	4	7¾	6
2	5	8¾	2, 4
2	6	9¾	2, 3, 4, 6	6	9¾	6
2	8	11¾	6	8	11¾	6
2½	4	7¾	2, 3, 4, 6
2½	5	8¾	4
2½	6	9¾	2, 4, 6
2½	8	11¾	6

All dimensions are in inches. All cutters are high-speed steel. Right-hand cutters with right-hand helix are standard. Helix angle is greater than 19 degrees but not more than 39 degrees.

Tolerances: On C and D, + 0.005 inch for 2, 3, 4 and 6 flutes: on W, ± 1/16 inch; and on L, ± 1/16 inch.

**Dimensions of American National Standard Weldon Shanks
ANSI/ASME B94.19-1997 (R2003)**

Shank		Flat		Shank		Flat	
Dia.	Length	X ^a	Length ^b	Dia.	Length	X ^a	Length ^b
3/8	1 1/16	0.325	0.280	1	2 2/32	0.925	0.515
1/2	1 25/32	0.440	0.330	1 1/4	2 2/32	1.156	0.515
5/8	1 29/32	0.560	0.400	1 1/2	2 11/16	1.406	0.515
3/4	2 1/32	0.675	0.455	2	3 1/4	1.900	0.700
7/8	2 1/32	0.810	0.455	2 1/2	3 1/2	2.400	0.700

^aX is distance from bottom of flat to opposite side of shank.

^bMinimum.

All dimensions are in inches.

Centerline of flat is at half-length of shank except for 1 1/2-, 2- and 2 1/2-inch shanks where it is 1 3/16, 1 27/32 and 1 15/16 from shank end, respectively.

Tolerance on shank diameter, - 0.0001 to - 0.0005 inch.

American National Standard Form Relieved, Concave, Convex, and Corner-Rounding Arbor-Type Cutters ANSI/ASME B94.19-1997 (R2003)

Diameter <i>C</i> or Radius <i>R</i>			Cutter Dia. <i>D</i> ^a	Width <i>W</i> ± .010 ^b	Diameter of Hole <i>H</i>		
Nom.	Max.	Min.			Nom.	Max.	Min.
Concave Cutters^c							
1/8	0.1270	0.1240	2 1/4	1/4	1	1.00075	1.00000
3/16	0.1895	0.1865	2 1/4	3/8	1	1.00075	1.00000
1/4	0.2520	0.2490	2 1/2	7/16	1	1.00075	1.00000
5/16	0.3145	0.3115	2 3/4	9/16	1	1.00075	1.00000
3/8	0.3770	0.3740	2 3/4	3/8	1	1.00075	1.00000
7/16	0.4395	0.4365	3	3/4	1	1.00075	1.00000
1/2	0.5040	0.4980	3	13/16	1	1.00075	1.00000
5/8	0.6290	0.6230	3 1/2	1	1 1/4	1.251	1.250
3/4	0.7540	0.7480	3 3/4	1 3/16	1 1/4	1.251	1.250
7/8	0.8790	0.8730	4	1 3/8	1 1/4	1.251	1.250
1	1.0040	0.9980	4 1/4	1 9/16	1 1/4	1.251	1.250
Convex Cutters^c							
1/8	0.1270	0.1230	2 1/4	1/8	1	1.00075	1.00000
3/16	0.1895	0.1855	2 1/4	3/16	1	1.00075	1.00000
1/4	0.2520	0.2480	2 1/2	1/4	1	1.00075	1.00000
5/16	0.3145	0.3105	2 3/4	5/16	1	1.00075	1.00000
3/8	0.3770	0.3730	2 3/4	3/8	1	1.00075	1.00000
7/16	0.4395	0.4355	3	7/16	1	1.00075	1.00000
1/2	0.5020	0.4980	3	1/2	1	1.00075	1.00000
5/8	0.6270	0.6230	3 1/2	5/8	1 1/4	1.251	1.250
3/4	0.7520	0.7480	3 3/4	3/4	1 1/4	1.251	1.250
7/8	0.8770	0.8730	4	7/8	1 1/4	1.251	1.250
1	1.0020	0.9980	4 1/4	1	1 1/4	1.251	1.250
Corner-rounding Cutters^d							
1/8	0.1260	0.1240	2 1/2	1/4	1	1.00075	1.00000
1/4	0.2520	0.2490	3	13/32	1	1.00075	1.00000
3/8	0.3770	0.3740	3 3/4	9/16	1 1/4	1.251	1.250
1/2	0.5020	0.4990	4 1/4	3/4	1 1/4	1.251	1.250
5/8	0.6270	0.6240	4 1/4	15/16	1 1/4	1.251	1.250

^a Tolerances on cutter diameter are + 1/16, - 1/16 inch for all sizes.

^b Tolerance does not apply to convex cutters.

^c Size of cutter is designated by specifying diameter *C* of circular form.


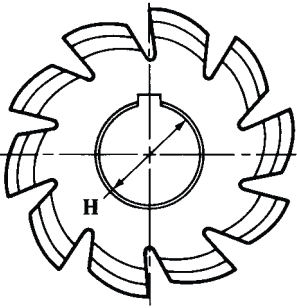
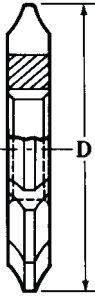
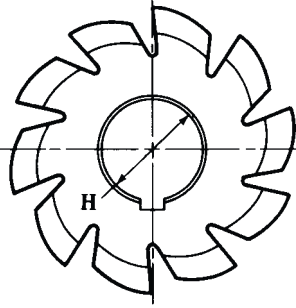
^d Size of cutter is designated by specifying radius *R* of circular form.

All dimensions in inches. All cutters are high-speed steel and are form relieved.

Right-hand corner rounding cutters are standard, but left-hand cutter for 1/4-inch size is also standard.

For key and keyway dimensions for these cutters, see page 831.

American National Standard Roughing and Finishing Gear Milling Cutters for Gears with $14\frac{1}{2}$ -Degree Pressure Angles ANSI/ASME B94.19-1997 (R2003)

ROUGHING		FINISHING						
								
Diametral Pitch	Dia. of Cutter, D	Dia. of Hole, H	Diametral Pitch	Dia. of Cutter, D	Dia. of Hole, H	Diametral Pitch	Dia. of Cutter, D	Dia. of Hole, H
Roughing Gear Milling Cutters								
1	$8\frac{1}{2}$	2	3	$5\frac{1}{4}$	$1\frac{1}{2}$	5	$3\frac{3}{8}$	1
$1\frac{1}{4}$	$7\frac{3}{4}$	2	3	$4\frac{3}{4}$	$1\frac{1}{4}$	6	$3\frac{3}{8}$	$1\frac{1}{2}$
$1\frac{1}{2}$	7	$1\frac{3}{4}$	4	$4\frac{3}{4}$	$1\frac{3}{4}$	6	$3\frac{1}{2}$	$1\frac{1}{4}$
$1\frac{3}{4}$	$6\frac{1}{2}$	$1\frac{3}{4}$	4	$4\frac{1}{2}$	$1\frac{1}{2}$	6	$3\frac{3}{8}$	1
2	$6\frac{1}{2}$	$1\frac{3}{4}$	4	$4\frac{1}{4}$	$1\frac{1}{4}$	7	$3\frac{3}{8}$	$1\frac{1}{4}$
2	$5\frac{3}{4}$	$1\frac{1}{2}$	4	$3\frac{3}{8}$	1	7	$2\frac{7}{8}$	1
$2\frac{1}{2}$	$6\frac{1}{8}$	$1\frac{3}{4}$	5	$4\frac{3}{8}$	$1\frac{3}{4}$	8	$3\frac{1}{4}$	$1\frac{1}{4}$
$2\frac{1}{2}$	$5\frac{3}{4}$	$1\frac{1}{2}$	5	$4\frac{1}{4}$	$1\frac{1}{2}$	8	$2\frac{7}{8}$	1
3	$5\frac{5}{8}$	$1\frac{3}{4}$	5	$3\frac{3}{4}$	$1\frac{1}{4}$
Finishing Gear Milling Cutters								
1	$8\frac{1}{2}$	2	6	$3\frac{7}{8}$	$1\frac{1}{2}$	14	$2\frac{1}{8}$	$\frac{7}{8}$
$1\frac{1}{4}$	$7\frac{3}{4}$	2	6	$3\frac{1}{2}$	$1\frac{1}{4}$	16	$2\frac{1}{2}$	1
$1\frac{1}{2}$	7	$1\frac{3}{4}$	6	$3\frac{3}{8}$	1	16	$2\frac{1}{8}$	$\frac{7}{8}$
$1\frac{3}{4}$	$6\frac{1}{2}$	$1\frac{3}{4}$	7	$3\frac{3}{8}$	$1\frac{1}{2}$	18	$2\frac{3}{8}$	1
2	$6\frac{1}{2}$	$1\frac{3}{4}$	7	$3\frac{3}{8}$	$1\frac{1}{4}$	18	2	$\frac{7}{8}$
2	$5\frac{3}{4}$	$1\frac{1}{2}$	7	$2\frac{7}{8}$	1	20	$2\frac{3}{8}$	1
$2\frac{1}{2}$	$6\frac{1}{8}$	$1\frac{3}{4}$	8	$3\frac{1}{2}$	$1\frac{1}{2}$	20	2	$\frac{7}{8}$
$2\frac{1}{2}$	$5\frac{3}{4}$	$1\frac{1}{2}$	8	$3\frac{1}{4}$	$1\frac{1}{4}$	22	$2\frac{1}{4}$	1
3	$5\frac{5}{8}$	$1\frac{3}{4}$	8	$2\frac{7}{8}$	1	22	2	$\frac{7}{8}$
3	$5\frac{1}{4}$	$1\frac{1}{2}$	9	$3\frac{1}{8}$	$1\frac{1}{4}$	24	$2\frac{1}{4}$	1
3	$4\frac{3}{4}$	$1\frac{1}{4}$	9	$2\frac{3}{4}$	1	24	$1\frac{3}{4}$	$\frac{7}{8}$
4	$4\frac{3}{4}$	$1\frac{3}{4}$	10	3	$1\frac{1}{4}$	26	$1\frac{3}{4}$	$\frac{7}{8}$
4	$4\frac{1}{2}$	$1\frac{1}{2}$	10	$2\frac{3}{4}$	1	28	$1\frac{3}{4}$	$\frac{7}{8}$
4	$4\frac{1}{4}$	$1\frac{1}{4}$	10	$2\frac{3}{8}$	$\frac{7}{8}$	30	$1\frac{3}{4}$	$\frac{7}{8}$
4	$3\frac{3}{8}$	1	11	$2\frac{5}{8}$	1	32	$1\frac{3}{4}$	$\frac{7}{8}$
5	$4\frac{3}{8}$	$1\frac{3}{4}$	11	$2\frac{3}{8}$	$\frac{7}{8}$	36	$1\frac{3}{4}$	$\frac{7}{8}$
5	$4\frac{1}{4}$	$1\frac{1}{2}$	12	$2\frac{7}{8}$	$1\frac{1}{4}$	40	$1\frac{3}{4}$	$\frac{7}{8}$
5	$3\frac{3}{4}$	$1\frac{1}{4}$	12	$2\frac{3}{8}$	1	48	$1\frac{3}{4}$	$\frac{7}{8}$
5	$3\frac{3}{8}$	1	12	$2\frac{1}{4}$	$\frac{7}{8}$
6	$4\frac{1}{4}$	$1\frac{3}{4}$	14	$2\frac{1}{2}$	1

All dimensions are in inches.

All gear milling cutters are high-speed steel and are form relieved.

For keyway dimensions see page 831.

Tolerances: On outside diameter, $+\frac{1}{16}$, $-\frac{1}{16}$ inch; on hole diameter, through 1-inch hole diameter, $+0.00075$ inch, over 1-inch and through 2-inch hole diameter, $+0.0010$ inch.

For cutter number relative to numbers of gear teeth, see page 2148. Roughing cutters are made with No. 1 cutter form only.

American National Standard Gear Milling Cutters for Mitre and Bevel Gears with 14½-Degree Pressure Angles ANSI/ASME B94.19-1997 (R2003)

Diametral Pitch	Diameter of Cutter, <i>D</i>	Diameter of Hole, <i>H</i>	Diametral Pitch	Diameter of Cutter, <i>D</i>	Diameter of Hole, <i>H</i>
3	4	1¼	10	2¾	¾
4	3⅝	1¼	12	2¼	¾
5	3¾	1¼	14	2⅛	¾
6	3⅛	1	16	2⅛	¾
7	2⅞	1	20	2	¾
8	2⅞	1	24	1¾	¾

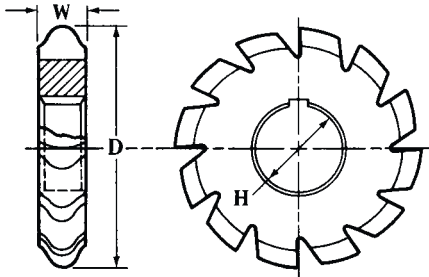
All dimensions are in inches.

All cutters are high-speed steel and are form relieved.

For keyway dimensions see page 831. For cutter selection see page 2187.

Tolerances: On outside diameter, +⅓₁₆, -⅓₁₆ inch; on hole diameter, through 1-inch hole diameter, +0.00075 inch, for 1¼-inch hole diameter, +0.0010 inch.

To select the cutter number for bevel gears with the axis at any angle, double the back cone radius and multiply the result by the diametral pitch. This procedure gives the number of equivalent spur gear teeth and is the basis for selecting the cutter number from the table on page 2150.



American National Standard
Roller Chain Sprocket
Milling Cutters

American National Standard Roller Chain Sprocket Milling Cutters ANSI/ASME B94.19-1997 (R2003)

Chain Pitch	Dia. of Roll	No. of Teeth in Sprocket	Dia. of Cutter, <i>D</i>	Width of Cutter, <i>W</i>	Dia. of Hole, <i>H</i>
¼	0.130	6	2¾	⅓ ₁₆	1
¼	0.130	7-8	2¾	⅓ ₁₆	1
¼	0.130	9-11	2¾	⅓ ₁₆	1
¼	0.130	12-17	2¾	⅓ ₁₆	1
¼	0.130	18-34	2¾	⅓ ₃₂	1
¼	0.130	35 and over	2¾	⅓ ₃₂	1
⅜	0.200	6	2¾	⅓ ₃₂	1
⅜	0.200	7-8	2¾	⅓ ₃₂	1
⅜	0.200	9-11	2¾	⅓ ₃₂	1
⅜	0.200	12-17	2¾	⅓ ₁₆	1
⅜	0.200	18-34	2¾	⅓ ₁₆	1
⅜	0.200	35 and over	2¾	⅓ ₃₂	1
½	0.313	6	3	⅓ ₄	1
½	0.313	7-8	3	⅓ ₄	1
½	0.313	9-11	3⅞	⅓ ₄	1
½	0.313	12-17	3⅞	⅓ ₄	1
½	0.313	18-34	3⅞	⅓ ₃₂	1
½	0.313	35 and over	3⅞	⅓ ₁₆	1
⅝	0.400	6	3⅞	⅓ ₄	1
⅝	0.400	7-8	3⅞	⅓ ₄	1
⅝	0.400	9-11	3¼	⅓ ₄	1
⅝	0.400	12-17	3¼	⅓ ₄	1
⅝	0.400	18-34	3¼	⅓ ₃₂	1
⅝	0.400	35 and over	3¼	⅓ ₁₆	1

**American National Standard Roller Chain Sprocket
Milling Cutters ANSI/ASME B94.19-1997 (R2003)(Continued)**

Chain Pitch	Dia. of Roll	No. of Teeth in Sprocket	Dia. of Cutter, <i>D</i>	Width of Cutter, <i>W</i>	Dia. of Hole, <i>H</i>
$\frac{3}{4}$	0.469	6	$3\frac{1}{4}$	$2\frac{9}{32}$	1
$\frac{3}{4}$	0.469	7-8	$3\frac{1}{4}$	$2\frac{9}{32}$	1
$\frac{3}{4}$	0.469	9-11	$3\frac{3}{8}$	$2\frac{9}{32}$	1
$\frac{3}{4}$	0.469	12-17	$3\frac{3}{8}$	$\frac{7}{8}$	1
$\frac{3}{4}$	0.469	18-34	$3\frac{3}{8}$	$2\frac{7}{32}$	1
$\frac{3}{4}$	0.469	35 and over	$3\frac{3}{8}$	$1\frac{3}{16}$	1
1	0.625	6	$3\frac{3}{8}$	$1\frac{1}{2}$	$1\frac{1}{4}$
1	0.625	7-8	4	$1\frac{1}{2}$	$1\frac{1}{4}$
1	0.625	9-11	$4\frac{1}{8}$	$1\frac{15}{32}$	$1\frac{1}{4}$
1	0.625	18-34	$4\frac{1}{4}$	$1\frac{13}{32}$	$1\frac{1}{4}$
1	0.625	35 and over	$4\frac{1}{4}$	$1\frac{11}{32}$	$1\frac{1}{4}$
$1\frac{1}{4}$	0.750	6	$4\frac{1}{4}$	$1\frac{13}{16}$	$1\frac{1}{4}$
$1\frac{1}{4}$	0.750	7-8	$4\frac{3}{8}$	$1\frac{11}{16}$	$1\frac{1}{4}$
$1\frac{1}{4}$	0.750	9-11	$4\frac{1}{2}$	$1\frac{25}{32}$	$1\frac{1}{4}$
$1\frac{1}{4}$	0.750	18-34	$4\frac{3}{8}$	$1\frac{11}{16}$	$1\frac{1}{4}$
$1\frac{1}{4}$	0.750	35 and over	$4\frac{5}{8}$	$1\frac{7}{8}$	$1\frac{1}{4}$
$1\frac{1}{2}$	0.875	6	$4\frac{3}{8}$	$1\frac{13}{16}$	$1\frac{1}{4}$
$1\frac{1}{2}$	0.875	7-8	$4\frac{1}{2}$	$1\frac{13}{16}$	$1\frac{1}{4}$
$1\frac{1}{2}$	0.875	9-11	$4\frac{3}{8}$	$1\frac{25}{32}$	$1\frac{1}{4}$
$1\frac{1}{2}$	0.875	12-17	$4\frac{5}{8}$	$1\frac{3}{4}$	$1\frac{1}{4}$
$1\frac{1}{2}$	0.875	18-34	$4\frac{3}{4}$	$1\frac{11}{16}$	$1\frac{1}{4}$
$1\frac{1}{2}$	0.875	35 and over	$4\frac{3}{4}$	$1\frac{7}{8}$	$1\frac{1}{4}$
$1\frac{3}{4}$	1.000	6	5	$2\frac{3}{32}$	$1\frac{1}{2}$
$1\frac{3}{4}$	1.000	7-8	$5\frac{1}{8}$	$2\frac{3}{32}$	$1\frac{1}{2}$
$1\frac{3}{4}$	1.000	9-11	$5\frac{1}{4}$	$2\frac{1}{16}$	$1\frac{1}{2}$
$1\frac{3}{4}$	1.000	12-17	$5\frac{3}{8}$	$2\frac{1}{32}$	$1\frac{1}{2}$
$1\frac{3}{4}$	1.000	18-34	$5\frac{1}{2}$	$1\frac{3}{32}$	$1\frac{1}{2}$
$1\frac{3}{4}$	1.000	35 and over	$5\frac{1}{2}$	$1\frac{7}{8}$	$1\frac{1}{2}$
2	1.125	6	$5\frac{3}{8}$	$2\frac{13}{32}$	$1\frac{1}{2}$
2	1.125	7-8	$5\frac{1}{2}$	$2\frac{13}{32}$	$1\frac{1}{2}$
2	1.125	9-11	$5\frac{3}{8}$	$2\frac{3}{8}$	$1\frac{1}{2}$
2	1.125	12-17	$5\frac{3}{4}$	$2\frac{3}{16}$	$1\frac{1}{2}$
2	1.125	18-34	$5\frac{7}{8}$	$2\frac{1}{4}$	$1\frac{1}{2}$
2	1.125	35 and over	$5\frac{7}{8}$	$2\frac{3}{32}$	$1\frac{1}{2}$
$2\frac{1}{4}$	1.406	6	$5\frac{7}{8}$	$2\frac{11}{16}$	$1\frac{1}{2}$
$2\frac{1}{4}$	1.406	7-8	6	$2\frac{11}{16}$	$1\frac{1}{2}$
$2\frac{1}{4}$	1.406	9-11	$6\frac{1}{4}$	$2\frac{1}{32}$	$1\frac{1}{2}$
$2\frac{1}{4}$	1.406	12-17	$6\frac{3}{8}$	$2\frac{19}{32}$	$1\frac{1}{2}$
$2\frac{1}{4}$	1.406	18-34	$6\frac{1}{2}$	$2\frac{15}{32}$	$1\frac{1}{2}$
$2\frac{1}{4}$	1.406	35 and over	$6\frac{1}{2}$	$2\frac{13}{32}$	$1\frac{1}{2}$
$2\frac{1}{2}$	1.563	6	$6\frac{3}{8}$	3	$1\frac{3}{4}$
$2\frac{1}{2}$	1.563	7-8	$6\frac{5}{8}$	3	$1\frac{3}{4}$
$2\frac{1}{2}$	1.563	9-11	$6\frac{3}{4}$	$2\frac{15}{16}$	$1\frac{3}{4}$
$2\frac{1}{2}$	1.563	12-17	$6\frac{7}{8}$	$2\frac{29}{32}$	$1\frac{3}{4}$
$2\frac{1}{2}$	1.563	18-34	7	$2\frac{3}{4}$	$1\frac{3}{4}$
$2\frac{1}{2}$	1.563	35 and over	$7\frac{1}{8}$	$2\frac{11}{16}$	$1\frac{3}{4}$
3	1.875	6	$7\frac{1}{2}$	$3\frac{19}{32}$	2
3	1.875	7-8	$7\frac{3}{4}$	$3\frac{17}{32}$	2
3	1.875	9-11	$7\frac{7}{8}$	$3\frac{17}{32}$	2
3	1.875	12-17	8	$3\frac{13}{32}$	2
3	1.875	18-34	8	$3\frac{11}{32}$	2
3	1.875	35 and over	$8\frac{1}{4}$	$3\frac{7}{32}$	2

All dimensions are in inches.

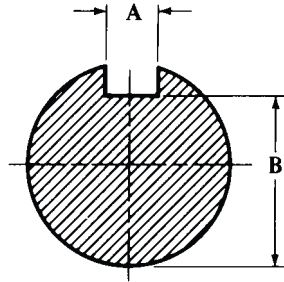
All cutters are high-speed steel and are form relieved.

For keyway dimensions see page 831.

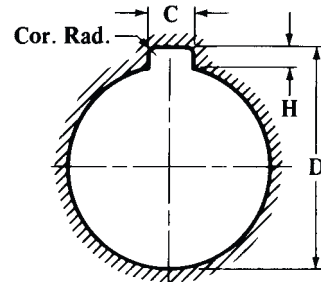
Tolerances: Outside diameter, $+\frac{1}{16}$, $-\frac{1}{16}$ inch; hole diameter, through 1-inch diameter, $+0.00075$ inch, above 1-inch diameter and through 2-inch diameter, $+0.0010$ inch.

For tooth form, see ANSI sprocket tooth form table on page 2554.

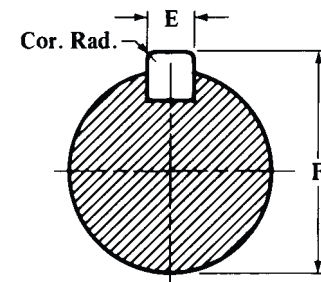
American National Standard Keys and Keyways for Milling Cutters and Arbors ANSI/ASME B94.19-1997 (R2003)



ARBOR AND KEYSEAT



CUTTER HOLE AND KEYWAY



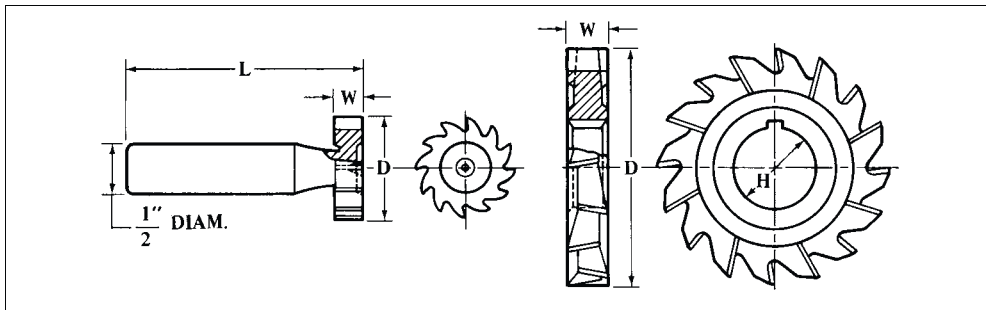
ARBOR AND KEY

Nom. Arbor and Cutter Hole Dia.	Nom. Size Key (Square)	Arbor and Keyseat				Hole and Keyway					Arbor and Key			
		A Max.	A Min.	B Max.	B Min.	C Max.	C Min.	D ^a Min.	H Nom.	Corner Radius	E Max.	E Min.	F Max.	F Min.
1/2	3/32	0.0947	0.0937	0.4531	0.4481	0.106	0.099	0.5578	3/64	0.020	0.0932	0.0927	0.5468	0.5408
5/8	1/8	0.1260	0.1250	0.5625	0.5575	0.137	0.130	0.6985	1/16	1/32	0.1245	0.1240	0.6875	0.6815
3/4	1/8	0.1260	0.1250	0.6875	0.6825	0.137	0.130	0.8225	1/16	1/32	0.1245	0.1240	0.8125	0.8065
7/8	1/8	0.1260	0.1250	0.8125	0.8075	0.137	0.130	0.9475	1/16	1/32	0.1245	0.1240	0.9375	0.9315
1	1/4	0.2510	0.2500	0.8438	0.8388	0.262	0.255	1.1040	3/32	3/64	0.2495	0.2490	1.0940	1.0880
1 1/4	5/16	0.3135	0.3125	1.0630	1.0580	0.343	0.318	1.3850	1/8	1/16	0.3120	0.3115	1.3750	1.3690
1 1/2	3/8	0.3760	0.3750	1.2810	1.2760	0.410	0.385	1.6660	5/32	1/16	0.3745	0.3740	1.6560	1.6500
1 3/4	7/16	0.4385	0.4375	1.5000	1.4950	0.473	0.448	1.9480	3/16	1/16	0.4370	0.4365	1.9380	1.9320
2	1/2	0.5010	0.5000	1.6870	1.6820	0.535	0.510	2.1980	3/16	1/16	0.4995	0.4990	2.1880	2.1820
2 1/2	5/8	0.6260	0.6250	2.0940	2.0890	0.660	0.635	2.7330	7/32	1/16	0.6245	0.6240	2.7180	2.7120
3	3/4	0.7510	0.7500	2.5000	2.4950	0.785	0.760	3.2650	1/4	3/32	0.7495	0.7490	3.2500	3.2440
3 1/2	7/8	0.8760	0.8750	3.0000	2.9950	0.910	0.885	3.8900	5/8	3/32	0.8745	0.8740	3.8750	3.8690
4	1	1.0010	1.0000	3.3750	3.3700	1.035	1.010	4.3900	3/8	3/32	0.9995	0.9990	4.3750	4.3690
4 1/2	1 1/8	1.1260	1.1250	3.8130	3.8080	1.160	1.135	4.9530	7/16	1/8	1.1245	1.1240	4.9380	4.9320
5	1 1/4	1.2510	1.2500	4.2500	4.2450	1.285	1.260	5.5150	1/2	1/8	1.2495	1.2490	5.5000	5.4940

^aD max. is 0.010 inch larger than D min.

All dimensions given in inches.

American National Standard Woodruff Keyseat Cutters—Shank-Type Straight-Teeth and Arbor-Type Staggered-Teeth ANSI/ASME B94.19-1997 (R2003)



Shank-type Cutters

Cutter Number	Nom. Dia. of Cutter, <i>D</i>	Width of Face, <i>W</i>	Length Overall, <i>L</i>	Cutter Number	Nom. Dia. of Cutter, <i>D</i>	Width of Face, <i>W</i>	Length Overall, <i>L</i>	Cutter Number	Nom. Dia. of Cutter, <i>D</i>	Width of Face, <i>W</i>	Length Overall, <i>L</i>
202	1/4	1/16	2 1/16	506	3/4	5/32	2 5/32	809	1 1/8	1/4	2 1/4
202 1/2	5/16	1/16	2 1/16	606	3/4	3/16	2 3/16	1009	1 1/8	5/16	2 5/16
302 1/2	5/16	3/32	2 3/32	806	3/4	1/4	2 1/4	610	1 1/4	3/16	2 3/16
203	3/8	1/16	2 1/16	507	7/8	5/32	2 5/32	710	1 1/4	7/32	2 7/32
303	3/8	3/32	2 3/32	607	7/8	3/16	2 3/16	810	1 1/4	1/4	2 1/4
403	3/8	1/8	2 1/8	707	7/8	7/32	2 7/32	1010	1 1/4	5/16	2 5/16
204	1/2	1/16	2 1/16	807	7/8	1/4	2 1/4	1210	1 1/4	3/8	2 3/8
304	1/2	3/32	2 3/32	608	1	3/16	2 3/16	811	1 3/8	1/4	2 1/4
404	1/2	1/8	2 1/8	708	1	7/32	2 7/32	1011	1 3/8	5/16	2 5/16
305	5/8	3/32	2 3/32	808	1	1/4	2 1/4	1211	1 3/8	3/8	2 3/8
405	5/8	1/8	2 1/8	1008	1	5/16	2 5/16	812	1 1/2	1/4	2 1/4
505	5/8	5/32	2 5/32	1208	1	3/8	2 3/8	1012	1 1/2	5/16	2 5/16
605	5/8	3/16	2 3/16	609	1 1/8	3/16	2 3/16	1212	1 1/2	3/8	2 3/8
406	3/4	1/8	2 1/8	709	1 1/8	7/32	2 7/32

Arbor-type Cutters

Cutter Number	Nom. Dia. of Cutter, <i>D</i>	Width of Face, <i>W</i>	Dia. of Hole, <i>H</i>	Cutter Number	Nom. Dia. of Cutter, <i>D</i>	Width of Face, <i>W</i>	Dia. of Hole, <i>H</i>	Cutter Number	Nom. Dia. of Cutter, <i>D</i>	Width of Face, <i>W</i>	Dia. of Hole, <i>H</i>
617	2 1/8	3/16	3/4	1022	2 3/4	5/16	1	1628	3 1/2	1/2	1
817	2 1/8	1/4	3/4	1222	2 3/4	3/8	1	1828	3 1/2	9/16	1
1017	2 1/8	5/16	3/4	1422	2 3/4	7/16	1	2028	3 1/2	5/8	1
1217	2 1/8	3/8	3/4	1622	2 3/4	1/2	1	2428	3 1/2	3/4	1
822	2 3/4	1/4	1	1228	3 1/2	3/8	1

All dimensions are given in inches. All cutters are high-speed steel.

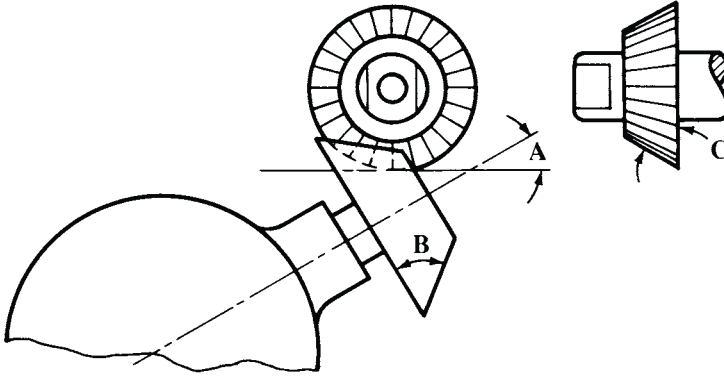
Shank type cutters are standard with right-hand cut and straight teeth. All sizes have 1/2-inch diameter straight shank.

Arbor type cutters have staggered teeth.

For Woodruff key and key-slot dimensions, see pages 2478 through 2480.

Tolerances: Face with *W* for shank type cutters: 1/16 - to 5/32 -inch face, + 0.0000, -0.0005; 3/16 to 7/32, - 0.0002, - 0.0007; 1/4, -0.0003, -0.0008; 5/16, -0.0004, -0.0009; 3/8, - 0.0005, -0.0010 inch. Face width *W* for arbor type cutters; 3/16 inch face, -0.0002, -0.0007; 1/4, -0.0003, -0.0008; 5/16, -0.0004, -0.0009; 3/8 and over, -0.0005, -0.0010 inch. Hole size *H*: +0.00075, -0.0000 inch. Diameter *D* for shank type cutters: 1/4 - through 3/4 -inch diameter, +0.010, +0.015, 7/8 through 1 1/8, +0.012, +0.017; 1 1/4 through 1 1/2, +0.015, +0.020 inch. These tolerances include an allowance for sharpening. For arbor type cutters diameter *D* is furnished 1/32 inch larger than listed and a tolerance of ±0.002 inch applies to the oversize diameter.

Setting Angles for Milling Straight Teeth of Uniform Land Width in End Mills, Angular Cutters, and Taper Reamers.—The accompanying tables give setting angles for the dividing head when straight teeth, having a land of uniform width throughout their length, are to be milled using single-angle fluting cutters. These setting angles depend upon three factors: the number of teeth to be cut; the angle of the blank in which the teeth are to be cut; and the angle of the fluting cutter. Setting angles for various combinations of these three factors are given in the tables. For example, assume that 12 teeth are to be cut on the end of an end mill using a 60-degree cutter. By following the horizontal line from 12 teeth, read in the column under 60 degrees that the dividing head should be set to an angle of 70 degrees and 32 minutes.



The following formulas, which were used to compile these tables, may be used to calculate the setting-angles for combinations of number of teeth, blank angle, and cutter angle not covered by the tables. In these formulas, A = setting-angle for dividing head, B = angle of blank in which teeth are to be cut, C = angle of fluting cutter, N = number of teeth to be cut, and D and E are angles not shown on the accompanying diagram and which are used only to simplify calculations.

$$\tan D = \cos(360^\circ/N) \times \cot B \quad (1)$$

$$\sin E = \tan(360^\circ/N) \times \cot C \times \sin D \quad (2)$$

$$\text{Setting-angle } A = D - E \quad (3)$$

Example: Suppose 9 teeth are to be cut in a 35-degree blank using a 55-degree single-angle fluting cutter. Then, $N = 9$, $B = 35^\circ$, and $C = 55^\circ$.

$$\tan D = \cos(360^\circ/9) \times \cot 35^\circ = 0.76604 \times 1.4281 = 1.0940; \text{ and } D = 47^\circ 34'$$

$$\begin{aligned} \sin E &= \tan(360^\circ/9) \times \cot 55^\circ \times \sin 47^\circ 34' = 0.83910 \times 0.70021 \times 0.73806 \\ &= 0.43365; \text{ and } E = 25^\circ 42' \end{aligned}$$

$$\text{Setting angle } A = 47^\circ 34' - 25^\circ 42' = 21^\circ 52'$$

For end mills and side mills the angle of the blank B is 0 degrees and the following simplified formula may be used to find the setting angle A

$$\cos A = \tan(360^\circ/N) \times \cot C \quad (4)$$

Example: If in the previous example the blank angle was 0 degrees,

$$\cos A = \tan(360^\circ/9) \times \cot 55^\circ = 0.83910 \times 0.70021 = 0.58755,$$

and setting-angle $A = 54^\circ 1'$

Angles of Elevation for Milling Straight Teeth in 0-, 5-, 10-, 15-, 20-, 25-, 30-, and 35-degree Blanks Using Single-Angle Fluting Cutters

No. of Teeth	Angle of Fluting Cutter									
	90°	80°	70°	60°	50°	90°	80°	70°	60°	50°
6 8 10 12 14 16 18 20 22 24	0° Blank (End Mill)					5° Blank				
	...	72° 13'	50° 55'	80° 4'	62° 34'	41° 41'
	...	79 51	68 39	54° 44'	32° 57'	82 57	72 52	61 47	48° 0'	25° 40'
	...	82 38	74 40	65 12	52 26	83 50	76 31	68 35	59 11	46 4
	...	84 9	77 52	70 32	61 2	84 14	78 25	72 10	64 52	55 5
	...	85 8	79 54	73 51	66 10	84 27	79 36	74 24	68 23	60 28
	...	85 49	81 20	76 10	69 40	84 35	80 25	75 57	70 49	64 7
	...	86 19	82 23	77 52	72 13	84 41	81 1	77 6	72 36	66 47
	...	86 43	83 13	79 11	74 11	84 45	81 29	77 59	73 59	68 50
	...	87 2	83 52	80 14	75 44	84 47	81 50	78 40	75 4	70 26
...	87 18	84 24	81 6	77 0	84 49	82 7	79 15	75 57	71 44	
6 8 10 12 14 16 18 20 22 24	10° Blank					15° Blank				
	70° 34'	53° 50'	34° 5'	61° 49'	46° 12'	28° 4'
	76 0	66 9	55 19	41° 56'	20° 39'	69 15	59 46	49 21	36° 34'	17° 34'
	77 42	70 31	62 44	53 30	40 42	71 40	64 41	57 8	48 12	36 18
	78 30	72 46	66 37	59 26	49 50	72 48	67 13	61 13	54 14	45 13
	78 56	74 9	69 2	63 6	55 19	73 26	68 46	63 46	57 59	50 38
	79 12	75 5	70 41	65 37	59 1	73 50	69 49	65 30	60 33	54 20
	79 22	75 45	71 53	67 27	61 43	74 5	70 33	66 46	62 26	57 0
	79 30	76 16	72 44	68 52	63 47	74 16	71 6	67 44	63 52	59 3
	79 35	76 40	73 33	69 59	65 25	74 24	71 32	68 29	65 0	60 40
79 39	76 59	74 9	70 54	66 44	74 30	71 53	69 6	65 56	61 59	
6 8 10 12 14 16 18 20 22 24	20° Blank					25° Blank				
	53° 57'	39° 39'	23° 18'	47° 0'	34° 6'	19° 33'
	62 46	53 45	43 53	31° 53'	14° 31'	56 36	48 8	38 55	27° 47'	11° 33'
	65 47	59 4	51 50	43 18	32 1	60 2	53 40	46 47	38 43	27 47
	67 12	61 49	56 2	49 18	40 40	61 42	56 33	51 2	44 38	36 10
	68 0	63 29	58 39	53 4	46 0	62 38	58 19	53 41	48 20	41 22
	68 30	64 36	60 26	55 39	49 38	63 13	59 29	55 29	50 53	44 57
	68 50	65 24	61 44	57 32	52 17	63 37	60 19	56 48	52 46	47 34
	69 3	65 59	62 43	58 58	54 18	63 53	60 56	57 47	54 11	49 33
	69 14	66 28	63 30	60 7	55 55	64 5	61 25	58 34	55 19	51 9
69 21	66 49	64 7	61 2	57 12	64 14	61 47	59 12	56 13	52 26	
6 8 10 12 14 16 18 20 22 24	30° Blank					35° Blank				
	40° 54'	29° 22'	16° 32'	35° 32'	25° 19'	14° 3'
	50 46	42 55	34 24	24° 12'	10° 14'	45 17	38 5	30 18	21° 4'	8° 41'
	54 29	48 30	42 3	34 31	24 44	49 7	43 33	37 35	30 38	21 40
	56 18	51 26	46 14	40 12	32 32	51 3	46 30	41 39	36 2	28 55
	57 21	53 15	48 52	43 49	37 27	52 9	48 19	44 12	39 28	33 33
	58 0	54 27	50 39	46 19	40 52	52 50	49 20	45 56	41 51	36 45
	58 26	55 18	51 57	48 7	43 20	53 18	50 21	47 12	43 36	39 8
	58 44	55 55	52 56	49 30	45 15	53 38	50 59	48 10	44 57	40 57
	58 57	56 24	53 42	50 36	46 46	53 53	51 29	48 56	46 1	42 24
59 8	56 48	54 20	51 30	48 0	54 4	51 53	49 32	46 52	43 35	

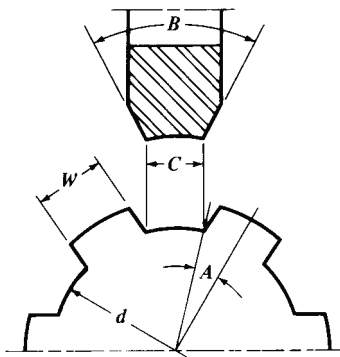
Angles of Elevation for Milling Straight Teeth in 40-, 45-, 50-, 55-, 60-, 65-, 70-, and 75-degree Blanks Using Single-Angle Fluting Cutters

No. of Teeth	Angle of Fluting Cutter									
	90°	80°	70°	60°	50°	90°	80°	70°	60°	50°
6	40° Blank					45° Blank				
	30° 48'	21° 48'	11° 58'	26° 34'	18° 43'	10° 11'
	40 7	33 36	26 33	18° 16'	7° 23'	35 16	29 25	23 8	15° 48'	5° 58'
	43 57	38 51	33 32	27 3	18 55	38 58	34 21	29 24	23 40	16 10
	45 54	41 43	37 14	32 3	25 33	40 54	37 5	33 0	28 18	22 13
	47 3	43 29	39 41	35 19	29 51	42 1	38 46	35 17	31 18	26 9
	47 45	44 39	41 21	37 33	32 50	42 44	39 54	36 52	33 24	28 57
	48 14	45 29	42 34	39 13	35 5	43 13	40 42	38 1	34 56	30 1
	48 35	46 7	43 30	40 30	36 47	43 34	41 18	38 53	36 8	32 37
	48 50	46 36	44 13	41 30	38 8	43 49	41 46	39 34	37 5	34 53
24	49 1	46 58	44 48	42 19	39 15	44 0	42 7	40 7	37 50	35 55
6	50° Blank					55° Blank				
	22° 45'	15° 58'	8° 38'	19° 17'	13° 30'	7° 15'
	30 41	25 31	19 59	13° 33'	5° 20'	26 21	21 52	17 3	11° 30'	4° 17'
	34 10	30 2	25 39	20 32	14 9	29 32	25 55	22 3	17 36	11 52
	36 0	32 34	28 53	24 42	19 27	31 14	28 12	24 59	21 17	16 32
	37 5	34 9	31 1	27 26	22 58	32 15	29 39	26 53	23 43	19 40
	37 47	35 13	32 29	29 22	25 30	32 54	30 38	28 12	25 26	21 54
	38 15	35 58	33 33	30 46	27 21	33 21	31 20	29 10	26 43	23 35
	38 35	36 32	34 21	31 52	28 47	33 40	31 51	29 54	27 42	24 53
	38 50	36 58	34 59	32 44	29 57	33 54	32 15	30 29	28 28	25 55
24	39 1	37 19	35 30	33 25	30 52	34 5	32 34	30 57	29 7	26 46
6	60° Blank					65° Blank				
	16° 6'	11° 12'	6° 2'	13° 7'	9° 8'	4° 53'
	22 13	18 24	14 19	9° 37'	3° 44'	18 15	15 6	11 42	7° 50'	3° 1'
	25 2	21 56	18 37	14 49	10 5	20 40	18 4	15 19	12 9	8 15
	26 34	23 57	21 10	17 59	14 13	21 59	19 48	17 28	14 49	11 32
	27 29	25 14	22 51	20 6	16 44	22 48	20 55	18 54	16 37	13 48
	28 5	26 7	24 1	21 37	18 40	23 18	21 39	19 53	17 53	15 24
	28 29	26 44	24 52	22 44	20 6	23 40	22 11	20 37	18 50	16 37
	28 46	27 11	25 30	23 35	21 14	23 55	22 35	21 10	19 33	17 34
	29 0	27 34	26 2	24 17	22 8	24 6	22 53	21 36	20 8	18 20
24	29 9	27 50	26 26	24 50	22 52	24 15	23 8	21 57	20 36	18 57
6	70° Blank					75° Blank				
	10° 18'	7° 9'	3° 48'	7° 38'	5° 19'	2° 50'
	14 26	11 55	9 14	6° 9'	2° 21'	10 44	8 51	6 51	4° 34'	1° 45'
	16 25	14 21	12 8	9 37	6 30	12 14	10 40	9 1	7 8	4 49
	17 30	15 45	13 53	11 45	9 8	13 4	11 45	10 21	8 45	6 47
	18 9	16 38	15 1	13 11	10 55	13 34	12 26	11 13	9 50	8 7
	18 35	17 15	15 50	14 13	12 13	13 54	12 54	11 50	10 37	9 7
	18 53	17 42	16 26	14 59	13 13	14 8	13 14	12 17	11 12	9 51
	19 6	18 1	16 53	15 35	13 59	14 18	13 29	12 38	11 39	10 27
	19 15	18 16	17 15	16 3	14 35	14 25	13 41	12 53	12 0	10 54
24	19 22	18 29	17 33	16 25	15 5	14 31	13 50	13 7	12 18	11 18

Angles of Elevation for Milling Straight Teeth in 80- and 85-degree Blanks Using Single-Angle Fluting Cutters

No. of Teeth	Angle of Fluting Cutter									
	90°	80°	70°	60°	50°	90°	80°	70°	60°	50°
	80° Blank					85° Blank				
6	5° 2'	3° 30'	1° 52'	2° 30'	1° 44'	0° 55'
8	7 6	5 51	4 31	3° 2'	1° 8'	3 32	2 55	2 15	1° 29'	0° 34'
10	8 7	7 5	5 59	4 44	3 11	4 3	3 32	2 59	2 21	1 35
12	8 41	7 48	6 52	5 48	4 29	4 20	3 53	3 25	2 53	2 15
14	9 2	8 16	7 28	6 32	5 24	4 30	4 7	3 43	3 15	2 42
16	9 15	8 35	7 51	7 3	6 3	4 37	4 17	3 56	3 30	3 1
18	9 24	8 48	8 10	7 26	6 33	4 42	4 24	4 5	3 43	3 16
20	9 31	8 58	8 24	7 44	6 56	4 46	4 29	4 12	3 52	3 28
22	9 36	9 6	8 35	7 59	7 15	4 48	4 33	4 18	3 59	3 37
24	9 40	9 13	8 43	8 11	7 30	4 50	4 36	4 22	4 5	3 45

Spline-Shaft Milling Cutter.—The most efficient method of forming splines on shafts is by hobbing, but special milling cutters may also be used. Since the cutter forms the space between adjacent splines, it must be made to suit the number of splines and the root diameter of the shaft. The cutter angle B equals 360 degrees divided by the number of splines. The following formulas are for determining the chordal width C at the root of the splines or the chordal width across the concave edge of the cutter. In these formulas, A = angle between center line of spline and a radial line passing through the intersection of the root circle and one side of the spline; W = width of spline; d = root diameter of splined shaft; C = chordal width at root circle between adjacent splines; N = number of splines.



$$\sin A = \frac{W}{d} \quad C = d \times \sin\left(\frac{180}{N} - A\right)$$

Splines of involute form are often used in preference to the straight-sided type. Dimensions of the American Standard involute splines and hobs are given in the section on splines.

Cutter Grinding

Wheels for Sharpening Milling Cutters.—Milling cutters may be sharpened either by using the periphery of a disk wheel or the face of a cup wheel. The latter grinds the lands of the teeth flat, whereas the periphery of a disk wheel leaves the teeth slightly concave back of the cutting edges. The concavity produced by disk wheels reduces the effective clearance angle on the teeth, the effect being more pronounced for wheels of small diameter than for wheels of large diameter. For this reason, large diameter wheels are preferred when sharpening milling cutters with disk type wheels. Irrespective of what type of wheel is used to sharpen a milling cutter, any burrs resulting from grinding should be carefully removed by a hand stoning operation. Stoning also helps to reduce the roughness of grind-

ing marks and improves the quality of the finish produced on the surface being machined. Unless done very carefully, hand stoning may dull the cutting edge. Stoning may be avoided and a sharper cutting edge produced if the wheel rotates toward the cutting edge, which requires that the operator maintain contact between the tool and the rest while the wheel rotation is trying to move the tool away from the rest. Though slightly more difficult, this method will eliminate the burr.

Specifications of Grinding Wheels for Sharpening Milling Cutters

Cutter Material	Operation	Grinding Wheel			
		Abrasive Material	Grain Size	Grade	Bond
Carbon Tool Steel	Roughing Finishing	Aluminum Oxide	46-60 100	K H	Vitrified Vitrified
High-speed Steel:					
18-4-1 {	Roughing	Aluminum Oxide	60	K,H	Vitrified
	Finishing		100	H	Vitrified
18-4-2 {	Roughing		80	F,G,H	Vitrified
	Finishing		100	H	Vitrified
Cast Non-Ferrous Tool Material	Roughing Finishing	Aluminum Oxide	46 100-120	H,K,L,N H	Vitrified Vitrified
Sintered Carbide	Roughing after Brazing	Silicon Carbide	60	G	Vitrified
	Roughing	Diamond	100	a	Resinoid
	Finishing	Diamond	Up to 500	a	Resinoid
Carbon Tool Steel and High-Speed Steel ^b	Roughing Finishing	Cubic Boron Nitride	80-100 100-120	R,P S,T	Resinoid Resinoid

^a Not indicated in diamond wheel markings.

^b For hardnesses above Rockwell C 56.

Wheel Speeds and Feeds for Sharpening Milling Cutters.—Relatively low cutting speeds should be used when sharpening milling cutters to avoid tempering and heat checking. Dry grinding is recommended in all cases except when diamond wheels are employed. The surface speed of grinding wheels should be in the range of 4500–6500 ft/min (22.8 to 33 m/s) for grinding milling cutters of high-speed steel or cast non-ferrous tool material. For sintered carbide cutters, 5000–5500 ft/min (25.4 to 27.9 m/s) should be used.

The maximum stock removed per pass of the grinding wheel should not exceed about 0.0004 inch (0.010 mm) for sintered carbide cutters; 0.003 inch (0.076 mm) for large high-speed steel and cast non-ferrous tool material cutters; and 0.0015 inch (0.038 mm) for narrow saws and slotting cutters of high-speed steel or cast non-ferrous tool material. The stock removed per pass of the wheel may be increased for backing-off operations such as the grinding of secondary clearance behind the teeth since there is usually a sufficient body of metal to carry off the heat.

Clearance Angles for Milling Cutter Teeth.—The clearance angle provided on the cutting edges of milling cutters has an important bearing on cutter performance, cutting efficiency, and cutter life between sharpenings. It is desirable in all cases to use a clearance angle as small as possible so as to leave more metal back of the cutting edges for better heat dissipation and to provide maximum support. Excessive clearance angles not only weaken the cutting edges, but also increase the likelihood of “chatter” which will result in poor finish on the machined surface and reduce the life of the cutter. According to The Cincinnati Milling Machine Co., milling cutters used for general purpose work and having diameters from $\frac{1}{8}$ to 3 inches (3.18-76.2 mm) should have clearance angles from 13 to 5 degrees, respectively, decreasing proportionately as the diameter increases. General purpose cutters over 3 inches (76.2 mm) in diameter should be provided with a clearance angle of 4 to

5 degrees. The land width is usually $\frac{1}{64}$, $\frac{1}{32}$, and $\frac{1}{16}$ inch (0.4, 0.8, and 1.6 mm), respectively, for small, medium, and large cutters.

The primary clearance or relief angle for best results varies according to the material being milled about as follows: low carbon, high carbon, and alloy steels, 3 to 5 degrees; cast iron and medium and hard bronze, 4 to 7 degrees; brass, soft bronze, aluminum, magnesium, plastics, etc., 10 to 12 degrees. When milling cutters are resharpened, it is customary to grind a secondary clearance angle of 3 to 5 degrees behind the primary clearance angle to reduce the land width to its original value and thus avoid interference with the surface to be milled. A general formula for plain milling cutters, face mills, and form relieved cutters which gives the clearance angle C , in degrees, necessitated by the feed per revolution F , in inches, the width of land L , in inches, the depth of cut d , in inches (mm), the cutter diameter D , in inches, and the Brinell hardness number B of the work being cut is:

$$C = \frac{45860}{DB} \left(1.5L + \frac{F}{\pi D} \sqrt{d(D-d)} \right)$$

Rake Angles for Milling Cutters.—In peripheral milling cutters, the rake angle is generally defined as the angle in degrees that the tooth face deviates from a radial line to the cutting edge. In face milling cutters, the teeth are inclined with respect to both the radial and axial lines. These angles are called *radial* and *axial* rake, respectively. The radial and axial rake angles may be positive, zero, or negative.

Positive rake angles should be used whenever possible for all types of high-speed steel milling cutters. For sintered carbide tipped cutters, zero and negative rake angles are frequently employed to provide more material back of the cutting edge to resist shock loads.

Rake Angles for High-speed Steel Cutters: Positive rake angles of 10 to 15 degrees are satisfactory for milling steels of various compositions with plain milling cutters. For softer materials such as magnesium and aluminum alloys, the rake angle may be 25 degrees or more. Metal slitting saws for cutting alloy steel usually have rake angles from 5 to 10 degrees, whereas zero and sometimes negative rake angles are used for saws to cut copper and other soft non-ferrous metals to reduce the tendency to “hog in.” Form relieved cutters usually have rake angles of 0, 5, or 10 degrees. Commercial face milling cutters usually have 10 degrees positive radial and axial rake angles for general use in milling cast iron, forged and alloy steel, brass, and bronze; for milling castings and forgings of magnesium and free-cutting aluminum and their alloys, the rake angles may be increased to 25 degrees positive or more, depending on the operating conditions; a smaller rake angle is used for abrasive or difficult to machine aluminum alloys.

Cast Non-ferrous Tool Material Milling Cutters: Positive rake angles are generally provided on milling cutters using cast non-ferrous tool materials although negative rake angles may be used advantageously for some operations such as those where shock loads are encountered or where it is necessary to eliminate vibration when milling thin sections.

Sintered Carbide Milling Cutters: Peripheral milling cutters such as slab mills, slotting cutters, saws, etc., tipped with sintered carbide, generally have negative radial rake angles of 5 degrees for soft low carbon steel and 10 degrees or more for alloy steels. Positive axial rake angles of 5 and 10 degrees, respectively, may be provided, and for slotting saws and cutters, 0 degree axial rake may be used. On soft materials such as free-cutting aluminum alloys, positive rake angles of 10 to so degrees are used. For milling abrasive or difficult to machine aluminum alloys, small positive or even negative rake angles are used.

Eccentric Type Radial Relief.—When the radial relief angles on peripheral teeth of milling cutters are ground with a disc type grinding wheel in the conventional manner the ground surfaces on the lands are slightly concave, conforming approximately to the radius of the wheel. A flat land is produced when the radial relief angle is ground with a cup wheel. Another entirely different method of grinding the radial angle is by the eccentric method, which produces a slightly convex surface on the land. If the radial relief angle at

the cutting edge is equal for all of the three types of land mentioned, it will be found that the land with the eccentric relief will drop away from the cutting edge a somewhat greater distance for a given distance around the land than will the others. This is evident from a study of Table 1 entitled, *Indicator Drops for Checking the Radial Relief Angle on Peripheral Teeth*. This feature is an advantage of the eccentric type relief which also produces an excellent finish.

Table 1. Indicator Drops for Checking the Radial Relief Angle on Peripheral Teeth

Cutter Diameter, Inch	Rec. Range of Radial Relief Angles, Degrees	Checking Distance, Inch	Indicator Drops, Inches				Rec. Max. Primary Land Width, Inch
			For Flat and Concave Relief		For Eccentric Relief		
			Min.	Max.	Min.	Max.	
1/16	20-25	.005	.0014	.0019	.0020	.0026	.007
3/32	16-20	.005	.0012	.0015	.0015	.0019	.007
1/8	15-19	.010	.0018	.0026	.0028	.0037	.015
5/32	13-17	.010	.0017	.0024	.0024	.0032	.015
3/16	12-16	.010	.0016	.0023	.0022	.0030	.015
7/32	11-15	.010	.0015	.0022	.0020	.0028	.015
1/4	10-14	.015	.0017	.0028	.0027	.0039	.020
9/32	10-14	.015	.0018	.0029	.0027	.0039	.020
5/16	10-13	.015	.0019	.0027	.0027	.0035	.020
11/32	10-13	.015	.0020	.0028	.0027	.0035	.020
3/8	10-13	.015	.0020	.0029	.0027	.0035	.020
13/32	9-12	.020	.0022	.0032	.0032	.0044	.025
7/16	9-12	.020	.0022	.0033	.0032	.0043	.025
15/32	9-12	.020	.0023	.0034	.0032	.0043	.025
1/2	9-12	.020	.0024	.0034	.0032	.0043	.025
9/16	9-12	.020	.0024	.0035	.0032	.0043	.025
5/8	8-11	.020	.0022	.0032	.0028	.0039	.025
11/16	8-11	.030	.0029	.0045	.0043	.0059	.035
3/4	8-11	.030	.0030	.0046	.0043	.0059	.035
13/16	8-11	.030	.0031	.0047	.0043	.0059	.035
7/8	8-11	.030	.0032	.0048	.0043	.0059	.035
15/16	7-10	.030	.0027	.0043	.0037	.0054	.035
1	7-10	.030	.0028	.0044	.0037	.0054	.035
1 1/8	7-10	.030	.0029	.0045	.0037	.0053	.035
1 1/4	6-9	.030	.0024	.0040	.0032	.0048	.035
1 3/8	6-9	.030	.0025	.0041	.0032	.0048	.035
1 1/2	6-9	.030	.0026	.0041	.0032	.0048	.035
1 5/8	6-9	.030	.0026	.0042	.0032	.0048	.035
1 3/4	6-9	.030	.0026	.0042	.0032	.0048	.035
1 7/8	6-9	.030	.0027	.0043	.0032	.0048	.035
2	6-9	.030	.0027	.0043	.0032	.0048	.035
2 1/4	5-8	.030	.0022	.0038	.0026	.0042	.040
2 1/2	5-8	.030	.0023	.0039	.0026	.0042	.040
2 3/4	5-8	.030	.0023	.0039	.0026	.0042	.040
3	5-8	.030	.0023	.0039	.0026	.0042	.040
3 1/2	5-8	.030	.0024	.0040	.0026	.0042	.047
4	5-8	.030	.0024	.0040	.0026	.0042	.047
5	4-7	.030	.0019	.0035	.0021	.0037	.047
6	4-7	.030	.0019	.0035	.0021	.0037	.047
7	4-7	.030	.0020	.0036	.0021	.0037	.060
8	4-7	.030	.0020	.0036	.0021	.0037	.060
10	4-7	.030	.0020	.0036	.0021	.0037	.060
12	4-7	.030	.0020	.0036	.0021	.0037	.060

The setup for grinding an eccentric relief is shown in Fig. 1. In this setup the point of contact between the cutter and the tooth rest must be in the same plane as the centers, or axes, of the grinding wheel and the cutter. A wide face is used on the grinding wheel, which is trued and dressed at an angle with respect to the axis of the cutter. An alternate method is to tilt the wheel at this angle. Then as the cutter is traversed and rotated past the grinding wheel while in contact with the tooth rest, an eccentric relief will be generated by the angular face of the wheel. This type of relief can only be ground on the peripheral teeth on milling cutters having helical flutes because the combination of the angular wheel face and the twisting motion of the cutter is required to generate the eccentric relief. Therefore, an eccentric relief cannot be ground on the peripheral teeth of straight fluted cutters.

Table 2 is a table of wheel angles for grinding an eccentric relief for different combinations of relief angles and helix angles. When angles are required that cannot be found in this table, the wheel angle, W , can be calculated by using the following formula, in which R is the radial relief angle and H is the helix angle of the flutes on the cutter.

$$\tan W = \tan R \times \tan H$$

Table 2. Grinding Wheel Angles for Grinding Eccentric Type Radial Relief Angle

Radial Relief Angle, R , Degrees	Helix Angle of Cutter Flutes, H , Degrees							
	12	18	20	30	40	45	50	52
	Wheel Angle, W , Degrees							
1	0°13'	0°19'	0°22'	0°35'	0°50'	1°00'	1°12'	1°17'
2	0°26'	0°39'	0°44'	1°09'	1°41'	2°00'	2°23'	2°34'
3	0°38'	0°59'	1°06'	1°44'	2°31'	3°00'	3°34'	3°50'
4	0°51'	1°18'	1°27'	2°19'	3°21'	4°00'	4°46'	5°07'
5	1°04'	1°38'	1°49'	2°53'	4°12'	5°00'	5°57'	6°23'
6	1°17'	1°57'	2°11'	3°28'	5°02'	6°00'	7°08'	7°40'
7	1°30'	2°17'	2°34'	4°03'	5°53'	7°00'	8°19'	8°56'
8	1°43'	2°37'	2°56'	4°38'	6°44'	8°00'	9°30'	10°12'
9	1°56'	2°57'	3°18'	5°13'	7°34'	9°00'	10°41'	11°28'
10	2°09'	3°17'	3°40'	5°49'	8°25'	10°00'	11°52'	12°43'
11	2°22'	3°37'	4°03'	6°24'	9°16'	11°00'	13°03'	13°58'
12	2°35'	3°57'	4°25'	7°00'	10°07'	12°00'	14°13'	15°13'
13	2°49'	4°17'	4°48'	7°36'	10°58'	13°00'	15°23'	16°28'
14	3°02'	4°38'	5°11'	8°11'	11°49'	14°00'	16°33'	17°42'
15	3°16'	4°59'	5°34'	8°48'	12°40'	15°00'	17°43'	18°56'
16	3°29'	5°19'	5°57'	9°24'	13°32'	16°00'	18°52'	20°09'
17	3°43'	5°40'	6°21'	10°01'	14°23'	17°00'	20°01'	21°22'
18	3°57'	6°02'	6°45'	10°37'	15°15'	18°00'	21°10'	22°35'
19	4°11'	6°23'	7°09'	11°15'	16°07'	19°00'	22°19'	23°47'
20	4°25'	6°45'	7°33'	11°52'	16°59'	20°00'	23°27'	24°59'
21	4°40'	7°07'	7°57'	12°30'	17°51'	21°00'	24°35'	26°10'
22	4°55'	7°29'	8°22'	13°08'	18°44'	22°00'	25°43'	27°21'
23	5°09'	7°51'	8°47'	13°46'	19°36'	23°00'	26°50'	28°31'
24	5°24'	8°14'	9°12'	14°25'	20°29'	24°00'	27°57'	29°41'
25	5°40'	8°37'	9°38'	15°04'	21°22'	25°00'	29°04'	30°50'

Indicator Drop Method of Checking Relief and Rake Angles.—The most convenient and inexpensive method of checking the relief and rake angles on milling cutters is by the indicator drop method. Three tables, **Tables 1, 3 and 4**, of indicator drops are provided in this section, for checking radial relief angles on the peripheral teeth, relief angles on side and end teeth, and rake angles on the tooth faces.

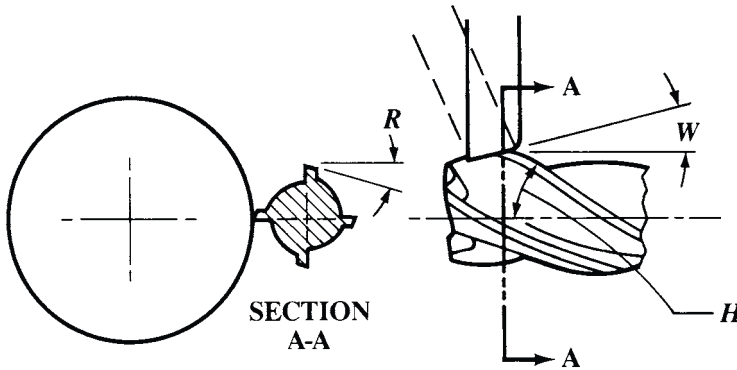


Fig. 1. Setup for Grinding Eccentric Type Radial Relief Angle

Table 3. Indicator Drops for Checking Relief Angles on Side Teeth and End Teeth

Checking Distance, Inch	Given Relief Angle								
	1°	2°	3°	4°	5°	6°	7°	8°	9°
	Indicator Drop, inch								
.005	.00009	.00017	.00026	.00035	.0004	.0005	.0006	.0007	.0008
.010	.00017	.00035	.00052	.0007	.0009	.0011	.0012	.0014	.0016
.015	.00026	.0005	.00079	.0010	.0013	.0016	.0018	.0021	.0024
.031	.00054	.0011	.0016	.0022	.0027	.0033	.0038	.0044	.0049
.047	.00082	.0016	.0025	.0033	.0041	.0049	.0058	.0066	.0074
.062	.00108	.0022	.0032	.0043	.0054	.0065	.0076	.0087	.0098

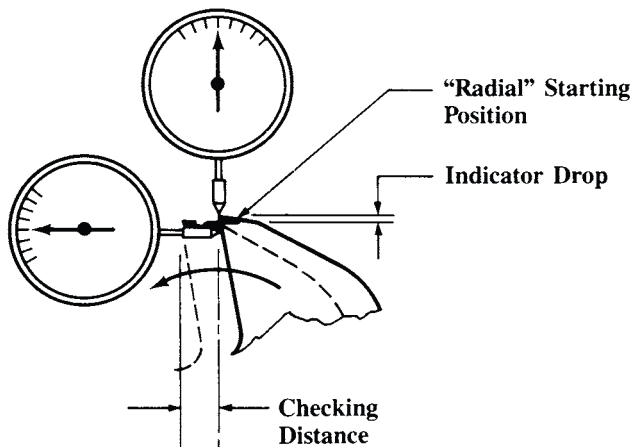


Fig. 2. Setup for Checking the Radial Relief Angle by Indicator Drop Method

The setup for checking the radial relief angle is illustrated in **Fig. 2**. Two dial test indicators are required, one of which should have a sharp pointed contact point. This indicator is positioned so that the axis of its spindle is vertical, passing through the axis of the cutter. The cutter may be held by its shank in the spindle of a tool and cutter grinder workhead, or

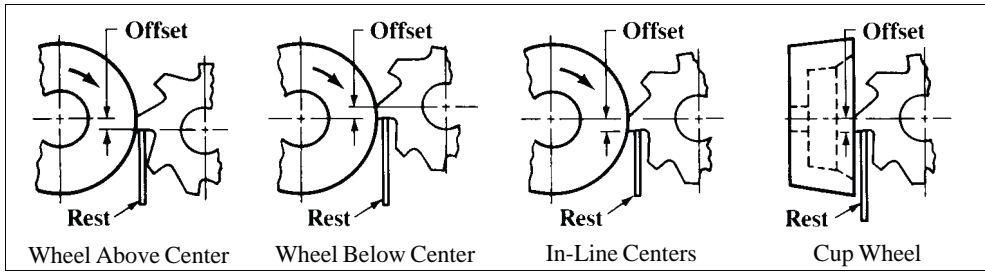
between centers while mounted on a mandrel. The cutter is rotated to the position where the vertical indicator contacts a cutting edge. The second indicator is positioned with its spindle axis horizontal and with the contact point touching the tool face just below the cutting edge. With both indicators adjusted to read zero, the cutter is rotated a distance equal to the checking distance, as determined by the reading on the second indicator. Then the indicator drop is read on the vertical indicator and checked against the values in the tables. The indicator drops for radial relief angles ground by a disc type grinding wheel and those ground with a cup wheel are so nearly equal that the values are listed together; values for the eccentric type relief are listed separately, since they are larger. A similar procedure is used to check the relief angles on the side and end teeth of milling cutters; however, only one indicator is used. Also, instead of rotating the cutter, the indicator or the cutter must be moved a distance equal to the checking distance in a straight line.

Table 4. Indicator Drops for Checking Rake Angles on Milling Cutter Face

Rate Angle, Deg.	Measuring Distance, inch				Rate Angle, Deg.	Measuring Distance, inch			
	.031	.062	.094	.125		.031	.062	.094	.125
	Indicator Drop, inch					Indicator Drop, inch			
1	.0005	.0011	.0016	.0022	11	.0060	.0121	.0183	.0243
2	.0011	.0022	.0033	.0044	12	.0066	.0132	.0200	.0266
3	.0016	.0032	.0049	.0066	13	.0072	.0143	.0217	.0289
4	.0022	.0043	.0066	.0087	14	.0077	.0155	.0234	.0312
5	.0027	.0054	.0082	.0109	15	.0083	.0166	.0252	.0335
6	.0033	.0065	.0099	.0131	16	.0089	.0178	.0270	.0358
7	.0038	.0076	.0115	.0153	17	.0095	.0190	.0287	.0382
8	.0044	.0087	.0132	.0176	18	.0101	.0201	.0305	.0406
9	.0049	.0098	.0149	.0198	19	.0107	.0213	.0324	.0430
10	.0055	.0109	.0166	.0220	20	.0113	.0226	.0342	.0455

Relieving Attachments.—A relieving attachment is a device applied to lathes (especially those used in tool-rooms) for imparting a reciprocating motion to the tool-slide and tool, in order to provide relief or clearance for the cutting edges of milling cutters, taps, hobs, etc. For example, in making a milling cutter of the formed type, such as is used for cutting gears, it is essential to provide clearance for the teeth and so form them that they may be ground repeatedly without changing the contour or shape of the cutting edge. This may be accomplished by using a relieving attachment. The tool for “backing off” or giving clearance to the teeth corresponds to the shape required, and it is given a certain amount of reciprocating movement, so that it forms a surface back of each cutting edge, which is of uniform cross-section on a radial plane but eccentric to the axis of the cutter sufficiently to provide the necessary clearance for the cutting edges.

Various Set-ups Used in Grinding the Clearance Angle on Milling Cutter Teeth



Distance to Set Center of Wheel Above the Cutter Center (Disk Wheel)

Dia. of Wheel, Inches	Desired Clearance Angle, Degrees											
	1	2	3	4	5	6	7	8	9	10	11	12
	Distance to Offset Wheel Center Above Cutter Center, Inches											
3	.026	.052	.079	.105	.131	.157	.183	.209	.235	.260	.286	.312
4	.035	.070	.105	.140	.174	.209	.244	.278	.313	.347	.382	.416
5	.044	.087	.131	.174	.218	.261	.305	.348	.391	.434	.477	.520
6	.052	.105	.157	.209	.261	.314	.366	.417	.469	.521	.572	.624
7	.061	.122	.183	.244	.305	.366	.427	.487	.547	.608	.668	.728
8	.070	.140	.209	.279	.349	.418	.488	.557	.626	.695	.763	.832
9	.079	.157	.236	.314	.392	.470	.548	.626	.704	.781	.859	.936
10	.087	.175	.262	.349	.436	.523	.609	.696	.782	.868	.954	1.040

^a Calculated from the formula: Offset = Wheel Diameter × 1/2 × Sine of Clearance Angle.

Distance to Set Center of Wheel Below the Cutter Center (Disk Wheel)

Dia. of Cutter, Inches	Desired Clearance Angle, Degrees											
	1	2	3	4	5	6	7	8	9	10	11	12
	Distance to Offset Wheel Center Below Cutter Center, Inches											
2	.017	.035	.052	.070	.087	.105	.122	.139	.156	.174	.191	.208
3	.026	.052	.079	.105	.131	.157	.183	.209	.235	.260	.286	.312
4	.035	.070	.105	.140	.174	.209	.244	.278	.313	.347	.382	.416
5	.044	.087	.131	.174	.218	.261	.305	.348	.391	.434	.477	.520
6	.052	.105	.157	.209	.261	.314	.366	.417	.469	.521	.572	.624
7	.061	.122	.183	.244	.305	.366	.427	.487	.547	.608	.668	.728
8	.070	.140	.209	.279	.349	.418	.488	.557	.626	.695	.763	.832
9	.079	.157	.236	.314	.392	.470	.548	.626	.704	.781	.859	.936
10	.087	.175	.262	.349	.436	.523	.609	.696	.782	.868	.954	1.040

^a Calculated from the formula: Offset = Cutter Diameter × 1/2 × Sine of Clearance Angle.

Distance to Set Tooth Rest Below Center Line of Wheel and Cutter.—When the clearance angle is ground with a disk type wheel by keeping the center line of the wheel in line with the center line of the cutter, the tooth rest should be lowered by an amount given by the following formula:

$$\text{Offset} = \frac{\text{Wheel Diam.} \times \text{Cutter Diam.} \times \text{Sine of One-half the Clearance Angle}}{\text{Wheel Diam.} + \text{Cutter Diam.}}$$

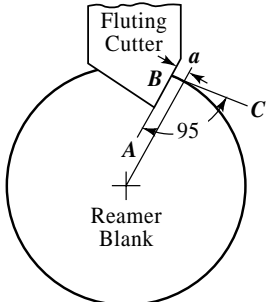
Distance to Set Tooth Rest Below Cutter Center When Cup Wheel is Used.—When the clearance is ground with a cup wheel, the tooth rest is set below the center of the cutter the same amount as given in the table for *Distance to Set Center of Wheel Below the Cutter Center (Disk Wheel)*.

REAMERS

Hand Reamers.—Hand reamers are made with both straight and helical flutes. Helical flutes provide a shearing cut and are especially useful in reaming holes having keyways or grooves, as these are bridged over by the helical flutes, thus preventing binding or chattering. Hand reamers are made in both solid and expansion forms. The American standard dimensions for solid forms are given in the accompanying table. The expansion type is useful whenever, in connection with repair or other work, it is necessary to enlarge a reamed hole by a few thousandths of an inch. The expansion form is split through the fluted section and a slight amount of expansion is obtained by screwing in a tapering plug. The diameter increase may vary from 0.005 to 0.008 inch (0.127–0.2 mm) for reamers up to about 1 inch (25.4 mm) diameter and from 0.010 to 0.012 inch (0.25–0.3 mm) for diameters between 1 and 2 inches (25.4 and 50.8 mm). Hand reamers are tapered slightly on the end to facilitate starting them properly. The actual diameter of the shanks of commercial reamers may be from 0.002 to 0.005 inch (0.05–0.13 mm) under the reamer size. That part of the shank that is squared should be turned smaller in diameter than the shank itself, so that, when applying a wrench, no burr may be raised that may mar the reamed hole if the reamer is passed clear through it.

When fluting reamers, the cutter is so set with relation to the center of the reamer blank that the tooth gets a slight negative rake; that is, the cutter should be set *ahead* of the center, as shown in the illustration accompanying the table giving the amount to set the cutter ahead of the radial line. The amount is so selected that a tangent to the circumference of the reamer at the cutting point makes an angle of approximately 95 degrees with the front face of the cutting edge.

Amount to Set Cutter Ahead of Radial Line to Obtain Negative Front Rake

Fluting Cutter	Size of Reamer	<i>a</i> , Inches	Size of Reamer	<i>a</i> , Inches	Size of Reamer	<i>a</i> , Inches
		1/4	0.011	7/8	0.038	2
3/8		0.016	1	0.044	2 1/4	0.098
1/2		0.022	1 1/4	0.055	2 1/2	0.109
5/8		0.027	1 1/2	0.066	2 3/4	0.120
3/4		0.033	1 3/4	0.076	3	0.131

When fluting reamers, it is necessary to “break up the flutes”; that is, to space the cutting edges unevenly around the reamer. The difference in spacing should be very slight and need not exceed two degrees one way or the other. The manner in which the breaking up of the flutes is usually done is to move the index head to which the reamer is fixed a certain amount more or less than it would be moved if the spacing were regular. A table is given showing the amount of this additional movement of the index crank for reamers with different numbers of flutes. When a reamer is provided with helical flutes, the angle of spiral should be such that the cutting edges make an angle of about 10 or at most 15 degrees with the axis of the reamer.

The relief of the cutting edges should be comparatively slight. An eccentric relief, that is, one where the land back of the cutting edge is convex, rather than flat, is used by one or two manufacturers, and is preferable for finishing reamers, as the reamer will hold its size longer. When hand reamers are used merely for removing stock, or simply for enlarging holes, the flat relief is better, because the reamer has a keener cutting edge. The width of the land of the cutting edges should be about 1/32 inch (0.79 mm) for a 1/4-inch (6.35 mm), 1/16 inch (1.59 mm) for a 1-inch (25.4 mm), and 3/32 inch (2.38 mm) for a 3-inch (76.2 mm) reamer.

Irregular Spacing of Teeth in Reamers

Number of flutes in reamer	4	6	8	10	12	14	16
Index circle to use	39	39	39	39	39	49	20
Before cutting	Move Spindle the Number of Holes below More or Less than for Regular Spacing						
2d flute	8 less	4 less	3 less	2 less	4 less	3 less	2 less
3d flute	4 more	5 more	5 more	3 more	4 more	2 more	2 more
4th flute	6 less	7 less	2 less	5 less	1 less	2 less	1 less
5th flute	...	6 more	4 more	2 more	3 more	4 more	2 more
6th flute	...	5 less	6 less	2 less	4 less	1 less	2 less
7th flute	2 more	3 more	4 more	3 more	1 more
8th flute	3 less	2 less	3 less	2 less	2 less
9th flute	5 more	2 more	1 more	2 more
10th flute	1 less	2 less	3 less	2 less
11th flute	3 more	3 more	1 more
12th flute	4 less	2 less	2 less
13th flute	2 more	2 more
14th flute	3 less	1 less
15th flute	2 more
16th flute	2 less

Threaded-end Hand Reamers.—Hand reamers are sometimes provided with a thread at the extreme point in order to give them a uniform feed when reaming. The diameter on the top of this thread at the point of the reamer is slightly smaller than the reamer itself, and the thread tapers upward until it reaches a dimension of from 0.003 to 0.008 inch (0.076–0.2 mm), according to size, below the size of the reamer; at this point, the thread stops and a short neck about $\frac{1}{16}$ -inch (1.59 mm) wide separates the threaded portion from the actual reamer, which is provided with a short taper from $\frac{3}{16}$ to $\frac{7}{16}$ inch (4.76–11.1 mm) long up to where the standard diameter is reached. The length of the threaded portion and the number of threads per inch for reamers of this kind are given in the accompanying table. The thread employed is a sharp V-thread.

Dimensions for Threaded-End Hand Reamers

Sizes of Reamers	Length of Threaded Part	No. of Threads per Inch	Dia. of Thread at Point of Reamer	Sizes of Reamers	Length of Threaded Part	No. of Threads per Inch	Dia. of Thread at Point of Reamer
			Full diameter				Full diameter
$\frac{1}{8}$ - $\frac{5}{16}$	$\frac{3}{8}$	32	-0.006	$1\frac{1}{32}$ - $1\frac{1}{2}$	$\frac{9}{16}$	18	-0.010
$\frac{11}{32}$ - $\frac{1}{2}$	$\frac{7}{16}$	28	-0.006	$1\frac{17}{32}$ -2	$\frac{9}{16}$	18	-0.012
$\frac{17}{32}$ - $\frac{3}{4}$	$\frac{1}{2}$	24	-0.008	$2\frac{1}{32}$ - $2\frac{1}{2}$	$\frac{9}{16}$	18	-0.015
$\frac{25}{32}$ -1	$\frac{9}{16}$	18	-0.008	$2\frac{17}{32}$ -3	$\frac{9}{16}$	18	-0.020

Fluted Chucking Reamers.—Reamers of this type are used in turret lathes, screw machines, etc., for enlarging holes and finishing them smooth and to the required size. The best results are obtained with a floating type of holder that permits a reamer to align itself with the hole being reamed. These reamers are intended for removing a small amount of metal, 0.005 to 0.010 inch (0.127–0.25 mm) being common allowances. Fluted chucking reamers are provided either with a straight shank or a standard taper shank. (See table for standard dimensions.)

Fluting Cutters for Reamers

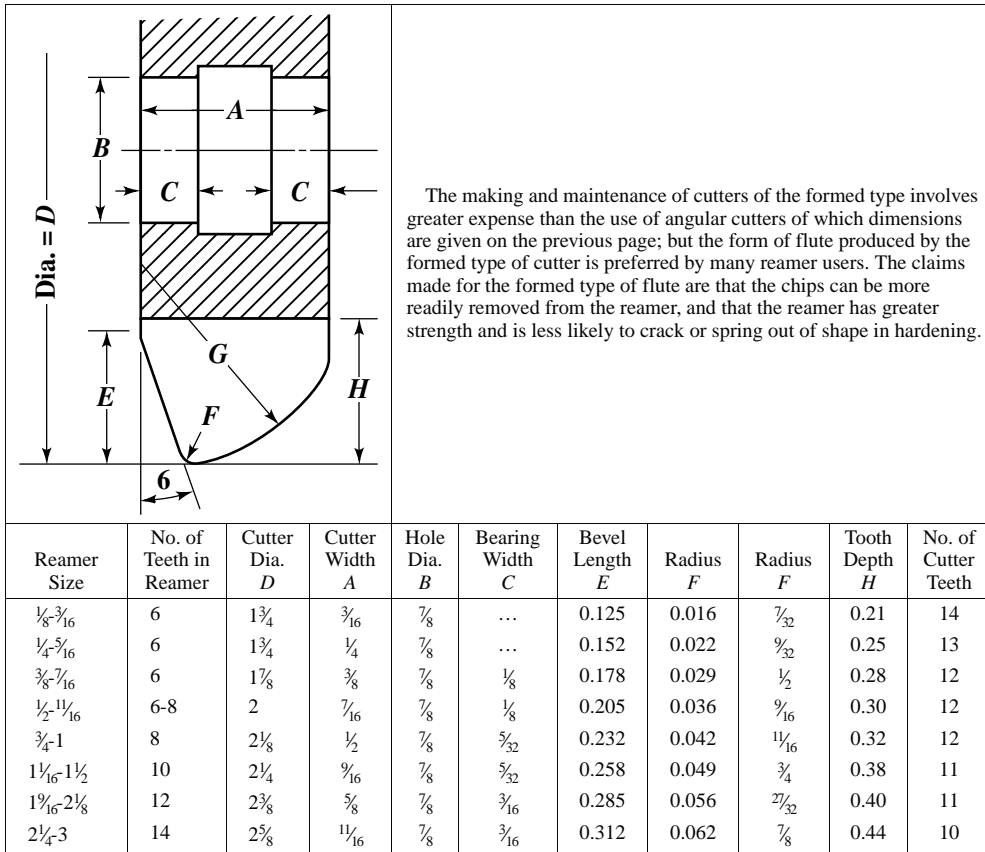
Reamer Dia.	Fluting Cutter Dia.	Fluting Cutter Thickness	Hole Dia. in Cutter	Radius between Cutting Faces	Reamer Dia.	Fluting Cutter Dia.	Fluting Cutter Thickness	Hole Dia. in Cutter	Radius between Cutting Faces
	A	B	C	D		A	B	C	D
1/8	1 3/4	3/16	3/4	none ^a	1 1/4	2 1/4	9/16	1	1/16
3/16	1 3/4	3/16	3/4	none ^a	1 1/2	2 1/4	5/8	1	1/16
1/4	1 3/4	3/16	3/4	1/64	1 3/4	2 1/4	5/8	1	5/64
3/8	2	1/4	3/4	1/64	2	2 1/2	3/4	1	5/64
1/2	2	5/16	3/4	1/32	2 1/4	2 1/2	3/4	1	5/64
5/8	2	3/8	3/4	1/32	2 1/2	2 1/2	7/8	1	3/16
3/4	2	7/16	3/4	3/64	2 3/4	2 1/2	7/8	1	3/16
1	2 1/4	1/2	1	3/64	3	2 1/2	1	1	3/16

^a Sharp corner, no radius

Rose Chucking Reamers.—The rose type of reamer is used for enlarging cored or other holes. The cutting edges at the end are ground to a 45-degree bevel. This type of reamer will remove considerable metal in one cut. The cylindrical part of the reamer has no cutting edges, but merely grooves cut for the full length of the reamer body, providing a way for the chips to escape and a channel for lubricant to reach the cutting edges. There is no relief on the cylindrical surface of the body part, but it is slightly back-tapered so that the diameter at the point with the beveled cutting edges is slightly larger than the diameter farther back. The back-taper should not exceed 0.001 inch per inch (or mm/mm). This form of reamer usually produces holes slightly larger than its size and it is, therefore, always made from 0.005 to 0.010 inch (0.127-0.25 mm) smaller than its nominal size, so that it may be followed by a fluted reamer for finishing. The grooves on the cylindrical portion are cut by a convex cutter having a width equal to from one-fifth to one-fourth the diameter of the rose reamer itself. The depth of the groove should be from one-eighth to one-sixth the diameter of the reamer. The teeth at the end of the reamer are milled with a 75-degree angular cutter; the width of the land of the cutting edge should be about one-fifth the distance from tooth to tooth. If an angular cutter is preferred to a convex cutter for milling the grooves on the cylindrical portion, because of the higher cutting speed possible when milling, an 80-degree angular cutter slightly rounded at the point may be used.

Cutters for Fluting Rose Chucking Reamers.—The cutters used for fluting rose chucking reamers on the end are 80-degree angular cutters for 1/4- and 5/16-inch diameter reamers; 75-degree angular cutters for 3/8- and 7/16-inch reamers; and 70-degree angular cutters for all larger sizes. The grooves on the cylindrical portion are milled with convex cutters of approximately the following sizes for given diameters of reamers: 5/32-inch convex cutter

Dimensions of Formed Reamer Fluting Cutters



The making and maintenance of cutters of the formed type involves greater expense than the use of angular cutters of which dimensions are given on the previous page; but the form of flute produced by the formed type of cutter is preferred by many reamer users. The claims made for the formed type of flute are that the chips can be more readily removed from the reamer, and that the reamer has greater strength and is less likely to crack or spring out of shape in hardening.

for $\frac{1}{2}$ -inch reamers; $\frac{5}{16}$ -inch cutter for 1-inch reamers; $\frac{3}{8}$ -inch cutter for $1\frac{1}{2}$ -inch reamers; $\frac{13}{32}$ -inch cutters for 2-inch reamers; and $\frac{15}{32}$ -inch cutters for $2\frac{1}{2}$ -inch reamers. The smaller sizes of reamers, from $\frac{1}{4}$ to $\frac{3}{8}$ inch in diameter, are often milled with regular double-angle reamer fluting cutters having a radius of $\frac{1}{64}$ inch for $\frac{1}{4}$ -inch reamer, and $\frac{1}{32}$ inch for $\frac{5}{16}$ - and $\frac{3}{8}$ -inch sizes.

Reamer Terms and Definitions.—*Reamer:* A rotary cutting tool with one or more cutting elements used for enlarging to size and contour a previously formed hole. Its principal support during the cutting action is obtained from the workpiece. (See Fig. 1.)

Actual Size: The actual measured diameter of a reamer, usually slightly larger than the nominal size to allow for wear.

Angle of Taper: The included angle of taper on a taper tool or taper shank.

Arbor Hole: The central mounting hole in a shell reamer.

Axis: the imaginary straight line which forms the longitudinal centerline of a reamer, usually established by rotating the reamer between centers.

Back Taper: A slight decrease in diameter, from front to back, in the flute length of reamers.

Bevel: An unrelieved angular surface of revolution (not to be confused with chamfer).

Body: The fluted full diameter portion of a reamer, inclusive of the chamfer, starting taper, and bevel.

Chamfer: The angular cutting portion at the entering end of a reamer (see also *Secondary Chamfer*).

Vertical Adjustment of Tooth-rest for Grinding Clearance on Reamers

Size of Reamer	Hand Reamer for Steel. Cutting Clearance Land 0.006 inch Wide		Hand Reamer for Cast Iron and Bronze. Cutting Clearance Land 0.025 inch Wide		Chuckling Reamer for Cast Iron and Bronze. Cutting Clearance Land 0.025 inch Wide		Rose Chucking Reamers for Steel
	For Cutting Clearance	For Second Clearance	For Cutting Clearance	For Second Clearance	For Cutting Clearance	For Second Clearance	For Cutting Clearance on Angular Edge at End
1/2	0.012	0.052	0.032	0.072	0.040	0.080	0.080
5/8	0.012	0.062	0.032	0.072	0.040	0.090	0.090
3/4	0.012	0.072	0.035	0.095	0.040	0.100	0.100
7/8	0.012	0.082	0.040	0.120	0.045	0.125	0.125
1	0.012	0.092	0.040	0.120	0.045	0.125	0.125
1 1/8	0.012	0.102	0.040	0.120	0.045	0.125	0.125
1 1/4	0.012	0.112	0.045	0.145	0.050	0.160	0.160
1 3/8	0.012	0.122	0.045	0.145	0.050	0.160	0.175
1 1/2	0.012	0.132	0.048	0.168	0.055	0.175	0.175
1 5/8	0.012	0.142	0.050	0.170	0.060	0.200	0.200
1 3/4	0.012	0.152	0.052	0.192	0.060	0.200	0.200
1 7/8	0.012	0.162	0.056	0.196	0.060	0.200	0.200
2	0.012	0.172	0.056	0.216	0.064	0.224	0.225
2 1/8	0.012	0.172	0.059	0.219	0.064	0.224	0.225
2 1/4	0.012	0.172	0.063	0.223	0.064	0.224	0.225
2 3/8	0.012	0.172	0.063	0.223	0.068	0.228	0.230
2 1/2	0.012	0.172	0.065	0.225	0.072	0.232	0.230
2 5/8	0.012	0.172	0.065	0.225	0.075	0.235	0.235
2 3/4	0.012	0.172	0.065	0.225	0.077	0.237	0.240
2 7/8	0.012	0.172	0.070	0.230	0.080	0.240	0.240
3	0.012	0.172	0.072	0.232	0.080	0.240	0.240
3 1/8	0.012	0.172	0.075	0.235	0.083	0.240	0.240
3 1/4	0.012	0.172	0.078	0.238	0.083	0.243	0.245
3 3/8	0.012	0.172	0.081	0.241	0.087	0.247	0.245
3 1/2	0.012	0.172	0.084	0.244	0.090	0.250	0.250
3 5/8	0.012	0.172	0.087	0.247	0.093	0.253	0.250
3 3/4	0.012	0.172	0.090	0.250	0.097	0.257	0.255
3 7/8	0.012	0.172	0.093	0.253	0.100	0.260	0.255
4	0.012	0.172	0.096	0.256	0.104	0.264	0.260
4 1/8	0.012	0.172	0.096	0.256	0.104	0.264	0.260
4 1/4	0.012	0.172	0.096	0.256	0.106	0.266	0.265
4 3/8	0.012	0.172	0.096	0.256	0.108	0.268	0.265
4 1/2	0.012	0.172	0.100	0.260	0.108	0.268	0.265
4 5/8	0.012	0.172	0.100	0.260	0.110	0.270	0.270
4 3/4	0.012	0.172	0.104	0.264	0.114	0.274	0.275
4 7/8	0.012	0.172	0.106	0.266	0.116	0.276	0.275
5	0.012	0.172	0.110	0.270	0.118	0.278	0.275

Chamfer Angle: The angle between the axis and the cutting edge of the chamfer measured in an axial plane at the cutting edge.

Chamfer Length: The length of the chamfer measured parallel to the axis at the cutting edge.

Chamfer Relief Angle: See under *Relief*.

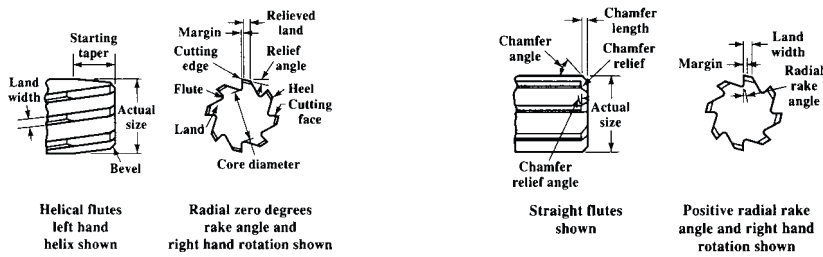
Chamfer Relief: See under *Relief*.

Chip Breakers: Notches or grooves in the cutting edges of some taper reamers designed to break the continuity of the chips.

Circular Land: See preferred term *Margin*.

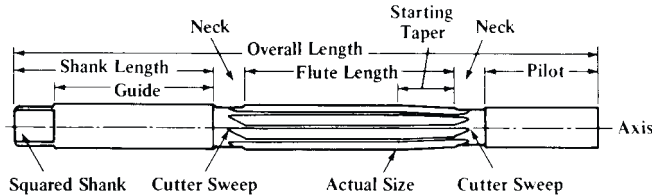
Clearance: The space created by the relief behind the cutting edge or margin of a reamer.

Illustration of Terms Applying to Reamers



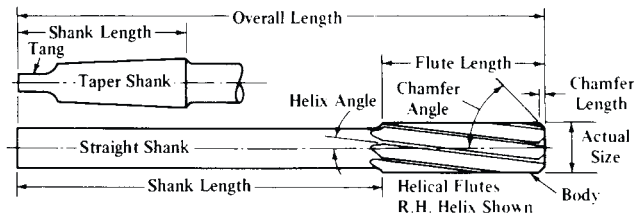
Hand Reamer

Machine Reamer



Straight Flutes

Hand Reamer, Pilot and Guide



Chucking Reamer, Straight and Taper Shank

Core: The central portion of a reamer below the flutes which joins the lands.

Core Diameter: The diameter at a given point along the axis of the largest circle which does not project into the flutes.

Cutter Sweep: The section removed by the milling cutter or grinding wheel in entering or leaving a flute.

Cutting Edge: The leading edge of the relieved land in the direction of rotation for cutting.

Cutting Face: The leading side of the relieved land in the direction of rotation for cutting on which the chip impinges.

External Center: The pointed end of a reamer. The included angle varies with manufacturing practice.

Flutes: Longitudinal channels formed in the body of the reamer to provide cutting edges, permit passage of chips, and allow cutting fluid to reach the cutting edges.

Angular Flute: A flute which forms a cutting face lying in a plane intersecting the reamer axis at an angle. It is unlike a helical flute in that it forms a cutting face which lies in a single plane.

Helical Flute: Sometimes called spiral flute, a flute which is formed in a helical path around the axis of a reamer.

Spiral flute: 1) On a taper reamer, a flute of constant lead; or, 2) in reference to a straight reamer, see preferred term helical flute.

Straight Flute: A flute which forms a cutting edge lying in an axial plane.

Flute Length: The length of the flutes not including the cutter sweep.

Guide: A cylindrical portion following the flutes of a reamer to maintain alignment.

Heel: The trailing edge of the land in the direction of rotation for cutting.

Helix Angle: The angle which a helical cutting edge at a given point makes with an axial plane through the same point.

Hook: A concave condition of a cutting face. The rake of a hooked cutting face must be determined at a given point.

Internal Center: A 60 degree countersink with clearance at the bottom, in one or both ends of a tool, which establishes the tool axis.

Irregular Spacing: A deliberate variation from uniform spacing of the reamer cutting edges.

Land: The section of the reamer between adjacent flutes.

Land Width: The distance between the leading edge of the land and the heel measured at a right angle to the leading edge.

Lead of Flute: The axial advance of a helical or spiral cutting edge in one turn around the reamer axis.

Length: The dimension of any reamer element measured parallel to the reamer axis.

Limits: The maximum and minimum values designated for a specific element.

Margin: The unrelieved part of the periphery of the land adjacent to the cutting edge.

Margin Width: The distance between the cutting edge and the primary relief measured at a right angle to the cutting edge.

Neck: The section of reduced diameter connecting shank to body, or connecting other portions of the reamer.

Nominal Size: The designated basic size of a reamer overall length-the extreme length of the complete reamer from end to end, but not including external centers or expansion screws.

Periphery: The outside circumference of a reamer.

Pilot: A cylindrical portion preceding the entering end of the reamer body to maintain alignment.

Rake: The angular relationship between the cutting face, or a tangent to the cutting face at a given point and a given reference plane or line.

Axial Rake: Applies to angular (not helical or spiral) cutting faces. It is the angle between a plane containing the cutting face, or tangent to the cutting face at a given point, and the reamer axis.

Helical Rake: Applies only to helical and spiral cutting faces (not angular). It is the angle between a plane, tangent to the cutting face at a given point on the cutting edge, and the reamer axis.

Negative Rake: Describes a cutting face in rotation whose cutting edge lags the surface of the cutting face.

Positive Rake: Describes a cutting face in rotation whose cutting edge leads the surface of the cutting face.

Radial Rake Angle: The angle in a transverse plane between a straight cutting face and a radial line passing through the cutting edge.

Relief: The result of the removal of tool material behind or adjacent to the cutting edge to provide clearance and prevent rubbing (heel drag).

Axial Relief: The relief measured in the axial direction between a plane perpendicular to the axis and the relieved surface. It can be measured by the amount of indicator drop at a given radius in a given amount of angular rotation.

Cam Relief: The relief from the cutting edge to the heel of the land produced by a cam action.

Chamfer Relief Angle: The axial relief angle at the outer corner of the chamfer. It is measured by projection into a plane tangent to the periphery at the outer corner of the chamfer.

Chamfer Relief: The axial relief on the chamfer of the reamer.

Eccentric Relief: A convex relieved surface behind the cutting edge.

Flat Relief: A relieved surface behind the cutting edge which is essentially flat.

Radial Relief: Relief in a radial direction measured in the plane of rotation. It can be measured by the amount of indicator drop at a given radius in a given amount of angular rotation.

Primary Relief: The relief immediately behind the cutting edge or margin. Properly called relief.

Secondary Relief: An additional relief behind the primary relief.

Relief Angle: The angle, measured in a transverse plane, between the relieved surface and a plane tangent to the periphery at the cutting edge.

Secondary Chamfer: A slight relieved chamfer adjacent to and following the initial chamfer on a reamer.

Shank: The portion of the reamer by which it is held and driven.

Squared Shank: A cylindrical shank having a driving square on the back end.

Starting Radius: A relieved radius at the entering end of a reamer in place of a chamfer.

Starting Taper: A slight relieved taper on the front end of a reamer.

Straight Shank: A cylindrical shank.

Tang: The flatted end of a taper shank which fits a slot in the socket.

Taper per Foot: The difference in diameter between two points 12 in. apart measured along the axis.

Taper Shank: A shank made to fit a specific (conical) taper socket.

Direction of Rotation and Helix.—The terms “right hand” and “left hand” are used to describe both direction of rotation and direction of flute helix or reamers.

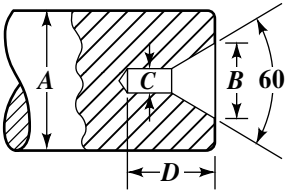
Hand of Rotation (or Hand of Cut): Right-hand Rotation (or Right-hand Cut): When viewed from the cutting end, the reamer must revolve counterclockwise to cut

Left-hand Rotation (or Left-hand Cut): When viewed from the cutting end, the reamer must revolve clockwise to cut

Hand of Flute Helix: Right-hand Helix: When the flutes twist away from the observer in a clockwise direction when viewed from either end of the reamer.

Left-hand helix: When the flutes twist away from the observer in a counterclockwise direction when viewed from either end of the reamer. The standard reamers on the tables that follow are all right-hand rotation.

Dimensions of Centers for Reamers and Arbors

				Arbor Dia. A	Large Center Dia. B	Drill No. C	Hole Depth D	Arbor Dia. A	Large Center Dia. B	Drill No. C	Hole Depth D
	3/4	3/8	25	7/16	2 1/2	11/16	J	27/32			
	13/16	13/32	20	1/2	2 5/8	45/64	K	7/8			
	7/8	7/16	17	17/32	2 3/4	23/32	L	29/32			
	15/16	15/32	12	9/16	2 7/8	47/64	M	29/32			
	1	1/2	8	19/32	3	3/4	N	15/16			
	1 1/8	33/64	5	5/8	3 1/8	49/64	N	3 1/32			
	1 1/4	17/32	3	21/32	3 1/4	25/32	O	3 1/32			
	1 3/8	35/64	2	21/32	3 3/8	51/64	O	1			
	1 1/2	9/16	1	11/16	3 1/2	13/16	P	1			
	Letter	...	3 5/8	53/64	Q	1 1/16			
	1 5/8	37/64	A	23/32	3 3/4	27/32	R	1 1/16			
	1 3/4	19/32	B	23/32	3 7/8	55/64	R	1 1/16			
	1 7/8	39/64	C	3/4	4	7/8	S	1 1/8			
	2	5/8	E	3/4	4 1/4	29/32	T	1 1/8			
	2 1/8	41/64	F	25/32	4 1/2	15/16	V	1 3/16			
	2 1/4	21/32	G	13/16	4 3/4	31/32	W	1 1/4			
	2 3/8	43/64	H	27/32	5	1	X	1 1/4			
Arbor Dia. A	Large Center Dia. B	Drill No. C	Hole Depth D								
1/4	1/8	55	5/32								
5/16	5/32	52	3/16								
3/8	3/16	48	7/32								
7/16	7/32	43	1/4								
1/2	1/4	39	5/16								
9/16	9/32	33	11/32								
5/8	5/16	30	3/8								
11/16	11/32	29	13/32								

Straight Shank Center Reamers and Machine Countersinks

ANSI B94.2-1983 (R1988)

Center Reamers (Short Countersinks)				Machine Countersinks			
Dia. of Cut	Approx. Length Overall, A	Length of Shank, S	Dia. of Shank, D	Dia. of Cut	Approx. Length Overall, A	Length of Shank, S	Dia. of Shank, D
$\frac{1}{4}$	$1\frac{1}{2}$	$\frac{3}{4}$	$\frac{3}{16}$	$\frac{1}{2}$	$3\frac{7}{8}$	$2\frac{1}{4}$	$\frac{1}{2}$
$\frac{3}{8}$	$1\frac{3}{4}$	$\frac{7}{8}$	$\frac{1}{4}$	$\frac{5}{8}$	4	$2\frac{1}{4}$	$\frac{1}{2}$
$\frac{1}{2}$	2	1	$\frac{3}{8}$	$\frac{3}{4}$	$4\frac{1}{8}$	$2\frac{1}{4}$	$\frac{1}{2}$
$\frac{5}{8}$	$2\frac{1}{4}$	1	$\frac{3}{8}$	$\frac{7}{8}$	$4\frac{1}{4}$	$2\frac{1}{4}$	$\frac{1}{2}$
$\frac{3}{4}$	$2\frac{5}{8}$	$1\frac{1}{4}$	$\frac{1}{2}$	1	$4\frac{3}{8}$	$2\frac{1}{4}$	$\frac{1}{2}$

All dimensions are given in inches. Material is high-speed steel. Reamers and countersinks have 3 or 4 flutes. Center reamers are standard with 60, 82, 90, or 100 degrees included angle. Machine countersinks are standard with either 60 or 82 degrees included angle.

Tolerances: On overall length A, the tolerance is $\pm\frac{1}{8}$ inch for center reamers in a size range of from $\frac{1}{4}$ to $\frac{3}{8}$ inch, incl., and machine countersinks in a size range of from $\frac{1}{2}$ to $\frac{5}{8}$ inch, incl.; $\pm\frac{3}{16}$ inch for center reamers, $\frac{1}{2}$ to $\frac{3}{4}$ inch, incl.; and machine countersinks, $\frac{3}{4}$ to 1 inch, incl. On shank diameter D, the tolerance is -0.0005 to -0.002 inch. On shank length S, the tolerance is $\pm\frac{1}{16}$ inch.

Reamer Difficulties.—Certain frequently occurring problems in reaming require remedial measures. These difficulties include the production of oversize holes, bellmouth holes, and holes with a poor finish. The following is taken from suggestions for correction of these difficulties by the National Twist Drill and Tool Co. and Winter Brothers Co.*

Oversize Holes: The cutting of a hole oversize from the start of the reaming operations usually indicates a mechanical defect in the setup or reamer. Thus, the wrong reamer for the workpiece material may have been used or there may be inadequate workpiece support, inadequate or worn guide bushings, or misalignment of the spindles, bushings, or workpiece or runout of the spindle or reamer holder. The reamer itself may be defective due to chamfer runout or runout of the cutting end due to a bent or nonconcentric shank.

When reamers gradually start to cut oversize, it is due to pickup or galling, principally on the reamer margins. This condition is partly due to the workpiece material. Mild steels, certain cast irons, and some aluminum alloys are particularly troublesome in this respect.

Corrective measures include reducing the reamer margin widths to about 0.005 to 0.010 inch (0.127-0.25 mm), use of hard case surface treatments on high-speed-steel reamers, either alone or in combination with black oxide treatments, and the use of a high-grade finish on the reamer faces, margins, and chamfer relief surfaces.

Bellmouth Holes: The cutting of a hole that becomes oversize at the entry end with the oversize decreasing gradually along its length always reflects misalignment of the cutting portion of the reamer with respect to the hole. The obvious solution is to provide improved guiding of the reamer by the use of accurate bushings and pilot surfaces. If this solution is not feasible, and the reamer is cutting in a vertical position, a flexible element may be employed to hold the reamer in such a way that it has both radial and axial float, with the hope that the reamer will follow the original hole and prevent the bellmouth condition.

In horizontal setups where the reamer is held fixed and the workpiece rotated, any misalignment exerts a sideways force on the reamer as it is fed to depth, resulting in the formation of a tapered hole. This type of bellmouthing can frequently be reduced by shortening

* "Some Aspects of Reamer Design and Operation," *Metal Cuttings*, April 1963.

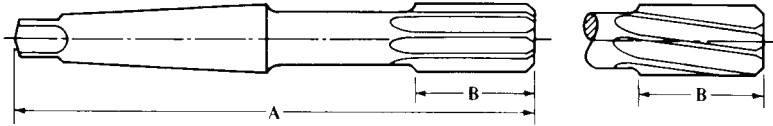
the bearing length of the cutting portion of the reamer. One way to do this is to reduce the reamer diameter by 0.010 to 0.030 inch (0.25–0.76 mm), depending on size and length, behind a short full-diameter section, $\frac{1}{8}$ to $\frac{1}{2}$ inch (3.18 to 12.7 mm) long according to length and size, following the chamfer. The second method is to grind a high back taper, 0.008 to 0.015 inch per inch (or mm/mm), behind the short full-diameter section. These modifications reduces the length of the reamer tooth that can cause the bellmouth condition.

Poor Finish: The most obvious step toward producing a good finish is to reduce the reamer feed per revolution. Feeds as low as 0.0002 to 0.0005 inch (0.005 to 0.013 mm) per tooth have been used successfully. However, reamer life will be better if the maximum feasible feed is used.

The minimum practical amount of reaming stock allowance will often improve finish by reducing the volume of chips and the resulting heat generated on the cutting portion of the chamfer. Too little reamer stock, however, can be troublesome in that the reamer teeth may not cut freely but will deflect or push the work material out of the way. When this happens, excessive heat, poor finish, and rapid reamer wear can occur.

Because of superior abrasion resistance, carbide reamers are often used when fine finishes are required. When properly conditioned, carbide reamers can produce a large number of good-quality holes. Careful honing of the carbide reamer edges is very important.

**American National Standard Fluted Taper Shank Chucking Reamers—
Straight and Helical Flutes, Fractional Sizes ANSI B94.2-1983 (R1988)**



Reamer Dia.	Length Overall A	Flute Length B	No. of Morse Taper Shank ^a	No. of Flutes	Reamer Dia.	Length Overall A	Flute Length B	No. of Morse Taper Shank ^a	No. of Flutes
$\frac{1}{4}$	6	$1\frac{1}{2}$	1	4 to 6	$\frac{27}{32}$	$9\frac{1}{2}$	$2\frac{1}{2}$	2	8 to 10
$\frac{5}{16}$	6	$1\frac{1}{2}$	1	4 to 6	$\frac{7}{8}$	10	$2\frac{5}{8}$	2	8 to 10
$\frac{3}{8}$	7	$1\frac{3}{4}$	1	4 to 6	$\frac{29}{32}$	10	$2\frac{5}{8}$	2	8 to 10
$\frac{7}{16}$	7	$1\frac{3}{4}$	1	6 to 8	$\frac{15}{16}$	10	$2\frac{5}{8}$	3	8 to 10
$\frac{1}{2}$	8	2	1	6 to 8	$\frac{31}{32}$	10	$2\frac{5}{8}$	3	8 to 10
$\frac{17}{32}$	8	2	1	6 to 8	1	$10\frac{1}{2}$	$2\frac{3}{4}$	3	8 to 12
$\frac{9}{16}$	8	2	1	6 to 8	$1\frac{1}{16}$	$10\frac{1}{2}$	$2\frac{3}{4}$	3	8 to 12
$\frac{19}{32}$	8	2	1	6 to 8	$1\frac{1}{8}$	11	$2\frac{7}{8}$	3	8 to 12
$\frac{5}{8}$	9	$2\frac{1}{4}$	2	6 to 8	$1\frac{3}{16}$	11	$2\frac{7}{8}$	3	8 to 12
$\frac{21}{32}$	9	$2\frac{1}{4}$	2	6 to 8	$1\frac{1}{4}$	$11\frac{1}{2}$	3	4	8 to 12
$\frac{11}{16}$	9	$2\frac{1}{4}$	2	6 to 8	$1\frac{5}{16}$	$11\frac{1}{2}$	3	4	8 to 12
$\frac{23}{32}$	9	$2\frac{1}{4}$	2	6 to 8	$1\frac{3}{8}$	12	$3\frac{1}{4}$	4	10 to 12
$\frac{3}{4}$	$9\frac{1}{2}$	$2\frac{1}{2}$	2	6 to 8	$1\frac{1}{16}$	12	$3\frac{1}{4}$	4	10 to 12
$\frac{25}{32}$	$9\frac{1}{2}$	$2\frac{1}{2}$	2	8 to 10	$1\frac{1}{2}$	$12\frac{1}{2}$	$3\frac{1}{2}$	4	10 to 12
$\frac{13}{16}$	$9\frac{1}{2}$	$2\frac{1}{2}$	2	8 to 10

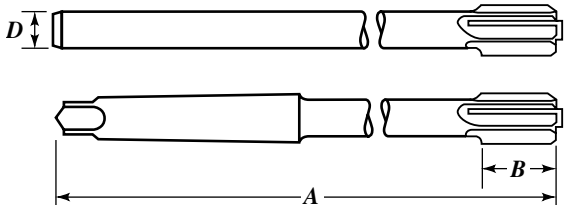
^a American National Standard self-holding tapers (see Table 7a on page 955.)

All dimensions are given in inches. Material is high-speed steel.

Helical flute reamers with right-hand helical flutes are standard.

Tolerances: On reamer diameter, $\frac{1}{4}$ -inch size, +.0001 to +.0004 inch; over $\frac{1}{4}$ - to 1-inch size, +.0001 to +.0005 inch; over 1-inch size, +.0002 to +.0006 inch. On length overall A and flute length B, $\frac{1}{4}$ - to 1-inch size, incl., $\pm\frac{1}{16}$ inch; $1\frac{1}{16}$ - to $1\frac{1}{2}$ -inch size, incl., $\frac{3}{32}$ inch.

Expansion Chucking Reamers—Straight and Taper Shanks
ANSI B94.2-1983 (R1988)



Dia of Reamer	Length, A	Flute Length, B	Shank Dia., D		Dia. of Reamer	Length, A	Flute Length, B	Shank Dia., D	
			Max.	Min.				Max.	Min.
3/8	7	3/4	0.3105	0.3095	1 3/32	10 1/2	1 5/8	0.8745	0.8730
13/32	7	3/4	0.3105	0.3095	1 1/8	11	1 3/4	0.8745	0.8730
7/16	7	7/8	0.3730	0.3720	1 5/32	11	1 3/4	0.8745	0.8730
15/32	7	7/8	0.3730	0.3720	1 3/16	11	1 3/4	0.9995	0.9980
1/2	8	1	0.4355	0.4345	1 7/32	11	1 3/4	0.9995	0.9980
17/32	8	1	0.4355	0.4345	1 1/4	11 1/2	1 7/8	0.9995	0.9980
9/16	8	1 1/8	0.4355	0.4345	1 5/16	11 1/2	1 7/8	0.9995	0.9980
19/32	8	1 1/8	0.4355	0.4345	1 3/8	12	2	0.9995	0.9980
5/8	9	1 1/4	0.5620	0.5605	1 7/16	12	2	1.2495	1.2480
21/32	9	1 1/4	0.5620	0.5605	1 1/2	12 1/2	2 1/8	1.2495	1.2480
11/16	9	1 1/4	0.5620	0.5605	1 9/16 ^a	12 1/2	2 1/8	1.2495	1.2480
23/32	9	1 1/4	0.5620	0.5605	1 5/8	13	2 1/4	1.2495	1.2480
3/4	9 1/2	1 3/8	0.6245	0.6230	1 11/16 ^a	13	2 1/4	1.2495	1.2480
25/32	9 1/2	1 3/8	0.6245	0.6230	1 3/4	13 1/2	2 3/8	1.2495	1.2480
13/16	9 1/2	1 3/8	0.6245	0.6230	1 13/16 ^a	13 1/2	2 3/8	1.4995	1.4980
27/32	9 1/2	1 3/8	0.6245	0.6230	1 7/8	14	2 1/2	1.4995	1.4980
7/8	10	1 1/2	0.7495	0.7480	1 15/16 ^a	14	2 1/2	1.4995	1.4980
29/32	10	1 1/2	0.7495	0.7480	2	14	2 1/2	1.4995	1.4980
15/16	10	1 1/2	0.7495	0.7480	2 1/8 ^b	14 1/2	2 3/4
31/32	10	1 1/2	0.7495	0.7480	2 1/4 ^b	14 1/2	2 3/4
1	10 1/2	1 5/8	0.8745	0.8730	2 3/8 ^b	15	3
1 1/32	10 1/2	1 5/8	0.8745	0.8730	2 1/2 ^b	15	3
1 1/16	10 1/2	1 5/8	0.8745	0.8730

^a Straight shank only.

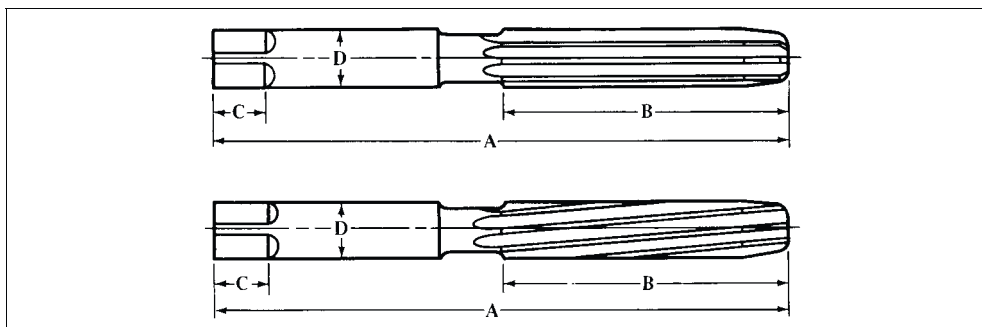
^b Taper shank only.

All dimensions in inches. Material is high-speed steel. The number of flutes is as follows: 3/8- to 15/32-inch sizes, 4 to 6; 1/2- to 31/32-inch sizes, 6 to 8; 1- to 1 1/16-inch sizes, 8 to 10; 1 3/4- to 1 15/16-inch sizes, 8 to 12; 2- to 2 1/4-inch sizes, 10 to 12; 2 3/8- and 2 1/2-inch sizes, 10 to 14. The expansion feature of these reamers provides a means of adjustment that is important in reaming holes to close tolerances. When worn undersize, they may be expanded and reground to the original size.

Tolerances: On reamer diameter, 3/8- to 1-inch sizes, incl., +0.0001 to +0.0005 inch; over 1-inch size, +0.0002 to +0.0006 inch. On length A and flute length B, 3/8- to 1-inch sizes, incl., ±1/16 inch; 1 1/32- to 2-inch sizes, incl., ±3/32 inch; over 2-inch sizes, ±1/8 inch.

Taper is Morse taper: No. 1 for sizes 3/8 to 19/32 inch, incl.; No. 2 for sizes 5/8 to 29/32 incl.; No. 3 for sizes 15/16 to 1 1/32, incl.; No. 4 for sizes 1 1/4 to 1 5/8, incl.; and No. 5 for sizes 1 3/4 to 2 1/2, incl. For amount of taper, see [Table](#) on page 948.

Hand Reamers—Straight and Helical Flutes ANSI B94.2-1983 (R1988)



Reamer Diameter			Length Overall A	Flute Length B	Square Length C	Size of Square	No. of Flutes
Straight Flutes	Helical Flutes	Decimal Equivalent					
1/8	...	0.1250	3	1 1/2	5/32	0.095	4 to 6
5/32	...	0.1562	3 1/4	1 5/8	7/32	0.115	4 to 6
3/16	...	0.1875	3 1/2	1 3/4	7/32	0.140	4 to 6
7/32	...	0.2188	3 3/4	1 7/8	1/4	0.165	4 to 6
1/4	1/4	0.2500	4	2	1/4	0.185	4 to 6
9/32	...	0.2812	4 1/4	2 1/8	1/4	0.210	4 to 6
5/16	5/16	0.3125	4 1/2	2 1/4	5/16	0.235	4 to 6
11/32	...	0.3438	4 3/4	2 3/8	5/16	0.255	4 to 6
3/8	3/8	0.3750	5	2 1/2	3/8	0.280	4 to 6
13/32	...	0.4062	5 1/4	2 5/8	3/8	0.305	6 to 8
7/16	7/16	0.4375	5 1/2	2 3/4	7/16	0.330	6 to 8
15/32	...	0.4688	5 3/4	2 7/8	7/16	0.350	6 to 8
1/2	1/2	0.5000	6	3	1/2	0.375	6 to 8
17/32	...	0.5312	6 1/4	3 1/8	1/2	0.400	6 to 8
9/16	9/16	0.5625	6 1/2	3 1/4	9/16	0.420	6 to 8
19/32	...	0.5938	6 3/4	3 3/8	9/16	0.445	6 to 8
5/8	5/8	0.6250	7	3 1/2	5/8	0.470	6 to 8
21/32	...	0.6562	7 3/8	3 11/16	5/8	0.490	6 to 8
11/16	11/16	0.6875	7 1/4	3 7/8	11/16	0.515	6 to 8
23/32	...	0.7188	8 1/8	4 1/16	11/16	0.540	6 to 8
3/4	3/4	0.7500	8 3/8	4 3/16	3/4	0.560	6 to 8
...	13/16	0.8125	9 1/8	4 9/16	13/16	0.610	8 to 10
7/8	7/8	0.8750	9 3/4	4 7/8	7/8	0.655	8 to 10
...	15/16	0.9375	10 1/4	5 1/8	15/16	0.705	8 to 10
1	1	1.0000	10 7/8	5 1/16	1	0.750	8 to 10
1 1/8	1 1/8	1.1250	11 5/8	5 13/16	1	0.845	8 to 10
1 1/4	1 1/4	1.2500	12 1/4	6 1/8	1	0.935	8 to 12
1 3/8	1 3/8	1.3750	12 5/8	6 5/16	1	1.030	10 to 12
1 1/2	1 1/2	1.5000	13	6 1/2	1 1/8	1.125	10 to 14

All dimensions in inches. Material is high-speed steel. The nominal shank diameter *D* is the same as the reamer diameter. Helical-flute hand reamers with left-hand helical flutes are standard. Reamers are tapered slightly on the end to facilitate proper starting.

Tolerances: On diameter of reamer, up to 1/4-inch size, incl., +.0001 to +.0004 inch; over 1/4- to 1-inch size, incl., +.0001 to +.0005 inch; over 1-inch size, +.0002 to +.0006 inch. On length overall *A* and flute length *B*, 1/8- to 1-inch size, incl., ± 1/16 inch; 1 1/8- to 1 1/2-inch size, incl., ± 3/32 inch. On length of square *C*, 1/8- to 1 inch size, incl., ± 1/32 inch; 1 1/8- to 1 1/2-inch size, incl., ± 1/16 inch. On shank diameter *D*, 1/8- to 1-inch size, incl., -.001 to -.005 inch; 1 1/8- to 1 1/2-inch size, incl., -.0015 to -.006 inch. On size of square, 1/8- to 1/2-inch size, incl., -.004 inch; 17/32- to 1-inch size, incl., -.006 inch; 1 1/8- to 1 1/2-inch size, incl., -.008 inch.

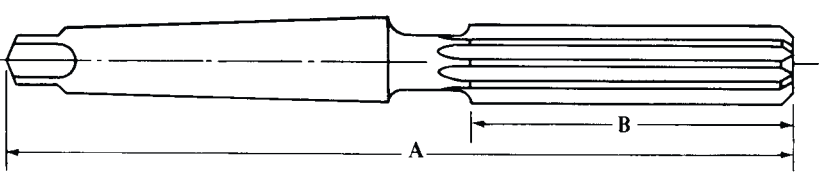
American National Standard Expansion Hand Reamers—Straight and Helical Flutes, Squared Shank ANSI B94.2-1983 (R1988)

Reamer Dia.	Length Overall A		Flute Length B		Length of Square C	Shank Dia. D	Size of Square	Number of Flutes
	Max	Min	Max	Min				
Straight Flutes								
1/4	4 3/8	3 3/4	1 3/4	1 1/2	1/4	1/4	0.185	6 to 8
5/16	4 3/8	4	1 7/8	1 1/2	5/16	5/16	0.235	6 to 8
3/8	5 3/8	4 1/4	2	1 3/4	3/8	3/8	0.280	6 to 9
7/16	5 3/8	4 1/2	2	1 3/4	7/16	7/16	0.330	6 to 9
1/2	6 1/2	5	2 1/2	1 3/4	1/2	1/2	0.375	6 to 9
9/16	6 1/2	5 3/8	2 1/2	1 7/8	9/16	9/16	0.420	6 to 9
5/8	7	5 3/4	3	2 1/4	5/8	5/8	0.470	6 to 9
11/16	7 5/8	6 1/4	3	2 1/2	11/16	11/16	0.515	6 to 10
3/4	8	6 1/2	3 1/2	2 5/8	3/4	3/4	0.560	6 to 10
7/8	9	7 1/2	4	3 1/8	7/8	7/8	0.655	8 to 10
1	10	8 3/8	4 1/2	3 7/8	1	1	0.750	8 to 10
1 1/8	10 1/2	9	4 3/4	3 1/2	1	1 1/8	0.845	8 to 12
1 1/4	11	9 3/4	5	4 1/4	1	1 1/4	0.935	8 to 12
Helical Flutes								
1/4	4 3/8	3 7/8	1 3/4	1 1/2	1/4	1/4	0.185	6 to 8
5/16	4 3/8	4	1 3/4	1 1/2	5/16	5/16	0.235	6 to 8
3/8	6 1/8	4 1/4	2	1 3/4	3/8	3/8	0.280	6 to 9
7/16	6 1/4	4 1/2	2	1 3/4	7/16	7/16	0.330	6 to 9
1/2	6 1/2	5	2 1/2	1 3/4	1/2	1/2	0.375	6 to 9
5/8	8	6	3	2 1/4	5/8	5/8	0.470	6 to 9
3/4	8 5/8	6 1/2	3 1/2	2 5/8	3/4	3/4	0.560	6 to 10
7/8	9 3/8	7 1/2	4	3 1/8	7/8	7/8	0.655	6 to 10
1	10 1/4	8 3/8	4 1/2	3 1/8	1	1	0.750	6 to 10
1 1/4	11 3/8	9 3/4	5	4 1/4	1	1 1/4	0.935	8 to 12

All dimensions are given in inches. Material is carbon steel. Reamers with helical flutes that are left hand are standard. Expansion hand reamers are primarily designed for work where it is necessary to enlarge reamed holes by a few thousandths. The pilots and guides on these reamers are ground under-size for clearance. The maximum expansion on these reamers is as follows: .006 inch for the 1/4- to 7/16-inch sizes, .010 inch for the 1/2- to 7/8-inch sizes and .012 inch for the 1- to 1 1/4-inch sizes.

Tolerances: On length overall A and flute length B, $\pm 1/16$ inch for 1/4- to 1-inch sizes, $\pm 3/32$ inch for 1 1/8- to 1 1/4-inch sizes; on length of square C, $\pm 1/32$ inch for 1/4- to 1-inch sizes, $\pm 1/16$ inch for 1 1/8- to 1 1/4-inch sizes; on shank diameter D, -0.001 to -0.005 inch for 1/4- to 1-inch sizes, -0.0015 to -0.006 inch for 1 1/8- to 1 1/4-inch sizes; on size of square, -0.004 inch for 1/4- to 1/2-inch sizes, -0.006 inch for 9/16- to 1-inch sizes, and -0.008 inch for 1 1/8- to 1 1/4-inch sizes.

Taper Shank Jobbers Reamers—Straight Flutes ANSI B94.2-1983 (R1988)



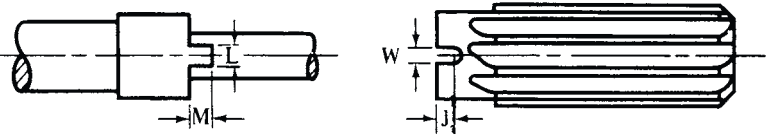
Reamer Diameter		Length Overall A	Length of Flute B	No. of Morse Taper Shank ^a	No. of Flutes
Fractional	Dec. Equiv.				
1/4	0.2500	5 5/16	2	1	6 to 8
5/16	0.3125	5 1/2	2 1/4	1	6 to 8
3/8	0.3750	5 13/16	2 1/2	1	6 to 8
7/16	0.4375	6 1/8	2 3/4	1	6 to 8
1/2	0.5000	6 7/16	3	1	6 to 8
9/16	0.5625	6 3/4	3 1/4	1	6 to 8
5/8	0.6250	7 1/16	3 1/2	2	6 to 8
11/16	0.6875	8	3 7/8	2	8 to 10
3/4	0.7500	8 3/8	4 3/16	2	8 to 10
13/16	0.8125	8 13/16	4 9/16	2	8 to 10
7/8	0.8750	9 3/16	4 7/8	2	8 to 10
15/16	0.9375	10	5 1/8	3	8 to 10
1	1.0000	10 3/8	5 7/16	3	8 to 10
1 1/16	1.0625	10 5/8	5 5/8	3	8 to 10
1 1/8	1.1250	10 7/8	5 13/16	3	8 to 10
1 3/16	1.1875	11 1/8	6	3	8 to 12
1 1/4	1.2500	12 1/16	6 1/8	4	8 to 12
1 3/8	1.3750	12 13/16	6 5/16	4	10 to 12
1 1/2	1.5000	13 1/8	6 1/2	4	10 to 12

^a American National Standard self-holding tapers (Table 7a on page 955.)

All dimensions in inches. Material is high-speed steel.

Tolerances: On reamer diameter, 1/4-inch size, +.0001 to +.0004 inch; over 1/4- to 1-inch size, incl., +.0001 to +.0005 inch; over 1-inch size, +.0002 to +.0006 inch. On overall length A and length of flute B, 1/4- to 1-inch size, incl., ±1/16 inch; and 1 1/16- to 1 1/2-inch size, incl., ±3/32 inch.

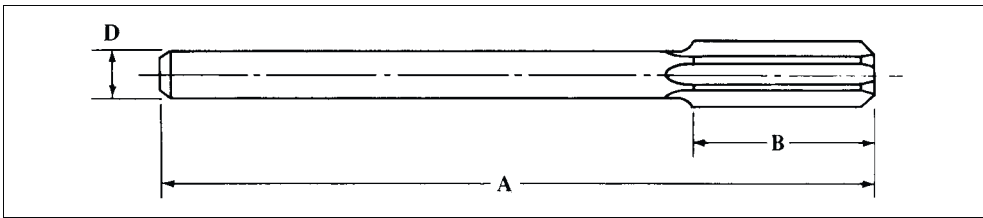
American National Standard Driving Slots and Lugs for Shell Reamers or Shell Reamer Arbors ANSI B94.2-1983 (R1988)



Arbor Size No.	Fitting Reamer Sizes	Driving Slot		Lug on Arbor		Reamer Hole Dia. at Large End
		Width W	Depth J	Width L	Depth M	
4	3/4	5/32	3/16	9/64	5/32	0.375
5	13/16 to 1	3/16	1/4	11/64	7/32	0.500
6	1 1/16 to 1 1/4	3/16	1/4	11/64	7/32	0.625
7	1 5/16 to 1 5/8	1/4	5/16	15/64	9/32	0.750
8	1 11/16 to 2	1/4	5/16	15/64	9/32	1.000
9	2 1/16 to 2 1/2	5/16	3/8	19/64	11/32	1.250

All dimension are given in inches. The hole in shell reamers has a taper of 1/8 inch per foot, with arbors tapered to correspond. Shell reamer arbor tapers are made to permit a driving fit with the reamer.

Straight Shank Chucking Reamers—Straight Flutes, Wire Gage Sizes
ANSI B94.2-1983 (R1988)

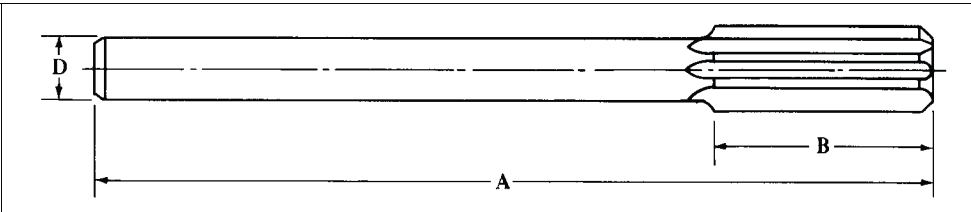


Reamer Diameter		Lgth. Overall A	Lgth. of Flute B	Shank Dia. D		No. of Flutes	Reamer Diameter		Lgth. Overall A	Lgth. of Flute B	Shank Dia. D		No. of Flutes
Wire Gage	Inch			Max	Min		Wire Gage	Inch			Max	Min	
60	.0400	2½	½	.0390	.0380	4	49	.0730	3	¾	.0660	.0650	4
59	.0410	2½	½	.0390	.0380	4	48	.0760	3	¾	.0720	.0710	4
58	.0420	2½	½	.0390	.0380	4	47	.0785	3	¾	.0720	.0710	4
57	.0430	2½	½	.0390	.0380	4	46	.0810	3	¾	.0771	.0701	4
56	.0465	2½	½	.0455	.0445	4	45	.0820	3	¾	.0771	.0761	4
55	.0520	2½	½	.0510	.0500	4	44	.0860	3	¾	.0810	.0800	4
54	.0550	2½	½	.0510	.0500	4	43	.0890	3	¾	.0810	.0800	4
53	.0595	2½	½	.0585	.0575	4	42	.0935	3	¾	.0880	.0870	4
52	.0635	2½	½	.0585	.0575	4	41	.0960	3½	7/8	.0928	.0918	4 to 6
51	.0670	3	¾	.0660	.0650	4	40	.0980	3½	7/8	.0928	.0918	4 to 6
50	.0700	3	¾	.0660	.0650	4	39	.0995	3½	7/8	.0928	.0918	4 to 6
38	.1015	3½	7/8	.0950	.0940	4 to 6	19	.1660	4½	1 1/8	.1595	.1585	4 to 6
37	.1040	3½	7/8	.0950	.0940	4 to 6	18	.1695	4½	1 1/8	.1595	.1585	4 to 6
36	.1065	3½	7/8	.1030	.1020	4 to 6	17	.1730	4½	1 1/8	.1645	.1635	4 to 6
35	.1100	3½	7/8	.1030	.1020	4 to 6	16	.1770	4½	1 1/8	.1704	.1694	4 to 6
34	.1110	3½	7/8	.1055	.1045	4 to 6	15	.1800	4½	1 1/8	.1755	.1745	4 to 6
33	.1130	3½	7/8	.1055	.1045	4 to 6	14	.1820	4½	1 1/8	.1755	.1745	4 to 6
32	.1160	3½	7/8	.1120	.1110	4 to 6	13	.1850	4½	1 1/8	.1805	.1795	4 to 6
31	.1200	3½	7/8	.1120	.1110	4 to 6	12	.1890	4½	1 1/8	.1805	.1795	4 to 6
30	.1285	3½	7/8	.1190	.1180	4 to 6	11	.1910	5	1 1/4	.1860	.1850	4 to 6
29	.1360	4	1	.1275	.1265	4 to 6	10	.1935	5	1 1/4	.1860	.1850	4 to 6
28	.1405	4	1	.1350	.1340	4 to 6	9	.1960	5	1 1/4	.1895	.1885	4 to 6
27	.1440	4	1	.1350	.1340	4 to 6	8	.1990	5	1 1/4	.1895	.1885	4 to 6
26	.1470	4	1	.1430	.1420	4 to 6	7	.2010	5	1 1/4	.1945	.1935	4 to 6
25	.1495	4	1	.1430	.1420	4 to 6	6	.2040	5	1 1/4	.1945	.1935	4 to 6
24	.1520	4	1	.1460	.1450	4 to 6	5	.2055	5	1 1/4	.2016	.2006	4 to 6
23	.1540	4	1	.1460	.1450	4 to 6	4	.2090	5	1 1/4	.2016	.2006	4 to 6
22	.1570	4	1	.1510	.1500	4 to 6	3	.2130	5	1 1/4	.2075	.2065	4 to 6
21	.1590	4½	1 1/8	.1530	.1520	4 to 6	2	.2210	6	1 1/2	.2173	.2163	4 to 6
20	.1610	4½	1 1/8	.1530	.1520	4 to 6	1	.2280	6	1 1/2	.2173	.2163	4 to 6

All dimensions in inches. Material is high-speed steel.

Tolerances: On diameter of reamer, plus .0001 to plus .0004 inch. On overall length A, plus or minus 1/16 inch. On length of flute B, plus or minus 1/16 inch.

Straight Shank Chucking Reamers—Straight Flutes, Letter Sizes
ANSI B94.2-1983 (R1988)

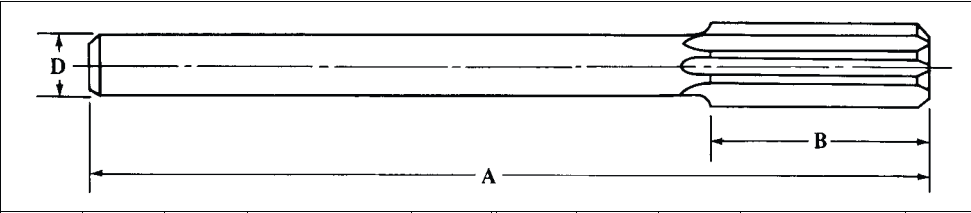


Reamer Diameter		Lgth. Overall A	Lgth. of Flute B	Shank Dia. D		No. of Flutes	Reamer Diameter		Lgth. Overall A	Lgth. of Flute B	Shank Dia. D		No. of Flutes
Letter	Inch			Max	Min		Letter	Inch			Max	Min	
A	0.2340	6	1½	0.2265	.2255	4 to 6	N	0.3020	6	1½	0.2792	0.2782	4 to 6
B	0.2380	6	1½	0.2329	.2319	4 to 6	O	0.3160	6	1½	0.2792	0.2782	4 to 6
C	0.2420	6	1½	0.2329	.2319	4 to 6	P	0.3230	6	1½	0.2792	0.2782	4 to 6
D	0.2460	6	1½	0.2329	.2319	4 to 6	Q	0.3320	6	1½	0.2792	0.2782	4 to 6
E	0.2500	6	1½	0.2405	.2395	4 to 6	R	0.3390	6	1½	0.2792	0.2782	4 to 6
F	0.2570	6	1½	0.2485	.2475	4 to 6	S	0.3480	7	1¾	0.3105	0.3095	4 to 6
G	0.2610	6	1½	0.2485	.2475	4 to 6	T	0.3580	7	1¾	0.3105	0.3095	4 to 6
H	0.2660	6	1½	0.2485	.2475	4 to 6	U	0.3680	7	1¾	0.3105	0.3095	4 to 6
I	0.2720	6	1½	0.2485	.2475	4 to 6	V	0.3770	7	1¾	0.3105	0.3095	4 to 6
J	0.2770	6	1½	0.2485	.2475	4 to 6	W	0.3860	7	1¾	0.3105	0.3095	4 to 6
K	0.2810	6	1½	0.2485	.2475	4 to 6	X	0.3970	7	1¾	0.3105	0.3095	4 to 6
L	0.2900	6	1½	0.2792	.2782	4 to 6	Y	0.4040	7	1¾	0.3105	0.3095	4 to 6
M	0.2950	6	1½	0.2792	.2782	4 to 6	Z	0.4130	7	1¾	0.3730	0.3720	6 to 8

All dimensions in inches. Material is high-speed steel.

Tolerances: On diameter of reamer, for sizes A to E, incl., plus .0001 to plus .0004 inch and for sizes F to Z, incl., plus .0001 to plus .0005 inch. On overall length A, plus or minus 1/16 inch. On length of flute B, plus or minus 1/16 inch.

Straight Shank Chucking Reamers—Straight Flutes, Decimal Sizes
ANSI B94.2-1983 (R1988)

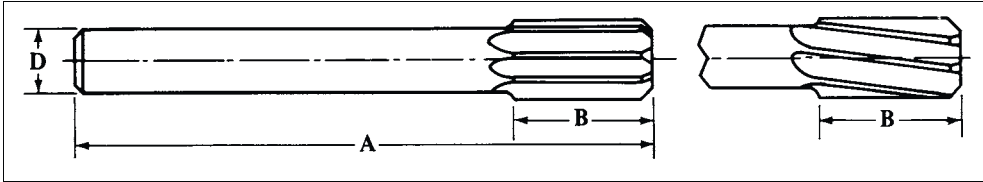


Reamer Dia.	Lgth. Overall A	Lgth. of Flute B	Shank Diameter D		No. of Flutes	Reamer Dia.	Lgth. Overall A	Lgth. of Flute B	Shank Diameter D		No. of Flutes
			Max.	Min.					Max.	Min.	
0.1240	3½	7/8	0.1190	0.1180	4 to 6	0.3135	6	1½	0.2792	0.2782	4 to 6
0.1260	3½	7/8	0.1190	0.1180	4 to 6	0.3740	7	1¾	0.3105	0.3095	6 to 8
0.1865	4½	1⅛	0.1805	0.1795	4 to 6	0.3760	7	1¾	0.3105	0.3095	6 to 8
0.1885	4½	1⅛	0.1805	0.1795	4 to 6	0.4365	7	1¾	0.3730	0.3720	6 to 8
0.2490	6	1½	0.2405	0.2395	4 to 6	0.4385	7	1¾	0.3730	0.3720	6 to 8
0.2510	6	1½	0.2405	0.2395	4 to 6	0.4990	8	2	0.4355	0.4345	6 to 8
0.3115	6	1½	0.2792	0.2782	4 to 6	0.5010	8	2	0.4355	0.4345	6 to 8

All dimensions in inches. Material is high-speed steel.

Tolerances: On diameter of reamer, for 0.124 to 0.249-inch sizes, plus .0001 to plus .0004 inch and for 0.251 to 0.501-inch sizes, plus .0001 to plus .0005 inch. On overall length A, plus or minus 1/16 inch. On length of flute B, plus or minus 1/16 inch.

American National Standard Straight Shank Rose Chucking and Chucking Reamers—Straight and Helical Flutes, Fractional Sizes ANSI B94.2-1983 (R1988)



Reamer Diameter		Length Overall A	Flute Length B	Shank Dia. D		No. of Flutes
Chucking	Rose Chucking			Max	Min	
3/64 ^a	...	2 1/2	1/2	0.0455	0.0445	4
1/16	...	2 1/2	1/2	0.0585	0.0575	4
5/64	...	3	3/4	0.0720	0.0710	4
7/32	...	3	3/4	0.0880	0.0870	4
7/64	...	3 1/2	7/8	0.1030	0.1020	4 to 6
1/8	1/8 ^a	3 1/2	7/8	0.1190	0.1180	4 to 6
9/64	...	4	1	0.1350	0.1340	4 to 6
5/32	...	4	1	0.1510	0.1500	4 to 6
11/64	...	4 1/2	1 1/8	0.1645	0.1635	4 to 6
3/16	3/16 ^a	4 1/2	1 1/8	0.1805	0.1795	4 to 6
13/64	...	5	1 1/4	0.1945	0.1935	4 to 6
7/32	...	5	1 1/4	0.2075	0.2065	4 to 6
15/64	...	6	1 1/2	0.2265	0.2255	4 to 6
1/4	1/4 ^a	6	1 1/2	0.2405	0.2395	4 to 6
17/64	...	6	1 1/2	0.2485	0.2475	4 to 6
9/32	...	6	1 1/2	0.2485	0.2475	4 to 6
19/64	...	6	1 1/2	0.2792	0.2782	4 to 6
5/16	5/16 ^a	6	1 1/2	0.2792	0.2782	4 to 6
21/64	...	6	1 1/2	0.2792	0.2782	4 to 6
11/32	...	6	1 1/2	0.2792	0.2782	4 to 6
23/64	...	7	1 3/4	0.3105	0.3095	4 to 6
3/8	3/8 ^a	7	1 3/4	0.3105	0.3095	4 to 6
25/64	...	7	1 3/4	0.3105	0.3095	4 to 6
13/32	...	7	1 3/4	0.3105	0.3095	4 to 6
27/64	...	7	1 3/4	0.3730	0.3720	6 to 8
7/16	7/16 ^a	7	1 3/4	0.3730	0.3720	6 to 8
29/64	...	7	1 3/4	0.3730	0.3720	6 to 8
15/32	...	7	1 3/4	0.3730	0.3720	6 to 8
31/64	...	8	2	0.4355	0.4345	6 to 8
1/2	1/2 ^a	8	2	0.4355	0.4345	6 to 8
17/32	...	8	2	0.4355	0.4345	6 to 8
9/16	...	8	2	0.4355	0.4345	6 to 8
19/32	...	8	2	0.4355	0.4345	6 to 8
5/8	...	9	2 1/4	0.5620	0.5605	6 to 8
21/32	...	9	2 1/4	0.5620	0.5605	6 to 8
11/16	...	9	2 1/4	0.5620	0.5605	6 to 8
23/32	...	9	2 1/4	0.5620	0.5605	6 to 8
3/4	...	9 1/2	2 1/2	0.6245	0.6230	6 to 8
25/32	...	9 1/2	2 1/2	0.6245	0.6230	8 to 10
13/16	...	9 1/2	2 1/2	0.6245	0.6230	8 to 10
27/32	...	9 1/2	2 1/2	0.6245	0.6230	8 to 10
7/8	...	10	2 5/8	0.7495	0.7480	8 to 10
29/32	...	10	2 5/8	0.7495	0.7480	8 to 10
15/16	...	10	2 5/8	0.7495	0.7480	8 to 10
31/32	...	10	2 5/8	0.7495	0.7480	8 to 10
1	...	10 1/2	2 3/4	0.8745	0.8730	8 to 12
1 1/16	...	10 1/2	2 3/4	0.8745	0.8730	8 to 12
1 1/8	...	11	2 7/8	0.8745	0.8730	8 to 12
1 1/16	...	11	2 7/8	0.9995	0.9980	8 to 12
1 1/4	...	11 1/2	3	0.9995	0.9980	8 to 12
1 5/16 ^b	...	11 1/2	3	0.9995	0.9980	10 to 12
1 3/8	...	12	3 1/4	0.9995	0.9980	10 to 12
1 7/16 ^b	...	12	3 1/4	1.2495	1.2480	10 to 12
1 1/2	...	12 1/2	3 1/2	1.2495	1.2480	10 to 12

^a Reamer with straight flutes is standard only.

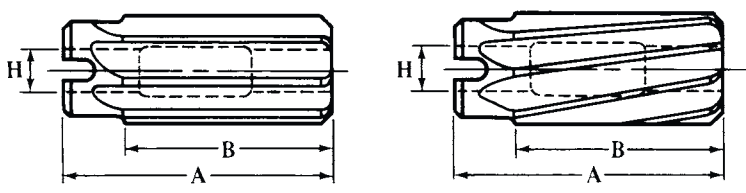
^b Reamer with helical flutes is standard only.

All dimensions are given in inches. Material is high-speed steel. Chucking reamers are end cutting on the chamfer and the relief for the outside diameter is ground in back of the margin for the full length of land. Lands of rose chucking reamers are not relieved on the periphery but have a relatively large amount of back taper.

Tolerances: On reamer diameter, up to ¼-inch size, incl., + .0001 to + .0004 inch; over ¼-to 1-inch size, incl., + .0001 to + .0005 inch; over 1-inch size, + .0002 to + .0006 inch. On length overall *A* and flute length *B*, up to 1-inch size, incl., ± 1/16 inch; 1 1/16- to 1 1/2-inch size, incl., ± 3/32 inch.

Helical flutes are right- or left-hand helix, right-hand cut, except sizes 1 1/16 through 1 1/2 inches, which are right-hand helix only.

Shell Reamers—Straight and Helical Flutes ANSI B94.2-1983 (R1988)



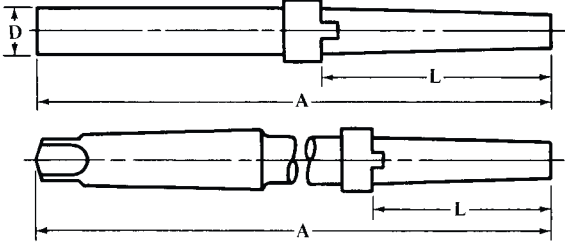
Diameter of Reamer	Length Overall <i>A</i>	Flute Length <i>B</i>	Hole Diameter Large End <i>H</i>	Fitting Arbor No.	Number of Flutes
3/4	2 1/4	1 1/2	0.375	4	8 to 10
7/8	2 1/2	1 3/4	0.500	5	8 to 10
1 1/16 ^a	2 1/2	1 3/4	0.500	5	8 to 10
1	2 1/2	1 3/4	0.500	5	8 to 10
1 1/16	2 3/4	2	0.625	6	8 to 12
1 1/8	2 3/4	2	0.625	6	8 to 12
1 3/16	2 3/4	2	0.625	6	8 to 12
1 1/4	2 3/4	2	0.625	6	8 to 12
1 5/16	3	2 1/4	0.750	7	8 to 12
1 3/8	3	2 1/4	0.750	7	8 to 12
1 7/16	3	2 1/4	0.750	7	8 to 12
1 1/2	3	2 1/4	0.750	7	10 to 14
1 9/16	3	2 1/4	0.750	7	10 to 14
1 5/8	3	2 1/4	0.750	7	10 to 14
1 11/16	3 1/2	2 1/2	1.000	8	10 to 14
1 3/4	3 1/2	2 1/2	1.000	8	12 to 14
1 13/16	3 1/2	2 1/2	1.000	8	12 to 14
1 7/8	3 1/2	2 1/2	1.000	8	12 to 14
1 15/16	3 1/2	2 1/2	1.000	8	12 to 14
2	3 1/2	2 1/2	1.000	8	12 to 14
2 1/16 ^a	3 3/4	2 3/4	1.250	9	12 to 16
2 1/8	3 3/4	2 3/4	1.250	9	12 to 16
2 3/16 ^a	3 3/4	2 3/4	1.250	9	12 to 16
2 1/4	3 3/4	2 3/4	1.250	9	12 to 16
2 3/8 ^a	3 3/4	2 3/4	1.250	9	14 to 16
2 1/2 ^a	3 3/4	2 3/4	1.250	9	14 to 16

^a Helical flutes only.

All dimensions are given in inches. Material is high-speed steel. Helical flute shell reamers with left-hand helical flutes are standard. Shell reamers are designed as a sizing or finishing reamer and are held on an arbor provided with driving lugs. The holes in these reamers are ground with a taper of 1/8 inch per foot.

Tolerances: On diameter of reamer, 3/4- to 1-inch size, incl., + .0001 to + .0005 inch; over 1-inch size, + .0002 to + .0006 inch. On length overall *A* and flute length *B*, 3/4- to 1-inch size, incl., ± 1/16 inch; 1 1/16- to 2-inch size, incl., ± 3/32 inch; 2 1/16- to 2 1/2-inch size, incl., ± 1/8 inch.

**American National Standard Arbors for Shell Reamers—
Straight and Taper Shanks ANSI B94.2-1983 (R1988)**

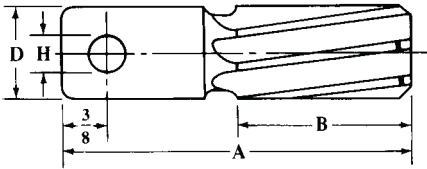


Arbor Size No.	Overall Length A	Approx. Length of Taper L	Reamer Size	Taper Shank No. ^a	Straight Shank Dia. D	Arbor Size No.	Overall Length A	Approx. Length of Taper L	Reamer Size	Taper Shank No. ^a	Straight Shank Dia. D
4	9	2¼	¾	2	½	7	11	3	1⅙ to 1⅝	3	⅞
5	9½	2½	1⅓ to 1	2	⅝	8	12	3½	1⅙ to 2	4	1⅙
6	10	2¾	1⅙ to 1¼	3	¾	9	13	3¾	2⅙ to 2½	4	1⅜

^a American National Standard self-holding tapers (see Table 7a on page 955.)

All dimensions are given in inches. These arbors are designed to fit standard shell reamers (see table). End which fits reamer has taper of ⅓ inch per foot.

Stub Screw Machine Reamers—Helical Flutes ANSI B94.2-1983 (R1988)



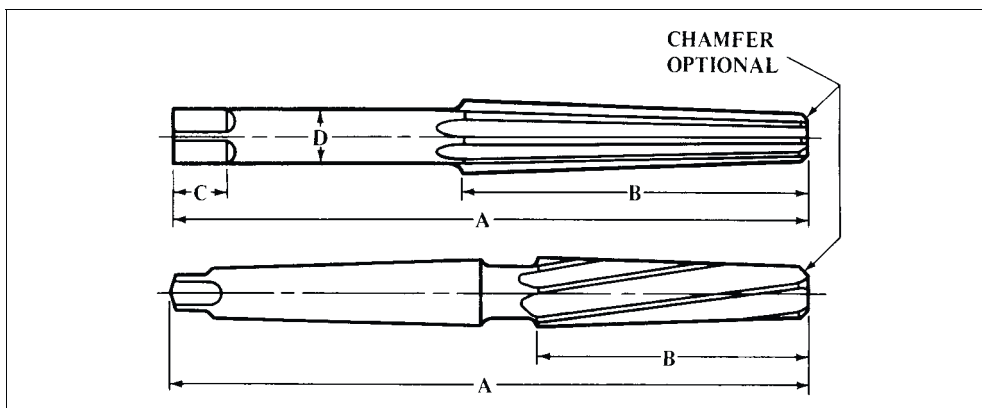
Series No.	Diameter Range	Length Overall	Length of Flute	Dia. of Shank	Size of Hole	Flute No.	Series No.	Diameter Range	Length Overall	Length of Flute	Dia. of Shank	Size of Hole	Flute No.
		A	B	D	H				A	B	D	H	
00	.0600-.066	1¾	½	⅛	⅙	4	12	.3761-.407	2½	1¼	½	⅜	6
0	.0661-.074	1¾	½	⅛	⅙	4	13	.4071-.439	2½	1¼	½	⅜	6
1	.0741-.084	1¾	½	⅛	⅙	4	14	.4391-.470	2½	1¼	½	⅜	6
2	.0841-.096	1¾	½	⅛	⅙	4	15	.4701-.505	2½	1¼	½	⅜	6
3	.0961-.126	2	¾	⅛	⅙	4	16	.5051-.567	3	1½	⅝	¼	6
4	.1261-.158	2¼	1	¼	⅜	4	17	.5671-.630	3	1½	⅝	¼	6
5	.1581-.188	2¼	1	¼	⅜	4	18	.6301-.692	3	1½	⅝	¼	6
6	.1881-.219	2¼	1	¼	⅜	6	19	.6921-.755	3	1½	¾	⅝	8
7	.2191-.251	2¼	1	¼	⅜	6	20	.7551-.817	3	1½	¾	⅝	8
8	.2511-.282	2¼	1	⅜	⅝	6	21	.8171-.880	3	1½	¾	⅝	8
9	.2821-.313	2¼	1	⅜	⅝	6	22	.8801-.942	3	1½	¾	⅝	8
10	.3131-.344	2½	1¼	⅜	⅝	6	23	.9421-1.010	3	1½	¾	⅝	8
11	.3441-.376	2½	1¼	⅜	⅝	6

All dimensions in inches. Material is high-speed steel.

These reamers are standard with right-hand cut and left-hand helical flutes within the size ranges shown.

Tolerances: On diameter of reamer, for sizes 00 to 7, incl., plus .0001 to plus .0004 inch and for sizes 8 to 23, incl., plus .0001 to plus .0005 inch. On overall length A, plus or minus ⅙ inch. On length of flute B, plus or minus ⅙ inch. On diameter of shank D, minus .0005 to minus .002 inch.

American National Standard Morse Taper Finishing Reamers
ANSI B94.2-1983 (R1988)



Straight Flutes and Squared Shank							
Taper No. ^a	Small End Dia. (Ref.)	Large End Dia. (Ref.)	Length Overall A	Flute Length B	Square Length C	Shank Dia. D	Square Size
0	0.2503	0.3674	3¾	2¼	5/16	5/16	0.235
1	0.3674	0.5170	5	3	7/16	7/16	0.330
2	0.5696	0.7444	6	3½	¾	¾	0.470
3	0.7748	0.9881	7¼	4¼	7/8	7/8	0.655
4	1.0167	1.2893	8½	5¼	1	1½	0.845
5	1.4717	1.8005	9¾	6¼	1½	1½	1.125
Straight and Spiral Flutes and Taper Shank							
Taper No. ^a	Small End Dia. (Ref.)	Large End Dia. (Ref.)	Length Overall A	Flute Length B	Taper Shank No. ^a	Squared and Taper Shank Number of Flutes	
0	0.2503	0.3674	5½/32	2¼	0	4 to 6 incl.	
1	0.3674	0.5170	65/16	3	1	6 to 8 incl.	
2	0.5696	0.7444	7¾	3½	2	6 to 8 incl.	
3	0.7748	0.9881	87/8	4¼	3	8 to 10 incl.	
4	1.0167	1.2893	107/8	5¼	4	8 to 10 incl.	
5	1.4717	1.8005	13¾	6¼	5	10 to 12 incl.	

^aMorse. For amount of taper see Table on page 948.

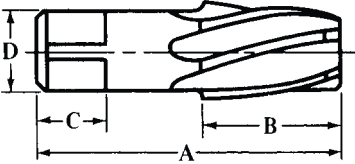
All dimension are given in inches. Material is high-speed steel. The chamfer on the cutting end of the reamer is optional. Squared shank reamers are standard with straight flutes. Tapered shank reamers are standard with straight or spiral flutes. Spiral flute reamers are standard with left-hand spiral flutes.

Tolerances: On overall length A and flute length B, in taper numbers 0 to 3, incl., ±1/16 inch, in taper numbers 4 and 5, ±3/32 inch. On length of square C, in taper numbers 0 to 3, incl., ±1/32 inch; in taper numbers 4 and 5, ±1/16 inch. On shank diameter D, - .0005 to - .002 inch. On size of square, in taper numbers 0 and 1, - .004 inch; in taper numbers 2 and 3, - .006 inch; in taper numbers 4 and 5, - .008 inch.

Center Reamers.—A “center reamer” is a reamer the teeth of which meet in a point. By their use small conical holes may be reamed in the ends of parts to be machined as on lathe centers. When large holes—usually cored—must be center-reamed, a large reamer is ordinarily used in which the teeth do not meet in a point, the reamer forming the frustum of a cone. Center reamers for such work are called “bull” or “pipe” center reamers.

Bull Center Reamer: A conical reamer used for reaming the ends of large holes—usually cored—so that they will fit on a lathe center. The cutting part of the reamer is generally in the shape of a frustum of a cone. It is also known as a pipe center reamer.

Taper Pipe Reamers—Spiral Flutes ANSI B94.2-1983 (R1988)



Nom. Size	Diameter		Length Overall A	Flute Length B	Square Length C	Shank Dia-eter D	Size of Square	No. of Flutes
	Large End	Small End						
1/8	0.362	0.316	2 1/8	3/4	3/8	0.4375	0.328	4 to 6
1/4	0.472	0.406	2 7/16	1 1/16	7/16	0.5625	0.421	4 to 6
3/8	0.606	0.540	2 9/16	1 1/16	1/2	0.7000	0.531	4 to 6
1/2	0.751	0.665	3 3/8	1 3/8	5/8	0.6875	0.515	4 to 6
3/4	0.962	0.876	3 1/4	1 3/8	1 1/16	0.9063	0.679	6 to 10
1	1.212	1.103	3 3/4	1 3/4	1 3/16	1.1250	0.843	6 to 10
1 1/4	1.553	1.444	4	1 3/4	1 5/16	1.3125	0.984	6 to 10
1 1/2	1.793	1.684	4 1/4	1 3/4	1	1.5000	1.125	6 to 10
2	2.268	2.159	4 1/2	1 3/4	1 1/8	1.8750	1.406	8 to 12

All dimensions are given in inches. These reamers are tapered 3/4 inch per foot and are intended for reaming holes to be tapped with American National Standard Taper Pipe Thread taps. Material is high-speed steel. Reamers are standard with left-hand spiral flutes.

Tolerances: On length overall A and flute length B, 1/8- to 3/4-inch size, incl., ±1/16 inch; 1- to 1 1/2-inch size, incl., ±3/32 inch; 2-inch size, ±1/8 inch. On length of square C, 1/8- to 3/4-inch size, incl., ±1/32 inch; 1- to 2-inch size, incl., ±1/16 inch. On shank diameter D, 1/8-inch size, - .0015 inch; 1/4- to 1-inch size, incl., - .002 inch; 1 1/4- to 2-inch size, incl., - .003 inch. On size of square, 1/8-inch size, - .004 inch; 1/4- to 3/4-inch size, incl., - .006 inch; 1- to 2-inch size, incl., - .008 inch.

B & S Taper Reamers—Straight and Spiral Flutes, Squared Shank

Taper No. ^a	Dia., Small End	Dia., Large End	Overall Length	Square Length	Flute Length	Dia. of Shank	Size of Square	No. of Flutes
1	0.1974	0.3176	4 3/4	1/4	2 7/8	9/32	0.210	4 to 6
2	0.2474	0.3781	5 1/8	5/16	3 1/8	1 1/32	0.255	4 to 6
3	0.3099	0.4510	5 1/2	3/8	3 3/8	1 1/32	0.305	4 to 6
4	0.3474	0.5017	5 7/8	7/16	3 11/16	7/16	0.330	4 to 6
5	0.4474	0.6145	6 3/8	1/2	4	9/16	0.420	4 to 6
6	0.4974	0.6808	6 7/8	5/8	4 3/8	5/8	0.470	4 to 6
7	0.5974	0.8011	7 1/2	3/4	4 7/8	3/4	0.560	6 to 8
8	0.7474	0.9770	8 1/8	1 1/16	5 1/2	1 1/16	0.610	6 to 8
9	0.8974	1.1530	8 7/8	7/8	6 1/8	1	0.750	6 to 8
10	1.0420	1.3376	9 3/4	1	6 7/8	1 1/8	0.845	6 to 8


^a For taper per foot, see Table 10 on page 958.

These reamers are no longer ANSI Standard.

All dimensions are given in inches. Material is high-speed steel. The chamfer on the cutting end of the reamer is optional. All reamers are finishing reamers. Spiral flute reamers are standard with left-hand spiral flutes. (Tapered reamers, especially those with left-hand spirals, should not have circular lands because cutting must take place on the outer diameter of the tool.) B & S taper reamers are designed for use in reaming out Brown & Sharpe standard taper sockets.

Tolerances: On length overall A and flute length B, taper nos. 1 to 7, incl., ±1/16 inch; taper nos. 8 to 10, incl., ±3/32 inch. On length of square C, taper nos. 1 to 9, incl., ±1/32 inch; taper no. 10, ±1/16 inch. On shank diameter D, - .0005 to - .002 inch. On size of square, taper nos. 1 to 3, incl., - .004 inch; taper nos. 4 to 9, incl., - .006 inch; taper no. 10, - .008 inch.

American National Standard Die-Maker's Reamers ANSI B94.2-1983 (R1988)



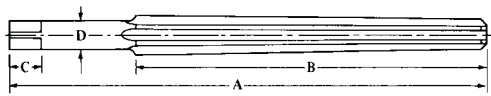
Letter Size	Diameter		Length		Letter Size	Diameter		Length		Letter Size	Diameter		Length	
	Small End	Large End	A	B		Small End	Large End	A	B		Small End	Large End	A	B
AAA	0.055	0.070	2¼	1⅛	G	0.135	0.158	3	1¾	O	0.250	0.296	5	3½
AA	0.065	0.080	2¼	1⅛	H	0.145	0.169	3¼	1⅞	P	0.275	0.327	5½	4
A	0.075	0.090	2¼	1⅛	I	0.160	0.184	3¼	1⅞	Q	0.300	0.358	6	4½
B	0.085	0.103	2⅜	1⅜	J	0.175	0.199	3¼	1⅞	R	0.335	0.397	6½	4¾
C	0.095	0.113	2½	1⅜	K	0.190	0.219	3½	2¼	S	0.370	0.435	6¾	5
D	0.105	0.126	2⅝	1⅝	L	0.205	0.234	3½	2¼	T	0.405	0.473	7	5¼
E	0.115	0.136	2¾	1⅝	M	0.220	0.252	4	2½	U	0.440	0.511	7¼	5½
F	0.125	0.148	3	1¾	N	0.235	0.274	4½	3

All dimensions in inches. Material is high-speed steel. These reamers are designed for use in die-making, have a taper of ¾ degree included angle or 0.013 inch per inch, and have 2 or 3 flutes. Reamers are standard with left-hand spiral flutes.

Tip of reamer may have conical end.

Tolerances: On length overall A and flute length B, ±1/16 inch.

Taper Pin Reamers — Straight and Left-Hand Spiral Flutes, Squared Shank; and Left-Hand High-Spiral Flutes, Round Shank ANSI B94.2-1983 (R1988)



No. of Taper Pin Reamer	Diameter at Large End of Reamer (Ref.)	Diameter at Small End of Reamer (Ref.)	Overall Length of Reamer A	Length of Flute B	Length of Square C ^a	Diameter of Shank D	Size of Square ^a
8/0 ^b	0.0514	0.0351	1⅝	2⅝ ₃₂	...	1/16	...
7/0	0.0666	0.0497	1⅞ ₁₆	1⅞ ₁₆	3/32	5/64	0.060
6/0	0.0806	0.0611	1⅞ ₁₆	1⅞ ₁₆	5/32	3/32	0.070
5/0	0.0966	0.0719	2⅜ ₁₆	1⅜ ₁₆	5/32	7/64	0.080
4/0	0.1142	0.0869	2⅝ ₁₆	1⅝ ₁₆	5/32	1/8	0.095
3/0	0.1302	0.1029	2⅝ ₁₆	1⅝ ₁₆	5/32	9/64	0.105
2/0	0.1462	0.1137	2⅝ ₁₆	1⅝ ₁₆	7/32	5/32	0.115
0	0.1638	0.1287	2⅞ ₁₆	1⅞ ₁₆	7/32	11/64	0.130
1	0.1798	0.1447	2⅞ ₁₆	1⅞ ₁₆	7/32	3/16	0.140
2	0.2008	0.1605	3⅜ ₁₆	1⅞ ₁₆	1/4	13/64	0.150
3	0.2294	0.1813	3⅞ ₁₆	2⅝ ₁₆	1/4	15/64	0.175
4	0.2604	0.2071	4⅞ ₁₆	2⅞ ₁₆	1/4	17/64	0.200
5	0.2994	0.2409	4⅞ ₁₆	2⅞ ₁₆	5/16	5/16	0.235
6	0.3540	0.2773	5⅞ ₁₆	3⅞ ₁₆	3/8	23/64	0.270
7	0.4220	0.3297	6⅞ ₁₆	4⅞ ₁₆	3/8	13/32	0.305
8	0.5050	0.3971	7⅞ ₁₆	5⅞ ₁₆	7/16	7/16	0.330
9	0.6066	0.4805	8⅞ ₁₆	6⅞ ₁₆	9/16	9/16	0.420
10	0.7216	0.5799	9⅞ ₁₆	6⅞ ₁₆	5/8	5/8	0.470

^a Not applicable to high-spiral flute reamers.

^b Not applicable to straight and left-hand spiral fluted, squared shank reamers.

All dimensions in inches. Reamers have a taper of ¼ inch per foot and are made of high-speed steel. Straight flute reamers of carbon steel are also standard. The number of flutes is as follows; 3 or 4, for 7/0 to 4/0 sizes; 4 to 6, for 3/0 to 0 sizes; 5 or 6, for 1 to 5 sizes; 6 to 8, for 6 to 9 sizes; 7 or 8, for the 10 size in the case of straight- and spiral-flute reamers; and 2 or 3, for 8/0 to 8 sizes; 2 to 4, for the 9 and 10 sizes in the case of high-spiral flute reamers.

Tolerances: On length overall A and flute length B, ±1/16 inch. On length of square C, ±1/32 inch. On shank diameter D, -.001 to -.005 inch for straight- and spiral-flute reamers and -.0005 to -.002 inch for high-spiral flute reamers. On size of square, -.004 inch for 7/0 to 7 sizes and -.006 inch for 8 to 10 sizes.

TWIST DRILLS AND COUNTERBORES

Twist drills are rotary end-cutting tools having one or more cutting lips and one or more straight or helical flutes for the passage of chips and cutting fluids. Twist drills are made with straight or tapered shanks, but most have straight shanks. All but the smaller sizes are ground with "back taper," reducing the diameter from the point toward the shank, to prevent binding in the hole when the drill is worn.

Straight Shank Drills: Straight shank drills have cylindrical shanks which may be of the same or of a different diameter than the body diameter of the drill and may be made with or without driving flats, tang, or grooves.

Taper Shank Drills: Taper shank drills are preferable to the straight shank type for drilling medium and large size holes. The taper on the shank conforms to one of the tapers in the American Standard (Morse) Series.

American National Standard.—American National Standard B94.11M-1993 covers nomenclature, definitions, sizes and tolerances for High Speed Steel Straight and Taper Shank Drills and Combined Drills and Countersinks, Plain and Bell types. It covers both inch and metric sizes. Dimensional tables from the Standard will be found on the following pages.

Definitions of Twist Drill Terms.—The following definitions are included in the Standard.

Axis: The imaginary straight line which forms the longitudinal center of the drill.

Back Taper: A slight decrease in diameter from point to back in the body of the drill.

Body: The portion of the drill extending from the shank or neck to the outer corners of the cutting lips.

Body Diameter Clearance: That portion of the land that has been cut away so it will not rub against the wall of the hole.

Chisel Edge: The edge at the ends of the web that connects the cutting lips.

Chisel Edge Angle: The angle included between the chisel edge and the cutting lip as viewed from the end of the drill.

Clearance Diameter: The diameter over the cutaway portion of the drill lands.

Drill Diameter: The diameter over the margins of the drill measured at the point.

Flutes: Helical or straight grooves cut or formed in the body of the drill to provide cutting lips, to permit removal of chips, and to allow cutting fluid to reach the cutting lips.

Helix Angle: The angle made by the leading edge of the land with a plane containing the axis of the drill.

Land: The peripheral portion of the drill body between adjacent flutes.

Land Width: The distance between the leading edge and the heel of the land measured at a right angle to the leading edge.

Lips—Two Flute Drill: The cutting edges extending from the chisel edge to the periphery.

Lips—Three or Four Flute Drill (Core Drill): The cutting edges extending from the bottom of the chamfer to the periphery.

Lip Relief: The axial relief on the drill point.

Lip Relief Angle: The axial relief angle at the outer corner of the lip. It is measured by projection into a plane tangent to the periphery at the outer corner of the lip. (Lip relief angle is usually measured across the margin of the twist drill.)

Margin: The cylindrical portion of the land which is not cut away to provide clearance.

Neck: The section of reduced diameter between the body and the shank of a drill.

Overall Length: The length from the extreme end of the shank to the outer corners of the cutting lips. It does not include the conical shank end often used on straight shank drills, nor does it include the conical cutting point used on both straight and taper shank drills. (For core drills with an external center on the cutting end it is the same as for two-flute

drills. For core drills with an internal center on the cutting end, the overall length is to the extreme ends of the tool.)

Point: The cutting end of a drill made up of the ends of the lands, the web, and the lips. In form, it resembles a cone, but departs from a true cone to furnish clearance behind the cutting lips.

Point Angle: The angle included between the lips projected upon a plane parallel to the drill axis and parallel to the cutting lips.

Shank: The part of the drill by which it is held and driven.

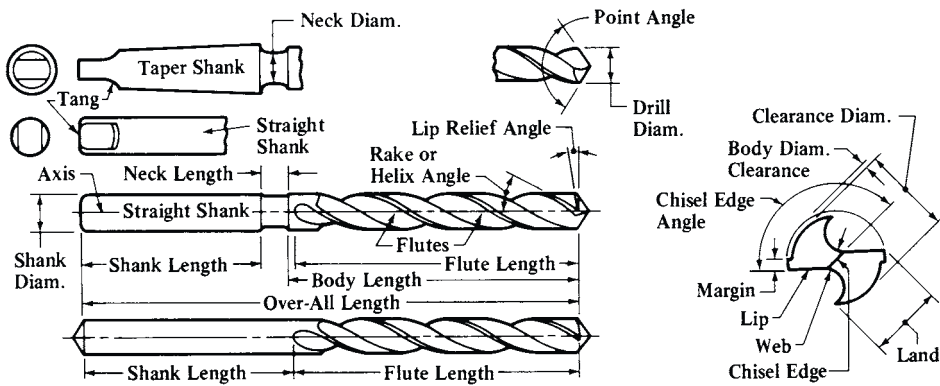
Tang: The flattened end of a taper shank, intended to fit into a driving slot in the socket.

Tang Drive: Two opposite parallel driving flats on the end of a straight shank.

Web: The central portion of the body that joins the end of the lands. The end of the web forms the chisel edge on a two-flute drill.

Web Thickness: The thickness of the web at the point unless another specific location is indicated.

Web Thinning: The operation of reducing the web thickness at the point to reduce drilling thrust.



ANSI Standard Twist Drill Nomenclature

Types of Drills.—Drills may be classified based on the type of shank, number of flutes or hand of cut.

Straight Shank Drills: Those having cylindrical shanks which may be the same or different diameter than the body of the drill. The shank may be with or without driving flats, tang, grooves, or threads.

Taper Shank Drills: Those having conical shanks suitable for direct fitting into tapered holes in machine spindles, driving sleeves, or sockets. Tapered shanks generally have a driving tang.

Two-Flute Drills: The conventional type of drill used for originating holes.

Three-Flute Drills (Core Drills): Drill commonly used for enlarging and finishing drilled, cast or punched holes. They will not produce original holes.

Four-Flute Drills (Core Drills): Used interchangeably with three-flute drills. They are of similar construction except for the number of flutes.

Right-Hand Cut: When viewed from the cutting point, the counterclockwise rotation of a drill in order to cut.

Left-Hand Cut: When viewed from the cutting point, the clockwise rotation of a drill in order to cut.

Teat Drill: The cutting edges of a teat drill are at right angles to the axis, and in the center there is a small teat of pyramid shape which leads the drill and holds it in position. This form is used for squaring the bottoms of holes made by ordinary twist drills or for drilling the entire hole, especially if it is not very deep and a square bottom is required. For instance, when drilling holes to form clearance spaces at the end of a keyseat, preparatory to cutting it out by planing or chipping, the teat drill is commonly used.

Table 1. (Continued) ANSI Straight Shank Twist Drills — Jobbers Length through 17.5 mm, Taper Length through 12.7 mm, and Screw Machine Length through 25.4 mm Diameter ANSI/ASME B94.11M-1993

Drill Diameter, D ^a				Jobbers Length				Taper Length				Screw Machine Length			
Frac- tion No. or Ltr.	mm	Equivalent		Flute		Overall		Flute		Overall		Flute		Overall	
		Decimal In.	mm	F		L		F		L		F		L	
				Inch	mm	Inch	mm	Inch	mm	Inch	mm	Inch	mm	Inch	mm
73		0.0240	0.610	5/16	8	1 1/8	29
72		0.0250	0.635	5/16	8	1 1/8	29
	0.65	0.0256	0.650	3/8	10	1 1/4	32
71		0.0260	0.660	3/8	10	1 1/4	32
	0.70	0.0276	0.700	3/8	10	1 1/4	32
70		0.0280	0.711	3/8	10	1 1/4	32
69		0.0292	0.742	1/2	13	1 3/8	35
	0.75	0.0295	0.750	1/2	13	1 3/8	35
68		0.0310	0.787	1/2	13	1 3/8	35
1/32		0.0312	0.792	1/2	13	1 3/8	35
	0.80	0.0315	0.800	1/2	13	1 3/8	35
67		0.0320	0.813	1/2	13	1 3/8	35
66		0.0330	0.838	1/2	13	1 3/8	35
	0.85	0.0335	0.850	5/8	16	1 1/2	38
65		0.0350	0.889	5/8	16	1 1/2	38
	0.90	0.0354	0.899	5/8	16	1 1/2	38
64		0.0360	0.914	5/8	16	1 1/2	38
63		0.0370	0.940	5/8	16	1 1/2	38
	0.95	0.0374	0.950	5/8	16	1 1/2	38
62		0.0380	0.965	5/8	16	1 1/2	38
61		0.0390	0.991	11/16	17	1 5/8	41
	1.00	0.0394	1.000	11/16	17	1 5/8	41	1 1/8	29	2 1/4	57	1/2	13	1 3/8	35
60		0.0400	1.016	11/16	17	1 5/8	41	1 1/8	29	2 1/4	57	1/2	13	1 3/8	35
59		0.0410	1.041	11/16	17	1 5/8	41	1 1/8	29	2 1/4	57	1/2	13	1 3/8	35
	1.05	0.0413	1.050	11/16	17	1 5/8	41	1 1/8	29	2 1/4	57	1/2	13	1 3/8	35
58		0.0420	1.067	11/16	17	1 5/8	41	1 1/8	29	2 1/4	57	1/2	13	1 3/8	35
57		0.0430	1.092	3/4	19	1 3/4	44	1 1/8	29	2 1/4	57	1/2	13	1 3/8	35
	1.10	0.0433	1.100	3/4	19	1 3/4	44	1 1/8	29	2 1/4	57	1/2	13	1 3/8	35
	1.15	0.0453	1.150	3/4	19	1 3/4	44	1 1/8	29	2 1/4	57	1/2	13	1 3/8	35
56		0.0465	1.181	3/4	19	1 3/4	44	1 1/8	29	2 1/4	57	1/2	13	1 3/8	35
3/64		0.0469	1.191	3/4	19	1 3/4	44	1 1/8	29	2 1/4	57	1/2	13	1 3/8	35
	1.20	0.0472	1.200	7/8	22	1 7/8	48	1 3/4	44	3	76	5/8	16	1 5/8	41
	1.25	0.0492	1.250	7/8	22	1 7/8	48	1 3/4	44	3	76	5/8	16	1 5/8	41
	1.30	0.0512	1.300	7/8	22	1 7/8	48	1 3/4	44	3	76	5/8	16	1 5/8	41
55		0.0520	1.321	7/8	22	1 7/8	48	1 3/4	44	3	76	5/8	16	1 5/8	41
	1.35	0.0531	1.350	7/8	22	1 7/8	48	1 3/4	44	3	76	5/8	16	1 5/8	41
54		0.0550	1.397	7/8	22	1 7/8	48	1 3/4	44	3	76	5/8	16	1 5/8	41
	1.40	0.0551	1.400	7/8	22	1 7/8	48	1 3/4	44	3	76	5/8	16	1 5/8	41
	1.45	0.0571	1.450	7/8	22	1 7/8	48	1 3/4	44	3	76	5/8	16	1 5/8	41
	1.50	0.0591	1.500	7/8	22	1 7/8	48	1 3/4	44	3	76	5/8	16	1 5/8	41
53		0.0595	1.511	7/8	22	1 7/8	48	1 3/4	44	3	76	5/8	16	1 5/8	41
	1.55	0.0610	1.550	7/8	22	1 7/8	48	1 3/4	44	3	76	5/8	16	1 5/8	41
1/16		0.0625	1.588	7/8	22	1 7/8	48	1 3/4	44	3	76	5/8	16	1 5/8	41
	1.60	0.0630	1.600	7/8	22	1 7/8	48	2	51	3 3/4	95	1 1/16	17	1 1 1/16	43
52		0.0635	1.613	7/8	22	1 7/8	48	2	51	3 3/4	95	1 1/16	17	1 1 1/16	43
	1.65	0.0650	1.650	1	25	2	51	2	51	3 3/4	95	1 1/16	17	1 1 1/16	43

Table 1. (Continued) ANSI Straight Shank Twist Drills — Jobbers Length through 17.5 mm, Taper Length through 12.7 mm, and Screw Machine Length through 25.4 mm Diameter ANSI/ASME B94.11M-1993

Drill Diameter, D ^a				Jobbers Length				Taper Length				Screw Machine Length			
Frac- tion No. or Ltr.	mm	Equivalent		Flute		Overall		Flute		Overall		Flute		Overall	
		Decimal In.	mm	F		L		F		L		F		L	
				Inch	mm	Inch	mm	Inch	mm	Inch	mm	Inch	mm	Inch	mm
51	1.70	0.0669	1.700	1	25	2	51	2	51	3 ³ / ₄	95	1 ¹ / ₁₆	17	1 ¹ / ₁₆	43
		0.0670	1.702	1	25	2	51	2	51	3 ³ / ₄	95	1 ¹ / ₁₆	17	1 ¹ / ₁₆	43
50	1.75	0.0689	1.750	1	25	2	51	2	51	3 ³ / ₄	95	1 ¹ / ₁₆	17	1 ¹ / ₁₆	43
		0.0700	1.778	1	25	2	51	2	51	3 ³ / ₄	95	1 ¹ / ₁₆	17	1 ¹ / ₁₆	43
49	1.80	0.0709	1.800	1	25	2	51	2	51	3 ³ / ₄	95	1 ¹ / ₁₆	17	1 ¹ / ₁₆	43
		0.0728	1.850	1	25	2	51	2	51	3 ³ / ₄	95	1 ¹ / ₁₆	17	1 ¹ / ₁₆	43
48	1.90	0.0730	1.854	1	25	2	51	2	51	3 ³ / ₄	95	1 ¹ / ₁₆	17	1 ¹ / ₁₆	43
		0.0748	1.900	1	25	2	51	2	51	3 ³ / ₄	95	1 ¹ / ₁₆	17	1 ¹ / ₁₆	43
47	1.95	0.0760	1.930	1	25	2	51	2	51	3 ³ / ₄	95	1 ¹ / ₁₆	17	1 ¹ / ₁₆	43
		0.0768	1.950	1	25	2	51	2	51	3 ³ / ₄	95	1 ¹ / ₁₆	17	1 ¹ / ₁₆	43
46	2.00	0.0781	1.984	1	25	2	51	2	51	3 ³ / ₄	95	1 ¹ / ₁₆	17	1 ¹ / ₁₆	43
		0.0785	1.994	1	25	2	51	2 ¹ / ₄	57	4 ¹ / ₄	108	1 ¹ / ₁₆	17	1 ¹ / ₁₆	43
45	2.05	0.0787	2.000	1	25	2	51	2 ¹ / ₄	57	4 ¹ / ₄	108	1 ¹ / ₁₆	17	1 ¹ / ₁₆	43
		0.0807	2.050	1 ¹ / ₈	29	2 ¹ / ₈	54	2 ¹ / ₄	57	4 ¹ / ₄	108	3 ³ / ₄	19	1 ³ / ₄	44
44	2.10	0.0810	2.057	1 ¹ / ₈	29	2 ¹ / ₈	54	2 ¹ / ₄	57	4 ¹ / ₄	108	3 ³ / ₄	19	1 ³ / ₄	44
		0.0820	2.083	1 ¹ / ₈	29	2 ¹ / ₈	54	2 ¹ / ₄	57	4 ¹ / ₄	108	3 ³ / ₄	19	1 ³ / ₄	44
43	2.15	0.0827	2.100	1 ¹ / ₈	29	2 ¹ / ₈	54	2 ¹ / ₄	57	4 ¹ / ₄	108	3 ³ / ₄	19	1 ³ / ₄	44
		0.0846	2.150	1 ¹ / ₈	29	2 ¹ / ₈	54	2 ¹ / ₄	57	4 ¹ / ₄	108	3 ³ / ₄	19	1 ³ / ₄	44
42	2.20	0.0860	2.184	1 ¹ / ₈	29	2 ¹ / ₈	54	2 ¹ / ₄	57	4 ¹ / ₄	108	3 ³ / ₄	19	1 ³ / ₄	44
		0.0866	2.200	1 ¹ / ₄	32	2 ¹ / ₄	57	2 ¹ / ₄	57	4 ¹ / ₄	108	3 ³ / ₄	19	1 ³ / ₄	44
41	2.25	0.0886	2.250	1 ¹ / ₄	32	2 ¹ / ₄	57	2 ¹ / ₄	57	4 ¹ / ₄	108	3 ³ / ₄	19	1 ³ / ₄	44
		0.0890	2.261	1 ¹ / ₄	32	2 ¹ / ₄	57	2 ¹ / ₄	57	4 ¹ / ₄	108	3 ³ / ₄	19	1 ³ / ₄	44
40	2.30	0.0906	2.300	1 ¹ / ₄	32	2 ¹ / ₄	57	2 ¹ / ₄	57	4 ¹ / ₄	108	3 ³ / ₄	19	1 ³ / ₄	44
		0.0925	2.350	1 ¹ / ₄	32	2 ¹ / ₄	57	2 ¹ / ₄	57	4 ¹ / ₄	108	3 ³ / ₄	19	1 ³ / ₄	44
39	2.35	0.0935	2.375	1 ¹ / ₄	32	2 ¹ / ₄	57	2 ¹ / ₄	57	4 ¹ / ₄	108	3 ³ / ₄	19	1 ³ / ₄	44
		0.0938	2.383	1 ¹ / ₄	32	2 ¹ / ₄	57	2 ¹ / ₄	57	4 ¹ / ₄	108	3 ³ / ₄	19	1 ³ / ₄	44
38	2.40	0.0945	2.400	1 ³ / ₈	35	2 ³ / ₈	60	2 ¹ / ₂	64	4 ⁵ / ₈	117	1 ¹³ / ₁₆	21	1 ¹³ / ₁₆	46
		0.0960	2.438	1 ³ / ₈	35	2 ³ / ₈	60	2 ¹ / ₂	64	4 ⁵ / ₈	117	1 ¹³ / ₁₆	21	1 ¹³ / ₁₆	46
37	2.46	0.0965	2.450	1 ³ / ₈	35	2 ³ / ₈	60	2 ¹ / ₂	64	4 ⁵ / ₈	117	1 ¹³ / ₁₆	21	1 ¹³ / ₁₆	46
		0.0980	2.489	1 ³ / ₈	35	2 ³ / ₈	60	2 ¹ / ₂	64	4 ⁵ / ₈	117	1 ¹³ / ₁₆	21	1 ¹³ / ₁₆	46
36	2.50	0.0984	2.500	1 ³ / ₈	35	2 ³ / ₈	60	2 ¹ / ₂	64	4 ⁵ / ₈	117	1 ¹³ / ₁₆	21	1 ¹³ / ₁₆	46
		0.0995	2.527	1 ³ / ₈	35	2 ³ / ₈	60	2 ¹ / ₂	64	4 ⁵ / ₈	117	1 ¹³ / ₁₆	21	1 ¹³ / ₁₆	46
35	2.60	0.1015	2.578	1 ⁷ / ₁₆	37	2 ¹ / ₂	64	2 ¹ / ₂	64	4 ⁵ / ₈	117	1 ¹³ / ₁₆	21	1 ¹³ / ₁₆	46
		0.1024	2.600	1 ⁷ / ₁₆	37	2 ¹ / ₂	64	2 ¹ / ₂	64	4 ⁵ / ₈	117	1 ¹³ / ₁₆	21	1 ¹³ / ₁₆	46
34	2.70	0.1040	2.642	1 ⁷ / ₁₆	37	2 ¹ / ₂	64	2 ¹ / ₂	64	4 ⁵ / ₈	117	1 ¹³ / ₁₆	21	1 ¹³ / ₁₆	46
		0.1063	2.700	1 ⁷ / ₁₆	37	2 ¹ / ₂	64	2 ¹ / ₂	64	4 ⁵ / ₈	117	1 ¹³ / ₁₆	21	1 ¹³ / ₁₆	46
33	2.80	0.1065	2.705	1 ⁷ / ₁₆	37	2 ¹ / ₂	64	2 ¹ / ₂	64	4 ⁵ / ₈	117	1 ¹³ / ₁₆	21	1 ¹³ / ₁₆	46
		0.1094	2.779	1 ¹ / ₂	38	2 ⁵ / ₈	67	2 ¹ / ₂	64	4 ⁵ / ₈	117	1 ¹³ / ₁₆	21	1 ¹³ / ₁₆	46
32	2.90	0.1100	2.794	1 ¹ / ₂	38	2 ⁵ / ₈	67	2 ³ / ₄	70	5 ¹ / ₈	130	7 ⁷ / ₈	22	1 ⁷ / ₈	48
		0.1102	2.800	1 ¹ / ₂	38	2 ⁵ / ₈	67	2 ³ / ₄	70	5 ¹ / ₈	130	7 ⁷ / ₈	22	1 ⁷ / ₈	48
31	3.00	0.1110	2.819	1 ¹ / ₂	38	2 ⁵ / ₈	67	2 ³ / ₄	70	5 ¹ / ₈	130	7 ⁷ / ₈	22	1 ⁷ / ₈	48
		0.1130	2.870	1 ¹ / ₂	38	2 ⁵ / ₈	67	2 ³ / ₄	70	5 ¹ / ₈	130	7 ⁷ / ₈	22	1 ⁷ / ₈	48
30	3.00	0.1142	2.900	1 ⁵ / ₈	41	2 ³ / ₄	70	2 ³ / ₄	70	5 ¹ / ₈	130	7 ⁷ / ₈	22	1 ⁷ / ₈	48
		0.1160	2.946	1 ⁵ / ₈	41	2 ³ / ₄	70	2 ³ / ₄	70	5 ¹ / ₈	130	7 ⁷ / ₈	22	1 ⁷ / ₈	48
29	3.00	0.1181	3.000	1 ⁵ / ₈	41	2 ³ / ₄	70	2 ³ / ₄	70	5 ¹ / ₈	130	7 ⁷ / ₈	22	1 ⁷ / ₈	48
		0.1200	3.048	1 ⁵ / ₈	41	2 ³ / ₄	70	2 ³ / ₄	70	5 ¹ / ₈	130	7 ⁷ / ₈	22	1 ⁷ / ₈	48

Table 1. (Continued) ANSI Straight Shank Twist Drills — Jobbers Length through 17.5 mm, Taper Length through 12.7 mm, and Screw Machine Length through 25.4 mm Diameter ANSI/ASME B94.11M-1993

Drill Diameter, D ^a		Jobbers Length						Taper Length				Screw Machine Length			
Frac- tion No. or Ltr.	mm	Equivalent		Flute		Overall		Flute		Overall		Flute		Overall	
		Decimal In.	mm	F		L		F		L		F		L	
				Inch	mm	Inch	mm	Inch	mm	Inch	mm	Inch	mm	Inch	mm
7	5.10	0.2008	5.100	2 ⁷ / ₁₆	62	3 ⁵ / ₈	92	3 ⁵ / ₈	92	6	152	1 ³ / ₁₆	30	2 ¹ / ₄	57
		0.2010	5.105	2 ⁷ / ₁₆	62	3 ⁵ / ₈	92	3 ⁵ / ₈	92	6	152	1 ³ / ₁₆	30	2 ¹ / ₄	57
		0.2031	5.159	2 ⁷ / ₁₆	62	3 ⁵ / ₈	92	3 ⁵ / ₈	92	6	152	1 ³ / ₁₆	30	2 ¹ / ₄	57
1 ³ / ₆₄	5.10	0.2031	5.159	2 ⁷ / ₁₆	62	3 ⁵ / ₈	92	3 ⁵ / ₈	92	6	152	1 ³ / ₁₆	30	2 ¹ / ₄	57
		0.2040	5.182	2 ¹ / ₂	64	3 ³ / ₄	95	3 ⁵ / ₈	92	6	152	1 ¹ / ₄	32	2 ³ / ₈	60
6	5.20	0.2047	5.200	2 ¹ / ₂	64	3 ³ / ₄	95	3 ⁵ / ₈	92	6	152	1 ¹ / ₄	32	2 ³ / ₈	60
5		0.2055	5.220	2 ¹ / ₂	64	3 ³ / ₄	95	3 ⁵ / ₈	92	6	152	1 ¹ / ₄	32	2 ³ / ₈	60
4	5.30	0.2087	5.300	2 ¹ / ₂	64	3 ³ / ₄	95	3 ⁵ / ₈	92	6	152	1 ¹ / ₄	32	2 ³ / ₈	60
	0.2090	5.309	2 ¹ / ₂	64	3 ³ / ₄	95	3 ⁵ / ₈	92	6	152	1 ¹ / ₄	32	2 ³ / ₈	60	
3	5.40	0.2126	5.400	2 ¹ / ₂	64	3 ³ / ₄	95	3 ⁵ / ₈	92	6	152	1 ¹ / ₄	32	2 ³ / ₈	60
	0.2130	5.410	2 ¹ / ₂	64	3 ³ / ₄	95	3 ⁵ / ₈	92	6	152	1 ¹ / ₄	32	2 ³ / ₈	60	
7 ¹ / ₃₂	5.50	0.2165	5.500	2 ¹ / ₂	64	3 ³ / ₄	95	3 ⁵ / ₈	92	6	152	1 ¹ / ₄	32	2 ³ / ₈	60
		0.2188	5.558	2 ¹ / ₂	64	3 ³ / ₄	95	3 ⁵ / ₈	92	6	152	1 ¹ / ₄	32	2 ³ / ₈	60
2	5.60	0.2205	5.600	2 ⁵ / ₈	67	3 ⁷ / ₈	98	3 ³ / ₄	95	6 ¹ / ₈	156	1 ⁵ / ₁₆	33	2 ⁷ / ₁₆	62
		0.2210	5.613	2 ⁵ / ₈	67	3 ⁷ / ₈	98	3 ³ / ₄	95	6 ¹ / ₈	156	1 ⁵ / ₁₆	33	2 ⁷ / ₁₆	62
1	5.70	0.2244	5.700	2 ⁵ / ₈	67	3 ⁷ / ₈	98	3 ³ / ₄	95	6 ¹ / ₈	156	1 ⁵ / ₁₆	33	2 ⁷ / ₁₆	62
		0.2280	5.791	2 ⁵ / ₈	67	3 ⁷ / ₈	98	3 ³ / ₄	95	6 ¹ / ₈	156	1 ⁵ / ₁₆	33	2 ⁷ / ₁₆	62
A	5.80	0.2283	5.800	2 ⁵ / ₈	67	3 ⁷ / ₈	98	3 ³ / ₄	95	6 ¹ / ₈	156	1 ⁵ / ₁₆	33	2 ⁷ / ₁₆	62
		0.2323	5.900	2 ⁵ / ₈	67	3 ⁷ / ₈	98	3 ³ / ₄	95	6 ¹ / ₈	156	1 ⁵ / ₁₆	33	2 ⁷ / ₁₆	62
1 ⁵ / ₆₄	5.90	0.2340	5.944	2 ⁵ / ₈	67	3 ⁷ / ₈	98	1 ⁵ / ₁₆	33	2 ⁷ / ₁₆	62
		0.2344	5.954	2 ⁵ / ₈	67	3 ⁷ / ₈	98	3 ³ / ₄	95	6 ¹ / ₈	156	1 ⁵ / ₁₆	33	2 ⁷ / ₁₆	62
B	6.00	0.2362	6.000	2 ³ / ₄	70	4	102	3 ³ / ₄	95	6 ¹ / ₈	156	1 ³ / ₈	35	2 ¹ / ₂	64
		0.2380	6.045	2 ³ / ₄	70	4	102	1 ³ / ₈	35	2 ¹ / ₂	64
C	6.10	0.2402	6.100	2 ³ / ₄	70	4	102	3 ³ / ₄	95	6 ¹ / ₈	156	1 ³ / ₈	35	2 ¹ / ₂	64
		0.2420	6.147	2 ³ / ₄	70	4	102	1 ³ / ₈	35	2 ¹ / ₂	64
D	6.20	0.2441	6.200	2 ³ / ₄	70	4	102	3 ³ / ₄	95	6 ¹ / ₈	156	1 ³ / ₈	35	2 ¹ / ₂	64
		0.2460	6.248	2 ³ / ₄	70	4	102	1 ³ / ₈	35	2 ¹ / ₂	64
E, 1 ¹ / ₄	6.30	0.2480	6.300	2 ³ / ₄	70	4	102	3 ³ / ₄	95	6 ¹ / ₈	156	1 ³ / ₈	35	2 ¹ / ₂	64
		0.2500	6.350	2 ³ / ₄	70	4	102	3 ³ / ₄	95	6 ¹ / ₈	156	1 ³ / ₈	35	2 ¹ / ₂	64
F	6.40	0.2520	6.400	2 ⁷ / ₈	73	4 ¹ / ₈	105	3 ⁷ / ₈	98	6 ¹ / ₄	159	1 ⁷ / ₁₆	37	2 ⁵ / ₈	67
		0.2559	6.500	2 ⁷ / ₈	73	4 ¹ / ₈	105	3 ⁷ / ₈	98	6 ¹ / ₄	159	1 ⁷ / ₁₆	37	2 ⁵ / ₈	67
G	6.50	0.2570	6.528	2 ⁷ / ₈	73	4 ¹ / ₈	105	1 ⁷ / ₁₆	37	2 ⁵ / ₈	67
		0.2598	6.600	2 ⁷ / ₈	73	4 ¹ / ₈	105	1 ⁷ / ₁₆	37	2 ⁵ / ₈	67
H	6.60	0.2610	6.629	2 ⁷ / ₈	73	4 ¹ / ₈	105	1 ⁷ / ₁₆	37	2 ⁵ / ₈	67
		0.2638	6.700	2 ⁷ / ₈	73	4 ¹ / ₈	105	1 ⁷ / ₁₆	37	2 ⁵ / ₈	67
1 ¹ / ₆₄	6.70	0.2656	6.746	2 ⁷ / ₈	73	4 ¹ / ₈	105	3 ⁷ / ₈	98	6 ¹ / ₄	159	1 ⁷ / ₁₆	37	2 ⁵ / ₈	67
		0.2660	6.756	2 ⁷ / ₈	73	4 ¹ / ₈	105	1 ¹ / ₂	38	2 ¹ / ₁₆	68
I	6.80	0.2677	6.800	2 ⁷ / ₈	73	4 ¹ / ₈	105	3 ⁷ / ₈	98	6 ¹ / ₄	159	1 ¹ / ₂	38	2 ¹ / ₁₆	68
		0.2717	6.900	2 ⁷ / ₈	73	4 ¹ / ₈	105	1 ¹ / ₂	38	2 ¹ / ₁₆	68
J	6.90	0.2720	6.909	2 ⁷ / ₈	73	4 ¹ / ₈	105	1 ¹ / ₂	38	2 ¹ / ₁₆	68
		0.2756	7.000	2 ⁷ / ₈	73	4 ¹ / ₈	105	3 ⁷ / ₈	98	6 ¹ / ₄	159	1 ¹ / ₂	38	2 ¹ / ₁₆	68
K	7.00	0.2770	7.036	2 ⁵ / ₈	73	4 ¹ / ₈	105	1 ¹ / ₂	38	2 ¹ / ₁₆	68
		0.2795	7.100	2 ⁵ / ₁₆	75	4 ¹ / ₄	108	1 ¹ / ₂	38	2 ¹ / ₁₆	68
3 ¹ / ₃₂	7.10	0.2810	7.137	2 ⁵ / ₁₆	75	4 ¹ / ₄	108	1 ¹ / ₂	38	2 ¹ / ₁₆	68
		0.2812	7.142	2 ⁵ / ₁₆	75	4 ¹ / ₄	108	3 ⁷ / ₈	98	6 ¹ / ₄	159	1 ¹ / ₂	38	2 ¹ / ₁₆	68
7.20	7.20	0.2835	7.200	2 ⁵ / ₁₆	75	4 ¹ / ₄	108	4	102	6 ³ / ₈	162	1 ¹ / ₁₆	40	2 ³ / ₄	70
		0.2874	7.300	2 ⁵ / ₁₆	75	4 ¹ / ₄	108	1 ¹ / ₁₆	40	2 ³ / ₄	70

Table 1. (Continued) ANSI Straight Shank Twist Drills — Jobbers Length through 17.5 mm, Taper Length through 12.7 mm, and Screw Machine Length through 25.4 mm Diameter ANSI/ASME B94.11M-1993

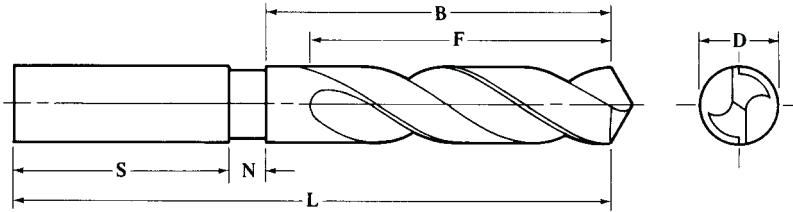
Drill Diameter, D ^a				Jobbers Length				Taper Length				Screw Machine Length			
Frac- tion No. or Ltr.	mm	Equivalent		Flute		Overall		Flute		Overall		Flute		Overall	
		Decimal In.	mm	F		L		F		L		F		L	
				Inch	mm	Inch	mm	Inch	mm	Inch	mm	Inch	mm	Inch	mm
L		0.2900	7.366	2 ¹⁵ / ₁₆	75	4 ¹ / ₄	108	1 ¹ / ₁₆	40	2 ³ / ₄	70
	7.40	0.2913	7.400	3 ¹ / ₁₆	78	4 ³ / ₈	111	1 ¹ / ₁₆	40	2 ³ / ₄	70
M		0.2950	7.493	3 ¹ / ₁₆	78	4 ³ / ₈	111	1 ¹ / ₁₆	40	2 ³ / ₄	70
	7.50	0.2953	7.500	3 ¹ / ₁₆	78	4 ³ / ₈	111	4	102	6 ³ / ₈	162	1 ¹ / ₁₆	40	2 ³ / ₄	70
¹ / ₆₄		0.2969	7.541	3 ¹ / ₁₆	78	4 ³ / ₈	111	4	102	6 ³ / ₈	162	1 ¹ / ₁₆	40	2 ³ / ₄	70
	7.60	0.2992	7.600	3 ¹ / ₁₆	78	4 ³ / ₈	111	1 ¹ / ₈	41	2 ¹³ / ₁₆	71
N		0.3020	7.671	3 ¹ / ₁₆	78	4 ³ / ₈	111	1 ¹ / ₈	41	2 ¹³ / ₁₆	71
	7.70	0.3031	7.700	3 ¹ / ₁₆	81	4 ¹ / ₂	114	1 ¹ / ₈	41	2 ¹³ / ₁₆	71
	7.80	0.3071	7.800	3 ¹ / ₁₆	81	4 ¹ / ₂	114	4	102	6 ³ / ₈	162	1 ¹ / ₈	41	2 ¹³ / ₁₆	71
	7.90	0.3110	7.900	3 ¹ / ₁₆	81	4 ¹ / ₂	114	1 ¹ / ₈	41	2 ¹³ / ₁₆	71
⁵ / ₁₆		0.3125	7.938	3 ¹ / ₁₆	81	4 ¹ / ₂	114	4	102	6 ³ / ₈	162	1 ¹ / ₈	41	2 ¹³ / ₁₆	71
	8.00	0.3150	8.000	3 ¹ / ₁₆	81	4 ¹ / ₂	114	4 ¹ / ₈	105	6 ¹ / ₂	165	1 ¹ / ₁₆	43	2 ¹⁵ / ₁₆	75
O		0.3160	8.026	3 ¹ / ₁₆	81	4 ¹ / ₂	114	1 ¹ / ₁₆	43	2 ¹⁵ / ₁₆	75
	8.10	0.3189	8.100	3 ¹ / ₁₆	84	4 ⁵ / ₈	117	1 ¹ / ₁₆	43	2 ¹⁵ / ₁₆	75
	8.20	0.3228	8.200	3 ¹ / ₁₆	84	4 ⁵ / ₈	117	4 ¹ / ₈	105	6 ¹ / ₂	165	1 ¹ / ₁₆	43	2 ¹⁵ / ₁₆	75
P		0.3230	8.204	3 ¹ / ₁₆	84	4 ⁵ / ₈	117	1 ¹ / ₁₆	43	2 ¹⁵ / ₁₆	75
	8.30	0.3268	8.300	3 ¹ / ₁₆	84	4 ⁵ / ₈	117	1 ¹ / ₁₆	43	2 ¹⁵ / ₁₆	75
² / ₆₄		0.3281	8.334	3 ¹ / ₁₆	84	4 ⁵ / ₈	117	4 ¹ / ₈	105	6 ¹ / ₂	165	1 ¹ / ₁₆	43	2 ¹⁵ / ₁₆	75
	8.40	0.3307	8.400	3 ¹ / ₁₆	87	4 ³ / ₄	121	1 ¹ / ₁₆	43	3	76
Q		0.3320	8.433	3 ¹ / ₁₆	87	4 ³ / ₄	121	1 ¹ / ₁₆	43	3	76
	8.50	0.3346	8.500	3 ¹ / ₁₆	87	4 ³ / ₄	121	4 ¹ / ₈	105	6 ¹ / ₂	165	1 ¹ / ₁₆	43	3	76
	8.60	0.3386	8.600	3 ¹ / ₁₆	87	4 ³ / ₄	121	1 ¹ / ₁₆	43	3	76
R		0.3390	8.611	3 ¹ / ₁₆	87	4 ³ / ₄	121	1 ¹ / ₁₆	43	3	76
	8.70	0.3425	8.700	3 ¹ / ₁₆	87	4 ³ / ₄	121	1 ¹ / ₁₆	43	3	76
¹ / ₃₂		0.3438	8.733	3 ¹ / ₁₆	87	4 ³ / ₄	121	4 ¹ / ₈	105	6 ¹ / ₂	165	1 ¹ / ₁₆	43	3	76
	8.80	0.3465	8.800	3 ¹ / ₂	89	4 ⁷ / ₈	124	4 ¹ / ₄	108	6 ³ / ₄	171	1 ³ / ₄	44	3 ¹ / ₁₆	78
S		0.3480	8.839	3 ¹ / ₂	89	4 ⁷ / ₈	124	1 ³ / ₄	44	3 ¹ / ₁₆	78
	8.90	0.3504	8.900	3 ¹ / ₂	89	4 ⁷ / ₈	124	1 ³ / ₄	44	3 ¹ / ₁₆	78
	9.00	0.3543	9.000	3 ¹ / ₂	89	4 ⁷ / ₈	124	4 ¹ / ₄	108	6 ³ / ₄	171	1 ³ / ₄	44	3 ¹ / ₁₆	78
T		0.3580	9.093	3 ¹ / ₂	89	4 ⁷ / ₈	124	1 ³ / ₄	44	3 ¹ / ₁₆	78
	9.10	0.3583	9.100	3 ¹ / ₂	89	4 ⁷ / ₈	124	1 ³ / ₄	44	3 ¹ / ₁₆	78
² / ₆₄		0.3594	9.129	3 ¹ / ₂	89	4 ⁷ / ₈	124	4 ¹ / ₄	108	6 ³ / ₄	171	1 ³ / ₄	44	3 ¹ / ₁₆	78
	9.20	0.3622	9.200	3 ⁵ / ₈	92	5	127	4 ¹ / ₄	108	6 ³ / ₄	171	1 ¹ / ₁₆	46	3 ¹ / ₈	79
	9.30	0.3661	9.300	3 ⁵ / ₈	92	5	127	1 ¹ / ₁₆	46	3 ¹ / ₈	79
U		0.3680	9.347	3 ⁵ / ₈	92	5	127	1 ¹ / ₁₆	46	3 ¹ / ₈	79
	9.40	0.3701	9.400	3 ⁵ / ₈	92	5	127	1 ¹ / ₁₆	46	3 ¹ / ₈	79
	9.50	0.3740	9.500	3 ⁵ / ₈	92	5	127	4 ¹ / ₄	108	6 ³ / ₄	171	1 ¹ / ₁₆	46	3 ¹ / ₈	79
³ / ₈		0.3750	9.525	3 ⁵ / ₈	92	5	127	4 ¹ / ₄	108	6 ³ / ₄	171	1 ¹ / ₁₆	46	3 ¹ / ₈	79
V		0.3770	9.576	3 ⁵ / ₈	92	5	127	1 ¹ / ₈	48	3 ¹ / ₄	83
	9.60	0.3780	9.600	3 ³ / ₄	95	5 ¹ / ₈	130	1 ¹ / ₈	48	3 ¹ / ₄	83
	9.70	0.3819	9.700	3 ³ / ₄	95	5 ¹ / ₈	130	1 ¹ / ₈	48	3 ¹ / ₄	83
	9.80	0.3858	9.800	3 ³ / ₄	95	5 ¹ / ₈	130	4 ³ / ₈	111	7	178	1 ¹ / ₈	48	3 ¹ / ₄	83
W		0.3860	9.804	3 ³ / ₄	95	5 ¹ / ₈	130	1 ¹ / ₈	48	3 ¹ / ₄	83
	9.90	0.3898	9.900	3 ³ / ₄	95	5 ¹ / ₈	130	1 ¹ / ₈	48	3 ¹ / ₄	83
²⁵ / ₆₄		0.3906	9.921	3 ³ / ₄	95	5 ¹ / ₈	130	4 ³ / ₈	111	7	178	1 ¹ / ₈	48	3 ¹ / ₄	83
	10.00	0.3937	10.000	3 ³ / ₄	95	5 ¹ / ₈	130	4 ³ / ₈	111	7	178	1 ¹ / ₁₆	49	3 ⁵ / ₁₆	84

Table 1. (Continued) ANSI Straight Shank Twist Drills — Jobbers Length through 17.5 mm, Taper Length through 12.7 mm, and Screw Machine Length through 25.4 mm Diameter ANSI/ASME B94.11M-1993

Drill Diameter, D ^a				Jobbers Length				Taper Length				Screw Machine Length			
Frac- tion No. or Ltr.	mm	Equivalent		Flute		Overall		Flute		Overall		Flute		Overall	
		Decimal In.	mm	F		L		F		L		F		L	
				Inch	mm	Inch	mm	Inch	mm	Inch	mm	Inch	mm	Inch	mm
3/16	16.75	0.6594	16.750	5/8	143	7/8	194	2 7/8	73	4 1/2	114
	17.00	0.6693	17.000	5/8	143	7/8	194	2 7/8	73	4 1/2	114
	17.25	0.6719	17.066	5/8	143	7/8	194	2 7/8	73	4 1/2	114
1/8	17.25	0.6791	17.250	5/8	143	7/8	194	2 7/8	73	4 1/2	114
	17.50	0.6875	17.462	5/8	143	7/8	194	2 7/8	73	4 1/2	114
5/64	17.50	0.6890	17.500	5/8	143	7/8	194	3	76	4 3/4	121
	18.00	0.7031	17.859	3	76	4 3/4	121
3/32	18.00	0.7087	18.000	3	76	4 3/4	121
	18.50	0.7188	18.258	3	76	4 3/4	121
7/64	18.50	0.7283	18.500	3 3/8	79	5	127
	19.00	0.7344	18.654	3 3/8	79	5	127
1/4	19.00	0.7480	19.000	3 3/8	79	5	127
	19.50	0.7500	19.050	3 3/8	79	5	127
9/64	19.50	0.7656	19.446	3 1/4	83	5 1/8	130
	20.00	0.7677	19.500	3 1/4	83	5 1/8	130
11/32	20.00	0.7812	19.845	3 1/4	83	5 1/8	130
	20.50	0.7879	20.000	3 3/8	86	5 1/4	133
3/16	20.50	0.7969	20.241	3 3/8	86	5 1/4	133
	21.00	0.8071	20.500	3 3/8	86	5 1/4	133
5/16	21.00	0.8125	20.638	3 3/8	86	5 1/4	133
	21.50	0.8268	21.000	3 1/2	89	5 3/8	137
3/8	21.50	0.8281	21.034	3 1/2	89	5 3/8	137
	22.00	0.8438	21.433	3 1/2	89	5 3/8	137
7/16	22.00	0.8465	21.500	3 1/2	89	5 3/8	137
	22.50	0.8594	21.829	3 1/2	89	5 3/8	137
1/2	22.50	0.8661	22.000	3 1/2	89	5 3/8	137
	23.00	0.8750	22.225	3 1/2	89	5 3/8	137
5/8	23.00	0.8858	22.500	3 3/8	92	5 5/8	143
	23.50	0.8906	22.621	3 3/8	92	5 5/8	143
3/4	23.50	0.9055	23.000	3 3/8	92	5 5/8	143
	24.00	0.9062	23.017	3 3/8	92	5 5/8	143
1 1/16	24.00	0.9219	23.416	3 3/4	95	5 3/4	146
	24.50	0.9252	23.500	3 3/4	95	5 3/4	146
1 1/8	24.50	0.9375	23.812	3 3/4	95	5 3/4	146
	25.00	0.9449	24.000	3 7/8	98	5 7/8	149
1 1/4	25.00	0.9531	24.209	3 7/8	98	5 7/8	149
	25.50	0.9646	24.500	3 7/8	98	5 7/8	149
1 1/2	25.50	0.9688	24.608	3 7/8	98	5 7/8	149
	26.00	0.9843	25.000	4	102	6	152
1 3/4	26.00	0.9844	25.004	4	102	6	152
	26.50	1.0000	25.400	4	102	6	152

^a Fractional inch, number, letter, and metric sizes.

TWIST DRILLS



Nominal Shank Size is Same as Nominal Drill Size

Table 2. ANSI Straight Shank Twist Drills — Taper Length — Over 1/2 in. (12.7 mm) Dia., Fractional and Metric Sizes ANSI/ASME B94.11M-1993

Diameter of Drill				Flute Length		Overall Length		Length of Body		Minimum Length of Shk.		Maximum Length of Neck	
D		Decimal	Millimeter	F		L		B		S		N	
Frac.	mm	Inch Equiv.	Equiv.	Inch	mm	Inch	mm	Inch	mm	Inch	mm	Inch	mm
3/64	12.80	0.5039	12.800	4 3/4	121	8	203	4 7/8	124	2 5/8	66	1/2	13
	13.00	0.5117	13.000	4 3/4	121	8	203	4 7/8	124	2 5/8	66	1/2	13
		0.5156	13.096	4 3/4	121	8	203	4 7/8	124	2 5/8	66	1/2	13
17/32	13.20	0.5197	13.200	4 3/4	121	8	203	4 7/8	124	2 5/8	66	1/2	13
		0.5312	13.492	4 3/4	121	8	203	4 7/8	124	2 5/8	66	1/2	13
35/64	13.50	0.5315	13.500	4 3/4	121	8	203	4 7/8	124	2 5/8	66	1/2	13
		0.5433	13.800	4 7/8	124	8 1/4	210	5	127	2 3/4	70	1/2	13
		0.5419	13.891	4 7/8	124	8 1/4	210	5	127	2 3/4	70	1/2	13
9/16	14.00	0.5512	14.000	4 7/8	124	8 1/4	210	5	127	2 3/4	70	1/2	13
		0.5610	14.250	4 7/8	124	8 1/4	210	5	127	2 3/4	70	1/2	13
		0.5625	14.288	4 7/8	124	8 1/4	210	5	127	2 3/4	70	1/2	13
3/8	14.50	0.5709	14.500	4 7/8	124	8 3/4	222	5	127	3 1/8	79	5/8	16
		0.5781	14.684	4 7/8	124	8 3/4	222	5	127	3 1/8	79	5/8	16
19/32	14.75	0.5807	14.750	4 7/8	124	8 3/4	222	5	127	3 1/8	79	5/8	16
		0.5906	15.000	4 7/8	124	8 3/4	222	5	127	3 1/8	79	5/8	16
		0.5938	15.083	4 7/8	124	8 3/4	222	5	127	3 1/8	79	5/8	16
39/64	15.25	0.6004	15.250	4 7/8	124	8 3/4	222	5	127	3 1/8	79	5/8	16
		0.6094	15.479	4 7/8	124	8 3/4	222	5	127	3 1/8	79	5/8	16
		0.6102	15.500	4 7/8	124	8 3/4	222	5	127	3 1/8	79	5/8	16
1/2	15.75	0.6201	15.750	4 7/8	124	8 3/4	222	5	127	3 1/8	79	5/8	16
		0.6250	15.875	4 7/8	124	8 3/4	222	5	127	3 1/8	79	5/8	16
		0.6299	16.000	5 1/8	130	9	228	5 1/4	133	3 3/8	79	5/8	16
41/64	16.25	0.6398	16.250	5 1/8	130	9	228	5 1/4	133	3 3/8	79	5/8	16
		0.6406	16.271	5 1/8	130	9	228	5 1/4	133	3 3/8	79	5/8	16
		0.6496	16.500	5 1/8	130	9	228	5 1/4	133	3 3/8	79	5/8	16
21/32	16.50	0.6562	16.667	5 1/8	130	9	228	5 1/4	133	3 3/8	79	5/8	16
		0.6594	16.750	5 3/8	137	9 1/4	235	5 1/2	140	3 3/8	79	5/8	16
		0.6693	17.000	5 3/8	137	9 1/4	235	5 1/2	140	3 3/8	79	5/8	16
43/64	17.00	0.6719	17.066	5 3/8	137	9 1/4	235	5 1/2	140	3 3/8	79	5/8	16
		0.6791	17.250	5 3/8	137	9 1/4	235	5 1/2	140	3 3/8	79	5/8	16
		0.6875	17.462	5 3/8	137	9 1/4	235	5 1/2	140	3 3/8	79	5/8	16
11/16	17.50	0.6890	17.500	5 3/8	143	9 1/2	241	5 3/4	146	3 3/8	79	5/8	16
		0.7031	17.859	5 3/8	143	9 1/2	241	5 3/4	146	3 3/8	79	5/8	16
45/64	18.00	0.7087	18.000	5 3/8	143	9 1/2	241	5 3/4	146	3 3/8	79	5/8	16
		0.7188	18.258	5 3/8	143	9 1/2	241	5 3/4	146	3 3/8	79	5/8	16
		0.7283	18.500	5 7/8	149	9 3/4	247	6	152	3 3/8	79	5/8	16
47/64	18.50	0.7283	18.500	5 7/8	149	9 3/4	247	6	152	3 3/8	79	5/8	16
		0.7344	18.654	5 7/8	149	9 3/4	247	6	152	3 3/8	79	5/8	16
		0.7480	19.000	5 7/8	149	9 3/4	247	6	152	3 3/8	79	5/8	16
3/4	19.00	0.7500	19.050	5 7/8	149	9 3/4	247	6	152	3 3/8	79	5/8	16
		0.7656	19.446	6	152	9 7/8	251	6 1/8	156	3 3/8	79	5/8	16
49/64	19.50	0.7677	19.500	6	152	9 7/8	251	6 1/8	156	3 3/8	79	5/8	16
		0.7812	19.842	6	152	9 7/8	251	6 1/8	156	3 3/8	79	5/8	16

Table 2. (Continued) ANSI Straight Shank Twist Drills — Taper Length — Over 1/2 in. (12.7 mm) Dia., Fractional and Metric Sizes ANSI/ASME B94.11M-1993

Diameter of Drill				Flute Length		Overall Length		Length of Body		Minimum Length of Shk.		Maximum Length of Neck	
D		Decimal Inch Equiv.	Millimeter Equiv.	F		L		B		S		N	
Frac.	mm			Inch	mm	Inch	mm	Inch	mm	Inch	mm	Inch	mm
	20.00	0.7874	20.000	6 1/8	156	10	254	6 1/4	159	3 1/8	79	5/8	16
5/64		0.7969	20.241	6 1/8	156	10	254	6 1/4	159	3 1/8	79	5/8	16
	20.50	0.8071	20.500	6 1/8	156	10	254	6 1/4	159	3 1/8	79	5/8	16
13/16		0.8125	20.638	6 1/8	156	10	254	6 1/4	159	3 1/8	79	5/8	16
	21.00	0.8268	21.000	6 1/8	156	10	254	6 1/4	159	3 1/8	79	5/8	16
53/64		0.8281	21.034	6 1/8	156	10	254	6 1/4	159	3 1/8	79	5/8	16
27/32		0.8438	21.433	6 1/8	156	10	254	6 1/4	159	3 1/8	79	5/8	16
	21.50	0.8465	21.500	6 1/8	156	10	254	6 1/4	159	3 1/8	79	5/8	16
55/64		0.8594	21.829	6 1/8	156	10	254	6 1/4	159	3 1/8	79	5/8	16
7/8		0.8661	22.000	6 1/8	156	10	254	6 1/4	159	3 1/8	79	5/8	16
	22.00	0.8750	22.225	6 1/8	156	10	254	6 1/4	159	3 1/8	79	5/8	16
7/8		0.8750	22.225	6 1/8	156	10	254	6 1/4	159	3 1/8	79	5/8	16
	22.50	0.8858	22.500	6 1/8	156	10	254	6 1/4	159	3 1/8	79	5/8	16
57/64		0.8906	22.621	6 1/8	156	10	254	6 1/4	159	3 1/8	79	5/8	16
	23.00	0.9055	23.000	6 1/8	156	10	254	6 1/4	159	3 1/8	79	5/8	16
29/32		0.9062	23.017	6 1/8	156	10	254	6 1/4	159	3 1/8	79	5/8	16
59/64		0.9219	23.416	6 1/8	156	10 3/4	273	6 1/4	159	3 1/8	98	5/8	16
	23.50	0.9252	23.500	6 1/8	156	10 3/4	273	6 1/4	159	3 1/8	98	5/8	16
15/16		0.9375	23.812	6 1/8	156	10 3/4	273	6 1/4	159	3 1/8	98	5/8	16
	24.00	0.9449	24.000	6 3/8	162	11	279	6 1/2	165	3 7/8	98	5/8	16
61/64		0.9531	24.209	6 3/8	162	11	279	6 1/2	165	3 7/8	98	5/8	16
	24.50	0.9646	24.500	6 3/8	162	11	279	6 1/2	165	3 7/8	98	5/8	16
31/32		0.9688	24.608	6 3/8	162	11	279	6 1/2	165	3 7/8	98	5/8	16
	25.00	0.9843	25.000	6 3/8	162	11	279	6 1/2	165	3 7/8	98	5/8	16
63/64		0.9844	25.004	6 3/8	162	11	279	6 1/2	165	3 7/8	98	5/8	16
1		1.0000	25.400	6 3/8	162	11	279	6 1/2	165	3 7/8	98	5/8	16
	25.50	1.0039	25.500	6 1/2	165	11 1/8	282	6 5/8	168	3 7/8	98	5/8	16
1 1/64		1.0156	25.796	6 1/2	165	11 1/8	282	6 5/8	168	3 7/8	98	5/8	16
	26.00	1.0236	26.000	6 1/2	165	11 1/8	282	6 5/8	168	3 7/8	98	5/8	16
1 1/32		1.0312	26.192	6 1/2	165	11 1/8	282	6 5/8	168	3 7/8	98	5/8	16
	26.50	1.0433	26.560	6 3/8	168	11 1/4	286	6 3/4	172	3 7/8	98	5/8	16
1 3/64		1.0469	26.591	6 3/8	168	11 1/4	286	6 3/4	172	3 7/8	98	5/8	16
1 1/16		1.0625	26.988	6 3/8	168	11 1/4	286	6 3/4	172	3 7/8	98	5/8	16
	27.00	1.0630	27.000	6 3/8	168	11 1/4	286	6 3/4	172	3 7/8	98	5/8	16
1 5/64		1.0781	27.384	6 3/8	175	11 1/2	292	7	178	3 7/8	98	5/8	16
	27.50	1.0827	27.500	6 3/8	175	11 1/2	292	7	178	3 7/8	98	5/8	16
1 3/32		1.0938	27.783	6 3/8	175	11 1/2	292	7	178	3 7/8	98	5/8	16
	28.00	1.1024	28.000	7 1/8	181	11 3/4	298	7 1/4	184	3 7/8	98	5/8	16
1 7/64		1.1094	28.179	7 1/8	181	11 3/4	298	7 1/4	184	3 7/8	98	5/8	16
	28.50	1.1220	28.500	7 1/8	181	11 3/4	298	7 1/4	184	3 7/8	98	5/8	16
1 1/8		1.1250	28.575	7 1/8	181	11 3/4	298	7 1/4	184	3 7/8	98	5/8	16
1 1/64		1.1406	28.971	7 1/4	184	11 7/8	301	7 3/8	187	3 7/8	98	5/8	16
	29.00	1.1417	29.000	7 1/4	184	11 7/8	301	7 3/8	187	3 7/8	98	5/8	16
1 5/32		1.1562	29.367	7 1/4	184	11 7/8	301	7 3/8	187	3 7/8	98	5/8	16
	29.50	1.1614	29.500	7 3/8	187	12	305	7 1/2	191	3 7/8	98	5/8	16
1 11/64		1.1719	29.766	7 3/8	187	12	305	7 1/2	191	3 7/8	98	5/8	16
	30.00	1.1811	30.000	7 3/8	187	12	305	7 1/2	191	3 7/8	98	5/8	16
1 3/16		1.1875	30.162	7 3/8	187	12	305	7 1/2	191	3 7/8	98	5/8	16
	30.50	1.2008	30.500	7 1/2	190	12 1/8	308	7 5/8	194	3 7/8	98	5/8	16
1 13/64		1.2031	30.559	7 1/2	190	12 1/8	308	7 5/8	194	3 7/8	98	5/8	16
1 7/32		1.2188	30.958	7 1/2	190	12 1/8	308	7 5/8	194	3 7/8	98	5/8	16
	31.00	1.2205	31.000	7 3/8	200	12 1/2	317	8	203	3 7/8	98	5/8	16
1 15/64		1.2344	31.354	7 3/8	200	12 1/2	317	8	203	3 7/8	98	5/8	16
	31.50	1.2402	31.500	7 3/8	200	12 1/2	317	8	203	3 7/8	98	5/8	16

Table 2. (Continued) ANSI Straight Shank Twist Drills — Taper Length — Over 1/2 in. (12.7 mm) Dia., Fractional and Metric Sizes ANSI/ASME B94.11M-1993

Diameter of Drill				Flute Length		Overall Length		Length of Body		Minimum Length of Shk.		Maximum Length of Neck	
D		Decimal	Millimeter	F		L		B		S		N	
Frac.	mm	Inch Equiv.	Equiv.	Inch	mm	Inch	mm	Inch	mm	Inch	mm	Inch	mm
1/4		1.2500	31.750	7/8	200	12 1/2	317	8	203	3 7/8	98	5/8	16
	32.00	1.2598	32.000	8 1/2	216	14 1/8	359	8 5/8	219	4 7/8	124	5/8	16
	32.50	1.2795	32.500	8 1/2	216	14 1/8	359	8 5/8	219	4 7/8	124	5/8	16
1/32		1.2812	32.542	8 1/2	216	14 1/8	359	8 5/8	219	4 7/8	124	5/8	16
	33.00	1.2992	33.000	8 3/8	219	14 1/4	362	8 3/4	222	4 7/8	124	5/8	16
1 5/16		1.3125	33.338	8 3/8	219	14 1/4	362	8 3/4	222	4 7/8	124	5/8	16
	33.50	1.3189	33.500	8 3/4	222	14 3/8	365	8 7/8	225	4 7/8	124	5/8	16
	34.00	1.3386	34.000	8 3/4	222	14 3/8	365	8 7/8	225	4 7/8	124	5/8	16
1 11/32		1.3438	34.133	8 3/4	222	14 3/8	365	8 7/8	225	4 7/8	124	5/8	16
	34.50	1.3583	34.500	8 7/8	225	14 1/2	368	9	229	4 7/8	124	5/8	16
1 3/8		1.3750	34.925	8 7/8	225	14 1/2	368	9	229	4 7/8	124	5/8	16
	35.00	1.3780	35.000	9	229	14 5/8	372	9 1/8	232	4 7/8	124	5/8	16
	35.50	1.3976	35.500	9	229	14 5/8	372	9 1/8	232	4 7/8	124	5/8	16
1 13/32		1.4062	35.717	9	229	14 5/8	372	9 1/8	232	4 7/8	124	5/8	16
	36.00	1.4173	36.000	9 1/8	232	14 3/4	375	9 1/4	235	4 7/8	124	5/8	16
	36.50	1.4370	36.500	9 1/8	232	14 3/4	375	9 1/4	235	4 7/8	124	5/8	16
1 7/16		1.4375	36.512	9 1/8	232	14 3/4	375	9 1/4	235	4 7/8	124	5/8	16
	37.00	1.4567	37.000	9 1/4	235	14 7/8	378	9 3/8	238	4 7/8	124	5/8	16
1 15/32		1.4688	37.308	9 1/4	235	14 7/8	378	9 3/8	238	4 7/8	124	5/8	16
	37.50	1.4764	37.500	9 3/8	238	15	381	9 1/2	241	4 7/8	124	5/8	16
	38.00	1.4961	38.000	9 3/8	238	15	381	9 1/2	241	4 7/8	124	5/8	16
1 1/2		1.5000	38.100	9 3/8	238	15	381	9 1/2	241	4 7/8	124	5/8	16
1 9/16		1.5625	39.688	9 5/8	244	15 1/4	387	9 3/4	247	4 7/8	124	5/8	16
1 3/8		1.6250	41.275	9 7/8	251	15 5/8	397	10	254	4 7/8	124	3/4	19
1 3/4		1.7500	44.450	10 1/2	267	16 1/4	413	10 5/8	270	4 7/8	124	3/4	19

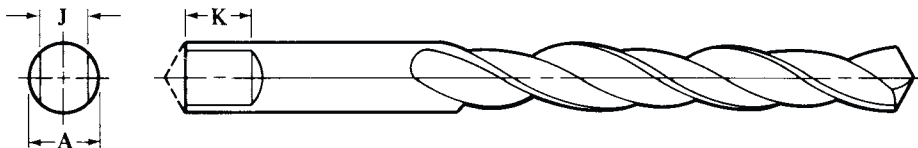
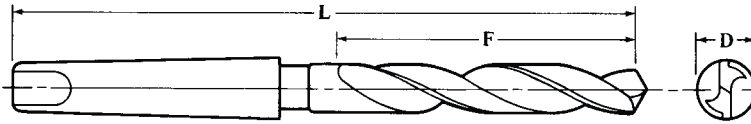


Table 3. American National Standard Tangs for Straight Shank Drills ANSI/ASME B94.11M-1993

Nominal Diameter of Drill Shank, A		Thickness of Tang, J				Length of Tang, K	
Inches	Millimeters	Inches		Millimeters		Inches	Millimeters
		Max.	Min.	Max.	Min.		
1/8 thru 3/16	3.18 thru 4.76	0.094	0.090	2.39	2.29	9/32	7.0
over 3/16 thru 1/4	over 4.76 thru 6.35	0.122	0.118	3.10	3.00	5/16	8.0
over 1/4 thru 5/16	over 6.35 thru 7.94	0.162	0.158	4.11	4.01	11/32	8.5
over 5/16 thru 3/8	over 7.94 thru 9.53	0.203	0.199	5.16	5.06	3/8	9.5
over 3/8 thru 15/32	over 9.53 thru 11.91	0.243	0.239	6.17	6.07	7/8	11.0
over 15/32 thru 1/2	over 11.91 thru 14.29	0.303	0.297	7.70	7.55	1/2	12.5
over 1/2 thru 21/32	over 14.29 thru 16.67	0.373	0.367	9.47	9.32	9/16	14.5
over 21/32 thru 3/4	over 16.67 thru 19.05	0.443	0.437	11.25	11.10	5/8	16.0
over 3/4 thru 7/8	over 19.05 thru 22.23	0.514	0.508	13.05	12.90	11/16	17.5
over 7/8 thru 1	over 22.23 thru 25.40	0.609	0.601	15.47	15.27	3/4	19.0
over 1 thru 1 1/16	over 25.40 thru 30.16	0.700	0.692	17.78	17.58	13/16	20.5
over 1 1/16 thru 1 3/8	over 30.16 thru 34.93	0.817	0.809	20.75	20.55	7/8	22.0

To fit split sleeve collet type drill drivers. See page 890.



**Table 5. American National Taper Shank Twist Drills
Fractional and Metric Sizes ANSI/ASME B94.11M-1993**

Drill Diameter, <i>D</i>				Regular Shank					Larger or Smaller Shank ^a				
Frac- tion	Equivalent			Morse Taper No.	Flute Length		Overall Length		Morse Taper No.	Flute Length		Overall Length	
	mm	Decimal Inch	mm		<i>F</i>		<i>L</i>			<i>F</i>		<i>L</i>	
		Inch			Inch	mm	Inch	mm		Inch	mm	Inch	mm
1/8	3.00	0.1181	3.000	1	1 7/8	48	5 1/8	130
		0.1250	3.175	1	1 7/8	48	5 1/8	130
	3.20	0.1260	3.200	1	2 1/8	54	5 3/8	137
9/64	3.50	0.1378	3.500	1	2 1/8	54	5 3/8	137
		0.1406	3.571	1	2 1/8	54	5 3/8	137
	3.80	0.1496	3.800	1	2 1/8	54	5 3/8	137
5/32	4.00	0.1562	3.967	1	2 1/8	54	5 3/8	137
		0.1575	4.000	1	2 1/2	64	5 3/4	146
	4.20	0.1654	4.200	1	2 1/2	64	5 3/4	146
11/64	4.50	0.1719	4.366	1	2 1/2	64	5 3/4	146
		0.1772	4.500	1	2 1/2	64	5 3/4	146
	4.80	0.1875	4.762	1	2 1/2	64	5 3/4	146
3/16	5.00	0.1890	4.800	1	2 3/4	70	6	152
		0.1969	5.000	1	2 3/4	70	6	152
	5.20	0.2031	5.159	1	2 3/4	70	6	152
13/64	5.50	0.2047	5.200	1	2 3/4	70	6	152
		0.2165	5.500	1	2 3/4	70	6	152
	5.80	0.2183	5.558	1	2 3/4	70	6	152
7/32	6.00	0.2223	5.800	1	2 7/8	73	6 1/8	156
		0.2344	5.954	1	2 7/8	73	6 1/8	156
	6.20	0.2362	6.000	1	2 7/8	73	6 1/8	156
15/64	6.20	0.2441	6.200	1	2 7/8	73	6 1/8	156
		0.2500	6.350	1	2 7/8	73	6 1/8	156
	6.50	0.2559	6.500	1	3	76	6 1/4	159
1/4	6.50	0.2656	6.746	1	3	76	6 1/4	159
		0.2677	6.800	1	3	76	6 1/4	159
	7.00	0.2756	7.000	1	3	76	6 1/4	159
9/32	7.00	0.2812	7.142	1	3	76	6 1/4	159
		0.2835	7.200	1	3 1/8	79	6 3/8	162
	7.20	0.2853	7.200	1	3 1/8	79	6 3/8	162
19/64	7.50	0.2953	7.500	1	3 1/8	79	6 3/8	162
		0.2969	7.541	1	3 1/8	79	6 3/8	162
	7.80	0.3071	7.800	1	3 1/8	79	6 3/8	162
5/16	8.00	0.3125	7.938	1	3 1/8	79	6 3/8	162
		0.3150	8.000	1	3 1/4	83	6 1/2	165
	8.20	0.3228	8.200	1	3 1/4	83	6 1/2	165
21/64	8.20	0.3281	8.334	1	3 1/4	83	6 1/2	165
		0.3346	8.500	1	3 1/4	83	6 1/2	165
	8.50	0.3438	8.733	1	3 1/4	83	6 1/2	165
11/32	8.80	0.3465	8.800	1	3 1/2	89	6 3/4	171
		0.3543	9.000	1	3 1/2	89	6 3/4	171
	9.00	0.3594	9.129	1	3 1/2	89	6 3/4	171
23/64	9.20	0.3622	9.200	1	3 1/2	89	6 3/4	171
		0.3740	9.500	1	3 1/2	89	6 3/4	171
	9.50	0.3750	9.525	1	3 1/2	89	6 3/4	171	2	3 1/2	89	7 3/8	187
3/8	9.80	0.3858	9.800	1	3 5/8	92	7	178
		0.3906	9.921	1	3 5/8	92	7	178	2	3 5/8	92	7 1/2	190
	10.00	0.3937	10.000	1	3 5/8	92	7	178

**Table 5. (Continued) American National Taper Shank Twist Drills
Fractional and Metric Sizes ANSI/ASME B94.11M-1993**

Drill Diameter, <i>D</i>				Regular Shank					Larger or Smaller Shank ^a				
Frac- tion	mm	Equivalent		Morse Taper No.	Flute Length <i>F</i>		Overall Length <i>L</i>		Morse Taper No.	Flute Length <i>F</i>		Overall Length <i>L</i>	
		Decimal Inch	mm		Inch	mm	Inch	mm		Inch	mm	Inch	mm
		13/32	10.20		0.4016	10.200	1	3 5/8		92	7	178	...
		0.4062	10.320	1	3 5/8	92	7	178	2	3 5/8	92	7 1/2	190
	10.50	0.4134	10.500	1	3 7/8	98	7 1/4	184
27/64		0.4219	10.716	1	3 7/8	98	7 1/4	184	2	3 7/8	98	7 3/4	197
	10.80	0.4252	10.800	1	3 7/8	98	7 1/4	184
	11.00	0.4331	11.000	1	3 7/8	98	7 1/4	184
7/16		0.4375	11.112	1	3 7/8	98	7 1/4	184	2	3 7/8	98	7 3/4	197
	11.20	0.4409	11.200	1	4 1/8	105	7 1/2	190
	11.50	0.4528	11.500	1	4 1/8	105	7 1/2	190
29/64		0.4531	11.509	1	4 1/8	105	7 1/2	190	2	4 1/8	105	8	203
	11.80	0.4646	11.800	1	4 1/8	105	7 1/2	190
15/32		0.4688	11.906	1	4 1/8	105	7 1/2	190	2	4 1/8	105	8	203
	12.00	0.4724	12.000	2	4 3/8	111	8 1/4	210	1	4 3/8	111	7 3/4	197
	12.20	0.4803	12.200	2	4 3/8	111	8 1/4	210	1	4 3/8	111	7 3/4	197
31/64		0.4844	12.304	2	4 3/8	111	8 1/4	210	1	4 3/8	111	7 3/4	197
	12.50	0.4921	12.500	2	4 3/8	111	8 1/4	210	1	4 3/8	111	7 3/4	197
1/2		0.5000	12.700	2	4 3/8	111	8 1/4	210	1	4 3/8	111	7 3/4	197
	12.80	0.5034	12.800	2	4 5/8	117	8 1/2	216	1	4 5/8	117	8	203
	13.00	0.5118	13.000	2	4 5/8	117	8 1/2	216	1	4 5/8	117	8	203
33/64		0.5156	13.096	2	4 5/8	117	8 1/2	216	1	4 5/8	117	8	203
	13.20	0.5197	13.200	2	4 5/8	117	8 1/2	216	1	4 5/8	117	8	203
17/32		0.5312	13.492	2	4 5/8	117	8 1/2	216	1	4 5/8	117	8	203
	13.50	0.5315	13.500	2	4 5/8	117	8 1/2	216	1	4 5/8	117	8	203
	13.80	0.5433	13.800	2	4 7/8	124	8 3/4	222	1	4 7/8	124	8 1/4	210
35/64		0.5469	13.891	2	4 7/8	124	8 3/4	222	1	4 7/8	124	8 1/4	210
	14.00	0.5572	14.000	2	4 7/8	124	8 3/4	222	1	4 7/8	124	8 1/4	210
	14.25	0.5610	14.250	2	4 7/8	124	8 3/4	222	1	4 7/8	124	8 1/4	210
9/16		0.5625	14.288	2	4 7/8	124	8 3/4	222	1	4 7/8	124	8 1/4	210
	14.50	0.5709	14.500	2	4 7/8	124	8 3/4	222
37/64		0.5781	14.684	2	4 7/8	124	8 3/4	222
	14.75	0.5807	14.750	2	4 7/8	124	8 3/4	222
	15.00	0.5906	15.000	2	4 7/8	124	8 3/4	222
19/32		0.5938	15.083	2	4 7/8	124	8 3/4	222
	15.25	0.6004	15.250	2	4 7/8	124	8 3/4	222
39/64		0.6094	15.479	2	4 7/8	124	8 3/4	222
	15.50	0.6102	15.500	2	4 7/8	124	8 3/4	222
	15.75	0.6201	15.750	2	4 7/8	124	8 3/4	222
5/8		0.6250	15.875	2	4 7/8	124	8 3/4	222
	16.00	0.6299	16.000	2	5 1/8	130	9	229
	16.25	0.6398	16.250	2	5 1/8	130	9	229
41/64		0.6406	16.271	2	5 1/8	130	9	229	3	5 1/8	130	9 3/4	248
	16.50	0.6496	16.500	2	5 1/8	130	9	229
21/32		0.6562	16.667	2	5 1/8	130	9	229	3	5 1/8	130	9 3/4	248
	16.75	0.6594	16.750	2	5 3/8	137	9 1/4	235
	17.00	0.6693	17.000	2	5 3/8	137	9 1/4	235
43/64		0.6719	17.066	2	5 3/8	137	9 1/4	235	3	5 3/8	137	10	254
	17.25	0.6791	17.250	2	5 3/8	137	9 1/4	235
11/16		0.6875	17.462	2	5 3/8	137	9 1/4	235	3	5 3/8	137	10	254
	17.50	0.6880	17.500	2	5 5/8	143	9 1/2	241
45/64		0.7031	17.859	2	5 5/8	143	9 1/2	241	3	5 5/8	143	10 1/4	260
	18.00	0.7087	18.000	2	5 5/8	143	9 1/2	241
23/32		0.7188	18.258	2	5 5/8	143	9 1/2	241	3	5 5/8	143	10 1/4	260
	18.50	0.7283	18.500	2	5 5/8	149	9 3/4	248
47/64		0.7344	18.654	2	5 5/8	149	9 3/4	248	3	5 5/8	149	10 1/2	267

**Table 5. (Continued) American National Taper Shank Twist Drills
Fractional and Metric Sizes ANSI/ASME B94.11M-1993**

Drill Diameter, <i>D</i>				Regular Shank					Larger or Smaller Shank ^a				
Frac- tion	mm	Equivalent		Morse Taper No.	Flute Length <i>F</i>		Overall Length <i>L</i>		Morse Taper No.	Flute Length <i>F</i>		Overall Length <i>L</i>	
		Decimal Inch	mm		Inch	mm	Inch	mm		Inch	mm	Inch	mm
		19.00	0.7480		19.000	2	5 ⁷ / ₈	149		9 ³ / ₄	248
3 ⁴ / ₁₆	0.7500	19.050	2	5 ⁷ / ₈	149	9 ³ / ₄	248	3	5 ⁷ / ₈	149	10 ¹ / ₂	267	
	0.7656	19.446	2	6	152	9 ⁷ / ₈	251	3	6	152	10 ³ / ₈	270	
49 ⁶⁴ / ₆₄	19.50	0.7677	2	6	152	9 ⁷ / ₈	251	
	0.7812	19.843	2	6	152	9 ⁷ / ₈	251	3	6	152	10 ³ / ₈	270	
25 ³² / ₃₂	20.00	0.7821	3	6 ¹ / ₈	156	10 ³ / ₄	273	2	6 ¹ / ₈	156	10	254	
51 ⁶⁴ / ₆₄	0.7969	20.241	3	6 ¹ / ₈	156	10 ³ / ₄	273	2	6 ¹ / ₈	156	10	254	
	20.50	0.8071	3	6 ¹ / ₈	156	10 ³ / ₄	273	2	6 ¹ / ₈	156	10	254	
13 ¹⁶ / ₁₆	0.8125	20.638	3	6 ¹ / ₈	156	10 ³ / ₄	273	2	6 ¹ / ₈	156	10	254	
	21.00	0.8268	3	6 ¹ / ₈	156	10 ³ / ₄	273	2	6 ¹ / ₈	156	10	254	
53 ⁶⁴ / ₆₄	0.8281	21.034	3	6 ¹ / ₈	156	10 ³ / ₄	273	2	6 ¹ / ₈	156	10	254	
	0.8438	21.433	3	6 ¹ / ₈	156	10 ³ / ₄	273	2	6 ¹ / ₈	156	10	254	
27 ³² / ₃₂	21.50	0.8465	3	6 ¹ / ₈	156	10 ³ / ₄	273	2	6 ¹ / ₈	156	10	254	
55 ⁶⁴ / ₆₄	0.8594	21.829	3	6 ¹ / ₈	156	10 ³ / ₄	273	2	6 ¹ / ₈	156	10	254	
	22.00	0.8661	3	6 ¹ / ₈	156	10 ³ / ₄	273	2	6 ¹ / ₈	156	10	254	
7 ⁸ / ₈	0.8750	22.225	3	6 ¹ / ₈	156	10 ³ / ₄	273	2	6 ¹ / ₈	156	10	254	
	22.50	0.8858	3	6 ¹ / ₈	156	10 ³ / ₄	273	2	6 ¹ / ₈	156	10	254	
57 ⁶⁴ / ₆₄	0.8906	22.621	3	6 ¹ / ₈	156	10 ³ / ₄	273	2	6 ¹ / ₈	156	10	254	
	23.00	0.9055	3	6 ¹ / ₈	156	10 ³ / ₄	273	2	6 ¹ / ₈	156	10	254	
29 ³² / ₃₂	0.9062	23.017	3	6 ¹ / ₈	156	10 ³ / ₄	273	2	6 ¹ / ₈	156	10	254	
	0.9219	23.416	3	6 ¹ / ₈	156	10 ³ / ₄	273	
59 ⁶⁴ / ₆₄	23.50	0.9252	3	6 ¹ / ₈	156	10 ³ / ₄	273	
	0.9375	23.813	3	6 ¹ / ₈	156	10 ³ / ₄	273	
15 ¹⁶ / ₁₆	24.00	0.9449	3	6 ³ / ₈	162	11	279	
	0.9531	24.209	3	6 ³ / ₈	162	11	279	
61 ⁶⁴ / ₆₄	24.50	0.9646	3	6 ³ / ₈	162	11	279	
	0.9688	24.608	3	6 ³ / ₈	162	11	279	
31 ³² / ₃₂	25.00	0.9843	3	6 ³ / ₈	162	11	279	
	0.9844	25.004	3	6 ³ / ₈	162	11	279	
63 ⁶⁴ / ₆₄	1	1.0000	3	6 ³ / ₈	162	11	279	4	6 ³ / ₈	162	12	305	
	25.50	1.0039	3	6 ¹ / ₂	165	11 ¹ / ₈	283	
11 ¹⁶ / ₁₆	1.0156	25.796	3	6 ¹ / ₂	165	11 ¹ / ₈	283	
	26.00	1.0236	3	6 ¹ / ₂	165	11 ¹ / ₈	283	
11 ¹⁶ / ₁₆	1.0312	26.192	3	6 ¹ / ₂	165	11 ¹ / ₈	283	4	6 ¹ / ₂	165	12 ¹ / ₈	308	
	26.50	1.0433	3	6 ⁵ / ₈	168	11 ¹ / ₄	286	
13 ¹⁶ / ₁₆	1.0469	26.591	3	6 ⁵ / ₈	168	11 ¹ / ₄	286	
	1.0625	26.988	3	6 ⁵ / ₈	168	11 ¹ / ₄	286	4	6 ⁵ / ₈	168	12 ¹ / ₄	311	
11 ¹⁶ / ₁₆	27.00	1.0630	3	6 ⁵ / ₈	168	11 ¹ / ₄	286	
	1.0781	27.384	4	6 ⁷ / ₈	175	12 ¹ / ₂	318	3	6 ⁷ / ₈	175	11 ¹ / ₂	292	
15 ¹⁶ / ₁₆	27.50	1.0827	4	6 ⁷ / ₈	175	12 ¹ / ₂	318	3	6 ⁷ / ₈	175	11 ¹ / ₂	292	
	1.0938	27.783	4	6 ⁷ / ₈	175	12 ¹ / ₂	318	3	6 ⁷ / ₈	175	11 ¹ / ₂	292	
13 ³² / ₃₂	28.00	1.1024	4	7 ¹ / ₈	181	12 ³ / ₄	324	3	7 ¹ / ₈	181	11 ³ / ₄	298	
	1.1094	28.179	4	7 ¹ / ₈	181	12 ³ / ₄	324	3	7 ¹ / ₈	181	11 ³ / ₄	298	
17 ⁶⁴ / ₆₄	28.50	1.1220	4	7 ¹ / ₈	181	12 ³ / ₄	324	3	7 ¹ / ₈	181	11 ³ / ₄	298	
	1.1250	28.575	4	7 ¹ / ₈	181	12 ³ / ₄	324	3	7 ¹ / ₈	181	11 ³ / ₄	298	
11 ¹⁶ / ₁₆	1.1406	28.971	4	7 ¹ / ₄	184	12 ⁷ / ₈	327	3	7 ¹ / ₄	184	11 ⁷ / ₈	302	
	29.00	1.1417	4	7 ¹ / ₄	184	12 ⁷ / ₈	327	3	7 ¹ / ₄	184	11 ⁷ / ₈	302	
15 ³² / ₃₂	1.1562	29.367	4	7 ¹ / ₄	184	12 ⁷ / ₈	327	3	7 ¹ / ₄	184	11 ⁷ / ₈	302	
	1.1614	29.500	4	7 ³ / ₈	187	13	330	3	7 ³ / ₈	187	12	305	
11 ¹⁶ / ₁₆	1.1719	29.797	4	7 ³ / ₈	187	13	330	3	7 ³ / ₈	187	12	305	
	30.00	1.1811	4	7 ³ / ₈	187	13	330	3	7 ³ / ₈	187	12	305	
13 ¹⁶ / ₁₆	1.1875	30.162	4	7 ³ / ₈	187	13	330	3	7 ³ / ₈	187	12	305	
	30.50	1.2008	4	7 ¹ / ₂	190	13 ³ / ₈	333	3	7 ¹ / ₂	190	12 ¹ / ₈	308	
13 ¹⁶ / ₁₆	1.2031	30.559	4	7 ¹ / ₂	190	13 ³ / ₈	333	3	7 ¹ / ₂	190	12 ¹ / ₈	308	

**Table 5. (Continued) American National Taper Shank Twist Drills
Fractional and Metric Sizes ANSI/ASME B94.11M-1993**

Drill Diameter, <i>D</i>				Regular Shank					Larger or Smaller Shank ^a				
Frac- tion.	mm	Equivalent		Morse Taper No.	Flute Length <i>F</i>		Overall Length <i>L</i>		Morse Taper No.	Flute Length <i>F</i>		Overall Length <i>L</i>	
		Decimal Inch	mm		Inch	mm	Inch	mm		Inch	mm	Inch	mm
1/32	31.00	1.2188	30.958	4	7 1/2	190	13 3/8	333	3	7 1/2	190	12 1/8	308
		1.2205	31.000	4	7 7/8	200	13 1/2	343	3	7 7/8	200	12 1/2	318
1 5/64	31.50	1.2344	31.354	4	7 7/8	200	13 1/2	343	3	7 7/8	200	12 1/2	318
		1.2402	31.500	4	7 7/8	200	13 1/2	343	3	7 7/8	200	12 1/2	318
1/4	32.00	1.2500	31.750	4	7 7/8	200	13 1/2	343	3	7 7/8	200	12 1/2	318
		1.2598	32.000	4	8 1/2	216	14 1/8	359
1 7/64	32.50	1.2656	32.146	4	8 1/2	216	14 1/8	359
		1.2795	32.500	4	8 1/2	216	14 1/8	359
1 9/32	33.00	1.2812	32.542	4	8 1/2	216	14 1/8	359
		1.2969	32.941	4	8 5/8	219	14 1/4	362
1 9/16	33.50	1.2992	33.000	4	8 5/8	219	14 1/4	362
		1.3125	33.338	4	8 5/8	219	14 1/4	362
1 21/64	34.00	1.3189	33.500	4	8 3/4	222	14 3/8	365
		1.3281	33.734	4	8 3/4	222	14 3/8	365
1 11/32	34.50	1.3386	34.000	4	8 3/4	222	14 3/8	365
		1.3438	34.133	4	8 3/4	222	14 3/8	365
1 25/64	35.00	1.3583	34.500	4	8 7/8	225	14 1/2	368
		1.3594	34.529	4	8 7/8	225	14 1/2	368
1 3/8	35.50	1.3750	34.925	4	8 7/8	225	14 1/2	368
		1.3780	35.000	4	9	229	14 5/8	371
1 29/64	36.00	1.3906	35.321	4	9	229	14 5/8	371
		1.3976	35.500	4	9	229	14 5/8	371
1 13/32	36.50	1.4062	35.717	4	9	229	14 5/8	371
		1.4173	36.000	4	9 1/8	232	14 3/4	375
1 27/64	36.50	1.4219	36.116	4	9 1/8	232	14 3/4	375
		1.4370	36.500	4	9 1/8	232	14 3/4	375
1 7/16	37.00	1.4375	36.512	4	9 1/8	232	14 3/4	375
		1.4531	36.909	4	9 1/4	235	14 7/8	378
1 29/64	37.50	1.4567	37.000	4	9 1/4	235	14 7/8	378
		1.4688	37.308	4	9 1/4	235	14 7/8	378
1 15/32	38.00	1.4764	37.500	4	9 3/8	238	15	381
		1.4844	37.704	4	9 3/8	238	15	381
1 31/64	38.00	1.4961	38.000	4	9 3/8	238	15	381
		1.5000	38.100	4	9 3/8	238	15	381
1 1/2	39.00	1.5156	38.496	4	9 3/4	238	15	381	
		1.5312	38.892	5	9 3/8	238	16 3/8	416	4	9 3/8	238	15	381
1 17/32	39.00	1.5354	39.000	5	9 5/8	244	16 5/8	422	4	9 5/8	244	15 1/4	387
		1.5469	39.291	4	9 5/8	244	15 1/4	387	
1 35/64	40.00	1.5625	39.688	5	9 5/8	244	16 3/8	422	4	9 5/8	244	15 1/4	387
		1.5748	40.000	5	9 7/8	251	16 7/8	429	4	9 7/8	251	15 1/2	394
1 37/64	40.00	1.5781	40.084	4	9 7/8	251	15 1/2	394	
		1.5938	40.483	5	9 7/8	251	16 3/8	429	4	9 7/8	251	15 1/2	394
1 19/32	41.00	1.6094	40.879	4	10	254	15 5/8	397	
		1.6142	41.000	5	10	254	17	432	4	10	254	15 5/8	397
1 39/64	41.00	1.6250	41.275	5	10	254	17	432	4	10	254	15 5/8	397
		1.6406	41.671	4	10 1/8	257	15 3/4	400	
1 41/64	42.00	1.6535	42.000	5	10 1/8	257	17 1/8	435	4	10 1/8	257	15 3/4	400
		1.6562	42.067	5	10 1/8	257	17 1/8	435	4	10 1/8	257	15 3/4	400
1 21/32	42.00	1.6719	42.466	4	10 1/8	257	15 3/4	400	
		1.6719	42.466	4	10 1/8	257	15 3/4	400	
1 43/64	43.00	1.6875	42.862	5	10 1/8	257	17 1/8	435	4	10 1/8	257	15 3/4	400
		1.6929	43.000	5	10 1/8	257	17 1/8	435	4	10 1/8	257	15 3/4	400
1 11/16	43.00	1.7031	43.259	4	10 1/8	257	15 3/4	400	
		1.7188	43.658	5	10 1/8	257	17 1/8	435	4	10 1/8	257	15 3/4	400
1 45/64	44.00	1.7323	44.000	5	10 1/8	257	17 1/8	435	4	10 1/8	257	15 3/4	400
		1.7323	44.000	5	10 1/8	257	17 1/8	435	4	10 3/8	264	16 1/4	413

**Table 5. (Continued) American National Taper Shank Twist Drills
Fractional and Metric Sizes ANSI/ASME B94.11M-1993**

Drill Diameter, <i>D</i>				Regular Shank						Larger or Smaller Shank ^a					
Frac- tion	mm	Equivalent		Morse Taper No.	Flute Length <i>F</i>		Overall Length <i>L</i>		Morse Taper No.	Flute Length <i>F</i>		Overall Length <i>L</i>			
		Inch	mm		Inch	mm	Inch	mm		Inch	mm	Inch	mm		
1 ⁴⁷ / ₆₄		1.7344	44.054	4	10 ³ / ₈	264	16 ¹ / ₄	413		
3 ¹ / ₄		1.7500	44.450	5	10 ¹ / ₈	257	17 ¹ / ₈	435	4	10 ³ / ₄	264	16 ¹ / ₄	413		
	45.00	1.7717	45.000	5	10 ¹ / ₈	257	17 ¹ / ₈	435	4	10 ³ / ₈	264	16 ¹ / ₄	413		
1 ²⁵ / ₃₂		1.7812	45.242	5	10 ¹ / ₈	257	17 ¹ / ₈	435	4	10 ³ / ₈	264	16 ¹ / ₄	413		
	46.00	1.8110	46.000	5	10 ¹ / ₈	257	17 ¹ / ₈	435	4	10 ³ / ₈	264	16 ¹ / ₄	413		
1 ¹³ / ₁₆		1.8125	46.038	5	10 ¹ / ₈	257	17 ¹ / ₈	435	4	10 ³ / ₈	264	16 ¹ / ₄	413		
1 ²⁷ / ₃₂		1.8438	46.833	5	10 ¹ / ₈	257	17 ¹ / ₈	435	4	10 ³ / ₈	264	16 ¹ / ₄	413		
	47.00	1.8504	47.000	5	10 ³ / ₈	264	17 ³ / ₈	441	4	10 ¹ / ₂	267	16 ¹ / ₂	419		
1 ⁷ / ₈		1.8750	47.625	5	10 ³ / ₈	264	17 ³ / ₈	441	4	10 ¹ / ₂	267	16 ¹ / ₂	419		
	48.00	1.8898	48.000	5	10 ³ / ₈	264	17 ³ / ₈	441	4	10 ¹ / ₂	267	16 ¹ / ₂	419		
1 ²⁹ / ₃₂		1.9062	48.417	5	10 ³ / ₈	264	17 ³ / ₈	441	4	10 ¹ / ₂	267	16 ¹ / ₂	419		
	49.00	1.9291	49.000	5	10 ³ / ₈	264	17 ³ / ₈	441	4	10 ³ / ₈	270	16 ⁵ / ₈	422		
1 ¹⁵ / ₁₆		1.9375	49.212	5	10 ³ / ₈	264	17 ³ / ₈	441	4	10 ³ / ₈	270	16 ⁵ / ₈	422		
	50.00	1.9625	50.000	5	10 ³ / ₈	264	17 ³ / ₈	441	4	10 ³ / ₈	270	16 ⁵ / ₈	422		
1 ³¹ / ₃₂		1.9688	50.008	5	10 ³ / ₈	264	17 ³ / ₈	441	4	10 ³ / ₈	270	16 ⁵ / ₈	422		
2		2.0000	50.800	5	10 ³ / ₈	264	17 ³ / ₈	441	4	10 ³ / ₈	270	16 ⁵ / ₈	422		
	51.00	2.0079	51.000	5	10 ³ / ₈	264	17 ³ / ₈	441		
2 ¹ / ₃₂		2.0312	51.592	5	10 ³ / ₈	264	17 ³ / ₈	441		
	52.00	2.0472	52.000	5	10 ¹ / ₄	260	17 ³ / ₈	441		
2 ¹ / ₁₆		2.0625	52.388	5	10 ¹ / ₄	260	17 ³ / ₈	441		
	53.00	2.0866	53.000	5	10 ¹ / ₄	260	17 ³ / ₈	441		
2 ³ / ₃₂		2.0938	53.183	5	10 ¹ / ₄	260	17 ³ / ₈	441		
2 ¹ / ₈		2.1250	53.975	5	10 ¹ / ₄	260	17 ³ / ₈	441		
	54.00	2.1260	54.000	5	10 ¹ / ₄	260	17 ³ / ₈	441		
2 ⁵ / ₃₂		2.1562	54.767	5	10 ¹ / ₄	260	17 ³ / ₈	441		
	55.00	2.1654	55.000	5	10 ¹ / ₄	260	17 ³ / ₈	441		
2 ³ / ₁₆		2.1875	55.563	5	10 ¹ / ₄	260	17 ³ / ₈	441		
	56.00	2.2000	56.000	5	10 ¹ / ₈	257	17 ³ / ₈	441		
2 ⁷ / ₃₂		2.2188	56.358	5	10 ¹ / ₈	257	17 ³ / ₈	441		
	57.00	2.2441	57.000	5	10 ¹ / ₈	257	17 ³ / ₈	441		
2 ¹ / ₄		2.2500	57.150	5	10 ¹ / ₈	257	17 ³ / ₈	441		
	58.00	2.2835	58.000	5	10 ¹ / ₈	257	17 ³ / ₈	441		
2 ⁵ / ₁₆		2.3125	58.738	5	10 ¹ / ₈	257	17 ³ / ₈	441		
	59.00	2.3228	59.000	5	10 ¹ / ₈	257	17 ³ / ₈	441		
	60.00	2.3622	60.000	5	10 ¹ / ₈	257	17 ³ / ₈	441		
2 ³ / ₈		2.3750	60.325	5	10 ¹ / ₈	257	17 ³ / ₈	441		
	61.00	2.4016	61.000	5	11 ¹ / ₄	286	18 ³ / ₄	476		
2 ⁷ / ₁₆		2.4375	61.912	5	11 ¹ / ₄	286	18 ³ / ₄	476		
	62.00	2.4409	62.000	5	11 ¹ / ₄	286	18 ³ / ₄	476		
	63.00	2.4803	63.000	5	11 ¹ / ₄	286	18 ³ / ₄	476		
2 ¹ / ₂		2.5000	63.500	5	11 ¹ / ₄	286	18 ³ / ₄	476		
	64.00	2.5197	64.000	5	11 ⁷ / ₈	302	19 ¹ / ₂	495		
	65.00	2.5591	65.000	5	11 ⁷ / ₈	302	19 ¹ / ₂	495		
2 ⁹ / ₁₆		2.5625	65.088	5	11 ⁷ / ₈	302	19 ¹ / ₂	495		
	66.00	2.5984	66.000	5	11 ⁷ / ₈	302	19 ¹ / ₂	495		
2 ⁵ / ₈		2.6250	66.675	5	11 ⁷ / ₈	302	19 ¹ / ₂	495		
	67.00	2.6378	67.000	5	12 ³ / ₄	324	20 ³ / ₈	518		
	68.00	2.6772	68.000	5	12 ³ / ₄	324	20 ³ / ₈	518		
2 ¹¹ / ₁₆		2.6875	68.262	5	12 ³ / ₄	324	20 ³ / ₈	518		
	69.00	2.7165	69.000	5	12 ³ / ₄	324	20 ³ / ₈	518		
2 ³ / ₄		2.7500	69.850	5	12 ³ / ₄	324	20 ³ / ₈	518		
	70.00	2.7559	70.000	5	13 ³ / ₈	340	21 ¹ / ₈	537		
	71.00	2.7953	71.000	5	13 ³ / ₈	340	21 ¹ / ₈	537		
2 ¹³ / ₁₆		2.8125	71.438	5	13 ³ / ₈	340	21 ¹ / ₈	537		

**Table 5. (Continued) American National Taper Shank Twist Drills
Fractional and Metric Sizes ANSI/ASME B94.11M-1993**

Drill Diameter, <i>D</i>				Regular Shank					Larger or Smaller Shank ^a				
Frac- tion	mm	Equivalent		Morse Taper No.	Flute Length <i>F</i>		Overall Length <i>L</i>		Morse Taper No.	Flute Length <i>F</i>		Overall Length <i>L</i>	
		Decimal Inch	mm		Inch	mm	Inch	mm		Inch	mm	Inch	mm
		27/8	72.00		2.8346	72.000	5	13 3/8		340	21 1/8	537	...
	73.00	2.8740	73.000	5	13 3/8	340	21 1/8	537
		2.8750	73.025	5	13 3/8	340	21 1/8	537
	74.00	2.9134	74.000	5	14	356	21 3/4	552
2 15/16		2.9375	74.612	5	14	356	21 3/4	552
	75.00	2.9528	75.000	5	14	356	21 3/4	552
	76.00	2.9921	76.000	5	14	356	21 3/4	552
3		3.0000	76.200	5	14	356	21 3/4	552
	77.00	3.0315	77.000	6	14 5/8	371	24 1/2	622	5	14 1/4	362	22	559
	78.00	3.0709	78.000	6	14 3/8	371	24 1/2	622	5	14 1/4	362	22	559
3 1/8		3.1250	79.375	6	14 5/8	371	24 1/2	622	5	14 1/4	362	22	559
3 1/4		3.2500	82.500	6	15 1/2	394	25 1/2	648	5	15 1/4	387	23	584
3 1/2		3.5000	88.900	5	16 1/4	413	24	610

^aLarger or smaller than regular shank.

**Table 6. American National Standard Combined Drills and Countersinks —
Plain and Bell Types ANSI/ASME B94.11M-1993**

PLAIN TYPE

BELL TYPE

Plain Type									
Size Designation	Body Diameter		Drill Diameter		Drill Length		Overall Length		
	<i>A</i>		<i>D</i>		<i>C</i>		<i>L</i>		
	Inches	Millimeters	Inches	Millimeters	Inches	Millimeters	Inches	Millimeters	
00	1/8	3.18	.025	0.64	.030	0.76	1 1/8	29	
0	1/8	3.18	1/32	0.79	.038	0.97	1 1/8	29	
1	1/8	3.18	3/64	1.19	3/64	1.19	1 1/4	32	
2	3/16	4.76	5/64	1.98	5/64	1.98	1 7/8	48	
3	1/4	6.35	7/64	2.78	7/64	2.78	2	51	
4	5/16	7.94	1/8	3.18	1/8	3.18	2 1/8	54	
5	3/8	11.11	3/16	4.76	3/16	4.76	2 3/4	70	
6	1/2	12.70	7/32	5.56	7/32	5.56	3	76	
7	5/8	15.88	1/4	6.35	1/4	6.35	3 1/4	83	
8	3/4	19.05	5/16	7.94	5/16	7.94	3 1/2	89	

Bell Type										
Size Designation	Body Diameter		Drill Diameter		Bell Diameter		Drill Length		Overall Length	
	<i>A</i>		<i>D</i>		<i>E</i>		<i>C</i>		<i>L</i>	
	Inches	mm	Inches	mm	Inches	mm	Inches	mm	Inches	mm
11	1/8	3.18	3/64	1.19	0.10	2.5	3/64	1.19	1 1/4	32
12	3/16	4.76	1/16	1.59	0.15	3.8	1/16	1.59	1 1/8	48
13	1/4	6.35	3/32	2.38	0.20	5.1	3/32	2.38	2	51
14	5/16	7.94	7/64	2.78	0.25	6.4	7/64	2.78	2 1/8	54
15	3/8	11.11	5/32	3.97	0.35	8.9	5/32	3.97	2 3/4	70
16	1/2	12.70	3/16	4.76	0.40	10.2	3/16	4.76	3	76
17	5/8	15.88	7/32	5.56	0.50	12.7	7/32	5.56	3 1/4	83
18	3/4	19.05	1/4	6.35	0.60	15.2	1/4	6.35	3 1/2	89

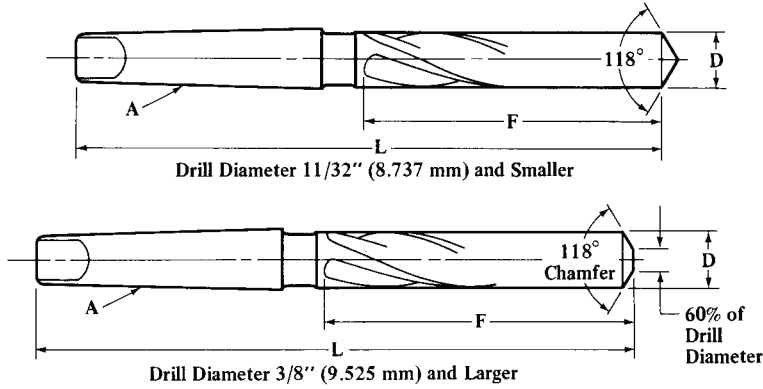


Table 7. American National Standard Three- and Four-Flute Taper Shank Core Drills — Fractional Sizes Only ANSI/ASME B94.11M-1993

Drill Diameter, <i>D</i>			Three-Flute Drills					Four-Flute Drills				
Inch	Equivalent		Morse Taper No.	Flute Length		Overall Length		Morse Taper No.	Flute Length		Overall Length	
	Decimal Inch	mm		<i>F</i>	<i>L</i>	<i>F</i>	<i>L</i>					
	A	Inch	mm	Inch	mm	Inch	mm	A	Inch	mm	Inch	mm
1/4	0.2500	6.350	1	2 7/8	73	6 1/8	156
5/32	0.2812	7.142	1	3	76	6 1/4	159
3/16	0.3175	7.938	1	3 1/8	79	6 3/8	162
11/32	0.3438	8.733	1	3 1/4	83	6 1/2	165
3/8	0.3750	9.525	1	3 1/2	89	6 3/4	171
13/32	0.4062	10.319	1	3 5/8	92	7	178
7/16	0.4375	11.112	1	3 3/8	98	7 1/4	184
15/32	0.4688	11.908	1	4 1/8	105	7 1/2	190
1/2	0.5000	12.700	2	4 3/8	111	8 1/4	210	2	4 3/8	111	8 1/4	210
17/32	0.5312	13.492	2	4 5/8	117	8 1/2	216	2	4 5/8	117	8 1/2	216
9/16	0.5625	14.288	2	4 7/8	124	8 3/4	222	2	4 7/8	124	8 3/4	222
19/32	0.5938	15.083	2	4 7/8	124	8 3/4	222	2	4 7/8	124	8 3/4	222
5/8	0.6250	15.815	2	4 7/8	124	8 3/4	222	2	4 7/8	124	8 3/4	222
21/32	0.6562	16.668	2	5 1/8	130	9	229	2	5 1/8	130	9	229
11/16	0.6875	17.462	2	5 3/8	137	9 1/4	235	2	5 3/8	137	9 1/4	235
23/32	0.7188	18.258	2	5 5/8	143	9 1/2	241	2	5 5/8	143	9 1/2	241
3/4	0.7500	19.050	2	5 7/8	149	9 3/4	248	2	5 7/8	149	9 3/4	248
25/32	0.7812	19.842	2	6	152	9 7/8	251	2	6	152	9 7/8	251
13/16	0.8125	20.638	3	6 1/8	156	10 3/4	273	3	6 1/8	156	10 3/4	273
27/32	0.8438	21.433	3	6 1/8	156	10 3/4	273	3	6 1/8	156	10 3/4	273
7/8	0.8750	22.225	3	6 1/8	156	10 3/4	273	3	6 1/8	156	10 3/4	273
29/32	0.9062	23.019	3	6 1/8	156	10 3/4	273	3	6 1/8	156	10 3/4	273
15/16	0.9375	23.812	3	6 1/8	156	10 3/4	273	3	6 1/8	156	10 3/4	273
31/32	0.9688	24.608	3	6 3/8	162	11	279	3	6 3/8	162	11	279
1	1.0000	25.400	3	6 3/8	162	11	279	3	6 3/8	162	11	279
1 1/32	1.0312	26.192	3	6 1/2	165	11 1/8	283	3	6 1/2	165	11 1/8	283
1 1/16	1.0625	26.988	3	6 5/8	168	11 1/4	286	3	6 5/8	168	11 1/4	286
1 1/8	1.0938	27.783	4	6 7/8	175	12 1/4	318	4	6 7/8	175	12 1/4	318
1 1/4	1.1250	28.575	4	7 1/8	181	12 3/4	324	4	7 1/8	181	12 3/4	324
1 5/32	1.1562	29.367	4	7 1/4	184	12 7/8	327	4	7 1/4	184	12 7/8	327
1 3/16	1.1875	30.162	4	7 3/8	187	13	330	4	7 3/8	187	13	330
1 7/32	1.2188	30.958	4	7 1/2	190	13 1/8	333	4	7 1/2	190	13 1/8	333
1 1/4	1.2500	31.750	4	7 7/8	200	13 1/2	343	4	7 7/8	200	13 1/2	343
1 5/32	1.2812	32.542	4	8 1/2	216	14 1/8	359

Table 7. American National Standard Three- and Four-Flute Taper Shank Core Drills — Fractional Sizes Only ANSI/ASME B94.11M-1993

Drill Diameter, <i>D</i>			Three-Flute Drills					Four-Flute Drills				
Inch	Equivalent		Morse Taper No.	Flute Length		Overall Length		Morse Taper No.	Flute Length		Overall Length	
	Decimal Inch	mm		<i>F</i>	<i>L</i>	<i>F</i>	<i>L</i>		<i>F</i>	<i>L</i>		
	A	Inch	mm					Inch			mm	A
1 5/16	1.3125	33.338	4	8 5/8	219	14 1/4	362
1 1/8	1.3438	34.133	4	8 3/4	222	14 3/8	365
1 3/8	1.3750	34.925	4	8 7/8	225	14 1/2	368
1 13/32	1.4062	35.717	4	9	229	14 5/8	371
1 7/16	1.4375	36.512	4	9 1/8	232	14 3/4	375
1 15/32	1.4688	37.306	4	9 1/4	235	14 7/8	378
1 1/2	1.5000	38.100	4	9 3/8	238	15	381
1 17/32	1.5312	38.892	5	9 3/8	238	16 3/8	416
1 9/16	1.5675	39.688	5	9 5/8	244	16 3/8	422
1 19/32	1.5938	40.483	5	9 7/8	251	16 7/8	429
1 5/8	1.6250	41.275	5	10	254	17	432
1 21/32	1.6562	42.067	5	10 1/8	257	17 1/8	435
1 11/16	1.6875	42.862	5	10 1/8	257	17 1/8	435
1 23/32	1.7188	43.658	5	10 1/8	257	17 1/8	435
1 3/4	1.7500	44.450	5	10 1/8	257	17 1/8	435
1 25/32	1.7812	45.244	5	10 1/8	257	17 1/8	435
1 15/16	1.8125	46.038	5	10 1/8	257	17 1/8	435
1 27/32	1.8438	46.833	5	10 1/8	257	17 1/8	435
1 7/8	1.8750	47.625	5	10 3/8	264	17 3/8	441
1 29/32	1.9062	48.417	5	10 3/8	264	17 3/8	441
1 15/16	1.9375	49.212	5	10 3/8	264	17 3/8	441
1 31/32	1.9688	50.008	5	10 3/8	264	17 3/8	441
2	2.0000	50.800	5	10 3/8	264	17 3/8	441
2 1/8	2.1250	53.975	5	10 1/4	260	17 3/8	441
2 1/4	2.2500	57.150	5	10 1/8	257	17 3/8	441
2 3/8	2.3750	60.325	5	10 1/8	257	17 3/8	441
2 1/2	2.5000	63.500	5	11 1/4	286	18 3/4	476

Table 8. American National Standard Drill Drivers — Split-Sleeve, Collet Type ANSI B94.35-1972 (R2010)

Taper Number	<i>G</i> Overall Length	<i>H</i> Diameter at Gage Line	<i>J</i> Taper per Foot ^a	<i>K</i> Length to Gage Line	<i>L</i> Driver Projection
0 ^b	2.38	0.356	0.62460	2.22	0.16
1	2.62	0.475	0.59858	2.44	0.19
2	3.19	0.700	0.59941	2.94	0.25

^a Taper rate in accordance with ANSI/ASME B5.10-1994 (R2008), Machine Tapers.

^b Size 0 is not an American National Standard but is included here to meet special needs.

All dimensions are in inches.

Table 9. ANSI Three- and Four-Flute Straight Shank Core Drills — Fractional Sizes Only ANSI/ASME B94.11M-1993

Drill Diameter 11/32" (8.733 mm) and Smaller

Drill Diameter 3/8" (9.525 mm) and Larger

Nominal Shank Size is same as Nominal Drill Size

Drill Diameter, <i>D</i>			Three-Flute Drills				Four-Flute Drills			
Inch	Equivalent		Flute Length		Overall Length		Flute Length		Overall Length	
	Decimal Inch	mm	<i>F</i>		<i>L</i>		<i>F</i>		<i>L</i>	
			Inch	mm	Inch	mm	Inch	mm	Inch	mm
1/4	0.2500	6.350	3 3/4	95	6 1/8	156
5/32	0.2812	7.142	3 7/8	98	6 1/4	159
3/16	0.3125	7.938	4	102	6 3/8	162
1/8	0.3438	8.733	4 1/8	105	6 1/2	165
3/8	0.3750	9.525	4 1/8	105	6 3/4	171
13/32	0.4062	10.317	4 3/8	111	7	178
7/16	0.4375	11.112	4 5/8	117	7 1/4	184
15/32	0.4688	11.908	4 3/4	121	7 1/2	190
1/2	0.5000	12.700	4 3/4	121	7 3/4	197	4 3/4	121	7 3/4	197
17/32	0.5312	13.492	4 3/4	121	8	203	4 3/4	121	8	203
9/16	0.5625	14.288	4 7/8	124	8 1/4	210	4 7/8	124	8 1/4	210
19/32	0.5938	15.083	4 7/8	124	8 3/4	222	4 7/8	124	8 3/4	222
5/8	0.6250	15.875	4 7/8	124	8 3/4	222	4 7/8	124	8 3/4	222
21/32	0.6562	16.667	5 1/8	130	9	229	5 1/8	130	9	229
11/16	0.6875	17.462	5 3/8	137	9 1/4	235	5 3/8	137	9 1/4	235
23/32	0.7188	18.258	5 5/8	143	9 1/2	241
3/4	0.7500	19.050	5 7/8	149	9 3/4	248	5 7/8	149	9 3/4	248
25/32	0.7812	19.842	6	152	9 7/8	251
13/16	0.8125	20.638	6 1/8	156	10	254
27/32	0.8438	21.433	6 1/8	156	10	254
7/8	0.8750	22.225	6 1/8	156	10	254
29/32	0.9062	23.017	6 1/8	156	10	254
15/16	0.9375	23.812	6 1/8	156	10 3/4	273
31/32	0.9688	24.608	6 3/8	162	11	279
1	1.0000	25.400	6 3/8	162	11	279
1 1/32	1.0312	26.192	6 1/2	165	11 1/8	283
1 1/16	1.0625	26.988	6 5/8	168	11 1/4	286
1 1/32	1.0938	27.783	6 7/8	175	11 1/2	292
1 1/8	1.1250	28.575	7 1/8	181	11 3/4	298
1 1/4	1.2500	31.750	7 7/8	200	12 1/2	318

Table 10. Length of Point on Twist Drills and Centering Tools

Size of Drill	Decimal Equivalent	Length of Point when Included Angle = 90°	Length of Point when Included Angle = 118°	Size of Drill	Decimal Equivalent	Length of Point when Included Angle = 90°	Length of Point when Included Angle = 118°	Size or Dia. of Drill	Decimal Equivalent	Length of Point when Included Angle = 90°	Length of Point when Included Angle = 118°	Dia. of Drill	Decimal Equivalent	Length of Point when Included Angle = 90°	Length of Point when Included Angle = 118°
60	0.0400	0.020	0.012	37	0.1040	0.052	0.031	14	0.1820	0.091	0.055	$\frac{3}{8}$	0.3750	0.188	0.113
59	0.0410	0.021	0.012	36	0.1065	0.054	0.032	13	0.1850	0.093	0.056	$\frac{25}{64}$	0.3906	0.195	0.117
58	0.0420	0.021	0.013	35	0.1100	0.055	0.033	12	0.1890	0.095	0.057	$\frac{13}{32}$	0.4063	0.203	0.122
57	0.0430	0.022	0.013	34	0.1110	0.056	0.033	11	0.1910	0.096	0.057	$\frac{27}{64}$	0.4219	0.211	0.127
56	0.0465	0.023	0.014	33	0.1130	0.057	0.034	10	0.1935	0.097	0.058	$\frac{7}{16}$	0.4375	0.219	0.131
55	0.0520	0.026	0.016	32	0.1160	0.058	0.035	9	0.1960	0.098	0.059	$\frac{29}{64}$	0.4531	0.227	0.136
54	0.0550	0.028	0.017	31	0.1200	0.060	0.036	8	0.1990	0.100	0.060	$\frac{15}{32}$	0.4688	0.234	0.141
53	0.0595	0.030	0.018	30	0.1285	0.065	0.039	7	0.2010	0.101	0.060	$\frac{31}{64}$	0.4844	0.242	0.145
52	0.0635	0.032	0.019	29	0.1360	0.068	0.041	6	0.2040	0.102	0.061	$\frac{1}{2}$	0.5000	0.250	0.150
51	0.0670	0.034	0.020	28	0.1405	0.070	0.042	5	0.2055	0.103	0.062	$\frac{33}{64}$	0.5156	0.258	0.155
50	0.0700	0.035	0.021	27	0.1440	0.072	0.043	4	0.2090	0.105	0.063	$\frac{17}{32}$	0.5313	0.266	0.159
49	0.0730	0.037	0.022	26	0.1470	0.074	0.044	3	0.2130	0.107	0.064	$\frac{35}{64}$	0.5469	0.273	0.164
48	0.0760	0.038	0.023	25	0.1495	0.075	0.045	2	0.2210	0.111	0.067	$\frac{9}{16}$	0.5625	0.281	0.169
47	0.0785	0.040	0.024	24	0.1520	0.076	0.046	1	0.2280	0.114	0.068	$\frac{37}{64}$	0.5781	0.289	0.173
46	0.0810	0.041	0.024	23	0.1540	0.077	0.046	$\frac{15}{64}$	0.2344	0.117	0.070	$\frac{19}{32}$	0.5938	0.297	0.178
45	0.0820	0.041	0.025	22	0.1570	0.079	0.047	$\frac{1}{4}$	0.2500	0.125	0.075	$\frac{39}{64}$	0.6094	0.305	0.183
44	0.0860	0.043	0.026	21	0.1590	0.080	0.048	$\frac{17}{64}$	0.2656	0.133	0.080	$\frac{5}{8}$	0.6250	0.313	0.188
43	0.0890	0.045	0.027	20	0.1610	0.081	0.048	$\frac{9}{32}$	0.2813	0.141	0.084	$\frac{41}{64}$	0.6406	0.320	0.192
42	0.0935	0.047	0.028	19	0.1660	0.083	0.050	$\frac{19}{64}$	0.2969	0.148	0.089	$\frac{21}{32}$	0.6563	0.328	0.197
41	0.0960	0.048	0.029	18	0.1695	0.085	0.051	$\frac{5}{16}$	0.3125	0.156	0.094	$\frac{43}{64}$	0.6719	0.336	0.202
40	0.0980	0.049	0.029	17	0.1730	0.087	0.052	$\frac{21}{64}$	0.3281	0.164	0.098	$\frac{11}{16}$	0.6875	0.344	0.206
39	0.0995	0.050	0.030	16	0.1770	0.089	0.053	$\frac{11}{32}$	0.3438	0.171	0.103	$\frac{23}{32}$	0.7188	0.359	0.216
38	0.1015	0.051	0.030	15	0.1800	0.090	0.054	$\frac{23}{64}$	0.3594	0.180	0.108	$\frac{3}{4}$	0.7500	0.375	0.225

TWIST DRILLS

British Standard Combined Drills and Countersinks (Center Drills).—BS 328: Part 2: 1972 (1990) provides dimensions of combined drills and countersinks for center holes. Three types of drill and countersink combinations are shown in this standard but are not given here. These three types will produce center holes without protecting chamfers, with protecting chamfers, and with protecting chamfers of radius form.

Drill Drivers—Split-Sleeve, Collet Type.—American National Standard ANSI B94.35-1972 (R2010) covers split-sleeve, collet-type drivers for driving straight shank drills, reamers, and similar tools, without tangs from 0.0390-inch through 0.1220-inch diameter, and with tangs from 0.1250-inch through 0.7500-inch diameter, including metric sizes.

For sizes 0.0390 through 0.0595 inch, the standard taper number is 1 and the optional taper number is 0. For sizes 0.0610 through 0.1875 inch, the standard taper number is 1, first optional taper number is 0, and second optional taper number is 2. For sizes 0.1890 through 0.2520 inch, the standard taper number is 1, first optional taper number is 2, and second optional taper number is 0. For sizes 0.2570 through 0.3750 inch, the standard taper number is 1 and the optional taper number is 2. For sizes 0.3860 through 0.5625 inch, the standard taper number is 2 and the optional taper number is 3. For sizes 0.5781 through 0.7500 inch, the standard taper number is 3 and the optional taper number is 4.

The depth B that the drill enters the driver is 0.44 inch for sizes 0.0390 through 0.0781 inch; 0.50 inch for sizes 0.0785 through 0.0938 inch; 0.56 inch for sizes 0.0960 through 0.1094 inch; 0.62 inch for sizes 0.1100 through 0.1220 inch; 0.75 inch for sizes 0.1250 through 0.1875 inch; 0.88 inch for sizes 0.1890 through 0.2500 inch; 1.00 inch for sizes 0.2520 through 0.3125 inch; 1.12 inches for sizes 0.3160 through 0.3750 inch; 1.25 inches for sizes 0.3860 through 0.4688 inch; 1.31 inches for sizes 0.4844 through 0.5625 inch; 1.47 inches for sizes 0.5781 through 0.6562 inch; and 1.62 inches for sizes 0.6719 through 0.7500 inch.

British Standard Metric Twist Drills.—BS 328: Part 1:1959 (incorporating amendments issued March 1960 and March 1964) covers twist drills made to inch and metric dimensions that are intended for general engineering purposes. ISO recommendations are taken into account. The accompanying tables give the standard metric sizes of Morse taper shank twist drills and core drills, parallel shank jobbing and long series drills, and stub drills.

All drills are right-hand cutting unless otherwise specified, and normal, slow, or quick helix angles may be provided. A “back-taper” is ground on the diameter from point to shank to provide longitudinal clearance. Core drills may have three or four flutes, and are intended for opening up cast holes or enlarging machined holes, for example. The parallel shank jobber, and long series drills, and stub drills are made without driving tenons.

Morse taper shank drills with oversize dimensions are also listed, and [Table 11](#) shows metric drill sizes superseding gage and letter size drills, which are now obsolete in Britain. To meet special requirements, the Standard lists nonstandard sizes for the various types of drills.

The limits of tolerance on cutting diameters, as measured across the lands at the outer corners of a drill, shall be h8, in accordance with BS 1916, Limits and Fits for Engineering (Part I, Limits and Tolerances), and [Table 14](#) shows the values common to the different types of drills mentioned before.

The drills shall be permanently and legibly marked whenever possible, preferably by rolling, showing the size, and the manufacturer's name or trademark. If they are made from high-speed steel, they shall be marked with the letters H.S. where practicable.

Drill Elements: The following definitions of drill elements are given.

Axis: The longitudinal center line.

Body: That portion of the drill extending from the extreme cutting end to the commencement of the shank.

Shank: That portion of the drill by which it is held and driven.

Flutes: The grooves in the body of the drill that provide lips and permit the removal of chips and allow cutting fluid to reach the lips.

Web (Core): The central portion of the drill situated between the roots of the flutes and extending from the point end toward the shank; the point end of the web or core forms the chisel edge.

Lands: The cylindrical-ground surfaces on the leading edges of the drill flutes. The width of the land is measured at right angles to the flute helix.

Body Clearance: The portion of the body surface that is reduced in diameter to provide diametral clearance.

Heel: The edge formed by the intersection of the flute surface and the body clearance.

Point: The sharpened end of the drill, consisting of all that part of the drill that is shaped to produce lips, faces, flanks, and chisel edge.

Face: That portion of the flute surface adjacent to the lip on which the chip impinges as it is cut from the work.

Flank: The surface on a drill point that extends behind the lip to the following flute.

Lip (Cutting Edge): The edge formed by the intersection of the flank and face.

Relative Lip Height: The relative position of the lips measured at the outer corners in a direction parallel to the drill axis.

Outer Corner: The corner formed by the intersection of the lip and the leading edge of the land.

Chisel Edge: The edge formed by the intersection of the flanks.

Chisel Edge Corner: The corner formed by the intersection of a lip and the chisel edge.

Table 11. British Standard Drills — Metric Sizes Superseding Gauge and Letter Sizes *BS 328: Part 1:1959, Appendix B*

Obsolete Drill Size	Recommended Metric Size (mm)	Obsolete Drill Size	Recommended Metric Size (mm)	Obsolete Drill Size	Recommended Metric Size (mm)	Obsolete Drill Size	Recommended Metric Size (mm)	Obsolete Drill Size	Recommended Metric Size (mm)
80	0.35	58	1.05	36	2.70	14	4.60	I	6.90
79	0.38	57	1.10	35	2.80	13	4.70	J	7.00
78	0.40	56	$\frac{3}{64}$ in.	34	2.80	12	4.80	K	$\frac{1}{32}$ in.
77	0.45	55	1.30	33	2.85	11	4.90	L	7.40
76	0.50	54	1.40	32	2.95	10	4.90	M	7.50
75	0.52	53	1.50	31	3.00	9	5.00	N	7.70
74	0.58	52	1.60	30	3.30	8	5.10	O	8.00
73	0.60	51	1.70	29	3.50	7	5.10	P	8.20
72	0.65	50	1.80	28	$\frac{1}{64}$ in.	6	5.20	Q	8.40
71	0.65	49	1.85	27	3.70	5	5.20	R	8.60
70	0.70	48	1.95	26	3.70	4	5.30	S	8.80
69	0.75	47	2.00	25	3.80	3	5.40	T	9.10
68	$\frac{1}{32}$ in.	46	2.05	24	3.90	2	5.60	U	9.30
67	0.82	45	2.10	23	3.90	1	5.80	V	$\frac{3}{8}$ in.
66	0.85	44	2.20	22	4.00	A	$\frac{1}{64}$ in.	W	9.80
65	0.90	43	2.25	21	4.00	B	6.00	X	10.10
64	0.92	42	$\frac{3}{32}$ in.	20	4.10	C	6.10	Y	10.30
63	0.95	41	2.45	19	4.20	D	6.20	Z	10.50
62	0.98	40	2.50	18	4.30	E	$\frac{1}{4}$ in.
61	1.00	39	2.55	17	4.40	F	6.50
60	1.00	38	2.60	16	4.50	G	6.60
59	1.05	37	2.65	15	4.60	H	$\frac{1}{64}$ in.

Gauge and letter size drills are now obsolete in the United Kingdom and should not be used in the production of new designs. The table is given to assist users in changing over to the recommended standard sizes.

**Table 12. British Standard Morse Taper Shank Twist Drills
and Core Drills — Standard Metric Sizes BS 328: Part 1:1959**

Diameter	Flute Length	Overall Length	Diameter	Flute Length	Overall Length	Diameter	Flute Length	Overall Length
3.00	33	114	16.75	125	223	30.25	180	301
3.20	36	117	17.00					
3.50	39	120	17.25	130	228	30.50		
3.80	43	123	17.50					
4.00			17.75					
4.20			18.00					
4.50	47	128	18.25	135	233	31.75	185	306
4.80	52	133	18.50					
5.00			18.75					
5.20			19.00					
5.50	57	138	19.25	140	238	32.00	185	334
5.80			19.50					
6.00			19.75					
6.20	63	144	20.00					
6.50			20.25					
6.80	69	150	20.50	145	243	34.00	190	339
7.00			20.75					
7.20			21.00					
7.50			21.25					
7.80	75	156	21.50	150	248	36.00	195	344
8.00			21.75					
8.20			22.00					
8.50			22.25					
8.80			22.50					
9.00	81	162	22.75	155	253	38.00	200	349
9.20			23.00					
9.50			23.25					
9.80	87	168	23.50	155	276	39.00	205	354
10.00			23.75					
10.20			24.00					
10.50			24.25					
10.80	94	175	24.50	160	281	40.00	210	359
11.00			24.75					
11.20			25.00					
11.50			25.25					
11.80			25.50					
12.00	101	182	25.75	165	286	41.00	215	364
12.20			26.00					
12.50			26.25					
12.80			26.50					
13.00			26.75					
13.20			27.00					
13.50	108	189	27.25	170	291	42.00	220	369
13.80			27.50					
14.00			27.75					
14.25			28.00					
14.50			28.25					
14.75	114	212	28.50	175	296	43.00	225	374
15.00			28.75					
15.25			29.00					
15.50			29.25					
15.75	120	218	29.50	175	296	44.00	230	417
16.00			29.75					
16.25			30.00					
16.50	125	223				45.00	235	422
						45.50		
						46.00		
						46.50		
						47.00		
						47.50		
						48.00		
						48.50		
						49.00		
						49.50		
						50.00		
						50.50		
						51.00		
						52.00		
						53.00		
						54.00		
						55.00		
						56.00		
						57.00		
						58.00		
						59.00		
						60.00		

Table 12. (Continued) British Standard Morse Taper Shank Twist Drills and Core Drills — Standard Metric Sizes BS 328: Part 1:1959

Diameter	Flute Length	Overall Length	Diameter	Flute Length	Overall Length	Diameter	Flute Length	Overall Length
61.00	240	427	76.00	260	477	91.00	275	529
62.00			77.00	260	514	92.00		
63.00			78.00			93.00		
64.00	245	432	79.00	265	519	94.00	280	534
65.00			80.00			95.00		
66.00			81.00			96.00		
67.00	250	437	82.00	270	524	97.00	280	534
68.00			83.00			98.00		
69.00			84.00			99.00		
70.00	250	437	85.00	270	524	100.00	280	534
71.00			86.00					
72.00			87.00					
73.00	255	442	88.00	270	524		280	534
74.00			89.00					
75.00			90.00					

All dimensions are in millimeters. Tolerances on diameters are given in the table below.

Table 13, shows twist drills that may be supplied with the shank and length oversize, but they should be regarded as non-preferred.

The Morse taper shanks of these twist and core drills are as follows: 3.00 to 14.00 mm diameter, M.T. No. 1; 14.25 to 23.00 mm diameter, M.T. No. 2; 23.25 to 31.50 mm diameter, M.T. No. 3; 31.75 to 50.50 mm diameter, M.T. No. 4; 51.00 to 76.00 mm diameter, M.T. No. 5; 77.00 to 100.00 mm diameter, M.T. No. 6.

Table 13. British Standard Morse Taper Shank Twist Drills — Metric Oversize Shank and Length Series BS 328: Part 1:1959

Dia. Range	Overall Length	M. T. No.	Dia. Range	Overall Length	M. T. No.	Dia. Range	Overall Length	M. T. No.
12.00 to 13.20	199	2	22.50 to 23.00	276	3	45.50 to 47.50	402	5
13.50 to 14.00	206	2	26.75 to 28.00	319	4	48.00 to 50.00	407	5
18.25 to 19.00	256	3	29.00 to 30.00	324	4	50.50	412	5
19.25 to 20.00	251	3	30.25 to 31.50	329	4	64.00 to 67.00	499	6
20.25 to 21.00	266	3	40.50 to 42.50	392	5	68.00 to 71.00	504	6
21.25 to 22.25	271	3	43.00 to 45.00	397	5	72.00 to 75.00	509	6

Diameters and lengths are given in millimeters. For the individual sizes within the diameter ranges given, see Table 12.

This series of drills should be regarded as non-preferred.

Table 14. British Standard Limits of Tolerance on Diameter for Twist Drills and Core Drills — Metric Series BS 328: Part 1:1959

Drill Size (Diameter measured across lands at outer corners)	Tolerance (h8)
0 to 1 inclusive	Plus 0.000 to Minus 0.014
Over 1 to 3 inclusive	Plus 0.000 to Minus 0.014
Over 3 to 6 inclusive	Plus 0.000 to Minus 0.018
Over 6 to 10 inclusive	Plus 0.000 to Minus 0.022
Over 10 to 18 inclusive	Plus 0.000 to Minus 0.027
Over 18 to 30 inclusive	Plus 0.000 to Minus 0.033
Over 30 to 50 inclusive	Plus 0.000 to Minus 0.039
Over 50 to 80 inclusive	Plus 0.000 to Minus 0.046
Over 80 to 120 inclusive	Plus 0.000 to Minus 0.054

All dimensions are given in millimeters.

Table 15. British Standard Parallel Shank Jobber Series Twist Drills — Standard Metric Sizes *BS 328: Part 1:1959*

Diameter	Flute Length	Overall Length	Diameter	Flute Length	Overall Length	Diameter	Flute Length	Overall Length	Diameter	Flute Length	Overall Length		
0.20	2.5	19	1.75	22	46	5.40	57	93	10.20	87	133		
0.22			1.80			5.50			10.30				
0.25	3.0	19	1.85			5.60			10.40				
0.28			1.90			5.70			10.50				
0.30	4	19	1.95	24	49	5.80			63	101	10.60	94	142
0.32			2.00			5.80					10.70		
0.35			2.05			5.90	10.80						
0.38			2.10			6.00	10.90						
0.40	5	20	2.15	27	53	6.10	69	109	11.00				
0.42			2.20			6.20			11.10				
0.45			2.25			6.30			11.20				
0.48			2.30			6.40			11.30				
0.50	6	22	2.35	30	57	6.50	75	117	11.40				
0.52			2.40			6.60			11.50				
0.55	7	24	2.45			6.70			11.60				
0.58			2.50			6.80			11.70				
0.60			2.55	6.90	11.80								
0.62	8	26	2.60	33	61	7.00	81	125	11.90	101	151		
0.65			2.65			7.10			12.00				
0.68	9	28	2.70			7.20			12.10				
0.70			2.75			7.30			12.20				
0.72			2.80	7.40	12.30								
0.75			2.85	7.50	12.40								
0.78	10	30	2.90	36	65	7.60	87	133	12.50				
0.80			2.95			7.70			12.60				
0.82			3.00			7.80			12.70				
0.85			3.10			7.90			12.80				
0.88	11	32	3.20	39	70	8.00	93	139	12.90				
0.90			3.30			8.10			13.00				
0.92			3.40			8.20			13.10				
0.95			3.50			8.30			13.20				
0.98	12	34	3.60	43	75	8.40	99	145	13.30				
1.00			3.70			8.50			13.40				
1.05			3.80			8.60			13.50				
1.10			3.90			8.70			13.60				
1.15	14	36	4.00	47	80	8.80	105	151	13.70				
1.20			4.10			8.90			13.80				
1.25			4.20			9.00			13.90				
1.30			4.30			9.10			14.00				
1.35	18	40	4.40	52	86	9.20	111	157	14.25				
1.40			4.50			9.30			14.50				
1.45			4.60			9.40			14.75				
1.50			4.70			9.50			15.00				
1.55	20	43	4.80	57	92	9.60	117	163	15.25				
1.60			4.90			9.70			15.50				
1.65			5.00			9.80			15.75				
1.70			5.10			9.90			16.00				
			5.20			10.00							
	5.30	10.10											

All dimensions are in millimeters. Tolerances on diameters are given in [Table 14](#).

**Table 16. British Standard Parallel Shank Long Series Twist Drills —
Standard Metric Sizes *BS 328: Part 1:1959***

Diameter	Flute Length	Overall Length	Diameter	Flute Length	Overall Length	Diameter	Flute Length	Overall Length				
2.00	56	85	6.80	102	156	12.70	134	205				
2.05			6.90			12.80						
2.10			7.00			12.90						
2.15	7.10	13.00										
2.20	7.20	13.10										
2.25	7.30	13.20										
2.30	59	90	7.40			13.30	140	214				
2.35			7.50			13.40						
2.40			7.60			13.50						
2.45			7.70			13.60						
2.50	62	95	7.80	109	165	13.70	140	214				
2.55			7.90			13.80						
2.60			8.00			13.90						
2.65			8.10			14.00						
2.70			8.20			14.25						
2.75	66	100	8.30			115	175	14.50	144	220		
2.80			8.40					14.75				
2.85			8.50					15.00				
2.90			8.60					15.25				
2.95			8.70					15.50				
3.00			8.80	15.75								
3.10	69	106	8.90	121	184			16.00	154	235		
3.20			9.00					16.25				
3.30			9.10					16.50				
3.40	73	112	9.20					128	195	16.75	158	241
3.50			9.30			17.00						
3.60			9.40			17.25						
3.70			9.50			17.50						
3.80			9.60			17.75						
3.90	78	119	9.70			134	205			18.00	162	247
4.00			9.80							18.25		
4.10			9.90	18.50								
4.20			10.00	18.75								
4.30			10.10	19.00								
4.40	82	126	10.20	148	214			19.25	166	254		
4.50			10.30					19.50				
4.60			10.40					19.75				
4.70			10.50					20.00				
4.80			10.60					20.25				
4.80	87	132	10.70			156	223	20.50	171	261		
4.90			10.80					20.75				
5.00			10.90					21.00				
5.10			11.00					21.25				
5.20			11.10					21.50				
5.30			11.20	21.75								
5.40	91	139	11.30	165	232			22.00	176	268		
5.50			11.40					22.25				
5.60			11.50					22.50				
5.70			11.60					22.75				
5.80			11.70			23.00						
5.90			11.80			23.25						
6.00			11.90			23.50						
6.10	97	148	12.00			174	241	23.75	180	275		
6.20			12.10					24.00				
6.30			12.20					24.25				
6.40			12.30	24.50								
6.50			12.40	24.75								
6.60			12.50	25.00								
6.70			12.60	25.00								

All dimensions are in millimeters. Tolerances on diameters are given in [Table 14](#).

Table 17. British Standard Stub Drills — Metric Sizes *BS 328: Part 1:1959*

Diameter	Flute Length	Overall Length	Diameter	Flute Length	Overall Length	Diameter	Flute Length	Overall Length	Diameter	Flute Length	Overall Length
0.50	3	20	5.00	26	62	9.50	40	84	14.00	54	107
0.80	5	24	5.20			9.80			14.50	56	111
1.00	6	26	5.50			10.00	43	89	15.00		
1.20	8	30	5.80	28	66	10.20			15.50	58	115
1.50	9	32	6.00			10.50			16.00		
1.80	11	36									
2.00	12	38	6.20	31	70	10.80			16.50	60	119
2.20	13	40	6.50			11.00			17.00		
2.50	14	43	6.80			11.20	47	95	17.50	62	123
2.80			7.00	34	74	11.50			18.00		
3.00	16	46	7.20			11.80			18.50	64	127
3.20	18	49	7.50			12.00			19.00		
3.50	20	52	7.80			12.20			19.50	66	131
			8.00	37	79	12.50			20.00		
3.80			8.20			12.80	51	102	21.00	68	136
4.00	22	55	8.50			13.00			22.00	70	141
4.20			8.80			13.20			23.00	72	146
4.50	24	58	9.00	40	84	13.50			24.00		
4.80	26	62	9.20			13.80	54	107	25.00	75	151

All dimensions are given in millimeters. Tolerances on diameters are given in [Table 14](#).

Steels for Twist Drills.—Twist drill steels need good toughness, abrasion resistance, and ability to resist softening due to heat generated by cutting. The amount of heat generated indicates the type of steel that should be used.

Carbon Tool Steel may be used where little heat is generated during drilling.

High-Speed Steel is preferred because of its combination of red hardness and wear resistance, which permit higher operating speeds and increased productivity. Optimum properties can be obtained by selection of alloy analysis and heat treatment.

Cobalt High-Speed Steel alloys have higher red hardness than standard high-speed steels, permitting drilling of materials such as heat-resistant alloys and materials with hardness greater than Rockwell 38 C. These high-speed drills can withstand cutting speeds beyond the range of conventional high-speed-steel drills and have superior resistance to abrasion but are not equal to tungsten-carbide tipped tools.

Accuracy of Drilled Holes.—Normally the diameter of drilled holes is not given a tolerance; the size of the hole is expected to be as close to the drill size as can be obtained.

The accuracy of holes drilled with a two-fluted twist drill is influenced by many factors, which include: the accuracy of the drill point; the size of the drill; length and shape of the chisel edge; whether or not a bushing is used to guide the drill; the work material; length of the drill; runout of the spindle and the chuck; rigidity of the machine tool, workpiece, and the setup; and also the cutting fluid used, if any.

The diameter of the drilled holes will be oversize in most materials. The table *Oversize Diameters in Drilling* on page 897 provides the results of tests reported by The United States Cutting Tool Institute in which the diameters of over 2800 holes drilled in steel and cast iron were measured. The values in this table indicate what might be expected under average shop conditions; however, when the drill point is accurately ground and the other machining conditions are correct, the resulting hole size is more likely to be between the mean and average minimum values given in this table. If the drill is ground and used incorrectly, holes that are even larger than the average maximum values can result.

Oversize Diameters in Drilling

Drill Dia., Inch	Amount Oversize, Inch			Drill Dia., Inch	Amount Oversize, Inch		
	Average Max.	Mean	Average Min.		Average Max.	Mean	Average Min.
$\frac{1}{16}$	0.002	0.0015	0.001	$\frac{1}{2}$	0.008	0.005	0.003
$\frac{1}{8}$	0.0045	0.003	0.001	$\frac{3}{4}$	0.008	0.005	0.003
$\frac{1}{4}$	0.0065	0.004	0.0025	1	0.009	0.007	0.004

Courtesy of The United States Cutting Tool Institute

Some conditions will cause the drilled hole to be undersize. For example, holes drilled in light metals and in other materials having a high coefficient of thermal expansion such as plastics, may contract to a size that is smaller than the diameter of the drill as the material surrounding the hole is cooled after having been heated by the drilling. The elastic action of the material surrounding the hole may also cause the drilled hole to be undersize when drilling high strength materials with a drill that is dull at its outer corner.

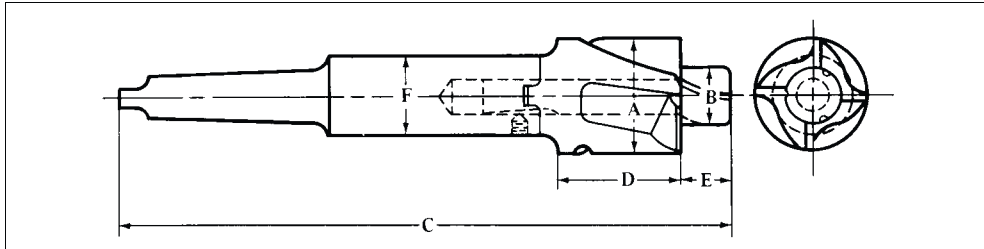
The accuracy of the drill point has a great effect on the accuracy of the drilled hole. An inaccurately ground twist drill will produce holes that are excessively over-size. The drill point must be symmetrical; i.e., the point angles must be equal, as well as the lip lengths and the axial height of the lips. Any alterations to the lips or to the chisel edge, such as thinning the web, must be done carefully to preserve the symmetry of the drill point. Adequate relief should be provided behind the chisel edge to prevent heel drag. On conventionally ground drill points this relief can be estimated by the chisel edge angle.

When drilling a hole, as the drill point starts to enter the workpiece, the drill will be unstable and will tend to wander. Then as the body of the drill enters the hole the drill will tend to stabilize. The result of this action is a tendency to drill a bellmouth shape in the hole at the entrance and perhaps beyond. Factors contributing to bellmouthing are: an unsymmetrically ground drill point; a large chisel edge length; inadequate relief behind the chisel edge; runout of the spindle and the chuck; using a slender drill that will bend easily; and lack of rigidity of the machine tool, workpiece, or the setup. Correcting these conditions as required will reduce the tendency for bellmouthing to occur and improve the accuracy of the hole diameter and its straightness. Starting the hole with a short stiff drill, such as a center drill, will quickly stabilize the drill that follows and reduce or eliminate bellmouthing; this procedure should always be used when drilling in a lathe, where the work is rotating. Bellmouthing can also be eliminated almost entirely and the accuracy of the hole improved by using a close fitting drill jig bushing placed close to the workpiece. Although specific recommendations cannot be made, many cutting fluids will help to increase the accuracy of the diameters of drilled holes. Double margin twist drills, available in the smaller sizes, will drill a more accurate hole than conventional twist drills having only a single margin at the leading edge of the land. The second land, located on the trailing edge of each land, provides greater stability in the drill bushing and in the hole. These drills are especially useful in drilling intersecting off-center holes. Single and double margin step drills, also available in the smaller sizes, will produce very accurate drilled holes, which are usually less than 0.002 inch (0.051 mm) larger than the drill size.

Counterboring.—Counterboring (called spot-facing if the depth is shallow) is the enlargement of a previously formed hole. Counterbores for screw holes are generally made in sets. Each set contains three counterbores: one with the body of the size of the screw head and the pilot the size of the hole to admit the body of the screw; one with the body the size of the head of the screw and the pilot the size of the tap drill; and the third with the body the size of the body of the screw and the pilot the size of the tap drill. Counterbores are usually provided with helical flutes to provide positive effective rake on the cutting edges. The four flutes are so positioned that the end teeth cut ahead of center to provide a shearing action and eliminate chatter in the cut. Three designs are most common: solid, two-piece, and three-piece. Solid designs have the body, cutter, and pilot all in one piece. Two-piece designs have an integral shank and counterbore cutter, with an interchangeable pilot, and provide true concentricity of the cutter diameter with the shank, but allowing use of various

pilot diameters. Three-piece counterbores have separate holder, counterbore cutter, and pilot, so that a holder will take any size of counterbore cutter. Each counterbore cutter, in turn, can be fitted with any suitable size diameter of pilot. Counterbores for brass are fluted straight.

Counterbores with Interchangeable Cutters and Guides



No. of Holder	No. of Morse Taper Shank	Range of Cutter Diameters, A	Range of Pilot Diameters, B	Total Length, C	Length of Cutter Body, D	Length of Pilot, E	Dia. of Shank, F
1	1 or 2	$\frac{3}{4}$ - $1\frac{1}{16}$	$\frac{1}{2}$ - $\frac{3}{4}$	$7\frac{1}{4}$	1	$\frac{5}{8}$	$\frac{3}{4}$
2	2 or 3	$1\frac{1}{8}$ - $1\frac{1}{16}$	$1\frac{1}{16}$ - $1\frac{1}{8}$	$9\frac{1}{2}$	$1\frac{3}{8}$	$\frac{7}{8}$	$1\frac{1}{8}$
3	3 or 4	$1\frac{3}{8}$ - $2\frac{1}{16}$	$\frac{7}{8}$ - $1\frac{3}{8}$	$12\frac{1}{2}$	$1\frac{3}{4}$	$1\frac{1}{8}$	$1\frac{3}{8}$
4	4 or 5	$2\frac{1}{8}$ - $3\frac{1}{2}$	1 - $2\frac{1}{8}$	15	$2\frac{1}{4}$	$1\frac{3}{8}$	$2\frac{1}{8}$

Small counterbores are often made with three flutes, but should then have the size plainly stamped on them before fluting, as they cannot afterwards be conveniently measured. The flutes should be deep enough to come below the surface of the pilot. The counterbore should be relieved on the end of the body only, and not on the cylindrical surface. To facilitate the relieving process, a small neck is turned between the guide and the body for clearance. The amount of clearance on the cutting edges is, for general work, from 4 to 5 degrees. The accompanying table gives dimensions for straight shank counterbores.

Solid Counterbores with Integral Pilot

Counterbore Diameters	Pilot Diameters			Straight Shank Diameter	Overall Length	
	Nominal	$+\frac{1}{64}$	$+\frac{1}{32}$		Short	Long
0.110	0.060	0.076	...	$\frac{7}{64}$	$2\frac{1}{2}$...
0.133	0.073	0.089	...	$\frac{1}{8}$	$2\frac{1}{2}$...
0.155	0.086	0.102	...	$\frac{5}{32}$	$2\frac{1}{2}$...
0.176	0.099	0.115	...	$\frac{11}{64}$	$2\frac{1}{2}$...
0.198	0.112	0.128	...	$\frac{3}{16}$	$2\frac{1}{2}$...
0.220	0.125	0.141	...	$\frac{3}{16}$	$2\frac{1}{2}$...
0.241	0.138	0.154	...	$\frac{7}{32}$	$2\frac{1}{2}$...
0.285	0.164	0.180	...	$\frac{1}{4}$	$2\frac{1}{2}$...
0.327	0.190	0.206	...	$\frac{9}{32}$	$2\frac{3}{4}$...
0.372	0.216	0.232	...	$\frac{5}{16}$	$2\frac{3}{4}$...
$\frac{13}{32}$	$\frac{1}{4}$	$\frac{17}{64}$	$\frac{9}{32}$	$\frac{3}{8}$	$3\frac{1}{2}$	$5\frac{1}{2}$
$\frac{1}{2}$	$\frac{5}{16}$	$\frac{21}{64}$	$\frac{11}{32}$	$\frac{3}{8}$	$3\frac{1}{2}$	$5\frac{1}{2}$
$\frac{19}{32}$	$\frac{3}{8}$	$\frac{25}{64}$	$\frac{13}{32}$	$\frac{1}{2}$	4	6
$\frac{11}{16}$	$\frac{7}{16}$	$\frac{29}{64}$	$\frac{15}{32}$	$\frac{1}{2}$	4	6
$\frac{25}{32}$	$\frac{1}{2}$	$\frac{33}{64}$	$\frac{17}{32}$	$\frac{1}{2}$	5	7

All dimensions are in inches.

Three Piece Counterbores.—Data shown for the first two styles of counterbores are for straight shank designs. These tools are also available with taper shanks in most sizes. Sizes of taper shanks for cutter diameters of $\frac{1}{4}$ to $\frac{9}{16}$ in. are No. 1, for $\frac{19}{32}$ to $\frac{7}{8}$ in., No. 2; for $\frac{15}{16}$ to $1\frac{3}{8}$ in., No. 3; for $1\frac{1}{2}$ to 2 in., No. 4; and for $2\frac{1}{8}$ to $2\frac{1}{2}$ in., No. 5.

Counterbore Sizes for Hex-head Bolts and Nuts.—Table 3a, page 1557, shows the maximum socket wrench dimensions for standard $\frac{1}{4}$ -, $\frac{1}{2}$ - and $\frac{3}{4}$ -inch drive socket sets. For a given socket size (nominal size equals the maximum width across the flats of nut or bolt head), the dimension *K* given in the table is the minimum counterbore diameter required to provide socket wrench clearance for access to the bolt or nut.

Sintered Carbide Boring Tools.—Industrial experience has shown that the shapes of tools used for boring operations need to be different from those of single-point tools ordinarily used for general applications such as lathe work. Accordingly, Section 5 of American National Standard ANSI B212.1-2002 gives standard sizes, styles and designations for four basic types of sintered carbide boring tools, namely: solid carbide square; carbide-tipped square; solid carbide round; and carbide-tipped round boring tools. In addition to these ready-to-use standard boring tools, solid carbide round and square unsharpened boring tool bits are provided.

Style Designations for Carbide Boring Tools: Table 1 shows designations used to specify the styles of American Standard sintered carbide boring tools. The first letter denotes solid (S) or tipped (T). The second letter denotes square (S) or round (R). The side cutting edge angle is denoted by a third letter (A through H) to complete the style designation. Solid square and round bits with the mounting surfaces ground but the cutting edges unsharpened (Table 3) are designated using the same system except that the third letter indicating the side cutting edge angle is omitted.

Table 1. American National Standard Sintered Carbide Boring Tools — Style Designations ANSI B212.1-2002 (R2007)

Side Cutting Edge Angle <i>E</i>		Boring Tool Styles			
Degrees	Designation	Solid Square (SS)	Tipped Square (TS)	Solid Round (SR)	Tipped Round (TR)
0	A		TSA		
10	B		TSB		
30	C	SSC	TSC	SRC	TRC
40	D		TSD		
45	E	SSE	TSE	SRE	TRE
55	F		TSF		
90 (0° Rake)	G				TRG
90 (10° Rake)	H				TRH

Size Designation of Carbide Boring Tools: Specific sizes of boring tools are identified by the addition of numbers after the style designation. The first number denotes the diameter or square size in number of $\frac{1}{32}$ nds for types SS and SR and in number of $\frac{1}{16}$ ths for types TS and TR. The second number denotes length in number of $\frac{1}{8}$ ths for types SS and SR. For styles TRG and TRH, a letter “U” after the number denotes a semi-finished tool (cutting edges unsharpened). Complete designations for the various standard sizes of carbide boring tools are given in Tables 2 through 7. In the diagrams in the tables, angles shown without tolerance are $\pm 1^\circ$.

Examples of Tool Designation: The designation TSC-8 indicates: a carbide-tipped tool (T); square cross-section (S); 30-degree side cutting edge angle (C); and $\frac{8}{16}$ or $\frac{1}{2}$ inch square size (8).

The designation SRE-66 indicates: a solid carbide tool (S); round cross-section (R); 45 degree side cutting edge angle (E); $\frac{6}{32}$ or $\frac{3}{16}$ inch diameter (6); and $\frac{6}{8}$ or $\frac{3}{4}$ inch long (6).

The designation SS-610 indicates: a solid carbide tool (S); square cross-section (S); $\frac{6}{32}$ or $\frac{3}{16}$ inch square size (6); $\frac{10}{8}$ or $1\frac{1}{4}$ inches long (10).

It should be noted in this last example that the absence of a third letter (from A to H) indicates that the tool has its mounting surfaces ground but that the cutting edges are unsharpened.

Table 2. ANSI Carbide-Tipped Round General-Purpose Square-End Boring Tools Style TRG with 0° Rake and Style TRH with 10° Rake ANSI B212.1-2002 (R2007)

Tool Designation		Shank Dimensions, Inches					Rake Angle Deg.	Tip No.	Tip Dimensions, Inches		
Finished	Semi-finished ^a	Dia. <i>D</i>	Length <i>C</i>	Dim. Over Flat <i>B</i>	Nose Height <i>H</i>	Set-back <i>M</i> (Min)			<i>T</i>	<i>W</i>	<i>L</i>
TRG-5	TRG-5U	5/16	1 1/2	19/64	3/16	3/16	0	1025	1/16	1/4	1/4
TRH-5	TRH-5U			±.005	7/32	3/16	10				
TRG-6	TRG-6U	3/8	1 3/4	11/32	7/32	3/16	0	1030	1/16	5/16	1/4
TRH-6	TRH-6U			±.010	1/4	10					
TRG-7	TRG-7U	7/16	2 1/2	13/32	1/4	3/16	0	1080	3/32	5/16	3/8
TRH-7	TRH-7U			±.010	5/16	10					
TRG-8	TRG-8U	1/2	2 1/2	15/32	9/32	1/4	0	1090	3/32	3/8	3/8
TRH-8	TRH-8U			±.010	11/32	10					

^a Semifinished tool will be without Flat (B) and carbide unground on the end.

Table 3. Solid Carbide Square and Round Boring Tool Bits

Square Bits				Round Bits								
Tool Designation	<i>A</i>	<i>B</i>	<i>C</i>	Tool Designation	<i>D</i>	<i>C</i>	Tool Designation	<i>D</i>	<i>C</i>	Tool Designation	<i>D</i>	<i>C</i>
SS-58	5/32	5/32	1	SR-33	3/32	3/8	SR-55	5/32	5/8	SR-88	1/4	1
SS-610	3/16	3/16	1 1/4	SR-34	3/32	1/2	SR-64	3/16	1/2	SR-810	1/4	1 1/4
SS-810	1/4	1/4	1 1/4	SR-44	1/8	1/2	SR-66	3/16	3/4	SR-1010	5/16	1 1/4
SS-1012	3/16	5/16	1 1/2	SR-46	1/8	3/4	SR-69	3/16	1 1/8
SS-1214	3/8	3/8	1 3/4	SR-48	1/8	1	SR-77	7/32	7/8

All dimensions are in inches.

Tolerance on Length: Through 1 inch, + 1/32, - 0; over 1 inch, + 1/16, - 0.

Table 4. ANSI Solid Carbide Square Boring Tools
Style SSC for 60° Boring Bar and Style SSE for 45° Boring Bar
ANSI B212.1-2002 (R2007)

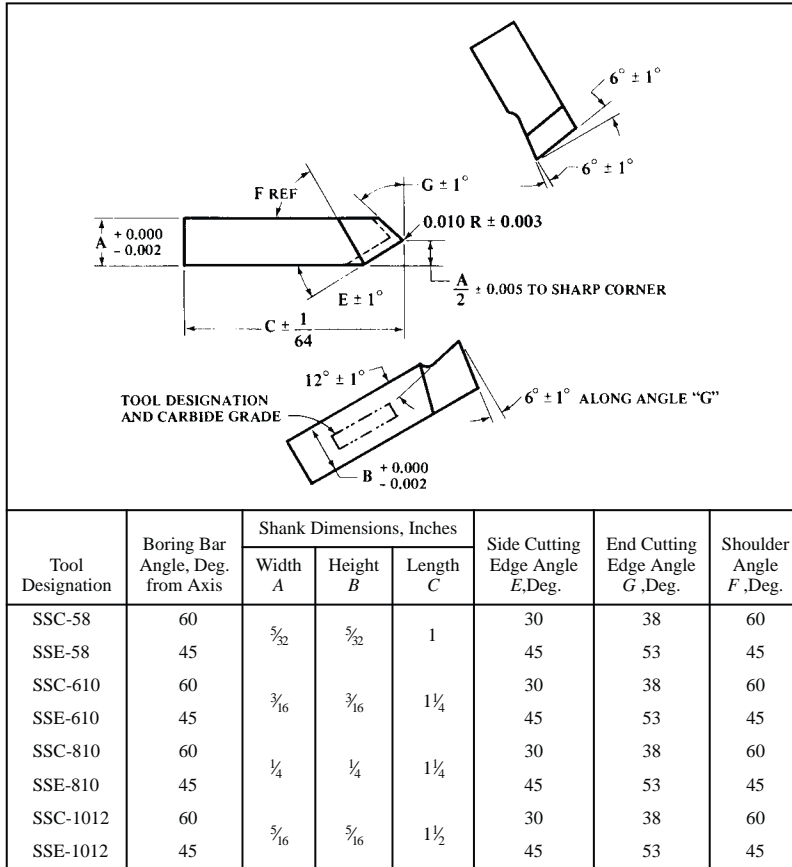


Table 5. ANSI Carbide-Tipped Round Boring Tools
Style TRC for 60° Boring Bar and Style TRE for 45° Boring Bar
ANSI B212.1-2002 (R2007)

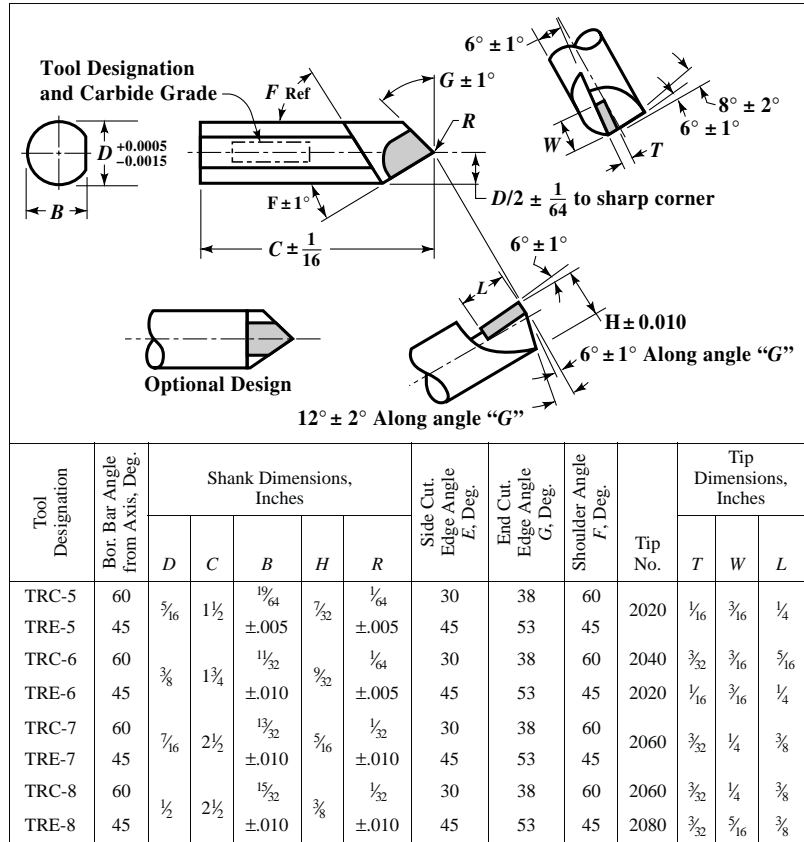


Table 6. ANSI Carbide-Tipped Square Boring Tools — ANSI B212.1-2002 (R2007)
Styles TSA and TSB for 90° Boring Bar, Styles TSC and TSD for 60° Boring Bar,
and Styles TSE and TSF for 45° Boring Bar

Tool Designation	Bor. Bar Angle from Axis, Deg.	Shank Dimensions, Inches				Side Cut, Edge Angle E, Deg.	End Cut, Edge Angle G, Deg.	Shoulder Angle F, Deg.	Tip Dimensions, Inches			
		A	B	C	R				Tip No.	T	W	L
TSA-5	90	5/16	5/16	1 1/2	(1/64 ± 0.005)	0	8	90	2040	3/32	3/16	5/16
TSB-5	90	5/16	5/16	1 1/2		10	8	90	2040	3/32	3/16	5/16
TSC-5	60	5/16	5/16	1 1/2		30	38	60	2040	3/32	3/16	5/16
TSD-5	60	5/16	5/16	1 1/2		40	38	60	2040	3/32	3/16	5/16
TSE-5	45	5/16	5/16	1 1/2		45	53	45	2040	3/32	3/16	5/16
TSF-5	45	5/16	5/16	1 1/2		55	53	45	2040	3/32	3/16	5/16
TSA-6	90	3/8	3/8	1 3/4	(1/32 ± 0.010)	0	8	90	2040	3/32	3/16	5/16
TSB-6	90	3/8	3/8	1 3/4		10	8	90	2040	3/32	3/16	5/16
TSC-6	60	3/8	3/8	1 3/4		30	38	60	2040	3/32	3/16	5/16
TSD-6	60	3/8	3/8	1 3/4		40	38	60	2040	3/32	3/16	5/16
TSE-6	45	3/8	3/8	1 3/4		45	53	45	2040	3/32	3/16	5/16
TSF-6	45	3/8	3/8	1 3/4		55	53	45	2040	3/32	3/16	5/16
TSA-7	90	7/16	7/16	2 1/2	(1/32 ± 0.010)	0	8	90	2060	3/32	1/4	3/8
TSB-7	90	7/16	7/16	2 1/2		10	8	90	2060	3/32	1/4	3/8
TSC-7	60	7/16	7/16	2 1/2		30	38	60	2060	3/32	1/4	3/8
TSD-7	60	7/16	7/16	2 1/2		40	38	60	2060	3/32	1/4	3/8
TSE-7	45	7/16	7/16	2 1/2		45	53	45	2060	3/32	1/4	3/8
TSF-7	45	7/16	7/16	2 1/2		55	53	45	2060	3/32	1/4	3/8
TSA-8	90	1/2	1/2	2 1/2	(1/32 ± 0.010)	0	8	90	2150	1/8	5/16	7/16
TSB-8	90	1/2	1/2	2 1/2		10	8	90	2150	1/8	5/16	7/16
TSC-8	60	1/2	1/2	2 1/2		30	38	60	2150	1/8	5/16	7/16
TSD-8	60	1/2	1/2	2 1/2		40	38	60	2150	1/8	5/16	7/16
TSE-8	45	1/2	1/2	2 1/2		45	53	45	2150	1/8	5/16	7/16
TSF-8	45	1/2	1/2	2 1/2		55	53	45	2150	1/8	5/16	7/16
TSA-10	90	5/8	5/8	3	(1/32 ± 0.010)	0	8	90	2220	3/32	3/8	9/16
TSB-10	90	5/8	5/8	3		10	8	90	2220	3/32	3/8	9/16
TSC-10	60	5/8	5/8	3		30	38	60	2220	3/32	3/8	9/16
TSD-10	60	5/8	5/8	3		40	38	60	2220	3/32	3/8	9/16
TSE-10	45	5/8	5/8	3		45	53	45	2220	3/32	3/8	9/16
TSF-10	45	5/8	5/8	3		55	53	45	2220	3/32	3/8	9/16
TSA-12	90	3/4	3/4	3 1/2	(1/32 ± 0.010)	0	8	90	2300	3/16	7/16	5/8
TSB-12	90	3/4	3/4	3 1/2		10	8	90	2300	3/16	7/16	5/8
TSC-12	60	3/4	3/4	3 1/2		30	38	60	2300	3/16	7/16	5/8
TSD-12	60	3/4	3/4	3 1/2		40	38	60	2300	3/16	7/16	5/8
TSE-12	45	3/4	3/4	3 1/2		45	53	45	2300	3/16	7/16	5/8
TSF-12	45	3/4	3/4	3 1/2		55	53	45	2300	3/16	7/16	5/8

**Table 7. ANSI Solid Carbide Round Boring Tools — ANSI B212.1-2002 (R2007)
Style SRC for 60° Boring Bar and Style SRE for 45° Boring Bar**

Tool Designation	Bor. Bar Angle from Axis, Deg.	Shank Dimensions, Inches				Side Cut. Edge Angle E, Deg.	End Cut. Edge Angle G, Deg.	Shoulder Angle F, Deg.	
		Dia. D	Length C	Dim. Over Flat B	Nose Height H				
SRC-33	60	3/32	3/8	0.088	0.070	[+0.000 -0.005]	30	38	60
SRE-33	45	3/32	3/8	0.088	0.070		45	53	45
SRC-44	60	1/8	1/2	0.118	0.094	[+0.000 -0.005]	30	38	60
SRE-44	45	1/8	1/2	0.118	0.094		45	53	45
SRC-55	60	3/32	3/8	0.149	0.117	±0.005	30	38	60
SRE-55	45	3/32	3/8	0.149	0.117	±0.005	45	53	45
SRC-66	60	3/16	3/4	0.177	0.140	±0.005	30	38	60
SRE-66	45	3/16	3/4	0.177	0.140	±0.005	45	53	45
SRC-88	60	1/4	1	0.240	0.187	±0.005	30	38	60
SRE-88	45	1/4	1	0.240	0.187	±0.005	45	53	45
SRC-1010	60	5/16	1 1/4	0.300	0.235	±0.005	30	38	60
SRE-1010	45	5/16	1 1/4	0.300	0.235	±0.005	45	53	45

Boring Machines, Origin.—The first boring machine was built by John Wilkinson, in 1775. Smeaton had built one in 1769 which had a large rotary head, with inserted cutters, carried on the end of a light, overhanging shaft. The cylinder to be bored was fed forward against the cutter on a rude carriage, running on a track laid in the floor. The cutter head followed the inaccuracies of the bore, doing little more than to smooth out local roughness of the surface. Watt's first steam cylinders were bored on this machine and he complained that one, 18 inches in diameter, was 3/8 inch out of true. Wilkinson thought of the expedient, which had escaped both Smeaton and Watt, of extending the boring-bar completely through the cylinder and giving it an out-board bearing, at the same time making it much larger and stiffer. With this machine cylinders 57 inches in diameter were bored which were within 1/16 inch of true. Its importance can hardly be overestimated as it insured the commercial success of Watt's steam engine which, up to that time, had not passed the experimental stage.

TAPS

A tap is a mechanical device applied to make a standard thread on a hole. A range of tap pitch diameter (PD) limits, from which the user may select to suit local conditions, is available. Taps included in the ASME B94.9 standard are categorized according to type, style, size and chamfer, and blank design. General dimensions and tap markings are given in the standard ASME B94.9 *Taps: Ground and Cut Threads (Inch and Metric Sizes)* for straight fluted taps, spiral pointed taps, spiral pointed only taps, spiral fluted taps, fast spiral fluted taps, thread forming taps, pulley taps, nut taps, and pipe taps. The standard also gives the thread limits for taps with cut threads and ground threads. The tap thread limits and tolerances are given in [Tables 2 to 4](#), tap dimensions for cut thread and ground thread are given in [Tables 5a through 10](#). Pulley tap dimensions and tolerances are given in [Table 12](#), straight and taper pipe thread tap dimensions and tolerances are given on [Tables 13a and 13b](#), and thread limits for cut thread and ground thread taps are given in [Tables 15 through 26a](#).

Thread Form, Styles, and Types

Thread Form.—The basic angle of thread between the flanks of thread measured in an axial plane is 60 degrees. The line bisecting this 60° angle is perpendicular to the axis of the screw thread. The symmetrical height of the thread form, h , is found as follows:

$$h = 0.64951905P = \frac{0.64951905}{n} \quad (1)$$

The basic pitch diameter (PD) is obtained by subtracting the symmetrical single thread height, h , from the basic major diameter as follows:

$$\text{Basic Pitch Diameter} = D_{bsc} - h \quad (2)$$

D_{bsc} = basic major diameter

P = pitch of thread

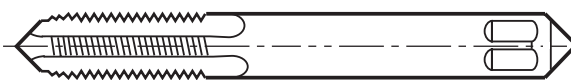
h = symmetrical height of thread

n = number of threads per inch

Types and Styles of Taps.—Tap *type* is based on general dimensions such as standard straight thread, taper and straight pipe, pulley, etc., or is based on purpose, such as thread forming and screw thread inserts (STI).

Tap *style* is based on flute construction for cutting taps, such as straight, spiral, or spiral point, and on lobe style and construction for forming taps, such as straight or spiral.

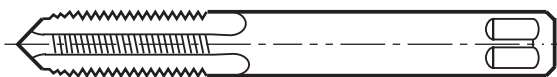
Straight Flute Taps: These taps have straight flutes of a number specified as either standard or optional, and are for general purpose applications. This standard applies to machine screw, fractional, metric, and STI sizes in high speed steel ground thread, and to machine screw and fractional sizes in high speed and carbon steel cut thread, with taper, plug, semibottom, and bottom chamfer.



BLANK Design 1



BLANK Design 3



BLANK Design 2

Spiral Pointed Taps: These taps have straight flutes and the cutting face of the first few threads is ground at an angle to force the chips ahead and prevent clogging in the flutes. This standard applies to machine screw, fractional, metric, and STI sizes in high

speed steel ground thread, and to cut thread in machine screw and fractional sizes with plug, semibottom, and bottom chamfer.



Blank Design 1

Blank Design 2



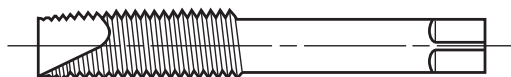
Blank Design 3

Spiral Pointed Only Taps: These taps are made with the spiral point feature only without longitudinal flutes. These taps are especially suitable for tapping thin materials. This standard applies to machine screw and fractional sizes in high speed steel, ground thread, with plug chamfer.



Blank Design 1

Blank Design 2



Blank Design 3

Spiral Fluted Taps: These taps have right-hand helical flutes with a helix angle of 25 to 35 degrees. These features are designed to help draw chips from the hole or to bridge a keyway. This standard applies to machine screw, fractional, metric, and STI sizes in high speed steel and to ground thread with plug, semibottom, and bottom chamfer.



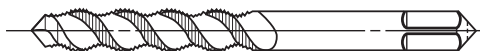
Blank Design 1

Blank Design 2

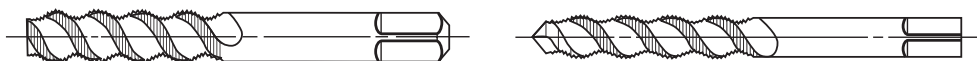


Blank Design 3

Fast Spiral Fluted Taps: These taps are similar to spiral fluted taps, except the helix angle is from 45 to 60 degrees. This standard applies to machine screw, fractional, metric, and STI sizes in high speed steel with plug, semibottom, and bottom chamfer.



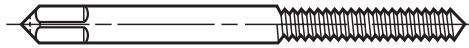
Blank Design 1



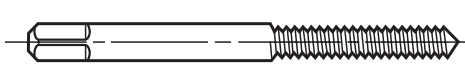
Blank Design 2

Blank Design 3

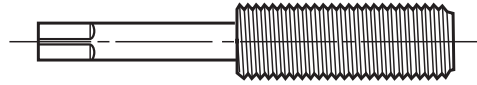
Thread Forming Taps: These taps are fluteless except as optionally designed with one or more lubricating grooves. The thread form on the tap is lobed, so that there are a finite number of points contacting the work thread form. The tap does not cut, but forms the thread by extrusion. This standard applies to machine screw, fractional, and metric sizes, in high speed steel, ground thread form, with plug, semibottom, and bottom entry taper.



Blank Design 1



Blank Design 2



Blank Design 3

Pulley Taps: These taps were originally designed for tapping line shaft pulleys by hand. Today, these taps have shanks that are extended in length by a standard amount for use where added reach is required. The shank is the same nominal diameter as the thread. This standard applies to fractional size and ground thread with plug and bottom chamfer.



Pipe Taps: These taps are used to produce standard straight or tapered pipe threads. This standard applies to fractional size in high speed steel, ground thread, to high speed steel and carbon steel in cut thread, and to straight pipe taps having plug chamfers and taper pipe taps.



Standard System of Tap Marking.—Ground thread taps specified in the U.S. customary system are marked with the nominal size, number of threads per inch, the proper symbol to identify the thread form, “HS” for high-speed steel, “G” for ground thread, and designators for tap pitch diameter and special features, such as left-hand and multi-start threads.

Cut thread taps specified in the U.S. customary system are marked with the nominal size, number of threads per inch, and the proper symbol to identify the thread form. High-speed steel taps are marked “HS,” but carbon steel taps need not be marked.

Ground thread taps made with metric screw threads (M profile) are marked with “M,” followed by the nominal size and pitch in millimeters, separated by “X”. Marking also includes “HS” for high-speed steel, “G” for ground thread, designators for tap pitch diameter and special features, such as left-hand and multi-start threads.

Thread symbol designators are listed in the accompanying table. Tap pitch diameter designators, systems of limits, special features, and examples for ground threads are given in the following section.

Standard System of Tap Thread Limits and Identification for Unified Inch Screw Threads, Ground Thread.—*H or L Limits:* For Unified inch screw threads, when the maximum tap pitch diameter is over basic pitch diameter by an even multiple of 0.0005 inches, or the minimum tap pitch diameter limit is under basic pitch diameter by an even multiple of 0.0005 inches, the taps are marked “H” or “L”, respectively, followed by a limit number, determined as follows:

$$\text{H Limit number} = \frac{\text{Tap PD} - \text{Basic PD}}{0.0005}$$

$$\text{L Limit number} = \frac{\text{Basic PD} - \text{Tap PD}}{0.0005}$$

The tap PD tolerances for ground threads are given in [Table 2](#), column D; PD tolerances for cut threads are given in [Table 3](#), column D. For standard taps, the PD limits for various H limit numbers are given in [Table 20](#). The minimum tap PD equals the basic PD minus the

number of half-thousandths (0.0005 in.) represented by the limit number. The maximum tap PD equals the minimum PD plus the PD tolerance given in [Table 20](#).

Tap Marking with H or L Limit Numbers

Example 1: $\frac{3}{8}$ -16 NC HS H1

$$\begin{aligned}\text{Maximum tap PD} &= \text{Basic PD} + 0.0005 \\ &= \frac{3}{8} - \left(0.64951904 \times \frac{1}{16}\right) + 0.0005 \\ &= 0.3344 + 0.0005 \\ &= 0.3349\end{aligned}$$

$$\begin{aligned}\text{Minimum tap PD} &= \text{Maximum tap PD} - 0.0005 \\ &= 0.3349 - 0.0005 \\ &= 0.3344\end{aligned}$$

Example 2: $\frac{3}{8}$ -16 NC HS G L2

$$\begin{aligned}\text{Minimum tap PD} &= \text{Basic PD} - 0.0010 \\ &= \frac{3}{8} - \left(0.64951904 \times \frac{1}{16}\right) - 0.0010 \\ &= 0.3344 - 0.0010 \\ &= 0.3334\end{aligned}$$

$$\begin{aligned}\text{Maximum tap PD} &= \text{Minimum tap PD} + 0.0005 \\ &= 0.3334 + 0.0005 \\ &= 0.3339\end{aligned}$$

Oversize or Undersize: When the maximum tap PD over basic PD or the minimum tap PD under basic PD is not an even multiple of 0.0005, the tap PD is usually designated as an amount oversize or undersize. The amount oversize is added to the basic PD to establish the *minimum* tap PD. The amount undersize is subtracted from the basic PD to establish the *minimum* tap PD. The PD tolerance from [Table 2](#) is added to the minimum tap PD to establish the maximum tap PD for both.

Example: $\frac{7}{16}$ -14 NC plus 0.0017 HS G

Min. tap PD = Basic PD + 0.0017 in.

Max. tap PD = Min. tap PD + 0.0005 in.

Whenever possible for oversize or other special tap PD requirements, the maximum and minimum tap PD requirements should be specified.

Special Tap Pitch Diameter: Taps not made to H or L limit numbers, to the specifications in, or to the formula for oversize or undersize taps, may be marked with the letter “S” enclosed by a circle or by some other special identifier. *Example:* $\frac{1}{2}$ -16 NC HS G.

Left-Hand Taps: Taps with left-hand threads are marked “LEFT HAND” or “LH.” *Example:* $\frac{3}{8}$ -16 NC LH HS G H3.

Table 1. Thread Series Designations

Standard Tap Marking	Product Thread Designation	Third Series	American National Standard References
M	M	Metric Screw Threads—M Profile, with basic ISO 68 profile	B1.13M B1.18M
M	MJ	Metric Screw Threads: MJ Profile, with rounded root of radius 0.15011 <i>P</i> to 0.18042 <i>P</i> (external thread only) Class 5 interference-fit thread	B1.121M
NC	NC5IF	Entire ferrous material range	B1.12
NC	NC5INF	Entire nonferrous material range	B1.12
NPS	NPSC	American Standard straight pipe threads in pipe couplings	B1.20.1
NPSF	NPSF	Dryseal American Standard fuel internal straight pipe threads	B1.20.3
NPSH	NPSH	American Standard straight hose coupling threads for joining to American Standard taper pipe threads	B1.20.7
NPSI	NPSI	Dryseal American Standard intermediate internal straight pipe threads	B1.20.3
NPSL	NPSL	American Standard straight pipe threads for loose-fitting mechanical joints with locknuts	B1.20.1
NPS	NPSM	American Standard straight pipe threads for free-fitting mechanical joints for fixtures	B1.20.1
ANPT	ANPT	Pipe threads, taper, aeronautical, national form	MIL-P-7105
NPT	NPT	American Standard taper pipe threads for general use	B1.20.1
NPTF	NPTF	Dryseal American Standard taper pipe threads	B1.20.3
NPTR	NPTR	American Standard taper pipe threads for railing joints	B1.20.1
PTF	PTF	Dryseal American Standard pipe threads	B1.20.3
PTF-SPL	PTF-SPL	Dryseal American Standard pipe threads	B1.20.3
STI	STI	Helical coil screw thread inserts—free running and screwlocking (inch series)	B18.29.1
Unified Inch Screw Thread			
N	UN	Constant-pitch series	B1.1
NC	UNC	Coarse pitch series	B1.1
NF	UNF	Fine pitch series	B1.1
NEF	UNEF	Extra-fine pitch series	B1.1
N	UNJ	Constant-pitch series, with rounded root of radius 0.15011 <i>P</i> to 0.18042 <i>P</i> (external thread only)	MIL-S-8879
NC	UNJC	Coarse pitch series, with rounded root of radius 0.15011 <i>P</i> to 0.18042 <i>P</i> (external thread only)	B1.15 MIL-S-8879
NF	UNJF	Fine pitch series, with rounded root of radius 0.15011 <i>P</i> to 0.18042 <i>P</i> (external thread only)	B1.15 MIL-S-8879
NEF	UNJEF	Extra-fine pitch series, with rounded root of radius 0.15011 <i>P</i> to 0.18042 <i>P</i> (external thread only)	B1.15 MIL-S-8879
N	UNR	Constant-pitch series, with rounded root of radius not less than 0.108 <i>P</i> (external thread only)	B1.1
NC	UNRC	Coarse thread series, with rounded root of radius not less than 0.108 <i>P</i> (external thread only)	B1.1
NF	UNRF	Fine pitch series, with rounded root of radius not less than 0.108 <i>P</i> (external thread only)	B1.1
NEF	UNREF	Extra-fine pitch series, with rounded root of radius not less than 0.108 <i>P</i> (external thread only)	B1.1
NS	UNS	Special diameter pitch, or length of engagement	B1.1

**Table 2. Tap Thread Limits and Tolerances ASME B94.9-1999
Formulas for Unified Inch Screw Threads (Ground Thread)**

Max. Major Diameter = Basic Diameter + A		Min. Pitch Diameter = Basic Diameter + C							
Min. Major Diameter = Max. Maj. Dia. - B		Max. Pitch Diameter = Min. Pitch Dia. + D							
A = Constant to add = 0.130P for all pitches									
B = Major diameter tolerance = 0.087P for 48 to 80 tpi; 0.076P for 36 to 47 tpi; 0.065P for 4 to 35 tpi									
C = Amount over basic for minimum pitch diameter									
D = Pitch diameter tolerance									
Threads per Inch	A	B	C				D		
			0 to 5/8	5/8 to 2 1/2	Over 2 1/2	0 to 1	1 to 1 1/2	1 1/2 to 2 1/2	Over 2 1/2
80	0.0016	0.0011	0.0005	0.0010	0.0015	0.0005	0.0010	0.0010	0.0015
72	0.0018	0.0012	0.0005	0.0010	0.0015	0.0005	0.0010	0.0010	0.0015
64	0.0020	0.0014	0.0005	0.0010	0.0015	0.0005	0.0010	0.0010	0.0015
56	0.0023	0.0016	0.0005	0.0010	0.0015	0.0005	0.0010	0.0010	0.0015
48	0.0027	0.0018	0.0005	0.0010	0.0015	0.0005	0.0010	0.0010	0.0015
44	0.0030	0.0017	0.0005	0.0010	0.0015	0.0005	0.0010	0.0010	0.0015
40	0.0032	0.0019	0.0005	0.0010	0.0015	0.0005	0.0010	0.0010	0.0015
36	0.0036	0.0021	0.0005	0.0010	0.0015	0.0005	0.0010	0.0010	0.0015
32	0.0041	0.0020	0.0010	0.0010	0.0015	0.0005	0.0010	0.0010	0.0015
28	0.0046	0.0023	0.0010	0.0010	0.0015	0.0005	0.0010	0.0010	0.0015
24	0.0054	0.0027	0.0010	0.0010	0.0015	0.0005	0.0010	0.0015	0.0015
20	0.0065	0.0032	0.0010	0.0010	0.0015	0.0005	0.0010	0.0015	0.0015
18	0.0072	0.0036	0.0010	0.0010	0.0015	0.0005	0.0010	0.0015	0.0015
16	0.0081	0.0041	0.0010	0.0010	0.0015	0.0005	0.0010	0.0015	0.0020
14	0.0093	0.0046	0.0010	0.0015	0.0015	0.0005	0.0010	0.0015	0.0020
13	0.0100	0.0050	0.0010	0.0015	0.0015	0.0005	0.0010	0.0015	0.0020
12	0.1080	0.0054	0.0010	0.0015	0.0015	0.0005	0.0010	0.0015	0.0020
11	0.0118	0.0059	0.0010	0.0015	0.0020	0.0005	0.0010	0.0015	0.0020
10	0.0130	0.0065	...	0.0015	0.0020	0.0005	0.0010	0.0015	0.0020
9	0.0144	0.0072	...	0.0015	0.0020	0.0005	0.0010	0.0015	0.0020
8	0.0162	0.0081	...	0.0015	0.0020	0.0005	0.0010	0.0015	0.0020
7	0.0186	0.0093	...	0.0015	0.0020	0.0010	0.0010	0.0020	0.0025
6	0.0217	0.0108	...	0.0015	0.0020	0.0010	0.0010	0.0020	0.0025
5 1/2	0.0236	0.0118	...	0.0015	0.0020	0.0010	0.0015	0.0020	0.0025
5	0.0260	0.0130	...	0.0015	0.0020	0.0010	0.0015	0.0020	0.0025
4 1/2	0.0289	0.0144	...	0.0015	0.0020	0.0010	0.0015	0.0020	0.0025
4	0.0325	0.0162	...	0.0015	0.0020	0.0010	0.0015	0.0020	0.0025

Dimensions are given in inches.

The tables and formulas are used in determining the limits and tolerances for ground thread taps having a thread lead angle not in excess of 5°, unless otherwise specified.

The tap major diameter must be determined from a specified tap pitch diameter, the maximum major diameter equals the minimum specified tap pitch diameter minus constant C, plus 0.64951904P plus constant A.

$$\text{Maximum Major Diameter} = \text{Tap Pitch Diameter} - C + 0.64951904P + A$$

For intermediate pitches use value of next coarser pitch for C and D, use formulas for A and B.

Lead Tolerance: ± 0.0005 inch within any two threads not farther apart than 1 inch.

Angle Tolerance: ± 20' in half angle for 4 to 5 1/2 pitch; ± 25' in half angle for 6 to 9 pitch, and ± 30' in half angle for 10 to 80 pitch.

**Table 3. Tap Thread Limits and Tolerances ASME B94.9-1999
Formulas for Unified Inch Screw Threads (Cut Thread)**

Min. Major Diameter = Basic Diameter + $B + C$		Min. Pitch Diameter = Basic Diameter + B			
Max. Major Diameter = Min. Maj. Dia. + A		Max. Pitch Diameter = Min. Pitch Dia. + D			
A = Major diameter tolerance					
B = Amount over basic for minimum pitch diameter					
C = A constant to add for major diameter: 20% of theoretical truncation for 2 to 5.5 threads per inch and 25% for 6 to 80 threads per inch					
D = Pitch diameter tolerance					
Diameter of Tap (Inch)	A	B		D	
		36 or more TPI	34 or less TPI	Coarser than N.F.	N.F. and Finer ^a
0 to 0.099	0.0015	0.0002	0.0005	0.0010	0.0010
0.10 to 0.249	0.0020	0.0002	0.0005	0.0015	0.0015
¼ to ⅜	0.0025	0.0005	0.0005	0.0020	0.0015
⅜ to ⅝	0.0030	0.0005	0.0005	0.0025	0.0020
⅝ to ¾	0.0040	0.0005	0.0005	0.0030	0.0025
¾ to 1	0.0040	0.0010	0.0010	0.0030	0.0025
1 to 1½	0.0045	0.0010	0.0010	0.0035	0.0030
1½ to 2	0.0055	0.0015	0.0015	0.0040	0.0030
2 to 2¼	0.0060	0.0015	0.0015	0.0045	0.0035
2¼ to 2½	0.0060	0.0020	0.0020	0.0045	0.0035
2½ to 3	0.0070	0.0020	0.0020	0.0050	0.0035
over 3	0.0070	0.0025	0.0025	0.0055	0.0045

^a Taps over 1½ inches with 10 or more threads per inch have tolerances for N.F. and finer.

Threads per Inch	C	Threads per Inch	C	Threads per Inch	C	Threads per Inch	C
2	0.0217	7	0.0077	18	0.0030	36	0.0015
2½	0.0173	8	0.0068	20	0.0027	40	0.0014
3	0.0144	9	0.0060	22	0.0025	48	0.0011
3½	0.0124	10	0.0054	24	0.0023	50	0.0011
4	0.0108	11	0.0049	26	0.0021	56	0.0010
4½	0.0096	12	0.0045	27	0.0020	60	0.0009
5	0.0087	13	0.0042	28	0.0019	64	0.0008
5½	0.0079	14	0.0039	30	0.0018	72	0.0008
6	0.0078	16	0.0034	32	0.0017	80	0.0007

Angle Tolerance

Threads per Inch	Deviation in Half angle	Deviation in Half angle	Threads per Inch	Deviation in Half angle	Deviation in Half angle
4 and coarser	± 30'	± 45'	10 to 28	± 45'	± 68'
4½ to 5½	± 35'	± 53'	30 and finer	± 60'	± 90'
6 to 9	± 40'	± 60'			

Dimensions are given in inches.

The tables and formulas are used in determining the limits and tolerances for cut thread metric taps having special diameter, special pitch, or both.

For intermediate pitches use value of next coarser pitch.

Lead Tolerance: ± 0.003 inch within any two threads not farther apart than 1 inch.

Taps over 1½ in. with 10 or more threads per inch have tolerances for N.F. and finer.

Standard System of Ground Thread Tap Limits and Identification for Metric Screw Threads, M Profile.—All calculations for metric taps use millimeter values. When U.S. customary values are needed, they are translated from the three-place millimeter tap diameters only after the calculations are completed.

**Table 4. Tap Thread Limits and Tolerances ASME B94.9-1999
Formulas for Metric Thread (Ground Thread)**

Minimum major diameter = Basic diameter + W			Maximum pitch diameter = Basic diameter + Y							
Maximum major diameter = Min. maj. dia. + X			Minimum pitch diameter = Max. pitch dia. + Z							
W = Constant to add with basic major diameter ($W=0.08P$) X = Major diameter tolerance Y = Amount over basic for maximum pitch diameter Z = Pitch diameter tolerance										
P Pitch (mm)	W ($0.08P$)	X	Y				Z			
			M1.6 to M6.3	Over M6.3 to to M25	Over M25 to M90	Over M90	M1.6 to M6.3	Over M6.3 to to M25	Over M25 to M90	Over M90
0.30	0.024	0.025	0.039	0.039	0.052	0.052	0.015	0.015	0.020	0.020
0.35	0.028	0.025	0.039	0.039	0.052	0.052	0.015	0.015	0.020	0.020
0.40	0.032	0.025	0.039	0.052	0.052	0.052	0.015	0.015	0.020	0.025
0.45	0.036	0.025	0.039	0.052	0.052	0.052	0.015	0.020	0.020	0.025
0.50	0.040	0.025	0.039	0.052	0.052	0.065	0.015	0.020	0.025	0.025
0.60	0.048	0.025	0.052	0.052	0.065	0.065	0.020	0.020	0.025	0.025
0.70	0.056	0.041	0.052	0.052	0.065	0.065	0.020	0.020	0.025	0.025
0.75	0.060	0.041	0.052	0.065	0.065	0.078	0.020	0.025	0.025	0.031
0.80	0.064	0.041	0.052	0.065	0.065	0.078	0.020	0.025	0.025	0.031
0.90	0.072	0.041	0.052	0.065	0.065	0.078	0.020	0.025	0.025	0.031
1.00	0.080	0.041	0.065	0.065	0.078	0.091	0.025	0.025	0.031	0.031
1.25	0.100	0.064	0.065	0.065	0.078	0.091	0.025	0.031	0.031	0.041
1.50	0.120	0.064	0.065	0.078	0.078	0.091	0.025	0.031	0.031	0.041
1.75	0.140	0.064	...	0.078	0.091	0.104	...	0.031	0.041	0.041
2.00	0.160	0.064	...	0.091	0.091	0.104	...	0.041	0.041	0.041
2.50	0.200	0.063	...	0.091	0.104	0.117	...	0.041	0.041	0.052
3.00	0.240	0.100	...	0.104	0.104	0.130	...	0.041	0.052	0.052
3.50	0.280	0.100	...	0.104	0.117	0.130	...	0.041	0.052	0.052
4.00	0.320	0.100	...	0.104	0.117	0.143	...	0.052	0.052	0.064
4.50	0.360	0.100	0.130	0.143	...	0.052	0.052	0.064
5.00	0.400	0.100	0.130	0.156	0.064	0.064
5.50	0.440	0.100	0.143	0.156	0.064	0.064
6.00	0.480	0.100	0.143	0.156	0.064	0.064

Dimensions are given in millimeters.

The tables and formulas are used in determining the limits and tolerances for ground thread metric taps having a thread lead angle not in excess of 5° , unless otherwise specified. They apply only to metric thread having a 60° form with a $P/8$ flat at the major diameter of the basic thread form. All calculations for metric taps are done using millimeters values as shown. When inch values are needed, they are translated from the three place millimeter tap diameters only after calculations are performed.

The tap major diameter must be determined from a specified tap pitch diameter, the minimum major diameter equals the maximum specified tap pitch diameter minus constant Y , plus $0.64951905P$ plus constant W .

$$\text{Minimum major diameter} = \text{Max. tap pitch diameter} - Y + 0.64951904P + W$$

For intermediate pitches use value of next coarser pitch.

Lead Tolerance: ± 0.013 mm within any two threads not farther apart than 25 mm.

Angle Tolerance: $\pm 30'$ in half angle for 0.25 to 2.5 pitch; $\pm 25'$ in half angle for 2.5 to 4 pitch, and $\pm 20'$ in half angle for 4 to 6 pitch.

D or DU Limits: When the maximum tap pitch diameter is over basic pitch diameter by an even multiple of 0.013 mm (0.000512 in. reference), or the minimum tap pitch diameter limit is under basic pitch diameter by an even multiple of 0.013 mm, the taps are marked

with the letters “D” or “DU,” respectively, followed by a limit number. The limit number is determined as follows:

$$\text{D Limit number} = \frac{\text{Tap PD} - \text{Basic PD}}{0.0013}$$

$$\text{DU Limit number} = \frac{\text{Basic PD} - \text{Tap PD}}{0.0013}$$

Example: M1.6×0.35 HS G D3

$$\begin{aligned} \text{Maximum tap PD} &= \text{Basic PD} + 0.0039 \\ &= 1.6 - (0.64951904 \times 0.35) + 0.0039 \\ &= 1.3727 + 0.039 \\ &= 1.412 \end{aligned}$$

$$\begin{aligned} \text{Minimum tap PD} &= \text{Maximum tap PD} - 0.015 \\ &= 1.412 - 0.015 \\ &= 1.397 \end{aligned}$$

M6×1 HS G DU4

$$\begin{aligned} \text{Minimum tap PD} &= \text{Basic PD} - 0.052 \\ &= 6 - (0.64951904 \times 1.0) - 0.052 \\ &= 5.350 - 0.052 \\ &= 5.298 \end{aligned}$$

$$\begin{aligned} \text{Maximum tap PD} &= \text{Minimum tap PD} + 0.025 \\ &= 5.298 + 0.025 \\ &= 5.323 \end{aligned}$$

Definitions of Tap Terms.—The definitions that follow are taken from ASME B94.9 but include only the more important terms. Some tap terms are the same as screw thread terms; therefore, see *Definitions of Screw Threads* starting on page 1808.

Actual size: The measured size of an element on an individual part.

Allowance: A prescribed difference between the maximum material limits of mating parts. It is the minimum clearance or maximum interference between such parts.

Basic Size: The size from which the limits are derived by application of allowance and tolerance.

Bottom Top: A tap having a chamfer length of 1 to 2 pitches.

Chamfer: Tapering of the threads at the front end of each land or chaser of a tap by cutting away and relieving the crest of the first few teeth to distribute the cutting action over several teeth.

Chamfer Angle: Angle formed between the chamfer and the axis of the tap measured in an axial plane at the cutting edge.

Chamfer Relief: The gradual degrees in land height from cutting edge to heel on the chamfered portion of the land to provide radial clearance for the cutting edge.

Chamfer Relief Angle: Complement of the angle formed between a tangent to the relieved surface at the cutting edge and a radial line to the same point on the cutting edge.

Classes of Thread: Designation of the class that determines the specification of the size, allowance, and tolerance to which a given threaded product is to be manufactured. It is not applicable to the tools used for threading.

Concentric: Having a common center.

Crest: The surface of the thread that joins the flanks of the thread and is farthest from the cylinder or cone from which the threads projects.

Cutter Sweep: The section removed by the milling cutter or the grinding wheel in entering or leaving a flute.

Cutting Edge: The intersection of cutting edge and the major diameter in the direction of rotation for cutting which does the actual cutting.

Core Diameter: The diameter of a circle that is tangent to the bottom of the flutes at a given point on the axis.

Diameter, Major: It is the major cylinder on a straight thread.

Diameter, Minor: It is the minor cylinder on a straight thread.

Dryseal: A thread system used for both external and internal pipe threads applications designed for use where the assembled product must withstand high fluid or gas pressure without the use of sealing compound.

Eccentric: Not having a common center.

Eccentricity: One half of the total indicator variation (TIV) with respect to the tool axis.

Entry Taper: The portion of the thread forming, where the thread forming is tapered toward the front to allow entry into the hole to be tapped.

External Center: The pointed end on a tap. On bottom chamfered taps the point on the front end may be removed.

Flank: The flank of a thread is the either surface connecting the crest with the root.

Flank Angle: Angle between the individual flank and the perpendicular to the axis of the thread, measured in an axial plane. A flank angle of a symmetrical thread is commonly termed the “half angle of thread.”

Flank, Leading: 1) Flank of a thread facing toward the chamfered end of a threading tool; and 2) The leading flank of a thread is the one which, when the thread is about to be assembled with a mating thread, faces the mating thread.

Flank, Trailing: The trailing flank of a thread is the one opposite the leading flank.

Flutes: Longitudinal channels formed in a tap to create cutting edges on the thread profile and to provide chip spaces and cutting fluid passages. On a parallel or straight thread tap they may be straight, angular or helical; on a taper thread tap they may be straight, angular or spiral.

Flute Lead Angle: Angle at which a helical or spiral cutting edge at a given point makes with an axial plane through the same point.

Flute, Spiral: A flute with uniform axial lead in a spiral path around the axis of a conical tap.

Flute, Straight: A flute which forms a cutting edge lying in an axial plane.

Flute, Tapered: A flute lying in a plane intersecting the tool axis at an angle.

Full Indicator Movement (FIM): The total movement of an indicator where appropriately applied to a surface to measure its surface.

Functional Size: The functional diameter of an external or internal thread is the PD of the enveloping thread of perfect pitch, lead, and flank angles, having full depth of engagement but clear at crests and roots, and of a specified length of engagement.

Heel: Edge of the land opposite the cutting edge.

Height of Thread: The height of a thread is the distance, measured radially between the major and minor cylinders or cones, respectively.

Holes, Blind: A hole that does not pass through the work piece and is not threaded to its full depth.

Holes, Bottom: A blind hole that is threaded close to the bottom.

Hook Angle: Inclination of a concave cutting face, usually specified either as Chordal Hook or Tangential Hook.

Hook, Chordal Angle: Angle between the chord passing through the root and crest of a thread form at the cutting face, and a radial line through the crest at the cutting edge.

Hook, Tangential Angle: Angle between a line tangent to a hook cutting face at the cutting edge and a radial line to the same point.

Internal Center: A countersink with clearance at the bottom, in one or both ends of a tool, which establishes the tool axis.

Interrupted Thread Tap: A tap having an odd number of lands with alternate teeth in the thread helix removed. In some designs alternate teeth are removed only for a portion of the thread length.

Land: One of the threaded sections between the flutes of a tap.

Lead: Distance a screw thread advances axially in one complete turn.

Lead Error: Deviation from prescribed limits.

Lead Deviation: Deviation from the basic nominal lead.

Progressive Lead Deviation: (1) On a straight thread the deviation from a true helix where the thread helix advances uniformly. (2) On a taper thread the deviation from a true spiral where the thread spiral advances uniformly.

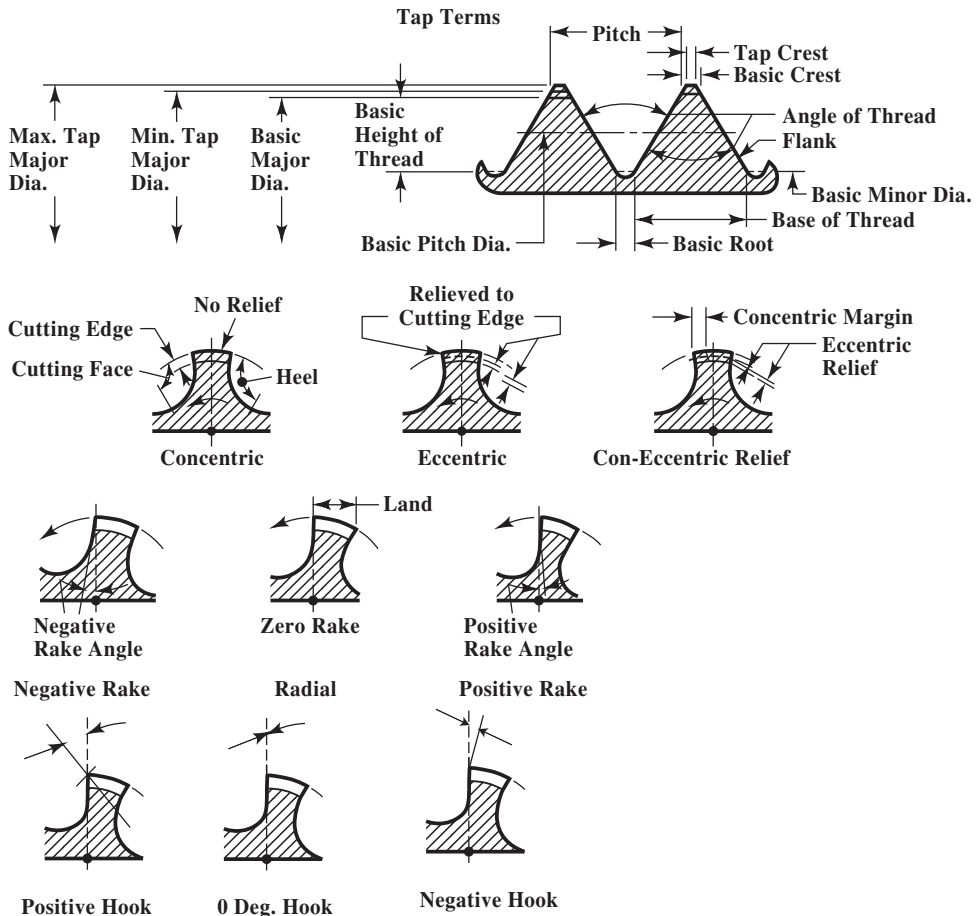


Fig. 3. Tap Terms

Left Hand Cut: Rotation in a clockwise direction from cutting when viewed from the chamfered end of a tap.

Length of Engagement: The length of engagement of two mating threads is the axial distance over which two mating threads are designed to contact.

Length of Thread: The length of the thread of the tap includes the chamfered threads and the full threads but does not include an external center. It is indicated by the letter "B" in the illustrations at the heads of the tables.

Limits: The limits of size are the applicable maximum and minimum sizes.

Major Diameter: On a straight thread the major diameter is that of the major cylinder. On a taper thread the major diameter at a given position on the thread axis is that of the major cone at that position.

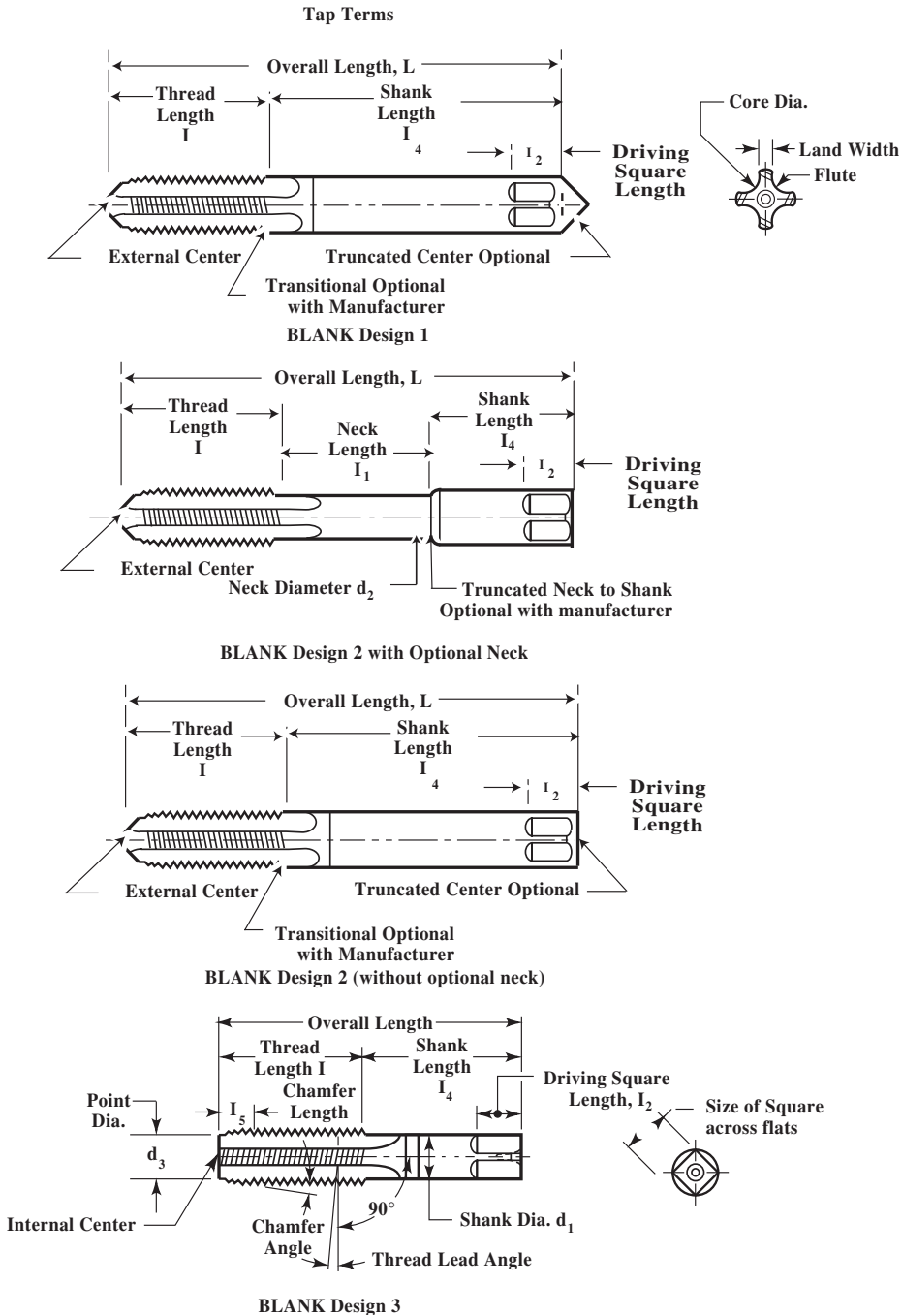


Fig. 1. Taps Terms

Minor Diameter: On a straight thread the minor diameter is that of the minor cylinder. On a taper thread the minor diameter at a given position on the thread axis is that of the minor cone at that position.

Neck: A section of reduced diameter between two adjacent portion of a tool.

Pitch: The distance from any point on a screw thread to a corresponding point in the next thread, measured parallel to the axis and on the same side of the axis.

Pitch Diameter (Simple Effective Diameter): On a straight thread, the pitch diameter is the diameter of the imaginary coaxial cylinder, the surface of which would pass through the thread profiles at such points as to make the width of the groove equal to one-half the basic pitch. On a perfect thread this coincidence occurs at the point where the widths of the thread and groove are equal. On a taper thread, the pitch diameter at a given position on the thread axis is the diameter of the pitch cone at that position.

Point Diameter: Diameter at the cutting edge of the leading end of the chamfered section.

Plug Tap: A tap having a chamfer length of 3 to 5 pitches.

Rake: Angular relationship of the straight cutting face of a tooth with respect to a radial line through the crest of the tooth at the cutting edge. Positive rake means that the crest of the cutting face is angularly ahead of the balance of the cutting face of the tooth. Negative rake means that the crest of the cutting face is angularly behind the balance of the cutting face of the tooth. Zero rake means that the cutting face is directly on a radial line.

Relief: Removal of metal behind the cutting edge to provide clearance between the part being threaded and the threaded land.

Relief, Center: Clearance produced on a portion of the tap land by reducing the diameter of the entire thread form between cutting edge and heel.

Relief, Chamfer: Gradual decrease in land height from cutting edge to heel on the chamfered portion of the land on a tap to provide radial clearance for the cutting edge.

Relief, Con-eccentric Thread: Radial relief in the thread form starting back of a concentric margin.

Relief, Double Eccentric Thread: Combination of a slight radial relief in the thread form starting at the cutting edge and continuing for a portion of the land width, and a greater radial relief for the balance of the land.

Relief, Eccentric Thread: Radial relief in the thread form starting at the cutting edge and continuing to the heel.

Relief, Flatted Land: Clearance produced on a portion of the tap land by truncating the thread between cutting edge and heel.

Relief, Grooved Land: Clearance produced on a tap land by forming a longitudinal groove in the center of the land.

Relief, Radial: Clearance produced by removal of metal from behind the cutting edge. Taps should have the chamfer relieved and should have back taper, but may or may not have relief in the angle and on the major diameter of the threads. When the thread angle is relieved, starting at the cutting edge and continuing to the heel, the tap is said to have "eccentric" relief. If the thread angle is relieved back of a concentric margin (usually one-third of land width), the tap is said to have "con-eccentric" relief.

Right Hand Cut: Rotation in clockwise direction for cutting when viewed from the chamfered end of a tap or die.

Roots: The surface of the thread that joins the flanks of adjacent thread forms and is identical to cone from which the thread projects.

Screw Thread: A uniform section produced by forming a groove in the form of helix on the external or the internal surface of a cylinder.

Screw Thread Inserts (STI): Screw thread bushing coiled from diamond shape cross section wire. They are screwed into oversized tapped holes to size nominal size internal threads.

Screw Thread Insert (STI) Taps: These taps are over the nominal size to the extent that the internal thread they produce will accommodate a helical coil screw insert, which at final assembly will accept a screw thread of the nominal size and pitch.

Shank: The portion of the tool body by which it is held and driven.

Shaving: The excessive removal of material from the product thread profile by the tool thread flanks caused by an axial advance per revolution less than or more than the actual lead in the tool.

Size, Actual: Measured size of an element on an individual part.

Size, Basic: That size from which the limits of size are derived by the application of allowances and tolerances.

Size, Functional: The functional diameter of an external or internal thread is the pitch diameter of the enveloping thread of perfect pitch, lead and flank angles, having full depth of engagement but clear at crests and roots, and of a specified length of engagement. It may be derived by adding to the pitch diameter in an external thread, or subtracting from the pitch diameter in an internal thread, the cumulative effects of deviations from specified profile, including variations in lead and flank angle over a specified length of engagement. The effects of taper, out-of-roundness, and surface defects may be positive or negative on either external or internal threads.

Size, Nominal: Designation used for the purpose of general identification.

Spiral Flute: See *Flutes*.

Spiral Point: Angular fluting in the cutting face of the land at the chamfered end. It is formed at an angle with respect to the tap axis of opposite hand to that of rotation. Its length is usually greater than the chamfer length and its angle with respect to the tap axis is usually made great enough to direct the chips ahead of the tap. The tap may or may not have longitudinal flutes.

Taper, Back: A gradual decrease in the diameter of the thread form on a tap from the chamfered end of the land towards the back, which creates a slight radial relief in the threads.

Taper per Inch: The difference in diameter in one inch measured parallel to the axis.

Taper Tap: A tap having a chamfer length of 7 to 10 pitches.

Taper Thread Tap: A tap with tapered threads for producing a tapered internal thread.

Thread, Angle of: The angle between the flanks of the thread measured in an axial plane.

Thread Lead Angle: On a straight thread, the lead angle is the angle made by the helix of the thread at the pitch line with a plane perpendicular to the axis. On a taper thread, the lead angle at a given axial position is the angle made by the conical spiral of the thread, with the plane perpendicular to the axis, at the pitch line.

Thread per Inch: The number of thread pitches in one inch of thread length.

Tolerance: The total permissible variation of size or difference between limits of size.

Total Indicator Variation (TIV): The difference between maximum and minimum indicator readings during a checking cycle.

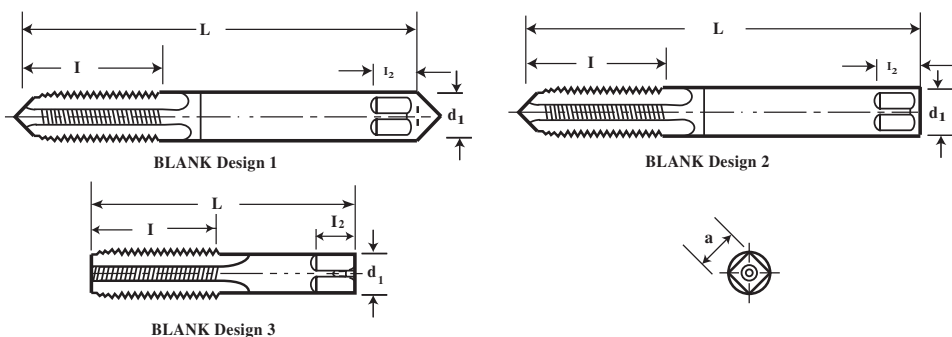


Table 5a. Standard Tap Dimensions (Ground and Cut Thread) ASME B94.9-1999

Nominal Diameter Range, inch		Nominal Diameter, inch		Nominal Metric Diameter		Blank Design No.	Tap Dimensions, inch				
		Machine Screw Size No. and Fractional Sizes	Decimal Equiv.	mm	inch		Overall Length L	Thread Length l	Square Length l_2	Shank Diameter d_1	Size of Square a
0.052	0.065	0	(0.0600)	M1.6	0.0630	1	1.63	0.31	0.19	0.141	0.110
0.065	0.078	1	(0.0730)	M1.8	0.0709	1	1.69	0.38	0.19	0.141	0.110
0.078	0.091	2	(0.0860)	M2.0	0.0787	1	1.75	0.44	0.19	0.141	0.110
				M2.2	0.0866						
0.091	0.104	3	(0.0990)	M2.5	0.0984	1	1.81	0.50	0.19	0.141	0.110
0.104	0.117	4	(0.1120)	1	1.88	0.56	0.19	0.141	0.110
0.117	0.130	5	(0.1250)	M3.0	0.1182	1	1.94	0.63	0.19	0.141	0.110
0.130	0.145	6	(0.1380)	M3.5	0.1378	1	2.00	0.69	0.19	0.141	0.110
0.145	0.171	8	(0.1640)	M4.0	0.1575	1	2.13	0.75	0.25	0.168	0.131
0.171	0.197	10	(0.1900)	M4.5	0.1772	1	2.38	0.88	0.25	0.194	0.152
				M5	0.1969						
0.197	0.223	12	(0.2160)	1	2.38	0.94	0.28	0.220	0.165
0.223	0.260	$\frac{1}{4}$	(0.2500)	M6	0.2363	2	2.50	1.00	0.31	0.255	0.191
0.260	0.323	$\frac{5}{16}$	(0.3125)	M7	0.2756	2	2.72	1.13	0.38	0.318	0.238
				M8	0.3150						
0.323	0.395	$\frac{3}{8}$	(0.3750)	M10	0.3937	2	2.94	1.25	0.44	0.381	0.286
0.395	0.448	$\frac{7}{16}$	(0.4375)	3	3.16	1.44	0.41	0.323	0.242
0.448	0.510	$\frac{1}{2}$	(0.5000)	M12	0.4724	3	3.38	1.66	0.44	0.367	0.275
0.510	0.573	$\frac{9}{16}$	(0.5625)	M14	0.5512	3	3.59	1.66	0.50	0.429	0.322
0.573	0.635	$\frac{5}{8}$	(0.6250)	M16	0.6299	3	3.81	1.81	0.56	0.480	0.360
0.635	0.709	$\frac{11}{16}$	(0.6875)	M18	0.7087	3	4.03	1.81	0.63	0.542	0.406
0.709	0.760	$\frac{3}{4}$	(0.7500)	3	4.25	2.00	0.69	0.590	0.442
0.760	0.823	$\frac{13}{16}$	(0.8125)	M20	0.7874	3	4.47	2.00	0.69	0.652	0.489
0.823	0.885	$\frac{7}{8}$	(0.8750)	M22	0.8661	3	4.69	2.22	0.75	0.697	0.523

Table 5a. Standard Tap Dimensions (Ground and Cut Thread)(Continued) ASME B94.9-1999

Nominal Diameter Range, inch		Nominal Diameter, inch		Nominal Metric Diameter		Blank Design No.	Tap Dimensions, inch				
		Machine Screw Size No. and Fractional Sizes	Decimal Equiv.	mm	inch		Overall Length <i>L</i>	Thread Length <i>l</i>	Square Length <i>l</i> ₂	Shank Diameter <i>d</i> ₁	Size of Square <i>a</i>
0.885	0.948	5/16	(0.9375)	M24	0.9449	3	4.91	2.22	0.75	0.760	0.570
0.948	1.010	1	(1.0000)	M25	0.9843	3	5.13	2.50	0.81	0.800	0.600
1.010	1.073	1 1/16	(1.0625)	M27	1.0630	3	5.13	2.50	0.88	0.896	0.672
1.073	1.135	1 1/8	(1.1250)	3	5.44	2.56	0.88	0.896	0.672
1.135	1.198	1 3/16	(1.1875)	M30	1.1811	3	5.44	2.56	1.00	1.021	0.766
1.198	1.260	1 1/4	(1.2500)	3	5.75	2.56	1.00	1.021	0.766
1.260	1.323	1 5/16	(1.3125)	M33	1.2992	3	5.75	2.56	1.06	1.108	0.831
1.323	1.385	1 3/8	(1.3750)	3	6.06	3.00	1.06	1.108	0.831
1.358	1.448	1 7/16	(1.4375)	M36	1.4173	3	6.06	3.00	1.13	1.233	0.925
1.448	1.510	1 1/2	(1.5000)	3	6.38	3.00	1.13	1.233	0.925
1.510	1.635	1 5/8	(1.6250)	M39	1.5353	3	6.69	3.19	1.13	1.305	0.979
1.635	1.760	1 3/4	(1.7500)	M42	1.6535	3	7.00	3.19	1.25	1.430	1.072
1.760	1.885	1 7/8	(1.8750)	3	7.31	3.56	1.25	1.519	1.139
1.885	2.010	2	(2.0000)	M48	1.8898	3	7.63	3.56	1.38	1.644	1.233

Special taps greater than 1.010 inch to 1.510 inch in diameter inclusive, having 14 or more threads per inch or 1.75- mm pitch and finer, and sizes over 1.510 inch in diameter with 10 or more threads per inch or 2.5- mm pitch and finer are made to general dimensions shown in [Table 10](#).

For standard ground thread tap limits see [Table 20](#), and [Table 21](#) for inch and [Table 16](#) for metric.

For cut thread tap limits [Table 22](#) and [23](#).

Special ground thread tap limits are determined by using the formulas shown in [Table 2](#) for unified inch screw threads and [Table 4](#) for metric M profile screw threads.

Tap sizes 0.395 inch and smaller have an external center on the thread end (may be removed on bottom taps). Sizes 0.223 inch and smaller have an external center on the shank end. Sizes 0.224 inch through 0.395 inch have truncated partial cone centers on the shank end (of diameter of shank). Sizes greater than 0.395 inch have internal centers on both the thread and shank ends.

For standard thread limits and tolerances see [Table 17](#) for unified inch screw threads and [Table 19](#) for metric threads.

For runout tolerances of tap elements see [Table 14](#).

For number of flutes see [Table 11](#).

Table 5b. Standard Tap Dimensions Tolerances (Ground and Cut Thread) ASME B94.9-1999

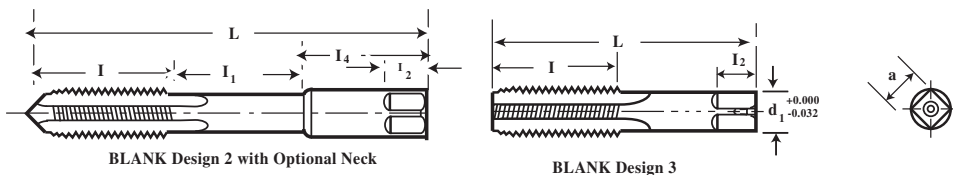
Element	Nominal Diameter Range, inch		Direction	Tolerance, inch	
	Over	To (inclusive)		Ground Thread	Cut Thread
Length overall, L	0.5200	1.0100	\pm	0.0300	0.0300
	1.0100	2.0000	\pm	0.0600	0.0600
Length of thread, I	0.0520	0.2230	\pm	0.0500	0.0500
	0.2230	0.5100	\pm	0.0600	0.0600
	0.5100	1.5100	\pm	0.0900	0.0900
	1.5100	2.0000	\pm	0.1300	0.1300
Length of thread, I_2	0.0520	1.0100	\pm	0.0300	0.0300
	1.0100	2.0000	\pm	0.0600	0.0600
Diameter of shank, d_1	0.0520	0.2230	-	0.0015	0.0040
	0.2230	0.6350	-	0.0015	0.0050
	0.6350	1.0100	-	0.0020	0.0050
	1.0100	1.5100	-	0.0020	0.0070
	1.5100	2.0000	-	0.0030	0.0070
Size of square, a	0.0520	0.5100	-	0.0040	0.0040
	0.5100	1.0100	-	0.0060	0.0060
	1.0100	2.0000	-	0.0080	0.0080

Entry Taper Length.—Entry taper length is measured on the full diameter of the thread forming lobes and is the axial distance from the entry diameter position to the theoretical intersection of tap major diameter and entry taper angle. Beveled end threads provided on taps having internal center or incomplete threads retained when external center is removed. Whenever entry taper length is specified in terms of number of threads, this length is measured in number of pitches, P .

$$\text{Bottom length} = 1 \sim 2\frac{1}{2} \text{ pitches}$$

$$\text{Plug length} = 3 \sim 5 \text{ pitches}$$

Entry diameter measured at the thread crest nearest the front of the tap, is an appropriate amount smaller than the diameter of the hole drilled for tapping.



Optional Neck and Optional Shortened Thread Length, Ground and Cut Thread (Table 6)

Table 6. Optional Neck and Optional Shortened Thread Length (Tap Dimensions, Ground and Cut Thread) ASME B94.9-1999

Nominal Diameter, inch		Nominal Diameter, inch		Nominal Metric Diameter		Blank Design No.	Tap Dimensions, inch					
Over	To (inclusive)	Machine Screw Size No. and Fractional Sizes	Decimal Equiv.	mm	inch		Overall Length L	Thread Length I	Neck Length I_1	Square Length I_2	Shank Diameter d_1	Size of Square a
0.104	0.117	4	(0.1120)			1	1.88	0.31	0.25	0.19	0.141	0.110
0.117	0.130	5	(0.1250)	M3.0	0.1181	1	1.94	0.31	0.31	0.19	0.141	0.110
0.130	0.145	6	(0.1380)	M3.5	0.1378	1	2.00	0.38	0.31	0.19	0.141	0.110
0.145	0.171	8	(0.1640)	M4.0	0.1575	1	2.13	0.38	0.38	0.25	0.168	0.131
0.171	0.197	10	(0.1900)	M4.5	0.1772	1	2.38	0.50	0.38	0.25	0.194	0.152
...	M5.0	0.1969
0.197	0.223	12	(0.2160)	1	2.38	0.50	0.44	0.28	0.220	0.165
0.223	0.260	1/4	(0.2500)	M6.0	0.2362	2	2.50	0.63	0.38	0.31	0.255	0.191
0.260	0.323	3/16	(0.3125)	M7.0	0.2756	2	2.72	0.69	0.44	0.38	0.318	0.238
...	M8.0	0.3150
0.323	0.395	3/8	(0.3750)	M10.0	0.3937	2	2.94	0.75	0.50	0.44	0.381	0.286
0.395	0.448	7/16	(0.4375)	3	3.16	0.88	0.50	0.41	0.323	0.242
0.448	0.510	1/2	(0.5000)	M12.0	0.4724	3	3.38	0.94	...	0.44	0.367	0.275
0.510	0.573	9/16	(0.5625)	M14.0	0.5512	3	3.59	1.00	...	0.50	0.429	0.322
0.573	0.635	5/8	(0.6250)	M16.0	0.6299	3	3.81	1.09	...	0.56	0.480	0.360
0.635	0.709	11/16	(0.6875)	M18.0	0.7087	3	4.03	1.09	...	0.63	0.542	0.406
0.709	0.760	3/4	(0.7500)	3	4.25	1.22	...	0.69	0.590	0.442
0.760	0.823	13/16	(0.8125)	M20.0	0.7874	3	4.47	1.22	...	0.69	0.652	0.489
0.823	0.885	7/8	(0.8750)	M22.0	0.8661	3	4.69	1.34	...	0.75	0.697	0.523
0.885	0.948	15/16	(0.9375)	M24.0	0.9449	3	4.91	1.34	...	0.75	0.760	0.570
0.948	1.010	1	(1.0000)	M25.0	0.9843	3	5.13	1.50	...	0.75	0.800	0.600

Thread length, I , is based on a length of 12 pitches of the UNC thread series.

Thread length, I , is a minimum value and has no tolerance.

When thread length, I , is added to neck length, I_1 , the total shall be no less than the minimum thread length, I .

Unless otherwise specified, all tolerances are in accordance with [Table 5b](#).

For runout tolerances, see [Table 14](#).

For number of flutes see [Table 11](#).

TAPS

Table 7. Machine Screw and Fractional Size Ground Thread Dimensions for Screw Thread Insert (STI) Taps ASME B94.9-1999

Nominal Size (STI)	Threads per inch		Blank Design No.	Tap Dimensions, inch					Table 5a Blank Equivalent (Reference)
	NC	NF		Overall length, <i>L</i>	Thread Length, <i>I</i>	Square Length, <i>I</i> ₂	Shank Diameter, <i>d</i> ₁	Size of Square, <i>a</i>	
1	64	...	1	1.81	0.50	0.19	0.141	0.110	No. 3
2	56	64	1	1.88	0.56	0.19	0.141	0.110	No. 4
3	48	56	1	1.94	0.63	0.19	0.141	0.110	No. 5
4	40	48	1	2.00	0.69	0.19	0.141	0.110	No. 6
5	40	...	1	2.13	0.75	0.25	0.168	0.131	No. 8
6	32	...	1	2.38	0.88	0.25	0.194	0.152	No. 10
	...	40	1	2.13	0.75	0.25	0.168	0.131	No. 8
8	32	36	1	2.38	0.94	0.28	0.220	0.165	No. 12
10	24	32	2	2.50	1.00	0.31	0.255	0.191	1/4
12	24	...	2	2.72	1.13	0.38	0.318	0.238	5/16
1/4	20	28	2	2.72	1.13	0.38	0.318	0.238	5/16
5/16	18	24	2	2.94	1.25	0.44	0.381	0.286	3/8
3/8	16	...	3	3.38	1.66	0.44	0.367	0.275	1/2
	...	24	3	3.16	1.44	0.41	0.323	0.242	7/16
7/16	14	...	3	3.59	1.66	0.50	0.429	0.322	9/16
	...	20	3	3.38	1.66	0.44	0.367	0.275	1/2
1/2	13	...	3	3.81	1.81	0.56	0.480	0.360	5/8
	...	20	3	3.59	1.66	0.50	0.429	0.322	9/16
9/16	12	...	3	4.03	1.81	0.63	0.542	0.406	11/16
	...	18	3	3.81	1.81	0.56	0.480	0.360	5/8
5/8	11	...	3	4.25	2.00	0.69	0.590	0.442	3/4
	...	18	3	4.03	1.81	0.63	0.542	0.406	11/16
3/4	10	...	3	4.69	2.22	0.75	0.697	0.523	7/8
	...	16	3	4.47	2.00	0.69	0.652	0.489	13/16
7/8	9	14	3	5.13	2.50	0.81	0.800	0.600	1
1	8	...	3	5.75	2.56	1.00	1.021	0.766	1 1/4
	...	12, 14 NS	3	5.44	2.56	0.88	0.896	0.672	1 1/8
1 1/8	7	...	3	6.06	3.00	1.06	1.108	0.831	1 3/8
	...	12	3	5.75	2.56	1.00	1.021	0.766	1 1/4
1 1/4	7	...	3	6.38	3.00	1.13	1.233	0.925	1 1/2
	...	12	3	6.06	3.00	1.06	1.108	0.831	1 3/8
1 3/8	6	...	3	6.69	3.19	1.13	1.305	0.979	1 5/8
	...	12	3	6.38	3.00	1.13	1.233	0.925	1 1/2
1 1/2	6	...	3	7.00	3.19	1.25	1.430	1.072	1 3/4
	...	12	3	6.69	3.19	1.13	1.305	0.979	1 5/8

These threads are larger than nominal size to the extent that the internal thread they produce will accommodate a helical coil screw inserts, which at final assembly will accept a screw thread of the nominal size and pitch.

For optional necks, refer to Table 6 using dimensions for equivalent blank sizes.

Ground Thread Taps: STI sizes 5/16 inch and smaller, have external center on thread end (may be removed on bottom taps); sizes 10 through 5/16 inch, will have an external partial cone center on shank end, with the length of the cone center approximately 1/4 of the diameter of shank; sizes larger than 5/16 inch may have internal centers on both the thread and shank ends.

For runout tolerances of tap elements, refer to Table 14 using dimensions for equivalent blank sizes.

For number of flutes, refer to Table 11 using dimensions for equivalent blank sizes.

For general dimension tolerances, refer to Table 5b using Table 5a equivalent blank size.

**Table 8. Standard Metric Size Tap Dimensions
for Screw Thread Insert (STI) Taps ASME B94.9-1999**

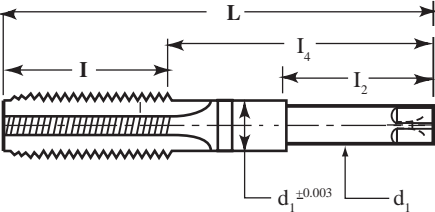
Nominal Size (STI)	Thread Pitch, mm Coarse Fine			Blank Design No.	Tap Dimensions, inch					Blank Diameter
					Overall length, L	Thread Length, l	Square Length, l_2	Shank Diameter, d_1	Size of square, a	
M2.2	0.45	...		1	1.88	0.56	0.19	0.141	0.110	No.4
M2.5	0.45	...		1	1.94	0.63	0.19	0.141	0.110	No.5
M3	0.50	...		1	2.00	0.69	0.19	0.141	0.110	No.6
M3.5	0.60	...		1	2.13	0.75	0.25	0.168	0.131	No.8
M4	0.70	...		1	2.38	0.88	0.25	0.194	0.152	No.10
M5	0.80	...		2	2.50	1.00	0.31	0.255	0.191	$\frac{1}{4}$
M6	1	...		2	2.72	1.13	0.38	0.318	0.238	$\frac{5}{16}$
M7	1	...		2	2.94	1.25	0.44	0.381	0.286	$\frac{3}{8}$
M8	1.25	1		2	2.94	1.25	0.44	0.381	0.286	$\frac{3}{8}$
M10	1.5	1.25		3	3.38	1.66	0.44	0.367	0.275	$\frac{1}{2}$
		3	3.16	1.44	0.41	0.323	0.242	$\frac{7}{16}$
M12	1.75	1.5	1.25	3	3.59	1.66	0.50	0.429	0.322	$\frac{9}{16}$
M14	2	...		3	4.03	1.81	0.63	0.542	0.406	$\frac{11}{16}$
	...	1.5		3	3.81	1.81	0.56	0.480	0.360	$\frac{5}{8}$
M16	2	...		3	4.25	2.00	0.69	0.590	0.442	$\frac{3}{4}$
	...	1.5		3	4.03	1.81	0.63	0.542	0.406	$\frac{11}{16}$
M18	2.5	...		3	4.69	2.22	0.75	0.697	0.523	$\frac{7}{8}$
	...	2.0	1.25	3	4.47	2.00	0.69	0.652	0.489	$\frac{13}{16}$
M20	2.5	2.0		3	4.91	2.22	0.75	0.760	0.570	$\frac{15}{16}$
	...		1.25	3	4.69	2.22	0.75	0.697	0.523	$\frac{7}{8}$
M22	2.5	2.0		3	5.13	2.50	0.81	0.800	0.600	1
	...	1.5		3	4.91	2.22	0.75	0.760	0.570	$\frac{15}{16}$
M24	3	...		3	5.44	2.56	0.88	0.896	0.672	$1\frac{1}{8}$
	...	2		3	5.13	2.50	0.88	0.896	0.672	$1\frac{1}{16}$
M27	3	...		3	5.75	2.56	1.00	1.021	0.766	$1\frac{1}{4}$
	...	2		3	5.44	2.56	0.88	0.896	0.672	$1\frac{1}{8}$
M30	3.5	...		3	6.06	3.00	1.06	1.108	0.831	$1\frac{3}{8}$
	...	2		3	5.75	2.56	1.00	1.021	0.766	$1\frac{1}{4}$
M33	3.5	...		3	6.38	3.00	1.13	1.233	0.925	$1\frac{1}{2}$
	...	2		3	6.06	3.00	1.06	1.108	0.831	$1\frac{3}{8}$
M36	4	3	2	3	6.69	3.19	1.13	1.305	0.979	$1\frac{5}{8}$
M39	4	3	2	3	7.00	3.19	1.25	1.430	1.072	$1\frac{3}{4}$

These taps are larger than nominal size to the extent that the internal thread they produce will accommodate a helical coil screw insert, which at final assembly will accept a screw thread of the nominal size and pitch. For optional necks, use [Table 6](#) and dimensions for equivalent blank sizes.

Ground Thread Taps: STI sizes M8 and smaller, have external center on thread end (may be removed on bottom taps); STI sizes M5 through M10, will have an external partial cone center on shank end, with the length of the cone center approximately $\frac{1}{4}$ of the diameter of shank; STI sizes larger than M10 inch, may have internal centers on both the thread and shank ends.

For runout tolerances of tap elements, refer to [Table 14](#) using dimensions for equivalent blank sizes. For number of flutes, refer to [Table 11](#) using dimensions for equivalent blank sizes. For general dimension tolerances, refer to [Table 5b](#) using [Table 5a](#) equivalent blank size.

Table 9. Special Extension Taps ASME B94.9-1999, Appendix (Tap Dimensions, Ground and Cut Threads)



Nominal Tap Size				Nominal Tap Size			
Fractional	Machine Screw	Pipe	Shank Length I_4	Fractional	Machine Screw	Pipe	Shank Length I_4
...	0-3	...	0.88	1½	3.00
...	4	...	1.00	1⅝	...	3	3.13
...	5-6	...	1.13	1¾	3.13
...	8	...	1.25	1⅞	3.25
...	10-12	⅓ to ¼ incl.	1.38	2	3.25
¼	14	...	1.50	2⅛	3.38
⅝	1.56	2¼	3.38
⅜	1.63	2⅜	3.50
7/16	...	⅜ to ½ incl.	1.69	2½	3.50
½	1.69	2⅝	3.63
9/16	...	¾	1.88	2¾	3.63
⅝	...	1	2.00	2⅞	3.75
11/16	2.13	3	3.75
¾	...	1¼	2.25	3⅞	3.88
13/16	...	1½	2.38	3¼	3.88
7/8	2.50	3⅜	...	4	4.00
15/16	2.63	3½	4.00
1	2.63	3⅝	4.13
1⅛	...	2	2.75	3¾	4.13
1¼	...	2½	2.88	3⅞	4.25
1⅜	3.00	4	4.25

Tolerances			
For shank diameter, d_1 for I_4 length			
Fractional, Inch	Machine Screw	Pipe, Inch	Tolerances
¼ to ⅝ incl.	0 to 14 incl.	⅓ to ⅞ incl.	-0.003
1/16 to 1½ incl.	...	¼ to 1 incl.	-0.004
1⅝ to 4 incl.	...	1¼ to 4 incl.	-0.006

Unless otherwise specified, special extension taps will be furnished with dimensions and tolerances as shown for machine screw and fractional taps [Tables 5a, 5b, and 6](#), and for pipe taps in [Table 13a](#). Exceptions are as follows: Types of centers are optional with manufacturer. Tolerances on shank diameter d_1 and I_4 length as shown on the above [Table 9](#). Shank runout tolerance in applies only to the I_4 length shown on the above [Table 9](#).

**Table 10. Special Fine Pitch Taps, Short Series ASME B94.9-1999, Appendix
(Taps Dimensions, Ground and Cut Threads)**

Nominal Diameter Range, inch		Nominal Fractional Diameter inch	Nominal Metric Diameter mm	Taps Dimensions, inches				
				Overall Length L	Thread Length I	Square Length I_2	Shank Diameter d_1	Size of Square a
Over	To							
1.070	1.073	1 $\frac{1}{16}$	M27	4.00	1.50	0.88	0.8960	0.672
1.073	1.135	1 $\frac{1}{8}$...	4.00	1.50	0.88	0.8960	0.672
1.135	1.198	1 $\frac{3}{16}$	M30	4.00	1.50	1.00	1.0210	0.766
1.198	1.260	1 $\frac{1}{4}$...	4.00	1.50	1.00	1.0210	0.766
1.260	1.323	1 $\frac{5}{16}$	M33	4.00	1.50	1.00	1.1080	0.831
1.323	1.385	1 $\frac{3}{8}$...	4.00	1.50	1.00	1.1080	0.831
1.385	1.448	1 $\frac{7}{16}$	M36	4.00	1.50	1.00	1.2330	0.925
1.448	1.510	1 $\frac{1}{2}$...	4.00	1.50	1.00	1.2330	0.925
1.510	1.635	1 $\frac{5}{8}$	M39	5.00	2.00	1.13	1.3050	0.979
1.635	1.760	1 $\frac{3}{4}$	M42	5.00	2.00	1.25	1.4300	1.072
1.760	1.885	1 $\frac{7}{8}$...	5.00	2.00	1.25	1.5190	1.139
1.885	2.010	2	M48	5.00	2.00	1.38	1.6440	1.233
2.010	2.135	2 $\frac{1}{8}$...	5.25	2.00	1.44	1.7690	1.327
2.135	2.260	2 $\frac{1}{4}$	M56	5.25	2.00	1.44	1.8940	1.420
2.260	2.385	2 $\frac{3}{8}$...	5.25	2.00	1.50	2.0190	1.514
2.385	2.510	2 $\frac{1}{2}$...	5.25	2.00	1.50	2.1000	1.575
2.510	2.635	2 $\frac{5}{8}$	M64	5.50	2.00	1.50	2.1000	1.575
2.635	2.760	2 $\frac{3}{4}$...	5.50	2.00	1.50	2.1000	1.575
2.760	2.885	2 $\frac{7}{8}$	M72	5.50	2.00	1.50	2.1000	1.575
2.885	3.010	3	...	5.50	2.00	1.50	2.1000	1.575
3.010	3.135	3 $\frac{1}{8}$...	5.75	2.00	1.50	2.1000	1.575
3.135	3.260	3 $\frac{1}{4}$	M80	5.75	2.00	1.50	2.1000	1.575
3.260	3.385	3 $\frac{3}{8}$...	5.75	2.00	1.50	2.1000	1.575
3.385	3.510	3 $\frac{1}{2}$...	5.75	2.00	1.50	2.1000	1.575
3.510	3.635	3 $\frac{5}{8}$	M90	6.00	2.00	1.75	2.1000	1.575
3.635	3.760	3 $\frac{3}{4}$...	6.00	2.00	1.75	2.1000	1.575
3.760	3.885	3 $\frac{7}{8}$...	6.00	2.00	1.75	2.1000	1.575
3.885	4.010	4	M100	6.00	2.00	1.75	2.1000	1.575

Unless otherwise specified, special taps 1.010 inches to 1.510 inches in diameter, inclusive, have 14 or more threads per inch or 1.75 mm pitch and finer. Sizes greater than 1.510 inch in diameter with 10 or more threads per inch, or 2.5 mm pitch and finer will be made to the general dimensions shown above.

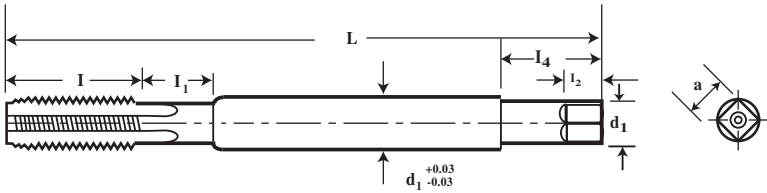
For tolerances see [Table 5b](#). For runout tolerances of tap elements, see [Table 14](#).

Table 11. Standard Number of Flutes (Ground and Cut Thread) ASME B94.9-1999

Machine Screw Size, Nom. Fractional Dia. inch	Nominal Metric Dia.		TPI/Pitch			Straight Flutes		Spiral Point		Spiral Point Only	Reg. Spiral Flute	Fast Spiral Flute
	mm	inch	UNC NC	UNF NF	mm	Standard	Optional	Standard	Optional			
0 (0.0600)	M1.6	0.0630	...	80	0.35	2	...	2
1 (0.0730)	64	72	...	2	...	2
2 (0.0860)	M2.0	0.0787	56	64	0.40	3	2	2
3 (0.0990)	M 2.5	0.0984	48	56	0.45	3	2	2	2
4 (0.1120)	40	48	...	3	2	2	...	2	2	2
5 (0.1250)	M3.0	0.1181	40	44	0.50	3	2	2	...	2	2	2
6 (0.1380)	M3.5	0.1378	32	40	0.60	3	2	2	...	2	2	2
8 (0.1640)	M4.0	0.1575	32	36	0.70	4	2/3	2	...	2	2	3
10 (0.1900)	M4.5	0.1772	24	32	0.75	4	2/3	2	...	2	2	3
...	M5	0.1969	0.80	4	2/3	2	...	2	2	3
12 (0.2160)	24	28	...	4	2/3	2	...	2	2	3
1/4 (0.2500)	M6	0.2362	20	28	1.00	4	2/2	2	3	2	3 (optional)	3
...	M7	0.2756	18	24	1.00	4	2/2	2	3	2	3	3
5/16 (0.3125)	M8	0.3150	18	24	1.25	4	2/3	2	3	2	3	3
3/8 (0.3750)	M10	0.3937	16	24	1.50	4	3	3	...	3	3	3
7/16 (0.4375)	14	20	...	4	3	3	...	3	3	3
1/2 (0.5000)	M12	0.4724	13	20	1.75	4	3	3	3
9/16 (0.5625)	M14	0.5512	12	18	2.00	4	...	3
5/8 (0.6250)	M16	0.6299	11	18	2.00	4	...	3
3/4 (0.7500)	10	16	...	4	...	3
...	M20	0.7874	2.5	4
7/8 (0.8750)	9	14	...	4
...	M24	0.9449	3.00	4
1 (1.0000)	8	12	...	4
1 1/8 (1.1250)	7	12	4.00
...	M30	1.1811	3.50	4
1 1/4 (1.2500)	7	4
...	12	...	6
1 3/8 (1.3750)	6	6
...	12	...	6
...	M36	1.4173	4.00	4
1 1/2 (1.5000)	6	4
...	12	...	6
1 3/4 (1.7500)	5	6
2 (2.0000)	4 1/2	6

For pulley taps see Table 12. For taper pipe see Table 13a. For straight pipe taps see Table 13a. For STI taps, use number of flutes for blank size equivalent on Table 5a. For optional flutes Table 6.

**Table 12. Pulley Taps, Fractional Size
(High Speed Steel, Ground Thread) ASME B94.9-1999**



Dia. of Tap	Threads per Inch NC UNC	Number of Flutes	Length Overall, L	Thread Length, I	Neck Length, I_1	Square Length I_2	Length ^d of Shank Close Tolerance, I_4	Dia. of Shank, d_1	Size ^b of Square, a
1/4	20	4	6, 8	1.00	0.38	0.31	1.50	0.255	0.191
5/16	18	4	6, 8	1.13	0.38	0.38	1.56	0.318	0.238
3/8	16	4	6, 8, 10	1.25	0.38	0.44	1.63	0.381	0.286
7/16	14	4	6, 8	1.44	0.44	0.50	1.69	0.444	0.333
1/2	13	4	6, 8, 10, 12	1.66	0.50	0.56	1.69	0.507	0.380
5/8	11	4	6, 8, 10, 12	1.81	0.63	0.69	2.00	0.633	0.475
3/4	10	4	10, 12	2.00	0.75	0.75	2.25	0.759	0.569

Tolerances for General Dimensions

Element	Diameter Range	Tolerance	Element	Diameter Range	Tolerance
Overall length, L	1/4 to 3/4	±0.06	Shank Diameter, d_1^a	1/4 to 1/2	-0.005
Thread length, I	1/4 to 3/4	±0.06	Size of Square, a^b	1/4 to 1/2	-0.004
Square length, I_2	1/4 to 3/4	±0.03		5/8 to 3/4	-0.006
Neck length, I_1	1/4 to 3/4	c	Length of close tolerance shank, I_4	1/4 to 3/4	d

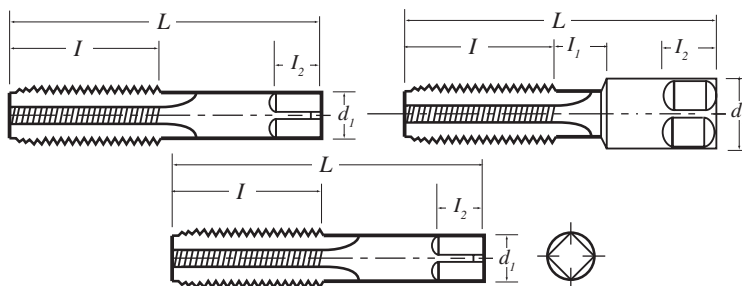
^a Shank diameter, d_1 , is approximately the same as the maximum major diameter for that size.

^b Size of square, a , is equal to $0.75d_1$ to the nearest 0.001 in.

^c Neck length I_1 is optional with manufacturer.

^d Length of close tolerance shank, I_4 , is a min. length that is held to runout tolerances per [Table 14](#).

These taps are standard with plug chamfer in H3 limit only. All dimensions are given in inches. These taps have an internal center in thread end. For standard thread limits see [Table 20](#). For runout tolerances of tap elements see [Table 14](#).



Straight and Taper Pipe Tap Dimensions, Ground and Cut Thread ([Tables 13a and 13b](#))

Table 13a. Straight and Taper Pipe Tap Dimensions (Ground and Cut Thread) ASME B94.9-1999

Nominal Size, Inch ^a	Threads per Inch	Number of Flutes		Length Overall, <i>L</i>	Thread Length, <i>I</i>	Square Length, <i>I</i> ₂	Shank Diameter, <i>d</i> ₁	Size of Square, <i>a</i>	Length Optional Neck, <i>I</i> ₁	Ground Thread		Cut Thread only	
		Regular Thread	Interrupted Thread							NPT, NPTF, ANPT	NPSC, NPSM, NPSF	NPT	NPSC, NPSM
1/16	27	4	...	2.13	0.69	0.38	0.3125	0.234	0.375	b
1/8	27	4	5	2.13	0.75	0.38	0.3125	0.234	...	b, c	d, e	f, g, h	...
1/8	27	4	5	2.13	0.75	0.38	0.4375	0.328	0.375	b, c	d, e	f, g, h	a
1/4	18	4	5	2.44	1.06	0.44	0.5625	0.421	0.375	b, c	d, e	f, g, h	a
3/8	18	4	5	2.56	1.06	0.50	0.7000	0.531	0.375	b, c	d, e	f, g, h	a
1/2	14	4	5	3.13	1.38	0.63	0.6875	0.515	...	b, c	d, e	f, g, h	a
3/4	14	5	5	3.25	1.38	0.69	0.9063	0.679	...	b, c	d	f, g, h	a
1	11 1/2	5	5	3.75	1.75	0.81	1.1250	0.843	...	b, c	d	f, g, h	a
1 1/4	11 1/2	5	5	4.00	1.75	0.94	1.3125	0.984	...	b, c	...	f, g, h	a
1 1/2	11 1/2	7	7	4.25	1.75	1.00	1.5000	1.125	...	b, i	...	f, h	...
2	11 1/2	7	7	4.25	1.75	1.13	1.8750	1.406	...	b, i	...	f, h	...
2 1/2	8	8	...	5.50	2.56	1.25	2.2500	1.687	h	...
3	8	8	...	6.00	2.63	1.38	2.6250	1.968	h	...

- ^a Pipe taps 1/8 inch are furnished with large size shanks unless the small shank is specified.
- ^b High-speed ground thread 1/16 to 2 inches including noninterrupted (NPT, NPTF, and ANPT).
- ^c High-speed ground thread 1/8 to 1/4 inches including interrupted (NPT, NPTF, and ANPT).
- ^d High-speed ground thread 1/8 to 1 inches including noninterrupted (NPSC, and NPSM).
- ^e High-speed cut thread 1/8 to 1 inches including noninterrupted (NPSC, and NPSM).
- ^f High-speed cut thread 1/8 to 1 inches including noninterrupted (NPT).
- ^g High-speed cut thread 1/8 to 1 1/4 inches including interrupted (NPT).
- ^h Carbon cut thread 1/8 to 1 1/4 inches including interrupted (NPT).
- ⁱ High-speed ground thread 1 1/2 to 2 inches including interrupted (NPT).

Table 13b. Straight and Taper Pipe Taps Tolerances (Ground and Cut Thread) ASME B94.9-1999

Ground Thread				Cut Thread			
Element	Nominal Diameter Range, inch		Tolerances, inch	Element	Nominal Diameter Range, inch		Tolerances, inch
	Over	To (inclusive)			Over	To (inclusive)	
Length overall, L	$\frac{1}{16}$	$\frac{3}{4}$	± 0.031	Length overall, L	$\frac{1}{8}$	$\frac{3}{4}$	± 0.031
	1	2	± 0.063		1	3	± 0.063
Length of thread, I	$\frac{1}{16}$	$\frac{3}{4}$	± 0.063	Length of thread, I	$\frac{1}{8}$	$\frac{3}{4}$	± 0.063
	1	$1\frac{1}{4}$	± 0.094		1	$1\frac{1}{4}$	± 0.094
	$1\frac{1}{2}$	2	± 0.125		$1\frac{1}{2}$	3	± 0.125
Length of square, I_2	$\frac{1}{16}$	$\frac{3}{4}$	± 0.031	Length of square, I_2	$\frac{1}{8}$	$\frac{3}{4}$	± 0.031
	1	2	± 0.063		1	3	± 0.063
Diameter of shank, d_1	$\frac{1}{16}$	$\frac{1}{8}$	-0.002	Diameter of shank, d_1	$\frac{1}{8}$	$\frac{1}{2}$	-0.007
	$\frac{1}{4}$	1	-0.002		$\frac{3}{4}$	3	-0.009
	$1\frac{1}{4}$	2	-0.002		$\frac{1}{8}$...	-0.004
Size of square, a	$\frac{1}{16}$	$\frac{1}{8}$	-0.004	Size of square, a	$\frac{1}{4}$	$\frac{3}{4}$	-0.006
	$\frac{1}{4}$	$\frac{3}{4}$	-0.006		1	3	-0.008
	1	2	-0.008				

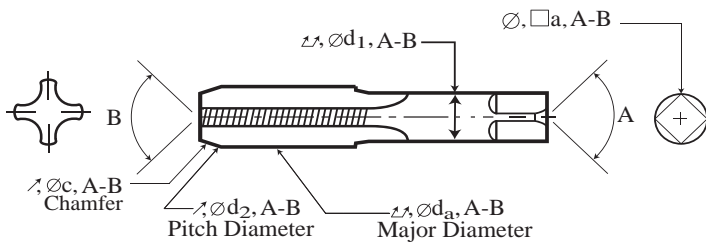
All dimensions are given in inches.

The first few threads on interrupted thread pipe thread pipe taps are left full. These taps have internal centers. For runout tolerances of tap elements see Table 14. Taps marked NPS are suitable for NPSC and NPSM. These taps have 2 to $3\frac{1}{2}$ threads chamfer, see Table 5a. Optional neck is for manufacturing use only. For taper pipe thread limit see Table 24a. For straight pipe thread limits see Tables 23a, 23b, and 23d.

Table 14. Runout and Locational Tolerance of Tap Elements ASME B94.9-1999

	Range Sizes (Inclusive)			Total Runout FIM, Inch		Location, Inch
	Machine Screw	Metric	Pipe, Inch	Cut Thread	Ground Thread	
Shank, d_1	#0 to $\frac{5}{16}$	M1.6 to M8	$\frac{1}{16}$	0.0060	0.0010	...
	$\frac{1}{32}$ to 4	M10 to M100	$\frac{1}{8}$ to 4	0.0080	0.0016	...
Major diameter, d_a	#0 to $\frac{5}{16}$	M1.6 to M8	$\frac{1}{16}$	0.0050	0.0010	...
	$\frac{1}{32}$ to 4	M10 to M100	$\frac{1}{8}$ to 4	0.0080	0.0016	...
Pitch Diameter, d_2	#0 to $\frac{5}{16}$	M1.6 to M8	$\frac{1}{16}$	0.0050	0.0010	...
	$\frac{1}{32}$ to 4	M10 to M100	$\frac{1}{8}$ to 4	0.0080	0.0016	...
Chamfer ^a , c	#0 to $\frac{1}{2}$	M1.6 to M12	$\frac{1}{16}$ to $\frac{1}{8}$	0.0040	0.0020	...
	$\frac{1}{32}$ to 4	M14 to M100	$\frac{1}{8}$ to 4	0.0060	0.0030	...
Square, a	#0 to $\frac{1}{2}$	M1.6 to M12	$\frac{1}{16}$ to $\frac{1}{8}$	0.0060
	$\frac{1}{32}$ to 4	M14 to M100	$\frac{1}{8}$ to 4	0.0080

^a Chamfer should preferably be inspected by light projection to avoid errors due to indicator contact points dropping into the thread groove.



**Table 15. Tap Thread Limits: Metric Sizes, Ground Thread
(M Profile Standard Thread Limits in Inches) ASME B94.9-1999**

Nom. Dia mm	Pitch, mm	Major Diameter (Inches)			Pitch Diameter (Inches)								
		Basic	Min.	Max.	Basic	Limit # D	D # Limit		Limit # D	D # Limit			
							Min.	Max.		Min.	Max.		
1.6	0.35	0.06299	0.06409	0.06508	0.05406	3	0.05500	0.05559		
2	0.4	0.07874	0.08000	0.08098	0.06850		0.06945	0.07004		
2.5	0.45	0.09843	0.09984	0.10083	0.08693		0.08787	0.08846		
3	0.5	0.11811	0.11969	0.12067	0.10531	4	0.10626	0.10685	5	0.10278 ^{a, b}	0.10787 ^{a, b}		
3.5	0.6	0.13780	0.13969	0.14067	0.12244		0.12370	0.12449
4	0.7	0.15748	0.15969	0.16130	0.13957		0.14083	0.14161	6			0.14185 ^{a, b}	0.14264 ^{a, b}
4.5	0.75	0.17717	0.17953	0.18114	0.15799	5	0.15925	0.16004		
5	0.8	0.19685	0.19937	0.20098	0.17638		0.17764	0.17843	7	0.17917 ^{b, c}	0.17996 ^{b, c}		
6	1	0.23622	0.23937	0.24098	0.21063		0.21220	0.21319	8	0.21374 ^{b, c}	0.2147 ^{b, c}		
7	1	0.27559	0.27874	0.28035	0.25000	6	0.25157	0.25256		
8	1.25	0.31496	0.31890	0.32142	0.28299		0.28433	0.28555	9	0.2864 ^{b, d}	0.2875 ^{b, d}		
10	1.5	0.39370	0.39843	0.40094	0.35535		0.35720	0.35843	10	0.3593 ^{b, e}	0.3605 ^{b, e}		
12	1.75	0.47244	0.47795	0.48047	0.42768	7	0.42953	0.43075	11	0.43209 ^e	0.43331 ^e		
14	2	0.55118	0.55748	0.56000	0.50004		0.50201	0.50362		
14	1.25	0.55118	0.55500	0.55600	0.51920		4	0.52070 ^f	0.52171 ^f	
16	2	0.62992	0.63622	0.63874	0.57878	4	7	0.58075	0.58236	
18	1.5	0.70870	0.71350	0.71450	0.67030		4	0.67180 ^f	0.67230 ^f	7	0.58075	0.58236	
20	2.5	0.78740	0.79528	0.79780	0.72346		7	0.72543	0.72705	
24	3	0.94488	0.95433	0.95827	0.86815	8	8	0.87063	0.8722	
30	3.5	1.18110	1.19213	1.19606	1.09161		1.0942	1.0962	
36	4	1.41732	1.42992	1.43386	1.31504		1.3176	1.3197	
42	4.5	1.65354	1.66772	1.71102	1.53846	9	1.5415	1.5436		
48	5	1.88976	1.90552	1.98819	1.76189		1.7649	1.7670	

^a Minimum and maximum major diameters are 0.00102 larger than shown.

^b Standard D limit for thread forming taps.

^c Minimum and maximum major diameters are 0.00154 larger than shown.

^d Minimum and maximum major diameters are 0.00205 larger than shown.

^e Minimum and maximum major diameters are 0.00256 larger than shown.

^f These sizes are intended for spark plug applications; use tolerances from Table 2 column D.

All dimensions are given in inches. Not all styles of taps are available with all limits listed. For calculation of limits other than those listed, see formulas in Table 4.

**Table 16. Tap Thread Limits: Metric Sizes, Ground Thread
(M Profile Standard Thread Limits in Millimeters) ASME B94.9-1999**

Size mm	Pitch	Major Diameter			Pitch Diameter							
		Basic	Min.	Max.	Basic	D #	D # Limit		D #	D # Limit		
							Min.	Max.		Min.	Max.	
1.6	0.35	1.60	1.628	1.653	1.373	3	1.397	1.412	
2	0.4	2.00	2.032	2.057	1.740		1.764	1.779	
2.5	0.45	2.50	2.536	2.561	2.208		2.232	2.247	
3	0.5	3.00	3.040	3.065	2.675	4	2.699	2.714	5	2.725 ^{a, b}	2.740 ^{a, b}	
3.5	0.6	3.50	3.548	3.573	3.110		3.142	3.162	
4	0.7	4.00	4.056	4.097	3.545		3.577	3.597	6	3.603 ^{a, b}	3.623 ^{a, b}	
4.5	0.75	4.50	4.560	4.601	4.013	5	4.045	4.065	
5	0.8	5.00	5.064	5.105	4.480		4.512	4.532	7	4.551 ^{b, c}	4.571 ^{b, c}	
6	1.00	6.00	6.121	6.351	5.391		5.391	5.416	8	5.429 ^{b, c}	5.454 ^{b, c}	
7	1.00	7.00	7.121	6.351	6.391	6	6.391	6.416	
8	1.25	8.00	8.10	8.164	7.188		7.222	7.253	9	7.274 ^{b, d}	7.305 ^{b, d}	
10	1.50	10.0	10.12	10.184	9.026		9.073	9.104	10	9.125 ^{b, d}	9.156 ^{b, d}	
12	1.75	12.0	12.14	12.204	10.863	7	10.910	10.941	11	10.975 ^{b, e}	11.006 ^{b, e}	
14	2.00	14.0	14.01	14.164	13.188		4	7.222 ^f	7.253 ^f
14	1.25	14.0	14.16	14.224	12.701		4	12.751	12.792
16	2.00	16.0	16.16	16.224	14.701	7		14.751	14.792
18	1.50	18.0	18.12	18.184	17.026	4		17.063 ^f	17.076 ^f

Table 16. (Continued) Tap Thread Limits: Metric Sizes, Ground Thread (M Profile Standard Thread Limits in Millimeters) ASME B94.9-1999

Size mm	Pitch	Major Diameter			Pitch Diameter						
					Basic	D #	D # Limit		D #	D # Limit	
		Min.	Max.	Min.			Max.	Min.		Max.	
20	2.50	20.0	20.20	20.263	18.376	7	18.426	18.467
24	3.00	24.0	24.24	24.34	22.051	8	22.114	22.155
30	3.50	30.0	30.28	30.38	27.727	9	27.792	27.844
36	4.00	36.0	36.32	36.42	33.402		33.467	33.519
42	4.50	42.0	42.36	42.46	39.077	10	39.155	39.207
48	5.00	48.0	48.48	48.58	44.103		44.182	44.246

^a Minimum and maximum major diameters are 0.026 larger than shown.

^b Standard D limit for thread forming taps.

^c Minimum and major diameters are 0.039 larger than shown.

^d Minimum and major diameters are 0.052 larger than shown.

^e Minimum and major diameters are 0.065 larger than shown.

^f These sizes are intended for spark plug applications; use tolerances from Table 2 column D.

Notes for Table 16: Inch translations are listed in Table 15. Limit listed in Table 16 are the most commonly used in industry. Not all styles of taps are available with all limits listed. For calculations of limits other than listed, see formulas in Table 4

Table 17. Tap Size Recommendations for Class 6H Metric Screw Threads

Nominal Diameter, mm	Pitch, mm	Recommended Thread Limit Number	Internal Threads, Pitch Diameter			
			Min. (mm)	Max. (mm)	Min. (inch)	Max. (inch)
1.6	0.35	D3	1.373	1.458	0.05406	0.05740
2	0.4	D3	1.740	1.830	0.06850	0.07250
2.5	0.45	D3	2.208	2.303	0.08693	0.09067
3	0.5	D3	2.675	2.775	0.10537	0.10925
3.5	0.6	D4	3.110	3.222	0.12244	0.12685
4	0.7	D4	3.545	3.663	0.13957	0.14421
4.5	0.75	D4	4.013	4.131	0.15789	0.16264
5	0.8	D4	4.480	4.605	0.17638	0.18130
6	1	D5	5.350	5.500	0.201063	0.21654
7	1	D5	6.350	6.500	0.2500	0.25591
8	1.25	D5	7.188	7.348	0.28299	0.28929
10	1.5	D6	9.206	9.206	0.35535	0.36244
12	1.75	D6	10.863	11.063	0.42768	0.43555
14	2	D7	12.701	12.913	0.50004	0.50839
16	2	D7	14.701	14.913	0.57878	0.58713
20	2.5	D7	18.376	18.600	0.72346	0.73228
24	3	D8	22.051	22.316	0.86815	0.87858
30	3.5	D9	27.727	28.007	1.09161	1.10264
36	4	D9	33.402	33.702	1.31504	1.32685

The above recommended taps normally produce the class of thread indicated in average materials when used with reasonable care. However, if the tap specified does not give a satisfactory gage fit in the work, a choice of some other limit tap will be necessary.

Table 18. Standard Chamfers for Thread Cutting Taps ASME B94.9-1999

Type of tap		Chamfer length		Type of tap		Chamfer length	
		Min.	Max.			Min.	Max.
Straight threads taps	Bottom	1P	2P	Taper pipe taps	2P	3½ P	
	Semibottom	2P	3P				
	Plug	3P	5P				
	Taper	7P	10P				

P = pitch.

The chamfered length is measured at the cutting edge and is the axial length from the point diameter to the theoretical intersection of the major diameter and the chamfer angle. Whenever chamfer length is specified in terms of threads, this length is measured in number of pitches as shown. The point diameter is approximately equal to the basic thread minor diameter.

Table 19. Taps Sizes for Classes 2B and 3B Unified Screw Threads Machine Screw, Numbered, and Fractional Sizes ASME B94.9-1999

Size	Threads per Inch		Recommended Tap For Class of Thread ^a		Pitch Diameter Limits For Class of Thread		
	NC UNC	NF UNF	Class 2B ^b	Class 3B ^c	Min., All Classes (Basic)	Max Class 2B	Max Class 3B
Machine Screw Numbered Size Taps							
0	...	80	G H2	G H1	0.0519	0.0542	0.0536
1	64	...	G H2	G H1	0.0629	0.0655	0.0648
1	...	72	G H2	G H1	0.0640	0.0665	0.0659
2	56	...	G H2	G H1	0.0744	0.0772	0.0765
2	...	64	G H2	G H1	0.0759	0.0786	0.0779
3	48	...	G H2	G H1	0.0855	0.0885	0.0877
3	...	56	G H2	G H1	0.0874	0.0902	0.0895
4	40	...	G H2	G H2	0.0958	0.0991	0.0982
4	...	48	G H2	G H1	0.0985	0.1016	0.1008
5	40	...	G H2	G H2	0.1088	0.1121	0.1113
5	...	44	G H2	G H1	0.1102	0.1134	0.1126
6	32	...	G H3	G H2	0.1177	0.1214	0.1204
6	...	40	G H2	G H2	0.1218	0.1252	0.1243
8	32	...	G H3	G H2	0.1437	0.1475	0.1465
8	...	36	G H2	G H2	0.1460	0.1496	0.1487
10	24	...	G H3	G H3	0.1629	0.1672	0.1661
10	...	32	G H3	G H2	0.1697	0.1736	0.1726
12	24	...	G H3	G H3	0.1889	0.1933	0.1922
12	...	28	G H3	G H3	0.1928	0.1970	0.1959
Fractional Size Taps							
1/4	20	...	G H5	G H3	0.2175	0.2224	0.2211
1/4	...	28	G H4	G H3	0.2268	0.2311	0.2300
5/16	18	...	G H5	G H3	0.2764	0.2817	0.2803
5/16	...	24	G H4	G H3	0.2854	0.2902	0.2890
3/8	16	...	G H5	G H3	0.3344	0.3401	0.3387
3/8	...	24	G H4	G H3	0.3479	0.3528	0.3516
7/16	14	...	G H5	G H3	0.3911	0.3972	0.3957
7/16	...	20	G H5	G H3	0.4050	0.4104	0.4091
1/2	13	...	G H5	G H3	0.4500	0.4565	0.4548
1/2	...	20	G H5	G H3	0.4675	0.4731	0.4717
9/16	12	...	G H5	G H3	0.5084	0.5152	0.5135
9/16	...	18	G H5	G H3	0.5264	0.5323	0.5308
5/8	11	...	G H5	G H3	0.5660	0.5732	0.5714
5/8	...	18	G H5	G H3	0.5889	0.5949	0.5934
3/4	10	...	G H5	G H5	0.6850	0.6927	0.6907
3/4	...	16	G H5	G H3	0.7094	0.7159	0.7143
7/8	9	...	G H6	G H4	0.8028	0.8110	0.8089
7/8	...	14	G H6	G H4	0.8286	0.8356	0.8339
1	8	...	G H6	G H4	0.9188	0.9276	0.9254
1	...	12	G H6	G H4	0.9459	0.9535	0.9516
1	14NS	14NS	G H6	G H4	0.9536	0.9609	0.9590
1 1/8	7	...	G H8	G H4	1.0322	1.0416	1.0393
1 1/8	...	12	G H6	G H4	1.0709	1.0787	1.0768
1 1/4	7	...	G H8	G H4	1.1572	1.1668	1.1644
1 1/4	...	12	G H6	G H4	1.1959	1.2039	1.2019
1 3/8	6	...	G H8	G H4	1.2667	1.2771	1.2745
1 3/8	...	12	G H6	G H4	1.3209	1.3291	1.3270
1 1/2	6	...	G H8	G H4	1.3917	1.4022	1.3996
1 1/2	...	12	G H6	G H4	1.4459	1.4542	1.4522

^a Recommended taps are for cutting threads only and are not for roll-form threads.

^b Cut thread taps in sizes #3 to 1 1/2 in. NC and NF, inclusive, may be used under all normal conditions and in average materials for producing Class 2B tapped holes.

^c Taps suited for class 3B are satisfactory for class 2B threads.

All dimensions are given in inches.

The above recommended taps normally produce the class of thread indicated in average materials when used with reasonable care. However, if the tap specified does not give a satisfactory gage fit in the work, a choice of some other limit tap will be necessary.

**Table 20. Tap Thread Limits: Machine Screw Sizes, Ground Thread ASME B94.9-1999
(Unified and American National Thread Forms, Standard Thread Limits)**

Size	Threads per Inch			Major Diameter			Pitch Diameter																
	NC UNF	NF UNF	NS	Basic	Min.	Max.	H1 limit		H2 limit		H3 limit		H4 limit		H5 limit		H6 limit ^a		H7 limit ^b		H8 limit ^c		
							Basic	Min.	Max.	Min.	Max.	Min.	Max.	Min.	Max.	Min.	Max.	Min.	Max.	Min.	Max.	Min.	Max.
0	...	80	...	0.0600	0.0605	0.0616	0.0519	0.0519	0.0524	0.0524	0.0529
1	64	0.0730	0.0736	0.0750	0.0629	0.0629	0.0634	0.0634	0.0639
1	...	72	...	0.0730	0.0736	0.0748	0.0640	0.064	0.0645	0.0645	0.0650
2	56	0.0860	0.0866	0.0883	0.0744	0.0744	0.0749	0.0749	0.0754
2	...	64	...	0.0860	0.0866	0.0880	0.0759	0.0764	0.0769
3	48	0.0990	0.0999	0.1017	0.0855	0.086	0.0865
3	...	56	...	0.0990	0.0997	0.1013	0.0874	0.0874	0.0879	0.0879	0.0884
4	40	0.1120	0.1134	0.1153	0.0958	0.0958	0.0963	0.0963	0.0968	0.0978 ^d	0.0983 ^d
4	36	0.1120	0.1135	0.1156	0.0940	0.094	0.0945	0.0945	0.0950	0.0960 ^d	0.0965 ^d
4	...	48	...	0.1120	0.1129	0.1147	0.0985	0.0985	0.0990	0.0990	0.0995	0.1005 ^d	0.1010 ^d
5	40	0.1250	0.1264	0.1283	0.1088	0.1088	0.1093	0.1093	0.1098	0.1108 ^d	0.1113 ^d
5	...	44	...	0.1250	0.1262	0.1280	0.1102	0.1107	0.1112	0.1122 ^d	0.1127 ^d
6	32	0.1380	0.1400	0.1421	0.1177	0.1177	0.1182	0.1182	0.1187	0.1187	0.1192	0.1197 ^a	0.1202 ^a	0.1207	0.1212	0.1222	0.1227
6	...	40	...	0.1380	0.1394	0.1413	0.1218	0.1218	0.1223	0.1223	0.1228	0.1238 ^a	0.1243 ^a
8	32	0.1640	0.1660	0.1681	0.1437	0.1437	0.1442	0.1442	0.1447	0.1447	0.1452	0.1457 ^a	0.1462 ^a	0.1467	0.1472	0.1482	0.1487
8	...	36	...	0.1640	0.1655	0.1676	0.1460	0.1465	0.1470	0.1480 ^a	0.1485 ^a
10	24	0.1900	0.1927	0.1954	0.1629	0.1629	0.1634	0.1634	0.1639	0.1639	0.1644	0.1644	0.1649	0.1654	0.1659	0.1659	0.1664
10	...	32	...	0.1900	0.1920	0.1941	0.1697	0.1697	0.1702	0.1702	0.1707	0.1707	0.1712	0.1712	0.1717	0.1722	0.1727	0.1727	0.1732	0.1742	0.1747
12	24	0.2160	0.2187	0.2214	0.1889	0.1899	0.1904	0.1904	0.1909	0.1914	0.1919
12	...	28	...	0.2160	0.2183	0.2206	0.1928	0.1938	0.1943	0.1943	0.1948	0.1953	0.1958

^a Minimum and maximum major diameters are 0.0010 larger than shown.

^b Minimum and maximum major diameters are 0.0020 larger than shown.

^c Minimum and maximum major diameters are 0.0035 larger than shown.

^d Minimum and maximum major diameters are 0.0015 larger than shown.

General notes:

Limits listed in above table are the most commonly used in the industry.

Not all styles of taps are available with all limits listed.

For calculation of limits other than those listed, see formulas and [Table 2](#).

**Table 21. Tap Thread Limits: Fractional Sizes, Ground Thread ASME B94.9-1999
(Unified and American National Thread Forms, Standard Thread Limits)**

Size inch	NC UNC	NF UNF	NS	Major Diameter			Pitch Diameter																
				Basic	Min.	Max.	Basic	H1 limit		H2 limit		H3 limit		H4 limit		H5 limit		H6 limit ^a		H7 limit		H8 limit ^b	
								Min.	Max.	Min.	Max.	Min.	Max.	Min.	Max.	Min.	Max.	Min.	Max.	Min.	Max.	Min.	Max.
1/4	20	0.2500	0.2532	0.2565	0.2175	0.2175	0.2180	0.2180	0.2185	0.2185	0.2190	0.2195 ^a	0.2200 ^a
1/4	...	28	...	0.2500	0.2523	0.2546	0.2268	0.2268	0.2273	0.2273	0.2278	0.2278	0.2283	0.2283	0.2288
5/16	18	0.3125	0.3161	0.3197	0.2764	0.2764	0.2769	0.2769	0.2774	0.2774	0.2779	0.2784 ^a	0.2789 ^a	0.2794 ^c	0.2799 ^c
5/16	...	24	...	0.3125	0.3152	0.3179	0.2854	0.2854	0.2859	0.2859	0.2864	0.2864	0.2869	0.2869	0.2874	0.2884 ^c	0.2889 ^c
3/8	16	0.3750	0.3790	0.3831	0.3344	0.3344	0.3349	0.3349	0.3354	0.3354	0.3359	0.3364 ^a	0.3369 ^a	0.3374 ^c	0.3379 ^c
3/8	...	24	...	0.3750	0.3777	0.3804	0.3479	0.3479	0.3484	0.3484	0.3489	0.3489	0.3494	0.3494	0.3499	0.3509 ^c	0.3514 ^c
7/16	14	0.4375	0.4422	0.4468	0.3911	0.3916	0.3921	0.3921	0.3926	0.3931 ^a	0.3936 ^a	0.3946	0.3951
7/16	...	20	...	0.4375	0.4407	0.4440	0.4050	0.4060	0.4065	0.4070 ^a	0.4075 ^a	0.4085	0.4090
1/2	13	0.5000	0.5050	0.5100	0.4500	0.4500	0.4505	0.4505	0.4510	0.4510	0.4515	0.4520 ^a	0.4525 ^a	0.4535	0.4540
1/2	...	20	...	0.5000	0.5032	0.5065	0.4675	0.4675	0.4680	0.4680	0.4685	0.4685	0.4690	0.4695 ^a	0.4700 ^a	0.4710	0.4715
9/16	12	0.5625	0.5679	0.5733	0.5084	0.5094	0.5099	0.5104 ^a	0.5109 ^a	0.5114 ^c	0.5119 ^c
9/16	...	18	...	0.5625	0.5661	0.5697	0.5264	0.5269	0.5274	0.5274	0.5279	0.5284 ^a	0.5289 ^a	0.5294 ^c	0.5299 ^c
5/8	11	0.6250	0.6309	0.6368	0.566	0.5665	0.567	0.567	0.5675	0.5680 ^a	0.5685 ^a	0.5690 ^c	0.5695 ^c
5/8	...	18	...	0.6250	0.6286	0.6322	0.5889	0.5894	0.5899	0.5899	0.5904	0.5909 ^a	0.5914 ^a	0.5919 ^c	0.5924 ^c
11/16	11	0.6875	0.6934	0.6993	0.6285	0.6295	0.6300
11/16	16	0.6875	0.6915	0.6956	0.6469	0.6479	0.6484
3/4	10	0.7500	0.7565	0.7630	0.6850	0.6855	0.6860	0.6860	0.6865	0.6870	0.6875	0.6880 ^d	0.6885 ^d
3/4	...	16	...	0.7500	0.7540	0.7581	0.7094	0.7094	0.7099	0.7099	0.7104	0.7104	0.7109	0.7114 ^a	0.7119 ^a	0.7124 ^d	0.7129 ^d
7/8	9	0.8750	0.8822	0.8894	0.8028	0.8043	0.8048	0.8053	0.8058

Table 21. (Continued) Tap Thread Limits: Fractional Sizes, Ground Thread ASME B94.9-1999 (Unified and American National Thread Forms, Standard Thread Limits)

Size inch	NC UNC	NF UNF	NS	Major Diameter				Pitch Diameter															
				Basic	Min.	Max.	Basic	H1 limit		H2 limit		H3 limit		H4 limit		H5 limit		H6 limit ^a		H7 limit		H8 limit ^b	
								Min.	Max.	Min.	Max.	Min.	Max.	Min.	Max.	Min.	Max.	Min.	Max.	Min.	Max.	Min.	Max.
7/8	...	14	...	0.8750	0.8797	0.8843	0.8286	0.8291	0.8296	0.8301	0.8306
1	8	1.0000	1.0082	1.0163	0.9188	0.9203	0.9208	0.9213	0.9218
1	...	12	...	1.0000	1.0054	1.0108	0.9459	0.9474	0.9479
1	1.0000	1.0047	1.0093	0.9536	0.9551	0.9556
1 1/8	7	1.1250	1.1343	1.1436	1.0322	1.0337	1.0342
1 1/8	...	12	...	1.1250	1.1304	1.1358	1.0709	1.0724	1.0729
1 1/4	7	1.2500	1.2593	1.2686	1.1572	1.1587	1.1592
1 1/4	...	12	...	1.2500	1.2554	1.2608	1.1959	1.1974	1.1979
1 3/8	6	1.3750	1.3859	1.3967	1.2667	1.2682	1.2687
1 3/8	...	12	...	1.3750	1.3804	1.3858	1.3209	1.3224	1.3229
1 1/2	6	1.5000	1.5109	1.5217	1.3917	1.3932	1.3937
1 1/2	...	12	...	1.5000	1.5054	1.5108	1.4459	1.4474	1.4479
1 3/4	5	1.7500	1.7630	1.7760	1.6201	1.6216	1.6221
2	...	4.5	...	2.0000	2.0145	2.0289	1.8557	1.8572	1.8577

^aMinimum and maximum major diameters are 0.0010 larger than shown.

^bMinimum and maximum major diameters are 0.0035 larger than shown.

^cMinimum and maximum major diameters are 0.0020 larger than shown.

^dMinimum and maximum major diameters are 0.0015 larger than shown.

General notes:

Limits listed in **Table 21** are the most commonly used in the industry.

Not all styles of taps are available with all limits listed.

For calculation of limits other than those listed, see formulas and **Table 2**.

Table 22. Tap Thread Limits: Machine Screw Sizes, Cut Thread ASME B94.9-1999 Unified and American National Thread Forms, Standard Thread Limits

Size	Threads per Inch			Major Diameter			Pitch Diameter		
	NC UNC	NF UNF	NS UNS	Basic	Min.	Max.	Basic	Min.	Max.
0	...	80	...	0.0600	0.0609	0.0624	0.0519	0.0521	0.0531
1	64	0.0730	0.0739	0.0754	0.0629	0.0631	0.0641
1	...	72	...	0.0730	0.0740	0.0755	0.0640	0.0642	0.0652
2	56	0.0860	0.0872	0.0887	0.0744	0.0746	0.0756
2	...	64	...	0.0860	0.0870	0.0885	0.0759	0.0761	0.0771
3	48	0.0990	0.1003	0.1018	0.0855	0.0857	0.0867
3	...	56	...	0.0990	0.1002	0.1017	0.0874	0.0876	0.0886
4	36	0.1120	0.1137	0.1157	0.0940	0.0942	0.0957
4	40	0.1120	0.1136	0.1156	0.0958	0.0960	0.0975
4	...	48	...	0.1120	0.1133	0.1153	0.0985	0.0987	0.1002
5	40	0.1250	0.1266	0.1286	0.1088	0.1090	0.1105
6	32	0.1380	0.1402	0.1422	0.1177	0.1182	0.1197
6	36	0.1380	0.1397	0.1417	0.1200	0.1202	0.1217
6	...	40	...	0.1380	0.1396	0.1416	0.1218	0.1220	0.1235
8	32	0.1640	0.1662	0.1682	0.1437	0.1442	0.1457
8	...	36	...	0.1640	0.1657	0.1677	0.1460	0.1462	0.1477
8	40	0.1640	0.1656	0.1676	0.1478	0.1480	0.1495
10	24	0.1900	0.1928	0.1948	0.1629	0.1634	0.1649
10	...	32	...	0.1900	0.1922	0.1942	0.1697	0.1702	0.1717
12	24	0.2160	0.2188	0.2208	0.1889	0.1894	0.1909
12	...	28	...	0.2160	0.2184	0.2204	0.1928	0.1933	0.1948
14	24	0.2420	0.2448	0.2473	0.2149	0.2154	0.2174

Angle Tolerance		
Threads per Inch	Half Angle	Full Angle
20 to 28	$\pm 0^{\circ}45'$	$\pm 0^{\circ}65'$
30 and finer	$\pm 0^{\circ}60'$	$\pm 0^{\circ}90'$

A maximum lead error of ± 0.003 inch in 1 inch of thread is permitted.

All dimensions are given in inches.

Thread limits are computed from [Table 3](#).

**Table 23. Tap Thread Limits: Fractional Sizes, Cut Thread ASME B94.9-1999
(Unified and American National Thread Forms)**

Size	Threads per Inch			Major Diameter			Pitch Diameter		
	NC UNC	NF UNF	NS UNS	Basic	Min.	Max.	Basic	Min.	Max.
1/8	40	0.1250	0.1266	0.1286	0.1088	0.1090	0.1105
5/32	32	0.1563	0.1585	0.1605	0.13595	0.13645	0.1380
3/16	24	0.1875	0.1903	0.1923	0.1604	0.1609	0.1624
3/16	32	0.1875	0.1897	0.1917	0.1672	0.1677	0.1692
1/4	20	0.2500	0.2532	0.2557	0.2175	0.2180	0.2200
1/4	...	28	...	0.2500	0.2524	0.2549	0.2268	0.2273	0.2288
5/16	18	0.3125	0.3160	0.3185	0.2764	0.2769	0.2789
5/16	...	24	...	0.3125	0.3153	0.3178	0.2854	0.2859	0.2874
3/8	16	0.3750	0.3789	0.3814	0.3344	0.3349	0.3369
3/8	...	24	...	0.3750	0.3778	0.3803	0.3479	0.3484	0.3499
7/16	14	0.4375	0.4419	0.4449	0.3911	0.3916	0.3941
7/16	...	20	...	0.4375	0.4407	0.4437	0.4050	0.4055	0.4075
1/2	13	0.5000	0.5047	0.5077	0.4500	0.4505	0.4530
1/2	...	20	...	0.5000	0.5032	0.5062	0.4675	0.4680	0.4700
9/16	12	0.5625	0.5675	0.5705	0.5084	0.5089	0.5114
9/16	...	18	...	0.5625	0.5660	0.5690	0.5264	0.5269	0.5289
5/8	11	0.6250	0.6304	0.6334	0.5660	0.5665	0.5690
5/8	...	18	...	0.6250	0.6285	0.6315	0.5889	0.5894	0.5914
3/4	10	0.7500	0.7559	0.7599	0.6850	0.6855	0.6885
3/4	...	16	...	0.7500	0.7539	0.7579	0.7094	0.7099	0.7124
7/8	9	0.8750	0.8820	0.8860	0.8028	0.8038	0.8068
7/8	...	14	...	0.8750	0.8799	0.8839	0.8286	0.8296	0.8321
1	8	1.0000	1.0078	1.0118	0.9188	0.9198	0.9228
1	...	12	...	1.0000	1.0055	1.0095	0.9459	0.9469	0.9494
1	14	1.0000	1.0049	1.0089	0.9536	0.9546	0.9571
1 1/8	7	1.1250	1.1337	1.1382	1.0322	1.0332	1.0367
1 1/8	...	12	...	1.1250	1.1305	1.1350	1.0709	1.0719	1.0749
1 1/4	7	1.2500	1.2587	1.2632	1.1572	1.1582	1.1617
1 1/4	...	12	...	1.2500	1.2555	1.2600	1.1959	1.1969	1.1999
1 3/8	6	1.3750	1.3850	1.3895	1.2667	1.2677	1.2712
1 3/8	...	12	...	1.3750	1.3805	1.3850	1.3209	1.3219	1.3249
1 1/2	6	1.5000	1.5100	1.5145	1.3917	1.3927	1.3962
1 1/2	...	12	...	1.5000	1.5055	1.5100	1.4459	1.4469	1.4499
1 3/4	5	1.7500	1.7602	1.7657	1.6201	1.6216	1.6256
2	4.5	2.0000	2.0111	2.0166	1.8557	1.8572	1.8612

Threads per Inch	Half Angle	Full Angle
4 1/2 to 5 1/2	±0° 35'	±0° 53'
6 to 9	±0° 40'	±0° 60'
10 to 28	±0° 45'	±0° 68'
30 to 64	±0° 60'	±0° 90'

A maximum lead error of ±0.003 inch in 1 inch of thread is permitted.

All dimensions are given in inches.

Thread limits are computed from [Table 3](#).

**Table 23a. Straight Pipe Thread Limits: NPS, Ground Thread
ANSI Straight Pipe Thread Form (NPSC, NPSM) ASME B94.9-1999**

Nominal Size, Inches	Threads per Inch, NPS, NPSC, NPSM	Major Diameter			Pitch Diameter		
		Plug at Gaging Notch	Min. <i>G</i>	Max. <i>H</i>	Plug at Gaging Notch <i>E</i>	Min. <i>K</i>	Max. <i>L</i>
1/8	27	0.3983	0.4022	0.4032	0.3736	0.3746	0.3751
1/4	18	0.5286	0.5347	0.5357	0.4916	0.4933	0.4938
3/8	18	0.6640	0.6701	0.6711	0.6270	0.6287	0.6292
1/2	14	0.8260	0.8347	0.8357	0.7784	0.7806	0.7811
3/4	14	1.0364	1.0447	1.0457	0.9889	0.9906	0.9916
1	11 1/2	1.2966	1.3062	1.3077	1.2386	1.2402	1.2412

Formulas for NPS Ground Thread Taps^a

Nominal Size	Major Diameter		Minor Dia.	Threads per Inch	<i>A</i>	<i>B</i>
	Min. <i>G</i>	Max. <i>H</i>	Max.	27	0.0296	0.0257
1/8	$H - 0.0010$	$(K + A) - 0.0010$	$M - B$	18	0.0444	0.0401
1/4 to 3/4	$H - 0.0010$	$(K + A) - 0.0020$	$M - B$	14	0.0571	0.0525
1	$H - 0.0015$	$(K + A) - 0.0021$	$M - B$	11 1/2	0.0696	0.0647

^a In the formulas, *M* equals the actual measured pitch diameter.

All dimensions are given in inches.

Maximum pitch diameter of tap is based upon an allowance deducted from the maximum product diameter of NPSC or NPSM, whichever is smaller.

Minimum pitch diameter of tap is derived by subtracting the ground thread pitch diameter tolerance for actual equivalent size.

Lead tolerance: A maximum lead deviation of ± 0.0005 inch within any two threads not farther apart than one inch.

Angle Tolerance: 11 1/2 to 27 threads per inch, plus or minus 30 min. in half angle.

Taps made to the specifications in **Table 23a** are to be marked NPS and used for NPSC and NPSM.

**Table 23b. Straight Pipe Thread Limits: NPSF Ground Thread
ANSI Standard Straight Pipe Thread Form (NPSF) ASME B94.9-1999**

Nominal Size, Inches	Threads per Inch	Major Diameter		Pitch Diameter			Minor ^a Dia. Flat, Max.
		Min. <i>G</i>	Max. <i>H</i>	Plug at Gaging Notch <i>E</i>	Min. <i>K</i>	Max. <i>L</i>	
1/16	27	0.3008	0.3018	0.2812	0.2772	0.2777	0.004
1/8	27	0.3932	0.3942	0.3736	0.3696	0.3701	0.004
1/4	18	0.5239	0.5249	0.4916	0.4859	0.4864	0.005
3/8	18	0.6593	0.6603	0.6270	0.6213	0.6218	0.005
1/2	14	0.8230	0.8240	0.7784	0.7712	0.7717	0.005
3/4	14	1.0335	1.0345	0.9889	0.9817	0.9822	0.005

All dimensions are given in inches.

^a As specified or sharper.

Table 23c. ASME Standard Straight Pipe Thread Limits: NPSF Ground Thread Dryseal ANSI Standard Straight Pipe Thread Form (NPSF) ASME B94.9-1999

Formulas For American Dryseal (NPSF) Ground Thread Taps					
Nominal Size, Inches	Major Diameter		Pitch Diameter		Max. Minor Dia.
	Min. <i>G</i>	Max. <i>H</i>	Min. <i>K</i>	Max. <i>L</i>	
1/16	$H - 0.0010$	$K + Q - 0.0005$	$L - 0.0005$	$E - F$	$M - Q$
1/8	$H - 0.0010$	$K + Q - 0.0005$	$L - 0.0005$	$E - F$	$M - Q$
1/4	$H - 0.0010$	$K + Q - 0.0005$	$L - 0.0005$	$E - F$	$M - Q$
3/8	$H - 0.0010$	$K + Q - 0.0005$	$L - 0.0005$	$E - F$	$M - Q$
1/2	$H - 0.0010$	$K + Q - 0.0005$	$L - 0.0005$	$E - F$	$M - Q$
3/4	$H - 0.0010$	$K + Q - 0.0005$	$L - 0.0005$	$E - F$	$M - Q$

Values to Use in Formulas				
Threads per Inch	<i>E</i>	<i>F</i>	<i>M</i>	<i>Q</i>
27	Pitch diameter of plug at gaging notch	0.0035	Actual measured pitch diameter	0.0251
18		0.0052		0.0395
14		0.0067		0.0533

All dimensions are given in inches.

Lead Tolerance: A maximum lead deviation of ± 0.0005 inch within any two threads not farther apart than one inch.

Angle Tolerance: Plus or minus 30 min. in half angle for 14 to 27 threads per inch, inclusive.

Table 23d. ANSI Standard Straight Pipe Tap Limits: (NPS)Cut Thread ANSI Straight Pipe Thread Form (NPSC) ASME B94.9-1999

Nominal Size	Threads per Inch, NPS, NPSC	Size at Gaging Notch	Pitch Diameter		Values to Use in Formulas		
			Min.	Max.	<i>A</i>	<i>B</i>	<i>C</i>
1/8	27	0.3736	0.3721	0.3751	0.0267	0.0296	0.0257
1/4	18	0.4916	0.4908	0.4938	0.0408	0.0444	0.0401
3/8	18	0.6270	0.6257	0.6292			
1/2	14	0.7784	0.7776	0.7811	0.0535	0.0571	0.0525
3/4	14	0.9889	0.9876	0.9916			
1	11 1/2	1.2386	1.2372	1.2412	0.0658	0.0696	0.0647

The following are approximate formulas, in which *M* = measured pitch diameter in inches:

$$\text{Major dia., min.} = M + A$$

$$\text{Major dia., max.} = M + B$$

$$\text{Minor dia., max.} = M - C$$

Maximum pitch diameter of tap is based on an allowance deducted from the maximum product pitch diameter of NPSC.

Minimum pitch diameter of tap equals maximum pitch diameter minus the tolerance.

All dimensions are given in inches.

Lead Tolerance: ± 0.003 inch per inch of thread.

Angle Tolerance: For all pitches, tolerance will be $\pm 45''$ for half angle and $\pm 68''$ for full angle. Taps made to these specifications are to be marked NPS and used for NPSC thread form.

Taps made to the specifications in [Table 23a](#) are to be marked NPS and used for NPSC.

As the American National Standard straight pipe thread form is to be maintained, the major and minor diameters vary with the pitch diameter. Either a flat or rounded form is allowable at both the crest and the root.

Table 24a. Taper Pipe Thread Limits (Ground and Cut Thread: Ground Thread For NPS, NPTF, and ANPT; Cut Thread for NPT only) ASME B94.9-1999

Nominal Size	Threads per Inch	Gage Measurement			Taper per Inch on Diameter ^a				Reference Dimensions	
		Projection Inch ^b	Tolerance ±		Cut Thread		Ground Thread		L ₁ , Length ^c	Tap Drill Size NPT, ANPT, NPTF ^d
			Cut Thread	Ground Thread	Min.	Max.	Min.	Max.		
1/16	27	0.312	0.0625	0.0625	0.0599	0.0703	0.0599	0.0651	0.1600	C
1/8	27	0.312	0.0625	0.0625	0.0599	0.0703	0.0599	0.0651	0.1615	Q
1/4	18	0.459	0.0625	0.0625	0.0599	0.0703	0.0599	0.0651	0.2278	7/16
3/8	18	0.454	0.0625	0.0625	0.0599	0.0703	0.0599	0.0651	0.2400	9/16
1/2	14	0.579	0.0625	0.0625	0.0599	0.0677	0.0599	0.0651	0.3200	45/64
3/4	11.5	0.565	0.0625	0.0625	0.0599	0.0677	0.0599	0.0651	0.3390	29/32
1	11.5	0.678	0.0937	0.0937	0.0599	0.0677	0.0599	0.0651	0.4000	1 1/64
1 1/4	11.5	0.686	0.0937	0.0937	0.0599	0.0677	0.0599	0.0651	0.4200	1 3/64
1 1/2	11.5	0.699	0.0937	0.0937	0.0599	0.0677	0.0599	0.0651	0.4200	1 23/32
2	8	0.667	0.0937	0.0937	0.0599	0.0677	0.0599	0.0651	0.4360	2 3/16
2 1/2	8	0.925	0.0937	0.0937	0.0612	0.0664	0.0612	0.0651	0.6820	2 39/64
3	20	0.925	0.0937	0.0937	0.0612	0.0664	0.0612	0.0651	0.7660	3 15/16

^a Taper is 0.0625 inch per 1.000 inch on diameter (1:16) (3/4 inch per 12 inches).

^b Distance small end of tap projects through L₁ taper ring gage.

^c Dimension, L₁, thickness on thin ring gage; see ASME B1.20.1 and B1.20.5.

^d Given sizes permit direct tapping without reaming the hole, but only give full threads for approximate L₁ distance.

All dimensions are given in inches.

Lead Tolerance: ± 0.003 inch per inch on cut thread, and ± 0.0005 inch per inch on ground thread.

Angle Tolerance: ± 40 min. in half angle and 60 min. in full angle for 8 cut threads per inch; ± 45 min. in half angle and 68 min. in full angle for 11 1/2 to 27 cut threads per inch; ± 25 min. in half angle for 8 ground threads per inch; and ± 30 min. in half angle for 11 1/2 to 27 ground threads per inch.

Table 24b. Taper Pipe Thread — Widths of Flats at Tap Crests and Roots for Cut Thread NPT and Ground Thread NPT, ANPT, and NPTF ASME B94.9-1999

Threads per Inch	Tap Flat Width at	Column I		Column II	
		NPT—Cut and Ground Thread ^a ANPT—Ground Thread ^a		NPTF	Ground Thread ^a
		Min. ^b	Max.		
27	Major diameter	0.0014	0.0041	0.0040	0.0055
	Minor diameter	...	0.0041	...	0.0040
18	Major diameter	0.0021	0.0057	0.0050	0.0065
	Minor diameter	...	0.0057	...	0.0050
14	Major diameter	0.0027	0.0064	0.0050	0.0065
	Minor diameter	...	0.0064	...	0.0050
11 1/2	Major diameter	0.0033	0.0073	0.0060	0.0083
	Minor diameter	...	0.0073	...	0.0060
8	Major diameter	0.0048	0.0090	0.0080	0.0103
	Minor diameter	...	0.0090	...	0.0080

^a Cut thread taps made to Column I are marked NPT but are not recommended for ANPT applications. Ground thread taps made to Column I are marked NPT and may be used for NPT and ANPT applications. Ground thread taps made to Column II are marked NPTF and used for dryseal application.

^b Minimum minor diameter flats are not specified and may be as sharp as practicable.

All dimensions are given in inches.

Table 25. Tap Thread Limits for Screw Thread Inserts (STI), Ground Thread, Machine Screw, and Fractional Size ASME B94.9-1999

Nominal Screw Size STI	Fractional Size STI	Threads Per Inch		Tap Major Diameter		Pitch Diameter Limits					
		NC	NF	Min.	Max.	2B			3B		
						H limit	Min.	Max.	H limit	Min.	Max.
1	...	64	...	0.0948	0.0958	H2	0.0837	0.0842	H1	0.0832	0.0837
2	...	56	...	0.1107	0.1117	H2	0.0981	0.0986	H1	0.0976	0.0981
	64	0.1088	0.1088	H2	0.0967	0.0972	H1	0.0962	0.0967
3	...	48	...	0.1289	0.1289	H2	0.1131	0.1136	H1	0.1126	0.1131
	56	0.1237	0.1247	H2	0.1111	0.1116	H1	0.1106	0.1111
4	...	40	...	0.1463	0.1473	H2	0.1288	0.1293	H1	0.1283	0.1288
	48	0.1409	0.1419	H2	0.1261	0.1266	H1	0.1256	0.1261
5	...	40	...	0.1593	0.1603	H2	0.1418	0.1423	H1	0.1413	0.1418
6	...	32	...	0.1807	0.1817	H3	0.1593	0.1598	H2	0.1588	0.1593
	40	0.1723	0.1733	H2	0.1548	0.1553	H1	0.1543	0.1548
8	...	32	...	0.2067	0.2077	H3	0.1853	0.1858	H2	0.1848	0.1853
	36	0.2022	0.2032	H2	0.1826	0.1831	H1	0.1821	0.1826
10	...	24	...	0.2465	0.2475	H3	0.2180	0.2185	H2	0.2175	0.2180
	32	0.2327	0.2337	H3	0.2113	0.2118	H2	0.2108	0.2113
12	...	24	...	0.2725	0.2735	H3	0.2440	0.2445	H2	0.2435	0.2440
...	1/4	20	...	0.3177	0.3187	H3	0.2835	0.2840	H2	0.2830	0.2835
...	28	0.2985	0.2995	H3	0.2742	0.2747	H2	0.2737	0.2742
...	5/16	18	...	0.3874	0.3884	H4	0.3501	0.3506	H3	0.3496	0.3501
...	24	0.3690	0.3700	H3	0.3405	0.3410	H2	0.3400	0.3405
...	3/8	16	...	0.4592	0.4602	H4	0.4171	0.4176	H3	0.4166	0.4171
...	24	0.4315	0.4325	H3	0.4030	0.4035	H2	0.4025	0.4030
...	7/16	14	...	0.5333	0.5343	H4	0.4854	0.4859	H3	0.4849	0.4854
...	20	0.5052	0.5062	H4	0.4715	0.4720	H3	0.4710	0.4715
...	1/2	13	...	0.6032	0.6042	H4	0.5514	0.5519	H3	0.5509	0.5514
...	20	0.5677	0.5687	H4	0.5340	0.5345	H3	0.5335	0.5340
...	9/16	12	...	0.6741	0.6751	H4	0.6182	0.6187	H3	0.6177	0.6182
...	18	0.6374	0.6384	H4	0.6001	0.6006	H3	0.5996	0.6001
...	5/8	11	...	0.7467	0.7477	H4	0.6856	0.6861	H3	0.6851	0.6856
...	18	0.6999	0.7009	H4	0.6626	0.6631	H3	0.6621	0.6626
...	3/4	10	...	0.8835	0.8850	H5	0.8169	0.8174	H3	0.8159	0.8164
...	18	0.8342	0.8352	H4	0.7921	0.7926	H3	0.7916	0.7921
...	7/8	9	...	1.0232	1.0247	H5	0.9491	0.9496	H3	0.9481	0.9486
...	14	0.9708	0.9718	H4	0.9234	0.9239	H3	0.9224	0.9229
...	1	8	...	1.1666	1.1681	H6	1.0832	1.0842	H4	1.0822	1.0832
...	12	1.1116	1.1126	H6	1.0562	1.0572	H4	1.0552	1.0562
...	14 NS	1.0958	1.0968	H6	1.0484	1.0494	H4	1.0474	1.0484
...	1 1/8	7	...	1.3151	1.3171	H6	1.2198	1.2208	H4	1.2188	1.2198
...	12	1.2366	1.2376	H6	1.1812	1.1822	H4	1.1802	1.1812
...	1 1/4	7	...	1.4401	1.4421	H6	1.3448	1.3458	H4	1.3438	1.3448
...	12	1.3616	1.3626	H6	1.3062	1.3072	H4	1.3052	1.3062
...	1 3/8	6	...	1.5962	1.5982	H8	1.4862	1.4872	H6	1.4852	1.4862
...	12	1.4866	1.4876	H6	1.4312	1.4322	H4	1.4302	1.4312
...	1 1/2	6	...	1.7212	1.7232	H8	1.6112	1.6122	H6	1.6102	1.6112
...	12	1.6116	1.6126	H6	1.5562	1.5572	H4	1.5552	1.5562

These taps are over the nominal size to the extent that the internal thread they produce will accommodate a helical coil screw insert, which at final assembly will accept a screw thread of the normal size and pitch.

**Table 26a. Tap Thread Limits ASME B94.9-1999
for Screw Thread Inserts (STI), Ground Thread, Metric Size (Inch)**

Metric Size STI	Pitch, mm	Tap Major Diameter, inch		Tap Pitch Diameter Limits, inch					
				Tolerance Class 4H			Tolerance Class 5H and 6H		
		Min.	Max.	H limit	Min.	Max.	H limit	Min.	Max.
M2.5	0.45	0.1239	0.1229	1	0.1105	0.1100	2	0.1110	0.1105
M3	0.5	0.1463	0.1453	1	0.1314	0.1309	2	0.1319	0.1314
M3.5	0.6	0.1714	0.1704	1	0.1537	0.1532	2	0.1542	0.1537
M4	0.7	0.1971	0.1955	2	0.1764	0.1759	3	0.1769	0.1764
M5	0.8	0.2418	0.2403	2	0.2184	0.2179	3	0.2187	0.2184
M6	1	0.2922	0.2906	2	0.2629	0.2624	3	0.2634	0.2629
M7	1	0.3316	0.3300	2	0.3022	0.3017	3	0.3027	0.3022
M8	1	0.3710	0.3694	2	0.3416	0.3411	3	0.3421	0.3416
M10	1.25	0.3853	0.3828	2	0.3480	0.3475	3	0.3485	0.3480
	1	0.4497	0.4481	2	0.4203	0.4198	3	0.4208	0.4203
	1	0.4641	0.4616	2	0.4267	0.4262	3	0.4272	0.4267
M12	1.25	0.4776	0.4751	3	0.4336	0.4331	4	0.4341	0.4336
	1.25	0.5428	0.5403	3	0.5059	0.5054	4	0.5064	0.5059
	1.5	0.5564	0.5539	3	0.5123	0.5118	4	0.5128	0.5123
M14	1.75	0.5700	0.5675	3	0.5187	0.5182	4	0.5192	0.5187
	1.5	0.6351	0.6326	3	0.5911	0.5906	4	0.5916	0.5911
M16	2	0.6623	0.6598	3	0.6039	0.6034	4	0.6049	0.6044
	1.5	0.7139	0.7114	3	0.6698	0.6693	4	0.6703	0.6698
M18	2	0.7410	0.7385	3	0.6826	0.6821	4	0.6836	0.6831
	1.5	0.7926	0.7901	3	0.7485	0.7480	4	0.7490	0.7485
M20	2	0.8198	0.8173	3	0.7613	0.7608	4	0.7623	0.7618
	2.5	0.8470	0.8445	3	0.7741	0.7736	4	0.7751	0.7748
	1.5	0.8713	0.8688	3	0.8273	0.8268	4	0.8278	0.8273
M22	2	0.8985	0.8960	3	0.8401	0.8396	4	0.8411	0.8406
	2.5	0.9257	0.9232	3	0.8529	0.8524	4	0.8539	0.8534
	1.5	0.9500	0.9475	3	0.9060	0.9055	4	0.9065	0.9060
M24	2	0.9773	0.9748	3	0.9188	0.9183	5	0.9198	0.9193
	2.5	1.0044	1.0019	3	0.9316	0.9311	5	0.9326	0.9321
	2	1.0559	1.0534	4	0.9981	0.9971	6	0.9991	0.9981
M27	3	1.1117	1.1078	4	1.0236	1.0226	6	1.0246	1.0236
	2	1.1741	1.1716	4	1.1162	1.1152	6	1.1172	1.1162
M30	3	1.2298	1.2259	4	1.1417	1.1407	6	1.1427	1.1417
	2	1.2922	1.2897	4	1.2343	1.2333	6	1.2353	1.2343
M33	3.5	1.3750	1.3711	4	1.2726	1.2716	6	1.2736	1.2726
	2	1.4103	1.4078	4	1.3525	1.3515	6	1.3535	1.3525
M36	3	1.4931	1.4892	4	1.3907	1.3797	6	1.3917	1.3907
	2	1.5284	1.5259	4	1.4706	1.4696	6	1.4716	1.4706
M39	3	1.5841	1.5802	6	1.4971	1.4961	8	1.4981	1.4971
	4	1.6384	1.6345	6	1.5226	1.5216	8	1.5236	1.5226
	2	1.6465	1.6440	4	1.5887	1.5877	6	1.5897	1.5887
M39	3	1.7022	1.6983	6	1.6152	1.6142	8	1.6162	1.6152
	4	1.7565	1.7516	6	1.6407	1.6397	8	1.6417	1.6407

These taps are over the nominal size to the extent that the internal thread they produce will accommodate a helical coil screw insert, which at final assembly will accept a screw thread of the normal size and pitch.

STI basic thread dimensions are determined by adding twice the single thread height ($2 \times 0.64952P$) to the basic dimensions of the nominal thread size.

Formulas for major and pitch diameters are presented in MIL-T-21309E.

**Table 26b. Tap Thread Limits ASME B94.9-1999
for Screw Thread Inserts (STI), Ground Thread, Metric Size (mm)**

Metric Size STI	Pitch, mm	Tap Major Diameter, mm		Tap Pitch Diameter Limits, mm					
				Tolerance Class 4H			Tolerance Class 5H and 6H		
		Min.	Max.	H limit	Min.	Max.	H limit	Min.	Max.
M2.5	0.45	3.147	3.122	1	2.807	2.794	2	2.819	2.807
M3	0.5	3.716	3.691	1	3.338	3.325	2	3.350	3.338
M3.5	0.6	4.354	4.328	1	3.904	3.891	2	3.917	3.904
M4	0.7	5.006	4.966	2	4.481	4.468	3	4.493	4.481
M5	0.8	6.142	6.104	2	5.547	5.535	3	5.555	5.547
M6	1	7.422	7.381	2	6.678	6.665	3	6.690	6.678
M7	1	8.423	8.382	2	7.676	7.663	3	7.689	7.676
M8	1	9.423	9.383	2	8.677	8.664	3	8.689	8.677
	1.25	9.787	9.723	2	8.839	8.827	3	8.852	8.839
M10	1	11.422	11.382	2	10.676	10.663	3	10.688	10.676
	1	11.788	11.725	2	10.838	10.825	3	10.851	10.838
	1.25	12.131	12.068	3	11.013	11.001	4	11.026	11.013
M12	1.25	13.787	13.724	3	12.850	12.837	4	12.863	12.850
	1.5	14.133	14.069	3	13.012	13.000	4	13.025	13.012
	1.75	14.478	14.415	3	13.175	13.162	4	13.188	13.175
M14	1.5	16.132	16.068	3	15.014	15.001	4	15.027	15.014
	2	16.822	16.759	3	15.339	15.326	4	15.364	15.352
M16	1.5	18.133	18.070	3	17.013	17.000	4	17.026	17.013
	2	18.821	18.758	3	17.338	17.325	4	17.363	17.351
M18	1.5	20.132	20.069	3	19.012	18.999	4	19.025	19.012
	2	20.823	20.759	3	19.337	19.324	4	19.362	19.350
	2.5	21.514	21.450	3	19.662	19.649	4	19.688	19.675
M20	1.5	22.131	22.068	3	21.013	21.001	4	21.026	21.013
	2	22.822	22.758	3	21.339	21.326	4	21.364	21.351
	2.5	23.513	23.449	3	21.664	21.651	4	21.689	21.676
M22	1.5	24.130	24.067	3	23.012	23.000	4	23.025	23.012
	2	24.823	24.760	3	23.338	23.325	5	23.363	23.350
	2.5	25.512	25.448	3	23.663	23.650	5	23.688	23.675
M24	2	26.820	26.756	4	25.352	25.352	6	25.377	25.352
	3	28.237	28.132	4	25.999	25.974	6	26.025	25.999
M27	2	29.822	29.759	4	28.351	28.326	6	28.377	28.351
	3	31.237	31.138	4	28.999	28.974	6	29.025	28.999
M30	2	32.822	32.758	4	31.351	31.326	6	31.377	31.351
	3.5	34.925	34.826	4	32.324	32.299	6	32.349	32.324
M33	2	35.822	35.758	4	34.354	34.324	6	34.379	34.354
	3	37.925	37.826	4	35.324	35.298	6	35.349	35.324
M36	2	38.821	38.758	4	37.353	37.328	6	37.379	37.353
	3	40.236	40.137	6	38.026	38.001	8	38.052	38.026
	4	41.615	41.516	6	38.674	38.649	8	38.699	37.674
M39	2	41.821	41.758	4	40.353	40.328	6	40.378	40.353
	3	43.236	43.137	6	41.026	41.001	8	41.051	41.026
	4	44.615	44.516	6	41.674	41.648	8	41.699	41.674

These taps are over the nominal size to the extent that the internal thread they produce will accommodate a helical coil screw insert, which at final assembly will accept a screw thread of the normal size and pitch.

STI basic thread dimensions are determined by adding twice the single thread height ($2 \times 0.64952P$) to the basic dimensions of the nominal thread size.

Formulas for major and pitch diameters are presented in MIL-T-21309E.

Acme and Square-Threaded Taps

These taps are usually made in sets, three taps in a set being the most common. For very fine pitches, two taps in a set will be found sufficient, whereas as many as five taps in a set are used for coarse pitches. The table on the next page gives dimensions for proportioning both Acme and square-threaded taps when made in sets. In cutting the threads of square-threaded taps, one leading tap maker uses the following rules: The width of the groove between two threads is made equal to one-half the pitch of the thread, less 0.004 inch (0.102 mm), making the width of the thread itself equal to one-half of the pitch, plus 0.004 inch (0.102 mm). The depth of the thread is made equal to 0.45 times the pitch, plus 0.0025 inch (0.064 mm). This latter rule produces a thread that for all the ordinarily used pitches for square-threaded taps has a depth less than the generally accepted standard depth, this latter depth being equal to one-half the pitch. The object of this shallow thread is to ensure that if the hole to be threaded by the tap is not bored out so as to provide clearance at the bottom of the thread, the tap will cut its own clearance. The hole should, however, always be drilled out large enough so that the cutting of the clearance is not required of the tap.

The table, *Dimensions of Acme Threads Taps in Sets of Three Taps*, may also be used for the length dimensions for Acme taps. The dimensions in this table apply to single-threaded taps. For multiple-threaded taps or taps with very coarse pitch, relative to the diameter, the length of the chamfered part of the thread may be increased. Square-threaded taps are made to the same table as Acme taps, with the exception of the figures in column *K*, which for square-threaded taps should be equal to the nominal diameter of the tap, no oversize allowance being customary in these taps. The first tap in a set of Acme taps (not square-threaded taps) should be turned to a taper at the bottom of the thread for a distance of about one-quarter of the length of the threaded part. The taper should be so selected that the root diameter is about $\frac{1}{32}$ inch (0.794 mm) smaller at the point than the proper root diameter of the tap. The first tap should preferably be provided with a short pilot at the point. For very coarse pitches, the first tap may be provided with spiral flutes at right angles to the angle of the thread. Acme and square-threaded taps should be relieved or backed off on the top of the thread of the chamfered portion on all the taps in the set. When the taps are used as machine taps, rather than as hand taps, they should be relieved in the angle of the thread, as well as on the top, for the whole length of the chamfered portion. Acme taps should also always be relieved on the front side of the thread to within $\frac{1}{32}$ inch (0.794 mm) of the cutting edge.

Adjustable Taps.—Many adjustable taps are now used, especially for accurate work. Some taps of this class are made of a solid piece of tool steel that is split and provided with means of expanding sufficiently to compensate for wear. Most of the larger adjustable taps have inserted blades or chasers that are held rigidly, but are capable of radial adjustment. The use of taps of this general class enables standard sizes to be maintained readily.

Drill Hole Sizes for Acme Threads.—Many tap and die manufacturers and vendors make available to their customers computer programs designed to calculate drill hole sizes for all the Acme threads in their ranges from the basic dimensions. The large variety and combination of dimensions for such tools prevent inclusion of a complete set of tables of tap drills for Acme taps in this Handbook. The following formulas (dimensions in inches) for calculating drill hole sizes for Acme threads are derived from the American National Standard, ANSI/ASME B1.5-1997, Acme Screw Threads.

To select a tap drill size for an Acme thread, first calculate the maximum and minimum internal product minor diameters for the thread to be produced. (Dimensions for general purpose, centralizing, and stub Acme screw threads are given in the Threads and Threading section, starting on page 1921.) Then select a drill that will yield a finished hole somewhere between the established maximum and minimum product minor diameters. Consider staying close to the maximum product limit in selecting the hole size, to reduce the amount of material to be removed when cutting the thread. If there is no standard drill

Table 27. Dimensions of Acme Threads Taps in Sets of Three Taps

The diagram illustrates the dimensions of three Acme thread taps in a set. The dimensions are labeled as follows:

- 1ST TAP IN SET:** Dimensions A, B, C, D, E. Root Dia. - 0.010"
- 2ND TAP IN SET:** Dimensions F, G. Root Dia. - 0.010"
- FINISHING TAP:** Dimensions H, I, K.

Nomi- nal Dia.	A	B	C	D	E	F	G	H	I	K
1/2	4 1/4	1 7/8	2 3/8	1/2	1 7/8	5/8	1 3/4	7/8	1 1/2	0.520
9/16	4 7/8	2 1/8	2 3/4	9/16	2 3/16	3/4	2	1	1 3/4	0.582
5/8	5 1/2	2 3/8	3 1/8	5/8	2 1/2	7/8	2 1/4	1 1/8	2	0.645
11/16	6	2 1/2	3 1/2	3 13/16	2 13/16	15/16	2 9/16	1 1/4	2 1/4	0.707
3/4	6 1/2	2 11/16	3 13/16	1 1/16	3 3/8	1	2 13/16	1 3/8	2 7/16	0.770
13/16	6 7/8	2 13/16	4 1/16	3/4	3 5/16	1 1/16	3	1 7/16	2 5/8	0.832
7/8	7 1/4	3	4 1/4	3/4	3 1/2	1 1/8	3 3/8	1 1/2	2 3/4	0.895
15/16	7 9/16	3 3/8	4 7/16	13/16	3 5/8	1 3/16	3 1/4	1 9/16	2 7/8	0.957
1	7 7/8	3 1/4	4 5/8	13/16	3 13/16	1 1/4	3 3/8	1 5/8	3	1.020
1 1/8	8 1/2	3 9/16	4 15/16	7/8	4 1/16	1 5/16	3 5/8	1 3/4	3 3/16	1.145
1 1/4	9	3 3/4	5 1/4	15/16	4 5/16	1 3/8	3 7/8	1 7/8	3 3/8	1.270
1 3/8	9 1/2	4	5 1/2	1	4 1/2	1 7/16	4 1/16	2	3 1/2	1.395
1 1/2	10	4 1/4	5 3/4	1	4 3/4	1 1/2	4 1/4	2 1/8	3 5/8	1.520
1 5/8	10 1/2	4 1/2	6	1	5	1 1/2	4 1/2	2 1/8	3 7/8	1.645
1 3/4	11	4 3/4	6 1/4	1 1/16	5 3/16	1 9/16	4 11/16	2 1/4	4	1.770
1 7/8	11 3/8	4 7/8	6 1/2	1 1/16	5 7/16	1 9/16	4 15/16	2 1/4	4 1/4	1.895
2	11 3/4	5	6 3/4	1 1/8	5 5/8	1 5/8	5 5/8	2 3/8	4 3/8	2.020
2 1/4	12 1/2	5 1/4	7 1/4	1 1/8	6 1/8	1 3/16	5 1/2	2 1/2	4 3/4	2.270
2 1/2	13 1/4	5 1/2	7 3/4	1 3/4	6 9/16	1 7/8	5 7/8	2 5/8	5 5/8	2.520
2 3/4	14	5 3/4	8 1/4	1 1/4	7	2	6 1/4	2 3/4	5 1/2	2.770
3	15	6 1/4	8 3/4	1 1/4	7 1/2	2	6 3/4	3	5 3/4	3.020

size that matches the hole diameter selected, it may be necessary to drill and ream, or bore the hole to size, to achieve the required hole diameter.

Diameters of General-Purpose Acme Screw Threads of Classes 2G, 3G, and 4G may be calculated from pitch = 1/number of threads per inch, and:

minimum diameter = basic major diameter – pitch

maximum diameter = minimum minor diameter + 0.05 × pitch

Table 28. Proportions of Acme and Square-Threaded Taps Made in Sets

$R - 0.010''$

A

B

C

L

$R = \text{root diameter of thread}$ $D = \text{full diameter of tap}$
 $T = \text{double depth of full thread}$

Types of Tap	No. of Taps in Set	Order of Tap in Set	A	B	C
Acme Thread Taps	2	1st	$R + 0.65T$	$R + 0.010$	$\frac{1}{8} L$ to $\frac{1}{6} L$
		2d	D	A on 1st tap - 0.005	$\frac{1}{4} L$ to $\frac{1}{3} L$
	3	1st	$R + 0.45T$	$R + 0.010$	$\frac{1}{8} L$ to $\frac{1}{6} L$
		2d	$R + 0.80T$	A on 1st tap - 0.005	$\frac{1}{6} L$ to $\frac{1}{4} L$
		3d	D	A on 2d tap - 0.005	$\frac{1}{4} L$ to $\frac{1}{3} L$
	4	1st	$R + 0.40T$	$R + 0.010$	$\frac{1}{8} L$
		2d	$R + 0.70T$	A on 1st tap - 0.005	$\frac{1}{6} L$
		3d	$R + 0.90T$	A on 2d tap - 0.005	$\frac{1}{5} L$
		4th	D	A on 3d tap - 0.005	$\frac{1}{4} L$ to $\frac{1}{3} L$
	5	1st	$R + 0.37T$	$R + 0.010$	$\frac{1}{8} L$
		2d	$R + 0.63T$	A on 1st tap - 0.005	$\frac{1}{6} L$
		3d	$R + 0.82T$	A on 2d tap - 0.005	$\frac{1}{5} L$
		4th	$R + 0.94T$	A on 3d tap - 0.005	$\frac{1}{5} L$ to $\frac{1}{4} L$
		5th	D	A on 4th tap - 0.005	$\frac{1}{4} L$ to $\frac{1}{3} L$
	Square-Threaded Taps	2	1st	$R + 0.67T$	R
2d			D	A on 1st tap - 0.005	$\frac{1}{4} L$ to $\frac{1}{3} L$
3		1st	$R + 0.41T$	R	$\frac{1}{8} L$ to $\frac{1}{6} L$
		2d	$R + 0.080T$	A on 1st tap - 0.005	$\frac{1}{6} L$ to $\frac{1}{4} L$
		3d	D	A on 2d tap - 0.005	$\frac{1}{4} L$ to $\frac{1}{3} L$
4		1st	$R + 0.32T$	R	$\frac{1}{8} L$
		2d	$R + 0.62T$	A on 1st tap - 0.005	$\frac{1}{6} L$
		3d	$R + 0.90T$	A on 2d tap - 0.005	$\frac{1}{5} L$
		4th	D	A on 3d tap - 0.005	$\frac{1}{4} L$ to $\frac{1}{3} L$
5		1st	$R + 0.26T$	R	$\frac{1}{8} L$
		2d	$R + 0.50T$	A on 1st tap - 0.005	$\frac{1}{6} L$
		3d	$R + 0.72T$	A on 2d tap - 0.005	$\frac{1}{5} L$
		4th	$R + 0.92T$	A on 3d tap - 0.005	$\frac{1}{5} L$ to $\frac{1}{4} L$
		5th	D	A on 4th tap - 0.005	$\frac{1}{4} L$ to $\frac{1}{3} L$

Example: $\frac{1}{2}$ -10 Acme 2G, pitch = $1/10 = 0.1$

minimum diameter = $0.5 - 0.1 = 0.4$

$$\text{maximum diameter} = 0.4 + (0.05 \times 0.1) = 0.405$$

$$\text{drill selected} = \text{letter X or } 0.3970 + 0.0046 \text{ (probable oversize)} = 0.4016$$

Diameters of Acme Centralizing Screw Threads of Classes 2C, 3C, and 4C may be calculated from pitch = 1/number of threads per inch, and:

$$\text{minimum diameter} = \text{basic major diameter} - 0.9 \times \text{pitch}$$

$$\text{maximum diameter} = \text{minimum minor diameter} + 0.05 \times \text{pitch}$$

$$\text{Example: } \frac{1}{2}\text{-10 Acme 2C, pitch} = 1/10 = 0.1$$

$$\text{minimum diameter} = 0.5 - (0.9 \times 0.1) = 0.41$$

$$\text{maximum diameter} = 0.41 + (0.05 \times 0.1) = 0.415$$

$$\text{drill selected} = \frac{13}{32} \text{ or } 0.4062 + 0.0046 \text{ (probable oversize)} = 0.4108.$$

Diameters for Acme Centralizing Screw Threads of Classes 5C and 6C: These classes are not recommended for new designs, but may be calculated from:

$$\text{minimum diameter} = [\text{basic major diameter} - (0.025 \sqrt{\text{basic major dia.}})] - 0.9 \times \text{pitch}$$

$$\text{maximum diameter} = \text{minimum minor diameter} + 0.05 \times \text{pitch}$$

$$\text{pitch} = 1/\text{number of threads per inch}$$

$$\text{Example: } \frac{1}{2}\text{-10 Acme 5C, pitch} = 1/10 = 0.1$$

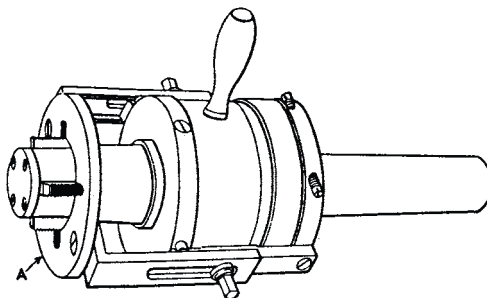
$$\text{minimum diameter} = [0.5 - (0.025 \sqrt{0.5})] - (0.9 \times 0.1) = 0.3923$$

$$\text{maximum diameter} = 0.3923 + (0.05 \times 0.1) = 0.3973$$

$$\text{drill selected} = \frac{25}{64} \text{ or } 0.3906 + 0.0046 \text{ (probable oversize)} = 0.3952$$

Tapping Square Threads.—If it is necessary to tap square threads, this should be done by using a set of taps that will form the thread by a progressive cutting action, the taps varying in size in order to distribute the work, especially for threads of comparatively coarse pitch. From three to five taps may be required in a set, depending upon the pitch. Each tap should have a pilot to steady it. The pilot of the first tap has a smooth cylindrical end from 0.003 to 0.005 inch (0.076-0.127 mm) smaller than the hole, and the pilots of following taps should have teeth.

Collapsible Taps.—The collapsing tap shown in the accompanying illustration is one of many different designs that are manufactured. These taps are often used in turret lathe practice in place of solid taps. When using this particular style of collapsing tap, the adjustable gage *A* is set for the length of thread required. When the tap has been fed to this depth, the gage comes into contact with the end of the work, which causes the chasers to collapse automatically. The tool is then withdrawn, after which the chasers are again expanded and locked in position by the handle seen at the side of the holder.



Collapsing Tap

Collapsible taps do not need to be backed out of the hole at the completion of the thread, reducing the tapping time and increasing production rates.

STANDARD TAPERS

Standard Tapers

Certain types of small tools and machine parts, such as twist drills, end mills, arbors, lathe centers, etc., are provided with taper shanks which fit into spindles or sockets of corresponding taper, thus providing not only accurate alignment between the tool or other part and its supporting member, but also more or less frictional resistance for driving the tool. There are several standards for “self-holding” tapers, but the American National, Morse, and the Brown & Sharpe are the standards most widely used by American manufacturers.

The name *self-holding* has been applied to the smaller tapers—like the Morse and the Brown & Sharpe—because, where the angle of the taper is only 2 or 3 degrees, the shank of a tool is so firmly seated in its socket that there is considerable frictional resistance to any force tending to turn or rotate the tool relative to the socket. The term “self-holding” is used to distinguish relatively small tapers from the larger or *self-releasing* type. A milling machine spindle having a taper of $3\frac{1}{2}$ inches per foot is an example of a self-releasing taper. The included angle in this case is over 16 degrees and the tool or arbor requires a positive locking device to prevent slipping, but the shank may be released or removed more readily than one having a smaller taper of the self-holding type.

Tapers for Machine Tool Spindles.—Various standard tapers have been used for the taper holes in the spindles of machine tools, such as drilling machines, lathes, milling machines, or other types requiring a taper hole for receiving either the shank of a cutter, an arbor, a center, or any tool or accessory requiring a tapering seat. The Morse taper represents a generally accepted standard for drilling machines. See more on this subject, page 959.

The headstock and tailstock spindles of lathes also have the Morse taper in most cases; but the Jarno, the Reed (which is the short Jarno), and the Brown & Sharpe have also been used. Milling machine spindles formerly had Brown & Sharpe tapers in most cases.

In 1927, the milling machine manufacturers of the National Machine Tool Builders' Association adopted a standard taper of $3\frac{1}{2}$ inches per foot. This comparatively steep taper has the advantage of insuring instant release of arbors or adapters.

National Machine Tool Builders' Association Tapers

Taper Number ^a	Large End Diameter	Taper Number ^a	Large End Diameter
30	$1\frac{1}{4}$	50	$2\frac{3}{4}$
40	$1\frac{3}{4}$	60	$4\frac{1}{4}$

^a Standard taper of $3\frac{1}{2}$ inches per foot

The British Standard for milling machine spindles is also $3\frac{1}{2}$ inches taper per foot and includes these large end diameters: $1\frac{3}{8}$ inches, $1\frac{3}{4}$ inches, $2\frac{3}{4}$ inches, and $3\frac{1}{4}$ inches.

Morse Taper.—Dimensions relating to Morse standard taper shanks and sockets may be found in an accompanying table. The taper for different numbers of Morse tapers is slightly different, but it is approximately $\frac{5}{8}$ inch per foot in most cases. The table gives the actual tapers, accurate to five decimal places. Morse taper shanks are used on a variety of tools, and exclusively on the shanks of twist drills. Dimensions for *Morse Stub Taper Shanks* are given in Table 1a, and for *Morse Standard Taper Shanks* in Table 1b.

Brown & Sharpe Taper.—This standard taper is used for taper shanks on tools such as end mills and reamers, the taper being approximately $\frac{1}{2}$ inch per foot for all sizes except for taper No. 10, where the taper is 0.5161 inch per foot. Brown & Sharpe taper sockets are used for many arbors, collets, and machine tool spindles, especially milling machines and grinding machines. In many cases there are a number of different lengths of sockets corre-

Table 1a. Morse Stub Taper Shanks

No. of Taper	Taper per Foot ^a	Taper per Inch ^b	Small End of Plug, ^b <i>D</i>	Dia. End of Socket, ^a <i>A</i>	Shank		Tang	
					Total Length, <i>B</i>	Depth, <i>C</i>	Thickness, <i>E</i>	Length, <i>F</i>
1	0.59858	0.049882	0.4314	0.475	1 ⁵ / ₁₆	1 ¹ / ₈	13 ³ / ₆₄	5 ¹ / ₁₆
2	0.59941	0.049951	0.6469	0.700	1 ¹¹ / ₁₆	1 ⁷ / ₁₆	19 ¹ / ₆₄	7 ¹ / ₁₆
3	0.60235	0.050196	0.8753	0.938	2	1 ³ / ₄	25 ⁵ / ₆₄	9 ¹ / ₁₆
4	0.62326	0.051938	1.1563	1.231	2 ³ / ₈	2 ¹ / ₁₆	33 ³ / ₆₄	11 ¹ / ₁₆
5	0.63151	0.052626	1.6526	1.748	3	2 ¹ / ₁₆	3 ¹ / ₄	15 ¹ / ₁₆
No. of Taper	Tang		Socket			Tang Slot		
	Radius of Mill, <i>G</i>	Diameter, <i>H</i>	Plug Depth, <i>P</i>	Min. Depth of Tapered Hole		Socket End to Tang Slot, <i>M</i>	Width, <i>N</i>	Length, <i>O</i>
				Drilled <i>X</i>	Reamed <i>Y</i>			
1	3 ¹ / ₁₆	13 ¹ / ₃₂	7 ¹ / ₈	5 ¹ / ₁₆	29 ¹ / ₃₂	25 ¹ / ₃₂	7 ¹ / ₃₂	23 ¹ / ₃₂
2	7 ¹ / ₃₂	39 ¹ / ₆₄	1 ¹ / ₁₆	15 ¹ / ₃₂	17 ¹ / ₆₄	15 ¹ / ₁₆	5 ¹ / ₁₆	15 ¹ / ₁₆
3	9 ¹ / ₃₂	13 ¹ / ₁₆	1 ¹ / ₄	1 ³ / ₈	13 ¹ / ₁₆	1 ¹ / ₁₆	13 ¹ / ₃₂	1 ¹ / ₈
4	3 ¹ / ₈	13 ¹ / ₃₂	17 ¹ / ₁₆	1 ¹ / ₁₆	1 ¹ / ₂	1 ³ / ₁₆	17 ¹ / ₃₂	1 ³ / ₈
5	9 ¹ / ₁₆	113 ¹ / ₃₂	113 ¹ / ₁₆	115 ¹ / ₁₆	17 ¹ / ₈	17 ¹ / ₁₆	25 ¹ / ₃₂	13 ¹ / ₄

All dimensions in inches.

Radius *J* is 3¹/₆₄, 1¹/₁₆, 5¹/₆₄, 3¹/₃₂, and 1¹/₈ inch respectively for Nos. 1, 2, 3, 4, and 5 tapers.

^a These are basic dimensions.

^b These dimensions are calculated for reference only.

sponding to the same number of taper; all these tapers, however, are of the same diameter at the small end.

Jarno Taper.—The Jarno taper was originally proposed by Oscar J. Beale of the Brown & Sharpe Mfg. Co. This taper is based on such simple formulas that practically no calculations are required when the number of taper is known. The taper per foot of all Jarno taper sizes is 0.600 inch on the diameter. The diameter at the large end is as many eighths, the diameter at the small end is as many tenths, and the length as many half inches as are indicated by the number of the taper. For example, a No. 7 Jarno taper is 7¹/₈ inch in diameter at the large end; 7¹/₁₀, or 0.700 inch at the small end; and 7¹/₂, or 3¹/₂ inches long; hence, diameter at large end = No. of taper ÷ 8; diameter at small end = No. of taper ÷ 10; length of taper = No. of taper ÷ 2. The Jarno taper is used on various machine tools, especially profiling machines and die-sinking machines. It has also been used for the headstock and tailstock spindles of some lathes.

American National Standard Machine Tapers: This standard includes a self-holding series (Tables 2, 3, 4, 5 and 7a) and a steep taper series, Table 6. The self-holding taper

Table 1b. Morse Standard Taper Shanks

No. of Taper	Taper per Foot	Taper per Inch	Small End of Plug <i>D</i>	Diameter End of Socket <i>A</i>	Shank		Depth of Hole <i>H</i>
					Length <i>B</i>	Depth <i>S</i>	
0	0.62460	0.05205	0.252	0.3561	2 ¹¹ / ₃₂	2 ⁷ / ₃₂	2 ¹ / ₃₂
1	0.59858	0.04988	0.369	0.475	2 ⁹ / ₁₆	2 ⁷ / ₁₆	2 ⁵ / ₃₂
2	0.59941	0.04995	0.572	0.700	3 ¹ / ₈	2 ¹⁵ / ₁₆	2 ³⁹ / ₆₄
3	0.60235	0.05019	0.778	0.938	3 ⁷ / ₈	3 ¹¹ / ₁₆	3 ¹ / ₄
4	0.62326	0.05193	1.020	1.231	4 ⁷ / ₈	4 ⁵ / ₈	4 ¹ / ₈
5	0.63151	0.05262	1.475	1.748	6 ¹ / ₈	5 ⁷ / ₈	5 ¹ / ₄
6	0.62565	0.05213	2.116	2.494	8 ⁹ / ₁₆	8 ¹ / ₄	7 ²¹ / ₆₄
7	0.62400	0.05200	2.750	3.270	11 ⁵ / ₈	11 ¹ / ₄	10 ⁵ / ₆₄
Plug Depth <i>P</i>	Tang or Tongue			Dia.	Keyway		Keyway to End <i>K</i>
	Thickness <i>t</i>	Length <i>T</i>	Radius <i>R</i>		Width <i>W</i>	Length <i>L</i>	
2	0.1562	1/4	5/32	0.235	1/64	9/16	1 ¹⁵ / ₁₆
2 ¹ / ₈	0.2031	3/8	3/16	0.343	0.218	3/4	2 ¹ / ₁₆
2 ¹ / ₁₆	0.2500	7/16	1/4	1 ⁷ / ₃₂	0.266	7/8	2 ¹ / ₂
3 ³ / ₁₆	0.3125	9/16	9/32	2 ³ / ₃₂	0.328	1 ¹ / ₁₆	3 ¹ / ₁₆
4 ¹ / ₁₆	0.4687	5/8	5/16	3 ¹ / ₃₂	0.484	1 ¹ / ₄	3 ⁷ / ₈
5 ³ / ₁₆	0.6250	3/4	3/8	1 ¹³ / ₃₂	0.656	1 ¹ / ₂	4 ¹⁵ / ₁₆
7 ¹ / ₄	0.7500	1 ¹ / ₈	1/2	2	0.781	1 ³ / ₄	7
10	1.1250	1 ³ / ₈	3/4	2 ⁵ / ₈	1.156	2 ⁵ / ₈	9 ¹ / ₂

ANGLE OF KEY, TAPER, 1.75 IN 12

Tolerances on rate of taper: all sizes 0.002 in. per foot. This tolerance may be applied on shanks only in the direction that increases the rate of taper, and on sockets only in the direction that decreases the rate of taper.

series consists of 22 sizes which are listed in **Table 7a**. The reference gage for the self-holding tapers is a plug gage. **Table 7b** gives the dimensions and tolerances for both plug and ring gages applying to this series. **Tables 2** through **5** inclusive give the dimensions for self-holding taper shanks and sockets which are classified as to (1) means of transmitting torque from spindle to the tool shank, and (2) means of retaining the shank in the socket. The steep machine tapers consist of a preferred series (bold-face type, **Table 6**) and an intermediate series (light-face type). A self-holding taper is defined as “a taper with an angle small enough to hold a shank in place ordinarily by friction without holding means. (Sometimes referred to as slow taper.)” A steep taper is defined as “a taper having an angle sufficiently large to insure the easy or self-releasing feature.” The term “gage line” indicates the basic diameter at or near the large end of the taper.

Table 2. American National Standard Taper Drive with Tang, Self-Holding Tapers ANSI/ASME B5.10-1994 (R2008)

No. of Taper	Diameter at Gage Line (1) A	Shank		Tang			
		Total Length of Shank B	Gage Line to End of Shank C	Thickness E	Length F	Radius of Mill G	Diameter H
0.239	0.23922	1.28	1.19	0.125	0.19	0.19	0.18
0.299	0.29968	1.59	1.50	0.156	0.25	0.19	0.22
0.375	0.37525	1.97	1.88	0.188	0.31	0.19	0.28
1	0.47500	2.56	2.44	0.203	0.38	0.19	0.34
2	0.70000	3.13	2.94	0.250	0.44	0.25	0.53
3	0.93800	3.88	3.69	0.312	0.56	0.22	0.72
4	1.23100	4.88	4.63	0.469	0.63	0.31	0.97
4½	1.50000	5.38	5.13	0.562	0.69	0.38	1.20
5	1.74800	6.12	5.88	0.625	0.75	0.38	1.41
6	2.49400	8.25	8.25	0.750	1.13	0.50	2.00
No. of Taper	Radius J	Socket		Tang Slot			
		Min. Depth of Hole K		Gage Line to Tang Slot M	Width N	Length O	Shank End to Back of Tang Slot P
		Drilled	Reamed				
0.239	0.03	1.06	1.00	0.94	0.141	0.38	0.13
0.299	0.03	1.31	1.25	1.17	0.172	0.50	0.17
0.375	0.05	1.63	1.56	1.47	0.203	0.63	0.22
1	0.05	2.19	2.16	2.06	0.218	0.75	0.38
2	0.06	2.66	2.61	2.50	0.266	0.88	0.44
3	0.08	3.31	3.25	3.06	0.328	1.19	0.56
4	0.09	4.19	4.13	3.88	0.484	1.25	0.50
4½	0.13	4.62	4.56	4.31	0.578	1.38	0.56
5	0.13	5.31	5.25	4.94	0.656	1.50	0.56
6	0.16	7.41	7.33	7.00	0.781	1.75	0.50

All dimensions are in inches. (1) See Table 7b for plug and ring gage dimensions.

Tolerances: For shank diameter A at gage line, + 0.002 – 0.000; for hole diameter A, + 0.000 – 0.002. For tang thickness E up to No. 5 inclusive, + 0.000 – 0.006; No. 6, + 0.000 – 0.008. For width N of tang slot up to No. 5 inclusive, + 0.006; – 0.000; No. 6, + 0.008 – 0.000. For centrality of tang E with center line of taper, 0.0025 (0.005 total indicator variation). These centrality tolerances also apply to the tang slot N. On rate of taper, all sizes 0.002 per foot. This tolerance may be applied on shanks only in the direction which increases the rate of taper and on sockets only in the direction which decreases the rate of taper. Tolerances for two-decimal dimensions are plus or minus 0.010, unless otherwise specified.

Table 3. American National Standard Taper Drive with Keeper Key Slot, Self-Holding Tapers ANSI/ASME B5.10-1994 (R2008)

No. of Taper	Dia. at Gage Line (1) A	Shank		Tang					Socket		
		Total Length B	Gage Line to End C	Thickness E	Length F	Radius of Mill G	Diameter H	Radius J	Min. Depth of Hole K		Gage Line to Tang Slot M
									Drill	Ream	
3	0.938	3.88	3.69	0.312	0.56	0.28	0.78	0.08	3.31	3.25	3.06
4	1.231	4.88	4.63	0.469	0.63	0.31	0.97	0.09	4.19	4.13	3.88
4½	1.500	5.38	5.13	0.562	0.69	0.38	1.20	0.13	4.63	4.56	4.32
5	1.748	6.13	5.88	0.625	0.75	0.38	1.41	0.13	5.31	5.25	4.94
6	2.494	8.56	8.25	0.750	1.13	0.50	2.00	0.16	7.41	7.33	7.00
7	3.270	11.63	11.25	1.125	1.38	0.75	2.63	0.19	10.16	10.08	9.50

No. of Taper	Tang Slot			Keeper Slot in Shank			Keeper Slot in Socket		
	Width N	Length O	Shank End to Back of Slot P	Gage Line to Bottom of Slot Y'	Length X	Width N'	Gage Line to Front of Slot Y	Length Z	Width N'
3	0.328	1.19	0.56	1.03	1.13	0.266	1.13	1.19	0.266
4	0.484	1.25	0.50	1.41	1.19	0.391	1.50	1.25	0.391
4½	0.578	1.38	0.56	1.72	1.25	0.453	1.81	1.38	0.453
5	0.656	1.50	0.56	2.00	1.38	0.516	2.13	1.50	0.516
6	0.781	1.75	0.50	2.13	1.63	0.641	2.25	1.75	0.641
7	1.156	2.63	0.88	2.50	1.69	0.766	2.63	1.81	0.766

All dimensions are in inches. (1) See Table 7b for plug and ring gage dimensions.

Tolerances: For shank diameter A at gage line, +0.002, -0; for hole diameter A, +0, -0.002. For tang thickness E up to No. 5 inclusive, +0, -0.006; larger than No. 5, +0, -0.008. For width of slots N and N' up to No. 5 inclusive, +0.006, -0; larger than No. 5, +0.008, -0. For centrality of tang E with center line of taper 0.0025 (0.005 total indicator variation). These centrality tolerances also apply to slots N and N'. On rate of taper, see footnote in Table 2. Tolerances for two-decimal dimensions are ±0.010 unless otherwise specified.

Table 4. American National Standard Nose Key Drive with Keeper Key Slot, Self-Holding Tapers ANSI/ASME B5.10-1994 (R2008)

Taper	A(1)	B'	C	Q	I'	I	R	S
200	2.000	5.13		0.25	1.38	1.63	1.010	0.562
250	2.500	5.88		0.25	1.38	2.06	1.010	0.562
300	3.000	6.63	Min	0.25	1.63	2.50	2.010	0.562
350	3.500	7.44	0.003	0.31	2.00	2.94	2.010	0.562
400	4.000	8.19	Max	0.31	2.13	3.31	2.010	0.562
450	4.500	9.00	0.035	0.38	2.38	3.81	3.010	0.812
500	5.000	9.75	for	0.38	2.50	4.25	3.010	0.812
600	6.000	11.31	all	0.44	3.00	5.19	3.010	0.812
800	8.000	14.38	sizes	0.50	3.50	7.00	4.010	1.062
1000	10.000	17.44		0.63	4.50	8.75	4.010	1.062
1200	12.000	20.50		0.75	5.38	10.50	4.010	1.062
Taper	D	D' ^a	W	X	N'	R'	S'	T
200	1.41	0.375	3.44	1.56	0.656	1.000	0.50	4.75
250	1.66	0.375	3.69	1.56	0.781	1.000	0.50	5.50
300	2.25	0.375	4.06	1.56	1.031	2.000	0.50	6.25
350	2.50	0.375	4.88	2.00	1.031	2.000	0.50	6.94
400	2.75	0.375	5.31	2.25	1.031	2.000	0.50	7.69
450	3.00	0.500	5.88	2.44	1.031	3.000	0.75	8.38
500	3.25	0.500	6.44	2.63	1.031	3.000	0.75	9.13
600	3.75	0.500	7.44	3.00	1.281	3.000	0.75	10.56
800	4.75	0.500	9.56	4.00	1.781	4.000	1.00	13.50
1000	11.50	4.75	2.031	4.000	1.00	16.31
1200	13.75	5.75	2.031	4.000	1.00	19.00
Taper	U	V	M	N	O	P	Y	Z
200	1.81	1.00	4.50	0.656	1.56	0.94	2.00	1.69
250	2.25	1.00	5.19	0.781	1.94	1.25	2.25	1.69
300	2.75	1.00	5.94	1.031	2.19	1.50	2.63	1.69
350	3.19	1.25	6.75	1.031	2.19	1.50	3.00	2.13
400	3.63	1.25	7.50	1.031	2.19	1.50	3.25	2.38
450	4.19	1.50	8.00	1.031	2.75	1.75	3.63	2.56
500	4.63	1.50	8.75	1.031	2.75	1.75	4.00	2.75
600	5.50	1.75	10.13	1.281	3.25	2.06	4.63	3.25
800	7.38	2.00	12.88	1.781	4.25	2.75	5.75	4.25
1000	9.19	2.50	15.75	2.031	5.00	3.31	7.00	5.00
1200	11.00	3.00	18.50	2.531	6.00	4.00	8.25	6.00

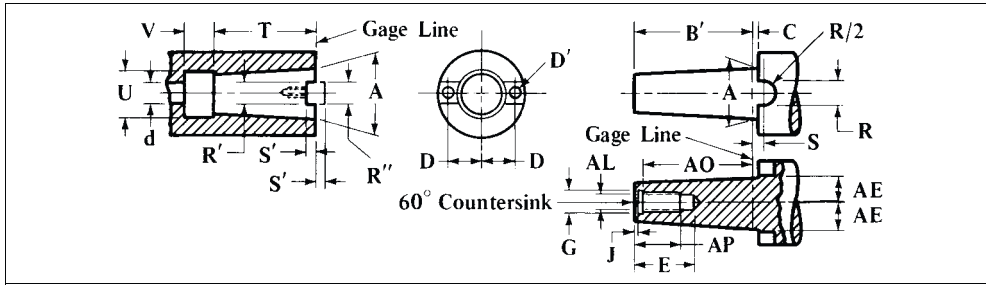
^a Thread is UNF-2B for hole; UNF-2A for screw. (1) See Table 7b for plug and ring gage dimensions.

All dimensions are in inches. AE is 0.005 greater than one-half of A.

Width of drive key R' is 0.001 less than width R'' of keyway.

Tolerances: For diameter A of hole at gage line, +0, -0.002; for diameter A of shank at gage line, +0.002, -0; for width of slots N and N', +0.008, -0; for width of drive keyway R' in socket, +0, -0.001; for width of drive keyway R in shank, 0.010, -0; for centrality of slots N and N' with center line of spindle, 0.007; for centrality of keyway with spindle center line: for R, 0.004 and for R', 0.002 T.I.V. On rate of taper, see footnote in Table 2. Two-decimal dimensions, ±0.010 unless otherwise specified.

Table 5. American National Standard Nose Key Drive with Drawbolt, Self-Holding Tapers ANSI/ASME B5.10-1994 (R2008)



Sockets										
No. of Taper	Dia. at Gage Line A ^a	Drive Key		Drive Keyway			Gage Line to Front of Relief T	Dia. of Relief U	Depth of Relief V	Dia. of Draw Bolt Hole d
		Center Line to Center of Screw D	UNF 2B Hole UNF 2A Screw D'	Width R''	Width R'	Depth S'				
200	2000	1.41	0.38	0.999	1.000	0.50	4.75	1.81	1.00	1.00
250	2500	1.66	0.38	0.999	1.000	0.50	5.50	2.25	1.00	1.00
300	3000	2.25	0.38	1.999	2.000	0.50	6.25	2.75	1.00	1.13
350	3500	2.50	0.38	1.999	2.000	0.50	6.94	3.19	1.25	1.13
400	4000	2.75	0.38	1.999	2.000	0.50	7.69	3.63	1.25	1.63
450	4500	3.00	0.50	2.999	3.000	0.75	8.38	4.19	1.50	1.63
500	5000	3.25	0.50	2.999	3.000	0.75	9.13	4.63	1.50	1.63
600	6000	3.75	0.50	2.999	3.000	0.75	10.56	5.50	1.75	2.25
800	8000	4.75	0.50	3.999	4.000	1.00	13.50	7.38	2.00	2.25
1000	10000	3.999	4.000	1.00	16.31	9.19	2.50	2.25
1200	12000	3.999	4.000	1.00	19.00	11.00	3.00	2.25

^aSee Table 7b for plug and ring gage dimensions.

Shanks										
No. of Taper	Length from Gage Line B'	Drawbar Hole						Drive Keyway		
		Dia. UNC-2B AL	Depth of Drilled Hole E	Depth of Thread AP	Dia. of Counter Bore G	Gage Line to First Thread AO	Depth of 60° Chamfer J	Width R	Depth S	Center Line to Bottom of Keyway AE
200	5.13	7/8-9	2.44	1.75	0.91	4.78	0.13	1.010	0.562	1.005
250	5.88	7/8-9	2.44	1.75	0.91	5.53	0.13	1.010	0.562	1.255
300	6.63	1-8	2.75	2.00	1.03	6.19	0.19	2.010	0.562	1.505
350	7.44	1-8	2.75	2.00	1.03	7.00	0.19	2.010	0.562	1.755
400	8.19	1 1/2-6	4.00	3.00	1.53	7.50	0.31	2.010	0.562	2.005
450	9.00	1 1/2-6	4.00	3.00	1.53	8.31	0.31	3.010	0.812	2.255
500	9.75	1 1/2-6	4.00	3.00	1.53	9.06	0.31	3.010	0.812	2.505
600	11.31	2-4 1/2	5.31	4.00	2.03	10.38	0.50	3.010	0.812	3.005
800	14.38	2-4 1/2	5.31	4.00	2.03	13.44	0.50	4.010	1.062	4.005
1000	17.44	2-4 1/2	5.31	4.00	2.03	16.50	0.50	4.010	1.062	5.005
1200	20.50	2-4 1/2	5.31	4.00	2.03	19.56	0.50	4.010	1.062	6.005

All dimensions in inches.

Exposed length C is 0.003 minimum and 0.035 maximum for all sizes.

Drive Key D' screw sizes are 3/8-24 UNF-2A up to taper No. 400 inclusive and 1/2-20 UNF-2A for larger tapers.

Tolerances: For diameter A of hole at gage line, +0.000, -0.002 for all sizes; for diameter A of shank at gage line, +0.002, -0.000; for all sizes; for width of drive keyway R' in socket, +0.000, -0.001; for width of drive keyway R in shank, +0.010, -0.000; for centrality of drive keyway R', with center line of shank, 0.004 total indicator variation, and for drive keyway R', with center line of spindle, 0.002. On rate of taper, see footnote in Table 2. Tolerances for two-decimal dimensions are ±0.010 unless otherwise specified.

Table 6. ANSI Standard Steep Machine Tapers ANSI/ASME B5.10-1994 (R2008)

No. of Taper	Taper per Foot ^a	Dia. at Gage Line ^b	Length Along Axis	No. of Taper	Taper per Foot ^a	Dia. at Gage Line ^b	Length Along Axis
5	3.500	0.500	0.6875	35	3.500	1.500	2.2500
10	3.500	0.625	0.8750	40	3.500	1.750	2.5625
15	3.500	0.750	1.0625	45	3.500	2.250	3.3125
20	3.500	0.875	1.3125	50	3.500	2.750	4.0000
25	3.500	1.000	1.5625	55	3.500	3.500	5.1875
30	3.500	1.250	1.8750	60	3.500	4.250	6.3750

^aThis taper corresponds to an included angle of 16°, 35', 39.4".

^bThe basic diameter at gage line is at large end of taper.

All dimensions given in inches.

The tapers numbered 10, 20, 30, 40, 50, and 60 that are printed in heavy-faced type are designated as the "Preferred Series." The tapers numbered 5, 15, 25, 35, 45, and 55 that are printed in light-faced type are designated as the "Intermediate Series."

Table 7a. American National Standard Self-holding Tapers — Basic Dimensions ANSI/ASME B5.10-1994 (R2008)

No. of Taper	Taper per Foot	Dia. at Gage Line ^a A	Means of Driving and Holding ^a	Origin of Series
.239	0.50200	0.23922	} Tang Drive With Shank Held in by Friction (See Table 2)	Brown & Sharpe Taper Series
.299	0.50200	0.29968		
.375	0.50200	0.37525		
1	0.59858	0.47500	} Tang Drive With Shank Held in by Key (See Table 3)	Morse Taper Series
2	0.59941	0.70000		
3	0.60235	0.93800		
4	0.62326	1.23100		
4½	0.62400	1.50000		
5	0.63151	1.74800		
6	0.62565	2.49400		
7	0.62400	3.27000		
200	0.750	2.000	} Key Drive With Shank Held in by Key (See Table 4) } Key Drive With Shank Held in by Draw-bolt (See Table 5)	¾ Inch per Foot Taper Series
250	0.750	2.500		
300	0.750	3.000		
350	0.750	3.500		
400	0.750	4.000		
450	0.750	4.500		
500	0.750	5.000		
600	0.750	6.000		
800	0.750	8.000		
1000	0.750	10.000		
1200	0.750	12.000		

^aSee illustrations above Tables 2 through 5.

All dimensions given in inches.

Table 7b. American National Standard Plug and Ring Gages for the Self-Holding Taper Series ANSI/ASME B5.10-1994 (R2008)

No. of Taper	Taper ^a per Foot	Diameter ^a at Gage Line A	Tolerances for Diameter A ^b			Diameter at Small End A'	Length Gage Line to End L	Depth of Gaging-Notch, Plug Gage L'
			Class X Gage	Class Y Gage	Class Z Gage			
0.239	0.50200	0.23922	0.00004	0.00007	0.00010	0.20000	0.94	0.048
0.299	0.50200	0.29968	0.00004	0.00007	0.00010	0.25000	1.19	0.048
0.375	0.50200	0.37525	0.00004	0.00007	0.00010	0.31250	1.50	0.048
1	0.59858	0.47500	0.00004	0.00007	0.00010	0.36900	2.13	0.040
2	0.59941	0.70000	0.00004	0.00007	0.00010	0.57200	2.56	0.040
3	0.60235	0.93800	0.00006	0.00009	0.00012	0.77800	3.19	0.040
4	0.62326	1.23100	0.00006	0.00009	0.00012	1.02000	4.06	0.038
4½	0.62400	1.50000	0.00006	0.00009	0.00012	1.26600	4.50	0.038
5	0.63151	1.74800	0.00008	0.00012	0.00016	1.47500	5.19	0.038
6	0.62565	2.49400	0.00008	0.00012	0.00016	2.11600	7.25	0.038
7	0.62400	3.27000	0.00010	0.00015	0.00020	2.75000	10.00	0.038
200	0.75000	2.00000	0.00008	0.00012	0.00016	1.703	4.75	0.032
250	0.75000	2.50000	0.00008	0.00012	0.00016	2.156	5.50	0.032
300	0.75000	3.00000	0.00010	0.00015	0.00020	2.609	6.25	0.032
350	0.75000	3.50000	0.00010	0.00015	0.00020	3.063	7.00	0.032
400	0.75000	4.00000	0.00010	0.00015	0.00020	3.516	7.75	0.032
450	0.75000	4.50000	0.00010	0.00015	0.00020	3.969	8.50	0.032
500	0.75000	5.00000	0.00013	0.00019	0.00025	4.422	9.25	0.032
600	0.75000	6.00000	0.00013	0.00019	0.00025	5.328	10.75	0.032
800	0.75000	8.00000	0.00016	0.00024	0.00032	7.141	13.75	0.032
1000	0.75000	10.00000	0.00020	0.00030	0.00040	8.953	16.75	0.032
1200	0.75000	12.00000	0.00020	0.00030	0.00040	10.766	19.75	0.032

^aThe taper per foot and diameter A at gage line are basic dimensions. Dimensions in Column A' are calculated for reference only.

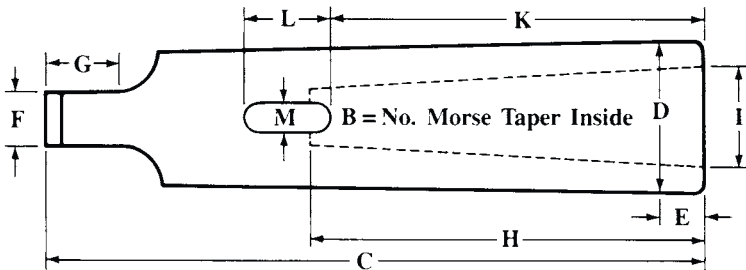
^bTolerances for diameter A are plus for plug gages and minus for ring gages.

All dimensions are in inches.

The amount of taper deviation for Class X, Class Y, and Class Z gages are the same, respectively, as the amounts shown for tolerances on diameter A. Taper deviation is the permissible allowance from true taper at any point of diameter in the length of the gage. On taper *plug* gages, this deviation may be applied only in the direction which *decreases* the rate of taper. On taper *ring* gages, this deviation may be applied only in the direction which *increases* the rate of taper. Tolerances on two-decimal dimensions are ±0.010.

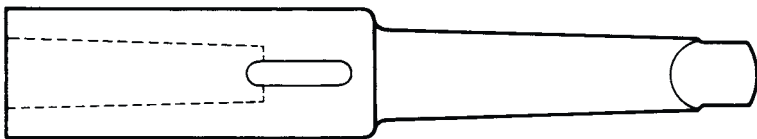
British Standard Tapers.—British Standard 1660: 1972, “Machine Tapers, Reduction Sleeves, and Extension Sockets,” contains dimensions for self-holding and self-releasing tapers, reduction sleeves, extension sockets, and turret sockets for tools having Morse and metric 5 per cent taper shanks. Adapters for use with 7/24 tapers and dimensions for spindle noses and tool shanks with self-release tapers and cotter slots are included in this Standard.

Table 8. Dimensions of Morse Taper Sleeves



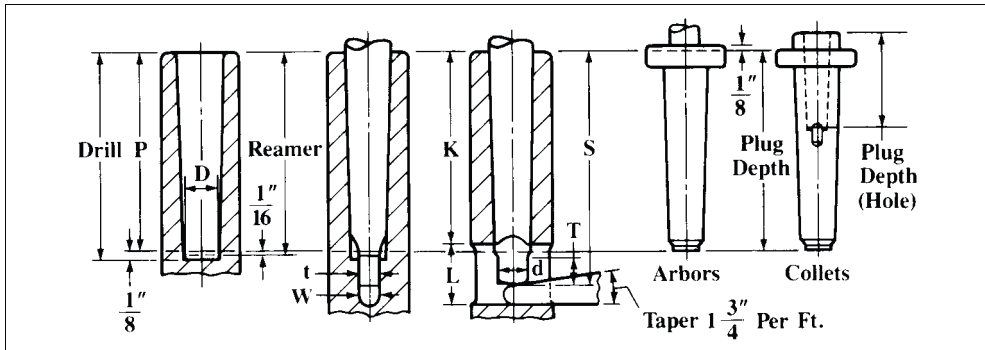
A	B	C	D	E	F	G	H	I	K	L	M
2	1	3 ³ / ₁₆	0.700	5 ⁵ / ₈	1 ¹ / ₄	7 ⁷ / ₁₆	2 ² / ₁₆	0.475	2 ² / ₁₆	3 ³ / ₄	0.213
3	1	3 ¹⁵ / ₁₆	0.938	1 ¹ / ₄	5 ⁵ / ₁₆	9 ⁹ / ₁₆	2 ² / ₁₆	0.475	2 ² / ₁₆	3 ³ / ₄	0.213
3	2	4 ⁷ / ₁₆	0.938	3 ³ / ₄	5 ⁵ / ₁₆	9 ⁹ / ₁₆	2 ² / ₈	0.700	2 ² / ₂	7 ⁷ / ₈	0.260
4	1	4 ⁷ / ₈	1.231	1 ¹ / ₄	15 ¹⁵ / ₃₂	5 ⁵ / ₈	2 ² / ₁₆	0.475	2 ² / ₁₆	3 ³ / ₄	0.213
4	2	4 ⁷ / ₈	1.231	1 ¹ / ₄	15 ¹⁵ / ₃₂	5 ⁵ / ₈	2 ² / ₈	0.700	2 ² / ₂	7 ⁷ / ₈	0.260
4	3	5 ³ / ₈	1.231	3 ³ / ₄	15 ¹⁵ / ₃₂	5 ⁵ / ₈	3 ³ / ₄	0.938	3 ³ / ₁₆	1 ¹ / ₁₆	0.322
5	1	6 ³ / ₈	1.748	1 ¹ / ₄	5 ⁵ / ₈	3 ³ / ₄	2 ² / ₁₆	0.475	2 ² / ₁₆	3 ³ / ₄	0.213
5	2	6 ³ / ₈	1.748	1 ¹ / ₄	5 ⁵ / ₈	3 ³ / ₄	2 ² / ₈	0.700	2 ² / ₂	7 ⁷ / ₈	0.260
5	3	6 ³ / ₈	1.748	1 ¹ / ₄	5 ⁵ / ₈	3 ³ / ₄	3 ³ / ₄	0.938	3 ³ / ₁₆	1 ¹ / ₁₆	0.322
5	4	6 ³ / ₈	1.748	3 ³ / ₄	5 ⁵ / ₈	3 ³ / ₄	4 ⁴ / ₈	1.231	3 ³ / ₈	1 ¹ / ₄	0.478
6	1	8 ³ / ₈	2.494	3 ³ / ₈	3 ³ / ₄	1 ¹ / ₈	2 ² / ₁₆	0.475	2 ² / ₁₆	3 ³ / ₄	0.213
6	2	8 ³ / ₈	2.494	3 ³ / ₈	3 ³ / ₄	1 ¹ / ₈	2 ² / ₈	0.700	2 ² / ₂	7 ⁷ / ₈	0.260
6	3	8 ³ / ₈	2.494	3 ³ / ₈	3 ³ / ₄	1 ¹ / ₈	3 ³ / ₄	0.938	3 ³ / ₁₆	1 ¹ / ₁₆	0.322
6	4	8 ³ / ₈	2.494	3 ³ / ₈	3 ³ / ₄	1 ¹ / ₈	4 ⁴ / ₈	1.231	3 ³ / ₈	1 ¹ / ₄	0.478
6	5	8 ³ / ₈	2.494	3 ³ / ₈	3 ³ / ₄	1 ¹ / ₈	5 ⁵ / ₄	1.748	4 ⁴ / ₁₆	1 ¹ / ₂	0.635
7	3	11 ⁵ / ₈	3.270	3 ³ / ₈	1 ¹ / ₈	1 ¹ / ₈	3 ³ / ₄	0.938	3 ³ / ₁₆	1 ¹ / ₁₆	0.322
7	4	11 ⁵ / ₈	3.270	3 ³ / ₈	1 ¹ / ₈	1 ¹ / ₈	4 ⁴ / ₈	1.231	3 ³ / ₈	1 ¹ / ₄	0.478
7	5	11 ⁵ / ₈	3.270	3 ³ / ₈	1 ¹ / ₈	1 ¹ / ₈	5 ⁵ / ₄	1.748	4 ⁴ / ₁₆	1 ¹ / ₂	0.635
7	6	12 ¹ / ₂	3.270	1 ¹ / ₄	1 ¹ / ₈	1 ¹ / ₈	7 ⁷ / ₈	2.494	7	1 ¹ / ₄	0.760

Table 9. Morse Taper Sockets — Hole and Shank Sizes



Size	Morse Taper		Size	Morse Taper		Size	Morse Taper	
	Hole	Shank		Hole	Shank		Hole	Shank
1 by 2	No. 1	No. 2	2 by 5	No. 2	No. 5	4 by 4	No. 4	No. 4
1 by 3	No. 1	No. 3	3 by 2	No. 3	No. 2	4 by 5	No. 4	No. 5
1 by 4	No. 1	No. 4	3 by 3	No. 3	No. 3	4 by 6	No. 4	No. 6
1 by 5	No. 1	No. 5	3 by 4	No. 3	No. 4	5 by 4	No. 5	No. 4
2 by 3	No. 2	No. 3	3 by 5	No. 3	No. 5	5 by 5	No. 5	No. 5
2 by 4	No. 2	No. 4	4 by 3	No. 4	No. 3	5 by 6	No. 5	No. 6

Table 10. Brown & Sharpe Taper Shanks



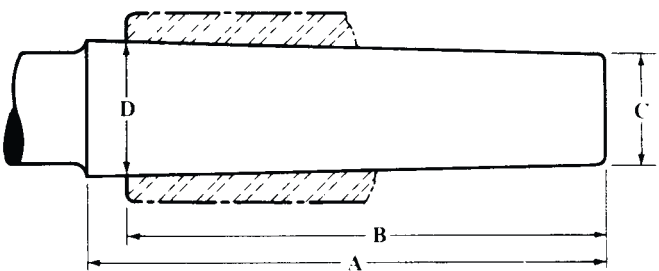
Number of Taper	Taper per Foot (inch)	Dia. of Plug at Small End D	Plug Depth, P			Keyway from End of Spindle K	Shank Depth S	Length of Key-way ^a L	Width of Key-way W	Length of Arbor Tongue T	Diameter of Arbor Tongue d	Thick-ness of Arbor Tongue t
			B & S ^b Standard	Mill. Mach. Standard	Miscell.							
1 ^c	.50200	.20000	$\frac{15}{16}$	$\frac{15}{16}$	$1\frac{3}{16}$	$\frac{3}{8}$.135	$\frac{3}{16}$.170	$\frac{1}{8}$
2 ^c	.50200	.25000	$1\frac{1}{16}$	$1\frac{11}{64}$	$1\frac{1}{2}$	$\frac{1}{2}$.166	$\frac{1}{4}$.220	$\frac{3}{32}$
3 ^c	.50200	.31250	$1\frac{1}{2}$	$1\frac{15}{32}$	$1\frac{7}{8}$	$\frac{5}{8}$.197	$\frac{3}{16}$.282	$\frac{3}{16}$
			$1\frac{23}{32}$	$2\frac{1}{8}$	$\frac{5}{8}$.197	$\frac{3}{16}$.282	$\frac{3}{16}$
			2	$1\frac{31}{32}$	$2\frac{3}{8}$	$\frac{5}{8}$.197	$\frac{3}{16}$.282	$\frac{3}{16}$
4	.50240	.35000	...	$1\frac{1}{4}$...	$1\frac{13}{64}$	$1\frac{21}{32}$	$1\frac{11}{16}$.228	$1\frac{1}{32}$.320	$\frac{7}{32}$
			$1\frac{11}{16}$	$1\frac{41}{64}$	$2\frac{3}{32}$	$1\frac{11}{16}$.228	$1\frac{1}{32}$.320	$\frac{7}{32}$
5	.50160	.45000	...	$1\frac{3}{4}$...	$1\frac{11}{16}$	$2\frac{3}{16}$	$\frac{3}{4}$.260	$\frac{3}{8}$.420	$\frac{1}{4}$
			2	$1\frac{15}{16}$	$2\frac{7}{16}$	$\frac{3}{4}$.260	$\frac{3}{8}$.420	$\frac{1}{4}$
			$2\frac{1}{8}$	$2\frac{1}{16}$	$2\frac{9}{16}$	$\frac{3}{4}$.260	$\frac{3}{8}$.420	$\frac{1}{4}$
6	.50329	.50000	$2\frac{3}{8}$	$2\frac{19}{64}$	$2\frac{7}{8}$	$\frac{7}{8}$.291	$\frac{7}{16}$.460	$\frac{9}{32}$
7	.50147	.60000	$2\frac{1}{2}$	$2\frac{13}{32}$	$3\frac{1}{32}$	$1\frac{15}{16}$.322	$\frac{15}{32}$.560	$\frac{5}{16}$
			$2\frac{7}{8}$	$2\frac{25}{32}$	$3\frac{13}{32}$	$1\frac{15}{16}$.322	$\frac{15}{32}$.560	$\frac{5}{16}$
			...	3	...	$2\frac{29}{32}$	$3\frac{17}{32}$	$1\frac{15}{16}$.322	$\frac{15}{32}$.560	$\frac{5}{16}$
8	.50100	.75000	$3\frac{3}{16}$	$3\frac{23}{64}$	$4\frac{1}{8}$	1	.353	$\frac{1}{2}$.710	$1\frac{1}{32}$
9	.50085	.90010	...	4	...	$3\frac{3}{8}$	$4\frac{3}{8}$	$1\frac{1}{8}$.385	$\frac{9}{16}$.860	$\frac{3}{8}$
			$4\frac{1}{4}$	$4\frac{1}{8}$	$4\frac{1}{8}$	$1\frac{1}{8}$.385	$\frac{9}{16}$.860	$\frac{3}{8}$
			5	$4\frac{27}{32}$	$5\frac{23}{32}$	$1\frac{1}{16}$.447	$\frac{21}{32}$	1.010	$\frac{7}{16}$
10	.51612	1.04465	...	$5\frac{11}{16}$...	$5\frac{17}{32}$	$6\frac{13}{32}$	$1\frac{5}{16}$.447	$\frac{21}{32}$	1.010	$\frac{7}{16}$
			$6\frac{7}{32}$	$6\frac{1}{16}$	$6\frac{15}{16}$	$1\frac{5}{16}$.447	$\frac{21}{32}$	1.010	$\frac{7}{16}$
			$5\frac{15}{16}$	$5\frac{25}{32}$	$6\frac{21}{32}$	$1\frac{5}{16}$.447	$\frac{21}{32}$	1.210	$\frac{7}{16}$
11	.50100	1.24995	...	$6\frac{3}{4}$...	$6\frac{19}{32}$	$7\frac{15}{32}$	$1\frac{5}{16}$.447	$\frac{21}{32}$	1.210	$\frac{7}{16}$
			$7\frac{7}{8}$	$7\frac{7}{8}$...	$6\frac{15}{16}$	$7\frac{15}{16}$	$1\frac{1}{2}$.510	$\frac{3}{4}$	1.460	$\frac{1}{2}$
12	.49973	1.50010	$6\frac{1}{4}$
			$7\frac{3}{4}$	$7\frac{9}{16}$	$8\frac{9}{16}$	$1\frac{1}{2}$.510	$\frac{3}{4}$	1.710	$\frac{1}{2}$
13	.50020	1.75005	$8\frac{1}{4}$	$8\frac{7}{32}$	$9\frac{5}{32}$	$1\frac{11}{16}$.572	$\frac{21}{32}$	1.960	$\frac{9}{16}$
14	.50000	2.00000	$8\frac{3}{4}$	$8\frac{3}{4}$...	$8\frac{31}{32}$	$9\frac{21}{32}$	$1\frac{11}{16}$.572	$\frac{21}{32}$	2.210	$\frac{9}{16}$
15	.5000	2.25000	$8\frac{3}{4}$	9	$10\frac{1}{4}$	$1\frac{1}{8}$.635	$\frac{15}{16}$	2.450	$\frac{3}{8}$
16	.50000	2.50000	$9\frac{1}{4}$
17	.50000	2.75000	$9\frac{3}{4}$
18	.50000	3.00000	$10\frac{1}{4}$

^a Special lengths of keyway are used instead of standard lengths in some places. Standard lengths need not be used when keyway is for driving only and not for admitting key to force out tool.

^b "B & S Standard" Plug Depths are not used in all cases.

^c Adopted by American Standards Association.

Table 11. Jarno Taper Shanks

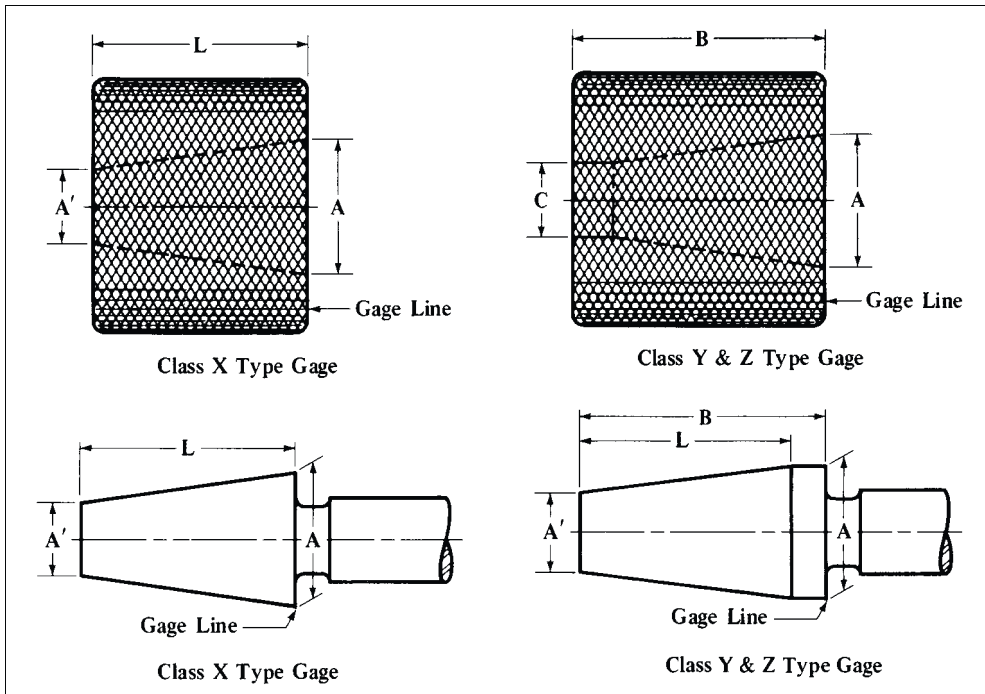


$$D = \frac{\text{no. of taper}}{8} \quad C = \frac{\text{no. of taper}}{10} \quad B = \frac{\text{no. of taper}}{2}$$

Number of Taper	Length A	Length B	Diameter C	Diameter D	Taper per foot
2	1 $\frac{1}{8}$	1	0.20	0.250	0.600
3	1 $\frac{5}{8}$	1 $\frac{1}{2}$	0.30	0.375	0.600
4	2 $\frac{3}{16}$	2	0.40	0.500	0.600
5	2 $\frac{11}{16}$	2 $\frac{1}{2}$	0.50	0.625	0.600
6	3 $\frac{3}{16}$	3	0.60	0.750	0.600
7	3 $\frac{11}{16}$	3 $\frac{1}{2}$	0.70	0.875	0.600
8	4 $\frac{3}{16}$	4	0.80	1.000	0.600
9	4 $\frac{11}{16}$	4 $\frac{1}{2}$	0.90	1.125	0.600
10	5 $\frac{1}{4}$	5	1.00	1.250	0.600
11	5 $\frac{3}{4}$	5 $\frac{1}{2}$	1.10	1.375	0.600
12	6 $\frac{1}{4}$	6	1.20	1.500	0.600
13	6 $\frac{3}{4}$	6 $\frac{1}{2}$	1.30	1.625	0.600
14	7 $\frac{1}{4}$	7	1.40	1.750	0.600
15	7 $\frac{3}{4}$	7 $\frac{1}{2}$	1.50	1.875	0.600
16	8 $\frac{5}{16}$	8	1.60	2.000	0.600
17	8 $\frac{13}{16}$	8 $\frac{1}{2}$	1.70	2.125	0.600
18	9 $\frac{5}{16}$	9	1.80	2.250	0.600
19	9 $\frac{13}{16}$	9 $\frac{1}{2}$	1.90	2.375	0.600
20	10 $\frac{5}{16}$	10	2.00	2.500	0.600

Tapers for Machine Tool Spindles.—Most lathe spindles have Morse tapers, most milling machine spindles have American Standard tapers, almost all smaller milling machine spindles have R8 tapers, page 968, and large vertical milling machine spindles have American Standard tapers. The spindles of drilling machines and the taper shanks of twist drills are made to fit the Morse taper. For lathes, the Morse taper is generally used, but lathes may have the Jarno, Brown & Sharpe, or a special taper. Of 33 lathe manufacturers, 20 use the Morse taper; 5, the Jarno; 3 use special tapers of their own; 2 use modified Morse (longer than the standard but the same taper); 2 use Reed (which is a short Jarno); 1 uses the Brown & Sharpe standard. For grinding machine centers, Jarno, Morse, and Brown & Sharpe tapers are used. Of ten grinding machine manufacturers, 3 use Brown & Sharpe; 3 use Morse; and 4 use Jarno. The Brown & Sharpe taper is used extensively for milling machine and dividing head spindles. The standard milling machine spindle adopted in 1927 by the milling machine manufacturers of the National Machine Tool Builders' Association (now The Association for Manufacturing Technology [AMT]), has a taper of 3 $\frac{1}{2}$ inches per foot. This comparatively steep taper was adopted to ensure easy release of arbors.

Table 12. American National Standard Plug and Ring Gages for Steep Machine Tapers ANSI/ASME B5.10-1994 (R2008)



No. of Taper	Taper per Foot ^a (Basic)	Diameter at Gage Line ^a A	Tolerances for Diameter A ^b			Diameter at Small End ^a A'	Length Gage Line to Small End L	Overall Length of Gage of Body B	Dia. of Opening C
			Class X Gage	Class Y Gage	Class Z Gage				
5	3.500	0.500	0.00004	0.00007	0.00010	0.2995	0.6875	0.81	0.30
10	3.500	0.625	0.00004	0.00007	0.00010	0.3698	0.8750	1.00	0.36
15	3.500	0.750	0.00004	0.00007	0.00010	0.4401	1.0625	1.25	0.44
20	3.500	0.875	0.00006	0.00009	0.00012	0.4922	1.3125	1.50	0.48
25	3.500	1.000	0.00006	0.00009	0.00012	0.5443	1.5625	1.75	0.53
30	3.500	1.250	0.00006	0.00009	0.00012	0.7031	1.8750	2.06	0.70
35	3.500	1.500	0.00006	0.00009	0.00012	0.8438	2.2500	2.44	0.84
40	3.500	1.750	0.00008	0.00012	0.00016	1.0026	2.5625	2.75	1.00
45	3.500	2.250	0.00008	0.00012	0.00016	1.2839	3.3125	3.50	1.00
50	3.500	2.750	0.00010	0.00015	0.00020	1.5833	4.0000	4.25	1.00
55	3.500	3.500	0.00010	0.00015	0.00020	1.9870	5.1875	5.50	1.00
60	3.500	4.250	0.00010	0.00015	0.00020	2.3906	6.3750	6.75	2.00

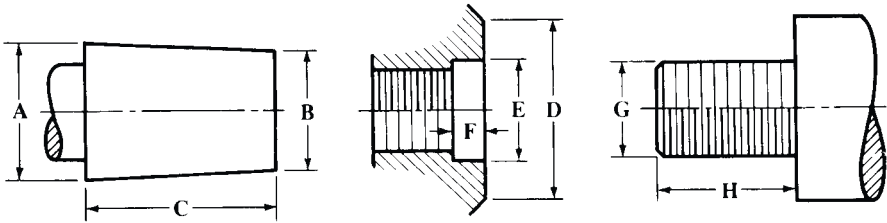
^aThe taper per foot and diameter A at gage line are basic dimensions. Dimensions in Column A' are calculated for reference only.

^bTolerances for diameter A are plus for plug gages and minus for ring gages.

All dimensions are in inches.

The amounts of taper deviation for Class X, Class Y, and Class Z gages are the same, respectively, as the amounts shown for tolerances on diameter A. Taper deviation is the permissible allowance from true taper at any point of diameter in the length of the gage. On taper *plug* gages, this deviation may be applied only in the direction which *decreases* the rate of taper. On taper *ring* gages, this deviation may be applied only in the direction which *increases* the rate of taper. Tolerances on two-decimal dimensions are ±0.010.

Table 13. Jacobs Tapers and Threads for Drill Chucks and Spindles



American Standard Thread Form

Taper Series	A	B	C	Taper per Ft.	Taper Series	A	B	C	Taper per Ft.
No. 0	0.2500	0.22844	0.43750	0.59145	No. 4	1.1240	1.0372	1.6563	0.62886
No. 1	0.3840	0.33341	0.65625	0.92508	No. 5	1.4130	1.3161	1.8750	0.62010
No. 2	0.5590	0.48764	0.87500	0.97861	No. 6	0.6760	0.6241	1.0000	0.62292
No. 2 ^a	0.5488	0.48764	0.75000	0.97861	No. 33	0.6240	0.5605	1.0000	0.76194
No. 3	0.8110	0.74610	1.21875	0.63898

^a These dimensions are for the No. 2 “short” taper.

Thread Size	Diameter <i>D</i>		Diameter <i>E</i>		Dimension <i>F</i>	
	Max.	Min.	Max.	Min.	Max.	Min.
5/16-24	0.531	0.516	0.3245	0.3195	0.135	0.115
3/16-24	0.633	0.618	0.3245	0.3195	0.135	0.115
3/8-24	0.633	0.618	0.385	0.380	0.135	0.115
1/2-20	0.860	0.845	0.510	0.505	0.135	0.115
5/8-11	1.125	1.110	0.635	0.630	0.166	0.146
3/4-16	1.125	1.110	0.635	0.630	0.166	0.146
45/64-16	1.250	1.235	0.713	0.708	0.166	0.146
3/4-16	1.250	1.235	0.760	0.755	0.166	0.146
1-8	1.437	1.422	1.036	1.026	0.281	0.250
1-10	1.437	1.422	1.036	1.026	0.281	0.250
1 1/2-8	1.871	1.851	1.536	1.526	0.343	0.312

Thread ^a Size	<i>G</i>		<i>H</i> ^b	Plug Gage Pitch Dia.		Ring Gage Pitch Dia.	
	Max	Min		Go	Not Go	Go	Not Go
5/16-24	0.3114	0.3042	0.437 ^c	0.2854	0.2902	0.2843	0.2806
3/8-24	0.3739	0.3667	0.562 ^d	0.3479	0.3528	0.3468	0.3430
1/2-20	0.4987	0.4906	0.562	0.4675	0.4731	0.4662	0.4619
5/8-11	0.6234	0.6113	0.687	0.5660	0.5732	0.5644	0.5589
3/4-16	0.6236	0.6142	0.687	0.5844	0.5906	0.5830	0.5782
45/64-16	0.7016	0.6922	0.687	0.6625	0.6687	0.6610	0.6561
3/4-16	0.7485	0.7391	0.687	0.7094	0.7159	0.7079	0.7029
1-8	1.000	0.9848	1.000	0.9188	0.9242	0.9188	0.9134
1-10	1.000	0.9872	1.000	0.9350	0.9395	0.9350	0.9305
1 1/2-8	1.500	1.4848	1.000	1.4188	1.4242	1.4188	1.4134

^a Except for 1-8, 1-10, 1 1/2-8 all threads are now manufactured to the American National Standard Unified Screw Thread System, Internal Class 2B, External Class 2A. Effective date 1976.

^b Tolerances for dimension *H* are as follows: 0.030 inch for thread sizes 5/16-24 to 3/4-16, inclusive and 0.125 inch for thread sizes 1-8 to 1 1/2-8, inclusive.

^c Length for Jacobs 0B5/16 chuck is 0.375 inch, length for 1B5/16 chuck is 0.437 inch.

^d Length for Jacobs No. 1BS chuck is 0.437 inch.

Usual Chuck Capacities for Different Taper Series Numbers: No. 0 taper, drill diameters, 0-5/32 inch; No. 1, 0-1/4 inch; No. 2, 0-1/2 inch; No. 2 “Short,” 0-5/16 inch; No. 3, 0-1/2, 1/8-5/8, 3/16-3/4, or 1/4-13/16 inch; No. 4, 1/8-3/4 inch; No. 5, 3/8-1; No. 6, 0-1/2 inch; No. 33, 0-1/2 inch.

Usual Chuck Capacities for Different Thread Sizes: Size 5/16-24, drill diameters 0-1/4 inch; size 3/8-24, drill diameters 0-3/8, 1/16-3/8, or 5/64-1/2 inch; size 1/2-20, drill diameters 0-1/2, 1/16-3/8, or 5/64-1/2 inch; size 5/8-11, drill diameters 0-1/2 inch; size 3/4-16, drill diameters 0-1/2, 1/8-5/8, or 3/16-3/4 inch; size 45/64-16, drill diameters 0-1/2 inch; size 3/4-16, drill diameters 0-1/2 or 3/16-3/4.

Table 1. Essential Dimensions of American National Standard Spindle Noses for Milling Machines *ANSI B5.18-1972 (R2009)*

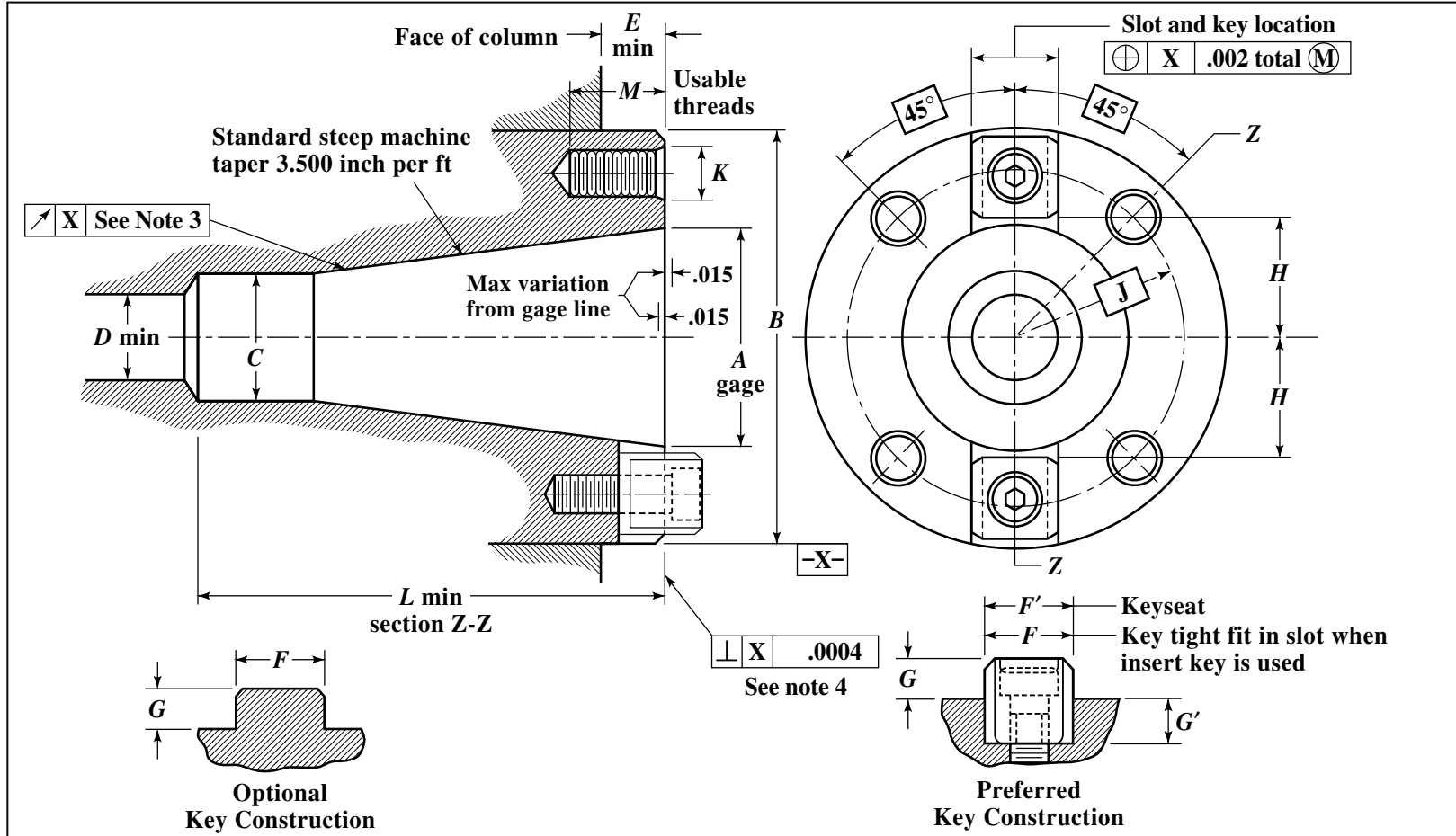


Table 1. (Continued) Essential Dimensions of American National Standard Spindle Noses for Milling Machines ANSI B5.18-1972 (R2009)

Size No.	Gage Dia. of Taper <i>A</i>	Dia. of Spindle <i>B</i>	Pilot Dia. <i>C</i>	Clearance Hole for Draw-in Bolt Min. <i>D</i>	Minimum Dimension Spindle End to Column <i>E</i>	Width of Driving Key <i>F</i>	Width of Keyseat <i>F'</i>	Maximum Height of Driving Key <i>G</i>	Minimum Depth of Keyseat <i>G'</i>	Distance from Center to Driving Keys <i>H</i>	Radius of Bolt Hole Circle <i>J</i>	Size of Threads for Bolt Holes UNC-2B <i>K</i>	Full Depth of Arbor Hole in Spindle Min. <i>L</i>	Depth of Usable Thread for Bolt Hole <i>M</i>
30	1.250	2.7493 2.7488	0.692 0.685	0.66	0.50	0.6255 0.6252	0.624 0.625	0.31	0.31	0.660 0.654	1.0625 (Note 1)	0.375-16	2.88	0.62
40	1.750	3.4993 3.4988	1.005 0.997	0.66	0.62	0.6255 0.6252	0.624 0.625	0.31	0.31	0.910 0.904	1.3125 (Note 1)	0.500-13	3.88	0.81
45	2.250	3.9993 3.9988	1.286 1.278	0.78	0.62	0.7505 0.7502	0.749 0.750	0.38	0.38	1.160 1.154	1.500 (Note 1)	0.500-13	4.75	0.81
50	2.750	5.0618 5.0613	1.568 1.559	1.06	0.75	1.0006 1.0002	0.999 1.000	0.50	0.50	1.410 1.404	2.000 (Note 2)	0.625-11	5.50	1.00
60	4.250	8.7180 8.7175	2.381 2.371	1.38	1.50	1.0006 1.0002	0.999 1.000	0.50	0.50	2.420 2.414	3.500 (Note 2)	0.750-10	8.62	1.25

All dimensions are given in inches.

Tolerances:

Two-digit decimal dimensions ± 0.010 unless otherwise specified.

A—Taper: Tolerance on rate of taper to be 0.001 inch per foot applied only in direction which decreases rate of taper.

F'—Centrality of keyway with axis of taper 0.002 total at maximum material condition. (0.002 Total indicator variation)

F—Centrality of solid key with axis of taper 0.002 total at maximum material condition. (0.002 Total indicator variation)

Note 1: Holes spaced as shown and located within 0.006 inch diameter of true position.

Note 2: Holes spaced as shown and located within 0.010 inch diameter of true position.

Note 3: Maximum turnout on test plug:

0.0004 at 1 inch projection from gage line.

0.0010 at 12 inch projection from gage line.

Note 4: Squareness of mounting face measured near mounting bolt hole circle.

Table 2. Essential Dimensions of American National Standard Tool Shanks for Milling Machines ANSI B5.18-1972 (R2009)

Size No.	Gage Dia. of Taper <i>N</i>	Tap Drill Size for Draw-in Thread <i>O</i>	Dia. of Neck <i>P</i>	Size of Thread for Draw-in Bolt UNC-2B <i>M</i>	Pilot Dia. <i>R</i>	Length of Pilot <i>S</i>	Minimum Length of Usable Thread <i>T</i>	Minimum Depth of Clearance Hole <i>U</i>
30	1.250	0.422 0.432	0.66 0.65	0.500-13	0.675 0.670	0.81	1.00	2.00
40	1.750	0.531 0.541	0.94 0.93	0.625-11	0.987 0.980	1.00	1.12	2.25
45	2.250	0.656 0.666	1.19 1.18	0.750-10	1.268 1.260	1.00	1.50	2.75
50	2.750	0.875 0.885	1.50 1.49	1.000-8	1.550 1.540	1.00	1.75	3.50
60	4.250	1.109 1.119	2.28 2.27	1.250-7	2.360 2.350	1.75	2.25	4.25

Size No.	Distance from Rear of Flange to End of Arbor <i>V</i>	Clearance of Flange from Gage Diameter <i>W</i>	Tool Shank Centerline to Driving Slot <i>X</i>	Width of Driving Slot <i>Y</i>	Distance from Gage Line to Bottom of C' bore <i>Z</i>	Depth of 60° Center <i>K</i>	Diameter of C' bore <i>L</i>
30	2.75	0.045 0.075	0.640 0.625	0.635 0.645	2.50	0.05 0.07	0.525 0.530
40	3.75	0.045 0.075	0.890 0.875	0.635 0.645	3.50	0.05 0.07	0.650 0.655
45	4.38	0.105 0.135	1.140 1.125	0.760 0.770	4.06	0.05 0.07	0.775 0.780
50	5.12	0.105 0.135	1.390 1.375	1.010 1.020	4.75	0.05 0.12	1.025 1.030
60	8.25	0.105 0.135	2.400 2.385	1.010 1.020	7.81	0.05 0.12	1.307 1.312

All dimensions are given in inches.

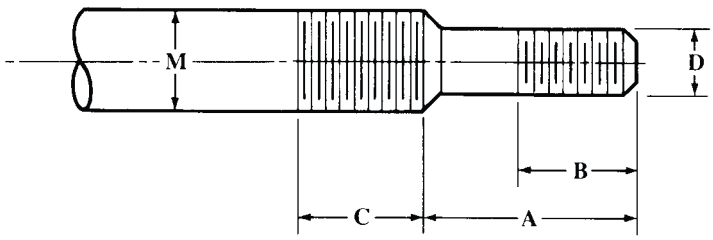
Tolerances: Two digit decimal dimensions ± 0.010 inch unless otherwise specified.

M—Permissible for Class 2B “NoGo” gage to enter five threads before interference.

N—Taper tolerance on rate of taper to be 0.001 inch per foot applied only in direction which increases rate of taper.

Y—Centrality of drive slot with axis of taper shank 0.004 inch at maximum material condition. (0.004 inch total indicator variation)

**Table 3. American National Standard Draw-in Bolt Ends
ANSI B5.18-1972 (R2009)**

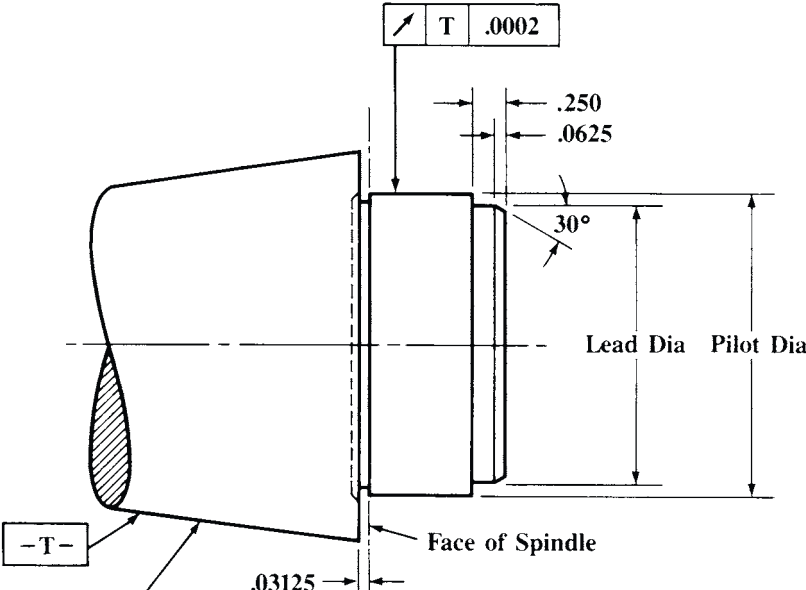


The diagram shows a side view of a draw-in bolt end. It consists of a large diameter section on the left and a smaller diameter section on the right. Dimension *M* is the diameter of the large end. Dimension *D* is the diameter of the small end. Dimension *A* is the length of the small diameter section. Dimension *B* is the length of the threaded portion of the small diameter section. Dimension *C* is the length of the threaded portion of the large diameter section.

Size No.	Length of Small End <i>A</i>	Length of Usable Thread at Small End <i>B</i>	Length of Usable Thread on Large Diameter <i>C</i>	Size of Thread for Large End UNC-2A <i>M</i>	Size of Thread for Small End UNC-2A <i>D</i>
30	1.06	0.75	0.75	0.500-13	0.375-16
40	1.25	1.00	1.12	0.625-11	0.500-13
45	1.50	1.12	1.25	0.750-10	0.625-11
50	1.50	1.25	1.38	1.000-8	0.625-11
60	1.75	1.37	2.00	1.250-7	1.000-8

All dimensions are given in inches.

Table 4. American National Standard Pilot Lead on Centering Plugs for Flatback Milling Cutters ANSI B5.18-1972 (R2009)

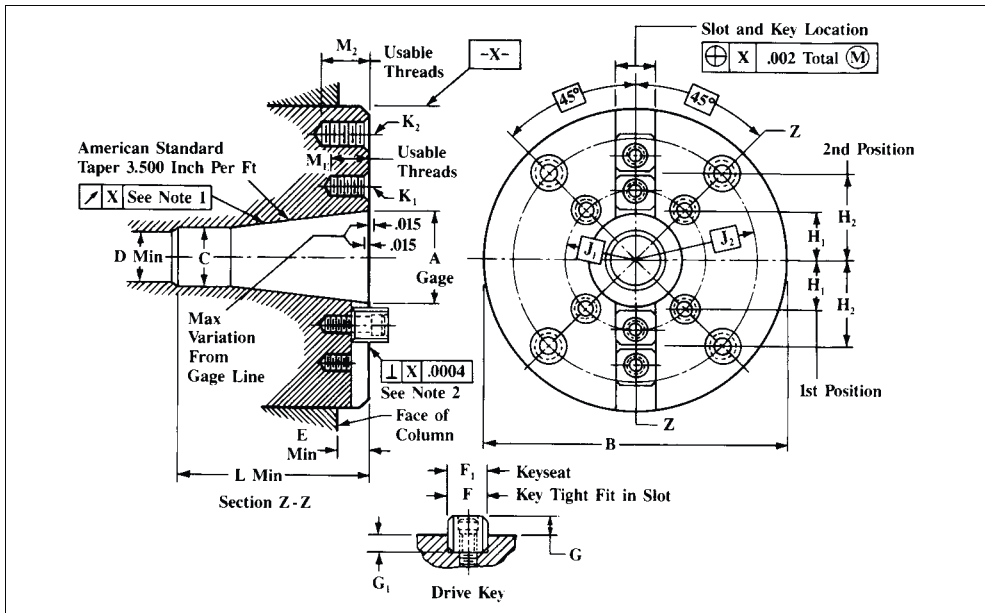


The diagram shows a cross-section of a centering plug. It features a tapered lead section on the left and a cylindrical pilot section on the right. The lead section has a 30-degree taper. The pilot section has a diameter labeled 'Pilot Dia' and a length of .03125 inches. The lead section has a diameter labeled 'Lead Dia'. A tolerance of $T \pm .0002$ is indicated for the lead section. The 'Face of Spindle' is shown on the right side of the plug. The diagram also shows a tolerance of $-T$ on the lead section.

American Standard Taper 3.500 Inch per Ft

Max Lead Dia = Max Pilot Dia - .003
Min Lead Dia = Min Pilot Dia - .006

Table 5. Essential Dimensions for American National Standard Spindle Nose with Large Flange ANSI B5.18-1972 (R2009)



Size No.	Gage Diam. of Taper A	Dia. of Spindle Flange B	Pilot Dia. C	Clearance Hole for Draw-in Bolt Min. D	Min. Dim. Spindle End to Column E	Width of Driving Key F	Height of Driving Key Max. G	Depth of Keyseat Min. G ₁	Distance from Center to Driving Keys First Position H ₁
50A	2.750	8.7180 8.7175	1.568 1.559	1.06	0.75	1.0006 1.0002	0.50	0.50	1.410 1.404
Size No.	Distance from Center to Driving Keys Second Position	Radius of Bolt Hole Circles (See Note 3)		Size of Threads for Bolt Holes UNC-2B		Full Depth of Arbor Hole in Spindle Min. L	Depth of Usable Thread for Bolt Holes		Width of Keyseat F ₁
	H ₂	J ₁	J ₂	K ₁	K ₂		M ₁	M ₂	
50A	2.420 2.410	2.000	3.500	0.625-11	0.750-10	5.50	1.00	1.25	0.999 1.000

All dimensions are given in inches.

Tolerances: Two-digit decimal dimensions ± 0.010 unless otherwise specified.

A—Tolerance on rate of taper to be 0.001 inch per foot applied only in direction which decreases rate of taper.

F—Centrality of solid key with axis of taper 0.002 inch total at maximum material condition. (0.002 inch Total indicator variation)

F₁—Centrality of keyseat with axis of taper 0.002 inch total at maximum material condition. (0.002 inch Total indicator variation)

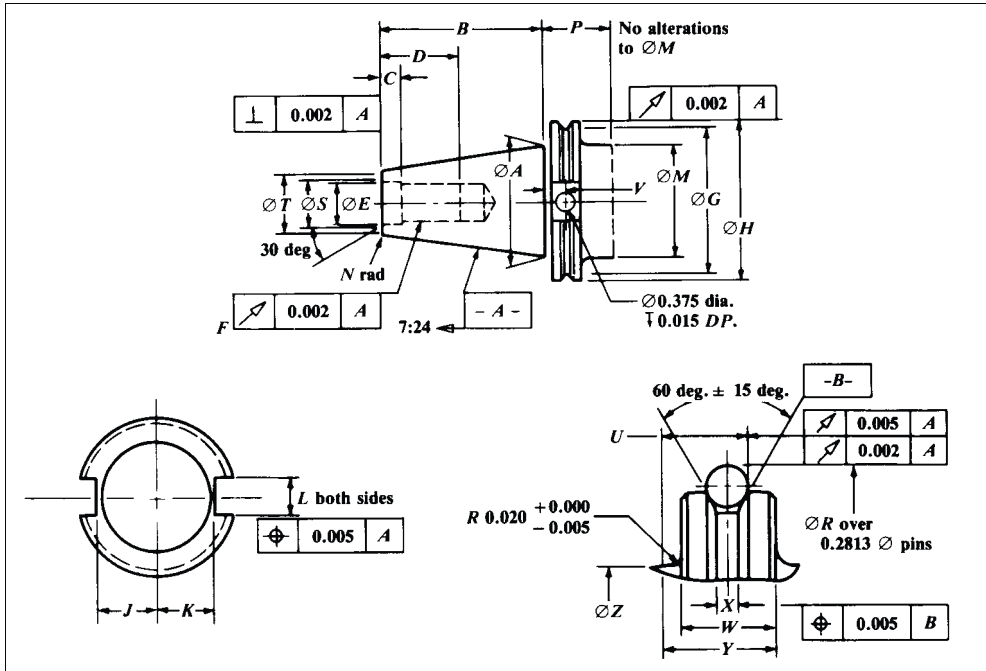
Note 1: Maximum runout on test plug:
0.0004 at 1 inch projection from gage line.
0.0010 at 12 inch projection from gage line.

Note 2: Squareness of mounting face measured near mounting bolt hole circle.

Note 3: Holes located as shown and within 0.010 inch diameter of true position.

V-Flange Tool Shanks and Retention Knobs.—Dimensions of ANSI B5.18-1972 (R2009) standard tool shanks and corresponding spindle noses are detailed on pages 962 through 965, and are suitable for spindles used in milling and associated machines. Corresponding equipment for higher-precision numerically controlled machines, using retention knobs instead of drawbars, is usually made to the ANSI/ASME B5.50-1985 standard.

Essential Dimensions of V-Flange Tool Shanks ANSI/ASME B5.50-1985

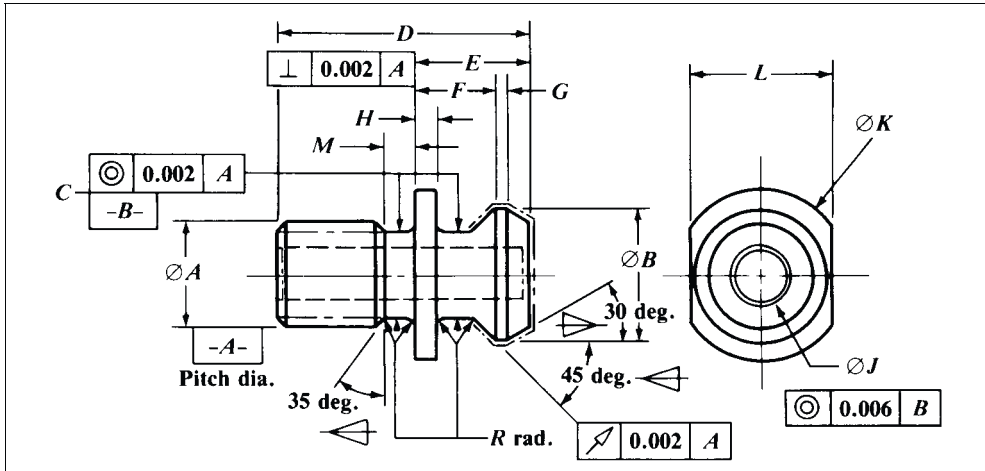


A		B	C	D	E	F	G	H	J	K
Tolerance		±0.005	±0.010	Min.	+0.015 -0.000	UNC 2B	±0.010	±0.002	+0.000 -0.015	+0.000 -0.015
Size	Gage Dia.									
30	1.250	1.875	0.188	1.00	0.516	0.500-13	1.531	1.812	0.735	0.640
40	1.750	2.687	0.188	1.12	0.641	0.625-11	2.219	2.500	0.985	0.890
45	2.250	3.250	0.188	1.50	0.766	0.750-10	2.969	3.250	1.235	1.140
50	2.750	4.000	0.250	1.75	1.031	1.000-8	3.594	3.875	1.485	1.390
60	4.250	6.375	0.312	2.25	1.281	1.250-7	5.219	5.500	2.235	2.140

A		L	M	N	P	R	S	T	Z
Tolerance		±0.001	±0.005	+0.000 -0.015	Min.	±0.002	±0.010	Min. Flat	+0.000 -0.005
Size	Gage Dia.								
30	1.250	0.645	1.250	0.030	1.38	2.176	0.590	0.650	1.250
40	1.750	0.645	1.750	0.060	1.38	2.863	0.720	0.860	1.750
45	2.250	0.770	2.250	0.090	1.38	3.613	0.850	1.090	2.250
50	2.750	1.020	2.750	0.090	1.38	4.238	1.125	1.380	2.750
60	4.250	1.020	4.250	0.120 0.200	1.500	5.683	1.375	2.04	4.250

Notes: Taper tolerance to be 0.001 in. in 12 in. applied in direction that increases rate of taper. Geometric dimensions symbols are to ANSI Y14.5M-1982. Dimensions are in inches. Deburr all sharp edges. Unspecified fillets and radii to be 0.03 ± 0.010R, or 0.03 ± 0.010 × 45 degrees. Data for size 60 are not part of Standard. For all sizes, the values for dimensions U (tol. ± 0.005) are 0.579; for V (tol. ± 0.010), 0.440; for W (tol. ± 0.002), 0.625; for X (tol. ± 0.005), 0.151; and for Y (tol. ± 0.002), 0.750.

Essential Dimensions of V-Flange Tool Shank Retention Knobs
ANSI/ASME B5.50-1985



Size	A	B	C	D	E	F
30	0.500-13	0.520	0.385	1.10	0.460	0.320
40	0.625-11	0.740	0.490	1.50	0.640	0.440
45	0.750-10	0.940	0.605	1.80	0.820	0.580
50	1.000-8	1.140	0.820	2.30	1.000	0.700
60	1.250-7	1.460	1.045	3.20	1.500	1.080
Tolerances	UNC- 2A	± 0.005	± 0.005	± 0.040	± 0.005	± 0.005

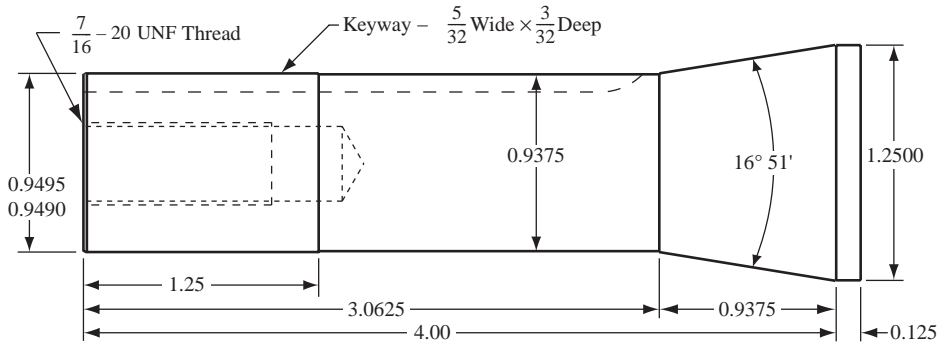
Size	G	H	J	K	L	M	R
30	0.04	0.10	0.187	0.65 0.64	0.53	0.19	0.094
40	0.06	0.12	0.281	0.94 0.92	0.75	0.22	0.094
45	0.08	0.16	0.375	1.20 1.18	1.00	0.22	0.094
50	0.10	0.20	0.468	1.44 1.42	1.25	0.25	0.125
60	0.14	0.30	0.500	2.14 2.06	1.50	0.31	0.125
Tolerances	± 0.010	± 0.010	± 0.010		+0.000 -0.010	± 0.040	+0.010 -0.005

Notes: Dimensions are in inches. Material: low-carbon steel. Heat treatment: carburize and harden to 0.016 to 0.028 in. effective case depth. Hardness of noted surfaces to be Rockwell 56-60; core hardness Rockwell C35-45. Hole J shall not be carburized. Surfaces C and R to be free from tool marks. Deburr all sharp edges. Geometric dimension symbols are to ANSI Y14.5M-1982.

Data for size 60 are not part of Standard.

Collets

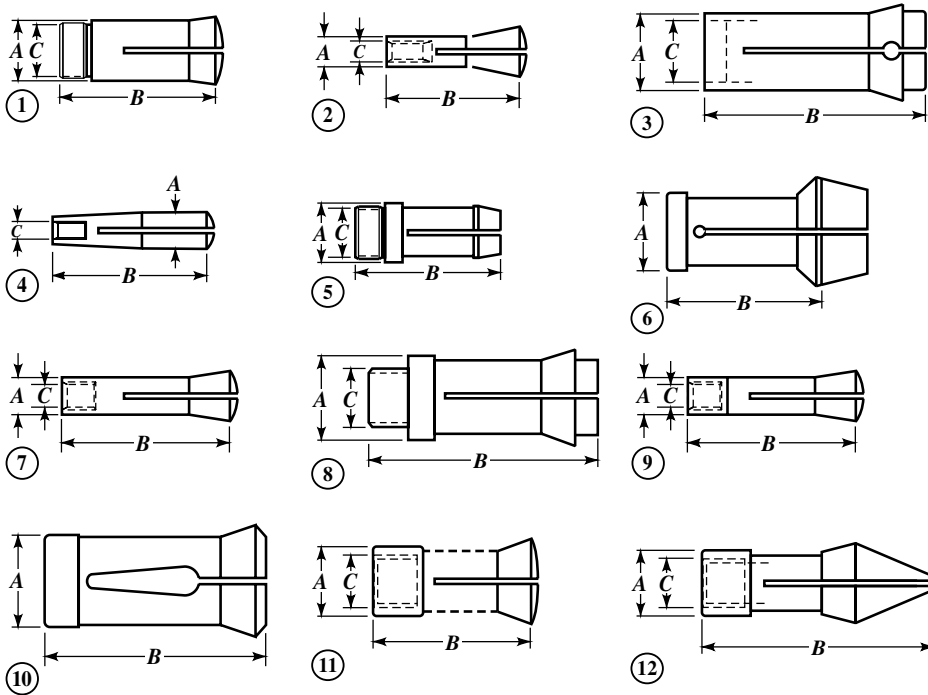
R8 Collet.—The dimensions in this figure are believed reliable. However, there are variations among manufacturers of R8 collets, especially regarding the width and depth of the keyway. Some sources do not agree with all dimensions in this figure. R8 collets are not always interchangeable.



All dimensions in inches.

Bridgeport R8 Collet Dimensions

Collets Styles for Lathes, Mills, Grinders, and Fixtures



Collet Styles

Collets for Lathes, Mills, Grinders, and Fixtures

Collet	Style	Dimensions			Max. Capacity (inches)		
		Bearing Diam., A	Length, B	Thread, C	Round	Hex	Square
1A	1	0.650	2.563	0.640 × 26 RH	0.500	0.438	0.344
1AM	1	1.125	3.906	1.118 × 24 RH	1.000	0.875	0.719
1B	2	0.437	1.750	0.312 × 30 RH	0.313	0.219	0.188
1C	1	0.335	1.438	0.322 × 40 RH	0.250	0.219	0.172
1J	1	1.250	3.000	1.238 × 20 RH	1.063	0.875	0.750
1K	3	1.250	2.813	None	1.000	0.875	0.719
2A	1	0.860	3.313	0.850 × 20 RH	0.688	0.594	0.469
2AB	2	0.750	2.563	0.500 × 20 RH	0.625	0.484	0.391
2AM	1	0.629	3.188	0.622 × 24 RH	0.500	0.438	0.344

Collets for Lathes, Mills, Grinders, and Fixtures (*Continued*)

Collet	Style	Dimensions			Max. Capacity (inches)		
		Bearing Diam., A	Length, B	Thread, C	Round	Hex	Square
2B	2	0.590	2.031	0.437 × 26 RH	0.500	0.438	0.344
2C	1	0.450	1.812	0.442 × 30 RH	0.344	0.594	0.234
2H	1	0.826	4.250	0.799 × 20 RH	0.625	0.531	1.000
2J	1	1.625	3.250	1.611 × 18 RH	1.375	1.188	0.438
2L	1	0.950	3.000	0.938 × 20 RH	0.750	0.656	1.000
2M	4	2 Morse	2.875	0.375 × 16 RH	0.500	0.438	0.344
2NS	1	0.324	1.562	0.318 × 40 RH	0.250	0.203	0.172
2OS	1	0.299	1.250	0.263 × 40 RH	0.188	0.156	0.125
2S	1	0.750	3.234	0.745 × 18 RH	0.563	0.484	0.391
2VB	2	0.595	2.438	0.437 × 26 RH	0.500	0.438	0.344
3AM	1	0.750	3.188	0.742 × 24 RH	0.625	0.531	0.438
3AT	1	0.687	2.313	0.637 × 26 RH	0.500	0.438	0.344
3B	2	0.875	3.438	0.625 × 16 RH	0.750	0.641	0.531
3C	1	0.650	2.688	0.640 × 26 RH	0.500	0.438	0.344
3H	1	1.125	4.438	1.050 × 20 RH	0.875	0.750	0.625
3J	1	2.000	3.750	1.988 × 20 RH	1.750	1.500	1.250
3NS	1	0.687	2.875	0.647 × 20 RH	0.500	0.438	0.344
3OS	1	0.589	2.094	0.518 × 26 RH	0.375	0.313	0.266
3PN	1	0.650	2.063	0.645 × 24 RH	0.500	0.438	0.344
3PO	1	0.599	2.063	0.500 × 24 RH	0.375	0.313	0.266
3S	1	1.000	4.594	0.995 × 20 RH	0.750	0.656	0.531
3SC	1	0.350	1.578	0.293 × 36 RH	0.188	0.156	0.125
3SS	1	0.589	2.125	0.515 × 26 RH	0.375	0.313	0.266
4C	1	0.950	3.000	0.938 × 20 RH	0.750	0.656	0.531
4NS	1	0.826	3.500	0.800 × 20 RH	0.625	0.531	0.438
4OS	1	0.750	2.781	0.660 × 20 RH	0.500	0.438	0.344
4PN	1	1.000	2.906	0.995 × 16 RH	0.750	0.656	0.531
4S	1	0.998	3.250	0.982 × 20 RH	0.750	0.656	0.531
5C	1	1.250	3.281	1.238 × 20 RH ^a	1.063	0.906	0.750
5M	5	1.438	3.438	1.238 × 20 RH	0.875	0.750	0.625
5NS	1	1.062	4.219	1.050 × 20 RH	0.875	0.750	0.625
5OS	1	3.500	3.406	0.937 × 18 RH	0.750	0.641	0.516
5P	1	0.812	3.687	0.807 × 24 RH	0.625	0.531	0.438
5PN	1	1.312	3.406	1.307 × 16 RH	1.000	0.875	0.719
5SC	1	0.600	2.438	0.500 × 26 RH	0.375	0.328	0.266
5ST	1	1.250	3.281	1.238 × 20 RH	1.063	0.906	0.750
5V	1	0.850	3.875	0.775 × 18 RH	0.563	0.484	0.391
6H	1	1.375	4.750	1.300 × 10 RH	1.125	0.969	0.797
6K	1	0.842	3.000	0.762 × 26 RH	0.625	0.531	0.438
6L	1	1.250	4.438	1.178 × 20 RH	1.000	0.875	0.719
6NS	1	1.312	5.906	1.234 × 14 RH	1.000	0.859	0.703
6R	1	1.375	4.938	1.300 × 20 RH	1.125	0.969	0.781
7B	4	7 B&S	3.125	0.375 × 16 RH	0.500	0.406	0.344
7 B&S	4	7 B&S	2.875	0.375 × 16 RH	0.500	0.406	0.344
7P	1	1.125	4.750	1.120 × 20 RH	0.875	0.750	0.625
7R	6	1.062	3.500	None	0.875	0.750	0.625
8H	1	1.500	4.750	1.425 × 20 RH	1.250	1.063	0.875
8ST	1	2.375	5.906	2.354 × 12 RH	2.125	1.844	1.500
8WN	1	1.250	3.875	1.245 × 16 RH	1.000	0.875	0.719
9B	4	9 B&S	4.125	0.500 × 13 RH	0.750	0.641	0.531
10L	1	1.562	5.500	1.490 × 18 RH	1.250	1.063	0.875
10P	1	1.500	4.750	1.495 × 20 RH	1.250	1.063	0.875
16C	1	1.889	4.516	1.875 × 1.75 mm RH ^b	1.625	1.406	1.141
20W	1	0.787	2.719	0.775 × 6-1 cm	0.563	0.484	0.391
22J	1	2.562	4.000	2.550 × 18 RH	2.250	1.938	1.563
32S	1	0.703	2.563	0.690 × 24 RH	0.500	0.438	0.344

Collets for Lathes, Mills, Grinders, and Fixtures (*Continued*)

Collet	Style	Dimensions			Max. Capacity (inches)		
		Bearing Diam., A	Length, B	Thread, C	Round	Hex	Square
35J	1	3.875	5.000	3.861 × 18 RH	3.500	3.000	2.438
42S	1	1.250	3.688	1.236 × 20 RH	1.000	0.875	0.719
50V	8	1.250	4.000	1.125 × 24 RH	0.938	0.813	0.656
52SC	1	0.800	3.688	0.795 × 20 RH	0.625	0.531	0.438
115	1	1.344	3.500	1.307 × 20 LH	1.125	0.969	0.797
215	1	2.030	4.750	1.990 × 18 LH	1.750	1.500	1.219
315	1	3.687	5.500	3.622 × 16 LH	3.250	2.813	2.250
B3	7	0.650	3.031	0.437 × 20 RH	0.500	0.438	0.344
D5	7	0.780	3.031	0.500 × 20 RH	0.625	0.531	0.438
GTM	7	0.625	2.437	0.437 × 20 RH	0.500	0.438	0.344
J&L	9	0.999	4.375	None	0.750	0.641	0.516
JC	8	1.360	4.000	None	1.188	1.000	0.813
LB	10	0.687	2.000	None	0.500	0.438	0.344
RO	11	1.250	2.938	0.875 × 16 RH	1.125	0.969	0.781
RO	12	1.250	4.437	0.875 × 16 RH	0.800	0.688	0.563
RO	12	1.250	4.437	0.875 × 16 RH	1.125	0.969	0.781
RO	11	1.250	2.938	0.875 × 16 RH	0.800	0.688	0.563
R8	7	0.950	4.000	0.437 × 20 RH	0.750	0.641	0.531

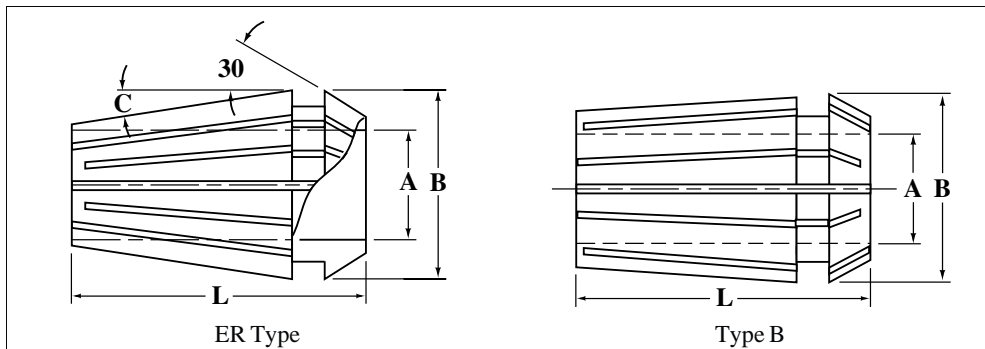
^a Internal stop thread is 1.041 × 24 RH.

^b Internal stop thread is 1.687 × 20 RH.

Dimensions in inches unless otherwise noted. Courtesy of Hardinge Brothers, Inc.

Additional dimensions of the R8 collet are given on page 968.

DIN 6388, Type B, and DIN 6499, ER Type Collets



Collet Standard	Type	Dimensions			
		B (mm)	L (mm)	A (mm)	C
Type B, DIN 6388	16	25.50	40	4.5-16	...
	20	29.80	45	5.5-20	...
	25	35.05	52	5.5-25	...
	32	43.70	60	9.5-32	...
ER Type, DIN 6499	ERA8	8.50	13.5	0.5-5	8°
	ERA11	11.50	18	0.5-7	8°
	ERA16	17	27	0.5-10	8°
	ERA20	21	31	0.5-13	8°
	ERA25	26	35	0.5-16	8°
	ERA32	33	40	2-20	8°
	ERA40	41	46	3-26	8°
		41	39	26-30	8°
ERA50	52	60	5-34	8°	

ARBORS, CHUCKS, AND SPINDLES

Portable Tool Spindles

Circular Saw Arbors.—ANSI Standard B107.4-1982 “Driving and Spindle Ends for Portable Hand, Air, and Air Electric Tools” calls for a round arbor of $\frac{5}{8}$ -inch diameter for nominal saw blade diameters of 6 to 8.5 inches, inclusive, and a $\frac{3}{4}$ -inch diameter round arbor for saw blade diameters of 9 to 12 inches, inclusive.

Spindles for Geared Chucks.—Recommended threaded and tapered spindles for portable tool geared chucks of various sizes are as given in the following table:

Recommended Spindle Sizes

Chuck Sizes, Inch	Recommended Spindles	
	Threaded	Taper ^a
$\frac{3}{16}$ and $\frac{1}{4}$ Light	$\frac{3}{8}$ -24	1
$\frac{1}{4}$ and $\frac{5}{16}$ Medium	$\frac{3}{8}$ -24 or $\frac{1}{2}$ -20	2 Short
$\frac{3}{8}$ Light	$\frac{3}{8}$ -24 or $\frac{1}{2}$ -20	2
$\frac{3}{8}$ Medium	$\frac{1}{2}$ -20 or $\frac{5}{8}$ -16	2
$\frac{1}{2}$ Light	$\frac{1}{2}$ -20 or $\frac{5}{8}$ -16	33
$\frac{1}{2}$ Medium	$\frac{5}{8}$ -16 or $\frac{3}{4}$ -16	6
$\frac{5}{8}$ and $\frac{3}{4}$ Medium	$\frac{5}{8}$ -16 or $\frac{3}{4}$ -16	3

^aJacobs number.

Vertical and Angle Portable Tool Grinder Spindles.—The $\frac{5}{8}$ -11 spindle with a length of $1\frac{1}{8}$ inches shown on page 974 is designed to permit the use of a jam nut with threaded cup wheels. When a revolving guard is used, the length of the spindle is measured from the wheel bearing surface of the guard. For unthreaded wheels with a $\frac{7}{8}$ -inch hole, a safety sleeve nut is recommended. The unthreaded wheel with $\frac{5}{8}$ -inch hole is not recommended because a jam nut alone may not resist the inertia effect when motor power is cut off.

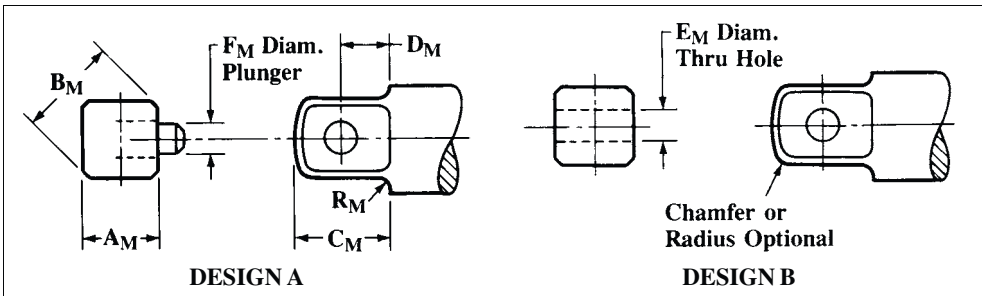
Straight Grinding Wheel Spindles for Portable Tools.—Portable grinders with pneumatic or induction electric motors should be designed for the use of organic bond wheels rated 9500 ft per min (48.25 m/s). Light-duty electric grinders may be designed for vitrified wheels rated 6500 ft per min (33.0 m/s). Recommended maximum sizes of wheels of both types are as given in the following table:

Recommended Maximum Grinding Wheel Sizes for Portable Tools

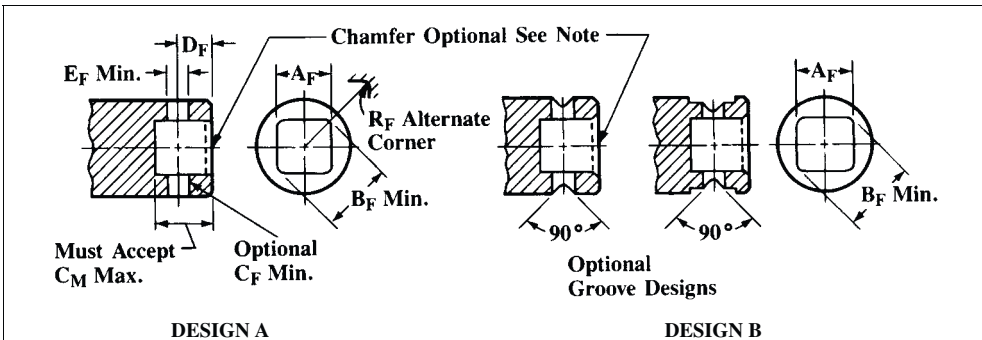
Spindle Size	Maximum Wheel Dimensions			
	9500 fpm		6500 fpm	
	Diameter <i>D</i>	Thickness <i>T</i>	Diameter <i>D</i>	Thickness <i>T</i>
$\frac{3}{8}$ -24 × $1\frac{1}{8}$	$2\frac{1}{2}$	$\frac{1}{2}$	4	$\frac{1}{2}$
$\frac{1}{2}$ -13 × $1\frac{3}{4}$	4	$\frac{3}{4}$	5	$\frac{3}{4}$
$\frac{5}{8}$ -11 × $2\frac{1}{8}$	8	1	8	1
$\frac{5}{8}$ -11 × $3\frac{1}{8}$	6	2
$\frac{5}{8}$ -11 × $3\frac{1}{8}$	8	$1\frac{1}{2}$
$\frac{3}{4}$ -10 × $3\frac{1}{4}$	8	2

Minimum *T* with the first three spindles is about $\frac{1}{8}$ inch to accommodate cutting off wheels. Flanges are assumed to be according to ANSI B7.1 and threads to ANSI B1.1.

American Standard Square Drives for Portable Air and Electric Tools ASA B5.38-1958



Drive Size	Male End										
	Design n.	A _M		B _M	C _M		D _M		E _M	F _M	R _M
		Max.	Min.	Max.	Max.	Min.	Max.	Min.	Min.	Max.	Max.
1/4	A	0.252	0.247	0.330	0.312	0.265	0.165	0.153	...	0.078	0.015
3/8	A	0.377	0.372	0.500	0.438	0.406	0.227	0.215	...	0.156	0.031
1/2	A	0.502	0.497	0.665	0.625	0.531	0.321	0.309	...	0.187	0.031
5/8	A	0.627	0.622	0.834	0.656	0.594	0.321	0.309	...	0.187	0.047
3/4	B	0.752	0.747	1.000	0.938	0.750	0.415	0.403	0.216	...	0.047
1	B	1.002	0.997	1.340	1.125	1.000	0.602	0.590	0.234	...	0.063
1 1/2	B	1.503	1.498	1.968	1.625	1.562	0.653	0.641	0.310	...	0.094



Drive Size	Female End							
	Design	A _F		B _F	D _F		E _F	R _F
		Max.	Min.	Min.	Max.	Min.	Min.	Max.
1/4	A	0.258	0.253	0.335	0.159	0.147	0.090	...
3/8	A	0.383	0.378	0.505	0.221	0.209	0.170	...
1/2	A	0.508	0.503	0.670	0.315	0.303	0.201	...
5/8	A	0.633	0.628	0.839	0.315	0.303	0.201	...
3/4	B	0.758	0.753	1.005	0.409	0.397	0.216	0.047
1	B	1.009	1.004	1.350	0.596	0.584	0.234	0.062
1 1/2	B	1.510	1.505	1.983	0.647	0.635	0.310	0.125

All dimensions in inches.

Incorporating fillet radius (R_M) at shoulder of male tang precludes use of minimum diameter cross-hole in socket (E_F), unless female drive end is chamfered (shown as optional).

If female drive end is not chamfered, socket cross-hole diameter (E_F) is increased to compensate for fillet radius R_M , max.

Minimum clearance across flats male to female is 0.001 inch through 3/4-inch size; 0.002 inch in 1- and 1 1/2-inch sizes. For impact wrenches A_M should be held as close to maximum as practical.

C_F , min. for both designs A and B should be equal to C_M , max.

American Standard Threaded and Tapered Spindles for Portable Air and Electric Tools ASA B5.38-1958

Nom. Dia. and Thd.	Pitch Dia.		R	L	No. ^a	D _M	L _M	E _G	D _G	L _G	Taper per Foot ^b
	Max.	Min.									
3/8-24	0.3479	0.3455	1/16	9/16 ^c	1	0.335-0.333	0.656	0.38400	0.33341	0.65625	0.92508
1/2-20	0.4675	0.4649	1/16	9/16	2S ^d	0.490-0.488	0.750	0.54880	0.48764	0.7500	0.97861
					2	0.490-0.488	0.875	0.55900	0.48764	0.87500	0.97861
5/8-16	0.5844	0.5812	3/32	1 1/16	33	0.563-0.561	1.000	0.62401	0.56051	1.000	0.76194
					6	0.626-0.624	1.000	0.67600	0.62409	1.000	0.62292
3/4-16	0.7094	0.7062	3/32	1 1/16	3	0.748-0.746	1.219	0.81100	0.74610	1.21875	0.63898

^aJacobs taper number.

^bCalculated from E_G, D_G, L_G for the master plug gage.

^cAlso 7/16 inch.

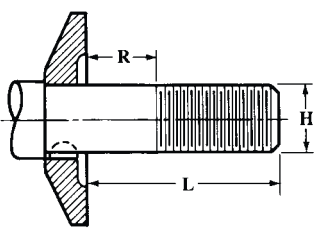
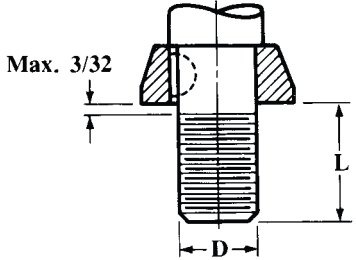
^d2S stands for 2 Short.

All dimensions in inches. Threads are per inch and right-hand. *Tolerances:* On R, plus or minus 1/64 inch; on L, plus 0.000, minus 0.030 inch.

American Standard Abrasion Tool Spindles for Portable Air and Electric Tools ASA B5.38-1958

Sanders and Polishers	
Vertical and Angle Grinders	
<p>With Revolving Cup Guard</p>	<p>Stationary Guard</p>

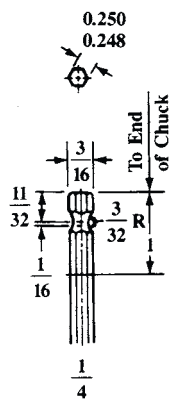
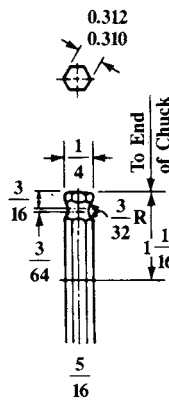
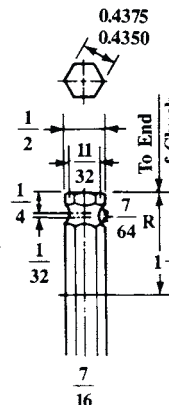
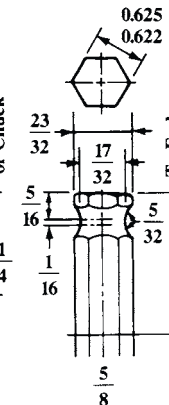
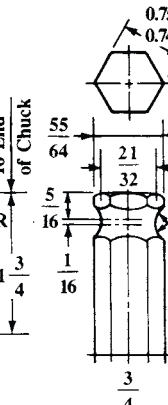
American Standard Abrasion Tool Spindles for Portable Air and Electric Tools ASA B5.38-1958 (Continued)

Straight Wheel Grinders			Cone Wheel Grinders	
				
<i>H</i>	<i>R</i>	<i>L</i>	<i>D</i>	<i>L</i>
3/8-24 UNF-2A	1/4	1 1/8	3/8-24 UNF-2A	9/16
1/2-13 UNC-2A	3/8	1 3/4	1/2-13 UNC-2A	11/16
5/8-11 UNC-2A	1/2	2 1/8	5/8-11 UNC-2A	15/16
5/8-11 UNC-2A	1	3 1/8		
3/4-10 UNC-2A	1	3 1/4		

All dimensions in inches. Threads are right-hand.

American Standard Hexagonal Chucks and Shanks for Portable Air and Electric Tools ASA B5.38-1958

Nominal Hexagon	<i>H</i>		<i>B</i>	<i>L</i> Max.	Nominal Hexagon	<i>H</i>		<i>B</i>	<i>L</i> Max.
	Min.	Max.				Min.	Max.		
1/4	0.253	0.255	3/8	15/16	5/8	0.630	0.632	11/32	1 5/8
5/16	0.314	0.316	13/64	1	3/4	0.755	0.758	11/32	1 7/8
7/16	0.442	0.444	17/64	1 1/8

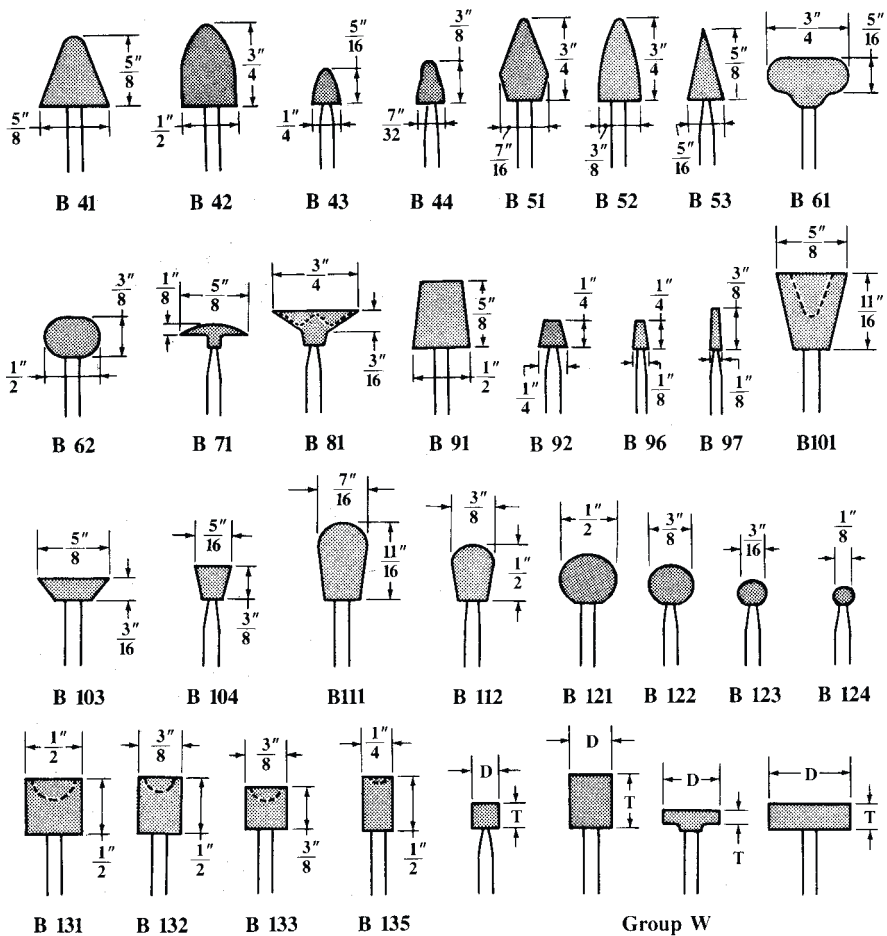
Shanks									
									

All dimensions in inches. Tolerances on *B* is plus or minus 0.005 inch.

Mounted Wheels and Mounted Points

These wheels and points are used in hard-to-get-at places and are available with a vitrified bond. The wheels are available with aluminum oxide or silicon carbide abrasive grains. The aluminum oxide wheels are used to grind tough and tempered die steels and the silicon carbide wheels, cast iron, chilled iron, bronze, and other non-ferrous metals.

The illustrations on pages 976 and 977 give the standard shapes of mounted wheels and points as published by the Grinding Wheel Institute. A note about the maximum operating speed for these wheels is given at the bottom of the first page of illustrations. Metric sizes are given on page 978.



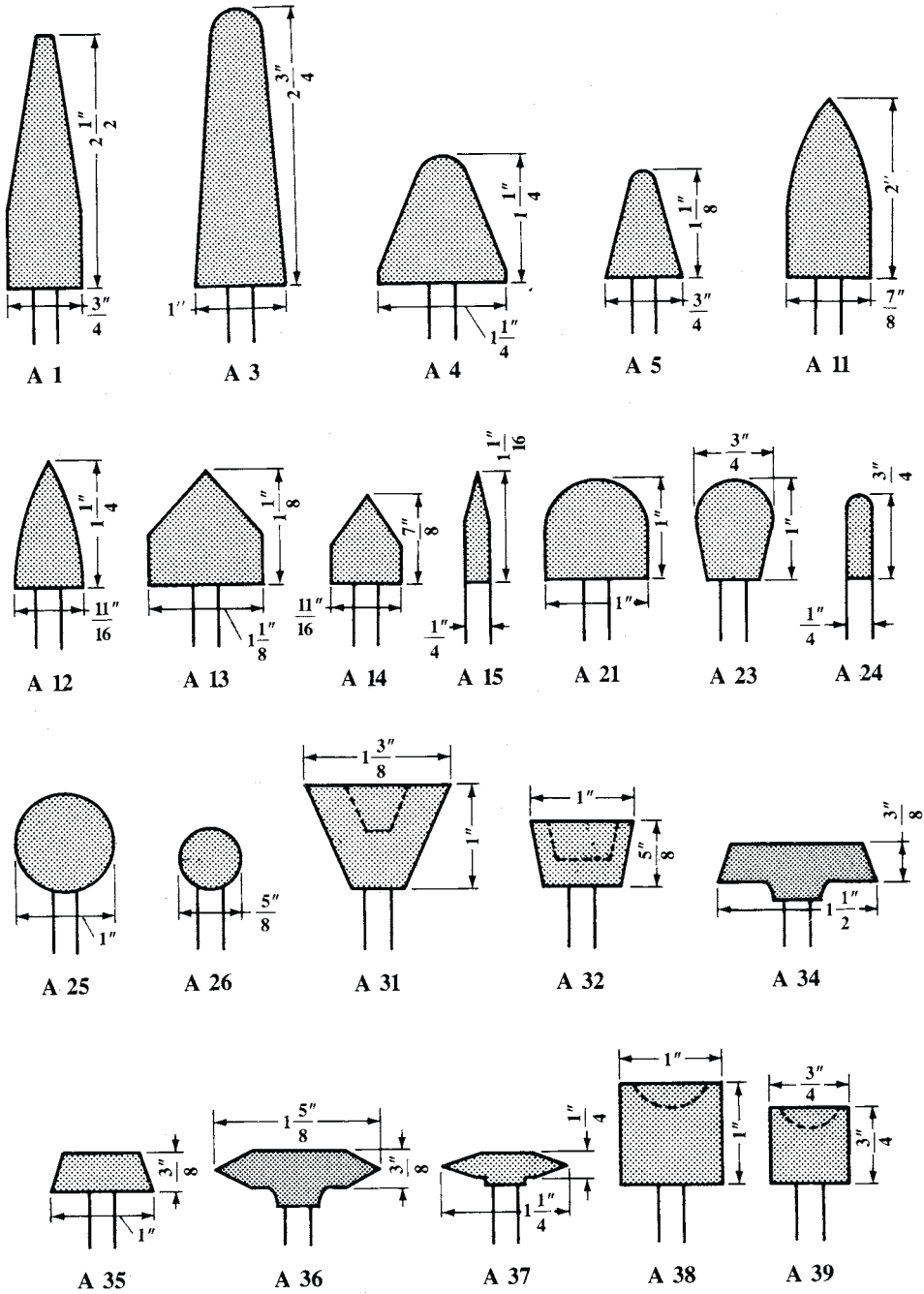


Fig. 1b. Standard Shapes and Sizes of Mounted Wheels and Points ANSI B74.2-1982

Table 1. Shapes and Sizes of Mounted Wheels and Points *ANSI B74.2-1982*

Abrasive Shape No. ^a	Abrasive Shape Size		Abrasive Shape No. ^a	Abrasive Shape Size	
	Diameter mm	Thickness mm		Diameter mm	Thickness mm
A 1	20	65	A 24	6	20
A 3	22	70	A 25	25	...
A 4	30	30	A 26	16	...
A 5	20	28	A 31	35	26
A 11	21	45	A 32	25	20
A 12	18	30	A 34	38	10
A 13	25	25	A 35	25	10
A 14	18	22	A 36	40	10
A 15	6	25	A 37	30	6
A 21	25	25	A 38	25	25
A 23	20	25	A 39	20	20
B 41	16	16	B 97	3	10
B 42	13	20	B 101	16	18
B 43	6	8	B 103	16	5
B 44	5.6	10	B 104	8	10
B 51	11	20	B 111	11	18
B 52	10	20	B 112	10	13
B 53	8	16	B 121	13	...
B 61	20	8	B 122	10	...
B 62	13	10	B 123	5	...
B 71	16	3	B 124	3	...
B 81	20	5	B 131	13	13
B 91	13	16	B 132	10	13
B 92	6	6	B 133	10	10
B 96	3	6	B 135	6	13

Abrasive Shape No. ^a	Abrasive Shape Size				Abrasive Shape No. ^a	Abrasive Shape Size			
	D mm	T mm	D inch	T inch		D mm	T mm	D inch	T inch
W 144	3	6	1/8	1/4	W 196	16	26	3/8	1
W 145	3	10	1/8	3/8	W 197	16	50	3/8	2
W 146	3	13	1/8	1/2	W 200	20	3	3/4	1/8
W 152	5	6	3/16	1/4	W 201	20	6	3/4	1/4
W 153	5	10	3/16	3/8	W 202	20	10	3/4	3/8
W 154	5	13	3/16	1/2	W 203	20	13	3/4	1/2
W 158	6	3	1/4	1/8	W 204	20	20	3/4	3/4
W 160	6	6	1/4	1/4	W 205	20	25	3/4	1
W 162	6	10	1/4	3/8	W 207	20	40	3/4	1 1/2
W 163	6	13	1/4	1/2	W 208	20	50	3/4	2
W 164	6	20	1/4	3/4	W 215	25	3	1	1/8
W 174	10	6	3/8	1/4	W 216	25	6	1	1/4
W 175	10	10	3/8	3/8	W 217	25	10	1	3/8
W 176	10	13	3/8	1/2	W 218	25	13	1	1/2
W 177	10	20	3/8	3/4	W 220	25	25	1	1
W 178	10	25	3/8	1	W 221	25	40	1	1 1/2
W 179	10	30	3/8	1 1/4	W 222	25	50	1	2
W 181	13	1.5	1/2	1/16	W 225	30	6	1 1/4	1/4
W 182	13	3	1/2	1/8	W 226	30	10	1 1/4	3/8
W 183	13	6	1/2	1/4	W 228	30	20	1 1/4	3/4
W 184	13	10	1/2	3/8	W 230	30	30	1 1/4	1 1/4
W 185	13	13	1/2	1/2	W 232	30	50	1 1/4	2
W 186	13	20	1/2	3/4	W 235	40	6	1 1/2	1/4
W 187	13	25	1/2	1	W 236	40	13	1 1/2	1/2
W 188	13	40	1/2	1 1/2	W 237	40	25	1 1/2	1
W 189	13	50	1/2	2	W 238	40	40	1 1/2	1 1/2
W 195	16	20	5/8	3/4	W 242	50	25	2	1

^a See shape diagrams in Figs. 1a and 1b on pages 976 and 977.

BROACHES AND BROACHING

The Broaching Process

The broaching process may be applied in machining holes or other internal surfaces and also to many flat or other external surfaces. Internal broaching is applied in forming either symmetrical or irregular holes, grooves, or slots in machine parts, especially when the size or shape of the opening, or its length in proportion to diameter or width, make other machining processes impracticable. Broaching originally was utilized for such work as cutting keyways, machining round holes into square, hexagonal, or other shapes, forming splined holes, and for a large variety of other internal operations. The development of broaching machines and broaches finally resulted in extensive application of the process to external, flat, and other surfaces. Most external or surface broaching is done on machines of vertical design, but horizontal machines are also used for some classes of work. The broaching process is very rapid, accurate, and it leaves a finish of good quality. It is employed extensively in automotive and other plants where duplicate parts must be produced in large quantities and for dimensions within small tolerances.

Types of Broaches.—A number of typical broaches and the operations for which they are intended are shown by the diagrams, Fig. 1. Broach *A* produces a round-cornered, square hole. Prior to broaching square holes, it is usually the practice to drill a round hole having a diameter d somewhat larger than the width of the square. Hence, the sides are not completely finished, but this unfinished part is not objectionable in most cases. In fact, this clearance space is an advantage during the broaching operation in that it serves as a channel for the broaching lubricant; moreover, the broach has less metal to remove. Broach *B* is for finishing round holes. Broaching is superior to reaming for some classes of work, because the broach will hold its size for a much longer period, thus insuring greater accuracy. Broaches *C* and *D* are for cutting single and double keyways, respectively. Broach *C* is of rectangular section and, when in use, slides through a guiding bushing which is inserted in the hole. Broach *E* is for forming four integral splines in a hub. The broach at *F* is for producing hexagonal holes. Rectangular holes are finished by broach *G*. The teeth on the sides of this broach are inclined in opposite directions, which has the following advantages: The broach is stronger than it would be if the teeth were opposite and parallel to each other; thin work cannot drop between the inclined teeth, as it tends to do when the teeth are at right angles, because at least two teeth are always cutting; the inclination in opposite directions neutralizes the lateral thrust. The teeth on the edges are staggered, the teeth on one side being midway between the teeth on the other edge, as shown by the dotted line. A double cut broach is shown at *H*. This type is for finishing, simultaneously, both sides f of a slot, and for similar work. Broach *I* is the style used for forming the teeth in internal gears. It is practically a series of gear-shaped cutters, the outside diameters of which gradually increase toward the finishing end of the broach. Broach *J* is for round holes but differs from style *B* in that it has a continuous helical cutting edge. Some prefer this form because it gives a shearing cut. Broach *K* is for cutting a series of helical grooves in a hub or bushing. In helical broaching, either the work or the broach is rotated to form the helical grooves as the broach is pulled through.

In addition to the typical broaches shown in Fig. 1, many special designs are now in use for performing more complex operations. Two surfaces on opposite sides of a casting or forging are sometimes machined simultaneously by twin broaches and, in other cases, three or four broaches are drawn through a part at the same time, for finishing as many duplicate holes or surfaces. Notable developments have been made in the design of broaches for external or "surface" broaching.

Burnishing Broach: This is a broach having teeth or projections which are rounded on the top instead of being provided with a cutting edge, as in the ordinary type of broach. The teeth are highly polished, the tool being used for broaching bearings and for operations on

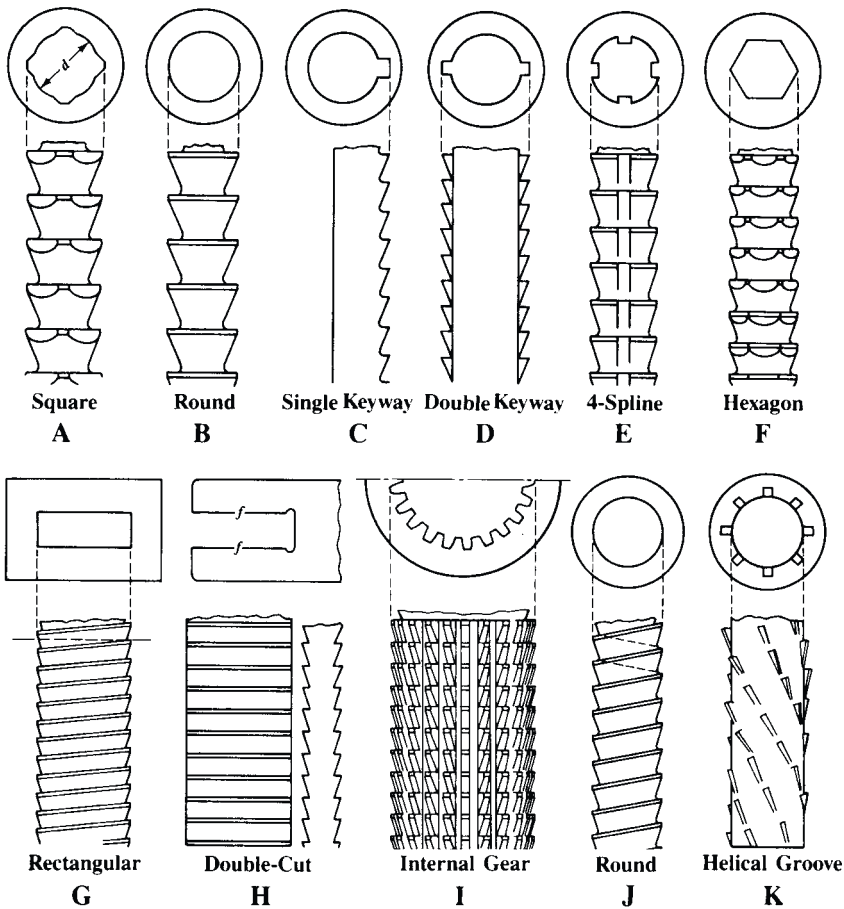


Fig. 1. Types of Broaches

other classes of work where the metal is relatively soft. The tool compresses the metal, thus making the surface hard and smooth. The amount of metal that can be displaced by a smooth-toothed burnishing broach is about the same as that removed by reaming. Such broaches are primarily intended for use on babbitt, white metal, and brass, but may also be satisfactorily used for producing a glazed surface on cast iron. This type of broach is also used when it is only required to accurately size a hole.

Pitch of Broach Teeth.—The pitch of broach teeth depends upon the depth of cut or chip thickness, length of cut, the cutting force required and power of the broaching machine. In the pitch formulas which follow

L = length, in inches (mm), of layer to be removed by broaching

d = depth of cut per tooth as shown by [Table 1](#) (For internal broaches, d = depth of cut as measured on one side of broach or one-half difference in diameters of successive teeth in case of a round broach.)

F = a factor (For brittle types of material, $F = 3$ or 4 for roughing teeth, and 6 for finishing teeth. For ductile types of material, $F = 4$ to 7 for roughing teeth and 8 for finishing teeth.)

b = width in inches (mm), of layer to be removed by broaching

P = pressure required in tons per square inch (MPa), of an area equal to depth of cut times width of cut, in inches (mm) ([Table 2](#))

T = usable capacity, in tons (metric tons), of broaching machine = 70% of maximum tonnage

Table 1. Designing Data for Surface Broaches

Material to be Broached	Depth of Cut per Tooth				Face Angle or Rake, Degrees	Clearance Angle, Degrees	
	Roughing ^a		Finishing			Rough	Finish
	inch	mm	inch	mm			
Steel, High Tensile Strength	0.0015–0.002	0.04–0.05	0.0005	0.013	10–12	1.5–3	0.5–1
Steel, Med. Tensile Strength	0.0025–0.005	0.06–0.13	0.0005	0.013	14–18	1.5–3	0.5–1
Cast Steel	0.0025–0.005	0.06–0.13	0.0005	0.013	10	1.53	0.5
Malleable Iron	0.0025–0.005	0.06–0.13	0.0005	0.013	7	1.5–3	0.5
Cast Iron, Soft	0.006–0.010	0.15–0.25	0.0005	0.013	10–15	1.5–3	0.5
Cast Iron, Hard	0.003–0.005	0.08–0.13	0.0005	0.013	5	1.5–3	0.5
Zinc Die Castings	0.005–0.010	0.13–0.25	0.0010	0.025	12 ^b	5	2
Cast Bronze	0.010–0.025	0.25–0.64	0.0005	0.013	8	0	0
Wrought Aluminum Alloys	0.005–0.010	0.13–0.25	0.0010	0.025	15 ^b	3	1
Cast Aluminum Alloys	0.005–0.010	0.13–0.25	0.0010	0.025	12 ^b	3	1
Magnesium Die Castings	0.010–0.015	0.25–0.38	0.0010	0.025	20 ^b	3	1

^a The lower depth-of-cut values for roughing are recommended when work is not very rigid, the tolerance is small, a good finish is required, or length of cut is comparatively short.

^b In broaching these materials, smooth surfaces for tooth and chip spaces are especially recommended.

Table 2. Broaching Pressure *P* for Use in Pitch Formulas (2a) and (2b)

Material to be Broached	Depth <i>d</i> of cut per tooth, inch (mm)										Side-cutting Broaches			
	0.024 (0.60)		0.01 (0.25)		0.004 (0.10)		0.002 (0.05)		0.001 (0.025)		Pressure, <i>P</i>		Cut, <i>d</i>	
	Pressure, <i>P</i>										Pressure, <i>P</i>		Cut, <i>d</i>	
	Ton/in ²	MPa	Ton/in ²	MPa	Ton/in ²	MPa	Ton/in ²	MPa	Ton/in ²	MPa	Ton/in ²	MPa	inch	mm
Steel, High Tensile Strength	158	2179	185	2551	243	3351	143	1972	0.006	0.15
Steel, Med. Tensile Strength	128	1765	158	2179	115	1586	0.006	0.15
Cast Steel	108	1489	128	1765	100	1379	0.006	0.15
Malleable Iron	115	1586	143	1972	115	1586	0.020	0.51
Cast Iron	50	689
Cast Brass	85	1172
Brass, Hot pressed	70	965
Zinc Die Castings
Cast Bronze	35	483	35	483
Wrought Aluminum	70	965
Cast Aluminum	85	1172
Magnesium Alloy	35	483	35	483

The minimum pitch shown by Formula (1) is based upon the receiving capacity of the chip space. The minimum pitch should not be less than 0.2 inch (5.0 mm) unless a smaller pitch is required for extremely short cuts to provide at least two teeth in contact simultaneously with the part being broached. A reduction below 0.2 inch (5.0 mm) is seldom required in surface broaching but may be necessary in connection with internal broaching.

$$\text{Minimum pitch} = 3\sqrt{LdF} \tag{1}$$

Whether the minimum pitch may be used or not depends upon the power of the available machine. The factor *F* in the formula provides for the increase in volume as the material is broached into chips. If a broach has adjustable inserts for the finishing teeth, the pitch of the finishing teeth may be smaller than the pitch of the roughing teeth because of the smaller depth *d* of the cut. The higher value of *F* for finishing teeth prevents the pitch from becoming too small, so that the spirally curled chips will not be crowded into too small a space.

The pitch of the roughing and finishing teeth should be equal for broaches without separate inserts (notwithstanding the different values of d and F) so that some of the finishing teeth may be ground into roughing teeth after wear makes this necessary.

$$\begin{array}{ccc} \text{US Units} & & \text{Metric Units} \\ \text{Allowable pitch} = \frac{dLbP}{T} \text{ inch} & (2a) & \text{Allowable pitch} = \frac{dLbP}{9810T} \text{ mm} & (2b) \end{array}$$

If the pitch obtained by **Formula (2b)**, or **Formula (2a)** in metric calculations, is larger than the minimum obtained by **Formula (1)**, this larger value should be used because it is based upon the usable power of the machine. As the notation indicates, 70 per cent of the maximum tonnage T is taken as the usable capacity. The 30 per cent reduction is to provide a margin for the increase in broaching load resulting from the gradual dulling of the cutting edges. The procedure in calculating both minimum and allowable pitches will be illustrated by an example.

✦ *Example:* Determine pitch of broach for cast iron if $L = 220$ mm; $d = 0.1$ mm; and $F = 4$.

$$\text{Minimum pitch} = 3\sqrt{220 \times 0.1 \times 4} = 28.14 \text{ mm}$$

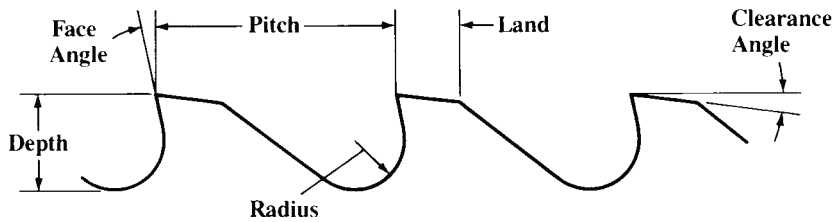
Next, apply **Formula (2b)**. Assume that $b = 75$ mm and $T = 8$ metric ton; for cast iron and depth d of 0.1 mm, $P = 1586$ MPa (**Table 2**). Then,

$$\text{Allowable pitch} = \frac{0.1 \times 220 \times 75 \times 1586}{9810(8)} = 33.34 \text{ mm}$$

This pitch is safely above the minimum. If in this case the usable tonnage of an available machine were, say, 7 metric tons instead of 8 metric tons, the pitch as shown by **Formula (2b)** might be increased to about 38.1 mm, thus reducing the number of teeth cutting simultaneously and, consequently, the load on the machine; or the cut per tooth might be reduced instead of increasing the pitch, especially if only a few teeth are in cutting contact, as might be the case with a short length of cut. If the usable tonnage in the preceding example were, say, 10 metric tons, then a pitch of 26.68 mm would be obtained by **Formula (2b)**; hence the pitch in this case should not be less than the minimum of approximately 28.14 mm obtained from **Formula (1)**.

Depth of Cut per Tooth.—The term “depth of cut” as applied to surface or external broaches means the difference in the heights of successive teeth. This term, as applied to internal broaches for round, hexagonal or other holes, may indicate the total increase in the diameter of successive teeth; however, to avoid confusion, the term as here used means in all cases and regardless of the type of broach, the depth of cut as measured on one side.

In broaching free cutting steel, the Broaching Tool Institute recommends 0.003 to 0.006 inch (0.076–0.15 mm) depth of cut for surface broaching; 0.002 to 0.003 inch (0.05–0.076 mm) for multispline broaching; and 0.0007 to 0.0015 inch (0.018–0.038 mm) for round hole broaching. The accompanying table contains data from a German source and applies specifically to surface broaches. All data relating to depth of cut are intended as a general guide only. While depth of cut is based primarily upon the machinability of the material, some reduction from the depth thus established may be required particularly when the work supporting fixture in surface broaching is not sufficiently rigid to resist the thrust from the broaching operation. In some cases, the pitch and cutting length may be increased to reduce the thrust force. Another possible remedy in surface broaching certain classes of work is to use a side-cutting broach instead of the ordinary depth cutting type. A broach designed for side cutting takes relatively deep narrow cuts which extend nearly to the full depth required. The side cutting section is followed by teeth arranged for depth cutting to obtain the required size and surface finish on the work. In general, small tolerances in surface broaching require a reduced cut per tooth to minimize work deflection resulting from the pressure of the cut. See *Cutting Speed for Broaching* starting on page 1073 for broaching speeds.



Terms Commonly Used in Broach Design

Face Angle or Rake.—The face angle (see diagram) of broach teeth affects the chip flow and varies considerably for different materials. While there are some variations in practice, even for the same material, the angles given in the accompanying table are believed to represent commonly used values. Some broach designers increase the rake angle for finishing teeth in order to improve the finish on the work.

Clearance Angle.—The clearance angle (see illustration) for roughing steel varies from 1.5 to 3 degrees and for finishing steel from 0.5 to 1 degree. Some recommend the same clearance angles for cast iron and others, larger clearance angles varying from 2 to 4 or 5 degrees. Additional data will be found in [Table 1](#).

Land Width.—The width of the land usually is about $0.25 \times$ pitch. It varies, however, from about one-fourth to one-third of the pitch. The land width is selected so as to obtain the proper balance between tooth strength and chip space.

Depth of Broach Teeth.—The tooth depth as established experimentally and on the basis of experience, usually varies from about 0.37 to 0.40 of the pitch. This depth is measured radially from the cutting edge to the bottom of the tooth fillet.

Radius of Tooth Fillet.—The “gullet” or bottom of the chip space between the teeth should have a rounded fillet to strengthen the broach, facilitate curling of the chips, and safeguard against cracking in connection with the hardening operation. One rule is to make the radius equal to one-fourth the pitch. Another is to make it equal 0.4 to 0.6 the tooth depth. A third method preferred by some broach designers is to make the radius equal one-third of the sum obtained by adding together the land width, one-half the tooth depth, and one-fourth of the pitch.

Total Length of Broach.—After the depth of cut per tooth has been determined, the total amount of material to be removed by a broach is divided by this decimal to ascertain the number of cutting teeth required. This number of teeth multiplied by the pitch gives the length of the active portion of the broach. By adding to this dimension the distance over three or four straight teeth, the length of a pilot to be provided at the finishing end of the broach, and the length of a shank which must project through the work and the faceplate of the machine to the draw-head, the overall length of the broach is found. This calculated length is often greater than the stroke of the machine, or greater than is practical for a broach of the diameter required. In such cases, a set of broaches must be used.

Chip Breakers.—The teeth of broaches frequently have rounded chip-breaking grooves located at intervals along the cutting edges. These grooves break up wide curling chips and prevent them from clogging the chip spaces, thus reducing the cutting pressure and strain on the broach. These chip-breaking grooves are on the roughing teeth only. They are staggered and applied to both round and flat or surface broaches. The grooves are formed by a round edged grinding wheel and usually vary in width from about $\frac{1}{32}$ to $\frac{3}{32}$ inch (0.79 to 2.38 mm) depending upon the size of broach. The more ductile the material, the wider the chip breaker grooves should be and the smaller the distance between them. Narrow slotting broaches may have the right- and left-hand corners of alternate teeth beveled to obtain chip-breaking action.

Shear Angle.—The teeth of surface broaches ordinarily are inclined so they are not at right angles to the broaching movement. The object of this inclination is to obtain a shearing cut which results in smoother cutting action and an improvement in surface finish. The shearing cut also tends to eliminate troublesome vibration. Shear angles for surface broaches are not suitable for broaching slots or any profiles that resist the outward movement of the chips. When the teeth are inclined, the fixture should be designed to resist the resulting thrusts unless it is practicable to incline the teeth of right- and left-hand sections in opposite directions to neutralize the thrust. The shear angle usually varies from 10 to 25 degrees.

Types of Broaching Machines.—Broaching machines may be divided into horizontal and vertical designs, and they may be classified further according to the method of operation, as, for example, whether a broach in a vertical machine is pulled up or pulled down in forcing it through the work. Horizontal machines usually pull the broach through the work in internal broaching but short rigid broaches may be pushed through. External surface broaching is also done on some machines of horizontal design, but usually vertical machines are employed for flat or other external broaching. Although parts usually are broached by traversing the broach itself, some machines are designed to hold the broach or broaches stationary during the actual broaching operation. This principle has been applied both to internal and surface broaching.

Vertical Duplex Type: The vertical duplex type of surface broaching machine has two slides or rams which move in opposite directions and operate alternately. While the broach connected to one slide is moving downward on the cutting stroke, the other broach and slide is returning to the starting position, and this returning time is utilized for reloading the fixture on that side; consequently, the broaching operation is practically continuous. Each ram or slide may be equipped to perform a separate operation on the same part when two operations are required.

Pull-up Type: Vertical hydraulically operated machines which pull the broach or broaches up through the work are used for internal broaching of holes of various shapes, for broaching bushings, splined holes, small internal gears, etc. A typical machine of this kind is so designed that all broach handling is done automatically.

Pull-down Type: The various movements in the operating cycle of a hydraulic pull-down type of machine equipped with an automatic broach-handling slide, are the reverse of the pull-up type. The broaches for a pull-down type of machine have shanks on each end, there being an upper one for the broach-handling slide and a lower one for pulling through the work.

Hydraulic Operation: Modern broaching machines, as a general rule, are operated hydraulically rather than by mechanical means. Hydraulic operation is efficient, flexible in the matter of speed adjustments, low in maintenance cost, and the “smooth” action required for fine precision finishing may be obtained. The hydraulic pressures required, which frequently are 800 to 1000 pounds per square inch (5.5 to 6.9 MPa), are obtained from a motor-driven pump forming part of the machine. The cutting speeds of broaching machines frequently are between 20 and 30 feet per minute (6.1 to 9.1 m/min), and the return speeds often are double the cutting speed, or higher, to reduce the idle period.

Ball-Broaching.—Ball-broaching is a method of securing bushings, gears, or other components without the need for keys, pins, or splines. A series of axial grooves, separated by ridges, is formed in the bore of the workpiece by cold plastic deformation of the metal when a tool, having a row of three rotating balls around its periphery, is pressed through the parts. When the bushing is pressed into a broached bore, the ridges displace the softer material of the bushing into the grooves, thus securing the assembly. The balls can be made of high-carbon chromium steel or carbide, depending on the hardness of the component.

Broaching Difficulties.—The accompanying table has been compiled from information supplied by the National Broach and Machine Co. and presents some of the common broaching difficulties, their causes and means of correction.

Causes of Broaching Difficulties

Broaching Difficulty	Possible Causes
Stuck broach	<p>Insufficient machine capacity; dulled teeth; clogged chip gullets; failure of power during cutting stroke.</p> <p>To remove a stuck broach, workpiece and broach are removed from the machine as a unit; never try to back out broach by reversing machine. If broach does not loosen by tapping workpiece lightly and trying to slide it off its starting end, mount workpiece and broach in a lathe and turn down workpiece to the tool surface. Workpiece may be sawed longitudinally into several sections in order to free the broach.</p> <p>Check broach design, perhaps tooth relief (back off) angle is too small or depth of cut per tooth is too great.</p>
Galling and pickup	<p>Lack of homogeneity of material being broached—uneven hardness, porosity; improper or insufficient coolant; poor broach design, mutilated broach; dull broach; improperly sharpened broach; improperly designed or outworn fixtures.</p> <p>Good broach design will do away with possible chip build-up on tooth faces and excessive heating. Grinding of teeth should be accurate so that the correct gullet contour is maintained. Contour should be fair and smooth.</p>
Broach breakage	<p>Overloading; broach dullness; improper sharpening; interrupted cutting stroke; backing up broach with workpiece in fixture; allowing broach to pass entirely through guide hole; ill fitting and/or sharp edged key; crooked holes; untrue locating surface; excessive hardness of workpiece; insufficient clearance angle; sharp corners on pull end of broach.</p> <p>When grinding bevels on pull end of broach use wheel that is not too pointed.</p>
Chatter	<p>Too few teeth in cutting contact simultaneously; excessive hardness of material being broached; loose or poorly constructed tooling; surging of ram due to load variations.</p> <p>Chatter can be alleviated by changing the broaching speed, by using shear cutting teeth instead of right angle teeth, and by changing the coolant and the face and relief angles of the teeth.</p>
Drifting or misalignment of tool during cutting stroke	<p>Lack of proper alignment when broach is sharpened in grinding machine, which may be caused by dirt in the female center of the broach; inadequate support of broach during the cutting stroke, on a horizontal machine especially; body diameter too small; cutting resistance variable around I.D. of hole due to lack of symmetry of surfaces to be cut; variations in hardness around I.D. of hole; too few teeth in cutting contact.</p>
Streaks in broached surface	<p>Lands too wide; presence of forging, casting or annealing scale; metal pickup; presence of grinding burrs and grinding and cleaning abrasives.</p>
Rings in the broached hole	<p>Due to surging resulting from uniform pitch of teeth; presence of sharpening burrs on broach; tooth clearance angle too large; locating face not smooth or square; broach not supported for all cutting teeth passing through the work. The use of differential tooth spacing or shear cutting teeth helps in preventing surging. Sharpening burrs on a broach may be removed with a wood block.</p>

FILES AND BURS

Files

Definitions of File Terms.—The following file terms apply to hand files but not to rotary files and burs.

Axis: Imaginary line extending the entire length of a file equidistant from faces and edges.

Back: The convex side of a file having the same or similar cross-section as a half-round file.

Bastard Cut: A grade of file coarseness between coarse and second cut of American pattern files and rasps.

Blank: A file in any process of manufacture before being cut.

Blunt: A file whose cross-sectional dimensions from point to tang remain unchanged.

Coarse Cut: The coarsest of all American pattern file and rasp cuts.

Coarseness: Term describing the relative number of teeth per unit length, the coarsest having the least number of file teeth per unit length; the smoothest, the most. American pattern files and rasps have four degrees of coarseness: coarse, bastard, second and smooth. Swiss pattern files usually have seven degrees of coarseness: 00, 0, 1, 2, 3, 4, 6 (from coarsest to smoothest). Curved tooth files have three degrees of coarseness: standard, fine and smooth.

Curved Cut: File teeth which are made in curved contour across the file blank.

Cut: Term used to describe file teeth with respect to their coarseness or their character (single, double, rasp, curved, special).

Double Cut: A file tooth arrangement formed by two series of cuts, namely the overcut followed, at an angle, by the upcut.

Edge: Surface joining faces of a file. May have teeth or be smooth.

Face: Widest cutting surface or surfaces that are used for filing.

Heel or Shoulder: That portion of a file that abuts the tang.

Hopped: A term used among file makers to represent a very wide skip or spacing between file teeth.

Length: The distance from the heel to the point.

Overcut: The first series of teeth put on a double-cut file.

Point: The front end of a file; the end opposite the tang.

Rasp Cut: A file tooth arrangement of round-topped teeth, usually not connected, that are formed individually by means of a narrow, punch-like tool.

Re-cut: A worn-out file which has been re-cut and re-hardened after annealing and grinding off the old teeth.

Safe Edge: An edge of a file that is made smooth or uncut, so that it will not injure that portion or surface of the workplace with which it may come in contact during filing.

Second Cut: A grade of file coarseness between bastard and smooth of American pattern files and rasps.

Set: To blunt the sharp edges or corners of file blanks before and after the overcut is made, in order to prevent weakness and breakage of the teeth along such edges or corners when the file is put to use.

Shoulder or Heel: See *Heel or Shoulder*.

Single Cut: A file tooth arrangement where the file teeth are composed of single unbroken rows of parallel teeth formed by a single series of cuts.

Smooth Cut: An American pattern file and rasp cut that is smoother than second cut.

Tang: The narrowed portion of a file which engages the handle.

Upcut: The series of teeth superimposed on the overcut, and at an angle to it, on a double-cut file.

File Characteristics.—Files are classified according to their shape or cross-section and according to the pitch or spacing of their teeth and the nature of the cut.

Cross-section and Outline: The cross-section may be quadrangular, circular, triangular, or some special shape. The outline or contour may be tapered or blunt. In the former, the point is more or less reduced in width and thickness by a gradually narrowing section that extends for one-half to two-thirds of the length. In the latter the cross-section remains uniform from tang to point.

Cut: The character of the teeth is designated as single, double, rasp or curved. The *single cut file* (or *float* as the coarser cuts are sometimes called) has a single series of parallel teeth extending across the face of the file at an angle of from 45 to 85 degrees with the axis of the file. This angle depends upon the form of the file and the nature of the work for which it is intended. The single cut file is customarily used with a light pressure to produce a smooth finish. The *double cut file* has a multiplicity of small pointed teeth inclining toward the point of the file arranged in two series of diagonal rows that cross each other. For general work, the angle of the first series of rows is from 40 to 45 degrees and of the second from 70 to 80 degrees. For *double cut finishing files* the first series has an angle of about 30 degrees and the second, from 80 to 87 degrees. The second, or upcut, is almost always deeper than the first or overcut. Double cut files are usually employed, under heavier pressure, for fast metal removal and where a rougher finish is permissible. The *rasp* is formed by raising a series of individual rounded teeth from the surface of the file blank with a sharp narrow, punch-like cutting tool and is used with a relatively heavy pressure on soft substances for fast removal of material. The curved tooth file has teeth that are in the form of parallel arcs extending across the face of the file, the middle portion of each arc being closest to the point of the file. The teeth are usually single cut and are relatively coarse. They may be formed by steel displacement but are more commonly formed by milling.

With reference to coarseness of cut the terms *coarse*, *bastard*, *second* and *smooth cuts* are used, the coarse or bastard files being used on the heavier classes of work and the second or smooth cut files for the finishing or more exacting work. These degrees of coarseness are only comparable when files of the same length are compared, as the number of teeth per inch of length decreases as the length of the file increases. The number of teeth per inch varies considerably for different sizes and shapes and for files of different makes. The coarseness range for the curved tooth files is given as standard, fine and smooth. In the case of Swiss pattern files, a series of numbers is used to designate coarseness instead of names; Nos. 00, 0, 1, 2, 3, 4 and 6 being the most common with No. 00 the coarsest and No. 6 the finest.

Classes of Files.—There are five main classes of files: mill or saw files; machinists' files; curved tooth files; Swiss pattern files; and rasps. The first two classes are commonly referred to as American pattern files.

Mill or Saw Files: These are used for sharpening mill or circular saws, large crosscut saws; for lathe work; for draw filing; for filing brass and bronze; and for smooth filing generally. The number identifying the following files refers to the illustration in Fig. 1

- 1) *Cantsaw files* have an obtuse isosceles triangular section, a blunt outline, are single cut and are used for sharpening saws having "M"-shaped teeth and teeth of less than 60-degree angle; 2) *Crosscut files* have a narrow triangular section with short side rounded, a blunt outline, are single cut and are used to sharpen crosscut saws. The rounded portion is used to deepen the gullets of saw teeth and the sides are used to sharpen the teeth themselves. ;
- 3) *Double ender files* have a triangular section, are tapered from the middle to both ends, are tangless are single cut and are used reversibly for sharpening saws; 4) The *mill file* itself, is usually single cut, tapered in width, and often has two square cutting edges in addition to the cutting sides. Either or both edges may be rounded, however, for filing the gul-

lets of saw teeth. The *blunt mill file* has a uniform rectangular cross-section from tip to tang; 5) The *triangular saw files or taper saw files* have an equilateral triangular section, are tapered, are single cut and are used for filing saws with 60-degree angle teeth. They come in taper, slim taper, extra slim taper and double extra slim taper thicknesses *Blunt triangular* and *blunt hand saw files* are without taper; and 6) *Web saw files* have a diamond-shaped section, a blunt outline, are single cut and are used for sharpening pulpwood or web saws.

Machinists' Files: These files are used throughout industry where metal must be removed rapidly and finish is of secondary importance. Except for certain exceptions in the round and half-round shapes, all are double cut. 7) *Flat files* have a rectangular section, are tapered in width and thickness, are cut on both sides and edges and are used for general utility work; 8) *Half round files* have a circular segmental section, are tapered in width and thickness, have their flat side double cut, their rounded side mostly double but sometimes single cut, and are used to file rounded holes, concave corners, etc. in general filing work; 9) *Hand files* are similar to flat files but taper in thickness only. One edge is uncut or "safe."; and 10) *Knife files* have a "knife-blade" section, are tapered in width only, are double cut, and are used by tool and die makers on work having acute angles.

Machinist's general purpose files have a rectangular section, are tapered and have single cut teeth divided by angular serrations which produce short cutting edges. These edges help stock removal but still leave a smooth finish and are suitable for use on various materials including aluminum, bronze, cast iron, malleable iron, mild steels and annealed tool steels.

11) *Pillar files* are similar to hand files but are thicker and not as wide; 12) *Round files* have a circular section, are tapered, single cut, and are generally used to file circular openings or curved surfaces; 13) *Square files* have a square section, are tapered, and are used for filing slots, keyways and for general surface filing where a heavier section is preferred; 14) *Three square files* have an equilateral triangular section and are tapered on all sides. They are double cut and have sharp corners as contrasted with taper triangular files which are single cut and have somewhat rounded corners. They are used for filing accurate internal angles, for clearing out square corners, and for filing taps and cutters; and 15) *Warding files* have a rectangular section, and taper in width to a narrow point. They are used for general narrow space filing.

Wood files are made in the same sections as flat and half round files but with coarser teeth especially suited for working on wood.

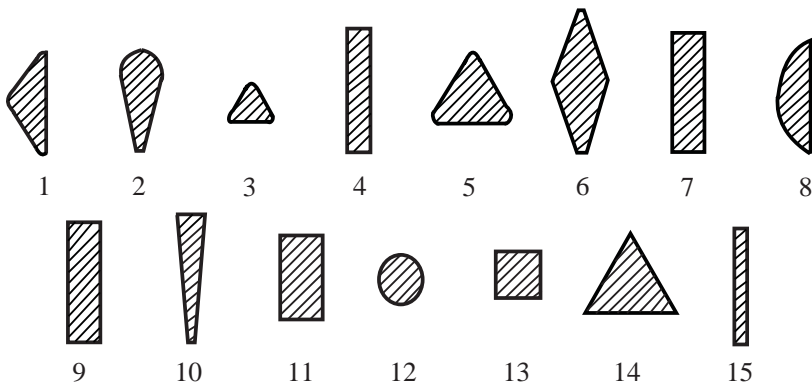


Fig. 1. Styles of Mill or Saw Files

Curved Tooth Files: Regular curved tooth files are made in both rigid and flexible forms. The rigid type has either a tang for a conventional handle or is made plain with a hole at each end for mounting in a special holder. The flexible type is furnished for use in special holders only. The curved tooth files come in standard fine and smooth cuts and in parallel

flat, square, pillar, pillar narrow, half round and shell types. A special curved tooth file is available with teeth divided by long angular serrations. The teeth are cut in an "off center" arc. When moved across the work toward one edge of the file a fast cutting action is provided; when moved toward the other edge, a smoothing action; thus the file is made to serve a dual purpose.

Swiss Pattern Files: These are used by tool and die makers, model makers and delicate instrument parts finishers. They are made to closer tolerances than the conventional American pattern files although with similar cross-sections. The points of the Swiss pattern files are smaller, the tapers are longer and they are available in much finer cuts. They are primarily finishing tools for removing burrs left from previous finishing operations truing up narrow grooves, notches and keyways, cleaning out corners and smoothing small parts. For very fine work, *round* and *square handled needle files*, available in numerous cross-sectional shapes in overall lengths from 4 to 7 $\frac{3}{4}$ inches, are used. Die sinkers use *die sinkers files* and *die sinkers rifflers*. The files, also made in many different cross-sectional shapes, are 3 $\frac{1}{2}$ inches in length and are available in the cut Nos. 0, 1, 2, and 4. The rifflers are from 5 $\frac{1}{2}$ to 6 $\frac{3}{4}$ inches long, have cutting surfaces on either end, and come in numerous cross-sectional shapes in cut Nos. 0, 2, 3, 4 and 6. These rifflers are used by die makers for getting into corners, crevices, holes and contours of intricate dies and molds. Used in the same fashion as die sinkers rifflers, *silversmiths rifflers*, that have a much heavier cross-section, are available in lengths from 6 $\frac{7}{8}$ to 8 inches and in cuts Nos. 0, 1, 2, and 3. *Blunt machine files* in Cut Nos. 00, 0, and 2 for use in ordinary and bench filing machines are available in many different cross-sectional shapes, in lengths from 3 to 8 inches.

Rasps: Rasps are employed for work on relatively soft substances such as wood, leather, and lead where fast removal of material is required. They come in rectangular and half round cross-sections, the latter with and without a sharp edge.

Special Purpose Files: Falling under one of the preceding five classes of files, but modified to meet the requirements of some particular function, are a number of special purpose files. The *long angle lathe file* is used for filing work that is rotating in a lathe. The long tooth angle provides a clean shear, eliminates drag or tear and is self-clearing. This file has safe or uncut edges to protect shoulders of the work which are not to be filed. The *foundry file* has especially sturdy teeth with heavy set edges for the snagging of castings—the removing of fins, sprues, and other projections. The *die casting file* has extra strong teeth on corners and edges as well as sides for working on die castings of magnesium, zinc, or aluminum alloys. A special file for stainless steel is designed to stand up under the abrasive action of stainless steel alloys. *Aluminum rasps* and *files* are designed to eliminate clogging. A special tooth construction is used in one type of aluminum file which breaks up the filings, allows the file to clear itself and overcomes chatter. A *brass file* is designed so that with a little pressure the sharp, high-cut teeth bite deep while with less pressure, their short uncut angle produces a smoothing effect. The *lead float* has coarse, single cut teeth at almost right angles to the file axis. These shear away the metal under ordinary pressure and produce a smoothing effect under light pressure. The *shear tooth file* has a coarse single cut with a long angle for soft metals or alloys, plastics, hard rubber and wood. *Chain saw files* are designed to sharpen all types of chain saw teeth. These files come in round, rectangular, square and diamond-shaped sections. The round and square sectioned files have either double or single cut teeth, the rectangular files have single cut teeth and the diamond-shaped files have double cut teeth.

Effectiveness of Rotary Files and Burs.—There is very little difference in the efficiency of rotary files or burs when used in electric tools and when used in air tools, provided the speeds have been reasonably well selected. Flexible-shaft and other machines used as a source of power for these tools have a limited number of speeds which govern the revolutions per minute at which the tools can be operated.

The carbide bur may be used on hard or soft materials with equally good results. The principle difference in construction of the carbide bur is that its teeth or flutes are provided with a negative rather than a radial rake. Carbide burs are relatively brittle, and must be treated more carefully than ordinary burs. They should be kept cutting freely, in order to prevent too much pressure, which might result in crumbling of the cutting edges.

At the same speeds, both high-speed steel and carbide burs remove approximately the same amount of metal. However, when carbide burs are used at their most efficient speeds, the rate of stock removal may be as much as four times that of ordinary burs. In certain cases, speeds much higher than those shown in the table can be used. It has been demonstrated that a carbide bur will last up to 100 times as long as a high-speed steel bur of corresponding size and shape.

Approximate Speeds of Rotary Files and Burs

Tool Diameter		Medium Cut, High-Speed Steel Bur or File					Carbide Bur	
		Mild Steel	Cast Iron	Bronze	Aluminum	Magnesium	Medium Cut	Fine Cut
inches	mm	Speed, Revolutions per Minute					Any Material	
1/8	3.2	4600	7000	15,000	20,000	30,000	45,000	30,000
1/4	6.4	3450	5250	11,250	15,000	22,500	30,000	20,000
3/8	9.5	2750	4200	9000	12,000	18,000	24,000	16,000
1/2	12.7	2300	3500	7500	10,000	15,000	20,000	13,350
5/8	15.9	2000	3100	6650	8900	13,350	18,000	12,000
3/4	19.1	1900	2900	6200	8300	12,400	16,000	10,650
7/8	22.2	1700	2600	5600	7500	11,250	14,500	9650
1	25.4	1600	2400	5150	6850	10,300	13,000	8650
1 1/8	28.6	1500	2300	4850	6500	9750
1 1/4	31.8	1400	2100	4500	6000	9000

As recommended by the Nicholson File Company.

Steel Wool.—Steel wool is made by shaving thin layers of steel from wire. The wire is pulled, by special machinery built for the purpose, past cutting tools or through cutting dies which shave off chips from the outside. Steel wool consists of long, relatively strong, and resilient steel shavings having sharp edges. This characteristic renders it an excellent abrasive. The fact that the cutting characteristics of steel wool vary with the size of the fiber, which is readily controlled in manufacture, has adapted it to many applications.

Metals other than steel have been made into wool by the same processes as steel, and when so manufactured have the same general characteristics. Thus wool has been made from copper, lead, aluminum, bronze, brass, monel metal, and nickel. The wire from which steel wool is made may be produced by either the Bessemer, or the basic or acid open-hearth processes. It should contain from 0.10 to 0.20 per cent carbon; from 0.50 to 1.00 per cent manganese; from 0.020 to 0.090 per cent sulphur; from 0.050 to 0.120 per cent phosphorus; and from 0.001 to 0.010 per cent silicon. When drawn on a standard tensile-strength testing machine, a sample of the steel should show an ultimate strength of not less than 120,000 pounds per square inch (828 MPa).

Steel Wool Grades

Description	Grade	Fiber Thickness		Description	Grade	Fiber Thickness	
		Inch	Millimeter			Inch	Millimeter
Super Fine	0000	0.001	0.025	Medium	1	0.0025	0.06
Extra Fine	000	0.0015	0.035	Medium Coarse	2	0.003	0.075
Very Fine	00	0.0018	0.04	Coarse	3	0.0035	0.09
Fine	0	0.002	0.05	Extra Coarse	4	0.004	0.10

KNURLS AND KNURLING

ANSI Standard Knurls and Knurling.—The ANSI/ASME Standard B94.6-1984 covers knurling tools with standardized diametral pitches and their dimensional relations with respect to the work in the production of straight, diagonal, and diamond knurling on cylindrical surfaces having teeth of uniform pitch parallel to the cylinder axis or at a helix angle not exceeding 45 degrees with the work axis.

These knurling tools and the recommendations for their use are equally applicable to general purpose and precision knurling. The advantage of this ANSI Standard system is the provision by which good tracking (the ability of teeth to mesh as the tool penetrates the work blank in successive revolutions) is obtained by tools designed on the basis of diametral pitch instead of TPI (teeth per inch) when used with work blank diameters that are multiples of 1/64 inch for 64 and 128 diametral pitch or 1/32 inch for 96 and 160 diametral pitch. The use of knurls and work blank diameters which will permit good tracking should improve the uniformity and appearance of knurling, eliminate the costly trial and error methods, reduce the failure of knurling tools and production of defective work, and decrease the number of tools required. Preferred sizes for cylindrical knurls are given in Table 1 and detailed specifications appear in Table 2.

**Table 1. ANSI Standard Preferred Sizes for Cylindrical Type Knurls
ANSI/ASME B94.6-1984 (R2009)**

Nominal Outside Diameter D_{nt}	Width of Face F	Diameter of Hole A	Standard Diametral Pitches, P			
			64	96	128	160
			Number of Teeth, N_p , for Standard Pitches			
1/2	3/16	3/16	32	48	64	80
5/8	1/4	1/4	40	60	80	100
3/4	3/8	1/4	48	72	96	120
7/8	3/8	1/4	56	84	112	140
Additional Sizes for Bench and Engine Lathe Tool Holders						
5/8	5/16	7/32	40	60	80	100
3/4	5/8	1/4	48	72	96	120
1	3/8	5/16	64	96	128	160

The 96 diametral pitch knurl should be given preference in the interest of tool simplification. Dimensions D_{nt} , F , and A are in inches.

Table 2. ANSI Standard Specifications for Cylindrical Knurls with Straight or Diagonal Teeth ANSI/ASME B94.6-1984 (R2009)

Diametral Pitch P	Nominal Diameter, D_{nt}					Tracking Correction Factor Q	Tooth Depth, h , + 0.0015, - 0.0000		Radius at Root R
	1/2	5/8	3/4	7/8	1		Straight	Diagonal	
	Major Diameter of Knurl, D_{on} +0.0000, -0.0015								
64	0.4932	0.6165	0.7398	0.8631	0.9864	0.0006676	0.024	0.021	0.0070 0.0050 0.0060 0.0040 0.0045 0.0030 0.0040 0.0025
96	0.4960	0.6200	0.7440	0.8680	0.9920	0.0002618	0.016	0.014	
128	0.4972	0.6215	0.7458	0.8701	0.9944	0.0001374	0.012	0.010	
160	0.4976	0.6220	0.7464	0.8708	0.9952	0.00009425	0.009	0.008	

All dimensions except diametral pitch are in inches.

Approximate angle of space between sides of adjacent teeth for both straight and diagonal teeth is 80 degrees. The permissible eccentricity of teeth for all knurls is 0.002 inch maximum (total indicator reading).

Number of teeth in a knurl equals diametral pitch multiplied by nominal diameter.

Diagonal teeth have 30-degree helix angle, ψ .

The term *Diametral Pitch* applies to the quotient obtained by dividing the total number of teeth in the circumference of the work by the basic blank diameter; in the case of the knurling tool it would be the total number of teeth in the circumference divided by the *nominal* diameter. In the Standard the diametral pitch and number of teeth are always measured in a transverse plane which is perpendicular to the axis of rotation for diagonal as well as straight knurls and knurling.

Cylindrical Knurling Tools.—The cylindrical type of knurling tool comprises a tool holder and one or more knurls. The knurl has a centrally located mounting hole and is provided with straight or diagonal teeth on its periphery. The knurl is used to reproduce this tooth pattern on the work blank as the knurl and work blank rotate together.

**Formulas for Cylindrical Knurls*

$$P = \text{diametral pitch of knurl} = N_t \div D_{nt} \quad (1)$$

$$D_{nt} = \text{nominal diameter of knurl} = N_t \div P \quad (2)$$

$$N_t = \text{no. of teeth on knurl} = P \times D_{nt} \quad (3)$$

$$*P_{nt} = \text{circular pitch on nominal diameter} = \pi \div P \quad (4)$$

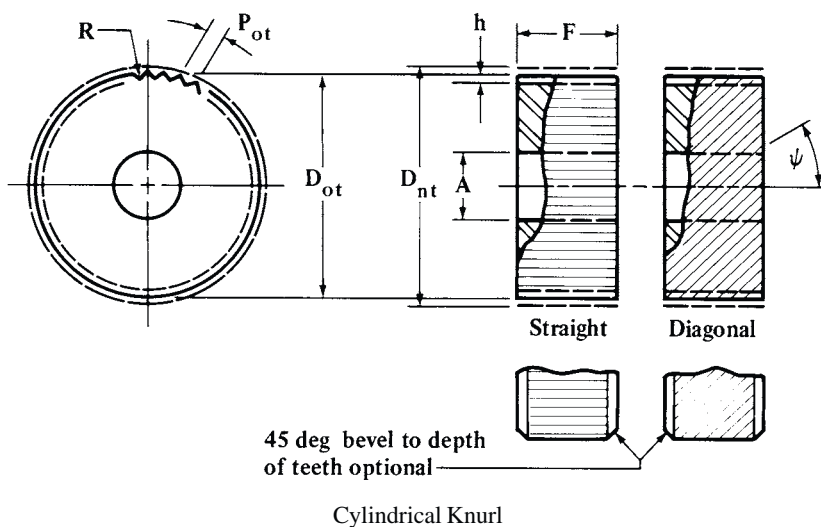
$$*P_{ot} = \text{circular pitch on major diameter} = \pi D_{ot} \div N_t \quad (5)$$

$$D_{ot} = \text{major diameter of knurl} = D_{nt} - (N_t Q \div \pi) \quad (6)$$

$$Q = P_{nt} - P_{ot} = \text{tracking correction factor in Formula} \quad (7)$$

Tracking Correction Factor Q : Use of the preferred pitches for cylindrical knurls, [Table 2](#), results in good tracking on all fractional work-blank diameters which are multiples of $\frac{1}{64}$ inch for 64 and 128 diametral pitch, and $\frac{1}{32}$ inch for 96 and 160 diametral pitch; an indication of good tracking is evenness of marking on the work surface during the first revolution of the work.

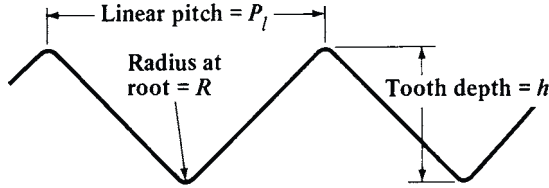
The many variables involved in knurling practice require that an empirical correction method be used to determine what actual circular pitch is needed at the major diameter of the knurl to produce good tracking and the required circular pitch on the workpiece. The empirical tracking correction factor, Q , in [Table 2](#) is used in the calculation of the major diameter of the knurl, Formula (6).



* *Note:* For diagonal knurls, P_{nt} and P_{ot} are the transverse circular pitches which are measured in the plane perpendicular to the axis of rotation.

Flat Knurling Tools.—The flat type of tool is a knurling die, commonly used in reciprocating types of rolling machines. Dies may be made with either single or duplex faces having either straight or diagonal teeth. No preferred sizes are established for flat dies.

Flat Knurling Die with Straight Teeth:



R = radius at root

$P = \text{diametral pitch} = N_w \div D_w$ (8)

$D_w = \text{work blank (pitch) diameter} = N_w \div P$ (9)

$N_w = \text{number of teeth on work} = P \times D_w$ (10)

h = tooth depth

Q = tracking correction factor (see Table 2)

P_l = linear pitch on die

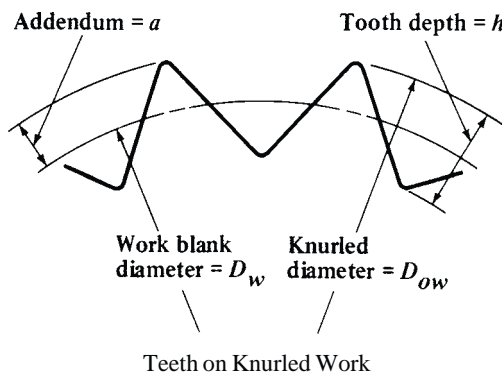
= circular pitch on work pitch diameter = $P - Q$ (11)

Table 3. ANSI Standard Specifications for Flat Knurling Dies
ANSI/ASME B94.6-1984 (R2009)

Diametral Pitch, P	Linear Pitch, ^a P_l	Tooth Depth, h		Radius at Root, R	Diametral Pitch, P	Linear Pitch, ^a P_l	Tooth Depth, h		Radius at Root, R
		Straight	Diagonal				Straight	Diagonal	
64	0.0484	0.024	0.021	0.0070 0.0050	128	0.0244	0.012	0.010	0.0045 0.0030
96	0.0325	0.016	0.014	0.0060 0.0040	160	0.0195	0.009	0.008	0.0040 0.0025

^a The linear pitches are theoretical. The exact linear pitch produced by a flat knurling die may vary slightly from those shown depending upon the rolling condition and the material being rolled.

All dimensions except diametral pitch are in inches.



Formulas Applicable to Knurled Work.—The following formulas are applicable to knurled work with straight, diagonal, and diamond knurling.

Formulas for Straight or Diagonal Knurling with Straight or Diagonal Tooth Cylindrical Knurling Tools Set with Knurl Axis Parallel with Work Axis:

$$P = \text{diametral pitch} = N_w \div D_w \tag{12}$$

$$D_w = \text{work blank diameter} = N_w \div P \tag{13}$$

$$N_w = \text{no. of teeth on work} = P \times D_w \tag{14}$$

$$a = \text{“addendum” of tooth on work} = (D_{ow} - D_w) \div 2 \tag{15}$$

h = tooth depth (see **Table 2**)

$$D_{ow} = \text{knurled diameter (outside diameter after knurling)} = D_w + 2a \tag{16}$$

Formulas for Diagonal and Diamond Knurling with Straight Tooth Knurling Tools Set at an Angle to the Work Axis:

If, ψ = angle between tool axis and work axis

P = diametral pitch on tool

P_ψ = diametral pitch produced on work blank (as measured in the transverse plane) by setting tool axis at an angle ψ with respect to work blank axis

D_w = diameter of work blank; and

N_w = number of teeth produced on work blank (as measured in the transverse plane)

then, $P_\psi = P \cos \psi$ (17)

and, $N = D_w P \cos \psi$ (18)

For example, if 30 degree diagonal knurling were to be produced on 1-inch diameter stock with a 160 pitch straight knurl:

$$N_w = D_w P \cos 30^\circ = 1.000 \times 160 \times 0.86603 = 138.56 \text{ teeth}$$

Good tracking is theoretically possible by changing the helix angle as follows to correspond to a whole number of teeth (138):

$$\cos \psi = N_w \div D_w P = 138 \div (1 \times 160) = 0.8625$$

$$\psi = 30\frac{1}{2} \text{ degrees, approximately}$$

Whenever it is more practical to machine the stock, good tracking can be obtained by reducing the work blank diameter as follows to correspond to a whole number of teeth (138):

$$D_w = \frac{N_w}{P \cos \psi} = \frac{138}{160 \times 0.866} = 0.996 \text{ inch}$$

**Table 4. ANSI Standard Recommended Tolerances on Knurled Diameters
ANSI/ASME B94.6-1984 (R2009)**

Tolerance Class	Diametral Pitch							
	64	96	128	160	64	96	128	160
	Tolerance on Knurled Outside Diameter				Tolerance on Work-Blank Diameter Before Knurling			
I	+ 0.005 - 0.012	+ 0.004 - 0.010	+ 0.003 - 0.008	+ 0.002 - 0.006	± 0.0015	± 0.0010	± 0.0007	± 0.0005
II	+ 0.000 - 0.010	+ 0.000 - 0.009	+ 0.000 - 0.008	+ 0.000 - 0.006	± 0.0015	± 0.0010	± 0.0007	± 0.0005
III	+ 0.000 - 0.006	+ 0.000 - 0.005	+ 0.000 - 0.004	+ 0.000 - 0.003	+ 0.000 - 0.0015	+ 0.0000 - 0.0010	+ 0.000 - 0.0007	+ 0.0000 - 0.0005

Recommended Tolerances on Knurled Outside Diameters.—The recommended applications of the tolerance classes shown in Table 4 are as follows:

Class I: Tolerances in this classification may be applied to straight, diagonal and raised diamond knurling where the knurled outside diameter of the work need not be held to close dimensional tolerances. Such applications include knurling for decorative effect, grip on thumb screws, and inserts for moldings and castings.

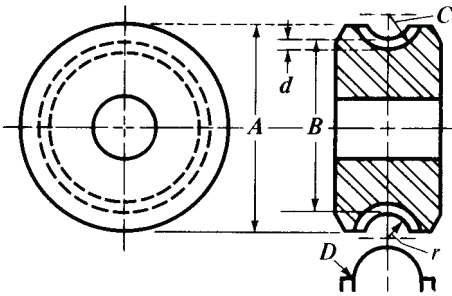
Class II: Tolerances in this classification may be applied to straight knurling only and are recommended for applications requiring closer dimensional control of the knurled outside diameter than provided for by Class I tolerances.

Class III: Tolerances in this classification may be applied to straight knurling only and are recommended for applications requiring closest possible dimensional control of the knurled outside diameter. Such applications include knurling for close fits.

Note: The width of the knurling should not exceed the diameter of the blank, and knurling wider than the knurling tool cannot be produced unless the knurl starts at the end of the work.

Marking on Knurls and Dies.—Each knurl and die should be marked as follows: *a.* when straight to indicate its diametral pitch; *b.* when diagonal, to indicate its diametral pitch, helix angle, and hand of angle.

Concave Knurls.—The radius of a concave knurl should not be the same as the radius of the piece to be knurled. If the knurl and the work are of the same radius, the material compressed by the knurl will be forced down on the shoulder *D* and spoil the appearance of the work. A design of concave knurl is shown in the accompanying illustration, and all the important dimensions are designated by letters. To find these dimensions, the pitch of the knurl required must be known, and also, approximately, the throat diameter *B*. This diameter must suit the knurl holder used, and be such that the circumference contains an even number of teeth with the required pitch. When these dimensions have been decided upon, all the other unknown factors can be found by the following formulas: Let *R* = radius of piece to be knurled; *r* = radius of concave part of knurl; *C* = radius of cutter or hob for cutting the teeth in the knurl; *B* = diameter over concave part of knurl (throat diameter); *A* = outside diameter of knurl; *d* = depth of tooth in knurl; *P* = pitch of knurl (number of teeth per inch circumference); *p* = circular pitch of knurl; then $r = R + \frac{1}{2}d$; $C = r + d$; $A = B + 2r - (3d + 0.010 \text{ inch})$; and $d = 0.5 \times p \times \cot \alpha/2$, where α is the included angle of the teeth.



As the depth of the tooth is usually very slight, the throat diameter *B* will be accurate enough for all practical purposes for calculating the pitch, and it is not necessary to take into consideration the pitch circle. For example, assume that the pitch of a knurl is 32, that the throat diameter *B* is 0.5561 inch, that the radius *R* of the piece to be knurled is $\frac{1}{16}$ inch, and that the angle of the teeth is 90 degrees; find the dimensions of the knurl. Using the notation given:

$$p = \frac{1}{P} = \frac{1}{32} = 0.03125 \text{ inch} \quad d = 0.5 \times 0.03125 \times \cot 45^\circ = 0.0156 \text{ inch}$$

$$r = \frac{1}{16} + \frac{0.0156}{2} = 0.0703 \text{ inch} \quad C = 0.0703 + 0.0156 = 0.0859 \text{ inch}$$

$$A = 0.5561 + 0.1406 - (0.0468 + 0.010) = 0.6399 \text{ inch}$$

TOOL WEAR AND SHARPENING

Metal cutting tools wear constantly when they are being used. A normal amount of wear should not be a cause for concern until the size of the worn region has reached the point where the tool should be replaced. Normal wear cannot be avoided and should be differentiated from abnormal tool breakage or excessively fast wear. Tool breakage and an excessive rate of wear indicate that the tool is not operating correctly and steps should be taken to correct this situation.

There are several basic mechanisms that cause tool wear. It is generally understood that tools wear as a result of abrasion which is caused by hard particles of work material plowing over the surface of the tool. Wear is also caused by diffusion or alloying between the work material and the tool material. In regions where the conditions of contact are favorable, the work material reacts with the tool material causing an attrition of the tool material. The rate of this attrition is dependent upon the temperature in the region of contact and the reactivity of the tool and the work materials with each other. Diffusion or alloying also occurs where particles of the work material are welded to the surface of the tool. These welded deposits are often quite visible in the form of a built-up edge, as particles or a layer of work material inside a crater or as small mounds attached to the face of the tool. The diffusion or alloying occurring between these deposits and the tool weakens the tool material below the weld. Frequently these deposits are again rejoined to the chip by welding or they are simply broken away by the force of collision with the passing chip. When this happens, a small amount of the tool material may remain attached to the deposit and be plucked from the surface of the tool, to be carried away with the chip. This mechanism can cause chips to be broken from the cutting edge and the formation of small craters on the tool face called pull-outs. It can also contribute to the enlargement of the larger crater that sometimes forms behind the cutting edge. Among the other mechanisms that can cause tool wear are severe thermal gradients and thermal shocks, which cause cracks to form near the cutting edge, ultimately leading to tool failure. This condition can be caused by improper tool grinding procedures, heavy interrupted cuts, or by the improper application of cutting fluids when machining at high cutting speeds. Chemical reactions between the active constituents in some cutting fluids sometimes accelerate the rate of tool wear. Oxidation of the heated metal near the cutting edge also contributes to tool wear, particularly when fast cutting speeds and high cutting temperatures are encountered. Breakage of the cutting edge caused by overloading, heavy shock loads, or improper tool design is not normal wear and should be corrected.

The wear mechanisms described bring about visible manifestations of wear on the tool which should be understood so that the proper corrective measures can be taken, when required. These visible signs of wear are described in the following paragraphs and the corrective measures that might be required are given in the accompanying Tool Trouble-Shooting Check List. The best procedure when trouble shooting is to try to correct only one condition at a time. When a correction has been made it should be checked. After one condition has been corrected, work can then start to correct the next condition.

Flank Wear.—Tool wear occurring on the flank of the tool below the cutting edge is called flank wear. Flank wear always takes place and cannot be avoided. It should not give rise to concern unless the rate of flank wear is too fast or the flank wear land becomes too large in size. The size of the flank wear can be measured as the distance between the top of the cutting edge and the bottom of the flank wear land. In practice, a visual estimate is usually made instead of a precise measurement, although in many instances flank wear is ignored and the tool wear is “measured” by the loss of size on the part. The best measure of tool wear, however, is flank wear. When it becomes too large, the rubbing action of the wear land against the workpiece increases and the cutting edge must be replaced. Because conditions vary, it is not possible to give an exact amount of flank wear at which the tool should be replaced. Although there are many exceptions, as a rough estimate, high-speed

steel tools should be replaced when the width of the flank wear land reaches 0.005 to 0.010 inch (0.13–0.25 mm) for finish turning and 0.030 to 0.060 inch (0.76–1.52 mm) for rough turning; and for cemented carbides 0.005 to 0.010 inch (0.13–0.25 mm) for finish turning and 0.020 to 0.040 inch (0.51–1.02 mm) for rough turning.

Under ideal conditions which, surprisingly, occur quite frequently, the width of the flank wear land will be very uniform along its entire length. When the depth of cut is uneven, such as when turning out-of-round stock, the bottom edge of the wear land may become somewhat slanted, the wear land being wider toward the nose. A jagged-appearing wear land usually is evidence of chipping at the cutting edge. Sometimes, only one or two sharp depressions of the lower edge of the wear land will appear, to indicate that the cutting edge has chipped above these depressions. A deep notch will sometimes occur at the “depth of cut line,” or that part of the cutting opposite the original surface of the work. This can be caused by a hard surface scale on the work, by a work-hardened surface layer on the work, or when machining high-temperature alloys. Often the size of the wear land is enlarged at the nose of the tool. This can be a sign of crater breakthrough near the nose or of chipping in this region. Under certain conditions, when machining with carbides, it can be an indication of deformation of the cutting edge in the region of the nose.

When a sharp tool is first used, the initial amount of flank wear is quite large in relation to the subsequent total amount. Under normal operating conditions, the width of the flank wear land will increase at a uniform rate until it reaches a critical size after which the cutting edge breaks down completely. This is called catastrophic failure and the cutting edge should be replaced before this occurs. When cutting at slow speeds with high-speed steel tools, there may be long periods when no increase in the flank wear can be observed. For a given work material and tool material, the rate of flank wear is primarily dependent on the cutting speed and then the feed rate.

Cratering.—A deep crater will sometimes form on the face of the tool which is easily recognizable. The crater forms at a short distance behind the side cutting edge leaving a small shelf between the cutting edge and the edge of the crater. This shelf is sometimes covered with the built-up edge and at other times it is uncovered. Often the bottom of the crater is obscured with work material that is welded to the tool in this region. Under normal operating conditions, the crater will gradually enlarge until it breaks through a part of the cutting edge. Usually this occurs on the end cutting edge just behind the nose. When this takes place, the flank wear at the nose increases rapidly and complete tool failure follows shortly. Sometimes cratering cannot be avoided and a slow increase in the size of the crater is considered normal. However, if the rate of crater growth is rapid, leading to a short tool life, corrective measures must be taken.

Cutting Edge Chipping.—Small chips are sometimes broken from the cutting edge which accelerates tool wear but does not necessarily cause immediate tool failure. Chipping can be recognized by the appearance of the cutting edge and the flank wear land. A sharp depression in the lower edge of the wear land is a sign of chipping and if this edge of the wear land has a jagged appearance it indicates that a large amount of chipping has taken place. Often the vacancy or cleft in the cutting edge that results from chipping is filled up with work material that is tightly welded in place. This occurs very rapidly when chipping is caused by a built-up edge on the face of the tool. In this manner the damage to the cutting edge is healed; however, the width of the wear land below the chip is usually increased and the tool life is shortened.

Deformation.—Deformation occurs on carbide cutting tools when taking a very heavy cut using a slow cutting speed and a high feed rate. A large section of the cutting edge then becomes very hot and the heavy cutting pressure compresses the nose of the cutting edge, thereby lowering the face of the tool in the area of the nose. This reduces the relief under the nose, increases the width of the wear land in this region, and shortens the tool life.

Surface Finish.—The finish on the machined surface does not necessarily indicate poor cutting tool performance unless there is a rapid deterioration. A good surface finish is, however, sometimes a requirement. The principal cause of a poor surface finish is the built-up edge which forms along the edge of the cutting tool. The elimination of the built-up edge will always result in an improvement of the surface finish. The most effective way to eliminate the built-up edge is to increase the cutting speed. When the cutting speed is increased beyond a certain critical cutting speed, there will be a rather sudden and large improvement in the surface finish. Cemented carbide tools can operate successfully at higher cutting speeds, where the built-up edge does not occur and where a good surface finish is obtained. Whenever possible, cemented carbide tools should be operated at cutting speeds where a good surface finish will result. There are times when such speeds are not possible. Also, high-speed tools cannot be operated at the speed where the built-up edge does not form. In these conditions the most effective method of obtaining a good surface finish is to employ a cutting fluid that has active sulphur or chlorine additives.

Cutting tool materials that do not alloy readily with the work material are also effective in obtaining an improved surface finish. Straight titanium carbide and diamond are the two principal tool materials that fall into this category.

The presence of feed marks can mar an otherwise good surface finish and attention must be paid to the feed rate and the nose radius of the tool if a good surface finish is desired. Changes in the tool geometry can also be helpful. A small “flat,” or secondary cutting edge, ground on the end cutting edge behind the nose will sometimes provide the desired surface finish. When the tool is in operation, the flank wear should not be allowed to become too large, particularly in the region of the nose where the finished surface is produced.

Sharpening Twist Drills.—Twist drills are cutting tools designed to perform concurrently several functions, such as penetrating directly into solid material, ejecting the removed chips outside the cutting area, maintaining the essentially straight direction of the advance movement and controlling the size of the drilled hole. The geometry needed for these multiple functions is incorporated into the design of the twist drill in such a manner that it can be retained even after repeated sharpening operations. Twist drills are resharpened many times during their service life, with the practically complete restitution of their original operational characteristics. However, in order to assure all the benefits which the design of the twist drill is capable of providing, the surfaces generated in the sharpening process must agree with the original form of the tool's operating surfaces, unless a change of shape is required for use on a different work material.

The principal elements of the tool geometry which are essential for the adequate cutting performance of twist drills are shown in Fig. 1. The generally used values for these dimensions are the following:

Point angle: Commonly 118° , except for high strength steels, 118° to 135° ; aluminum alloys, 90° to 140° ; and magnesium alloys, 70° to 118° .

Helix angle: Commonly 24° to 32° , except for magnesium and copper alloys, 10° to 30° .

Lip relief angle: Commonly 10° to 15° , except for high strength or tough steels, 7° to 12° .

The lower values of these angle ranges are used for drills of larger diameter, the higher values for the smaller diameters. For drills of diameters less than $\frac{1}{4}$ inch (6.35 mm), the lip relief angles are increased beyond the listed maximum values up to 24° . For soft and free machining materials, 12° to 18° except for diameters less than $\frac{1}{4}$ inch (6.35 mm), 20° to 26° .

Relief Grinding of the Tool Flanks.—In sharpening twist drills the tool flanks containing the two cutting edges are ground. Each flank consists of a curved surface which provides the relief needed for the easy penetration and free cutting of the tool edges. In grinding the flanks, Fig. 2, the drill is swung around the axis *A* of an imaginary cone while resting in a support which holds the drill at one-half the point angle *B* with respect to the face of the grinding wheel. Feed *f* for stock removal is in the direction of the drill axis. The

relief angle is usually measured at the periphery of the twist drill and is also specified by that value. It is not a constant but should increase toward the center of the drill.

The relief grinding of the flank surfaces will generate the chisel angle on the web of the twist drill. The value of that angle, typically 55° , which can be measured, for example, with the protractor of an optical projector, is indicative of the correctness of the relief grinding.

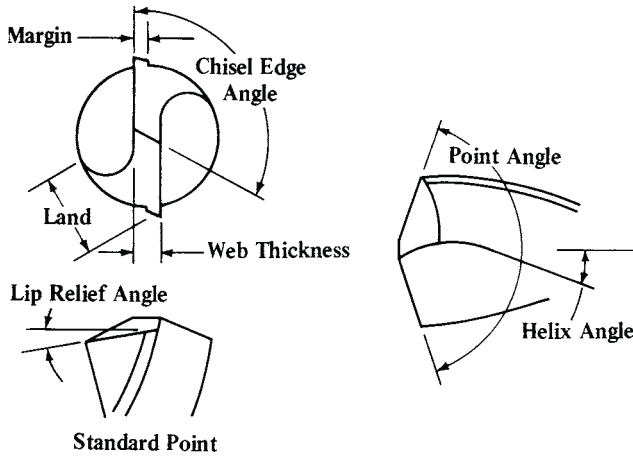


Fig. 1. The principal elements of tool geometry on twist drills.

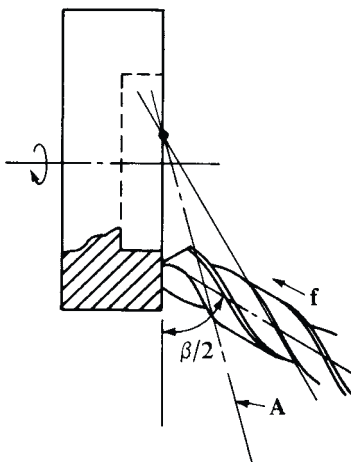


Fig. 2. In grinding the face of the twist drill the tool is swung around the axis *A* of an imaginary cone, while resting in a support tilted by half of the point angle β with respect to the face of the grinding wheel. Feed *f* for stock removal is in the direction of the drill axis.

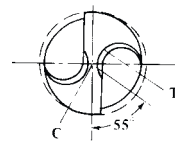


Fig. 3. The chisel edge *C* after thinning the web by grinding off area *T*.

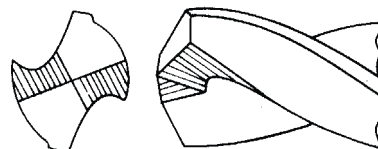


Fig. 4. Split point or "crankshaft" type web thinning.

Drill Point Thinning.—The chisel edge is the least efficient operating surface element of the twist drill because it does not cut, but actually squeezes or extrudes the work material. To improve the inefficient cutting conditions caused by the chisel edge, the point width is often reduced in a drill-point thinning operation, resulting in a condition such as that shown in Fig. 3. Point thinning is particularly desirable on larger size drills and also on those which become shorter in usage, because the thickness of the web increases toward the shaft of the twist drill, thereby adding to the length of the chisel edge. The extent of point thinning is limited by the minimum strength of the web needed to avoid splitting of the drill point under the influence of cutting forces.

Both sharpening operations—the relieved face grinding and the point thinning—should be carried out in special drill grinding machines or with twist drill grinding fixtures mounted on general-purpose tool grinding machines, designed to assure the essential accuracy of the required tool geometry. Off-hand grinding may be used for the important web thinning when a special machine is not available; however, such operation requires skill and experience.

Improperly sharpened twist drills, e.g. those with unequal edge length or asymmetrical point angle, will tend to produce holes with poor diameter and directional control.

For deep holes and also drilling into stainless steel, titanium alloys, high temperature alloys, nickel alloys, very high strength materials and in some cases tool steels, split point grinding, resulting in a “crankshaft” type drill point, is recommended. In this type of pointing, see Fig. 4, the chisel edge is entirely eliminated, extending the positive rake cutting edges to the center of the drill, thereby greatly reducing the required thrust in drilling. Points on modified-point drills must be restored after sharpening to maintain their increased drilling efficiency.

Sharpening Carbide Tools.—Cemented carbide indexable inserts are usually not resharpened but sometimes they require a special grind in order to form a contour on the cutting edge to suit a special purpose. Brazed type carbide cutting tools are resharpened after the cutting edge has become worn. On brazed carbide tools the cutting-edge wear should not be allowed to become excessive before the tool is re-sharpened. One method of determining when brazed carbide tools need resharpening is by periodic inspection of the flank wear and the condition of the face. Another method is to determine the amount of production which is normally obtained before excessive wear has taken place, or to determine the equivalent period of time. One disadvantage of this method is that slight variations in the work material will often cause the wear rate not to be uniform and the number of parts machined before regrinding will not be the same each time. Usually, sharpening should not require removal of more than 0.005 to 0.010 inch (0.13–0.25 mm) of carbide.

General Procedure in Carbide Tool Grinding: The general procedure depends upon the kind of grinding operation required. If the operation is to resharpen a dull tool, a diamond wheel of 100 to 120 grain size is recommended although a finer wheel—up to 150 grain size—is sometimes used to obtain a better finish. If the tool is new or is a “standard” design and changes in shape are necessary, a 100-grit diamond wheel is recommended for roughing and a finer grit diamond wheel can be used for finishing. Some shops prefer to rough grind the carbide with a vitrified silicon carbide wheel, the finish grinding being done with a diamond wheel. A final operation commonly designated as lapping may or may not be employed for obtaining an extra-fine finish.

Wheel Speeds: The speed of silicon carbide wheels usually is about 5000 feet per minute (25.4 m/s). The speeds of diamond wheels generally range from 5000–6000 fpm (25.4–30.5 m/s); yet lower speeds (550–3000 fpm or 2.8–15.2 m/s) can be effective.

Offhand Grinding: In grinding single-point tools (excepting chip breakers) the common practice is to hold the tool by hand, press it against the wheel face and traverse it continuously across the wheel face while the tool is supported on the machine rest or table which is adjusted to the required angle. This is known as “offhand grinding” to distinguish it from the machine grinding of cutters as in regular cutter grinding practice. The selection of wheels adapted to carbide tool grinding is very important.

Silicon Carbide Wheels.—The green colored silicon carbide wheels generally are preferred to the dark gray or gray-black variety, although the latter are sometimes used.

Grain or Grit Sizes: For roughing, a grain size of 60 is very generally used. For finish grinding with silicon carbide wheels, a finer grain size of 100 or 120 is common. A silicon carbide wheel such as C60-I-7V may be used for grinding both the steel shank and carbide tip. However, for under-cutting steel shanks up to the carbide tip, it may be advantageous to use an aluminum oxide wheel suitable for grinding softer, carbon steel.

Grade: According to the standard system of marking, different grades from soft to hard are indicated by letters from A to Z. For carbide tool grinding fairly soft grades such as G, H, I, and J are used. The usual grades for roughing are I or J and for finishing H, I, and J. The grade should be such that a sharp free-cutting wheel will be maintained without excessive grinding pressure. Harder grades than those indicated tend to overheat and crack the carbide.

Structure: The common structure numbers for carbide tool grinding are 7 and 8. The larger cup-wheels (10 to 14 inches or 254–356 mm) may be of the porous type and be designated as 12P. The standard structure numbers range from 1 to 15 with progressively higher numbers indicating less density and more open wheel structure.

Diamond Wheels.—Wheels with diamond-impregnated grinding faces are fast and cool cutting and have a very low rate of wear. They are used extensively both for resharpening and for finish grinding of carbide tools when preliminary roughing is required. Diamond wheels are also adapted for sharpening multi-tooth cutters such as milling cutters, reamers, etc., which are ground in a cutter grinding machine.

Resinoid bonded wheels are commonly used for grinding chip breakers, milling cutters, reamers or other multi-tooth cutters. They are also applicable to precision grinding of carbide dies, gages, and various external, internal and surface grinding operations. Fast, cool cutting action is characteristic of these wheels.

Metal bonded wheels are often used for offhand grinding of single-point tools especially when durability or long life and resistance to grooving of the cutting face, are considered more important than the rate of cutting. *Vitrified bonded* wheels are used both for roughing of chipped or very dull tools and for ordinary resharpening and finishing. They provide rigidity for precision grinding, a porous structure for fast cool cutting, sharp cutting action and durability.

Diamond Wheel Grit Sizes.—For roughing with diamond wheels a grit size of 100 is the most common both for offhand and machine grinding.

Grit sizes of 120 and 150 are frequently used in offhand grinding of single point tools 1) for resharpening; 2) for a combination roughing and finishing wheel; and 3) for chip-breaker grinding.

Grit sizes of 220 or 240 are used for ordinary finish grinding all types of tools (offhand and machine) and also for cylindrical, internal and surface finish grinding. Grits of 320 and 400 are used for “lapping” to obtain very fine finishes, and for hand hones. A grit of 500 is for lapping to a mirror finish on such work as carbide gages and boring or other tools for exceptionally fine finishes.

Diamond Wheel Grades.—Diamond wheels are made in several different grades to better adapt them to different classes of work. The grades vary for different types and shapes of wheels. Standard Norton grades are H, J, and L, for resinoid bonded wheels, grade N for metal bonded wheels and grades J, L, N, and P, for vitrified wheels. Harder and softer grades than standard may at times be used to advantage.

Diamond Concentration.—The relative amount (by carat weight) of diamond in the diamond section of the wheel is known as the “diamond concentration.” Concentrations of 100 (high), 50 (medium) and 25 (low) ordinarily are supplied. A concentration of 50 represents one-half the diamond content of 100 (if the depth of the diamond is the same in each case) and 25 equals one-fourth the content of 100 or one-half the content of 50 concentration.

100 Concentration: Generally interpreted to mean 72 carats of diamond/in³ of abrasive section. (A 75 concentration indicates 54 carats/in³.) Recommended (especially in grit sizes up to about 220) for general machine grinding of carbides, and for grinding cutters and chip breakers. Vitrified and metal bonded wheels usually have 100 concentration.

50 Concentration: In the finer grit sizes of 220, 240, 320, 400, and 500, a 50 concentration is recommended for offhand grinding with resinoid bonded cup-wheels.

25 Concentration: A low concentration of 25 is recommended for offhand grinding with resinoid bonded cup-wheels with grit sizes of 100, 120 and 150.

Depth of Diamond Section: The radial depth of the diamond section usually varies from $\frac{1}{16}$ to $\frac{1}{4}$ inch (1.6 to 6.4 mm). The depth varies somewhat according to the wheel size and type of bond.

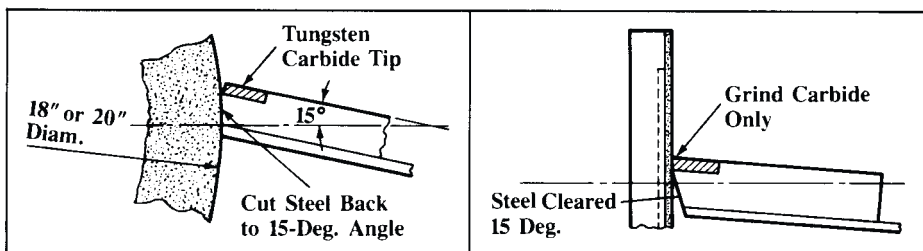
Dry Versus Wet Grinding of Carbide Tools.—In using silicon carbide wheels, grinding should be done either absolutely dry or with enough coolant to flood the wheel and tool. Satisfactory results may be obtained either by the wet or dry method. However, dry grinding is the most prevalent usually because, in wet grinding, operators tend to use an inadequate supply of coolant to obtain better visibility of the grinding operation and avoid getting wet; hence checking or cracking in many cases is more likely to occur in wet grinding than in dry grinding.

Wet Grinding with Silicon Carbide Wheels: One advantage commonly cited in connection with wet grinding is that an ample supply of coolant permits using wheels about one grade harder than in dry grinding thus increasing the wheel life. Plenty of coolant also prevents thermal stresses and the resulting cracks, and there is less tendency for the wheel to load. A dust exhaust system also is unnecessary.

Wet Grinding with Diamond Wheels: In grinding with diamond wheels the general practice is to use a coolant to keep the wheel face clean and promote free cutting. The amount of coolant may vary from a small stream to a coating applied to the wheel face by a felt pad.

Coolants for Carbide Tool Grinding.—In grinding either with silicon carbide or diamond wheels a coolant that is used extensively consists of water plus a small amount either of soluble oil, sal soda, or soda ash to prevent corrosion. One prominent manufacturer recommends for silicon carbide wheels about 1 ounce of soda ash per gallon of water and for diamond wheels kerosene. The use of kerosene is quite general for diamond wheels and usually it is applied to the wheel face by a felt pad. Another coolant recommended for diamond wheels consists of 80 per cent water and 20 per cent soluble oil.

Peripheral Versus Flat Side Grinding.—In grinding single point carbide tools with silicon carbide wheels, the roughing preparatory to finishing with diamond wheels may be done either by using the flat face of a cup-shaped wheel (side grinding) or the periphery of a “straight” or disk-shaped wheel. Even where side grinding is preferred, the periphery of a straight wheel may be used for heavy roughing as in grinding back chipped or broken tools (see left-hand diagram). Reasons for preferring peripheral grinding include faster cutting with less danger of localized heating and checking especially in grinding broad surfaces. The advantages usually claimed for side grinding are that proper rake or relief angles are easier to obtain and the relief or land is ground flat. The diamond wheels used for tool sharpening are designed for side grinding. (See right-hand diagram.)



Lapping Carbide Tools.—Carbide tools may be finished by lapping, especially if an exceptionally fine finish is required on the work as, for example, tools used for precision boring or turning non-ferrous metals. If the finishing is done by using a diamond wheel of very fine grit (such as 240, 320, or 400), the operation is often called “lapping.” A second lapping method is by means of a power-driven lapping disk charged with diamond dust, Norbide powder, or silicon carbide finishing compound. A third method is by using a hand lap or hone usually of 320 or 400 grit. In many plants the finishes obtained with carbide tools meet requirements without a special lapping operation. In all cases any feather edge which may be left on tools should be removed and it is good practice to bevel the edges of roughing tools at 45 degrees to leave a chamfer 0.005 to 0.010 inch wide (0.127–0.254 mm). This is done by hand honing and the object is to prevent crumbling or flaking off at the edges when hard scale or heavy chip pressure is encountered.

Hand Honing: The cutting edge of carbide tools, and tools made from other tool materials, is sometimes hand honed before it is used in order to strengthen the cutting edge. When interrupted cuts or heavy roughing cuts are to be taken, or when the grade of carbide is slightly too hard, hand honing is beneficial because it will prevent chipping, or even possibly, breakage of the cutting edge. Whenever chipping is encountered, hand honing the cutting edge before use will be helpful. It is important, however, to hone the edge lightly and only when necessary. Heavy honing will always cause a reduction in tool life. Normally, removing 0.002 to 0.004 inch (0.051–0.102 mm) from the cutting edge is sufficient. When indexable inserts are used, the use of pre-honed inserts is preferred to hand honing although sometimes an additional amount of honing is required. Hand honing of carbide tools in between cuts is sometimes done to defer grinding or to increase the life of a cutting edge on an indexable insert. If correctly done, so as not to change the relief angle, this procedure is sometimes helpful. If improperly done, it can result in a reduction in tool life.

Chip Breaker Grinding.—For this operation a straight diamond wheel is used on a universal tool and cutter grinder, a small surface grinder, or a special chipbreaker grinder. A resinoid bonded wheel of the grade J or N commonly is used and the tool is held rigidly in an adjustable holder or vise. The width of the diamond wheel usually varies from $\frac{1}{8}$ to $\frac{1}{4}$ inch (3.2–6.4 mm). A vitrified bond may be used for wheels as thick as $\frac{1}{4}$ inch (6.35 mm), and a resinoid bond for relatively narrow wheels.

Summary of Miscellaneous Points.—In grinding a single-point carbide tool, traverse it across the wheel face continuously to avoid localized heating. This traverse movement should be quite rapid in using silicon carbide wheels and comparatively slow with diamond wheels. A hand traversing and feeding movement, whenever practicable, is generally recommended because of greater sensitivity. In grinding, maintain a constant, moderate pressure. Manipulating the tool so as to keep the contact area with the wheel as small as possible will reduce heating and increase the rate of stock removal. Never cool a hot tool by dipping it in a liquid, as this may crack the tip. Wheel rotation should preferably be *against* the cutting edge or from the front face toward the back. If the grinder is driven by a reversing motor, opposite sides of a cup wheel can be used for grinding right- and left-hand tools and with rotation against the cutting edge. If it is necessary to grind the top face of a single-point tool, this should precede the grinding of the side and front relief, and top-face grinding should be minimized to maintain the tip thickness. In machine grinding with a diamond wheel, limit the feed per traverse to 0.001 inch (0.025 mm) for 100 to 120 grit; 0.0005 inch (0.013 mm) for 150 to 240 grit; and 0.0002 inch (0.005 mm) for 320 grit and finer.

TABLE OF CONTENTS
MACHINING OPERATIONS

CUTTING SPEEDS AND FEEDS	ESTIMATING SPEEDS AND MACHINING POWER
1008 Introduction to Speeds and Feeds	1081 Planer Cutting Speeds
1008 Cutting Tool Materials	1081 Cutting Speed and Time
1013 Cutting Speeds	1081 Planing Time
1013 Cutting Conditions	1081 Speeds for Metal-Cutting Saws
1013 Selecting Cutting Conditions	1081 Turning Unusual Material
1014 Tool Troubleshooting	1083 Estimating Machining Power
1015 Cutting Speed Formulas	1083 Power Constants
1017 RPM for Various Cutting Speeds and Diameter	1084 Feed Factors
	1084 Tool Wear Factors
	1087 Metal Removal Rates
	1089 Estimating Drilling Thrust, Torque, and Power
	1089 Work Material Factor
	1090 Chisel Edge Factors
	1090 Feed Factors
	1090 Drill Diameter Factors
SPEED AND FEED TABLES	MICROMACHINING
1021 How to Use the Tables	1092 Introduction
1021 Principal Speed and Feed Tables	1092 Machine Tool Requirements
1025 Speed and Feed Tables for Turning	1093 Microcutting Tools
1026 Plain Carbon and Alloy Steels	1093 Tool Stiffness
1030 Tool Steels	1094 Tool Sharpness
1031 Stainless Steels	1096 Tool Materials
1032 Ferrous Cast Metals	1097 Tool Offset and Positioning
1034 Speed and Tool Life Adjustments	1100 Tool Damage
1036 Copper Alloys	1102 Tool Life
1037 Titanium and Titanium Alloys	1106 Workpiece Materials
1038 Superalloys	1108 Ductile Regime Micromachining
1039 Speed and Feed Tables for Milling	1108 Crystallographic Directions and Planes
1042 Slit Milling	1109 Introduction
1043 Aluminum Alloys	1109 Theory
1044 Plain Carbon and Alloy Steels	1110 Ductile Regime Case Studies
1048 Tool Steels	1111 Cutting Fluids in Micromachining
1049 Stainless Steels	1112 Safety
1051 Ferrous Cast Metals	1112 Benefits
1053 High Speed Steel Cutters	1113 Selection of Cutting Fluid
1055 Speed Adjustment Factors	1113 Drop Size Measurement
1056 Radial Depth of Cut Adjustments	1115 Contact Angle Measurement
1058 Tool Life Adjustments	1118 Dynamics of Microdroplets
1059 Drilling, Reaming, and Threading	1120 Micromist Case Studies
1060 Plain Carbon and Alloy Steels	1122 Microfabrication Processes
1065 Tool Steels	1122 Micromilling
1066 Stainless Steels	1125 Microdrilling
1067 Ferrous Cast Metals	1127 Microturning
1069 Light Metals	1128 Speeds and Feeds
1070 Adjustment Factors for HSS	
1071 Copper Alloys	
1071 Tapping and Threading	
1073 Cutting Speed for Broaching	
1074 Spade Drills	
1074 Spade Drill Geometry	
1076 Spade Drilling	
1078 Feed Rates	
1079 Power Consumption	
1080 Trepanning	

TABLE OF CONTENTS
MACHINING OPERATIONS

MACHINING ECONOMETRICS	
1132	Tool Wear and Tool Life
1132	Equivalent Chip Thickness (ECT)
1133	Tool-life Relationships
1137	The G- and H-curves
1138	Tool-life Envelope
1141	Forces and Tool-life
1143	Surface Finish and Tool-life
1145	Shape of Tool-life Relationships
1146	Minimum Cost
1147	Production Rate
1147	The Cost Function
1148	Global Optimum
1149	Economic Tool-life
1152	Machine Settings and Cost Calculations
1152	Nomenclature
1153	Cutting Formulas
1157	Tooling And Total Cost
1158	Optimized Data
1161	High-speed Machining Econometrics
1162	Chip Geometry in Milling
1164	Chip Thickness
1166	Forces and Tool-life
1167	High-speed Milling
1168	Econometrics Comparison

SCREW MACHINES, BAND SAWS, CUTTING FLUIDS	
1170	Screw Machine Operations
1170	Knurling
1170	Revolutions for Knurling
1170	Cams for Threading
1171	Cutting Speeds and Feeds
1173	Spindle Revolutions
1174	Practical Points on Cam Design
1175	Stock for Screw Machine Products
1177	Band Saw Blade Selection
1178	Tooth Forms
1178	Types of Blades
1179	Band Saw Speed and Feed Rate
1180	Bimetal Band Saw Speeds
1181	Band Saw Blade Break-In
1182	Cutting Fluids for Machining
1183	Types of Fluids
1183	Cutting Oils
1183	Water-Miscible Fluids

SCREW MACHINES, BAND SAWS, CUTTING FLUIDS	
<i>(Continued)</i>	
1184	Selection of Cutting Fluids
1185	Turning, Milling, Drilling and Tapping
1186	Machining
1187	Machining Magnesium
1188	Metalworking Fluids
1188	Classes of Metalworking Fluids
1188	Occupational Exposures
1189	Fluid Selection, Use, and Application
1190	Fluid Maintenance
1191	Respiratory Protection

MACHINING NONFERROUS METALS AND NON-METALLIC MATERIALS	
1192	Machining Nonferrous Metals
1192	Aluminum
1193	Magnesium
1194	Zinc Alloy Die-Castings
1194	Monel and Nickel Alloys
1195	Copper Alloys
1195	Machining Non-metals
1195	Hard Rubber
1195	Formica Machining
1196	Micarta Machining
1196	Ultrasonic Machining

GRINDING FEEDS AND SPEEDS	
1197	Basic Rules
1197	Wheel life T and Grinding Ratio
1198	ECT in Grinding
1199	Optimum Grinding Data
1201	Surface Finish, Ra
1202	Spark-out Time
1203	Grinding Cutting Forces
1204	Grinding Data
1205	Grindability Groups
1205	Side Feed, Roughing and Finishing
1206	Relative Grindability
1207	Grindability Overview
1207	Procedure to Determine Data
1213	Calibration of Recommendations
1215	Optimization

TABLE OF CONTENTS
MACHINING OPERATIONS

GRINDING AND OTHER ABRASIVE PROCESSES	GRINDING AND OTHER ABRASIVE PROCESSES
1216 Grinding Wheels	1253 Wheel Recommendations
1216 Abrasive Materials	1253 Operational Data
1217 Bond Properties	1254 Basic Process Data
1217 Structure	1254 High-Speed
1218 ANSI Markings	1255 Areas and Degrees of Automation
1218 Sequence of Markings	1255 Troubles and Their Correction
1219 ANSI Shapes and Sizes	1259 Centerless Grinding
1219 Selection of Grinding Wheel	1260 Through-feed Method of Grinding
1220 Standard Shapes Ranges	1260 In-feed Method
1227 Grinding Wheel Faces	1260 End-feed Method
1228 Classification of Tool Steels	1260 Automatic Centerless Method
1229 Hardened Tool Steels	1260 Centerless Grinding
1233 Constructional Steels	1261 Surface Grinding
1234 Cubic Boron Nitride	1262 Principal Systems
1235 Dressing and Truing	1264 Grinding Wheel Recommendations
1235 Tools and Methods for Dressing and Truing	1265 Process Data for Surface Grinding
1237 Guidelines for Truing and Dressing	1265 Basic Process Data
1238 Diamond Truing and Crossfeeds	1266 Faults and Possible Causes
1239 Size Selection Guide	1266 Vitrified Grinding Wheels
1239 Minimum Sizes for Single-Point Truing Diamonds	1266 Silicate Bonding Process
1240 Diamond Wheels	1266 Oilstones
1240 Shapes	1268 Offhand Grinding
1241 Core Shapes and Designations	1268 Floor- and Bench-Stand Grinding
1241 Cross-sections and Designations	1268 Portable Grinding
1242 Designations for Location	1268 Swing-Frame Grinding
1243 Composition	1269 Abrasive Belt Grinding
1244 Designation Letters	1269 Application of Abrasive Belts
1245 Selection of Diamond Wheels	1269 Selection Contact Wheels
1245 Abrasive Specification	1269 Abrasive Cutting
1246 Handling and Operation	1272 Cutting-Off Difficulties
1246 Speeds and Feeds	1272 Honing Process
1246 Grinding Wheel Safety	1272 Rate of Stock Removal
1246 Safety in Operating	1273 Formulas for Rotative Speeds
1247 Handling, Storage and Inspection	1274 Eliminating Undesirable Honing Conditions
1247 Machine Conditions	1274 Tolerances
1247 Grinding Wheel Mounting	1274 Laps and Lapping
1248 Safe Operating Speeds	1274 Material for Laps
1249 Portable Grinders	1275 Laps for Flat Surfaces
1251 Cylindrical Grinding	1275 Grading Abrasives
1251 Plain, Universal, and Limited- Purpose Machines	1276 Charging Laps
1251 Traverse or Plunge Grinding	1276 Rotary Diamond Lap
1251 Work Holding on Machines	1276 Grading Diamond Dust
1252 Work-Holding Methods	1277 Cutting Properties
1252 Selection of Grinding Wheels	1277 Cutting Qualities
	1277 Wear of Laps
	1277 Lapping Abrasives

TABLE OF CONTENTS
MACHINING OPERATIONS

<p style="text-align: center;">GRINDING AND OTHER ABRASIVE PROCESSES</p> <p><i>(Continued)</i></p> <p>1277 Effect on Lapping Lubricants 1278 Lapping Pressures 1278 Wet and Dry Lapping 1278 Lapping Tests</p> <hr/> <p style="text-align: center;">CNC NUMERICAL CONTROL PROGRAMMING</p> <hr/> <p>1279 Introduction 1279 CNC Coordinate Geometry 1280 CNC Programming Process 1281 Word Address Format 1281 Program Development 1283 Control System 1284 CNC Program Data 1284 Program Structure 1287 Measurement, (G20, G21) 1287 Absolute and Incremental Programming (G90, G91) 1287 Spindle Function (S-address) 1288 Feed Rate Function (F-address) 1289 Inverse Time Feed Rate 1289 Feed Rate Override 1289 Tool Function (T-address) 1289 Tool Nose Radius Compensation 1290 Rapid Motion (G00) 1290 Linear Interpolation (G01) 1290 Circular Interpolation (G02, G03) 1292 Helical, Other Interpolation 1292 Offsets for Milling 1292 Work Offset (G54 though G59) 1293 Tool Length Offset (G43, G44) 1293 Cutter Radius Offset (G41, G42) 1294 Machining Holes 1295 Fixed Cycles 1300 Contouring 1300 Turning and Boring</p>	<p style="text-align: center;">CNC NUMERICAL CONTROL PROGRAMMING</p> <p><i>(Continued)</i></p> <p>1302 Thread Cutting on CNC Lathes 1302 Depth of Thread Calculations 1303 Infeed Methods 1303 Radial Infeed 1304 Compound Infeed 1304 Threading Operations 1304 Threading Cycle (G32) 1304 Threading Cycle (G76) 1305 Multi-start Threads 1305 Subprograms, Macros and Parametric Programming 1305 Subprograms 1306 Macros and Parametric Programming 1307 Basic Macro Skills 1307 Confirming Macro Capability 1307 Common Features, Functions 1308 Macro Structure 1308 Macro Definition and Call 1308 Variable Definition (G65) 1309 Types of Variables 1309 Variable Declarations and Expressions 1310 Macro Functions 1313 Branching and Looping 1313 Macro Example 1315 Axis Nomenclature 1317 Total Indicator Reading 1319 Machine Tool Accuracy 1322 Degree of Accuracy Expected 1323 Part Tolerances</p>
--	--

CUTTING SPEEDS AND FEEDS

Introduction to Speeds and Feeds

Work Materials.—The large number of work materials that are commonly machined vary greatly in their basic structure and the ease with which they can be machined. Yet it is possible to group together certain materials having similar machining characteristics, for the purpose of recommending the cutting speed at which they can be cut. Most materials that are machined are metals and it has been found that the most important single factor influencing the ease with which a metal can be cut is its microstructure, followed by any cold work that may have been done to the metal, which increases its hardness. Metals that have a similar, but not necessarily the same microstructure, will tend to have similar machining characteristics. Thus, the grouping of the metals in the accompanying tables has been done on the basis of their microstructure.

Except for a few soft and gummy metals, experience indicates that harder metals are more difficult to cut than softer metals. Also, any given metal is more difficult to cut when it is in a harder form than when it is softer. It is more difficult to penetrate the harder metal and more power is required. These factors in turn will generate a higher cutting temperature at any given cutting speed, thereby making it necessary to use a slower speed, for the cutting temperature must always be kept within the limits that can be sustained by the cutting tool without failure. Hardness, then, is an important property that must be considered when machining a given metal. Hardness alone, however, cannot be used as a measure of cutting speed. For example, if pieces of AISI 11L17 and AISI 1117 steel both have a hardness of 150 Bhn, their recommended cutting speeds for high-speed steel tools may be 140 fpm (0.71 m/s) and 130 fpm (0.66 m/s), respectively. In some metals, two entirely different microstructures can produce the same hardness. As an example, a fine pearlite microstructure and a tempered martensite microstructure can result in the same hardness in a steel. These microstructures will not machine alike. For practical purposes, however, information on hardness is usually easier to obtain than information on microstructure; thus, hardness alone is usually used to differentiate between different cutting speeds for machining a metal. In some situations, the hardness of a metal to be machined is not known. When the hardness is not known, the material condition can be used as a guide.

The surface of ferrous metal castings has a scale that is more difficult to machine than the metal below. Some scale is more difficult to machine than others, depending on the foundry sand used, the casting process, the method of cleaning the casting, and the type of metal cast. Special electrochemical treatments sometimes can be used that almost entirely eliminate the effect of the scale on machining, although castings so treated are not frequently encountered. Usually, when casting scale is encountered, the cutting speed is reduced approximately 5 or 10 per cent. Difficult-to-machine surface scale can also be encountered when machining hot-rolled or forged steel bars.

Metallurgical differences that affect machining characteristics are often found within a single piece of metal. The occurrence of hard spots in castings is an example. Different microstructures and hardness levels may occur within a casting as a result of variations in the cooling rate in different parts of the casting. Such variations are less severe in castings that have been heat treated. Steel bar stock is usually harder toward the outside than toward the center of the bar. Sometimes there are slight metallurgical differences along the length of a bar that can affect its cutting characteristics.

Cutting Tool Materials.—The recommended cutting feeds and speeds in the accompanying tables are given for high-speed steel, coated and uncoated carbides, ceramics, cermets, and polycrystalline diamonds. More data are available for HSS and carbides because these materials are the most commonly used. Other materials that are used to make cutting tools are cemented oxides or ceramics, cermets, cast nonferrous alloys (Stellite), single-crystal diamonds, polycrystalline diamonds, and cubic boron nitride.

Carbon Tool Steel: It is used primarily to make the less expensive drills, taps, and reamers. It is seldom used to make single-point cutting tools. Hardening in carbon steels is very shallow, although some have a small amount of vanadium and chromium added to improve their hardening quality. The cutting speed to use for plain carbon tool steel should be approximately one-half of the recommended speed for high-speed steel.

High-Speed Steel: This designates a number of steels having several properties that enhance their value as cutting tool material. They can be hardened to a high initial or room-temperature hardness ranging from 63 Rc to 65 Rc for ordinary high-speed steels and up to 70 Rc for the so-called superhigh-speed steels. They retain sufficient hardness at temperatures up to 1,000 or 1,100°F (573 or 593°C) to enable them to cut at cutting speeds that will generate these tool temperatures, and return to their original hardness when cooled to room temperature. They harden very deeply, enabling high-speed steels to be ground to the tool shape from solid stock and to be reground many times without sacrificing hardness at the cutting edge. High-speed steels can be made soft by annealing so that they can be machined into complex cutting tools such as drills, reamers, and milling cutters and then hardened.

The principal alloying elements of high-speed steels are tungsten (W), molybdenum (Mo), chromium (Cr), vanadium (V), together with carbon (C). There are a number of grades of high-speed steel that are divided into two types: tungsten high-speed steels and molybdenum high-speed steels. Tungsten high-speed steels are designated by the prefix T before the number that designates the grade. Molybdenum high-speed steels are designated by the prefix letter M. There is little performance difference between comparable grades of tungsten or molybdenum high-speed steel.

The addition of 5 to 12 per cent cobalt to high-speed steel increases its hardness at the temperatures encountered in cutting, thereby improving its wear resistance and cutting efficiency. Cobalt slightly increases the brittleness of high-speed steel, making it susceptible to chipping at the cutting edge. For this reason, cobalt high-speed steels are primarily made into single-point cutting tools that are used to take heavy roughing cuts in abrasive materials and through rough abrasive surface scales.

The M40 series and T15 are a group of high-hardness or so-called super high-speed steels that can be hardened to 70 Rc; however, they tend to be brittle and difficult to grind. For cutting applications, they are usually heat treated to 67-68 Rc to reduce their brittleness and tendency to chip. The M40 series is appreciably easier to grind than T15. They are recommended for machining tough die steels and other difficult-to-cut materials; they are not recommended for applications where conventional high-speed steels perform well. High-speed steels made by the powder-metallurgy process are tougher and have an improved grindability when compared with similar grades made by the customary process. Tools made of these steels can be hardened about 1 Rc higher than comparable high-speed steels made by the customary process without a sacrifice in toughness. They are particularly useful in applications involving intermittent cutting and where tool life is limited by chipping. All these steels augment rather than replace the conventional high-speed steels.

Cemented Carbides are also called sintered carbides or simply carbides. They are harder than high-speed steels and have excellent wear resistance. Information on these and other hard metal tools is included in the section **CEMENTED CARBIDES** starting on page 785.

Cemented carbides retain a very high degree of hardness at temperatures up to 1400°F (760°C) and even higher; therefore, very fast cutting speeds can be used. When used at fast cutting speeds, they produce good surface finishes on the workpiece. Carbides are more brittle than high-speed steel and, therefore, must be used with more care.

There are four distinct types of carbides: 1) straight tungsten carbides; 2) crater-resistant carbides; 3) titanium carbides; and 4) coated carbides.

Straight Tungsten Carbide: This is the most abrasion-resistant cemented carbide and is used to machine gray cast iron, most nonferrous metals, and nonmetallic materials, where abrasion resistance is the primary criterion. Straight tungsten carbide will rapidly form a

crater on the tool face when used to machine steel, which reduces the life of the tool. Titanium carbide is added to tungsten carbide in order to counteract the rapid formation of the crater. In addition, tantalum carbide is usually added to prevent the cutting edge from deforming when subjected to the intense heat and pressure generated in taking heavy cuts.

Crater-Resistant Carbides: These carbides, containing titanium and tantalum carbides in addition to tungsten carbide, are used to cut steels, alloy cast irons, and other materials that have a strong tendency to form a crater.

Titanium Carbides: These carbides are made entirely from titanium carbide and small amounts of nickel and molybdenum. They have an excellent resistance to cratering and to heat. Their high hot hardness enables them to operate at higher cutting speeds, but they are more brittle and less resistant to mechanical and thermal shock. Therefore, they are not recommended for taking heavy or interrupted cuts. Titanium carbides are less abrasion-resistant and not recommended for cutting through scale or oxide films on steel. Although the resistance to cratering of titanium carbides is excellent, failure caused by crater formation can sometimes occur because the chip tends to curl very close to the cutting edge, thereby forming a small crater in this region that may break through.

Coated Carbides: These are available only as indexable inserts because the coating would be removed by grinding. The principal coating materials are titanium carbide (TiC), titanium nitride (TiN), and aluminum oxide (Al_2O_3). A very thin layer approximately 0.0002 inch (5.08 μ m) of coating material is deposited over a cemented carbide insert; the material below the coating is the substrate. The overall performance of the coated carbide is limited by the substrate, which provides the required toughness, resistance to deformation, and thermal shock. With an equal tool life, coated carbides can operate at higher cutting speeds than uncoated carbides. The increase may be 20 to 30 per cent and sometimes up to 50 per cent faster. Titanium carbide and titanium nitride coated carbides usually operate in the medium (200-800 fpm, 1.0-4.1 m/s) cutting speed range, and aluminum oxide coated carbides are used in the higher (800-1600 fpm, 4.1-8.1 m/s) cutting speed range.

Carbide Grade Selection: The selection of the best grade of carbide for a particular application is very important. An improper grade of carbide will result in a poor performance—it may even cause the cutting edge to fail before any significant amount of cutting has been done. Because of the many grades and the many variables that are involved, the carbide producers should be consulted to obtain recommendations for the application of their grades of carbide. A few general guidelines can be given that are useful to form an orientation. Metal cutting carbides usually range in hardness from about 89.5 Ra (Rockwell A Scale) to 93.0 Ra with the exception of titanium carbide, which has a hardness range of 90.5 Ra to 93.5 Ra. Generally, the harder carbides are more wear-resistant and more brittle, whereas the softer carbides are less wear-resistant but tougher. A choice of hardness must be made to suit the given application. The very hard carbides are generally used for taking light finishing cuts. For other applications, select the carbide that has the highest hardness with sufficient strength to prevent chipping or breaking. Straight tungsten carbide grades should always be used unless cratering is encountered. Straight tungsten carbides are used to machine gray cast iron, ferritic malleable iron, austenitic stainless steel, high-temperature alloys, copper, brass, bronze, aluminum alloys, zinc alloy die castings, and plastics. Crater-resistant carbides should be used to machine plain carbon steel, alloy steel, tool steel, pearlitic malleable iron, nodular iron, other highly alloyed cast irons, ferritic stainless steel, martensitic stainless steel, and certain high-temperature alloys. Titanium carbides are recommended for taking high-speed finishing and semifinishing cuts on steel, especially the low-carbon, low-alloy steels, which are less abrasive and have a strong tendency to form a crater. They are also used to take light cuts on alloy cast iron and on some high-nickel alloys. Nonferrous materials, such as some aluminum alloys and brass, that are essentially nonabrasive may also be machined with titanium carbides. Abrasive materials and others that should not be machined with titanium carbides include gray cast

iron, titanium alloys, cobalt- and nickel-base superalloys, stainless steel, bronze, many aluminum alloys, fiberglass, plastics, and graphite. The feed used should not exceed about 0.020 inch/rev (0.51 mm/rev).

Coated carbides can be used to take cuts ranging from light finishing to heavy roughing on most materials that can be cut with these carbides. The coated carbides are recommended for machining all free-machining steels, all plain carbon and alloy steels, tool steels, martensitic and ferritic stainless steels, precipitation-hardening stainless steels, alloy cast iron, pearlitic and martensitic malleable iron, and nodular iron. They are also recommended for taking light finishing and roughing cuts on austenitic stainless steels. Coated carbides should not be used to machine nickel- and cobalt-base superalloys, titanium and titanium alloys, brass, bronze, aluminum alloys, pure metals, refractory metals, and nonmetals such as fiberglass, graphite, and plastics.

Ceramic Cutting Tool Materials: These are made from finely powdered aluminum oxide particles sintered into a hard dense structure without a binder material. Aluminum oxide is also combined with titanium carbide to form a composite, which is called a cermet. These materials have a very high hot hardness enabling very high cutting speeds to be used. For example, ceramic cutting tools have been used to cut AISI 1040 steel at a cutting speed of 18,000 fpm (91.4 m/s) with a satisfactory tool life. However, much lower cutting speeds, in the range of 1000-4000 fpm (5.1-20.3 m/s) and lower, are more common because of limitations placed by the machine tool, cutters, and chucks. Although most applications of ceramic and cermet cutting tool materials are for turning, they have also been used successfully for milling. Ceramics and cermets are relatively brittle and a special cutting edge preparation is required to prevent chipping or edge breakage. This preparation consists of honing or grinding a narrow flat land, 0.002 to 0.006 inch (50.8-152.4 μm) wide, on the cutting edge that is made about 30 degrees with respect to the tool face. For some heavy-duty applications, a wider land is used. The setup should be as rigid as possible and the feed rate should not normally exceed 0.020 inch (508 μm), although 0.030 inch (762 μm) has been used successfully. Ceramics and cermets are recommended for roughing and finishing operations on all cast irons, plain carbon and alloy steels, and stainless steels. Materials up to a hardness of 60 Rockwell C scale can be cut with ceramic and cermet cutting tools. These tools should not be used to machine aluminum and aluminum alloys, magnesium alloys, titanium, and titanium alloys.

Cast Nonferrous Alloy: Cutting tools of this alloy are made from tungsten, tantalum, chromium, and cobalt plus carbon. Other alloying elements are also used to produce materials with high temperature and wear resistance. These alloys cannot be softened by heat treatment and must be cast and ground to shape. The room-temperature hardness of cast nonferrous alloys is lower than for high-speed steel, but the hardness and wear resistance is retained to a higher temperature. The alloys are generally marketed under trade names such as Stellite, Crobalt, and Tantung. The initial cutting speed for cast nonferrous tools can be 20 to 50 per cent greater than the recommended cutting speed for high-speed steel.

Diamond Cutting Tools are available in three forms: single-crystal natural diamonds shaped to a cutting edge and mounted on a tool holder on a boring bar; polycrystalline diamond indexable inserts made from synthetic or natural diamond powders that have been compacted and sintered into a solid mass, and chemically vapor-deposited diamond. Single-crystal and polycrystalline diamond cutting tools are very wear-resistant, and recommended for machining abrasive materials that cause other cutting tool materials to wear rapidly. Typical of abrasive materials machined with single-crystal and polycrystalline diamond tools and cutting speeds used are the following: fiberglass, 300 to 1000 fpm (1.5 to 5.1 m/s); fused silica, 900 to 950 fpm (4.6 to 4.8 m/s); reinforced melamine plastics, 350 to 1000 fpm (1.8 to 5.1 m/s); reinforced phenolic plastics, 350 to 1000 fpm (1.8 to 5.1 m/s); thermosetting plastics, 300 to 2000 fpm (1.5 to 10.2 m/s); Teflon, 600 fpm (3.0 m/s); nylon, 200 to 300 fpm (1.0 to 1.5 m/s); mica, 300 to 1000 fpm (1.5 to 5.1 m/s); graphite, 200

to 2000 fpm (1.0 to 10.1 m/s); babbitt bearing metal, 700 fpm (3.6 m/s); and aluminum-silicon alloys, 1000 to 2000 fpm (5.1 to 10.2 m/s).

Another important application of diamond cutting tools is to produce fine surface finishes on soft nonferrous metals that are difficult to finish by other methods. Surface finishes of 1 to 2 microinches (0.025 to 0.051 μm) can be readily obtained with single-crystal diamond tools, and finishes down to 10 microinches (0.25 μm) can be obtained with polycrystalline diamond tools. In addition to babbitt and the aluminum-silicon alloys, other metals finished with diamond tools include: soft aluminum, 1000 to 2000 fpm (5.1 to 10.2 m/s); all wrought and cast aluminum alloys, 600 to 1500 fpm (3.0 to 7.6 m/s); copper, 1000 fpm (5.1 m/s); brass, 500 to 1000 fpm (2.5 to 5.1 m/s); bronze, 300 to 600 fpm (1.5 to 3.0 m/s); oilite bearing metal, 500 fpm (2.5 m/s); silver, gold, and platinum, 300 to 2500 fpm (1.5 to 12.7 m/s); and zinc, 1000 fpm (5.1 m/s). Ferrous alloys, such as cast iron and steel, should not be machined with diamond cutting tools because the high cutting temperatures generated will cause the diamond to transform into carbon.

Chemically Vapor-Deposited (CVD) Diamond: This tool material offers performance characteristics well suited to highly abrasive or corrosive materials, and hard-to-machine composites. CVD diamond is available in two forms: thick-film tools, which are fabricated by brazing CVD diamond tips, approximately 0.020 inch (0.51 mm) thick, to carbide substrates; and thin-film tools, having a pure diamond coating over the rake and flank surfaces of a ceramic or carbide substrate.

CVD is pure diamond, made at low temperatures and pressures, with no metallic binder phase. This diamond purity gives CVD diamond tools extreme hardness, high abrasion resistance, low friction, high thermal conductivity, and chemical inertness. CVD tools are generally used as direct replacements for PCD (polycrystalline diamond) tools, primarily in finishing, semifinishing, and continuous turning applications of extremely wear-intensive materials. The small grain size of CVD diamond (ranging from less than 1 μm to 50 μm) yields superior surface finishes compared with PCD, and the higher thermal conductivity and better thermal and chemical stability of pure diamond allow CVD tools to operate at faster speeds without generating harmful levels of heat. The extreme hardness of CVD tools may also result in significantly longer tool life.

CVD diamond cutting tools are recommended for the following materials: aluminum and other ductile; nonferrous alloys such as copper, brass, and bronze; and highly abrasive composite materials such as graphite, carbon-carbon, carbon-filled phenolic, fiberglass, and honeycomb materials.

Cubic Boron Nitride (CBN): Next to diamond, CBN is the hardest known material. It will retain its hardness at a temperature of 1800°F and higher, making it an ideal cutting tool material for machining very hard and tough materials at cutting speeds beyond those possible with other cutting tool materials. Indexable inserts and cutting tool blanks made from this material consist of a layer, approximately 0.020 inch thick, of polycrystalline cubic boron nitride firmly bonded to the top of a cemented carbide substrate. Cubic boron nitride is recommended for rough and finish turning hardened plain carbon and alloy steels, hardened tool steels, hard cast irons, all hardness grades of gray cast iron, and superalloys. As a class, the superalloys are not as hard as hardened steel; however, their combination of high strength and tendency to deform plastically under the pressure of the cut, or gumminess, places them in the class of hard-to-machine materials. Conventional materials that can be readily machined with other cutting tool materials should not be machined with cubic boron nitride. Round indexable CBN inserts are recommended when taking severe cuts in order to provide maximum strength to the insert. When using square or triangular inserts, a large lead angle should be used, normally 15°, and whenever possible, 45°. A negative rake angle should always be used, which for most applications is negative 5°. The relief angle should be 5° to 9°. Although cubic boron nitride cutting tools can be used without a coolant, flooding the tool with a water-soluble type coolant is recommended.

Cutting Speed, Feed, Depth of Cut, Tool Wear, and Tool Life.—The cutting conditions that determine the rate of metal removal are the cutting speed, the feed rate, and the depth of cut. These cutting conditions and the nature of the material to be cut determine the power required to take the cut. The cutting conditions must be adjusted to stay within the power available on the machine tool to be used. Power requirements are discussed in *ESTIMATING SPEEDS AND MACHINING POWER* starting on page 1081.

Cutting conditions must also be considered in relation to the tool life. Tool life is defined as the cutting time to reach a predetermined amount of wear, usually flank wear. Tool life is determined by assessing the time—the tool life—at which a given predetermined flank wear is reached, 0.01 in. (0.25 mm), 0.015 in. (0.38 mm), 0.025 in. (0.64 mm), 0.03 in. (0.76 mm), for example. This amount of wear is called the tool wear criterion, and its size depends on the tool grade used. Usually, a tougher grade can be used with a bigger flank wear, but for finishing operations, where close tolerances are required, the wear criterion is relatively small. Other wear criteria are a predetermined value of the machined surface roughness and the depth of the crater that develops on the rake face of the tool.

ANSI B94.55M, specification for tool life testing with single-point tools, defines the end of tool life as a given amount of wear on the flank of a tool. This standard is followed when making scientific machinability tests with single-point cutting tools in order to achieve uniformity in testing procedures so that results from different machinability laboratories can be readily compared. It is not practicable or necessary to follow this standard in the shop; however, it should be understood that the cutting conditions and tool life are related.

Tool life is influenced most by cutting speed, then by feed rate, and least by depth of cut. When depth of cut is increased to about 10 times greater than the feed, a further increase in the depth of cut will have no significant effect on tool life. This characteristic of the cutting tool performance is very important in determining the operating or cutting conditions for machining metals. Conversely, if the cutting speed or feed is decreased, the increase in the tool life will be proportionately greater than the decrease in the cutting speed or the feed.

Tool life is reduced when either feed or cutting speed is increased. For example, the cutting speed and the feed may be increased if a shorter tool life is accepted; furthermore, the reduction in the tool life will be proportionately greater than the increase in the cutting speed or the feed. However, it is less well understood that a higher feed rate (feed/rev \times speed) may result in a longer tool life if a higher feed/rev is used in combination with a lower cutting speed. This principle is well illustrated in the speed tables of this section, where two sets of feed and speed data are given (labeled *optimum* and *average*) that result in the same tool life. The *optimum* set results in a greater feed rate (i.e., increased productivity) although the feed/rev is higher and cutting speed lower than the *average* set. Complete instructions for using the speed tables and for estimating tool life are given in *How to Use the Feeds and Speeds Tables* starting on page 1021.

Selecting Cutting Conditions.—The first step in establishing cutting conditions is to select depth of cut. The depth of cut will be limited by the amount of metal to be machined from the workpiece, by the power available on the machine tool, by the rigidity of the workpiece and cutting tool, and by the rigidity of the setup. Depth of cut has the least effect upon tool life, so the heaviest possible depth of cut should always be used.

The second step is to select the feed (feed/rev for turning, drilling, and reaming, or feed/tooth for milling). The available power must be sufficient to make the required depth of cut at the selected feed. The maximum feed possible that will produce an acceptable surface finish should be selected.

The third step is to select the cutting speed. Although the accompanying tables provide recommended cutting speeds and feeds for many materials, experience in machining a certain material may form the best basis for adjusting given cutting speeds to a particular job. In general, depth of cut should be selected first, followed by feed, and last cutting speed.

Table 1. Tool Troubleshooting Check List

Problem	Tool Material	Remedy
Excessive flank wear—Tool life too short	Carbide	<ol style="list-style-type: none"> 1. Change to harder, more wear-resistant grade 2. Reduce the cutting speed 3. Reduce the cutting speed and increase the feed to maintain production 4. Reduce the feed 5. For work-hardenable materials—increase the feed 6. Increase the lead angle 7. Increase the relief angles
	HSS	<ol style="list-style-type: none"> 1. Use a coolant 2. Reduce the cutting speed 3. Reduce the cutting speed and increase the feed to maintain production 4. Reduce the feed 5. For work-hardenable materials—increase the feed 6. Increase the lead angle 7. Increase the relief angle
Excessive cratering	Carbide	<ol style="list-style-type: none"> 1. Use a crater-resistant grade 2. Use a harder, more wear-resistant grade 3. Reduce the cutting speed 4. Reduce the feed 5. Widen the chip breaker groove
	HSS	<ol style="list-style-type: none"> 1. Use a coolant 2. Reduce the cutting speed 3. Reduce the feed 4. Widen the chip breaker groove
Cutting edge chipping	Carbide	<ol style="list-style-type: none"> 1. Increase the cutting speed 2. Lightly hone the cutting edge 3. Change to a tougher grade 4. Use negative-rake tools 5. Increase the lead angle 6. Reduce the feed 7. Reduce the depth of cut 8. Reduce the relief angles 9. If low cutting speed must be used, use a high-additive EP cutting fluid
	HSS	<ol style="list-style-type: none"> 1. Use a high additive EP cutting fluid 2. Lightly hone the cutting edge before using 3. Increase the lead angle 4. Reduce the feed 5. Reduce the depth of cut 6. Use a negative rake angle 7. Reduce the relief angles
	Carbide and HSS	<ol style="list-style-type: none"> 1. Check the setup for cause if chatter occurs 2. Check the grinding procedure for tool overheating 3. Reduce the tool overhang
Cutting edge deformation	Carbide	<ol style="list-style-type: none"> 1. Change to a grade containing more tantalum 2. Reduce the cutting speed 3. Reduce the feed
Poor surface finish	Carbide	<ol style="list-style-type: none"> 1. Increase the cutting speed 2. If low cutting speed must be used, use a high additive EP cutting fluid 4. For light cuts, use straight titanium carbide grade 5. Increase the nose radius 6. Reduce the feed 7. Increase the relief angles 8. Use positive rake tools

Table 1. (Continued) Tool Troubleshooting Check List

Problem	Tool Material	Remedy
Poor surface finish (Continued)	HSS	1. Use a high additive EP cutting fluid 2. Increase the nose radius 3. Reduce the feed 4. Increase the relief angles 5. Increase the rake angles
	Diamond	1. Use diamond tool for soft materials
Notching at the depth of cut line	Carbide and HSS	1. Increase the lead angle 2. Reduce the feed

Cutting Speed Formulas

Most machining operations are conducted on machine tools having a rotating spindle. Cutting speeds are usually given in feet or meters per minute and these speeds must be converted to spindle speeds, in revolutions per minute, to operate the machine. Conversion is accomplished by use of the following formulas:

$$\begin{array}{ll}
 \text{For U.S. units:} & \text{For metric units:} \\
 N = \frac{12V}{\pi D} = \frac{12 \times 252}{\pi \times 8} = 120 \text{ rpm} & N = \frac{1000V}{\pi D} = 318.3 \frac{V}{D} \text{ rpm}
 \end{array}$$

where N is the spindle speed in revolutions per minute (rpm); V is the cutting speed in feet per minute (fpm) for U.S. units and meters per minute (m/min) for metric units. In turning, D is the diameter of the workpiece; in milling, drilling, reaming, and other operations that use a rotating tool, D is the cutter diameter in inches for U.S. units and in millimeters for metric units. $\pi = 3.1416$.

Example: The cutting speed for turning a 4-inch (101.6-mm) diameter bar has been found to be 575 fpm (175.3 m/min). Using both the inch and metric formulas, calculate the lathe spindle speed.

$$N = \frac{12V}{\pi D} = \frac{12 \times 575}{3.1416 \times 4} = 549 \text{ rpm} \qquad N = \frac{1000V}{\pi D} = \frac{1000 \times 175.3}{3.1416 \times 101.6} = 549 \text{ rpm}$$

When the cutting tool or workpiece diameter and the spindle speed in rpm are known, it is often necessary to calculate the cutting speed in feet or meters per minute. In this event, the following formulas are used.

$$\begin{array}{ll}
 \text{For U.S. units:} & \text{For metric units:} \\
 V = \frac{\pi DN}{12} \text{ fpm} & V = \frac{\pi DN}{1000} \text{ m/min}
 \end{array}$$

As in the previous formulas, N is the rpm and D is the diameter in inches for the U.S. unit formula and in millimeters for the metric formula.

Example: Calculate the cutting speed in feet per minute and in meters per minute if the spindle speed of a $\frac{3}{4}$ -inch (19.05-mm) drill is 400 rpm.

$$\begin{array}{l}
 V = \frac{\pi DN}{12} = \frac{\pi \times 0.75 \times 400}{12} = 78.5 \text{ fpm} \\
 V = \frac{\pi DN}{1000} = \frac{\pi \times 19.05 \times 400}{1000} = 24.9 \text{ m/min}
 \end{array}$$

Cutting Speeds and Equivalent RPM for Drills of Number and Letter Sizes

Size No.	Cutting Speed, Feet per Minute										
	30'	40'	50'	60'	70'	80'	90'	100'	110'	130'	150'
	Revolutions per Minute for Number Sizes										
1	503	670	838	1005	1173	1340	1508	1675	1843	2179	2513
2	518	691	864	1037	1210	1382	1555	1728	1901	2247	2593
4	548	731	914	1097	1280	1462	1645	1828	2010	2376	2741
6	562	749	936	1123	1310	1498	1685	1872	2060	2434	2809
8	576	768	960	1151	1343	1535	1727	1919	2111	2495	2879
10	592	790	987	1184	1382	1579	1777	1974	2171	2566	2961
12	606	808	1010	1213	1415	1617	1819	2021	2223	2627	3032
14	630	840	1050	1259	1469	1679	1889	2099	2309	2728	3148
16	647	863	1079	1295	1511	1726	1942	2158	2374	2806	3237
18	678	904	1130	1356	1582	1808	2034	2260	2479	2930	3380
20	712	949	1186	1423	1660	1898	2135	2372	2610	3084	3559
22	730	973	1217	1460	1703	1946	2190	2433	2676	3164	3649
24	754	1005	1257	1508	1759	2010	2262	2513	2764	3267	3769
26	779	1039	1299	1559	1819	2078	2338	2598	2858	3378	3898
28	816	1088	1360	1631	1903	2175	2447	2719	2990	3534	4078
30	892	1189	1487	1784	2081	2378	2676	2973	3270	3864	4459
32	988	1317	1647	1976	2305	2634	2964	3293	3622	4281	4939
34	1032	1376	1721	2065	2409	2753	3097	3442	3785	4474	5162
36	1076	1435	1794	2152	2511	2870	3228	3587	3945	4663	5380
38	1129	1505	1882	2258	2634	3010	3387	3763	4140	4892	5645
40	1169	1559	1949	2339	2729	3118	3508	3898	4287	5067	5846
42	1226	1634	2043	2451	2860	3268	3677	4085	4494	5311	6128
44	1333	1777	2221	2665	3109	3554	3999	4442	4886	5774	6662
46	1415	1886	2358	2830	3301	3773	4244	4716	5187	6130	7074
48	1508	2010	2513	3016	3518	4021	4523	5026	5528	6534	7539
50	1637	2183	2729	3274	3820	4366	4911	5457	6002	7094	8185
52	1805	2406	3008	3609	4211	4812	5414	6015	6619	7820	9023
54	2084	2778	3473	4167	4862	5556	6251	6945	7639	9028	10417
Size	Revolutions per Minute for Letter Sizes										
A	491	654	818	982	1145	1309	1472	1636	1796	2122	2448
B	482	642	803	963	1124	1284	1445	1605	1765	2086	2407
C	473	631	789	947	1105	1262	1420	1578	1736	2052	2368
D	467	622	778	934	1089	1245	1400	1556	1708	2018	2329
E	458	611	764	917	1070	1222	1375	1528	1681	1968	2292
F	446	594	743	892	1040	1189	1337	1486	1635	1932	2229
G	440	585	732	878	1024	1170	1317	1463	1610	1903	2195
H	430	574	718	862	1005	1149	1292	1436	1580	1867	2154
I	421	562	702	842	983	1123	1264	1404	1545	1826	2106
J	414	552	690	827	965	1103	1241	1379	1517	1793	2068
K	408	544	680	815	951	1087	1223	1359	1495	1767	2039
L	395	527	659	790	922	1054	1185	1317	1449	1712	1976
M	389	518	648	777	907	1036	1166	1295	1424	1683	1942
N	380	506	633	759	886	1012	1139	1265	1391	1644	1897
O	363	484	605	725	846	967	1088	1209	1330	1571	1813
P	355	473	592	710	828	946	1065	1183	1301	1537	1774
Q	345	460	575	690	805	920	1035	1150	1266	1496	1726
R	338	451	564	676	789	902	1014	1127	1239	1465	1690
S	329	439	549	659	769	878	988	1098	1207	1427	1646
T	320	426	533	640	746	853	959	1066	1173	1387	1600
U	311	415	519	623	727	830	934	1038	1142	1349	1557
V	304	405	507	608	709	810	912	1013	1114	1317	1520
W	297	396	495	594	693	792	891	989	1088	1286	1484
X	289	385	481	576	672	769	865	962	1058	1251	1443
Y	284	378	473	567	662	756	851	945	1040	1229	1418
Z	277	370	462	555	647	740	832	925	1017	1202	1387

For fractional drill sizes, use the following table.

Revolutions per Minute for Various Cutting Speeds and Diameters

Dia., Inches	Cutting Speed, Feet per Minute											
	40	50	60	70	80	90	100	120	140	160	180	200
	Revolutions per Minute											
1/4	611	764	917	1070	1222	1376	1528	1834	2139	2445	2750	3056
3/16	489	611	733	856	978	1100	1222	1466	1711	1955	2200	2444
3/8	408	509	611	713	815	916	1018	1222	1425	1629	1832	2036
7/16	349	437	524	611	699	786	874	1049	1224	1398	1573	1748
1/2	306	382	459	535	611	688	764	917	1070	1222	1375	1528
5/16	272	340	407	475	543	611	679	813	951	1086	1222	1358
5/8	245	306	367	428	489	552	612	736	857	979	1102	1224
11/16	222	273	333	389	444	500	555	666	770	888	999	1101
3/4	203	254	306	357	408	458	508	610	711	813	914	1016
13/16	190	237	284	332	379	427	474	569	664	758	853	948
7/8	175	219	262	306	349	392	438	526	613	701	788	876
15/16	163	204	244	285	326	366	407	488	570	651	733	814
1	153	191	229	267	306	344	382	458	535	611	688	764
1 1/16	144	180	215	251	287	323	359	431	503	575	646	718
1 1/8	136	170	204	238	272	306	340	408	476	544	612	680
1 3/16	129	161	193	225	258	290	322	386	451	515	580	644
1 1/4	123	153	183	214	245	274	306	367	428	490	551	612
1 5/16	116	146	175	204	233	262	291	349	407	466	524	582
1 3/8	111	139	167	195	222	250	278	334	389	445	500	556
1 7/16	106	133	159	186	212	239	265	318	371	424	477	530
1 1/2	102	127	153	178	204	230	254	305	356	406	457	508
1 5/8	97.6	122	146	171	195	220	244	293	342	390	439	488
1 3/4	93.9	117	141	165	188	212	234	281	328	374	421	468
1 11/16	90.4	113	136	158	181	203	226	271	316	362	407	452
1 3/4	87.3	109	131	153	175	196	218	262	305	349	392	436
1 7/8	81.5	102	122	143	163	184	204	244	286	326	367	408
2	76.4	95.5	115	134	153	172	191	229	267	306	344	382
2 1/16	72.0	90.0	108	126	144	162	180	216	252	288	324	360
2 1/4	68.0	85.5	102	119	136	153	170	204	238	272	306	340
2 3/8	64.4	80.5	96.6	113	129	145	161	193	225	258	290	322
2 1/2	61.2	76.3	91.7	107	122	138	153	184	213	245	275	306
2 5/8	58.0	72.5	87.0	102	116	131	145	174	203	232	261	290
2 3/4	55.6	69.5	83.4	97.2	111	125	139	167	195	222	250	278
2 7/8	52.8	66.0	79.2	92.4	106	119	132	158	185	211	238	264
3	51.0	63.7	76.4	89.1	102	114	127	152	178	203	228	254
3 1/8	48.8	61.0	73.2	85.4	97.6	110	122	146	171	195	219	244
3 1/4	46.8	58.5	70.2	81.9	93.6	105	117	140	164	188	211	234
3 3/8	45.2	56.5	67.8	79.1	90.4	102	113	136	158	181	203	226
3 1/2	43.6	54.5	65.5	76.4	87.4	98.1	109	131	153	174	196	218
3 5/8	42.0	52.5	63.0	73.5	84.0	94.5	105	126	147	168	189	210
3 3/4	40.8	51.0	61.2	71.4	81.6	91.8	102	122	143	163	184	205
3 7/8	39.4	49.3	59.1	69.0	78.8	88.6	98.5	118	138	158	177	197
4	38.2	47.8	57.3	66.9	76.4	86.0	95.6	115	134	153	172	191
4 1/4	35.9	44.9	53.9	62.9	71.8	80.8	89.8	108	126	144	162	180
4 1/2	34.0	42.4	51.0	59.4	67.9	76.3	84.8	102	119	136	153	170
4 3/4	32.2	40.2	48.2	56.3	64.3	72.4	80.4	96.9	113	129	145	161
5	30.6	38.2	45.9	53.5	61.1	68.8	76.4	91.7	107	122	138	153
5 1/4	29.1	36.4	43.6	50.9	58.2	65.4	72.7	87.2	102	116	131	145
5 1/2	27.8	34.7	41.7	48.6	55.6	62.5	69.4	83.3	97.2	111	125	139
5 3/4	26.6	33.2	39.8	46.5	53.1	59.8	66.4	80.0	93.0	106	120	133
6	25.5	31.8	38.2	44.6	51.0	57.2	63.6	76.3	89.0	102	114	127
6 1/4	24.4	30.6	36.7	42.8	48.9	55.0	61.1	73.3	85.5	97.7	110	122
6 1/2	23.5	29.4	35.2	41.1	47.0	52.8	58.7	70.4	82.2	93.9	106	117
6 3/4	22.6	28.3	34.0	39.6	45.3	50.9	56.6	67.9	79.2	90.6	102	113
7	21.8	27.3	32.7	38.2	43.7	49.1	54.6	65.5	76.4	87.4	98.3	109
7 1/4	21.1	26.4	31.6	36.9	42.2	47.4	52.7	63.2	73.8	84.3	94.9	105
7 1/2	20.4	25.4	30.5	35.6	40.7	45.8	50.9	61.1	71.0	81.4	91.6	102
7 3/4	19.7	24.6	29.5	34.4	39.4	44.3	49.2	59.0	68.9	78.7	88.6	98.4
8	19.1	23.9	28.7	33.4	38.2	43.0	47.8	57.4	66.9	76.5	86.0	95.6

Revolutions per Minute for Various Cutting Speeds and Diameters

Dia., Inches	Cutting Speed, Feet per Minute											
	225	250	275	300	325	350	375	400	425	450	500	550
	Revolutions per Minute											
1/4	3438	3820	4202	4584	4966	5348	5730	6112	6493	6875	7639	8403
5/16	2750	3056	3362	3667	3973	4278	4584	4889	5195	5501	6112	6723
3/8	2292	2546	2801	3056	3310	3565	3820	4074	4329	4584	5093	5602
7/16	1964	2182	2401	2619	2837	3056	3274	3492	3710	3929	4365	4802
1/2	1719	1910	2101	2292	2483	2675	2866	3057	3248	3439	3821	4203
9/16	1528	1698	1868	2037	2207	2377	2547	2717	2887	3056	3396	3736
5/8	1375	1528	1681	1834	1987	2139	2292	2445	2598	2751	3057	3362
11/16	1250	1389	1528	1667	1806	1941	2084	2223	2362	2501	2779	3056
3/4	1146	1273	1401	1528	1655	1783	1910	2038	2165	2292	2547	2802
13/16	1058	1175	1293	1410	1528	1646	1763	1881	1998	2116	2351	2586
7/8	982	1091	1200	1310	1419	1528	1637	1746	1855	1965	2183	2401
15/16	917	1019	1120	1222	1324	1426	1528	1630	1732	1834	2038	2241
1	859	955	1050	1146	1241	1337	1432	1528	1623	1719	1910	2101
1 1/16	809	899	988	1078	1168	1258	1348	1438	1528	1618	1798	1977
1 1/8	764	849	933	1018	1103	1188	1273	1358	1443	1528	1698	1867
1 3/16	724	804	884	965	1045	1126	1206	1287	1367	1448	1609	1769
1 1/4	687	764	840	917	993	1069	1146	1222	1299	1375	1528	1681
1 5/16	654	727	800	873	946	1018	1091	1164	1237	1309	1455	1601
1 3/8	625	694	764	833	903	972	1042	1111	1181	1250	1389	1528
1 7/16	598	664	730	797	863	930	996	1063	1129	1196	1329	1461
1 1/2	573	636	700	764	827	891	955	1018	1082	1146	1273	1400
1 5/16	550	611	672	733	794	855	916	978	1039	1100	1222	1344
1 3/8	528	587	646	705	764	822	881	940	999	1057	1175	1293
1 11/16	509	566	622	679	735	792	849	905	962	1018	1132	1245
1 3/4	491	545	600	654	709	764	818	873	927	982	1091	1200
1 13/16	474	527	579	632	685	737	790	843	895	948	1054	1159
1 7/8	458	509	560	611	662	713	764	815	866	917	1019	1120
1 15/16	443	493	542	591	640	690	739	788	838	887	986	1084
2	429	477	525	573	620	668	716	764	811	859	955	1050
2 1/8	404	449	494	539	584	629	674	719	764	809	899	988
2 1/4	382	424	468	509	551	594	636	679	721	764	849	933
2 3/8	362	402	442	482	522	563	603	643	683	724	804	884
2 1/2	343	382	420	458	496	534	573	611	649	687	764	840
2 5/8	327	363	400	436	472	509	545	582	618	654	727	800
2 3/4	312	347	381	416	451	486	520	555	590	625	694	763
2 7/8	299	332	365	398	431	465	498	531	564	598	664	730
3	286	318	350	381	413	445	477	509	541	572	636	700
3 1/8	274	305	336	366	397	427	458	488	519	549	611	672
3 1/4	264	293	323	352	381	411	440	470	499	528	587	646
3 3/8	254	283	311	339	367	396	424	452	481	509	566	622
3 1/2	245	272	300	327	354	381	409	436	463	490	545	600
3 5/8	237	263	289	316	342	368	395	421	447	474	527	579
3 3/4	229	254	280	305	331	356	382	407	433	458	509	560
3 7/8	221	246	271	295	320	345	369	394	419	443	493	542
4	214	238	262	286	310	334	358	382	405	429	477	525
4 1/4	202	224	247	269	292	314	337	359	383	404	449	494
4 1/2	191	212	233	254	275	297	318	339	360	382	424	466
4 3/4	180	201	221	241	261	281	301	321	341	361	402	442
5	171	191	210	229	248	267	286	305	324	343	382	420
5 1/4	163	181	199	218	236	254	272	290	308	327	363	399
5 1/2	156	173	190	208	225	242	260	277	294	312	347	381
5 3/4	149	166	182	199	215	232	249	265	282	298	332	365
6	143	159	174	190	206	222	238	254	270	286	318	349
6 1/4	137	152	168	183	198	213	229	244	259	274	305	336
6 1/2	132	146	161	176	190	205	220	234	249	264	293	322
6 3/4	127	141	155	169	183	198	212	226	240	254	283	311
7	122	136	149	163	177	190	204	218	231	245	272	299
7 1/4	118	131	144	158	171	184	197	210	223	237	263	289
7 1/2	114	127	139	152	165	178	190	203	216	229	254	279
7 3/4	111	123	135	148	160	172	185	197	209	222	246	271
8	107	119	131	143	155	167	179	191	203	215	238	262

Revolutions per Minute for Various Cutting Speeds and Diameters (Metric Units)

Dia., mm	Cutting Speed, Meters per Minute											
	5	6	8	10	12	16	20	25	30	35	40	45
	Revolutions per Minute											
5	318	382	509	637	764	1019	1273	1592	1910	2228	2546	2865
6	265	318	424	530	637	849	1061	1326	1592	1857	2122	2387
8	199	239	318	398	477	637	796	995	1194	1393	1592	1790
10	159	191	255	318	382	509	637	796	955	1114	1273	1432
12	133	159	212	265	318	424	531	663	796	928	1061	1194
16	99.5	119	159	199	239	318	398	497	597	696	796	895
20	79.6	95.5	127	159	191	255	318	398	477	557	637	716
25	63.7	76.4	102	127	153	204	255	318	382	446	509	573
30	53.1	63.7	84.9	106	127	170	212	265	318	371	424	477
35	45.5	54.6	72.8	90.9	109	145	182	227	273	318	364	409
40	39.8	47.7	63.7	79.6	95.5	127	159	199	239	279	318	358
45	35.4	42.4	56.6	70.7	84.9	113	141	177	212	248	283	318
50	31.8	38.2	51	63.7	76.4	102	127	159	191	223	255	286
55	28.9	34.7	46.3	57.9	69.4	92.6	116	145	174	203	231	260
60	26.6	31.8	42.4	53.1	63.7	84.9	106	133	159	186	212	239
65	24.5	29.4	39.2	49	58.8	78.4	98	122	147	171	196	220
70	22.7	27.3	36.4	45.5	54.6	72.8	90.9	114	136	159	182	205
75	21.2	25.5	34	42.4	51	68	84.9	106	127	149	170	191
80	19.9	23.9	31.8	39.8	47.7	63.7	79.6	99.5	119	139	159	179
90	17.7	21.2	28.3	35.4	42.4	56.6	70.7	88.4	106	124	141	159
100	15.9	19.1	25.5	31.8	38.2	51	63.7	79.6	95.5	111	127	143
110	14.5	17.4	23.1	28.9	34.7	46.2	57.9	72.3	86.8	101	116	130
120	13.3	15.9	21.2	26.5	31.8	42.4	53.1	66.3	79.6	92.8	106	119
130	12.2	14.7	19.6	24.5	29.4	39.2	49	61.2	73.4	85.7	97.9	110
140	11.4	13.6	18.2	22.7	27.3	36.4	45.5	56.8	68.2	79.6	90.9	102
150	10.6	12.7	17	21.2	25.5	34	42.4	53.1	63.7	74.3	84.9	95.5
160	9.9	11.9	15.9	19.9	23.9	31.8	39.8	49.7	59.7	69.6	79.6	89.5
170	9.4	11.2	15	18.7	22.5	30	37.4	46.8	56.2	65.5	74.9	84.2
180	8.8	10.6	14.1	17.7	21.2	28.3	35.4	44.2	53.1	61.9	70.7	79.6
190	8.3	10	13.4	16.8	20.1	26.8	33.5	41.9	50.3	58.6	67	75.4
200	8	39.5	12.7	15.9	19.1	25.5	31.8	39.8	47.7	55.7	63.7	71.6
220	7.2	8.7	11.6	14.5	17.4	23.1	28.9	36.2	43.4	50.6	57.9	65.1
240	6.6	8	10.6	13.3	15.9	21.2	26.5	33.2	39.8	46.4	53.1	59.7
260	6.1	7.3	9.8	12.2	14.7	19.6	24.5	30.6	36.7	42.8	49	55.1
280	5.7	6.8	9.1	11.4	13.6	18.2	22.7	28.4	34.1	39.8	45.5	51.1
300	5.3	6.4	8.5	10.6	12.7	17	21.2	26.5	31.8	37.1	42.4	47.7
350	4.5	5.4	7.3	9.1	10.9	14.6	18.2	22.7	27.3	31.8	36.4	40.9
400	4	4.8	6.4	8	9.5	12.7	15.9	19.9	23.9	27.9	31.8	35.8
450	3.5	4.2	5.7	7.1	8.5	11.3	14.1	17.7	21.2	24.8	28.3	31.8
500	3.2	3.8	5.1	6.4	7.6	10.2	12.7	15.9	19.1	22.3	25.5	28.6

Revolutions per Minute for Various Cutting Speeds and Diameters (Metric Units)

Dia., mm	Cutting Speed, Meters per Minute											
	50	55	60	65	70	75	80	85	90	95	100	200
	Revolutions per Minute											
5	3183	3501	3820	4138	4456	4775	5093	5411	5730	6048	6366	12,732
6	2653	2918	3183	3448	3714	3979	4244	4509	4775	5039	5305	10,610
8	1989	2188	2387	2586	2785	2984	3183	3382	3581	3780	3979	7958
10	1592	1751	1910	2069	2228	2387	2546	2706	2865	3024	3183	6366
12	1326	1459	1592	1724	1857	1989	2122	2255	2387	2520	2653	5305
16	995	1094	1194	1293	1393	1492	1591	1691	1790	1890	1989	3979
20	796	875	955	1034	1114	1194	1273	1353	1432	1512	1592	3183
25	637	700	764	828	891	955	1019	1082	1146	1210	1273	2546
30	530	584	637	690	743	796	849	902	955	1008	1061	2122
35	455	500	546	591	637	682	728	773	819	864	909	1818
40	398	438	477	517	557	597	637	676	716	756	796	1592
45	354	389	424	460	495	531	566	601	637	672	707	1415
50	318	350	382	414	446	477	509	541	573	605	637	1273
55	289	318	347	376	405	434	463	492	521	550	579	1157
60	265	292	318	345	371	398	424	451	477	504	530	1061
65	245	269	294	318	343	367	392	416	441	465	490	979
70	227	250	273	296	318	341	364	387	409	432	455	909
75	212	233	255	276	297	318	340	361	382	403	424	849
80	199	219	239	259	279	298	318	338	358	378	398	796
90	177	195	212	230	248	265	283	301	318	336	354	707
100	159	175	191	207	223	239	255	271	286	302	318	637
110	145	159	174	188	203	217	231	246	260	275	289	579
120	133	146	159	172	186	199	212	225	239	252	265	530
130	122	135	147	159	171	184	196	208	220	233	245	490
140	114	125	136	148	159	171	182	193	205	216	227	455
150	106	117	127	138	149	159	170	180	191	202	212	424
160	99.5	109	119	129	139	149	159	169	179	189	199	398
170	93.6	103	112	122	131	140	150	159	169	178	187	374
180	88.4	97.3	106	115	124	133	141	150	159	168	177	354
190	83.8	92.1	101	109	117	126	134	142	151	159	167	335
200	79.6	87.5	95.5	103	111	119	127	135	143	151	159	318
220	72.3	79.6	86.8	94	101	109	116	123	130	137	145	289
240	66.3	72.9	79.6	86.2	92.8	99.5	106	113	119	126	132	265
260	61.2	67.3	73.4	79.6	85.7	91.8	97.9	104	110	116	122	245
280	56.8	62.5	68.2	73.9	79.6	85.3	90.9	96.6	102	108	114	227
300	53.1	58.3	63.7	69	74.3	79.6	84.9	90.2	95.5	101	106	212
350	45.5	50	54.6	59.1	63.7	68.2	72.8	77.3	81.8	99.1	91	182
400	39.8	43.8	47.7	51.7	55.7	59.7	63.7	67.6	71.6	75.6	79.6	159
450	35.4	38.9	42.4	46	49.5	53.1	56.6	60.1	63.6	67.2	70.7	141
500	31.8	35	38.2	41.4	44.6	47.7	50.9	54.1	57.3	60.5	63.6	127

SPEED AND FEED TABLES

How to Use the Feeds and Speeds Tables

Introduction to the Feed and Speed Tables.—The principal tables of feed and speed values are listed in the table below. In this section, [Tables 1 through 9](#) give data for turning, [Tables 10 through 15e](#) give data for milling, and [Tables 17 through 23](#) give data for reaming, drilling, threading.

The materials in these tables are categorized by description, and Brinell hardness number (Bhn) range or material condition. So far as possible, work materials are grouped by similar machining characteristics. The types of cutting tools (HSS end mill, for example) are identified in one or more rows across the tops of the tables. Other important details concerning the use of the tables are contained in the footnotes to [Tables 1, 10 and 17](#). Information concerning specific cutting tool grades is given in notes at the end of each table.

Principal Speed and Feed Tables

Feeds and Speeds for Turning
Table 1. Cutting Feeds and Speeds for Turning Plain Carbon and Alloy Steels
Table 2. Cutting Feeds and Speeds for Turning Tool Steels
Table 3. Cutting Feeds and Speeds for Turning Stainless Steels
Table 4a. Cutting Feeds and Speeds for Turning Ferrous Cast Metals
Table 4b. Cutting Feeds and Speeds for Turning Ferrous Cast Metals
Table 5c. Cutting-Speed Adjustment Factors for Turning with HSS Tools
Table 5a. Turning-Speed Adjustment Factors for Feed, Depth of Cut, and Lead Angle
Table 5b. Tool Life Factors for Turning with Carbides, Ceramics, Cermets, CBN, and Polycrystalline Diamond
Table 6. Cutting Feeds and Speeds for Turning Copper Alloys
Table 7. Cutting Feeds and Speeds for Turning Titanium and Titanium Alloys
Table 8. Cutting Feeds and Speeds for Turning Light Metals
Table 9. Cutting Feeds and Speeds for Turning Superalloys
Feeds and Speeds for Milling
Table 10. Cutting Feeds and Speeds for Milling Aluminum Alloys
Table 11. Cutting Feeds and Speeds for Milling Plain Carbon and Alloy Steels
Table 12. Cutting Feeds and Speeds for Milling Tool Steels
Table 13. Cutting Feeds and Speeds for Milling Stainless Steels
Table 14. Cutting Feeds and Speeds for Milling Ferrous Cast Metals
Table 15a. Recommended Feed in Inches per Tooth (ft) for Milling with High Speed Steel Cutters
Table 15b. End Milling (Full Slot) Speed Adjustment Factors for Feed, Depth of Cut, and Lead Angle
Table 15c. End, Slit, and Side Milling Speed Adjustment Factors for Radial Depth of Cut
Table 15d. Face Milling Speed Adjustment Factors for Feed, Depth of Cut, and Lead Angle
Table 15e. Tool Life Adjustment Factors for Face Milling, End Milling, Drilling, and Reaming
Table 16. Cutting Tool Grade Descriptions and Common Vendor Equivalents
Feeds and Speeds for Drilling, Reaming, and Threading
Table 17. Feeds and Speeds for Drilling, Reaming, and Threading Plain Carbon and Alloy Steels
Table 18. Feeds and Speeds for Drilling, Reaming, and Threading Tool Steels
Table 19. Feeds and Speeds for Drilling, Reaming, and Threading Stainless Steels
Table 20. Feeds and Speeds for Drilling, Reaming, and Threading Ferrous Cast Metals
Table 21. Feeds and Speeds for Drilling, Reaming, and Threading Light Metals
Table 22. Feed and Diameter Speed Adjustment Factors for HSS Twist Drills and Reamers
Table 23. Feeds and Speeds for Drilling and Reaming Copper Alloys

Each of the cutting speed tables in this section contains two distinct types of cutting speed data. The speed columns at the left of each table contain traditional Handbook cutting speeds for use with high-speed steel (HSS) tools. For many years, this extensive collection of cutting data has been used successfully as starting speed values for turning, milling, drilling, and reaming operations. Instructions and adjustment factors for use with these speeds are given in [Table 5c](#) (feed and depth-of-cut factors) for turning, and in [Table 15a](#) (feed, depth of cut, and cutter diameter) for milling. Feeds for drilling and reaming are discussed in [Using the Feed and Speed Tables for Drilling, Reaming, and Threading](#). With traditional speeds and feeds, tool life may vary greatly from material to material, making it very difficult to plan efficient cutting operations, in particular for setting up unattended jobs on CNC equipment where the tool life must exceed cutting time, or at least be predictable so that tool changes can be scheduled. This limitation is reduced by using the combined feed/speed data contained in the remaining columns of the speed tables.

The combined feed/speed portion of the speed tables gives two sets of feed and speed data for each material represented. These feed/speed pairs are the *optimum* and *average* data (identified by *Opt.* and *Avg.*); the *optimum* set is always on the left side of the column and the *average* set is on the right. The *optimum* feed/speed data are approximate values of feed and speed that achieve minimum-cost machining by combining a high productivity rate with low tooling cost at a fixed tool life. The *average* feed/speed data are expected to achieve approximately the same tool life and tooling costs, but productivity is usually lower, so machining costs are higher. The data in this portion of the tables are given in the form of two numbers, of which the first is the feed in thousandths of an inch per revolution (or per tooth, for milling) and the second is the cutting speed in feet per minute. For example, the feed/speed set 15/215 represents a feed of 0.015 in/rev (0.38 mm/rev) at a speed of 215 fpm (65.6 m/min). Blank cells in the data tables indicate that feed/speed data for these materials were not available at the time of publication.

Generally, the feed given in the *optimum* set should be interpreted as the maximum safe feed for the given work material and cutting tool grade, and the use of a greater feed may result in premature tool wear or tool failure before the end of the expected tool life. The primary exception to this rule occurs in milling, where the feed may be greater than the *optimum* feed if the radial depth of cut is less than the value established in the table footnote; this topic is covered later in the milling examples. Thus, except for milling, the speed and tool life adjustment tables, to be discussed later, do not permit feeds that are greater than the *optimum* feed. On the other hand, the speed and tool life adjustment factors often result in cutting speeds that are well outside the given *optimum* to *average* speed range.

The combined feed/speed data in this section were contributed by Dr. Colding of Colding International Corp., Ann Arbor, MI. The speed, feed, and tool life calculations were made by means of a special computer program and a large database of cutting speed and tool life testing data. The COMP computer program uses tool life equations that are extensions of the F. W. Taylor tool life equation, first proposed in the early 1900s. The Colding tool life equations use a concept called equivalent chip thickness (*ECT*), which simplifies cutting speed and tool life predictions, and the calculation of cutting forces, torque, and power requirements. *ECT* is a basic metal cutting parameter that combines the four basic turning variables (depth of cut, lead angle, nose radius, and feed per revolution) into one basic parameter. For other metal cutting operations (milling, drilling, and grinding, for example), *ECT* also includes additional variables such as the number of teeth, width of cut, and cutter diameter. The *ECT* concept was first presented in 1931 by Prof. R. Woxen, who showed that equivalent chip thickness is a basic metal cutting parameter for high-speed cutting tools. Dr. Colding later extended the theory to include other tool materials and metal cutting operations, including grinding.

The equivalent chip thickness is defined by $ECT = A/CEL$, where *A* is the cross-sectional area of the cut (approximately equal to the feed times the depth of cut), and *CEL* is the cutting edge length or tool contact rubbing length. *ECT* and several other terms related to tool

geometry are illustrated in Figs. 1 and 2. Many combinations of feed, lead angle, nose radius and cutter diameter, axial and radial depth of cut, and numbers of teeth can give the same value of ECT . However, for a constant cutting speed, no matter how the depth of cut, feed, or lead angle, etc., are varied, if a constant value of ECT is maintained, the tool life will also remain constant. A constant value of ECT means that a constant cutting speed gives a constant tool life and an increase in speed results in a reduced tool life. Likewise, if ECT were increased and cutting speed were held constant, as illustrated in the generalized cutting speed vs. ECT graph that follows, tool life would be reduced.

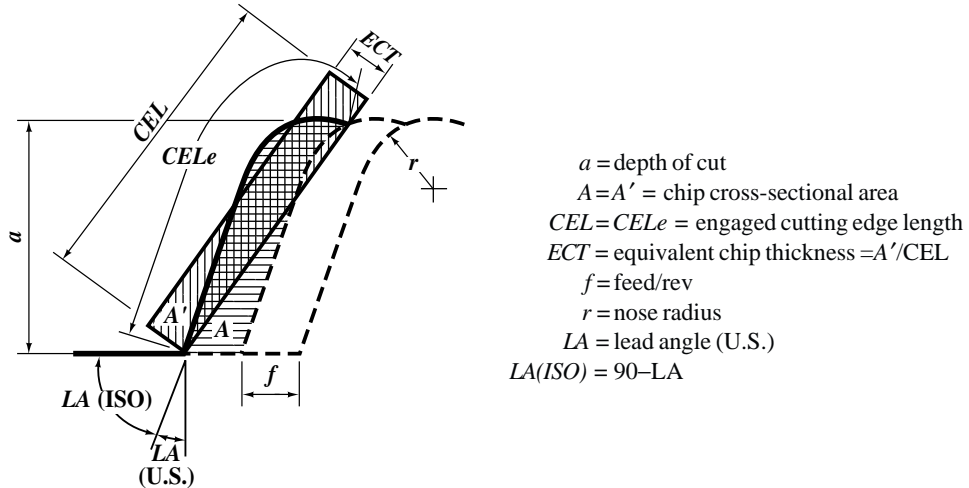


Fig. 1. Cutting Geometry, Equivalent Chip Thickness, and Cutting Edge Length

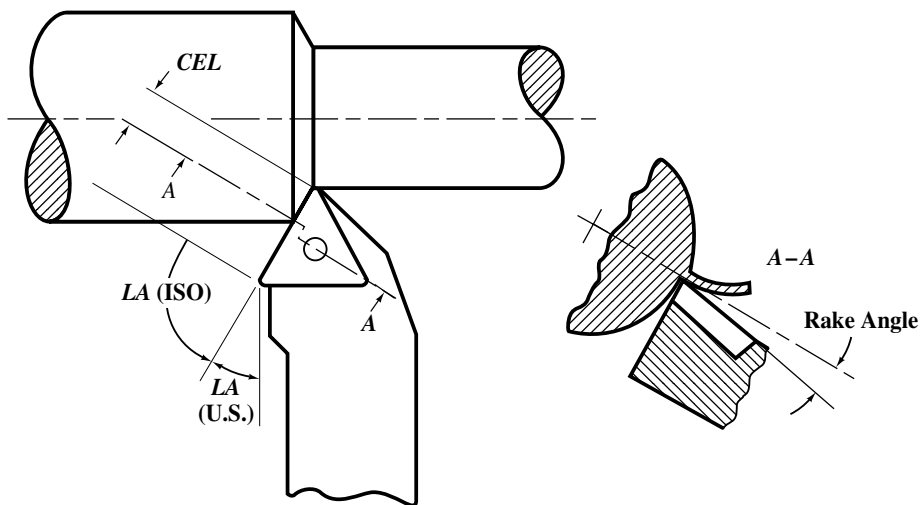


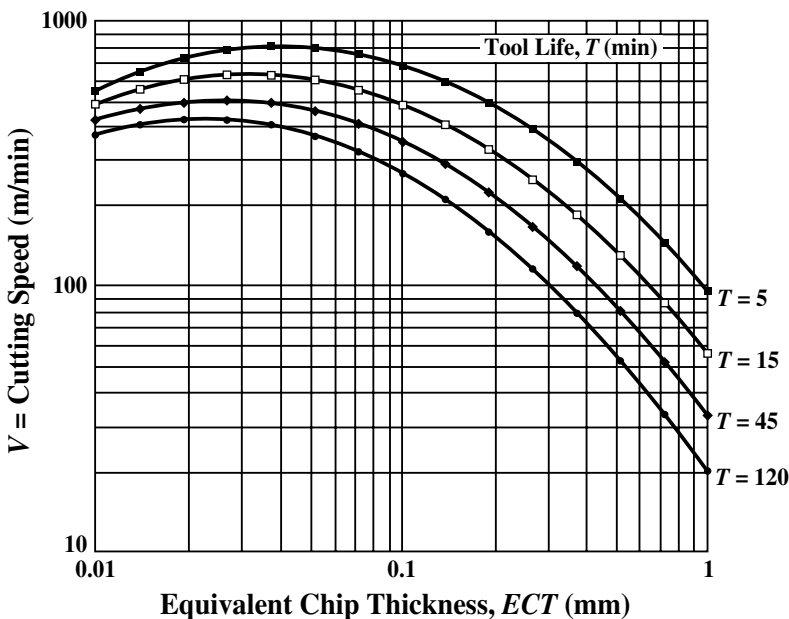
Fig. 2. Cutting Geometry for Turning

In the tables, the *optimum* feed/speed data have been calculated by COMP to achieve a fixed tool life based on the maximum ECT that will result in successful cutting, without premature tool wear or early tool failure. The same tool life is used to calculate the *average* feed/speed data, but these values are based on one-half of the maximum ECT . Because the data are not linear except over a small range of values, both *optimum* and *average* sets are required to adjust speeds for feed, lead angle, depth of cut, and other factors.

Tool life is the most important factor in a machining system, so feeds and speeds cannot be selected as simple numbers, but must be considered with respect to the many parameters that influence tool life. The accuracy of the combined feed/speed data presented is believed to be very high. However, machining is a variable and complicated process and use of the feed and speed tables requires the user to follow the instructions carefully to achieve good predictability. The results achieved, therefore, may vary due to material condition, tool material, machine setup, and other factors, and cannot be guaranteed.

The feed values given in the tables are valid for the standard tool geometries and fixed depths of cut that are identified in the table footnotes. If the cutting parameters and tool geometry established in the table footnotes are maintained, turning operations using either the *optimum* or *average* feed/speed data (Tables 1 through 9) should achieve a constant tool life of approximately 15 minutes; tool life for milling, drilling, reaming, and threading data (Tables 10 through 14 and Tables 17 through 22) should be approximately 45 minutes. The reason for the different economic tool lives is the higher tooling cost associated with milling-drilling operations than for turning. If the cutting parameters or tool geometry are different from those established in the table footnotes, the same tool life (15 or 45 minutes) still may be maintained by applying the appropriate speed adjustment factors, or tool life may be increased or decreased using tool life adjustment factors. The use of the speed and tool life adjustment factors is described in the examples that follow.

Both the *optimum* and *average* feed/speed data given are reasonable values for effective cutting. However, the *optimum* set with its higher feed and lower speed (always the left entry in each table cell) will usually achieve greater productivity. In Table 1, for example, the two entries for turning 1212 free-machining plain carbon steel with uncoated carbide are 17/805 and 8/1075. These values indicate that a feed of 0.017 in./rev and a speed of 805 ft/min, or a feed of 0.008 in./rev and a speed of 1075 ft/min can be used for this material. The tool life, in each case, will be approximately 15 minutes. If one of these feed and speed pairs is assigned an arbitrary cutting time of 1 minute, then the relative cutting time of the second pair to the first is equal to the ratio of their respective feed \times speed products. Here, the same amount of material that can be cut in 1 minute, at the higher feed and lower speed (17/805), will require 1.6 minutes at the lower feed and higher speed (8/1075) because $17 \times 805 / (8 \times 1075) = 1.6$ minutes.



Cutting Speed versus Equivalent Chip Thickness with Tool Life as a Parameter

Speed and Feed Tables for Turning.—Speeds for HSS (high-speed steel) tools are based on a feed of 0.012 inch/rev and a depth of cut of 0.125 inch; use [Table 5c](#) to adjust the given speeds for other feeds and depths of cut. The combined feed/speed data in the remaining columns are based on a depth of cut of 0.1 inch, lead angle of 15 degrees, and nose radius of $\frac{3}{64}$ inch. Use [Table 5a](#) to adjust given speeds for other feeds, depths of cut, and lead angles; use [Table 5b](#) to adjust given speeds for increased tool life up to 180 minutes. Examples are given in the text.

Examples Using the Feed and Speed Tables for Turning: The examples that follow give instructions for determining cutting speeds for turning. In general, the same methods are also used to find cutting speeds for milling, drilling, reaming, and threading, so reading through these examples may bring some additional insight to those other metalworking processes as well. The first step in determining cutting speeds is to locate the work material in the left column of the appropriate table for turning, milling, or drilling, reaming, and threading.

Example 1, Turning: Find the cutting speed for turning SAE 1074 plain carbon steel of 225 to 275 Brinell hardness, using an uncoated carbide insert, a feed of 0.015 in./rev, and a depth of cut of 0.1 inch.

In [Table 1](#), feed and speed data for two types of uncoated carbide tools are given, one for hard tool grades, the other for tough tool grades. In general, use the speed data from the tool category that most closely matches the tool to be used because there are often significant differences in the speeds and feeds for different tool grades. From the uncoated carbide hard grade values, the *optimum* and *average* feed/speed data given in [Table 1](#) are 17/615 and 8/815, or 0.017 in./rev at 615 ft/min and 0.008 in./rev at 815 ft/min. Because the selected feed (0.015 in./rev) is different from either of the feeds given in the table, the cutting speed must be adjusted to match the feed. The other cutting parameters to be used must also be compared with the general tool and cutting parameters given in the speed tables to determine if adjustments need to be made for these parameters as well. The general tool and cutting parameters for turning, given in the footnote to [Table 1](#), are depth of cut = 0.1 inch, lead angle = 15°, and tool nose radius = $\frac{3}{64}$ inch.

[Table 5a](#) is used to adjust the cutting speeds for turning (from [Tables 1](#) through [9](#)) for changes in feed, depth of cut, and lead angle. The new cutting speed V is found from $V = V_{opt} \times F_f \times F_d$, where V_{opt} is the *optimum* speed from the table (always the lower of the two speeds given), and F_f and F_d are the adjustment factors from [Table 5a](#) for feed and depth of cut, respectively.

To determine the two factors F_f and F_d , calculate the ratio of the selected feed to the *optimum* feed, $0.015/0.017 = 0.9$, and the ratio of the two given speeds V_{avg} and V_{opt} , $815/615 = 1.35$ (approximately). The feed factor $F_f = 1.07$ is found in [Table 5a](#) at the intersection of the feed ratio row and the speed ratio column. The depth-of-cut factor $F_d = 1.0$ is found in the same row as the feed factor in the column for depth of cut = 0.1 inch and lead angle = 15°, or for a tool with a 45° lead angle, $F_d = 1.18$. The final cutting speed for a 15° lead angle is $V = V_{opt} \times F_f \times F_d = 615 \times 1.07 \times 1.0 = 658$ fpm. Notice that increasing the lead angle tends to permit higher cutting speeds; such an increase is also the general effect of increasing the tool nose radius, although nose radius correction factors are not included in this table. Increasing lead angle also increases the radial pressure exerted by the cutting tool on the workpiece, which may cause unfavorable results on long, slender workpieces.

Example 2, Turning: For the same material and feed as the previous example, what is the cutting speed for a 0.4-inch depth of cut and a 45° lead angle?

As before, the feed is 0.015 in./rev, so F_f is 1.07, but $F_d = 1.03$ for depth of cut equal to 0.4 inch and a 45° lead angle. Therefore, $V = 615 \times 1.07 \times 1.03 = 676$ fpm. Increasing the lead angle from 15° to 45° permits a much greater (four times) depth of cut, at the same feed and nearly constant speed. Tool life remains constant at 15 minutes. (*Continued on page 1035*)

Table 1. Cutting Feeds and Speeds for Turning Plain Carbon and Alloy Steels

Material AISI/SAE Designation	Brinell Hardness	Tool Material															
		HSS	Uncoated Carbide				Coated Carbide				Ceramic				Cermets		
			Hard		Tough		Hard		Tough		Hard		Tough				
		Speed (fpm)	f = feed (0.001 in./rev), s = speed (ft/min) Metric Units: f × 25.4 = mm/rev, s × 0.3048 = m/min														
	Opt.	Avg.	Opt.	Avg.	Opt.	Avg.	Opt.	Avg.	Opt.	Avg.	Opt.	Avg.	Opt.	Avg.	Opt.	Avg.	
Free-machining plain carbon steels (resulturized): 1212, 1213, 1215	100-150	150	f s	17 805	8 1075	36 405	17 555	17 1165	8 1295	28 850	13 1200	15 3340	8 4985	15 1670	8 2500	7 1610	3 2055
	150-200	160	f s	17 745	8 935	36 345	17 470	28 915	13 1130	28 785	13 1110	15 1795	8 2680	15 1485	8 2215	7 1490	3 1815
1108, 1109, 1115, 1117, 1118, 1120, 1126, 1211	100-150	130	f s	17 730	8 990	36 300	17 430	17 1090	8 1410	28 780	13 1105	15 1610	8 2780	15 1345	8 2005	7 1355	3 1695
	150-200	120	f s	17 730	8 990	36 300	17 430	17 1090	8 1410	28 780	13 1105	15 1610	8 2780	15 1345	8 2005	7 1355	3 1695
1132, 1137, 1139, 1140, 1144, 1146, 1151	175-225	120	f s	17 615	8 815	36 300	17 405	17 865	8 960	28 755	13 960	13 1400	7 1965	13 1170	7 1640		
	275-325	75															
	325-375	50	f s	17 515	8 685	36 235	17 340	17 720	8 805	28 650	13 810	10 1430	5 1745	10 1070	5 1305		
	375-425	40															
(Leaded): 11L17, 11L18, 12L13, 12L14	100-150	140	f s	17 745	8 935	36 345	17 470	28 915	13 1130	28 785	13 1110	15 1795	8 2680	15 1485	8 2215	7 1490	3 1815
	150-200	145															
	200-250	110	f s	17 615	8 815	36 300	17 405	17 865	8 960	28 755	13 960	13 1400	7 1965	13 1170	7 1640		
Plain carbon steels: 1006, 1008, 1009, 1010, 1012, 1015, 1016, 1017, 1018, 1019, 1020, 1021, 1022, 1023, 1024, 1025, 1026, 1513, 1514	100-125	120	f s	17 805	8 1075	36 405	17 555	17 1165	8 1295	28 850	13 1200	15 3340	8 4985	15 1670	8 2500	7 1610	3 2055
	125-175	110	f s	17 745	8 935	36 345	17 470	28 915	13 1130	28 785	13 1110	15 1795	8 2680	15 1485	8 2215	7 1490	3 1815
	175-225	90															
	225-275	70	f s	17 615	8 815	36 300	17 405	17 865	8 960	28 755	13 960	13 1400	7 1965	13 1170	7 1640		

Table 1. (Continued) Cutting Feeds and Speeds for Turning Plain Carbon and Alloy Steels

Material AISI/SAE Designation	Brinell Hardness	Tool Material															
		HSS	Uncoated Carbide				Coated Carbide				Ceramic				Cermets		
			Hard		Tough		Hard		Tough		Hard		Tough		Opt.	Avg.	
		$f = \text{feed (0.001 in./rev)}$, $s = \text{speed (ft/min)}$ <i>Metric Units:</i> $f \times 25.4 = \text{mm/rev}$, $s \times 0.3048 = \text{m/min}$															
Speed (fpm)	<i>f</i>	<i>s</i>	<i>Opt.</i>	<i>Avg.</i>	<i>Opt.</i>	<i>Avg.</i>	<i>Opt.</i>	<i>Avg.</i>	<i>Opt.</i>	<i>Avg.</i>	<i>Opt.</i>	<i>Avg.</i>	<i>Opt.</i>	<i>Avg.</i>			
Plain carbon steels (continued): 1027, 1030, 1033, 1035, 1036, 1037, 1038, 1039, 1040, 1041, 1042, 1043, 1045, 1046, 1048, 1049, 1050, 1052, 1524, 1526, 1527, 1541	125-175	100	<i>f</i>	17	8	36	17	28	13	28	13	15	8	15	8	7	3
			<i>s</i>	745	935	345	470	915	1130	785	1110	1795	2680	1485	2215	1490	1815
	175-225	85	<i>f</i>	17	8	36	17	17	8	28	13	13	7	13	7		
			<i>s</i>	615	815	300	405	865	960	755	960	1400	1965	1170	1640		
	225-275	70	<i>f</i>	17	8	36	17	17	8	28	13	10	5	10	5		
			<i>s</i>	515	685	235	340	720	805	650	810	1430	1745	1070	1305		
275-325	60	<i>f</i>	17	8	36	17	17	8	28	13	10	5	10	5			
		<i>s</i>	515	685	235	340	720	805	650	810	1430	1745	1070	1305			
325-375	40	<i>f</i>	17	8	36	17	17	8	28	13	10	5	10	5			
		<i>s</i>	515	685	235	340	720	805	650	810	1430	1745	1070	1305			
375-425	30	<i>f</i>	17	8	36	17	17	8	28	13	10	5	10	5			
		<i>s</i>	515	685	235	340	720	805	650	810	1430	1745	1070	1305			
Plain carbon steels (continued): 1055, 1060, 1064, 1065, 1070, 1074, 1078, 1080, 1084, 1086, 1090, 1095, 1548, 1551, 1552, 1561, 1566	125-175	100	<i>f</i>	17	8	36	17	17	8	28	13	15	8	15	8	7	3
			<i>s</i>	730	990	300	430	1090	1410	780	1105	1610	2780	1345	2005	1355	1695
	175-225	80	<i>f</i>	17	8	36	17	17	8	28	13	13	7	13	7	7	3
			<i>s</i>	615	815	300	405	865	960	755	960	1400	1965	1170	1640	1365	1695
	225-275	65	<i>f</i>	17	8	36	17	17	8	28	13	10	5	10	5		
			<i>s</i>	515	685	235	340	720	805	650	810	1430	1745	1070	1305		
275-325	50	<i>f</i>	17	8	36	17	17	8	28	13	10	5	10	5			
		<i>s</i>	515	685	235	340	720	805	650	810	1430	1745	1070	1305			
325-375	35	<i>f</i>	17	8	36	17	17	8	28	13	10	5	10	5			
		<i>s</i>	515	685	235	340	720	805	650	810	1430	1745	1070	1305			
375-425	30	<i>f</i>	17	8	36	17	17	8	28	13	10	5	10	5			
		<i>s</i>	515	685	235	340	720	805	650	810	1430	1745	1070	1305			
Free-machining alloy steels, (resulfurized): 4140, 4150	175-200	110	<i>f</i>	17	8	36	17	17	8	28	13	15	8	15	8	7	3
			<i>s</i>	525	705	235	320	505	525	685	960	1490	2220	1190	1780	1040	1310
	200-250	90	<i>f</i>	17	8	36	17	17	8	28	13	10	5	10	5	7	3
			<i>s</i>	355	445	140	200	630	850	455	650	1230	1510	990	1210	715	915
	250-300	65	<i>f</i>	17	8	36	17	17	8	28	13	8	4	8	4	7	3
			<i>s</i>	330	440	125	175	585	790	125	220	1200	1320	960	1060	575	740
300-375	50	<i>f</i>	17	8	36	17	17	8	28	13	8	4	8	4	7	3	
		<i>s</i>	330	440	125	175	585	790	125	220	1200	1320	960	1060	575	740	
375-425	40	<i>f</i>	17	8	36	17	17	8	28	13	8	4	8	4	7	3	
		<i>s</i>	330	440	125	175	585	790	125	220	1200	1320	960	1060	575	740	

SPEEDS AND FEEDS

1027

Table 1. (Continued) Cutting Feeds and Speeds for Turning Plain Carbon and Alloy Steels

Material AISI/SAE Designation	Brinell Hardness	Tool Material															
		HSS	Uncoated Carbide				Coated Carbide				Ceramic				Cermet		
		Speed (fpm)	Hard		Tough		Hard		Tough		Hard		Tough		Opt.	Avg.	
			<i>f</i>	<i>s</i>	<i>Opt.</i>	<i>Avg.</i>	<i>Opt.</i>	<i>Avg.</i>	<i>Opt.</i>	<i>Avg.</i>	<i>Opt.</i>	<i>Avg.</i>	<i>Opt.</i>	<i>Avg.</i>			
f = feed (0.001 in./rev), s = speed (ft/min) Metric Units: f × 25.4 = mm/rev, s × 0.3048 = m/min																	
Free-machining alloy steels: (leadeds): 41L30, 41L40, 41L47, 41L50, 43L47, 51L32, 52L100, 86L20, 86L40	150-200	120	f	17	8	36	17	17	8	28	13	15	8	15	8	7	3
			s	730	990	300	430	1090	1410	780	1105	1610	2780	1345	2005	1355	1695
	200-250	100	f	17	8	36	17	17	8	28	13	13	7	13	7	7	3
			s	615	815	300	405	865	960	755	960	1400	1965	1170	1640	1355	1695
	250-300	75															
	300-375	55	f	17	8	36	17	17	8	28	13	10	5	10	5		
			s	515	685	235	340	720	805	650	810	1430	1745	1070	1305		
	375-425	50															
Alloy steels: 4012, 4023, 4024, 4028, 4118, 4320, 4419, 4422, 4427, 4615, 4620, 4621, 4626, 4718, 4720, 4815, 4817, 4820, 5015, 5117, 5120, 6118, 8115, 8615, 8617, 8620, 8622, 8625, 8627, 8720, 8822, 94B17	125-175	100	f	17	8	36	17	17	8	28	13	15	8	15	8	7	3
			s	525	705	235	320	505	525	685	960	1490	2220	1190	1780	1040	1310
	175-225	90															
	225-275	70	f	17	8	36	17	17	8	28	13	10	5	10	5	7	3
			s	355	445	140	200	630	850	455	650	1230	1510	990	1210	715	915
	275-325	60	f	17	8	36	17	17	8	28	13	9	5	8	5	7	3
			s	330	440	135	190	585	790	240	350	1230	1430	990	1150	655	840
	325-35	50															
	375-425	30 (20)	f	17	8	36	17	17	8	28	13	8	4	8	4	7	3
			s	330	440	125	175	585	790	125	220	1200	1320	960	1060	575	740
Alloy steels: 1330, 1335, 1340, 1345, 4032, 4037, 4042, 4047, 4130, 4135, 4137, 4140, 4142, 4145, 4147, 4150, 4161, 4337, 4340, 50B44, 50B46, 50B50, 50B60, 5130, 5132, 5140, 5145, 5147, 5150, 5160, 51B60, 6150, 81B45, 8630, 8635, 8637, 8640, 8642, 8645, 8650, 8655, 8660, 8740, 9254, 9255, 9260, 9262, 94B30 E51100, E52100 use (HSS Speeds)	175-225	85 (70)	f	17	8	36	17	17	8	28	13	15	8	15	8	7	3
			s	525	705	235	320	505	525	685	960	1490	2220	1190	1780	1020	1310
	225-275	70 (65)	f	17	8	36	17	17	8	28	13	10	5	10	5	7	3
			s	355	445	140	200	630	850	455	650	1230	1510	990	1210	715	915
	275-325	60 (50)	f	17	8	36	17	17	8	28	13	9	5	8	5	7	3
		s	330	440	135	190	585	790	240	350	1230	1430	990	1150	655	840	
	325-375	40 (30)															
	375-425	30 (20)	f	17	8	36	17	17	8	28	13	8	4	8	4	7	3
			s	330	440	125	175	585	790	125	220	1200	1320	960	1060	575	740

Table 1. (Continued) Cutting Feeds and Speeds for Turning Plain Carbon and Alloy Steels

Material AISI/SAE Designation	Brinell Hardness	Tool Material															
		HSS	Uncoated Carbide				Coated Carbide				Ceramic				Cermets		
		Speed (fpm)	Hard		Tough		Hard		Tough		Hard		Tough		Opt.	Avg.	
			f = feed (0.001 in./rev), s = speed (ft/min) <i>Metric Units:</i> $f \times 25.4 = \text{mm/rev}$, $s \times 0.3048 = \text{m/min}$														
		Opt.	Avg.	Opt.	Avg.	Opt.	Avg.	Opt.	Avg.	Opt.	Avg.	Opt.	Avg.	Opt.	Avg.		
Ultra-high-strength steels (not ASI): AMS alloys 6421 (98B37 Mod.), 6422 (98BV40), 6424, 6427, 6428, 6430, 6432, 6433, 6434, 6436, and 6442; 300M and D6ac	220-300	65															
	300-350	50	f s	17 220	8 295	36 100	17 150	20 355	10 525	28 600	13 865			10 660	5 810	7 570	3 740
	350-400	35	f s	17 165	8 185	36 55	17 105	17 325	8 350	28 175	13 260			8 660	4 730	7 445	3 560
	43-48 Rc	25															
	48-52 Rc	10	f s			17 55†	8 90					7 385	3 645	10 270	5 500		
Maraging steels (not AISI): 18% Ni, Grades 200, 250, 300, and 350	250-325	60	f s	17 220	8 295	36 100	17 150	20 355	10 525	28 600	13 865	660	810	10 570	5 740	7	3
	50-52 Rc	10	f s			17 55†	8 90					7 385‡	3 645	10 270	5 500		
Nitriding steels (not AISI): Nitralloy 125, 135, 135 Mod., 225, and 230, Nitralloy N, Nitralloy EZ, Nitrex I	200-250	70	f s	17 525	8 705	36 235	17 320	17 505	8 525	28 685	13 960	15 1490	8 2220	15 1190	8 1780	7 1040	3 1310
	300-350	30	f s	17 330	8 440	36 125	17 175	17 585	8 790	28 125	13 220	8 1200	4 1320	8 960	4 1060	7 575	3 740

Speeds for HSS (high-speed steel) tools are based on a feed of 0.012 inch/rev and a depth of cut of 0.125 inch; use [Table 5c](#) to adjust the given speeds for other feeds and depths of cut. The combined feed/speed data in the remaining columns are based on a depth of cut of 0.1 inch, lead angle of 15 degrees, and nose radius of $\frac{3}{64}$ inch. Use [Table 5a](#) to adjust given speeds for other feeds, depths of cut, and lead angles; use [Table 5b](#) to adjust given speeds for increased tool life up to 180 minutes. Examples are given in the text.

The combined feed/speed data in this table are based on tool grades (identified in [Table 16](#)) as follows: uncoated carbides, hard = 17, tough = 19, † = 15; coated carbides, hard = 11, tough = 14; ceramics, hard = 2, tough = 3, ‡ = 4; cermet = 7.

Table 2. Cutting Feeds and Speeds for Turning Tool Steels

Material AISI Designation	Brinell Hardness	Tool Material															
		Uncoated HSS	Uncoated Carbide				Coated Carbide				Ceramic				Cermet		
		Speed (fpm)	Hard		Tough		Hard		Tough		Hard		Tough		Opt.	Avg.	
			f = feed (0.001 in./rev), s = speed (ft/min) Metric Units: f × 25.4 = mm/rev, s × 0.3048 = m/min														
														Opt.	Avg.		
Water hardening: W1, W2, W5	150-200	100															
Shock resisting: S1, S2, S5, S6, S7	175-225	70															
Cold work, oil hardening: O1, O2, O6, O7	175-225	70	f	17	8	36	17	17	8	28	13	13	7	13	7	7	3
Cold work, high carbon, high chromium: D2, D3, D4, D5, D7	200-250	45	s	455	610	210	270	830	1110	575	805	935	1310	790	1110	915	1150
Cold work, air hardening: A2, A3, A8, A9, A10	200-250	70															
A4, A6	200-250	55	f	17	8	36	17	17	8	28	13	13	7	13	7	7	3
A7	225-275	45	s	445	490	170	235	705	940	515	770	660	925	750	1210	1150	1510
Hot work, chromium type: H10, H11, H12, H13, H14, H19	150-200	80															
	200-250	65															
	325-375	50	f	17	8	36	17	17	8	28	13			8	4	7	3
			s	165	185	55	105	325	350	175	260			660	730	445	560
Hot work, tungsten type: H21, H22, H23, H24, H25, H26	150-200	60															
	200-250	50	f	17	8	36	17	17	8	28	13	13	7	13	7	7	3
			s	445	490	170	235	705	940	515	770	660	925	750	1210	1150	1510
Hot work, molybdenum type: H41, H42, H43	150-200	55															
	200-250	45															
Special purpose, low alloy: L2, L3, L6	150-200	75	f	17	8	36	17	17	8	28	13	13	7	13	7	7	3
			s	445	610	210	270	830	1110	575	805	935	1310	790	1110	915	1150
Mold: P2, P3, P4, P5, P6, P26, P21	100-150	90	f	17	8	36	17	17	8	28	13	13	7	13	7	7	3
	150-200	80	s	445	610	210	270	830	1110	575	805	935	1310	790	1110	915	1150
High-speed steel: M1, M2, M6, M10, T1, T2, T6	200-250	65															
	M3-1, M4 M7, M30, M33, M34, M36, M41, M42, M43, M44, M46, M47, T5, T8	225-275	f	17	8	36	17	17	8	28	13	13	7	13	7	7	3
	T15, M3-2	225-275	s	445	490	170	235	705	940	515	770	660	925	750	1210	1150	1510

Speeds for HSS (high-speed steel) tools are based on a feed of 0.012 inch/rev and a depth of cut of 0.125 inch; use Table 5c to adjust the given speeds for other feeds and depths of cut. The combined feed/speed data in the remaining columns are based on a depth of cut of 0.1 inch, lead angle of 15 degrees, and nose radius of 3/64 inch. Use Table 5a to adjust given speeds for other feeds, depths of cut, and lead angles; use Table 5b to adjust given speeds for increased tool life up to 180 minutes. Examples are given in the text. The combined feed/speed data in this table are based on tool grades (identified in Table 16) as follows: uncoated carbides, hard = 17, tough = 19, † = 15; coated carbides, hard = 11, tough = 14; ceramics, hard = 2, tough = 3, ‡ = 4; cermet = 7.

Table 3. Cutting Feeds and Speeds for Turning Stainless Steels

Material	Brinell Hardness	Tool Material											
		Uncoated HSS	Uncoated Carbide				Coated Carbide				Cermet		
			Hard		Tough		Hard		Tough				
		Speed (fpm)	f = feed (0.001 in./rev), s = speed (ft/min)								Metric Units: f × 25.4 = mm/rev, s × 0.3048 = m/min		
Opt.	Avg.		Opt.	Avg.	Opt.	Avg.	Opt.	Avg.	Opt.	Avg.			
Free-machining stainless steel (Ferritic): 430F, 430FSe (Austenitic): 203EZ, 303, 303Se, 303MA, 303Pb, 303Cu, 303 Plus X	135-185	110	f s	20 480	10 660	36 370	17 395	17 755	8 945	28 640	13 810	7 790	3 995
	135-185 225-275	100 80	f s	13 520	7 640	36 310	17 345			28 625	13 815	7 695	3 875
(Martensitic): 416, 416Se, 416 Plus X, 420F, 420FSe, 440F, 440FSe	135-185	110	f	13	7	36				28	13	7	3
	185-240	100	s	520	640	310				625	815	695	875
	275-325	60	f	13	7	36	17			28	13		
	375-425	30	s	210	260	85	135			130	165		
Stainless steels (Ferritic): 405, 409 429, 430, 434, 436, 442, 446, 502 (Austenitic): 201, 202, 301, 302, 304, 304L, 305, 308, 321, 347, 348 (Austenitic): 302B, 309, 309S, 310, 310S, 314, 316, 316L, 317, 330 (Martensitic): 403, 410, 420, 501 (Martensitic): 414, 431, Greek Ascoloy, 440A, 440B, 440C	135-185	90	f s	20 480	10 660	36 370	17 395	17 755	8 945	28 640	13 810	7 790	3 995
	135-185 225-275	75 65											
	135-185	70	f s	13 520	7 640	36 310	17 345			28 625	13 815	7 695	3 875
	135-175 175-225	95 85											
	275-325 375-425	55 35											
	225-275 275-325 375-425	55-60 45-50 30	f s	13 210	7 260	36 85	17 135			28 130	13 165	13 200†	7 230
	150-200 275-325	60 50	f s	13 520	7 640	36 310	17 345			28 625	13 815	13 695	7 875
325-375 375-450	40 25	f s	13 195	7 240	36 85	17 155							

See footnote to Table 1 for more information. The combined feed/speed data in this table are based on tool grades (identified in Table 16) as follows: uncoated carbides, hard = 17, tough = 19; coated carbides, hard = 11, tough = 14; cermet = 7, † = 18.

Table 4a. Cutting Feeds and Speeds for Turning Ferrous Cast Metals

Material	Brinell Hardness	Tool Material																
		HSS	Uncoated Carbide				Coated Carbide				Ceramic				Cermets		CBN	
		Speed (fpm)	Tough		Hard		Tough		Hard		Tough		Opt.		Avg.			
			f = feed (0.001 in./rev), s = speed (ft/min) Metric Units: f × 25.4 = mm/rev, s × 0.3048 = m/min															
		Opt.	Avg.	Opt.	Avg.	Opt.	Avg.	Opt.	Avg.	Opt.	Avg.	Opt.	Avg.	Opt.	Avg.			
Gray Cast Iron																		
ASTM Class 20	120-150	120	f	28	13	28	13	28	13	15	8	15	8	8	4	24	11	
ASTM Class 25	160-200	90	s	240	365	665	1040	585	945	1490	2220	1180	1880	395	510	8490	36380	
ASTM Class 30, 35, and 40	190-220	80																
ASTM Class 45 and 50	220-260	60	f	28	13	28	13	28	13	11	6	11	6	8	4	24	11	
ASTM Class 55 and 60	250-320	35	s	160	245	400	630	360	580	1440	1880	1200	1570	335	420	1590	2200	
ASTM Type 1, 1b, 5 (Ni resist)	100-215	70																
ASTM Type 2, 3, 6 (Ni resist)	120-175	65	f	28	13			28	13	15	8	15	8	8	4			
ASTM Type 2b, 4 (Ni resist)	150-250	50	s	110	175			410	575	1060	1590	885	1320	260	325			
Malleable Iron																		
(Ferritic): 32510, 35018	110-160	130	f	28	13	28	13	28	13	15	8	15	8					
			s	180	280	730	940	660	885	1640	2450	1410	2110					
(Pearlitic): 40010, 43010, 45006, 45008, 48005, 50005	160-200 200-240	95 75	f	28	13	28	13	28	13	13	7	13	7					
			s	125	200	335	505	340	510	1640	2310	1400	1970					
(Martensitic): 53004, 60003, 60004	200-255	70																
(Martensitic): 70002, 70003	220-260	60	f	28	13			28	13	11	6	11	6					
(Martensitic): 80002	240-280	50	s	100	120			205	250	1720	2240	1460	1910					
(Martensitic): 90001	250-320	30																

Speeds for HSS (high-speed steel) tools are based on a feed of 0.012 inch/rev and a depth of cut of 0.125 inch; use [Table 5c](#) to adjust the given speeds for other feeds and depths of cut. The combined feed/speed data in the remaining columns are based on a depth of cut of 0.1 inch, lead angle of 15 degrees, and nose radius of $\frac{3}{64}$ inch. Use [Table 5a](#) to adjust the given speeds for other feeds, depths of cut, and lead angles; use [Table 5b](#) to adjust given speeds for increased tool life up to 180 minutes. Examples are given in the text.

The combined feed/speed data in this table are based on tool grades (identified in [Table 16](#)) as follows: uncoated carbides, tough = 15; Coated carbides, hard = 11, tough = 14; ceramics, hard = 2, tough = 3; cermet = 7; CBN = 1.

Table 4b. Cutting Feeds and Speeds for Turning Ferrous Cast Metals

Material	Brinell Hardness	Tool Material														
		Uncoated HSS	Uncoated Carbide				Coated Carbide				Ceramic				Cermets	
			Hard		Tough		Hard		Tough		Hard		Tough			
		Speed (fpm)	f = feed (0.001 in./rev), s = speed (ft/min) Metric Units: f × 25.4 = mm/rev, s × 0.3048 = m/min													
Opt.	Avg.		Opt.	Avg.	Opt.	Avg.	Opt.	Avg.	Opt.	Avg.	Opt.	Avg.	Opt.	Avg.		
Nodular (Ductile) Iron																
(Ferritic): 60-40-18, 65-45-12	140-190	100	f		28	13	28	13	28	13	15	8	15	8	8	4
			s		200	325	490	700	435	665	970	1450	845	1260	365	480
(Ferritic-Pearlitic): 80-55-06	190-225 225-260	80 65	f		28	13	28	13	28	13	11	6	11	6	8	4
			s		130	210	355	510	310	460	765	995	1260	1640	355	445
(Pearlitic-Martensitic): 100-70-03	240-300	45														
(Martensitic): 120-90-02	270-330 300-400	30 15	f		28	13			28	13	10	5	10	5	8	4
			s		40	65			145	175	615	750	500	615	120	145
Cast Steels																
(Low-carbon): 1010, 1020	100-150 125-175	110 100	f	17	8	36	17	17	8	28	13	15	8		7	3
			s	370	490	230	285	665	815	495	675	2090	3120		625	790
(Medium-carbon): 1030, 1040, 1050	175-225 225-300	9070														
			f	17	8	36	17	17	8	28	13	15	8		7	3
(Low-carbon alloy): 1320, 2315, 2320, 4110, 4120, 4320, 8020, 8620	150-200 200-250 250-300	90 80 60	s	370	490	150	200	595	815	410	590	1460	2170		625	790
			f	17	8	36	17	17	8			15	8			
			s	310	415	115	150	555	760			830	1240			
(Medium-carbon alloy): 1330, 1340, 2325, 2330, 4125, 4130, 4140, 4330, 4340, 8030, 80B30, 8040, 8430, 8440, 8630, 8640, 9525, 9530, 9535	175-225 225-250 250-300 300-350	80 70 55 45	f	17	8	36	17	17	8			15	8			
			s	310	415	115	150	555	760			830	1240			
			f			28	13					1544	8			
			s			70†	145					5	665			
	350-400	30	f			28	13			28	13		15	8		
			s			115†	355			335	345		955	1430		

The combined feed/speed data in this table are based on tool grades (identified in Table 16) as shown: uncoated carbides, hard = 17; tough = 19, † = 15; coated carbides, hard = 11; tough = 14; ceramics, hard = 2; tough = 3; cermet = 7. Also, see footnote to Table 4a.

Table 5a. Turning-Speed Adjustment Factors for Feed, Depth of Cut, and Lead Angle

Ratio of Chosen Feed to Optimum Feed	Ratio of the two cutting speeds given in the tables V_{avg}/V_{opt}							Depth of Cut and Lead Angle									
								1 in. (25.4 mm)		0.4 in. (10.2 mm)		0.2 in. (5.1 mm)		0.1 in. (2.5 mm)		0.04 in. (1.0 mm)	
	1.00	1.10	1.25	1.35	1.50	1.75	2.00	15°	45°	15°	45°	15°	45°	15°	45°	15°	45°
	Feed Factor, F_f							Depth of Cut and Lead Angle Factor, F_d									
1.00	1.0	1.0	1.0	1.0	1.0	1.0	1.0	0.74	1.0	0.79	1.03	0.85	1.08	1.0	1.18	1.29	1.35
0.90	1.00	1.02	1.05	1.07	1.09	1.10	1.12	0.75	1.0	0.80	1.03	0.86	1.08	1.0	1.17	1.27	1.34
0.80	1.00	1.03	1.09	1.10	1.15	1.20	1.25	0.77	1.0	0.81	1.03	0.87	1.07	1.0	1.15	1.25	1.31
0.70	1.00	1.05	1.13	1.22	1.22	1.32	1.43	0.77	1.0	0.82	1.03	0.87	1.08	1.0	1.15	1.24	1.30
0.60	1.00	1.08	1.20	1.25	1.35	1.50	1.66	0.78	1.0	0.82	1.03	0.88	1.07	1.0	1.14	1.23	1.29
0.50	1.00	1.10	1.25	1.35	1.50	1.75	2.00	0.78	1.0	0.82	1.03	0.88	1.07	1.0	1.14	1.23	1.28
0.40	1.00	1.09	1.28	1.44	1.66	2.03	2.43	0.78	1.0	0.84	1.03	0.89	1.06	1.0	1.13	1.21	1.26
0.30	1.00	1.06	1.32	1.52	1.85	2.42	3.05	0.81	1.0	0.85	1.02	0.90	1.06	1.0	1.12	1.18	1.23
0.20	1.00	1.00	1.34	1.60	2.07	2.96	4.03	0.84	1.0	0.89	1.02	0.91	1.05	1.0	1.10	1.15	1.19
0.10	1.00	0.80	1.20	1.55	2.24	3.74	5.84	0.88	1.0	0.91	1.01	0.92	1.03	1.0	1.06	1.10	1.12

Use with Tables 1 through 9. Not for HSS tools. Tables 1 through 9 data, except for HSS tools, are based on depth of cut = 0.1 inch, lead angle = 15 degrees, and tool life = 15 minutes. For other depths of cut, lead angles, or feeds, use the two feed/speed pairs from the tables and calculate the ratio of desired (new) feed to optimum feed (largest of the two feeds given in the tables), and the ratio of the two cutting speeds (V_{avg}/V_{opt}). Use the value of these ratios to find the feed factor F_f at the intersection of the feed ratio row and the speed ratio column in the left half of the table. The depth-of-cut factor F_d is found in the same row as the feed factor in the right half of the table under the column corresponding to the depth of cut and lead angle. The adjusted cutting speed can be calculated from $V = V_{opt} \times F_f \times F_d$, where V_{opt} is the smaller (optimum) of the two speeds from the speed table (from the left side of the column containing the two feed/speed pairs). See the text for examples.

Table 5b. Tool Life Factors for Turning with Carbides, Ceramics, Cermets, CBN, and Polycrystalline Diamond

Tool Life, T (minutes)	Turning with Carbides: Workpiece < 300 Bhn			Turning with Carbides: Workpiece > 300 Bhn; Turning with Ceramics: Any Hardness			Turning with Mixed Ceramics: Any Workpiece Hardness		
	f_s	f_m	f_l	f_s	f_m	f_l	f_s	f_m	f_l
15	1.0	1.0	1.0	1.0	1.0	1.0	1.0	1.0	1.0
45	0.86	0.81	0.76	0.80	0.75	0.70	0.89	0.87	0.84
90	0.78	0.71	0.64	0.70	0.63	0.56	0.82	0.79	0.75
180	0.71	0.63	0.54	0.61	0.53	0.45	0.76	0.72	0.67

Except for HSS speed tools, feeds and speeds given in Tables 1 through 9 are based on 15-minute tool life. To adjust speeds for another tool life, multiply the cutting speed for 15-minute tool life V_{15} by the tool life factor from this table according to the following rules: for small feeds where $feed \leq \frac{1}{2}f_{opt}$, the cutting speed for desired tool life is $V_T = f_s \times V_{15}$; for medium feeds where $\frac{1}{2}f_{opt} < feed < \frac{3}{4}f_{opt}$, $V_T = f_m \times V_{15}$; and for larger feeds where $\frac{3}{4}f_{opt} \leq feed \leq f_{opt}$, $V_T = f_l \times V_{15}$. Here, f_{opt} is the largest (optimum) feed of the two feed/speed values given in the speed tables.

Table 5c. Cutting-Speed Adjustment Factors for Turning with HSS Tools

Feed		Feed Factor F_f	Depth of Cut		Depth-of-Cut Factor F_d
in.	mm		in.	mm	
0.002	0.05	1.50	0.005	0.13	1.50
0.003	0.08	1.50	0.010	0.25	1.42
0.004	0.10	1.50	0.016	0.41	1.33
0.005	0.13	1.44	0.031	0.79	1.21
0.006	0.15	1.34	0.047	1.19	1.15
0.007	0.18	1.25	0.062	1.57	1.10
0.008	0.20	1.18	0.078	1.98	1.07
0.009	0.23	1.12	0.094	2.39	1.04
0.010	0.25	1.08	0.100	2.54	1.03
0.011	0.28	1.04	0.125	3.18	1.00
0.012	0.30	1.00	0.150	3.81	0.97
0.013	0.33	0.97	0.188	4.78	0.94
0.014	0.36	0.94	0.200	5.08	0.93
0.015	0.38	0.91	0.250	6.35	0.91
0.016	0.41	0.88	0.312	7.92	0.88
0.018	0.46	0.84	0.375	9.53	0.86
0.020	0.51	0.80	0.438	11.13	0.84
0.022	0.56	0.77	0.500	12.70	0.82
0.025	0.64	0.73	0.625	15.88	0.80
0.028	0.71	0.70	0.688	17.48	0.78
0.030	0.76	0.68	0.750	19.05	0.77
0.032	0.81	0.66	0.812	20.62	0.76
0.035	0.89	0.64	0.938	23.83	0.75
0.040	1.02	0.60	1.000	25.40	0.74
0.045	1.14	0.57	1.250	31.75	0.73
0.050	1.27	0.55	1.250	31.75	0.72
0.060	1.52	0.50	1.375	34.93	0.71

For use with HSS tool data only from **Tables 1** through **9**. Adjusted cutting speed $V = V_{HSS} \times F_f \times F_d$, where V_{HSS} is the tabular speed for turning with high-speed tools.

Example 3, Turning: Determine the cutting speed for turning 1055 steel of 175 to 225 Brinell hardness using a hard ceramic insert, a 15° lead angle, a 0.04-inch depth of cut and 0.0075 in./rev feed.

The two feed/speed combinations given in **Table 5a** for 1055 steel are 15/1610 and 8/2780, corresponding to 0.015 in./rev at 1610 fpm and 0.008 in./rev at 2780 fpm, respectively. In **Table 5a**, the feed factor $F_f = 1.75$ is found at the intersection of the row corresponding to $\text{feed}/f_{opt} = 7.5/15 = 0.5$ and the column corresponding to $V_{avg}/V_{opt} = 2780/1610 = 1.75$ (approximately). The depth-of-cut factor $F_d = 1.23$ is found in the same row, under the column heading for a depth of cut = 0.04 inch and lead angle = 15° . The adjusted cutting speed is $V = 1610 \times 1.75 \times 1.23 = 3466$ fpm.

Example 4, Turning: The cutting speed for 1055 steel calculated in **Example 3** represents the speed required to obtain a 15-minute tool life. Estimate the cutting speed needed to obtain a tool life of 45, 90, and 180 minutes using the results of **Example 3**.

To estimate the cutting speed corresponding to another tool life, multiply the cutting speed for 15-minute tool life V_{15} by the adjustment factor from the **Table 5b**, Tool Life Factors for Turning. This table gives three factors for adjusting tool life based on the feed used, f_s for feeds less than or equal to $\frac{1}{2}f_{opr}$, f_m for midrange feeds between $\frac{1}{2}$ and $\frac{3}{4}f_{opr}$, and f_l for large feeds greater than or equal to $\frac{3}{4}f_{opr}$ and less than f_{opr} . In **Example 3**, f_{opr} is 0.015 in./rev and the selected feed is 0.0075 in./rev = $\frac{1}{2}f_{opr}$. The new cutting speeds for the various tool lives are obtained by multiplying the cutting speed for 15-minute tool life V_{15} by the factor

for small feeds f_s from the column for turning with ceramics in [Table 5b](#). These calculations, using the cutting speed obtained in Example 3, follow.

<i>Tool Life</i>	<i>Cutting Speed</i>
15 min	$V_{15} = 3466$ fpm
45 min	$V_{45} = V_{15} \times 0.80 = 2773$ fpm
90 min	$V_{90} = V_{15} \times 0.70 = 2426$ fpm
180 min	$V_{180} = V_{15} \times 0.61 = 2114$ fpm

Depth of cut, feed, and lead angle remain the same as in Example 3. Notice, increasing the tool life from 15 to 180 minutes, a factor of 12, reduces the cutting speed by only about one-third of the V_{15} speed.

Table 6. Cutting Feeds and Speeds for Turning Copper Alloys

Group 1								
Architectural bronze (C38500); Extra-high-headed brass (C35600); Forging brass (C37700); Free-cutting phosphor bronze, B2 (C54400); Free-cutting brass (C36000); Free-cutting Muntz metal (C37000); High-leaded brass (C33200; C34200); High-leaded brass tube (C35300); Leaded commercial bronze (C31400); Leaded naval brass (C48500); Medium-leaded brass (C34000)								
Group 2								
Aluminum brass, arsenical (C68700); Cartridge brass, 70% (C26000); High-silicon bronze, B (C65500); Admiralty brass (inhibited) (C44300, C44500); Jewelry bronze, 87.5% (C22600); Leaded Muntz metal (C36500, C36800); Leaded nickel silver (C79600); Low brass, 80% (C24000); Low-leaded brass (C33500); Low-silicon bronze, B (C65100); Manganese bronze, A (C67500); Muntz metal, 60% (C28000); Nickel silver, 55-18 (C77000); Red brass, 85% (C23000); Yellow brass (C26800)								
Group 3								
Aluminum bronze, D (C61400); Beryllium copper (C17000, C17200, C17500); Commercial-bronze, 90% (C22000); Copper nickel, 10% (C70600); Copper nickel, 30% (C71500); Electrolytic tough pitch copper (C11000); Guilding, 95% (C21000); Nickel silver, 65-10 (C74500); Nickel silver, 65-12 (C75700); Nickel silver, 65-15 (C75400); Nickel silver, 65-18 (C75200); Oxygen-free copper (C10200); Phosphor bronze, 1.25% (C50200); Phosphor bronze, 10% D (C52400) Phosphor bronze, 5% A (C51000); Phosphor bronze, 8% C (C52100); Phosphorus deoxidized copper (C12200)								
Wrought Alloys Description and UNS Alloy Numbers	Material Condition	HSS Speed (fpm)	Uncoated Carbide			Polycrystalline Diamond		
			f = feed (0.001 in./rev), s = speed (ft/min) <i>Metric Units:</i> $f \times 25.4 = \text{mm/rev}$, $s \times 0.3048 = \text{m/min}$					
			<i>Opt.</i>	<i>Avg.</i>	<i>Opt.</i>	<i>Avg.</i>		
Group 1	A	300	f	28	13			
	CD	350	s	1170	1680			
Group 2	A	200	f	28	13			
	CD	250	s	715	900			
Group 3	A	100	f	28	13	7	13	
	CD	110	s	440	610	1780	2080	

Abbreviations designate: A, annealed; CD, cold drawn.

The combined feed/speed data in this table are based on tool grades (identified in [Table 16](#)) as follows: uncoated carbide, 15; diamond, 9. See the footnote to [Table 7](#).

Table 7. Cutting Feeds and Speeds for Turning Titanium and Titanium Alloys

Material	Brinell Hardness	Tool Material			
		HSS	Uncoated Carbide (Tough)		
		Speed (fpm)	f = feed (0.001 in./rev), s = speed (ft/min) Metric Units: f × 25.4 = mm/rev, s × 0.3048 = m/min		
Opt.	Avg.				
Commercially Pure and Low Alloyed					
99.5Ti, 99.5Ti-0.15Pd	110-150	100-105	f s	28 55	13 190
99.1Ti, 99.2Ti, 99.2Ti-0.15Pd, 98.9Ti-0.8Ni-0.3Mo	180-240	85-90	f s	28 50	13 170
99.0 Ti	250-275	70	f s	20 75	10 210
Alpha Alloys and Alpha-Beta Alloys					
5Al-2.5Sn, 8Mn, 2Al-11Sn-5Zr- 1Mo, 4Al-3Mo-1V, 5Al-6Sn-2Zr- 1Mo, 6Al-2Sn-4Zr-2Mo, 6Al-2Sn- 4Zr-6Mo, 6Al-2Sn-4Zr-2Mo-0.25Si	300-350	50			
6Al-4V	310-350	40	f s	17 95	8 250
6Al-6V-2Sn, Al-4Mo, 8V-5Fe-1Al	320-370 320-380	30 20			
6Al-4V, 6Al-2Sn-4Zr-2Mo, 6Al-2Sn-4Zr-6Mo, 6Al-2Sn-4Zr-2Mo-0.25Si	320-380	40			
4Al-3Mo-1V, 6Al-6V-2Sn, 7Al-4Mo	375-420	20			
1 Al-8V-5Fe	375-440	20			
Beta Alloys					
13V-11Cr-3Al, 8Mo-8V-2Fe-3Al, 3Al-8V-6Cr-4Mo-4Zr, 11.5Mo-6Zr-4.5Sn	275-350 375-440	25 20	f s	17 55	8 150

The speed recommendations for turning with HSS (high-speed steel) tools may be used as starting speeds for milling titanium alloys, using [Table 15a](#) to estimate the feed required. Speeds for HSS (high-speed steel) tools are based on a feed of 0.012 inch/rev and a depth of cut of 0.125 inch; use [Table 5c](#) to adjust the given speeds for other feeds and depths of cut. The combined feed/speed data in the remaining columns are based on a depth of cut of 0.1 inch, lead angle of 15 degrees, and nose radius of $\frac{3}{64}$ inch. Use [Table 5a](#) to adjust given speeds for other feeds, depths of cut, and lead angles; use [Table 5b](#) to adjust given speeds for increased tool life up to 180 minutes. Examples are given in the text. The combined feed/speed data in this table are based on tool grades (identified in [Table 16](#)) as follows: uncoated carbide, 15.

Table 8. Cutting Feeds and Speeds for Turning Light Metals

Material Description	Material Condition	Tool Material					
		HSS	Uncoated Carbide (Tough)		Polycrystalline Diamond		
		Speed (fpm)	f = feed (0.001 in./rev), s = speed (ft/min) Metric: f × 25.4 = mm/rev, s × 0.3048 = m/min				
Opt.	Avg.		Opt.	Avg.			
All wrought and cast magnesium alloys	A, CD, ST, and A	800					
All wrought aluminum alloys, including 6061-T651, 5000, 6000, and 7000 series	CD ST and A	600 500	f s	36 2820	17 4570		
All aluminum sand and permanent mold casting alloys	AC ST and A	750 600					
Aluminum Die-Casting Alloys							
Alloys 308.0 and 319.0	—	—	f s	36 865	17 1280	11 5890 ^a	8 8270
Alloys 390.0 and 392.0	AC ST and A	80 60	f s	24 2010	11 2760	8 4765	4 5755
Alloy 413	—	—	f s	32 430	15 720	10 5085	5 6570
All other aluminum die-casting alloys including alloys 360.0 and 380.0	ST and A AC	100 125	f s	36 630	17 1060	11 7560	6 9930

^aThe feeds and speeds for turning Al alloys 308.0 and 319.0 with (polycrystalline) diamond tooling represent an expected tool life $T = 960$ minutes = 16 hours; corresponding feeds and speeds for 15-minute tool life are 11/28600 and 6/37500.

Abbreviations for material condition: A, annealed; AC, as cast; CD, cold drawn; and ST and A, solution treated and aged, respectively. Speeds for HSS (high-speed steel) tools are based on a feed of 0.012 inch/rev and a depth of cut of 0.125 inch; use Table 5c to adjust the HSS speeds for other feeds and depths of cut. The combined feed/speed data are based on a depth of cut of 0.1 inch, lead angle of 15 degrees, and nose radius of $\frac{3}{64}$ inch. Use Table 5a to adjust given speeds for other feeds, depths of cut, and lead angles; use Table 5b to adjust given speeds for increased tool life up to 180 minutes. The data are based on tool grades (identified in Table 16) as follows: uncoated carbide, 15; diamond, 9.

Table 9. Cutting Feeds and Speeds for Turning Superalloys

Material Description	Tool Material										
	HSS Turning		Uncoated Carbide		Ceramic				CBN		
	Rough	Finish	Tough		Hard		Tough		CBN		
	Speed (fpm)		$f = \text{feed (0.001 in./rev)}$, $s = \text{speed (ft/min)}$ $\text{Metric Units: } f \times 25.4 = \text{mm/rev}$, $s \times 0.3048 = \text{m/min}$								
		Opt.	Avg.	Opt.	Avg.	Opt.	Avg.	Opt.	Avg.		
T-D Nickel	70-80	80-100									
Disalloy	15-35	35-40									
19-9DL, W-545	25-35	30-40	f	24	11				20	10	
16-25-6, A-286, Incoloy 800, 801, and 802, V-57	30-35	35-40	s	90	170				365	630	
Refractaloy 26	15-20	20-25	f	20	10				20	10	
J1300	15-25	20-30	s	75	135				245	420	
Inconel 700 and 702, Nimonic 90 and 95	10-12	12-15									
S-816, V-36	10-15	15-20									
S-590	10-20	15-30									
Udimet 630		20-25									
N-155		15-25									
Air Resist 213; Hastelloy B, C, G and X (wrought); Haynes 25 and 188; J1570; M252 (wrought); Mar-M905 and M918; Nimonic 75 and 80	15-20	20-25	f	20	10	11	6	11	6	20	10
			s	75	125	1170	2590	405	900	230	400
CW-12M; Hastelloy B and C (cast); N-12M	8-12	10-15									
Rene 95 (Hot Isostatic Pressed)	—	—									
HS 6, 21, 2, 31 (X 40), 36, and 151; Haynes 36 and 151; Mar-M302, M322, and M509, WI-52	10-12	10-15									
Rene 41	10-15	12-20									
Incoloy 901	10-20	20-35									
Waspaloy	10-30	25-35	f	28	13	11	6	10	5	20	10
Inconel 625, 702, 706, 718 (wrought), 721, 722, X750, 751, 901, 600, and 604	15-20	20-35	s	20	40	895	2230	345	815	185	315
AF2-1DA, Unitemp 1753	8-10	10-15									
Colmonoy, Inconel 600, 718, K-Monel, Stellite	—	—									
Air Resist 13 and 215, FSH-H14, Nasa C-W-Re, X-45	10-12	10-15									
Udimet 500, 700, and 710	10-15	12-20									
Astroloy	5-10	5-15									
Mar-M200, M246, M421, and Rene 77, 80, and 95 (forged)		10-12	f	28	13	11	6	10	5	20	10
		10-15	s	15	15	615	1720	290	700	165	280
B-1900, GMR-235 and 235D, IN 100 and 738, Inconel 713C and 718 (cast), M252 (cast)	8-10	8-10									

The speed recommendations for rough turning may be used as starting values for milling and drilling with HSS tools. The combined feed/speed data in this table are based on tool grades (identified in Table 16) as follows: uncoated carbide = 15; ceramic, hard = 4, tough = 3; CBN = 1.

Speeds for HSS (high-speed steel) tools are based on a feed of 0.012 inch/rev and a depth of cut of 0.125 inch; use [Table 5c](#) to adjust the given speeds for other feeds and depths of cut. The combined feed/speed data in the remaining columns are based on a depth of cut of 0.1 inch, lead angle of 15 degrees, and nose radius of $\frac{3}{64}$ inch. Use [Table 5a](#) to adjust given speeds for other feeds, depths of cut, and lead angles; use [Table 5b](#) to adjust given speeds for increased tool life up to 180 minutes. Examples are given in the text.

Speed and Feed Tables for Milling.—[Tables 10](#) through [14](#) give feeds and speeds for milling. The data in the first speed column can be used with high-speed steel tools using the feeds given in [Table 15a](#); these are the same speeds contained in previous editions of the Handbook. The remaining data in [Tables 10](#) through [14](#) are combined feeds and speeds for end, face, and slit, slot, and side milling that use the speed adjustment factors given in [Tables 15b](#), [15c](#), and [15d](#). Tool life for the combined feed/speed data can also be adjusted using the factors in [Table 15e](#). [Table 16](#) lists cutting tool grades and vendor equivalents.

End Milling: Table data for end milling are based on a 3-tooth, 20-degree helix angle tool with a diameter of 1.0 inch, an axial depth of cut of 0.2 inch, and a radial depth of cut of 1 inch (full slot). Use [Table 15b](#) to adjust speeds for other feeds and axial depths of cut, and [Table 15c](#) to adjust speeds if the radial depth of cut is less than the tool diameter. Speeds are valid for all tool diameters.

Face Milling: Table data for face milling are based on a 10-tooth, 8-inch diameter face mill, operating with a 15-degree lead angle, $\frac{3}{64}$ -inch nose radius, axial depth of cut = 0.1 inch, and radial depth (width) of cut = 6 inches (i.e., width of cut to cutter diameter ratio = $\frac{3}{4}$). These speeds are valid if the cutter axis is above or close to the center line of the workpiece (eccentricity is small). Under these conditions, use [Table 15d](#) to adjust speeds for other feeds and axial and radial depths of cut. For larger eccentricity (i.e., when the cutter axis to workpiece center line offset is one half the cutter diameter or more), use the end and side milling adjustment factors ([Tables 15b](#) and [15c](#)) instead of the face milling factors.

Slit and Slot Milling: Table data for slit milling are based on an 8-tooth, 10-degree helix angle tool with a cutter width of 0.4 inch, diameter D of 4.0 inch, and a depth of cut of 0.6 inch. Speeds are valid for all tool diameters and widths. See the examples in the text for adjustments to the given speeds for other feeds and depths of cut.

Tool life for all tabulated values is approximately 45 minutes; use [Table 15e](#) to adjust tool life from 15 to 180 minutes.

Using the Feed and Speed Tables for Milling: The basic feed for milling cutters is the feed per tooth (f), which is expressed in inches per tooth. There are many factors to consider in selecting the feed per tooth and no formula is available to resolve these factors. Among the factors to consider are the cutting tool material; the work material and its hardness; the width and the depth of the cut to be taken; the type of milling cutter to be used and its size; the surface finish to be produced; the power available on the milling machine; and the rigidity of the milling machine, the workpiece, the workpiece setup, the milling cutter, and the cutter mounting.

The cardinal principle is to always use the maximum feed that conditions will permit. Avoid, if possible, using a feed that is less than 0.001 inch per tooth because such low feeds reduce the tool life of the cutter. When milling hard materials with small-diameter end mills, such small feeds may be necessary, but otherwise use as much feed as possible. Harder materials in general will require lower feeds than softer materials. The width and the depth of cut also affect the feeds. Wider and deeper cuts must be fed somewhat more slowly than narrow and shallow cuts. A slower feed rate will result in a better surface finish; however, always use the heaviest feed that will produce the surface finish desired. Fine chips produced by fine feeds are dangerous when milling magnesium because spontaneous combustion can occur. Thus, when milling magnesium, a fast feed that will produce a relatively thick chip should be used. Cutting stainless steel produces a work-hardened layer on the surface that has been cut. Thus, when milling this material, the feed should be large enough to allow each cutting edge on the cutter to penetrate below the work-hardened

layer produced by the previous cutting edge. The heavy feeds recommended for face milling cutters are to be used primarily with larger cutters on milling machines having an adequate amount of power. For smaller face milling cutters, start with smaller feeds and increase as indicated by the performance of the cutter and the machine.

When planning a milling operation that requires a high cutting speed and a fast feed, always check to determine if the power required to take the cut is within the capacity of the milling machine. Excessive power requirements are often encountered when milling with cemented carbide cutters. The large metal removal rates that can be attained require a high horsepower output. An example of this type of calculation is given in the section on Machining Power that follows this section. If the size of the cut must be reduced in order to stay within the power capacity of the machine, start by reducing the cutting speed rather than the feed in inches per tooth.

The formula for calculating the table feed rate, when the feed in inches per tooth is known, is as follows:

$$f_m = f_t n_t N$$

where f_m = milling machine table feed rate in inches per minute (ipm)

f_t = feed in inch per tooth (ipt)

n_t = number of teeth in the milling cutter

N = spindle speed of the milling machine in revolutions per minute (rpm)

Example: Calculate the feed rate for milling a piece of AISI 1040 steel having a hardness of 180 Bhn. The cutter is a 3-inch diameter high-speed steel plain or slab milling cutter with 8 teeth. The width of the cut is 2 inches, the depth of cut is 0.062 inch, and the cutting speed from [Table 11](#) is 85 fpm. From [Table 15a](#), the feed rate selected is 0.008 inch per tooth.

$$N = \frac{12V}{\pi D} = \frac{12 \times 85}{3.14 \times 3} = 108 \text{ rpm}$$

$$\begin{aligned} f_m &= f_t n_t N = 0.008 \times 8 \times 108 \\ &= 7 \text{ ipm (approximately)} \end{aligned}$$

Example 1, Face Milling: Determine the cutting speed and machine operating speed for face milling an aluminum die casting (alloy 413) using a 4-inch polycrystalline diamond cutter, a 3-inch width of cut, a 0.10-inch depth of cut, and a feed of 0.006 inch/tooth.

[Table 10](#) gives the feeds and speeds for milling aluminum alloys. The feed/speed pairs for face milling die cast alloy 413 with polycrystalline diamond (PCD) are 8/2320 (0.008 in./tooth feed at 2320 fpm) and 4/4755 (0.004 in./tooth feed at 4755 fpm). These speeds are based on an axial depth of cut of 0.10 inch, an 8-inch cutter diameter D , a 6-inch radial depth (width) of cut ar , with the cutter approximately centered above the workpiece, i.e., eccentricity is low, as shown in [Fig. 3](#). If the preceding conditions apply, the given feeds and speeds can be used without adjustment for a 45-minute tool life. The given speeds are valid for all cutter diameters if a radial depth of cut to cutter diameter ratio (ar/D) of $\frac{3}{4}$ is maintained (i.e., $\frac{\%}{8} = \frac{3}{4}$). However, if a different feed or axial depth of cut is required, or if the ar/D ratio is not equal to $\frac{3}{4}$, the cutting speed must be adjusted for the conditions. The adjusted cutting speed V is calculated from $V = V_{opt} \times F_f \times F_d \times F_{ar}$, where V_{opt} is the lower of the two speeds given in the speed table, and F_f , F_d , and F_{ar} are adjustment factors for feed, axial depth of cut, and radial depth of cut, respectively, obtained from [Table 15d](#) (face milling); except, when cutting near the end or edge of the workpiece as in [Fig. 4](#), [Table 15c](#) (side milling) is used to obtain F_f .

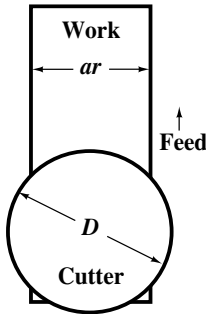


Fig. 3.

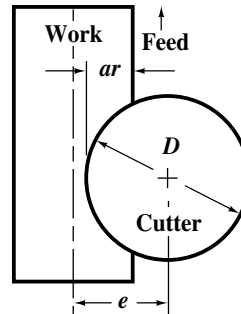


Fig. 4.

In this example, the cutting conditions match the standard conditions specified in the speed table for radial depth of cut to cutter diameter (3 in./4 in.), and depth of cut (0.01 in.), but the desired feed of 0.006 in./tooth does not match either of the feeds given in the speed table (0.004 or 0.008). Therefore, the cutting speed must be adjusted for this feed. As with turning, the feed factor F_f is determined by calculating the ratio of the desired feed f to maximum feed f_{opt} from the speed table, and from the ratio V_{avg}/V_{opt} of the two speeds given in the speed table. The feed factor is found at the intersection of the feed ratio row and the speed ratio column in **Table 15d**. The speed is then obtained using the following equation:

$$\frac{\text{Chosen feed}}{\text{Optimum feed}} = \frac{f}{f_{opt}} = \frac{0.006}{0.008} = 0.75 \quad \frac{\text{Average speed}}{\text{Optimum speed}} = \frac{V_{avg}}{V_{opt}} = \frac{4755}{2320} \approx 2.0$$

$$F_f = (1.25 + 1.43)/2 = 1.34$$

$$F_d = 1.0$$

$$F_{ar} = 1.0$$

$$V = 2320 \times 1.34 \times 1.0 \times 1.0 = 3109 \text{ fpm, and } 3.82 \times 3109/4 = 2970 \text{ rpm}$$

Example 2, End Milling: What cutting speed should be used for cutting a full slot (i.e., a slot cut from the solid, in one pass, that is the same width as the cutter) in 5140 steel with hardness of 300 Bhn using a 1-inch diameter coated carbide (insert) 0° lead angle end mill, a feed of 0.003 in./tooth, and a 0.2-inch axial depth of cut?

The feed and speed data for end milling 5140 steel, Brinell hardness = 275-325, with a coated carbide tool are given in **Table 11** as 15/80 and 8/240 for *optimum* and *average* sets, respectively. The speed adjustment factors for feed and depth of cut for full slot (end milling) are obtained from **Table 15b**. The calculations are the same as in the previous examples: $f/f_{opt} = 3/15 = 0.2$ and $V_{avg}/V_{opt} = 240/80 = 3.0$, therefore, $F_f = 6.86$ and $F_d = 1.0$. The cutting speed for a 45-minute tool life is $V = 80 \times 6.86 \times 1.0 = 548.8$, approximately 550 ft/min.

Example 3, End Milling: What cutting speed should be used in Example 2 if the radial depth of cut ar is 0.02 inch and axial depth of cut is 1 inch?

In end milling, when the radial depth of cut is less than the cutter diameter (as in **Fig. 4**), first obtain the feed factor F_f from **Table 15c**, then the axial depth of cut and lead angle factor F_d from **Table 15b**. The radial depth of cut to cutter diameter ratio ar/D is used in **Table 15c** to determine the maximum and minimum feeds that guard against tool failure at high feeds and against premature tool wear caused by the tool rubbing against the work at very low feeds. The feed used should be selected so that it falls within the minimum to maximum feed range, and then the feed factor F_f can be determined from the feed factors at minimum and maximum feeds, F_{f1} and F_{f2} as explained below.

The maximum feed f_{max} is found in Table 15c by multiplying the *optimum* feed from the speed table by the maximum feed factor that corresponds to the ar/D ratio, which in this instance is $0.02/1 = 0.02$; the minimum feed f_{min} is found by multiplying the *optimum* feed by the minimum feed factor. Thus, $f_{max} = 4.5 \times 0.015 = 0.0675$ in./tooth and $f_{min} = 3.1 \times 0.015 = 0.0465$ in./tooth. If a feed between these maximum and minimum values is selected, 0.050 in./tooth for example, then for $ar/D = 0.02$ and $V_{avg}/V_{opt} = 3.0$, the feed factors at maximum and minimum feeds are $F_{f1} = 7.90$ and $F_{f2} = 7.01$, respectively, and by interpolation, $F_f = 7.90 + (0.050 - 0.0465)/(0.0675 - 0.0465) \times (7.01 - 7.90) = 7.75$.

The depth of cut factor F_d is obtained from Table 15b, using f_{max} from Table 15c instead of the *optimum* feed f_{opt} for calculating the feed ratio (chosen feed/*optimum* feed). In this example, the feed ratio = chosen feed/ $f_{max} = 0.050/0.0675 = 0.74$, so the feed factor is $F_d = 0.93$ for a depth of cut = 1.0 inch and 0° lead angle. Therefore, the final cutting speed is $80 \times 7.75 \times 0.93 = 577$ ft/min. Notice that f_{max} obtained from Table 15c was used instead of the *optimum* feed from the speed table, in determining the feed ratio needed to find F_d .

Slit Milling.—The tabular data for slit milling is based on an 8-tooth, 10-degree helix angle cutter with a width of 0.4 inch, a diameter D of 4.0 inch, and a depth of cut of 0.6 inch. The given feeds and speeds are valid for any diameters and tool widths, as long as sufficient machine power is available. Adjustments to cutting speeds for other feeds and depths of cut are made using Table 15c or 15d, depending on the orientation of the cutter to the work, as illustrated in Case 1 and Case 2 of Fig. 5. The situation illustrated in Case 1 is approximately equivalent to that illustrated in Fig. 3, and Case 2 is approximately equivalent to that shown in Fig. 4.

Case 1: If the cutter is fed directly into the workpiece, i.e., the feed is perpendicular to the surface of the workpiece, as in cutting off, then Table 15d (face milling) is used to adjust speeds for other feeds. The depth of cut portion of Table 15d is not used in this case ($F_d = 1.0$), so the adjusted cutting speed $V = V_{opt} \times F_f \times F_{ar}$. In determining the factor F_{ar} from Table 15d, the radial depth of cut ar is the length of cut created by the portion of the cutter engaged in the work.

Case 2: If the cutter feed is parallel to the surface of the workpiece, as in slotting or side milling, then Table 15c (side milling) is used to adjust the given speeds for other feeds. In Table 15c, the cutting depth (slot depth, for example) is the radial depth of cut ar that is used to determine maximum and minimum allowable feed/tooth and the feed factor F_f . These minimum and maximum feeds are determined in the manner described previously, however, the axial depth of cut factor F_d is not required. The adjusted cutting speed, valid for cutters of any thickness (width), is given by $V = V_{opt} \times F_f$.

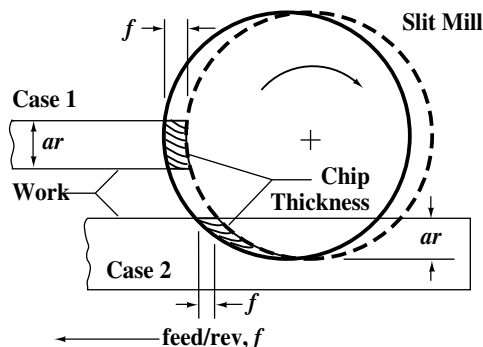


Fig. 5. Determination of Radial Depth of Cut or in Slit Milling

Table 10. Cutting Feeds and Speeds for Milling Aluminum Alloys

Material	Material Condition*	End Milling				Face Milling				Slit Milling				
		HSS		Indexable Insert Uncoated Carbide		Indexable Insert Uncoated Carbide		Polycrystalline Diamond		HSS		Indexable Insert Uncoated Carbide		
		f = feed (0.001 in./tooth), s = speed (ft/min) Metric Units: f × 25.4 = mm/rev, s × 0.3048 = m/min												
			Opt.	Avg.	Opt.	Avg.	Opt.	Avg.	Opt.	Avg.	Opt.	Avg.	Opt.	Avg.
All wrought aluminum alloys, 6061-T651, 5000, 6000, 7000 series	CD ST and A	f	15	8	15	8	39	20	8	4	16	8	39	20
All aluminum sand and permanent mold casting alloys	CD ST and A	s	165	850	620	2020	755	1720	3750	8430	1600	4680	840	2390
Aluminum Die-Casting Alloys														
Alloys 308.0 and 319.0	—	f	15	8	15	8	39	20			16	8	39	20
		s	30	100	620	2020	755	1720			160	375	840	2390
Alloys 360.0 and 380.0	—	f	15	8	15	8	39	20	8	4	16	8	39	20
		s	30	90	485	1905	555	1380	3105	7845	145	355	690	2320
Alloys 390.0 and 392.0	—	f					39	20						
		s					220	370						
Alloy 413	—	f			15	8	39	20	8	4			39	20
		s			355	1385	405	665	2320	4755			500	1680
All other aluminum die-casting alloys	ST and A	f												
		s												
	AC	f	15	8	15	8	39	20	8	4	16	8	39	20
		s	30	90	485	1905	555	1380	3105	7845	145	335	690	2320

Abbreviations designate: A, annealed; AC, as cast; CD, cold drawn; and ST and A, solution treated and aged, respectively.

End Milling: Table data for end milling are based on a 3-tooth, 20-degree helix angle tool with a diameter of 1.0 inch, an axial depth of cut of 0.2 inch, and a radial depth of cut of 1 inch (full slot). Use [Table 15b](#) to adjust speeds for other feeds and axial depths of cut, and [Table 15c](#) to adjust speeds if the radial depth of cut is less than the tool diameter. Speeds are valid for all tool diameters.

Face Milling: Table data for face milling are based on a 10-tooth, 8-inch diameter face mill, operating with a 15-degree lead angle, 3/64-inch nose radius, axial depth of cut = 0.1 inch, and radial depth (width) of cut = 6 inches (i.e., width of cut to cutter diameter ratio = 3/4). These speeds are valid if the cutter axis is above or close to the center line of the workpiece (eccentricity is small). Under these conditions, use [Table 15d](#) to adjust speeds for other feeds and axial and radial depths of cut. For larger eccentricity (i.e., when the cutter axis to workpiece center line offset is one half the cutter diameter or more), use the end and side milling adjustment factors ([Tables 15b](#) and [15c](#)) instead of the face milling factors.

Slit and Slot Milling: Table data for slit milling are based on an 8-tooth, 10-degree helix angle tool with a cutter width of 0.4 inch, diameter *D* of 4.0 inch, and a depth of cut of 0.6 inch. Speeds are valid for all tool diameters and widths. See the examples in the text for adjustments to the given speeds for other feeds and depths of cut.

Tool life for all tabulated values is approximately 45 minutes; use [Table 15e](#) to adjust tool life from 15 to 180 minutes. The combined feed/speed data in this table are based on tool grades (identified in [Table 16](#)) as follows: uncoated carbide = 15; diamond = 9.

Table 11. Cutting Feeds and Speeds for Milling Plain Carbon and Alloy Steels

Material	Brinell Hardness	HSS Speed (fpm)	End Milling						Face Milling				Slit Milling			
			HSS		Uncoated Carbide		Coated Carbide		Uncoated Carbide		Coated Carbide		Uncoated Carbide		Coated Carbide	
			<i>f</i>	<i>s</i>	<i>f</i>	<i>s</i>	<i>f</i>	<i>s</i>	<i>f</i>	<i>s</i>	<i>f</i>	<i>s</i>	<i>f</i>	<i>s</i>	<i>f</i>	<i>s</i>
			<i>f</i> = feed (0.001 in./tooth), <i>s</i> = speed (ft/min) <i>Metric Units:</i> <i>f</i> × 25.4 = mm/rev, <i>s</i> × 0.3048 = m/min													
			<i>Opt.</i>	<i>Avg.</i>	<i>Opt.</i>	<i>Avg.</i>	<i>Opt.</i>	<i>Avg.</i>	<i>Opt.</i>	<i>Avg.</i>	<i>Opt.</i>	<i>Avg.</i>	<i>Opt.</i>	<i>Avg.</i>	<i>Opt.</i>	<i>Avg.</i>
Free-machining plain carbon steels (resulfurized): 1212, 1213, 1215	100-150	140	<i>f</i> 7 <i>s</i> 45	4 125	7 465	4 735	7 800	4 1050	39 225	20 335	39 415	20 685	39 265	20 495	39 525	20 830
	150-200	130	<i>f</i> 7 <i>s</i> 35	4 100							39 215	20 405				
(Resulfurized): 1108, 1109, 1115, 1117, 1118, 1120, 1126, 1211	100-150	130	<i>f</i> 7 <i>s</i> 730	4 4	7 7	4 4	7 7	4 4	39 39	20 20	39 39	20 20	39 39	20 20	39 39	20 20
	150-200	115	<i>f</i> 7 <i>s</i> 85	4 85	325 325	565 565	465 465	720 720	140 140	220 220	195 195	365 365	170 170	350 350	245 245	495 495
	175-225	115	<i>f</i> 7 <i>s</i> 30	4 85									39 185	20 350		
(Resulfurized): 1132, 1137, 1139, 1140, 1144, 1146, 1151	275-325	70	<i>f</i> 7 <i>s</i> 25	4 70	7 210	4 435	7 300	4 560	39 90	20 170	39 175	20 330	39 90	20 235	39 135	20 325
	325-375	45	<i>f</i> 7 <i>s</i> 25	4 70	7 210	4 435	7 300	4 560	39 90	20 170	39 175	20 330	39 90	20 235	39 135	20 325
	375-425	35	<i>f</i> 7 <i>s</i> 30	4 85												
(Leaded): 11L17, 11L18, 12L13, 12L14	100-150	140	<i>f</i> 7 <i>s</i> 35	4 100							39 215	20 405				
	150-200	130	<i>f</i> 7 <i>s</i> 30	4 85							39 185	20 350				
	200-250	110	<i>f</i> 7 <i>s</i> 30	4 85							39 185	20 350				
Plain carbon steels: 1006, 1008, 1009, 1010, 1012, 1015, 1016, 1017, 1018, 1019, 1020, 1021, 1022, 1023, 1024, 1025, 1026, 1513, 1514	100-125	110	<i>f</i> 7 <i>s</i> 45	4 125	7 465	4 735	7 800	4 1050	39 225	20 335	39 415	20 685	39 265	20 495	39 525	20 830
	125-175	110	<i>f</i> 7 <i>s</i> 35	4 100							39 215	20 405				
	175-225	90	<i>f</i> 7 <i>s</i> 30	4 85							39 185	20 350				
	225-275	65	<i>f</i> 7 <i>s</i> 30	4 85							39 185	20 350				

Table 11. (Continued) Cutting Feeds and Speeds for Milling Plain Carbon and Alloy Steels

Material	Brinell Hardness	HSS	End Milling						Face Milling				Slit Milling					
			HSS		Uncoated Carbide		Coated Carbide		Uncoated Carbide		Coated Carbide		Uncoated Carbide		Coated Carbide			
			f = feed (0.001 in./tooth), s = speed (ft/min) Metric Units: f × 25.4 = mm/rev, s × 0.3048 = m/min															
			Speed (fpm)	Opt.	Avg.	Opt.	Avg.	Opt.	Avg.	Opt.	Avg.	Opt.	Avg.	Opt.	Avg.	Opt.	Avg.	
Plain carbon steels: 1027, 1030, 1033, 1035, 1036, 1037, 1038, 1039, 1040, 1041, 1042, 1043, 1045, 1046, 1048, 1049, 1050, 1052, 1524, 1526, 1527, 1541	125-175	100	f s	7 35	4 100							39 215	20 405					
	175-225	85	f s	7 30	4 85							39 185	20 350					
	225-275	70																
	275-325	55																
	325-375	35	f s	7 25	4 70	7 210	4 435	7 300	4 560	39 90	20 170	39 175	20 330	39 90	20 235	39 135	20 325	
Plain carbon steels: 1055, 1060, 1064, 1065, 1070, 1074, 1078, 1080, 1084, 1086, 1090, 1095, 1548, 1551, 1552, 1561, 1566	125-175	90	f s	7 30	4 85	7 325	4 565	7 465	4 720	39 140	20 220	39 195	20 365	39 170	20 350	39 245	20 495	
	175-225	75																
	225-275	60	f s	7 30	4 85							39 185	20 350					
	275-325	45																
	325-375	30	f s	7 25	4 70	7 210	4 435	7 300	4 560	39 90	20 170	39 175	20 330	39 90	20 235	39 135	20 325	
Free-machining alloy steels (Resulfurized): 4140, 4150	175-200	100	f s	15 7	8 30	15 105	8 270	15 270	8 450			39 295	20 475	39 135	20 305	7 25	4 70	
	200-250	90																
	250-300	60	f s	15 6	8 25	15 50	8 175	15 85	8 255			39 200	20 320	39 70	20 210	7 25	4 70	
	300-375	45	f s	15 5	8 20	15 40	8 155	15 75	8 225			39 175	20 280					
	375-425	35																

SPEEDS AND FEEDS

1045

Table 11. (Continued) Cutting Feeds and Speeds for Milling Plain Carbon and Alloy Steels

Material	Brinell Hardness	HSS	End Milling						Face Milling				Slit Milling					
			HSS		Uncoated Carbide		Coated Carbide		Uncoated Carbide		Coated Carbide		Uncoated Carbide		Coated Carbide			
			f = feed (0.001 in./tooth), s = speed (ft/min) <i>Metric Units: f</i> × 25.4 = mm/rev, <i>s</i> × 0.3048 = m/min															
			Speed (fpm)	Opt.	Avg.	Opt.	Avg.	Opt.	Avg.	Opt.	Avg.	Opt.	Avg.	Opt.	Avg.	Opt.	Avg.	
Free-machining alloy steels (Leaded): 41L30, 41L40, 41L47, 41L50, 43L47, 51L32, 52L100, 86L20, 86L40	150-200	115	f 7 s 30	4 85	7 325	4 565	7 465	4 720	39 140	20 220	39 195	20 365	39 170	20 350	39 245	20 495		
	200-250	95	f 7 s 30	4 85							39 185	20 350						
	250-300	70	f 7 s 25	4 70	7 210	4 435	7 300	4 560	39 90	20 170	39 175	20 330	39 90	20 235	39 135	20 325		
	300-375 375-425	50 40	f 7 s 25	4 70	7 210	4 435	7 300	4 560	39 90	20 170	39 175	20 330	39 90	20 235	39 135	20 325		
Alloy steels: 4012, 4023, 4024, 4028, 4118, 4320, 4419, 4422, 4427, 4615, 4620, 4621, 4626, 4718, 4720, 4815, 4817, 4820, 5015, 5117, 5120, 6118, 8115, 8615, 8617, 8620, 8622, 8625, 8627, 8720, 8822, 94B17	125-175	100	f 15 s 7	8 30	15 105	8 270	15 220	8 450			39 295	20 475	39 135	20 305	39 265	20 495		
	175-225	90	f 15 s 6	8 25	15 50	8 175	15 85	8 255			39 200	20 320	39 70	20 210	39 115	20 290		
	225-275	60	f 15 s 5	8 20	15 45	8 170	15 80	8 240			39 190	20 305						
	275-325 325-375 375-425	50 40 25	f 15 s 5	8 20	15 40	8 155	15 75	8 225			39 175	20 280						
Alloy steels: 1330, 1335, 1340, 1345, 4032, 4037, 4042, 4047, 4130, 4135, 4137, 4140, 4142, 4145, 4147, 4150, 4161, 4337, 4340, 50B44, 50B46, 50B50, 50B60, 5130, 5132, 5140, 5145, 5147, 5150, 5160, 51B60, 6150, 81B45, 8630, 8635, 8637, 8640, 8642, 8645, 8650, 8655, 8660, 8740, 9254, 9255, 9260, 9262, 94B30 E51100, E52100: use (HSS speeds)	175-225	75 (65)	f 15 s 5	8 30	15 105	8 270	15 220	8 450			39 295	20 475	39 135	20 305	39 265	20 495		
	225-275	60	f 15 s 5	8 25	15 50	8 175	15 85	8 255			39 200	20 320	39 70	20 210	39 115	20 290		
	275-325	50 (40)	f 15 s 5	8 25	15 45	8 170	15 80	8 240			39 190	20 305						
	325-375	35 (30)	f 15 s 5	8 20	15 40	8 155	15 75	8 225			39 175	20 280						

Table 11. (Continued) Cutting Feeds and Speeds for Milling Plain Carbon and Alloy Steels

Material	Brinell Hardness	HSS	End Milling						Face Milling				Slit Milling			
			HSS		Uncoated Carbide		Coated Carbide		Uncoated Carbide		Coated Carbide		Uncoated Carbide		Coated Carbide	
			f = feed (0.001 in./tooth), s = speed (ft/min) <i>Metric Units: f</i> × 25.4 = mm/rev, <i>s</i> × 0.3048 = m/min													
			Speed (fpm)	Opt.	Avg.	Opt.	Avg.	Opt.	Avg.	Opt.	Avg.	Opt.	Avg.	Opt.	Avg.	Opt.
Ultra-high-strength steels (not AISI): AMS 6421 (98B37 Mod.), 6422 (98BV40), 6424, 6427, 6428, 6430, 6432, 6433, 6434, 6436, and 6442; 300M, D6ac	220-300	60	f		8	4	8	4								
	300-350	45	s		165	355	300	480								
	350-400	20	f	8 4	8 4					39 20	39 20					
	43-52 Rc	—	s	15 45	150 320					130 235	75 175					
Maraging steels (not AISI): 18% Ni Grades 200, 250, 300, and 350	250-325	50	f		5 3	20† 55										
	50-52 Rc	—	s		8 4	165 355	300 480									
Nitriding steels (not AISI): Nitralloy 125, 135, 135 Mod., 225, and 230, Nitralloy N, Nitralloy EZ, Nitrex 1	200-250	60	f	15 8	15 8	15 8	15 8			39 20	39 20	39 20	39 20			
	300-350	25	s	7 30	105 270	220 450				295 475	135 305	265 495				
			f	15 8	15 8	15 8	15 8			39 20						
			s	5 20	40 155	75 225				175 280						

For HSS (high-speed steel) tools in the first speed column only, use [Table 15a](#) for recommended feed in inches per tooth and depth of cut.

End Milling: Table data for end milling are based on a 3-tooth, 20-degree helix angle tool with a diameter of 1.0 inch, an axial depth of cut of 0.2 inch, and a radial depth of cut of 1 inch (full slot). Use [Table 15b](#) to adjust speeds for other feeds and axial depths of cut, and [Table 15c](#) to adjust speeds if the radial depth of cut is less than the tool diameter. Speeds are valid for all tool diameters.

Face Milling: Table data for face milling are based on a 10-tooth, 8-inch diameter face mill, operating with a 15-degree lead angle, 3/64-inch nose radius, axial depth of cut = 0.1 inch, and radial depth (width) of cut = 6 inches (i.e., width of cut to cutter diameter ratio = 3/4). These speeds are valid if the cutter axis is above or close to the center line of the workpiece (eccentricity is small). Under these conditions, use [Table 15d](#) to adjust speeds for other feeds and axial and radial depths of cut. For larger eccentricity (i.e., when the cutter axis to workpiece center line offset is one half the cutter diameter or more), use the end and side milling adjustment factors ([Tables 15b](#) and [15c](#)) instead of the face milling factors.

Slit and Slot Milling: Table data for slit milling are based on an 8-tooth, 10-degree helix angle tool with a cutter width of 0.4 inch, diameter *D* of 4.0 inches, and a depth of cut of 0.6 inch. Speeds are valid for all tool diameters and widths. See the examples in the text for adjustments to the given speeds for other feeds and depths of cut.

Tool life for all tabulated values is approximately 45 minutes; use [Table 15e](#) to adjust tool life from 15 to 180 minutes. The combined feed/speed data in this table are based on tool grades (identified in [Table 16](#)) as follows: end and slit milling uncoated carbide = 20 except † = 15; face milling uncoated carbide = 19; end, face, and slit milling coated carbide = 10.

Table 12. Cutting Feeds and Speeds for Milling Tool Steels

Material	Brinell Hardness	HSS Speed (fpm)	End Milling						Face Milling				Slit Milling				
			HSS		Uncoated Carbide		Coated Carbide		Uncoated Carbide		CBN		Uncoated Carbide		Coated Carbide		
			Opt.	Avg.	Opt.	Avg.	Opt.	Avg.	Opt.	Avg.	Opt.	Avg.	Opt.	Avg.	Opt.	Avg.	
			f = feed (0.001 in./tooth), s = speed (ft/min) <i>Metric Units: f</i> × 25.4 = mm/rev, <i>s</i> × 0.3048 = m/min														
Water hardening: W1, W2, W5	150-200	85															
Shock resisting: S1, S2, S5, S6, S7	175-225	55															
Cold work, oil hardening: O1, O2, O6, O7	175-225	50	f	8	4	8	4	8	4	39	20			39	20	39	20
			s	25	70	235	455	405	635	235	385			115	265	245	445
Cold work, high carbon, high chromium: D2, D3, D4, D5, D7	200-250	40															
Cold work, air hardening: A2, A3, A8, A9, A10 A4, A6 A7	200-250	50	f							39	20						
	200-250	45	s							255	385						
	225-275	40															
Hot work, chromium type: H10, H11, H12, H13, H14, H19	150-200	60															
	200-250	50															
	325-375	30	f	8	4	8	4			39	20			39	20		
			s	15	45	150	320			130	235			75	175		
	48-50 Rc	—	f			5	3					39	20	39	20		
50-52 Rc	—	s			20†	55					50	135	5†	15			
52-56 Rc	—																
Hot work, tungsten and molybdenum types: H21, H22, H23, H24, H25, H26, H41, H42, H43	150-200	55	f							39	20						
	200-250	45	s							255	385						
Special-purpose, low alloy: L2, L3, L6	150-200	65	f	8	4	8	4	8	4	39	20			39	20	39	20
			s	25	70	235	455	405	635	235	385			115	265	245	445
Mold: P2, P3, P4, P5, P6 P20, P21	100-150 150-200	75 60															
High-speed steel: M1, M2, M6, M10, T1, T2, T6 M3-1, M4, M7, M30, M33, M34, M36, M41, M42, M43, M44, M46, M47, T5, T8 T15, M3-2	200-250	50															
	225-275	40	f							39	20						
	225-275	30	s							255	385						

For HSS (high-speed steel) tools in the first speed column only, use **Table 15a** for recommended feed in inches per tooth and depth of cut.

End Milling: Table data for end milling are based on a 3-tooth, 20-degree helix angle tool with a diameter of 1.0 inch, an axial depth of cut of 0.2 inch, and a radial depth of cut of 1 inch (full slot). Use **Table 15b** to adjust speeds for other feeds and axial depths of cut, and **Table 15c** to adjust speeds if the radial depth of cut is less than the tool diameter. Speeds are valid for all tool diameters.

Face Milling: Table data for face milling are based on a 10-tooth, 8-inch diameter face mill, operating with a 15-degree lead angle, $\frac{3}{64}$ -inch nose radius, axial depth of cut = 0.1 inch, and radial depth (width) of cut = 6 inches (i.e., width of cut to cutter diameter ratio = $\frac{3}{4}$). These speeds are valid if the cutter axis is above or close to the center line of the workpiece (eccentricity is small). Under these conditions, use **Table 15d** to adjust speeds for other feeds and axial and radial depths of cut. For larger eccentricity (i.e., when the cutter axis to workpiece center line offset is one half the cutter diameter or more), use the end and side milling adjustment factors (**Tables 15b** and **15c**) instead of the face milling factors.

Slit and Slot Milling: Table data for slit milling are based on an 8-tooth, 10-degree helix angle tool with a cutter width of 0.4 inch, diameter *D* of 4.0 inches, and a depth of cut of 0.6 inch. Speeds are valid for all tool diameters and widths. See the examples in the text for adjustments to the given speeds for other feeds and depths of cut.

Tool life for all tabulated values is approximately 45 minutes; use **Table 15e** to adjust tool life from 15 to 180 minutes. The combined feed/speed data in this table are based on tool grades (identified in **Table 16**) as follows: uncoated carbide = 20, † = 15; coated carbide = 10; CBN = 1.

Table 13. Cutting Feeds and Speeds for Milling Stainless Steels

Material	Brinell Hardness	HSS Speed (fpm)	End Milling						Face Milling		Slit Milling																																
			HSS		Uncoated Carbide		Coated Carbide		Coated Carbide		Uncoated Carbide		Coated Carbide																														
			<i>f</i>	<i>s</i>	<i>f</i>	<i>s</i>	<i>f</i>	<i>s</i>	<i>f</i>	<i>s</i>	<i>f</i>	<i>s</i>	<i>f</i>	<i>s</i>																													
			<i>f</i> = feed (0.001 in./tooth), <i>s</i> = speed (ft/min) <i>Metric Units:</i> <i>f</i> × 25.4 = mm/rev, <i>s</i> × 0.3048 = m/min <i>Opt.</i> <i>Avg.</i> <i>Opt.</i> <i>Avg.</i> <i>Opt.</i> <i>Avg.</i> <i>Opt.</i> <i>Avg.</i> <i>Opt.</i> <i>Avg.</i> <i>Opt.</i> <i>Avg.</i>																																								
Free-machining stainless steels (Ferritic): 430F, 430FSe	135-185	110	f	7	4	7	4	7	4	39	20	39	20	39	20																												
			s	30	80	305	780	420	1240	210	385	120	345	155	475																												
(Austenitic): 203EZ, 303, 303Se, 303MA, 303Pb, 303Cu, 303 Plus X	135-185	100	f	7	4	7	4					39	20																														
	225-275	80														s	20	55	210	585					75	240																	
	135-185	110																																									
	185-240	100																																									
275-325	60																																										
375-425	30																																										
Stainless steels (Ferritic): 405, 409, 429, 430, 434, 436, 442, 446, 502	135-185																												90	f	7	4	7	4	7	4	39	20	39	20	39		
																														s	30	80	305	780	420	1240	210	385	120	345	155	475	
(Austenitic): 201, 202, 301, 302, 304, 304L, 305, 308, 321, 347, 348	135-185	75	f	7	4	7	4					39	20																														
	225-275	65														s	20	55	210	585					75	240																	
	135-185	70																																									
	135-175	95																																									
175-225	85																																										
275-325	55																																										
375-425	35																																										
(Martensitic): 403, 410, 420, 501																																											

Table 13. Cutting Feeds and Speeds for Milling Stainless Steels

Material	Brinell Hardness	HSS	End Milling						Face Milling		Slit Milling			
			HSS		Uncoated Carbide		Coated Carbide		Coated Carbide		Uncoated Carbide		Coated Carbide	
			f = feed (0.001 in./tooth), s = speed (ft/min) Metric Units: f × 25.4 = mm/rev, s × 0.3048 = m/min											
			Opt.	Avg.	Opt.	Avg.	Opt.	Avg.	Opt.	Avg.	Opt.	Avg.	Opt.	Avg.
Stainless Steels (Martensitic): 414, 431, Greek Ascology, 440A, 440B, 440C	225-275	55-60												
	275-325	45-50												
	375-425	30												
(Precipitation hardening): 15-5PH, 17-4PH, 17-7PH, AF-71, 17-14CuMo, AFC-77, AM-350, AM-355, AM-362, Custom 455, HNM, PH13-8, PH14-8Mo, PH15-7Mo, Stainless W	150-200	60	f s	7 20	4 55	7 210	4 585				39 75	20 240		
	275-325	50												
	325-375	40												
	375-450	25												

For HSS (high-speed steel) tools in the first speed column only, use [Table 15a](#) for recommended feed in inches per tooth and depth of cut.

End Milling: Table data for end milling are based on a 3-tooth, 20-degree helix angle tool with a diameter of 1.0 inch, an axial depth of cut of 0.2 inch, and a radial depth of cut of 1 inch (full slot). Use [Table 15b](#) to adjust speeds for other feeds and axial depths of cut, and [Table 15c](#) to adjust speeds if the radial depth of cut is less than the tool diameter. Speeds are valid for all tool diameters.

Face Milling: Table data for face milling are based on a 10-tooth, 8-inch diameter face mill, operating with a 15-degree lead angle, 3/64-inch nose radius, axial depth of cut = 0.1 inch, and radial depth (width) of cut = 6 inches (i.e., width of cut to cutter diameter ratio = 3/4). These speeds are valid if the cutter axis is above or close to the center line of the workpiece (eccentricity is small). Under these conditions, use [Table 15d](#) to adjust speeds for other feeds and axial and radial depths of cut. For larger eccentricity (i.e., when the cutter axis to workpiece center line offset is one half the cutter diameter or more), use the end and side milling adjustment factors ([Tables 15b](#) and [15c](#)) instead of the face milling factors.

Slit and Slot Milling: Table data for slit milling are based on an 8-tooth, 10-degree helix angle tool with a cutter width of 0.4 inch, diameter *D* of 4.0 inch, and a depth of cut of 0.6 inch. Speeds are valid for all tool diameters and widths. See the examples in the text for adjustments to the given speeds for other feeds and depths of cut.

Tool life for all tabulated values is approximately 45 minutes; use [Table 15e](#) to adjust tool life from 15 to 180 minutes. The combined feed/speed data in this table are based on tool grades (identified in [Table 16](#)) as follows: uncoated carbide = 20; coated carbide = 10.

Table 14. Cutting Feeds and Speeds for Milling Ferrous Cast Metals

Material	Brinell Hardness	Speed (fpm)	End Milling				Face Milling				Slit Milling	
			HSS		Uncoated Carbide	Coated Carbide	Uncoated Carbide	Coated Carbide	Ceramic	CBN	Uncoated Carbide	Coated Carbide
			Opt.	Avg.	Opt.	Avg.	Opt.	Avg.	Opt.	Avg.	Opt.	Avg.
			f = feed (0.001 in./tooth), s = speed (ft/min) Metric Units: f × 25.4 = mm/rev, s × 0.3048 = m/min									
Gray Cast Iron												
ASTM Class 20	120-150	100	f	5 3	5 3		39 20	39 20	39 20	39 20	39 20	
ASTM Class 25	160-200	80	s	35 90	520 855		140 225	285 535	1130 1630	200 530	205 420	
ASTM Class 30, 35, and 40	190-220	70										
ASTM Class 45 and 50	220-260	50	f	5 3	5 3		39 20	39 20	39 20	39 20	39 20	
ASTM Class 55 and 60	250-320	30	s	30 70	515 1100		95 160	185 395	845 1220	150 400	145 380	
ASTM Type 1, 1b, 5 (Ni resist)	100-215	50										
ASTM Type 2, 3, 6 (Ni resist)	120-175	40										
ASTM Type 2b, 4 (Ni resist)	150-250	30										
Malleable Iron												
(Ferritic): 32510, 35018	110-160	110	f	5 3	5 3		39 20	39 20	39 20		39 20	
			s	30 70	180 250		120 195	225 520	490 925		85 150	
(Pearlitic): 40010, 43010, 45006, 45008, 48005, 50005	160-200	80	f	5 3	5 3		39 20	39 20	39 20		39 20	
	200-240	65	s	25 65	150 215		90 150	210 400	295 645		70 125	
(Martensitic): 53004, 60003, 60004	200-255	55										
(Martensitic): 70002, 70003	220-260	50										
(Martensitic): 80002	240-280	45										
(Martensitic): 90001	250-320	25										
Nodular (Ductile) Iron												
(Ferritic): 60-40-18, 65-45-12	140-190	75	f	7 4	7 4		39 20	39 20	39 20		39 20	
			s	15 35	125 240		100 155	120 255	580 920		60 135	
(Ferritic-Pearlitic): 80-55-06	190-225	60	f	7 4	7 4		39 20	39 20	39 20		39 20	
	225-260	50	s	10 30	90 210		95 145	150 275	170 415		40 100	
(Pearlitic-Martensitic): 100-70-03	240-300	40										
(Martensitic): 120-90-02	270-330	25										

SPEEDS AND FEEDS

1051

Table 14. Cutting Feeds and Speeds for Milling Ferrous Cast Metals

Material	Brinell Hardness	HSS	End Milling						Face Milling				Slit Milling							
			HSS		Uncoated Carbide		Coated Carbide		Uncoated Carbide		Coated Carbide		Ceramic		CBN		Uncoated Carbide		Coated Carbide	
			f = feed (0.001 in./tooth), s = speed (ft/min) Metric Units: f × 25.4 = mm/rev, s × 0.3048 = m/min																	
			Speed (fpm)	Opt.	Avg.	Opt.	Avg.	Opt.	Avg.	Opt.	Avg.	Opt.	Avg.	Opt.	Avg.	Opt.	Avg.	Opt.	Avg.	
Cast Steels																				
(Low carbon): 1010, 1020	100-150	100	f	7	4	7	4	7	4			39	20			39	20	39	20	
	125-175	95	s	25	70	245†	410	420	650			265‡	430			135†	260	245	450	
(Medium carbon): 1030, 1040 1050	175-225	80																		
	225-300	60																		
	150-200	85	f	7	4	7	4	7	4			39	20			39	20	39	20	
(Low-carbon alloy): 1320, 2315, 2320, 4110, 4120, 4320, 8020, 8620	200-250	75	s	20	55	160†	400	345	560			205‡	340			65†	180	180	370	
	250-300	50																		
	175-225	70	f	7	4	7	4									39	20			
(Medium-carbon alloy): 1330, 1340, 2325, 2330, 4125, 4130, 4140, 4330, 4340, 8030, 80B30, 8040, 8430, 8440, 8630, 8640, 9525, 9530, 9535	225-250	65	s	15	45	120†	310									45†	135			
	250-300	50	f																	
	300-350	30	s							39	20	25	40							

For HSS (high-speed steel) tools in the first speed column only, use [Table 15a](#) for recommended feed in inches per tooth and depth of cut.

End Milling: Table data for end milling are based on a 3-tooth, 20-degree helix angle tool with a diameter of 1.0 inch, an axial depth of cut of 0.2 inch, and a radial depth of cut of 1 inch (full slot). Use [Table 15b](#) to adjust speeds for other feeds and axial depths of cut, and [Table 15c](#) to adjust speeds if the radial depth of cut is less than the tool diameter. Speeds are valid for all tool diameters.

Face Milling: Table data for face milling are based on a 10-tooth, 8-inch diameter face mill, operating with a 15-degree lead angle, 3/64-inch nose radius, axial depth of cut = 0.1 inch, and radial depth (width) of cut = 6 inches (i.e., width of cut to cutter diameter ratio = 3/4). These speeds are valid if the cutter axis is above or close to the center line of the workpiece (eccentricity is small). Under these conditions, use [Table 15d](#) to adjust speeds for other feeds and axial and radial depths of cut. For larger eccentricity (i.e., when the cutter axis to workpiece center line offset is one half the cutter diameter or more), use the end and side milling adjustment factors ([Tables 15b](#) and [15c](#)) instead of the face milling factors.

Slit and Slot Milling: Table data for slit milling are based on an 8-tooth, 10-degree helix angle tool with a cutter width of 0.4 inch, diameter D of 4.0 inches, and a depth of cut of 0.6 inch. Speeds are valid for all tool diameters and widths. See the examples in the text for adjustments to the given speeds for other feeds and depths of cut.

Tool life for all tabulated values is approximately 45 minutes; use [Table 15e](#) to adjust tool life from 15 to 180 minutes. The combined feed/speed data in this table are based on tool grades (identified in [Table 16](#)) as follows: uncoated carbide = 15 except † = 20; end and slit milling coated carbide = 10; face milling coated carbide = 11 except ‡ = 10. ceramic = 6; CBN = 1.

Table 15a. Recommended Feed in Inches per Tooth (f_t) for Milling with High Speed Steel Cutters

Material	Hardness, HB	End Mills							Plain or Slab Mills	Form Relieved Cutters	Face Mills and Shell End Mills	Slotting and Side Mills
		Depth of Cut, .250 inch (6.35 mm)			Depth of Cut, .050 inch (1.27 mm)							
		Cutter Diameter, inch (mm)			Cutter Diameter, inch (mm)							
		½ inch (12.7 mm)	¾ inch (25.4 mm)	1 inch and up (19.05 mm)	¼ inch (6.35 mm)	½ inch (12.7 mm)	¾ inch (19.05 mm)	1 inch and up (25.4 mm)				
		f_t = feed per tooth, inch; <i>Metric Units:</i> $f_t \times 25.4 = \text{mm}$										
Free-machining plain carbon steels	100-185	.001	.003	.004	.001	.002	.003	.004	.003-.008	.005	.004-.012	.002-.008
Plain carbon steels, AISI 1006 to 1030; 1513 to 1522 AISI 1033 to 1095; 1524 to 1566	100-150	.001	.003	.003	.001	.002	.003	.004	.003-.008	.004	.004-.012	.002-.008
	150-200	.001	.002	.003	.001	.002	.002	.003	.003-.008	.004	.003-.012	.002-.008
	120-180	.001	.003	.003	.001	.002	.003	.004	.003-.008	.004	.004-.012	.002-.008
	180-220	.001	.002	.003	.001	.002	.002	.003	.003-.008	.004	.003-.012	.002-.008
	220-300	.001	.002	.002	.001	.001	.002	.003	.002-.006	.003	.002-.008	.002-.006
Alloy steels having less than 3% carbon. Typical examples: AISI 4012, 4023, 4027, 4118, 4320 4422, 4427, 4615, 4620, 4626, 4720, 4820, 5015, 5120, 6118, 8115, 8620 8627, 8720, 8820, 8822, 9310, 93B17	125-175	.001	.003	.003	.001	.002	.003	.004	.003-.008	.004	.004-.012	.002-.008
	175-225	.001	.002	.003	.001	.002	.003	.003	.003-.008	.004	.003-.012	.002-.008
	225-275	.001	.002	.003	.001	.001	.002	.003	.002-.006	.003	.003-.008	.002-.006
	275-325	.001	.002	.002	.001	.001	.002	.002	.002-.005	.003	.002-.008	.002-.005
Alloy steels having 3% carbon or more. Typical examples: AISI 1330, 1340, 4032, 4037, 4130, 4140, 4150, 4340, 50B40, 50B60, 5130, 51B60, 6150, 81B45, 8630, 8640, 86B45, 8660, 8740, 94B30	175-225	.001	.002	.003	.001	.002	.003	.004	.003-.008	.004	.003-.012	.002-.008
	225-275	.001	.002	.003	.001	.001	.002	.003	.002-.006	.003	.003-.010	.002-.006
	275-325	.001	.002	.002	.001	.001	.002	.003	.002-.005	.003	.002-.008	.002-.005
	325-375	.001	.002	.002	.001	.001	.002	.002	.002-.004	.002	.002-.008	.002-.005
Tool steel	150-200	.001	.002	.002	.001	.002	.003	.003	.003-.008	.004	.003-.010	.002-.006
	200-250	.001	.002	.002	.001	.002	.002	.003	.002-.006	.003	.003-.008	.002-.005
Gray cast iron	120-180	.001	.003	.004	.002	.003	.004	.004	.004-.012	.005	.005-.016	.002-.010
	180-225	.001	.002	.003	.001	.002	.003	.003	.003-.010	.004	.004-.012	.002-.008
	225-300	.001	.002	.002	.001	.001	.002	.002	.002-.006	.003	.002-.008	.002-.005
Free malleable iron	110-160	.001	.003	.004	.002	.003	.004	.004	.003-.010	.005	.005-.016	.002-.010

Table 15a. Recommended Feed in Inches per Tooth (f_t) for Milling with High Speed Steel Cutters

Material	Hardness, HB	End Mills							Plain or Slab Mills	Form Relieved Cutters	Face Mills and Shell End Mills	Slotting and Side Mills
		Depth of Cut, .250 inch (6.35 mm)			Depth of Cut, .050 inch (1.27 mm)							
		Cutter Diameter, inch (mm)			Cutter Diameter, inch (mm)							
		½ inch (12.7 mm)	¾ inch (25.4 mm)	1 inch and up (19.05 mm)	¼ inch (6.35 mm)	½ inch (12.7 mm)	¾ inch (19.05 mm)	1 inch and up (25.4 mm)				
f_t = feed per tooth, inch; <i>Metric Units:</i> $f_t \times 25.4 = \text{mm}$												
Pearlitic-Martensitic malleable iron	160-200	.001	.003	.004	.001	.002	.003	.004	.003-.010	.004	.004-.012	.002-.018
	200-240	.001	.002	.003	.001	.002	.003	.003	.003-.007	.004	.003-.010	.002-.006
	240-300	.001	.002	.002	.001	.001	.002	.002	.002-.006	.003	.002-.008	.002-.005
Cast steel	100-180	.001	.003	.003	.001	.002	.003	.004	.003-.008	.004	.003-.012	.002-.008
	180-240	.001	.002	.003	.001	.002	.003	.003	.003-.008	.004	.003-.010	.002-.006
	240-300	.001	.002	.002	.005	.002	.002	.002	.002-.006	.003	.003-.008	.002-.005
Zinc alloys (die castings)002	.003	.004	.001	.003	.004	.006	.003-.010	.005	.004-.015	.002-.012
Copper alloys (brasses & bronzes)	100-150	.002	.004	.005	.002	.003	.005	.006	.003-.015	.004	.004-.020	.002-.010
	150-250	.002	.003	.004	.001	.003	.004	.005	.003-.015	.004	.003-.012	.002-.008
Free cutting brasses & bronzes	80-100	.002	.004	.005	.002	.003	.005	.006	.003-.015	.004	.004-.015	.002-.010
Cast aluminum alloys—as cast003	.004	.005	.002	.004	.005	.006	.005-.016	.006	.005-.020	.004-.012
Cast aluminum alloys—hardened003	.004	.005	.002	.003	.004	.005	.004-.012	.005	.005-.020	.004-.012
Wrought aluminum alloys—cold drawn003	.004	.005	.002	.003	.004	.005	.004-.014	.005	.005-.020	.004-.012
Wrought aluminum alloys—hardened002	.003	.004	.001	.002	.003	.004	.003-.012	.004	.005-.020	.004-.012
Magnesium alloys003	.004	.005	.003	.004	.005	.007	.005-.016	.006	.008-.020	.005-.012
Ferritic stainless steel	135-185	.001	.002	.003	.001	.002	.003	.003	.002-.006	.004	.004-.008	.002-.007
Austenitic stainless steel	135-185	.001	.002	.003	.001	.002	.003	.003	.003-.007	.004	.005-.008	.002-.007
	185-275	.001	.002	.003	.001	.002	.002	.002	.003-.006	.003	.004-.006	.002-.007
Martensitic stainless steel	135-185	.001	.002	.002	.001	.002	.003	.003	.003-.006	.004	.004-.010	.002-.007
	185-225	.001	.002	.002	.001	.002	.002	.003	.003-.006	.004	.003-.008	.002-.007
	225-300	.0005	.002	.002	.0005	.001	.002	.002	.002-.005	.003	.002-.006	.002-.005
Monel	100-160	.001	.003	.004	.001	.002	.003	.004	.002-.006	.004	.002-.008	.002-.006

Table 15b. End Milling (Full Slot) Speed Adjustment Factors for Feed, Depth of Cut, and Lead Angle

Cutting Speed, $V = V_{opt} \times F_f \times F_d$																	
Ratio of Chosen Feed to Optimum Feed	Ratio of the two cutting speeds (average/optimum) given in the tables V_{avg}/V_{opt}							Depth of Cut and Lead Angle									
	1.00	1.25	1.50	2.00	2.50	3.00	4.00	1 in	(25.4 mm)	0.4 in	(10.2 mm)	0.2 in	(5.1 mm)	0.1 in	(2.4 mm)	0.04 in	(1.0 mm)
								0°	45°	0°	45°	0°	45°	0°	45°	0°	45°
Feed Factor, F_f							Depth of Cut and Lead Angle Factor, F_d										
1.00	1.0	1.0	1.0	1.0	1.0	1.0	1.0	0.91	1.36	0.94	1.38	1.00	0.71	1.29	1.48	1.44	1.66
0.90	1.00	1.06	1.09	1.14	1.18	1.21	1.27	0.91	1.33	0.94	1.35	1.00	0.72	1.26	1.43	1.40	1.59
0.80	1.00	1.12	1.19	1.31	1.40	1.49	1.63	0.92	1.30	0.95	1.32	1.00	0.74	1.24	1.39	1.35	1.53
0.70	1.00	1.18	1.30	1.50	1.69	1.85	2.15	0.93	1.26	0.95	1.27	1.00	0.76	1.21	1.35	1.31	1.44
0.60	1.00	1.20	1.40	1.73	2.04	2.34	2.89	0.94	1.22	0.96	1.25	1.00	0.79	1.18	1.28	1.26	1.26
0.50	1.00	1.25	1.50	2.00	2.50	3.00	4.00	0.95	1.17	0.97	1.18	1.00	0.82	1.14	1.21	1.20	1.21
0.40	1.00	1.23	1.57	2.29	3.08	3.92	5.70	0.96	1.11	0.97	1.12	1.00	0.86	1.09	1.14	1.13	1.16
0.30	1.00	1.14	1.56	2.57	3.78	5.19	8.56	0.98	1.04	0.99	1.04	1.00	0.91	1.04	1.07	1.05	1.09
0.20	1.00	0.90	1.37	2.68	4.49	6.86	17.60	1.00	0.85	1.00	0.95	1.00	0.99	0.97	0.93	0.94	0.88
0.10	1.00	0.44	0.80	2.08	4.26	8.00	20.80	1.05	0.82	1.00	0.81	1.00	1.50	0.85	0.76	0.78	0.67

SPEEDS AND FEEDS

1055

For HSS (high-speed steel) tool speeds in the first speed column of Tables 10 through 14, use Table 15a to determine appropriate feeds and depths of cut.

Cutting feeds and speeds for end milling given in Tables 11 through 14 (except those for high-speed steel in the first speed column) are based on milling a 0.20-inch deep full slot (i.e., radial depth of cut = end mill diameter) with a 1-inch diameter, 20-degree helix angle, 0-degree lead angle end mill. For other depths of cut (axial), lead angles, or feed, use the two feed/speed pairs from the tables and calculate the ratio of desired (new) feed to optimum feed (largest of the two feeds are given in the tables), and the ratio of the two cutting speeds (V_{avg}/V_{opt}). Find the feed factor F_f at the intersection of the feed ratio row and the speed ratio column in the left half of the Table. The depth of cut factor F_d is found in the same row as the feed factor, in the right half of the table under the column corresponding to the depth of cut and lead angle. The adjusted cutting speed can be calculated from $V = V_{opt} \times F_f \times F_d$, where V_{opt} is the smaller (optimum) of the two speeds from the speed table (from the left side of the column containing the two feed/speed pairs). See the text for examples.

If the radial depth of cut is less than the cutter diameter (i.e., for cutting less than a full slot), the feed factor F_f in the previous equation and the maximum feed f_{max} must be obtained from Table 15c. The axial depth of cut factor F_d can then be obtained from this table using f_{max} in place of the optimum feed in the feed ratio. Also see the footnote to Table 15c.

Table 15c. End, Slit, and Side Milling Speed Adjustment Factors for Radial Depth of Cut

Ratio of Radial Depth of Cut to Diameter	Cutting Speed, $V = V_{opt} \times F_f \times F_d$													
	Maximum Feed/Tooth Factor	V_{avg}/V_{opt}						Minimum Feed/Tooth Factor	V_{avg}/V_{opt}					
		1.25	1.50	2.00	2.50	3.00	4.00		1.25	1.50	2.00	2.50	3.00	4.00
Feed Factor F_f at Maximum Feed per Tooth, F_{f1}								Feed Factor F_f at Minimum Feed per Tooth, F_{f2}						
1.00	1.00	1.00	1.00	1.00	1.00	1.00	1.00	0.70	1.18	1.30	1.50	1.69	1.85	2.15
0.75	1.00	1.15	1.24	1.46	1.54	1.66	1.87	0.70	1.24	1.48	1.93	2.38	2.81	3.68
0.60	1.00	1.23	1.40	1.73	2.04	2.34	2.89	0.70	1.24	1.56	2.23	2.95	3.71	5.32
0.50	1.00	1.25	1.50	2.00	2.50	3.00	4.00	0.70	1.20	1.58	2.44	3.42	4.51	6.96
0.40	1.10	1.25	1.55	2.17	2.83	3.51	4.94	0.77	1.25	1.55	2.55	3.72	5.08	8.30
0.30	1.35	1.20	1.57	2.28	3.05	3.86	5.62	0.88	1.23	1.57	2.64	4.06	5.76	10.00
0.20	1.50	1.14	1.56	2.57	3.78	5.19	8.56	1.05	1.40	1.56	2.68	4.43	6.37	11.80
0.10	2.05	0.92	1.39	2.68	4.46	6.77	13.10	1.44	0.92	1.29	2.50	4.66	7.76	17.40
0.05	2.90	0.68	1.12	2.50	4.66	7.75	17.30	2.00	0.68	1.12	2.08	4.36	8.00	20.80
0.02	4.50	0.38	0.71	1.93	4.19	7.90	21.50	3.10	0.38	0.70	1.38	3.37	7.01	22.20

This table is for side milling, end milling when the radial depth of cut (width of cut) is less than the tool diameter (i.e., less than full slot milling), and slit milling when the feed is parallel to the work surface (slotting). The radial depth of cut to diameter ratio is used to determine the recommended maximum and minimum values of feed/tooth, which are found by multiplying the feed/tooth factor from the appropriate column above (maximum or minimum) by $feed_{opt}$ from the speed tables. For example, given two feed/speed pairs $7/15$ and $4/45$ for end milling cast, medium-carbon, alloy steel, and a radial depth of cut to diameter ratio ar/D of 0.10 (a 0.05-inch width of cut for a $1/2$ -inch diameter end mill, for example), the maximum feed $f_{max} = 2.05 \times 0.007 = 0.014$ in./tooth and the minimum feed $f_{min} = 1.44 \times 0.007 = 0.010$ in./tooth. The feed selected should fall in the range between f_{min} and f_{max} . The feed factor F_d is determined by interpolating between the feed factors F_{f1} and F_{f2} corresponding to the maximum and minimum feed per tooth, at the appropriate ar/D and speed ratio. In the example given, $ar/D = 0.10$ and $V_{avg}/V_{opt} = 45/15 = 3$, so the feed factor F_{f1} at the maximum feed per tooth is 6.77, and the feed factor F_{f2} at the minimum feed per tooth is 7.76. If a working feed of 0.012 in./tooth is chosen, the feed factor F_f is half way between 6.77 and 7.76 or by formula, $F_f = F_{f2} + (feed - f_{min}) / (f_{max} - f_{min}) \times (F_{f1} - F_{f2}) = 7.76 + (0.012 - 0.010) / (0.014 - 0.010) \times (6.77 - 7.76) = 7.27$. The cutting speed is $V = V_{opt} \times F_f \times F_d$, where F_d is the depth of cut and lead angle factor from Table 15b that corresponds to the feed ratio (chosen feed)/ f_{max} , not the ratio (chosen feed)/optimum feed. For a feed ratio = $0.012/0.014 = 0.86$ (chosen feed/ f_{max}), depth of cut = 0.2 inch and lead angle = 45° , the depth of cut factor F_d in Table 15b is between 0.72 and 0.74. Therefore, the final cutting speed for this example is $V = V_{opt} \times F_f \times F_d = 15 \times 7.27 \times 0.73 = 80$ ft/min.

Slit and Side Milling: This table only applies when feed is parallel to the work surface, as in slotting. If feed is perpendicular to the work surface, as in cutting off, obtain the required speed-correction factor from Table 15d (face milling). The minimum and maximum feeds/tooth for slit and side milling are determined in the manner described above, however, the axial depth of cut factor F_d is not required. The adjusted cutting speed, valid for cutters of any thickness (width), is given by $V = V_{opt} \times F_f$. Examples are given in the text.

Table 15d. Face Milling Speed Adjustment Factors for Feed, Depth of Cut, and Lead Angle

Ratio of Chosen Feed to Optimum Feed	Ratio of the two cutting speeds (average/optimum) given in the tables V_{avg}/V_{opt}							Cutting Speed $V = V_{opt} \times F_f \times F_d \times F_{ar}$																
								Depth of Cut, inch (mm), and Lead Angle										Ratio of Radial Depth of Cut/Cutter Diameter, ar/D						
	1 in (25.4 mm)		0.4 in (10.2 mm)		0.2 in (5.1 mm)		0.1 in (2.4 mm)		0.04 in (1.0 mm)		1.00	0.75	0.50	0.40	0.30	0.20	0.10							
	15°	45°	15°	45°	15°	45°	15°	45°	15°	45°	15°	45°	Radial Depth of Cut Factor, F_{ar}											
	Feed Factor, F_f							Depth of Cut Factor, F_d										Radial Depth of Cut Factor, F_{ar}						
1.00	1.0	1.0	1.0	1.0	1.0	1.0	1.0	0.78	1.11	0.94	1.16	0.90	1.10	1.00	1.29	1.47	1.66	0.72	1.00	1.53	1.89	2.43	3.32	5.09
0.90	1.00	1.02	1.05	1.07	1.09	1.10	1.12	0.78	1.10	0.94	1.16	0.90	1.09	1.00	1.27	1.45	1.58	0.73	1.00	1.50	1.84	2.24	3.16	4.69
0.80	1.00	1.03	1.09	1.10	1.15	1.20	1.25	0.80	1.10	0.94	1.14	0.91	1.08	1.00	1.25	1.40	1.52	0.75	1.00	1.45	1.73	2.15	2.79	3.89
0.70	1.00	1.05	1.13	1.22	1.22	1.32	1.43	0.81	1.09	0.95	1.14	0.91	1.08	1.00	1.24	1.39	1.50	0.75	1.00	1.44	1.72	2.12	2.73	3.77
0.60	1.00	1.08	1.20	1.25	1.35	1.50	1.66	0.81	1.09	0.95	1.13	0.92	1.08	1.00	1.23	1.38	1.48	0.76	1.00	1.42	1.68	2.05	2.61	3.52
0.50	1.00	1.10	1.25	1.35	1.50	1.75	2.00	0.81	1.09	0.95	1.13	0.92	1.08	1.00	1.23	1.37	1.47	0.76	1.00	1.41	1.66	2.02	2.54	3.39
0.40	1.00	1.09	1.28	1.44	1.66	2.03	2.43	0.82	1.08	0.95	1.12	0.92	1.07	1.00	1.21	1.34	1.43	0.78	1.00	1.37	1.60	1.90	2.34	2.99
0.30	1.00	1.06	1.32	1.52	1.85	2.42	3.05	0.84	1.07	0.96	1.11	0.93	1.06	1.00	1.18	1.30	1.37	0.80	1.00	1.32	1.51	1.76	2.10	2.52
0.20	1.00	1.00	1.34	1.60	2.07	2.96	4.03	0.86	1.06	0.96	1.09	0.94	1.05	1.00	1.15	1.24	1.29	0.82	1.00	1.26	1.40	1.58	1.79	1.98
0.10	1.00	0.80	1.20	1.55	2.24	3.74	5.84	0.90	1.04	0.97	1.06	0.96	1.04	1.00	1.10	1.15	1.18	0.87	1.00	1.16	1.24	1.31	1.37	1.32

For HSS (high-speed steel) tool speeds in the first speed column, use Table 15a to determine appropriate feeds and depths of cut.

Tabular feeds and speeds data for face milling in Tables 11 through 14 are based on a 10-tooth, 8-inch diameter face mill, operating with a 15-degree lead angle, $\frac{3}{64}$ -inch cutter insert nose radius, axial depth of cut = 0.1 inch, and radial depth (width) of cut = 6 inches (i.e., width of cut to cutter diameter ratio = $\frac{3}{4}$). For other depths of cut (radial or axial), lead angles, or feed, calculate the ratio of desired (new) feed to optimum feed (largest of the two feeds given in the speed table), and the ratio of the two cutting speeds (V_{avg}/V_{opt}). Use these ratios to find the feed factor F_f at the intersection of the feed ratio row and the speed ratio column in the left third of the table. The depth of cut factor F_d is found in the same row as the feed factor, in the center third of the table, in the column corresponding to the depth of cut and lead angle. The radial depth of cut factor F_{ar} is found in the same row as the feed factor, in the right third of the table, in the column corresponding to the radial depth of cut to cutter diameter ratio ar/D . The adjusted cutting speed can be calculated from $V = V_{opt} \times F_f \times F_d \times F_{ar}$, where V_{opt} is the smaller (optimum) of the two speeds from the speed table (from the left side of the column containing the two feed/speed pairs).

The cutting speeds as calculated above are valid if the cutter axis is centered above or close to the center line of the workpiece (eccentricity is small). For larger eccentricity (i.e., the cutter axis is offset from the center line of the workpiece by about one-half the cutter diameter or more), use the adjustment factors from Tables 15b and 15c (end and side milling) instead of the factors from this table. Use Table 15e to adjust end and face milling speeds for increased tool life up to 180 minutes.

Slit and Slot Milling: Tabular speeds are valid for all tool diameters and widths. Adjustments to the given speeds for other feeds and depths of cut depend on the circumstances of the cut. *Case 1:* If the cutter is fed directly into the workpiece, i.e., the feed is perpendicular to the surface of the workpiece, as in cutting off, then this table (face milling) is used to adjust speeds for other feeds. The depth of cut factor is not used for slit milling ($F_d = 1.0$), so the adjusted cutting speed $V = V_{opt} \times F_f \times F_{ar}$. For determining the factor F_{ar} , the radial depth of cut ar is the length of cut created by the portion of the cutter engaged in the work. *Case 2:* If the cutter is fed parallel to the surface of the workpiece, as in slotting, then Tables 15b and 15c are used to adjust the given speeds for other feeds. See Fig. 5.

Table 15e. Tool Life Adjustment Factors for Face Milling, End Milling, Drilling, and Reaming

Tool Life, T (minutes)	Face Milling with Carbides and Mixed Ceramics			End Milling with Carbides and HSS			Twist Drilling and Reaming with HSS		
	f_s	f_m	f_l	f_s	f_m	f_l	f_s	f_m	f_l
15	1.69	1.78	1.87	1.10	1.23	1.35	1.11	1.21	1.30
45	1.00	1.00	1.00	1.00	1.00	1.00	1.00	1.00	1.00
90	0.72	0.70	0.67	0.94	0.89	0.83	0.93	0.89	0.85
180	0.51	0.48	0.45	0.69	0.69	0.69	0.87	0.80	0.72

The feeds and speeds given in Tables 11 through 14 and Tables 17 through 23 (except for HSS speeds in the first speed column) are based on a 45-minute tool life. To adjust the given speeds to obtain another tool life, multiply the adjusted cutting speed for the 45-minute tool life V_{45} by the tool life factor from this table according to the following rules: for small feeds, where feed $\leq \frac{1}{2}f_{opt}$, the cutting speed for the desired tool life T is $V_T = f_s \times V_{15}$; for medium feeds, where $\frac{1}{2}f_{opt} < \text{feed} < \frac{3}{4}f_{opt}$, $V_T = f_m \times V_{15}$; and for larger feeds, where $\frac{3}{4}f_{opt} \leq \text{feed} \leq f_{opt}$, $V_T = f_l \times V_{15}$. Here, f_{opt} is the largest (optimum) feed of the two feed/speed values given in the speed tables or the maximum feed f_{max} obtained from Table 15c, if that table was used in calculating speed adjustment factors.

Table 16. Cutting Tool Grade Descriptions and Common Vendor Equivalents

Grade Description	Tool Identification Code	Approximate Vendor Equivalents			
		Sandvik Coromant	Kennametal	Seco	Valenite
Cubic boron nitride	1	CB50	KD050	CBN20	VC721
Ceramics	2	CC620	K060	480	—
	3	CC650	K090	480	Q32
	4 (Whiskers)	CC670	KYON2500	—	—
	5 (Sialon)	CC680	KYON2000	480	—
	6	CC690	KYON3000	—	Q6
Cermets	7	CT515	KT125	CM	VC605
	8	CT525	KT150	CR	VC610
Polycrystalline	9	CD10	KD100	PAX20	VC727
Coated carbides	10	GC-A	—	—	—
	11	GC3015	KC910	TP100	SV310
	12	GC235	KC9045	TP300	SV235
	13	GC4025	KC9025	TP200	SV325
	14	GC415	KC950	TP100	SV315
Uncoated carbides	15	H13A	K8, K4H	883	VC2
	16	S10T	K420, K28	CP20	VC7
	17	S1P	K45	CP20	VC7
	18	S30T	—	CP25	VC5
	19	S6	K21, K25	CP50	VC56
	20	SM30	KC710	CP25	VC35M

See Table 2 on page 791 and the section *Cemented Carbides and Other Hard Materials* for more detailed information on cutting tool grades.

The identification codes in column two correspond to the grade numbers given in the footnotes to Tables 1 to 4b, 6 to 14, and 17 to 23.

Using the Feed and Speed Tables for Drilling, Reaming, and Threading.—The first two speed columns in Tables 17 through 23 give traditional Handbook speeds for drilling and reaming. The following material can be used for selecting feeds for use with the traditional speeds.

The remaining columns in Tables 17 through 23 contain combined feed/speed data for drilling, reaming, and threading, organized in the same manner as in the turning and milling tables. Operating at the given feeds and speeds is expected to result in a tool life of approximately 45 minutes, except for indexable insert drills, which have an expected tool life of approximately 15 minutes per edge. Examples of using this data follow.

Adjustments to HSS drilling speeds for feed and diameter are made using Table 22; Table 5a is used for adjustments to indexable insert drilling speeds, where one-half the drill diameter D is used for the depth of cut. Tool life for HSS drills, reamers, and thread chasers and taps may be adjusted using Table 15e and for indexable insert drills using Table 5b.

The feed for drilling is governed primarily by the size of the drill and by the material to be drilled. Other factors that also affect selection of the feed are the workpiece configuration, the rigidity of the machine tool and the workpiece setup, and the length of the chisel edge. A chisel edge that is too long will result in a very significant increase in the thrust force, which may cause large deflections to occur on the machine tool and drill breakage.

For ordinary twist drills, the feed rate used is given in the table that follows. For additional information also see the table *Approximate Cutting Speeds and Feeds for Standard Automatic Screw Machine Tools—Brown and Sharpe* on page 1171.

Feed Rate for Twist Drills

Drill Size, inch (mm)	Feed Rate, inch/rev (mm/rev)
smaller than $\frac{1}{8}$ inch (3.175 mm)	0.001 to 0.003 in/rev (0.025–0.08 mm/rev)
from $\frac{1}{8}$ - to $\frac{1}{4}$ -inch (3.175–6.35 mm)	0.002 to 0.006 in/rev (0.05–0.15 mm/rev)
from $\frac{1}{4}$ - to $\frac{1}{2}$ -inch (6.35–12.7 mm)	0.004 to 0.010 in/rev (0.10–0.25 mm/rev)
from $\frac{1}{2}$ - to 1-inch (12.7–25.4 mm)	0.007 to 0.015 in./rev (0.18–0.38 mm/rev)
larger than 1 inch (25.4 mm)	0.010 to 0.025 in/rev (0.25–0.64 mm/rev)

The lower values in the feed ranges should be used for hard materials such as tool steels, superalloys, and work-hardening stainless steels; the higher values in the feed ranges should be used to drill soft materials such as aluminum and brass.

Example 1, Drilling: Determine the cutting speed and feed for use with HSS drills in drilling 1120 steel.

Table 17 gives two sets of feed and speed parameters for drilling 1120 steel with HSS drills. These sets are 16/50 and 8/95, i.e., 0.016 in./rev feed at 50 ft/min and 0.008 in./rev at 95 fpm, respectively. These feed/speed sets are based on a 0.6-inch diameter drill. Tool life for either of the given feed/speed settings is expected to be approximately 45 minutes.

For different feeds or drill diameters, the cutting speeds must be adjusted and can be determined from $V = V_{opt} \times F_f \times F_d$, where V_{opt} is the minimum speed for this material given in the speed table (50 fpm in this example) and F_f and F_d are the adjustment factors for feed and diameter, respectively, found in Table 22.

Table 17. Feeds and Speeds for Drilling, Reaming, and Threading Plain Carbon and Alloy Steels

Material	Brinell Hardness	Drilling	Reaming	Drilling				Reaming		Threading	
		HSS		HSS		Indexable Insert Coated Carbide		HSS		HSS	
		Speed (fpm)		f = feed (0.001 in./rev), s = speed (ft/min) Metric Units: f × 25.4 = mm/rev, s × 0.3048 = m/min							
		Opt.	Avg.	Opt.	Avg.	Opt.	Avg.	Opt.	Avg.	Opt.	Avg.
Free-machining plain carbon steels (Resulfurized): 1212, 1213, 1215	100-150	120	80	f 21 s 55	11 125	8 310	4 620	36 140	18 185	83 140	20 185
	150-200	125	80								
(Resulfurized): 1108, 1109, 1115, 1117, 1118, 1120, 1126, 1211	100-150	110	75	f 16 s 50	8 95	8 370	4 740	27 105	14 115	83 90	20 115
	150-200	120	80								
(Resulfurized): 1132, 1137, 1139, 1140, 1144, 1146, 1151	175-225	100	65	f s		8 365	4 735				
	275-325	70	45								
	325-375	45	30								
	375-425	35	20								
(Leaded): 11L17, 11L18, 12L13, 12L14	100-150	130	85								
	150-200	120	80								
Plain carbon steels: 1006, 1008, 1009, 1010, 1012, 1015, 1016, 1017, 1018, 1019, 1020, 1021, 1022, 1023, 1024, 1025, 1026, 1513, 1514	200-250	90	60	f s		8 365	4 735				
	100-125	100	65	f 21 s 55	11 125	8 310	4 620	36 140	18 185	83 140	20 185
Plain carbon steels: 1027, 1030, 1033, 1035, 1036, 1037, 1038, 1039, 1040, 1041, 1042, 1043, 1045, 1046, 1048, 1049, 1050, 1052, 1524, 1526, 1527, 1541	125-175	90	60								
	175-225	70	45	f s		8 365	4 735				
	225-275	60	40								
	125-175	90	60								
	175-225	75	50								
	225-275	60	40	f s		8 365	4 735				
	275-325	50	30								
325-375	35	20									
375-425	25	15									

Table 17. Feeds and Speeds for Drilling, Reaming, and Threading Plain Carbon and Alloy Steels

Material	Brinell Hardness	Drilling	Reaming	Drilling				Reaming		Threading		
		HSS		HSS		Indexable Insert Coated Carbide		HSS		HSS		
		Speed (fpm)		f = feed (0.001 in./rev), s = speed (ft/min) Metric Units: f × 25.4 = mm/rev, s × 0.3048 = m/min								
		Opt.	Avg.	Opt.	Avg.	Opt.	Avg.	Opt.	Avg.	Opt.	Avg.	
Plain carbon steels (Continued): 1055, 1060, 1064, 1065, 1070, 1074, 1078, 1080, 1084, 1086, 1090, 1095, 1548, 1551, 1552, 1561, 1566	125-175	85	55	f	16	8	8	4	27	14	83	20
	175-225	70	45	s	50	95	370	740	105	115	90	115
	225-275	50	30	f			8	4				
	275-325	40	25	s			365	735				
	325-375	30	20									
375-425	15	10										
Free-machining alloy steels (Resulfurized): 4140, 4150	175-200	90	60	f	16	8	8	4	26	13	83	20
	200-250	80	50	s	75	140	410	685	150	160	125	160
	250-300	55	30	f			8	4				
	300-375	40	25	s			355	600				
	375-425	30	15				310	525				
(Leaded): 41L30, 41L40, 41L47, 41L50, 43L47, 51L32, 52L100, 86L20, 86L40	150-200	100	65	f	16	8	8	4	27	14	83	20
	200-250	90	60	s	50	95	370	740	105	115	90	115
	250-300	65	40	f			8	4				
	300-375	45	30	s			365	735				
	375-425	30	15									
Alloy steels: 4012, 4023, 4024, 4028, 4118, 4320, 4419, 4422, 4427, 4615, 4620, 4621, 4626, 4718, 4720, 4815, 4817, 4820, 5015, 5117, 5120, 6118, 8115, 8615, 8617, 8620, 8622, 8625, 8627, 8720, 8822, 94B17	125-175	85	55	f	16	8	8	4	26	13	83	20
	175-225	70	45	s	75	140	410	685	150	160	125	160
	225-275	55	35	f			8	4				
	275-325	50	30	s	11	6	8	4	19	10	83	20
	325-375	35	25	f	50	85	335	570	95	135	60	95
375-425	25	15	s			310	525					

Table 17. Feeds and Speeds for Drilling, Reaming, and Threading Plain Carbon and Alloy Steels

Material	Brinell Hardness	Drilling	Reaming	Drilling				Reaming		Threading			
		HSS		HSS		Indexable Insert Coated Carbide		HSS		HSS			
		Speed (fpm)		f = feed (0.001 in./rev), s = speed (ft/min) Metric Units: f × 25.4 = mm/rev, s × 0.3048 = m/min									
		Opt.	Avg.	Opt.	Avg.	Opt.	Avg.	Opt.	Avg.	Opt.	Avg.		
Alloy steels: 1330, 1335, 1340, 1345, 4032, 4037, 4042, 4047, 4130, 4135, 4137, 4140, 4142, 4145, 4147, 4150, 4161, 4337, 4340, 50B44, 50B46, 50B50, 50B60, 5130, 5132, 5140, 5145, 5147, 5150, 5160, 51B60, 6150, 81B45, 8630, 8635, 8637, 8640, 8642, 8645, 8650, 8655, 8660, 8740, 9254, 9255, 9260, 9262, 94B30 E51100, E52100: use (HSS speeds)	175-225	75 (60)	50 (40)	f s	16 75	8 140	8 410	4 685	26 150	13 160	83 125	20 160	
	225-275	60 (50)	40 (30)	f s			8 355	4 600					
	275-325	45 (35)	30 (25)	f s	11 50	6 85	8 335	4 570	19 95	10 135	83 60	20 95	
	325-375 375-425	30 (30) 20 (20)	15 (20) 15 (10)	f s			8 310	4 525					
Ultra-high-strength steels (not AISI): AMS 6421 (98B37 Mod.), 6422 (98BV40), 6424, 6427, 6428, 6430, 6432, 6433, 6434, 6436, and 6442; 300M, D6ac	220-300	50	30	f s			8 325	4 545					
	300-350	35	20	f s			8 270	4 450					
Maraging steels (not AISI): 18% Ni Grade 200, 250, 300, and 350	250-325	50	30	f s			8 325	4 545					
Nitriding steels (not AISI): Nitralloy 125, 135, 135 Mod., 225, and 230, Nitralloy N, Nitralloy EZ, Nitrex I	200-250	60	40	f s	16 75	8 140	8 410	4 685	26 150	13 160	83 125	20 160	
	300-350	35	20	f s			8 310	4 525					

The two leftmost speed columns in this table contain traditional Handbook speeds for drilling and reaming with HSS steel tools. The section Feed Rates for Drilling and Reaming contains useful information concerning feeds to use in conjunction with these speeds.

HSS Drilling and Reaming: The combined feed/speed data for drilling are based on a 0.60-inch diameter HSS drill with standard drill point geometry (2-flute with 118° tip angle). Speed adjustment factors in Table 22 are used to adjust drilling speeds for other feeds and drill diameters. Examples of using this data are given in the text. The given feeds and speeds for reaming are based on an 8-tooth, ²⁵/₃₂-inch diameter, 30° lead angle reamer, and a 0.008-inch radial depth of cut. For other feeds, the correct speed can be obtained by interpolation using the given speeds if the desired feed lies in the recommended range (between the given values of *optimum* and *average* feed). If a feed lower than the given *average* value is chosen, the speed should be maintained at the corresponding *average* speed (i.e., the highest of the two speed values given). The cutting speeds for reaming do not require adjustment for tool diameters for standard ratios of radial depth of cut to reamer diameter (i.e., $f_d = 1.00$). Speed adjustment factors to modify tool life are found in Table 15e.

Indexable Insert Drilling: The feed/speed data for indexable insert drilling are based on a tool with two cutting edges, an insert nose radius of $\frac{3}{64}$ inch (1.2 mm), a 10-degree lead angle, and diameter $D = 1$ inch (2.54 mm). Adjustments to cutting speed for feed and depth of cut are made using [Table 5a](#) on page [1034](#) (Adjustment Factors) using a depth of cut of $D/2$, or one-half the drill diameter. Expected tool life at the given feeds and speeds is approximately 15 minutes for short hole drilling (i.e., where maximum hole depth is about $2D$ or less). Speed adjustment factors to increase tool life are found in [Table 5b](#).

Tapping and Threading: The data in this column are intended for use with thread chasers and for tapping. The feed used for tapping and threading must be equal to the lead (feed = lead = pitch) of the thread being cut. The two feed/speed pairs given for each material, therefore, are representative speeds for two thread pitches, 12 and 50 threads per inch ($1/0.083 = 12$, and $1/0.020 = 50$). Tool life is expected to be approximately 45 minutes at the given feeds and speeds. When cutting fewer than 12 threads per inch (pitch ≥ 0.08 inch or 2.1 mm), use the lower (*optimum*) speed; for cutting more than 50 threads per inch (pitch ≤ 0.02 inch or 0.51 mm), use the larger (*average*) speed; and, in the intermediate range between 12 and 50 threads per inch, interpolate between the given *average* and *optimum* speeds.

The combined feed/speed data in this table are based on tool grades (identified in [Table 16](#)) as follows: coated carbide = 10.

Example 2, Drilling: If the 1120 steel of Example 1 is to be drilled with a 0.60-inch drill at a feed of 0.012 in./rev, what is the cutting speed in ft/min? Also, what spindle rpm of the drilling machine is required to obtain this cutting speed?

To find the feed factor F_d in [Table 22](#), calculate the ratio of the desired feed to the *optimum* feed and the ratio of the two cutting speeds given in the speed tables. The desired feed is 0.012 in./rev and the *optimum* feed, as explained above is 0.016 in./rev, therefore, $\text{feed}/f_{opt} = 0.012/0.016 = 0.75$ and $V_{avg}/V_{opt} = 95/50 = 1.9$, approximately 2.

The feed factor F_f is found at the intersection of the feed ratio row and the speed ratio column. $F_f = 1.40$ corresponds to about halfway between 1.31 and 1.50, which are the feed factors that correspond to $V_{avg}/V_{opt} = 2.0$ and feed/f_{opt} ratios of 0.7 and 0.8, respectively. F_d , the diameter factor, is found on the same row as the feed factor (halfway between the 0.7 and 0.8 rows, for this example) under the column for drill diameter = 0.60 inch. Because the speed table values are based on a 0.60-inch drill diameter, $F_d = 1.0$ for this example, and the cutting speed is $V = V_{opt} \times F_f \times F_d = 50 \times 1.4 \times 1.0 = 70$ ft/min. The spindle speed in rpm is $N = 12 \times V/(\pi \times D) = 12 \times 70/(3.14 \times 0.6) = 445$ rpm.

Example 3, Drilling: Using the same material and feed as in the previous example, what cutting speeds are required for 0.079-inch and 4-inch diameter drills? What machine rpm is required for each?

Because the feed is the same as in the previous example, the feed factor is $F_f = 1.40$ and does not need to be recalculated. The diameter factors are found in [Table 22](#) on the same row as the feed factor for the previous example (about halfway between the diameter factors corresponding to feed/f_{opt} values of 0.7 and 0.8) in the column corresponding to drill diameters 0.079 and 4.0 inches, respectively. Results of the calculations are summarized below.

<i>Drill diameter = 0.079 inch</i>	<i>Drill diameter = 4.0 inches</i>
$F_f = 1.40$	$F_f = 1.40$
$F_d = (0.34 + 0.38)/2 = 0.36$	$F_d = (1.95 + 1.73)/2 = 1.85$
$V = 50 \times 1.4 \times 0.36 = 25.2$ fpm	$V = 50 \times 1.4 \times 1.85 = 129.5$ fpm
$12 \times 25.2/(3.14 \times 0.079) = 1219$ rpm	$12 \times 129.5/(3.14 \times 4) = 124$ rpm

Drilling Difficulties: A drill split at the web is evidence of too much feed or insufficient lip clearance at the center due to improper grinding. Rapid wearing away of the extreme outer corners of the cutting edges indicates that the speed is too high. A drill chipping or breaking out at the cutting edges indicates that either the feed is too heavy or the drill has been ground with too much lip clearance. Nothing will “check” a high-speed steel drill quicker than to turn a stream of cold water on it after it has been heated while in use. It is equally bad to plunge it in cold water after the point has been heated in grinding. The small checks or cracks resulting from this practice will eventually chip out and cause rapid wear or breakage. Insufficient speed in drilling small holes with hand feed greatly increases the risk of breakage, especially at the moment the drill is breaking through the farther side of the work, due to the operator's inability to gage the feed when the drill is running too slowly.

Small drills have heavier webs and smaller flutes in proportion to their size than do larger drills, so breakage due to clogging of chips in the flutes is more likely to occur. When drilling holes deeper than three times the diameter of the drill, it is advisable to withdraw the drill (peck feed) at intervals to remove the chips and permit coolant to reach the tip of the drill.

Drilling Holes in Glass: The simplest method of drilling holes in glass is to use a standard, tungsten-carbide-tipped masonry drill of the appropriate diameter, in a gun-drill. The edges of the carbide in contact with the glass should be sharp. Kerosene or other liquid may be used as a lubricant, and a light force is maintained on the drill until just before the point breaks through. The hole should then be started from the other side if possible, or a very light force applied for the remainder of the operation, to prevent excessive breaking of material from the sides of the hole. As the hard particles of glass are abraded, they accumulate and act to abrade the hole, so it may be advisable to use a slightly smaller drill than the required diameter of the finished hole.

Alternatively, for holes of medium and large size, use brass or copper tubing, having an outside diameter equal to the size of hole required. Revolve the tube at a peripheral speed of about 100 feet per minute (30.5 m/min), and use carborundum (80 to 100 grit) and light machine oil between the end of the pipe and the glass. Insert the abrasive under the drill with a thin piece of soft wood, to avoid scratching the glass. The glass should be supported by a felt or rubber cushion, not much larger than the hole to be drilled. If practicable, it is advisable to drill about halfway through, then turn the glass over, and drill down to meet the first cut. Any fin that may be left in the hole can be removed with a round second-cut file wetted with turpentine.

Smaller-diameter holes may also be drilled with triangular-shaped cemented carbide drills that can be purchased in standard sizes. The end of the drill is shaped into a long tapering triangular point. The other end of the cemented carbide bit is brazed onto a steel shank. A glass drill can be made to the same shape from hardened drill rod or an old three-cornered file. The location at which the hole is to be drilled is marked on the workpiece. A dam of putty or glazing compound is built up on the work surface to contain the cutting fluid, which can be either kerosene or turpentine mixed with camphor. Chipping on the back edge of the hole can be prevented by placing a scrap plate of glass behind the area to be drilled and drilling into the backup glass. This procedure also provides additional support to the workpiece and is essential for drilling very thin plates. The hole is usually drilled with an electric hand drill. When the hole is being produced, the drill should be given a small circular motion using the point as a fulcrum, thereby providing a clearance for the drill in the hole.

Very small round or intricately shaped holes and narrow slots can be cut in glass by the ultrasonic machining process or by the abrasive jet cutting process.

Table 18. Feeds and Speeds for Drilling, Reaming, and Threading Tool Steels

Material	Brinell Hardness	Drilling	Reaming	Drilling				Reaming		Threading		
		HSS		HSS		Indexable Insert Uncoated Carbide		HSS		HSS		
		Speed (fpm)		f = feed (0.001 in/rev), s = speed (ft/min) Metric Units: f × 25.4 = mm/rev, s × 0.3048 = m/min								
		Opt.	Avg.	Opt.	Avg.	Opt.	Avg.	Opt.	Avg.	Opt.	Avg.	
Water hardening: W1, W2, W5	150-200	85	55	f s	15 45	7 85	8 360	4 605	24 90	12 95	83 75	20 95
Shock resisting: S1, S2, S5, S6, S7	175-225	50	35									
Cold work (oil hardening): O1, O2, O6, O7	175-225	45	30									
(High carbon, high chromium): D2, D3, D4, D5, D7	200-250	30	20									
(Air hardening): A2, A3, A8, A9, A10	200-250	50	35									
A4, A6	200-250	45	30									
A7	225-275	30	20									
Hot work (chromium type): H10, H11, H12, H13, H14, H19	150-200	60	40									
	200-250	50	30									
(Tungsten type): H21, H22, H23, H24, H25, H26	150-200	55	35									
	200-250	40	25									
(Molybdenum type): H41, H42, H43	150-200	45	30									
	200-250	35	20									
Special-purpose, low alloy: L2, L3, L6	150-200	60	40	f s	15 45	7 85	8 360	4 605	24 90	12 95	83 75	20 95
Mold steel: P2, P3, P4, P5, P6P20, P21	100-150	75	50									
	150-200	60	40									
High-speed steel: M1, M2, M6, M10, T1, T2, T6	200-250	45	30									
M3-1, M4, M7, M30, M33, M34, M36, M41, M42, M43, M44, M46, M47, T5, T8	225-275	35	20									
	225-275	25	15									

See the footnote to Table 17 for instructions concerning the use of this table. The combined feed/speed data in this table are based on tool grades (identified in Table 16) as follows: coated carbide = 10.

Table 19. Feeds and Speeds for Drilling, Reaming, and Threading Stainless Steels

Material	Brinell Hardness	Drilling	Reaming	Drilling				Reaming		Threading		
		HSS		HSS		Indexable Insert Coated Carbide		HSS		HSS		
		Speed (fpm)		f = feed (0.001 in/rev), s = speed (ft/min) Metric Units: f × 25.4 = mm/rev, s × 0.3048 = m/min								
		Opt.	Avg.	Opt.	Avg.	Opt.	Avg.	Opt.	Avg.	Opt.	Avg.	
Free-machining stainless steels (Ferritic): 430F, 430FSe	135-185	90	60	f s	15 25	7 45	8 320	4 540	24 50	12 50	83 40	20 51
(Austenitic): 203EZ, 303, 303Se, 303MA, 303Pb, 303Cu, 303 Plus X	135-185	85	55	f s	15 20	7 40	8 250	4 425	24 40	12 40	83 35	20 45
	225-275	70	45									
(Martensitic): 416, 416Se, 416 Plus X, 420F, 420FSe, 440F, 440FSe	135-185	90	60	f s	15 20	7 40	8 250	4 425	24 40	12 40	83 35	20 45
	185-240	70	45									
	275-325	40	25									
	375-425	20	10									
Stainless steels (Ferritic): 405, 409, 429, 430, 434	135-185	65	45	f s	15 25	7 45	8 320	4 540	24 50	12 50	83 40	20 51
(Austenitic): 201, 202, 301, 302, 304, 304L, 305, 308, 321, 347, 348	135-185	55	35	f s	15 20	7 40	8 250	4 425	24 40	12 40	83 35	20 45
	225-275	50	30									
(Austenitic): 302B, 309, 309S, 310, 310S, 314, 316	135-185	50	30	f s	15 20	7 40	8 250	4 425	24 40	12 40	83 35	20 45
	135-175	75	50									
(Martensitic): 403, 410, 420, 501	175-225	65	45	f s	15 20	7 40	8 250	4 425	24 40	12 40	83 35	20 45
	275-325	40	25									
	375-425	25	15									
(Martensitic): 414, 431, Greek Ascoloy	225-275	50	30	f s	15 20	7 40	8 250	4 425	24 40	12 40	83 35	20 45
	275-325	40	25									
	375-425	25	15									
(Martensitic): 440A, 440B, 440C	225-275	45	30	f s	15 20	7 40	8 250	4 425	24 40	12 40	83 35	20 45
	275-325	40	25									
	375-425	20	10									
(Precipitation hardening): 15-5PH, 17-4PH, 17-7PH, AF-71, 17-14CuMo, AFC-77, AM-350, AM-355, AM-362, Custom 455, HNM, PH13-8, PH14-8Mo, PH15-7Mo, Stainless W	150-200	50	30	f s	15 20	7 40	8 250	4 425	24 40	12 40	83 35	20 45
	275-325	45	25	f s	15 20	7 40	8 250	4 425	24 40	12 40	83 35	20 45
	325-375	35	20									
	375-450	20	10									

See the footnote to Table 17 for instructions concerning the use of this table. The combined feed/speed data in this table are based on tool grades (identified in Table 16) as follows: coated carbide = 10.

Table 20. Feeds and Speeds for Drilling, Reaming, and Threading Ferrous Cast Metals

Material	Brinell Hardness	Drilling	Reaming	Drilling						Reaming		Threading		
		HSS		HSS		Indexable Carbide Insert				HSS		HSS		
		Speed (fpm)				Uncoated		Coated						
						Opt.	Avg.	Opt.	Avg.	Opt.	Avg.	Opt.	Avg.	
ASTM Class 20	120-150	100	65											
ASTM Class 25	160-200	90	60	f	16	8	11	6	11	6	26	13	83	20
ASTM Class 30, 35, and 40	190-220	80	55	s	80	90	85	180	235	485	85	65	90	80
ASTM Class 45 and 50	220-260	60	40	f	13	6	11	6	11	6	21	10	83	20
ASTM Class 55 and 60	250-320	30	20	s	50	50	70	150	195	405	50	30	55	45
ASTM Type 1, 1b, 5 (Ni resist)	100-215	50	30											
ASTM Type 2, 3, 6 (Ni resist)	120-175	40	25											
ASTM Type 2b, 4 (Ni resist)	150-250	30	20											
Malleable Iron														
(Ferritic): 32510, 35018	110-160	110	75	f	19	10			11	6	30	16	83	20
				s	80	100	11	6	270	555	95	80	100	85
(Pearlitic): 40010, 43010, 45006, 45008, 48005, 50005	160-200	80	55	f	14	7	85	180	11	6	22	11	83	20
	200-240	70	45	s	65	65			235	485	65	45	70	60
(Martensitic): 53004, 60003, 60004	200-255	55	35											
(Martensitic): 70002, 70003	220-260	50	30											
(Martensitic): 80002	240-280	45	30											
(Martensitic): 90001	250-320	25	15											
Nodular (Ductile) Iron														
(Ferritic): 60-40-18, 65-45-12	140-190	100	65	f	17	9	11	6	11	6	28	14	83	20
				s	70	80	85	180	235	485	80	60	80	70

Table 20. Feeds and Speeds for Drilling, Reaming, and Threading Ferrous Cast Metals

Material	Brinell Hardness	Drilling	Reaming	Drilling				Reaming		Threading				
		HSS		HSS		Indexable Carbide Insert		HSS		HSS				
						Uncoated	Coated							
		Speed (fpm)		f = feed (0.001 in/rev), s = speed (ft/min) Metric Units: f × 25.4 = mm/rev, s × 0.3048 = m/min										
		Opt.	Avg.	Opt.	Avg.	Opt.	Avg.	Opt.	Avg.	Opt.	Avg.			
(Martensitic): 120-90-02	270-330	25	15											
	330-400	10	5											
(Ferritic-Pearlitic): 80-55-06	190-225	70	45	f	13	6	11	6	11	6	21	11	83	20
	225-260	50	30	s	60	60	70	150	195	405	55	40	60	55
(Pearlitic-Martensitic): 100-70-03	240-300	40	25											
Cast Steels														
(Low carbon): 1010, 1020	100-150	100	65	f	18	9					29	15	83	20
				s	35	70					75	85	65	85
(Medium carbon): 1030, 1040, 1050	125-175	90	60											
	175-225	70	45											
(Low-carbon alloy): 1320, 2315, 2320, 4110, 4120, 4320, 8020, 8620	225-300	55	35	f	15	7			8	4	24	12	83	20
	150-200	75	50	s	35	60			195†	475	65	70	55	70
(Medium-carbon alloy): 1330, 1340, 2325, 2330, 4125, 4130, 4140, 4330, 4340, 8030, 80B30, 8040, 8430, 8440, 8630, 8640, 9525, 9530, 9535	200-250	65	40											
	250-300	50	30											
	175-225	70	45	f					8	4				
	225-250	60	35	s					130†	315				
	250-300	45	30											
	300-350	30	20											
	350-400	20	10											

See the footnote to Table 17 for instructions concerning the use of this table. The combined feed/speed data in this table are based on tool grades (identified in Table 16) as follows: uncoated = 15; coated carbide = 11, † = 10.

Table 21. Feeds and Speeds for Drilling, Reaming, and Threading Light Metals

Material	Brinell Hardness	Drilling	Reaming	Drilling				Reaming		Threading			
		HSS		HSS		Indexable Insert Uncoated Carbide		HSS		HSS			
		Speed (fpm)		f = feed (0.001 in/rev), s = speed (ft/min) Metric Units: f × 25.4 = mm/rev, s × 0.3048 = m/min									
				Opt.	Avg.	Opt.	Avg.	Opt.	Avg.	Opt.	Avg.		
All wrought aluminum alloys, 6061-T651, 5000, 6000, 7000 series	CD	400	400	f	31	16	11	6	52	26	83	20	
	ST and A	350	350										s
All aluminum sand and permanent mold casting alloys	AC	500	500	s	390	580	3235	11370	610	615	635	565	
	ST and A	350	350										
Aluminum Die-Casting Alloys													
Alloys 308.0 and 319.0	—	—	—	f	23	11	11	6	38	19	83	20	
					s	110	145	945	3325	145	130	145	130
Alloys 360.0 and 380.0	—	—	—	f	27	14	11	6	45	23	83	20	
					s	90	125	855	3000	130	125	130	115
Alloys 390.0 and 392.0	AC	300	300										
	ST and A	70	70										
Alloys 413	—	—	—	f	24	12	11	6	40	20	83	20	
					s	65	85	555	1955	85	80	85	80
All other aluminum die-casting alloys	AC	125	100	f	27	14	11	6	45	23	83	20	
					s	90	125	855	3000	130	125	130	115
Magnesium Alloys													
All wrought magnesium alloys	A,CD,ST and A	500	500										
All cast magnesium alloys	A,AC, ST and A	450	450										

Abbreviations designate: A, annealed; AC, as cast; CD, cold drawn; and ST and A, solution treated and aged, respectively. See the footnote to Table 17 for instructions concerning the use of this table. The combined feed/speed data in this table are based on tool grades (identified in Table 16) as follows; uncoated carbide = 15.

Table 22. Feed and Diameter Speed Adjustment Factors for HSS Twist Drills and Reamers

Cutting Speed, $V = V_{opt} \times F_f \times F_d$																
Ratio of Chosen Feed to Optimum Feed	Ratio of the two cutting speeds (average/optimum) given in the tables V_{avg}/V_{opt}							Tool Diameter								
								0.08 in (2 mm)	0.15 in (4 mm)	0.25 in (6 mm)	0.40 in (10 mm)	0.60 in (15 mm)	1.00 in (25 mm)	2.00 in (50 mm)	3.00 in (75 mm)	4.00 in (100 mm)
	Feed Factor, F_f							Diameter Factor, F_d								
1.00	1.00	1.00	1.00	1.00	1.00	1.00	1.00	0.30	0.44	0.56	0.78	1.00	1.32	1.81	2.11	2.29
0.90	1.00	1.06	1.09	1.14	1.18	1.21	1.27	0.32	0.46	0.59	0.79	1.00	1.30	1.72	1.97	2.10
0.80	1.00	1.12	1.19	1.31	1.40	1.49	1.63	0.34	0.48	0.61	0.80	1.00	1.27	1.64	1.89	1.95
0.70	1.00	1.15	1.30	1.50	1.69	1.85	2.15	0.38	0.52	0.64	0.82	1.00	1.25	1.52	1.67	1.73
0.60	1.00	1.23	1.40	1.73	2.04	2.34	2.89	0.42	0.55	0.67	0.84	1.00	1.20	1.46	1.51	1.54
0.50	1.00	1.25	1.50	2.00	2.50	3.00	5.00	0.47	0.60	0.71	0.87	1.00	1.15	1.30	1.34	1.94
0.40	1.00	1.23	1.57	2.29	3.08	3.92	5.70	0.53	0.67	0.77	0.90	1.00	1.10	1.17	1.16	1.12
0.30	1.00	1.14	1.56	2.57	3.78	5.19	8.56	0.64	0.76	0.84	0.94	1.00	1.04	1.02	0.96	0.90
0.20	1.00	0.90	1.37	2.68	4.49	6.86	17.60	0.83	0.92	0.96	1.00	1.00	0.96	0.81	0.73	0.66
0.10	1.00	1.44	0.80	2.08	4.36	8.00	20.80	1.29	1.26	1.21	1.11	1.00	0.84	0.60	0.46	0.38

This table is specifically for use with the combined feed/speed data for HSS twist drills in Tables 17 through 23; use Tables 5a and 5b to adjust speed and tool life for indexable insert drilling with carbides. The combined feed/speed data for HSS twist drilling are based on a 0.60-inch diameter HSS drill with standard drill point geometry (2-flute with 118° tip angle). To adjust the given speeds for different feeds and drill diameters, use the two feed/speed pairs from the tables and calculate the ratio of desired (new) feed to optimum feed (largest of the two feeds from the speed table), and the ratio of the two cutting speeds V_{avg}/V_{opt} . Use the values of these ratios to find the feed factor F_f at the intersection of the feed ratio row and the speed ratio column in the left half of the table. The diameter factor F_d is found in the same row as the feed factor, in the right half of the table, under the column corresponding to the drill diameter. For diameters not given, interpolate between the nearest available sizes. The adjusted cutting speed can be calculated from $V = V_{opt} \times F_f \times F_d$, where V_{opt} is the smaller (optimum) of the two speeds from the speed table (from the left side of the column containing the two feed/speed pairs). Tool life using the selected feed and the adjusted speed should be approximately 45 minutes. Speed adjustment factors to modify tool life are found in Table 15e.

Table 23. Feeds and Speeds for Drilling and Reaming Copper Alloys

Group 1										
Architectural bronze(C38500); Extra-high-leaded brass (C35600); Forging brass (C37700); Free-cutting phosphor bronze (B-2) (C54400); Free-cutting brass (C36000); Free-cutting Muntz metal (C37000); High-leaded brass (C33200, C34200); High-leaded brass tube (C35300); Leaded commercial bronze (C31400); Leaded naval brass (C48500); Medium-leaded brass (C34000)										
Group 2										
Aluminum brass, arsenical (C68700); Cartridge brass, 70% (C26000); High-silicon bronze, B (C65500); Admiralty brass (inhibited) (C44300, C44500); Jewelry bronze, 87.5% (C22600); Leaded Muntz metal (C36500, C36800); Leaded nickel silver (C79600); Low brass, 80% (C24000); Low-leaded brass (C33500); Low-silicon bronze, B (C65100); Manganese bronze, A (C67500); Muntz metal, 60% (C28000); Nickel silver, 55-18 (C77000); Red brass, 85% (C23000); Yellow brass (C26800)										
Group 3										
Aluminum bronze, D (C61400); Beryllium copper (C17000, C17200, C17500); Commercial bronze, 90% (C22000); Copper nickel, 10% (C70600); Copper nickel, 30% (C71500); Electrolytic tough-pitch copper (C11000); Gilding, 95% (C21000); Nickel silver, 65-10 (C74500); Nickel silver, 65-12 (C75700); Nickel silver, 65-15 (C75400); Nickel silver, 65-18 (C75200); Oxygen-free copper (C10200); Phosphor bronze, 1.25% (C50200); Phosphor bronze, 10% D (C52400); Phosphor bronze, 5% A (C51000); Phosphor bronze, 8% C (C52100); Phosphorus deoxidized copper (C12200)										
Alloy Description and UNS Alloy Numbers	Material Condition	Drilling	Reaming	Drilling				Reaming		
		HSS		HSS		Indexable Insert Uncoated Carbide		HSS		
		Speed (fpm)		f = feed (0.001 in./rev), s = speed (ft/min) Metric Units: f × 25.4 = mm/rev, s × 0.3048 = m/min						
Wrought Alloys										
Group 1	A	160	160	f	21	11	11	6	36	18
	CD	175	175	s	210	265	405	915	265	230
Group 2	A	120	110	f	24	12	11	6	40	20
	CD	140	120	s	100	130	205	455	130	120
Group 3	A	60	50	f	23	11	11	6	38	19
	CD	65	60	s	155	195	150	340	100	175

Abbreviations designate: A, annealed; CD, cold drawn. The two leftmost speed columns in this table contain traditional Handbook speeds for HSS steel tools. The text contains information concerning feeds to use in conjunction with these speeds.

HSS Drilling and Reaming: The combined feed/speed data for drilling and Table 22 are used to adjust drilling speeds for other feeds and drill diameters. Examples are given in the text. The given feeds and speeds for reaming are based on an 8-tooth, ²⁵/₃₂-inch diameter, 30° lead angle reamer, and a 0.008-inch radial depth of cut. For other feeds, the correct speed can be obtained by interpolation using the given speeds if the desired feed lies in the recommended range (between the given values of *optimum* and *average* feed). The cutting speeds for reaming do not require adjustment for tool diameter as long as the radial depth of cut does not become too large. Speed adjustment factors to modify tool life are found in Table 15e.

Indexable Insert Drilling: The feed/speed data for indexable insert drilling are based on a tool with two cutting edges, an insert nose radius of ³/₆₄ inch, a 10-degree lead angle, and diameter *D* of 1 inch. Adjustments for feed and depth of cut are made using Table 5a (Turning Speed Adjustment Factors) using a depth of cut of *D*/2, or one-half the drill diameter. Expected tool life at the given feeds and speeds is 15 minutes for short hole drilling (i.e., where hole depth is about 2*D* or less). Speed adjustment factors to increase tool life are found in Table 5b. The combined feed/speed data in this table are based on tool grades (identified in Table 16) as follows: uncoated carbide = 15.

Using the Feed and Speed Tables for Tapping and Threading.—The feed used in tapping and threading is always equal to the pitch of the screw thread being formed. The threading data contained in the tables for drilling, reaming, and threading (Tables 17

through 23) are primarily for tapping and thread chasing, and do not apply to thread cutting with single-point tools.

The threading data in Tables 17 through 23 give two sets of feed (pitch) and speed values, for 12 and 50 threads/inch, but these values can be used to obtain the cutting speed for any other thread pitches. If the desired pitch falls between the values given in the tables, i.e., between 0.020 inch (50 tpi) and 0.083 inch (12 tpi), the required cutting speed is obtained by interpolation between the given speeds. If the pitch is less than 0.020 inch (more than 50 tpi), use the *average* speed, i.e., the largest of the two given speeds. For pitches greater than 0.083 inch (fewer than 12 tpi), the *optimum* speed should be used. Tool life using the given feed/speed data is intended to be approximately 45 minutes, and should be about the same for threads between 12 and 50 threads per inch.

Example: Determine the cutting speed required for tapping 303 stainless steel with a ½-20 coated HSS tap.

The two feed/speed pairs for 303 stainless steel, in Table 19, are 83/35 (0.083 in./rev at 35 fpm) and 20/45 (0.020 in./rev at 45 fpm). The pitch of a ½-20 thread is 1/20 = 0.05 inch, so the required feed is 0.05 in./rev. Because 0.05 is between the two given feeds (Table 19), the cutting speed can be obtained by interpolation between the two given speeds as follows:

$$V = 35 + \frac{0.05 - 0.02}{0.083 - 0.02}(45 - 35) = 40 \text{ fpm}$$

The cutting speed for coarse-pitch taps must be lower than for fine-pitch taps with the same diameter. Usually, the difference in pitch becomes more pronounced as the diameter of the tap becomes larger and slight differences in the pitch of smaller-diameter taps have little significant effect on the cutting speed. Unlike all other cutting tools, the feed per revolution of a tap cannot be independently adjusted—it is always equal to the lead of the thread and is always greater for coarse pitches than for fine pitches. Furthermore, the thread form of a coarse-pitch thread is larger than that of a fine-pitch thread; therefore, it is necessary to remove more metal when cutting a coarse-pitch thread.

Taps with a long chamfer, such as starting or tapper taps, can cut faster in a short hole than short chamfer taps, such as plug taps. In deep holes, however, short chamfer or plug taps can run faster than long chamfer taps. Bottoming taps must be run more slowly than either starting or plug taps. The chamfer helps to start the tap in the hole. It also functions to involve more threads, or thread form cutting edges, on the tap in cutting the thread in the hole, thus reducing the cutting load on any one set of thread form cutting edges. In so doing, more chips and thinner chips are produced that are difficult to remove from deeper holes. Shortening the chamfer length causes fewer thread form cutting edges to cut, thereby producing fewer and thicker chips that can easily be disposed of. Only one or two sets of thread form cutting edges are cut on bottoming taps, causing these cutting edges to assume a heavy cutting load and produce very thick chips.

Spiral-pointed taps can operate at a faster cutting speed than taps with normal flutes. These taps are made with supplementary angular flutes on the end that push the chips ahead of the tap and prevent the tapped hole from becoming clogged with chips. They are used primarily to tap open or through holes although some are made with shorter supplementary flutes for tapping blind holes.

The tapping speed must be reduced as the percentage of full thread to be cut is increased. Experiments have shown that the torque required to cut a 100 per cent thread form is more than twice that required to cut a 50 per cent thread form. An increase in the percentage of full thread will also produce a greater volume of chips.

The tapping speed must be lowered as the length of the hole to be tapped is increased. More friction must be overcome in turning the tap and more chips accumulate in the hole. It will be more difficult to apply the cutting fluid at the cutting edges and to lubricate the tap

to reduce friction. This problem becomes greater when the hole is being tapped in a horizontal position.

Cutting fluids have a very great effect on the cutting speed for tapping. Although other operating conditions when tapping frequently cannot be changed, a free selection of the cutting fluid usually can be made. When planning the tapping operation, the selection of a cutting fluid warrants a very careful consideration and perhaps an investigation.

Taper threaded taps, such as pipe taps, must be operated at a slower speed than straight thread taps with a comparable diameter. All the thread form cutting edges of a taper threaded tap that are engaged in the work cut and produce a chip, but only those cutting edges along the chamfer length cut on straight thread taps. Pipe taps often are required to cut the tapered thread from a straight hole, adding to the cutting burden.

The machine tool used for the tapping operation must be considered in selecting the tapping speed. Tapping machines and other machines that are able to feed the tap at a rate of advance equal to the lead of the tap, and that have provisions for quickly reversing the spindle, can be operated at high cutting speeds. On machines where the feed of the tap is controlled manually—such as on drill presses and turret lathes—the tapping speed must be reduced to allow the operator to maintain safe control of the operation.

There are other special considerations in selecting the tapping speed. Very accurate threads are usually tapped more slowly than threads with a commercial grade of accuracy. Thread forms that require deep threads for which a large amount of metal must be removed, producing a large volume of chips, require special techniques and slower cutting speeds. Acme, buttress, and square threads, therefore, are generally cut at lower speeds.

Cutting Speed for Broaching.—Broaching offers many advantages in manufacturing metal parts, including high production rates, excellent surface finishes, and close dimensional tolerances. These advantages are not derived from the use of high cutting speeds; they are derived from the large number of cutting teeth that can be applied consecutively in a given period of time, from their configuration and precise dimensions, and from the width or diameter of the surface that can be machined in a single stroke. Most broaching cutters are expensive in their initial cost and are expensive to sharpen. For these reasons, a long tool life is desirable, and to obtain a long tool life, relatively slow cutting speeds are used. In many instances, slower cutting speeds are used because of the limitations of the machine in accelerating and stopping heavy broaching cutters. At other times, the available power on the machine places a limit on the cutting speed that can be used; i.e., the cubic inches of metal removed per minute must be within the power capacity of the machine.

The cutting speeds for high-speed steel broaches range from 3 to 50 feet per minute, although faster speeds have been used. In general, the harder and more difficult to machine materials are cut at a slower cutting speed and those that are easier to machine are cut at a faster speed. Some typical recommendations for high-speed steel broaches are: AISI 1040, 10 to 30 fpm; AISI 1060, 10 to 25 fpm; AISI 4140, 10 to 25 fpm; AISI 41L40, 20 to 30 fpm; 201 austenitic stainless steel, 10 to 20 fpm; Class 20 gray cast iron, 20 to 30 fpm; Class 40 gray cast iron, 15 to 25 fpm; aluminum and magnesium alloys, 30 to 50 fpm; copper alloys, 20 to 30 fpm; commercially pure titanium, 20 to 25 fpm; alpha and beta titanium alloys, 5 fpm; and the superalloys, 3 to 10 fpm. Surface broaching operations on gray iron castings have been conducted at a cutting speed of 150 fpm, using indexable insert cemented carbide broaching cutters. In selecting the speed for broaching, the cardinal principle of the performance of all metal cutting tools should be kept in mind; i.e., increasing the cutting speed may result in a proportionately larger reduction in tool life, and reducing the cutting speed may result in a proportionately larger increase in the tool life. When broaching most materials, a suitable cutting fluid should be used to obtain a good surface finish and a better tool life. Gray cast iron can be broached without using a cutting fluid although some shops prefer to use a soluble oil.

Spade Drills

Spade drills are used to produce holes ranging in size from about 1 inch to 6 inches (approximately 25–150 mm) diameter, and even larger. Very deep holes can be drilled and blades are available for core drilling, counterboring, and for bottoming to a flat or contoured shape. There are two principal parts to a spade drill, the blade and the holder. The holder has a slot into which the blade fits; a wide slot at the back of the blade engages with a tongue in the holder slot to locate the blade accurately. A retaining screw holds the two parts together. The blade is usually made from high-speed steel, although cast nonferrous metal and cemented carbide-tipped blades are also available. Spade drill holders are classified by a letter symbol designating the range of blade sizes that can be held and by their length. Standard stub, short, long, and extra long holders are available; for very deep holes, special holders having wear strips to support and guide the drill are often used. Long, extra long, and many short length holders have coolant holes to direct cutting fluid, under pressure, to the cutting edges. In addition to its function in cooling and lubricating the tool, the cutting fluid also flushes the chips out of the hole. The shank of the holder may be straight or tapered; special automotive shanks are also used. A holder and different shank designs are shown in Fig. 1; Figs. 2a through Fig. 2f show some typical blades.

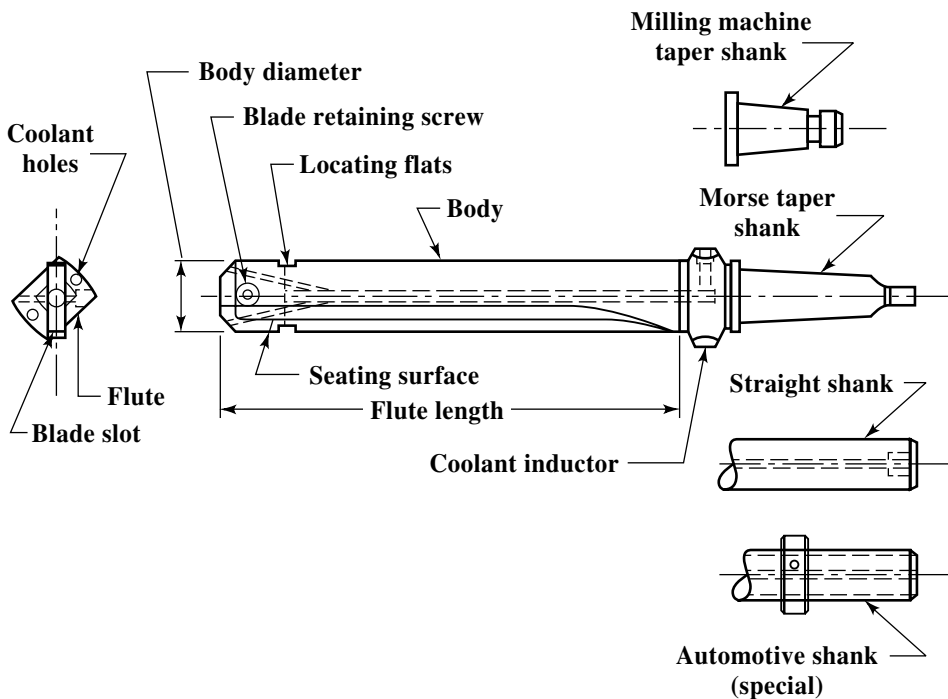


Fig. 1. Spade Drill Blade Holder

Spade Drill Geometry.—Metal separation from the work is accomplished in a like manner by both twist and spade drills, and the same mechanisms are involved for each. The two cutting lips separate the metal by a shearing action that is identical to that of chip formation by a single-point cutting tool. At the chisel edge, a much more complex condition exists. Here the metal is extruded sideways and at the same time is sheared by the rotation of the blunt wedge-formed chisel edge. This combination accounts for the very high thrust force required to penetrate the work. The chisel edge of a twist drill is slightly rounded, but on spade drills, it is a straight edge. Thus, it is likely that it is more difficult for the extruded metal to escape from the region of the chisel edge with spade drills. However, the chisel edge is shorter in length than on twist drills and the thrust for spade drilling is less.

Typical Spade Drill Blades

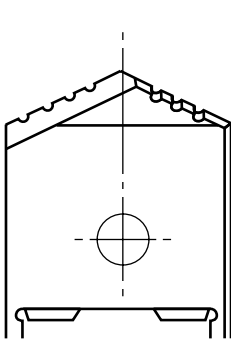


Fig. 2a. Standard blade

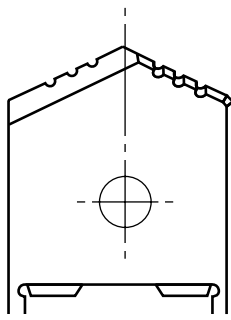


Fig. 2b. Standard blade with corner chamfer

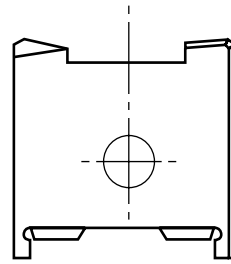


Fig. 2c. Core drilling blade

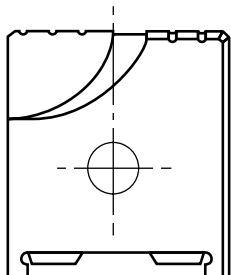


Fig. 2d. Center cutting facing or bottoming blade

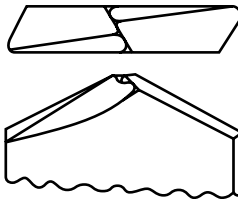


Fig. 2e. Standard blade with split point or crankshaft point

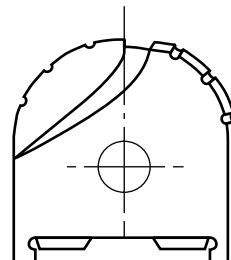


Fig. 2f. Center cutting radius blade

Basic spade drill geometry is shown in Fig. 3. Normally, the point angle of a standard tool is 130 degrees and the lip clearance angle is 18 degrees, resulting in a chisel edge angle of 108 degrees. The web thickness is usually about $\frac{1}{4}$ to $\frac{5}{16}$ as thick as the blade thickness. Usually, the cutting edge angle is selected to provide this web thickness and to provide the necessary strength along the entire length of the cutting lip. A further reduction of the chisel edge length is sometimes desirable to reduce the thrust force in drilling. This reduction can be accomplished by grinding a secondary rake surface at the center or by grinding a split point, or crankshaft point, on the point of the drill.

The larger point angle of a standard spade drill—130 degrees as compared with 118 degrees on a twist drill—causes the chips to flow more toward the periphery of the drill, thereby allowing the chips to enter the flutes of the holder more readily. The rake angle facilitates the formation of the chip along the cutting lips. For drilling materials of average hardness, the rake angle should be 10 to 12 degrees; for hard or tough steels, it should be 5 to 7 degrees; and for soft and ductile materials, it can be increased to 15 to 20 degrees. The rake surface may be flat or rounded, and the latter design is called radial rake. Radial rake is usually ground so that the rake angle is maximum at the periphery and decreases uniformly toward the center to provide greater cutting edge strength at the center. A flat rake surface is recommended for drilling hard and tough materials in order to reduce the tendency to chipping and to reduce heat damage.

A most important feature of the cutting edge is the chip splitters, which are also called chip breaker grooves. Functionally, these grooves are chip dividers; instead of forming a single wide chip along the entire length of the cutting edge, these grooves cause formation of several chips that can be readily disposed of through the flutes of the holder. Chip splitters must be carefully ground to prevent the chips from packing in the grooves, which greatly reduces their effectiveness. Splitters should be ground perpendicular to the cutting lip and parallel to the surface formed by the clearance angle. The grooves on the two cut-

ting lips must not overlap when measured radially along the cutting lip. Fig. 4 and the accompanying table show the groove form and dimensions.

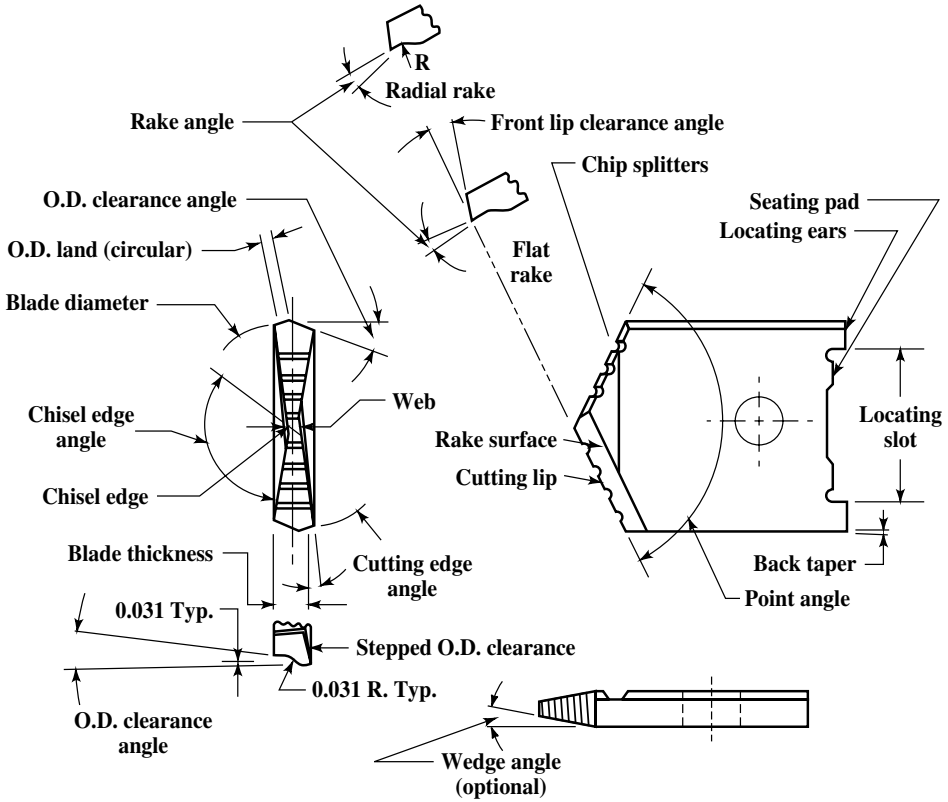


Fig. 3. Spade Drill Blade

On spade drills, the front lip clearance angle provides the relief. It may be ground on a drill grinding machine but usually it is ground flat. The normal front lip clearance angle is 8 degrees; in some instances, a secondary relief angle of about 14 degrees is ground below the primary clearance. The wedge angle on the blade is optional. It is generally ground on thicker blades having a larger diameter to prevent heel dragging below the cutting lip and to reduce the chisel edge length. The outside-diameter land is circular, serving to support and guide the blade in the hole. Usually it is ground to have a back taper of 0.001 to 0.002 inch per inch (or mm/mm) per side. The width of the land is approximately 20 to 25 per cent of the blade thickness. Normally, the outside-diameter clearance angle behind the land is 7 to 10 degrees. On many spade drill blades, the outside-diameter clearance surface is stepped about 0.030 inch (0.76 mm) below the land.

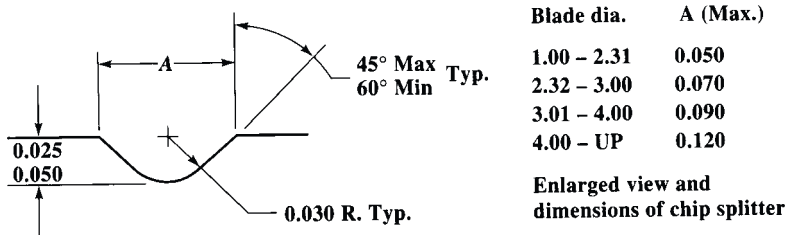


Fig. 4. Spade Drill Chip Splitter Dimensions in Inches

Spade Drilling.—Spade drills are used on drilling machines and other machine tools where the cutting tool rotates; they are also used on turning machines where the work

rotates and the tool is stationary. Although there are some slight operational differences, the methods of using spade drills are basically the same. An adequate supply of cutting fluid must be used, which serves to cool and lubricate the cutting edges; to cool the chips, thus making them brittle and more easily broken; and to flush chips out of the hole. Flood cooling from outside the hole can be used for drilling relatively shallow holes, of about one to two and one-half times the diameter in depth. For deeper holes, the cutting fluid should be injected through the holes in the drill. When drilling very deep holes, it is often helpful to blow compressed air through the drill in addition to the cutting fluid to facilitate ejection of the chips. Air at full shop pressure is throttled down to a pressure that provides the most efficient ejection. The cutting fluids used are light and medium cutting oils, water-soluble oils, and synthetics, and the type selected depends on the work material.

Starting a spade drill in the workpiece needs special attention. The straight chisel edge on the spade drill has a tendency to wander as it starts to enter the work, especially if the feed is too light. This wander can result in a mispositioned hole and possible breakage of the drill point. The best method of starting the hole is to use a stub or short-length spade drill holder and a blade of full size that should penetrate at least $\frac{1}{8}$ inch (3.18 mm) at full diameter. The holder is then changed for a longer one as required to complete the hole to depth. Difficulties can be encountered if spotting with a center drill or starting drill is employed because the angles on these drills do not match the 130-degree point angle of the spade drill. Longer spade drills can be started without this starting procedure if the drill is guided by a jig bushing and if the holder is provided with wear strips.

Chip formation warrants the most careful attention as success in spade drilling is dependent on producing short, well-broken chips that can be easily ejected from the hole. Straight, stringy chips or chips that are wound like a clock spring cannot be ejected properly; they tend to pack around the blade, which may result in blade failure. The chip splitters must be functioning to produce a series of narrow chips along each cutting edge. Each chip must be broken, and for drilling ductile materials they should be formed into a "C" or "figure 9" shape. Such chips will readily enter the flutes on the holder and flow out of the hole.

Proper chip formation is dependent on the work material, the spade drill geometry, and the cutting conditions. Brittle materials such as gray cast iron seldom pose a problem because they produce a discontinuous chip, but austenitic stainless steels and very soft and ductile materials require much attention to obtain satisfactory chip control. Thinning the web or grinding a split point on the blade will sometimes be helpful in obtaining better chip control, as these modifications allow use of a heavier feed. Reducing the rake angle to obtain a tighter curl on the chip and grinding a corner chamfer on the tool will sometimes help to produce more manageable chips.

In most instances, it is not necessary to experiment with the spade drill blade geometry to obtain satisfactory chip control. Control usually can be accomplished by adjusting the cutting conditions; i.e., the cutting speed and the feed rate.

Normally, the cutting speed for spade drilling should be 10 to 15 per cent lower than that for an equivalent twist drill, although the same speed can be used if a lower tool life is acceptable. The recommended cutting speeds for twist drills on [Tables 17 through 23](#), starting on page [1060](#), can be used as a starting point; however, they should be decreased by the percentage just given. It is essential to use a heavy feed rate when spade drilling to produce a thick chip, and to force the chisel edge into the work. In ductile materials, a light feed will produce a thin chip that is very difficult to break. The thick chip on the other hand, which often contains many rupture planes, will curl and break readily. The table on page [1078](#) gives suggested feed rates for different spade drill sizes and materials. These rates should be used as a starting point and some adjustments may be necessary as experience is gained.

Feed Rates for Spade Drilling

Material	Hardness, Bhn	Spade Drill Diameter, inches						Spade Drill Diameter, mm					
		1-1/4	1 1/2	2-3	3-4	4-5	5-8	25 - 32	32 - 50	50 - 76	76 - 102	102 - 127	127 - 203
		Feed—inch/rev						Feed—mm/rev					
Free Machining Steel	100-240 240-325	0.014 0.010	0.016 0.014	0.018 0.016	0.022 0.020	0.025 0.022	0.030 0.025	0.36 0.25	0.41 0.36	0.46 0.41	0.56 0.51	0.64 0.56	0.76 0.64
Plain Carbon Steels	100-225 225-275 275-325	0.012 0.010 0.008	0.015 0.013 0.010	0.018 0.015 0.013	0.022 0.018 0.015	0.025 0.020 0.018	0.030 0.025 0.020	0.30 0.25 0.20	0.38 0.33 0.25	0.46 0.38 0.33	0.56 0.46 0.38	0.64 0.51 0.46	0.76 0.64 0.51
Free Machining Alloy Steels	150-250 250-325 325-375	0.014 0.012 0.010	0.016 0.014 0.010	0.018 0.016 0.014	0.022 0.018 0.016	0.025 0.020 0.018	0.030 0.025 0.020	0.36 0.30 0.25	0.41 0.36 0.25	0.46 0.41 0.36	0.56 0.46 0.41	0.64 0.51 0.46	0.76 0.64 0.51
Alloy Steels	125-180 180-225 225-325 325-400	0.012 0.010 0.009 0.006	0.015 0.012 0.010 0.008	0.018 0.016 0.013 0.010	0.022 0.018 0.015 0.012	0.025 0.022 0.018 0.014	0.030 0.025 0.020 0.016	0.30 0.25 0.23 0.15	0.38 0.30 0.25 0.20	0.46 0.41 0.33 0.25	0.56 0.46 0.38 0.30	0.64 0.56 0.46 0.36	0.76 0.64 0.51 0.41
Tool Steels													
Water Hardening	150-250	0.012	0.014	0.016	0.018	0.020	0.022	0.30	0.36	0.41	0.46	0.51	0.56
Shock Resisting	175-225	0.012	0.014	0.015	0.016	0.017	0.018	0.30	0.36	0.38	0.41	0.43	0.46
Cold Work	200-250	0.007	0.008	0.009	0.010	0.011	0.012	0.18	0.20	0.23	0.25	0.28	0.30
Hot Work	150-250	0.012	0.013	0.015	0.016	0.018	0.020	0.30	0.33	0.38	0.41	0.46	0.51
Mold	150-200	0.010	0.012	0.014	0.016	0.018	0.018	0.25	0.30	0.36	0.41	0.46	0.46
Special-Purpose	150-225	0.010	0.012	0.014	0.016	0.016	0.018	0.25	0.30	0.36	0.41	0.41	0.46
High-Speed Steel	200-240	0.010	0.012	0.013	0.015	0.017	0.018	0.25	0.30	0.33	0.38	0.43	0.46
Gray Cast Iron	110-160 160-190 190-240 240-320	0.020 0.015 0.012 0.010	0.022 0.018 0.014 0.012	0.026 0.020 0.016 0.018	0.028 0.024 0.018 0.018	0.030 0.026 0.020 0.018	0.034 0.028 0.022 0.018	0.51 0.38 0.30 0.25	0.56 0.46 0.36 0.30	0.66 0.51 0.41 0.41	0.71 0.61 0.46 0.46	0.76 0.66 0.51 0.46	0.86 0.71 0.56 0.46
Ductile or Nodular Iron	140-190 190-250 250-300	0.014 0.012 0.010	0.016 0.014 0.012	0.018 0.016 0.016	0.020 0.018 0.018	0.022 0.018 0.018	0.024 0.020 0.018	0.36 0.30 0.25	0.41 0.36 0.30	0.46 0.41 0.41	0.51 0.46 0.46	0.56 0.46 0.46	0.61 0.51 0.46
Malleable Iron													
Ferritic	110-160	0.014	0.016	0.018	0.020	0.022	0.024	0.36	0.41	0.46	0.51	0.56	0.61
Pearlitic {	160-220	0.012	0.014	0.016	0.018	0.020	0.020	0.30	0.36	0.41	0.46	0.51	0.51
	220-280	0.010	0.012	0.014	0.016	0.018	0.018	0.25	0.30	0.36	0.41	0.46	0.46
Free Machining Stainless Steel													
Ferritic	...	0.016	0.018	0.020	0.024	0.026	0.028	0.41	0.46	0.51	0.61	0.66	0.71
Austenitic	...	0.016	0.018	0.020	0.022	0.024	0.026	0.41	0.46	0.51	0.56	0.61	0.66
Martensitic	...	0.012	0.014	0.016	0.016	0.018	0.020	0.30	0.36	0.41	0.41	0.46	0.51
Stainless Steel													
Ferritic	...	0.012	0.014	0.018	0.020	0.020	0.022	0.30	0.36	0.46	0.51	0.51	0.56
Austenitic	...	0.012	0.014	0.016	0.018	0.020	0.020	0.30	0.36	0.41	0.46	0.51	0.51
Martensitic	...	0.010	0.012	0.012	0.014	0.016	0.018	0.25	0.30	0.30	0.36	0.41	0.46
Aluminum Alloys	...	0.020	0.022	0.024	0.028	0.030	0.040	0.51	0.56	0.61	0.71	0.76	1.02
Copper Alloys	(Soft)	0.016	0.018	0.020	0.026	0.028	0.030	0.41	0.46	0.51	0.66	0.71	0.76
	(Hard)	0.010	0.012	0.014	0.016	0.018	0.018	0.25	0.30	0.36	0.41	0.46	0.46
Titanium Alloys	...	0.008	0.010	0.012	0.014	0.014	0.016	0.20	0.25	0.30	0.36	0.36	0.41
High-Temperature Alloys	...	0.008	0.010	0.012	0.012	0.014	0.014	0.20	0.25	0.30	0.30	0.36	0.36

Power Consumption and Thrust for Spade Drilling.—In each individual setup, there are factors and conditions influencing power consumption that cannot be accounted for in a simple equation; however, those given below will enable the user to estimate power consumption and thrust accurately enough for most practical purposes. They are based on experimentally derived values of unit horsepower, as given in Table 24. As a word of caution, these values are for sharp tools. In spade drilling, it is reasonable to estimate that a dull tool will increase the power consumption and the thrust by 25 to 50 per cent. The unit horsepower values in the table are for the power consumed at the cutting edge, to which must be added the power required to drive the machine tool itself, in order to obtain the horsepower required by the machine tool motor. An allowance for power to drive the machine is provided by dividing the horsepower at the cutter by a mechanical efficiency factor, e_m . This factor can be estimated to be 0.90 for a direct spindle drive with a belt, 0.75 for a back gear drive, and 0.70 to 0.80 for geared head drives. Thus, for spade drilling the formulas are

$$hp_c = uhp \left(\frac{\pi D^2}{4} \right) fN$$

$$kw_c = \frac{1}{1000} ukw \left(\frac{\pi D^2}{4} \right) fN$$

$$B_s = 148,500 uhp (fD)$$

$$B_s = 22500 ukw \times f \times D$$

$$hp_m = \frac{hp_c}{e_m}$$

$$kw_m = \frac{hp_c}{e_m}$$

$$f = \frac{f_m}{N}$$

$$f = \frac{f_m}{N}$$

where

- hp_c = horsepower at the cutter
- hp_m = horsepower at the motor
- B_s = thrust for spade drilling in pounds
- uhp = unit horsepower
- D = drill diameter in inches
- f = feed in inches per revolution
- f_m = feed in inches per minute
- N = spindle speed in revolutions per minute
- e_m = mechanical efficiency factor

where

- kw_c = power at the cutter in kilowatts
- kw_m = power at the motor kilowatts
- B_s = thrust for spade drilling in newtons
- ukw = unit kilowatt power
- D = drill diameter in millimeters
- f = feed in millimeters per revolution
- f_m = feed in millimeters per minute
- N = spindle speed in revolutions per minute
- e_m = mechanical efficiency factor

Table 24. Unit Horsepower / Kilowatt for Spade Drilling

Material	Hardness	uhp	ukw	Material	Hardness	uhp	ukw
Plain Carbon and Alloy Steel	85–200 Bhn	0.79	0.0359	Titanium Alloys	250–375 Bhn	0.72	0.0328
	200–275	0.94	0.0428	High-Temp Alloys	200–360 Bhn	1.44	0.0655
	275–375	1.00	0.0455	Aluminum Alloys	...	0.22	0.0100
	375–425	1.15	0.0523	Magnesium Alloys	...	0.16	0.0073
	45–52 Rc	1.44	0.0655	Copper Alloys	20–80 Rb	0.43	0.0196
Cast Irons	110–200 Bhn	0.50	0.0228		80–100 Rb	0.72	0.0328
	200–300	1.08	0.0491				
Stainless Steels	135–275 Bhn	0.94	0.0428				
	30–45 Rc	1.08	0.0491				

Example: Estimate the horsepower and thrust required to drive a 2-inch diameter spade drill in AISI 1045 steel that is quenched and tempered to a hardness of 275 Bhn. From Table 17 on page 1060, the cutting speed, V , for drilling this material with a twist drill is 50 feet per minute. This value is reduced by 10 per cent for spade drilling and the speed selected is thus $0.9 \times 50 = 45$ feet per minute. The feed rate (from Table , page 1078) is 0.015 in/rev. and the unit horsepower from Table 24 above is 0.94. The machine efficiency factor is estimated to be 0.80 and it will be assumed that a 50 per cent increase in the unit horsepower must be allowed for dull tools.

Step 1. Calculate the spindle speed from the formula:

$$N = \frac{12V}{\pi D}$$

where N = spindle speed in revolutions per minute

V = cutting speed in feet per minute

D = drill diameter in inches

$$\text{Thus, } N = \frac{12 \times 45}{\pi \times 2} = 86 \text{ revolutions per minute}$$

Step 2. Calculate the horsepower at the cutter:

$$\text{hp}_c = \text{uhp} \left(\frac{\pi D^2}{4} \right) f N = 0.94 \left(\frac{\pi \times 2^2}{4} \right) 0.015 \times 86 = 3.8$$

Step 3. Calculate the horsepower at the motor and provide for a 50 per cent power increase for the dull tool:

$$\text{hp}_m = \frac{\text{hp}_c}{e_m} = \frac{3.8}{0.80} = 4.75 \text{ horsepower}$$

$$\text{hp}_m \text{ (dull tool)} = 1.5 \times 4.75 = 7.125 \text{ horsepower}$$

Step 4. Estimate the spade drill thrust:

$$B_s = 148,500 \times \text{uhp} \times f D = 148,500 \times 0.94 \times 0.015 \times 2 = 4188 \text{ lb (sharp tool)}$$

$$B_s = 1.5 \times 4188 = 6282 \text{ lb (dull tool)}$$

Trepanning.—Cutting a groove in the form of a circle or boring or cutting a hole by removing the center or core in one piece is called trepanning. Shallow trepanning, also called face grooving, can be performed on a lathe using a single-point tool that is similar to a grooving tool but has a curved blade. Generally, the minimum outside diameter that can be cut by this method is about 3 inches (76.2 mm) and the maximum groove depth is about 2 inches (50.8 mm). Trepanning is probably the most economical method of producing deep holes that are 2 inches (50.8 mm), and larger, in diameter. Fast production rates can be achieved. The tool consists of a hollow bar, or stem, and a hollow cylindrical head to which a carbide or high-speed steel, single-point cutting tool is attached. Usually, only one cutting tool is used although for some applications a multiple cutter head must be used; e.g., heads used to start the hole have multiple tools. In operation, the cutting tool produces a circular groove and a residue core that enters the hollow stem after passing through the head. On outside-diameter exhaust trepanning tools, the cutting fluid is applied through the stem and the chips are flushed around the outside of the tool; inside-diameter exhaust tools flush the chips out through the stem with the cutting fluid applied from the outside. For starting the cut, a tool that cuts a starting groove in the work must be used, or the trepanning tool must be guided by a bushing. For holes less than about five diameters deep, a machine that rotates the trepanning tool can be used. Often, an ordinary drill press is satisfactory; deeper holes should be machined on a lathe with the work rotating. A hole diameter tolerance of ± 0.010 inch (± 0.254 mm) can be obtained easily by trepanning and a tolerance of ± 0.001 inch (± 0.0254 mm) has sometimes been held. Hole runout can be held to ± 0.003 inch per foot (± 0.25 mm/m) and, at times, to ± 0.001 inch per foot (± 0.083 mm/m). On heat-treated metal, a surface finish of 125 to 150 μm AA can be obtained and on annealed metals 100 to 250 μm AA is common.

ESTIMATING SPEEDS AND MACHINING POWER

Estimating Planer Cutting Speeds.—Whereas most planers of modern design have a means of indicating the speed at which the table is traveling, or cutting, many older planers do not. The following formulas are useful for planers that do not have a means of indicating the table or cutting speed. It is not practicable to provide a formula for calculating the exact cutting speed at which a planer is operating because the time to stop and start the table when reversing varies greatly. The formulas below will provide a reasonable estimate.

$$V_c \cong S_c L \quad \text{and} \quad S_c \cong \frac{V_c}{L}$$

where V_c = cutting speed; fpm or m/min

S_c = number of cutting strokes per minute of planer table

L = length of table cutting stroke; ft or m

Cutting Speed for Planing and Shaping.—The traditional HSS cutting tool speeds in [Tables 1](#) through [4b](#) and [Tables 6](#) through [9](#), pages [1026](#) through [1038](#), can be used for planing and shaping. The feed and depth of cut factors in [Tables 5c](#) should also be used, as explained previously. Very often, other factors relating to the machine or the setup will require a reduction in the cutting speed used on a specific job.

Cutting Time for Turning, Boring, and Facing.—The time required to turn a length of metal can be determined by the following formula in which T = time in minutes, L = length of cut in inches (or mm), f = feed in inches per revolution (or mm/min), and N = lathe spindle speed in revolutions per minute.

$$T = \frac{L}{fN}$$

When making job estimates, the time required to load and to unload the workpiece on the machine, and the machine handling time, must be added to the cutting time for each length cut to obtain the floor-to-floor time.

Planing Time.—The approximate time required to plane a surface can be determined from the following formula in which T = time in minutes, L = length of stroke in feet (or meter), V_c = cutting speed in feet per minute (m/min), V_r = return speed in feet per minute (m/min); W = width of surface to be planed in inches (or mm), F = feed in inches (or mm), and 0.025 = approximate reversal time factor per stroke in minutes for most planers:

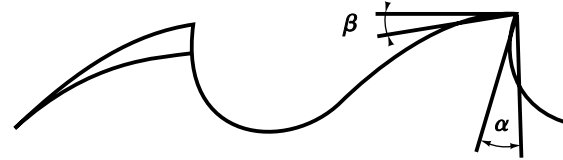
$$T = \frac{W}{F} \left[L \times \left(\frac{1}{V_c} + \frac{1}{V_r} \right) + 0.025 \right]$$

Speeds for Metal-Cutting Saws.—The table on page [1082](#) gives speeds and feeds for solid-tooth, high-speed-steel, circular, metal-cutting saws are recommended by Saws International, Inc. (sfpm = surface feet per minute = $3.142 \times$ blade diameter in inches \times rpm of saw shaft \div 12). Also see page [1180](#) for bandsaw blade speeds.

Speeds for Turning Unusual Materials.—*Slate*, on account of its peculiarly stratified formation, is rather difficult to turn, but if handled carefully, can be machined in an ordinary lathe. The cutting speed should be about the same as for cast iron. A sheet of fiber or pressed paper should be interposed between the chuck or steadyrest jaws and the slate, to protect the latter. Slate rolls must not be centered and run on the tailstock. A satisfactory method of supporting a slate roll having journals at the ends is to bore a piece of lignum vitae to receive the turned end of the roll, and center it for the tailstock spindle.

Rubber can be turned at a peripheral speed of 200 feet per minute (61 m/min), although it is much easier to grind it with an abrasive wheel that is porous and soft. For cutting a rubber roll in two, the ordinary parting tool should not be used, but a tool shaped like a knife; such a tool severs the rubber without removing any material.

Speeds, Feeds, and Tooth Angles for Sawing Various Material with Solid-tooth, High-speed-steel, Circular, Metal-cutting Saws



First entry is cutting speed, second entry is feed
 α = Cutting angle (Front), degree
 β = Relief angle (Back), degree

Materials	Rake Angle		Stock Diameters, inches				Stock Diameters, millimeters			
	α	β	$\frac{1}{4}$ - $\frac{3}{4}$	$\frac{3}{4}$ - $1\frac{1}{2}$	$1\frac{1}{2}$ - $2\frac{1}{2}$	$2\frac{1}{2}$ - $3\frac{1}{2}$	6 - 19	19 - 38	38 - 63	63 - 89
Aluminum	24	12	6500 sfpm 100 in/min	6200 sfpm 85 in/min	6000 sfpm 80 in/min	5000 sfpm, 75 in/min	1981 m/min 2540 mm/min	1890 m/min 2159 mm/min	1829 m/min 2159 mm/min	1524 m/min 2159 mm/min
Light Alloys with Cu, Mg, and Zn	22	10	3600 sfpm 70 in/min	3300 sfpm 65 in/min	3000 sfpm, 63 in/min	2600 sfpm 60 in/min	1097 m/min 1778 mm/min	1006 m/min 1651 mm/min	914 m/min 1600 mm/min	792 m/min 1524 mm/min
Light Alloys with High Si	20	8	650 sfpm 16 in/min	600 sfpm 14 in/min	550 sfpm 12 in/min	550 sfpm 12 in/min	198 m/min 406 mm/min	183 m/min 406 mm/min	168 m/min 356 mm/min	168 m/min 305 mm/min
Copper	20	10	1300 sfpm 24 in/min	1150 sfpm 24 in/min	1000 sfpm 22 in/min	800 sfpm 22 in/min	396 m/min 610 mm/min	351 m/min 610 mm/min	305 m/min 559 mm/min	244 m/min 559 mm/min
Bronze	15	8	1300 sfpm 24 in/min	1150 sfpm 24 in/min	1000 sfpm 22 in/min	800 sfpm 20 in/min	396 m/min 610 mm/min	351 m/min 610 mm/min	305 m/min 559 mm/min	244 m/min 508 mm/min
Hard Bronze	10	8	400 sfpm 6.3 in/min	360 sfpm 6 in/min	325 sfpm 5.5 in/min	300 sfpm 5.1 in/min	122 m/min 152 mm/min	110 m/min 152 mm/min	99 m/min 140 mm/min	91 m/min 130 mm/min
Cu-Zn Brass	16	8	2000 sfpm 43 in/min	2000 sfpm 43 in/min	1800 sfpm 39 in/min	1800 sfpm 35 in/min	610 m/min 1092 mm/min	610 m/min 192 mm/min	549 m/min 991 mm/min	549 m/min 889 mm/min
Gray Cast Iron	12	8	82 sfpm 4 in/min	75 sfpm 4 in/min	72 sfpm 3.5 in/min	66 sfpm 3 in/min	25 m/min 102 mm/min	23 m/min 102 mm/min	22 m/min 89 mm/min	20 m/min 76 mm/min
Carbon Steel	20	8	160 sfpm 6.3 in/min	150 sfpm 5.9 in/min	150 sfpm 5.5 in/min	130 sfpm 5.1 in/min	49 m/min 160 mm/min	46 m/min 150 mm/min	46 m/min 140 mm/min	40 m/min 130 mm/min
Medium Hard Steel	18	8	100 sfpm 5.1 in/min	100 sfpm 4.7 in/min	80 sfpm 4.3 in/min	80 sfpm 4.3 in/min	30 m/min 130 mm/min	30 m/min 119 mm/min	24 m/min 109 mm/min	24 m/min 109 mm/min
Hard Steel	15	8	66 sfpm 4.3 in/min	66 sfpm 4.3 in/min	60 sfpm 4 in/min	57 sfpm 3.5 in/min	20 m/min 109 mm/min	20 m/min 109 mm/min	18 m/min 102 mm/min	17 m/min 89 mm/min
Stainless Steel	15	8	66 sfpm 2 in/min	63 sfpm 1.75 in/min	60 sfpm 1.75 in/min	57 sfpm 1.5 in/min	20 m/min 51 mm/min	19 m/min 44 mm/min	18 m/min 44 mm/min	17 m/min 38 mm/min

Gutta percha can be turned as easily as wood, but the tools must be sharp and a good soap-and-water lubricant used.

Copper can be turned easily at 200 feet per minute (61 m/min). See also [Table 6](#) on page 1036.

Limestone such as is used in the construction of pillars for balconies, etc., can be turned at 150 feet per minute (46 m/min), and the formation of ornamental contours is quite easy. *Marble* is a treacherous material to turn. It should be cut with a tool such as would be used for brass, but at a speed suitable for cast iron. It must be handled very carefully to prevent flaws in the surface.

The foregoing speeds are for high-speed steel tools. Tools tipped with tungsten carbide are adapted for cutting various non-metallic products which cannot be machined readily with steel tools, such as slate, marble, synthetic plastic materials, etc. In drilling slate and marble, use flat drills; and for plastic materials, tungsten-carbide-tipped twist drills. Cutting speeds ranging from 75 to 150 feet per minute (23–46 m/min) have been used for drilling slate (without coolant) and a feed of 0.025 inch per revolution (0.64 mm/rev) for drills 3/4 and 1 inch (19.05 and 25.4 mm) in diameter.

Estimating Machining Power

Knowledge of the power required to perform machining operations is useful when planning new machining operations, for optimizing existing machining operations, and to develop specifications for new machine tools that are to be acquired. The available power on any machine tool places a limit on the size of the cut that it can take. When much metal must be removed from the workpiece it is advisable to estimate the cutting conditions that will utilize the maximum power on the machine. Many machining operations require only light cuts to be taken for which the machine obviously has ample power; in this event, estimating the power required is a wasteful effort. Conditions in different shops may vary and machine tools are not all designed alike, so some variations between the estimated results and those obtained on the job are to be expected. However, by using the methods provided in this section a reasonable estimate of the power required can be made, which will suffice in most practical situations.

The measure of power in customary inch units is the horsepower; in SI metric units it is the kilowatt, which is used for both mechanical and electrical power. The power required to cut a material depends upon the rate at which the material is being cut and upon an experimentally determined power constant, K_p , which is also called the unit horsepower, unit power, or specific power consumption. The power constant is equal to the horsepower required to cut a material at a rate of one cubic inch per minute; in SI metric units the power constant is equal to the power in kilowatts required to cut a material at a rate of one cubic centimeter per second, or 1000 cubic millimeters per second ($1 \text{ cm}^3 = 1000 \text{ mm}^3$). Different values of the power constant are required for inch and for metric units, which are related as follows: to obtain the SI metric power constant, multiply the inch power constant by 2.73; to obtain the inch power constant, divide the SI metric power constant by 2.73. Values of the power constant in **Tables 1a**, and **1b** can be used for all machining operations except drilling and grinding. Values given are for sharp tools.

Table 1a. Power Constants, K_p , Using Sharp Cutting Tools

Material	Brinell Hardness	K_p Inch Units	K_p Metric Units	Material	Brinell Hardness	K_p Inch Units	K_p Metric Units
Ferrous Cast Metals							
Gray Cast Iron	100-120	0.28	0.76	Malleable Iron			
	120-140	0.35	0.96	Ferritic	150-175	0.42	1.15
	140-160	0.38	1.04				
	160-180	0.52	1.42	Pearlitic	200-250	0.82	2.24
	180-200	0.60	1.64				
	200-220	0.71	1.94				
220-240	0.91	2.48					
Alloy Cast Iron	150-175	0.30	0.82	Cast Steel	150-175	0.62	1.69
	175-200	0.63	1.72		175-200	0.78	2.13
	200-250	0.92	2.51	...	200-250	0.86	2.35
				

Table 1a. (Continued) Power Constants, K_p , Using Sharp Cutting Tools

Material	Brinell Hardness	K_p Inch Units	K_p Metric Units	Material	Brinell Hardness	K_p Inch Units	K_p Metric Units
High-Temperature Alloys, Tool Steel, Stainless Steel, and Nonferrous Metals							
High-Temperature Alloys					150-175	0.60	1.64
A286	165	0.82	2.24	Stainless Steel {	175-200	0.72	1.97
A286	285	0.93	2.54		200-250	0.88	2.40
Chromoloy	200	0.78	3.22		Zinc Die Cast Alloys	...	0.25
Chromoloy	310	1.18	3.00	Copper (pure)	...	0.91	2.48
Inco 700	330	1.12	3.06	Brass			
Inco 702	230	1.10	3.00	Hard	...	0.83	2.27
Hastelloy-B	230	1.10	3.00	Medium	...	0.50	1.36
M-252	230	1.10	3.00	Soft	...	0.25	0.68
M-252	310	1.20	3.28	Leaded	...	0.30	0.82
Ti-150A	340	0.65	1.77				
U-500	375	1.10	3.00	Bronze			
				Hard	...	0.91	2.48
Monel Metal	...	1.00	2.73	Medium	...	0.50	1.36
	175-200	0.75	2.05	Aluminum			
	200-250	0.88	2.40	Cast	...	0.25	0.68
Tool Steel {	250-300	0.98	2.68	Rolled (hard)	...	0.33	0.90
	300-350	1.20	3.28				
	350-400	1.30	3.55	Magnesium Alloys	...	0.10	0.27

The value of the power constant is essentially unaffected by the cutting speed, the depth of cut, and the cutting tool material. Factors that do affect the value of the power constant, and thereby the power required to cut a material, include the hardness and microstructure of the work material, the feed rate, the rake angle of the cutting tool, and whether the cutting edge of the tool is sharp or dull. Values are given in the power constant tables for different material hardness levels, whenever this information is available. Feed factors for the power constant are given in [Table 2](#). All metal cutting tools wear but a worn cutting edge requires more power to cut than a sharp cutting edge.

Factors to provide for tool wear are given in [Table 3](#). In this table, the extra-heavy-duty category for milling and turning occurs only on operations where the tool is allowed to wear more than a normal amount before it is replaced, such as roll turning. The effect of the rake angle usually can be disregarded. The rake angle for which most of the data in the power constant tables are given is positive 14 degrees. Only when the deviation from this angle is large is it necessary to make an adjustment. Using a rake angle that is more positive reduces the power required approximately 1 per cent per degree; using a rake angle that is more negative increases the power required; again approximately 1 per cent per degree.

Many indexable insert cutting tools are formed with an integral chip breaker or other cutting edge modifications, which have the effect of reducing the power required to cut a material. The extent of this effect cannot be predicted without a test of each design. Cutting fluids will also usually reduce the power required, when operating in the lower range of cutting speeds. Again, the extent of this effect cannot be predicted because each cutting fluid exhibits its own characteristics.

Table 1b. Power Constants, K_p , Using Sharp Cutting Tools

Material	Brinell Hardness	K_p Inch Units	K_p Metric Units	Material	Brinell Hardness	K_p Inch Units	K_p SI Metric Units
Wrought Steels							
Plain Carbon Steels							
All Plain Carbon Steels	80-100	0.63	1.72	All Plain Carbon Steels	220-240	0.89	2.43
	100-120	0.66	1.80		240-260	0.92	2.51
	120-140	0.69	1.88		260-280	0.95	2.59
	140-160	0.74	2.02		280-300	1.00	2.73
	160-180	0.78	2.13		300-320	1.03	2.81
	180-200	0.82	2.24		320-340	1.06	2.89
	200-220	0.85	2.32		340-360	1.14	3.11
Free Machining Steels							
AISI 1108, 1109, 1110, 1115, 1116, 1117, 1118, 1119, 1120, 1125, 1126, 1132	100-120	0.41	1.12	AISI 1137, 1138, 1139, 1140, 1141, 1144, 1145, 1146, 1148, 1151	180-200	0.51	1.39
	120-140	0.42	1.15		200-220	0.55	1.50
	140-160	0.44	1.20		220-240	0.57	1.56
	160-180	0.48	1.31		240-260	0.62	1.69
	180-200	0.50	1.36	
Alloy Steels							
AISI 4023, 4024, 4027, 4028, 4032, 4037, 4042, 4047, 4137, 4140, 4142, 4145, 4147, 4150, 4340, 4640, 4815, 4817, 4820, 5130, 5132, 5135, 5140, 5145, 5150, 6118, 6150, 8637, 8640, 8642, 8645, 8650, 8740	140-160	0.62	1.69	AISI 4130, 4320, 4615, 4620, 4626, 5120, 8615, 8617, 8620, 8622, 8625, 8630, 8720	140-160	0.56	1.53
	160-180	0.65	1.77		160-180	0.59	1.61
	180-200	0.69	1.88		180-200	0.62	1.69
	200-220	0.72	1.97		200-220	0.65	1.77
	220-240	0.76	2.07		220-240	0.70	1.91
	240-260	0.80	2.18		240-260	0.74	2.02
	260-280	0.84	2.29		260-280	0.77	2.10
	280-300	0.87	2.38		280-300	0.80	2.18
	300-320	0.91	2.48		300-320	0.83	2.27
	320-340	0.96	2.62		320-340	0.89	2.43
	340-360	1.00	2.73	
AISI 1330, 1335, 1340, E52100	160-180	0.79	2.16	
	180-200	0.83	2.27	
	200-220	0.87	2.38	

The machine tool transmits the power from the driving motor to the workpiece, where it is used to cut the material. The effectiveness of this transmission is measured by the machine tool efficiency factor, E . Average values of this factor are given in Table 4. Formulas for calculating the metal removal rate, Q , for different machining operations are given in Table 5. These formulas are used together with others given below. The following formulas can be used with either customary inch or with SI metric units.

$$P_c = K_p C Q W \tag{1}$$

$$P_m = \frac{P_c}{E} = \frac{K_p C Q W}{E} \tag{2}$$

where P_c = power at the cutting tool; hp, or kW

Table 2. Feed Factors, C , for Power Constants

Inch Units				SI Metric Units			
Feed in. ^a	C	Feed in. ^a	C	Feed mm ^b	C	Feed mm ^b	C
0.001	1.60	0.014	0.97	0.02	1.70	0.35	0.97
0.002	1.40	0.015	0.96	0.05	1.40	0.38	0.95
0.003	1.30	0.016	0.94	0.07	1.30	0.40	0.94
0.004	1.25	0.018	0.92	0.10	1.25	0.45	0.92
0.005	1.19	0.020	0.90	0.12	1.20	0.50	0.90
0.006	1.15	0.022	0.88	0.15	1.15	0.55	0.88
0.007	1.11	0.025	0.86	0.18	1.11	0.60	0.87
0.008	1.08	0.028	0.84	0.20	1.08	0.70	0.84
0.009	1.06	0.030	0.83	0.22	1.06	0.75	0.83
0.010	1.04	0.032	0.82	0.25	1.04	0.80	0.82
0.011	1.02	0.035	0.80	0.28	1.01	0.90	0.80
0.012	1.00	0.040	0.78	0.30	1.00	1.00	0.78
0.013	0.98	0.060	0.72	0.33	0.98	1.50	0.72

^aTurning, in/rev; milling, in/tooth; planing and shaping, in/stroke; broaching, in/tooth.

^bTurning, mm/rev; milling, mm/tooth; planing and shaping, mm/stroke; broaching, mm/tooth.

Table 3. Tool Wear Factors, W

Type of Operation		W
For all operations with sharp cutting tools		1.00
Turning:	Finish turning (light cuts)	1.10
	Normal rough and semifinish turning	1.30
	Extra-heavy-duty rough turning	1.60-2.00
	Milling:	
Milling:	Slab milling	1.10
	End milling	1.10
	Light and medium face milling	1.10-1.25
	Extra-heavy-duty face milling	1.30-1.60
Drilling:	Normal drilling	1.30
	Drilling hard-to-machine materials and drilling with a very dull drill	1.50
Broaching:	Normal broaching	1.05-1.10
	Heavy-duty surface broaching	1.20-1.30
Planing and Shaping	Use values given for turning	

P_m = power at the motor; hp, or kW

K_p = power constant (see Tables 1a and 1b)

Q = metal removal rate; in³/min or cm³/s (see Table 5)

C = feed factor for power constant (see Table 2)

W = tool wear factor (see Table 3)

E = machine tool efficiency factor (see Table 4)

V = cutting speed, fpm, or m/min

N = cutting speed, rpm

f = feed rate for turning; in/rev or mm/rev

f = feed rate for planing and shaping; in/stroke, or mm/stroke

- f_t = feed per tooth; in/tooth, or mm/tooth
- f_m = feed rate; in/min or mm/min
- d_t = maximum depth of cut per tooth: inch, or mm
- d = depth of cut; inch, or mm
- n_t = number of teeth on milling cutter
- n_c = number of teeth engaged in work
- w = width of cut; inch, or mm

Table 4. Machine Tool Efficiency Factors, E

Type of Drive	E	Type of Drive	E
Direct Belt Drive	0.90	Geared Head Drive	0.70-0.80
Back Gear Drive	0.75	Oil-Hydraulic Drive	0.60-0.90

Table 5. Formulas for Calculating the Metal Removal Rate, Q

Operation	Metal Removal Rate	
	For Inch Units Only $Q = \text{in}^3/\text{min}$	For SI Metric Units Only $Q = \text{cm}^3/\text{s}$
Single-Point Tools (Turning, Planing, and Shaping)	$12Vfd$	$\frac{V}{60}fd$
Milling	f_mwd	$\frac{f_mwd}{60,000}$
Surface Broaching	$12Vwn_c d_t$	$\frac{V}{60}un_c d_t$

Example: A 180-200 Bhn AISI 4130 shaft is to be turned on a geared head lathe using a cutting speed of 350 fpm (107 m/min), a feed rate of 0.016 in/rev (0.40 mm/rev), and a depth of cut of 0.100 inch (2.54 mm). Estimate the power at the cutting tool and at the motor, using both the inch and metric data.

Inch units:

$$\begin{aligned}
 K_p &= 0.62 \text{ (from Table 1b)} \\
 C &= 0.94 \text{ (from Table 2)} \\
 W &= 1.30 \text{ (from Table 3)} \\
 E &= 0.80 \text{ (from Table 4)} \\
 Q &= 12 Vfd = 12 \times 350 \times 0.016 \times 0.100 \text{ (from Table 5)} \\
 Q &= 6.72 \text{ in}^3/\text{min} \\
 P_c &= K_p C Q W = 0.62 \times 0.94 \times 6.72 \times 1.30 = 5.1 \text{ hp}
 \end{aligned}$$

$$P_m = \frac{P_c}{E} = \frac{5}{0.80} = 6.4 \text{ hp}$$

SI metric units:

$$\begin{aligned}
 K_p &= 1.69 \text{ (from Table 1b)} \\
 C &= 0.94 \text{ (from Table 2)} \\
 W &= 1.30 \text{ (from Table 3)} \\
 E &= 0.80 \text{ (from Table 4)} \\
 Q &= \frac{V}{60}fd = \frac{107}{60} \times 0.40 \times 2.54 = 1.81 \text{ cm}^3/\text{s} \text{ (from Table 5)}
 \end{aligned}$$

$$P_c = K_p C Q W = 1.69 \times 0.94 \times 1.81 \times 1.30 = 3.74 \text{ kW}$$

$$P_m = \frac{P_c}{E} = \frac{3.74}{0.80} = 4.677 \text{ kW}$$

Whenever possible the maximum power available on a machine tool should be used when heavy cuts must be taken.

The cutting conditions for utilizing the maximum power should be selected in the following order: 1) select the maximum depth of cut that can be used; 2) select the maximum feed rate that can be used; and 3) estimate the cutting speed that will utilize the maximum power available on the machine. This sequence is based on obtaining the longest tool life of the cutting tool and at the same time obtaining as much production as possible from the machine.

The life of a cutting tool is most affected by the cutting speed, then by the feed rate, and least of all by the depth of cut. The maximum metal removal rate that a given machine is capable of machining from a given material is used as the basis for estimating the cutting speed that will utilize all the power available on the machine.

✦ *Example:* A 3.2 mm deep cut is to be taken on a 200–210 Bhn AISI 1050 steel part using a 7.5 kW geared head lathe. The feed rate selected for this job is 0.45 mm/rev. Estimate the cutting speed that will utilize the maximum power available on the lathe.

$$K_p = 2.32 \text{ (From Table 1b)}$$

$$C = 0.92 \text{ (From Table 2)}$$

$$W = 1.30 \text{ (From Table 3)}$$

$$E = 0.80 \text{ (From Table 4)}$$

$$Q_{max} = \frac{P_m E}{K_p C W} = \frac{7.5 \times 0.80}{2.32 \times 0.92 \times 1.30} \quad \left(P_m = \frac{K_p C Q W}{E} \right)$$

$$= 2.16 \text{ cm}^3/\text{sec}$$

$$V = \frac{60 Q_{max}}{fd} = \frac{60 \times 2.16}{0.45 \times 3.2} \quad \left(Q = \frac{V}{60} fd \right)$$

$$= 90.0 \text{ m/min}$$

✦ *Example:* A 160-180 Bhn gray iron casting that is 6 inches wide is to have $\frac{1}{8}$ inch stock removed on a 10 hp milling machine, using an 8 inch diameter, 10 tooth, indexable insert cemented carbide face milling cutter. The feed rate selected for this cutter is 0.012 in/tooth, and all the stock (0.125 inch) will be removed in one cut. Estimate the cutting speed that will utilize the maximum power available on the machine.

$$K_p = 0.52 \text{ (From Table 1a)}$$

$$C = 1.00 \text{ (From Table 2)}$$

$$W = 1.20 \text{ (From Table 3)}$$

$$E = 0.80 \text{ (From Table 4)}$$

$$Q_{max} = \frac{P_m E}{K_p C W} = \frac{10 \times 0.80}{0.52 \times 1.00 \times 1.20} = 12.82 \text{ in}^3/\text{min} \quad \left(P_m = \frac{K_p C Q W}{E} \right)$$

$$f_m = \frac{Q_{max}}{w d} = \frac{12.82}{6 \times 0.125} = 17.1 \text{ in/min} \quad (Q = f_m w d)$$

$$N = \frac{f_{max}}{f_t n_t} = \frac{17}{0.012 \times 10} = 142.4 \text{ rpm} \quad (f_m = f_t n_t N)$$

$$V = \frac{\pi D N}{12} = \frac{\pi \times 8 \times 142}{12} = 298.3 \text{ fpm} \quad \left(N = \frac{12 V}{\pi D} \right)$$

Estimating Drilling Thrust, Torque, and Power.—Although the lips of a drill cut metal and produce a chip in the same manner as the cutting edges of other metal cutting tools, the chisel edge removes the metal by means of a very complex combination of extrusion and cutting. For this reason a separate method must be used to estimate the power required for drilling. Also, it is often desirable to know the magnitude of the thrust and the torque required to drill a hole. The formulas and tabular data provided in this section are based on information supplied by the National Twist Drill Division of Regal-Beloit Corp. The values in Tables 6 through 9 are for sharp drills and the tool wear factors are given in Table 3. For most ordinary drilling operations 1.30 can be used as the tool wear factor. When drilling most difficult-to-machine materials and when the drill is allowed to become very dull, 1.50 should be used as the value of this factor. It is usually more convenient to measure the web thickness at the drill point than the length of the chisel edge; for this reason, the approximate *w/d* ratio corresponding to each *c/d* ratio for a correctly ground drill is provided in Table 7. For most standard twist drills the *c/d* ratio is 0.18, unless the drill has been ground short or the web has been thinned. The *c/d* ratio of split point drills is 0.03. The formulas given below can be used for spade drills, as well as for twist drills. Separate formulas are required for use with customary inch units and for SI metric units.

Table 6. Work Material Factor, *K_d*, for Drilling with a Sharp Drill

Work Material	Material Constant, <i>K_d</i>
AISI 1117 (Resulfurized free machining mild steel)	12,000
Steel, 200 Bhn	24,000
Steel, 300 Bhn	31,000
Steel, 400 Bhn	34,000
Cast Iron, 150 Bhn	14,000
Most Aluminum Alloys	7,000
Most Magnesium Alloys	4,000
Most Brasses	14,000
Leaded Brass	7,000
Austenitic Stainless Steel (Type 316)	24,000 ^a for Torque 35,000 ^a for Thrust
Titanium Alloy Ti6Al4V 40R _c	18,000 ^a for Torque 29,000 ^a for Thrust
René 41 40R _c	40,000 ^{ab} min.
Hastelloy-C	30,000 ^a for Torque 37,000 ^a for Thrust

^a Values based upon a limited number of tests.

^b Will increase with rapid wear.

Table 7. Chisel Edge Factors for Torque and Thrust

c/d	Approx. w/d	Torque Factor A	Thrust Factor B	Thrust Factor J	c/d	Approx. w/d	Torque Factor A	Thrust Factor B	Thrust Factor J
0.03	0.025	1.000	1.100	0.001	0.18	0.155	1.085	1.355	0.030
0.05	0.045	1.005	1.140	0.003	0.20	0.175	1.105	1.380	0.040
0.08	0.070	1.015	1.200	0.006	0.25	0.220	1.155	1.445	0.065
0.10	0.085	1.020	1.235	0.010	0.30	0.260	1.235	1.500	0.090
0.13	0.110	1.040	1.270	0.017	0.35	0.300	1.310	1.575	0.120
0.15	0.130	1.080	1.310	0.022	0.40	0.350	1.395	1.620	0.160

For drills of standard design, use $c/d = 0.18$; for split point drills, use $c/d = 0.03$

$c/d = \text{Length of Chisel Edge} \div \text{Drill Diameter}$.

$w/d = \text{Web Thickness at Drill Point} \div \text{Drill Diameter}$.

For inch units only:

$$T = 2K_d F_f F_T B W + K_d D^2 J W \quad (1)$$

$$M = K_d F_f F_M A W \quad (2)$$

$$P_c = MN/63.025 \quad (3)$$

For SI metric units only:

$$T = 0.05 K_d F_f F_T B W + 0.007 K_d D^2 J W \quad (4)$$

$$M = \frac{K_d F_f F_M A W}{40,000} = 0.000025 K_d F_f F_M A W \quad (5)$$

$$P_c = MN/9550 \quad (6)$$

Use with either inch or metric units:

$$P_m = \frac{P_c}{E} \quad (7)$$

where $P_c = \text{Power at the cutter; hp, or kW}$ $P_m = \text{Power at the motor; hp, or kW}$

$M = \text{Torque; in. lb, or N.m}$

$T = \text{Thrust; lb, or N}$

$K_d = \text{Work material factor (See Table 6)}$

$F_f = \text{Feed factor (See Table 8)}$

$F_T = \text{Thrust factor for drill diameter (See Table 9)}$

$F_M = \text{Torque factor for drill diameter (See Table 9)}$

$A = \text{Chisel edge factor for torque (See Table 7)}$

$B = \text{Chisel edge factor for thrust (See Table 7)}$

$J = \text{Chisel edge factor for thrust (See Table 7)}$

$W = \text{Tool wear factor (See Table 3)}$

$N = \text{Spindle speed; rpm}$

$E = \text{Machine tool efficiency factor (See Table 4)}$

$D = \text{Drill diameter; in., or mm}$

$c = \text{Chisel edge length; in., or mm (See Table 7)}$

$w = \text{Web thickness at drill point; in., or mm (See Table 7)}$

Example: A standard $\frac{7}{8}$ inch drill is to drill steel parts having a hardness of 200 Bhn on a drilling machine having an efficiency of 0.80. The spindle speed to be used is 350 rpm and the feed rate will be 0.008 in./rev. Calculate the thrust, torque, and power required to drill these holes:

$$K_d = 24,000 \text{ (From Table 6)} \quad F_f = 0.021 \text{ (From Table 8)}$$

$$F_T = 0.899 \text{ (From Table 9)} \quad F_M = 0.786 \text{ (From Table 9)}$$

$$A = 1.085 \text{ (From Table 7)} \quad B = 1.355 \text{ (From Table 7)} \quad J = 0.030 \text{ (From Table 7)}$$

Table 8. Feed Factors F_f for Drilling

Inch Units				SI Metric Units			
Feed, in./rev	F_f	Feed, in./rev	F_f	Feed, mm/rev	F_f	Feed, mm/rev	F_f
0.0005	0.0023	0.012	0.029	0.01	0.025	0.30	0.382
0.001	0.004	0.013	0.031	0.03	0.060	0.35	0.432
0.002	0.007	0.015	0.035	0.05	0.091	0.40	0.480
0.003	0.010	0.018	0.040	0.08	0.133	0.45	0.528
0.004	0.012	0.020	0.044	0.10	0.158	0.50	0.574
0.005	0.014	0.022	0.047	0.12	0.183	0.55	0.620
0.006	0.017	0.025	0.052	0.15	0.219	0.65	0.708
0.007	0.019	0.030	0.060	0.18	0.254	0.75	0.794
0.008	0.021	0.035	0.068	0.20	0.276	0.90	0.919
0.009	0.023	0.040	0.076	0.22	0.298	1.00	1.000
0.010	0.025	0.050	0.091	0.25	0.330	1.25	1.195

Table 9. Drill Diameter Factors: F_T for Thrust, F_M for Torque

Inch Units						SI Metric Units					
Drill Dia., in.	F_T	F_M	Drill Dia., in.	F_T	F_M	Drill Dia., mm	F_T	F_M	Drill Dia., mm	F_T	F_M
0.063	0.110	0.007	0.875	0.899	0.786	1.60	1.46	2.33	22.00	11.86	260.8
0.094	0.151	0.014	0.938	0.950	0.891	2.40	2.02	4.84	24.00	12.71	305.1
0.125	0.189	0.024	1.000	1.000	1.000	3.20	2.54	8.12	25.50	13.34	340.2
0.156	0.226	0.035	1.063	1.050	1.116	4.00	3.03	12.12	27.00	13.97	377.1
0.188	0.263	0.049	1.125	1.099	1.236	4.80	3.51	16.84	28.50	14.58	415.6
0.219	0.297	0.065	1.250	1.195	1.494	5.60	3.97	22.22	32.00	16.00	512.0
0.250	0.330	0.082	1.375	1.290	1.774	6.40	4.42	28.26	35.00	17.19	601.6
0.281	0.362	0.102	1.500	1.383	2.075	7.20	4.85	34.93	38.00	18.36	697.6
0.313	0.395	0.124	1.625	1.475	2.396	8.00	5.28	42.22	42.00	19.89	835.3
0.344	0.426	0.146	1.750	1.565	2.738	8.80	5.96	50.13	45.00	21.02	945.8
0.375	0.456	0.171	1.875	1.653	3.100	9.50	6.06	57.53	48.00	22.13	1062
0.438	0.517	0.226	2.000	1.741	3.482	11.00	6.81	74.90	50.00	22.86	1143
0.500	0.574	0.287	2.250	1.913	4.305	12.50	7.54	94.28	58.00	25.75	1493
0.563	0.632	0.355	2.500	2.081	5.203	14.50	8.49	123.1	64.00	27.86	1783
0.625	0.687	0.429	2.750	2.246	6.177	16.00	9.19	147.0	70.00	29.93	2095
0.688	0.741	0.510	3.000	2.408	7.225	17.50	9.87	172.8	76.00	31.96	2429
0.750	0.794	0.596	3.500	2.724	9.535	19.00	10.54	200.3	90.00	36.53	3293
0.813	0.847	0.689	4.000	3.031	12.13	20.00	10.98	219.7	100.00	39.81	3981

$W = 1.30$ (From Table 3)

$$T = 2K_d F_f F_T B W + K_d d^2 J W$$

$$= 2 \times 24,000 \times 0.21 \times 0.899 \times 1.355 \times 1.30 + 24,000 \times 0.875^2 \times 0.030 \times 1.30$$

$$= 2313 \text{ lb}$$

$$M = K_d F_f F_M A W$$

$$= 24,000 \times 0.021 \times 0.786 \times 1.085 \times 1.30 = 559 \text{ in. lb}$$

$$\frac{12V}{\pi D} = \frac{12 \times 101}{\pi \times 0.750} = 514 \text{ rpm}$$

Twist drills are generally the most highly stressed of all metal cutting tools. They must not only resist the cutting forces on the lips, but also the drill torque resulting from these forces and the very large thrust force required to push the drill through the hole. Therefore, often when drilling smaller holes, the twist drill places a limit on the power used and for very large holes, the machine may limit the power.

MICROMACHINING

Introduction

Recent technological advancement and market need for product miniaturization demand three-dimensional (3D) microcomponents. Although microelectronic manufacturing techniques can produce pseudo 3D microdevices using silicon and other semiconducting materials, such materials are neither robust nor biocompatible for demanding applications in aerospace, medical, sensor, defense, petroleum, and transportation. Examples of robust applications include microdrilling holes for fuel or ink injection nozzles, electronic printed circuit boards, microfabrication of watch components, air bearings, cooling holes in turbomachinery, high aspect ratio features on tool steel molds and dies, etc. There are alternative nontraditional processes to produce microfeatures on robust engineering materials such as laser micromachining, electrical discharge microdrilling, electrochemical micromachining, chemical etching, electron/ion beam machining; however, these processes are either cost prohibitive, limited to conductive materials, or inferior when comparing resulting surface integrity, subsurface damage, high aspect ratio, or microfeature quality. Microfabrication with traditional processes such as micromilling, microdrilling, microturning... are still the preferred choice in most applications. There is no standard that defines micromachining, but most researchers use cutting tools to produce components with key dimensions less than 1 mm (0.040 inch) or when depth of cut is comparable to tool sharpness or tool grain size in their micromachining studies.

Realizing the needs for traditional micromanufacturing, there are more commercially available machine tools and microtools in the market. However, costly equipment, lack of in-depth understanding of micromachining, and limited guidelines for effective use of microtools are still the bottleneck for full application of micromachining. Universities and research institutes worldwide have started theoretical investigation of micromachining and produced positive results from the academic point of view. Without practical guidelines on micromachining, technicians and machinists probably would make wrong and costly decisions when simply extending macroscale machining practices into microscale machining applications – a microtool simply breaks at even conservative macroscale parameters for speeds, feeds, and depth of cut. This section, while complementing other chapters in this Handbook, focuses on practicality, based on proven theories and published data, to help decision makers to understand the requirements for micromachining, and as a guide to people on the shop floor to quickly and confidently begin using the recommended parameters and techniques. Both US standard and SI metric units are included for convenience. Examples of how to use the data and equations are given throughout this chapter.

Machine Tool Requirements

To obtain the same surface speed as in macromachining, a machine tool must:

- a) Be capable of rotating a workpiece or tool at high speeds of 25,000 rpm or above
- b) Control spindle runout to submicron level
- c) Have a very robust mechanical and thermal structure that is not affected by vibration or thermal drift
- d) Have high resolution tool positioning and feeding mechanisms

Success in micromachining depends on tool quality and precision of the machine tool. Machine spindle runout, tool concentricity and tool positioning accuracy must be in the neighborhood of 1/100th of tool diameter or less for successful operation. Tolerance stack up for spindle runout, tool eccentricity, and wandering of a microdrill causes cyclic bending of the tool that lead to catastrophic failure. At a low rotational speeds, the displacement of a spindle can be monitored with a sensitive mechanical indicator. However, this option is not applicable for machines that operate at or above a few thousands rpm. Other non-contact techniques using capacitance, magnetism, or light would be more appropriate.

Fig. 1a shows an example of spindle runout measuring setup. A laser beam is pointed at a

rotating precision plug gage. The spindle displacement is then recorded on a computer for further analysis and display in either frequency or time domain. Commercial laser systems can provide displacement readings to $\pm 0.1 \mu\text{m}$ resolution.

An example of spindle runout is shown in Fig. 1b; the spindle runout of a Haas OM2 machine was measured with a Keyence laser system to be $\pm 1.25 \mu\text{m}$. Care must be practiced to isolate vibration of the spindle or it would affect the sensor reading, and avoid direct eye contact with the reflected laser from the shiny plug gage.

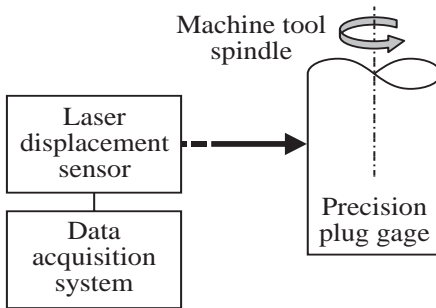


Fig. 1a. Setup for spindle runout measurement.

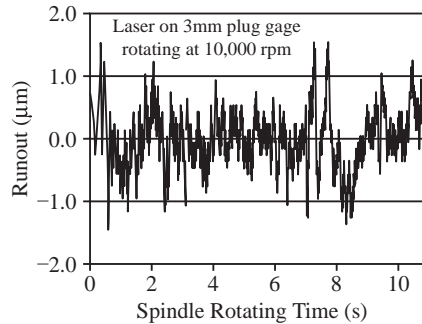


Fig. 1b. Spindle runout of Haas OM2 CNC micromilling machine.

Example 1, Spindle Speed for Macro vs. Micro Machining: The speed and feed table on page 1049 recommends a milling speed of 585 ft/min (178 m/min) and feed of 0.004 in/tooth (0.1 mm/tooth) for end milling 316L stainless steel using an uncoated carbide tool.

Macromachining: To have the said surface speed for an $\text{\O}1/2$ inch ($\text{\O}12.5$ mm) end mill, the required spindle speed is

$$N = \frac{V}{\pi D} = \frac{585(\text{ft}/\text{min})}{\pi(\text{rad}/\text{rev}) \times 0.5(\text{in})} \times 12(\text{in}/\text{ft}) = 4,469 \text{ rpm}$$

Micromachining: To obtain the same surface speed for an $\text{\O}0.004$ inch ($\text{\O}0.1$ mm) micromill, the new spindle speed is

$$N = \frac{V}{\pi D} = \frac{585(\text{ft}/\text{min})}{\pi(\text{rad}/\text{rev}) \times 0.004(\text{in})} \times 12(\text{in}/\text{ft}) = 558,633 \text{ rpm}$$

To turn, face, or bore a stainless steel microshaft of $\text{\O}0.004$ inch ($\text{\O}0.1$ mm) at this cutting speed, a lathe spindle would need to rotate at 558,633 rpm too. A machine tool with spindle speed exceeding 500,000 rpm is rare or simply not commercially available at this time.

Applying the recommended macro feed of 0.004 in/tooth (0.1 mm/tooth) for an 0.004 inch (0.1 mm) diameter micromill would break the tool because the feed/tooth is as large as the microtool diameter.

Microcutting Tools

Tool Stiffness.—It is relatively easy to have a rigid turning or facing microtool, but it requires careful planning to maintain rigidity of a micromill or a microdrill. Geometries of macroscale and microscale drilling/milling tools are the same: tool diameter, number of cutting flutes, point included angle for microdrill, helix angle, web thickness, clearance angle, flute length, shank diameter, and overall length. A careful selection of microtools must consider the intended machined features and highest possible tool stiffness. The two most important geometries that affect the microtool stiffness are the tool diameter and flute length assuming the number of flutes has been chosen. It can be shown that the torsional stiffness of a mill/drill is proportional to (tool diameter)⁴ and (flute length)⁻². For a specific mill/drill tool dimension, the milling/drilling strategy must be adjusted accordingly to avoid tool breakage.

Example 2, Stiffness of Microtools: If a drill diameter of 0.8 mm is selected instead of 1.0 mm, then the 20% reduction of diameter will result in a reduction in torsional stiffness E of:

$$\Delta E = \frac{(D_2)^4 - (D_1)^4}{(D_1)^4} = \frac{0.8^4 - 1.0^4}{1.0^4} = -59\%$$

Similarly, if a flute length of 1.2 mm is chosen instead of 1.0 mm, the 20% change in flute length will lead to a decrease in torsional stiffness E of:

$$\Delta E = \frac{(L_2)^{-2} - (L_1)^{-2}}{(L_1)^{-2}} = \frac{1.2^{-2} - 1.0^{-2}}{1.0^{-2}} = -30\%$$

Tool Sharpness.—The tool edge radius is critical in micromachining. Figs. 2a through 2d shows two scenarios for the same microcutting tools with edge radius r . The tool can be either a turning, facing, or boring microtool that linearly engages a workpiece material at a certain depth of cut. A similar tool can move in a circular path as a microdrill or micromill, and engage a workpiece at a certain chip load (feed per tooth). If the depth of cut (or chip load) is too shallow, the tool simply plows the material and pushes it away elastically. This elastic material layer just springs back after the tool passes by. If the depth of cut is substantial (recommended), then a chip is formed and a new machined surface is generated with negligible spring back.

Chip load is commonly used interchangeably with feedrate for a cutting tool with multiple cutting edges (teeth) such as in milling or drilling. Chip load is defined as tool feed distance for each tooth and represents the chip size forming for each tooth. Chip load can also be interpreted as the radial depth of cut for each tooth in milling. The following equation converts chip load of a cutting edge to feedrate of a multiple-edge cutting tool:

$$f = c_L n N$$

where f = feedrate of tool (mm/min, in/min)

c_L = chip load of a cutting edge (mm/tooth, in/tooth)

n = number of cutting flutes or cutting edges (#teeth/rev)

N = rotational speed (rpm)

Example 3: A two-flute uncoated carbide end mill with diameter $\varnothing 1$ mm ($\varnothing 0.040$ in) is used for micromilling pure titanium. Table 13b suggests a chip load of $17 \mu\text{m}/\text{tooth}$ and cutting speed of 90 m/min. The rotational speed is computed as:

$$N = \frac{V}{\pi D} = \frac{90 \text{ (m/min)}}{\pi \left(\frac{\text{rad}}{\text{rev}}\right) \times 0.001 \text{ (m)}} = 28,600 \text{ rpm}$$

The feedrate for this operation is:

$$f = c_L n N = 17 \left(\frac{\mu\text{m}}{\text{tooth}}\right) \times 2 \left(\frac{\text{teeth}}{\text{rev}}\right) \times 28,600 \left(\frac{\text{rev}}{\text{min}}\right) = 972,400 \frac{\mu\text{m}}{\text{min}} \approx 972 \frac{\text{mm}}{\text{min}} \approx 38 \frac{\text{in}}{\text{min}}$$

Typical fine grain carbide tools are first sintered from submicron carbide particles in a cobalt matrix, and then ground and lapped to final geometry. Optimal edge radii of 1–4 μm (39–156 μin) are typically designed for sintered tools to balance edge sharpness and edge strength. Only single crystalline diamond tools can be ground and lapped to edge radii within the nanometer range.

The threshold for minimum depth of cut has been investigated theoretically and verified experimentally by many researchers. It varies from 5–40% of the tool edge radius depending on the workpiece material and original rake angles. The threshold depth of cut or chip load, therefore, can be conservatively set to be 50% of the tool edge radius. When machining below this threshold, a microtool just rubs and plows the surface with negative effective rake angle and deforms it elastically during the first pass. This results in high cutting force, high specific energy, fast tool wear, rough surface finish, and significant burrs. In

Effect of Depth of Cut (Chip Load) in Micromachining

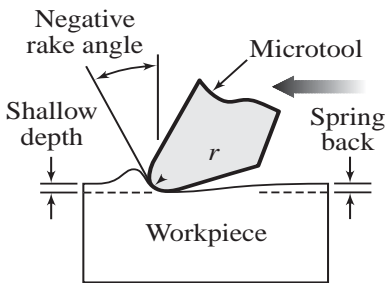


Fig. 2a. (a) Microfaceting, depth of cut $< 0.5 r$.

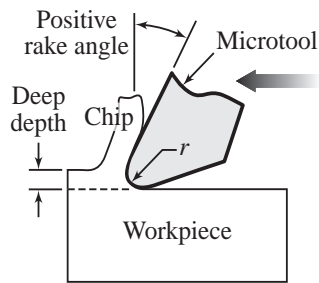


Fig. 2b. (b) Microfaceting, depth of cut $> 0.5 r$.

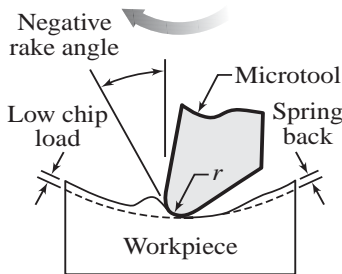


Fig. 2c. (c) Micromilling, chip load $< 0.5 r$.

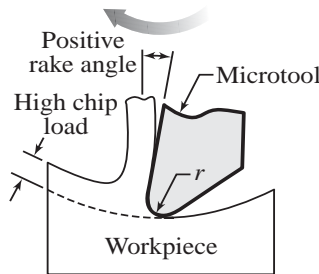


Fig. 2d. (d) Micromilling, chip load $> 0.5 r$.

Figs. 2a and 2c illustrate rubbing and plowing of material with negative effective rake angle at a shallow depth of cut. Figs. 2b and 2d illustrate chip removal from material with positive effective rake angle at a deep depth of cut.

subsequent passes when the cumulative depth is greater than the critical depth of cut, then a tool can remove materials as chips and the cycle repeats.

It is crucial to verify the tool edge radius before deciding on cutting parameters. Measuring of tool edge radius, however, is not trivial. A tool edge radius can be estimated from a scanning electron microscopic picture when the cutting edge is parallel to the electron beam (Fig. 6), or from a scanned image at the neighborhood of a cutting edge on an atomic force microscope (Figs. 3a and 3b), or by scanning an edge on an optical microscope profiler in different views to reconstruct a 3D image of the tool edge before finding its radius.

Tool Edge Measurement by Atomic Force Microscopy

Note the different vertical and horizontal scales.

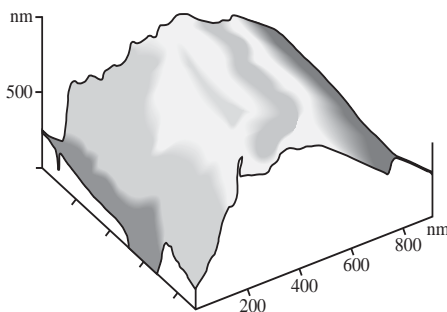


Fig. 3a. New polycrystalline diamond tool with a 750 nm edge radius.

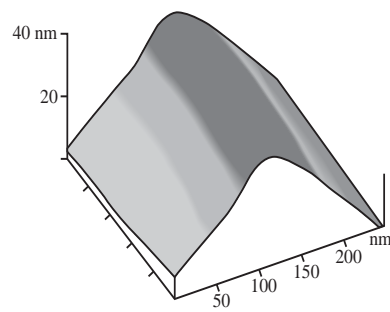


Fig. 3b. New single crystalline diamond tool with a 10 nm edge radius.

Tool Materials.—Using the right microtool is essential for micromachining. A microtool that successfully drills through holes on a plastic printed circuit board is not necessarily able to drill deep blind holes on titanium alloys. Understanding the requirements and selecting the right microtool for each condition saves time, money, and frustration. It has been theoretically derived and experimentally proven that the smaller is the chip, then the higher is the stress to generate it. Microcutting tools, therefore, have to be designed for higher stress with extreme geometrical constraints. When depth of cut is smaller than the average grain size of a workpiece, each grain generates different stress on the cutting edge and eventually fatigues the tool.

Microtools as small as 25 μm (0.001 inch) are commercially available. Common tool materials are high speed steel (HSS), cermet, carbide, cubic boron nitride (CBN), polycrystalline diamond (PCD), and single crystalline diamond (SCD). The HSS is commonly not used in micromachining of metal since it does not have required hardness and strength to resist plastic deformation. A SCD tool is available for microturning, but not for microdrilling or micromilling. Carbide and cermet, having properties between HSS and diamond, are most suitable for microcutting tools. They are sintered from random abrasive grains in either cobalt or nickel binder with a small addition of molybdenum or chromium. A higher binder content increases the tool toughness and crack resistance, but reduces the tool bulk hardness. Using ultra fine grain (submicron size) abrasives in a lesser amount of binder is the optimal solution because a tool with submicron carbide grains can maintain a high hardness while improving its crack resistance against chattering, interrupted cuts, or cyclic deflection due to spindle runout.

Microtool failure modes include shearing, chipping, and wear. To minimize shearing and catastrophic tool failure, a tool should be made from a high hardness substrate and with a geometry suitable for micromachining, i.e., large included angle and sharp cutting edge (Fig. 4). A tool with smaller than minimum included angle will be deformed and fractured in service.

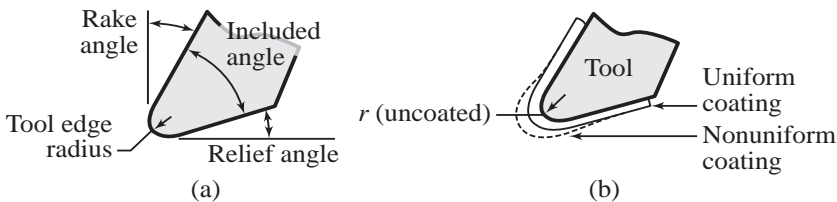


Fig. 4. (a) Tool geometry, and (b) change of tool edge radius due to coating.

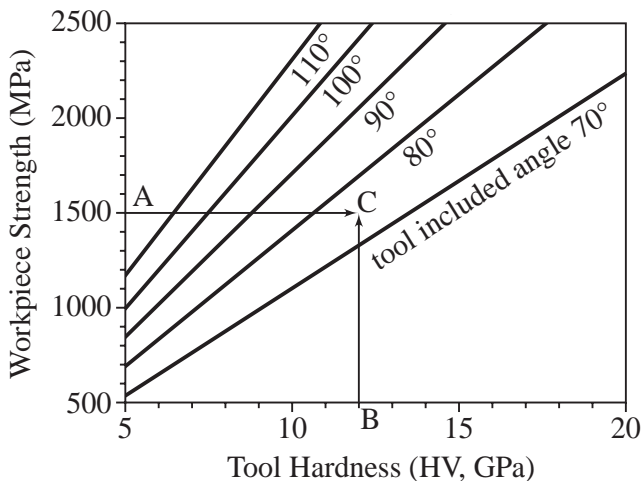


Fig. 5. Microtool minimum included angles.

Example 4, Required Included Angle: Find the minimum included angle for an ultra-fine grain carbide tool of 12 GPa Vicker hardness to machine the F799 Co-Cr alloy of 1500 MPa (0.2×10^6 psi) tensile strength.

Solution: Referring to Fig. 5, locate workpiece strength at point A on the vertical axis (1500 MPa). Locate point B for tool hardness on the horizontal axis (12 GPa). The intersection at C of the horizontal line from A and the vertical line from B indicates that the minimum included tool angle should be 75° .

Coating of microtools is still a technical challenge due to conflicting constraints for tool performance. Chemical or physical vapor deposition (CVD or PVD) techniques have been developed to coat cutting tools with mono/multiple layers of intermetallic or ceramic compounds (Table 1). Criteria for acceptable tool coating are numerous: uniformity, high hardness, high toughness, low friction, high wear resistance, surface smoothness, high chemical/diffusion resistance, and high temperature stability at a reasonable cost. Although a coating thickness of 2-4 μm (79-157 μin) is acceptable for a macrotool, the coating thickness on a microtool should be thinner to minimize fracture and peeling of the coating. Both CVD and PVD processes not only add the coating thickness to the edge radius, but the extra coating also increases the radius at sharp corners (Fig. 4b). This is unfortunate since the thicker coating reduces the tool sharpness by enlarging the tool edge radius and causes an unfavorable plowing effect with negative effective rake angle. An uncoated microtool might perform satisfactorily, but the same machining parameters can be devastating to an over-coated microtool (Fig. 6). A thin coating of less than 1.5 μm following by an edge sharpening process would improve the tool performance, however, at the expense of higher tool cost. Published data indicate that micrograin carbide tools with 1.5 μm TiN coating is the best for micromilling of H13 tool steel hardened to 45 HRC.

Table 1. Commercial Coatings for Microtools

Coating	Structure	Hardness		Coefficient of Friction	Coating Thickness		Maximum Temperature	
		GPa	10^6 psi		μm	μin	$^\circ\text{C}$	$^\circ\text{F}$
TiN	monolayer	24	3.5	0.55	1-5	39-197	600	1110
TiCN	gradient	37	5.4	0.20	1-4	39-157	400	750
TiAlCN	gradient	28	4.1	0.30	1-4	39-157	500	930
TiAlN	multilayer	28	4.1	0.60	1-4	39-157	700	1290
AlTiN	gradient	38	5.5	0.70	1-3	39-118	900	1650
ZrN	monolayer	20	2.9	0.40	1-4	39-157	550	1020
CrN	monolayer	18	2.6	0.30	1-4	39-157	700	1290
Diamond like	gradient	20	2.9	0.15	0.5-1.5	20-59	400	750
AlTiN/Si ₃ N ₄	nanocomposite	45	6.5	0.45	1-4	39-157	1200	2190
AlCrN/Si ₃ N ₄	nanocomposite	42	6.1	0.35	1-5	39-197	1100	2010

Tool Offset and Positioning.—Tool offset and tool positioning are crucial in micromilling and microdrilling because a tool is small and extremely fragile especially if it has a high aspect ratio (length to diameter ratio). Common shop practices to find tool offset and position often damage a tool or workpiece. Non-contact techniques using light, magnetism, capacitance, ultrasound, etc. are the preferred choice for precisely locating the relative position between tool and workpiece. Selection of a suitable sensor depends at least on following criteria:

- Better resolution compared to that of the machine tool axis
- Small working zone to cover a microtool
- Fast sampling rate for intended tool speed

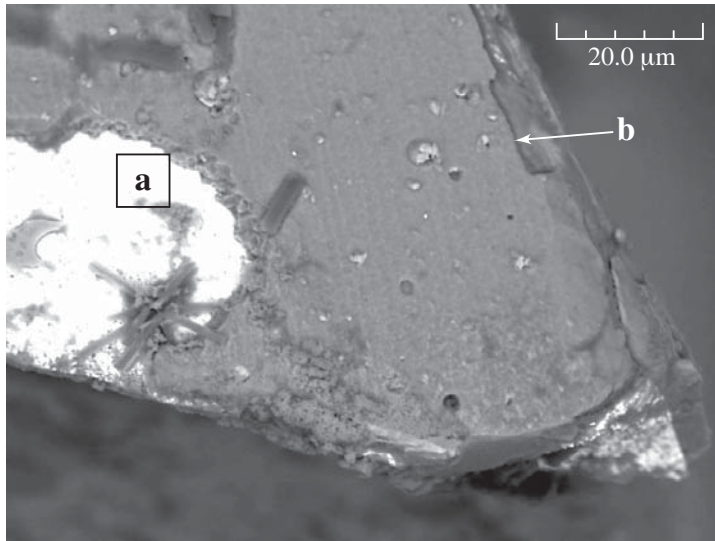


Fig. 6. Peeling (a) and cracking (b) of 4 μ m-thick TiN coating layer on a WC micromill. Back scattered electron technique shows high contrast of a dark TiN coating layer against the bright WC/Co substrate in the background.

Example 5, Sensor Requirement: Select a sensor for microdrilling using
Microdrill: 100 μ m diameter, 1 mm flute length ($\text{\O}0.004$ inch, 0.040 inch flute length).
Machine tool: 1 μ m (40 μ inch) repeatability and 500,000 rpm capability.

Solution: A laser displacement sensor is selected to satisfy the following specifications:

Resolution: 0.1 μ m (4 μ inch)

Spot size: 25-75 μ m (0.001-0.003 μ inch). Although most drill shanks are $\text{\O}3.175$ mm ($\text{\O}0.125$ inch), the working zone should be as small as possible to detect the shank center.

In order to make 6 measurements when a tool is rotating at 500,000 rpm, the time between measurements is:

$$t = \left(\frac{1 \text{ rev}}{6 \text{ measurements}} \right) \left(\frac{1 \text{ min}}{500,000 \text{ rev}} \right) \left(\frac{60 \text{ s}}{1 \text{ min}} \right) = 2 \times 10^{-5} \text{ s} = 20 \mu\text{s}$$

A laser with minimum 20 μ s sampling rate (50 kHz) would be sufficient.

A mechanical edge finder is adequate for most macromachining setups, but it is not suitable for micromachining especially with small and pliable parts. Fig. 7a shows a non-contact technique to detect part edge or find lateral tool offset. A rotating precision plug gage, mounted on a machine spindle, is positioned between a stationary laser sensor and the workpiece. The small laser beam is aimed at the plug gage center and on the part edge when the plug gage is withdrawn away from the beam path. These two laser sensor readings allow computing the tool center offset. A precision plug gage should be used instead of a cutting tool shank for better repeatability.

Example 6, Lateral Tool Offset Calculation: Use a laser displacement sensor and a $\text{\O}3.175$ mm ($\text{\O}1/8$ inch) plug gage to detect the edge of a ground block.

Solution:

- i) Mount the plug gage on the machine spindle and rotate it at 5000 rpm.
- ii) Scan a laser beam across the plug gage and stop when the distance from the laser source to the target is minimum, i.e., the beam is at the gage center. Read $L_1 = 35$ mm.
- iii) Jog the plug gage away from the beam path, read distance to the part edge $L_2 = 55$ mm.
- iv) The lateral offset from the spindle center to the workpiece edge is then:

$$\text{Lateral offset} = L_2 - L_1 - D/2 = 55 - 35 - (3.175/2) = 18.412 \text{ mm}$$

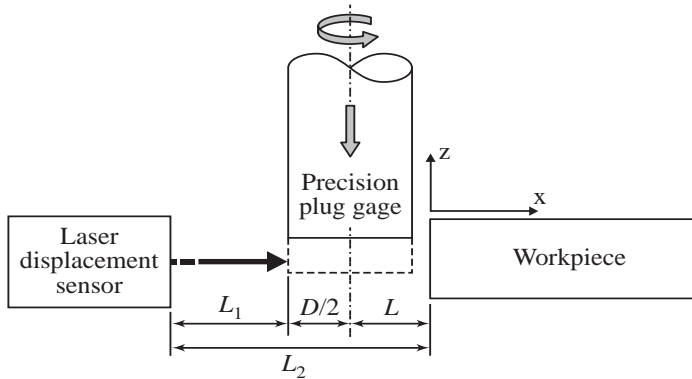


Fig. 7a. Setup for lateral edge detection using laser sensor.

Fig. 7b compares the accuracy and repeatability of the non-contact method shown in Fig. 7a against those of a mechanical edge finder.

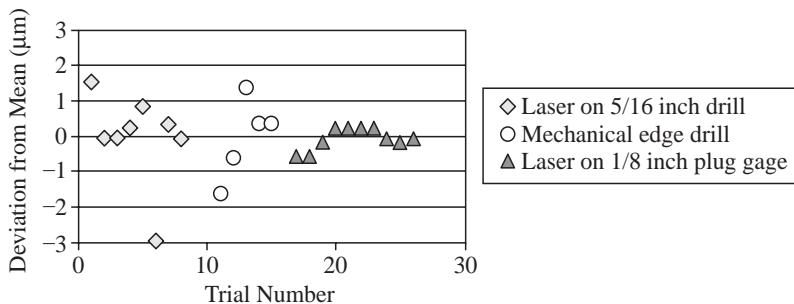


Fig. 7b. Superior accuracy and repeatability of laser edge detection technique compared to mechanical technique.

It is rather simple to find the lateral offset as illustrated in Example 6, but it is more difficult to find the exact vertical offset for a slender microdrill or micromill without damaging it. One can attempt to use the common “paper technique” or take a risk with an available contact sensor for z-setting. In the paper technique, one would use a hand to slide a piece of paper on top of a workpiece while gradually lowering a tool. The tool stops when a resistance on the paper is felt. The paper technique is tedious, subjective, and tool dependent. Fig. 8b shows scattering of data up to $\pm 5 \mu\text{m}$ when finding z-offset for a center drill, but it is $\pm 15 \mu\text{m}$ for a milling cutter with 4 teeth.

A commercial contact sensor requires a tool to move down and press against a solid surface. A pressure sensor then triggers an audible or visual signal to indicate a positive contact. The pressure level on such sensor is preset for macrotool setting and cannot be adjusted for a microtool. In both cases, the tool tip is one paper thickness or one contact sensor height above the workpiece – if the tool survives.

A non-contact sensor is more practical and reliable. The same laser displacement sensor used for lateral tool offset can also be used for vertical tool offset. Fig. 8a shows a precision ring with secured circular plastic membrane that is used for indirect measurement. The membrane center is marked with a reference (e.g., crossing lines) at which the height can be measured with the laser displacement sensor. Upon placing the fixture on top of a workpiece and then lowering a tool onto the reference mark, a slight contact of the tool and the flexible membrane is precisely detected with the laser beam pointing near the contact point. When this happens, the tool tip is at the same height as the membrane. The repeatability of tool offset using this technique is well within the positioning repeatability $3 \mu\text{m}$ of the tested Haas OM2 machine tool (Fig. 8b).

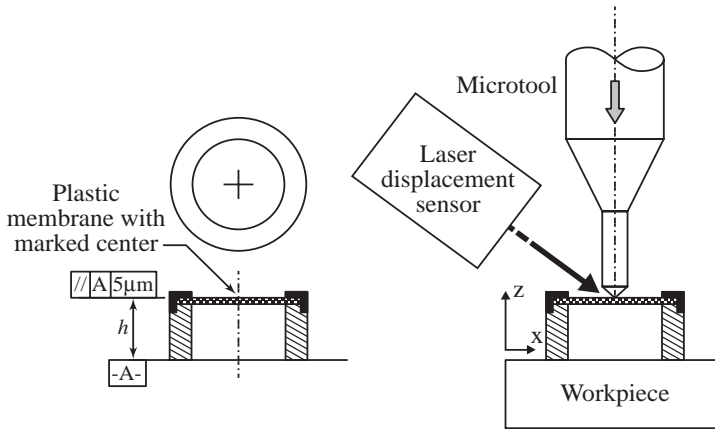


Fig. 8a. Microtool offset and microtool height detection using laser.

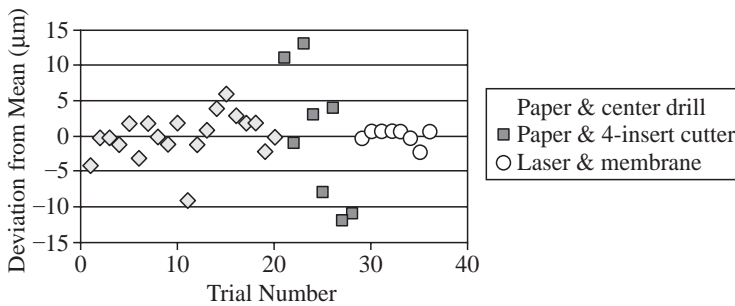


Fig. 8b. Superior accuracy and repeatability of laser offset and height detection technique compared to paper technique.

When a part is small or does not have a large surface for the fixture to rest on, then an indirect technique to find vertical tool offset for a microdrill or micromill is recommended. The following example illustrates this.

Example 7, Vertical Tool Offset Calculation: A vice or collet is used to clamp a micropart for drilling. The micropart protrudes upward a distance $h_1 = 0.1000$ inch. If the vice surface has been qualified as a reference, it can be used to find the vertical offset of a microdrill tip (Fig. 9).

- i) Measure the fixture height at the reference mark using the laser sensor, $h_2 = 0.3500$ inch.
- ii) Position the fixture on top of the vice.
- iii) Lower the microdrill onto the reference mark of the membrane. Stop when the membrane is slightly deflected which can be detected easily with the laser sensor.
- iv) Calculate the required drill vertical offset:

$$\text{Vertical offset} = h_2 - h_1 = 0.3500 - 0.1000 = 0.2500 \text{ inch.}$$

Tool Damage.—Tool damage can be categorized by the relative size of the damage, ranging from submicron to hundreds of microns, as indicated in Table 2. The tool failure mechanisms include damages due to mechanical, thermal, and chemical effects, and adhesion. Examples of microtool damages are illustrated in Figs. 10a through 10d.

Mechanical effect is the most common source of tool damage. Abrasive wear is caused by sliding of hard particles from workpiece or tool against the cutting tool surface. Attrition wear is larger than abrasion wear; it occurs when one or a few grains of the tool are weakened at their grain boundaries and are dislodged from the tool. Microchipping and chipping are larger chunks of tool being removed due to mechanical or thermal shocks upon loading and unloading. Machining at optimal parameters and with a rigid setup will reduce vibration, shock, and mechanical damage to a microtool.

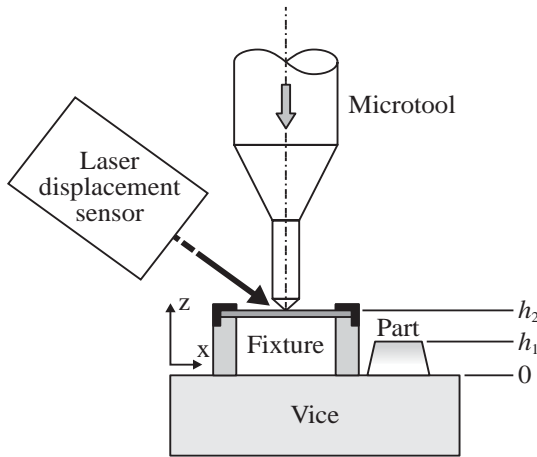


Fig. 9. Indirect vertical tool offset detection technique.

Microtool Damages

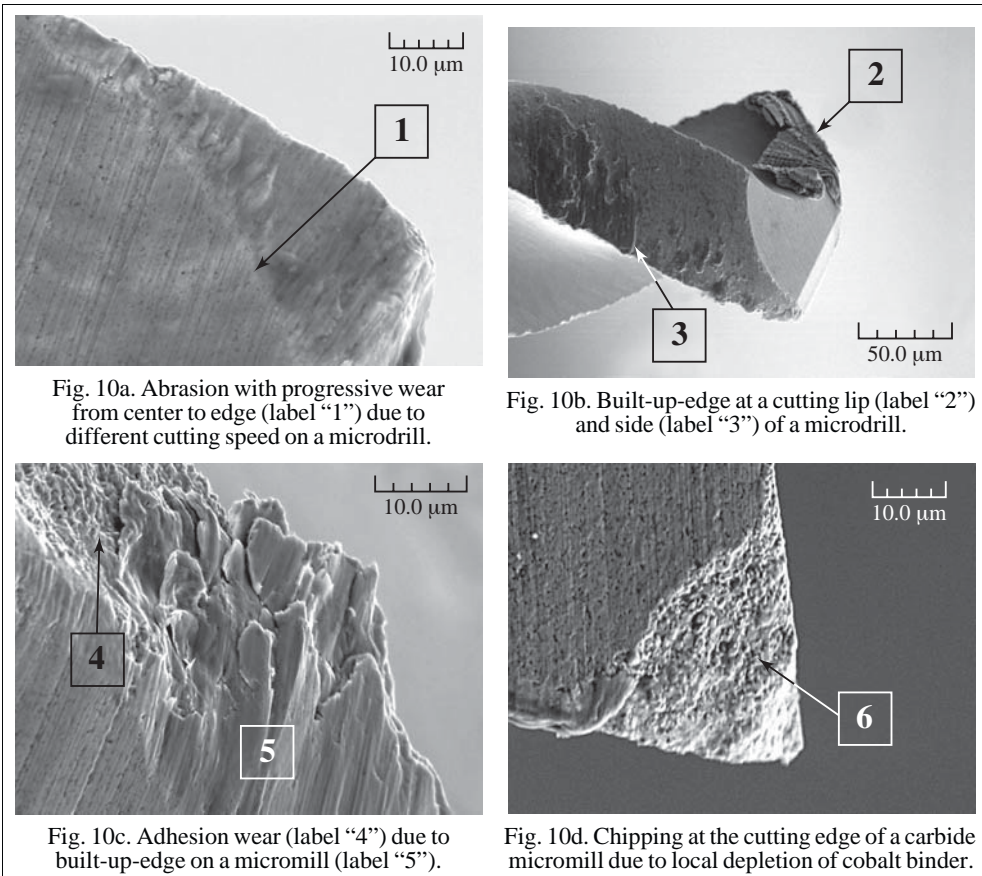


Fig. 10a. Abrasion with progressive wear from center to edge (label “1”) due to different cutting speed on a microdrill.

Fig. 10b. Built-up-edge at a cutting lip (label “2”) and side (label “3”) of a microdrill.

Fig. 10c. Adhesion wear (label “4”) due to built-up-edge on a micromill (label “5”).

Fig. 10d. Chipping at the cutting edge of a carbide micromill due to local depletion of cobalt binder.

Thermal effect is the second cause of tool damage. A cutting tool edge is softened at high machining temperature, deformed plastically, and removed from the tool. Both high speed steel tools and carbide tools with high cobalt content are vulnerable to thermal damage. High temperature also promotes diffusion, i.e., atoms from the tool and workpiece move

mutually across their interfaces, therefore degrading their properties and causing diffusion wear. Diamond with a carbon-rich matrix cannot be used with low-carbon ferrous alloys like steels or stainless steels because diamond carbonizes at temperatures exceeding 600°C and carbon diffuses to the steel due to its lower carbon content and high affinity to carbon. The useful life of a tool can be extended by proper application of coolant to reduce thermal damage, or by use of a protective coating that blocks undesirable thermal diffusion from/to a tool surface.

Chemical damage of a tool is due to a chemical reaction between a tool material and its environment like air, cutting fluid, or workpiece material. Tool oxidation is common when cutting in air at high speed. An oxidation reaction is accelerated with temperature, but can be eliminated when inert gas is used to shield the cutting tool from surrounding oxygen. A chain reaction can also occur and further degrade a tool. For example, iron in steel is first oxidized at high cutting temperature to form iron oxide; the iron oxide then weakens the aluminum oxide coating of a tool and leads to peeling and chipping of the coating.

Adhesion tool damage happens when a built-up-edge (BUE) welds strongly to a tool surface and then breaks away with a minute amount of tool material. When machining soft materials, a chip tends to adhere to the tool and grow in size. When the BUE is large and becomes unstable, it is removed with the chip while also shearing off part of the cutting tool due to the higher adhesion strength between BUE and tool than the intergrain binding strength of the tool. Stainless steel, nickel and titanium alloys are known for causing adhesion wear on carbide microtools. Adhesion damage can be reduced by using proper lubricant to reduce friction between chip and tool, by coating the tool with a smooth and low friction layer, by reducing tool edge radius, or by increasing cutting speed to raise the tool surface temperature and soften the BUE while reducing its weldability to the tool surface.

Microtool failures occur due to a combination of the above mechanisms. For example, peeling of tool coating might be due to coating defects, or to mechanical mechanisms when a large gradient of stress exists across a thick coating layer; the loosened coating particles then rub and cause mechanical abrasive wear on a tool. Thermal mechanisms may cause workpiece atoms to diffuse, weaken, and dislodge several tool grains as microchipping.

Table 2. Categories of Tool Damage

Microtool damage	Damage size		Mechanism
	μm	μinch	
Abrasion	< 1	< 39	Mechanical, thermal
Attrition	1 – 3	39 – 118	Mechanical, thermal
Peeling	1 – 3	39 – 118	Mechanical, chemical
Microchipping	3 – 10	118 – 394	Mechanical, adhesion
Chipping	10 – 30	394 – 1,180	Mechanical
Fracture	> 100	> 3,940	Mechanical

Tool Life.—Tool life criteria in macromachining are documented in ANSI/ASME B94.55M-1985, *Tool Life Testing with Single-Point Turning Tools*. This standard suggests an end of tool life when a tool exhibits:

- An average flank wear of 300 μm (0.0118 in), or
- Any maximum flank wear land of 600 μm (0.0236 in), or
- Any tool wear notch of 1000 μm (0.0394 in), or
- A crater wear of 100 μm (0.0039 in).

It is obvious that such criteria for a macrotool cannot be applied to a microtool because (i) it would be cost prohibitive to continue testing until 300 μm flank wear, and (ii) the wear criteria are even larger than most tool dimensions.

In the absence of a microtool standard, researchers have set their own criteria based on direct observation and/or indirect monitoring of microtool tool wear effects. Published data varies on microtool wear thresholds: 5 μm flank/nose wear on diamond tools, or 50

μm flank/nose wear on carbide tools, or chipping dimensions relative to cutting tool grain size, or peeling of tool coating, etc. A variety of techniques have been suggested for tool monitoring; the direct techniques measure the tool conditions (e.g., flank wear, crater wear) while the indirect techniques measure the consequence of tool wear (e.g., burr size, change of microhole diameter).

Table 3. Microtool Wear and Monitoring Techniques

	Measurement	Metrology Equipment / Sensor
Direct	Tool wear Tool edge conditions	Microscope
	Wear particles Particle radioactivity	Spectrophotometer, scintillator
	Tool-workpiece junction resistance	Voltmeter
	Workpiece features (hole diameter, slot depth...)	Microscope Interferometer
Indirect	Cutting force, torque, power	Dynamometer Strain gage, ampere meter
	Sound emitted from tool-workpiece friction	Acoustic emission transducer Microphone
	Vibration	Accelerometer Displacement sensor
	Temperature	Thermocouple Pyrometer
	Surface roughness	Profilometer, interferometer, optical profiler...
	Burr dimension	Microscope, interferometer, optical profiler...

The importance of tool life monitoring and tool life prediction is presented in the section *MACHINING ECONOMETRICS* starting on page 1132. The following material expands from that and covers relevant information for tool life of microtools.

The general Taylor equation that relates tool life and machining parameters also applies in micromachining:

$$V^a f^b d^c T = g \quad (1)$$

where V = surface cutting speed (m/min, ft/min)

f = tool feed (mm/rev, in/rev) or chip load (mm/tooth, in/tooth)

d = depth of cut (mm, inch)

T = tool life (min)

g, a, b, c = constants

When thermal damage mechanism dominates then $a \gg b, c$ in Equation (1). The term a dominates mathematically and the effects of feed and depth of cut are insignificant compared to speed. The general Taylor equation can be rewritten as:

$$V^a T = \frac{g}{f^b d^c} \quad (2)$$

If $n = 1/a$, then this equation is the same as that in the *Econometrics* section:

$$VT^n = \left(\frac{g}{f^b d^c} \right)^n = C \quad (3)$$

When tool chipping occurs then both terms $b, c \gg a$, therefore the feed and depth of cut are more important than surface speed. The general tool life reduces to

$$f^b d^c T = \frac{g}{V^a} = C' \quad (4)$$

Chipping is generally not acceptable since a chipped tool generates excessive burr and a very rough surface. By reducing depth of cut and feed, then chipping should be eliminated assuming micromachining with a quality tool and machine tool. When stable parameters are applied, then the only damage mechanism is thermal and tool life can be predicted with Equation (3).

It has been shown that flank wear due to abrasion is directly proportional to the magnitude of acoustic signal or feeding force. An increase of 300% in micromilling feeding force from an initial value was established as a threshold for reaching the tool life. A reduction in feeding force, however, might indicate gradual failure of a microtool due to fatigue crack propagation. Indirect monitoring of tool wear by monitoring feeding force for both micromilling and microdrilling would be a preferred technique since this does not interfere with the machining process and reduce productivity. In the absence of a sensitive commercial system that can reliably and accurately monitor tool force and tool life in micromachining, direct tool wear monitoring should still be a popular practice.

Traditional tests using the Taylor approach would machine at the same cutting speed until reaching the predetermined tool failure criteria. Such tests can be time consuming if a chosen speed is too low, and only applicable to turning since a constant cutting speed is required. In reality, a part must be machined with the same tool in different directions and speeds to obtain the final profile and surface finish. Several techniques were developed to accelerate the testing method since turning tests alone are tedious, expensive, and do not reflect actual part machining. The cumulative wear technique, assuming that the abrasion wear mechanism is the same at different cutting speeds, is more flexible and can reduce the testing time and cost. The proposed cumulative tool life testing technique:

- Is flexible. If an initial speed is too slow, testing speed can be increased and the cumulative time and tool wear recorded.
- Is simple. Manual machines can be used instead of CNC machines. The same rpm on a manual lathe can be used for the turning test until tool failure. Times and cutting speeds for all passes are used to calculate the equivalent time and speed.
- Is more cost effective. Both turning and facing can be combined to completely consume an expensive workpiece material.
- Is order independent. The level of cutting speed is not important if providing the same tool wear mechanism. Experimental data for macromachining shows no difference of tool life if changing cutting speeds from low to high, or in reverse order.

Consider a tool that machines at cutting speed V and stops after machining time Δt before reaching its tool life T . The tool then cuts at different speeds and times until reaching the tool life criteria – for example, 50 μm flank wear on a carbide microendmill. The fraction of tool life when cutting at each speed and time is $\Delta t/T$, and the total tool life fraction is

$$\frac{\Delta t_1}{T_1} + \frac{\Delta t_2}{T_2} + \dots + \frac{\Delta t_k}{T_k} = \sum_{i=1}^k \frac{\Delta t_i}{T_i} = Q \quad (5)$$

The theoretical value of the total tool life fraction Q should be one. Experimental values for Q were found to be in the range 1.2-1.5. When combining with Taylor Equation (3), then Equation (5) becomes

$$\sum_{i=1}^k \Delta t_i V_i^{1/n} = QC^{1/n} \quad (6)$$

After machining with a tool at different times and speeds in different conditions (e.g., different tool coatings), it is necessary to compare the tool performance by calculating its

equivalent tool life and equivalent tool speed. The equivalent tool life T_e is just the sum of all machining time periods:

$$T_e = \sum_{i=1}^k \Delta t_i \quad (7)$$

The equivalent tool speed must produce the same tool damage as a tool after cumulative machining. The total tool damage is given in Equation (6) as:

$$\frac{1}{Q} \sum_{i=1}^k \Delta t_i V_i^{1/n} = C^{1/n} = T_e V_e^{1/n} \quad (8a)$$

Solving for the equivalent cutting speed V_e

$$V_e = \left(\frac{\sum_{i=1}^k \Delta t_i V_i^{1/n}}{\frac{1}{Q} \sum_{i=1}^k \Delta t_i} \right)^n \quad (8b)$$

When $Q = 1$ then, $(V_e)^{1/n}$ is the mathematical average of all $(V_i)^{1/n}$ terms, by definition.

Mathematical models for cumulative tool wear are now derived for most popular machining operations, namely turning, drilling, facing, and milling.

- For turning with different cutting speeds, Equation (6) is applied. If turning speeds are kept the same from one pass to another, substitute $V=V_i$, into Equation (6) to obtain:

$$V^{1/n} \sum_{i=1}^k \Delta t_i = Q C^{1/n} \quad (9)$$

- For drilling, tool wear would be most substantial at the cutting lip where cutting speed is at the highest. Since cutting speed is constant during drilling as in turning, the tool wear model for drilling is the same as in Equation (6) for variable speeds, and Equation (9) for constant speed.
- For facing, the cutting speed reduces linearly from the maximum V_i at the outer most radius to zero at the spindle center. It can be shown that the cumulative tool life model for facing is:

$$\sum_{i=1}^k \Delta t_i V_i^{1/n} = \frac{n+1}{n} Q C^{1/n} \quad (10)$$

- For milling, the actual machining time is the time during which chips are produced. The chip generating time involves geometry of a tool and milling parameters. The cumulative tool life model for face milling is

$$\sum_{i=1}^k \Delta t_i V_i^{1/n} = \frac{1}{\lambda} Q C^{1/n} \quad \text{and} \quad \lambda = \frac{M \cos^{-1} \left(1 - 2 \frac{a}{D} \right)}{360^\circ} \quad (11)$$

where λ = milling factor
 a = width of cut (radial depth) in milling
 M = number of teeth
 D = milling cutter diameter

Example 8, Cumulative Tool Life:

Turning Test: Dry turning a metal matrix composite rod ($\varnothing 18$ mm, 100mm long) at constant 256 rpm on a manual lathe, depth of cut 0.5 mm, feed 0.07 mm/rev. Carbide tool TNPR331M-H1, tool holder MTENN2020-33.

This Al-SiC composite is very abrasive and is ideal for tool life model testing since abrasive wear is the main mechanism and flank wear is clearly seen and measured on a carbide tool. In this test, a tool is turned at constant rpm until reaching 300 μm flank wear. At least two data points are required to calculate the effect of speed, or the slope n in Taylor equation. From **Table 4**, the speed and tool life pairs are (14.48 m/min, 3.54 min) and (9.56 m/min, 5.58 min). The slope n is derived from **Equation (3)** for these two data points is

$$n = \frac{\log(V_2/V_1)}{\log(T_1/T_2)} = \frac{\log(9.56/14.48)}{\log(3.54/5.58)} = 0.91$$

When considering many data points, the averaged value of n is 0.94. A spread sheet such as **Table 4** is a convenient way to tabulate cumulative values of each Δt and $\Delta t V^{1/n}$ term, and then use these to calculate the equivalent tool life T_e with **Equation (7)**, and the equivalent tool speed V_e with **Equation (8b)**. The plot for all experimental data at constant cutting speeds and cumulative speeds is shown in **Fig. 11a**. Having all data points fitting on the same line indicates the validity of cumulative tool life models.

Facing Test: The same material and cutting tools are used in the facing test. Tool wear and tool life plots are shown in **Figs. 11b** and **11c**. There is no difference in tool life when machining at low then high speed or the other way around.

Table 4. Spread Sheet for Example 8, Cumulative Tool Life in Turning

RPM	Δ Length (mm)	Diameter (mm)	Speed (m/min)	Δt (min)	$\Delta t V^{1/n}$	Cumulative		Flank Wear (μm)	Feed (mm/rev)	Equivalent	
						$\Delta t V^{1/n}$	Δt (min)			V_e (m/min)	T_e (min)
256	26.5	18.0	14.48	1.48	25.39	25.39	1.48	199	0.07		
256	16.0	18.0	14.48	0.89	15.33	40.72	2.37	242	0.07		
256	21.0	18.0	14.48	1.17	20.12	60.84	3.54	300	0.07	14.48	3.54
179	18.5	17.0	9.56	1.48	16.30	16.30	1.48	160	0.07		
179	21.5	17.0	9.56	1.72	18.95	35.25	3.19	233	0.07		
179	25.0	17.0	9.56	2.00	22.03	57.28	5.19	289	0.07		
					projected	61.61	5.58	300		9.56	5.58

Workpiece Materials

Micromachining is often utilized to fabricate components for miniaturized sensors, medical, optical, and electronic devices, etc. Common engineering materials for these applications include stainless steel, aluminum, titanium, copper, and tool steel for miniature molds and dies.

Workpiece materials must meet certain conditions for successful micromachining. Unlike macromachining, a micromachining tool is subjected to fluctuating cutting force when it encounters each grain since microtool size is comparable to material grain size. A microtool is more vulnerable to fatigue fracture and the resulting surface – if the tool survives – would be rough due to different spring-back protrusion from each grain due to different crystallographic orientations of the grains, and direction-dependent properties of the material. Homogenous workpiece materials with very fine and uniform grain sizes should be chosen for micromachining. Inclusions and large precipitates should be minimized to avoid damage to a fragile tool edge.

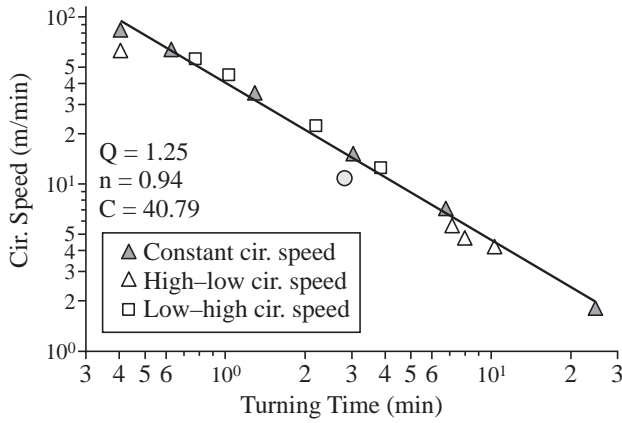


Fig. 11a. Tool life plot for turning tools. Circumference speed refers to the maximum cutting speed at the outer radius in turning.

Cast A359/SiC/20p; tool H1 WC (-8,0,9,5,60,30,0.4mm); 0.5 mm depth; 0.07 mm/rev feed; dry.

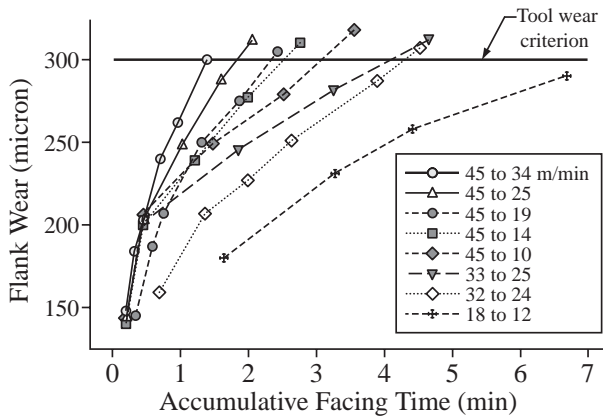


Fig. 11b. Cumulative flank wear of tool facing at high-to-low circumference speed.

Cast A359/SiC/20p; tool H1 WC (-8,0,9,5,60,30,0.4mm); 0.5 mm depth; 0.07 mm/rev feed; dry.

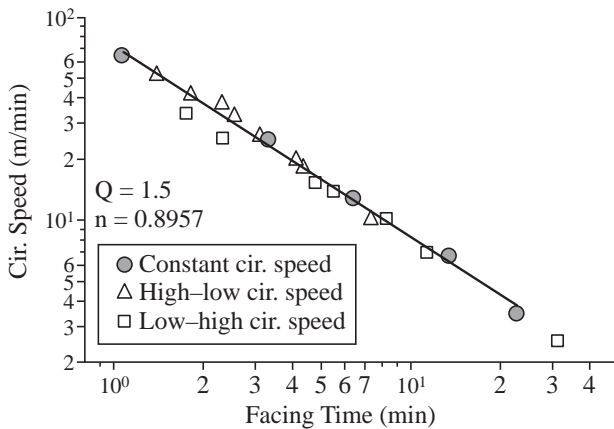


Fig. 11c. Tool life plot for facing tools. Circumference speed refers to the maximum cutting speed at the outer radius in facing.

Cast A359/SiC/20p; tool H1 WC (-8,0,9,5,60,30,0.4mm); 0.5 mm depth; 0.07 mm/rev feed; dry.

Example 9, Grain Size Consideration: The speed and feed table on page 1049 recommends a chip load (feed) of 0.1 mm/tooth (0.004 in/tooth) for macro-scale end milling 316L stainless steel using an uncoated carbide tool. Assume the average material grain size is 15 μm .

Macromilling: Using a $\text{\O}1/2$ inch ($\text{\O}12.5$ mm) end mill, the number of grains being cut by each tooth would be

$$\frac{\text{chip load}}{\text{grain size}} = \frac{0.1 \text{ mm}}{15 \mu\text{m}/\text{grain}} = \frac{100 \mu\text{m}}{15 \mu\text{m}/\text{grain}} = 6.67 \text{ grains}$$

Micromilling: Selecting a $\text{\O}0.1$ mm ($\text{\O}0.004$ in) end mill, the recommended chip load would be 13 μm for stainless steel (see Table 13b, page 1131). The number of grains being cut by each tooth is

$$\frac{\text{chip load}}{\text{grain size}} = \frac{13 \mu\text{m}}{15 \mu\text{m}/\text{grain}} = 0.87 \text{ grains}$$

The cutting force on the macrotool and resulting surface finish are uniform due to the averaging effect from seven grains. Because a microtool shears less than one single grain at a time, the micromachined surface is irregular due to different spring-back amounts of each individual grain, and the cutting force on the microtool fluctuates depending on each grain orientation.

Ductile Regime Micromachining

Crystallographic Directions and Planes.—When machining in micro or nano scale, the workpiece atom orientation affects the machining performance because the material properties change with crystalline orientation. Figs. 12a and 12b show blocks of same material but with different surfaces. For example, the surface of the silicon block shown in Fig. 12a is harder, stiffer (higher elastic modulus), and is more difficult to machine than the same silicon block in Fig. 12b. Miller indices are commonly used to specify particular crystallographic orientations of atoms.

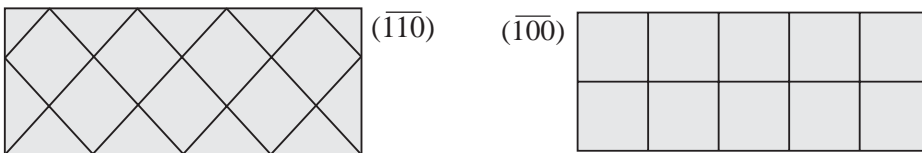


Fig. 12a. Block of materials with (110) surface. Fig. 12b. Block of same material with (100) surface.

Consider a simple cubic system where atoms are located at corners (cubic as with manganese), at corners and inside (body centered cubic as with iron and chromium), or at corners and on the surfaces (face centered cubic as with aluminum and copper) systems. For convenience, we will set a coordinate system $Oxyz$, as shown in Fig. 13a, and the size of the cube is set at one atomic spacing unit ($OA = OC = OD = 1$).

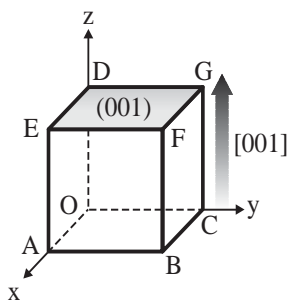


Fig. 13a.

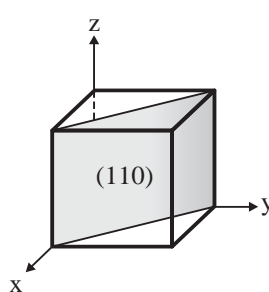


Fig. 13b.

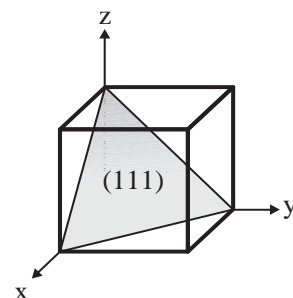


Fig. 13c.

During a micro/nano machining process, a cutting tool pushes and shears a grain. The cutting action forces some atoms to slide in certain directions and planes to form chips on

the tool rake face. These specific directions and planes are called slip systems. Soft materials such as copper and aluminum have more slip systems, therefore, are easier to be machined compared to harder materials such as steel with fewer slip systems.

The directional Miller index is the coordinate of a vector representing the atom sliding direction. In Fig. 13a, if the atom slides from C to G (also the same as sliding from O to D), then this vector with corresponding coordinates are given by:

$$\vec{CG} = \vec{OD} = [x_D - x_O, y_D - y_O, z_D - z_O] = [0, 0, 1] \text{ or } [001] \text{ direction}$$

Similarly, if an atom slides from B to A (or C to O) then the Miller direction is:

$$\vec{BA} = \vec{CO} = [x_O - x_C, y_O - y_C, z_O - z_C] = [0, -1, 0] \text{ or } [0\bar{1}0] \text{ direction}$$

The Miller plane represents the planes that intersect with the coordinate system. The plane DEFG in Fig. 13a, congruent with OABC, intersects the z-axis while parallel with the x and y axes. The Miller index for this plane is represented by the inverse of the axis intersection:

$$\text{Plane DEFG} = \left(\frac{1}{x\text{-intercept}}, \frac{1}{y\text{-intercept}}, \frac{1}{z\text{-intercept}} \right) = \left(\frac{1}{\infty}, \frac{1}{\infty}, \frac{1}{1} \right) = (0, 0, 1) \text{ or } (001) \text{ plane}$$

The plane EGCA in Fig. 13b, congruent with DFBO, intersects the x and y axes while parallel with z axis. The Miller index for this plane is:

$$\text{Plane EGCA} = \left(\frac{1}{x\text{-intercept}}, \frac{1}{y\text{-intercept}}, \frac{1}{z\text{-intercept}} \right) = \left(\frac{1}{1}, \frac{1}{1}, \frac{1}{\infty} \right) = (1, 1, 0) \text{ or } (110) \text{ plane}$$

The plane DCA in Fig. 13c, congruent with BEG, intersects all the x, y, and z axes. The Miller index for this plane is:

$$\text{Plane DCA} = \left(\frac{1}{x\text{-intercept}}, \frac{1}{y\text{-intercept}}, \frac{1}{z\text{-intercept}} \right) = \left(\frac{1}{1}, \frac{1}{1}, \frac{1}{1} \right) = (1, 1, 1) \text{ or } (111) \text{ plane}$$

Miller Index Nomenclature: In both direction and plane Miller indices, any minus sign is written on top of the number and all commas are omitted for simplicity.

A pair of square brackets "[]" are used to indicate a specific direction, and the pointed brackets "< >" are used to indicate a family of directions with similar geometries. For example, the <100> family has 12 directions similar to [100], [001]... which are all the edges of the cube in Fig. 13a.

A pair of regular brackets "()" are used to indicate a specific plane, and the curly brackets "{ }" are used to indicate a family of planes with similar geometries. For example, the {100} family has 6 planes similar to (100), (001)... which are all the surfaces of the cube in Fig. 13a.

Introduction.—The concept of ductile-regime machining has been investigated since the 1960s for amorphous brittle materials such as glasses. Silicon, germanium, and glasses have become strategic materials that are widely used to fabricate intricate components in microelectronics, optical, defense industries, and recently as micro optical-electrical-mechanical systems. Silicon and other brittle materials are known for their low machinability unless they are machined in the ductile-regime conditions. When utilized at the optimal machining conditions, only minimum effort is required for the subsequent etching, grinding, or polishing to remove the damaged subsurface. This section summarizes the theory and provides practical guidance for ductile regime machining.

Theory.—The mechanism of ductile-regime machining has been studied by many researchers. Using fracture mechanics approach, it can be shown that there is a threshold below which the ductile regime prevails:

$$d_c = \frac{\text{plastic flow energy}}{\text{fracture energy}} = A \left(\frac{E}{H} \right) \left(\frac{K_c}{H} \right)^2 \tag{12}$$

where d_c = critical depth of cut (m, inch)

A = constant

E = Young's modulus (Pa, psi)

K_c = surface fracture toughness ($\text{Pa}\cdot\text{m}^{0.5}$, $\text{psi}\cdot\text{in}^{0.5}$)

H = surface microhardness (Pa, psi)

A shallow depth of cut, therefore, would energetically promote plastic flow rather than brittle fracture in the substrate and the chips. **Table 5** tabulates properties of some brittle materials and their experimental critical depths of cut.

Table 5. Selected Properties of Some Brittle Materials

Materials	Young modulus (GPa)	Fracture toughness ($\text{MPa}\cdot\text{m}^{0.5}$)	Knoop hardness (GPa)	Critical depth of cut (μm)
$\alpha\text{-Al}_2\text{O}_3$	275–393	3.85–5.90	19.6–20.1	1.0
SiC	382–475	2.50–3.50	24.5–25.0	0.2
Si	168	0.6	10	0.5

The constant A in **Equation (12)** varies in the range 0.1–0.6 due to measuring uncertainty of surface toughness K_c , elastic modulus E , and microhardness H in a testing environment. These properties depend on crystalline orientation of the materials, surface conditions, and tool geometry.

- The critical resolved shear stress, on a crystalline plane due to the cutting action, is directly proportional to the Schmid factor $\cos\lambda\cos\phi$, where ϕ and λ are the orientations of the slip plane and slip direction. An ideal ductile mode machining would happen when the cutting shear stress is parallel to both the slip plane and the slip direction, otherwise a pseudo ductile mode with micro cleavages occurs. True ductile-regime machining happens only along certain crystalline orientations, but brittle machining occurs at other crystalline orientations. This explains why micromachining a crystalline specimen at the same speed, depth of cut, and coolant produces ductile machined surfaces in one direction but brittle machined surfaces on others.
- Cutting fluid changes the surface properties of materials (K_c , E , and H) and affects conditions for ductile regime micromachining. When micromachining the (100) germanium using a single crystalline diamond tool, the critical depth of cut changes from 0.13 μm (5 $\mu\text{in.}$) with distilled water as cutting fluid to 0.29 μm (11 $\mu\text{in.}$) in dry machining.
- Tool geometry also affects the results. Plowing and fracture of material occurs when depth of cut is less than approximately half of the tool cutting edge radius (see **Microcutting Tools** on page 1093). Tools with negative top rake angle are usually utilized because a negative rake causes a compressive zone in the workpiece ahead of and below the tool and suppresses microcrack formation.

Example 10, Mirror-finish Micromachining: Diamond tools with sharp cutting edge radii are very effective to machine brittle or ductile material with the exception of ferrous alloys such as tool steels or stainless steels. The cutting speed has minimum effect on surface finish, but a reduction of the feedrate leads to improvement of surface finish.

An optical quality surface of 1.4–1.9 nm R_{max} was obtained when turning single crystalline quartz with a diamond tool (-20° rake, 0.8 mm nose radius) at $< 0.3 \mu\text{m}$ depth of cut, 3 m/s speed, and 8.1 $\mu\text{m}/\text{rev}$ feedrate.

Case Study.—A study used polished (001) p-type silicon wafers of $\text{Ø}100 \text{ mm}$ ($\text{Ø}4 \text{ inch}$). Small grooves were faced at different constant depth of cut or gradually changing depth of cut to study the ductile behavior (**Fig. 14**). Single crystalline diamond tools with (001) rake surface, 10–40 nm edge sharpness, $+5^\circ$ rake angle, and 0.51 mm or 2.00 mm nose radii were used for a facing operation. The complete tool nomenclature follows the American Standards Association (back rake angle, side rake angle, end relief angle, end clearance angle,

side relief angle, side clearance angle, end cutting edge angle, side cutting edge angle, nose radius) with the addition of edge sharpness as ($5^\circ, 0^\circ, 0^\circ, 5^\circ, 5^\circ, 30^\circ, 0^\circ, 0.51\text{--}2.00\text{ mm}, 10\text{--}40\text{ nm}$). The ultraprecision machining process was performed on a rigid system that has 9 nm positioning accuracy. Compressed air was used to blow chips away from the finish machined area. Surface finish of a machined wafer was measured with an atomic force microscope (AFM) and a phase-shift interferometer (PSI).

Surface finish measurements indicated ductile or brittle chip fracture on machined surfaces. As depth of cut reduced below $1\text{ }\mu\text{m}$, the surface finish was also diminished due to a higher percentage of ductile machined surfaces. Perfect ductile regime machining was achieved when depth of cut was between $0.1\text{--}0.5\text{ }\mu\text{m}$. A smaller depth of cut in the neighborhood of $0.05\text{ }\mu\text{m}$ (50 nm), however, worsened the surface finish because machining at such shallow depth of cut (close to the cutting tool edge radius of 40 nm) would plow and fracture the material surface. At the same cutting parameters, micromachining along the silicon $\langle 110 \rangle$ directions gave better surface finish while brittle chipping was seen when cutting along the silicon $\langle 100 \rangle$ directions (Figs. 15, 16a, and 16b).

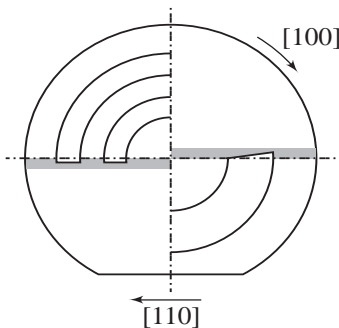


Fig. 14. Machining plan on (001) wafers. A wafer was faced at a constant depth in different zones (left) or changing cutting depth in a taper cut (right).

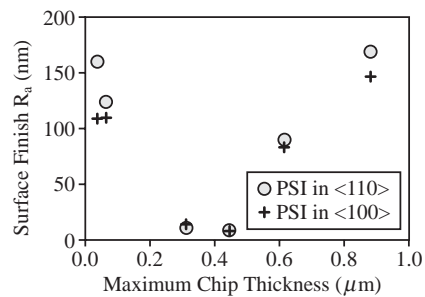


Fig. 15. Surface finish as a function of the maximum chip thickness (depth of cut) and crystalline direction of the silicon wafer. The minimum surface finish is with ductile machined surface.

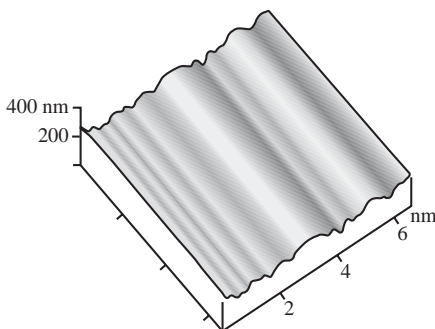


Fig. 16a. Perfect ductile regime machining of (001) silicon along $[110]$.

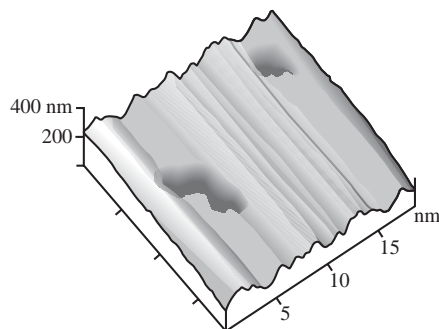


Fig. 16b. Mixed mode of ductile regime and pitting along $[100]$.

Speed 75 m/min , feed $2.5\text{ }\mu\text{m/rev}$; depth $0.5\text{ }\mu\text{m}$; SCD tool ($5^\circ, 0^\circ, 0^\circ, 5^\circ, 5^\circ, 30^\circ, 0^\circ, 0.5\text{ mm}, 10\text{--}40\text{ nm}$).

Cutting Fluids in Micromachining

Micromilling and microdrilling, among the most versatile manufacturing processes, can be leveraged from existing technology to produce 3D microparts or microcavities in molds and dies for mass-replication. Although macro-scale milling and drilling technology is mature, micro-scale milling/drilling technology is yet to be fully developed. Extending common practices in macromachining to micromachining often ends up with failure. Very short tool life is experienced with micromachining, and flood cooling is not effective in

microdrilling because coolant cannot flow into a partially drilled microhole. This section recommends how to select and apply a cutting fluid for effective micro milling/drilling.

Micro milling/drilling requires high rotation speed exceeding 25,000 rpm of a small tool to achieve an acceptable surface cutting speed for material removal. When drilling steel, 50% of the heat generated conducts into the drill, but 80% of heat will go to the tool when drilling titanium. A microdrill with sharp cutting edges subjected to high temperature and high stress will fail easily if cutting fluid is not adequate. When rotating a microtool at a very high rotating speed, flood coolant is not effective since it does not have enough momentum to penetrate the boundary layer (fast moving air layer) around a fast rotating tool, or wet the bottom of a deep microhole. In addition, any unfiltered chip from recycled coolant can damage a microtool or fragile workpiece. Micromist (minimum quantity lubrication, MQL) has been studied by many researchers and is proven to provide proper cooling and lubricating in micromachining. In ideal conditions, a stream of micron-size lubricant particles in micromist:

- Does not contain any chip or solid contaminant
- Has enough momentum to penetrate the boundary layer of a fast rotating tool
- Adheres to the fast rotating tool despite high centrifugal force, and
- Wets the tool and workpiece to provide effective cooling and lubricating.

The following section discusses safety, selection of cutting fluid, application method, and recommends optimal setup for micromachining.

Safety.—The aspect of health and safety when using micromist is a concern. A mist does not only cause potential health issues for workers in the environment, but also contaminates other instruments and machines nearby. Biodegradable fluids must be used; polyol esters are superior to common vegetable oils because the former have higher biodegradability, are less “sticky” due to oxidizing, and increase in molecular weight with time and temperature. Due to the aerosol formation during mist flow at high pressure, an air purification unit or proper ventilating fan should be installed to minimize breathing of the aerosol particles by operators, and prevent damage to adjacent equipment.

Benefits.—Most conventional machining processes like turning, milling, drilling, and grinding can benefit from micromist lubrication when applied properly. Although application of micromist is limited when the mist flow is obstructed — as in gun drilling — successful microdrilling has been reported for microholes with 10:1 aspect ratio (depth/diameter). At optimal conditions, micromist significantly minimizes built-up-edges, reduces burr size and cutting force, and therefore improves tool life for both coated and uncoated tools. Depending on which cutting fluid is used and how it is applied, researchers have found the effect of micromist ranges from “the same as flood cooling” to “extending tool life 3-10 times over flood cooling.” There is yet any published paper on inferior results of micromist over dry and flood cooling.

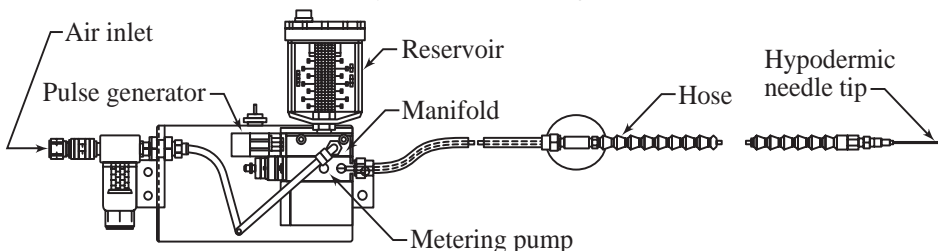


Fig. 17. Schematic of a micromist system for micromachining. *Courtesy of Unist Inc.*

Systems that can generate micromist for minimum quantity lubrication machining are commercially available. A typical design (Fig. 17) includes a reservoir for biocompatible oil, feeding tubes, and an atomizing unit that mixes a compressed air flow with a controlled volume of oil. A needle is necessary to direct the mist to a predetermined location. The resulting oil microdroplets – size and speed – should be adjustable to effectively penetrate

and wet a tool/part interface. This can be done by adjusting the air pressure, type of oil, and volume of oil released into the air stream.

Selection of Cutting Fluid.—A cutting fluid is selected for both cooling and lubricating purposes in micromachining. It should be environmentally friendly, should not interact chemically at high temperature with tool or workpiece, and can be cleaned and disinfected from the machined parts. It must have low surface energy relative to the surface energy of the cutting tool and workpiece material, high thermal diffusivity, and lubricity. For micro-mist applications, a cutting fluid must be able to flow easily in a small tube (low viscosity) and to form microdroplets.

Complete wetting is desirable for a cutting fluid because it covers large surface areas of tool and workpiece and effectively removes heat from the source. Its self spreading capability due to the differential surface energy allows cutting fluid to penetrate deep into the chip/tool interface to effectively lubricate and cool this zone. Wetting condition can be assessed by two methods:

Pendant drop technique: A drop of liquid is formed and suspended vertically at the end of a solid tube. The side view of a drop is analyzed to compute the liquid surface tension using a tensiometer (Figs. 18a and 18b).

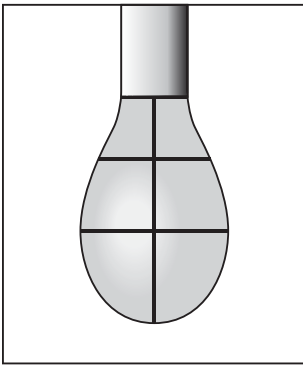


Fig. 18a. Side view of a pendant drop below a stainless steel tube.

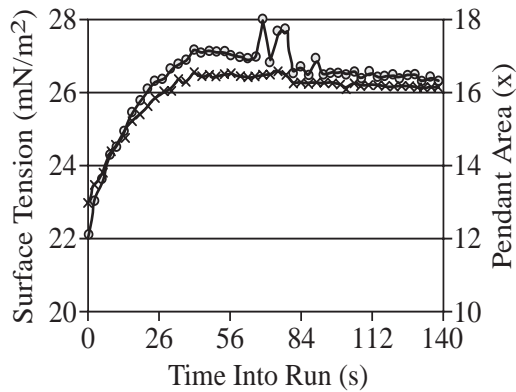


Fig. 18b. Calculated surface tension from starting to full forming of a droplet.

Sessile drop technique: A drop of liquid is placed on a horizontal surface. The side view of the drop is analyzed to calculate the liquid contact angle or measure it with a goniometer (Fig. 19).

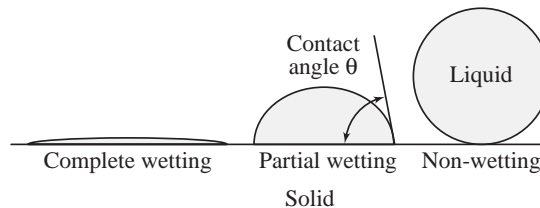


Fig. 19. Sessile drop technique to assess wetting of cutting fluid.

The following section presents a simpler approach to calculating the contact angle and drop size using a modified sessile drop technique. This technique uses a toolmaker's microscope, available at most manufacturing shops, to measure the top view of a drop, instead of a goniometer to measure the side view.

Drop Size Measurement.—A microdroplet must have sufficient momentum to penetrate the boundary air layer moving around a fast rotating microtool and to wet the tool afterward. Calculation of momentum and contact angle for wetting assessment requires the droplet dimension. Knowing the lubricant drop size allows proper calibration of a microm-

ist system to maintain the system effectiveness. Table 6 summarizes different techniques to measure the liquid drop size. The techniques are basically intrusive and nonintrusive methods to either collect the droplets for subsequent analysis, or in situ imaging the in-flight droplets.

The nonintrusive techniques use dedicated laboratory research instruments to provide accurate dimensions and comprehensive statistical information of microdroplets. The effect of variables like air pressure on drop size and speed can be automatically calculated and analyzed.

The intrusive techniques use less sophisticated instruments to collect and analyze droplets directly or indirectly. These simpler techniques, however, depend on operator skills for collecting reliable data.

Table 6. Liquid Droplet Measurement Techniques

Intrusive	Nonintrusive
<i>Slide:</i> collect droplets on a slide for microscopic assessment.	<i>Light shadowing:</i> analyze shadows of in flight droplets.
<i>Solidification:</i> transform droplets to solid for sieving or weighting.	<i>Laser Doppler Anemometry:</i> analyze visibility, intensity and phase shift of scattered laser from a small sample of droplets.
<i>Momentum:</i> analyze droplet impact.	<i>Laser Diffractometry:</i> scan and analyze a large group of droplets.
<i>Heat Transfer:</i> analyze cooling effect of droplets with a hot wire anemometer.	

The slide technique is a simple way to study drop size and its wetting characteristic. The setup is shown in Fig. 20a, in which a mask and glass plate are quickly exposed to a steady stream of micromist droplets. Only few droplets are able to pass through the mask opening and deposit on a clean glass plate behind it.

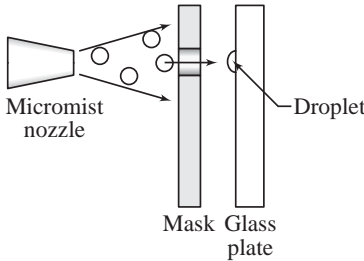


Fig. 20a. Setup for microdroplet collection.

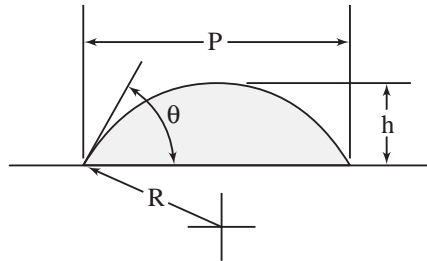


Fig. 20b. Analysis of droplet geometry.

It is assumed that (i) droplet volume remains the same before and after touching the glass plate, (ii) gravity effect on a microscale droplet is negligible, and (iii) the droplet forms part of a sphere on the plate to minimize its total surface energy. Using Equations (13) and (14) that follow, the average volume of a single droplet can be calculated by measuring the average projected droplet diameter P and its height h on a toolmaker's microscope:

$$V = \frac{\pi h^2}{2} \left(\frac{h}{3} + \frac{P^2}{4h} \right) = \frac{\pi D^3}{6} \tag{13}$$

$$D = \left(\frac{6V}{\pi} \right)^{1/3} = \left[3h^2 \left(\frac{h}{3} + \frac{P^2}{4h} \right) \right]^{1/3} \tag{14}$$

- where V = volume of microdroplet (mm³, in³)
- P = projected droplet diameter (mm, in)
- h = height of a microdroplet (mm, in)
- D = air-borne diameter of microdroplet (mm, in)

The drop size varies with air pressure and volume of oil for atomization. In general, higher air pressure and velocity give more uniform and smaller drop size. Table 7 lists results of average drop sizes measured using this technique. Among different cutting fluids, the average diameter of in-flight droplets is approximately 1 μm for the CL2210EP lubricant, but it can be as large as 9 μm for other fluids.

Table 7. Properties of Selected Lubricants

Lubricant	2210EP	2210	2200	2300HD
Surface tension (mN/m)	26	29	34	34
Droplet diameter (μm)	0.97	2.3	6.7	8.4
Viscosity (Pa-s) @270s ⁻¹ shear rate	0.016	0.014	0.023	0.061
Contact angle on 316L (°)	7	14	10	18
Contact angle on WC (°)	7	7	10	12

Example 11, Drop Size Calculation: Set the Unist system at 32 strokes/min, 3.6 mm stroke length, 3.78 bar pressure. Collect droplets of CL2100EP and measure with a toolmaker's microscope.

The average projected drop size is 2 μm and average drop height is 0.3 μm . The drop volume is calculated using Equation (13) to be

$$V = \frac{\pi h^2}{2} \left(\frac{h}{3} + \frac{P^2}{4h} \right) = \frac{\pi (0.3 \mu\text{m})^2}{2} \left(\frac{0.3 \mu\text{m}}{3} + \frac{(2 \mu\text{m})^2}{4 \times 0.3 \mu\text{m}} \right) = 0.49 \mu\text{m}^3$$

Using Equation (14), the average air-borne diameter of a droplet is

$$D = \left(\frac{6V}{\pi} \right)^{1/3} = \left(\frac{6 \times 0.49 \mu\text{m}^3}{\pi} \right)^{1/3} = 0.97 \mu\text{m}$$

The following practical guides will assist in obtaining reliable results using the slide technique.

- The solid surface (glass plate, workpiece, or cutting tool) should be as smooth as possible, flat and polished, clean and positioned horizontally. Any surface defect such as machining marks or burrs will distort the droplet profile.
- The solid must be cleaned thoroughly before testing to avoid contamination of the tested liquid and distorted data. Ultrasonic cleaning in alcohol or degreaser following by dry air blowing should be adequate.
- For meaningful information, about 10-20 droplets should be measured. Ignore very large drops that are coalesced from smaller droplets, and very small satellite drops that are splashed off upon impact of a droplet on the glass plate.
- A measurement should be as quick as possible, using minimum light since a tiny liquid droplet might evaporate or spread when heated in bright light.

Contact Angle Measurement.—Droplet volume is calculated in the previous section by the sessile drop technique, and the same volume can be used for calculating the droplet contact angle. Alternatively, a predetermined droplet volume can be set and dispensed on a solid surface using a micropipette. The contact angle of a sessile droplet on a flat surface can be computed from the following equation:

$$\frac{P}{V^{1/3}} = \left[\frac{24 (1 - K \cos^2 \theta)^{3/2}}{\pi (2 - 3 \cos \theta + \cos^3 \theta)} \right]^{1/3} \quad (15)$$

where P = projected droplet diameter (mm, in)

V = droplet volume (mm³, in³)

θ = contact angle (°)

$K = 0$ for θ between 90° and 180°, $K = 1$ for θ between 0° and 90°

The ratio P over $V^{1/3}$ is called the *normalized diameter* of the droplet. Using the normalized diameter, the contact angle can be calculated using Equation (15), by looking up the value in a table (Table 8), or read from a graph (Figs. 22a and 22b).

Fig. 21 shows the top view of some liquid droplets on stainless steel sheets from which contact angles are calculated and plotted for comparison. The cutting fluids are chosen from different commercially available oil-based lubricants: CL2200, CL2210, CL2210EP, and CL2300HD. Other coolants were also included for comparison: water, KM, and water-soluble coolants RL1:15, BC1:5, and CL1:30. The nomenclature x:y indicates dilution ratio of concentrated coolant in water for the water soluble fluids.

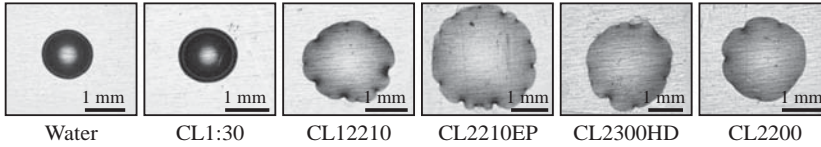


Fig. 21. Wetting of Different Cutting Fluids on 316L Stainless Steel. Constant Drop Volume = 0.25 μ L.

Table 7 and Fig. 23 compare contact angles of these cutting fluids on different solids. The oil-based CL2210EP lubricant forms the lowest contact angle of 7° on 316L stainless steel, uncoated carbide, and titanium. This is in contrast to 60-70° from other water-based fluids. Surface tension of the CL2210EP lubricant is 26 mN/m, the lowest among others, thus it easily wets a carbide microtool and workpiece surfaces during machining.

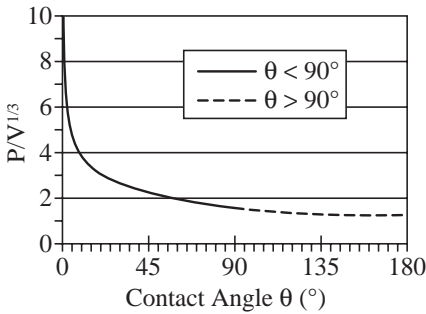


Fig. 22a. Plot of contact angle vs. normalized diameter for all angles.

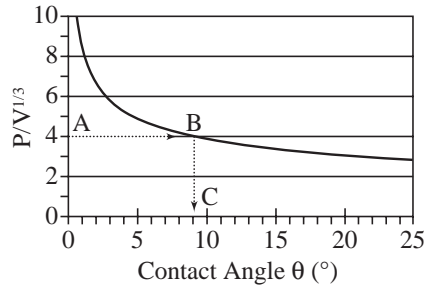


Fig. 22b. Plot of contact angle vs. normalized diameter for small angles.

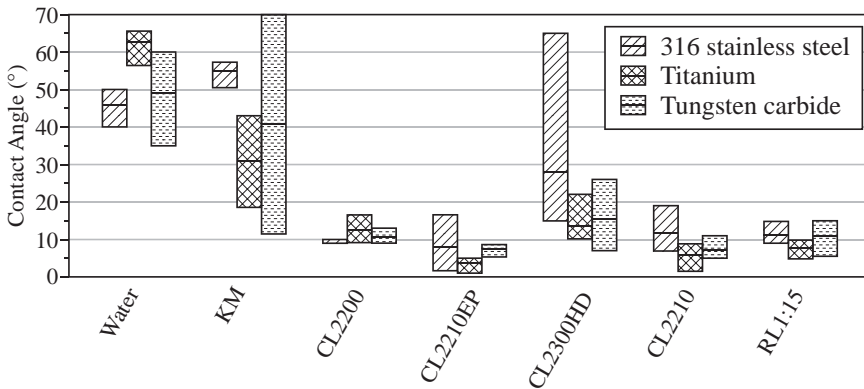


Fig. 23. Average and range of contact angles for different cutting fluids on 316L stainless steel, tungsten carbide, and titanium.

Table 8. Contact Angle (θ°) of Micromist Droplets for Practical Tests

Drop Size, P		Drop Volume, V (μL)																				
mm	inch	0.10	0.11	0.12	0.13	0.14	0.15	0.16	0.17	0.18	0.19	0.20	0.21	0.22	0.23	0.24	0.25	0.26	0.27	0.28	0.29	0.30
1.00	0.039	51	54	58	61	64	67	70	73	75	77	79	81	83	85	87	88	90	91	93	94	95
1.10	0.043	40	44	47	50	53	55	58	61	63	65	67	69	71	73	75	77	78	80	81	83	84
1.20	0.047	32	35	38	40	43	45	48	50	52	54	57	59	60	62	64	66	67	69	71	72	73
1.30	0.051	26	28	30	33	35	37	39	41	43	45	47	49	51	53	54	56	57	59	60	62	63
1.40	0.055	21	23	25	27	29	30	32	34	36	38	39	41	42	44	46	47	49	50	51	53	54
1.50	0.059	17	19	20	22	24	25	27	28	30	31	33	34	36	37	38	40	41	42	44	45	46
1.60	0.063	14	15	17	18	20	21	22	24	25	26	27	29	30	31	32	34	35	36	37	38	39
1.70	0.067	12	13	14	15	16	18	19	20	21	22	23	24	25	26	27	28	30	21	32	33	34
1.80	0.071	10	11	12	13	14	15	16	17	18	19	20	21	21	22	23	24	25	26	27	28	29
1.90	0.075	8.5	9.3	10	11	12	13	13	14	15	16	17	18	18	19	20	21	22	22	23	24	25
2.00	0.079	7.3	8.0	8.7	9.4	10	11	12	12	13	14	14	15	16	17	17	18	19	19	20	21	21
2.10	0.083	6.3	6.9	7.5	8.2	8.8	9.4	10	11	11	12	13	13	14	14	15	16	16	17	17	18	19
2.20	0.087	5.5	6.0	6.6	7.1	7.7	8.2	8.7	9.3	10	10	11	11	12	13	13	14	14	15	15	16	16
2.30	0.091	4.8	5.3	5.7	6.2	6.7	7.2	7.7	8.1	8.6	9.1	10	10	10	11	11	12	12	13	13	14	14
2.40	0.094	4.2	4.6	5.1	5.5	5.9	6.3	6.7	7.2	7.6	8.0	8.4	8.8	9.2	10	10	10	11	11	12	12	13
2.50	0.098	3.7	4.1	4.5	4.8	5.2	5.6	6.0	6.3	6.7	7.1	7.4	7.8	8.2	8.6	8.9	9.3	10	10	10	11	11
2.60	0.102	3.3	3.7	4.0	4.3	4.6	5.0	5.3	5.6	6.0	6.3	6.6	7.0	7.3	7.6	7.9	8.3	8.6	8.9	9.3	10	10
2.70	0.106	3.0	3.3	3.6	3.9	4.1	4.4	4.7	5.0	5.3	5.6	5.9	6.2	6.5	6.8	7.1	7.4	7.7	8.0	8.3	8.6	8.9
2.80	0.110	2.7	2.9	3.2	3.5	3.7	4.0	4.2	4.5	4.8	5.0	5.3	5.6	5.8	6.1	6.4	6.6	6.9	7.2	7.4	7.7	8.0
2.90	0.114	2.4	2.6	2.9	3.1	3.3	3.6	3.8	4.1	4.3	4.5	4.8	5.0	5.3	5.5	5.7	6.0	6.2	6.4	6.7	6.9	7.2
3.00	0.118	2.2	2.4	2.6	2.8	3.0	3.2	3.5	3.7	3.9	4.1	4.3	4.5	4.7	5.0	5.2	5.4	5.6	5.8	6.0	6.3	6.5

Example 12, Contact Angle Measurement: Set volume $V = 0.25 \mu\text{L}$ on a micropipette and then dispense several droplets of CL2100EP on a clean titanium plate. The average size of the droplets, measured on a toolmaker's microscope, is $P = 2.520 \text{ mm}$. To find wetting capability of this coolant on titanium, it is necessary to calculate its contact angle.

Graphical Solution: Using $1 \mu\text{L} = 10^{-6} \text{ L} = 1 \text{ mm}^3$, the normalized diameter is

$$\frac{P}{V^{1/3}} = \frac{2.520 \text{ mm}}{(0.25 \text{ mm}^3)^{1/3}} = 4.0$$

Starting at point A = 4.0 on the vertical Normalized Diameter ($P/V^{1/3}$) axis of Fig. 22b, draw a horizontal line until it intersects with the curve at B.

Draw a vertical line from point B until it intersects with the Contact Angle axis at C. Read the contact angle $\sim 9^\circ$ for this oil and titanium.

Table Look-up Solution: Locate drop volume of $0.25 \mu\text{L}$ on the first row of Table 8.

Locate projected drop size of 2.52 mm on the first column. Since 2.52 mm is not available, choose the closest number, 2.50 mm .

Read the contact angle from the intersection of row and column as 9.3°

Example 13, Contact Angle Measurement (continued from Example 11): In Example 11, droplets of CL2100EP were collected on a glass plate, the average projected drop size $P = 2 \mu\text{m}$ was measured, and the average drop volume was calculated to be $V = 0.49 \mu\text{m}^3$. The information obtained can be used to calculate contact angle.

a) The normalized diameter is

$$\frac{P}{V^{1/3}} = \frac{2 \mu\text{m}}{(0.49 \mu\text{m}^3)^{1/3}} = 2.53$$

b) Use Fig. 22b with normalized diameter of 2.53, and read the contact angle of $\sim 18^\circ$.

The same cutting fluid CL2100EP forms different contact angles of 18° on glass and 9° on titanium. This is due to the different surface energies of glass and titanium.

Dynamics of Microdroplets.—Several models are derived to study the dynamics of a microdroplet when it approaches a fast rotating tool. To effectively wet and lubricate a rotating tool, a microdroplet must (i) have enough momentum to penetrate the boundary layer around a fast rotating tool to reach the tool surface, and then (ii) adhere and wet the tool surface despite centrifugal force acting on the microdroplet.

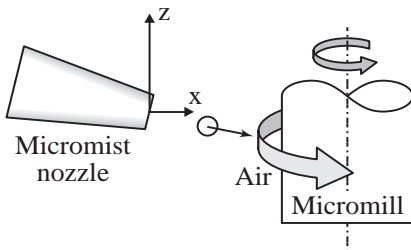


Fig. 24a. Propelling of microdroplets toward a rotating tool.

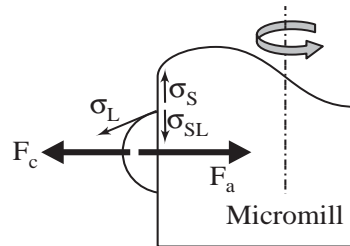


Fig. 24b. Force balancing of a microdroplet on the rotating tool.

Propelling Microdroplets Toward a Rotating Tool: The coordinates of a microdroplet after leaving a nozzle and moving toward a rotating tool can be expressed as

$$x_{pn} = V_f t + \frac{\alpha}{m} (V_0 \cos \beta - V_f) (1 - e^{-\alpha t/m}) \tag{16}$$

$$y_{pn} = \frac{\alpha}{m} V_0 \sin \beta (1 - e^{-\alpha t/m}) \tag{17}$$

where x_{pn} , y_{pn} = coordinates of a microdroplet from the nozzle

$$\alpha = 3\mu D$$

D , m = diameter and mass of a droplet

t = time

V_f = velocity of boundary air layer

V_0 = velocity of a microdroplet when leaving the mist nozzle

μ = viscosity

β = angle between microdroplet velocity and the x-axis

The distance y_{pn} away from a nozzle will reach a steady state value $(\alpha/m)V_0\sin\beta$ after a long time ($t \rightarrow \infty$). This means if a tool and nozzle distance is closer than this steady state value, then the microdroplets will reach the tool surface.

Force Balancing of Microdroplets on a Rotating Tool: After reaching the tool surface, a microdroplet on a rotating tool is subject to adhesion force along lubricant/solid interface and centrifugal force. The work of adhesion is given by Young-Dupre equation:

$$W_a = \sigma_S + \sigma_L - \sigma_{SL} = (1 + \cos\theta)\sigma_L \quad (18a)$$

where σ_L = surface tension of lubricant/air

σ_S = surface tension of solid/air

σ_{SL} = surface tension of solid/lubricant

W_a = work of adhesion between solid/lubricant

θ = contact angle

If the adhesion force from surface tension is greater than centrifugal force, then the microdroplet will adhere and spread on the tool surface. Otherwise, the droplet will be separated from the rotating tool due to a higher centrifugal force. The condition for a microdroplet to adhere to the rotating cutting tool is given in Equation (18b) and plotted with tool surface speed and microdroplet size as two independent variables.

$$\frac{2m(V_c)^2}{D_t} \leq P(1 + \cos\theta)\sigma_L \quad (18b)$$

where σ_L = surface tension of lubricant/air (N/m)

θ = contact angle ($^\circ$)

m = mass of microdroplet (kg)

V_c = cutting tool surface speed (m/s)

P = projected drop size (m)

D_t = tool diameter (m)

The plot in Fig. 25 is for CL2210EP lubricant and uncoated carbide tool with $\varnothing 1$ mm flute diameter. The curve divides the plot into two regions: the upper region where adhesion is dominating, and the lower region where centrifugal force is stronger, i.e., a microdroplet is propelled radially away and does not wet the tool. With the droplet size of 1-10 μm for all lubricants in this study, the adhesion force is dominating and a microdroplet should adhere to the rotating tool at any rotating speed of the tested machine (0-50,000 rpm or 0-150 m/min for a $\varnothing 1$ mm tool). Wetting of CL2210EP microdroplets on carbide tools was also experimentally verified.

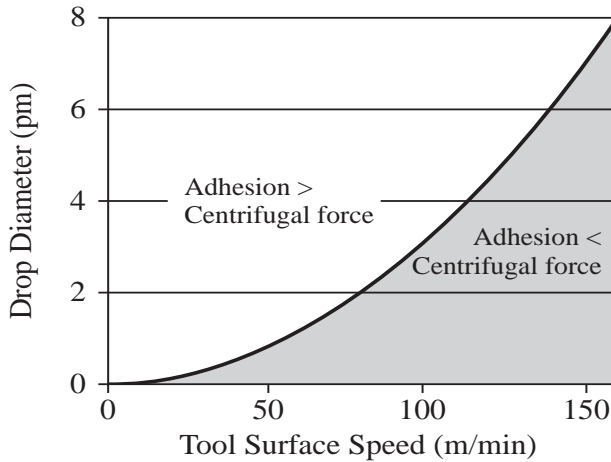


Fig. 25. Adhesion threshold of microdroplets on a rotating tool. CL2210EP lubricant, Ø1 mm uncoated carbide tool at different speeds. Note: 1pm = 1 picometer = 10^{-12} meter.

Simulation using computational fluid dynamics is used to study the 2D flow of microdroplets near a rotating cutting tool. Fig. 26a shows the velocity field of microdroplets moving from left to right and around a counter-clockwise rotating cylinder. A stagnant location with zero microdroplet speed is found near the top of the cylinder (cutting tool). When micromilling in MQL condition, a workpiece should not be positioned at such stagnant location since it would receive no lubrication. Practical setups are suggested in Fig. 26b.

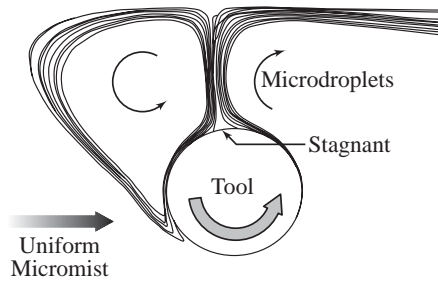


Fig. 26a. Computational fluid dynamic simulation of microdroplet dynamics.

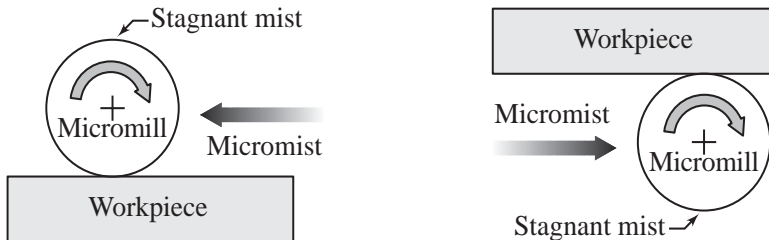


Fig. 26b. Practical machining setups of tool and workpiece to avoid stagnant zone.

Case Studies.—Many researchers have applied micromist in their micro and macro machining studies. An example of each is given in this section.

Use of Micromist in Micromilling of 316L Stainless Steel: Micromilling using Ø1 mm WC tool, 10 µm/tooth chip load, 0.348 mm axial depth, 0.558 mm radial depth were performed on 316L stainless steel with different coolants. Using the cumulative tool life models (see *Tool Life* on page 1102), tool life of micromilling tools are plotted and compared in Fig. 27. Large scattering of data and low machinability is observed when dry micromilling

of 316L stainless steel. The machinability improves with flood cooling, spray mist, and micromist respectively. Fig. 27 shows the data points start at lower left corner for dry machining then shift to the upper right corner of the graph for micromilling in MQL, i.e., a tool can be used at higher speed for longer time to reach the same flank wear of $50\mu\text{m}$. Scanning electron microscopy examination indicates significant built-up edges and attrition failure of dry cutting tools (Fig. 28a). In contrast, a well-defined abrasive tool wear is observed on a long lasting tool after micromilling with spray mist or in MQL conditions (Fig. 28b). Micromilling in MQL condition using CL2210EP extends tool life significantly over dry machining of 316L stainless steel.

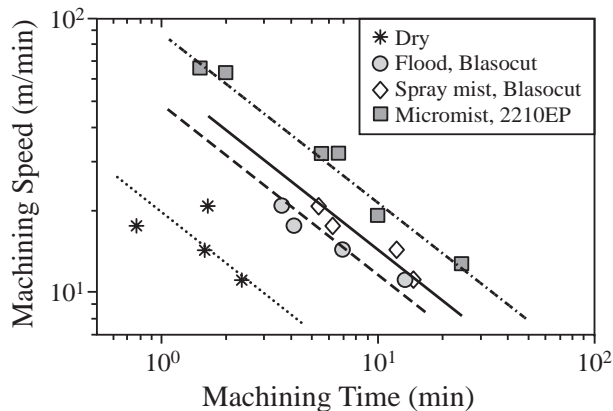


Fig. 27. Effect of cutting fluid conditions on micromilling of 316L stainless steel. $10\mu\text{m}$ /tooth chip load, 0.348 mm axial depth, 0.558 mm radial depth, $\text{Ø}1\text{ mm}$ uncoated carbide tool.

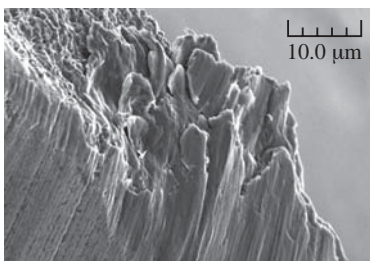


Fig. 28a. Built-up edge (lower right) and adhesion wear (upper left) on a carbide tool. (dry cutting, 1.4 min @ 18 m/min)

Micromill $\text{Ø}1\text{ mm}$, $10\mu\text{m}$ /tooth chip load, 0.348 mm axial depth, 0.558 mm radial depth.

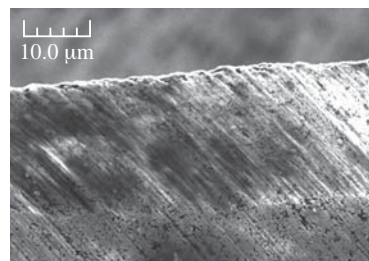


Fig. 28b. Uniform abrasive flank wear on a carbide tool. (micromist, 21.7 min @ 15 m/min)

Use of Micromist in Macrofacings of 4140 Steel: Bars of 4140 steel, 2 inch (50 mm) diameter, 6 inch (150 mm) long were faced at 54 m/min (177 ft/min) maximum surface cutting speed, 0.1 mm/rev feed (0.004 in/rev), and 0.5 mm (0.020 in.) depth of cut. Uncoated carbide inserts TNG431 were used in the study. The operation was in dry condition, flood with Rustlick 1:15 water soluble water-based coolant, and CL2210EP oil micromist. Periodic interruption of the operation was made to remove a tool for wear assessment on a toolmaker's microscope. Fig. 29 plots flank wear of all tools and Figs. 30a, 30b, and 30c compare the tool tip conditions after 75 passes. At identical machining conditions, crater, flank and nose wear are worst for dry machining. Flood cooling improves the tool wear but nose wear is still substantial. Micromist provides the best tool protection with reduced flank and crater wear, and negligible nose wear.

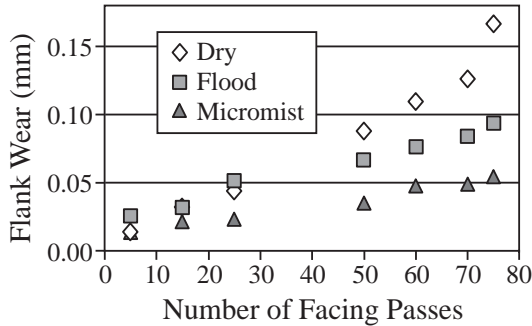


Fig. 29. Flank wear of uncoated carbide tools in different cutting fluids. Macrofacing of 4140 steel, 54 m/min, 0.1 mm/rev feed, 0.5 mm depth of cut.

Comparison of Tool Wear After 75 Facing Passes

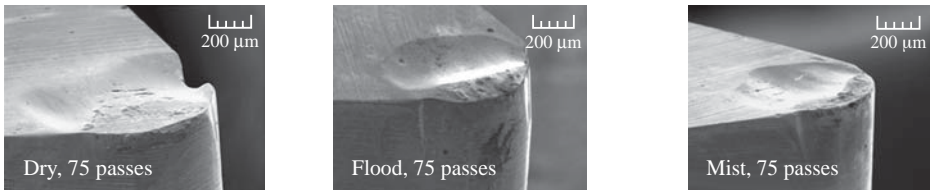


Fig. 30a. Dry machining. Fig. 30b. Rustlick 1:15 flood cooling. Fig. 30c. CL2210EP micromist.

There is negligible nose wear for machining in micromist.

Macrofacing on 4140 steel, 54 m/min, 0.1 mm/rev feed, 0.5 mm depth of cut.

Microfabrication Processes and Parameters

This section discusses three major microfabrication processes: micromilling, microdrilling, and microturning. Setup, tooling, and process parameters for common engineering materials are then recommended.

Micromilling.—Micromilling is among the most versatile of microfabrication processes. Although alternative nontraditional processes to produce microfeatures such as laser micromachining, electrical discharge micromachining, electrochemical micromachining, chemical microetching, electron/ion beam micromachining are available, these processes are either cost prohibitive, or inferior when comparing resulting surface and subsurface integrity, anisotropic aspect ratio or feature quality. Successful micromilling requires new tool geometry, tool material, machining parameters, and machining skills. It is technically incorrect and costly to perform micromilling by just scaling down a milling cutter, or parameters from macroscale milling. Commercial micromills are available for diameters of 25 μm (0.001 inch) and up, see [Table 9](#).

- Tool material. Carbide tools should be sintered from fine grains, and ground to small cutting edge radius (see [Microcutting Tools](#) on page 1093).
- Milling direction. Down milling is the preferred mode since a micromill will engage a workpiece and remove a wedge shape chip with decreasing chip thickness. In contrast, a tool in upmilling would rub on the workpiece until the effective chip thickness is greater than one-half of the cutting edge radius (see [Tool Sharpness](#) on page 1094).
- Lubrication. Micromist should be used with all micromachining, but adequate ventilation and filtering are required to avoid inhaling of micromist. The nozzle should be as close as possible to the work and positioned to let the cutting flutes pull the mist into the cutting zone. Tool and workpiece should be arranged to avoid the stagnant zone (see [Figs. 26a, 26b, 31a, and 31b](#)).
- Tool vibration. Avoid unnecessary disengaging then engaging of microtool and workpiece in a milling program when programming the tool path. Vibration and bending

of a microtool when starting and ending a cut could fatigue and shorten the tool life of the microtool (Fig. 32).

Positioning of a Micromist Nozzle in Micromilling

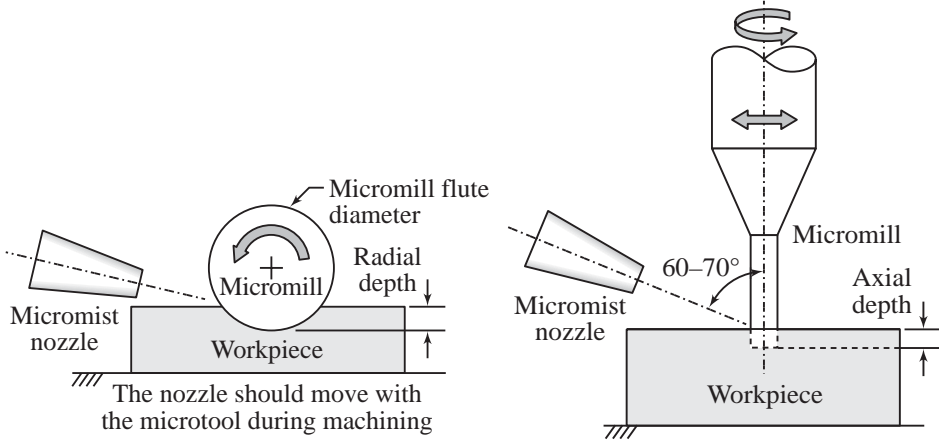


Fig. 31a. Top view.

Fig. 31b. Side view.

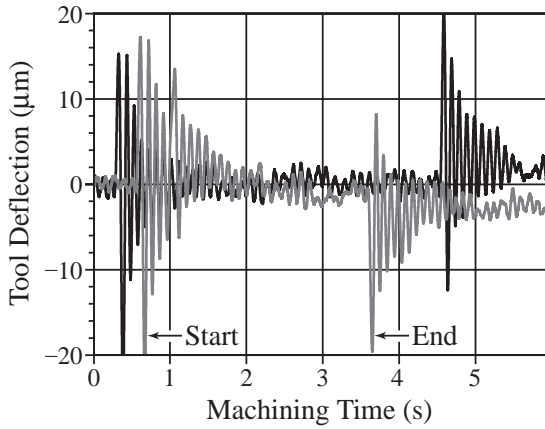


Fig. 32. Vibration of a micromill when engaging and disengaging a workpiece. Carbide mill Ø1 mm (Ø0.040 inch), 316L stainless steel, 25000 rpm, 10µm/tooth feed, 0.348 mm axial depth, 0.558mm radial depth.

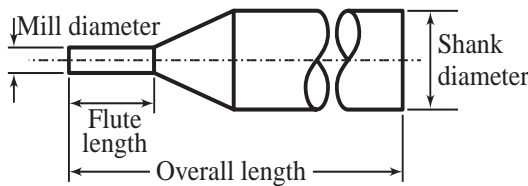


Fig. 33. Micromill nomenclature.

Table 9. Commercial Micromills
(A stub flute length is about half of standard flute length)

Mill diameter		Stub flute length		Standard flute length		Overall length		Shank diameter	
(mm)	(inch)	(mm)	(inch)	(mm)	(inch)	(mm)	(inch)	(mm)	(inch)
0.025	0.0010	0.051	0.002	0.076	0.003	38.1	1.5	3.175	0.125
0.051	0.0020	0.076	0.003	0.152	0.006	38.1	1.5	3.175	0.125
0.076	0.0030	0.127	0.005	0.229	0.009	38.1	1.5	3.175	0.125
0.102	0.0040	0.152	0.006	0.305	0.012	38.1	1.5	3.175	0.125
0.127	0.0050	0.203	0.008	0.381	0.015	38.1	1.5	3.175	0.125
0.152	0.0060	0.254	0.010	0.457	0.018	38.1	1.5	3.175	0.125
0.178	0.0070	0.279	0.011	0.533	0.021	38.1	1.5	3.175	0.125
0.203	0.0080	0.305	0.012	0.610	0.024	38.1	1.5	3.175	0.125
0.229	0.0090	0.356	0.014	0.686	0.027	38.1	1.5	3.175	0.125
0.254	0.0100	0.381	0.015	0.762	0.030	38.1	1.5	3.175	0.125
0.279	0.0110	0.432	0.017	0.838	0.033	38.1	1.5	3.175	0.125
0.305	0.0120	0.457	0.018	0.914	0.036	38.1	1.5	3.175	0.125
0.330	0.0130	0.508	0.020	0.991	0.039	38.1	1.5	3.175	0.125
0.356	0.0140	0.533	0.021	1.067	0.042	38.1	1.5	3.175	0.125
0.381	0.0150	0.584	0.023	1.143	0.045	38.1	1.5	3.175	0.125
0.406	0.0160	0.610	0.024	1.219	0.048	38.1	1.5	3.175	0.125
0.432	0.0170	0.660	0.026	1.295	0.051	38.1	1.5	3.175	0.125
0.457	0.0180	0.686	0.027	1.372	0.054	38.1	1.5	3.175	0.125
0.483	0.0190	0.737	0.029	1.448	0.057	38.1	1.5	3.175	0.125
0.508	0.0200	0.762	0.030	1.524	0.060	38.1	1.5	3.175	0.125
0.533	0.0210	0.813	0.032	1.600	0.063	38.1	1.5	3.175	0.125
0.559	0.0220	0.838	0.033	1.676	0.066	38.1	1.5	3.175	0.125
0.584	0.0230	0.889	0.035	1.753	0.069	38.1	1.5	3.175	0.125
0.610	0.0240	0.914	0.036	1.829	0.072	38.1	1.5	3.175	0.125
0.635	0.0250	0.965	0.038	1.905	0.075	38.1	1.5	3.175	0.125
0.660	0.0260	0.991	0.039	1.981	0.078	38.1	1.5	3.175	0.125
0.686	0.0270	1.041	0.041	2.057	0.081	38.1	1.5	3.175	0.125
0.711	0.0280	1.067	0.042	2.134	0.084	38.1	1.5	3.175	0.125
0.737	0.0290	1.118	0.044	2.210	0.087	38.1	1.5	3.175	0.125
0.762	0.0300	1.143	0.045	2.286	0.090	38.1	1.5	3.175	0.125
0.792	0.0312	1.194	0.047	2.388	0.094	38.1	1.5	3.175	0.125
0.889	0.0350	1.346	0.053	2.667	0.105	38.1	1.5	3.175	0.125
1.016	0.0400	1.524	0.060	3.048	0.120	38.1	1.5	3.175	0.125
1.143	0.0450	1.727	0.068	3.429	0.135	38.1	1.5	3.175	0.125
1.194	0.0470	1.803	0.071	3.581	0.141	38.1	1.5	3.175	0.125
1.270	0.0500	1.905	0.075	3.810	0.150	38.1	1.5	3.175	0.125
1.397	0.0550	2.108	0.083	4.191	0.165	38.1	1.5	3.175	0.125
1.524	0.0600	2.286	0.090	4.572	0.180	38.1	1.5	3.175	0.125

Optional geometries include: Flute lengths: stub, standard, or optional extended length (10-80% longer); Number of flutes: 2, 3, or 4; Helix angles: 25°, 30°, 50°; End configuration: hemisphere, flat; Units: metric and US customary.

Microdrilling.—Microdrilling is a more complex operation compared to turning or milling. Chip removal and effective supply of cutting fluid is easy with the latter, but not with microdrilling due to extremely limited space around a microdrill.

- Tool material. As with a micromill, a carbide microdrill should be sintered from fine grains, and ground to small cutting edge radius (*Tool Sharpness* on page 1094).
- Hole quality. Spindle runout, tool eccentricity, and wandering of a microdrill causes cyclic bending of the tool that leads to catastrophic failure. To control drill wandering, precision pre-drilling of a center hole can be tried, or the drilled surface must be ground to minimize deflection of a slender drill when starting on an irregular surface.
- High aspect ratio. Pecking is essential for microhole drilling since chips have to be extracted and cutting fluid must penetrate into a small and deep microhole. The pecking depth can be deep in the beginning, but it must be reduced when drilling deeper. Start with an initial pecking depth of $2 \times$ drill diameter and gradually reduce it to $0.5 \times$ diameter at a depth of $10 \times$ diameter. Pecking depth and cycles can be calculated from:

$$\frac{P}{D} = \frac{1}{9}(-1.5R + 19.5) \quad \text{for } R \leq 10$$

$$\frac{P}{D} = 0.5 \quad \text{for } R > 10$$
(19)

P = incremental pecking depth (mm, in)
 D = drill diameter (mm, in)
 R = drill aspect ratio = hole depth / drill diameter

See **Example 14** for more on the the use of **Equation (19)**.

- Apply micromist with a fixed nozzle pointing to the drill tip; making an angle of $60\text{--}70^\circ$ with the tool axis is recommended (**Fig. 34**). In this way, the chip is blown away after a pecking cycle and the microdrill is re-lubricated before re-entering into the hole. Adequate ventilation and filtering are required to avoid inhaling of micromist.

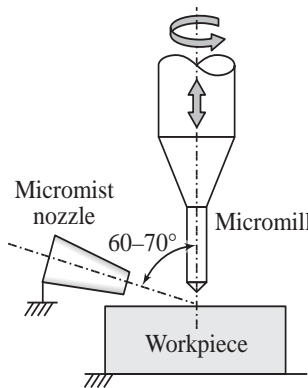


Fig. 34. Positioning of a micromist nozzle in microdrilling. The nozzle and workpiece should be stationary.

Commercial microdrills are available for drill diameters of $100 \mu\text{m}$ (0.004 inch) and above (**Table 10**).

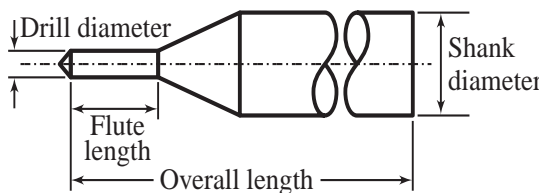


Fig. 35. Microdrill Nomenclature.

Table 10. Commercial Microdrills

Drill diameter		Standard flute length		Extended flute length		Overall length		Shank diameter	
(mm)	(inch)	(mm)	(inch)	(mm)	(inch)	(mm)	(inch)	(mm)	(inch)
0.102	0.0040	1.016	0.040	1.778	0.070	38.1	1.5	3.175	0.125
0.127	0.0050	1.524	0.060	2.286	0.090	38.1	1.5	3.175	0.125
0.150	0.0059	2.032	0.080	3.048	0.120	38.1	1.5	3.175	0.125
0.160	0.0063	2.032	0.080	3.048	0.120	38.1	1.5	3.175	0.125
0.170	0.0067	2.032	0.080	3.048	0.120	38.1	1.5	3.175	0.125
0.180	0.0071	2.540	0.100	3.810	0.150	38.1	1.5	3.175	0.125
0.191	0.0075	2.540	0.100	3.810	0.150	38.1	1.5	3.175	0.125
0.201	0.0079	2.540	0.100	3.810	0.150	38.1	1.5	3.175	0.125
0.211	0.0083	2.540	0.100	3.810	0.150	38.1	1.5	3.175	0.125
0.221	0.0087	2.540	0.100	3.810	0.150	38.1	1.5	3.175	0.125
0.231	0.0091	3.810	0.150	5.588	0.220	38.1	1.5	3.175	0.125
0.241	0.0095	3.810	0.150	5.588	0.220	38.1	1.5	3.175	0.125
0.249	0.0098	3.810	0.150	5.588	0.220	38.1	1.5	3.175	0.125
0.254	0.0100	3.810	0.150	5.588	0.220	38.1	1.5	3.175	0.125
0.267	0.0105	3.810	0.150	5.588	0.220	38.1	1.5	3.175	0.125
0.279	0.0110	3.810	0.150	5.588	0.220	38.1	1.5	3.175	0.125
0.292	0.0115	3.810	0.150	5.588	0.220	38.1	1.5	3.175	0.125
0.300	0.0118	5.715	0.225	7.112	0.280	38.1	1.5	3.175	0.125
0.305	0.0120	5.715	0.225	7.112	0.280	38.1	1.5	3.175	0.125
0.318	0.0125	5.715	0.225	7.112	0.280	38.1	1.5	3.175	0.125
0.330	0.0130	5.715	0.225	7.112	0.280	38.1	1.5	3.175	0.125
0.343	0.0135	5.715	0.225	7.112	0.280	38.1	1.5	3.175	0.125
0.351	0.0138	5.715	0.225	7.112	0.280	38.1	1.5	3.175	0.125
0.368	0.0145	5.715	0.225	7.112	0.280	38.1	1.5	3.175	0.125
0.396	0.0156	6.350	0.250	7.112	0.280	38.1	1.5	3.175	0.125
0.399	0.0157	6.350	0.250	7.493	0.295	38.1	1.5	3.175	0.125
0.406	0.0160	6.350	0.250	7.493	0.295	38.1	1.5	3.175	0.125
0.450	0.0177	6.350	0.250	7.493	0.295	38.1	1.5	3.175	0.125
0.457	0.0180	6.350	0.250	7.493	0.295	38.1	1.5	3.175	0.125
0.500	0.0197	6.604	0.260	7.874	0.310	38.1	1.5	3.175	0.125
0.508	0.0200	6.604	0.260	7.874	0.310	38.1	1.5	3.175	0.125

Optional geometries include: Flute lengths: standard or extended length (10-80% longer); Number of flutes: 2, 3, or 4; Included angles: 118°, 130°; Helix angles: 25°, 30°, 50°; Units: metric and US customary.

Example 14: Select a microdrill and pecking cycles to drill Ø0.005 inch holes to 0.050 inch depth in titanium.

From **Table 10**, select the Ø0.005 inch drill with the 0.060 inch standard length. A drill with extended length of 0.090 inch is unnecessary because the extra length would decrease the drill stiffness by about 56% (see **Example 2**). Use micromist to lubricate the drill and blow the extracted chips away. The pecking cycle in **Table 11** is recommended.

During the first pecking cycle, drill to 0.0100 inch depth then withdraw the tool. For the second pecking cycle, the incremental pecking depth P of 0.0092 inch is calculated from **Equation (19)**. During the 2nd pecking cycle, the drill travels to a depth of 0.0192 inch, withdraws to remove chips, then continues down for pecking cycle #3. The incremental pecking in cycle #7 should be increased by 0.0003 inch so that the pecking cycle #8 will drill the hole to the required depth of 0.0500 inch.

Table 11. Pecking Cycle, Drill Dia. $D = 0.005$ inch

Pecking cycle #	Hole depth (inch)	Aspect ratio	P/D	Pecking depth, P (inch)
1	0.0100	2.00	1.83	0.0092
2	0.0192	3.83	1.53	0.0076
3	0.0268	5.36	1.27	0.0064
4	0.0332	6.63	1.06	0.0053
5	0.0385	7.70	0.88	0.0044
6	0.0429	8.58	0.74	0.0037
7	0.0466	9.32	0.61	0.0031
8	0.0497	9.93	0.51	0.0026
9	0.0522	10.44	0.43	0.0021

Microturning.—Product miniaturization and the demand for ultraprecision products drives the rapid development of micro/nano turning. This technology produces polished and high quality spherical and aspherical parts from metals, ceramics, semiconductors, and polymers that cannot be economically produced by traditional grinding, lapping, or polishing processes. Micro/nano turning also produces intricate shapes with low or no sub-surface damage because it operates in the ductile-regime mode (see *Ductile Regime Micro-machining* on page 1108).

Diamonds are commonly used for micro/nano turning. Polycrystalline diamond (PCD) tools are sintered from microsize diamond grains. PCD tools are less expensive but with limited capability due to large edge radius (few hundred nanometers) and lower edge strength due to attrition wear. Single crystalline diamond (SCD) tools are best for micro/nano turning because they:

- Have single crystalline structure that allows a sharp cutting edge as small as 10 nm,
- Have the highest thermal conductivity among all engineering materials,
- Retain high strength and hardness at high temperature,
- Have high elastic and shear moduli to resist plastic deformation, and
- Have a low coefficient of friction.

A diamond tool, however, is costly and brittle. A tool with zero or negative rake angle (i) improves its edge strength, and (ii) forms a hydrostatic compressive stress field in the material just in front of and below the tool, and therefore, minimizes crack initiation. Single crystal diamond typically have the (110) crystal plane as the rake face and are brazed onto a steel shanks of different shapes and sizes.

Not any material can be successfully micro/nano turned with a diamond tool. Ferrous alloys and silicon carbide (SiC) are not suitable for diamond turning because of diffusion from the highly concentrated carbon in the diamond tool to a lower concentration zone of carbon in the workpiece materials. Other materials, although machinable with diamond, should be homogeneous and contain few if no impurities. Any hard inclusions might either damage a sharp diamond edge or be sheared off and smear against the machined surface.

Fig. 36a shows hard beryllides in beryllium copper CA173 that plow and smear a mirror finish surface (Fig. 36b).

Table 12. Examples of Diamond Machinable Materials

Semiconductor	Metal	Ceramic	Plastics
Cadmium telluride	Aluminum alloys	Aluminum oxide	Acrylic
Gallium arsenide	Copper alloys	Zirconium oxide	Fluoroplastics
Germanium	Electroless nickel	Optical glasses	Nylon
Lithium niobate	Gold	Quartz	Polycarbonate
Silicon	Magnesium		Polymethylmethacrylate
Silicon nitride	Silver		Propylene
Zinc selenide	Zinc		Styrene
Zinc sulphide			

Micromist is required to lubricate and cool both the tool and the machined surface. The micromist nozzle should move with the tool while blowing the micro/nano chips away from the machined surface. Adequate ventilation and filtering of micromist are required to avoid environmental issues.

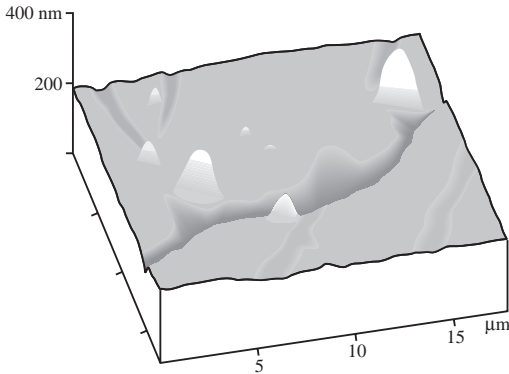


Fig. 36a. Beryllide particles at grain boundaries of diamond turned beryllium copper.

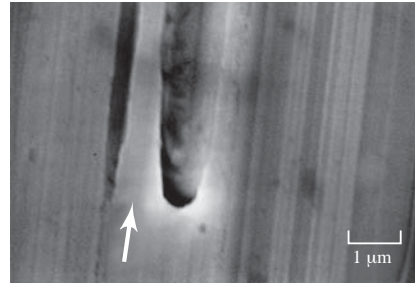


Fig. 36b. Deep scratch on machined surface caused by a broken beryllide. The arrow shows tool cutting direction.

Speeds and Feeds.—In macromachining of engineering materials, the material grains are very small compared to the cutting tool dimensions and edge radius. Only bulk material properties such as material strength, hardness, and thermal conductivity affect machining performance. However, when the workpiece grain size is similar to the tool edge radius then the workpiece material will have more influence on micromachining performance (see *Workpiece Materials* on page 1106). Since plastically deformed materials are normally harder than the original material, machining feed must be (i) deeper than this hardened layer, and (ii) at least half of the tool edge radius (see *Microcutting Tools* on page 1093).

Example 15, Work Hardening of Titanium Alloy: Micromachining Ti 6Al4V alloy with a carbide tool generates a work-hardening depth of about 1-2 μm (40-80 μinch). The microhardness increases 8-14% above the base material hardness to ~ 350 Vicker. Chip load for microdrilling or micromilling should be greater than this hardened zone depth.

Microturning Parameters: Criteria for selecting turning speed and feed are tool life and surface finish, and less concern on tool fracture since a turning tool is robust and rigid. Cutting speeds for single crystalline diamond are very high and depend mostly on the rigidity of the setup and the machine tool capability. Turning at 100-500 m/min (330-1650 ft/min) is common for most metals and metal matrix composites.

Selection of feed depends on the surface finish required, because this is the main objective for using diamond for turning in the ductile regime mode. Models for a macromachined surface finish have been proposed which assume:

- The depth of cut is less than tool nose radius but more than cutting edge radius,
- There is no built-up-edge on the tool, therefore, effect of cutting speed is negligible,
- Workpiece of polycrystalline material with fine grains is used and grain orientation does not significantly affect surface finish of large areas,
- Chips are completely removed without side-burr, and
- No error is introduced from imperfect machine kinematics (such as asynchronous spindle error motion).

The theoretical surface finish values are functions of feed and tool nose radius, and can be computed from [Equations \(20\) and \(21\)](#) and plotted as in [Figs. 37a and 37b](#).

$$R_t = R - \sqrt{R^2 - \frac{f^2}{4}} = R - R \sqrt{1 - \left(\frac{f}{2R}\right)^2} \cong 0.125 \frac{f^2}{R} \tag{20}$$

$$R_a = k(f, R) \frac{f^2}{R} \cong 0.031553 \frac{f^2}{R} \text{ for } \frac{f}{R} < 0.1 \tag{21}$$

where R_a = average surface finish (m, inch)
 R_t = peak-to-valley surface finish (m, inch)
 f = tool feed for each revolution (m, inch)
 R = tool nose radius (m, inch)

Example 16, Turning Parameter Selection: Select tool and parameters to achieve $R_a = 1 \mu\text{m}$ when turning 6061-T6 aluminum.

Solution: Use a single crystalline diamond tool with tool nose radius $R = 1 \text{ mm}$ (0.040 inch) and cutting edge radius of 80 nm (3 μin).

Depth of cut: Depth must be between the nose radius and edge radius, so choose 0.5 mm.

Cutting speed: Speed does not affect surface finish, so choose 303 m/min (1000 ft/min).

Feed: Referring to Fig. 37b, from point A ($R = 1 \text{ mm}$), draw a vertical line to intersect with $R_a = 1 \mu\text{m}$ curve at B. Draw a horizontal line at B and intersect vertical axis at C, and read the feed = 0.18 mm/rev (0.007 in/rev). Alternatively, Equation (21) can be rearranged and used to compute the feed distance for each revolution as follows:

$$f = \sqrt{\frac{R_a R}{0.031553}} = \sqrt{\frac{1 \mu\text{m} \times 1 \text{ mm}}{0.031553} \frac{1 \text{ mm}}{1000 \mu\text{m}}} = 0.178 \text{ mm}$$

Effect of Tool Nose Radius and Tool Feed on Surface Finish

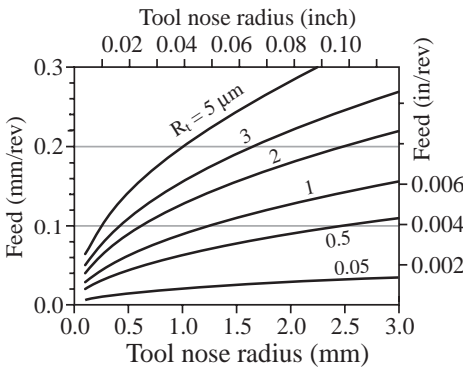


Fig. 37a. Peak-to-valley surface finish R_t .

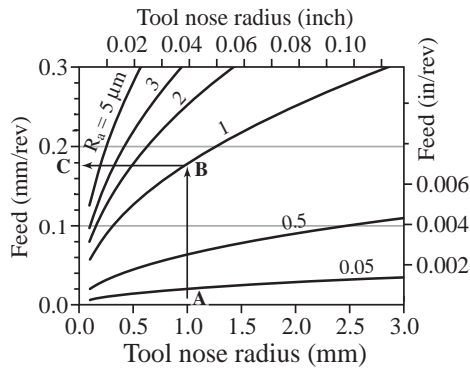


Fig. 37b. Average surface finish R_a .

Microdrilling/Milling Parameters: The combination of spindle runout and radial cutting force can deflect and break a tool. Finite element analysis (FEA) of a micromill shows that the critical area is the junction between the cylindrical flute and solid conical shank. Using 4.7 GPa and 93 GPa as the average values of measured flexural strength and elastic modulus of carbide, the analysis indicates that a $\text{Ø}1 \text{ mm}$ carbide micromill will break if deflected more than 34% of its diameter.

Fig. 38 shows crash-test and calculated data for catastrophic tool failure when micromilling 316L stainless steel. The radial depth of cut and chip load are normalized to the tool diameter for ease of comparison. The data points form a line that divides the plane into two regions: tool failure and tool safe areas. A tool will break if milling parameters are chosen to be above this threshold line. Therefore, all milling parameters should be conservatively selected below the threshold for a production run.

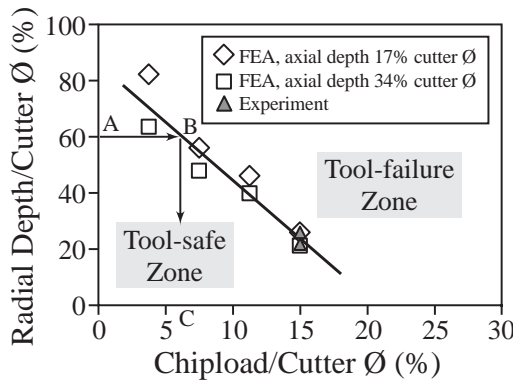


Fig. 38. Catastrophic failure threshold of micro-milling tools as percentage of tool diameter. Dry milling 316L stainless steel, Ø1 mm tool diameter, 2 flutes, 0.348 mm axial depth of cut.

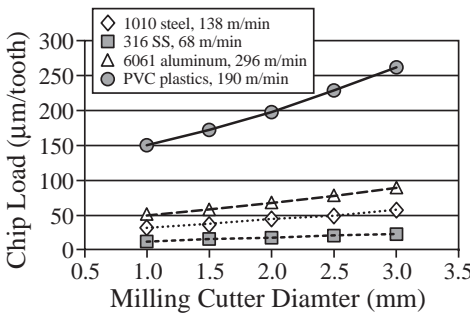


Fig. 39. Recommended chip load as a function of carbide cutter size for various materials.

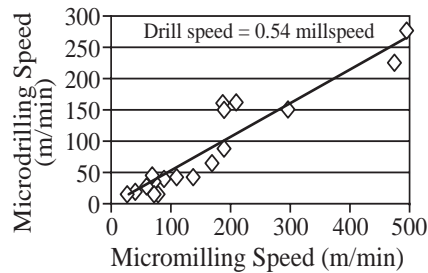


Fig. 40. Relationship of drilling vs. milling speed using carbide tools on different engineering materials.

Tables 13a and 13b tabulate starting speeds and feeds for uncoated micrograin carbide micromilling and microdrilling tools, in US customary and metric units respectively. Drilling speed is normally reduced to approximately 50% of the milling speed of the same material, due to the high aspect ratio and difficulty of chip evacuation in microdrilling (Fig. 40).

Example 17, Micromill and Microdrill Selection: Select parameters to micromill and micro-drill 316L stainless steel using an uncoated carbide Ø1 mm, 2 flute microtool.

Micromilling: Speed selection depends on tool life and cutting fluid. Table 13b suggests 68 m/min for micromilling. Both radial and axial depth of cut affect selection of feed. Select 35% axial depth ($0.35 \times \text{tool diameter} = 0.35 \text{ mm}$), and 60% radial depth ($0.60 \times \text{tool diameter} = 0.6 \text{ mm}$). From point A (60%) on the vertical axis of Fig. 38, draw a horizontal line that intersects the threshold line at point B, then find point C on the horizontal axis. The chip load that causes immediate tool fracture would be slightly more than 5% of tool diameter ($50 \mu\text{m/tooth}$). A conservative chip load would be $13 \mu\text{m/tooth}$ as indicated in Table 13b.

Microdrilling: Table 13b suggests 28 m/min speed and $13 \mu\text{m/tooth}$ feed for drilling. Reduction of drilling speed to only 50-60% (59% in this example) of milling speed is necessary to facilitate chip removal in microdrilling.

Table 13a. Speeds and Feeds for Micro Milling/Drilling with Uncoated Carbide Tools (US Customary Units)

Materials	Examples	Vicker micro-hardness	Mill speed (ft/min)	Drill speed (ft/min)	Chip load ($\mu\text{in}/\text{tooth}$), $D = \text{drill or mill diameter}$				
					$D < 0.04 \text{ in.}$	$D < 0.06 \text{ in.}$	$D < 0.08 \text{ in.}$	$D < 0.10 \text{ in.}$	$D < 0.12 \text{ in.}$
Steel	12L14	<120	558	213	1400	1700	2000	2300	2600
	1010	<265	453	141	1300	1500	1700	2000	2300
	4063	<208	361	141	1300	1500	1700	2000	2300
Stainless steel	409, 410, 446	<318	246	125	600	600	800	900	1000
	304, 316, 316L	<265	223	92	500	600	700	800	900
	17-7 PH	<318	230	148	400	450	600	700	900
Nickel	Pure nickel		197	92	500	600	700	800	900
	Monel 400		138	66	500	600	700	800	900
	Inconel 718		98	56	300	300	350	400	500
Titanium	Pure titanium		295	131	650	700	850	950	1100
	Cast titanium		266	52	650	700	850	950	1100
	Ti 6Al 4V		243	52	650	700	850	950	1100
Aluminum	1100		1624	902	1500	1700	1950	2250	2550
	A356		1558	738	2100	2350	2700	3150	3600
	6061		971	492	2100	2350	2700	3150	3600
Copper	C17200 (soft Be-Cu)		617	531	1299	1457	1693	1969	2244
	C85400 (annealed brass)		689	531	1772	2047	2362	2677	3071
	C95400 (Al bronze)		623	289	1457	1732	1969	2244	2598
Plastics	ABS, PVC thermoplastics		623	492	5900	6800	7800	9000	10300

Table 13b. Speeds and Feeds for Micro Milling/Drilling with Uncoated Carbide Tools (SI Metric Units)

Materials	Examples	Vicker micro-hardness	Mill speed (m/min)	Drill speed (m/min)	Chip load ($\mu\text{m}/\text{tooth}$), $D = \text{drill or mill diameter}$				
					$D < 1.0 \text{ mm}$	$D < 1.5 \text{ mm}$	$D < 2.0 \text{ mm}$	$D < 2.5 \text{ mm}$	$D < 3.0 \text{ mm}$
Steel	12L14	<120	170	65	38	43	50	57	65
	1010	<265	138	43	33	38	43	51	58
	4063	<208	110	43	33	38	43	51	58
Stainless steel	409, 410, 446	<318	75	38	15	15	20	23	25
	304, 316, 316L	<265	68	28	13	15	18	20	23
	17-7 PH	<318	70	45	10	11	15	18	23
Nickel	Pure nickel		60	28	13	15	18	20	23
	Monel 400		42	20	13	15	18	20	23
	Inconel 718		30	17	8	8	9	10	13
Titanium	Pure titanium		90	40	17	18	22	24	28
	Cast titanium		81	16	17	18	22	24	28
	Ti 6Al 4V		74	16	17	18	22	24	28
Aluminum	1100		495	275	38	43	50	57	65
	A356		475	225	53	60	69	80	91
	6061		296	150	53	60	69	80	91
Copper	C17200 (soft Be-Cu)		188	162	33	37	43	50	57
	C85400 (annealed brass)		210	162	45	52	60	68	78
	C95400 Al bronze		190	88	37	44	50	57	66
Plastics	ABS, PVC thermoplastics		190	150	150	173	198	229	262

MACHINING ECONOMETRICS

Tool Wear And Tool Life Relationships

Tool Wear.—Tool-life is defined as the cutting time to reach a predetermined wear, called the tool wear criterion. The size of tool wear criterion depends on the grade used, usually a tougher grade can be used at bigger flank wear. For finishing operations, where close tolerances are required, the wear criterion is relatively small. Other alternative wear criteria are a predetermined value of the surface roughness, or a given depth of the crater which develops on the rake face of the tool. The most appropriate wear criteria depends on cutting geometry, grade, and materials.

Tool-life is determined by assessing the time — the tool-life — at which a given predetermined flank wear is reached, 0.25, 0.4, 0.6, 0.8 mm etc. Fig. 1 depicts how flank wear varies with cutting time (approximately straight lines in a semi-logarithmic graph) for three combinations of cutting speeds and feeds. Alternatively, these curves may represent how variations of machinability impact on tool-life, when cutting speed and feed are constant. All tool wear curves will sooner or later bend upwards abruptly and the cutting edge will break, i.e., catastrophic failure as indicated by the white arrows in Fig. 1.

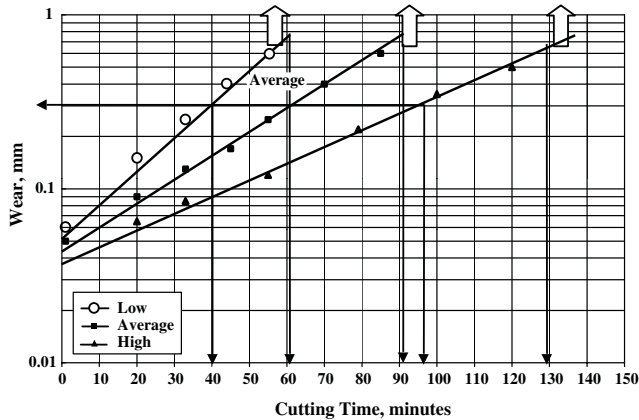


Fig. 1. Flank Wear as a Function of Cutting Time

The maximum deviation from the average tool-life 60 minutes in Fig. 1 is assumed to range between 40 and 95 minutes, i.e. -33% and $+58\%$ variation. The positive deviation from the average (longer than expected tool-life) is not important, but the negative one (shorter life) is, as the edge may break before the scheduled tool change after 60 minutes, when the flank wear is 0.6 mm.

It is therefore important to set the wear criterion at a safe level such that tool failures due to “normal” wear become negligible. This is the way machinability variations are mastered.

Equivalent Chip Thickness (*ECT*).—*ECT* combines the four basic turning variables, depth of cut, lead angle, nose radius and feed per revolution into one basic parameter. For all other metal cutting operations such as drilling, milling and grinding, additional variables such as number of teeth, width of cut, and cutter diameter are included in the parameter *ECT*. In turning, milling, and drilling, according to the *ECT* principle, when the product of feed times depth of cut is constant the tool-life is constant no matter how the depth of cut or feed is selected, provided that the cutting speed and cutting edge length are maintained constant. By replacing the geometric parameters with *ECT*, the number of tool-life tests to evaluate cutting parameters can be reduced considerably, by a factor of 4 in turning, and in milling by a factor of 7 because radial depth of cut, cutter diameter and number of teeth are additional parameters.

The introduction of the *ECT* concept constitutes a major simplification when predicting tool-life and calculating cutting forces, torque, and power. *ECT* was first presented in 1931 by Professor R. Woxen, who both theoretically and experimentally proved that *ECT* is a basic metal cutting parameter for high-speed cutting tools. Dr. Colding later proved that the concept also holds for carbide tools, and extended the calculation of *ECT* to be valid for cutting conditions when the depth of cut is smaller than the tool nose radius, or for round inserts. Colding later extended the concept to all other metal cutting operations, including the grinding process.

The definition of *ECT* is:

$$ECT = \frac{Area}{CEL} \text{ (mm or inch)}$$

where A = cross sectional area of cut (approximately = feed \times depth of cut), (mm² or inch²)

CEL = cutting edge length (tool contact rubbing length), (mm or inch), see Fig. 1 on page 1023.

An exact value of A is obtained by the product of *ECT* and CEL . In turning, milling, and drilling, *ECT* varies between 0.05 and 1 mm, and is always less than the feed/rev or feed/tooth; its value is usually about 0.7 to 0.9 times the feed.

Example 1: For a feed of 0.8 mm/rev, depth of cut $a = 3$ mm, and a cutting edge length $CEL = 4$ mm, the value of *ECT* is approximately $ECT = 0.8 \times 3 \div 4 = 0.6$ mm.

The product of *ECT*, CEL , and cutting speed V (m/min or ft/min) equals the metal removal rate, *MRR*, measured in terms of the volume of chips removed per minute:

$$\begin{aligned} MRR &= 1000V \times Area = 1000V \times ECT \times CEL \text{ mm}^3/\text{min} \\ &= V \times Area \text{ cm}^3/\text{min or inch}^3/\text{min} \end{aligned}$$

The specific metal removal rate *SMRR* is the metal removal rate per mm cutting edge length CEL , thus:

$$\begin{aligned} SMRR &= 1000V \times ECT \text{ mm}^3/\text{min/mm} \\ &= V \times ECT \text{ cm}^3/\text{min/mm or inch}^3/\text{min/inch} \end{aligned}$$

Example 2: Using above data and a cutting speed of $V = 250$ m/min specific metal removal rate becomes $SMRR = 0.6 \times 250 = 150$ (cm³/min/mm).

ECT in Grinding: In grinding *ECT* is defined as in the other metal cutting processes, and is approximately equal to $ECT = V_w \times ar \div V$, where V_w is the work speed, ar is the depth of cut, and $A = V_w \times ar$. Wheel life is constant no matter how depth ar , or work speed V_w , is selected at $V = \text{constant}$ (usually the influence of grinding contact width can be neglected). This translates into the same wheel life as long as the specific metal removal rate is constant, thus:

$$SMRR = 1000V_w \times ar \text{ mm}^3/\text{min/mm}$$

In grinding, *ECT* is much smaller than in the other cutting processes, ranging from about 0.0001 to 0.001 mm (0.000004 to 0.00004 inch). The grinding process is described in a separate chapter *GRINDING FEEDS AND SPEEDS* starting on page 1197.

Tool-life Relationships.—Plotting the cutting times to reach predetermined values of wear typically results in curves similar to those shown in Fig. 2 (cutting time versus cutting speed at constant feed per tooth) and Fig. 3 (cutting time versus feed per tooth at constant cutting speed). These tests were run in 1993 with mixed ceramics turn-milling hard steel, 82 R_C, at the Technische Hochschule Darmstadt.

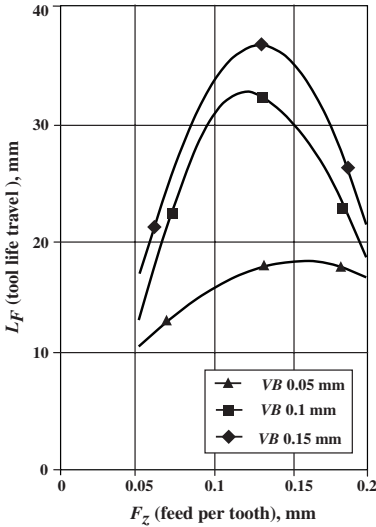


Fig. 2. Influence of feed per tooth on cutting time

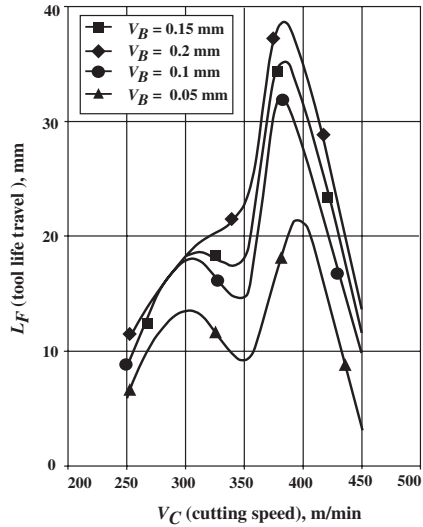


Fig. 3. Influence of cutting speed on tool-life

Tool-life has a maximum value at a particular setting of feed and speed. Economic and productive cutting speeds always occur on the right side of the curves in Figs. 2 and 4, which are called Taylor curves, represented by the so called Taylor’s equation.

The variation of tool-life with feed and speed constitute complicated relationships, illustrated in Figs. 6a, 6b, and 6c.

Taylor’s Equation.—Taylor’s equation is the most commonly used relationship between tool-life T , and cutting speed V . It constitutes a straight line in a log-log plot, one line for each feed, nose radius, lead angle, or depth of cut, mathematically represented by:

$$V \times T^n = C \tag{1a}$$

where n = is the slope of the line

C = is a constant equal to the cutting speed for $T = 1$ minute

By transforming the equation to logarithmic axes, the Taylor lines become straight lines with slope $= n$. The constant C is the cutting speed on the horizontal (V) axis at tool-life $T = 1$ minute, expressed as follows

$$\ln V + n \times \ln T = \ln C \tag{1b}$$

For different values of feed or ECT , log-log plots of Equation (1a) form approximately straight lines in which the slope decreases slightly with a larger value of feed or ECT . In practice, the Taylor lines are usually drawn parallel to each other, i.e., the slope n is assumed to be constant.

Fig. 4 illustrates the Taylor equation, tool-life T versus cutting speed V , plotted in log-log coordinates, for four values of $ECT = 0.1, 0.25, 0.5$ and 0.7 mm.

In Fig. 4, starting from the right, each T - V line forms a generally straight line that bends off and reaches its maximum tool-life, then drops off with decreasing speed (see also Figs. 2 and 3). When operating at short tool-lives, approximately when T is less than 5 minutes, each line bends a little so that the cutting speed for 1 minute life becomes less than the value calculated by constant C .

The Taylor equation is a very good approximation of the right hand side of the real tool-life curve (slightly bent). The portion of the curve to the left of the maximum tool-life gives shorter and shorter tool-lives when decreasing the cutting speed starting from the point of maximum tool-life. Operating at the maximum point of maximum tool-life, or to the left of it, causes poor surface finish, high cutting forces, and sometimes vibrations.

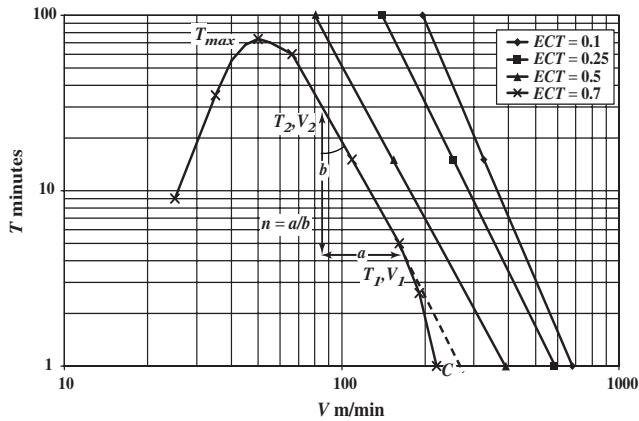


Fig. 4. Definition of slope n and constant C in Taylor’s equation

Evaluation of Slope n , and Constant C .—When evaluating the value of the Taylor slope based on wear tests, care must be taken in selecting the tool-life range over which the slope is measured, as the lines are slightly curved.

The slope n can be found in three ways:

- Calculate n from the formula $n = (\ln C - \ln V) / \ln T$, reading the values of C and V for any value of T in the graph.
- Alternatively, using two points on the line, (V_1, T_1) and (V_2, T_2) , calculate n using the relationship $V_1 \times T_1^n = V_2 \times T_2^n$. Then, solving for n ,

$$n = \frac{\ln(V_1/V_2)}{\ln(T_2/T_1)}$$

- Graphically, n may be determined from the graph by measuring the distances “ a ” and “ b ” using a mm scale, and n is the ratio of a and b , thus, $n = a/b$

Example: Using Fig. 4, and a given value of $ECT = 0.7$ mm, calculate the slope and constant of the Taylor line.

On the Taylor line for $ECT = 0.7$, locate points corresponding to tool-lives $T_1 = 15$ minutes and $T_2 = 60$ minutes. Read off the associated cutting speeds as, approximately, $V_1 = 110$ m/min and $V_2 = 65$ m/min.

The slope n is then found to be $n = \ln(110/65) / \ln(60/15) = 0.38$

The constant C can be then determined using the Taylor equation and either point (T_1, V_1) or point (T_2, V_2) , with equivalent results, as follows:

$$C = V \times T^n = 110 \times 15^{0.38} = 65 \times 60^{0.38} = 308 \text{ m/min (1027 fpm)}$$

The Generalized Taylor Equation.—The above calculated slope and constant C define tool-life at one particular value of feed f , depth of cut a , lead angle LA , nose radius r , and other relevant factors.

The generalized Taylor equation includes these parameters and is written

$$T^n = A \times f^m \times a^p \times LA^q \times r^s \tag{2}$$

where $A =$ area; and, $n, m, p, q,$ and $s =$ constants.

There are two problems with the generalized equation: 1) a great number of tests have to be run in order to establish the constants $n, m, p, q, s,$ etc.; and 2) the accuracy is not very good because Equation (2) yields straight lines when plotted versus $f, a, LA,$ and $r,$ when in reality, they are parabolic curves..

The Generalized Taylor Equation using Equivalent Chip Thickness (ECT): Due to the compression of the aforementioned geometrical variables ($f, a, LA, r, \text{etc.}$) into ECT, Equation (2) can now be rewritten:

$$V \times T^n = A \times ECT^m \tag{3}$$

Experimental data confirms that the Equation (3) holds, approximately, within the range of the test data, but as soon as the equation is extended beyond the test results, the error can become very great because the V-ECT curves are represented as straight lines by Equation (3) and the real curves have a parabolic shape.

The Colding Tool-life Relationship.—This relationship contains 5 constants $H, K, L, M,$ and N_0 , which attain different values depending on tool grade, work material, and the type of operation, such as longitudinal turning versus grooving, face milling versus end milling, etc.

This tool-life relationship is proven to describe, with reasonable accuracy, how tool-life varies with ECT and cutting speed for any metal cutting and grinding operation. It is expressed mathematically as follows either as a generalized Taylor equation (4a), or, in logarithmic coordinates (4b):

$$V \times T^{(N_0 - L \times \ln ECT)} \times ECT^{\left(-\frac{H}{2M} + \frac{\ln ECT}{4M}\right)} = e^{\left(K - \frac{H}{4M}\right)} \tag{4a}$$

$$y = K - \frac{x - H}{4M} - z(N_0 - L_x) \tag{4b}$$

where $x = \ln ECT$ $y = \ln V$ $z = \ln T$

M = the vertical distance between the maximum point of cutting speed (ECT_H, V_H) for $T = 1$ minute and the speed V_G at point (ECT_G, V_G), as shown in Fig. 5.

$2M$ = the horizontal distance between point (ECT_H, V_G) and point (V_G, ECT_G)

H and K = the logarithms of the coordinates of the maximum speed point (ECT_H, V_H) at tool-life $T = 1$ minute, thus $H = \ln(ECT_H)$ and $K = \ln(V_H)$

N_0 and L = the variation of the Taylor slope n with ECT: $n = N_0 - L \times \ln(ECT)$

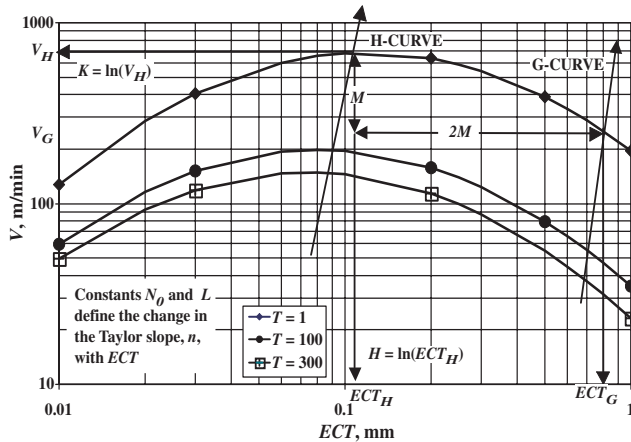


Fig. 5. Definitions of the constants $H, K, L, M,$ and N_0 for tool-life equation in the V-ECT plane with tool-life constant

The constants L and N_0 are determined from the slopes n_1 and n_2 of two Taylor lines at ECT_1 and ECT_2 , and the constant M from 3 V-ECT values at any constant tool-life. Constants H and K are then solved using the tool-life equation with the above-calculated values of L, N_0 and M .

The G- and H-curves.—The *G*-curve defines the longest possible tool-life for any given metal removal rate, *MRR*, or specific metal removal rate, *SMRR*. It also defines the point where the total machining cost is minimum, after the economic tool-life T_E , or optimal tool-life T_O , has been calculated, see *Optimization Models, Economic Tool-life when Feed is Constant* starting on page 1149.

The tool-life relationship is depicted in the 3 planes: *T-V*, where *ECT* is the plotted parameter (the Taylor plane); *T-ECT*, where *V* is plotted; and, *V-ECT*, where *T* is a parameter. The latter plane is the most useful because the optimal cutting conditions are more readily understood when viewing in the *V-ECT* plane. Figs. 6a, 6b, and 6c show how the tool-life curves look in these 3 planes in log-log coordinates.

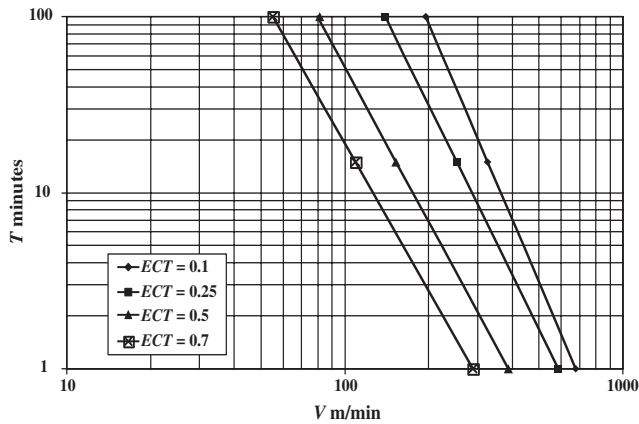


Fig. 6a. Tool-life vs. cutting speed *T-V*, *ECT* plotted

Fig. 6a shows the Taylor lines, and Fig. 6b illustrates how tool-life varies with *ECT* at different values of cutting speed, and shows the *H*-curve. Fig. 6c illustrates how cutting speed varies with *ECT* at different values of tool-life. The *H*- and *G*-curves are also drawn in Fig. 6c.

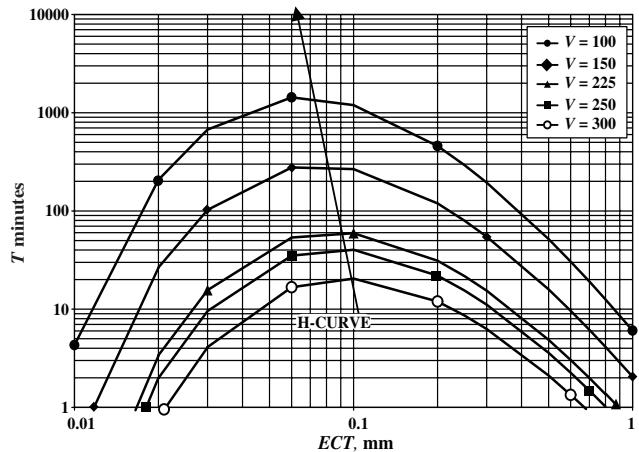


Fig. 6b. Tool-life vs. *ECT*, *T-ECT*, cutting speed plotted

A simple and practical method to ascertain that machining is not done to the left of the *H*-curve is to examine the chips. When *ECT* is too small, about 0.03-0.05 mm, the chips tend to become irregular and show up more or less as dust.

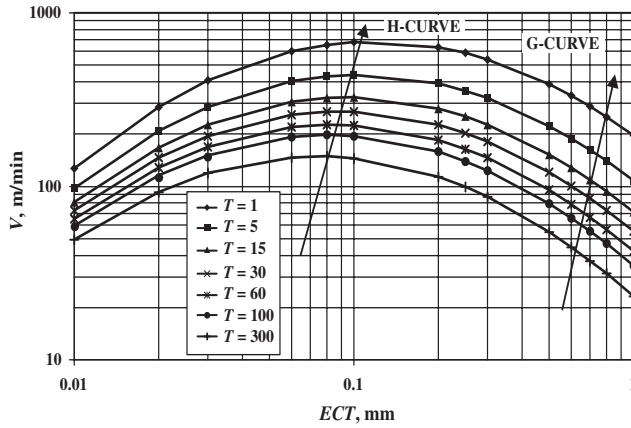


Fig. 6c. Cutting speed vs. *ECT*, *V-ECT*, tool-life plotted

The *V-ECT-T* Graph and the Tool-life Envelope.— The tool-life envelope, in Fig. 7, is an area laid over the *V-ECT-T* graph, bounded by the points A, B, C, D, and E, within which successful cutting can be realized. The H- and G-curves represent two borders, lines \overline{AE} and \overline{BC} . The border curve, line \overline{AB} , shows a lower limit of tool-life, $T_{MIN} = 5$ minutes, and border curve, line \overline{DE} , represents a maximum tool-life, $T_{MAX} = 300$ minutes.

T_{MIN} is usually 5 minutes due to the fact that tool-life versus cutting speed does not follow a straight line for short tool-lives; it decreases sharply towards one minute tool-life. T_{MAX} varies with tool grade, material, speed and *ECT* from 300 minutes for some carbide tools to 10000 minutes for diamond tools or diamond grinding wheels, although systematic studies of maximum tool-lives have not been conducted.

Sometimes the metal cutting system cannot utilize the maximum values of the *V-ECT-T* envelope, that is, cutting at optimum *V-ECT* values along the *G*-curve, due to machine power or fixture constraints, or vibrations. Maximum *ECT* values, ECT_{MAX} , are related to the strength of the tool material and the tool geometry, and depend on the tool grade and material selection, and require a relatively large nose radius.

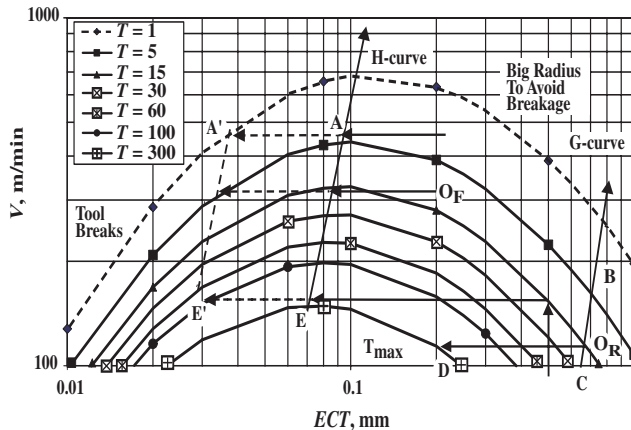


Fig. 7. Cutting speed vs. *ECT*, *V-ECT*, tool-life plotted

Minimum *ECT* values, ECT_{MIN} , are defined by the conditions at which surface finish suddenly deteriorates and the cutting edge begins rubbing rather than cutting. These conditions begin left of the *H*-curve, and are often accompanied by vibrations and built-up edges on the tool. If feed or *ECT* is reduced still further, excessive tool wear with sparks and tool breakage, or melting of the edge occurs. For this reason, values of *ECT* lower than approx-

imately 0.03 mm should not be allowed. In Fig. 7, the ECT_{MIN} boundary is indicated by contour line $\overline{A'E'}$.

In milling the minimum feed/tooth depends on the ratio ar/D , of radial depth of cut ar , and cutter diameter D . For small ar/D ratios, the chip thickness becomes so small that it is necessary to compensate by increasing the feed/tooth. See *High-speed Machining Econometrics* starting on page 1161 for more on this topic.

Fig. 7 demonstrates, in principle, minimum cost conditions for roughing at point O_R , and for finishing at point O_F , where surface finish or tolerances have set a limit. Maintaining the speed at O_R , 125 m/min, and decreasing feed reaches a maximum tool-life = 300 minutes at $ECT = 0.2$, and a further decrease of feed will result in shorter lives.

Similarly, starting at point X ($V = 150, ECT = 0.5, T = 15$) and reducing feed, the H -curve will be reached at point E ($ECT = 0.075, T = 300$). Continuing to the left, tool-life will decrease and serious troubles occur at point E' ($ECT = 0.03$).

Starting at point O_F ($V = 300, ECT = 0.2, T = 15$) and reducing feed the H -curve will be reached at point E ($ECT = 0.08, T = 15$). Continuing to the left, life will decrease and serious troubles occur at $ECT = 0.03$.

Starting at point X ($V = 400, ECT = 0.2, T = 5$) and reducing feed the H -curve will be reached at point E ($ECT = 0.09, T = 7$). Continuing to the left, life will decrease and serious troubles occur at point A' ($ECT = 0.03$), where $T = 1$ minute.

Cutting Forces and Chip Flow Angle.—There are three cutting forces, illustrated in Fig. 8, that are associated with the cutting edge with its nose radius r , depth of cut a , lead angle LA , and feed per revolution f , or in milling feed per tooth f_z . There is one drawing for roughing and one for finishing operations.

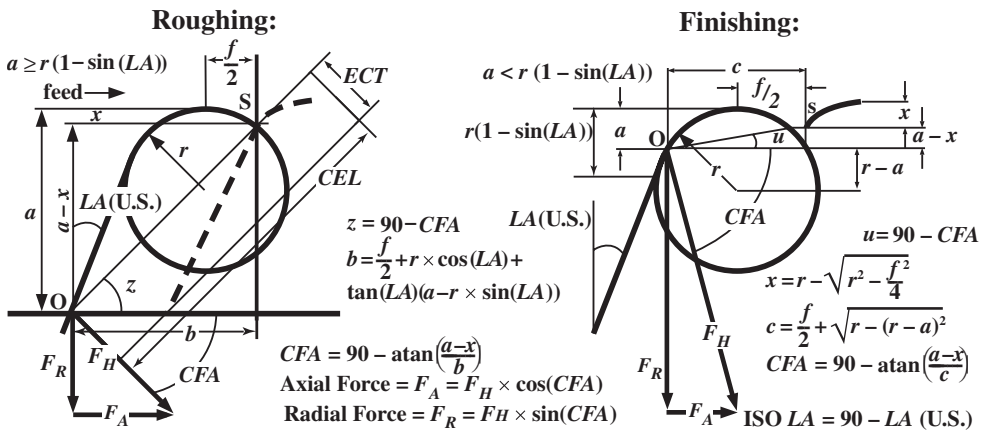


Fig. 8. Definitions of equivalent chip thickness, ECT , and chip flow angle, CFA .

The cutting force F_C , or tangential force, is perpendicular to the paper plane. The other two forces are the feed or axial force F_A , and the radial force F_R directed towards the work piece. The resultant of F_A and F_R is called F_H . When finishing, F_R is bigger than F_A , while in roughing F_A is usually bigger than F_R . The direction of F_H , measured by the chip flow angle CFA , is perpendicular to the rectangle formed by the cutting edge length CEL and ECT (the product of ECT and CEL constitutes the cross sectional area of cut, A). The important task of determining the direction of F_H , and calculation of F_A and F_R , are shown in the formulas given in the Fig. 8.

The method for calculating the magnitudes of F_H, F_A , and F_R is described in the following. The first thing is to determine the value of the cutting force F_C . Approximate formulas

to calculate the tangential cutting force, torque and required machining power are found in the section *ESTIMATING SPEEDS AND MACHINING POWER* starting on page 1081.

Specific Cutting Force, K_c : The specific cutting force, or the specific energy to cut, K_c , is defined as the ratio between the cutting force F_C and the chip cross sectional area, A . thus, $K_c = F_C \div A$ N/mm².

The value of K_c decreases when ECT increases, and when the cutting speed V increases. Usually, K_c is written in terms of its value at $ECT = 1$, called K_{c1} , and neglecting the effect of cutting speed, thus $K_c = K_{c1} \times ECT^B$, where B = slope in log-log coordinates

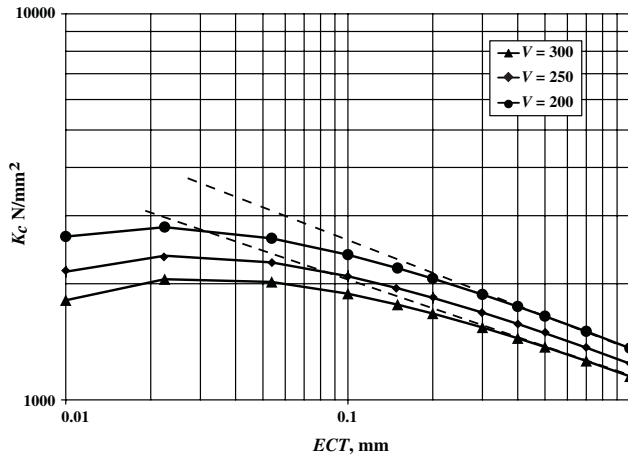


Fig. 9. K_c vs. ECT , cutting speed plotted

A more accurate relationship is illustrated in Fig. 9, where K_c is plotted versus ECT at 3 different cutting speeds. In Fig. 9, the two dashed lines represent the aforementioned equation, which each have different slopes, B . For the middle value of cutting speed, K_c varies with ECT from about 1900 to 1300 N/mm² when ECT increases from 0.1 to 0.7 mm. Generally the speed effect on the magnitude of K_c is approximately 5 to 15 percent when using economic speeds.

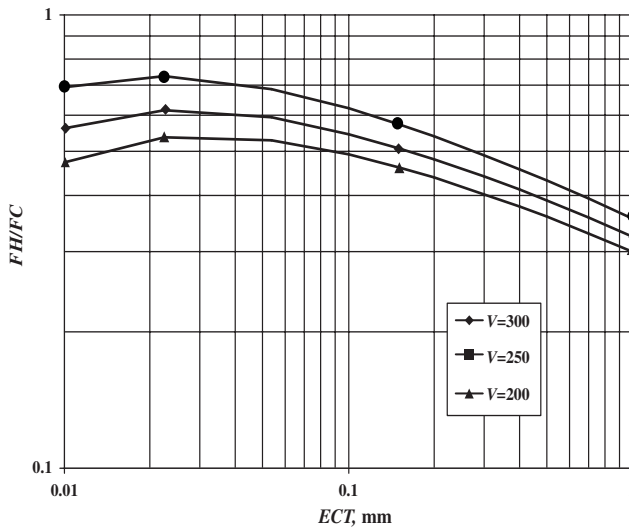


Fig. 10. F_H/F_C vs. ECT , cutting speed plotted

Determination of Axial, F_A , and Radial, F_R , Forces: This is done by first determining the resultant force F_H and then calculating F_A and F_R using the Fig. 8 formulas. F_H is derived

from the ratio F_H/F_C , which varies with ECT and speed in a fashion similar to Kc . Fig. 10 shows how this relationship may vary.

As seen in Fig. 10, F_H/F_C is in the range 0.3 to 0.6 when ECT varies from 0.1 to 1 mm, and speed varies from 200 to 250 m/min using modern insert designs and grades. Hence, using reasonable large feeds F_H/F_C is around 0.3 - 0.4 and when finishing about 0.5 - 0.6.

Example: Determine F_A and F_R , based on the chip flow angle CFA and the cutting force F_C , in turning.

Using a value of $Kc = 1500 \text{ N/mm}^2$ for roughing, when $ECT = 0.4$, and the cutting edge length $CEL = 5 \text{ mm}$, first calculate the area $A = 0.4 \times 5 = 2 \text{ mm}^2$. Then, determine the cutting force $F_C = 2 \times 1500 = 3000 \text{ Newton}$, and an approximate value of $F_H = 0.5 \times 3000 = 1500 \text{ Newton}$.

Using a value of $Kc = 1700 \text{ N/mm}^2$ for finishing, when $ECT = 0.2$, and the cutting edge length $CEL = 2 \text{ mm}$, calculate the area $A = 0.2 \times 2 = 0.4 \text{ mm}^2$. The cutting force $F_C = 0.4 \times 1700 = 680 \text{ Newton}$ and an approximate value of $F_H = 0.35 \times 680 = 238 \text{ Newton}$.

Fig. 8 can be used to estimate CFA for rough and finish turning. When the lead angle LA is 15 degrees and the nose radius is relatively large, an estimated value of the chip flow angle becomes about 30 degrees when roughing, and about 60 degrees in finishing. Using the formulas for F_A and F_R relative to F_H gives:

Roughing:

$$F_A = F_H \times \cos(CFA) = 1500 \times \cos 30 = 1299 \text{ Newton}$$

$$F_R = F_H \times \sin(CFA) = 1500 \times \sin 30 = 750 \text{ Newton}$$

Finishing:

$$F_A = F_H \times \cos(CFA) = 238 \times \cos 60 = 119 \text{ Newton}$$

$$F_R = F_H \times \sin(CFA) = 238 \times \sin 60 = 206 \text{ Newton}$$

The force ratio F_H/F_C also varies with the tool rake angle and increases with negative rakes. In grinding, F_H is much larger than the grinding cutting force F_C ; generally F_H/F_C is approximately 2 to 4, because grinding grits have negative rakes of the order -35 to -45 degrees.

Forces and Tool-life.—Forces and tool life are closely linked. The ratio F_H/F_C is of particular interest because of the unique relationship of F_H/F_C with tool-life.

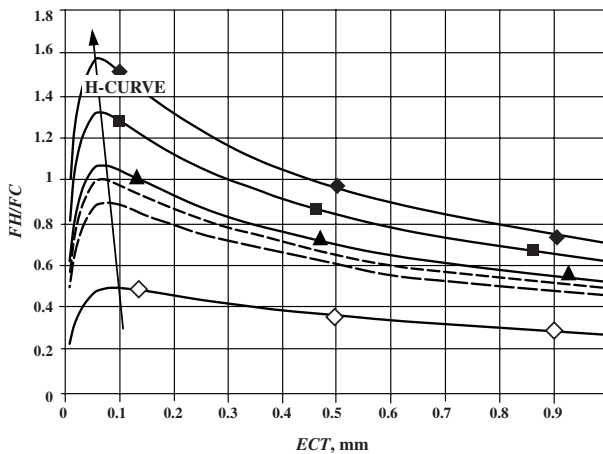


Fig. 11a. F_H/F_C vs. ECT

The results of extensive tests at Ford Motor Company are shown in Figs. 11a and 11b, where F_H/F_C and tool-life T are plotted versus ECT at different values of cutting speed V .

For any constant speed, tool-life has a maximum at approximately the same values of ECT as has the function F_H/F_C .

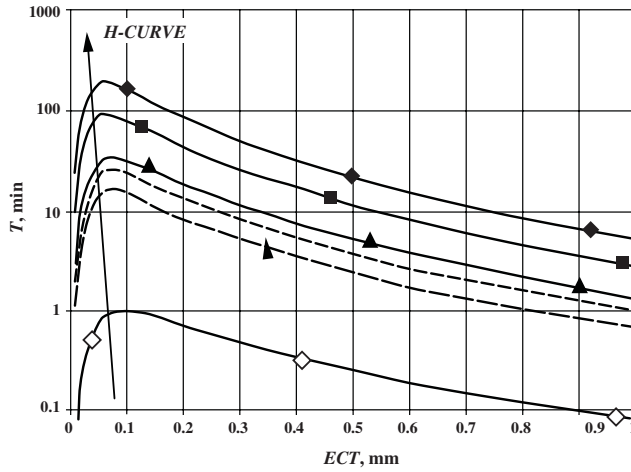


Fig. 11b. Tool-life vs. ECT

The Force Relationship: Similar tests performed elsewhere confirm that the F_H/F_C function can be determined using the 5 tool-life constants (H, K, M, L, N_0) introduced previously, and a new constant (L_F/L).

$$\ln\left(\frac{1}{a} \cdot \frac{F_H}{F_C}\right) = \frac{K - y - \frac{(x - H)^2}{4M}}{\frac{L_F}{L}(N_0 - Lx)} \tag{5}$$

The constant a depends on the rake angle; in turning a is approximately 0.25 to 0.5 and L_F/L is 10 to 20. F_C attains its maximum values versus ECT along the H -curve, when the tool-life equation has maxima, and the relationships in the three force ratio planes look very similar to the tool-life functions shown in the tool-life planes in Figs. 6a, 6b, and 6c.

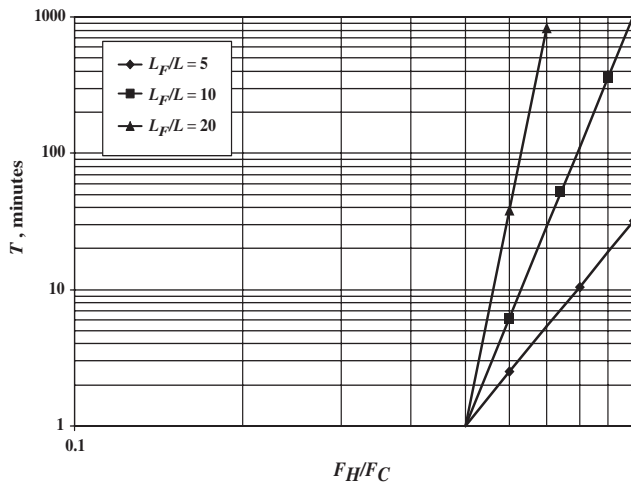


Fig. 12. Tool-life vs. F_H/F_C

Tool-life varies with F_H/F_C with a simple formula according to Equation (5) as follows:

$$T = \left(\frac{F_H}{aF_C} \right)^{\frac{L_F}{L}}$$

where L is the constant in the tool-life equation, Equation (4a) or (4b), and L_F is the corresponding constant in the force ratio equation, Equation (5). In Fig. 12 this function is plotted for $a = 0.5$ and for $L_F/L = 5, 10,$ and 20 .

Accurate calculations of aforementioned relationships require elaborate laboratory tests, or better, the design of a special test and follow-up program for parts running in the ordinary production. A software machining program, such as Colding International Corp. *COMP* program can be used to generate the values of all 3 forces, torque and power requirements both for sharp and worn tools

Surface Finish R_a and Tool-life.—It is well known that the surface finish in turning decreases with a bigger tool nose radius and increases with feed; usually it is assumed that R_a increases with the square of the feed per revolution, and decreases inversely with increasing size of the nose radius. This formula, derived from simple geometry, gives rise to great errors. In reality, the relationship is more complicated because the tool geometry must be taken into account, and the work material and the cutting conditions also have a significant influence.

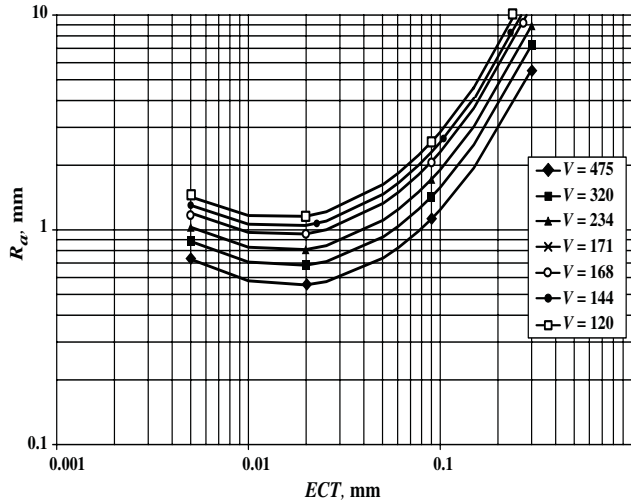


Fig. 13. R_a vs. ECT , nose radius r constant

Fig. 13 shows surface finish R_a versus ECT at various cutting speeds for turning cast iron with carbide tools and a nose radius $r = 1.2$ mm. Increasing the cutting speed leads to a smaller R_a value.

Fig. 14 shows how the finish improves when the tool nose radius, r , increases at a constant cutting speed (168 m/min) in cutting nodular cast iron.

In Fig. 15, R_a is plotted versus ECT with cutting speed V for turning a 4310 steel with carbide tools, for a nose radius $r = 1.2$ mm, illustrating that increasing the speed also leads to a smaller R_a value for steel machining.

A simple rule of thumb for the effect of increasing nose radius r on decreasing surface finish R_a , regardless of the ranges of ECT or speeds used, albeit within common practical values, is as follows. In finishing,

$$\frac{R_{a1}}{R_{a2}} = \left(\frac{r_2}{r_1} \right)^{0.5} \tag{6}$$

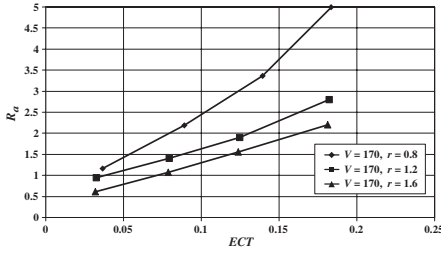


Fig. 14. R_a vs. ECT
cutting speed constant, nose radius r varies

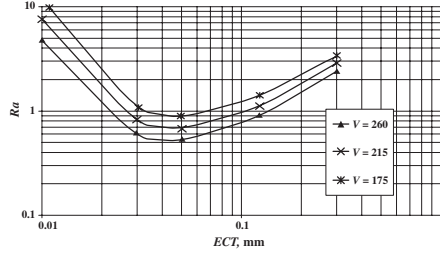


Fig. 15. R_a vs. ECT ,
cutting speed and nose radius r constant

In roughing, multiply the finishing values found using Equation (6) by 1.5, thus, $R_{a(Rough)} = 1.5 \times R_{a(Finish)}$ for each ECT and speed.

Example 1: Find the decrease in surface roughness resulting from a tool nose radius change from $r = 0.8$ mm to $r = 1.6$ mm in finishing. Also, find the comparable effect in roughing.

For finishing, using $r_2 = 1.6$ and $r_1 = 0.8$, $R_{a1}/R_{a2} = (1.6/0.8)^{0.5} = 1.414$, thus, the surface roughness using the larger tool radius is $R_{a2} = R_{a1} \div 1.414 = 0.7R_{a1}$

In roughing, at the same ECT and speed, $R_a = 1.5 \times R_{a2} = 1.5 \times 0.7R_{a1} = 1.05R_{a1}$

Example 2: Find the decrease in surface roughness resulting from a tool nose radius change from $r = 0.8$ mm to $r = 1.2$ mm

For finishing, using $r_2 = 1.2$ and $r_1 = 0.8$, $R_{a1}/R_{a2} = (1.2/0.8)^{0.5} = 1.224$, thus, the surface roughness using the larger tool radius is $R_{a2} = R_{a1} \div 1.224 = 0.82R_{a1}$

In roughing, at the same ECT and speed, $R_a = 1.5 \times R_{a2} = 1.5 \times 0.82R_{a1} = 1.23R_{a1}$

It is interesting to note that, at a given ECT , the R_a curves have a minimum, see Figs. 13 and 15, while tool-life shows a maximum, see Figs. 6b and 6c. As illustrated in Fig. 16, R_a increases with tool-life T when ECT is constant, in principle in the same way as does the force ratio.

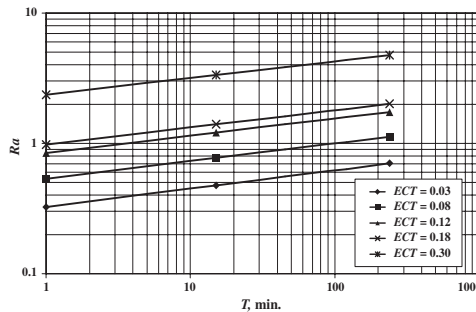


Fig. 16. R_a vs. T , holding ECT constant

The Surface Finish Relationship: R_a is determined using the same type of mathematical relationship as for tool-life and force calculations:

$$y = K_{Ra} - \frac{x - H_{Ra}^2}{4M_{Ra}} - (N_{ORa} - L_{Ra}) \ln(R_a)$$

where K_{Ra} , H_{Ra} , M_{Ra} , N_{ORa} , and L_{Ra} are the 5 surface finish constants.

Shape of Tool-life Relationships for Turning, Milling, Drilling and Grinding Operations—Overview.—A summary of the general shapes of tool-life curves (V - ECT - T graphs) for the most common machining processes, including grinding, is shown in double logarithmic coordinates in Fig. 17a through Fig. 17h.

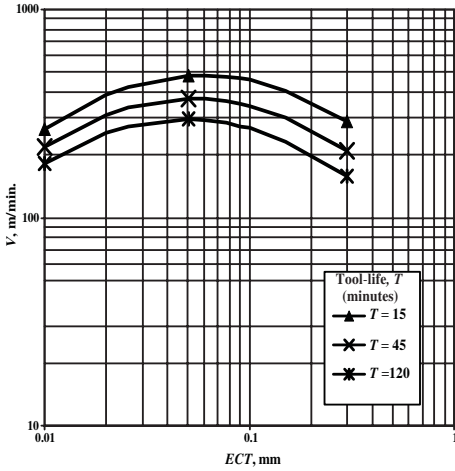


Fig. 17a. Tool-life for turning cast iron using coated carbide

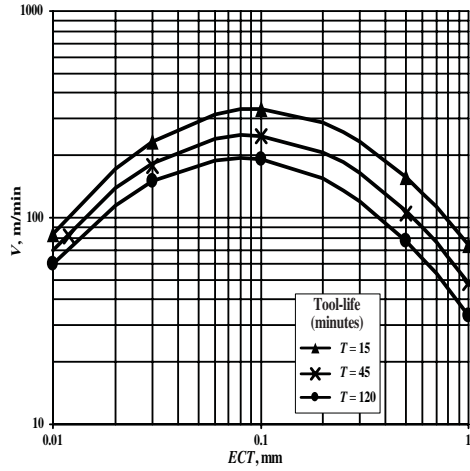


Fig. 17b. Tool-life for turning low-alloy steel using coated carbide

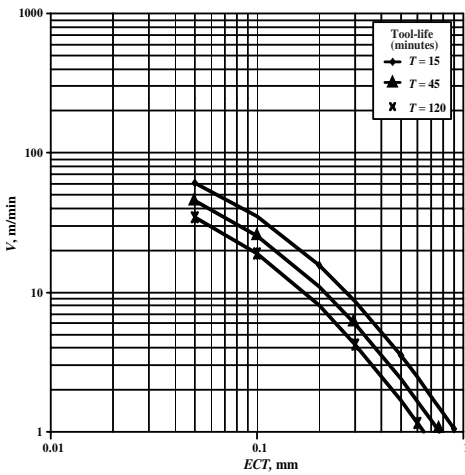


Fig. 17c. Tool-life for end-milling AISI 4140 steel using high-speed steel

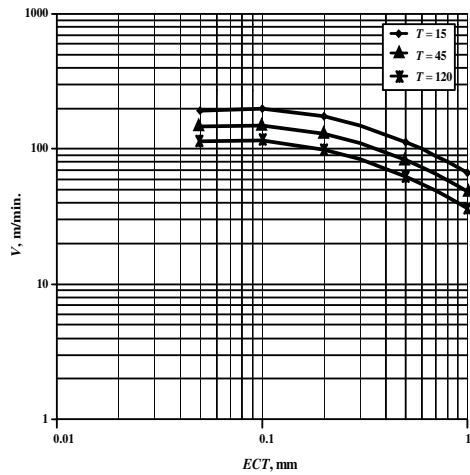


Fig. 17d. Tool-life for end-milling low-alloy steel using uncoated carbide

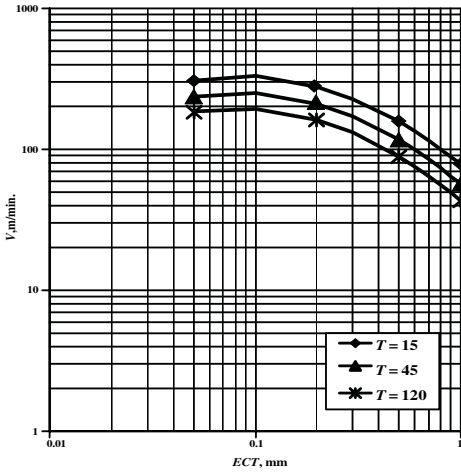


Fig. 17e. Tool-life for end-milling low-alloy steel using coated carbide

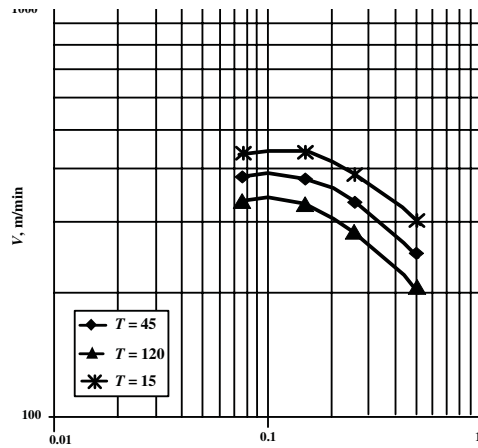


Fig. 17f. Tool-life for face-milling SAE 1045 steel using coated carbide

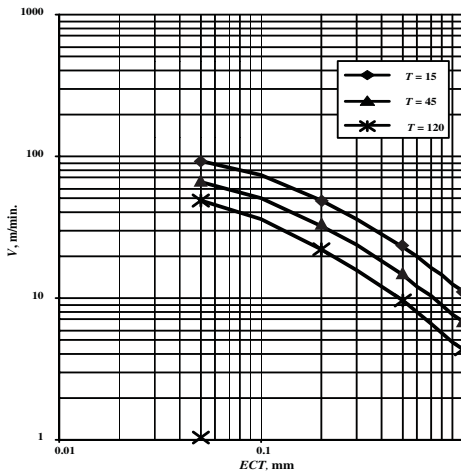


Fig. 17g. Tool-life for solid carbide drill

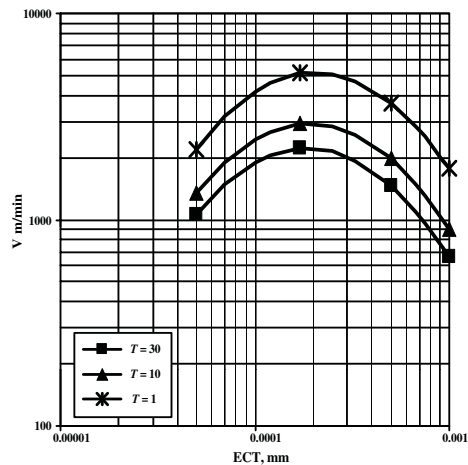


Fig. 17h. Wheel-life in grinding M4 tool-steel

Calculation Of Optimized Values Of Tool-life, Feed And Cutting Speed

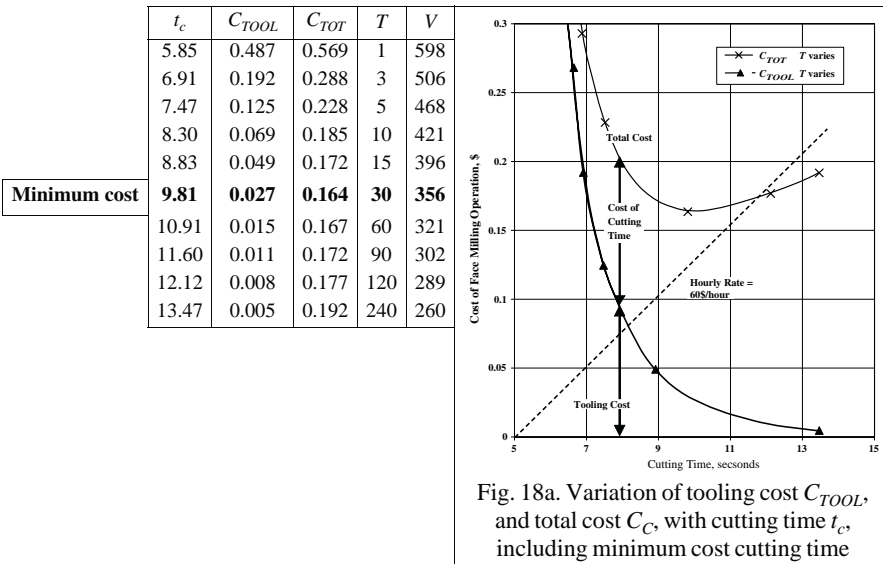
Minimum Cost.—Global optimum is defined as the absolute minimum cost considering all alternative speeds, feeds and tool-lives, and refers to the determination of optimum tool-life T_O , feed f_O , and cutting speed V_O , for either minimum cost or maximum production rate. When using the tool-life equation, $T = f(V, ECT)$, determine the corresponding feed, for given values of depth of cut and operation geometry, from optimum equivalent chip thickness, ECT_O . Mathematically the task is to determine minimum cost, employing the cost function $C_{TOT} = \text{cost of machining time} + \text{tool changing cost} + \text{tooling cost}$. Minimum cost optima occur along the so-called *G*-curve, identified in Fig. 6c.

Another important factor when optimizing cutting conditions involves choosing the proper cost values for cost per edge C_E , replacement time per edge T_{RPL} , and not least, the hourly rate H_R that should be applied. H_R is defined as the portion of the hourly shop rate that is applied to the operations and machines in question. If optimizing all operations in the portion of the shop for which H_R is calculated, use the full rate; if only one machine is involved, apply a lower rate, as only a portion of the general overhead rate should be used, otherwise the optimum, and anticipated savings, are erroneous.

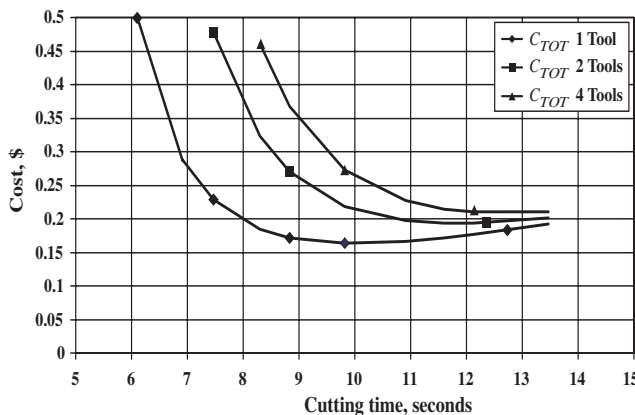
Production Rate.—The production rate is defined as the cutting time or the metal removal rate, corrected for the time required for tool changes, but neglecting the cost of tools.

The result of optimizing production rate is a shorter tool-life, higher cutting speed, and a higher feed compared to minimum cost optimization, and the tooling cost is considerably higher. Production rates optima also occur along the *G*-curve.

The Cost Function.—There are a number of ways the total machining cost C_{TOT} can be plotted, for example, versus feed, *ECT*, tool-life, cutting speed or other parameter. In Fig. 18a, cost for a face milling operation is plotted versus cutting time, holding feed constant, and using a range of tool-lives, *T*, varying from 1 to 240 minutes.



The tabulated values show the corresponding cutting speeds determined from the tool-life equation, and the influence of tooling on total cost. Tooling cost, C_{TOOL} = sum of tool cost + cost of replacing worn tools, decreases the longer the cutting time, while the total cost, C_{TOT} , has a minimum at around 10 seconds of cutting time. The dashed line in the graph represents the cost of machining time: the product of hourly rate H_R , and the cutting time t_c divided by 60. The slope of the line defines the value of H_R .



The cutting time for minimum cost varies with the ratio of tooling cost and H_R . Minimum cost moves towards a longer cutting time (longer tool-life) when either the price of the tooling increases, or when several tools cut simultaneously on the same part. In Fig. 18b, this is exemplified by running 2 and 4 cutters simultaneously on the same work piece, at the same feed and depth of cut, and with a similar tool as in Fig. 18a. As the tooling cost goes up 2 and 4 times, respectively, and H_R is the same, the total costs curves move up, but also moves to the right, as do the points of minimum cost and optimal cutting times. This means that going somewhat slower, with more simultaneously cutting tools, is advantageous.

Global Optimum.—Usually, global optimum occurs for large values of feed, heavy roughing, and in many cases the cutting edge will break trying to apply the large feeds required. Therefore, true optima cannot generally be achieved when roughing, in particular when using coated and wear resistant grades; instead, use the maximum values of feed, ECT_{max} , along the tool-life envelope, see Fig. 7.

As will be shown in the following, the first step is to determine the optimal tool-life T_O , and then determine the optimum values of feeds and speeds.

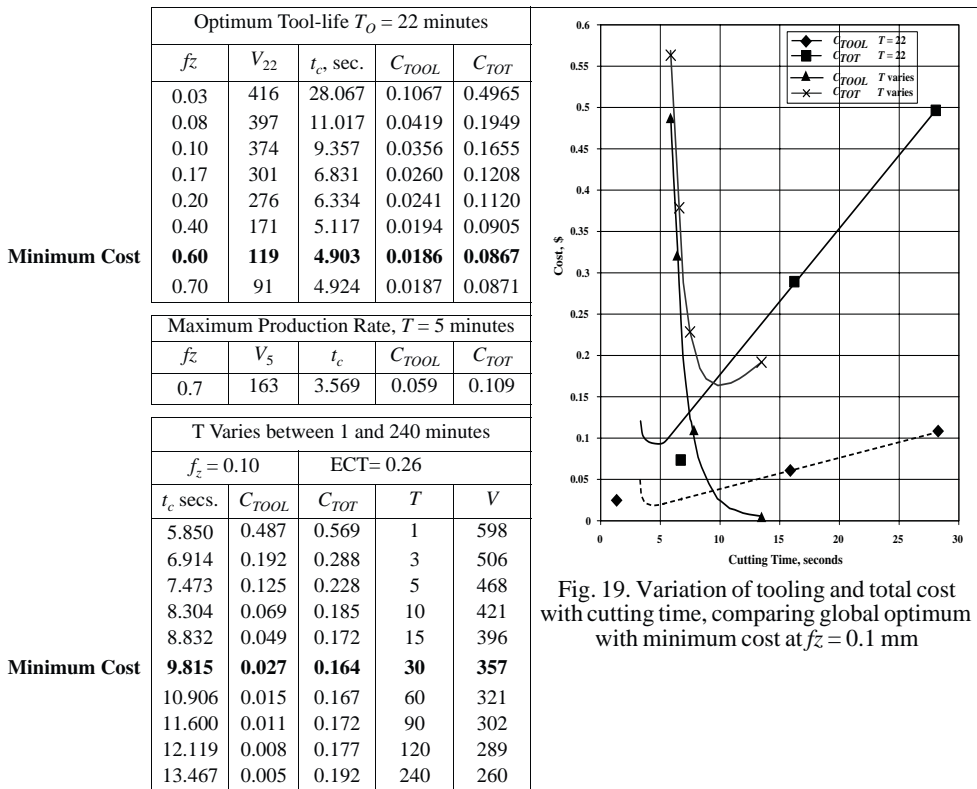


Fig. 19. Variation of tooling and total cost with cutting time, comparing global optimum with minimum cost at $f_z = 0.1$ mm

The example in Fig. 19 assumes that $T_O = 22$ minutes and the feed and speed optima were calculated as $f_O = 0.6$ mm/tooth, $V_O = 119$ m/min, and cutting time $t_{cO} = 4.9$ secs.

The point of maximum production rate corresponds to $f_O = 0.7$ mm/tooth, $V_O = 163$ m/min, at tool-life $T_O = 5$ minutes, and cutting time $t_{cO} = 3.6$ secs. The tooling cost is approximately 3 times higher than at minimum cost (0.059 versus 0.0186), while the piece cost is only slightly higher: \$0.109 versus \$0.087.

When comparing the global optimum cost with the minimum at feed = 0.1 mm/tooth the graph shows it to be less than half (0.087 versus 0.164), but also the tooling cost is about 1/3 lower (0.0186 versus 0.027). The reason why tooling cost is lower depends on the tooling cost term $t_c \times C_E/T$ (see *Calculation of Cost of Cutting and Grinding Operations* on page

1154). In this example, cutting times $t_c = 4.9$ and 9.81 seconds, at $T = 22$ and 30 minutes respectively, and the ratios are proportional to $4.9/22 = 0.222$ and $9.81/30 = 0.327$ respectively.

The portions of the total cost curve for shorter cutting times than at minimum corresponds to using feeds and speeds right of the G -curve, and those on the other side are left of this curve.

Optimization Models, Economic Tool-life when Feed is Constant.—Usually, optimization is performed versus the parameters tool-life and cutting speed, keeping feed at a constant value. The cost of cutting as function of cutting time is a straight line with the slope = $H_R =$ hourly rate. This cost is independent of the values of tool change and tooling. Adding the cost of tool change and tooling, gives the variation of total cutting cost which shows a minimum with cutting time that corresponds to an economic tool-life, T_E . Economic tool-life represents a local optima (minimum cost) at a given constant value of feed, feed/tooth, or ECT .

Using the Taylor Equation: $V \times T = C$ and differentiating C_{TOT} with respect to T yields:

Economic tool-life:

$$T_E = T_V \times (1/n - 1), \text{ minutes}$$

Economic cutting speed:

$$V_E = C/T_E^n, \text{ m/min, or sfm}$$

In these equations, n and C are constants in the Taylor equation for the given value of feed. Values of Taylor slopes, n , are estimated using the speed and feed **Tables 1** through **23** starting on page **1026** and handbook **Table 5b** on page **1034** for turning, and **Table 15e** on page **1058** for milling and drilling; T_V is the equivalent tooling-cost time. $T_V = T_{RPL} + 60 \times C_E \div H_R$, minutes, where T_{RPL} = time for replacing a worn insert, or a set of inserts in a milling cutter or inserted drill, or a twist drill, reamer, thread chaser, or tap. T_V is described in detail, later; C_E = cost per edge, or set of edges, or cost per regrind including amortized price of tool; and H_R = hourly shop rate, or that rate that is impacted by the changes of cutting conditions .

In two dimensions, **Fig. 20a** shows how economic tool-life varies with feed per tooth. In this figure, the equivalent tooling-cost time T_V is constant, however the Taylor constant n varies with the feed per tooth.

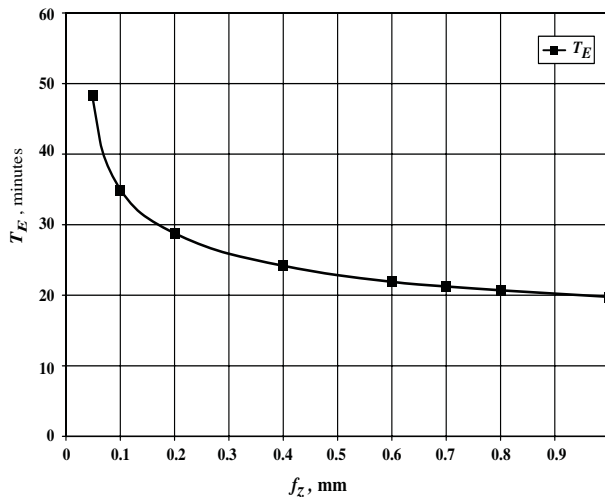


Fig. 20a. Economic tool-life, T_E vs. feed per tooth, f_z

Economic tool-life increases with greater values of T_V , either when T_{RPL} is longer, or when cost per edge C_E is larger for constant H_R , or when H_R is smaller and T_{RPL} and C_E are unchanged. For example, when using an expensive machine (which makes H_R bigger) the value of T_V gets smaller, as does the economic tool-life, $T_E = T_V \times (1/n - 1)$. Reducing T_E results in an increase in the economic cutting speed, V_E . This means raising the cutting speed, and illustrates the importance, in an expensive system, of utilizing the equipment better by using more aggressive machining data.

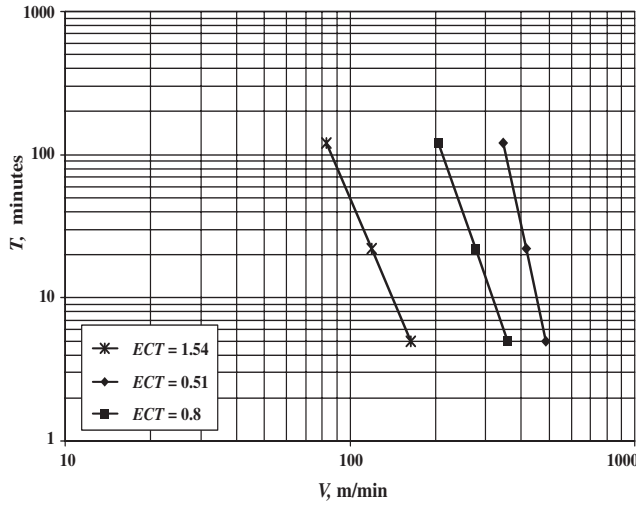


Fig. 20b. Tool-life vs. cutting speed, constant ECT

As shown in Fig. 20a for a face milling operation, economic tool-life T_E varies considerably with feed/tooth f_z , in spite of the fact that the Taylor lines have only slightly different slopes ($ECT = 0.51, 0.6, 1.54$), as shown in Fig. 20b. The calculation is based on the following cost data: $T_V = 6$, hourly shop rate $H_R = \$60/\text{hour}$, cutter diameter $D = 125$ mm with number of teeth $z = 10$, and radial depth of cut $ar = 40$ mm.

The conclusion relating to the determination of economic tool-life is that both hourly rate H_R and slope n must be evaluated with reasonable accuracy in order to arrive at good values. However, the method shown will aid in setting the trend for general machining economics evaluations.

Global Optimum, Graphical Method.—There are several ways to demonstrate in graphs how cost varies with the production parameters including optimal conditions. In all cases, tool-life is a crucial parameter.

Cutting time t_c is inversely proportional to the specific metal removal rate, $SMRR = V \times ECT$, thus, $1/t_c = V \times ECT$. Taking the log of both sides,

$$\ln V = - \ln ECT - \ln t_c + C \tag{7}$$

where C is a constant.

Equation (7) is a straight line with slope (- 1) in the $V-ECT$ graph when plotted in a log-log graph. This means that a constant cutting time is a straight 45-degree line in the $V-ECT$ graph, when plotted in log-log coordinates with the same scale on both axis (a square graph).

The points at which the constant cutting time lines (at 45 degrees slope) are tangent to the tool-life curves define the G -curve, along which global optimum cutting occurs.

Note: If the ratio a/CEL is not constant when ECT varies, the constant cutting time lines are not straight, but the cutting time deviation is quite small in most cases.

In the $V-ECT$ graph, Fig. 21, 45-degree lines have been drawn tangent to each tool-life curve: $T=1, 5, 15, 30, 60, 100$ and 300 minutes. The tangential points define the G -curve, and the 45-degree lines represent different constant cutting times: 1, 2, 3, 10 minutes, etc. Following one of these lines and noting the intersection points with the tool-life curves $T = 1, 5, \text{etc.}$, many different speed and feed combinations can be found that will give the same cutting time. As tool-life gets longer (tooling cost is reduced), ECT (feed) increases but the cutting speed has to be reduced.

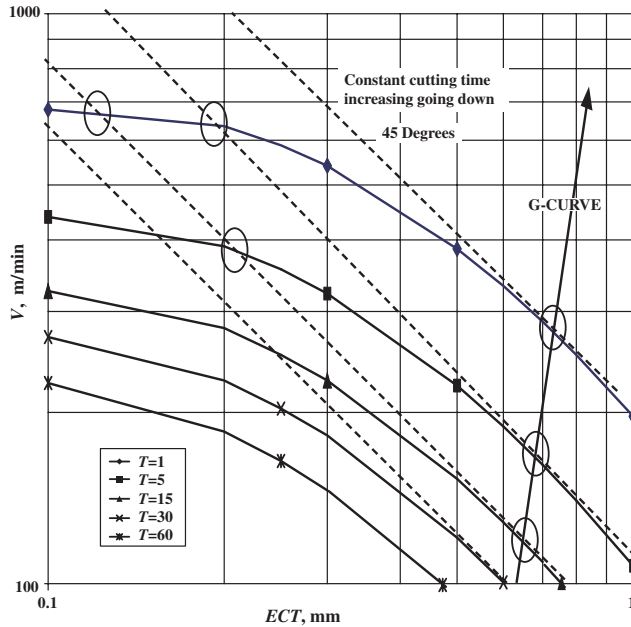


Fig. 21. Constant cutting time in the $V-ECT$ plane, tool-life constant

Global Optimum, Mathematical Method.—Global optimization is the search for extremum of C_{TOT} for the three parameters: T , ECT , and V . The results, in terms of the tool-life equation constants, are:

Optimum tool-life:

$$T_O = T_V \times \left(\frac{1}{n_O} - 1 \right)$$

$$n_O = 2M \times (L \times \ln T_O)^2 + 1 - N_0 + L \times (2M + H)$$

where n_O = slope at optimum ECT .

The same approach is used when searching for maximum production rate, but without the term containing tooling cost.

Optimum cutting speed:

$$V_O = e^{-M + K + (H \times L - N_0) \times \ln T_O + M \times L^2 \times (\ln T_O)^2}$$

Optimum ECT :

$$ECT_O = e^{H + 2M \times (L \times \ln(T_O) + 1)}$$

Global optimum is not reached when face milling for very large feeds, and C_{TOT} decreases continually with increasing feed/tooth, but can be reached for a cutter with many teeth, say 20 to 30. In end milling, global optimum can often be achieved for big feeds and for 3 to 8 teeth.

Determination Of Machine Settings And Calculation Of Costs

Based on the rules and knowledge presented in Chapters 1 and 2, this chapter demonstrates, with examples, how machining times and costs are calculated.

Additional formulas are given, and the speed and feed tables given in *SPEED AND FEED TABLES* starting on page 1021 should be used. Finally the selection of feeds, speeds and tool-lives for optimized conditions are described with examples related to turning, end milling, and face milling.

There are an infinite number of machine settings available in the machine tool power train producing widely different results. In practice only a limited number of available settings are utilized. Often, feed is generally selected independently of the material being cut, however, the influence of material is critical in the choice of cutting speed. The tool-life is normally not known or directly determined, but the number of pieces produced before the change of worn tools is better known, and tool-life can be calculated using the formula for piece cutting time t_c given in this chapter.

It is well known that increasing feeds or speeds reduces the number of pieces cut between tool changes, but not how big are the changes in the basic parameter tool-life. Therefore, there is a tendency to select "safe" data in order to get a long tool-life. Another common practice is to search for a tool grade yielding a longer life using the current speeds and feeds, or a 10-20% increase in cutting speed while maintaining the current tool-life. The reason for this old-fashioned approach is the lack of knowledge about the opportunities the metal cutting process offers for increased productivity.

For example, when somebody wants to calculate the cutting time, he/she can select a value of the feed rate (product of feed and rpm), and easily find the cutting time by dividing cutting distance by the feed rate. The number of pieces obtained out of a tool is a guess-work, however. This problem is very common and usually the engineers find desired tool-lives after a number of trial and error runs using a variety of feeds and speeds. If the user is not well familiar with the material cut, the tool-life obtained could be any number of seconds or minutes, or the cutting edge might break.

There are an infinite number of feeds and speeds, giving the same feed rate, producing equal cutting time. The same cutting time per piece t_c is obtained independent of the selection of feed/rev f and cutting speed V , (or rpm), as long as the feed rate F_R remains the same: $F_R = f_1 \times \text{rpm}_1 = f_2 \times \text{rpm}_2 = f_3 \times \text{rpm}_3 \dots$, etc. However, the number of parts before tool change N_{ch} will vary considerably including the tooling cost c_{tool} and the total cutting cost c_{tot} .

The dilemma confronting the machining-tool engineer or the process planner is how to set feeds and speeds for either desired cycle time, or number of parts between tool changes, while balancing the process versus other operations or balancing the total times in one cell with another. These problems are addressed in this section.

Nomenclature

f = feed/rev or tooth, mm f_E = economic feed f_O = optimum feed
 T = tool-life, minutes T_E = economic tool-life T_O = optimum tool-life
 V = cutting speed, m/min V_E = economic cutting speed V_O = optimum cutting speed, m/min

Similarly, economic and optimum values of:

c_{tool} = piece cost of tooling, \$ C_{TOOL} = cost of tooling per batch, \$
 c_{tot} = piece total cost of cutting, \$ C_{TOT} = total cost of cutting per batch, \$
 F_R = feed rate measured in the feeding direction, mm/rev
 N = batch size
 N_{ch} = number of parts before tool change
 t_c = piece cutting time, minutes T_C = cutting time per batch, minutes
 t_{cyc} = piece cycle time, minutes T_{CYC} = cycle time before tool change, minutes

t_i = idle time (tool “air” motions during cycle), minutes

z = cutter number of teeth

The following variables are used for calculating the per batch cost of cutting:

C_C = cost of cutting time per batch, \$

C_{CH} = cost of tool changes per batch, \$

C_E = cost per edge, for replacing or regrinding, \$

H_R = hourly rate, \$

T_V = equivalent tooling-cost time, minutes

T_{RPL} = time for replacing worn edge(s), or tool for regrinding, minutes

Note: In the list above, when two variables use the same name, one in capital letters and one lower case, T_C and t_c for example, the variable name in capital letters refers to batch processing and lowercase letters to per piece processing, such as $T_C = N_{ch} \times t_c$, $C_{TOT} = N_{ch} \times c_{tot}$, etc.

Formulas Valid For All Operation Types Including Grinding

Calculation of Cutting Time and Feed Rate

Feed Rate:

$F_R = f \times \text{rpm}$ (mm/min), where f is the feed in mm/rev along the feeding direction, rpm is defined in terms of work piece or cutter diameter D in mm, and cutting speed V in m/min, as follows:

$$\text{rpm} = \frac{1000V}{\pi D} = \frac{318V}{D}$$

Cutting time per piece:

Note: Constant cutting time is a straight 45-degree line in the V - ECT graph, along which tool-life varies considerably, as is shown in Chapter 2.

$$t_c = \frac{Dist}{F_R} = \frac{Dist}{f \times \text{rpm}} = \frac{Dist \times \pi D}{1000V \times f}$$

where the units of distance cut $Dist$, diameter D , and feed f are mm, and V is in m/min.

In terms of ECT , cutting time per piece, t_c , is as follows:

$$t_c = \frac{Dist \times \pi D}{1000V} \times \frac{a}{CEL \times ECT}$$

where a = depth of cut, because feed \times cross sectional chip area = $f \times a = CEL \times ECT$.

Example 3, Cutting Time: Given $Dist = 105$ mm, $D = 100$ mm, $f = 0.3$ mm, $V = 300$ m/min, rpm = 700, $F_R = 210$ mm/min, find the cutting time.

Cutting time = $t_c = 105 \times 3.1416 \times 100 \div (1000 \times 300 \times 0.3) = 0.366$ minutes = 22 seconds

Scheduling of Tool Changes

Number of parts before tool change:

$$N_{ch} = T \div t_c$$

Cycle time before tool change:

$T_{CYC} = N_{ch} \times (t_c + t_i)$, where $t_{cyc} = t_c + t_i$, where t_c = cutting time per piece, t_i = idle time per piece

Tool-life:

$$T = N_{ch} \times t_c$$

Example 4: Given tool-life $T = 90$ minutes, cutting time $t_c = 3$ minutes, and idle time $t_i = 3$ minutes, find the number of parts produced before a tool change is required and the time until a tool change is required.

Number of parts before tool change = $N_{ch} = 90/3 = 30$ parts.

Cycle time before tool change = $T_{CYC} = 30 \times (3 + 3) = 180$ minutes

Example 5: Given cutting time, $t_c = 1$ minute, idle time $t_i = 1$ minute, $N_{ch} = 100$ parts, calculate the tool-life T required to complete the job without a tool change, and the cycle time before a tool change is required.

Tool-life = $T = N_{ch} \times t_c = 100 \times 1 = 100$ minutes.

Cycle time before tool change = $T_{CYC} = 100 \times (1 + 1) = 200$ minutes.

Calculation of Cost of Cutting and Grinding Operations.—When machining data varies, the cost of cutting, tool changing, and tooling will change, but the costs of idle and slack time are considered constant.

Cost of Cutting per Batch:

$$C_C = H_R \times T_C / 60$$

T_C = cutting time per batch = (number of parts) $\times t_c$, minutes, or when determining time for tool change $T_{Cch} = N_{ch} \times t_c$ minutes = cutting time before tool change.

t_c = Cutting time/part, minutes

H_R = Hourly Rate

Cost of Tool Changes per Batch:

$$C_{CH} = \frac{H_R}{60} \times T_C \times \frac{T_{RPL}}{T} \quad \frac{\$}{min} \cdot min = \$$$

where T = tool-life, minutes, and T_{RPL} = time for replacing a worn edge(s), or tool for regrinding, minutes

Cost of Tooling per Batch:

Including cutting tools and holders, but without tool changing costs,

$$C_{TOOL} = \frac{H_R}{60} \times T_C \times \frac{60C_E}{H_R} \quad \frac{\$}{min} \cdot min \cdot \frac{min}{hr} \cdot \frac{\$}{min} = \$$$

Cost of Tooling + Tool Changes per Batch:

Including cutting tools, holders, and tool changing costs,

$$(C_{TOOL} + C_{CH}) = \frac{H_R}{60} \times T_C \times \frac{T_{RPL} + \frac{60C_E}{H_R}}{T}$$

Total Cost of Cutting per Batch:

$$C_{TOT} = \frac{H_R}{60} \times T_C \left(1 + \frac{T_{RPL} + \frac{60C_E}{H_R}}{T} \right)$$

Equivalent Tooling-cost Time, T_V :

The two previous expressions can be simplified by using $T_V = T_{RPL} + \frac{60C_E}{H_R}$

thus:

$$(C_{TOOL} + C_{CH}) = \frac{H_R}{60} \times T_C \times \frac{T_V}{T}$$

$$C_{TOT} = \frac{H_R}{60} \times T_C \left(1 + \frac{T_V}{T} \right)$$

C_E = cost per edge(s) is determined using two alternate formulas, depending on whether tools are reground or inserts are replaced:

Cost per Edge, Tools for Regrinding

$$C_E = \frac{\text{cost of tool} + (\text{number of regrinds} \times \text{cost/regrind})}{1 + \text{number of regrinds}}$$

Cost per Edge, Tools with Inserts:

$$C_E = \frac{\text{cost of insert(s)}}{\text{number of edges per insert}} + \frac{\text{cost of cutter body}}{\text{cutter body life in number of edges}}$$

Note: In practice allow for insert failures by multiplying the insert cost by 4/3, that is, assuming only 3 out of 4 edges can be effectively used.

Example 6, Cost per Edge-Tools for Regrinding: Use the data in the table below to calculate the cost per edge(s) C_E , and the equivalent tooling-cost time T_V , for a drill.

Time for cutter replacement T_{RPL} , minute	Cutter Price, \$	Cost per regrind, \$	Number of regrinds	Hourly shop rate, \$	Batch size	Taylor slope, n	Economic cutting time, t_{cE} minute
1	40	6	5	50	1000	0.25	1.5

Using the cost per edge formula for reground tools, $C_E = (40 + 5 \times 6) \div (1 + 5) = \6.80

When the hourly rate is \$50/hr, $T_V = T_{RPL} + \frac{60C_E}{H_R} = 1 + \frac{60(6.8)}{50} = 9.16$ minutes

Calculate economic tool-life using $T_E = T_V \times \left(\frac{1}{n} - 1 \right)$ thus, $T_E = 9.17 \times (1/0.25 - 1) = 9.16 \times 3 = 27.48$ minutes.

Having determined, elsewhere, the economic cutting time per piece to be $t_{cE} = 1.5$ minutes, for a batch size = 1000 calculate:

Cost of Tooling + Tool Change per Batch:

$$(C_{TOOL} + C_{CH}) = \frac{H_R}{60} \times T_C \times \frac{T_V}{T} = \frac{50}{60} \times 1000 \times 1.5 \times \frac{9.16}{27.48} = \$ 417$$

Total Cost of Cutting per Batch:

$$C_{TOT} = \frac{H_R}{60} \times T_C \left(1 + \frac{T_V}{T} \right) = \frac{50}{60} \times 1000 \times 1.5 \times \left(1 + \frac{9.16}{27.48} \right) = \$ 1617$$

Example 7, Cost per Edge-Tools with Inserts: Use data from the table below to calculate the cost of tooling and tool changes, and the total cost of cutting.

For face milling, multiply insert price by safety factor 4/3 then calculate the cost per edge: $C_E = 10 \times (5/3) \times (4/3) + 750/500 = 23.72$ per set of edges

When the hourly rate is \$50, equivalent tooling-cost time is $T_V = 2 + 23.72 \times 60/50 = 30.466$ minutes (first line in table below). The economic tool-life for Taylor slope $n = 0.333$ would be $T_E = 30.466 \times (1/0.333 - 1) = 30.466 \times 2 = 61$ minutes.

When the hourly rate is \$25, equivalent tooling-cost time is $T_V = 2 + 23.72 \times 60/25 = 58.928$ minutes (second line in table below). The economic tool-life for Taylor slope $n = 0.333$ would be $T_E = 58.928 \times (1/0.333 - 1) = 58.928 \times 2 = 118$ minutes.

Time for replacement of inserts T_{RPL} , minutes	Number of inserts	Price per insert	Edges per insert	Cutter Price	Edges per cutter	Cost per set of edges, C_E	Hourly shop rate	T_V minutes
Face mill								
2	10	5	3	750	500	23.72	50	30.466
2	10	5	3	750	500	23.72	25	58.928
End mill								
1	3	6	2	75	200	4.375	50	6.25
Turning								
1	1	5	3	50	100	2.72	30	6.44

With above data for the face mill, and after having determined the economic cutting time as $t_{cE} = 1.5$ minutes, calculate for a batch size = 1000 and \$50 per hour rate:

Cost of Tooling + Tool Change per Batch:

$$(C_{TOOL} + C_{CH}) = \frac{H_R}{60} \times T_C \times \frac{T_V}{T} = \frac{50}{60} \times 1000 \times 1.5 \times \frac{30.466}{61} = \$ 624$$

Total Cost of Cutting per Batch:

$$C_{TOT} = \frac{H_R}{60} \times T_C \left(1 + \frac{T_V}{T}\right) = \frac{50}{60} \times 1000 \times 1.5 \times \left(1 + \frac{30.466}{61}\right) = \$ 1874$$

Similarly, at the \$25/hour shop rate, ($C_{TOOL} + C_{CH}$) and C_{TOT} are \$312 and \$937, respectively.

Example 8, Turning: Production parts were run in the shop at feed/rev = 0.25 mm. One series was run with speed $V_1 = 200$ m/min and tool-life was $T_1 = 45$ minutes. Another was run with speed $V_2 = 263$ m/min and tool-life was $T_2 = 15$ minutes. Given idle time $t_i = 1$ minute, cutting distance $Dist = 1000$ mm, work diameter $D = 50$ mm.

First, calculate Taylor slope, n , using Taylor's equation $V_1 \times T_1^n = V_2 \times T_2^n$, as follows:

$$n = \ln \frac{V_1}{V_2} \div \ln \frac{T_2}{T_1} = \ln \frac{200}{263} \div \ln \frac{15}{45} = 0.25$$

Economic tool-life T_E is next calculated using the equivalent tooling-cost time T_V , as described previously. Assuming a calculated value of $T_V = 4$ minutes, then T_E can be calculated from

$$T_E = T_V \times \left(\frac{1}{n} - 1\right) = 4 \times \left(\frac{1}{0.25} - 1\right) = 12 \text{ minutes}$$

Economic cutting speed, V_E can be found using Taylor's equation again, this time using the economic tool-life, as follows,

$$V_{E1} \times (T_E)^n = V_2 \times (T_2)^n$$

$$V_{E1} = V_2 \times \left(\frac{T_2}{T_E}\right)^n = 263 \times \left(\frac{15}{12}\right)^{0.25} = 278 \text{ m/min}$$

Using the process data, the remaining economic parameters can be calculated as follows:

Economic spindle rpm, $rpm_E = (1000V_E)/(\pi D) = (1000 \times 278)/(3.1416 \times 50) = 1770$ rpm

Economic feed rate, $F_{RE} = f \times rpm_E = 0.25 \times 1770 = 443$ mm/min

Economic cutting time, $t_{cE} = Dist / F_{RE} = 1000 / 443 = 2.259$ minutes

Economic number of parts before tool change, $N_{chE} = T_E \div t_{cE} = 12 \div 2.259 = 5.31$ parts

Economic cycle time before tool change, $T_{CYCE} = N_{chE} \times (t_c + t_i) = 5.31 \times (2.259 + 1) = 17.3$ minutes.

Variation Of Tooling And Total Cost With The Selection Of Feeds And Speeds

It is a well-known fact that tool-life is reduced when either feed or cutting speed is increased. When a higher feed/rev is selected, the cutting speed must be decreased in order to maintain tool-life. However, a higher feed rate (feed rate = feed/rev \times rpm, mm/min) can result in a longer tool-life if proper cutting data are applied. Optimized cutting data require accurate machinability databases and a computer program to analyze the options. Reasonably accurate optimized results can be obtained by selecting a large feed/rev or tooth, and then calculating the economic tool-life T_E . Because the cost versus feed or ECT curve is shallow around the true minimum point, i.e., the global optimum, the error in applying a large feed is small compared with the exact solution.

Once a feed has been determined, the economic cutting speed V_E can be found by calculating the Taylor slope, and the time/cost calculations can be completed using the formulas described in last section.

The remainder of this section contains examples useful for demonstrating the required procedures. Global optimum may or may not be reached, and tooling cost may or may not be reduced, compared to currently used data. However, the following examples prove that significant time and cost reductions are achievable in today's industry.

Note: Starting values of reasonable feeds in mm/rev can be found in the Handbook speed and feed tables, see *Principal Speed and Feed Tables* on page 1021, by using the f_{avg} values converted to mm as follows: feed (mm/rev) = feed (inch/rev) \times 25.4 (mm/inch), thus 0.001 inch/rev = 0.001 \times 25.4 = 0.0254 mm/rev. When using speed and feed Tables 1 through 23, where feed values are given in thousandths of inch per revolution, simply multiply the given feed by 25.4/1000 = 0.0254, thus feed (mm/rev) = feed (0.001 inch/rev) \times 0.0254 (mm/0.001inch).

Example 9, Converting Handbook Feed Values From Inches to Millimeters: Handbook tables give feed values f_{opt} and f_{avg} for 4140 steel as 17 and $8 \times (0.001 \text{ inch/rev}) = 0.017$ and 0.009 inch/rev, respectively. Convert the given feeds to mm/rev.

$$\text{feed} = 0.017 \times 25.4 = 17 \times 0.0254 = 0.4318 \text{ mm/rev}$$

$$\text{feed} = 0.008 \times 25.4 = 8 \times 0.0254 = 0.2032 \text{ mm/rev}$$

Example 10, Using Handbook Tables to Find the Taylor Slope and Constant: Calculate the Taylor slope and constant, using cutting speed data for 4140 steel in Table 1 starting on page 1026, and for ASTM Class 20 grey cast iron using data from Table 4a on page 1032, as follows:

For the 175-250 Brinell hardness range, and the hard tool grade,

$$n = \frac{\ln(V_1/V_2)}{\ln(T_2/T_1)} = \frac{\ln(525/705)}{\ln(15/45)} = 0.27 \quad C = V_1 \times (T_1)^n = 1458$$

For the 175-250 Brinell hardness range, and the tough tool grade,

$$n = \frac{\ln(V_1/V_2)}{\ln(T_2/T_1)} = \frac{\ln(235/320)}{\ln(15/45)} = 0.28 \quad C = V_1 \times (T_1)^n = 685$$

For the 300-425 Brinell hardness range, and the hard tool grade,

$$n = \frac{\ln(V_1/V_2)}{\ln(T_2/T_1)} = \frac{\ln(330/440)}{\ln(15/45)} = 0.26 \quad C = V_1 \times (T_1)^n = 894$$

For the 300-425 Brinell hardness range, and the tough tool grade,

$$n = \frac{\ln(V_1/V_2)}{\ln(T_2/T_1)} = \frac{\ln(125/175)}{\ln(15/45)} = 0.31 \quad C = V_1 \times (T_1)^n = 401$$

For ASTM Class 20 grey cast iron, using hard ceramic,

$$n = \frac{\ln(V_1/V_2)}{\ln(T_2/T_1)} = \frac{\ln(1490/2220)}{\ln(15/45)} = 0.36 \quad C = V_1 \times (T_1)^n = 5932$$

Selection of Optimized Data.—Fig. 22 illustrates cutting time, cycle time, number of parts before a tool change, tooling cost, and total cost, each plotted versus feed for a constant tool-life. Approximate minimum cost conditions can be determined using the formulas previously given in this section.

First, select a large feed/rev or tooth, and then calculate economic tool-life T_E , and the economic cutting speed V_E , and do all calculations using the time/cost formulas as described previously.

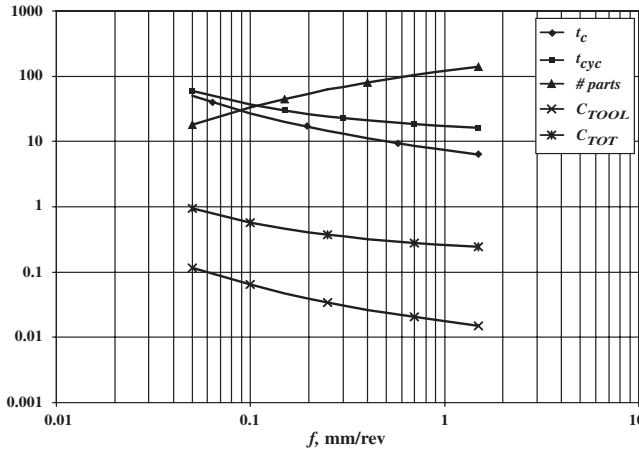


Fig. 22. Cutting time, cycle time, number of parts before tool change, tooling cost, and total cost vs. feed for tool-life = 15 minutes, idle time = 10 s, and batch size = 1000 parts

Example 11, Step by Step Procedure: Turning - Facing out: 1) Select a big feed/rev, in this case $f = 0.9$ mm/rev (0.035 inch/rev). A Taylor slope n is first determined using the Handbook tables and the method described in Example 10. In this example, use $n = 0.35$ and $C = 280$.

2) Calculate T_V from the tooling cost parameters:

If cost of insert = \$7.50; edges per insert = 2; cost of tool holder = \$100; life of holder = 100 insert sets; and for tools with inserts, allowance for insert failures = cost per insert by 4/3, assuming only 3 out of 4 edges can be effectively used.

Then, cost per edge = C_E is calculated as follows:

$$C_E = \frac{\text{cost of insert(s)}}{\text{number of edges per insert}} + \frac{\text{cost of cutter body}}{\text{cutter body life in number of edges}}$$

$$= \frac{7.50 \times 4/3}{2} + \frac{100}{100} = \$6.00$$

The time for replacing a worn edge of the facing insert = $T_{RPL} = 2.24$ minutes. Assuming an hourly rate $H_R = \$50/\text{hour}$, calculate the equivalent tooling-cost time T_V

$$T_V = T_{RPL} + 60 \times C_E/H_R = 2.24 + 60 \times 6/50 = 9.44 \text{ minutes}$$

3) Determine economic tool-life T_E

$$T_E = T_V \times (1/n - 1) = 9.44 \times (1/0.35 - 1) = 17.5 \text{ minutes}$$

4) Determine economic cutting speed using the Handbook tables using the method shown in Example 10,

$$V_E = C/T_E^n \text{ m/min} = 280 / 17.5^{0.35} = 103 \text{ m/min}$$

5) Determine cost of tooling per batch (cutting tools, holders and tool changing) then total cost of cutting per batch:

$$C_{TOOL} = H_R \times T_C \times (C_E/T)/60$$

$$(C_{TOOL} + C_{CH}) = H_R \times T_C \times ((T_{RPL} + C_E/T)/60)$$

$$C_{TOT} = H_R \times T_C (1 + (T_{RPL} + C_E)/T)$$

Example 12, Face Milling - Minimum Cost: This example demonstrates how a modern firm, using the formulas previously described, can determine optimal data. It is here applied to a face mill with 10 teeth, milling a 1045 type steel, and the radial depth versus the cutter diameter is 0.8. The *V-ECT-T* curves for tool-lives 5, 22, and 120 minutes for this operation are shown in Fig. 23a.

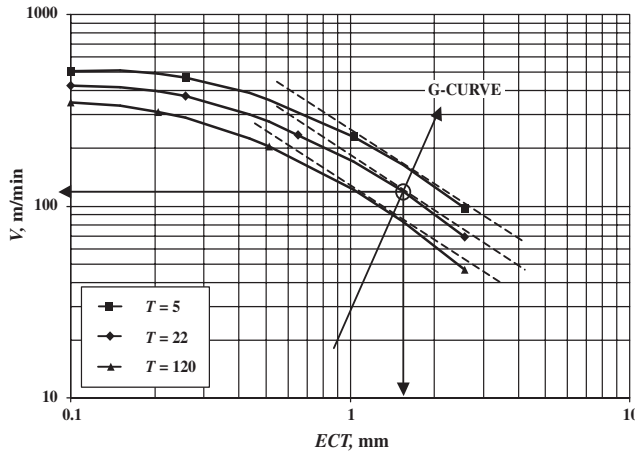


Fig. 23a. Cutting speed vs. ECT, tool-life constant

The global cost minimum occurs along the *G-curve*, see Fig. 6c and Fig. 23a, where the 45-degree line defines this curve. Optimum *ECT* is in the range 1.5 to 2 mm.

For face and end milling operations, $ECT = z \times f_z \times ar/D \times aa/CEL \div \pi$. The ratio $aa/CEL = 0.95$ for lead angle $LA = 0$, and for $ar/D = 0.8$ and 10 teeth, using the formula to calculate the feed/tooth range gives for $ECT = 1.5, f_z = 0.62$ mm and for $ECT = 2, f_z = 0.83$ mm.

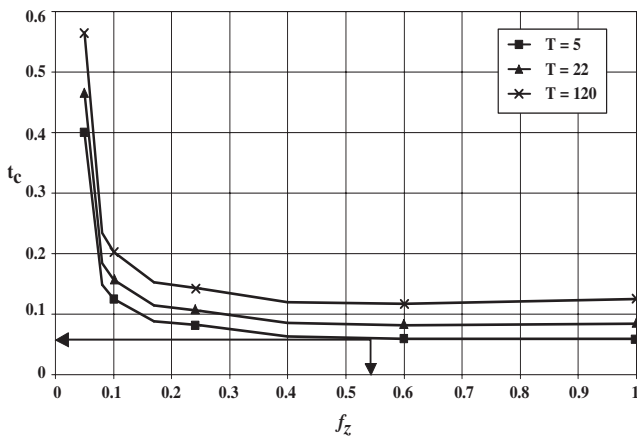


Fig. 23b. Cutting time per part vs. feed per tooth

Using computer simulation, the minimum cost occurs approximately where Fig. 23a indicates it should be. Total cost has a global minimum at f_z around 0.6 to 0.7 mm and a speed of around 110 m/min. *ECT* is about 1.9 mm and the optimal cutter life is $T_O = 22$ minutes. Because it may be impossible to reach the optimum feed value due to tool breakage,

the maximum practical feed f_{max} is used as the optimal value. The difference in costs between a global optimum and a practical minimum cost condition is negligible, as shown in Figs. 23c and 23e. A summary of the results are shown in Figs. 23a through 23e, and Table 1.

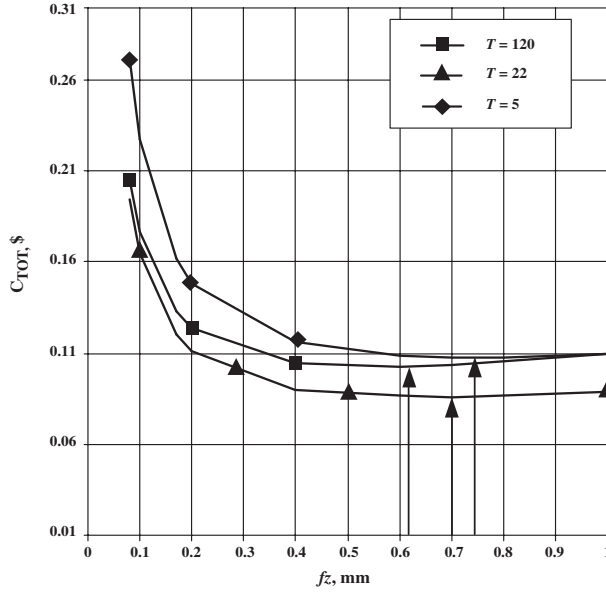


Fig. 23c. Total cost vs. feed/tooth

When plotting cutting time/part, t_c , versus feed/tooth, f_z , at $T = 5, 22, 120$ in Figs. 23b, tool-life $T = 5$ minutes yields the shortest cutting time, but total cost is the highest; the minimum occurs for f_z about 0.75 mm, see Figs. 23c. The minimum for $T = 120$ minutes is about 0.6 mm and for $T = 22$ minutes around 0.7 mm.

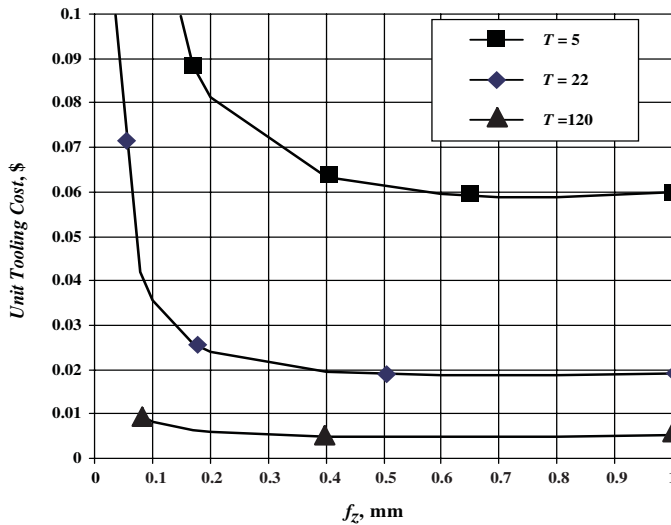


Fig. 23d. Tooling cost versus feed/tooth

Fig. 23d shows that tooling cost drop off quickly when increasing feed from 0.1 to 0.3 to 0.4 mm, and then diminishes slowly and is almost constant up to 0.7 to 0.8 mm/tooth. It is generally very high at the short tool-life 5 minutes, while tooling cost of optimal tool-life 22 minutes is about 3 times higher than when going slow at $T = 120$ minutes.

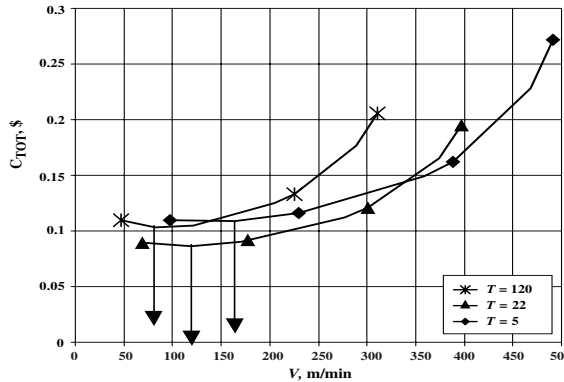


Fig. 23e. Total cost vs. cutting speed at 3 constant tool-lives, feed varies

The total cost curves in Fig. 23e. were obtained by varying feed and cutting speed in order to maintain constant tool-lives at 5, 22 and 120 minutes. Cost is plotted as a function of speed V instead of feed/tooth. Approximate optimum speeds are $V = 150$ m/min at $T = 5$ minutes, $V = 180$ m/min at $T = 120$ minutes, and the global optimum speed is $V_0 = 110$ m/min for $T_0 = 22$ minutes.

Table 1 displays the exact numerical values of cutting speed, tooling cost and total cost for the selected tool-lives of 5, 22, and 120 minutes, obtained from the software program.

Table 1. Face Milling, Total and Tooling Cost versus ECT, Feed/tooth f_z , and Cutting Speed V , at Tool-lives 5, 22, and 120 minutes

f_z	ECT	T = 5 minutes			T = 22 minutes			T = 120 minutes		
		V	C_{TOT}	C_{TOOL}	V	C_{TOT}	C_{TOOL}	V	C_{TOT}	C_{TOOL}
0.03	0.08	489	0.72891	0.39759	416	0.49650	0.10667	344	0.49378	0.02351
0.08	0.21	492	0.27196	0.14834	397	0.19489	0.04187	311	0.20534	0.00978
0.10	0.26	469	0.22834	0.12455	374	0.16553	0.03556	289	0.17674	0.00842
0.17	0.44	388	0.16218	0.08846	301	0.12084	0.02596	225	0.13316	0.00634
0.20	0.51	359	0.14911	0.08133	276	0.11204	0.02407	205	0.12466	0.00594
0.40	1.03	230	0.11622	0.06339	171	0.09051	0.01945	122	0.10495	0.00500
0.60	1.54	164	0.10904	0.05948	119	0.08672	0.01863	83	0.10301	0.00491
0.70	1.80	141	0.10802	0.05892	102	0.08665	0.01862	70	0.10393	0.00495
0.80	2.06	124	0.10800	0.05891	89	0.08723	0.01874	60	0.10547	0.00502
1.00	2.57	98	0.10968	0.05982	69	0.08957	0.01924	47	0.10967	0.00522

High-speed Machining Econometrics

High-speed Machining - No Mystery.—This section describes the theory and gives the basic formulas for any milling operation and high-speed milling in particular, followed by several examples on high-speed milling econometrics. These rules constitute the basis on which selection of milling feed factors is done. Selection of cutting speeds for general milling is done using the Handbook Table 10 through 14, starting on page 1043.

High-speed machining is no mystery to those having a good knowledge of metal cutting. Machining materials with very good machinability, such as low-alloyed aluminum, have for ages been performed at cutting speeds well below the speed values at which these materials should be cut. Operating at these low speeds often results in built-up edges and poor surface finish, because the operating conditions selected are on the wrong side of the Taylor curve, i.e. to the left of the H -curve representing maximum tool-life values (see Fig. 4 on page 1135).

In the 1950's it was discovered that cutting speed could be raised by a factor of 5 to 10 when hobbing steel with HSS cutters. This is another example of being on the wrong side of the Taylor curve.

One of the first reports on high-speed end milling using high-speed steel (HSS) and carbide cutters for milling 6061-T651 and A356-T6 aluminum was reported in a study funded by Defense Advanced Research Project Agency (DARPA). Cutting speeds of up to 4400 m/min (14140 fpm) were used. Maximum tool-lives of 20 through 40 minutes were obtained when the feed/tooth was 0.2 through 0.25 mm (0.008 to 0.01 inch), or measured in terms of ECT around 0.07 to 0.09 mm. Lower or higher feed/tooth resulted in shorter cutter lives. The same types of previously described curves, namely $T-ECT$ curves with maximum tool-life along the H -curve, were produced.

When examining the influence of ECT , or feed/rev, or feed/tooth, it is found that too small values cause chipping, vibrations, and poor surface finish. This is caused by inadequate (too small) chip thickness, and as a result the material is not cut but plowed away or scratched, due to the fact that operating conditions are on the wrong (left) side of the tool-life versus ECT curve ($T-ECT$ with constant speed plotted).

There is a great difference in the thickness of chips produced by a tooth traveling through the cutting arc in the milling process, depending on how the center of the cutter is placed in relation to the workpiece centerline, in the feed direction. Although end and face milling cut in the same way, from a geometry and kinematics standpoint they are in practice distinguished by the cutter center placement away from, or close to, the work centerline, respectively, because of the effect of cutter placement on chip thickness. This is the criteria used to distinguishing between the end and face milling processes in the following.

Depth of Cut/Cutter Diameter, ar/D is the ratio of the radial depth of cut ar and the cutter diameter D . In face milling when the cutter axis points approximately to the middle of the work piece axis, eccentricity is close to zero, as illustrated in Figs. 3 and 4, page 1041, and Fig. 5 on page 1042. In end milling, $ar/D = 1$ for full slot milling.

Mean Chip Thickness, hm is a key parameter that is used to calculate forces and power requirements in high-speed milling. If the mean chip thickness hm is too small, which may occur when feed/tooth is too small (this holds for all milling operations), or when ar/D decreases (this holds for ball nose as well as for straight end mills), then cutting occurs on the left (wrong side) of the tool-life versus ECT curve, as illustrated in Figs. 6b and 6c.

In order to maintain a given chip thickness in end milling, the feed/tooth has to be increased, up to 10 times for very small ar/D values in an extreme case with no run out and otherwise perfect conditions. A 10 times increase in feed/tooth results in 10 times bigger feed rates (F_R) compared to data for full slot milling (valid for $ar/D = 1$), yet maintain a given chip thickness. The cutter life at any given cutting speed will not be the same, however.

Increasing the number of teeth from say 2 to 6 increases equivalent chip thickness ECT by a factor of 3 while the mean chip thickness hm remains the same, but does not increase the feed rate to 30 (3×10) times bigger, because the cutting speed must be reduced. However, when the ar/D ratio matches the number of teeth, such that one tooth enters when the second tooth leaves the cutting arc, then $ECT = hm$. Hence, ECT is proportional to the number of teeth. Under ideal conditions, an increase in number of teeth z from 2 to 6 increases the feed rate by, say, 20 times, maintaining tool-life at a reduced speed. In practice about 5 times greater feed rates can be expected for small ar/D ratios (0.01 to 0.02), and up to 10 times with 3 times as many teeth. So, high-speed end milling is no mystery.

Chip Geometry in End and Face Milling.—Fig. 24 illustrates how the chip forming process develops differently in face and end milling, and how mean chip thickness hm varies with the angle of engagement AE , which depends on the ar/D ratio. The pertinent chip geometry formulas are given in the text that follows.

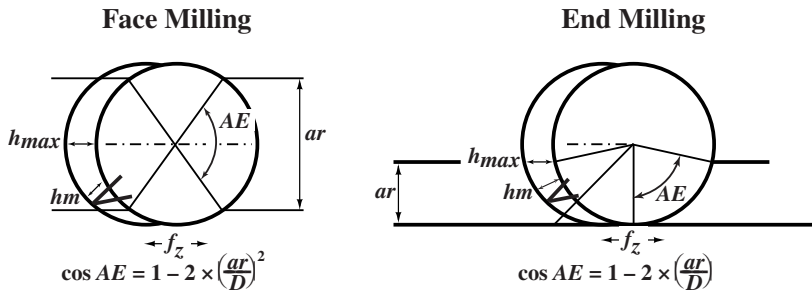


Fig. 24.

Comparison of face milling and end milling geometry. High-speed end milling refers to values of ar/D that are less than 0.5, in particular to ar/D ratios which are considerably smaller. When $ar/D = 0.5$ ($AE = 90$ degrees) and diminishing in end milling, the chip thickness gets so small that poor cutting action develops, including plowing or scratching. This situation is remedied by increasing the feed/tooth, as shown in Table 2a as an increasing f_z/f_{z0} ratio with decreasing ar/D . For end milling, the f_z/f_{z0} feed ratio is 1.0 for $ar/D = 1$ and also for $ar/D = 0.5$. In order to maintain the same hm as at $ar/D = 1$, the feed/tooth should be increased, by a factor of 6.38 when ar/D is 0.01 and by more than 10 when ar/D is less than 0.01. Hence high-speed end milling could be said to begin when ar/D is less than 0.5

In end milling, the ratio $f_z/f_{z0} = 1$ is set at $ar/D = 1.0$ (full slot), a common value in vendor catalogs and handbooks, for $hm = 0.108$ mm.

The face milling chip making process is exactly the same as end milling when face milling the side of a work piece and $ar/D = 0.5$ or less. However, when face milling close to and along the work centerline (eccentricity is close to zero) chip making is quite different, as shown in Fig. 24. When $ar/D = 0.74$ ($AE = 95$ degrees) in face milling, the f_z/f_{z0} ratio is 1 and increases up to 1.4 when the work width is equal to the cutter diameter ($ar/D = 1$). The face milling f_z/f_{z0} ratio continues to diminish when the ar/D ratio decreases below $ar/D = 0.74$, but very insignificantly, only about 11 percent when $ar/D = 0.01$.

In face milling $f_z/f_{z0} = 1$ is set at $ar/D = 0.74$, a common value recommended in vendor catalogs and handbooks, for $hm = 0.151$ mm.

Fig. 25 shows the variation of the feed/tooth-ratio in a graph for end and face milling.

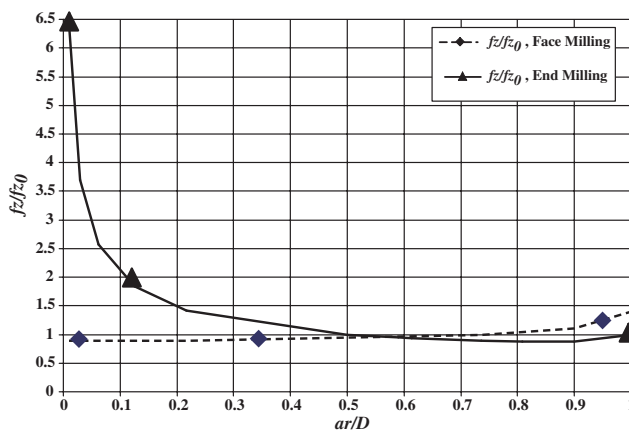


Fig. 25. Feed/tooth versus ar/D for face and end milling

Table 2a. Variation of Chip Thickness and f_z/f_{z0} with ar/D

ar/D	Face Milling					End Milling (straight)				
	eccentricity $e = 0$ $z = 8$ $f_{z0} = 0.17$ $\cos AE = 1 - 2 \times (ar/D)^2$					$z = 2$ $f_{z0} = 0.17$ $\cos AE = 1 - 2 \times (ar/D)$				
	AE	hm/f_z	hm	ECT/hm	f_z/f_{z0}	AE	hm/f_z	hm	ECT/hm	f_z/f_{z0}
1.0000	180.000	0.637	0.108	5.000	1.398	180.000	0.637	0.108	1.000	1.000
0.9000	128.316	0.804	0.137	3.564	1.107	143.130	0.721	0.122	0.795	0.884
0.8000	106.260	0.863	0.147	2.952	1.032	126.870	0.723	0.123	0.711	0.881
0.7355	94.702	0.890	0.151	2.631	1.000	118.102	0.714	0.122	0.667	0.892
0.6137	75.715	0.929	0.158	1.683	0.958	103.144	0.682	0.116	0.573	0.934
0.5000	60.000	1.025	0.162	1.267	0.932	90.000	0.674	0.115	0.558	1.000
0.3930	46.282	0.973	0.165	1.028	0.915	77.643	0.580	0.099	0.431	1.098
0.2170	25.066	0.992	0.169	0.557	0.897	55.528	0.448	0.076	0.308	1.422
0.1250	14.361	0.997	0.170	0.319	0.892	41.410	0.346	0.059	0.230	1.840
0.0625	7.167	0.999	0.170	0.159	0.891	28.955	0.247	0.042	0.161	2.574
0.0300	3.438	1.000	0.170	0.076	0.890	19.948	0.172	0.029	0.111	3.694
0.0100	1.146	1.000	0.170	0.025	0.890	11.478	0.100	0.017	0.064	6.377
0.0010	0.115	1.000	0.000	0.000	0.890	3.624	0.000	0.000	0.000	20.135

In **Table 2a**, a standard value $f_{z0} = 0.17$ mm/tooth (commonly recommended average feed) was used, but the f_z/f_{z0} values are independent of the value of feed/tooth, and the previously mentioned relationships are valid whether $f_{z0} = 0.17$ or any other value.

In both end and face milling, $hm = 0.108$ mm for $f_{z0} = 0.17$ mm when $ar/D = 1$. When the f_z/f_{z0} ratio = 1, $hm = 0.15$ for face milling, and 0.108 in end milling both at $ar/D = 1$ and 0.5. The tabulated data hold for perfect milling conditions, such as, zero run-out and accurate sharpening of all teeth and edges.

Mean Chip Thickness hm and Equivalent Chip Thickness ECT .—The basic formula for equivalent chip thickness ECT for any milling process is:

$ECT = f_z \times z/\pi \times (ar/D) \times aa/CEL$, where f_z = feed/tooth, z = number of teeth, D = cutter diameter, ar = radial depth of cut, aa = axial depth of cut, and CEL = cutting edge length. As a function of mean chip thickness hm :

$$ECT = hm \times (z/2) \times (AE/180), \text{ where } AE = \text{angle of engagement.}$$

Both terms are exactly equal when one tooth engages as soon as the preceding tooth leaves the cutting section. Mathematically, $hm = ECT$ when $z = 360/AE$; thus:

$$\text{for face milling, } AE = \arccos(1 - 2 \times (ar/D)^2)$$

$$\text{for end milling, } AE = \arccos(1 - 2 \times (ar/D))$$

Calculation of Equivalent Chip Thickness (ECT) versus Feed/tooth and Number of teeth.: **Table 2b** is a continuation of **Table 2a**, showing the values of ECT for face and end milling for decreasing values ar/D , and the resulting ECT when multiplied by the f_z/f_{z0} ratio $f_{z0} = 0.17$ (based on $hm = 0.108$).

Small ar/D ratios produce too small mean chip thickness for cutting chips. In practice, minimum values of hm are approximately 0.02 through 0.04 mm for both end and face milling.

Formulas.— Equivalent chip thickness can be calculated for other values of f_z and z by means of the following formulas:

$$\text{Face milling: } ECT_F = ECT_{0F} \times (z/8) \times (f_z/0.17) \times (aa/CEL)$$

or, if ECT_F is known calculate f_z using:

$$f_z = 0.17 \times (ECT_F/ECT_{0F}) \times (8/z) \times (CEL/aa)$$

Table 2b. Variation of ECT, Chip Thickness and f_z/f_{z0} with ar/D

ar/D	Face Milling				End Milling (straight)			
	hm	f_z/f_{z0}	ECT	ECT_0 corrected- for f_z/f_{z0}	hm	f_z/f_{z0}	ECT	ECT_0 corrected- for f_z/f_{z0}
1.0000	0.108	1.398	0.411	0.575	0.108	1.000	0.103	0.103
0.9000	0.137	1.107	0.370	0.410	0.122	0.884	0.093	0.082
0.8080	0.146	1.036	0.332	0.344	0.123	0.880	0.083	0.073
0.7360	0.151	1.000	0.303	0.303	0.121	0.892	0.076	0.067
0.6137	0.158	0.958	0.252	0.242	0.116	0.934	0.063	0.059
0.5900	0.159	0.952	0.243	0.231	0.115	0.945	0.061	0.057
0.5000	0.162	0.932	0.206	0.192	0.108	1.000	0.051	0.051
0.2170	0.169	0.897	0.089	0.080	0.076	1.422	0.022	0.032
0.1250	0.170	0.892	0.051	0.046	0.059	1.840	0.013	0.024
0.0625	0.170	0.891	0.026	0.023	0.042	2.574	0.006	0.017
0.0300	0.170	0.890	0.012	0.011	0.029	3.694	0.003	0.011
0.0100	0.170	0.890	0.004	0.004	0.017	6.377	0.001	0.007
0.0010	0.170	0.890	0.002	0.002	0.005	20.135	0.001	0.005

In face milling, the approximate values of $aa/CEL = 0.95$ for lead angle $LA = 0^\circ$ (90° in the metric system); for other values of LA , $aa/CEL = 0.95 \times \sin(LA)$, and $0.95 \times \cos(LA)$ in the metric system.

Example, Face Milling: For a cutter with $D = 250$ mm and $ar = 125$ mm, calculate ECT_F for $f_z = 0.1$, $z = 12$, and $LA = 30$ degrees. First calculate $ar/D = 0.5$, and then use **Table 2b** and find $ECT_{0F} = 0.2$.

Calculate ECT_F with above formula:

$$ECT_F = 0.2 \times (12/8) \times (0.1/0.17) \times 0.95 \times \sin 30 = 0.084 \text{ mm.}$$

End milling: $ECT_E = ECT_{0E} \times (z/2) \times (f_z/0.17) \times (aa/CEL)$,

or if ECT_E is known calculate f_z from:

$$f_z = 0.17 \times (ECT_E/ECT_{0E}) \times (2/z) \times (CEL/aa)$$

The approximate values of $aa/CEL = 0.95$ for lead angle $LA = 0^\circ$ (90° in the metric system).

Example, High-speed End Milling: For a cutter with $D = 25$ mm and $ar = 3.125$ mm, calculate ECT_E for $f_z = 0.1$ and $z = 6$. First calculate $ar/D = 0.125$, and then use **Table 2b** and find $ECT_{0E} = 0.0249$.

Calculate ECT_E with above formula:

$$ECT_E = 0.0249 \times (6/2) \times (0.1/0.17) \times 0.95 \times 1 = 0.042 \text{ mm.}$$

Example, High-speed End Milling: For a cutter with $D = 25$ mm and $ar = 0.75$ mm, calculate ECT_E for $f_z = 0.17$ and $z = 2$ and 6 . First calculate $ar/D = 0.03$, and then use **Table 2b** and find $f_z/f_{z0} = 3.694$

Then, $f_z = 3.694 \times 0.17 = 0.58$ mm/tooth and $ECT_E = 0.0119 \times 0.95 = 0.0113$ mm and $0.0357 \times 0.95 = 0.0339$ mm for 2 and 6 teeth respectively. These cutters are marked HS2 and HS6 in **Figs. 26a, 26d, and 26e**.

Example, High-speed End Milling: For a cutter with $D = 25$ mm and $ar = 0.25$ mm, calculate ECT_E for $f_z = 0.17$ and $z = 2$ and 6 . First calculate $ar/D = 0.01$, and then use **Table 2b** and find $ECT_{0E} = 0.0069$ and 0.0207 for 2 and 6 teeth respectively. When obtaining such small values of ECT , there is a great danger to be far on the left side of the H -curve, at least when there are only 2 teeth. Doubling the feed would be the solution if cutter design and material permit.

Example, Full Slot Milling: For a cutter with $D = 25$ mm and $ar = 25$ mm, calculate ECT_E for $f_z = 0.17$ and $z = 2$ and 6 . First calculate $ar/D = 1$, and then use **Table 2b** and find $ECT_E =$

$0.108 \times 0.95 = 0.103$ and $3 \times 0.108 \times 0.95 = 0.308$ for 2 and 6 teeth, respectively. These cutters are marked SL2 and SL6 in Figs. 26a, 26d, and 26e.

Physics behind hm and ECT , Forces and Tool-life (T).—The ECT concept for all metal cutting and grinding operations says that the more energy put into the process, by increasing feed/rev, feed/tooth, or cutting speed, the life of the edge decreases. When increasing the number of teeth (keeping everything else constant) the work and the process are subjected to a higher energy input resulting in a higher rate of tool wear.

In high-speed milling when the angle of engagement AE is small the contact time is shorter compared to slot milling ($ar/D = 1$) but the chip becomes shorter as well. Maintaining the same chip thickness as in slot milling has the effect that the energy consumption to remove the chip will be different. Hence, maintaining a constant chip thickness is a good measure when calculating cutting forces (keeping speed constant), but not when determining tool wear. Depending on cutting conditions the wear rate can either increase or decrease, this depends on whether cutting occurs on the left or right side of the H -curve.

Fig. 26a shows an example of end milling of steel with coated carbide inserts, where cutting speed V is plotted versus ECT at 5, 15, 45 and 180 minutes tool-lives. Notice that the ECT values are independent of ar/D or number of teeth or feed/tooth, or whether f_z or f_{z0} is used, as long as the corresponding f_z/f_{z0} -ratio is applied to determine ECT_E . The result is one single curve per tool-life. Had cutting speed been plotted versus f_{z0} , ar/D , or z values (number of teeth), several curves would be required at each constant tool-life, one for each of these parameters This illustrates the advantage of using the basic parameter ECT rather than f_z , or hm , or ar/D on the horizontal axis.

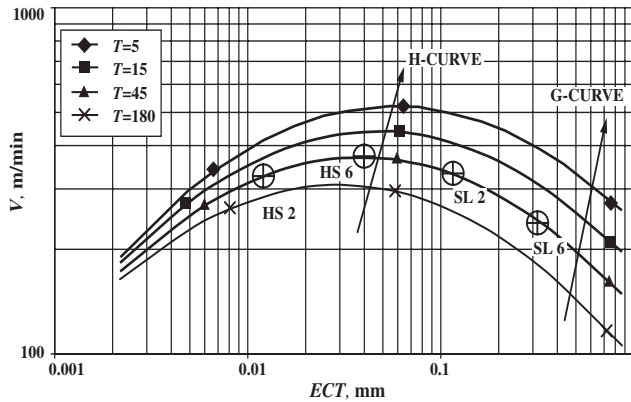


Fig. 26a. Cutting speed vs. ECT, tool-life plotted, for end milling

Example: The points (HS2, HS6) and (SL2, SL6) on the 45-minute curve in Fig. 26a relate to the previous high-speed and full slot milling examples for 2 and 6 teeth, respectively.

Running a slot at $f_{z0} = 0.17$ mm/tooth ($hm = 0.108$, $ECT_E = 0.103$ mm) with 2 teeth and for a tool-life 45 minutes, the cutting speed should be selected at $V = 340$ m/min at point SL2 and for six teeth ($hm = 0.108$ mm, $ECT_E = 0.308$) at $V = 240$ m/min at point SL6.

When high-speed milling for $ar/D = 0.03$ at $f_z = 3.394 \times 0.17 = 0.58$ mm/tooth = 0.58 mm/tooth, ECT is reduced to 0.011 mm ($hm = 0.108$) the cutting speed is 290 m/min to maintain $T = 45$ minutes, point HS2. This point is far to the left of the H -curve in Fig.26b, but if the number of teeth is increased to 6 ($ECT_E = 3 \times 0.103 = 0.3090$), the cutting speed is 360 m/min at $T = 45$ minutes and is close to the H -curve, point HS6. Slotting data using 6 teeth are on the right of this curve at point SL6, approaching the G -curve, but at a lower slotting speed of 240 m/min.

Depending on the starting f_z value and on the combination of cutter grade - work material, the location of the H -curve plays an important role when selecting high-speed end milling data.

Feed Rate and Tool-life in High-speed Milling, Effect of ECT and Number of Teeth.—Calculation of feed rate is done using the formulas in previously given:

Feed Rate:

$$F_R = z \times f_z \times \text{rpm}, \text{ where } z \times f_z = f \text{ (feed/rev of cutter). Feed is measured along the feeding direction.}$$

$$\text{rpm} = 1000 \times V/3.1416/D, \text{ where } D \text{ is diameter of cutter.}$$

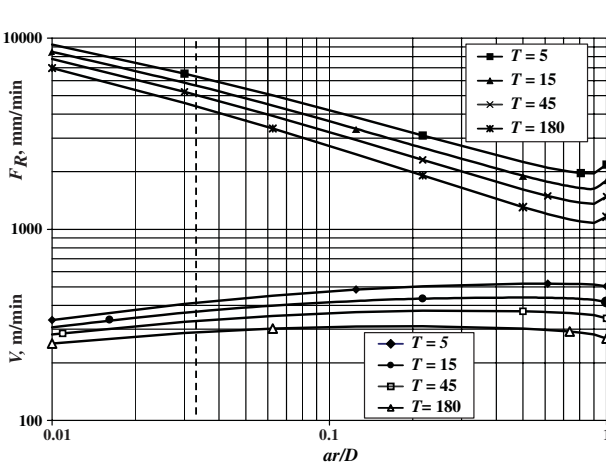


Fig. 26b. High speed feed rate and cutting speed versus ar/D at $T = 5, 15, 45,$ and 180 minutes

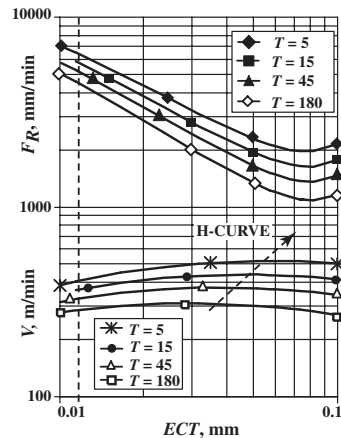


Fig. 26c. High speed feed rate and cutting speed versus $ECT, ar/D$ plotted at $T = 5, 15, 45,$ and 180 minutes

Fig. 26b shows the variation of feed rate F_R plotted versus ar/D for tool-lives 5, 15, 45 and 180 minutes with a 25 mm diameter cutter and 2 teeth. Fig. 26c shows the variation of feed rate F_R when plotted versus ECT . In both graphs the corresponding cutting speeds are also plotted. The values for $ar/D = 0.03$ in Fig. 26b correspond to $ECT = 0.011$ in Fig. 26c.

Feed rates have minimum around values of $ar/D = 0.8$ and $ECT = 0.75$ and not along the H -curve. This is due to the fact that the f_z/f_{z0} ratio to maintain a mean chip thickness = 0.108 mm changes F_R in a different proportion than the cutting speed.

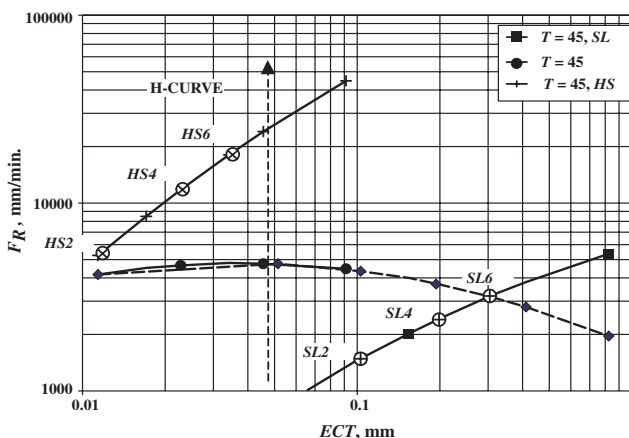


Fig. 26d. Feed rate versus *ECT* comparison of slot milling ($ar/D = 1$) and high-speed milling at ($ar/D = 0.03$) for 2, 4, and 6 teeth at $T = 45$ minutes

A comparison of feed rates for full slot ($ar/D = 1$) and high-speed end milling ($ar/D = 0.03$ and $f_z = 3.69 \times f_{z0} = 0.628$ mm) for tool-life 45 minutes is shown in Fig. 26d. The points SL2, SL4, SL6 and HS2, HS4, HS6, refer to 2, 4, and 6 teeth (2 to 6 teeth are commonly used in practice). Feed rate is also plotted versus number of teeth z in Fig. 26e, for up to 16 teeth, still at $f_z = 0.628$ mm.

Comparing the effect of using 2 versus 6 teeth in high-speed milling shows that feed rates increase from 5250 mm/min (413 ipm) up to 18000 mm/min (1417 ipm) at 45 minutes tool-life. The effect of using 2 versus 6 teeth in full slot milling is that feed rate increases from 1480 mm/min (58 ipm) up to 3230 mm/min (127 ipm) at tool-life 45 minutes. If 16 teeth could be used at $ar/D = 0.03$, the feed rate increases to $F_R = 44700$ mm/min (1760 ipm), and for full slot milling $F_R = 5350$ mm/min (210 ipm).

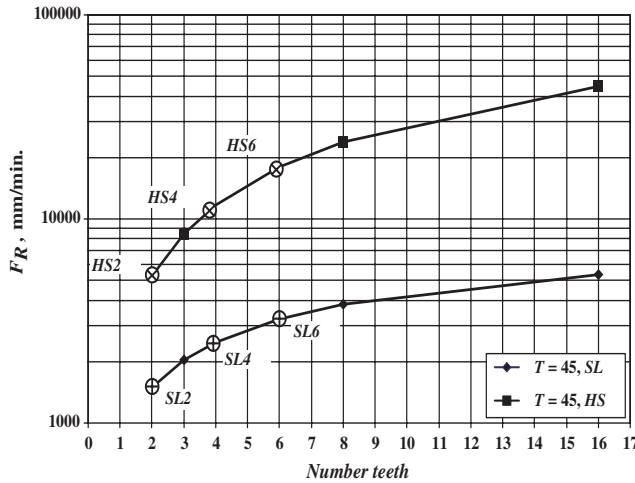


Fig. 26e. Feed rate versus number of teeth comparison of slot milling ($ar/D = 1$) and high-speed milling at ($ar/D = 0.03$) for 2, 4, and 6 teeth at $T = 45$ minutes

Comparing the feed rates that can be obtained in steel cutting with the one achieved in the earlier referred DARPA investigation, using HSS and carbide cutters milling 6061-T651 and A356-T6 aluminum, it is obvious that aluminium end milling can be run at 3 to 6 times higher feed rates. This requires 3 to 6 times higher spindle speeds (cutter diameter 25 mm, radial depth of cut $ar = 12.5$ mm, 2 teeth). Had these tests been run with 6 teeth, the feed rates would increase up to 150000-300000 mm/min, when feed/tooth = $3.4 \times 0.25 = 0.8$ mm/tooth at $ar/D = 0.03$.

Process Econometrics Comparison of High-speed and Slot End Milling.— When making a process econometrics comparison of high-speed milling and slot end milling use the formulas for total cost c_{tot} (*Determination Of Machine Settings And Calculation Of Costs* starting on page 1152). Total cost is the sum of the cost of cutting, tool changing, and tooling:

$$c_{tot} = H_R \times (Dist/F_R) \times (1 + T_V/T)/60$$

where $T_V = T_{RPL} + 60 \times C_E/H_R =$ equivalent tooling-cost time, minutes

T_{RPL} = replacement time for a set of edges or tool for regrinding

C_E = cost per edge(s)

H_R = hourly rate, \$

Fig. 27. compares total cost c_{tot} , using the end milling cutters of the previous examples, for full slot milling with high-speed milling at $ar/D=0.03$, and versus ECT at $T=45$ minutes.

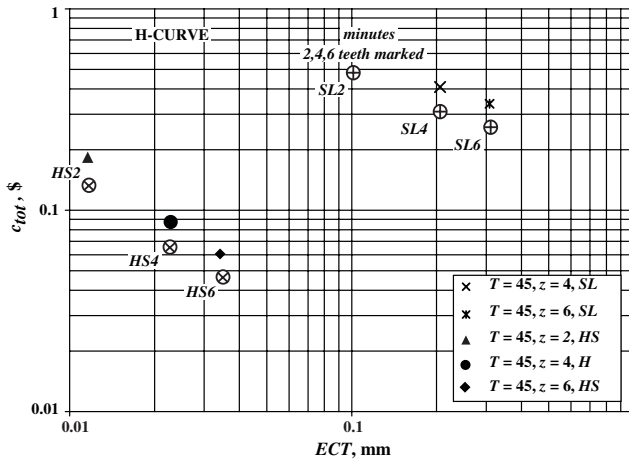


Fig. 27. Cost comparison of slot milling ($ar/D = 1$) and high-speed milling at ($ar/D = 0.03$) for 2, 4, and 6 teeth at $T = 45$ minutes

The feed/tooth for slot milling is $f_{z0} = 0.17$ and for high-speed milling at $ar/D = 0.03$ the feed is $f_z = 3.69 \times f_{z0} = 0.628$ mm.

The calculations for total cost are done according to above formula using tooling cost at $T_V = 6, 10,$ and 14 minutes, for $z = 2, 4,$ and 6 teeth respectively. The distance cut is $Dist = 1000$ mm. Full slot milling costs are,

at feed rate $F_R = 3230$ and $z = 6$

$$c_{tot} = 50 \times (1000/3230) \times (1 + 14/45)/60 = \$0.338 \text{ per part}$$

at feed rate $F_R = 1480$ and $z = 2$

$$c_{tot} = 50 \times (1000/1480) \times (1 + 6/45)/60 = \$0.638 \text{ per part}$$

High-speed milling costs,

at $F_R = 18000, z = 6$

$$c_{tot} = 50 \times (1000/18000) \times (1 + 14/45)/60 = \$0.0606 \text{ per part}$$

at $F_R = 5250, z = 2$

$$c_{tot} = 50 \times (1000/5250) \times (1 + 6/45)/60 = \$0.180 \text{ per part}$$

The cost reduction using high-speed milling compared to slotting is enormous. For high-speed milling with 2 teeth, the cost for high-speed milling with 2 teeth is 61 percent ($0.208/0.338$) of full slot milling with 6 teeth ($z = 6$). The cost for high-speed milling with 6 teeth is 19 percent ($0.0638/0.338$) of full slot for $z = 6$.

Aluminium end milling can be run at 3 to 6 times lower costs than when cutting steel. Costs of idle (non-machining) and slack time (waste) are not considered in the example. These data hold for perfect milling conditions such as zero run-out and accurate sharpening of all teeth and edges.

SCREW MACHINES, BAND SAWS, CUTTING FLUIDS

Automatic Screw Machine Tool Operations

Feeds and Speeds for Automatic Screw Machine Tools.—Approximate feeds and speeds for standard screw machine tools are given in [Table 1](#) on page 1171.

Knurling in Automatic Screw Machines.—When knurling is done from the cross slide, it is good practice to feed the knurl gradually to the center of the work, starting to feed when the knurl touches the work and then passing off the center of the work with a quick rise of the cam. The knurl should also dwell for a certain number of revolutions, depending on the pitch of the knurl and the kind of material being knurled. See also *KNURLS AND KNURLING* starting on page 991.

When two knurls are employed for spiral and diamond knurling from the turret, the knurls can be operated at a higher rate of feed for producing a spiral than they can for producing a diamond pattern. The reason for this is that in the first case the knurls work in the same groove, whereas in the latter case they work independently of each other.

Revolutions Required for Top Knurling.—The depth of the teeth and the feed per revolution govern the number of revolutions required for top knurling from the cross slide. If R is the radius of the stock, d is the depth of the teeth, c is the distance the knurl travels from the point of contact to the center of the work at the feed required for knurling, and r is the radius of the knurl. Inch or metric units may be used in the following equation.

$$c = \sqrt{(R + r)^2 - (R + r - d)^2}$$

Example: If the stock radius R is $\frac{5}{32}$ inch (or mm), depth of teeth d is 0.0156 inch (or mm), and radius of knurl r is 0.3125 inch (or mm), then

$$\begin{aligned} c &= \sqrt{(0.1562 + 0.3125)^2 - (0.1562 + 0.3125 - 0.0156)^2} \\ &= 0.120 \text{ inch (or mm) = cam rise required} \end{aligned}$$

Example: Assume that it is required to find the number of revolutions to knurl a piece of brass $\frac{5}{16}$ inch in diameter using a 32 pitch knurl. The included angle of the teeth for brass is 90 degrees, the circular pitch is 0.03125 inch, and the calculated tooth depth is 0.0156 inch. The distance c (as determined in the previous example) is 0.120 inch. Referring to [Table 1](#) on page 1171, the feed for top knurling brass is 0.005 inch per revolution. The number of revolutions required for knurling is, therefore, $0.120 \div 0.005 = 24$ revolutions. If conditions permit, the higher feed of 0.008 inch per revolution given in the table may be used, and 15 revolutions are then required for knurling.

Cams for Threading.—[Table 2](#) on page 1173 gives the revolutions required for threading various lengths and pitches and the corresponding rise for the cam lobe. To illustrate the use of this table, suppose a set of cams is required for threading a screw to the length of $\frac{3}{8}$ inch in a Brown & Sharpe machine. Assume that the spindle speed is 2400 revolutions per minute; the number of revolutions to complete one piece, 400; time required to make one piece, 10 seconds; pitch of the thread, $\frac{1}{32}$ inch or 32 threads per inch. By referring to [Table 2](#), under 32 threads per inch, and opposite $\frac{3}{8}$ inch (length of threaded part), the number of revolutions required is found to be 15 and the rise required for the cam, 0.413 inch.

Table 1. Approximate Cutting Speeds and Feeds for Standard Automatic Screw Machine Tools—Brown and Sharpe

Tool	Cut		Material to be Machined						
	Width or Depth, Inches	Dia. of Hole, Inches	Brass ^a	Mild or Soft Steel			Tool Steel, 0.80-1.00% C		
			Feed, Inches per Rev.	Feed, Inches per Rev.	Surface Speed, Feet per Min.		Feed, Inches per Rev.	Surface Speed, Feet per Min.	
					Carbon Tools	H.S.S. Tools		Carbon Tools	H.S.S. Tools
Boring tools	0.005	0.008	50	110	0.004	30	60
Box tools, roller rest Single chip finishing	1/32	...	0.012	0.010	70	150	0.005	40	75
	1/16	...	0.010	0.008	70	150	0.004	40	75
	1/8	...	0.008	0.007	70	150	0.003	40	75
	3/16	...	0.008	0.006	70	150	0.002	40	75
	1/4	...	0.006	0.005	70	150	0.0015	40	75
Finishing	0.005	...	0.010	0.010	70	150	0.006	40	75
Center drills	...	Under 1/8	0.003	0.0015	50	110	0.001	30	75
	...	Over 1/8	0.006	0.0035	50	110	0.002	30	75
Cutoff tools { Stock diameter under 1/8 in.	Angular	...	0.0015	0.0006	80	150	0.0004	50	85
	Circular	...	0.0035	0.0015	80	150	0.001	50	85
	Straight	...	0.0035	0.0015	80	150	0.001	50	85
	0.002	0.0008	80	150	0.0005	50	85
Dies {	Button	30	14	...
	Chaser	30	40	...	16	20
Drills, twist cut	...	0.02	0.0014	0.001	40	60	0.0006	30	45
	...	0.04	0.002	0.0014	40	60	0.0008	30	45
	...	1/16	0.004	0.002	40	60	0.0012	30	45
	...	3/32	0.006	0.0025	40	60	0.0016	30	45
	...	1/8	0.009	0.0035	40	75	0.002	30	60
	...	3/16	0.012	0.004	40	75	0.003	30	60
	...	1/4	0.014	0.005	40	75	0.003	30	60
	...	3/16	0.016	0.005	40	75	0.0035	30	60
	...	3/8-5/8	0.016	0.006	40	85	0.004	30	60
Form tools, circular	1/8	...	0.002	0.0009	80	150	0.0006	50	85
	1/4	...	0.002	0.0008	80	150	0.0005	50	85
	3/8	...	0.0015	0.0007	80	150	0.0004	50	85
	1/2	...	0.0012	0.0006	80	150	0.0004	50	85
	5/8	...	0.001	0.0005	80	150	0.0003	50	85
	3/4	...	0.001	0.0005	80	150	0.0003	50	85
	1	...	0.001	0.0004	80	150

Table 1. Approximate Cutting Speeds and Feeds for Standard Automatic Screw Machine Tools—Brown and Sharpe (Continued)

Tool	Cut		Material to be Machined							
	Width or Depth, Inches	Dia. of Hole, Inches	Brass ^a	Mild or Soft Steel		Tool Steel, 0.80-1.00% C				
			Feed, Inches per Rev.	Feed, Inches per Rev.	Surface Speed, Feet per Min.		Feed, Inches per Rev.	Surface Speed, Feet per Min.		
					Carbon Tools	H.S.S. Tools		Carbon Tools	H.S.S. Tools	
Hollow mills and balance turning tools {	Turned diam. under 5/32 in. {	1/32	...	0.012	0.010	70	150	0.008	40	85
		1/16	...	0.010	0.009	70	150	0.006	40	85
		1/32	...	0.017	0.014	70	150	0.010	40	85
	Turned diam. over 5/32 in. {	1/16	...	0.015	0.012	70	150	0.008	40	85
		1/8	...	0.012	0.010	70	150	0.008	40	85
		3/16	...	0.010	0.008	70	150	0.006	40	85
		1/4	...	0.009	0.007	70	150	0.0045	40	85
Knee tools	1/32	0.010	70	150	0.008	40	85	
Knurling tools {	Turret {	On	...	0.020	0.015	150	...	0.010	105	...
		Off	...	0.040	0.030	150	...	0.025	105	...
	Side or swing {	0.004	0.002	150	...	0.002	105	...
		0.006	0.004	150	...	0.003	105	...
		0.005	0.003	150	...	0.002	105	...
Top {	0.008	0.006	150	...	0.004	105	...	
Pointing and facing tools	0.001	0.0008	70	150	0.0005	40	80	
	0.0025	0.002	70	150	0.0008	40	80	
Reamers and bits	0.003 - 0.004	1/8 or less	0.010 - 0.007	0.008 - 0.006	70	105	0.006 - 0.004	40	60	
	0.004 - 0.008	1/8 or over	0.010	0.010	70	105	0.006 - 0.008	40	60	
Recessing tools {	End cut {	0.001	0.0006	70	150	0.0004	40	75
		0.005	0.003	70	150	0.002	40	75
	Inside cut {	0.0025	0.002	70	105	0.0015	40	60
		1/16-1/8	...	0.0008	0.0006	70	105	0.0004	40	60
Swing tools, forming	1/8	...	0.002	0.0007	70	150	0.0005	40	85	
	1/4	...	0.0012	0.0005	70	150	0.0003	40	85	
	3/8	...	0.001	0.0004	70	150	0.0002	40	85	
	1/2	...	0.0008	0.0003	70	150	0.0002	40	85	

Turning, straight and taper ^b	1/32	...	0.008	0.006	70	150	0.0035	40	85	
	1/16	...	0.006	0.004	70	150	0.003	40	85	
	1/8	...	0.005	0.003	70	150	0.002	40	85	
	3/16	...	0.004	0.0025	70	150	0.0015	40	85	
Taps	25	30	...	12	15	

^a Use maximum spindle speed on machine.

^b For taper turning use feed slow enough for greatest depth of cut.

Table 2. Spindle Revolutions and Cam Rise for Threading

Length of Threaded Portion, Inch	Number of Threads per Inch														
	80	72	64	56	48	40	36	32	30	28	24	20	18	16	14
	First Line: Revolutions of Spindle for Threading. Second Line: Rise on Cam for Threading, Inch														
1/16	9.50	9.00	8.50	8.00	6.00	5.50	5.50	5.00	5.00	5.00	3.00
	0.107	0.113	0.120	0.129	0.110	0.121	0.134	0.138	0.147	0.157	0.106
1/8	14.50	13.50	12.50	11.50	9.00	8.00	7.00	7.00	7.00	6.50	4.50	4.00	3.50	3.50	...
	0.163	0.169	0.176	0.185	0.165	0.176	0.171	0.193	0.205	0.204	0.159	0.170	0.165	0.186	...
3/16	19.50	18.00	16.50	15.00	12.00	10.50	10.00	9.00	8.50	8.50	6.00	5.50	5.00	4.50	4.00
	0.219	0.225	0.232	0.241	0.220	0.231	0.244	0.248	0.249	0.267	0.213	0.234	0.236	0.239	0.243
1/4	24.50	23.508	20.50	18.50	15.00	13.00	12.00	11.00	10.50	10.00	7.50	6.50	6.00	5.50	5.00
	0.276	0.294	0.288	0.297	0.275	0.286	0.293	0.303	0.308	0.314	0.266	0.276	0.283	0.292	0.304
5/16	29.50	27.00	24.50	22.00	18.00	15.50	14.50	13.00	12.50	12.00	9.00	8.00	7.00	6.50	6.00
	0.332	0.338	0.345	0.354	0.340	0.341	0.354	0.358	0.367	0.377	0.319	0.340	0.330	0.345	0.364
3/8	34.50	31.50	28.50	25.50	21.00	18.00	16.50	15.00	14.50	13.50	10.50	9.00	8.50	7.50	7.00
	0.388	0.394	0.401	0.410	0.385	0.396	0.403	0.413	0.425	0.424	0.372	0.383	0.401	0.398	0.425
7/16	39.50	36.00	32.50	29.00	24.00	20.50	19.00	17.00	16.00	15.50	12.00	10.50	9.50	8.50	7.50
	0.444	0.450	0.457	0.466	0.440	0.451	0.464	0.468	0.469	0.487	0.425	0.446	0.448	0.451	0.455
1/2	44.50	40.50	36.50	32.50	27.00	23.00	21.00	19.00	18.00	17.00	13.50	11.50	10.50	9.50	8.50
	0.501	0.506	0.513	0.522	0.495	0.506	0.513	0.523	0.528	0.534	0.478	0.489	0.496	0.504	0.516
9/16	49.50	45.00	40.50	36.00	30.00	25.50	23.50	21.00	20.00	19.00	15.00	13.00	11.50	10.50	9.50
	0.559	0.563	0.570	0.579	0.550	0.561	0.574	0.578	0.587	0.597	0.531	0.553	0.543	0.558	0.577
5/8	54.50	49.50	44.50	39.50	33.00	28.00	25.50	23.00	22.00	20.50	16.50	14.00	13.00	11.50	10.50
	0.613	0.619	0.626	0.635	0.605	0.616	0.623	0.633	0.645	0.644	0.584	0.595	0.614	0.611	0.637
11/16	59.50	54.00	48.50	43.00	36.00	30.50	28.00	25.00	23.50	22.50	18.00	15.50	14.00	12.50	11.00
	0.679	0.675	0.682	0.691	0.660	0.671	0.684	0.688	0.689	0.707	0.638	0.659	0.661	0.664	0.668
3/4	64.50	58.50	52.50	46.50	39.00	33.00	30.00	27.00	25.50	24.00	19.50	16.50	15.00	13.50	12.00
	0.726	0.731	0.738	0.747	0.715	0.726	0.733	0.743	0.748	0.754	0.691	0.701	0.708	0.717	0.728

Threading cams are often cut on a circular milling attachment. When this method is employed, the number of minutes the attachment should be revolved for each 0.001 inch rise, is first determined. As 15 spindle revolutions are required for threading and 400 for completing one piece, that part of the cam surface required for the actual threading operation equals $15 \div 400 = 0.0375$, which is equivalent to 810 minutes of the circumference. The total rise, through an arc of 810 minutes is 0.413 inch, so the number of minutes for each 0.001 inch rise equals $810 \div 413 = 1.96$ or, approximately, two minutes. If the attachment is graduated to read to five minutes, the cam will be fed laterally 0.0025 inch each time it is turned through five minutes of arc.

Practical Points on Cam and Tool Design.—The following general rules are given to aid in designing cams and special tools for automatic screw machines, and apply particularly to Brown and Sharpe machines:

- 1) Use the highest speeds recommended for the material used that the various tools will stand.
- 2) Use the arrangement of circular tools best suited for the class of work.
- 3) Decide on the quickest and best method of arranging the operations before designing the cams.
- 4) Do not use turret tools for forming when the cross-slide tools can be used to better advantage.
- 5) Make the shoulder on the circular cutoff tool large enough so that the clamping screw will grip firmly.
- 6) Do not use too narrow a cutoff blade.
- 7) Allow 0.005 to 0.010 inch (0.127–0.254 mm) for the circular tools to approach the work and 0.003 to 0.005 inch (0.076–0.127 mm) for the cutoff tool to pass the center.
- 8) When cutting off work, the feed of the cutoff tool should be decreased near the end of the cut where the piece breaks off.
- 9) When a thread is cut up to a shoulder, the piece should be grooved or necked to make allowance for the lead on the die. An extra projection on the forming tool and an extra amount of rise on the cam will be needed.
- 10) Allow sufficient clearance for tools to pass one another.
- 11) Always make a diagram of the cross-slide tools in position on the work when difficult operations are to be performed; do the same for the tools held in the turret.
- 12) Do not drill a hole the depth of which is more than 3 times the diameter of the drill, but rather use two or more drills as required. If there are not enough turret positions for the extra drills needed, make provision for withdrawing the drill clear of the hole and then advancing it into the hole again.
- 13) Do not run drills at low speeds. Feeds and speeds recommended in [Table 1](#) on page [1171](#) should be followed as far as is practicable.
- 14) When the turret tools operate farther in than the face of the chuck, see that they will clear the chuck when the turret is revolved.
- 15) See that the bodies of all turret tools will clear the side of the chute when the turret is revolved.
- 16) Use a balance turning tool or a hollow mill for roughing cuts.
- 17) The rise on the thread lobe should be reduced so that the spindle will reverse when the tap or die holder is drawn out.
- 18) When bringing another tool into position after a threading operation, allow clearance before revolving the turret.
- 19) Make provision to revolve the turret rapidly, especially when pieces are being made in from three to five seconds and when only a few tools are used in the turret. It is sometimes desirable to use two sets of tools.
- 20) When using a belt-shifting attachment for threading, clearance should be allowed, as it requires extra time to shift the belt.

21) When laying out a set of cams for operating on a piece that requires to be slotted, cross-drilled or burred, allowance should be made on the lead cam so that the transferring arm can descend and ascend to and from the work without coming in contact with any of the turret tools.

22) Always provide a vacant hole in the turret when it is necessary to use the transferring arm.

23) When designing special tools allow as much clearance as possible. Do not make them so that they will just clear each other, as a slight inaccuracy in the dimensions will often cause trouble.

24) When designing special tools having intricate movements, avoid springs as much as possible, and use positive actions.

Stock for Screw Machine Products.—The amount of stock required for the production of 1000 pieces on the automatic screw machine can be obtained directly from **Table 3** on page 1176. To use this table, add to the length of the work the width of the cut-off tool blade; then the number of feet of material required for 1000 pieces can be found opposite the figure thus obtained, in the column headed “Feet per 1000 Parts.” Screw machine stock usually comes in bars 10 feet (3.048 m) long, and in compiling this table an allowance was made for chucking on each bar.

The table can be extended by using the following formula, in which

F = number of feet required for 1000 pieces

L = length of piece in inches

W = width of cut-off tool blade in inches

$$F = (L + W) \times 84$$

The amount to add to the length of the work, or the width of the cut-off tool, is given in the following, which is standard in a number of machine shops:

Diameter of Stock		Width of Cut-off Tool Blade	
in	mm	in	mm
0.000–0.250	0.000–6.35	0.045	1.44
0.251–0.375	6.38–9.53	0.062	1.57
0.376–0.625	9.55–15.88	0.093	2.36
0.626–1.000	15.90–25.40	0.125	3.18
1.001–1.500	25.43–38.10	0.156	3.96

It is sometimes convenient to know the weight of a certain number of pieces, when estimating the price. The weight of round bar stock can be found by means of the following formulas, in which

W = weight in pounds

D = diameter of stock in inches

F = length in feet

For brass stock: $W = D^2 \times 2.86 \times F$

For steel stock: $W = D^2 \times 2.675 \times F$

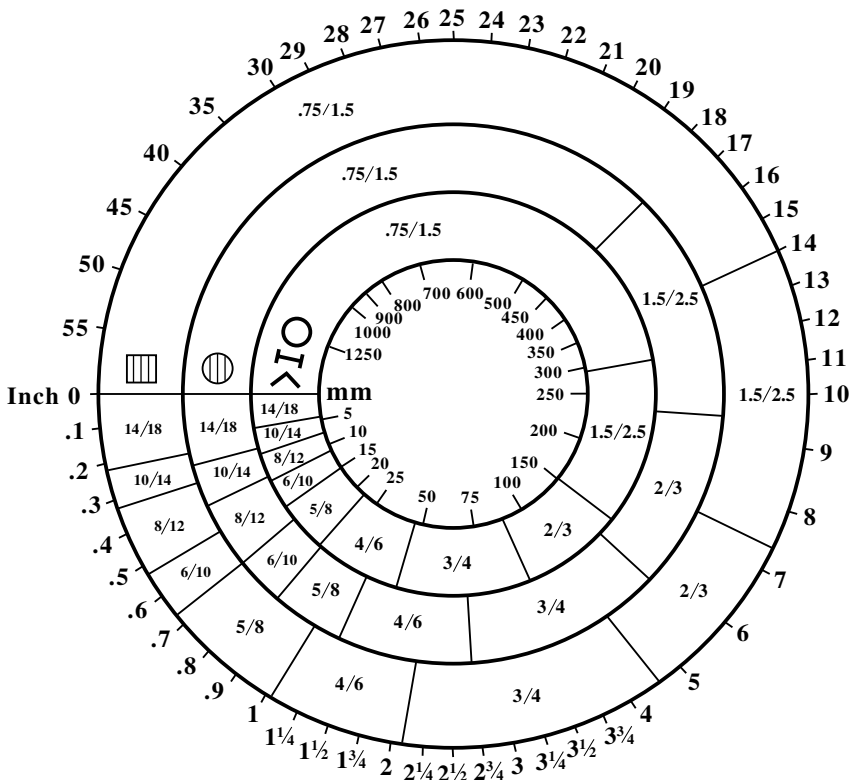
For iron stock: $W = D^2 \times 2.65 \times F$

Table 3. Stock Required for Screw Machine Products

The table gives the amount of stock, in feet, required for 1000 pieces, when the length of the finished part plus the thickness of the cut-off tool blade is known. Allowance has been made for chucking. To illustrate, if length of cut-off tool and work equals 0.140 inch, 11.8 feet of stock is required for the production of 1000 parts.							
Length of Piece and Cut-Off Tool	Feet per 1000 Parts	Length of Piece and Cut-Off Tool	Feet per 1000 Parts	Length of Piece and Cut-Off Tool	Feet per 1000 Parts	Length of Piece and Cut-Off Tool	Feet per 1000 Parts
0.050	4.2	0.430	36.1	0.810	68.1	1.380	116.0
0.060	5.0	0.440	37.0	0.820	68.9	1.400	117.6
0.070	5.9	0.450	37.8	0.830	69.7	1.420	119.3
0.080	6.7	0.460	38.7	0.840	70.6	1.440	121.0
0.090	7.6	0.470	39.5	0.850	71.4	1.460	122.7
0.100	8.4	0.480	40.3	0.860	72.3	1.480	124.4
0.110	9.2	0.490	41.2	0.870	73.1	1.500	126.1
0.120	10.1	0.500	42.0	0.880	73.9	1.520	127.7
0.130	10.9	0.510	42.9	0.890	74.8	1.540	129.4
0.140	11.8	0.520	43.7	0.900	75.6	1.560	131.1
0.150	12.6	0.530	44.5	0.910	76.5	1.580	132.8
0.160	13.4	0.540	45.4	0.920	77.3	1.600	134.5
0.170	14.3	0.550	46.2	0.930	78.2	1.620	136.1
0.180	15.1	0.560	47.1	0.940	79.0	1.640	137.8
0.190	16.0	0.570	47.9	0.950	79.8	1.660	139.5
0.200	16.8	0.580	48.7	0.960	80.7	1.680	141.2
0.210	17.6	0.590	49.6	0.970	81.5	1.700	142.9
0.220	18.5	0.600	50.4	0.980	82.4	1.720	144.5
0.230	19.3	0.610	51.3	0.990	83.2	1.740	146.2
0.240	20.2	0.620	52.1	1.000	84.0	1.760	147.9
0.250	21.0	0.630	52.9	1.020	85.7	1.780	149.6
0.260	21.8	0.640	53.8	1.040	87.4	1.800	151.3
0.270	22.7	0.650	54.6	1.060	89.1	1.820	152.9
0.280	23.5	0.660	55.5	1.080	90.8	1.840	154.6
0.290	24.4	0.670	56.3	1.100	92.4	1.860	156.3
0.300	25.2	0.680	57.1	1.120	94.1	1.880	158.0
0.310	26.1	0.690	58.0	1.140	95.8	1.900	159.7
0.320	26.9	0.700	58.8	1.160	97.5	1.920	161.3
0.330	27.7	0.710	59.7	1.180	99.2	1.940	163.0
0.340	28.6	0.720	60.5	1.200	100.8	1.960	164.7
0.350	29.4	0.730	61.3	1.220	102.5	1.980	166.4
0.360	30.3	0.740	62.2	1.240	104.2	2.000	168.1
0.370	31.1	0.750	63.0	1.260	105.9	2.100	176.5
0.380	31.9	0.760	63.9	1.280	107.6	2.200	184.9
0.390	32.8	0.770	64.7	1.300	109.2	2.300	193.3
0.400	33.6	0.780	65.5	1.320	110.9	2.400	201.7
0.410	34.5	0.790	66.4	1.340	112.6	2.500	210.1
0.420	35.3	0.800	67.2	1.360	114.3	2.600	218.5

Band Saw Blade Selection

The primary factors to consider in choosing a saw blade are: the pitch, or the number of teeth per inch of blade; the tooth form; and the blade type (material and construction). Tooth pitch selection depends on the size and shape of the work, whereas tooth form and blade type depend on material properties of the workpiece and on economic considerations of the job.



Courtesy of American Saw and Manufacturing Company

The tooth selection chart above is a guide to help determine the best blade pitch for a particular job. The tooth specifications in the chart are standard variable-pitch blade sizes as specified by the Hack and Band Saw Association. The variable-pitch blades listed are designated by two numbers that refer to the approximate maximum and minimum tooth pitch. A 4/6 blade, for example, has a maximum tooth spacing of approximately 1/4 inch (6.4 mm) and a minimum tooth spacing of about 1/6 inch (4.2 mm). Blades are available, from most manufacturers, in sizes within about ±10 per cent of the sizes listed.

To use the chart, locate the length of cut in inches on the outside circle of the table (for millimeters use the inside circle) and then find the tooth specification that aligns with the length, on the ring corresponding to the material shape. The length of cut is the distance that any tooth of the blade is in contact with the work as it passes once through the cut. For cutting solid round stock, use the diameter as the length of cut and select a blade from the ring with the solid circle. When cutting angles, channels, I-beams, tubular pieces, pipe, and hollow or irregular shapes, the length of cut is found by dividing the cross-sectional area of the cut by the distance the blade needs to travel to finish the cut. Locate the length of cut on the outer ring (inner ring for mm) and select a blade from the ring marked with the angle, I-beam, and pipe sections.

Example: A 4-inch pipe with a 3-inch inside diameter is to be cut. Select a variable pitch blade for cutting this material.

The area of the pipe is $\pi/4 \times (4^2 - 3^2) = 5.5 \text{ in.}^2$ The blade has to travel 4 inches to cut through the pipe, so the average length of cut is $5.5/4 = 1.4$ inches. On the tooth selection wheel, estimate the location of 1.4 inches on the outer ring, and read the tooth specification from the ring marked with the pipe, angle, and I-beam symbols. The chart indicates that a 4/6 variable-pitch blade is the preferred blade for this cut.

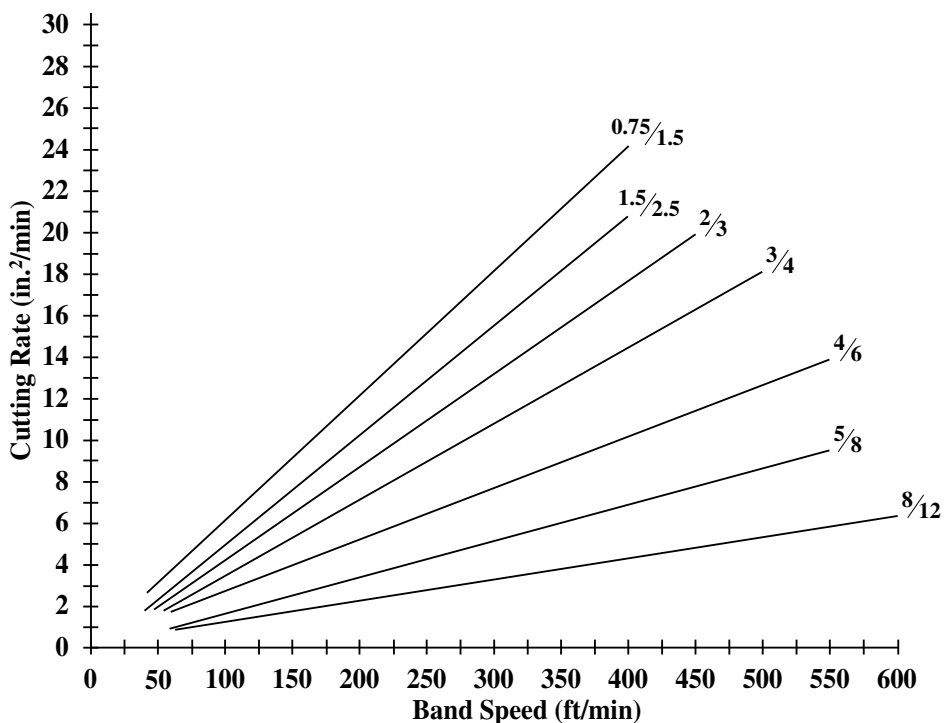
Tooth Forms.—Band saw teeth are characterized by a tooth form that includes the shape, spacing (pitch), rake angle, and gullet capacity of the tooth. Tooth form affects the cutting efficiency, noise level, blade life, chip-carrying capacity, and the surface finish quality of the cut. The rake angle, which is the angle between the face of the tooth and a line perpendicular to the direction of blade travel, influences the cutting speed. In general, positive rake angles cut faster. The *standard tooth* form has conventional shape teeth, evenly spaced with deep gullets and a 0° rake angle. Standard tooth blades are used for general-purpose cutting on a wide variety of materials. The *skip tooth* form has shallow, widely spaced teeth arranged in narrow bands and a 0° rake angle. Skip tooth blades are used for cutting soft metals, wood, plastics, and composite materials. The *hook tooth* form is similar to the skip tooth, but has a positive rake angle and is used for faster cutting of large sections of soft metal, wood, and plastics, as well as for cutting some metals, such as cast iron, that form a discontinuous chip. The *variable-tooth* (variable-pitch) form has a conventional tooth shape, but the tips of the teeth are spaced a variable distance (pitch) apart. The variable pitch reduces vibration of the blade and gives smoother cutting, better surface finish, and longer blade life. The *variable positive tooth* form is a variable-pitch tooth with a positive rake angle that causes the blade to penetrate the work faster. The variable positive tooth blade increases production and gives the longest blade life.

Set is the angle that the teeth are offset from the straight line of a blade. The set affects the blade efficiency (i.e., cutting rate), chip-carrying ability, and quality of the surface finish. *Alternate set* blades have adjacent teeth set alternately one to each side. Alternate set blades, which cut faster but with a poorer finish than other blades, are especially useful for rapid rough cutting. A *raker set* is similar to the alternate set, but every few teeth, one of the teeth is set to the center, not to the side (typically every third tooth, but sometimes every fifth or seventh tooth). The raker set pattern cuts rapidly and produces a good surface finish. The *vari-raker set*, or variable raker, is a variable-tooth blade with a raker set. The vari-raker is quieter and produces a better surface finish than a raker set standard tooth blade. *Wavy set* teeth are set in groups, alternately to one side, then to the other. Both wavy set and vari-raker set blades are used for cutting tubing and other interrupted cuts, but the blade efficiency and surface finish produced are better with a vari-raker set blade.

Types of Blades.—The most important band saw blade types are carbon steel, bimetal, carbide tooth, and grit blades made with embedded carbide or diamond. *Carbon steel blades* have the lowest initial cost, but they may wear out faster. Carbon steel blades are used for cutting a wide variety of materials, including mild steels, aluminum, brass, bronze, cast iron, copper, lead, and zinc, as well as some abrasive materials such as cork, fiberglass, graphite, and plastics. *Bimetal blades* are made with a high-speed steel cutting edge that is welded to a spring steel blade back. Bimetal blades are stronger and last longer, and they tend to produce straighter cuts because the blade can be tensioned higher than carbon steel blades. Because bimetal blades last longer, the cost per cut is frequently lower than when using carbon steel blades. Bimetal blades are used for cutting all ferrous and nonferrous metals, a wide range of shapes of easy to moderately machinable material, and solids and heavy wall tubing with moderate to difficult machinability. *Tungsten carbide blades* are similar to bimetal blades but have tungsten carbide teeth welded to the blade back. The welded teeth of carbide blades have greater wear and high-temperature resistance than either carbon steel or bimetal blades and produce less tooth vibration, while giving smoother, straighter, faster, and quieter cuts requiring less feed force. Carbide blades

are used on tough alloys such as cobalt, nickel- and titanium-based alloys, and for nonferrous materials such as aluminum castings, fiberglass, and graphite. The *carbide grit blade* has tungsten carbide grit metallurgically bonded to either a gulletted (serrated) or toothless steel band. The blades are made in several styles and grit sizes. Both carbide grit and diamond grit blades are used to cut materials that conventional (carbon and bimetal) blades are unable to cut such as: fiberglass, reinforced plastics, composite materials, carbon and graphite, aramid fibers, plastics, cast iron, stellites, high-hardness tool steels, and superalloys.

Band Saw Speed and Feed Rate.—The band speed necessary to cut a particular material is measured in feet per minute (fpm) or in meters per minute (m/min), and depends on material characteristics and size of the workpiece. Typical speeds for a bimetal blade cutting 4-inch material with coolant are given in the speed selection table that follows. For other size materials or when cutting without coolant, adjust speeds according to the instructions at the bottom of the table.



Cutting Rates for Band Saws

The feed or cutting rate, usually measured in square inches or square meters per minute, indicates how fast material is being removed and depends on the speed and pitch of the blade, not on the workpiece material. The graph above, based on material provided by American Saw and Mfg., gives approximate cutting rates (in.²/min) for various variable-pitch blades and cutting speeds. Use the value from the graph as an initial starting value and then adjust the feed based on the performance of the saw. The size and character of the chips being produced are the best indicators of the correct feed force. Chips that are curly, silvery, and warm indicate the best feed rate and band speed. If the chips appear burned and heavy, the feed is too great, so reduce the feed rate, the band speed, or both. If the chips are thin or powdery, the feed rate is too low, so increase the feed rate or reduce the band speed. The actual cutting rate achieved during a cut is equal to the area of the cut divided by the time required to finish the cut. The time required to make a cut is equal to the area of the cut divided by the cutting rate in square inches per minute.

Bimetal Band Saw Speeds for Cutting 4-Inch Material with Coolant

Material	Category (AISI/SAE)	Speed (fpm)	Speed (m/min)
Aluminum Alloys	1100, 2011, 2017, 2024, 3003, 5052, 5086, 6061, 6063, 6101, 6262, 7075	500	152
Cast Iron	A536 (60-40-18)	360	110
	A47	300	91
	A220 (50005), A536 (80-55-06)	240	73
	A48 (20 ksi)	230	70
	A536 (100-70-03)	185	56
	A48 (40 ksi)	180	55
	A220 (60004)	170	52
	A436 (1B)	150	46
	A220 (70003)	145	44
	A436 (2)	140	43
	A220 (80002), A436 (2B)	125	38
	A536 (120-90-02)	120	37
	A220 (90001), A48 (60 ksi)	100	30
A439 (D-2)	80	24	
A439 (D-2B)	60	18	
Cobalt	WF-11	65	20
	Astroloy M	60	18
Copper	356, 360	450	137
	353	400	122
	187, 1452	375	114
	380, 544	350	107
	173, 932, 934	315	96
	330, 365	285	87
	623, 624	265	81
	230, 260, 272, 280, 464, 632, 655	245	75
	101, 102, 110, 122, 172, 17510, 182, 220, 510, 625, 706, 715	235	72
	630	230	70
	811	215	66
Iron Base Super Alloy	Pyromet X-15	120	37
	A286, Incoloy 800 and 801	90	27
Magnesium	AZ31B	900	274
Nickel	Nickel 200, 201, 205	85	26
Nickel Alloy	Inconel 625	100	30
	Incoloy 802, 804	90	27
	Monel R405	85	26
	20CB3	80	24
	Monel 400, 401	75	23
	Hastelloy B, B2, C, C4, C22, C276, F, G, G2, G3, G30, N, S, W, X, Incoloy 825, 926, Inconel 751, X750, Waspaloy	70	21
	Monel K500	65	20
	Incoloy 901, 903, Inconel 600, 718, Ni-Span-C902, Nimonic 263, Rene 41, Udimet 500	60	18
	Nimonic 75	50	15
	Stainless Steel	416, 420	190
203EZ, 430, 430F, 4302		150	46
303, 303PB, 303SE, 410, 440F, 30323		140	43
304		120	37
414, 30403		115	35
347		110	34
316, 31603		100	30
Greek Ascology		95	29
18-18-2, 309, Ferralium		90	27
15-5PH, 17-4PH, 2205, 310, AM350, AM355, Custom 450, Custom 455, PH13-8Mo, PH14-8Mo, PH15-7Mo		80	24
22-13-5, Nitronic 50, 60		60	18

Bimetal Band Saw Speeds for Cutting 4-Inch Material with Coolant (Continued)

Material	Category (AISI/SAE)	Speed (fpm)	Speed (m/min)
Steel	12L14	425	130
	1213, 1215	400	122
	1117	340	104
	1030	330	101
	1008, 1015, 1020, 1025	320	98
	1035	310	94
	1018, 1021, 1022, 1026, 1513, A242 Cor-Ten A	300	91
	1137	290	88
	1141, 1144, 1144 Hi Stress	280	85
	41L40	275	84
	1040, 4130, A242 Cor-Ten B, (A36 Shapes)	270	82
	1042, 1541, 4140, 4142	250	76
	8615, 8620, 8622	240	73
	W-1	225	69
	1044, 1045, 1330, 4340, E4340, 5160, 8630	220	67
	1345, 4145, 6150	210	64
	1060, 4150, 8640, A-6, O-1, S-1	200	61
	H-11, H-12, H-13, L-6, O-6	190	58
	1095	185	56
	A-2	180	55
	E9310	175	53
	300M, A-10, E52100, HY-80, HY-100	160	49
	S-5	140	43
	S-7	125	38
	M-1	110	34
	HP 9-4-20, HP 9-4-25	105	32
	M-2, M-42, T1	100	30
	D-2	90	27
T-15	70	21	
Titanium	Pure, Ti-3Al-8V-6Cr-4Mo-4Zr, Ti-8Mo-8V-2Fe-3Al	80	24
	Ti-2Al-11Sn-5Zr-1Mo, Ti-5Al-2.5Sn, Ti-6Al-2Sn-4Zr-2Mo	75	23
	Ti-6Al-4V	70	21
	Ti-7Al-4Mo, Ti-8Al-1Mo-1V	65	20

The speed figures given are for 4-in. material (length of cut) using a 3/4 variable-tooth bimetal blade and cutting fluid. For cutting dry, reduce speed 30-50%; for carbon steel band saw blades, reduce speed 50%. For other cutting lengths: increase speed 15% for 1/4-in. material (10/14 blade); increase speed 12% for 3/4-in. material (6/10 blade); increase speed 10% for 1 1/4-in. material (4/6 blade); decrease speed 12% for 8-in. material (2/3 blade).

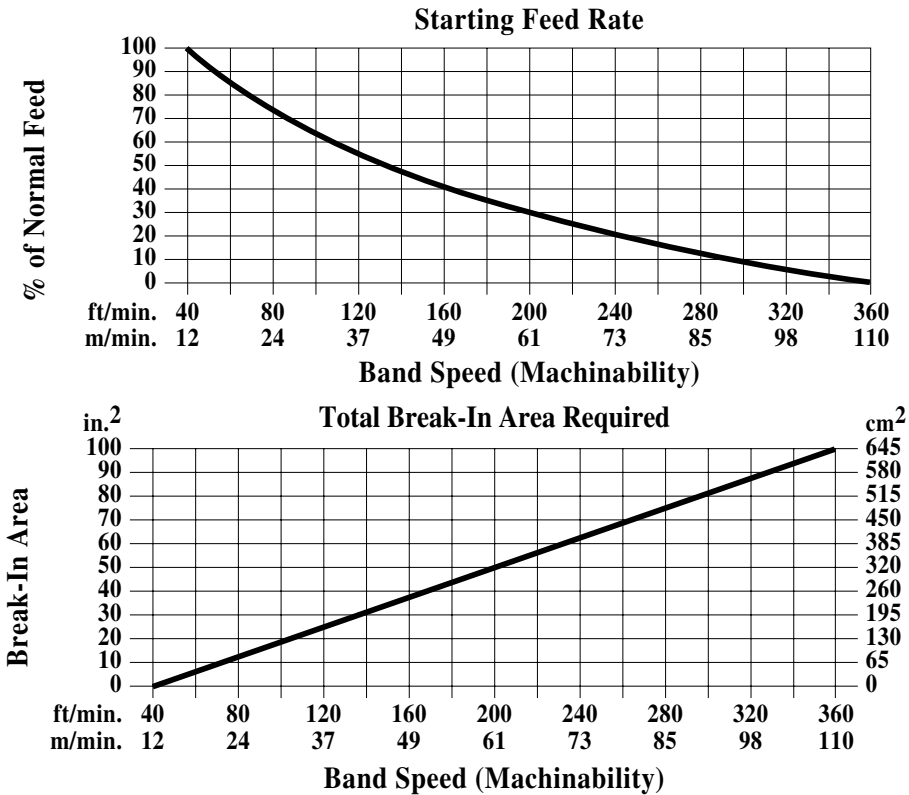
Data are based on material provided by LENOX Blades, American Saw & Manufacturing Co.

Example: Find the band speed, the cutting rate, and the cutting time if the 4-inch pipe of the previous example is made of 304 stainless steel.

The preceding blade speed table gives the band speed for 4-inch 304 stainless steel as 120 fpm (feet per minute). The average length of cut for this pipe (see the previous example) is 1.4 inches, so increase the band saw speed by about 10 per cent (see table footnote on page 1181) to 130 fpm to account for the size of the piece. On the cutting rate graph above, locate the point on the 4/6 blade line that corresponds to the band speed of 130 fpm and then read the cutting rate from the left axis of the graph. The cutting rate for this example is approximately 4 in²/min. The cutting time is equal to the area of the cut divided by the cutting rate, so cutting time = 5.5/4 = 1.375 minutes.

Band Saw Blade Break-In.—A new band saw blade must be broken in gradually before it is allowed to operate at its full recommended feed rate. Break-in relieves the blade of residual stresses caused by the manufacturing process so that the blade retains its cutting ability longer. Break-in requires starting the cut at the material cutting speed with a low feed rate and then gradually increasing the feed rate over time until enough material has been cut. A blade should be broken in with the material to be cut.

To break in a new blade, first set the band saw speed at the recommended cutting speed for the material and start the first cut at the feed indicated on the starting feed rate graph below. After the saw has penetrated the work to a distance equal to the width of the blade, increase the feed slowly. When the blade is about halfway through the cut, increase the feed again slightly and finish the cut without increasing the feed again. Start the next and each successive cut with the same feed rate that ended the previous cut, and increase the feed rate slightly again before the blade reaches the center of the cut. Repeat this procedure until the area cut by the new blade is equal to the total area required as indicated on the graph below. At the end of the break-in period, the blade should be cutting at the recommended feed rate, otherwise adjusted to that rate.



Cutting Fluids for Machining

The goal in all conventional metal-removal operations is to raise productivity and reduce costs by machining at the highest practical speed consistent with long tool life, fewest rejects, and minimum downtime, and with the production of surfaces of satisfactory accuracy and finish. Many machining operations can be performed “dry,” but the proper application of a cutting fluid generally makes possible: higher cutting speeds, higher feed rates, greater depths of cut, lengthened tool life, decreased surface roughness, increased dimensional accuracy, and reduced power consumption. Selecting the proper cutting fluid for a specific machining situation requires knowledge of fluid functions, properties, and limitations. Cutting fluid selection deserves as much attention as the choice of machine tool, tooling, speeds, and feeds.

To understand the action of a cutting fluid it is important to realize that almost all the energy expended in cutting metal is transformed into heat, primarily by the deformation of the metal into the chip and, to a lesser degree, by the friction of the chip sliding against the tool face. With these factors in mind it becomes clear that the primary functions of any cut-

ting fluid are: cooling of the tool, workpiece, and chip; reducing friction at the sliding contacts; and reducing or preventing welding or adhesion at the contact surfaces, which forms the “built-up edge” on the tool. Two other functions of cutting fluids are flushing away chips from the cutting zone and protecting the workpiece and tool from corrosion.

The relative importance of the functions is dependent on the material being machined, the cutting tool and conditions, and the finish and accuracy required on the part. For example, cutting fluids with greater lubricity are generally used in low-speed machining and on most difficult-to-cut materials. Cutting fluids with greater cooling ability are generally used in high-speed machining on easier-to-cut materials.

Types of Cutting and Grinding Fluids.—In recent years a wide range of cutting fluids has been developed to satisfy the requirements of new materials of construction and new tool materials and coatings.

There are four basic types of cutting fluids; each has distinctive features, as well as advantages and limitations. Selection of the right fluid is made more complex because the dividing line between types is not always clear. Most machine shops try to use as few different fluids as possible and prefer fluids that have long life, do not require constant changing or modifying, have reasonably pleasant odors, do not smoke or fog in use, and, most important, are neither toxic nor cause irritation to the skin. Other issues in selection are the cost and ease of disposal.

The major divisions and subdivisions used in classifying cutting fluids are:

Cutting Oils, including straight and compounded mineral oils plus additives.

Water-Miscible Fluids, including emulsifiable oils; chemical or synthetic fluids; and semichemical fluids.

Gases.

Paste and Solid Lubricants.

Since the cutting oils and water-miscible types are the most commonly used cutting fluids in machine shops, discussion will be limited primarily to these types. It should be noted, however, that compressed air and inert gases, such as carbon dioxide, nitrogen, and Freon, are sometimes used in machining. Paste, waxes, soaps, graphite, and molybdenum disulfide may also be used, either applied directly to the workpiece or as an impregnant in the tool, such as in a grinding wheel.

Cutting Oils.—Cutting oils are generally compounds of mineral oil with the addition of animal, vegetable, or marine oils to improve the wetting and lubricating properties. Sulfur, chlorine, and phosphorous compounds, sometimes called extreme pressure (EP) additives, provide for even greater lubricity. In general, these cutting oils do not cool as well as water-miscible fluids.

Water-Miscible Fluids.—*Emulsions or soluble oils* are a suspension of oil droplets in water. These suspensions are made by blending the oil with emulsifying agents (soap and soaplike materials) and other materials. These fluids combine the lubricating and rust-prevention properties of oil with water's excellent cooling properties. Their properties are affected by the emulsion concentration, with “lean” concentrations providing better cooling but poorer lubrication, and with “rich” concentrations having the opposite effect. Additions of sulfur, chlorine, and phosphorus, as with cutting oils, yield “extreme pressure” (EP) grades.

Chemical fluids are true solutions composed of organic and inorganic materials dissolved in water. Inactive types are usually clear fluids combining high rust inhibition, high cooling, and low lubricity characteristics with high surface tension. Surface-active types include wetting agents and possess moderate rust inhibition, high cooling, and moderate lubricating properties with low surface tension. They may also contain chlorine and/or sulfur compounds for extreme pressure properties.

Semichemical fluids are combinations of chemical fluids and emulsions. These fluids have a lower oil content but a higher emulsifier and surface-active-agent content than

emulsions, producing oil droplets of much smaller diameter. They possess low surface tension, moderate lubricity and cooling properties, and very good rust inhibition. Sulfur, chlorine, and phosphorus also are sometimes added.

Selection of Cutting Fluids for Different Materials and Operations.—The choice of a cutting fluid depends on many complex interactions including the machinability of the metal; the severity of the operation; the cutting tool material; metallurgical, chemical, and human compatibility; fluid properties, reliability, and stability; and finally cost. Other factors affect results. Some shops standardize on a few cutting fluids which have to serve all purposes. In other shops, one cutting fluid must be used for all the operations performed on a machine. Sometimes, a very severe operating condition may be alleviated by applying the “right” cutting fluid manually while the machine supplies the cutting fluid for other operations through its coolant system. Several voluminous textbooks are available with specific recommendations for the use of particular cutting fluids for almost every combination of machining operation and workpiece and tool material. In general, when experience is lacking, it is wise to consult the material supplier and/or any of the many suppliers of different cutting fluids for advice and recommendations. Another excellent source is the Machinability Data Center, one of the many information centers supported by the U.S. Department of Defense. While the following recommendations represent good practice, they are to serve as a guide only, and it is not intended to say that other cutting fluids will not, in certain specific cases, also be effective.

Steels: Caution should be used when using a cutting fluid on steel that is being turned at a high cutting speed with cemented carbide cutting tools. See *Application of Cutting Fluids to Carbides* later. Frequently this operation is performed dry. If a cutting fluid is used, it should be a soluble oil mixed to a consistency of about 1 part oil to 20 to 30 parts water. A sulfurized mineral oil is recommended for reaming with carbide tipped reamers although a heavy-duty soluble oil has also been used successfully.

The cutting fluid recommended for machining steel with high speed cutting tools depends largely on the severity of the operation. For ordinary turning, boring, drilling, and milling on medium and low strength steels, use a soluble oil having a consistency of 1 part oil to 10 to 20 parts water. For tool steels and tough alloy steels, a heavy-duty soluble oil having a consistency of 1 part oil to 10 parts water is recommended for turning and milling. For drilling and reaming these materials, a light sulfurized mineral-fatty oil is used. For tough operations such as tapping, threading, and broaching, a sulfochlorinated mineral-fatty oil is recommended for tool steels and high-strength steels, and a heavy sulfurized mineral-fatty oil or a sulfochlorinated mineral oil can be used for medium- and low-strength steels. Straight sulfurized mineral oils are often recommended for machining tough, stringy low carbon steels to reduce tearing and produce smooth surface finishes.

Stainless Steel: For ordinary turning and milling a heavy-duty soluble oil mixed to a consistency of 1 part oil to 5 parts water is recommended. Broaching, threading, drilling, and reaming produce best results using a sulfochlorinated mineral-fatty oil.

Copper Alloys: Most brasses, bronzes, and copper are stained when exposed to cutting oils containing active sulfur and chlorine; thus, sulfurized and sulfochlorinated oils should not be used. For most operations a straight soluble oil, mixed to 1 part oil and 20 to 25 parts water is satisfactory. For very severe operations and for automatic screw machine work a mineral-fatty oil is used. A typical mineral-fatty oil might contain 5 to 10 per cent lard oil with the remainder mineral oil.

Monel Metal: When turning this material, an emulsion gives a slightly longer tool life than a sulfurized mineral oil, but the latter aids in chip breakage, which is frequently desirable.

Aluminum Alloys: Aluminum and aluminum alloys are frequently machined dry. When a cutting fluid is used it should be selected for its ability to act as a coolant. Soluble oils mixed to a consistency of 1 part oil to 20 to 30 parts water can be used. Mineral oil-base

cutting fluids, when used to machine aluminum alloys, are frequently cut back to increase their viscosity so as to obtain good cooling characteristics and to make them flow easily to cover the tool and the work. For example, a mineral-fatty oil or a mineral plus a sulfurized fatty oil can be cut back by the addition of as much as 50 per cent kerosene.

Cast Iron: Ordinarily, cast iron is machined dry. Some increase in tool life can be obtained or a faster cutting speed can be used with a chemical cutting fluid or a soluble oil mixed to consistency of 1 part oil and 20 to 40 parts water. A soluble oil is sometimes used to reduce the amount of dust around the machine.

Magnesium: Magnesium may be machined dry, or with an air blast for cooling. A light mineral oil of low acid content may be used on difficult cuts. Coolants containing water should not be used on magnesium because of the danger of releasing hydrogen caused by reaction of the chips with water. Proprietary water-soluble oil emulsions containing inhibitors that reduce the rate of hydrogen generation are available.

Grinding: Soluble oil emulsions or emulsions made from paste compounds are used extensively in precision grinding operations. For cylindrical grinding, 1 part oil to 40 to 50 parts water is used. Solution type fluids and translucent grinding emulsions are particularly suited for many fine-finish grinding applications. Mineral oil-base grinding fluids are recommended for many applications where a fine surface finish is required on the ground surface. Mineral oils are used with vitrified wheels but are not recommended for wheels with rubber or shellac bonds. Under certain conditions the oil vapor mist caused by the action of the grinding wheel can be ignited by the grinding sparks and explode. To quench the grinding spark a secondary coolant line to direct a flow of grinding oil below the grinding wheel is recommended.

Broaching: For steel, a heavy mineral oil such as sulfurized oil of 300 to 500 Saybolt viscosity at 100°F (38°C) can be used to provide adequate lubricating effect and a dampening of the shock loads. Soluble oil emulsions may be used for the lighter broaching operations.

Cutting Fluids for Turning, Milling, Drilling and Tapping.—The following table, *Cutting Fluids Recommended for Machining Operations*, gives specific cutting oil recommendations for common machining operations.

Soluble Oils: Types of oils paste compounds that form emulsions when mixed with water: Soluble oils are used extensively in machining both ferrous and non-ferrous metals when the cooling quality is paramount and the chip-bearing pressure is not excessive. Care should be taken in selecting the proper soluble oil for precision grinding operations. Grinding coolants should be free from fatty materials that tend to load the wheel, thus affecting the finish on the machined part. Soluble coolants should contain rust preventive constituents to prevent corrosion.

Base Oils: Various types of highly sulfurized and chlorinated oils containing inorganic, animal, or fatty materials. This “base stock” usually is “cut back” or blended with a lighter oil, unless the chip-bearing pressures are high, as when cutting alloy steel. Base oils usually have a viscosity range of from 300 to 900 seconds at 100°F (38°C).

Mineral Oils: This group includes all types of oils extracted from petroleum such as paraffin oil, mineral seal oil, and kerosene. Mineral oils are often blended with base stocks, but they are generally used in the original form for light machining operations on both free-machining steels and non-ferrous metals. The coolants in this class should be of a type that has a relatively high flash point. Care should be taken to see that they are nontoxic, so that they will not be injurious to the operator. The heavier mineral oils (paraffin oils) usually have a viscosity of about 100 seconds at 100°F (38°C). Mineral seal oil and kerosene have a viscosity of 35 to 60 seconds at 100°F (38°C).

Cutting Fluids Recommended for Machining Operations

Material to be Cut	Turning	Milling
Aluminum ^a	Mineral Oil with 10 Per cent Fat (or) Soluble Oil	Soluble Oil (96 Per Cent Water) (or) Mineral Seal Oil (or) Mineral Oil
Alloy Steels ^b	25 Per Cent Sulfur base Oil ^b with 75 Per Cent Mineral Oil	10 Per Cent Lard Oil with 90 Per Cent Mineral Oil
Brass	Mineral Oil with 10 Per Cent Fat	Soluble Oil (96 Per Cent Water)
Tool Steels and Low-car- bon Steels	25 Per Cent Lard Oil with 75 Per Cent Mineral Oil	Soluble Oil
Copper	Soluble Oil	Soluble Oil
Monel Metal	Soluble Oil	Soluble Oil
Cast Iron ^c	Dry	Dry
Malleable Iron	Soluble Oil	Soluble Oil
Bronze	Soluble Oil	Soluble Oil
Magnesium ^d	10 Per Cent Lard Oil with 90 Per Cent Mineral Oil	Mineral Seal Oil
Material to be Cut	Drilling	Tapping
Aluminum ^e	Soluble Oil (75 to 90 Per Cent Water) (or) 10 Per Cent Lard Oil with 90 Per Cent Mineral Oil	Lard Oil (or) Sperm Oil (or) Wool Grease (or) 25 Per Cent Sulfur-base Oil ^b Mixed with Mineral Oil
Alloy Steels ^b	Soluble Oil	30 Per Cent Lard Oil with 70 Per Cent Mineral Oil
Brass	Soluble Oil (75 to 90 Per Cent Water) (or) 30 Per Cent Lard Oil with 70 Per Cent Mineral Oil	10 to 20 Per Cent Lard Oil with Mineral Oil
Tool Steels and Low-car- bon Steels	Soluble Oil	25 to 40 Per Cent Lard Oil with Mineral Oil (or) 25 Per Cent Sulfur-base Oil ^b with 75 Per Cent Mineral Oil
Copper	Soluble Oil	Soluble Oil
Monel Metal	Soluble Oil	25 to 40 Per Cent Lard Oil Mixed with Mineral Oil (or) Sulfur-base Oil ^b Mixed with Min- eral Oil
Cast Iron ^c	Dry	Dry (or) 25 Per Cent Lard Oil with 75 Per Cent Mineral Oil
Malleable Iron	Soluble Oil	Soluble Oil
Bronze	Soluble Oil	20 Per Cent Lard Oil with 80 Per Cent Mineral Oil
Magnesium ^d	60-second Mineral Oil	20 Per Cent Lard Oil with 80 Per Cent Mineral Oil

^aIn machining aluminum, several varieties of coolants may be used. For rough machining, where the stock removal is sufficient to produce heat, water soluble mixtures can be used with good results to dissipate the heat. Other oils that may be recommended are straight mineral seal oil; a 50-50 mixture of mineral seal oil and kerosene; a mixture of 10 per cent lard oil with 90 per cent kerosene; and a 100-second mineral oil cut back with mineral seal oil or kerosene.

^bThe sulfur-base oil referred to contains 4½ per cent sulfur compound. Base oils are usually dark in color. As a rule, they contain sulfur compounds resulting from a thermal or catalytic refinery process. When so processed, they are more suitable for industrial coolants than when they have had such compounds as flowers of sulfur added by hand. The adding of sulfur compounds by hand to the coolant reservoir is of temporary value only, and the non-uniformity of the solution may affect the machining operation.

^cA soluble oil or low-viscosity mineral oil may be used in machining cast iron to prevent excessive metal dust.

^d When a cutting fluid is needed for machining magnesium, low or nonacid mineral seal or lard oils are recommended. Coolants containing water should not be used because of the fire danger when magnesium chips react with water, forming hydrogen gas.

^e Sulfurized oils ordinarily are not recommended for tapping aluminum; however, for some tapping operations they have proved very satisfactory, although the work should be rinsed in a solvent right after machining to prevent discoloration.

Application of Cutting Fluids to Carbides.—Turning, boring, and similar operations on lathes using carbides are performed dry or with the help of soluble oil or chemical cutting fluids. The effectiveness of cutting fluids in improving tool life or by permitting higher cutting speeds to be used, is less with carbides than with high-speed steel tools. Furthermore, the effectiveness of the cutting fluid is reduced as the cutting speed is increased. Cemented carbides are very sensitive to sudden changes in temperature and to temperature gradients within the carbide. Thermal shocks to the carbide will cause thermal cracks to form near the cutting edge, which are a prelude to tool failure. An unsteady or interrupted flow of the coolant reaching the cutting edge will generally cause these thermal cracks. The flow of the chip over the face of the tool can cause an interruption to the flow of the coolant reaching the cutting edge even though a steady stream of coolant is directed at the tool. When a cutting fluid is used and frequent tool breakage is encountered, it is often best to cut dry. When a cutting fluid must be used to keep the workpiece cool for size control or to allow it to be handled by the operator, special precautions must be used. Sometimes applying the coolant from the front and the side of the tool simultaneously is helpful. On lathes equipped with overhead shields, it is very effective to apply the coolant from below the tool into the space between the shoulder of the work and the tool flank, in addition to applying the coolant from the top. Another method is not to direct the coolant stream at the cutting tool at all but to direct it at the workpiece above or behind the cutting tool.

The danger of thermal cracking is great when milling with carbide cutters. The nature of the milling operation itself tends to promote thermal cracking because the cutting edge is constantly heated to a high temperature and rapidly cooled as it enters and leaves the workpiece. For this reason, carbide milling operations should be performed dry.

Lower cutting-edge temperatures diminish the danger of thermal cracking. The cutting-edge temperatures usually encountered when reaming with solid carbide or carbide-tipped reamers are generally such that thermal cracking is not apt to occur except when reaming certain difficult-to-machine metals. Therefore, cutting fluids are very effective when used on carbide reamers. Practically every kind of cutting fluid has been used, depending on the job material encountered. For difficult surface-finish problems in holes, heavy duty soluble oils, sulfurized mineral-fatty oils, and sulfochlorinated mineral-fatty oils have been used successfully. On some work, the grade and the hardness of the carbide also have an effect on the surface finish of the hole.

Cutting fluids should be applied where the cutting action is taking place and at the highest possible velocity without causing splashing. As a general rule, it is preferable to supply from 3 to 5 gallons per minute (11-19 liter/min) for each single-point tool on a machine such as a turret lathe or automatic. The temperature of the cutting fluid should be kept below 110°F (43°C). If the volume of fluid used is not sufficient to maintain the proper temperature, means of cooling the fluid should be provided.

Cutting Fluids for Machining Magnesium.—In machining magnesium, it is the general but not invariable practice in the United States to use a cutting fluid. In other places, magnesium usually is machined dry except where heat generated by high cutting speeds would not be dissipated rapidly enough without a cutting fluid. This condition may exist when, for example, small tools without much heat-conducting capacity are employed on automatics.

The cutting fluid for magnesium should be an anhydrous oil having, at most, a very low acid content. Various mineral-oil cutting fluids are used for magnesium.

Occupational Exposure To Metalworking Fluids

The term *metalworking fluids* (MWFs) describes coolants and lubricants used during the fabrication of products from metals and metal substitutes. These fluids are used to prolong the life of machine tools, carry away debris, and protect or treat the surfaces of the material being processed. MWFs reduce friction between the cutting tool and work surfaces, reduce wear and galling, protect surface characteristics, reduce surface adhesion or welding, carry away generated heat, and flush away swarf, chips, fines, and residues. **Table 1** describes the four different classes of metal working fluids:

Table 1. Classes of Metalworking Fluids (MWFs)

MWF	Description	Dilution factor
Straight oil (neat oil or cutting oil)	Highly refined petroleum oils (lubricant-base oils) or other animal, marine, vegetable, or synthetic oils used singly or in combination with or without additives. These are lubricants, or function to improve the finish on the metal cut, and prevent corrosion.	none
Soluble oil (emulsifiable oil)	Combinations of 30% to 85% highly refined, high-viscosity lubricant-base oils and emulsifiers that may include other performance additives. Soluble oils are diluted with water before use at ratios of parts water.	1 part concentrate to 5 to 40 parts water
Semisynthetic	Contain smaller amounts of severely refined lubricant-base oil (5 to 30% in the concentrate), a higher proportion of emulsifiers that may include other performance additives, and 30 to 50% water.	1 part concentrate to 10 to 40 parts water
Synthetic^a	Contain no petroleum oils and may be water soluble or water dispersible. The simplest synthetics are made with organic and inorganic salts dissolved in water. Offer good rust protection and heat removal but usually have poor lubricating ability. May be formulated with other performance additives. Stable, can be made bioresistant.	1 part concentrate to 10 to 40 parts water

^a Over the last several decades major changes in the U.S. machine tool industry have increased the consumption of MWFs. Specifically, the use of synthetic MWFs increased as tool and cutting speeds increased.

Occupational Exposures to Metal Working Fluids (MWFs).—Workers can be exposed to MWFs by inhalation of aerosols (mists) or by skin contact resulting in an increased risk of respiratory (lung) and skin disease. Health effects vary based on the type of MWF, route of exposure, concentration, and length of exposure.

Skin contact usually occurs when the worker dips his/her hands into the fluid, floods the machine tool, or handling parts, tools, equipment or workpieces coated with the fluid, without the use of personal protective equipment such as gloves and apron. Skin contact can also result from fluid splashing onto worker from the machine if guarding is absent or inadequate.

Inhalation exposures result from breathing MWF mist or aerosol. The amount of mist generated (and the severity of the exposure) depends on a variety of factors: the type of MWF and its application process; the MWF temperature; the specific machining or grinding operation; the presence of splash guarding; and the effectiveness of the ventilation system. In general, the exposure will be higher if the worker is in close proximity to the machine, the operation involves high tool speeds and deep cuts, the machine is not enclosed, or if ventilation equipment was improperly selected or poorly maintained. In addition, high-pressure and/or excessive fluid application, contamination of the fluid with tramp oils, and improper fluid selection and maintenance will tend to result in higher exposure.

Each MWF class consists of a wide variety of chemicals used in different combinations and the risk these chemicals pose to workers may vary because of different manufacturing processes, various degrees of refining, recycling, improperly reclaimed chemicals, different degrees of chemical purity, and potential chemical reactions between components.

Exposure to hazardous contaminants in MWFs may present health risks to workers. Contamination may occur from: process chemicals and ancillary lubricants inadvertently introduced; contaminants, metals, and alloys from parts being machined; water and cleaning agents used for routine housekeeping; and, contaminants from other environmental sources at the worksite. In addition, bacterial and fungal contaminants may metabolize and degrade the MWFs to hazardous end-products as well as produce endotoxins.

The improper use of biocides to manage microbial growth may result in potential health risks. Attempts to manage microbial growth solely with biocides may result in the emergence of biocide-resistant strains from complex interactions that may occur among different member species or groups within the population. For example, the growth of one species, or the elimination of one group of organisms may permit the overgrowth of another. Studies also suggest that exposure to certain biocides can cause either allergic or contact dermatitis.

Fluid Selection, Use, and Application.—The MWFs selected should be as nonirritating and nonsensitizing as possible while remaining consistent with operational requirements. Petroleum-containing MWFs should be evaluated for potential carcinogenicity using ASTM Standard E1687-98, “Determining Carcinogenic Potential of Virgin Base Oils in Metalworking Fluids”. If soluble oil or synthetic MWFs are used, ASTM Standard E1497-94, “Safe Use of Water-Miscible Metalworking Fluids” should be consulted for safe use guidelines, including those for product selection, storage, dispensing, and maintenance. To minimize the potential for nitrosamine formation, nitrate-containing materials should not be added to MWFs containing ethanolamines.

Many factors influence the generation of MWF mists, which can be minimized through the proper design and operation of the MWF delivery system. ANSI Technical Report B11 TR2-1997, “Mist Control Considerations for the Design, Installation and Use of Machine Tools Using Metalworking Fluids” provides directives for minimizing mist and vapor generation. These include minimizing fluid delivery pressure, matching the fluid to the application, using MWF formulations with low oil concentrations, avoiding contamination with tramp oils, minimizing the MWF flow rate, covering fluid reservoirs and return systems where possible, and maintaining control of the MWF chemistry. Also, proper application of MWFs can minimize splashing and mist generation. Proper application includes: applying MWFs at the lowest possible pressure and flow volume consistent with provisions for adequate part cooling, chip removal, and lubrication; applying MWFs at the tool/workpiece interface to minimize contact with other rotating equipment; ceasing fluid delivery when not performing machining; not allowing MWFs to flow over the unprotected hands of workers loading or unloading parts; and using mist collectors engineered for the operation and specific machine enclosures.

Properly maintained filtration and delivery systems provide cleaner MWFs, reduce mist, and minimize splashing and emissions. Proper maintenance of the filtration and delivery systems includes: the selection of appropriate filters; ancillary equipment such as chip handling operations, dissolved air-flotation devices, belt-skimmers, chillers or plate and frame heat exchangers, and decantation tanks; guard coolant return trenches to prevent dumping of floor wash water and other waste fluids; covering sumps or coolant tanks to prevent contamination with waste or garbage (e.g., cigarette butts, food, etc.); and, keeping the machine(s) clean of debris. Parts washing before machining can be an important part of maintaining cleaner MWFs.

Since all additives will be depleted with time, the MWF and additives concentrations should be monitored frequently so that components and additives can be made up as needed. The MWF should be maintained within the pH and concentration ranges recom-

mended by the formulator or supplier. MWF temperature should be maintained at the lowest practical level to slow the growth of microorganisms, reduce water losses and changes in viscosity, and—in the case of straight oils—reduce fire hazards.

Fluid Maintenance.—Drums, tanks, or other containers of MWF concentrates should be stored appropriately to protect them from outdoor weather conditions and exposure to low or high temperatures. Extreme temperature changes may destabilize the fluid concentrates, especially in the case of concentrates mixed with water, and cause water to seep into unopened drums encouraging bacterial growth. MWFs should be maintained at as low a temperature as is practical. Low temperatures slow the growth of microorganisms, reduce water losses and change in viscosity, and in the case of straight oils, reduce the fire hazard risks.

To maintain proper MWF concentrations, neither water nor concentrate should be used to top off the system. The MWF mixture should be prepared by first adding the concentrate to the clean water (in a clean container) and then adding the emulsion to that mixture in the coolant tank. MWFs should be mixed just before use; large amounts should not be stored, as they may deteriorate before use.

Personal Protective Clothing: Personal protective clothing and equipment should always be worn when removing MWF concentrates from the original container, mixing and diluting concentrate, preparing additives (including biocides), and adding MWF emulsions, biocides, or other potentially hazardous ingredients to the coolant reservoir. Personal protective clothing includes eye protection or face shields, gloves, and aprons which do not react with but shed MWF ingredients and additives.

System Service: Coolant systems should be regularly serviced, and the machines should be rigorously maintained to prevent contamination of the fluids by tramp oils (e.g., hydraulic oils, gear box oils, and machine lubricants leaking from the machines or total loss slide-way lubrication). Tramp oils can destabilize emulsions, cause pumping problems, and clog filters. Tramp oils can also float to the top of MWFs, effectively sealing the fluids from the air, allowing metabolic products such as volatile fatty acids, mercaptols, scatols, ammonia, and hydrogen sulfide are produced by the anaerobic and facultative anaerobic species growing within the biofilm to accumulate in the reduced state.

When replacing the fluids, thoroughly clean all parts of the system to inhibit the growth of microorganisms growing on surfaces. Some bacteria secrete layers of slime that may grow in stringy configurations that resemble fungal growth. Many bacteria secrete polymers of polysaccharide and/or protein, forming a glycocalyx which cements cells together much as mortar holds bricks. Fungi may grow as masses of hyphae forming mycelial mats. The attached community of microorganisms is called a biofilm and may be very difficult to remove by ordinary cleaning procedures.

Biocide Treatment: Biocides are used to maintain the functionality and efficacy of MWFs by preventing microbial overgrowth. These compounds are often added to the stock fluids as they are formulated, but over time the biocides are consumed by chemical and biological demands. Biocides with a wide spectrum of biocidal activity should be used to suppress the growth of the widely diverse contaminant population. Only the concentration of biocide needed to meet fluid specifications should be used since overdosing could lead to skin or respiratory irritation in workers, and under-dosing could lead to an inadequate level of microbial control.

Ventilation Systems: The ventilation system should be designed and operated to prevent the accumulation or recirculation of airborne contaminants in the workplace. The ventilation system should include a positive means of bringing in at least an equal volume of air from the outside, conditioning it, and evenly distributing it throughout the exhausted area.

Exhaust ventilation systems function through suction openings placed near a source of contamination. The suction opening or exhaust hood creates an air motion sufficient to overcome room air currents and any airflow generated by the process. This airflow cap-

tures the contaminants and conveys them to a point where they can either be discharged or removed from the airstream. Exhaust hoods are classified by their position relative to the process as canopy, side draft, down draft or enclosure. ANSI Technical Report B11 TR 2-1997 contains guidelines for exhaust ventilation of machining and grinding operations. Enclosures are the only type of exhaust hood recommended by the ANSI committee. They consist of physical barriers between the process and the worker's environment. Enclosures can be further classified by the extent of the enclosure: close capture (enclosure of the point of operation, total enclosure (enclosure of the entire machine), or tunnel enclosure (continuous enclosure over several machines).

If no fresh make up air is introduced into the plant, air will enter the building through open doors and windows, potentially causing cross-contamination of all process areas. Ideally, all air exhausted from the building should be replaced by tempered air from an uncontaminated location. By providing a slight excess of make up air in relatively clean areas and slight deficit of make up air in dirty areas, cross-contamination can be reduced. In addition, this air can be channeled directly to operator work areas, providing the cleanest possible work environment. Ideally, this fresh air should be supplied in the form of a low-velocity air shower (<100 ft/min or <30 m/min) to prevent interference with the exhaust hoods) directly above the worker.

Protective Clothing and Equipment: Engineering controls are used to reduce worker exposure to MWFs. But in the event of airborne exposures that exceed the NIOSH REL or dermal contact with the MWFs, the added protection of chemical protective clothing (CPC) and respirators should be provided. Maintenance staff may also need CPC because their work requires contact with MWFs during certain operations. All workers should be trained in the proper use and care of CPC. After any item of CPC has been in routine use, it should be examined to ensure that its effectiveness has not been compromised.

Selection of the appropriate respirator depends on the operation, chemical components, and airborne concentrations in the worker's breathing zone. Table 2. lists the NIOSH- recommended respiratory protection for workers exposed to MWF aerosol.

Table 2. Respiratory Protection for Workers Exposed to MWF Aerosols*

Concentration of MWF aerosol (mg/m ³)	Minimum respiratory protection ^a
#0.5 mg/m ³ (1 REL) ^b	No respiratory protection required for healthy workers ^c
#5.0 mg/m ³ (10 REL)	Any air-purifying, half-mask respirator including a disposable respirator ^{d,e} equipped with any P- or R-series particulate filter (P95, P99, P100, R95, R99, or R100) number
#12.5 mg/m ³ (25 REL)	Any powered, air-purifying respirator equipped with a hood or helmet and a HEPA filter ^f

^aRespirators with higher assigned protection factors (APFs) may be substituted for those with lower APFs [NIOSH 1987a].

^bAPF times the NIOSH REL for total particulate mass. The APF [NIOSH 1987b] is the minimum anticipated level of protection provided by each type of respirator.

^c See text for recommendations regarding workers with asthma and for other workers affected by MWF aerosols.

^d A respirator that should be discarded after the end of the manufacturer's recommended period of use or after a noticeable increase in breathing resistance or when physical damage, hygiene considerations, or other warning indicators render the respirator unsuitable for further use.

^e An APF of 10 is assigned to disposable particulate respirators if they have been properly fitted.

^fHigh-efficiency particulate air filter. When organic vapors are a potential hazard during metalworking operations, a combination particulate and organic vapor filter is necessary.

* Only NIOSH/MSHA-approved or NIOSH-approved (effective date July 10, 1995) respiratory equipment should be used.

MACHINING NONFERROUS METALS AND NON-METALLIC MATERIALS

Nonferrous Metals

Machining Aluminum.—Some of the alloys of aluminum have been machined successfully without any lubricant or cutting compound, but some form of lubricant is desirable to obtain the best results. For many purposes, a soluble cutting oil is good.

Tools for aluminum and aluminum alloys should have larger relief and rake angles than tools for cutting steel. For high-speed steel turning tools the following angles are recommended: relief angles, 14 to 16 degrees; back rake angle, 5 to 20 degrees; side rake angle, 15 to 35 degrees. For very soft alloys even larger side rake angles are sometimes used. High silicon aluminum alloys and some others have a very abrasive effect on the cutting tool. While these alloys can be cut successfully with high-speed-steel tools, cemented carbides are recommended because of their superior abrasion resistance. The tool angles recommended for cemented carbide turning tools are: relief angles, 12 to 14 degrees; back rake angle, 0 to 15 degrees; side rake angle, 8 to 30 degrees.

Cut-off tools and necking tools for machining aluminum and its alloys should have from 12 to 20 degrees back rake angle and the end relief angle should be from 8 to 12 degrees. Excellent threads can be cut with single-point tools in even the softest aluminum. Experience seems to vary somewhat regarding the rake angle for single-point thread cutting tools. Some prefer to use a rather large back and side rake angle although this requires a modification in the included angle of the tool to produce the correct thread contour. When both rake angles are zero, the included angle of the tool is ground equal to the included angle of the thread. Excellent threads have been cut in aluminum with zero rake angle thread-cutting tools using large relief angles, which are 16 to 18 degrees opposite the front side of the thread and 12 to 14 degrees opposite the back side of the thread. In either case, the cutting edges should be ground and honed to a keen edge. It is sometimes advisable to give the face of the tool a few strokes with a hone between cuts when chasing the thread to remove any built-up edge on the cutting edge.

Fine surface finishes are often difficult to obtain on aluminum and aluminum alloys, particularly the softer metals. When a fine finish is required, the cutting tool should be honed to a keen edge and the surfaces of the face and the flank will also benefit by being honed smooth. Tool wear is inevitable, but it should not be allowed to progress too far before the tool is changed or sharpened. A sulphurized mineral oil or a heavy-duty soluble oil will sometimes be helpful in obtaining a satisfactory surface finish. For best results, however, a diamond cutting tool is recommended. Excellent surface finishes can be obtained on even the softest aluminum and aluminum alloys with these tools.

Although ordinary milling cutters can be used successfully in shops where aluminum parts are only machined occasionally, the best results are obtained with coarse-tooth, large helix-angle cutters having large rake and clearance angles. Clearance angles up to 10 to 12 degrees are recommended. When slab milling and end milling a profile, using the peripheral teeth on the end mill, climb milling (also called down milling) will generally produce a better finish on the machined surface than conventional (or up) milling. Face milling cutters should have a large axial rake angle. Standard twist drills can be used without difficulty in drilling aluminum and aluminum alloys although high helix-angle drills are preferred. The wide flutes and high helix-angle in these drills helps to clear the chips. Sometimes split-point drills are preferred. Carbide tipped twist drills can be used for drilling aluminum and its alloys and may afford advantages in some production applications. Ordinary hand and machine taps can be used to tap aluminum and its alloys although spiral-fluted ground thread taps give superior results. Experience has shown that such taps should have a right-hand ground flute when intended to cut right-hand threads and the helix angle should be similar to that used in an ordinary twist drill.

Machining Magnesium.—Magnesium alloys are readily machined and with relatively low power consumption per cubic inch of metal removed. The usual practice is to employ high cutting speeds with relatively coarse feeds and deep cuts. Exceptionally fine finishes can be obtained so that grinding to improve the finish usually is unnecessary. The horsepower normally required in machining magnesium varies from 0.15 to 0.30 hp per cubic inch per minute (0.41-0.82 kw/cm³/s). While this value is low, especially in comparison with power required for cast iron and steel, the total amount of power for machining magnesium usually is high because of the exceptionally rapid rate at which metal is removed.

Carbide tools are recommended for maximum efficiency, although high-speed steel frequently is employed. Tools should be designed so as to dispose of chips readily or without excessive friction, by employing polished chip-bearing surfaces, ample chip spaces, large clearances, and small contact areas. *Keen-edged tools should always be used.*

Feeds and Speeds for Magnesium: Speeds ordinarily range up to 5000 ft/min (1524 m/min) for rough- and finish-turning, up to 3000 ft/min (915 m/min) for rough-milling, and up to 9000 ft/min (2743 m/min) for finish-milling. The following combinations of speed, feed per revolution, and depth of cut are recommended:

Process	Speed		Feed		Depth of Cut	
	ft/min	m/min	in/rev	mm/rev	inch	mm
Rough Turning	300–600	90–185	0.030–0.100	0.76–2.5	0.5	12.7
	600–1000	185–305	0.020–0.080	0.50–2.0	0.4	10
	1000–1500	305–460	0.010–0.060	0.25–1.5	0.3	7.6
	1500–2000	460–610	0.010–0.040	0.25–1.0	0.2	5.0
	2000–5000	610–1525	0.010–0.030	0.25–0.76	0.1	3.8
Rough Milling	up to 900	up to 275	0.005–0.025	0.13–0.64	up to 0.5	up to 12.7
	900–1500	275–455	0.005–0.020	0.13–0.51	up to 0.375	up to 9.5
	1500–3000	455–915	0.005–0.010	0.13–0.25	up to 0.2	up to 5.1

Lathe Tool Angles for Magnesium: The true or actual rake angle resulting from back and side rakes usually varies from 10 to 15 degrees. Back rake varies from 10 to 20, and side rake from 0 to 10 degrees. Reduced back rake may be employed to obtain better chip breakage. The back rake may also be reduced to from 2 to 8 degrees on form tools or other broad tools to prevent chatter.

Parting Tools: For parting tools, the back rake varies from 15 to 20 degrees, the front end relief 8 to 10 degrees, the side relief measured perpendicular to the top face 8 degrees, the side relief measured in the plane of the top face from 3 to 5 degrees.

Milling Magnesium: In general, the coarse-tooth type of cutter is recommended. The number of teeth or cutting blades may be one-third to one-half the number normally used; however, the two-blade fly-cutter has proved to be very satisfactory. As a rule, the land relief or primary peripheral clearance is 10 degrees followed by secondary clearance of 20 degrees. The lands should be narrow, the width being about $\frac{3}{64}$ to $\frac{1}{16}$ inch (1.19 to 1.59 mm). The rake, which is positive, is about 15 degrees.

Drilling Magnesium: If the depth of a hole is less than five times the drill diameter, an ordinary twist drill with highly polished flutes may be used. The included angle of the point may vary from 70 degrees to the usual angle of 118 degrees. The relief angle is about 12 degrees. The drill should be kept sharp and the outer corners rounded to produce a smooth finish and prevent burr formation. For deep hole drilling, use a drill having a helix angle of 40 to 45 degrees with large polished flutes of uniform cross-section throughout the drill length to facilitate the flow of chips. A pyramid-shaped “spur” or “pilot point” at the tip of the drill will reduce the “spiraling or run-off.”

Drilling speeds vary from 300 to 2000 feet per minute (90-610 m/min) with feeds per revolution ranging from 0.015 to 0.050 inch (0.38-1.27 mm).

Reaming Magnesium: Reamers up to 1 inch in diameter should have four flutes; larger sizes, six flutes. These flutes may be either parallel with the axis or have a negative helix

angle of 10 degrees. The positive rake angle varies from 5 to 8 degrees, the relief angle from 4 to 7 degrees, and the clearance angle from 15 to 20 degrees.

Tapping Magnesium: Standard taps may be used unless Class 3B tolerances are required, in which case the tap should be designed for use in magnesium. A high-speed steel concentric type with a ground thread is recommended. The concentric form, which eliminates the radial thread relief, prevents jamming of chips while the tap is being backed out of the hole. The positive rake angle at the front may vary from 10 to 25 degrees and the "heel rake angle" at the back of the tooth from 3 to 5 degrees. The chamfer extends over two to three threads. For holes up to $\frac{1}{4}$ inch (6.35 mm) in diameter, two-fluted taps are recommended; for sizes from $\frac{1}{2}$ to $\frac{3}{4}$ inch (12.7-19.05 mm), three flutes; and for larger holes, four flutes. Tapping speeds ordinarily range from 75 to 200 feet per minute (23-61 m/min), and mineral oil cutting fluid should be used.

Threading Dies for Magnesium should have about the same cutting angles as taps. Narrow lands should be used to provide ample chip space. Either solid or self-opening dies may be used. The latter type is recommended when maximum smoothness is required. Threads may be cut at speeds up to 1000 feet per minute (305 m/min).

Grinding Magnesium: As a general rule, magnesium is ground dry. The highly inflammable dust should be formed into a sludge by means of a spray of water or low-viscosity mineral oil. Accumulations of dust or sludge should be avoided. For surface grinding, when a fine finish is desirable, a low-viscosity mineral oil may be used.

Machining Zinc Alloy Die-Castings.—Machining of zinc alloy die-castings is mostly done without a lubricant. For particular work, especially deep drilling and tapping, a lubricant such as lard oil and kerosene (about half and half) or a 50-50 mixture of kerosene and machine oil may be used to advantage. A mixture of turpentine and kerosene has been found effective on certain difficult jobs.

Reaming: In reaming, tools with six straight flutes are commonly used, although tools with eight flutes irregularly spaced have been found to yield better results by one manufacturer. Many standard reamers have a land that is too wide for best results. A land about 0.015 inch (0.38 mm) wide is recommended but this may often be ground down to around 0.007 or even 0.005 inch (0.18 or even 0.127 mm) to obtain freer cutting, less tendency to loading, and reduced heating.

Turning: Tools of high-speed steel are commonly employed although the application of Stellite and carbide tools, even on short runs, is feasible. For steel or Stellite, a positive top rake of from 0 to 20 degrees and an end clearance of about 15 degrees are commonly recommended. Where side cutting is involved, a side clearance of about 4 degrees minimum is recommended. With carbide tools, the end clearance should not exceed 6 to 8 degrees and the top rake should be from 5 to 10 degrees positive. For boring, facing, and other lathe operations, rake and clearance angles are about the same as for tools used in turning.

Machining Monel and Nickel Alloys.—These alloys are machined with high-speed steel and with cemented carbide cutting tools. High-speed steel lathe tools usually have a back rake of 6 to 8 degrees, a side rake of 10 to 15 degrees, and relief angles of 8 to 12 degrees. Broad-nose finishing tools have a back rake of 20 to 25 degrees and an end relief angle of 12 to 15 degrees. In most instances, standard commercial cemented-carbide tool holders and tool shanks can be used which provide an acceptable tool geometry. Honing the cutting edge lightly will help if chipping is encountered.

The most satisfactory tool materials for machining Monel and the softer nickel alloys, such as Nickel 200 and Nickel 230, are M2 and T5 for high-speed steel and crater resistant grades of cemented carbides. For the harder nickel alloys such as K Monel, Permanickel, Duranickel, and Nitinol alloys, the recommended tool materials are T15, M41, M42, M43, and for high-speed steel, M42. For carbides, a grade of crater resistant carbide is recommended when the hardness is less than 300 Bhn, and when the hardness is more than 300

Bhn, a grade of straight tungsten carbide will often work best, although some crater resistant grades will also work well.

A sulfurized oil or a water-soluble oil is recommended for rough and finish turning. A sulfurized oil is also recommended for milling, threading, tapping, reaming, and broaching. Recommended cutting speeds for Monel and the softer nickel alloys are 70 to 100 fpm (20-30 m/min) for high-speed steel tools and 200 to 300 fpm (60-90 m/min) for cemented carbide tools. For the harder nickel alloys, the recommended speed for high-speed steel is 40 to 70 fpm (12-21 m/min) for a hardness up to 300 Bhn and for a higher hardness, 10 to 20 fpm (3-6 m/min); for cemented carbides, 175 to 225 fpm (55-70 m/min) when the hardness is less than 300 Bhn and for a higher hardness, 30 to 70 fpm (9-21 m/min).

Nickel alloys have a high tendency to work harden. To minimize work hardening caused by machining, the cutting tools should be provided with adequate relief angles and positive rake angles. Furthermore, the cutting edges should be kept sharp and replaced when dull to prevent burnishing of the work surface. The depth of cut and feed should be sufficiently large to ensure that the tool penetrates the work without rubbing.

Machining Copper Alloys.—Copper alloys can be machined by tooling and methods similar to those used for steel, but at higher surface speeds. Machinability of copper alloys is discussed in [Table 2](#) on page 515 and [Table 3](#) on page 519. Machinability is based on a rating of 100 per cent for the free-cutting alloy C35000, which machines with small, easily broken chips. As with steels, copper alloys containing lead have the best machining properties, with alloys containing tin, and lead, having machinability ratings of 80 and 70 per cent. Tellurium and sulphur are added to copper alloys to increase machinability with minimum effect on conductivity. Lead additions are made to facilitate machining, as their effect is to produce easily broken chips.

Copper alloys containing silicon, aluminum, manganese and nickel become progressively more difficult to machine, and produce long, stringy chips, the latter alloys having only 20 per cent of the machinability of the free-cutting alloys. Although copper is frequently machined dry, a cooling compound is recommended. Other lubricants that have been used include tallow for drilling, gasoline for turning, and beeswax for threading.

Machining Non-metals

Machining Hard Rubber.—Tools suitable for steel may be used for hard rubber, with no top or side rake angles and 10 to 20 degree clearance angles, of high speed steel or tungsten carbide. Without coolant, surface speeds of about 200 ft/min (60m/min) are recommended for turning, boring and facing; with coolant, increase up to 300 surface ft/min (90 m/min).

Drilling of hard rubber requires high speed steel drills of 35 to 40 degree helix angle to obtain maximum cutting speeds and drill life. Feed rates for drilling range up to 0.015 in/rev (0.38 mm/rev). Deep-fluted taps are best for threading hard rubber, and should be 0.002 to 0.005 inch (0.05-0.13 mm) oversize if close tolerances are to be held. Machine oil is used for a lubricant. Hard rubber may be sawn with band saws having 5 to 10 teeth per inch (2-4 teeth/cm), running at about 3000 ft/min (914 m/min). or cut with abrasive wheels. Use of coolant in grinding rubber gives a smoother finish.

Piercing and blanking of sheet rubber is best performed with the rubber or dies heated. Straightening of the often-distorted blanks may be carried out by dropping them into a pan of hot water.

Formica Machining.—Blanks can be cut from sheets of "Formica" either by a band saw or by trepanning tools in a boring mill or a drill press. To saw blanks, first describe a circle as a guide line, then use a 21-gage 3½-point saw running at a speed of 5000 ft/min (1525 m/min). The saw should be sharp, with a ¼-inch (0.4 mm) set on both sides. In drilling, use an ordinary high-speed drill whose point is ground to an included angle of 55 to 60 degrees. Another method is to grind the drill point slightly off center. The feed must be rapid and

caution used to prevent the drill from lagging in its work, and the speed must be 1200 rpm. For all machining operations on "Formica" gear material, provision must be made in grinding for the tools to clear themselves. For reaming, the entry of the reamer and the reaming process must be rapid. There must not be a lag between the end of the reaming operation and the withdrawal of the reamer. In turning the outside diameter and the sides of blanks, the tools must be sharp and have 3 to 5 degrees more rake than is common practice for metal. A cutting speed of 750 fpm (228.6 m/min), equal to 720 rpm on a 4-inch diameter blank, is recommended. The depth of the cut can be $\frac{1}{16}$ to $\frac{1}{8}$ inch (1.6-3.2 mm), but the feed should be 0.010 inch (0.25 mm), regardless of the depth of the cut. Teeth may be cut on a hobbing machine, shaper, or milling machine. The speed of the cutter should be 150 fpm (46 m/min), and the feed from 0.023 to 0.040 inch per revolution (0.59-1.02 mm/rev). It is advisable to back up the blank to prevent fraying or breaking out of the material as the cutter comes through. The backing plates can be economically made from hard wood.

Micarta Machining.—In cutting blanks from sheets of "micarta" a band saw running at a speed of 350 revolutions per minute has been found suitable. The saw should be of the bevel-tooth type, seven teeth to the inch. For large quantities a trepanning tool should be used. In trepanning blanks, the tool should be fed so as to cut part way through all of the "layouts"; then the micarta plate should be turned over, and the cutting completed from the reverse side.

Turning tools should be high-speed steel cutting at speeds similar to those for bronze or cast iron. If two cuts are taken, about 0.010 inch (0.254 mm) of stock should be left for the finishing cut.

Drilling at right angles to the layers is done with a standard drill, which should be backed off sufficiently to provide plenty of clearance. When drilling parallel to layers, a "flat" or "bottom" drill should be used. In rough-drilling, the hole should preferably be drilled partly through the material from each side to prevent possible splitting as the tool protrudes. If this is impracticable, the hole can be drilled all the way through the material, provided the material is "backed up" with wood, stiff cardboard, or any other material that is sufficiently rigid to support the under surface at the point where the drill comes through.

The methods described for drilling apply as well to tapping, except that when the tapping is done parallel to the layers, it is advisable to clamp the material to equalize the stress on the layers and prevent possible splitting.

In milling, a standard tool may be used at a speed and feed corresponding to that used in working bronze or soft steel. The cutting angle of the cutter will give better results if ground with a slight rake.

While there is a wide range of practice as to feeds and speeds in cutting gears on hobbing machines, a hob speed of not less than 140 revolutions per minute, has given satisfaction. In machining gear teeth on a gear shaper, a speed of about 100 to 130 strokes per minute with a fairly fine feed has given good results. Backing-up plates should be used in machining micarta gears.

Ultrasonic Machining.—This method of cutting and engraving hard materials such as glass, precious stones, and carbides uses a transducer (vibratory unit) to obtain the necessary mechanical vibrations needed. The transducer converts the input energy, in this case electrical, into another form of energy, in this case mechanical.

A tool of the required size and shape is made of brass or other soft material and is attached to the transducer. The tool is lowered until it just barely touches the work, and current is applied. At the same time, a slurry of water and fine abrasive, usually boron carbide, is pumped over the work. The tool does not actually touch the work, but the vibrations literally hammer the particles of abrasive into the surface and chip off tiny fragments. Some wear does take place in the tool, but it is very slight and, as it is equally distributed, it does not change the shape. The method is commonly applied to cutting designs in stones of signet rings, and also applied to cutting intricately shaped holes in carbide or hardened steel.

GRINDING FEEDS AND SPEEDS

Grinding data are scarcely available in handbooks, which usually recommend a small range of depths and work speeds at constant wheel speed, including small variations in wheel and work material composition. Wheel life or grinding stiffness are seldom considered.

Grinding parameter recommendations typically range as follows:

- Wheel speeds are usually recommended in the 1200 to 1800 m/min (4000 to 6000 fpm) range, or in rare cases up to 3600 m/min (12000 fpm)
- Work speeds are in the range 20 to 40 m/min (70 to 140 fpm); and, depths of cut of 0.01 to 0.025 mm (0.0004 to 0.001 inch) for roughing, and around 0.005 mm (.0002 in.) for finish grinding.
- Grit sizes for roughing are around 46 to 60 for easy-to-grind materials, and for difficult-to-grind materials higher such as 80 grit. In finishing, a smaller grit size (higher grit number) is recommended. Internal grinding grit sizes for small holes are approximately 100 to 320.
- Specific metal removal rate, $SMRR$, represents the rate of material removal per unit of wheel contact width and are commonly recommended from 200 to 500 mm³/mm width/min (0.3 to 0.75 in³/inch width/min).
- Grinding stiffness is a major variable in determining wheel-life and spark-out time. A typical value of system stiffness in outside-diameter grinding, for 10:1 length/diameter ratio, is approximately $K_{ST} = 30\text{--}50 \text{ N}/\mu\text{m}$. System stiffness K_{ST} is calculated from the stiffness of the part, K_w and the machine and fixtures, K_m . Machine values can be obtained from manufacturers, or can be measured using simple equipment along with the part stiffness.
- Generally a lower wheel hardness (soft wheel) is recommended when the system stiffness is poor or when a better finish is desired.

Basic Rules

The wheel speed V and *equivalent chip thickness* $ECT = SMRR \div V \div 1000$ are the primary parameters that determine wheel-life, forces and surface finish in grinding. The following general rules and recommendations, using ECT , are based on extensive laboratory and industry tests both in Europe and USA. The relationships and shapes of curves pertaining to grinding tool-life, grinding time, and cost are similar to those of any metal cutting operation such as turning, milling and drilling.

In turning and milling, the ECT theory says that if the product of feed times depth of cut is constant, the tool-life is constant no matter how the depth of cut or feed is varied, provided that the cutting speed and cutting edge length are maintained constant.

In grinding, wheel-life T remains constant for constant cutting speed V , regardless of how depth of cut a_r or work speed V_w are selected as long as the specific metal removal rate $SMRR = V_w \times a_r$ is held constant (neglecting the influence of grinding contact width).

ECT is much smaller in grinding than in milling, ranging from about 0.0001 to 0.001 mm (0.000004 to 0.00004 inch). See the section *MACHINING ECONOMETRICS* starting on page 1132 for a detailed explanation of the role of ECT in conventional machining.

Wheel life T and Grinding Ratio.—A commonly used measure of relative wheel-life in grinding is the *grinding ratio* that is used to compare grindability when varying grinding wheel composition and work material properties under otherwise constant cutting conditions.

The *grinding ratio* is defined as the slope of the wear curve versus metal removal rate: $grinding\ ratio = MRR \div W^*$, where MRR is the metal removal rate, and W^* is the volume wheel wear at which the wheel has to be dressed. The grinding ratio is not a measure of wheel-life, but a relationship between *grinding ratio* and wheel-life T can be obtained from

the formula $grinding\ ratio = SMRR \times T \div W^*$, where $SMRR$ (specific metal removal rate) is determined from $MRR = SMRR \times T$ or from $ECT = SMRR \div V \div 1000$.

Thus, $grinding\ ratio = 1000 \times ECT \times V \times T \div W^*$, and $T = grinding\ ratio \times W^* \div (1000 \times ECT \times V)$, provided that the wheel wear criterion W^* is valid for all data combinations.

Example 1: If W^* in one test is found to be 500 mm^3 for $ECT = 0.00033\text{ mm}$ and $V = 3600\text{ m/min}$, and $grinding\ ratio = 10$, then wheel-life will vary with measured grinding ratios, wheel speed, and ECT as follows: $T = 500 \times grinding\ ratio \div (V \times ECT) = 4.2\text{ minutes}$.

In the remainder of this section the $grinding\ ratio$ will not be used, and wheel-life is expressed in terms of ECT or $SMRR$ and wheel speed V .

ECT in Grinding.—In turning and milling, ECT is defined as the volume of chips removed per unit cutting edge length per revolution of the work or cutter. In milling specifically, ECT is defined as the ratio of (number of teeth $z \times$ feed per tooth $f_z \times$ radial depth of cut $a_r \times$ and axial depth of cut a_a) and (cutting edge length CEL divided by πD), where D is the cutter diameter, thus,

$$ECT = \frac{\pi D z f_z a_r a_a}{CEL}$$

In grinding, the same definition of ECT applies if we replace the number of teeth with the average number of grits along the wheel periphery, and replace the feed per tooth by the average feed per grit. This definition is not very practical, however, and ECT is better defined by the ratio of the specific metal removal rate $SMRR$, and the wheel speed V . Thus, $ECT = 1000 \times SMRR \div V$. Keeping ECT constant when varying $SMRR$ requires that the wheel speed must be changed proportionally.

In milling and turning ECT can also be redefined in terms of $SMRR$ divided by the work and the cutter speeds, respectively, because $SMRR$ is proportional to the feed rate F_R .

Work Speed and Depth of Cut Selection: Work speed V_w is determined by dividing $SMRR$ by the depth of cut a_r , or by using the graph in Fig. 1.

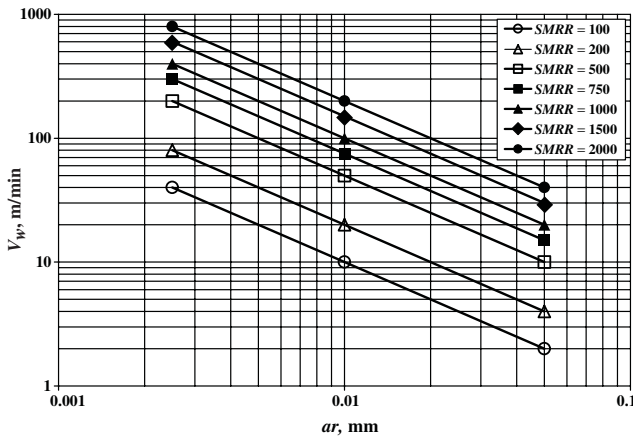


Fig. 1. Work speed V_w vs. depth of cut a_r .

Referring to Fig. 1, for depths of cuts of 0.01 and 0.0025 mm, a specific metal removal rate $SMRR = 1000\text{ mm}^3/\text{mm width/min}$ is achieved at work speeds of 100 and 400 m/min, respectively, and for $SMRR = 100\text{ mm}^3/\text{mm width/min}$ at work speeds of 10 and 40 m/min, respectively.

Unfortunately, the common use of low values of work speed (20 to 40 m/min) in finishing cause thermal surface damage, disastrous in critical parts such as aircraft components. As the grains slide across the work they generate surface heat and fatigue-type loading may cause residual tensile stresses and severe surface cracks. Proper finish grinding conditions

are obtained by increasing the work speed 5 to 10 times higher than the above recommendations indicate. These higher work speeds will create compressive stresses that are not detrimental to the surface. The by-product of higher work speeds is much higher *SMRR* values and thereby much shorter grinding times. Compressive stresses are also obtained by reducing the depth of cut a_r .

Wheel Life Relationships and Optimum Grinding Data.—Figs. 2a, 2b, and 2c show, in three planes, the 3-dimensional variation of wheel-life T with wheel speed V and ECT when grinding a hardened tool steel. Fig. 2a depicts wheel-life versus wheel speed (the T - V plane) with constant ECT appearing as approximately straight lines when plotted in log-log coordinates.

In grinding, the wheel-life variation follows curves similar to those obtained for conventional metal cutting processes, including a bend-off of the Taylor lines (T - V graph) towards shorter life and lower cutting speeds when a certain maximum life is achieved for each value of ECT . In the two other planes (T - ECT , and V - ECT) we usually find smooth curves in which the maximum values of wheel-life are defined by points along a curve called the H -curve.

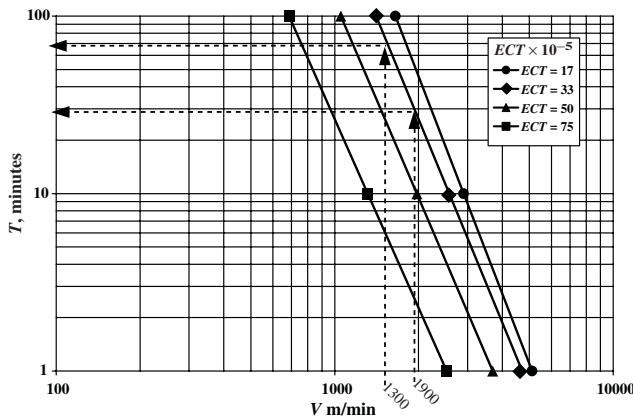


Fig. 2a. Taylor lines: T vs. V , ECT plotted for grinding M4 tool steel, hardness Rc 64

Example 2: The variation of $SMRR = V \times ECT \times 1000$ and wheel-life at various wheel speeds can be obtained from Fig. 2a. Using sample values of $ECT = 33 \times 10^{-5}$ mm and $V = 1300$ and 1900 m/min, $SMRR = 1300 \times 33 \times 10^{-5} \times 1000 = 429$, and $1900 \times 33 \times 10^{-5} \times 1000 = 627$ mm³/mm width/min, respectively; the corresponding wheel lives are read off as approximately 70 and 30 minutes, respectively.

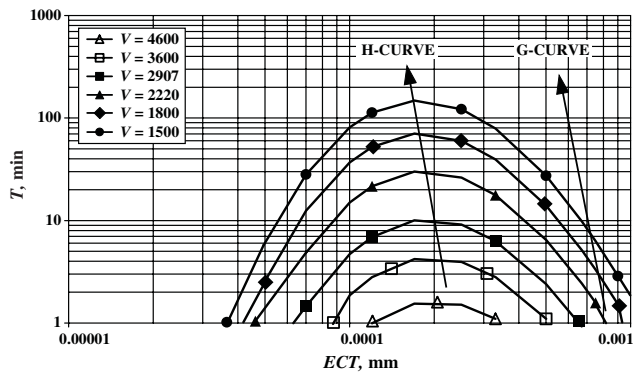


Fig. 2b. T vs. ECT , V plotted

Fig. 2b depicts wheel-life T versus ECT with constant wheel speed V shown as curves plotted in log-log coordinates, similar to those for the other cutting operations.

Example 3: Fig. 2b shows that maximum values of wheel-life occur along the *H*-curve. For the 3 speeds 1800, 2700, and 3600 m/min, maximum wheel lives are approximately 70, 14 and 4 minutes, respectively, at *ECT* around 17×10^{-5} through 20×10^{-5} mm along the *H*-curve. Left and right of the *H*-curve wheel-life is shorter.

Fig. 2c depicts wheel speed *V* versus *ECT* with wheel-life *T* parameter shown as curves in log-log coordinates, similar to those for the other cutting operations, with the characteristic *H*- and *G*-curves.

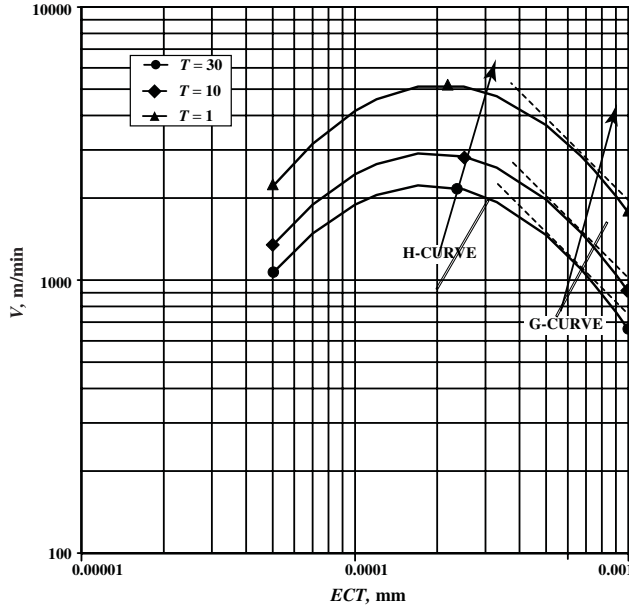


Fig. 2c. *V* vs. *ECT*, *T* plotted

Optimum grinding data for roughing occur along the *G*-curve, which is determined from the *V-ECT* graph by drawing 45-degree lines tangent to the *T*-curves, as shown in Fig. 2c, and drawing a line (the *G*-curve) through the points of tangency on the respective *T*-curves, thus the location and direction of the *G*-curve is determined. Globally optimum data correspond to the *T*-curve for which wheel-life is calculated using the corresponding equivalent tooling-cost time, T_V , calculated from $T_V = T_{RPL} + 60 \times C_E \div H_R$, minutes, where T_{RPL} is the time required to replace wheel, C_E = cost per wheel dressing = wheel cost + cost per dressing, and H_R is the hourly rate.

Minimum cost conditions occur along the *G*-curve; if optimum life T_O was determined at either 10 or 30 minutes then $V_O = 1500$ and 1100 m/min, respectively, and *ECT* is around $65 - 70 \times 10^{-5}$ mm in both cases. The corresponding optimum values of *SMRR* are $1000 \times 1500 \times 67 \times 10^{-5} = 1000$ and $1000 \times 1100 \times 67 \times 10^{-5} = 740$ mm³/min/mm wheel contact width (1.5 to 1.1 in³/in/min).

Using Fig. 1 we find optimum work speeds for depths of cut $a_r = 0.01$ and 0.005 mm to be $V_w = 100$ and 75 m/min, and 200 and 150 m/min (330 and 250 fpm, and 660 and 500 fpm) respectively for 10- and 30-minute wheel-life.

These high work speeds are possible using proper dressing conditions, high system stiffness, good grinding fluid quality and wheel composition.

Fig. 3 shows the variation of specific metal removal rate with wheel speed for several materials and a range of *ECT*s at 10- and 30-minutes wheel-life. *ECT* decreases when moving to the left and down along each curve. The two curves for unhardened 1020 steel have the largest values of *SMRR*, and represent the most productive grinding conditions, while the heat resistant alloy Inconel yields the least productive grinding conditions. Each

branch attains a maximum $SMRR$ along the G -curve (compare with the same curve in the V - ECT graph, Fig. 2c) and a maximum speed region along the H -curve. When the $SMRR$ -values are lower than the H -curve the ECT values for each branch decrease towards the bottom of the graph, then the speed for constant wheel-life must be reduced due to the fact that the ECT values are to the left of their respective H -curves in V - ECT graphs.

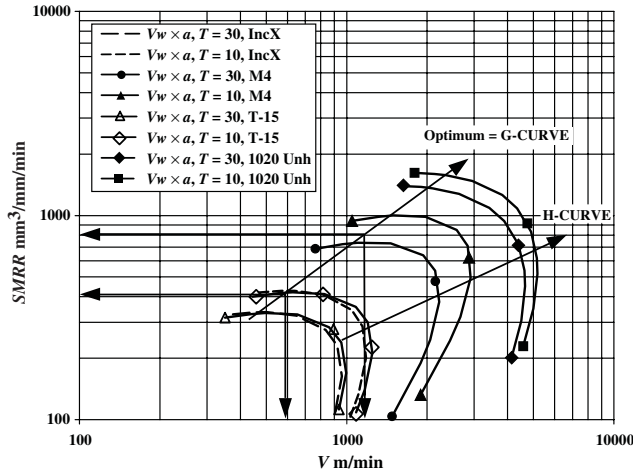


Fig. 3. Specific metal removal rate vs. cutting speed at $T=10$ and 30 minutes wheel life

In the figure, IncX is Inconel; M4, and T-15 are tool steels; and 1020 Unh is unhardened 1020 steel.

Surface Finish, R_a .—The finish is improved by decreasing the value of ECT as shown in Fig. 4, where R_a is plotted versus ECT at 3 different wheel lives 1, 10 and 30 minutes at constant wheel speed. Because ECT is proportional to the depth of cut, a smaller depth of cut is favorable for reducing surface roughness when the work speed is constant.

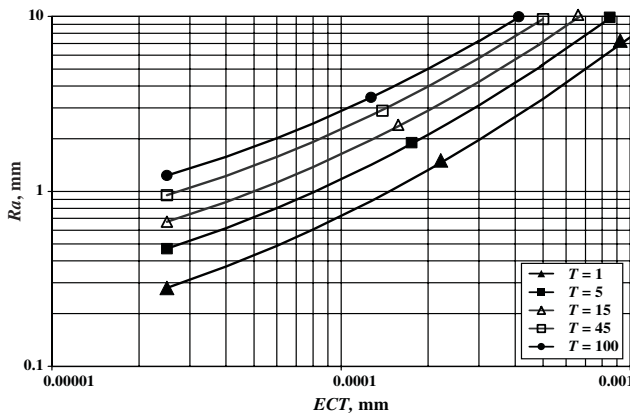


Fig. 4. Surface finish, R_a vs. ECT , wheel-life T plotted

In Fig. 5, R_a is plotted versus wheel-life at 5 different ECT 's. Both Figs. 4 and 5 illustrate that a shorter life improves the surface finish, which means that either an increased wheel speed (wheel-life decreases) at constant ECT , or a smaller ECT at constant speed (wheel-life increases), will result in an improved finish. For a required surface finish, ECT and wheel-life have to be selected appropriately in order to also achieve an optimum grinding time or cost. In cylindrical grinding a reduction of side feed f_s improves R_a as well.

In terms of specific metal removal rate, reducing $SMRR$ will improve the surface finish R_A .

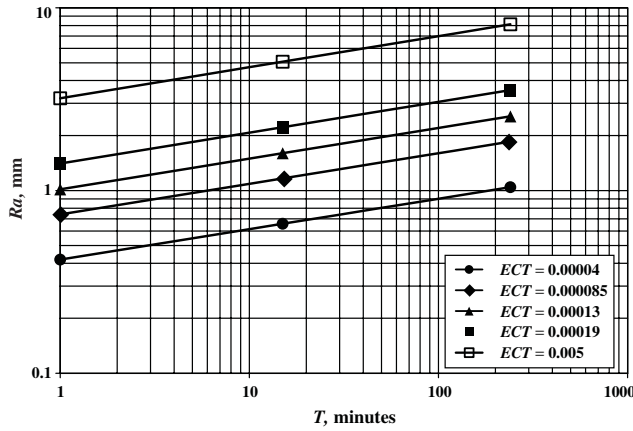


Fig. 5. Surface roughness, R_a vs. wheel life T , ECT plotted

Example 4, Specific Metal Removal Rates and Work Speeds in Rough and Finish Grinding: The tabulated values in the following table indicate that a decreasing ECT combined with a higher wheel speed for 10 minutes wheel-life will decrease the metal removal rate and thereby increasing the grinding time. This change is accompanied by a better finish in both roughing and finishing operations. Note the high work speeds when finishing.

ECT mm	Tool Life $T = 10$ minutes		Roughing Depth $a_r = 0.025$ mm	Finishing Depth $a_r = 0.0025$ mm
	Wheel speed V_{10} m/min	Removal Rate $SMRR_{10}$ mm ³ /mm/min	Work speed V_w m/min	
0.00050	1970	985	39	390
0.00033	2580	850	34	340
0.00017	2910	500	20	200

The grit size, however, is a major parameter. Fig. 6, shows that a high wheel speed, combined with a small grit size, say 320 Mesh, can achieve R_A values as small as 0.03 microns.

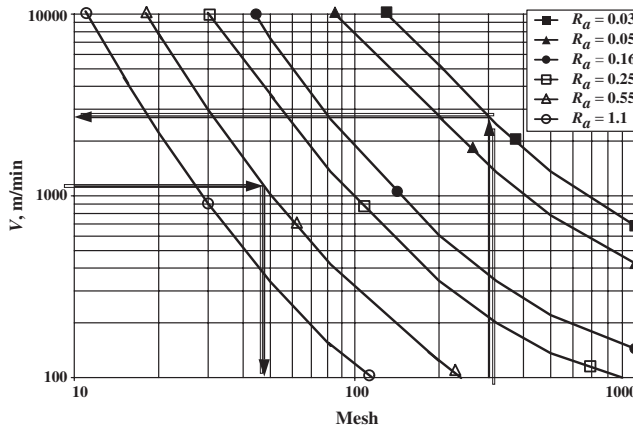


Fig. 6. Wheel speed vs. wheel mesh, R_a plotted

Spark-out Time.—Fig. 7 shows how spark-out time varies with system stiffness. As with surface finish, when wheel-life is short (high wear rate) the spark-out time decreases.

Equivalent Diameter (Work Conformity) Factor: The difference in curvature of the work and wheel in the contact region, determined by the equivalent diameter or work conformity formula, is an important factor for calculating spark-out time and forces, but has a negligible influence on wheel-life. Therefore, an equivalent diameter, $D_e = D/(1 \pm (D/D_w))$,

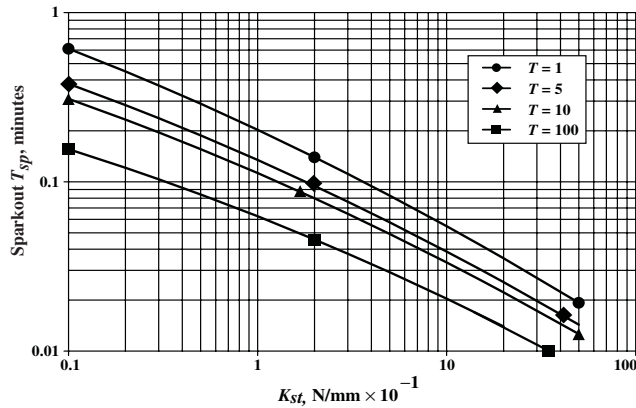


Fig. 7. Sparkout time vs. system stiffness, wheel-life T plotted with the minus sign for internal grinding and the plus sign for external grinding operations, is used to consider the effect of conformity when using internal and external grinding with varying work and wheel diameters. D_e is equal to the wheel diameter in surface grinding (work flat); in internal grinding, the wheel conforms closely to the work and D_e is therefore larger than in external grinding.

Grinding Cutting Forces, Torque and Power.—Formulas to calculate the tangential cutting force, torque and required machining power are found in *Estimating Machining Power* on page 1083, but the values of K_c , specific cutting force or specific energy, are approximately 30 to 40 times higher in grinding than in turning, milling and drilling. This is primarily due to the fact that the ECT values in grinding are 1000 to 10000 times smaller, and also due to the negative rake angles of the grit. Average grinding rake angles are around -35 to -45 degrees. K_c for grinding unhardened steel is around 50000 to 70000 N/mm^2 and up to 150000 to 200000 N/mm^2 for hardened steels and heat resistant alloys. The grinding cutting forces are relatively small because the chip area is very small.

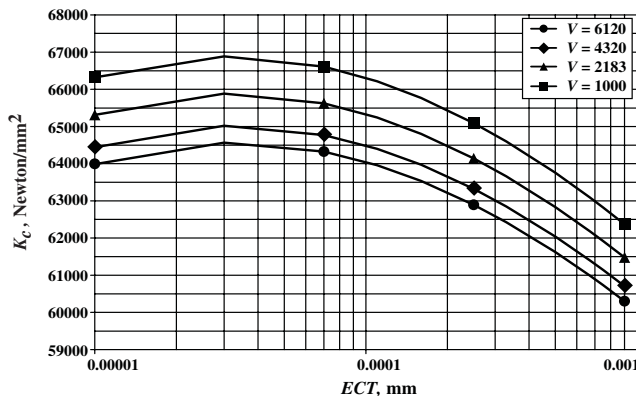


Fig. 8. Specific grinding force K_c vs. ECT ; V plotted

As in the other metal cutting operations, the forces vary with ECT and to a smaller extent with the wheel speed V . An example is shown in Fig. 8, where K_c , specific cutting force, is plotted versus ECT at wheel speeds between 1000 and 6000 m/min. The material is medium unhardened carbon steel ground by an aluminum oxide wheel. The impact of wheel speed is relatively small (2 to 5% lower with increasing speed).

Example 5: Find the cutting force when $ECT = 0.00017$ mm, the cutting edge length (width of cut) CEL is 10 mm, and $K_c = 150000$ N/mm^2 .

The chip area is $ECT \times CEL = 0.0017 \text{ mm}^2$. For $K_c = 150000$, the cutting force is $0.0017 \times 150000 = 255 \text{ Newton}$.

Another difference compared to turning is the influence of the negative rake angles, illustrated by the ratio of F_H/F_C , where F_H is the normal force and F_C the tangential grinding force acting in the wheel speed direction. F_H is much larger than the grinding cutting force, generally F_H/F_C ratio is approximately 2 to 4. An example is shown in Fig. 9, where F_H/F_C is plotted versus ECT at wheel speeds between 1000 and 6000 m/min, under the same conditions as in Fig. 8.

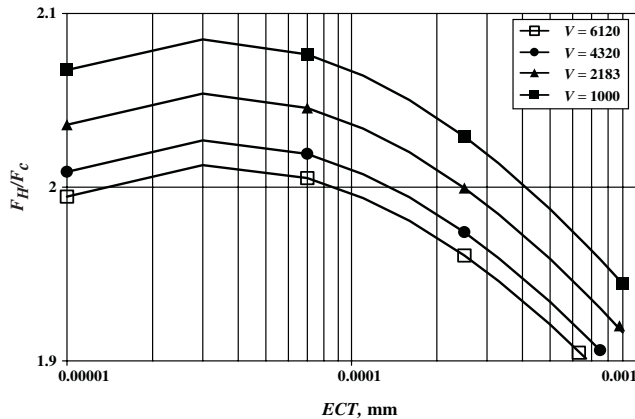


Fig. 9. F_H/F_C vs. ECT ; cutting speed plotted

In both Fig. 8 and Fig. 9, it is apparent that both K_c and F_H/F_C attain maximum values for given small values of ECT , in this case approximately $ECT = 0.00005 \text{ mm}$. This fact illustrates that forces and wheel-life are closely linked; for example, wheel speed has a maximum for constant wheel-life at approximately the same values of ECT shown in the two graphs (compare with the trends illustrated in Figs. 2a, 2b, 2c, and 3). As a matter of fact, force relationships obey the same type of relationships as those of wheel-life. Colding's force relationship uses the same 5 constants as the tool life equation, but requires values for the specific cutting force at $ECT = 0.001$ and an additional constant, obtained by a special data base generator. This requires more elaborate laboratory tests, or better, the design of a special test and follow-up program for parts running in the ordinary production.

Grinding Data Selection Including Wheel Life

The first estimate of machine settings is based on dividing work materials into 10 groups, based on grindability, as given in Table 1. Compositions of these work materials are found in the Handbook in the section *STANDARD STEELS* starting on page 396.

Grinding wheel nomenclature is described in *American National Standard Grinding Wheel Markings* starting on page 1218. The wheel compositions are selected according to the grade recommendations in the section *The Selection of Grinding Wheels* starting on page 1219. Grinding fluid recommendations are given in *Cutting Fluids for Machining* starting on page 1182.

Note: Maximum wheel speeds should always be checked using the safety standards in the section *Safe Operating Speeds* starting on page 1248, because the recommendations will sometimes lead to speeds above safety levels.

The material in this section is based on the use of a typical standard wheel composition such as 51-A-46-L-5-V-23, with wheel grade (wheel hardness) = L or above, and mesh (grit size) = 46 or above.

Table 1. Grindability Groups

Group	Examples
Group 1 Unhardened Steels	
Group 2 Stainless Steels	SAE 30201-30347, 51409-51501
Group 3 Cast Iron	
Group 4 Tool Steels	M1, M8, T1, H, O, L, F, 52100
Group 5 Tool Steels	M2, T2, T5, T6, D2, H41, H42, H43, M50
Group 6 Tool Steels	M3, M4, T3, D7
Group 7 Tool Steels	T15, M15
Group 8 Heat Resistant Steels	Inconel, Rene etc.
Group 9 Carbide Materials	P30 Diamond Wheel
Group 10 Ceramic Materials	

For each grindability group there is one table and 2 graphs (one with Taylor lines and the other with $SMRR$ versus wheel speed V) that are used to get a first estimate of standardized machine settings, assuming a good system stiffness ($K_{ST} > 30 \text{ N}/\mu\text{m}$). These data are then calibrated with the users own data in order to refine the estimate and optimize the grinding process, as discussed in *User Calibration of Recommendations*. The recommendations are valid for all grinding processes such as plunge grinding, cylindrical, and surface grinding with periphery or side of wheel, as well as for creep feed grinding.

The grinding data machinability system is based on the basic parameters equivalent chip thickness ECT , and wheel speed V , and is used to determine specific metal removal rates $SMRR$ and wheel-life T , including the work speed V_w after the grinding depths for roughing and finishing are specified.

For each material group, the grinding data machinability system consists of T - V Taylor lines in log-log coordinates for 3 wheel speeds at wheel lives of 1, 10 and 100 minutes wheel-life with 4 different values of equivalent chip thickness ECT . The wheel speeds are designated V_1 , V_{10} , and V_{100} respectively. In each table the corresponding specific metal removal rates $SMRR$ are also tabulated and designated as $SMRR_1$, $SMRR_{10}$ and $SMRR_{100}$ respectively. The user can select any value of ECT and interpolate between the Taylor lines. These curves look the same in grinding as in the other metal cutting processes and the slope is set at $n = 0.26$, so each Taylor line is formulated by $V \times T^{0.26} = C$, where C is a constant tabulated at four ECT values, $ECT = 17, 33, 50$ and $75 \times 10^{-5} \text{ mm}$, for each material group. Hence, for each value of ECT , $V_1 \times 1^{0.26} = V_{10} \times 10^{0.26} = V_{100} \times 100^{0.26} = C$.

Side Feed, Roughing and Finishing.—In cylindrical grinding, the side feed, $f_s = C \times \text{Width}$, does not impact on the values in the tables, but on the feed rate F_R , where the fraction of the wheel width C is usually selected for roughing and in finishing operations, as shown in the following table.

Work Material	Roughing, C	Finishing, C
Unhardened Steel	2/3-3/4	1/3-3/8
Stainless Steel	1/2	1/4
Cast Iron	3/4	3/8
Hardened Steel	1/2	1/4

Finishing: The depth of cut in rough grinding is determined by the allowance and usually set at $a_r = 0.01$ to 0.025 mm . The depth of cut for finishing is usually set at $a_r = 0.0025 \text{ mm}$ and accompanied by higher wheel speeds in order to improve surface finish. However, the most important criterion for critical parts is to increase the work speed in order to avoid thermal damage and surface cracks. In cylindrical grinding, a reduction of side feed f_s

improves R_a as well. Small grit sizes are very important when very small finishes are required. See Figs. 4, 5, and 6 for reference.

Terms and Definitions

a_a = depth of cut

a_r = radial depth of cut, mm

C = fraction of grinding wheel width

CEL = cutting edge length, mm

C_U = Taylor constant

D = wheel diameter, mm

$DIST$ = grinding distance, mm

d_w = work diameter, mm

ECT = equivalent chip thickness = $f(a_r, V, V_w f_s)$, mm

$$= 1 \div (V \div V_w \div a_r + 1 \div f_s) = \frac{V_w f_s (a_r + 1)}{V}$$

= approximately $V_w \times a_r \div V = SMRR \div V \div 1000$

= $z \times f_z \times a_r \times a_a \div CEL \div (\pi D)$ mm

F_R = feed rate, mm/min

= $f_s \times RPM_w$ for cylindrical grinding

= $f_i \times RPM_w$ for plunge (in-feed) grinding

f_i = in-feed in plunge grinding, mm/rev of work

f_s = side feed or engaged wheel width in cylindrical grinding = $C \times Width$ =

a_a approximately equal to the cutting edge length CEL

Grinding ratio = $MRR \div W^* = SMRR \times T \div W^* = 1000 \times ECT \times V \times T \div W^*$

MRR = metal removal rate = $SMRR \times T = 1000 \times f_s \times a_r \times V_w$ mm³/min

$SMRR$ = specific metal removal rate obtained by dividing MRR by the engaged wheel width ($C \times Width$) = $1000 \times a_r \times V_w$ mm³/mm width/min

Note: 100 mm³/mm/min = 0.155 in³/in/min, and 1 in³/in/min = 645.16 mm³/mm/min

T, T_U = wheel-life = *Grinding ratio* $\times W \div (1000 \times ECT \times V)$ minutes

t_c = grinding time per pass = $DIST \div F_R$ min

= $DIST \div F_R + t_{sp}$ (min) when spark-out time is included

= # Strokes $\times (DIST \div F_R + t_{sp})$ (min) when spark-out time and strokes are included

t_{sp} = spark-out time, minutes

V, V_U = wheel speed, m/min

V_w, V_{wU} = work speed = $SMRR \div 1000 \div a_r$ m/min

W^* = volume wheel wear, mm³

$Width$ = wheel width (mm)

RPM = wheel speed = $1000 \times V \div D \div \pi$ rpm

RPM_w = work speed = $1000 \times V_w \div D_w \div \pi$ rpm

Relative Grindability.—An overview of grindability of the data base, which must be based on a constant wheel wear rate, or wheel-life, is demonstrated using 10 minutes wheel-life shown in Table 2.

Table 2. Grindability Overview

Material Group	$ECT \times 10^{-5}$	V_{10}	$SMRR_{10}$	V_w	
				Roughing Depth $a_r = 0.025$	Finishing Depth $a_r = 0.0025$
1 Unhardened	33	3827	1263	50	500
2 Stainless	33	1080	360	15	150
3 Cast Iron	33	4000	1320	53	530
4 Tool Steel	33	3190	1050	42	420
5 Tool Steel	33	2870	950	38	380
6 Tool Steel	33	2580	850	35	350
7 Tool Steel	33	1080	360	15	150
8 Heat resistant	33	1045	345	14	140
9 Carbide with Diamond Wheel	5	$V_{600} = 1200$	$SMRR_{600} = 50$	2	20
10 Ceramics with Diamond Wheel	5	$V_{600} = 411$	$SMRR_{600} = 21$	0.84	84

Procedure to Determine Data.—The following wheel-life recommendations are designed for 4 values of $ECT = 0.00017, 0.00033, 0.00050$ and 0.00075 mm (shown as 17, 33, 50 and 75 in the tables). Lower values of ECT than 0.00010 mm (0.000004 in.) are not recommended as these may lie to the left of the H -curve.

The user selects any one of the ECT values, or interpolates between these, and selects the wheel speed for 10 or 100 minutes life, denoted by V_{10} and V_{100} , respectively. For other desired wheel lives the wheel speed can be calculated from the tabulated Taylor constants C and $n = 0.26$ as follows:

$$(V \times T_{(desired)})^{0.26} = C, \text{ the value of which is tabulated for each } ECT \text{ value. } C \text{ is the value of cutting speed } V \text{ at } T = 1 \text{ minute, hence is the same as for the speed } V_I \\ (V_I \times 1^{0.26} = C)$$

$$V_{10} = C \div 10^{0.26} = C \div 1.82$$

$$V_{100} = C \div 100^{0.26} = C \div 3.31.$$

Example 6: A tool steel in material group 6 with $ECT = 0.00033$, has constant $C = 4690$, $V_{10} = 2578$ m/min, and $V_{100} = 1417$ m/min. From this information, find the wheel speed for desired wheel-life of $T = 15$ minutes and $T = 45$ minutes

For $T = 15$ minutes we get $V_{15} = 4690 \div 15^{0.26} = 2319$ m/min (7730 fpm) and for $T = 45$ minutes $V_{45} = 4690 \div 45^{0.26} = 1743$ m/min (5810 fpm).

The Tables are arranged in 3 sections:

1. Speeds V_{10} and $V_I = \text{Constant CST(standard)}$ for 4 ECT values $0.00017, 0.00033, 0.00050$ and 0.00075 mm. Values C_U and V_{10U} refer to user calibration of the standard values in each material group, explained in the following.

2. Speeds V_{100} (first row of 3), V_{10} and V_I (last in row) corresponding to wheel lives 100, 10 and 1 minutes, for 4 ECT values $0.00017, 0.00033, 0.00050$ and 0.00075 mm.

3. Specific metal removal rates $SMRR_{100}$, $SMRR_{10}$ and $SMRR_I$ corresponding to wheel lives 100, 10 and 1 minutes, for the 4 ECT values $0.00017, 0.00033, 0.00050$, and 0.00075 mm

The 2 Graphs show: wheel life versus wheel speed in double logarithmic coordinates (Taylor lines); and, $SMRR$ versus wheel speed in double logarithmic coordinates for 4 ECT values: $0.00017, 0.00033, 0.00050$ and 0.00075 mm.

Table 1. Group 1—Unhardened Steels

Tool Life <i>T</i> (min)	<i>ECT</i> = 0.00017 mm		<i>ECT</i> = 0.00033 mm		<i>ECT</i> = 0.00050 mm		<i>ECT</i> = 0.00075 mm	
	Constant <i>C</i> = 8925		Constant <i>C</i> = 6965		Constant <i>C</i> = 5385		Constant <i>C</i> = 3885	
	<i>V_T</i>	<i>SMRR</i>	<i>V_T</i>	<i>SMRR</i>	<i>V_T</i>	<i>SMRR</i>	<i>V_T</i>	<i>SMRR</i>
100	2695	460	2105	695	1625	815	1175	880
10	4905	835	3830	1265	2960	1480	2135	1600
1	8925	1520	6965	2300	5385	2695	3885	2915

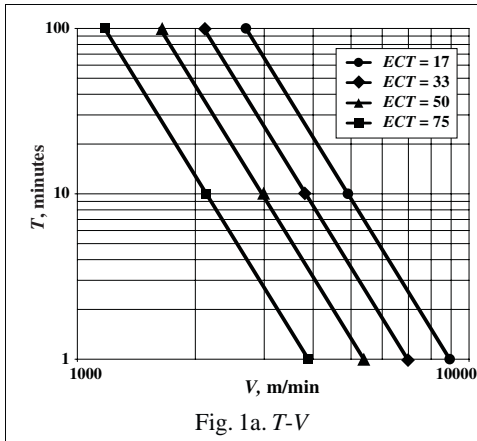


Fig. 1a. *T*-*V*

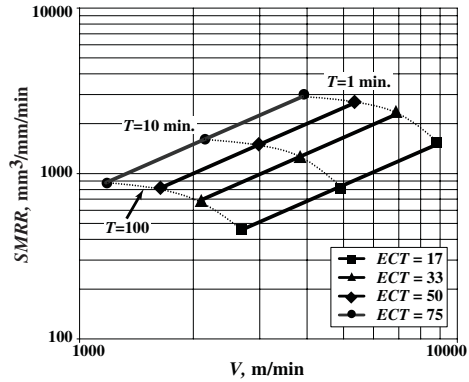


Fig. 1b. *SMRR* vs. *V*, *T* = 100, 10, 1 minutes

Table 2. Group 2—Stainless Steels SAE 30201 - 30347, SAE 51409 - 51501

Tool Life <i>T</i> (min)	<i>ECT</i> = 0.00017 mm		<i>ECT</i> = 0.00033 mm		<i>ECT</i> = 0.00050 mm		<i>ECT</i> = 0.00075 mm	
	Constant <i>C</i> = 2270		Constant <i>C</i> = 1970		Constant <i>C</i> = 1505		Constant <i>C</i> = 1010	
	<i>V_T</i>	<i>SMRR</i>	<i>V_T</i>	<i>SMRR</i>	<i>V_T</i>	<i>SMRR</i>	<i>V_T</i>	<i>SMRR</i>
100	685	115	595	195	455	225	305	230
10	1250	210	1080	355	825	415	555	415
1	2270	385	1970	650	1505	750	1010	760

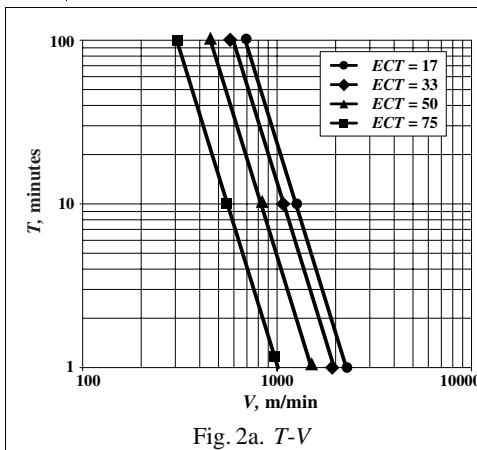


Fig. 2a. *T*-*V*

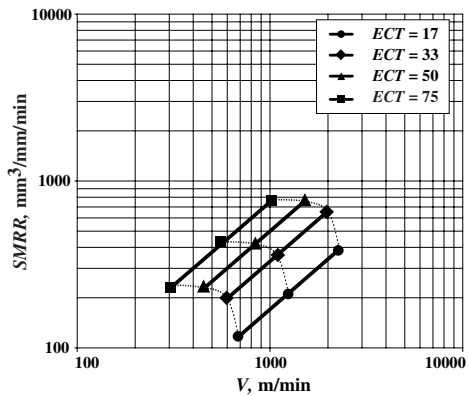


Fig. 2b. *SMRR* vs. *V*, *T* = 100, 10, 1 minutes

Table 3. Group 3—Cast Iron

Tool Life T (min)	$ECT = 0.00017$ mm		$ECT = 0.00033$ mm		$ECT = 0.00050$ mm		$ECT = 0.00075$ mm	
	Constant $C = 10710$		Constant $C = 8360$		Constant $C = 6465$		Constant $C = 4665$	
	V_T	$SMRR$	V_T	$SMRR$	V_T	$SMRR$	V_T	$SMRR$
100	3235	550	2525	835	1950	975	1410	1055
10	5885	1000	4595	1515	3550	1775	2565	1920
1	10710	1820	8360	2760	6465	3230	4665	3500

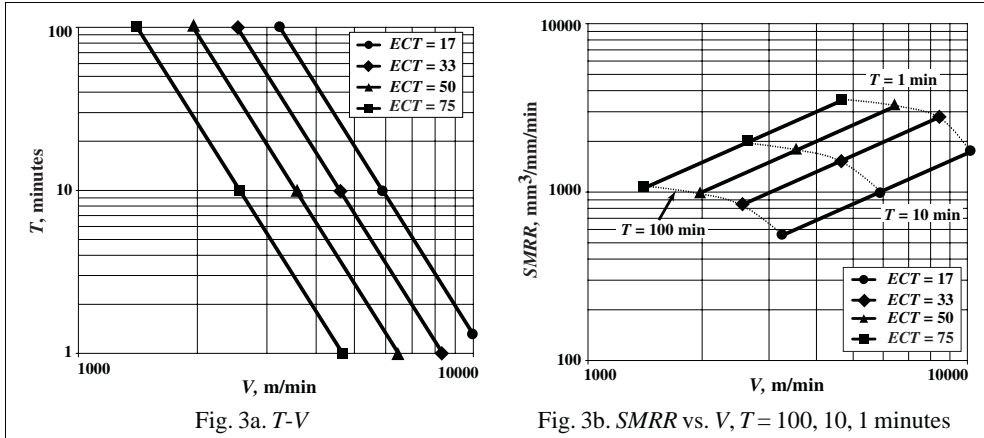


Table 4. Group 4—Tool Steels, M1, M8, T1, H, O, L, F, 52100

Tool Life T (min)	$ECT = 0.00017$ mm		$ECT = 0.00033$ mm		$ECT = 0.00050$ mm		$ECT = 0.00075$ mm	
	Constant $C = 7440$		Constant $C = 5805$		Constant $C = 4490$		Constant $C = 3240$	
	V_T	$SMRR$	V_T	$SMRR$	V_T	$SMRR$	V_T	$SMRR$
100	2245	380	1755	580	1355	680	980	735
10	4090	695	3190	1055	2465	1235	1780	1335
1	7440	1265	5805	1915	4490	2245	3240	2430

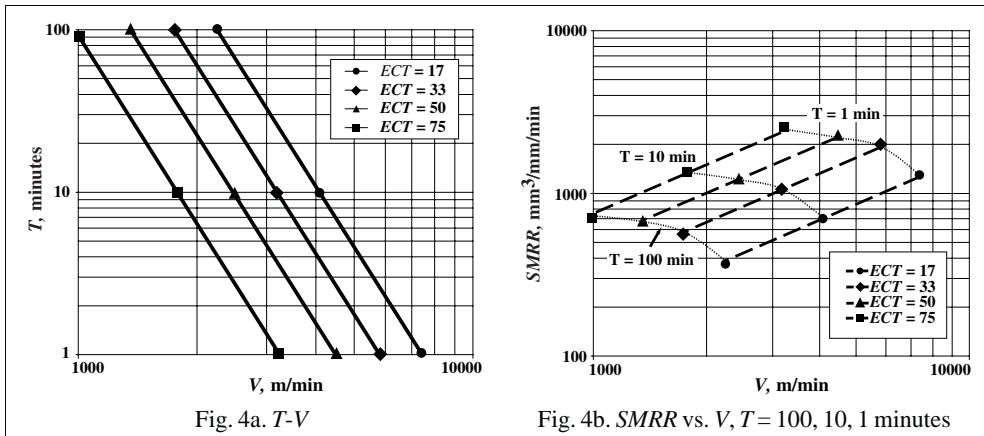


Table 5. Group 5—Tool Steels, M2, T2, T5, T6, D2, D5, H41, H42, H43, M50

Tool Life <i>T</i> (min)	<i>ECT</i> = 0.00017 mm		<i>ECT</i> = 0.00033 mm		<i>ECT</i> = 0.00050 mm		<i>ECT</i> = 0.00075 mm	
	Constant <i>C</i> = 6695		Constant <i>C</i> = 5224		Constant <i>C</i> = 4040		Constant <i>C</i> = 2915	
	<i>V_T</i>	<i>SMRR</i>	<i>V_T</i>	<i>SMRR</i>	<i>V_T</i>	<i>SMRR</i>	<i>V_T</i>	<i>SMRR</i>
100	2020	345	1580	520	1220	610	880	660
10	3680	625	2870	945	2220	1110	1600	1200
1	6695	1140	5225	1725	4040	2020	2915	2185

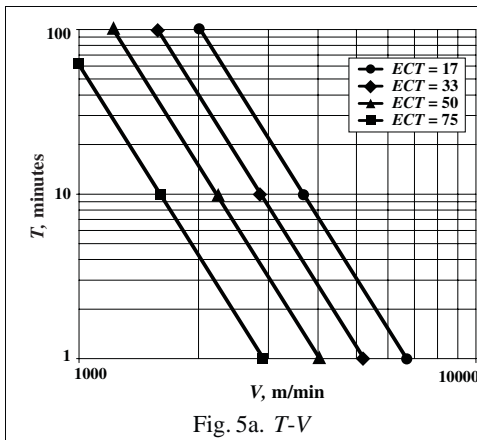


Fig. 5a. *T-V*

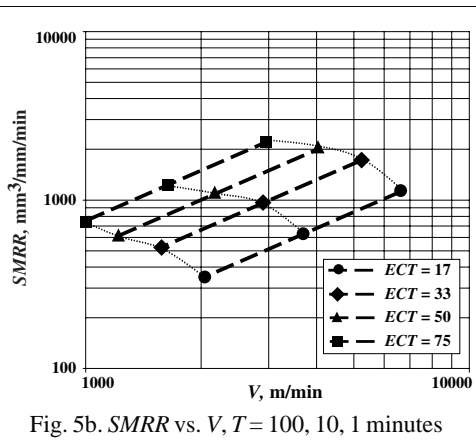


Fig. 5b. *SMRR vs. V, T = 100, 10, 1 minutes*

Table 6. Group 6—Tool Steels, M3, M4, T3, D7

Tool Life <i>T</i> (min)	<i>ECT</i> = 0.00017 mm		<i>ECT</i> = 0.00033 mm		<i>ECT</i> = 0.00050 mm		<i>ECT</i> = 0.00075 mm	
	Constant <i>C</i> = 5290		Constant <i>C</i> = 4690		Constant <i>C</i> = 3585		Constant <i>C</i> = 2395	
	<i>V_T</i>	<i>SMRR</i>	<i>V_T</i>	<i>SMRR</i>	<i>V_T</i>	<i>SMRR</i>	<i>V_T</i>	<i>SMRR</i>
100	1600	270	1415	465	1085	540	725	540
10	2910	495	2580	850	1970	985	1315	985
1	5290	900	4690	1550	3585	1795	2395	1795

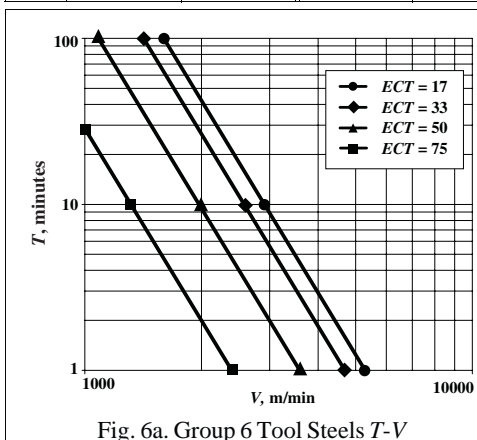


Fig. 6a. Group 6 Tool Steels *T-V*

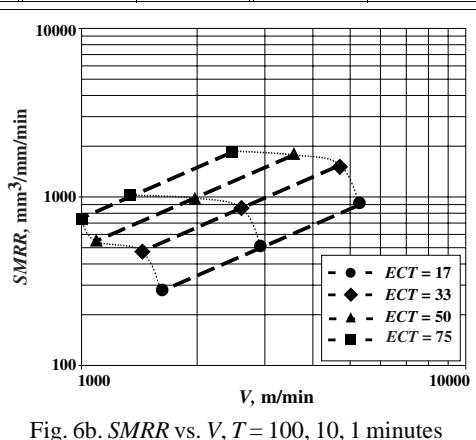


Fig. 6b. *SMRR vs. V, T = 100, 10, 1 minutes*

Table 7. Group 7—Tool Steels, T15, M15

Tool Life T (min)	$ECT = 0.00017$ mm		$ECT = 0.00033$ mm		$ECT = 0.00050$ mm		$ECT = 0.00075$ mm	
	Constant $C = 2270$		Constant $C = 1970$		Constant $C = 1505$		Constant $C = 1010$	
	V_T	$SMRR$	V_T	$SMRR$	V_T	$SMRR$	V_T	$SMRR$
100	685	115	595	195	455	225	305	230
10	1250	210	1080	355	825	415	555	415
1	2270	385	1970	650	1505	750	1010	760

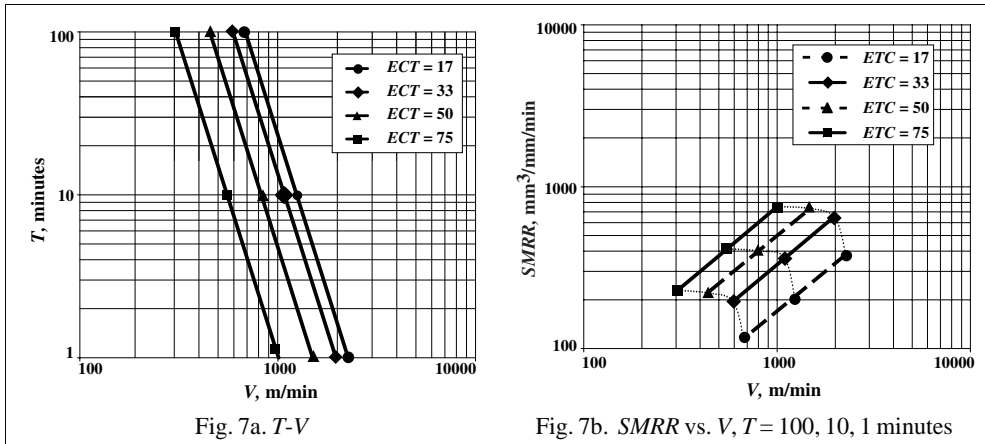


Table 8. Group 8—Heat Resistant Alloys, Inconel, Rene, etc.

Tool Life T (min)	$ECT = 0.00017$ mm		$ECT = 0.00033$ mm		$ECT = 0.00050$ mm		$ECT = 0.00075$ mm	
	Constant $C = 2150$		Constant $C = 1900$		Constant $C = 1490$		Constant $C = 1035$	
	V_T	$SMRR$	V_T	$SMRR$	V_T	$SMRR$	V_T	$SMRR$
100	650	110	575	190	450	225	315	235
10	1185	200	1045	345	820	410	570	425
1	2150	365	1900	625	1490	745	1035	780

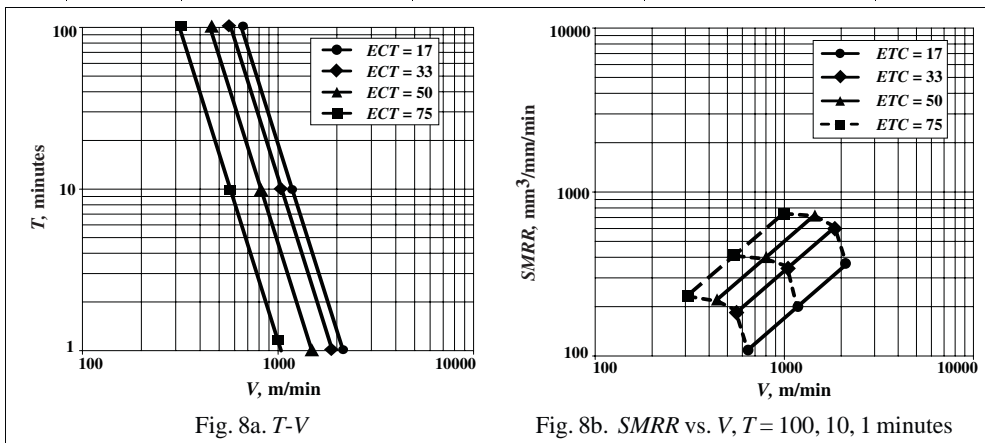


Table 9. Group 9—Carbide Materials, Diamond Wheel

Tool Life T (min)	$ECT = 0.00002$ mm		$ECT = 0.00003$ mm		$ECT = 0.00005$ mm		$ECT = 0.00008$ mm	
	Constant $C = 9030$		Constant $C = 8030$		Constant $C = 5365$		Constant $C = 2880$	
	V_T	$SMRR$	V_T	$SMRR$	V_T	$SMRR$	V_T	$SMRR$
4800	1395	30	1195	35	760	40	390	30
600	2140	45	1855	55	1200	60	625	50
10	4960	100	4415	130	2950	145	1580	125

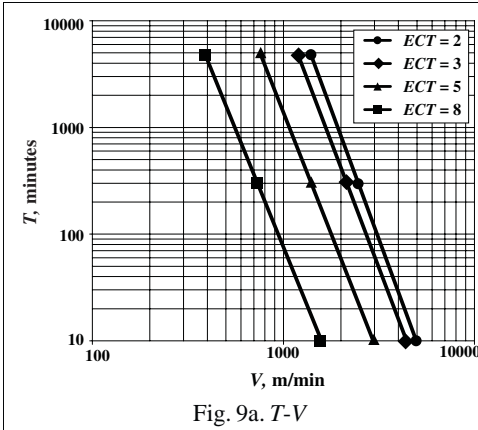


Fig. 9a. T - V

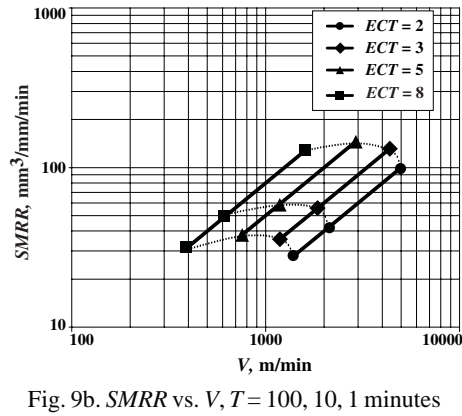


Fig. 9b. $SMRR$ vs. V , $T = 100, 10, 1$ minutes

Table 10. Group 10—Ceramic Materials, Al_2O_3 , ZrO_2 , SiC , Si_3N_4 , Diamond Wheel

Tool Life T (min)	$ECT = 0.00002$ mm		$ECT = 0.00003$ mm		$ECT = 0.00005$ mm		$ECT = 0.00008$ mm	
	Constant $C = 2460$		Constant $C = 2130$		Constant $C = 1740$		Constant $C = 1420$	
	V_T	$SMRR$	V_T	$SMRR$	V_T	$SMRR$	V_T	$SMRR$
4800	395	8	335	10	265	13	210	17
600	595	12	510	15	410	20	330	25
10	1355	25	1170	35	955	50	780	60

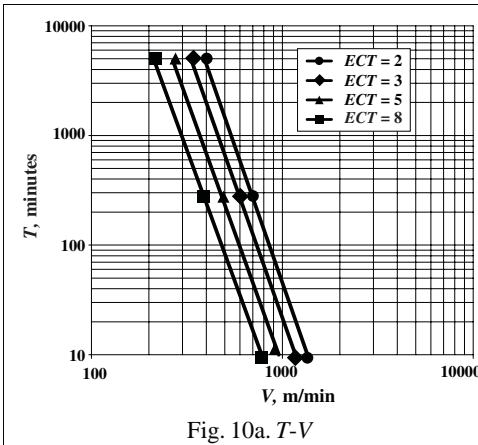


Fig. 10a. T - V

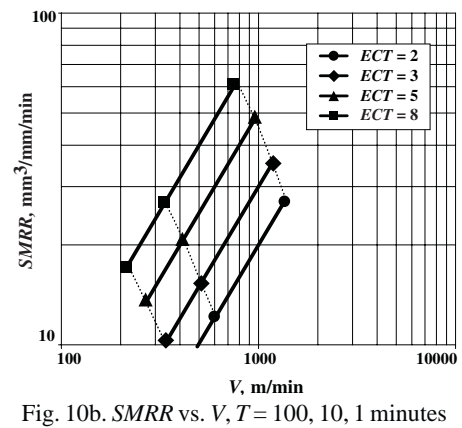


Fig. 10b. $SMRR$ vs. V , $T = 100, 10, 1$ minutes

User Calibration of Recommendations

It is recommended to copy or redraw the standard graph for any of the material groups before applying the data calibration method described below. The method is based on the user’s own experience and data. The procedure is described in the following and illustrated in **Table 11** and **Fig. 12**.

Only one shop data set is needed to adjust all four Taylor lines as shown below. The required shop data is the user’s wheel-life T_U obtained at the user’s wheel speed V_U , the user’s work speed V_{wU} , and depth of cut a_r .

1) First the user finds out which wheel-life T_U was obtained in the shop, and the corresponding wheel speed V_U , depth of cut a_r , and work speed V_{wU} .

2) Second, calculate:

a) $ECT = V_{wU} \times ar \div V_U$

b) the user Taylor constant $C_U = V_U \times T_U^{0.26}$

c) $V_{10U} = C_U \div 10^{0.26}$ d) $V_{100U} = C_U \div 100^{0.26}$

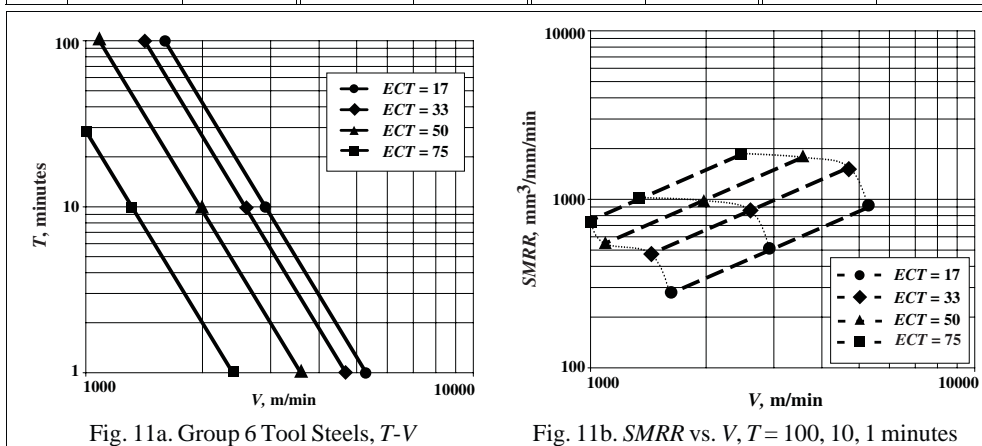
3) Thirdly, the user Taylor line is drawn in the pertinent graph. If the user wheel-life T_U is longer than that in the standard graph the speed values will be higher, or if the user wheel-life is shorter the speeds C_U, V_{10U}, V_{100U} will be lower than the standard values C, V_{10} and V_{100} .

The results are a series of lines moved to the right or to the left of the standard Taylor lines for $ECT = 17, 33, 50$ and 75×10^{-5} mm. Each standard table contains the values $C = V_1, V_{10}, V_{100}$ and empty spaces for filling out the calculated user values: $C_U = V_U \times T_U^{0.26}, V_{10U} = C_U \div 10^{0.26}$ and $V_{100U} = C_U \div 100^{0.26}$.

Example 7: Assume the following test results on a Group 6 material: user speed is $V_U = 1800$ m/min, wheel-life $T_U = 7$ minutes, and $ECT = 0.00017$ mm. The Group 6 data is repeated below for convenience.

Standard Table Data, Group 6 Material

Tool Life T (min)	$ECT = 0.00017$ mm		$ECT = 0.00033$ mm		$ECT = 0.00050$ mm		$ECT = 0.00075$ mm	
	Constant $C = 5290$		Constant $C = 4690$		Constant $C = 3585$		Constant $C = 2395$	
	V_T	$SMRR$	V_T	$SMRR$	V_T	$SMRR$	V_T	$SMRR$
100	1600	270	1415	465	1085	540	725	540
10	2910	495	2580	850	1970	985	1315	985
1	5290	900	4690	1550	3585	1795	2395	1795



Calculation Procedure

- 1) Calculate V_{1U} , V_{10U} , V_{100U} and $SMRR_{1U}$, $SMRR_{10U}$, $SMRR_{100U}$ for $ECT = 0.00017$ mm
- V_{1U} = the user Taylor constant $C_U = V_U \times T_U^{0.26} = 1800 \times 7^{0.26} = 2985$ m/min, and $SMRR_{1U} = 1000 \times 2985 \times 0.00017 = 507$ mm³/mm width/min
 - $V_{10U} = C_U \div 10^{0.26} = 2985 \div 10^{0.26} = 1640$ m/min, and $SMRR_{10U} = 1000 \times 1640 \times 0.00017 = 279$ mm³/mm width/min
 - $V_{100U} = C_U \div 100^{0.26} = 2985 \div 100^{0.26} = 900$ m/min, and $SMRR_{100U} = 1000 \times 900 \times 0.00017 = 153$ mm³/mm width/min
- 2) For $ECT = 0.00017$ mm, calculate the ratio of user Taylor constant to standard Taylor constant from the tables $= C_U \div C_{ST} = C_U \div V_I = 2985 \div 5290 = 0.564$ (see Table 6 for the value of $C_{ST} = V_I$ at $ECT = 0.00017$ mm).
- 3) For $ECT = 0.00033$, 0.00050 , and 0.00075 mm calculate the user Taylor constants from $C_U = C_{ST} \times$ (the ratio calculated in step 2) $= V_I \times 0.564 = V_{1U}$. Then, calculate V_{10U} and V_{100U} and $SMRR_{1U}$, $SMRR_{10U}$, $SMRR_{100U}$ using the method in items 1b) and 1c) above.
- For $ECT = 0.00033$ mm

$V_{1U} = C_U = 4690 \times 0.564 = 2645$ m/min
 $V_{10U} = C_U \div 10^{0.26} = 2645 \div 10^{0.26} = 1455$ m/min
 $V_{100U} = C_U \div 100^{0.26} = 2645 \div 100^{0.26} = 800$ m/min
 $SMRR_{1U}$, $SMRR_{10U}$, and $SMRR_{100U} = 876, 480,$ and 264 mm³/mm width/min
 - For $ECT = 0.00050$ mm

$V_{1U} = C_U = 3590 \times 0.564 = 2025$ m/min
 $V_{10U} = C_U \div 10^{0.26} = 2025 \div 10^{0.26} = 1110$ m/min
 $V_{100U} = C_U \div 100^{0.26} = 2025 \div 100^{0.26} = 610$ m/min
 $SMRR_{1U}$, $SMRR_{10U}$, and $SMRR_{100U} = 1013, 555,$ and 305 mm³/mm width/min
 - For $ECT = 0.00075$ mm

$V_{1U} = C_U = 2395 \times 0.564 = 1350$ m/min
 $V_{10U} = C_U \div 10^{0.26} = 1350 \div 10^{0.26} = 740$ m/min
 $V_{100U} = C_U \div 100^{0.26} = 1350 \div 100^{0.26} = 405$ m/min
 $SMRR_{1U}$, $SMRR_{10U}$, and $SMRR_{100U} = 1013, 555,$ and 305 mm³/mm width/min

Thus, the wheel speed for any desired wheel-life at a given ECT can be calculated from $V = C_U \div T^{0.26}$. For example, at $ECT = 0.00050$ mm and desired tool-life $T = 9$, $V_9 = 2025 \div 9^{0.26} = 1144$ m/min. The corresponding specific metal removal rate is $SMRR = 1000 \times 1144 \times 0.0005 = 572$ mm³/mm width/min (0.886 in³/inch width/min).

Table 11. User Calculated Data, Group 6 Material

Tool Life T (min)	$ECT = 0.00017$ mm		$ECT = 0.00033$ mm		$ECT = 0.00050$ mm		$ECT = 0.00075$ mm	
	User Constant $C_U = 2985$		User Constant $C_U = 2645$		User Constant $C_U = 2025$		User Constant $C_U = 1350$	
	V_T	$SMRR$	V_T	$SMRR$	V_T	$SMRR$	V_T	$SMRR$
100	900	153	800	264	610	305	405	305
10	1640	279	1455	480	1110	555	740	555
1	2985	507	2645	876	2025	1013	1350	1013

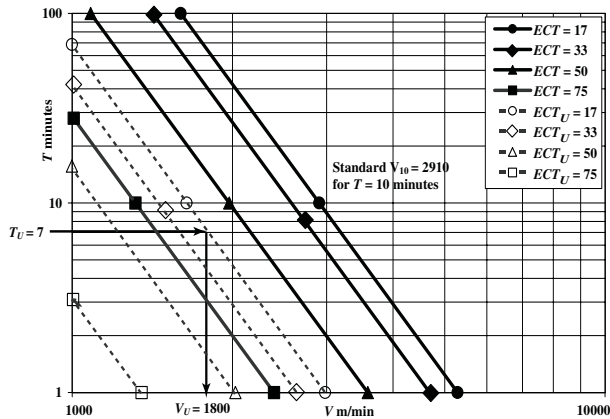


Fig. 12. Calibration of user grinding data to standard Taylor Lines
User Input: $V_U = 1800$ m/min, $T_U = 7$ minutes, $ECT = 0.00017$ mm

Optimization.— As shown, a global optimum occurs along the G -curve, in selected cases for values of ECT around 0.00075, i.e. at high metal removal rates as in other machining operations. It is recommended to use the simple formula for economic life: $T_E = 3 \times T_V$ minutes. $T_V = T_{RPL} + 60 \times C_E \div H_R$, minutes, where T_{RPL} is the time required to replace wheel, $C_E = \text{cost per wheel dressing} = \text{wheel cost} + \text{cost per dressing}$, and H_R is the hourly rate.

In grinding, values of T_V range between 2 and 5 minutes in conventional grinders, which means that the economic wheel lives range between 6 and 15 minutes indicating higher metal removal rates than are commonly used. When wheels are sharpened automatically after each stroke as in internal grinding, or when grits are continually replaced as in abrasive grinding (machining), T_V may be less than one minute. This translates into wheel lives around one minute in order to achieve minimum cost grinding.

Grinding Cost, Optimization and Process Planning: More accurate results are obtained when the firm collects and systemizes the information on wheel lives, wheel and work speeds, and depths of cut from production runs. A computer program can be used to plan the grinding process and apply the rules and formulas presented in this chapter. A complete grinding process planning program, such as that developed by Colding International Corporation, can be used to optimize machine settings for various feed-speed preferences corresponding wheel-life requirements, minimum cost or maximum production rate grinding, required surface finish and sparkout time; machine and fixture requirements based on the grinding forces, torque and power for sharp and worn grinding wheels; and, detailed time and cost analysis per part and per batch including wheel dressing and wheel changing schedules.

Table 12 summarizes the time and cost savings per batch as it relates to tool life. The sensitivity of how grinding parameters are selected is obvious. Minimum cost conditions yield a 51% reduction of time and 44% reduction of cost, while maximum production rate reduces total time by 65% but, at the expense of heavy wheel consumption (continuous dressing), cost by only 18%.

Table 12. Wheel Life vs. Cost

Preferences	Time per Batch, minutes	Cost per Batch, \$		Reduction from Long Life, %	
		Tooling	Total Cost	Time	Cost
Long Life	2995	39	2412	—	—
Economic Life	2433	252	2211	19	8
Minimum Cost	1465	199	1344	51	44
Max Production Rate	1041	1244	1980	65	18

GRINDING AND OTHER ABRASIVE PROCESSES

Processes and equipment discussed under this heading use abrasive grains for shaping workpieces by means of machining or related methods. Abrasive grains are hard crystals either found in nature or manufactured. The most commonly used materials are aluminum oxide, silicon carbide, cubic boron nitride and diamond. Other materials such as garnet, zirconia, glass and even walnut shells are used for some applications. Abrasive products are used in three basic forms by industry:

a) *Bonded* to form a solid shaped tool such as disks (the basic shape of grinding wheels), cylinders, rings, cups, segments, or sticks to name a few.

b) *Coated* on backings made of paper or cloth, in the form of sheets, strips, or belts.

c) *Loose*, held in some liquid or solid carrier (for lapping, polishing, tumbling), or propelled by centrifugal force, air, or water pressure against the work surface (blast cleaning).

The applications for abrasive processes are multiple and varied. They include:

a) *Cleaning* of surfaces, also the coarse removal of excess material—such as rough off-hand grinding in foundries to remove gates and risers.

b) *Shaping*, such as in form grinding and tool sharpening.

c) *Sizing*, a general objective, but of primary importance in precision grinding.

d) *Surface finish improvement*, either primarily as in lapping, honing, and polishing or as a secondary objective in other types of abrasive processes.

e) *Separating*, as in cut-off or slicing operations.

The main field of application of abrasive processes is in metalworking, because of the capacity of abrasive grains to penetrate into even the hardest metals and alloys. However, the great hardness of the abrasive grains also makes the process preferred for working other hard materials, such as stones, glass, and certain types of plastics. Abrasive processes are also chosen for working relatively soft materials, such as wood, rubber, etc., for such reasons as high stock removal rates, long-lasting cutting ability, good form control, and fine finish of the worked surface.

Grinding Wheels

Abrasive Materials.—In earlier times, only natural abrasives were available. From about the beginning of this century, however, manufactured abrasives, primarily silicon carbide and aluminum oxide, have replaced the natural materials; even natural diamonds have been almost completely supplanted by synthetics. Superior and controllable properties, and dependable uniformity characterize the manufactured abrasives.

Both silicon carbide and aluminum oxide abrasives are very hard and brittle. This brittleness, called friability, is controllable for different applications. Friable abrasives break easily, thus forming sharp edges. This decreases the force needed to penetrate into the work material and the heat generated during cutting. Friable abrasives are most commonly used for precision and finish grinding. Tough abrasives resist fracture and last longer. They are used for rough grinding, snagging, and off-hand grinding.

As a general rule, although subject to variation:

1) Aluminum oxide abrasives are used for grinding plain and alloyed steel in a soft or hardened condition.

2) Silicon carbide abrasives are selected for cast iron, nonferrous metals, and nonmetallic materials.

3) Diamond is the best type of abrasive for grinding cemented carbides. It is also used for grinding glass, ceramics, and hardened tool steel.

4) Cubic Boron Nitride (CBN) is known by several trade names including Borazon (General Electric Co.), ABN (De Beers), Sho-bon (Showa-Denko), and Elbor (USSR). CBN is a synthetic superabrasive used for grinding hardened steels and wear-resistant superalloys. (See *Cubic Boron Nitride (CBN)* starting on page 1012.) CBN grinding wheels have long lives and can maintain close tolerances with superior surface finishes.

Bond Properties and Grinding Wheel Grades.—The four main types of bonds used for grinding wheels are the vitrified, resinoid, rubber, and metal.

Vitrified bonds are used for more than half of all grinding wheels made, and are preferred because of their strength and other desirable qualities. Being inert, glass-like materials, vitrified bonds are not affected by water or by the chemical composition of different grinding fluids. Vitrified bonds also withstand the high temperatures generated during normal grinding operations. The structure of vitrified wheels can be controlled over a wide range of strength and porosity. Vitrified wheels, however, are more sensitive to impact than those made with organic bonds.

Resinoid bonds are selected for wheels subjected to impact, or sudden loads, or very high operating speeds. They are preferred for snagging, portable grinder uses, or roughing operations. The higher flexibility of this type of bond—essentially a filled thermosetting plastic—helps it withstand rough treatment.

Rubber bonds are even more flexible than the resinoid type, and for that reason are used for producing a high finish and for resisting sudden rises in load. Rubber bonded wheels are commonly used for wet cut-off wheels because of the nearly burr-free cuts they produce, and for centerless grinder regulating wheels to provide a stronger grip and more reliable workpiece control.

Metal bonds are used in CBN and diamond wheels. In metal bonds produced by electrodeposition, a single layer of superabrasive material (diamond or CBN) is bonded to a metal core by a matrix of metal, usually nickel. The process is so controlled that about 30-40 per cent of each abrasive particle projects above the deposited surface, giving the wheel a very aggressive and free-cutting action. With proper use, such wheels have remarkably long lives. When dulled, or worn down, the abrasive can be stripped off and the wheel renewed by a further deposit process. These wheels are also used in electrical discharge grinding and electrochemical grinding where an electrically conductive wheel is needed.

In addition to the basic properties of the various bond materials, each can also be applied in different proportions, thereby controlling the grade of the grinding wheel.

Grinding wheel grades commonly associated with hardness, express the amount of bond material in a grinding wheel, and hence the strength by which the bond retains the individual grains.

During grinding, the forces generated when cutting the work material tend to dislodge the abrasive grains. As the grains get dull and if they don't fracture to resharpen themselves, the cutting forces will eventually tear the grains from their supporting bond. For a "soft" wheel the cutting forces will dislodge the abrasive grains before they have an opportunity to fracture. When a "hard" wheel is used, the situation is reversed. Because of the extra bond in the wheel the grains are so firmly held that they never break loose and the wheel becomes glazed. During most grinding operations it is desirable to have an intermediate wheel where there is a continual slow wearing process composed of both grain fracture and dislodgement.

The grades of the grinding wheels are designated by capital letters used in alphabetical order to express increasing "hardness" from A to Z.

Grinding Wheel Structure.—The individual grains, which are encased and held together by the bond material, do not fill the entire volume of the grinding wheel; the intermediate open space is needed for several functional purposes such as heat dissipation, coolant application, and particularly, for the temporary storage of chips. It follows that the

spacing of the grains must be greater for coarse grains which cut thicker chips and for large contact areas within which the chips have to be retained on the surface of the wheel before being disposed of. On the other hand, a wide spacing reduces the number of grains that contact the work surface within a given advance distance, thereby producing a coarser finish.

In general, denser structures are specified for grinding hard materials, for high-speed grinding operations, when the contact area is narrow, and for producing fine finishes and/or accurate forms. Wheels with open structure are used for tough materials, high stock removal rates, and extended contact areas, such as grinding with the face of the wheel. There are, however, several exceptions to these basic rules, an important one being the grinding of parts made by powder metallurgy, such as cemented carbides; although they represent one of the hardest industrial materials, grinding carbides requires wheels with an open structure.

Most kinds of general grinding operations, when carried out with the periphery of the wheel, call for medium spacing of the grains. The structure of the grinding wheels is expressed by numerals from 1 to 16, ranging from dense to open. Sometimes, "induced porosity" is used with open structure wheels. This term means that the grinding wheel manufacturer has placed filler material (which later burns out when the wheel is fired to vitrify the bond) in the grinding wheel mix. These fillers create large "pores" between grain clusters without changing the total volume of the "pores" in the grinding wheel. Thus, an A46-H12V wheel and an A46H12VP wheel will contain the same amounts of bond, abrasive, and air space. In the former, a large number of relatively small pores will be distributed throughout the wheel. The latter will have a smaller number of larger pores.

American National Standard Grinding Wheel Markings.—ANSI Standard B74.13 "Markings for Identifying Grinding Wheels and Other Bonded Abrasives," applies to grinding wheels and other bonded abrasives, segments, bricks, sticks, hones, rubs, and other shapes that are for removing material, or producing a desired surface or dimension. It does not apply to specialties such as sharpening stones and provides only a standard system of markings. Wheels having the same standard markings but made by different wheel manufacturers may not—and probably will not—produce exactly the same grinding action. This desirable result cannot be obtained because of the impossibility of closely correlating any measurable physical properties of bonded abrasive products in terms of their grinding action.

Symbols for designating diamond and cubic boron wheel compositions are given on page 1243.

Sequence of Markings.—The accompanying illustration taken from ANSI B74.13-1990 shows the makeup of a typical wheel or bonded abrasive marking.

	1	2	3	4	5	6
Prefix	Abrasive Type	Grain Size	Grade	Structure	Bond Type	Manufacturer's Record
51	- A	- 36	- L	- 5	- V	- 23

The meaning of each letter and number in this or other markings is indicated by the following complete list.

1) *Abrasive Letters:* The letter (A) is used for aluminum oxide, (C) for silicon carbide, and (Z) for aluminum zirconium. The manufacturer may designate some particular type in any one of these broad classes, by using his own symbol as a prefix (example, 51).

2) *Grain Size:* The grain sizes commonly used and varying from coarse to very fine are indicated by the following numbers: 8, 10, 12, 14, 16, 20, 24, 30, 36, 46, 54, 60, 70, 80, 90, 100, 120, 150, 180, and 220. The following additional sizes are used occasionally: 240, 280, 320, 400, 500, and 600. The wheel manufacturer may add to the regular grain number an additional symbol to indicate a special grain combination.

3) *Grade*: Grades are indicated by letters of the alphabet from A to Z in all bonds or processes. Wheel grades from A to Z range from soft to hard.

4) *Structure*: The use of a structure symbol is optional. The structure is indicated by Nos. 1 to 16 (or higher, if necessary) with progressively higher numbers indicating a progressively wider grain spacing (more open structure).

5) *Bond or Process*: Bonds are indicated by the following letters: V, vitrified; S, silicate; E, shellac or elastic; R, rubber; RF, rubber reinforced; B, resinoid (synthetic resins); BF, resinoid reinforced; O, oxychloride.

6) *Manufacturer's Record*: The sixth position may be used for manufacturer's private factory records; this is optional.

American National Standard Shapes and Sizes of Grinding Wheels.—The ANSI Standard B74.2-1982 which includes shapes and sizes of grinding wheels, gives a wide variety of grinding wheel shape and size combinations. These are suitable for the majority of applications. Although grinding wheels can be manufactured to shapes and dimensions different from those listed, it is advisable, for reasons of cost and inventory control, to avoid using special shapes and sizes, unless technically warranted.

Standard shapes and size ranges as given in this Standard together with typical applications are shown in [Table 1a](#) for inch dimensions and in [Table 1b](#) for metric dimensions.

The operating surface of the grinding wheel is often referred to as the wheel face. In the majority of cases it is the periphery of the grinding wheel which, when not specified otherwise, has a straight profile. However, other face shapes can also be supplied by the grinding wheel manufacturers, and also reproduced during usage by appropriate truing. ANSI B74.2-1982 standard offers 13 different shapes for grinding wheel faces, which are shown in [Table 2](#).

The Selection of Grinding Wheels.—In selecting a grinding wheel, the determining factors are the composition of the work material, the type of grinding machine, the size range of the wheels used, and the expected grinding results, in this approximate order.

The Norton Company has developed, as the result of extensive test series, a method of grinding wheel recommendation that is more flexible and also better adapted to taking into consideration pertinent factors of the job, than are listings based solely on workpiece categories. This approach is the basis for [Tables 3](#) through [6](#), inclusive. Tool steels and constructional steels are considered in the detailed recommendations presented in these tables.

[Table 3](#) assigns most of the standardized tool steels to five different grindability groups. The AISI-SAE tool steel designations are used.

After having defined the grindability group of the tool steel to be ground, the operation to be carried out is found in the first column of [Table 4](#). The second column in this table distinguishes between different grinding wheel size ranges, because wheel size is a factor in determining the contact area between wheel and work, thus affecting the apparent hardness of the grinding wheel. Distinction is also made between wet and dry grinding.

Finally, the last two columns define the essential characteristics of the recommended types of grinding wheels under the headings of first and second choice, respectively. Where letters are used *preceding* A, the standard designation for aluminum oxide, they indicate a degree of friability different from the regular, thus: SF = semi friable (Norton equivalent 16A) and F = friable (Norton equivalent 33A and 38A). The suffix P, where applied, expresses a degree of porosity that is more open than the regular.

Table 1a. Standard Shapes and Inch Size Ranges of Grinding Wheels
ANSI B74.2-1982

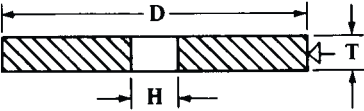
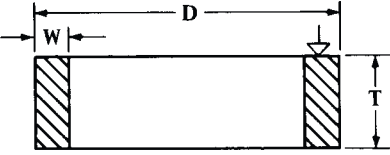
Applications	Size Ranges of Principal Dimensions, Inches		
	D = Dia.	T = Thick.	H = Hole
 <p>Type 1. Straight Wheel For peripheral grinding.</p>			
CUTTING OFF (Organic bonds only)	1 to 48	1/64 to 3/8	1/16 to 6
CYLINDRICAL GRINDING Between centers	12 to 48	1/2 to 6	5 to 20
CYLINDRICAL GRINDING Centerless grinding wheels	14 to 30	1 to 20	5 or 12
CYLINDRICAL GRINDING Centerless regulating wheels	8 to 14	1 to 12	3 to 6
INTERNAL GRINDING	1/4 to 4	1/4 to 2	3/32 to 7/8
OFFHAND GRINDING Grinding on the periphery			
General purpose	6 to 36	1/2 to 4	1/2 to 3
For wet tool grinding only	30 or 36	3 or 4	20
SAW GUMMING (F-type face)	6 to 12	1/4 to 1 1/2	1/2 to 1 1/4
SNAGGING Floor stand machines	12 to 24	1 to 3	1 1/4 to 2 1/2
SNAGGING Floor stand machines (Organic bond, wheel speed over 6500 sfpm)	20 to 36	2 to 4	6 or 12
SNAGGING Mechanical grinders (Organic bond, wheel speed up to 16,500 sfpm)	24	2 to 3	12
SNAGGING Portable machines	3 to 8	1/4 to 1	3/8 to 5/8
SNAGGING Portable machines (Reinforced organic bond, 17,000 sfpm)	6 or 8	3/4 or 1	1
SNAGGING Swing frame machines	12 to 24	2 to 3	3 1/2 to 12
SURFACE GRINDING Horizontal spindle machines	6 to 24	1/2 to 6	1 1/4 to 12
TOOL GRINDING Broaches, cutters, mills, reamers, taps, etc.	6 to 10	1/4 to 1/2	5/8 to 5
 <p>Type 2. Cylindrical Wheel Side grinding wheel — mounted on the diameter; may also be mounted in a chuck or on a plate.</p>			
			W = Wall
SURFACE GRINDING Vertical spindle machines	8 to 20	4 or 5	1 to 4

Table 1a. (Continued) Standard Shapes and Inch Size Ranges of Grinding Wheels
ANSI B74.2-1982

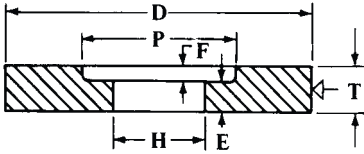
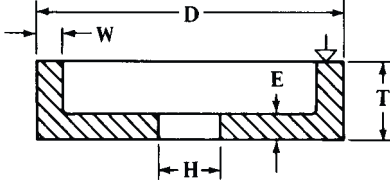
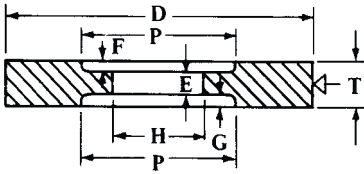
Applications	Size Ranges of Principal Dimensions, Inches		
	D = Dia.	T = Thick.	H = Hole
 <p>Type 5. Wheel, recessed one side For peripheral grinding. Allows wider faced wheels than the available mounting thickness, also grinding clearance for the nut and flange.</p>			
CYLINDRICAL GRINDING Between centers	12 to 36	1½ to 4	5 or 12
CYLINDRICAL GRINDING Centerless regulating wheel	8 to 14	3 to 6	3 or 5
INTERNAL GRINDING	¾ to 4	¾ to 2	⅛ to 7⁄8
SURFACE GRINDING Horizontal spindle machines	7 to 24	¾ to 6	1¼ to 12
 <p>Type 6. Straight-Cup Wheel Side grinding wheel, in whose dimensioning the wall thickness (W) takes precedence over the diameter of the recess. Hole is 5⁄8-11UNC-2B threaded for the snagging wheels and ½ or 1¼" for the tool grinding wheels.</p>			
			W = Wall
SNAGGING Portable machines, organic bond only.	4 to 6	2	¾ to 1½
TOOL GRINDING Broaches, cutters, mills, reamers, taps, etc.	2 to 6	1 ¼ to 2	5⁄16 or 3⁄8
 <p>Type 7. Wheel, recessed two sides Peripheral grinding. Recesses allow grinding clearance for both flanges and also narrower mounting thickness than overall thickness.</p>			
CYLINDRICAL GRINDING Between centers	12 to 36	1½ to 4	5 or 12
CYLINDRICAL GRINDING Centerless regulating wheel	8 to 14	4 to 20	3 to 6
SURFACE GRINDING Horizontal spindle machines	12 to 24	2 to 6	5 to 12

Table 1a. (Continued) Standard Shapes and Inch Size Ranges of Grinding Wheels
ANSI B74.2-1982

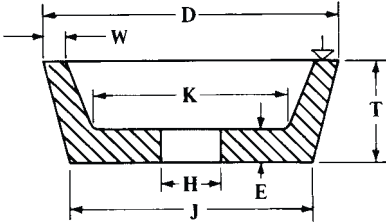
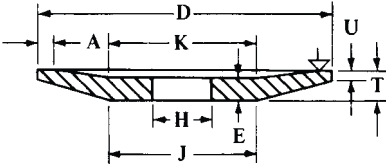
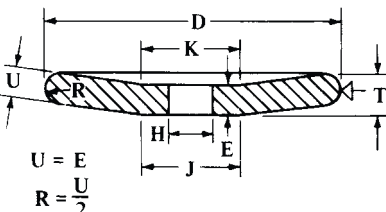
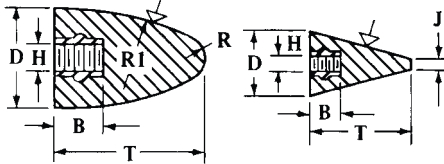
Applications	Size Ranges of Principal Dimensions, Inches		
	D = Dia.	T = Thick.	H = Hole
	<p>Type 11. Flaring-Cup Wheel Side grinding wheel with wall tapered outward from the back; wall generally thicker in the back.</p>		
<p>SNAGGING Portable machines, organic bonds only, threaded hole</p>	4 to 6	2	$\frac{5}{8}$ -11 UNC-2B
<p>TOOL GRINDING Broaches, cutters, mills, reamers, taps, etc.</p>	2 to 5	1 $\frac{1}{4}$ to 2	$\frac{1}{2}$ to 1 $\frac{1}{4}$
	<p>Type 12. Dish Wheel Grinding on the side or on the U-face of the wheel, the U-face being always present in this type.</p>		
<p>TOOL GRINDING Broaches, cutters, mills, reamers, taps, etc.</p>	3 to 8	$\frac{1}{2}$ or $\frac{3}{4}$	$\frac{1}{2}$ to 1 $\frac{1}{4}$
	<p>Type 13. Saucer Wheel Peripheral grinding wheel, resembling the shape of a saucer, with cross section equal throughout.</p>		
<p>SAW GUMMING Saw tooth shaping and sharpening</p>	8 to 12	$\frac{1}{2}$ to 1 $\frac{3}{4}$ U & E $\frac{1}{4}$ to 1 $\frac{1}{2}$	$\frac{3}{4}$ to 1 $\frac{1}{4}$
	<p>Type 16. Cone, Curved Side Type 17. Cone, Straight Side, Square Tip Type 17R. Cone, Straight Side, Round Tip (Tip Radius $R = J/2$)</p>		
<p>SNAGGING Portable machine, threaded holes</p>	1 $\frac{1}{4}$ to 3	2 to 3 $\frac{1}{2}$	$\frac{3}{8}$ -24UNF-2B to $\frac{5}{8}$ -11UNC-2B

Table 1a. (Continued) Standard Shapes and Inch Size Ranges of Grinding Wheels
ANSI B74.2-1982

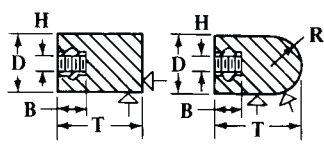
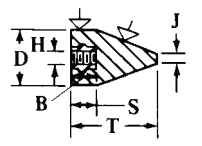
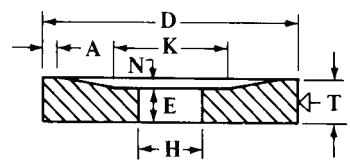
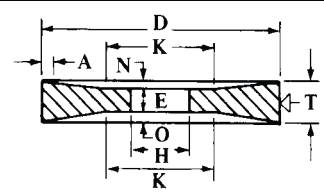
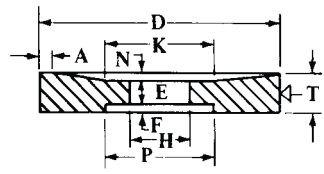
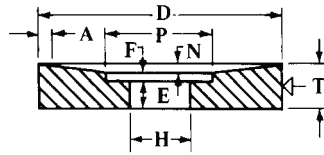
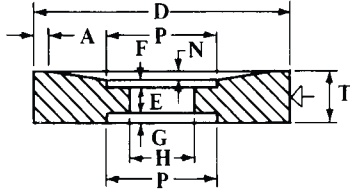
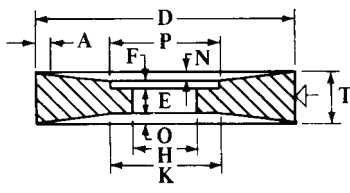
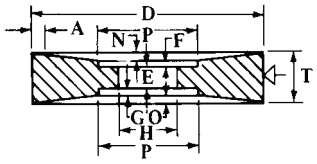
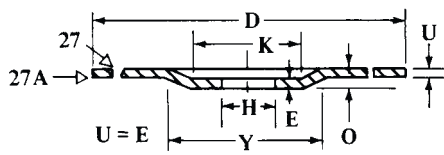
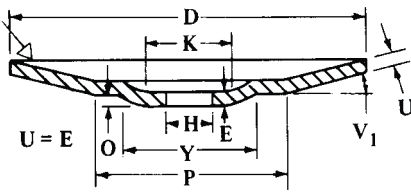
Applications	Size Ranges of Principal Dimensions, Inches		
	<i>D</i> = Dia.	<i>T</i> = Thick.	<i>H</i> = Hole
	<p>Type 18. Plug, Square End Type 18R. Plug, Round End $R = D/2$</p>		
	<p>Type 19. Plugs, Conical End, Square Tip Type 19R. Plugs, Conical End, Round Tip (Tip Radius $R = J/2$)</p>		
<p>SNAGGING Portable machine, threaded holes</p>	1¼ to 3	2 to 3½	$\frac{3}{8}$ -24UNF-2B to $\frac{5}{8}$ -11UNC-2B
	<p>Type 20. Wheel, Relieved One Side Peripheral grinding wheel, one side flat, the other side relieved to a flat.</p>		
<p>CYLINDRICAL GRINDING Between centers</p>	12 to 36	¾ to 4	5 to 20
	<p>Type 21. Wheel, Relieved Two Sides Both sides relieved to a flat.</p>		
	<p>Type 22. Wheel, Relieved One Side, Recessed Other Side One side relieved to a flat.</p>		
	<p>Type 23. Wheel, Relieved and Recessed Same Side The other side is straight.</p>		
<p>CYLINDRICAL GRINDING Between centers, with wheel periphery</p>	20 to 36	2 to 4	12 or 20

Table 1a. (Continued) Standard Shapes and Inch Size Ranges of Grinding Wheels
ANSI B74.2-1982

Applications	Size Ranges of Principal Dimensions, Inches		
	D = Dia.	T = Thick.	H = Hole
	<p>Type 24. Wheel, Relieved and Recessed One Side, Recessed Other Side One side recessed, the other side is relieved to a recess.</p>		
	<p>Type 25. Wheel, Relieved and Recessed One Side, Relieved Other Side One side relieved to a flat, the other side relieved to a recess.</p>		
	<p>Type 26. Wheel, Relieved and Recessed Both Sides</p>		
<p>CYLINDRICAL GRINDING Between centers, with the periphery of the wheel</p>	20 to 36	2 to 4	12 or 20
	<p>TYPES 27 & 27A. Wheel, Depressed Center 27. <i>Portable Grinding</i>: Grinding normally done by contact with work at approx. a 15° angle with face of the wheel. 27A. <i>Cutting-off</i>: Using the periphery as grinding face.</p>		
<p>CUTTING OFF Reinforced organic bonds only</p>	16 to 30	$U = E = \frac{5}{32} \text{ to } \frac{1}{4}$	1 or 1 1/2
<p>SNAGGING Portable machine</p>	3 to 9	U = Uniform thick. 1/8 to 3/8	3/8 or 7/8
	<p>Type 28. Wheel, Depressed Center (Saucer Shaped Grinding Face) Grinding at approx. 15° angle with wheel face.</p>		
<p>SNAGGING Portable machine</p>	7 or 9	U = Uniform thickness 1/4	7/8

Throughout table large open-head arrows indicate grinding surfaces.

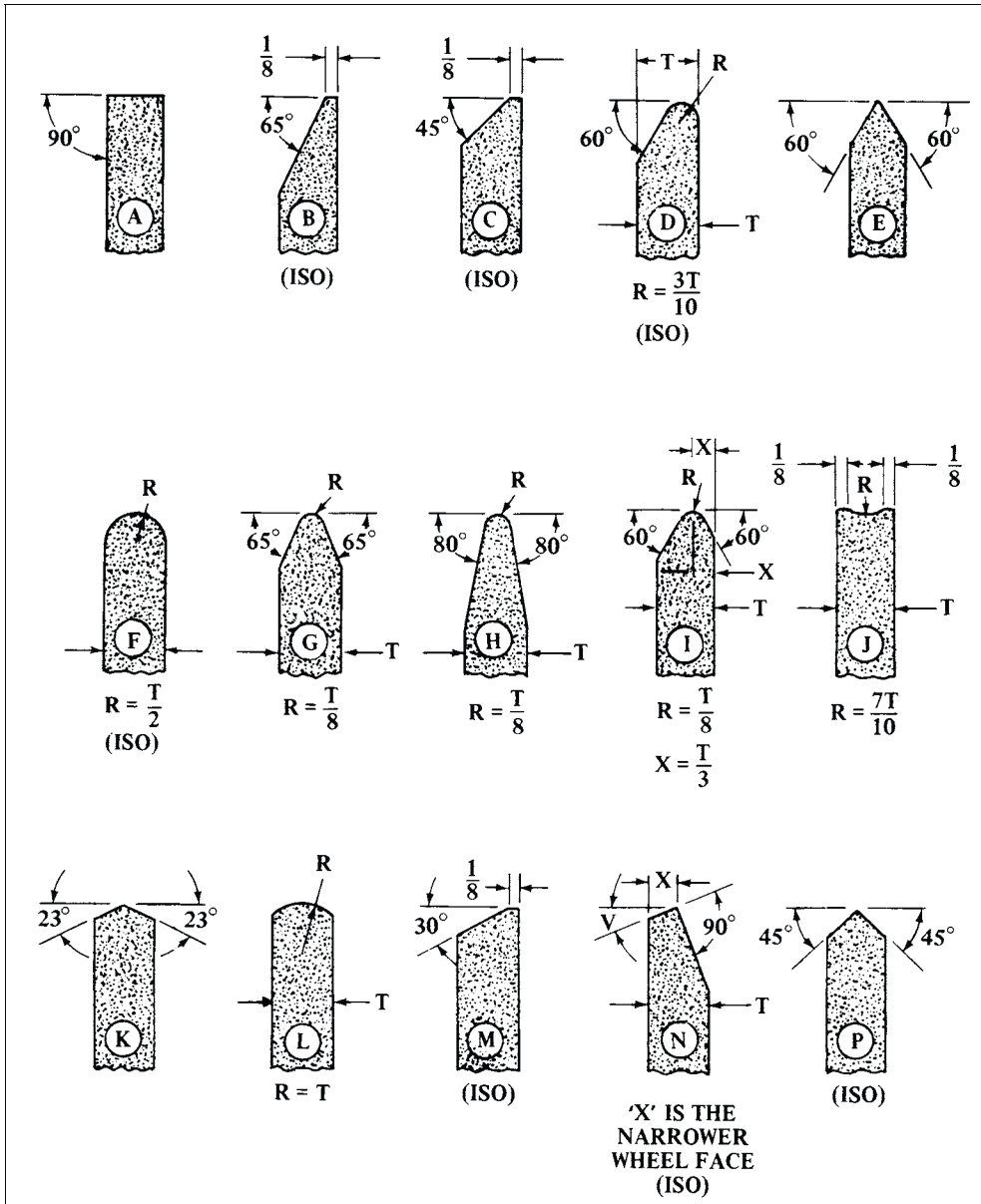
Table 1b. Standard Shapes and Metric Size Ranges of Grinding Wheels
ANSI B74.2-1982

Applications	Size Ranges of Principal Dimensions, Millimeters		
	<i>D</i> = Diam.	<i>T</i> = Thick.	<i>H</i> = Hole
Type 1. Straight Wheel^a			
CUTTING OFF (nonreinforced and reinforced organic bonds only)	150 to 1250	0.8 to 10	16 to 152.4
CYLINDRICAL GRINDING Between centers	300 to 1250	20 to 160	127 to 508
CYLINDRICAL GRINDING Centerless grinding wheels	350 to 750	25 to 500	127 or 304.8
CYLINDRICAL GRINDING Centerless regulating wheels	200 to 350	25 to 315	76.2 to 152.4
INTERNAL GRINDING	6 to 100	6 to 50	2.5 to 25
OFFHAND GRINDING Grinding on the periphery			
General purpose	150 to 900	13 to 100	20 to 76.2
For wet tool grinding only	750 or 900	80 or 100	508
SAW GUMMING (F-type face)	150 to 300	6 to 40	32
SNAGGING Floor stand machines	300 to 600	25 to 80	32 to 76.2
SNAGGING Floor stand machines(organic bond, wheel speed over 33 meters per second)	500 to 900	50 to 100	152.4 or 304.8
SNAGGING Mechanical grinders (organic bond, wheel speed up to 84 meters per second)	600	50 to 80	304.8
SNAGGING Portable machines	80 to 200	6 to 25	10 to 16
SNAGGING Swing frame machines (organic bond)	300 to 600	50 to 80	88.9 to 304.8
SURFACE GRINDING Horizontal spindle machines	150 to 600	13 to 160	32 to 304.8
TOOL GRINDING Broaches, cutters, mills, reamers, taps, etc.	150 to 250	6 to 20	32 to 127
Type 2. Cylindrical Wheel^a			
			<i>W</i> = Wall
SURFACE GRINDING Vertical spindle machines	200 to 500	100 or 125	25 to 100

**Table 1b. (Continued) Standard Shapes and Metric Size Ranges of Grinding Wheels
ANSI B74.2-1982**

Applications	Size Ranges of Principal Dimensions, Millimeters		
	<i>D</i> = Diam.	<i>T</i> = Thick.	<i>H</i> = Hole
Type 5. Wheel, recessed one side^a			
CYLINDRICAL GRINDING Between centers	300 to 900	40 to 100	127 or 304.8
CYLINDRICAL GRINDING Centerless regulating wheels	200 to 350	80 to 160	76.2 or 127
INTERNAL GRINDING	10 to 100	10 to 50	3.18 to 25
Type 6. Straight-Cup Wheel^a			
			<i>W</i> = Wall
SNAGGING Portable machines, organic bond only (hole is $\frac{5}{8}$ 11 UNC-2B)	100 to 150	50	20 to 40
TOOL GRINDING Broaches, cutters, mills, reamers, taps, etc. (Hole is 13 to 32 mm)	50 to 150	32 to 50	8 or 10
Type 7. Wheel, recessed two sides^a			
CYLINDRICAL GRINDING Between centers	300 to 900	40 to 100	127 or 304.8
CYLINDRICAL GRINDING Centerless regulating wheels	200 to 350	100 to 500	76.2 to 152.4
Type 11. Flaring-Cup Wheel^a			
SNAGGING Portable machines, organic bonds only, threaded hole	100 to 150	50	$\frac{5}{8}$ 11 UNC-2B
TOOL GRINDING Broaches, cutters, mills, reamers, taps, etc.	50 to 125	32 to 50	13 to 32
Type 12. Dish Wheel^a			
TOOL GRINDING Broaches, cutters, mills, reamers, taps, etc.	80 to 200	13 or 20	13 to 32
Type 27 and 27A. Wheel, depressed center^a			
CUTTING OFF Reinforced organic bonds only	400 to 750	$U = E = 6$	25.4 or 38.1
SNAGGING Portable machines	80 to 230	$U = E = 3.2$ to 10	9.53 or 22.23

^a See Table 1a for diagrams and descriptions of each wheel type.
All dimensions in millimeters.

Table 2. Standard Shapes of Grinding Wheel Faces *ANSI B74.2-1982*

Recommendations, similar in principle, yet somewhat less discriminating have been developed by the Norton Company for *constructional steels*. These materials can be ground either in their original state (soft) or in their after-hardened state (directly or following carburization). Constructional steels must be distinguished from structural steels which are used primarily by the building industry in mill shapes, without or with a minimum of machining.

Constructional steels are either plain carbon or alloy type steels assigned in the AISI-SAE specifications to different groups, according to the predominant types of alloying elements. In the following recommendations no distinction is made because of different compositions since that factor generally, has a minor effect on grinding wheel choice in constructional steels. However, separate recommendations are made for soft (Table 5) and hardened (Table 6) constructional steels. For the relatively rare instance where the use of a

single type of wheel for both soft and hardened steel materials is considered more important than the selection of the best suited types for each condition of the work materials, [Table 5](#) lists “All Around” wheels in its last column.

For applications where cool cutting properties of the wheel are particularly important, [Table 6](#) lists, as a second alternative, porous-type wheels. The sequence of choices as presented in these tables does not necessarily represent a second, or third best; it can also apply to conditions where the first choice did not provide optimum results and by varying slightly the composition of the grinding wheel, as indicated in the subsequent choices, the performance experience of the first choice might be improved.

Table 3. Classification of Tool Steels by their Relative Grindability

Relative Grindability Group	AISI-SAE Designation of Tool Steels
<p><i>GROUP 1—Any area of work surface</i></p> <p>High grindability tool and die steels (Grindability index greater than 12)</p>	<p>W1, W2, W5</p> <p>S1, S2, S4, S5, S6, S7</p> <p>O1, O2, O6, O7</p> <p>H10, H11, H12, H13, H14</p> <p>L2, L6</p>
<p><i>GROUP 2—Small area of work surface (as found in tools)</i></p> <p>Medium grindability tool and die steels (Grindability index 3 to 12)</p>	<p>H19, H20, H21, H22, H23, H24, H26</p> <p>P6, P20, P21</p> <p>T1, T7, T8</p> <p>M1, M2, M8, M10, M33, M50</p> <p>D1, D2, D3, D4, D5, D6</p> <p>A2, A4, A6, A8, A9, A10</p>
<p><i>GROUP 3—Small area of work surface (as found in tools)</i></p> <p>Low grindability tool and die steels (Grindability index between 1.0 and 3)</p>	<p>T4, T5, T6, T8</p> <p>M3, M6, M7, M34, M36, M41, M42, M46, M48, M52, M62</p> <p>D2, D5</p> <p>A11</p>
<p><i>GROUP 4—Large area of work surface (as found in dies)</i></p> <p>Medium and low grindability tool and die steels (Grindability index between 1.0 and 12)</p>	<p>All steels found in Groups 2 and 3</p>
<p><i>GROUP 5—Any area of work surface</i></p> <p>Very low grindability tool and die steels (Grindability index less than 1.0)</p>	<p>D3, D4, D7</p> <p>M4</p> <p>A7</p> <p>T15</p>

**Table 4. Grinding Wheel Recommendations for Hardened Tool Steels
According to their Grindability**

Operation	Wheel or Rim Diameter, Inches	First-Choice Specifications	Second-Choice Specifications
Group 1 Steels			
Surfacing Surfacing wheels	14 and smaller 14 and smaller Over 14	Wet FA46-I8V Dry FA46-H8V Wet FA36-I8V	SFA46-G12VP FA46-F12VP SFA36-I8V
Segments or Cylinders	1½ rim or less	Wet FA30-H8V	FA30-F12VP
Cups	¾ rim or less (for rims wider than 1½ inches, go one grade softer in available specifications)	Wet FA36-H8V	FA46-F12VP
Cutter sharpening Straight wheel	...	Wet FA46-K8V Dry FA46-J8V	FA60-K8V FA46-H12VP
Dish shape	...	Dry FA60-J8V	FA60-H12VP
Cup shape	...	Dry FA46-L8V Wet SFA46-L5V	FA60-H12VP SFA60-L5V
Form tool grinding	8 and smaller 8 and smaller 10 and larger	Wet FA60-L8V to FA100-M7V Dry FA60-K8V to FA100-L8V Wet FA60-L8V to FA80-M6V	
Cylindrical	14 and smaller 16 and larger	Wet SFA60-L5V Wet SFA60-M5V
Centerless	...	Wet SFA60-M5V	...
Internal Production grinding	Under ½ ½ to 1 Over 1 to 3 Over 3	Wet SPA80-N6V Wet SFA60-M5V Wet SFA54-L5V Wet SFA46-L5V	SFA80-N7V SFA60-M6V SFA54-L6V SFA46-K5V
Tool room grinding	Under ½ ½ to 1 Over 1 to 3 Over 3	Dry FA80-L6V Dry FA70-K7V Dry FA60-J8V Dry FA46-J8V	SFA80-L7V SFA70-K7V FA60-H12VP FA54-H12VP
Group 2 Steels			
Surfacing Straight wheels	14 and smaller 14 and smaller Over 14	Wet FA46-I8V Dry FA46-H8V Wet FA46-H8V	FA46-G12VP FA46-F12VP SFA46-I8V
Segments or Cylinders	1½ rim or less	Wet FA30-G8V	FA36-E12VP
Cups	¾ rim or less (for rims wider than 1½ inches, go one grade softer in available specifications)	Wet FA36-H8V	FA46-F12VP

Table 4. (Continued) Grinding Wheel Recommendations for Hardened Tool Steels According to their Grindability

Operation	Wheel or Rim Diameter, Inches	First-Choice Specifications	Second-Choice Specifications
Cutter sharpening			
Straight wheel	...	Wet FA46-L5V	FA60-K8V
	...	Dry FA46-J8V	FA60-H12VP
Dish shape	...	Dry FA60-J5V	FA60-G12VP
Cup shape	...	Dry FA46-K5V	FA60-G12VP
	...	Wet FA46-L5V	FA60-J8V
Form tool grinding	8 and smaller 8 and smaller 10 and larger	Wet FA60-K8V to FA120-L8V Dry FA80-K8V to FA150-K8V Wet FA60-K8V to FA120-L8V	
Cylindrical	14 and less 16 and larger	Wet FA60-L5V Wet FA60-K5V	SFA60-L5V SFA60-K5V
Centerless	...	Wet FA60-M5V	SFA60-M5V
Internal			
Production grinding	Under ½ ½ to 1 Over 1 to 3 Over 3	Wet FA80-L6V Wet FA70-K5V Wet FA60-J8V Wet FA54-J8V	SFA80-L6V SFA70-K5V SFA60-J7V SFA54-J8V
Tool room grinding	Under ½ ½ to 1 Over 1 to 3 Over 3	Dry FA80-I8V Dry FA70-J8V Dry FA60-I8V Dry FA54-I8V	SFA80-K7V SFA70-J7V FA60-G12VP FA54-G12VP
Group 3 Steels			
Surfacing			
Straight wheels	14 and smaller 14 and smaller Over 14	Wet FA60-I8V Dry FA60-H8V Wet FA60-H8V	FA60-G12VP FA60-F12VP SFA60-I8V
Segments or Cylinders	1½ rim or less	Wet FA46-G8V	FA46-E12VP
Cups	¾ rim or less	Wet FA46-G8V	FA46-E12VP
(for rims wider than 1½ inches, go one grade softer in available specifications)			
Cutter grinding			
Straight wheel	...	Wet FA46-J8V	FA60-J8V
	...	Dry FA46-I8V	FA46-G12VP
Dish shape	...	Dry FA60-H8V	FA60-F12VP
Cup shape	...	Dry FA46-I8V	FA60-F12VP
	...	Wet FA46-J8V	FA60-J8V
Form tool grinding	8 and smaller 8 and smaller 10 and larger	Wet FA80-K8V to FA150-L9V Dry FA100-J8V to FA150-K8V Wet FA80-J8V to FA150-J8V	

Table 4. (Continued) Grinding Wheel Recommendations for Hardened Tool Steels According to their Grindability

Operation	Wheel or Rim Diameter, Inches	First-Choice Specifications	Second-Choice Specifications
Cylindrical	14 and less	Wet FA80-L5V	SFA80-L6V
	16 and larger	Wet FA60-L6V	SFA60-K5V
Centerless	...	Wet FA60-L5V	SFA60-L5V
Internal			
Production grinding	Under ½	Wet FA90-L6V	SFA90-L6V
	½ to 1	Wet FA80-L6V	SFA80-L6V
	Over 1 to 3	Wet FA70-K5V	SFA70-K5V
	Over 3	Wet FA60-J5V	SFA60-J5V
Tool room grinding	Under ½	Dry FA90-K8V	SFA90-K7V
	½ to 1	Dry FA80-J8V	SFA80-J7V
	Over 1 to 3	Dry FA70-I8V	SFA70-G12VP
	Over 3	Dry FA60-I8V	SFA60-G12VP
Group 4 Steels			
Surfacing			
Straight wheels	14 and smaller	Wet FA60-I8V	C60-JV
	14 and smaller	Wet FA60-H8V	C60-IV
	Over 14	Wet FA46-H8V	C60-HV
Segments	1 ½ rim or less	Wet FA46-G8V	C46-HV
	1 ½ rim or less	Wet FA46-G8V	C60-HV
Cylinders	1 ½ rim or less	Wet FA46-G8V	C60-HV
Cups	¾ rim or less	Wet FA46-G6V	C60-IV
(for rims wider than 1 ½ inches, go one grade softer in available specifications)			
Form tool grinding	8 and smaller	Wet FA60-J8V to FA150-K8V	
	8 and smaller	Dry FA80-I8V to FA180-J8V	
	10 and larger	Wet FA60-J8V to FA150-K8V	
Cylindrical	14 and less	Wet FA80-K8V	C60-KV
	16 and larger	Wet FA60-J8V	C60-KV
Internal			
Production grinding	Under ½	Wet FA90-L8V	C90-LV
	½ to 1	Wet FA80-K5V	C80-KV
	Over 1 to 3	Wet FA70-J8V	C70-JV
	Over 3	Wet FA60-I8V	C60-IV
Tool room grinding	Under ½	Dry FA90-K8V	C90-KV
	½ to 1	Dry FA80-J8V	C80-JV
	Over 1 to 3	Dry FA70-I8V	C70-IV
	Over 3	Dry FA60-H8V	C60-HV

Table 4. (Continued) Grinding Wheel Recommendations for Hardened Tool Steels According to their Grindability

Operation	Wheel or Rim Diameter, Inches	First-Choice Specifications	Second-Choice Specifications	Third-Choice Specifications	
Group 5 Steels					
Surfacing Straight wheels	14 and smaller	Wet SFA60-H8V	FA60-E12VP	C60-IV	
	14 and smaller	Dry SFA80-H8V	FA80-E12VP	C80-HV	
	Over 14	Wet SFA60-H8V	FA60-E12VP	C60-HV	
	Segments or Cylinders	1 ½ rim or less	Wet SFA46-G8V	FA46-E12VP	C46-GV
		¾ rim or less	Wet SFA60-G8V	FA60-E12VP	C60-GV
Cups	(for rims wider than 1 ½ inches, go one grade softer in available specifications)				
Cutter grinding Straight wheels	...	Wet SFA60-I8V	SFA60-G12VP	...	
	...	Dry SFA60-H8V	SFA80-F12VP	...	
	Dish shape	Dry SFA80-H8V	SFA80-F12VP	...	
	Cup shape	...	Dry SFA60-I8V	SFA60-G12VP	...
		...	Wet SFA60-J8V	SFA60-H12VP	...
Form tool grinding	8 and smaller	Wet FA80-J8V to FA180-J9V		...	
	8 and smaller	Dry FA100-I8V to FA220-J9V		...	
	10 and larger	Wet FA80-J8V to FA180-J9V		...	
Cylindrical	14 and less	Wet FA80-J8V	C80-KV	FA80-H12VP	
	16 and larger	Wet FA80-I8V	C80-KV	FA80-G12VP	
Centerless	...	Wet FA80-J5V	C80-LV	...	
Internal Production grind- ing	Under ½	Wet FA100-L8V	C90-MV	...	
	½ to 1	Wet FA90-K8V	C80-LV	...	
	Over 1 to 3	Wet FA80-J8V	C70-KV	FA80-H12VP	
	Over 3	Wet FA70-I8V	C60-JV	FA70-G12VP	
	Tool room grind- ing	Under ½	Dry FA100-K8V	C90-KV	...
		½ to 1	Dry FA90-J8V	C80-JV	...
		Over 1 to 3	Dry FA80-I8V	C70-IV	FA80-G12VP
		Over 3	Dry FA70-I8V	C60-IV	FA70-G12VP

Table 5. Grinding Wheel Recommendations for Constructional Steels (Soft)

Grinding Operation	Wheel or Rim Diameter, Inches	First Choice	Alternate Choice (Porous type)	All-Around Wheel
Surfacing Straight wheels	14 and smaller	Wet FA46-J8V	FA46-H12VP	FA46-J8V
	14 and smaller	Dry FA46-I8V	FA46-H12VP	FA46-I8V
Segments	Over 14	Wet FA36-J8V	FA36-H12VP	FA36-J8V
	1½ rim or less	Wet FA24-H8V	FA30-F12VP	FA24-H8V
Cylinders	1½ rim or less	Wet FA24-I8V	FA30-G12VP	FA24-H8V
	¾ rim or less	Wet FA24-H8V	FA30-F12VP	FA30-H8V
(for wider rims, go one grade softer)				
Cylindrical	14 and smaller	Wet SFA60-M5V	...	SFA60-L5V
	16 and larger	Wet SFA54-M5V	...	SFA54-L5V
Centerless	...	Wet SFA54-N5V	...	SFA60-M5V
	Under ½	Wet SFA60-M5V	...	SFA80-L6V
Internal	½ to 1	Wet SFA60-L5V	...	SFA60-K5V
	Over 1 to 3	Wet SFA54-K5V	...	SFA54-J5V
	Over 3	Wet SFA46-K5V	...	SFA46-J5V
	Over 3	Wet SFA46-K5V	...	SFA46-J5V

Table 6. Grinding Wheel Recommendations for Constructional Steels (Hardened or Carburized)

Grinding Operation	Wheel or Rim Diameter, Inches	First Choice	Alternate Choice (Porous Type)	
Surfacing Straight wheels	14 and smaller	Wet FA46-I8V	FA46-G12VP	
	14 and smaller	Dry FA46-H8V	FA46-F12VP	
Segments or Cylinders	Over 14	Wet FA36-I8V	FA36-G12VP	
	1½ rim or less	Wet FA30-H8V	FA36-F12VP	
Cups	¾ rim or less	Wet FA36-H8V	FA46-F12VP	
	(for wider rims, go one grade softer)			
Forms and Radius Grinding	8 and smaller	Wet FA60-L7V to FA100-M8V		
	8 and smaller	Dry FA60-K8V to FA100-L8V		
	10 and larger	Wet FA60-L7V to FA80-M7V		
Cylindrical Work diameter	1 inch and smaller	Wet SFA80-L6V	...	
	Over 1 inch	Wet SFA80-K5V	...	
	1 inch and smaller	Wet SFA60-L5V	...	
	Over 1 inch	Wet SFA60-L5V	...	
	Centerless	...	Wet SFA80-M6V	...
	Internal	Under ½	Wet SFA80-N6V	...
½ to 1		Wet SFA60-M5V	...	
Over 1 to 3		Wet SFA54-L5V	...	
Over 3		Wet SFA46-K5V	...	
Under ½		Dry FA80-L6V	...	
½ to 1		Dry FA70-K8V	...	
Over 1 to 3		Dry FA60-J8V	FA60-H12VP	
Over 3		Dry FA46-J8V	FA54-H12VP	

Cubic Boron Nitride (CBN) Grinding Wheels.—Although CBN is not quite as hard, strong, and wear-resistant as a diamond, it is far harder, stronger, and more resistant to wear than aluminum oxide and silicon carbide. As with diamond, CBN materials are available in different types for grinding workpieces of 50 Rc and above, and for superalloys of 35 Rc and harder. Microcrystalline CBN grinding wheels are suitable for grinding mild steels, medium-hard alloy steels, stainless steels, cast irons, and forged steels. Wheels with larger mesh size grains (up to 20/30), now available, provide for higher rates of metal removal.

Special types of CBN are produced for resin, vitrified, and electrodeposited bonds. Wheel standards and nomenclature generally conform to those used for diamond wheels (page 1240), except that the letter **B** instead of **D** is used to denote the type of abrasive. Grinding machines for CBN wheels are generally designed to take full advantage of the ability of CBN to operate at high surface speeds of 9,000-25,000 sfm (2745-7620 m/min). CBN is very responsive to changes in grinding conditions, and an increase in wheel speed from 5,000 to 10,000 sfm (1525-3050 m/min) can increase wheel life by a factor of 6 or more. A change from a water-based coolant to a coolant such as a sulfochlorinated or sulfurized straight grinding oil can increase wheel life by a factor of 10 or more.

Machines designed specifically for use with CBN grinding wheels generally use either electrodeposited wheels or have special trueing systems for other CBN bond wheels, and are totally enclosed so they can use oil as a coolant. Numerical control systems are used, often running fully automatically, including loading and unloading. Machines designed for CBN grinding with electrodeposited wheels are extensively used for form and gear grinding, special systems being used to ensure rapid mounting to exact concentricity and truth in running, no trueing or dressing being required. CBN wheels can produce workpieces having excellent accuracy and finish, with no trueing or dressing for the life of the wheel, even over many hours or days of production grinding of hardened steel components.

Resin-, metal-, and vitrified-bond wheels are used extensively in production grinding, in standard and special machines. Resin-bonded wheels are used widely for dry tool and cutter resharpening on conventional hand-operated tool and cutter grinders. A typical wheel for such work would be designated 11V9 cup type, 100/120 mesh, 75 concentration, with a $\frac{1}{16}$ or $\frac{1}{8}$ inch (1.6 or 3.2 mm) rim section. Special shapes of resin-bonded wheels are used on dedicated machines for cutting tool manufacture. These types of wheels are usually self-dressing, and allow full machine control of the operation without the need for an operator to see, hear, or feel the action.

Metal-bonded CBN wheels are usually somewhat cheaper than those using other types of bond because only a thin layer of abrasive is present. Metal bonding is also used in manufacture of CBN honing stones. Vitrified-bond CBN wheels are a recent innovation, and high-performance bonds are still being developed. These wheels are used for grinding cams, internal diameters, and bearing components, and can be easily redressed.

An important aspect of grinding with CBN and diamond wheels is reduced heating of the workpiece, thought to result from their superior thermal conductivity compared with aluminum oxide, for instance. CBN and diamond grains also are harder, which means that they stay sharp longer than aluminum oxide grains. The superior ability to absorb heat from the workpiece during the grinding process reduces formation of untempered martensite in the ground surface, caused by overheating followed by rapid quenching. At the same time, a higher compressive residual stress is induced in the surface, giving increased fatigue resistance, compared with the tensile stresses found in surfaces ground with aluminum oxide abrasives. Increased fatigue resistance is of particular importance for gear grinding, especially in the root area.

Variations from General Grinding Wheel Recommendations.—Recommendations for the selection of grinding wheels are usually based on average values with regard to both operational conditions and process objectives. With variations from such average values,

the composition of the grinding wheels must be adjusted to obtain optimum results. Although it is impossible to list and to appraise all possible variations and to define their effects on the selection of the best suited grinding wheels, some guidance is obtained from experience. The following tabulation indicates the general directions in which the characteristics of the initially selected grinding wheel may have to be altered in order to approach optimum performance. Variations in a sense opposite to those shown will call for wheel characteristic changes in reverse.

Conditions or Objectives	Direction of Change
To increase cutting rate	Coarser grain, softer bond, higher porosity
To retain wheel size and/or form	Finer grain, harder bond
For small or narrow work surface	Finer grain, harder bond
For larger wheel diameter	Coarser grain
To improve finish on work	Finer grain, harder bond, or resilient bond
For increased work speed or feed rate	Harder bond
For increased wheel speed	Generally, softer bond, except for high-speed grinding, which requires a harder bond for added wheel strength
For interrupted or coarse work surface	Harder bond
For thin walled parts	Softer bond
To reduce load on the machine drive motor	Softer bond

Dressing and Truing Grinding Wheels.—The perfect grinding wheel operating under ideal conditions will be self sharpening, i.e., as the abrasive grains become dull, they will tend to fracture and be dislodged from the wheel by the grinding forces, thereby exposing new, sharp abrasive grains. Although in precision machine grinding this ideal sometimes may be partially attained, it is almost never attained completely. Usually, the grinding wheel must be dressed and trued after mounting on the precision grinding machine spindle and periodically thereafter.

Dressing may be defined as any operation performed on the face of a grinding wheel that improves its cutting action. Truing is a dressing operation but is more precise, i.e., the face of the wheel may be made parallel to the spindle or made into a radius or special shape. Regularly applied truing is also needed for accurate size control of the work, particularly in automatic grinding. The tools and processes generally used in grinding wheel dressing and truing are listed and described in [Table 1](#).

Table 1. Tools and Methods for Grinding Wheel Dressing and Truing

Designation	Description	Application
Rotating Hand Dressers	Freely rotating discs, either star-shaped with protruding points or discs with corrugated or twisted perimeter, supported in a fork-type handle, the lugs of which can lean on the tool rest of the grinding machine.	Preferred for bench- or floor-type grinding machines; also for use on heavy portable grinders (snagging grinders) where free-cutting properties of the grinding wheel are primarily sought and the accuracy of the trued profile is not critical.
Abrasive Sticks	Made of silicon carbide grains with a hard bond. Applied directly or supported in a handle. Less frequently abrasive sticks are also made of boron carbide.	Usually hand held and use limited to smaller-size wheels. Because it also shears the grains of the grinding wheel, or preshaping, prior to final dressing with, e.g., a diamond.

Table 1. (Continued) Tools and Methods for Grinding Wheel Dressing and Truing

Designation	Description	Application
Abrasive Wheels (Rolls)	Silicon carbide grains in a hard vitrified bond are cemented on ball-bearing mounted spindles. Use either as hand tools with handles or rigidly held in a supporting member of the grinding machine. Generally freely rotating; also available with adjustable brake for diamond wheel dressing.	Preferred for large grinding wheels as a diamond saver, but also for improved control of the dressed surface characteristics. By skewing the abrasive dresser wheel by a few degrees out of parallel with the grinding wheel axis, the basic crushing action is supplemented with wiping and shearing, thus producing the desired degree of wheel surface smoothness.
Single-Point Diamonds	A diamond stone of selected size is mounted in a steel nib of cylindrical shape with or without head, dimensioned to fit the truing spindle of specific grinding machines. Proper orientation and retainment of the diamond point in the setting is an important requirement.	The most widely used tool for dressing and truing grinding wheels in precision grinding. Permits precisely controlled dressing action by regulating infeed and cross feed rate of the truing spindle when the latter is guided by cams or templates for accurate form truing.
Single-Point Form Truing Diamonds	Selected diamonds having symmetrically located natural edges with precisely lapped diamond points, controlled cone angles and vertex radius, and the axis coinciding with that of the nib.	Used for truing operations requiring very accurately controlled, and often steeply inclined wheel profiles, such as are needed for thread and gear grinding, where one or more diamond points participate in generating the resulting wheel periphery form. Dependent on specially designed and made truing diamonds and nibs.
Cluster-Type Diamond Dresser	Several, usually seven, smaller diamond stones are mounted in spaced relationship across the working surface of the nib. In some tools, more than a single layer of such clusters is set at parallel levels in the matrix, the deeper positioned layer becoming active after the preceding layer has worn away.	Intended for straight-face dressing and permits the utilization of smaller, less expensive diamond stones. In use, the holder is canted at a 3° to 10° angle, bringing two to five points into contact with the wheel. The multiple-point contact permits faster cross feed rates during truing than may be used with single-point diamonds for generating a specific degree of wheel-face finish.
Impregnated Matrix-Type Diamond Dressers	The operating surface consists of a layer of small, randomly distributed, yet rather uniformly spaced diamonds that are retained in a bond holding the points in an essentially common plane. Supplied either with straight or canted shaft, the latter being used to cancel the tilt of angular truing posts.	For the truing of wheel surfaces consisting of a single or several flat elements. The nib face should be held tangent to the grinding wheel periphery or parallel with a flat working surface. Offers economic advantages where technically applicable because of using less expensive diamond splinters presented in a manner permitting efficient utilization.
Form-Generating Truing Devices	Swiveling diamond holder post with adjustable pivot location, arm length, and swivel arc, mounted on angularly adjustable cross slides with controlled traverse movement, permits the generation of various straight and circular profile elements, kept in specific mutual locations.	Such devices are made in various degrees of complexity for the positionally controlled interrelation of several different profile elements. Limited to regular straight and circular sections, yet offers great flexibility of setup, very accurate adjustment, and unique versatility for handling a large variety of frequently changing profiles.

Table 1. (Continued) Tools and Methods for Grinding Wheel Dressing and Truing

Designation	Description	Application
Contour-Duplicating Truing Devices	The form of a master, called cam or template, shaped to match the profile to be produced on the wheel, or its magnified version, is translated into the path of the diamond point by means of mechanical linkage, a fluid actuator, or a pantograph device.	Preferred single-point truing method for profiles to be produced in quantities warranting the making of special profile bars or templates. Used also in small- and medium-volume production when the complexity of the profile to be produced excludes alternate methods of form generation.
Grinding Wheel Contouring by Crush Truing	A hardened steel or carbide roll, which is free to rotate and has the desired form of the workpiece, is fed gradually into the grinding wheel, which runs at slow speed. The roll will, by crushing action, produce its reverse form in the wheel. Crushing produces a free-cutting wheel face with sharp grains.	Requires grinding machines designed for crush truing, having stiff spindle bearings, rigid construction, slow wheel speed for truing, etc. Due to the cost of crush rolls and equipment, the process is used for repetitive work only. It is one of the most efficient methods for precisely duplicating complex wheel profiles that are capable of grinding in the 8- μ in. (0.2032 μ m) AA range. Applicable for both surface and cylindrical grinding.
Rotating Diamond Roll-Type Grinding Wheel Truing	Special rolls made to agree with specific profile specifications have their periphery coated with a large number of uniformly distributed diamonds, held in a matrix into which the individual stones are set by hand (for larger diamonds) or bonded by a plating process (for smaller elements).	The diamond rolls must be rotated by an air, hydraulic, or electric motor at about one-fourth of the grinding wheel surface speed and in opposite direction to the wheel rotation. Whereas the initial costs are substantially higher than for single-point diamond truing the savings in truing time warrants the method's application in large-volume production of profile-ground components.
Diamond Dressing Blocks	Made as flat blocks for straight wheel surfaces, are also available for radius dressing and profile truing. The working surface consists of a layer of electroplated diamond grains, uniformly distributed and capable of truing even closely toleranced profiles.	For straight wheels, dressing blocks can reduce dressing time and offer easy installation on surface grinders, where the blocks mount on the magnetic plate. Recommended for small- and medium-volume production for truing intricate profiles on regular surface grinders, because the higher pressure developed in crush dressing is avoided.

Guidelines for Dressing and Truing with Single-Point Diamonds.—The diamond nib should be canted at an angle of 10 to 15 degrees in the direction of the wheel rotation and also, if possible, by the same amount in the direction of the cross feed traverse during the truing (see diagram). The dragging effect resulting from this “angling,” combined with the occasional rotation of the diamond nib in its holder, will prolong the diamond life by limiting the extent of wear facets and will also tend to produce a pyramid shape of the diamond tip. The diamond may also be set to contact the wheel at about $\frac{1}{8}$ to $\frac{1}{4}$ inch (3.2-6.4 mm) below its centerline.

Depth of Cut: This amount should not exceed 0.001 inch (0.025 mm) per pass for general work, and will have to be reduced to 0.0002 to 0.0004 inch (0.005-0.010 mm) per pass for wheels with fine grains used for precise finishing work.

Diamond crossfeed rate: This value may be varied to some extent depending on the required wheel surface: faster crossfeed for free cutting, and slower crossfeed for produc-

ing fine finishes. Such variations, however, must always stay within the limits set by the grain size of the wheel. Thus, the advance rate of the truing diamond per wheel revolution should not exceed the diameter of a grain or be less than half of that rate. Consequently, the diamond crossfeed must be slower for a large wheel than for a smaller wheel having the same grain size number. Typical crossfeed values for frequently used grain sizes are given in Table 2.

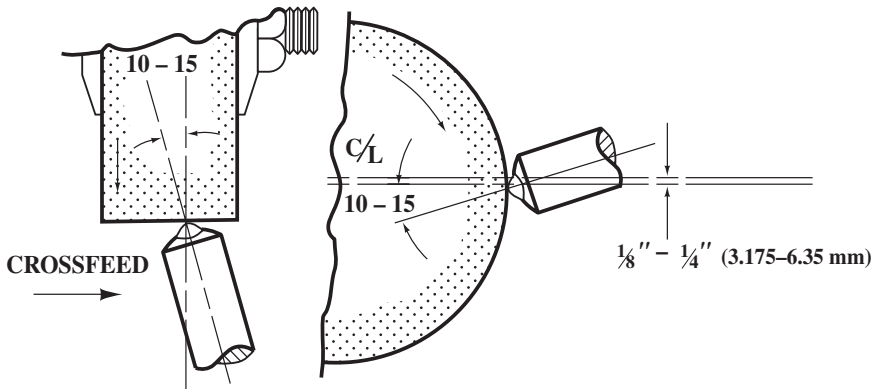


Table 2. Typical Diamond Truing and Crossfeeds

Grain Size	Crossfeed per Wheel Rev.		Grain Size	Crossfeed per Wheel Rev.	
	inch	mm		inch	mm
30	0.014–0.024	0.35–0.61	60	0.006–0.010	0.15–0.25
36	0.012–0.019	0.30–0.48	80	0.004–0.007	0.10–0.18
46	0.008–0.014	0.20–0.35	120	0.0025–0.004	0.06–0.10
50	0.007–0.012	0.18–0.30

These values can be easily converted into the more conveniently used inch-per-minute units, simply by multiplying the crossfeed rate in inches by the rpm of the grinding wheel.

Example: For a 20-inch diameter wheel, Grain No. 46, running at 1200 rpm: Crossfeed rate for roughing-cut truing, approximately 17 ipm; for finishing-cut truing, approximately 10 ipm.

Coolant should be applied before the diamond comes into contact with the wheel and must be continued in generous supply while truing.

The speed of the grinding wheel should be at the regular grinding rate, or not much lower. For that reason, the feed wheels of centerless grinding machines usually have an additional speed rate higher than functionally needed, that speed being provided for wheel truing only.

The initial approach of the diamond to the wheel surface must be carried out carefully to prevent sudden contact with the diamond, resulting in penetration in excess of the selected depth of cut. It should be noted that the highest point of a worn wheel is often in its center portion and not at the edge from which the crossfeed of the diamond starts.

The general conditions of the truing device are important for best truing results and for assuring extended diamond life. A rigid truing spindle, well-seated diamond nib, and firmly set diamond point are mandatory. Sensitive infeed and smooth traverse movement at uniform speed also must be maintained.

Resetting of the diamond point.: Never let the diamond point wear to a degree where the grinding wheel is in contact with the steel nib. Such contact can damage the setting of the diamond point and result in its loss. Expert resetting of a worn diamond can repeatedly add to its useful life, even when applied to lighter work because of reduced size.

Size Selection Guide for Single-Point Truing Diamonds.—There are no rigid rules for determining the proper size of the diamond for any particular truing application because of the very large number of factors affecting that choice. Several of these factors are related to the condition, particularly the rigidity, of the grinding machine and truing device, as well as to such characteristics of the diamond itself as purity, crystalline structure, etc. Although these factors are difficult to evaluate in a generally applicable manner, the expected effects of several other conditions can be appraised and should be considered in the selection of the proper diamond size.

The recommended sizes in **Table 3** must be considered as informative only and as representing minimum values for generally favorable conditions. Factors calling for larger diamond sizes than listed are the following:

Silicon carbide wheels (**Table 3** refers to aluminum oxide wheels)

Dry truing

Grain sizes coarser than No. 46

Bonds harder than M

Wheel speed substantially higher than 6500 sfm (1981 m/min).

It is advisable to consider any single or pair of these factors as justifying the selection of one size larger diamond. As an example: for truing an SiC wheel, with grain size No. 36 and hardness P, select a diamond that is two sizes larger than that shown in **Table 3** for the wheel size in use.

Table 3. Recommended Minimum Sizes for Single-Point Truing Diamonds

Diamond Size in Carats ^a	Index Number (Wheel Dia. × Width, Inches)	Examples of Max. Grinding Wheel Dimensions (inches)	
		Diameter	Width
0.25	3	4	0.75
0.35	6	6	1
0.50	10	8	1.25
0.60	15	10	1.50
0.75	21	12	1.75
1.00	30	12	2.50
1.25	48	14	3.50
1.50	65	16	4.00
1.75	80	20	4.00
2.00	100	20	5.00
2.50	150	24	6.00
3.00	200	24	8.00
3.50	260	30	8.00
4.00	350	36	10.00

^aOne carat equals 0.2 gram.

Single-point diamonds are available as loose stones, but are preferably procured from specialized manufacturers supplying the diamonds set into steel nibs. Expert setting, comprising both the optimum orientation of the stone and its firm retainment, is mandatory for assuring adequate diamond life and satisfactory truing. Because the holding devices for truing diamonds are not yet standardized, the required nib dimensions vary depending on the make and type of different grinding machines. Some nibs are made with angular heads, usually hexagonal, to permit occasional rotation of the nib either manually, with a wrench, or automatically.

Diamond Wheels

Diamond Wheels.—A diamond wheel is a special type of grinding wheel in which the abrasive elements are diamond grains held in a bond and applied to form a layer on the operating face of a non-abrasive core. Diamond wheels are used for grinding very hard or highly abrasive materials. Primary applications are the grinding of cemented carbides, such as the sharpening of carbide cutting tools; the grinding of glass, ceramics, asbestos, and cement products; and the cutting and slicing of germanium and silicon.

Shapes of Diamond Wheels.—The industry-wide accepted Standard (ANSI B74.3-1974) specifies ten basic diamond wheel core shapes which are shown in Table 1 with the applicable designation symbols. The applied diamond abrasive layer may have different cross-sectional shapes. Those standardized are shown in Table 2. The third aspect which is standardized is the location of the diamond section on the wheel as shown by the diagrams in Table 3. Finally, modifications of the general core shape together with pertinent designation letters are given in Table 4.

The characteristics of the wheel shape listed in these four tables make up the components of the standard designation symbol for diamond wheel shapes. An example of that symbol with arbitrarily selected components is shown in Fig. 1.

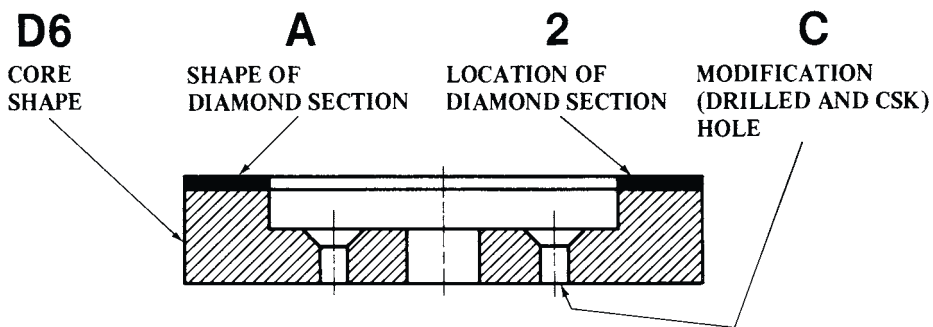


Fig. 1. A Typical Diamond Wheel Shape Designation Symbol

An explanation of these components is as follows:

Basic Core Shape: This portion of the symbol indicates the basic shape of the core on which the diamond abrasive section is mounted. The shape is actually designated by a number. The various core shapes and their designations are given in Table 1.

Diamond Cross-Section Shape: This, the second component, consisting of one or two letters, denotes the cross-sectional shape of the diamond abrasive section. The various shapes and their corresponding letter designations are given in Table 2.

Diamond Section Location: The third component of the symbol consists of a number which gives the location of the diamond section, i.e., periphery, side, corner, etc. An explanation of these numbers is shown in Table 3.

Modification: The fourth component of the symbol is a letter designating some modification, such as drilled and counterbored holes for mounting or special relieving of diamond section or core. This modification position of the symbol is used only when required. The modifications and their designations are given in Table 4.

Table 1. Diamond Wheel Core Shapes and Designations ANSI B74.3-1974

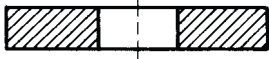
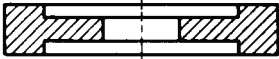

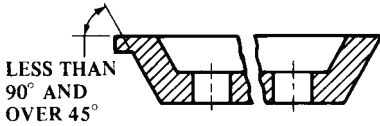
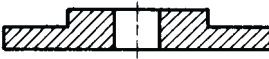
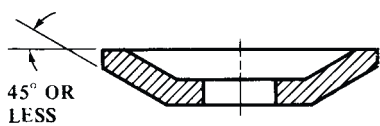
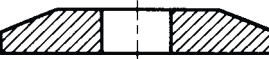

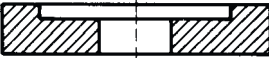

	1		9
	2		11
	3		12
	4		14
	6		15

Table 2. Diamond Cross-sections and Designations ANSI B74.3-1974








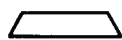























	A		CH		ER		GN		LL		S
	AH		D		ET		H		M		U
	B		DD		F		J		P		V
	BT		E		FF		K		Q		Y
	C		EE		G		L		QQ		

Table 3. Designations for Location of Diamond Section on Diamond Wheel *ANSI B74.3-1974*

Designation No. and Location	Description	Illustration
1 — Periphery	The diamond section shall be placed on the periphery of the core and shall extend the full thickness of the wheel. The axial length of this section may be greater than, equal to, or less than the depth of diamond, measured radially. A hub or hubs shall not be considered as part of the wheel thickness for this definition.	
2 — Side	The diamond section shall be placed on the side of the wheel and the length of the diamond section shall extend from the periphery toward the center. It may or may not include the entire side and shall be greater than the diamond depth measured axially. It shall be on that side of the wheel which is commonly used for grinding purposes.	
3 — Both Sides	The diamond sections shall be placed on both sides of the wheel and shall extend from the periphery toward the center. They may or may not include the entire sides, and the radial length of the diamond section shall exceed the axial diamond depth.	
4 — Inside Bevel or Arc	This designation shall apply to the general wheel types 2, 6, 11, 12, and 15 and shall locate the diamond section on the side wall. This wall shall have an angle or arc extending from a higher point at the wheel periphery to a lower point toward the wheel center.	
5 — Outside Bevel or Arc	This designation shall apply to the general wheel types 2, 6, 11, and 15 and shall locate the diamond section on the side wall. This wall shall have an angle or arc extending from a lower point at the wheel periphery to a higher point toward the wheel center.	
6 — Part of Periphery	The diamond section shall be placed on the periphery of the core but shall not extend the full thickness of the wheel and shall not reach to either side.	
7 — Part of Side	The diamond section shall be placed on the side of the core and shall not extend to the wheel periphery. It may or may not extend to the center.	
8 — Throughout	Designates wheels of solid diamond abrasive section without cores.	

Table 3. (Continued) Designations for Location of Diamond Section on Diamond Wheel ANSI B74.3-1974

Designation No. and Location	Description	Illustration
9 — Corner	Designates a location which would commonly be considered to be on the periphery except that the diamond section shall be on the corner but shall not extend to the other corner.	
10 — Annular	Designates a location of the diamond abrasive section on the inner annular surface of the wheel.	

Composition of Diamond and Cubic Boron Nitride Wheels.—According to American National Standard ANSI B74.13-1990, a series of symbols is used to designate the composition of these wheels. An example is shown below.

Prefix	Abrasive	Grain Size	Grade	Concentration	Bond Type	Bond Modification	Depth of Abrasive	Manufacturer's Identification Symbol
M	D	120	R	100	B	56	$\frac{1}{8}$	*

Fig. 2. Designation Symbols for Composition of Diamond and Cubic Boron Nitride Wheels

The meaning of each symbol is indicated by the following list:

1) *Prefix*: The prefix is a manufacturer's symbol indicating the exact kind of abrasive. Its use is optional.

2) *Abrasive Type*: The letter (B) is used for cubic boron nitride and (D) for diamond.

3) *Grain Size*: The grain sizes commonly used and varying from coarse to very fine are indicated by the following numbers: 8, 10, 12, 14, 16, 20, 24, 30, 36, 46, 54, 60, 70, 80, 90, 100, 120, 150, 180, and 220. The following additional sizes are used occasionally: 240, 280, 320, 400, 500, and 600. The wheel manufacturer may add to the regular grain number an additional symbol to indicate a special grain combination.

4) *Grade*: Grades are indicated by letters of the alphabet from A to Z in all bonds or processes. Wheel grades from A to Z range from soft to hard.

5) *Concentration*: The concentration symbol is a manufacturer's designation. It may be a number or a symbol.




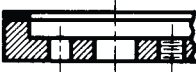






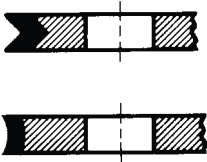
6) *Bond*: Bonds are indicated by the following letters: B, resinoid; V, vitrified; M, metal.

7) *Bond Modification*: Within each bond type a manufacturer may have modifications to tailor the bond to a specific application. These modifications may be identified by either letters or numbers.

8) *Abrasive Depth*: Abrasive section depth, in inches or millimeters (inches illustrated), is indicated by a number or letter which is the amount of total dimensional wear a user may expect from the abrasive portion of the product. Most diamond and CBN wheels are made with a depth of coating on the order of $\frac{1}{16}$ in., $\frac{1}{8}$ in., (1.6 mm, 3.2 mm) or more as specified. In some cases the diamond is applied in thinner layers, as thin as one thickness of diamond grains. The L is included in the marking system to identify a layered type product.

9) *Manufacturer's Identification Symbol*: The use of this symbol is optional.

Table 4. Designation Letters for Modifications of Diamond Wheels
ANSI B74.3-1974

Designation Letter ^a	Description	Illustration
B — Drilled and Counterbored	Holes drilled and counterbored in core.	
C — Drilled and Countersunk	Holes drilled and countersunk in core.	
H — Plain Hole	Straight hole drilled in core.	
M — Holes Plain and Threaded	Mixed holes, some plain, some threaded, are in core.	
P — Relieved One Side	Core relieved on one side of wheel. Thickness of core is less than wheel thickness.	
R — Relieved Two Sides	Core relieved on both sides of wheel. Thickness of core is less than wheel thickness.	
S — Segmented-Diamond Section	Wheel has segmental diamond section mounted on core. (Clearance between segments has no bearing on definition.)	
SS — Segmental and Slotted	Wheel has separated segments mounted on a slotted core.	
T — Threaded Holes	Threaded holes are in core.	
Q — Diamond Inserted	Three surfaces of the diamond section are partially or completely enclosed by the core.	
V — Diamond Inverted	Any diamond cross section, which is mounted on the core so that the interior point of any angle, or the concave side of any arc, is exposed shall be considered inverted. <i>Exception:</i> Diamond cross section AH shall be placed on the core with the concave side of the arc exposed.	

^aY — Diamond Inserted and Inverted. See definitions for Q and V.

The Selection of Diamond Wheels.—Two general aspects must be defined: (a) The shape of the wheel, also referred to as the basic wheel type and (b) The specification of the abrasive portion.

Table 5. General Diamond Wheel Recommendations for Wheel Type and Abrasive Specification

Typical Applications or Operation	Basic Wheel Type	Abrasive Specification
Single Point Tools (offhand grinding)	D6A2C	<i>Rough:</i> MD100-N100-B $\frac{1}{8}$ <i>Finish:</i> MD220-P75-B $\frac{1}{8}$
Single Point Tools (machine ground)	D6A2H	<i>Rough:</i> MD180-J100-B $\frac{1}{8}$ <i>Finish:</i> MD320-L75-B $\frac{1}{8}$
Chip Breakers	D1A1	MD150-R100-B $\frac{1}{8}$
Multitooth Tools and Cutters (face mills, end mills, reamers, broaches, etc.)		
Sharpening and Backing off	D11V9	<i>Rough:</i> MD100-R100-B $\frac{1}{8}$ <i>Combination:</i> MD150-R100-B $\frac{1}{8}$ <i>Finish:</i> MD220-R100-B $\frac{1}{8}$
Fluting	D12A2	MD180-N100-B $\frac{1}{8}$
Saw Sharpening	D12A2	MD180-R100-B $\frac{1}{8}$
Surface Grinding (horizontal spindle)	D1A1	<i>Rough:</i> MD120-N100-B $\frac{1}{8}$ <i>Finish:</i> MD240-P100-B $\frac{1}{8}$
Surface Grinding (vertical spindle)	D2A2T	MD80-R75-B $\frac{1}{8}$
Cylindrical or Centertype Grinding	D1A1	MD120-P100-B $\frac{1}{8}$
Internal Grinding	D1A1	MD150-N100-B $\frac{1}{8}$
Slotting and Cutoff	D1A1R	MD150-R100-B $\frac{1}{4}$
Lapping	Disc	MD400-L50-B $\frac{1}{16}$
Hand Honing	DH1, DH2	<i>Rough:</i> MD220-B $\frac{1}{16}$ <i>Finish:</i> MD320-B $\frac{1}{6}$

General recommendations for the dry grinding, with resin bond diamond wheels, of most grades of cemented carbides of average surface to ordinary finishes at normal rates of metal removal with average size wheels, as published by Cincinnati Milacron, are listed in [Table 5](#).

A further set of variables are *the dimensions of the wheel*, which must be adapted to the available grinding machine and, in some cases, to the configuration of the work.

The general abrasive specifications in [Table 5](#) may be modified to suit operating conditions by the following suggestions:

Use softer wheel grades for harder grades of carbides, for grinding larger areas or larger or wider wheel faces.

Use harder wheel grades for softer grades of carbides, for grinding smaller areas, for using smaller and narrower face wheels and for light cuts.

Use fine grit sizes for harder grades of carbides and to obtain better finishes.

Use coarser grit sizes for softer grades of carbides and for roughing cuts.

Use higher diamond concentration for harder grades of carbides, for larger diameter or wider face wheels, for heavier cuts, and for obtaining better finish.

Guidelines for the Handling and Operation of Diamond Wheels.—Grinding machines used for grinding with diamond wheels should be of the precision type, in good service condition, with true running spindles and smooth slide movements.

Mounting of Diamond Wheels: Wheel mounts should be used which permit the precise centering of the wheel, resulting in a runout of less than 0.001 inch (0.0254 mm) axially and 0.0005 inch (0.0127 mm) radially. These conditions should be checked with a 0.0001-inch (0.001 mm) type dial indicator. Once mounted and centered, the diamond wheel should be retained on its mount and stored in that condition when temporarily removed from the machine.

Truing and Dressing: Resinoid bonded diamond wheels seldom require dressing, but when necessary a soft silicon carbide stick may be hand-held against the wheel. Peripheral and cup type wheels may be sharpened by grinding the cutting face with a 60 to 80 grit silicon carbide wheel. This can be done with the diamond wheel mounted on the spindle of the machine, and with the silicon carbide wheel driven at a relatively slow speed by a specially designed table-mounted grinder or by a small table-mounted tool post grinder. The diamond wheel can be mounted on a special arbor and ground on a lathe with a tool post grinder; peripheral wheels can be ground on a cylindrical grinder or with a special brake-controlled truing device with the wheel mounted on the machine on which it is used. Cup and face type wheels are often lapped on a cast iron or glass plate using a 100 grit silicon carbide abrasive. Care must be used to lap the face parallel to the back, otherwise they must be ground to restore parallelism. Peripheral diamond wheels can be trued and dressed by grinding a silicon carbide block or a special diamond impregnated bronze block in a manner similar to surface grinding. Conventional diamonds must not be used for truing and dressing diamond wheels.

Speeds and Feeds in Diamond Grinding.—General recommendations are as follows:

Wheel Speeds: The generally recommended wheel speeds for diamond grinding are in the range of 5000 to 6000 surface feet per minute (1525-1830 m/min), with this upper limit as a maximum to avoid harmful “overspeeding.” Exceptions from that general rule are diamond wheels with coarse grains and high concentration (100 per cent) where the wheel wear in dry surface grinding can be reduced by lowering the speed to 2500-3000 sfpm (760-915 m/min). However, this lower speed range can cause rapid wheel breakdown in finer grit wheels or in those with reduced diamond concentration.

Work Speeds: In diamond grinding, work rotation and table traverse are usually established by experience, adjusting these values to the selected infeed so as to avoid excessive wheel wear.

Infeed per Pass: Often referred to as downfeed and usually a function of the grit size of the wheel. The following are general values which may be increased for raising the productivity, or lowered to improve finish or to reduce wheel wear.

Wheel Grit Size Range	Infeed per Pass
100 to 120	0.001 inch (0.025 mm)
150 to 220	0.0005 inch (0.013 mm)
250 and finer	0.00025 inch (0.006 mm)

Grinding Wheel Safety

Safety in Operating Grinding Wheels.—Grinding wheels, although capable of exceptional cutting performance due to hardness and wear resistance, are prone to damage caused by improper handling and operation. Vitrified wheels, comprising the major part of

grinding wheels used in industry, are held together by an inorganic bond which is actually a type of pottery product and therefore brittle and breakable. Although most of the organic bond types are somewhat more resistant to shocks, it must be realized that all grinding wheels are conglomerates of individual grains joined by a bond material whose strength is limited by the need of releasing the dull, abrasive grains during use.

It must also be understood that during the grinding process very substantial forces act on the grinding wheel, including the centrifugal force due to rotation, the grinding forces resulting from the resistance of the work material, and shocks caused by sudden contact with the work. To be able to resist these forces, the grinding wheel must have a substantial minimum strength throughout that is well beyond that needed to hold the wheel together under static conditions.

Finally, a damaged grinding wheel can disintegrate during grinding, liberating dormant forces which normally are constrained by the resistance of the bond, thus presenting great hazards to both operator and equipment.

To avoid breakage of the operating wheel and, should such a mishap occur, to prevent damage or injury, specific precautions must be applied. These safeguards have been formulated into rules and regulations and are set forth in the American National Standard ANSI B7.1-1988, entitled the American National Standard Safety Requirements for the Use, Care, and Protection of Abrasive Wheels.

Handling, Storage and Inspection.—Grinding wheels should be hand carried, or transported, with proper support, by truck or conveyor. A grinding wheel must not be rolled around on its periphery.

The storage area, positioned not far from the location of the grinding machines, should be free from excessive temperature variations and humidity. Specially built racks are recommended on which the smaller or thin wheels are stacked lying on their sides and the larger wheels in an upright position on two-point cradle supports consisting of appropriately spaced wooden bars. Partitions should separate either the individual wheels, or a small group of identical wheels. Good accessibility to the stored wheels reduces the need of undesirable handling.

Inspection will primarily be directed at detecting visible damage, mostly originating from handling and shipping. Cracks which are not obvious can usually be detected by “ring testing,” which consists of suspending the wheel from its hole and tapping it with a non-metallic implement. Heavy wheels may be allowed to rest vertically on a clean, hard floor while performing this test. A clear metallic tone, a “ring”, should be heard; a dead sound being indicative of a possible crack or cracks in the wheel.

Machine Conditions.—The general design of the grinding machines must ensure safe operation under normal conditions. The bearings and grinding wheel spindle must be dimensioned to withstand the expected forces and ample driving power should be provided to ensure maintenance of the rated spindle speed. For the protection of the operator, stationary machines used for dry grinding should have a provision made for connection to an exhaust system and when used for off-hand grinding, a work support must be available.

Wheel guards are particularly important protection elements and their material specifications, wall thicknesses and construction principles should agree with the Standard’s specifications. The exposure of the wheel should be just enough to avoid interference with the grinding operation. The need for access of the work to the grinding wheel will define the boundary of guard opening, particularly in the direction of the operator.

Grinding Wheel Mounting.—The mass and speed of the operating grinding wheel makes it particularly sensitive to imbalance. Vibrations that result from such conditions are harmful to the machine, particularly the spindle bearings, and they also affect the ground surface, i.e., wheel imbalance causes chatter marks and interferes with size control. Grinding wheels are shipped from the manufacturer’s plant in a balanced condition, but retaining the balanced state after mounting the wheel is quite uncertain. Balancing of the

mounted wheel is thus required, and is particularly important for medium and large size wheels, as well as for producing accurate and smooth surfaces. The most common way of balancing mounted wheels is by using balancing flanges with adjustable weights. The wheel and balancing flanges are mounted on a short balancing arbor, the two concentric and round stub ends of which are supported in a balancing stand.

Such stands are of two types: 1) the parallel straight-edged, which must be set up precisely level; and 2) the disk type having two pairs of ball bearing mounted overlapping disks, which form a V for containing the arbor ends without hindering the free rotation of the wheel mounted on that arbor.

The wheel will then rotate only when it is out of balance and its heavy spot is not in the lowest position. Rotating the wheel by hand to different positions will move the heavy spot, should such exist, from the bottom to a higher location where it can reveal its presence by causing the wheel to turn. Having detected the presence and location of the heavy spot, its effect can be cancelled by displacing the weights in the circular groove of the flange until a balanced condition is accomplished.

Flanges are commonly used means for holding grinding wheels on the machine spindle. For that purpose, the wheel can either be mounted directly through its hole or by means of a sleeve which slips over a tapered section of the machine spindle. Either way, the flanges must be of equal diameter, usually not less than one-third of the new wheel's diameter. The purpose is to securely hold the wheel between the flanges without interfering with the grinding operation even when the wheel becomes worn down to the point where it is ready to be discarded. Blotters or flange facings of compressible material should cover the entire contact area of the flanges.

One of the flanges is usually fixed while the other is loose and can be removed and adjusted along the machine spindle. The movable flange is held against the mounted grinding wheel by means of a nut engaging a threaded section of the machine spindle. The sense of that thread should be such that the nut will tend to tighten as the spindle revolves. In other words, to remove the nut, it must be turned in the direction that the spindle revolves when the wheel is in operation.

Safe Operating Speeds.—Safe grinding processes are predicated on the proper use of the previously discussed equipment and procedures, and are greatly dependent on the application of adequate operating speeds.

The Standard establishes maximum speeds at which grinding wheels can be operated, assigning the various types of wheels to several classification groups. Different values are listed according to bond type and to wheel strength, distinguishing between low, medium and high strength wheels.

For the purpose of general information, the accompanying [Table 1](#) shows an abbreviated version of the Standard's specification. However, for the governing limits, the authoritative source is the manufacturer's tag on the wheel which, particularly for wheels of lower strength, might specify speeds below those of the table.

All grinding wheels of 6 inches or greater diameter must be test run in the wheel manufacturer's plant at a speed that for all wheels having operating speeds in excess of 5000 sfpm is 1.5 times the maximum speed marked on the tag of the wheel.

The table shows the permissible wheel speeds in surface feet per minute (sfpm) units, whereas the tags on the grinding wheels state, for the convenience of the user, the maximum operating speed in revolutions per minute (rpm). The sfpm unit has the advantage of remaining valid for worn wheels whose rotational speed may be increased to the applicable sfpm value. The conversion from either one to the other of these two kinds of units is a matter of simple calculation using the formulas:

$$\text{sfpm} = \text{rpm} \times \frac{D}{12} \times \pi \quad \text{or} \quad \text{rpm} = \frac{\text{sfpm} \times 12}{D \times \pi}$$

where D = maximum diameter of the grinding wheel, in inches. **Table 2**, showing the conversion values from surface speed into rotational speed, can be used for the direct reading of the rpm values corresponding to several different wheel diameters and surface speeds.

Special Speeds: Continuing progress in grinding methods has led to the recognition of certain advantages that can result from operating grinding wheels above, sometimes even higher than twice, the speeds considered earlier as the safe limits of grinding wheel operations. Advantages from the application of high speed grinding are limited to specific processes, but the Standard admits, and offers code regulations for the use of wheels at special high speeds. These regulations define the structural requirements of the grinding machine and the responsibilities of the grinding wheel manufacturers, as well as of the users. High speed grinding should not be applied unless the machines, particularly guards, spindle assemblies, and drive motors, are suitable for such methods. Also, appropriate grinding wheels expressly made for special high speeds must be used and, of course, the maximum operating speeds indicated on the wheel's tag must never be exceeded.

Portable Grinders.—The above discussed rules and regulations, devised primarily for stationary grinding machines apply also to portable grinders. In addition, the details of various other regulations, specially applicable to different types of portable grinders are discussed in the Standard, which should be consulted, particularly for safe applications of portable grinding machines.

**Table 1. Maximum Peripheral Speeds for Grinding Wheels
Based on ANSI B7.1–1988**

Maximum Operating Speeds Depending on Strength of Bond					
Classification No and Types of Wheels ^a		Inorganic Bonds		Organic Bonds	
		sfp/m	m/min	sfp/m	m/min
1	Straight wheels — Type 1, except classifications 6, 7, 9, 10, 11, and 12 below Taper Side Wheels — Type 4 ^b Types 5, 7, 20, 21, 22, 23, 24, 25, 26 Dish wheels — Type 12 Saucer wheels — Type 13 Cones and plugs — Types 16, 17, 18, 19	5500-6500	1675-1980	6500-9500	1980-2895
2	Cylinder wheels — Type 2 Segments	5000-6000	1525-1830	5000-7000	1525-2135
3	Cup shape tool grinding wheels — Types 6 and 11 (for fixed base machines)	4500-6000	1370-1830	6000-8500	1830-2590
4	Cup shape snagging wheels — Types 6 and 11 (for portable machines)	4500-6500	1370-1980	6000-9500	1830-2895
5	Abrasive disks	5500-6500	1675-1980	5500-8500	1675-2590
6	Reinforced wheels — except cutting-off wheels (depending on diameter and thickness)	9500-16000	2895-4875
7	Type 1 wheels for bench and pedestal grinders, Types 1 and 5 also in certain sizes for surface grinders	5500-7550	1675-2300	6500-9500	1980-2895
8	Diamond and cubic boron nitride wheels Metal bond Steel centered cutting off	to 6500 to 12000 to 16000	to 1980 to 3660 to 4875	to 9500 ...	to 2895 ...
9	Cutting-off wheels — Larger than 16-inch diameter (incl. reinforced organic)	9500-14200	2895-4330
10	Cutting-off wheels — 16-inch diameter and smaller (incl. reinforced organic)	9500-16000	2895-4875
11	Thread and flute grinding wheels	8000-12000	2440-3660	8000-12000	2440-3660
12	Crankshaft and camshaft grinding wheels	5500-8500	1675-2590	6500-9500	1980-2895

^a See **Tables 1a** and **1b** starting on page **1220**.

^b Non-standard shape. For snagging wheels, 16 inches and larger — Type 1, internal wheels — Types 1 and 5, and mounted wheels, see ANSI B7.1–1988. Under no conditions should a wheel be operated faster than the maximum operating speed established by the manufacturer.

Values in this table are for general information only.

Table 2. Revolutions per Minute for Various Grinding Speeds and Wheel Diameters (Based on ANSI B7.1-1988)

Wheel Diameter, Inch	Peripheral (Surface) Speed, Feet per Minute															Wheel Diameter, Inch	
	4,000	4,500	5,000	5,500	6,000	6,500	7,000	7,500	8,000	8,500	9,000	9,500	10,000	12,000	14,000		16,000
	Revolutions per Minute																
1	15,279	17,189	19,099	21,008	22,918	24,828	26,738	28,648	30,558	32,468	34,377	36,287	38,197	45,837	53,476	61,115	1
2	7,639	8,594	9,549	10,504	11,459	12,414	13,369	14,324	15,279	16,234	17,189	18,144	19,099	22,918	26,738	30,558	2
3	5,093	5,730	6,366	7,003	7,639	8,276	8,913	9,549	10,186	10,823	11,459	12,096	12,732	15,279	17,825	20,372	3
4	3,820	4,297	4,775	5,252	5,730	6,207	6,685	7,162	7,639	8,117	8,594	9,072	9,549	11,459	13,369	15,279	4
5	3,056	3,438	3,820	4,202	4,584	4,966	5,348	5,730	6,112	6,494	6,875	7,257	7,639	9,167	10,695	12,223	5
6	2,546	2,865	3,183	3,501	3,820	4,138	4,456	4,775	5,093	5,411	5,730	6,048	6,366	7,639	8,913	10,186	6
7	2,183	2,456	2,728	3,001	3,274	3,547	3,820	4,093	4,365	4,638	4,911	5,184	5,457	6,548	7,639	8,731	7
8	1,910	2,149	2,387	2,626	2,865	3,104	3,342	3,581	3,820	4,058	4,297	4,536	4,775	5,730	6,685	7,639	8
9	1,698	1,910	2,122	2,334	2,546	2,759	2,971	3,183	3,395	3,608	3,820	4,032	4,244	5,093	5,942	6,791	9
10	1,528	1,719	1,910	2,101	2,292	2,483	2,674	2,865	3,056	3,247	3,438	3,629	3,820	4,584	5,348	6,112	10
12	1,273	1,432	1,592	1,751	1,910	2,069	2,228	2,387	2,546	2,706	2,865	3,024	3,183	3,820	4,456	5,093	12
14	1,091	1,228	1,364	1,501	1,637	1,773	1,910	2,046	2,183	2,319	2,456	2,592	2,728	3,274	3,820	4,365	14
16	955	1,074	1,194	1,313	1,432	1,552	1,671	1,790	1,910	2,029	2,149	2,268	2,387	2,865	3,342	3,820	16
18	849	955	1,061	1,167	1,273	1,379	1,485	1,592	1,698	1,804	1,910	2,016	2,122	2,546	2,971	3,395	18
20	764	859	955	1,050	1,146	1,241	1,337	1,432	1,528	1,623	1,719	1,814	1,910	2,292	2,674	3,056	20
22	694	781	868	955	1,042	1,129	1,215	1,302	1,389	1,476	1,563	1,649	1,736	2,083	2,431	2,778	22
24	637	716	796	875	955	1,035	1,114	1,194	1,273	1,353	1,432	1,512	1,592	1,910	2,228	2,546	24
26	588	661	735	808	881	955	1,028	1,102	1,175	1,249	1,322	1,396	1,469	1,763	2,057	2,351	26
28	546	614	682	750	819	887	955	1,023	1,091	1,160	1,228	1,296	1,364	1,637	1,910	2,183	28
30	509	573	637	700	764	828	891	955	1,019	1,082	1,146	1,210	1,273	1,528	1,783	2,037	30
32	477	537	597	657	716	776	836	895	955	1,015	1,074	1,134	1,194	1,432	1,671	1,910	32
34	449	506	562	618	674	730	786	843	899	955	1,011	1,067	1,123	1,348	1,573	1,798	34
36	424	477	531	584	637	690	743	796	849	902	955	1,008	1,061	1,273	1,485	1,698	36
38	402	452	503	553	603	653	704	754	804	854	905	955	1,005	1,206	1,407	1,608	38
40	382	430	477	525	573	621	668	716	764	812	859	907	955	1,146	1,337	1,528	40
42	364	409	455	500	546	591	637	682	728	773	819	864	909	1,091	1,273	1,455	42
44	347	391	434	477	521	564	608	651	694	738	781	825	868	1,042	1,215	1,389	44
46	332	374	415	457	498	540	581	623	664	706	747	789	830	996	1,163	1,329	46
48	318	358	398	438	477	517	557	597	637	676	716	756	796	955	1,114	1,273	48
53	288	324	360	396	432	468	504	541	577	613	649	685	721	865	1,009	1,153	53
60	255	286	318	350	382	414	446	477	509	541	573	605	637	764	891	1,019	60
72	212	239	265	292	318	345	371	398	424	451	477	504	531	637	743	849	72

Cylindrical Grinding

Cylindrical grinding designates a general category of various grinding methods that have the common characteristic of rotating the workpiece around a fixed axis while grinding outside surface sections in controlled relation to that axis of rotation.

The form of the part or section being ground in this process is frequently cylindrical, hence the designation of the general category. However, the shape of the part may be tapered or of curvilinear profile; the position of the ground surface may also be perpendicular to the axis; and it is possible to grind concurrently several surface sections, adjacent or separated, of equal or different diameters, located in parallel or mutually inclined planes, etc., as long as the condition of a common axis of rotation is satisfied.

Size Range of Workpieces and Machines: Cylindrical grinding is applied in the manufacture of miniature parts, such as instrument components and, at the opposite extreme, for grinding rolling mill rolls weighing several tons. Accordingly, there are cylindrical grinding machines of many different types, each adapted to a specific work-size range. Machine capacities are usually expressed by such factors as maximum work diameter, work length and weight, complemented, of course, by many other significant data.

Plain, Universal, and Limited-Purpose Cylindrical Grinding Machines.—The plain cylindrical grinding machine is considered the basic type of this general category, and is used for grinding parts with cylindrical or slightly tapered form.

The universal cylindrical grinder can be used, in addition to grinding the basic cylindrical forms, for the grinding of parts with steep tapers, of surfaces normal to the part axis, including the entire face of the workpiece, and for internal grinding independently or in conjunction with the grinding of the part's outer surfaces. Such variety of part configurations requiring grinding is typical of work in the tool room, which constitutes the major area of application for universal cylindrical grinding machines.

Limited-purpose cylindrical grinders are needed for special work configurations and for high-volume production, where productivity is more important than flexibility of adaptation. Examples of limited-purpose cylindrical grinding machines are crankshaft and camshaft grinders, polygonal grinding machines, roll grinders, etc.

Traverse or Plunge Grinding.—In traverse grinding, the machine table carrying the work performs a reciprocating movement of specific travel length for transporting the rotating workpiece along the face of the grinding wheel. At each or at alternate stroke ends, the wheel slide advances for the gradual feeding of the wheel into the work. The length of the surface that can be ground by this method is generally limited only by the stroke length of the machine table. In large roll grinders, the relative movement between work and wheel is accomplished by the traverse of the wheel slide along a stationary machine table.

In plunge grinding, the machine table, after having been set, is locked and, while the part is rotating, the wheel slide continually advances at a preset rate, until the finish size of the part is reached. The width of the grinding wheel is a limiting factor of the section length that can be ground in this process. Plunge grinding is required for profiled surfaces and for the simultaneous grinding of multiple surfaces of different diameters or located in different planes.

When the configuration of the part does not make use of either method mandatory, the choice may be made on the basis of the following general considerations: traverse grinding usually produces a better finish, and the productivity of plunge grinding is generally higher.

Work Holding on Cylindrical Grinding Machines.—The manner in which the work is located and held in the machine during the grinding process determines the configuration of the part that can be adapted for cylindrical grinding and affects the resulting accuracy of the ground surface. The method of work holding also affects the attainable production rate, because the mounting and dismounting of the part can represent a substantial portion of the total operating time.

Whatever method is used for holding the part on cylindrical types of grinding machines, two basic conditions must be satisfied: 1) the part should be located with respect to its correct axis of rotation; and 2) the work drive must cause the part to rotate, at a specific speed, around the established axis.

The lengthwise location of the part, although controlled, is not too critical in traverse grinding; however, in plunge grinding, particularly when shoulder sections are also involved, it must be assured with great accuracy.

Table 1 presents a listing, with brief discussions, of work-holding methods and devices that are most frequently used in cylindrical grinding.

Table 1. Work-Holding Methods and Devices for Cylindrical Grinding

Designation	Description	Discussion
Centers, nonrotating ("dead"), with drive plate	Headstock with nonrotating spindle holds the center. Around the spindle, an independently supported sleeve carries the drive plate for rotating the work. Tailstock for opposite center.	The simplest method of holding the work between two opposite centers is also the potentially most accurate, as long as correctly prepared and located center holes are used in the work.
Centers, driving type	Work held between two centers obtains its rotation from the concurrently applied drive by the live headstock spindle and live tailstock spindle.	Eliminates the drawback of the common center-type grinding with driver plate, which requires a dog attached to the workpiece. Driven spindles permit the grinding of the work up to both ends.
Chuck, geared, or cam-actuated	Two, three, or four jaws moved radially through mechanical elements, hand-, or power-operated, exert concentrically acting clamping force on the workpiece.	Adaptable to workpieces of different configurations and within a generally wide capacity of the chuck. Flexible in uses that, however, do not include high-precision work.
Chuck, diaphragm	Force applied by hand or power of a flexible diaphragm causes the attached jaws to deflect temporarily for accepting the work, which is held when force is released.	Rapid action and flexible adaptation to different work configurations by means of special jaws offer varied uses for the grinding of disk-shaped and similar parts.
Collets	Holding devices with externally or internally acting clamping force, easily adaptable to power actuation, assuring high centering accuracy.	Limited to parts with previously machined or ground holding surfaces, because of the small range of clamping movement of the collet jaws.
Face plate	Has four independently actuated jaws, any or several of which may be used, or entirely removed, using the base plate for supporting special clamps.	Used for holding bulky parts, or those of awkward shape, which are ground in small quantities not warranting special fixtures.
Magnetic plate	Flat plates, with pole distribution adapted to the work, are mounted on the spindle like chucks and may be used for work with the locating face normal to the axis.	Applicable for light cuts such as are frequent in tool making, where the rapid clamping action and easy access to both the O.D. and the exposed face are sometimes of advantage.
Steady rests	Two basic types are used: (a) the two-jaw type supporting the work from the back (back rest), leaving access by the wheel; (b) the three-jaw type (center rest).	A complementary work-holding device, used in conjunction with primary work holders, to provide additional support, particularly to long and/or slender parts.
Special fixtures	Single-purpose devices, designed for a particular workpiece, primarily for providing special locating elements.	Typical workpieces requiring special fixturing are, as examples, crankshafts where the holding is combined with balancing functions; or internal gears located on the pitch circle of the teeth for O.D. grinding.

Selection of Grinding Wheels for Cylindrical Grinding.—For cylindrical grinding, as for grinding in general, the primary factor to be considered in wheel selection is the work material. Other factors are the amount of excess stock and its rate of removal (speeds and feeds), the desired accuracy and surface finish, the ratio of wheel and work diameter, wet or dry grinding, etc. In view of these many variables, it is not practical to set up a complete list of grinding wheel recommendations with general validity. Instead, examples of recom-

recommendations embracing a wide range of typical applications and assuming common practices are presented in Table 2. This is intended as a guide for the starting selection of grinding-wheel specifications which, in case of a not entirely satisfactory performance, can be refined subsequently. The content of the table is a version of the grinding-wheel recommendations for cylindrical grinding by the Norton Company using, however, non-proprietary designations for the abrasive types and bonds.

Table 2. Wheel Recommendations for Cylindrical Grinding

Material	Wheel Marking	Material	Wheel Marking
Aluminum	SFA46-18V	Forgings	A46-M5V
Armatures (laminated)	SFA100-18V	Gages (plug)	SFA80-K8V
Axles (auto & railway)	A54-M5V	General-purpose grinding	SFA54-L5V
Brass	C36-KV	Glass	BFA220-011V
Bronze		Gun barrels	
Soft	C36-KV	Spotting and O.D.	BFA60-M5V
Hard	A46-M5V	Nitralloy	
Bushings (hardened steel)	BFA60-L5V	Before nitriding	A60-K5V
Bushings (cast iron)	C36-JV	After nitriding	
Cam lobes (cast alloy)		Commercial finish	SFA60-18V
Roughing	BFA54-N5V	High finish	C100-1V
Finishing	A70-P6B	Reflective finish	C500-19E
Cam lobes (hardened steel)		Pistons (aluminum)	SFA46-18V
Roughing	BFA54-L5V	(cast iron)	C36-KV
Finishing	BFA80-T8B	Plastics	C46-JV
Cast iron	C36-JV	Rubber	
Chromium plating		Soft	SFA20-K5B
Commercial finish	SFA60-J8V	Hard	C36-KB
High finish	A150-K5E	Spline shafts	SFA60-N5V
Reflective finish	C500-19E	Sprayed metal	C60-JV
Commutators (copper)	C60-M4E	Steel	
Crankshafts (airplane)		Soft	
Pins	BFA46-K5V	1 in. dia. and smaller	SFA60-M5V
Bearings	A46-L5V	over 1 in dia.	SFA46-L5V
Crankshafts (automotive		Hardened	
pins and bearings)		1 in. dia. and smaller	SFA80-L8V
Finishing	A54-N5V	over 1 in. dia.	SFA60-K5V
Roughing & finishing	A54-O5V	300 series stainless	SFA46-K8V
Regrinding	A54-M5V	Stellite	BFA46-M5V
Regrinding, sprayed		Titanium	C60-JV
metal	C60-JV	Valve stems (automotive)	BFA54-N5V
Drills	BFA54-N5V	Valve tappets	BFA54-M5V

Note: Prefixes to the standard designation "A" of aluminum oxide indicate modified abrasives as follows: BFA = Blended friable (a blend of regular and friable), SFA = Semifriable.

Operational Data for Cylindrical Grinding.—In cylindrical grinding, similarly to other metalcutting processes, the applied speed and feed rates must be adjusted to the operational conditions as well as to the objectives of the process. Grinding differs, however, from other types of metalcutting methods in regard to the cutting speed of the tool which, in grinding, is generally not a variable; it should be maintained at, or close to the optimum rate, commonly 6500 feet per minute (1980 m/min) peripheral speed.

In establishing the proper process values for grinding, of prime consideration are the work material, its condition (hardened or soft), and the type of operation (roughing or finishing). Other influencing factors are the characteristics of the grinding machine (stability, power), the specifications of the grinding wheel, the material allowance, the rigidity and balance of the workpiece, as well as several grinding process conditions, such as wet or dry grinding, the manner of wheel truing, etc.

Variables of the cylindrical grinding process, often referred to as *grinding data*, comprise the speed of work rotation (measured as the surface speed of the work); the infeed (in inches per pass for traverse grinding, or in inches per minute for plunge grinding); and, in the case of traverse grinding, the speed of the reciprocating table movement (expressed either in feet per minute, or as a fraction of the wheel width for each revolution of the work).

For the purpose of starting values in setting up a cylindrical grinding process, a brief listing of basic data for common cylindrical grinding conditions and involving frequently used materials, is presented in [Table 3](#).

Table 3. Basic Process Data for Cylindrical Grinding

Traverse Grinding								Traverse for Each Work Revolution, In Fractions of the Wheel Width	
Work Material	Material Condition	Work Surface Speed,		Infeed per Pass					
				inch		mm			
		fpm	m/min	Rough	Finish	Rough	Finish	Rough	Finish
Plain Carbon Steel	Annealed	100	30.5	0.002	0.0005	0.05	0.013	$\frac{1}{2}$	$\frac{1}{6}$
	Hardened	70	21	0.002	0.0003–0.0005	0.05	0.007–0.013	$\frac{1}{4}$	$\frac{1}{8}$
Alloy Steel	Annealed	100	30.5	0.002	0.0005	0.05	0.013	$\frac{1}{2}$	$\frac{1}{6}$
	Hardened	70	21	0.002	0.0002–0.0005	0.05	0.005–0.013	$\frac{1}{4}$	$\frac{1}{8}$
Tool Steel	Annealed	60	18	0.002	0.0005 max.	0.05	0.013 max.	$\frac{1}{2}$	$\frac{1}{6}$
	Hardened	50	15	0.002	0.0001–0.0005	0.05	0.003–0.013	$\frac{1}{4}$	$\frac{1}{8}$
Copper Alloys	Annealed or Cold Drawn	100	30.5	0.002	0.0005 max.	0.05	0.013 max.	$\frac{1}{3}$	$\frac{1}{6}$
Aluminum Alloys	Cold Drawn or Solution Treated	150	45.7	0.002	0.0005 max.	0.05	0.013 max.	$\frac{1}{3}$	$\frac{1}{6}$

Plunge Grinding, Infeed per Revolution of the Work				
Work Material	Inch		Millimeter	
	Roughing	Finishing	Roughing	Finishing
Steel, soft	0.0005	0.0002	0.013	0.005
Plain carbon steel, hardened	0.0002	0.000050	0.005	0.0013
Alloy and tool steel, hardened	0.0001	0.000025	0.003	0.00064

These data, which are, in general, considered conservative, are based on average operating conditions and may be modified subsequently by: a) reducing the values in case of unsatisfactory quality of the grinding or the occurrence of failures; and b) increasing the rates for raising the productivity of the process, particularly for rigid workpieces, substantial stock allowance, etc.

High-Speed Cylindrical Grinding.—The maximum peripheral speed of the wheels in regular cylindrical grinding is generally 6500 feet per minute (1980 m/min); the commonly used grinding wheels and machines are designed to operate efficiently at this speed. Recently, efforts were made to raise the productivity of different grinding methods, including cylindrical grinding, by increasing the peripheral speed of the grinding wheel to a substantially higher than traditional level, such as 12,000 feet per minute (3658 m/min) or more. Such methods are designated by the distinguishing term of high-speed grinding.

For high-speed grinding, special grinding machines have been built with high dynamic stiffness and static rigidity, equipped with powerful drive motors, extra-strong spindles and bearings, reinforced wheel guards, etc., and using grinding wheels expressly made and tested for operating at high peripheral speeds. The higher stock-removal rate accomplished by high-speed grinding represents an advantage when the work configuration and material permit, and the removable stock allowance warrants its application.

CAUTION: High-speed grinding must *not* be applied on standard types of equipment, such as general types of grinding machines and regular grinding wheels. Operating grind-

ing wheels, even temporarily, at higher than approved speed constitutes a grave safety hazard.

Areas and Degrees of Automation in Cylindrical Grinding.—Power drive for the work rotation and for the reciprocating table traverse are fundamental machine movements that, once set for a certain rate, will function without requiring additional attention. Loading and removing the work, starting and stopping the main movements, and applying infeed by hand wheel are carried out by the operator on cylindrical grinding machines in their basic degree of mechanization. Such equipment is still frequently used in tool room and jobbing-type work.

More advanced levels of automation have been developed for cylindrical grinders and are being applied in different degrees, particularly in the following principal respects:

a) *Infeed*, in which different rates are provided for rapid approach, roughing and finishing, followed by a spark-out period, with presetting of the advance rates, the cutoff points, and the duration of time-related functions.

b) *Automatic cycling* actuated by a single lever to start work rotation, table reciprocation, grinding-fluid supply, and infeed, followed at the end of the operation by wheel slide retraction, the successive stopping of the table movement, the work rotation, and the fluid supply.

c) *Table traverse dwells* (tarry) in the extreme positions of the travel, over preset periods, to assure uniform exposure to the wheel contact of the entire work section.

d) *Mechanized work loading*, clamping, and, after termination of the operation, unloading, combined with appropriate work-feeding devices such as indexing-type drums.

e) *Size control* by in-process or post-process measurements. Signals originated by the gage will control the advance movement or cause automatic compensation of size variations by adjusting the cutoff points of the infeed.

f) *Automatic wheel dressing* at preset frequency, combined with appropriate compensation in the infeed movement.

g) *Numerical control* obviates the time-consuming setups for repetitive work performed on small- or medium-size lots. As an application example: shafts with several sections of different lengths and diameters can be ground automatically in a single operation, grinding the sections in consecutive order to close dimensional limits, controlled by an in-process gage, which is also automatically set by means of the program.

The choice of the grinding machine functions to be automated and the extent of automation will generally be guided by economic considerations, after a thorough review of the available standard and optional equipment. Numerical control of partial or complete cycles is being applied to modern cylindrical and other grinding machines.

Cylindrical Grinding Troubles and Their Correction.—Troubles that may be encountered in cylindrical grinding may be classified as work defects (chatter, checking, burning, scratching, and inaccuracies), improperly operating machines (jumpy infeed or traverse), and wheel defects (too hard or soft action, loading, glazing, and breakage). The Landis Tool Company has listed some of these troubles, their causes, and corrections as follows:

Chatter: Sources of chatter include: 1) faulty coolant; 2) wheel out of balance; 3) wheel out of round; 4) wheel too hard; 5) improper dressing; 6) faulty work support or rotation; 7) improper operation; 8) faulty traverse; 9) work vibration; 10) outside vibration transmitted to machine; 11) interference; 12) wheel base; and 13) headstock.

Suggested procedures for correction of these troubles are:

1) *Faulty coolant*: Clean tanks and lines. Replace dirty or heavy coolant with correct mixture.

2) *Wheel out of balance*: Rebalance on mounting before and after dressing. Run wheel without coolant to remove excess water. Store a removed wheel on its side to keep retained water from causing a false heavy side. Tighten wheel mounting flanges. Make sure wheel center fits spindle.

3) *Wheel out of round*: True before and after balancing. True sides to face.

4) *Wheel too hard*: Use coarser grit, softer grade, more open bond. See *Wheel Defects* on page 1258.

5) *Improper dressing*: Use sharp diamond and hold rigidly close to wheel. It must not overhang excessively. Check diamond in mounting.

6) *Faulty work support or rotation*: Use sufficient number of work rests and adjust them more carefully. Use proper angles in centers of work. Clean dirt from footstock spindle and be sure spindle is tight. Make certain that work centers fit properly in spindles.

7) *Improper operation*: Reduce rate of wheel feed.

8) *Faulty traverse*: See *Uneven Traverse or Infeed of Wheel Head* on page 1258.

9) *Work vibration*: Reduce work speed. Check workpiece for balance.

10) *Outside vibration transmitted to machine*: Check and make sure that machine is level and sitting solidly on foundation. Isolate machine or foundation.

11) *Interference*: Check all guards for clearance.

12) *Wheel base*: Check spindle bearing clearance. Use belts of equal lengths or uniform cross-section on motor drive. Check drive motor for unbalance. Check balance and fit of pulleys. Check wheel feed mechanism to see that all parts are tight.

13) *Headstock*: Put belts of same length and cross-section on motor drive; check for correct work speeds. Check drive motor for unbalance. Make certain that headstock spindle is not loose. Check work center fit in spindle. Check wear of face plate and jackshaft bearings.

Spirals on Work (traverse lines with same lead on work as rate of traverse): Sources of spirals include: 1) machine parts out of line; and 2) truing.

Suggested procedures for correction of these troubles are:

1) *Machine parts out of line*: Check wheel base, headstock, and footstock for proper alignment.

2) *Truing*: Point truing tool down 3 degrees at the workwheel contact line. Round off wheel edges.

Check Marks on Work: Sources of check marks include: 1) improper operation; 2) improper heat treatment; 3) improper size control; 4) improper wheel; and 5) improper dressing.

Suggested procedures for correction of these troubles are:

1) *Improper operation*: Make wheel act softer. See *Wheel Defects*. Do not force wheel into work. Use greater volume of coolant and a more even flow. Check the correct positioning of coolant nozzles to direct a copious flow of clean coolant at the proper location.

2) *Improper heat treatment*: Take corrective measures in heat-treating operations.

3) *Improper size control*: Make sure that engineering establishes reasonable size limits. See that they are maintained.

4) *Improper wheel*: Make wheel act softer. Use softer-grade wheel. Review the grain size and type of abrasive. A finer grit or more friable abrasive or both may be called for.

5) *Improper dressing*: Check that the diamond is sharp, of good quality, and well set. Increase speed of the dressing cycle. Make sure diamond is not cracked.

Burning and Discoloration of Work: Sources of burning and discoloration are improper operation, and improper wheel.

Suggested procedures for correction of these troubles are:

1) *Improper operation*: Decrease rate of infeed. Don't stop work while in contact with wheel.

2) *Improper wheel*: Use softer wheel or obtain softer effect. See *Wheel Defects*. Use greater volume of coolant.

Isolated Deep Marks on Work: Source of trouble is an unsuitable wheel. Use a finer wheel and consider a change in abrasive type.

Fine Spiral or Thread on Work: Sources of this trouble are: 1) improper operation; and 2) faulty wheel dressing.

Suggested procedures for corrections of these troubles are:

1) *Improper operation:* Reduce wheel pressure. Use more work rests. Reduce traverse with respect to work rotation. Use different traverse rates to break up pattern when making numerous passes. Prevent edge of wheel from penetrating by dressing wheel face parallel to work.

2) *Faulty wheel dressing:* Use slower or more even dressing traverse. Set dressing tool at least 3 degrees down and 30 degrees to the side from time to time. Tighten holder. Don't take too deep a cut. Round off wheel edges. Start dressing cut from wheel edge.

Narrow and Deep Regular Marks on Work: Source of trouble is that the wheel is too coarse. Use finer grain size.

Wide, Irregular Marks of Varying Depth on Work: Source of trouble is too soft a wheel. Use a harder grade wheel. See *Wheel Defects*.

Widely Spaced Spots on Work: Sources of trouble are oil spots or glazed areas on wheel face. Balance and true wheel. Keep oil from wheel face.

Irregular "Fish-tail" Marks of Various Lengths and Widths on Work: Source of trouble is dirty coolant. Clean tank frequently. Use filter for fine finish grinding. Flush wheel guards after dressing or when changing to finer wheel.

Wavy Traverse Lines on Work: Source of trouble is wheel edges. Round off. Check for loose thrust on spindle and correct if necessary.

Irregular Marks on Work: Cause is loose dirt. Keep machine clean.

Deep, Irregular Marks on Work: Source of trouble is loose wheel flanges. Tighten and make sure blotters are used.

Isolated Deep Marks on Work: Sources of trouble are: 1) grains pull out; coolant too strong; 2) coarse grains or foreign matter in wheel face; and 3) improper dressing.

Respective suggested procedures for corrections of these troubles are: 1) decrease soda content in coolant mixture; 2) dress wheel; and 3) use sharper dressing tool.

Brush wheel after dressing with stiff bristle brush.

Grain Marks on Work: Sources of trouble are: 1) improper finishing cut; 2) grain sizes of roughing and finishing wheels differ too much; 3) dressing too coarse; and 4) wheel too coarse or too soft.

Respective suggested procedures for corrections of these troubles are: start with high work and traverse speeds; finish with high work speed and slow traverse, letting wheel "spark-out" completely; finish out better with roughing wheel or use finer roughing wheel; use shallower and slower cut; and use finer grain size or harder-grade wheel.

Inaccuracies in Work: Work out-of-round, out-of-parallel, or tapered.

Sources of trouble are: 1) misalignment of machine parts; 2) work centers; 3) improper operation; 4) coolant; 5) wheel; 6) improper dressing; 7) spindle bearings; and 8) work.

Suggested procedures for corrections of these troubles are:

1) *Misalignment of machine parts:* Check headstock and tailstock for alignment and proper clamping.

2) *Work centers:* Centers in work must be deep enough to clear center point. Keep work centers clean and lubricated. Check play of footstock spindle and see that footstock spindle is clean and tightly seated. Regrind work centers if worn. Work centers must fit taper of work-center holes. Footstock must be checked for proper tension.

3) *Improper operation:* Don't let wheel traverse beyond end of work. Decrease wheel pressure so work won't spring. Use harder wheel or change feeds and speeds to make wheel act harder. Allow work to "spark-out." Decrease feed rate. Use proper number of

work rests. Allow proper amount of tarry. Workpiece must be balanced if it is an odd shape.

4) *Coolant*: Use greater volume of coolant.

5) *Wheel*: Rebalance wheel on mounting before and after truing.

6) *Improper dressing*: Use same positions and machine conditions for dressing as in grinding.

7) *Spindle bearings*: Check clearance.

8) *Work*: Work must come to machine in reasonably accurate form.

Inaccurate Work Sizing (when wheel is fed to same position, it grinds one piece to correct size, another oversize, and still another undersize): Sources of trouble are: 1) improper work support or rotation; 2) wheel out of balance; 3) loaded wheel; 4) improper infeed; 5) improper traverse; 6) coolant; 7) misalignment; and 8) work.

Suggested procedures for corrections of these troubles are:

1) *Improper work support or rotation*: Keep work centers clean and lubricated. Regrind work-center tips to proper angle. Be sure footstock spindle is tight. Use sufficient work rests, properly spaced.

2) *Wheel out of balance*: Balance wheel on mounting before and after truing.

3) *Loaded wheel*: See *Wheel Defects*.

4) *Improper infeed*: Check forward stops of rapid feed and slow feed. When readjusting position of wheel base by means of the fine feed, move the wheel base back after making the adjustment and then bring it forward again to take up backlash and relieve strain in feed-up parts. Check wheel spindle bearings. Don't let excessive lubrication of wheel base slide cause "floating." Check and tighten wheel feed mechanism. Check parts for wear. Check pressure in hydraulic system. Set infeed cushion properly. Check to see that pistons are not sticking.

5) *Improper traverse*: Check traverse hydraulic system and the operating pressure. Prevent excessive lubrication of carriage ways with resultant "floating" condition. Check to see if carriage traverse piston rods are binding. Carriage rack and driving gear must not bind. Change length of tarry period.

6) *Coolant*: Use greater volume of clean coolant.

7) *Misalignment*: Check level and alignment of machine.

8) *Work*: Workpieces may vary too much in length, permitting uneven center pressure.

Uneven Traverse or Infeed of Wheel Head: Sources of uneven traverse or infeed of wheel head are: carriage and wheel head, hydraulic system, interference, unbalanced conditions, and wheel out of balance. Suggested procedures for correction of these troubles are:

1) *Carriage and wheel head*: Ways may be scored. Be sure to use recommended oil for both lubrication and hydraulic system. Make sure ways are not so smooth that they press out oil film. Check lubrication of ways. Check wheel feed mechanism, traverse gear, and carriage rack clearance. Prevent binding of carriage traverse cylinder rods.

2) *Hydraulic systems*: Remove air and check pressure of hydraulic oil. Check pistons and valves for oil leakage and for gumminess caused by incorrect oil. Check worn valves or pistons that permit leakage.

3) *Interference*: Make sure guard strips do not interfere.

4) *Unbalanced conditions*: Eliminate loose pulleys, unbalanced wheel drive motor, uneven belts, or high spindle keys.

5) *Wheel out of balance*: Balance wheel on mounting before and after truing.

Wheel Defects: When *wheel is acting too hard*, such defects as glazing, some loading, lack of cut, chatter, and burning of work result.

Suggested procedures for correction of these faults are: 1) Increase work and traverse speeds as well as rate of in-feed; 2) decrease wheel speed, diameter, or width; 3) dress more sharply; 4) use thinner coolant; 5) don't tarry at end of traverse; 6) select softer wheel grade and coarser grain size; 7) avoid gummy coolant; and 8) on hardened work select finer grit, more fragile abrasive or both to get penetration. Use softer grade.

When *wheel is acting too soft*, such defects as wheel marks, tapered work, short wheel life, and not-holding-cut result.

Suggested procedures for correction of these faults are: 1) Decrease work and traverse speeds as well as rate of in-feed; 2) increase wheel speed, diameter, or width; 3) dress with little in-feed and slow traverse; 4) use heavier coolants; 5) don't let wheel run off work at end of traverse; and 6) select harder wheel or less fragile grain or both.

Wheel Loading and Glazing: Sources of the trouble of wheel loading or glazing are: 1) Incorrect wheel; 2) improper dress; 3) faulty operation; 4) faulty coolant; and 5) gummy coolant.

Suggested procedures for correction of these faults are:

1) *Incorrect wheel:* Use coarser grain size, more open bond, or softer grade.

2) *Improper dressing:* Keep wheel sharp with sharp dresser, clean wheel after dressing, use faster dressing traverse, and deeper dressing cut.

3) *Faulty operation:* Control speeds and feeds to soften action of wheel. Use less in-feed to prevent loading; more in-feed to stop glazing.

4) *Faulty coolant:* Use more, cleaner and thinner coolant, and less oily coolant.

5) *Gummy coolant:* To stop wheel glazing, increase soda content and avoid the use of soluble oils if water is hard. In using soluble oil coolant with hard water a suitable conditioner or "softener" should be added.

Wheel Breakage: Suggested procedures for the correction of a radial break with three or more pieces are: 1) Reduce wheel speed to or below rated speed; 2) mount wheel properly, use blotters, tight arbors, even flange pressure and be sure to keep out dirt between flange and wheel; 3) use plenty of coolant to prevent over-heating; 4) use less in-feed; and 5) don't allow wheel to become jammed on work.

A radial break with two pieces may be caused by excessive side strain. To prevent an irregular wheel break, don't let wheel become jammed on work; don't allow striking of wheel; and never use wheels that have been damaged in handling. In general, do not use a wheel that is too tight on the arbor since the wheel is apt to break when started. Prevent excessive hammering action of wheel. Follow rules of the American National Standard Safety Requirements for the Use, Care, and Protection of Abrasive Wheels (ANSI B7.1-1988).

Centerless Grinding

In centerless grinding the work is supported on a work rest blade and is between the grinding wheel and a regulating wheel. The regulating wheel generally is a rubber bonded abrasive wheel. In the normal grinding position the grinding wheel forces the work downward against the work rest blade and also against the regulating wheel. The latter imparts a uniform rotation to the work giving it its same peripheral speed which is adjustable.

The higher the work center is placed above the line joining the centers of the grinding and regulating wheels the quicker the rounding action. Rounding action is also increased by a high work speed and a slow rate of traverse (if a through-feed operation). It is possible to have a higher work center when using softer wheels, as their use gives decreased contact pressures and the tendency of the workpiece to lift off the work rest blade is lessened.

Long rods or bars are sometimes ground with their centers below the line-of-centers of the wheels to eliminate the whipping and chattering due to slight bends or kinks in the rods or bars, as they are held more firmly down on the blade by the wheels.

There are three general methods of centerless grinding which may be described as through-feed, in-feed, and end-feed methods.

Through-feed Method of Grinding.—The through-feed method is applied to straight cylindrical parts. The work is given an axial movement by the regulating wheel and passes between the grinding and regulating wheels from one side to the other. The rate of feed depends upon the diameter and speed of the regulating wheel and its inclination which is adjustable. It may be necessary to pass the work between the wheels more than once, the number of passes depending upon such factors as the amount of stock to be removed, the roundness and straightness of the unground work, and the limits of accuracy required.

The work rest fixture also contains adjustable guides on either side of the wheels that directs the work to and from the wheels in a straight line.

In-feed Method of Centerless Grinding.—When parts have shoulders, heads or some part larger than the ground diameter, the in-feed method usually is employed. This method is similar to “plungecut” form grinding on a center type of grinder. The length or sections to be ground in any one operation are limited by the width of the wheel. As there is no axial feeding movement, the regulating wheel is set with its axis approximately parallel to that of the grinding wheel, there being a slight inclination to keep the work tight against the end stop.

End-feed Method of Grinding.—The end-feed method is applied only to taper work. The grinding wheel, regulating wheel, and the work rest blade are set in a fixed relation to each other and the work is fed in from the front mechanically or manually to a fixed end stop. Either the grinding or regulating wheel, or both, are dressed to the proper taper.

Automatic Centerless Grinding.—The grinding of relatively small parts may be done automatically by equipping the machine with a magazine, gravity chute, or hopper feed, provided the shape of the part will permit using these feed mechanisms.

Internal Centerless Grinding.—Internal grinding machines based upon the centerless principle utilize the outside diameter of the work as a guide for grinding the bore which is concentric with the outer surface. In addition to straight and tapered bores, interrupted and “blind” holes can be ground by the centerless method. When two or more grinding operations such as roughing and finishing must be performed on the same part, the work can be rechucked in the same location as often as required.

Centerless Grinding Troubles.—A number of troubles and some corrective measures compiled by a manufacturer are listed here for the through-feed and in-feed methods of centerless grinding.

Chattermarks are caused by having the work center too high above the line joining the centers of the grinding and regulating wheels; using too hard or too fine a grinding wheel; using too steep an angle on the work support blade; using too thin a work support blade; “play” in the set-up due to loosely clamped members; having the grinding wheel fit loosely on the spindle; having vibration either transmitted to the machine or caused by a defective drive in the machine; having the grinding wheel out-of-balance; using too heavy a stock removal; and having the grinding wheel or the regulating wheel spindles not properly adjusted.

Feed lines or spiral marks in through-feed grinding are caused by too sharp a corner on the exit side of the grinding wheel which may be alleviated by dressing the grinding wheel to a slight taper about $\frac{1}{2}$ inch (1.27 mm) from the edge, dressing the edge to a slight radius, or swiveling the regulating wheel a bit.

Scored work is caused by burrs, abrasive grains, or removed material being imbedded in or fused to the work support blade. This condition may be alleviated by using a coolant with increased lubricating properties and if this does not help a softer grade wheel should be used.

Work not ground round may be due to the work center not being high enough above the line joining the centers of the grinding and regulating wheels. Placing the work center higher and using a softer grade wheel should help to alleviate this condition.

Work not ground straight in through-feed grinding may be due to an incorrect setting of the guides used in introducing and removing the work from the wheels, and the existence of convex or concave faces on the regulating wheel. For example, if the work is tapered on the front end, the work guide on the entering side is deflected toward the regulating wheel. If tapered on the back end, then the work guide on the exit side is deflected toward the regulating wheel. If both ends are tapered, then both work guides are deflected toward the regulating wheel. The same barrel-shaped pieces are also obtained if the face of the regulating wheel is convex at the line of contact with the work. Conversely, the work would be ground with hollow shapes if the work guides were deflected toward the grinding wheel or if the face of the regulating wheel were concave at the line of contact with the work. The use of a warped work rest blade may also result in the work not being ground straight and the blade should be removed and checked with a straight edge.

In in-feed grinding, in order to keep the wheel faces straight which will insure straightness of the cylindrical pieces being ground, the first item to be checked is the straightness and the angle of inclination of the work rest blade. If this is satisfactory then one of three corrective measures may be taken: the first might be to swivel the regulating wheel to compensate for the taper, the second might be to true the grinding wheel to that angle that will give a perfectly straight workpiece, and the third might be to change the inclination of the regulating wheel (this is true only for correcting very slight tapers up to 0.0005 inch or 0.0127 mm).

Difficulties in sizing the work in in-feed grinding are generally due to a worn in-feed mechanism and may be overcome by adjusting the in-feed nut.

Flat spots on the workpiece in in-feed grinding usually occur when grinding heavy work and generally when the stock removal is light. This condition is due to insufficient driving power between the work and the regulating wheel which may be alleviated by equipping the work rest with a roller that exerts a force against the workpiece; and by feeding the workpiece to the end stop using the upper slide.

Surface Grinding

The term surface grinding implies, in current technical usage, the grinding of surfaces which are essentially flat. Several methods of surface grinding, however, are adapted and used to produce surfaces characterized by parallel straight line elements in one direction, while normal to that direction the contour of the surface may consist of several straight line sections at different angles to each other (e.g., the guideways of a lathe bed); in other cases the contour may be curved or profiled (e.g., a thread cutting chaser).

Advantages of Surface Grinding.—Alternate methods for machining work surfaces similar to those produced by surface grinding are milling and, to a much more limited degree, planing. Surface grinding, however, has several advantages over alternate methods that are carried out with metal-cutting tools. Examples of such potential advantages are as follows:

- 1) Grinding is applicable to very hard and/or abrasive work materials, without significant effect on the efficiency of the stock removal.
- 2) The desired form and dimensional accuracy of the work surface can be obtained to a much higher degree and in a more consistent manner.
- 3) Surface textures of very high finish and—when the appropriate system is utilized—with the required lay, are generally produced.
- 4) Tooling for surface grinding as a rule is substantially less expensive, particularly for producing profiled surfaces, the shapes of which may be dressed into the wheel, often with simple devices, in processes that are much more economical than the making and the maintenance of form cutters.

5) Fixturing for work holding is generally very simple in surface grinding, particularly when magnetic chucks are applicable, although the mechanical holding fixture can also be simpler, because of the smaller clamping force required than in milling or planing.

6) Parallel surfaces on opposite sides of the work are produced accurately, either in consecutive operations using the first ground surface as a dependable reference plane or, simultaneously, in double face grinding, which usually operates without the need for holding the parts by clamping.

7) Surface grinding is well adapted to process automation, particularly for size control, but also for mechanized work handling in the large volume production of a wide range of component parts.

Principal Systems of Surface Grinding.—Flat surfaces can be ground with different surface portions of the wheel, by different arrangements of the work and wheel, as well as by different interrelated movements. The various systems of surface grinding, with their respective capabilities, can best be reviewed by considering two major distinguishing characteristics:

1) *The operating surface of the grinding wheel*, which may be the periphery or the face (the side);

2) *The movement of the work during the process*, which may be traverse (generally reciprocating) or rotary (continuous), depending on the design of a particular category of surface grinders.

The accompanying [Table 1](#) and the text that follows provides a concise review of the principal surface grinding systems, defined by the preceding characteristics. It should be noted that many surface grinders are built for specific applications, and do not fit exactly into any one of these major categories.

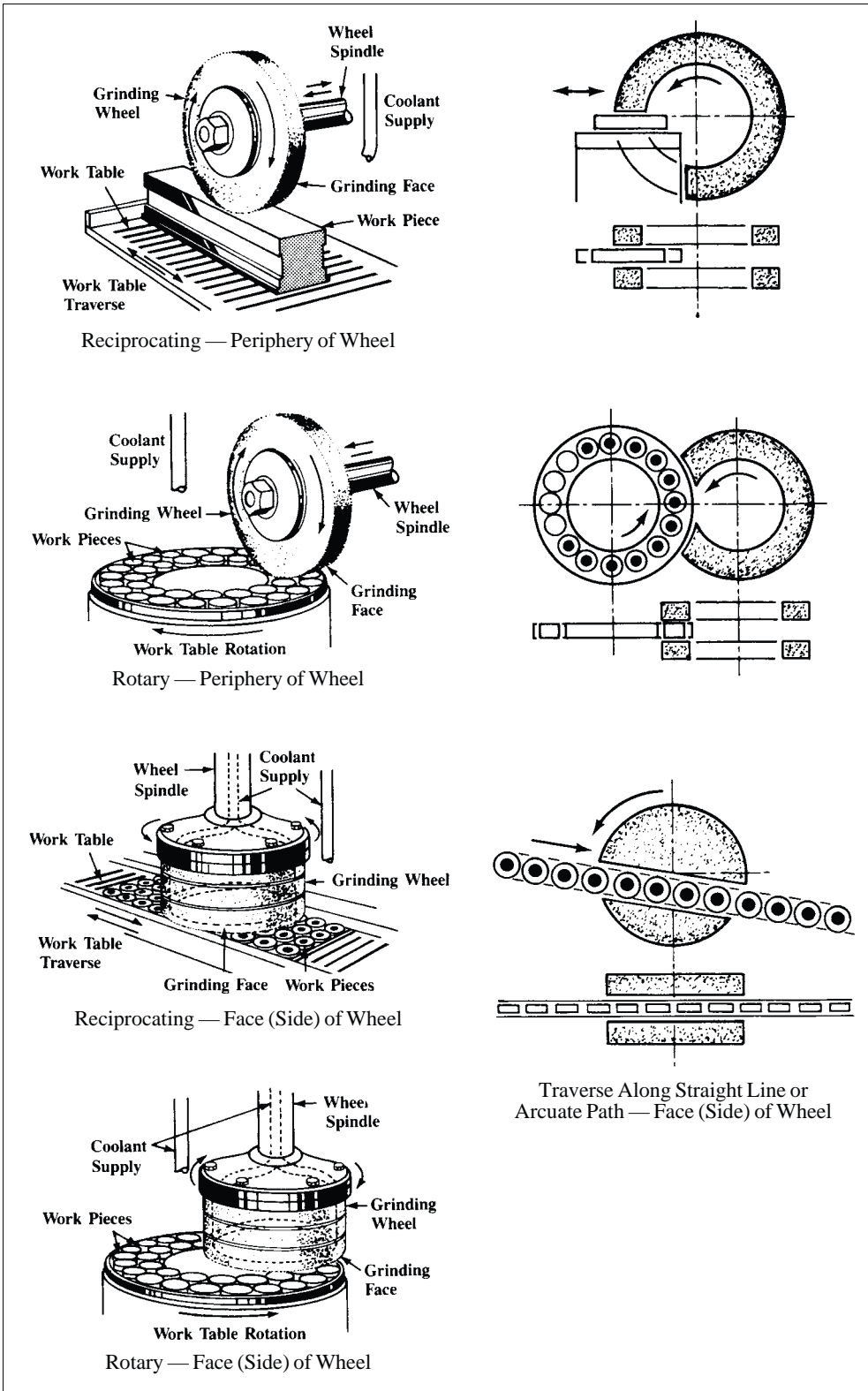
Operating Surface, Periphery of Wheel: Movement of Work, Reciprocating: Work is mounted on the horizontal machine table that is traversed in a reciprocating movement at a speed generally selected from a steplessly variable range. The transverse movement, called cross feed of the table or of the wheel slide, operates at the end of the reciprocating stroke and assures the gradual exposure of the entire work surface, which commonly exceeds the width of the wheel. The depth of the cut is controlled by the downfeed of the wheel, applied in increments at the reversal of the transverse movement.

Operating Surface, Periphery of Wheel: Movement of Work, Rotary: Work is mounted, usually on the full-diameter magnetic chuck of the circular machine table that rotates at a preset constant or automatically varying speed, the latter maintaining an approximately equal peripheral speed of the work surface area being ground. The wheelhead, installed on a cross slide, traverses over the table along a radial path, moving in alternating directions, toward and away from the center of the table. Infeed is by vertical movement of the saddle along the guideways of the vertical column, at the end of the radial wheelhead stroke. The saddle contains the guideways along which the wheelhead slide reciprocates.

Operating Surface, Face of Wheel: Movement of Work, Reciprocating: Operation is similar to the reciprocating table-type peripheral surface grinder, but grinding is with the face, usually with the rim of a cup-shaped wheel, or a segmental wheel for large machines. Capable of covering a much wider area of the work surface than the peripheral grinder, thus frequently no need for cross feed. Provides efficient stock removal, but is less adaptable than the reciprocating table-type peripheral grinder.

Operating Surface, Face of Wheel: Movement of Work, Rotary: The grinding wheel, usually of segmental type, is set in a position to cover either an annular area near the periphery of the table or, more commonly, to reach beyond the table center. A large circular magnetic chuck generally covers the entire table surface and facilitates the mounting of workpieces, even of fixtures, when needed. The uninterrupted passage of the work in contact with the large wheel face permits a very high rate of stock removal and the machine,

Table 1. Principal Systems of Surface Grinding — Diagrams



with single or double wheelhead, can be adapted also to automatic operation with continuous part feed by mechanized work handling.

Operating Surface, Face of Wheel: Movement of Work, Traverse Along Straight or Arcuate Path: The grinding wheel, usually of segmental type, is set in a position to cover either an annular area near the periphery of the table or, more commonly, to reach beyond the table center. A large circular magnetic chuck generally covers the entire table surface and facilitates the mounting of workpieces, even of fixtures, when needed. The uninterrupted passage of the work in contact with the large wheel face permits a very high rate of stock removal and the machine, with single or double wheelhead, can be adapted also to automatic operation with continuous part feed by mechanized work handling.

Selection of Grinding Wheels for Surface Grinding.—The most practical way to select a grinding wheel for surface grinding is to base the selection on the work material. **Table 2a** gives the grinding wheel recommendations for Types 1, 5, and 7 straight wheels used on reciprocating and rotary table surface grinders with horizontal spindles. **Table 2b** gives the grinding wheel recommendations for Type 2 cylinder wheels, Type 6 cup wheels, and wheel segments used on vertical spindle surface grinders.

The last letters (two or three) that may follow the bond designation V (vitrified) or B (resinoid) refer to: 1) bond modification, “BE” being especially suitable for surface grinding; 2) special structure, “P” type being distinctively porous; and 3) for segments made of 23A type abrasives, the term 12VSM implies porous structure, and the letter “P” is not needed.

The wheel markings in **Tables 2a** and **2b** are those used by the Norton Co., complementing the basic standard markings with Norton symbols. The complementary symbols used in these tables, that is, those preceding the letter designating A (aluminum oxide) or C (silicon carbide), indicate the special type of basic abrasive that has the friability best suited for particular work materials. Those preceding A (aluminum oxide) are

57—a versatile abrasive suitable for grinding steel in either a hard or soft state.

38—the most friable abrasive.

32—the abrasive suited for tool steel grinding.

23—an abrasive with intermediate grinding action, and

19—the abrasive produced for less heat-sensitive steels.

Those preceding C (silicon carbide) are

37—a general application abrasive, and

39—an abrasive for grinding hard cemented carbide.

**Table 2a. Grinding Wheel Recommendations for Surface Grinding—
Using Straight Wheel Types 1, 5, and 7**

Material	Horizontal-spindle, reciprocating-table surface grinders		Horizontal-spindle, rotary-table surface grinders
	Wheels less than 16 inches diameter	Wheels 16 inches diameter and over	Wheels of any diameter
Cast iron	37C36-K8V or 23A46-I8VBE	23A36-I8VBE	37C36-K8V or 23A46-I8VBE
Nonferrous metal	37C36-K8V	37C36-K8V	37C36-K8V
Soft steel	23A46-J8VBE	23A36-J8VBE	23A46-J8VBE
Hardened steel, broad contact	32A46-H8VBE or 32A60-F12VBEP	32A36-H8VBE or 32A36-F12VBEP	32A46-I8VBE
Hardened steel, narrow contact or interrupted cut	32A46-I8VBE	32A36-J8VBE	32A46-J8VBE
General-purpose wheel	23A46-H8VBE	23A36-I8VBE	23A46-I8VBE
Cemented carbides	Diamond wheels ^a	Diamond wheels ^a	Diamond wheels ^a

^a General diamond wheel recommendations are listed in **Table 5** on page 1245.

Table 2b. Grinding Wheel Recommendations for Surface Grinding—Using Type 2 Cylinder Wheels, Type 6 Cup Wheels, and Wheel Segments

Material	Type 2 Cylinder Wheels	Type 6 Cup Wheels	Wheel Segments
High tensile cast iron and non-ferrous metals	37C24-HKV	37C24-HVK	37C24-HVK
Soft steel, malleable cast iron, steel castings, boiler plate	23A24-I8VBE or 23A30-G12VBEP	23A24-I8VBE	23A24-I8VSM or 23A30-H12VSM
Hardened steel—broad contact	32A46-G8VBE or 32A36-E12VBEP	32A46-G8VBE or 32A60-E12VBEP	32A36-G8VBE or 32A46-E12VBEP
Hardened steel—narrow contact or interrupt cut	32A46-H8VBE	32A60-H8VBE	32A46-G8VBE or 32A60-G12VBEP
General-purpose use	23A30-H8VBE or 23A30-E12VBEP	...	23A30-H8VSM or 23A30-G12VSM

Process Data for Surface Grinding.—In surface grinding, similarly to other metal-cutting processes, the speed and feed rates that are applied must be adjusted to the operational conditions as well as to the objectives of the process. Grinding differs, however, from other types of metal cutting methods in regard to the cutting speed of the tool; the peripheral speed of the grinding wheel is maintained within a narrow range, generally 5500 to 6500 surface feet per minute. Speed ranges different from the common one are used in particular processes which require special wheels and equipment.

Table 3. Basic Process Data for Peripheral Surface Grinding on Reciprocating Table Surface Grinders

Work Material	Hardness	Material Condition	Wheel Speed, fpm	Table Speed, fpm	Downfeed, in. per pass		Crossfeed per pass, fraction of wheel width
					Rough	Finish, max.	
Plain carbon steel	52 Rc max.	Annealed, cold drawn	5500-6500	50-100	0.003	0.0005	1/4
	52-65 Rc	Carburized and/or quenched and tempered	5500-6500	50-100	0.003	0.0005	1/10
Alloy steels	52 Rc max.	Annealed or quenched and tempered	5500-6500	50-100	0.003	0.001	1/4
	52-65 Rc	Carburized and/or quenched and tempered	5500-6500	50-100	0.003	0.0005	1/10
Tool steels	150-275 Bhn	Annealed	5500-6500	50-100	0.002	0.0005	1/5
	56-65 Rc	Quenched and tempered	5500-6500	50-100	0.002	0.0005	1/10
Nitriding steels	200-350 Bhn	Normalized, annealed	5500-6500	50-100	0.003	0.001	1/4
	60-65 Rc	Nitrided	5500-6500	50-100	0.003	0.0005	1/10
Cast steels	52 Rc max.	Normalized, annealed	5500-6500	50-100	0.003	0.001	1/4
	Over 52 Rc	Carburized and/or quenched and tempered	5500-6500	50-100	0.003	0.0005	1/10
Gray irons	52 Rc max.	As cast, annealed, and/or quenched and tempered	5000-6500	50-100	0.003	0.001	1/3
Ductile irons	52 Rc max.	As cast, annealed or quenched and tempered	5500-6500	50-100	0.003	0.001	1/5
Stainless steels, martensitic	135-235 Bhn	Annealed or cold drawn	5500-6500	50-100	0.002	0.0005	1/4
	Over 275 Bhn	Quenched and tempered	5500-6500	50-100	0.001	0.0005	1/8
Aluminum alloys	30-150 Bhn	As cast, cold drawn or treated	5500-6500	50-100	0.003	0.001	1/5

In establishing the proper process values for grinding, of prime consideration are the work material, its condition, and the type of operation (roughing or finishing). **Table 3** gives basic process data for peripheral surface grinding on reciprocating table surface

grinders. For different work materials and hardness ranges data are given regarding table speeds, downfeed (infeed) rates and cross feed, the latter as a function of the wheel width.

Common Faults and Possible Causes in Surface Grinding.—Approaching the ideal performance with regard to both the quality of the ground surface and the efficiency of surface grinding, requires the monitoring of the process and the correction of conditions adverse to the attainment of that goal.

Defective, or just not entirely satisfactory surface grinding may have any one or more of several causes. Exploring and determining the cause for eliminating its harmful effects is facilitated by knowing the possible sources of the experienced undesirable performance. **Table 4**, associating the common faults with their possible causes, is intended to aid in determining the actual cause, the correction of which should restore the desired performance level.

While the table lists the more common faults in surface grinding, and points out their frequent causes, other types of improper performance and/or other causes, in addition to those indicated, are not excluded.

Vitrified Grinding Wheels.—The term “vitrified” denotes the type of bond used in these grinding wheels. The bond in a grinding wheel is the material which holds the abrasive grains together and supports them while they cut. With a given type of bond, it is the *amount* of bond that determines the “hardness” or softness” of wheels. The abrasive itself is extremely hard in all wheels, and the terms “hard” and “soft” refer to the *strength of bonding*; the greater the percentage of bond with respect to the abrasive, the heavier the coating of bond around the abrasive grains and the stronger the bond posts, the “harder” the wheel.

Most wheels are made with a vitrified bond composed of clays and feldspar selected for their fusibility. During the “burning” process in grinding wheel manufacture, the clays are fused into a molten glass condition. Upon cooling, a span or post of this glass connects each abrasive grain to its neighbors to make a rigid, strong, grinding wheel. These wheels are porous, free cutting and unaffected by water, acids, oils, heat, or cold. Vitrified wheels are extensively used for cylindrical grinding, surface grinding, internal grinding and cutter grinding.

Silicate Bonding Process.—Silicate grinding wheels derive their name from the fact that silicate of soda or water glass is the principal ingredient used in the bond. These wheels are also sometimes referred to as *semi-vitrified* wheels. Ordinarily, they cut smoothly and with comparatively little heat, and for grinding operations requiring the lowest wheel wear, compatible with cool cutting, silicate wheels are often used. Their grade is also dependable and much larger wheels can be made by this bonding process than by the vitrified process. Some of the grinding operations for which silicate wheels have been found to be especially adapted are as follows: for grinding high-speed steel machine shop tools, such as reamers, milling cutters, etc.; for hand-grinding lathe and planer tools; for surface grinding with machines of the vertical ring-wheel type; and for operations requiring dish-shaped wheels and cool cutting. These wheels are unequalled for wet grinding on hardened steel and for wet tool grinding. They are easily recognized by their light gray color.

Oilstones.—The natural oilstones commonly used are the *Washita* and *Arkansas*. The Washita is a coarser and more rapidly cutting stone, and is generally considered the most satisfactory for sharpening woodworkers’ tools. There are various grades of Washita rock, varying from the perfect crystallized and porous whetstone grit, to vitreous flint and hard sandstone. The best whetstones are porous and uniform in texture and are composed entirely of silica crystals. The poorer grades are less porous, making them vitreous or “glassy.” They may also have hard spots or sand holes, or contain grains of sand among the crystals. For general work, a soft, free-grit, quick-cutting stone is required, although a fine-grit medium-hard stone is sometimes preferable. These are commonly furnished in three grits: fine, medium, and coarse, and in all required shapes.

Table 4. Common Faults and Possible Causes in Surface Grinding

CAUSES	FAULTS	WORK DIMENSION			METALLURGICAL DEFECTS		SURFACE QUALITY				WHEEL CONDITION			WORK RETAINMENT	
		Work not flat	Work not parallel	Poor size holding	Burnishing of work	Burning or checking	Feed lines	Chatter marks	Scratches on surface	Poor finish	Wheel loading	Wheel glazing	Rapid wheel wear	Not firmly seated	Work sliding on chuck
WORK CONDITION	Heat treat stresses	●
	Work too thin	●	●
	Work warped	●	●	..
	Abrupt section changes	●	●
GRINDING WHEEL	Grit too fine	●	●	●	●
	Grit too coarse	●
	Grade too hard	●	●	●	..	●	●	●
	Grade too soft	●	●	●	●
	Wheel not balanced	●
	Dense structure	●	●
TOOLING AND COOLANT	Improper coolant	●
	Insufficient coolant	●	●	..	●	●	●
	Dirty coolant	●
	Diamond loose or chipped	●	●	●
	Diamond dull	●	●	●
	No or poor magnetic force	●	●	●
	Chuck surface worn or burred	●	●	●	..
MACHINE AND SETUP	Chuck not aligned	●	●
	Vibrations in machine	●
	Plane of movement out of parallel	●	●
OPERATIONAL CONDITIONS	Too low work speed	●
	Too light feed	●
	Too heavy cut	●	●
	Chuck retained swarf	●	●	●
	Chuck loading improper	●	●	●
	Insufficient blocking of parts
	Wheel runs off the work	..	●	●	●
	Wheel dressing too fine	●
	Wheel edge not chamfered	●
	Loose dirt under guard

SURFACE GRINDING

Offhand Grinding

Offhand grinding consists of holding the wheel to the work or the work to the wheel and grinding to broad tolerances and includes such operations as certain types of tool sharpening, weld grinding, snagging castings and other rough grinding. Types of machines that are used for rough grinding in foundries are floor- and bench-stand machines. Wheels for these machines vary from 6 to 30 inches in diameter. Portable grinding machines (electric, flexible shaft, or air-driven) are used for cleaning and smoothing castings.

Many rough grinding operations on castings can be best done with shaped wheels, such as cup wheels (including plate mounted) or cone wheels, and it is advisable to have a good assortment of such wheels on hand to do the odd jobs the best way.

Floor- and Bench-Stand Grinding.—The most common method of rough grinding is on double-end floor and bench stands. In machine shops, welding shops, and automotive repair shops, these grinders are usually provided with a fairly coarse grit wheel on one end for miscellaneous rough grinding and a finer grit wheel on the other end for sharpening tools. The pressure exerted is a very important factor in selecting the proper grinding wheel. If grinding is to be done mostly on hard sharp fins, then durable, coarse and hard wheels are required, but if grinding is mostly on large gate and riser pads, then finer and softer wheels should be used for best cutting action.

Portable Grinding.—Portable grinding machines are usually classified as air grinders, flexible shaft grinders, and electric grinders. The electric grinders are of two types; namely, those driven by standard 60 cycle current and so-called high-cycle grinders. Portable grinders are used for grinding down and smoothing weld seams; cleaning metal before welding; grinding out imperfections, fins and parting lines in castings and smoothing castings; grinding punch press dies and patterns to proper size and shape; and grinding manganese steel castings.

Wheels used on portable grinders are of three bond types; namely, resinoid, rubber, and vitrified. By far the largest percentage is resinoid. Rubber bond is used for relatively thin wheels and where a good finish is required. Some of the smaller wheels such as cone and plug wheels are vitrified bonded.

Grit sizes most generally used in wheels from 4 to 8 inches (102-203 mm) in diameter are 16, 20, and 24. In the still smaller diameters, finer sizes are used, such as 30, 36, and 46.

The particular grit size to use depends chiefly on the kind of grinding to be done. If the work consists of sharp fins and the machine has ample power, a coarse grain size combined with a fairly hard grade should be used. If the job is more in the nature of smoothing or surfacing and a fairly good finish is required, then finer and softer wheels are called for.

Swing-Frame Grinding.—This type of grinding is employed where a considerable amount of material is to be removed as on snagging large castings. It may be possible to remove 10 times as much material from steel castings using swing-frame grinders as with portable grinders; and 3 times as much material as with high-speed floor-stand grinders.

The largest field of application for swing-frame machines is on castings which are too heavy to handle on a floor stand; but often it is found that comparatively large gates and risers on smaller castings can be ground more quickly with swing-frame grinders, even if fins and parting lines have to be ground on floor stands as a second operation.

In foundries, the swing-frame machines are usually suspended from a trolley on a jib that can be swung out of the way when placing the work on the floor with the help of an overhead crane. In steel mills when grinding billets, a number of swing-frame machines are usually suspended from trolleys on a line of beams which facilitate their use as required.

The grinding wheels used on swing-frame machines are made with coarser grit sizes and harder grades than wheels used on floor stands for the same work. The reason is that greater grinding pressures can be obtained on the swing-frame machines.

Abrasive Belt Grinding

Abrasive belts are used in the metalworking industry for removing stock, light cleaning up of metal surfaces, grinding welds, deburring, breaking and polishing hole edges, and finish grinding of sheet steel. The types of belts that are used may be coated with aluminum oxide (the most common coating) for stock removal and finishing of all alloy steels, high-carbon steel, and tough bronzes; and silicon carbide for use on hard, brittle, and low-tensile strength metals which would include aluminum and cast irons.

Table 1 is a guide to the selection of the proper abrasive belt, lubricant, and contact wheel. This table is entered on the basis of the material used and type of operation to be done and gives the abrasive belt specifications (type of bonding and abrasive grain size and material), the range of speeds at which the belt may best be operated, the type of lubricant to use, and the type and hardness of the contact wheel to use. **Table 2** serves as a guide in the selection of contact wheels. This table is entered on the basis of the type of contact wheel surface and the contact wheel material. The table gives the hardness and/or density, the type of abrasive belt grinding for which the contact wheel is intended, the character of the wheel action and such comments as the uses, and hints for best use. Both tables are intended only as guides for general shop practice; selections may be altered to suit individual requirements.

There are three types of abrasive belt grinding machines. One type employs a contact wheel behind the belt at the point of contact of the workpiece to the belt and facilitates a high rate of stock removal. Another type uses an accurate parallel ground platen over which the abrasive belt passes and facilitates the finishing of precision parts. A third type which has no platens or contact wheel is used for finishing parts having uneven surfaces or contours. In this type there is no support behind the belt at the point of contact of the belt with the workpiece. Some machines are so constructed that besides grinding against a platen or a contact wheel the workpiece may be moved and ground against an unsupported portion of the belt, thereby in effect making it a dual machine.

Although abrasive belts at the time of their introduction were used dry, since the advent of the improved waterproof abrasive belts, they have been used with coolants, oil-mists, and greases to aid the cutting action. The application of a coolant to the area of contact retards loading, resulting in a cool, free cutting action, a good finish and a long belt life.

Abrasive Cutting

Abrasive cut-off wheels are used for cutting steel, brass and aluminum bars and tubes of all shapes and hardnesses, ceramics, plastics, insulating materials, glass and cemented carbides. Originally a tool or stock room procedure, this method has developed into a high-speed production operation. While the abrasive cut-off machine and cut-off wheel can be said to have revolutionized the practice of cutting-off materials, the metal saw continues to be the more economical method for cutting-off large cross-sections of certain materials. However, there are innumerable materials and shapes that can be cut with much greater speed and economy by the abrasive wheel method. On conventional chop-stroke abrasive cutting machines using 16-inch (406.4 mm) diameter wheels, 2-inch (50.8 mm) diameter bar stock is the maximum size that can be cut with satisfactory wheel efficiency, but bar stock up to 6 inches (152.4 mm) in diameter can be cut efficiently on oscillating-stroke machines. Tubing up to 3½ inches (88.9 mm) in diameter can also be cut efficiently.

Abrasive wheels are commonly available in four types of bonds: Resinoid, rubber, shellac and fiber or fabric reinforced. In general, resinoid bonded cut-off wheels are used for dry cutting where burrs and some burn are not objectionable and rubber bonded wheels are used for wet cutting where cuts are to be smooth, clean and free from burrs. Shellac bonded wheels have a soft, free cutting quality which makes them particularly useful in the tool room where tool steels are to be cut without discoloration. Fiber reinforced bonded wheels are able to withstand severe flexing and side pressures and fabric reinforced bonded

Table 1. Guide to the Selection and Application of Abrasive Belts

Material	Type of Operation	Abrasive Belt ^a	Grit	Belt Speed		Type of Grease Lubricant	Contact Wheel	
				fpm	m/min		Type	Durometer Hardness
Hot-and Cold-Rolled Steel	Roughing	R/R Al ₂ O ₃	24–60	4000–6500	1219–1981	Light-body or none	Cog-tooth, serrated rubber	70–90
	Polishing	R/G or R/R Al ₂ O ₃	80–150	4500–7000	1372–2134	Light-body or none	Plain or serrated rubber, sectional or finger-type cloth wheel, free belt	20–60
	Fine Polishing	R/G or electro-coated Al ₂ O ₃ cloth	180–500	4500–7000	1372–2134	Heavy or with abrasive compound	Smooth-faced rubber or cloth	20–40
Stainless Steel	Roughing	R/R Al ₂ O ₃	50–80	3500–5000	1067–1524	Light-body or none	Cog-tooth, serrated rubber	70–90
	Polishing	R/G or R/R Al ₂ O ₃	80–120	4000–5500	1219–1676	Light-body or none	Plain or serrated rubber, sectional or finger-type cloth wheel, free belt	30–60
	Fine Polishing	Closed-coat SiC	150–280	4500–5500	1372–1676	Heavy or oil mist	Smooth-faced rubber or cloth	20–40
Aluminum, Cast or Fabricated	Roughing	R/R SiC or Al ₂ O ₃	24–80	5000–6500	1524–1981	Light	Cog-tooth, serrated rubber	70–90
	Polishing	R/G SiC or Al ₂ O ₃	100–180	4500–6500	1372–1981	Light	Plain or serrated rubber, sectional or finger-type cloth wheel, free belt	30–50
	Fine Polishing	Closed-coat SiC or electro-coated Al ₂ O ₃	220–320	4500–6500	1372–1981	Heavy or with abrasive compound	Plain faced rubber, finger-type cloth or free belt	20–50
Copper Alloys or Brass	Roughing	R/R SiC or Al ₂ O ₃	36–80	2200–4500	671–1372	Light-body	Cog-tooth, serrated rubber	70–90
	Polishing	Closed-coat SiC or electro-coated Al ₂ O ₃ or R/G SiC or Al ₂ O ₃	100–150	4000–6500	1219–1981	Light-body	Plain or serrated rubber, sectional or finger-type cloth wheel, free belt	30–50
	Fine Polishing	Closed-coat SiC or electro-coated Al ₂ O ₃	180–320	4000–6500	1219–1981	Light or with abrasive compound	Same as for polishing	20–30
Non-ferrous Die-castings	Roughing	R/R SiC or Al ₂ O ₃	24–80	4500–6500	1372–1981	Light-body	Hard wheel depending on application	50–70
	Polishing	R/G SiC or Al ₂ O ₃	100–180	4500–6500	1372–1981	Light-body	Plain rubber, cloth or free belt	30–50
	Fine Polishing	Electro-coated Al ₂ O ₃ or closed-coat SiC	220–320	4500–6500	1372–1981	Heavy or with abrasive compound	Plain or finger-type cloth wheel, or free belt	20–30
Cast Iron	Roughing	R/R Al ₂ O ₃	24–60	2000–4000	610–1219	None	Cog-tooth, serrated rubber	70–90
	Polishing	R/R Al ₂ O ₃	80–150	4000–5500	1219–1676	None	Serrated rubber	30–70
	Fine Polishing	R/R Al ₂ O ₃	120–240	4000–5500	1219–1676	Light-body	Smooth-faced rubber	30–40
Titanium	Roughing	R/R SiC or Al ₂ O ₃	36–50	700–1500	213–457	Sulfur-chlorinated	Small-diameter, cog-tooth serrated rubber	70–80
	Polishing	R/R SiC	60–120	1200–2000	366–610	Light-body	Standard serrated rubber	50
	Fine Polishing	R/R SiC	120–240	1200–2000	366–610	Light-body	Smooth-faced rubber or cloth	20–40

^aR/R indicates that both the making and sizing bond coats are resin. R/G indicates that the making coat is glue and the sizing coat is resin. The abbreviations Al₂O₃ for aluminum oxide and SiC for silicon carbide are used. Almost all R/R and R/G Al₂O₃ and SiC belts have a heavy-drill weight cloth backing. Most electro-coated Al₂O₃ and closed-coat SiC belts have a jeans weight cloth backing.

Table 2. Guide to the Selection and Application of Contact Wheels

Surface	Material	Hardness and Density	Purposes	Wheel Action	Comments
Cog-tooth	Rubber	70 to 90 durometer	Roughing	Fast cutting, allows long belt life.	For cutting down projections on castings and weld beads.
Standard serrated	Rubber	40 to 50 durometer, medium density	Roughing	Leaves rough- to medium-ground surface.	For smoothing projections and face defects.
X-shaped serrations	Rubber	20 to 50 durometer	Roughing and polishing	Flexibility of rubber allows entry into contours. Medium polishing, light removal.	Same as for standard serrated wheels but preferred for soft non-ferrous metals.
Plain face	Rubber	20 to 70 durometer	Roughing and polishing	Plain wheel face allows controlled penetration of abrasive grain. Softer wheels give better finishes.	For large or small flat faces.
Flat flexible	Compressed canvas	About nine densities from very hard to very soft	Roughing and polishing	Hard wheels can remove metal, but not as quickly as cog-tooth rubber wheels. Softer wheels polish well.	Good for medium-range grinding and polishing.
Flat flexible	Solid sectional canvas	Soft, medium, and hard	Polishing	Uniform polishing. Avoids abrasive pattern on work. Adjusts to contours. Can be performed for contours.	A low-cost wheel with uniform density at the face. Handles all types of polishing.
Flat flexible	Buff section canvas	Soft	Contour polishing	For fine polishing and finishing.	Can be widened or narrowed by adding or removing sections. Low cost.
Flat flexible	Sponge rubber inserts	5 to 10 durometer, soft	Polishing	Uniform polishing and finishing. Polishes and blends contours.	Has replaceable segments. Polishes and blends contours. Segments allow density changes.
Flexible	Fingers of canvas attached to hub	Soft	Polishing	Uniform polishing and finishing.	For polishing and finishing.
Flat flexible	Rubber segments	Varies in hardness	Roughing and polishing	Grinds or polishes depending on density and hardness of inserts.	For portable machines. Uses replaceable segments that save on wheel costs and allow density changes.
Flat flexible	Inflated rubber	Air pressure controls hardness	Roughing and polishing	Uniform finishing.	Adjusts to contours.

wheels which are highly resistant to breakage caused by extreme side pressures, are fast cutting and have a low rate of wear.

The types of abrasives available in cut-off wheels are: Aluminum oxide, for cutting steel and most other metals; silicon carbide, for cutting non-metallic materials such as carbon, tile, slate, ceramics, etc.; and diamond, for cutting cemented carbides. The method of denoting abrasive type, grain size, grade, structure and bond type by using a system of markings is the same as for grinding wheels (see page 1218). Maximum wheel speeds given in the ANSI Standard “Safety Requirements for The Use, Care, and Protection of Abrasive Wheels” (ANSI B7.1-1988) range from 9500 to 14,200 sfpm (2896-4328 m/min) for organic bonded cut-off wheels larger than 16 inches (40.6 cm) in diameter and from 9500 to 16,000 sfpm (2896-4877 m/min) for organic bonded cut-off wheels 16 inches in diameter and smaller. Maximum wheel speeds specified by the manufacturer should never be exceeded even though they may be lower than those given in the B7.1 Standard.

There are four basic types of abrasive cutting machines: Chop-stroke, oscillating stroke, horizontal stroke and work rotating. Each of these four types may be designed for dry cutting or for wet cutting (includes submerged cutting).

The accompanying table based upon information made available by The Carborundum Co. gives some of the probable causes of cutting off difficulties that might be experienced when using abrasive cut-off wheels.

Probable Causes of Cutting-Off Difficulties

Difficulty	Probable Cause
Angular Cuts and Wheel Breakage	(1) Inadequate clamping which allows movement of work while the wheel is in the cut. The work should be clamped on both sides of the cut. (2) Work vise higher on one side than the other causing wheel to be pinched. (3) Wheel vibration resulting from worn spindle bearings. (4) Too fast feeding into the cut when cutting wet.
Burning of Stock	(1) Insufficient power or drive allowing wheel to stall. (2) Cuts too heavy for grade of wheel being used. (3) Wheel fed through the work too slowly. This causes a heating up of the material being cut. This difficulty encountered chiefly in dry cutting.
Excessive Wheel Wear	(1) Too rapid cutting when cutting wet. (2) Grade of wheel too hard for work, resulting in excessive heating and burning out of bond. (3) Inadequate coolant supply in wet cutting. (4) Grade of wheel too soft for work. (5) Worn spindle bearings allowing wheel vibration.
Excessive Burring	(1) Feeding too slowly when cutting dry. (2) Grit size in wheel too coarse. (3) Grade of wheel too hard. (4) Wheel too thick for job.

Honing Process

The hone-abrading process for obtaining cylindrical forms with precise dimensions and surfaces can be applied to internal cylindrical surfaces with a wide range of diameters such as engine cylinders, bearing bores, pin holes, etc. and also to some external cylindrical surfaces.

The process is used to: 1) eliminate inaccuracies resulting from previous operations by generating a true cylindrical form with respect to roundness and straightness within minimum dimensional limits; 2) generate final dimensional size accuracy within low tolerances, as may be required for interchangeability of parts; 3) provide rapid and economical stock removal consistent with accomplishment of the other results; and 4) generate surface finishes of a specified degree of surface smoothness with high surface quality.

Amount and Rate of Stock Removal.—Honing may be employed to increase bore diameters by as much as 0.100 inch (2.5 mm) or as little as 0.001 inch (0.25 mm). The amount of stock removed by the honing process is entirely a question of processing economy. If other operations are performed before honing then the bulk of the stock should be taken off by the operation that can do it most economically. In large diameter bores that have been distorted in heat treating, it may be necessary to remove as much as 0.030 to 0.040 inch (0.76-1.02 mm) from the diameter to make the bore round and straight. For out-of-round or tapered bores, a good “rule of thumb” is to leave twice as much stock (on the diameter) for honing as there is error in the bore. Another general rule is: For bores over one inch (25.4 mm) in diameter, leave 0.001 to 0.0015 inch stock per inch of diameter (0.025-0.038 mm stock/mm). For example, 0.002 to 0.003 inch (0.05-0.08 mm) of stock is left in two-inch bores (50.8 mm) and 0.010 to 0.015 inch (0.25-0.38 mm) in ten-inch (254 mm) bores. Where parts are to be honed for finish only, the amount of metal to be left for removing tool marks may be as little as 0.0002 to 0.015 inch (0.005-0.38 mm) on the diameter.

In general, the honing process can be employed to remove stock from bore diameters at the rate of 0.009 to 0.012 inch per minute (0.23-0.30 mm/min) on cast-iron parts and from 0.005 to 0.008 inch per minute (0.13-0.20 mm/min) on steel parts having a hardness of 60 to 65 Rockwell C. These rates are based on parts having a length equal to three or four times the diameter. Stock has been removed from long parts such as gun barrels, at the rate of 65 cubic inches per hour (17.75 cc/s). Recommended honing speeds for cast iron range from 110 to 200 surface feet per minute (34-61 m/min) of rotation and from 50 to 110 lineal feet per minute (15-34 m/min) of reciprocation. For steel, rotating surface speeds range from 50 to 110 feet per minute (15-34 m/min) and reciprocation speeds from 20 to 90 lineal feet per minute (6-27 m/min). The exact rotation and reciprocation speeds to be used depend

upon the size of the work, the amount and characteristics of the material to be removed and the quality of the finish desired. In general, the harder the material to be honed, the lower the speed. Interrupted bores are usually honed at faster speeds than plain bores.

Formulas for Rotative Speeds.—Empirical formulas for determining rotative speeds for honing have been developed by the Micromatic Hone Corp. These formulas take into consideration the type of material being honed, its hardness and its surface characteristics; the abrasive area; and the type of surface pattern and degree of surface roughness desired. Because of the wide variations in material characteristics, abrasives available, and types of finishes specified, these formulas should be considered as a guide only in determining which of the available speeds (pulley or gear combinations) should be used for any particular application.

The formula for rotative speed, S , in surface feet per minute is:
$$S = \frac{K \times D}{W \times N}$$

The formula for rotative speed in revolutions per minute is:
$$R.P.M = \frac{R}{W \times N}$$

where, K and R are factors taken from the table on the following page, D is the diameter of the bore in inches, W is the width of the abrasive stone or stock in inches, and N is the number of stones.

Although the actual speed of the abrasive is the resultant of both the rotative speed and the reciprocation speed, this latter quantity is seldom solved for or used. The reciprocation speed is not determined empirically but by testing under operating conditions. Changing the reciprocation speed affects the dressing action of the abrasive stones, therefore, the reciprocation speed is adjusted to provide for a desired surface finish which is usually a well lubricated bearing surface that will not scuff.

Table of Factors for Use in Rotative Speed Formulas

Character of Surface ^a	Material	Hardness ^b					
		Soft		Medium		Hard	
		Factors					
		K	R	K	R	K	R
Base Metal	Cast Iron	110	420	80	300	60	230
	Steel	80	300	60	230	50	190
Dressing Surface	Cast Iron	150	570	110	420	80	300
	Steel	110	420	80	300	60	230
Severe Dressing	Cast Iron	200	760	150	570	110	420
	Steel	150	570	110	420	80	300

^a The character of the surface is classified according to its effect on the abrasive; *Base Metal* being a honed, ground or fine bored section that has little dressing action on the grit; *Dressing Surface* being a rough bored, reamed or broached surface or any surface broken by cross holes or ports; *Severe Dressing* being a surface interrupted by keyways, undercuts or burrs that dress the stones severely. If over half of the stock is to be removed after the surface is cleaned up, the speed should be computed using the *Base Metal* factors for K and R .

^b Hardness designations of soft, medium and hard cover the following ranges on the Rockwell “C” hardness scale, respectively: 15 to 45, 45 to 60 and 60 to 70.

Possible Adjustments for Eliminating Undesirable Honing Conditions

Undesirable Condition	Adjustment Required to Correct Condition ^a								
	Abrasive ^b				Other				
	Friability	Grain Size	Hardness	Structure	Feed Pressure	Reciprocation	R.P.M.	Runout Time	Stroke Length
Abrasive Glazing	+	--	--	+	++	++	--	-	0
Abrasive Loading	0	--	-	-	++	+	--	0	0
Too Rough Surface Finish	0	++	++	-	-	-	++	+	0
Too Smooth Surface Finish	0	--	--	+	+	+	--	-	0
Poor Stone Life	-	+	++	-	-	-	+	0	0
Slow Stock Removal	+	--	-	+	++	++	--	0	0
Taper — Large at Ends	0	0	0	0	0	0	0	0	-
Taper — Small at Ends	0	0	0	0	0	0	0	0	+

^a The + and ++ symbols generally indicate that there should be an increase or addition while the - and -- symbols indicate that there should be a reduction or elimination. In each case, the double symbol indicates that the contemplated change would have the greatest effect. The 0 symbol means that a change would have no effect.

^b For the abrasive adjustments the + and ++ symbols indicate a more friable grain, a finer grain, a harder grade or a more open structure and the - and -- symbols just the reverse.

Compiled by Micromatic Hone Corp.

Abrasive Stones for Honing.—Honing stones consist of aluminum oxide, silicon carbide, CBN or diamond abrasive grits, held together in stick form by a vitrified clay, resinoid or metal bond. CBN metal-bond stones are particularly suitable and widely used for honing. The grain and grade of abrasive to be used in any particular honing operation depend upon the quality of finish desired, the amount of stock to be removed, the material being honed and other factors.

The following general rules may be followed in the application of abrasive for honing: 1) Silicon-carbide abrasive is commonly used for honing cast iron, while aluminum-oxide abrasive is generally used on steel; 2) The harder the material being honed, the softer the abrasive stick used; 3) A rapid reciprocating speed will tend to make the abrasive cut fast because the dressing action on the grits will be severe; and 4) To improve the finish, use a finer abrasive grit, incorporate more multi-direction action, allow more “run-out” time after honing to size, or increase the speed of rotation.

Surface roughnesses ranging from less than 1 micro-inch rms (0.0254 μm rms) to a relatively coarse roughness can be obtained by judicious choice of abrasive and honing time but the most common range is from 3 to 50 micro-inches rms (0.0762–1.27 μm rms).

Adjustments for Eliminating Undesirable Honing Conditions.—The accompanying table indicates adjustments that may be made to correct certain undesirable conditions encountered in honing. Only one change should be made at a time and its effect noted before making other adjustments.

Tolerances.—For bore diameters above 4 inches (101.6 mm) the tolerance of honed surfaces with respect to roundness and straightness ranges from 0.0005 to 0.001 inch (0.0127–0.0254 mm); for bore diameters from 1 to 4 inches (25.4–101.6 mm), 0.0003 to 0.0005 inch (0.0076–0.0127 mm); and for bore diameters below 1 inch (25.4 mm), 0.00005 to 0.0003 inch (0.0013–0.0076 mm).

Laps and Lapping

Material for Laps.—Laps are usually made of soft cast iron, copper, brass or lead. In general, the best material for laps to be used on very accurate work is soft, close-grained cast iron. If the grinding, prior to lapping, is of inferior quality, or an excessive allowance has been left for lapping, copper laps may be preferable. They can be charged more easily and

cut more rapidly than cast iron, but do not produce as good a finish. Whatever material is used, the lap should be softer than the work, as, otherwise, the latter will become charged with the abrasive and cut the lap, the order of the operation being reversed. A common and inexpensive form of lap for holes is made of lead which is cast around a tapering steel arbor. The arbor usually has a groove or keyway extending lengthwise, into which the lead flows, thus forming a key that prevents the lap from turning. When the lap has worn slightly smaller than the hole and ceases to cut, the lead is expanded or stretched a little by the driving in of the arbor. When this expanding operation has been repeated two or three times, the lap usually must be trued or replaced with a new one, owing to distortion.

The tendency of lead laps to lose their form is an objectionable feature. They are, however, easily molded, inexpensive, and quickly charged with the cutting abrasive. A more elaborate form for holes is composed of a steel arbor and a split cast-iron or copper shell which is sometimes prevented from turning by a small dowel pin. The lap is split so that it can be expanded to accurately fit the hole being operated upon. For hardened work, some toolmakers prefer copper to either cast iron or lead. For holes varying from $\frac{1}{4}$ to $\frac{1}{2}$ inch (6.35–12.7 mm) in diameter, copper or brass is sometimes used; cast iron is used for holes larger than $\frac{1}{2}$ inch (12.7 mm) in diameter. The arbors for these laps should have a taper of about $\frac{1}{4}$ or $\frac{3}{8}$ inch per foot (20.83 or 31.25 mm/m). The length of the lap should be somewhat greater than the length of the hole, and the thickness of the shell or lap proper should be from $\frac{1}{8}$ to $\frac{1}{6}$ its diameter.

External laps are commonly made in the form of a ring, there being an outer ring or holder and an inner shell which forms the lap proper. This inner shell is made of cast iron, copper, brass or lead. Ordinarily the lap is split and screws are provided in the holder for adjustment. The length of an external lap should at least equal the diameter of the work, and might well be longer. Large ring laps usually have a handle for moving them across the work.

Laps for Flat Surfaces.—Laps for producing plane surfaces are made of cast iron. In order to secure accurate results, the lapping surface must be a true plane. A flat lap that is used for roughing or “blocking down” will cut better if the surface is scored by narrow grooves. These are usually located about $\frac{1}{2}$ inch (12.7 mm) apart and extend both lengthwise and crosswise, thus forming a series of squares similar to those on a checker-board. An abrasive of No. 100 or 120 emery and lard oil can be used for charging the roughing lap. For finer work, a lap having an unscored surface is used, and the lap is charged with a finer abrasive. After a lap is charged, all loose abrasive should be washed off with gasoline, for fine work, and when lapping, the surface should be kept moist, preferably with kerosene. Gasoline will cause the lap to cut a little faster, but it evaporates so rapidly that the lap soon becomes dry and the surface caked and glossy in spots. Loose emery should not be applied while lapping, for if the lap is well charged with abrasive in the beginning, is kept well moistened and not crowded too hard, it will cut for a considerable time. The pressure upon the work should be just enough to insure constant contact. The lap can be made to cut only so fast, and if excessive pressure is applied it will become “stripped” in places. The causes of scratches are: Loose abrasive on the lap; too much pressure on the work, and poorly graded abrasive. To produce a perfectly smooth surface free from scratches, the lap should be charged with a very fine abrasive.

Grading Abrasives for Lapping.—For high-grade lapping, abrasives can be evenly graded as follows: A quantity of flour-emery or other abrasive is placed in a heavy cloth bag, which is gently tapped, causing very fine particles to be sifted through. When a sufficient quantity has been obtained in this way, it is placed in a dish of lard or sperm oil. The largest particles will then sink to the bottom and in about one hour the oil should be poured into another dish, care being taken not to disturb the sediment at the bottom. The oil is then allowed to stand for several hours, after which it is poured again, and so on, until the desired grade is obtained.

Charging Laps.—To charge a flat cast-iron lap, spread a very thin coating of the prepared abrasive over the surface and press the small cutting particles into the lap with a hard steel block. There should be as little rubbing as possible. When the entire surface is apparently charged, clean and examine for bright spots; if any are visible, continue charging until the entire surface has a uniform gray appearance. When the lap is once charged, it should be used without applying more abrasive until it ceases to cut. If a lap is over-charged and an excessive amount of abrasive is used, there is a rolling action between the work and lap which results in inaccuracy. The surface of a flat lap is usually finished true, prior to charging, by scraping and testing with a standard surface-plate, or by the well-known method of scraping-in three plates together, in order to secure a plane surface. In any case, the bearing marks or spots should be uniform and close together. These spots can be blended by covering the plates evenly with a fine abrasive and rubbing them together. While the plates are being ground in, they should be carefully tested and any high spots which may form should be reduced by rubbing them down with a smaller block.

To charge cylindrical laps for internal work, spread a thin coating of prepared abrasive over the surface of a hard steel block, preferably by rubbing lightly with a cast-iron or copper block; then insert an arbor through the lap and roll the latter over the steel block, pressing it down firmly to embed the abrasive into the surface of the lap. For external cylindrical laps, the inner surface can be charged by rolling-in the abrasive with a hard steel roller that is somewhat smaller in diameter than the lap. The taper cast-iron blocks which are sometimes used for lapping taper holes can also be charged by rolling-in the abrasive, as previously described; there is usually one roughing and one finishing lap, and when charging the former, it may be necessary to vary the charge in accordance with any error which might exist in the taper.

Rotary Diamond Lap.—This style of lap is used for accurately finishing very small holes, which, because of their size, cannot be ground. While the operation is referred to as lapping, it is, in reality, a grinding process, the lap being used the same as a grinding wheel. Laps employed for this work are made of mild steel, soft material being desirable because it can be charged readily. Charging is usually done by rolling the lap between two hardened steel plates. The diamond dust and a little oil is placed on the lower plate, and as the lap revolves, the diamond is forced into its surface. After charging, the lap should be washed in benzine. The rolling plates should also be cleaned before charging with dust of a finer grade. It is very important not to force the lap when in use, especially if it is a small size. The lap should just make contact with the high spots and gradually grind them off. If a diamond lap is lubricated with kerosene, it will cut freer and faster. These small laps are run at very high speeds, the rate depending upon the lap diameter. Soft work should never be ground with diamond dust because the dust will leave the lap and charge the work.

When using a diamond lap, it should be remembered that such a lap will not produce sparks like a regular grinding wheel; hence, it is easy to crowd the lap and “strip” some of the diamond dust. To prevent this, a sound intensifier or “harker” should be used. This is placed against some stationary part of the grinder spindle, and indicates when the lap touches the work, the sound produced by the slightest contact being intensified.

Grading Diamond Dust.—The grades of diamond dust used for charging laps are designated by numbers, the fineness of the dust increasing as the numbers increase. The diamond, after being crushed to powder in a mortar, is thoroughly mixed with high-grade olive oil. This mixture is allowed to stand five minutes and then the oil is poured into another receptacle. The coarse sediment which is left is removed and labeled No. 0, according to one system. The oil poured from No. 0 is again stirred and allowed to stand ten minutes, after which it is poured into another receptacle and the sediment remaining is labeled No. 1. This operation is repeated until practically all of the dust has been recovered from the oil, the time that the oil is allowed to stand being increased as shown by the following table. This is done in order to obtain the smaller particles that require a longer time for precipitation:

To obtain No. 1 — 10 minutes	To obtain No. 4 — 2 hours
To obtain No. 2 — 30 minutes	To obtain No. 5 — 10 hours
To obtain No. 3 — 1 hour	To obtain No. 6 — until oil is clear

The No. 0 or coarse diamond which is obtained from the first settling is usually washed in benzine, and re-crushed unless very coarse dust is required. This No. 0 grade is sometimes known as "ungraded" dust. In some places the time for settling, in order to obtain the various numbers, is greater than that given in the table.

Cutting Properties of Laps and Abrasives.—In order to determine the cutting properties of abrasives when used with different lapping materials and lubricants, a series of tests was conducted, the results of which were given in a paper by W. A. Knight and A. A. Case, presented before the American Society of Mechanical Engineers. In connection with these tests, a special machine was used, the construction being such that quantitative results could be obtained with various combinations of abrasive, lubricant, and lap material. These tests were confined to surface lapping.

It was not the intention to test a large variety of abrasives, three being selected as representative; namely, Naxos emery, carborundum, and alundum. Abrasive No. 150 was used in each case, and seven different lubricants, five different pressures, and three different lap materials were employed. The lubricants were lard oil, machine oil, kerosene, gasoline, turpentine, alcohol, and soda water.

These tests indicated throughout that there is, for each different combination of lap and lubricant, a definite size of grain that will give the maximum amount of cutting. With all the tests, except when using the two heavier lubricants, some reduction in the size of the grain below that used in the tests (No. 150) seemed necessary before the maximum rate of cutting was reached. This reduction, however, was continuous and soon passed below that which gave the maximum cutting rate.

Cutting Qualities with Different Laps.—The surfaces of the steel and cast-iron laps were finished by grinding. The hardness of the different laps, as determined by the scleroscope was, for cast-iron, 28; steel, 18; copper, 5. The total amount ground from the test-pieces with each of the three laps showed that, taking the whole number of tests as a standard, there is scarcely any difference between the steel and cast iron, but that copper has somewhat better cutting qualities, although, when comparing the laps on the basis of the highest and lowest values obtained with each lap, steel and cast iron are as good for all practical purposes as copper, when the proper abrasive and lubricant are used.

Wear of Laps.—The wear of laps depends upon the material from which they are made and the abrasive used. The wear on all laps was about twice as fast with carborundum as with emery, while with alundum the wear was about one and one-fourth times that with emery. On an average, the wear of the copper lap was about three times that of the cast-iron lap. This is not absolute wear, but wear in proportion to the amount ground from the test-pieces.

Lapping Abrasives.—As to the qualities of the three abrasives tested, it was found that carborundum usually began at a lower rate than the other abrasives, but, when once started, its rate was better maintained. The performance gave a curve that was more nearly a straight line. The charge or residue as the grinding proceeded remained cleaner and sharper and did not tend to become pasty or mucklike, as is so frequently the case with emery. When using a copper lap, carborundum shows but little gain over the cast-iron and steel laps, whereas, with emery and alundum, the gain is considerable.

Effect of Different Lapping Lubricants.—The action of the different lubricants, when tested, was found to depend upon the kind of abrasive and the lap material.

Lard and Machine Oil. The test showed that lard oil, without exception, gave the higher rate of cutting, and that, in general, the initial rate of cutting is higher with the lighter lubri-

cants, but falls off more rapidly as the test continues. The lowest results were obtained with machine oil, when using an emery-charged, cast-iron lap. When using lard oil and a carborundum-charged steel lap, the highest results were obtained.

Gasoline and Kerosene: On the cast-iron lap, gasoline was superior to any of the lubricants tested. Considering all three abrasives, the relative value of gasoline, when applied to the different laps, is as follows: Cast iron, 127; copper, 115; steel, 106. Kerosene, like gasoline, gives the best results on cast iron and the poorest on steel. The values obtained by carborundum were invariably higher than those obtained with emery, except when using gasoline and kerosene on a copper lap.

Turpentine and Alcohol: Turpentine was found to do good work with carborundum on any lap. With emery, turpentine did fair work on the copper lap, but, with the emery on cast-iron and steel laps, it was distinctly inferior. Alcohol gives the lowest results with emery on the cast-iron and steel laps.

Soda Water: Soda water gives medium results with almost any combination of lap and abrasives, the best work being on the copper lap and the poorest on the steel lap. On the cast-iron lap, soda water is better than machine or lard oil, but not so good as gasoline or kerosene. Soda water when used with alundum on the copper lap, gave the highest results of any of the lubricants used with that particular combination.

Lapping Pressures.—Within the limits of the pressures used, that is, up to 25 pounds per square inch (172 kPa), the rate of cutting was found to be practically proportional to the pressure. The higher pressures of 20 and 25 pounds per square inch (138 and 172 kPa) are not so effective on the copper lap as on the other materials.

Wet and Dry Lapping.—With the “wet method” of using a surface lap, there is a surplus of oil and abrasive on the surface of the lap. As the specimen being lapped is moved over it, there is more or less movement or shifting of the abrasive particles. With the “dry method,” the lap is first charged by rubbing or rolling the abrasive into its surface. All surplus oil and abrasive are then washed off, leaving a clean surface, but one that has embedded uniformly over it small particles of the abrasive. It is then like the surface of a very fine oilstone and will cut away hardened steel that is rubbed over it. While this has been termed the dry method, in practice, the lap surface is kept moistened with kerosene or gasoline.

Experiments on dry lapping were carried out on the cast-iron, steel, and copper laps used in the previous tests, and also on one of tin made expressly for the purpose. Carborundum alone was used as the abrasive and a uniform pressure of 15 pounds per square inch (103 kPa) was applied to the specimen throughout the tests. In dry lapping, much depends upon the manner of charging the lap. The rate of cutting decreased much more rapidly after the first 100 revolutions than with the wet method. Considering the amounts ground off during the first 100 revolutions, and the best result obtained with each lap taken as the basis of comparison, it was found that with a tin lap, charged by rolling No. 150 carborundum into the surface, the rate of cutting, when dry, approached that obtained with the wet method. With the other lap materials, the rate with the dry method was about one-half that of the wet method.

Summary of Lapping Tests.—The initial rate of cutting does not greatly differ for different abrasives. There is no advantage in using an abrasive coarser than No. 150. The rate of cutting is practically proportional to the pressure. The wear of the laps is in the following proportions: cast iron, 1.00; steel, 1.27; copper, 2.62. In general, copper and steel cut faster than cast iron, but, where permanence of form is a consideration, cast iron is the superior metal. Gasoline and kerosene are the best lubricants to use with a cast-iron lap. Machine and lard oil are the best lubricants to use with copper or steel laps. They are, however, least effective on a cast-iron lap. In general, wet lapping is from 1.2 to 6 times as fast as dry lapping, depending upon the material of the lap and the manner of charging.

CNC NUMERICAL CONTROL PROGRAMMING

Introduction

Numerical control programming - better known as CNC programming - is an integral part of technology known as Numerical Control (NC), or its modern equivalent - Computerized Numerical Control (CNC). This technology can be defined as an operation of machine tools by means of specifically coded sequential instructions to be processed by the control system. These instructions are combinations of letters of the English alphabet "A-Z", all ten digits "0-9", and a few selected symbols, such as a decimal point ".", negative sign "-", parentheses "()", forward slash "/", and several others. The main purpose of a CNC program is to provide detailed instructions necessary to machine a part (also called a workpiece) for a given machine setup - with minimal human interaction. All instructions to the control system must be written in a logical order and in a specified format called the program structure. The resulting CNC Program or a Part Program can be stored on various media for the future and used repeatedly to achieve identical machining results at any time.

A completed part program is processed by the CNC unit - commonly called the control system - and individual program instructions are carried out to complete desired actions of the CNC machine. These actions include all required machine activities, such as motion control, spindle speed, cutting feed rates, coolant functions, program flow control, various adjustments, etc. In order to develop a CNC program, a qualified person - typically called a CNC Programmer - is assigned to the task.

As a key person in the production environment, the CNC programmer has the responsibility for developing safe, efficient, and error free programs for CNC machines installed in the machine shop. Many CNC programmers have machining skills and hands-on experience as machine operators working on manual or CNC machines. Typical skills of a CNC programmer include the ability to interpret drawings, mathematical aptitude, knowledge of setup and tooling, and the very important understanding of "*how to machine a part*". The programmer has to be able to visualize all tool motions and recognize any restricting factors that may be involved. The programmer collects, analyzes, processes, and logically integrates all data into a single, production ready, part program. Equally important skills include knowledge of mathematics, particularly the ability to solve equations and trigonometry. The knowledge of manual programming is absolutely essential even in the age of computers and computer based programming software. Another important quality of a professional CNC programmer is his or her ability to listen to and work with other people such as engineers, operators, customers, and managers.

CNC Coordinate Geometry

A basic step in understanding CNC principles is to understand the geometry of machine tools. This term covers the relationship between the machine data, part data, and tool data, which includes setup.

As with all CAD/CAM systems, CNC is based on the same principles of a system of coordinates that define the location of a point in three dimensional space (3-D). A system of coordinates is founded on the concept of two perpendicular lines (named axes "X" and "Y"), intersecting at a point called *origin*, where both coordinates have a value of zero (X0, Y0). Both lines are divided into equal units of measurement.

A point can be defined in a plane (any two axes = 2D) or in space (three axes = 3D). For CNC work, the *rectangular coordinate system* - also known as the *Cartesian coordinate system* - is the most commonly used system. It is based on three standard axes: X, Y, Z. *Points* are defined as locations with a distance from the origin defined by projecting a line at 90 degrees to each axis, forming a visual rectangle. For example, in Fig. 2, P1 is defined as X3.0, Y2.0, P2 is defined as X-4.0, Y1.0, P3 as X-2.0, Y-3.0, and P4 as X2.0, Y-2.0.

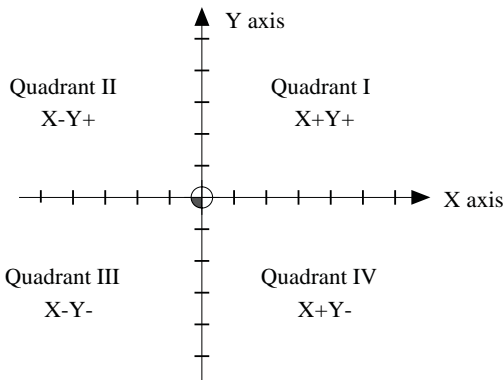


Fig. 1. Rectangular Coordinate System.

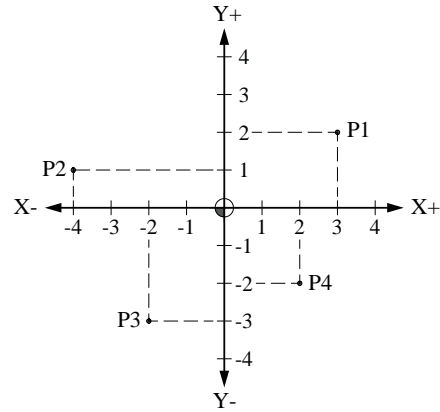


Fig. 2. Absolute Coordinates.

Once the point locations are established, the programmer can use them as points representing the center of individual holes to be machined or as endpoints for a continuous contour. The points can also be connected by providing specific motion instructions, as a toolpath between given points. Fig. 3 shows a linear motion from P1 to P2 to P3 to P4 and back to P1.

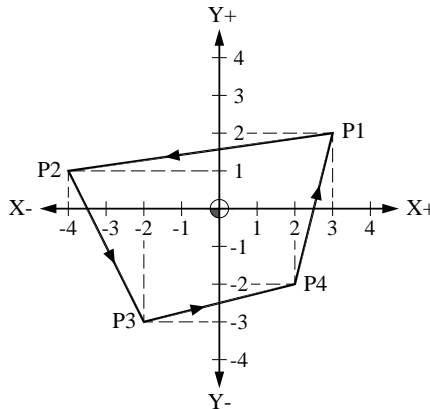


Fig. 3. Incremental Motions.

CNC Programming Process

CNC program (also called *part program*) development starts with an engineering drawing and material stock. Initial decisions include tasks to be done and goals to be achieved. The part program has to provide a safe and efficient method of machining a part, it should have a consistent structure (method of data entry), and be as portable as possible. Program portability allows the same program to run on machines that have similar characteristics. Typical logical process of program development can be summarized in a short, general list shown below. In actual use, specific steps will vary:

Program Development List

- a) Evaluation of initial drawing and material.
- b) Sequence of machining operations.
- c) Tooling selection and arrangement of cutting tools.
- d) Part setup method.
- e) Technological data selection (speeds, feed rates, depths, etc.)
- f) Toolpath determination.
- g) Mathematical calculations.

- h) Program writing and preparation for transfer to CNC.
- i) Program testing.
- j) Program documentation.

Word Address Format.—Writing any data to be processed by a computer requires a certain input format called a program. CNC program instructions are written in a special coded form obeying strict rules required by the programming language. These alpha-numerical instructions are called *words*. Where a single letter is followed by one or more digits - the letter must always be first. Special symbols, such as a decimal point or a negative sign may also be used, if required. Each letter, digit, or symbol represents one program character as well as one character in the control memory. A *character* is the basic unit of a CNC program. CNC programs only use characters that are readily available on a standard computer keyboard, without any multi-key combinations. A *word* in CNC program consists of two or more characters and is a single instruction to the control system. It can be used individually or it can be grouped into a series of combined instructions (words), to be performed at the same time. A program word is the *unit of instruction* to the control system. Instructions performed simultaneously are called a *block*, which is always represented by one line of the program. Individual instructions (blocks) are written in sequential order. Some typical words used in a block are:

M08 D14 X7.875 H03 /M01 Y0 G01 S850 Z-2.5 N49 T0707 T05 F10.0

Within a word, there cannot be any spaces, but spaces are allowed in a block, between words only. The numeric value that immediately follows the address (letter) has to be entered in a format specific for that address. Using some of the words above, a meaningful block can be constructed:

N49 G01 Z- 2.5 F10.0 M08

where:

N49 = Block number (sequence number)

G01 = Linear motion selected

Z-2.5 = Z-axis motion only

F10.0 = Feed rate specification

M08 = Coolant ON function

An early standard of *Electronic Industry Association* (EIA) RS-274 from the 1960's defines various commands and functions for part programming. It was last updated in February 1980 to RS-274D but has never fully succeeded in its attempt to provide a uniform CNC programming environment for different control systems, mainly because of competitive forces in industry. However, many features of this standard have become common practice in programming and are used to this day.

Program Development.—There are several methods of programming CNC equipment that will generate a working part program:

- a) Manual programming (also known as G-code programming)
- b) Computer based programming (also known as CAM programming)
- c) Shop-floor programming (also known as Conversational programming)
- d) Macro programming

Manual (G-code) Programming requires the most effort, is time consuming, and prone to errors. The programmer writes every instruction separately, typically using a text editor on a computer to enter programming instructions. All calculations are done with the use of a pocket calculator. In spite of its disadvantages, manual programming has two major advantages - it offers complete human control over every detailed aspect of toolpath development and all related activities. Also, it provides important learning ground for part programming using computer methods.

Originally, all manual programming was done all by hand and written on paper. Now, any computer can be used to write the program using a keyboard, several software based

calculators can be used instead of hand-held devices, and simulation software can verify the toolpath graphically, on a computer screen.

Computer Based Programming: Computer generated programs are based on graphical input, and typically require development of part geometry (point, lines, arcs, etc.). The final edited geometry serves as the toolpath geometry and can be assigned machining parameters. Specifying tool definition, spindle speeds and cutting feeds, and various cutting conditions is part of the programming process. A good knowledge of manual programming provides many necessary skills for computer based part programming.

Computer based programming is sometimes called (incorrectly) “CAM programming”, because of the multitude of CNC software that uses the “cam” in the product title. It has nothing to do with a mechanical motion control device of the same name.

Any CAD/CAM system that provides CNC capabilities also has to provide precise formatting of the final program output. This output is always based on a particular machine tool and control system combination. Software vendors offering program development software are very much aware of this need, yet face the extremely difficult task to cover every machine tool design with every control system available. When the toolpath is initially processed, it is generic - it has no connection to any particular control or machine specifications. The same toolpath has to be processed again (post processed) for a specific type of formatting, unique to a particular machine and control. The majority of post processors are customizable by the users who have thorough knowledge of manual programming methods, as well as a various machine and control systems.

The major advantage of computer based program generation is elimination of tedious calculations, minimizing errors, and providing a program in much shorter time than using the manual approach. Graphical interfaces quickly allow obvious errors to be detected visually.

Shop-floor Programming: Shop-floor programming, sometimes called conversational programming, is performed at the machine by the CNC operator using programming software built into the control system. Using the keyboard and control display screen, the programmer/operator interactively defines tools, material, setup, toolpath, cutting conditions, etc. Virtually all work is completed at the display screen. The resulting program can be stored externally, to be used at another time. Although relatively fast, visual, and easy to edit, the built-in programming software adds to the overall cost of the machine. If not managed efficiently, it does not offer the same flexibility in toolpath control as other methods. It may also tie up the machine from production and is not as portable as some alternatives.

Depending on the control system, conversational programming software ranges from some software having only minimum basic features to others with very advanced features. In addition to defining points, lines, and arcs, typical features include various patterns of holes, pocketing cycles, automatic roughing, corner rounding and chamfering, threading, and other operations.

Typically, the programming method selected is also the most convenient programming method available. Type and complexity of the job is always a major factor. The choice between manual and computer based programming has become rather narrow. Complex parts always benefit from a computer generated programs, while simple parts will typically benefit from a manual program.

Macro Programming: Macro programming is the highest level of manual programming. It requires thorough knowledge of manual programming concepts at all levels. In principle, the single purpose of a macro program is to develop a generic toolpath or other activity for a particular purpose. Once the macro program is stored in the control memory, it can be used many times in the future - with variable data supplied for a specific job. Typical examples include a bolt circle or a rectangular pocket - in both cases the basic input features remain the same, but the actual dimensions change from part to part. All basic shapes of a

bolt circle or pocket are retained while their sizes change - the macro itself does not change. See page 1305 for detailed information on macro programming.

Control System.—The control system, the actual computer controlling a CNC machine, is the main core of any CNC machine activity. It has many features that are important not only to the machine operator, but to the programmer as well. Some features are unique to a particular type of control system (mill, lathe, wire, etc.), while others are optional and may not be available on all controls.

Typical features of various CNC systems include:

ON/OFF switch: Power switch for the main power and the control unit.

Cycle start: Starts program execution or an MDI command.

Emergency stop: Stops all machine activity and turns off power to the control unit.

Feedhold: Temporarily stops motion of all axes.

Single block: Allows program to run one block at a time.

Optional stop: Temporarily stops the program execution (requires M01).

Block skip: Ignores blocks preceded with a forward slash (/) in the program.

Dry run: Enables program testing at fast feed rates (without a mounted part).

Spindle override: Overrides programmed spindle speed within 50-120% range.

Feed rate override: Overrides the programmed feed rate, within 0-200% range.

Chuck clamp: Displays current status of chuck clamping (Outside / Inside).

Table clamp: Shows current status of table clamping.

Coolant switch: Coolant control ON / OFF / AUTO.

Gear selection: Shows current status of working gear range selection.

Spindle rotation: Spindle rotation direction indicator (CW or CCW).

Spindle orientation: Manual spindle orientation.

Tool change: Switch allowing a manual tool change.

Reference position: Switches and lights relating to machine zero position (HOME).

Tailstock switch: Tailstock and/or quill switch to manually position tailstock.

Index table switch: Manually indexes machine table during setup.

M-S-T lock: Disables machine, spindle, and tool functions in the program.

Machine lock: Disables all machine motions.

Manual absolute: Coordinate system update on/off.

Z-axis neglect: Milling Z-axis can be turned off during program verification.

MDI mode: Manual Data Input mode.

AUTO mode: Allows automatic operations.

MEMORY mode: Allows program execution from memory of the CNC unit.

DNC mode: Allows program execution from an external device.

EDIT mode: Allows changes to programs stored in the CNC memory.

MANUAL mode: Allows manual operations during setup.

HOME mode: Allows manual return to machine zero.

HANDLE mode: Manual Pulse Generator (MPG) for manual axis movement.

JOG mode: Selects the jog mode for setup (manual feed rate motion).

RAPID mode: Selects the rapid mode for setup.

Memory access: Key (switch) to allow program editing.

Lube light: Indicates low level of slide lubrication.

Error lights: Red light indicating an error.

Optional Stop and Block Skip: Switches function only if the part program supports their use. For optional stop, part program must contain M01 function, and for block skip, the slash (/) symbol.

Manual Data Input (MDI): Manual Data Input is a feature of the control panel that allows quick entry of program data. An operating mode can be selected as MDI, which allows program data to be entered by the machine operator. This feature is not intended to enter complete machining programs, but allows the operator a great deal of flexibility dur-

ing setup. Typical applications include position data for setup, tool motion to a given location, machine functions control, even some special settings of machine parameters. Knowledge of basic programming principles is necessary, as MDI requires the use of normal programming methods.

CNC Program Data

The program data is a collection of all the program entries that will be accepted by the CNC system. Although the basic program principles are the same, the actual methods of inputting will always vary to a certain extent with different control models.

Program Structure.—A CNC program structure is a method of developing a part program that is well designed and written. This means that the program should be easy to read on paper or computer screen and written in a consistent manner. Program initialization should be logical; repetition of any tool should be made easy (without manual interaction); it should include important comments; and be as short as possible. A part program should always be designed with the machine operator in mind.

Comments and Messages: Various comments and other messages can be included in the program, provided they are enclosed with a single set of matching parentheses. An abundance of comments may strain the CNC memory, but when used in moderation, comments are an excellent way to inform the machine operator about key issues relating to the job at hand.

Typical comments should be in capital letters (for best compatibility between programs) and contain a short message, description, or caution. Comments may be used as separate blocks or at the end of a block - for example, both the following comments are valid:

Comment as a whole block: (CHECK HOLE DEPTH)

Comment as part of a block: N55 M00 (CHECK HOLE DEPTH)

Program Number (O-address): In most cases, a program number can be assigned at the machine, by the CNC operator. Only special program numbers can be selected by the programmer, typically, for subprograms. Program number requires the letter “O” to be followed by four or five numeric digits (O1 to O9999 or O99999), depending on the control.

Block Number (N-address): One or more instructions can be programmed in a single program sequence (block). A typical program may only require a very small number of blocks for a simple machining job, but - literally - hundreds or thousands of blocks for complex work. To distinguish one instruction (one block) from another, a simple numbering system can be used for each block sequence. Depending on the control system, the block numbers can be ascending, descending, or even mixed. Most control systems offer all these options, and it is up to the programmer to choose the most advantageous ones.

The address “N” is used for block numbering. The smallest block number is N1 (N0 is usually not allowed), the largest is either N9999 or N99999, depending on the control system. Block numbers can be used for each program sequence, or they can be used selectively, to enable more efficient search.

A forward slash symbol “/” placed in front of the N-address identifies a block that can be selectively skipped during processing. This block skip function is activated or deactivated from the operation panel of the CNC machine.

Preparatory Commands (G-address, G-codes): Preparatory commands are commonly known as G-codes. The address “G” identifies a preparatory command, which has one and only objective - to preset or to prepare the control system for a certain desired condition, or to a certain mode or a state of operation. For example, the address G00 presets (prepares or selects) a rapid motion mode, G01 selects a linear motion, G81 selects the drilling cycle, etc. The term *preparatory command* indicates its meaning - a G-code will prepare the control to correctly interpret the programming instructions following the G-code in a specific way.

Standard G-codes are programmed in the range of G00 to G99, although not all numbers are available. G-codes with three digits usually apply to special machine functions provided by the control manufacturers. Most - but not all - of G-codes are standard for various controls, and most - but not all - are *modal*. A modal G-code is one that is programmed only once and remains in effect until changed or canceled. Non-modal G-codes have to be repeated anytime they are used. On the majority of controls, one or more G-codes can be programmed in a single block, providing there is no conflict between them. It is customary to program a G-code or G-codes at the beginning of the block, after the sequence number.

Table 1. Typical Turning G-codes

G code	Description	G code	Description
G00	Rapid positioning	G57	Work coordinate offset 4
G01	Linear interpolation	G58	Work coordinate offset 5
G02	Circular interpolation clockwise	G59	Work coordinate offset 6
G03	Circular interpolation counterclockwise	G61	Exact stop mode
G04	Dwell (as a separate block)	G62	Automatic corner override mode
G09	Exact stop check - one block only	G64	Cutting mode
G10	Programmable data input (Data setting)	G65	Custom macro call
G11	Data setting mode - cancel	G66	Custom macro modal call
G20	U.S. customary units of input	G67	Custom macro modal call - cancel
G21	Metric units of input	G68	Mirror image for double turrets
G22	Stored stroke check ON	G69	Mirror image for double turrets - cancel
G23	Stored stroke check OFF	G70	Profile finishing cycle
G25	Spindle speed fluctuation detection ON	G71	Profile roughing cycle - Z axis direction
G26	Spindle speed fluctuation detection OFF	G72	Profile roughing cycle - X axis direction
G27	Machine zero position check	G73	Pattern repetition cycle
G28	Machine zero return (reference point 1)	G74	Drilling cycle
G29	Return from machine zero	G75	Grooving cycle
G30	Machine zero return (reference point 2)	G76	Threading cycle
G31	Skip function	G90	Cutting cycle A (Group type A)
G32	Threading - constant lead	G90	Absolute command (Group type B)
G35	Circular threading CW	G91	Incremental command (Group type B)
G36	Circular threading CCW	G92	Thread cutting cycle (Group type A)
G40	Cutter radius - cancel (Tool nose radius offset cancel)	G92	Tool position register (Group type B)
G41	Cutter radius - left (Tool nose radius offset left)	G94	Cutting cycle B (Group type A)
G42	Cutter radius - right (Tool nose radius compensation right)	G94	Feed rate per minute (Group type B)
G50	Tool position register (obsolete) / Maximum r/min preset	G95	Feed rate per revolution (Group type B)
G52	Local coordinate system setting	G96	Constant surface speed
G53	Machine coordinate system setting	G97	Constant spindle speed (r/min)
G54	Work coordinate offset 1	G98	Feed rate per minute (Group type A)
G55	Work coordinate offset 2	G99	Feed rate per revolution (Group type A)
G56	Work coordinate offset 3		

Note that some G-codes are optional and some will vary from one control system to another.

Typical list includes Group type A and Group type B - where some G-codes are different. For example, Group A uses addresses U and W to identify incremental motion, while Group B uses G91 and G92. There are other differences as well. Group A is the most common.

Table 2. Typical Milling G-codes

G- code	Description	G- code	Description
G00	Rapid positioning	G52	Local coordinate system setting
G01	Linear interpolation	G53	Machine coordinate system
G02	Circular interpolation clockwise	G54	Work coordinate offset 1
G03	Circular interpolation counterclockwise	G55	Work coordinate offset 2
G04	Dwell (as a separate block)	G56	Work coordinate offset 3
G09	Exact stop check - one block only	G57	Work coordinate offset 4
G10	Programmable data input (Data setting)	G58	Work coordinate offset 5
G11	Data setting mode - cancel	G59	Work coordinate offset 6
G15	Polar coordinate command - cancel	G60	Single direction positioning
G16	Polar coordinate command	G61	Exact stop mode
G17	XY plane designation	G62	Automatic corner override mode
G18	ZX plane designation	G63	Tapping mode
G19	YZ plane designation	G64	Cutting mode
G20	U.S. customary units of input (G70 on some controls)	G65	Custom macro call
G21	Metric units of input (G71 on some controls)	G66	Custom macro modal call
G22	Stored stroke check ON	G67	Custom macro modal call - cancel
G23	Stored stroke check OFF	G68	Coordinate system rotation
G25	Spindle speed fluctuation detection ON	G69	Coordinate system rotation - cancel
G26	Spindle speed fluctuation detection OFF	G73	High speed peck drilling cycle (deep hole)
G27	Machine zero position check	G74	Left hand threading cycle
G28	Machine zero return (reference point 1)	G76	Fine boring cycle
G29	Return from machine zero	G80	Fixed cycle - cancel
G30	Machine zero return (reference point 2)	G81	Drilling cycle
G31	Skip function	G82	Spot-drilling cycle
G40	Cutter radius offset - cancel	G83	Peck-drilling cycle (deep hole drilling cycle)
G41	Cutter radius offset - left	G84	Right hand threading cycle
G42	Cutter radius offset - right	G85	Boring cycle
G43	Tool length offset - positive	G86	Boring cycle
G44	Tool length offset - negative	G87	Back boring cycle
G45	Position compensation - single increase (obsolete)	G88	Boring cycle
G46	Position compensation - single decrease (obsolete)	G89	Boring cycle
G47	Position compensation - double increase (obsolete)	G90	Absolute dimensioning mode
G48	Position compensation - double decrease (obsolete)	G91	Incremental dimensioning mode
G49	Tool length offset cancel	G92	Tool position register
G50	Scaling function cancel	G98	Return to initial level in a fixed cycle
G51	Scaling function	G99	Return to R level in a fixed cycle

Note that some G-codes are optional and some will vary from one control system to another.

A typical example of using G-codes is a simple program entry, such as X18.0. X-address is mainly used as a dimension, but not exclusively. The amount of 18.0 could be in millimeters or inches, it can be an absolute location from part zero or an incremental distance and direction from current point. In addition, the same address can be a dwell time in sec-

onds (a pause). Using one or more G-codes will narrow down the options to only those required by the program. Here are some examples:

G21 G90 G00 X18.0 ... rapid to absolute location of 18 mm

G20 G91 G01 X18.0 F10.0 ... feed by the distance of 18 inches in positive direction

G04 X18.0 ... dwell for 18 seconds

Miscellaneous Function (M-codes).—Along with G-codes (preparatory commands), a CNC program requires a number of miscellaneous functions, called M-codes or M-functions. These auxiliary functions fall into two groups - those that control various machine functions and those that control program flow. Miscellaneous functions are the least standard words in CNC applications and vary greatly between control systems. Those that are typical to most controls are:

Three-digit M-codes are normally specific to a particular machine and various functions associated with it.

Table 3. M-codes

M code	Description	M code	Description
M00	Program stop	M09	Coolant OFF
M01	Optional program stop	M19	Spindle orientation
M03	Spindle rotation normal (clockwise)	M30	Program end
M04	Spindle rotation reverse (counterclockwise)	M60	Automatic Pallet Change (APC)
M05	Spindle stop	M98	Subprogram call
M06	Automatic Tool Change (ATC)	M99	Subprogram end
M08	Coolant ON		

Units of Measurement (G20, G21).—Dimension words in CNC programming are data that contain a location, distance, radius or feed rate. In all cases, such data is dependent on the active units of measurement. For CNC work, either metric or U.S. customary units can be selected by the program or by manual setting. U.S. customary units can be set by G20 (G70 for older controls) command, metric units by G21 (G71 for older controls) command, and each command cancels the other. U.S. customary mode is specified in inches, metric mode in millimeters. In some cases, feet/min or m/min are also used.

Dimensions measured along an axis can be programmed up to four decimal places in inches, and three decimal places in millimeters. Minimum increment (i.e., amount of motion) possible is 0.0001 inch or 0.001 mm. Maximum programmable motion amount is typically 9999.9999 inches or 99999.999 mm. Note that there is no actual unit conversion involved, just a shift in decimal point position.

Absolute and Incremental Programming (G90, G91).—A motion dimension along X, Y, Z axes (as well as any parallel or rotary axis) can be programmed in two ways - as an absolute location measured from part zero (origin) or as an incremental distance and direction measured from the current tool position.

The *absolute* method of programming is selected by the G90 command, the *incremental* method by the G91 command. One command cancels the other. The benefit of the absolute programming method is that one change of a point location requires only one change in the program. The same change in incremental program will require two changes. The main benefit of incremental programming method is that it can be used for a toolpath repetition, typically in the form of subprograms or macros.

Spindle Function (S-address).—The *spindle* function programmed with the S-address causes the machine spindle to rotate at a defined rate in revolutions per minute (r/min). Its programmable range is set by the machine manufacturer in increments of one revolution. The major difference between machining centers and some lathe operations defines the meaning of the S-address used in the program:

- 1) Milling - direct spindle speed in r/min (all operations)
- 2) Turning, Boring, Facing, and Grooving - cutting speed in ft/min or m/min

3) Threading and Centerline Operations - direct spindle speed in r/min

In all three application groups, spindle rotation direction must also be specified, using M03 or M04 miscellaneous functions.

Example: For milling, the programming is straightforward:

S800 M03 - normal spindle rotation (CW) at 800 revolutions per minute

S750 M04 - reverse spindle rotation (CCW) at 750 revolutions per minute

CNC Lathes: For CNC lathes, the situation is somewhat different, because the part itself is rotating and cutting diameters change constantly, particularly during turning and boring operations. To select the required spindle speed mode, two G-codes are available:

G96 - constant cutting speed - programmed in ft/min or m/min

G97 - constant spindle speed - programmed in r/min

Example: G96 S300 M03 is 300 ft/min in G20 mode, or 300 m/min in G21 mode.

G97 S1200 M03 is 1200 r/min, regardless of the measuring units selected.

Cutting Speed: The purpose of cutting speed, (CS), also known as peripheral speed or surface speed, is to increase or decrease the spindle speed with each change in cutting diameter. The speed will be slowed down for increasing diameters, and speeded up for decreasing diameters. These changes are automatically adjusted by the control system in very fine increments.

In order to limit the spindle speed from increasing to potentially dangerous levels at very small diameters, the programmer can limit the maximum spindle speed by using the G50 command.

Example: G50 S2500 limit r/min to 2500 in cutting speed mode

Example: (G96) G96 S300 M03 cutting speed of 300 ft/min or 300 m/min.

G50 is only applicable in G96 mode and has no effect in G97 mode. Its setting should always be less than the maximum spindle speed of the machine.

Cutting speed, "CS", can be converted to spindle speed using the following formulas:

$$\text{U.S. Customary units: } r/\text{min} = (\text{ft}/\text{min} \times 12) / (3.14 \times \text{diameter in inches})$$

$$\text{Metric units: } r/\text{min} = (\text{m}/\text{min} \times 1000) / (3.14 \times \text{diameter in mm})$$

The mathematical constant of 3.14 represents mathematical function π (π), rounded to two decimal places, is more than suitable for such calculations. An even shorter formula can be used for U.S. customary units, also suitable for most applications, particularly without a calculator:

$$r/\text{min} = (\text{ft}/\text{min} \times 4) / \text{Diameter in inches}$$

Spindle Override: Spindle override is a feature of CNC machines that allows temporary adjustments to the programmed spindle speed during program execution, without changing the program itself. For this purpose, a spindle override switch is provided at the operation panel. Usually a rotary switch, it is graduated in 10% increments, typically between 50% and 120%. Permanent changes to the speed must be made in the program itself.

Feed Rate Function (F-address).—Cutting motions are defined as motions of a cutter that is in contact with the material, including clearances. Non-cutting motions are typically rapid motions without a physical contact with the material. Programming the feed rate address depends on the type of machine and the units of measurement. Milling machines and machining centers generally use feed rate per minute (inch/min or mm/min), while lathes and turning centers use feed rate per revolution (inch/rev or mm/rev). For lathes, preparatory commands G94 and G95 determine whether feed rate per minute is selected (G94) or feed rate per revolution is selected (G95). G94 mode - feed rate per revolution - is the default for lathe work. Feed rate specification is always modal, and remains in effect until a different feed rate is selected.

Feed rate per revolution (feed/rev) can be converted to feed rate per minute (feed/min) by multiplying spindle speed in revolutions per minute (r/min) by the feed rate per revolution:

$$\text{Feed/min} = r/\text{min} \times \text{feed/rev}$$

For multi-edge cutters, feed rate is also given as “per tooth” or “per flute.” This feed rate per edge is also generally called “chipload,” specified in inches or millimeters. Feed per tooth (fpt) can be converted to cutting feed rate:

$$\text{Feed/rev} = \text{feed per tooth} \times \text{number of teeth}$$

Once the feed/rev is known, feed rate per minute can be calculated, if desired.

Inverse Time Feed Rate.—One type of feed rate that may be required in some special applications is the *inverse time* feed rate. This feed rate represents the reciprocal of the time in minutes required to complete a programmed motion. The feed command is indicated by a G93 command followed by an F-address value found by dividing the feed rate, in inches (millimeters) or degrees per minute, by the distance moved in the block:

$$\text{Inverse time feed command} = \text{feed rate} / \text{distance} = (\text{distance} / \text{time}) / \text{distance} = 1 / \text{time}$$

The inverse time feed rate has been used in some rotary and multi-axis applications.

Feed Rate Override.—The *feed rate override* is a feature of CNC machines that allows temporary adjustments to the programmed cutting feed rate during program execution, without changing the program itself. For this purpose, a feed rate override switch is provided at the operation panel. Usually a rotary switch, it is graduated in 10% increments, typically between 0% and 150% or 200%. Permanent changes to the feed rate must be made in the program itself.

Tool Function (T-address).—Both CNC milling and turning machine groups use automatic tool change (ATC). In the program, each tool has to be numbered using the T-address. On machining centers, tools are stored in a special tool magazine, located on a side of the machine. On lathes, tools are stored in an indexing turret, located within the machining area. There is a difference in programming each group. In both groups, the T-address indicates the tool number of the next tool. For example, on a machining center, T06 is tool number six. Tools can be stored in any magazine position, but must be registered in the control system prior to use. On lathes, the four-digit tool number is determined by the turret station number, followed by a wear offset number. The turret station number is also equivalent to the geometry offset for the stored tool. Wear offset is used for fine-tuning. For example T0313 calls a tool located in turret station three, activates geometry offset three as well as work offset thirteen.

Tool offset screens (geometry and wear) are special tables visible on the control display panel that show the setting information about each tool. Such information includes the XZ setting, tool nose radius (R), and the tool tip number (T) which should not to be confused with tool number.

Tool Nose Radius Compensation.—A typical manually generated program uses both coordinate points read directly from drawings and calculated on the basis of drawing dimensions. In both cases, these calculated coordinate points represent a toolpath along the part edge suitable only for a cutter that has a radius of zero. Since a zero tool radius is not practical, the tool’s actual radius has to be considered. This is achieved by using a powerful control feature called cutter radius offset (compensation) or - for lathe terms - tool nose radius compensation.

During program development, the programmer ignores the cutter radius, and uses drawing based dimensions. In order to allow for radius compensation at the machine, two preparatory commands are used - G41 for the compensation to left, and G42 for the compensation to the right. In both cases, the direction is determined by viewing along the cutter path direction.

At the control, the operator sets not only the XZ geometry and wear offsets, but also enters the tool nose radius (R-column) and the tool tip number (T-column). The purpose of the tool tip number is to establish the location of the tool nose radius center point.

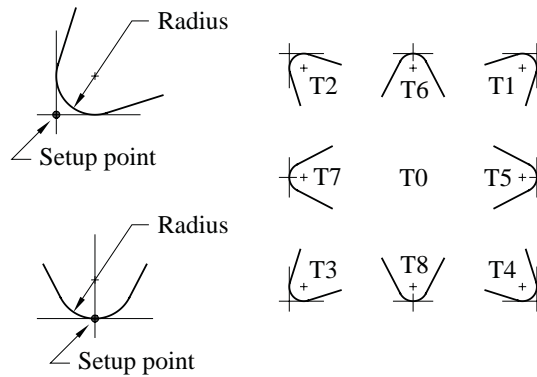


Fig. 4. Tool Tip Numbers - Rear Lathe.

Rapid Motion (G00).—In basic terms, machine motions are divided into two groups, non-cutting motions (unproductive) and cutting motions (productive). Rapid motion is the only non-cutting and non-productive motion available to the CNC programmer. Its single purpose is to move the cutter from one location to another at the highest speed possible, typically between actual cuts. CNC manufacturers determine the maximum rapid motion rate.

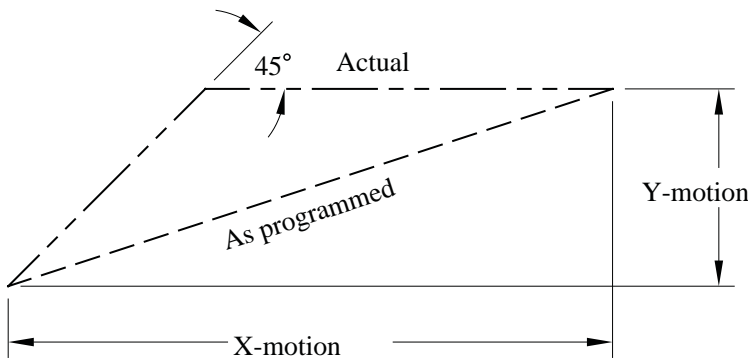


Fig. 5. Rapid motion G00.

Fig. 5 shows the effect of programmed and actual rapid motion applied on a machining center. As both X and Y axes have the same rapid rate - and the actual toolpath is not important - the resulting motion starts at 45 degrees. When one axis reaches its destination, the other axis continues as a single axis motion. Some machines can produce rapid motion as programmed.

Linear Interpolation (G01).—In *linear interpolation mode* (programmed in G01 mode with a cutting feed rate in effect), the tool moves along a linear path, directly from one point to the next (traversing the shortest distance). This is a major departure from the rapid motion mode (programmed in G00 mode), where the shortest distance is disregarded and the result is the fastest motion available. The word *interpolation* defines a mathematical process that translates into synchronized feed rate for all programmed axes. This is done by the control system automatically.

The programming command for linear interpolation is G01 (modal), which cancels any other active motion command. Feed Rate is required with G01 and its selection is based on cutting conditions.

Circular Interpolation (G02, G03).—*Circular interpolation* applies to a cutting tool-path moving along an arc or a circle. An arc (circle) can be programmed directly, without linear approximation. The cutting motion along an arc is two-dimensional and always takes place in a single plane. No arc or circle exists as a three-dimensional entity (it

becomes a helix). Depending on the required outcome, the desired plane can be defined using one of three specific G-codes (Figs. 6- 8):

- G17 = XY plane - arc/circle uses XY coordinates at a given Z-depth
- G18 = ZX plane - arc/circle uses ZX coordinates at a given Y-depth
- G19 = YZ plane - arc/circle uses YZ coordinates at a given X-depth

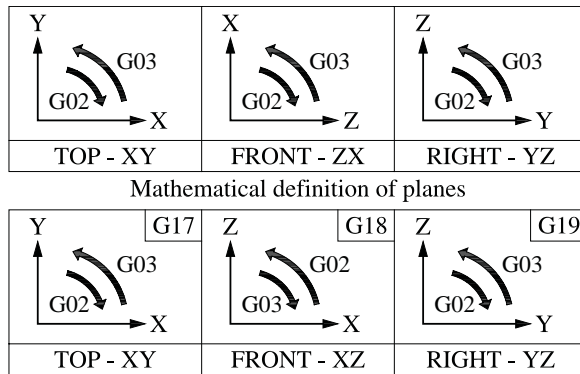


Fig. 6. Planes on a CNC Vertical Machining Center.

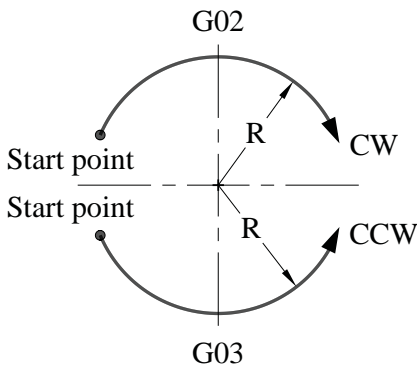


Fig. 7. Circular Interpolation.

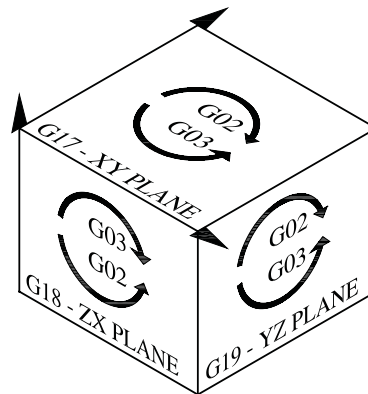


Fig. 8. Circular Interpolation in Planes.

It is very important to understand that the G18 mathematical plane does not correspond to the machine axes orientation and that the arc direction appears to be incorrect. Programming an arc requires a direction of motion in the plane (G02 = CW, G03 = CCW), a start point (typically the current block), an end point (typically the target point, the end of motion), as well as the arc radius. The arc radius can be specified directly (for example R1.5), or it can be defined by special vectors, using IJK addresses.

When using direct radius R, there are some limitations. Radius R (positive) can only be programmed for arcs up to and including 180 degree arc sweep angle. If the sweep angle exceeds 180 degrees but is less than 360 degrees, R- (negative) must be used. For a full circle (360 degrees arc sweep angle), the address R cannot be used at all and a two-vector combination must be used. There is no need to break arc motion at the quadrants.

The definition of IJK vectors is the same for all three axes, where X and I, Y and J, Z and K are related (paired): The I-J-K vector is the distance and direction from the start point of the arc to the arc center, measured along X-Y-Z axis respectively.

A typical milling application in the XY plane is shown in Fig. 9. Current plane selection determines the arc vectors. Some controls use I-J-K as an absolute location. The start point of the arc is defined as the endpoint of the previous motion.

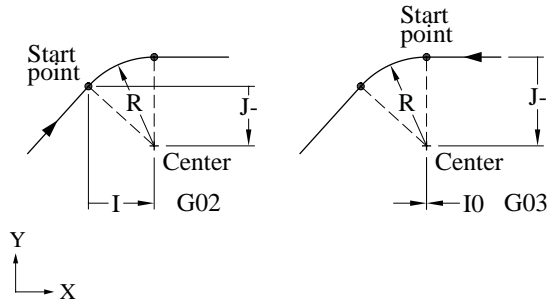


Fig. 9. Arc Vectors.

Helical and Other Interpolation Methods.—Most milling controls offer another motion - helical interpolation (either as a standard feature or as an option), but only very few specialized controls offer parabolic or hyperbolic interpolation. Helical interpolation produces a helix. Two axes (typically XY) form the circle while the third axis (typically Z-axis) provides synchronized linear motion. The selected plane (G17, G18, or G19) determines the circular axes, while the remaining axis is linear motion. Helical interpolation is most commonly used for thread milling - a method of thread development that offers many advantages over tapping.

Offsets for Milling

In CNC terms, the word *offset* means an adjustment. The primary purpose of offsets is to provide a link between the known information at the time of programming and the unknown situation at the time of setup and machining. The single most important purpose of offsets is to provide adjustments necessary to keep precise part dimensions. Such adjustments allow corrections for tool wear, cutter length, or radius at the machine. Offsets can also be used for machining applications, for example, to use the same program for a roughing contour and a finishing contour, or to use a tool with a different diameter or length. Offsets allow the programmer to virtually ignore tool dimensions. There are three groups of offsets for milling applications:

Work Offset = Offset to link machine zero and part zero.

Tool Length Offset = Offset to link tool tip and part zero.

Cutter Radius Offset = Offset to link tool radius and drawing dimensions.

Work Offset (G54 though G59).—Every CNC machine has a built-in location called the machine reference point (also known as machine zero or home position). By default, this location has coordinates of X0Y0Z0. The purpose of *work offset* is to establish the difference between machine zero and part zero. All machine axes can be set, although only X and Y axes are normally used.

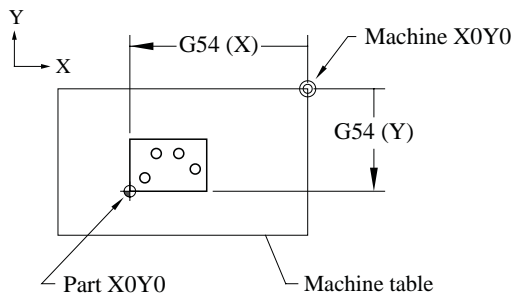


Fig. 10. Work Offset Using G54.

Work offset allows the programmer to use the dimensions from the drawing without considering the actual position of the part on the machine table. There are six standard work

offsets defined by G54 through G59 commands, with additional sets available optionally. Fig. 10 shows the most commonly used work offset, G54. Note the direction is from machine zero to part zero, along an axis. A typical program entry combines the work offset with other data, for example:

```
N3 G90 G54 G00 X__ Y__ S__ M03 T__
```

Tool Length Offset (G43, G44).—The *tool length offset* is a setting that specifies the distance between the tool reference point and part zero, along the Z-axis. Two methods are available - the *preset method* and the *touch-off method*. The preset method requires additional equipment and is used off-machine. The touch-off method is much simpler, and is done at the CNC machine. Each tool used in the program normally requires one tool length offset. A specific offset number is necessary to include with the G43 command. For example,

```
N5 G43 Z0.1 H01 M08
```

G44 is used by only a very few programmers, for specific applications only. Fig. 11 shows typical tool length offset measurement using the touch-off method with G43 command.

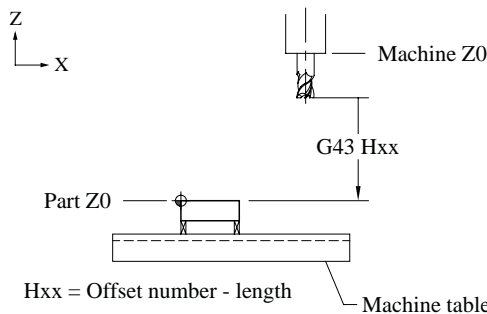


Fig. 11. Tool Length of Offset.

Cutter Radius Offset (G41, G42).—The *cutter radius offset* is an adjustment of the contour toolpath from the part edge to the cutter center. It is also known as *cutter radius compensation* or *tool nose radius compensation for lathes* (see page 1289).

Point calculations based on the drawing dimensions are far more convenient and practical than programming coordinates to the center of a cutter. Fig. 12 illustrates a toolpath offset by the cutter radius. The toolpath generated on the basis of drawing dimensions may only be suitable for holes where the spindle centerline and hole centerline match. Such a toolpath cannot be used on a contour because the cutter centerline must be shifted - offset - away from the contour by the cutter radius. The purpose of the cutter radius offset is to provide automatic adjustment for the toolpath. This toolpath shifts the cutter center in such a way that the cutter edge is in constant contact with the programmed contour. This control generated toolpath is called an *equidistant toolpath*.

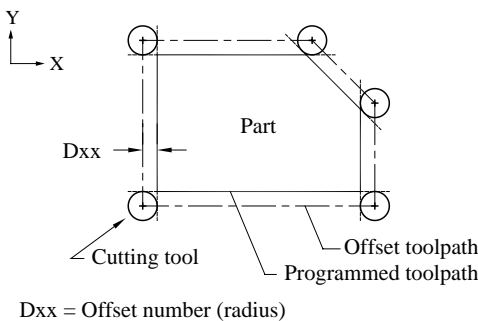


Fig. 12. Cutter Radius Offset.

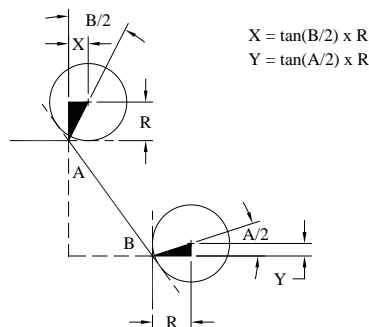


Fig. 13. Manually Calculated Radius Offset.

Programming to the center of the cutter requires tedious calculations for every point on the contour. Fig. 13 shows such a typical calculation. In addition, manually calculated center toolpaths cannot be adjusted at the machine.

To activate a cutter radius offset, two preparatory commands are available - G41 (offset to the left) and G42 (offset to the right) - both left and right offsets are determined by the cutting direction. As more than one tool can use cutter radius offset, G41 or G42 has to be programmed together with corresponding offset number, using the D-address. Many control systems use only a single offset registry for both tool length offset and cutter radius offset. In such cases, the D-address must have a distinct number from the tool length offset, even if the addresses are different.

Example: Tool 1 will be programmed as T01, using G43 H01 as the tool length offset, and G41 D51 as the cutter radius offset. G40 command cancels the cutter radius offset.

Programming the cutter radius offset is relatively simple, but several rules have to be observed. The most important rule requires the G41/G42 command to be applied after completing the Z-depth motion and in G00 or G01 mode only (not on an arc).

Example: N44 G01 Z-0.5 F15.0; N45 G41 X0.25 D51 F20.0; N46 Y__


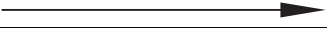



Cutter radius offset uses a so called look-ahead type of radius compensation. During program execution, the control stores the next motion block in the buffer - it “looks ahead” in the program in order to compensate correctly and consistently.

Machining Holes

Virtually all applications of CNC machining include machining holes. Regardless of what type of machining takes place at a single hole location, there are similarities important to CNC programming, particularly for CNC milling machines and machining centers. In the majority of applications, machining holes is not a complicated procedure. The only cutting tool motion that takes place is along the Z axis, after a required XY location has been applied. This type of machining is commonly known as point-to-point machining and is applied to operations such as drilling, spot drilling, spot facing, counter-boring, counter-sinking, tapping, boring, and reaming.

Each toolpath step relating to a particular machining operation on a hole is always consistent and can be preset within the control system software (built-in software routine). This is the basis for shortening programming holes by using fixed cycles. As the name suggests, these cycles contain an internal set order of tool motions and cannot be changed. Table 4 shows symbols and abbreviations used in the following cycle descriptions.

Table 4. Fixed Cycle Descriptions

Symbol	Description
	Rapid Motion and Direction
	Cutting Motion and Direction
	Manual Motion and Direction
	Boring Bar Shift and Direction
	Programmed Coordinate (XY)
Q	Depth of Peck / Shift Amount
d	Clearance Value (built in)
CW / CCW	Spindle Rotation Direction
OSS	Oriented Spindle Stop
DWELL	Dwell Function Executed

Fixed Cycles.—“Fixed cycles” sometimes called canned cycles, are series of preset sequences of toolpath motions, allowing consecutive motions to be performed with a single block of program. Typical fixed cycles are:

Table 5. Fixed Cycle Codes

G-code	Description	G-code	Description
G81	Drilling cycle	G86	Boring cycle
G82	Drilling cycle with dwell (spot drilling cycle)	G76	Fine boring cycle
G83	Deep hole drilling cycle (peck drilling cycle)	G87	Back boring cycle
G73	Chip-breaking cycle	G88	Boring cycle (with manual action)
G84	Right hand tapping cycle	G89	Boring cycle
G74	Left hand tapping cycle	G80	Fixed cycle cancel
G85	Boring cycle		
In addition, two preparatory commands are also used with fixed cycles see Fig. 14:			
G98	Retract to initial level	G99	Retract to R-level

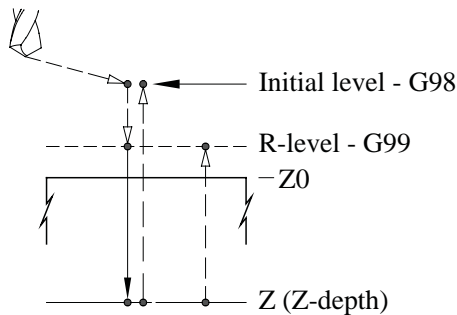


Fig. 14. Initial level and R-level.

All cycles are modal and are typically canceled by G80. Between the cycle call and the cycle cancel block, only the data that changed is programmed, usually the XY position, occasionally the R-level, or the Z-depth. The general and most commonly used format for all fixed cycles is:

$$N_ G98 (G99) G_ X_ Y_ R_ Z_ P_ Q_ F_$$

where:

$N_$ = block number,

$G_$ = cycle number,

$X_Y_$ = hole location,

$R_$ = start position from where feed rate mode starts,

$Z_$ = final depth,

$P_$ = amount time delay (dwell) for G82 and G89,

$Q_$ = either the depth of each peck for G83 and G73, or the shift amount for G76 and G87,

$F_$ = cutting feed rate in feed per minute mode.

Fixed Cycle (G81): The G81 code is used mainly for drilling, and has the following format see Fig. 15:

$$N_ G99 (G98) G81 X_ Y_ R_ Z_ F_$$

In the G81 cycle, the tool rapids to XY location first, than to the R-level (feed plane). From that position it feeds to the depth, followed by a rapid retract to the R-level in G99 mode or the initial level, in G98 mode.

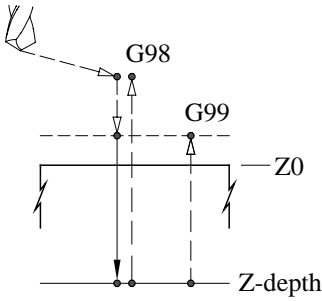


Fig. 15. G81 Fixed Cycle.

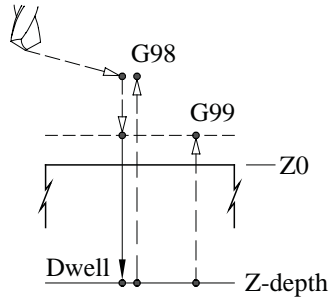


Fig. 16. G82 Fixed Cycle.

Spot Drilling, Facing, Counterboring-sinking (G82): The G82 fixed cycle is used for spot drilling, spot facing, counter boring, countersinking, and any other operation where a dwell at the bottom of the hole is required. It has the following format **Fig. 16:**

```
N__ G99 (G98) G82 X__ Y__ R__ Z__ P__ F__
```

All tool motions are identical to G81 cycle, with the added pause P__ (dwell). Pause is programmed in milliseconds (ms), without decimal a point. Its purpose is to smooth out the bottom of the hole. The dwell period should be a minimum of two spindle revolutions to allow for a full clean-up in case 50% spindle speed override is in effect. To calculate minimum dwell, divide 60 by the spindle revolutions (r/min):

$$\text{Minimum Dwell (seconds)} = \frac{60}{r/min}$$

To convert to milliseconds, multiply the result by 1000.

Example: For 750 r/min, the minimum dwell will be $60 / 750 \times 1000 = 80$ ms.

Deep Hole Drilling (G83): The G83 fixed cycle is used mainly for deep hole drilling using the following format:

```
N__ G99 (G98) G83 X__ Y__ R__ Z__ Q__ F__
```

From the R-level, the drill will cut by the amount of Q__, which specifies the depth of each peck. When the peck depth Q__ is completed, the drill retract to R-level, than rapids back to cut another depth - there is small non-programmable clearance between the cuts, that is part of the cycle (See **Fig. 17**).

A general rule of peck drilling is that the greater the Q__ amount is, the fewer pecks will be generated and vice versa. Some controls allow programming of the actual number of pecks required. No peck motion will ever exceed the final Z__ depth.

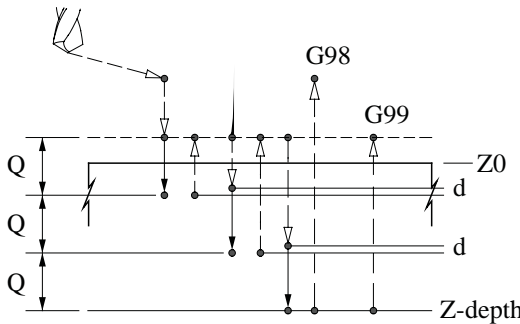


Fig. 17. G83 Fixed Cycle.

Chip Breaking (G73): The G73 fixed cycle is used mainly for chip breaking and has the following format

```
N__ G99 (G98) G73 X__ Y__ R__ Z__ Q__ F__
```

Its basic function is the same as for G83, but the drill does not retract after each peck, only after the last peck. In both cases, the G98 or G99 retract method will be applied for the last peck only (see Fig. 18).

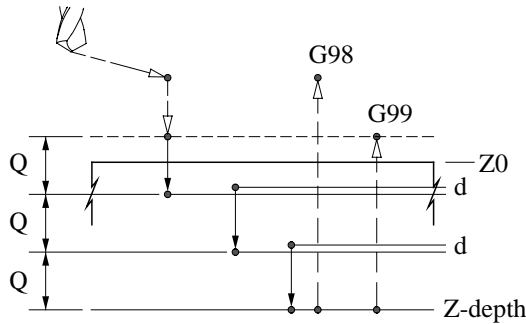


Fig. 18. G73 Fixed Cycle.

Right Hand Thread (G84): The G84 fixed cycle is used for cutting a right hand thread and has the following format

```
N__ G99 (G98) G84 X__ Y__ R__ Z__ F__
```

The cycle will start feeding from the R-level to the Z-depth, where the tap stops, reverses its rotation and feeds back to the R-level, where it stops again and resumes normal spindle rotation (see Fig. 19).

G84 cycle must be programmed with spindle rotation CW (normal), typical in M03 mode.

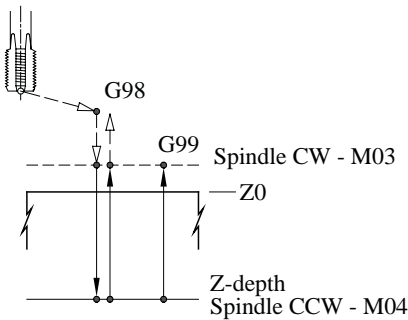


Fig. 19. G84 Fixed Cycle.

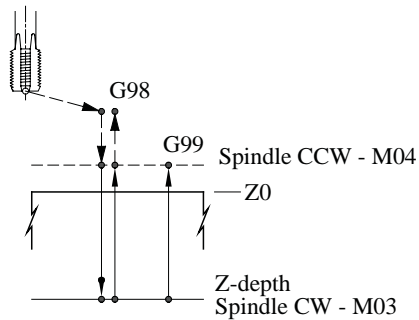


Fig. 20. G74 Fixed Cycle.

Left Hand Thread (G74): The G74 fixed cycle is used for cutting a left hand thread and has the following format

```
N__ G99 (G98) G74 X__ Y__ R__ Z__ F__
```

G74 cycle must be programmed with spindle rotation CCW (reverse), typical in M04 mode. In all other respects, G74 is identical to G84 (see Fig. 20).

Boring Cycle (G85): The G85 fixed cycle is used for boring and has the following format

```
N__ G99 (G98) G85 X__ Y__ R__ Z__ F__
```

From the R-level, the boring bar will feed to the Z-depth, than feeds back to R-level, both at the programmed feed rate F__. A similar cycle G89 has a dwell at the bottom of the hole. Either one of these cycles is commonly used for reaming (see Fig. 21).

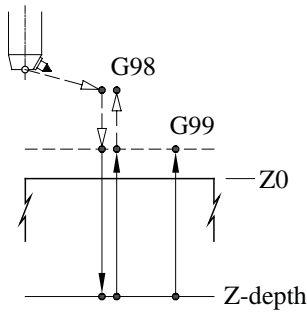


Fig. 21. G85 Fixed Cycle.

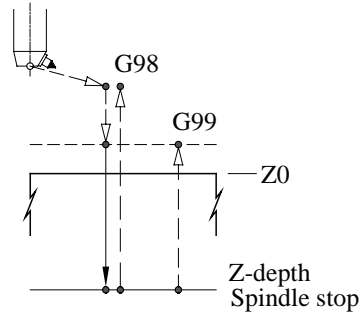


Fig. 22. G86 Fixed Cycle.

Boring Cycle (G86): The G86 fixed cycle is used for boring and has the following format:

```
N__ G99 (G98) G86 X__ Y__ R__ Z__ F__
```

In G86 mode, the boring bar will feed from the R-level to the Z-depth, where the spindle stops rotating and the tool is retracted at a rapid rate. Note that a straight line (tool mark) will be generated on the bored hole (see Fig. 22).

Boring Cycle (G76): The G76 fixed cycle is used for fine boring and has the following format:

```
N__ G99 (G98) G76 X__ Y__ R__ Z__ Q__ F__
```

This cycle is called a “fine” boring cycle, because it does not leave any tool marks on the bored hole. The Q__ in the block is the amount of shift away from the hole centerline that takes place before tool retraction. Typically, the amount of Q__ is very small, usually in the range of 0.005-0.010 inches or 0.125-0.250 mm.

In this internally complex cycle, the tool starts at the R-level and feeds to the Z-depth. When the depth is reached, the spindle stops and orients (so called OSS - oriented spindle stop). When oriented, the tool moves away by the Q__ amount, then retracts to the R-level. Once outside of the hole, it moves back by the Q__ amount and the spindle resumes normal rotation (see Fig. 23).

When setting a boring bar used with G76 at the machine, the operator has to align the cutting tip in such a way that it is aimed in the opposite direction of the shift motion. This is done in oriented spindle mode, using the M19 command in MDI.

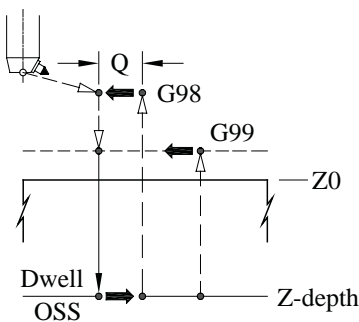


Fig. 23. G76 Fixed Cycle.

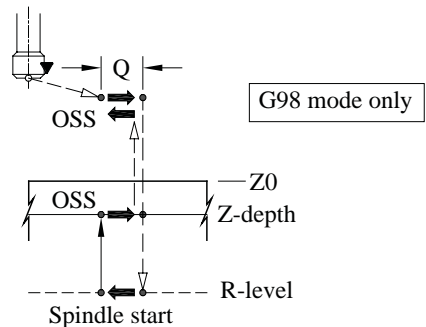


Fig. 24. G87 Fixed Cycle.

Back Boring (G87): The G87 fixed cycle is used for back boring and has the following format:

```
N__ G98 G87 X__ Y__ R__ Z__ Q__ F__
```

As the name suggests, this cycle is used to bore upwards, starting at the bottom of an existing hole. The R-level is below the part, and only G98 retract method can be used with this cycle. The Q__ amount is also the amount of shift away from the centerline.

When the tool reaches X__Y__ hole location at the initial level, the spindle stops, tool orients and shifts away from hole centerline by the amount of Q__. Then, it rapids to the R-level, shifts back, and feeds to the Z-depth. When the depth is reached, the tool stops again, orients, and shifts by the Q__ amount. The following retract will be to the initial level, where the tool shifts back, and the spindle resumes normal rotation (see Fig. 24).

This cycle can only be used if the boring bar can move clearly through the existing hole. The shift amount Q__ must be greater than one half of the difference between the back bore diameter and the existing hole diameter. Note that G99 retract mode cannot be used.

Manual Boring (G88): The G88 fixed cycle is used for boring with manual intervention and has the following format:

N__ G99 (G98) G88 X__ Y__ R__ Z__ P__ F__

The G88 fixed cycle is rather rare. Its use is limited to boring operations with special tools that require manual interference at the bottom of a hole. When such an operation is completed, the tool is moved out of the hole for safety reasons. This cycle may be used by some tool manufacturers for certain special operations (see Fig. 25).

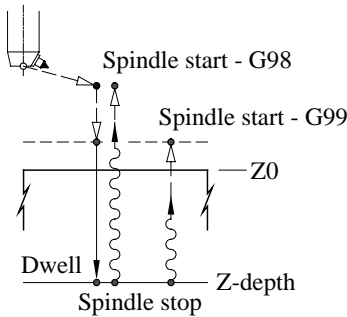


Fig. 25. G88 Fixed Cycle.

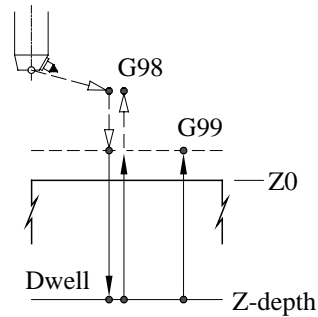


Fig. 26. G89 Fixed Cycle.

Boring with Dwell (G89): The G89 fixed cycle is used for boring with dwell and has the following format:

N__ G99 (G98) G89 X__ Y__ R__ Z__ P__ F__

From the R-level, the boring bar will feed to the Z-depth, dwells for the number of milliseconds specified by P__, then feeds back to R-level, both at the programmed feed rate F__. G85, a similar cycle, does not have a dwell. Either one of these cycles is commonly used for reaming (see Fig. 26).

Fixed Cycle Cancellation (G80): The G80 fixed cycle cancel is used to cancel any fixed cycle and has the following format:

N__ G80

G80 is the recommended method for fixed cycle cancellation, although programming any motion command (G00, G01, G02, G03) will also cancel any active cycle.

General Notes on Fixed Cycles: Except G87, all fixed cycles can retract to either the R-level (using G99) or the initial level (using G98). The R-level is often called the feed plane and is the Z-position from where the feed rate mode begins. In the cycle, the Z-address is used for depth and the R-address is used for the feed plane to avoid a conflict of two identical addresses. The initial level is the last Z-address programmed before a fixed cycle is called. Although the initial level can be equivalent of the R-level, it usually is higher. Its purpose is to provide means for special clearance setting to bypass obstacles between holes.

Fixed cycles for boring can be applied to either single point or double point boring bars, with the exception of G76 and G87 cycles, which require a shift. In all cases, boring bars must be preset to the diameter of the hole machined.

Contouring.—Contouring is the most common semi-finishing and finishing toolpath for both machining centers and lathes. The programmer has to calculate every single point of the part in the order of machining. Using a cutter radius offset, the toolpath is based on the drawing dimensions. Not every point is identified in the drawing and its coordinates have to be calculated manually. For vertical and horizontal lines the calculations are quite simple, but for angular lines and partial arcs trigonometric calculations are necessary.

Fig. 27 shows typical calculations for start and end points of an arc tangent to two lines, a common situation in programming. As in any calculations, certain features must be known. For the calculations shown, point P, radius R, and angle A (as shown) must be known.

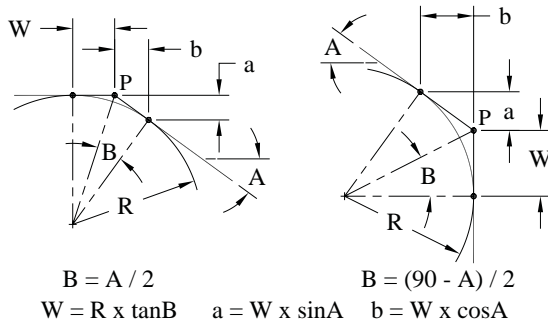


Fig. 27. Calculation of Tangent Points.

Turning and Boring.—With the advancement of computer technology, control manufacturers have developed cutting cycles capable of complex lathe operations and made them an integral part of the lathe control systems. These special cycles are called *Multiple Repetitive Cycles*. Their main attraction is their excellent flexibility. Some of these advanced cycles cover turning and boring, others grooving and threading. These cycles are only complex in the mathematical sense and even then, only within the control system. In practice, these advanced machining cycles are easy to program. Their other benefit is that they can be easily changed at the control terminal to be optimized for best performance.

The most common multiple repetitive cycles are:

Table 6. Multiple Repetitive Cycles

G-code	Description	G-code	Description
G70	Contour finishing cycle (used after G71, G72, and G73)	G74	Peck drilling cycle - along the Z-axis
G71	Roughing cycle - horizontal direction	G75	Peck grooving cycle - along the X-axis
G72	Roughing cycle - vertical direction	G76	Single point threading cycle (straight or tapered)
G73	Pattern repeating roughing cycle		

For turning and boring operations, G71 cycle is the most common, along with G76 cycle for threading (described separately).

Roughing Cycle (G71): The most common roughing cycle is G71. Its purpose is to remove stock by horizontal cutting, primarily along the Z axis, typically from the right to the left. It is used for roughing out material out of a solid cylinder. It is available in two formats - a one-block and a two-block format, depending on the control system.

Older controls use a one-block format:

N_ G71 P_ Q_ I_ K_ U_ W_ D_ F_ S_

where:

$P_{__}$ = first block number of the finishing profile,

$Q_{__}$ = last block number of the finishing profile,

$I_{__}$ = distance and direction of rough semi finishing in the X axis - per side,

$K_{__}$ = distance and direction of rough semi finishing in the Z axis,

$U_{__}$ = stock amount for finishing on the X axis diameter,

$W_{__}$ = stock left for finishing on the Z axis,

$D_{__}$ = depth of roughing cut,

$F_{__}$ = cutting feed rate per revolution,

$S_{__}$ = spindle speed in ft/min or m/min (cutting speed).

The I and K parameters are not available on all machines. They control the amount of cut for semi finishing, the last continuous cut before final roughing motions.

Newer controls require a two-block data entry for the G71 cycle, and the programming format is:

G71 $U_{__}$ $R_{__}$; G71 $P_{__}$ $Q_{__}$ $U_{__}$ $W_{__}$ $F_{__}$ $S_{__}$

where the parameters in the first block are:

$U_{__}$ = depth of roughing cut,

$R_{__}$ = amount of retract from each cut.

where the parameters in the second block are:

$P_{__}$ = first block number of the finishing profile,

$Q_{__}$ = last block number of the finishing profile,

$U_{__}$ = stock amount for finishing on the X axis diameter,

$W_{__}$ = stock left for finishing on the Z axis,

$F_{__}$ = cutting feed rate per revolution,

$S_{__}$ = spindle speed in ft/min or m/min (cutting speed).

The U-address in the first block is independent of the U-address in the second block. The I and K parameters may be used only on some controls and the retract amount R is set by a system parameter.

G71 cycle can be used for external roughing (turning) as well as for internal roughing (boring). The control system determines the type of machining by comparing the start point SP with the point P.

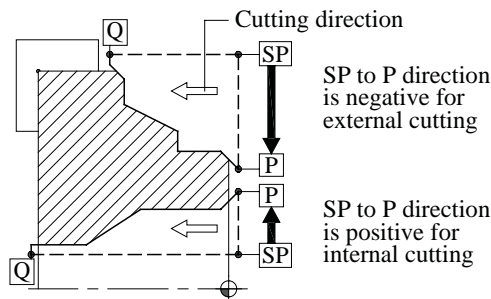


Fig. 28. G71 Roughing Cycle.

A typical program segment will have the following structure (tool O1 used):

```
N1 G20 T0100; N2 G96 S__ M03;
N3 G00 X__ Z__ T0101 M08 (START POINT SP); N4 G71 U0.15 R0.04;
N5 G71 P6 Q11 U0.06 W0.005 F0.015; N6 G00 X__ (POINT P BLOCK); N7 ...;
N8 ...
N9 ...
N10 ...
```

N11 U0.2 (POINT Q BLOCK); N12 G28 U0 W0; N13 M30; %;

G72 Roughing cycle is similar, but applies for vertical direction of cut.

There are two types of G71 and G72 - Type I and Type II. Type I does not allow for a change of direction, whereby Type II allows for a change in one axis only.

Repeated Finish Counting (G73): G73 pattern repeating cycle is used to machine a finishing contour repeatedly, by a given distance, in specified number of steps.

Finish Cycle (G70): G70 is programmed after G71, G72, and G73 as a finishing cycle, and has a simple format:

$$N_ G70 P_ Q_ F_ S_$$

where:

$P_$ = the first block number of the finishing profile,

$Q_$ = the last block number of the finishing profile,

$F_$ = the cutting feed rate per revolution,

$S_$ = the spindle speed in ft/min or m/min (cutting speed).

In all the examples, the spindle speed or feed rate can be omitted in the cycle, if already active (declared previously). The program example for G70 will use the data from the roughing operation:

$$N_ G70 P6 Q11 F0.01 S400$$

Basic Rules for G71, G73 Cycles: It is important to observe some general rules, in order to make the multiple repetitive safe and efficient. Here are some more important rules:

- a) Apply a tool nose radius offset before the stock removal cycle is called.
- b) Cancel the tool nose radius offset after the stock removal cycle is completed.
- c) Return motion to the start point is automatic and must not be programmed.
- d) The P block in G71 should not include the Z-axis value for cycle Type I.
- e) Change of direction is allowed only for Type II G71 cycle and along one axis only.
- f) Stock amount U is programmed on a diameter (U+ for turning, U- for boring.)
- g) The Feed Rate programmed between the P and Q points will be ignored during roughing.
- h) Multiple repetitive cycles can be optimized at the machine by changing one or more settings. G72 and G73 are programmed in a similar way. G74 and G75 are used much less frequently and have a simpler format.

Thread Cutting on CNC Lathes

The method of thread cutting on CNC lathes is called *single point threading* using an indexable threading insert. As a threading operation is both a cutting and a forming operation, the shape and size of the threading insert must correspond to the shape and size of the finished thread. By definition, a single point threading is a machining process of cutting a helical groove of a specific shape with a uniform advancement per spindle revolution. The uniformity of the thread is controlled by the programmed feed rate in feed rate per revolution. Feed rate for threading is always the lead of the thread, never the pitch. For single start threads, the lead and the pitch are identical. As single point threading is a multi-pass operation, the CNC system provides spindle synchronization for each threading pass.

Depth of Thread Calculations.—Regardless of the threading method used, the depth of a thread will be required for various calculations. It can be calculated from these common formulas (*TPI* is the number of threads per inch):

External V-threads (60-degrees for metric or U.S. customary units):

$$\text{Depth of Thread} = \frac{0.61343}{TPI} = 0.61343 \times \text{Pitch} \quad (1)$$

Internal V-threads (60-degrees for metric or U.S. customary units):

$$\text{Depth of Thread} = \frac{0.54127}{TPI} = 0.54127 \times \text{Pitch} \quad (2)$$

Thread Pitch = the distance between two corresponding points of adjacent threads.

$$\text{Pitch} = \frac{1}{TPI} \quad (3)$$

In metric drawings, the pitch is specified as part of the thread designation.

Thread Lead = the distance the threading tool will advance along an axis in one revolution of the spindle

$$\text{Feed Rate} = \text{Lead} = \frac{\text{Number of Starts}}{TPI} = \text{Number of Starts} \times \text{Pitch} \quad (4)$$

Spindle speed is always programmed in direct r/min mode (G97) not in the constant surface speed mode G96.

Infeed Methods.—The way a threading tool enters into the material can be programmed in several ways, using two infeed methods available. Infeed is the type of motion from one pass to the next. Three basic thread infeed methods are shown in Fig. 29:

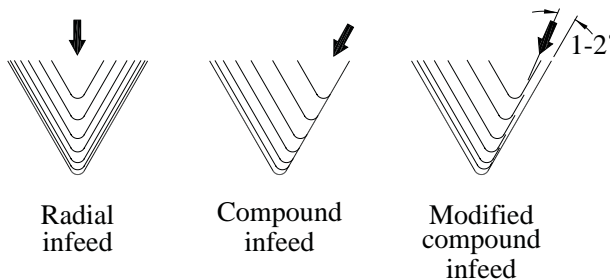


Fig. 29. Thread Infeed Methods.

- 1) Plunge method - also known as the radial infeed
- 2) Angular method - also known as the compound or flank infeed
- 3) Modified angular method - also known as the modified compound (flank) infeed

Specified infeed is typically selected to achieve the best cutting conditions for the insert edge in a given material. With the exception of some very fine leads and soft material, the majority of threading cuts will benefit from a compound infeed or modified compound infeed (angular method), providing the thread geometry allows this method. For example, a square thread will require a radial infeed, while an Acme thread will benefit from compound infeed. Four methods can be applied for compound infeed threading:

- 1) Constant cutting amount
- 2) Constant cutting depth
- 3) One edge cutting
- 4) Both edges cutting

Radial Infeed.—Radial infeed is one of the more common threading methods, if the conditions are suitable. It is applied to a cutting motion that is perpendicular to the diameter being cut. Each threading pass diameter is specified as the X-axis, while the Z-axis start point remains unchanged. This infeed method is suitable for soft materials, such as brass, certain aluminum grades, etc. In harder materials it could damage the thread integrity and is not recommended.

The inevitable outcome of a radial infeed motion is that both insert edges are working simultaneously. Since the insert edges are opposite of each other, the chips are formed at both edges at the same time, causing problems that can be traced to high temperatures, lack of coolant access, and tool wear problems. If the radial infeed results in a poor quality thread, a compound infeed method will usually solve the problem.

Compound Infeed.—Compound infeed method - also known as a flank infeed method - works on a different principle. Instead of feeding the threading tool perpendicularly towards the part diameter, the position for each pass is shifted by trigonometric calculation to a new Z-position. This approach results in a threading pass where most of the cutting takes place at one edge. As only one insert edge does most of the work, the generated heat can dissipate away from the tool edge while the cutting chips curl away, which extends the tool life.

Using the compound threading method, a heavier pass depth with fewer passes can be used for the majority of threads. Compound infeed can be modified by providing 1 to 2 degrees of clearance on one edge to prevent rubbing. The angle of the thread will be maintained by the angle of the threading insert.

Threading Operations.—There are many threading operations that can be programmed for a typical CNC lathe. Several operations require a special type of threading insert and some operations can only be programmed if the control system is equipped with special (optional) features:

- a) Constant lead single start threads (typically using G32 or G76)
- b) Variable lead threads - increasing or decreasing (special option) (G34 and G35)
- c) External and internal threading
- d) Tapered threads (conical threads)
- e) Right hand (R/H) and left hand (L/H) threads
- f) Face threads (scroll threads)
- g) Multi-start threads
- h) Circular threads (special option)
- i) Multi-block threads (so called long-hand threading, block-by-block) (G32)

The most common threading modes use either G32 (G33 on some controls) and G76.

Threading Cycle (G32).—The G32 command is sometimes called “long-hand threading,” because each tool motion is programmed as one block. Programs using G32 can be quite long and virtually impossible to edit without major reprogramming. On the other hand, G32 method offers great flexibility and often is the only method that can be used, particularly for special threads. The programming format for G32 requires at least four blocks of input for a single thread pass from a start position:

N__ G00 X__ Z__	
N__ (G00) X__	Current threading pass diameter
N__ G32 Z__ F__	Actual thread cutting (X__ Z__ for taper threads)
N__ G00 X__	Retract to X-start position
N__ Z__	Return to Z-start position

Threading Cycle (G76).—G76 is a multiple repetitive cycle for threading, and is the most common method used to generate most of thread forms. Similar to roughing cycles, G76 is programmed in two versions, depending on the control system used. For older controls, a one-block format is used, for newer controls a two-block format is used. The two-block format offers additional settings that are not available in the one-block method.

The G76 threading cycle requires information about the thread and the cutting method.

One Block Cycle: For a one-block G76 cycle, the format is:

N__ G76 X__ Z__ I__ K__ D__ A__ (P__) F__

Where:

- X = the diameter of the last threading pass
- Z = the end of thread along the Z axis
- I = the amount of taper over the total length (per side)
- K = the single depth of the thread
- D = the depth of the first threading pass
- A = the included insert angle (only A0, A29, A30, A55, A60, and A80 allowed)

P = the infeed method adjustment - positive (not available on all controls)

F = the feed rate (thread lead)

Two Block Cycle: The two-block G76 format includes several additional programmable features that make the cycle more flexible. For a two-block G76 cycle, the format is:

```
N__ G76 P__ Q__ R__
N__ G76 X__ Z__ R__ P__ Q__ F__
```

Where the first block:

P = a six-digit data entry in three pairs:

Digits 1 and 2 - number of finishing cuts (01-99)

Digits 3 and 4 - number of leads for gradual pull-out (0.0-9.9 times lead), no decimal point used (00-99)

Digits 5 and 6 - angle of thread (00, 29, 30, 55, 60, 80 degrees only)

Q = the minimum cutting depth (positive radial value - no decimal point)

R = the fixed amount for finish allowance (decimal point allowed)

Where the second block:

X = the diameter of the last threading pass

Z = the end of thread along the Z axis

R = the amount of taper over the total length (per side)

P = the single depth of the thread (positive radial value - no decimal point)

Q = the depth of the first threading pass (positive radial value - no decimal point)

F = the feed rate (thread lead)

The P/Q/R addresses of the first block are not related to the P/Q/R addresses of the second block. They have their own meaning, applied within each block only.

The G76 threading cycle is used to program the majority of CNC thread cutting operations. Several of parameters of the G76 cycle can be changed at the machine to optimize the threading operation.

Example: The code block for cutting an external thread on 2 inch diameter, 12 threads per inch, using tool number 6 to the length of 1.5 inches (thread ends in a recess) would be:

```
N31 T0600; N32 G97 S800 M03; N33 G00 X2.2 Z0.3 T0606 M08 (START POINT FOR THE THREAD); N34 G76 P010060 Q0040 R0.002; N35 G76 X1.8978 Z-1.5 R0 P0511 Q0100 F0.083333; N36 G00 X8.0 Z5.0 T0600; N37 M01;
```

Multi-start Threads.—Threads with more than one start can be programmed using either G32 or G76 threading commands. The lead (and feed rate) for multi-start threads is always the number of starts times the pitch. For example, a triple start thread with the pitch of 0.0625 (16 TPI) will be 0.1875 (F0.1875). In order to achieve proper distribution of each start around the cylinder, each thread has to start at an equal angle, determined by the following calculation:

$$\text{Thread cylindrical spacing angle} = 360 / \text{Number of starts}$$

To achieve this angular spacing, the Z-axis point for each start must be one pitch further than the previous start:

$$\text{Shift amount} = \text{Pitch}$$

$$\text{Number of shifts} = \text{Number of starts} - 1$$

Subprograms, Macros and Parametric Programming

CNC programs use several techniques to allow the programmer to create complex pieces of code using CNC code building blocks.

Subprograms.—*Subprograms* (also known as subroutines), are specially designed programs that can be called on demand by another program and repeated as desired. Such rep-

edition can take place in one program or in several programs. The content of standard subprograms is fixed and can be used only for the intended, specific purpose. For variable type subprograms - called macros - a special control option is required (see page 1306).

The main advantages of subprograms include transportability between programs (even machines), shorter programs, and easier editing. Any repetitive toolpath or machine activity is suitable to be developed as a subprogram.

Any subprogram has to have a number (for example O6001), in the same format as the main program (or other program of origin). The end of subprogram uses the M99 function, which transfers the processing put of the subprogram back to the program of origin. Another miscellaneous function - M98 - is used to call a previously stored subprogram, for example M98 P6001. The address O is used for storing the subprogram, address P is used for calling the subprogram.

If required, a subprogram can be repeated, up to 9999 times. That is achieved in three ways, depending on the control system:

Method 1: M98 P6001 L5 will repeat subprogram O6001 five times

Method 2: M98 P6001 K5 will repeat subprogram O6001 five times

Method 3: M98 P00056001 will repeat subprogram O6001 five times

Subprograms can be nested. Nesting is a feature that allows one subprogram to call another subprogram up to four levels deep.

In the example of a simple subprogram application Fig. 30, a complete toolpath is developed for one pocket, stored as a subprogram, and called at the equivalent location of the three remaining pockets. Typical programming methods will use an incremental method of dimensioning.

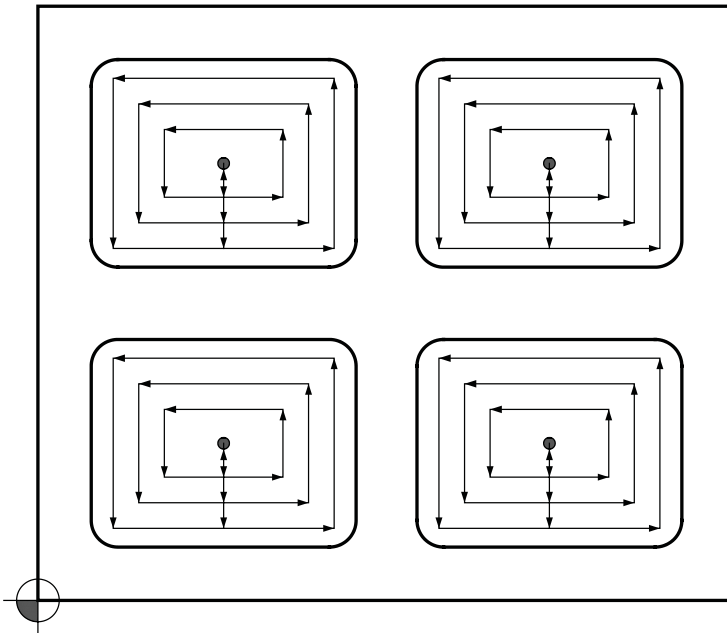


Fig. 30. Typical Subprogram Application.

Macros and Parametric Programming.—In this general introduction to the subject of macros and parametric programming, the most common development tool is known as Fanuc Custom Macros B. In spite of the great advancement of CAD/CAM software, macros have their special place. In addition to manual or computer assisted programming, macros are used to provide a special solution to a special requirement. Macro programming is a method using variable data in a special subprogram (now called a macro), with actual values defined in the main program. This method provides a single ‘master’ pro-

gram that can be used many times with different numerical values. A typical example is a bolt circle, where only a few values change. The main purpose of a macro program is to save programming time.

Basic Macro Skills.—Depending on the complexity of the macro to be developed, some basic knowledge and skills are required. The following list identifies the most important items:

- a) Understanding various methods of data settings
- b) CNC machines and controls - operation and programming
- c) Machining skills - how to machine a part
- d) Basic mathematics skills - calculations, formulas
- e) Program structure development skills - convenience and consistency
- f) Offsets and compensations applications skills - various adjustments
- g) Fixed cycles in depth - how they work, in detail
- h) Subprograms in depth, including multi nesting applications
- i) System parameters, their purpose and functions

In addition, if a macro is written for a particular function of the machine, knowledge of that function as it relates to the machine is also very important. If the macro is developed for probing or in-process gauging, the programmer has to understand the full process as well as the objective of the macro development.

Confirming Macro Capability.—A macro is a control option, and may not be automatically available to the user. There is a simple way to find out if a macro is active. Set the control to MDI mode (Manual Data Input) and enter this command:

```
#1=1
```

After pressing the “Cycle Start” button, the control will either accept the statement or reject it. The # symbol identifies the subsequent number as a variable number 1 with an assigned value of 1. A statement using the # symbol is unique to macros. If the control rejects it, or it is impossible to enter the symbols, that means the control does not support macro functions.

Common Features and Applications.—Typical features found in macros are:

- 1) Arithmetic and algebraic calculations
- 2) Trigonometric calculations
- 3) Variable data storage
- 4) Logical operations
- 5) Branching
- 6) Looping
- 7) Error detection
- 8) Alarm generation
- 9) Input and Output
- 10) Miscellaneous features

A macro program looks like a regular CNC program, but includes many other features. A macro program is structured as a subprogram - it is stored under its own program number (O-), and it is usually called by the main program, using the G65 preparatory command. In a simple form, macro features can be used in the main program, without the macro call. The following list highlights some of the most common applications of macros:

- 1) Groups of similar parts (parametric programming)
- 2) Offset control
- 3) Custom cycles
- 4) Non-standard tool motions (simulating curves)
- 5) Special G-codes and M-codes
- 6) Alarm and message generation
- 7) Hiding and protecting macro programs
- 8) Probing and gauging

9) Various shortcuts and utilities

Macro Structure.—There are three basic areas to understand for successful macro development. These three areas offer many special functions that are used within the macro.

Variables are the key element of all macros. They provide flexibility by easily storing changeable data. When a value is assigned to a variable, it is stored for future use. Stored values are called *Defined Variables*.

Functions and Constants are also an important part of macros. Functions calculate something - they solve a mathematical calculation or a formula. For example, a “+” (plus) function will sum two or more values together. In addition to functions, constants can be defined in a macro as well, for example the pi (π) with the value of 3.14159265359

Logical Functions are used for branching and looping purposes. Looping and branching provide a change in the program flow that is based on a certain condition that has been previously defined. The given condition may be tested (evaluated), using the comparison functions, such as 'greater than' (>), 'equal to' (=), 'less than or equal to' (<=), and several others, used together with the IF function. They are called Boolean or logical operators. The given condition can be tested only once, using the IF checking function or it may be evaluated repeatedly, using the loop function WHILE - while the given condition is true, the loop is repeated. The result of the evaluation will determine further flow of the program.

Macro Definition and Call.—Macros are defined in a similar way as subprograms, but they are called or invoked by the G65 command:

```
O7001 (MACRO)
...
...
M99
%
```

Variable Definition (G65).—The G65 macro command accepts variable definitions, called arguments. Arguments are actual program values required for a particular macro only. They are passed to the macro. Variable data in the macro is then replaced with the supplied arguments. A typical program sample of a G65 macro using three arguments may have the following format: G65 P7001 A6.0 B8.5 F10.0

G65... Macro call command

P7001... Program number containing the macro - stored as O7001

A6.0... Assignment of local variable A (#1) argument to be passed to macro

B8.5... Assignment of local variable B (#2) argument to be passed to macro F10.0...

Assignment of a local variable F (#9) argument to be passed to macro

The illustration Fig. 31 shows graphically the flow between the main program and a macro, as well as the definition and use of the three variables (defined as arguments). In the example, a macro linear motion command will be replaced with the defined amounts:

G01 X#1 Y#2 F#9 = G01 X6.0 Y8.5 F10.0

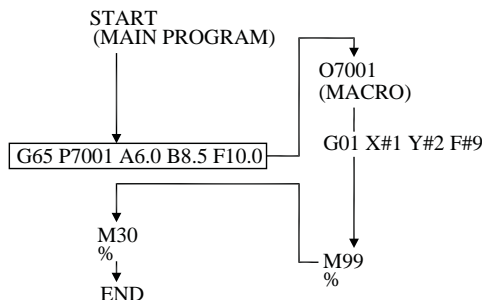


Fig. 31. Macro Call From Main Program.

Assignment of macro variables as arguments is one of the most important parts of developing any macro. Macro B has an arbitrary list of variables (called *Argument List 1*) and their meaning, shown in the following table:

Table 7. Macro B Argument List

Argument List 1	Macro Local Variable	Argument List 1	Macro Local Variable	Argument List 1	Macro Local Variable	Argument List 1	Macro Local Variable
A	1	H	11	O	Not assigned	V	22
B	2	I	4	P	Not assigned	W	23
C	3	J	5	Q	17	X	24
D	7	K	6	R	18	Y	25
E	8	L	Not assigned	S	19	Z	26
F	9	M	13	T	20		
G	Not assigned	N	Not assigned	U	21		

The above variables are LOCAL variables and can be used in arguments or in the macro.

Note that there are five letters missing (not assigned) - they are G N O P L. These letters are reserved and cannot be used as arguments. The letter L is used for the number of macro repetitions.

Variables #10, #12, #14, #15, #16, #27, #28, #29, #30, #31, #32 and #33 can only be used in a macro, not as an argument.

Types of Variables.—There are four types of variables available for macros:

Null Variable: Variable identified as #0 is a null variable. A null variable has no value - it is an empty variable, often called a vacant variable. This variable can be read by the macro program, but it cannot be assigned a value, which means data cannot be assigned to it.

Local Variables: Local variables are temporary only - they are used in macro body and hold certain data. When the macro is called, the local variables are set to their assigned values. When the macro is completed and exits (using the miscellaneous function M99), or the control power is turned off, all local variables are set to null values - they will no longer exist.

Common Variables: Common - or global - variables are still stored in the control memory when macro is completed. These variables are maintained by the system and they can be shared by several other macro programs. This group of variables is normally cleared by a specially designed macro program.

System Variables: System variables are used for setting and/or changing default conditions and can read and write different CNC data, for example, a current status of a G-code mode, the current work offset, etc. Their numbers are assigned by the control system manufacturer.

Variable Declarations and Expressions.—Variable data is not only defined in the argument section of the G65 macro call, variables can also be defined - or declared - in the macro body itself. Compare the two following declarations:

#19 = 800	A value of 800 is assigned to variable number 19 - it can be spindle speed (r/min)
#9 = 15.0	A value of 15.0 is assigned to variable number 9 - it can be a feed rate (mm/min, m/min, ft/min, in/min, etc.)

Both declarations store values - the value of “800” is stored into the variable #19 and the value of “15.0” into the variable #9. Both values shown in the example are numbers, but they are two different types of a number. 800 is an integer, 15.0 is a real number. In macros, this distinction is important. Variables may also use special expressions. For example, the variable definition #9 = 15.0 can be redefined later, as #9 = #9 * 1.1, which returns 16.5. If #9 defines the cutting feed rate, the new feed rate will be F16.5. Expressions can also be nested, following the standard mathematical hierarchy of the order of calculations:

#1 = 5.0
#2 = 8.5

#3 = 10.0

#4 = [#3 * #2] / #1; which returns 17.0

Note that brackets are used for nesting, not parentheses. Parentheses indicate a program comment or a message:

#19 = 800(SPINDLE SPEED DEFINED)

#9 = 15.0(CUTTING FEEDRATE DEFINED)

If a macro feature is available, variables can be defined and used in the main program directly, for example:

#19 = 800

N4 G90 G54 G00 X24.0 Y13.5 S#19 M03

Many variations and applications are possible.

Macro Functions.—The available macro functions can be divided into six groups:

- 1) ARITHMETIC functions
- 2) TRIGONOMETRIC functions
- 3) ROUNDING functions
- 4) MISCELLANEOUS functions
- 5) LOGICAL functions and operations
- 6) CONVERSION functions

Macro Arithmetic Functions: There are four arithmetic functions:

+	Addition	*	Multiplication
-	Subtraction	/	Division

Example:

#1 = 3.5	3.5	Returned value of variable #1 is 3.5
#2 = 4.25	4.25	Returned value of variable #2 is 4.25
#3 = 2.0 + 5.0	7.0	Returned value of variable #3 is a sum of 2+5
#4 = #3 + 1	8.0	Add 1 to the result of variable #3
#5 = #2 - 0.8	3.45	Subtract 0.8 from the current value of variable #2
#6 = #1 - #3	-3.5	Subtract contents of #3 from the contents of #1
#7 = #2 * 6	25.5	Multiply contents of #2 by 6
#8 = 7.0 / 8.0	0.875	Divide 7 by 8 as real numbers
#9 = 7 / 8	0.875	Divide 7 by 8 as integer numbers

Trigonometric Functions: The following trigonometric functions are generally available for macros:

SIN	Sine	COS	Cosine	TAN	Tangent
ASIN	arcsine	ACOS	arccosine	ATAN	arctangent

All inputs for SIN, COS, and TAN are in degrees and the output of the inverse functions ATAN, ASIN and ACOS is also in degrees. Inverse functions are usually marked as tan-1, sin-1, and cos-1 on the calculator.

Example:

#1 = SIN[38]	0.6156615	Actual value must be in brackets
#2 = 23.7	23.7	
#3 = COS[#2]	0.9156626	Reference to a variable must be in brackets
#4 = TAN[12.86]	0.2282959	

The inverse trigonometric functions accept the length of two sides of a triangle, both enclosed in brackets, “[]”, and separated by the slash symbol, “/”, standing alone between them. The acceptable range is within $0 \leq \text{RESULT} < 360$:

Example:

#5 = ATAN[0.25]/[0.5] 26.5650512 Position of the slash symbol is important

ASIN and ACOS functions are not available on all controls.

Rounding Functions: Rounding functions control how decimal places are handled. There are three rounding functions:

- 1) ROUND
- 2) FIX
- 3) UP

(1) *ROUND:* The ROUND function rounds off a value to the nearest whole number. The function disregards fractions that are less than 0.5. For fractions that are equal to or greater than 0.5, the next whole number is the rounded value:

ROUND[0.00001]	Returns 0.0
ROUND[0.5]	Returns 1.0
ROUND[0.99999]	Returns 1.0
ROUND[1.0]	Returns 1.0

There is one very important difference between using the ROUND function directly in a program statement or in a variable definition. Consider the following two blocks:

#101 = 27/32

G91 G00 X[ROUND[#101]]

The incremental motion will be X0.8438 (U.S. customary) or X0.844 (metric). However, if the ROUND function is used in a variable definition, the result will be different:

#101 = [ROUND[27/32]]Returns 1.0

G91 G00 X[#101]

The incremental motion will be X1.0

Rounding can also be performed to a given number of decimal places, but it is a two step process. In the first step, the given value must be multiplied by the factor of:

10... to round off to one decimal place

100... to round off to two decimal places

1000... to round off to three decimal places (typical for metric system)

10000... to round off to four decimal places (typical for U.S. customary system)

The second step is to use the ROUND function together with the multiplier. For example, to round 123.56789 to three decimal places:

#101 = 123.456789

#101 = #101*1000Returns 123456.789

#101 = ROUND[#101]Returns 123457.0 (nearest whole number)

#101 = #101/1000Returns 123.457

Note that only a single variable has been used for all four calculations. If the original value is not required later, this is a very efficient method of defining variables in the macro body.

The remaining two rounding functions FIX and FUP are used to round a given value up or down only, regardless of whether the decimal portion is over or under 0.5. The FIX and FUP functions are commonly used for counting rather than calculations.

(2) *FIX:* The FIX function is designed to round down the given value (discard fractions less than 1.0) i.e., strip all values after decimal point.

ROUND[0.00001]	Returns 0.0
ROUND[0.5]	Returns 0.0
ROUND[0.99999]	Returns 0.0

ROUND[1.0] Returns 1.0

(3) *FUP*: The FUP function is designed to round up the given value (raise fractions less than 1.0).

ROUND[0.00001] Returns 1.0

ROUND[0.5] Returns 1.0

ROUND[0.99999] Returns 1.0

ROUND[1.0] Returns 1.0

Miscellaneous Functions: There are two common miscellaneous functions, SQRT and ABS. Several others exist but are not available on all control models.

(1) *SQRT*: The SQRT function calculates the square root of a number supplied between brackets:

SQRT[25.0] Returns 5.0

(2) *ABS*: The ABS function (absolute function) always returns a positive value of a given number:

ABS[-1.3] Returns 1.3

ABS[1.3] Returns 1.3

Using the ABS function is very useful in many applications, for example, to guarantee a positive or a negative value:

#26 = 1.3 Positive input

G01 Z-[ABS[#26]] The motion will be equivalent to Z-1.3

#26 = -1.3 Negative input

G01 Z-[ABS[#26]] The motion will be equivalent to Z-1.3

Logical Functions: Logical functions consist of Boolean operators and bitwise or binary functions:

Boolean functions (operators) compare two values and return a true or false condition:

EQ	Equal to	GT	Greater than	GE	Greater than or equal to
NE	Not equal to	LT	Less than	LE	Less than or equal to

Bitwise functions provide a means of combining comparisons.

AND	And	OR	Or	XOR	Exclusive Or
-----	-----	----	----	-----	--------------

The AND, OR, and XOR functions compare two defined conditions simultaneously. The compared conditions are evaluated, and return either a TRUE value or a FALSE value. In English language, it is easy to understand the difference between the AND and the OR functions, because they follow the basic logic of everyday language. Function XOR is not used with the same frequency in machining macros. Examples of usage:

Example 1, (OR): #33 = [#1 EQ #2] OR [#3 EQ #4]

Variable #33 returns true (return value is 1) if #1 equals #2 OR #3 equals #4 - otherwise it returns zero (false).

Example 2, (AND): #33 = [#1 EQ 1] AND [#2 EQ 2]

Variable #33 returns 1 (true) if #1 equals 1 AND #2 equals 2 - otherwise it returns 0 (false).

Example 3, (XOR): #33 = [#1 EQ 1] XOR [#2 EQ 2]

Variable #33 returns 0 (false) if both expressions are true or both expressions are false. If only one expression is true and the other is expression false, #33 returns 1 (true). XOR function is also known as the “exclusive or” function.

Branching and Looping.—Both branches and loops (iterations) are based on the return value of an evaluated condition. There are three macro functions available: “IF”, “GOTO”, and WHILE (also IF-THEN on some controls).

IF function: The “IF” function evaluates a given condition and branches to a specified block number providing the condition is true. If the condition is false, the macro processing continues in the next block. This function is commonly used when choosing between two alternatives. Effectively, the IF function bypasses one or more blocks if a certain condition is true. The programming format is:

IF [*<this condition is true>*] GOTO n

GOTO Function: The “GOTO” function is an unconditional branch and is programmed by itself in the block. the “n” is replaced by the block number to branch to. For example, GOTO901 will branch to block N901. The programming format is:

GOTO901

WHILE function: The “WHILE” function is for looping - it also requires a specified condition to be true for the loop to be processed. The word “while” can be interpreted as meaning “as long as”. Its programming format is:

WHILE [*<this condition is true>*] DON

The “ENDn” is the end of loop identification. There can be up to three levels of loop nesting. Each nested loop will have its own WHILE-ENDn. For a single loop, the ENDn is END1.

Note - there is also IF-THEN method available on some control systems. If available, the programming is much more streamlined. The programming format is:

IF [*<this condition is true>*] THEN [*<argument>*]

The ‘THEN’ argument is a statement, normally a definition based on the condition being true:

Example : IF [#1 EQ 1] THEN #33 = 0

All branching and looping functions are extremely powerful and are a fundamental part of effective use of macros.

Macro Example.—A classic example of macro development is an equally spaced arrangement of holes along a circle - a bolt circle pattern, see Fig. 32. Many versions can be developed, depending on the actual needs

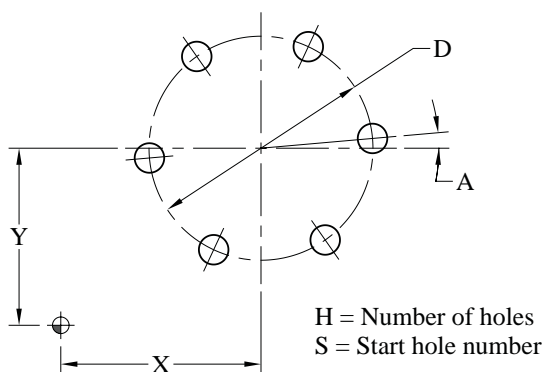


Fig. 32. Bolt Circle Macro Sample

(MAIN PROGRAM - CALLS MACRO **O7051**)

```

N1 G20
N2 G90 G00 G54 X0 Y0 S900 M03
N3 G43 Z1.0 H01 M08
N4 G99 G81 R0.1 Z-0.6 P250 F12.0 L0
N5 G65 P7051 X3.0 Y6.5 D4.5 H6 A5.0 S1
N6 G80 Z10.0 M09
N7 G28 Z10.0 M05
N8 M01
...
%
```

O7051 (BOLT HOLE CIRCLE MACRO)

```

#10 = #4003 (STORE CURRENT G90 OR G91)
IF [#7 LE 0] GOTO 9101
IF [#11 NE FUP[#11]] GOTO 9102
IF [#11 LE 0] GOTO 9103
IF [#19 EQ #0] THEN #19 = 1
IF [#19 NE FUP[#19]] GOTO 9102
IF [#19 LT 1] GOTO 9104
IF [#19 GT #11] GOTO 9105
#7 = #7/2 (BOLT CIRCLE RADIUS)
WHILE [#19 LE #11] DO1
  #30 = [#19 - 1] * 360 / #11 + #1
  X[ $\text{COS}[\#30] * \#7 + \#24$ ] Y[ $\text{SIN}[\#30] * \#7 + \#25$ ]
  #19 = #19 + 1
END1
GOTO 9999
N9101 #3000=101 (DIA MUST BE POSITIVE)
N9102 #3000=102 (ONLY INTEGER NUMBER ALLOWED)
N9103 #3000=103 (ONLY POSITIVE NUMBER OF HOLES)
N9104 #3000=104 (START HOLE MUST BE AN INTEGER)
N9105 #3000=105 (START HOLE NUMBER IS TOO HIGH)
N9999 G#10 (RESTORE ORIGINAL G90 OR G91)
M99
%
```

The macro call in block N5 includes six arguments that will be passed to the macro:

X = #24 = Bolt circle center distance from X0 (X3.0)

Y = #25 = Bolt circle center distance from Y0 (Y6.5)

D = #7 = Bolt circle diameter (D4.5)

H = #11 = Number of EQSP holes (H6)

A = #1 = Bolt circle angular orientation (default is 0) (A5.0)

S = #19 = Start hole number (default is 1) (S1)

Axis Nomenclature

To distinguish among the different motions, or axes, of a machine tool, a system of letter addresses has been developed. A letter is assigned, for example, to the table of the machine, another to the saddle, and still another to the spindle head. These letter addresses, or axis designations, are necessary for the electronic control system to assign movement instructions to the proper machine element. The assignment of these letter addresses has been standardized on a worldwide basis and is contained in three standards, all of which are in agreement. These standards are EIA RS-267-B, issued by the Electronics Industries Association; AIA NAS-938, issued by the Aerospace Industries Association; and ISO/R 841, issued by the International Organization for Standardization.

The standards are based on a “right-hand rule,” which describes the orientation of the motions as well as whether the motions are positive or negative. If a right hand is laid palm up on the table of a vertical milling machine, as shown in Fig. 1, for example, the thumb will point in the positive X-direction, the forefinger in the positive Y-direction, and the erect middle finger in the positive Z-direction, or up. The direction signs are based on the motion of the cutter relative to the workpiece. The movement of the table shown in Fig. 2 is therefore positive, even though the table is moving to the left, because the motion of the cutter relative to the workpiece is to the right, or in the positive direction. The motions are considered from the part programmer's viewpoint, which assumes that the cutter always moves around the part, regardless of whether the cutter or the part moves. The right-hand rule also holds with a horizontal-spindle machine and a vertical table, or angle plate, as shown in Fig. 3. Here, spindle movement back and away from the angle plate, or workpiece, is a positive Z-motion, and movement toward the angle plate is a negative Z-motion.

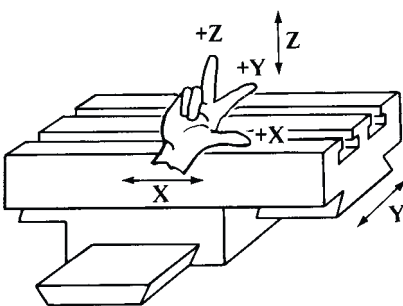


Fig. 1.

Table movement to the left in effect moves the cutter to the right, relative to the workpiece, or in the + direction

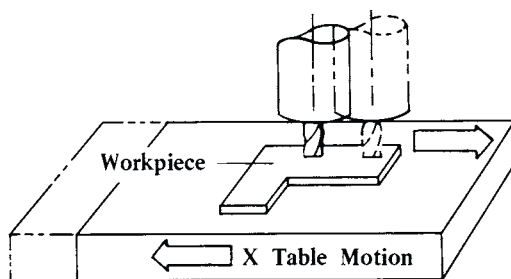


Fig. 2.

Rotary motions also are governed by a right-hand rule, but the fingers are joined and the thumb is pointed in the positive direction of the axis. Fig. 4 shows the designations of the rotary motions about the three linear axes, X, Y, and Z. Rotary motion about the X-axis is designated as A; rotary motion about the Y-axis is B; and rotary motion about the Z-axis is C. The fingers point in the positive rotary directions. Movement of the rotary table around the Y-axis shown in Fig. 4 is a B motion and is common with horizontal machining centers. Here, the view is from the spindle face looking toward the rotary table. Referring, again, to linear motions, if the spindle is withdrawn axially from the work, the motion is a positive Z. A move toward the work is a negative Z.

When a second linear motion is parallel to another linear motion, as with the horizontal boring mill seen in Fig. 5, the horizontal motion of the spindle, or quill, is designated as Z and a parallel motion of the angle plate is W. A movement parallel to the X-axis is U and a movement parallel to the Y-axis is V. Corresponding motions are summarized as follows:

Linear	Rotary	Linear and Parallel
X	A	U
Y	B	V
Z	C	W

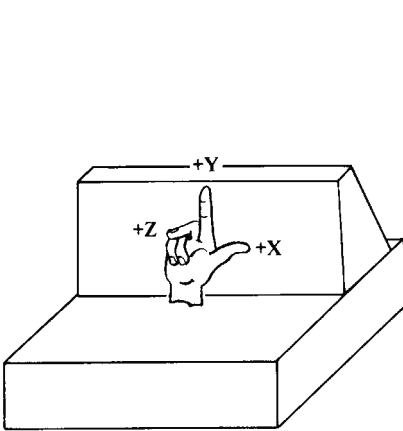


Fig. 3.

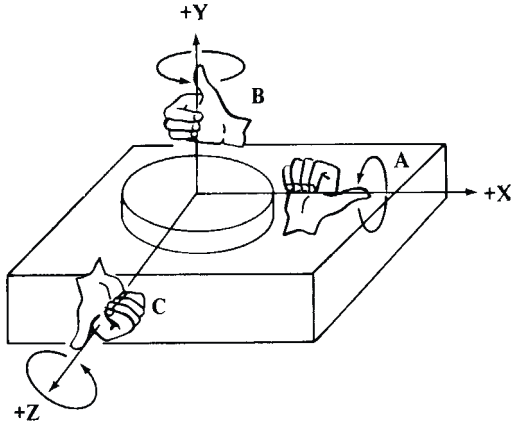


Fig. 4.

Axis designations for a lathe are shown in Fig. 6. Movement of the cross-slide away from the workpiece, or the centerline of the spindle, is noted as a plus X. Movement toward the workpiece is a minus X. The middle finger points in the positive Z-direction; therefore, movement away from the headstock is positive and movement toward the headstock is negative. Generally, there is no Y-movement.

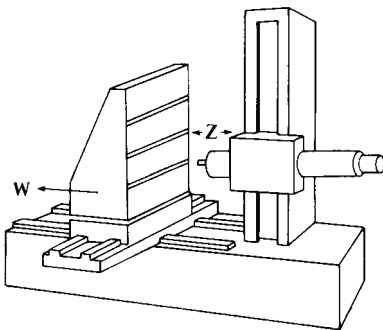


Fig. 5.

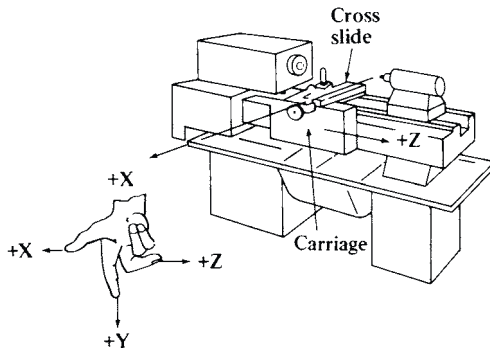
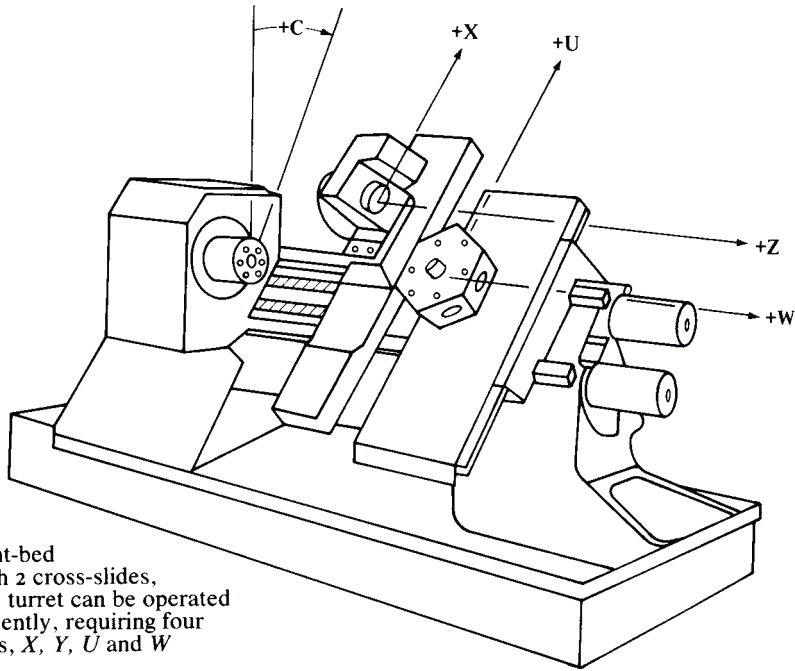


Fig. 6.

The machine shown in Fig. 6 is of conventional design, but most NC lathes look more like that shown in Fig. 7. The same right-hand rule applies to this four-axis lathe, on which each turret moves along its own two independent axes. Movement of the outside-diameter or upper turret, up and away from the workpiece, or spindle centerline, is a positive X-motion, and movement toward the workpiece is a negative X-motion. The same rules apply to the U-movement of the inside-diameter, or boring, turret. Movement of the lower turret parallel to the Z-motion of the outside-diameter turret is called the W-motion. A popular lathe configuration is to have both turrets on one slide, giving a two-axis system rather than

the four-axis system shown. X - and Z -motions may be addressed for either of the two heads. Upward movement of the boring head therefore is a positive X -motion.



On a slant-bed lathe with 2 cross-slides, each tool turret can be operated independently, requiring four addresses, X , Y , U and W

Fig. 7.

Axis nomenclature for other machine configurations is shown in Fig. 8. The letters with the prime notation (e.g., X' , Y' , Z' , W' , A' , and B') mean that the motion shown is positive, because the movement of the cutter with respect to the work is in a positive direction. In these instances, the workpiece is moving rather than the cutter.

Total Indicator Reading (TIR).—Total indicator reading is used as a measure of the range of machine tool error. TIR is particularly useful for describing the error in a machine tool spindle, referred to as runout. As shown in Fig. 9, there are two types of runout: axial and radial, which can be measured with a dial indicator. Axial runout refers to the wobble of a spindle and is measured at the spindle face. Radial runout is the range of movement of the spindle centerline and is measured on the side of the spindle or quill.

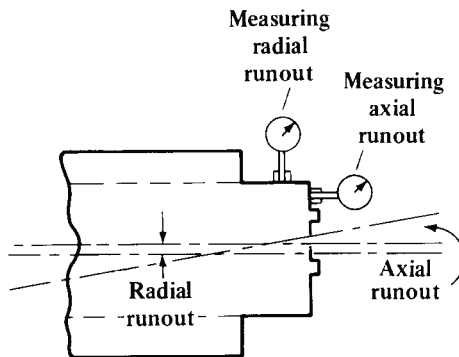
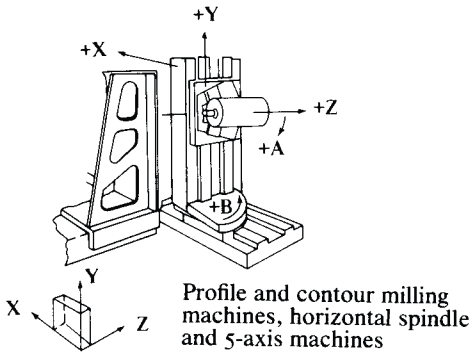
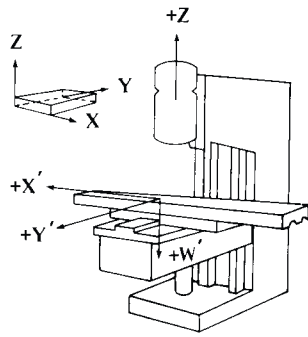


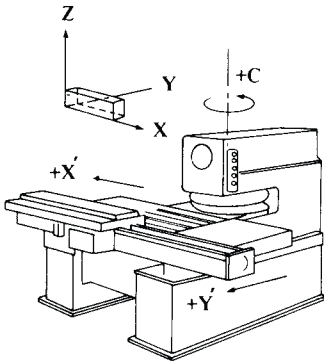
Fig. 9.



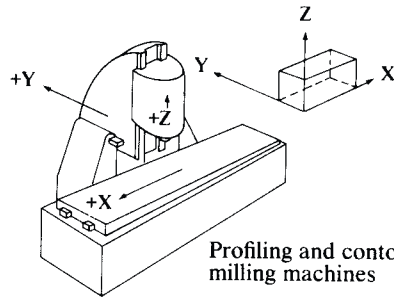
Profile and contour milling machines, horizontal spindle and 5-axis machines



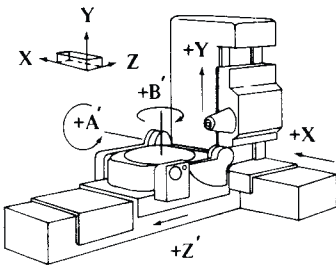
Vertical knee-type milling, drilling, or jig-boring machines



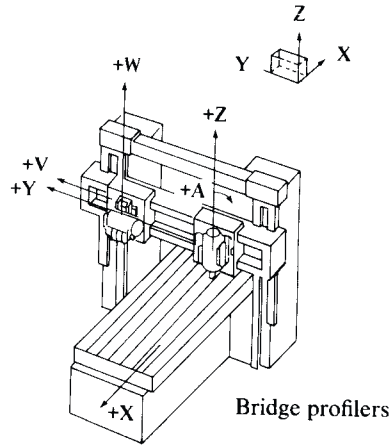
Turret type punch presses



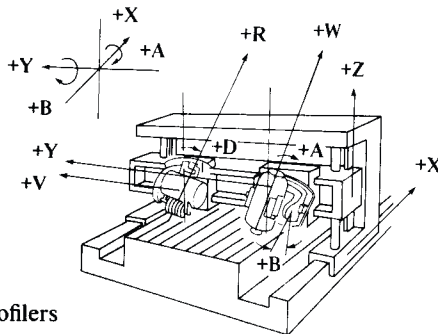
Profiling and contour milling machines



Tilting table, profile and contour milling and 5-axis machines



Bridge profilers



Gantry profilers

Fig. 8.

Machine Tool Accuracy

Accuracy, Repeatability, and Resolution: In machine tools, accuracy is the maximum spread in measurements made of slide movements during successive runs at a number of target points, as discussed below. Repeatability is the spread of the normal curve at the target point that has the largest spread. A rule of thumb says that repeatability is approximately half the accuracy value, or twice as good as the accuracy, but this rule is somewhat nullified due to the introduction of error-compensation features on NC machines. Resolution refers to the smallest units of measurement that the system (controller plus servo) can recognize. Resolution is an electronic/electrical term and the unit is usually smaller than either the accuracy or the repeatability. Low values for resolution are usually, though not necessarily, applied to machines of high accuracy. In addition to high cost, a low-resolution-value design usually has a low maximum feed rate and the use of such designs is usually restricted to applications requiring high accuracy.

Positioning Accuracy: The positioning accuracy of a numerically controlled machine tool refers to the ability of an NC machine to place the tip of a tool at a preprogrammed target. Although no metal cutting is involved, this test is very significant for a machine tool and the cost of an NC machine will rise almost geometrically with respect to its positioning accuracy. Care, therefore, should be taken when deciding on the purchase of such a machine, to avoid paying the premium for unneeded accuracy but instead to obtain a machine that will meet the tolerance requirements for the parts to be produced.

Accuracy can be measured in many ways. A tool tip on an NC machine could be moved, for example, to a target point whose X-coordinate is 10.0000 inches. If the move is along the X-axis, and the tool tip arrives at a point that measures 10.0001 inches, does this mean that the machine has an accuracy of 0.0001 inch? What if a repetition of this move brought the tool tip to a point measuring 10.0003 inches, and another repetition moved the tool to a point that measured 9.9998 inches? In practice, it is expected that there would be a scattering or distribution of measurements and some kind of averaging is normally used.

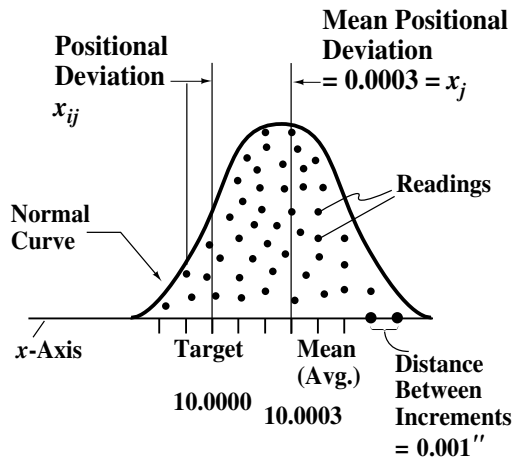


Fig. 1. In a Normal Distribution, Plotted Points Cluster Around the Mean.

Although averaging the results of several runs is an improvement over a single run, the main problem with averaging is that it does not consider the extent or width of the spread of readings. For example, if one measurement to the 10.0000-inch target is 9.9000 inches and another is 10.1000 inches, the difference of the two readings is 0.2000 inch, and the accuracy is poor. However, the readings average a perfect 10 inches. Therefore, the average and the spread of several readings must both be considered in determining the accuracy.

Plotting the results of a large number of runs generates a *normal distribution curve*, as shown in Fig. 1. In this example, the readings are plotted along the X-axis in increments of 0.0001 inch (0.0025 mm). Usually, five to ten such readings are sufficient. The distance of

any one reading from the target is called the *positional deviation* of the point. The distance of the mean, or average, for the normal distribution from the target is called the *mean positional deviation*.

The spread for the normal curve is determined by a mathematical formula that calculates the distance from the mean that a certain percentage of the readings fall into. The mathematical formula used calculates one *standard deviation*, which represents approximately 32 per cent of the points that will fall within the normal curve, as shown in Fig. 2. One standard deviation is also called one sigma, or 1σ . Plus or minus one sigma ($\pm 1\sigma$) represents 64 per cent of all the points under the normal curve. A wider range on the curve, $\pm 2\sigma$, means that 95.44 per cent of the points are within the normal curve, and $\pm 3\sigma$ means that 99.74 per cent of the points are within the normal curve. If an infinite number of runs were made, almost all the measurements would fall within the $\pm 3\sigma$ range.

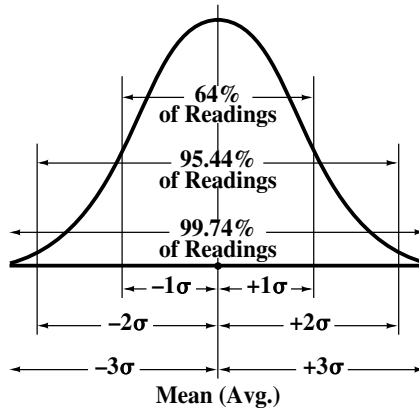


Fig. 2. Percentages of Points Falling in the $\pm 1\sigma$ (64%), $\pm 2\sigma$ (95.44%), and $\pm 3\sigma$ (99.74%) Ranges
The formula for calculating one standard deviation is

$$1\sigma = \sqrt{\frac{1}{n-1} \sum_{i=1}^n (X_{ij} - \bar{X}_j)^2}$$

where n = number of runs to the target; i = identification for any one run; X_{ij} = positional deviation for any one run (see Fig. 1); and, \bar{X}_j = mean positional deviation (see Fig. 1).

The bar over the \bar{X} in the formula indicates that the value is the mean or average for the normal distribution.

Example: From Fig. 3, five runs were made at a target point that is 10.0000 inches along the X-axis and the positional deviations for each run were: $x_{1j} = -0.0002$, $x_{2j} = +0.0002$, $x_{3j} = +0.0005$, $x_{4j} = +0.0007$, and $x_{5j} = +0.0008$ inch. The algebraic total of these five runs is $+0.0020$, and the mean positional deviation = $\bar{X}_j = 0.0020/5 = 0.0004$.

The calculations for one standard deviation are:

$$\begin{aligned} 1\sigma &= \sqrt{\frac{1}{n-1} [(X_{1j} - \bar{X}_j)^2 + (X_{2j} - \bar{X}_j)^2 + (X_{3j} - \bar{X}_j)^2 + (X_{4j} - \bar{X}_j)^2 + (X_{5j} - \bar{X}_j)^2]} \\ 1\sigma &= \sqrt{\frac{1}{5-1} [(-0.0002 - 0.0004)^2 + (0.0002 - 0.0004)^2 + (0.0005 - 0.0004)^2 + (0.0007 - 0.0004)^2 + (0.0008 - 0.0004)^2]} \\ &= \sqrt{\frac{1}{4} (0.00000066)} = \sqrt{0.17 \times 10^{-6}} = 0.0004 \end{aligned}$$

Three sigma variations or 3σ , is 3 times sigma, equal to 0.0012 for the example.

If an infinite number of trials were made to the target position of 10.0000 inches for the ongoing example, 99.74 per cent of the points would fall between 9.9992 and 10.0016 inches, giving a spread of $\pm 3\sigma$, or 0.0024 inch. This spread alone is not considered as the accuracy but rather the repeatability for the target point 10.0000.

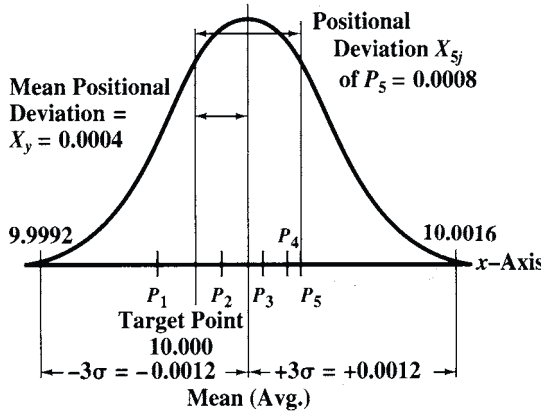


Fig. 3. Readings for Five Runs to Target Points $P_1, P_2, P_3, P_4,$ and P_5 Result in a Mean Positional Deviation of 0.0004

To calculate the accuracy, it is not sufficient to make a number of runs to one target point along a particular axis, but rather to a number of points along the axis, the number depending on the length of axis travel provided. For example, a travel of about 3 ft requires 5, and a travel of 6 ft requires 10 target points. The standard deviation and spread for the normal curve must be determined at each target point, as shown in Fig. 4. The accuracy for the axis would then be the spread between the normal curve with the most negative position and the normal curve with the most positive position. Technically, the accuracy is a spread rather than a \pm figure, but it is often referred to as a \pm figure and it may be assumed that a ± 0.003 , for expediency, is equal to a spread of 0.006.

The above description for measuring accuracy considers unidirectional approaches to target points. Bidirectional movements (additional movements to the same target point from either direction) will give different results, mostly due to backlash in the lead-screw, though backlash is small with ballnut leadscrews. Measurements made with bidirectional movements will show greater spreads and somewhat less accuracy than will unidirectional movements.

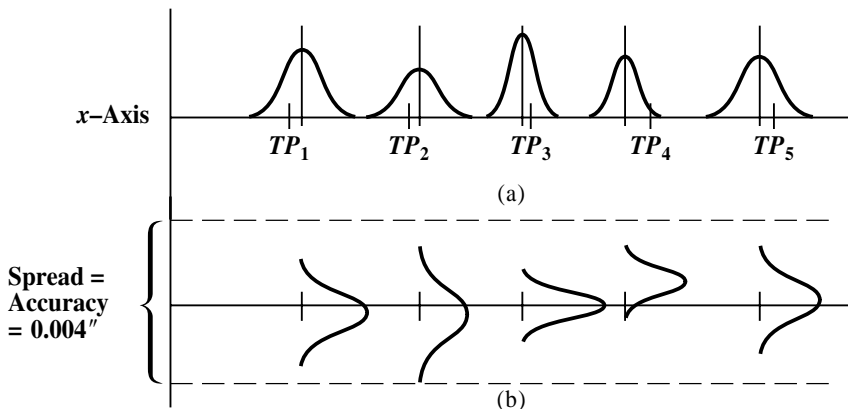


Fig. 4. Two Ways of Plotting Five Target Point Spreads

Rules for determining accuracy were standardized in guidelines last revised by the Association for Manufacturing Technology (AMT) in 1972. Some European machine tool builders use the VDI/DGQ 3441 (German) guidelines, which are similar to those of the

AMT in that normal distributions are used and a number of target points are selected along an axis. Japanese standards JIS B6201, JIS B6336, and JIS B6338 are somewhat simpler and consider only the spread of the readings, so that the final accuracy figure may be almost double that given by the AMT or VDI methods. The International Standards Organization (ISO), in 1988, issued ISO 230-2, which follows the procedures discussed above, but is somewhat less strict than the AMT recommendations. **Table 1** lists some types of NC machines and the degree of accuracy that they normally provide.

Table 1. Degrees of Accuracy Expected with NC Machine Tools

Type of NC Machine	Accuracy	
	inches	mm
Large boring machines or boring mills	0.0010-0.0020	0.025-0.050
Small milling machines	0.0006-0.0010	0.015-0.025
Large machining centers	0.0005-0.0008	0.012-0.020
Small and medium-sized machining centers	0.0003-0.0006	0.008-0.015
Lathes, slant bed, small and medium sizes	0.0002-0.0005	0.006-0.012
Lathes, small precision	0.0002-0.0003	0.004-0.008
Horizontal jigmill	0.0002-0.0004	0.004-0.010
Vertical jig boring machines	0.0001-0.0002	0.002-0.005
Vertical jig grinding machines	0.0001-0.0002	0.002-0.005
Cylindrical grinding machines, small to medium sizes	0.00004-0.0003	0.001-0.007
Diamond turning lathes	0.00002-0.0001	0.0005-0.003

Significance of Accuracy: Numerically controlled machines are generally considered to be more accurate and more consistent in their movements than their conventional counterparts. CNC controllers have improved the accuracy by providing the ability to compensate for mechanical inaccuracies. Thus, compensation for errors in the lead-screw, parallelism and squareness of the machine ways, and for the effects of heating can be made automatically on NC machines. Some machine tool types are expected to be more accurate than others; for instance, grinding machines are more accurate than milling machines, and lathes for diamond turning are more accurate than normal slant-bed lathes.

Accuracy of machine tools depends on temperature, air pressure, local vibrations, and humidity. ISO standard 230-2 requires that, where possible, the ambient temperature for conducting such tests be held between 67.1 and 68.9 degrees F (19.5 and 20.5 degrees C).

Autocollimation: Checks on movements of slides and spindles, and alignment and other characteristics of machine tools are performed with great accuracy by means of an autocollimator, which is an optical, noncontact, angle-measuring instrument. Flatness, straightness, perpendicularity, and runout can also be checked by autocollimation. The instrument is designed to project a beam of light from a laser or an incandescent bulb onto an optically flat mirror. When the light beam is reflected back to the instrument, the distance traveled by the beam, also deviations from a straight line, can be detected by the projector and calculated electronically or measured by the scale.

Autocollimators have a small angular measuring range and are usually calibrated in arc-seconds. One arc-second is an angle of 4.85 millionths of an inch (0.00000485 in.) per inch of distance from the vertex, and is often rounded to 5 millionths of an inch per inch. Angles can also be described in terms of radians and 1 arc-second is equal to 4.85 microradians, or 0.0000573 deg.

In practice, the interferometer or autocollimator is fixed to a rigid structure and the optical mirror, which should have a flatness of one-quarter wavelength of the light used (see page 731), is fixed to the workpiece to be measured. The initial reading is taken, and then

the workpiece is moved to another position. Readings of movement can be made to within a few millionths of an inch. Angular displacements, corresponding to successive positions, of about 1 arc-second can be taken from most autocollimators, in azimuth or elevation or a combination of the two. Generally, the line width of the reticle limits the accuracy of reading such instruments.

Laser interferometers are designed to allow autocollimation readings to be taken by a photodetector instead of the eye, and some designs can measure angles to 0.001 arc-second, closer than is required for most machine shop applications. Output from an electronic autocollimator is usually transferred to a computer for recording or analysis if required. The computer calculates, lists, and plots the readings for the target points automatically, under control of the inspection program.

A typical plot from such a setup is seen in Fig. 5, where the central line connects the averages for the normal distributions at each target point. The upper line connects the positive outer limits and the lower line the negative outer limits for the normal distributions. The normal spread, indicating the accuracy of positioning, is 0.00065 inch (0.016 mm), for the Y-axis along which the measurements were taken.

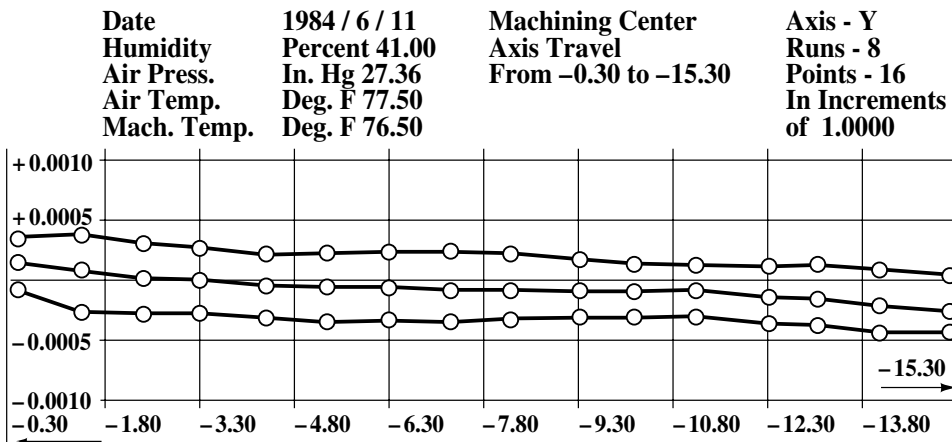


Fig. 5. Laser Interferometer Plots of Movements of Slides on a Large Horizontal Machining Center Showing an Accuracy of 0.00065 inch (0.016 mm) for the y Axis

Effect of Machine Accuracy on Part Tolerances

Part tolerances are usually shown on prints, usually in a control block to ANSI Standard 14.5M-1994 (see *Geometric Dimensioning and Tolerancing (GD&T)* starting on page 613.) Table 2 shows some part tolerance symbols that relate to machine tool positioning accuracy. The accuracy of a part is affected by machine and cutting tool dynamics, alignment, fixture accuracy, operator settings, and accuracies of the cutting tools, holders, and collets, but the positioning accuracy of the machine probably has the greatest influence. Spindle rotation accuracy, or runout, also has a large influence on part accuracy.

The ratio of the attainable part accuracy to the no-load positioning accuracy can vary from 1.7:1 to 8.31:1, depending on the type of cutting operation. For instance, making a hole by drilling, followed by a light boring or reaming operation, produces a quite accurate result in about the 1.7:1 range, whereas contour milling on hard material could be at the higher end of the range. A good average for part accuracy versus machine positioning accuracy is 3.3:1, which means that the part accuracy is 3.3 times the positioning accuracy.

Table 2. Symbols and Feature Control Frames ANSI Y14.5M-1994 (R1999)



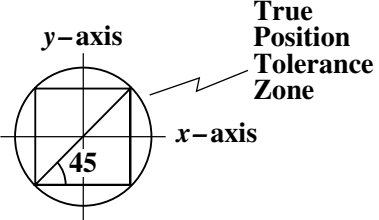
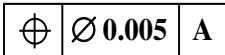
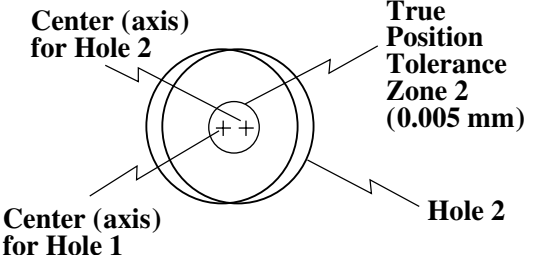
Symbol	Characteristic	Meaning of Characteristic	Relationship to the Machine Tool
	Position	<p>The allowable true position tolerance of a feature from a datum (assume feature to be a drilled hole). Feature control block might appear as:</p> <div style="text-align: center;">  </div> <p>A is the datum, which can be another surface, another hole, or other feature</p>	<p>Assume tolerance is 0.005 mm. Machine positioning accuracy would be at least $0.005 \times 0.707 = 0.0035$ mm even if it is assumed that the hole accuracy is the same as the positioning accuracy. Machine could be milling, drilling, or machining center.</p> <div style="text-align: center;">  </div>
	Position	<p>Assume feature to be a turned circumference, the axis of which has to be within a tolerance to another feature. Feature control block would appear as follows if feature A were the axis of hole 1:</p> <div style="text-align: center;">  </div>	<div style="text-align: center;">  </div>

Table 2. Symbols and Feature Control Frames ANSI Y14.5M-1994 (R1999)


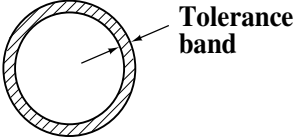


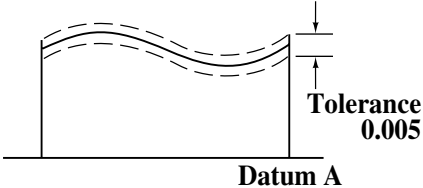
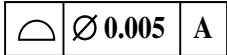
Symbol	Characteristic	Meaning of Characteristic	Relationship to the Machine Tool
	Roundness	<p>The roundness tolerance establishes a band.</p> 	<p>This tolerance would apply to turning and would be the result of radial spindle runout.</p>
	Diameter	<p>Usually expressed as a \pm tolerance attached to the dimension.</p>	<p>Diametral accuracy of the part would depend on the positioning accuracy of the cross-slide of lathe or grinder. Positioning accuracy would be from $\frac{1}{2}$ to $\frac{1}{4}$ of part accuracy, depending chiefly on the rigidity of the tool, depth of cut, and material being cut.</p>
	Profile of a surface	<p>Specifies a uniform boundary, along a true profile.</p>  <p>Feature control block might appear as:</p> 	<p>Affected by positioning accuracy of machine. There would be side and/or end forces on the tool so expect part to machine positioning accuracy to be high, say, 5:1</p>

Table 2. Symbols and Feature Control Frames ANSI Y14.5M-1994 (R1999)

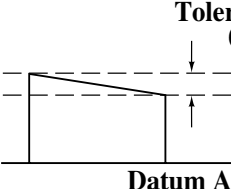

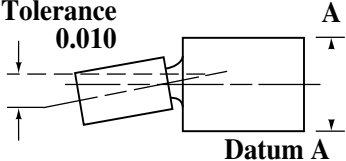

Symbol	Characteristic	Meaning of Characteristic	Relationship to the Machine Tool
//	Parallelism	<p>A feature (surface) parallel to a datum plane or datum axis.</p>  <p>Feature control block might appear as:</p> <div style="border: 1px solid black; padding: 5px; display: inline-block; text-align: center;"> // ∅0.010 A </div>	<p>Affected by positioning accuracy, machine alignment, and fixturing.</p>
	Concentricity	<p>Applies to turning. The axis of the feature must lie within the tolerance zone of another axis.</p>  <p>Feature control block might appear as follows:</p> <div style="border: 1px solid black; padding: 5px; display: inline-block; text-align: center;">  ∅0.005 A </div>	<p>Affected by positioning accuracy, most likely along Z axis.</p>

Table 2. Symbols and Feature Control Frames ANSI Y14.5M-1994 (R1999)


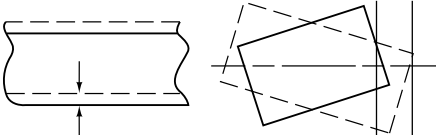


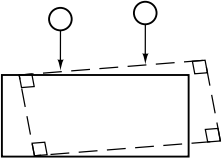

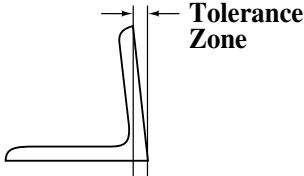
Symbol	Characteristic	Meaning of Characteristic	Relationship to the Machine Tool
	Runout	<p>Applies to the runout (both radial and axial) of a circular feature at any one position around the circumference or flat, perpendicular to the axis.</p>  <p>Runout at a Point (Radial) Runout at a Point (Axial)</p> <p>Runout at a Point (Radial)</p>	<p>Radial runout on part is not affected by spindle radial runout unless whole machine is untrue.</p> <p>Axial runout on part is affected by axial runout on machine. Feature would normally be perpendicular to datum.</p> <p>Feature control block might appear as:</p> 
	Total runout	<p>Similar to runout but applies to total surface and therefore consider both radial and axial runout.</p> 	<p>Would be affected by either radial or axial runout, or both, machine misalignment, or setup.</p>
	Perpendicularity	<p>A feature is perpendicular to a datum plane or axis.</p>  <p>Tolerance Zone</p>	<p>Affected principally by misalignment of machine or fixturing.</p>

TABLE OF CONTENTS
MANUFACTURING PROCESSES

SHEET METAL WORKING AND PRESSES	ELECTRICAL DISCHARGE MACHINING
1331 Basic Theory of Metal Working	1393 EDM Terms
1334 Designing Parts for Production	1395 EDM Process
1336 Shearing	1398 Electrical Control Adjustments
1338 Cutoff and Parting	1399 Workpiece Materials
1339 Blanking and Punching	1399 Characteristics of Materials
1340 Blanking and Punching Clearance	1399 Electrode Materials
1342 Die Opening Profile	1400 Types of Electrodes
1342 Force and Work	1401 Making Electrodes
1343 Fine Blanking	1403 Wire EDM
1345 Shaving	
1346 Bending	IRON AND STEEL CASTINGS
1346 Bend Radius	1404 Material Properties
1347 Bend Allowances	1404 Gray Cast Iron
1351 Springback	1404 White Cast Iron
1353 Three-roll Bending	1404 Chilled Cast Iron
1353 Drawing	1404 Alloy Cast Iron
1353 Mechanics of Deep Drawing	1405 Malleable-iron Castings
1355 Diameters of Shell Blanks	1405 Ductile Cast Iron
1359 Blanks for Rectangular Shells	1406 Steel Castings
1360 Ironing Process	1406 Carbon Steel Castings
1361 Stretch Forming	1407 Mechanical Properties
1362 Spinning	1407 Alloy Steel Castings
1364 Rubber Pad and Hydroforming	1408 Heat-Resistant Steel Castings
1365 Superplastic Forming and Diffusion Bonding	1408 Corrosion-Resistant Steel
1369 High-Energy Rate Metal Forming	1409 Casting of Metals
1369 Explosive Forming	1409 Definitions
1370 Electromagnetic Forming	1411 Removal of Gates and Risers
1371 Electrohydraulic Forming	1412 Blast Cleaning of Castings
1372 Lubricants and Their Effects	1412 Heat Treatment of Steel Castings
1374 Sheet Metal Joints	1412 Estimating Casting Weight
1378 Classification of Dies	1412 Woods for Patterns
1378 Single-Station Dies	1413 Selection of Wood
1378 Multiple-Station Dies	1413 Pattern Varnish
1379 Steel Rule Dies	1413 Shrinkage Allowances
1382 Pipe and Tube Bending	1413 Metal Patterns
1383 Press Bending	1414 Weight of Casting
1384 Rotary Draw Bending	1414 Die Casting
1385 Compression Bending	1415 Porosity
1385 Roll Bending	1415 Designing Die Castings
1386 Presses for Sheet Metal Working	1415 Alloys Used for Die Casting
1386 Mechanical Presses	1415 Aluminum-Base Alloys
1388 Gap-frame Presses	1416 Zinc-Base Alloys
1389 Straight Side Presses	1416 Copper-Base Alloys
1389 Hydraulic Presses	1416 Magnesium-Base Alloys
1390 Mechanical vs. Hydraulic	1417 Tin-Base Alloys
1391 Lubrication System	1417 Lead-Base Alloys
1392 Press Selection	1417 Dies for Die-Casting Machines

TABLE OF CONTENTS
MANUFACTURING PROCESSES

IRON AND STEEL CASTINGS

(Continued)

1417	Die-Casting Bearing Metal
1417	Injection Molding of Metal
1418	Precision Investment Casting
1418	Casting Materials
1419	Master Mold
1419	Shrinkage Allowances
1419	Casting Dimensions
1419	Investment Materials
1420	Casting Operations
1420	Investment Removal
1420	Investment Castings
1420	Casting Weights and Sizes
1420	Design for Investment Casting
1421	Casting Milling Cutters
1421	Extrusion of Metals
1423	Powder Metallurgy
1423	Advantages of Powder Metallurgy
1423	Limiting Factors
1423	Design of Briquetting Tools

SOLDERING AND BRAZING

1424	Soldering
1424	Forms Available
1424	Fluxes for Soldering
1424	Methods of Application
1426	Ultrasonic Fluxless Soldering
1426	Brazing
1426	Filler Metals
1426	Selection of Filler Metals
1426	Fluxes for Brazing
1427	Brazing Filler Metals
1431	Steadying Work
1431	Supplying Heat
1431	Symbol Application

WELDING

1433	Electrodes, Fluxes, and Processes
1434	Gas Metal Arc Welding (GMAW)
1434	Electrode Diameters
1435	Maximum Deposition Rates
1435	GMAW Welding of Sheet Steel
1435	Application of Shielding Gases
1437	Welding Controls
1439	GMAW Spray Transfer
1439	Deposition Rates of Electrodes
1441	Optimum Settings for GMAW
1441	Spray Transfer Voltage
1442	Flux-Cored Arc Welding

WELDING

(Continued)

1442	Flux-Cored Welding Electrodes
1442	Gas-Shielded Electrodes
1443	Settings for FCAW Electrodes
1443	Weld Requirements
1443	Selecting an FCAW Electrode
1444	FCAW Electrodes
1445	Contact Tip Recess
1445	Porosity and Worm Tracks
1445	Welding with Various Diameter
1446	High-Deposition Electrodes
1447	Deposition Rates
1447	Vertical Up Welding
1447	Flat and Horizontal Welds
1447	Electrode Diameters and
	Deposition Rates
1449	Shielding Gases and FCAW
	Electrodes
1449	Shielded Metal Arc Welding
1449	ANSI/AWS Standard
1450	AWS E60XX Electrodes
1452	AWS E70XX Electrodes
1453	Gas Tungsten Arc Welding
1453	GTAW Welding Current
1455	Tungsten Electrode Type
1456	Selection of GTAW
1456	Tungsten Electrode Compositions
1456	Electrode and Current Selection
1456	Current Ranges
1456	GTAW Electrodes
1457	EWP, EWZ, GTAW Electrodes
1458	Filler Metals
1458	Shielding Gases
1458	Plasma Arc Welding (PAW)
1458	Gases for Plasma Arc Welding
1459	Shielding Gases
1459	PAW Welding Equipment
1459	Applications
1460	Welding Aluminum
1461	Plasma Arc Surface Coating
1462	Plasma Arc Cutting of Metals
1462	Precision Plasma Arc Cutting
1462	Flame Cutting of Metals
1462	Arc Cutting
1462	The Cutting Torch
1463	Adjustment of Cutting Torch
1463	Metals That Can Be Cut
1463	Cutting Stainless Steel
1463	Cutting Cast Iron
1463	Mechanically Guided Torches

TABLE OF CONTENTS
MANUFACTURING PROCESSES

WELDING	LASERS
<p><i>(Continued)</i></p> <p>1463 Cutting Steel Castings</p> <p>1464 Thickness of Metal</p> <p>1464 Hard Facing</p> <p>1464 Hard-Facing Materials</p> <p>1464 High-Speed Steels</p> <p>1465 Austenitic Manganese Steels</p> <p>1465 Austenitic High-Chromium Irons</p> <p>1465 Cobalt-Base Alloys</p> <p>1466 Copper-Base Alloys</p> <p>1467 Nickel-Chromium-Boron Alloys</p> <p>1467 Chromium Plating</p> <p>1468 Electron-Beam (EB) Welding</p> <p>1469 Pipe Welding</p> <p>1472 Use of Flux-cored Electrodes</p> <p>1472 Complete Weld Fusion</p> <p>1473 Other Methods</p> <p>1473 Pipe Welding Procedure</p> <p>1473 Thick-Wall, Carbon-Steel Pipes</p> <p>1473 Root Welding</p> <p>1474 Fill and Cover Welds</p> <p>1475 Thin-Walled Carbon Steel Pipes, Root, Fill and Cover Pass</p> <p>1476 Weld and Welding Symbols</p> <p>1476 ANSI Weld and Welding Symbols</p> <p>1477 Basic Weld Symbols</p> <p>1478 Supplementary Weld Symbols</p> <p>1478 Welding Codes, Rules, Regulations, and Specifications</p> <p>1479 Letter Designations for Welding</p> <p>1480 ANSI Welding Symbols</p> <p>1485 Nondestructive Testing</p> <p>1485 Symbols</p>	<p><i>(Continued)</i></p> <p>1495 Laser Welding Theory</p> <p>1496 Welded Joint Design</p> <p>1496 Welding Rates</p> <p>1496 Processing Gas</p> <p>1497 Drilling with Lasers</p> <p>1497 Laser Drilling Theory</p> <p>1497 Direct Drilling</p> <p>1497 Percussive Drilling</p> <p>1498 Trepanning</p> <p>1498 Drilling Rates</p> <p>1498 Heat Treatment with Lasers</p> <p>1498 Materials Applicability</p> <p>1498 Hardening Rates</p> <p>1498 Cladding with Lasers</p> <p>1499 Marking with Lasers</p> <p>1499 Mask Marking</p> <p>1499 Scanned-Beam Marking</p>
LASERS	FINISHING OPERATIONS
<p>1487 Introduction</p> <p>1487 Laser Light</p> <p>1487 Laser Beams</p> <p>1488 Beam Focusing</p> <p>1489 Types of Industrial Lasers</p> <p>1489 Industrial Laser Systems</p> <p>1490 Safety</p> <p>1490 Laser Beam/Material Interaction</p> <p>1491 Thermal Properties of Workpieces</p> <p>1491 Cutting Metal with Lasers</p> <p>1492 Beam Assistance Techniques</p> <p>1492 Cut Edge Roughness</p> <p>1493 Heat-Affected Zones</p> <p>1494 Cutting of Nonmetals</p> <p>1495 Welding with Lasers</p>	<p>1500 Power Brush Finishing</p> <p>1500 Description of Brushes</p> <p>1500 Use of Brushes</p> <p>1500 Deburring and Producing a Radius</p> <p>1501 Eliminating Undesirable Conditions</p> <p>1501 Characteristics in Power Brush</p> <p>1501 Polishing and Buffing</p> <p>1501 Polishing Wheels</p> <p>1504 Polishing Operations and Abrasives</p> <p>1504 Buffing Wheels</p> <p>1504 Speed of Polishing Wheels</p> <p>1505 Grain Numbers of Emery</p> <p>1505 Grades of Emery Cloth</p> <p>1505 Etching and Etching Fluids</p> <p>1505 Etching Fluids</p> <p>1506 Conversion Coatings and the Coloring of Metals</p> <p>1506 Passivation of Copper</p> <p>1506 Coloring of Copper Alloys</p> <p>1507 Coloring of Iron and Steel</p> <p>1507 Anodizing Aluminum Alloys</p> <p>1508 Magnesium Alloys</p> <p>1508 Titanium Alloys</p> <p>1508 Plating</p> <p>1508 Surface Coatings</p> <p>1516 Flame Spraying Process</p>

SHEET METAL WORKING AND PRESSES

Basic Theory of Metal Working

Metal working theory provides a background from which reasonable evaluations may be made of the deformations obtainable without instability and fracture. The fundamental principles, rules, and laws of metal working theory are used to describe the plastic flow or deformation of solid materials when subjected to external loads. For this purpose, such materials are considered as homogeneous, continuous, isotropic media. Understanding the theory underlying metal working is important for both the design and production engineer.

Solid materials may be subjected to forces that may be classified as either volume forces or surface forces. In this discussion, only surface forces acting on the surface as external forces are considered.

In analyzing design situations for either dimensioning purposes or forming processes, it is most appropriate to use force per unit area as a measure of the load rather than the total force distributed over the area.

The force per unit area is called the *stress* (σ) and is described as follows:

$$\sigma = \frac{\text{force}}{\text{area}} \quad (1)$$

Common ways of loading solid bodies include compression, tension, shear, torsion, or a combination of these stresses, such as fatigue. In Fig. 1 is shown a tensile specimen loaded with force F . The stress on a cross section A perpendicular to the longitudinal axis is defined

$$\sigma = \frac{F}{A} \quad (2)$$

where F = force (lb) and A = cross-section area (in²).

If a cross section is inclined at an angle to the longitudinal axis, the mean oblique stress may be defined by

$$\sigma_m = \frac{F}{A_\theta} = \frac{F}{A} \sin \theta \quad (3)$$

where A_θ = inclined cross section area of specimen (in²); and, θ = inclined angle cross section area of specimen (°).

The mean oblique stress lies in the direction of the longitudinal axis of the specimen. Force F can be divided into components F_n , which is perpendicular to cross-section A_θ and F_t , which is parallel to cross section A_θ , so that the state of the stresses can be defined by

$$\begin{aligned} \sigma_\theta &= \frac{F_n}{A_\theta} = \frac{F}{A} \sin^2 \theta \\ \tau_\theta &= \frac{F_t}{A_\theta} = \frac{F}{2A} \sin 2\theta \end{aligned} \quad (4)$$

where σ_θ = normal stress—stress normal to cross section A_θ (lb/in²); and τ_θ = shear stress—stress parallel to cross section A_θ (lb/in²).

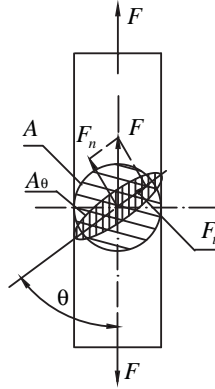


Fig. 1. A Tensile Specimen with Cross Section Area A Subjected to the Load F

Stress-Strain Relationship.—When solid materials are subjected to stress, they usually respond in an elastic fashion; that is, the strain produced by the stress is reversible (the strain goes back to zero when the stress is removed), and the magnitude of the strain is directly proportional to the magnitude of the stress. This relationship between stress and strain is usually referred to as *Hooke's Law* and can be written

$$\frac{\text{stress}}{\text{strain}} = E = \text{constant} \quad (5)$$

where E = modulus of elasticity (lb/in²).

The most common procedure for describing the various relationships between stress and strain is the tensile test, which is used to determine the modulus of elasticity, the elastic limit, the elongation, the proportional limit, the reduction area, the tensile strength, the yield point, the yield strength, and other tensile properties. The stress (σ), calculated from the load, and the strain (ϵ), calculated from the extension, can either be plotted as

- 1) nominal (engineering) stress-strain, or
- 2) true stress-strain

The first is more important in design, and the second is more important in manufacturing. The graphs used in each case will be different.

Nominal Stress-Strain: Nominal stress, also called engineering stress, is defined as the ratio of the applied load F to the original cross-section area A of the specimen:

$$\sigma_n = \frac{F}{A_0} \quad (6)$$

where σ_n = nominal stress (lb/in²); F = applied load in the test (lb); and, A_0 = original cross-section area of specimen (in²).

Nominal strain is defined as

$$\epsilon_n = \frac{l - l_0}{l_0} = \frac{\Delta l}{l_0} \quad (7)$$

where ϵ_n = nominal strain (in/in); l_0 = original gauge length (in); and l = instantaneous length of the specimen (in).

True Stress-Strain: A nominal stress-strain curve does not give a true indication of the deformation characteristic of a solid because it is based on the original cross-section area A_0 of the specimen, and this dimension changes continuously during the test. In the solution of technical problems in metalworking, true stress and true strain are much more important.

True stress σ is defined as the ratio of the load F to the actual stress-section area A of the specimen:

$$\sigma = \frac{F}{A} \tag{8}$$

where σ = true stress (lb/in²); F = applied load in the test (lb); A = actual area (instantaneous area resisting the load (in²).

True strain in a tensile test can be defined by dividing the total elongation into small increments of actual change in length. Then, using calculus, it can be shown that true strain is defined by the equation

$$\epsilon = \ln\left(\frac{l}{l_0}\right) \tag{9}$$

where ϵ = true strain (in/in); and l = instantaneous length at any moment during elongation (in).

If the true stress, based on the actual (instantaneous) cross-sectional area of the specimen, is used, it is found that the stress-strain curve increases continuously up to fracture. If the strain measurement is also based on instantaneous measurements, the curve obtained is known as a true stress-strain curve (Fig. 2).

The stress-strain curve in Fig. 2(a) can be represented by the equation

$$\sigma = K\epsilon^n \tag{10}$$

where K = is the strength coefficient (lb/in²), and n = strain-hardening (work-hardening) exponent.

This equation is called the *flow curve*, and it represents the behavior of metals in the plastic zone, including their capacity for cold strain hardening.

When the curve shown in Fig. 2(a) is plotted on a logarithmic graph as in Fig. 2(b), it is found that the curve is a straight line, and the slope of the line is equal to the exponent n . The value of constant K equals the value of true stress at a true strain value to 1.

The strain-hardening exponent may have a value from $n = 0$ (perfectly plastic solid) to $n = 1$ (elastic solid). For most metals, n has values between 0.10 and 0.50.

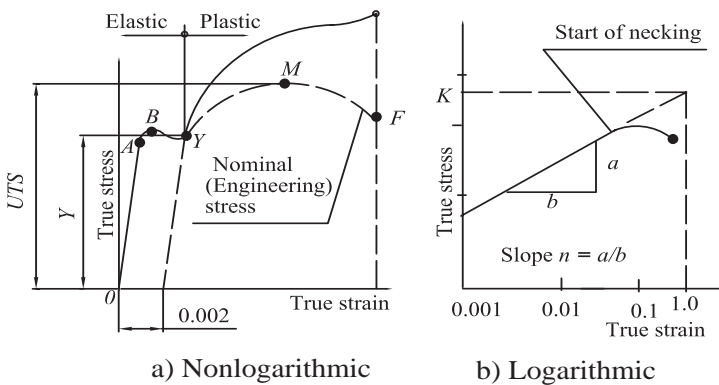


Fig. 2. True Stress-strain Curve for Medium Steel: a) Nonlogarithmic; b) Logarithmic

Ductility is most commonly defined as the ability of a metal to plastically deform easily upon application of a tensile force without breaking or fracturing. Ductility may be expressed as either percentage of elongation or percentage of area reduction in the specimen.

Elongation can be defined as

$$\delta = \frac{l_f - l_0}{l_0} \times 100 \tag{11}$$

Reduction can be defined as

$$\psi = \frac{A_0 - A_f}{A_0} \times 100 \tag{12}$$

where l_f = length at the fracture (in); l_0 = the original specimen's gauge length (in); A_0 = original specimen's gauge cross-section area, (in²); A_f = cross-section area of the specimen at the fracture, (in²). *Note:* l_f length is measured between the original gauge marks after the pieces of the broken specimen are placed together.

Elongation ranges approximately between 8% and 60% for most metals, and 20% and 90% are typical measurements for the reduction of area. Ductile materials such as thermo-plastic and superplastic materials show large deformation before fracture, and of course, exhibit much higher ductility, but brittle materials have little or no ductility.

Designing Sheet Metal Parts for Production

Sheet metal parts should be designed to satisfy the following criteria:

The parts should allow high productivity rates.

They should make highly efficient use of the materials involved.

The production machines should be easy to service.

Machines should be usable by workers with relatively basic skills.

Unfortunately, very few product designers concern themselves with suitability of production, their prime concern is usually the function of the part.

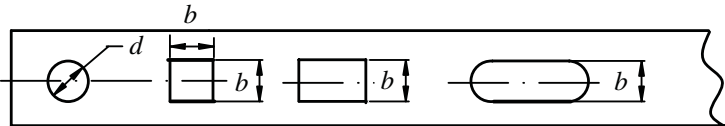
Design rules for parts to be produced by blanking and punching:

Avoid part design with complex configurations.

Use minimum dimensions of punched openings relative to material thickness given in **Table 1**.

Use minimum distances between punched opening and rounded radius relative to material thickness given in **Table 2**.

Table 1. Minimal Dimensions of Punched Openings



Material	Form of opening			
	Circle $d_{\min} =$	Square $b_{\min} =$	Rectangular $b_{\min} =$	Oval $b_{\min} =$
Stainless steel	1.50 T	1.40 T	1.20 T	1.10 T
High-carbon steel	1.20 T	1.10 T	0.90 T	0.80 T
Medium-carbon steel	1.00 T	0.90 T	0.70 T	0.60 T
Low-carbon steel	0.90 T	0.80 T	0.60 T	0.55 T
Brass and copper	0.80 T	0.70 T	0.60 T	0.55 T
Magnesium alloy at 500° F	0.25 T	0.45 T	0.35 T	0.30 T

Note: With fine punching process, minimal diameter of punched hole is (0.50 - 0.70) T .

Table 2. Minimum Distance between Punched Opening and Edges and Rounded Radius

Part is	Form of opening	Minimum Distance	Sketch
Blanked	Circle	$c \geq T$ $r \geq 0.5T$	
	Rectangle	$c \geq 1.2T$ $r \geq 0.5T$	
Bent	Circle	$c \geq 2T$ $r \geq (0.5 - 1.0)T^a$ $r \geq (1.0 - 2.0)T^b$ $r \geq (2.0 - 3.0)T^c$	
Drawn	Circle	$d \leq (d_1 - 2r)$ $D_1 \geq (d_1 - 2r)$ $D \geq (D_1 + 3T + d_2)$ $c \geq r + 0.5T$	

^a Al and brass

^b Steel

^c Al-alloy 6000 series

Design rules for parts produced by bending:

Minimum bend radius should be used only if it is necessary for correct function of part.

The bend radius should be larger than the thickness of the material.

Use minimum distances between punched opening and bend radius given in **Table 2**.

Flange length as shown in **Table 2** needs to be $h \geq 2T$.

If a part has more than one bend, it is necessary to define technological data.

Design rules of parts produced by drawing:

Avoid very complicated parts.

Make diameter of flange D less than three times the diameter of shell ($D < 3d$), if height h of shell is greater than twice the diameter of shell ($h > 2d$) as shown in Table 2.

Avoid design of rectangular and square shells with bottom radii less than the corner radius in the junction area.

The shortest distance between corner radii should be no less than the depth of shell.

Shearing

Shearing involves the cutting of flat material such as metal sheets, plates, or strips. To be classified as shearing, the cutting action must be along a straight line. The piece of sheet metal sheared off may or may not be called a blank. Shearing is performed in a special machine with different types of blades or cutters. The machines may be foot-, hand-, or power-operated. The shear is equipped with long or rotary blades for cutting. The upper blade of power shears is often inclined to reduce the required cutting force.

During shearing operations, three phases (Fig. 3) may be noted:

Phase I - Plastic Deformation: As the upper blade begins to push into the work material, plastic deformation occurs in the surfaces of the sheet, and the stress on the material is lower than the yield stress.

Phase II - Penetration: As the blade moves downward, penetration occurs, in which the blade compresses the work material and cuts into the metal. In this phase, the stress on the material is higher than the yield stress but lower than the UTS.

Phase III - Fracture: As the blade continues to travel into the work material, fracture begins in the material at the two cutting edges. The stress on the work material is equal to the shearing stress. If the clearance between the blades is correct, the two fracture lines meet, resulting in a separation of the work material into two parts.

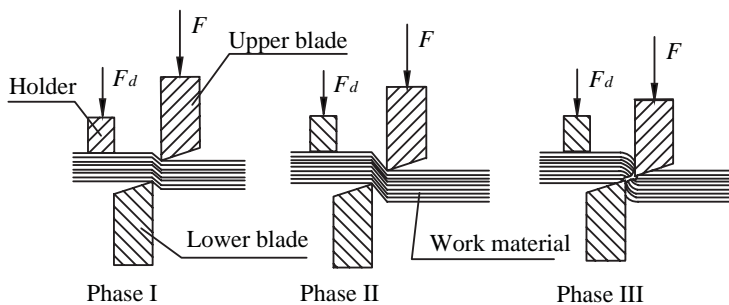


Fig. 3. Schematic Illustration of the Phases of Shearing

Shearing is the preferred way to cut blanks whenever the blank shape permits its use. In most cases, however, the limitation of straight lines in the shape of the blank eliminates the use of shears. Shearing is economical because no expensive dies have to be made for cutting out the blanks. Shearing is used for the following purposes:

- 1) To cut strip or coiled stock into blanks
- 2) To cut strip or coiled stock into smaller strips to feed into a blanking or drawing die
- 3) To trim large sheets, squaring the edges of the sheet.

Shearing Forces.—Calculating the force and power involved in shearing operations varies according to the types of blades. There are three types of blades:

a) straight parallel blades; b) straight inclined blades; and c) rotary cutters.

Shearing with Straight Parallel Blades: The shearing force with straight parallel cutters can be calculated approximately as

$$F = \tau A \quad (13)$$

where F = shearing force (lb); τ = shear strength of the material (lb/in²); and A = cutting area (in²). The cutting area is calculated as

$$A = bT \quad (13a)$$

where b = length of the cutting material (in), and T = thickness of material (in).

This calculated shearing force needs to be increased by 20 to 40% depending on whether the following conditions exist: an enlarged clearance between the blades, variations in the thickness of the material, the obtuseness of the cutting edge angles, and other unpredictable factors.

The real force of the shearing machine is

$$F_M = 1.3F \quad (14)$$

Shearing with Straight Inclined Blades: Shears with straight inclined blades are used for cutting material of relatively small thickness compared with the width of cutting. Using inclined blades reduces the shearing force and increases the range of movement necessary to disjoin the material. The penetration of the upper blade into the material is gradual and as a result, the shearing force is lower.

The shearing force can be calculated as

$$F = n \cdot k \cdot UTS \cdot \lambda \frac{T^2}{\tan \phi} \quad (15)$$

where where $n = 0.75$ to 0.85 (for most materials); $k = 0.7$ to 0.8 (ratio UTS/τ); λ = the relative amount of penetration of the upper blade into material (Table 3); and, ϕ = angle of inclination of the upper blade.

Table 3. Relative Amount of Penetration of the Blade into the Material

Material	Thickness of material T , inch (mm)			
	< 0.04 inch (< 1.0 mm)	0.04 – 0.08 inch (1.0 – 2.0 mm)	0.08 – 0.16 inch (2 – 4 mm)	> 0.16 inch (> 4 mm)
Plain carbon steel	0.75 to 0.70	0.70 to 0.65	0.65 to 0.55	0.50 to 0.40
Medium steel	0.65 to 0.60	0.60 to 0.55	0.55 to 0.48	0.45 to 0.35
Hard steel	0.50 to 0.47	0.47 to 0.45	0.44 to 0.38	0.35 to 0.25
Aluminum and copper (annealed)	0.80 to 0.75	0.75 to 0.70	0.70 to 0.60	0.60 to 0.50

The real force of the shearing machine is

$$F_M = 1.3F \quad (16)$$

Shearing with Rotary Cutters: The rotary shearing operation is much like shearing with straight inclined blades because the straight blade may be thought of as a rotary cutter with an endless radius. It is possible to make straight line cuts as well as to produce circular blanks and irregular shapes by this method. In Fig. 4 is illustrated the conventional arrangement of the cutters in a rotary shearing machine for the production of a perpendicular edge. Only the upper cutter is rotated by the power drive system. The upper cutter pinches the material and causes it to rotate between the two cutters.

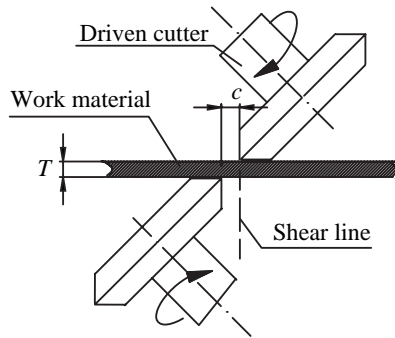


Fig. 4. Schematic Illustration of Shearing with Rotary Cutters

Shearing force with rotary cutters can be calculated approximately as

$$F = n \cdot k \cdot UTS \cdot \lambda \frac{T^2}{2 \tan \phi} \quad (17)$$

where where $\phi = \arccos \left[1 - \frac{\mu + T}{D} \right]$; μ = lap of cutters, (inch); T = thickness of material, (inch); D = diameter of cutter, (inch); $n = 0.75$ to 0.85 (for most materials); $k = 0.7$ to 0.8 (ratio UTS/τ); and, λ = relative amount of penetration of the cutters, (Table 3).

The real force of a shearing machine with rotary cutter is

$$F_M = 1.3F \quad (18)$$

Rotary shearing machines are equipped with special holding fixtures that rotate the work material to generate the desired circle.

Clearance.—Clearance is defined as the space between the upper and lower blades. Without proper clearance, the cutting action no longer progresses. With too little clearance, a defect known as “secondary shear” is produced. If too much clearance is used, extreme plastic deformation will occur. Proper clearance may be defined as that clearance which causes no secondary shear and a minimum of plastic deformation.

The clearance between straight blades (parallel and inclined) is: $c = (0.02 \text{ to } 0.05)$, mm.

The clearance between rotary cutters with parallel inclined axes is

$$c = (0.1 \text{ to } 0.2)T \quad (19)$$

where T = material thickness (in).

Cutoff and Parting

Cutoff.—Cutoff is a shearing operation in which the shearing action must be along a line. The pieces of sheet metal cutoff are the blanks. Fig. 5 shows several types of cutoff operations. As seen in the illustration, a cutoff is made by one or more single line cuts. The line of cutting may be straight, curved, or angular. The blanks need to be nested on the strip in such a way that scrap is avoided. Some scrap may be produced at the start of a new strip or coil of sheet metal in certain cases. This small amount is usually negligible.

The use of cutoff operations is limited by the shape of a blank. Only blanks that nest perfectly may be produced by this operation. Cutoff is performed in a die and therefore may be classified as a stamping operation. With each cut, a new part is produced. More blanks may be produced per stroke of the press ram by adding more single-line cutting edges.

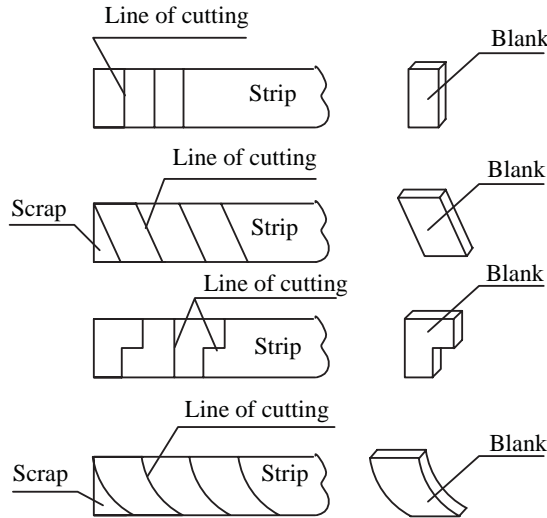


Fig. 5. Types of Cutoff

Parting.—Parting is a cutting operation of a sheet-metal strip by a die with cutting edges on two opposite sides. During parting, some amount of scrap is produced, as shown in Fig. 6. This might be required when the blank outline is not a regular shape and is precluded from perfectly nesting on the strip. Thus, parting is not as efficient an operation as cutoff.

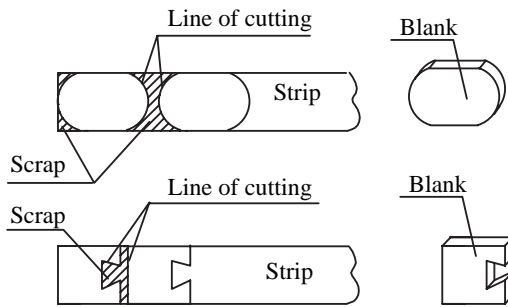


Fig. 6. Types of Parting

Blanking and Punching

Blanking and punching are fabricating processes used to cut materials into forms by the use of a die. Major variables in these processes are as follows: the punch force, the speed of the punch, the surface condition and materials of the punch and die, the condition of the blade edge of the punch and die, the lubricant, and the amount of clearance.

In blanking, a workpiece is removed from the primary material strip or sheet when it is punched. The material that is removed is the new workpiece or blank. Punching is a fabricating process that removes a scrap slug from the workpiece each time a punch enters the punching die. This process leaves a hole in the workpiece (Fig. 7).

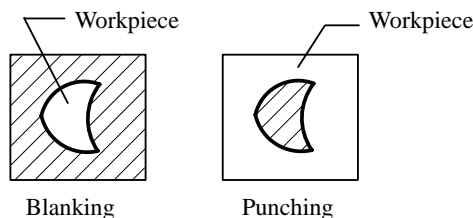


Fig. 7. Blanking and Punching

Characteristics of the blanking process include:

- 1) Ability to produce workpieces in both strip and sheet material during medium and mass production.
- 2) Removal of the workpiece from the primary material stock as a punch enters a die.
- 3) Control of the quality by the punch and die clearance.
- 4) Ability to produce holes of varying shapes quickly.

Characteristics of the punching process include:

- 1) Ability to produce holes in both strip and sheet material during medium and mass production.
- 2) Ability to produce holes of varying shapes quickly.

There are three phases in the process of shearing during blanking and punching as illustrated in Fig. 8.

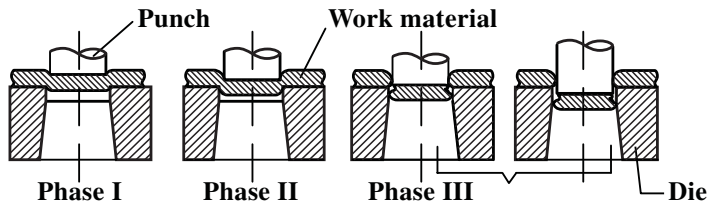


Fig. 8. Phases in the Process of Shearing

In Phase I, work material is compressed across and slightly deformed between the punch and die, but the stress and deformation in the material does not exceed the plastic limit. This phase is known as the elastic phase.

In Phase II, the work material is pushed farther into the die opening by the punch; at this point in the operation the material has been obviously deformed at the rim, between the cutting edges of the punch and the die. The concentration of outside forces causes plastic deformation at the rim of the material. At the end of this phase, the stress in the work material close to the cutting edges reaches a value corresponding to the material shear strength, but the material resists fracture. This phase is called the plastic phase.

During Phase III, the strain in the work material reaches the fracture limit, and micro-cracks appear, which turn into macro-cracks, followed by separation of the parts of the workpiece. The cracks in the material start at the cutting edge of the punch on the upper side of the work material, and at the die edge on the lower side of the material; the crack propagates along the slip planes until complete separation of the part from the sheet occurs. A slight burr is generally left at the bottom of the hole and at the top of the slug. The slug is then pushed farther into the die opening. The slug burnish zone expands and is held in the die opening. The whole burnish zone contracts and clings to the punch.

Blanking and Punching Clearance.—*Clearance, c* , is the space (per side) between the punch and the die opening shown in Fig. 9, such that:
$$c = \frac{D_d - d_p}{2}$$

Ideally, proper clearance between the cutting edges enables the fractures to start at the cutting edge of the punch and the die. The fractures will proceed toward each other until they meet. The fractured portion of the sheared edge then has a clean appearance. For optimum finish of a cut edge, correct clearance is necessary. This clearance is a function of the type, thickness, and temper of the material.

When clearance is not sufficient, additional layers of the material must be cut before complete separation is accomplished. With correct clearance, the angle of the fracture will permit a clean break below the burnish zone because the upper and lower fractures will extend toward one another. Excessive clearance will result in a tapered cut edge, because for any cutting operation, the opposite side of the material that the punch enters after cutting will be the same size as the die opening.

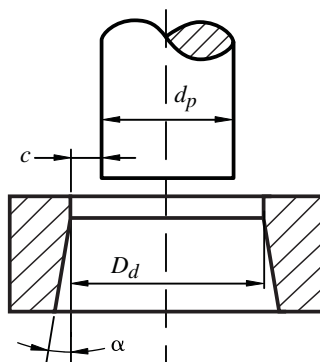


Fig. 9. Punch and Die Clearance

Where Clearance is Applied: Whether clearance is deducted from the dimensions of the punch or added to the dimensions of the die opening depends upon the nature of the work-piece. In the blanking process (a blank of given size is required), the die opening is made to that size and the punch is made smaller. Conversely, in the punching process (when holes of a given size are required), the punch is made to the dimensions and the die opening is made larger. Therefore, for blanking, the clearance is deducted from the size of the punch, and for piercing the clearance is added to the size of the die opening.

Value for Clearance: Clearance is generally expressed as a percentage of the material thickness, although an absolute value is sometimes specified.

Table 4 shows the value of the shear clearance in percentages, depending on the type and thickness of the material.

Table 4. Values for Clearance as a Percentage of the Thickness of the Material

Material	Material Thickness, T				
	< 0.040 inch (< 1.0 mm)	0.040-0.080 inch (1.0-2.0 mm)	0.082-0.118 inch (2.1- 3.0 mm)	0.122-0.197 inch (3.1-5.0 mm)	0.200-0.275 inch (5.1-7.0 mm)
Low carbon steel	5.0	6.0	7.0	8.0	9.0
Copper and soft brass	5.0	6.0	7.0	8.0	9.0
Medium carbon steel 0.20% to 0.25% carbon	6.0	7.0	8.0	9.0	10.0
Hard brass	6.0	7.0	8.0	9.0	10.0
Hard steel, 0.40% to 0.60% carbon	7.0	8.0	9.0	10.0	12.0

Table 5 shows absolute values for the blanking and punching clearance for high-carbon steel (0.60% to 1.0% carbon) depending on the thickness of the work material.

Table 5. Absolute Values of Clearance for Blanking and Punching High-Carbon Steel

Material Thickness, T		Clearance, c		Material Thickness, T		Clearance, c	
(inch)	(mm)	(inch)	(mm)	(inch)	(mm)	(inch)	(mm)
0.012	0.3048	0.00006	0.001524	0.157	3.9878	0.0095	0.24130
0.197	5.0038	0.0009	0.02286	0.177	4.4958	0.0116	0.29464
0.315	8.0010	0.0013	0.03302	0.197	5.0038	0.0138	0.35052
0.040	1.0160	0.0016	0.04064	0.236	5.9944	0.0177	0.44958
0.047	1.1938	0.0020	0.05080	0.275	6.9850	0.0226	0.57404
0.060	1.5240	0.0026	0.06604	0.315	8.0010	0.0285	0.72390
0.078	1.9812	0.0035	0.08890	0.394	10.0076	0.0394	1.00076
0.098	2.4892	0.0047	0.11938	0.472	11.9888	0.0502	1.27508
0.118	2.9972	0.0059	0.14986	0.590	14.9860	0.0689	1.75006
0.138	3.5052	0.0077	0.19558	0.748	18.9992	0.0935	2.37490

Effect of Clearance: Manufacturers have performed many studies on the effect of clearance on punching and blanking. Clearance affects not only the smoothness of the fracture, but also the deformation force and deformation work. A tighter blanking and punching clearance generates more heat on the cutting edge and the bulging area tightens around the punch. These effects produce a faster breakdown of the cutting edge. If the clearance increases, the bulging area disappears and the roll-over surface is stretched and will retract after the slug breaks free. Less heat is generated with increases in the blanking and punching clearance, and the edge breakdown rate is reduced. The deformation force is greatest when the punch diameter is small compared to the thickness of the work material. In one test, for example, a punching force of about 142 kN was required to punch 19 mm holes into 8 mm mild steel when the clearance was about 10 percent. With a clearance of about 4.5 per cent, the punching force increased to 147 kN and a clearance of 2.75 per cent resulted in a force of 153.5 kN.

Die Opening Profile.— Die opening profiles depend on the purpose and required tolerance of the workpiece. Two opening profiles are shown in Figs. 10a and 10b.

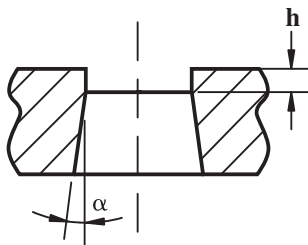


Fig. 10a. Opening Profile for High Quality Part

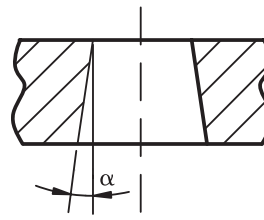


Fig. 10b. Opening for Low Accuracy Part

The profile in Fig. 10a gives the highest quality workpiece. To allow a die block to be sharpened more times, the height h of the die block needs to be greater than the thickness of the workpiece. The value of h is given in Table 6. The die opening profile in Fig. 10b is used for making a small part with low accuracy from very soft material, such as soft thin brass. The angle of the cone $\alpha = 15'$ to $45'$.

Table 6. Value of Dimension h Based on Material Thickness

	Work material thickness, T		
	< 0.04 inch (< 1 mm)	> 0.04 to 0.2 inch (> 1 to 5 mm)	> 0.2 to 0.4 inch (> 5 to 10 mm)
Height h	0.14 in (3.5 mm)	0.26 in (6.5 mm)	0.45 in (11.5 mm)

Angle $\alpha = 3^\circ$ to 5°

Deformation Force, Deformation Work, and Force of Press.—*Deformation Force:*

Deformation force F for punching and blanking with flat face of punch is defined by the following equation:

$$F = LT\tau_m = 0.8LT(UTS) \quad (20)$$

where F = deformation force, lb (N)

L = the total length of cutting, inch (mm)

T = thickness of the material, inch (mm)

τ_m = shear stress, lb/in² (MPa)

UTS = the ultimate tensile strength of the work material, lb/in² (MPa)

Force of Press: Such variables as unequal thickness of the material, friction between the punch and workpiece, or dull cutting edges, can increase the necessary force by up to 30 per cent, so these variables must be considered in selecting the power requirements of the press. That is, the force requirement of the press, F_p is

$$F_p = 1.3F \tag{21}$$

The blanking and punching force can be reduced if the punch or die has bevel-cut edges. In blanking operations, bevel shear angles should be used on the die to ensure that the workpiece remains flat. In punching operations, bevel shear angles should be used on the punch.

Deformation Work W for punching and blanking with flat face of punch is defined by the following equation:

$$W = kFT \tag{22}$$

where k = a coefficient that depends on the shear strength of the material and the thickness of the material

F = deformation force (lb)

T = material thickness (in)

Table 7. Values for Coefficient k for Some Materials

Material	Shear Strength lb/in ² (MPa)	Material Thickness, inch (mm)			
		< 0.040 in. < (1.0 mm)	0.040–0.078 in. (1.0–2.0 mm)	0.078–0.157 in. (2.0–4.0 mm)	> 0.157 in. > 4.0 mm
Low carbon steel	35,000–50,000 (240–345)	0.70–0.65	0.64–0.60	0.58–0.50	0.45–0.35
Medium carbon steel 0.20 to 0.25% carbon	50,000–70,000 (345–483)	0.60–0.55	0.54–0.50	0.49–0.42	0.40–0.30
Hard steel 0.40 to 0.60% carbon	70,000–95,000 (483–655)	0.45–0.42	0.41–0.38	0.36–0.32	0.30–0.20
Copper, annealed	21,000 (145)	0.75–0.69	0.70–0.65	0.64–0.55	0.50–0.40

Stripper Force.—*Elastic Stripper:* When spring strippers are used, it is necessary to calculate the amount of force required to effect stripping. This force may be calculated by the following equation:

$$F_s = \frac{1}{0.00117}PT = 855PT \tag{23a} \qquad F_s = 5.9PT \tag{23b}$$

where F_s = stripping force (lb)

P = sum of the perimeters of all the punching or blanking faces (inch)

T = thickness of material (inch)

where F_s = stripping force (N)

P = sum of the perimeters of all the punching or blanking faces (mm)

T = thickness of material (mm)

This formula has been used for many years by a number of manufacturers and has been found to be satisfactory for most punching and blanking operations.

After the total stripping force has been determined, the stripping force per spring must be found in order to establish the number and dimensions of springs required. Maximum force per spring is usually listed in the manufacturer's catalog.

The correct determined force per spring must satisfy the following relationship:

$$F_{max} > F_{so} > \frac{F_s}{n} \tag{24}$$

where F_{max} = maximum force per spring, lb (newton)

F_{SO} = stripping force per spring, lb (newton)

F_s = total stripping force, lb (newton)

n = number of springs

Fine Blanking.—The process called fine blanking uses special presses and tooling to produce flat components from sheet metal or plate, with high dimensional accuracy. According to Hydrel A. G., Romanshorn, Switzerland, fine-blanking presses can be powered hydraulically or mechanically, or by a combination of these methods, but they must have three separate and distinct movements. These movements serve to clamp the work material, to perform the blanking operation, and to eject the finished part from the tool. Forces

of 1.5-2.5 times those used in conventional stamping are needed for fine blanking, so machines and tools must be designed and constructed accordingly. In mechanical fine-blanking presses the clamping and ejection forces are exerted hydraulically. Such presses generally are of toggle-type design and are limited to total forces of up to about 280 tons. Higher forces generally require all-hydraulic designs. These presses are also suited to embossing, coining, and impact extrusion work.

Cutting elements of tooling for fine blanking generally are made from 12 per cent chromium steel, although high speed steel and tungsten carbide also are used for long runs or improved quality. Cutting clearances between the punch and die as a percentage of the thickness of material are given in [Table 8](#). The clamping elements are sharp projections of 90-degree V-section that follow the outline of the workpiece and are incorporated into each tool as part of the stripper plate with thin material and also as part of the die plate when material thicker than 0.15 inch (3.81 mm) is to be blanked. Pressure applied to the elements containing the V-projections prior to the blanking operation causes the sharp edges to enter the material surface preventing sideways movement of the blank. The pressure applied as the projections bite into the work surface near the contour edges also squeezes the material, causing it to flow toward the cutting edges, reducing the usual rounding effect at the cut edge. When small details such as gear teeth are to be produced, V-projections are often used on both sides of the work, even with thin materials, to enhance the flow effect. With suitable tooling, workpieces can be produced with edges that are perpendicular to top and bottom surfaces within 0.004 inch (0.1mm) on thicknesses of 0.2 inch (5.0 mm), for instance. V-projection dimensions for various material thicknesses are shown in [Table 9](#). [Dimensions for V-projections Used in Fine-Blanking Tools](#) .

Table 8. Values for Clearances Used in Fine-Blanking Tools as a Percentage of the Thickness of the Material

Material Thickness		Clearance, %	
(in.)	(mm)	Inside Contour	Outside Contour
<0.040	<1.016	2.0	1.0
0.040 - 0.063	1.016 - 1.600	1.5	
0.063 - 0.098	1.600 - 2.489	1.25	
0.098 - 0.125	2.489 - 3.175	1.0	
0.125 - 0.197	3.175 - 5.004	0.8	0.5
0.197 - 0.315	5.004 - 8.001	0.7	
0.315 - 0.630	8.001 - 16.002	0.5	

Fine-blanked edges are free from the fractures that result from conventional tooling and can have surface finishes down to 80 μin . (2.0 μm) Ra with suitable tooling. Close tolerances can be held on inner and outer forms and on hole center distances. Flatness of fine-blanked components is better than that of parts made by conventional methods but distortion may occur with thin materials due to release of internal stresses. Widths must be slightly greater than are required for conventional press working. Generally, the strip width must be 2-3 times the thickness, plus the width of the part measured transverse to the feed direction. Other factors to be considered are shape, material quality, size and shape of the V-projection in relation to the die outline, and spacing between adjacent blanked parts. Holes and slots can be produced with ratios of width to material thickness down to 0.7, compared with the 1:1 ratio normally specified for conventional tooling. Operations such as countersinking, coining, and bending up to 60 degrees can be incorporated in fine-blanking tooling.

The cutting force in pounds, lb (Newton, N) exerted in fine blanking is 0.9 times the length of the cut in inches (mm) times the material thickness in inches (mm), times the tensile strength in lb/in^2 (MPa). Pressure in lb (N) exerted by the clamping element(s) carrying the V-projections is calculated by multiplying the length of the V-projection, which depends on its shape, in inches (mm) by its height (h), times the material tensile strength in

Table 9. Dimensions for V-projections Used in Fine-Blanking Tools

V-Projections On Stripper Plate Only		V-Projections On Both Stripper and Die Plate			
Material Thickness	A	h	r	H	R
V-Projections On Stripper Plate Only					
0.040-0.063	0.040	0.012	0.008
0.063-0.098	0.055	0.015	0.008
0.098-0.125	0.083	0.024	0.012
0.125-0.157	0.098	0.028	0.012
0.157-0.197	0.110	0.032	0.012
V-Projections On Both Stripper and Die Plate					
0.157-0.197	0.098	0.020	0.008	0.032	0.032
0.197-0.248	0.118	0.028	0.008	0.040	0.040
0.248-0.315	0.138	0.032	0.008	0.047	0.047
0.315-0.394	0.177	0.040	0.020	0.060	0.060
0.394-0.492	0.217	0.047	0.020	0.070	0.080
0.492-0.630	0.276	0.063	0.020	0.087	0.118

All units are in inches.

lb_f/in^2 (MPa), times an empirical factor f . Factor f has been determined to be 2.4–4.4 for a tensile strength of 28,000–113,000 lb_f/in^2 (193–779 MPa). The clamping pressure is approximately 30 per cent of the cutting force, calculated previously. Dimensions and positioning of the V-projection(s) are related to the material thickness, quality, and tensile strength. A small V-projection close to the line of cut has about the same effect as a large V-projection spaced away from the cut. However, if the V-projection is too close to the cut, it may move out of the material at the start of the cutting process, reducing its effectiveness. Positioning the V-projection at a distance from the line of cut increases both material and blanking force requirements. Location of the V-projection relative to the line of cut also affects tool life.

Shaving.— The edges of punched and blanked parts are generally rough and uneven. A shaving operation is used to achieve very precise clean parts. Shaving is the process of removing a thin layer of material from the inside or outside contour of a workpiece or from both sides with a sharp punch and die.

Shaving a Punched Workpiece: It is necessary to provide a small amount of stock on the punched or blanked workpiece for subsequent shaving. This amount, δ , is the difference between diameters of the hole after shaving and before shaving.

$$\delta = d - d_o \quad (25)$$

where where d = diameter of hole after shaving (inch or mm); and, d_o = diameter of hole before shaving (inch or mm).

The value of δ is 0.006 to 0.0098 inch (0.15 to 0.25 mm) for a previously-punched hole, and 0.004 to 0.006 inch (0.10 to 0.15 mm) for a previously-drilled hole.

The diameter of punch d_p can be calculated from the formula:

$$d_p = d + \varepsilon + i \quad (26)$$

where d = diameter of hole after shaving (inch or mm)

ε = production tolerance of the hole (inch or mm)

i = amount of compensation for tightening of the hole after shaving (inch or mm)
($i = 0.0002$ to 0.00067 in. or 0.005 - 0.017 mm)

The diameter of the die D_d is

$$D_d = (1.20 \text{ to } 1.30)d_p \quad (27)$$

Shaving a Blanked Workpiece: Thin layers of material can be removed from a blanked surface by a process similar to punching. If the workpiece after shaving needs to have a diameter D , the punch diameter for the blanking operation is

$$d_p = D + \delta \quad (28)$$

The die diameter for the blanking operation is

$$d_d = d_p + 2c = D + \delta + 2c \quad (29)$$

where D = diameter of final piece (inch or mm)

c = clearance between die and punch (inch or mm)

δ = amount of material for shaving (inch or mm)

Bending

One of the most common processes for sheet-metal forming is bending, which is used to form pieces such as L, U, or V-profiles, and also to improve the stiffness of a piece by increasing its moment of inertia. Bending metal is a uniform straining process that plastically deforms the material and changes its shape. The material is stressed above the yield strength but below the ultimate tensile strength. The surface area of the material changes only in the bending zone. "Bending" usually refers to linear deformation about one axis. Bending may be performed by air bending, bottoming bending, or coining.

Air Bending: Air bending is done with the punch touching the workpiece but not bottoming it in the lower die. The profile of a die for air bending can have a right angle or an acute angle. The edges of the die with which the workpiece is in contact are rounded, and the radius of the punch will always be smaller than the bending radius.

Bottoming Bending and Coining: Bottoming or coining bending is the process by which the punch and the workpiece bottom on the die. It is necessary to flatten the bottom bend area of the workpiece between the tip of the punch and bottom on the die in order to avoid springback. The tonnage required on this type of press is higher than in air bending.

Inside Bend Radius. — Fig. 11 shows the terminology used in the bending process.

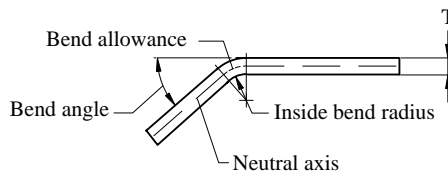


Fig. 11. Schematic Illustration of Terminology Used in the Bending Process

One of the most important factors influencing the quality of bent workpieces is the inside bend radius which must be within defined limits.

Minimum Bend Radius: If the bend radius is less than R_{min} given in Equation (30), particularly in harder materials, the material at the outside of the bend will tend to "orange peel." If this orange peeling, or opening of the grain, is severe enough, the metal will fracture or crack off completely in extreme cases.

The minimum bend radius, R_{min} is given by the following formula:

$$R_{min} = T \left(\frac{50}{r} - 1 \right) \tag{30}$$

where T = material thickness (inch or mm); and, r = percentage reduction in a tensile test for a given material (%).

Maximum Bend Radius: If the bend radius is greater than R_{max} given in Equation (31), the bend will be very hard to control and will spring back erratically. The amount of spring-back will worsen on thinner materials. When large radius bends are required an allowance should always be made for this in the tolerance of the part.

To achieve permanent plastic deformation in the outer fibers of the bent workpiece the maximum bend radius must be

$$R_{max} \leq \frac{TE}{2(YS)} \tag{31}$$

where E = modulus of elasticity, lb/in² (N/mm²); YS = yield strength, lb/in² (N/mm²); and, T = thickness of material, inches (mm).

Neutral Axis: When material is formed, the deformation in the inside fibers of the material will compress during forming and the fibers of the material on the outside of the bend will expand. The material between these two regions remains neutral during forming and is referred to as the neutral axis of the material. The length of fibers along the neutral axis of the bend does not change during forming. This neutral axis is used when figuring the bend allowance for flat blank layouts.

Allowances for Bending Sheet Metal: In bending steel, brass, bronze, or other metals, the problem is to find the length of straight stock required for each bend; these lengths are added to the lengths of the straight sections to obtain the total length of the material before bending.

If L = length (inch or mm) of straight stock required before bending; T = thickness (inch or mm); and R = inside radius of bend (inch or mm):

For 90° bends in soft brass and soft copper see Table 10 or:

$$L = (0.55 \times T) + (1.57 \times R) \tag{32}$$

For 90° bends in half-hard copper and brass, soft steel, and aluminum see Table 11 or:

$$L = (0.64 \times T) + (1.57 \times R) \tag{33}$$

For 90° bends in bronze, hard copper, cold-rolled steel, and spring steel see Table 12 or:

$$L = (0.71 \times T) + (1.57 \times R) \tag{34}$$

Example, Showing Application of Formulas: Find the length before bending of the part illustrated by Fig. 12. Soft steel is to be used.

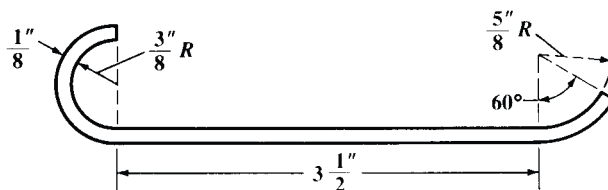


Fig. 12.

Table 10. Lengths of Straight Stock Required for 90-Degree Bends in Soft Copper and Soft Brass

Radius <i>R</i> of Bend, Inches	Thickness <i>T</i> of Material, Inch												
	$\frac{1}{64}$	$\frac{1}{32}$	$\frac{3}{64}$	$\frac{1}{16}$	$\frac{5}{64}$	$\frac{3}{32}$	$\frac{1}{8}$	$\frac{5}{32}$	$\frac{3}{16}$	$\frac{7}{32}$	$\frac{1}{4}$	$\frac{9}{32}$	$\frac{5}{16}$
$\frac{1}{32}$	0.058	0.066	0.075	0.083	0.092	0.101	0.118	0.135	0.152	0.169	0.187	0.204	0.221
$\frac{3}{64}$	0.083	0.091	0.100	0.108	0.117	0.126	0.143	0.160	0.177	0.194	0.212	0.229	0.246
$\frac{1}{16}$	0.107	0.115	0.124	0.132	0.141	0.150	0.167	0.184	0.201	0.218	0.236	0.253	0.270
$\frac{3}{32}$	0.156	0.164	0.173	0.181	0.190	0.199	0.216	0.233	0.250	0.267	0.285	0.302	0.319
$\frac{1}{8}$	0.205	0.213	0.222	0.230	0.239	0.248	0.265	0.282	0.299	0.316	0.334	0.351	0.368
$\frac{5}{32}$	0.254	0.262	0.271	0.279	0.288	0.297	0.314	0.331	0.348	0.365	0.383	0.400	0.417
$\frac{3}{16}$	0.303	0.311	0.320	0.328	0.337	0.346	0.363	0.380	0.397	0.414	0.432	0.449	0.466
$\frac{7}{32}$	0.353	0.361	0.370	0.378	0.387	0.396	0.413	0.430	0.447	0.464	0.482	0.499	0.516
$\frac{1}{4}$	0.401	0.409	0.418	0.426	0.435	0.444	0.461	0.478	0.495	0.512	0.530	0.547	0.564
$\frac{9}{32}$	0.450	0.458	0.467	0.475	0.484	0.493	0.510	0.527	0.544	0.561	0.579	0.596	0.613
$\frac{5}{16}$	0.499	0.507	0.516	0.524	0.533	0.542	0.559	0.576	0.593	0.610	0.628	0.645	0.662
$\frac{11}{32}$	0.549	0.557	0.566	0.574	0.583	0.592	0.609	0.626	0.643	0.660	0.678	0.695	0.712
$\frac{3}{8}$	0.598	0.606	0.615	0.623	0.632	0.641	0.658	0.675	0.692	0.709	0.727	0.744	0.761
$\frac{13}{32}$	0.646	0.654	0.663	0.671	0.680	0.689	0.706	0.723	0.740	0.757	0.775	0.792	0.809
$\frac{7}{16}$	0.695	0.703	0.712	0.720	0.729	0.738	0.755	0.772	0.789	0.806	0.824	0.841	0.858
$\frac{15}{32}$	0.734	0.742	0.751	0.759	0.768	0.777	0.794	0.811	0.828	0.845	0.863	0.880	0.897
$\frac{1}{2}$	0.794	0.802	0.811	0.819	0.828	0.837	0.854	0.871	0.888	0.905	0.923	0.940	0.957
$\frac{9}{16}$	0.892	0.900	0.909	0.917	0.926	0.935	0.952	0.969	0.986	1.003	1.021	1.038	1.055
$\frac{5}{8}$	0.990	0.998	1.007	1.015	1.024	1.033	1.050	1.067	1.084	1.101	1.119	1.136	1.153
$\frac{11}{16}$	1.089	1.097	1.106	1.114	1.123	1.132	1.149	1.166	1.183	1.200	1.218	1.235	1.252
$\frac{3}{4}$	1.187	1.195	1.204	1.212	1.221	1.230	1.247	1.264	1.281	1.298	1.316	1.333	1.350
$\frac{13}{16}$	1.286	1.294	1.303	1.311	1.320	1.329	1.346	1.363	1.380	1.397	1.415	1.432	1.449
$\frac{7}{8}$	1.384	1.392	1.401	1.409	1.418	1.427	1.444	1.461	1.478	1.495	1.513	1.530	1.547
$\frac{15}{16}$	1.481	1.489	1.498	1.506	1.515	1.524	1.541	1.558	1.575	1.592	1.610	1.627	1.644
1	1.580	1.588	1.597	1.605	1.614	1.623	1.640	1.657	1.674	1.691	1.709	1.726	1.743
1 $\frac{1}{16}$	1.678	1.686	1.695	1.703	1.712	1.721	1.738	1.755	1.772	1.789	1.807	1.824	1.841
1 $\frac{1}{8}$	1.777	1.785	1.794	1.802	1.811	1.820	1.837	1.854	1.871	1.888	1.906	1.923	1.940
1 $\frac{3}{16}$	1.875	1.883	1.892	1.900	1.909	1.918	1.935	1.952	1.969	1.986	2.004	2.021	2.038
1 $\frac{1}{4}$	1.972	1.980	1.989	1.997	2.006	2.015	2.032	2.049	2.066	2.083	2.101	2.118	2.135

Table 11. Lengths of Straight Stock Required for 90-Degree Bends in Half-Hard Brass and Sheet Copper, Soft Steel, and Aluminum

Radius <i>R</i> of Bend, Inches	Thickness <i>T</i> of Material, Inch												
	$\frac{1}{64}$	$\frac{1}{32}$	$\frac{3}{64}$	$\frac{1}{16}$	$\frac{5}{64}$	$\frac{3}{32}$	$\frac{1}{8}$	$\frac{5}{32}$	$\frac{3}{16}$	$\frac{7}{32}$	$\frac{1}{4}$	$\frac{9}{32}$	$\frac{5}{16}$
$\frac{1}{32}$	0.059	0.069	0.079	0.089	0.099	0.109	0.129	0.149	0.169	0.189	0.209	0.229	0.249
$\frac{3}{64}$	0.084	0.094	0.104	0.114	0.124	0.134	0.154	0.174	0.194	0.214	0.234	0.254	0.274
$\frac{1}{16}$	0.108	0.118	0.128	0.138	0.148	0.158	0.178	0.198	0.218	0.238	0.258	0.278	0.298
$\frac{3}{32}$	0.157	0.167	0.177	0.187	0.197	0.207	0.227	0.247	0.267	0.287	0.307	0.327	0.347
$\frac{1}{8}$	0.206	0.216	0.226	0.236	0.246	0.256	0.276	0.296	0.316	0.336	0.356	0.376	0.396
$\frac{5}{32}$	0.255	0.265	0.275	0.285	0.295	0.305	0.325	0.345	0.365	0.385	0.405	0.425	0.445
$\frac{3}{16}$	0.305	0.315	0.325	0.335	0.345	0.355	0.375	0.395	0.415	0.435	0.455	0.475	0.495
$\frac{7}{32}$	0.354	0.364	0.374	0.384	0.394	0.404	0.424	0.444	0.464	0.484	0.504	0.524	0.544
$\frac{1}{4}$	0.403	0.413	0.423	0.433	0.443	0.453	0.473	0.493	0.513	0.533	0.553	0.573	0.593
$\frac{9}{32}$	0.452	0.462	0.472	0.482	0.492	0.502	0.522	0.542	0.562	0.582	0.602	0.622	0.642
$\frac{5}{16}$	0.501	0.511	0.521	0.531	0.541	0.551	0.571	0.591	0.611	0.631	0.651	0.671	0.691
$\frac{11}{32}$	0.550	0.560	0.570	0.580	0.590	0.600	0.620	0.640	0.660	0.680	0.700	0.720	0.740
$\frac{3}{8}$	0.599	0.609	0.619	0.629	0.639	0.649	0.669	0.689	0.709	0.729	0.749	0.769	0.789
$\frac{13}{32}$	0.648	0.658	0.668	0.678	0.688	0.698	0.718	0.738	0.758	0.778	0.798	0.818	0.838
$\frac{7}{16}$	0.697	0.707	0.717	0.727	0.737	0.747	0.767	0.787	0.807	0.827	0.847	0.867	0.887
$\frac{15}{32}$	0.746	0.756	0.766	0.776	0.786	0.796	0.816	0.836	0.856	0.876	0.896	0.916	0.936
$\frac{1}{2}$	0.795	0.805	0.815	0.825	0.835	0.845	0.865	0.885	0.905	0.925	0.945	0.965	0.985
$\frac{17}{32}$	0.844	0.854	0.864	0.874	0.884	0.894	0.914	0.934	0.954	0.974	0.994	1.014	1.034
$\frac{9}{16}$	0.894	0.904	0.914	0.924	0.934	0.944	0.964	0.984	1.004	1.024	1.044	1.064	1.084
$\frac{5}{8}$	0.992	1.002	1.012	1.022	1.032	1.042	1.062	1.082	1.102	1.122	1.142	1.162	1.182
$\frac{11}{16}$	1.090	1.100	1.110	1.120	1.130	1.140	1.160	1.180	1.200	1.220	1.240	1.260	1.280
$\frac{3}{4}$	1.188	1.198	1.208	1.218	1.228	1.238	1.258	1.278	1.298	1.318	1.338	1.358	1.378
$\frac{13}{16}$	1.286	1.296	1.306	1.316	1.326	1.336	1.356	1.376	1.396	1.416	1.436	1.456	1.476
$\frac{7}{8}$	1.384	1.394	1.404	1.414	1.424	1.434	1.454	1.474	1.494	1.514	1.534	1.554	1.574
$\frac{15}{8}$	1.483	1.493	1.503	1.513	1.523	1.553	1.553	1.573	1.693	1.613	1.633	1.653	1.673
1	1.581	1.591	1.601	1.611	1.621	1.631	1.651	1.671	1.691	1.711	1.731	1.751	1.771
1 $\frac{1}{16}$	1.697	1.689	1.699	1.709	1.719	1.729	1.749	1.769	1.789	1.809	1.829	1.849	1.869
1 $\frac{1}{8}$	1.777	1.787	1.797	1.807	1.817	1.827	1.847	1.867	1.887	1.907	1.927	1.947	1.967
1 $\frac{3}{16}$	1.875	1.885	1.895	1.905	1.915	1.925	1.945	1.965	1.985	2.005	2.025	2.045	2.065
1 $\frac{1}{4}$	1.973	1.983	1.993	2.003	2.013	2.023	2.043	2.063	2.083	2.103	2.123	2.143	2.163

Table 12. Lengths of Straight Stock Required for 90-Degree Bends in Hard Copper, Bronze, Cold-Rolled Steel, and Spring Steel

Radius <i>R</i> of Bend, Inches	Thickness <i>T</i> of Material, Inch												
	$\frac{1}{64}$	$\frac{1}{32}$	$\frac{3}{64}$	$\frac{1}{16}$	$\frac{5}{64}$	$\frac{3}{32}$	$\frac{1}{8}$	$\frac{5}{32}$	$\frac{3}{16}$	$\frac{7}{32}$	$\frac{1}{4}$	$\frac{9}{32}$	$\frac{5}{16}$
$\frac{1}{32}$	0.060	0.071	0.082	0.093	0.104	0.116	0.138	0.160	0.182	0.204	0.227	0.249	0.271
$\frac{3}{64}$	0.085	0.096	0.107	0.118	0.129	0.141	0.163	0.185	0.207	0.229	0.252	0.274	0.296
$\frac{1}{16}$	0.109	0.120	0.131	0.142	0.153	0.165	0.187	0.209	0.231	0.253	0.276	0.298	0.320
$\frac{3}{32}$	0.158	0.169	0.180	0.191	0.202	0.214	0.236	0.258	0.280	0.302	0.325	0.347	0.369
$\frac{1}{8}$	0.207	0.218	0.229	0.240	0.251	0.263	0.285	0.307	0.329	0.351	0.374	0.396	0.418
$\frac{5}{32}$	0.256	0.267	0.278	0.289	0.300	0.312	0.334	0.356	0.378	0.400	0.423	0.445	0.467
$\frac{3}{16}$	0.305	0.316	0.327	0.338	0.349	0.361	0.383	0.405	0.427	0.449	0.472	0.494	0.516
$\frac{7}{32}$	0.355	0.366	0.377	0.388	0.399	0.411	0.433	0.455	0.477	0.499	0.522	0.544	0.566
$\frac{1}{4}$	0.403	0.414	0.425	0.436	0.447	0.459	0.481	0.503	0.525	0.547	0.570	0.592	0.614
$\frac{9}{32}$	0.452	0.463	0.474	0.485	0.496	0.508	0.530	0.552	0.574	0.596	0.619	0.641	0.663
$\frac{5}{16}$	0.501	0.512	0.523	0.534	0.545	0.557	0.579	0.601	0.623	0.645	0.668	0.690	0.712
$\frac{11}{32}$	0.551	0.562	0.573	0.584	0.595	0.607	0.629	0.651	0.673	0.695	0.718	0.740	0.762
$\frac{3}{8}$	0.600	0.611	0.622	0.633	0.644	0.656	0.678	0.700	0.722	0.744	0.767	0.789	0.811
$\frac{13}{32}$	0.648	0.659	0.670	0.681	0.692	0.704	0.726	0.748	0.770	0.792	0.815	0.837	0.859
$\frac{7}{16}$	0.697	0.708	0.719	0.730	0.741	0.753	0.775	0.797	0.819	0.841	0.864	0.886	0.908
$\frac{15}{32}$	0.736	0.747	0.758	0.769	0.780	0.792	0.814	0.836	0.858	0.880	0.903	0.925	0.947
$\frac{1}{2}$	0.796	0.807	0.818	0.829	0.840	0.852	0.874	0.896	0.918	0.940	0.963	0.985	1.007
$\frac{9}{16}$	0.894	0.905	0.916	0.927	0.938	0.950	0.972	0.994	1.016	1.038	1.061	1.083	1.105
$\frac{5}{8}$	0.992	1.003	1.014	1.025	1.036	1.048	1.070	1.092	1.114	1.136	1.159	1.181	1.203
$\frac{11}{16}$	1.091	1.102	1.113	1.124	1.135	1.147	1.169	1.191	1.213	1.235	1.258	1.280	1.302
$\frac{3}{4}$	1.189	1.200	1.211	1.222	1.233	1.245	1.267	1.289	1.311	1.333	1.356	1.378	1.400
$\frac{13}{16}$	1.288	1.299	1.310	1.321	1.332	1.344	1.366	1.388	1.410	1.432	1.455	1.477	1.499
$\frac{7}{8}$	1.386	1.397	1.408	1.419	1.430	1.442	1.464	1.486	1.508	1.530	1.553	1.575	1.597
$\frac{15}{16}$	1.483	1.494	1.505	1.516	1.527	1.539	1.561	1.583	1.605	1.627	1.650	1.672	1.694
1	1.582	1.593	1.604	1.615	1.626	1.638	1.660	1.682	1.704	1.726	1.749	1.771	1.793
1 $\frac{1}{16}$	1.680	1.691	1.702	1.713	1.724	1.736	1.758	1.780	1.802	1.824	1.847	1.869	1.891
1 $\frac{1}{8}$	1.779	1.790	1.801	1.812	1.823	1.835	1.857	1.879	1.901	1.923	1.946	1.968	1.990
1 $\frac{3}{16}$	1.877	1.888	1.899	1.910	1.921	1.933	1.955	1.977	1.999	2.021	2.044	2.066	2.088
1 $\frac{1}{4}$	1.974	1.985	1.996	2.007	2.018	2.030	2.052	2.074	2.096	2.118	2.141	2.163	2.185

For bend at left-hand end (180-degree bend)

$$L = [(0.64 \times 0.125) + (1.57 \times 0.375)] \times \frac{180}{90} = 1.338$$

For bend at right-hand end (60-degree bend)

$$L = [(0.64 \times 0.125) + (1.57 \times 0.625)] \times \frac{60}{90} = 0.707$$

Total length before bending = 3.5 + 1.338 + 0.707 = 5.545 inches

Angle of Bend Other Than 90 Degrees: For angles other than 90 degrees, find length L , using tables or formulas, and multiply L by angle of bend, in degrees, divided by 90 to find length of stock before bending. In using this rule, note that *angle of bend* is the angle through which the material has actually been bent; hence, it is not always the angle as given on a drawing. To illustrate, in Fig. 13, the angle on the drawing is 60 degrees, but the angle of bend A is 120 degrees ($180 - 60 = 120$); in Fig. 14, the angle of bend A is 60 degrees; in Fig. 15, angle A is $90 - 30 = 60$ degrees. Formulas (32), (33), and (34) apply to parts bent with simple tools or on the bench, where limits of $\pm \frac{1}{64}$ inch are specified. If a part has two or more bends of the same radius, it is, of course, only necessary to obtain the length required for one of the bends and then multiply by the number of bends, to obtain the total allowance for the bent sections.

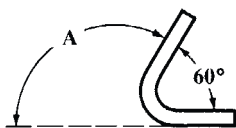


Fig. 13.

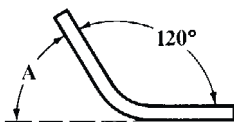


Fig. 14.

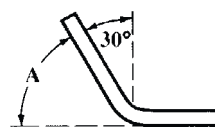


Fig. 15.

Springback: Every plastic deformation is followed by elastic recovery. As a consequence of this phenomenon, which occurs when a flat-rolled metal or alloy is cold-worked, upon release of the forming force, the material has a tendency to partially return to its original shape. This effect is called springback and is influenced not only by the tensile and yield strengths, but also by the thickness, bend radius, and bend angle. To estimate springback, an approximate formula in terms of the bend radius before springback R_i and bend radius after springback R_f is as follows

$$\frac{R_i}{R_f} = 4 \left(\frac{R_i(YS)}{ET} \right)^3 - 3 \left(\frac{R_i(YS)}{ET} \right) + 1 \quad (35)$$

where R_i = bend radius before springback, inch (mm); R_f = bend radius after springback, inch (mm); YS = yield strength of the material, lb/in² (MPa); E = modulus of elasticity of the material lb/in² (MPa); and, T = material thickness, inch (mm).

Other Bending Allowance Formulas: When bending sheet steel or brass, add from $\frac{1}{3}$ to $\frac{1}{2}$ the thickness of the stock, for each bend, to the sum of the inside dimensions of the finished piece, to get the length of the straight blank. The harder the material the greater the allowance ($\frac{1}{3}$ of the thickness is added for soft stock and $\frac{1}{2}$ of the thickness for hard material). The data given in, Table 13, refers particularly to the bending of sheet metal for counters, bank fittings, and general office fixtures, for which purpose it is not absolutely essential to have the sections of the bends within very close limits. Absolutely accurate data for this work cannot be deduced as the hardness and other mechanical properties vary considerably. The values given in the table apply to sheet steel, aluminum, brass and bronze. Experience has demonstrated that for semi-square corners, such as those formed in a V-die, the amount to be deducted from the sum of the outside bend dimensions, shown in Fig. 16 as the sum of the letters from a to e , is as follows: $X = 1.67 BG$, where X = the amount to be

deducted; B = the number of bends; and G = the decimal equivalent of the gage thickness of the stock. The values of X for different gages and numbers of bends are given in the table.

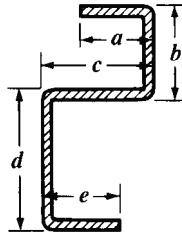


Fig. 16.

The lower part of the table applies to square bends that are either drawn through a block of steel made to the required shape, or are drawn through rollers in a drawbench. The pressure applied not only gives a much sharper corner, but it also elongates the material more than in the V-die process. In this example, the deduction is $X = 1.33 BG$.

Example: The following further illustrates this type of calculation. A strip having two bends is to have outside dimensions of 2, 1½ and 2 inches, and is made of stock 0.125 inch thick. The sum of the outside dimensions is thus 5½ inches, and from Table 13 the amount to be deducted is found to be 0.416; hence the blank will be 5.5 – 0.416 = 5.084 inches long.

Table 13. Allowances for Square Bends in Sheet Metal

Square Bends	Gage	Thickness Inches	Amount to be deducted from the sum of the outside bend dimensions, (in)						
			1 Bend	2 Bends	3 Bends	4 Bends	5 Bends	6 Bends	7 Bends
Formed in a Press by a V-die	18	0.0500	0.083	0.166	0.250	0.333	0.416	0.500	0.583
	16	0.0625	0.104	0.208	0.312	0.416	0.520	0.625	0.729
	14	0.0781	0.130	0.260	0.390	0.520	0.651	0.781	0.911
	13	0.0937	0.156	0.312	0.468	0.625	0.781	0.937	1.093
	12	0.1093	0.182	0.364	0.546	0.729	0.911	1.093	1.276
	11	0.1250	0.208	0.416	0.625	0.833	1.041	1.250	1.458
	10	0.1406	0.234	0.468	0.703	0.937	1.171	1.406	1.643
Rolled or Drawn in a Draw-bench	18	0.0500	0.066	0.133	0.200	0.266	0.333	0.400	0.466
	16	0.0625	0.083	0.166	0.250	0.333	0.416	0.500	0.583
	14	0.0781	0.104	0.208	0.312	0.416	0.521	0.625	0.729
	13	0.0937	0.125	0.250	0.375	0.500	0.625	0.750	0.875
	12	0.1093	0.145	0.291	0.437	0.583	0.729	0.875	1.020
	11	0.1250	0.166	0.333	0.500	0.666	0.833	1.000	1.166
	10	0.1406	0.187	0.375	0.562	0.750	0.937	1.125	1.312

Approximate values for sheet steel, aluminum, brass, and bronze.

Bending Force: The bending force is a function of the strength of the material, the length of the workpiece, and the die opening. A good approximation of the required force F is

$$F = \frac{LT^2(UTS)}{W} \tag{36}$$

where F = bending force (lb or N)
 L = length of the workpiece (inch or mm)
 T = material thickness (inch or mm)

UTS = ultimate tensile strength of the material (lb/in² or MPa)

W = die opening (inch or mm)

Three-roll Bending.—Many curved sheet metal parts, such as rings, cylinders, truncated cones, or segments of these shapes, are impractical to produce by press forming. Such parts are best produced by a process called roll bending. In this process workpiece is produced from a flat blank by passing it between three staggered rolls. Depending upon such variables as the composition of the work material, machine capability, or workpiece size, the shape may be formed in a single pass or a series of passes, with roll adjustments necessary after each pass. Fig. 17 illustrates the basic set-up for three-roll bending on pyramid-type machines.

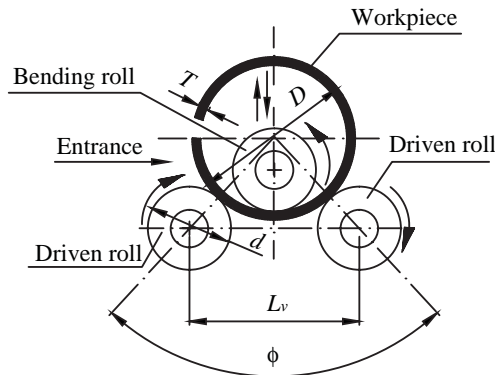


Fig. 17. Three-roll Bending

To achieve permanent deformation in the outside and inside fibers of the material, the following relationship must apply:

$$\frac{D}{T} < \frac{E}{YS} + 1 \quad (37)$$

where D = outer diameter of the workpiece, inch (mm)

T = material thickness, inch (mm)

E = modulus of elasticity, lb/in² (MPa)

YS = yield stress, lb/in² (MPa)

Nowadays, three-roll bending is one of the bending operations most used in industrial manufacturing. With only one set of rolls and by setting only one axis, it is possible to achieve different radii or a distribution of radii along the profile length within the bending plane. In addition to the high flexibility and thus economy of this process, it can achieve high quality standards, too, if suitable measures are used.

Drawing

The drawing of metal, or deep drawing is the process by which a punch is used to force sheet metal to flow between the surfaces of a punch and a die. Many products made from sheet metals are given the required shape by using a drawing operation. A blank is first cut from flat stock, and then a shell of cylindrical, conical or special shape is produced from this flat blank by means of one or more drawing dies. Most drawn parts are of cylindrical shape, but rectangular, square, and specialized shapes are sometimes produced. With this process, it is possible to get a final part-using minimal operations and generating minimal scrap—that can be assembled without further operations.

Mechanics of Deep Drawing.—As the material is drawn into the die by the punch, it flows into a three-dimensional shape. The blank is held in place with a blank holder using

a fixed force. High compressive stresses act upon the metal, which without the offsetting effect of a blank holder, would result in a severely wrinkled workpiece.

Wrinkling is one of the major defects in deep drawing; it can damage the dies and adversely affect part assembly and function. The prediction and prevention of wrinkling is very important. There are a number of different analytical and experimental methods that can help to predict and prevent flange wrinkling, including finite element modeling (FEM).

There are many important variables in the deep drawing process but they can be classified as either: material and friction factors, or tooling and equipment factors.

Important material properties such as the strain hardening coefficient (n) and normal anisotropy (R) affect deep-drawing operations. Friction and lubrication at the punch, die, and workpiece interfaces are very important in a successful deep drawing process.

Unlike bending operations, in which metal is plastically deformed in a relatively small area, drawing operations impose plastic deformation over large areas and stress states are different in different regions of the part. As a starting point, consider what appear to be three zones undergoing types of deformation:

- 1) The flat portion of the blank that has not yet entered the die cavity (the flange)
- 2) The portion of the blank that is in the die cavity (the wall)
- 3) The zone of contact between the punch and the blank (bottom)

The radial tensile stress is due to the blank being pulled into the female die, and the compressive stress, normal in the blank sheet, is due to the blank holder pressure. The punch transmits force F to the bottom of the cup, so the part of the blank that is formed into the bottom of the cup is subjected to radial and tangential tensile stress. From the bottom, the punch transmits the force through the walls of the cup to the flange. In this stressed state, the walls tend to elongate in a longitudinal direction. Elongation causes the cup wall to become thinner, which can cause the workpiece to tear.

If a drawing die radius in a deep drawing operation is too small, it will cause fracture of the cup in the zone between the wall and the flange. If a punch corner radius is too small it may cause fracture in the zone between a wall and bottom of a cup. Fracture can also result from high longitudinal tensile stresses in the bottom cup, due to a high ratio between the blank diameter and the punch diameter. Parts made by deep drawing usually require several successive draws. One or more annealing operations may be required to reduce work hardening by restoring the ductile grain structure.

Number of Draws: The number of successive draws n required is a function of the ratio of the part height h to the part diameter d , and is given by this formula:

$$n = \frac{h}{d} \quad (38)$$

where where n = number of draws; h = part height; and, d = part diameter.

The value of n for the cylindrical cup draw is given in **Table 14**.

Table 14. Number of Draws (n) for a Cylindrical Cup Draw.

h/d	< 0.6	0.6 to 1.4	1.4 to 2.5	2.5 to 4.0	4.0 to 7.0	7.0 to 12.0
n	1	2	3	4	5	6

Deep Drawability: Deep drawability is the ability of a sheet metal to be formed, or drawn, into a cupped or cavity shape without cracking or otherwise failing. The depth to which metal can be drawn in one operation depends upon the quality and kind of material, its thickness, and the amount that the work material is thinned in drawing.

Drawing a Cylindrical Cup Without a Flange: A general rule for determining the depth to which a cylindrical cup without a flange can be drawn in one operation is defined as the ratio of the mean diameter d_m of the drawn cup to the blank diameter D . This relation is

known as the drawing ratio m . The value of the drawing ratio for the first and succeeding operations is given by:

$$m_1 = \frac{d_{m_1}}{D} \quad m_2 = \frac{d_{m_2}}{D_{m_1}} \quad m_3 = \frac{d_{m_3}}{D_{m_2}} \quad \dots \quad m_n = \frac{d_{m_n}}{D_{m_{n-1}}}$$

The magnitude of these ratios determines the following parameters:

- 1) the stresses and forces of the deep drawing processes
- 2) the number of successive draws
- 3) the blank holder force
- 4) the quality of the final drawn parts.

Table 15 shows optimal drawing ratios for cylindrical cups of sheet steel and brass without a flange.

Table 15. Optimal Ratios M for Drawing a Cylindrical Cup Without Flanges

Drawing ratio m	Relative Thickness of the Material $T_r = \frac{T}{D} 100$ (%)					
	2.0 – 1.5	1.5 – 1.0	1.0 – 0.6	0.6 – 0.3	0.3 – 0.15	0.15 – 0.08
m_1	0.48 – 0.50	0.50 – 0.53	0.53 – 0.55	0.55 – 0.58	0.58 – 0.60	0.60 – 0.63
m_2	0.73 – 0.75	0.75 – 0.76	0.76 – 0.78	0.78 – 0.79	0.79 – 0.80	0.80 – 0.82
m_3	0.76 – 0.78	0.78 – 0.79	0.79 – 0.80	0.81 – 0.82	0.81 – 0.82	0.82 – 0.84
m_4	0.78 – 0.80	0.80 – 0.81	0.81 – 0.82	0.82 – 0.83	0.83 – 0.85	0.85 – 0.86
m_5	0.80 – 0.82	0.82 – 0.84	0.84 – 0.85	0.85 – 0.86	0.86 – 0.87	0.78 – 0.90

Diameters of drawing workpieces for the first and succeeding operations are given by:

$$d_1 = m_1 D \quad d_2 = m_2 d_1 \quad \dots \quad d_i = m_i d_{i-1}$$

Drawing a Cylindrical Cup With a Flange: **Table 16** gives values of the drawing ratio m for the first and succeeding operations for drawing a cylindrical cup with flange.

Diameters of drawing workpiece for the first and succeeding operations are given by

$$d_1 = m_1 D \quad d_2 = m_2 d_1 \quad \dots \quad d_i = m_i d_{i-1}$$

However, diameter D_f needs to be accomplished in the first drawing operation if possible.

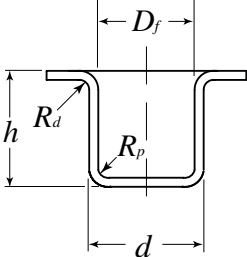
Diameters of Shell Blanks: The diameters of blanks for drawing plain cylindrical shells can be obtained from **Table 17**, which gives a very close approximation for thin stock. The blank diameters given in this table are for sharp-cornered shells and are found by the following formula

$$D = \sqrt{d^2 + 4dh} \quad (39)$$

where where D = diameter of flat blank (inch or mm); d = diameter of finished shell (inch or mm); and, h = height of finished shell (inch or mm).

Example 1: If the diameter of the finished shell d , is to be 1.5 inches (mm), and the height h , 2 inches (mm), the trial diameter of the blank D , would be found as follows:

Table 16. Values of Ratio m for Drawing a Cylindrical Cup With Flange

						
Drawing ratio m	$\frac{D_f}{d}$	Relative thickness of the material $T_r = \frac{T}{D} 100$ (%)				
		2.0 - 1.5	1.5 - 1.0	1.0 - 0.6	0.6 - 0.3	0.3 - 0.15
m_1	1.1	0.51	0.53	0.55	0.57	0.59
	1.3	0.49	0.51	0.53	0.54	0.55
	1.5	0.47	0.49	0.50	0.51	0.52
	1.8	0.45	0.46	0.47	0.48	0.48
	2.0	0.42	0.43	0.44	0.45	0.45
	2.5	0.37	0.38	0.38	0.38	0.38
	3.0	0.32	0.33	0.33	0.33	0.33
m_2	...	0.73	0.75	0.76	0.78	0.80
m_3	...	0.75	0.78	0.79	0.80	0.82
m_4	...	0.78	0.80	0.82	0.83	0.84
m_5	...	0.80	0.82	0.84	0.85	0.86

$$D = \sqrt{1.5^2 + 4 \times 1.5 \times 2} = \sqrt{14.25} = 3.78 \text{ inches (mm)}$$

For a round-cornered cup, the following formula, in which r equals the radius of the corner, will give fairly accurate diameters, provided the radius does not exceed, say, $\frac{1}{4}$ the height of the shell:

$$D = \sqrt{d^2 + 4dh} - r \quad (40)$$

These formulas are based on the assumption that the thickness of the drawn shell is to be the same as the original thickness of the stock and that the blank is so proportioned that its area will equal the area of the drawn shell. This method of calculating the blank diameter is quite accurate for thin material, when there is only a slight reduction in the thickness of the metal incident to drawing; but when heavy stock is drawn and the thickness of the finished shell is much less than the original thickness of the stock, the blank diameter obtained from [Formulas \(39\) or \(40\)](#) will be too large, because when the stock is drawn thinner, there is an increase in area. When an appreciable reduction in thickness is to be made, the blank diameter can be obtained by first determining the “mean height” of the drawn shell by the following formula. This formula is only approximately correct, but will give results sufficiently accurate for most work:

$$M = \frac{ht}{T} \quad (41)$$

where M = approximate mean height of drawn shell (inch or mm); h = height of drawn shell (inch or mm); t = thickness of shell (inch or mm); and T = thickness of metal (inch or mm) before drawing.

After determining the mean height, the blank diameter for the required shell diameter is obtained from [Table 16](#), the mean height being used instead of the actual height.

Table 17. Diameters of Blanks for Drawn Cylindrical Shells

Dia. of Shell	Height of Shell																			
	¼	½	¾	1	1 ¼	1 ½	1 ¾	2	2 ¼	2 ½	2 ¾	3	3 ¼	3 ½	3 ¾	4	4 ½	5	5 ½	6
¼	0.56	0.75	0.90	1.03	1.14	1.25	1.35	1.44	1.52	1.60	1.68	1.75	1.82	1.89	1.95	2.01	2.14	2.25	2.36	2.46
½	0.87	1.12	1.32	1.50	1.66	1.80	1.94	2.06	2.18	2.29	2.40	2.50	2.60	2.69	2.78	2.87	3.04	3.21	3.36	3.50
¾	1.14	1.44	1.68	1.89	2.08	2.25	2.41	2.56	2.70	2.84	2.97	3.09	3.21	3.33	3.44	3.54	3.75	3.95	4.13	4.31
1	1.41	1.73	2.00	2.24	2.45	2.65	2.83	3.00	3.16	3.32	3.46	3.61	3.74	3.87	4.00	4.12	4.36	4.58	4.80	5.00
1 ¼	1.68	2.01	2.30	2.56	2.79	3.01	3.21	3.40	3.58	3.75	3.91	4.07	4.22	4.37	4.51	4.64	4.91	5.15	5.39	5.62
1 ½	1.94	2.29	2.60	2.87	3.12	3.36	3.57	3.78	3.97	4.15	4.33	4.50	4.66	4.82	4.98	5.12	5.41	5.68	5.94	6.18
1 ¾	2.19	2.56	2.88	3.17	3.44	3.68	3.91	4.13	4.34	4.53	4.72	4.91	5.08	5.26	5.41	5.58	5.88	6.17	6.45	6.71
2	2.45	2.83	3.16	3.46	3.74	4.00	4.24	4.47	4.69	4.90	5.10	5.29	5.48	5.66	5.83	6.00	6.32	6.63	6.93	7.21
2 ¼	2.70	3.09	3.44	3.75	4.04	4.31	4.56	4.80	5.03	5.25	5.46	5.66	5.86	6.05	6.23	6.41	6.75	7.07	7.39	7.69
2 ½	2.96	3.36	3.71	4.03	4.33	4.61	4.87	5.12	5.36	5.59	5.81	6.02	6.22	6.42	6.61	6.80	7.16	7.50	7.82	8.14
2 ¾	3.21	3.61	3.98	4.31	4.62	4.91	5.18	5.44	5.68	5.92	6.15	6.37	6.58	6.79	6.99	7.18	7.55	7.91	8.25	8.58
3	3.46	3.87	4.24	4.58	4.90	5.20	5.48	5.74	6.00	6.25	6.48	6.71	6.93	7.14	7.35	7.55	7.94	8.31	8.66	9.00
3 ¼	3.71	4.13	4.51	4.85	5.18	5.48	5.77	6.04	6.31	6.56	6.80	7.04	7.27	7.49	7.70	7.91	8.31	8.69	9.06	9.41
3 ½	3.97	4.39	4.77	5.12	5.45	5.77	6.06	6.34	6.61	6.87	7.12	7.36	7.60	7.83	8.05	8.26	8.67	9.07	9.45	9.81
3 ¾	4.22	4.64	5.03	5.39	5.73	6.05	6.35	6.64	6.91	7.18	7.44	7.69	7.92	8.16	8.38	8.61	9.03	9.44	9.83	10.20
4	4.47	4.90	5.29	5.66	6.00	6.32	6.63	6.93	7.21	7.48	7.75	8.00	8.25	8.49	8.72	8.94	9.38	9.80	10.20	10.58
4 ¼	4.72	5.15	5.55	5.92	6.27	6.60	6.91	7.22	7.50	7.78	8.05	8.31	8.56	8.81	9.04	9.28	9.72	10.15	10.56	10.96
4 ½	4.98	5.41	5.81	6.19	6.54	6.87	7.19	7.50	7.79	8.08	8.35	8.62	8.87	9.12	9.37	9.60	10.06	10.50	10.92	11.32
4 ¾	5.22	5.66	6.07	6.45	6.80	7.15	7.47	7.78	8.08	8.37	8.65	8.92	9.18	9.44	9.69	9.93	10.40	10.84	11.27	11.69
5	5.48	5.92	6.32	6.71	7.07	7.42	7.75	8.06	8.37	8.66	8.94	9.22	9.49	9.75	10.00	10.25	10.72	11.18	11.62	12.04
5 ¼	5.73	6.17	6.58	6.97	7.33	7.68	8.02	8.34	8.65	8.95	9.24	9.52	9.79	10.05	10.31	10.56	11.05	11.51	11.96	12.39
5 ½	5.98	6.42	6.84	7.23	7.60	7.95	8.29	8.62	8.93	9.23	9.53	9.81	10.08	10.36	10.62	10.87	11.37	11.84	12.30	12.74
5 ¾	6.23	6.68	7.09	7.49	7.86	8.22	8.56	8.89	9.21	9.52	9.81	10.10	10.38	10.66	10.92	11.18	11.69	12.17	12.63	13.08
6	6.48	6.93	7.35	7.75	8.12	8.49	8.83	9.17	9.49	9.80	10.10	10.39	10.68	10.95	11.23	11.49	12.00	12.49	12.96	13.42

Example 2: Suppose a shell 2 inches (mm) in diameter and $3\frac{3}{4}$ inches (mm) high is to be drawn, and that the original thickness of the stock is 0.050 inch (mm), and the thickness of drawn shell, 0.040 inch (mm). To what diameter should the blank be cut? Obtain the mean height from **Formula (41)**:

$$M = \frac{ht}{T} = \frac{3.75 \times 0.040}{0.050} = 3 \text{ inches (mm)}$$

According to **Table 16**, the blank diameter for a shell 2 inches (mm) in diameter and 3 inches (mm) high is 5.29 inches (mm). **Formula (41)** is accurate enough for all practical purposes, unless the reduction in the thickness of the metal is greater than about one-fifth the original thickness. When there is considerable reduction, a blank calculated by this formula produces a shell that is too long. However, the error is in the right direction, as the edges of drawn shells are ordinarily trimmed.

If the shell has a rounded corner, the radius of the corner should be deducted from the figures given in the table. For example, if the shell referred to in **Example 2** had a corner of $\frac{1}{4}$ -inch (mm) radius, the blank diameter would equal $5.29 - 0.25 = 5.04$ inches (mm).

Another formula that is sometimes used for obtaining blank diameters for shells, when there is a reduction in the thickness of the stock, is as follows:

$$D = \sqrt{a^2 + (a^2 - b^2)\frac{h}{t}} \quad (42)$$

where In this formula D = blank diameter (inch or mm); a = outside diameter (inch or mm); b = inside diameter (inch or mm); t = thickness of shell at bottom (inch or mm); and, h = depth of shell (inch or mm).

Equation (42) is based on the volume of metal in the drawn shell. It is assumed that the shells are cylindrical, and no allowance is made for a rounded corner at the bottom, or for trimming the shell after drawing. To allow for trimming, add required amount to depth h .

When a shell is of irregular cross-section, if its weight is known, the blank diameter (D), can be determined by the following formula:

$$D = 1.1284 \sqrt{\frac{W}{wt}} \quad (43)$$

where D = blank diameter, inches (mm)

W = weight of shell, lbs (kg)

w = weight of metal, lb/in³ (kg/mm³)

t = thickness of the shell, inch (mm)

In the construction of dies for producing shells, especially of irregular form, a common method to be used is to make the drawing tool first. The required blank diameter then can be determined by trial. One method is to cut a trial blank as near to size and shape as can be estimated. The outline of this blank is then scribed on a flat sheet, after which the blank is drawn. If the finished shell shows that the blank is not of the right diameter or shape, a new trial blank is cut either larger or smaller than the size indicated by the line previously scribed, this line acting as a guide. If a model shell is available, the blank diameter can also be determined as follows:

First, cut a blank somewhat large, and from the same material used for making the model; then, reduce the size of the blank until its weight equals the weight of the model.

Forces: The punch force for drawing a cylindrical shell needs to supply the various types of work required in deep drawing, such as the work of deformation, redundant work, friction work, and the work required for ing (if required).

Force for the First Drawing Operation: The calculation of the punch force for the first drawing operation (neglecting friction) is given by the following formula:

$$F_1 = \pi d_{m1} T(UTS) \quad (44)$$

where d_{m1} = mean diameter of shell after the first operation, (inch or mm)
 T = material thickness, (inch or mm)
 UTS = ultimate tensile strength of the material, (lb/in² or N/mm²)

Force for Subsequent Drawing Operations: Subsequent drawing operations are different from the first operation: as in the deep-drawing process, the flange diameter decreases but the zone of the plastic deformation does not change. The punch force for the next drawing operation can be calculated by the approximate empirical formula as follows:

$$F_i = \pi d_p T(UTS) \cdot \left(\frac{D}{d_p} - 0.7 \right) \quad (45)$$

where d_p = punch diameter (inch or mm)
 D = blank diameter (inch or mm)
 T = material thickness (inch or mm)
 UTS = ultimate tensile strength of the material (lb/in² or MPa)

Shapes of Blanks for Rectangular Shells: There is no formula for determining the shape of the blank for rectangular drawing that will produce the part as drawn to print. All corner contours must be developed. However, the following conservative procedure will get the die in the final design ballpark with a minimum of trials. When laying out a blank by this method, first draw a plan view of the finished shell or lines representing the shape of the part at the bottom, the corners being given the required radius, as shown in Fig. 18. Next, insert the sides and ends, making the length L and the width W equal to the length and width of the drawn part minus twice the radius r at the corners. To provide just the right amount of material for the corners, the first step is to find what blank diameter will be required to draw a cylindrical shell having a radius r . This diameter can be calculated by the formula for the blank diameter (D) of the cylindrical shell:

$$D = \sqrt{d^2 - 4dh} \quad (46)$$

where D = blank diameter (inch or mm)
 d = diameter of drawn shell (inch or mm)
 h = height of shell (inch or mm)

After determining the diameter D , scribe arcs at each corner having radius R equal to one-half of diameter D . The outline of the blank for the rectangular part is then obtained by drawing curved lines between the ends and the sides, as shown in Fig. 18. These curves should touch the arcs R .

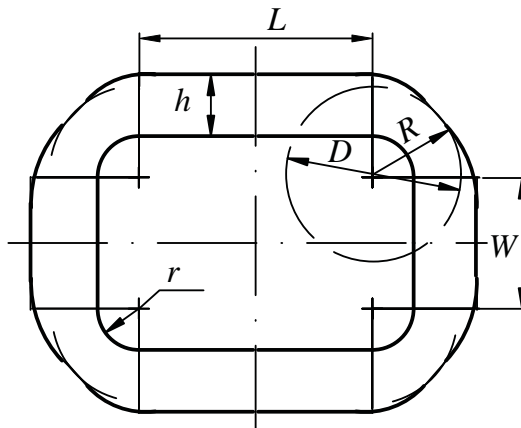


Fig. 18. Layout Design for Deep Drawn Rectangular Shell

When laying out the blank it is usually advisable to plan for a form that will produce corners a little higher than the sides. The wear of the die is at the corners, and when it occurs, the material will thicken and the drawn part will be low at the corners if no allowance for this wear has been made on the blank.

Blank for Rectangular Flanged Shells: The shape of the blank for a rectangular flanged shell may be determined in practically the same way as described in the foregoing, except that the width of the flange must be considered. Referring to Fig. 18, the dimension h in the flat blank is made equal to the height of the drawn part plus the width of the flange; however, the blank diameter D for a cylindrical shell having a flange can be determined by the formula

$$D = \sqrt{d^2 + 4dh} \quad (47)$$

where D = blank diameter, (inch or mm)
 d = diameter of drawn shell, (inch or mm)
 d_1 = diameter measured across the flange, (inch or mm)
 h = height of shell, (inch or mm)

After determining diameter D and the corresponding radius R , the outline of the blank is drawn the same as for a rectangular shell without the flange.

Ironing Process.—The ironing process is the reduction in thickness of drawn shell walls by pulling them through tight dies. Ironing is a very useful process when employed in combination with deep drawing to produce a uniform wall thickness and to increase the wall height. It is done to obtain a wall that is thin compared with the shell bottom; or merely to correct natural wall thickening toward the top edge of a drawn shell.

Basically, in the ironing processes, a previously deep-drawn shell is placed on a punch and pushed through one or more ironing die rings that have a smaller inside diameter than the outside diameter of the shell (Fig. 19). Hence, the clearance between the ironing rings and the punch is less than the shell's wall thickness, so the shell after ironing has a constant wall thickness equal to the clearance. The theoretical maximum reduction in wall thickness per operation due to ironing is approximately 60%.

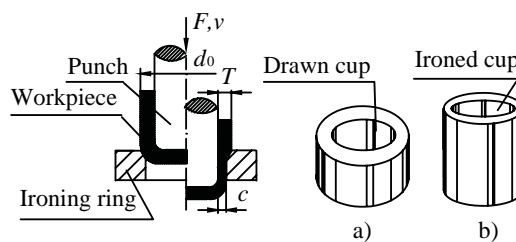


Fig. 19. Ironing of drawn cup: a) cup before ironing; b) cup after ironing.

a) Ironing Force: Ironing involves the compression and additional work hardening of the metal. The stress on the sidewall can be quite severe, creating the additional possibility of cup failure.

The force required to iron a cylindrical workpiece can be calculated as

$$F_{ir} = S_c \pi d_0 (T - c) \quad (48)$$

where F_{ir} = ironing force (lb); d_0 = outside diameter of cylindrical cup (in.); S_c = compressive strength of metal (lb/in²); T = thickness of material (in.); and, c = clearance between punch and die (in.).

Stretch Forming

Stretch forming is a metal forming process in which a blank of sheet metal is formed by the simultaneous application of tensile loads to the material over a die in order to form large contoured parts in the required shape.

During stretch forming, the sheet blank is subjected to both *elastic* and *plastic deformation*. The most appropriate measure of formability for stretch forming is the strain hardening exponent, or n value:

$$c = k\epsilon^n \quad (49)$$

where k = a constant.

A high value of n is desired if the sheet is to show good stretch formability. To assess the formability of sheet metals while forming a workpiece, a technique called circle grade analysis (CGA) is used to construct a forming limit diagram of the sheet metal to be used.

Two methods are used in stretch forming: simple stretch forming, also called the *block method*, and stretch-wrap forming, also called *tangential stretch forming*.

Simple Stretch Forming.—In the simple stretch forming process, the sheet blank to be formed is clamped between two gripping jaws located on opposite ends, and the tool moves into the clamped sheet blank as shown in Fig. 20.

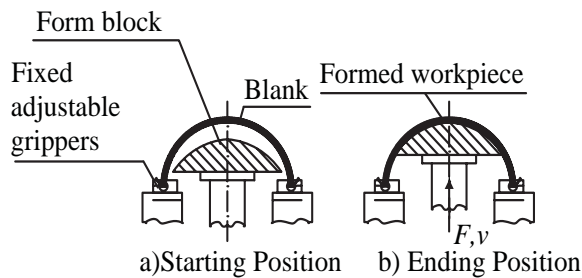


Fig. 20. Simple Stretch Forming: a) Starting Position; b) Final Position

The most common stretch presses are oriented vertically; the form die rests on a press table that can be raised to the sheet by a hydraulic ram. As the form die is driven into the sheet, the tensile forces increase and the sheet plastically deforms into a new shape.

At the beginning of the process, the sheet blank first drapes itself around the form block, following its contours. Due to the large contact area between form block and blank, the frictional forces prevent a deformation of the sheet in this region.

Stretch-Wrap Forming.—In this method also, a sheet blank is gripped from two opposite ends and stretched into the plastic region before being wrapped over a punch, so that the whole cross-section of the material undergoes a uniform plastic deformation; then the die is brought down to complete the operation. The main difference from the simple stretch forming process is that both the form block and the gripping jaws are movable (Fig. 21).

Stretch formed parts are typically large and possess large radial bends. The shapes that can be produced range from a simple curved surface to complex non-uniform cross sections. Stretch forming is capable of shaping parts with very high accuracy and smooth surfaces. Ductile materials are preferable, the most commonly used being aluminum, steel, and titanium. Typical stretch formed parts are large curved panels such as door panels in cars or wing panels on aircraft.

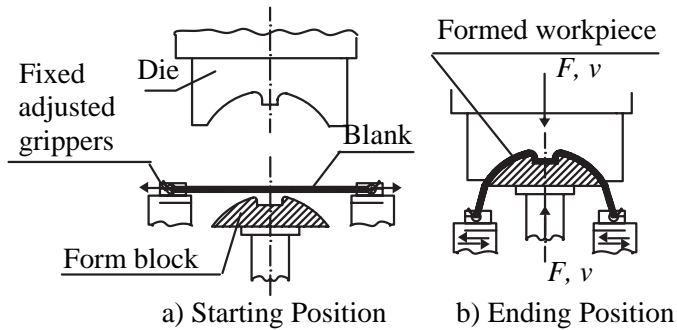


Fig. 21. Stretch Draw Forming: a) Starting Position; b) Final Position.

The advantages of this process are the following:

- a) The tensile forces applied always act tangentially to the body of the blank
- b) The lack of springback in the finished part
- c) Flexible low-cost tooling
- d) Increase of yield stress up to 10%
- e) Less forming pressure required
- f) The die can be made of inexpensive material

The disadvantages are these:

- a) More material required for gripping
- b) Difficulty of adaptation to modern high-speed automated lines
- c) Reduction of material thickness by 5 to 7%

Spinning

Metal spinning is the process of forming various seamless and axially symmetrical parts from flat circles of sheet metal (blank) or from a length of tubing over a mandrel with tools or rollers. There are three types of metal spinning processes: conventional spinning, shear spinning, and tube spinning.

Conventional Spinning.—In conventional metal spinning, a disc of metal is rotated at controlled speeds on a specialized machine similar in design to a machine lathe. Instead of the clamping chuck common on a machine lathe, a wood or metal spinning mandrel is used, the form of which corresponds with the internal contour of the part to be produced. The blank is clamped between the spinning mandrel and a follower on the tailstock spindle, as shown in Fig. 22.

The mandrel, blank, and holder are then set in rotation. Spinning tools or spinning rollers are forced against the rotating blank by hand or by a computer controlled hydraulic mechanism. The process requires a series of crossing steps, as indicated in Fig. 22, to complete the shaping of the workpiece. With this forming technique, a material's thickness generally does not change from the blank to the finished component. If the spinning forces applied with the hydraulic mechanism are higher in comparison to hand spinning, mandrels made of a harder material have to be used, e.g., boiler plate, chilled cast iron, or hardened tool steel.

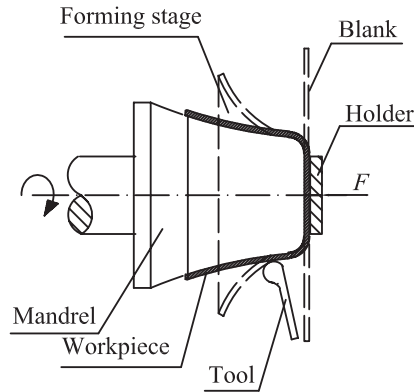


Fig. 22. Conventional Spinning

Shear Spinning.—Shear spinning is the process of forming complex shapes such as cones with tapering walls or symmetrical-axis curvilinear shapes such as the nose cones of missiles. This process achieves a deliberate and controlled reduction in blank thickness (Fig. 23), as opposed to a limited reduction of blank thickness in conventional spinning.

The shear forming roller or rollers achieve local metal flow, which applies a pressure on the blank against the support from the steel mandrel. Special shear forming rollers control the material's flow, and they move the free material parallel to the axis of the mandrel. The remaining portion of the blank, which does not take part in the actual deformation, remains always at right angles with respect to the axis of rotation and does not change its external diameter. The material flow takes place in the axial direction. The wall of the workpiece is produced from the reduction in blank thickness, but the diameter of the blank stays constant, as shown in Fig. 23. The thickness of the initial blank depends on the angle of the final part and the finished wall requirements and can be calculated by the formula:

$$T = \frac{T_w}{\sin \alpha} \quad (50)$$

where T = thickness of the initial blank (inch or mm); T_w = wall thickness of the spun part (inch or mm); and, α = half angle of cone.

The bottom and the flange maintain their original thickness. A particular advantage is that the surface finishes achieved are comparable to those achieved with grinding or fine turning. The accuracy of the shape and the dimensional repeatability are excellent.

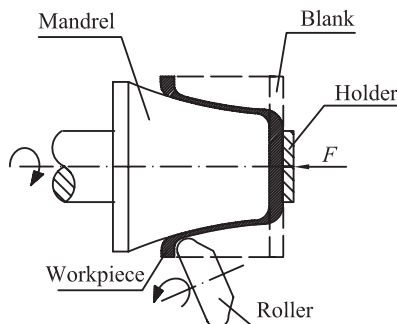


Fig. 23. Shear Spinning

Tube Spinning.—Tube spinning is used to reduce the wall thickness of a hollow cylindrical blank while it is spinning on a cylindrical mandrel using spinning tools (Fig. 24). Applying the spinning tool to the cylindrical blank internally or externally achieves reduction of the workpiece wall, and this reduction in turn results in an increase in the workpiece's length. Workpieces may be spun either forward and backward.

The ideal tangential force in forward tube spinning may be calculated by the following formula:

$$F_t = \sigma_{f(m)}(T - T_w)f \quad (51)$$

where where F_t = ideal tangential force (lb or N); $\sigma_{f(m)}$ = average flow stress of the material (lb/in² or MPa); T = thickness of the initial blank (inch or mm); T_w = wall thickness of the spun part (inch or mm); and, f = feed (inch or mm).

Because of friction and other influencing factors, the force exerted is about twice that of the ideal force.

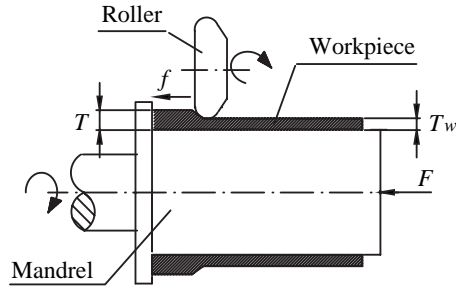
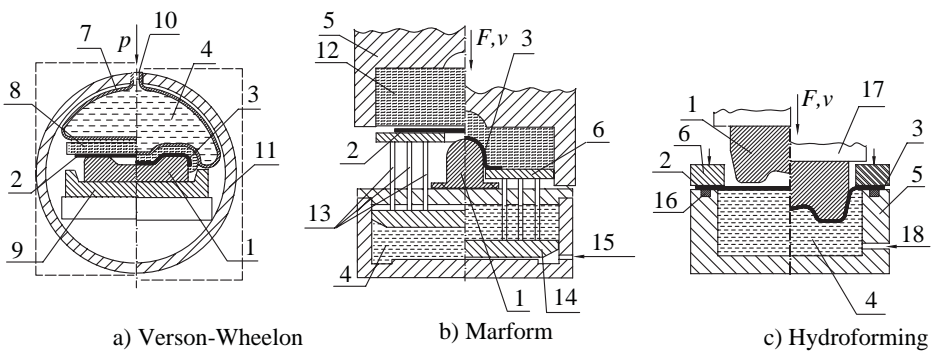


Fig. 24. Tube Spinning

Rubber Pad and Hydroforming Processes

In the rubber pad forming process, one of the dies in a set (punch or die) is replaced with a flexible material such as rubber or polyurethane. Polyurethane is widely used because of its resistance to abrasion and its long fatigue life. Several processes utilize rubber pad forming techniques. Fig. 25 schematically illustrates the Verson-Wheelon, Marform, and hydroforming processes.



- | | | |
|--------------------|------------------------|----------------------------|
| 1. Form block | 7. Flexible fluid cell | 13. Support rods |
| 2. Blank | 8. Trown rubber pad | 14. Piston |
| 3. Workpiece | 9. Loading tray | 15. Pressure control valve |
| 4. Hydraulic fluid | 10. Hydraulic inlet | 16. Seal |
| 5. Container | 11. Body of press | 17. Press ram |
| 6. Blankholder | 12. Rubber pad | 18. Hydraulic servo valve |

Fig. 25. Rubber Pad Forming Processes: a) Verson-Wheelon; b) Marform; c) Hydroforming

Guerin Process.—Fig. 26 shows the Guerin process, synonymous with the term “rubber pad forming,” in which a rigid forming block is placed on the lower bed of the press; on top of this block, the blank is positioned and a soft die of rubber or polyurethane (hardness 50 to 70 Shore) is forced over the rigid block and blank into its required shape. The thickness of the rubber pad, which is held in a sturdy cast-iron or steel container, is usually three times the height of the formed block, but it must be a minimum of 1.5 times thicker than the

height of a rigid form block. During the process cycle, the rubber pad deforms elastically over the form block and the blank, applying a strong pressure. The pressure that the soft die exerts on the blank is uniform, so that the forming process creates no thinning of the material, but the radii are more shallow than those produced in conventional dies.

The following formula can be used to determine total pad forming pressure:

$$p = \frac{F}{A} \times 2000$$

where where p = total rubber pad pressure (psi); F = capacity of press (tons); and, A = area of pad (in²).

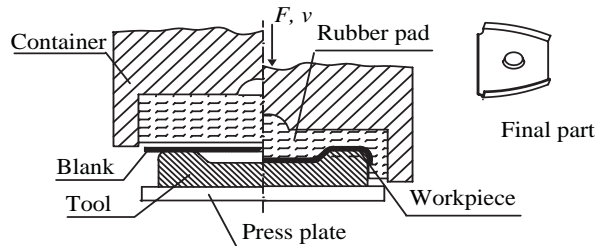


Fig. 26. Guerin Forming Process

An improvement over the Guerin process is the Marform process (see Fig. 25), which features the addition of a blankholder and die cushion to make this process suitable for deeper draws and to alleviate the wrinkling problems common to the Guerin process.

The advantages of the rubber pad forming processes compared to conventional forming processes are the following:

- a) For forming a workpiece, only one part of the tool (punch or die) is necessary.
- b) One rubber pad or diaphragm takes the place of many different shapes, thicknesses, and kinds of tools, returning to its original shape when the pressure is released.
- c) Tool material is low cost and easy to machine.
- d) No tool marks are created during forming, so parts with very fine surfaces can be formed.
- e) Set-up time is usually shorter than in conventional forming operations.

However, these processes also have some disadvantages:

- a) The rubber pad and diaphragm have limited lifetimes.
- b) The production rate is relatively slow.
- c) Rubber pads or diaphragms exert less pressure than conventional die, resulting in less sharply formed workpieces that usually need some hand finishing.

Superplastic Forming and Diffusion Bonding

Conventional metals and alloys will extend in tension no more than 120%, regardless of the temperature or speed with which the metal is pulled. However, it was known since the 1920s that some materials could endure enormous tensile strains without necking. This phenomenon of materials, called “superplasticity,” has been scientifically investigated. In the beginning, activities were primarily concentrated in research laboratories and were entirely directed towards the exploration of basic material science. The materials investigated appeared not to be sufficiently attractive for real production. But this changed with the development of supersonic aircraft with high requirements for power density and skin temperature.

A general definition of the term “superplasticity” was formulated for the first time in 1991 during the International World Conference on Superplasticity of Advanced Materials: “Superplasticity is the ability of a polycrystalline material to exhibit, in a generally isotropic manner, very high tensile elongations prior to failure.”

Some materials developed for superplastic forming include

- titanium (Ti-6Al-N)
- aluminum (2004, 2419, 7475)
- aluminum-lithium (2090, 2091, 8090)
- stainless steel (2205 series).

In general, the alloys chosen for superplastic forming should have a grain size below 10 microns in diameter. The grain size must not increase if it is kept at temperatures 90% of melting for a few hours, and the alloys must have strain rate sensitivity parameters of $0.35 < m \leq 0.85$.

High strain rate sensitivity is necessary for reducing the rate of flow localization, i.e., necking. A low rate of damage accumulation, e.g., cavitation, is necessary to allow large plastic strains to be reached.

Superplastic Forming.—Superplastic forming (SPF) is a metal forming process that takes advantage of the high extendability of certain materials in order to form components whose shapes might be otherwise very difficult to obtain. Today, superplastic forming of titanium and aluminum alloys is a standard industrial practice that is accepted worldwide. Due to the high temperatures and simultaneously relatively low gas pressure (typically less than 200 psi) superplastic forming has found widespread application. Because of titanium's (and some other alloys') high affinity with oxygen and hydrogen, inert gases are exclusively used as the pressure medium. Fig. 27 schematically illustrates the SPF process in four steps.

Typically, the closed die and the blank with created seal are heated to the same temperature in a special hydraulic hot-press (Step 1). Inert gas pressure is introduced at a controlled rate using a sophisticated gas management system until the sheet is fully formed against the die surface (Steps 2 and 3). Each workpiece's geometry is unique and requires a unique pressure/time profile to maintain the appropriate strain rate. As the sheet thins, it requires less forming pressure. However, as the workpiece radius decreases, more pressure is required.

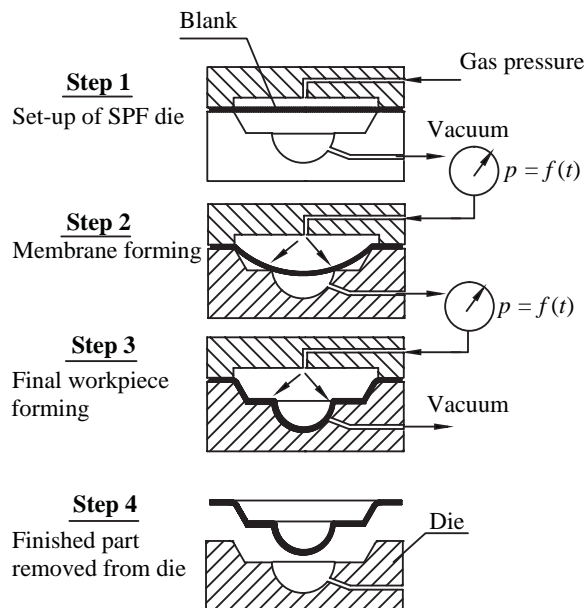


Fig. 27. Schematic Illustration of Superplastic Forming Process

The advantages of the superplastic process are the following:

- Using one of the alloys with superplastic capabilities means getting to the finished product in fewer steps, which means lower costs.

- b) Products that are usually formed in several parts separately can be integrally formed as a single part through superplastic forming. The single piece forming minimizes the number of parts and joints, and thus leads to weight savings.
- c) Since the forming needs only the female die, the investment cost for the die is reduced.
- d) Little or no residual stress develops in the formed parts.
- e) Superior transferability of the die surface to the workpiece is provided.
- f) Material waste is minimized.

Disadvantages are these:

- a) There is low productivity because of low strain rates, typically 10^{-4} to $10^{-2}/s$
- b) Material costs are high.

Although the process is increasingly being applied in the aerospace and automotive industries as a way of manufacturing very complex geometries at a fraction of the cost of conventional stamping, some practical problems are still of concern, the main ones being predicting the final thickness distribution of the formed parts, determining the optimum pressure cycles, and learning more about the microstructure of superplastic material and how it changes during such dramatic elongation.

Diffusion Bonding.—The International Institute of Welding (IIW) has accepted the definition of solid state diffusion bonding proposed by Kazakov. This definition is: “Diffusion bonding of materials in the solid state is a process for making a monolithic joint through the formation of bonds at atomic level, as a result of closure of plastic deformation at elevated temperature, which aids interdiffusion at the surface layers of the materials being joined.”

The process is dependent on a number of parameters, such as time, applied pressure, bonding temperature, and the method of heat application. The process allows bonding of homogeneous or heterogeneous materials. Hence, structures can be manufactured from two or three metal sheets. Diffusion bonding generally occurs in three stages:

- a) The deformation process results in the surfaces to be joined coming into intimate contact, but not enough to produce gross deformation.
- b) Bonds are formed by diffusion-controlled mechanisms where the diffusion grain boundary predominates. At this stage, pores are eliminated and finally the grain boundary arrangement ensues.
- c) In the third stage, volume diffusion dominates and the joining process is completed.

The mechanism of diffusion bonding involves holding together sheet metal components under moderate pressure, about 10 MPa, (1450 psi) at an elevated temperature of $(0.5 - 0.8)T_m$ (where T_m is the melting temperature in K), usually in a protective atmosphere or vacuum to protect oxidation during bonding. The length of time the materials are held at this temperature depends upon the materials being bonded, the joint properties required, and the remaining bonding parameters.

The aim in diffusion bonding is to bring the surfaces of two or more pieces being joined sufficiently close so that interdiffusion can result in bond formation. To form a high quality bond, surface roughness must be limited to minimum values ($Ra < 4$ microns); cleanliness must be absolute; and flat surfaces' waviness must be held to less than 400 microns.

A minimum of deformation and an almost complete lack of residual stresses are characteristics of the process, except possibly when two different metals being diffusion-bonded together have large differences in their coefficients of thermal expansion (CTE). This can cause strains to develop at the interface, which can cause premature failure of the bond.

The process is most commonly used for titanium in the aerospace industry, and sometimes it is combined with superplastic forming. Titanium is the easiest of all common engineering materials to join by diffusion bonding, due to its ability to dissolve its own oxide at bonding temperatures (bonding of Ti alloys takes place at 925°C).

The more conventional form of diffusion bonding usually takes place in a uniaxial loading press. Pressure and heat can be applied by different means. More complex geometries than are possible by the uniaxial process can be handled by hot isocratic pressing, which

involves the application of high-temperature, high-pressure argon gas to components. A hot isostatic press consists of a furnace within a gas pressure vessel. The components must be encapsulated in a sealed can to prevent the gas from entering the site of the bond.

The advantages of diffusion bonding include the following:

- a) Limited microstructural changes.
- b) The ability to join dissimilar alloys.
- c) The ability to fabricate very complex shapes, especially using superplastic forming.
- d) Minimal deformation.
- e) A highly automated process that does not require highly skilled workers
- f) The ability to produce high quality joints so that neither metallurgical discontinuities nor porosity exist across the interface.
- g) Diffusion bonding is free from ultraviolet radiation and gas emission, so there is no direct detrimental effect on the environment, and health and safety standards are maintained.

Disadvantages:

- a) Slowness of the process.
- b) Protective atmosphere required.
- c) Expensive equipment.
- d) Smooth surface finish requirements.
- e) Need for exceptional cleanliness.

Electron beam diffusion bonding is a variant of diffusion bonding in which only the interface region is heated, resulting in considerable energy savings. The heating source is an electron beam that is swept over the area of the joint at such a speed that fusion of the titanium or aluminum alloy is prevented. A force is applied across the joint. As the heated area is very limited, higher forces can be used without the risk of plastic collapse of the components being bonded, resulting in a significant reduction of bonding time.

Combined DB/SPF.—Diffusion bonding (DB) is often combined with superplastic forming (SPF) in the manufacture of complex structures in the aerospace industry. This process is probably the most spectacular near-net shape process that has been developed specifically within the aerospace industry, and its industrial importance is such that it should be considered separately. The process is used commercially for titanium and its alloys.

The most common SPF/DB approaches are 2-sheet (hat stiffened structures), 3-sheet (truss-core structures) and 4-sheet (rib-stiffed structures).

The processing conditions for superplastic forming and diffusion bonding are similar, both requiring an elevated temperature and benefiting from the fine grain size. Therefore, these two processes have been combined into one manufacturing process known as DB/SPF, which produces parts of greater complexity than sheet forming alone can. [Fig. 28](#) schematically illustrates diffusion bonding with superplastic forming to create a more complicated part shape in the same die.

The combined DB/SPF process generally occurs in two steps.

Step 1: The sheets have a stop-off material, such as boron nitride, placed on them in locations where no bonding is to occur in order to prevent diffusion bonding. Sheets are put down in layers, with stop-off areas into the die, heated together at an elevated temperature, and then bonded together by the use of pressure.

Step 2: In the same die, the SPF process is used to shape the outside of the laminated sheets. Pressure is applied by blowing gas between the sheets, usually into two phases. In the first phase, gas pressure is applied to cause a plastic stretching of the sheets, which eventually contact the die cavity and take a shape like that of the membrane. In the second phase, the pressure is increased to make the final shape of the part. This process generates a part that is very well bonded in the required locations.

However, this process also has its challenges. One of these involves how to apply the stop-off material in the proper location using the most cost-effective process. Historically,

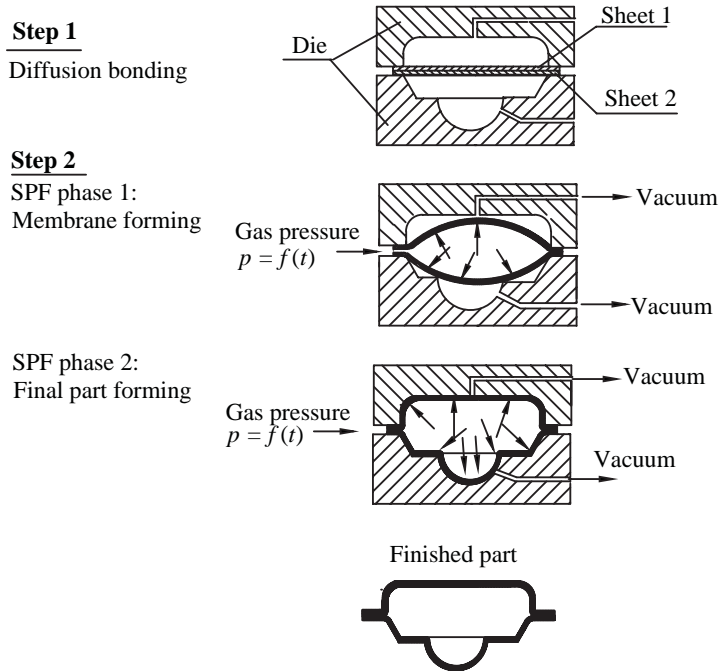


Fig. 28. Schematic Illustration DB/SPF Process

silk screening has been used to define the required pattern for the stop-off material. This process requires several pieces of equipment, including a wash booth, since the screen needs to be cleaned after each part. A masking paper and laser scribing process has also been developed for defining the stop-off pattern.

There are a number of commercial applications of superplastic forming and diffusion bonding, including aerospace, ground transportation, and numerous miscellaneous other uses. Examples are wing access panels in the Airbus A310 and A320; bathroom sinks in the Boeing 737, turbo fan engine-cooling duct components in the B-1, the T-38, the C-17, and the F-15E, and external window frames in the space shuttle.

High-Energy Rate Metal Forming Processes

The term “high-energy rate forming processes” (HERF) refers to dynamic metal forming processes that form workpieces at very high velocities and extremely high pressure. HERF processes involve a short sharp forming energy input usually of microsecond duration that is transmitted to the workpiece surface through a medium such as air or water. The resulting shockwave accelerates the workpiece to high velocity and with its significant kinetic energy impacts the die, which has the desired shape of the finished part.

High-energy rate metal forming was studied fairly extensively as early as the 1950s. Several processes have been developed, including explosive forming and two-capacitor, discharge-based forming methods; they are *electrohydraulic* and *electromagnetic forming*.

Explosive Forming.—Explosive forming is a manufacturing process that uses explosions to force sheet metal into dies. In this method, the explosive charge is located at some predetermined distance from the workpiece, and the energy is transmitted through an intervening medium such as air, oil, or water. The maximum pressure at the workpiece may range from a few thousand psi to several hundred thousand psi, depending on the parameters of the operation. Fig. 29 shows a typical explosive forming operation.

The workpiece is clamped and sealed over the die cavity. A vacuum is then created in the die cavity. The die assembly is put together at the bottom of the tank. The explosive charge

is placed in the intervening medium at a certain distance above the workpiece. After the detonation of the charge, the liquid buffer is instantaneously converted from a fluid of low density, temperature, and pressure to a fluid of high density, high temperature, and high pressure, causing the rapid forming of the blank into the cavity die. The extremely high forming velocity of explosive forming minimizes material springback, but it does not completely eliminate it. If the relative elongation of material is more than 10% it can be formed without the chance of fracturing.

The distance between the charge and the blank is called the “standoff distance.” The standoff distance and the amount of charge determine the amount of pressure transmitted to the workpiece. Other factors, such as the explosive type, the explosive’s shape, and the type of buffer medium, also affect the pressure.

An understanding of the compression waves and rarefactions developed in detonation is extremely important in predicting the forming metal’s reaction. In the aviation and aerospace industries, the explosive method of forming has been used since the 1980’s.

Explosive: Explosives are substances that undergo rapid chemical reaction, during which heat and large quantities of gaseous products are evolved. Explosives can be solid (TNT-trinitro toluene), liquid (nitroglycerine), or gaseous (oxygen-acetylene mixtures).

Die Material: Different materials are used for the explosive forming process. For instance: kirksite and fiberglass are used for low pressure and few parts; epoxy and concrete are used for low pressure and larger numbers of parts; and ductile iron, tool steel, and cast steel are used for high pressure and many parts.

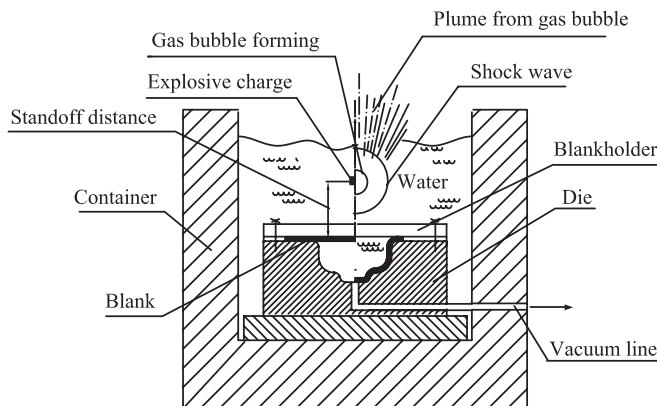


Fig. 29. Explosive Forming Set-up

Explosive forming has the following characteristic features: a) very large sheets with relatively complex shapes, although usually axisymmetric; b) low tooling costs, but high labor costs; c) long cycle times; d) suitability for low-quantity production; e) maintenance of precise tolerances; and f) controllable smoothness of contours.

An exceptionally interesting development in the field of explosive method forming is the fabrication of spherical pressure vessels with diameters up to 13 ft, thickness from 0.12 to 0.79 in. of high strength steel designed for water or oil storage in the chemical industry, and other uses.

Electromagnetic Forming.—Electromagnetic metal forming (EMF) is a high-energy rate cold forming process that can deform metal workpieces without contact. This process uses ultrastrong pulsed magnetic fields to form metal parts rapidly. A capacitor bank is suddenly discharged by means of a switch through a coil in which the workpiece is placed.

Basically, whenever an electrical current is rapidly sent through an electrical conductor, it will develop a magnetic field. This change in magnetic field will induce eddy currents in the workpiece that generally run in a direction opposite to the current in the coil (Lenz’s law). The two antiparallel currents repel each other, supplying energy to the workpiece in the form of kinetic energy, which accelerates in the workpiece up to a certain velocity, such

as 650 to 1000 ft/s. This kinetic energy drives the material into the die, causing forming on impact. This method is quite useful for general applications and suitable for any workpiece made from a good conductor, provided the current pulse is of a sufficiently high frequency.

There are two very broad ways in which this technique can be employed:

Radial forming, in which a round part such as a tube or ring is compressed or expanded. The forming can be done either inward or outward onto a die to give the tube a more complex shape (Fig. 30). One of the most common applications of electromagnetic forming is the compression crimp sealing and assembly of axis-symmetric components such as automotive oil filter canisters.

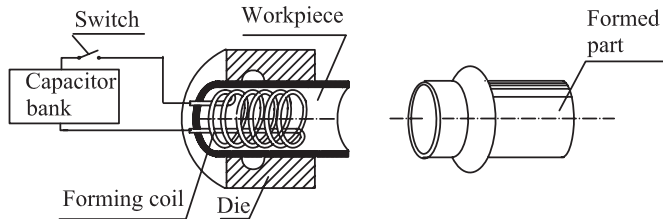


Fig. 30. Schematic Illustration of Electromagnetic Radial Forming of Tube

Sheet metal forming, in which using the flat coil configuration shown in Fig. 31 forms a sheet metal. The velocity of the workpiece is sufficient to cause its impact against a die to give it a more complex shape. The workpiece material should have an electrical resistance of less than $38 \mu\Omega/\text{in}$. The die needs to be made of either nonmetallic materials or of poor electric conductors.

Advantages of electromagnetic metal forming include: a) reduced number of operations needed; b) narrow tolerances; c) improved strain distribution; d) high repeatability; e) high productivity; f) less reliance on lubricants; and g) lower energy cost.

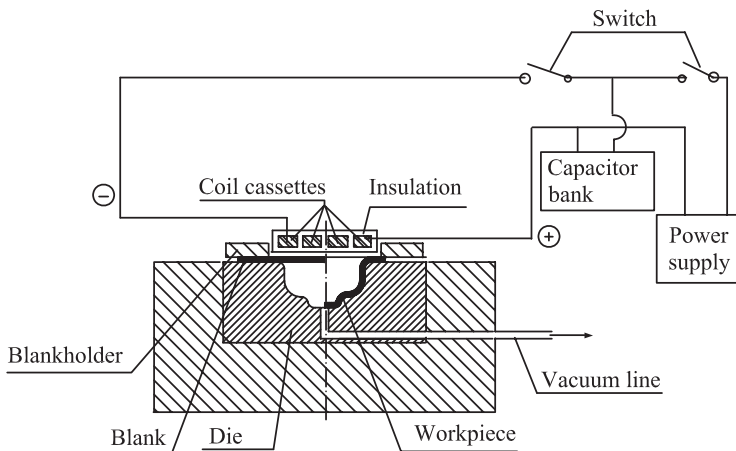


Fig. 31. Schematic Illustration of Electromagnetic Sheet Metal Forming

Electrohydraulic Forming.—Electrohydraulic forming is also known as electric spark forming or electric discharge forming. In this process an electric arc's discharge is used to convert electrical energy to mechanical energy. Electrical energy is stored in large capacitors, and then a pulse of high current is delivered across two electrodes positioned a short distance apart while submerged in a transfer medium (water or oil). Capacitor banks have typically stored 55 to 58 BTU at a charged voltage of 20 kV. This creates a sudden release of steam, which, along with ionization, causes the development of a high pressure shock wave within the transfer medium. The die cavity containing the blank to be formed is immersed in the tank as well. When exposed to the shock wave, the blank is forced to take on the shape of the die. A schematic illustration of the process is shown in Fig. 32.

Electrohydraulic forming is a hybrid between explosive forming and electromagnetic forming. The liquid-based shock is very similar to what would be produced by the explosive method. However, this method uses essentially the same equipment (capacitor banks) that produces the current in electromagnetic forming method. Electrohydraulic forming methods are adapted for use to the production of smaller part sizes. On the other hand, this method is more favorable for automation because of the fine control of energy discharges and the compactness of the system.

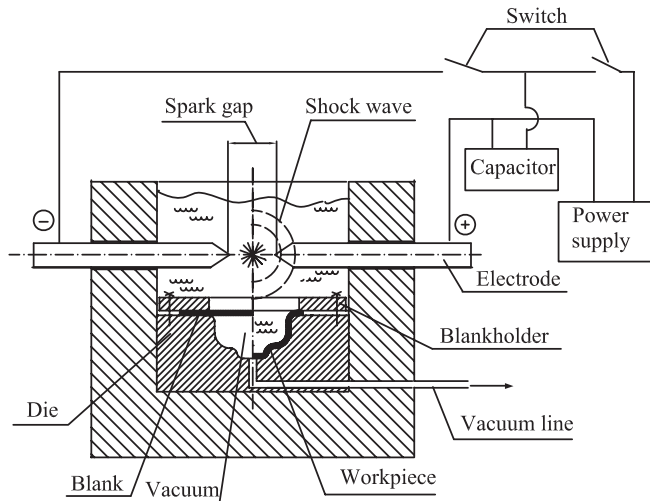


Fig. 32. Electrohydraulic Forming Set-up

Lubricants and Their Effects on Press Work

Most sheet-metal forming operations use lubricants to protect the die and part from excessive wear caused by scratching, scoring, welding, and galling. The physical characteristics of the lubricant and metal-forming operation involved determine the application method to be used.

Methods for applying lubricant to sheet metal include dips, swabs, brushes, wipers, rollers, or recirculation. Of these, the three most common are the following: 1) manually wiping lubricant onto a surface with a rag; 2) roll coating, during which metal blanks pass through rollers that apply the compound; and 3) flooding, during which tooling and metal sheets are drenched with lubricant, and the excess liquid is recovered via a filtration and recirculation system.

Lubricants for Blanking Operations.—Blanking dies used for carbon and low-alloy steels are often run with only mill lubricant, but will last longer if lightly oiled. Higher alloy and stainless steels require thicker lubricants. Kerosene is usually used with aluminum. Lubricant thickness needs to be about 0.0001 inch (0.0025 mm). During successive strokes, metal debris adheres to the punch and may accelerate wear, but damage may be reduced by application of the lubricant to the sheet or strip. High-speed blanking may require heavier applications of lubrication. For sheets thicker than 1/8 inch (3.18 mm) and for stainless steel, high-pressure lubricants containing sulfurs and chlorines are often used.

Lubricants for Drawing Operations.—Shallow drawing and forming of steel can be done with low-viscosity oils and soap solutions, but during deep drawing, different lubrication requirements exist, from hydrodynamic lubrication in the blank holder to boundary lubrication at the drawing radius, where breakdown of the film very often occurs. Characteristic of deep drawing is the high pressure involved in the operation, on the order of 100,000 pounds per square inch (690 MPa). To deal with such force, the choice of lubricant is critical to the success of the operation. Under such pressure, the drawing lubricant should cool the die and the workpiece, provide boundary lubrication between the die and

the workpiece, prevent metal-to-metal adhesion or welding, and cushion the die during the drawing operation.

Lubricants work by forming lubricating films between two sliding surfaces in contact with each other. When these metal surfaces are viewed under magnification, peaks and valleys become apparent, even on finely-ground surfaces.

The lubricating film needs to prevent the asperities (peaks) on the two surfaces in sliding contact with each other from damaging the mating surface. Under hydrodynamic or full-film lubrication, two surfaces are completely separated by a fluid film, with no contact between the asperities. This condition could change as speeds vary during start-and-stop modes or if the pressure and temperature increase beyond the lubricant's film strength. Boundary lubricants work up to a certain temperature and pressure, and then the boundary additive breaks down and metal contacts metal. The working temperature varies with the type and amount of additive used and its interaction with other additives.

Three types of drawing lubricants are used: 1) drawing oils; 2) emulsions; and 3) lubricants containing both oil and solid substances.

Drawing oils become an absorbed film, and they take the form of light or soluble oils such as straight mineral oil or emulsions of soluble oil and soap, or of heavy oils, fats, and greases such as tallow or lard oil. Aqueous solutions of non-oily lubricants containing some suspended solids are called emulsions. These lubricants are not widely used in deep drawing because they contain little or no oil.

Lubricants containing both oil and solid substances are used in applications involving severe drawing; these lubricants contain oily components that reduce friction and heat. The combination of the oil and the solids produces enough lubrication for severe drawing applications such as deep drawing. Deep drawing often involves ironing or thinning the wall by up to 35 per cent, and lubricant containing high proportions of chemically-active components. Dry soaps and polymer films are frequently used for these purposes. Aluminum can be shallow drawn with oils of low to medium viscosity, and for deep drawing, tallow may be added, as well as wax or soap suspensions for very large reductions.

Lubricant Removal.—Removing lubricant from a formed part after the deep drawing operation is important because any lubricant left behind can interfere with subsequent steps in the manufacturing of the part. Mineral oils, animal fat, and vegetable oils can be removed with an organic solvent by emulsification or saponification, or with an aqueous alkaline cleaner. Greases can also be removed from sheet metal with an organic solvent or an alkaline cleaner. Solids are more difficult to remove because they are not readily soluble. The presence of solids often requires that additional cleaning methods be used. Petroleum oils can raise special issues from removal through disposal. These oils require the use of alkaline cleaners for removal, which can then contaminate cleaner tanks with oil, leading to potential disposal challenges. Vegetable oils can be removed with hot water if the parts are cleaned immediately, and with a mildly to moderately alkaline cleaner if the parts are cleaned after they have been left standing for a few days.

Joining and Edging

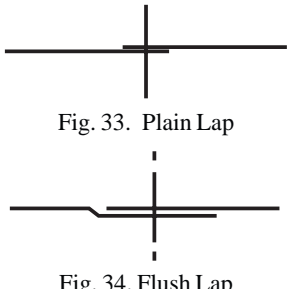
A duct system is an assembly whose main function is to convey air. Elements of the duct system are sheets, transverse joints, longitudinal seams, and reinforcements. The sheets must be able to withstand deflection caused by both internal pressure and vibration due to turbulent air flow. Transverse joints must be able to withstand 1.5 times the maximum operating pressure without failure. Transverse joint designs should be consistent with the static pressure class, sealing requirements, materials involved, and support interval distances. Notching, bending, folding, and fit up tolerances shall be appropriate for the proper class. Longitudinal seams also must be able to withstand 1.5 times the operating pressure without deformation. Seams must be formed and assembled with proper dimension and proportion for tight and secure fit up. Seams may be a butt, corner, plug, or spot weld

design. Seam types must be selected based on material and pressure. A duct section between adjacent hangers must be able to carry its own weight and to resist external loads for which it is constructed. The reinforcing members must be able to resist the external deflection of the sheet, and their own deflection.

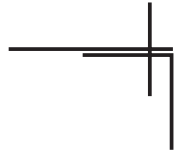
There is a relationship between duct width, reinforcement spacing, reinforcement size, pressure, and sheet thickness. For constant pressure and constant duct size, the thicker sheet allows more distance between reinforcements. The higher the pressure the shorter the spacing between reinforcements. Joints and intermediate reinforcements are labor intensive and may be more costly than the savings gained by a reduction in wall thickness. Thicker duct wall and stronger joints are more cost effective than using more reinforcement. The following material illustrates various joint designs, used both in duct work and other sheet metal assemblies.

Sheet Metal Joints

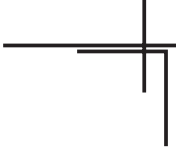
Plain Lap and Flush Lap:

 <p>Fig. 33. Plain Lap</p> <p>Fig. 34. Flush Lap</p>	<p>The <i>plain lap</i> (Fig. 33) and <i>flush lap</i> (Fig. 34) are both used for various materials such as galvanized or black iron, copper, stainless steel, aluminum, or other metals, and may be soldered, and/or riveted, as well as spot, tack, or solid-welded. Lap dimensions vary with the particular application, and since it is the duty of the draftsman to specify straight joints in lengths that use full-sheet sizes, transverse lap dimensions must be known.</p>
---	--


Raw and Flange Corner:

 <p>Fig. 35. Raw and Flange Corner</p>	<p>The <i>raw and flange corner</i> (Fig. 35) is generally spot-welded, but may be riveted or soldered. For heavy gages it is tack-welded or solid-welded.</p>
---	--

Flange and Flange Corner:

 <p>Fig. 36. Flange and Flange Corner</p>	<p>The <i>flange and flange corner</i> (Fig. 36) is a refinement of the raw and flange corner. It is particularly useful for heavy-gage duct sections which require flush outside corners and must be field-erected.</p>
--	--

Standing Seam:

 <p>Fig. 37. Standing Seam</p>	<p>The <i>standing seam</i> (Fig. 37) is often used for large plenums, or casings. Before the draftsman is able to lay out a casing drawing, one of the items of information needed is seam allowance measurements, so that panel sizes can be detailed for economical use of standard sheets. Considering velocity levels, standing seams are considered for duct interiors: 1-inch (25.4 mm) seam is normally applied for duct widths up to 42-inch (1067 mm), and 1½-inch (38 mm) for bigger ducts.</p>
---	--

Groove Seam:

Fig. 38. Groove Seam

The *groove seam* (Fig. 38) is often used for rectangular or round duct straight joints, or to join some sheets for fittings that are too large to be cut out from standard sheets. It is also known as the pipelock, or flat lock seam.

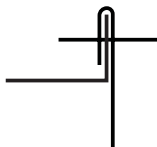
Corner Standing Seam:

Fig. 39. Corner Standing Seam

The *corner standing seam* (Fig. 39) has applications similar to the standing seam, and also can be used for straight-duct sections. This type of seam is mostly applied at the ends at 8 inches (203 mm) intervals.

Double Seam:

Fig. 40. Double Corner Seam

The *double corner seam* (Fig. 40) at one time was the most commonly used method for duct fabrication. However, although it is seldom used because of the hand operations required for assembly, the double seam can be used advantageously for duct fittings with compound curves. It is called the slide lock seam. Machines are available to automatically close this seam.

Slide-Corner:

Fig. 41. Slide Corner

The *slide-corner* (Fig. 41) is a large version of the double seam. It is often used for field assembly of straight joints, such as in an existing ceiling space, or other restricted working area where ducts must be built in place. To assemble the duct segments, opposite ends of each seam are merely “entered” and then pushed into position. Ducts are sent to job sites “knocked-down” for more efficient use of shipping space.

Button Punch Snap Lock:

Fig. 42. Button Punch Snap Lock

The *button punch snap lock* (Fig. 42) is a flush-type seam which may be soldered or caulked. This seam can be modified slightly for use as a “snap lock”. This type of seam is not applicable for aluminum or other soft metals. This seam may be used up to 4” (10.2 cm) w.g. by using screws at the ends. The pocket depth should not be smaller than $\frac{5}{8}$ inch (15.88 mm) for 20, 22 and 26 gage material (0.91- 0.45 mm).

Pittsburg:

Fig. 43. Pittsburgh


The *Pittsburg* (Fig. 43) is the most commonly used seam for standard gage duct construction. The common pocket depths are $\frac{5}{16}$ inch (7.94 mm) and $\frac{5}{8}$ inch (15.88 mm) depending on the thickness of the sheet.

Flange:

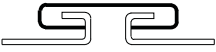
Fig. 44. Flange

The *flange* (Fig. 44) is an end edge stiffener. The draftsman must indicate size of flange, direction of bend, degree of bend (if other than 90°) and when full corners are desired. Full corners are generally advisable for collar connections to concrete or masonry wall openings at louvers.

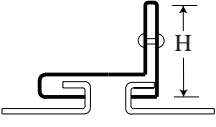
Hem:

 <p>Fig. 45. Hem</p>	<p>The <i>hem edge</i> (Fig. 45) is a flat, finished edge. As with the flange, this hem must be designated by the draftsman. For example, drawing should show: $\frac{3}{4}$ inch (19 mm) hem out.</p>
---	---


Flat Drive Slip:

 <p>Fig. 46. Drive Slip</p>	<p>The drive slip is one of the simplest transverse joints. It is applicable where pressure is less than 2 inches (50.8 mm) w.g. This is a slide type connection generally used on small ducts in combination of "S" slips but should not be used above 2 inches w.g.</p>
--	---

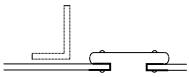
Standing Drive Slip:

 <p>Fig. 47. Standing Drive Slip</p>	<p>This slip is also a slide type connection. It is made by elongating the flat drive slip and fastening standing portions 2 inches (50.8 mm) from each end. The design is applicable for any length in 2 inches w.g, 36 inches (914 mm) for 3 inches w.g., and 30 inches (762 mm) at 4 inches w.g. service.</p>
---	--


Flat Drive Slip Reinforced:

 <p>Fig. 48. Drive Slip Reinforced</p>	<p>This reinforcement on the flat drive slip is made by adding a transverse angle section after a fixed interval.</p>
---	---

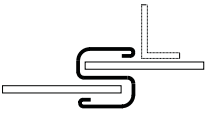
Double "S" Slip Reinforced:

 <p>Fig. 49. Double "S" Slip</p>	<p>The double "S" slip is used, to eliminate the problem of notching and bending, especially for large ducts. Use 24 gage sheet for 30 inches (762 mm) width or less, and 22 gage sheet over 30 inches-width. (22 gage = 0.76 mm, 24 gage = 0.60 mm)</p>
---	--


Flat "S" Slip:

 <p>Fig. 50. Plain "S" Slip</p>	<p>Normally the "S" slip is used for small ducts. However, it is also useful if the connection of a large duct is tight to a beam, column or other object, and an "S" slip is substituted for the shop standard slip. Service above 2 inches w.g. is not applicable. Gage shall not be less than 24, and shall not be less than the duct gage. When it is applied on all four edges, fasten within 2 inches of the corners and at 12 inches (305 mm) maximum interval.</p>
--	--

Hemmed "S" Slip:

 <p>Fig. 51. Hemmed "S" Slip</p>	<p>This modified "S" slip is made by adding hem and an angle for reinforcing. The hem edge is a flat and finished edge. Hemmed "S" slip is mostly applied with angle. The drive is generally 16 gage (0.76 mm), forming a 1 inch height slip pocket and screws at the end. Notching and bending operations on "S" slip joints can be cumbersome and costly, especially for large sizes. Tie each section of the duct within 2 inches (50 mm) from the corner at maximum 6 inches (152.4 mm) interval.</p>
---	---

Other Types of Duct Connections*Clinch-bar Slip and Flange:*

 <p>Fig. 52. Clinch-bar Slip and Flange</p>	<p>The <i>clinch-bar slip and flange</i> (Fig. 52), uses the principle of the standing seam, but with a duct lap in the direction of airflow. These slips are generally assembled as a framed unit with full corners either riveted or spot-welded, which adds to the duct cross-section rigidity. Reinforcement may be accomplished by spot welding the flat-bar to the flange of the large end. Accessibility to all four sides of the duct is required because the flange of the slip must be folded over the flange on the large end after the ducts are connected.</p>
--	---

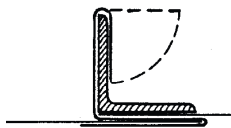
Clinch-bar Slip and Angle :

Fig. 53. Clinch-bar Slip and Angle

The *clinch bar slip and angle* (Fig. 53), is similar to clinch bar slip (Fig. 52), but it has a riveted or spot-welded angle on the large end. This connection can also have a raw large end which is inserted into the space between the angle and the shop-fabricated slip. Matched angles, minimum of 16 gage (1.52 mm), are riveted or spot welded to the smaller sides of the ducts, to pull the connection “home.”

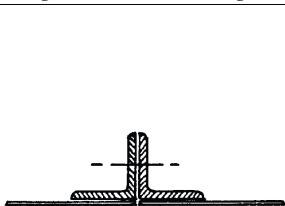
Flanged Duct Connections*Angle Frame, or Ring:*

Fig. 54. Raw Ends and Matched Zs

Any of the following flanged connections may have gaskets. The draftsman should not allow for gasket thicknesses in calculations for running length dimensions, nor should he indicate angle sizes, bolt centers, etc., as these items are established in job specifications and approved shop standards. Generally, angles are fastened to duct sections in the shop. If conditions at job site require consideration for length contingencies, the draftsman should specify “loose angles” such as at a connection to equipment that may be located later. The most common matched angle connection is the *angle frame, or ring* (Fig. 54). The angles are fastened flush to the end of the duct.

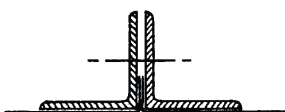
Flanged End and Angle:

Fig. 55. Flanged Ends and Matched Zs

The *flanged end and angle* (Fig. 55), is often used for ducts 16 ga or lighter, as the flange provides a metal-to-metal gasket and holds the angle frame or ring on the duct without additional fastening. The draftsman may indicate in a field note that a round-duct fitting is to be “rotated as required”. This type of angle-ring-connection is convenient for such a condition.

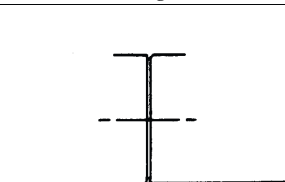
Formed Flanges:

Fig. 56. Formed Flanges

Double flanges (Fig. 56), are similar to Fig. 44, except that the connecting flange has a series of matched bolt holes. This connection, caulked airtight, is ideal for single-wall apparatus casings or plenums. The flanges are formed at the ends of the duct, after assembly they will form a T shape. Mating flanges shall be locked together by long clips. In order to form effective seal, gasket is used with suitable density and resiliency. At the corners 16 gage (1.5 mm) thickness steel corners are used with $\frac{3}{8}$ inch (9.5 mm) diameter bolts.

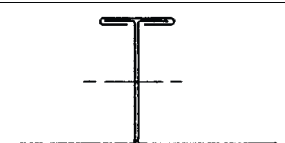
Double Flanges and Cleat:

Fig. 57. Double Flanges and Cleat

Double Flanges and Cleat (Fig. 57) is identical to (Fig. 56), but has an air seal cleat. The reinforcements are attached to the duct wall on both sides of the joint.

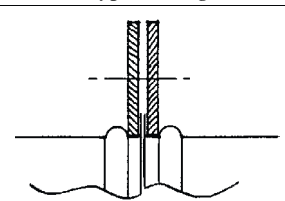
Clinch-type Flanged Connections:

Fig. 58. Bead Clinch and Z Rings

Clinch-type flanged connections for round ducts, 16 ga or lighter, are shown in Fig. 58. The angles or rings can be loose, as explained in *Flanged End and Angle*, (Fig. 55). The draftsman should indicate flange sizes, bend direction, and type of assembly. An example such as the flange lap for a field assembly of a 10 gage (3.4 mm) casing corner would be written: $1\frac{1}{2}$ inches (38 mm) flange out square on side with $\frac{5}{32}$ inch (7 mm) \varnothing bolt holes 12 inches (30 cm) CC. At the beginning and ending angles are connected by rivets or welding. The bolt will be $\frac{5}{16}$ inch (8 mm) \varnothing at 6 inch (152 mm) maximum spacing.

Classification of Dies

Dies may be classified according to a variety of elements and in keeping with the diversity of die design. According to the number of stations involved, dies for sheet metal working may be classified as: a) single-station dies (either compound dies or combination dies) and, b) multiple-station dies (progressive dies and transfer dies).

Single-Station Dies.—Single-station dies may be compound dies or combination dies.

Compound Die: This is a die in which two or more cutting operations are performed to produce a part in a single press stroke. A die that produces washers is a good example of a compound die (Fig. 59).

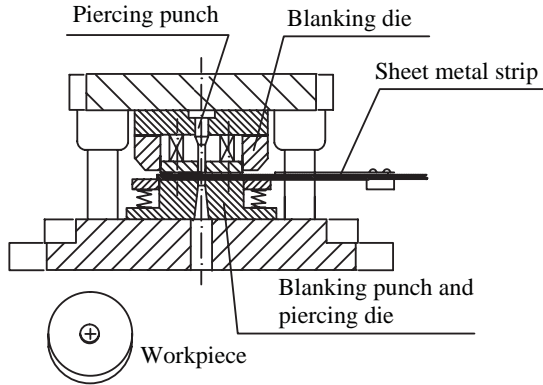


Fig. 59. Compound Die

Combination Die: This is a die in which both cutting and noncutting operations are performed to produce a part at one stroke of the press. A combination die is economical, and a more accurate part is obtained because it eliminates the problem of relocating the workpiece. However, a combination die is not always desirable; for example, when the punching hole is too close to the edge of the blank, the cutting edge would be so weak that failure would result. A die that produces cups with flanges is a good example of the suitable use of combination dies (Fig. 60).

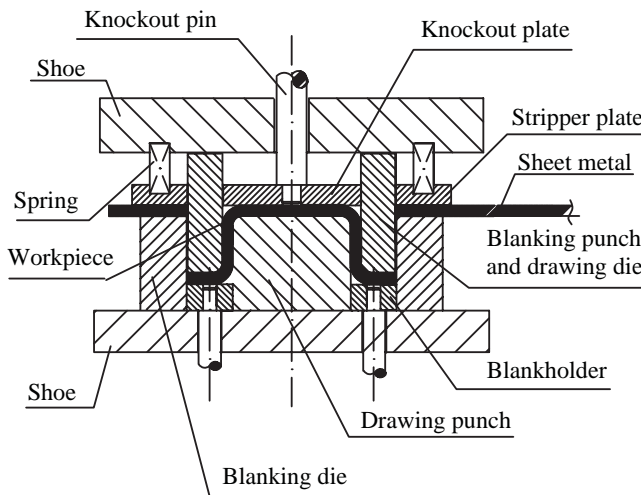


Fig. 60. Combination Die

Multiple-Station Dies.—Multiple-station dies are arranged so that a series of sequential operations is performed with each press stroke. Two die types are used:

Progressive Die: A progressive die (Fig. 61) is used to transform coil stock or strips into a finished part. This transformation is performed progressively by a series of stations aligned in a row; the workpiece is fed from station to station with each stroke, by being attached to the scrap skeleton. Force for the movement is applied to the incoming sheet metal strip or coil and outgoing scrap skeleton by means of rolls.

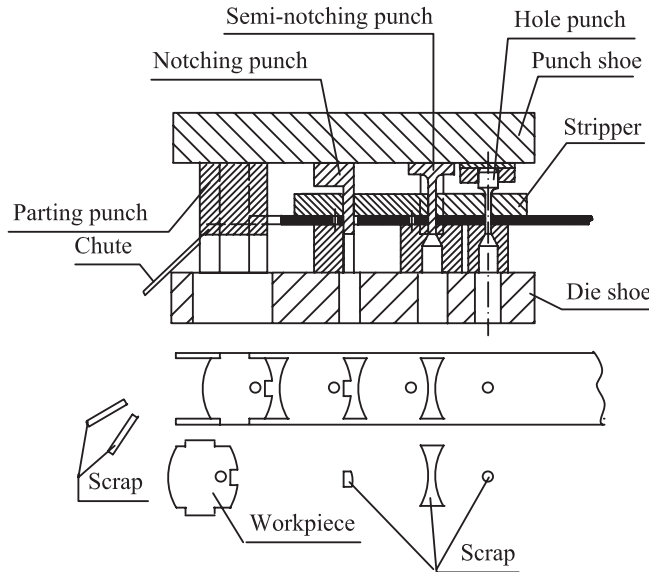


Fig. 61. Progressive Die

The cost of a progressive die is high, so it is best used for high-volume production.

Transfer Die: In transfer die operations, individual stock blanks are mechanically moved from die station to die station within a single die set. Large workpieces are done with tandem press lines, in which the stock is moved from press to press where specific operations are performed.

Steel Rule Dies.—Steel rule dies (or knife dies) were patented by Robert Gair in 1879, and, as the name implies, have cutting edges made from steel strips of about the same proportions as the steel strips used in making graduated rules for measuring purposes. According to J. A. Richards, Sr., of the J. A. Richards Co., Kalamazoo, MI, a pioneer in the field, these dies were first used in the printing and shoemaking industries for cutting out shapes in paper, cardboard, leather, rubber, cork, felt, and similar soft materials. Steel rule dies were later adopted for cutting upholstery material for the automotive and other industries, and for cutting out simple to intricate shapes in sheet metal, including copper, brass, and aluminum. A typical steel rule die, partially cut away to show the construction, is shown in Fig. 62, and is designed for cutting a simple circular shape. Such dies generally cost 25 to 35 per cent of the cost of conventional blanking dies, and can be produced in much less time. The die shown also cuts a rectangular opening in the workpiece, and pierces four holes, all in one press stroke.

The die blocks that hold the steel strips on edge on the press platen or in the die set may be made from plaster, hot lead or type metal, or epoxy resin, all of which can be poured to shape. However, the material most widely used for light work is $\frac{3}{4}$ -in. (19.05 mm) thick, five- or seven-ply maple or birch wood. Narrow slots are cut in this wood with a jig saw to hold the strips vertically. Where greater forces are involved, as with operations on metal sheets, the blocks usually are made from Lignostone densified wood or from metal. In the $\frac{3}{4}$ -in. thickness mostly used, medium- and high-density grades of Lignostone are available. The $\frac{3}{4}$ -in. thickness is made from about 35 plies of highly compressed lignite wood,

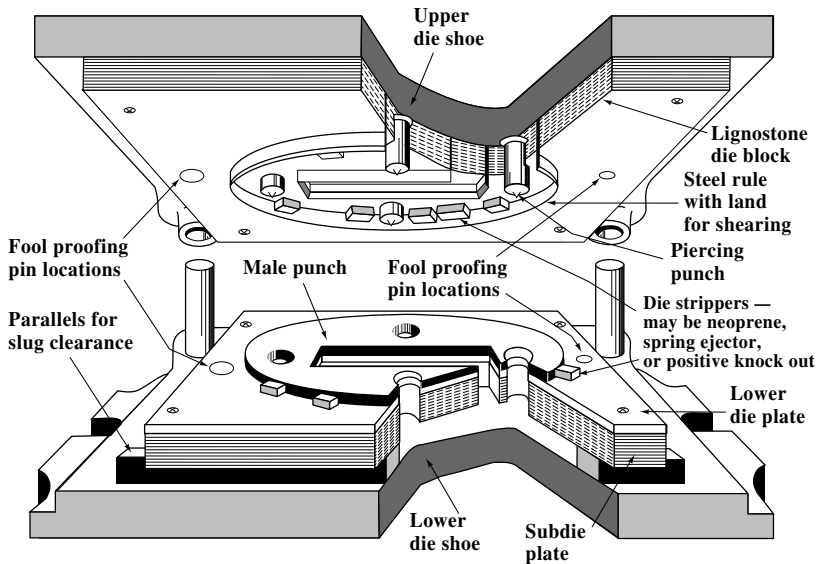


Fig. 62. Steel Rule Die for Cutting a Circular Shape, Sectioned to Show the Construction

bonded with phenolformaldehyde resin, which imparts great density and strength. The material is made in thicknesses up to 6 in. (15.24 cm), and in various widths and lengths.

Steel rule die blocks can carry punches of various shapes to pierce holes in the stock, also projections designed to form strengthening ribs and other shapes in material such as aluminum, at the same time as the die cuts the component to shape. Several dies can be combined or nested, and operated together in a large press, to produce various shapes simultaneously from one sheet of material.

As shown in Fig. 62, the die steel is held in the die block slot on its edge, usually against the flat platen of a die set attached to the moving slide of the press. The sharp, free end of the rule faces toward the workpiece, which is supported by the face of the other die half. This other die half may be flat or may have a punch attached to it, as shown, and it withstands the pressure exerted in the cutting or forming action when the press is operated. The closed height of the die is adjusted to permit the cutting edge to penetrate into the material to the extent needed, or, if there is a punch, to carry the cutting edges just past the punch edges for the cutting operation. After the sharp edge has penetrated it, the material often clings to the sides of the knife. Ejector inserts made from rubber, combinations of cork and rubber, and specially compounded plastics material, or purpose-made ejectors, either spring- or positively actuated, are installed in various positions alongside the steel rules and the punch. These ejectors are compressed as the dies close, and when the dies open, they expand, pushing the material clear of the knives or the punch.

The cutting edges of the steel rules can be of several shapes, as shown in profile in Fig. 63, to suit the material to be cut, or the type of cutting operation. Shape *A* is used for shearing in the punch in making tools for blanking and piercing operations, the sharp edge later being modified to a flat, producing a 90° cutting edge, *B*. The other shapes in Fig. 63 are used for cutting various soft materials that are pressed against a flat surface for cutting. The shape at *C* is used for thin, and the shape at *D* for thicker materials.

Steel rule die steel is supplied in lengths of 30 and 50 in., or in coils of any length, with the edges ground to the desired shape, and heat treated, ready for use. The rule material width is usually referred to as the height, and material can be obtained in heights of 0.95, 1, 1 $\frac{1}{8}$, 1 $\frac{1}{4}$, and 1 $\frac{1}{2}$ in. Rules are available in thicknesses of 0.055, 0.083, 0.11, 0.138, 0.166, and 0.25 in. (4 to 18 points in printers' measure of 72 points = 1 in.). Generally, stock thick-

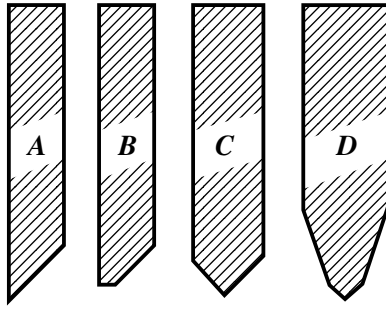


Fig. 63. Cutting Edges for Steel Rule Dies

nesses of 0.138 or 0.166 in. (10 and 12 points) are preferred, the thinner rules being used mainly for dies requiring intricate outlines. The stock can be obtained in soft or hard temper. The standard edge bevel is 46° , but bevels of 40 to 50° can be used. Thinner rule stock is easiest to form to shape and is often used for short runs of 50 pieces or thereabouts. The thickness and hardness of the material to be blanked also must be considered when choosing rule thickness.

Making of Steel Rule Dies: Die making begins with a drawing of the shape required. Saw cutting lines may be marked directly on the face of the die block in a conventional layout procedure using a height gage, or a paper drawing may be pasted to or drawn on the die board. Because paper stretches and shrinks, Mylar or other nonshrink plastics sheets may be preferred for the drawing. A hole is drilled off the line to allow a jig saw to be inserted, and jig saw or circular saw cuts are then made under manual control along the drawing lines to produce the slots for the rules. Jig saw blades are available in a range of sizes to suit various thicknesses of rule and for sawing medium-density Lignostone, a speed of 300 strokes/min is recommended, the saw having a stroke of about 2 inch (50.8 mm). To make sure the rule thickness to be used will be a tight fit in the slot, trials are usually carried out on scrap pieces of die block before cuts are made on a new block.

During slot cutting, the saw blade must always be maintained vertical to the board being cut, and magnifying lenses are often used to keep the blade close to the line. Carbide or carbide-tipped saw blades are recommended for clean cuts as well as for long life. To keep any "islands" (such as the center of a circle) in position, various places in the sawn line are cut to less than full depth for lengths of $\frac{1}{4}$ - $\frac{1}{2}$ in. (6.4-12.7 mm), and to heights of $\frac{5}{8}$ to $\frac{3}{4}$ in. (16-19 mm) to bridge the gaps. Slots of suitable proportions must be provided in the steel rules, on sides away from cutting edges, to accommodate these die block bridges.

Rules for steel rule dies are bent to shape to fit the contours called for on the drawing by means of small, purpose-built bending machines, fitted with suitable tooling. For bends of small radius, the tooling on these machines is arranged to perform a peening or hammering action to force the steel rule into close contact with the radius-forming component of the machine so that quite small radii, as required for jig saw puzzles, for instance, can be produced with good accuracy. Some forms are best made in two or more pieces, then joined by welding or brazing. The edges to be joined are mitered for a perfect fit, and are clamped securely in place for joining. Electrical resistance or a gas heating torch is used to heat the joint. Wet rags are applied to the steel at each side of the joint to keep the material cool and the hardness at the preset level, as long as possible.

When shapes are to be blanked from sheet metal, the steel rule die is arranged with flat, 90° edges (B, in Fig. 63), which cut by pushing the work past a close-fitting counter-punch. This counterpunch, shown in Fig. 62, may be simply a pad of steel or other material, and has an outline corresponding to the shape of the part to be cut. Sometimes the pad may be given a gradual, slight reduction in height to provide a shearing action as the moving tool pushes the work material past the pad edges. As shown in Fig. 62, punches can be incorporated in the die to pierce holes, cut slots, or form ribs and other details during the blanking

operation. These punches are preferably made from high-carbon, high-vanadium, alloy steel, heat treated to Rc 61 to 63, with the head end tempered to Rc 45 to 50.

Heat treatment of the high-carbon-steel rules is designed to produce a hardness suited to the application. Rules in dies for cutting cartons and similar purposes, with mostly straight cuts, are hardened to Rc 51 to 58. For dies requiring many intricate bends, lower-carbon material is used, and is hardened to Rc 38 to 45. And for dies to cut very intricate shapes, a steel in dead-soft condition with hardness of about Rb 95 is recommended. After the intricate bends are made, this steel must be carburized before it is hardened and tempered. For this material, heat treatment uses an automatic cycle furnace, and consists of carburizing in a liquid compound heated to 1500°F (816°C) and quenching in oil, followed by “tough” tempering at 550°F (288°C) and cooling in the furnace.

After the hardened rule has been reinstalled in the die block, the tool is loaded into the press and the sharp die is used with care to shear the sides of the pad to match the die contours exactly. A close fit, with clearances of about half those used in conventional blanking dies, is thus ensured between the steel rule and the punch. Adjustments to the clearances can be made at this point by grinding the die steel or the punch. After the adjustment work is done, the sharp edges of the rule steel are ground flat to produce a land of about $\frac{1}{64}$ in. (0.40 mm) wide (B in Fig. 63), for the working edges of the die. Clearances for piercing punches should be similar to those used on conventional piercing dies.

Pipe and Tube Bending

The difference between a pipe and a tube is how they are measured, and ultimately what they are used for. A pipe is a vessel - a tube is structural. A pipe is measured by the inner diameter; a tube is measured by the outer diameter.

Generally, a tube will have a consistent outer diameter and its inner diameter may have varying wall thicknesses to increase its strength. However, a pipe will have a consistent inner diameter and its outer diameter may have varying wall thicknesses.

The terms used in tube bending are defined in Fig. 64a, and those used in pipe bending are defined in Fig. 64b.

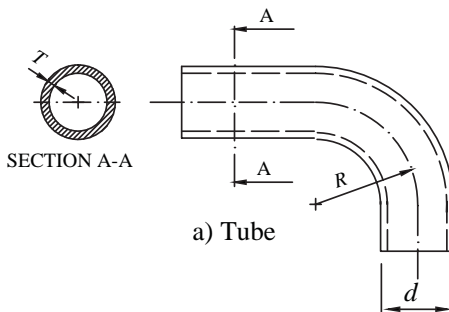


Fig. 64a. Dimension and Terms: a) Tube

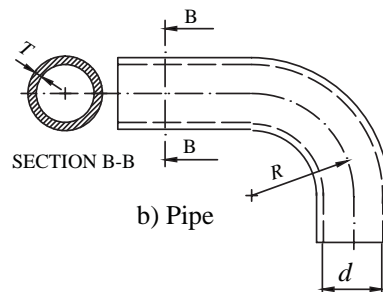


Fig. 64b. Dimension and Terms: b) Pipe

The radius of the bend R is defined with respect to the centerline of the tube or pipe. When the tube or pipe is bent, fibers at the outside wall are in tension and fibers at the wall on the inside bend are in compression. This condition of tensile stress causes thinning and elongation of the wall at the outside, and the compression stress causes thickening and shortening of the inner wall. As a result, the cross-section of the bent section of the tube is flattened. The oval distortions grow stronger if thinner tube/pipe walls and smaller bending radii of the workpiece have been selected. Ovality can be calculated by the following formula:

$$u = \frac{D_{max} - D_{min}}{D} 100 \% \quad (52)$$

where u = percent ovality of tube

D_{max} = maximum outer tube diameter after bending (inch or mm)

D_{min} = minimum outer tube diameter after bending (inch or mm)

D = initial outside tube diameter (inch or mm)

When the ratio of the tube diameter to the wall thickness is small enough, the tube can be bent on a relatively small radius. The material-specific diagram in Fig. 65 may be used for a first proposition to determine whether a tube or pipe with defined dimensions (outer diameter and wall thickness) can be bent at all.

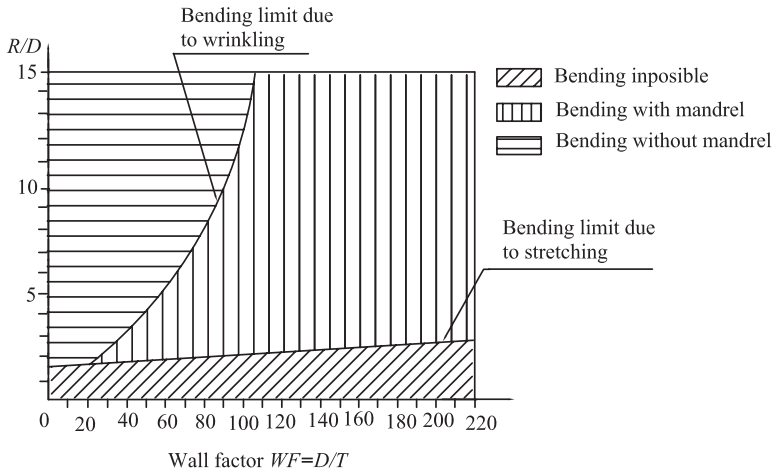


Fig. 65. Technical Limits of the Tube/pipe Bending Process

Bending without workpiece failure is impossible below the bending limit determined by stretching. The bending limit due to wrinkling separates the range where bending with mandrel and wiper shoe is possible from the range in which the tubes/pipes can also be bent without a mandrel.

Due to the elastic-plastic behavior of metallic materials, the tube/pipe will spring back by a certain angle after every bending attempt because of the phenomenon of elasticity. While in the valid range of Hooke's law (elastic line), the shaping energy is completely given back as work of elastic strain in the form of resiliency. But after the external strain has been removed, it is partly dissipated as work of plasticity when performing the elastic-plastic shaping. In this case, the extent of springback is only caused by the elastic (reversible) part of the shaping workpiece that is stored in the tube/pipe as potential energy during the bending process. Springback is an inevitable phenomenon of bending and can only be compensated for by overbending the workpiece.

Different methods can be used for bending tubes/pipes, depending on the material in use and the required finishing precision. The most common processes for bending tubes or pipes include press bending (ram tube bending), rotary draw bending (round bending), compression bending, and 3-roll bending.

Press Bending.—Press bending, also called *ram tube bending*, was probably the first tube/pipe bending method used to cold-form materials. When press bending is applied, the bending tool with the inwrought bending radius is pressed against two counter rollers, either manually or by means of hydraulics. This motion forces the tube/pipe inserted between the radius block (die) and the counter-rollers to bend around the die radius (Fig. 66). The tube/pipe cannot be supported by the mandrel. This tube bending method creates some cross-section ovality; therefore, this method is suitable for thick-walled pipes and large bending radii where high levels of cross-section ovality are acceptable, such as in furniture tubing and handrails. Large sweeping curves can be bent in small increments, moving the tube/pipe for each bend.

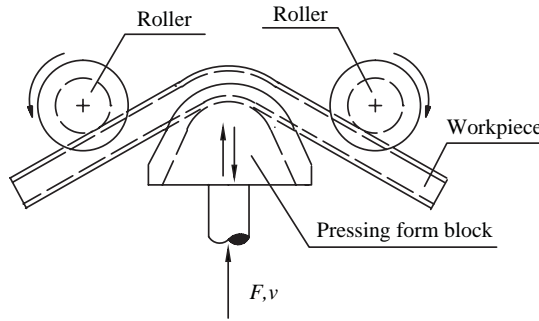


Fig. 66. Press Bending

Rotary Draw Bending.—Today, rotary draw bending is the most widely used method of bending tube and pipe, particularly for tight radii, good finishes, and thin-walled tubes. When rotary draw bending is used, the tube/pipe is inserted in the bending machine and fastened between the bend die and the clamp die. The rotation of both tools (the bending die and the clamp) around the bending axis bend the tube/pipe according to the radius of the bend die (Fig. 67).

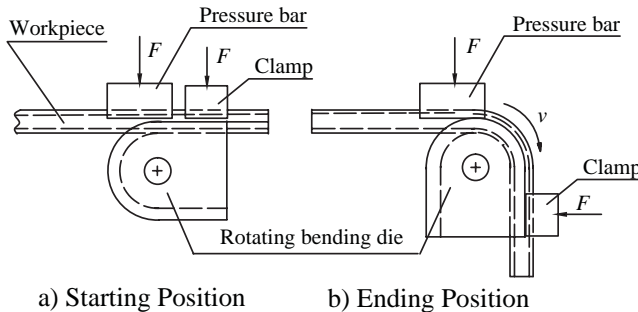


Fig. 67. Rotary Draw Bending: a) Starting Position; b) Ending Position

The pressure bar serves the purpose of receiving the radial stress that is generated during the forming process, and in addition it supports the straight tube/pipe end from outside. If a mandrel and a wiper shoe are applied additionally (mandrel bending), high workpiece quality can be achieved even in thin-walled pipes and in tight-bending radii.

The steel plug, or mandrel, fits inside the tube during rotary draw bending. The plug or mandrel supports the tube internally to reduce the amount of tube cross-section flattening during tube bending. After the tube has been bent, the operator extracts the mandrel from the tube, releases the clamp, and then removes the workpiece from the machine.

With modern mandrel bending machines, almost any kind of cold formable tube/pipe, depending on the material, can be safely bent to bending radii of approximately $1.5D$ with the desired precision. The forming possibilities are not at all limited to bending only round pipes. Oval pipes and flat and mono-block material can be formed just as well by bending as square or other open profiles. Depending on the shape of the workpiece, the required forming tools are adapted accordingly.

This method of bending tube/pipe is used in the manufacture of exhaust pipes, custom exhaust pipes, turbocharger exhaust and intake tubing, dairy tubing and process tubing, heat exchanger tubing, and all stainless and aluminum tubing where a nondeformed diameter finish is critical.

The main differences among rotary-draw-bending machines are the maximum workable outside pipe diameter and the degree of automation of the various functions. Only the bending function of the so-called “1-axis controlled bending machines” is automatic; in them, feeding and contortion are carried out manually. For the user of CNC or bending

machines with fully automatic control, however, all functions are available automatically. These bending machines can be supplemented with automatic feeding and unloading systems for the production of large series without any problems.

Compression Bending.—Compression bending is a process whereby pipe or tube is bent to a reasonably tight radius, usually without the use of mandrel or precision tooling. It is accomplished by clamping the tube/pipe behind the rear tangent point and then by a wiper shoe on a rotary arm rolling or compressing the material around and onto a bending die (Fig. 68).

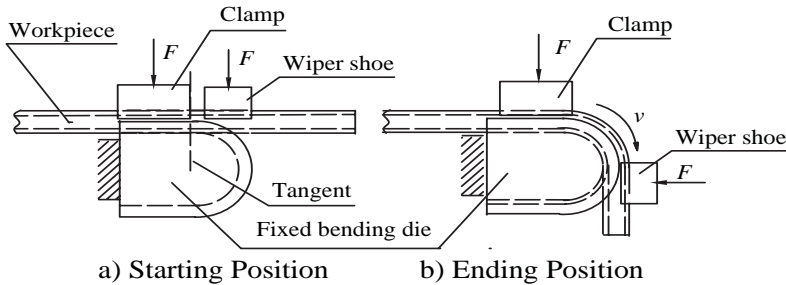


Fig. 68. Compression Bending: a) Starting Position; b) Ending Position

Roll Bending.—Roll bending is used for bending tube/pipe to a large radius (i.e., to a large circumference). Pipe and tube roll benders comprise three rolls on separate shafts; the tube or pipe is rolled through the rolls while the top roller exerts downward pressure on the top roll to deform the tube or pipe (Fig. 69). Roll pipe and tube benders are available in 2- or 3-driven roll machines, with either manual or hydraulic adjustment of the top roll.

This tube/pipe bending process is ideal for forming helical pipe coils for heat transfer applications, as well as for making long sweeping sections such as those used in steel construction-curved trusses and roof components for structures requiring large open spaces. Pipe cross-sections are defined very little when such sweeping sections are formed.

The oldest method of bending a tube/pipe consists of first packing its inside with loose particles (usually sand) and then bending it into a suitable tool. The filler functions to prevent the tube from buckling inward. After the tube has been bent, the sand is shaken out.

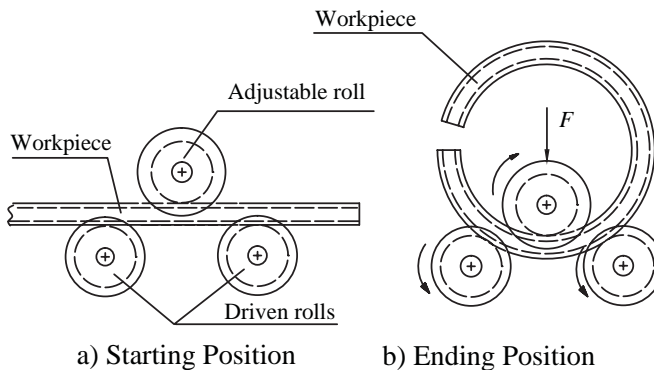


Fig. 69. Roll Bending: a) Starting Position; b) Finished

Use of Filling Material in Bending.—A simple method of preventing distortion consists in using filling material inside the pipe, supporting the walls to prevent flattening at the bend. Dry sand is often used. Materials such as resin, tar, or lead are also sometimes employed. The pipe is first filled with the molten resin, lead, or low-melting-point alloy, and then after bending, the pipe is heated to melt and remove the filling material. Resin has often been used for bending small brass and copper pipes, and lead or other alloys for small

iron and steel pipes. Before bending copper or brass pipe or tubing, the latter should be annealed.

Alloy of Low Melting Point Used as Filler: Filling tubes with lead may result in satisfactory bends, but the comparatively high melting point of lead often negatively effects on the physical properties of the tube. Commercial alloys such as “Cerrobend” and “Bendalloy” have melting points of about 160 degrees F. They are composed of bismuth, lead, tin, and cadmium. With these materials, tubes having a wall as thin as 0.007 inch have been bent to small radii. The metal filler conforms to the inside of the tube so closely that the tube can be bent just as though it were a solid rod.

This method has been applied to the bending of copper, brass, duralumin, plain steel, and stainless steel tubes with uniform success. Tubes plated with chromium or nickel can be bent without danger of the plate flaking off. The practice usually is economical for tubes up to 2 inches in diameter. The method is considered ideal when the number of tubes of a given size or kind is more or less limited or when the bend is especially severe.

When a tube-bending operation has been completed, removal of the metal filler is accomplished by heating the tube in steam, in a bath of boiling water, or in air of about the same temperature. The metal can then be drained out and used again and again.

Presses for Sheet Metal Working

A stamping press is a metal working machine tool that utilizes the force and speed of a moving ram to transmit force, or an amount of tonnage, to a specific die in order to achieve a workpiece's final shape, often with little or no scrap, and whenever possible, with minimal operator intervention. There are two major types of press brakes, which are classified by the nature of their drive systems: mechanical and hydraulic. Mechanical and hydraulic sheet metal working presses are available in several basic designs and a wide range of sizes, tonnage capacities, and operating speeds. The moving forces of the presses are generated by either mechanical or hydraulic mechanisms that are mounted in the frame. The two most common types of frames are the gap-frame (C-frame) and the straight side frame. Each has its advantages and disadvantages. Frames may be fabricated by casting or by welding heavy rolled steel plates. Both mechanical and hydraulic sheet metal stamping presses are classified by the following main characteristics: frame, drive, action, tonnage, stroke, and strokes per minute.

Mechanical Presses.—Mechanical presses are manufacturing devices designed and built to operate all types of dies. Mechanical presses typically store energy in a rotating flywheel driven by an electric motor. The flywheel revolves around a crankshaft until engaged by a clutch device. The energy of the rotating flywheel is transmitted to the vertical movement of the ram by the use of a press drive mechanism.

Drive: The press drive refers to the style of mechanism used to obtain the ram movement. The most common press drive mechanisms for mechanical presses are the crankshaft, the eccentric, the screw, and the knuckle.

The *crankshaft* is a mechanical element for translating the rotational motion of the electrical drive motor to the linear motion of the ram assembly in an up-and-down motion. In the press, each revolution of the crankshaft drives the ram through one complete up-and-down cycle of the machine. In a flywheel press, the flywheel is connected directly to the crankshaft, and each revolution of the flywheel completes one ram movement. The function of the flywheel is to store the necessary energy to carry out a pressing operation.

Eccentric—many of the newer presses are made using an eccentric for translating the rotational motion of the electric drive motor to the linear motion of the ram. The main disadvantage of the eccentric press drive is the limitation of press strokes. To obtain more press strokes, the eccentric offset must be increased in diameter.

The *screw* drive press is not as widely used, but the unique characteristics of the screw press have driven an increase in its use. As the name suggests, this type of press drive uses

a mechanical screw to translate rotational motion into the linear motion of the ram. Briefly, the ram acts as the nut on a rotating screw shaft, moving up or down depending on the screw rotation. Energy is either delivered from a flywheel, which is usually coupled with a torque-limiting (slipping) clutch, or by a direct drive reversing electric motor.

The *knuckle*—the knuckle press is a modified version of the crankshaft style. The crankshaft is behind the press frame in this type of press. The knuckle crankshaft runs from left to right in relation to the press frame. The knuckle is a group of three levers, one lever or connector of which joins the crankshaft throw to the other two levers. The upper lever or knuckle is fixed to a pivot point in the press crown at one end. The lower knuckle is fixed to a pivot point on the press ram at one end. The knuckle press is used for dies that coin, or when heavy sheet metal is drawn or formed. Because of the knuckle, the stroke of the press is limited. Fig. 70 schematically illustrates a knuckle drive mechanism.

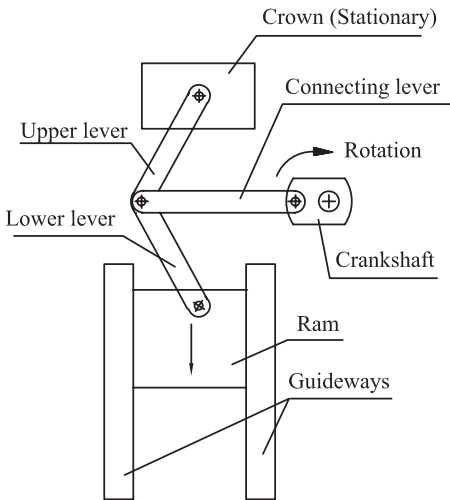


Fig. 70. Knuckle Drive Mechanism

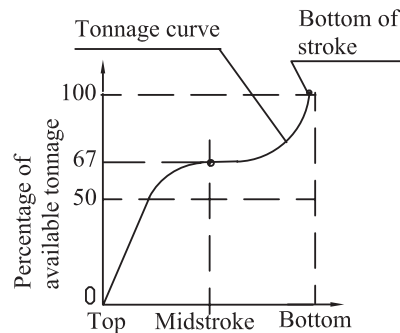


Fig. 71. Available Tonnage Curve for a Mechanical Press

Tonnage: The tonnage of a press is the force that a press ram is able to exert. In actual practice, press rams can and do exert forces greater than the rated tonnage. A safety factor is designed into the frame and drive mechanism. The tonnage of a mechanical press is calculated when the ram is near the bottom of its stroke. Thus, the tonnage of a mechanical press is constant and cannot be varied as in the hydraulic press.

The tonnage of a mechanical press when the ram is not near the bottom of its stroke is greatly reduced. Most press manufacturers will supply curves showing the tonnage available for each inch of stroke. Fig. 71 illustrates the available tonnage curve for mechanical press. Mechanical presses have forces that typically range from 20 to 5,000 tons. A few specially designed large capacity presses with ratings up to 6,000 tons are in operation.

Stroke: The stroke of a press is the distance of ram movement from its up position to its down position. The offset on a crankshaft determines the press stroke. The stroke is constant for the crankshaft and eccentric drives. Strokes on mechanical presses range from 0.2 to 45 inches.

Strokes per Minute: Strokes per minute (press speed) is a self-explanatory term. The C-frame low tonnage presses (15 to 30 tons) have the highest stroke per minute of all press types. They run at up to 1,800 strokes per minute and typically involve light forming, such as electrical connectors; when cutting dies are operated, the speeds usually range from around 20 to 800 strokes per minute.

Action: The term “action” simply means the number of rams on the press. The types of press actions include the following:

Single action: One ram operated by a mechanism located in the crown or bed of a press. These presses are used for blanking, bending, forming, and other operations. They perform a single action with each cycle of the press.

Double action: One inner ram and one outer ram are operated by a mechanism located in the crown or bed on the press. The rams move from the crown towards the bed on the down-stroke. They are used for severe forming and drawing operations.

Triple action: Same as double action with the addition of a third ram located in the bed of the press. The third ram moves upward in the bed soon after the other two rams lower.

Large presses (like the ones used in the automotive industry) have a die cushion integrated in the bolster plate to apply the blank holder force. This is necessary when a single acting press is used for deep drawing.

Fig. 72 schematically illustrates a mechanical press with its basic components.

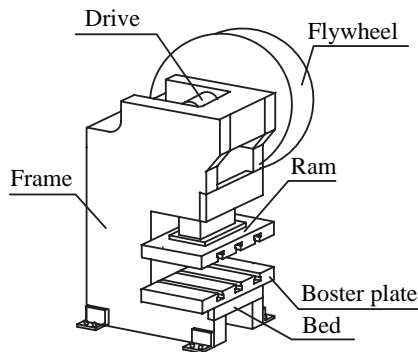


Fig. 72. Schematic Illustration of Mechanical Drive Presses with Basic Components

Gap-frame Presses.—The most noticeable characteristic of a press is the frame's style of construction. The frame is the supporting element of a press. All of the shafts and bearings, as well as the ram and gearing, are mounted in the frame. Frames may be fabricated by casting or by welding heavy rolled steel plates.

The cast frame has excellent rigidity but is expensive. The welded frame is lower in cost in most cases. Due to the greater toughness of rolled steel, welded frames have more resistance to shock loading.

The C-frame press gets its name from its shape. The most common types of C-frame are the inclinable or open-back inclinable (OBI), the solid frame or open-back stationary (OBS), the open-end press, and the adjustable bed or knee frame press.

Inclinable-frame press: The frame of an inclinable press can be tilted backward to an angle of around 30°. This inclination permits finished parts, slugs, or both, to slide to the rear of the machine upon completion. As the name implies, a fixed-position, or noninclinable machine does not tilt, and parts and/or slugs must either drop vertically or be removed by some other means.

Solid-frame press: Because of the more rigid base and solid construction, solid frame presses or OBS presses are built in higher tonnages than inclinable presses. These presses have larger beds and frame openings than inclinable presses and can handle larger dies.

Adjustable-bed press: The third type of C-frame press is the adjustable bed or knee press. The lower leg of the "C-frame forms an adjustable table or bed, and thus a wide range of shut heights may be obtained. Because of possible lack of rigidity, only smaller tonnages are made with this style of frame. The adjustable bed press is one of the most versatile presses.

Open-end press: This press has the unusual feature of having the driveshaft located from front to back. Most presses of the C-frame type have the driveshaft from right to left. The

advantage gained in the open-end press is great accessibility. All of the large gears and fly-wheel are at the back and out of the way. Only smaller tonnage presses are made in this style, however.

Straight Side Presses.—Straight side presses are so named because of the vertical columns on either side of the machine. This design eliminates the problem of angular deflection. Also, die life and part accuracy are enhanced. Straight side presses have frames consisting of a crown member, two upright side members, a bed or fundament of the press, and the bolster, which mounts on the press bed and accommodates the die while strengthening the bed. These components are often secured in a preloaded position by four tie rods. They may also be bolted and keyed together or welded into one piece. As a result, straight side presses are stiffer vertically than gap frame units, and any deflection under load tends to be symmetrical.

Straight side presses are suitable for progressive die and transfer die applications and cover an enormous range of types, sizes, and speeds.

Hydraulic Presses.—Hydraulic presses are manufacturing devices designed and built to operate dies using hydraulic drive systems to deliver a controlled force.

Drive System: These systems are relatively less complex, and comprise a motor, a pump, a valving system, and a hydraulic cylinder with the piston connected to the ram. The cylinder is usually double-acting so that hydraulic fluid (oil or water) is pumped under pressure into the top, above the piston, to make the ram move down; to make it come up, fluid is pumped into the bottom, under the piston. The pressure of the fluid under the piston is generally held between 10 to 15% of the pressure of the fluid above the piston. This is done to keep the ram from dropping by force of gravity, and also to help control the ram throughout the stroke.

Valving System: The valving system ensures the desired control and direction of flow either into or out of the cylinder. Fig. 73 schematically illustrates a hydraulic press drive system with its basic components.

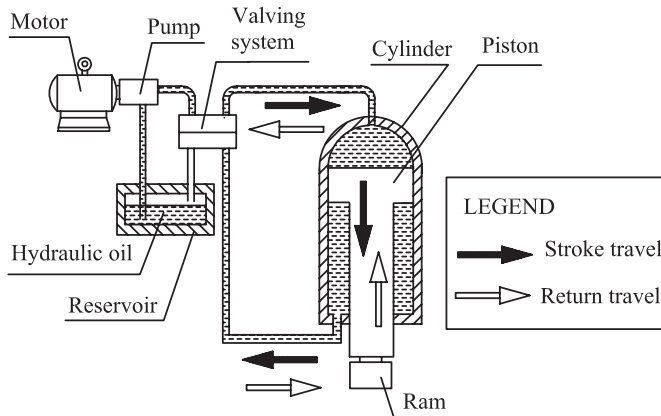


Fig. 73. Schematic Illustration of Hydraulic Press Drive System

Frame: Hydraulic presses have various frame types, including C-frames, straight-sided frames, H-frames, four-column frames, and other shapes depending on the application.

Tonnage: The tonnage of a hydraulic press is simple: the piston area times the hydraulic pressure in the cylinder. By changing the pressure, the tonnage may be varied. The tonnage of a hydraulic press ranges from about 50 tons to 50,000 tons.

Stroke: The stroke is variable on the hydraulic press and can vary from 0.4 in. to 48 in.

Strokes per Minute: Hydraulic presses are faster and more reliable than ever. The technology has undergone constant change. Improvements in seals, more efficient pumps, and stronger hoses and couplings have virtually eliminated leaks and minimized maintenance.

So, for operations requiring very short strokes, such as punching and blanking, a hydraulic press can achieve speeds that compare favorably with those of mechanical presses, especially when the material is hand fed. Because drawing and forming operations must be run more slowly to allow time for the metal to flow, press speeds usually range from around 5 to 100 strokes per minute, depending on the part size and the severity of the operation being performed.

Mechanical and Hydraulic Presses, Advantages and Disadvantages.—The mechanical press has been the first choice of many press users for years. Training of tool and die makers and tool designers has been oriented toward applying mechanical presses to sheet metal pressworking. However, modern hydraulic presses also offer good performance and reliability. Factors that may favor the use of hydraulic presses over their mechanical counterparts may include the following:

- a) Full power during the stroke: Maximum power is maintained during the entire stroke of a hydraulic press. This allows for rapid movement to a position just above the part, when the stroke is slowed for the working stroke and an adjustable slowdown speed during forming. The result is more strokes per minute.
- b) Overload protection: Because the pressure is pre-adjusted, if the pressure exceeds a limit, such as might occur when a part is not properly ejected, the machine shuts down, eliminating catastrophic results to tooling or to the machine.
- c) Cost: Depending on the application, a hydraulic press may cost less than an equivalent mechanical press.
- d) Lower operating costs: Hydraulic presses have fewer operating parts; therefore, there are fewer things to break. Automatic lubrication of moving parts helps eliminate maintenance problems.
- e) Flexibility: Owing primarily to electronic controls and robotics, hydraulic presses fit well into such areas as flexible manufacturing systems (FMS) and factory automation.
- f) No design limitations: The principles of hydraulic force allow for creative engineering. Presses can be designed for traditional down-acting, up-acting, side-acting and multi-action operation. Power systems can be placed above, below, or away from the press and force actuators. Large bed presses can be designed for low tonnage applications and small bed presses can be designed for high tonnage requirements.
- g) Unlimited control options: The hydraulic press can be controlled in a variety of ways, ranging from basic relays to more sophisticated PLC or PC control systems. Operator interfaces can be added to press systems to facilitate ease of job set by storing individual job parameters for each die. Presses can be controlled for precise pressure and position, including pressure holding, speed control, and dynamic adjustments to real-time operating variances. Ram force and speed can be controlled in any direction with various levels of precision.
- h) Small footprint: Hydraulics allow for generation of high pressure over a small surface area. This reduces the overall structure required for support of the force actuators. When compared to mechanical presses, hydraulic presses consume almost 50 percent less space for the same tonnage capability. This size advantage results in lower manufacturing costs and a faster return on investment by requiring less long-term overhead expense.
- i) Hydroforming: Hydroforming is one of the areas in which hydraulic presses have no competition. The hydraulic press ram moves down to close the die and the hydroforming high-pressure fluid fills and acts onto the inside tubular parts and expands it to fill the die. The mechanical presses are not capable of carrying out the hydroforming operation, as they do not have the speed control or the ability to stay on the bottom for performing the high pressure forming operations.

Although hydraulic presses have many advantages, they also suffer from some disadvantages when compared to mechanical presses. Some of the disadvantages include:

- a) Tolerances: While some hydraulic presses do maintain high tolerances, most of them are limited to approximately 0.020 inch. When closer tolerances are required on these machines, they are usually accounted for in the tooling, which increases the cost of the die or other tooling.
- b) Speed: Although high speed is attainable in hydraulic presses, generally, a mechanical press will produce parts faster. This is especially true when short strokes are used.
- c) Automatic feeding: Because of fewer moving parts, there is less equipment on which to attach automatic feed mechanisms. Therefore, most automatic feed equipment must be integrated into the process via electronic components, which increase cost.

Factors that may favor the use of mechanical presses over their hydraulic counterparts may include these:

- The mechanical press is faster than the hydraulic press.
- The mechanical press is by far the most suitable for blanking and punching.
- Mechanical presses do not require as large a motor as hydraulic presses because they can store energy in the flywheel and then dissipate the energy throughout the press stroke.
- Mechanical presses can be easily adapted to use different rolls and transfer feeds for progressive dies.
- Mechanical presses with short strokes are more economical than hydraulic presses.

Lubrication System.—The lubrication systems of mechanical and hydraulic presses are very important. If the lubricating system should fail, not only will the press stop, but also many of the parts are likely to be damaged beyond repair. Therefore, when lubrication failure occurs, the press can seldom be run again without a major overhaul.

The lubricating system delivers oil to the moving parts of the press to reduce friction and to assist in keeping the parts cool. Most newer and more modern presses are equipped with a pressure re-circulating lubricating system that delivers the oil under pressure to the bearings and bushings and other lubricant points.

After selection of the correct lubricant, the next most critical factors to long machine and lubricant life are keeping the lubricant clean and dry. Details such as machine criticality, operating environment, and component clearances as well as lubricant type, viscosity, flow rate, and economic issues must be carefully considered for optimum lubricant contamination control.

In any press application, the most important aspect for insuring maximum press and lubricant life is the selection of the correct lubricant. This process includes choosing the correct base oil, the correct oil viscosity, and the correct additives for the application. Next in importance is keeping the oil clean and dry. Particulate and water contamination can have devastating effects on machine and lubricant life. The primary source of particulate contamination in lubricants is ambient dust and dirt. While the composition can vary, in general, dust and dirt will contain materials such as silicon oxides and aluminum oxides. Elemental indicators of dirt ingress would be silicon (Si), aluminum (Al), and in some cases calcium (Ca) and magnesium (Mg). If a contaminant particle is larger than the clearance between two slide surfaces, the particle will grind against them, removing metal from the slide surfaces in a process called abrasive wear. The resultant wear particles can cause a chain reaction by increasing the total number of particulates in the lubricant. Additionally, this newly generated abrasive wear material can get broken into smaller particles and become harder due to the process of work hardening. These more numerous and harder particles combine with the original solid contaminants to increase the amount of abrasive material that is in the lubricant. Under conditions of high velocity or high pressure or both, small particles can impinge on a press surface and result in erosive wear. In this case, particles can be much smaller than the machine clearances and still cause extensive damage due to the velocities and pressures involved. Particles generated during erosive wear also add to the overall contamination of the system and further increase machine wear. Erosive

wear most commonly occurs in hydraulic systems that contain servo or proportional devices. Two most commonly lubricant systems are:

Lost Lubricant Systems: Lost lubricant systems are used on smaller gap presses. Older presses are usually lubricated by grease, and newer ones by oil. A hand pump is often used in lost lubricant systems. The major disadvantages of this system are that used lubricant must be cleaned periodically, and if a hand pump is used, lubrication of the machine depends on the reliability of the operator.

Re-circulating Lubricant Systems: In these, oil is pumped from a reservoir, filtered, and then distributed to all lubrication points. The pump is powered by an electric motor or by a press-driven mechanical device. The circulating oil lubricates, cools, and flushes small particles from the bearing and friction surfaces.

If the failure of the lubrication system is not detected early, serious damage to the machine will occur. Thermo-chromatic indicators are often used for early detection of lubrication system failure. By the use of thermo-chromatic indicators, mechanical or electrical problems can be detected immediately by the operator or maintenance person. The machine can then be inspected and repaired before serious damage occurs. A few dollars invested in thermo-chromatic indicators can save thousands of dollars on expensive repairs and production losses.

Another sign of lubrication system failure is the presence of bronze particles around the bearing. In this case, it is usually too late for inexpensive repairs because serious damage of the bearing or friction surfaces has already occurred.

Press Selection.—When selecting a press, compromises must be made if more than just one type of stamping operation is desired; there is not a single universal type of press that provides productive and efficient operation. Such compromises include consideration of the following primary factors: a) tonnage; b) energy capacity; c) press size and frame design; d) speed; and e) control system for press.

Other factors can be considered as well, such as the number of operations to be performed, quantities and production rates, size, geometry and accuracy of workpieces, and equipment costs.

A press-rated tonnage for mechanical presses is the maximum force that should be exerted by the slide against the workpiece at a given distance above the bottom of the stroke. The higher the rating is, the greater the torque capacity of its drive members and its capability of delivering more flywheel energy. Presses with flywheel-type drives are basically used for light blanking and piercing operations. The energy requirements of these machines are small and the machines operate at relatively high speeds. Single-gear presses are mostly used for shallow drawn workpieces and require more energy than flywheel types. Double-gear presses are used for deeper draw operations when a larger amount of energy is needed.

As stamping operations become more automated, the use of CNC system and various electro-mechanical systems to feed material to the press must also be factored in. There are mechanical blank handing systems where manual handling is not practical due to speed and size. High volume feeding is done with coil stock, which also requires an investment in additional feeding equipment.

ELECTRICAL DISCHARGE MACHINING

Generally called EDM, electrical discharge machining uses an electrode to remove metal from a workpiece by generating electric sparks between conducting surfaces. The two main types of EDM are termed sinker or plunge, used for making mold or die cavities, and wire, used to cut shapes such as are needed for stamping dies. For die sinking, the electrode usually is made from copper or graphite and is shaped as a positive replica of the shape to be formed on or in the workpiece. A typical EDM sinker machine, shown diagrammatically in Fig. 1, resembles a vertical milling machine, with the electrode attached to the vertical slide. The slide is moved down and up by an electronic, servo-controlled drive unit that controls the spacing between the electrode and the workpiece on the table. The table can be adjusted in three directions, often under numerical control, to positions that bring a workpiece surface to within 0.0005-0.030 inch (0.013–0.76 mm) from the electrode surface, where a spark is generated.

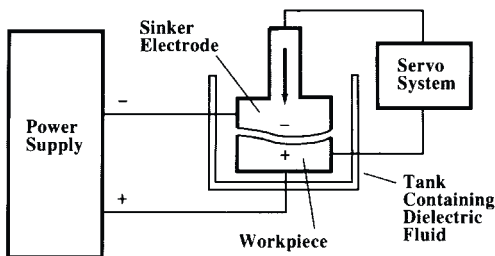


Fig. 1. Sinker or Plunge Type EDM Machines Are Used to Sink Cavities in Molds and Dies

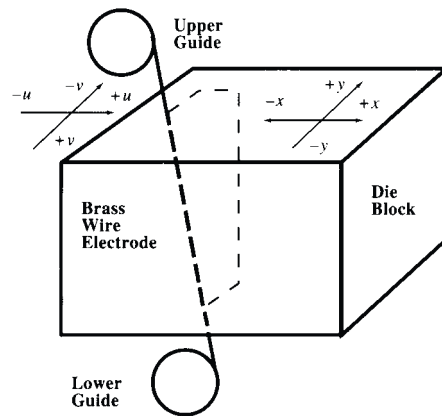


Fig. 2. Wire Type EDM Machines Are Used to Cut Stamping Die Profiles.

Wire EDM, shown diagrammatically in Fig. 2, are numerically controlled and somewhat resemble a bandsaw with the saw blade replaced by a fine brass or copper wire, which forms the electrode. This wire is wound off one reel, passed through tensioning and guide rollers, then through the workpiece and through lower guide rollers before being wound onto another reel for storage and eventual recycling. One set of guide rollers, usually the lower, can be moved on two axes at 90 degrees apart under numerical control to adjust the angle of the wire when profiles of varying angles are to be produced. The table also is movable in two directions under numerical control to adjust the position of the workpiece relative to the wire. Provision must be made for the cut-out part to be supported when it is freed from the workpiece so that it does not pinch and break the wire.

EDM applied to grinding machines is termed EDG. The process uses a graphite wheel as an electrode, and wheels can be up to 12 inch (30.48 cm) in diameter by 6 inch (15.24 cm) wide. The wheel periphery is dressed to the profile required on the workpiece and the wheel profile can then be transferred to the workpiece as it is traversed past the wheel, which rotates but does not touch the work. EDG machines are highly specialized and are mainly used for producing complex profiles on polycrystalline diamond cutting tools and for shaping carbide tooling such as form tools, thread chasers, dies, and crushing rolls.

EDM Terms*.—*Anode*: The positive terminal of an electrolytic cell or battery. In EDM, incorrectly applied to the tool or electrode.

* Source: Hansvedt Industries

Barrel effect: In wire EDM, a condition where the center of the cut is wider than the entry and exit points of the wire, due to secondary discharges caused by particles being pushed to the center by flushing pressure from above and beneath the workpiece.

Capacitor: An electrical component that stores an electric charge. In some EDM power supplies, several capacitors are connected across the machining gap and the current for the spark comes directly from the capacitors when they are discharged.

Cathode: The negative terminal in an electrolytic cell or battery. In EDM incorrectly applied to the workpiece.

Colloidal suspension: Particles suspended in a liquid that are too fine to settle out. In EDM, the tiny particles produced in the sparking action form a colloidal suspension in the dielectric fluid.

Craters: Small cavities left on an EDM surface by the sparking action, also known as pits.

Dielectric filter : A filter that removes particles from 5 μm (0.00020 inch) down to as fine as 1 μm (0.00004 inch) in size, from dielectric fluid.

Dielectric fluid : The non-conductive fluid that circulates between the electrode and the workpiece to provide the dielectric strength across which an arc can occur, to act as a coolant to solidify particles melted by the arc, and to flush away the solidified particles.

Dielectric strength: In EDM, the electrical potential (voltage) needed to break down (ionize) the dielectric fluid in the gap between the electrode and the workpiece.

Discharge channel: The conductive pathway formed by ionized dielectric and vapor between the electrode and the workpiece.

Dither: A slight up and down movement of the machine ram and attached electrode, used to improve cutting stability.

Duty cycle: The percentage of a pulse cycle during which the current is turned on (on time), relative to the total duration of the cycle.

EDG: Electrical discharge grinding using a machine that resembles a surface grinder but has a wheel made from electrode material. Metal is removed by an EDM process rather than by grinding.

Electrode growth: A plating action that occurs at certain low-power settings, whereby workpiece material builds up on the electrode, causing an increase in size.

Electrode wear: Amount of material removed from the electrode during the EDM process. This removal can be end wear or corner wear, and is measured linearly or volumetrically but is most often expressed as end wear per cent, measured linearly.

Electro-forming: An electro-plating process used to make metal EDM electrodes.

Energy: Measured in joules, is the equivalent of volt-coulombs or volt-ampere-seconds.

Farad: Unit of electrical capacitance, or the energy-storing capacity of a capacitor.

Gap: The closest point between the electrode and the workpiece where an electrical discharge will occur. (See *Overcut*)

Gap current: The average amperage flowing across the machining gap.

Gap voltage: The voltage across the gap while current is flowing. The voltage across the electrode/workpiece before current flows is called the open gap voltage. Heat-affected zone. The layer below the recast layer, which has been subjected to elevated temperatures that have altered the properties of the workpiece metal.

Ion: An atom or group of atoms that has lost or gained one or more electrons and is therefore carrying a positive or negative electrical charge, and is described as being ionized.

Ionization: The change in the dielectric fluid that is subjected to a voltage potential whereby it becomes electrically conductive, allowing it to conduct the arc.

Low-wear: An EDM process in which the volume of electrode wear is between 2 and 15 per cent of the volume of workpiece wear. Normal negative polarity wear ratios are 15 to 40 per cent.

Negative electrode: The electrode voltage potential is negative relative to the workpiece.

No-wear: An EDM process in which electrode wear is virtually eliminated and the wear ratio is usually less than 2 per cent by volume.

Orbit: A programmable motion between the electrode and the workpiece, produced by a feature built in to the machine, or an accessory, that produces a cavity or hole larger than the electrode. The path can be planetary (circular), vectorial, or polygonal (trace). These motions can often be performed in sequence, and combined with x-axis movement of the electrode.

Overcut: The distance between one side of an electrode and the adjacent wall of the workpiece cavity.

Overcut taper: The difference between the overcut dimensions at the top (entrance) and at the bottom of the cavity.

Plasma: A superheated, highly ionized gas that forms in the discharge channel due to the applied voltage.

Positive electrode: The electrode voltage potential is positive with respect to the workpiece. is the opposite of this condition.

Power parameters: A set of power supply, servo, electrode material, workpiece material, and flushing settings that are selected to produce a desired metal removal rate and surface finish.

Quench: The rapid cooling of the EDM surface by the dielectric fluid, which is partially responsible for metallurgical changes in the recast layer and in the heat-affected zone.

Recast layer: A layer created by the solidification of molten metal on the workpiece surface after it has been melted by the EDM process.

Secondary discharge: A discharge that occurs as conductive particles are carried out along the side of the electrode by the dielectric fluid.

Spark in: A method of locating an electrode with respect to the workpiece, using high frequency, low amperage settings so that there is no cutting action. The electrode is advanced toward the workpiece until contact is indicated and this point is used as the basis for setting up the job.

Spark out: A technique used in orbiting, which moves the electrode in the same path until sparking ceases.

Square wave: An electrical wave shape generated by a solid state power supply.

Stroke: The distance the ram travels under servo control.

UV axis: A mechanism that provides for movement of the upper head of a wire EDM machine to allow inclined surfaces to be generated.

White layer: The surface layer of an EDM cut that is affected by the heat generated during the process. The characteristics of the layer depend on the material, and may be extremely hard martensite or an annealed layer.

Wire EDM: An EDM machine or process in which the electrode is a continuously unspooling, conducting wire that moves in preset patterns in relation to the workpiece.

Wire guide: A replaceable precision round diamond insert, sized to match the wire, that guides the wire at the entrance and exit points of a wire cut.

Wire speed: The rate at which the wire is fed axially through the workpiece (not the rate at which cutting takes place), adjusted so that clean wire is maintained in the cut but slow enough to minimize waste.

The EDM Process.—During the EDM process, energy from the sparks created between the electrode and the workpiece is dissipated by the melting and vaporizing of the workpiece material preferentially, only small amounts of material being lost from the electrode. When current starts to flow between the electrode and the work, the dielectric fluid in the small area in which the gap is smallest, and in which the spark will occur, is transformed into a plasma of hydrogen, carbon, and various oxides. This plasma forms a conducting passageway, consisting of ionized or electrically charged particles, through which the spark can form between the electrode and the workpiece. After current starts to flow, to heat and vaporize a tiny area, the striking voltage is reached, the voltage drops, and the field of ionized particles loses its energy, so that the spark can no longer be sustained. As the voltage then begins to rise again with the increase in resistance, the electrical supply is

cut off by the control, causing the plasma to implode and creating a low-pressure pulse that draws in dielectric fluid to flush away metallic debris and cool the impinged area. Such a cycle typically lasts a few microseconds (millionths of a second, or μs), and is repeated continuously in various places on the workpiece as the electrode is moved into the work by the control system.

Flushing: An insulating dielectric fluid is made to flow in the space between the workpiece and the electrode to prevent premature spark discharge, cool the workpiece and the electrode, and flush away the debris. For sinker machines, this fluid is paraffin, kerosene, or a silicon-based dielectric fluid, and for wire machines, the dielectric fluid is usually deionized water. The dielectric fluid can be cooled in a heat exchanger to prevent it from rising above about 100°F (38°C), at which cooling efficiency may be reduced. The fluid must also be filtered to remove workpiece particles that would prevent efficient flushing of the spark gaps. Care must be taken to avoid the possibility of entrapment of gases generated by sparking. These gases may explode, causing danger to life, breaking a valuable electrode or workpiece, or causing a fire.

Flushing away of particles generated during the process is vital to successful EDM operations. A secondary consideration is the heat transferred to the side walls of a cavity, which may cause the workpiece material to expand and close in around the electrode, leading to formation of dc arcs where conductive particles are trapped. Flushing can be done by forcing the fluid to pass through the spark gap under pressure, by sucking it through the gap, or by directing a side nozzle to move the fluid in the tank surrounding the workpiece. In pressure flushing, fluid is usually pumped through strategically placed holes in the electrode or in the workpiece. Vacuum flushing is used when side walls must be accurately formed and straight, and is seldom needed on numerically controlled machines because the table can be programmed to move the workpiece sideways.

Flushing needs careful consideration because of the forces involved, especially where fluid is pumped or sucked through narrow passageways, and large hydraulic forces can easily be generated. Excessively high pressures can lead to displacement of the electrode, the workpiece, or both, causing inaccuracy in the finished product. Many low-pressure flushing holes are preferable to a few high-pressure holes. Pressure-relief valves in the system are recommended.

Electronic Controls: The electrical circuit that produces the sparks between the electrode and the workpiece is controlled electronically, the length of the extremely short on and off periods being matched by the operator or the programmer to the materials of the electrode and the workpiece, the dielectric, the rate of flushing, the speed of metal removal, and the quality of surface finish required. The average current flowing between the electrode and the workpiece is shown on an ammeter on the power source, and is the determining factor in machining time for a specific operation. The average spark gap voltage is shown on a voltmeter.

EDM machines can incorporate provision for orbiting the electrode so that flushing is easier, and cutting is faster and increased on one side. Numerical control can also be used to move the workpiece in relation to the electrode with the same results. Numerical control can also be used for checking dimensions and changing electrodes when necessary. The clearance on all sides between the electrode and the workpiece, after the machining operation, is called the overcut or overburn. The overcut becomes greater with increases in the on time, the spark energy, or the amperage applied, but its size is little affected by voltage changes. Allowances must be made for overcut in the dimensioning of electrodes. Side-wall encroachment and secondary discharge can take up parts of these allowances, and electrodes must always be made smaller to avoid making a cavity or hole too large.

Polarity: Polarity can affect processing speed, finish, wear, and stability of the EDM operation. On sinker machines, the electrode is generally, made positive to protect the electrode from excessive wear and preserve its dimensional accuracy. This arrangement

removes metal at a slower rate than electrode negative, which is mostly used for high-speed metal removal with graphite electrodes. Negative polarity is also used for machining carbides, titanium, and refractory alloys using metallic electrodes. Metal removal with graphite electrodes can be as much as 50 per cent faster with electrode negative polarity than with electrode positive, but negative polarity results in much faster electrode wear, so it is generally restricted to electrode shapes that can be redressed easily.

Newer generators can provide less than 1 per cent wear with either copper or graphite electrodes during roughing operations. Roughing is typically done with a positive-polarity electrode using elevated on times. Some electrodes, particularly micrograin graphites, have a high resistance to wear. Fine-grain, high-density graphites provide better wear characteristics than coarser, less dense grades, and copper-tungsten resists wear better than pure copper electrodes.

Machine Settings: For vertical machines, a rule of thumb for power selection on graphite and copper electrodes is 50 to 65 amps per square inch of electrode engagement. For example, an electrode that is $\frac{1}{2}$ in² (3.2 cm²) might use $0.5 \times 0.5 \times 50 = 12.5$ amps. Although each square inch of electrode surface may be able to withstand higher currents, lower settings should be used with very large jobs or the workpiece may become overheated and it may be difficult to clean up the recast layer. Lower amperage settings are required for electrodes that are thin or have sharp details. The voltage applied across the arc gap between the electrode and the workpiece is ideally about 35 volts, but should be as small as possible to maintain stability of the process.

Spark Frequency: Spark frequency is the number of times per second that the current is switched on and off. Higher frequencies are used for finishing operations and for work on cemented carbide, titanium, and copper alloys. The frequency of sparking affects the surface finish produced, low frequencies being used with large spark gaps for rapid metal removal with a rough finish, and higher frequencies with small gaps for finer finishes. High frequency usually increases, and low frequency reduces electrode wear.

The Duty Cycle: Electronic units on modern EDM machines provide extremely close control of each stage in the sparking cycle, down to millionths of a second (μ s). A typical EDM cycle might last 100 μ s. Of this time, the current might be on for 40 μ s and off for 60 μ s. The relationship between the lengths of the on and off times is called the duty cycle and it indicates the degree of efficiency of the operation. The duty cycle states the on time as a percentage of the total cycle time and in the previous example it is 40 per cent. Although reducing the off time will increase the duty cycle, factors such as flushing efficiency, electrode and workpiece material, and dielectric condition control the minimum off time. Some EDM units incorporate sensors and fuzzy logic circuits that provide for adaptive control of cutting conditions for unattended operation. Efficiency is also reported as the amount of metal removed, expressed as in³/hr.

In the EDM process, work is done only during the on time, and the longer the on time, the more material is removed in each sparking cycle. Roughing operations use extended on time for high metal-removal rates, resulting in fewer cycles per second, or lower frequency. The resulting craters are broader and deeper so that the surface is rougher and the heat-affected zone (HAZ) on the workpiece is deeper. With positively charged electrodes, the spark moves from the electrode toward the workpiece and the maximum material is removed from the workpiece. However, every spark takes a minute particle from the electrode so that the electrode also is worn away. Finishing electrodes tend to wear much faster than roughing electrodes because more sparks are generated in unit time.

The part of the cycle needed for reionizing the dielectric (the off time) greatly affects the operating speed. Although increasing the off time slows the process, longer off times can increase stability by providing more time for the ejected material to be swept away by the flow of the dielectric fluid, and for deionization of the fluid, so that erratic cycling of the servo-mechanisms that advance and retract the electrode is avoided. In any vertical EDM

operation, if the overcut, wear, and finish are satisfactory, machining speed can best be adjusted by slowly decreasing the off time setting in small increments of 1 to 5 μs until machining becomes erratic, then returning to the previous stable setting. As the off time is decreased, the machining gap or gap voltage will slowly fall and the working current will rise. The gap voltage should not be allowed to drop below 35 to 40 volts.

Metal Removal Rates (MRR): Amounts of metal removed in any EDM process depend largely on the length of the on time, the energy/spark, and the number of sparks/second. The following data were provided by Poco Graphite, Inc., in their *EDM Technical Manual*. For a typical roughing operation using electrode positive polarity on high-carbon steel, a 67 per cent duty cycle removed $0.28 \text{ in}^3/\text{hr}$ ($4.59 \text{ cm}^3/\text{hr}$). For the same material, a 50 per cent duty cycle removed $0.15 \text{ in}^3/\text{hr}$ ($2.46 \text{ cm}^3/\text{hr}$), and a 33 per cent duty cycle for finishing removed $0.075 \text{ in}^3/\text{hr}$ ($1.23 \text{ cm}^3/\text{hr}$).

In another example, shown in the top data row in **Table 1**, a 40 per cent duty cycle with a frequency of 10 kHz and peak current of 50 amps was run for 5 minutes of cutting time. Metal was removed at the rate of $0.8 \text{ in}^3/\text{hr}$ ($13.11 \text{ cm}^3/\text{hr}$) with electrode wear of 2.5 per cent and a surface finish of 400 $\mu\text{inch } R_a$. When the on and off times in this cycle were halved, as shown in the second data row in **Table 1**, the duty cycle remained at 40 per cent, but the frequency doubled to 20 kHz. The result was that the peak current remained unaltered, but with only half the on time the MRR was reduced to $0.7 \text{ in}^3/\text{hr}$ ($11.47 \text{ cm}^3/\text{hr}$), the electrode wear increased to 6.3 per cent, and the surface finish improved to 300 $\mu\text{inch } R_a$. The third and fourth rows in **Table 1** show other variations in the basic cycle and the results.

Table 1. Effect of Electrical Control Adjustments on EDM Operations

On Time (μs)	Off Time (μs)	Frequency (kHz)	Peak Current (Amps)	Metal Removal Rate		Electrode Wear (%)	Surface Finish ($\mu\text{in } R_a$)
				(in^3/hr)	(cm^3/hr)		
40	60	10	50	0.08	1.31	2.5	400
20	30	20	50	0.7	11.47	6.3	300
40	10	20	50	1.2	19.66	1.4	430
40	60	10	25	0.28	4.59	2.5	350

The Recast Layer: One drawback of the EDM process when used for steel is the recast layer, which is created wherever sparking occurs. The oil used as a dielectric fluid causes the EDM operation to become a random heat-treatment process in which the metal surface is heated to a very high temperature, then quenched in oil. The heat breaks down the oil into hydrocarbons, tars, and resins, and the molten metal draws out the carbon atoms and traps them in the resolidified metal to form the very thin, hard, brittle surface called the recast layer that covers the heat-affected zone (HAZ). This recast layer has a white appearance and consists of particles of material that have been melted by the sparks, enriched with carbon, and drawn back to the surface or retained by surface tension. The recast layer is harder than the parent metal and can be as hard as glass, and must be reduced or removed by vapor blasting with glass beads, polishing, electrochemical or abrasive flow machining, after the shaping process is completed, to avoid cracking or flaking of surface layers that may cause failure of the part in service.

Beneath the thin recast layer, the HAZ, in steel, consists of martensite that usually has been hardened by the heating and cooling sequences coupled with the heat-sink cooling effect of a thick steel workpiece. This martensite is hard and its rates of expansion and contraction are different from those of the parent metal. If the workpiece is subjected to heating and cooling cycles in use, the two layers are constantly stressed and these stresses may cause formation of surface cracks. The HAZ is usually much deeper in a workpiece cut on a sinker than on a wire machine, especially after roughing, because of the increased heating effect caused by the higher amounts of energy applied.

The depth of the HAZ depends on the amperage and the length of the on time, increasing as these values increase, to about 0.012-0.015 in ch (0.30–0.38 mm) deep. Residual stress in the HAZ can range up to 650 N/mm². The HAZ cannot be removed easily, so it is best avoided by programming the series of cuts taken on the machine so that most of the HAZ produced by one cut is removed by the following cut. If time is available, cut depth can be reduced gradually until the finishing cuts produce an HAZ having a thickness of less than 0.0001 inch (2.54 mm).

Workpiece Materials.—Most homogeneous materials used in metalworking can be shaped by the EDM process. Some data on typical workpiece materials are given in [Table 2](#). Sintered materials present some difficulties caused by the use of a cobalt or other binder used to hold the carbide or other particles in the matrix. The binder usually melts at a lower temperature than the tungsten, molybdenum, titanium, or other carbides, so it is preferentially removed by the sparking sequence and the carbide particles are thus loosened and freed from the matrix. The structures of sintered materials based on tungsten, cobalt, and molybdenum require higher EDM frequencies with very short on times, so that there is less danger of excessive heat buildup, leading to melting. Copper-tungsten electrodes are recommended for EDM of tungsten carbides. When used with high frequencies for powdered metals, graphite electrodes often suffer from excessive wear.

Workpieces of aluminum, brass, and copper should be processed with metallic electrodes of low melting points such as copper or copper-tungsten. Workpieces of carbon and stainless steel that have high melting points should be processed with graphite electrodes. The melting points and specific gravities of the electrode material and of the workpiece should preferably be similar.

Table 2. Characteristics of Common Workpiece Materials for EDM

Material	Specific Gravity	Melting Point		Vaporization Temperature		Conductivity (Silver = 100)
		°F	°C	°F	°C	
Aluminum	2.70	1220	660	4442	2450	63.00
Brass	8.40	1710	930
Cobalt	8.71	2696	1480	5520	2900	16.93
Copper	8.89	1980	1082	4710	2595	97.61
Graphite	2.07	N/A		6330	3500	70.00
Inconel	...	2350	1285
Magnesium	1.83	1202	650	2025	1110	39.40
Manganese	7.30	2300	1260	3870	2150	15.75
Molybdenum	10.20	4748	2620	10,040	5560	17.60
Nickel	8.80	2651	1455	4900	2730	12.89
Carbon Steel	7.80	2500	1371	12.00
Tool Steel	...	2730	1500
Stainless Steel	...	2750	1510
Titanium	4.50	3200	1700	5900	3260	13.73
Tungsten	18.85	6098	3370	10,670	5930	14.00
Zinc	6.40	790	420	1663	906	26.00

Electrode Materials.—Most EDM electrodes are made from graphite, which provides a much superior rate of metal removal than copper because of the ability of graphite to resist thermal damage. Graphite has a density of 1.55 to 1.85 g/cm³, lower than most metals. Instead of melting when heated, graphite sublimates, that is, it changes directly from a solid to a gas without passing through the liquid stage. Sublimation of graphite occurs at a temperature of 3350°C (6062°F). EDM graphite is made by sintering a compressed mixture of fine graphite powder (1 to 100 micron particle size) and coal tar pitch in a furnace. The open structure of graphite means that it is eroded more rapidly than metal in the EDM process. The electrode surface is also reproduced on the surface of the workpiece. The sizes of individual surface recesses may be reduced during sparking when the work is moved under numerical control of workpiece table movements.

The fine grain sizes and high densities of graphite materials that are specially made for high-quality EDM finishing provide high wear resistance, better finish, and good reproduction of fine details, but these fine grades cost more than graphite of larger grain sizes and lower densities. Premium grades of graphite cost up to five times as much as the least expensive and about three times as much as copper, but the extra cost often can be justified by savings during machining or shaping of the electrode.

Graphite has a high resistance to heat and wear at lower frequencies, but will wear more rapidly when used with high frequencies or with negative polarity. Infiltrated graphites for EDM electrodes are also available as a mixture of copper particles in a graphite matrix, for applications where good machinability of the electrode is required. This material presents a trade-off between lower arcing and greater wear with a slower metal-removal rate, but costs more than plain graphite.

EDM electrodes are also made from copper, tungsten, silver-tungsten, brass, and zinc, which all have good electrical and thermal conductivity. However, all these metals have melting points below those encountered in the spark gap, so they wear rapidly. Copper with 5 per cent tellurium, added for better machining properties, is the most commonly used metal alloy. Tungsten resists wear better than brass or copper and is more rigid when used for thin electrodes but is expensive and difficult to machine. Metal electrodes, with their more even surfaces and slower wear rates, are often preferred for finishing operations on work that requires a smooth finish. In fine-finishing operations, the arc gap between the surfaces of the electrode and the workpiece is very small and there is a danger of dc arcs being struck, causing pitting of the surface. This pitting is caused when particles dislodged from a graphite electrode during fine-finishing cuts are not flushed from the gap. If struck by a spark, such a particle may provide a path for a continuous discharge of current that will mar the almost completed work surface.

Some combinations of electrode and workpiece material, electrode polarity, and likely amounts of corner wear are listed in Table 3. Corner wear rates indicate the ability of the electrode to maintain its shape and reproduce fine detail. The column headed Capacitance refers to the use of capacitors in the control circuits to increase the impact of the spark without increasing the amperage. Such circuits can accomplish more work in a given time, at the expense of surface-finish quality and increased electrode wear.

Table 3. Types of Electrodes Used for Various Workpiece Materials

Electrode	Electrode Polarity	Workpiece Material	Corner Wear (%)	Capacitance
Copper	+	Steel	2–10	No
Copper	+	Inconel	2–10	No
Copper	+	Aluminum	<3	No
Copper	–	Titanium	20–40	Yes
Copper	–	Carbide	35–60	Yes
Copper	–	Copper	34–45	Yes
Copper	–	Copper-tungsten	40–60	Yes
Copper-tungsten	+	Steel	1–10	No
Copper-tungsten	–	Copper	20–40	Yes
Copper-tungsten	–	Copper-tungsten	30–50	Yes
Copper-tungsten	–	Titanium	15–25	Yes
Copper-tungsten	–	Carbide	35–50	Yes
Graphite	+	Steel	<1	No
Graphite	–	Steel	30–40	No
Graphite	+	Inconel	<1	No
Graphite	–	Inconel	30–40	No
Graphite	+	Aluminum	<1	No
Graphite	–	Aluminum	10–20	No
Graphite	–	Titanium	40–70	No
Graphite	–	Copper	N/A	Yes

Electrode Wear: Wear of electrodes can be reduced by leaving the smallest amounts of finishing stock possible on the workpiece and using no-wear or low-wear settings to remove most of the remaining material so that only a thin layer remains for finishing with the redressed electrode. The material left for removal in the finishing step should be only slightly more than the maximum depth of the craters left by the previous cut. Finishing operations should be regarded as only changing the quality of the finish, not removing metal or sizing. Low power with very high frequencies and minimal amounts of offset for each finishing cut are recommended.

On manually adjusted machines, fine finishing is usually carried out by several passes of a full-size finishing electrode. Removal of a few thousandths of an inch from a cavity with such an arrangement requires the leading edge of the electrode to recut the cavity over the entire vertical depth. By the time the electrode has been sunk to full depth, it is so worn that precision is lost. This problem sometimes can be avoided on a manual machine by use of an orbiting attachment that will cause the electrode to traverse the cavity walls, providing improved speed, finish, and flushing, and reducing corner wear on the electrode.

Selection of Electrode Material: Factors that affect selection of electrode material include metal-removal rate, wear resistance (including volumetric, corner, end, and side, with corner wear being the greatest concern), desired surface finish, costs of electrode manufacture and material, and characteristics of the material to be machined. A major factor is the ability of the electrode material to resist thermal damage, but the electrode's density, the polarity, and the frequencies used are all important factors in wear rates. Copper melts at about 1085°C (1985°F) and spark-gap temperatures must generally exceed 3800°C (6872°F), so use of copper may be made unacceptable because of its rapid wear rates. Graphites have good resistance to heat and wear at low frequencies, but will wear more with high frequency, negative polarity, or a combination of these.

Making Electrodes.—Electrodes made from copper and its alloys can be machined conventionally by lathes, and milling and grinding machines, but copper acquires a burr on run-off edges during turning and milling operations. For grinding copper, the wheel must often be charged with beeswax or similar material to prevent loading of the surface. Flat grinding of copper is done with wheels having open grain structures (46-J, for instance) to contain the wax and to allow room for the soft, gummy, copper chips. For finish grinding, wheels of at least 60 and up to 80 grit should be used for electrodes requiring sharp corners and fine detail. These wheels will cut hot and load up much faster, but are necessary to avoid rapid breakdown of sharp corners.

Factors to be considered in selection of electrode materials are: the electrode material cost cost/in³; the time to manufacture electrodes; difficulty of flushing; the number of electrodes needed to complete the job; speed of the EDM; amount of electrode wear during EDM; and workpiece surface-finish requirements.

Copper electrodes have the advantage over graphite in their ability to be discharge-dressed in the EDM, usually under computer numerical control (CNC). The worn electrode is engaged with a premachined dressing block made from copper-tungsten or carbide. The process renews the original electrode shape, and can provide sharp, burr-free edges. Because of its higher vaporization temperature and wear resistance, discharge dressing of graphite is slow, but graphite has the advantage that it can be machined conventionally with ease.

Machining Graphite: Graphites used for EDM are very abrasive, so carbide tools are required for machining them. Graphite does not shear away and flow across the face of the tool as metal does, but fractures or is crushed by the tool pressure and floats away as a fine powder or dust. Graphite particles have sharp edges and, if allowed to mix with the machine lubricant, will form an abrasive slurry that causes rapid wear of machine guiding surfaces. Dust may also cause respiratory problems and allergic reactions, especially if the graphite is infiltrated with copper, so an efficient exhaust system is needed for machining.

Compressed air can be used to flush out the graphite dust from blind holes, for instance, but provision must be made for vacuum removal of the dust to avoid hazards to health and problems with wear caused by the hard, sharp-edged particles. Air velocities of at least 500 ft/min (152 m/min) are recommended for flushing, and of 2000 ft/min (610 m/min) in collector ducts to prevent settling out. Fluids can also be used, but small-pore filters are needed to keep the fluid clean. High-strength graphite can be clamped or chucked tightly but care must be taken to avoid crushing. Collets are preferred for turning because of the uniform pressure they apply to the workpiece. Sharp corners on electrodes made from less dense graphite are liable to chip or break away during machining.

For conventional machining of graphite, tools of high-quality tungsten carbide or polycrystalline diamond are preferred and must be kept sharp. Recommended cutting speeds for high-speed steel tools are 100-300 ft/min (30-91 m/min), tungsten carbide 500-750 ft/min (152-229 m/min), and polycrystalline diamond, 500-2000 surface ft/min (152-610 m/min). Tools for turning should have positive rake angles and nose radii of $\frac{1}{64}$ to $\frac{1}{32}$ inch. Depths of cut of 0.015 to 0.020 inch produce a better finish than light cuts such as 0.005 inch because of the tendency of graphite to chip away rather than flow across the tool face. Low feed rates of 0.005 inch/rev for rough- and 0.001 to 0.003 inch/rev for finish-turning are preferred. Cutting off is best done with a tool having an angle of 20° .

For bandsawing graphite, standard carbon steel blades can be run at 2100-3100 surface ft/min (640-945 m/min). Use low power feed rates to avoid overloading the teeth and the feed rate should be adjusted until the saw has a very slight speed up at the breakthrough point. Milling operations require rigid machines, short tool extensions, and firm clamping of parts. Milling cutters will chip the exit side of the cut, but chipping can be reduced by use of sharp tools, positive rake angles, and low feed rates to reduce tool pressure. Feed/tooth for two-flute end mills is 0.003 to 0.005 inch (0.076 to 0.13 mm) for roughing and 0.001 to 0.003 inch (0.025 to 0.076 mm) for finishing.

Standard high-speed steel drills can be used for drilling holes but will wear rapidly, causing holes that are tapered or undersized, or both. High-spiral, tungsten carbide drills should be used for large numbers of holes over $\frac{1}{16}$ inch (1.59 mm) diameter, but diamond-tipped drills will last longer. Pecking cycles should be used to clear dust from the holes. Compressed air can be passed through drills with through coolant holes to clear dust. Feed rates for drilling are 0.0015 to 0.002 inch/rev for drills up to $\frac{1}{32}$, 0.001 to 0.003 inch/rev for $\frac{1}{32}$ - to $\frac{1}{8}$ -inch drills, and 0.002 to 0.005 inch/rev for larger drills. Standard taps without fluid are best used for through holes, and for blind holes, tapping should be completed as far as possible with a taper tap before the bottoming tap is used.

For surface grinding of graphite, a medium (60) grade, medium-open structure, vitreous-bond, green-grit, silicon-carbide wheel is most commonly used. The wheel speed should be 5300-6000 surface ft/min (1615-1829 m/min), with traversing feed rates at about 56 ft/min (17.1 m/min). Roughing cuts are taken at 0.005 to 0.010 inch/pass (0.13 - 0.25 mm/pass), and finishing cuts at 0.001 to 0.003 inch/pass (0.025 - 0.076 mm/pass). Surface finishes in the range of 18 to 32 μ inch (0.457 - 0.813 micron) R_a are normal, and can be improved by longer spark-out times and finer grit wheels, or by lapping. Graphite can be centerless ground using a silicon-carbide, resinoid-bond work wheel and a regulating wheel speed of 195 ft/min (59.4 m/min).

Wire EDM, orbital abrading, and ultrasonic machining are also used to shape graphite electrodes. Orbital abrading uses a die containing hard particles to remove graphite, and can produce a fine surface finish. In ultrasonic machining, a water-based abrasive slurry is pumped between the die attached to the ultrasonic transducer and the graphite workpiece on the machine table. Ultrasonic machining is rapid and can reproduce small details down to 0.002 inch (0.05 mm) in size, with surface finishes down to 8 μ in (0.203 micron) R_a . If coolants are used, the graphite should be dried for 1 hour at over 400°F (204°C) (but not in a microwave oven) to remove liquids before used.

Wire EDM.—In the wire EDM process, with deionized water as the dielectric fluid, carbon is extracted from the recast layer, rather than added to it. When copper-base wire is used, copper atoms migrate into the recast layer, softening the surface slightly so that wire-cut surfaces are sometimes softer than the parent metal. On wire EDM machines, very high amperages are used with very short on times, so that the heat-affected zone (HAZ) is quite shallow. With proper adjustment of the on and off times, the depth of the HAZ can be held below 1 micron (0.00004 inch).

The cutting wire is used only once, so that the portion in the cut is always cylindrical and has no spark-eroded sections that might affect the cut accuracy. The power source controls the electrical supply to the wire and to the drive motors on the table to maintain the preset arc gap within 0.1 micron (0.000004 inch) of the programmed position. On wire EDM machines, the water used as a dielectric fluid is deionized by a deionizer included in the cooling system, to improve its properties as an insulator. Chemical balance of the water is also important for good dielectric properties.

Drilling Holes for Wire EDM: Before an aperture can be cut in a die plate, a hole must be provided in the workpiece. Such holes are often “drilled” by EDM, and the wire threaded through the workpiece before starting the cut. The “EDM drill” does not need to be rotated, but rotation will help in flushing and reduce electrode wear. The EDM process can drill a hole 0.04 inch (1 mm) in diameter through 4-inch (101 mm) thick steel in about 3 minutes, using an electrode made from brass or copper tubing. Holes of smaller diameter can be drilled, but the practical limit is 0.012 inch (0.3 mm) because of the overcut, the lack of rigidity of tubing in small sizes, and the excessive wear on such small electrodes. The practical upper size limit on holes is about 0.12 inch (3 mm) because of the comparatively large amounts of material that must be eroded away for larger sizes. However, EDM is commonly used for making large or deep holes in such hard materials as tungsten carbide. For instance, a 0.2-inch (5 mm) hole has been made in carbide 2.9 inch (74 mm) thick in 49 minutes by EDM. Blind holes are difficult to produce with accuracy, and must often be made with cut-and-try methods.

Deionized water is usually used for drilling and is directed through the axial hole in the tubular electrode to flush away the debris created by the sparking sequence. Because of the need to keep the extremely small cutting area clear of metal particles, the dielectric fluid is often not filtered but is replaced continuously by clean fluid that is pumped from a supply tank to a disposal tank on the machine.

Wire Electrodes: Wire for EDM generally is made from yellow brass containing copper 63 and zinc 37 per cent, with a tensile strength of 50,000-145,000 lb_f/in² (345–1000 MPa), and may be from 0.002-0.012 inch (0.05–0.30 mm) diameter.

In addition to yellow brass, electrode wires are also made from brass alloyed with aluminum or titanium for tensile strengths of 140,000-160,000 lb_f/in² (965–1103 MPa). Wires with homogeneous, uniform electrolytic coatings of alloys such as brass or zinc are also used. Zinc is favored as a coating on brass wires because it gives faster cutting and reduced wire breakage due to its low melting temperature of 419°C, and vaporization temperature of 906°C. The layer of zinc can boil off while the brass core, which melts at 930°C, continues to deliver current.

Some wires for EDM are made from steel for strength, with a coating of brass, copper, or other metal. Most wire machines use wire negative polarity (the wire is negative) because the wire is constantly renewed and is used only once, so wear is not important. Important qualities of wire for EDM include smooth surfaces, free from nicks, scratches and cracks, precise diameters to ± 0.00004 inch (± 1 micron) for drawn and ± 0.00006 inch (± 2 $\mu\text{χ}\rho\text{v}$) for plated, high tensile strength, consistently good ductility, uniform spooling, and good protective packaging.

IRON AND STEEL CASTINGS

Material Properties

Cast irons and cast steels encompass a large family of ferrous alloys, which, as the name implies, are cast to shape rather than being formed by working in the solid state. In general, cast irons contain more than 2 per cent carbon and from 1 to 3 per cent silicon. Varying the balance between carbon and silicon, alloying with different elements, and changing melting, casting, and heat-treating practices can produce a broad range of properties. In most cases, the carbon exists in two forms: free carbon in the form of graphite and combined carbon in the form of iron carbide (cementite). Mechanical and physical properties depend strongly on the shape and distribution of the free graphite and the type of matrix surrounding the graphite particles.

The four basic types of cast iron are white iron, gray iron, malleable iron, and ductile iron. In addition to these basic types, there are other specific forms of cast iron to which special names have been applied, such as chilled iron, alloy iron, and compacted graphite cast iron.

Gray Cast Iron.—Gray cast iron may easily be cast into any desirable form and it may also be machined readily. It usually contains from 1.7 to 4.5 per cent carbon, and from 1 to 3 per cent silicon. The excess carbon is in the form of graphite flakes and these flakes impart to the material the dark-colored fracture which gives it its name. Gray iron castings are widely used for such applications as machine tools, automotive cylinder blocks, cast-iron pipe and fittings and agricultural implements.

The American National Standard Specifications for Gray Iron Castings—ANSI/ASTM A48-76 groups the castings into two categories. Gray iron castings in Classes 20A, 20B, 20C, 25A, 25B, 25C, 30A, 30B, 30C, 35A, 35B, and 35C are characterized by excellent machinability, high damping capacity, low modulus of elasticity, and comparative ease of manufacture. Castings in Classes 40B, 40C, 45B, 45C, 50B, 50C, 60B, and 60C are usually more difficult to machine, have lower damping capacity, higher modulus of elasticity, and are more difficult to manufacture. The prefix number indicates minimum tensile strength in pounds per square inch, i.e., 20 is 20,000 psi (138 MPa), 25 is 25,000 psi (172 MPa), 30 is 30,000 psi (207 MPa), etc.

High-strength iron castings produced by the Meehanite-controlled process may have various combinations of physical properties to meet different requirements. In addition to a number of general engineering types, there are heat-resisting, wear-resisting and corrosion-resisting Meehanite castings.

White Cast Iron.—When nearly all of the carbon in a casting is in the combined or cementite form, it is known as white cast iron. It is so named because it has a silvery-white fracture. White cast iron is very hard and also brittle; its ductility is practically zero. Castings of this material need particular attention with respect to design since sharp corners and thin sections result in material failures at the foundry. These castings are less resistant to impact loading than gray iron castings, but they have a compressive strength that is usually higher than 200,000 psi (1379 MPa) as compared to 65,000–160,000 psi (448–1103 MPa) for gray iron castings. Some white iron castings are used for applications that require maximum wear resistance but most of them are used in the production of malleable iron castings.

Chilled Cast Iron.—Many gray iron castings have wear-resisting surfaces of white cast iron. These surfaces are designated by the term “chilled cast iron” since they are produced in molds having metal chills for cooling the molten metal rapidly. This rapid cooling results in the formation of cementite and white cast iron.

Alloy Cast Iron.—This term designates castings containing alloying elements such as nickel, chromium, molybdenum, copper, and manganese in sufficient amounts to appreciably change the physical properties. These elements may be added either to increase the strength or to obtain special properties such as higher wear resistance, corrosion resistance,

or heat resistance. Alloy cast irons are used extensively for such parts as automotive cylinders, pistons, piston rings, crankcases, brake drums; for certain machine tool castings, for certain types of dies, for parts of crushing and grinding machinery, and for application where the casting must resist scaling at high temperatures. Machinable alloy cast irons having tensile strengths up to 70,000 psi (483 MPa) or even higher may be produced.

Malleable-iron Castings.—Malleable iron is produced by the annealing or graphitization of white iron castings. The graphitization in this case produces temper carbon which is graphite in the form of compact rounded aggregates. Malleable castings are used for many industrial applications where strength, ductility, machinability, and resistance to shock are important factors. In manufacturing these castings, the usual procedure is to first produce a hard, brittle white iron from a charge of pig iron and scrap. These hard white-iron castings are then placed in stationary batch-type furnaces or car-bottom furnaces and the graphitization (malleablizing) of the castings is accomplished by means of a suitable annealing heat treatment. During this annealing period the temperature is slowly (50 hours) increased to as much as 1650 or 1700°F (899 or 927°C), after which time it is slowly (60 hours) cooled. The American National Standard Specifications for Malleable Iron Castings—ANSI/ASTM A47-77 specifies the following grades and their properties: No. 32520, having a minimum tensile strength of 50,000 psi (345 MPa), a minimum yield strength of 32,500 psi (224 MPa), and a minimum elongation in 2 inches (50.8 mm) of 10 per cent; and No. 35018, having a minimum tensile strength of 53,000 psi (365 MPa), a minimum yield strength of 35,000 psi (241 MPa), and a minimum elongation in 2 inches of 18 per cent.

Cupola Malleable Iron: Another method of producing malleable iron involves initially the use of a cupola or a cupola in conjunction with an air furnace. This type of malleable iron, called cupola malleable iron, exhibits good fluidity and will produce sound castings. It is used in the making of pipe fittings, valves, and similar parts and possesses the useful property of being well suited to galvanizing. The American National Standard Specifications for Cupola Malleable Iron — ANSI/ASTM 197-79 calls for a minimum tensile strength of 40,000 pounds per square inch (276 MPa); a minimum yield strength of 30,000 psi (207 MPa); and a minimum elongation in 2 inches of 5 per cent.

Pearlitic Malleable Iron: This type of malleable iron contains some combined carbon in various forms. It may be produced either by stopping the heat treatment of regular malleable iron during production before the combined carbon contained therein has all been transformed to graphite or by reheating regular malleable iron above the transformation range. Pearlitic malleable irons exhibit a wide range of properties and are used in place of steel castings or forgings or to replace malleable iron when a greater strength or wear resistance is required. Some forms are made rigid to resist deformation while others will undergo considerable deformation before breaking. This material has been used in axle housings, differential housings, camshafts, and crankshafts for automobiles; machine parts; ordnance equipment; and tools. Tension test requirements of pearlitic malleable iron castings called for in ASTM Specification A 220-79 are given in the accompanying table.

Tension Test Requirements of Pearlitic Malleable Iron Castings ASTM A220-79

Casting Grade Numbers		40010	45008	45006	50005	60004	70003	80002	90001
Min. Tensile Strength	psi	60000	65000	65000	70000	80000	85000	95000	105000
	MPa	414	448	448	483	552	586	655	724
Min. Yield Strength	psi	40000	45000	45000	50000	60000	70000	80000	90000
	MPa	276	310	310	345	414	483	552	621
Min. Elongation in 2 Inch, %		10	8	6	5	4	3	2	1

Ductile Cast Iron.—A distinguishing feature of this widely used type of cast iron, also known as spheroidal graphite iron or nodular iron, is that the graphite is present in ball-like form instead of in flakes as in ordinary gray cast iron. The addition of small amounts of magnesium- or cerium-bearing alloys together with special processing produces this spheroidal graphite structure and results in a casting of high strength and appreciable ductility.

Its toughness is intermediate between that of cast iron and steel, and its shock resistance is comparable to ordinary grades of mild carbon steel. Melting point and fluidity are similar to those of the high-carbon cast irons. It exhibits good pressure tightness under high stress and can be welded and brazed. It can be softened by annealing or hardened by normalizing and air cooling or oil quenching and drawing.

Five grades of this iron are specified in ASTM A 536-80—Standard Specification for Ductile Iron Castings. The grades and their corresponding matrix microstructures and heat treatments are as follows: Grade 60-40-18, ferritic, may be annealed; Grade 65-45-12, mostly ferritic, as-cast or annealed; Grade 80-55-06, ferritic/pearlitic, as-cast; Grade 100-70-03, mostly pearlitic, may be normalized; Grade 120-90-02, martensitic, oil quenched and tempered. The grade nomenclature identifies the minimum tensile strength, on per cent yield strength, and per cent elongation in 2 inches. Thus, Grade 60-40-18 has a minimum tensile strength of 60,000 psi, a minimum 0.2 per cent yield strength of 40,000 psi, and minimum elongation in 2 inches of 18 per cent. Several other types are commercially available to meet specific needs. The common grades of ductile iron can also be specified by only Brinell hardness, although the appropriate microstructure for the indicated hardness is also a requirement. This method is used in SAE Specification J434C for automotive castings and similar applications. Other specifications not only specify tensile properties, but also have limitations in composition. Austenitic types with high nickel content, high corrosion resistance, and good strength at elevated temperatures, are specified in ASTM A439-80.

Ductile cast iron can be cast in molds containing metal chills if wear-resisting surfaces are desired. Hard carbide areas will form in a manner similar to the forming of areas of chilled cast iron in gray iron castings. Surface hardening by flame or induction methods is also feasible. Ductile cast iron can be machined with the same ease as gray cast iron. It finds use as crankshafts, pistons, and cylinder heads in the automotive industry; forging hammer anvils, cylinders, guides, and control levers in the heavy machinery field; and wrenches, clamp frames, face-plates, chuck bodies, and dies for forming metals in the tool and die field. The production of ductile iron castings involves complex metallurgy, the use of special melting stock, and close process control. The majority of applications of ductile iron have been made to utilize its excellent mechanical properties in combination with the castability, machinability, and corrosion resistance of gray iron.

Steel Castings.—Steel castings are especially adapted for machine parts that must withstand shocks or heavy loads. They are stronger than either wrought iron, cast iron, or malleable iron and are very tough. The steel used for making steel castings may be produced either by the open-hearth, electric arc, side-blow converter, or electric induction methods. The raw materials used are steel scrap, pig iron, and iron ore, the materials and their proportions varying according to the process and the type of furnace used. The open-hearth method is used when large tonnages are continually required while a small electric furnace might be used for steels of widely differing analyses, which are required in small lot production. The high frequency induction furnace is used for small quantity production of expensive steels of special composition such as high-alloy steels. Steel castings are used for such parts as hydroelectric turbine wheels, forging presses, gears, railroad car frames, valve bodies, pump casings, mining machinery, marine equipment, engine casings, etc.

Steel castings can generally be made from any of the many types of carbon and alloy steels produced in wrought form and respond similarly to heat treatment; they also do not exhibit directionality effects that are typical of wrought steel. Steel castings are classified into two general groups: carbon steel and alloy steel.

Carbon Steel Castings.—Carbon steel castings may be designated as low-carbon, medium-carbon, and high-carbon. Low-carbon steel castings have a carbon content of less than 0.20 per cent (most are produced in the 0.16 to 0.19 per cent range). Other elements present are: manganese, 0.50 to 0.85 per cent; silicon, 0.25 to 0.70 per cent; phosphorus, 0.05 per cent max.; and sulfur, 0.06 per cent max. Their tensile strengths (annealed condi-

tion) range from 40,000 to 70,000 pounds per square inch (276-483 MPa). Medium-carbon steel castings have a carbon content of from 0.20 to 0.50 per cent. Other elements present are: manganese, 0.50 to 1.00 per cent; silicon, 0.20 to 0.80 per cent; phosphorus, 0.05 per cent max.; and sulfur, 0.06 per cent max. Their tensile strengths range from 65,000 to 105,000 pounds per square inch (448-724 MPa) depending, in part, upon heat treatment. High-carbon steel castings have a carbon content of more than 0.50 per cent and also contain: manganese, 0.50 to 1.00 per cent; silicon, 0.20 to 0.70 per cent; and phosphorus and sulfur, 0.05 per cent max. each. Fully annealed high-carbon steel castings exhibit tensile strengths of from 95,000 to 125,000 pounds per square inch (655-125 MPa). See [Table 1](#) for grades and properties of carbon steel castings.

Table 1. Mechanical Properties of Steel Castings

Tensile Strength, ksi (MPa)	Yield Point, ksi (MPa)	Elongation in 2 Inch, Per Cent	Brinell Hardness Number	Type of Heat Treatment	Application Indicating Properties
Structural Grades of Carbon Steel Castings					
60 (414)	30 (207)	32	120	Annealed	Low electric resistivity. Desirable magnetic properties. Carburizing and case hardening grades. Weldability.
65 (448) 70 (483)	35 (241) 38 (262)	30 28	130 140	Normalized Normalized	Good weldability. Medium strength with good machinability and high ductility.
80 (552) 85 (586)	45 (310) 50 (345)	26 24	160 175	Normalized and tempered	High strength carbon steels with good machinability, toughness and good fatigue resistance.
100 (689)	70 (483)	20	200	Quenched and tempered	Wear resistance. Hardness.
Engineering Grades of Low Alloy Steel Castings					
70 (483) 80 (552)	45 (310) 50 (345)	26 24	150 170	Normalized and tempered	Good weldability. Medium strength with high toughness and good machinability. For high temperature service.
90 (621) 100 (689)	60 (414) 68 (469)	22 20	190 209	Normalized and tempered ^a	Certain steels of these classes have good high temperature properties and deep hardening properties. Toughness.
110 (758) 120 (827)	85 (586) 95 (655)	20 16	235 245	Quenched and tempered	Impact resistance. Good low temperature properties for certain steels. Deep hardening. Good combination of strength and toughness.
150 (1034)	125 (862)	12	300	Quenched and tempered	Deep hardening. High strength. Wear and fatigue resistance.
175 (1207) 200 (1379)	148 (1020) 170 (1172)	8 5	340 400	Quenched and tempered	High strength and hardness. Wear resistance. High fatigue resistance.

For general information only. Not for use as design or specification limit values. The values listed above have been compiled by the Steel Founders' Society of America as those normally expected in the production of steel castings. The castings are classified according to tensile strength values which are given in the first column. Specifications covering steel castings are prepared by the American Society for Testing and Materials, the Association of American Railroads, the Society of Automotive Engineers, the United States Government (Federal and Military Specifications), etc. These specifications appear in publications issued by these organizations.

ksi = kips per square inch = 1000s of pounds per square inch; MPa = megapascals.

^a Quench and temper heat treatments may also be employed for these classes.

Alloy Steel Castings.—Alloy cast steels are those in which special alloying elements such as manganese, chromium, nickel, molybdenum, vanadium have been added in sufficient quantities to obtain or increase certain desirable properties. Alloy cast steels are comprised of two groups—the low-alloy steels with their alloy content totaling less than 8 per cent and the high-alloy steels with their alloy content totaling 8 per cent or more. The addition of these various alloying elements in conjunction with suitable heat-treatments, makes it possible to secure steel castings having a wide range of properties. The three accompanying tables give information on these steels. The lower portion of [Table 1](#) gives the engineering grades of low-alloy cast steels grouped according to tensile strengths and gives properties normally expected in the production of steel castings. [Tables 2](#) and [3](#) give the standard designations and nominal chemical composition ranges of high-alloy castings

which may be classified according to heat or corrosion resistance. The grades given in these tables are recognized in whole or in part by the Alloy Casting Institute (ACI), the American Society for Testing and Materials (ASTM), and the Society of Automotive Engineers (SAE).

Table 2. Nominal Chemical Composition and Mechanical Properties of Heat-Resistant Steel Castings ASTM A297-81

Grade	Nominal Chemical Composition, Per Cent ^a	Tensile Strength, min		0.2 Per Cent Yield Strength, min		Per Cent Elongation in 2 inch, or 50 mm, min.
		ksi	MPa	ksi	MPa	
HF	19 Chromium, 9 Nickel	70	485	35	240	25
HH	25 Chromium, 12 Nickel	75	515	35	240	10
HI	28 Chromium, 15 Nickel	70	485	35	240	10
HK	25 Chromium, 20 Nickel	65	450	35	240	10
HE	29 Chromium, 9 Nickel	85	585	40	275	9
HT	15 Chromium, 35 Nickel	65	450	4
HU	19 Chromium, 39 Nickel	65	450	4
HW	12 Chromium, 60 Nickel	60	415
HX	17 Chromium, 66 Nickel	60	415
HC	28 Chromium	55	380
HD	28 Chromium, 5 Nickel	75	515	35	240	8
HL	29 Chromium, 20 Nickel	65	450	35	240	10
HN	20 Chromium, 25 Nickel	63	435	8
HP	26 Chromium, 35 Nickel	62.5	430	34	235	4.5

ksi = kips per square inch = 1000s of pounds per square inch; MPa = megapascals.

^aRemainder is iron.

The specifications committee of the Steel Founders Society issues a *Steel Castings Handbook* with supplements. Supplement 1 provides design rules and data based on the fluidity and solidification of steel, mechanical principles involved in production of molds and cores, cleaning of castings, machining, and functionality and weight aspects. Data and examples are included to show how these rules are applied. Supplement 2 summarizes the standard steel castings specification issued by the ASTM SAE, Assoc. of Am. Railroads (AAR), Am. Bur of Shipping (ABS), and Federal authorities, and provides guidance as to their applications. Information is included for carbon and alloy cast steels, high alloy cast steels, and centrifugally cast steel pipe. Details are also given of standard test methods for steel castings, including mechanical, non-destructive (visual, liquid penetrant, magnetic particle, radiographic, and ultrasonic), and testing of qualifications of welding procedures and personnel. Other supplements cover such subjects as tolerances, drafting practices, properties, repair and fabrication welding, of carbon, low alloy and high alloy castings, foundry terms, and hardenability and heat treatment.

Austenitic Manganese Cast Steel: Austenitic manganese cast steel is an important high-alloy cast steel which provides a high degree of shock and wear resistance. Its composition normally falls within the following ranges: carbon, 1.00 to 1.40 per cent; manganese, 10.00 to 14.00 per cent; silicon, 0.30 to 1.00 per cent; sulfur, 0.06 per cent max.; phosphorus, 0.10 per cent, max. In the as-cast condition, austenitic manganese steel is quite brittle. In order to strengthen and toughen the steel, it is heated to between 1830 and 1940°F (999 and 1060°C) and quenched in cold water. Physical properties of quenched austenitic manganese steel that has been cast to size are as follows: tensile strength, 80,000-100,000 psi (552–689 MPa); shear strength (single shear), 84,000 psi (579 MPa); elongation in 2 inches (50.8 mm), 15 to 35 per cent; reduction in area, 15 to 35 per cent; and Brinell hardness number, 180 to 220. When cold worked, the surface of such a casting increases to a Brinell hardness of from 450 to 550. In many cases the surfaces are cold worked to maximum hardness to assure immediate hardness in use. Heat-treated austenitic manganese

Table 3. Nominal Chemical Composition and Mechanical Properties of Corrosion-Resistant Steel Castings ASTM A743-81a

Grade	Nominal Chemical Composition, Per Cent ^a	Tensile Strength, min		0.2% Yield Strength, min		Per Cent Elongation in 2 inch, or 50 mm, min	Per Cent Reduction of Area, min
		ksi	MPa	ksi	MPa		
CF-8	9 Chromium, 9 Nickel	70 ^b	485 ^b	30 ^b	205 ^b	35	...
CG-12	22 Chromium, 12 Nickel	70	485	28	195	35	...
CF-20	19 Chromium, 9 Nickel	70	485	30	205	30	...
CF-8M	19 Chromium, 10 Nickel, with Molybdenum	70	485	30	205	30	...
CF-8C	19 Chromium, 10 Nickel with Niobium	70	485	30	205	30	...
CF-16, CF-16Fa	19 Chromium, 9 Nickel, Free Machining	70	485	30	205	25	...
CH-20, CH-10	25 Chromium, 12 Nickel	70	485	30	205	30	...
CK-20	25 Chromium, 20 Nickel	65	450	28	195	30	...
CE-30	29 Chromium, 9 Nickel	80	550	40	275	10	...
CA-15, CA-15M	12 Chromium	90	620	65	450	18	30
CB-30	20 Chromium	65	450	30	205
CC-50	28 Chromium	55	380
CA-40	12 Chromium	100	690	70	485	15	25
CF-3	19 Chromium, 9 Nickel	70	485	30	205	35	...
CF-3M	19 Chromium, 10 Nickel, with Molybdenum	70	485	30	205	30	...
CG6MMN	Chromium-Nickel-Manganese -Molybdenum	75	515	35	240	30	...
CG-8M	19 Chromium, 11 Nickel, with Molybdenum	75	520	35	240	25	...
CN-7M	20 Chromium, 29 Nickel, with Copper and Molybdenum	62	425	25	170	35	...
CN-7MS	19 Chromium, 24 Nickel, with Copper and Molybdenum	70	485	30	205	35	...
CW-12M	Nickel, Molybdenum, Chromium	72	495	46	315	4.0	...
CY-40	Nickel, Chromium, Iron	70	485	28	195	30	...
CZ-100	Nickel Alloy	50	345	18	125	10	...
M-35-1	Nickel-Copper Alloy	65	450	25	170	25	...
M-35-2	Nickel-Copper Alloy	65	450	30	205	25	...
CA-6NM	12 Chromium, 4 Nickel	110	755	80	550	15	35
CD-4MCu	25 Chromium, 5 Nickel, 2 Molybdenum, 3 Copper	100	690	70	485	16	...
CA-6N	11 Chromium, 7 Nickel	140	965	135	930	15	50

^a Remainder is iron.

^b For low ferrite or non-magnetic castings of this grade, the following values shall apply: tensile strength, min, 65 ksi (450 MPa); yield point, min, 28 ksi (195 MPa).

steel is machined only with great difficulty since it hardens at and slightly ahead of the point of contact of the cutting tool. Grinding wheels mounted on specially adapted machines are used for boring, planing, keyway cutting, and similar operations on this steel. Where grinding cannot be employed and machining must be resorted to, high-speed tool steel or cemented carbide tools are used with heavy, rigid equipment and slow, steady operation. In any event, this procedure tends to be both tedious and expensive. Austenitic manganese cast steel can be arc-welded with manganese-nickel steel welding rods containing from 3 to 5 per cent nickel, 10 to 15 per cent manganese, and, usually, 0.60 to 0.80 per cent carbon.

Casting of Metals

Definitions.—Molten metals are shaped by pouring (casting) into a mold of the required form, which they enter under gravity, centrifugal force, or various degrees of pressure. Molds are made of refractory materials like sand, plaster, graphite, or metal. Sand molds are formed around a pattern or replica of the part to be made, usually of wood though plastics or metal may be used when large numbers of molds for similar parts are to be made.

Green-sand molding is used for most sand castings, sand mixed with a binder being packed around the pattern by hand, with power tools, or in a vibrating machine which may also exert a compressive force to pack the grains more closely. The term “green-sand”

implies that the binder is not cured by heating or chemical reactions. The pattern is made in two “halves,” which usually are attached to opposite sides of a flat plate. Shaped bars and other projections are fastened to the plate to form connecting channels and funnels in the sand for entry of the molten metal into the casting cavities. The sand is supported at the plate edges by a box-shaped frame or flask, with locating tabs that align the two mold halves when they are later assembled for the pouring operation.

Hollows and undercut surfaces in the casting are produced by cores, also made from sand, that are placed in position before the mold is closed, and held in place by tenons in grooves (called prints) formed in the sand by pattern projections. An *undercut surface* is one from which the pattern cannot be withdrawn in a straight line, so must be formed by a core in the mold. When the poured metal has solidified, the frame is removed and the sand falls or is cleaned off, leaving the finished casting(s) ready to be cut from the runners.

Gray iron is easily cast in complex shapes in green-sand and other molds and can be machined readily. The iron usually contains carbon, 1.7–4.5, and silicon, 1–3 per cent by weight. Excess carbon in the form of graphite flakes produces the gray surface from which the name is derived, when a casting is fractured.

Shell molding invented by a German engineer, Croning, uses a resin binder to lock the grains of sand in a $\frac{1}{4}$ - to $\frac{3}{8}$ -inch (6.4–9.5mm)-thick layer of sand/resin mixture, which adheres to a heated pattern plate after the mass of the mixture has been dumped back into the container. The hot resin quickly hardens enough to make the shell thus formed sufficiently rigid to be removed from the pattern, producing a half mold. The other half mold is produced on another plate by the same method. Pattern projections form runner channels, basins, core prints, and locating tenons in each mold half. Cores are inserted to form internal passages and undercuts. The shell assembly is placed in a molding box and supported with some other material such as steel shot or a coarse sand, when the molten metal is to be poured in. Some shell molds are strong enough to be filled without backup, and the two mold halves are merely clamped together for metal to be poured in to make the casting(s).

V-Process is a method whereby dry, unbonded sand is held to the shape of a pattern by a vacuum. The pattern is provided with multiple vent passages that terminate in various positions all over its surface, and are connected to a common plenum chamber. A heat-softened, 0.002–0.005 inch (51–127 mm) thick plastics film is draped over the pattern and a vacuum of 200–400 mm of mercury is applied to the chamber, sucking out the air beneath the film so that the plastics is drawn into close contact with the pattern. A sand box or flask with walls that also contain hollow chambers and a flat grid that spans the central area is placed on the pattern plate to confine the dry unbonded sand that is allowed to fall through the grid on to the pattern.

After vibration to compact the sand around the pattern, a former is used to shape a sprue cup into the upper surface of the sand, connecting with a riser on the pattern, and the top surface of the sand is covered with a plastics film that extends over the flask sides. The hollow chambers in the flask walls are then connected to the vacuum source. The vacuum is sufficient to hold the sand grains in their packed condition between the plastics films above and beneath, firmly in the shape defined by the pattern, so that the flask and the sand half-mold can be lifted from the pattern plate. Matching half molds made by these procedures are assembled into a complete mold, with cores inserted if needed. With both mold halves still held by vacuum, molten metal is poured through the sprue cup into the mold, the plastics film between the mold surfaces being melted and evaporated by the hot metal. After solidification, the vacuum is released and the sand, together with the casting(s), falls from the mold flasks. The castings emerge cleanly, and the sand needs only to be cooled before reuse.

Permanent mold, or gravity die, casting is mainly used for nonferrous metals and alloys. The mold (or die) is usually iron or steel, or graphite, and is cooled by water channels or by air jets on the outer surfaces. Cavity surfaces in metal dies are coated with a thin layer of

heat-resistant material. The mold or die design is usually in two halves, although many multiple-part molds are in use, with loose sand or metal cores to form undercut surfaces. The cast metal is simply poured into a funnel formed in the top of the mold, although elaborate tilting mechanisms are often used to control the passage of metal into (and emergence of air from) the remote portions of die cavities.

Because the die temperature varies during the casting cycle, its dimensions vary correspondingly. The die is opened and ejectors push the casting(s) out as soon as its temperature is low enough for sufficient strength to build up. During the period after solidification and before ejection, cooling continues but shrinkage of the casting(s) is restricted by the die. The alloy being cast must be sufficiently ductile to accommodate these restrictions without fracturing. An alloy that tears or splits during cooling in the die is said to be *hot short* and cannot be cast in rigid molds. Dimensions of the casting(s) at shop temperatures will be related to the die temperature and the dimensions at ejection. Rules for casting shrinkage that apply to friable (sand) molds do not hold for rigid molds. Designers of metal molds and dies rely on temperature-based calculations and experience in evolving shrinkage allowances.

Low-pressure casting uses mold or die designs similar to those for gravity casting. The container (crucible) for the molten metal has provision for an airtight seal with the mold, and when gas or air pressure (6–10 lb/in² or 41.37–68.95 kPa) is applied to the bath surface inside the crucible, the metal is forced up a hollow refractory tube (stalk) projecting from the die underside. This stalk extends below the bath level so that metal entering the die is free from oxides and impurities floating on the surface. The rate of filling is controlled so that air can be expelled from the die by the entering metal. With good design and control, high-quality, nonporous castings are made by both gravity and low-pressure methods, though the extra pressure in low-pressure die casting may increase the density and improve the reproduction of fine detail in the die.

Squeeze casting uses a metal die, of which one half is clamped to the bed of a large (usually) hydraulic press and the other to the vertically moving ram of the press. Molten metal is poured into the lower die and the upper die is brought down until the die is closed. The amount of metal in the die is controlled to produce a slight overflow as the die closes to ensure complete filling of the cavity. The heated dies are lubricated with graphite and pressures up to 25 tons/in² (345 MPa) may be applied by the press to squeeze the molten metal into the tiniest recesses in the die. When the press is opened, the solidified casting is pushed out by ejectors.

Finishing Operations for Castings

Removal of Gates and Risers from Castings.—After the molten iron or steel has solidified and cooled, the castings are removed from their molds, either manually or by placing them on vibratory machines and shaking the sand loose from the castings. The gates and risers that are not broken off in the shake-out are removed by impact, sawing, shearing, or burning-off methods. In the impact method, a hammer is used to knock off the gates and risers. Where the possibility exists that the fracture would extend into the casting itself, the gates or risers are first notched to assure fracture in the proper place. Some risers have a necked-down section at which the riser breaks off when struck. Sprue-cutter machines are also used to shear off gates. These machines facilitate the removal of a number of small castings from a central runner. Band saws, power saws, and abrasive cut-off wheel machines are also used to remove gates and risers. The use of band saws permits following the contour of the casting when removing unwanted appendages. Abrasive cut-off wheels are used when the castings are too hard or difficult to saw. Oxyacetylene cutting torches are used to cut off gates and risers and to gouge out or remove surface defects on castings. These torches are used on steel castings where the gates and risers are of a relatively large size. Surface defects are subsequently repaired by conventional welding methods.

Any unwanted material in the form of fins, gates, and riser pads that come above the casting surface, chaplets, parting-line flash, etc., is removed by chipping with pneumatic hammers, or by grinding with such equipment as floor or bench-stand grinders, portable grinders, and swing-frame grinders.

Blast Cleaning of Castings.—Blast cleaning of castings is performed to remove adhering sand, to remove cores, to improve the casting appearance, and to prepare the castings for their final finishing operation, which includes painting, machining, or assembling. Scale produced as a result of heat treating can also be removed. A variety of machines are used to handle all sizes of casting. The methods employed include blasting with sand, metal shot, or grit; and hydraulic cleaning or tumbling. In blasting, sharp sand, shot, or grit is carried by a stream of compressed air or water or by centrifugal force (gained as a result of whirling in a rapidly rotating machine) and directed against the casting surface by means of nozzles. The operation is usually performed in cabinets or enclosed booths. In some setups the castings are placed on a revolving table and the abrasive from the nozzles that are either mechanically or hand-held is directed against all the casting surfaces. Tumbling machines are also employed for cleaning, the castings being placed in large revolving drums together with slugs, balls, pins, metal punchings, or some abrasive, such as sandstone or granite chips, slag, silica, sand, or pumice. Quite frequently, the tumbling and blasting methods are used together, the parts then being tumbled and blasted simultaneously. Castings may also be cleaned by hydroblasting. This method uses a water-tight room in which a mixture of water and sand under high pressure is directed at the castings by means of nozzles. The action of the water and sand mixture cleans the castings very effectively.

Heat Treatment of Steel Castings.—Steel castings can be heat treated to bring about diffusion of carbon or alloying elements, softening, hardening, stress-relieving, toughening, improved machinability, increased wear resistance, and removal of hydrogen entrapped at the surface of the casting. Heat treatment of steel castings of a given composition follows closely that of wrought steel of similar composition. For discussion of types of heat treatment refer to *Heat Treatment Of Standard Steels* starting on page 461 of this Handbook.

Estimating Casting Weight.—Where no pattern or die has yet been made, as when preparing a quotation for making a casting, the weight of a cast component can be estimated with fair accuracy by calculating the volume of each of the casting features, such as box- or rectangular-section features, cylindrical bosses, housings, ribs, and other parts, and adding them together. Several computer programs, also measuring mechanisms that can be applied to a drawing, are available to assist with these calculations. When the volume of metal has been determined it is necessary only to multiply by the unit weight of the alloy to be used, to arrive at the weight of the finished casting. The cost of the metal in the finished casting can then be estimated by multiplying the weight in lb by the cost/lb of the alloy. Allowances for melting losses, and for the extra metal used in risers and runners, and the cost of melting and machining may also be added to the cost/lb. Estimates of the costs of pattern- or die-making, molding, pouring and finishing of the casting(s), may also be added, to complete the quotation estimate.

Pattern Materials—Shrinkage, Draft, and Finish Allowances

Woods for Patterns.—Woods commonly used for patterns are white pine, mahogany, cherry, maple, birch, white wood, and fir. For most patterns, white pine is considered superior because it is easily worked, readily takes glue and varnish, and is fairly durable. For medium- and small-sized patterns, especially if they are to be used extensively, a harder wood is preferable. Mahogany is often used for patterns of this class, although many prefer cherry. As mahogany has a close grain, it is not as susceptible to atmospheric changes as a wood of coarser grain. Mahogany is superior in this respect to cherry, but is more expensive. In selecting cherry, never use young timber. Maple and birch are employed quite extensively, especially for turned parts, as they take a good finish. White wood is some-

times substituted for pine, but it is inferior to the latter in being more susceptible to atmospheric changes.

Selection of Wood.—It is very important to select well-seasoned wood for patterns; that is, it should either be kiln-dried or kept 1 or 2 years before using, the time depending upon the size of the lumber. During the seasoning or drying process, the moisture leaves the wood cells and the wood shrinks, the shrinkage being almost entirely across the grain rather than in a lengthwise direction. Naturally, after this change takes place, the wood is less liable to warp, although it will absorb moisture in damp weather. Patterns also tend to absorb moisture from the damp sand of molds, and to minimize troubles from this source they are covered with varnish. Green or water-soaked lumber should not be put in a drying room, because the ends will dry out faster than the rest of the log, thus causing cracks. In a log, there is what is called “sap wood” and “heart wood.” The outer layers form the sap wood, which is not as firm as the heart wood and is more likely to warp; hence, it should be avoided, if possible.

Pattern Varnish.—Patterns intended for repeated use are varnished to protect them against moisture, especially when in the damp molding sand. The varnish used should dry quickly to give a smooth surface that readily draws from the sand. Yellow shellac varnish is generally used. It is made by dissolving gum shellac in grain alcohol. Wood alcohol is sometimes substituted, but is inferior. The color of the varnish is commonly changed for covering core prints, in order that the prints may be readily distinguished from the body of the pattern. Black shellac varnish is generally used. At least three coats of varnish should be applied to patterns, the surfaces being rubbed down with sandpaper after applying the preliminary coats, in order to obtain a smooth surface.

Shrinkage Allowances.—The shrinkage allowances ordinarily specified for patterns to compensate for the contraction of castings in cooling are as follows: cast iron, $\frac{3}{32}$ – $\frac{1}{8}$ inch/ft (7.8–10.4 mm/m); common brass, $\frac{3}{16}$ inch/ft (15.6 mm/m); yellow brass, $\frac{7}{32}$ inch/ft (18.23 mm/m); bronze, $\frac{5}{32}$ inch/ft (13 mm/m); aluminum, $\frac{1}{8}$ – $\frac{5}{32}$ inch/ft (10.42–13.02 mm/m); magnesium, $\frac{1}{8}$ – $\frac{11}{64}$ inch/ft (10.42–14.32 mm/m); steel, $\frac{3}{16}$ inch/ft (15.62 mm/m). These shrinkage allowances are approximate values only because the exact allowance depends upon the size and shape of the casting and the resistance of the mold to the normal contraction of the casting during cooling. It is, therefore, possible that more than one shrinkage allowance will be required for different parts of the same pattern. Another factor that affects shrinkage allowance is the molding method, which may vary to such an extent from one foundry to another, that different shrinkage allowances for each would have to be used for the same pattern. For these reasons it is recommended that patterns be made at the foundry where the castings are to be produced to eliminate difficulties due to lack of accurate knowledge of shrinkage requirements.

An example of how casting shape can affect shrinkage allowance is given in the Steel Castings Handbook. In this example a straight round steel bar required a shrinkage allowance of approximately $\frac{9}{32}$ inch/ft (23.4 mm/m). The same bar but with a large knob on each end required a shrinkage allowance of only $\frac{3}{16}$ inch/ft (15.6 mm/m). A third steel bar with large flanges at each end required a shrinkage allowance of only $\frac{7}{64}$ inch/ft (9.1 mm/m). This example would seem to indicate that the best practice in designing castings and making patterns is to obtain shrinkage values from the foundry that is to make the casting because there can be no fixed allowances.

Metal Patterns.—Metal patterns are especially adapted to molding machine practice, owing to their durability and superiority in retaining the required shape. The original master pattern is generally made of wood, the casting obtained from the wood pattern being finished to make the metal pattern. The materials commonly used are brass, cast iron, aluminum, and steel. Brass patterns should have a rather large percentage of tin, to improve the casting surface. Cast iron is generally used for large patterns because it is cheaper than

brass and more durable. Cast-iron patterns are largely used on molding machines. Aluminum patterns are light but they require large shrinkage allowances. White metal is sometimes used when it is necessary to avoid shrinkage. The gates for the mold may be cast or made of sheet brass. Some patterns are made of vulcanized rubber, especially for light match-board work.

Obtaining Weight of Casting from Pattern Weight.—To obtain the approximate weight of a casting, multiply the weight of the pattern by the factor given in the accompanying table. For example, if the weight of a white-pine pattern is 4 pounds what is the weight of a solid cast-iron casting obtained from that pattern? Casting weight = $4 \times 16 = 64$ pounds. If the casting is cored, fill the core-boxes with dry sand, and multiply the weight of the sand by one of the following factors: For cast iron, 4; for brass, 4.65; for aluminum, 1.4. Then subtract the product of the sand weight and the factor just given from the weight of the solid casting, to obtain the weight of the cored casting. The weight of wood varies considerably, so the results obtained by the use of the table are only approximate, the factors being based on the average weight of the woods listed. For metal patterns, the results may be more accurate.

Factors for Obtaining Weight of Casting from Pattern Weight

Pattern Material	Factors				
	Cast Iron	Aluminum	Copper	Zinc	Brass: 70% Copper, 30% Zinc
White pine	16.00	5.70	19.60	15.00	19.00
Mahogany, Honduras	12.00	4.50	14.70	11.50	14.00
Cherry	10.50	3.80	13.00	10.00	12.50
Cast Iron	1.00	0.35	1.22	0.95	1.17
Aluminum	2.85	1.00	3.44	2.70	3.30

Die Casting

Die casting is a method of producing finished castings by forcing molten metal into a hard metal die, which is arranged to open after the metal has solidified so that the casting can be removed. The die-casting process makes it possible to secure accuracy and uniformity in castings, and machining costs are either eliminated altogether or are greatly reduced. The greatest advantage of the die-casting process is that parts are accurately and often completely finished when taken from the die. When the dies are properly made, castings may be accurate within 0.001 inch (25.4 μm) or even less and a limit of 0.002 or 0.003 inch/inch (or mm/mm) of casting dimension can be maintained on many classes of work.

Die castings are used extensively in the manufacture of such products as cash registers, meters, time-controlling devices, small housings, washing machines, and parts for a great variety of mechanisms. Lugs and gear teeth are cast in place and both external and internal screw threads can be cast. Holes can be formed within about 0.001 inch (25.4 μm) of size and the most accurate bearings require only a finish-reaming operation. Figures and letters may be cast sunken or in relief on wheels for counting or printing devices, and with ingenious die designs, many shapes that formerly were believed too intricate for die casting are now produced successfully by this process.

Die casting uses hardened steel molds (dies) into which the molten metal is injected at high speed, reaching pressures up to 10 tons/in² (152 MPa), force being applied by a hydraulically actuated plunger moving in a cylindrical pressure chamber connected to the die cavity(s). If the plan area of the casting and its runner system cover 50 in² (322.6 cm²), the total power applied is 10 tons/in² of pressure on the metal \times 50 in² of projected area, producing a force of 500 tons, and the die-casting machine must hold the die shut against this force. Massive toggle mechanisms stretch the heavy 6-in (15.24 cm) diameter steel tie bars through about 0.045 inch (1.14 mm) on a typical (500-ton) machine to generate this force. Although the die is hot, metal entering the die cavity is cooled quickly, producing layers of rapidly chilled, dense material about 0.015 inch (0.38 mm) thick in the metal hav-

ing direct contact with the die cavity surfaces. Because the high injection forces allow castings to be made with thin walls, these dense layers form a large proportion of the total wall thickness, producing high casting strength. This phenomenon is known as the skin effect, and should be taken into account when considering the tensile strengths and other properties measured in (usually thicker) test bars.

As to the limitations of the die-casting process it may be mentioned that the cost of dies is high, and, therefore, die casting is economical only when large numbers of duplicate parts are required. The stronger and harder metals cannot be die cast, so that the process is not applicable for casting parts that must necessarily be made of iron or steel, although special alloys have been developed for die casting that have considerable tensile and compressive strength.

Many die castings are produced by the hot-chamber method in which the pressure chamber connected to the die cavity is immersed permanently in the molten metal and is automatically refilled through a hole that is uncovered as the (vertical) pressure plunger moves back after filling the die. This method can be used for alloys of low melting point and high fluidity such as zinc, lead, tin, and magnesium. Other alloys requiring higher pressure, such as brass, or that can attack and dissolve the ferrous pressure chamber material, such as aluminum, must use the slower cold-chamber method with a water-cooled (horizontal) pressure chamber outside the molten metal.

Porosity.—Molten metal injected into a die cavity displaces most of the air, but some of the air is trapped and is mixed with the metal. The high pressure applied to the metal squeezes the pores containing the air to very small size, but subsequent heating will soften the casting so that air in the surface pores can expand and cause blisters. Die castings are seldom solution heat treated or welded because of this blistering problem. The chilling effect of the comparatively cold die causes the outer layers of a die casting to be dense and relatively free of porosity. Vacuum die casting, in which the cavity atmosphere is evacuated before metal is injected, is sometimes used to reduce porosity. Another method is to displace the air by filling the cavity with oxygen just prior to injection. The oxygen is burned by the hot metal so that porosity does not occur.

When these special methods are not used, machining depths must be limited to 0.020–0.035 inch (0.50–0.89 mm) if pores are not to be exposed, but as-cast accuracy is usually good enough for only light finishing cuts to be needed. Special pore-sealing techniques must be used if pressure tightness is required.

Designing Die Castings.—Die castings are best designed with uniform wall thicknesses (to reduce cooling stresses) and cores of simple shapes (to facilitate extraction from the die). Heavy sections should be avoided or cored out to reduce metal concentrations that may attract trapped gases and cause porosity concentrations. Designs should aim at arranging for metal to travel through thick sections to reach thin ones if possible. Because of the high metal injection pressures, conventional sand cores cannot be used, so cored holes and apertures are made by metal cores that form part of the die. Small and slender cores are easily bent or broken, so should be avoided in favor of piercing or drilling operations on the finished castings. Ribbing adds strength to thin sections, and fillets should be used on all inside corners to avoid high stress concentrations in the castings. Sharp outside corners should be avoided. Draft allowances on a die casting are usually from 0.5 to 1.5 degrees per side to permit the castings to be pushed off cores or out of the cavity.

Alloys Used for Die Casting.—The alloys used in modern die-casting practice are based on aluminum, zinc, and copper, with small numbers of castings also being made from magnesium, tin, and lead based alloys.

Aluminum-Base Alloys.—Aluminum-base die-casting alloys are used more extensively than any other base metal alloy because of their superior strength combined with ease of castability. Linear shrinkage of aluminum alloys on cooling is about 12.9 to 15.5×10^{-6} inch/inch-°F. Casting temperatures are of the order of 1200°F (649°C). Most aluminum

die castings are produced in aluminum-silicon-copper alloys such as the Aluminum Association (AA) No. 380 (ASTM SC84A; UNS A038000), containing silicon 7.5 to 9.5 and copper 3 to 4 per cent. Silicon increases fluidity for complete die filling, but reduces machinability, and copper adds hardness but reduces ductility in aluminum alloys. A less-used alloy having slightly greater fluidity is AA No. 384 (ASTM SC114A; UNS A03840) containing silicon 10.5 to 12.0 and copper 3.0 to 4.5 per cent. For marine applications, AA 360 (ASTM 100A; UNS A03600) containing silicon 9 to 10 and copper 0.6 per cent is recommended, the copper content being kept low to reduce susceptibility to corrosion in salt atmospheres. The tensile strengths of AA 380, 384, and 360 alloys are 47,000, 48,000, and 46,000 lb/in² (324, 331, and 317 MPa), respectively. Although 380, 384, and 360 are the most widely used die-castable alloys, several other aluminum alloys are used for special applications. For instance, the AA 390 alloy, with its high silicon content (16 to 18 per cent), is used for internal combustion engine cylinder castings, to take advantage of the good wear resistance provided by the hard silicon grains. No. 390 alloy also contains 4 to 5 per cent copper, and has a hardness of 120 Brinell with low ductility, and a tensile strength of 41,000 lb/in² (283 MPa).

Zinc-Base Alloys.—In the molten state, zinc is extremely fluid and can therefore be cast into very intricate shapes. The metal also is plentiful and has good mechanical properties. Zinc die castings can be made to closer dimensional limits and with thinner walls than aluminum. Linear shrinkage of these alloys on cooling is about 9 to 13×10^{-6} in/in-°F. The low casting temperatures (750–800°F or 399–427°C) and the hot-chamber process allow high production rates with simple automation. Zinc die castings can be produced with extremely smooth surfaces, lending themselves well to plating and other finishing methods. The established zinc alloys numbered 3, 5 and 7 [ASTM B86 (AG40A; UNS Z33520), AG41A (UNS Z35531), and AG40B (UNS Z33522)] each contains 3.5 to 4.3 per cent of aluminum, which adds strength and hardness, plus carefully controlled amounts of other elements. Recent research has brought forward three new alloys of zinc containing 8, 12, and 27 per cent of aluminum, which confer tensile strength of 50,000–62,000 lb/in² (345–427 MPa) and hardness approaching that of cast iron (105–125 Brinell). These alloys can be used for gears and racks, for instance, and as housings for shafts that run directly in reamed or bored holes, with no need for bearing bushes.

Copper-Base Alloys.—Brass alloys are used for plumbing, electrical, and marine components where resistance to corrosion must be combined with strength and wear resistance. With the development of the cold-chamber casting process, it became possible to make die castings from several standard alloys of copper and zinc such as yellow brass (ASTM B176-Z30A; UNS C85800) containing copper 58, zinc 40, tin 1, and lead 1 per cent. Tin and lead are included to improve corrosion resistance and machinability, respectively, and this alloy has a tensile strength of 45,000 lb/in² (310 MPa). Silicon brass (ASTM B176-ZS331A; UNS C87800) with copper 65 and zinc 34 per cent also contains 1 per cent silicon, giving it more fluidity for castability and with higher tensile strength (58,000 psi or 400 MPa) and better resistance to corrosion. High silicon brass or tombasil (ASTM B176-ZS144A), containing copper 82, zinc 14, and silicon 4 per cent, has a tensile strength of 70,000 lb/in² (483 MPa) and good wear resistance, but at the expense of machinability.

Magnesium-Base Alloys.—Light weight combined with good mechanical properties and excellent damping characteristics are principal reasons for using magnesium die castings. Magnesium has a low specific heat and does not dissolve iron so it may be die cast by the cold- or hot-chamber methods. For the same reasons, die life is usually much longer than for aluminum. The lower specific heat and more rapid solidification make production about 50 per cent faster than with aluminum. To prevent oxidation, an atmosphere of CO₂ and air, containing about 0.5 per cent of SF₆ gas, is used to exclude oxygen from the surface of the molten metal. The most widely used alloy is AZ91D (ASTM B94; UNS 11916), a high-purity alloy containing aluminum 9 and zinc 0.7 per cent, and having a yield strength

of 23,000 lb/in² (Table 8a on page 546). AZ91D has a corrosion rate similar to that of 380 aluminum (see *Aluminum-Base Alloys* on page 1415).

Tin-Base Alloys.—In this group tin is alloyed with copper, antimony, and lead. SAE Alloy No. 10 contains, as the principal ingredients, in percentages, tin, 90; copper, 4 to 5; antimony, 4 to 5; lead, maximum, 0.35. This high-quality babbitt mixture is used for main-shaft and connecting-rod bearings or bronze-backed bearings in the automotive and aircraft industries. SAE No. 110 contains tin, 87.75; antimony, 7.0 to 8.5; copper, maximum, 2.25 to 3.75 per cent and other constituents the same as No. 10. SAE No. 11, which contains a little more copper and antimony and about 4 per cent less tin than No. 10, is also used for bearings or other applications requiring a high-class tin-base alloy. These tin-base compositions are used chiefly for automotive bearings but they are also used for milking machines, soda fountains, syrup pumps, and similar apparatus requiring resistance against the action of acids, alkalies, and moisture.

Lead-Base Alloys.—These alloys are employed usually where a cheap noncorrosive metal is needed and strength is relatively unimportant. Such alloys are used for parts of lead-acid batteries, for automobile wheel balancing weights, for parts that must withstand the action of strong mineral acids and for parts of X-ray apparatus. SAE Composition No. 13 contains (in percentages) lead, 86; antimony, 9.25 to 10.75; tin, 4.5 to 5.5 per cent. SAE Specification No. 14 contains less lead and more antimony and copper. The lead content is 76; antimony, 14 to 16; and tin, 9.25 to 10.75 per cent. Alloys Nos. 13 and 14 are inexpensive owing to the high lead content and may be used for bearings that are large and subjected to light service.

Dies for Die-Casting Machines.—Dies for die-casting machines are generally made of steel although cast iron and nonmetallic materials of a refractory nature have been used, the latter intended especially for bronze or brass castings, which, owing to their comparatively high melting temperatures, would damage ordinary steel dies. The steel most generally used is low-carbon steel. Chromium-vanadium and tungsten steels are used for aluminum, magnesium, and brass alloys, when dies must withstand relatively high temperatures.

Making die-casting dies requires considerable skill and experience. Dies must be so designed that the metal will rapidly flow to all parts of the impression and at the same time allow the air to escape through shallow vent channels, 0.003-0.005 inch (76-127 mm) deep, cut into the parting of the die. To secure solid castings, the gates and vents must be located with reference to the particular shape to be cast. Shrinkage is another important feature, especially on accurate work. The amount usually varies from 0.002-0.007 inch per inch (or mm per mm), but to determine the exact shrinkage allowance for an alloy containing three or four elements is difficult except by experiment.

Die-Casting Bearing Metals in Place.—Practically all the metals that are suitable for bearings can be die cast in place. Automobile connecting rods are an example of work to which this process has been applied successfully. After the bearings are cast in place, they are finished by boring or reaming. The best metals for the bearings, and those that also can be die cast most readily, are the babbitts containing about 85 per cent tin with the remainder copper and antimony. These metals should not contain over 9 per cent copper. The copper constitutes the hardening element in the bearing. A recommended composition for a high-class bearing metal is 85 per cent tin, 10 per cent antimony, and 5 per cent copper. The antimony may vary from 7 to 10 per cent and the copper from 5 to 8 per cent. To reduce costs, some bearing metals use lead instead of tin. One bearing alloy contains from 95 to 98 per cent lead. The die-cast metal becomes harder upon seasoning a few days. In die-casting bearings, the work is located from the bolt holes that are drilled previous to die casting. It is important that the bolt holes be drilled accurately with relation to the remainder of the machined surfaces.

Injection Molding of Metal.—The die casting and injection molding processes have been combined to make possible the injection molding of many metal alloys by mixing

powdered metal, of 5 to 10 μm (0.0002 to 0.0004 inch) particle size with thermoplastic binders. These binders are chosen for maximum flow characteristics to ensure that the mixture can penetrate to the most remote parts of the die/mold cavities. Moderate pressures and temperatures are used for the injection molding of these mixtures, and the molded parts harden as they cool so that they can be removed as solids from the mold. Shrinkage allowances for the cavities are greater than are required for the die casting process, because the injection molded parts are subject to a larger shrinkage (10 to 35 per cent) after removal from the die, due to evaporation of the binder and consolidation of the powder.

Binder removal may take several days because of the need to avoid distortion, and when it is almost complete the molded parts are sintered in a controlled atmosphere furnace at high temperatures to remove the remaining binder and consolidate the powdered metal component that remains. Density can thus be increased to about 95 per cent of the density of similar material produced by other processes. Tolerances are similar to those in die casting, and some parts are sized by a coining process for greater accuracy. The main limitation of the process is size, parts being restricted to about a 1.5-inch cube.

Precision Investment Casting

Investment casting is a highly developed process that is capable of great casting accuracy and can form extremely intricate contours. The process may be utilized when metals are too hard to machine or otherwise fabricate; when it is the only practical method of producing a part; or when it is more economical than any other method of obtaining work of the quality required. Precision investment casting is especially applicable in producing either exterior or interior contours of intricate form with surfaces so located that they could not be machined readily if at all. The process provides efficient, accurate means of producing such parts as turbine blades, airplane, or other parts made from alloys that have high melting points and must withstand exceptionally high temperatures, and many other products. The accuracy and finish of precision investment castings may either eliminate machining entirely or reduce it to a minimum. The quantity that may be produced economically may range from a few to thousands of duplicate parts.

Investment casting uses an expendable pattern, usually of wax or injection-molded plastics. Several wax replicas or patterns are usually joined together or to bars of wax that are shaped to form runner channels in the mold. Wax shapes that will produce pouring funnels also are fastened to the runner bars. The mold is formed by dipping the wax assembly (tree) into a thick slurry containing refractory particles. This process is known as investing. After the coating has dried, the process is repeated until a sufficient thickness of material has been built up to form a one-piece mold shell. Because the mold is in one piece, undercuts, apertures, and hollows can be produced easily. As in shell molding, this invested shell is baked to increase its strength, and the wax or plastics pattern melts and runs out or evaporates (lost-wax casting). Some molds are backed up with solid refractory material that is also dried and baked to increase the strength. Molds for lighter castings are often treated similarly to shell molds described before. Filling of the molds may take place in the atmosphere, in a chamber filled with inert gas or under vacuum, to suit the metal being cast.

Materials That May Be Cast.—The precision investment process may be applied to a wide range of both ferrous and nonferrous alloys. In industrial applications, these include alloys of aluminum and bronze, Stellite, Hastelloys, stainless and other alloy steels, and iron castings, especially where thick and thin sections are encountered. In producing investment castings, it is possible to control the process in various ways so as to change the porosity or density of castings, obtain hardness variations in different sections, and vary the corrosion resistance and strength by special alloying.

General Procedure in Making Investment Castings.—Precision investment casting is similar in principle to the “lost-wax” process that has long been used in manufacturing jewelry, ornamental pieces, and individual dentures, inlays, and other items required in

dentistry, which is not discussed here. When this process is employed, both the pattern and mold used in producing the casting are destroyed after each casting operation, but they may both be replaced readily. The “dispensable patterns” (or cluster of duplicate patterns) is first formed in a permanent mold or die and is then used to form the cavity in the mold or “investment” in which the casting (or castings) is made. The investment or casting mold consists of a refractory material contained within a reinforcing steel flask. The pattern is made of wax, plastics, or a mixture of the two. The material used is evacuated from the investment to form a cavity (without parting lines) for receiving the metal to be cast. Evacuation of the pattern (by the application of sufficient heat to melt and vaporize it) and the use of a master mold or die for reproducing it quickly and accurately in making duplicate castings are distinguishing features of this casting process. Modern applications of the process include many developments such as variations in the preparation of molds, patterns, investments, etc., as well as in the casting procedure. Application of the process requires specialized knowledge and experience.

Master Mold for Making Dispensable Patterns.—Duplicate patterns for each casting operation are made by injecting the wax, plastics, or other pattern material into a master mold or die that usually is made either of carbon steel or of a soft metal alloy. Rubber, alloy steels, and other materials may also be used. The mold cavity commonly is designed to form a cluster of patterns for multiple castings. The mold cavity is not, as a rule, an exact duplicate of the part to be cast because it is necessary to allow for shrinkage and perhaps to compensate for distortion that might affect the accuracy of the cast product. In producing master pattern molds there is considerable variation in practice. One general method is to form the cavity by machining; another is by pouring a molten alloy around a master pattern that usually is made of monel metal or of a high-alloy stainless steel. If the cavity is not machined, a master pattern is required. Sometimes, a sample of the product itself may be used as a master pattern, when, for example, a slight reduction in size due to shrinkage is not objectionable. The dispensable pattern material, which may consist of waxes, plastics, or a combination of these materials, is injected into the mold by pressure, by gravity, or by the centrifugal method. The mold is made in sections to permit removal of the dispensable pattern. The mold while in use may be kept at the correct temperature by electrical means, by steam heating, or by a water jacket.

Shrinkage Allowances for Patterns.—The shrinkage allowance varies considerably for different materials. In casting accurate parts, experimental preliminary casting operations may be necessary to determine the required shrinkage allowance and possible effects of distortion. Shrinkage allowances, in inches per inch, usually average about 0.022 for steel, 0.012 for gray iron, 0.016 for brass, 0.012 to 0.022 for bronze, 0.014 for aluminum and magnesium alloys. (See also *Shrinkage Allowances* on page 1413.)

Casting Dimensions and Tolerances.—Generally, dimensions on investment castings can be held to ± 0.005 inch and on specified dimensions to as low as ± 0.002 inch. Many factors, such as the grade of refractory used for the initial coating on the pattern, the alloy composition, and the pouring temperature, affect the cast surface finish. Surface discontinuities on the as-cast products therefore can range from 30-300 min (0.76–7.6 mm) in height.

Investment Materials.—For investment casting of materials having low melting points, a mixture of plaster of Paris and powdered silica in water may be used to make the molds, the silica forming the refractory and the plaster acting as the binder. To cast materials having high melting points, the refractory may be changed to sillimanite, an alumina-silicate material having a low coefficient of expansion that is mixed with powdered silica as the binder. Powdered silica is then used as the binder. The interior surfaces of the mold are reproduced on the casting so, when fine finishes are needed, a first coating of fine sillimanite sand and a silicon ester such as ethyl silicate with a small amount of piperidine, is applied and built up to a thickness of about 0.06 inch (1.5 mm). This investment is covered

with a coarser grade of refractory that acts to improve bonding with the main refractory coatings, before the back up coatings are applied.

With light castings, the invested material may be used as a shell, without further reinforcement. With heavy castings the shell is placed in a larger container which may be of thick waxed paper or card, and further slurry is poured around it to form a thicker mold of whatever proportions are needed to withstand the forces generated during pouring and solidification. After drying in air for several hours, the invested mold is passed through an oven where it is heated to a temperature high enough to cause the wax to run out. When pouring is to take place, the mold is pre-heated to between 700 and 1000°C (1292 and 1832°F), to get rid of any remaining wax, to harden the binder and prepare for pouring the molten alloy. Pouring metal into a hot mold helps to ensure complete filling of intricate details in the castings. Pouring may be done under gravity, under a vacuum under pressure, or with a centrifuge. When pressure is used, attention must be paid to mold permeability to ensure gases can escape as the metal enters the cavities.

Casting Operations.—The temperature of the flask for casting may range all the way from a chilled condition up to 2000°F (1093°C) or higher, depending upon the metal to be cast, the size and shape of the casting or cluster, and the desired metallurgical conditions. During casting, metals are nearly always subjected to centrifugal force vacuum, or other pressure. The procedure is governed by the kind of alloy, the size of the investment cavity, and its contours or shape.

Investment Removal.—When the casting has solidified, the investment material is removed by destroying it. Some investments are soluble in water, but those used for ferrous castings are broken by using pneumatic tools, hammers, or by shot or abrasive blasting and tumbling to remove all particles. Gates, sprues, and runners may be removed from the castings by an abrasive cutting wheel or a band saw according to the shape of the cluster and machinability of the material.

Accuracy of Investment Castings.—The accuracy of precision investment castings may, in general, compare favorably with that of many machined parts. The overall tolerance varies with the size of the work, the kind of metal and the skill and experience of the operators. Under normal conditions, tolerances may vary from ± 0.005 or ± 0.006 inch per inch (or mm/mm), down to ± 0.0015 to ± 0.002 inch per inch (or mm/mm), and even smaller tolerances are possible on very small dimensions. Where tolerances applying to a lengthwise dimension must be smaller than would be normal for the casting process, the casting gate may be placed at one end to permit controlling the length by a grinding operation when the gate is removed.

Casting Weights and Sizes.—Investment castings may vary in weight from a fractional part of an ounce up to 75 pounds (34 kg) or more. Although the range of weights representing the practice of different firms specializing in investment casting may vary from about $\frac{1}{2}$ pound up to 10 or 20 lb (4.5 or 9.1 kg), a practical limit of 10 or 15 lb (4.5 or 6.8 kg) is common. The length of investment castings ordinarily does not exceed 12 or 15 in (30 or 38 cm), but much longer parts may be cast. It is possible to cast sections having a thickness of only a few thousandths of an inch, but the preferred minimum thickness, as a general rule, is about 0.020 inch (0.50 mm) for alloys of high castability and 0.040 inch (1 mm) for alloys of low castability.

Design for Investment Casting.—As with most casting processes, best results from investment casting are achieved when uniform wall thicknesses between 0.040 and 0.375 inch (1 and 10 mm) are used for both cast components and channels forming runners in the mold. Gradual transition from thick to thin sections is also desirable. It is important that molten metal should not have to pass through a thin section to fill a thick part of the casting. Thin edges should be avoided because of the difficulty of producing them in the wax pattern. Fillets should be used in all internal corners to avoid stress concentrations that usually accompany sharp angles. Thermal contraction usually causes distortion of the casting, and

should be allowed for if machining is to be minimized. Machining allowances vary from 0.010 inch (0.25 mm) on small, to 0.04 inch (1mm) on large parts. With proper arrangement of castings in the mold, grain size and orientation can be controlled and directional solidification can often be used to advantage to ensure desired physical properties in the finished components.

Casting Milling Cutters by Investment Method.—Possible applications of precision investment casting in tool manufacture and in other industrial applications are indicated by its use in producing high-speed steel milling cutters of various forms and sizes. Removal of the risers, sand blasting to improve the appearance, and grinding the cutting edges are the only machining operations required. The bore is used as cast. Numerous tests have shown that the life of these cutters compares favorably with high-speed steel cutters made in the usual way.

Extrusion of Metals

The Basic Process.—Extrusion is a metalworking process used to produce long, straight semifinished products such as bars, tubes, solid and hollow sections, wire and strips by squeezing a solid slug of metal, either cast or wrought, from a closed container through a die. An analogy to the process is the dispensing of toothpaste from a collapsible tube.

During extrusion, compressive and shear, but no tensile, forces are developed in the stock, thus allowing the material to be heavily deformed without fracturing. The extrusion process can be performed at either room or high temperature, depending on the alloy and method. Cross sections of varying complexity can also be produced, depending on the materials and dies used.

In the specially constructed presses used for extrusion, the load is transmitted by a ram through an intermediate dummy block to the stock. The press container is usually fitted with a wear-resistant liner and is constructed to withstand high radial loads. The die stack consists of the die, die holder, and die backer, all of which are supported in the press end housing or platen, which resists the axial loads.

The following are characteristics of different extrusion methods and presses:

- 1) The movement of the extrusion relative to the ram. In “direct extrusion,” the ram is advanced toward the die stack; in “indirect extrusion,” the die moves down the container bore
- 2) The position of the press axis, which is either horizontal or vertical
- 3) The type of drive, which is either hydraulic or mechanical
- 4) The method of load application, which is either conventional or hydrostatic

In forming a hollow extrusion, such as a tube, a mandrel integral with the ram is pushed through the previously pierced raw billet.

Cold Extrusion: Cold extrusion has often been considered a separate process from hot extrusion; however, the only real difference is that cold or only slightly warm billets are used as starting stock. Cold extrusion is not limited to certain materials; the only limiting factor is the stresses in the tooling. In addition to the soft metals such as lead and tin, aluminum alloys, copper, zirconium, titanium, molybdenum, beryllium, vanadium, niobium, and steel can be extruded cold or at low deformation temperatures. Cold extrusion has many advantages, such as no oxidation or gas/metal reactions; high mechanical properties due to cold working if the heat of deformation does not initiate recrystallization; narrow tolerances; good surface finish if optimum lubrication is used; fast extrusion speeds can be used with alloys subject to hot shortness. Examples of cold extruded parts are collapsible tubes, aluminum cans, fire extinguisher cases, shock absorber cylinders, automotive pistons, and gear blanks.

Hot Extrusion: Most hot extrusion is performed in horizontal hydraulic presses rated in size from 250 to 12,000 tons. The extrusions are long pieces of uniform cross sections, but complex cross sections are also produced. Most types of alloys can be hot extruded.

Owing to the temperatures and pressures encountered in hot extrusion, the major problems are the construction and the preservation of the equipment. The following are approximate temperature ranges used to extrude various types of alloys:

magnesium, 650–850°F (343–454°C)	aluminum, 650–900°F (343–482°C)
copper, 1200–2000°F (649–1093°C)	steel, 2200–2400°F (1204–1316°C)
titanium, 1300–2100°F (704–1149°C)	nickel 1900–2200°F (1038–1204°C)
refractory alloys, up to 4000°F (2204°C).	

In addition, pressures range from as low as 5000 psi (34.5 MPa) to over 100,000 psi (690 MPa). Therefore, lubrication and protection of the chamber, ram, and die are generally required. The use of oil and graphite mixtures is often sufficient at the lower temperatures; while at higher temperatures, glass powder, which becomes a molten lubricant, is used.

Extrusion Applications: The stress conditions in extrusion make it possible to work materials that are brittle and tend to crack when deformed by other primary metalworking processes. The most outstanding feature of the extrusion process, however, is its ability to produce a wide variety of cross-sectional configurations; shapes can be extruded that have complex, nonuniform, and nonsymmetrical sections that would be difficult or impossible to roll or forge. Extrusions in many instances can take the place of bulkier, more costly assemblies made by welding, bolting, or riveting. Many machining operations may also be reduced through the use of extruded sections. However, as extrusion temperatures increase, processing costs also increase, and the range of shapes and section sizes that can be obtained becomes narrower.

While many asymmetrical shapes are produced, symmetry is the most important factor in determining extrudability. Adjacent sections should be as nearly equal as possible to permit uniform metal flow through the die. The length of their protruding legs should not exceed 10 times their thickness.

The size and weight of extruded shapes are limited by the section configuration and properties of the material extruded. The maximum size that can be extruded on a press of a given capacity is determined by the “circumscribing circle,” which is defined as the smallest diameter circle that will enclose the shape. This diameter controls the die size, which in turn is limited by the press size. For instance, the larger presses are generally capable of extruding aluminum shapes with a 25-inch (63.5 cm)-diameter circumscribing circle and steel and titanium shapes with about 22-inch (55.9 cm)-diameter circle.

The minimum cross-sectional area and minimum thickness that can be extruded on a given size press are dependent on the properties of the material, the extrusion ratio (ratio of the cross-sectional area of the billet to the extruded section), and the complexity of shape. As a rule thicker sections are required with increased section size. The table gives approximate minimum cross section and minimum thickness of some commonly extruded metals.

Material	Minimum Cross Section		Minimum Thickness	
	inch ²	mm ²	inch	mm
Carbon and alloy steels	0.40	258	0.120	3
Stainless steels	0.45 - 0.70	290 - 452	0.120 - 0.187	3.0 - 4.8
Titanium	0.50	323	0.150	3.8
Aluminum	< 0.40	< 258	0.040	1.0
Magnesium	< 0.40	< 258	0.040	1.0

Extruded shapes minimize and sometimes eliminate the need for machining; however, they do not have the dimensional accuracy of machined parts. Smooth surfaces with finishes better than 30 μ inch (0.762 mm) rms are attainable in magnesium and aluminum; an extruded finish of 125 μ inch (3.175 mm) rms is generally obtained with most steels and titanium alloys. Minimum corner and fillet radii of $\frac{1}{64}$ inch (0.39 mm) are preferred for aluminum and magnesium alloys; while for steel, minimum corner radii of 0.030 inch (0.76 mm) and fillet radii of 0.125 inch (3.2 mm) are typical.

Extrusion of Tubes: In tube extrusion, the metal passes through a die, which determines its outer diameter, and around a central mandrel, which determines its inner diameter. Either solid or hollow billets may be used, with the solid billet being used most often.

When a solid billet is extruded, the mandrel must pierce the billet by pushing axially through it before the metal can pass through the annular gap between the die and the mandrel. Special presses are used in tube extrusion to increase the output and improve the quality compared to what is obtained using ordinary extrusion presses. These special hydraulic presses independently control ram and mandrel positioning and movement.

Powder Metallurgy

Powder metallurgy is a process whereby metal parts in large quantities can be made by the compressing and sintering of various powdered metals such as brass, bronze, aluminum, and iron. Compressing of the metal powder into the shape of the part to be made is done by accurately formed dies and punches in special types of hydraulic or mechanical presses. The "green" compressed pieces are then sintered in an atmosphere controlled furnace at high temperatures, causing the metal powder to be bonded together into a solid mass. A subsequent sizing or pressing operation and supplementary heat treatments may also be employed. The physical properties of the final product are usually comparable to those of cast or wrought products of the same composition. Using closely controlled conditions, steel of high hardness and tensile strength has also been made by this process.

Any desired porosity from 5 to 50 per cent can be obtained in the final product. Large quantities of porous bronze and iron bearings, which are impregnated with oil for self-lubrication, have been made by this process. Other porous powder metal products are used for filtering liquids and gases. Where continuous porosity is desired in the final product, the voids between particles are kept connected or open by mixing one per cent of zinc stearate or other finely powdered metallic soap throughout the metal powder before briquetting and then boiling this out in a low temperature baking before the piece is sintered.

The dense type of powdered metal products include refractory metal wire and sheet, cemented carbide tools, and electrical contact materials (products which could not be made as satisfactorily by other processes) and gears or other complex shapes which might also have been made by die casting or the precise machining of wrought or cast metal.

Advantages of Powder Metallurgy.—Parts requiring irregular curves, eccentrics, radial projections, or recesses often can be produced only by powder metallurgy. Parts that require irregular holes, keyways, flat sides, splines or square holes that are not easily machined, can usually be made by this process. Tapered holes and counter-bores are easily produced. Axial projections can be formed but the permissible size depends on the extent to which the powder will flow into the die recesses. Projections not more than one-quarter the length of the part are practicable. Slots, grooves, blind holes, and recesses of varied depths are also obtainable.

Limiting Factors in Powdered Metal Process.—The number and variety of shapes that may be obtained are limited by lack of plastic flow of powders, i.e., the difficulty with which they can be made to flow around corners. Tolerances in diameter usually cannot be held closer than 0.001 inch (0.025 mm) and tolerances in length are limited to 0.005 inch (0.13 mm). This difference in diameter and length tolerances may be due to the elasticity of the powder and spring of the press.

Factors Affecting Design of Briquetting Tools.—High-speed steel is recommended for dies and punches and oil-hardening steel for strippers and knock-outs. One manufacturer specifies dimensional tolerances of 0.0002 inch (5 mm) and super-finished surfaces for these tools. Because of the high pressures employed and the abrasive character of certain refractory materials used in some powdered metal composition, there is frequently a tendency toward severe wear of dies and punches. In such instances, carbide inserts, chrome plating, or highly resistant die steels are employed. With regard to the shape of the die, corner radii, fillets, and bevels should be used to avoid sharp corners. Feather edges, threads, and reentrant angles are usually impracticable. The making of punches and dies is particularly exacting because allowances must be made for changes in dimensions due to growth after pressing and shrinkage or growth during sintering.

SOLDERING AND BRAZING

Metals may be joined without using fasteners by employing soldering, brazing, and welding. Soldering involves the use of a non-ferrous metal whose melting point is below that of the base metal and in all cases below 800°F (427°C). Brazing entails the use of a non-ferrous filler metal with a melting point below that of the base metal but above 800°F (427°C). In fusion welding, abutting metal surfaces are made molten, are joined in the molten state, and then allowed to cool. The use of a filler metal and the application of pressure are considered to be optional in the practice of fusion welding.

Soldering

Soldering employs lead- or tin-base alloys with melting points below 800°F (427°C) and is commonly referred to as soft soldering. Use of hard solders, silver solders and spelter solders which have silver, copper, or nickel bases and have melting points above 800°F (427°C) is known as brazing. Soldering is used to provide a convenient joint that does not require any great mechanical strength. It is used in a great many instances in combination with mechanical staking, crimping or folding, the solder being used only to seal against leakage or to assure electrical contact. The accompanying table, page 1425, gives some of the properties and uses of various solders that are generally available.

Forms Available.—Soft solders can be obtained in bar, cake, wire, pig, slab ingot, ribbon, segment, powder, and foil-form for various uses to which they are put. In bar form they are commonly used for hand soldering. The pigs, ingots, and slabs are used in operations that employ melting kettles. The ribbon, segment, powder and foil forms are used for special applications and the cake form is used for wiping. Wire forms are either solid or they contain acid or rosin cores for fluxing. These wire forms, both solid and core containing, are used in hand and automatic machine applications. Prealloyed powders, suspended in a fluxing medium, are frequently applied by brush and, upon heating, consistently wet the solderable surfaces to produce a satisfactory joint.

Fluxes for Soldering.—The surfaces of the metals being joined in the soldering operation must be clean in order to obtain an efficient joint. Fluxes clean the surfaces of the metal in the joint area by removing the oxide coating present, keep the area clean by preventing formation of oxide films, and lower the surface tension of the solder thereby increasing its wetting properties. Rosin, tallow, and stearin are mild fluxes which prevent oxidation but are not too effective in removing oxides present. Rosin is used for electrical applications since the residue is non-corrosive and non-conductive. Zinc chloride and ammonium chloride (sal ammoniac), used separately or in combination, are common fluxes that remove oxide films readily. The residue from these fluxes may in time cause trouble, due to their corrosive effects, if they are not removed or neutralized. Washing with water containing about 5 ounces (142 g) of sodium citrate (for non-ferrous soldering) or 1 ounce (28.35 g) of trisodium phosphate (for ferrous and non-ferrous soldering) per gallon (1 U.S. gallon = 3.754 liters) followed by a clear water rinse or washing with commercial water-soluble detergents are methods of inactivating and removing this residue.

Methods of Application.—Solder is applied using a soldering iron, a torch, a solder bath, electric induction or resistance heating, a stream of hot neutral gas or by wiping. Clean surfaces which are hot enough to melt the solder being applied or accept molten solder are necessary to obtain a good clean bond. Parts being soldered should be free of oxides, dirt, oil, and scale. Scraping and the use of abrasives as well as fluxes are resorted to for preparing surfaces for soldering. The procedures followed in soldering aluminum, magnesium and stainless steel differ somewhat from conventional soldering techniques and are indicated in the material which follows

Soldering Aluminum: Two properties of aluminum which tend to make it more difficult to solder are its high thermal conductivity and the tenacity of its ever-present oxide film.

Properties of Soft Solder Alloys *Appendix, ASTM:B 32-70*

Nominal Composition ^a Per Cent				Specific Gravity ^b	Melting Ranges, ^c Degrees Fahrenheit		Uses
Sn	Pb	Sb	Ag		Solidus	Liquidus	
70	30	8.32	361	378	For coating metals.
63	37	8.40	361	361	As lowest melting solder for dip and hand soldering methods.
60	40	8.65	361	374	"Fine Solder." For general purposes, but particularly where the temperature requirements are critical.
50	50	8.85	361	421	For general purposes. Most popular of all.
45	55	8.97	361	441	For automobile radiator cores and roofing seams.
40	60	9.30	361	460	Wiping solder for joining lead pipes and cable sheaths. For automobile radiator cores and heating units.
35	65	9.50	361	477	General purpose and wiping solder.
30	70	9.70	361	491	For machine and torch soldering.
25	75	10.00	361	511	For machine and torch soldering.
20	80	10.20	361	531	For coating and joining metals. For filling dents or seams in automobile bodies.
15	85	10.50	440 ^d	550	For coating and joining metals.
10	90	10.80	514 ^d	570	For coating and joining metals.
5	95	11.30	518	594	For coating and joining metals.
40	58	2	...	9.23	365	448	Same uses as (50-50) tin-lead but not recommended for use on galvanized iron.
35	63.2	1.8	...	9.44	365	470	For wiping and all uses except on galvanized iron.
30	68.4	1.6	...	9.65	364	482	For torch soldering or machine soldering, except on galvanized iron.
25	73.7	1.3	...	9.96	364	504	For torch and machine soldering, except on galvanized iron.
20	79	1	...	10.17	363	517	For machine soldering and coating of metals, tipping, and like uses, but not recommended for use on galvanized iron.
95	...	5	...	7.25	452	464	For joints on copper in electrical, plumbing and heating work.
...	97.5	...	2.5	11.35	579	579	For use on copper, brass, and similar metals with torch heating. Not recommended in humid environments due to its known susceptibility to corrosion.
1	97.5	...	1.5	11.28	588	588	For use on copper, brass, and similar metals with torch heating.

^a Abbreviations of alloying elements are as follows: Sn, tin; Pb, lead; Sb, antimony; and Ag, silver.

^b The specific gravity multiplied by 0.0361 equals the density in pounds per cubic inch.

^c The alloys are completely solid below the lower point given, designated "solidus," and completely liquid above the higher point given, designated "liquidus." In the range of temperatures between these two points the alloys are partly solid and partly liquid.

^d For some engineering design purposes, it is well to consider these alloys as having practically no mechanical strength above 360 degrees F (182°C).

Aluminum soldering is performed in a temperature range of from 550-770°F (288-410°C), compared to 375-400°F (191-204°C) temperature range for ordinary metals, because of the metal's high thermal conductivity. Two methods can be used, one using flux and one using abrasion. The method employing flux is most widely used and is known as flow soldering. In this method flux dissolves the aluminum oxide and keeps it from reforming. The flux should be fluid at soldering temperatures so that the solder can displace it in the joint. In the friction method the oxide film is mechanically abraded with a soldering iron, wire brush, or multi-toothed tool while being covered with molten solder. The molten solder keeps the oxygen in the atmosphere from reacting with the newly-exposed aluminum surface; thus wetting of the surface can take place.

The alloys that are used in soldering aluminum generally contain from 50 to 75 per cent tin with the remainder zinc.

The following aluminum alloys are listed in order of ease of soldering: commercial and high-purity aluminum; wrought alloys containing not more than 1 per cent manganese or magnesium; and finally the heat-treatable alloys which are the most difficult.

Cast and forged aluminum parts are not generally soldered.

Soldering Magnesium: Magnesium is not ordinarily soldered to itself or other metals. Soldering is generally used for filling small surface defects, voids or dents in castings or sheets where the soldered area is not to be subjected to any load. Two solders can be used: one with a composition of 60 per cent cadmium, 30 per cent zinc, and 10 per cent tin has a melting point of 315°F (157°C); the other has a melting point of 500°F (260°C) and has a nominal composition of 90 per cent cadmium and 10 per cent zinc.

The surfaces to be soldered are cleaned to a bright metallic luster by abrasive methods before soldering. The parts are preheated with a torch to the approximate melting temperature of the solder being used. The solder is applied and the surface under the molten solder is rubbed vigorously with a sharp pointed tool or wire brush. This action results in the wetting of the magnesium surface. To completely wet the surface, the solder is kept molten and the rubbing action continued. The use of flux is not recommended.

Soldering Stainless Steel: Stainless steel is somewhat more difficult to solder than other common metals. This is true because of a tightly adhering oxide film on the surface of the metal and because of its low thermal conductivity. The surface of the stainless steel must be thoroughly cleaned. This can be done by abrasion or by clean white pickling with acid. Muriatic (hydrochloric) acid saturated with zinc or combinations of this mixture and 25 per cent additional muriatic acid, or 10 per cent additional acetic acid, or 10 to 20 per cent additional water solution of orthophosphoric acid may all be used as fluxes for soldering stainless steel. Tin-lead solder can be used successfully. Because of the low thermal conductivity of stainless steel, a large soldering iron is needed to bring the surfaces to the proper temperature. The proper temperature is reached when the solder flows freely into the area of the joint. Removal of the corrosive flux is important in order to prevent joint failure. Soap and water or a commercial detergent may be used to remove the flux residue.

Ultrasonic Fluxless Soldering.—This more recently introduced method of soldering makes use of ultrasonic vibrations which facilitates the penetration of surface films by the molten solder thus eliminating the need for flux. The equipment offered by one manufacturer consists of an ultrasonic generator, ultrasonic soldering head which includes a transducer coupling, soldering tip, tip heater, and heating platen. Metals that can be soldered by this method include aluminum, copper, brass, silver, magnesium, germanium, and silicon.

Brazing

Brazing is a metal joining process which uses a non-ferrous filler metal with a melting point below that of the base metals but above 800°F (427°C). The filler metal wets the base metal when molten in a manner similar to that of a solder and its base metal. There is a slight diffusion of the filler metal into the hot, solid base metal or a surface alloying of the base and filler metal. The molten metal flows between the close-fitting metals because of capillary forces.

Filler Metals for Brazing Applications.—Brazing filler metals have melting points that are lower than those of the base metals being joined and have the ability when molten to flow readily into closely fitted surfaces by capillary action. The commonly used brazing metals may be considered as grouped into the seven standard classifications shown in [Tables 1a](#) and [1b](#). These are aluminum-silicon; copper-phosphorus; silver; nickel; copper and copper-zinc; magnesium; and precious metals.

The solidus and liquidus are given in [Tables 1a](#) and [1b](#) instead of the melting and flow points in order to avoid confusion. The solidus is the highest temperature at which the metal is completely solid or, in other words, the temperature above which the melting starts. The liquidus is the lowest temperature at which the metal is completely liquid, that is, the temperature below which the solidification starts.

Fluxes for Brazing.—In order to obtain a sound joint the surfaces in and adjacent to the joint must be free from dirt, oil, and oxides or other foreign matter at the time of brazing.

Table 1a. Brazing Filler Metals [Based on Specification and Appendix of American Welding Society AWS A5.8–81]

AWS Classification ^a	Nominal Composition, ^b Per Cent						Temperature, Degrees F			Standard Form ^c	Uses
	Ag	Cu	Zn	Al	Ni	Other	Solidus	Liquidus	Brazing Range		
BAISi-2	92.5	...	Si, 7.5	1070	1135	1110–1150	7	For joining the following aluminum alloys: 1060, EC, 1100, 3003, 3004, 5005, 5050, 6053, 6061, 6062, 6063, 6951 and cast alloys A612 and C612. All of these filler metals are suitable for furnace and dip brazing. BAISi-3, -4 and -5 are suitable for torch brazing. Used with lap and tee joints rather than butt joints. Joint clearances run from .006 to .025 inch.
BAISi-3	...	4	...	86	...	Si, 10	970	1085	1160–1120	2, 3, 5	
BAISi-4	88	...	Si, 12	1070	1080	1080–1120	2, 3, 4, 5	
BAISi-5	90	...	Si, 10	1070	1095	1090–1120	7	
BAISi-6	90	...	Si, 7.5; Mg, 2.5	1038	1125	1110–1150	7	BAISi-6 through -11 are vacuum brazing filler metals. Magnesium is present as an O ₂ getter. When used in vacuum, solidus & liquidus temperatures are different from those shown.
BAISi-7	88.5	...	Si, 10; Mg, 1.5	1038	1105	1090–1120	7	
BAISi-8	86.5	...	Si, 12; Mg, 1.5	1038	1075	1080–1120	2, 7	
BAISi-9	87	...	Si, 12; Mg, 0.3	1044	1080	1080–1120	7	
BAISi-10	86.5	...	Si, 11; Mg, 2.5	1038	1086	1080–1120	2	
BAISi-11	88.4	...	Si, 10 Mg, 1.5; Bi, 0.1	1038	1105	1090–1120	7	
BCuP-1	...	95	P, 5	1310	1695	1450–1700	1	For joining copper and its alloys with some limited use on silver, tungsten and molybdenum. Not for use on ferrous or nickel-base alloys. Are used for cupro-nickels but caution should be exercised when nickel content is greater than 30 per cent. Suitable for all brazing processes. Lap joints recommended but butt joints may be used. Clearances used range from .001 to .005 inch.
BCuP-2	...	93	P, 7	1310	1460	1350–1550	2, 3, 4	
BCuP-3	5	89	P, 6	1190	1485	1300–1500	2, 3, 4	
BCuP-4	6	87	P, 7	1190	1335	1300–1450	2, 3, 4	
BCuP-5	15	80	P, 5	1190	1475	1300–1500	1, 2, 3, 4	
BCuP-6	2	91	P, 7	1190	1450	1350–1500	2, 3, 4	
BCuP-7	5	88	P, 6.8	1190	1420	1300–1500	2, 3, 4	
BAG-1	45	15	16	Cd, 24	1125	1145	1145–1400	1, 2, 4	For joining most ferrous and nonferrous metals except aluminum and magnesium. These filler metals have good brazing properties and are suitable for preplacement in the joint or for manual feeding into the joint. All methods of heating may be used. Lap joints are generally used; however, butt joints may be used. Joint clearances of .002 to .005 inch are recommended. Flux is generally required.
BAG-1a	50	15.5	16.5	Cd, 18	1160	1175	1175–1400	1, 2, 4	
BAG-2	35	26	21	Cd, 18	1125	1295	1295–1550	1, 2, 4, 7	

Table 1a. (Continued) Brazing Filler Metals [Based on Specification and Appendix of American Welding Society AWS A5.8–81]

AWS Classification ^a	Nominal Composition, ^b Per Cent						Temperature, Degrees F			Standard Form ^c	Uses
	Ag	Cu	Zn	Al	Ni	Other	Solidus	Liquidus	Brazing Range		
B _{Ag} -2a	30	27	23	Cd, 20	1125	1310	1310–1550	1, 2, 4	For joining most ferrous and nonferrous metals except aluminum and magnesium. These filler metals have good brazing properties and are suitable for preplacement in the joint or for manual feeding into the joint. All methods of heating may be used. Lap joints are generally used; however, butt joints may be used. Joint clearances of .002 to .005 inch are recommended. Flux is generally required.
B _{Ag} -3	50	15.5	15.5	...	3	Cd, 16	1170	1270	1270–1500	1, 2, 4, 7	
B _{Ag} -4	40	30	28	...	2	...	1240	1435	1435–1650	1, 2	
B _{Ag} -5	45	30	25	1250	1370	1370–1550	1, 2	
B _{Ag} -6	50	34	16	1270	1425	1425–1600	1, 2	
B _{Ag} -7	56	22	17	Sn, 5	1145	1205	1205–1400	1, 2	
B _{Ag} -8	72	28	1435	1435	1435–1650	1, 2, 4	
B _{Ag} -8a	72	27.8	Li, 2.	1410	1410	1410–1600	1, 2	
B _{Ag} -13	54	40	5	...	1	...	1325	1575	1575–1775	1, 2	
B _{Ag} -13a	56	42	2	...	1420	1640	1600–1800	1, 2	
B _{Ag} -18	60	30	Sn, 10	1115	1325	1325–1550	1, 2	
B _{Ag} -19	92.5	7.3	Li, 2	1435	1635	1610–1800	1, 2	
B _{Ag} -20	30	38	32	1250	1410	1410–1600	1, 2, 4	
B _{Ag} -21	63	28.5	2.5	Sn, 6	1275	1475	1475–1650	1, 2, 4	
B _{Ag} -22	49	16	23	...	4.5	Mn, 7.5	1260	1290	1290–1525	1, 2, 4, 7	
B _{Ag} -23	85	Mn, 15	1760	1780	1780–1900	1, 2, 4	
B _{Ag} -24	50	20	28	...	2	...	1220	1305	1305–1550	1, 2	
B _{Ag} -25	20	40	35	Mn, 5	1360	1455	1455–1555	2, 4	
B _{Ag} -26	25	38	33	...	2	Mn, 2	1305	1475	1475–1600	1, 2, 4, 7	
B _{Ag} -27	25	35	26.5	Cd, 13.5	1125	1375	1375–1575	1, 2, 4	
B _{Ag} -28	40	30	28	Sn, 2	1200	1310	1310–1550	1, 2, 4	

^a These classifications contain chemical symbols preceded by “B” which stands for brazing filler metal.

^b These are nominal compositions. Trace elements may be present in small amounts and are not shown. Abbreviations used are: Ag, silver; Cu, copper; Zn, zinc; Al, aluminum; Ni, nickel; Ot, other; Si, silicon; P, phosphorus; Cd, cadmium; Sn, tin; Li, lithium; Cr, chromium; B, boron; Fe, iron; O, oxygen; Mg, magnesium; W, tungsten; Pd, palladium; and Au, gold.

^c Numbers specify standard forms as follows: 1, strip; 2, wire; 3, rod; 4, powder; 5, sheet; 6, paste; 7, clad sheet or strip; and 8, transfer tape.

Table 1b. Brazing Filler Metals [Based on Specification and Appendix of American Welding Society AWS A5.8–81]

AWS Classification ^a	Nominal Composition, ^b Per Cent						Temperature, Degrees F			Standard Form ^c	Uses
	Ni	Cu	Cr	B	Si	Other	Solidus	Liquidus	Brazing Range		
BNi-1	74	...	14	3.5	4	Fe, 4.5	1790	1900	1950–2200	1, 2, 3, 4, 8	For brazing AISI 300 and 400 series stainless steels, and nickel- and cobalt-base alloys. Particularly suited to vacuum systems and vacuum tube applications because of their very low vapor pressure. The limiting element is chromium in those alloys in which it is employed. Special brazing procedures required with filler metal containing manganese.
BNi-2	82.5	...	7	3	4.5	Fe, 3	1780	1830	1850–2150	1, 2, 3, 4, 8	
BNi-3	91	3	4.5	Fe, 1.5	1800	1900	1850–2150	1, 2, 3, 4, 8	
BNi-4	93.5	1.5	3.5	Fe, 1.5	1800	1950	1850–2150	1, 2, 3, 4, 8	
BNi-5	71	...	19	...	10	...	1975	2075	2100–2200	1, 2, 3, 4, 8	
BNi-6	89	P, 11	1610	1610	1700–1875	1, 2, 3, 4, 8	
BNi-7	77	...	13	P, 10	1630	1630	1700–1900	1, 2, 3, 4, 8	
BNi-8	65.5	4.5	7	Mn, 23	1800	1850	1850–2000	1, 2, 3, 4, 8	
BCu-1	...	100	1980	1980	2000–2100	1, 2	For joining various ferrous and nonferrous metals. They can also be used with various brazing processes. Avoid overheating the Cu-Zn alloys. Lap and butt joints are commonly used.
BCu-1a	...	99	Ot, 1	1980	1980	2000–2100	4	
BCu-2	...	86.5	O, 13.5	1980	1980	2000–2100	6	
RBCuZn-A	...	59	Zn, 41	1630	1650	1670–1750	1, 2, 3	
RBCuZn-C	...	58	0.1	Zn, 40; Fe, 0.7; Mn, 0.3; Sn, 1	1590	1630	1670–1750	2	
RBCuZn-D	10	48	0.2	Zn, 42	1690	1715	1720–1800	1, 2, 3	
BCuZn-E	...	50	Zn, 50	1595	1610	1610–1725	1, 2, 3, 4, 5	
BCuZn-F	...	50	Zn, 46.5; Sn, 3.5	1570	1580	1580–1700	1, 2, 3, 4, 5	
BCuZn-G	...	70	Zn, 30	1680	1750	1750–1850	1, 2, 3, 4, 5	
BCuZn-H	...	80	Zn, 20	1770	1830	1830–1950	1, 2, 3, 4, 5	
BMg-1	^a	830	1100	1120–1160	2, 3	BMg-1 is used for joining AZ10A, K1A, and M1A magnesium-base metals.
BAu-1	...	63	Au, 37	1815	1860	1860–2000	1, 2, 4	For brazing of iron, nickel, and cobalt-base metals where resistance to oxidation or corrosion is required. Low rate of interaction with base metal facilitates use on thin base metals. Used with induction, furnace, or resistance heating in a reducing atmosphere or in a vacuum and with no flux. For other applications, a borax-boric acid flux is used.
BAu-2	...	20.5	Au, 79.5	1635	1635	1635–1850	1, 2, 4	
BAu-3	3	62.5	Au, 34.5	1785	1885	1885–1995	1, 2, 4	
BAu-4	18.5	Au, 81.5	1740	1740	1740–1840	1, 2, 4	
BAu-5	36	Au, 30; Pd, 34	2075	2130	2130–2250	1, 2, 4	
BAu-6	22	Au, 70; Pd, 8	1845	1915	1915–2050	1, 2, 4	
BCo-1	17	8	Cr, 19; W, 4; B, 0.8; C, 0.4; Co, 59	2050	2100	2100–2250	1, 3, 4, 8	Generally used for high temperature properties and compatibility with cobalt-base metals.

^a Al, 9; Zn, 2; Mg, 89.

Table 2. Guide to Selection of Brazing Filler Metals and Fluxes

Base Metals Being Brazed	Filler Metals Recommended ^a	AWS Brazing Flux Type No.	Effective Temperature Range, °F(°C)	Flux Ingredients	Flux Supplied As	Flux Method of Use ^b
All brazeable aluminum alloys	BA1Si	1	700–1190 (371–643)	Chlorides, Fluorides	Powder	1, 2 3, 4
All brazeable magnesium alloys	BMg	2	900–1200 (482–649)	Chloides, Fluorides	Powder	3, 4
Alloys such as aluminum-bronze; aluminum-brass containing additions of aluminum of 0.5 per cent or more	BCuZn, BCuP	4 ^c	1050–1800 (566–982)	Chlorides, Fluorides, Borates, Wetting agent	Paste or Powder	1, 2, 3
Titanium and zirconium in base alloys	B _{Ag}	6	700–1600 (371–871)	Chlorides, Fluorides, Wetting agent	Paste or Powder	1, 2, 3
Any other brazeable alloys not listed above	All brazing filler metals except BA1Si and BMg	3	700–2000 (371–1093)	Boric acid, Borates, Fluorides, Fluooates, Wetting agent <i>Must contain fluorine compound</i>	Paste, Powder, or Liquid	1, 2, 3
	All brazing filler metals except BA1Si, BMg, and B _{Ag} 1 through B _{Ag} 7	5	1000–2200 (538–1204)	Borax, Boric acid, Borates, Wetting agent <i>No fluorine in any form</i>	Paste, Powder, or Liquid	1, 2, 3

^a Abbreviations used in this column are as follows: B, brazing filler metal; Al, aluminum; Si, silicon; Mg, magnesium; Cu, copper; Zn, zinc; P, phosphorus; and Ag, silver.

^b Explanation of numbering system used is as follows: 1—dry powder is sprinkled in joint region; 2—heated metal filler rod is dipped into powder or paste; 3—flux is mixed with alcohol, water, monochlorobenzene, etc., to form a paste or slurry; 4—flux is used molten in a bath.

^c Types 1 and 3 fluxes, alone or in combination, may be used with some of these base metals also.

Cleaning may be achieved by chemical or mechanical means. Some of the mechanical means employed are filing, grinding, scratch brushing and machining. The chemical means include the use of trisodium phosphate, carbon tetrachloride, and trichloroethylene for removing oils and greases.

Fluxes are used mainly to prevent the formation of oxides and to remove any oxides on the base and filler metals. They also promote free flow of the filler metal during the course of the brazing operation.

They are made available in the following forms: powders; pastes or solutions; gases or vapors; and as coatings on the brazing rods.

In the powder form a flux can be sprinkled along the joint, provided that the joint has been preheated sufficiently to permit the sprinkled flux to adhere and not be blown away by the torch flame during brazing. A thin paste or solution is easily applied and when spread on evenly, with no bare spots, gives a very satisfactory flux coating. Gases or vapors are used in controlled atmosphere furnace brazing where large amounts of assemblies are mass-brazed. Coatings on the brazing rods protect the filler metal from becoming oxidized and eliminate the need for dipping rods into the flux, but it is recommended that flux be applied to the base metal since it may become oxidized in the heating operation. No matter which flux is used, it performs its task only if it is chemically active at the brazing temperature.

Chemical compounds incorporated into brazing fluxes include borates (sodium, potassium, lithium, etc.), fused borax, fluoborates (potassium, sodium, etc.), fluorides (sodium, potassium, lithium, etc.), chlorides (sodium, potassium, lithium), acids (boric, calcined boric acid), alkalies (potassium hydroxide, sodium hydroxide), wetting agents, and water

(either as water of crystallization or as an addition for paste fluxes). [Table 2](#) provides a guide which will aid in the selection of brazing fluxes that are available commercially.

Methods of Steadying Work for Brazing.—Pieces to be joined by brazing after being properly jointed may be held in a stable position by means of clamping devices, spot welds, or mechanical means such as crimping, staking, or spinning. When using clamping devices care must be taken to avoid the use of devices containing springs for applying pressure because springs tend to lose their properties under the influence of heat. Care must also be taken to be sure that the clamping devices are no larger than is necessary for strength considerations, because a large metal mass in contact with the base metal near the brazing area would tend to conduct heat away from the area too quickly and result in an inefficient braze. Thin sections that are to be brazed are frequently held together by spot welds. It must be remembered that these spot welds may interfere with the flow of the molten brazing alloy and appropriate steps must be taken to be sure that the alloy is placed where it can flow into all portions of the joint.

Methods of Supplying Heat for Brazing.—The methods of supplying heat for brazing form the basis of the classification of the different brazing methods and are as follows.

Torch or Blowpipe Brazing: Air-gas, oxy-acetylene, air-acetylene, and oxy-other fuel gas blowpipes are used to bring the areas of the joint and the filler material to the proper heat for brazing. The flames should generally be neutral or slightly reducing but in some instances some types of bronze welding require a slightly oxidizing flame.

Dip Brazing: Baths of molten alloy, covered with flux, or baths of molten salts are used for dip brazing. The parts to be brazed are first assembled, usually with the aid of jigs, and are dipped into the molten metal, then raised and allowed to drain. The molten alloy enters the joint by capillary action. When the salt bath is used, the filler metal is first inserted between the parts being joined, or, in the form of wire, is wrapped around the area of the joint. The brazing metal melts and flows into the joint, again by capillary action.

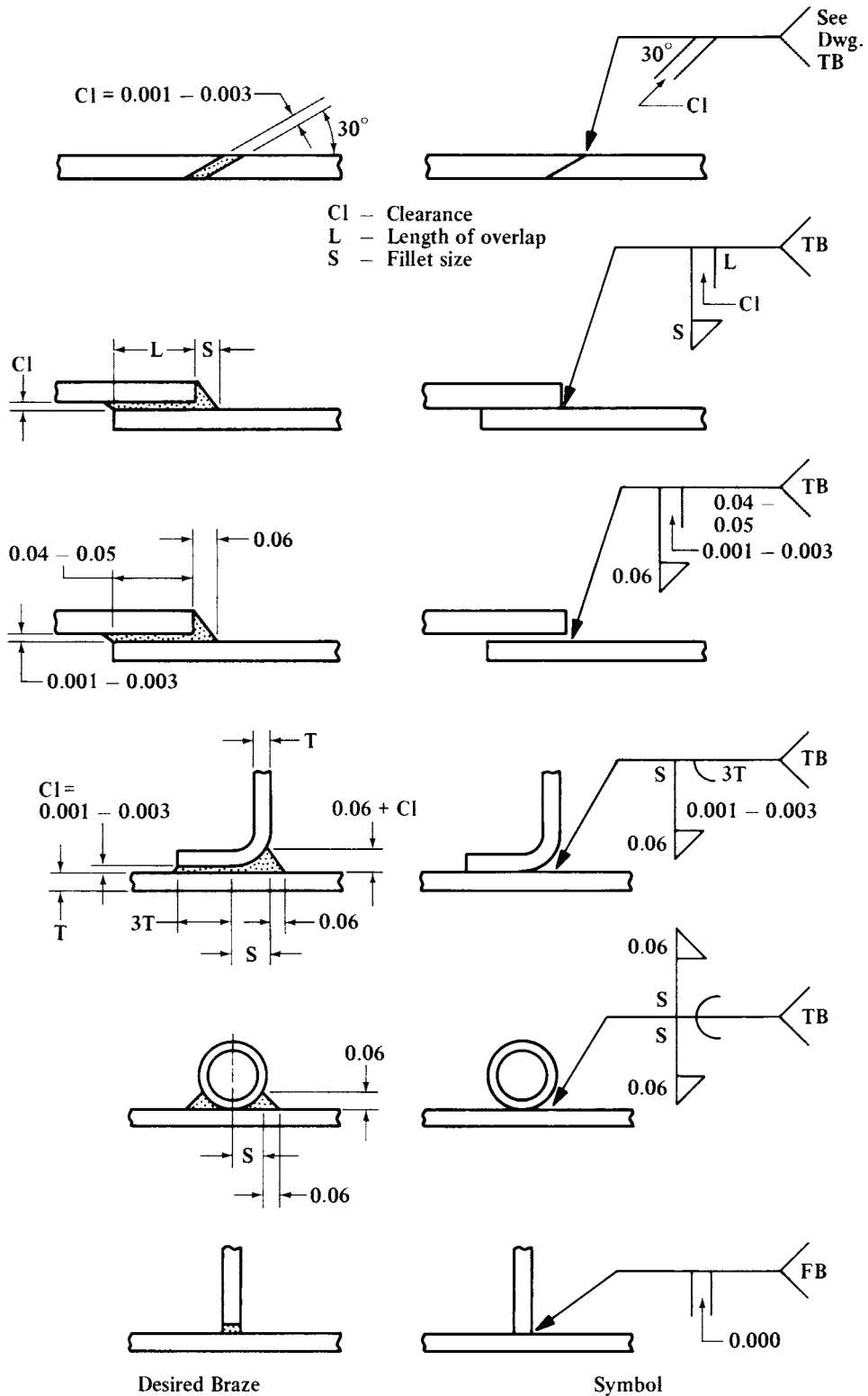
Furnace Brazing: Furnaces that are heated electrically or by gas or oil with auxiliary equipment that maintains a reducing or protective atmosphere and controlled temperatures therein are used for brazing large numbers of units, usually without flux.

Resistance Brazing: Heat is supplied by means of hot or incandescent electrodes. The heat is produced by the resistance of the electrodes to the flow of electricity and the filler metal is frequently used as an insert between the parts being joined.

Induction Brazing: Parts to be joined are heated by being placed near a coil carrying an electric current. Eddy current losses of the induced electric current are dissipated in the form of heat raising the temperature of the work to a point higher than the melting point of the brazing alloy. This method is both quick and clean.

Vacuum Furnace Brazing: Cold-wall vacuum furnaces, with electrical-resistance radiant heaters, and pumping systems capable of evacuating a conditioned chamber to moderate vacuum (about 0.01 micron) in 5 minutes are recommended for vacuum brazing. Metals commonly brazed in vacuum are the stainless steels, heat-resistant alloys, titanium, refractory metals, and aluminum. Fluxes and filler metals containing alloying elements with low boiling points or high vapor pressure are not used.

Brazing Symbol Application.—ANSI/AWS A2.4-79 symbols for brazing are also used for welding with the exception of the symbol for a scarf joint (see the diagram at the top of page [1432](#), and the symbol for a scarf joint in the table *Basic Weld Symbols* on page [1477](#), for applications of brazing symbols). The second, third and fourth figures from the top of the next page show how joint clearances are indicated. If no special joint preparation is required, only the arrow is used with the brazing process indicated in the tail.



Typical Applications of Standard Brazing Symbols

WELDING

Welding of metals requires that they be heated to a molten state so that they fuse together. A filler wire or rod is held in the heated zone to add material that will replace metal consumed by the process and to produce a slightly raised area that can be dressed down to make a level surface if needed. Most welding operations today use an electric arc, though the autogenous method using a torch that burns a mixture of (usually) acetylene and oxygen gases to heat the components is still used for certain work. Lasers are also used as the heating medium for some welding operations. In arc welding, a low-voltage, high-current arc is struck between the end of an electrode in a holder and the work, generating intense heat that immediately melts the surface.

Electrodes, Fluxes, and Processes

Electrodes for welding may be made of a tungsten or other alloy that does not melt at welding temperatures (nonconsumable) or of an alloy similar to that of the work so that it melts and acts as the filler wire (consumable). In welding with a nonconsumable electrode, filler metal is added to the pool as welding proceeds. Filler metals that will produce welds having strength properties similar to those of the work are used where high-strength welds are specified.

Briefly, the effects of the main alloying elements in welding filler wires and electrodes are: carbon adds strength but may cause brittle weld metal if cooling is rapid, so low-carbon wire is preferred; silicon adds strength and reduces oxidation, changes fluidity, and gives a flatter weld bead; manganese strengthens and assists deoxidation, plus it reduces effects of sulfur, lowering the risk of hot cracking; sulfur may help form iron sulfide, which increases the risk of hot cracking; and phosphorus, may contribute to hot cracking.

Fluxes in (usually) granular form are added to the weld zone, as coatings on the filler wire or as a core in the tube that forms the (consumable) electrode. The flux melts and flows in the weld zone, shielding the arc from the oxygen in the atmosphere, and often contains materials that clean impurities from the molten metal and prevent grain growth during recrystallization.

Processes.—There are approximately 100 welding and allied welding processes but the four manual arc welding processes: gas metal arc welding (GMAW) (which is also commonly known as MIG for metal inert gas), flux-cored arc (FCAW), shielded metal arc (SMAW), gas tungsten arc welding (GTAW), account for over 90 per cent of the arc welding used in production, fabrication, structural, and repair applications. FCAW and SMAW use fluxes to shield the arc and FCAW uses fluxes and gases to protect the weld from oxygen and nitrogen. GMAW and GTAW use mixtures of gases to protect the weld.

There are two groups of weld types, groove and fillet, which are self-explanatory. Each type of weld may be made with the work at any angle from horizontal (flat) to inverted (overhead). In a vertical orientation, the electrode tip may move down the groove or fillet (vertical down), or up (vertical up). In any weld other than flat, skill is needed to prevent the molten metal falling from the weld area.

Because of the many variables, such as material to be welded and its thickness, equipment, fluxes, gases, electrodes, degree of skill, and strength requirements for the finished welds, it is not practicable to set up a complete list of welding recommendations that would have general validity. Instead, examples embracing a wide range of typical applications, and assuming common practices, are presented here for the most-used welding processes. The recommendations given are intended as a guide to finding the best approach to any welding job, and are to be varied by the user to fit the conditions encountered in the specific welding situation.

Gas Metal Arc Welding (GMAW)

The two most cost-effective manual arc welding processes are GMAW and FCAW. These two welding processes are used with more than 50 per cent of the arc welding consumable electrodes purchased. Gas metal arc welding modes extend from short-circuit welding, where the consumable electrode wire is melted into the molten pool in a rapid succession of short circuits during which the arc is extinguished, to pulsed and regular spray transfer, where a stream of fine drops and vaporized weld metal is propelled across the continuous arc gap by electromagnetic forces in the arc.

GMAW is the most-used welding process and the two most common GMAW low-carbon steel electrodes used for production welding in North America are the E70S-3 and E70S-6 from the ANSI/AWS Standard A5 series of specifications for arc welding. The E70S-3 contains manganese and silicon as deoxidants and is mainly used for welding low-carbon steels, using argon mixtures as shielding gases. The wire used in the E70S-6 electrodes has more silicon than wire used for the E70S-3 electrodes, and is preferred where straight CO₂ or argon mixes are used as the shielding gas or if the metal to be welded is contaminated. The deoxidizing properties of the E70S-6 electrode also may be beneficial for high-current, deep-penetration welds, and welds in which higher than normal impact-strength properties are required.

E80S-D2 wire contains more manganese and silicon, plus 0.5 per cent molybdenum for welding such steels as AISI 4130, and steels for high-temperature service. The argon + CO₂ mixture is preferred to exert the influence of argon's inertness over the oxidizing action of CO₂. E70S-2 electrodes contain aluminum, titanium, and zirconium to provide greater deoxidation action and are valuable for welding contaminated steel plate.

When the GMAW welding process is used for galvanized steels, minute welding cracks may be caused by the reaction of the zinc coating on the work with silicon in the electrode. Galvanized steel should be welded with an electrode having the lowest possible silicon content such as the E70S-3. For welding low-carbon and low-alloy steels with conventional argon mixture shielding gases, there is little difference between the E70S-3 and E70S-6.

Electrode Diameters.—One of the most important welding decisions is selecting the optimum GMAW electrode diameter. Selection of electrode diameters should be based on the material thickness, as shown for carbon and stainless steels in [Table 1](#), the compatibility of the electrode current requirements with the material thickness, the mode of weld metal transfer, and the deposition rate potential shown in [Table 2](#). The two most popular GMAW electrode sizes are 0.035 inch (1.0 mm) and 0.045 inch (1.2 mm). Diameters of electrodes used for GMAW exert a strong influence on cost of welding. [Table 2](#) also shows how the weld deposition rate varies in short-circuit and spray transfer modes in welding carbon and stainless steels.

Table 1. GMAW Electrode Sizes for Welding Carbon and Stainless Steels

Material Thickness	Electrode Diameter			
	0.030 inch (0.8 mm)	0.035 inch (1.0 mm)	0.045 inch (1.2 mm)	0.062 inch (1.6 mm)
25 to 21 gage (0.020 to 0.032 inch)	yes
20 gage to ¼ inch (0.036 to 0.25 inch)	...	yes
⅜ to ⅞ inch flat and horizontal	yes	...
½ inch and up	yes

The table is based on suitability of the electrode size to mode of weld transfer, material thickness, and cost effectiveness. If a smaller electrode size is selected, the lower deposition rates could increase welding costs by 20 to 60 per cent.

Table 2. Typical Maximum GMAW Deposition Rates for Carbon and Stainless Steels. Constant-Voltage 450-amp Power Source and Standard Wire Feeder

Weld transfer mode	Electrode Diameter			
	0.030 inch (0.8 mm)	0.035 inch (1.0 mm)	0.045 inch (1.2 mm)	0.062 inch (1.6 mm)
Short circuit	5 lb/h (2.3 kg/h)	7 lb/h (3.2 kg/h)	9 lb/h (4 kg/h)	...
Spray transfer	9 lb/h (4 kg/h)	11 lb/h (5 kg/h)	19 lb/h (8.6 kg/h)	21 lb/h (9.5 kg/h)

For the lowest-cost welds with GMAW electrodes larger than 0.030 inch in diameter, the power source should provide a minimum of 350 amps. The compatibility of the optimum current range of the 0.035-inch (1.0-mm) electrode and its deposition potential make it the first choice for welding of 20 gage to $\frac{1}{4}$ inch (0.88 to 6.4 mm) thicknesses. For welding thinner sheet metals of 25 to 21 gage, the optimum electrode diameter is 0.030 inch (0.8 mm). The 0.045-inch (1.2-mm) electrode is the most practical choice for spray transfer applications on materials over $\frac{1}{4}$ inch (6.4 mm) thick and thicker.

As an example, when welding $\frac{1}{4}$ -in. (6.4-mm) thick steel, with 100 per cent arc-on time and a labor cost of \$15/h, the deposition rate with a 0.035-in. (0.9-mm) electrode is approximately 11 lb/h (5 kg/h). The labor cost per lb at $\$15/h \div 11 \text{ lb/h} = \$1.36/\text{lb}$ (\$3.00/kg). If an electrode of 0.045-in. (1.2-mm) diameter is used for the same application, the deposition rate is 16 lb/h (7.2 kg/h) and at a \$15/h labor rate, the cost of weld metal deposited = $\$15/h \div 16 \text{ lb/h} = \$0.93/\text{lb}$ (\$2.00/kg). The 0.045-in. diameter electrode would also cost less per pound than a smaller wire, and the weld time with the 0.045-in. electrode would be reduced, so less shielding gas also would be consumed.

GMAW Welding of Sheet Steel.—In GMAW, the short-circuit transfer mode is used to weld carbon steel, low-alloy steel, and stainless steel sheet of 24 gage (0.023 in., or 0.6 mm) to 11 gage (0.12 in., or 3 mm). The most common gage sizes welded with short-circuit transfer are 20 gage to 11 gage (0.88 to 3 mm) and the best GMAW electrode for these thin, sheet metal gages is the 0.035-in. (1-mm) diameter electrode. The short-circuit current requirements for these operations are typically 50 to 200 amps with voltages in the range of 14 to 22 volts. The optimum short-circuit voltage for the majority of applications is 16 to 18 volts.

Shielding Gases for Welding Carbon and Low-Alloy Steels.—With more than 40 GMAW gas mixtures available for welding carbon steels, low-alloy steels, and stainless steels, selection is often confusing. Reactive oxygen and carbon dioxide (CO₂) are added to argon to stabilize the arc and add energy to the weld. CO₂ can provide more energy to the weld than oxygen. As the CO₂ content in a shielding gas mixture is increased to certain levels, the voltage requirements are increased. Argon + oxygen mixtures will require lower voltages than mixtures containing argon with 10 to 25 per cent CO₂. Helium may also be added to argon if increased weld energy is required.

Shielding Gases for Short-Circuit Welding of Carbon Steels.—GMAW short-circuit transfer (SCT) is used mainly for welding thin metals of less than 10 gage, and gaps. With the SCT mode of weld metal transfer, the arc short circuits many times each second. The numerous short circuits switch the arc energy on and off. The short circuits and low current cause the transferred weld to freeze rapidly. Short-circuit transfer on carbon steel gage metals thicker than $\frac{1}{16}$ in. (1.6 mm) requires a shielding gas that will provide substantial weld energy. For these applications, argon with 15–25 per cent CO₂ is recommended.

If short-circuit transfer is used on metals thinner than 18 gage (0.047 in., 1.2 mm), melt-through and distortion often occur. Melt-through and distortion can be reduced on very thin-gage carbon and low-alloy steels by using a shielding gas that provides less weld energy than argon + 15 to 25 per cent CO₂ mixes. Argon + oxygen mixtures can utilize

lower voltages to sustain the arc. Argon mixed with 2 to 5 per cent oxygen is a practical mixture for thin carbon steel of less than 16 gage, where there is sensitivity to heat.

Shielding Gases for Spray Transfer Welding of Carbon Steels.—With GMAW spray transfer, all traditional argon gas mixtures will provide spatter-free spray weld transfer, depending on the electrode diameter and welding parameters used. The electrode diameter and the electrode current density influence the formation of the weld metal to be transferred. For example, with a 0.035-inch (0.9 mm) diameter electrode using a mixture containing argon 75 + CO₂ 25 per cent, a small globular weld droplet is formed on the end of the electrode tip in the conventional spray transfer parameter range. With the same gas mixture, a 0.045-inch (1.14-mm) diameter electrode, and current above 330 amps, the globular formation disappears and the metal transfers in the spray mode.

Spatter potential stemming from shielding gas, with 0.035 inch (0.90 mm) and smaller diameter electrodes can be controlled by reducing the CO₂ content in the argon mixture to less than 21 per cent. Each different shielding gas will primarily influence the open arc spray transfer mode by variations in the weld energy provided through the welding voltage requirements.

Gas selection in spray transfer must be given careful consideration. In welding of clean cold-rolled carbon steel or low-alloy steel less than $\frac{3}{8}$ inch (9.5 mm) thick, the energy potential of the arc is less important than it is for welding of steels thicker than $\frac{1}{2}$ inch (13 mm) or steels with mill scale. The energy level of the arc is also a key factor in welding steels for which higher than normal impact properties are specified.

A simple, practical multipurpose gas mixture for carbon and low-alloy steels is argon + 15 to 20 per cent CO₂, and a mixture of argon + 17 per cent CO₂ would be ideal. This two-part argon/CO₂ mixture provides higher weld energy than two-component argon + CO₂ mixtures having less than 10 per cent CO₂, argon + oxygen mixtures, or argon + CO₂ + oxygen tri-component mixtures. The argon + 17 per cent CO₂ mixture will provide an arc slightly less sensitive to mill scale than the other mixtures mentioned.

The argon + 17 per cent CO₂ mixture also has practical benefits in that it provides sufficient weld energy for all GMAW short-circuit and spray transfer applications with cylinder or bulk gases. The argon + 17 per cent CO₂ mixture may also be used for all-position FCAW electrodes in welding carbon steels, low-alloy steels, and stainless steels.

Shielding Gases for GMAW Welding of Stainless Steels.—The major problems encountered when using GMAW on stainless steels of thinner than 14 gage include controlling potential melt-through, controlling distortion, and black oxidation on the weld surface. These three welding problems have a common denominator, which is heat. The key to welding thin stainless steel is to minimize the potential heat when welding, by appropriate choice of gas mixture.

A popular gas mixture that is often recommended for GMAW welding of thin-gage stainless steel is the three-part helium gas mixture containing helium 90 + argon 7.5 + CO₂ 2.5 per cent. In contrast to gas mixtures without helium, the helium tri-mixture requires the use of higher voltages to sustain the arc, which adds unnecessary heat to the heat-sensitive thin-gage welds.

A practical and lower-cost alternative for GMAW short-circuit transfer on stainless steels is an argon mixture with 2 to 4 per cent CO₂. The argon + CO₂ mixture allows use of lower voltages than is practical with argon/helium mixtures, and the lower voltages resulting from the argon + CO₂ mixture will help to reduce distortion and oxidation, and decrease the melt-through potential. The mixture that works with short-circuit transfer is also a logical practical choice for spray transfer welding of stainless steel because it is less oxidizing than argon/oxygen mixtures. [Table 3](#) provides practical gas mixture recommendations for specific applications.

Table 3. Shielding Gases for Welding Carbon Steels and Stainless Steels

Application	Gas mixtures					
	Argon + Oxygen	Argon + CO ₂ + Oxygen	Argon + 2–4% CO ₂	Argon + 6–10% CO ₂	Argon + 13–20% CO ₂	Argon + 25% CO ₂
Short-circuit melt-through problems; less than 20 gage	1	1	1	1	2	3
Short-circuit 18 to 11 gage	1	1
Spray if mill scale or surface problems; carbon steels	1	2
Spray if low energy required; carbon steel	1	1	1	1
Spray, best impact strengths, lowest porosity; carbon steels	1	...
Best single gas mixture for carbon steels	1	...
Short-circuit; stainless steels	1
Spray; stainless steels	2	...	1
Best single gas mixture for stainless and duplex steels	1

Preferred choice of shielding gas is 1, followed by 2 and 3.

For GMAW spray transfer welding of stainless steels thicker than 11 gage, the traditional GMAW shielding gas has been argon 98 + oxygen 2 per cent. The argon + oxygen mixture provides excellent, stable, spray transfer, but the oxygen promotes oxidation, leaving the weld with a black surface. To reduce the oxidation, the 2 per cent oxygen can be replaced with the less oxidizing 2–4 per cent CO₂.

Shielding Gases for GMAW Welding of Aluminum.—For GMAW welding of aluminum, helium is added to argon to provide additional weld energy, increasing penetration width, and reducing porosity potential. A gas mixture that has worked well in practice and can be used on the majority of aluminum applications is argon + 25 to 35 per cent helium. Mixtures with higher helium content, of 50 to 90 per cent, require voltages and flow rates that may be excessive for many established aluminum applications.

Welding Controls.—The two primary controls for welding with GMAW are the electrode wire feed control on the wire feeder and the voltage control on the power source. As shown in Fig. 1, these controls typically consist of switches and knobs but do not have the scales, seen enlarged at the upper left, that indicate combinations of wire feed rate, wire gage, volts, and amps. These scales have been added here to allow clearer explanation of the functioning of the wire feed control.

The typical wire feed unit provides maximum feed rates of 600 to 800 in/min (15.2–20.3 m/min). The scale surrounding the setting knob on a wire feed control unit usually has only 10 unnumbered graduations, somewhat like the hour markers on a clock face. On most machines, each of these graduations represents an adjustment of the feed rate

of approximately 70 in/min (1.8 m/min). For each increase in the wire feed rate of 70 in/min (1.8 m/min), depending on the voltage, the welding current increases by approximately 20 to 40 amps, depending on the wire diameter and wire feed positions.

In Fig. 1, a black sector has been drawn in on the wire feed rate adjustment knob to indicate the range of wire feed rates usable with the gas mixture and the electrode diameter (gage) specified. The wire feed and voltage settings shown are for welding thin-gage carbon, low-alloy, or stainless steels with a 0.030 or 0.035 inch (0.76 or 0.89 mm) diameter electrode. The left edge of the sector on the wire feed knob is set to the eight o'clock position, corresponding to 70 in/min (1.8 m/min). The optimum voltage for this wire feed rate is 15. If a setting is too low, the knob is turned to the second (nine o'clock) or third (ten o'clock) position to increase the current. The voltage typically increases or decreases by 1 volt for each graduation of the wire feed quadrant.

The short-circuit transfer current range of 50 to 200 amps corresponds to a wire feed rate of 70 to 420 in/min (1.8–10.7 m/min), and is typically found between the eight and one o'clock positions on the scale, as indicated by the black sector on the knob in Fig. 1.

Diagrammatic quadrants have been added at the left in Fig. 1, to show the material thickness, voltage, and current that correspond to the setting of the wire feed rate adjustment knob. Optimum settings are easily made for short-circuit welding of sheet metals. When using a 0.030-in. (0.8-mm) or 0.035-in. (1-mm) diameter GMAW electrode, for instance, to weld 16-gage carbon or stainless steel with a conventional 200-to-450-amp constant-voltage power source and wire feeder, the wire feed control is set to the ten o'clock position for a feed rate of 210 in/min (5.3 m/min). With digital wire feed units, the short-circuit current range is typically between 100 and 400 in/min (2.54 and 10.16 m/min), so a good starting point is to set the wire feeder at 210 in/min (5.3 m/min). The welding voltage is set to 17.

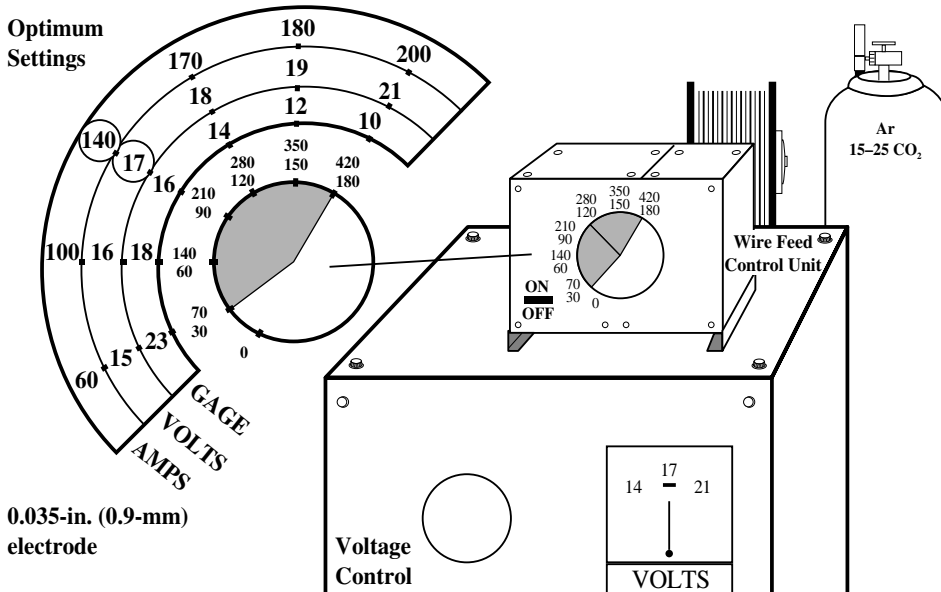


Fig. 1. Wire Feed Settings for Short-Circuit Welding of Carbon, Low-Alloy, and Stainless Steel Sheet.

Many welders set their parameters by an established mark on the equipment or by the sound of the arc as the weld is being made. The sound of the arc, influenced by the optimum current and voltage set, should be a consistent, smooth, crackling noise. If the SCT sound is harsh, the voltage should be increased slightly. If the sound is soft, the voltage should be decreased in volt increments until the sound becomes a smooth crackle. For welding metals thicker than 16 gage but less than 10 gage, the wire feed control should be moved to the eleven o'clock position (280 in/min, or 7.1 m/min), and the voltage reset to 18.

Welding of thicknesses less than 16 gage should be started with the wire feed control at the nine o'clock position (140 in/min, or 3.6 m/min) and the voltage control set to 16. The parameters discussed above apply when using argon mixtures containing 15 to 25 per cent CO₂.

GMAW Spray Transfer.—In the spray transfer mode, spatter is often caused by the voltage being set so low that the electrode runs into the weld, resulting in expulsion of molten metal from the weld pool. GMAW spray transfer is normally used for welding carbon, low-alloy, and stainless steels of a minimum thickness of $\frac{1}{8}$ in. (3.2 mm).

In Table 4, typical deposition rates with a 0.045-in. (1.2-mm) carbon steel electrode are compared with rates for larger carbon steel GMAW and flux-cored electrodes. These welds are typically carried out in the flat and horizontal positions. The practical GMAW electrode diameters commonly used for spray transfer are 0.035-in. (1-mm), 0.045-in. (1.2-mm), and 0.062-in. (1.6-mm) diameter. The most cost-effective GMAW electrode that also has the greatest range of applications on metals over $\frac{3}{16}$ in. thick is the 0.045-in. (1.2-mm) diameter size.

Table 4. Typical Deposition Rates for Carbon Steel Welding Electrodes

Electrode Diameter		Electrode Type	Amperage ^a	Deposit Rates	
inch	mm			lb/h	kg/h
0.035	1.0	GMAW	350	11	5
0.045	1.2	GMAW	380	13	6
0.062	1.6	GMAW	400	14	6.4
$\frac{1}{16}$	1.6	FCAW	350	15	7
$\frac{3}{32}$	2.4	FCAW	450	16	7.3

^aThe optimum ampere value for the electrode type is shown. The 0.045 GMAW electrode is the most versatile and cost-effective electrode for welding material of 14 gage to 1 inch thick.

GMAW Spray Transfer Welding of Metal Thicknesses Less than $\frac{1}{4}$ in. (6.4 mm).—

The most versatile GMAW electrode for a welding shop that welds carbon, low-alloy, and stainless steels from 20 gage to $\frac{1}{4}$ in. (6.4 mm) thick is the 0.035 in. (1.0 mm) diameter electrode. The traditional practical spray transfer current range of between 200 and 350 amps for the 0.035 in. electrode is well suited for welding thicknesses from 10 gage to $\frac{1}{4}$ in. (6.4 mm).

The correct parameters for a 0.035 in. (1 mm) electrode and spray transfer welding are found on the wire feed unit between the one and five o'clock positions, or, on a digital wire feeder, between 420 and 700 in/min (10.7 and 17.8 m/min). In the drawing at the left in Fig. 2, the spray transfer wire feed range is shaded. When the wire feed rate has been set, the voltage should be fine-tuned so that the electrode wire tip is just touching the weld and a smooth crackling sound without spatter is produced.

An optimum single spray transfer mode current setting for a 0.035-in. (1-mm) diameter electrode for most welding applications is approximately 280 amps with the wire feed set at the three o'clock position for 560 in/min. Manual or high-speed mechanized welds on material of 10 gage to $\frac{1}{4}$ in. thick can be made at the three o'clock wire feed position with only an adjustment for voltage, which should be set initially at 31 volts, when using an argon + CO₂ mixture.

GMAW Spray Transfer for Metal Thicknesses $\frac{1}{4}$ in. (6.4 mm) and Up.—The 0.045-in. (1.2-mm) diameter is the most cost-effective GMAW electrode for spray transfer welding of carbon, low-alloy, and stainless steels $\frac{1}{4}$ in. and thicker. A $\frac{7}{16}$ -in. (11.2-mm) single-pass, no-weave, fillet weld can be produced with this electrode. If larger single-pass welds are required, use of flux-cored electrodes should be considered.

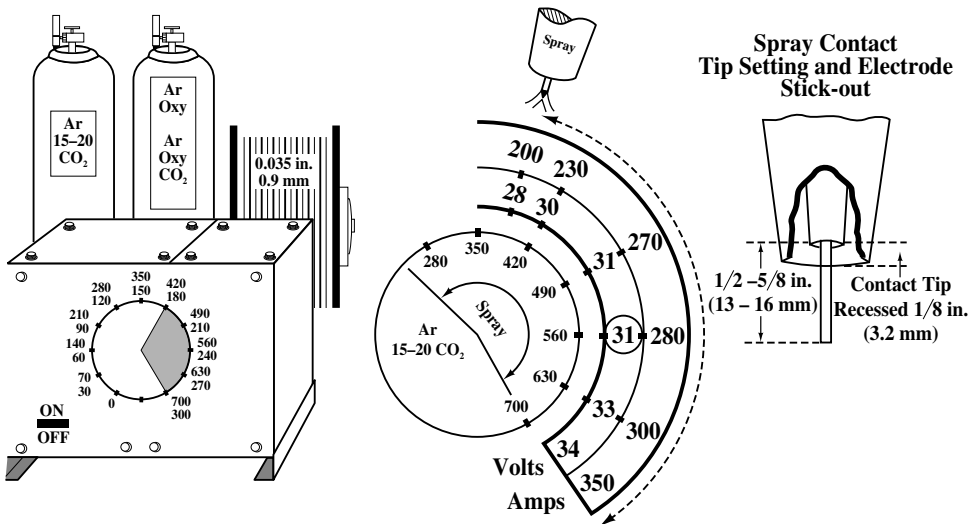


Fig. 2. GMAW Spray Transfer Parameters with 0.035-inch (0.9-mm) Diameter Electrodes

A 400-amp power source is a practical cost-effective unit to use with the 0.045-in. diameter electrode. Globular spray transfer, obtained at the ten o'clock position on the wire feed adjustment knob, starts at current levels of approximately 230 amps and requires a wire feed rate of approximately 210 in./min (90 mm/s). Most spray applications are carried out in the higher-energy, deeper-penetrating 270- to 380-amp range, or between twelve and two o'clock wire feed positions giving 350 to 490 in./min (150 to 210 mm/s). In this range, in which there is minimum weld spatter, the weld deposits are in the form of minute droplets and vaporized weld metal.

The quadrants at the top in Fig. 3 show some typical settings for feed rate, voltage, and current, with different shielding gases. An ideal starting point with a 0.045-in. (1.2-mm) diameter electrode is to set the wire feed rate knob at the one o'clock position, or 420 in./min, at which rate the current drawn, depending on the power source used, should be about 320 to 350 amps. The best starting voltage for the 0.045-in. (1.2-mm) electrode is 30 volts. The arc length should then be set as indicated in Fig. 4. With current over 400 amps at 560 in./min, the 0.045-in. diameter electrode may produce a turbulent weld puddle and a digging arc, which can lead to lack of fusion, porosity, and cracks.

GMAW Spray Transfer with 0.062-in. (1.6-mm) Diameter Electrodes.—Electrode wire of 0.062-in. (1.6-mm) diameter is the largest size in normal use and is often chosen for its high deposition rates. Due to the high-current requirements for the spray transfer mode, use of these thicker electrodes is generally restricted to metal thicknesses of 1/2 in. (13 mm) and thicker. The high-current requirement reduces ease of welding. This electrode size is suitable for mechanized welding in which fillet welds greater than 3/8 in. (9.6 mm) are required.

As indicated at the lower left in Fig. 3, the current range for 0.062-in. (1.6-mm) electrodes is narrow and most welds are made in the range of 360 to 420 amps, or between the ten and eleven o'clock positions on the wire feed control unit for 210 to 280 in./min (90 to 120 mm/s). The quadrants at the lower center and lower right in Fig. 3 show deposition rates in lb/h and kg/h for 0.045-in. (1.2-mm) and 0.062-in. (1.6-mm) diameter electrodes.

Some optimum settings for GMAW welding with a mixture of argon + 15 to 20 per cent CO₂ gases are given in Table 5.

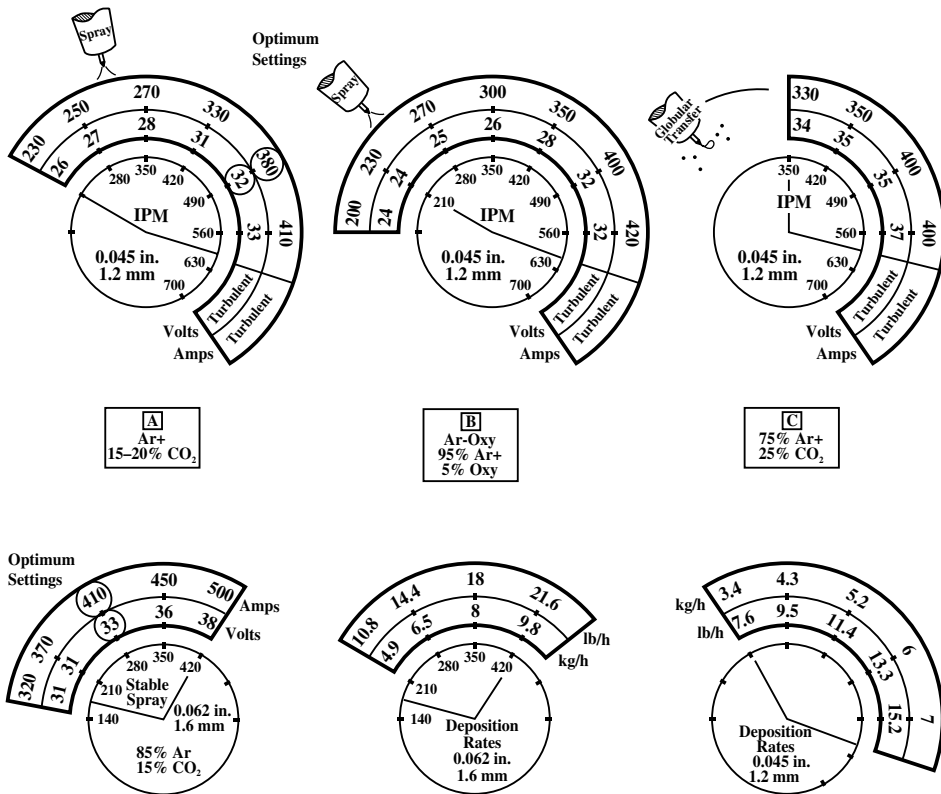


Fig. 3. GMAW Spray Transfer Parameters for Various Electrodes and Gases.

Table 5. Optimum Settings for GMAW with Argon + 15–20 per cent CO₂

Diameters		Mode	Wire Feed Rates		Amps	Volts
inch	mm		in/min	m/min		
0.035	1.0	short circuit	210	5.3	140	17
		spray transfer	560	14.2	280	29–30
0.045	1.2	short circuit	210	5.3	190	18
		spray transfer	420	10.7	380	30–31
0.052	1.4	spray transfer	280	7.1	370	31–32
0.062	1.6	spray transfer	280	7.1	410	31–32

Note: If argon + oxygen gas mixtures are used, voltage should be lowered by 1 to 4 volts for the spray transfer mode. The faster the weld travel speed, the lower the voltage required.

Spray Transfer Voltage.—The usual setting for spray transfer welding with commonly used electrode diameters is between 25 and 35 volts (see Fig. 4A). To set the optimum voltage for GMAW spray transfer, set the voltage initially so that it is too high, usually between 30 and 35 volts. With excess voltage, there should be a visible gap between the tip of the electrode and the weld, and the arc sound should be free from crackle. With the sequence shown in Fig. 4, the voltage should now be reduced until a consistent smooth crackle sound is produced. If the voltage is lowered too much, the electrode will run into the weld, making a harsh crackling sound, and the resulting weld expulsion will cause spatter.

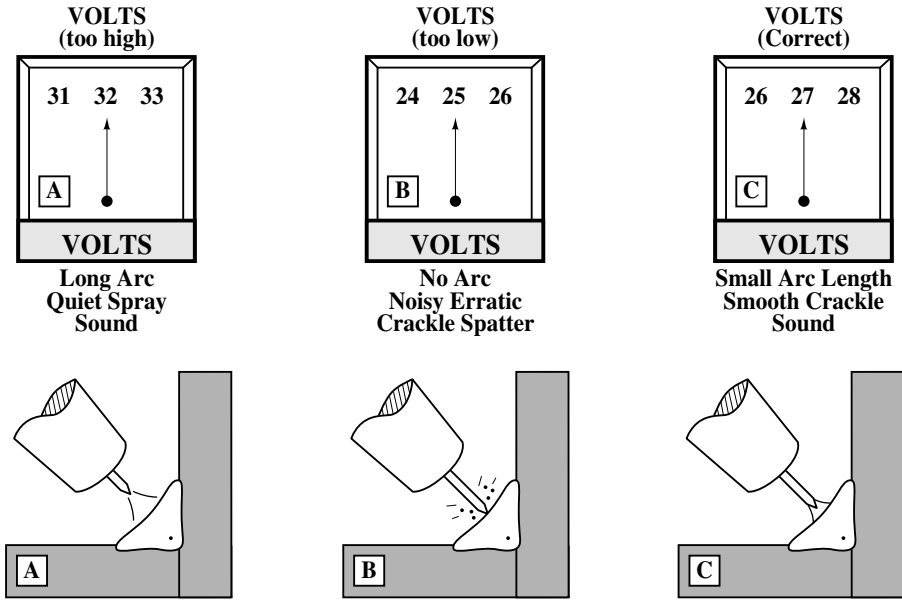


Fig. 4. Setting Optimum Voltage for GMAW Spray Transfer Welding.

Flux-Cored Arc Welding

FCAW welding offers unique benefits for specific applications, but flux-cored consumable electrodes cost more than the solid electrodes used in gas metal arc welding, so users need to be aware of FCAW benefits and disadvantages compared with those of GMAW welding. Generally, flux-cored electrodes designed for use without a shielding gas are intended for welding outdoors. Most indoor FCAW welding is done with gas-shielded FCAW welding electrode wire. Some Standards for gas-shielded FCAW electrodes for various countries are listed in [Table 6](#).

Table 6. Standards for Gas-Shielded, Flux-Cored Welding Electrodes

Steel Type	Country	Standard
Low-Carbon Steels	USA	AWS A5.20
	Canada	CSA W48.5
	Japan	JIS Z3313
	Germany	DIN 8559
Low-Alloy Steels	USA	AWS A5.29
	Canada	CSA W48.3-M
	United Kingdom	BS 639-2492
Stainless Steels	USA	AWS A5.22

All-Position, Gas-Shielded Electrodes.—The term “all-position” does not necessarily mean that these electrodes are the best choice for all positions. Also, flux-cored electrodes may meet all standard specifications, but there will inevitably be subtle differences in weld transfer characteristics and recommended current, voltage, and other settings between electrodes made by different manufacturers. The chemistry and slag of the electrodes developed for welding in the flat and horizontal positions (E70T-X) typically provide superior results when they are used for flat and horizontal applications where the surface conditions of the plate are suspect or large, deep-penetrating welds are required. All-position electrodes are intended for, and best used in, vertical and overhead welds. For exten-

sive welding in flat or horizontal positions, the welder is better served with the electrodes designed for these specific positions.

All-position, gas-shielded FCAW electrodes provide unique benefits and potential for cost savings. In contrast with short-circuit GMAW, or pulsed GMAW, the all-position FCAW electrodes used for vertical up welding of carbon, low-alloy, or stainless steels are simpler to operate, are capable of greater weld quality, and will provide two to three times the rate of weld deposition. The electrode most commonly used in the USA for vertical up welding on carbon steels is the type E71T-1. The equivalent to the E71T-1 standardized electrode specification now in use in other countries include: Canada, E4801T9; Germany, SGR1; and Japan, YFW 24.

If the end user selects the correct all-position electrode diameter, the routine weaving of the electrode during vertical up and overhead applications may be minimized. Keeping the weld weave to a minimum reduces the skill level needed by the welder and increases the potential for consistent side-wall fusion and minimum porosity. If weaving is necessary, a straight-line oscillation technique is often preferred. Typical settings for welding with various sizes of gas-shielded FCAW electrodes are shown in Table 7.

Table 7. Typical Settings for Welding with Gas-Shielded FCAW Electrodes

Electrode Diameter inch (mm)	Vertical Up Welds	Flat and Horizontal Welds
0.035 (1)	Feed rate 450 ipm (11.4 m/min) Current 165 amps Voltage 28 volts	Feed rate 630 ipm (16.0 m/min) Current 250 amps Voltage 30 volts
0.045 (1.2)	Feed rate 350 ipm (8.9 m/min) Current 200 amps Voltage 25 volts	Feed rate 560 ipm (14.2 m/min) Current 280 amps Voltage 26 Volts
0.052 (1.4)	Feed rate 240 ipm (6.1 m/min) Current 200 amps Voltage 25 volts	Feed rate 520 ipm (13.2 m/min) Current 300 amps Voltage 30 volts
0.062 (1.6)	Feed rate 210 ipm (5.3 m/min) Current 240 amps Voltage 25 volts	Feed rate 350 ipm (8.9 m/min) Current 340 amps Voltage 29 volts
$\frac{3}{32}$ (2.4)	...	Feed rate 210 ipm (5.3 m/min) Current 460 amps Voltage 32 volts

Material Condition and Weld Requirements.—Practical considerations for selecting a gas-shielded, flux-cored electrode depend on the material condition and weld requirements. FCAW electrodes are beneficial if the surface of the material to be welded is contaminated with mill scale, rust, oil, or paint; the fillet weld size is to be over $\frac{3}{8}$ in. (9.6 mm) wide (a GMAW single-pass fillet weld with an electrode size of 0.045 in. is typically $\frac{3}{8}$ in. wide); the weld is vertical up, or overhead; the required impact strengths and other mechanical properties are above normal levels; crack resistance needs to be high; and increased penetration is required.

Selecting an FCAW Electrode.—Selection of FCAW electrodes is simplified by matching the characteristics of flux-cored types with the material and weld requirements listed above. Once the correct electrode type is selected, the next step is to choose the optimum size. In selecting an all-position, flux-cored electrode for vertical up or overhead welding, the steel thickness is the prime consideration. Selecting the optimum electrode diameter allows the high current capability of the electrode to be fully used to attain maximum deposition rates and allows use of the highest penetrating current without concern for excessive heat-related problems during welding. When used in the optimum current range, the deposited filler metal matches the required amount of filler metal for the specific size of the weld, determined by the plate thickness.

The following suggestions and recommendations are made for FCAW welding of carbon, low-alloy, and stainless steels having flat surfaces. For vertical up welds on steels of thicknesses from $\frac{1}{8}$ to $\frac{3}{16}$ in. (3.2 to 4.8 mm) and for vertical up welds on pipe in the thickness range of $\frac{1}{4}$ to $\frac{1}{2}$ in. (6.4 to 13 mm), consider the 0.035-in. (1.0-mm) diameter E71T-1 electrode. For vertical up welds on steels in the range of $\frac{1}{4}$ to $\frac{3}{8}$ in. (6.4 to 9.6 mm) thickness, consider the 0.045-in. (1.2-mm) diameter E71T-1 electrode or, in nonheat-sensitive applications, the 0.062-in. (1.6-mm) diameter E71T-1 electrode. For vertical up welds on steels of over $\frac{3}{8}$ in. (9.6 mm) thickness, consider the 0.062-in. (1.6-mm) diameter E71T-1 electrodes for optimum deposition rates. For flat and horizontal welds on steels of $\frac{3}{8}$ to $\frac{3}{4}$ in. (9.6 to 19 mm) thickness, consider the $\frac{1}{16}$ -in. (1.6-mm) diameter E70T-X electrodes. For flat and horizontal welds on steels over $\frac{3}{4}$ in. (19 mm) in thickness, consider the $\frac{3}{32}$ -in. (2.4-mm) E70T-X electrodes.

FCAW Welding of Low-Carbon Steels.—Low-carbon steel is usually called carbon steel or mild steel. The most-used FCAW electrode for welding carbon steels in the flat or horizontal welding positions is the type E70T-1, which is suited to welding of reasonably clean steel using single-pass or multi-pass welds. Type E70T-2 has added deoxidizers and is suited to surfaces with mill scale or other contamination. This type is used when no more than two layers of weld are to be applied. Type E70T-5 is used for single-pass or multi-pass welds where superior impact properties or improved crack resistance are required. The E70T-X electrodes typically range in size from 0.045 to $\frac{3}{32}$ in. (1.2 to 2.4 mm) in diameter. Type E71T-1 all-position electrodes are available in diameters of 0.035 in. (1 mm) to 0.062 in. (1.6 mm). With the FCAW process, multi-pass welds are defined as a condition where three or more weld passes are placed on top of each other.

Settings for Gas-Shielded, All-Position, FCAW Electrodes.—The optimum setting range (volts and amps) for vertical up welding with all-position FCAW electrodes is rather narrow. The welder usually obtains the greatest degree of weld puddle control at the recommended low to medium current settings. The electrode manufacturers' recommended current range for an E71T-1 electrode of 0.045-in. (1.2-mm) diameter for vertical up welding may be approximately 130 to 250 amps. Using the 0.045-in. (1.2-mm) diameter electrode at 250 amps for a vertical up weld in $\frac{1}{4}$ -in. (6.4-mm) thick steel, the welder may find that after 3 to 4 inches (75–100 mm) of weld, the weld heat built up in the steel being welded is sufficient to make the weld puddle fluidity increasingly difficult to control. Reducing the current to 160–220 amps will make it possible to maintain control over the weld puddle.

A typical optimum setting for a vertical up weld with an E71T-1, 0.035-in. (1.2-mm) diameter, all-position electrode is as follows. First, set the wire feed rate. If the wire feeder maximum rate is 650 to 750 in/min (16.5–19.0 m/min), the setting mark on the adjustment knob should be set between the one and two o'clock positions on the dial to obtain a feed rate of 450 in/min (11 m/min). If the wire feeder has a digital readout, the rate setting should be the same. At the 450-in./min setting, the welding current with the 0.035-in. all-position electrode should be optimized at between 160 and 170 amps. The welding voltage should be set at 27 to 28 volts with the electrode tip just touching the weld. If there is a gap causing the weld puddle to become too fluid, the voltage should be lowered. If the electrode runs into the weld, causing spatter, the voltage needs to be increased.

With the above conditions, welding steel of $\frac{1}{8}$ to $\frac{1}{4}$ in. thickness will deposit 5 to 7 lb/h (2.2 to 3 kg/h). The 0.035-in. electrode is also ideal for welding steel pipe with wall thicknesses of less than $\frac{1}{2}$ in. (13 mm). The thickness of the pipe after bevelling controls the size of electrode to be used. The 0.035-in. (6.4-mm) electrode can produce a $\frac{1}{4}$ -in. (6.4-mm) vertical up fillet weld on such a pipe without weaving.

Contact Tip Recess.—The dimension labeled contact tip recess in Fig. 2, and indicated as $\frac{1}{8}$ in. (3 mm), should be about $\frac{1}{2}$ in. (13 mm) for a minimum electrode extension of $\frac{3}{4}$ in. (19 mm), for FCAW welding. This dimension is critical for obtaining high-quality welds with all-position electrodes because they have a fast-freezing slag and operate with low to medium current and voltage. If the recess dimension is less than the optimum, the voltage may be lower than the minimum recommended, and if the settings are less than the minimum, the fast-freezing slag may solidify too rapidly, causing excess porosity or “worm tracks” on the weld surface.

The recommended length of electrode extension for all-position FCAW, E71T-1 electrodes is $\frac{3}{4}$ to 1 in. (19 to 25 mm). The size of this extension not only affects the minimum required parameters, but a long electrode extension also ensures preheating of the electrode and allows lower current to be used. Preheating the electrode is further beneficial as it reduces moisture on the electrode surface, and in the electrode flux. When a change is made from the GMAW to the FCAW process, welders must be aware of the influence on weld quality of the electrode extension in the FCAW process.

Porosity and Worm Tracks.—As mentioned above, porosity and worm tracks typically result from a combination of incorrect electrode extension, incorrect welding settings, humidity, electrode moisture, refill scale, rust, paint, oils, or poor welding technique. Where humidity levels are high, potential for porosity and worm tracks increases. The FCAW process is less sensitive to mill scale than the GMAW spray transfer mode but mill scale will often cause excess weld porosity. The best way to avoid the effects of mill scale, rust, oil, and surface contaminants is to grind the area to be welded.

Another way to reduce porosity is to keep weaving to a minimum. If the correct size flux-cored electrode is used, weaving can be kept to a minimum for most flux-cored applications. The forehand technique produces the best weld bead surface on fillet weld beads up to $\frac{3}{4}$ in. (19 mm) steel thickness in the flat and horizontal weld positions. On larger single-pass fillet welds, the backhand technique is beneficial because the voltage directed at the weld provides additional weld puddle control to the fluid welds. The backhand technique used for flat and horizontal welds produces a more convex weld bead, reduces potential for porosity, and increases penetration.

If porosity or worm tracks occur, the prime solution is in weld practices that increase heat at the weld, but the following remedies can also be tried. Grind clean the surface to be welded; use recommended electrode extensions; increase current (wire feed rate) decrease voltage; use the backhand welding technique; slow down travel speed, consider use of a different electrode formulation containing increased deoxidizers, avoid weaving; change from argon + CO₂ mixture to straight CO₂; and provide a protective cover to keep the electrode spool clean and dry.

Welding with 0.045-in. (1.2-mm) Diameter All-Position Electrodes.—Fig. 5 shows wire feed settings for welding of steel with 0.045-in. (1.2-mm) diameter, E71T-1 all-position electrodes using a mixture of argon + 15 to 25 per cent CO₂ as the shielding gas, and an electrode extension of $\frac{3}{4}$ in. (18 mm). Parameters for vertical up welding, shown at the left in Fig. 5, include setting the wire feed rate at the twelve o'clock position, or about 350 in./min, using 200 to 190 amps, and setting the voltage between 24 and 25 volts. Optimum parameters for flat welding, shown at the right in Fig. 5 include setting the wire feed rate at three o'clock position, or 560 in./min (240 mm/s), and 270 amps at 25 to 27 volts.

Welding with 0.052-in. (1.3-mm) Diameter All-Position Electrodes.—Settings for vertical up and flat welding with all-position E71T-1 electrodes of 0.052-in. (1.3-mm) diameter are seen at the left in Fig. 6. These electrodes are suited to welding steel having thicknesses of $\frac{1}{4}$ in. (6 mm) and thicker. For vertical up welding, the wire feed rate is set between the ten and eleven o'clock positions, or 250 in./min (106 mm/s), with about 200 amps at 25 volts. Flat welding with these electrodes is best done with the wire feed rate set

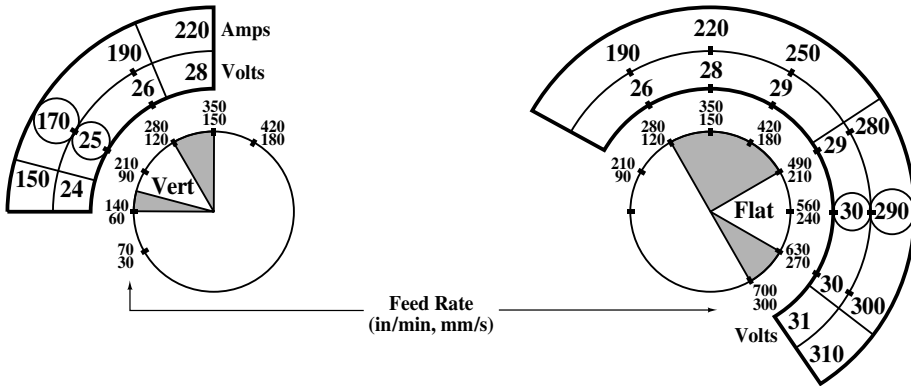


Fig. 5. Wire Feed and Voltage Settings for FCAW Welding with 0.045-in. (1.2-mm) Diameter E71T-1 Electrodes. Optimum settings are circled.

between the two and three o'clock positions, or 490 to 560 in./min (207 to 237 mm/s), giving approximately 300 amps at 28 volts.

Settings for all-position E71T-1 electrodes of 0.062-in. (1.6-mm) diameter, shown at the right in Fig. 6, for vertical up welding are just before the ten o'clock position, or 190 in./min, giving 230 to 240 amps with voltage adjusted to 24–25 volts. For flat welding, the wire feed is set to the twelve o'clock position, giving 340–350 amps with a voltage of 29–30 volts.

High-Deposition, All-Position Electrodes.—Vertical up weld deposition rates of 10 to 14 lb/h can be achieved with the E71T-1, 0.062-in. (1.6-mm) and 0.045-in. (1.2-mm) flux-cored electrodes. Settings are shown in Fig. 6 for E71T-1, FCAW electrodes of 0.052- and 0.062-in. (1.4- and 1.6-mm) diameter. These electrodes are suited to applications in which the steel thickness is ¼ in. and thicker, and are the most cost-effective diameter for all-position welds on carbon and stainless steels of ¼ in. (6.35 mm) thickness and thicker. In contrast, vertical up welds, using GMAW or SMAW, may deposit an average of 2 to 4 lb/h (1 to 2 kg/h). Deposition rates are based on welding 60 minutes of each hour. Pulsed GMAW provides deposition rates of 3 to 6 lb/h (1.3-2.7 kg/h). Average rates for vertical up welding with all-position, flux-cored electrodes are shown in Table 8.

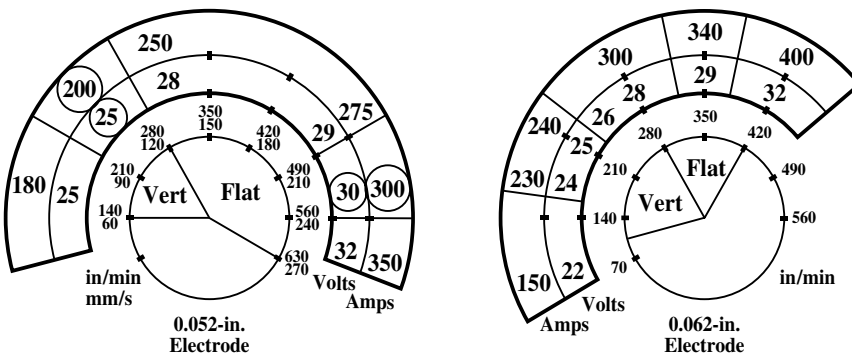


Fig. 6. Wire Feed and Voltage Settings for Vertical Up Welding with 0.052- and 0.062-in. Diameter Electrodes

The average deposition rates in Table 9 are to be expected with FCAW electrodes available today. Special electrodes are also available that are specifically designed to provide higher deposition rates. A typical manual welder, welding on steel of ¼ to ⅜ in. thickness for 30 minutes of each hour with an all-position flux-cored 0.062-in. (1.6-mm) or 0.045-in. (1.2-mm) diameter electrode would deposit about 4–5 lb/h.

Table 8. Deposition Rates for Vertical Up Welding with All-Position, Flux-Cored Electrodes (ET71T-1)

Electrode Diameter in. (mm)		Typical Deposition Rate Range		Average Deposition Rate	
		lb/h	(kg/h)	lb/h	(kg/h)
0.035	(1)	2.7–6.5	(1.2–3)	5	(2.3)
0.045	(1.2)	5–11	(2.3–5)	8	(3.6)
0.052	(1.4)	4–8	(1.8–3.6)	6.5	(3)
0.062	(1.6)	4–11	(1.8–5)	8.5	(4)

Table 9. Average Deposition Rates for Flat and Horizontal Welds

Process	Electrode Size		Cost-Effective Current Range (amps)	Optimum Current (amps)	Deposition Rate	
	in.	(mm)			lb/h	(kg/h)
GMAW spray transfer	0.035	(1)	250–350	285	9	(4)
	0.045	(1.2)	300–400	385	13	(5.9)
	0.052	(1.4)	350–470	410	11	(5)
	0.062	(1.6)	375–500	450	17	(7.7)
FCAW	0.045	(1.2)	225–310	300	14	(6.4)
	0.052	(1.4)	260–350	310	15	(6.8)
	0.062	(1.6)	300–400	340	15	(6.8)
	$\frac{3}{32}$	(2.4)	380–560	460	17	(7.7)

The average deposition rates of pulsed GMAW and FCAW for vertical up welds are similar for applications where the steel thickness is $\frac{1}{8}$ in. (3.2 mm) or less. On steels thicker than $\frac{1}{8}$ in., where the current may be increased, and larger-diameter all-position FCAW electrodes may be used, deposition rates will be much greater than with pulsed GMAW. Compared with GMAW electrodes for pulsed welding, FCAW all-position electrodes require less costly equipment, less welding skill, and have potential for increased weld fusion with less porosity than with GMAW pulsed techniques.

Electrode Diameters and Deposition Rates.—A cost-effective welding shop can achieve deposition rates on flat and horizontal welds of 12 to 15 lb/h (5 to 7 kg/h) with both the GMAW 0.045-in. wire and the 0.062-in. flux-cored wire electrodes, without welder discomfort, and with welds of consistent quality.

The first consideration in selecting the optimum size of gas-shielded FCAW E70T-X electrode for manual flat and horizontal welds on steels thicker than $\frac{1}{4}$ in. (6.4 mm) is the current requirements needed to achieve deposition rates of 12 to 15 lb/h (5 to 7 kg/h). Large-size electrodes of $\frac{3}{32}$ -in. (2.4-mm) diameter require 500 amps or more to attain optimum deposition rates. These $\frac{3}{32}$ -in. diameter electrodes are often used with power sources in the 300–400 amp range, but even when the power source provides 500 to 600 amps, welding is often performed at the low end of the electrode's current requirements. With the large, $\frac{3}{32}$ -in. diameter electrodes, welder appeal is low, smoke is often excessive, and deposition rates are often only comparable with smaller, easier-to-operate FCAW electrodes.

Typical deposition rates for flat and horizontal welds with various electrode sizes and weld settings are shown in Table 9. In connection with this table, it may be noted that high deposition rates in welding steel plate thicker than $\frac{1}{4}$ in. require use of currents above the minimum shown for the various sizes of electrodes. The optimum current requirements for the most popular electrode sizes indicate that a 450-amp power source is the most suitable for welding steel of more than $\frac{1}{4}$ in. thickness. The two most cost-effective and versatile

consumables for thin and thick steel sections are the 0.045 in. for GMAW and the 0.062 in. for FCAW electrodes.

The approach to a welding application is critical to achievement of optimum weld quality at minimum cost. In many applications, minimal consideration is given to weld costs. Half of every man-hour of welding in many shops could be saved with selection of the correct electrode diameter used with optimum parameter settings. A practical point that is often overlooked in selection of FCAW electrodes is that the larger the electrode diameter, the more restricted is the application thickness range. Large FCAW electrodes such as the $\frac{3}{32}$ in. (2.4 mm) are neither suitable nor cost-effective for the common steel thickness range of $\frac{1}{4}$ to $\frac{1}{2}$ in. (6.4 to 13 mm). Smaller FCAW electrodes such as the $\frac{1}{16}$ in. (1.6-mm) diameter, are suitable for both thin and thick applications. A $\frac{1}{16}$ -in. diameter FCAW electrode used in the 300- to 350-amp range provides excellent deposition rates with superior welder appeal and negligible smoke.

Large-diameter $\frac{3}{32}$ -in. (2.4-mm) electrodes are popular for manual applications. However, from a practical point of view, this electrode size is often better suited to mechanized high-current welding in which the high currents required for optimum deposition rates may be safely used without health risks. Use of an electrode at 60 to 80 per cent of its welding current capability indicates that the correct diameter electrode has been selected for the application. When an electrode is used at its maximum-current capability, it shows that the next size larger electrode should be preferred, and when the low end of the current capability is in use, the electrode selected is typically too large.

The 0.062-in. (1.6-mm) Diameter, E70T-X Electrode.—The 0.062-in. (1.6-mm) diameter FCAW electrode is the most practical size of its type and will provide excellent deposition rate potential with a practical current range and the broadest application range. Settings for the common $\frac{1}{16}$ -in. diameter E70T-1 electrode are shown in Fig. 7. With the GMAW process, a $\frac{3}{8}$ - to $\frac{7}{16}$ -in. (9.6- to 11-mm) minimum-weave fillet weld is typically the maximum size that can be made in a single pass. The 0.062-in. ($\frac{1}{16}$ -in., 1.6-mm) FCAW electrode can easily produce a $\frac{3}{4}$ -in. (19-mm), nonweave, single-pass fillet weld. This size of electrode is also a practical choice for welding steel of $\frac{1}{4}$ in. (6.4 mm) or greater thickness. From a cost perspective, FCAW consumable electrodes should be used whenever the GMAW process is not suitable.

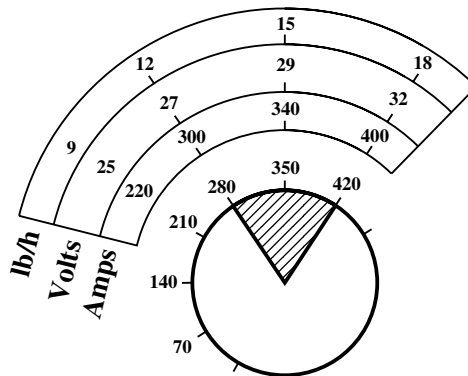


Fig. 7. Settings for $\frac{1}{16}$ -in. (1.6-mm) FCAW, E70T-X Electrodes.

The average deposition efficiency of a flux-cored electrode is 85 per cent, which means that for every 100 lb or kg of electrode material used, 85 lb or kg ends up as weld material. In contrast, the average deposition efficiency of a GMAW electrode used with argon mixtures and correct equipment settings should be a minimum of 99 per cent.

Shielding Gases and FCAW Electrodes.—The E70T-X flux-cored electrodes that are recommended for flat and horizontal welds use CO₂ gas shielding. Because of new OSHA welding smoke restrictions, manufacturers of FCAW electrodes now provide E70T-X consumable electrodes that can be used with less reactive argon + CO₂ mixtures to reduce smoke levels. The fast-freezing slag, all-position, E71T-1 flux-cored electrodes can use either CO₂ or argon + 15 to 25 per cent CO₂ mixtures for welding carbon, low-alloy, or stainless steels. The argon + CO₂ mixture is often selected because it provides the highest energy from a reactive gas mixture with a compatible voltage range.

Instead of CO₂, welders often prefer the arc characteristics, lower smoke levels, and lower voltage requirements of the argon + CO₂ mixtures for all-position welding. However, if lower reactive argon mixtures such as argon + oxygen, or argon with less than 13 per cent CO₂, are used, the weld voltage requirements and the arc plasma energy are reduced, adding to the possibility of changing the mechanical properties significantly, increasing the porosity, and raising the potential for forming worm tracks.

Shielded Metal Arc Welding

With the shielded metal arc welding (SMAW) process, commonly known as stick welding, it is most important to select an electrode that is suited to the application. For welding austenitic stainless or high-alloy steels, the electrode is first selected to match the mechanical and chemical requirements of the metal to be welded. Secondary requirements such as the welding position, penetration potential, deposition capabilities, and ease of slag removal are then considered. Many electrodes for SMAW welding of low- to medium-carbon steels have unique characteristics making them the most suitable and cost-effective for a specific welding application.

In interpreting the ANSI/AWS Standard specification code for SMAW electrodes shown in Table 10, for example, E60XX, the E stands for a low-carbon steel, metal arc welding electrode. The next two digits, such as 60 or 70, indicate the approximate tensile strength of the weld deposit in thousands of psi.

Of the last two digits, the first indicates the usability as follows: 1 = usable in all welding positions; 2 = usable for flat or horizontal positions; and 3 = usable in flat position only.

The final digit, combined with the above, indicates the type of flux coating, as shown in Table 10.

British Standard BS 639:1986 defines requirements for covered carbon- and carbon-manganese-steel electrodes for manual metal arc welding, depositing weld metal having a tensile strength of not more than 650 N/mm². Appendix A of this standard lists minimum mandatory and optional characteristics of these electrodes. The extensive classifications provide for electrodes to be rated for strength, toughness, and covering (STC), with codes such as E 51 5 4 BB [160 3 0 H]. In this series, E indicates that the electrode is covered and is for manual metal arc welding. The next two digits (51) indicate the strength (tensile, yield, and elongation) properties. The next digits (5 and 4) give the temperatures at which minimum average impact strengths of 28J (at -40°C) and 47J (at -30°C), using Charpy V-notch test specimens, are required. The next group is for the covering and the BB stands for basic, high efficiency. Other letters are B for basic; C for cellulosic; R for rutile, RR for rutile, heavy coated; and S for other.

Table 10. Significance of Digits in ANSI/AWS A5.18-1979 Standard

Third and Fourth Digits	Flux Type and Characteristics, SMAW Electrodes
10	High-cellulose coating bonded with sodium silicate. Deep penetration, energetic spray-type arc. All-positional, DCEP ^a only
11	Similar to 10 but bonded with potassium silicate to permit use with AC or DCEP

Third and Fourth Digits	Flux Type and Characteristics, SMAW Electrodes
12	High-rutile coating, bonded with sodium silicate. Quiet arc, medium penetration, all-positional, AC or DCEN
13	Similar to 12 but bonded with sodium silicate and with easily ionized materials added. Gives steady arc on low voltage. All-positional, AC or DCEN
14	Similar to 12 with addition of medium amount of iron powder. All-positional, AC or DC
15	Lime-fluoride coating (basic low-hydrogen) bonded with sodium silicate. All-positional. For welding high-tensile steels. DCEP only
16	Similar to 15 but bonded with potassium silicate. AC or DCEP
18	Similar to 15 but with addition of iron powder. All-positional, AC or DC
20	High iron-oxide coating bonded with sodium silicate. Flat or HV positions. Good X-ray quality. AC or DC
24	Heavy coating containing high percentage of iron powder for fast deposition rates. Flat and horizontal positions only. AC or DC
27	Very heavy coating with ingredients similar to 20 and high percentage of iron powder. Flat or horizontal positions. High X-ray quality. AC or DC
28	Similar to 18 but heavier coating and suited for use in flat and HV positions only. AC or DC
30	High-iron-oxide-type coating but produces less fluid slag than 20. For use in flat position only (primarily narrow-groove butt welds). Good X-ray quality. AC or DC

^aDC = direct current, AC = alternating current, EP = electrode positive, EN = electrode negative.

The letters in brackets are optional, and the first group indicates the efficiency, which is the ratio of the mass of weld metal to the mass of nominal diameter core wire consumed with the largest diameter electrode, rounded up to the nearest multiple of 10. The next digit (3) is the maker's advice for the position(s) to be used. Codes for this category include 1, all positions; 2, all positions except vertical down; 3, flat, and for fillet welds, horizontal/vertical; 4, flat; 5, flat, vertical/down; and for fillet welds, horizontal/vertical; and 9, other. The digit at (0), which may have numbers from 0 to 9, shows the polarity, and the minimum open-circuit voltage to be used for that electrode. A 0 here indicates that the electrode is not suited for use with AC. The (H) is included only for hydrogen-controlled electrodes that will deposit not more than 15 ml of diffusible hydrogen for each 100 g of deposited weld metal. The corresponding ISO Standard for BS 639 is ISO 2560. Low-alloy steel electrodes and chromium and chromium nickel steel electrodes are covered in BS 2493 and BS 2926.

The most common electrodes used for the SMAW process are the AWS types E60XX and E70XX. SMAW welding electrode Standards are issued by the American Welding Society (AWS), the British Standards Institute (BS), Canada (CSA), Germany (DIN), and Japan (JIS) and are shown in [Table 11](#).

AWS E60XX Electrodes.—Characteristics of the E60XX electrodes influence the weld position capability, ease of slag removal, penetration potential, weld travel speed capability, and weld deposition rates. These electrodes are designed for welding low-carbon steels and they provide welds with typical tensile strength in the range of 58,000–65,000 lb_f/in² (400–448 MPa), depending on the specific electrode utilized, the base metal condition and chemistry, and the amount of weld dilution. In selecting an electrode for SMAW welding, knowing that the mechanical and chemical requirements have been matched, it is necessary to choose electrodes with characteristics that influence the features required, as shown in [Table 11](#).

Table 11. Characteristics of SMAW Welding Electrodes Made to Standards of Various Countries

Standard	Description
AWS E6010 CSA E41010 BS E4343C10 DIN E4343C4 JIS	Designed for welding pipe and general structures. Excellent for all-position and vertical down welding. Slag is light and easy to remove. Deep, penetrating arc. Low deposition rates. Polarity DC + (electrode positive).
AWS E6011 CSA E41011 BS E4343C13 DIN E4343C4 JIS D4311	Similar to E6010 but modified to allow use of AC. Excellent for welding sheet metal corner joints vertical down. Polarity AC or DC + (electrode positive).
AWS 6012 CSA E41012 BS E4332R12 DIN E4332R(C) JIS D4313	Designed for welding sheet metal and light structural steels. Medium penetration suitable for gaps or where minimum weld dilution is needed. Ideal for flat, horizontal, or vertical down welding. Will weld faster than the E6010-11 electrode. Polarity AC or DC—(electrode negative).
AWS E6013 CSA E41013 BS E4332R21 DIN E4332R3 JIS D4313	Excellent AC or DC—performance. All-position. Shallow penetration. Good choice for low open-circuit welding machines. AC or DC both excellent on thin structural applications. Polarity AC or DC (DC both polarities).
AWS 6027 CSA 41027 BSE4343A13035 DIN 4343AR11 JIS D4327	Iron powder is added to the flux to provide higher deposition rates. Ideal for multipass groove and fillet welding in flat and horizontal positions. Polarity AC or DC (both polarities).

Table 12 shows approximate current requirements for AWS E60XX electrodes for welding sheet metal carbon steels. The current ranges specified vary slightly with different electrode manufacturers. For welding sheet metal start at the low end of the given current requirements with electrodes of $\frac{3}{16}$ -in (5-mm) diameter or smaller. For metals thicker than 10 gage (0.134 in.), start in the center of the current range, then adjust to suit. A high DC current may result in arc blow, and improved results may then be obtained with AC.

Table 12. Diameters of AWS E6010/E6011 SMAW Electrodes for Welding Low-Carbon Steel Sheet Metal

SWG of Sheet Metal to be Welded	Electrode Diameter		Current Starting Level (amps)
	in.	(mm)	
18	$\frac{3}{32}$	(2.5)	45–60
16–14	$\frac{1}{8}$	(3.2)	80–110
12	$\frac{5}{32}$	(4)	125–135
10	$\frac{3}{16}$	(5)	135–150

For welding thicker materials, a good starting setting is in the middle of the current range shown in Table 12. In welding material less than $\frac{1}{4}$ -in. (6.4-mm) thick, vertically, with an E6010 electrode, try a $\frac{1}{8}$ -in. (3.2-mm) electrode at 90 to 100 amps. For welding thicknesses between $\frac{3}{16}$ and $\frac{5}{16}$ in. (5 and 8 mm) with the E6010 electrode, vertically, try the $\frac{5}{16}$ -in. (8-mm) diameter electrode at 100 to 125 amps. For thicknesses of $\frac{3}{8}$ to 1 in. (9.5 to 25 mm), try a $\frac{3}{16}$ -in. (5-mm) diameter electrode at 155 to 165 amps.

Recommended current ranges, shown in Table 13 for the various sizes of AWS E60XX electrodes most commonly used for welding carbon steel, will give optimum results with SMAW electrodes. An ideal starting point for the current setting for any SMAW electrode diameter is in the middle of the range. The current ranges shown are average values taken from literature of electrode manufacturers in three different countries.

Table 13. Current Ranges for AWS E60XX SMAW Electrodes

Electrode Diameter		E6010/E6011	E6012	E6013	E6027
in.	(mm)	(amps)	(amps)	(amps)	(amps)
$\frac{1}{16}$	(1.6)	...	25–50	20–40	...
$\frac{3}{32}$	(2.5)	40–75	40–100	50–100	...
$\frac{1}{8}$	(3.2)	75–130	85–140	75–135	120–180
$\frac{5}{32}$	(4)	90–170	115–185	110–185	155–245
$\frac{3}{16}$	(5)	135–220	145–240	150–235	200–300
$\frac{1}{4}$	(6.4)	205–325	250–390	240–340	300–410
$\frac{5}{16}$	(8)	260–420	290–480	310–425	370–480

AWS E70XX Electrodes.—Information on the most commonly used AWS E70XX electrodes is given in [Table 15](#). For critical welding applications, low-hydrogen electrodes are typically used. It is most important that manufacturers' instructions regarding storage requirements for keeping low-hydrogen electrodes free from moisture are followed. Current ranges for welding low-carbon steel sheet metal with E70XX electrodes of diameters from $\frac{3}{32}$ to $\frac{3}{16}$ in. (2.5 to 5 mm) are shown in [Table 14](#). The optimum starting point is in the middle of the current range indicated.

Table 14. Current Ranges for SMAW E70XX Welding Electrodes

Electrode Diameter		E7014	E7018	E7024
in.	(mm)	(amps)	(amps)	(amps)
$\frac{3}{32}$	(2.5)	75–120	70–105	85–135
$\frac{1}{8}$	(3.2)	110–155	110–160	130–180
$\frac{5}{32}$	(4)	145–210	150–215	175–240
$\frac{3}{16}$	(5)	190–280	180–275	230–315
$\frac{7}{32}$	(5.5)	255–335	255–350	280–370
$\frac{1}{4}$	(6.4)	330–415	295–360	325–450
$\frac{5}{16}$	(8)	380–490	370–480	390–530

In using AWS E7018 electrodes for vertical up welding of plate thicknesses of $\frac{3}{16}$ to $\frac{5}{16}$ in. (5 to 8 mm), try a $\frac{1}{8}$ -in. (3.2-mm) diameter electrode. For vertical up welding of thicknesses greater than $\frac{5}{16}$ in. (8 mm), try a $\frac{5}{32}$ -in. (4-mm) electrode. With AWS E7018 electrodes, to make horizontal fillet welds in plate thicknesses of 10 swg (0.135 in., 3.4 mm), try a $\frac{3}{16}$ -in. (5-mm) electrode, for $\frac{1}{4}$ -in. (6.4-mm) plate, try the $\frac{7}{32}$ -in. (5.5-mm) electrode, and for steel plate thicker than $\frac{1}{4}$ in., try the $\frac{1}{4}$ -in. (6.4-mm) diameter electrode.

Table 15. Characteristics of AWS Electrodes for SMAW Welding

Standard	Description
AWS E7014 CSA E48014 BS E5121RR11011 DIN E5121RR8 JIS D4313	An iron-powder, all-position electrode for shallow penetration. Excellent for vertical down and applications with poor fit. Similar to AWS E6012-E6013 with added iron powder. For welding mild and low-alloy steels. Polarity AC or DC, + or –.

Standard	Description
AWS E7018 CSA E48018 BS E5154B11026(H) DIN E5154B(R)10 JIS D5016	An iron-powder, low-hydrogen, all-position electrode. Excellent for rigid, highly stressed structures of low- to medium-carbon steel. Can also be used for welding mild and high-strength steels, high-carbon steels, and alloy steels. Polarity AC or DC + reverse polarity.
AWS 7024 CSA E48024 BS E5122RR13034 DIN E5122RR11 JIS D4324	An iron-powder electrode with low hydrogen, usable in all positions. Excellent for high-amperage, large, fillet welds in flat and horizontal positions. Polarity AC or DC, + or -.
AWS E7028 CSA E48028 BS E514B12036(H) DIN E5143B(R)12 JIS D5026	An iron-powder, low-hydrogen electrode suitable for horizontal fillets and grooved flat position welding. Higher deposition rates. More cost-effective than the AWS E7018 electrode. Polarity AC or DC + reverse polarity.

The E7024 electrode is suggested for horizontal fillet welds. For 10-gage (0.135-in, 3.4-mm) material, try the $\frac{1}{8}$ -in. (3.2-mm) diameter electrode; for above 10-gage to $\frac{3}{16}$ -in. (5-mm) material, try the $\frac{5}{32}$ -in. (4-mm) diameter electrode. For plate of $\frac{3}{16}$ to $\frac{1}{4}$ -in. thickness, try the $\frac{3}{16}$ -in. size, and for plate thicker than $\frac{1}{4}$ in., try the $\frac{1}{4}$ -in. (6.4-mm) electrode.

Gas Tungsten Arc Welding

Often called TIG (for tungsten inert gas) welding, gas tungsten arc welding (GTAW) uses a nonconsumable tungsten electrode with a gas shield, and was, until the development of plasma arc welding (PAW), the most versatile of all common manual welding processes. Plasma arc welding is a modified GTAW process. In contrast to GTAW, plasma arc welding has less sensitivity to arc length variations, superior low-current arc stability, greater potential tungsten life, and the capability for single-pass, full-penetration welds on thick sections.

In examining a potential welding application, the three primary considerations are: achieving a quality weld, ease of welding, and cost. Selecting the optimum weld process becomes more complex as sophisticated electronic technology is applied to conventional welding equipment and consumable electrodes. Rapid advances in gas metal arc and PAW welding power source technology, and the development of many new flux-cored electrodes, have made selection of the optimum welding process or weld consumable more difficult. When several manual welding processes are available, the logical approach in considering GTAW for production welding is to first examine whether the job can be welded by gas metal arc or flux-cored methods.

GTAW Welding Current.—A major benefit offered by GTAW, compared with GMAW, FCAW, or SMAW, is the highly concentrated, spatter-free, inert heat from the tungsten arc, which is beneficial for many applications. The GTAW process can use any of three types of welding current, including: direct-current straight polarity, electrode negative (DC-), direct-current reverse polarity, electrode positive (DC+), alternating current with high frequency for arc stabilization (ACHF). Each of the different current types provides benefits that can be used for a specific application.

GTAW Direct-Current Straight Polarity (DC-): The most common GTAW current is straight polarity, where the electrode is connected to the negative terminal on the power source and the ground is connected to the positive terminal. Gas tungsten arc welding is used with inert gases such as argon, and argon + helium to weld most metals. During a DC-straight-polarity weld, electrons flow from the negative tungsten electrode tip and pass through the electric field in the arc plasma to the positive workpiece, as shown in Fig. 8.

Plasma is a high-temperature, ionized, gaseous column that is formed when electrons in the arc collide with the shielding gas molecules. The gas atoms lose one or more electrons, leaving them positively charged. The electrons and the resulting plasma are concentrated at the electrode tip, where they cause the plasma pressure to be at its greatest. The electron density thins out as the electrons travel from the straight-polarity, negatively charged, tungsten electrode across the open arc. As the electrons traverse the arc to the work, the resulting arc column width increases slightly, controlled in part by the electromagnetic forces generated by the current. With the increase in the arc column width, the density and pressure of the plasma decrease. The electrons collide with the work, liberating much heat. The downward pressure of the plasma is exerted against the surface of the weld pool. The gas ions in the plasma are positively charged and greater in mass than the electrons.

In DC⁻, straight-polarity welding, the positive gas ions are drawn to the negative electrode. The electron flow to the weld ensures that most of the arc heat is generated at the positive work side of the arc. This current setup provides maximum penetration potential, as indicated in Fig. 8. With DC⁻, straight polarity, the tungsten electrode can carry a higher current and operate at lower temperatures than with the other current arrangements.

Direct-Current Reverse Polarity (DC⁺): With direct-current positive polarity (DC⁺), the tungsten electrode is connected to the power-source positive terminal so that the electrons flow from the negative work to the positive electrode. As illustrated in Fig. 9, the electrons impinging on the electrode tip reverse the direction of the heat concentration that occurs with straight polarity, as described above. Approximately two-thirds of the heat generated with DC⁺ reverse polarity is at the electrode tip, and the electrode becomes very hot, even with low current levels. DC⁺ reverse polarity requires large-diameter electrodes.

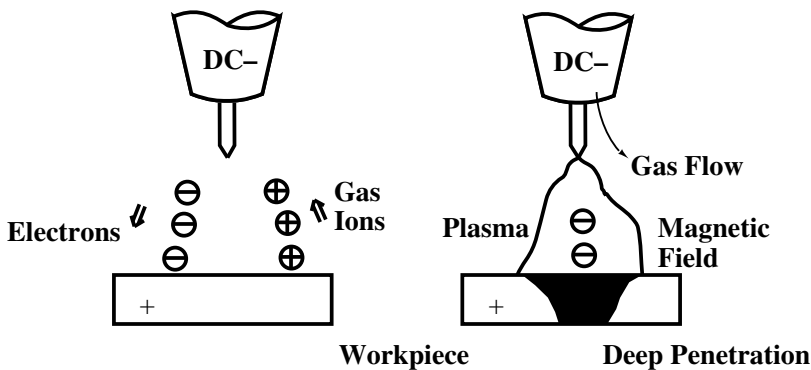


Fig. 8. Straight Polarity (DC⁻) Provides Highest Electrode Current Capacity and Deepest Penetration Potential.

In the current range of 100 to 150 amps, DC⁺ reverse polarity requires a $\frac{1}{4}$ -in. (6.4-mm) diameter electrode. This larger electrode produces a weld puddle almost twice as wide as that produced by a 120-amp, $\frac{1}{16}$ -in. (1.6-mm) diameter, DC⁻ straight polarity electrode. Most of the heat is generated at the electrode tip with DC⁺ reverse polarity, so penetration is much less than with DC⁻ straight polarity. With DC⁺ reverse polarity, the positive gas ions in the arc plasma are drawn to the negative workpiece where they bombard and break up the surface oxides that form on metals such as aluminum and magnesium. However, the best welding method for aluminum and magnesium is to use alternating current (AC), which combines the benefits of DC⁻ straight and DC⁺ reverse polarity.

Alternating Current (AC): The surface oxides formed on metals such as aluminum and magnesium disturb the arc and reduce the weld quality. Welding of these metals requires DC⁺ reverse or AC polarity to break up the surface oxides. An alternating current (AC) cycle consists of one-half cycle of straight polarity and one-half cycle of reverse polarity. With alternating current, the cleaning action benefits of the reverse-polarity arc can be combined with the electrode current-carrying capacity of the straight-polarity arc. In weld-

ing aluminum and magnesium, the half cycles of AC polarity may become unbalanced. During the AC cycle, the reverse electrode-positive portion of the cycle is restricted by the oxides on the surfaces of these materials. The surface oxides are poor conductors and make it difficult for the electrons generated by the reverse-polarity part of the cycle to flow from the work to the electrode tip, but they do not upset the straight polarity in which the electrons flow from the electrode to the work.

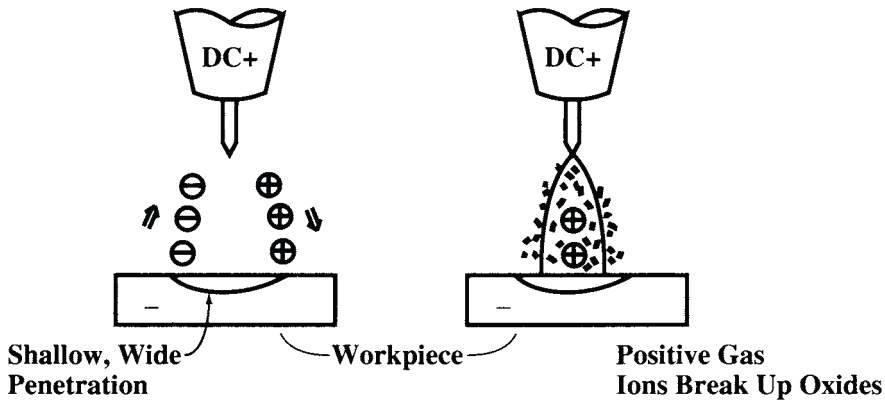


Fig. 9. Direct-Current (DC+) Reverse Polarity Provides a Shallow, Wide, Weld Pool.

DC Component: The part of the reverse-polarity cycle of alternating current (AC) that is upset by the poor conductivity of the oxides is changed into direct-current, straight polarity (DC-) and is directed back to the power source where it may cause overheating. The feedback is referred to as the DC component and its characteristics are important in deciding which process to use because, if an AC power source designed for shielded metal arc welding is to be used to weld aluminum by the GTAW process, the power source must be derated to protect the equipment. The power-source manufacturer will provide information on the level of derating required.

Power sources are available for GTAW that provide a balanced AC wave, and manufacturers will provide information about the benefits of balanced wave versus unbalanced wave, GTAW power sources, and equipment to protect against the DC component.

High Frequency and AC: To maintain the stability of the alternating-current (AC) arc when the positive cycle of the arc is upset by the aluminum oxide, and to avoid contamination of the tungsten electrode, high-frequency current is used to assist in arc ignition during each AC cycle. In direct-current, straight-polarity (DC-) welding of carbon and stainless steels, the high-frequency current is typically selected by the HF arc start-only switch. During AC welding of steels without oxide problems, the HF switch may be left on the arc start-only setting. When AC is used on aluminum, magnesium, or other metals with poor electron-conductive oxides, the HF switch should be moved to the continuous setting.

High-frequency current is also beneficial in that it promotes gas ionization. The more positively charged molecules produced, the more cleaning action takes place in the direct-current, reverse-polarity (DCRP) cycle.

Selecting the Tungsten Electrode Type.—Use of the correct tungsten electrode composition is vital to producing good-quality GTAW welds. Tungsten has the highest melting temperature of all metals. Pure tungsten provides a low-current capacity and requires addition of such alloying elements as thorium or zirconium to increase the current-carrying capability. The electrode diameter and the electrode tip configuration also require consideration as both have a great influence on the performance and application potential of GTAW welding.

Table 17 shows typical compositions of commonly used GTAW tungsten electrode materials from the American Welding Society AWS A5.12 Standard. New electrode com-

positions have been designed that utilize other alloys and rare-earth metals. These electrodes are designed for longer lives in both GTAW and plasma welding.

Pure Tungsten: Pure tungsten electrode material provides good arc stability with alternating current (AC). Tungsten has low current capacity and low resistance to electrode contamination. Pure tungsten is good for low-amperage welding of aluminum and magnesium alloys. On medium- to high-current ferrous applications, there is a potential for tungsten inclusions in the weld.

With DC, the current capacity of pure tungsten is lower than with the alloyed tungsten electrodes. During AC welding, a molten ball shape forms at the pure tungsten electrode tip, and this formation is desirable for welding aluminum.

Table 16. Selection of Gas Tungsten Arc Welding (GTAW) Electrodes

Base Metal	Electrode	Current	Recommendations
Carbon, low-alloy, stainless, and nickel steels	Thoriated	DCEN	Use EWZr electrodes with AC on thin materials
Aluminum	Zirconium or pure tungsten	AC	Use EWZr on critical applications
Aluminum	Thoriated zirconium	DCEP	Use EWZr or EWP electrodes with DCEP on thin sections
Copper and copper alloys	Thoriated	DCEN	Use EWZr or EWP with AC on thin sections
Magnesium	Zirconium	AC	Use DCEP with same electrode on thin sections
Titanium	Thoriated	DCEN	...

Table 17. Common Tungsten Electrode Compositions

Classification	Color	Tungsten (%)	Thorium Oxide (%)	Zirconium Oxide (%)
EWP	Green	99.50
EWTh-1	Yellow	98.50	0.8–1.2	...
EWTh-2	Red	97.50	1.7–2.2	...
EWTh-3	Blue	98.95	0.35–0.55	...
EWZr	Brown	99.20	...	0.15–0.4

In the classification column, E = electrode; W = tungsten; P = pure; Th = thoriated (thorium oxide); Zr = zirconiated (zirconium oxide). The colors are codes used by manufacturers to identify the material. Tungsten percentages are minimum requirements. The EWTh-3 is also called striped tungsten because it is made with a strip of thoriated material along the length. This electrode needs to be preheated by striking an arc to melt the tip, providing for the thorium and the tungsten to combine before welding is started.

The electrode recommendations in **Table 16** are a guide to attaining good-quality GTAW welds from the venous types of polarities available.

Electrode and Current Selection.—**Tables 18** and **19** show approximate current recommendations for common electrode types and diameters. The GTAW electrode size should be selected so that its midrange current provides the energy required for the intended application. If the electrode is too thin, excess current may be required, causing the electrode to wear too quickly or melt and contaminate the weld. If the electrodes used are found to be constantly at the top end of the current range, a change should be made to the next larger size. **Tables 20** and **21** show recommended sizes of electrodes and filler metal rods or wires for welding various thicknesses of carbon, low-alloy, and stainless steels and aluminum.

Table 18. Recommended Current Ranges for Thoriated GTAW Electrodes

Electrode	Current Range (amps)
$\frac{1}{16}$ in. (1.6 mm)	60–150
$\frac{3}{32}$ in. (2.4 mm)	150–250
$\frac{1}{8}$ in. (3.2 mm)	250–400
$\frac{5}{32}$ in. (4 mm)	400–500

The electrode selected must suit the application and the current capacity of the power source.

Table 19. Current Ranges for EWP and EWZr GTAW Electrodes

Electrode		Ampere Range AC Balanced		Ampere Range AC Unbalanced	
		EWP	EWZr	EWP	EWZr
in.	(mm)				
$\frac{1}{16}$	(1.6)	30–80	60–120	50–100	70–150
$\frac{3}{32}$	(2.4)	60–130	100–180	100–160	140–235
$\frac{1}{8}$	(3.2)	100–180	160–250	150–210	225–325
$\frac{5}{32}$	(4)	160–240	200–320	200–275	300–400

**Table 20. Electrode and Current Recommendations
for Carbon, Low-Alloy, and Stainless Steels**

Material Thickness		Electrode Diameter		Filler Rod Diameter		Current Range (amps)			
		in.	(mm)	in.	(mm)	in.	(mm)	DCEN	EWTh
$\frac{1}{16}$	(1.6)	$\frac{1}{16}$	(1.6)	$\frac{1}{16}$	(1.6)			60–100	
$\frac{1}{8}$	(3.2)	$\frac{3}{32}$	(2.4)	$\frac{3}{32}$	(2.4)			150–170	
$\frac{3}{16}$	(4.8)	$\frac{3}{32}$	(2.4)	$\frac{1}{8}$	(3.2)			180–220	
$\frac{1}{4}$	(6.4)	$\frac{1}{8}$	(3.2)	$\frac{5}{32}$	(7.2)			260–300	

Note: The shielding gas is argon at 15 to 20 cu ft/h (CFH). For stainless steel, reduce the current by approximately 10 per cent.

**Table 21. Recommendations for GTAW Welding of Aluminum
with EWP Electrodes Using AC and High-Frequency Current**

Material Thickness		Electrode Diameter		Filler Rod Diameter		AC Current Range (amps)
		in.	(mm)	in.	(mm)	
$\frac{1}{16}$	(1.6)	$\frac{1}{16}$	(1.6)	$\frac{1}{16}$	(1.6)	40–70
$\frac{1}{8}$	(3.2)	$\frac{3}{32}$	(2.4)	$\frac{3}{32}$	(2.4)	70–125
$\frac{3}{16}$	(4.8)	$\frac{1}{8}$	(3.2)	$\frac{1}{8}$	(3.2)	110–170
$\frac{1}{4}$	(6.4)	$\frac{5}{32}$	(4)	$\frac{3}{16}$	(4.8)	170–220

Thoriated Electrodes: In contrast with the pure EWP electrodes, thoriated electrodes have a higher melting temperature and up to about 50 per cent more current-carrying capacity, with superior arc starting and arc stability. These electrodes are typically the first choice for critical DC welding applications, but do not have the potential to maintain a rounded ball shape at the tip. The best welding mode for these electrodes is with the tip ground to a tapered or fine point.

Zirconiated Electrodes: Tungsten electrodes with zirconium are practical for critical applications and have less sensitivity to contamination and superior current capacity than pure tungsten electrodes.

Protecting and Prolonging Electrode Life: To improve tungsten electrode life, the tip should be tapered in accordance with the manufacturer's recommendations. There must also be preflow, postflow shielding gas coverage to protect the electrode before and after the weld. When possible, high frequency should be used to avoid scratch starts, which contaminate the electrode. The shortest possible electrode extension should be employed, to avoid the possibility of the electrode touching the filler or weld metal. The grinding wheel used to sharpen the tungsten must not be contaminated from grinding other metals or with dirt.

Filler Metals.—Specifications covering composition and mechanical properties for GTAW filler metal are published by the American Welding Society under the following classifications: A5.7, copper and copper alloys; A5.9, chromium and chromium nickel; A5.10, aluminum; A5.14, nickel; A5.16, titanium; A5.18, carbon steels; A5.19, magnesium; and A5.28, low-alloy steels.

Filler metals must be kept dry and clean if they are to be used satisfactorily.

Shielding Gases.—Inert gases such as argon, and argon + helium mixtures are most commonly used for GTAW. Helium provides greater thermal conductivity and additional arc voltage potential than argon, and is normally added to argon when more weld energy is required for improved penetration and increased mechanized welding travel speeds. Argon gas mixtures containing 30 to 75 per cent helium provide benefits for manual welding of aluminum over $\frac{3}{8}$ in. (9.6 mm) thick; mechanized welding of aluminum where high speeds are required; mechanized welding of carbon and stainless steels where good penetration is needed; mechanized welding of stainless steel where good penetration and faster speeds are required; and for copper of $\frac{1}{4}$ in. (6.4 mm) thickness and thicker.

Shielding gas purity for GTAW welding is important. Welding-grade argon is supplied at a purity of at least 99.996 per cent and helium is produced to a minimum purity of 99.995 per cent. However, shielding gases may be contaminated due to poor cylinder filling practices. If impure gas is suspected, the following test is suggested. With the HF and power on, create an arc without welding and hold the arc for about 30 seconds. Examine the electrode tip for signs of unusual coloration, oxidation, or contamination, which result from impurities in the shielding gas.

Plasma Arc Welding (PAW)

When an electric current passes between two electrodes through certain gases, the energy of the gas molecules is increased so that they accelerate and collide with each other more often. With increases in energy, the binding forces between the nuclei and the electrons are exceeded, and electrons are released from the nuclei. The gas now consists of neutral molecules, positively charged atoms, and negatively charged electrons. The plasma gas is said to be ionized, so that it is capable of conducting electric current. Plasma forms in all welding arcs but in plasma arc welding it is generated by a series of events that begins with inert gas passing through the welding torch nozzle. High-frequency current is then generated between the tungsten electrode (cathode) and the torch nozzle (anode), forming a low-current pilot arc. The ionized path of this nontransferred arc is then transferred from the tungsten electrode to the work, and a preset plasma current is generated.

The above sequence of events provides the ionized path for the plasma current between the electrode and the work so that arcing between the electrode and the nozzle ceases. (Nontransferred arcs may be used for metal spraying or nonmetallic welds.) Forcing the ionized gas through the small orifice in the nozzle increases both the level of ionization and the arc velocity, and arc temperatures between 30,000 and 50,000°F (16,650 and 27,770°C) are generated.

Gases for Plasma Arc Welding.—Argon is the preferred gas for plasma arc welding (PAW) as it is easily ionized and the plasma column formed by argon can be sustained by a low voltage. The low thermal conductivity of argon produces a plasma column with a narrow, concentrated hot core surrounded by a cooler outer zone. Argon plasmas are suited to welding steel up to $\frac{1}{8}$ in. (3.2 mm). For thicker materials, requiring a hotter arc and using higher current melt-in technique, a mixture of argon 25 + helium 75 per cent may be used. Additions of helium and hydrogen to the gas mixture improve heat transfer, reduce porosity, and increase weld travel speed. For welding materials thinner than $\frac{1}{8}$ in. thick by the plasma gas keyhole method (full penetration welds), gases may contain up to 15 per cent

hydrogen with the remainder argon. Good results are obtained with argon + 5 per cent hydrogen in welding stainless and nickel steels over $\frac{1}{8}$ in. thick.

Shielding Gases.—A shielding gas is needed to protect the narrow plasma arc column and the weld pool, and generally is provided by mixtures of argon, argon + hydrogen, argon + helium, or argon + O₂ + CO₂, depending on compatibility with the material being welded. Shielding gas flow rates vary from 5 to 35 cu ft/h (2.4 to 17 l/min). However, if argon is used for both plasma and shielding, the plasma gas will become less concentrated. The normally tight plasma arc column will expand in contact with the colder shielding gas, reducing ionization and thus concentration and intensity of the plasma column. With no shielding gas, the tight column is unaffected by the surrounding oxygen and nitrogen of the atmosphere, which are not easily ionized.

Hydrogen is added to the shielding gas when welding low-alloy steels of less than $\frac{1}{16}$ in. (1.6 mm) thickness, or stainless and nickel steels, with many benefits. The hydrogen molecules dissociate in contact with the arc at temperatures of about 7,000°F (3,870°C) and the energy thus created is released when the hydrogen molecules recombine on contact with the work surface. The diatomic molecular action creates a barrier around the plasma, maintaining column stiffness. Hydrogen in the shielding gas combines with oxygen in the weld zone, releasing it into the atmosphere and keeping the weld clean. Hydrogen reduces the surface tension of the weld pool, increasing fluidity, and the added energy increases penetration.

Helium mixed with the argon shielding gas is beneficial for all metals as it increases the ionization potential, allowing use of higher voltages that give increased welding temperatures. Flow rates are in the range of 15 to 50 cu ft/h (7 to 24 l/min). Arc-starting efficiency is reduced with pure helium, but adding 25 per cent of argon helps both arc starting and stability. Helium additions of 25 to 75 per cent are made to obtain increased thermal benefits.

Argon + CO₂ shielding gas mixtures are beneficial in fusion welding of carbon steels. A mixture of argon with 20 to 30 per cent CO₂ improves weld fluidity. Shielding gas mixtures of argon + CO₂ with an argon + 5 per cent hydrogen plasma should be considered for welding carbon steel of $\frac{1}{16}$ to $\frac{1}{4}$ in. thickness. Steels with higher amounts of carbon have higher heat conductivity and need application of more heat than is needed with stainless steels. Manufacturers usually make recommendations on types of gas mixtures to use with their equipment.

PAW Welding Equipment.—The PAW process uses electrode negative (DCEN) polarity in a current range from 25 to 400 amps, and equipment is offered by many manufacturers. Solid-state inverter units are available with nonmechanical contactors. Most PAW units contain a high-frequency generator, a small DC power supply, controls for welding and shielding gas mixtures, and a torch coolant control. A weld sequencer is recommended, especially for keyhole mode welding, but it is also useful in automated fusion welding. The sequencer provides control of up-slope and down-slope conditions for gas mixtures and current, so that it is possible to make welds without run-on and run-off tabs, as is necessary with circumferential welds.

Generally, plasma arc torches are liquid-cooled using deionized water in the coolant lines to the torch to avoid effects of electrolysis. Electrodes are usually tungsten with 2 per cent thorium. If the welding shop already has a constant-current power supply and a coolant recirculator, plasma arc welding may be used by addition of a pilot arc welding console and a torch.

Applications.—Fusion welding is the main use for plasma arc welding. The process is used for high-volume, repetitive, high-duty cycle, manual and automated operations on lap, flange, butt, and corner fusion welds, in all positions. Joint design for materials less than 0.01 in. (0.254 mm) thick may require a flange type joint for rigidity and to allow use of extra, weld metal reinforcement. Filler metal may be added during fusion welding, and

automated hot or cold wire feeders can be used. Fusion welding uses a soft, less-restricted arc with low gas flows, and the current level may vary from approximately 25 to 200 amps. The soft arc is obtained by setting the end of the tungsten electrode level with the face of the torch nozzle, in which position lower currents and gas flows are required. With these conditions, the weld bead is slightly wider than a bead produced with a recessed electrode.

Low-Current Plasma Fusion Welding: With the reduced consumption of gas and electric current, the low-current plasma fusion welding method is ideal for welding metals down to 0.001 in. (0.025 mm) in thickness, as the low-current plasma pilot arc allows arcs to be started consistently with currents of less than 1 amp. With currents below 1 amp, the pilot arc is usually left in the continuous mode to maintain the arc. In the conditions described, arc stability is improved and the process is much less sensitive to variations in the distance of the torch from the workpiece. Given this height tolerance, setting up is simplified, and with the smaller torches required, it is often easier to see the weld pool than with the GTAW process. Some plasma welding units incorporate gas flow meters that are designed for low flow rates, and currents in the range of 0.1 to 15 amps can be selected.

Low-current plasma arc welding is more economical than other gas tungsten arc welding methods, especially with solid-state inverter systems and smaller torches. The process is useful for sealing type welds where joint access is good, and for welding components of office furniture, household items, electronic and aerospace parts, metallic screening, and thin-wall tubing.

Keyhole mode welding describes a method whereby abutting edges of two plates are melted simultaneously, forming a vapor capillary (or keyhole) and the resulting molten-walled hole moves along the joint line. This method requires the end of the tungsten electrode to be positioned well back inside the torch nozzle to produce a high-velocity, restricted arc column with sufficient energy to pierce the workpiece. This mode is also used for the plasma cutting process, but the major difference is that welding uses very low plasma flow rates of the order of 1 to 3 cu ft/h (0.5 to 1.4 l/min) for work thicknesses of $\frac{1}{16}$ to $\frac{5}{32}$ in. (1.6 to 4 mm). These low rates avoid unwanted displacement of the weld metal. After the arc pierces the workpiece, the torch moves along the weld line and the thin layer of molten metal is supported by surface tension as it flows to the rear of the line of movement, where it solidifies and forms the weld.

As it passes through the keyhole, the high-velocity plasma gas column flushes the molten weld pool and carries away trapped gases and contaminants that otherwise would be trapped in the weld. Plasma arc keyhole welding is affected less by surface and internal defects in the work material than is the GTAW process. Most metals that can be welded by the gas tungsten arc method can be plasma arc welded with the conventional DC electrode, negative keyhole method, except aluminum, which requires a variable polarity keyhole method.

Plasma keyhole welding is usually automated because it requires consistent travel speed and torch height above the work. A typical operation is welding steel with square abutting edges (no bevels) in thicknesses of 0.09 to 0.375 in. (2.3 to 9 mm), where 100 per cent penetration in a single pass is required. Producing square-groove butt welds in materials thicker than $\frac{1}{2}$ in. by the plasma arc keyhole process requires some edge preparation and several filler passes. The finished weld is uniformly narrow and the even distribution of heat means that distortion is minimized.

Welding Aluminum.—The variable polarity plasma arc (VPPA) process was developed for welding metals that form an oxide skin, such as aluminum. Electrode negative (straight) polarity is necessary for the plasma arc to provide sufficient heat to the workpiece and minimize heat buildup in the tungsten electrode. With electrode negative polarity, electrons move rapidly from the negative cathode tungsten electrode to the positive anode workpiece, generating most of the heat in the workpiece. Because of the oxide skin on aluminum, however, straight polarity produces an erratic arc, poor weld fluidity, and an

irregularly shaped weld bead. The oxide skin must be broken up if the metal flow is to be controlled, and this breakup is effected by a power supply that constantly switches from negative to positive polarity.

A typical cycle uses a 20-ms pulse of electrode negative polarity and a 3-ms pulse of electrode positive polarity. The pulses are generated as square waves and the positive (cleaning) pulse is set at 30 to 80 amps higher than the negative pulse for greater oxide-breaking action. The tenacious oxide skin is thus broken constantly and the rapid cycle changes result in optimum cathode cleaning with minimum deterioration of the tungsten electrode and consistent arc stability. Varying polarity has advantages in both gas metal arc and plasma arc welding, but with the keyhole process it allows single-pass, square-groove, full-penetration welds in materials up to $\frac{1}{2}$ in. (12.7 mm) thick.

The VPPA process ensures extremely low levels of porosity in weld areas in aluminum. VPPA welding is often used in the vertical up position for aluminum because it provides superior control of root reinforcement, which tends to be excessive when welding is done in the flat position. Pulsing in the VPPA process when welding aluminum of $\frac{1}{8}$ to $\frac{1}{4}$ in. thickness in the flat position gives satisfactory root profiles. Pulsing gives improved arc control in keyhole welds in both ferrous and nonferrous metals and is beneficial with melt-in fusion welding of thin materials as it provides better control of heat input to the workpiece.

Plasma Arc Surface Coating

Plasma Arc Surfacing uses an arc struck between the electrode and the workpiece, or transferred arc, to apply coatings of other metals or alloys to the workpiece surface. This high-temperature process produces homogeneous welds in which the ionized plasma gas stream melts both the work surface and a stream of powdered alloy or filler wire fed into the arc. Dilution of the base metal can be held below 5 per cent if required. With arc temperatures between 25,000 and 50,000°F (14,000 and 28,000°C), deposition occurs rapidly, and a rate of 15 lb/h (6.8 kg/h) of powdered alloy is not unusual. Deposition from wire can be performed at rates up to 28 lb/h (12.7 kg/h), much higher than with oxygen/fuel or gas metal/arc methods.

In the nontransferred arc process used for coating of surfaces, the arc is struck between the electrode and the torch nozzle, so that it does not attach to the work surface. This process is sometimes called metal spraying, and is used for building up surfaces for hard facing, and for application of anticorrosion and barrier layers. Argon is frequently used as the plasma gas. As the coating material in the form of powder or wire enters the plasma, it is melted thoroughly by the plasma column and is propelled toward the work at high velocity to form a mechanical bond with the work surface. Some 500 different powder combinations are available for this process, so that a variety of requirements can be fulfilled, and deposition rates up to 100 lb/h (45 kg/h) can be achieved.

The plasma arc process allows parts to be modified or recovered if worn, and surfaces with unique properties can be provided on new or existing components. Low levels of porosity in the deposited metal can be achieved. Metal spraying can be performed manually or automatically, and its use depends primarily on whether a mechanical bond is acceptable. Other factors include the volume of parts to be treated, the time needed for the process and for subsequent finishing, the quality requirements for the finished parts, rejection rates, and costs of consumable materials and energy.

Some systems are available that can use either metal powder or wire as the spray material, and can be operated at higher voltage settings that result in longer plasma arc lengths at temperatures over 10,000°F (5,537°C). With these systems, the plasma velocity is increased to about 12,000 ft/s (3,658 m/s), giving an extremely dense coating with less than 1 per cent porosity. Current ranges of 30 to 500 amps are available, and nitrogen is frequently used as the plasma gas, coupled with CO₂, nitrogen, or compressed air as the

shielding gas. Gas flow rates are between 50 and 350 cubic feet per hour (24 and 165 l/min). Large or small surface areas can be coated at low cost, with minimum heat input, if other aspects of the process are compatible with the product being made.

Plasma Arc Cutting of Metals

Plasma Arc Cutting.—Higher current and gas flow rates than for plasma arc welding are used for the plasma arc cutting (PAC) process, which operates on DC straight polarity, and uses a transferred arc to melt through the material to be cut. The nozzle is positioned close to the work surface and the velocity of the plasma jet is greatly increased by a restricting nozzle orifice so that it blows away the metal as it is melted to make the cut. The higher energy level makes the process much faster than cutting with an oxygen/fuel torch on cutting steel of less than $\frac{1}{2}$ in. (12.7 mm) thick, but the process produces kerfs with some variation in the width and in the bevel angle, affecting the precision of the part. Some of the molten metal may recast itself on the edges of the cut and may be difficult to remove.

Factors that affect plasma cutting include the type and pressure of the gas, its flow pattern, the current, the size and shape of the nozzle orifice, and its closeness to the work surface. To reduce noise and fumes, mechanized plasma arc cutting is often performed with the workpiece submerged in water. Oxidation of cut surfaces is almost nonexistent with the underwater method.

Precision Plasma Arc Cutting.—A later development of the above process uses a magnetic field in the cutter head to stabilize the plasma arc by means of Lorentz forces that cause it to spin faster and tighter on the electrode tip. The magnetic field also confines the spinning plasma so that a narrower kerf is produced without adverse effect on cutting speed. Results from this process are somewhat comparable with those from laser cutting and, with numerical control of machine movements, it is used for production of small batches of blanks for stamping and similar applications. With galvanized and aluminized steel, edges are clean and free from burrs, but some slag may cling to edges of mild-steel parts.

Cutting Metals with an Oxidizing Flame

The oxyhydrogen and oxyacetylene flames are especially adapted to cutting metals. When iron or steel is heated to a high temperature, it has a great affinity for oxygen and readily combines with it to form various oxides, and causing the metal to be disintegrated and burned with great rapidity. The metal-cutting or burning torch operates on this principle. A torch tip is designed to preheat the metal, which is then burned or oxidized by a jet of pure oxygen. The kerf or path left by the flame is suggestive of a saw cut when the cutting torch has been properly adjusted and used. The traversing motion of the torch along the work may be controlled either by hand or mechanically.

Arc Cutting.—According to the *Procedure Handbook of Arc-Welding Design & Practice*, published by The Lincoln Electric Co., a steel may be cut easily, and with great accuracy by means of the oxyacetylene torch. All metals, however, do not cut as easily as steel. Cast iron, stainless steels, manganese steels, and nonferrous materials are not as readily cut and shaped with the oxyacetylene cutting process because of their reluctance to oxidize. For these materials, arc cutting is often used to good advantage.

The cutting of steel is a chemical action. The oxygen combines readily with the iron to form iron oxide. In cast iron, this action is hindered by the presence of carbon in graphite form. Thus, cast iron cannot be cut as readily as steel; higher temperatures are necessary and cutting is slower. In steel, the action starts at bright red heat, whereas in cast iron, the temperature must be nearer to the melting point to obtain a sufficient reaction.

The Cutting Torch.—The ordinary cutting torch consists of a heating jet using oxygen and acetylene, oxygen and hydrogen, or, in fact, any other gas that, when combined with oxygen, will produce sufficient heat. By the use of this heating jet, the metal is first brought

to a sufficiently high temperature, and an auxiliary jet of pure oxygen is then turned onto the red-hot metal, and the action just referred to takes place. Some cutting torches have a number of preheating flame ports surrounding the central oxygen port, so that a preheating flame will precede the oxygen regardless of the direction in which the torch is moved. This arrangement has been used to advantage in mechanically guided torches. The rate of cutting varies with the thickness of the steel, the size of the tip, and the oxygen pressure.

Adjustment and Use of Cutting Torch.—When using the cutting torch for the cutting of steel plate, the preheating flame first comes into contact with the edge of the plate and quickly raises it to a white-hot temperature. The oxygen valve is then opened, and as the pure oxygen comes into contact with the heated metal, the latter is burned or oxidized.

Metals That Can Be Cut.—Metals such as wrought iron and steels of comparatively low-carbon content can be cut readily with the cutting torch. High-carbon steels may be cut successfully if preheated to a temperature that depends somewhat on the carbon content. The higher the carbon content, the greater the degree of preheating required. A black heat is sufficient for ordinary tool steel, but a low red heat may be required for some alloy tool steels. Brass and bronze plates have been cut by interposing them between steel plates.

Cutting Stainless Steel.—Stainless steel can be cut readily by the flux-injection method. The elements that give stainless steels their desirable properties produce oxides that reduce the flame cutting operation to a slow melting-away process when the conventional oxy-acetylene cutting equipment is used. By injecting a suitable flux directly into the stream of cutting oxygen before it enters the torch, the obstructing oxides can be removed. Portable flux feeding units are designed to inject a predetermined amount of the flux powder. The rate of flux flow is accurately regulated by a vibrator type of dispenser with rheostat control. The flux-injection method is applicable either to machine cutting or to a hand-controlled torch. The operating procedure and speed of cutting are practically the same as in cutting mild steel.

Cutting Cast Iron.—The cutting of cast iron with the oxyacetylene torch is practicable, although it cannot be cut as readily as steel. The ease of cutting seems to depend largely on the physical character of the cast iron, very soft cast iron being more difficult to cut than harder varieties. The cost is much higher than that for cutting the same thickness of steel, because of the larger preheating flame necessary and the larger oxygen consumption. In spite of this extra cost, however, this method is often economical. The slag from a cast-iron cut contains considerable melted cast iron, whereas in steel, the slag is practically free from particles of the metal, indicating that cast-iron cutting is partly a melting operation. Increased speed and decreased cost often can be obtained by feeding a steel rod, about $\frac{1}{4}$ inch (6.35 mm) in diameter, into the top of the cut, beneath the torch tip. This rod furnishes a large amount of slag that flows over the cut and increases the temperature of the cast iron. Special tips are used because of the larger amounts of heat and oxygen required.

Mechanically Guided Torches.—Cutting torches used for cutting openings in plates or blocks or for cutting parts to some definite outline are often guided mechanically or by numerical control. Torches guided by pantograph mechanisms are especially adapted for tracing the outline to be cut from a pattern or drawing. Other designs are preferable for straight-line cutting and one type is designed for circular cutting.

Cutting Steel Castings.—When cutting steel castings, care should be taken to prevent burning pockets in the metal when the flame strikes a blowhole. If a blowhole is penetrated, the molten oxide will splash into the cavity and the flame will be diverted. The presence of the blowhole is generally indicated by excessive sparks. The operator should immediately move the torch back along the cut and direct it at an angle so as to strike the metal beneath the blowhole and burn it away if possible beyond the cavity. Cutting in the normal position then may be resumed.

Thickness of Metal That Can Be Cut.—The maximum thickness of metal that can be cut by these high-temperature flames depends largely upon the gases used and the pressure of the oxygen, which may be as high as 150 lb/in.² (1034 kPa). The thicker the metal, the higher the pressure required. When using an oxyacetylene flame, it might be practicable to cut iron or steel up to 12 or 14 inches (30.5 or 35.6 cm) in thickness, whereas an oxyhydrogen flame has been used to cut steel plates 24 inches (61 cm) thick. The oxyhydrogen flame will cut thicker material principally because it is longer than the oxyacetylene flame and can penetrate to the full depth of the cut, thus keeping all the oxide in a molten condition so that it can be easily blown out by the oxygen cutting jet. A mechanically guided torch will cut thick material more satisfactorily than a hand-guided torch, because the flame is directed straight into the cut and does not wobble, as it tends to do when the torch is held by hand. With any flame, the cut is less accurate and the kerf wider, as the thickness of the metal increases. When cutting light material, the kerf might be $\frac{1}{16}$ inch (1.59 mm) wide, whereas for heavy stock, it might be $\frac{1}{4}$ or $\frac{3}{8}$ inch (6.35 or 9.5 mm) wide.

Hard Facing

Hard facing is a method of adding a coating, edge, or point, of a metal or alloy capable of resisting abrasion, corrosion, heat, or impact, to a metal component. The process can be applied equally well to new parts or old worn parts. The most common welding methods used to apply hard-facing materials include the oxyacetylene gas, shielded-metal arc, submerged arc, plasma arc, and inert-gas-shielded arc (consuming and nonconsuming electrode). Such coatings can also be applied by a spraying process, using equipment designed to handle the coating material in the form of a wire or a powder.

Hard-Facing Materials.—The first thing to be considered in the selection of a hard-facing material is the type of service the part in question is to undergo. Other considerations include machinability, cost of hard-facing material, porosity of the deposit, appearance in use, and ease of application. Only generalized information can be given here to guide the selection of a material as the choice is dependent upon experience with a particular type of service. Generally, the greater the hardness of the facing material, the greater is its resistance to abrasion and shock or impact wear. Many hardenable materials may be used for hard facing such as carbon steels, low-alloy steels, medium-alloy steels, and medium-high alloys but none of these is outstanding. Some of the materials that might be considered to be preferable are high-speed steel, austenitic manganese steel, austenitic high-chromium iron, cobalt-chromium alloy, copper-base alloy, and nickel-chromium-boron alloy.

High-Speed Steels.—These steels are available in the form of welding rods (RFe5) and electrodes (EFe5) for hard facing where hardness is required at service temperatures up to 1100°F (593°C) and where wear resistance and toughness are also required. Typical surfacing operations are done on cutting tools, shear blades, reamers, forming dies, shearing dies, guides, ingot tongs, and broaches using these metals.

Hardness: These steels have a hardness of 55 to 60 on the Rockwell C scale in the as-welded condition and a hardness of 30 Rockwell C in the annealed condition. At a temperature of 1100°F (593°C), the as-deposited hardness of 60 Rockwell C falls off very slowly to 47 Rockwell C. At about 1200°F (649°C), the maximum Rockwell C hardness is 30.

Resistance Properties: As deposited, the alloys can withstand only medium impact, but when tempered, the impact resistance is increased appreciably. Deposits of these alloys will oxidize readily because of their high molybdenum content but can withstand atmospheric corrosion. They do not withstand liquid corrosives.

Other Properties or Characteristics: The metals are well suited for metal-to-metal wear especially at elevated temperatures. They retain their hardness at elevated temperatures and can take a high polish. For machining, these alloys must first be annealed. Full hardness may be regained by a subsequent heat treatment of the metal.

Austenitic Manganese Steels.—These metals are available in the form of electrodes (EFeMn) for hard facing when dealing with metal-to-metal wear and impact. Uses include facing rock-crushing equipment and railway frogs and crossings.

Hardness: Hardness of the as-deposited metals are 170 to 230 Bhn, but they can be work-hardened to 450 to 550 Bhn very readily. For all practical purposes, these metals have no hot hardness as they become brittle when reheated above 500-600 °F(260–316 °C).

Resistance Properties: These metals have high impact resistance. Their corrosion and oxidation resistance are similar to those of ordinary carbon steels. Their resistance to abrasion is only mediocre compared with hard abrasives like quartz.

Other Properties or Characteristics: The yield strength of the deposited metal in compression is low, but any compressive deformation rapidly raises it until plastic flow ceases. This property is an asset in impact wear situations. Machining is difficult with ordinary tools and equipment; finished surfaces are usually ground.

Austenitic High-Chromium Irons.—These metals are available in rod (RFeCr-A) and electrode (EFeCr-A) form and are used for facing agricultural machinery parts, coke chutes, steel mill guides, sand-blasting equipment, and brick-making machinery.

Hardness: The as-welded deposit ranges in hardness from 51 to 62 Rockwell C. Under impact, the deposit work hardens somewhat, but the resulting deformation also leads to cracking and impact service is therefore avoided. Hot hardness decreases slowly at temperatures up to 800 and 900°F (427 and 482°C). At 900°F (482°C), the instantaneous hardness is 43 Rockwell C. In 3 minutes under load, the hardness drops to 37 Rockwell C. At 1200°F (649°C), the instantaneous hardness is 5 Rockwell C. The decrease in hardness during hot testing is practically recovered on cooling to ambient temperatures.

Resistance Properties: Deposits will withstand only light impact without cracking. Dynamic compression stresses above 60,000 psi (414 MPa) should be avoided. These metals exhibit good oxidation resistance up to 1800°F (982°C) and can be considered for hot wear applications where hot plasticity is not objectionable. They are not very resistant to corrosion from liquids and will rust in moist air, but are more stable than ordinary iron and steel. Resistance to low-stress scratching is outstanding and is related to the amount of hard carbides present. However, under high-stress grinding abrasion, performance is only mediocre and they are not deemed suitable for such service.

Other Properties or Characteristics: The deposited metals have a yield strength (0.1 per cent offset) of between 80,000 and 140,000 pounds per square inch (552 and 965 MPa) in compression and an ultimate strength of from 150,000 to 280,000 psi (1034–1930 MPa). Their tensile strength is low and therefore tension uses are avoided in design. These deposits are considered to be commercially unmachinable and are also very difficult to grind. When ground, a grinding wheel of aluminum oxide abrasive with a 24-grit size and a hard (Q) and medium-spaced resinoid bond is recommended for off-hand high-speed work and a slightly softer (P) vitrified bond for off-hand low-speed work.

Cobalt-Base Alloys.—These metals are available in both rod (RCoCr) and electrode (ECoCr) form and are frequently used to surface the contact surfaces of exhaust valves in aircraft, truck, and bus engines. Other uses include parts such as valve trim in steam engines, and on pump shafts, where conditions of corrosion and erosion are encountered. Several metals with a greater carbon content are available (CoCr-B, CoCr-C) and are used in applications requiring greater hardness and abrasion resistance but where impact resistance is not mandatory or expected to be a factor.

Hardness: Hardness ranges on the Rockwell C scale for gas-welded deposits are as follows: CoCr-A, 38 to 47; CoCr-B, 45 to 49; and CoCr-C, 48 to 58. For arc-welded deposits, hardness ranges (Rockwell C) as follows: CoCr-A, 23 to 47; CoCr-B, 34 to 47; and CoCr-C, 43 to 58. The values for arc-weld deposits depend for the most part on the base metal dilution. The greater the dilution, the lower the hardness. Many surfacing alloys are soft-

ened permanently by heating to elevated temperatures, however, these metals are exceptional. They do exhibit lower hardness values when hot but return to their approximate original hardness values upon cooling. Elevated-temperature strength and hardness are outstanding properties of this group. Their use at 1200°F (649°C) and above is considered advantageous but between 1000 and 1200°F (538–649°C), their advantages are not definitely established, and at temperatures below 1000°F (538°C), other surfacing metals may prove better.

Resistance Properties: In the temperature range from 1000 to 1200 degrees F (538–649°C), weld deposits of these metals have a great resistance to creep. Tough martensitic steel deposits are considered superior to cobalt-base deposits in both flow resistance and toughness. The chromium in the deposited metal promotes the formation of a thin, tightly adherent scale that provides a scaling resistance to combustion products of internal combustion engines, including deposits from leaded fuels. These metals are corrosion-resistant in such media as air, food, and certain acids. It is advisable to conduct field tests to determine specific corrosion resistance for the application being considered.

Other Properties or Characteristics: Deposits are able to take a high polish and have a low coefficient of friction and therefore are well suited for metal-to-metal wear resistance. Machining of these deposits is difficult; the difficulty increases in proportion to the increase in carbon content. CoCr-A alloys are preferably machined with sintered carbide tools. CoCr-C deposits are finished by grinding.

Copper-Base Alloys.—These metals are available in rod (RCuA1-A2, RCuA1-B, RCuA1-C, RCuA1-D, RCuA1-E, RCuSi-A, RCuSn, RCuSn-D, RCuSn-E, and RCuZn-E) and electrode (ECuA1-A2, ECuA1-B, ECuA1-C, ECuA1-D, ECuA1-E, ECuSi, ECuSn-A, ECuSn-C, ECuSn-E, and ECuZn-E) forms and are used in depositing overlays and inlays for bearing, corrosion-resistant, and wear-resistant surfaces. The CuA1-A2 rods and electrodes are used for surfacing bearing surfaces between the hardness ranges of 130 to 190 Bhn as well as for corrosion-resistant surfaces. The CuA1-B and CuA1-C rods and electrodes are used for surfacing bearing surfaces of hardness ranges 140 to 290 Bhn. The CuA1-D and CuA1-E rods and electrodes are used on bearing and wear-resistant surfaces requiring the higher hardnesses of 230 to 390 Bhn such as are found on gears, cams, wear plates, and dies. The copper-tin (CuSn) metals are used where a lower hardness is required for surfacing, for corrosion-resistant surfaces, and sometimes for wear-resistant applications.

Hardness: Hardness of a deposit depends upon the welding process employed and the manner of depositing the metal. Deposits made by the inert-gas metal-arc process (both consumable and nonconsumable electrode) will be higher in hardness than deposits made with the gas, metal-arc, and carbon-arc processes because lower losses of aluminum, tin, silicon, and zinc are achieved due to the better shielding from oxidation. Copper-base alloys are not recommended for use at elevated temperatures because their hardness and mechanical properties decrease consistently as the temperature goes above 400°F (204°C).

Resistance Properties: The highest impact resistance of the copper-base alloy metals is exhibited by CuA1-A2 deposits. As the aluminum content increases, the impact resistance decreases markedly. CuSi weld deposits have good impact properties. CuSn metals as deposited have low impact resistance and CuZn-E deposits have a very low impact resistance. Deposits of the CuA1 filler metals form a protective oxide coating upon exposure to the atmosphere. Oxidation resistance of CuSi deposits is fair and that of CuSn deposits are comparable to pure copper. With the exception of the CuSn-E and CuZn-E alloys, these metals are widely used to resist many acids, mild alkalis, and salt water. Copper-base alloy deposits are not recommended for use where severe abrasion is encountered in service. CuA1 filler metals are used to overlay surfaces subjected to excessive wear from metal-to-metal contact such as gears, cams, sheaves, wear plates, and dies.

Other Properties or Characteristics: All copper-base alloy metals are used for overlays and inlays for bearing surfaces with the exception of the CuSi metals. Metals selected for bearing surfaces should have a Brinell hardness of 50 to 75 units below that of the mating metal surface. Slight porosity is generally acceptable in bearing service as a porous deposit is able to retain oil for lubricating purposes. CuAl deposits in compression have elastic limits ranging from 25,000 to 65,000 (172 to 448 MPa) and ultimate strengths of 120,000 to 171,000 (827 to 1179 MPa). The elastic limit and ultimate strength of CuSi deposits in compression are 22,000 and 60,000 (152 to 414 MPa), respectively. CuZn-E deposits in compression have an elastic limit of only about 5000 (34 MPa) and an ultimate strength of 20,000 (138 MPa). All copper-base alloy deposits can be machined.

Nickel-Chromium-Boron Alloys.—These metals are available in both rod (RNiCr) and electrode (ENiCr) form and their deposits have good metal-to-metal wear resistance, good low-stress, scratch-abrasion resistance, corrosion resistance, and retention of hardness at elevated temperatures. These properties make the alloys suitable for use on seal rings, cement pump screws, valves, screw conveyors, and cams. Three different formulations of these metals are recognized (NiCr-A, NiCr-B, and NiCr-C).

Hardness: Hardness of the deposited NiCr-A from rods range from 35 to 40 Rockwell C; of NiCr-B rods, 45 to 50 Rockwell C; of NiCr-C rods, 56 to 62 Rockwell C. Hardness of the deposited NiCr-A from electrodes ranges from 24 to 35 Rockwell C; of NiCr-B from electrodes, 30 to 45 Rockwell C; and of NiCr-C electrodes, 35 to 56. The lower hardness values and greater ranges of hardness values of the electrode deposits are attributed to the dilution of deposit and base metals. Hot Rockwell C hardness values of NiCr-A electrode deposits range from 30 to 19 in the temperature range from 600-1000°F (316–538°C) from instantaneous loading to a 3-minute loading interval. NiCr-A rod deposits range from 34 to 24 in the same temperature range and under the same load conditions. Hot Rockwell C hardness values of NiCr-B electrode deposits range from 41 to 26 in the temperature range from 600 to 1000°F (315–538°C) from instantaneous loading to a 3-minute loading interval. NiCr-B rod deposits range from 46 to 37 in the same temperature range and under the same load conditions. Hot Rockwell C hardness values of NiCr-C electrode deposits range from 49 to 31 in the temperature range from 600 to 1000 degrees F from instantaneous loading to a 3-minute loading interval. NiCr-C rod deposits range from 55 to 40 in the same temperature range and under the same load conditions.

Resistance Properties: Deposits of these metal alloys will withstand light impact fairly well. When plastic deformation occurs, cracks are more likely to appear in the NiCr-C deposit than in the NiCr-A and NiCr-B deposits. NiCr deposits are oxidation-resistant up to 1800°F (982°C). Their use above 1750°F (954°C) is not recommended because fusion may begin near this temperature. NiCr deposits are completely resistant to atmospheric, steam, salt water, and salt spray corrosion and to the milder acids and many common corrosive chemicals. It is advisable to conduct field tests when a corrosion application is contemplated. These metals are not recommended for high-stress grinding abrasion. NiCr deposits have good metal-to-metal wear resistance, take a high polish under wearing conditions, and are particularly resistant to galling. These properties are especially evident in the NiCr-C alloy.

Other Properties or Characteristics: In compression, these alloys have an elastic limit of 42,000 lb/in² (290 MPa). Their yield strength in compression is 92,000 lb/in² (634 MPa) (0.01 per cent offset), 150,000 lb/in² (1034 MPa) (0.10 per cent offset), and 210,000 lb/in² (1448 MPa) (0.20 per cent offset). Deposits of NiCr filler metals may be machined with tungsten carbide tools using slow speeds, light feeds, and heavy tool shanks. They are also finished by grinding using a soft-to-medium vitrified silicon carbide wheel.

Chromium Plating.—Chromium plating is an electrolytic process of depositing chromium on metals either as a protection against corrosion or to increase the surface-wearing qualities. The value of chromium-plating plug and ring gages has probably been more

thoroughly demonstrated than any other single application of this treatment. Chromium-plated gages not only wear longer, but when worn, the chromium may be removed and the gage replated and reground to size.

In general, chromium-plated tools have operated well, giving greatly improved performance on nearly all classes of materials such as brass, bronze, copper, nickel, aluminum, cast iron, steel, plastics, asbestos compositions, and similar materials. Increased cutting life has been obtained with chromium-plated drills, taps, reamers, files, broaches, tool tips, saws, thread chasers, and the like. Dies for stamping, drawing, hot forging, die casting, and for molding plastics materials have shown greatly increased life after being plated with hard chromium.

Special care is essential in grinding and lapping tools preparatory to plating the cutting edges, because the chromium deposit is influenced materially by the grain structure and hardness of the base metal. The thickness of the plating may vary from 0.0001 to 0.001 or 0.002 inch, the thicker platings being used to build up undersize tools such as taps and reamers. A common procedure in the hard chromium plating of tools, as well as for parts to be salvaged by depositing chromium to increase diameters, is as follows:

- 1) Degrease with solvent; 2) Mount the tools on racks; 3) Clean in an anodic alkali bath held at a temperature of 82°C (180°F) for 3 to 5 minutes; 4) Rinse in boiling water;
- 5) Immerse in a 20 per cent hydrochloric acid solution for 2 to 3 seconds; 6) Rinse in cold water; 7) Rinse in hot water; 8) Etch in a reverse-current chromic acid bath for 2 to 5 minutes; 9) Place work immediately in the chromium plating bath; and 10) Remove hydrogen embrittlement, if necessary, by immersing the plated tools for 2 hours in an oil bath maintained at 177°C (350°F).

Chromium has a very low coefficient of friction. The static coefficient of friction for steel on chromium-plated steel is 0.17, and the sliding coefficient of friction is 0.16. This value may be compared with the static coefficient of friction for steel on steel of 0.30 and a sliding coefficient of friction of 0.20. The static coefficient of friction for steel on babbitt is 0.25, and the sliding coefficient of friction 0.20, whereas for chromium-plated steel on babbitt, the static coefficient of friction is 0.15, and the sliding coefficient of friction is 0.13. These figures apply to highly polished bearing surfaces. Articles that are to be chromium plated in order to resist frictional wear should be highly polished before plating so that full advantage can be taken of the low coefficient of friction that is characteristic of chromium. Chromium resists attack by almost all organic and inorganic compounds, except muriatic and sulfuric acids. The melting point of chromium is 2930°F (1610°C), and it remains bright up to 1200°F (649°C). Above 1200 degrees F, a light adherent oxide forms and does not readily become detached. For this reason, chromium has been used successfully for protecting articles that must resist high temperatures, even above 2000°F (1093°C).

Electron-Beam (EB) Welding

Heat for melting of metals in electron-beam welding is obtained by generating electrons, concentrating them into a beam, and accelerating them to between 30 and 70 per cent of the speed of light, using voltages between 25 and 200 kV. The apparatus used is called an electron-beam gun, and it is provided with electrical coils to focus and deflect the beam as needed for the welding operation. Energy input depends on the number of electrons impinging on the work in unit time, their velocity, the degree of concentration of the beam, and the traveling speed of the workpiece being welded. Some 6.3×10^{15} electrons/s are generated in a 1-mA current stream. With beam diameters of 0.01 to 0.03 in. (0.25 to 0.76 mm), beam power can reach 100 kW and power density can be as high as 10^7 W/in² (1.55×10^4 W/mm²), higher than most arc welding levels.

At these power densities, an electron beam can penetrate steel up to 4 in thick and form a vapor capillary or keyhole, as described earlier. Although patterns can be traced by deflecting the beam, the method used in welding is to move the electron gun or the workpiece. A

numerical control, or computer numerical control, program is used because of the accuracy required to position the narrow beam in relation to the weld line.

Equipment is available for electron-beam welding under atmospheric pressure or at various degrees of vacuum. The process is most efficient (produces the narrowest width and deepest penetration welds) at high levels of vacuum, of the order of 10^{-6} to 10^{-3} torr or lower (standard atmospheric pressure is about 760 torr, or 760 mm of mercury), so that a vacuum chamber large enough to enclose the work is needed. Operation in a vacuum minimizes contamination of the molten weld material by oxygen and nitrogen. Gases produced during welding are also extracted rapidly by the vacuum pump so that welding of reactive metals is eased. However, the pumping time and the size of many workpieces restrict the use of high-vacuum enclosures.

At atmospheric pressures, scattering of the beam electrons by gas molecules is increased in relation to the number of stray molecules and the distance traveled, so that penetration depth is less and the beam spread is greater. In the atmosphere, the gun-to-work distance must be less than about 1.5 in. (38 mm). Electron-beam welding at atmospheric pressure requires beam-accelerating voltages above 150 kV, but lower values can be used with a protective gas. Helium is preferred because it is lighter than air and permits greater penetration. Argon, which is heavier than air and allows less penetration, can also be used to prevent contamination.

Required safety precautions, such as radiation shields to guard workers against the effects of X-rays when the electron beam strikes the work, are essential when electron-beam welding is done at atmospheric pressure. Such barriers are usually built into enclosures that are designed specifically for electron-beam welding in a partial vacuum. Adequate ventilation is also required to remove ozone and other gases generated when the process is used in the atmosphere.

Carbon, low-alloy, and stainless steels; high-temperature and refractory alloys; copper and aluminum alloys can be electron-beam welded, and single-pass, reasonably square, butt welds can be made in materials up to 1 in. (25.4 mm) thick at good speeds with nonvacuum equipment rated at 60 kW. Edges of thick material to be electron-beam welded require precision machining to provide good joint alignment and minimize the joint gap. Dissimilar metals usually may be welded without problems.

Because of the heat-sink effect, electron-beam welds solidify and cool very rapidly, causing cracking in certain materials such as low-ferrite stainless steel. Although capital costs for electron-beam welding are generally higher than for other methods, welding of large numbers of parts and the high welding travel rates make the process competitive.

Pipe Welding

Pipe Welding.—Welding of (usually steel) pipe is commonly performed manually, with the pipe joint stationary, or held in a fixture whereby rotation can be used to keep the weld location in a fixed, downhand, position. Alternatively, pipe may need to be welded on site, without rotation, and the welder then has to exert considerable skill to produce a satisfactory, pressure-tight joint. Before welding stationary pipe, a welder must be proficient in welding in the four basic positions: 1G flat, 2G horizontal, 3G vertical and 4G overhead, depicted at the top in [Figs. 1a](#), [1b](#), [1c](#), and [1d](#).

Positioning of Joint Components in Pipe Welding

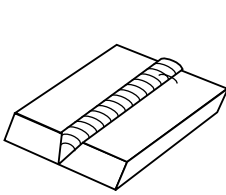


Fig. 1a. Flat Position 1G

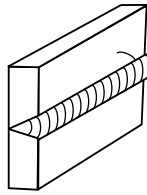


Fig. 1b. Horizontal Position 2G

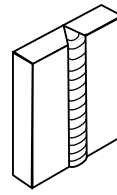


Fig. 1c. Vertical Position 3G

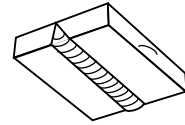
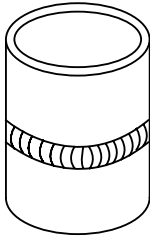
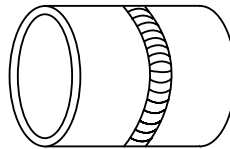
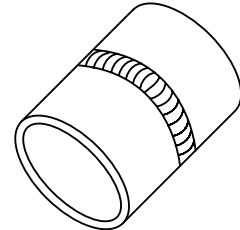


Fig. 1d. Overhead Position 4G

Fig. 1e. Horizontal position 2G
Pipe Axis VerticalFig. 1f. Position 5G
Pipe Fixed, Axis HorizontalFig. 1g. Position 6G
Pipe Fixed, Axis Inclined

At the bottom are shown pipe joints in three positions, the first of which, **Fig. 1e**, corresponds to the 2G horizontal (non-rotational) position in the upper row. The remaining two are respectively 5G, **Fig. 1f**, that represents pipe with the weld in a fixed vertical (non-rotational) position; and 6G, **Fig. 1g**, that typifies pipe to be welded at an angle and not rotated during welding.

For satisfactory pipe welding, consideration must be given to the chemical composition and thickness of the metal to be welded; selection of a suitable electrode material composition and size; determination of the current, voltage and wire feed rate to be used; preparation of the joint or edges of the pipes; and ways of holding the pipes in the positions needed while welding is carried out. High-quality tack welds, each about 1.5 inches (38 mm) long, and projecting about $\frac{1}{16}$ inch (1.6 mm) beyond the inner wall of the pipe, are usually made to hold the parts of the assembly in position during welding.

SMAW (stick) welding was used almost exclusively for pipe welding until the advent of MIG welding with its potential for much greater rates of deposition. It cannot be emphasized too strongly that practices suitable for SMAW cannot be transferred to MIG welding, for which greater expertise is required if satisfactory welds are to be produced. MIG short-circuit, globular, and spray transfer, and pulsed MIG, with flux or metal-cored consumables (electrodes) can now all be used for pipe welding. Use of all-position, flux-cored, MIG consumables in particular, can reduce skill requirements, improve weld quality, and hold down costs in pipe welding.

Among the important items involved in the change to the MIG process is the automatic wire feeder. With today's wire feeding equipment, an increase of one increment on the dial, say from the 9 to the 10 o'clock position, can increase the wire feed rate by 70 in/min (1.8 m/min). As an example, such an increase could raise the weld current from 110 to 145 amps and the weld voltage from 16 to 17, resulting in an increase of 40 per cent in the energy supplied to the weld. Another vital parameter is the amount that the wire sticks out from the contact tip. In low-parameter, short-circuit welding, a small change in the wire stick-out can alter the energy supplied to the weld by 20 to 30 per cent.

Root passes: Whatever welding process is selected, the most important step in pipe welding, as in other types of welding, is the root pass, which helps to determine the degree of penetration of the weld metal, and affects the amount of lack of fusion in the finished weld. During the root pass, the action of the arc in the weld area should reshape the gap between

the adjacent sides of the joint into a pear-shaped opening, often called a “keyhole.” As the work proceeds, this keyhole opening is continuously being filled, on the trailing side of the weld, by the metal being deposited from the electrode. The keyhole travels along with the weld so that the root pass produces a weld that penetrates slightly through the inner wall of the pipe.

MIG short-circuit root welding of carbon steel pipe requires a gap of $\frac{5}{32} \pm \frac{1}{32}$ (4 ± 0.8 mm), between the ends of the pipe, and the width of the root faces (at the base of the bevels) should be $\frac{1}{16}$ to $\frac{3}{32}$ inch (1.6 to 2.4 mm). The recommended bevel angle for MIG pipe welding is 40E (80E included angle) and the maximum root gap is $\frac{3}{16}$ inch (4.8 mm). The root pass in 1G welds should be made in the vertical-down direction with the electrode held between the 2 and 3 o'clock positions. When an 0.035-inch (0.9-mm) diameter E70S-3 MIG wire is used with the above root dimensions, weaving is not needed for the root pass except when welding over tack welds.

Fill passes: In welding carbon steel pipe in the 1G position with an 0.035-inch diameter electrode wire, MIG short circuit fill passes should use a minimum of 135 amps and be done in the vertical-up position. Fill passes should deposit a maximum thickness of no more than $\frac{1}{8}$ inch (3.2 mm). Inclusion of CO₂ gas in the mixture will improve weld fusion. With flux-cored electrodes, the minimum amount of wire stick out is $\frac{3}{4}$ inch (19 mm). Weld fusion can be improved in welding pipe of 0.4 inch (10 mm) wall thickness and thicker by preheating the work to a temperature between 400 and 500°F (204 and 260°C).

Horizontal Pipe Welding: In 1G welds (see Fig. 1a), the pipe should be rotated in the direction that moves the solidifying area away from the wire tip, to minimize penetration and resulting breakthrough. Welding of pipe in the 2G, horizontal position is made more difficult by the tendency for the molten metal to drip from the weld pool. Such dripping may cause an excessively large keyhole to form during the root-welding pass, and in subsequent passes electrode metal may be lost. Metal may also be lost from the edge of the upper pipe, causing an undercut at that side of the weld.

Vertical-down welding: With the pipe axis horizontal (as in the 5G position in Fig. 1f), vertical-down welding is usually started at the top or 12 o'clock location, and proceeds until the 6 o'clock location is reached. Welding then starts again at the 12 o'clock location and continues in the opposite direction until the 6 o'clock location is reached. Vertical-down welding is mainly used for thin-walled, low-carbon steel pipe of $\frac{1}{8}$ to $\frac{5}{16}$ inch (3.2 to 7.9 mm) wall thickness, which has low heat-retaining capacity so that the weld metal cools slowly, producing a soft and ductile structure. The slow rate of cooling also permits faster weld deposition, and, when several beads are deposited, causes an annealing effect that may refine the entire weld structure.

Vertical-up welding: In the 5G position, vertical-up welding normally begins at the 6 o'clock location and continues up to the 12 o'clock location, the weld then being completed by starting at the 6 o'clock location on the other side of the pipe and traversing up to the 12 o'clock location again. Vertical-up welding is more suited to pipe with thick walls and to alloy steels. However, the greater heat sink effect of the heavy-walled pipe may result in a faster cooling rate and embrittlement of the material, especially in alloy steels. The cooling rate can be reduced by slowing the rate of traverse and depositing a heavier bead of metal, both facilitated by welding in the vertical-up direction.

Using a thicker electrode and higher current for thicker-walled pipe to reduce the number of beads required may result in dripping from the molten puddle of metal. Defects such as pin holes, lack of fusion, and cold lap, may then appear in the weld. Vertical-up welding of pipe in the 5G, fixed, horizontal position, Fig. 1f, used for thick-walled pipe, is probably the most difficult for a welder, but once mastered will form the basis for other methods of pipe welding. Starting at the 6 o'clock location, the arc for the root pass is struck overhead, with the electrode at an angle of 5 to 10° from the vertical, on the joint, not on the tack weld.

A long arc should be maintained for a short-period while weaving the electrode to pre-heat the area ahead of the weld. Only small amounts of filler metal will be transferred while this long arc is maintained in the overhead position. The electrode tip is then advanced to establish the correct arc length and held in position long enough for the keyhole to form before starting to lay down the root bead, moving up toward the 12 o'clock location.

Thin-wall pipe: The optimum globular/spray parameters for welding rotated, (1G position) thin-wall pipe of less than 12 inch (305 mm) diameter are 0.035-inch (1 mm) electrode wire fed at 380-420 in./min (9.7-10.7 m/min) with a protective gas mixture of argon 80 to 85, CO₂ 15 to 20 per cent, and current of 190 to 210 amps. These conditions will provide deposition rates of about 6 lb/hr (3 kg/hr).

Use of Flux-cored Electrodes.—Small diameter, flux cored electrodes developed in the eighties are still a rarity in many pipe welding shops, but flux cored welding can produce consistent, high-quality, low-cost welds on carbon steel or stainless pipe. Flux cored E71T-1, 0.035-inch (1 mm) diameter wire provides a continuous, medium energy, open arc, with a practical current range of 135 to 165 amps for welding pipe. This current range is similar to the optimum MIG short-circuit current range, and is 25 to 30 percent less current than the minimum open arc spray transfer current for an 0.035-inch (1 mm) diameter MIG wire.

In contrast to MIG short circuit welding, FCAW works with an open arc and no short circuits. The FCAW arc energy is continuous, and, in contrast to short-circuit transfer, provides increased weld fusion potential. The weld metal from the flux-cored tubular wire is transferred from the periphery and the center of the wire, resulting in broad coverage of the weld. The plasma in the flux cored arc is wider than MIG plasma, and the flux-cored arc is less focused and easier to control than the MIG spray arc.

Open arc, gas shielded, flux-cored welding can produce spray type transfer at lower currents than open arc MIG spray transfer. With FCAW, the current density is high because the electrode wire cross-sectional area is less than that of the same size MIG solid wire due to the central core of flux. This higher density provides for improved weld penetration potential. The FCAW process produces slag, which serves as a mold to hold the fluid molten metal in place, an ideal arrangement for vertical-up and overhead welds.

All position, flux-cored wires require less operator skill for vertical-up and overhead welds than MIG, SMAW, and TIG processes. Fill passes can also be completed in 30 to 50 percent less time with all-position, flux-cored wires than with MIG short circuit and SMAW wires.

For good quality FCAW, welders need to know the best root and bevel dimensions, and the importance of maintaining those dimensions for continuous weld fusion; the preferred direction of pipe rotation; the diameter of flux cored electrode best suited for welding thin wall pipe; the optimum parameter range for that electrode on 1G and 5G welds; the preferred amount of wire stick out (typically 0.7 inch or 18 mm); and how to fine tune the voltage. When flux-cored welding is to be used for the fill passes, MIG short circuit welding is recommended for the root welds to reduce the possibility of slag from the flux being trapped in the weld. Higher weld deposit rates are provided with flux-cored, vertical-up welding, and there is the temptation to weld faster with a process that's easy to use. Conservative wire feed setting are recommended unless the high deposition rates are shown to provide consistent weld fusion. Wire feed settings should allow the welder time to control and direct the weave into the critical groove locations.

Complete Weld Fusion.—It is essential that new weld metal deposits be completely fused with the pipe components, and with metal laid down in successive passes. Factors that can prevent complete fusing are too numerous to list here. Some basic rules that, if followed, will improve weld fusion and quality in MIG welding in the 1G and 5G positions are:

- 1) The maximum gap at the root should be $\frac{3}{16}$ inch (5 mm)
- 2) The root land should be $\frac{1}{16}$ to $\frac{3}{32}$ inch (1.6 to 2.4 mm) wide

- 3) A bevel angle of 80° inclusive should be used for MIG and flux-cored welding of pipe to provide width for weaving and improve fusion.
- 4) An 0.035-in MIG electrode should have a minimum short circuit current of 135 amps for fill passes
- 5) Tack and root welds should be made in the vertical-down position.
- 6) Tack welds should be about 1.5 in (38 mm) long by $\frac{1}{16}$ to $\frac{3}{32}$ inch (1.6 to 2.4 mm) thick.
- 7) Short circuit fill passes should be made in the vertical-up position.
- 8) With flux-cored electrodes, a minimum of 0.7 inch (18 mm) wire stick out from the contact tip must be maintained.
- 9) Current and voltage must be related to the pipe wall thickness
- 10) Argon + 25 per cent CO₂ is recommended for short circuit welding of pipe roots.
- 11) Use of undiluted CO₂ gas will improve MIG weld fusion in fill passes because of the “digging” action of the arc, and the increased weld energy
- 12) With pipe wall thicknesses of 0.4 inch (10 mm) or greater, preheating to between 400 and 500°F (205 and 260°C), will help make fusion complete.

Other Methods.—Pulsed MIG is a viable alternative to flux-cored for all-position welds on 5G pipe, but requires more costly equipment. The pulsed MIG process however, has few advantages over conventional MIG and flux-cored when the latter are used correctly. Pulsed MIG may have some advantage on mechanized 5G welds, and on welding of stainless steel, pipe in the 5G position.

Metal-cored electrode wire also has few advantages for pipe welds because they work best with low-energy gas welds, which cancels out the increased current density claimed for them.

On most manual pipe welds, the welder needs time to control and direct the weave to ensure even heating and avoid lack of fusion. Satisfactory welds are often performed at travel speeds of 4 to 12 in/min (0.10–0.31 m/min) giving deposit rates of 3-5 lb/hr (1.36–2.27 kg/hr).

Pipe Welding Procedure

Because of the variety of parameter combinations that can be used in pipe welding, it is suggested that charts be prepared and displayed in welding booths to remind welders of the basic settings to be used. Examples of such charts for tack, root, fill and cover passes, are included in what follows:

FCAW 5G (Non-rotated) MIG Welding of Thick-Walled, Carbon-steel Pipes, Procedure for Root Welding.—This procedure can be applied to most pipe sizes, and should be given special consideration for 5G (non-rotated) welds on carbon steel pipe with $\frac{3}{8}$ inch (10 mm) wall thickness and thicker.

Pipe and Weld Data

Pipe bevel included angle = 80

Root face land = $\frac{3}{32} \pm \frac{1}{32}$ inch (2.4 ± 0.8 mm)

Root gap between faces = $\frac{5}{32} \pm \frac{1}{32}$ inch (4 ± 0.8 mm)

Electrode for root weld = 0.035-inch (0.9 mm) diameter, E70S-3 flux-cored.

Gas = argon with 15–25% CO₂

Gas flow rates = 30 to 40 cubic ft/hr (0.85–1.13 m³/hr)

Set wire feeder to 210–280 in/min (10 to 11 o'clock position on many feeders) for current of 140–170 amps, 17–18 volts.

Wire extension: For MIG root weld, set contact tip to stick outside the nozzle, $\frac{1}{16}$ to $\frac{1}{8}$ inch (1.6 to 3 mm). Maintain $\frac{3}{8}$ to $\frac{5}{8}$ inch (10 to 16 mm) maximum wire stick out from contact tip.

Tack Welding Procedures for FCAW 5G Pipe Welds: Make tack welds 1.5 to 2 inches (38 to 50 mm) long. After welding, grind full length of tack to thickness of approximately $\frac{1}{16}$ inch (1.6 mm). Feather tack ends back $\frac{3}{8}$ to $\frac{1}{2}$ inches (9.5 to 13 mm).

On pipes of less than 6 inches (15 cm) outside diameter, use three tack welds, equally spaced, starting at 12 o'clock.

On pipes over 6 inches outside diameter use 4 tack welds. Locate tack welds at 12, 3, 6, and 9 o'clock.

Root Welding Procedures for FCAW 5G Pipe Welds: Root weld MIG vertical-down. Weld sequence: 12 to 3, 9 to 6, 3 to 6, and 12 to 9 o'clock positions.

Start and finish MIG root welds at tack centers. Use slight weave oscillation over tacks. No weave necessary if $\frac{1}{8}$ - to $\frac{5}{32}$ -inch root gap is maintained. Weaving may be required if root gap is less than $\frac{1}{8}$ inch (3 mm). Weaving is also beneficial for root welds between 7 and 6 o'clock, and between 5 and 6 o'clock. After each root pass, blend the starts and stops back to the original tack thickness.

To complete the root, ensure that the weld stops and starts on the last tack, and that the root weld center is ground flat or slightly concave. Remove any slag islands.

FCAW 5G (Non-rotated) MIG Welding of Thick-Walled, Carbon-steel Pipes, Procedure for Fill and Cover Welds.—This procedure can be applied to most common pipe sizes, and should be given special consideration for 5G (non-rotated) welds on carbon steel pipe with $\frac{3}{8}$ inch (10 mm) wall thickness and thicker.

Pipe and Weld Data

Electrode for fill and cover passes = 0.035 inch (0.9 mm) diameter,
71T-1 flux-cored

Gas = argon with 15–25% CO₂

Gas flow rates = 30 to 40 cubic ft/hr

Set an initial wire feed rate of 350 to 450 in/min (12 to 1 o'clock position on typical wire feed unit), 135–165 amps, 25–28 volts. Alternatively, use a wire feed setting of 350 in/min (12 o'clock on wire feed unit), which should result in about 135–145 amps, 25–26 volts. If the weld pool and weld heat build up permit, increase the wire feed rate to 380 in/min (between the 12 and 1 o'clock positions), 150 amps, 27 volts. Try also a wire feed setting of 420 in/min (1 o'clock on the wire feeder), 165 amps, 28 volts. Determine the low and maximum wire feed rates to be used by examination of the weld fusion obtained in sectioned test samples.

Wire extension: Adjust contact tip so it is recessed $\frac{1}{2}$ inch within the nozzle to provide a total wire stick out from the contact tip of 0.7 to 1 inch (18 to 25 mm).

Fill and Cover Pass Procedures for FCAW 5G Pipe Welds: Weld vertical-up. If the pipe diameter allows the fill pass to be made in two passes, start at the 7 o'clock position and weld to the 1 o'clock position. This approach is preferable to starting and finishing on the root tacks. Starting at the 7 o'clock position will ensure that optimum weld energy is achieved as the first pass welds over the initial 6 o'clock root tack location. Use the grinder to feather the first 1 inch (25 mm) of the weld start and stop of the first pass, before applying the second vertical-up weld pass. Use a slight weave action for the fill pass.

Remove all flux-cored slag between weld passes. Make sure no fill pass is greater in depth than $\frac{1}{8}$ inch (3 mm). Use a straight weave across the root face. At the bevel edge use a slight upward motion with the gun. The motion should be no greater than the wire diameter. Then use a slight back step for added bevel fusion and to avoid undercuts.

Leave $\frac{1}{32}$ to $\frac{1}{16}$ inch (0.8 to 1.6 mm) of the groove depth to provide for the optimum cover pass profile. The bevel edge will act as a guide for the cover pass weld. If more weld fusion is required for pipe thicker than $\frac{3}{8}$ inch (10 mm), after the root weld is complete, preheat the

pipe to between 400 and 600°F (200–300°C) before welding. Preheating is typically not necessary for a cover pass.

For pipe diameters on which the welder needs more than two passes for the vertical-up welds, the recommended sequence for vertical-up welding is:

- 1) First pass, weld from the 7 to the 4 o'clock position. Start with a slight forehand nozzle angle. At the 4 o'clock position, the gun should be at the same angle as the pipe.
- 2) Second pass, weld from the 10 to the 1 o'clock position, then grind all stops and start again at the 1-inch (25 mm) position.
- 3) Third pass, weld from the 4 to the 1 o'clock position.
- 4) Fourth pass, weld from the 7 to the 10 o'clock position.

FCAW 5G (Non-rotated) Welding of Thin-Walled Carbon Steel Pipes, Procedure for Root, Fill and Cover Pass Welding.—This procedure can be applied to most common pipe sizes, and should be given special consideration for 5G (non-rotated) welding of carbon steel pipe with wall thicknesses up to $\frac{3}{8}$ inch (10 mm).

Pipe and Weld Data

Electrode for root weld = 0.035 inch diameter, E70S-6 flux cored.

Gas = argon with 15–25% CO₂

Gas flow rates = 30 to 40 cubic ft/hr

Root Welding Procedure for 5G Welds: Use root welding data from *Root Welding Procedures for FCAW 5G Pipe Welds*, above.

Fill and Cover Pass Procedures for 5G Welds: Use MIG short-circuit, vertical-up for fill and cover passes. Electrode wire and gas, same as for root weld.

Weld vertical-up. If the vertical-up fill pass can be made in two passes, weld from the 7 to the 1 o'clock position, to avoid starting and finishing on the root tacks. Starting just past 6 o'clock ensures that optimum weld energy is achieved as the first pass welds over the initial 6 o'clock root tack location. Feather 1 inch (25 mm) of the weld start and stop on the first pass with the grinder before applying the second vertical-up weld pass. Use a slight weave action.

Use MIG short-circuit wire feed, 200–230 in/min 125–135 amps, 19–22 volts. Start at optimum 210 in/min (10 o'clock on the wire feeder) for 130 amps, 21–22 volts. Fine tune voltage by listening to arc sound to obtain a consistent rapid crackle sound.

Electrode sticks out $\frac{1}{2}$ to $\frac{5}{8}$ inch, contact tip flush with nozzle end.

Remove MIG surface slag islands between weld passes. No fill pass should be thicker than $\frac{1}{8}$ inch (3 mm). Use straight weave across the root face. At the bevel, use a slight upward motion with the gun. The motion should be no greater than the wire diameter. Then use a slight back step for added bevel fusion and to avoid possibility of undercut.

For the cover pass, leave $\frac{1}{32}$ to $\frac{1}{16}$ inch of the groove depth for the optimum cover pass profile. The bevel edge will act as a guide for the cover pass weld.

If more weld fusion is required after the root is complete and between fill passes, pre-heat pipe to 200–400°F (93–204°C).

For pipe diameters on which more than two passes are required for the circumference the weld sequence is:

- 1) First pass, weld from the 7 to the 4 o'clock position. Start with a slight forehand nozzle angle. At the 4 o'clock position the gun should point straight at the joint;
- 2) Second pass, weld from the 10 to the 1 o'clock position, then grind all stops and starts for at least 1 inch (25 mm);
- 3) Third pass, weld from the 4 to the 1 o'clock position; and
- 4) Fourth pass, weld from the 7 to the 10 o'clock position.

center of the reference line, either above or below it or on both sides of it as shown in Fig. 1. Welds on the arrow side of the joint are shown by placing the weld symbols on the side of the reference line towards the reader (lower side). Welds on the other side of the joint are shown by placing the weld symbols on the side of the reference line away from the reader (upper side).

Supplementary Symbols: These convey additional information relative to the extent of the welding, where the welding is to be performed, and the contour of the weld bead. The “weld-all-around” and “field” symbols are placed at the end of the reference line at the base of the arrow as shown in Fig. 1 and the table *Supplementary Weld Symbols*.

Dimensions: These include the size, length, spacing, etc., of the weld or welds. The size of the weld is given to the left of the basic weld symbol and the length to the right. If the length is followed by a dash and another number, this number indicates the center-to-center spacing of intermittent welds. Other pertinent information such as groove angles, included angle of countersink for plug welds and the designation of the number of spot or projection welds are also located above or below the weld symbol. The number designating the number of spot or projection welds is always enclosed in parentheses.

Contour and Finish Symbols: The contour symbol is placed above or below the weld symbol. The finish symbol always appears above or below the contour symbol (see Fig. 1).

The following finish symbols indicate the method, not the degrees of finish: C—chipping; G—grinding; M—machining; R—rolling; and H—hammering.

For indication of surface finish refer to the section *SURFACE TEXTURE* starting on page 733.

Tail: The tail which appears on the end of the reference line opposite to the arrow end is used when a specification, process, or other reference is made in the welding symbol. When no specification, process, or other reference is used with a welding symbol, the tail may be omitted.

Table 1. Basic Weld Symbols

Groove Weld Symbols							
Square	Scarf ^a	V	Bevel	U	J	Flare V	Flare bevel
Other Weld Symbols							
Fillet	Plug or slot	Spot or projection	Seam	Back or backing	Surfacing	Flange	
						Edge	Corner

^aThis scarf symbol used for brazing only (see page 1432).

For examples of basic weld symbol applications see starting on page 1480.

Table 2. Supplementary Weld Symbols

Weld all around	Field weld	Melt-thru	Backing or spacer material	Contour		
				Flush	Convex	Concave

Melt-Thru Symbol: The melt-thru symbol is used only where 100 per cent joint or member penetration plus reinforcement are required.

Specification, Process, or Other Designation: These are placed in the tail of the welding symbol and are in accordance with the American National Standard. They do not have to be used if a note is placed on the drawing indicating that the welding is to be done to some specification or that instructions are given elsewhere as to the welding procedure to be used.

Letter Designations: American National Standard letter designations for welding and allied processes are shown in the table on page 1479.

Further Information: For complete information concerning welding specification by the use of standard symbols, reference should be made to American National Standard ANSI/AWS A2.4-79, which may be obtained from either the American National Standards Institute or the American Welding Society listed below.

Welding Codes, Rules, Regulations, and Specifications.—Codes recommending procedures for obtaining specified results in the welding of various structures have been established by societies, institutes, bureaus, and associations, as well as state and federal departments.

The latest codes, rules, etc., may be obtained from these agencies, whose names and addresses are listed as follows: PV = Pressure Vessels; P = Piping; T = Tanks; SB = Structural and Bridges; S = Ships; AC = Aircraft Construction; and EWM = Electrical Welding Machinery.

Air Force/LGM, Department of the Air Force, Washington, DC 20330. (AC)

American Bureau of Shipping, 45 Eisenhower Drive, Paramus, NJ 07652. (S)

American Institute of Steel Construction., 1 E. Wacker Drive, Chicago, IL 60601. (SB)

American National Standards Institute, 25 W. 43rd St. NY, NY 10036. (PV, P, EWM)

American Petroleum Institute, 1220 L St., NW, Washington, DC 20005. (PV)

American Society of Mechanical Engineers, 3 Park Avenue, NY, NY 10016. (PV)

American Welding Society, N.W. 550 LeJeune Road, Miami, FL 33126. (T, S, SB, AC)

Federal Aviation Administration, 800 Independence Avenue, S.W. Washington DC 20591. (AC)

Insurance Services Office, 545 Washington Blvd., Jersey City, NJ 07310. (PV)

Lloyd's Register of North America, 1401 Enclave Parkway, Houston, TX 77077 (S)

Mechanical Contractors Association., 1385 Piccard Drive, Rockville, MD 20850. (P)

National Electrical Manufacturers. Association., 1300 North Street, Rosslyn, VA 22209. (EWM)

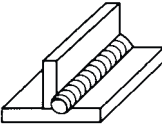
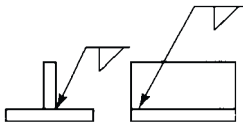
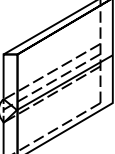
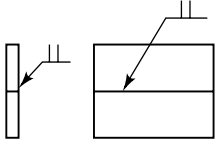
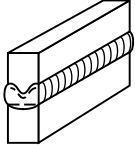
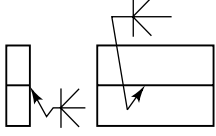
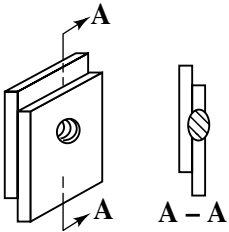
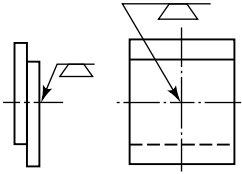
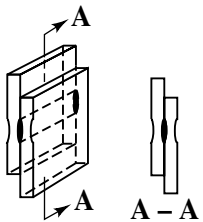
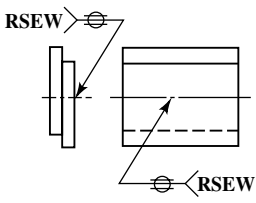
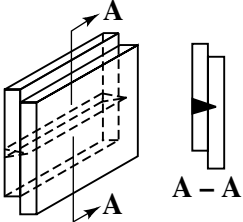
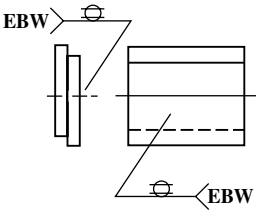
Naval Facilities Engineering Command, 1322 Patterson Ave., Washington Navy Yard, DC 20374. (SB)

U.S. Government Printing Office, Washington, 732 N. Capitol St, N.W. DC 20401. (PV)

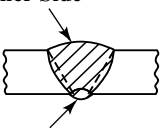
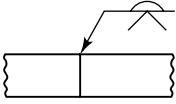
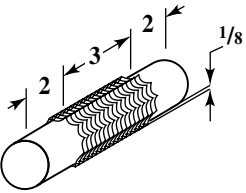
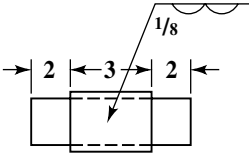

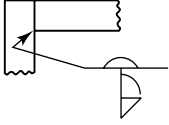
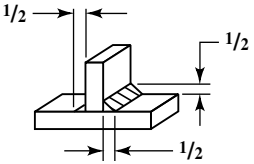
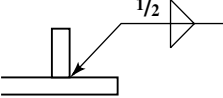
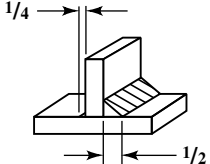
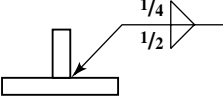
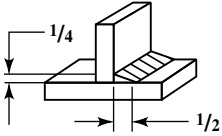
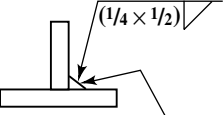
American National Standard Letter Designations for Welding and Allied Processes
ANSI/AWS A2.4-91

Letter Designation	Welding and Allied Processes	Letter Designation	Welding and Allied Processes
AAC	air carbon arc cutting	HPW	hot pressure welding
AAW	air acetylene welding	IB	induction brazing
AB	arc brazing	INS	iron soldering
ABD	adhesive bonding	IRB	infrared brazing
AC	arc cutting	IRS	infrared soldering
AHW	atomic hydrogen welding	IS	induction soldering
AOC	oxygen arc cutting	IW	induction welding
ASP	arc spraying	LBC	laser beam cutting
AW	carbon arc welding	LBC-A	laser beam cutting—air
B	brazing	LBC-EV	laser beam cutting— evaporative
BB	block brazing	LBC-IG	laser beam cutting— inert gas
BMAW	bare metal arc welding	LBC-O	laser beam cutting—oxygen
CAB	carbon arc brazing	LBW	laser beam welding
CAC	carbon arc cutting	LOC	oxygen lance cutting
CAW	carbon arc welding	MAC	metal arc cutting
CAW-G	gas carbon arc welding	OAW	oxyacetylene welding
CAW-S	shielded carbon arc welding	OC	oxygen cutting
CAW-T	twin carbon arc welding	OFC	oxyfuel gas cutting
CEW	coextrusion welding	OFC-A	oxyacetylene cutting
CW	cold welding	OFC-H	oxyhydrogen cutting
DB	dip brazing	OFC-N	oxynatural gas cutting
DFB	diffusion brazing	OFC-P	oxypropane cutting
DFW	diffusion welding	OFW	oxyfuel gas cutting
DS	dip soldering	OHW	oxyhydrogen welding
EBC	electron beam cutting	PAC	plasma arc cutting
EBW	electron beam welding	PAW	plasma arc welding
EBW-HV	electron beam welding— high vacuum	PEW	percussion welding
EBW-MV	electron beam welding— medium vacuum	PGW	pressure gas welding
EBW-NV	electron beam welding— nonvacuum	POC	metal powder cutting
EGW	electrogas welding	PSP	plasma spraying
ESW	electroslag welding	PW	projection welding
EXW	explosion welding	RB	resistance brazing
FB	furnace brazing	RS	resistance soldering
FCAW	flux-cored arc welding	RSEW	resistance seam welding
FLB	flow brazing	RSEW-HF	resistance seam welding— high frequency
FLOW	flow welding	RSEW-I	resistance seam welding— induction
FLSP	flame spraying	RSW	resistance spot welding
FOC	chemical flux cutting	ROW	roll welding
FOW	forge welding	RW	resistance welding
FRW	friction welding	S	soldering
FS	furnace soldering	SAW	submerged arc welding
FW	flash welding	SAW-S	series submerged arc welding
GMAC	gas metal arc cutting	SMAC	shielded metal arccutting
GMAW	gas metal arc welding	SMAW	shielded metal arc welding
GMAW-P	gas metal arc welding—pulsed arc	SSW	solid state welding
GMAW-S	gas metal arc welding— short-circuiting arc	SW	stud arc welding
GTAC	gas tungsten arc cutting		
GTAW	gas tungsten arc welding		
GTAW-P	gas tungsten arc welding— pulsed arc		

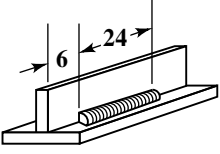
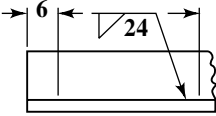
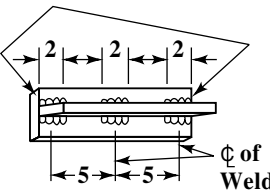
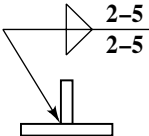
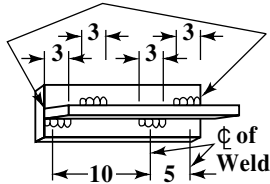
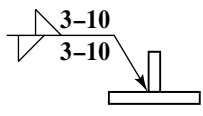
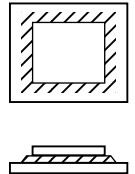
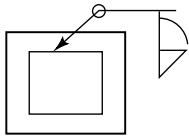
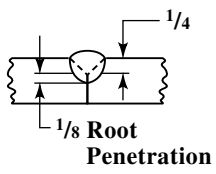
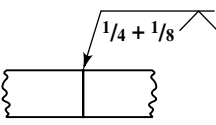
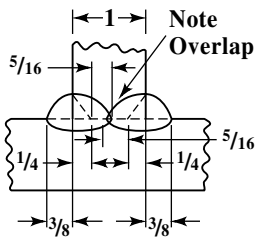
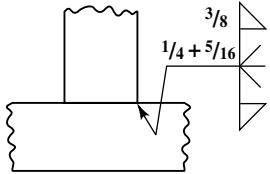
Application of American National Standard Welding Symbols

Desired Weld	Symbol	Symbol Meaning
		<p>Symbol indicates fillet weld on <i>arrow side</i> of the joint.</p>
		<p>Symbol indicates square-groove weld on <i>other side</i> of the joint.</p>
		<p>Symbol indicates bevel-groove weld on both sides of joint. Breaks in arrow indicate bevels on upper member of joint. Breaks in arrows are used on symbols designating bevel and J-groove welds.</p>
		<p>Symbol indicates plug weld on <i>arrow side</i> of joint.</p>
		<p>Symbol indicates resistance-seam weld. Weld symbol appears on both sides of reference line pointing up the fact that <i>arrow</i> and <i>other side</i> of joint references have no significance.</p>
		<p>Symbol indicates electron beam seam weld on <i>other side</i> of joint.</p>

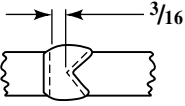
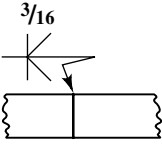
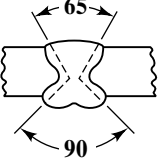
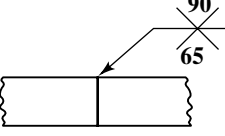

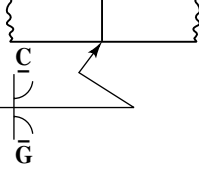
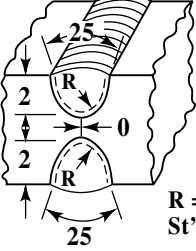
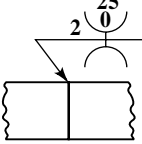
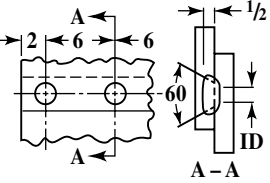
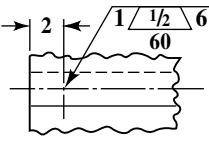
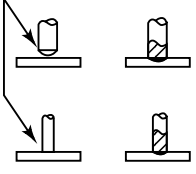
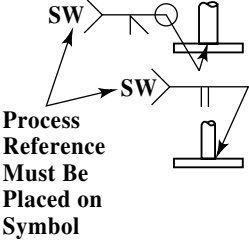
Application of American National Standard Welding Symbols (Continued)

Desired Weld	Symbol	Symbol Meaning
<p>Groove Weld Made Before Welding Other Side</p>  <p>Back Weld</p>		<p>Symbol indicates single-pass back weld.</p>
		<p>Symbol indicates a built-up surface $\frac{1}{8}$ inch thick.</p>
		<p>Symbol indicates a bead-type back weld on the <i>other side</i> of joint, and a J-groove grooved horizontal member (shown by break in arrow) and fillet weld on <i>arrow side</i> of the joint.</p>
		<p>Symbol indicates two fillet welds, both with $\frac{1}{2}$-inch leg dimensions.</p>
		<p>Symbol indicates a $\frac{1}{2}$-inch fillet weld on <i>arrow side</i> of the joint and a $\frac{1}{4}$-inch fillet weld on <i>far side</i> of the joint.</p>
	 <p>Orientation Shown on Drawing</p>	<p>Symbol indicates a fillet weld on <i>arrow side</i> of joint with $\frac{1}{4}$- and $\frac{1}{2}$-inch legs. Orientation of legs must be shown on drawing.</p>

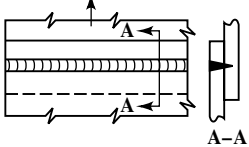
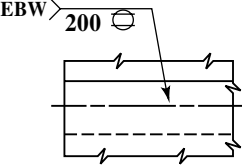
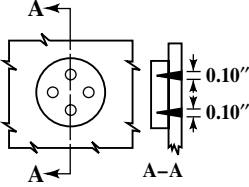
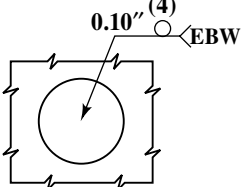
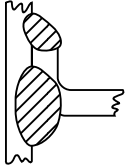
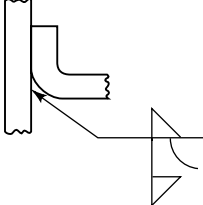
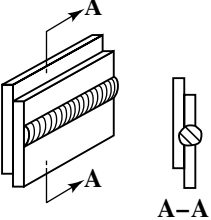
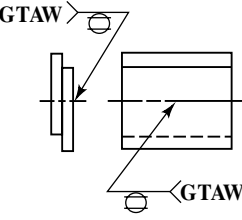
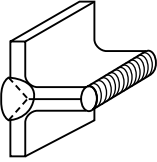
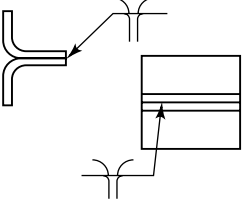
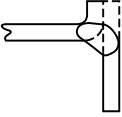
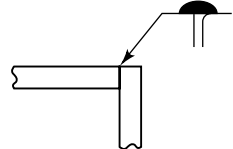
Application of American National Standard Welding Symbols (Continued)

Desired Weld	Symbol	Symbol Meaning
		<p>Symbol indicates a 24-inch long fillet weld on the <i>arrow side</i> of the joint.</p>
<p>Locate Welds at Ends of Joint</p> 		<p>Symbol indicates a series of intermittent fillet welds each 2 inches long and spaced 5 inches apart on centers directly opposite each other on both sides of the joint.</p>
<p>Locate Welds at Ends of Joint</p> 		<p>Symbol indicates a series of intermittent fillet welds each 3 inches long and spaced 10 inches apart on centers. The centers of the welds on one side of the joint are displaced from those on the other.</p>
		<p>Symbol indicates a fillet weld around the perimeter of the member.</p>
 <p>1/8 Root Penetration</p>		<p>Symbol indicates a 1/4-inch V-groove weld with a 1/8-inch root penetration.</p>
 <p>Note Overlap</p>		<p>Symbol indicates a 1/4-inch bevel weld with a 5/16-inch root penetration plus a subsequent 3/8-inch fillet weld.</p>

Application of American National Standard Welding Symbols (Continued)

Desired Weld	Symbol	Symbol Meaning
		<p>Symbol indicates a bevel weld with a root opening of $\frac{3}{36}$ inch.</p>
		<p>Symbol indicates a V-groove weld with a groove angle of 65 degrees on the <i>arrow side</i> and 90 degrees on the <i>other side</i>.</p>
		<p>Symbol indicates a flush surface with the reinforcement removed by chipping on the <i>other side</i> of the joint and a smooth grind on the <i>arrow side</i>. The symbols C and G should be the user's standard finish symbols.</p>
 <p>R = User's St'd.</p>		<p>Symbol indicates a 2-inch U-groove weld with a 25-degree groove angle and no root opening for both sides of the joint.</p>
		<p>Symbol indicates plug welds of 1-inch diameter, a depth of filling of $\frac{1}{2}$ inch and a 60-degree angle of countersink spaced 6 inches apart on centers.</p>
<p>Preparation</p> 	 <p>Process Reference Must Be Placed on Symbol</p>	<p>Symbol indicates all-around bevel and square-groove weld of these studs.</p>

Application of American National Standard Welding Symbols (Continued)

Desired Weld	Symbol	Symbol Meaning
<p>Min. Acceptable Shear Strength 200 lb/lin. in.</p> 		<p>Symbol indicates an electron beam seam weld with a minimum acceptable joint strength of 200 pounds per lineal inch.</p>
		<p>Symbol indicates four 0.10-inch diameter electron beam spot welds located at random.</p>
		<p>Symbol indicates a fillet weld on the <i>other side</i> of joint and a flare-bevel-groove weld and a fillet weld on the <i>arrow side</i> of the joint.</p>
		<p>Symbol indicates gas tungsten-arc seam weld on <i>arrow side</i> of joint.</p>
		<p>Symbol indicates edge-flange weld on <i>arrow side</i> of joint and flare-V-groove weld on <i>other side</i> of joint.</p>
		<p>Symbol indicates melt-thru weld. By convention, this symbol is placed on the opposite side of the reference line from the corner-flange symbol.</p>

Nondestructive Testing

Nondestructive testing (NDT) is aimed at examination of a component or assembly, usually for surface or internal cracks or other nonhomogeneities, to determine the structure, or to measure thickness, by some means that will not impair its use for the intended purpose. Traditional methods include use of radiography, ultrasonic vibration, dye penetrants, magnetic particles, acoustic emission, leakage, and eddy currents. These methods are simple to use but some thought needs to be given to their application and to interpretation of the results. Space limitations preclude a full discussion of NDT here, but the nature of the welding process makes these methods particularly useful, so some information on use of NDT for testing welds is given below.

Nondestructive Testing Symbol Application.—The application of nondestructive testing symbols is also covered in American National Standard ANSI/AWS A2.4-79.

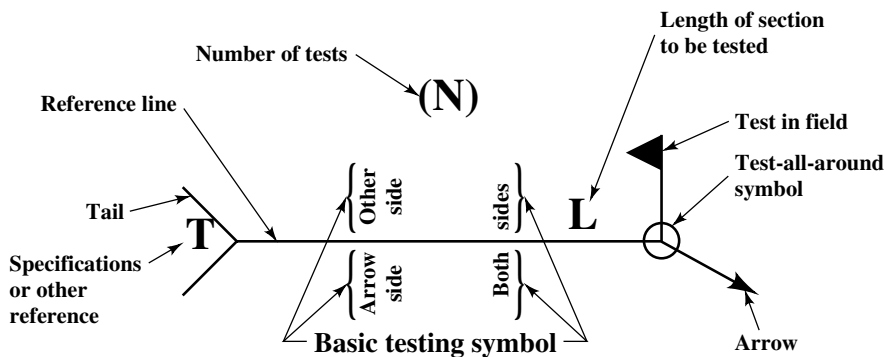
Basic Testing Symbols: These are shown in the following table.

ANSI Basic Symbols for Nondestructive Testing ANSI/AWS A2.4-79

Symbol	Type of Test	Symbol	Type of Test
AET	Acoustic Emission	PT	Penetrant
ET	Eddy Current	PRT	Proof
LT	Leak	RT	Radiographic
MT	Magnetic Particle	UT	Ultrasonic
NRT	Neutron Radiographic	VT	Visual

Testing Symbol Elements: The testing symbol consists of the following elements: Reference Line, Arrow, Basic Testing Symbol, Test-all-around Symbol, (N) Number of Tests, Test in Field, Tail, and Specification or other reference.

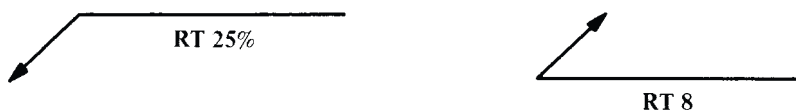
The standard location of the testing symbol elements are shown in the following figure.



Locations of Testing Symbol Elements

The arrow connects the reference line to the part to be tested. The side of the part to which the arrow points is considered to be the *arrow side*. The side opposite the arrow side is considered to be the *other side*.

Location of Testing Symbol: Tests to be made on the arrow side of the part are indicated by the basic testing symbol on the side of the reference line toward the reader.



Tests to be made on the other side of the part are indicated by the basic testing symbol on the side of the reference line away from the reader.

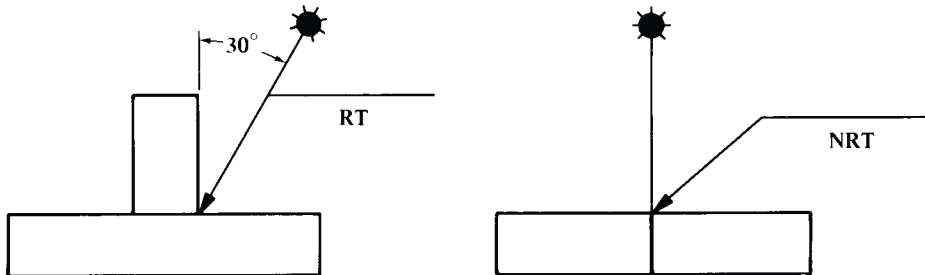


To specify where only a certain length of a section is to be considered, the actual length or percentage of length to be tested is shown to the right of the basic test symbol. To specify the number of tests to be taken on a joint or part, the number of tests is shown in parentheses.

Tests to be made on both sides of the part are indicated by test symbols on both sides of the reference line. Where nondestructive symbols have no arrow or other significance, the testing symbols are centered in the reference line.

Combination of Symbols: Nondestructive basic testing symbols may be combined and nondestructive and welding symbols may be combined.

Direction of Radiation: When specified, the direction of radiation may be shown in conjunction with the radiographic or neutron radiographic basic testing symbols by means of a radiation symbol located on the drawing at the desired angle.



Tests Made All Around the Joint: To specify tests to be made all around a joint a circular test-all-around symbol is used.



Areas of Revolution: For nondestructive testing of areas of revolution, the area is indicated by the test-all-around symbol and appropriate dimensions.

Plane Areas: The area to be examined is enclosed by straight broken lines having a small circle around the angle apex at each change in direction.

LASERS

Introduction

Lasers are used for cutting, welding, drilling, surface treatment, and marking. The word laser stands for Light Amplification by Stimulated Emission of Radiation, and a laser is a unit that produces optical-frequency radiation in intense, controllable quantities of energy. When directed against the surface of a material, this quantity of energy is high enough to cause a localized effect. Heating by a laser is controlled to produce only the desired result in a specific area, ensuring low part distortion.

The four basic components of a laser, shown in Fig. 1, are an amplifying medium, a means to excite this medium, mirrors arranged to form an optical resonator, and an output transmission device to cause beam energy to exit from the laser. The laser output wavelength is controlled by the type of amplifying medium used. The most efficient industrial lasers use optical excitation or electrical discharge to stimulate the medium and start the lasing action.

Solid-state lasers, in which the medium is a solid crystal of an optically pure material such as glass or yttrium aluminum garnet (YAG) doped with neodymium (Nd), are excited by a burst of light from a flashlamp(s) arranged in a reflective cavity that acts to concentrate the excitation energy into the crystal. Neodymium lasers emit radiation at $1.06\ \mu\text{m}$ ($1\ \mu\text{m} = 0.00004\ \text{in.}$), in the near infrared portion of the spectrum.

The carbon dioxide (CO_2) laser uses a gaseous mixture of helium, nitrogen, and carbon dioxide. The gas molecules are energized by an electric discharge between strategically placed cathodes and anodes. The light produced by CO_2 lasers has a wavelength of approximately $10.6\ \mu\text{m}$.

Laser Light.—The characteristics of light emitted from a laser are determined by the medium and the design of the optical resonator. Photons traveling parallel to the optical axis are amplified and the design provides for a certain portion of this light energy to be transmitted from the resonator. This amplifier/resonator action determines the wavelength and spatial distribution of the laser light.

The transmitted laser light beam is monochromatic (one color) and coherent (parallel rays), with low divergence and high brightness, characteristics that distinguish coherent laser light from ordinary incoherent light and set the laser apart as a beam source with high energy density. A typical industrial laser operating in a very narrow wavelength band determined by the laser medium is called monochromatic because it emits light in a specific segment of the optical spectrum. The wavelength is important for beam focusing and material absorption effects.

Coherent laser light can be 100,000 times higher in energy density than equivalent-power incoherent light. The most important aspect of coherent light for industrial laser applications is directionality, which reduces dispersion of energy as the beam is directed over comparatively long distances to the workpiece.

Laser Beams.—The slight tendency of a laser beam to expand in diameter as it moves away from its source is called beam divergence, and is important in determining the size of the spot where it is focused on the work surface. The beam-divergence angle for high-power lasers used in processing industrial materials is larger than the diffraction-limited value because the divergence angle tends to increase with increasing laser output power. The amount of divergence thus is a major factor in concentration of energy in the work.

The power emitted per unit area per unit solid angle is called brightness. Because the laser can produce very high levels of power in very narrowly collimated beams, it is a source of high brightness energy. This brightness factor is a major characteristic of solid-state lasers. Other important beam characteristics in industrial lasers include spatial mode and depth of focus. Ideally, the output beam of the laser selected should have a mode structure, divergence, and wavelength sufficient to process the application in optimum time and

with a minimum of heat input. A beam-quality factor, M^2 , is commonly used to define the productive performance of a laser. This factor is a measure of the ratio between the spot diameter of a given laser to that of a theoretically perfect beam. Beam quality is expressed as “times diffraction” and is always greater than 1. For CO₂ lasers at the 1-kW level, $M^2 = 1.5$, and for YAG lasers at 500 W, $M^2 = 12.0$ is typical.

The mode of a laser beam is described by the power distribution profile over its cross-section. Called transverse modes, these profiles are represented by the term TEM_{*mn*}, where TEM stands for transverse electromagnetic, and m and n are small integers indicating that power distribution is bell-shaped (Gaussian) TEM₀₀, or donut-shaped TEM₀₁*.

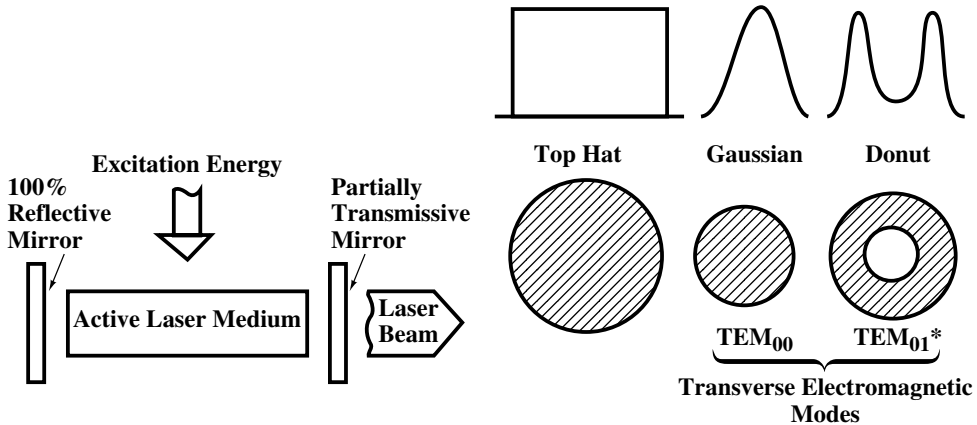


Fig. 1. Basic Components of a Laser

Fig. 2. Spatial Intensity Distribution in Laser Beams

Fig. 2 shows various transverse electromagnetic modes commonly used in materials processing applications. For such applications, it is helpful to determine the peak and total power generated by the laser. Diffraction in Gaussian beams is inherently limited and other modes of operation may have larger beam-divergence angles, causing less power to be delivered to the workpiece. The selection process for industrial applications should consider only those lasers that produce the lowest-order mode beam, in a Gaussian-shaped energy profile (see Fig. 2), with a narrow beam divergence. Solid-state lasers do not meet all these criteria, and with high-power CO₂ lasers, it is sometimes necessary to compromise because of reduced output power, large physical size, and complexity of the laser design.

Although a laser with a TEM₀₀ output beam is preferred for optimum performance, the application may not always require such a beam. For example, many CO₂ laser cutting operations are performed with a TEM₀₁* beam and welding is often done with a mixture of each of these modes. Lasers can be operated in three temporal modes, continuous wave (CW), pulsed, and superpulsed (called Q-switched for YAG lasers), depending on the materials being processed.

The smallest focused spot diameter that will provide the highest energy intensity can be produced by a TEM₀₀ laser. The fundamental mode output of CO₂ lasers is limited to 2500 watts. Complex spatial patterns are often caused by inhomogeneities in solid-state laser crystals and are controlled by insertion of apertures that greatly reduce output power. However, standard lasers suit the needs of most industrial users as beam divergence is only one factor in laser design.

Beam Focusing.—The diameter of a focused laser beam spot can be estimated by multiplying the published beam divergence value by the focal length of the lens or by the relationship of the wavelength to the unfocused beam diameter. Thus, the beam from a CO₂ laser operating at a 10.6- μ m wavelength, using the same focal length lens, will produce a

focused spot ten times larger than the beam from a Nd:YAG laser operating at a 1.06- μm wavelength.

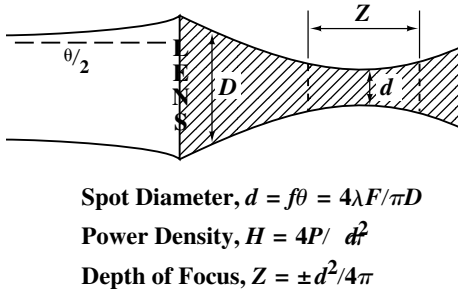


Fig. 3. Focus Characteristics of a Laser Beam.

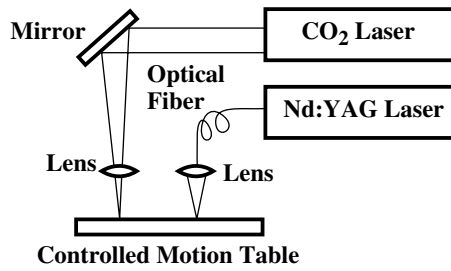


Fig. 4. Typical Laser Systems.

Effects of various beam spot sizes and depths of focus are shown in Fig. 3. High-power density is required for most focused beam applications such as cutting, welding, drilling, and scribing, so these applications generally require a tightly focused beam. The peak power density of a Gaussian beam is found by dividing the power at the workpiece by the area of the focused spot. Power density varies with the square of the area, so that a change in the focused spot size can influence power density by a factor of 4 and careful attention must be given to maintaining beam focus.

Another factor of concern in laser processing is depth of focus, defined as the range of depth over which the focused spot varies by ± 5 per cent. This relationship is extremely important in cutting sheet metal, where it is affected by variations in surface flatness. Cutting heads that adapt automatically to maintain constant surface-to-nozzle spacing are used to reduce this effect.

Types of Industrial Lasers.—Specific types of lasers are suited to specific applications, and Table 1 lists the most common lasers used in processing typical industrial materials. Solid-state lasers are typically used for drilling, cutting, spot and seam welding, and marking on thin sheet metal. CO₂ lasers are used to weld, cut, surface treat, and mark both metals and nonmetals. For example, CO₂ lasers are suited to ceramic scribing and Nd:YAG lasers for drilling turbine blades. Factors that affect suitability include wavelength, power density, and spot size. Some applications can use more than one laser type. Cutting sheet metal, an established kilowatt-level CO₂ laser application, can also be done with kilowatt-level Nd:YAG lasers. For some on-line applications that require multiaxis beam motion, the Nd:YAG laser may have advantages in close coupling the laser beam to the workpiece through fiber optics.

Table 1. Common Industrial Laser Applications

Type	Wavelength (μm)	Operating Mode	Power Range (watts)	Applications
Nd:YAG	1.06	Pulsed	10-2,000	A, B, D, E, F
Nd: YAG	1.06	Continuous	500-3,000	A, B, C
Nd: YAG	1.06	Q-switched	5-150	D, E, F
CO ₂	10.6	Pulsed	5-3,000	A, B, D, E
CO ₂	10.6	Superpulsed	1,000-5,000	A
CO ₂	10.6	Continuous	100-25,000	A, B, C

Applications: A = cutting, B = welding, C = surface treatment, D =drilling, E = marking, F = micro-machining.

Industrial Laser Systems.—The laser should be located as close as possible to the workpiece to minimize beam-handling problems. Ability to locate the beam source away from its power supply and ancillary equipment, and to arrange the beam source at an angle to the

workpiece allows the laser to be used in many automatic and numerically controlled set ups. Fig. 4 shows typical laser system arrangements.

Lasers require power supplies and controllers for lasers are usually housed in industrial grade enclosures suited to factory floor conditions. Because the laser is a relatively inefficient converter of electrical energy to electromagnetic energy (light), the waste heat from the beam source must be removed by heat exchangers located away from the processing area. Flowing gas CO₂ lasers require a source of laser gas, used to make up any volume lost in the normal recycling process. Gas can be supplied from closely linked tanks or piped from remote bulk storage.

Delivery of a high-quality beam from the laser to the workpiece often requires sub-systems that change the beam path by optical means or cause the beam to be directed along two or more axes. Five-axis beam motion systems, for example, using multiple optical elements to move the beam in X, Y, Z, and rotation/tilt, are available.

Solid-state laser beams can be transmitted through flexible optical fibers. If there is no beam motion, the workpiece must be moved. The motion systems used can be as simple as an XY or rotary table, or as complex as a multistation, dual-feed table. Hybrid systems offer a combination of beam and workpiece motion and are frequently used in multiaxis cutting applications. All motions are controlled by an auxiliary unit such as a CNC, NC, paper tape, or programmable controller. Newer types of controllers interface with the beam source to control the entire process. Gas jet nozzles, wire feed, or seam tracking equipment are often used, and processing may be monitored and controlled by signals from height sensors, ionized by-product (plasma) detectors, and other systems.

Safety.—Safety for lasers is covered in ANSI Z136.1-2000: Safe Use Of Lasers. Most industrial lasers require substantial electrical input at high-voltage and amperage conditions. Design of the beam source and the associated power supply should be to accepted industry electrical standards. Protective shielding is advised where an operator could interact, physically, with the laser beam, and would be similar to safety shields provided on other industrial equipment.

Radiation from a laser is intense light concentrated in tight bundles of energy. The high energy density and selective absorption characteristics of the laser beam have the potential to cause serious damage to the eye. For this reason, direct viewing of the beam from the laser should be restricted. Safety eyewear is commercially available to provide protection for each type of laser used. Certain lasers, such as the 1.06- μm solid-state units, should be arranged in a system such that workers are shielded from direct and indirect radiation. Other types of lasers, such as the 10.6- μm CO₂ laser, when operated without shielding, should meet industry standards for maximum permissible exposure levels. Much information is published on laser radiation safety, so that the subject is highly documented. Laser suppliers are very familiar with local regulations and are a good source for prepurchase information. Certain materials, notably many plastics compositions, when vaporized, will produce potentially harmful fumes. Precautionary measures such as workstation exhaust systems typically handle this problem.

Laser Beam/Material Interaction.—Industrial lasers fall into categories of effectiveness because the absorption of laser light by industrial materials depends on the specific wavelength. However, at room temperature, CO₂ laser light at 10.6 μm wavelength is fully absorbed by most organic and inorganic nonmetals.

Both CO₂ and YAG can be used in metalworking applications, although YAG laser light at 1.06 μm is absorbed to a higher degree in metals. Compensation for the lower absorption of CO₂ light by metals is afforded by high-energy-density beams, which create small amounts of surface temperature change that tend to increase the beam-coupling coefficient.

At CO₂ power densities in excess of 10⁶ W/cm², effective absorptivity in metals approaches that of nonmetals. Above certain temperatures, metals will absorb more infra-

red energy. In steel at 400°C, for instance, the absorption rate is increased by 50 per cent. In broad-area beam processing, where the energy density (10^4 W/cm²) is low, some form of surface coating may be required to couple the beam energy into a metal surface.

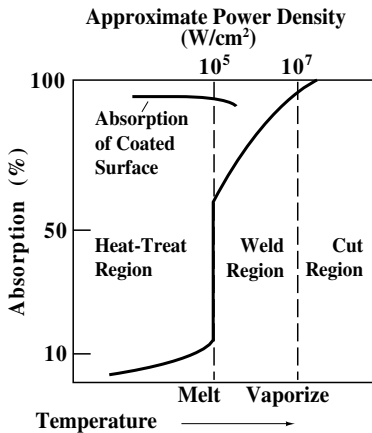


Fig. 5. Laser Energy Absorption Intensity vs. Temperature

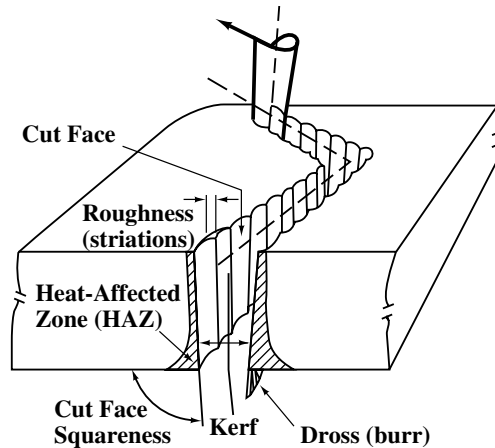


Fig. 6. Factors in Laser Cutting.

Thermal Properties of Workpieces.—When a laser beam is coupled to a workpiece, initial conversion of energy to work, in the form of heat, is confined to a very thin layer (100–200 Ångstroms) of surface material. The absorbed energy converted to heat will change the physical state of the workpiece, and depending on the energy intensity of the beam, a material will heat, melt, or vaporize. Fig. 5 shows percentage of energy absorption versus temperature for various phase changes in materials.

Heating, melting, and vaporization of a material by laser radiation depends on the thermal conductivity and specific heat of the material. The heating rate is inversely proportional to the specific heat per unit volume, so that the important factor for heat flow is the thermal diffusivity of the work material. This value determines how rapidly a material will accept and conduct thermal energy, and a high thermal diffusivity will allow a greater depth of fusion penetration with less risk of thermal cracking.

Heat produced by a laser in surface layers is rapidly quenched into the material and the complementary cooling rate is also rapid. In some metals, the rate is 10^6 C°/s. This rapid cooling results in minimum residual heat effects, due to the slower thermal diffusivity of heat spreading from the processed area. However, rapid cooling may produce undesired effects in some metals. Cooling that is too rapid prevents chemical mixing and may result in brittle welds.

Thermosetting plastics are specifically sensitive to reheating, which may produce a gummy appearance or a charred, ashlike residue. Generally, the sensitivity of a material to heat from a laser is as apparent as with any other localized heating process. Any literature describing the behavior of materials when exposed to heat will apply to laser processing.

Cutting Metal with Lasers

The energy in a laser beam is absorbed by the surface of the impinged material, and the energy is converted into work in the form of heat, which raises the temperature to the melting or vaporization point. A jet of gas is arranged to expel excess molten metal and vapor from the molten area. Moving the resulting molten-walled hole along a path with continuous or rapidly pulsed beam power produces a cut. The width of this cut (kerf), the quality of the cut edges, and the appearance of the underside of the cut (where the dross collects) are determined by choice of laser, beam quality, delivered power, and type of motion

employed (beam, workpiece, or combination). Fig. 6 identifies the factors involved in producing a high-quality cut.

Power versus penetration and cutting rate are essentially straight-line functions for most ferrous metals cut with lasers. A simple relationship states that process depth is proportional to power and inversely proportional to speed. Thus, for example, doubling power will double penetration depth. The maximum possible thickness that can be cut is, therefore, a function of power, cutting rate, and compromise on cut quality. Currently, 25 mm (1 in.) is considered the maximum thickness of steel alloys that can be cut. The most economically efficient range of thicknesses is up to 12.5 mm (0.49 in.).

Metals reflect laser light at increasing percentages with increasing wavelength. The high-energy densities generated by high-power CO₂ lasers overcome these reflectivity effects. Shorter-wavelength lasers such as Nd:YAG do not suffer these problems because more of their beam energy is absorbed.

Beam Assistance Techniques.—In cutting ferrous alloys, a jet of oxygen concentric with the laser beam is directed against the heated surface of the metal. The heat of the molten puddle of steel produced by the laser power causes the oxygen to combine with the metal, so that the jet burns through the entire thickness of the steel. This melt ablation process also uses the gas pressure to eject the molten metal from the cut kerf. Control of the gas pressure, shape of the gas stream, and positioning of the gas nozzle orifice above the metal surface are critical factors. A typical gas jet nozzle is shown in Fig. 7. Cutting highly alloyed steels, such as stainless steel, is done with pulsed CO₂ laser beams. High-pressure gas jets with the nozzle on the surface of the metal and nonoxidizing gas assistance can be used to minimize or eliminate clinging dross.

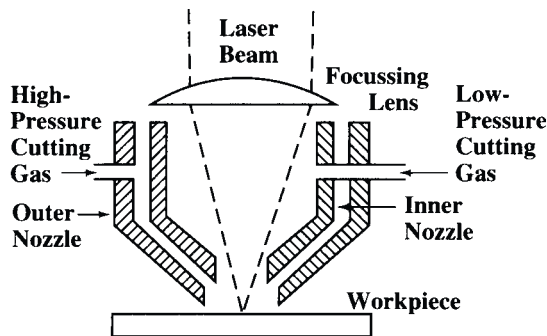


Fig. 7. Laser Gas Cutting Nozzle for Steel.

The narrow kerf produced by the laser allows cut patterns to be nested as close as one beam diameter apart, and sharply contoured and profiled cuts can be made, even in narrow angle locations. For this type of work and for other reasons, confining the kerf width to a dimension equal to, or slightly greater than, the diameter of the laser beam is important. Kerf width is a function of beam quality, focus, focus position, gas pressure, gas nozzle to surface spacing, and processing rate. Table 2 shows typical kerf widths.

Cut Edge Roughness.—Cutting with a continuous-wave (CW) output CO₂ laser can produce surface roughness values of 8-15 μm (315-590 μin) in 1.6-mm (0.063-in) cold-rolled steel and 30-35 μm (1180-1380 μin) in mild steel. Surface roughness of 30-50 μm (1180-1970 μin) in thin-gage stainless steel sheets is routine when using oxygen to assist cutting. Table 3 lists some surface roughness values.

Table 2. Typical Kerf Widths in CO₂ Laser Cutting

Material	Thickness		Kerf	
	mm	in.	mm	in.
Carbon Steel	1.5	0.06	0.05	0.002
	2.25	0.09	0.12	0.005
	3.12	0.12	0.2	0.008
	6.25	0.25	0.3	0.012
Aluminum	2.25	0.09	0.25	0.01
Plastics	<4.0	<0.16	2 × beam diameter	

Table 3. Surface Roughness Values for Laser Cutting with Oxygen

Material	Thickness		Surface Finish	
	mm	in.	µm	µin
Stainless Steel	1	0.04	30	1200
	2	0.08	35	1400
	3	0.12	50	2000
Cold-Rolled Steel	1	0.04	8	320
	2	0.08	10	400
	3	0.12	15	600
Mild Steel	1	0.04	30	1200
	2	0.08	30	1200
	3	0.12	35	1400

Heat-Affected Zones.—Control of beam focus, focus position, assist gas conditions, and processing rates produces differences in hardness that are barely discernible in steels up to 2 mm (0.078 in.) thick. Small increases in hardness to a depth of 0.1-0.2 mm (0.004-0.008 in.) are common. Cutting with a pulsed CO₂ laser reduces these values to less than 0.1 mm (0.004 in.), making this mode of operation beneficial for some end-use applications. Table 4 shows typical values for the heat-affected zone in mild steels.

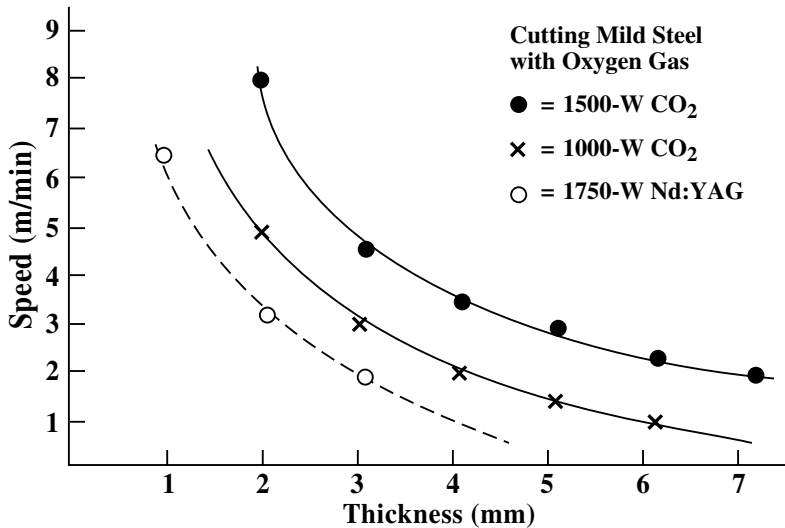
Table 4. Heat-Affected Zone in Mild Steels

Material Thickness		CW HAZ		Pulsed HAZ	
mm	in.	mm	in.	mm	in.
4	0.157	0.50	0.020	0.15	0.006
3	0.118	0.37	0.015	0.15	0.006
2	0.078	0.10	0.004	0.12	0.005
1	0.039	0.75	0.030	0.07	0.003

Rates for laser cutting of metals are typically reported as data developed under ideal conditions, that is, in a controlled development laboratory environment using technician-operated equipment. Rates achieved on the shop floor using semiskilled system operators to produce complicated shapes may vary dramatically from published data. Speed versus thickness for cutting steel is shown in Fig. 8 for 1000- and 1500-W power levels, and cutting performance for several other metals of various thicknesses is shown in Table 5. Cutting rate data for pulsed and CW Nd:YAG lasers for steel also are shown in Fig. 8, and for Nd:YAG cutting of other metals in Table 5.

Table 5. CO₂ and Nd: YAG Cutting Speeds for Nonferrous Metals

Material	CO ₂ (1500 watts)				Nd: YAG				
	Thickness		Speed		Thickness		Speed		Power watts
	mm	in.	m/min	ft/min	mm	in.	m/min	ft/min	
Copper	1	0.04	2.25	7.4
	2	0.08	0.75	2.5
	3	0.12	0.35	1.15
Aluminum	1	0.04	8	26.2	1.5	0.06	2.5	8.2	1000
	2	0.08	4	13.1	2.5	0.1	1.0	3.3	1000
	3	0.12	1.5	4.9	3.5	0.14	0.5	1.6	1000
Titanium	1	0.04	6	19.7	0.4	0.016	1.0	3.3	150
	2	0.08	3	9.8
Tungsten	0.08	0.003	0.03	0.1	250
Brass	1	0.04	3	9.8
	2	0.08	1.5	4.9
Hastalloy	2.5	0.1	2.8	9.2
Hastalloy X	0.08	0.003	0.5	1.6	150
Inconel 718	4	0.16	1.1	3.6

Fig. 8. Typical Cutting Rates for CO₂ and YAG Lasers.

Cutting of Nonmetals.—Laser cutting of nonmetals has three requirements: a focused beam of energy at a wavelength that will be absorbed easily by the material so that melting or vaporization can occur; a concentric jet of gas, usually compressed air, to remove the by-products from the cut area; and a means to generate cuts in straight or curved outlines. Residual thermal effects resulting from the process present a greater problem than in cutting of metals and limit applications of lasers in nonmetal processing.

When subjected to a laser beam, paper, wood, and other cellular materials undergo vaporization caused by combustion. The cutting speed depends on laser power, material thickness, and water and air content of the material. Thermoplastic polymer materials are cut by melting and gas jet expulsion of the melted material from the cut area. The cutting speed is governed by laser power, material thickness, and pressure of gas used to eject the displaced material.

Polymers that may be cut by combustion or chemical degradation include the thermosetting plastics, for example, epoxies and phenolics. Cutting speed is determined by the laser

power and is higher for thermosets than for other polymers due to the phase change to vapor.

Composite materials are generally easy to cut, but the resulting cut may not be of the highest quality, depending on the heat sensitivity of the composite materials. High-pressure cutting processes such as fluid jets have proven to be more effective than lasers for cutting many composite materials.

Nonmetal cutting processes require moderate amounts of power, so the only limitation on cut thickness is the quality of the cut. In practice, the majority of cutting applications are to materials less than 12 mm thick. Cutting rates for some commonly used nonmetals are shown in Table 6. Nonmetal cutting applications require a gas jet to remove molten, vaporized, or chemically degraded matter from the cut area.

Compressed air is used for many plastics cutting applications because it is widely available and cheap to produce, so it is a small cost factor in nonmetal cutting. A narrow kerf is a feature of nonmetal cutting, and it is especially important in the cutting of compactly nested parts such as those produced in cutting of fabrics. Nonmetals react in a variety of ways to laser-generated heat, so that it is difficult to generalize on edge roughness, but thermally sensitive materials will usually show edge effects.

Table 6. CO₂ Laser Cutting Rates for Nonmetals

Material	Thickness		Speed		Power	Material	Thickness		Speed		Power
	mm	in	m/min	ft/min	watts		mm	in	m/min	ft/min	watts
Polythene	1	0.04	11	36	500	Fiberglass	1.6	0.063	5.2	17	450
Polypropylene	1	0.04	17	56	500	Glass	1	0.04	1.5	4.9	500
Polystyrene	1	0.04	19	62	500	Alumina	1	0.04	1.4	4.6	500
Nylon	1	0.04	20	66	500	Hardwood	10	0.39	2.6	8.5	500
ABS	1	0.04	21	69	500	Plywood	12	0.47	4.8	15.7	1000
Polycarbonate	1	0.04	21	69	500	Cardboard	4.6	0.18	9.0	29.5	350
PVC	1	0.04	28	92	500						

Welding with Lasers

Laser Welding Theory.—Conversion of absorbed laser energy into heat causes metals to undergo a phase change from solid to liquid and, as energy is removed, back to solid. This fusion welding process is used to produce selective area spot welds or linear continuous seam welds. The two types of laser welding processes, conduction and deep penetration, or keyhole, are shown in Fig. 9.

Conduction welding: relies on the thermal diffusivity characteristics of the metal to conduct heat into the joint area. By concentrating heat into the focused beam diameter and programming this heat input for short time periods, more heat is conducted into the joint than is radiated outward from the joint. Conduction welds are generally used for spot welding and partial penetration seam welding.

Deep penetration keyhole welding: is produced by beam energy converted to heat that causes a hole to be produced through the thickness of the metal. Vapor pressure of evaporated metal holds a layer of molten metal in place against the hole wall.

Movement of the hole, by beam or workpiece motion, causes the molten metal to flow around the hole and solidify behind the beam interaction point. The resolidified metal has a different structure than the base metal. Maximum practical penetration limits are approximately 25 mm (2 in.) with today's available laser power technology.

If the physical change from solid to liquid to solid does not produce a ductile fusion zone, and if the brittleness of the resolidified metal cannot be reduced easily by postweld annealing, then the laser welding process, as with other fusion welding processes, may not be viable. If the metal-to-metal combination does not produce an effective weld, other

considerations such as filler metal additions to modify fusion zone chemistry should be considered.

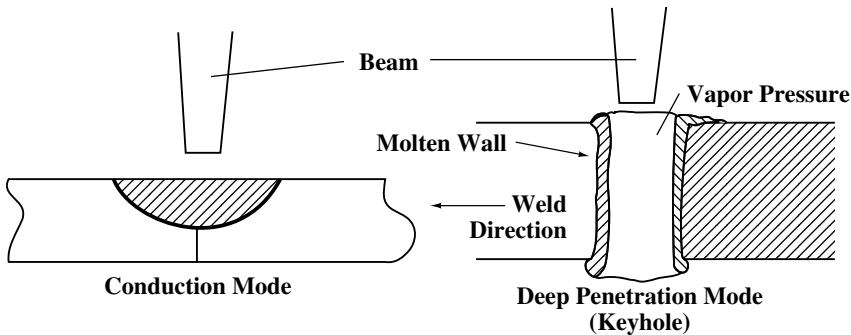


Fig. 9. Types of Laser Welds.

Welded Joint Design.—For optimum results, the edges of parts to be laser beam welded should be in close contact. When a part is being designed and there is a choice of welding process, designers should design joints and joint tolerances to the optimum for laser welding. Fig. 10 shows suitable joint designs for the laser fusion welding process. Joint tolerances are one of the more important parameters influencing part weldability, and for corner, tee, and lap joints, gaps should be not more than 25 per cent of the thickness of the thinnest section. For butt and edge joints, the percentage is reduced to 10. Addition of filler metal to compensate for large joint gaps is becoming popular.

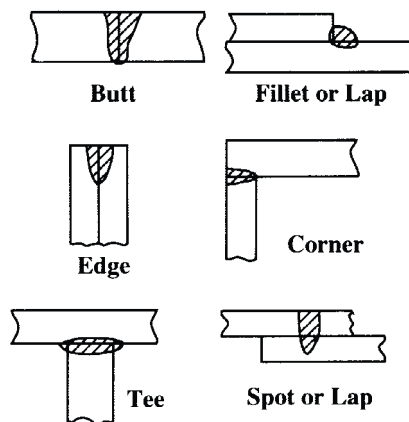


Fig. 10. Examples of Laser Weld Joint Designs.

Welding Rates.—The information presented in Fig. 11 for welding with CO₂ and Nd:YAG lasers should be considered as typical for the specific lasers shown and is for use in optimum conditions. These data are provided only as guidelines.

Processing Gas.—The proper choice of processing gas is important for both conduction and keyhole welding. Gases that ionize easily should not be used to shield the beam/material interaction point. Energy intensities of 10⁶ W/cm² or higher can occur in the zone where incident and reflected laser light overlap and gases can vaporize, producing a plasma that attenuates further beam transmission.

One of the most important advantages of laser welding is the low total heat input characteristic of the focused high-energy density beam. Heat concentration resulting from the beam energy conversion at the workpiece surface causes most conduction to be perpendicular to the direction of motion. With the beam (or workpiece) moving faster than the speed of thermal conduction, there is significant heat flow only in the perpendicular direction. Thus, material solid to solid, or solid to liquid, changes tend to occur only in the narrow

path of heat conduction, and the amount of heat necessary to penetrate a given material thickness is reduced to only that needed to fuse the joint. With limited excess heat through the low total heat mechanism, parts can be produced by laser welding with minimum thermal distortion.

Helium is the ideal gas for laser welding, but other gases such as CO_2 and argon have been used. Neither CO_2 nor argon produces a clean, perfectly smooth weld, but weld integrity seems sufficient to suggest them as alternatives. The cost of welding assistance gas can be greater than for laser gases in CO_2 laser welding and may be a significant factor in manufacturing cost per welded part.

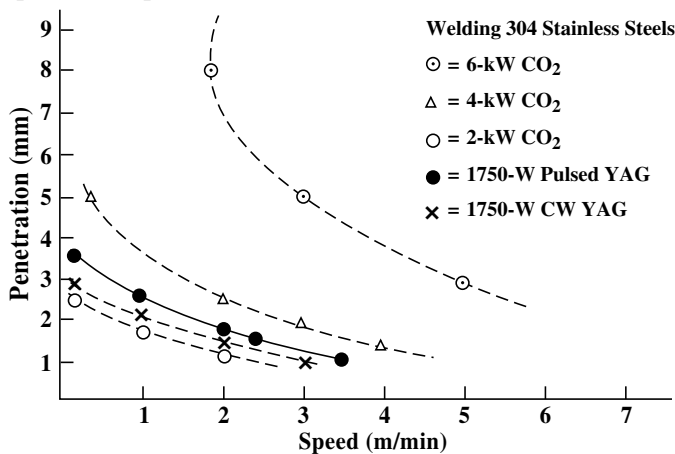


Fig. 11. Rates for CO_2 and Nd:YAG Laser Welding.

Drilling with Lasers

Laser Drilling Theory.—Laser drilling is performed by direct, percussive, and trepanning methods that produce holes of increasing quality respectively, using increasingly more sophisticated equipment. The drilling process occurs when the localized heating of the material by a focused laser beam raises the surface temperature above the melting temperature for metal or, for nonmetals, above the vaporization temperature.

Direct Drilling.—The single-pulse, single-hole process is called direct drilling. The process hole size is determined by the thermal characteristics of the material, the beam spot size, the power density, the beam quality, and the focus location. Of these parameters, beam quality, in terms of beam divergence, is an important criterion because of its effect on the hole size. Single-pulse drilled holes are usually limited to a depth of 1.5 mm (0.06 in.) in metals and up to 8 mm (0.315 in.) in nonmetals. Maximum hole diameter for pulsed solid-state laser metal drilling is in the 0.5-to 0.75-mm (0.02- to 0.03-in.) range, and CO_2 direct drilling can produce holes up to 1.0 mm (0.04 in.) in diameter. The aspect ratio (depth to midhole diameter) is typically under 10:1 in metals and for many nonmetals it can be 15:1. Hole taper is usually present in direct drilling of metals. The amount of taper (entrance hole to exit hole diameter change) can be as much as 25 per cent in many metals. Direct drilling produces a recast layer with a depth of about 0.1 mm (0.004 in.). Diameter tolerances are ± 10 per cent for the entrance hole, depending on beam quality and assist gas pressure.

Percussive Drilling.—Firing a rapid sequence of pulses produces a hole of higher quality than direct drilling in metal thicknesses up to 25 mm (1 in.). This process is known as percussive drilling. Multiple pulses may be necessary, depending on the metal thickness. Typical results using percussion drilled holes are: maximum depth achievable, 25 mm (1 in.); maximum hole diameter, 1.5 mm (0.06 in.); aspect ratio, 50:1; recast layer, 0.5 mm (0.02 in.); taper under 10 per cent; and hole diameter tolerance ± 5 per cent.

Trepanning.—To improve hole quality, some companies use the trepanning method to cut a hole. In this process, a focused beam is moved around the circumference of the hole to be drilled by a rotating mirror assembly. The closeness of spacing of the beam pulses that need to be overlapped to produce the hole depends on the quality requirements. Typical results are: maximum hole depth, 10 mm (0.39 in.); maximum hole diameter, 2.5 mm (0.1 in.); and recast layer thickness, 25 μm (985 μin).

Drilling Rates.—Laser drilling is a fast process but is very dependent on the above-mentioned process factors. It is difficult to generalize on laser drilling rates because of the large number of combinations of material, hole diameter, depth, number of holes per part, and part throughput. With Nd:YAG lasers, direct drilling rates of 1 ms are typical.

Heat Treatment with Lasers

The defocused beam from a CO_2 laser impinging on a metal surface at room temperature will have 90 per cent or more of its power reflected. In steels, the value is about 93 per cent. Compared with focused beam processing, which uses power densities greater than 10^5 W/cm^2 , the power density of laser beams designed for heat treatment, at less than 10^4 W/cm^2 , is insufficient to overcome reflectivity effects. Therefore, the metal surface needs to be prepared by one of several processes that will enhance absorption characteristics. Surface roughening can be used to produce tiny craters that can trap portions of the beam long enough to raise the surface temperature to a point where more beam energy is absorbed. Coating the metal surface is a common expedient. Black enamel paint is easy to apply and the laser beam causes the enamel to vaporize, leaving a clean surface.

The absorbed laser beam energy, converted to heat, raises the temperature of the metal in the beam pattern for as long as the beam remains in one place. The length of the dwell time is used to control the depth of the heat treatment and is an extremely effective means for control of case depth in hardening.

Materials Applicability.—Hardenable ferrous metals, such as medium- and high-carbon steels, tool steels, low-alloy steels and cast irons, and steels with fine-carbide dispersion, are good candidates for laser heat treating. Marginally hardenable metals include annealed carbon steels, spheroidized carbon steels, mild-carbon steels (0.2 per cent C), and ferritic nodular cast irons. Low-carbon steels (<0.1 per cent C), austenitic stainless steels, and non-ferrous alloys and metals are not hardenable.

The effect of the metal microstructure on depth of hardening is an important factor. Cast iron, with a graphite and tempered martensite structure, presents a low carbon-diffusion distance that favors deep-hardened cases. The same is true for steel with a tempered martensite or bainite structure. On the other hand, cast iron with a graphite/ferrite structure and spheroidized iron (Fe_3C plus ferrite) structures have large carbon-diffusion patterns and therefore produce very shallow or no case depths.

Hardening Rates.—Laser hardening is typically slower than conventional techniques such as induction heating. However, by limiting the area to be hardened, the laser can prove to be cost-effective through the elimination of residual heat effects that cause part distortion. A typical hardening rate is 130 cm^2/min . (20 in^2/min .) for a 1-mm (0.039-in) case depth in 4140 steel.

Cladding with Lasers

In laser cladding, for applying a coating of a hard metal to a softer alloy, for instance, a shaped or defocused laser beam is used to heat either preplaced or gravity-fed powdered alloys. The cladding alloy melts and flows across the surface of the substrate, rapidly solidifying when laser power is removed. Control of laser power, beam or part travel speed, clad thickness, substrate thickness, powder feed rate, and shielding gas are process variables that are determined for each part.

Many of the alloys currently used in plasma arc or metal inert gas cladding techniques can be used with the laser cladding process. Among these materials, Stellites, Colmonoys, and other alloys containing carbides are included, plus Inconel, Triballoy, Fe-Cr-C-X alloys, and tungsten and titanium carbides.

Controlled minimal dilution may be the key technical advantage of the laser cladding process. Dilution is defined as the total volume of the surface layer contributed by melting of the substrate, and it increases with increasing power, but decreases with either increasing travel speed or increasing beam width transverse to the direction of travel. Tests comparing laser dilution to other cladding techniques show the laser at <2 per cent compared to 5-15 per cent for plasma arc and 20-25 per cent for stick electrode processes.

The laser cladding process results in a dense, homogenous, nonporous clad layer that is metallurgically bonded to the substrate. These qualities are in contrast to the mechanically bonded, more porous layer produced by other methods.

Marking with Lasers

Laser marking technology can be divided into two groups; those that produce a repetitive mark are listed as mask marking, and those that involve rapid changes of mark characteristics are classified as scanned beam marking. The amount of data that can be marked in a unit of time (writing speed) depends on laser energy density, galvanometer speed, computer control, and the dimensions of the mark. Heat-type marks have been made at rates up to 2500 mm/s (100 in/s) and engraved marks at rates of 500-800 mm/s (20-30 in/s). Writing fields are of various sizes, but a typical field measures 100×100 mm (4×4 in.).

Mask Marking.—In mask marking, the beam from a CO₂ laser is projected through a reflective mask that passes beam energy only through uncoated areas. The beam energy is reimaged by a wide field lens onto the material's surface where the absorbed heat changes the molecular structure of the material to produce a visible mark. Examples are clouding PVC or acrylics, effecting a change in a colored surface (usually by adjusting proportions of pigment dyes), or by ablating a surface layer to expose a sublayer of a different color.

CO₂ lasers can be pulsed at high rates and have produced legible marks at line speeds of 20,000 marks/h. These lasers produce energy densities in the 1-20 J/cm² range, which corresponds to millions of watts/cm² of power density and allows marking to be performed in areas covering 0.06 to 6 cm². The minimum width of an individual line is 0.1 mm (0.004 in.). Mask marking is done by allowing the beam from a laser to be projected through a mask containing the mark to be made. Reimaging the beam by optics onto the workpiece causes a visible change in the material, resulting in a permanent mark. Mask marking is used for materials that are compatible with the wavelength of the laser used.

Scanned-Beam Marking.—Focusing a pulsed laser beam to a small diameter concentrates the power and produces high-energy density that will cause a material to change its visual character. Identified by several names (spot, stroke, pattern generation, or engraving), this application is best known as scanned beam.

In the scanned-beam method, the beam from a pulsed YAG or CO₂ laser is directed onto the surface of a part by a controlled mirror oscillation that changes the beam path in a pre-programmed manner. The programming provides virtually unlimited choice of patterns to be traced on the part. The pulsed laser output can be sequenced with beam manipulation to produce a continuous line or a series of discrete spots that visually suggest a pattern (dot matrix).

The energy density in the focused beam is sufficient to produce a physical or chemical change in most materials. For certain highly reflective metals, such as aluminum, better results are obtained by pretreating the surface (anodizing). Not all scanned beam applications result in removal of base metal. Some remove only a coating or produce a discoloration, caused by heating, that serves as a mark.

FINISHING OPERATIONS

Power Brush Finishing

Power brush finishing is a production method of metal finishing that employs wire, elastomer bonded wire, or non-metallic (cord, natural fiber or synthetic) brushing wheels in automatic machines, semi-automatic machines and portable air tools to smooth or roughen surfaces, remove surface oxidation and weld scale or remove burrs.

Description of Brushes.—Brushes work in the following ways: the wire points of a brush can be considered to act as individual cutting tools so that the brush, in effect, is a multiple-tipped cutting tool. The fill material, as it is rotated, contacts the surface of the work and imparts an impact action which produces a coldworking effect. The type of finish produced depends upon the wheel material, wheel speed, and how the wheel is applied.

Brushes differ in the following ways 1) fill material (wire—carbon steel, stainless steel; synthetic; Tampico; and cord); 2) length of fill material (or trim); and 3) the density of the fill material.

To aid in wheel selection and use, the accompanying table made up from information supplied by *The Osborn Manufacturing Company* lists the characteristics and mayor uses of brushing wheels.

Use of Brushes.—The brushes should be located so as to bring the full face of the brush in contact with the work. Full face contact is necessary to avoid grooving the brush. Operations that are set up with the brush face not in full contact with the work require some provision for dressing the brush face. When the tips of a brush, used with full face contact, become dull during use with subsequent loss of working clearance, reconditioning and resharpenering is necessary. This is accomplished simply and efficiently by alternately reversing the direction of rotation during use.

Deburring and Producing a Radius on the Tooth Profile of Gears.—The brush employed for deburring and producing a radius on the tooth profile of gears is a short trim, dense, wire-fill radial brush. The brush should be set up so as to brush across the edge as shown in Fig. 1A. Line contact brushing, as shown in Fig. 1B should be avoided because the Crisis face will wear non-uniformly; and the wire points, being flexible, tend to flare to the side, thus minimizing the effectiveness of the brushing operation. When brushing gears, the brushes are spaced and contact the tooth profile on the center line of the gear as shown in Fig. 2. This facilitates using brush reversal to maintain the wire brushing points at their maximum cutting efficiency.

The setup for brushing spline bores differs from brushing gears in that the brushes are located off-center, as illustrated in Fig. 3. When helical gears are brushed, it is sometimes necessary to favor the acute side of the gear tooth to develop a generous radius prior to shaving. This can be accomplished by locating the brushes as shown In Fig. 4. Elastomer bonded wire-filled brushes are used for deburring fine pitch gears. These brushes remove the burrs without leaving any secondary roll. The use of bonded brushes is necessary when the gears are not shaved after hobbing or gear shaping.

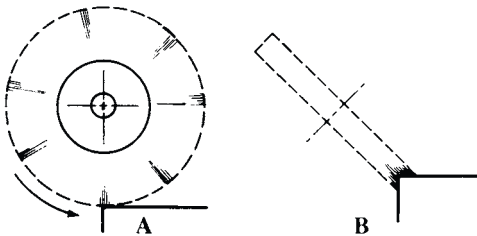


Fig. 1. Methods of Brushing an Edge; (A) Correct, (B) Incorrect

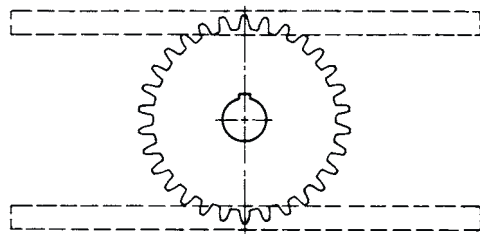


Fig. 2. Setup for Deburring Gears

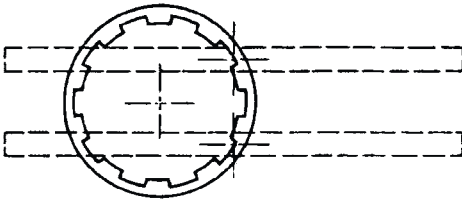


Fig. 3. Setup for Brushing Broached Splines

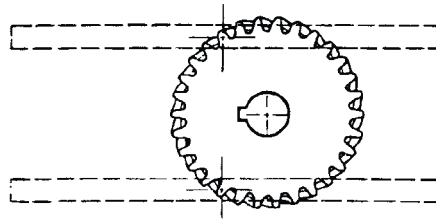


Fig. 4. Setup for Finishing Helical Gears

Adjustments for Eliminating Undesirable Conditions in Power Brush Finishing

Undesirable Condition	Possible Adjustments for Eliminating Condition
Brush works too slowly	(1) Decrease trim length and increase fill density. (2) Increase filament diameter. (3) Increase surface speed by increasing R.P.M. or outside diameter.
Brush works too fast	(1) Reduce filament diameter. (2) Reduce surface speed by reducing R.P.M. or outside diameter. (3) Reduce fill density. (4) Increase trim length.
Action of brush peens burr to adjacent surface	(1) Decrease trim length and increase fill density. (2) If wire brush tests indicate metal too ductile (burr is peened rather than removed), change to nonmetallic brush such as a treated Tampico brush used with a burring compound.
Finer or smoother finish required	(1) Decrease trim length and increase fill density. (2) Decrease filament diameter. (3) Try treated Tampico or cord brushes with suitable compounds at recommended speeds. (4) Use auxiliary buffing compound with brush.
Finish too smooth and lustrous	(1) Increase trim length. (2) Reduce brush fill density. (3) Reduce surface speed. (4) Increase filament diameter.
Brushing action not sufficiently uniform	(1) Devise hand-held or mechanical fixture or machine which will avoid irregular off-hand manipulation. (2) Increase trim length and decrease fill density.

Polishing and Buffing

The terms “polishing” and “buffing” are sometimes applied to similar classes of work in different plants, but according to approved usage of the terms, there is the following distinction: Polishing is any operation performed with wheels having abrasive glued to the working surfaces, whereas buffing is done with wheels having the abrasive applied loosely instead of imbedding it into glue; moreover, buffing is not so harsh an operation as ordinary polishing, and it is commonly utilized to obtain very fine surfaces having a “grainless finish.”

Polishing Wheels.—The principal materials from which polishing wheels are made are wood, leather, canvas, cotton cloth, plastics, felt, paper, sheepskin, impregnated rubber, canvas composition, and wool. Leather and canvas are the materials most commonly used in polishing wheel construction. Wooden wheels covered with material to which emery or some other abrasive is glued are employed extensively for polishing flat surfaces, espe-

Characteristics and Applications of Brushes Used in Power Finishing

Brush Type	Description	Operating Speed Range, sfpm	Uses	Remarks
Radial, short trim dense wire fill	Develops very little impact action but maximum cutting action.	6500	Removal of burrs from gear teeth and sprockets. Produces blends and radii at juncture of intersecting surfaces.	Brush should be set up so as to brush across any edge. Reversal of rotation needed to maintain maximum cutting efficiency of brush points.
Radial, medium to long trim twisted knot wire fill	Normally used singly and on portable tools. Brush is versatile and provides high impact action.	7500-9500 for high speeds. 1200 for slow speeds.	For cleaning welds in the automotive and pipeline industries. Also for cleaning surfaces prior to painting, stripping rubber flash from molded products and cleaning mesh-wire conveyor belts.	Surface speed plays an important role since at low speeds the brush is very flexible and at high speeds it is extremely hard and fast cutting.
Radial, medium to long trim crimped wire fill	With the 4- to 8-inch diameter brush, part is hand held. With the 10- to 15-inch diameter brush, part is held by machine.	4500-6000	Serves as utility tool on bench grinder for removing feather grinding burrs, machining burrs, and for cleaning and producing a satin or matte finish.	Good for hand held parts as brush is soft enough to conform to irregular surfaces and hard-to-reach areas. Smaller diameter brushes are not recommended for high-production operations.
Radial, sectional, non-metallic fill (treated and untreated Tampico or cord)	Provides means for improving finish or improving surface for plating. Works best with grease base deburring or buffing compound.	5500-6500 7500 for polishing	For producing radii and improving surface finish. Removes the sharp peaks that fixed abrasives leave on a surface so that surface will accept a uniform plating. Polishing marks and draw marks can be successfully blended.	Brush is selective to an edge which means that it removes metal from an edge but not from adjoining surfaces. It will produce a very uniform radius without peening or rolling any secondary metal.
Radial, wide-face, nonmetallic fill (natural fibers or synthetics)	Can be used with flow-through mounting which facilitates feeding of cold water and hot alkaline solutions through brush face to prevent buildup.	750-1200 for cleaning steel. 600 when used with slurries	For cleaning steel. Used in electrolytic tinplate lines, continuous galvanizing and annealing lines, and cold reduction lines. Used to produce dull or matte-type finishes on stainless steel and synthetics.	Speeds above 3600 sfpm will not appreciably improve operation as brush wear will be excessive. Avoid excessive pressures. Ammeters should be installed in drive-motor circuit to indicate brushing pressure.

Characteristics and Applications of Brushes Used in Power Finishing (Continued)

Brush Type	Description	Operating Speed Range, sfpm	Uses	Remarks
Radial, wide face, metallic fill	This brush is made to customer's specifications. It is dynamically balanced at the speed at which it will operate.	2000-4000	Removes buildup of aluminum oxide from work rolls in aluminum mill. Removes lime or magnesium coatings from certain types of steel. Burinishes hot-dipped galvanized steel to produce a minimum spangled surface.	Each brush should have its own drive. An ammeter should be present in drive-motor circuit to measure brushing pressure. If strip is being brushed, a steel backup roll should be opposite the brush roll.
Radial, wide face, strip (interrupted brush face)	Performs cleaning operations that would cause a solid face brush to become loaded and unusable.	When cleaning conveyor belts, brush speed is 2 to 3 times that of conveyor belt.	Need for cleaning rubber and fabric conveyor belts of carry-back material which would normally foul snubber pulley and return idlers.	Designed for medium- to light-duty work. Brush face does not load.
Radial, Cup, Flared End, and Straight End, wire fill elastomer bonded	Extremely fast cutting with maximum operator safety. No loss of wire through fatigue. Always has uniform face.	3600-9000	For removing oxide weld scale, burrs, and insulation from wire.	Periodic reversing of brush direction will result in a brush life ten times greater than non-bonded wheels. Fast cutting action necessitates precise holding of part with respect to brush.
Cup, twisted knot wire fill	Fast cutting wheel used on portable tools to clean welds, scale, rust, and other oxides.	8000-10,000 4500-6500 for deburring and producing a radius around periphery of holes.	Used in shipyards and in structural steel industry. For cleaning outside diameter of pipe and removing burrs and producing radii on heat exchanger tube sheets and laminations for stator cores.	Fast acting brush cleans large areas economically. Setup time is short.
Radial, wire or treated Tampico or cord	For use with standard centerless grinders. Brush will not remove metal from a cylindrical surface. Parts must be ground to size before brushing.	...	For removing feather grinding burrs and improving surface finish. Parts of 24 microinches can be finished down to 15 to 10 microinches. Parts of 10 to 12 microinches can be finished down to 7 to 4 microinches.	Follows centerless grinding principles, except that accuracy in pressure and adjustment is not critical. A machine no longer acceptable for grinding can be used for brushing.

cially when good edges must be maintained. Cloth wheels are made in various ways; wheels having disks that are cemented together are very hard and used for rough, coarse work, whereas those having sewn disks are made of varying densities by sewing together a larger or smaller number of disks into sections and gluing them.

Wheels in which the disks are held together by thread or metal stitches and which are not stiffened by the use of glue usually require metal side plates to support the canvas disks. Muslin wheels are made from sewed or stapled buffs glued together, but the outer edges of a wheel frequently are left open or free from glue to provide an open face of any desired depth. Wool felt wheels are flexible and resilient, and the density may be varied by sewing two or more disks together and then cementing to form a wheel. Solid felt wheels are quite popular for fine finishing but have little value as general utility wheels. Paper wheels are made from strawboard paper disks and are cemented together under pressure to form a very hard wheel for rough work. Softer wheels are similarly made from felt paper. The "compress" canvas wheel has a cushion of polishing material formed by pieces of leather, canvas, or felt, that are held in a crosswise radial position by two side plates attached to the wheel hub. This cushion of polishing material may be varied in density to suit the requirements; it may be readily shaped to conform to the curvature of the work and this shape can be maintained. Sheepskin polishing wheels and paper wheels are little used.

Polishing Operations and Abrasives.—Polishing operations on such parts as chisels, hammers, screwdrivers, wrenches, and similar parts that are given a fine finish but are not plated, usually require four operations, which are "roughing," "dry fining," "greasing," and "coloring." The roughing is frequently regarded as a solid grinding wheel job. Sometimes there are two steps to the greasing operation—rough and fine greasing. For some hardware, such as the cheaper screwdrivers, wrenches, etc., the operations of roughing and dry fining are considered sufficient. For knife blades and cutlery, the roughing operation is performed with solid grinding wheels and the polishing is known as fine or blue glazing, but these terms are never used when referring to the polishing of hardware parts, plumbers' supplies, etc. A term used in finishing German silver, white metal, and similar materials is "sand-buffing," which, in distinction from the ordinary buffing operation that is used only to produce a very high finish, actually removes considerable metal, as in rough polishing or flexible grinding. For sand-buffing, pumice and other abrasive powders are loosely applied.

Aluminum oxide abrasives are widely used for polishing high-tensile-strength metals such as carbon and alloy steels, tough iron, and nonferrous alloys. Silicon carbide abrasives are recommended for hard, brittle substances such as grey iron, cemented carbide tools, and materials of low tensile strength such as brass, aluminum, and copper.

Buffing Wheels.—Buffing wheels are manufactured from disks (either whole or pieced) of bleached or unbleached cotton or woolen cloth, and they are used as the agent for carrying abrasive powders, such as tripoli, crocus, rouge, lime, etc., which are mixed with waxes or greases as a bond. There are two main classes of buffs, one of which is known as the "pieced-sewed" buffs, and is made from various weaves and weights of cloth. The other is the "full-disk" buffs, which are made from specially woven material. Bleached cloth is harder and stiffer than unbleached cloth, and is used for the faster cutting buffs. Coarsely woven unbleached cloth is recommended for highly colored work on soft metals, and the finer woven unbleached cloths are better adapted for harder metals. When working at the usual speed, a stiff buff is not suitable for "cutting down" soft metal or for light plated ware, but is used on harder metals and for heavy nickel-plated articles.

Speed of Polishing Wheels.—The proper speed for polishing is governed to some extent by the nature of the work, but for ordinary operations, the polishing wheel should have a peripheral speed of about 7500 ft/min (2286 m/min). If run at a lower speed, the work tends to tear the polishing material from the wheel too readily, and the work is not as good in quality. Muslin, felt, or leather polishing wheels having wood or iron centers should be run at peripheral speeds varying from 300 to 7000 ft/min (91–2133 m/min). It is rarely neces-

sary to exceed 6000 ft/min (1829 m/min), and for most purposes, 4000 ft/min (1219 m/min) is sufficient. If the wheels are kept in good condition, in perfect balance, and are suitably mounted on substantial buffing lathes, they can be used safely at speeds within the limits given. However, manufacturers' recommendations concerning wheel speeds should be followed, where they apply.

Grain Numbers of Emery.—The numbers commonly used in designating the different grains of emery, corundum, and other abrasives are 10, 12, 14, 16, 18, 20, 24, 30, 36, 40, 46, 54, 60, 70, 80, 90, 100, 120, 150, 180, and 200, ranging from coarse to fine, respectively. These numbers represent the number of meshes per linear inch in the grading sieve. An abrasive finer than No. 200 is known as “flour” and the degree of fineness is designated by the letters CF, F, FF, FFF, FFFF, and PCF or SF, ranging from coarse to fine. The methods of grading flour-emery adopted by different manufacturers do not exactly agree, the letters differing somewhat for the finer grades. Again, manufacturers' recommendations should be followed.

Grades of Emery Cloth.—The coarseness of emery cloth is indicated by letters and numbers corresponding to the grain number of the loose emery used in the manufacture of the cloth. The letters and numbers for grits ranging from fine to coarse are as follows: FF, F, 120, 100, 90, 80, 70, 60, 54, 46, and 40. For large work roughly filed, use coarse cloth such as numbers 46 or 54, and then finer grades to obtain the required polish. If the work has been carefully filed, a good polish can be obtained with numbers 60 and 90 cloth, and a brilliant polish can be achieved by finishing with number 120 and flour-emery.

Mixture for Cementing Emery Cloth to a Lapping Wheel.—Many proprietary adhesives are available for application of emery cloth to the periphery of a buffing or lapping wheel, and generally are supplied with application instructions. In the absence of such instructions, clean the wheel thoroughly before applying the adhesive, and then rub the emery cloth down so as to exclude all air from between the surface of the wheel and the cloth.

Etching and Etching Fluids

Etching Fluids for Different Metals.—A common method of etching names or simple designs upon steel is to apply a thin, even coating of beeswax or some similar substance which will resist acid; then mark the required lines or letters in the wax with a sharp-pointed scriber, thus exposing the steel (where the wax has been removed by the scriber point) to the action of an acid, which is finally applied. To apply a very thin coating of beeswax, place the latter in a silk cloth, warm the piece to be etched, and tub the pad over it. Regular coach varnish is also used instead of wax, as a “resist.”

An etching fluid ordinarily used for carbon steel consists of nitric acid, 1 part; water, 4 parts. It may be necessary to vary the amount of water, as the exact proportion depends upon the carbon content and whether the steel is hard or soft. For hard steel, use nitric acid, 2 parts; acetic acid, 1 part. For high-speed steel, nickel or brass, use nitro-hydrochloric acid (nitric, 1 part; hydrochloric, 4 parts). For high-speed steel it is sometimes better to add a little more nitric acid. For etching bronze, use nitric acid, 100 parts; muriatic acid, 5 parts. For brass, nitric acid, 16 parts; water, 160 parts, dissolve 6 parts potassium chlorate in 100 parts of water; then mix the two solutions and apply.

A fluid which may be used either for producing a frosted effect or for deep etching (depending upon the time it is allowed to act) is composed of 1 ounce sulphate of copper (blue vitriol); $\frac{1}{4}$ ounce alum; $\frac{1}{2}$ teaspoonful of salt; 1 gill of vinegar, and 20 drops of nitric acid. For aluminum, use a solution composed of alcohol, 4 ounces; acetic acid, 6 ounces; antimony chloride, 4 ounces; water, 40 ounces (1 ounce = 0.02957 liter).

Various acid-resisting materials are used for covering the surfaces of steel rules etc., prior to marking off the lines on a graduating machine. When the graduation lines are fine and very closely spaced, as on machinists' scales which are divided into hundredths or

sixty-fourths, it is very important to use a thin resist that will cling to the metal and prevent any under-cutting of the acid: the resist should also enable fine lines to be drawn without tearing or crumbling as the tool passes through it. One resist that has been extensively used is composed of about 50 per cent of asphaltum, 25 per cent of beeswax, and, in addition, a small percentage of Burgundy pitch, black pitch, and turpentine. A thin covering of this resisting material is applied to the clean polished surface to be graduated and, after it is dry, the work is ready for the graduating machine. For some classes of work, paraffin is used for protecting the surface surrounding the graduation lines which are to be etched. The method of application consists in melting the paraffin and raising its temperature high enough so that it will flow freely; then the work is held at a slight angle and the paraffin is poured on its upper surface. The melted paraffin forms a thin protective coating.

Conversion Coatings and the Coloring of Metals

Conversion Coatings.—Conversion coatings are thin, adherent chemical compounds that are produced on metallic surfaces by chemical or electrochemical treatment. These coatings are insoluble, passive, and protective, and are divided into two basic systems: oxides or mixtures of oxides with other compounds, usually chromates or phosphates. Conversion coatings are used for corrosion protection, as an adherent paint base; and for decorative purposes because of their inherent color and because they can absorb dyes and colored sealants.

Conversion coatings are produced in three or four steps. First there is a pretreatment, which often involves mechanical surface preparation followed by decreasing and/or chemical or electrochemical cleaning or etching. Then thermal, chemical, or electrochemical surface conversion processes take place in acid or alkaline solutions applied by immersion spraying, or brushing. A post treatment follows, which includes rinsing and drying, and may also include sealing or dyeing. If coloring is the main purpose of the coating, then oiling, waxing, or lacquering may be required.

Passivation of Copper.—The blue-green patina that forms on copper alloys during atmospheric exposure is a passivated film; i.e., it prevents corrosion. This patina may be produced artificially or its growth may be accelerated by a solution of ammonium sulfate, 6 pounds (2.7 kg); copper sulfate, 3 ounces (85 g); ammonia (technical grade, 0.90 specific gravity), 1.34 fluid ounces (39.6 cc); and water, 6.5 gallons (24.6 liters). This solution is applied as a fine spray to a chemically cleaned surface and is allowed to dry between each of five or six applications. In about 6 hours a patina somewhat bluer than natural begins to develop and continues after exposure to weathering.

Small copper parts can be coated with a passivated film by immersion in or brushing with a solution consisting of the following weight proportions: copper, 30; nitric acid, concentrated, 60; acetic acid (6%), 600; ammonium chloride, 11; and ammonium hydroxide (technical grade, 0.90 specific gravity), 20. To prepare the solution, the copper is dissolved in the nitric acid before the remaining chemicals are added, and the solution is allowed to stand for several days before use. A coating of linseed oil is applied to the treated parts.

Coloring of Copper Alloys.—Metals are colored to enhance their appearance, to produce an undercoat for an organic finish, or to reduce light reflection. Copper alloys can be treated to produce a variety of colors, with the final color depending on the base metal composition, the coloring solution's composition, the immersion time, and the operator's skill. Cleaning is an important part of the pretreatment; nitric and sulfuric acid solutions are used to remove oxides and to activate the surface.

The following solutions are used to color alloys that contain 85 per cent or more of copper. A dark red color is produced by immersing the parts in molten potassium nitrate, at 1200–1300°F (649–704°C), for up to 20 seconds, followed by a hot water quench. The parts must then be lacquered. A steel black color can be obtained by immersing the parts in a 180°F (82°C) solution of arsenious oxide (white arsenic), 4 ounces (113 g); hydrochloric acid

(1.16 specific gravity), 8 fluid ounces (23.6 cc); and water, 1 gallon (3.9 liters). The parts are immersed until a uniform color is obtained; they are scratch brushed while wet, and then dried and lacquered. A light brown color is obtained using a room-temperature solution of barium sulfate, 0.5 ounce (14g); ammonium carbonate, 0.25 ounce (7g); and water, 1 gallon (3.8 liters).

The following solutions are used to color alloys that contain less than 85 per cent copper. To color brass black, parts are placed in an oblique tumbling barrel made of stainless steel and covered with 3 to 5 gallons (11.2 to 19.8 liters) of water. Three ounces (85 g) of copper sulfate and 6 ounces (170 g) of sodium thiosulfate are dissolved in warm water and added to the barrel's contents. After tumbling for 15 to 30 minutes to obtain the finish, the solution is drained from the barrel, and the parts are washed thoroughly in clean water, dried in sawdust or air-blasted and, if necessary, lacquered. To produce a blue-black color, the parts are immersed in a 130–175°F (54–79°C) solution of copper carbonate 1 pound (450 g); ammonium hydroxide (0.89 specific gravity), 1 quart (940 cc); and water, 3 quarts. Excess copper carbonate should be present. The proper color is obtained in 1 minute. To color brass a hardware green, immerse the parts in a 160°F (71°C) solution of ferric nitrate, 1 ounce (28 g); sodium thiosulfate, 6 ounces; and water, 1 gallon. To color brass a light brown, immerse the parts in a 195–212°F (91–100°C) solution of potassium chlorate, 5.5 ounces; nickel sulfate, 2.75 ounces (170 g); copper sulfate, 24 ounces (680 g); and water, 1 gallon (3.8 liters).

Post treatment: The treated parts should be scratch brushed to remove any excess or loose deposits. A contrast of colors may be obtained by brushing with a slurry of fine pumice, hand nabbing with an abrasive paste, mass finishing, or buffing to remove the color from the highlights. In order to prolong the life of parts used for outdoor decorative purposes, a clear lacquer should be applied. Parts intended for indoor purposes are often used without additional protection.

Coloring of Iron and Steel.—Thin black oxide coatings are applied to steel by immersing the parts to be coated in a boiling solution of sodium hydroxide and mixtures of nitrates and nitrites. These coatings serve as paint bases and, in some cases, as final finishes. When the coatings are impregnated with oil or wax, they furnish fairly good corrosion resistance. These finishes are relatively inexpensive compared to other coatings.

Phosphate Coatings are applied to iron and steel parts by reacting them with a dilute solution of phosphoric acid and other chemicals. The surface of the metal is converted into an integral, mildly protective layer of insoluble crystalline phosphate. Small items are coated in tumbling barrels; large items are spray coated on conveyors.

The three types of phosphate coatings in general use are zinc, iron, and manganese. Zinc phosphate coatings vary from light to dark gray. The color depends on the carbon content and pretreatment of the steel's surface, as well as the composition of the solution. Zinc phosphate coatings are generally used as a base for paint or oil, as an aid in cold working, for increased wear resistance, or for rustproofing. Iron phosphate coatings were the first type to be used; they produce dark gray coatings and their chief application is as a paint base. Manganese phosphate coatings are usually dark gray; however, since they are used almost exclusively as an oil base, for break in and to prevent galling, they become black in appearance. In general, stainless steels and certain alloy steels cannot be phosphated. Most cast irons and alloy steels accept coating with various degrees of difficulty depending on alloy content.

Anodizing Aluminum Alloys.—In the anodizing process, the aluminum object to be treated is immersed as the anode in an acid electrolyte, and a direct current is applied. Oxidation of the surface occurs, producing a greatly thickened, hard, porous film of aluminum oxide. The object is then immersed in boiling water to seal the porosity and render the film impermeable. Before sealing, the film can be colored by impregnation with dyes or pigments. Special electrolytes may also be used to produce colored anodic films directly in the

anodizing bath. The anodic coatings are used primarily for corrosion protection and abrasion resistance, and as a paint base.

The three principal types of anodizing processes are: chromic, in which the active agent is chromic acid; sulfuric, in which the active agent is sulfuric acid, and hard anodizing, in which sulfuric acid is used by itself or with additives in a low-temperature electrolyte bath. Most of the anodic coatings range in thickness from 0.2 to 0.7 mil. The hard anodizing process can produce coatings up to 2 mils. The chromic acid coating is less brittle than the sulfuric, and, since the chromic electrolyte does not attack aluminum, it does not present a corrosion problem when it is trapped in crevices. The chromic coating is less resistant to abrasion than the sulfuric, but it cannot be used with alloys containing more than 5 per cent copper due to corrosion of the base metal.

Chemical Conversion Coatings for Aluminum: Chemical conversion coatings for aluminum alloys are adherent surface layers of low volatility oxide, phosphate, or chromate compounds produced by the reaction of the metal surface with suitable reagents. The conversion coatings are much thinner and softer than anodic coatings but they are less expensive and serve as an excellent paint base.

Magnesium Alloys.—Chemical treatment of magnesium alloys is used to provide a paint base and to improve corrosion resistance. The popular conversion “dip” coatings are chrome pickle and dichromate treatments, and they are very thin. Anodic coatings are thicker and harder, and, after sealing, give the same protection against corrosion, although painting is still desirable.

Titanium Alloys.—Chemical conversion coatings are used on titanium alloys to improve lubricity by acting as a base for the retention of lubricants. The coatings are applied by immersion, spraying, or brushing. A popular coating bath is an aqueous solution of phosphates, fluorides, and hydrofluoric acid. The coating is composed primarily of titanium and potassium fluorides and phosphates.

Plating

Surface Coatings.—The following is a list of military plating and coating specifications.

Anodize (Chromic and Sulfuric), MIL-A-8625F: Conventional Types I, IB, and II anodic coatings are intended to improve surface corrosion protection under severe conditions or as a base for paint systems. Coatings can be colored with a large variety of dyes and pigments. Class 1 is non-dyed; Class 2 dyed. Color is to be specified on the contract. Prior to dyeing or sealing, coatings shall meet the weight requirements.

Type I and IB coatings should be used on fatigue critical components (due to thinness of coating). Type I unless otherwise specified shall not be applied to aluminum alloys with over 5% copper or 7% silicon or total alloying constituents over 7.5%. Type IC is a mineral or mixed mineral/organic acid that anodizes. It provides a non-chromate alternative for Type I and IB coatings where corrosion resistance, paint adhesion, and fatigue resistance are required. Type IIB is a thin sulfuric anodizing coating for use as non-chromate alternatives for Type I and IB coatings where corrosion resistance, paint adhesion, and fatigue resistance are required. Be sure to specify the class of anodic coating and any special sealing requirements.

Types I, IB, IC, and IIB shall have a thickness between 0.0002 and 0.0007 inch (0.5 and 17.78 μm). Type II shall be between 0.0007 and 0.0010 inch (17.8 and 25.4 μm).

Black Chrome, MIL-C-14538C: A hard, non-reflective, abrasion, heat and corrosion resistant coating approximately 0.0002 in. (5.08 μm) thick. Provides limited corrosion protection, but added protection can be obtained by specifying underplate such as nickel. Color is a dull dark gray, approaching black and may be waxed or oiled to darken.

Black chromium has poor throwing power, and conforming anodes are necessary for intricate shapes. Apply coating after heat treating and all mechanical operations are performed. Steel parts with hardness in excess of 40 Rc shall be stress relieved prior to plating

by baking one hour or more, 300–500°F (149–260°C) and baked after plating, 375 ± 25°F (190 ± 14°C) for 3 hours.

Black Oxide Coating, MIL-C-13924C: A uniform, mostly decorative black coating for ferrous metals used to decrease light reflection. Only very limited corrosion protection under mild corrosion conditions. Black oxide coatings should normally be given a supplementary treatment.

Used for moving parts that cannot tolerate the dimensional change of a more corrosion resistant finish. Use alkaline oxidizing for wrought iron, cast and malleable irons, plain carbon, low alloy steel and corrosion resistant steel alloys. Alkaline-chromite oxidizing may be used on certain corrosion resistant steel alloys tempered at less than 900°F (482°C) Salt oxidizing is suitable for corrosion resistant steel alloys that are tempered at 900°F or higher.

Cadmium, QQ-P-416F: Cadmium plating is required to be smooth, adherent, uniform in appearance, free from blisters, pits, nodules, burning, and other defects when examined visually without magnification. Unless otherwise specified in the engineering drawing or procurement documentation, the use of brightening agents in the plating solution to modify luster is prohibited on components with a specified heat treatment of 180 ksi (1241 MPa) minimum tensile strength (or 40 Rc) and higher. Either a bright (not caused by brightening agents) or dull luster shall be acceptable. Baking on Types II and III shall be done prior to application of supplementary coatings. For Classes 1, 2, and 3 the minimum thicknesses shall be 0.0005, 0.0003, and 0.0002 inch (12.7, 7.62, and 5.08 μm) respectively.

Type I is to be used as plated. Types II and III require supplementary chromate and phosphate treatment respectively. Chromate treatment required for type II may be colored iridescent bronze to brown including olive drab, yellow and forest green. Type II is recommended for corrosion resistance. Type III is used as a paint base and is excellent for plating stainless steels that are to be used in conjunction with aluminum to prevent galvanic corrosion. For Types II and III the minimum cadmium thickness requirement shall be met after the supplementary treatment.

Chemical Films, MIL-C-5541E: The materials that qualify produce coatings that range in color from clear to iridescent yellow or brown. Inspection difficulties may arise with clear coatings because of their invisibility.

Class 1A chemical conversion coatings are intended to provide corrosion prevention when left unpainted as well as to improve adhesion of paint finish systems on aluminum and aluminum alloys. May be used on tanks, tubings, and component structures where paint finishes are not required for the exterior surfaces but are required for the interior surfaces.

Class 3 chemical conversion coatings are intended for use as a corrosive film for electrical and electronic applications where lower resistant contacts are required. The primary difference between Class 1A and Class 3 coating is thickness.

Chemical Finish: Black, MIL-F-495E: A uniform black corrosion retardant for copper. Coating has no abrasion resistance. Used to blacken color and reduce gloss on copper-alloy surfaces other than food service and water supply items. Also used as a base for subsequent coatings such as lacquer, varnish, oil, and wax.

Chrome, QQ-C-320B: Has excellent hardness, wear resistance, and erosion resistance. In addition chrome has a low coefficient of friction, is resistant to heat, and can be rendered porous for lubrication purposes.

Types I and II have bright and satin appearances respectively.

Class 1 is used as plating for corrosion protection and Class 2, for engineering plating. Class 1 and 2 both shall have a minimum thickness of 0.00001 in. (0.25 μm) on all visible surfaces. If thickness is not specified use 0.002 in (50.8 μm).

Class 2a will be plated to specified dimensions or processed to specified dimensions after plating. Class 2b will be used on parts below 40 Rc and subject to static loads or designed

for limited life under dynamic loads. Class 2c will be used on parts below 40 Rc and designed for unlimited life under dynamic loads. Class 2d parts have hardness of 40 Rc or above, which are subject to static loads or designed for unlimited life under dynamic loads. Class 2e parts have hardness of 40 Rc or above, which are designed for unlimited life under dynamic loads.

All coated steel parts having a hardness of Rc 36 and higher shall be baked at a minimum of $375 \pm 25^\circ\text{F}$ ($190 \pm 14^\circ\text{C}$) per the following conditions. With a tensile strength of 160-180 ksi (1103-1241 MPa), the time at temperature will be 3 hr.; at 181-220 ksi (1248-1517 MPa), the time will be 8 hr.; and at 221 ksi (1524 MPa) and above, the time will be 12 hr.

Copper, MIL-C-14550B: Has good corrosion resistance when used as an undercoat. A number of copper processes are available, each designed for a specific purpose such as, to improve brightness (to eliminate the need for buffing), high speed (for electro-forming), and fine grain (to prevent case-hardening).

All steel parts having a hardness of Rc 35 and higher shall be baked at $375 \pm 25^\circ\text{F}$ ($190 \pm 14^\circ\text{C}$) for 24 hours, within four hours after plating to provide hydrogen embrittlement relief. Plated springs and other parts subject to flexure shall not be flexed prior to baking operations.

Class 0 will have a thickness 0.001 - 0.005 in. (25.4-127 μm) and is used for heat treatment stop-off; Class 1 is 0.001 in. (25.4 μm) and is used to provide carburizing shield, also for plated through printed circuit boards. Class 2 is 0.0005 in. (12.7 μm) thick and is used as an undercoat for nickel and other platings. Class 3 is 0.0002 in. (5.08 μm) thick and is used to prevent basis metal migration into tin (prevents poisoning solderability). Class 4 is 0.0001 in. (2.54 μm) thick.

Tin Lead, MIL-P-81728A: It has excellent solderability. Either a matte or bright luster is acceptable. For electronics components, use only parts with a matte or flow brightened finish.

For brightened electronic components, the maximum thickness will be 0.0003 in. (7.62 μm) Tin 50 to 70% by weight and with a lead remainder, 0.0003-0.0005 in (7.62-12.7 μm).

Magnesium Process, MIL-M-3171C: Process #1-A chrome pickle treatment for magnesium. Color varies from matte gray to yellow-red. Has only fair corrosion resistance (< 24 hours, 20% salt spray resistance).

#7-A dichromate treatment for magnesium. Color varies from light brown to gray depending on alloy. Only fair corrosion resistance (< 24 hours, 20% salt spray resistance).

#9-A galvanic anodize treatment for magnesium. Produces a dark brown to black coating. Designed to give a protective film on alloys which do not react to Dow No. 7 treatment. Only fair corrosion resistance (< 24 hours, 20% salt spray resistance).

Type/Class	Thickness (inch)	Comments
Type I	Removes metal. (approx. 0.0006 for wrought, less for die castings.) No dimensional change	Used for protecting magnesium during shipment, storage and machining. Can be used as a paint base. NOTE: Must remove Type I coating before applying Type III and Type IV treatments.
Type III	...	<i>Note</i> : precleaning and pickling may result in dimensional changes due to metal loss.
Type IV	No dimensional change	Can be used as a paint base, and is applicable to all magnesium alloys. Used where optical properties (black) are required on close tolerance parts. NOTE: Precleaning and pickling may result in dimensional changes due to metal loss.

Magnesium Anodic Treatment, MIL-M-45202C: The HAE anodic finish is probably the hardest coating currently available for magnesium. It exhibits stability at high temperatures and has good dielectric strength. It serves as an excellent paint base. It requires resin seal or paint for maximum corrosion protection.

Coatings range from thin clear to light gray-green, to thick dark-green coatings. The clear coatings are used as a base for subsequent clear lacquers or paints to produce a final appearance similar to clear anodizing on aluminum. The light gray-green coatings are used in most applications which are to be painted. The thick, dark-green coating offers the best combination of abrasion resistance, protective value and paint base characteristics.

Type/Class	Typical Thickness	Comments
Type I, Light coating.		
Class A	0.2 mil	Tan coating (HAE)
Grade 1	...	Without post treatment (dyed)
Grade 2	...	With bifluoride-dichromate post treatment
Class C	0.3 mil	Light green coating (Dow #17)
Type II, Heavy coating		
Class A	1.5 mil	Hard brown coating (HAE)
Grade 1	...	Without post treatment
Grade 3	...	With bifluoride-dichromate post treatment
Grade 4	...	With bifluoride-dichromate post treatment including moist heat aging
Grade 5	...	With double application of bifluoride-dichromate post treatment including moist heat aging.
Class D	1.2 mil	Dark green coating (Dow #17)

Electroless Nickel, AMS 2404C, AMS 2405B, AMS 2433B: Is typically used as a coating to provide a hard-ductile, wear-resistant, and corrosion-resistant surface for operation in service up to 1000F, to provide uniform build-up on complex shapes.

AMS 2404C, is deposited directly on the basis metal without a flash coating of other metal, unless otherwise specified. AMS 2405B, is deposited directly on the basis metal except where parts fabricated from corrosion resistant steels or alloys where a "strike" coating of nickel or other suitable metal is required, unless otherwise specified. AMS 2433B, is a type of electroless nickel typically used to enhance the solderability of surfaces, but usage is not limited to such applications. Generally, the plate shall be placed directly on the basis metal. However, aluminum alloys shall be zinc immersion coated per ASTM B253 followed by copper flash; corrosion resistant steels and nickel and cobalt alloys or other basis metals may use a nickel or copper flash undercoat when the purchaser permits.

Electroless Nickel Preparation: Parts having a hardness higher than Rc 40 and have been machined or ground after heat treatment shall be suitably stress-relieved before cleaning and plating.

After treatment, parts having a hardness of Rc 33 and over shall be heated to 375 ± 15°F (190.5 ± 8.5°C) for three hours. If such treatment is injurious to the parts, bake at 275 ± 15°F (135 ± 8.5°C) for four hours.

Electroless Nickel, Low-Phosphorous, Note: If permitted by drawing, the maximum hardness and wear resistance are obtained by heating parts for 30-60 minutes, preferably in an inert atmosphere, at 750°F ± 15°F (399 ± 8°C) except aluminum parts shall be baked at 450 ± 15°F (231.5 ± 8.5°C) for four hours. If such heating is not specified, bake at 375 ± 15°F (190.5 ± 8.5°C) for three hours. If this treatment is injurious to parts or assemblies, bake at 275°F (135°C) for five hours.

Plating: nickel-thallium-boron (Electroless Deposition) and nickel-boron (Electroless Deposition)

Preparation: All fabrication-type operations shall be completed.

Post-treatment: Cold worked or heat treated parts and aluminum alloys and other parts requiring special thermal treatment shall be post treated as agreed upon by purchaser and vendor. Other plated parts within four hours after plating shall be heat treated for 90 ± 10 minutes at $675^{\circ}\text{F} \pm 15^{\circ}\text{F}$ ($357.5 \pm 8.5^{\circ}\text{C}$).

Electropolishing, (No MIL-SPEC No.): This process electrolytically removes or diminishes scratches, burrs, and unwanted sharp edges from most metals. Finishes from satin to mirror-bright are produced by controlling time, temperature, or both.

Typically the thickness loss is 0.0002 inch ($5 \mu\text{m}$). This process is not recommended for close tolerance surfaces.

Gold, MIL-G-45204C: Has a yellow to orange color depending on the proprietary process used. Will range from matte to bright finish depending on basis metal. It has good corrosive resistance and a high tarnish resistance. It provides a low contact resistance, is a good conductor of electricity, and has excellent solderability. If the hardness grade for the gold coating is not specified, Type I shall be furnished at a hardness of Grade A, and Type II furnished at a hardness of Grade C.

For soldering, a thin pure soft gold coating is preferred. A minimum and maximum thickness 0.00005 and 0.00010 inch (1.27 and $2.54 \mu\text{m}$), respectively, shall be plated.

Unless otherwise specified, gold over silver underplate combinations shall be excluded from electronics hardware. Silver or copper plus silver may not be used as an underplate unless required by the item specification. When gold is applied to brass bronze or beryllium copper, or a copper plate or strike, an antidiffusion underplate such as nickel shall be applied.

Type I is 99.7% gold minimum (Grades A, B, or C); Type II is 99.0% (Grades B, C, or D); and Type III is 99.9% (Grade A only).

Grade A is 90 Knoop maximum; Grade B is 91-129 Knoop; Grade C is 130-200 Knoop; and Grade D is 201 Knoop and over.

Class 00 has a thickness of 0.00002 inch ($0.5 \mu\text{m}$) minimum; Class 0, 0.00003 inch ($0.76 \mu\text{m}$); Class 1, 0.00005 inch ($1.3 \mu\text{m}$); Class 2, 0.0001 inch ($2.5 \mu\text{m}$); Class 3, 0.0002 inch ($5 \mu\text{m}$); Class 4, 0.0003 inch ($7.6 \mu\text{m}$); Class 5, 0.0005 inch ($12.7 \mu\text{m}$); and Class 6, 0.0015 inch ($38.1 \mu\text{m}$).

Hard Anodize, MIL-A-8625F: The color will vary from light tan to black depending on alloy and thickness. Can be dyed in darker colors depending on the thickness. Coating penetrates base metal as much as builds up on the surface. The term thickness includes both the buildup and penetration. It provides a very hard ceramic type coating. Abrasion resistance will vary with alloy and thickness of coating. Has good dielectric properties.

Do not seal coatings where the main function is to obtain maximum abrasion or wear resistance. When used for exterior applications requiring corrosion resistance but permitting reduced abrasion, the coating shall be sealed (boiling deionized water or hot 5% sodium dichromate solution, or other suitable chemical solutions).

Type III will have a thickness specified on the contract or applicable drawing. If not specified use a nominal thickness of 0.002 inch ($50.8 \mu\text{m}$). Hard coatings may vary in thickness from 0.0005 - 0.0045 inch (12.7 – $114.3 \mu\text{m}$).

Class 1 shall be not dyed or pigmented. Class 2 shall be dyed and the color specified on the contract. The process can be controlled to very close thickness tolerances. Where maximum serviceability or special properties are required, consult metal finisher for best alloy choice. Thick coatings (those over 0.004 inch ($101 \mu\text{m}$)) will tend to break down sharp edges. Can be used as an electrical insulation coating. "Flash" hard anodize may be used instead of conventional anodize for corrosion resistance and may be more economical in conjunction with other hard anodized areas.

Lubrication, Solid Film MIL-L-46010D: The Military Plating Specification establishes the requirements for three types of heat cured solid film lubricants that are intended to

reduce wear and prevent galling, corrosion, and seizure of metals. For use on aluminum, copper, steel, stainless steel, titanium, and chromium, and nickel bearing surfaces.

Types I, II, and III have a thicknesses of 0.008 - 0.013 mm. No single reading less than 0.005 mm or greater than 0.018 mm.

Type I has a curing temperature of $150 \pm 15^\circ\text{C}$ and an endurance life of 250 minutes; Type II, $204 \pm 15^\circ\text{C}$ and 450 minutes; and Type III is a low volatile organic compound (VOC) content lubricant with cure cycles of $150 \pm 15^\circ\text{C}$ for two hours, or $204 \pm 15^\circ\text{C}$ for one hour with an endurance life of 450 minutes. Color 1 has a natural product color and Color 2 has a black color.

Nickel, QQ-N-290A: There is a nickel finish for almost any need. Nickel can be deposited soft, hard-dull, or bright, depending on process used and conditions employed in plating. Thus, hardness can range from 150-500 Vickers. Nickel can be similar to stainless steel in color, or can be a dull gray (almost white) color. Corrosion resistance is a function of thickness. Nickel has a low coefficient of thermal expansion.

All steel parts having a tensile strength of 220,000 or greater shall not be a nickel plate without specific approval of procuring agency.

Class 1 is used for corrosion protection. Plating shall be applied over an underplating of copper or yellow brass on zinc and zinc based alloys. In no case, shall the copper underplate be substituted for any part of the specified nickel thickness. Class 2 is used in engineering applications.

Grade A has a thickness of 0.0016 inch (41 μm); Grade B, 0.0012 in. (30.48 μm); Grade C, 0.001 in. (25.4 μm); Grade D, 0.0008 in. (20.32 μm); Grade E, 0.0006 in. (15.24 μm); Grade F, 0.0004 in. (10.16 μm); and Grade G, 0.002 in (50.8 μm).

Palladium, MIL-P-45209B: A gray, dense deposit good for undercoats. Has good wear characteristics, corrosion resistance, catalytic properties, and good conductivity.

The thickness shall be 0.00005 in. (1.27 μm) unless otherwise specified.

Steel springs and other steel parts subject to flexure or repeated impact and of hardness greater than Rc 40 shall be heated to $375 \pm 25^\circ\text{F}$ ($190 \pm 14^\circ\text{C}$) for three hours after plating.

Passivate, QQ-P-35C: Intended to improve the corrosion resistance of parts made from austenitic, ferritic, and martensitic corrosion-resistant steels of the 200, 300, and 400 series and precipitation hardened corrosion resistant steels. 440°C grades may be exempt from passivation treatments of the procuring activity.

Type II is a medium temperature nitric acid solution with sodium dichromate additive. Type VI, a low temperature nitric acid solution; Type VII, a medium temperature nitric acid solution; and Type VIII, a medium temperature high concentration nitric acid solution.

Phosphate Coating: Light, TT-C-490D: This specification covers cleaning methods and pretreatment processes.

Methods /Types	Typical Thickness (in.)	Comments
Cleaning Methods		
	...	Light coating for use as a paint base.
Method I	...	Mechanical or abrasive cleaning (for ferrous surfaces only).
Method II	...	Used for solvent cleaning.
Method III	...	Used for hot alkalines (for ferrous surfaces only).
Method IV	...	Emulsion.
Method V	...	Used for alkaline derusting (for ferrous surfaces only).
Method VI	...	Phosphoric acid.

Methods /Types	Typical Thickness (in.)	Comments
Pretreatment Coatings		
Type I	...	Zinc phosphate. Class 1-spray application: Class 2A and 2B-Immersion or Dip application
Type II	...	Aqueous Iron Phosphate
Type III	0.0003 – 0.0005	Is an organic pretreatment coating
Type IV	...	Non-aqueous iron phosphate
Type V	...	Zinc phosphate

Type I is intended as a general all-purpose pretreatment prior to painting. Type II and IV are intended primarily for use where metal parts are to be formed after painting. Type III is intended for use where size and shape preclude using Type I, II, or IV and where items containing mixed metal components are assembled prior to treatment.

Phosphate Coating: Heavy, DOD-P-16232-F: The primary differences are that Type M is used as a heavy manganese phosphate coating for corrosion and wear resistance and Type Z is used as a Zinc phosphate coating.

Type M has a thickness from 0.0002-0.0004 in. (5–10 μm) and Type Z, 0.0002-0.0006 in. (5–15 μm) Class 1, for both types has a supplementary preservative treatment or coating as specified; Class 2, has a supplementary treatment with lubricating oil; and Class 3, no supplementary treatment is required. For Type M, Class 4 is chemically converted (may be dyed to color as specified) with no supplementary coating or supplementary coating as specified. For Type Z, Class 4 is the same as Class 3.

This coating is for medium and low alloy steels. The coatings range from gray to black in color. The "heavy" phosphate coatings covered by this specification are intended as a base for holding/retaining supplemental coatings which provide the major portion of the corrosion resistance. "Light" phosphate coatings used for a paint base are covered by other specifications. Heavy zinc phosphate coatings may be used when paint and supplemental oil coatings are required on various parts or assemblies.

Rhodium, MIL-R-46085B: Rhodium is metallic and similar to stainless steel in color, has excellent corrosion and abrasion resistance, is almost as hard as chromium, and has a high reflectivity. Thicker coatings of Rhodium are very brittle.

Class/Types	Thickness (in.)	Comments
Type I	...	Over nickel, silver, gold, or platinum.
Type II	...	Over other metals, requires nickel undercoat.
Class 1	0.000002	Used on silver for tarnish resistance.
Class 2	0.00001	
Class 3	0.00002	Applications range from electronic to nose cones -wherever wear, corrosion resist solderability and reflectivity are important.
Class 4	0.00010	
Class 5	0.00025	

Parts having a hardness of Rc 33 or above shall be baked at 375°F (191°C) for three hours prior to cleaning. Parts having hardness of 40 Rc and above shall be baked within four hours after plating at 375°F (191°C) for three hours.

Silver, QQ-S-365D: Silver has an increasing use in both decorative and engineering fields, including electrical and electronic fields.

Silver is white matte to very bright in appearance. Has good corrosion resistance, depending on base metal and will tarnish easily. Its hardness varies from about 90-135 Brinell depending on process and plating conditions. Solderability is excellent, but decreases with age. Silver is the best conductor of electricity. Has excellent lubricity and smear characteristics for antigalling uses on static seals, bushing, etc. Stress relief steel

parts at a minimum $375 \pm 25^\circ\text{F}$ ($190 \pm 14^\circ\text{C}$) or more prior to cleaning and plating if they contain or are suspected of having damaging residual tensile stresses.

All types and grades will have a minimum thickness of 0.0005 in. (12.7 μm) unless otherwise specified. Type I is matte, Type II is semi-bright, and Type III is bright. Grade A has a chromate post-treatment to improve tarnish resistance. In contrast Grade B has no supplementary treatment.

Tin, MIL-T-10727C: There are two different types of coating methods used, electrodeposited (based on Use ASTM B545 standard specification for electrodeposited coatings of tin) and hot dipped.

Thickness as specified on drawing (thickness is not part of the specification) is 0.0001-0.0025 inch (2.5–63.5 μm), flash for soldering; 0.0002-0.0004 inch (5.08–10.16 μm), to prevent galling and seizing; 0.0003 inch (7.62 μm) minimum, where corrosion resistance is important; and 0.0002-0.0006 inch (5.08–15.24 μm) to prevent formation of case during nitriding.

Color is a gray-white color in plated condition. Tin is soft, but very ductile. It has good corrosion resistance, and has excellent solderability. Tin is not good for low temperature applications.

If a bright finish is desired to be used in lieu of fused tin, specify Bright Tin plate. Thickness can exceed that of fused tin and deposit shows excellent corrosion resistance and solderability.

Vacuum Cadmium, MIL-C-8837B: Is used primarily to provide corrosion resistance to ferrous parts free from hydrogen contamination and possible embrittlement. Recommended on steels with a strength of 2.2×10^5 psi (1517 MPa) or above.

Coating is applied after all machining, brazing, welding, and forming has been completed. Prior to coating, all steel parts shall be stress relieved by baking at $375 \pm 25^\circ\text{F}$ ($190 \pm 14^\circ\text{C}$) for three hours if suspected of having residual tensile stresses. Immediately prior to coating, lightly dry abrasive blast areas are to be coated.

Type I shall be as plated; and Types II and III require supplementary chromate and phosphate treatments respectively.

Classes 1, 2, and 3 have thicknesses of 0.0005, 0.0003, and 0.0002 inch (12.7, 7.62, and 5.08 μm) respectively.

Cadmium coating shall not be used, if in service, temperature reaches 450°F (232°C).

A salt spray test is required for type II and is 96 hours.

Zinc, ASTM-B633: This specification covers requirements for electrodeposited zinc coatings applied to iron or steel articles to protect them from corrosion. It does not cover zinc-coated wire or sheets.

Type I will be as plated; Type II will have colored chromate conversion coatings; Type III will have colorless chromate conversion coatings; and Type IV will have phosphate conversion coatings.

High strength steels (tensile strength over 1700 MPa or 246,500 psi) shall not be electroplated.

Stress relief: All parts with ultimate tensile strength 1000 MPa (145,000 psi) and above at minimum 190°C (374°F) for three hours or more before cleaning and plating.

Hydrogen embrittlement relief: All electroplated parts 1200 MPa (174,000 psi) or higher shall be baked at 190°C (374°F) for 3 hours or more within four hours after electroplating.

Corrosion Resistance Requirements	
Types	Test Period Hr.
II	96
III	12

Flame Spraying Process

In this process, the forerunner of which was called the metal spraying process, metals, alloys, ceramics, and cermets are deposited on metallic or other surfaces. The object may be to build up worn or undersize parts, provide wear-resisting or corrosion-resisting surfaces, correct defective castings, etc.

Different types of equipment are available that provide the means of depositing the coatings on the surfaces. In one, wire is fed automatically through the nozzle of the spray gun; then a combustible gas, oxygen and compressed air serve to melt and blow the atomized metal against the surface to be coated. The gas usually used is acetylene but other gases may be used. Any desired thickness of metal may be deposited and the metals include steels, ranging from low to high carbon content, various brass and bronze compositions, babbitt metal, tin, zinc, lead, nickel, copper, and aluminum. The movement of the spray gun, in covering a given surface, is controlled either mechanically or by hand. In enlarging worn or undersize shafts, spindles, etc., it is common practice to clamp the gun in a lathe toolholder and use the feed mechanism to traverse the gun at a uniform rate while the metal is being deposited upon the rotating workpiece. The spraying operation may be followed by machining or grinding to obtain a more precise dimension.

Some typical production applications using the wire process are the coating of automotive exhaust valves, refinishing of transfer ink rollers for the printing industry and the rebuilding of worn truck clutch plates. Other production applications include the metallizing of glass meter box windows, the spraying of aluminum onto cloth gauze to produce electrolytic condenser plates, and the spraying of zinc or copper for coating ceramic insulators.

With another type of equipment, metal, refractory, and ceramic powder are used instead of wire. Ordinarily this equipment employs the use of two gases, oxygen and a fuel gas. The fuel gas is usually acetylene but in some instances hydrogen may be used. When hand-held, a small reservoir supplies the powder to the equipment but a larger reservoir is used for lathe-mounted equipment or for large-scale production work. The four basic types of coating powders used with this equipment are ceramics, oxidation-resistant metals and alloys, self-bonding alloys, and alloys for fused coatings. These powders are used to produce wear-resistant, corrosion-resistant, heat-resistant, and electrically conductive coatings.

Still other equipment employs the use of plasma flame with which vapors of materials are raised to a higher energy level than the ordinary gaseous state. Its use raises the temperature ceiling and provides a controlled atmosphere by permitting employment of an inert or chemically inactive gas so that chemical action, such as oxidation, during the heating and application of the spray material can be controlled. The temperatures that can be obtained with commercially available plasma equipment often exceed 30,000°F (16,650°C) but for most plasma flame spray processes the temperature range of from 12,000 to 20,000°F (6650–11,093°C) is optimum. Plasma flame spray materials include alumina, zirconia, tungsten, molybdenum, tantalum, copper, aluminum, carbides, and nickel-base alloys.

Regardless of the equipment used, what is important is the proper preparation of the surface that will receive the sprayed coating. Preparation activities include the degreasing or solvent cleaning of the surface, undercutting of the surface to provide room for the proper coating thickness, abrasive or grit blasting the substrate to provide a roughened surface, grooving (in the case of flat surfaces) or rough threading (in the case of cylindrical work) the surface to be coated, preheating the base metal. Methods of obtaining a bond between the sprayed material and the substrate are: heating the base, roughening the base, or spraying a “self-bonding” material onto a smooth surface; however, heating alone is seldom used in machine element work as the elevated temperatures required to obtain the proper bond causes problems of warpage and surface corrosion.

TABLE OF CONTENTS

FASTENERS

TORQUE AND TENSION IN FASTENERS		INCH THREADED FASTENERS	
1521	Tightening Bolts	1562	Type A Plain Washer
1522	Wrench Torque	1563	ANSI Standard Plain Washers
1522	Preload in Loaded Joint	1564	Type B Plain Washers
1522	Preload In Shear	1565	Helical Spring and Tooth Lock Washers
1523	General Application of Preload	1566	Helical Spring Lock Washer
1524	Preload Adjustments	1568	Tooth Lock Washers
1524	Coefficients of Friction	1570	Fasteners for Structural Applications
1525	Preload Relaxation	1570	Heavy Hex Structural Bolts
1525	Measuring Preload	1573	Heavy Hex Nuts
1526	Bolt Preload Application Methods	1576	Hardened Steel Washers
1526	Elongation Measurement	1576	Flat Washers
1528	Tensile Stress Area	1576	Circular and Clipped Washers
1529	Torque and Clamping Force	1577	Beveled Washers
1531	Torque and Friction Coefficients	1579	Compressible Tension Indicators
1532	Torque-Tension Relationships		
1534	Grade Marks		
1534	Grade Identification Marks		
1535	Detecting Counterfeit Fasteners		
1535	Mechanical Properties of Nuts		
1535	Working Strength of Bolts		
1536	Lengths of Engagement		
1537	Breaking Force		
1537	Lock Wire Procedure Detail		
INCH THREADED FASTENERS		METRIC THREADED FASTENERS	
1538	Bolts, Screws, and Nuts	1581	Comparison with ISO Standards
1539	Square and Hex Bolts	1582	Metric Hex Cap Screws
1540	ANSI Square Bolts	1583	Metric Formed Hex Screws
1541	ANSI Hex and Heavy Hex Bolts	1584	Metric Heavy Hex Screws
1542	Heavy Hex Screws	1584	Metric Screw and Bolt Diameters
1543	Square Lag Screws	1585	Metric Hex Screws and Bolts
1544	Hex Lag Screws	1586	Metric Hex Lag Screws
1545	Hex Nuts and Jam Nuts	1587	Metric Socket Head Shoulder Screws
1546	Heavy Hex Flat Nuts	1588	Heavy Hex Flange Screws
1547	Heavy Hex Slotted Nuts	1589	Hex Flange Screws
1548	Square Nuts	1589	Round Head Square Neck Bolts
1549	Low and High Crown Nuts	1591	Heavy Hex Bolts
1551	Round Head Square Neck Bolts	1591	Heavy Hex Structural Bolts
1551	T Head Bolts	1592	Hex Bolts
1552	Round Head Square Neck Bolts	1592	Mechanical Properties
1552	Round Head Fin Neck Bolts	1593	Identification Symbols
1553	Round Head Ribbed Neck Bolts	1593	Designation
1554	Countersunk Square Neck Bolts	1594	Socket Head Cap Screws
1555	Countersunk Bolts	1594	Diameter-Length Combinations
1555	Wrench Clearance Dimensions	1594	Metric Hex Lag Screws
1556	Wrench Openings for Nuts	1595	Cap, Heavy, Hex Flange Screws
	Washers	1596	Heavy Hex Structural Bolts
		1596	Round Head Square Neck Bolts
		1596	Socket Head Cap Screws Lengths
		1598	Socket Head Cap Screws Sizes
		1599	Drilled Head Dimensions
		1599	Metric Nuts
		1599	Comparison with ISO Standards

TABLE OF CONTENTS

FASTENERS

METRIC THREADED FASTENERS	BRITISH FASTENERS
<i>(Continued)</i>	1626 British Standard Bolts and Nuts
1601 Tops and Bearing Surfaces	1626 Square and Hexagon Bolts
1601 Slotted Hex Nuts	1626 British Standard Screwed Studs
1601 Hex Nuts	1627 Whitworth and Fine Precision Hexagon Bolts, Screws
1601 Hex Flange Nuts	1630 ISO Metric Precision Hexagon Bolts, Screws and Nuts
1601 Mechanical Properties	1631 Hexagon Bolts and Screws
1603 Thread Series	1632 Hexagon Nuts and Thin Nuts
1603 Prevailing-Torque Type Nuts	1633 Hexagon Slotted Nuts
1604 Metric Hex Flange Nuts	1634 Hexagon Bolts, Screws and Nuts
1604 Metric Nut Identification Symbols	1634 Nominal Lengths
1604 Metric Nut Designation	1636 Strength and Grade Designation
1607 Metric Washers	1636 Bolt and Nut Combinations
1607 Metric Plain Washers	1637 British Standard Studs
1607 Comparison with ISO Standards	Washers
1607 Types of Metric Plain Washers	1638 British Standard Spring Washers
1607 Materials and Finish	1639 Double Coil Washers
1607 Metric Plain Washer Designation	1640 Square Section Spring Washers
1609 Clearance Holes for Bolts, Screws, and Studs	1640 British Standard Metric Washers
1609 Inch Fasteners	
1610 Metric Fasteners	
1610 Recommended Substitute Drills	
1612 Metric Socket Head Cap Screws	
	MACHINE SCREWS AND NUTS
HELICAL COIL SCREW THREAD INSERTS	1643 ANSI Machine Screws, Inch
1613 Introduction	1643 Threads
1613 Tolerance Classes	1643 Length of Thread
1613 STI-tapped Hole	1643 Square and Hexagon Nuts
1614 Helical Coil Insert	1644 Diameter of Body
1614 Material	1644 Designation
1614 Properties	1644 Slotted Flat Countersunk Head
1614 Coatings	1646 Washer Head Machine Screws
1614 Configuration and Dimensions	1647 Slotted Truss Head
1615 STI Threaded Hole Data	1648 Slotted Pan Head
1617 Insert Length Data	1649 Slotted Fillister
1617 Inspection and Quality Assurance	1650 Slotted Oval Countersunk Head
1617 Inspection (Nondestructive)	1651 Slotted Binding Head
1618 Self-Locking Torque (Destructive)	1652 Slotted Round Head
1624 Torque Test Spacer	1652 Machine Screw Cross Recesses
1624 Insert Length Selection	1653 Slotted Head Miniature Screws
1624 Engaged Length of Bolt	1653 Head Types
1624 Material Strengths	1653 Fillister Head Dimensions
1625 Hardness Number Conversion	1654 Pan Head Dimensions
1625 Screw Thread Insert Taps	1654 100 Deg. Flat Head Dimensions
	1654 Binding Head Dimensions
	1655 Specifications
	1657 Standard Lengths
	1658 ANSI Metric Machine Screws
	1659 Thread Lengths
	1660 Square Recessed Flat Countersunk Head

TABLE OF CONTENTS

FASTENERS

MACHINE SCREWS AND NUTS	SELF-THREADING SCREWS
<i>(Continued)</i>	<i>(Continued)</i>
1661 Oval Countersunk Head	1716 Torsional Strength
1662 Square Recessed Pan Head	1716 Self-tapping Thread Inserts
1663 Hex and Hex Flange Head	1716 Screw Thread Inserts
1665 Nominal Screw Lengths	1716 Thread Cutting Tapping Screws
1666 BS Metric Machine Screws	1717 Threads and Points
1666 British Machine Screws	1718 Method of Designation
1669 Slotted Countersunk Head	1719 Nominal Screw Lengths
1670 Slotted Raised Countersunk Head	1720 Types BF, BT, D, F, and T Screws
1672 Machine Screw Nuts	1720 Material and Heat Treatment
1673 Slotted Pan Head	1721 Clearance Holes
1674 Slotted Cheese Head	1722 Clean-Punched Hole Sizes
1676 BS Unified Machine Screws	1725 BF and BT Metric Thread
1679 Whitworth Machine Screws	
CAP AND SET SCREWS	T-SLOTS, BOLTS, AND NUTS
1680 Cap Screws	1726 T-Slots
1681 Slotted Round	1727 T-Bolts
1682 Hexagon and Spline Socket	1728 T-Nuts
1683 Drill and Counterbore Size	
1684 Hexagon and Spline Socket	
1686 Socket Head Shoulder Screws	
1687 Slotted Headless Set Screws	
1688 Screw Optional Cup Points	
1689 Hexagon and Spline Sockets	
1690 Square Head Set Screws	
1692 Hexagon and Spline Keys and Bits	
1694 Hexagon Socket Screws	
1698 Button Head Screws	
1699 Hexagon Socket Set Screws	
1699 Holding Power of Set-screws	
1700 Bright Square Head Set-Screws	
SELF-THREADING SCREWS	RIVETS AND RIVETED JOINTS
1701 Sheet Metal, Self-Tapping, and Metallic Drive Screws	1729 Riveted Joint Design
1702 Method of Designation	1729 Classes and Types of Joints
1703 Self-Tapping Screws	1729 General Design Considerations
1704 Threads and Points	1730 Failure of Riveted Joints
1704 Cross Recesses	1731 Allowable Stresses
1705 Forming Tapping Screws	1731 Analysis of Joint Strength
1706 B and BP Thread	1732 Formulas for Riveted Joint Design
1707 Thread and Point Dimensions	1734 American National Standard Rivets
1708 D, F, G, and T Thread	1734 ANSI Large Rivets
1709 Hole Sizes	1734 Additional ANSI Rivet Tables
1710 Types A, B, and BP Screws	1734 ANSI Small Solid Rivets
1712 Types D, F, G, and T Screws	1735 Rivet Lengths for Forming Heads
1715 Types BF and BT Screws	1736 British Standard Rivets
1716 Type U Hardened Screw	1736 Rivets for General Engineering
	1736 Flat and Oval Head Countersunk
	1737 Button, Cone, and Pan Head
	1738 Swell Neck Rivets
	1738 Dimensions for Dolly Bars
	1739 Truss Head and Coopers Rivets
	1740 Tinnerns and Belt Rivets
	1741 Flat, Countersunk, Button, and Pan Head Rivets
	1742 British Standard Tables
	1742 General Purpose Small Rivets
	1742 Dimensions of Rivets
	1743 Countersunk, Snap, Universal, and Flat Head Rivets
	1744 BS Small Rivets
	1745 BS Standard Rivets

TABLE OF CONTENTS

FASTENERS

PINS AND STUDS		WING NUTS, WING SCREWS, AND THUMB SCREWS	
1746	Dowel & Cotter Pins	1791	Wing Nuts
1747	Clevis Pins	1794	Specification of Wing Nuts
1747	Metric Series Dowel Pins	1794	Threads for Wing Nuts
1748	Steel Dowel Pins	1795	Materials and Finish
1749	Hardened Ground Machine	1795	Wing Screws and Thumb Screws
1751	Unhardened Ground Dowel Pin	1796	Types A and B Wing Screws
1752	ANSI Straight Pins	1797	Types C and D Wing Screws
1753	ANSI Taper Pins	1798	Types A and B Thumb Screws
1754	Drilling Specifications	1799	Threads for Wing Screws
1756	ANSI Grooved Pins	1799	Points for Wing Screws
1757	T-Head Cotter Pins and Round Head Grooved Drive Studs		
1760	Grooved T-Head Cotter Pins	NAILS, SPIKES, AND WOOD SCREWS	
1760	Grooved Drive Studs	1800	Wire Nails and Spikes
1761	Slotted Type Spring Pins	1801	Wood Screws
1761	Spring Pins		
1762	Coiled Type Spring Pins		
RETAINING RINGS			
1763	Retaining Rings		
1763	Tapered Retaining Rings		
1766	Reduced Cross Section		
1769	Basic Internal Series		
1771	E-Type External Series		
1776	Heavy Duty Internal Spiral		
1778	Heavy Duty External Spiral		
1780	Dimensions of Retaining Rings		
1786	Inch Series Self-Locking		
1788	Retaining Ring Failure		
1789	Retaining Ring Standards		

TORQUE AND TENSION IN FASTENERS

Tightening Bolts.—Bolts are often tightened by applying torque to the head or nut, which causes the bolt to stretch. The stretching results in bolt tension or preload, which is the force that holds a joint together. Torque is relatively easy to measure with a torque wrench, so it is the most frequently used indicator of bolt tension. Unfortunately, a torque wrench does not measure bolt tension accurately, mainly because it does not take friction into account. The friction depends on bolt, nut, and washer material, surface smoothness, machining accuracy, degree of lubrication, and the number of times a bolt has been installed. Fastener manufacturers often provide information for determining torque requirements for tightening various bolts, accounting for friction and other effects. If this information is not available, the methods described in what follows give general guidelines for determining how much tension should be present in a bolt, and how much torque may need to be applied to arrive at that tension.

High preload tension helps keep bolts tight, increases joint strength, creates friction between parts to resist shear, and improves the fatigue resistance of bolted connections. The recommended preload F_i , which can be used for either static (stationary) or fatigue (alternating) applications, can be determined from: $F_i = 0.75 \times A_t \times S_p$ for reusable connections, and $F_i = 0.9 \times A_t \times S_p$ for permanent connections. In these formulas, F_i is the bolt preload, A_t is the tensile stress area of the bolt, and S_p is the proof strength of the bolt. Determine A_t from screw-thread tables or by means of formulas in this section. Proof strength S_p of commonly used ASTM and SAE steel fasteners is given in this section and in the section on metric screws and bolts for those fasteners. For other materials, an approximate value of proof strength can be obtained from: $S_p = 0.85 \times S_y$, where S_y is the yield strength of the material. Soft materials should not be used for threaded fasteners.

Once the required preload has been determined, one of the best ways to be sure that a bolt is properly tensioned is to measure its tension directly with a strain gage. Next best is to measure the change in length (elongation) of the bolt during tightening, using a micrometer or dial indicator. Each of the following two formulas calculates the required change in length of a bolt needed to make the bolt tension equal to the recommended preload. The change in length δ of the bolt is given by:

$$\delta = F_i \times \frac{A_d \times l_t + A_t \times l_d}{A_d \times A_t \times E} \quad (1) \quad \text{or} \quad \delta = \frac{F_i \times l}{A \times E} \quad (2)$$

In [Equation \(1\)](#), F_i is the bolt preload; A_d is the major-diameter area of the bolt; A_t is the tensile-stress area of the bolt; E is the bolt modulus of elasticity; l_t is the length of the threaded portion of the fastener within the grip; and l_d is the length of the unthreaded portion of the grip. Here, the grip is defined as the total thickness of the clamped material. [Equation \(2\)](#) is a simplified formula for use when the area of the fastener is constant, and gives approximately the same results as [Equation \(1\)](#). In [Equation \(2\)](#), l is the bolt length; A is the bolt area; and δ , F_i , and E are as described before.

If measuring bolt elongation is not possible, the torque necessary to tighten the bolt must be estimated. If the recommended preload is known, use the following general relation for the torque: $T = K \times F_i \times d$, where T is the wrench torque, K is a constant that depends on the bolt material and size, F_i is the preload, and d is the nominal bolt diameter. A value of $K = 0.2$ may be used in this equation for mild-steel bolts in the size range of $\frac{1}{4}$ to 1 inch (6.35–25.4 mm). For other steel bolts, use the following values of K : nonplated black finish, 0.3; zinc-plated, 0.2; lubricated, 0.18; cadmium-plated, 0.16. Check with bolt manufacturers and suppliers for values of K to use with bolts of other sizes and materials.

The proper torque to use for tightening bolts in sizes up to about $\frac{1}{2}$ inch (12.7 mm) may also be determined by trial. Test a bolt by measuring the amount of torque required to fracture it (use bolt, nut, and washers equivalent to those chosen for the real application). Then, use a tightening torque of about 50 to 60 per cent of the fracture torque determined by the test. The tension in a bolt tightened using this procedure will be about 60 to 70 per cent of the elastic limit (yield strength) of the bolt material.

The table that follows can be used to get a rough idea of the torque necessary to properly tension a bolt by using the bolt diameter d and the coefficients b and m from the table; the approximate tightening torque T in ft-lb for the listed fasteners is obtained by solving the equation $T = 10^{b+m \log d}$. This equation is approximate, for use with unlubricated fasteners as supplied by the mill. See the notes at the end of the table for more details on using the equation.

Wrench Torque $T = 10^{b+m \log d}$ for Steel Bolts, Studs, and Cap Screws (see notes)

Fastener Grade(s)	Bolt Diameter d (in.)	m	b
SAE 2, ASTM A307	$\frac{1}{4}$ to 3	2.940	2.533
SAE 3	$\frac{1}{4}$ to 3	3.060	2.775
ASTM A-449, A-354-BB, SAE 5	$\frac{1}{4}$ to 3	2.965	2.759
ASTM A-325 ^a	$\frac{1}{2}$ to $1\frac{1}{2}$	2.922	2.893
ASTM A-354-BC	$\frac{1}{4}$ to $\frac{5}{8}$	3.046	2.837
SAE 6, SAE 7	$\frac{1}{4}$ to 3	3.095	2.948
SAE 8	$\frac{1}{4}$ to 3	3.095	2.983
ASTM A-354-BD, ASTM A490 ^a	$\frac{3}{8}$ to $1\frac{3}{4}$	3.092	3.057
Socket Head Cap Screws	$\frac{1}{4}$ to 3	3.096	3.014

^a Values for permanent fastenings on steel structures.

Usage: Values calculated using the preceding equation are for standard, unplated industrial fasteners as received from the manufacturer; for cadmium-plated cap screws, multiply the torque by 0.9; for cadmium-plated nuts and bolts, multiply the torque by 0.8; for fasteners used with special lubricants, multiply the torque by 0.9; for studs, use cap screw values for equivalent grade.

Preload for Bolts in Loaded Joints.—The following recommendations are based on MIL-HDBK-60, a subsection of FED-STD-H28, Screw Thread Standards for Federal Service. Generally, bolt preload in joints should be high enough to maintain joint members in contact and in compression. Loss of compression in a joint may result in leakage of pressurized fluids past compression gaskets, loosening of fasteners under conditions of cyclic loading, and reduction of fastener fatigue life.

The relationship between fastener fatigue life and fastener preload is illustrated by Fig. 1. An axially loaded bolted joint in which there is no bolt preload is represented by line OAB, that is, the bolt load is equal to the joint load. When joint load varies between P_a and P_b , the bolt load varies accordingly between P_{Ba} and P_{Bb} . However, if preload P_{B1} is applied to the bolt, the joint is compressed and bolt load changes more slowly than the joint load (indicated by line $P_{B1}A$, whose slope is less than line OAB) because some of the load is absorbed as a reduction of compression in the joint. Thus, the axial load applied to the joint varies between $P_{Ba'}$ and $P_{Bb'}$ as joint load varies between P_a and P_b . This condition results in a considerable reduction in cyclic bolt-load variation and thereby increases the fatigue life of the fastener.

Preload for Bolts In Shear.—In shear-loaded joints, with members that slide, the joint members transmit shear loads to the fasteners in the joint and the preload must be sufficient to hold the joint members in contact. In joints that do not slide (i.e., there is no relative motion between joint members), shear loads are transmitted within the joint by frictional forces that mainly result from the preload. Therefore, preload must be great enough for the resulting friction forces to be greater than the applied shear force. With high applied shear loads, the shear stress induced in the fastener during application of the preload must also be

considered in the bolted-joint design. Joints with combined axial and shear loads must be analyzed to ensure that the bolts will not fail in either tension or shear.

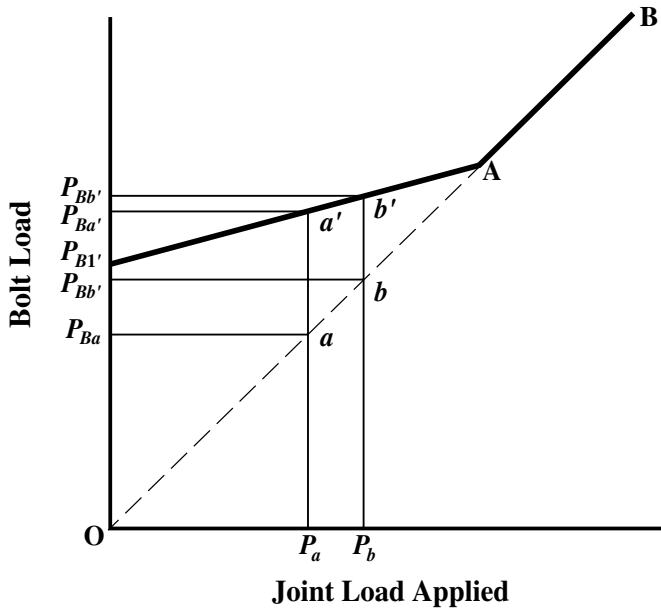


Fig. 1. Bolt Load in a Joint with Applied Axial Load

General Application of Preload.—Preload values should be based on joint requirements, as outlined before. Fastener applications are generally designed for maximum utilization of the fastener material; that is to say, the fastener size is the minimum required to perform its function and a maximum safe preload is generally applied to it. However, if a low-strength fastener is replaced by one of higher strength, for the sake of convenience or standardization, the preload in the replacement should not be increased beyond that required in the original fastener.

To utilize the maximum amount of bolt strength, bolts are sometimes tightened to or beyond the yield point of the material. This practice is generally limited to ductile materials, where there is considerable difference between the yield strength and the ultimate (breaking) strength, because low-ductility materials are more likely to fail due to unexpected overloads when preloaded to yield. Joints designed for primarily static load conditions that use ductile bolts, with a yield strain that is relatively far from the strain at fracture, are often preloaded above the yield point of the bolt material. Methods for tightening up to and beyond the yield point include tightening by feel without special tools, and the use of electronic equipment designed to compare the applied torque with the angular rotation of the fastener and detect changes that occur in the elastic properties of fasteners at yield.

Bolt loads are maintained below the yield point in joints subjected to cyclic loading and in joints using bolts of high-strength material where the yield strain is close to the strain at fracture. For these conditions, the maximum preloads generally fall within the following ranges: 50 to 80 per cent of the minimum tensile ultimate strength; 75 to 90 per cent of the minimum tensile yield strength or proof load; or 100 per cent of the observed proportional limit or onset of yield.

Bolt heads, driving recesses (in socket screws, for example), and the juncture of head and shank must be sufficiently strong to withstand the preload and any additional stress encountered during tightening. There must also be sufficient thread to prevent stripping (generally, at least three fully engaged threads). Materials susceptible to stress-corrosion cracking may require further preload limitations.

Preload Adjustments.—Preloads may be applied directly by axial loading or indirectly by turning of the nut or bolt. When preload is applied by turning of nuts or bolts, a torsion load component is added to the desired axial bolt load. This combined loading increases the tensile stress on the bolt. It is frequently assumed that the additional torsion load component dissipates quickly after the driving force is removed and, therefore, can be largely ignored. This assumption may be reasonable for fasteners loaded near to or beyond yield strength, but for critical applications where bolt tension must be maintained below yield, it is important to adjust the axial tension requirements to include the effects of the preload torsion. For this adjustment, the combined tensile stress (*von Mises* stress) F_{tc} in psi (MPa) can be calculated from the following:

$$F_{tc} = \sqrt{F_t^2 + 3F_s^2} \quad (3)$$

where F_t is the axial applied tensile stress in psi (MPa), and F_s is the shear stress in psi (MPa) caused by the torsion load application.

Some of the torsion load on a bolt, acquired when applying a preload, may be released by springback when the wrenching torque is removed. The amount of relaxation depends on the friction under the bolt head or nut. With controlled back turning of the nut, the torsional load may be reduced or eliminated without loss of axial load, reducing bolt stress and lowering creep and fatigue potential. However, calculation and control of the back-turn angle is difficult, so this method has limited application and cannot be used for short bolts because of the small angles involved.

For relatively soft work-hardenable materials, tightening bolts in a joint slightly beyond yield will work-harden the bolt to some degree. Back turning of the bolt to the desired tension will reduce embedment and metal flow and improve resistance to preload loss.

The following formula for use with single-start Unified inch screw threads calculates the combined tensile stress, F_{tc} :

$$F_{tc} = F_t \sqrt{1 + 3 \left(\frac{1.96 + 2.31\mu}{1 - 0.325P/d_2} - 1.96 \right)^2} \quad (4)$$

Single-start UNJ screw threads in accordance with MIL-S-8879 have a thread stress diameter equal to the bolt pitch diameter. For these threads, F_{tc} can be calculated from:

$$F_{tc} = F_t \sqrt{1 + 3 \left(\frac{0.637P}{d_2} + 2.31\mu \right)^2} \quad (5)$$

where μ is the coefficient of friction between threads, P is the thread pitch ($P = 1/n$, and n is the number of threads per inch), and d_2 is the bolt-thread pitch diameter in inches. Both **Equations (2) and (3)** are derived from **Equation (1)**; thus, the quantity within the radical ($\sqrt{\quad}$) represents the proportion of increase in axial bolt tension resulting from preload torsion. In these equations, tensile stress due to torsion load application becomes most significant when the thread friction, μ , is high.

Coefficients of Friction for Bolts and Nuts.—**Table 1** gives examples of coefficients of friction that are frequently used in determining torque requirements. Dry threads, indicated by the words "None added" in the Lubricant column, are assumed to have some residual machine oil lubrication. **Table 1** values are not valid for threads that have been cleaned to remove all traces of lubrication because the coefficient of friction of these threads may be very much higher unless a plating or other film is acting as a lubricant.

Table 1. Coefficients of Friction of Bolts and Nuts

Bolt/Nut Materials	Lubricant	Coefficient of Friction, $\mu \pm 20\%$
Steel ^a	Graphite in petrolatum or oil	0.07
	Molybdenum disulfide grease	0.11
	Machine oil	0.15
Steel, ^a cadmium-plated	None added	0.12
Steel, ^a zinc-plated	None added	0.17
Steel ^a /bronze	None added	0.15
Corrosion-resistant steel or nickel-base alloys/silver-plated materials	None added	0.14
Titanium/steel ^a	Graphite in petrolatum	0.08
Titanium	Molybdenum disulfide grease	0.10

^a“Steel” includes carbon and low-alloy steels but not corrosion-resistant steels.

Where two materials are separated by a slash (/), either may be the bolt material; the other is the nut material.

Preload Relaxation.—Local yielding, due to excess bearing stress under nuts and bolt heads (caused by high local spots, rough surface finish, and lack of perfect squareness of bolt and nut bearing surfaces), may result in preload relaxation after preloads are first applied to a bolt. Bolt tension also may be unevenly distributed over the threads in a joint, so thread deformation may occur, causing the load to be redistributed more evenly over the threaded length. Preload relaxation occurs over a period of minutes to hours after the application of the preload, so retightening after several minutes to several days may be required. As a general rule, an allowance for loss of preload of about 10 per cent may be made when designing a joint.

Increasing the resilience of a joint will make it more resistant to local yielding, that is, there will be less loss of preload due to yielding. When practical, a joint-length to bolt-diameter ratio of 4 or more is recommended; for example, a ¼-inch (6.35 mm) bolt and a 1-inch (25.4 mm) or greater joint length. Through bolts, far-side tapped holes, spacers, and washers can be used in the joint design to improve the joint-length to bolt-diameter ratio.

Over an extended period of time, preload may be reduced or completely lost due to vibration; temperature cycling, including changes in ambient temperature; creep; joint load; and other factors. An increase in the initial bolt preload or the use of thread-locking methods that prevent relative motion of the joint may reduce the problem of preload relaxation due to vibration and temperature cycling. Creep is generally a high-temperature effect, although some loss of bolt tension can be expected even at normal temperatures. Harder materials and creep-resistant materials should be considered if creep is a problem or high-temperature service of the joint is expected.

Mechanical properties of fastener materials vary significantly with temperature, and allowance must be made for these changes when ambient temperatures range beyond 30 to 200°F (–1 to 93°C). Mechanical properties that may change include tensile strength, yield strength, and modulus of elasticity. Where bolts and flange materials are generically dissimilar, such as carbon steel and corrosion-resistant steel, or steel and brass, differences in thermal expansion that might cause preload to increase or decrease must be taken into consideration.

Methods of Applying and Measuring Preload.—Depending on the tightening method, the accuracy of preload application may vary up to 25 per cent or more. Care must be taken to maintain the calibration of torque and load indicators. Allowance should be made for uncertainties in bolt load to prevent overstressing the bolts or failing to obtain sufficient preload. The method of tensioning should be based on required accuracy and relative costs.

The most common methods of bolt tension control are indirect because it is usually difficult or impractical to measure the tension produced in each fastener during assembly. Table 2 lists the most frequently used methods of applying bolt preload and the approximate accuracy of each method. For many applications, fastener tension can be satisfactorily controlled within certain limits by applying a known torque to the fastener. Laboratory tests have shown that whereas a satisfactory torque tension relationship can be established for a given set of conditions, a change of any of the variables, such as fastener material, surface finish, and the presence or absence of lubrication, may severely alter the relationship. Because most of the applied torque is absorbed in intermediate friction, a change in the surface roughness of the bearing surfaces or a change in the lubrication will drastically affect the friction and thus the torque tension relationship. Regardless of the method or accuracy of applying the preload, tension will decrease in time if the bolt, nut, or washer seating faces deform under load, if the bolt stretches or creeps under tensile load, or if cyclic loading causes relative motion between joint members.

Table 2. Accuracy of Bolt Preload Application Methods

Method	Accuracy	Method	Accuracy
By feel	±35%	Computer-controlled wrench	
Torque wrench	±25%	below yield (turn-of-nut)	±15%
Turn-of-nut	±15%	yield-point sensing	±8%
Preload indicating washer	±10%	Bolt elongation	±3–5%
Strain gages	±1%	Ultrasonic sensing	±1%

Tightening methods using power drivers are similar in accuracy to equivalent manual methods.

Elongation Measurement.—Bolt elongation is directly proportional to axial stress when the applied stress is within the elastic range of the material. If both ends of a bolt are accessible, a micrometer measurement of bolt length made before and after the application of tension will ensure the required axial stress is applied. The elongation δ in inches (mm) can be determined from the formula $\delta = F_t \times L_B \div E$, given the required axial stress F_t in psi (MPa), the bolt modulus of elasticity E in psi (MPa), and the effective bolt length L_B in inches (mm). L_B , as indicated in Fig. 2, includes the contribution of bolt area and ends (head and nut) and is calculated from:

$$L_B = \left(\frac{d_{ts}}{d}\right)^2 \times \left(L_s + \frac{H_B}{2}\right) + L_J - L_S + \frac{H_N}{2} \tag{6}$$

where d_{ts} is the thread stress diameter, d is the bolt diameter, L_s is the unthreaded length of the bolt shank, L_j is the overall joint length, H_B is the height of the bolt head, and H_N is the height of the nut.

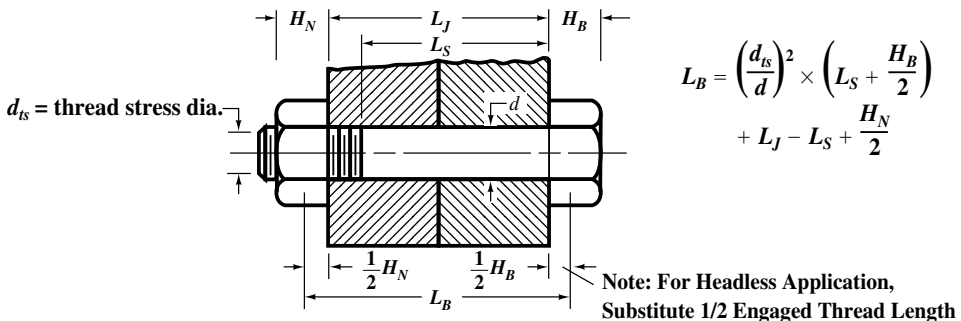


Fig. 2. Effective Length Applicable in Elongation Formulas

The micrometer method is most easily and accurately applied to bolts that are essentially uniform throughout the bolt length, that is, threaded along the entire length or that have only a few threads in the bolt grip area. If the bolt geometry is complex, such as tapered or stepped, the elongation is equal to the sum of the elongations of each section with allowances made for transitional stresses in bolt head height and nut engagement length.

The direct method of measuring elongation is practical only if both ends of a bolt are accessible. Otherwise, if the diameter of the bolt or stud is sufficiently large, an axial hole can be drilled, as shown in Fig. 3, and a micrometer depth gage or other means used to determine the change in length of the hole as the fastener is tightened. A similar method uses a special indicating bolt that has a blind axial hole containing a pin fixed at the bottom. The pin is usually made flush with the bolt head surface before load application. As the bolt is loaded, the elongation causes the end of the pin to move below the reference surface. The displacement of the pin can be converted directly into unit stress by means of a calibrated gage. In some bolts of this type, the pin is set a distance above the bolt so that the pin is flush with the bolt head when the required axial load is reached.

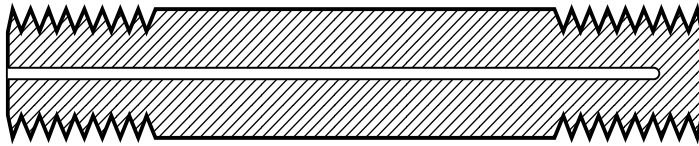


Fig. 3. Hole Drilled to Measure Elongation When One End of Stud or Bolt Is Not Accessible

The *ultrasonic method* of measuring elongation uses a sound pulse, generated at one end of a bolt, that travels the length of a bolt, bounces off the far end, and returns to the sound generator in a measured period of time. The time required for the sound pulse to return depends on the length of the bolt and the speed of sound in the bolt material. The speed of sound in the bolt depends on the material, the temperature, and the stress level. The ultrasonic measurement system can compute the stress, load, or elongation of the bolt at any time by comparing the pulse travel time in the loaded and unstressed conditions. In a similar method, measuring round-trip transit times of longitudinal and shear wave sonic pulses allows calculation of tensile stress in a bolt without consideration of bolt length. This method permits checking bolt tension at any time and does not require a record of the ultrasonic characteristics of each bolt at zero load.

To ensure consistent results, the ultrasonic method requires that both ends of the bolt be finished square to the bolt axis. The accuracy of ultrasonic measurement compares favorably with strain gage methods, but is limited by sonic velocity variations between bolts of the same material and by corrections that must be made for unstressed portions of the bolt heads and threads.

The *turn-of-nut method* applies preload by turning a nut through an angle that corresponds to a given elongation. The elongation of the bolt is related to the angle turned by the formula: $\delta_B = \theta \times l \div 360$, where δ_B is the elongation in inches (mm), θ is the turn angle of the nut in degrees, and l is the lead of the thread helix in inches (mm). Substituting $F_t \times L_B \div E$ for elongation δ_B in this equation gives the turn-of-nut angle required to attain preload F_t :

$$\theta = 360 \frac{F_t L_B}{E l} \quad (7)$$

where L_B is given by Equation (6), and E is the modulus of elasticity.

Accuracy of the turn-of-nut method is affected by elastic deformation of the threads, by roughness of the bearing surfaces, and by the difficulty of determining the starting point for measuring the angle. The starting point is usually found by tightening the nut enough to seat the contact surfaces firmly, and then loosening it just enough to release any tension and twisting in the bolt. The nut-turn angle will be different for each bolt size, length, mate-

rial, and thread lead. The preceding method of calculating the nut-turn angle also requires elongation of the bolt without a corresponding compression of the joint material. The turn-of-nut method, as just outlined, is not valid for joints with compressible gaskets or other soft material, or if there is a significant deformation of the nut and joint material relative to that of the bolt. The nut-turn angle would then have to be determined empirically using a simulated joint and a tension-measuring device.

The Japanese Industrial Standards (JIS) Handbook, *Fasteners and Screw Threads*, indicates that the turn-of-nut tightening method is applicable in both elastic and plastic region tightening. Refer to JIS B 1083 for more detail on this subject.

Heating causes a bolt to expand at a rate proportional to its coefficient of expansion. When a hot bolt and nut are fastened in a joint and cooled, the bolt shrinks and tension is developed. The temperature necessary to develop an axial stress, F_t , (when the stress is below the elastic limit) can be found as follows:

$$T = \frac{F_t}{Ee} + T_o \quad (8)$$

In this equation, T is the temperature in degrees Fahrenheit needed to develop the axial tensile stress F_t in psi, E is the bolt material modulus of elasticity in psi, e is the coefficient of linear expansion in in./in.-°F, and T_o is the temperature in degrees Fahrenheit to which the bolt will be cooled. $T - T_o$ is, therefore, the temperature change of the bolt. In finite-element simulations, heating and cooling are frequently used to preload mesh elements in tension or compression. Equation (8) can be used to determine required temperature changes in such problems.

Example: A tensile stress of 40,000 psi is required for a steel bolt in a joint operating at 70°F. If E is 30×10^6 psi and e is 6.2×10^{-6} in./in.-°F, determine the temperature of the bolt needed to develop the required stress on cooling.

$$T = \frac{40,000}{(30 \times 10^6)(6.2 \times 10^{-6})} + 70 = 285^\circ\text{F}$$

In practice, the bolt is heated slightly above the required temperature (to allow for some cooling while the nut is screwed down) and the nut is tightened snugly. Tension develops as the bolt cools. In another method, the nut is tightened snugly on the bolt, and the bolt is heated in place. When the bolt has elongated sufficiently, as indicated by inserting a thickness gage between the nut and the bearing surface of the joint, the nut is tightened. The bolt develops the required tension as it cools; however, preload may be lost if the joint temperature increases appreciably while the bolt is being heated.

Calculating Thread Tensile-Stress Area.—The tensile-stress area for Unified threads is based on a diameter equivalent to the mean of the pitch and minor diameters. The pitch and the minor diameters for Unified screw threads can be found from the major (nominal) diameter, d , and the screw pitch, $P = 1/n$, where n is the number of threads per inch, by use of the following formulas: the pitch diameter $d_p = d - 0.649519 \times P$; the minor diameter $d_m = d - 1.299038 \times P$. The tensile stress area, A_s , for Unified threads can then be found as follows:

$$A_s = \frac{\pi}{4} \left(\frac{d_m + d_p}{2} \right)^2 \quad (9)$$

UNJ threads in accordance with MIL-S-8879 have a tensile thread area that is usually considered to be at the basic bolt pitch diameter; for these threads, $A_s = (\pi d_p^2)/4$. The tensile stress area for Unified screw threads is smaller than this area, so the required tightening torque for UNJ threaded bolts is greater than for an equally stressed Unified threaded

bolt in an equivalent joint. To convert tightening torque for a Unified fastener to the equivalent torque required with a UNJ fastener, use the following relationship:

$$\text{UNJ}_{\text{torque}} = \left(\frac{d \times n - 0.6495}{d \times n - 0.9743} \right)^2 \times \text{Unified}_{\text{torque}} \tag{10}$$

where d is the basic thread major diameter, and n is the number of threads per inch.

The tensile stress area for metric threads is based on a diameter equivalent to the mean of the pitch diameter and a diameter obtained by subtracting $\frac{1}{6}$ the height of the fundamental thread triangle from the external-thread minor diameter. The Japanese Industrial Standard JIS B 1082 (see also ISO 898/1) defines the stress area of metric screw threads as follows:

$$A_s = \frac{\pi}{4} \left(\frac{d_2 + d_3}{2} \right)^2 \tag{11}$$

In Equation (11), A_s is the stress area of the metric screw thread in mm^2 ; d_2 is the pitch diameter of the external thread in mm, given by $d_2 = d - 0.649515 \times P$; and d_3 is defined by $d_3 = d_1 - H/6$. Here, d is the nominal bolt diameter; P is the thread pitch; $d_1 = d - 1.082532 \times P$ is the minor diameter of the external thread in mm; and $H = 0.866025 \times P$ is the height of the fundamental thread triangle. Substituting the formulas for d_2 and d_3 into Equation (11) results in $A_s = 0.7854(d - 0.9382P)^2$.

The stress area, A_s , of Unified threads in mm^2 is given in JIS B 1082 as:

$$A_s = 0.7854 \left(d - \frac{0.9743}{n} \times 25.4 \right)^2 \tag{12}$$

Relation between Torque and Clamping Force.—The Japanese Industrial Standard JIS B 1803 defines fastener tightening torque T_f as the sum of the bearing surface torque T_w and the shank (threaded) portion torque T_s . The relationship between the applied tightening torque and bolt preload F_f is as follows: $T_f = T_s + T_w = K \times F_f \times d$. In the preceding, d is the nominal diameter of the screw thread, and K is the torque coefficient defined as follows:

$$K = \frac{1}{2d} \left(\frac{P}{\pi} + \mu_s d_2 \sec \alpha' + \mu_w D_w \right) \tag{13}$$

where P is the screw thread pitch; μ_s is the coefficient of friction between threads; d_2 is the pitch diameter of the thread; μ_w is the coefficient of friction between bearing surfaces; D_w is the equivalent diameter of the friction torque bearing surfaces; and α' is the flank angle at the ridge perpendicular section of the thread ridge, defined by $\tan \alpha' = \tan \alpha \cos \beta$, where α is the thread half angle (30° , for example), and β is the thread helix, or lead, angle. β can be found from $\tan \beta = l \div 2\pi r$, where l is the thread lead, and r is the thread radius (i.e., one-half the nominal diameter d). When the bearing surface contact area is circular, D_w can be obtained as follows:

$$D_w = \frac{2}{3} \times \frac{D_o^3 - D_i^3}{D_o^2 - D_i^2} \tag{14}$$

where D_o and D_i are the outside and inside diameters, respectively, of the bearing surface contact area.

The torques attributable to the threaded portion of a fastener, T_s , and bearing surfaces of a joint, T_w , are as follows:

$$T_s = \frac{F_f}{2} \left(\frac{P}{\pi} + \mu_s d_2 \sec \alpha' \right) \tag{15} \qquad T_w = \frac{F_f}{2} \mu_w D_w \tag{16}$$

where F_f , P , μ , d_2 , α' , μ_w , and D_w are as previously defined.

Tables 3 and 4 give values of torque coefficient K for coarse- and fine-pitch metric screw threads corresponding to various values of μ_s and μ_w . When a fastener material yields according to the shearing-strain energy theory, the torque corresponding to the yield clamping force (see Fig. 4) is $T_{fy} = K \times F_{fy} \times d$, where the yield clamping force F_{fy} is given by:

$$F_{fy} = \frac{\sigma_y A_s}{\sqrt{1 + 3 \left[\frac{2}{d_A} \left(\frac{P}{\pi} + \mu_s d_2 \sec \alpha' \right) \right]^2}} \tag{17}$$

Table 3. Torque Coefficients K for Metric Hexagon Head Bolt and Nut Coarse Screw Threads

Between Threads, μ_s	Coefficient of Friction									
	Between Bearing Surfaces, μ_w									
	0.08	0.10	0.12	0.15	0.20	0.25	0.30	0.35	0.40	0.45
0.08	0.117	0.130	0.143	0.163	0.195	0.228	0.261	0.293	0.326	0.359
0.10	0.127	0.140	0.153	0.173	0.206	0.239	0.271	0.304	0.337	0.369
0.12	0.138	0.151	0.164	0.184	0.216	0.249	0.282	0.314	0.347	0.380
0.15	0.153	0.167	0.180	0.199	0.232	0.265	0.297	0.330	0.363	0.396
0.20	0.180	0.193	0.206	0.226	0.258	0.291	0.324	0.356	0.389	0.422
0.25	0.206	0.219	0.232	0.252	0.284	0.317	0.350	0.383	0.415	0.448
0.30	0.232	0.245	0.258	0.278	0.311	0.343	0.376	0.409	0.442	0.474
0.35	0.258	0.271	0.284	0.304	0.337	0.370	0.402	0.435	0.468	0.500
0.40	0.285	0.298	0.311	0.330	0.363	0.396	0.428	0.461	0.494	0.527
0.45	0.311	0.324	0.337	0.357	0.389	0.422	0.455	0.487	0.520	0.553

Values in the table are average values of torque coefficient calculated using: Equations (13) and (14) for K and D_w ; diameters d of 4, 5, 6, 8, 10, 12, 16, 20, 24, 30, and 36 mm; and selected corresponding pitches P and pitch diameters d_2 according to JIS B 0205 (ISO 724) thread standard. Dimension D_i was obtained for a Class 2 fit without chamfer from JIS B 1001, Diameters of Clearance Holes and Counterbores for Bolts and Screws (equivalent to ISO 273-1979). The value of D_o was obtained by multiplying the reference dimension from JIS B 1002, width across the flats of the hexagon head, by 0.95.

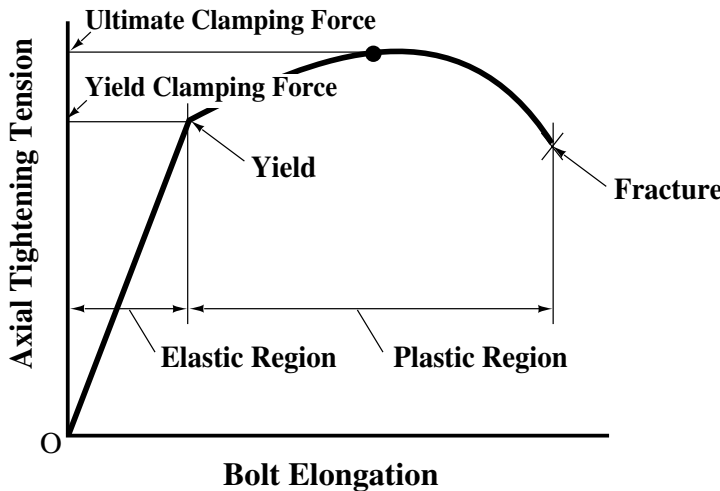


Fig. 4. The Relationship between Bolt Elongation and Axial Tightening Tension

Table 4. Torque Coefficients K for Metric Hexagon Head Bolt and Nut Fine-Screw Threads

Coefficient of Friction										
Between Threads, μ_s	Between Bearing Surfaces, μ_w									
	0.08	0.10	0.12	0.15	0.20	0.25	0.30	0.35	0.40	0.45
0.08	0.106	0.118	0.130	0.148	0.177	0.207	0.237	0.267	0.296	0.326
0.10	0.117	0.129	0.141	0.158	0.188	0.218	0.248	0.278	0.307	0.337
0.12	0.128	0.140	0.151	0.169	0.199	0.229	0.259	0.288	0.318	0.348
0.15	0.144	0.156	0.168	0.186	0.215	0.245	0.275	0.305	0.334	0.364
0.20	0.171	0.183	0.195	0.213	0.242	0.272	0.302	0.332	0.361	0.391
0.25	0.198	0.210	0.222	0.240	0.270	0.299	0.329	0.359	0.389	0.418
0.30	0.225	0.237	0.249	0.267	0.297	0.326	0.356	0.386	0.416	0.445
0.35	0.252	0.264	0.276	0.294	0.324	0.353	0.383	0.413	0.443	0.472
0.40	0.279	0.291	0.303	0.321	0.351	0.381	0.410	0.440	0.470	0.500
0.45	0.306	0.318	0.330	0.348	0.378	0.408	0.437	0.467	0.497	0.527

Values in the table are average values of torque coefficient calculated using Equations (13) and (14) for K and D_w ; diameters d of 8, 10, 12, 16, 20, 24, 30, and 36 mm; and selected respective pitches P and pitch diameters d_2 according to JIS B 0207 thread standard (ISO 724). Dimension D_i was obtained for a Class 1 fit without chamfer from JIS B 1001, Diameters of Clearance Holes and Counterbores for Bolts and Screws (equivalent to ISO 273-1979). The value of D_o was obtained by multiplying the reference dimension from JIS B 1002 (small type series), width across the flats of the hexagon head, by 0.95.

In Equation (17), σ_y is the yield point or proof stress of the bolt, A_s is the stress area of the thread, and $d_A = (4A_s/\pi)^{1/2}$ is the diameter of a circle having an area equal to the stress area of the thread. The other variables have been identified previously.

Example: Find the torque required to tighten a 10-mm coarse-threaded ($P = 1.5$) grade 8.8 bolt to yield assuming that both the thread- and bearing-friction coefficients are 0.12.

Solution: From Equation (17), calculate F_{fy} and then solve $T_{fy} = KF_{fy}d$ to obtain the torque required to stress the bolt to the yield point.

$$\begin{aligned} \sigma_y &= 640 \text{ N/mm}^2 \text{ (MPa) (minimum, based on 8.8 grade rating)} \\ A_s &= 0.7854(10 - 0.9382 \times 1.5)^2 = 57.99 \text{ mm}^2 \\ d_A &= (4A_s/\pi)^{1/2} = 8.6 \text{ mm} \\ d_2 &= 9.026 \text{ mm (see JIS B 0205 or ISO 724)} \end{aligned}$$

Find α' from $\tan \alpha' = \tan \alpha \cos \beta$ using:

$$\begin{aligned} \alpha &= 30^\circ; \tan \beta = l \div 2\pi r; l = P = 1.5; \text{ and } r = d \div 2 = 5 \text{ mm} \\ \tan \beta &= 1.5 \div 10\pi = 0.0477, \text{ therefore } \beta = 2.73^\circ \\ \tan \alpha' &= \tan \alpha \cos \beta = \tan 30^\circ \times \cos 2.73^\circ = 0.577, \text{ and } \alpha' = 29.97^\circ \end{aligned}$$

Solving Equation (17) gives the yield clamping force as follows:

$$F_{fy} = \frac{640 \times 57.99}{\sqrt{1 + 3 \left[\frac{2}{8.6} \left(\frac{1.5}{\pi} + 0.12 \times 9.026 \times \sec 29.97^\circ \right) \right]^2}} = 30,463 \text{ N}$$

K can be determined from Tables 3 (coarse thread) and Tables 4 (fine thread) or from Equations (13) and (14). From Table 3, for μ_s and μ_w equal to 0.12, $K = 0.164$. The yield-point tightening torque can then be found from $T_{fy} = K \times F_{fy} \times d = 0.164 \times 30,463 \times 10 = 49.9 \times 10^3 \text{ N}\cdot\text{mm} = 49.9 \text{ N}\cdot\text{m}$.

Obtaining Torque and Friction Coefficients.—Given suitable test equipment, the torque coefficient K and friction coefficients between threads μ_s or between bearing surfaces μ_w can be determined experimentally as follows: Measure the value of the axial tight-

ening tension and the corresponding tightening torque at an arbitrary point in the 50 to 80 per cent range of the bolt yield point or proof stress (for steel bolts, use the minimum value of the yield point or proof stress multiplied by the stress area of the bolt). Repeat this test several times and average the results. The tightening torque may be considered as the sum of the torque on the threads plus the torque on the bolt head- or nut-to-joint bearing surface. The torque coefficient can be found from $K = T_f \div F_f \times d$, where F_f is the measured axial tension, and T_f is the measured tightening torque.

To measure the coefficient of friction between threads or bearing surfaces, obtain the total tightening torque and that portion of the torque due to the thread or bearing surface friction. If only tightening torque and the torque on the bearing surfaces can be measured, then the difference between these two measurements can be taken as the thread-tightening torque. Likewise, if only the tightening torque and threaded-portion torque are known, the torque due to bearing can be taken as the difference between the known torques. The coefficients of friction between threads and bearing surfaces, respectively, can be obtained from the following:

$$\mu_s = \frac{2T_s \cos \alpha'}{d_2 F_f} - \cos \alpha' \tan \beta \quad (18) \quad \mu_w = \frac{2T_w}{D_w F_f} \quad (19)$$

As before, T_s is the torque attributable to the threaded portion of the screw, T_w is the torque due to bearing, D_w is the equivalent diameter of friction torque on bearing surfaces according to Equation (14), and F_f is the measured axial tension.

Torque-Tension Relationships.—Torque is usually applied to develop an axial load in a bolt. To achieve the desired axial load in a bolt, the torque must overcome friction in the threads and friction under the nut or bolt head. In Fig. 5, the axial load P_B is a component of the normal force developed between threads. The normal-force component perpendicular to the thread helix is $P_{N\beta}$ and the other component of this force is the torque load $P_B \tan \beta$ that is applied in tightening the fastener. Assuming the turning force is applied at the pitch diameter of the thread, the torque T_1 needed to develop the axial load is $T_1 = P_B \times \tan \beta \times d_2/2$. Substituting $\tan \beta = l \div \pi d_2$ into the previous expression gives $T_1 = P_B \times l \div 2\pi$.

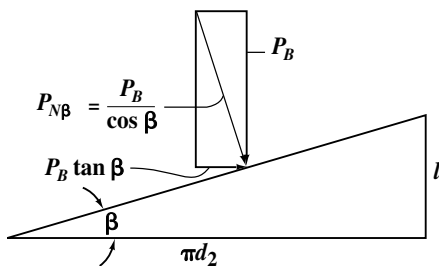


Fig. 5. Free Body Diagram of Thread Helix Forces

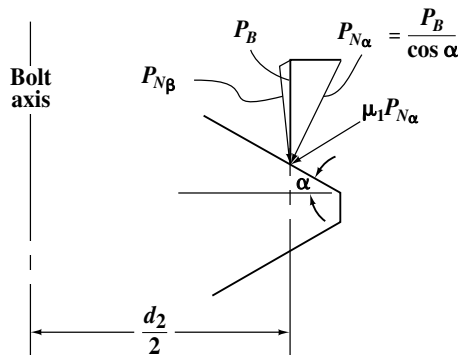


Fig. 6. Thread Friction Force

In Fig. 6, the normal-force component perpendicular to the thread flanks is $P_{N\alpha}$. With a coefficient of friction μ_1 between the threads, the friction load is equal to $\mu_1 P_{N\alpha}$, or $\mu_1 P_B \div \cos \alpha$. Assuming the force is applied at the pitch diameter of the thread, the torque T_2 to overcome thread friction is given by:

$$T_2 = \frac{d_2 \mu_1 P_B}{2 \cos \alpha} \quad (20)$$

With the coefficient of friction μ_2 between a nut or bolt-head pressure face and a component face, as in Fig. 7, the friction load is equal to $\mu_2 P_B$. Assuming the force is applied midway between the nominal (bolt) diameter d and the pressure-face diameter b , the torque T_3 to overcome the nut or bolt underhead friction is:

$$T_3 = \frac{d+b}{4} \mu_2 P_B \tag{21}$$

The total torque, T , required to develop axial bolt load, P_B , is equal to the sum of the torques T_1 , T_2 , and T_3 as follows:

$$T = P_B \left(\frac{l}{2\pi} + \frac{d_2 \mu_1}{2 \cos \alpha} + \frac{(d+b)\mu_2}{4} \right) \tag{22}$$

For a fastener system with 60° threads, $\alpha = 30^\circ$ and d_2 is approximately $0.92d$. If no loose washer is used under the rotated nut or bolt head, b is approximately $1.5d$ and Equation (22) reduces to:

$$T = P_B [0.159 \times l + d(0.531\mu_1 + 0.625\mu_2)] \tag{23}$$

In addition to the conditions of Equation (23), if the thread and bearing friction coefficients, μ_1 and μ_2 , are equal (which is not necessarily so), then $\mu_1 = \mu_2 = \mu$, and the previous equation reduces to:

$$T = P_B (0.159l + 1.156\mu d) \tag{24}$$

Example: Estimate the torque required to tighten a UNC $\frac{1}{2}$ -13 grade 8 steel bolt to a preload equivalent to 55 per cent of the minimum tensile bolt strength. Assume that the bolt is unplated and both the thread and bearing friction coefficients equal 0.15.

Solution: The minimum tensile strength for SAE grade 8 bolt material is 150,000 psi (from page 1534). To use Equation (24), find the stress area of the bolt using Equation (9) with $P = 1/13$, $d_m = d - 1.2990P$, and $d_p = d - 0.6495P$, and then calculate the necessary preload, P_B , and the applied torque, T .

$$A_s = \frac{\pi}{4} \left(\frac{0.4500 + 0.4001}{2} \right)^2 = 0.1419 \text{ in.}^2$$

$$P_B = \sigma_{\text{allow}} \times A_s = 0.55 \times 150,000 \times 0.1419 = 11,707 \text{ lb}_f$$

$$T = 11,707 \left(\frac{0.159}{13} + 1.156 \times 0.15 \times 0.500 \right) = 1158 \text{ lb-in.} = 96.5 \text{ lb-ft}$$

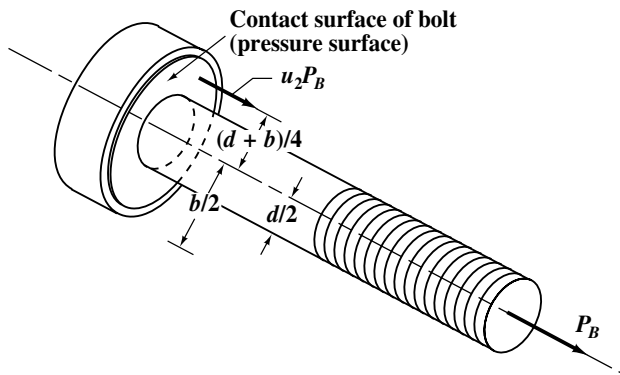


Fig. 7. Nut or Bolt Head Friction Force

Grade Marks and Material Properties for Bolts and Screws.—Bolts, screws, and other fasteners are marked on the head with a symbol that identifies the grade of the fastener. The grade specification establishes the minimum mechanical properties that the fastener must meet. Additionally, industrial fasteners must be stamped with a registered head mark that identifies the manufacturer. The grade identification table identifies the grade markings and gives mechanical properties for some commonly used ASTM and SAE steel fasteners. Metric fasteners are identified by property grade marks, which are specified in ISO and SAE standards. These marks are discussed with metric fasteners.

Grade Identification Marks and Mechanical Properties of Bolts and Screws

Identifier	Grade	Size (in.)	Min. Strength (10 ³ psi)			Material & Treatment
			Proof	Tensile	Yield	
A	SAE Grade 1	¼ to 1½	33	60	36	1
	ASTM A307	¼ to 1½	33	60	36	3
	SAE Grade 2	¼ to ¾	55	74	57	1
		⅞ to 1½	33	60	36	
	SAE Grade 4	¼ to 1½	65	115	100	2, a
B	SAE Grade 5	¼ to 1	85	120	92	2, b
	ASTM A449	1⅛ to 1½	74	105	81	
	ASTM A449	1¾ to 3	55	90	58	
C	SAE Grade 5.2	¼ to 1	85	120	92	4, b
D	ASTM A325, Type 1	½ to 1	85	120	92	2, b
		1⅛ to 1½	74	105	81	
E	ASTM A325, Type 2	½ to 1	85	120	92	4, b
		1⅛ to 1½	74	105	81	
F	ASTM A325, Type 3	½ to 1	85	120	92	5, b
		1⅛ to 1½	74	105	81	
G	ASTM A354, Grade BC	¼ to 2½	105	125	109	5, b
		2¾ to 4	95	115	99	
H	SAE Grade 7	¼ to 1½	105	133	115	7, b
I	SAE Grade 8	¼ to 1½	120	150	130	7, b
	ASTM A354, Grade BD	¼ to 1½	120	150	130	6, b
J	SAE Grade 8.2	¼ to 1	120	150	130	4, b
K	ASTM A490, Type 1	½ to 1½	120	150	130	6, b
L	ASTM A490, Type 3					5, b

Material Steel: 1—low or medium carbon; 2—medium carbon; 3—low carbon; 4—low-carbon martensite; 5—weathering steel; 6—alloy steel; 7—medium-carbon alloy. Treatment: a—cold drawn; b—quench and temper.

Detecting Counterfeit Fasteners.—Fasteners that have markings identifying them as belonging to a specific grade or property class are counterfeit if they do not meet the standards established for that class. Counterfeit fasteners may break unexpectedly at smaller loads than expected. Generally, these fasteners are made from the wrong material or they are not properly strengthened during manufacture. Either way, counterfeit fasteners can lead to dangerous failures in assemblies. The law now requires testing of fasteners used in some critical applications. Detection of counterfeit fasteners is difficult because the counterfeits look genuine. The only sure way to determine if a fastener meets its specification is to test it. However, reputable distributors will assist in verifying the authenticity of the fasteners they sell. For important applications, fasteners can be checked to determine whether they perform according to the standard. Typical laboratory checks used to detect fakes include testing hardness, elongation, and ultimate loading, and a variety of chemical tests.

Mechanical Properties and Grade Markings of Nuts.—Three grades of hex and square nuts designated Grades 2, 5, and 8 are specified by the SAE J995 standard covering nuts in the $\frac{1}{4}$ - to $1\frac{1}{2}$ -inch diameter range. Grades 2, 5, and 8 nuts roughly correspond to the SAE specified bolts of the same grade. Additional specifications are given for miscellaneous nuts such as hex jam nuts, hex slotted nuts, heavy hex nuts, etc. Generally speaking, use nuts of a grade equal to or greater than the grade of the bolt being used. Grade 2 nuts are not required to be marked, however, all Grades 5 and 8 nuts in the $\frac{1}{4}$ - to $1\frac{1}{2}$ -inch range must be marked in one of three ways: Grade 5 nuts may be marked with a dot on the face of the nut and a radial or circumferential mark at 120° counterclockwise from the dot; or a dot at one corner of the nut and a radial line at 120° clockwise from the nut, or one notch at each of the six corners of the nut. Grade 8 nuts may be identified by a dot on the face of the nut with a radial or circumferential mark at 60° counterclockwise from the dot; or a dot at one corner of the nut and a radial line at 60° clockwise from the nut, or two notches at each of the six corners of the nut.

Working Strength of Bolts.—When the nut on a bolt is tightened, an initial tensile load is placed on the bolt that must be taken into account in determining its safe working strength or external load-carrying capacity. The total load on the bolt theoretically varies from a maximum equal to the sum of the initial and external loads (when the bolt is absolutely rigid and the parts held together are elastic) to a minimum equal to either the initial or external loads, whichever is the greater (where the bolt is elastic and the parts held together are absolutely rigid). No material is absolutely rigid, so in practice the total load values fall somewhere between these maximum and minimum limits, depending upon the relative elasticity of the bolt and joint members.

Some experiments made at Cornell University to determine the initial stress due to tightening nuts on bolts sufficiently to make a packed joint steam-tight showed that experienced mechanics tighten nuts with a pull roughly proportional to the bolt diameter. It was also found that the stress due to nut tightening was often sufficient to break a $\frac{1}{2}$ -inch (12.7-mm) bolt, but not larger sizes, assuming that the nut is tightened by an experienced mechanic. It may be concluded, therefore, that bolts smaller than $\frac{5}{8}$ inch (15.9 mm) should not be used for holding cylinder heads or other parts requiring a tight joint. As a result of these tests, the following empirical formula was established for the working strength of bolts used for packed joints or joints where the elasticity of a gasket is greater than the elasticity of the studs or bolts.

$$W = S_t(0.55d^2 - 0.25d)$$

In this formula, W = working strength of bolt or permissible load, in pounds, after allowance is made for initial load due to tightening; S_t = allowable working stress in tension, pounds per square inch; and d = nominal outside diameter of stud or bolt, inches. A somewhat more convenient formula, and one that gives approximately the same results, is

$$W = S_t(A - 0.25d)$$

In this formula, W , S_t , and d are as previously given, and A = area at the root of the thread, square inches.

Example: What is the working strength of a 1-inch bolt that is screwed tightly in a packed joint when the allowable working stress is 10,000 psi?

$$W = 10,000(0.55 \times 1^2 - 0.25 \times 1) = 3000 \text{ pounds approx.}$$

Formulas for Stress Areas and Lengths of Engagement of Screw Threads.—The critical areas of stress of mating screw threads are: 1) The effective cross-sectional area, or tensile-stress area, of the external thread; 2) the shear area of the external thread, which depends principally on the minor diameter of the tapped hole; and 3) the shear area of the internal thread, which depends principally on the major diameter of the external thread. The relation of these three stress areas to each other is an important factor in determining how a threaded connection will fail, whether by breakage in the threaded section of the screw (or bolt) or by stripping of either the external or internal thread.

If failure of a threaded assembly should occur, it is preferable for the screw to break rather than have either the external or internal thread strip. In other words, the length of engagement of mating threads should be sufficient to carry the full load necessary to break the screw without the threads stripping.

If mating internal and external threads are manufactured of materials having equal tensile strengths, then to prevent stripping of the external thread, the length of engagement should be not less than that given by **Formula (1)**:

$$L_e = \frac{2 \times A_t}{3.1416K_n \max[\frac{1}{2} + 0.57735n(E_s \text{ min} - K_n \text{ max})]} \quad (1)$$

In this formula, the factor of 2 means that it is assumed that the area of the screw in shear must be twice the tensile-stress area to attain the full strength of the screw (this value is slightly larger than required and thus provides a small factor of safety against stripping); L_e = length of engagement, in inches; n = number of threads per inch; $K_n \text{ max}$ = maximum minor diameter of internal thread; $E_s \text{ min}$ = minimum pitch diameter of external thread for the class of thread specified; and A_t = tensile-stress area of screw thread given by **Formula (2a)** or **(2b)** or the thread tables for Unified threads, **Tables 4a** through **5h** starting on page **1844**, which are based on **Formula (2a)**.

For steels of up to 180,000 psi ultimate tensile strength,

$$A_t = 3.1416 \left(\frac{E}{2} - \frac{3H}{16} \right)^2 \quad \text{or} \quad A_t = 0.7854 \left(D - \frac{0.9743}{n} \right)^2 \quad (2a)$$

For steels of over 180,000 psi ultimate tensile strength,

$$A_t = 3.1416 \left(\frac{E_s \text{ min}}{2} - \frac{0.16238}{n} \right)^2 \quad (2b)$$

In these formulas, D = basic major diameter of the thread, E = basic pitch diameter, and the other symbols have the same meanings as before.

Stripping of Internal Thread: If the internal thread is made of material of lower strength than the external thread, stripping of the internal thread may take place before the screw breaks. To determine whether this condition exists, it is necessary to calculate the factor J for the relative strength of the external and internal threads given by **Formula (3)**:

$$J = \frac{A_s \times \text{tensile strength of external thread material}}{A_n \times \text{tensile strength of internal thread material}} \quad (3)$$

If J is less than or equal to 1, the length of engagement determined by **Formula (1)** is adequate to prevent stripping of the internal thread; if J is greater than 1, the required length of engagement Q to prevent stripping of the internal thread is obtained by multiplying the length of engagement L_e , **Formula (1)**, by J :

$$Q = JL_e \tag{4}$$

In **Formula (3)**, A_s and A_n are the shear areas of the external and internal threads, respectively, given by **Formulas (5)** and **(6)**:

$$A_s = 3.1416nL_eK_n\max\left[\frac{1}{2n} + 0.57735(E_s\min - K_n\max)\right] \tag{5}$$

$$A_n = 3.1416nL_eD_s\min\left[\frac{1}{2n} + 0.57735(D_s\min - E_n\max)\right] \tag{6}$$

In these formulas, n = threads per inch; L_e = length of engagement from **Formula (1)**; $K_n\max$ = maximum minor diameter of internal thread; $E_s\min$ = minimum pitch diameter of the external thread for the class of thread specified; $D_s\min$ = minimum major diameter of the external thread; and $E_n\max$ = maximum pitch diameter of internal thread.

Load to Break Threaded Portion of Screws and Bolts.—The direct tensile load P to break the threaded portion of a screw or bolt (assuming that no shearing or torsional stresses are acting) can be determined from the following formula:

$$P = SA_t$$

where P = load in pounds to break screw; S = ultimate tensile strength of material of screw or bolt in pounds per square inch; and A_t = tensile-stress area in square inches from **Formula (2a)**, **(2b)**, or from the screw thread tables.

Lock Wire Procedure Detail.—Wire ties are frequently used as a locking device for bolted connections to prevent loosening due to vibration and loading conditions, or tampering. The use of safety wire ties is illustrated in **Figs. 1** and **2** below. The illustrations assume the use of right-hand threaded fasteners and the following additional rules apply:

- 1) No more that three (3) bolts may be tied together; 2) Bolt heads may be tied as shown only when the female thread receiver is captive; 3) Pre-drilled nuts may be tied in a fashion similar to that illustrated with the following conditions. a) Nuts must be heat-treated; and b) Nuts are factory drilled for use with lock wire. 4) Lock wire must fill a minimum of 75% of the drilled hole provided for the use of lock wire; and 5) Lock wire must be aircraft quality stainless steel of 0.508 mm (0.020 inch) diameter, 0.8128 mm (0.032 inch) diameter, or 1.067 mm (0.042 inch) diameter. Diameter of lock wire is determined by the thread size of the fastener to be safe-tied. a) Thread sizes of 6 mm (0.25 inch) and smaller use 0.508 mm (0.020 inch) wire; b) Thread sizes of 6 mm (0.25 inch) to 12 mm (0.5 inch) use 0.8128 mm (0.032 inch) wire; c) Thread sizes > 12 mm (0.5 inch) use 1.067 mm (0.042 inch) wire; and d) The larger wire may be used in smaller bolts in cases of convenience, but smaller wire must not be used in larger fastener sizes.

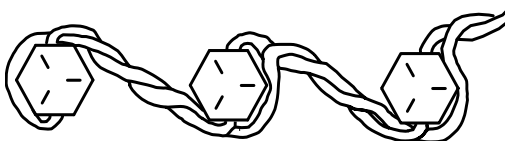


Fig. 1. Three (3) Bolt Procedure

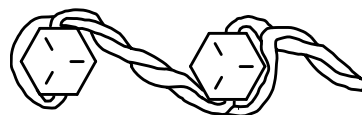


Fig. 2. Two (2) Bolt Procedure

INCH THREADED FASTENERS

Dimensions of bolts, screws, nuts, and washers used in machine construction are given here. For data on thread forms, see the section *SCREW THREAD SYSTEMS* starting on page 1806.

American Square and Hexagon Bolts, Screws, and Nuts.—The 1941 American Standard ASA B18.2 covered head dimensions only. In 1952 and 1955 the Standard was revised to cover the entire product. Some bolt and nut classifications were simplified by elimination or consolidation in agreements reached with the British and Canadians. In 1965 ASA B18.2 was redesignated into two standards: B18.2.1 covering square and hexagon bolts and screws including hexagon cap screws and lag screws and B18.2.2 covering square and hexagon nuts. In B18.2.1-1965, hexagon head cap screws and finished hexagon bolts were consolidated into a single product heavy semifinished hexagon bolts and heavy finished hexagon bolts were consolidated into a single product; regular semifinished hexagon bolts were eliminated; a new tolerance pattern for all bolts and screws and a positive identification procedure for determining whether an externally threaded product should be designated as a bolt or screw were established. Also included in this standard are heavy hexagon bolts and heavy hexagon structural bolts. In B18.2.2-1965, regular semifinished nuts were discontinued; regular hexagon and heavy hexagon nuts in sizes $\frac{1}{4}$ through 1 inch, finished hexagon nuts in sizes larger than $1\frac{1}{2}$ inches, washer-faced semifinished style of finished nuts in sizes $\frac{5}{8}$ -inch and smaller and heavy series nuts in sizes $\frac{7}{16}$ -inch and smaller were eliminated.

Further revisions and refinements include the addition of a skew head bolts and hex head lag screws and the specifying of countersunk diameters for the various hex nuts. Heavy hex structural bolts and heavy hex nuts were moved to a new structural applications standard, ASME B18.2.6-1996, *Fasteners for Use in Structural Applications*. Additionally, B18.2.1 has been revised to allow easier conformance to Public Law 101-592. All these changes are reflected in ANSI/ASME B18.2.1-1996, and ANSI/ASME B18.2.2-1987 (R1999).

Unified Square and Hexagon Bolts, Screws, and Nuts.—Items that are recognized in the Standard as “unified” dimensionally with British and Canadian standards are shown in bold-face in certain tables.

The other items in the same tables are based on formulas accepted and published by the British for sizes outside the ranges listed in their standards which, as a matter of information, are BS 1768:1963 (obsolescent) for Precision (Normal Series) Unified Hexagon Bolts, Screws, Nuts (UNC and UNF Threads) and B.S. 1769 and amendments for Black (Heavy Series) Unified Hexagon Bolts, etc. Tolerances applied to comparable dimensions of American and British Unified bolts and nuts may differ because of rounding off practices and other factors.

Differentiation between Bolt and Screw.—A bolt is an externally threaded fastener designed for insertion through holes in assembled parts, and is normally intended to be tightened or released by torquing a nut.

A screw is an externally threaded fastener capable of being inserted into holes in assembled parts, of mating with a preformed internal thread or forming its own thread and of being tightened or released by torquing the head.

An externally threaded fastener which is prevented from being turned during assembly, and which can be tightened or released only by torquing a nut is a *bolt*. (*Example*: round head bolts, track bolts, plow bolts.)

An externally threaded fastener that has a thread form which prohibits assembly with a nut having a straight thread of multiple pitch length is a *screw*. (*Example*: wood screws, tapping screws.)

An externally threaded fastener that must be assembled with a nut to perform its intended service is a *bolt*. (Example: heavy hex structural bolt.)

An externally threaded fastener that must be torqued by its head into a tapped or other preformed hole to perform its intended service is a *screw*. (Example: square head set screw.)

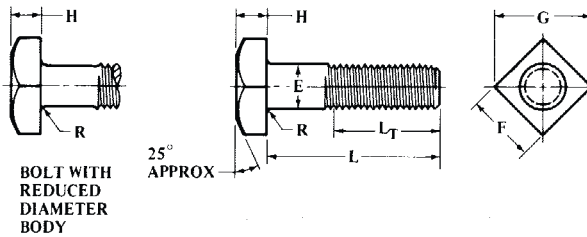


Fig. 1. Square Bolts (Table 1)

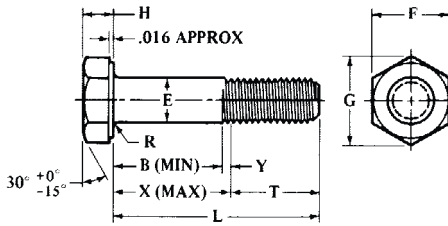


Fig. 2. Heavy Hex Structural Bolts (Table 2)

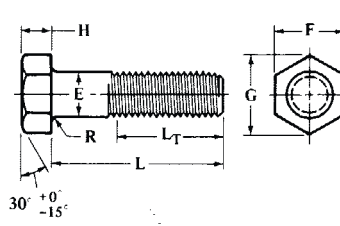


Fig. 3. Hex Bolts, Heavy Hex Bolts (Table 3)

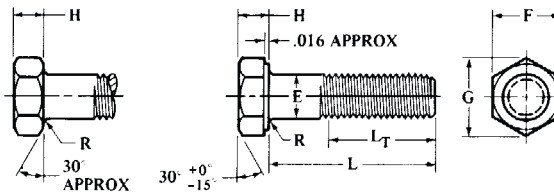


Fig. 4. Hex Cap Screws, Heavy Hex Screws (Table 4)

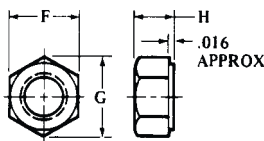


Fig. 5. Hex Nuts, Heavy Hex Nuts (Table 7)

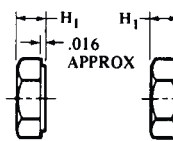


Fig. 6. Hex Jam Nuts, Heavy Hex Jam Nuts (Table 7)

Square and Hex Bolts, Screws, and Nuts.—The dimensions for square and hex bolts and screws given in the following tables have been taken from American National Standard ANSI/ASME B18.2.1-1996 and for nuts from American National Standard ANSI/ASME B18.2.2-1987 (R1999) Reference should be made to these Standards for information or data not found in the following text and tables:

Designation: Bolts and screws should be designated by the following data in the sequence shown: nominal size (fractional and decimal equivalent); threads per inch (omit for lag screws); product length for bolts and screws (fractional or two-place decimal equivalent); product name; material, including specification, where necessary; and protective finish, if required. Examples: (1) $\frac{3}{8}$ -16 \times 1 $\frac{1}{2}$ Square Bolt, Steel, Zinc Plated; (2) $\frac{1}{2}$ -13 \times 3

Hex Cap Screw, SAE Grade 8 Steel; and (3) .75 × 5.00 Hex Lag Screw, Steel. (4) 1/2-13 Square Nut, Steel, Zinc Plated; (5) 3/4-16 Heavy Hex Nut, SAE J995 Grade 5 Steel; and (6) 1000-8 Hex Thick Slotted Nut, ASTM F594 (Alloy Group 1) Corrosion-Resistant Steel.

Table 1. American National Standard and Unified Standard Square Bolts
ANSI/ASME B18.2.1-1996

SQUARE BOLTS (Fig. 1)											
Nominal Size ^a or Basic Product Dia.		Body Dia. ^b E		Width Across Flats F		Width Across Corners G		Head Height H			Thread Length ^c L _T
		Max.	Basic	Max.	Min.	Max.	Min.	Basic	Max.	Min.	Nom.
1/4	0.2500	0.260	3/8	0.375	0.362	0.530	0.498	11/64	0.188	0.156	0.750
5/16	0.3125	0.324	1/2	0.500	0.484	0.707	0.665	13/64	0.220	0.186	0.875
3/8	0.3750	0.388	9/16	0.562	0.544	0.795	0.747	1/4	0.268	0.232	1.000
7/16	0.4375	0.452	5/8	0.625	0.603	0.884	0.828	19/64	0.316	0.278	1.125
1/2	0.5000	0.515	3/4	0.750	0.725	1.061	0.995	21/64	0.348	0.308	1.250
5/8	0.6250	0.642	15/16	0.938	0.906	1.326	1.244	27/64	0.444	0.400	1.500
3/4	0.7500	0.768	1 1/8	1.125	1.088	1.591	1.494	1/2	0.524	0.476	1.750
7/8	0.8750	0.895	1 1/16	1.312	1.269	1.856	1.742	19/32	0.620	0.568	2.000
1	1.0000	1.022	1 1/2	1.500	1.450	2.121	1.991	21/32	0.684	0.628	2.250
1 1/8	1.1250	1.149	1 11/16	1.688	1.631	2.386	2.239	3/4	0.780	0.720	2.500
1 1/4	1.2500	1.277	1 7/8	1.875	1.812	2.652	2.489	27/32	0.876	0.812	2.750
1 3/8	1.3750	1.404	2 1/16	2.602	1.994	2.917	2.738	29/32	0.940	0.872	3.000
1 1/2	1.5000	1.531	2 1/4	2.250	2.175	3.182	2.986	1	1.036	0.964	3.250

^a Where specifying nominal size in decimals, zeros before the decimal point and in the fourth decimal place are omitted.

^b See *Body Diameter* footnote in Table 3.

^c Thread lengths, L_T, shown are for bolt lengths 6 inches and shorter. For longer bolt lengths add 0.250 inch to thread lengths shown.

Table 2. American National Standard Heavy Hex Structural Bolts
ANSI/ASME B18.2.1-1981 (R1992)^a

HEAVY HEX STRUCTURAL BOLTS (Fig. 2)													
Nominal Size ^a or Basic Product Dia.		Body Dia. ^b E		Width Across Flats F		Width Across Corners G		Height H		Radius of Fillet R		Thrd. Lgth L _T	Transition Thrd. Y
		Max.	Min.	Max.	Min.	Max.	Min.	Max.	Min.	Max.	Min.	Basic	Max.
1/2	0.5000	0.515	0.482	0.875	0.850	1.010	0.969	0.323	0.302	0.031	0.009	1.00	0.19
3/8	0.6250	0.642	0.605	1.062	1.031	1.227	1.175	0.403	0.378	0.062	0.021	1.25	0.22
3/4	0.7500	0.768	0.729	1.250	1.212	1.443	1.383	0.483	0.455	0.062	0.021	1.38	0.25
7/8	0.8750	0.895	0.852	1.438	1.394	1.660	1.589	0.563	0.531	0.062	0.031	1.50	0.28
1	1.0000	1.022	0.976	1.625	1.575	1.876	1.796	0.627	0.591	0.093	0.062	1.75	0.31
1 1/8	1.1250	1.149	1.098	1.812	1.756	2.093	2.002	0.718	0.658	0.093	0.062	2.00	0.34
1 1/4	1.2500	1.277	1.223	2.000	1.938	2.309	2.209	0.813	0.749	0.093	0.062	2.00	0.38
1 3/8	1.3750	1.404	1.345	2.188	2.119	2.526	2.416	0.878	0.810	0.093	0.062	2.25	0.44
1 1/2	1.5000	1.531	1.470	2.375	2.300	2.742	2.622	0.974	0.902	0.093	0.062	2.25	0.44

^a The table has been included for reference only. Heavy hex structural bolts have been removed from ANSI/ASME B18.2.1 and are now included in ASME B18.2.6.

All dimensions are in inches. **Bold type shows bolts unified dimensionally with British and Canadian Standards.** Threads, when rolled, shall be Unified Coarse, Fine, or 8-thread series (UNRC, UNRF, or 8 UNR Series), Class 2A. Threads produced by other methods may be Unified Coarse, Fine, or 8-thread series (UNC, UNF, or 8 UN Series), Class 2A.

Table 3. American National Standard and Unified Standard Hex and Heavy Hex Bolts ANSI/ASME B18.2.1-1996

Nominal Size ^a or Basic Dia.	Full Size Body Dia. <i>E</i>		Width Across Flats <i>F</i>			Width Across Corners <i>G</i>		Head Height <i>H</i>			Thread Length ^b <i>L_T</i>
	Max.		Basic	Max.	Min.	Max.	Min.	Basic	Max.	Min.	Nom.
HEX BOLTS (Fig. 3)											
1/4	0.2500	0.260	7/16	0.438	0.425	0.505	0.484	11/64	0.188	0.150	0.750
5/16	0.3125	0.324	1/2	0.500	0.484	0.577	0.552	7/32	0.235	0.195	0.875
3/8	0.3750	0.388	9/16	0.562	0.544	0.650	0.620	1/4	0.268	0.226	1.000
7/16	0.4375	0.452	5/8	0.625	0.603	0.722	0.687	19/64	0.316	0.272	1.125
1/2	0.5000	0.515	3/4	0.750	0.725	0.866	0.826	11/32	0.364	0.302	1.250
5/8	0.6250	0.642	15/16	0.938	0.906	1.083	1.033	27/64	0.444	0.378	1.500
3/4	0.7500	0.768	1 1/8	1.125	1.088	1.299	1.240	1/2	0.524	0.455	1.750
7/8	0.8750	0.895	1 1/16	1.312	1.269	1.516	1.447	37/64	0.604	0.531	2.000
1	1.0000	1.022	1 1/2	1.500	1.450	1.732	1.653	43/64	0.700	0.591	2.250
1 1/8	1.1250	1.149	1 11/16	1.688	1.631	1.949	1.859	3/4	0.780	0.658	2.500
1 1/4	1.2500	1.277	1 7/8	1.875	1.812	2.165	2.066	27/32	0.876	0.749	2.750
1 3/8	1.3750	1.404	2 1/16	2.062	1.994	2.382	2.273	29/32	0.940	0.810	3.000
1 1/2	1.5000	1.531	2 1/4	2.250	2.175	2.598	2.480	1	1.036	0.902	3.250
1 3/4	1.7500	1.785	2 5/8	2.625	2.538	3.031	2.893	1 5/32	1.196	1.054	3.750
2	2.0000	2.039	3	3.000	2.900	3.464	3.306	1 11/32	1.388	1.175	4.250
2 1/4	2.2500	2.305	3 3/8	3.375	3.262	3.897	3.719	1 1/2	1.548	1.327	4.750
2 1/2	2.5000	2.559	3 3/4	3.750	3.625	4.330	4.133	1 21/32	1.708	1.479	5.250
2 3/4	2.7500	2.827	4 1/8	4.125	3.988	4.763	4.546	1 13/16	1.869	1.632	5.750
3	3.0000	3.081	4 1/2	4.500	4.350	5.196	4.959	2	2.060	1.815	6.250
3 1/4	3.2500	3.335	4 7/8	4.875	4.712	5.629	5.372	2 3/16	2.251	1.936	6.750
3 1/2	3.5000	3.589	5 1/4	5.250	5.075	6.062	5.786	2 1/2	2.380	2.057	7.250
3 3/4	3.7500	3.858	5 5/8	5.625	5.437	6.495	6.198	2 1/2	2.572	2.241	7.750
4	4.0000	4.111	6	6.000	5.800	6.928	6.612	2 11/16	2.764	2.424	8.250
HEAVY HEX BOLTS (Fig. 3)											
1/2	0.5000	0.515	7/8	0.875	0.850	1.010	0.969	1 1/32	0.364	0.302	1.250
5/8	0.6250	0.642	1 1/16	1.062	1.031	1.227	1.175	27/64	0.444	0.378	1.500
3/4	0.7500	0.768	1 1/4	1.250	1.212	1.443	1.383	1/2	0.524	0.455	1.750
7/8	0.8750	0.895	1 1/16	1.438	1.394	1.660	1.589	37/64	0.604	0.531	2.000
1	1.0000	1.022	1 5/8	1.625	1.575	1.876	1.796	43/64	0.700	0.591	2.250
1 1/8	1.1250	1.149	1 13/16	1.812	1.756	2.093	2.002	3/4	0.780	0.658	2.500
1 1/4	1.2500	1.277	2	2.000	1.938	2.309	2.209	27/32	0.876	0.749	2.750
1 3/8	1.3750	1.404	2 3/16	2.188	2.119	2.526	2.416	29/32	0.940	0.810	3.000
1 1/2	1.5000	1.531	2 3/8	2.375	2.300	2.742	2.622	1	1.036	0.902	3.250
1 3/4	1.7500	1.785	2 3/4	2.750	2.662	3.175	3.035	1 5/32	1.196	1.054	3.750
2	2.0000	2.039	3 1/8	3.125	3.025	3.608	3.449	1 11/32	1.388	1.175	4.250
2 1/4	2.2500	2.305	3 1/2	3.500	3.388	4.041	3.862	1 1/2	1.548	1.327	4.750
2 1/2	2.5000	2.559	3 7/8	3.875	3.750	4.474	4.275	1 21/32	1.708	1.479	5.250
2 3/4	2.7500	2.827	4 1/4	4.250	4.112	4.907	4.688	1 13/16	1.869	1.632	5.750
3	3.0000	3.081	4 5/8	4.625	4.475	5.340	5.102	2	2.060	1.815	6.250

^a *Nominal Size*: Where specifying nominal size in decimals, zeros preceding the decimal point and in the fourth decimal place are omitted.

^b Thread lengths, *L_T*, shown are for bolt lengths 6 inches and shorter. For longer bolt lengths add 0.250 inch to thread lengths shown.

All dimensions are in inches.

Bold type shows bolts unified dimensionally with British and Canadian Standards.

Threads: Threads, when rolled, are Unified Coarse, Fine, or 8-thread series (UNRC, UNRF, or 8 UNR Series), Class 2A. Threads produced by other methods may be Unified Coarse, Fine or 8-thread series (UNC, UNF, or 8 UN Series), Class 2A.

Body Diameter: Bolts may be obtained in “reduced diameter body.” Where “reduced diameter body” is specified, the body diameter may be reduced to approximately the pitch diameter of the thread. A shoulder of full body diameter under the head may be supplied at the option of the manufacturer.

Material: Unless otherwise specified, chemical and mechanical properties of steel bolts conform to ASTM A307, Grade A. Other materials are as agreed upon by manufacturer and purchaser.

Table 4. American National Standard and Unified Standard Heavy Hex Screws and Hex Cap Screws ANSI/ASME B18.2.1-1996

Nominal Size ^a or Basic Product Dia.	Body Dia. <i>E</i>		Width Across Flats <i>F</i>			Width Across Corners <i>G</i>		Height <i>H</i>			Thread Length ^b <i>L_T</i>	
	Max.	Min.	Basic	Max.	Min.	Max.	Min.	Basic	Max.	Min.	Basic	
HEAVY HEX SCREWS (Fig. 4)												
1/2	0.5000	0.5000	0.482	7/8	0.875	0.850	1.010	0.969	5/16	0.323	0.302	1.250
5/8	0.6250	0.6250	0.605	1 1/16	1.062	1.031	1.227	1.175	25/64	0.403	0.378	1.500
3/4	0.7500	0.7500	0.729	1 1/4	1.250	1.212	1.443	1.383	15/32	0.483	0.455	1.750
7/8	0.8750	0.8750	0.852	1 1/16	1.438	1.394	1.660	1.589	35/64	0.563	0.531	2.000
1	1.0000	1.0000	0.976	1 3/8	1.625	1.575	1.876	1.796	39/64	0.627	0.591	2.250
1 1/8	1.1250	1.1250	1.098	1 13/16	1.812	1.756	2.093	2.002	1 1/16	0.718	0.658	2.500
1 1/4	1.2500	1.2500	1.223	2	2.000	1.938	2.309	2.209	25/32	0.813	0.749	2.750
1 3/8	1.3750	1.3750	1.345	2 3/16	2.188	2.119	2.526	2.416	27/32	0.878	0.810	3.000
1 1/2	1.5000	1.5000	1.470	2 3/8	2.375	2.300	2.742	2.622	15/16	0.974	0.902	3.250
1 3/4	1.7500	1.7500	1.716	2 3/4	2.750	2.662	3.175	3.035	1 3/32	1.134	1.054	3.750
2	2.0000	2.0000	1.964	3 1/8	3.125	3.025	3.608	3.449	1 1/32	1.263	1.175	4.250
2 1/4	2.2500	2.2500	2.214	3 1/2	3.500	3.388	4.041	3.862	1 3/8	1.423	1.327	5.000 ^c
2 1/2	2.5000	2.5000	2.461	3 3/8	3.875	3.750	4.474	4.275	1 17/32	1.583	1.479	5.500 ^c
2 3/4	2.7500	2.7500	2.711	4 1/4	4.250	4.112	4.907	4.688	1 11/16	1.744	1.632	6.000 ^c
3	3.0000	3.0000	2.961	4 5/8	4.625	4.475	5.340	5.102	1 7/8	1.935	1.815	6.500 ^c
HEX CAP SCREWS (Finished Hex Bolts) (Fig. 4)												
1/4	0.2500	0.2500	0.2450	7/16	0.438	0.428	0.505	0.488	5/32	0.163	0.150	0.750
5/16	0.3125	0.3125	0.3065	1/2	0.500	0.489	0.577	0.557	13/64	0.211	0.195	0.875
3/8	0.3750	0.3750	0.3690	9/16	0.562	0.551	0.650	0.628	15/64	0.243	0.226	1.000
7/16	0.4375	0.4375	0.4305	5/8	0.625	0.612	0.722	0.698	9/32	0.291	0.272	1.125
1/2	0.5000	0.5000	0.4930	3/4	0.750	0.736	0.866	0.840	5/16	0.323	0.302	1.250
9/16	0.5625	0.5625	0.5545	13/16	0.812	0.798	0.938	0.910	23/64	0.371	0.348	1.375
5/8	0.6250	0.6250	0.6170	15/16	0.938	0.922	1.083	1.051	25/64	0.403	0.378	1.500
3/4	0.7500	0.7500	0.7410	1 1/8	1.125	1.100	1.299	1.254	15/32	0.483	0.455	1.750
7/8	0.8750	0.8750	0.8660	1 1/16	1.312	1.285	1.516	1.465	35/64	0.563	0.531	2.000
1	1.0000	1.0000	0.9900	1 1/2	1.500	1.469	1.732	1.675	39/64	0.627	0.591	2.250
1 1/8	1.1250	1.1250	1.1140	1 11/16	1.688	1.631	1.949	1.859	1 1/16	0.718	0.658	2.500
1 1/4	1.2500	1.2500	1.2390	1 7/8	1.875	1.812	2.165	2.066	25/32	0.813	0.749	2.750
1 3/8	1.3750	1.3750	1.3630	2 1/16	2.062	1.994	2.382	2.273	27/32	0.878	0.810	3.000
1 1/2	1.5000	1.5000	1.4880	2 1/4	2.250	2.175	2.598	2.480	15/16	0.974	0.902	3.250
1 3/4	1.7500	1.7500	1.7380	2 5/8	2.625	2.538	3.031	2.893	1 3/32	1.134	1.054	3.750
2	2.0000	2.0000	1.9880	3	3.000	2.900	3.464	3.306	1 1/32	1.263	1.175	4.250
2 1/4	2.2500	2.2500	2.2380	3 3/8	3.375	3.262	3.897	3.719	1 3/8	1.423	1.327	5.000 ^c
2 1/2	2.5000	2.5000	2.4880	3 3/4	3.750	3.625	4.330	4.133	1 17/32	1.583	1.479	5.500 ^c
2 3/4	2.7500	2.7500	2.7380	4 1/8	4.125	3.988	4.763	4.546	1 11/16	1.744	1.632	6.000 ^c
3	3.0000	3.0000	2.9880	4 1/2	4.500	4.350	5.196	4.959	1 7/8	1.935	1.815	6.500 ^c

^aNominal Size: Where specifying nominal size in decimals, zeros preceding the decimal and in the fourth decimal place are omitted.

^bThread lengths, *L_T*, shown are for bolt lengths 6 inches and shorter. For longer bolt lengths add 0.250 inch to thread lengths shown.

^cThread lengths, *L_T*, shown are for bolt lengths over 6 inches.

All dimensions are in inches.

Unification: Bold type indicates product features unified dimensionally with British and Canadian Standards. Unification of fine thread products is limited to sizes 1 inch and smaller.

Bearing Surface: Bearing surface is flat and washer faced. Diameter of bearing surface is equal to the maximum width across flats within a tolerance of minus 10 per cent.

Threads Series: Threads, when rolled, are Unified Coarse, Fine, or 8-thread series (UNRC, UNRF, or 8 UNR Series), Class 2A. Threads produced by other methods shall preferably be UNRC, UNRF or 8 UNR but, at manufacturer's option, may be Unified Coarse, Fine or 8-thread series (UNC, UNF, or 8 UN Series), Class 2A.

Material: Chemical and mechanical properties of steel screws normally conform to Grades 2, 5, or 8 of SAE J429, ASTM A449 or ASTM A354 Grade BD. Where specified, screws may also be made from brass, bronze, corrosion-resisting steel, aluminum alloy or other materials.

Table 5. American National Standard Square Lag Screws ANSI/ASME B18.2.1-1996

Nominal Size ^a or Basic Product Dia.	Body or Shoulder Dia. <i>E</i>		Width Across Flats <i>F</i>			Width Across Corners <i>G</i>		Height <i>H</i>			Shoulder Length <i>S</i>	Radius of Fillet <i>R</i>	Thds. per Inch	Thread Dimensions				
	Max.	Min.	Basic	Max.	Min.	Max.	Min.	Basic	Max.	Min.	Min.	Max.		Pitch <i>P</i>	Flat at Root <i>B</i>	Depth of Thd. <i>T</i>	Root Dia. <i>D₁</i>	
No. 10	0.1900	0.199	0.178	5/32	0.281	0.271	0.398	0.372	1/8	0.140	0.110	0.094	0.03	11	0.091	0.039	0.035	0.120
1/4	0.2500	0.260	0.237	3/8	0.375	0.362	0.530	0.498	11/64	0.188	0.156	0.094	0.03	10	0.100	0.043	0.039	0.173
5/16	0.3125	0.324	0.298	1/2	0.500	0.484	0.707	0.665	13/64	0.220	0.186	0.125	0.03	9	0.111	0.048	0.043	0.227
3/8	0.3750	0.388	0.360	5/16	0.562	0.544	0.795	0.747	1/4	0.268	0.232	0.125	0.03	7	0.143	0.062	0.055	0.265
7/16	0.4375	0.452	0.421	3/8	0.625	0.603	0.884	0.828	19/64	0.316	0.278	0.156	0.03	7	0.143	0.062	0.055	0.328
1/2	0.5000	0.515	0.482	3/4	0.750	0.725	1.061	0.995	21/64	0.348	0.308	0.156	0.03	6	0.167	0.072	0.064	0.371
5/8	0.6250	0.642	0.605	15/16	0.938	0.906	1.326	1.244	27/64	0.444	0.400	0.312	0.06	5	0.200	0.086	0.077	0.471
3/4	0.7500	0.768	0.729	1 1/8	1.125	1.088	1.591	1.494	1/2	0.524	0.476	0.375	0.06	4 1/2	0.222	0.096	0.085	0.579
7/8	0.8750	0.895	0.852	1 1/16	1.312	1.269	1.856	1.742	19/32	0.620	0.568	0.375	0.06	4	0.250	0.108	0.096	0.683
1	1.0000	1.022	0.976	1 1/2	1.500	1.450	2.121	1.991	21/32	0.684	0.628	0.625	0.09	3 1/2	0.286	0.123	0.110	0.780
1 1/8	1.1250	1.149	1.098	1 11/16	1.688	1.631	2.386	2.239	3/4	0.780	0.720	0.625	0.09	3 1/4	0.308	0.133	0.119	0.887
1 1/4	1.2500	1.277	1.223	1 7/8	1.875	1.812	2.652	2.489	27/32	0.876	0.812	0.625	0.09	3 3/4	0.308	0.133	0.119	1.012

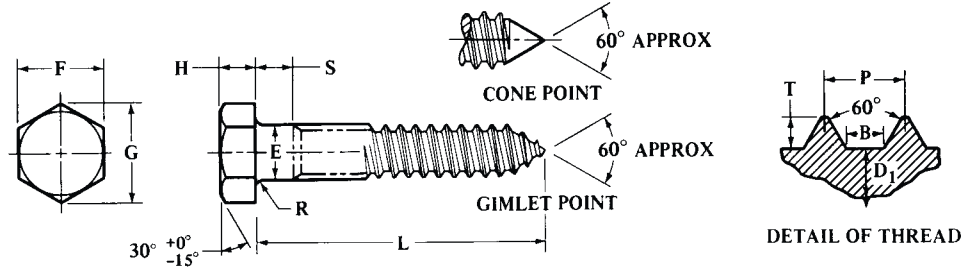
^a When specifying decimal nominal size, zeros before decimal point and in fourth decimal place are omitted.

All dimensions in inches.

Minimum thread length is 1/2 length of screw plus 0.50 inch, or 6.00 inches, whichever is shorter. Screws too short for the formula thread length shall be threaded as close to the head as practicable.

Thread formulas: Pitch = 1 ÷ thds. per inch. Flat at root = 0.4305 × pitch. Depth of single thread = 0.385 × pitch.

Table 6. American National Standard Hex Lag Screws ANSI/ASME B18.2.1-1996



Nominal Size ^a or Basic Product Dia.	Body or Shoulder Dia. <i>E</i>		Width Across Flats <i>F</i>			Width Across Corners <i>G</i>		Height <i>H</i>			Shoulder Length <i>S</i>	Radius of Fillet <i>R</i>	Thds. per Inch	Thread Dimensions				
	Max.	Min.	Basic	Max.	Min.	Max.	Min.	Basic	Max.	Min.	Min.	Max.		Pitch <i>P</i>	Flat at Root <i>B</i>	Depth of Thd. <i>T</i>	Root Dia. <i>D₁</i>	
No. 10	0.1900	0.199	0.178	$\frac{5}{32}$	0.281	0.271	0.323	0.309	$\frac{1}{8}$	0.140	0.110	0.094	0.03	11	0.091	0.039	0.035	0.120
$\frac{1}{4}$	0.2500	0.260	0.237	$\frac{3}{8}$	0.438	0.425	0.505	0.484	$\frac{11}{64}$	0.188	0.150	0.094	0.03	10	0.100	0.043	0.039	0.173
$\frac{5}{16}$	0.3125	0.324	0.298	$\frac{1}{2}$	0.500	0.484	0.577	0.552	$\frac{7}{32}$	0.235	0.195	0.125	0.03	9	0.111	0.048	0.043	0.227
$\frac{3}{8}$	0.3750	0.388	0.360	$\frac{5}{16}$	0.562	0.544	0.650	0.620	$\frac{1}{4}$	0.268	0.226	0.125	0.03	7	0.143	0.062	0.055	0.265
$\frac{7}{16}$	0.4375	0.452	0.421	$\frac{3}{8}$	0.625	0.603	0.722	0.687	$\frac{9}{64}$	0.316	0.272	0.156	0.03	7	0.143	0.062	0.055	0.328
$\frac{1}{2}$	0.5000	0.515	0.482	$\frac{3}{4}$	0.750	0.725	0.866	0.826	$\frac{11}{32}$	0.364	0.302	0.156	0.03	6	0.167	0.072	0.064	0.371
$\frac{5}{8}$	0.6250	0.642	0.605	$\frac{15}{16}$	0.938	0.906	1.083	1.033	$\frac{27}{64}$	0.444	0.378	0.312	0.06	5	0.200	0.086	0.077	0.471
$\frac{3}{4}$	0.7500	0.768	0.729	$1\frac{1}{8}$	1.125	1.088	1.299	1.240	$\frac{1}{2}$	0.524	0.455	0.375	0.06	4 $\frac{1}{2}$	0.222	0.096	0.085	0.579
$\frac{7}{8}$	0.8750	0.895	0.852	$1\frac{1}{16}$	1.312	1.269	1.516	1.447	$\frac{37}{64}$	0.604	0.531	0.375	0.06	4	0.250	0.108	0.096	0.683
1	1.0000	1.022	0.976	$1\frac{1}{2}$	1.500	1.450	1.732	1.653	$\frac{43}{64}$	0.700	0.591	0.625	0.09	3 $\frac{1}{2}$	0.286	0.123	0.110	0.780
$1\frac{1}{8}$	1.1250	1.149	1.098	$1\frac{1}{16}$	1.688	1.631	1.949	1.859	$\frac{3}{4}$	0.780	0.658	0.625	0.09	3 $\frac{1}{4}$	0.308	0.133	0.119	0.887
$1\frac{1}{4}$	1.2500	1.277	1.223	$1\frac{1}{8}$	1.875	1.812	2.165	2.066	$\frac{27}{32}$	0.876	0.749	0.625	0.09	3 $\frac{1}{4}$	0.308	0.133	0.119	1.012

^aWhen specifying decimal nominal size, zeros before decimal point and in fourth decimal place are omitted.

All dimensions in inches.

Minimum thread length is $\frac{1}{2}$ length of screw plus 0.50 inch, or 6.00 inches, whichever is shorter. Screws too short for the formula thread length shall be threaded as close to the head as practicable.

Thread formulas: Pitch = $1 \div$ thds. per inch. Flat at root = $0.4305 \times$ pitch. Depth of single thread = $0.385 \times$ pitch.

Table 7. American National Standard and Unified Standard Hex Nuts and Jam Nuts and Heavy Hex Nuts and Jam Nuts *ANSI/ASME B18.2.2-1987 (R1999)*

Nominal Size or Basic Major Dia. of Thread		Width Across Flats <i>F</i>			Width Across Corners <i>G</i>		Thickness, Nuts <i>H</i>			Thickness, Jam Nuts <i>H</i> ₁		
		Basic	Max.	Min.	Max.	Min.	Basic	Max.	Min.	Basic	Max.	Min.
Hex Nuts (Fig. 5) and Hex Jam Nuts (Fig. 6)												
¼	0.2500	⅞	0.438	0.428	0.505	0.488	⅞	0.226	0.212	⅝	0.163	0.150
⅜	0.3125	½	0.500	0.489	0.577	0.557	⅞	0.273	0.258	⅜	0.195	0.180
½	0.3750	⅜	0.562	0.551	0.650	0.628	⅞	0.337	0.320	⅜	0.227	0.210
⅝	0.4375	⅜	0.688	0.675	0.794	0.768	⅞	0.385	0.365	⅜	0.260	0.240
¾	0.5000	⅜	0.750	0.736	0.866	0.840	⅞	0.448	0.427	⅜	0.323	0.302
⅞	0.5625	⅜	0.875	0.861	1.010	0.982	⅞	0.496	0.473	⅜	0.324	0.301
1	0.6250	⅜	0.938	0.922	1.083	1.051	⅞	0.559	0.535	⅜	0.387	0.363
1 ⅛	0.7500	1 ⅛	1.125	1.088	1.299	1.240	1 ⅛	0.665	0.617	1 ⅛	0.446	0.398
1 ¼	0.8750	1 ⅛	1.312	1.269	1.516	1.447	1 ⅛	0.776	0.724	1 ⅛	0.510	0.458
1 ⅜	1.0000	1 ½	1.500	1.450	1.732	1.653	1 ½	0.887	0.831	1 ½	0.575	0.519
1 ½	1.1250	1 ½	1.688	1.631	1.949	1.859	1 ½	0.999	0.939	1 ½	0.639	0.579
1 ¾	1.2500	1 ¾	1.875	1.812	2.165	2.066	1 ¾	1.094	1.030	1 ¾	0.751	0.687
1 ⅞	1.3750	1 ¾	2.062	1.994	2.382	2.273	1 ¾	1.206	1.138	1 ¾	0.815	0.747
2	1.5000	2	2.250	2.175	2.598	2.480	2	1.317	1.245	2	0.880	0.808
Heavy Hex Nuts (Fig. 5) and Heavy Hex Jam Nuts (Fig. 6)												
¼	0.2500	½	0.500	0.488	0.577	0.556	⅞	0.250	0.218	⅞	0.188	0.156
⅜	0.3125	⅜	0.562	0.546	0.650	0.622	⅞	0.314	0.280	⅞	0.220	0.186
½	0.3750	⅜	0.688	0.669	0.794	0.763	⅞	0.377	0.341	⅞	0.252	0.216
⅝	0.4375	⅜	0.750	0.728	0.866	0.830	⅞	0.441	0.403	⅞	0.285	0.247
¾	0.5000	⅜	0.875	0.850	1.010	0.969	⅞	0.504	0.464	⅞	0.317	0.277
⅞	0.5625	⅜	0.938	0.909	1.083	1.037	⅞	0.568	0.526	⅞	0.349	0.307
1	0.6250	1 ⅛	1.062	1.031	1.227	1.1175	1 ⅛	0.631	0.587	1 ⅛	0.381	0.337
1 ⅛	0.7500	1 ¼	1.250	1.212	1.443	1.382	1 ¼	0.758	0.710	1 ¼	0.446	0.398
1 ¼	0.8750	1 ⅝	1.438	1.394	1.660	1.589	1 ⅝	0.885	0.833	1 ⅝	0.510	0.458
1 ⅝	1.0000	1 ¾	1.625	1.575	1.876	1.796	1 ¾	1.012	0.956	1 ¾	0.575	0.519
1 ¾	1.1250	1 ¾	1.812	1.756	2.093	2.002	1 ¾	1.139	1.079	1 ¾	0.639	0.579
1 ¾	1.2500	2	2.000	1.938	2.309	2.209	2	1.251	1.187	2	0.751	0.687
1 ¾	1.3750	2 ⅛	2.188	2.119	2.526	2.416	2 ⅛	1.378	1.310	2 ⅛	0.815	0.747
1 ¾	1.5000	2 ⅜	2.375	2.300	2.742	2.622	2 ⅜	1.505	1.433	2 ⅜	0.880	0.808
1 ¾	1.6250	2 ⅝	2.562	2.481	2.959	2.828	2 ⅝	1.632	1.556	2 ⅝	0.944	0.868
1 ¾	1.7500	2 ¾	2.750	2.662	3.175	3.035	2 ¾	1.759	1.679	2 ¾	1.009	0.929
1 ¾	1.8750	2 ⅞	2.938	2.844	3.392	3.242	2 ⅞	1.886	1.802	2 ⅞	1.073	0.989
2	2.0000	3 ⅛	3.125	3.025	3.608	3.449	3 ⅛	2.013	1.925	3 ⅛	1.138	1.050
2 ¼	2.2500	3 ½	3.500	3.388	4.041	3.862	3 ½	2.251	2.155	3 ½	1.251	1.155
2 ½	2.5000	3 ¾	3.875	3.750	4.474	4.275	3 ¾	2.505	2.401	3 ¾	1.505	1.401
2 ¾	2.7500	4 ¼	4.250	4.112	4.907	4.688	4 ¼	2.759	2.647	4 ¼	1.634	1.522
3	3.0000	4 ⅝	4.625	4.475	5.340	5.102	4 ⅝	3.013	2.893	4 ⅝	1.763	1.643
3 ¼	3.2500	5	5.000	4.838	5.774	5.515	5	3.252	3.124	5	1.876	1.748
3 ½	3.5000	5 ⅜	5.375	5.200	6.207	5.928	5 ⅜	3.506	3.370	5 ⅜	2.006	1.870
3 ¾	3.7500	5 ½	5.750	5.562	6.640	6.341	5 ½	3.760	3.616	5 ½	2.134	1.990
4	4.0000	6 ⅛	6.125	5.925	7.073	6.755	6 ⅛	4.014	3.862	6 ⅛	2.264	2.112

All dimensions are in inches.

Bold type shows nuts unified dimensionally with British and Canadian Standards.

Threads are Unified Coarse-, Fine-, or 8-thread series (UNC, UNF or 8UN), Class 2B. Unification of fine-thread nuts is limited to sizes 1 inch and under.

**Table 8. American National Standard and Unified Standard Hex Flat Nuts and Flat Jam Nuts and Heavy Hex Flat Nuts and Flat Jam Nuts
ANSI/ASME B18.2.2-1987 (R1999)**

Nominal Size or Basic Major Dia. of Thread	Width Across Flats <i>F</i>			Width Across Corners <i>G</i>		Thickness, Flat Nuts <i>H</i>			Thickness, Flat Jam Nuts <i>H</i> ₁			
	Basic	Max.	Min.	Max.	Min.	Basic	Max.	Min.	Basic	Max.	Min.	
Hex Flat Nuts and Hex Flat Jam Nuts (Fig. 7)												
1/8	1.1250	1 1/16	1.688	1.631	1.949	1.859	1	1.030	0.970	5/8	0.655	0.595
1/4	1.2500	1 7/8	1.875	1.812	2.165	2.066	1 3/32	1.126	1.062	3/4	0.782	0.718
3/8	1.3750	2 1/16	2.062	1.994	2.382	2.273	1 13/64	1.237	1.169	13/16	0.846	0.778
1/2	1.5000	2 1/4	2.250	2.175	2.598	2.480	1 5/16	1.348	1.276	7/8	0.911	0.839
Heavy Hex Flat Nuts and Heavy Hex Flat Jam Nuts (Fig. 7)												
1/8	1.1250	1 13/16	1.812	1.756	2.093	2.002	1 1/8	1.155	1.079	5/8	0.655	0.579
1/4	1.2500	2	2.000	1.938	2.309	2.209	1 1/4	1.282	1.187	3/4	0.782	0.687
3/8	1.3750	2 3/16	2.188	2.119	2.526	2.416	1 3/8	1.409	1.310	13/16	0.846	0.747
1/2	1.5000	2 3/8	2.375	2.300	2.742	2.622	1 1/2	1.536	1.433	7/8	0.911	0.808
3/4	1.7500	2 3/4	2.750	2.662	3.175	3.035	1 3/4	1.790	1.679	1	1.040	0.929
2	2.0000	3 3/8	3.125	3.025	3.608	3.449	2	2.044	1.925	1 1/8	1.169	1.050
2 1/4	2.2500	3 1/2	3.500	3.388	4.041	3.862	2 1/4	2.298	2.155	1 1/4	1.298	1.155
2 1/2	2.5000	3 7/8	3.875	3.750	4.474	4.275	2 1/2	2.552	2.401	1 1/2	1.552	1.401
2 3/4	2.7500	4 1/4	4.250	4.112	4.907	4.688	2 3/4	2.806	2.647	1 5/8	1.681	1.522
3	3.0000	4 5/8	4.625	4.475	5.340	5.102	3	3.060	2.893	1 3/4	1.810	1.643
3 1/4	3.2500	5	5.000	4.838	5.774	5.515	3 1/4	3.314	3.124	1 7/8	1.939	1.748
3 1/2	3.5000	5 3/8	5.375	5.200	6.207	5.928	3 1/2	3.568	3.370	2	2.068	1.870
3 3/4	3.7500	5 3/4	5.750	5.562	6.640	6.341	3 3/4	3.822	3.616	2 1/8	2.197	1.990
4	4.0000	6 1/8	6.125	5.925	7.073	6.755	4	4.076	3.862	2 1/4	2.326	2.112

All dimensions are in inches.

Bold type indicates nuts unified dimensionally with British and Canadian Standards.

Threads are Unified Coarse-thread series (UNC), Class 2B.

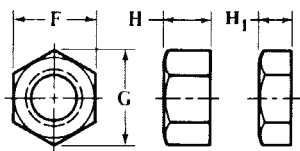


Fig. 7. Hex Flat Nuts, Heavy Hex Flat Nuts, Hex Flat Jam Nuts, and Heavy Hex Flat Jam Nuts (Table 8)

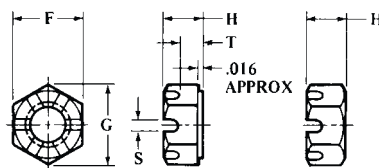


Fig. 8. Hex Slotted Nuts, Heavy Hex Slotted Nuts, and Hex Thick Slotted Nuts (Table 9)

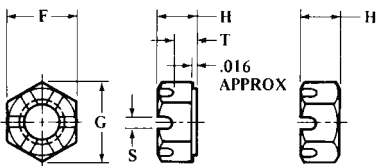


Fig. 9. Hex Thick Nuts (Table 10)

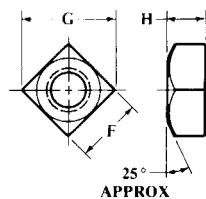


Fig. 10. Square Nuts, Heavy Square Nuts (Table 10)

Table 9. American National and Unified Standard Hex Slotted Nuts, Heavy Hex Slotted Nuts, and Hex Thick Slotted Nuts ANSI/ASME B18.2.2-1987 (R1999)

Nominal Size or Basic Major Dia. of Thread	Width Across Flats <i>F</i>			Width Across Corners <i>G</i>		Thickness <i>H</i>			Unslotted Thickness <i>T</i>		Width of Slot <i>S</i>		
	Basic	Max.	Min.	Max.	Min.	Basic	Max.	Min.	Max.	Min.	Max.	Min.	
Hex Slotted Nuts (Fig. 8)													
1/4	0.2500	7/16	0.438	0.428	0.505	0.488	7/32	0.226	0.212	0.14	0.12	0.10	0.07
5/16	0.3125	1/2	0.500	0.489	0.577	0.577	17/64	0.273	0.258	0.18	0.16	0.12	0.09
3/8	0.3750	9/16	0.562	0.551	0.650	0.628	27/64	0.337	0.320	0.21	0.19	0.15	0.12
7/16	0.4375	11/16	0.688	0.675	0.794	0.768	3/8	0.385	0.365	0.23	0.21	0.15	0.12
1/2	0.5000	3/4	0.750	0.736	0.866	0.840	7/16	0.448	0.427	0.29	0.27	0.18	0.15
5/16	0.5625	7/8	0.875	0.861	1.010	0.982	31/64	0.496	0.473	0.31	0.29	0.18	0.15
5/8	0.6250	15/16	0.938	0.922	1.083	1.051	35/64	0.559	0.535	0.34	0.32	0.24	0.18
3/4	0.7500	1 1/8	1.125	1.088	1.299	1.240	41/64	0.665	0.617	0.40	0.38	0.24	0.18
7/8	0.8750	1 1/16	1.312	1.269	1.516	1.447	3/4	0.776	0.724	0.52	0.49	0.24	0.18
1	1.0000	1 1/2	1.500	1.450	1.732	1.653	55/64	0.887	0.831	0.59	0.56	0.30	0.24
1 1/8	1.1250	1 1/16	1.688	1.631	1.949	1.859	37/32	0.999	0.939	0.64	0.61	0.33	0.24
1 1/4	1.2500	1 7/8	1.875	1.812	2.165	2.066	1 1/16	1.094	1.030	0.70	0.67	0.40	0.31
1 3/8	1.3750	2 1/16	2.062	1.994	2.382	2.273	1 1/64	1.206	1.138	0.82	0.78	0.40	0.31
1 1/2	1.5000	2 1/4	2.250	2.175	2.598	2.480	1 1/32	1.317	1.245	0.86	0.82	0.46	0.37
Heavy Hex Slotted Nuts (Fig. 8)													
1/4	0.2500	1/2	0.500	0.488	0.577	0.556	15/64	0.250	0.218	0.15	0.13	0.10	0.07
5/16	0.3125	9/16	0.562	0.546	0.650	0.622	19/64	0.314	0.280	0.21	0.19	0.12	0.09
3/8	0.3750	11/16	0.688	0.669	0.794	0.763	23/64	0.377	0.341	0.24	0.22	0.15	0.12
7/16	0.4375	3/4	0.750	0.728	0.866	0.830	27/64	0.441	0.403	0.28	0.26	0.15	0.12
1/2	0.5000	7/8	0.875	0.850	1.010	0.969	31/64	0.504	0.464	0.34	0.32	0.18	0.15
5/16	0.5625	15/16	0.938	0.909	1.083	1.037	35/64	0.568	0.526	0.37	0.35	0.18	0.15
5/8	0.6250	1 1/16	1.062	1.031	1.227	1.175	39/64	0.631	0.587	0.40	0.38	0.24	0.18
3/4	0.7500	1 1/4	1.250	1.212	1.443	1.382	47/64	0.758	0.710	0.49	0.47	0.24	0.18
7/8	0.8750	1 7/16	1.438	1.394	1.660	1.589	55/64	0.885	0.833	0.62	0.59	0.24	0.18
1	1.0000	1 3/8	1.625	1.575	1.876	1.796	63/64	1.012	0.956	0.72	0.69	0.30	0.24
1 1/8	1.1250	1 13/16	1.812	1.756	2.093	2.002	1 1/64	1.139	1.079	0.78	0.75	0.33	0.24
1 1/4	1.2500	2	2.000	1.938	2.309	2.209	1 7/32	1.251	1.187	0.86	0.83	0.40	0.31
1 3/8	1.3750	2 3/16	2.188	2.119	2.526	2.416	1 1/32	1.378	1.310	0.99	0.95	0.40	0.31
1 1/2	1.5000	2 3/8	2.375	2.300	2.742	2.622	1 5/32	1.505	1.433	1.05	1.01	0.46	0.37
1 3/4	1.7500	2 3/4	2.750	2.662	3.175	3.035	1 3/32	1.759	1.679	1.24	1.20	0.52	0.43
2	2.0000	3 1/2	3.125	3.025	3.608	3.449	1 3/16	2.013	1.925	1.43	1.38	0.52	0.43
2 1/4	2.2500	3 1/2	3.500	3.388	4.041	3.862	2 1/32	2.251	2.155	1.67	1.62	0.52	0.43
2 1/2	2.5000	3 7/8	3.875	3.750	4.474	4.275	2 3/64	2.505	2.401	1.79	1.74	0.64	0.55
2 3/4	2.7500	4 1/4	4.250	4.112	4.907	4.688	2 5/64	2.759	2.647	2.05	1.99	0.64	0.55
3	3.0000	4 3/8	4.625	4.475	5.340	5.102	2 9/64	3.013	2.893	2.23	2.17	0.71	0.62
3 1/4	3.2500	5	5.000	4.838	5.774	5.515	3 1/16	3.252	3.124	2.47	2.41	0.71	0.62
3 1/2	3.5000	5 3/8	5.375	5.200	6.207	5.928	3 1/8	3.506	3.370	2.72	2.65	0.71	0.62
3 3/4	3.7500	5 3/4	5.750	5.562	6.640	6.341	3 1/2	3.760	3.616	2.97	2.90	0.71	0.62
4	4.0000	6 1/8	6.125	5.925	7.073	6.755	3 15/16	4.014	3.862	3.22	3.15	0.71	0.62
Hex Thick Slotted Nuts (Fig. 8)													
1/4	0.2500	7/16	0.438	0.428	0.505	0.488	9/32	0.288	0.274	0.20	0.18	0.10	0.07
5/16	0.3125	1/2	0.500	0.489	0.577	0.557	21/64	0.336	0.320	0.24	0.22	0.12	0.09
3/8	0.3750	9/16	0.562	0.551	0.650	0.628	13/32	0.415	0.398	0.29	0.27	0.15	0.12
7/16	0.4375	11/16	0.688	0.675	0.794	0.768	29/64	0.463	0.444	0.31	0.29	0.15	0.12
1/2	0.5000	3/4	0.750	0.736	0.866	0.840	9/16	0.573	0.552	0.42	0.40	0.18	0.15
5/16	0.5625	7/8	0.875	0.861	1.010	0.982	39/64	0.621	0.598	0.43	0.41	0.18	0.15
5/8	0.6250	15/16	0.938	0.922	1.083	1.051	23/32	0.731	0.706	0.51	0.49	0.24	0.18
3/4	0.7500	1 1/8	1.125	1.088	1.299	1.240	13/16	0.827	0.798	0.57	0.55	0.24	0.18
7/8	0.8750	1 5/16	1.312	1.269	1.516	1.447	27/32	0.922	0.890	0.67	0.64	0.24	0.18
1	1.0000	1 1/2	1.500	1.450	1.732	1.653	1	1.018	0.982	0.73	0.70	0.30	0.24
1 1/8	1.1250	1 11/16	1.688	1.631	1.949	1.859	1 5/32	1.176	1.136	0.83	0.80	0.33	0.24
1 1/4	1.2500	1 7/8	1.875	1.812	2.165	2.066	1 1/4	1.272	1.228	0.89	0.86	0.40	0.31
1 3/8	1.3750	2 1/16	2.062	1.994	2.382	2.273	1 3/8	1.399	1.351	1.02	0.98	0.40	0.31
1 1/2	1.5000	2 1/4	2.250	2.175	2.598	2.480	1 1/2	1.526	1.474	1.08	1.04	0.46	0.37

All dimensions are in inches.

Bold type indicates nuts unified dimensionally with British and Canadian Standards.

Threads are Unified Coarse-, Fine-, or 8-thread series (UNC, UNF, or 8UN), Class 2B.

Unification of fine-thread nuts is limited to sizes 1 inch and under.

Table 10. American National and Unified Standard Square Nuts and Heavy Square Nuts and American National Standard Hex Thick Nuts
ANSI/ASME B18.2.2-1987 (R1999)

Nominal Size or Basic Major Dia. of Thread		Width Across Flats <i>F</i>			Width Across Corners <i>G</i>		Thickness <i>H</i>		
		Basic	Max.	Min.	Max.	Min.	Basic	Max.	Min.
Square Nuts ^a (Fig. 10)									
$\frac{1}{4}$	0.2500	$\frac{7}{16}$	0.438	0.425	0.619	0.554	$\frac{7}{32}$	0.235	0.203
$\frac{5}{16}$	0.3125	$\frac{9}{16}$	0.562	0.547	0.795	0.721	$\frac{17}{64}$	0.283	0.249
$\frac{3}{8}$	0.3750	$\frac{5}{8}$	0.625	0.606	0.884	0.802	$\frac{21}{64}$	0.346	0.310
$\frac{7}{16}$	0.4375	$\frac{3}{4}$	0.750	0.728	1.061	0.970	$\frac{3}{8}$	0.394	0.356
$\frac{1}{2}$	0.5000	$\frac{13}{16}$	0.812	0.788	1.149	1.052	$\frac{7}{16}$	0.458	0.418
$\frac{5}{8}$	0.6250	1	1.000	0.969	1.414	1.300	$\frac{35}{64}$	0.569	0.525
$\frac{3}{4}$	0.7500	$1\frac{1}{8}$	1.125	1.088	1.591	1.464	$\frac{21}{32}$	0.680	0.632
$\frac{7}{8}$	0.8750	$1\frac{5}{16}$	1.312	1.269	1.856	1.712	$\frac{49}{64}$	0.792	0.740
1	1.0000	$1\frac{1}{2}$	1.500	1.450	2.121	1.961	$\frac{7}{8}$	0.903	0.847
$1\frac{1}{8}$	1.1250	$1\frac{11}{16}$	1.688	1.631	2.386	2.209	1	1.030	0.970
$1\frac{1}{4}$	1.2500	$1\frac{7}{8}$	1.875	1.812	2.652	2.458	$1\frac{3}{32}$	1.126	1.062
$1\frac{3}{8}$	1.3750	$2\frac{1}{16}$	2.062	1.994	2.917	2.708	$1\frac{13}{64}$	1.237	1.169
$1\frac{1}{2}$	1.5000	$2\frac{1}{4}$	2.250	2.175	3.182	2.956	$1\frac{5}{16}$	1.348	1.276
Heavy Square Nuts ^a (Fig. 10)									
$\frac{1}{4}$	0.2500	$\frac{1}{2}$	0.500	0.488	0.707	0.640	$\frac{1}{4}$	0.266	0.218
$\frac{5}{16}$	0.3125	$\frac{9}{16}$	0.562	0.546	0.795	0.720	$\frac{3}{16}$	0.330	0.280
$\frac{3}{8}$	0.3750	$\frac{11}{16}$	0.688	0.669	0.973	0.889	$\frac{3}{8}$	0.393	0.341
$\frac{7}{16}$	0.4375	$\frac{3}{4}$	0.750	0.728	1.060	0.970	$\frac{7}{16}$	0.456	0.403
$\frac{1}{2}$	0.5000	$\frac{7}{8}$	0.875	0.850	1.237	1.137	$\frac{1}{2}$	0.520	0.464
$\frac{5}{8}$	0.6250	$1\frac{1}{16}$	1.062	1.031	1.503	1.386	$\frac{5}{8}$	0.647	0.587
$\frac{3}{4}$	0.7500	$1\frac{1}{4}$	1.250	1.212	1.768	1.635	$\frac{3}{4}$	0.774	0.710
$\frac{7}{8}$	0.8750	$1\frac{7}{16}$	1.438	1.394	2.033	1.884	$\frac{7}{8}$	0.901	0.833
1	1.0000	$1\frac{5}{8}$	1.625	1.575	2.298	2.132	1	1.028	0.956
$1\frac{1}{8}$	1.1250	$1\frac{13}{16}$	1.812	1.756	2.563	2.381	$1\frac{1}{8}$	1.155	1.079
$1\frac{1}{4}$	1.2500	2	2.000	1.938	2.828	2.631	$1\frac{1}{4}$	1.282	1.187
$1\frac{3}{8}$	1.3750	$2\frac{3}{16}$	2.188	2.119	3.094	2.879	$1\frac{3}{8}$	1.409	1.310
$1\frac{1}{2}$	1.5000	$2\frac{3}{8}$	2.375	2.300	3.359	3.128	$1\frac{1}{2}$	1.536	1.433
Hex Thick Nuts ^b (Fig. 10)									
$\frac{1}{4}$	0.2500	$\frac{7}{16}$	0.438	0.428	0.505	0.488	$\frac{9}{32}$	0.288	0.274
$\frac{5}{16}$	0.3125	$\frac{1}{2}$	0.500	0.489	0.577	0.557	$\frac{21}{64}$	0.336	0.320
$\frac{3}{8}$	0.3750	$\frac{9}{16}$	0.562	0.551	0.650	0.628	$\frac{13}{32}$	0.415	0.398
$\frac{7}{16}$	0.4375	$\frac{11}{16}$	0.688	0.675	0.794	0.768	$\frac{29}{64}$	0.463	0.444
$\frac{1}{2}$	0.5000	$\frac{3}{4}$	0.750	0.736	0.866	0.840	$\frac{9}{16}$	0.573	0.552
$\frac{5}{16}$	0.5625	$\frac{7}{8}$	0.875	0.861	1.010	0.982	$\frac{39}{64}$	0.621	0.598
$\frac{3}{8}$	0.6250	$\frac{15}{16}$	0.938	0.922	1.083	1.051	$\frac{23}{32}$	0.731	0.706
$\frac{3}{4}$	0.7500	$1\frac{1}{8}$	1.125	1.088	1.299	1.240	$1\frac{1}{16}$	0.827	0.798
$\frac{7}{8}$	0.8750	$1\frac{3}{16}$	1.312	1.269	1.516	1.447	$\frac{29}{32}$	0.922	0.890
1	1.0000	$1\frac{1}{2}$	1.500	1.450	1.732	1.653	1	1.018	0.982
$1\frac{1}{8}$	1.1250	$1\frac{11}{16}$	1.688	1.631	1.949	1.859	$1\frac{5}{32}$	1.176	1.136
$1\frac{1}{4}$	1.2500	$1\frac{7}{8}$	1.875	1.812	2.165	2.066	$1\frac{1}{4}$	1.272	1.228
$1\frac{3}{8}$	1.3750	$2\frac{1}{16}$	2.062	1.994	2.382	2.273	$1\frac{3}{8}$	1.399	1.351
$1\frac{1}{2}$	1.5000	$2\frac{1}{4}$	2.250	2.175	2.598	2.480	$1\frac{1}{2}$	1.526	1.474

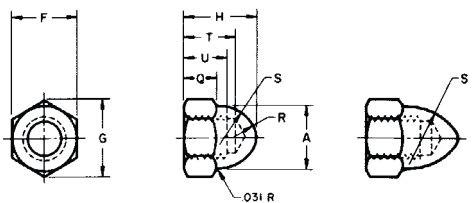
^a Coarse-thread series, Class 2B.

^b Unified Coarse-, Fine-, or 8-thread series (8 UN), Class 2B.

All dimensions are in inches.

Bold type indicates nuts unified dimensionally with British and Canadian Standards.

Low and High Crown (Blind, Acorn) Nuts SAE Recommended Practice J483a



Low Crown													
Nom. Size ^a or Basic Major Dia. of Thread	Width Across Flats, <i>F</i>	Width Across Corners, <i>G</i>		Body Dia., <i>A</i>	Over- all Hgt., <i>H</i>	Hexa- gon Hgt., <i>Q</i>	Nose Rad., <i>R</i>	Body Rad., <i>S</i>	Drill Dep., <i>T</i>	Full Thd., <i>U</i>			
		Max.	(Basic)								Min.	Max.	Min.
6	0.1380	5/16	0.3125	0.302	0.361	0.344	0.30	0.34	0.16	0.08	0.17	0.25	0.16
8	0.1640	5/16	0.3125	0.302	0.361	0.344	0.30	0.34	0.16	0.08	0.17	0.25	0.16
10	0.1900	3/8	0.3750	0.362	0.433	0.413	0.36	0.41	0.19	0.09	0.22	0.28	0.19
12	0.2160	3/8	0.3750	0.362	0.433	0.413	0.36	0.41	0.19	0.09	0.22	0.31	0.22
1/4	0.2500	7/16	0.4375	0.428	0.505	0.488	0.41	0.47	0.22	0.11	0.25	0.34	0.25
5/16	0.3125	1/2	0.5000	0.489	0.577	0.557	0.47	0.53	0.25	0.12	0.28	0.41	0.31
3/8	0.3750	9/16	0.5625	0.551	0.650	0.628	0.53	0.62	0.28	0.14	0.33	0.45	0.38
7/16	0.4375	5/8	0.6250	0.612	0.722	0.698	0.59	0.69	0.31	0.16	0.36	0.52	0.44
1/2	0.5000	3/4	0.7500	0.736	0.866	0.840	0.72	0.81	0.38	0.19	0.42	0.59	0.50
9/16	0.5625	7/8	0.8750	0.861	1.010	0.982	0.84	0.94	0.44	0.22	0.50	0.69	0.56
5/8	0.6250	15/16	0.9375	0.922	1.083	1.051	0.91	1.00	0.47	0.23	0.53	0.75	0.62
3/4	0.7500	1 1/16	1.0625	1.045	1.227	1.191	1.03	1.16	0.53	0.27	0.59	0.88	0.75
7/8	0.8750	1 1/4	1.2500	1.231	1.443	1.403	1.22	1.36	0.62	0.31	0.70	1.00	0.88
1	1.0000	1 1/8	1.4375	1.417	1.660	1.615	1.41	1.55	0.72	0.36	0.81	1.12	1.00
1 1/8	1.1250	1 3/8	1.6250	1.602	1.876	1.826	1.59	1.75	0.81	0.41	0.92	1.31	1.12
1 1/4	1.2500	1 3/4	1.8125	1.788	2.093	2.038	1.78	1.95	0.91	0.45	1.03	1.44	1.25
High Crown													
Nom. Size ^a or Basic Major Dia. of Thread	Width Across Flats, <i>F</i>	Width Across Corners, <i>G</i>		Body Dia., <i>A</i>	Over- all Hgt., <i>H</i>	Hexa- gon Hgt., <i>Q</i>	Nose Rad., <i>R</i>	Body Rad., <i>S</i>	Drill Dep., <i>T</i>	Full Thd., <i>U</i>			
		Max.	(Basic)								Min.	Max.	Min.
6	0.1380	5/16	0.3125	0.302	0.361	0.344	0.30	0.42	0.17	0.05	0.25	0.28	0.19
8	0.1640	5/16	0.3125	0.302	0.361	0.344	0.30	0.42	0.17	0.05	0.25	0.28	0.19
10	0.1900	3/8	0.3750	0.362	0.433	0.413	0.36	0.52	0.20	0.06	0.30	0.34	0.25
12	0.2160	3/8	0.3750	0.362	0.433	0.413	0.36	0.52	0.20	0.06	0.30	0.38	0.28
1/4	0.2500	7/16	0.4375	0.428	0.505	0.488	0.41	0.59	0.23	0.06	0.34	0.41	0.31
5/16	0.3125	1/2	0.5000	0.489	0.577	0.557	0.47	0.69	0.28	0.08	0.41	0.47	0.38
3/8	0.3750	9/16	0.5625	0.551	0.650	0.628	0.53	0.78	0.31	0.09	0.44	0.56	0.47
7/16	0.4375	5/8	0.6250	0.612	0.722	0.698	0.59	0.88	0.34	0.09	0.50	0.62	0.53
1/2	0.5000	3/4	0.7500	0.736	0.866	0.840	0.72	1.03	0.42	0.12	0.59	0.75	0.62
9/16	0.5625	7/8	0.8750	0.861	1.010	0.982	0.84	1.19	0.48	0.16	0.69	0.81	0.69
5/8	0.6250	15/16	0.9375	0.922	1.083	1.051	0.91	1.28	0.53	0.16	0.75	0.91	0.78
3/4	0.7500	1 1/16	1.0625	1.045	1.227	1.191	1.03	1.45	0.59	0.17	0.84	1.06	0.94
7/8	0.8750	1 1/4	1.2500	1.231	1.443	1.403	1.22	1.72	0.70	0.20	0.98	1.22	1.09
1	1.0000	1 1/8	1.4375	1.417	1.660	1.615	1.41	1.97	0.81	0.23	1.14	1.38	1.25
1 1/8	1.1250	1 3/8	1.6250	1.602	1.876	1.826	1.59	2.22	0.92	0.27	1.28	1.59	1.41
1 1/4	1.2500	1 3/4	1.8125	1.788	2.093	2.038	1.78	2.47	1.03	0.28	1.44	1.75	1.56

^a When specifying a nominal size in decimals, any zero in the fourth decimal place is omitted. Reprinted with permission. Copyright © 1990, Society of Automotive Engineers, Inc. All rights reserved.

All dimensions are in inches. Threads are Unified Standard Class 2B, UNC or UNF Series.

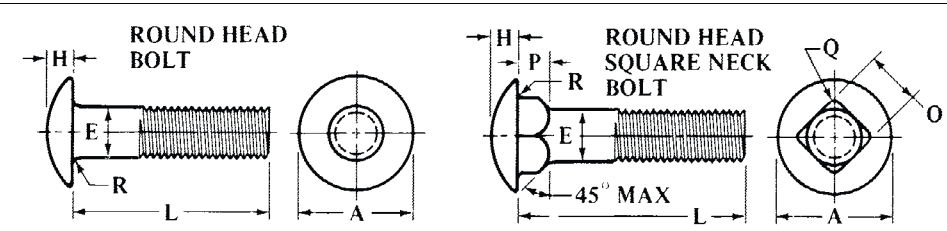
Hex High and Hex Slotted High Nuts SAE Standard J482a

Nominal Size ^a or Basic Major Diameter of Thread		Width Across Flats, <i>F</i>			Width Across Corners, <i>G</i>		Slot Width, <i>S</i>	
		Basic	Max.	Min.	Max.	Min.	Min.	Max.
1/4	0.2500	7/16	0.4375	0.428	0.505	0.488	0.07	0.10
5/16	0.3125	1/2	0.5000	0.489	0.577	0.557	0.09	0.12
3/8	0.3750	9/16	0.5625	0.551	0.650	0.628	0.12	0.15
7/16	0.4375	11/16	0.6875	0.675	0.794	0.768	0.12	0.15
1/2	0.5000	3/4	0.7500	0.736	0.866	0.840	0.15	0.18
9/16	0.5625	7/8	0.8750	0.861	1.010	0.982	0.15	0.18
5/8	0.6250	15/16	0.9375	0.922	1.083	1.051	0.18	0.24
3/4	0.7500	1 1/8	1.1250	1.088	1.299	1.240	0.18	0.24
7/8	0.8750	1 5/16	1.3125	1.269	1.516	1.447	0.18	0.24
1	1.0000	1 1/2	1.5000	1.450	1.732	1.653	0.24	0.30
1 1/8	1.1250	1 11/16	1.6875	1.631	1.949	1.859	0.24	0.33
1 1/4	1.2500	1 7/8	1.8750	1.812	2.165	2.066	0.31	0.40
Nominal Size ^a or Basic Major Diameter of Thread		Thickness, <i>H</i>			Unslotted Thickness, <i>T</i>		Counterbore (Optional)	
		Basic	Max.	Min.	Max.	Min.	Dia., <i>A</i>	Depth, <i>D</i>
1/4	0.2500	3/8	0.382	0.368	0.29	0.27	0.266	0.062
5/16	0.3125	29/64	0.461	0.445	0.37	0.35	0.328	0.078
3/8	0.3750	1/2	0.509	0.491	0.38	0.36	0.391	0.094
7/16	0.4375	39/64	0.619	0.599	0.46	0.44	0.453	0.109
1/2	0.5000	21/32	0.667	0.645	0.51	0.49	0.516	0.125
9/16	0.5625	49/64	0.778	0.754	0.59	0.57	0.594	0.141
5/8	0.6250	27/32	0.857	0.831	0.63	0.61	0.656	0.156
3/4	0.7500	1	1.015	0.985	0.76	0.73	0.781	0.188
7/8	0.8750	1 5/32	1.172	1.140	0.92	0.89	0.906	0.219
1	1.0000	1 3/16	1.330	1.292	1.05	1.01	1.031	0.250
1 1/8	1.1250	1 1/2	1.520	1.480	1.18	1.14	1.156	0.281
1 1/4	1.2500	1 11/16	1.710	1.666	1.34	1.29	1.281	0.312

^a When specifying a nominal size in decimals, any zero in the fourth decimal place is omitted. Reprinted with permission. Copyright © 1990, Society of Automotive Engineers, Inc. All rights reserved.

All dimensions are in inches. Threads are Unified Standard Class 2B, UNC or UNF Series.

**American National Standard Round Head and Round Head Square Neck Bolts
ANSI/ASME B18.5 -1990 (R2003)**



Nominal Size	Body Dia., E		Dia. of Head, A		Height of Head, H		Fillet Rad., R	Width of Square, O		Depth of Square, P		Corner Rad. on Square, Q
	Max.	Min.	Max.	Min.	Max.	Min.	Max.	Max.	Min.	Max.	Min.	Max.
No. 10	0.199	.182	.469	.438	.114	.094	.031	.199	.185	.125	.094	.031
1/4	0.260	.237	.594	.563	.145	.125	.031	.260	.245	.156	.125	.031
5/16	0.324	.298	.719	.688	.176	.156	.031	.324	.307	.187	.156	.031
3/8	0.388	.360	.844	.782	.208	.188	.031	.388	.368	.219	.188	.047
7/16	0.452	.421	.969	.907	.239	.219	.031	.452	.431	.250	.219	.047
1/2	0.515	.483	1.094	1.032	.270	.250	.031	.515	.492	.281	.250	.047
5/8	0.642	.605	1.344	1.219	.344	.313	.062	.642	.616	.344	.313	.078
3/4	0.768	.729	1.594	1.469	.406	.375	.062	.768	.741	.406	.375	.078
7/8	0.895	.852	1.844	1.719	.469	.438	.062	.895	.865	.469	.438	.094
1	1.022	.976	2.094	1.969	.531	.500	.062	1.022	.990	.531	.500	.094

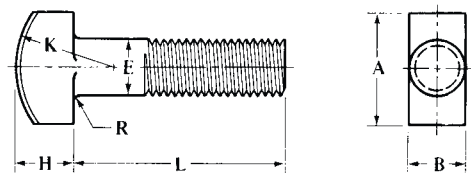
All dimensions are in inches unless otherwise specified.

Threads are Unified Standard, Class 2A, UNC Series, in accordance with ANSI B1.1. For threads with additive finish, the maximum diameters of Class 2A shall apply before plating or coating, whereas the basic diameters (Class 2A maximum diameters plus the allowance) shall apply to a bolt after plating or coating.

Bolts are designated in the sequence shown: nominal size (number, fraction or decimal equivalent); threads per inch; nominal length (fraction or decimal equivalent); product name; material; and protective finish, if required.

i.e.: 1/2-13 x 3 Round Head Square Neck Bolt, Steel .375-16 x 2.50 Step Bolt, Steel, Zinc Plated

American National Standard T-Head Bolts ANSI/ASME B18.5 -1990 (R2003)

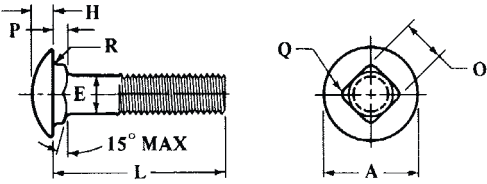


Nom. Size ^a or Basic Bolt Dia.	Body Dia., E		Head Length, A		Head Width, B		Head Height, H		Head Rad., K	Fillet Rad., R	
	Max.	Min.	Max.	Min.	Max.	Min.	Max.	Min.	Basic	Max.	
1/4	0.2500	.260	.237	.500	.488	.280	.245	.204	.172	.438	.031
3/16	0.3125	.324	.298	.625	.609	.342	.307	.267	.233	.500	.031
5/8	0.3750	.388	.360	.750	.731	.405	.368	.331	.295	.625	.031
7/16	0.4375	.452	.421	.875	.853	.468	.431	.394	.356	.875	.031
1/2	0.5000	.515	.483	1.000	.975	.530	.492	.458	.418	.875	.031
5/8	0.6250	.642	.605	1.250	1.218	.675	.616	.585	.541	1.062	.062
3/4	0.7500	.768	.729	1.500	1.462	.800	.741	.649	.601	1.250	.062
7/8	0.8750	.895	.852	1.750	1.706	.938	.865	.776	.724	1.375	.062
1	1.0000	1.022	.976	2.000	1.950	1.063	.990	.903	.847	1.500	.062

^a Where specifying nominal size in decimals, zeros preceding the decimal point and in the fourth decimal place are omitted. For information as to threads and method of bolt designation, see footnotes to preceding table.

All dimensions are given in inches.

American National Standard Round Head Short Square Neck Bolts
ANSI/ASME B18.5-1990 (R2003)



Nominal Size	Body Dia., <i>E</i>		Head Dia., <i>A</i>		Head Height, <i>H</i>		Square Width, <i>O</i>		Square Depth, <i>P</i>		Cor. Rad. on Sq., <i>Q</i>	Fillet Rad., <i>R</i>
	Max	Min	Max	Min	Max	Min	Max	Min	Max	Min	Max	Max
1/4	0.260	0.213	0.594	0.563	0.145	0.125	0.260	0.245	0.124	0.093	0.031	0.031
5/16	0.324	0.272	0.719	0.688	0.176	0.156	0.324	0.307	0.124	0.093	0.031	0.031
3/8	0.388	0.329	0.844	0.782	0.208	0.188	0.388	0.368	0.156	0.125	0.047	0.031
7/16	0.452	0.385	0.969	0.907	0.239	0.219	0.452	0.431	0.156	0.125	0.047	0.031
1/2	0.515	0.444	1.094	1.032	0.270	0.250	0.515	0.492	0.156	0.125	0.047	0.031
5/8	0.642	0.559	1.344	1.219	0.344	0.313	0.642	0.616	0.218	0.187	0.078	0.062
3/4	0.768	0.678	1.594	1.469	0.406	0.375	0.768	0.741	0.218	0.187	0.078	0.062

All dimensions are given in inches.

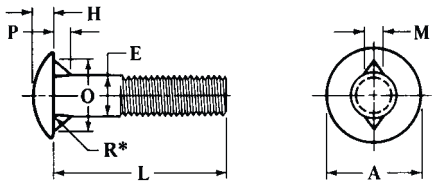
Threads are Unified Standard, Class 2A, UNC Series, in accordance with ANSI B1.1. For threads with additive finish, the maximum diameters of Class 2A apply before plating or coating, whereas the basic diameters (Class 2A maximum diameters plus the allowance) apply to a bolt after plating or coating.

Bolts are designated in the sequence shown: nominal size (number, fraction or decimal equivalent); threads per inch; nominal length (fraction or decimal equivalent); product name; material; and protective finish, if required. For example,

1/2-13 x 3 Round Head Short Square Neck Bolt, Steel

.375-16 x 2.50 Round Head Short Square Neck Bolt, Steel, Zinc Plated

American National Standard Round Head Fin Neck Bolts
ANSI/ASME B18.5-1990 (R2003)



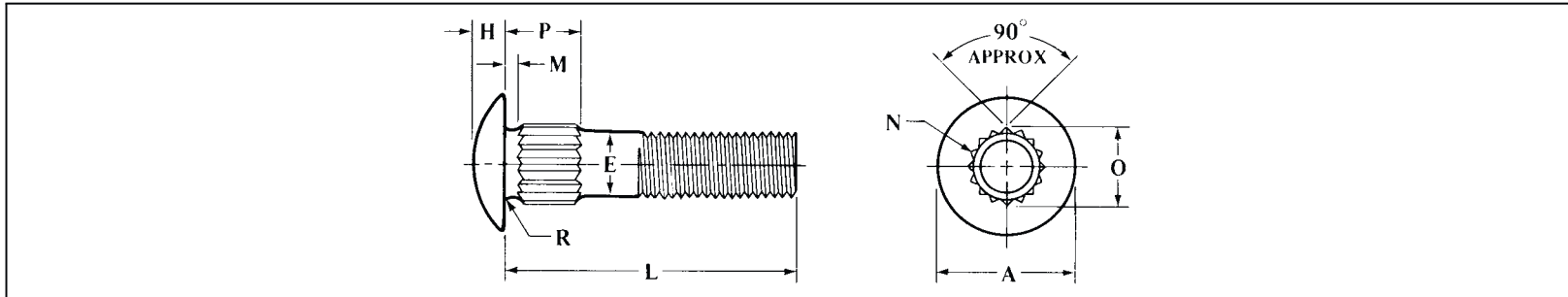
Nominal Size	Body Dia., <i>E</i>		Head Dia., <i>A</i>		Head Height, <i>H</i>		Fin Thick., <i>M</i>		Dist. Across Fins, <i>O</i>		Fin Depth, <i>P</i>	
	Max	Min	Max	Min	Max	Min	Max	Min	Max	Min	Max	Min
No. 10	0.199	0.182	0.469	0.438	0.114	0.094	0.098	0.078	0.395	0.375	0.088	0.078
1/4	0.260	0.237	0.594	0.563	0.145	0.125	0.114	0.094	0.458	0.438	0.104	0.094
5/16	0.324	0.298	0.719	0.688	0.176	0.156	0.145	0.125	0.551	0.531	0.135	0.125
3/8	0.388	0.360	0.844	0.782	0.208	0.188	0.161	0.141	0.645	0.625	0.151	0.141
7/16	0.452	0.421	0.969	0.907	0.239	0.219	0.192	0.172	0.739	0.719	0.182	0.172
1/2	0.515	0.483	1.094	1.032	0.270	0.250	0.208	0.188	0.833	0.813	0.198	0.188

All dimensions are given in inches unless otherwise specified.

*Maximum fillet radius *R* is 0.031 inch for all sizes.

For information as to threads and method of bolt designation, see footnotes to the preceding table.

American National Standard Round Head Ribbed Neck Bolts ANSI/ASME B18.5-1990 (R2003)



Nominal Size ^a or Basic Bolt Diameter		Body Diameter, <i>E</i>		Head Diameter, <i>A</i>		Head Height, <i>H</i>		Head to Ribs, <i>M</i>		Number of Ribs, <i>N</i>	Dia. Over Ribs, <i>O</i>	Depth Over Ribs, <i>P</i>			Fillet Radius, <i>R</i>
								For Lengths of				For Lengths of			
								⅞ in. and Shorter	1 in. and Longer			⅞ in. and Shorter	1 in. and 1 ⅛ in.	¼ in. and Longer	
								±0.031 ^b				±0.031			
No. 10	0.1900	0.199	0.182	0.469	0.438	0.114	0.094	0.031†	0.063	9	0.210	0.250	0.407	0.594	0.031
¼	0.2500	0.260	0.237	0.594	0.563	0.145	0.125	0.031†	0.063	10	0.274	0.250	0.407	0.594	0.031
⅝ ₁₆	0.3125	0.324	0.298	0.719	0.688	0.176	0.156	0.031†	0.063	12	0.340	0.250	0.407	0.594	0.031
⅜	0.3750	0.388	0.360	0.844	0.782	0.208	0.188	0.031†	0.063	12	0.405	0.250	0.407	0.594	0.031
⅞ ₁₆	0.4375	0.452	0.421	0.969	0.907	0.239	0.219	0.031†	0.063	14	0.470	0.250	0.407	0.594	0.031
½	0.5000	0.515	0.483	1.094	1.032	0.270	0.250	0.031†	0.063	16	0.534	0.250	0.407	0.594	0.031
⅝ ₈	0.6250	0.642	0.605	1.344	1.219	0.344	0.313	0.094	0.094	19	0.660	0.313	0.438	0.625	0.062
¾	0.7500	0.768	0.729	1.594	1.469	0.406	0.375	0.094	0.094	22	0.785	0.313	0.438	0.625	0.062

^a Where specifying nominal size in decimals, zeros preceding decimal and in the fourth decimal place shall be omitted.

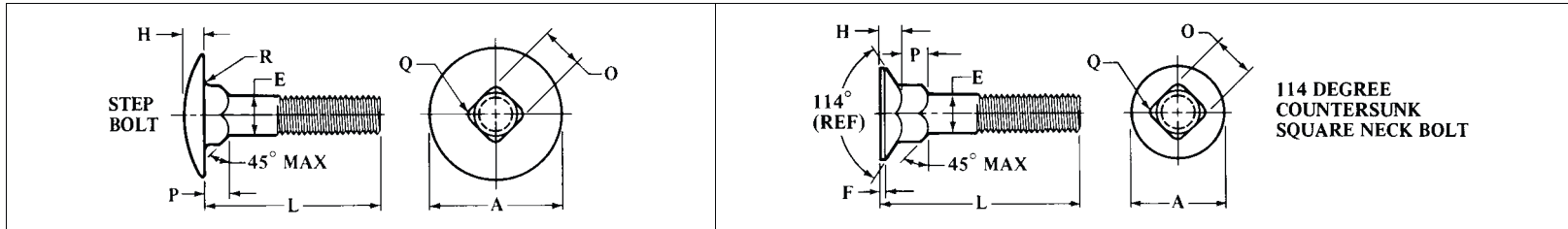
^b Tolerance on the No. 10 through ½ in. sizes for nominal lengths ⅞ in. and shorter shall be + 0.031 and – 0.000.

^c The minimum radius is one half of the value shown.

All dimensions are given in inches unless otherwise specified.

For information as to threads and method of designating bolts, see following table.

**American National Standard Step and 114 Degree Countersunk Square Neck Bolts
ANSI/ASME B18.5-1990 (R2003)**



Nominal Size	Step & 114° Countersunk Bolts					Step Bolts							114° Countersunk Square Neck Bolts						
	Body Dia., E		Corner Rad. on Square, Q	Width of Square, O		Depth of Square, P		Dia. of Head, A		Height of Head, H		Fillet Radius, R	Depth of Square, P		Dia. of Head, A		Flat on Head, F	Height of Head, H	
	Max.	Min.	Max.	Min.	Min.	Max.	Min.	Max.	Min.	Max.	Min.	Max.	Max.	Min.	Max.	Min.	Min.	Max.	Min.
No. 10	0.199	0.182	0.031	0.199	0.185	0.125	0.094	0.656	0.625	0.114	0.094	0.031	0.125	0.094	0.548	0.500	0.015	0.131	0.112
¼	0.260	0.237	0.031	0.260	0.245	0.156	0.125	0.844	0.813	0.145	0.125	0.031	0.156	0.125	0.682	0.625	0.018	0.154	0.135
⅜	0.324	0.298	0.031	0.324	0.307	0.187	0.156	1.031	1.000	0.176	0.156	0.031	0.219	0.188	0.821	0.750	0.023	0.184	0.159
½	0.388	0.360	0.047	0.388	0.368	0.219	0.188	1.219	1.188	0.208	0.188	0.031	0.250	0.219	0.960	0.875	0.027	0.212	0.183
⅝	0.452	0.421	0.047	0.452	0.431	0.250	0.219	1.406	1.375	0.239	0.219	0.031	0.281	0.250	1.093	1.000	0.030	0.235	0.205
¾	0.515	0.483	0.047	0.515	0.492	0.281	0.250	1.594	1.563	0.270	0.250	0.031	0.312	0.281	1.233	1.125	0.035	0.265	0.229
⅞ ^a	.642	0.605	0.078	0.642	0.616	0.406	0.375	1.495	1.375	0.038	0.316	0.272
1 ^a	0.768	0.729	0.078	0.768	0.741	0.500	0.469	10.754	1.625	0.041	0.368	0.314

^aThese sizes pertain to 114 degree countersunk square neck bolts only. Dimensions given in last seven columns to the right are for these bolts only.

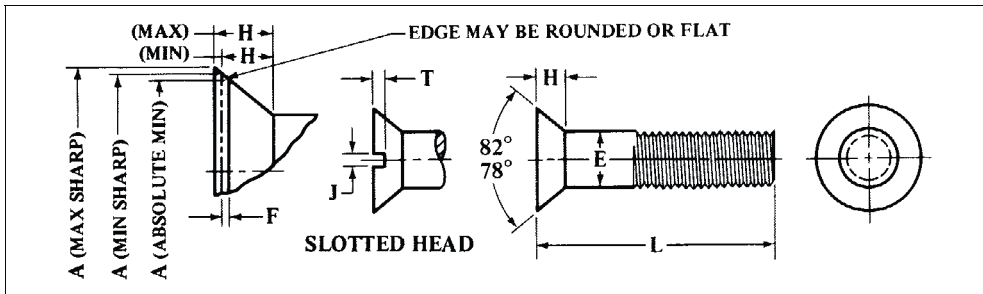
All dimensions are in inches unless otherwise specified.

Threads are Unified Standard, Class 2A, UNC Series, in accordance with ANSI B1.1. For threads with additive finish, the maximum diameters of Class 2A shall apply before plating or coating, whereas the basic diameters (Class 2A maximum diameters plus the allowance) shall apply to a bolt after plating or coating.

Bolts are designated in the sequence shown: nominal size (number, fraction or decimal equivalent); threads per inch; nominal length (fraction or decimal equivalent); product name; material; and protective finish, if required. For example

½-13 × 3 Round Head Square Neck Bolt, Steel .375-16 × 2.50 Step Bolt, Steel, Zinc Plated

**American National Standard Countersunk Bolts and Slotted Countersunk Bolts
ANSI/ASME B18.5-1990 (R2003)**



Nominal Size ^a or Basic Bolt Diameter	Body Diameter, E		Head Diameter, A			Flat on Min Dia., Head, F ^b	
	Max	Min	Max Edge Sharp	Min Edge Sharp	Absolute Min Edge Rounded or Flat		
1/4	0.2500	0.260	0.237	0.493	0.477	0.445	0.018
5/16	0.3125	0.324	0.298	0.618	0.598	0.558	0.023
3/8	0.3750	0.388	0.360	0.740	0.715	0.668	0.027
7/16	0.4375	0.452	0.421	0.803	0.778	0.726	0.030
1/2	0.5000	0.515	0.483	0.935	0.905	0.845	0.035
5/8	0.6250	0.642	0.605	1.169	1.132	1.066	0.038
3/4	0.7500	0.768	0.729	1.402	1.357	1.285	0.041
7/8	0.8750	0.895	0.852	1.637	1.584	1.511	0.042
1	1.0000	1.022	0.976	1.869	1.810	1.735	0.043
1 1/8	1.1250	1.149	1.098	2.104	2.037	1.962	0.043
1 1/4	1.2500	1.277	1.223	2.337	2.262	2.187	0.043
1 3/8	1.3750	1.404	1.345	2.571	2.489	2.414	0.043
1 1/2	1.5000	1.531	1.470	2.804	2.715	2.640	0.043

Nom. Size or Basic Bolt Dia.	Head Height, H		Slot Width, J		Slot Depth, T		
	Max ^c	Min ^d	Max	Min	Max	Min	
1/4	0.2500	0.150	0.131	0.075	0.064	0.068	0.045
5/16	0.3125	0.189	0.164	0.084	0.072	0.086	0.057
3/8	0.3750	0.225	0.196	0.094	0.081	0.103	0.068
7/16	0.4375	0.226	0.196	0.094	0.081	0.103	0.068
1/2	0.5000	0.269	0.233	0.106	0.091	0.103	0.068
5/8	0.6250	0.336	0.292	0.133	0.116	0.137	0.091
3/4	0.7500	0.403	0.349	0.149	0.131	0.171	0.115
7/8	0.8750	0.470	0.408	0.167	0.147	0.206	0.138
1	1.0000	0.537	0.466	0.188	0.166	0.240	0.162
1 1/8	1.1250	0.604	0.525	0.196	0.178	0.257	0.173
1 1/4	1.2500	0.671	0.582	0.211	0.193	0.291	0.197
1 3/8	1.3750	0.738	0.641	0.226	0.208	0.326	0.220
1 1/2	1.5000	0.805	0.698	0.258	0.240	0.360	0.244

^a Where specifying size in decimals, zeros preceding decimal and in fourth decimal place omitted.

^b Flat on minimum diameter head calculated on minimum sharp and absolute minimum head diameters and 82° head angle.

^c Maximum head height calculated on maximum sharp head diameter, basic bolt diameter, and 78° head angle.

^d Minimum head height calculated on minimum sharp head diameter, basic bolt diameter, and 82° head angle.

All dimensions are given in inches. For thread information and method of bolt designation see foot-notes to previous table. Heads are unslotted unless otherwise specified. For slot dimensions see **Table 1** in *Slotted Head Cap Screws* on page 1680.

Wrench Clearance Dimensions.—Wrench openings for nuts are given in **Table 1**, clearances for open end engineers wrenches in **Table 2**, clearances for single and double hexagon socket wrenches in **Tables 3a** (inch) and **3b** (metric), clearances for 12-point box wrenches (inch and metric) are given in **Table 4**. They are based on the dimensions across the flats of the fastener.

Table 1. Wrench Openings for Nuts ANSI/ASME B18.2.2-1987 (R1999), Appendix

Max. ^a Width Across Flats of Nut	Wrench Opening ^b		Max. ^a Width Across Flats of Nut	Wrench Opening ^b		Max. ^a Width Across Flats of Nut	Wrench Opening ^b	
	Min.	Max.		Min.	Max.		Min.	Max.
$\frac{5}{32}$	0.158	0.163	$\frac{1}{4}$	1.257	1.267	$2\frac{15}{16}$	2.954	2.973
$\frac{3}{16}$	0.190	0.195	$1\frac{5}{16}$	1.320	1.331	3	3.016	3.035
$\frac{7}{32}$	0.220	0.225	$1\frac{3}{8}$	1.383	1.394	$3\frac{1}{8}$	3.142	3.162
$\frac{1}{4}$	0.252	0.257	$1\frac{1}{16}$	1.446	1.457	$3\frac{3}{8}$	3.393	3.414
$\frac{9}{32}$	0.283	0.288	$1\frac{1}{2}$	1.508	1.520	$3\frac{1}{2}$	3.518	3.540
$\frac{5}{16}$	0.316	0.322	$1\frac{3}{8}$	1.634	1.646	$3\frac{3}{4}$	3.770	3.793
$1\frac{1}{32}$	0.347	0.353	$1\frac{11}{16}$	1.696	1.708	$3\frac{7}{8}$	3.895	3.918
$\frac{3}{8}$	0.378	0.384	$1\frac{13}{16}$	1.822	1.835	$4\frac{1}{8}$	4.147	4.172
$\frac{7}{16}$	0.440	0.446	$1\frac{7}{8}$	1.885	1.898	$4\frac{1}{4}$	4.272	4.297
$\frac{1}{2}$	0.504	0.510	2	2.011	2.025	$4\frac{1}{2}$	4.524	4.550
$\frac{9}{16}$	0.566	0.573	$2\frac{1}{16}$	2.074	2.088	$4\frac{3}{8}$	4.649	4.676
$\frac{5}{8}$	0.629	0.636	$2\frac{3}{16}$	2.200	2.215	$4\frac{7}{8}$	4.900	4.928
$1\frac{1}{16}$	0.692	0.699	$2\frac{1}{4}$	2.262	2.277	5	5.026	5.055
$\frac{3}{4}$	0.755	0.763	$2\frac{3}{8}$	2.388	2.404	$5\frac{1}{4}$	5.277	5.307
$1\frac{3}{16}$	0.818	0.826	$2\frac{7}{16}$	2.450	2.466	$5\frac{3}{8}$	5.403	5.434
$\frac{7}{8}$	0.880	0.888	$2\frac{9}{16}$	2.576	2.593	$5\frac{5}{8}$	5.654	5.686
$1\frac{5}{16}$	0.944	0.953	$2\frac{5}{8}$	2.639	2.656	$5\frac{3}{4}$	5.780	5.813
1	1.006	1.015	$2\frac{3}{4}$	2.766	2.783	6	6.031	6.157
$1\frac{1}{16}$	1.068	1.077	$2\frac{13}{16}$	2.827	2.845	$6\frac{1}{8}$	6.065	6.192
$1\frac{1}{8}$	1.132	1.142						

^a Wrenches are marked with the “Nominal Size of Wrench,” which is equal to the basic or maximum width across flats of the corresponding nut. Minimum wrench opening is (1.005W + 0.001). Tolerance on wrench opening is (0.005W + 0.004) from minimum, where W equals nominal size of wrench.

^b Openings for $\frac{5}{32}$ to $\frac{3}{8}$ widths from old ASA B18.2-1960 and italic values are from former ANSI B18.2.2-1972.

All dimensions given in inches.

Table 2. Clearances for Open End Engineers Wrench (15°)

Nominal Wrench Size	A		B ^a		C		D		E		F ^b		G		H ^c		J Min ^d in-lbf
	Min. (in)	Max. (in)	Min. (in)	Max. (in)	Min. (in)	Max. (in)	Min. (in)	Max. (in)	Min. (in)	Max. (in)	Ref. (in)	Min. (in)	Max. (in)	Min. (in)	Max. (in)		
$\frac{5}{32}$	0.156	0.220	0.250	0.390	0.160	0.250	0.200	0.030	0.094	35							
$\frac{3}{16}$	0.188	0.250	0.280	0.430	0.190	0.270	0.230	0.030	0.172	45							
$\frac{1}{4}$	0.250	0.280	0.340	0.530	0.270	0.310	0.310	0.030	0.172	67							
$\frac{5}{16}$	0.313	0.380	0.470	0.660	0.280	0.390	0.390	0.050	0.203	138							
$1\frac{1}{32}$	0.344	0.420	0.500	0.750	0.340	0.450	0.450	0.050	0.203	193							
$\frac{3}{8}$	0.375	0.420	0.500	0.780	0.360	0.450	0.520	0.050	0.219	275							
$\frac{7}{16}$	0.438	0.470	0.590	0.890	0.420	0.520	0.640	0.050	0.250	413							
$\frac{1}{2}$	0.500	0.520	0.640	1.000	0.470	0.580	0.660	0.050	0.266	550							
$\frac{9}{16}$	0.563	0.590	0.770	1.130	0.520	0.660	0.700	0.050	0.297	770							
$\frac{5}{8}$	0.625	0.640	0.830	1.230	0.550	0.700	0.700	0.050	0.344	1100							
$1\frac{1}{16}$	0.688	0.770	0.920	1.470	0.660	0.880	0.800	0.060	0.375	1375							
$\frac{3}{4}$	0.750	0.770	0.920	1.510	0.670	0.880	0.800	0.060	0.375	1650							
$1\frac{3}{16}$	0.813	0.910	1.120	1.660	0.720	0.970	0.860	0.060	0.406	2200							
$\frac{7}{8}$	0.875	0.970	1.150	1.810	0.800	1.060	0.910	0.060	0.438	2475							
$1\frac{5}{16}$	0.938	0.970	1.150	1.850	0.810	1.060	0.950	0.060	0.438	3025							
1	1.000	1.050	1.230	2.000	0.880	1.160	1.060	0.060	0.500	3575							
$1\frac{1}{16}$	1.063	1.090	1.250	2.100	0.970	1.200	1.200	0.080	0.500	3850							
$1\frac{1}{8}$	1.125	1.140	1.370	2.210	1.000	1.270	1.230	0.080	0.500	4400							
$1\frac{1}{4}$	1.250	1.270	1.420	2.440	1.080	1.390	1.310	0.080	0.562	5775							
$1\frac{3}{8}$	1.313	1.390	1.690	2.630	1.170	1.520	1.340	0.080	0.562	8400							
$1\frac{7}{16}$	1.438	1.470	1.720	2.800	1.250	1.590	1.340	0.090	0.641	8250							
$1\frac{1}{2}$	1.500	1.470	1.720	2.840	1.270	1.590	1.450	0.090	0.641	8500							
$1\frac{5}{8}$	1.625	1.560	1.880	3.100	1.380	1.750	1.560	0.090	0.641	9000							

^a B = arc radius created by the swing of the wrench.

^b F = inside arc radius of part.

^c H = thickness of wrench head. (Dimension line not shown.)

^d J = torque that wrench will withstand in inch-pounds. Values updated from ANSI/ASME B107.100- 2002, Wrenches.

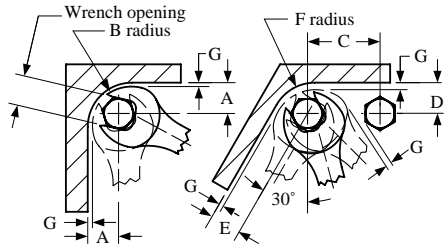


Fig. 1. Clearances for Open End Engineers Wrench (See Table 2)

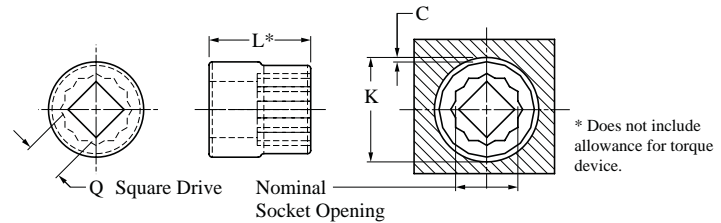


Fig. 2. Clearance Dimensions for Single and Double Hexagon Socket Wrenches (See Tables 3a and 3b)

Table 3a. Clearance for Single and Double Hexagon Socket Wrenches, Regular Length - Inch Series

See Fig. 2, page 1557 for Dimensions																					
Nominal Opening	Radial Clearance C Ref. ^a	1/4 in. Square Drive, Q					3/8 in. Square Drive, Q					1/2 in. Square Drive, Q					3/4 in. Square Drive, Q				
		Length L Max.	Nut End Dia. D1 Max.	Drive End Dia. D2 Max.	C-Bore Dia. K Min.	Proof Torque P (Lbf-in.) Min.	Length L Max.	Nut End Dia. D1 Max.	Drive End Dia. D2 Max.	Counter-Bore Dia. K Min.	Proof Torque P (Lbf-in.) Min.	Length L Max.	Nut End Dia. D1 Max.	Drive End Dia. D2 Max.	Counter-Bore Dia. K Min.	Proof Torque P (Lbf-in.) Min.	Length L Max.	Nut End Dia. D1 Max.	Drive End Dia. D2 Max.	Counter-Bore Dia. K Min.	Proof Torque P (Lbf-in.) Min.
1/8 (0.125)	0.030	1.010	0.250	0.510	0.540	35
5/32 (0.156)	0.030	1.010	0.281	0.510	0.540	60
3/16 (0.188)	0.030	1.010	0.338	0.510	0.540	95
7/32 (0.219)	0.030	1.010	0.382	0.510	0.540	135
1/4 (0.250)	0.030	1.010	0.425	0.510	0.540	190	1.260	0.472	0.690	0.720	270
9/32 (0.281)	0.030	1.010	0.457	0.510	0.540	250	1.260	0.496	0.690	0.720	350
5/16 (0.313)	0.030	1.010	0.510	0.510	0.540	320	1.260	0.521	0.690	0.720	440
11/32 (0.344)	0.030	1.010	0.547	0.547	0.577	400	1.260	0.567	0.690	0.720	550
3/8 (0.375)	0.030	1.010	0.597	0.597	0.627	500	1.260	0.613	0.690	0.720	660	1.525	0.655	0.940	0.970	1100
7/16 (0.438)	0.030	1.010	0.683	0.683	0.713	500	1.260	0.683	0.690	0.720	930	1.525	0.730	0.940	0.970	1500
1/2 (0.500)	0.030	1.010	0.697	0.697	0.727	500	1.260	0.751	0.880	0.910	1240	1.525	0.775	0.940	0.970	2000
9/16 (0.563)	0.030	1.010	0.778	0.778	0.808	500	1.260	0.814	0.880	0.910	1610	1.572	0.845	0.940	0.970	2600
5/8 (0.625)	0.030	1.260	0.890	0.890	0.920	200	1.572	0.942	0.970	1.000	3300

Table 3a. (Continued) Clearance for Single and Double Hexagon Socket Wrenches, Regular Length - Inch Series

See Fig. 2, page 1557 for Dimensions																					
Nominal Opening	Radial Clearance C Ref. ^a	1/4 in. Square Drive, Q					3/8 in. Square Drive, Q					1/2 in. Square Drive, Q					3/4 in. Square Drive, Q				
		Length L Max.	Nut End Dia. D1 Max.	Drive End Dia. D2 Max.	C-Bore Dia. K Min.	Proof Torque P (Lbf-in.) Min.	Length L Max.	Nut End Dia. D1 Max.	Drive End Dia. D2 Max.	Counter-Bore Dia. K Min.	Proof Torque P (Lbf-in.) Min.	Length L Max.	Nut End Dia. D1 Max.	Drive End Dia. D2 Max.	Counter-Bore Dia. K Min.	Proof Torque P (Lbf-in.) Min.	Length L Max.	Nut End Dia. D1 Max.	Drive End Dia. D2 Max.	Counter-Bore Dia. K Min.	Proof Torque P (Lbf-in.) Min.
1/16 (0.688)	0.030	1.260	0.968	0.968	0.998	2200	1.572	1.010	1.010	1.040	4100
3/4 (0.750)	0.030	1.260	1.110	1.110	1.140	2200	1.572	1.080	1.080	1.110	5000	2.000	1.285	1.450	1.480	6000
13/16 (0.813)	0.030	1.406	1.141	1.141	1.171	2200	1.635	1.145	1.145	1.175	5000	2.000	1.300	1.450	1.480	6800
7/8 (0.875)	0.030	1.406	1.250	1.250	1.280	2200	1.760	1.218	1.218	1.248	5000	2.010	1.385	1.575	1.605	7700
15/16 (0.938)	0.030	1.650	1.310	1.310	1.340	2200	1.760	1.300	1.300	1.330	5000	2.010	1.450	1.575	1.605	8700
1 (1.000)	0.030	1.650	1.380	1.380	1.410	2200	1.760	1.375	1.375	1.405	5000	2.072	1.520	1.575	1.605	9700
1 1/16 (1.063)	0.030	1.853	1.480	1.480	1.510	5000	2.200	1.595	1.595	1.625	10,800
1 1/8 (1.125)	0.030	1.947	1.540	1.540	1.570	5000	2.322	1.600	1.680	1.710	11,900
1 3/16 (1.188)	0.030	1.947	1.675	1.675	1.705	5000	2.322	1.735	1.735	1.765	13,000
1 1/4 (1.250)	0.030	2.015	1.750	1.750	1.780	5000	2.385	1.870	1.870	1.900	14,200
1 5/16 (1.313)	0.030	2.015	1.820	1.820	1.850	5000	2.510	1.920	1.920	1.950	15,400
1 3/8 (1.375)	0.030	2.155	1.885	1.885	1.915	5000	2.635	1.980	1.980	2.010	16,700
1 7/16 (1.438)	0.030	2.295	1.955	1.955	1.985	5000	2.635	2.075	2.075	2.105	18,000
1 1/2 (1.500)	0.030	2.295	2.025	2.025	2.055	5000	2.635	2.145	2.145	2.175	18,000
1 5/8 (1.625)	0.030	2.760	2.260	2.260	2.290	18,000
1 3/4 (1.750)	0.030	2.760	2.325	2.325	2.355	18,000
1 13/16 (1.813)	0.030	3.135	2.400	2.400	2.430	18,000
1 7/8 (1.875)	0.030	3.135	2.510	2.510	2.540	18,000
2 (2.000)	0.030	3.260	2.575	2.575	2.605	18,000
2 1/16 (2.063)	0.030	3.385	2.695	2.695	2.725	18,000
2 1/8 (2.125)	0.030	3.510	2.885	2.885	2.915	18,000
2 3/16 (2.188)	0.030	3.697	3.025	3.025	3.055	18,000
2 1/4 (2.250)	0.030	3.697	3.075	3.075	3.105	18,000

^aFrom the SAE Aeronautical Drafting Manual

All dimensions are in inches. For details not shown and additional socket sizes, see ANSI/ASME B107.1-2002, Socket Wrenches, Hand (Inch Series).

Table 3b. Single and Double Hexagon Socket, Regular Length - Metric Series

(See Fig. 2, page 1557 for Dimensions)																					
6.3 mm Square Drive, Q							10 mm Square Drive, Q					12.5 mm Square Drive, Q					20 mm Square Drive, Q				
Nominal Opening	Radial Clearance C Ref. ^a	Length L Max.	Nut End Dia. D1 Max.	Drive End Dia. D2 Max.	C-Bore Dia. K Min.	Proof Torque P (N-m) Min.	Length L Max.	Nut End Dia. D1 Max.	Drive End Dia. D2 Max.	Counter-Bore Dia. K Min.	Proof Torque P (N-m) Min.	Length L Max.	Nut End Dia. D1 Max.	Drive End Dia. D2 Max.	Counter-Bore Dia. K Min.	Proof Torque P (N-m) Min.	Length L Max.	Nut End Dia. D1 Max.	Drive End Dia. D2 Max.	Counter-Bore Dia. K Min.	Proof Torque P (N-m) Min.
3.2	0.762	26	6.10	12.95	14.47	7
4	0.762	26	7.10	12.95	14.47	8
4.5	0.762	26	7.60	12.95	14.47	9
5	0.762	26	8.15	12.95	14.47	10
5.5	0.762	26	8.90	12.95	14.47	14	32	10.10	17.60	19.124	270
6	0.762	26	9.90	12.95	14.47	16	32	10.10	17.60	19.124	350
6.3	0.762	26	9.90	12.95	14.47	21	32	10.10	17.60	19.124	440
7	0.762	26	10.90	12.95	14.47	27	32	11.05	17.60	19.124	550
8	0.762	26	12.20	12.95	14.47	38	32	12.20	17.60	19.124	660	39	14.00	23.87	25.39	80
9	0.762	26	13.45	13.45	14.97	49	32	13.60	17.60	19.124	930	39	15.10	23.87	25.39	110
10	0.762	26	14.75	14.75	16.27	63	32	15.00	17.60	19.124	1240	39	16.80	23.87	25.39	153
11	0.762	26	16.00	16.00	17.52	68	32	16.75	17.60	19.124	1610	39	18.20	23.87	25.39	170
12	0.762	26	17.30	17.30	18.82	68	32	17.80	22.40	23.924	200	39	18.70	23.87	25.39	203
13	0.762	26	18.55	18.55	20.07	68	32	18.80	22.40	23.924	2200	39	20.25	23.87	25.39	249
14	0.762	26	19.80	19.80	21.32	68	32	20.00	22.40	23.924	2200	39	21.80	23.87	25.39	282
15	0.762	26	21.50	21.50	23.02	68	32	22.40	22.40	23.924	2200	40	22.40	23.87	25.39	339
16	0.762	26	22.00	22.00	23.52	68	32	22.50	22.50	24.024	2200	40	23.87	23.87	25.39	407
17	0.762	32	23.80	23.80	25.324	2200	40	24.75	24.75	26.27	475
18	0.762	32	24.60	24.60	26.124	2200	40	26.14	26.14	27.66	542
19	0.762	32	25.70	25.70	27.224	...	40	27.20	27.20	28.72	575	51	30.50	33.00	33.76	780
20	0.762	32	27.76	27.76	29.284	...	42	27.95	27.95	29.47	570
21	0.762	34	28.80	28.80	30.324	...	42	28.95	28.95	30.47	570	51	33.00	33.00	33.76	930
22	0.762	34	30.00	30.00	31.524	...	45	30.20	30.20	31.72	570	51	35.05	38.10	38.86	972
23	0.762	35	31.30	31.30	32.824	...	45	31.25	31.25	32.77	570	51	36.10	39.10	39.86	1015

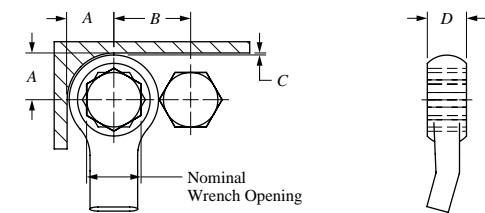
Table 3b. (Continued) Single and Double Hexagon Socket, Regular Length - Metric Series

(See Fig. 2, page 1557 for Dimensions)																					
Nominal Opening	Radial Clearance C Ref. ^a	6.3 mm Square Drive, Q					10 mm Square Drive, Q					12.5 mm Square Drive, Q					20 mm Square Drive, Q				
		Length L Max.	Nut End Dia. D1 Max.	Drive End Dia. D2 Max.	C-Bore Dia. K Min.	Proof Torque P (N-m) Min.	Length L Max.	Nut End Dia. D1 Max.	Drive End Dia. D2 Max.	Counter-Bore Dia. K Min.	Proof Torque P (N-m) Min.	Length L Max.	Nut End Dia. D1 Max.	Drive End Dia. D2 Max.	Counter-Bore Dia. K Min.	Proof Torque P (N-m) Min.	Length L Max.	Nut End Dia. D1 Max.	Drive End Dia. D2 Max.	Counter-Bore Dia. K Min.	Proof Torque P (N-m) Min.
24	0.762	36	32.50	32.50	34.024	...	45	32.15	32.15	33.67	570	51	37.00	40.00	40.76	1085
25	0.762	38	33.00	33.00	34.524	...	45	33.40	33.40	34.92	570	52	37.85	40.00	40.76	1160
26	0.762	38	35.00	35.00	36.524	...	48	35.05	35.05	36.57	570	53	38.85	40.00	40.76	1240
27	0.762	48	36.75	36.75	38.27	570	54	41.00	41.00	41.76	1330
28	0.762	50	37.80	37.80	39.32	570	57	41.00	41.00	41.76	1420
29	0.762	50	39.50	39.50	41.02	570	59	42.10	42.10	42.86	1520
30	0.762	50	42.40	42.40	43.92	570	59	43.00	43.00	43.76	1640
31	0.762	50	43.20	43.20	44.72	570	60	45.10	45.10	45.86	1730
32	0.762	51	44.05	44.05	45.57	570	60	47.05	47.05	47.81	1820
34	0.762	64	49.00	49.00	49.76	2000
35	0.762	67	50.40	50.40	51.16	2030
36	0.762	67	51.80	51.80	52.56	2030
38	0.762	67	54.10	54.10	54.86	2030
40	0.762	70	57.65	57.65	58.41	2030
41	0.762	70	58.80	58.80	59.56	2030
42	0.762	70	58.80	58.80	59.56	2030
46	0.762	83	65.40	65.40	66.16	2030
50	0.762	89	72.15	72.15	72.91	2030
54	0.762	94	78.10	78.10	78.86	2030
55	0.762	95	79.10	79.10	79.86	2030
58	0.762	97	80.00	80.00	80.76	2030
60	0.762	100	84.45	84.45	85.21	2030

^a Converted from inch dimensions given in the SAE Aeronautical Drafting Manual.

All dimensions are in mm. For details not shown and additional socket sizes, see ANSI/ASME B107.5M-2002, Socket Wrenches, Hand (Metric Series).

Table 4. Clearances for Box Wrenches - 12 Point Inch and Metric Series



US Customary (inch)							Metric (mm)					
Nominal Wrench Opening (in)	A Min. (in)	B Min. (in)	C Ref. ^a (in)	Head Thickness D Max., (in)	Proof Torque (Lbf-in)	Nominal Wrench Opening (mm)	A Min. (mm)	B Min. (mm)	C Ref. ^b (mm)	Head Thickness D Max., (mm)	Proof Torque (N-m)	
1/8	(0.125)	0.179	0.219	0.030	0.172	60	4	4.56	6.03	0.762	4.0	12
3/32	(0.156)	0.187	0.244	0.030	0.172	90	5	5.26	7.29	0.762	4.6	17
3/16	(0.188)	0.218	0.301	0.030	0.203	150	5.5	6.66	8.97	0.762	6.0	18
7/32	(0.219)	0.233	0.325	0.030	0.234	165	6	7.11	9.69	0.762	7.4	20
1/4	(0.250)	0.269	0.378	0.030	0.295	220	7	7.91	11.05	0.762	7.7	27
5/32	(0.281)	0.280	0.407	0.030	0.280	248	8	8.26	11.98	0.762	8.2	30
5/16	(0.313)	0.316	0.461	0.030	0.330	275	9	9.46	13.76	0.762	9.0	40
11/32	(0.344)	0.336	0.499	0.030	0.335	275	10	10.16	15.04	0.762	9.0	71
3/8	(0.375)	0.362	0.543	0.030	0.344	605	11	10.71	16.15	0.762	10.0	80
7/16	(0.438)	0.395	0.612	0.030	0.391	715	12	11.46	17.47	0.762	10.0	91
1/2	(0.500)	0.442	0.694	0.030	0.394	1020	13	12.31	18.89	0.762	10.5	115
9/16	(0.563)	0.492	0.779	0.030	0.425	1500	14	12.96	20.10	0.762	11.5	158
5/8	(0.625)	0.530	0.853	0.030	0.500	2200	15	13.76	21.46	0.762	11.5	200
11/16	(0.688)	0.577	0.935	0.030	0.535	2640	16	14.26	22.53	0.762	12.1	248
3/4	(0.750)	0.618	1.012	0.030	0.594	2860	17	15.41	24.25	0.762	12.7	267
13/16	(0.813)	0.702	1.132	0.030	0.609	3300	18	15.41	24.83	0.762	12.7	304
7/8	(0.875)	0.718	1.183	0.030	0.688	3630	19	16.36	26.35	0.762	14.8	323
15/16	(0.938)	0.765	1.266	0.030	0.701	4510	20	17.21	27.77	0.762	14.8	347
1	(1.000)	0.796	1.330	0.030	0.719	5390	21	17.66	28.79	0.762	16.3	372
1 1/16	(1.063)	0.874	1.445	0.030	0.790	5940	22	18.56	30.27	0.762	16.3	408
1 1/8	(1.125)	0.892	1.498	0.030	0.860	6430	23	19.41	31.69	0.762	16.5	455
1 3/16	(1.188)	0.937	1.579	0.030	0.890	7200	24	19.81	32.65	0.762	17.8	509
1 1/4	(1.250)	0.983	1.661	0.030	0.940	7920	25	20.86	34.24	0.762	17.9	559
1 5/16	(1.313)	1.062	1.775	0.030	0.940	8400	26	12.86	26.79	0.762	18.0	608
1 3/8	(1.375)	1.087	1.836	0.030	0.940	8970	27	22.86	37.37	0.762	19.8	671
1 7/16	(1.438)	1.144	1.929	0.030	0.953	9240	28	23.41	38.49	0.762	19.8	710
1 1/2	(1.500)	1.228	2.049	0.030	1.008	10,365	29	23.41	39.06	0.762	19.8	750
1 9/16	(1.563)	1.249	2.104	0.030	1.031	11,495	30	24.51	40.73	0.762	20.0	795
1 5/8	(1.625)	1.351	2.241	0.030	1.063	12,800	31	25.06	41.85	0.762	20.5	850
1 11/16	(1.688)	1.425	2.351	0.030	1.063	13,570	32	25.66	43.03	0.762	22.0	905
1 3/4	(1.750)	1.499	2.461	0.030	1.125	14,300	33	25.91	43.84	0.762	22.3	950
1 13/16	(1.813)	1.499	2.496	0.030	1.125	15,100	34	26.76	45.26	0.762	23.2	994
1 7/8	(1.875)	1.593	2.625	0.030	1.125	15,900	36	28.81	48.47	0.762	25.1	1165
2	(2.000)	1.593	2.696	0.030	1.125	17,400	41	32.21	54.68	0.762	25.3	1579
2 1/16	(2.063)	1.687	2.825	0.030	1.234	18,200	46	34.76	60.06	0.762	25.8	2067
2 1/8	(2.125)	1.687	2.861	0.030	1.234	19,000	50	38.76	66.33	0.762	27.6	2512
2 3/16	(2.188)	1.687	2.896	0.030	1.234	19,700
2 1/4	(2.250)	1.687	2.931	0.030	1.234	20,500

^a From SAE Aeronautical Drafting Manual

^b Converted from SAE Aeronautical Drafting Manual. For details not shown, including material, see ANSI/ASME B107.100 Wrenches

**Table 1a. American National Standard Type A Plain Washers—
Preferred Sizes ANSI/ASME B18.2.1-1965 (R2008)**

Nominal Washer Size ^a		Series	Inside Diameter			Outside Diameter			Thickness		
			Basic	Tolerance		Basic	Tolerance		Basic	Max.	Min.
				Plus	Minus		Plus	Minus			
—	—		0.078	0.000	0.005	0.188	0.000	0.005	0.020	0.025	0.016
—	—		0.094	0.000	0.005	0.250	0.000	0.005	0.020	0.025	0.016
—	—		0.125	0.008	0.005	0.312	0.008	0.005	0.032	0.040	0.025
No. 6	0.138		0.156	0.008	0.005	0.375	0.015	0.005	0.049	0.065	0.036
No. 8	0.164		0.188	0.008	0.005	0.438	0.015	0.005	0.049	0.065	0.036
No. 10	0.190		0.219	0.008	0.005	0.500	0.015	0.005	0.049	0.065	0.036
$\frac{3}{16}$	0.188		0.250	0.015	0.005	0.562	0.015	0.005	0.049	0.065	0.036
No. 12	0.216		0.250	0.015	0.005	0.562	0.015	0.005	0.065	0.080	0.051
$\frac{1}{4}$	0.250	N	0.281	0.015	0.005	0.625	0.015	0.005	0.065	0.080	0.051
$\frac{1}{4}$	0.250	W	0.312	0.015	0.005	0.734 ^b	0.015	0.007	0.065	0.080	0.051
$\frac{5}{16}$	0.312	N	0.344	0.015	0.005	0.688	0.015	0.007	0.065	0.080	0.051
$\frac{5}{16}$	0.312	W	0.375	0.015	0.005	0.875	0.030	0.007	0.083	0.104	0.064
$\frac{3}{8}$	0.375	N	0.406	0.015	0.005	0.812	0.015	0.007	0.065	0.080	0.051
$\frac{3}{8}$	0.375	W	0.438	0.015	0.005	1.000	0.030	0.007	0.083	0.104	0.064
$\frac{7}{16}$	0.438	N	0.469	0.015	0.005	0.922	0.015	0.007	0.065	0.080	0.051
$\frac{7}{16}$	0.438	W	0.500	0.015	0.005	1.250	0.030	0.007	0.083	0.104	0.064
$\frac{1}{2}$	0.500	N	0.531	0.015	0.005	1.062	0.030	0.007	0.095	0.121	0.074
$\frac{1}{2}$	0.500	W	0.562	0.015	0.005	1.375	0.030	0.007	0.109	0.132	0.086
$\frac{9}{16}$	0.562	N	0.594	0.015	0.005	1.156 ^b	0.030	0.007	0.095	0.121	0.074
$\frac{9}{16}$	0.562	W	0.625	0.015	0.005	1.469 ^b	0.030	0.007	0.109	0.132	0.086
$\frac{5}{8}$	0.625	N	0.656	0.030	0.007	1.312	0.030	0.007	0.095	0.121	0.074
$\frac{5}{8}$	0.625	W	0.688	0.030	0.007	1.750	0.030	0.007	0.134	0.160	0.108
$\frac{3}{4}$	0.750	N	0.812	0.030	0.007	1.469	0.030	0.007	0.134	0.160	0.108
$\frac{3}{4}$	0.750	W	0.812	0.030	0.007	2.000	0.030	0.007	0.148	0.177	0.122
$\frac{7}{8}$	0.875	N	0.938	0.030	0.007	1.750	0.030	0.007	0.134	0.160	0.108
$\frac{7}{8}$	0.875	W	0.938	0.030	0.007	2.250	0.030	0.007	0.165	0.192	0.136
1	1.000	N	1.062	0.030	0.007	2.000	0.030	0.007	0.134	0.160	0.108
1	1.000	W	1.062	0.030	0.007	2.500	0.030	0.007	0.165	0.192	0.136
$1\frac{1}{8}$	1.125	N	1.250	0.030	0.007	2.250	0.030	0.007	0.134	0.160	0.108
$1\frac{1}{8}$	1.125	W	1.250	0.030	0.007	2.750	0.030	0.007	0.165	0.192	0.136
$1\frac{1}{4}$	1.250	N	1.375	0.030	0.007	2.500	0.030	0.007	0.165	0.192	0.136
$1\frac{1}{4}$	1.250	W	1.375	0.030	0.007	3.000	0.030	0.007	0.165	0.192	0.136
$1\frac{3}{8}$	1.375	N	1.500	0.030	0.007	2.750	0.030	0.007	0.165	0.192	0.136
$1\frac{3}{8}$	1.375	W	1.500	0.045	0.010	3.250	0.045	0.010	0.180	0.213	0.153
$1\frac{1}{2}$	1.500	N	1.625	0.030	0.007	3.000	0.030	0.007	0.165	0.192	0.136
$1\frac{1}{2}$	1.500	W	1.625	0.045	0.010	3.500	0.045	0.010	0.180	0.213	0.153
$1\frac{5}{8}$	1.625		1.750	0.045	0.010	3.750	0.045	0.010	0.180	0.213	0.153
$1\frac{3}{4}$	1.750		1.875	0.045	0.010	4.000	0.045	0.010	0.180	0.213	0.153
$1\frac{7}{8}$	1.875		2.000	0.045	0.010	4.250	0.045	0.010	0.180	0.213	0.153
2	2.000		2.125	0.045	0.010	4.500	0.045	0.010	0.180	0.213	0.153
$2\frac{1}{4}$	2.250		2.375	0.045	0.010	4.750	0.045	0.010	0.220	0.248	0.193
$2\frac{1}{2}$	2.500		2.625	0.045	0.010	5.000	0.045	0.010	0.238	0.280	0.210
$2\frac{3}{4}$	2.750		2.875	0.065	0.010	5.250	0.065	0.010	0.259	0.310	0.228
3	3.000		3.125	0.065	0.010	5.500	0.065	0.010	0.284	0.327	0.249

^a Nominal washer sizes are intended for use with comparable nominal screw or bolt sizes.

^b The 0.734-inch, 1.156-inch, and 1.469-inch outside diameters avoid washers which could be used in coin operated devices.

All dimensions are in inches.

Preferred sizes are for the most part from series previously designated “Standard Plate” and “SAE.” Where common sizes existed in the two series, the SAE size is designated “N” (narrow) and the Standard Plate “W” (wide). These sizes as well as all other sizes of Type A Plain Washers are to be ordered by ID, OD, and thickness dimensions.

Additional selected sizes of Type A Plain Washers are shown in [Table 1b](#).

**Table 1b. American National Standard Type A Plain Washers —
Additional Selected Sizes *ANSI/ASME B18.22.1-1965 (R2008)***

Inside Diameter			Outside Diameter			Thickness		
Basic	Tolerance		Basic	Tolerance		Basic	Max.	Min.
	Plus	Minus		Plus	Minus			
0.094	0.000	0.005	0.219	0.000	0.005	0.020	0.025	0.016
0.125	0.000	0.005	0.250	0.000	0.005	0.022	0.028	0.017
0.156	0.008	0.005	0.312	0.008	0.005	0.035	0.048	0.027
0.172	0.008	0.005	0.406	0.015	0.005	0.049	0.065	0.036
0.188	0.008	0.005	0.375	0.015	0.005	0.049	0.065	0.036
0.203	0.008	0.005	0.469	0.015	0.005	0.049	0.065	0.036
0.219	0.008	0.005	0.438	0.015	0.005	0.049	0.065	0.036
0.234	0.008	0.005	0.531	0.015	0.005	0.049	0.065	0.036
0.250	0.015	0.005	0.500	0.015	0.005	0.049	0.065	0.036
0.266	0.015	0.005	0.625	0.015	0.005	0.049	0.065	0.036
0.312	0.015	0.005	0.875	0.015	0.007	0.065	0.080	0.051
0.375	0.015	0.005	0.734 ^a	0.015	0.007	0.065	0.080	0.051
0.375	0.015	0.005	1.125	0.015	0.007	0.065	0.080	0.051
0.438	0.015	0.005	0.875	0.030	0.007	0.083	0.104	0.064
0.438	0.015	0.005	1.375	0.030	0.007	0.083	0.104	0.064
0.500	0.015	0.005	1.125	0.030	0.007	0.083	0.104	0.064
0.500	0.015	0.005	1.625	0.030	0.007	0.083	0.104	0.064
0.562	0.015	0.005	1.250	0.030	0.007	0.109	0.132	0.086
0.562	0.015	0.005	1.875	0.030	0.007	0.109	0.132	0.086
0.625	0.015	0.005	1.375	0.030	0.007	0.109	0.132	0.086
0.625	0.015	0.005	2.125	0.030	0.007	0.134	0.160	0.108
0.688	0.030	0.007	1.469 ^a	0.030	0.007	0.134	0.160	0.108
0.688	0.030	0.007	2.375	0.030	0.007	0.165	0.192	0.136
0.812	0.030	0.007	1.750	0.030	0.007	0.148	0.177	0.122
0.812	0.030	0.007	2.875	0.030	0.007	0.165	0.192	0.136
0.938	0.030	0.007	2.000	0.030	0.007	0.165	0.192	0.136
0.938	0.030	0.007	3.375	0.045	0.010	0.180	0.213	0.153
1.062	0.030	0.007	2.250	0.030	0.007	0.165	0.192	0.136
1.062	0.045	0.010	3.875	0.045	0.010	0.238	0.280	0.210
1.250	0.030	0.007	2.500	0.030	0.007	0.165	0.192	0.136
1.375	0.030	0.007	2.750	0.030	0.007	0.165	0.192	0.136
1.500	0.045	0.010	3.000	0.045	0.010	0.180	0.213	0.153
1.625	0.045	0.010	3.250	0.045	0.010	0.180	0.213	0.153
1.688	0.045	0.010	3.500	0.045	0.010	0.180	0.213	0.153
1.812	0.045	0.010	3.750	0.045	0.010	0.180	0.213	0.153
1.938	0.045	0.010	4.000	0.045	0.010	0.180	0.213	0.153
2.062	0.045	0.010	4.250	0.045	0.010	0.180	0.213	0.153

^a The 0.734-inch and 1.469-inch outside diameters avoid washers which could be used in coin operated devices.

All dimensions are in inches.

The above sizes are to be ordered by ID, OD, and thickness dimensions.

Preferred Sizes of Type A Plain Washers are shown in [Table 1a](#).

ANSI Standard Plain Washers.—The Type A plain washers were originally developed in a light, medium, heavy and extra heavy series. These series have been discontinued and the washers are now designated by their nominal dimensions.

The Type B plain washers are available in a narrow, regular and wide series with proportions designed to distribute the load over larger areas of lower strength materials.

Plain washers are made of ferrous or non-ferrous metal, plastic or other material as specified. The tolerances indicated in the tables are intended for metal washers only.

Table 2. American National Standard Type B Plain Washers —

Nominal Washer Size ^a		Series ^b	Inside Diameter			Outside Diameter			Thickness		
			Basic	Tolerance		Basic	Tolerance		Basic	Max.	Min.
				Plus	Minus		Plus	Minus			
No. 0	0.060	N	0.068	0.000	0.005	0.125	0.000	0.005	0.025	0.028	0.022
		R	0.068	0.000	0.005	0.188	0.000	0.005	0.025	0.028	0.022
		W	0.068	0.000	0.005	0.250	0.000	0.005	0.025	0.028	0.022
No. 1	0.073	N	0.084	0.000	0.005	0.156	0.000	0.005	0.025	0.028	0.022
		R	0.084	0.000	0.005	0.219	0.000	0.005	0.025	0.028	0.022
		W	0.084	0.000	0.005	0.281	0.000	0.005	0.032	0.036	0.028
No. 2	0.086	N	0.094	0.000	0.005	0.188	0.000	0.005	0.025	0.028	0.022
		R	0.094	0.000	0.005	0.250	0.000	0.005	0.032	0.036	0.028
		W	0.094	0.000	0.005	0.344	0.000	0.005	0.032	0.036	0.028
No. 3	0.099	N	0.109	0.000	0.005	0.219	0.000	0.005	0.025	0.028	0.022
		R	0.109	0.000	0.005	0.312	0.000	0.005	0.032	0.036	0.028
		W	0.109	0.008	0.005	0.406	0.008	0.005	0.040	0.045	0.036
No. 4	0.112	N	0.125	0.000	0.005	0.250	0.000	0.005	0.032	0.036	0.028
		R	0.125	0.008	0.005	0.375	0.008	0.005	0.040	0.045	0.036
		W	0.125	0.008	0.005	0.438	0.008	0.005	0.040	0.045	0.036
No. 5	0.125	N	0.141	0.000	0.005	0.281	0.000	0.005	0.032	0.036	0.028
		R	0.141	0.008	0.005	0.406	0.008	0.005	0.040	0.045	0.036
		W	0.141	0.008	0.005	0.500	0.008	0.005	0.040	0.045	0.036
No. 6	0.138	N	0.156	0.000	0.005	0.312	0.000	0.005	0.032	0.036	0.028
		R	0.156	0.008	0.005	0.438	0.008	0.005	0.040	0.045	0.036
		W	0.156	0.008	0.005	0.562	0.008	0.005	0.040	0.045	0.036
No. 8	0.164	N	0.188	0.008	0.005	0.375	0.008	0.005	0.040	0.045	0.036
		R	0.188	0.008	0.005	0.500	0.008	0.005	0.040	0.045	0.036
		W	0.188	0.008	0.005	0.625	0.015	0.005	0.063	0.071	0.056
No. 10	0.190	N	0.203	0.008	0.005	0.406	0.008	0.005	0.040	0.045	0.036
		R	0.203	0.008	0.005	0.562	0.008	0.005	0.040	0.045	0.036
		W	0.203	0.008	0.005	0.734 ^c	0.015	0.007	0.063	0.071	0.056
No. 12	0.216	N	0.234	0.008	0.005	0.438	0.008	0.005	0.040	0.045	0.036
		R	0.234	0.008	0.005	0.625	0.015	0.005	0.063	0.071	0.056
		W	0.234	0.008	0.005	0.875	0.015	0.007	0.063	0.071	0.056
¼	0.250	N	0.281	0.015	0.005	0.500	0.015	0.005	0.063	0.071	0.056
		R	0.281	0.015	0.005	0.734 ^c	0.015	0.007	0.063	0.071	0.056
		W	0.281	0.015	0.005	1.000	0.015	0.007	0.063	0.071	0.056
⅜	0.312	N	0.344	0.015	0.005	0.625	0.015	0.005	0.063	0.071	0.056
		R	0.344	0.015	0.005	0.875	0.015	0.007	0.063	0.071	0.056
		W	0.344	0.015	0.005	1.125	0.015	0.007	0.063	0.071	0.056
½	0.375	N	0.406	0.015	0.005	0.734 ^c	0.015	0.007	0.063	0.071	0.056
		R	0.406	0.015	0.005	1.000	0.015	0.007	0.063	0.071	0.056
		W	0.406	0.015	0.005	1.250	0.030	0.007	0.100	0.112	0.090
⅞	0.438	N	0.469	0.015	0.005	0.875	0.015	0.007	0.063	0.071	0.056
		R	0.469	0.015	0.005	1.125	0.015	0.007	0.063	0.071	0.056
		W	0.469	0.015	0.005	1.469 ^c	0.030	0.007	0.100	0.112	0.090
1	0.500	N	0.531	0.015	0.005	1.000	0.015	0.007	0.063	0.071	0.056
		R	0.531	0.015	0.005	1.250	0.030	0.007	0.100	0.112	0.090
		W	0.531	0.015	0.005	1.750	0.030	0.007	0.100	0.112	0.090
1 ¼	0.562	N	0.594	0.015	0.005	1.125	0.015	0.007	0.063	0.071	0.056
		R	0.594	0.015	0.005	1.469 ^c	0.030	0.007	0.100	0.112	0.090
		W	0.594	0.015	0.005	2.000	0.030	0.007	0.100	0.112	0.090
1 ½	0.625	N	0.656	0.030	0.007	1.250	0.030	0.007	0.100	0.112	0.090
		R	0.656	0.030	0.007	1.750	0.030	0.007	0.100	0.112	0.090
		W	0.656	0.030	0.007	2.250	0.030	0.007	0.160	0.174	0.146

Table 2. American National Standard Type B Plain Washers —

Nominal Washer Size ^a		Series ^b	Inside Diameter			Outside Diameter			Thickness		
			Basic	Tolerance		Basic	Tolerance		Basic	Max.	Min.
				Plus	Minus		Plus	Minus			
¾	0.750	N	0.812	0.030	0.007	1.375	0.030	0.007	0.100	0.112	0.090
		R	0.812	0.030	0.007	2.000	0.030	0.007	0.100	0.112	0.090
		W	0.812	0.030	0.007	2.500	0.030	0.007	0.160	0.174	0.146
⅞	0.875	N	0.938	0.030	0.007	1.469 ^c	0.030	0.007	0.100	0.112	0.090
		R	0.938	0.030	0.007	2.250	0.030	0.007	0.160	0.174	0.146
		W	0.938	0.030	0.007	2.750	0.030	0.007	0.160	0.174	0.146
1	1.000	N	1.062	0.030	0.007	1.750	0.030	0.007	0.100	0.112	0.090
		R	1.062	0.030	0.007	2.500	0.030	0.007	0.160	0.174	0.146
		W	1.062	0.030	0.007	3.000	0.030	0.007	0.160	0.174	0.146
1¼	1.125	N	1.188	0.030	0.007	2.000	0.030	0.007	0.100	0.112	0.090
		R	1.188	0.030	0.007	2.750	0.030	0.007	0.160	0.174	0.146
		W	1.188	0.030	0.007	3.250	0.030	0.007	0.160	0.174	0.146
1½	1.250	N	1.312	0.030	0.007	2.250	0.030	0.007	0.160	0.174	0.146
		R	1.312	0.030	0.007	3.000	0.030	0.007	0.160	0.174	0.146
		W	1.312	0.045	0.010	3.500	0.045	0.010	0.250	0.266	0.234
1¾	1.375	N	1.438	0.030	0.007	2.500	0.030	0.007	0.160	0.174	0.146
		R	1.438	0.030	0.007	3.250	0.030	0.007	0.160	0.174	0.146
		W	1.438	0.045	0.010	3.750	0.045	0.010	0.250	0.266	0.234
1½	1.500	N	1.562	0.030	0.007	2.750	0.030	0.007	0.160	0.174	0.146
		R	1.562	0.045	0.010	3.500	0.045	0.010	0.250	0.266	0.234
		W	1.562	0.045	0.010	4.000	0.045	0.010	0.250	0.266	0.234
1⅝	1.625	N	1.750	0.030	0.007	3.000	0.030	0.007	0.160	0.174	0.146
		R	1.750	0.045	0.010	3.750	0.045	0.010	0.250	0.266	0.234
		W	1.750	0.045	0.010	4.250	0.045	0.010	0.250	0.266	0.234
1¾	1.750	N	1.875	0.030	0.007	3.250	0.030	0.007	0.160	0.174	0.146
		R	1.875	0.045	0.010	4.000	0.045	0.010	0.250	0.266	0.234
		W	1.875	0.045	0.010	4.500	0.045	0.010	0.250	0.266	0.234
1⅞	1.875	N	2.000	0.045	0.010	3.500	0.045	0.010	0.250	0.266	0.234
		R	2.000	0.045	0.010	4.250	0.045	0.010	0.250	0.266	0.234
		W	2.000	0.045	0.010	4.750	0.045	0.010	0.250	0.266	0.234
2	2.000	N	2.125	0.045	0.010	3.750	0.045	0.010	0.250	0.266	0.234
		R	2.125	0.045	0.010	4.500	0.045	0.010	0.250	0.266	0.234
		W	2.125	0.045	0.010	5.000	0.045	0.010	0.250	0.266	0.234

^aNominal washer sizes are intended for use with comparable nominal screw or bolt sizes.

^bN indicates Narrow; R, Regular; and W, Wide Series.

^cThe 0.734-inch and 1.469-inch outside diameter avoids washers which could be used in coin operated devices.

All dimensions are in inches.

Inside and outside diameters shall be concentric within at least the inside diameter tolerance.

Washers shall be flat within 0.005-inch for basic outside diameters up through 0.875-inch and within 0.010 inch for larger outside diameters.

For 2¼, 2½, 2¾, and 3-inch sizes see ANSI/ASME B18.22.1-1965 (R2008).

American National Standard Helical Spring and Tooth Lock Washers ANSI/ASME B18.21.1-1999.—This standard covers helical spring lock washers of carbon steel; boron steel; corrosion resistant steel, Types 302 and 305; aluminum-zinc alloy; phosphor-bronze; silicon-bronze; and K-Monel; in various series. Tooth lock washers of carbon steel having internal teeth, external teeth, and both internal and external teeth, of two constructions, designated as Type A and Type B. Washers intended for general industrial application are also covered. American National Standard Lock Washers (Metric Series) ANSI/ASME B18.21.2M-1999 covers metric sizes for helical spring and tooth lock washers.

Helical spring lock washers: These washers are used to provide: 1) good bolt tension per unit of applied torque for tight assemblies; 2) hardened bearing surfaces to create uniform torque control; 3) uniform load distribution through controlled radii—section—cut-off; and 4) protection against looseness resulting from vibration and corrosion.

Nominal washer sizes are intended for use with comparable nominal screw or bolt sizes. These washers are designated by the following data in the sequence shown: Product name; nominal size (number, fraction or decimal equivalent); series; material; and protective finish, if required. For example: Helical Spring Lock Washer, 0.375 Extra Duty, Steel, Phosphate Coated.

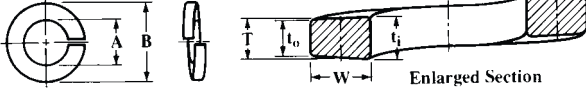
Helical spring lock washers are available in four series: Regular, heavy, extra duty and hi-collar as given in [Tables 2](#) and [1](#). Helical spring lock washers made of materials other than carbon steel are available in the regular series as given in [Table 2](#).

**Table 1. American National Standard High Collar Helical Spring Lock Washers
ANSI/ASME B18.21.1-1999**

Nominal Washer Size		Inside Diameter		Outside Diameter	Washer Section	
					Width	Thickness ^a
		Min.	Max.	Max.	Min.	Min.
No. 4	0.112	0.114	0.120	0.173	0.022	0.022
No. 5	0.125	0.127	0.133	0.202	0.030	0.030
No. 6	0.138	0.141	0.148	0.216	0.030	0.030
No. 8	0.164	0.167	0.174	0.267	0.042	0.047
No. 10	0.190	0.193	0.200	0.294	0.042	0.047
¼	0.250	0.252	0.260	0.363	0.047	0.078
⅝ ₁₆	0.3125	0.314	0.322	0.457	0.062	0.093
⅜	0.375	0.377	0.385	0.550	0.076	0.125
⅞ ₁₆	0.4375	0.440	0.450	0.644	0.090	0.140
½	0.500	0.502	0.512	0.733	0.103	0.172
⅝ ₈	0.625	0.628	0.641	0.917	0.125	0.203
¾	0.750	0.753	0.766	1.105	0.154	0.218
⅞ ₈	0.875	0.878	0.894	1.291	0.182	0.234
1	1.000	1.003	1.024	1.478	0.208	0.250
1⅛ ₈	1.125	1.129	1.153	1.663	0.236	0.313
1¼	1.250	1.254	1.280	1.790	0.236	0.313
1⅜ ₈	1.375	1.379	1.408	2.031	0.292	0.375
1½	1.500	1.504	1.534	2.159	0.292	0.375
1¾	1.750	1.758	1.789	2.596	0.383	0.469
2	2.000	2.008	2.039	2.846	0.383	0.469
2¼	2.250	2.262	2.293	3.345	0.508	0.508
2½	2.500	2.512	2.543	3.595	0.508	0.508
2¾	2.750	2.762	2.793	4.095	0.633	0.633
3	3.000	3.012	3.043	4.345	0.633	0.633

^aMean section thickness = (inside thickness + outside thickness) ÷ 2.

Table 2. American National Standard Helical Spring Lock Washers ANSI/ASME B18.21.1-1999



Nominal Washer Size	Inside Diameter, A		Regular			Heavy			Extra Duty			
	Max.	Min.	O.D., B Max.	Section Width, W	Section Thickness, T ^a	O.D., B Max.	Section Width, W	Section Thickness, T ^a	O.D., B Max.	Section Width, W	Section Thickness, T ^a	
No. 2	0.086	0.094	0.088	0.172	0.035	0.020	0.182	0.040	0.025	0.208	0.053	0.027
No. 3	0.099	0.107	0.101	0.195	0.040	0.025	0.209	0.047	0.031	0.239	0.062	0.034
No. 4	0.112	0.120	0.114	0.209	0.040	0.025	0.223	0.047	0.031	0.253	0.062	0.034
No. 5	0.125	0.133	0.127	0.236	0.047	0.031	0.252	0.055	0.040	0.300	0.079	0.045
No. 6	0.138	0.148	0.141	0.250	0.047	0.031	0.266	0.055	0.040	0.314	0.079	0.045
No. 8	0.164	0.174	0.167	0.293	0.055	0.040	0.307	0.062	0.047	0.375	0.096	0.057
No. 10	0.190	0.200	0.193	0.334	0.062	0.047	0.350	0.070	0.056	0.434	0.112	0.068
No. 12	0.216	0.227	0.220	0.377	0.070	0.056	0.391	0.077	0.063	0.497	0.130	0.080
¼	0.250	0.260	0.252	0.487	0.109	0.062	0.489	0.110	0.077	0.533	0.132	0.084
⅜	0.3125	0.322	0.314	0.583	0.125	0.078	0.593	0.130	0.097	0.619	0.143	0.108
½	0.375	0.385	0.377	0.680	0.141	0.094	0.688	0.145	0.115	0.738	0.170	0.123
⅝	0.4375	0.450	0.440	0.776	0.156	0.109	0.784	0.160	0.133	0.836	0.186	0.143
¾	0.500	0.512	0.502	0.869	0.171	0.125	0.879	0.176	0.151	0.935	0.204	0.162
7/16	0.5625	0.574	0.564	0.965	0.188	0.141	0.975	0.193	0.170	1.035	0.223	0.182
15/16	0.625	0.641	0.628	1.073	0.203	0.156	1.087	0.210	0.189	1.151	0.242	0.202
1	0.6875	0.704	0.691	1.170	0.219	0.172	1.186	0.227	0.207	1.252	0.260	0.221
1 1/16	0.750	0.766	0.753	1.265	0.234	0.188	1.285	0.244	0.226	1.355	0.279	0.241
1 1/8	0.8125	0.832	0.816	1.363	0.250	0.203	1.387	0.262	0.246	1.458	0.298	0.261
1 1/4	0.875	0.894	0.878	1.459	0.266	0.219	1.489	0.281	0.266	1.571	0.322	0.285
1 1/2	0.9375	0.958	0.941	1.556	0.281	0.234	1.590	0.298	0.284	1.684	0.345	0.308
1 3/8	1.000	1.024	1.003	1.656	0.297	0.250	1.700	0.319	0.306	1.794	0.366	0.330
1 5/16	1.0625	1.087	1.066	1.751	0.312	0.266	1.803	0.338	0.326	1.905	0.389	0.352
1 3/4	1.125	1.153	1.129	1.847	0.328	0.281	1.903	0.356	0.345	2.013	0.411	0.375
1 7/8	1.1875	1.217	1.192	1.943	0.344	0.297	2.001	0.373	0.364	2.107	0.431	0.396
2	1.250	1.280	1.254	2.036	0.359	0.312	2.104	0.393	0.384	2.222	0.452	0.417
2 1/16	1.3125	1.344	1.317	2.133	0.375	0.328	2.203	0.410	0.403	2.327	0.472	0.438
2 1/8	1.375	1.408	1.379	2.219	0.391	0.344	2.301	0.427	0.422	2.429	0.491	0.458
2 1/4	1.4375	1.472	1.442	2.324	0.406	0.359	2.396	0.442	0.440	2.530	0.509	0.478
2 1/2	1.500	1.534	1.504	2.419	0.422	0.375	2.491	0.458	0.458	2.627	0.526	0.496

^aT = mean section thickness = (t_i + t_o) ÷ 2.

All dimensions are given in inches.*See ANSI/ASME B18.21.1-1999 standard for sizes over 1½ to 3, inclusive, for regular and heavy helical spring lock washers and over 1½ to 2, inclusive, for extra-duty helical spring lock washers.

When carbon steel helical spring lock washers are to be hot-dipped galvanized for use with hot-dipped galvanized bolts or screws, they are to be coated to limits onto inch in excess of those specified in Tables 2 and 1 for minimum inside diameter and maximum outside diameter. Galvanizing washers under ¼ inch nominal size are not recommended.

Tooth lock washers: These washers serve to lock fasteners, such as bolts and nuts, to the component parts of an assembly, or increase the friction between the fasteners and the assembly. They are designated in a manner similar to helical spring lock washers, and are available in carbon steel. Dimensions are given in Tables 3 and 4.

**Table 3. American National Standard Internal-External Tooth Lock Washers
ANSI/ASME B18.21.1-1999**

All dimensions are given in inches except whole numbers under "Size"

Size	A		B		C		Size	A		B		C	
	Inside Diameter		Outside Diameter		Thickness			Inside Diameter		Outside Diameter		Thickness	
	Max.	Min.	Max.	Min.	Max.	Min.		Max.	Min.	Max.	Min.	Max.	Min.
No. 4 (0.112)	0.123	0.115	0.475	0.460	0.021	0.016	5/16 (0.312)	0.332	0.320	0.900	0.865	0.040	0.032
			0.510	0.495	0.021	0.017				0.985	0.965	0.045	0.037
			0.610	0.580	0.021	0.017				1.070	1.045	0.050	0.042
No. 6 (0.138)	.150	.0141	0.510	0.495	0.028	0.023	3/8 (0.375)	0.398	0.384	.985	.965	0.045	0.037
			0.610	0.580	0.028	0.023				1.070	1.045	0.050	0.042
			0.690	0.670	0.028	0.023				1.155	1.130	0.050	0.042
No. 8 (0.164)	0.176	0.168	0.610	0.580	0.034	0.028	7/16 (0.438)	0.464	0.448	1.070	1.045	0.050	0.042
			0.690	0.670	0.034	0.028				1.155	1.130	0.050	0.042
			0.760	0.740	0.034	0.028				1.260	1.220	0.050	0.042
No. 10 (0.190)	0.204	0.195	0.610	0.580	0.034	0.028	1/2 (0.500)	0.530	0.512	1.070	1.045	0.050	0.042
			0.690	0.670	0.040	0.032				1.155	1.130	0.050	0.042
			0.760	0.740	0.040	0.032				1.260	1.220	0.055	0.047
No. 12 (0.216)	0.231	0.221	0.900	0.880	0.040	0.032	9/16 (0.562)	.596	.576	1.315	1.290	0.055	0.047
			0.985	0.965	0.045	0.037				1.410	1.380	0.060	0.052
			1.070	1.045	0.045	0.037				1.620	1.590	0.067	0.059
1/4 (0.250)	0.267	0.256	0.760	0.725	0.040	0.032	5/8 (0.625)	.663	.640	1.315	1.290	0.055	0.047
			0.900	0.880	0.040	0.032				1.430	1.380	0.060	0.052
			0.985	0.965	0.045	0.037				1.620	1.590	0.067	0.059
			1.070	1.045	0.045	0.037			1.830	1.797	0.067	0.059	
									1.410	1.380	0.060	0.052	
									1.620	1.590	0.067	0.059	
									1.830	1.797	0.067	0.059	
									1.975	1.935	0.067	0.059	

All dimensions are given in inches.

Table 4. American National Standard Internal and External Tooth Lock Washers ANSI/ASME B18.21.1-1999

Internal Tooth Lock Washers											Countersunk External Tooth Lock Washers ^a												
	Size	#2	#3	#4	#5	#6	#8	#10	#12	1/4	5/16	3/8	7/16	1/2	9/16	5/8	11/16	3/4	13/16	7/8	1	1 1/8	1 1/4
A	Max	0.095	0.109	0.123	0.136	0.150	0.176	0.204	0.231	0.267	0.332	0.398	0.464	0.530	0.596	0.663	0.728	0.795	0.861	0.927	1.060	1.192	1.325
	Min	0.089	0.102	0.115	0.129	0.141	0.168	0.195	0.221	0.256	0.320	0.384	0.448	0.512	0.576	0.640	0.704	0.769	0.832	0.894	1.019	1.144	1.275
B	Max	0.200	0.232	0.270	0.280	0.295	0.340	0.381	0.410	0.478	0.610	0.692	0.789	0.900	0.985	1.071	1.166	1.245	1.315	1.410	1.637	1.830	1.975
	Min	0.175	0.215	0.245	0.255	0.275	0.325	0.365	0.394	0.460	0.594	0.670	0.740	0.867	0.957	1.045	1.130	1.220	1.290	1.364	1.590	1.799	1.921
C	Max	0.016	0.016	0.018	0.020	0.022	0.023	0.024	0.027	0.028	0.034	0.040	0.040	0.045	0.045	0.050	0.050	0.055	0.055	0.060	0.067	0.067	0.067
	Min	0.010	0.010	0.012	0.014	0.016	0.018	0.018	0.020	0.023	0.028	0.032	0.032	0.037	0.037	0.042	0.042	0.047	0.047	0.052	0.059	0.059	0.059
External Tooth Lock Washers																							
A	Max	...	0.109	0.123	0.136	0.150	0.176	0.204	0.231	0.267	0.332	0.398	0.464	0.530	0.596	0.663	0.728	0.795	0.861	0.927	1.060
	Min	...	0.102	0.115	0.129	0.141	0.168	0.195	0.221	0.256	0.320	0.384	0.448	0.513	0.576	0.641	0.704	0.768	0.833	0.897	1.025
B	Max	...	0.235	0.260	0.285	0.320	0.381	0.410	0.475	0.510	0.610	0.694	0.760	0.900	0.985	1.070	1.155	1.260	1.315	1.410	1.620
	Min	...	0.220	0.245	0.270	0.305	0.365	0.395	0.460	0.494	0.588	0.670	0.740	0.880	0.960	1.045	1.130	1.220	1.290	1.380	1.590
C	Max	...	0.016	0.018	0.020	0.022	0.023	0.024	0.027	0.028	0.034	0.040	0.040	0.045	0.045	0.050	0.050	0.055	0.055	0.060	0.067
	Min	...	0.010	0.012	0.014	0.016	0.018	0.018	0.020	0.023	0.028	0.032	0.032	0.037	0.037	0.042	0.042	0.047	0.047	0.052	0.059
Heavy Internal Tooth Lock Washers																							
	Size	1/4	5/16	3/8	7/16	1/2	9/16	5/8	3/4	7/8		Size	#4	#6	#8	#10	#12	1/4	#16	5/16	3/8	7/16	1/2
A	Max	0.267	0.332	0.398	0.464	0.530	0.596	0.663	0.795	0.927	A	Max	0.123	0.150	0.177	0.205	0.231	0.267	0.287	0.333	0.398	0.463	0.529
	Min	0.256	0.320	0.384	0.448	0.512	0.576	0.640	0.768	0.894		Min	0.113	0.140	0.167	0.195	0.220	0.255	0.273	0.318	0.383	0.448	0.512
B	Max	0.536	0.607	0.748	0.858	0.924	1.034	1.135	1.265	1.447	C	Max	0.019	0.021	0.021	0.025	0.025	0.028	0.028	0.034	0.045	0.045	0.045
	Min	0.500	0.590	0.700	0.800	0.880	0.990	1.100	1.240	1.400		Min	0.015	0.017	0.017	0.020	0.020	0.023	0.023	0.028	0.037	0.037	0.037
C	Max	0.045	0.050	0.050	0.067	0.067	0.067	0.067	0.084	0.084	D	Max	0.065	0.092	0.099	0.105	0.128	0.128	0.147	0.192	0.255	0.270	0.304
	Min	0.035	0.040	0.042	0.050	0.055	0.055	0.059	0.070	0.075		Min	0.050	0.082	0.083	0.088	0.118	0.137	0.165	0.242	0.260	0.294	0.294

^a Starting with #4, approx. O.D.'s are: 0.213, 0.289, 0.322, 0.354, 0.421 0.454, 0.505, 0.599, 0.765, 0.867, and 0.976.

All dimensions are given in inches.

Fasteners for Use in Structural Applications

The ASME B18.2.6 standard covers the complete general and dimensional data for four products in the inch series recognized as American National Standard. Heavy hex nut thickness formulas and those for width across flats and width across corners are found in the Appendix of ASME B18.2.2. The inclusion of dimensional data in this standard is not intended to imply that all products described herein are stock production sizes. Fasteners intended for use in structural applications and purchased for government use shall conform to this standard. All dimensions in ASME B18.2.6 are in inches unless stated otherwise, and apply to unplated or uncoated product.

Symbols specifying geometric characteristics are in accord with ASME Y14.5M, *Dimensioning and Tolerancing*. Standards for chemical and mechanical requirements for structural bolts are included in ASTM A 325 and ASTM A 490. Heavy hex nuts are included in ASTM A 563. Hardened steel washers are included in ASTM F436, and compressible washer type direct tension indicators in ASTM F 959.

Heavy Hex Structural Bolts.—*Head Width Across Flats:* The width across flats of heads shall be the distance measured perpendicular to the axis of product, overall between two opposite sides of the head in accordance with the notes in the dimensional table.

Head Height: The head height shall be that overall distance measured parallel to the axis of the product from the top of the head to the bearing surface and shall include the thickness of the washer face. Raised grade and manufacturer's identification are excluded from head height.

Bolt Length: The bolt length shall be the distance measured parallel to the axis of the product from the bearing surface of the head to the extreme end of the bolt including point.

Threads: Threads shall be cut or rolled in accordance with ASME B 1.1. When specified, 8 thread series may be used on bolts over 1 inch in diameter. Structural bolts shall not be undersized to accommodate heavy coatings. Threads which have been hot-dipped or mechanically zinc coated shall meet the requirements specified in ASTM A 325.

Body Diameter: The body diameter limits are shown in [Table 5](#).

Finish: Unless otherwise specified, bolts shall be supplied with a plain (as processed) finish. Bolts to ASTM A 490 shall not be metallic coated.

Materials: Chemical and mechanical properties of steel bolts shall conform to ASTM A 325 or ASTM A 490.

Workmanship: Bolts shall be free from burrs, seams, laps, loose scale, irregular surfaces, and any defects affecting serviceability. When control of surface discontinuities is required, the purchaser shall specify conformance to ASTM F 788/F 788M, surface discontinuities of bolts, screws, and studs, inch and metric series.

Designation: Heavy hex structural bolts shall be designated by the following data in the sequence shown: product name, nominal size (fractional or decimal equivalent), threads per inch, material (including specification and type where necessary), and protective finish (if required). See example below:

Example: Heavy Hex Structural Bolt, $\frac{3}{4}$ -10 \times 2 $\frac{1}{4}$, ASTM A 325, Type 1, hot dipped zinc coated.

Identification Grade Symbols: Each bolt shall be marked in accordance with the requirements of the applicable specification; ASTM A 325 or ASTM A 490 and requirements of [Table 5](#), Note (13).

Table 5. Dimensions of Heavy Hex Structural Bolts ASME B18.2.6-1996 (R2004)

Nominal Size or Basic Product Diameter Note (15)		Body Diameter, <i>E</i> Note (5)		Width Across Flats <i>F</i> Note (2)			Width Across Corners <i>G</i>		Head Height <i>H</i>			Radius of Fillet <i>R</i>		Thread Length <i>L_T</i> Note (10)	Transition Thread Length <i>Y</i> Note (10)	Total Runout of Bearing Surface FIM Note (3)
		Max.	Min.	Basic	Max.	Min.	Max.	Min.	Basic	Max.	Min.	Max.	Min.	Ref.	Max., Ref.	Max.
½	0.5000	0.515	0.482	⅞	0.875	0.850	1.010	0.969	⅝	0.323	0.302	0.031	0.009	1.00	0.19	0.016
⅜	0.6250	0.642	0.605	1¼	1.062	1.031	1.227	1.175	⅝	0.403	0.378	0.062	0.021	1.25	0.22	0.019
¾	0.7500	0.768	0.729	1¼	1.250	1.212	1.443	1.383	1½	0.483	0.455	0.062	0.021	1.38	0.25	0.022
⅞	0.8750	0.895	0.852	1½	1.438	1.394	1.660	1.589	1½	0.563	0.531	0.062	0.031	1.50	0.28	0.025
1	1.0000	1.022	0.976	1½	1.625	1.575	1.876	1.796	1½	0.627	0.591	0.093	0.062	1.75	0.31	0.028
1⅛	1.1250	1.149	1.098	1½	1.812	1.756	2.093	2.002	1½	0.718	0.658	0.093	0.062	2.00	0.34	0.032
1¼	1.2500	1.277	1.223	2	2.000	1.938	2.309	2.209	1½	0.813	0.749	0.093	0.062	2.00	0.38	0.035
1⅜	1.3750	1.404	1.345	2	2.188	2.119	2.526	2.416	1½	0.878	0.810	0.093	0.062	2.25	0.44	0.038
1½	1.5000	1.531	1.470	2	2.375	2.300	2.742	2.622	1½	0.974	0.902	0.093	0.062	2.25	0.44	0.041

(1) *Top of Head*: Top of head shall be full form and chamfered or rounded with the diameter of chamfer circle or start of rounding being equal to the maximum width across flats within a tolerance of minus 15%.

(2) *Head Taper*: Maximum width across flats shall not be exceeded. No transverse section through the head between 25% and 75% of actual head height, as measured from the bearing surface, shall be less than the minimum width across flats.

(3) *Bearing Surface*: Bearing surface shall be flat and washer faced. Diameter of washer face shall be equal to the maximum width across flats within a tolerance of minus 10%.

Thickness of the washer face shall be not less than 0.015 inch nor greater than 0.025 inch for bolt sizes $\frac{3}{4}$ inch and smaller; and not less than 0.015 inch nor greater than 0.035 inch for sizes larger than $\frac{3}{4}$ inch.

The plane of the bearing surface shall be perpendicular to the axis of the body within the FIM limits specified for total runout. Measurement of FIM shall extend as close to the periphery of the bearing surface as possible while the bolt is being held in a collet or other gripping device at a distance of one bolt diameter from the underside of the head.

(4) *True Position of Head*: The axis of the head shall be located at true position with respect to the axis of the body (determined over a distance under the head equal to one diameter) within a tolerance zone having a diameter equivalent to 6% of the maximum width across flats at maximum material condition.

(5) *Body Diameter*: Any swell or fin under the head or any die seam on the body should not exceed the basic bolt diameter by the following: 0.030 in, for sizes $\frac{1}{2}$ inch; 0.050 inch for sizes $\frac{5}{8}$ and $\frac{3}{4}$ inch; 0.060 inch for sizes over $\frac{3}{4}$ inch to $1\frac{1}{4}$ inch; 0.090 inch for sizes over $1\frac{1}{4}$ inch.

(6) *Point*: Point shall be chamfered or rounded at the manufacturer's option from approximately 0.016 inch below the minor diameter of the thread. The first full formed thread at major diameter is located a distance no greater than 2 times the pitch measured from the end of the screw. This distance is to be determined by measuring how far the point enters into a cylindrical NOT GO major diameter ring gage.

(7) *Straightness*: Shanks of bolts shall be straight within the following limits at MMC; for bolts with nominal lengths to and including 12 inches the maximum camber shall be 0.006 inch per inch (0.006L) of bolt length, and for bolts with nominal lengths over 12 inches to and including 24 inches the maximum camber shall be 0.008 inch per inch (0.008L) of length.

(8) *Bolt Length*: Bolts are normally supplied in $\frac{1}{4}$ inch length increments, all lengths.

(9) *Length Tolerance*: Bolt length tolerances shall be as tabulated below:

Nominal Bolt Size	$\frac{1}{2}$	$\frac{5}{8}$	$\frac{3}{4}$ through 1	$1\frac{1}{8}$ through $1\frac{1}{2}$
Nominal Bolt Length	Tolerance of Length			
Through 6 inches	-0.12	-0.12	-0.19	-0.25
Over 6 inches	-0.19	-0.25	-0.25	-0.25

(10) *Thread Length*: The length of thread on bolts shall be controlled by the grip gaging length, L_G , max., and the body length, L_B , min., as follows.

Grip gaging length, L_G , max., is the distance measured parallel to the axis of bolt from the underhead bearing surface to the face of a noncounterbored or noncountersunk standard G0 thread ring gage assembled by hand as far as the thread will permit. It shall be used as the criterion for inspection. The maximum grip gaging length, as calculated and rounded to two decimal places for any bolt not threaded full length, shall be equal to the nominal bolt length minus the basic thread length (L_G , max. = $L_{nom.} - L_T$). For bolts which are threaded full length, L_G , max. defines the unthreaded length under the head and shall not exceed the length of 2.5 times the thread pitch for sizes up to and including 1 inch, and 3.5 times the thread pitch for sizes larger than 1 inch, L_G , max. represents the minimum design grip length of the bolt and may be used for determining thread availability when selecting bolt lengths even though usable threads may extend beyond this point.

Basic thread length, L_T , is a reference dimension, intended for calculation purposes only, which represents the distance from the extreme end of the bolt to the last complete (full form) thread.

Body length, L_B , min., is the distance measured parallel to the axis of bolt from the underhead bearing surface to the last scratch of thread or to the top of the extrusion angle. It shall be used as a criterion for inspection. The minimum body length, as calculated and rounded to two decimal places, shall be equal to the maximum grip gaging length minus the maximum transition thread length

($L_{B, min} = L_{G, max} - Y_{max}$). Bolts of nominal lengths which have a calculated $L_{B, min}$ length equal to or shorter than 2.5 times the thread pitch for sizes 1 inch and smaller, and 3.5 times the thread pitch for sizes larger than 1 inch shall be threaded for full length.

Transition thread length Y is a reference dimension, intended for calculation purposes only, which represents the length of incomplete threads and tolerance on grip gaging length.

(11) *Incomplete Thread Diameter*: The major diameter of incomplete thread shall not exceed the actual major diameter of the full form thread.

(12) *Threads*: Threads, when rolled, shall be in the unified inch coarse or 8 thread series (UNRC or 8 UNR Series), Class 2A. Threads produced by other methods may be Unified Inch coarse or 8 thread series (UNC or 8 UN Series), Class 2A. Acceptability of screw threads shall be determined based on System 21, ASME B1.3M, screw thread gaging systems for dimensional acceptability, unless otherwise specified.

(13) *Identification Symbols*: Identification marking symbols on the tops of heads for bolt sizes $\frac{5}{8}$ inch and smaller shall project not less than 0.005 inch above the surface nor more than 0.015 inch over the specified maximum head height. Bolt sizes larger than $\frac{5}{8}$ inch shall project not less than the equivalent in inches of 0.0075 times the basic bolt diameter above the surface nor more than 0.030 inch over the specified maximum head height.

(14) *Material*. Chemical and mechanical properties of steel bolts shall conform to ASTM A 325 or ASTM A 490.

(15) *Nominal Size*. Where specifying nominal size in decimals, zeros preceding the decimal and in the fourth decimal place shall be omitted.

(16) *Dimensional Conformance*. Heavy hex structural bolts shall have the following characteristics inspected to ASME B18.18.2M to the inspection level C: threads, width across comers, head height, grip length, visual.

If verifiable in-process inspection is used, see *Dimensional Characteristics* on page 1573.

Identification Source Symbols: Each bolt shall be marked to identify its source (manufacturer, or private label distributor) accepting the responsibility for conformance to this and other applicable specifications.

Quality Assurance: Unless otherwise specified, products shall be furnished in accordance with ASME B18.18.1M and ASME B18.18.2M as noted as below.

Dimensional Characteristics: Bolts shall conform to the dimensions indicated in [Table 5](#). The designated characteristics defined in [Table 5](#), Note (16) shall be inspected in accordance with ASME B18.18.2M. For nondesignated characteristics, the provisions of ASME B18.18.1M shall apply. Should a nondesignated dimension be determined to have a variance, it shall be deemed conforming to this Standard if the user, who is the installer, accepts the variance based on fit, form, and function considerations. Where verifiable in process inspection is used in accordance with ASME B18.18.3M or ASME B18.18.4M, the final inspection level sample sizes of those respective standards shall apply.

Heavy Hex Nuts.—*Width Across Flats*: The width across flats of heavy hex nuts shall be the overall distance measured, perpendicular to the axis of the nut, between two opposite sides of the nut in accordance with the notes of [Table 6](#). For milled-from-bar hex nuts, the nominal bar size used shall be the closest commercially available size to the specified basic width across flats of the nut.

Table 6. Dimensions of Heavy Hex Nuts for Use with Structural Bolts ASME B18.2.6-1996 (R2004)

Nominal Size or Basic Product Diameter	F			G		H			Runout of Bearing Face FIM		
	Width Across Flats			Width Across Corners		Thickness			Heavy Hex Nuts		
	Basic	Max.	Min.	Max.	Min.	Basic	Max.	Min.	Specified Proof Load		
[Note (1)]	[Note (6)]			[Note (5)]					[Note (2)]		
1/2	0.5000	7/8	0.875	0.850	1.010	0.969	31/64	0.504	0.464	0.023	0.016
5/8	0.6250	11/16	1.062	1.031	1.227	1.175	39/64	0.631	0.587	0.025	0.018
3/4	0.7500	1 1/4	1.250	1.212	1.443	1.382	47/64	0.758	0.710	0.027	0.020
7/8	0.8750	1 7/16	1.438	1.394	1.660	1.589	55/64	0.885	0.833	0.029	0.022
1	1.0000	1 5/8	1.625	1.575	1.876	1.796	63/64	1.012	0.956	0.031	0.024
1 1/8	1.1250	1 13/16	1.812	1.756	2.093	2.002	1 7/64	1.139	1.079	0.033	0.027
1 1/4	1.2500	2	2.000	1.938	2.309	2.209	1 1/32	1.215	1.187	0.035	0.030
1 3/8	1.3750	2 3/16	2.188	2.119	2.526	2.416	1 11/32	1.378	1.310	0.038	0.033
1 1/2	1.5000	2 3/8	2.375	2.300	2.742	2.622	1 15/32	1.505	1.433	0.041	0.036

Note: Complete table included in B18.2.2 Square and Hex Nuts (Inch Series)

(1) *Unification*: Only the 5/16 size is not unified dimensionally with British and Canadian standards. Unification of fine thread products is limited to sizes 1 inch and under.

(2) *Tops and Bearing Surfaces of Nuts*: Nuts may be double chamfered or have washer faced bearing surface and chamfered top.

The diameter of chamfer circle on double chamfered nuts and diameter of washer face shall be within the limits of the maximum width across flats and 95% of the minimum width across flats.

The tops of washer faced nuts shall be flat and the diameter of chamfer circle shall be equal to the maximum width across flats within a tolerance of -15%. The length of chamfer at hex corners shall be 5% to 15% of the basic thread diameter. The surface of chamfer may be slightly convex or rounded.

Bearing surfaces shall be flat and, unless otherwise specified, shall be perpendicular to the axis of the threaded hole within the total runout (FIM) tabulated for the respective nut size, type, and strength level.

(3) *True Position of Tapped Hole*: At maximum material condition, the axis of nut body shall be located at true position with respect to the axis of the tapped hole within a tolerance zone having a diameter equivalent to 4% of the maximum width across flats for 1 1/2 inch nominal size nuts or smaller.

(4) *Countersink*: Tapped hole shall be countersunk on the bearing face or faces. The maximum countersink diameter shall be 1.08 times the thread basic (nominal) major diameter. No part of the threaded portion shall project beyond the bearing surface.

(5) *Corner Fill*: A rounding or lack of fill at junction of hex corners with chamfer shall be permissible provided the width across corners is within specified limits at and beyond a distance equal to 17.5% of the basic thread diameter from the chamfered faces.

(6) *Width Across Flats*: Maximum width across flats shall not be exceeded (see exception in *Width Across Flats*). No transverse section through the nut between 25% and 75% of the actual nut thickness, as measured from the bearing surface, shall be less than the minimum width across flats. For milled-from-bar nuts, *Width Across Flats*, pertaining to the nominal bar size to be used.

(7) *Threads*: Threads shall be UNC or 8 UN Class 2B in accordance with ASME B1.1, Unified Inch Screw Threads. When specified, 8 thread series may be used on nuts over 1 inch in diameter.

(8) *Dimensional Conformance*: Heavy hex nuts shall have the following characteristics inspected to ASME B18.18.2M to the inspection levels as follows: Width across corners, inspection level C; Thickness, inspection level B; Visual, inspection level C.

If verifiable in-process inspection is used, see *Dimensional Characteristics* on page 1575.

Nut Thickness: The nut thickness shall be the overall distance measured parallel to the axis of nut, from the top of the nut to the bearing surface, and shall include the thickness of the washer face where provided.

Threads: Threads shall be in accordance with **Table 6**, Note (7).

Thread Gaging: Unless otherwise specified by the purchaser, gaging for screw thread dimensional acceptability shall be in accordance with Gaging System 21 as specified in ASME B1.3M Screw Thread Gaging Systems for Dimensional Acceptability-Inch and Metric Screw Threads (UN, UNR, UNJ, M, and MJ).

Overtapping: When nuts are zinc coated, they shall be overtapped after coating in accordance with the provisions of ASTM A 563.

Finish: Unless otherwise specified, nuts shall be supplied with a plain (as-processed) finish, unplated or uncoated.

Materials: Chemical and mechanical properties of heavy hex nuts shall conform to ASTM A 563.

Workmanship: Nuts shall be free from burrs, seams, laps, loose scale, irregular surfaces, and any defects affecting their serviceability. When control of surface discontinuities is required, the purchaser shall specify conformance to ASTM F 812/F 812M, Surface Discontinuities of Nuts-Inch and Metric Series.

Designation: Nuts shall be designated by the following data in sequence shown: product name, nominal size (fraction or decimal), threads per inch, material (including specification, where necessary), protective finish (if required). See example below:

Example: Heavy Hex Nut, $\frac{1}{2}$ -13, ASTM A 563 Grade C, Plain Finish

Identification Grade Symbols: Each nut shall be marked in accordance with the requirements of the applicable specification: ASTM A 563 or ASTM A 194.

Identification Source Symbols: Each nut shall be marked to identify its source (manufacturer, or private label distributor) accepting the responsibility for conformance to this and other applicable specifications.

Quality Assurance: Unless otherwise specified, products shall be furnished in accordance with ASME B18.18.1M and ASME B18.18.2M as noted in *Dimensional Characteristics*.

Dimensional Characteristics: Products shall conform to the dimensions indicated for the heavy hex nut in **Table 6**. The designated characteristics defined in **Table 6**, Note (8) shall be inspected in accordance with ASME B18.18.2M. For nondesignated characteristics, the provision of B18.18.1M shall apply. Should a nondesignated dimension be determined to have a variance, it shall be deemed conforming to this Standard if the user, who is the installer, accepts the variance based on fit, form, and function considerations. Where verifiable inprocess inspection is used in accordance with ASME B18.18.3M or ASME B18.18.4M, the final inspection level sample sizes of those respective standards shall apply.

Hardened Steel Washers

Flat Washers.—*Flat Washers Dimensions:* All circular and circular clipped washers shall conform to the dimensions shown in **Table 7**.

Table 7. Dimensions for Hardened Steel Circular and Circular Clipped Washers ASME B18.2.6-1996 (R2004)

Bolt Size or Nominal ^a Washer Size, Inch	Inside Diameter A			Outside Diameter B			Thickness C		Minimum Edge Distance E
	Basic Washer	Tolerance		Basic	Tolerance		Min.	Max.	
		Plus	Minus		Plus	Minus			
1/2	0.531	0.0313	0	1.063	0.0313	0.0313	0.097	0.177	0.438
5/8	0.688	0.0313	0	1.313	0.0313	0.0313	0.122	0.177	0.547
3/4	0.813	0.0313	0	1.469	0.0313	0.0313	0.122	0.177	0.656
7/8	0.938	0.0313	0	1.750	0.0313	0.0313	0.136	0.177	0.766
1	1.125	0.0313	0	2.000	0.0313	0.0313	0.136	0.177	0.875
1 1/8	1.250	0.0313	0	2.250	0.0313	0.0313	0.136	0.177	0.984
1 1/4	1.375	0.0313	0	2.500	0.0313	0.0313	0.136	0.177	1.094
1 3/8	1.500	0.0313	0	2.750	0.0313	0.0313	0.136	0.177	1.203
1 1/2	1.625	0.0313	0	3.000	0.0313	0.0313	0.136	0.177	1.313

^aNominal washer sizes are intended for use with comparable nominal bolt diameters.

General Notes:

(1) *Dimensional Conformance:* Circular and circular clipped washers shall have the following characteristics inspected to ASME B18.18.2M to the inspection levels as follows: Width across corners, inspection level B; Visual, inspection level C.

If verifiable in-process inspection is used, see *Dimensional Characteristics* on page 1577.

(2) Nominal washer sizes are intended for use with comparable nominal bolt diameters.

(3) Additional requirements are in *Beveled Washers* on page 1577.

Flat Washers Tolerances: Washer inside diameter, outside diameter, thickness, and edge distance shall be in accordance with **Table 7**. The deviation from flatness shall not exceed 0.010 inch as the maximum deviation from a straight edge placed on the cut side. Circular runout of the outside diameter with respect to the hole shall not exceed 0.030 FIM. Burrs shall not project above immediately adjacent washer surface more than 0.010 inch.

Finish: Unless otherwise specified, washers shall be supplied with a plain (as processed) finish. If zinc coatings are required, they shall be in accordance with ASTM F 436.

Materials: Materials shall conform to the requirements established by ASTM F 436.

Workmanship: Washers shall be free from burrs, seams, laps, loose scale, irregular surfaces, and any defects affecting serviceability.

Designation: Washers shall be designated by the following data in the sequence shown: product name, nominal size (fraction or decimal), material specification, protective finish. See example below:

Example: Hardened Steel Circular Washer, $1\frac{1}{2}$ ASTM F 436, Hot-Dip Galvanized in Accordance with ASTM A 153 Class C.

Identification Symbols: Grade and source marking and symbols shall conform to the requirements of ASTM F 436. The source marking is intended to identify the source accepting the responsibility for the conformance to this and other applicable specifications.

Quality Assurance: Unless otherwise specified, products shall be furnished in accordance with ASME B18.18M and ASME B18.18.2M as noted in *Dimensional Characteristics*.

Dimensional Characteristics: Washers shall conform to the dimensions indicated in *Table 7*. The designated characteristics defined in *Table 7*, Note (1) shall be inspected in accordance with ASME B18.18.2M. For nondesignated characteristics, the provisions of ASME B18.18.1M shall apply. Should a nondesignated dimension be determined to have a variance, it shall be deemed conforming to this Standard if the user, who is the installer, accepts the variance based on fit, form, and function considerations. Where verifiable in-process inspection is used in accordance with ASME B18.18.3M or ASME B18.18.4M, the final inspection level sample sizes of those respective standards shall apply.

Beveled Washers.—*Dimensions:* All square beveled and clipped square beveled washers shall conform to the dimensions shown in *Table 8*.

Tolerances: Tolerances for inside diameter for beveled washers shall be in accordance with *Table 8*. The flatness shall not exceed 0.010 inch as the maximum deviation from a straight edge placed on the cut side. Burrs shall not project above immediately adjacent washer surface more than 0.010 inch.

Finish: Unless otherwise specified, washers shall be supplied with a plain (as-processed) finish. If zinc coatings are required, they shall be in accordance with ASTM F 436.

Materials and Mechanical Properties: Materials and properties shall conform to the requirements established by ASTM F 436.

Workmanship: Washers shall be free from burrs, seams, laps, loose scale, irregular surfaces, and any defects affecting serviceability.

Designation: Washers shall be designated by the following data in the sequence shown: product name, nominal washer size (fraction or decimal), material specification, protective finish. See example below:

Example: Square Beveled Washer, $1\frac{1}{4}$ ASTM F 436, hot-dip galvanized in accordance with ASTM A 153 Class C.

Table 8. Dimensions for Hardened Beveled Washers with Slope or Taper in Thickness 1:6 ASME B18.2.6-1996 (R2004)

Nominal Washer Size [Note (3)]	Inside Diameter A				Minimum Side Length L	Thickness T	Minimum Edge Distance E
	Basic	Tolerance					
		Plus	Minus				
1/2	0.500	0.531	0.0313	0	1.750	0.313	0.438
5/8	0.625	0.688	0.0313	0	1.750	0.313	0.547
3/4	0.750	0.813	0.0313	0	1.750	0.313	0.656
7/8	0.875	0.938	0.0313	0	1.750	0.313	0.766
1	1.000	1.125	0.0313	0	1.750	0.313	0.875
1 1/8	1.125	1.250	0.0313	0	2.250	0.313	0.984
1 1/4	1.250	1.375	0.0313	0	2.250	0.313	1.094
1 3/8	1.375	1.500	0.0313	0	2.250	0.313	1.203
1 1/2	1.500	1.625	0.0313	0	2.250	0.313	1.313

General notes for Table 8:

(1) *Dimensional Conformance:* Beveled washers shall have the following characteristics inspected to ASME B18.18.2M to the inspection levels as follows: Width across corners, inspection level B; Visual, inspection level C.

If verifiable in-process inspection is used, see *Dimensional Characteristics* on page 1578.

(2) Nonclipped washers may be rectangular providing neither side dimension is less than L.

(3) Nominal washer sizes are intended for use with comparable nominal bolt diameters.

(4) Additional requirements are in *Beveled Washers* on page 1577.

Identification Symbols: Grade and source marking and symbols shall conform to the requirements of ASTM F 436. The source marking is intended to identify the source accepting the responsibility for conformance to this and other applicable specifications.

Quality Assurance: Unless otherwise specified, products shall be furnished in accordance with ASME B18.18M and ASME B18.18.2M as noted in *Dimensional Characteristics* on page 1578.

Dimensional Characteristics: Washers shall conform to the dimensions specified in Table 8. The designated characteristics defined in Table 8, Note (1) shall be inspected in accordance with ASME B18.18.2M. For nondesignated characteristics, the provisions of ASME B18.18.1M shall apply. Should a nondesignated dimension be determined to have a variance, it shall be deemed conforming to this Standard if the user, who is the installer,

accepts the variance based on fit, form, and function considerations. Where verifiable in-process inspection is used in accordance with ASME B18.18.3M or B18.18.4M, the final inspection level sample sizes of these respective standards shall apply.

Compressible Washer-type Direct Tension Indicators.—*Dimensions:* The dimensions for the two washer types of direct tension indicators, Type A 325 and A 490, shall be in accordance with [Table 9](#).

Finish: Unless otherwise specified, direct tension indicators shall be supplied with a plain (as-processed) finish, tinplated, or uncoated. If zinc coatings are required, they shall be in accordance with ASTM F 959.

Materials and Performance: Direct tension indicators shall conform to the requirements of ASTM F 959.

Workmanship: The workmanship shall be smooth and free of burrs, laps, seams, excess mill scale, and foreign material on bearing surfaces or in protrusion welds, or other defects which would make them unsuitable for intended application.

Designation: Compressible washer-type direct tension indicators shall be designated by the following data in the sequence shown: product name, nominal size (fractional or decimal equivalent), type (325 or 490), finish (plain, zinc, or epoxy). See example below:

Example: DTI, ½ Type 325, Plain Finish

Identification Symbols: Grade and source marking and symbols shall conform to the requirements of ASTM F 959.

Lot Number: Each direct tension indicator shall be marked with a lot number in accordance with ASTM F 959.

Quality Assurance: Unless otherwise specified, products shall be furnished in accordance with ASME B18.18.1M and ASME B18.18.2M as noted in *Dimensional Characteristics*.

Dimensional Characteristics: Direct tension indicators shall conform to the dimensions indicated in [Table 9](#). The designated characteristics defined in [Table 9](#), Note (1) shall be inspected in accordance with ASME B18.18.2M. For nondesignated characteristics, the provisions of ASME B18.18.1M shall apply. Should a nondesignated dimension be determined to have a variance, it shall be deemed conforming to this Standard if the user, who is the installer, accepts the variance based on fit, form, and function considerations. Where verifiable in-process inspection is used in accordance with ASME B18.18.3M or B18.18.4M, the final inspection level sample sizes of these respective standards shall apply.

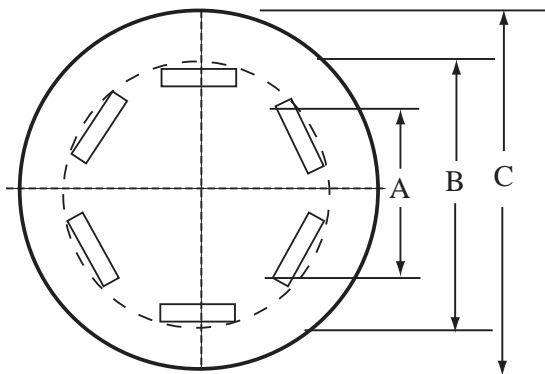


Fig. 3. Compressible Washer Dimensions

Table 9. Dimensions for Compressible Washer-Type Direct Tension Indicators ASME B18.2.6-1996 (R2004)

Bolt Size, inch	All Types			Type A 325					Type A 490				
	Inside Diameter, inch		Protrusion Tangential Diameter, inch B, Max.	Outside Diameter, inch C		Number of Protrusions (Equally Spaced)	Thickness, inch		Outside Diameter, inch		Number of Protrusions (Equally Spaced)	Thickness, inch	
							Without Protrusion-Min.	With Protrusion-Max.				Without Protrusion Min.	With Protrusion Max.
	Min.	Max.	Min.	Max.	Min.	Max.	Min.	Max.					
1/2	0.523	0.527	0.788	1.167	1.187	4	0.104	0.180	1.355	1.375	5	0.104	0.180
5/8	0.654	0.658	0.956	1.355	1.375	4	0.126	0.220	1.605	1.625	5	0.126	0.220
3/4	0.786	0.790	1.125	1.605	1.825	5	0.126	0.230	1.730	1.750	6	0.142	0.240
7/8	0.917	0.921	1.294	1.855	1.875	5	0.142	0.240	1.980	2.000	6	0.158	0.260
1	1.048	1.052	1.463	1.980	2.000	6	0.158	0.270	2.230	2.250	7	0.158	0.270
1 1/8	1.179	1.183	1.631	2.230	2.250	6	0.158	0.270	2.480	2.500	7	0.158	0.280
1 1/4	1.311	1.315	1.800	2.480	2.600	7	0.158	0.270	2.730	2.750	8	0.158	0.280
1 3/8	1.442	1.446	1.969	2.730	2.750	7	0.158	0.270	2.980	3.000	8	0.158	0.280
1 1/2	1.573	1.577	2.138	2.980	3.000	8	0.158	0.270	3.230	3.260	9	0.158	0.280

General Notes:

- (1) *Dimensional Conformance:* Direct tension indicators shall have the following characteristics inspected to ASME B18.18.2M to the inspection levels as follows: Inside diameter and Width across corners, inspection level B; Visual, inspection level C. If verifiable in-process inspection is used, *Dimensional Characteristics* on page 1578.
- (2) Nonclipped washers may be rectangular providing neither side dimension is less than *L*.
- (3) Nominal washer sizes are intended for use with comparable nominal bolt diameters.
- (4) Additional requirements are in *Compressible Washer-type Direct Tension Indicators* on page 1579.

METRIC THREADED FASTENERS

A number of American National Standards covering metric bolts, screws, nuts, and washers have been established in cooperation with the Department of Defense in such a way that they could be used by the Government for procurement purposes. Extensive information concerning these metric fasteners is given in the following text and tables, but for additional manufacturing and acceptance specifications reference should be made to the respective Standards which may be obtained by nongovernmental agencies from the American National Standards Institute, 25 West 43rd Street, New York, N.Y. 10036. These Standards are:

ANSI B18.2.3.1M-1999 (R2011) Metric Hex Cap Screws	Table 1
ANSI B18.2.3.2M-1979 (R1995) Metric Formed Hex Screws	Table 2
ANSI B18.2.3.3M-1979 (R2001) Metric Heavy Hex Screws	Table 3
ANSI B18.2.3.8M-1981 (R2005) Metric Hex Lag Screws	Table 5
ANSI B18.3.3M-1986, (R2002) Metric Socket Hd. Shldr. Screws	Table 6a
ANSI B18.2.3.9M-1984 Metric Heavy Hex Flange Screws	Table 7
ANSI B18.2.3.4M-2001 Metric Hex Flange Screws	Table 8
ANSI B18.5.2.2M-1982 (R2000) Metric Round Head Square Neck Bolts	Table 10
ANSI B18.2.3.6M-1979 (R2001) Metric Heavy Hex Bolts	Table 11
ANSI B18.2.3.7M-1979 (R2001) Metric Heavy Hex Structural Bolts	Table 12
ANSI B18.2.3.5M-1979 (R2001) Metric Hex Bolts	Table 13
ANSI B18.3.1M-1986 (R2002) Socket Head Cap Screws (Metric Series)	Table 21
ANSI B18.2.4.1M-2002 (R2007) Metric Hex Nuts, Style 1	Table 25
ANSI B18.2.4.2M-2005 Metric Hex Nuts, Style 2	Table 25
ANSI B18.2.4.3M-1979 (R2001) Metric Slotted Hex Nuts	Table 24
ANSI B18.2.4.4M-1982 (R1999) Metric Hex Flange Nuts	Table 26
ANSI B18.16.3M-1998 Prevailing-Torque Metric Hex Nuts	Table 29
ANSI B18.16.3M-1998 Prevailing-Torque Metric Hex Flange Nuts	Table 27
ANSI B18.2.4.5M-1979 (R2003) Metric Hex Jam Nuts	Table 28
ANSI B18.2.4.6M-1979 (R2003) Metric Heavy Hex Nuts	Table 28
ANSI B18.22M-1981 (R2000) Metric Plain Washers	Table 30

Manufacturers should be consulted concerning items and sizes in stock production.

Comparison with ISO Standards.—American National Standards for metric bolts, screws and nuts have been coordinated to the extent possible with the comparable ISO Standards or proposed Standards. The dimensional differences between the ANSI and the comparable ISO Standards or proposed Standards are few, relatively minor, and none will affect the functional interchangeability of bolts, screws, and nuts manufactured to the requirements of either.

Where no comparable ISO Standard had been developed, as was the case when the ANSI Standards for Metric Heavy Hex Screws, Metric Heavy Hex Bolts, and Metric Hex Lag Screws were adopted, nominal diameters, thread pitches, body diameters, widths across flats, head heights, thread lengths, thread dimensions, and nominal lengths are in accord with ISO Standards for related hex head screws and bolts. At the time of ANSI adoption (1982) there was no ISO Standard for round head square neck bolts.

The following functional characteristics of hex head screws and bolts are in agreement between the respective ANSI Standard and the comparable ISO Standard or proposed Standard: diameters and thread pitches, body diameters, widths across flats (see exception below), bearing surface diameters (except for metric hex bolts), flange diameters (for metric hex flange screws), head heights, thread lengths, thread dimensions, and nominal lengths.

**Table 1. American National Standard Metric Hex Cap Screws
ANSI/ASME B18.2.3.1M-1999 (R2011)**

PROPERTY CLASS AND MANUFACTURER'S IDENTIFICATION TO APPEAR ON TOP OF HEAD

Nominal Screw Diameter, D and Thread Pitch	Body Diameter D_s		Width Across Flats, S		Width Across Corners, E		Head Height, K		Wrenching Height, K_1	Washer Face Thick., C		Washer Face Dia., D_w
	Max	Min	Max	Min	Max	Min	Max	Min		Max	Min	
M5 × 0.8	5.00	4.82	8.00	7.78	9.24	8.79	3.65	3.35	2.4	0.5	0.2	7.0
M6 × 1	6.00	5.82	10.00	9.78	11.55	11.05	4.15	3.85	2.8	0.5	0.2	8.9
M8 × 1.25	8.00	7.78	13.00	12.73	15.01	14.38	5.50	5.10	3.7	0.6	0.3	11.6
^a M10 × 1.5	10.00	9.78	15.00	14.73	17.32	16.64	6.63	6.17	4.5	0.6	0.3	13.6
M10 × 1.5	10.00	9.78	16.00	15.73	18.48	17.77	6.63	6.17	4.5	0.6	0.3	14.6
M12 × 1.75	12.00	11.73	18.00	17.73	20.78	20.03	7.76	7.24	5.2	0.6	0.3	16.6
M14 × 2	14.00	13.73	21.00	20.67	24.25	23.35	9.09	8.51	6.2	0.6	0.3	19.6
M16 × 2	16.00	15.73	24.00	23.67	27.71	26.75	10.32	9.68	7.0	0.8	0.4	22.49
M20 × 2.5	20.00	19.67	30.00	29.16	34.64	32.95	12.88	12.12	8.8	0.8	0.4	27.7
M24 × 3	24.00	23.67	36.00	35.00	41.57	39.55	15.44	14.56	10.5	0.8	0.4	33.2
M30 × 3.5	30.00	29.67	46.00	45.00	53.12	50.85	19.48	17.92	13.1	0.8	0.4	42.7
M36 × 4	36.00	35.61	55.00	53.80	63.51	60.79	23.38	21.62	15.8	0.8	0.4	51.1
M42 × 4.5	42.00	41.38	65.00	62.90	75.06	71.71	26.97	25.03	18.2	1.0	0.5	59.8
M48 × 5	48.00	47.38	75.00	72.60	86.60	82.76	31.07	28.93	21.0	1.0	0.5	69.0
M56 × 5.5	56.00	55.26	85.00	82.20	98.15	93.71	36.20	33.80	24.5	1.0	0.5	78.1
M64 × 6	64.00	63.26	95.00	91.80	109.70	104.65	41.32	38.68	28.0	1.0	0.5	87.2
M72 × 6	72.00	71.26	105.00	101.40	121.24	115.60	46.45	43.55	31.5	1.2	0.6	96.3
M80 × 6	80.00	79.26	115.00	111.00	132.72	126.54	51.58	48.42	35.0	1.2	0.6	105.4
M90 × 6	90.00	89.13	130.00	125.50	150.11	143.07	57.75	54.26	39.2	1.2	0.6	119.2
M100 × 6	100.00	99.13	145.00	140.00	167.43	159.60	63.90	60.10	43.4	1.2	0.6	133.0

^a This size with width across flats of 15 mm is not standard. M10 screws with 15 mm width across flats are commonly produced in USA and other countries. The width across flats for all M10's should be specified. All sizes except the following are included in ISO 4014 and ISO 4017: M10 × 1.5 with 15 mm width across flats, and M72 thru M100.

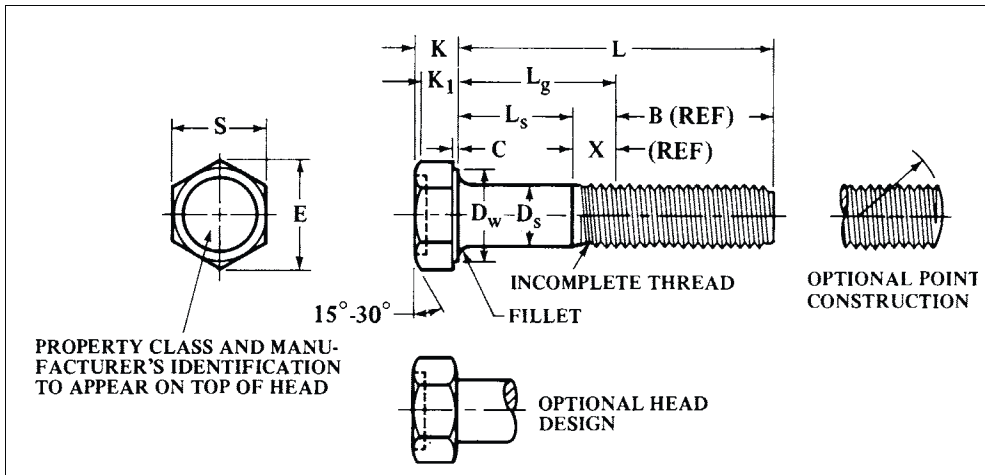
All dimensions are in millimeters.

Basic thread lengths, B , are the same as given in Table 13.

Transition thread length, X , includes the length of incomplete threads and tolerances on grip gaging length and body length. It is intended for calculation purposes.

For additional manufacturing and acceptance specifications, reference should be made to the ANSI/ASME B18.2.3.1M-1999.

**Table 2. American National Standard Metric Formed Hex Screws
ANSI/ASME B18.2.3.2M-1979 (R1995)**



Nominal Screw Dia., <i>D</i> , and Thread Pitch	Body Dia., <i>D_s</i>		Width Across Flats, <i>S</i>		Width Across Corners, <i>E</i>		Head Height, <i>K</i>		Wrenching Height, <i>K₁</i>	Washer Face Thick., <i>C</i>		Washer Face Dia., <i>D_w</i>
	Max	Min	Max	Min	Max	Min	Max	Min		Max	Min	
M5 × 0.8	5.00	4.82	8.00	7.64	9.24	8.56	3.65	3.35	2.4	0.5	0.2	6.9
M6 × 1	6.00	5.82	10.00	9.64	11.55	10.80	4.15	3.85	2.0	0.5	0.2	8.9
M8 × 1.25	8.00	7.78	13.00	12.57	15.01	14.08	5.50	5.10	3.7	0.6	0.3	11.6
^a M10 × 1.5	10.00	9.78	15.00	14.57	17.32	16.32	6.63	6.17	4.5	0.6	0.3	13.6
M10 × 1.5	10.00	9.78	16.00	15.57	18.48	17.43	6.63	6.17	4.5	0.6	0.3	14.6
M12 × 1.75	12.00	11.73	18.00	17.57	20.78	19.68	7.76	7.24	5.2	0.6	0.3	16.6
M14 × 2	14.00	13.73	21.00	20.16	24.25	22.58	9.09	8.51	6.2	0.6	0.3	19.6
M16 × 2	16.00	15.73	24.00	23.16	27.71	25.94	10.32	9.68	7.0	0.8	0.4	22.5
M20 × 2.5	20.00	19.67	30.00	29.16	34.64	32.66	12.88	12.12	8.8	0.8	0.4	27.7
M24 × 3	24.00	23.67	36.00	35.00	41.57	39.20	15.44	14.56	10.5	0.8	0.4	33.2

^aThis size with width across flats of 15 mm is not standard. Unless specifically ordered, M10 formed hex screws with 16 mm width across flats will be furnished.

All dimensions are in millimeters.

†Basic thread lengths, *B*, are the same as given in Table 13.

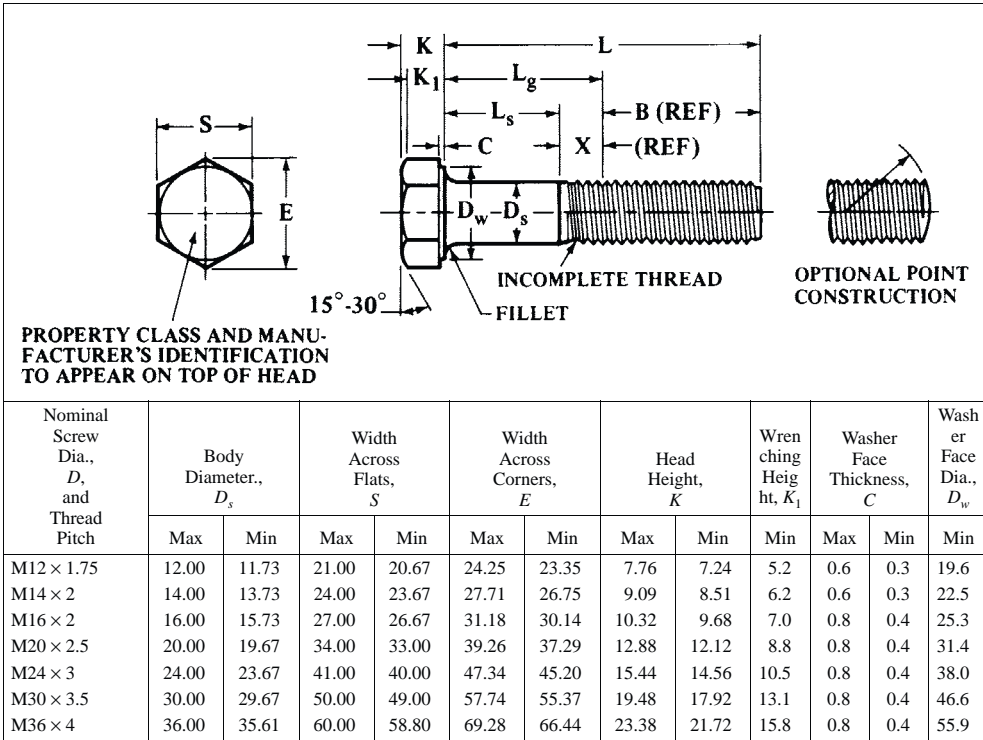
‡Transition thread length, *X*, includes the length of incomplete threads and tolerances on the gripping length and body length. It is intended for calculation purposes.

For additional manufacturing and acceptance specifications, reference should be made to the Standard.

Socket head cap screws ANSI B18.3.1M-1986 (R2002) are functionally interchangeable with screws which conform to ISO R861-1968 or ISO 4762-1977. However, the thread lengths specified in the ANSI Standard are equal to or longer than required by either ISO Standard. Consequently the grip lengths also vary on screws where the North American thread length practice differs. Minor variations in head diameter, head height, key engagement and wall thickness are due to diverse tolerancing practice and will be found documented in the ANSI Standard.

One exception with respect to width across flats for metric hex cap screws, formed hex screws, and hex bolts is the M10 size. These are currently being produced in the United States with a width across flats of 15 mm. This size, however, is not an ISO Standard. Unless these M10 screws and bolts with 15 mm width across flats are specifically ordered, the M10 size with 16 mm across flats will be furnished.

**Table 3. American National Standard Metric Heavy Hex Screws
ANSI B18.2.3.3M-1979 (R2001)**



All dimensions are in millimeters.

Basic thread lengths, B , are the same as given in [Table 13](#).

Transition thread length, X , includes the length of incomplete threads and tolerances on grip gaging length and body length. It is intended for calculation purposes.

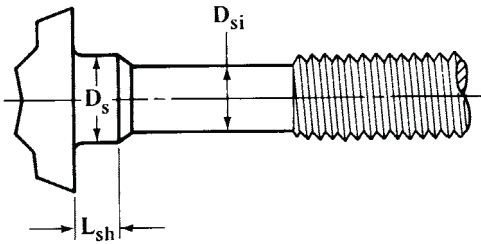
For additional manufacturing and acceptance specifications, reference should be made to the Standard.

ANSI letter symbols designating dimensional characteristics are in accord with those used in ISO Standards except capitals have been used for data processing convenience instead of the lower case letters used in the ISO Standards.

Metric Screw and Bolt Diameters.—Metric screws and bolts are furnished with full diameter body within the limits shown in the respective dimensional tables, or are threaded to the head (see [Metric Screw and Bolt Thread Lengths](#) on page 1593) unless the purchaser specifies “reduced body diameter.” Metric formed hex screws ([Table 4](#)), hex flange screws ([Table 4](#)), hex bolts ([Table 4](#)), heavy hex bolts ([Table 4](#)), hex lag screws ([Table 5](#)), heavy hex flange screws ([Table 7](#)), and round head square neck bolts ([Table 9](#)) may be obtained with reduced diameter body, if so specified; however, formed hex screws, hex flange screws, heavy hex flange screws, hex bolts, or heavy hex bolts with nominal lengths shorter than $4D$, where D is the nominal diameter, are not recommended. Metric formed hex screws, hex flange screws, heavy hex flange screws, and hex lag screws with reduced body diameter will be furnished with a shoulder under the head. For metric hex bolts and heavy hex bolts this is optional with the manufacturer.

For bolts and lag screws there may be a reasonable swell, fin, or die seam on the body adjacent to the head not exceeding the nominal bolt diameter by: 0.50 mm for M5, 0.65 mm for M6, 0.75 mm for M8 through M14, 1.25 mm for M16, 1.50 mm for M20 through M30, 2.30 mm for M36 through M48, 3.00 mm for M56 through M72, and 4.80 mm for M80 through M100.

Table 4. American National Standard Metric Hex Screws and Bolts — Reduced Body Diameters



Nominal Dia., <i>D</i> , and Thread Pitch	Shoulder Diameter, ^a <i>D_s</i>		Body Diameter, <i>D_{si}</i>		Shoulder Length, ^a <i>L_{sh}</i>		Nominal Dia., <i>D</i> , and Thread Pitch	Shoulder Diameter, ^a <i>D_s</i>		Body Diameter, <i>D_{si}</i>		Shoulder Length, ^a <i>L_{sh}</i>	
	Max	Min	Max	Min	Max	Min		Max	Min	Max	Min	Max	Min
Metric Formed Hex Screws (ANSI B18.2.3.2M-1979, R1995)													
M5 × 0.8	5.00	4.82	4.46	4.36	3.5	2.5	M14 × 2	14.00	13.73	12.77	12.50	8.0	7.0
M6 × 1	6.00	5.82	5.39	5.21	4.0	3.0	M16 × 2	16.00	15.73	14.77	14.50	9.0	8.0
M8 × 1.25	8.00	7.78	7.26	7.04	5.0	4.0	M20 × 2.5	20.00	19.67	18.49	18.16	11.0	10.0
M10 × 1.5	10.00	9.78	9.08	8.86	6.0	5.0	M24 × 3	24.00	23.67	22.13	21.80	13.0	12.0
M12 × 1.75	12.00	11.73	10.95	10.68	7.0	6.0
Metric Hex Flange Screws (ANSI B18.2.3.4M-2001)													
M5 × 0.8	5.00	4.82	4.54	4.36	3.5	2.5	M12 × 1.75	12.00	11.73	10.95	10.68	7.0	6.0
M6 × 1	6.00	5.82	5.39	5.21	4.0	3.0	M14 × 2	14.00	13.73	12.77	12.50	8.0	7.0
M8 × 1.25	8.00	7.78	7.26	7.04	5.0	4.0	M16 × 2	16.00	15.73	14.77	14.50	9.0	8.0
M10 × 1.5	10.00	9.78	9.08	8.86	6.0	5.0
Metric Hex Bolts (ANSI B18.2.3.5M-1979, R2001)													
M5 × 0.8	5.48	4.52	4.46	4.36	3.5	2.5	M14 × 2	14.70	13.30	12.77	12.50	8.0	7.0
M6 × 1	6.48	5.52	5.39	5.21	4.0	3.0	M16 × 2	16.70	15.30	14.77	14.50	9.0	8.0
M8 × 1.25	8.58	7.42	7.26	7.04	5.0	4.0	M20 × 2.5	20.84	19.16	18.49	18.16	11.0	10.0
M10 × 1.5	10.58	9.42	9.08	8.86	6.0	5.0	M24 × 3	24.84	23.16	22.13	21.80	13.0	12.0
M12 × 1.75	12.70	11.30	10.95	10.68	7.0	6.0
Metric Heavy Hex Bolts (ANSI B18.2.3.6M-1979, R2001)													
M12 × 1.75	12.70	11.30	10.95	10.68	7.0	6.0	M20 × 2.5	20.84	19.16	18.49	18.16	11.0	10.0
M14 × 2	14.70	13.30	12.77	12.50	8.0	7.0	M24 × 3	24.84	23.16	22.13	21.80	13.0	12.0
M16 × 2	16.70	15.30	14.77	14.50	9.0	8.0
Metric Heavy Hex Flange Screws (ANSI B18.2.3.9M-1984)													
M10 × 1.5	10.00	9.78	9.08	8.86	6.0	5.0	M16 × 2	16.00	15.73	14.77	14.50	9.0	8.0
M12 × 1.75	12.00	11.73	10.95	10.68	7.0	6.0	M20 × 2.5	20.00	19.67	18.49	18.16	11.0	10.0
M14 × 2	14.00	13.73	12.77	12.50	8.0	7.0

^a Shoulder is mandatory for formed hex screws, hex flange screws, and heavy hex flange screws. Shoulder is optional for hex bolts and heavy hex bolts.

All dimensions are in millimeters.

**Table 5. American National Standard Metric Hex Lag Screws
ANSI B18.2.3.8M-1981 (R2005)**

INDENTATION AND CONFIGURATION OPTIONAL									
		15°-30°							
Nominal Screw Dia., <i>D</i>	Body Diameter, <i>D_s</i>		Width Across Flats, <i>S</i>		Width Across Corners, <i>E</i>		Head Height, <i>K</i>		Wrenching Height, <i>K₁</i>
	Max	Min	Max	Min	Max	Min	Max	Min	Min
5	5.48	4.52	8.00	7.64	9.24	8.63	3.9	3.1	2.4
6	6.48	5.52	10.00	9.64	11.55	10.89	4.4	3.6	2.8
8	8.58	7.42	13.00	12.57	15.01	14.20	5.7	4.9	3.7
10	10.58	9.42	16.00	15.57	18.48	17.59	6.9	5.9	4.5
12	12.70	11.30	18.00	17.57	20.78	19.85	8.0	7.0	5.2
16	16.70	15.30	24.00	23.16	27.71	26.17	10.8	9.3	7.0
20	20.84	19.16	30.00	29.16	34.64	32.95	13.4	11.6	8.8
24	24.84	23.16	36.00	35.00	41.57	39.55	15.9	14.1	10.5
Nominal Screw Dia., <i>D</i>	Thread Dimensions				Nominal Screw Dia., <i>D</i>	Thread Dimensions			
	Thread Pitch, <i>P</i>	Flat at Root, <i>V</i>	Depth of Thread, <i>T</i>	Root Dia., <i>D₁</i>		Thread Pitch, <i>P</i>	Flat at Root, <i>V</i>	Depth of Thread, <i>T</i>	Root Dia., <i>D₁</i>
5	2.3	1.0	0.9	3.2	12	4.2	1.8	1.6	8.7
6	2.5	1.1	1.0	4.0	16	5.1	2.2	2.0	12.0
8	2.8	1.2	1.1	5.8	20	5.6	2.4	2.2	15.6
10	3.6	1.6	1.4	7.2	24	7.3	3.1	2.8	18.1
REDUCED BODY DIAMETER									
Nominal Screw Dia., <i>D</i>	Shoulder Diameter, <i>D_s</i>		Shoulder Length, <i>L_{sh}</i>		Nominal Screw Dia., <i>D</i>	Shoulder Diameter, <i>D_s</i>		Shoulder Length, <i>L_{sh}</i>	
	Max	Min	Max	Min		Max	Min	Max	Min
5	5.48	4.52	3.5	2.5	12	12.70	11.30	7.0	6.0
6	6.48	5.52	4.0	3.0	16	16.70	15.30	9.0	8.0
8	8.58	7.42	5.0	4.0	20	20.84	19.16	11.0	10.0
10	10.58	9.42	6.0	5.0	24	24.84	23.16	13.0	12.0

All dimensions are in millimeters. Reduced body diameter, *D_{si}*, is the blank diameter before rolling. Shoulder is mandatory when body diameter is reduced.

Table 6a. Hexagon Socket Head Shoulder Screws - Metric Series
ANSI/ASME B18.3.3M-1986 (R2002)

Nominal Shoulder Dia.	Shoulder Dia ^a , <i>D</i>		Head Diameter, <i>A</i>		Head Height, <i>H</i>		Chamfer or Radius, <i>S</i>	Nominal Thread Size, <i>D</i> ₁	Thread Length, <i>E</i>
	Max.	Min.	Max.	Min.	Max.	Min.			
6.5	6.487	6.451	10.00	9.78	4.50	4.32	0.6	M5 × 0.8	9.75
8.0	7.987	7.951	13.00	12.73	5.50	5.32	0.8	M6 × 1	11.25
10.0	9.987	9.951	16.00	15.73	7.00	6.78	1.0	M8 × 1.25	13.25
13.0	12.984	12.941	18.00	17.73	9.00	8.78	1.2	M10 × 1.5	16.40
16.0	15.984	15.941	24.00	23.67	11.00	10.73	1.6	M12 × 1.75	18.40
20.0	19.980	19.928	30.00	29.67	14.00	13.73	2.0	M16 × 2	22.40
25.0	24.980	24.928	36.00	35.61	16.00	15.73	2.4	M20 × 2.5	27.40

Nominal Shoulder Diameter	Thread Neck Dia., <i>G</i>		Thread Neck Width, <i>I</i>	Shoulder Neck Dia., <i>K</i>	Shoulder Neck Width, <i>F</i>	Thread Neck Fillet, <i>N</i>		Head Fillet Extension above <i>D</i> , <i>M</i>	Hexagon Socket Size, <i>J</i>
	Max.	Min.				Max.	Min.		
6.5	3.86	3.68	2.4	5.92	2.5	0.66	0.50	7.5	3
8.0	4.58	4.40	2.6	7.42	2.5	0.69	0.53	9.2	4
10.0	6.25	6.03	2.8	9.42	2.5	0.80	0.64	11.2	5
13.0	7.91	7.69	3.0	12.42	2.5	0.93	0.77	15.2	6
16.0	9.57	9.35	4.0	15.42	2.5	1.03	0.87	18.2	8
20.0	13.23	12.96	4.8	19.42	2.5	1.30	1.14	22.4	10
25.0	16.57	16.30	5.6	24.42	3.0	1.46	1.30	27.4	12

^aThe shoulder is the enlarged, unthreaded portion of the screw.

Table 6b. Standard Sizes and Socket Dimensions ANSI/ASME B18.3.3M-1986

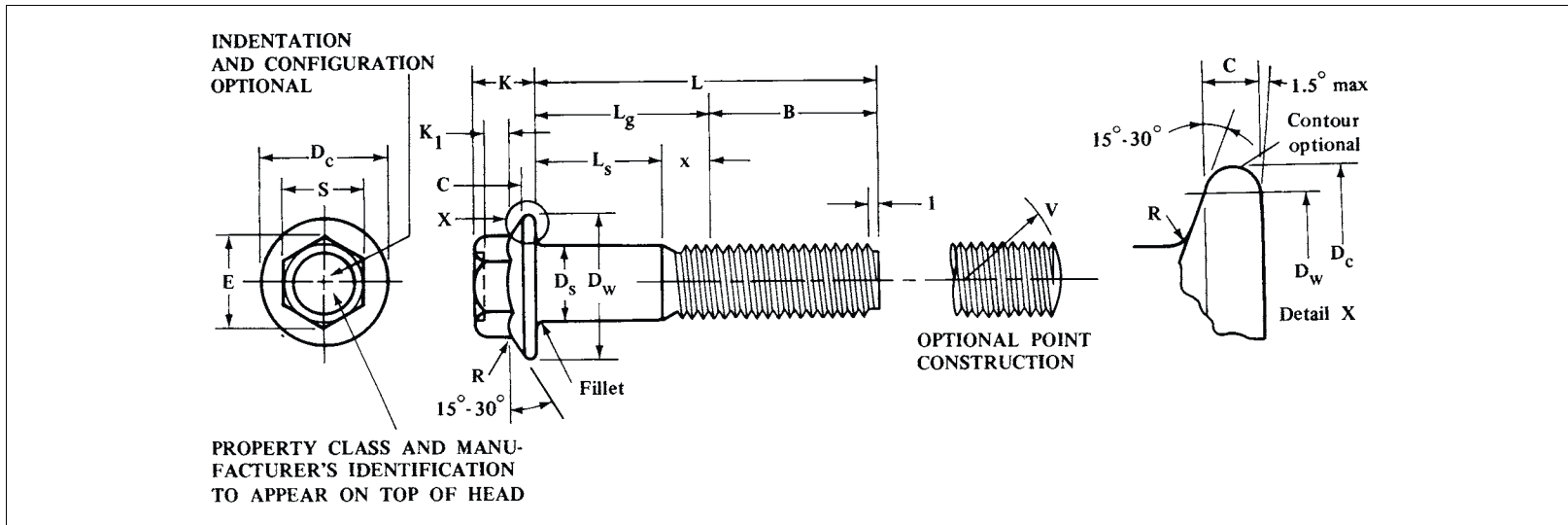
Nominal Shoulder Length	Standard Sizes for Government Use							Dimensions Hexagon Sockets - Metric			
	Nominal Shoulder Diameter							Nominal Socket Size	Socket Width Across Flats <i>J</i>		Socket Width Across Corners, <i>C</i>
	6.5	8	10	13	16	20	25		Max	Min	
10.0	065010	080010	100010					3	3.071	3.020	3.44
12.0				130012				4	4.084	4.020	4.58
16.0								5	5.084	5.020	5.72
20.0								6	6.095	6.020	6.86
25.0								8	8.115	8.025	9.15
30.0						160030		10	10.127	10.025	11.50
40.0	065040						200040	12	12.146	12.032	13.80
50.0		080050									
60.0											
70.0											
80.0											
90.0											
100.0			100100								
110.0											
120.0				130120	160120	200120	250120				

All dimensions are in millimeters.

R₁ rounded or chamfered: R₁ ≤ 0.15 mm for M5, M6, M10; R₁ ≤ 0.20 mm for M12, M16, M20

Unless specified otherwise, threads are metric coarse series in accordance with ANSI/ASME B1.13M, Metric Screw Threads - M Profile. Tolerances for threads are to ISO Tolerance Class 4g6g. Standard length and diameter combinations are shown in the lower chart. The government encourages the general use of the part number system (PIN) to achieve maximum parts standardization. For details not shown, including material and complete PIN system, see ANSI/ASME B18.3.3M.

Table 7. American National Standard Metric Heavy Hex Flange Screws ANSI/ASME B18.2.3.9M-1984



Nominal Screw Dia., D , and Thread Pitch	Body Dia., D_s		Width Across Flats, S		Width Across Corners, E		Flange Dia., D_c	Bearing Circle Dia., D_w	Flange Edge Thickness, C	Head Height, K	Wrenching Height K_1	Fillet Radius, R
	Max	Min	Max	Min	Max	Min	Max	Min	Min	Max	Min	Max
M10 × 1.5	10.00	9.78	15.00	14.57	17.32	16.32	22.3	19.6	1.5	8.6	3.70	0.6
M12 × 1.75	12.00	11.73	18.00	17.57	20.78	19.68	26.6	23.8	1.8	10.4	4.60	0.7
M14 × 2	14.00	13.73	21.00	20.48	24.25	22.94	30.5	27.6	2.1	12.4	5.50	0.9
M16 × 2	16.00	15.73	24.00	23.16	27.71	25.94	35.0	31.9	2.4	14.1	6.20	1.0
M20 × 2.5	20.00	19.67	30.00	29.16	34.64	32.66	43.0	39.9	3.0	17.7	7.90	1.2

All dimensions are in millimeters. Basic thread lengths, B , are as given in Table 13. Transition thread length, x , includes the length of incomplete threads and tolerances on grip gaging length and body length. It is intended for calculation purposes. For additional manufacturing and acceptance specifications, reference should be made to ANSI/ASME B18.2.3.9M-1984 standard.

**Table 8. American National Standard Metric Hex Flange Screws
ANSI/ASME B18.2.3.4M-2001**

Nominal Screw Dia., D , and Thread Pitch	Body Dia., D_s		Width Across Flats, S		Width Across Corners, E		Flange Dia., D_c	Bearing Circle Dia., D_b	Flange Edge Thickness, C	Head Height, K	Wrenching Height, K_1	Fillet Radius, R
	Max	Min	Max	Min	Max	Min	Max	Min	Min	Max	Min	Max
M5 × 0.8	5.00	4.82	7.00	6.64	8.08	7.44	11.4	9.4	1.0	5.6	2.30	0.3
M6 × 1	6.00	5.82	8.00	7.64	9.24	8.56	13.6	11.6	1.1	6.8	2.90	0.4
M8 × 1.25	8.00	7.78	10.00	9.64	11.55	10.80	17.0	14.9	1.2	8.5	3.80	0.5
M10 × 1.5	10.00	9.78	13.00	12.57	15.01	14.08	20.8	18.7	1.5	9.7	4.30	0.6
M12 × 1.75	12.00	11.73	15.00	14.57	17.32	16.32	24.7	22.0	1.8	11.9	5.40	0.7
M14 × 2	14.00	13.73	18.00	17.57	20.78	19.68	28.6	25.9	2.1	12.9	5.60	0.8
M16 × 2	16.00	15.73	21.00	20.48	24.25	22.94	32.8	30.1	2.4	15.1	6.70	1.0

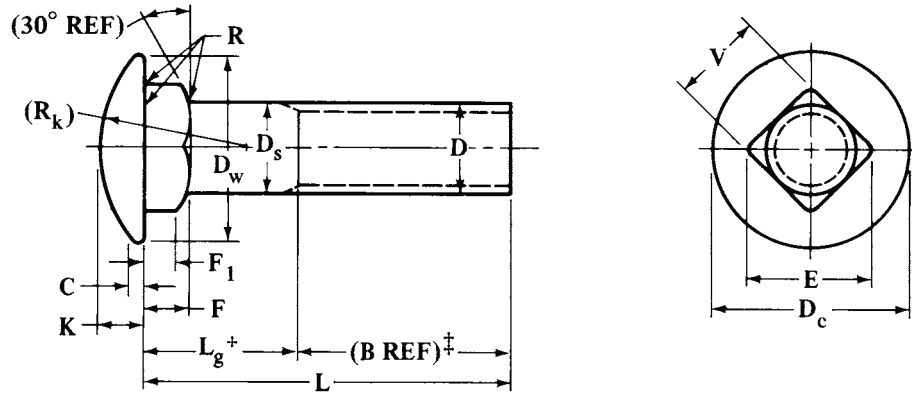
All dimensions are in millimeters. Basic thread lengths, B , are the same as given in Table 13. Transition thread length, X , includes the length of incomplete threads and tolerances on grip gaging length and body length. This dimension is intended for calculation purposes only. For additional manufacturing and acceptance specifications, reference should be made to ANSI/ASME B18.2.3.4M-2001 standard.

**Table 9. American National Standard Metric Round Head Square Neck Bolts
Reduced Body Diameters ANSI/ASME B18.5.2.2M-1982 (R2000)**

Nominal Bolt Dia., D and Thread Pitch	Diameter of Reduced Body D_r		Nominal Bolt Dia., D and Thread Pitch	Diameter of Reduced Body D_r	
	Max	Min		Max	Min
M5 × 0.8	5.00	4.36	M14 × 2	14.00	12.50
M6 × 1	6.00	5.21	M16 × 2	16.00	14.50
M8 × 1.25	8.00	7.04	M20 × 2.5	20.00	18.16
M10 × 1.5	10.00	8.86	M24 × 3	24.00	21.80
M12 × 1.75	12.00	10.68

All dimensions are in millimeters.

Table 10. American National Standard Metric Round Head Square Neck Bolts ANSI B18.2.3.7M-1979 (R2001)



Nominal Bolt Dia., D and Thread Pitch	Diameter of Full Body, D_s		Head Radius, (R_k)	Head height, K		Head Edge Thickness, C		Head Dia., D_c	Bearing Surface Dia., D_w	Square Depth, F		Square Corner Depth, F_1	Square Width Across Flats, V		Square Width Across Corners, E	
	Max	Min		Ref.	Max	Min	Max			Min	Max		Min	Max	Min	Max
M5 × 0.8	5.48	4.52	8.8	3.1	2.5	1.8	1.0	11.8	9.8	3.1	2.5	1.6	5.48	4.88	7.75	6.34
M6 × 1	6.48	5.52	10.7	3.6	3.0	1.9	1.1	14.2	12.2	3.6	3.0	1.9	6.48	5.88	9.16	7.64
M8 × 1.25	8.58	7.42	12.5	4.8	4.0	2.2	1.2	18.0	15.8	4.8	4.0	2.5	8.58	7.85	12.13	10.20
M10 × 1.5	10.58	9.42	15.5	5.8	5.0	2.5	1.5	22.3	19.6	5.8	5.0	3.2	10.58	9.85	14.96	12.80
M12 × 1.75	12.70	11.30	19.0	6.8	6.0	2.8	1.8	26.6	23.8	6.8	6.0	3.8	12.70	11.82	17.96	15.37
M14 × 2	14.70	13.30	21.9	7.9	7.0	3.3	2.1	30.5	27.6	7.9	7.0	4.4	14.70	13.82	20.79	17.97
M16 × 2	16.70	15.30	25.5	8.9	8.0	3.6	2.4	35.0	31.9	8.9	8.0	5.0	16.70	15.82	23.62	20.57
M20 × 2.5	20.84	19.16	31.9	10.9	10.0	4.2	3.0	43.0	39.9	10.9	10.0	6.3	20.84	19.79	29.47	25.73
M24 × 3	24.84	23.16	37.9	13.1	12.0	5.1	3.6	51.0	47.6	13.1	12.0	7.6	24.84	23.79	35.13	30.93

All dimensions are in millimeters.

† L_g is the grip gaging length which controls the length of thread B .

‡ B is the basic thread length and is a reference dimension (see Table 14).

For additional manufacturing and acceptance specifications, see ANSI/ASME B18.5.2.2M-1982, R2000.

Table 11. ANSI Heavy Hex Bolts ANSI B18.2.3.6M-1979 (R2001)

Nominal Dia., <i>D</i> and Thread Pitch	Body Diameter, <i>D_s</i>		Width Across Flats, <i>S</i>		Width Across Corners, <i>E</i>		Head Height, <i>K</i>		Wrenching Height, <i>K₁</i>
	Max	Min	Max	Min	Max	Min	Max	Min	Min
M12 × 1.75	12.70	11.30	21.00	20.16	24.25	22.78	7.95	7.24	5.2
M14 × 2	14.70	13.30	24.00	23.16	27.71	26.17	9.25	8.51	6.2
M16 × 2	16.70	15.30	27.00	26.16	31.18	29.56	10.75	9.68	7.0
M20 × 2.5	20.84	19.16	34.00	33.00	39.26	37.29	13.40	12.12	8.8
M24 × 3	24.84	23.16	41.00	40.00	47.34	45.20	15.90	14.56	10.5
M30 × 3.5	30.84	29.16	50.00	49.00	57.74	55.37	19.75	17.92	13.1
M36 × 4	37.00	35.00	60.00	58.80	69.28	66.44	23.55	21.72	15.8

All dimensions are in millimeters.*Basic thread lengths, *B*, are the same as given in Table 13. For additional manufacturing and acceptance specifications, reference should be made to the ANSI B18.2.3.6M-1979, R2001 standard.

Table 12. ANSI Metric Heavy Hex Structural Bolts ANSI B18.2.3.7M-1979 (R2001)

Dia. <i>D</i> , and Thread Pitch	Body Diameter, <i>D_s</i>		Width Across Flats, <i>S</i>		Width Across Corners, <i>E</i>		Head Height, <i>K</i>		Wrenching Height, <i>K₁</i>	Washer Face Dia., <i>D_w</i>	Washer Face Thickness, <i>C</i>		Thread Length, <i>B^a</i>		Transition Thread Length, <i>X^b</i>		
	Max	Min	Max	Min	Max	Min	Max	Min			Max	Min	Lengths ≤ 100	Lengths > 100		Basic	Max
													Basic	Max			
M16 × 2	16.70	15.30	27.00	26.16	31.18	29.56	10.75	9.25	6.5	24.9	0.8	0.4	31	38	6.0		
M20 × 2.5	20.84	19.16	34.00	33.00	39.26	37.29	13.40	11.60	8.1	31.4	0.8	0.4	36	43	7.5		
M22 × 2.5	22.84	21.16	36.00	35.00	41.57	39.55	14.90	13.10	9.2	33.3	0.8	0.4	38	45	7.5		
M24 × 3	24.84	23.16	41.00	40.00	47.34	45.20	15.90	14.10	9.9	38.0	0.8	0.4	41	48	9.0		
M27 × 3	27.84	26.16	46.00	45.00	53.12	50.85	17.90	16.10	11.3	42.8	0.8	0.4	44	51	9.0		
M30 × 3.5	30.84	29.16	50.00	49.00	57.74	55.37	19.75	17.65	12.4	46.5	0.8	0.4	49	56	10.5		
M36 × 4	37.00	35.00	60.00	58.80	69.28	66.44	23.55	21.45	15.0	55.9	0.8	0.4	56	63	12.0		

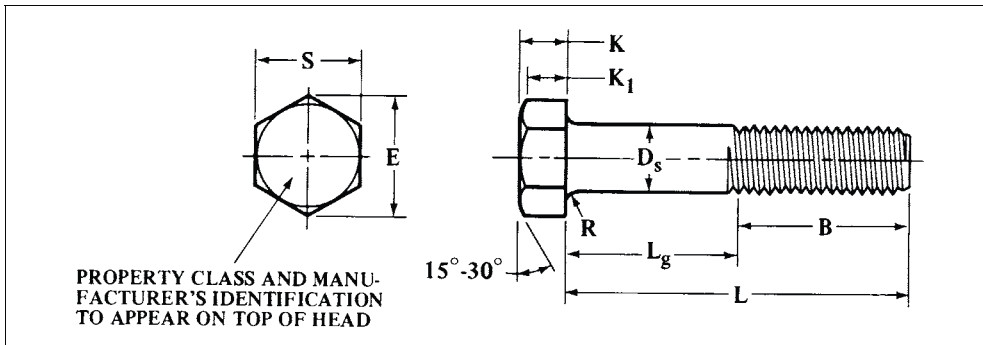
^a Basic thread length, *B*, is a reference dimension.

^b Transition thread length, *X*, includes the length of incomplete threads and tolerances on grip gaging length and body length. It is intended for calculation purposes.

All dimensions are in millimeters.

For additional manufacturing and acceptance specifications, reference should be made to the ANSI B18.2.3.7M-1979 (R2001) standard.

**Table 13. American National Standard Metric Hex Bolts
ANSI/ASME B18.2.3.5M (R2001)**



Nominal Bolt Dia., <i>D</i> and Thread Pitch	Body Diameter, <i>D_s</i>		Width Across Flats, <i>S</i>		Width Across Corners, <i>E</i>		Head Height, <i>K</i>		Wrenching Height, <i>K₁</i>	For Bolt Lengths		
	Max	Min	Max	Min	Max	Min	Max	Min		Min	125 mm \wedge 200 mm \vee	200 mm \wedge
											Basic Thread Length, ^a <i>B</i>	
M5 × 0.8	5.48	4.52	8.00	7.64	9.24	8.63	3.58	3.35	2.4	16	22	35
M6 × 1	6.19	5.52	10.00	9.64	11.55	10.89	4.38	3.55	2.8	18	24	37
M8 × 1.25	8.58	7.42	13.00	12.57	15.01	14.20	5.68	5.10	3.7	22	28	41
^b M10 × 1.5	10.58	9.42	15.00	14.57	17.32	16.46	6.85	6.17	4.5	26	32	45
M10 × 1.5	10.58	9.42	16.00	15.57	18.48	17.59	6.85	6.17	4.5	26	32	45
M12 × 1.75	12.70	11.30	18.00	17.57	20.78	19.85	7.95	7.24	5.2	30	36	49
M14 × 2	14.70	13.30	21.00	20.16	24.25	22.78	9.25	8.51	6.2	34	40	53
M16 × 2	16.70	15.30	24.00	23.16	27.71	26.17	10.75	9.68	7.0	38	44	57
M20 × 2.5	20.84	19.16	30.00	29.16	34.64	32.95	13.40	12.12	8.8	46	52	65
M24 × 3	24.84	23.16	36.00	35.00	41.57	39.55	15.90	14.56	10.5	54	60	73
M30 × 3.5	30.84	29.16	46.00	45.00	53.12	50.55	19.75	17.92	13.1	66	72	85
M36 × 4	37.00	35.00	55.00	53.80	63.51	60.79	23.55	21.72	15.8	78	84	97
M42 × 4.5	43.00	41.00	65.00	62.90	75.06	71.71	27.05	25.03	18.2	90	96	109
M48 × 5	49.00	47.00	75.00	72.60	86.60	82.76	31.07	28.93	21.0	102	108	121
M56 × 5.5	57.20	54.80	85.00	82.20	98.15	93.71	36.20	33.80	24.5	...	124	137
M64 × 6	65.52	62.80	95.00	91.80	109.70	104.65	41.32	38.68	28.0	...	140	153
M72 × 6	73.84	70.80	105.00	101.40	121.24	115.60	46.45	43.55	31.5	...	156	169
M80 × 6	82.16	78.80	115.00	111.00	132.79	126.54	51.58	48.42	35.0	...	172	185
M90 × 6	92.48	88.60	130.00	125.50	150.11	143.07	57.74	54.26	39.2	...	192	205
M100 × 6	102.80	98.60	145.00	140.00	167.43	159.60	63.90	60.10	43.4	...	212	225

^a Basic thread length, *B*, is a reference dimension.

^b This size with width across flats of 15 mm is not standard. Unless specifically ordered, M10 hex bolts with 16 mm width across flats will be furnished.

All dimensions are in millimeters.

For additional manufacturing and acceptance specifications, reference should be made to the ANSI B18.2.3.5M-1979 (R2001) standard.

Materials and Mechanical Properties.—Unless otherwise specified, steel metric screws and bolts, with the exception of heavy hex structural bolts, hex lag screws, and socket head cap screws, conform to the requirements specified in SAE J1199 or ASTM F568. Steel heavy hex structural bolts conform to ASTM A325M or ASTM A490M. Alloy steel socket head cap screws conform to ASTM A574M, property class 12.9, where the numeral 12 represents approximately one-hundredth of the minimum tensile strength in megapascals and the decimal .9 approximates the ratio of the minimum yield stress to the minimum tensile stress. This is in accord with ISO designation practice. Screws and bolts

of other materials, and all materials for hex lag bolts, have properties as agreed upon by the purchaser and the manufacturer.

Except for socket head cap screws, metric screws and bolts are furnished with a natural (as processed) finish, unplated or uncoated unless otherwise specified.

Alloy steel socket head cap screws are furnished with an oiled black oxide coating (thermal or chemical) unless a protective plating or coating is specified by the purchaser.

Metric Screw and Bolt Identification Symbols.—Screws and bolts are identified on the top of the head by property class symbols and manufacturer's identification symbol.

Metric Screw and Bolt Designation.—Metric screws and bolts with the exception of socket head cap screws are designated by the following data, preferably in the sequence shown: product name, nominal diameter and thread pitch (except for hex lag screws), nominal length, steel property class or material identification, and protective coating, if required.

Example: Hex cap screw, M10 × 1.5 × 50, class 9.8, zinc plated

Heavy hex structural bolt, M24 × 3 × 80, ASTM A490M

Hex lag screw, 6 × 35, silicon bronze.

Socket head cap screws (metric series) are designated by the following data in the order shown: ANSI Standard number, nominal size, thread pitch, nominal screw length, name of product (may be abbreviated SHCS), material and property class (alloy steel screws are supplied to property class 12.9 as specified in ASTM A574M: corrosion-resistant steel screws are specified to the property class and material requirements in ASTM F837M), and protective finish, if required.

Example: B18.3.1M—6 × 1 × 20 Hexagon Socket Head Cap Screw, Alloy Steel

B18.3.1M—10 × 1.5 × 40 SHCS, Alloy Steel Zinc Plated.

Metric Screw and Bolt Thread Lengths.—The length of thread on metric screws and bolts (except for metric lag screws) is controlled by the grip gaging length, L_g max. This is the distance measured parallel to the axis of the screw or bolt, from under the head bearing surface to the face of a noncounterbored or noncountersunk standard GO thread ring gage assembled by hand as far as the thread will permit. The maximum grip gaging length, as calculated and rounded to one decimal place, is equal to the nominal screw length, L , minus the basic thread length, B , or in the case of socket head cap screws, minus the minimum thread length L_T . B and L_T are reference dimensions intended for calculation purposes only and will be found in Tables 13 and 15, respectively.

Table 14. Basic Thread Lengths for Metric Round Head Square Neck Bolts
ANSI/ASME B18.5.2.2M-1982 (R2000)

Nom. Bolt Dia., D and Thread Pitch	Bolt Length, L			Nom. Bolt Dia., D and Thread Pitch	Bolt Length, L		
	≤ 125	> 125 and ≤ 200	> 200		≤ 125	> 125 and ≤ 200	> 200
	Basic Thread Length, B				Basic Thread length, B		
M5 × 0.8	16	22	35	M14 × 2	34	40	53
M6 × 1	18	24	37	M16 × 2	38	44	57
M8 × 1.25	22	28	41	M20 × 2.5	46	52	65
M10 × 1.5	26	32	45	M24 × 3	54	60	73
M12 × 1.75	30	36	49

All dimensions are in millimeters

Basic thread length B is a reference dimension intended for calculation purposes only.

**Table 15. Socket Head Cap Screws (Metric Series)—Length of Complete Thread
ANSI/ASME B18.3.1M-1986 (R2002)**

Nominal Size	Length of Complete Thread, L_T	Nominal Size	Length of Complete Thread, L_T	Nominal Size	Length of Complete Thread, L_T
M1.6	15.2	M6	24.0	M20	52.0
M2	16.0	M8	28.0	M24	60.0
M2.5	17.0	M10	32.0	M30	72.0
M3	18.0	M12	36.0	M36	84.0
M4	20.0	M14	40.0	M42	96.0
M5	22.0	M16	44.0	M48	108.0

Grip length, L_G equals screw length, L , minus L_T . Total length of thread L_{TT} equals L_T plus 5 times the pitch of the coarse thread for the respective screw size. Body length L_B equals L minus L_{TT} .

The minimum thread length for hex lag screws is equal to one-half the nominal screw length plus 12 mm, or 150 mm, whichever is shorter. Screws too short for this formula to apply are threaded as close to the head as practicable.

Metric Screw and Bolt Diameter-Length Combinations.—For a given diameter, the recommended range of lengths of metric cap screws, formed hex screws, heavy hex screws, hex flange screws, and heavy hex flange screws can be found in Table 17, for heavy hex structural bolts in Table 18, for hex lag screws in Table 16, for round head square neck bolts in Table 19, and for socket head cap screws in Table 20. No recommendations for diameter-length combinations are given in the Standards for hex bolts and heavy hex bolts.

Hex bolts in sizes M5 through M24 and heavy hex bolts in sizes M12 through M24 are standard only in lengths longer than 150 mm or $10D$, whichever is shorter. When shorter lengths of these sizes are ordered, hex cap screws are normally supplied in place of hex bolts and heavy hex screws in place of heavy hex bolts. Hex bolts in sizes M30 and larger and heavy hex bolts in sizes M30 and M36 are standard in all lengths; however, at manufacturer's option, hex cap screws may be substituted for hex bolts and heavy hex screws for heavy hex bolts for any diameter-length combination.

**Table 16. Recommended Diameter-Length Combinations for
Metric Hex Lag Screws ANSI B18.2.3.8M-1981 (R2005)**

Nominal Length, L	Nominal Screw Diameter								Nominal Length, L	Nominal Screw Diameter				
	5	6	8	10	12	16	20	24		10	12	16	20	24
8	●	90	●	●	●	●	●
10	●	●	100	●	●	●	●	●
12	●	●	●	110	...	●	●	●	●
14	●	●	●	120	...	●	●	●	●
16	●	●	●	●	130	●	●	●
20	●	●	●	●	●	140	●	●	●
25	●	●	●	●	●	●	150	●	●	●
30	●	●	●	●	●	●	●	...	160	●	●	●
35	●	●	●	●	●	●	●	●	180	●	●
40	●	●	●	●	●	●	●	●	200	●	●
45	●	●	●	●	●	●	●	●	220	●
50	●	●	●	●	●	●	●	●	240	●
60	...	●	●	●	●	●	●	●	260	●
70	●	●	●	●	●	●	280	●
80	●	●	●	●	●	●	300	●

All dimensions are in millimeters.

Recommended diameter-length combinations are indicated by the symbol ●.

Table 17. Rec'd Diameter-Length Combinations for Metric Hex Cap Screws, Formed Hex and Heavy Hex Screws, Hex Flange and Heavy Hex Flange Screws

Nominal Length ^a	Diameter—Pitch										
	M5 ×0.8	M6 ×1	M8 ×1.25	M10 ×1.5	M12 ×1.75	M14 ×2	M16 ×2	M20 ×2.5	M24 ×3	M30 ×3.5	M36 ×4
8	●
10	●	●
12	●	●	●
14	●	●	●	● ^b
16	●	●	●	●	● ^b	● ^b
20	●	●	●	●	●	●
25	●	●	●	●	●	●	●
30	●	●	●	●	●	●	●	●
35	●	●	●	●	●	●	●	●	●
40	●	●	●	●	●	●	●	●	●	●	...
45	●	●	●	●	●	●	●	●	●	●	...
50	●	●	●	●	●	●	●	●	●	●	●
(55)	...	●	●	●	●	●	●	●	●	●	●
60	...	●	●	●	●	●	●	●	●	●	●
(65)	●	●	●	●	●	●	●	●	●
70	●	●	●	●	●	●	●	●	●
(75)	●	●	●	●	●	●	●	●	●
80	●	●	●	●	●	●	●	●	●
(85)	●	●	●	●	●	●	●	●
90	●	●	●	●	●	●	●	●
100	●	●	●	●	●	●	●	●
110	●	●	●	●	●	●	●
120	●	●	●	●	●	●	●
130	●	●	●	●	●	●
140	●	●	●	●	●	●
150	●	●	●	●	●
160	●	●	●	●	●
(170)	●	●	●	●
180	●	●	●	●
(190)	●	●	●	●
200	●	●	●	●
220	●	●	●
240	●	●	●
260	●	●
280	●	●
300	●	●

^aLengths in parentheses are not recommended. Recommended lengths of formed hex screws, hex flange screws, and heavy hex flange screws do not extend above 150 mm. Recommended lengths of heavy hex screws do not extend below 20 mm. Standard sizes for government use. Recommended diameter-length combinations are indicated by the symbol ●. Screws with lengths above heavy cross lines are threaded full length.

^bDoes not apply to hex flange screws and heavy hex flange screws.

All dimensions are in millimeters.

For available diameters of each type of screw, see respective dimensional table.

Table 18. Recommended Diameter-Length Combinations for Metric Heavy Hex Structural Bolts

Nominal Length, <i>L</i>	Nominal Diameter and Thread Pitch						
	M16 × 2	M20 × 2.5	M22 × 2.5	M24 × 3	M27 × 3	M30 × 3.5	M36 × 4
45	●
50	●	●
55	●	●	●
60	●	●	●	●
65	●	●	●	●	●
70	●	●	●	●	●	●	...
75	●	●	●	●	●	●	●
80	●	●	●	●	●	●	●
85	●	●	●	●	●	●	●
90	●	●	●	●	●	●	●
95	●	●	●	●	●	●	●
100	●	●	●	●	●	●	●
110	●	●	●	●	●	●	●
120	●	●	●	●	●	●	●
130	●	●	●	●	●	●	●
140	●	●	●	●	●	●	●
150	●	●	●	●	●	●	●
160	●	●	●	●	●	●	●
170	●	●	●	●	●	●	●
180	●	●	●	●	●	●	●
190	●	●	●	●	●	●	●
200	●	●	●	●	●	●	●
210	●	●	●	●	●	●	●
220	●	●	●	●	●	●	●
230	●	●	●	●	●	●	●
240	●	●	●	●	●	●	●
250	●	●	●	●	●	●	●
260	●	●	●	●	●	●	●
270	●	●	●	●	●	●	●
280	●	●	●	●	●	●	●
290	●	●	●	●	●	●	●
300	●	●	●	●	●	●	●

All dimensions are in millimeters.

Recommended diameter-length combinations are indicated by the symbol ●.

Bolts with lengths above the heavy cross lines are threaded full length.

Table 19. Recommended Diameter-Length Combinations for Metric Round Head Square Neck Bolts

Nominal Length, ^a <i>L</i>	Nominal Diameter and Thread Pitch								
	M5 × 0.8	M6 × 1	M8 × 1.25	M10 × 1.5	M12 × 1.75	M14 × 2	M16 × 2	M20 × 2.5	M24 × 3
10	●
12	●	●
(14)	●	●
16	●	●	●
20	●	●	●	●
25	●	●	●	●	●
30	●	●	●	●	●	●
35	●	●	●	●	●	●	●
40	●	●	●	●	●	●	●	●	...
45	●	●	●	●	●	●	●	●	●
50	●	●	●	●	●	●	●	●	●
(55)	...	●	●	●	●	●	●	●	●
60	...	●	●	●	●	●	●	●	●
(65)	●	●	●	●	●	●	●
70	●	●	●	●	●	●	●
(75)	●	●	●	●	●	●	●
80	●	●	●	●	●	●	●

Table 19. (Continued) Recommended Diameter-Length Combinations for Metric Round Head Square Neck Bolts

Nominal Length, ^a <i>L</i>	Nominal Diameter and Thread Pitch								
	M5 × 0.8	M6 × 1	M8 × 1.25	M10 × 1.5	M12 × 1.75	M14 × 2	M16 × 2	M20 × 2.5	M24 × 3
(85)	●	●	●	●	●	●
90	●	●	●	●	●	●
100	●	●	●	●	●	●
110	●	●	●	●	●
120	●	●	●	●	●
130	●	●	●	●
140	●	●	●	●
150	●	●	●
160	●	●	●
(170)	●	●
180	●	●
(190)	●	●
200	●	●
220	●
240	●

^a Bolts with lengths above the heavy cross lines are threaded full length. Lengths in () are not recommended.

All dimensions are in millimeters. Recommended diameter-length combinations are indicated by the symbol ●. Standard sizes for government use.

Table 20. Diameter-Length Combinations for Socket Head Cap Screws (Metric Series)

Nominal Length, <i>L</i>	Nominal Size													
	M1.6	M2	M2.5	M3	M4	M5	M6	M8	M10	M12	M14	M16	M20	M24
20	●	●	●	●	●	●	●	●	●	●	●	●	●	●
25	●	●	●	●	●	●	●	●	●	●	●	●	●	●
30	●	●	●	●	●	●	●	●	●	●	●	●	●	●
35	...	●	●	●	●	●	●	●	●	●	●	●	●	●
40	...	●	●	●	●	●	●	●	●	●	●	●	●	●
45	●	●	●	●	●	●	●	●	●	●	●	●
50	●	●	●	●	●	●	●	●	●	●	●	●
55	●	●	●	●	●	●	●	●	●	●	●
60	●	●	●	●	●	●	●	●	●	●	●
65	●	●	●	●	●	●	●	●	●	●
70	●	●	●	●	●	●	●	●	●	●
80	●	●	●	●	●	●	●	●	●	●
90	●	●	●	●	●	●	●	●	●
100	●	●	●	●	●	●	●	●	●
110	●	●	●	●	●	●	●	●
120	●	●	●	●	●	●	●	●
130	●	●	●	●	●	●	●
140	●	●	●	●	●	●	●
150	●	●	●	●	●	●	●
160	●	●	●	●	●	●	●
180	●	●	●	●	●	●
200	●	●	●	●	●	●
220	●	●	●	●	●
240	●	●	●	●
260	●	●	●
300	●	●

All dimensions are in millimeters. Screws with lengths above heavy cross lines are threaded full length. Diameter-length combinations are indicated by the symbol ●. Standard sizes for government use. In addition to the lengths shown, the following lengths are standard: 3, 4, 5, 6, 8, 10, 12, and 16 mm. No diameter-length combinations are given in the Standard for these lengths. Screws larger than M24 with lengths equal to or shorter than L_{TT} (see Table 15 footnote) are threaded full length.

**Table 21. American National Standard Socket Head Cap Screws
Metric Series ANSI/ASME B18.3.1M-1986 (R2002)**

Nom. Size and Thread Pitch	Body Diameter, <i>D</i>		Head Diameter <i>A</i>		Head Height <i>H</i>		Chamfer or Radius <i>S</i>	Hexagon Socket Size ^a <i>J</i>	Spline Socket Size ^a <i>M</i>	Key Engagement <i>T</i>	Transition Dia. <i>B</i> ^a
	Max	Min	Max	Min	Max	Min					
M1.6 × 0.35	1.60	1.46	3.00	2.87	1.60	1.52	0.16	1.5	1.829	0.80	2.0
M2 × 0.4	2.00	1.86	3.80	3.65	2.00	1.91	0.20	1.5	1.829	1.00	2.6
M2.5 × 0.45	2.50	2.36	4.50	4.33	2.50	2.40	0.25	2.0	2.438	1.25	3.1
M3 × 0.5	3.00	2.86	5.50	5.32	3.00	2.89	0.30	2.5	2.819	1.50	3.6
M4 × 0.7	4.00	3.82	7.00	6.80	4.00	3.88	0.40	3.0	3.378	2.00	4.7
M5 × 0.8	5.00	4.82	8.50	8.27	5.00	4.86	0.50	4.0	4.648	2.50	5.7
M6 × 1	6.00	5.82	10.00	9.74	6.00	5.85	0.60	5.0	5.486	3.00	6.8
M8 × 1.25	8.00	7.78	13.00	12.70	8.00	7.83	0.80	6.0	7.391	4.00	9.2
M10 × 1.5	10.00	9.78	16.00	15.67	10.00	9.81	1.00	8.0	...	5.00	11.2
M12 × 1.75	12.00	11.73	18.00	17.63	12.00	11.79	1.20	10.0	...	6.00	14.2
M14 × 2 ^b	14.00	13.73	21.00	20.60	14.00	13.77	1.40	12.0	...	7.00	16.2
M16 × 2	16.00	15.73	24.00	23.58	16.00	15.76	1.60	14.0	...	8.00	18.2
M20 × 2.5	20.00	19.67	30.00	29.53	20.00	19.73	2.00	17.0	...	10.00	22.4
M24 × 3	24.00	23.67	36.00	35.48	24.00	23.70	2.40	19.0	...	12.00	26.4
M30 × 3.5	30.00	29.67	45.00	44.42	30.00	29.67	3.00	22.0	...	15.00	33.4
M36 × 4	36.00	35.61	54.00	53.37	36.00	35.64	3.60	27.0	...	18.00	39.4
M42 × 4.5	42.00	41.61	63.00	62.31	42.00	41.61	4.20	32.0	...	21.00	45.6
M48 × 5	48.00	47.61	72.00	71.27	48.00	47.58	4.80	36.0	...	24.00	52.6

^a See also Table 23.

^b The M14 × 2 size is not recommended for use in new designs.

All dimensions are in millimeters

L_G is grip length and L_B is body length (see Table 15). For length of complete thread, see Table 15.

For additional manufacturing and acceptance specifications, see ANSI/ASME B18.3.1M.

Table 22. Drilled Head Dimensions for Metric Hex Socket Head Cap Screws

Nominal Size or Basic Screw Diameter	Hole Center Location, W		Drilled Hole Diameter, X		Hole Alignment Check Plug Diameter
	Max	Min	Max	Min	Basic
M3	1.20	0.80	0.95	0.80	0.75
M4	1.60	1.20	1.35	1.20	0.90
M5	2.00	1.50	1.35	1.20	0.90
M6	2.30	1.80	1.35	1.20	0.90
M8	2.70	2.20	1.35	1.20	0.90
M10	3.30	2.80	1.65	1.50	1.40
M12	4.00	3.50	1.65	1.50	1.40
M16	5.00	4.50	1.65	1.50	1.40
M20	6.30	5.80	2.15	2.00	1.80
M24	7.30	6.80	2.15	2.00	1.80
M30	9.00	8.50	2.15	2.00	1.80
M36	10.50	10.00	2.15	2.00	1.80

All dimensions are in millimeters.

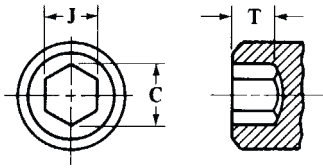
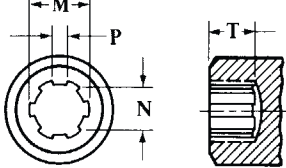
Drilled head metric hexagon socket head cap screws normally are not available in screw sizes smaller than M3 nor larger than M36. The M3 and M4 nominal screw sizes have two drilled holes spaced 180 degrees apart. Nominal screw sizes M5 and larger have six drilled holes spaced 60 degrees apart unless the purchaser specifies two drilled holes. The positioning of holes on opposite sides of the socket should be such that the hole alignment check plug will pass completely through the head without any deflection. When so specified by the purchaser, the edges of holes on the outside surface of the head will be chamfered 45 degrees to a depth of 0.30 to 0.50 mm.

Metric Nuts

The American National Standards covering metric nuts have been established in cooperation with the Department of Defense in such a way that they could be used by the Government for procurement purposes. Extensive information concerning these nuts is given in the following text and tables, but for more complete manufacturing and acceptance specifications, reference should be made to the respective Standards, which may be obtained by non-governmental agencies from the American National Standards Institute, 25 West 43rd Street, New York, N.Y. 10036. Manufacturers should be consulted concerning items and sizes which are in stock production.

Comparison with ISO Standards.—American National Standards for metric nuts have been coordinated to the extent possible with comparable ISO Standards or proposed Standards, thus: ANSI B18.2.4.1M Metric Hex Nuts, Style 1 with ISO 4032; B18.2.4.2M Metric Hex Nuts, Style 2 with ISO 4033; B18.2.4.4M Metric Hex Flange Nuts with ISO 4161; B18.2.4.5M Metric Hex Jam Nuts with ISO 4035; and B18.2.4.3M Metric Slotted Hex Nuts, B18.2.4.6M Metric Heavy Hex Nuts in sizes M12 through M36, and B18.16.3M Prevailing-Torque Type Steel Metric Hex Nuts and Hex Flange Nuts with comparable draft ISO Standards. The dimensional differences between each ANSI Standard and the comparable ISO Standard or draft Standard are very few, relatively minor, and none will affect the interchangeability of nuts manufactured to the requirements of either.

Table 23. American National Standard Hexagon and Spline Sockets for Socket Head Cap Screws—Metric Series ANSI/ASME B18.3.1M-1986 (R2002)

							
METRIC HEXAGON SOCKETS			METRIC SPLINE SOCKET				
See Table 21			See Table 21				
Nominal Hexagon Socket Size	Socket Width Across Flats, <i>J</i>	Socket Width Across Corners, <i>C</i>	Nominal Hexagon Socket Size	Socket Width Across Flats, <i>J</i>	Socket Width Across Corners, <i>C</i>		
Metric Hexagon Sockets							
	Max	Min	Min		Max	Min	Min
1.5	1.545	1.520	1.73	12	12.146	12.032	13.80
2	2.045	2.020	2.30	14	14.159	14.032	16.09
2.5	2.560	2.520	2.87	17	17.216	17.050	19.56
3	3.071	3.020	3.44	19	19.243	19.065	21.87
4	4.084	4.020	4.58	22	22.319	22.065	25.31
5	5.084	5.020	5.72	24	24.319	24.065	27.60
6	6.095	6.020	6.86	27	27.319	27.065	31.04
8	8.115	8.025	9.15	32	32.461	32.080	36.80
10	10.127	10.025	11.50	36	36.461	36.080	41.38
Metric Spline Sockets ^a							
Nominal Spline Socket Size	Socket Major Diameter, <i>M</i>		Socket Minor Diameter, <i>N</i>		Width of Tooth, <i>P</i>		
	Max	Min	Max	Min	Max	Min	
1.829	1.8796	1.8542	1.6256	1.6002	0.4064	0.3810	
2.438	2.4892	2.4638	2.0828	2.0320	0.5588	0.5334	
2.819	2.9210	2.8702	2.4892	2.4384	0.6350	0.5842	
3.378	3.4798	3.4290	2.9972	2.9464	0.7620	0.7112	
4.648	4.7752	4.7244	4.1402	4.0894	0.9906	0.9398	
5.486	5.6134	5.5626	4.8260	4.7752	1.2700	1.2192	
7.391	7.5692	7.5184	6.4516	6.4008	1.7272	2.6764	

^a The tabulated dimensions represent direct metric conversions of the equivalent inch size spline sockets shown in American National Standard Socket Cap, Shoulder and Set Screws — Inch Series ANSI B18.3. Therefore, the spline keys and bits shown therein are applicable for wrenching the corresponding size metric spline sockets.

At its meeting in Varna, May 1977, ISO/TC2 studied several technical reports analyzing design considerations influencing determination of the best series of widths across flats for hex bolts, screws, and nuts. A primary technical objective was to achieve a logical ratio between under head (nut) bearing surface area (which determines the magnitude of compressive stress on the bolted members) and the tensile stress area of the screw thread (which governs the clamping force that can be developed by tightening the fastener). The series of widths across flats in the ANSI Standards agree with those which were selected by ISO/TC2 to be ISO Standards.

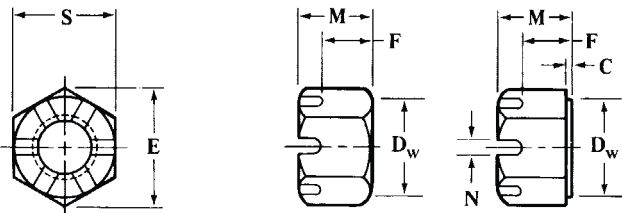
One exception for width across flats of metric hex nuts, styles 1 and 2, metric slotted hex nuts, metric hex jam nuts, and prevailing-torque metric hex nuts is the M10 size. These nuts in M10 size are currently being produced in the United States with a width across flats of 15 mm. This width, however, is not an ISO Standard. Unless these M10 nuts with width

across flats of 15 mm are specifically ordered, the M10 size with 16 mm width across flats will be furnished.

In ANSI Standards for metric nuts, letter symbols designating dimensional characteristics are in accord with those used in ISO Standards, except capitals have been used for data processing convenience instead of lower case letters used in ISO Standards.

Metric Nut Tops and Bearing Surfaces.—Metric hex nuts, styles 1 and 2, slotted hex nuts, and hex jam nuts are double chamfered in sizes M16 and smaller and in sizes M20 and larger may either be double chamfered or have a washer-faced bearing surface and a chamfered top at the option of the manufacturer. Metric heavy hex nuts are optional either way in all sizes. Metric hex flange nuts have a flange bearing surface and a chamfered top and prevailing-torque type metric hex nuts have a chamfered bearing surface. Prevailing-torque type metric hex flange nuts have a flange bearing surface. All types of metric nuts have the tapped hole countersunk on the bearing face and metric slotted hex nuts, hex flange nuts, and prevailing-torque type hex nuts and hex flange nuts may be countersunk on the top face.

Table 24. American National Standard Metric Slotted Hex Nuts
ANSI B18.2.4.3M-1979 (R2001)



Nominal Nut Dia. and Thread Pitch	Width Across Flats, <i>S</i>		Width Across Corners, <i>E</i>		Thickness, <i>M</i>		Bearing Face Dia., <i>D_w</i>	Unslotted Thickness, <i>F</i>		Width of Slot, <i>N</i>		Washer Face Thickness <i>C</i>	
	Max	Min	Max	Min	Max	Min	Min	Max	Min	Max	Min	Max	Min
M5 × 0.8	8.00	7.78	9.24	8.79	5.10	4.80	6.9	3.2	2.9	2.0	1.4
M6 × 1	10.00	9.78	11.55	11.05	5.70	5.40	8.9	3.5	3.2	2.4	1.8
M8 × 1.25	13.00	12.73	15.01	14.38	7.50	7.14	11.6	4.4	4.1	2.9	2.3
^a M10 × 1.5	15.00	14.73	17.32	16.64	10.0	9.6	13.6	5.7	5.4	3.4	2.8	0.6	0.3
M10 × 1.5	16.00	15.73	18.48	17.77	9.30	8.94	14.6	5.2	4.9	3.4	2.8
M12 × 1.75	18.00	17.73	20.78	20.03	12.00	11.57	16.6	7.3	6.9	4.0	3.2
M14 × 2	21.00	20.67	24.25	23.35	14.10	13.40	19.6	8.6	8.0	4.3	3.5
M16 × 2	24.00	23.67	27.71	26.75	16.40	15.70	22.5	9.9	9.3	5.3	4.5
M20 × 2.5	30.00	29.16	34.64	32.95	20.30	19.00	27.7	13.3	12.2	5.7	4.5	0.8	0.4
M24 × 3	36.00	35.00	41.57	39.55	23.90	22.60	33.2	15.4	14.3	6.7	5.5	0.8	0.4
M30 × 3.5	46.00	45.00	53.12	50.85	28.60	27.30	42.7	18.1	16.8	8.5	7.0	0.8	0.4
M36 × 4	55.00	53.80	63.51	60.79	34.70	33.10	51.1	23.7	22.4	8.5	7.0	0.8	0.4

^aThis size with width across flats of 15 mm is not standard. Unless specifically ordered, M10 slotted hex nuts with 16 mm width across flats will be furnished.

All dimensions are in millimeters.

Materials and Mechanical Properties.—Nonheat-treated carbon steel metric hex nuts, style 1 and slotted hex nuts conform to material and property class requirements specified for property class 5 nuts; hex nuts, style 2 and hex flange nuts to property class 9 nuts; hex jam nuts to property class 04 nuts, and nonheat-treated carbon and alloy steel heavy hex nuts to property classes 5, 9, 8S, or 8S3 nuts; all as covered in ASTM A563M. Carbon steel metric hex nuts, style 1 and slotted hex nuts that have specified heat treatment conform to material and property class requirements specified for property class 10 nuts; hex nuts, style 2 to property class 12 nuts; hex jam nuts to property class 05 nuts; hex flange nuts to

Table 25. American National Standard Metric Hex Nuts, Styles 1 and 2
ANSI/ASME B18.2.4.1M-2002 and B18.2.4.2M-2005

Nominal Nut Dia. and Thread Pitch	Width Across Flats ^a , <i>S</i>		Width Across Corners ^b , <i>E</i>		Thickness ^c , <i>M</i>		Bearing Face Dia. ^d , <i>D_w</i>	Washer Face Thickness ^d , <i>C</i>	
	Max	Min	Max	Min	Max	Min	Min	Max	Min
Metric Hex Nuts — Style 1									
M1.6 × 0.35	3.20	3.02	3.70	3.41	1.30	1.05	2.3
M2 × 0.4	4.00	3.82	4.62	4.32	1.60	1.35	3.1
M2.5 × 0.45	5.00	4.82	5.77	5.45	2.00	1.75	4.1
M3 × 0.5	5.50	5.32	6.35	6.01	2.40	2.15	4.6
M3.5 × 0.6	6.00	5.82	6.93	6.58	2.80	2.55	5.1
M4 × 0.7	7.00	6.78	8.08	7.66	3.20	2.90	6.0
M5 × 0.8	8.00	7.78	9.24	8.79	4.70	4.40	7.0
M6 × 1	10.00	9.78	11.55	11.05	5.20	4.90	8.9
M8 × 1.25	13.00	12.73	15.01	14.38	6.80	6.44	11.6
^e M10 × 1.5	15.00	14.73	17.32	16.64	9.1	8.7	13.6
^f M10 × 1.5	16.00	15.73	18.48	17.77	8.40	8.04	14.6
M12 × 1.75	18.00	17.73	20.78	20.03	10.80	10.37	16.6
M14 × 2	21.00	20.67	24.25	23.36	12.80	12.10	19.4
M16 × 2	24.00	23.67	27.71	26.75	14.80	14.10	22.4
M20 × 2.5	30.00	29.16	34.64	32.95	18.00	16.90	27.9	0.8	0.4
M24 × 3	36.00	35.00	41.57	39.55	21.50	20.20	32.5	0.8	0.4
M30 × 3.5	46.00	45.00	53.12	50.85	25.60	24.30	42.5	0.8	0.4
M36 × 4	55.00	53.80	63.51	60.79	31.00	29.40	50.8	0.8	0.4
Metric Hex Nuts — Style 2									
M3 × 0.5	5.50	5.32	6.35	6.01	2.90	2.65	4.6
M3.5 × 0.6	6.00	5.82	6.93	6.58	3.30	3.00	5.1
M4 × 0.7	7.00	6.78	8.08	7.66	3.80	3.50	5.9
M5 × 0.8	8.00	7.78	9.24	8.79	5.10	4.80	6.9
M6 × 1	10.00	9.78	11.55	11.05	5.70	5.40	8.9
M8 × 1.25	13.00	12.73	15.01	14.38	7.50	7.14	11.6
^e M10 × 1.5	15.00	14.73	17.32	16.64	10.0	9.6	13.6
^f M10 × 1.5	16.00	15.73	18.48	17.77	9.30	8.94	14.6
M12 × 1.75	18.00	17.73	20.78	20.03	12.00	11.57	16.6
M14 × 2	21.00	20.67	24.25	23.35	14.10	13.40	19.6
M16 × 2	24.00	23.67	27.71	26.75	16.40	15.70	22.5
M20 × 2.5	30.00	29.16	34.64	32.95	20.30	19.00	27.7	0.8	0.4
M24 × 3	36.00	35.00	41.57	39.55	23.90	22.60	33.2	0.8	0.4
M30 × 3.5	46.00	45.00	53.12	50.85	28.60	27.30	42.7	0.8	0.4
M36 × 4	55.00	53.80	63.51	60.79	34.70	33.10	51.1	0.8	0.4

^a The width across flats shall be the distance, measured perpendicular to the axis of the nut, between two opposite wrenching flats.

^b A rounding or lack of fill at the junction of hex corners with the chamfer shall be permissible.

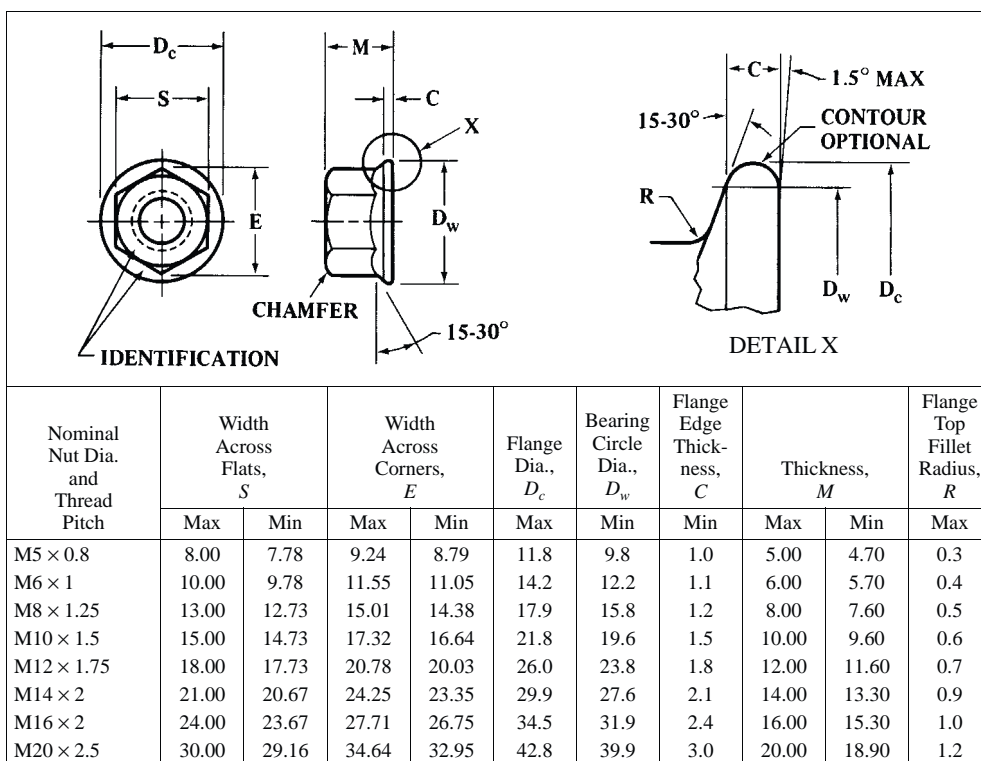
^c The nut thickness shall be the overall distance, measured parallel to the axis of the nut, from the top of the nut to the bearing surface, and shall include the thickness of the washer face where provided.

^d M16 and smaller nuts shall be double chamfered. M20 and larger nuts shall be either double chamfered or have a washer faced bearing surface and a chamfered top.

^e Dimensional requirements shown in bold type are in addition to or differ from ISO 4032.

^f When M10 hex nuts are ordered, nuts with 16 mm width across flats shall be furnished unless 15mm width across flats is specified.

Table 26. American National Standard Metric Hex Flange Nuts
ANSI B18.2.4M-1982 (R1999)



All dimensions are in millimeters.

property classes 10 and 12 nuts; and carbon or alloy steel heavy hex nuts to property classes 10S, 10S3, or 12 nuts, all as covered in ASTM A563M. Carbon steel prevailing-torque type hex nuts and hex flange nuts conform to mechanical and property class requirements as given in ANSI B18.16.1M.

Metric nuts of other materials, such as stainless steel, brass, bronze, and aluminum alloys, have properties as agreed upon by the manufacturer and purchaser. Properties of nuts of several grades of non-ferrous materials are covered in ASTM F467M.

Unless otherwise specified, metric nuts are furnished with a natural (unprocessed) finish, unplated or uncoated.

Metric Nut Thread Series.—Metric nuts have metric coarse threads with class 6H tolerances in accordance with ANSI B1.13M (see *Metric Screw and Bolt Diameter-Length Combinations* on page 1594). For prevailing-torque type metric nuts this condition applies before introduction of the prevailing torque feature. Nuts intended for use with externally threaded fasteners which are plated or coated with a plating or coating thickness (e.g., hot dip galvanized) requiring overlapping of the nut thread to permit assembly, have overlapped threads in conformance with requirements specified in ASTM A563M.

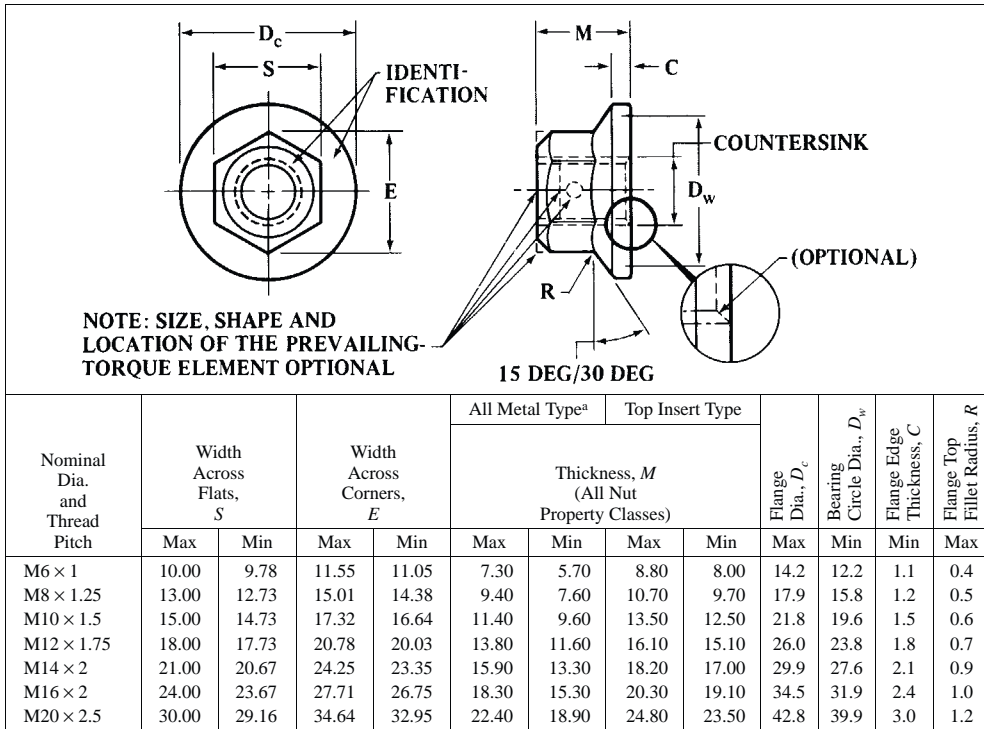
Types of Metric Prevailing-Torque Type Nuts.—There are three basic designs for prevailing-torque type nuts:

- 1) All-metal, one-piece construction nuts which derive their prevailing-torque characteristics from controlled distortion of the nut thread and/or body.
- 2) Metal nuts which derive their prevailing-torque characteristics from addition or fusion of a nonmetallic insert, plug, or patch in their threads.

3) Top insert, two-piece construction nuts which derive their prevailing-torque characteristics from an insert, usually a full ring of non-metallic material, located and retained in the nut at its top surface.

The first two designs are designated in Tables 29 and 27 as “all-metal” type and the third design as “top-insert” type.

Table 27. American National Standard Prevailing-Torque Metric Hex Flange Nuts ANSI B18.16.3M-1998



^a Also includes metal nuts with nonmetallic inserts, plugs, or patches in their threads.

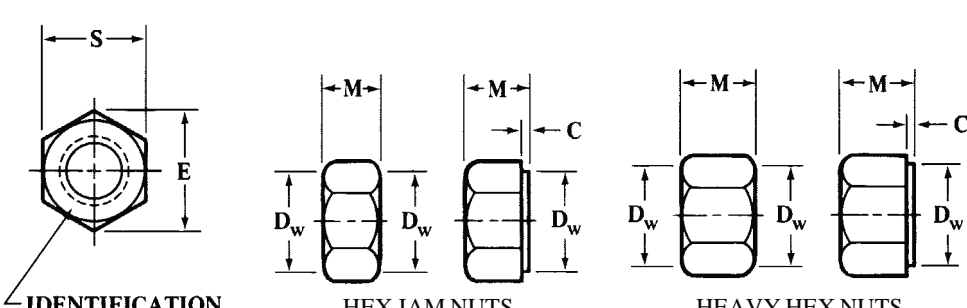
All dimensions are in millimeters.

Metric Nut Identification Symbols.—Carbon steel hex nuts, styles 1 and 2, hex flange nuts, and carbon and alloy steel heavy hex nuts are marked to identify the property class and manufacturer in accordance with requirements specified in ASTM A563M. The aforementioned nuts when made of other materials, as well as slotted hex nuts and hex jam nuts, are marked to identify the property class and manufacturer as agreed upon by manufacturer and purchaser. Carbon steel prevailing-torque type hex nuts and hex flange nuts are marked to identify property class and manufacturer as specified in ANSI B18.16.1M. Prevailing-torque type nuts of other materials are identified as agreed upon by the manufacturer and purchaser.

Metric Nut Designation.—Metric nuts are designated by the following data, preferably in the sequence shown: product name, nominal diameter and thread pitch, steel property class or material identification, and protective coating, if required. (Note: It is common practice in ISO Standards to omit thread pitch from the product designation when the nut threads are the metric coarse thread series, e.g., M10 stands for M10 × 1.5).

- Example:* Hex nut, style 1, M10 × 1.5, ASTM A563M class 10, zinc plated
- Heavy hex nut, M20 × 2.5, silicon bronze, ASTM F467, grade 651
- Slotted hex nut, M20, ASTM A563M class 10.

**Table 28. American National Standard Metric Hex Jam Nuts and Heavy Hex Nuts
ANSI B18.2.4.5M-1979 (R2003) and B18.2.4.6M-1979 (R2003)**



Nominal Nut Dia. and Thread Pitch	Width Across Flats, S		Width Across Corners, E		Thickness, M		Bearing Face Dia., Dw	Washer Face Thickness, C	
	Max	Min	Max	Min	Max	Min	Min	Max	Min
Metric Hex Jam Nuts									
M5 × 0.8	8.00	7.78	9.24	8.79	2.70	2.45	6.9
M6 × 1	10.00	9.78	11.55	11.05	3.20	2.90	8.9
M8 × 1.25	13.00	12.73	15.01	14.38	4.00	3.70	11.6
^a M10 × 1.5	15.00	14.73	17.32	16.64	5.00	4.70	13.6
M10 × 1.5	16.00	15.73	18.48	17.77	5.00	4.70	14.6
M12 × 1.75	18.00	17.73	20.78	20.03	6.00	5.70	16.6
M14 × 2	21.00	20.67	24.25	23.35	7.00	6.42	19.6
M16 × 2	24.00	23.67	27.71	26.75	8.00	7.42	22.5
M20 × 2.5	30.00	29.16	34.64	32.95	10.00	9.10	27.7	0.8	0.4
M24 × 3	36.00	35.00	41.57	39.55	12.00	10.90	33.2	0.8	0.4
M30 × 3.5	46.00	45.00	53.12	50.85	15.00	13.90	42.7	0.8	0.4
M36 × 4	55.00	53.80	63.51	60.79	18.00	16.90	51.1	0.8	0.4
Metric Heavy Hex Nuts									
M12 × 1.75	21.00	20.16	24.25	22.78	12.3	11.9	19.2	0.8	0.4
M14 × 2	24.00	23.16	27.71	26.17	14.3	13.6	22.0	0.8	0.4
M16 × 2	27.00	26.16	31.18	29.56	17.1	16.4	24.9	0.8	0.4
M20 × 2.5	34.00	33.00	39.26	37.29	20.7	19.4	31.4	0.8	0.4
M22 × 2.5	36.00	35.00	41.57	39.55	23.6	22.3	33.3	0.8	0.4
M24 × 3	41.00	40.00	47.34	45.20	24.2	22.9	38.0	0.8	0.4
M27 × 3	46.00	45.00	53.12	50.85	27.6	26.3	42.8	0.8	0.4
M30 × 3.5	50.00	49.00	57.74	55.37	30.7	29.1	46.6	0.8	0.4
M36 × 4	60.00	58.80	69.28	66.44	36.6	35.0	55.9	0.8	0.4
M42 × 4.5	70.00	67.90	80.83	77.41	42.0	40.4	64.5	1.0	0.5
M48 × 5	80.00	77.60	92.38	88.46	48.0	46.4	73.7	1.0	0.5
M56 × 5.5	90.00	87.20	103.92	99.41	56.0	54.1	82.8	1.0	0.5
M64 × 6	100.00	96.80	115.47	110.35	64.0	62.1	92.0	1.0	0.5
M72 × 6	110.00	106.40	127.02	121.30	72.0	70.1	101.1	1.2	0.6
M80 × 6	120.00	116.00	138.56	132.24	80.0	78.1	110.2	1.2	0.6
M90 × 6	135.00	130.50	155.88	148.77	90.0	87.8	124.0	1.2	0.6
M100 × 6	150.00	145.00	173.21	165.30	100.0	97.8	137.8	1.2	0.6

^a This size with width across flats of 15 mm is not standard. Unless specifically ordered, M10 hex jam nuts with 16 mm width across flats will be furnished.

All dimensions are in millimeters.

Table 29. American National Standard Prevailing-Torque Metric Hex Nuts — Property Classes 5, 9, and 10 ANSI/ASME B18.16.3M-1998

NOTE: SIZE, SHAPE AND LOCATION OF THE PREVAILING-TORQUE ELEMENT OPTIONAL

Nominal Nut Dia. and Thread Pitch	Width Across Flats, <i>S</i>		Width Across Corners, <i>E</i>		Property Classes 5 and 10 Nuts				Property Class 9 Nuts				Property Class		Bearing Face Dia., <i>D_w</i>		
					All Metal ^a Type		Top Insert Type		All Metal Type		Top Insert Type		5 and 10 Nuts	9 Nuts			
	Thickness, <i>M</i>															Wrenching Height, <i>M₁</i>	
	Max	Min	Max	Min	Max	Min	Max	Min	Max	Min	Max	Min	Max	Min		Min	Min
M3 × 0.5	5.50	5.32	6.35	6.01	3.10	2.65	4.50	3.90	3.10	2.65	4.50	3.90	1.4	1.4	4.6		
M3.5 × 0.6	6.00	5.82	6.93	6.58	3.50	3.00	5.00	4.30	3.50	3.00	5.00	4.30	1.7	1.7	5.1		
M4 × 0.7	7.00	6.78	8.08	7.66	4.00	3.50	6.00	5.30	4.00	3.50	6.00	5.30	1.9	1.9	5.9		
M5 × 0.8	8.00	7.78	9.24	8.79	5.30	4.80	6.80	6.00	5.30	4.80	7.20	6.40	2.7	2.7	6.9		
M6 × 1	10.00	9.78	11.55	11.05	5.90	5.40	8.00	7.20	6.70	5.40	8.50	7.70	3.0	3.0	8.9		
M8 × 1.25	13.00	12.73	15.01	14.38	7.10	6.44	9.50	8.50	8.00	7.14	10.20	9.20	3.7	4.3	11.6		
^b M10 × 1.5	15.00	14.73	17.32	16.64	9.70	8.70	12.50	11.50	11.20	9.60	13.50	12.50	5.6	6.2	13.6		
M10 × 1.5	16.00	15.73	18.48	17.77	9.00	8.04	11.90	10.90	10.50	8.94	12.80	11.80	4.8	5.6	14.6		
M12 × 1.75	18.00	17.73	20.78	20.03	11.60	10.37	14.90	13.90	13.30	11.57	16.10	15.10	6.7	7.7	16.6		
M14 × 2	21.00	20.67	24.25	23.35	13.20	12.10	17.00	15.80	15.40	13.40	18.30	17.10	7.8	8.9	19.6		
M16 × 2	24.00	23.67	27.71	26.75	15.20	14.10	19.10	17.90	17.90	15.70	20.70	19.50	9.1	10.5	22.5		
M20 × 2.5	30.00	29.16	34.64	32.95	19.00	16.90	22.80	21.50	21.80	19.00	25.10	23.80	10.9	12.7	27.7		
M24 × 3	36.00	35.00	41.57	39.55	23.00	20.20	27.10	25.60	26.40	22.60	29.50	28.00	13.0	15.1	33.2		
M30 × 3.5	46.00	45.00	53.12	50.85	26.90	24.30	32.60	30.60	31.80	27.30	35.60	33.60	15.7	18.2	42.7		
M36 × 4	55.00	53.80	63.51	60.79	32.50	29.40	38.90	36.90	38.50	33.10	42.60	40.60	19.0	22.1	51.1		

^a Also includes metal nuts with non-metallic inserts, plugs, or patches in their threads.

^b This size with width across flats of 15 mm is not standard. Unless specifically ordered, M10 slotted hex nuts with 16 mm width across flats will be furnished.

All dimensions are in millimeters.

Metric Washers

Metric Plain Washers.—American National Standard ANSI B18.22M-1981 (R2000) covers general specifications and dimensions for flat, round-hole washers, both soft (as fabricated) and hardened, intended for use in general-purpose applications. Dimensions are given in the following table. Manufacturers should be consulted for current information on stock sizes.

Comparison with ISO Standards.—The washers covered by this ANSI Standard are nominally similar to those covered in various ISO documents. Outside diameters were selected, where possible, from ISO/TC2/WG6/N47 “General Plan for Plain Washers for Metric Bolts, Screws, and Nuts.” The thicknesses given in the ANSI Standard are similar to the nominal ISO thicknesses, however the tolerances differ. Inside diameters also differ.

ISO metric washers are currently covered in ISO 887, “Plain Washers for Metric Bolts, Screws, and Nuts - General Plan.”

Types of Metric Plain Washers.—Soft (as fabricated) washers are generally available in nominal sizes 1.6 mm through 36 mm in a variety of materials. They are normally used in low-strength applications to distribute bearing load, to provide a uniform bearing surface, and to prevent marring of the work surface.

Hardened steel washers are normally available in sizes 6 mm through 36 mm in the narrow and regular series. They are intended primarily for use in high-strength joints to minimize embedment, to provide a uniform bearing surface, and to bridge large clearance holes and slots.

Metric Plain Washer Materials and Finish.—Soft (as fabricated) washers are made of nonhardened steel unless otherwise specified by the purchaser. Hardened washers are made of through-hardened steel tempered to a hardness of 38 to 45 Rockwell C.

Unless otherwise specified, washers are furnished with a natural (as fabricated) finish, unplated or uncoated with a light film of oil or rust inhibitor.

Metric Plain Washer Designation.—When specifying metric plain washers, the designation should include the following data in the sequence shown: description, nominal size, series, material type, and finish, if required.

Example: Plain washer, 6 mm, narrow, soft, steel, zinc plated

Plain washer, 10 mm, regular, hardened steel.

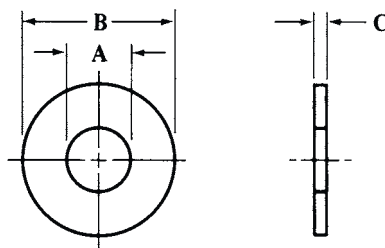


Table 30. American National Standard Metric Plain Washers
ANSI B18.22M-1981 (R2000)

Nominal Washer Size ^a	Washer Series	Inside Diameter, <i>A</i>		Outside Diameter, <i>B</i>		Thickness, <i>C</i>	
		Max	Min	Max	Min	Max	Min
1.6	Narrow	2.09	1.95	4.00	3.70	0.70	0.50
	Regular	2.09	1.95	5.00	4.70	0.70	0.50
	Wide	2.09	1.95	6.00	5.70	0.90	0.60
2	Narrow	2.64	2.50	5.00	4.70	0.90	0.60
	Regular	2.64	2.50	6.00	5.70	0.90	0.60
	Wide	2.64	2.50	8.00	7.64	0.90	0.60
2.5	Narrow	3.14	3.00	6.00	5.70	0.90	0.60
	Regular	3.14	3.00	8.00	7.64	0.90	0.60
	Wide	3.14	3.00	10.00	9.64	1.20	0.80
3	Narrow	3.68	3.50	7.00	6.64	0.90	0.60
	Regular	3.68	3.50	10.00	9.64	1.20	0.80
	Wide	3.68	3.50	12.00	11.57	1.40	1.00
3.5	Narrow	4.18	4.00	9.00	8.64	1.20	0.80
	Regular	4.18	4.00	10.00	9.64	1.40	1.00
	Wide	4.18	4.00	15.00	14.57	1.75	1.20
4	Narrow	4.88	4.70	10.00	9.64	1.20	0.80
	Regular	4.88	4.70	12.00	11.57	1.40	1.00
	Wide	4.88	4.70	16.00	15.57	2.30	1.60
5	Narrow	5.78	5.50	11.00	10.57	1.40	1.00
	Regular	5.78	5.50	15.00	14.57	1.75	1.20
	Wide	5.78	5.50	20.00	19.48	2.30	1.60
6	Narrow	6.87	6.65	13.00	12.57	1.75	1.20
	Regular	6.87	6.65	18.80	18.37	1.75	1.20
	Wide	6.87	6.65	25.40	24.88	2.30	1.60
8	Narrow	9.12	8.90	18.80 ^b	18.37 ^b	2.30	1.60
	Regular	9.12	8.90	25.40 ^b	24.48 ^b	2.30	1.60
	Wide	9.12	8.90	32.00	31.38	2.80	2.00
10	Narrow	11.12	10.85	20.00	19.48	2.30	1.60
	Regular	11.12	10.85	28.00	27.48	2.80	2.00
	Wide	11.12	10.85	39.00	38.38	3.50	2.50
12	Narrow	13.57	13.30	25.40	24.88	2.80	2.00
	Regular	13.57	13.30	34.00	33.38	3.50	2.50
	Wide	13.57	13.30	44.00	43.38	3.50	2.50
14	Narrow	15.52	15.25	28.00	27.48	2.80	2.00
	Regular	15.52	15.25	39.00	38.38	3.50	2.50
	Wide	15.52	15.25	50.00	49.38	4.00	3.00
16	Narrow	17.52	17.25	32.00	31.38	3.50	2.50
	Regular	17.52	17.25	44.00	43.38	4.00	3.00
	Wide	17.52	17.25	56.00	54.80	4.60	3.50
20	Narrow	22.32	21.80	39.00	38.38	4.00	3.00
	Regular	22.32	21.80	50.00	49.38	4.60	3.50
	Wide	22.32	21.80	66.00	64.80	5.10	4.00
24	Narrow	26.12	25.60	44.00	43.38	4.60	3.50
	Regular	26.12	25.60	56.00	54.80	5.10	4.00
	Wide	26.12	25.60	72.00	70.80	5.60	4.50
30	Narrow	33.02	32.40	56.00	54.80	5.10	4.00
	Regular	33.02	32.40	72.00	70.80	5.60	4.50
	Wide	33.02	32.40	90.00	88.60	6.40	5.00
36	Narrow	38.92	38.30	66.00	64.80	5.60	4.50
	Regular	38.92	38.30	90.00	88.60	6.40	5.00
	Wide	38.92	38.30	110.00	108.60	8.50	7.00

^a Nominal washer sizes are intended for use with comparable screw and bolt sizes.

^b The 18.80/18.37 and 25.40/24.48 mm outside diameters avoid washers which could be used in coin-operated devices.

All dimensions are in millimeters.

Clearance Holes for Bolts, Screws, and Studs

The Standard ASME B18.2.8-1999, R2005 covers the recommended clearance hole sizes for #0 through 1.5 inch and M1.6 through M100 metric fasteners in three classes of clearance using a close-, normal-, and loose-fit category.

The clearance hole tolerances for both inch and metric holes are based on ISO 286, *ISO System of Limits and Fits*, using tolerance class H12 for close-fit, H13 for normal-fit, and H14 for loose-fit clearance holes. The clearances provided by the three classes of fit are based on regularly stepped clearances as listed in **Table 1a** for inch and **Table 2b** for metric.

Inch Fasteners.—The hole sizes for inch fasteners are patterned after USA common usage and the general clearances translated from the metric standard. The hole tolerances are based on the *ISO System of Limits and Fits*, as required by ISO 273.

The tabulated drill and hole sizes, **Table 1a**, list the inch fastener clearance hole recommendations. The recommended drill sizes for inch fasteners are tabulated by nominal drill designation as letter, numbers, or fractional sizes. The drill sizes were selected to provide as nearly as practical a step-patterned clearance size for the minimum recommended hole (**Table 1b**). The maximum recommended hole size is based on standard hole tolerances.

Table 1a. Clearance Holes for Inch Fasteners ASME B18.2.8-1999, R2005

Nominal Screw Size	Normal			Close			Loose		
	Nominal Drill Size	Hole Diameter		Nominal Drill Size	Hole Diameter		Nominal Drill Size	Hole Diameter	
		Min.	Max.		Min.	Max.		Min.	Max.
#0	#48	0.076	0.082	#51	0.067	0.071	$\frac{3}{32}$	0.094	0.104
#1	#43	0.089	0.095	#46	0.081	0.085	#37	0.104	0.114
#2	#38	0.102	0.108	$\frac{3}{32}$	0.094	0.098	#32	0.116	0.126
#3	#32	0.116	0.122	#36	0.106	0.110	#30	0.128	0.140
#4	#30	0.128	0.135	#31	0.120	0.124	#27	0.144	0.156
#5	$\frac{5}{32}$	0.156	0.163	$\frac{1}{64}$	0.141	0.146	$\frac{1}{64}$	0.172	0.184
#6	#18	0.170	0.177	#23	0.154	0.159	#13	0.185	0.197
#8	#9	0.196	0.203	#15	0.180	0.185	#3	0.213	0.225
#10	#2	0.221	0.228	#5	0.206	0.211	B	0.238	0.250
$\frac{1}{4}$	$\frac{9}{32}$	0.281	0.290	$\frac{1}{64}$	0.266	0.272	$\frac{1}{64}$	0.297	0.311
$\frac{5}{16}$	$\frac{11}{32}$	0.344	0.354	$\frac{2}{64}$	0.328	0.334	$\frac{2}{64}$	0.359	0.373
$\frac{3}{8}$	$\frac{13}{32}$	0.406	0.416	$\frac{25}{64}$	0.391	0.397	$\frac{27}{64}$	0.422	0.438
$\frac{7}{16}$	$\frac{15}{32}$	0.469	0.479	$\frac{29}{64}$	0.453	0.460	$\frac{31}{64}$	0.484	0.500
$\frac{1}{2}$	$\frac{9}{16}$	0.562	0.572	$\frac{1}{32}$	0.531	0.538	$\frac{39}{64}$	0.609	0.625
$\frac{5}{8}$	$\frac{11}{16}$	0.688	0.698	$\frac{2}{32}$	0.656	0.663	$\frac{47}{64}$	0.734	0.754
$\frac{3}{4}$	$\frac{13}{16}$	0.812	0.824	$\frac{25}{32}$	0.781	0.789	$1\frac{29}{32}$	0.906	0.926
$\frac{7}{8}$	$\frac{15}{16}$	0.938	0.950	$\frac{29}{32}$	0.906	0.914	$1\frac{1}{32}$	1.031	1.051
1	$1\frac{3}{32}$	1.094	1.106	$1\frac{1}{32}$	1.031	1.039	$1\frac{15}{32}$	1.156	1.181
$1\frac{1}{8}$	$1\frac{1}{32}$	1.219	1.235	$1\frac{5}{32}$	1.156	1.164	$1\frac{15}{16}$	1.312	1.337
$1\frac{1}{4}$	$1\frac{11}{32}$	1.344	1.360	$1\frac{9}{32}$	1.281	1.291	$1\frac{7}{16}$	1.438	1.463
$1\frac{3}{8}$	$1\frac{1}{2}$	1.500	1.516	$1\frac{7}{16}$	1.438	1.448	$1\frac{39}{64}$	1.609	1.634
$1\frac{1}{2}$	$1\frac{5}{8}$	1.625	1.641	$1\frac{1}{16}$	1.562	1.572	$1\frac{47}{64}$	1.734	1.759

Table 1b. Inch Clearance Hole Allowances

Nominal Screw Size	Fit Classes			Nominal Screw Size	Fit Classes		
	Normal	Close	Loose		Normal	Close	Loose
#0 – #4	$\frac{1}{64}$	0.008	$\frac{1}{32}$	1	$\frac{3}{32}$	$\frac{1}{32}$	$\frac{5}{32}$
#5 – $\frac{7}{16}$	$\frac{1}{32}$	$\frac{1}{64}$	$\frac{3}{64}$	$1\frac{1}{8}$, $1\frac{1}{4}$	$\frac{3}{32}$	$\frac{1}{32}$	$\frac{3}{16}$
$\frac{1}{2}$, $\frac{5}{8}$	$\frac{1}{16}$	$\frac{1}{32}$	$\frac{7}{64}$	$1\frac{3}{8}$, $1\frac{1}{2}$	$\frac{1}{8}$	$\frac{1}{16}$	$\frac{15}{64}$
$\frac{3}{4}$, $\frac{7}{8}$	$\frac{1}{16}$	$\frac{1}{32}$	$\frac{5}{32}$

Dimensions are in inches.

Metric Fasteners.—The recommended drill and hole sizes for metric fasteners are tabulated in **Table 2a**. The minimum recommended hole is the drill size and the maximum recommended hole size is based on standard tolerances. The hole sizes for metric fasteners are in agreement with ISO 273, *Fasteners-Clearance Holes for Bolts and Screws*, except that ISO 273 covers fastener sizes M1 through M150.

Table 2a. Clearance Holes for Metric Fasteners ASME B18.2.8-1999, R2005

Nominal Screw Size	Normal			Close			Loose		
	Nominal Drill Size	Hole Diameter		Nominal Drill Size	Hole Diameter		Nominal Drill Size	Hole Diameter	
		Min.	Max.		Min.	Max.		Min.	Max.
M1.6	1.8	1.8	1.94	1.7	1.7	1.8	2	2	2.25
M2	2.4	2.4	2.54	2.2	2.2	2.3	2.6	2.6	2.85
M2.5	2.9	2.9	3.04	2.7	2.7	2.8	3.1	3.1	3.4
M3	3.4	3.4	3.58	3.2	3.2	3.32	3.6	3.6	3.9
M4	4.5	4.5	4.68	4.3	4.3	4.42	4.8	4.8	5.1
M5	5.5	5.5	5.68	5.3	5.3	5.42	5.8	5.8	6.1
M6	6.6	6.6	6.82	6.4	6.4	6.55	7	7	7.36
M8	9	9	9.22	8.4	8.4	8.55	10	10	10.36
M10	11	11	11.27	10.5	10.5	10.68	12	12	12.43
M12	13.5	13.5	13.77	13	13	13.18	14.5	14.5	14.93
M14	15.5	15.5	15.77	15	15	15.18	16.5	16.5	16.93
M16	17.5	17.5	17.77	17	17	17.18	18.5	18.5	19.02
M20	22	22	22.33	21	21	21.21	24	24	24.52
M24	26	26	26.33	25	25	25.21	28	28	28.52
M30	33	33	33.39	31	31	31.25	35	35	35.62
M36	39	39	39.39	37	37	37.25	42	42	42.62
M42	45	45	45.39	43	43	43.25	48	48	48.62
M48	52	52	52.46	50	50	50.25	56	56	56.74
M56	62	62	62.46	58	58	58.3	66	66	66.74
M64	70	70	70.46	66	66	66.3	74	74	74.74
M72	78	78	78.46	74	74	74.3	82	82	82.87
M80	86	86	86.54	82	82	82.35	91	91	91.87
M90	96	96	96.54	93	93	93.35	101	101	101.87
M100	107	107	107.54	104	104	104.35	112	112	112.87

Table 2b. Metric Clearance Hole Allowances

Nominal Screw Size	Fit Classes			Nominal Screw Size	Fit Classes		
	Normal	Close	Loose		Normal	Close	Loose
M1.6	0.2	0.1	0.25	M20, M24	2	1	4
M2	0.4	0.1	0.3	M30	3	1	5
M2.5	0.4	0.1	0.3	M36, M42	3	1	6
M3	0.4	0.2	0.6	M48	4	2	8
M4, M5	0.5	0.3	0.8	M56-M72	6	2	10
M6	0.6	0.4	1	M80	6	2	11
M8	1	0.4	2	M90	6	3	11
M10	1	0.5	2	M100	7	4	12
M12-M16	1.5	1	2.5

Dimensions are in millimeters.

Recommended Substitute Drills.—If the clearance hole application is dimensioned in metric drill sizes for inch fasteners, or inch drill sizes for metric fasteners, **Tables 3a** and **3b** list the nearest standard drill size translations for the designated drills of **Tables 1a** and **2a**.

Table 3a. Standard Metric Drills For Inch Fasteners
ASME B18.2.8-1999, R2005 (Appendix 1)

Nominal Screw Size, inch	Nominal Drill Size, mm			Nominal Screw Size, inch	Nominal Drill Size, mm		
	Fit Classes				Fit Classes		
	Normal	Close	Loose		Normal	Close	Loose
#0	1.9	1.7	2.4	$\frac{3}{8}$	10.2	9.9	10.5
#1	2.25	2.05	2.6	$\frac{7}{16}$	11.8	11.5	12.2
#2	2.6	2.4	2.9	$\frac{1}{2}$	14.25	13.5	15.5
#3	2.9	2.7	3.3	$\frac{5}{8}$	17.5	16.75	19
#4	3.3	3	3.7	$\frac{3}{4}$	20.5	20	23
#5	4	3.6	4.4	$\frac{7}{8}$	24	23	26
#6	4.3	3.9	4.7	1	27.5	26	29.5
#8	5	4.6	5.4	$1\frac{1}{8}$	31	29.5	33.5
#10	5.6	5.2	6	$1\frac{1}{4}$	34	32.5	36.5
$\frac{1}{4}$	7.1	6.7	7.5	$1\frac{3}{8}$	38	36.5	41
$\frac{5}{16}$	8.7	8.3	9.1	$1\frac{1}{2}$	41	39.5	44

Table 3b. Standard Inch Drills For Metric Fasteners
ASME B18.2.8-1999, R2005 (Appendix 1)

Nominal Screw Size, mm	Nominal Drill Size, inch			Nominal Screw Size, mm	Nominal Drill Size, inch		
	Fit Classes				Fit Classes		
	Normal	Close	Loose		Normal	Close	Loose
M1.6	#50	#51	#47	M16	$\frac{11}{32}$	$\frac{43}{64}$	$\frac{47}{64}$
M2	$\frac{3}{32}$	#44	#38	M20	$\frac{53}{64}$	$\frac{53}{64}$	$\frac{15}{16}$
M2.5	#33	#36	#31	M24	$1\frac{1}{32}$	$\frac{63}{64}$	$1\frac{7}{64}$
M3	#29	$\frac{1}{8}$	$\frac{9}{64}$	M30	$1\frac{9}{32}$	$1\frac{7}{32}$	$1\frac{3}{8}$
M4	#16	#19	#12	M36	$1\frac{17}{32}$	$1\frac{15}{32}$	$1\frac{21}{32}$
M5	$\frac{7}{32}$	#4	#1	M42	$1\frac{25}{32}$	$1\frac{11}{16}$	$1\frac{29}{32}$
M6	G	$\frac{1}{4}$	J	M48	$2\frac{1}{32}$	$1\frac{31}{2}$	$2\frac{3}{16}$
M8	T	Q	$\frac{25}{64}$	M56	$2\frac{7}{16}$	$2\frac{3}{16}$	$2\frac{3}{8}$
M10	$\frac{7}{16}$	Z	$\frac{31}{64}$	M64	$2\frac{3}{4}$	$2\frac{5}{8}$	$2\frac{3}{16}$
M12	$1\frac{17}{32}$	$\frac{33}{64}$	$\frac{37}{64}$	M72	$3\frac{1}{8}$	$2\frac{15}{16}$	$3\frac{1}{4}$
M14	$\frac{39}{64}$	$\frac{19}{32}$	$\frac{21}{32}$

Table 4. Recommended Clearance Holes for Metric Round Head Square Neck Bolts

Close Clearance: Close clearance should be specified only for square holes in very thin and/or soft material, or for slots, or where conditions such as critical alignment of assembled parts, wall thickness, or other limitations necessitate use of a minimal hole. Allowable swell or fins on the bolt body and/or fins on the corners of the square neck may interfere with close clearance round or square holes.

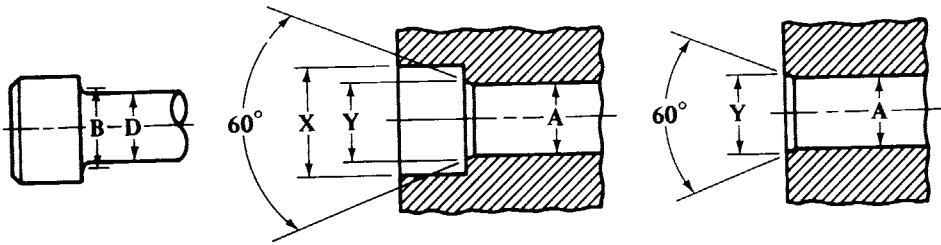
Normal Clearance: Normal clearance hole sizes are preferred for general purpose applications and should be specified unless special design considerations dictate the need for either a close or loose clearance hole.

Nom. Bolt Dia., <i>D</i> and Thd. Pitch	Clearance			Corner Radius <i>R_h</i>	Nom. Bolt Dia., <i>D</i> and Thd. Pitch	Clearance			Corner Radius <i>R_h</i>
	Close	Normal	Loose			Close	Normal	Loose	
	Min. Hole Diameter or Square Width, <i>H</i>								
M5 × 0.8	5.5	...	5.8	0.2	M14 × 2	15.0	15.5	16.5	0.6
M6 × 1	6.6	...	7.0	0.3	M16 × 2	17.0	17.5	18.5	0.6
M8 × 1.25	...	9.0	10.0	0.4	M20 × 2.5	21.0	22.0	24.0	0.8
M10 × 1.5	...	11.0	12.0	0.4	M24 × 3	25.0	26.0	28.0	1.0
M12 × 1.75	13.0	13.5	14.5	0.6

Loose Clearance: Loose clearance hole sizes should be specified only for applications where maximum adjustment capability between components being assembled is necessary. Loose clearance square hole or slots may not prevent bolt turning during wrenching.

All dimensions are in millimeters. Source: ANSI/ASME B18.5.2.2M-1982 (R2000), Appendix II

Table 5. Drill and Counterbore Sizes for Metric Socket Head Cap Screws



Nominal Size or Basic Screw Diameter	Nominal Drill Size, A		Counterbore Diameter, X	Countersink Diameter, ^a Y
	Close Fit ^b	Normal Fit ^c		
M1.6	1.80	1.95	3.50	2.0
M2	2.20	2.40	4.40	2.6
M2.5	2.70	3.00	5.40	3.1
M3	3.40	3.70	6.50	3.6
M4	4.40	4.80	8.25	4.7
M5	5.40	5.80	9.75	5.7
M6	6.40	6.80	11.25	6.8
M8	8.40	8.80	14.25	9.2
M10	10.50	10.80	17.25	11.2
M12	12.50	12.80	19.25	14.2
M14	14.50	14.75	22.25	16.2
M16	16.50	16.75	25.50	18.2
M20	20.50	20.75	31.50	22.4
M24	24.50	24.75	37.50	26.4
M30	30.75	31.75	47.50	33.4
M36	37.00	37.50	56.50	39.4
M42	43.00	44.00	66.00	45.6
M48	49.00	50.00	75.00	52.6

^a *Countersink*: It is considered good practice to countersink or break the edges of holes which are smaller than B Max. (see Table 21, page 1598) in parts having a hardness which approaches, equals, or exceeds the screw hardness. If such holes are not countersunk, the heads of screws may not seat properly or the sharp edges on holes may deform the fillets on screws, thereby making them susceptible to fatigue in applications involving dynamic loading. The countersink or corner relief, however, should not be larger than is necessary to ensure that the fillet on the screw is cleared. Normally, the diameter of countersink does not have to exceed B Max. Countersinks or corner reliefs in excess of this diameter reduce the effective bearing area and introduce the possibility of embedment where the parts to be fastened are softer than the screws or of brinnelling or flaring the heads of the screws where the parts to be fastened are harder than the screws.

^b *Close Fit*: The close fit is normally limited to holes for those lengths of screws which are threaded to the head in assemblies where only one screw is to be used or where two or more screws are to be used and the mating holes are to be produced either at assembly or by matched and coordinated tooling.

^c *Normal Fit*: The normal fit is intended for screws of relatively long length or for assemblies involving two or more screws where the mating holes are to be produced by conventional tolerancing methods. It provides for the maximum allowable eccentricity of the longest standard screws and for certain variations in the parts to be fastened, such as: deviations in hole straightness, angularity between the axis of the tapped hole and that of the hole for shank, differences in center distances of the mating holes, etc.

All dimensions are in millimeters.

HELICAL COIL SCREW THREAD INSERTS

Introduction

The ASME B18.29.2M standard delineates the dimensional, mechanical, and performance data for the metric series helical coil screw thread insert and threaded hole into which it is installed. Appendices that describe insert selection, STI (screw thread insert) taps, insert installation, and removal tooling are also included.

Helical coil inserts are screw thread bushings coiled from wire of diamond-shape cross-section. Inserts are screwed into STI-tapped holes to form nominal size internal threads. Inserts are installed by torquing through a diametral tang. This tang is notched for removal after installation. In the free state, they are larger in diameter than the tapped hole into which they are installed. In the assembly operation, the torque applied to the tang reduces the diameter of the leading coil and permits it to enter the tapped thread. The remaining coils are reduced in diameter as they, in turn, are screwed into the tapped hole. When the torque or rotation is stopped, the coils expand with a spring-like action anchoring the insert in place against the tapped hole.

Dimensions.—Dimensions in this standard are in millimeters and apply before any coating. Symbols specifying geometric characteristics are in accordance with ASME Y14.5M.

Tolerance Classes 4H5H and 5H.—Because helical coil inserts are flexible, the class of fit of the final assembly is a function of the size of the tapped hole. Helical coil STI taps are available for both tolerance class 4H5H (or class 4H6H) and class 5H tapped holes. Tolerance class 5H tapped holes provide maximum production tolerances but result in lower locking torques when screw-locking inserts are used. The higher and more consistent torques given in [Table 5](#) are met by the screw-locking inserts when assembled and tested in tolerance class 4H5H (or class 4H6H) tapped holes.

Compatibility.—Assembled helical coil inserts will mate properly with items that have M Profile external threads in accordance with ASME B1.13M. Also, due to the radius on the crest of the insert at the minor diameter, the assembled insert will mate with MJ Profile externally threaded parts with controlled radius root threads per ASME B1.21M.

Types of Inserts.— *Free-running* inserts provides a smooth, hard, and free-running thread. *Screw-locking* inserts provides a resilient locking thread produced by a series of chords on one or more of the insert coils.

STI-tapped Hole.—The tapped hole into which the insert is installed shall be in accordance with ASME B1.13M, except that diameters are larger to accommodate the wire cross-section of the insert (See Fig. 1.). Dimensions of the STI-tapped hole are shown in [Table 1](#) and are calculated per General Note (c) to [Table 1](#).

Screw Thread Designation for Tapped Hole: The drawing note for the STI-threaded hole per [Table 1](#) to accept the helical coil insert shall be in accordance with the following:

Example 1: MS $\times 1.25$ -5H STI; 23.5 T per ASME B18.29.2M.

Designation for a Helical Coil Insert: Helical coil inserts shall be designated by the following data, in the sequence shown:

a) product name; b) designation of the standard; c) nominal diameter and thread pitch (4) nominal length; and d) insert type (free-running or screw-locking).

Example 2: Helical Coil insert, ASME B18.29.2M, M8 $\times 1.25 \times 12.0$ free-running.

Helical Coil insert, ASME B18.29.2M, M5 $\times 0.8 \times 7.5$ screw-locking.

The recommended B18 part number (PIN) code system for helical coil inserts is included in ASME B18.24. This system may be used by user needing definitive part-numbering.

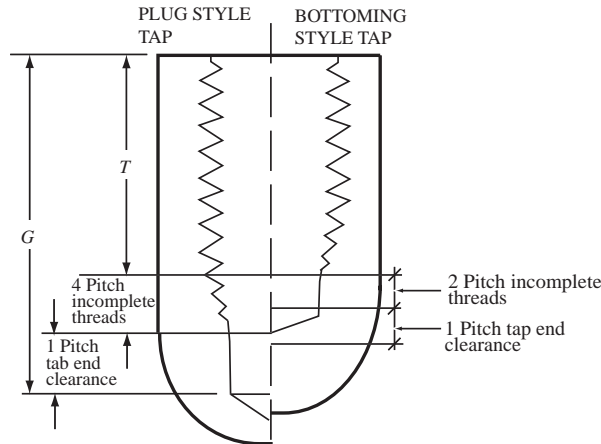


Fig. 1. Tapping Depth

Designation for STI-Threaded Hole Including Installed Helical Coil Insert: The drawing note for the STI-threaded hole per [Table 1](#) having a helical coil insert installed shall be in accordance with this example.

Example 3: M8 × 1.25 STI 23.5 deep;

Helical Coil insert, ASME B18.29.2M, M8 × 1.25 × 12.0, free running

Gages and Gaging: Acceptance of the threaded hole is determined by gaging with STI GO, NOT GO (HI), and plain cylindrical gages designed and applied in accordance with System 21 of ASME B1.3M and with ASME B1.16M.

Helical Coil Insert

Material.—Chemical composition of the inserts is austenitic corrosion-resistant (stainless) steel material within the limits of [Table 2](#).

Properties.—Wire, before coiling into inserts, shall have tensile strength not lower than 1035 MPa, determined in accordance with ASTM A 370. Wire shall withstand, without cracking, bending in accordance with ASTM E 290 at room temperature through an angle of 180° around a diameter equal to twice the cross-sectional dimension of the wire in the plane of the bend. The formed wire shall be of uniform quality and temper; it shall be smooth, clean, and free from kinks, waviness, splits, cracks, laps, seams, scale, segregation, and other defects that may impair the serviceability of the insert.

Coatings.—At the option of the user, dry film lubricant coating can be applied to helical coil inserts. The color of dry film-lubricated inserts is dark gray to black. Lubricant shall meet requirements of Aerospace Standard SAE AS5272, type I, lubricant, solid film heat cured, and corrosion inhibiting. Coating shall be uniformly deposited on the insert with the minimum thickness being complete coverage. Maximum thickness shall be the avoidance of bridging between coils. Slight fill in between closely wound coils, which immediately separates as the coils are axially pulled apart by hand, shall not be considered bridging.

Configuration and Dimensions.—Insert configurations shall be in accordance with [Fig. 2](#), and dimensions shall be in accordance with [Tables 3](#) and [4](#). Each nominal insert size is standardized in five lengths, which are multiples of the insert's nominal diameter. These are 1, 1.5, 2, 2.5, and 3 times nominal diameter. Each nominal length is the minimum through-hole length (material thickness), without countersink, into which that insert can be installed. The nominal insert length is a reference value and cannot be measured. Actual assembled length of the insert equals nominal length minus 0.5 pitch to minus 0.75 pitch, with insert installed in a basic STI threaded hole. Assembled length cannot be measured in the insert's free state.

Table 1. Screw Thread Insert Threaded Hole Data ASME B18.29.2M-2005

Nominal Thread Size	Minimum Drilling Depth for Each Insert Length, <i>G</i>										Countersink Diameter, <i>M</i> (120°±5° included angle)		Minor Diameter		Pitch Diameter				Min. Major Diam.	Minimum Tapping Depth, <i>T</i>				
	Plug Taps					Bottoming Taps														Insert Length				
	<i>1D</i>	<i>1.5D</i>	<i>2D</i>	<i>2.5D</i>	<i>3D</i>	<i>1D</i>	<i>1.5D</i>	<i>2D</i>	<i>2.5D</i>	<i>3D</i>	Min.	Max.	Min.	Max.	Min.	4H Max.	5H Max.	6H Max.	All Classes	<i>1D</i>	<i>1.5D</i>	<i>2D</i>	<i>2.5D</i>	<i>3D</i>
	M2 × 0.4	5.40	6.40	7.40	8.40	9.40	3.60	4.60	5.60	6.60	7.60	2.30	2.70	2.087	2.199	2.260	2.295	2.310	2.329	2.520	2.40	3.40	4.40	5.40
M2.5 × 0.45	6.45	7.70	8.95	10.20	11.45	4.30	5.55	6.80	8.05	9.30	2.90	3.40	2.597	2.722	2.792	2.832	2.847	2.867	3.084	2.95	4.20	5.45	6.70	7.95
M3 × 0.5	7.50	9.00	10.50	12.00	13.50	5.00	5.00	8.00	9.50	11.00	3.40	4.00	3.108	3.248	3.326	3.367	3.384	3.404	3.650	3.50	5.00	6.50	8.00	9.50
M3.5 × 0.6	8.86	10.60	12.35	14.10	15.85	5.90	7.65	9.40	11.15	12.90	4.10	4.70	3.630	3.790	3.890	3.940	3.959	3.981	4.280	4.10	5.85	7.60	9.35	11.10
M4 × 0.7	10.20	12.20	14.20	16.20	18.20	6.80	8.80	10.80	12.80	14.80	4.70	5.30	4.162	4.332	4.455	4.508	4.529	4.522	4.910	4.70	6.70	8.70	10.70	12.70
M5 × 0.8	12.30	14.80	17.30	19.80	22.30	8.20	10.70	13.20	15.70	18.20	5.80	6.40	5.174	5.374	5.520	5.577	5.597	5.622	6.040	5.80	8.30	10.80	13.30	15.80
M6 × 1	15.00	18.00	21.00	24.00	27.00	10.00	13.00	16.00	19.00	22.00	7.10	7.70	6.217	6.407	6.650	6.719	6.742	6.774	7.300	7.00	10.00	13.00	16.00	19.00
M7 × 1	16.50	20.00	23.50	27.00	30.50	11.00	14.50	18.00	21.50	25.00	8.10	8.70	7.217	7.407	7.650	7.719	7.742	7.774	8.300	8.00	11.50	15.00	18.50	22.00
M8 × 1	18.00	22.00	26.00	30.00	34.00	12.00	16.00	20.00	24.00	28.00	9.10	9.70	8.217	8.407	8.650	8.719	8.742	8.774	9.300	9.00	13.00	17.00	21.00	25.00
M8 × 1.25	19.50	23.60	27.50	31.50	35.50	13.00	17.00	21.00	25.00	29.00	10.10	10.70	8.271	8.483	8.812	8.886	8.911	8.946	9.624	9.26	13.25	17.26	21.25	25.25
M10 × 1	16.00	21.00	26.00	31.00	36.00	14.00	19.00	24.00	29.00	34.00	11.10	11.70	10.217	10.407	10.650	10.719	10.742	10.774	11.300	11.00	16.00	21.00	26.00	31.00
M10 × 1.25	17.50	22.60	27.50	32.50	37.50	15.00	20.00	25.00	30.00	35.00	12.10	12.70	10.271	10.483	10.812	10.886	10.911	10.946	11.624	11.26	16.25	21.26	26.25	31.25
M10 × 1.5	19.00	24.00	29.00	34.00	39.00	16.00	21.00	26.00	31.00	36.00	13.10	13.70	10.324	10.580	10.974	11.061	11.089	11.129	11.948	11.50	16.50	21.50	26.50	31.50
M12 × 1.25	19.50	25.50	31.50	37.50	43.50	17.00	23.00	29.00	35.00	41.00	13.50	14.10	12.271	12.483	12.812	12.896	12.926	12.966	13.624	13.25	19.25	25.25	31.25	37.25
M12 × 1.5	21.00	27.00	33.00	39.00	45.00	18.00	24.00	30.00	36.00	42.00	14.00	14.60	12.324	12.560	12.974	13.067	13.099	13.139	13.948	13.50	19.50	25.50	31.50	37.60
M12 × 1.75	22.50	28.50	34.50	40.50	46.50	19.00	25.00	31.00	37.00	43.00	14.20	14.80	12.379	12.644	13.137	13.236	13.271	13.311	14.274	13.75	19.75	25.75	31.75	37.75
M14 × 1.5	23.00	30.00	37.00	44.00	51.00	20.00	27.00	34.00	41.00	48.00	15.80	16.40	14.324	14.560	14.974	15.067	15.099	15.139	15.940	15.50	22.50	29.50	38.50	43.50
M14 × 2	26.00	33.00	40.00	47.00	54.00	22.00	29.00	36.00	43.00	50.00	16.50	17.10	14.433	14.733	15.299	15.406	15.444	15.486	16.958	16.00	23.00	30.00	37.00	44.00
M16 × 1.5	25.00	33.00	41.00	49.00	57.00	22.00	30.00	38.00	46.00	54.00	17.80	18.40	16.324	16.560	16.974	17.067	17.099	17.139	17.948	17.50	25.50	33.50	41.50	49.50
M16 × 2	28.00	36.00	44.00	52.00	60.00	24.00	32.00	40.00	48.00	56.00	18.50	19.10	16.433	16.733	17.299	17.406	17.444	17.486	18.598	18.00	26.00	34.00	42.00	50.00
M18 × 1.5	27.00	36.00	45.00	54.00	63.00	24.00	33.00	42.00	51.00	60.00	19.80	20.40	18.324	18.560	18.974	19.067	19.099	19.139	19.948	19.50	28.50	37.50	46.50	55.50
M18 × 2	30.00	39.00	48.00	57.00	66.00	26.00	35.00	44.00	53.00	62.00	20.50	21.10	18.433	18.733	19.299	19.406	19.444	19.486	20.598	20.00	29.00	38.00	47.00	56.00
M18 × 2.5	33.00	42.00	51.00	60.00	69.00	28.00	37.00	46.00	55.00	64.00	21.20	21.80	18.541	18.896	19.624	19.738	19.778	19.822	21.248	20.50	29.50	38.50	47.50	56.50
M20 × 1.5	29.00	39.00	49.00	59.00	69.00	26.00	36.00	46.00	56.00	66.00	21.80	22.40	20.324	20.560	20.974	21.067	21.099	21.139	21.940	21.50	31.50	41.50	51.50	61.50
M20 × 2	32.00	42.00	52.00	62.00	72.00	28.00	38.00	48.00	58.00	68.00	22.50	23.10	20.433	20.733	21.299	21.406	21.444	21.486	22.598	22.00	32.00	42.00	52.00	62.00
M20 × 2.5	35.00	45.00	55.00	65.00	75.00	30.00	40.00	50.00	60.00	70.00	23.20	23.80	20.541	20.896	21.624	21.738	21.778	21.822	23.248	22.50	32.50	42.50	52.50	62.50
M22 × 1.5	31.00	42.00	53.00	64.00	75.00	28.00	39.00	50.00	61.00	72.00	23.80	24.40	22.324	22.560	22.974	23.067	23.099	23.139	23.948	23.50	34.50	45.50	56.50	67.50
M22 × 2	34.00	45.00	56.00	67.00	78.00	30.00	41.00	52.00	63.00	74.00	24.50	25.10	22.433	22.733	23.299	23.406	23.444	23.486	24.598	24.00	35.00	46.00	57.00	68.00
M22 × 2.5	37.00	48.00	59.00	70.00	81.00	32.00	43.00	54.00	65.00	76.00	25.20	25.80	22.541	22.896	23.624	23.738	23.778	23.822	25.248	24.50	35.50	46.50	57.50	68.50
M24 × 2	38.00	48.00	60.00	72.00	84.00	32.00	44.00	56.00	68.00	80.00	26.50	27.10	24.433	24.733	25.299	25.414	15.454	25.498	26.598	26.00	38.00	50.00	62.00	74.00
M24 × 3	42.00	54.00	66.00	78.00	90.00	36.00	48.00	60.00	72.00	84.00	27.90	28.50	24.649	25.049	25.948	26.093	26.135	26.188	27.897	27.00	39.00	51.00	63.00	75.00
M27 × 2	39.00	52.50	66.00	79.50	93.00	35.00	48.50	62.00	75.50	89.00	29.50	30.10	27.433	27.733	28.299	28.414	28.454	28.498	29.598	29.00	42.50	58.00	69.50	83.00

HELICAL COIL SCREW THREAD INSERTS

Table 1. (Continued) Screw Thread Insert Threaded Hole Data ASME B18.29.2M-2005

Nominal Thread Size	Minimum Drilling Depth for Each Insert Length, <i>G</i>										Countersink Diameter, <i>M</i> (120°±5° included angle)		Minor Diameter		Pitch Diameter				Min. Major Diam.	Minimum Tapping Depth, <i>T</i>				
	Plug Taps					Bottoming Taps														Insert Length				
	1 <i>D</i>	1.5 <i>D</i>	2 <i>D</i>	2.5 <i>D</i>	3 <i>D</i>	1 <i>D</i>	1.5 <i>D</i>	2 <i>D</i>	2.5 <i>D</i>	3 <i>D</i>	Min.	Max.	Min.	Max.	Min.	4H Max.	5H Max.	6H Max.	All Classes	1 <i>D</i>	1.5 <i>D</i>	2 <i>D</i>	2.5 <i>D</i>	3 <i>D</i>
	M27 × 3	45.00	68.50	72.00	85.50	99.00	39.00	52.50	66.00	79.50	93.00	30.90	31.50	27.649	28.049	28.948	29.093	29.135	29.188	30.897	30.00	43.50	57.00	70.50
M30 × 2	42.00	67.00	72.00	87.00	102.00	38.00	53.00	68.00	83.00	98.00	32.50	33.10	30.433	30.733	31.299	31.414	31.454	31.489	32.598	32.00	47.00	62.00	77.00	92.00
M30 × 3	48.00	63.00	78.00	93.00	108.00	42.00	57.00	72.00	87.00	102.00	33.90	34.50	30.649	31.049	31.948	32.093	32.136	32.188	33.897	33.00	48.00	63.00	78.00	93.00
M30 × 3.5	51.00	66.00	81.00	96.00	111.00	44.00	59.00	74.00	89.00	104.00	34.60	35.20	30.767	31.207	32.273	32.428	32.472	32.628	34.546	33.50	48.50	63.50	78.50	93.50
M33 × 2	45.00	61.60	78.00	94.50	111.00	41.00	57.50	74.00	90.50	107.00	35.50	36.10	33.433	33.733	34.299	34.414	34.454	34.498	35.598	35.00	51.50	68.00	84.50	101.00
M33 × 3	51.00	67.60	84.00	104.50	117.00	45.00	61.50	78.00	94.50	111.00	36.90	37.50	33.649	34.049	34.948	35.093	35.135	36.188	36.897	36.00	52.50	69.00	85.50	102.00
M36 × 2	48.00	66.00	84.00	102.00	120.00	44.00	62.00	80.00	98.00	116.00	38.50	39.10	36.433	36.733	37.299	37.414	37.464	37.498	38.598	38.00	58.00	74.00	92.00	110.00
M36 × 3	54.00	72.00	90.00	108.00	126.00	48.00	66.00	84.00	102.00	120.00	39.90	40.50	36.649	37.049	37.948	38.093	38.135	38.188	39.897	39.00	57.00	75.00	93.00	111.00
M36 × 4	60.00	78.00	96.00	114.00	132.00	52.00	70.00	88.00	106.00	124.00	41.30	41.90	36.866	37.341	38.598	38.763	38.809	38.873	41.196	40.00	58.00	76.00	94.00	112.00
M39 × 2	51.00	70.50	90.00	109.50	129.00	47.00	66.50	88.00	105.50	125.00	41.50	42.10	39.433	39.733	40.299	40.414	40.454	40.498	41.598	41.00	60.50	80.00	99.50	119.00
M39 × 3	57.00	76.50	96.00	115.50	135.00	51.00	70.50	90.00	109.50	129.00	42.90	43.50	39.649	40.049	40.948	41.093	41.136	41.188	42.897	42.00	61.50	81.00	100.50	120.00

Notes:

- (1) The minimum drilling depths allow for
 - a) countersinking the drilled hole to prevent a feather edge at the start of the tapped hole.
 - b) 0.75 to 1.5 pitch of insert set-down to allow for maximum production tolerance.
 - c) Dimensions are shown for both plug and bottoming taps. Plug taps 8 mm and smaller have a male center, and the drilled hole depth dimensions allow for this length (one-half of the diameter of the bolt). Calculation of minimum drilling depth dimension *G* is as follows:
 - Plug taps 8mm and smaller, $G = \text{insert nominal length} + 0.5 \times \text{nominal bolt diameter} + 4 \text{ pitches for tap chamfer} + 1 \text{ pitch for tap end clearance} + 1 \text{ pitch allowance for countersink and maximum insert set-down.}$
 - Plug taps larger than 8 mm, $G = \text{insert nominal length} + 4 \text{ pitches for tap chamfer} + 1 \text{ pitch for tap end clearance} + 1 \text{ pitch allowance for countersink and maximum insert set-down.}$
 - Bottoming taps, $G = \text{insert nominal length} + 2 \text{ pitches for tap chamfer} + 1 \text{ pitch for tap end clearance} + 1 \text{ pitch allowance for countersink and maximum insert set-down.}$

(2) The minimum tapping depth (dimension *T*) is the minimum for countersink holes with insert set-down of 1.5 pitch maximum (See Fig. 1.). The dimension $T = \text{insert nominal length} + 1 \text{ pitch.}$

(3) Thread diameters are calculated as follows:

Pitch diameter, min. = Pitch diameter, min. of nominal thread + $2 \times H_{max}$

Pitch diameter, max. = Pitch diameter, max. of nominal thread + $2 \times H_{min}$

Major diameter, min. = Pitch diameter min. + $0.649519 \times P$

Minor diameter, min. = Pitch diameter min. - $0.433013 \times P$

Minor diameter, max. = Minor diameter min. + tolerance

where H_{max} and H_{min} are from Table 1, and tolerance is selected from the appropriate table in ASME B1.13M with basic major diameter equal to the minimum major diameter of the STI thread.

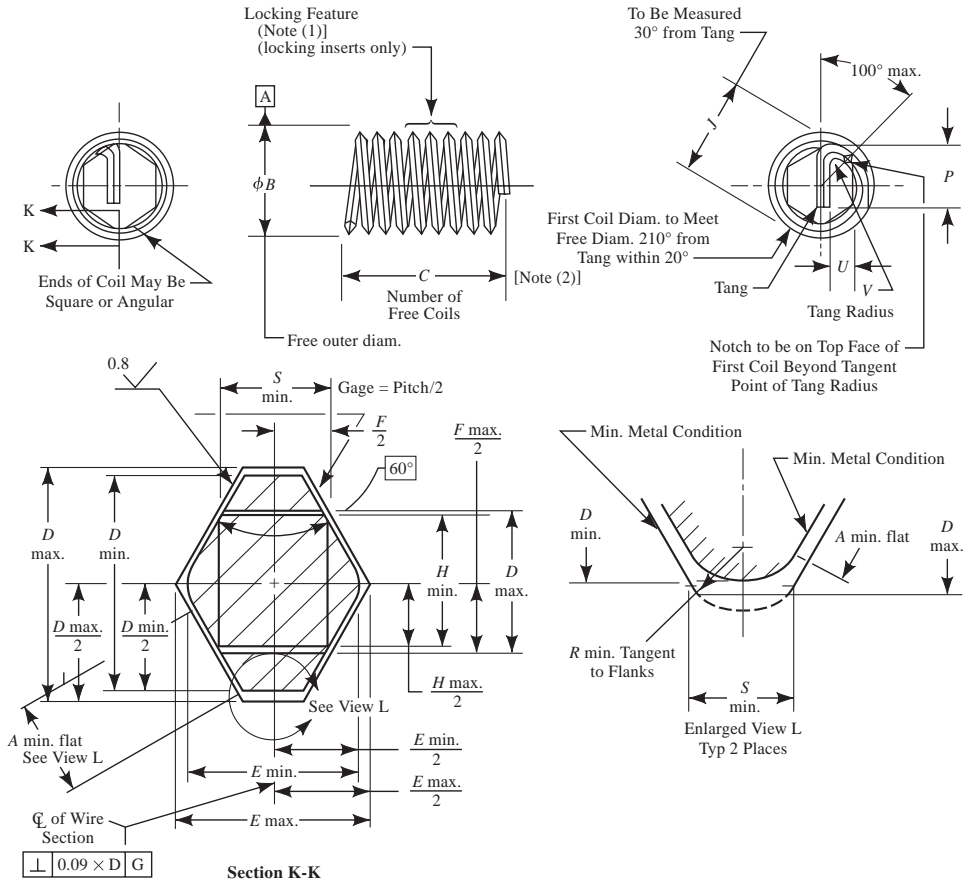


Fig. 2. Insert Configuration

General Notes for Fig. 2:

- (a) Assembled length of insert to be measured from notch.
- (b) Dimensions apply before supplementary coating (see Tables 3 and 4).
- (c) Surface texture; symbols per ASME Y14.35, requirements per ASME B46.1.
- (d) Dimensions and tolerancing; ASME Y14.5M.

Notes:

- (1) Number of locking coils, spacing of locking coils, number of locking deformations, shape and orientation optional locking feature for 1, 1.5, and 2 diam. length inserts symmetrically positioned about the center of insert, and for 2.5 and 3 diam. length inserts at 1 diam. from tang end of insert.
- (2) Number of free coils to be counted from notch.

Inspection and Quality Assurance

The inspection of inserts shall be in accordance with ASME B18.18.1M, with inspection level 3 for the 15 cycle torque test.

Inspection (Nondestructive).—Inserts shall be visually examined for conformance with drawings and workmanship requirements in accordance with ASME B18.18.1M.

Threads: The inserts, when assembled in STI threaded holes conforming to Table 1, shall form threads conforming to ASME B1.13M tolerance class 4H5H or 5H except for the locking feature of screw-locking inserts. The assembled insert, both types, shall accept and function with parts having external MJ threads per ASME B1.21M.

Table 2. Screw Thread Insert Chemical Composition ASME B18.29.2M-2005

Element	Analysis,%	Check Analysis	
		Under, Min.	Over, Max.
Carbon	0.15 max.	...	0.01
Manganese	2.00 max.	...	0.04
Silicon	1.00 max.	...	0.05
Phosphorous	0.045 max.	...	0.01
Sulphur	0.035 max.	...	0.005
Chromium	17.00 to 20.00	0.20	0.20
Nickel	8.00 to 10.50	0.15	0.15
Molybdenum	0.75 max.	...	0.05
Copper	0.75 max.	...	0.05
Iron	Remainder

The accuracy of the finished thread when the insert is installed depends on the accuracy of the tapped hole. If the finished tapped hole gages satisfactorily, the installed insert will be within the thread tolerance when the insert meets the requirements of the Standard. It is, therefore, not necessary to gage the installed insert. After the insert is installed, the GO thread plug gage may not enter freely because the insert may not have been fully seated in the tapped hole. However, the insert should become seated after a bolt or screw is installed and tightened.

Tang Removal Notch: The tang removal notch shall be located as shown in Fig. 2 and of such depth that the part may be installed without failure of the tang and that the tang may be removed, after assembly, without affecting the function of the installed insert.

Torque Test Bolts: Assembled screw-locking inserts shall be torque tested with bolts in accordance with ASME B1.13M or ASME B1.21M, cadmium plated, or having other coating with a similar coefficient of friction and hardness of 36 HRC to 44 HRC. The bolts selected for this test shall be of sufficient length so the thread runout does not enter the insert and that a minimum of one full thread extends past the end of the insert when the bolt is fully seated. Acceptability of bolt threads shall be determined based on System 22 of ASME B1.3M.

Until a replacement for cadmium plating on the torque test bolts is found, and test data completed, an alternate coating/lubricant can be used to perform the torque test.

Self-Locking Torque (Destructive).—The screw-locking insert, when assembled in threaded holes conforming to Table 1 and tested in accordance with the following paragraphs, shall provide a frictional lock to retain the bolt threads within the torque limits specified in Table 5.

Torque Test Block and Spacer: The insert to be tested shall be installed in a tolerance class 4H5H or 4H6H threaded hole conforming to Table 1 in a test block made from 2024-T4 (SAE AMS4120 or ASTM B 209M) aluminum alloy. After installation, the tang shall be removed. The surface of the test block from which the insert is assembled shall be marked “TOP” and shall be marked to indicate the radial location where the assembled insert begins. A steel spacer meeting the requirements of Fig. 3 and Table 6 shall be used for developing the bolt load.

Torque Test Method: The torque test shall consist of a 15-cycle, room temperature test. A new bolt or screw and new tapped hole shall be used for each complete 15-cycle test. For each of the 15 cycles, bolts shall be assembled and seated to the assembly torque specified

Table 3. Screw Thread Insert Length Data ASME B18.29.2M-2005

Nominal Thread Size	1 × Diam.				1½ × Diam.				2 × Diam.				2½ × Diam.				3 × Diam.			
	Nominal	Assembled		C (Ref.)	Nominal	Assembled		C (Ref.)	Nominal	Assembled		C (Ref.)	Nominal	Assembled		C (Ref.)	Nominal	Assembled		C (Ref.)
		Max.	Min.			Max.	Min.			Max.	Min.			Max.	Min.			Max.	Min.	
M2 × 0.4	2.00	1.80	1.70	3.250	3.00	2.80	2.70	5.500	4.00	3.80	3.70	7.750	5.00	4.80	4.70	10.125	6.00	5.80	5.70	12.375
M2.5 × 0.45	2.50	2.28	2.16	3.575	3.80	3.52	3.41	5.750	5.00	4.78	4.66	8.125	6.30	6.02	5.91	10.500	7.50	7.28	7.16	12.750
M3 × 0.5	3.00	2.75	2.62	3.750	4.50	4.25	4.12	6.375	6.00	5.75	5.62	8.875	7.50	7.25	7.12	11.375	9.00	8.75	8.62	13.875
M3.5 × 0.6	3.50	3.20	3.05	3.750	5.30	5.00	4.80	6.375	7.00	6.70	6.55	8.750	8.80	8.50	8.30	11.375	10.50	10.20	10.05	13.750
M4 × 0.7	4.00	3.65	3.47	3.625	6.00	5.65	5.47	6.125	8.00	7.65	7.47	8.625	10.00	9.65	9.47	11.125	12.00	11.65	11.47	13.625
M5 × 0.8	5.00	4.60	4.40	4.125	7.50	7.10	6.90	6.875	10.00	9.60	9.40	9.625	12.50	12.10	11.90	12.375	15.00	14.60	14.40	15.125
M6 × 1	6.00	5.50	5.25	4.000	9.00	8.50	8.25	6.750	12.00	11.50	11.25	9.500	15.00	14.50	14.25	12.125	18.00	17.50	17.25	14.875
M7 × 1	7.00	6.50	6.25	4.875	10.50	10.00	9.75	8.000	14.00	13.50	13.25	11.125	17.50	17.00	16.75	14.125	21.00	20.50	20.25	17.250
M8 × 1	8.00	7.50	7.25	5.875	12.00	11.50	11.25	9.375	16.00	15.50	15.25	13.000	20.00	19.50	19.25	16.500	24.00	23.50	23.25	20.125
M8 × 1.25	8.00	7.38	7.06	4.500	12.00	11.38	11.06	7.375	16.00	15.38	15.06	10.250	20.00	19.38	19.06	13.250	24.00	23.38	23.06	16.125
M10 × 1	10.00	9.50	9.25	7.625	15.00	14.50	14.25	12.000	20.00	19.50	19.25	16.500	25.00	24.50	24.25	21.000	30.00	29.50	29.25	25.500
M10 × 1.25	10.00	9.38	9.06	5.875	15.00	14.38	14.06	9.500	20.00	19.38	19.06	13.125	25.00	24.38	24.06	16.750	30.00	29.38	29.06	20.375
M10 × 1.5	10.00	9.25	8.87	4.875	15.00	14.25	13.87	8.000	20.00	19.25	18.87	11.125	25.00	24.25	23.87	14.250	30.00	29.25	28.87	17.375
M12 × 1.25	12.00	11.38	11.06	7.250	18.00	17.38	17.06	11.625	24.00	23.38	23.06	15.875	30.00	29.38	29.06	20.250	36.00	35.38	35.06	24.500
M12 × 1.5	12.00	11.25	10.87	6.000	18.00	17.25	16.87	9.625	24.00	23.25	22.87	13.375	30.00	29.25	28.87	17.000	36.00	35.25	34.87	20.750
M12 × 1.75	12.00	11.12	10.68	5.000	18.00	17.12	16.68	8.250	24.00	23.12	22.68	11.500	30.00	29.12	28.68	14.625	36.00	35.12	34.68	17.875
M14 × 1.5	14.00	13.25	12.87	7.125	21.00	20.25	19.87	11.375	28.00	27.25	26.87	15.625	35.00	4.25	33.87	20.000	42.00	41.25	40.87	24.250
M14 × 2	14.00	13.00	12.50	5.125	21.00	20.00	19.50	8.500	28.00	27.00	26.50	11.750	35.00	34.00	33.50	15.000	42.00	41.00	40.50	18.375
M16 × 1.5	16.00	15.25	14.87	8.250	24.00	23.25	22.87	13.125	32.00	31.25	30.87	18.000	40.00	39.25	38.87	22.750	48.00	47.25	46.87	27.625
M16 × 2	16.00	15.00	14.50	6.125	24.00	23.00	22.50	9.750	32.00	31.00	30.50	13.500	40.00	39.00	38.50	17.250	48.00	47.00	46.50	21.000
M18 × 1.5	18.00	17.25	16.87	9.500	27.00	26.25	25.87	15.000	36.00	35.25	34.87	20.375	45.00	44.25	43.87	25.875	54.00	53.25	52.87	31.375
M18 × 2	18.00	17.00	16.50	7.000	27.00	26.00	25.50	11.125	36.00	35.00	34.50	15.375	45.00	44.00	43.50	19.500	54.00	53.00	52.50	23.625

HELICAL COIL SCREW THREAD INSERTS

Table 3. (Continued) Screw Thread Insert Length Data ASME B18.29.2M-2005

Nominal Thread Size	1 × Diam.				1½ × Diam.				2 × Diam.				2½ × Diam.				3 × Diam.			
	Nominal	Assembled		C (Ref.)	Nominal	Assembled		C (Ref.)	Nominal	Assembled		C (Ref.)	Nominal	Assembled		C (Ref.)	Nominal	Assembled		C (Ref.)
		Max.	Min.			Max.	Min.			Max.	Min.			Max.	Min.			Max.	Min.	
M18 × 2.5	18.00	16.75	16.12	5.375	27.00	25.75	25.12	8.875	36.00	34.75	34.12	12.250	45.00	43.75	43.12	15.625	54.00	52.75	52.12	19.000
M20 × 1.5	20.00	19.25	18.87	10.750	30.00	29.25	28.87	16.875	40.00	39.25	38.87	22.875	50.00	49.25	48.87	28.875	60.00	59.25	58.87	35.000
M20 × 2	20.00	19.00	18.50	7.875	30.00	29.00	28.50	12.500	40.00	39.00	38.50	17.250	50.00	49.00	48.50	21.875	60.00	59.00	58.50	26.500
M20 × 2.5	20.00	18.75	18.12	6.125	30.00	28.75	28.12	9.875	40.00	38.75	38.12	13.625	50.00	48.75	48.12	17.375	60.00	58.75	58.12	21.125
M22 × 1.5	22.00	21.25	20.87	11.875	33.00	32.25	31.87	18.500	44.00	43.25	42.87	25.125	55.00	54.25	53.87	31.625	66.00	65.25	64.87	38.250
M22 × 2	22.00	21.00	20.50	8.750	33.00	32.00	31.50	13.750	44.00	43.00	42.50	18.875	55.00	54.00	53.50	23.875	66.00	65.00	64.50	29.000
M22 × 2.5	22.00	20.75	20.12	6.750	33.00	31.75	31.12	10.875	44.00	42.75	42.12	14.875	55.00	53.75	53.12	19.000	66.00	64.75	64.12	23.125
M24 × 2	24.00	23.00	22.50	9.500	36.00	35.00	34.50	15.000	48.00	47.00	46.50	20.375	60.00	59.00	58.50	25.875	72.00	71.00	70.50	31.250
M24 × 3	24.00	22.50	21.75	6.125	36.00	34.50	33.75	10.000	48.00	46.50	45.75	13.750	60.00	58.50	57.75	17.500	72.00	70.50	69.75	21.375
M27 × 2	27.00	26.00	25.50	10.875	40.50	39.50	39.00	17.000	54.00	53.00	52.50	23.250	67.50	66.50	66.00	29.375	81.00	80.00	79.50	35.500
M27 × 3	27.00	25.50	24.75	7.000	40.50	39.00	38.25	11.250	54.00	52.50	51.75	15.500	67.50	66.50	65.25	19.750	81.00	79.50	78.75	24.000
M30 × 2	30.00	29.00	28.50	12.250	45.00	44.00	43.50	19.125	60.00	59.00	58.50	25.875	75.00	74.00	73.50	32.750	90.00	89.00	88.50	39.500
M30 × 3	30.00	28.50	27.75	7.875	45.00	43.50	42.75	12.500	60.00	58.50	57.75	17.125	75.00	73.50	72.75	21.875	90.00	88.50	87.75	26.500
M30 × 3.5	30.00	28.25	27.37	6.750	45.00	43.25	42.37	10.750	60.00	58.25	57.37	14.875	75.00	73.25	72.37	18.875	90.00	88.25	87.37	23.000
M33 × 2	33.00	32.00	31.50	13.625	49.50	48.50	48.00	21.125	66.00	65.00	64.50	28.625	82.50	81.50	81.00	35.000	99.00	98.00	97.50	43.500
M33 × 3	33.00	32.50	30.75	8.750	49.50	48.00	47.25	13.875	66.00	64.50	63.75	19.000	82.50	81.00	80.25	24.125	99.00	97.50	96.75	29.250
M36 × 2	36.00	35.00	34.50	15.000	54.00	53.00	52.50	23.250	72.00	71.00	70.50	31.375	90.00	89.00	88.50	39.500	108.00	107.00	106.50	47.750
M36 × 3	36.00	34.50	33.75	9.750	54.00	52.50	51.75	15.250	72.00	70.50	69.75	20.875	90.00	88.50	87.75	26.500	108.00	106.50	105.75	32.000
M36 × 4	36.00	34.00	33.00	7.125	54.00	52.00	51.00	11.375	72.00	70.00	69.00	15.625	90.00	88.00	87.00	19.875	108.00	106.00	105.00	24.250
M39 × 2	39.00	38.00	37.50	16.375	58.50	57.50	57.00	25.250	78.00	77.00	76.50	34.125	97.50	96.50	96.00	43.000	117.00	116.00	115.50	51.875
M39 × 3	39.00	37.50	36.75	10.750	58.50	57.00	56.25	15.750	78.00	76.50	75.75	22.750	97.50	96.00	95.25	28.875	117.00	115.50	114.75	34.875

Table 4. Screw Thread Insert Dimensions ASME B18.29.2M-2005

Nominal Thread Size	A, Min.	B		D		E		Gage, F	H		J		P		R, Min.	S, Min.	U		V, Max.
		Min.	Max.	Min.	Max.	Min.	Max.		Min.	Max.	Min.	Max.	Min.	Max.			Min.	Max.	
M2 × 0.4	0.074	2.50	2.70	0.389	0.433	0.274	0.350	0.200	0.2495	0.2600	2.50	2.70	1.30	1.90	0.072	0.125	0.66	0.37	0.22
M2.5 × 0.45	0.082	3.20	3.70	0.437	0.487	0.318	0.394	0.225	0.2820	0.2920	3.05	3.65	1.60	2.25	0.081	0.141	1.22	0.81	0.30
M3 × 0.5	0.105	3.80	4.35	0.482	0.541	0.352	0.438	0.250	0.3145	0.3250	3.60	4.30	1.95	2.80	0.090	0.156	1.33	0.56	0.30
M3.5 × 0.6	1.160	4.40	4.95	0.586	0.650	0.449	0.525	0.300	0.3795	0.3900	4.25	4.90	2.20	3.00	0.108	0.158	1.47	0.92	0.30
M4 × 0.7	0.163	5.05	5.60	0.683	0.758	0.510	0.612	0.350	0.4445	0.4550	4.90	5.55	2.50	3.55	0.126	0.219	1.67	1.02	0.45
M5 × 0.8	0.209	6.25	6.80	0.775	0.866	0.598	0.700	0.400	0.5085	0.5200	6.10	6.75	3.15	4.55	0.144	0.250	2.09	1.41	0.60
M6 × 1	0.267	7.40	7.95	0.975	1.083	0.748	0.875	0.500	0.6370	0.6500	7.25	7.90	3.70	4.85	0.180	0.312	2.55	1.65	0.60
M7 × 1	0.267	8.65	9.20	0.975	1.083	0.748	0.875	0.500	0.6370	0.6500	8.40	9.15	4.30	5.50	0.180	0.312	3.10	2.09	0.75
M8 × 1	0.267	9.70	10.25	0.975	1.083	0.748	0.875	0.500	0.6370	0.6500	9.20	9.65	4.75	6.50	0.180	0.312	3.58	2.27	0.75
M8 × 1.25	0.415	9.80	10.35	1.251	1.353	0.967	1.094	0.625	0.7990	0.8120	9.50	9.90	4.75	6.50	0.226	0.391	3.60	2.02	0.75
M10 × 1	0.267	11.95	12.50	0.975	1.083	0.748	0.875	0.500	0.6370	0.6500	11.10	11.55	5.50	8.00	0.180	0.312	4.90	2.95	0.75
M10 × 1.25	0.415	12.10	12.65	1.251	1.353	0.967	1.094	0.625	0.7990	0.8120	11.50	11.95	5.50	8.00	0.226	0.391	4.77	2.56	0.75
M10 × 1.5	0.511	11.95	12.50	1.522	1.624	1.160	1.312	0.750	0.9615	0.9740	11.80	12.25	5.50	8.00	0.271	0.469	4.54	2.56	0.75
M12 × 1.25	0.415	14.30	15.00	1.251	1.353	0.967	1.094	0.625	0.7990	0.8120	13.50	14.00	6.70	9.75	0.226	0.391	5.84	3.77	1.00
M12 × 1.5	0.511	14.25	14.95	1.522	1.624	1.160	1.312	0.750	0.9615	0.9740	13.80	14.30	6.70	9.75	0.271	0.469	5.58	3.50	1.20
M12 × 1.75	0.654	14.30	15.00	1.792	1.894	1.379	1.531	0.875	1.1240	1.1370	14.10	14.60	6.70	9.75	0.316	0.547	5.36	3.23	1.40
M14 × 1.5	0.511	16.55	17.25	1.522	1.624	1.160	1.312	0.750	0.9615	0.9740	15.80	16.30	7.20	11.25	0.271	0.469	6.76	4.34	1.15
M14 × 2	0.799	16.65	17.35	2.063	2.165	1.598	1.750	1.000	1.2865	1.2990	16.40	16.90	7.20	11.25	0.361	0.625	6.26	3.79	1.40
M16 × 1.5	0.511	18.90	19.60	1.522	1.624	1.160	1.312	0.750	0.9615	0.9740	17.80	18.30	8.30	12.75	0.271	0.469	7.78	5.32	1.45
M16 × 2	0.799	18.90	19.60	2.063	2.165	1.598	1.750	1.000	1.2865	1.2990	18.40	18.90	8.30	12.75	0.361	0.625	7.30	4.76	2.70
M18 × 1.5	0.511	21.05	21.75	1.522	1.624	1.160	1.312	0.750	0.9615	0.9740	19.80	20.35	9.30	14.00	0.271	0.469	8.83	6.26	1.75
M18 × 2	0.799	21.15	21.85	2.063	2.165	1.598	1.750	1.000	1.2865	1.2990	20.40	20.95	9.30	14.00	0.361	0.625	8.30	5.74	2.70

Table 4. (Continued) Screw Thread Insert Dimensions ASME B18.29.2M-2005

Nominal Thread Size	A, Min.	B		D		E		Gage, F	H		J		P		R, Min.	S, Min.	U		V, Max.
		Min.	Max.	Min.	Max.	Min.	Max.		Min.	Max.	Min.	Max.	Min.	Max.			Min.	Max.	
M18 × 2.5	1.017	21.30	22.00	2.604	2.706	1.998	2.188	1.250	1.6110	1.6240	20.90	21.45	9.30	14.00	0.451	0.781	7.79	5.20	2.85
M20 × 1.5	0.511	23.15	24.00	1.522	1.624	1.160	1.312	0.750	0.9615	0.9740	21.80	22.50	10.40	14.50	0.271	0.469	9.77	7.19	2.85
M20 × 2	0.799	23.20	24.05	2.063	2.165	1.598	1.750	1.000	1.2865	1.2990	22.40	23.10	10.40	14.50	0.361	0.625	9.40	6.65	2.85
M20 × 2.5	1.017	23.55	24.40	2.604	2.706	1.998	2.188	1.250	1.6110	1.6240	22.90	23.60	10.40	14.50	0.451	0.781	8.89	6.11	2.85
M20 × 1.5	0.511	23.15	24.00	1.522	1.624	1.160	1.312	0.750	0.9615	0.9740	24.10	24.80	11.40	16.00	0.271	0.469	11.10	8.01	2.85
M22 × 2	0.799	25.60	26.50	2.063	2.165	1.598	1.750	1.000	1.2865	1.2990	24.40	25.10	11.40	16.00	0.361	0.625	10.45	7.61	2.85
M22 × 2.5	1.017	25.90	26.90	2.604	2.706	1.998	2.188	1.250	1.6110	1.6240	24.90	25.60	11.40	16.00	0.451	0.781	9.94	7.07	2.85
M24 × 2	0.799	28.10	29.10	2.063	2.165	1.598	1.750	1.000	1.2865	1.2990	26.40	27.10	12.50	16.50	0.361	0.625	11.48	8.60	2.85
M24 × 3	1.234	28.00	29.00	3.146	3.248	2.396	2.625	1.500	1.9360	1.9485	27.50	28.20	12.50	16.50	0.541	0.938	10.45	7.51	2.85
M27 × 2	0.799	31.30	32.30	2.063	2.165	1.598	1.750	1.000	1.2865	1.2990	29.40	30.10	14.00	17.50	0.361	0.625	13.14	9.93	2.85
M27 × 3	1.234	31.40	32.40	3.146	3.248	2.396	2.625	1.500	1.9360	1.9485	30.50	31.20	14.00	17.50	0.541	0.938	12.13	8.85	2.85
M30 × 2	0.799	34.50	35.70	2.063	2.165	1.598	1.750	1.000	1.2865	1.2990	32.50	33.20	15.00	19.00	0.361	0.625	14.81	11.26	2.85
M30 × 3	1.234	34.90	36.10	3.146	3.248	2.396	2.625	1.500	1.9360	1.9485	33.50	34.20	15.00	19.00	0.541	0.938	13.65	10.32	2.85
M30 × 3.5	1.451	34.90	36.10	3.687	3.789	2.833	3.062	1.750	2.2605	2.2750	34.10	34.60	15.00	19.00	0.631	1.094	13.13	9.65	2.85
M33 × 2	0.799	37.80	39.20	2.063	2.165	1.598	1.750	1.000	1.2865	1.2990	35.80	36.50	17.00	21.00	0.361	0.625	16.35	12.74	2.85
M33 × 3	1.234	38.10	39.50	3.146	3.248	2.396	2.625	1.500	1.9360	1.9485	36.50	37.20	17.00	21.00	0.541	0.938	15.19	11.78	2.85
M36 × 2	0.799	41.00	42.40	2.063	2.165	1.598	1.750	1.000	1.2865	1.2990	39.00	39.70	18.50	22.50	0.361	0.625	17.77	14.29	2.85
M36 × 3	1.234	41.30	42.70	3.146	3.248	2.396	2.625	1.500	1.9360	1.9485	39.50	40.20	18.50	22.50	0.541	0.938	16.73	13.23	2.85
M36 × 4	1.688	41.50	42.90	4.228	4.330	3.271	3.500	2.000	2.5855	2.5980	40.60	41.10	18.50	22.50	0.722	1.250	15.57	12.12	2.85
M39 × 2	0.799	44.30	45.70	2.063	2.165	1.598	1.750	1.000	1.2865	1.2990	42.30	43.00	20.00	24.00	0.361	0.625	19.28	15.77	2.85
M39 × 3	1.234	44.40	45.80	3.146	3.248	2.396	2.625	1.500	1.9360	1.9485	42.50	43.20	20.00	24.00	0.541	0.938	18.28	14.68	2.85

in **Table 5**. Bolts shall be completely disengaged from the locking coils of the insert at the end of each cycle. The test shall be run at less than 40 rpm to yield a dependable measure of torque and avoid heating of the bolt.

Maximum Locking Torque: Maximum locking torque shall be the highest torque value encountered on any installation or removal cycle and shall not exceed the values specified in **Table 5**. Maximum locking torque readings shall be taken on the first and seventh installation cycles before the assembly torque is applied and on the 15th removal cycle.

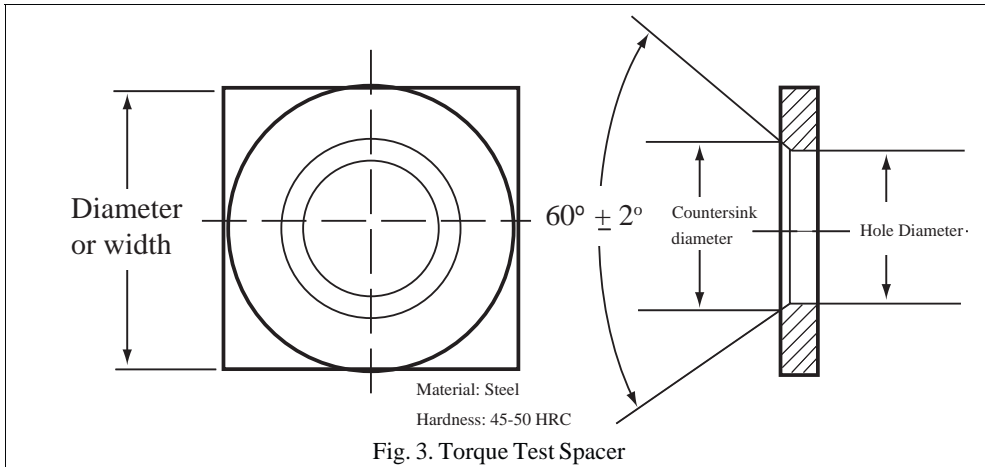
Table 5. Self Locking Torque ASME B18.29.2M-2005

Nominal Thread Size	Maximum Locking Torque Installation or Removal, N-m	Minimum Breakaway Torque, N-m	Nominal Thread Size	Maximum Locking Torque Installation or Removal, N-m	Minimum Breakaway Torque, N-m
M2 × 0.4	0.12	0.03	M18 × 1.5	42	5.5
M2.5 × 0.45	0.22	0.06	M18 × 2	42	5.5
M3 × 0.5	0.44	0.1	M18 × 2.5	42	5.5
M3.5 × 0.6	0.68	0.12	M20 × 1.5	54	7
M4 × 0.7	0.9	0.16	M20 × 2	54	7
M5 × 0.8	1.6	0.3	M20 × 2.5	54	7
M6 × 1	3	0.4	M22 × 1.5	70	9
M7 × 1	4.4	0.6	M22 × 2	70	9
M8 × 1	6	0.8	M22 × 2.5	70	9
M8 × 1.25	6	0.8	M24 × 2	80	11
M10 × 1	10	1.4	M24 × 3	80	11
M10 × 1.25	10	1.4	M27 × 2	95	12
M10 × 1.5	10	1.4	M27 × 3	95	12
M12 × 1.25	15	2.2	M30 × 2	110	14
M12 × 1.5	15	2.2	M30 × 3	110	14
M12 × 1.75	15	2.2	M30 × 3.5	110	14
M14 × 1.5	23	3	M33 × 2	125	16
M14 × 2	23	3	M33 × 3	125	16
M16 × 1.5	32	4.2	M36 × 2	140	18
M16 × 2	32	4.2	M36 × 3	140	18
...	M36 × 4	140	18
...	M39 × 2	150	20
...	M39 × 3	150	20

Minimum Breakaway Torque: Minimum breakaway torque shall be the torque required to overcome static friction when 100% of the locking feature is engaged and the bolt or screw is not seated (no axial load). It shall be recorded at the start of the 15th removal cycle. The torque value for any cycle shall be not less than the applicable value shown in **Table 5**.

Acceptance: The inserts shall be considered to have failed if, at the completion of any of the tests and inspection, any of the following conditions exist:

- a) any break or crack in the insert
- b) installation or removal torque exceeds the maximum locking torque value in **Table 5**
- c) breakaway torque less than the values in **Table 5**
- d) movement of the insert beyond 90° relative to the top surface when installing or removing the test bolt
- e) seizure or galling of the insert or test bolt
- f) tang not broken off, which interferes with the test bolt at installation
- g) tang breaks off during insert installation

Table 6. Torque Test Spacer Dimensions ASME B18.29.2M-2005

Nominal Insert Size	Minimum Diameter or Width	Hole Diameter		Countersink Diameter		Minimum Thickness
		Max.	Min.	Max.	Min.	
2	7.0	2.3	2.1	2.7	2.5	1.5
2.5	8.0	2.8	2.6	3.3	3.1	1.5
3	9.0	3.5	3.3	3.8	3.6	2.0
3.5	10.0	4.0	3.8	4.3	4.1	2.0
4	11.0	4.5	4.3	4.9	4.7	3.0
5	12.0	5.5	5.3	5.9	5.7	3.0
6	14.0	6.5	6.3	7.0	6.8	3.5
7	17.0	7.6	7.3	8.4	8.2	3.5
8	19.0	8.6	8.3	9.5	9.2	4.0
10	23.0	10.7	10.4	11.5	11.2	4.0
12	27.0	12.7	12.4	14.5	14.2	4.5
14	31.0	14.8	14.4	16.5	16.2	4.5
16	35.0	16.8	16.4	18.5	18.2	4.5
18	39.0	18.8	18.4	20.7	20.4	4.5
20	43.0	20.8	20.4	22.7	22.4	5.0
22	47.0	22.8	22.4	24.7	24.4	5.0
24	51.0	24.8	24.4	26.7	26.4	5.0
27	56.0	28.3	27.9	29.8	29.4	5.0
30	62.0	31.3	30.9	33.8	33.4	6.0
33	67.0	34.3	33.9	36.8	36.4	6.0
36	72.0	37.3	36.9	39.8	39.4	6.0
39	77.0	40.3	39.9	42.8	42.4	6.0

Insert Length Selection

Engaged Length of Bolt.—Normally, the engaged length of bolt in an insert is determined by strength considerations.

Material Strengths.—The standard engineering practice of balancing the tensile strength of the bolt material against the shear strength of the parent or boss material also applies to helical coil inserts. Tables 7 and 8 will aid in developing the full load value of the bolt rather than stripping the parent or tapped material.

In using this table, the following factors must be considered:

a) The parent material shear strengths are for room temperature. Elevated temperatures call for significant shear value reductions; compensation should be made when required. Shear values are appropriate because the parent material is subject to shearing stress at the major diameter of the tapped threads.

b) When parent material shear strength falls between two tabulated values, use the lower of the two.

c) Bolt thread length; overall length, insert length, and full tapped thread depth must be adequate to ensure full-thread engagement when assembled to comply with its design function.

Table 7. Insert Length Selection ASME B18.29.2M-2005

Parent Material Shear Strength, MPa	Bolt Property Class						
	4.6	4.8	5.8	8.8	9.8	10.9	12.9
	Insert Length in Terms of Diameters						
70	3	3	3
100	2	2	2	3
150	1.5	1.5	1.5	2	2.5	2.5	3
200	1.5	1.5	1.5	2	2	2	2
250	1	1	1	1.5	1.5	1.5	1.5
300	1	1	1	1.5	1.5	1.5	1.5
350	1	1	1	1	1	1.5	1.5

Table 8. Hardness Number Conversion ASME B18.29.2M-2005

Bolt Property Class	Max. Rockwell Hardness	Max. Tensile Strength, MPa	Bolt Property Class	Max. Rockwell Hardness	Max. Tensile Strength, MPa
4.6	95 HRB	705	9.8	36 HRC	1115
4.8	95 HRB	705	10.9	39 HRC	1215
5.8	95 HRB	705	12.9	44 HRC	1435
8.8	34 HRC	1055			

Bolt strength upon which insert length recommendations are based is developed by taking the maximum hardness per ASTM F568M *Carbon and Alloy Steel Externally Threaded Metric Fasteners* and the equivalent tensile strength from SAE J417 *Hardness Tests and Hardness Number Conversions*.

Screw Thread Insert Taps.—ASME B94.9 covers design and dimensions for taps for producing Metric Series STI-threaded holes required for the installation of helical coil screw thread inserts. Threaded hole dimensions are shown in Table 1 of this standard. Helical coil screw thread insert taps are identified by the designation STI. Various types and styles of STI taps are available. General dimensions and tolerances are in accordance with ASME B94.9.

Tap Thread Limits: Ground thread taps are recommended for screw thread inserts. Tap thread limits are in accordance with ASME B94.9. Basic pitch diameter used for determining values is the “Pitch Diameter, min.” from Table 1.

Marking: Taps are marked in accordance with ASME B94.9.

Example: M6 × 1 STI HS G H2.

BRITISH FASTENERS

British Standard Square and Hexagon Bolts, Screws and Nuts.—Important dimensions of precision hexagon bolts, screws and nuts (BSW and BSF threads) as covered by British Standard 1083:1965 are given in [Tables 1](#) and [2](#). The use of fasteners in this standard will decrease as fasteners having Unified inch and ISO metric threads come into increasing use.

Dimensions of Unified precision hexagon bolts, screws and nuts (UNC and UNF threads) are given in BS 1768:1963 (obsolescent); of Unified black hexagon bolts, screws and nuts (UNC and UNF threads) in BS 1769:1951 (obsolescent); and of Unified black square and hexagon bolts, screws and nuts (UNC and UNF threads) in BS 2708:1956 (withdrawn). Unified nominal and basic dimensions in these British Standards are the same as the comparable dimensions in the American Standards, but the tolerances applied to these basic dimensions may differ because of rounding-off practices and other factors. For Unified dimensions of square and hexagon bolts and nuts as given in ANSI/ASME B18.2.1-1996 and ANSI/ASME B18.2.2-1987 (R2005) see [Tables 1](#) through [4](#) starting on page [1540](#), and [7](#) to [10](#) starting on page [1545](#).

ISO metric precision hexagon bolts, screws and nuts are specified in the British Standard BS 3692:1967 (obsolescent) (see *British Standard ISO Metric Precision Hexagon Bolts, Screws and Nuts* starting on page [1634](#)), and ISO metric black hexagon bolts, screws and nuts are covered by British Standard BS 4190:1967 (obsolescent).

See the section *MACHINE SCREWS AND NUTS* starting on page [1643](#) for information on British Standard metric, Unified, Whitworth, and BSF machine screws and nuts.

British Standard Screwed Studs.—General purpose screwed studs are covered in British Standard 2693: Part 1:1956. The aim in this standard is to provide for a stud having tolerances which would not render it expensive to manufacture and which could be used in association with standard tapped holes for most purposes. Provision has been made for the use of both Unified Fine threads, Unified Coarse threads, British Standard Fine threads, and British Standard Whitworth threads as shown in the table on page [1629](#).

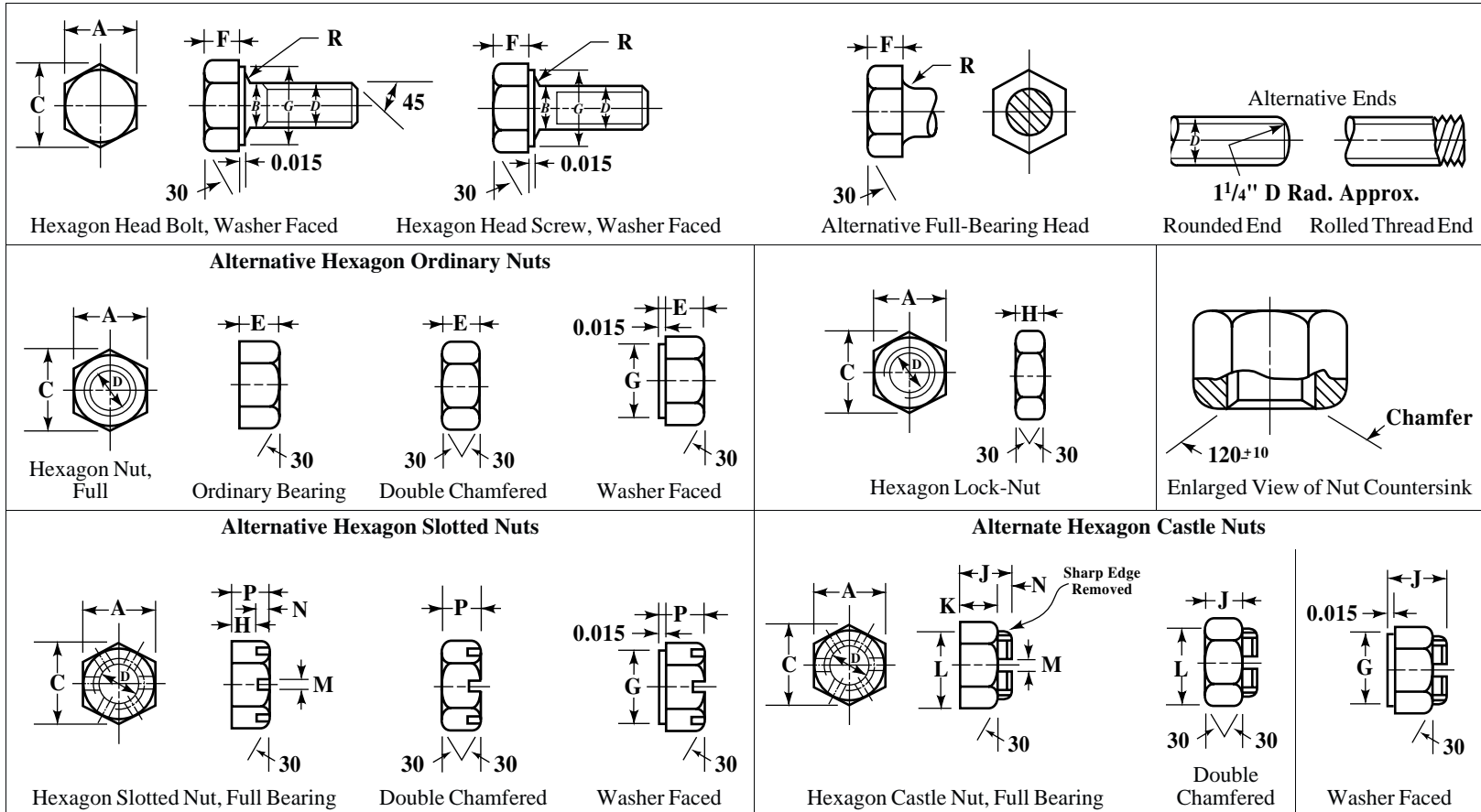
Designations: The *metal end* of the stud is the end which is screwed into the component. The *nut end* is the end of the screw of the stud which is not screwed into the component. The *plain portion* of the stud is the unthreaded length.

Recommended Fitting Practices for Metal End of Stud: It is recommended that holes tapped to Class 3B limits (see [Table 3](#), page [1817](#)) in accordance with B.S. 1580 “Unified Screw Threads” or to Close Class limits in accordance with B.S. 84 “Screw Threads of Whitworth Form” as appropriate, be used in association with the metal end of the stud specified in this standard. Where fits are not critical, however, holes may be tapped to Class 2B limits (see table on page [1817](#)) in accordance with B.S. 1580 or Normal Class limits in accordance with B.S. 84.

It is recommended that the B.A. stud specified in this standard be associated with holes tapped to the limits specified for nuts in B.S. 93, 1919 edition. Where fits for these studs are not critical, holes may be tapped to limits specified for nuts in the current edition of B.S. 93.

In general, it will be found that the amount of oversize specified for the studs will produce a satisfactory fit in conjunction with the standard tapping as above. Even when interference is not present, locking will take place on the thread runout which has been carefully controlled for this purpose. Where it is considered essential to assure a true interference fit, higher grade studs should be used. It is recommended that standard studs be used even under special conditions where selective assembly may be necessary.

British Standard Whitworth (BSW) and Fine (BSF) Precision Hexagon Bolts, Screws, and Nuts



For dimensions, see [Tables 1](#) and [2](#).

Table 1. British Standard Whitworth (BSW) and Fine (BSF) Precision Hexagon Slotted and Castle Nuts BS 1083:1965 (obsolescent)

Nominal Size <i>D</i>	Number of Threads per Inch		Bolts, Screws, and Nuts					Bolts and Screws						Nuts			
			Width			Diameter of Washer Face <i>G</i>	Radius Under Head <i>R</i>		Diameter of Unthreaded Portion of Shank <i>B</i>		Thickness		Thickness				
			Across Flats <i>A</i>	Across Corners <i>C</i>	Max.						Min. ^a	Max.	Max.	Min.	Max.	Min.	Max.
	Max.	Min.				Max.	Min.	Max.	Min.								
¼	20	26	0.445	0.438	0.51	0.428	0.418	0.025	0.015	0.2500	0.2465	0.176	0.166	0.200	0.190	0.185	0.180
⅕	18	22	0.525	0.518	0.61	0.508	0.498	0.025	0.015	0.3125	0.3090	0.218	0.208	0.250	0.240	0.210	0.200
⅜	16	20	0.600	0.592	0.69	0.582	0.572	0.025	0.015	0.3750	0.3715	0.260	0.250	0.312	0.302	0.260	0.250
⅞	14	18	0.710	0.702	0.82	0.690	0.680	0.025	0.015	0.4375	0.4335	0.302	0.292	0.375	0.365	0.275	0.265
½	12	16	0.820	0.812	0.95	0.800	0.790	0.025	0.015	0.5000	0.4960	0.343	0.333	0.437	0.427	0.300	0.290
⅝	12	16	0.920	0.912	1.06	0.900	0.890	0.045	0.020	0.5625	0.5585	0.375	0.365	0.500	0.490	0.333	0.323
⅝	11	14	1.010	1.000	1.17	0.985	0.975	0.045	0.020	0.6250	0.6190	0.417	0.407	0.562	0.552	0.375	0.365
¾	10	12	1.200	1.190	1.39	1.175	1.165	0.045	0.020	0.7500	0.7440	0.500	0.480	0.687	0.677	0.458	0.448
⅞	9	11	1.300	1.288	1.50	1.273	1.263	0.065	0.040	0.8750	0.8670	0.583	0.563	0.750	0.740	0.500	0.490
1	8	10	1.480	1.468	1.71	1.453	1.443	0.095	0.060	1.0000	0.9920	0.666	0.636	0.875	0.865	0.583	0.573
1⅛	7	9	1.670	1.640	1.93	1.620	1.610	0.095	0.060	1.1250	1.1170	0.750	0.710	1.000	0.990	0.666	0.656
1¼	7	9	1.860	1.815	2.15	1.795	1.785	0.095	0.060	1.2500	1.2420	0.830	0.790	1.125	1.105	0.750	0.730
1⅜ ^b	...	8	2.050	2.005	2.37	1.985	1.975	0.095	0.060	1.3750	1.3650	0.920	0.880	1.250	1.230	0.833	0.813
1½	6	8	2.220	2.175	2.56	2.155	2.145	0.095	0.060	1.5000	1.4900	1.000	0.960	1.375	1.355	0.916	0.896
1¾	5	7	2.580	2.520	2.98	2.495	2.485	0.095	0.060	1.7500	1.7400	1.170	1.110	1.625	1.605	1.083	1.063
2	4.5	7	2.760	2.700	3.19	2.675	2.665	0.095	0.060	2.0000	1.9900	1.330	1.270	1.750	1.730	1.166	1.146

^aWhen bolts from ¼ to 1 inch are hot forged, the tolerance on the width across flats shall be two and a half times the tolerance shown in the table and shall be unilaterally minus from maximum size. For dimensional notation, see diagram on page 1627.

^bNoted standard with BSW thread.

All dimensions in inches except where otherwise noted.

Table 2. British Standard Whitworth (BSW) and Fine (BSF) Precision Hexagon Slotted and Castle Nuts BS 1083:1965 (obsolescent)

Nominal Size <i>D</i>	Number of Threads per Inch		Slotted Nuts				Castle Nuts						Slotted and Castle Nuts		
			Thickness <i>P</i>		Lower Face to Bottom of Slot <i>H</i>		Total Thickness <i>J</i>		Lower Face to Bottom of Slot <i>K</i>		Castellated Portion		Slots		
											Diameter <i>L</i>		Width <i>M</i>		Depth <i>N</i>
	BSW	BSF	Max.	Min.	Max.	Min.	Max.	Min.	Max.	Min.	Max.	Min.	Max.	Min.	Approx.
1/4	20	26	0.200	0.190	0.170	0.160	0.290	0.280	0.200	0.190	0.430	0.425	0.100	0.090	0.090
5/16	18	22	0.250	0.240	0.190	0.180	0.340	0.330	0.250	0.240	0.510	0.500	0.100	0.090	0.090
3/8	16	20	0.312	0.302	0.222	0.212	0.402	0.392	0.312	0.302	0.585	0.575	0.100	0.090	0.090
7/16	14	18	0.375	0.365	0.235	0.225	0.515	0.505	0.375	0.365	0.695	0.685	0.135	0.125	0.140
1/2	12	16	0.437	0.427	0.297	0.287	0.577	0.567	0.437	0.427	0.805	0.795	0.135	0.125	0.140
9/16	12	16	0.500	0.490	0.313	0.303	0.687	0.677	0.500	0.490	0.905	0.895	0.175	0.165	0.187
5/8	11	14	0.562	0.552	0.375	0.365	0.749	0.739	0.562	0.552	0.995	0.985	0.175	0.165	0.187
3/4	10	12	0.687	0.677	0.453	0.443	0.921	0.911	0.687	0.677	1.185	1.165	0.218	0.208	0.234
7/8	9	11	0.750	0.740	0.516	0.506	0.984	0.974	0.750	0.740	1.285	1.265	0.218	0.208	0.234
1	8	10	0.875	0.865	0.595	0.585	1.155	1.145	0.875	0.865	1.465	1.445	0.260	0.250	0.280
1 1/8	7	9	1.000	0.990	0.720	0.710	1.280	1.270	1.000	0.990	1.655	1.635	0.260	0.250	0.280
1 1/4	7	9	1.125	1.105	0.797	0.777	1.453	1.433	1.125	1.105	1.845	1.825	0.300	0.290	0.328
1 3/8 ^a	...	8	1.250	1.230	0.922	0.902	1.578	1.558	1.250	1.230	2.035	2.015	0.300	0.290	0.328
1 1/2	6	8	1.375	1.355	1.047	1.027	1.703	1.683	1.375	1.355	2.200	2.180	0.300	0.290	0.328
1 3/4	5	7	1.625	1.605	1.250	1.230	2.000	1.980	1.625	1.605	2.555	2.535	0.343	0.333	0.375
2	4.5	7	1.750	1.730	1.282	1.262	2.218	2.198	1.750	1.730	2.735	2.715	0.426	0.416	0.468

^aNot standard with BSW thread. For widths across flats, widths across corners, and diameter of washer face see Table 1. For dimensional notation, see diagram on page 1627.

All dimensions in inches except where otherwise noted.

Table 3. British Standard ISO Metric Precision Hexagon Bolts, Screws and Nuts
BS 3692:1967 (obsolescent)

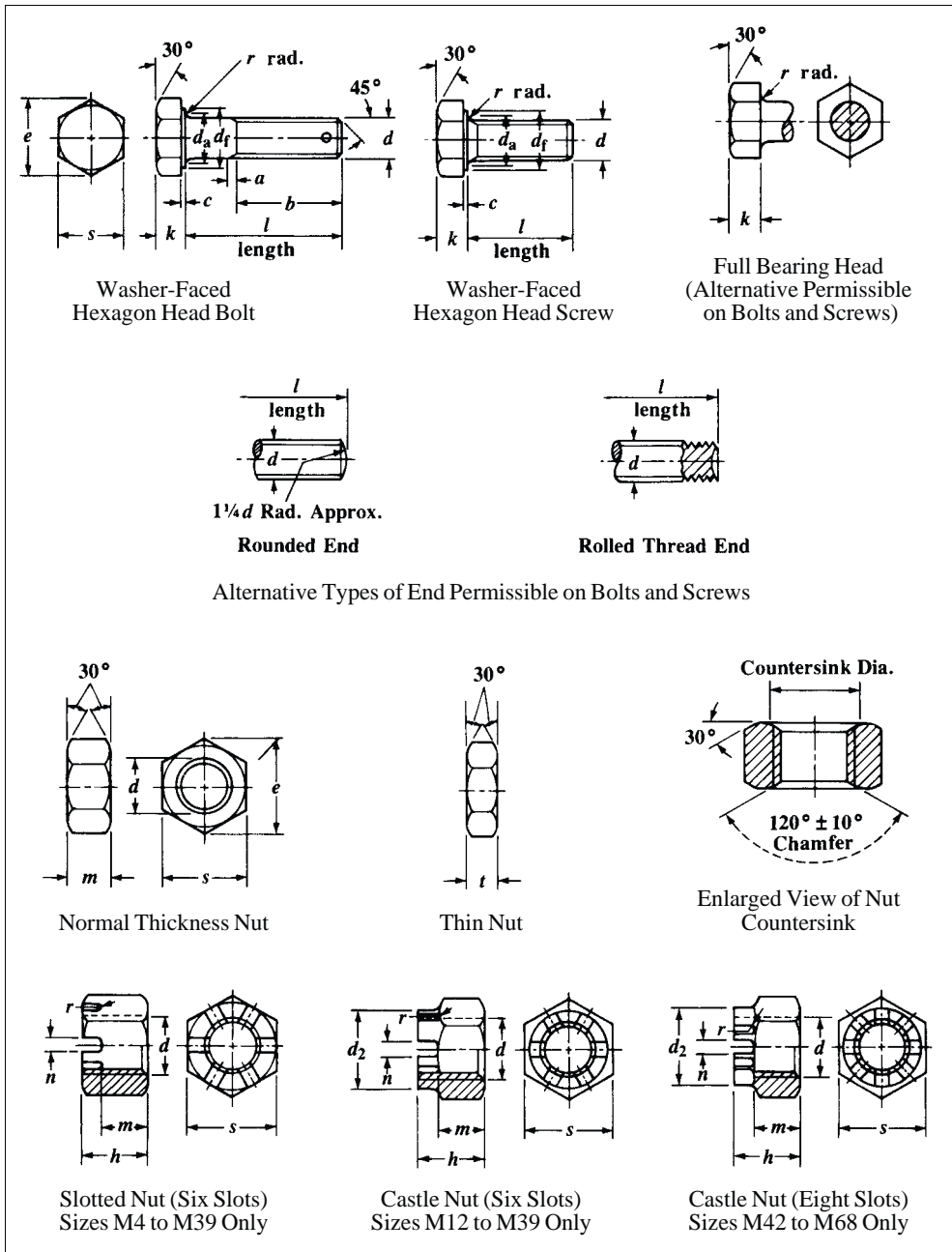


Table 4. British Standard ISO Metric Precision Hexagon Bolts and Screws BS 3692:1967 (obsolescent)

Nom. Size and Thread Dia. ^a <i>d</i>	Pitch of Thread (Coarse Pitch-Series)	Thread Runout <i>a</i>	Dia. of Unthreaded Shank <i>d</i>		Width Across Flats <i>s</i>		Width Across Corners <i>e</i>		Dia. of Washer Face <i>d_f</i>		Depth of Washer Face <i>c</i>	Transition Dia. ^b <i>d_t</i>	Radius Under Head ^b <i>r</i>		Height of Head <i>k</i>		Eccentricity of Head	Eccentricity of Shank and Split Pin Hole to the Thread
			Max.	Min.	Max.	Min.	Max.	Min.	Max.	Min.			Max.	Min.	Max.	Min.		
			Max.	Min.	Max.	Min.	Max.	Min.	Max.	Min.			Max.	Min.	Max.	Min.		
M1.6	0.35	0.8	1.6	1.46	3.2	3.08	3.7	3.48	2.0	0.2	0.1	1.225	0.975	0.18	0.14
M2	0.4	1.0	2.0	1.86	4.0	3.88	4.6	4.38	2.6	0.3	0.1	1.525	1.275	0.18	0.14
M2.5	0.45	1.0	2.5	2.36	5.0	4.88	5.8	5.51	3.1	0.3	0.1	2.125	1.875	0.18	0.14
M3	0.5	1.2	3.0	2.86	5.5	5.38	6.4	6.08	5.08	4.83	0.1	3.6	0.3	0.1	2.125	1.875	0.18	0.14
M4	0.7	1.6	4.0	3.82	7.0	6.85	8.1	7.74	6.55	6.30	0.1	4.7	0.35	0.2	2.925	2.675	0.22	0.18
M5	0.8	2.0	5.0	4.82	8.0	7.85	9.2	8.87	7.55	7.30	0.2	5.7	0.35	0.2	3.650	3.35	0.22	0.18
M6	1	2.5	6.0	5.82	10.0	9.78	11.5	11.05	9.48	9.23	0.3	6.8	0.4	0.25	4.15	3.85	0.22	0.18
M8	1.25	3.0	8.0	7.78	13.0	12.73	15.0	14.38	12.43	12.18	0.4	9.2	0.6	0.4	5.65	5.35	0.27	0.22
M10	1.5	3.5	10.0	9.78	17.0	16.73	19.6	18.90	16.43	16.18	0.4	11.2	0.6	0.4	7.18	6.82	0.27	0.22
M12	1.75	4.0	12.0	11.73	19.0	18.67	21.9	21.10	18.37	18.12	0.4	14.2	1.1	0.6	8.18	7.82	0.33	0.27
(M14)	2	5.0	14.0	13.73	22.0	21.67	25.4	24.49	21.37	21.12	0.4	16.2	1.1	0.6	9.18	8.82	0.33	0.27
M16	2	5.0	16.0	15.73	24.0	23.67	27.7	26.75	23.27	23.02	0.4	18.2	1.1	0.6	10.18	9.82	0.33	0.27
(M18)	2.5	6.0	18.0	17.73	27.0	26.67	31.2	30.14	26.27	26.02	0.4	20.2	1.1	0.6	12.215	11.785	0.33	0.27
M20	2.5	6.0	20.0	19.67	30.0	29.67	34.6	33.53	29.27	28.80	0.4	22.4	1.2	0.8	13.215	12.785	0.33	0.33
(M22)	2.5	6.0	22.0	21.67	32.0	31.61	36.9	35.72	31.21	30.74	0.4	24.4	1.2	0.8	14.215	13.785	0.39	0.33
M24	3	7.0	24.0	23.67	36.0	35.38	41.6	39.98	34.98	34.51	0.5	26.4	1.2	0.8	15.215	14.785	0.39	0.33
(M27)	3	7.0	27.0	26.67	41.0	40.38	47.3	45.63	39.98	39.36	0.5	30.4	1.7	1.0	17.215	16.785	0.39	0.33
M30	3.5	8.0	30.0	29.67	46.0	45.38	53.1	51.28	44.98	44.36	0.5	33.4	1.7	1.0	19.26	18.74	0.39	0.33
(M33)	3.5	8.0	33.0	32.61	50.0	49.38	57.7	55.80	48.98	48.36	0.5	36.4	1.7	1.0	21.26	20.74	0.39	0.39
M36	4	10.0	36.0	35.61	55.0	54.26	63.5	61.31	53.86	53.24	0.5	39.4	1.7	1.0	23.26	22.74	0.46	0.39
(M39)	4	10.0	39.0	38.61	60.0	59.26	69.3	66.96	58.86	58.24	0.6	42.4	1.7	1.0	25.26	24.74	0.46	0.39
M42	4.5	11.0	42.0	41.61	65.0	64.26	75.1	72.61	63.76	63.04	0.6	45.6	1.8	1.2	26.26	25.74	0.46	0.39
(M45)	4.5	11.0	45.0	44.61	70.0	69.26	80.8	78.26	68.76	68.04	0.6	48.6	1.8	1.2	28.26	27.74	0.46	0.39
M48	5	12.0	48.0	47.61	75.0	74.26	86.6	83.91	73.76	73.04	0.6	52.6	2.3	1.6	30.26	29.74	0.46	0.39
(M52)	5	12.0	52.0	51.54	80.0	79.26	92.4	89.56	56.6	2.3	1.6	33.31	32.69	0.46	0.46
M56	5.5	19.0	56.0	55.54	85.0	84.13	98.1	95.07	63.0	3.5	2.0	35.31	34.69	0.54	0.46
(M60)	5.5	19.0	60.0	59.54	90.0	89.13	103.9	100.72	67.0	3.5	2.0	38.31	37.69	0.54	0.46
M64	6	21.0	64.0	63.54	95.0	94.13	109.7	106.37	71.0	3.5	2.0	40.31	39.69	0.54	0.46
(M68)	6	21.0	68.0	67.54	100.0	99.13	115.5	112.02	75.0	3.5	2.0	43.31	42.69	0.54	0.46

^a Sizes shown in parentheses are non-preferred.

^b A true radius is not essential provided that the curve is smooth and lies wholly within the maximum radius, determined from the maximum transitional diameter, and the minimum radius specified.

All dimensions are in millimeters. For illustration of bolts and screws see [Table 3](#).

Table 5. British Standard ISO Metric Precision Hexagon Nuts and Thin Nuts BS 3692:1967 (obsolescent)

Nominal Size and Thread Diameter ^a <i>d</i>	Pitch of Thread (Coarse Pitch Series)	Width Across Flats <i>s</i>		Width Across Corners <i>e</i>		Thickness of Normal Nut <i>m</i>		Tolerance on Squareness of Thread to Face of Nut ^b	Eccentricity of Hexagon	Thickness of Thin Nut <i>t</i>	
		Max.	Min.	Max.	Min.	Max.	Min.	Max.	Max.	Max.	Min.
M1.6	0.35	3.20	3.08	3.70	3.48	1.30	1.05	0.05	0.14
M2	0.4	4.00	3.88	4.60	4.38	1.60	1.35	0.06	0.14
M2.5	0.45	5.00	4.88	5.80	5.51	2.00	1.75	0.08	0.14
M3	0.5	5.50	5.38	6.40	6.08	2.40	2.15	0.09	0.14
M4	0.7	7.00	6.85	8.10	7.74	3.20	2.90	0.11	0.18
M5	0.8	8.00	7.85	9.20	8.87	4.00	3.70	0.13	0.18
M6	1	10.00	9.78	11.50	11.05	5.00	4.70	0.17	0.18
M8	1.25	13.00	12.73	15.00	14.38	6.50	6.14	0.22	0.22	5.0	4.70
M10	1.5	17.00	16.73	19.60	18.90	8.00	7.64	0.29	0.22	6.0	5.70
M12	1.75	19.00	18.67	21.90	21.10	10.00	9.64	0.32	0.27	7.0	6.64
(M14)	2	22.00	21.67	25.4	24.49	11.00	10.57	0.37	0.27	8.0	7.64
M16	2	24.00	23.67	27.7	6.75	13.00	12.57	0.41	0.27	8.0	7.64
(M18)	2.5	27.00	26.67	31.20	30.14	15.00	14.57	0.46	0.27	9.0	8.64
M20	2.5	30.00	29.67	34.60	33.53	16.00	15.57	0.51	0.33	9.0	8.64
(M22)	2.5	32.00	31.61	36.90	35.72	18.00	17.57	0.54	0.33	10.0	9.64
M24	3	36.00	35.38	41.60	39.98	19.00	18.48	0.61	0.33	10.0	9.64
(M27)	3	41.00	40.38	47.3	45.63	22.00	21.48	0.70	0.33	12.0	11.57
M30	3.5	46.00	45.38	53.1	51.28	24.00	23.48	0.78	0.33	12.0	11.57
(M33)	3.5	50.00	49.38	57.70	55.80	26.00	25.48	0.85	0.39	14.0	13.57
M36	4	55.00	54.26	63.50	61.31	29.00	28.48	0.94	0.39	14.0	13.57
(M39)	4	60.00	59.26	69.30	66.96	31.00	30.38	1.03	0.39	16.0	15.57
M42	4.5	65.00	64.26	75.10	72.61	34.00	33.38	1.11	0.39	16.0	15.57
(M45)	4.5	70.00	69.26	80.80	78.26	36.00	35.38	1.20	0.39	18.0	17.57
M48	5	75.00	74.26	86.60	83.91	38.00	37.38	1.29	0.39	18.0	17.57
(M52)	5	80.00	79.26	92.40	89.56	42.00	41.38	1.37	0.46	20.0	19.48
M56	5.5	85.00	84.13	98.10	95.07	45.00	44.38	1.46	0.46
(M60)	5.5	90.00	89.13	103.90	100.72	48.00	47.38	1.55	0.46
M64	6	95.00	94.13	109.70	106.37	51.00	50.26	1.63	0.46
(M68)	6	100.00	99.13	115.50	112.02	54.00	53.26	1.72	0.46

^a Sizes shown in parentheses are non-preferred.

^b As measured with the nut squareness gage described in the text and illustrated in Appendix A of the Standard and a feeler gage.

All dimensions are in millimeters. For illustration of hexagon nuts and thin nuts see [Table 3](#).

Table 6. British Standard ISO Metric Precision Hexagon Slotted Nuts and Castle Nuts BS 3692:1967 (obsolescent)

Nominal Size and Thread Diameter ^a <i>d</i>	Width Across Flats <i>s</i>		Width Across Corners <i>e</i>		Diameter <i>d₂</i>		Thickness <i>h</i>		Lower Face of Nut to Bottom of Slot <i>m</i>		Width of Slot <i>n</i>		Radius (0.25 <i>n</i>) <i>r</i>	Eccentricity of the Slots
	Max.	Min.	Max.	Min.	Max.	Min.	Max.	Min.	Max.	Min.	Max.	Min.	Min.	Max.
M4	7.00	6.85	8.10	7.74	5	4.70	3.2	2.90	1.45	1.2	0.3	0.18
M5	8.00	7.85	9.20	8.87	6	5.70	4.0	3.70	1.65	1.4	0.35	0.18
M6	10.00	9.78	11.50	11.05	7.5	7.14	5	4.70	2.25	2	0.5	0.18
M8	13.00	12.73	15.00	14.38	9.5	9.14	6.5	6.14	2.75	2.5	0.625	0.22
M10	17.00	16.73	19.60	18.90	12	11.57	8	7.64	3.05	2.8	0.70	0.22
M12	19.00	18.67	21.90	21.10	17	16.57	15	14.57	10	9.64	3.80	3.5	0.875	0.27
(M14)	22.00	21.67	25.4	24.49	19	18.48	16	15.57	11	10.57	3.80	3.5	0.875	0.27
M16	24.00	23.67	27.7	26.75	22	21.48	19	18.48	13	12.57	4.80	4.5	1.125	0.27
(M18)	27.00	26.67	31.20	30.14	25	24.48	21	20.48	15	14.57	4.80	4.5	1.125	0.27
M20	30.00	29.67	34.60	33.53	28	27.48	22	21.48	16	15.57	4.80	4.5	1.125	0.33
(M22)	32.00	31.61	36.90	35.72	30	29.48	26	25.48	18	17.57	5.80	5.5	1.375	0.33
M24	36.00	35.38	41.60	39.98	34	33.38	27	26.48	19	18.48	5.80	5.5	1.375	0.33
(M27)	41.00	40.38	47.3	45.63	38	37.38	30	29.48	22	21.48	5.80	5.5	1.375	0.33
M30	46.00	45.38	53.1	51.28	42	41.38	33	32.38	24	23.48	7.36	7	1.75	0.33
(M33)	50.00	49.38	57.70	55.80	46	45.38	35	34.38	26	25.48	7.36	7	1.75	0.39
M36	55.00	54.26	63.50	61.31	50	49.38	38	37.38	29	28.48	7.36	7	1.75	0.39
(M39)	60.00	59.26	69.30	66.96	55	54.26	40	39.38	31	30.38	7.36	7	1.75	0.39
M42	65.00	64.26	75.10	72.61	58	57.26	46	45.38	34	33.38	9.36	9	2.25	0.39
(M45)	70.00	69.26	80.80	78.26	62	61.26	48	47.38	36	35.38	9.36	9	2.25	0.39
M48	75.00	74.26	86.60	83.91	65	64.26	50	49.38	38	37.38	9.36	9	2.25	0.39
(M52)	80.00	79.26	92.40	89.56	70	69.26	54	53.26	42	41.38	9.36	9	2.25	0.46
M56	85.00	84.13	98.10	95.07	75	74.26	57	56.26	45	44.38	9.36	9	2.25	0.46
(M60)	90.00	89.13	103.90	100.72	80	79.26	63	62.26	48	47.38	11.43	11	2.75	0.46
M64	95.00	94.13	109.70	106.37	85	84.13	66	65.26	51	50.26	11.43	11	2.75	0.46
(M68)	100.00	99.13	115.50	112.02	90	89.13	69	68.26	54	53.26	11.43	11	2.75	0.46

^a Sizes shown in parentheses are non-preferred.

All dimensions are in millimeters. For illustration of hexagon slotted nuts and castle nuts see [Table 3](#).

After several years of use of BS 2693:Part 1:1956 (obsolescent), it was recognized that it would not meet the requirements of all stud users. The thread tolerances specified could result in clearance of interference fits because locking depended on the run-out threads. Thus, some users felt that true interference fits were essential for their needs. As a result, the British Standards Committee has incorporated the Class 5 interference fit threads specified in American Standard ASA B1.12 into the BS 2693:Part 2:1964, "Recommendations for High Grade Studs."

British Standard ISO Metric Precision Hexagon Bolts, Screws and Nuts.—This British Standard BS 3692:1967 (obsolescent) gives the general dimensions and tolerances of precision hexagon bolts, screws and nuts with ISO metric threads in diameters from 1.6 to 68 mm. It is based on the following ISO recommendations and draft recommendations: R 272, R 288, DR 911, DR 947, DR 950, DR 952 and DR 987. Mechanical properties are given only with respect to carbon or alloy steel bolts, screws and nuts, which are not to be used for special applications such as those requiring weldability, corrosion resistance or ability to withstand temperatures above 300°C or below –50°C. The dimensional requirements of this standard also apply to non-ferrous and stainless steel bolts, screws and nuts.

Finish: Finishes may be dull black which results from the heat-treating operation or may be bright finish, the result of bright drawing. Other finishes are possible by mutual agreement between purchaser and producer. It is recommended that reference be made to BS 3382 "Electroplated Coatings on Threaded Components" in this respect.

General Dimensions: The bolts, screws and nuts conform to the general dimensions given in Tables 3, 4, 5 and 6.

Nominal Lengths of Bolts and Screws: The nominal length of a bolt or screw is the distance from the underside of the head to the extreme end of the shank including any chamfer or radius. Standard nominal lengths and tolerances thereon are given in Table 7.

**Table 7. British Standard ISO Metric Bolt and Screw Nominal Lengths
BS 3692:1967 (obsolescent)**

Nominal Length ^a <i>l</i>	Tolerance	Nominal Length ^a <i>l</i>	Tolerance	Nominal Length ^a <i>l</i>	Tolerance	Nominal Length ^a <i>l</i>	Tolerance
5	± 0.24	30	± 0.42	90	± 0.70	200	± 0.925
6	± 0.24	(32)	± 0.50	(95)	± 0.70	220	± 0.925
(7)	± 0.29	35	± 0.50	100	± 0.70	240	± 0.925
8	± 0.29	(38)	± 0.50	(105)	± 0.70	260	± 1.05
(9)	± 0.29	40	± 0.50	110	± 0.70	280	± 1.05
10	± 0.29	45	± 0.50	(115)	± 0.70	300	± 1.05
(11)	± 0.35	50	± 0.50	120	± 0.70	325	± 1.15
12	± 0.35	55	± 0.60	(125)	± 0.80	350	± 1.15
14	± 0.35	60	± 0.60	130	± 0.80	375	± 1.15
16	± 0.35	65	± 0.60	140	± 0.80	400	± 1.15
(18)	± 0.35	70	± 0.60	150	± 0.80	425	± 1.25
20	± 0.42	75	± 0.60	160	± 0.80	450	± 1.25
(22)	± 0.42	80	± 0.60	170	± 0.80	475	± 1.25
25	± 0.42	85	± 0.70	180	± 0.80	500	± 1.25
(28)	± 0.42	190	± 0.925

^aNominal lengths shown in parentheses are non-preferred.

All dimensions are in millimeters.

Bolt and Screw Ends: The ends of bolts and screws may be finished with either a 45-degree chamfer to a depth slightly exceeding the depth of thread or a radius approximately

equal to $1\frac{1}{4}$ times the nominal diameter of the shank. With rolled threads, the lead formed at the end of the bolt by the thread rolling operation may be regarded as providing the necessary chamfer to the end; the end being reasonably square with the center line of the shank.

Screw Thread Form: The form of thread and diameters and associated pitches of standard ISO metric bolts, screws, and nuts are in accordance with BS 3643:Part 1:1981 (2004), "Principles and Basic Data" The screw threads are made to the tolerances for the medium class of fit (6H/6g) as specified in BS 3643:Part 2:1981 (1998), "Specification for Selected Limits of Size."

Length of Thread on Bolts: The length of thread on bolts is the distance from the end of the bolt (including any chamfer or radius) to the leading face of a screw ring gage which has been screwed as far as possible onto the bolt by hand. Standard thread lengths of bolts are $2d + 6$ mm for a nominal length of bolt up to and including 125 mm, $2d + 12$ mm for a nominal bolt length over 125 mm up to and including 200 mm, and $2d + 25$ mm for a nominal bolt length over 200 mm. Bolts that are too short for minimum thread lengths are threaded as screws and designated as screws. The tolerance on bolt thread lengths are plus two pitches for all diameters.

Length of Thread on Screws: Screws are threaded to permit a screw ring gage being screwed by hand to within a distance from the underside of the head not exceeding two and a half times the pitch for diameters up to and including 52 mm and three and a half times the pitch for diameters over 52 mm.

Angularity and Eccentricity of Bolts, Screws and Nuts: The axis of the thread of the nut is square to the face of the nut subject to the "squareness tolerance" given in [Table 5](#).

In gaging, the nut is screwed by hand onto a gage, having a truncated taper thread, until the thread of the nut is tight on the thread of the gage. A sleeve sliding on a parallel extension of the gage, which has a face of diameter equal to the minimum distance across the flats of the nut and exactly at 90 degrees to the axis of the gage, is brought into contact with the leading face of the nut. With the sleeve in this position, it should not be possible for a feeler gage of thickness equal to the "squareness tolerance" to enter anywhere between the leading nut face and sleeve face.

The hexagon flats of bolts, screws and nuts are square to the bearing face, and the angularity of the head is within the limits of 90 degrees, plus or minus 1 degree. The eccentricity of the hexagon flats of nuts relative to the thread diameter should not exceed the values given in [Table 5](#) and the eccentricity of the head relative to the width across flats and eccentricity between the shank and thread of bolts and screws should not exceed the values given in [Table 4](#).

Chamfering, Washer Facing and Countersinking: Bolt and screw heads have a chamfer of approximately 30 degrees on their upper faces and, at the option of the manufacturer, a washer face or full bearing face on the underside. Nuts are countersunk at an included angle of 120 degrees plus or minus 10 degrees at both ends of the thread. The diameter of the countersink should not exceed the nominal major diameter of the thread plus 0.13 mm up to and including 12 mm diameter, and plus 0.25 mm above 12 mm diameter. This stipulation does not apply to slotted, castle or thin nuts.

Strength Grade Designation System for Steel Bolts and Screws: This Standard includes a strength grade designation system consisting of two figures. The first figure is one tenth of the minimum tensile strength in kgf/mm^2 , and the second figure is one tenth of the ratio between the minimum yield stress (or stress at permanent set limit, $R_{0.2}$) and the minimum tensile strength, expressed as a percentage. For example with the strength designation grade 8.8, the first figure 8 represents $\frac{1}{10}$ the minimum tensile strength of 80 kgf/mm^2 and the second figure 8 represents $\frac{1}{10}$ the ratio

$$\frac{\text{stress at permanent set limit } R_{0.2}\%}{\text{minimum tensile strength}} = \frac{1}{10} \times \frac{64}{80} \times \frac{100}{1}$$

the numerical values of stress and strength being obtained from the accompanying table.

Strength Grade Designations of Steel Bolts and Screws

Strength Grade Designation	4.6	4.8	5.6	5.8	6.6	6.8	8.8	10.9	12.9	14.9
Tensile Strength (R_m), Min.	40	40	50	50	60	60	80	100	120	140
Yield Stress (R_e), Min.	24	32	30	40	36	48
Stress at Permanent Set Limit ($R_{0.2}$), Min.	64	90	108	126
All stress and strength values are in kgf/mm ² units.										

Strength Grade Designation System for Steel Nuts: The strength grade designation system for steel nuts is a number which is one-tenth of the specified proof load stress in kgf/mm². The proof load stress corresponds to the minimum tensile strength of the highest grade of bolt or screw with which the nut can be used.

Strength Grade Designations of Steel Nuts

Strength Grade Designation	4	5	6	8	12	14
Proof Load Stress (kgf/mm ²)	40	50	60	80	120	140

Recommended Bolt and Nut Combinations

Grade of Bolt	4.6	4.8	5.6	5.8	6.6	6.8	8.8	10.9	12.9	14.9
Recommended Grade of Nut	4	4	5	5	6	6	8	12	12	14
<i>Note:</i> Nuts of a higher strength grade may be substituted for nuts of a lower strength grade.										

Marking: The marking and identification requirements of this Standard are only mandatory for steel bolts, screws and nuts of 6 mm diameter and larger; manufactured to strength grade designations 8.8 (for bolts or screws) and 8 (for nuts) or higher. Bolts and screws are identified as ISO metric by either of the symbols “ISO M” or “M”, embossed or indented on top of the head. Nuts may be indented or embossed by alternative methods depending on their method of manufacture.

Designation: Bolts 10 mm diameter, 50 mm long manufactured from steel of strength grade 8.8, would be designated:

“Bolts M10 × 50 to BS 3692 — 8.8.”

Brass screws 8 mm diameter, 20 mm long would be designated:

“Brass screws M8 × 20 to BS 3692.”

Nuts 12 mm diameter, manufactured from steel of strength grade 6, cadmium plated could be designated:

“Nuts M12 to BS 3692 — 6, plated to BS 3382: Part 1.”

Miscellaneous Information: The Standard also gives mechanical properties of steel bolts, screws and nuts [i.e., tensile strengths; hardnesses (Brinell, Rockwell, Vickers); stresses (yield, proof load); etc.], material and manufacture of steel bolts, screws and nuts; and information on inspection and testing. Appendices to the Standard give information on gaging; chemical composition; testing of mechanical properties; examples of marking of bolts, screws and nuts; and a table of preferred standard sizes of bolts and screws, to name some.

British Standard General Purpose Studs BS 2693:Part 1:1956 (obsolescent)

Limits for End Screwed into Component (All threads except BA)													
Nom. Dia. <i>D</i>	Major Dia.	Thds. per In.	Major Dia.	Effective Diameter		Minor Diameter		Thds. per In.	Major Dia.	Effective Diameter		Minor Dia.	
				Max.	Min.	Max.	Min.			Min.	Max.	Min.	Max.
UN THREADS			UNF THREADS				UNC THREADS						
1/4	0.2500	28	0.2435	0.2294	0.2265	0.2088	0.2037	20	0.2419	0.2201	0.2172	0.1913	0.1849
5/16	0.3125	24	0.3053	0.2883	0.2852	0.2643	0.2586	18	0.3038	0.2793	0.2762	0.2472	0.2402
3/8	0.3750	24	0.3678	0.3510	0.3478	0.3270	0.3211	16	0.3656	0.3375	0.3343	0.3014	0.2936
7/16	0.4375	20	0.4294	0.4084	0.4050	0.3796	0.3729	14	0.4272	0.3945	0.3911	0.3533	0.3447
1/2	0.5000	20	0.4919	0.4712	0.4675	0.4424	0.4356	13	0.4891	0.4537	0.4500	0.4093	0.4000
9/16	0.5625	18	0.5538	0.5302	0.5264	0.4981	0.4907	12	0.5511	0.5122	0.5084	0.4641	0.4542
5/8	0.6250	18	0.6163	0.5929	0.5889	0.5608	0.5533	11	0.6129	0.5700	0.5660	0.5175	0.5069
3/4	0.7500	16	0.7406	0.7137	0.7094	0.6776	0.6693	10	0.7371	0.6893	0.6850	0.6316	0.6200
7/8	0.8750	14	0.8647	0.8332	0.8286	0.7920	0.7828	9	0.8611	0.8074	0.8028	0.7433	0.7306
1	1.0000	12	0.9886	0.9510	0.9459	0.9029	0.8925	8	0.9850	0.9239	0.9188	0.8517	0.8376
1 1/8	1.1250	12	1.1136	1.0762	1.0709	1.0281	1.0176	7	1.1086	1.0375	1.0322	0.9550	0.9393
1 1/4	1.2500	12	1.2386	1.2014	1.1959	1.1533	1.1427	7	1.2336	1.1627	1.1572	1.0802	1.0644
1 3/8	1.3750	12	1.3636	1.3265	1.3209	1.2784	1.2677	6	1.3568	1.2723	1.2667	1.1761	1.1581
1 1/2	1.5000	12	1.4886	1.4517	1.4459	1.4036	1.3928	6	1.4818	1.3975	1.3917	1.3013	1.2832
BS THREADS			BSF THREADS				BSW THREADS						
1/4	0.2500	26	0.2455	0.2280	0.2251	0.2034	0.1984	20	0.2452	0.2206	0.2177	0.1886	0.1831
5/16	0.3125	22	0.3077	0.2863	0.2832	0.2572	0.2517	18	0.3073	0.2798	0.2767	0.2442	0.2383
3/8	0.3750	20	0.3699	0.3461	0.3429	0.3141	0.3083	16	0.3695	0.3381	0.3349	0.0981	0.2919
7/16	0.4375	18	0.4320	0.4053	0.4019	0.3697	0.3635	14	0.4316	0.3952	0.3918	0.3495	0.3428
1/2	0.5000	16	0.4942	0.4637	0.4600	0.4237	0.4172	12	0.4937	0.4503	0.4466	0.3969	0.3897
9/16	0.5625	16	0.5566	0.5263	0.5225	0.4863	0.4797	12	0.5560	0.5129	0.5091	0.4595	0.4521
5/8	0.6250	14	0.6187	0.5833	0.5793	0.5376	0.5305	11	0.6183	0.5708	0.5668	0.5126	0.5050
3/4	0.7500	12	0.7432	0.7009	0.6966	0.6475	0.6398	10	0.7428	0.6903	0.6860	0.6263	0.6182
7/8	0.8750	11	0.8678	0.8214	0.8168	0.7632	0.7551	9	0.8674	0.8085	0.8039	0.7374	0.7288
1	1.0000	10	0.9924	0.9411	0.9360	0.8771	0.8686	8	0.9920	0.9251	0.9200	0.8451	0.8360
1 1/8	1.1250	9	1.1171	1.0592	1.0539	0.9881	0.9792	7	1.1164	1.0388	1.0335	0.9473	0.9376
1 1/4	1.2500	9	1.2419	1.1844	1.1789	1.1133	1.1042	7	1.2413	1.1640	1.1585	1.0725	1.0627
1 3/8	1.3750	8	1.3665	1.3006	1.2950	1.2206	1.2110	6	1.4906	1.3991	1.3933	1.2924	1.2818
1 1/2	1.5000	8	1.4913	1.4258	1.4200	1.3458	1.3360

Limits for End Screwed into Component (BA Threads) ^a							
Designation No.	Pitch	Major Diameter		Effective Diameter		Minor Diameter	
		Max.	Min.	Max.	Min.	Max.	Min.
2	0.8100 mm 0.03189 in.	4.700 mm 0.1850 in.	4.580 mm 0.1803 in.	4.275 mm 0.1683 in.	4.200 mm 0.1654 in.	3.790 mm 0.1492 in.	3.620 mm 0.1425 in.
4	0.6600 mm 0.2598 in.	3.600 mm 0.1417 in.	3.500 mm 0.1378 in.	3.260 mm 0.1283 in.	3.190 mm 0.1256 in.	2.865 mm 0.1128 in.	2.720 mm 0.1071 in.

^a Approximate inch equivalents are shown below the dimensions given in mm.

Minimum Nominal Lengths of Studs ^a								
Nom. Stud. Dia.	For Thread Length (Component End) of		Nom. Stud. Dia.	For Thread Length (Component End) of		Nom. Stud. Dia.	For Thread Length (Component End) of	
	1D	1.5D		1D	1.5D		1D	1.5D
1/4	3/8	1	5/16	2	2 3/8	1 1/8	4	4 3/8
5/16	1 1/8	1 3/8	3/8	2 1/4	2 5/8	1 1/4	4 3/4	5 1/2
3/8	1 3/8	1 5/8	3/4	2 5/8	3	1 3/8	5	5 3/4
7/16	1 5/8	1 7/8	7/8	3 3/8	3 3/8	1 1/2	5 1/4	6
1/2	1 3/4	2	1	3 1/2	4

^a The standard also gives preferred and standard lengths of studs: *Preferred* lengths of studs: 7/8, 1, 1 1/8, 1 1/4, 1 3/8, 1 1/2, 1 3/4, 2, 2 1/4, 2 1/2, 2 3/4, 3, 3 1/4, 3 1/2 and for lengths above 3 1/2 the preferred increment is 1/2. *Standard* lengths of studs: 7/8, 1, 1 1/8, 1 1/4, 1 3/8, 1 1/2, 1 5/8, 1 3/4, 1 7/8, 2, 2 1/8, 2 1/4, 2 3/8, 2 1/2, 2 5/8, 2 3/4, 2 7/8, 3, 3 1/8, 3 1/4, 3 3/8, 3 1/2 and for lengths above 3 1/2 the standard increment is 1/4.

All dimensions are in inches except where otherwise noted.

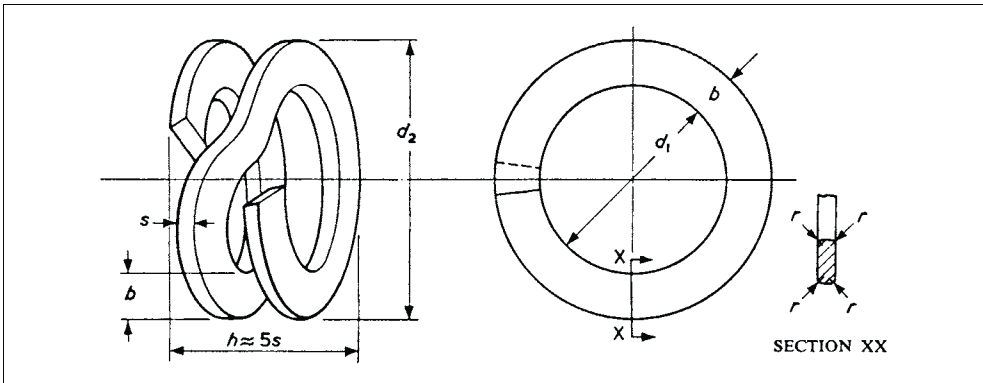
See page 1973 for interference-fit threads.

**British Standard Single Coil Rectangular Section Spring Washers
Metric Series — Types B and BP BS 4464:1969 (2004)**

Nom. Size & Thread Dia., <i>d</i>	Inside Dia., <i>d</i> ₁		Width, <i>b</i>	Thickness, <i>s</i>	Outside Dia., <i>d</i> ₂ Max	Radius, <i>r</i> Max	<i>k</i> (Type BP Only)
	Max	Min					
M1.6	1.9	1.7	0.7 ± 0.1	0.4 ± 0.1	3.5	0.15	...
M2	2.3	2.1	0.9 ± 0.1	0.5 ± 0.1	4.3	0.15	...
(M2.2)	2.5	2.3	1.0 ± 0.1	0.6 ± 0.1	4.7	0.2	...
M2.5	2.8	2.6	1.0 ± 0.1	0.6 ± 0.1	5.0	0.2	...
M3	3.3	3.1	1.3 ± 0.1	0.8 ± 0.1	6.1	0.25	...
(M3.5)	3.8	3.6	1.3 ± 0.1	0.8 ± 0.1	6.6	0.25	0.15
M4	4.35	4.1	1.5 ± 0.1	0.9 ± 0.1	7.55	0.3	0.15
M5	5.35	5.1	1.8 ± 0.1	1.2 ± 0.1	9.15	0.4	0.15
M6	6.4	6.1	2.5 ± 0.15	1.6 ± 0.1	11.7	0.5	0.2
M8	8.55	8.2	3 ± 0.15	2 ± 0.1	14.85	0.65	0.3
M10	10.6	10.2	3.5 ± 0.2	2.2 ± 0.15	18.0	0.7	0.3
M12	12.6	12.2	4 ± 0.2	2.5 ± 0.15	21.0	0.8	0.4
(M14)	14.7	14.2	4.5 ± 0.2	3 ± 0.15	24.1	1.0	0.4
M16	16.9	16.3	5 ± 0.2	3.5 ± 0.2	27.3	1.15	0.4
(M18)	19.0	18.3	5 ± 0.2	3.5 ± 0.2	29.4	1.15	0.4
M20	21.1	20.3	6 ± 0.2	4 ± 0.2	33.5	1.3	0.4
(M22)	23.3	22.4	6 ± 0.2	4 ± 0.2	35.7	1.3	0.4
M24	25.3	24.4	7 ± 0.25	5 ± 0.2	39.8	1.65	0.5
(M27)	28.5	27.5	7 ± 0.25	5 ± 0.2	43.0	1.65	0.5
M30	31.5	30.5	8 ± 0.25	6 ± 0.25	48.0	2.0	0.8
(M33)	34.6	33.5	10 ± 0.25	6 ± 0.25	55.1	2.0	0.8
M36	37.6	36.5	10 ± 0.25	6 ± 0.25	58.1	2.0	0.8
(M39)	40.8	39.6	10 ± 0.25	6 ± 0.25	61.3	2.0	0.8
M42	43.8	42.6	12 ± 0.25	7 ± 0.25	68.3	2.3	0.8
(M45)	46.8	45.6	12 ± 0.25	7 ± 0.25	71.3	2.3	0.8
M48	50.0	48.8	12 ± 0.25	7 ± 0.25	74.5	2.3	0.8
(M52)	54.1	52.8	14 ± 0.25	8 ± 0.25	82.6	2.65	1.0
M56	58.1	56.8	14 ± 0.25	8 ± 0.25	86.6	2.65	1.0
(M60)	62.3	60.9	14 ± 0.25	8 ± 0.25	90.8	2.65	1.0
M64	66.3	64.9	14 ± 0.25	8 ± 0.25	93.8	2.65	1.0
(M68)	70.5	69.0	14 ± 0.25	8 ± 0.25	99.0	2.65	1.0

All dimensions are given in millimeters. Sizes shown in parentheses are non-preferred, and are not usually stock sizes.

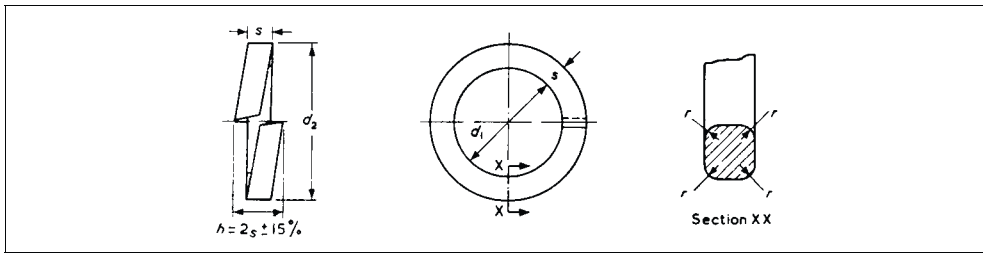
**British Standard Double Coil Rectangular Section Spring Washers; Metric Series —
Type D BS 4464:1969 (2004)**



Nom. Size, <i>d</i>	Inside Dia., <i>d</i> ₁		Width, <i>b</i>	Thickness, <i>s</i>	O.D., <i>d</i> ₂ Max	Radius, <i>r</i> Max
	Max	Min				
M2	2.4	2.1	0.9 ± 0.1	0.5 ± 0.05	4.4	0.15
(M2.2)	2.6	2.3	1.0 ± 0.1	0.6 ± 0.05	4.8	0.2
M2.5	2.9	2.6	1.2 ± 0.1	0.7 ± 0.1	5.5	0.23
M3.0	3.6	3.3	1.2 ± 0.1	0.8 ± 0.1	6.2	0.25
(M3.5)	4.1	3.8	1.6 ± 0.1	0.8 ± 0.1	7.5	0.25
M4	4.6	4.3	1.6 ± 0.1	0.8 ± 0.1	8.0	0.25
M5	5.6	5.3	2 ± 0.1	0.9 ± 0.1	9.8	0.3
M6	6.6	6.3	3 ± 0.15	1 ± 0.1	12.9	0.33
M8	8.8	8.4	3 ± 0.15	1.2 ± 0.1	15.1	0.4
M10	10.8	10.4	3.5 ± 0.20	1.2 ± 0.1	18.2	0.4
M12	12.8	12.4	3.5 ± 0.2	1.6 ± 0.1	20.2	0.5
(M14)	15.0	14.5	5 ± 0.2	1.6 ± 0.1	25.4	0.5
M16	17.0	16.5	5 ± 0.2	2 ± 0.1	27.4	0.65
(M18)	19.0	18.5	5 ± 0.2	2 ± 0.1	29.4	0.65
M20	21.5	20.8	5 ± 0.2	2 ± 0.1	31.9	0.65
(M22)	23.5	22.8	6 ± 0.2	2.5 ± 0.15	35.9	0.8
M24	26.0	25.0	6.5 ± 0.2	3.25 ± 0.15	39.4	1.1
(M27)	29.5	28.0	7 ± 0.25	3.25 ± 0.15	44.0	1.1
M30	33.0	31.5	8 ± 0.25	3.25 ± 0.15	49.5	1.1
(M33)	36.0	34.5	8 ± 0.25	3.25 ± 0.15	52.5	1.1
M36	40.0	38.0	10 ± 0.25	3.25 ± 0.15	60.5	1.1
(M39)	43.0	41.0	10 ± 0.25	3.25 ± 0.15	63.5	1.1
M42	46.0	44.0	10 ± 0.25	4.5 ± 0.2	66.5	1.5
M48	52.0	50.0	10 ± 0.25	4.5 ± 0.2	72.5	1.5
M56	60.0	58.0	12 ± 0.25	4.5 ± 0.2	84.5	1.5
M64	70.0	67.0	12 ± 0.25	4.5 ± 0.2	94.5	1.5

All dimensions are given in millimeters. Sizes shown in parentheses are non-preferred, and are not usually stock sizes. The free height of double coil washers before compression is normally approximately five times the thickness but, if required, washers with other free heights may be obtained by arrangement with manufacturer.

**British Standard Single Coil Square Section Spring Washers; Metric Series —
Type A-1 BS 4464:1969 (2004)**



**British Standard Single Coil Square Section Spring Washers; Metric Series —
Type A-2 BS 4464:1969 (2004)**

Nom. Size, d	Inside Dia., d_1		Thickness & Width, s	O.D., d_2 Max	Radius, r Max
	Max	Min			
M3	3.3	3.1	1 ± 0.1	5.5	0.3
(M3.5)	3.8	3.6	1 ± 0.1	6.0	0.3
M4	4.35	4.1	1.2 ± 0.1	6.95	0.4
M5	5.35	5.1	1.5 ± 0.1	8.55	0.5
M6	6.4	6.1	1.5 ± 0.1	9.6	0.5
M8	8.55	8.2	2 ± 0.1	12.75	0.65
M10	10.6	10.2	2.5 ± 0.15	15.9	0.8
M12	12.6	12.2	2.5 ± 0.15	17.9	0.8
(M14)	14.7	14.2	3 ± 0.2	21.1	1.0
M16	16.9	16.3	3.5 ± 0.2	24.3	1.15
(M18)	19.0	18.3	3.5 ± 0.2	26.4	1.15
M20	21.1	20.3	4.5 ± 0.2	30.5	1.5
(M22)	23.3	22.4	4.5 ± 0.2	32.7	1.5
M24	25.3	24.4	5 ± 0.2	35.7	1.65
(M27)	28.5	27.5	5 ± 0.2	38.9	1.65
M30	31.5	30.5	6 ± 0.2	43.9	2.0
(M33)	34.6	33.5	6 ± 0.2	47.0	2.0
M36	37.6	36.5	7 ± 0.25	52.1	2.3
(M39)	40.8	39.6	7 ± 0.25	55.3	2.3
M42	43.8	42.6	8 ± 0.25	60.3	2.65
(M45)	46.8	45.6	8 ± 0.25	63.3	2.65
M48	50.0	48.8	8 ± 0.25	66.5	2.65

All dimensions are in millimeters. Sizes shown in parentheses are nonpreferred and are not usually stock sizes.

British Standard for Metric Series Metal Washers.—BS 4320:1968 (1998) specifies bright and black metal washers for general engineering purposes.

Bright Metal Washers: These washers are made from either CS4 cold-rolled strip steel BS 1449:Part 3B or from CZ 108 brass strip B.S. 2870: 1980, both in the hard condition. However, by mutual agreement between purchaser and supplier, washers may be made available with the material in any other condition, or they may be made from another material, or may be coated with a protective or decorative finish to some appropriate British Standard. Washers are reasonably flat and free from burrs and are normally supplied unchamfered. They may, however, have a 30-degree chamfer on one edge of the external diameter. These washers are made available in two size categories, normal and large diameter, and in two thicknesses, normal (Form A or C) and light (Form B or D). The thickness of a light-range washer is from $\frac{1}{2}$ to $\frac{2}{3}$ the thickness of a normal range washer.

Black Metal Washers: These washers are made from mild steel, and can be supplied in three size categories designated normal, large, and extra large diameters. The normal-diameter series is intended for bolts ranging from M5 to M68 (Form E washers), the large-diameter series for bolts ranging from M8 to M39 (Form F washers), and the extra large series for bolts from M5 to M39 (Form G washers). A protective finish can be specified by the purchaser in accordance with any appropriate British Standard.

Washer Designations: The Standard specifies the details that should be given when ordering or placing an inquiry for washers. These details are the general description, namely, bright or black washers; the nominal size of the bolt or screw involved, for example, M5; the designated form, for example, Form A or Form E; the dimensions of any chamfer required on bright washers; the number of the Standard BS 4320:1968 (1998), and coating information if required, with the number of the appropriate British Standard and the coating thickness needed. As an example, in the use of this information, the designation for a chamfered, normal-diameter series washer of normal-range thickness to suit a 12-mm diameter bolt would be: Bright washers M12 (Form A) chamfered to B.S. 4320.

British Standard Bright Metal Washers — Metric Series BS 4320:1968 (1998)

NORMAL DIAMETER SIZES												
Nominal Size of Bolt or Screw	Inside Diameter			Outside Diameter			Thickness					
							Form A (Normal Range)			Form B (Light Range)		
	Nom	Max	Min	Nom	Max	Min	Nom	Max	Min	Nom	Max	Min
M 1.0	1.1	1.25	1.1	2.5	2.5	2.3	0.3	0.4	0.2
M 1.2	1.3	1.45	1.3	3.0	3.0	2.8	0.3	0.4	0.2
(M 1.4)	1.5	1.65	1.5	3.0	3.0	2.8	0.3	0.4	0.2
M 1.6	1.7	1.85	1.7	4.0	4.0	3.7	0.3	0.4	0.2
M 2.0	2.2	2.35	2.2	5.0	5.0	4.7	0.3	0.4	0.2
(M 2.2)	2.4	2.55	2.4	5.0	5.0	4.7	0.5	0.6	0.4
M 2.5	2.7	2.85	2.7	6.5	6.5	6.2	0.5	0.6	0.4
M3	3.2	3.4	3.2	7	7	6.7	0.5	0.6	0.4
(M 3.5)	3.7	3.9	3.7	7	7	6.7	0.5	0.6	0.4
M4	4.3	4.5	4.3	9	9	8.7	0.8	0.9	0.7
(M 4.5)	4.8	5.0	4.8	9	9	8.7	0.8	0.9	0.7
M 5	5.3	5.5	5.3	10	10	9.7	1.0	1.1	0.9
M 6	6.4	6.7	6.4	12.5	12.5	12.1	1.6	1.8	1.4	0.8	0.9	0.7
(M 7)	7.4	7.7	7.4	14	14	13.6	1.6	1.8	1.4	0.8	0.9	0.7
M 8	8.4	8.7	8.4	17	17	16.6	1.6	1.8	1.4	1.0	1.1	0.9
M 10	10.5	10.9	10.5	21	21	20.5	2.0	2.2	1.8	1.25	1.45	1.05
M 12	13.0	13.4	13.0	24	24	23.5	2.5	2.7	2.3	1.6	1.80	1.40
(M 14)	15.0	15.4	15.0	28	28	27.5	2.5	2.7	2.3	1.6	1.8	1.4
M 16	17.0	17.4	17.0	30	30	29.5	3.0	3.3	2.7	2.0	2.2	1.8
(M 18)	19.0	19.5	19.0	34	34	33.2	3.0	3.3	2.7	2.0	2.2	1.8
M 20	21	21.5	21	37	37	36.2	3.0	3.3	2.7	2.0	2.2	1.8
(M 22)	23	23.5	23	39	39	38.2	3.0	3.3	2.7	2.0	2.2	1.8
M24	25	25.5	25	44	44	43.2	4.0	4.3	3.7	2.5	2.7	2.3
(M 27)	28	28.5	28	50	50	49.2	4.0	4.3	3.7	2.5	2.7	2.3
M30	31	31.6	31	56	56	55.0	4.0	4.3	3.7	2.5	2.7	2.3
(M 33)	34	34.6	34	60	60	59.0	5.0	5.6	4.4	3.0	3.3	2.7
M 36	37	37.6	37	66	66	65.0	5.0	5.6	4.4	3.0	3.3	2.7
(M 39)	40	40.6	40	72	72	71.0	6.0	6.6	5.4	3.0	3.3	2.7
LARGE DIAMETER SIZES												
Nominal Size of Bolt or Screw	Inside Diameter			Outside Diameter			Thickness					
							Form C (Normal Range)			Form D (Light Range)		
	Nom	Max	Min	Nom	Max	Min	Nom	Max	Min	Nom	Max	Min
M 4	4.3	4.5	4.3	10.0	10.0	9.7	0.8	0.9	0.7
M 5	5.3	5.5	5.3	12.5	12.5	12.1	1.0	1.1	0.9
M 6	6.4	6.7	6.4	14	14	13.6	1.6	1.8	1.4	0.8	0.9	0.7
M 8	8.4	8.7	8.4	21	21	20.5	1.6	1.8	1.4	1.0	1.1	0.9
M 10	10.5	10.9	10.5	24	24	23.5	2.0	2.2	1.8	1.25	1.45	1.05
M 12	13.0	13.4	13.0	28	28	27.5	2.5	2.7	2.3	1.6	1.8	1.4
(M 14)	15.0	15.4	15	30	30	29.5	2.5	2.7	2.3	1.6	1.8	1.4
M 16	17.0	17.4	17	34	34	33.2	3.0	3.3	2.7	2.0	2.2	1.8
(M 18)	19.0	19.5	19	37	37	36.2	3.0	3.3	2.7	2.0	2.2	1.8
M 20	21	21.5	21	39	39	38.2	3.0	3.3	2.7	2.0	2.2	1.8
(M 22)	23	23.5	23	44	44	43.2	3.0	3.3	2.7	2.0	2.2	1.8
M 24	25	25.5	25	50	50	49.2	4.0	4.3	3.7	2.5	2.7	2.3
(M 27)	28	28.5	28	56	56	55	4.0	4.3	3.7	2.5	2.7	2.3
M 30	31	31.6	31	60	60	59	4.0	4.3	3.7	2.5	2.7	2.3
(M 33)	34	34.6	34	66	66	65	5.0	5.6	4.4	3.0	3.3	2.7
M 36	37	37.6	37	72	72	71	5.0	5.6	4.4	3.0	3.3	2.7
(M 39)	40	40.6	40	77	77	76	6.0	6.6	5.4	3.0	3.3	2.7

All dimensions are in millimeters.

Nominal bolt or screw sizes shown in parentheses are nonpreferred.

British Standard Black Metal Washers — Metric Series *BS 4320:1968 (1998)*

NORMAL DIAMETER SIZES (Form E)									
Nom Bolt or Screw Size	Inside Diameter			Outside Diameter			Thickness		
	Nom	Max	Min	Nom	Max	Min	Nom	Max	Min
M 5	5.5	5.8	5.5	10.0	10.0	9.2	1.0	1.2	0.8
M 6	6.6	7.0	6.6	12.5	12.5	11.7	1.6	1.9	1.3
(M 7)	7.6	8.0	7.6	14.0	14.0	13.2	1.6	1.9	1.3
M 8	9.0	9.4	9.0	17	17	16.2	1.6	1.9	1.3
M 10	11.0	11.5	11.0	21	21	20.2	2.0	2.3	1.7
M 12	14	14.5	14	24	24	23.2	2.5	2.8	2.2
(M 14)	16	16.5	16	28	28	27.2	2.5	2.8	2.2
M 16	18	18.5	18	30	30	29.2	3.0	3.6	2.4
(M 18)	20	20.6	20	34	34	32.8	3.0	3.6	2.4
M 20	22	22.6	22	37	37	35.8	3.0	3.6	2.4
(M 22)	24	24.6	24	39	39	37.8	3.0	3.6	2.4
M 24	26	26.6	26	44	44	42.8	4	4.6	3.4
(M 27)	30	30.6	30	50	50	48.8	4	4.6	3.4
M 30	33	33.8	33	56	56	54.5	4	4.6	3.4
(M 33)	36	36.8	36	60	60	58.5	5	6.0	4.0
M 36	39	39.8	39	66	66	64.5	5	6.0	4.0
(M 39)	42	42.8	42	72	72	70.5	6	7.0	5.0
M 42	45	45.8	45	78	78	76.5	7	8.2	5.8
(M 45)	48	48.8	48	85	85	83	7	8.2	5.8
M 48	52	53	52	92	92	90	8	9.2	6.8
(M 52)	56	57	56	98	98	96	8	9.2	6.8
M 56	62	63	62	105	105	103	9	10.2	7.8
(M 60)	66	67	66	110	110	108	9	10.2	7.8
M 64	70	71	70	115	115	113	9	10.2	7.8
(M 68)	74	75	74	120	120	118	10	11.2	8.8
LARGE DIAMETER SIZES (Form F)									
M 8	9	9.4	9.0	21	21	20.2	1.6	1.9	1.3
M 10	11	11.5	11	24	24	23.2	2	2.3	1.7
M 12	14	14.5	14	28	28	27.2	2.5	2.8	2.2
(M 14)	16	16.5	16	30	30	29.2	2.5	2.8	2.2
M 16	18	18.5	18	34	34	32.8	3	3.6	2.4
(M 18)	20	20.6	20	37	37	35.8	3	3.6	2.4
M 20	22	22.6	22	39	39	37.8	3	3.6	2.4
(M 22)	24	24.6	24	44	44	42.8	3	3.6	2.4
M 24	26	26.6	26	50	50	48.8	4	4.6	3.4
(M 27)	30	30.6	30	56	56	54.5	4	4.6	3.4
M 30	33	33.8	33	60	60	58.5	4	4.6	3.4
(M 33)	36	36.8	36	66	66	64.5	5	6.0	4
M 36	39	39.8	39	72	72	70.5	5	6.0	4
(M 39)	42	42.8	42	77	77	75.5	6	7	5
EXTRA LARGE DIAMETER SIZES (Form G)									
M 5	5.5	5.8	5.5	15	15	14.2	1.6	1.9	1.3
M 6	6.6	7.0	6.6	18	18	17.2	2	2.3	1.7
(M 7)	7.6	8.0	7.6	21	21	20.2	2	2.3	1.7
M 8	9	9.4	9.0	24	24	23.2	2	2.3	1.7
M 10	11	11.5	11.0	30	30	29.2	2.5	2.8	2.2
M 12	14	14.5	14.0	36	36	34.8	3	3.6	2.4
(M 14)	16	16.5	16.0	42	42	40.8	3	3.6	2.4
M 16	18	18.5	18	48	48	46.8	4	4.6	3.4
(M 18)	20	20.6	20	54	54	52.5	4	4.6	3.4
M 20	22	22.6	22	60	60	58.5	5	6.0	4
(M 22)	24	24.6	24	66	66	64.5	5	6.0	4
M 24	26	26.6	26	72	72	70.5	6	7	5
(M 27)	30	30.6	30	81	81	79	6	7	5
M 30	33	33.8	33	90	90	88	8	9.2	6.8
(M 33)	36	36.8	36	99	99	97	8	9.2	6.8
M 36	39	39.8	39	108	108	106	10	11.2	8.8
(M39)	42	42.8	42	117	117	115	10	11.2	8.8

All dimensions are in millimeters.

Nominal bolt or screw sizes shown in parentheses are nonpreferred.

MACHINE SCREWS AND NUTS

American National Standard Machine Screws and Machine Screw Nuts

This Standard ANSI B18.6.3 covers both slotted and recessed head machine screws. Dimensions of various types of slotted machine screws, machine screw nuts, and header points are given in **Tables 1** through **12**. The Standard also covers flat trim head, oval trim head and drilled fillister head machine screws and gives cross recess dimensions and gaging dimensions for all types of machine screw heads. Information on metric machine screws B18.6.7M is given beginning on page **1658**.

Threads.—Except for sizes 0000, 000, and 00, machine screw threads may be either Unified Coarse (UNC) and Fine thread (UNF) Class 2A (see *American Standard for Unified Screw Threads* starting on page **1813**) or UNRC and UNRF Series, at option of manufacturer. Thread dimensions for sizes 0000, 000, and 00 are given in **Table 7** on page **1648**.

Threads for hexagon machine screw nuts may be either UNC or UNF, Class 2B, and for square machine screw nuts are UNC Class 2B.

Length of Thread.—Machine screws of sizes No. 5 and smaller with nominal lengths equal to 3 diameters and shorter have full form threads extending to within 1 pitch (thread) of the bearing surface of the head, or closer, if practicable. Nominal lengths greater than 3 diameters, up to and including 1 1/8 inch, have full form threads extending to within two pitches (threads) of the bearing surface of the head, or closer, if practicable. Unless otherwise specified, screws of longer nominal length have a minimum length of full form thread of 1.00 inch. Machine screws of sizes No. 6 and larger with nominal length equal to 3 diameters and shorter have full form threads extending to within 1 pitch (thread) of the bearing surface of the head, or closer, if practicable. Nominal lengths greater than 3 diameters, up to and including 2 inches, have full form threads extending to within 2 pitches (threads) of the bearing surface of the head, or closer, if practicable. Screws of longer nominal length, unless otherwise specified, have a minimum length of full form thread of 1.50 inches.

Table 1. Square and Hexagon Machine Screw Nuts ANSI B18.6.3-1972 (R1991)

Nom. Size	Basic Dia.	Basic F	Max. F	Min. F	Max. G	Min. G	Max. G ₁	Min. G ₁	Max. H	Min. H
0	0.0600	5/32	0.156	0.150	0.221	0.206	0.180	0.171	0.050	0.043
1	0.0730	5/32	0.156	0.150	0.221	0.206	0.180	0.171	0.050	0.043
2	0.0860	3/16	0.188	0.180	0.265	0.247	0.217	0.205	0.066	0.057
3	0.0990	3/16	0.188	0.180	0.265	0.247	0.217	0.205	0.066	0.057
4	0.1120	1/4	0.250	0.241	0.354	0.331	0.289	0.275	0.098	0.087
5	0.1250	5/16	0.312	0.302	0.442	0.415	0.361	0.344	0.114	0.102
6	0.1380	5/16	0.312	0.302	0.442	0.415	0.361	0.344	0.114	0.102
8	0.1640	11/32	0.344	0.332	0.486	0.456	0.397	0.378	0.130	0.117
10	0.1900	3/8	0.375	0.362	0.530	0.497	0.433	0.413	0.130	0.117
12	0.2160	7/16	0.438	0.423	0.619	0.581	0.505	0.482	0.161	0.148
1/4	0.2500	7/16	0.438	0.423	0.619	0.581	0.505	0.482	0.193	0.178
5/16	0.3125	7/16	0.562	0.545	0.795	0.748	0.650	0.621	0.225	0.208
3/8	0.3750	5/8	0.625	0.607	0.884	0.833	0.722	0.692	0.257	0.239

All dimensions in inches. Hexagon machine screw nuts have tops flat and chamfered. Diameter of top circle should be the maximum width across flats within a tolerance of minus 15 per cent. Bottoms are flat but may be chamfered if so specified. Square machine screw nuts have tops and bottoms flat without chamfer.

Diameter of Body.—The diameter of machine screw bodies is not less than Class 2A thread minimum pitch diameter nor greater than the basic major diameter of the thread. Cross-recessed trim head machine screws not threaded to the head have an 0.062 in. minimum length shoulder under the head with diameter limits as specified in the dimensional tables in the standard.

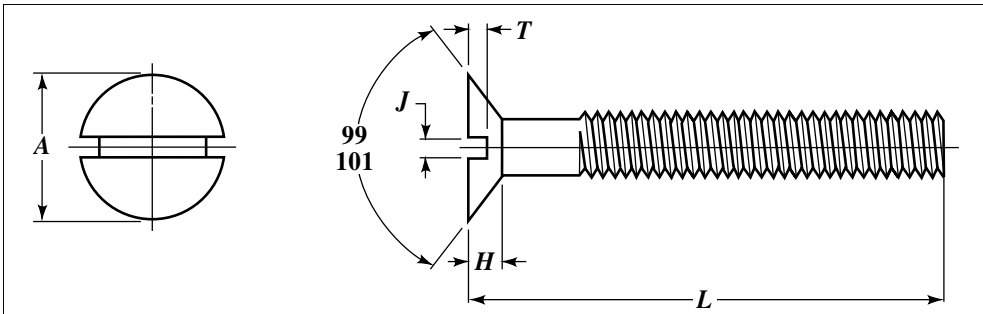
Designation.—Machine screws are designated by the following data in the sequence shown: Nominal size (number, fraction, or decimal equivalent); threads per inch; nominal length (fraction or decimal equivalent); product name, including head type and driving provision; header point, if desired; material; and protective finish, if required. For example:

- 1/4 – 20 × 1 1/4 Slotted Pan Head Machine Screw, Steel, Zinc Plated
- 6 – 32 × 3/4 Type IA Cross Recessed Fillister Head Machine Screw, Brass

Machine screw nuts are designated by the following data in the sequence shown: Nominal size (number, fraction, or decimal equivalent); threads per inch; product name; material; and protective finish, if required. For example:

- 10 – 24 Hexagon Machine Screw Nut, Steel, Zinc Plated
- 0.138 – 32 Square Machine Screw Nut, Brass

Table 2. American National Standard Slotted 100-Degree Flat Countersunk Head Machine Screws ANSI B18.6.3-1972 (R1977)



Nominal Size ^a or Basic Screw Dia.	Head Dia., A		Head Height, H	Slot Width, J		Slot Depth, T		
	Max., Edge Sharp	Min., Edge Rounded or Flat		Ref.	Max.	Min.	Max.	Min.
	0000	0.0210	0.043		0.037	0.009	0.008	0.005
000	0.0340	0.064	0.058	0.014	0.012	0.008	0.011	0.007
00	0.0470	0.093	0.085	0.020	0.017	0.010	0.013	0.008
0	0.0600	0.119	0.096	0.026	0.023	0.016	0.013	0.008
1	0.0730	0.146	0.120	0.031	0.026	0.019	0.016	0.010
2	0.0860	0.172	0.143	0.037	0.031	0.023	0.019	0.012
3	0.0990	0.199	0.167	0.043	0.035	0.027	0.022	0.014
4	0.1120	0.225	0.191	0.049	0.039	0.031	0.024	0.017
6	0.1380	0.279	0.238	0.060	0.048	0.039	0.030	0.022
8	0.1640	0.332	0.285	0.072	0.054	0.045	0.036	0.027
10	0.1900	0.385	0.333	0.083	0.060	0.050	0.042	0.031
1/4	0.2500	0.507	0.442	0.110	0.075	0.064	0.055	0.042
5/16	0.3125	0.635	0.556	0.138	0.084	0.072	0.069	0.053
3/8	0.3750	0.762	0.670	0.165	0.094	0.081	0.083	0.065

^aWhen specifying nominal size in decimals, zeros preceding the decimal point and in the fourth decimal place are omitted.

All dimensions are in inches.

**Table 3. American National Standard Slotted Flat Countersunk Head and Close Tolerance 100-Degree Flat Countersunk Head Machine Screws
ANSI B18.6.3-1972 (R1991)**

SLOTTED FLAT COUNTERSUNK HEAD TYPE									
Nominal Size ^a or Basic Screw Dia.	Max., L^b	Head Dia., A		Head Height, H	Slot Width, J		Slot Depth, T		
		Max., Edge Sharp	Min., Edge ^c		Ref.	Max.	Min.	Max.	Min.
		0000	0.0210	...	0.043	0.037	0.011	0.008	0.004
000	0.0340	...	0.064	0.058	0.016	0.011	0.007	0.009	0.005
00	0.0470	...	0.093	0.085	0.028	0.017	0.010	0.014	0.009
0	0.0600	$\frac{1}{8}$	0.119	0.099	0.035	0.023	0.016	0.015	0.010
1	0.0730	$\frac{1}{8}$	0.146	0.123	0.043	0.026	0.019	0.019	0.012
2	0.0860	$\frac{1}{8}$	0.172	0.147	0.051	0.031	0.023	0.023	0.015
3	0.0990	$\frac{1}{8}$	0.199	0.171	0.059	0.035	0.027	0.027	0.017
4	0.1120	$\frac{3}{16}$	0.225	0.195	0.067	0.039	0.031	0.030	0.020
5	0.1250	$\frac{3}{16}$	0.252	0.220	0.075	0.043	0.035	0.034	0.022
6	0.1380	$\frac{3}{16}$	0.279	0.244	0.083	0.048	0.039	0.038	0.024
8	0.1640	$\frac{1}{4}$	0.332	0.292	0.100	0.054	0.045	0.045	0.029
10	0.1900	$\frac{5}{16}$	0.385	0.340	0.116	0.060	0.050	0.053	0.034
12	0.2160	$\frac{3}{8}$	0.438	0.389	0.132	0.067	0.056	0.060	0.039
$\frac{1}{4}$	0.2500	$\frac{7}{16}$	0.507	0.452	0.153	0.075	0.064	0.070	0.046
$\frac{5}{16}$	0.3125	$\frac{1}{2}$	0.635	0.568	0.191	0.084	0.072	0.088	0.058
$\frac{3}{8}$	0.3750	$\frac{5}{8}$	0.762	0.685	0.230	0.094	0.081	0.106	0.070
$\frac{7}{16}$	0.4375	$\frac{3}{4}$	0.812	0.723	0.223	0.094	0.081	0.103	0.066
$\frac{1}{2}$	0.5000	$\frac{3}{4}$	0.875	0.775	0.223	0.106	0.091	0.103	0.065
$\frac{9}{16}$	0.5625	...	1.000	0.889	0.260	0.118	0.102	0.120	0.077
$\frac{5}{8}$	0.6250	...	1.125	1.002	0.298	0.133	0.116	0.137	0.088
$\frac{3}{4}$	0.7500	...	1.375	1.230	0.372	0.149	0.131	0.171	0.111

^a When specifying nominal size in decimals, zeros preceding the decimal point and in the fourth decimal place are omitted.

^b These lengths or shorter are undercut.

^c May be rounded or flat.

CLOSE TOLERANCE 100-DEGREE FLAT COUNTERSUNK HEAD TYPE								
Nominal Size ^a or Basic Screw Dia.	Head Diameter, A		Head Height, H	Slot Width, J		Slot Depth, T		
	Max., Edge Sharp	Min., Edge ^c		Ref.	Max.	Min.	Max.	Min.
	4	0.1120	0.225	0.191	0.049	0.039	0.031	0.024
6	0.1380	0.279	0.238	0.060	0.048	0.039	0.030	0.022
8	0.1640	0.332	0.285	0.072	0.054	0.045	0.036	0.027
10	0.1900	0.385	0.333	0.083	0.060	0.050	0.042	0.031
$\frac{1}{4}$	0.2500	0.507	0.442	0.110	0.075	0.064	0.055	0.042
$\frac{5}{16}$	0.3125	0.635	0.556	0.138	0.084	0.072	0.069	0.053
$\frac{3}{8}$	0.3750	0.762	0.670	0.165	0.094	0.081	0.083	0.065
$\frac{7}{16}$	0.4375	0.890	0.783	0.193	0.094	0.081	0.097	0.076
$\frac{1}{2}$	0.5000	1.017	0.897	0.221	0.106	0.091	0.111	0.088
$\frac{9}{16}$	0.5625	1.145	1.011	0.249	0.118	0.102	0.125	0.099
$\frac{5}{8}$	0.6250	1.272	1.124	0.276	0.133	0.116	0.139	0.111

All dimensions are in inches.

Table 4. American National Standard Slotted Undercut Flat Countersunk Head and Plain and Slotted Hex Washer Head Machine Screws ANSI B18.6.3-1972 (R1991)

SLOTTED UNDERCUT FLAT COUNTERSUNK HEAD TYPE										
Nominal Size ^a or Basic Screw Dia.	Max., L ^b	Head Dia., A		Head Height, H		Slot Width, J		Slot Depth, T		
		Max., Edge Sharp	Min., Edge Rnded. or Flat	Max.	Min.	Max.	Min.	Max.	Min.	
0	0.0600	1/8	0.119	0.099	0.025	0.018	0.023	0.016	0.011	0.007
1	0.0730	1/8	0.146	0.123	0.031	0.023	0.026	0.019	0.014	0.009
2	0.0860	1/8	0.172	0.147	0.036	0.028	0.031	0.023	0.016	0.011
3	0.0990	1/8	0.199	0.171	0.042	0.033	0.035	0.027	0.019	0.012
4	0.1120	3/16	0.225	0.195	0.047	0.038	0.039	0.031	0.022	0.014
5	0.1250	3/16	0.252	0.220	0.053	0.043	0.043	0.035	0.024	0.016
6	0.1380	3/16	0.279	0.244	0.059	0.048	0.048	0.039	0.027	0.017
8	0.1640	1/4	0.332	0.292	0.070	0.058	0.054	0.045	0.032	0.021
10	0.1900	5/16	0.385	0.340	0.081	0.068	0.060	0.050	0.037	0.024
12	0.2160	3/8	0.438	0.389	0.092	0.078	0.067	0.056	0.043	0.028
1/4	0.2500	7/16	0.507	0.452	0.107	0.092	0.075	0.064	0.050	0.032
5/16	0.3125	1/2	0.635	0.568	0.134	0.116	0.084	0.072	0.062	0.041
3/8	0.3750	9/16	0.762	0.685	0.161	0.140	0.094	0.081	0.075	0.049
7/16	0.4375	5/8	0.812	0.723	0.156	0.133	0.094	0.081	0.072	0.045
1/2	0.5000	3/4	0.875	0.775	0.156	0.130	0.106	0.091	0.072	0.046

^aWhen specifying nominal size in decimals, zeros preceding the decimal point and in the fourth decimal place are omitted.

^bThese lengths or shorter are undercut.

PLAIN AND SLOTTED HEX WASHER HEAD TYPES														
Nominal Size ^a or Basic Screw Dia.	Width Across Flats, A	Width Across Corn., W		Head Height, H		Washer Dia., B		Washer Thick., U		Slot ^a Width, J		Slot ^a Depth, T		
		Max.	Min.	Max.	Min.	Max.	Min.	Max.	Min.	Max.	Min.	Max.	Min.	
2	0.0860	0.125	0.120	0.134	0.050	0.040	0.166	0.154	0.016	0.010
3	0.0990	0.125	0.120	0.134	0.055	0.044	0.177	0.163	0.016	0.010
4	0.1120	0.188	0.181	0.202	0.060	0.049	0.243	0.225	0.019	0.011	0.039	0.031	0.042	0.025
5	0.1250	0.188	0.181	0.202	0.070	0.058	0.260	0.240	0.025	0.015	0.043	0.035	0.049	0.030
6	0.1380	0.250	0.244	0.272	0.093	0.080	0.328	0.302	0.025	0.015	0.048	0.039	0.053	0.033
8	0.1640	0.250	0.244	0.272	0.110	0.096	0.348	0.322	0.031	0.019	0.054	0.045	0.074	0.052
10	0.1900	0.312	0.305	0.340	0.120	0.105	0.414	0.384	0.031	0.019	0.060	0.050	0.080	0.057
12	0.2160	0.312	0.305	0.340	0.155	0.139	0.432	0.398	0.039	0.022	0.067	0.056	0.103	0.077
1/4	0.2500	0.375	0.367	0.409	0.190	0.172	0.520	0.480	0.050	0.030	0.075	0.064	0.111	0.083
5/16	0.3125	0.500	0.489	0.545	0.230	0.208	0.676	0.624	0.055	0.035	0.084	0.072	0.134	0.100
3/8	0.3750	0.562	0.551	0.614	0.295	0.270	0.780	0.720	0.063	0.037	0.094	0.081	0.168	0.131

^aUnless otherwise specified, hexagon washer head machine screws are not slotted.

All dimensions are in inches.

Table 5. American National Standard Slotted Truss Head and Plain and Slotted Hexagon Head Machine Screws ANSI B18.6.3-1972 (R1991)

SLOTTED TRUSS HEAD TYPE										
Nominal Size ^a or Basic Screw Dia.	Head Dia., A		Head Height, H		Head Radius, R	Slot Width, J		Slot Depth, T		
	Max.	Min.	Max.	Min.	Max.	Max.	Min.	Max.	Min.	
0000	0.0210	0.049	0.043	0.014	0.010	0.032	0.009	0.005	0.009	0.005
000	0.0340	0.077	0.071	0.022	0.018	0.051	0.013	0.009	0.013	0.009
00	0.0470	0.106	0.098	0.030	0.024	0.070	0.017	0.010	0.018	0.012
0	0.0600	0.131	0.119	0.037	0.029	0.087	0.023	0.016	0.022	0.014
1	0.0730	0.164	0.149	0.045	0.037	0.107	0.026	0.019	0.027	0.018
2	0.0860	0.194	0.180	0.053	0.044	0.129	0.031	0.023	0.031	0.022
3	0.0990	0.226	0.211	0.061	0.051	0.151	0.035	0.027	0.036	0.026
4	0.1120	0.257	0.241	0.069	0.059	0.169	0.039	0.031	0.040	0.030
5	0.1250	0.289	0.272	0.078	0.066	0.191	0.043	0.035	0.045	0.034
6	0.1380	0.321	0.303	0.086	0.074	0.211	0.048	0.039	0.050	0.037
8	0.1640	0.384	0.364	0.102	0.088	0.254	0.054	0.045	0.058	0.045
10	0.1900	0.448	0.425	0.118	0.103	0.283	0.060	0.050	0.068	0.053
12	0.2160	0.511	0.487	0.134	0.118	0.336	0.067	0.056	0.077	0.061
1/4	0.2500	0.573	0.546	0.150	0.133	0.375	0.075	0.064	0.087	0.070
3/16	0.3125	0.698	0.666	0.183	0.162	0.457	0.084	0.072	0.106	0.085
3/8	0.3750	0.823	0.787	0.215	0.191	0.538	0.094	0.081	0.124	0.100
7/16	0.4375	0.948	0.907	0.248	0.221	0.619	0.094	0.081	0.142	0.116
1/2	0.5000	1.073	1.028	0.280	0.250	0.701	0.106	0.091	0.161	0.131
9/16	0.5625	1.198	1.149	0.312	0.279	0.783	0.118	0.102	0.179	0.146
5/8	0.6250	1.323	1.269	0.345	0.309	0.863	0.133	0.116	0.196	0.162
3/4	0.7500	1.573	1.511	0.410	0.368	1.024	0.149	0.131	0.234	0.182

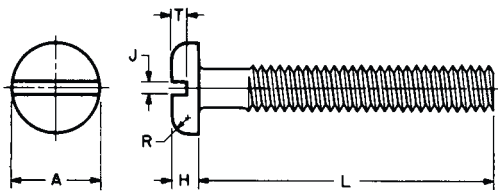
^aWhere specifying nominal size in decimals, zeros preceding decimal points and in the fourth decimal place are omitted.

PLAIN AND SLOTTED HEXAGON HEAD TYPES													
Nominal Size ^a or Basic Screw Dia.	Regular Head		Large Head			Head Height, H		Slot ^a Width, J		Slot ^a Depth, T			
	Width Across Flats, A		Width Across Flats, A		Across Corn., W	Max.	Min.	Max.	Min.	Max.	Min.		
	Max.	Min.	Max.	Min.									
1	.0730	.125	.120	.134044	.036	
2	0.0860	.125	.120	.134050	.040	
3	0.0990	.188	.181	.202055	.044	
4	0.1120	.188	.181	.202	.219	.213	.238	.060	.049	.039	.031	.036	.02
5	0.1250	.188	.181	.202	.250	.244	.272	.070	.058	.043	.035	.042	.03
6	0.1380	.250	.244	.272093	.080	.048	.039	.046	.03
8	0.1640	.250	.244	.272	.312	.305	.340	.110	.096	.054	.045	.066	.05
10	0.1900	.312	.305	.340120	.105	.060	.050	.072	.057
12	0.2160	.312	.305	.340	.375	.367	.409	.155	.139	.067	.056	.093	.07
1/4	0.2500	.375	.367	.409	.438	.428	.477	.190	.172	.075	.064	.101	.08
5/16	0.3125	.500	.489	.545230	.208	.084	.072	.122	.10
3/8	0.3750	.562	.551	.614295	.270	.094	.081	.156	.13

^aUnless otherwise specified, hexagon head machine screws are not slotted.

All dimensions are in inches.

**Table 6. American National Standard Slotted Pan Head Machine Screws
ANSI B18.6.3-1972 (R1991)**



Nominal Size ^a or Basic Screw Dia.	Head Dia., A		Head Height, H		Head Radius, R	Slot Width, J		Slot Depth, T		
	Max.	Min.	Max.	Min.	Max.	Max.	Min.	Max.	Min.	
0000	0.0210	.042	.036	.016	.010	.007	.008	.004	.008	.004
000	0.0340	.066	.060	.023	.017	.010	.012	.008	.012	.008
00	0.0470	.090	.082	.032	.025	.015	.017	.010	.016	.010
0	0.0600	.116	.104	.039	.031	.020	.023	.016	.022	.014
1	0.0730	.142	.130	.046	.038	.025	.026	.019	.027	.018
2	0.0860	.167	.155	.053	.045	.035	.031	.023	.031	.022
3	0.0990	.193	.180	.060	.051	.037	.035	.027	.036	.026
4	0.1120	.219	.205	.068	.058	.042	.039	.031	.040	.030
5	0.1250	.245	.231	.075	.065	.044	.043	.035	.045	.034
6	0.1380	.270	.256	.082	.072	.046	.048	.039	.050	.037
8	0.1640	.322	.306	.096	.085	.052	.054	.045	.058	.045
10	0.1900	.373	.357	.110	.099	.061	.060	.050	.068	.053
12	0.2160	.425	.407	.125	.112	.078	.067	.056	.077	.061
¼	0.2500	.492	.473	.144	.130	.087	.075	.064	.087	.070
⅕	0.3125	.615	.594	.178	.162	.099	.084	.072	.106	.085
⅜	0.3750	.740	.716	.212	.195	.143	.094	.081	.124	.100
7/16	0.4375	.863	.837	.247	.228	.153	.094	.081	.142	.116
½	0.5000	.987	.958	.281	.260	.175	.106	.091	.161	.131
9/16	0.5625	1.041	1.000	.315	.293	.197	.118	.102	.179	.146
⅝	0.6250	1.172	1.125	.350	.325	.219	.133	.116	.197	.162
¾	0.7500	1.435	1.375	.419	.390	.263	.149	.131	.234	.192

^a Where specifying nominal size in decimals, zeros preceding decimal and in the fourth decimal place are omitted.

All dimensions are in inches.

Table 7. Nos. 0000, 000 and 00 Threads ANSI B18.6.3-1972 (R1991) Appendix

Nominal Size ^a and Threads Per Inch	Series Designat.	External ^b						Internal ^c					
		Class	Major Diameter		Pitch Diameter			Minor Dia.	Class	Pitch Diameter			Major Dia.
			Max.	Min.	Max.	Min.	Tol.			Min.	Max.	Tol.	
0000-160 or 0.0210-160	NS	2	.0210	.0195	.0169	.0158	.0011	.0128	2	.0169	.0181	.0012	.0210
000-120 or 0.0340-120	NS	2	.0340	.0325	.0286	0.272	.0014	.0232	2	.0286	.0300	.0014	.034
00-90 or 0.0470-90	NS	2	.0470	.0450	.0398	.0382	.0016	.0326	2	.0398	.0414	.0016	.047
00-96 or 0.0470-96	NS	2	.0470	.0450	.0402	.0386	.0016	.0334	2	.0402	.0418	.0016	.047

^a Where specifying nominal size in decimals, zeros preceding decimal and in the fourth decimal place are omitted.

^b There is no allowance provided on the external threads.

^c The minor diameter limits for internal threads are not specified, they being determined by the amount of thread engagement necessary to satisfy the strength requirements and tapping performance in the intended application.

All dimensions are in inches.

Table 8. American National Standard Slotted Fillister and Slotted Drilled Fillister Head Machine Screws ANSI B18.6.3-1972 (R1991)

SLOTTED FILLISTER HEAD TYPE											
Nominal Size ¹ or Basic Screw Dia.		Head Dia., A		Head Side Height, H		Total Head Height, O		Slot Width, J		Slot Depth, T	
		Max.	Min.	Max.	Min.	Max.	Min.	Max.	Min.	Max.	Min.
0000	0.0210	.038	.032	.019	.011	.025	.15	.008	.004	.012	.006
000	0.0340	.059	.053	.029	.021	.035	.027	.012	.006	.017	.011
00	0.0470	.082	.072	.037	.028	.047	.039	.017	.010	.022	.015
0	0.0600	.096	.083	.043	.038	.055	.047	.023	.016	.025	.015
1	0.0730	.118	.104	.053	.045	.066	.058	.026	.019	.031	.020
2	0.0860	.140	.124	.062	.053	.083	.066	.031	.023	.037	.025
3	0.0990	.161	.145	.070	.061	.095	.077	.035	.027	.043	.030
4	0.1120	.183	.166	.079	.069	.107	.088	.039	.031	.048	.035
5	0.1250	.205	.187	.088	.078	.120	.100	.043	.035	.054	.040
6	0.1380	.226	.208	.096	.086	.132	.111	.048	.039	.060	.045
8	0.1640	.270	.250	.113	.102	.156	.133	.054	.045	.071	.054
10	0.1900	.313	.292	.130	.118	.180	.156	.060	.050	.083	.064
12	0.2160	.357	.334	.148	.134	.205	.178	.067	.056	.094	.074
¼	0.2500	.414	.389	.170	.155	.237	.207	.075	.064	.109	.087
⅜	0.3125	.518	.490	.211	.194	.295	.262	.084	.072	.137	.110
½	0.3750	.622	.590	.253	.233	.355	.315	.094	.081	.164	.133
⅝	0.4375	.625	.589	.265	.242	.368	.321	.094	.081	.170	.135
¾	0.5000	.750	.710	.297	.273	.412	.362	.106	.091	.190	.151
⅞	0.5625	.812	.768	.336	.308	.466	.410	.118	.102	.214	.172
1	0.6250	.875	.827	.375	.345	.521	.461	.133	.116	.240	.193
1 ¼	0.7500	1.000	.945	.441	.406	.612	.542	.149	.131	.281	.226

SLOTTED DRILLED FILLISTER HEAD TYPE													
Nominal Size ¹ or Basic Screw Dia.		Head Dia., A		Head Side Height, H		Total Head Height, O		Slot Width, J		Slot Depth, T		Drilled Hole Locat., E	Drilled Hole Dia., F
		Max.	Min.	Max.	Min.	Max.	Min.	Max.	Min.	Max.	Min.	Basic	Basic
2	0.0860	.140	.124	.062	.055	.083	.070	.031	.023	.030	.022	.026	.031
3	0.0990	.161	.145	.070	.064	.095	.082	.035	.027	.034	.026	.030	.037
4	0.1120	.183	.166	.079	.072	.107	.094	.039	.031	.038	.030	.035	.037
5	0.1250	.205	.187	.088	.081	.120	.106	.043	.035	.042	.033	.038	.046
6	0.1380	.226	.208	.096	.089	.132	.118	.048	.039	.045	.035	.043	.046
8	0.1640	.270	.250	.113	.106	.156	.141	.054	.045	.065	.054	.043	.046
10	0.1900	.313	.292	.130	.123	.180	.165	.060	.050	.075	.064	.043	.046
12	0.2160	.357	.334	.148	.139	.205	.188	.067	.056	.087	.074	.053	.046
¼	0.2500	.414	.389	.170	.161	.237	.219	.075	.064	.102	.087	.062	.062
⅜	0.3125	.518	.490	.211	.201	.295	.276	.084	.072	.130	.110	.078	.070
½	0.3750	.622	.590	.253	.242	.355	.333	.094	.081	.154	.134	.094	.070

All dimensions are in inches.

¹Where specifying nominal size in decimals, zeros preceding decimal points and in the fourth decimal place are omitted.

²Drilled hole shall be approximately perpendicular to the axis of slot and may be permitted to break through bottom of the slot. Edges of the hole shall be free from burrs.

³A slight rounding of the edges at periphery of head is permissible provided the diameter of the bearing circle is equal to no less than 90 per cent of the specified minimum head diameter.

Table 9. American National Standard Slotted Oval Countersunk Head Machine Screws ANSI B18.6.3-1972 (R1991)

Nominal Size ^a or Basic Screw Dia.	Max <i>L^b</i>	Head Dia., <i>A</i>		Head Side Height, <i>H</i> ,	Total Head Height, <i>O</i>		Slot Width, <i>J</i>		Slot Depth, <i>T</i>		
		Max., Edge Sharp	Min., Edge Rnded. or Flat		Ref.	Max.	Min.	Max.	Min.	Max.	Min.
		00	0.0470093	.085	.028	.042	.034	.017	.010
0	0.0600	1/8	.119	.099	.035	.056	.041	.023	.016	.030	.025
1	0.0730	1/8	.146	.123	.043	.068	.052	.026	.019	.038	.031
2	0.0860	1/8	.172	.147	.051	.080	.063	.031	.023	.045	.037
3	0.0990	1/8	.199	.171	.059	.092	.073	.035	.027	.052	.043
4	0.1120	3/16	.225	.195	.067	.104	.084	.039	.031	.059	.049
5	0.1250	3/16	.252	.220	.075	.116	.095	.043	.035	.067	.055
6	0.1380	3/16	.279	.244	.083	.128	.105	.048	.039	.074	.060
8	0.1640	1/4	.332	.292	.100	.152	.126	.054	.045	.088	.072
10	0.1900	5/16	.385	.340	.116	.176	.148	.060	.050	.103	.084
12	0.2160	3/8	.438	.389	.132	.200	.169	.067	.056	.117	.096
1/4	0.2500	7/16	.507	.452	.153	.232	.197	.075	.064	.136	.112
5/16	0.3125	1/2	.635	.568	.191	.290	.249	.084	.072	.171	.141
3/8	0.3750	5/16	.762	.685	.230	.347	.300	.094	.081	.206	.170
7/16	0.4375	3/8	.812	.723	.223	.345	.295	.094	.081	.210	.174
1/2	0.5000	3/4	.875	.775	.223	.354	.299	.106	.091	.216	.176
9/16	0.5625	...	1.000	.889	.260	.410	.350	.118	.102	.250	.207
5/8	0.6250	...	1.125	1.002	.298	.467	.399	.133	.116	.285	.235
3/4	0.7500	...	1.375	1.230	.372	.578	.497	.149	.131	.353	.293

^aWhen specifying nominal size in decimals, zeros preceding decimal points and in the fourth decimal place are omitted.

^bThese lengths or shorter are undercut.

All dimensions are in inches.

Table 10. American National Standard Header Points for Machine Screws before Threading ANSI B18.6.3-1972 (R1991)

Nom. Size.	Threads per Inch	Max. <i>P</i>	Min. <i>P</i>	Max. <i>L</i>	Nom. Size	Threads per Inch	Max. <i>P</i>	Min. <i>P</i>	Max. <i>L</i>
					10	24	0.125	0.112	1 1/4
12	24	0.149	0.134	1 3/8	28	0.156	0.141		
2	56	0.057	0.050	1/2	1/4	20	0.170	0.153	1 1/2
	64	0.060	0.053			28	0.187	0.169	
4	40	0.074	0.065	1/2	5/16	18	0.221	0.200	1 1/2
	48	0.079	0.070			24	0.237	0.215	
5	40	0.086	0.076	1/2	3/8	16	0.270	0.244	1 1/2
	44	0.088	0.079			24	0.295	0.267	
6	32	0.090	0.080	3/4	7/16	14	0.316	0.287	1 1/2
	40	0.098	0.087			20	0.342	0.310	
8	32	0.114	0.102	1	1/2	13	0.367	0.333	1 1/2
	36	0.118	0.106			20	0.399	0.362	

All dimensions in inches. Edges of point may be rounded and end of point need not be flat nor perpendicular to shank. Machine screws normally have plain sheared ends but when specified may have header points, as shown above.

Table 11. American National Standard Slotted Binding Head and Slotted Undercut Oval Countersunk Head Machine Screws ANSI B18.6.3-1972 (R1991)

SLOTTED BINDING HEAD TYPE															
Nominal Size ^a or Basic Screw Dia.	Head Dia., A		Total Head Height, O		Head Oval Height, F		Slot Width, J		Slot Depth, T		Undercut ^b Dia., U		Undercut ^b Depth, X		
	Max.	Min.	Max.	Min.	Max.	Min.	Max.	Min.	Max.	Min.	Max.	Min.	Max.	Min.	
0000	0.0210	.046	.040	.014	.009	.006	.003	.008	.004	.009	.005
000	0.0340	.073	.067	.021	.015	.008	.005	.012	.006	.013	.009
00	0.0470	.098	.090	.028	.023	.011	.007	.017	.010	.018	.012
0	0.0600	.126	.119	.032	.026	.012	.008	.023	.016	.018	.009	.098	.086	.007	.002
1	0.0730	.153	.145	.041	.035	.015	.011	.026	.019	.024	.014	.120	.105	.008	.003
2	0.0860	.181	.171	.050	.043	.018	.013	.031	.023	.030	.020	.141	.124	.010	.005
3	0.0990	.208	.197	.059	.052	.022	.016	.035	.027	.036	.025	.162	.143	.011	.006
4	0.1120	.235	.223	.068	.061	.025	.018	.039	.031	.042	.030	.184	.161	.012	.007
5	0.1250	.263	.249	.078	.069	.029	.021	.043	.035	.048	.035	.205	.180	.014	.009
6	0.1380	.290	.275	.087	.078	.032	.024	.048	.039	.053	.040	.226	.199	.015	.010
8	0.1640	.344	.326	.105	.095	.039	.029	.054	.045	.065	.050	.269	.236	.017	.012
10	0.1900	.399	.378	.123	.112	.045	.034	.060	.050	.077	.060	.312	.274	.020	.015
12	0.2160	.454	.430	.141	.130	.052	.039	.067	.056	.089	.070	.354	.311	.023	.018
¼	0.2500	.525	.498	.165	.152	.061	.046	.075	.064	.105	.084	.410	.360	.026	.021
⅜	0.3125	.656	.622	.209	.194	.077	.059	.084	.072	.134	.108	.513	.450	.032	.027
⅝	0.3750	.788	.746	.253	.235	.094	.071	.094	.081	.163	.132	.615	.540	.039	.034

^a Where specifying nominal size in decimals, zeros preceding decimal points and in the fourth decimal place are omitted.

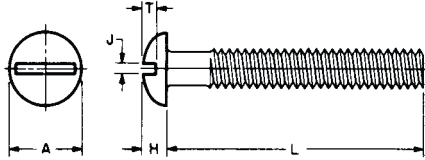
^b Unless otherwise specified, slotted binding head machine screws are not undercut.

SLOTTED UNDERCUT OVAL COUNTERSUNK HEAD TYPES											
Nominal Size ^a or Basic Screw Dia.	Max. L ^a	Head Dia., A		Head Side Height, H	Total Head Height, O		Slot Width, J		Slot Depth, T		
		Max., Edge Sharp	Min., Edge Rnded. or Flat		Ref.	Max.	Min.	Max.	Min.	Max.	Min.
0	0.0600	⅛	.119	.099	.025	.046	.033	.023	.016	.028	.022
1	0.0730	⅛	.146	.123	.031	.056	.042	.026	.019	.034	.027
2	0.0860	⅛	.172	.147	.036	.065	.050	.031	.023	.040	.033
3	0.0990	⅛	.199	.171	.042	.075	.059	.035	.027	.047	.038
4	0.1120	⅜	.225	.195	.047	.084	.067	.039	.031	.053	.043
5	0.1250	⅜	.252	.220	.053	.094	.076	.043	.035	.059	.048
6	0.1380	⅜	.279	.244	.059	.104	.084	.048	.039	.065	.053
8	0.1640	¼	.332	.292	.070	.123	.101	.054	.045	.078	.064
10	0.1900	⅜	.385	.340	.081	.142	.118	.060	.050	.090	.074
12	0.2160	⅝	.438	.389	.092	.161	.135	.067	.056	.103	.085
¼	0.2500	⅜	.507	.452	.107	.186	.158	.075	.064	.119	.098
⅜	0.3125	½	.635	.568	.134	.232	.198	.084	.072	.149	.124
⅝	0.3750	⅝	.762	.685	.161	.278	.239	.094	.081	.179	.149
⅞	0.4375	⅝	.812	.723	.156	.279	.239	.094	.081	.184	.154
½	0.5000	¾	.875	.775	.156	.288	.244	.106	.091	.204	.169

^a These lengths or shorter are undercut.

All dimensions are in inches.

**Table 12. Slotted Round Head Machine Screws
ANSI B18.6.3-1972 (R1991) Appendix**



Nominal Size ^a or Basic Screw Dia.		Head Diameter, A		Head Height, H		Slot Width, J		Slot Depth, T	
		Max.	Min.	Max.	Min.	Max.	Min.	Max.	Min.
0000	0.0210	.041	.035	.022	.016	.008	.004	.017	.013
000	0.0340	.062	.056	.031	.025	.012	.008	.018	.012
00	0.0470	.089	.080	.045	.036	.017	.010	.026	.018
0	0.0600	.113	.099	.053	.043	.023	.016	.039	.029
1	0.0730	.138	.122	.061	.051	.026	.019	.044	.033
2	0.0860	.162	.146	.069	.059	.031	.023	.048	.037
3	0.0990	.187	.169	.078	.067	.035	.027	.053	.040
4	0.1120	.211	.193	.086	.075	.039	.031	.058	.044
5	0.1250	.236	.217	.095	.083	.043	.035	.063	.047
6	0.1380	.260	.240	.103	.091	.048	.039	.068	.051
8	0.1640	.309	.287	.120	.107	.054	.045	.077	.058
10	0.1900	.359	.334	.137	.123	.060	.050	.087	.065
12	0.2160	.408	.382	.153	.139	.067	.056	.096	.073
1/4	0.2500	.472	.443	.175	.160	.075	.064	.109	.082
5/16	0.3125	.590	.557	.216	.198	.084	.072	.132	.099
3/8	0.3750	.708	.670	.256	.237	.094	.081	.155	.117
7/16	0.4375	.750	.707	.328	.307	.094	.081	.196	.148
1/2	0.5000	.813	.766	.355	.332	.106	.091	.211	.159
9/16	0.5625	.938	.887	.410	.385	.118	.102	.242	.183
5/8	0.6250	1.000	.944	.438	.411	.133	.116	.258	.195
3/4	0.7500	1.250	1.185	.547	.516	.149	.131	.320	.242

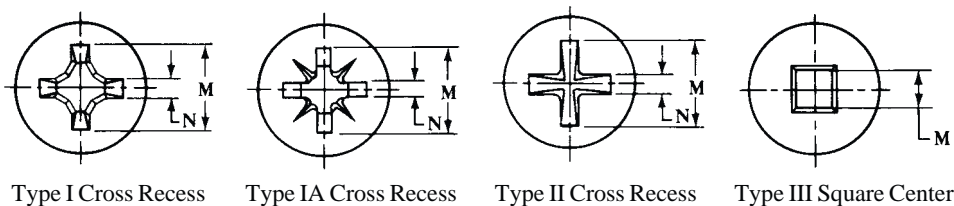
^a When specifying nominal size in decimals, zeros preceding decimal point and in the fourth decimal place are omitted.

All dimensions are in inches.

Not recommended, use Pan Head machine screws.

Machine Screw Cross Recesses.—Four cross recesses, Types I, IA, II, and III, may be used in lieu of slots in machine screw heads. Dimensions for recess diameter *M*, width *N*, and depth *T* (not shown above) together with recess penetration gaging depths are given in American National Standard ANSI B18.6.3-1972 (R1991) for machine screws, and in ANSI/ASME B18.6.7M-1985 for metric machine screws.

ANSI Cross Recesses for Machine Screws and Metric Machine Screw



Slotted Head Miniature Screws

The ASA B18.11 standard establishes head types, their dimensions, and lengths of slotted head miniature screws, threaded in conformance with American Standard Unified Miniature Screw Threads, ASA B1.10. The standard covers threads of a nominal diameter from 0.0118 inch (0.3 mm) to 0.0551 inch (1.4 mm). Preferred diameter pitch combinations for general use are shown in bold type in the tables.

Head Types.—Fillister Head: The fillister head has a flat top surface (oval crown optional) with cylindrical sides and a flat bearing surface. The head proportions are given in [Table 1](#).

Pan Head: The pan head has a flat top surface, cylindrical sides, and a flat bearing surface. The head height is less than the fillister but the head diameter is slightly larger. Head proportions are given in [Table 2](#).

Flat Head: The flat head has a flat top surface and a conical bearing surface with an included angle of approximately 100°. Head proportions are given in [Table 3](#).

Binding Head: The head height is less than the pan head but the head diameter is greater, and is intended for applications which would otherwise require washers. Head proportions are given in [Table 4](#).

Table 1. Miniature Screws - Fillister Head ASA B18.11-1961, R2010

The diagram shows a side view and a top view of a fillister head miniature screw. Dimensions are labeled as follows: A (head diameter), H (head height), J (slot width), T (slot depth), C (chamfer), R (radius), L (total length), and L_T (thread length). The thread is labeled as UNM THREADED TO ASA B1.10. An oval crown detail is shown with a minimum radius of 0.85 of the nominal head diameter and a chamfer angle of 45° ± 5° to the minor diameter.

Size Designation	Thds per Inch	D Basic Major Dia.	Fillister Head Dimensions									
			A Head Dia.		H Head Hgt		J Slot Width		T Slot Depth ^a		C Chamfer	R Radius ^b
			Max	Min	Max	Min	Max	Min	Max	Min		
30 UNM	318	0.0118	0.021	0.019	0.012	0.010	0.004	0.003	0.006	0.004	0.002	0.002
35 UNM	282	0.0138	0.023	0.021	0.014	0.012	0.004	0.003	0.007	0.005	0.002	0.002
40 UNM	254	0.0157	0.025	0.023	0.016	0.013	0.005	0.003	0.008	0.006	0.002	0.002
45 UNM	254	0.0177	0.029	0.027	0.018	0.015	0.005	0.003	0.009	0.007	0.002	0.002
50 UNM	203	0.0197	0.033	0.031	0.020	0.017	0.006	0.004	0.010	0.007	0.003	0.002
55 UNM	203	0.0217	0.037	0.035	0.022	0.019	0.006	0.004	0.011	0.008	0.003	0.002
60 UNM	169	0.0236	0.041	0.039	0.025	0.021	0.008	0.005	0.012	0.009	0.004	0.003
70 UNM	145	0.0276	0.045	0.043	0.028	0.024	0.008	0.005	0.014	0.011	0.004	0.003
80 UNM	127	0.0315	0.051	0.049	0.032	0.028	0.010	0.007	0.016	0.012	0.005	0.004
90 UNM	113	0.0354	0.056	0.054	0.036	0.032	0.010	0.007	0.018	0.014	0.005	0.004
100 UNM	102	0.0394	0.062	0.058	0.040	0.035	0.012	0.008	0.020	0.016	0.006	0.005
110 UNM	102	0.0433	0.072	0.068	0.045	0.040	0.012	0.008	0.022	0.018	0.006	0.005
120 UNM	102	0.0472	0.082	0.078	0.050	0.045	0.016	0.012	0.025	0.020	0.008	0.006
140 UNM	85	0.0551	0.092	0.088	0.055	0.050	0.016	0.012	0.028	0.023	0.008	0.006

Bold face type indicates preferred sizes. See [Notes for Tables 1 through 4](#) on page 1654.

^a T measured from bearing surface.

^b Relative to maximum major diameter.

Notes for Tables 1 through 4

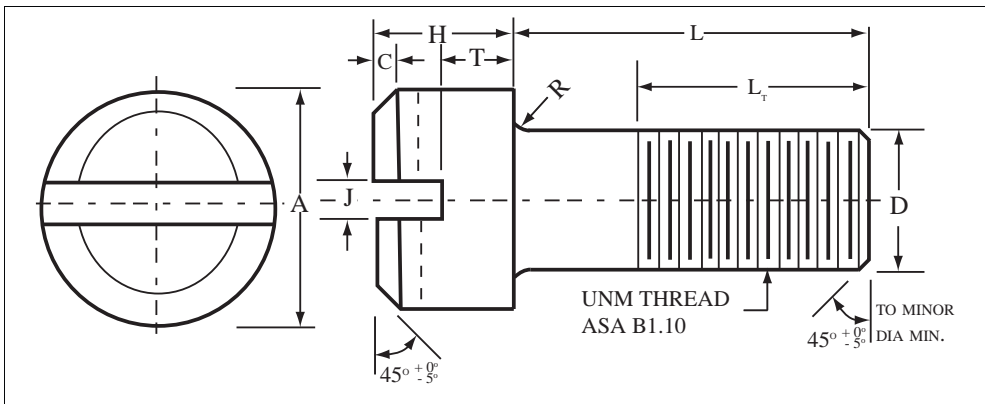
Material:
 Corrosion resistant steels: ASTM Designation A276
 CLASS 303, COND A
 CLASS 416, COND A, heat treat to approx 120,000-150,000 PSI (ROCKWELL C28-34)
 CLASS 420, COND A, heat treat to approx 220,000-240,000 PSI (ROCKWELL C50-53)
 Brass: Temper half hard ASTM Designation B16
 Nickel Silver: Temper hard ASTM Designation B151, Alloy C

Machine Finish:
 Machined surface roughness of heads shall be approximately 63µin. arithmetical average determined by visual comparison.

Applied coatings:
 Corrosion resistant steel: Passivate; Brass: Bare, black oxide, or nickel flash.
 Nickel silver: None

Notes:
 1) The diameter of the unthreaded body shall not be more than the maximum major diameter nor less than the minimum pitch diameter of the thread.
 2) For screw lengths four times the major diameter or less, thread length (L_T) shall extend to within two threads of the head bearing surface. Screws of greater length shall have complete threads for a minimum of four major diameters.
 3) Screws shall be free of all projecting burrs, observed at 3× magnification.
 4) All dimensions are in inches.

Table 2. Miniature Screws - Pan Head ASA B18.11-1961, R2010



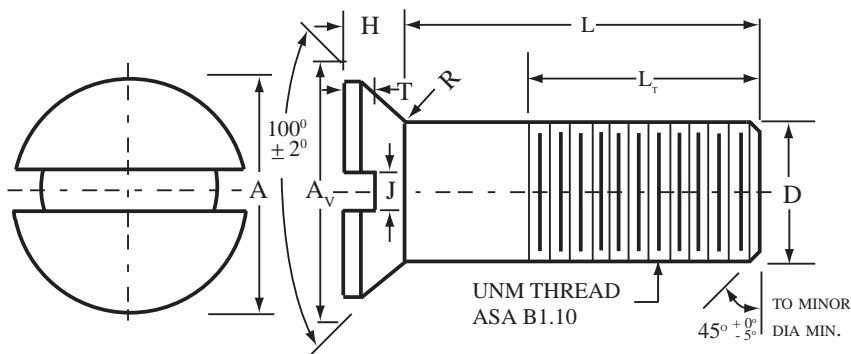
Size Designation	Thds per Inch	D Basic Major Dia., Max	Pan Head Dimensions									
			A Head Dia.		H Head Hgt		J Slot Width		T Slot Depth ^a		C Chamfer	R Radius ^b
			Max	Min	Max	Min	Max	Min	Max	Min	Max	Min
30 UNM	318	0.0118	0.025	0.023	0.010	0.008	0.005	0.003	0.005	0.003	0.002	0.002
35 UNM	282	0.0138	0.029	0.027	0.011	0.009	0.005	0.003	0.006	0.004	0.002	0.002
40 UNM	254	0.0157	0.033	0.031	0.012	0.010	0.006	0.004	0.006	0.004	0.002	0.002
45 UNM	254	0.0177	0.037	0.035	0.014	0.012	0.006	0.004	0.007	0.005	0.002	0.002
50 UNM	203	0.0197	0.041	0.039	0.016	0.013	0.008	0.005	0.008	0.006	0.003	0.002
55 UNM	203	0.0217	0.045	0.043	0.018	0.015	0.008	0.005	0.009	0.007	0.003	0.002
60 UNM	169	0.0236	0.051	0.049	0.020	0.017	0.010	0.007	0.010	0.007	0.004	0.003
70 UNM	145	0.0276	0.056	0.054	0.022	0.019	0.010	0.007	0.011	0.008	0.004	0.003
80 UNM	127	0.0315	0.062	0.058	0.025	0.021	0.012	0.008	0.012	0.009	0.005	0.004
90 UNM	113	0.0354	0.072	0.068	0.028	0.024	0.012	0.008	0.014	0.011	0.005	0.004
100 UNM	102	0.0394	0.082	0.078	0.032	0.028	0.016	0.012	0.018	0.014	0.006	0.005
110 UNM	102	0.0433	0.092	0.088	0.036	0.032	0.016	0.012	0.018	0.014	0.006	0.005
120 UNM	102	0.0472	0.103	0.097	0.040	0.035	0.020	0.015	0.020	0.016	0.008	0.006
140 UNM	85	0.0551	0.113	0.107	0.045	0.040	0.020	0.015	0.022	0.018	0.008	0.006

Bold face type indicates preferred sizes. See Notes for Tables 1 through 4 on page 1654.

^a T measured from bearing surface.

^b Relative to maximum major diameter.

Table 3. Miniature Screws - 100° Flat Head ASA B18.11-1961, R2010



Size Designation	Thds per Inch	D Basic Major Dia.	Head Dimensions									
			A Head Dia.		Av at Full Cone ^a at max H	H Head Hgt		J Slot Width		T Slot Depth		R Radius ^b
			Max	Min		Max	Min	Max	Min	Max	Min	
30 UNM	318	0.0118	0.023	0.021	0.0285	0.007	0.005	0.004	0.003	0.004	0.002	0.005
35 UNM	282	0.0138	0.025	0.023	0.0305	0.007	0.005	0.004	0.003	0.004	0.002	0.005
40 UNM	254	0.0157	0.029	0.027	0.0348	0.008	0.006	0.005	0.003	0.005	0.003	0.006
45 UNM	254	0.0177	0.033	0.031	0.0392	0.009	0.007	0.005	0.003	0.005	0.003	0.006
50 UNM	203	0.0197	0.037	0.035	0.0459	0.011	0.008	0.006	0.004	0.006	0.004	0.008
55 UNM	203	0.0217	0.041	0.039	0.0503	0.012	0.009	0.006	0.004	0.006	0.004	0.008
60 UNM	169	0.0236	0.045	0.043	0.0546	0.013	0.010	0.008	0.005	0.008	0.005	0.010
70 UNM	145	0.0276	0.051	0.049	0.0610	0.014	0.011	0.008	0.005	0.008	0.005	0.010
80 UNM	127	0.0315	0.056	0.054	0.0696	0.016	0.012	0.010	0.007	0.010	0.006	0.012
90 UNM	113	0.0354	0.062	0.058	0.0759	0.017	0.013	0.010	0.007	0.010	0.006	0.012
100 UNM	102	0.0394	0.072	0.068	0.0847	0.019	0.015	0.012	0.008	0.012	0.008	0.016
110 UNM	102	0.0433	0.082	0.078	0.0957	0.022	0.018	0.012	0.008	0.012	0.008	0.016
120 UNM	102	0.0472	0.092	0.088	0.1068	0.025	0.020	0.016	0.012	0.016	0.010	0.020
140 UNM	85	0.0551	0.103	0.097	0.1197	0.027	0.022	0.016	0.012	0.016	0.010	0.020

Bold face type indicates preferred sizes. See *Notes for Tables 1 through 4* on page 1654.

^a Av derived from maximum D, maximum H, and mean angle.

^b Relative to maximum major diameter.

Specifications.—Head Height: The head heights given in the dimensional tables represent the metal measurement (after slotting).

Depth of Slots: The depth of slots on fillister, pan and binding head screws is measured from the bearing surface to the intersection of the bottom of the slot with the head diameter. On heads with a conical bearing surface, the depth of slots is measured parallel to the axis of the screw from the flat top surface to the intersection of the bottom of the slot with the bearing surface. The maximum permissible concavity of the slot shall not exceed 3 per cent of the mean head diameter.

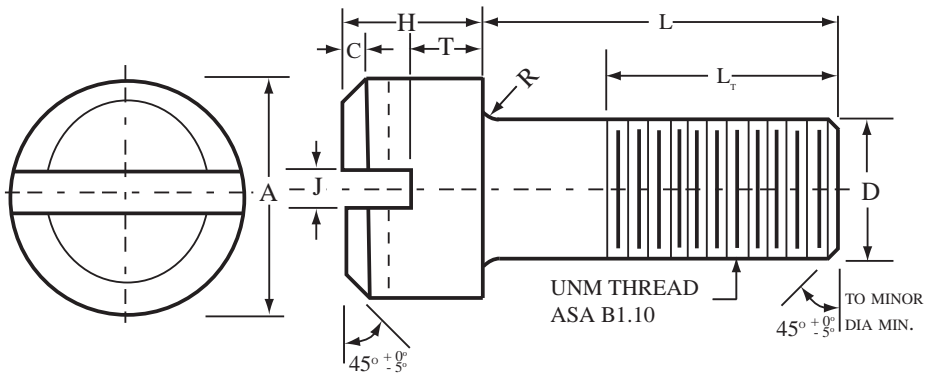
Bearing Surface: The bearing surface of fillister, pan and binding head screws shall be at right angles to the axis of the body within 2°.

Eccentricity: Eccentricity is defined as one half of the total indicator reading.

Head Eccentricity: The heads of miniature fastening screws shall not be eccentric with the screw bodies by more than 2 per cent of the maximum head diameter or 0.001 inch, whichever is the greater.

Eccentricity of Slots: Slots in miniature fastening screw heads shall not be eccentric with screw bodies by more than 5 per cent of the nominal body diameter.

Table 4. Miniature Screws - Binding Head ASA B18.11-1961, R2010



Size Designation	Thds per Inch	D Basic Major Dia	Binding Head Dimensions										
			A Head Dia.		H Head Hgt		J Slot Width		T Slot Depth ^a		C Chamfer	R Radius	
			Max	Min	Max	Min	Max	Min	Max	Min	Max	Min	Max
40 UNM	254	0.0157	0.041	0.039	0.010	0.008	0.006	0.004	0.005	0.003	0.002	0.004	0.002
45 UNM	254	0.0177	0.045	0.043	0.011	0.009	0.006	0.004	0.006	0.004	0.002	0.004	0.002
50 UNM	203	0.0197	0.051	0.049	0.012	0.010	0.008	0.005	0.006	0.004	0.003	0.004	0.002
55 UNM	203	0.0217	0.056	0.054	0.014	0.012	0.008	0.005	0.007	0.005	0.003	0.004	0.002
60 UNM	169	0.0236	0.062	0.058	0.016	0.013	0.010	0.007	0.008	0.006	0.004	0.006	0.003
70 UNM	145	0.0276	0.072	0.068	0.018	0.015	0.010	0.007	0.009	0.007	0.004	0.006	0.003
80 UNM	127	0.0315	0.082	0.078	0.020	0.017	0.012	0.008	0.010	0.007	0.005	0.008	0.004
90 UNM	113	0.0354	0.092	0.088	0.022	0.019	0.012	0.008	0.011	0.008	0.005	0.008	0.004
100 UNM	102	0.0394	0.103	0.097	0.025	0.021	0.016	0.012	0.012	0.009	0.006	0.010	0.005
110 UNM	102	0.0433	0.113	0.107	0.028	0.024	0.016	0.012	0.014	0.011	0.006	0.010	0.005
120 UNM	102	0.0472	0.124	0.116	0.032	0.028	0.020	0.015	0.016	0.012	0.008	0.012	0.006
140 UNM	85	0.0551	0.144	0.136	0.036	0.032	0.020	0.015	0.018	0.014	0.008	0.012	0.006

Bold face type indicates preferred sizes. See *Notes for Tables 1 through 4* below.

^a T measured from bearing surface.

Underhead Fillets: The radius of the fillet under perpendicular bearing surface type heads shall not exceed 1/2 times the pitch of the thread. The radius of the fillet under conical bearing surface type heads shall not exceed 2 times the pitch of the thread. The radius of the fillet under the binding head is given in **Table 4**.

Unthreaded Diameter: On miniature fastening screws not threaded to the head, the diameter of the unthreaded body shall not be more than the maximum major diameter of the thread nor less than the minimum pitch diameter of the thread.

Length: The length of miniature screws having perpendicular bearing surface type heads shall be measured from the bearing surface to the extreme end in a line parallel to the axis of the screw. The length of screws with conical bearing surface type heads shall be measured from the top of the head to the extreme end in a line parallel to the axis of the screw. Preferred lengths are those listed in **Table 5**.

Tolerance on Length: The length tolerance of miniature screws shall conform to the limits given in **Table 5**.

Length of Thread: On all miniature screws having a length four times the nominal body diameter or less the threaded length shall extend to within two threads of the bearing surface of the head. Screws of greater length shall possess complete threads for a minimum of four diameters.

Table 5. Miniature Screw Standard Lengths - Fillister Head, Pan Head, Binding Head, and 100° Flat Head ASA B18.11

Length (In.)		30 UNM ^a	35 UNM ^a	40 UNM	45 UNM	50 UNM	55 UNM	60 UNM	70 UNM	80 UNM	90 UNM	100 UNM	110 UNM	120 UNM	140 UNM	
Min.	Max.	(0.0118)	(0.0138)	(0.0157)	(0.0177)	(0.0197)	(0.0217)	(0.0236)	(0.0276)	(0.0315)	(0.0354)	(0.0394)	(0.0433)	(0.0472)	(0.0551)	
0.016	0.020	30-020^b														
0.020	0.025	30-025	35-025	40-025												
0.021	0.025	30-025	35-025	40-025												
0.027	0.032	30-032	35-032	40-032	45-032	50-032										
0.035	0.040	30-040	35-040	40-040	45-040	50-040	55-040	60-040								
0.044	0.050	30-050	35-050	40-050	45-050	50-050	50-050	60-050	70-050	80-050						
0.054	0.060	30-060	35-060	40-060	45-060	50-060	55-060	60-060	70-060	80-060	90-060	100-060				
0.072	0.080	30-080	35-080	40-080	45-080	50-080	55-080	60-080	70-080	80-080	90-080	100-080	110-080	120-080		
0.092	0.100	30-100	35-100	40-100	45-100	50-100	55-100	60-100	70-100	80-100	90-100	100-100	110-100	120-100	140-100	
0.110	0.120	30-120	35-120	40-120	45-120	50-120	55-120	60-120	70-120	80-120	90-120	100-120	110-120	120-120	140-120	
0.150	0.160	30-160	35-160	40-160	45-160	50-160	55-160	60-160	70-160	80-160	90-160	100-160	110-160	120-160	140-160	
0.188	0.200		35-200	40-200	45-200	50-200	55-200	60-200	70-200	80-200	90-200	100-200	110-200	120-200	140-200	
0.238	0.250				45-250	50-250	55-250	60-250	70-250	80-250	90-250	100-250	110-250	120-250	140-250	
0.304	0.320							55-320	60-320	70-320	80-320	90-320	100-320	110-320	120-320	140-320
0.384	0.400								70-400	80-400	90-400	100-400	110-400	120-400	140-400	
0.480	0.500										90-500	100-500	110-500	120-500	140-500	
0.580	0.600												110-600	120-600	140-600	

^a Sizes 30 UNM and 35 UNM are not specified for Binding Head.

^b Does not apply to 100° Flat Head.

Bold face type indicates preferred sizes. Sizes surrounded by heavy line apply to 100° Flat Head only.

End of Body: Miniature fastening screws shall be regularly supplied with flat ends having a chamfer of approximately 45° extending to the minor diameter of the thread as a minimum depth.

Thread Series and Tolerances: The screw threads of miniature screws shall be in conformance with American Standard Unified Miniature Screw Threads, ASA B1.10-1958.

Material and Finish: Miniature screws are generally supplied in ferrous and nonferrous materials, coatings and heat treatments which must be specified by the user. Coatings, when required, are limited to those of electro-plating or chemical oxidation.

Designation: Screws in conformance with this standard shall be identified by the designation for thread size in conformance with American Standard ASA B1.10 followed by the nominal length in units of $\frac{1}{1000}$ inch (omitting the decimal point) and the head type. Typical examples are:

60 UNM × 040 FIL HD

100 UNM × 080 PAN HD

120 UNM × 120 FLAT HD

140 UNM × 250 BIND HD

Machined Finish: Roughness of the machined surfaces of heads shall not exceed 63 micro-inches arithmetical average (per ASA B46.1, Surface Texture) determined by visual comparison with roughness comparison specimens.

American National Standard Metric Machine Screws

This Standard B18.6.7M covers metric flat and oval countersunk and slotted and recessed pan head machine screws and metric hex head and hex flange head machine screws. Dimensions are given in [Tables 1](#) through [4](#) and [5](#).

Threads: Threads for metric machine screws are coarse M profile threads, as given in ANSI B1.13M (see page [1878](#)), unless otherwise specified.

Length of Thread: The lengths of threads on metric machine screws are given in [Table 1](#) for the applicable screw type, size, and length. Also see [Table 6](#).

Diameter of Body: The body diameters of metric machine screws are within the limits specified in the dimensional tables ([Tables 3](#) through [4](#) and [5](#)).

Designation: Metric machine screws are designated by the following data in the sequence shown: Nominal size and thread pitch; nominal length; product name, including head type and driving provision; header point if desired; material (including property class, if steel); and protective finish, if required. For example:

M8 × 1.25 × 30 Slotted Pan Head Machine Screw, Class 4.8 Steel, Zinc Plated

M3.5 × 0.6 × 20 Type IA Cross Recessed Oval Countersunk Head Machine Screw, Header Point, Brass

It is common ISO practice to omit the thread pitch from the product size designation when screw threads are the metric coarse thread series, e.g., M10 stands for M10 × 1.5.

**Table 1. American National Standard Thread Lengths for Metric Machine Screws
ANSI/ASME B18.6.7M-1985**

Nominal Screw Size and Thread Pitch	L	L _{US}	L _U	L		L _{US}	L _U L	L	B
	Nominal Screw Length Equal to or Shorter than ^a	Unthreaded Length ^b		Nominal Screw Length ^a		Unthreaded Length ^b		Nominal Screw Length Longer than ^a	Full Form Thread Length ^c
		Max ^d	Max ^e	Over	To and Including	Max ^d	Max ^e		Min
M2 × 0.4	6	1.0	0.4	6	30	1.0	0.8	30	25.0
M2.5 × 0.45	8	1.1	0.5	8	30	1.1	0.9	30	25.0
M3 × 0.5	9	1.2	0.5	9	30	1.2	1.0	30	25.0
M3.5 × 0.6	10	1.5	0.6	10	50	1.5	1.2	50	38.0
M4 × 0.7	12	1.8	0.7	12	50	1.8	1.4	50	38.0
M5 × 0.8	15	2.0	0.8	15	50	2.0	1.6	50	38.0
M6 × 1	18	2.5	1.0	18	50	2.5	2.0	50	38.0
M8 × 1.25	24	3.1	1.2	24	50	3.1	2.5	50	38.0
M10 × 1.5	30	3.8	1.5	30	50	3.8	3.0	50	38.0
M12 × 1.75	36	4.4	1.8	36	50	4.4	3.5	50	38.0

^aThe length tolerances for metric machine screws are: up to 3 mm, incl., ± 0.2 mm; over 3 to 10 mm, incl., ± 0.3 mm; over 10 to 16 mm, incl., ± 0.4 mm; over 16 to 50 mm, incl., ± 0.5 mm; over 50 mm, ± 1.0 mm.

^bUnthreaded lengths L_U and L_{US} represent the distance, measured parallel to the axis of screw, from the underside of the head to the face of a nonchamfered or noncounterbored standard GO thread ring gage assembled by hand as far as the thread will permit.

^cRefer to the illustrations for respective screw head styles.

^dThe L_{US} values apply only to heat treated recessed flat countersunk head screws.

^eThe L_U values apply to all screws except heat treated recessed flat countersunk head screws.

All dimensions in millimeters.

**Table 2. American National Standard Slotted, Cross and Square Recessed Flat Countersunk Head Metric Machine Screws
ANSI/ASME B18.6.7M-1985**

Nominal Screw Size and Thread Pitch	Slotted and Style A		Style B					D _K		K	R	N		T			
	D _S		D _{SH} ^a		D _S	L _{SH} ^a		Head Diameter				Head Height	Underhead Fillet Radius		Slot Width		Slot Depth
	Body Diameter		Body and Shoulder Diameter	Shoulder Diameter	Body Diameter	Shoulder Length		Theoretical Sharp	Actual	Max Ref	Max		Min	Max	Min	Max	Min
	Max	Min	Max	Min	Min	Max	Min	Max	Min								
M2 × 0.4 ^b	2.00	1.65	2.00	1.86	1.65	0.50	0.30	4.4	4.1	3.5	1.2	0.8	0.4	0.7	0.5	0.6	0.4
M2.5 × 0.45	2.50	2.12	2.50	2.36	2.12	0.55	0.35	5.5	5.1	4.4	1.5	1.0	0.5	0.8	0.6	0.7	0.5
M3 × 0.5	3.00	2.58	3.00	2.86	2.58	0.60	0.40	6.3	5.9	5.2	1.7	1.2	0.6	1.0	0.8	0.9	0.6
M3.5 × 0.6	3.50	3.00	3.50	3.32	3.00	0.70	0.50	8.2	7.7	6.9	2.3	1.4	0.7	1.2	1.0	1.2	0.9
M4 × 0.7	4.00	3.43	4.00	3.82	3.43	0.80	0.60	9.4	8.9	8.0	2.7	1.6	0.8	1.5	1.2	1.3	1.0
M5 × 0.8	5.00	4.36	5.00	4.82	4.36	0.90	0.70	10.4	9.8	8.9	2.7	2.0	1.0	1.5	1.2	1.4	1.1
M6 × 1	6.00	5.21	6.00	5.82	5.21	1.10	0.90	12.6	11.9	10.9	3.3	2.4	1.2	1.9	1.6	1.6	1.2
M8 × 1.25	8.00	7.04	8.00	7.78	7.04	1.40	1.10	17.3	16.5	15.4	4.6	3.2	1.6	2.3	2.0	2.3	1.8
M10 × 1.5	10.00	8.86	10.00	9.78	8.86	1.70	1.30	20.0	19.2	17.8	5.0	4.0	2.0	2.8	2.5	2.6	2.0

^a All recessed head heat-treated steel screws of property class 9.8 or higher strength have the Style B head form. Recessed head screws other than those specifically designated to be Style B have the Style A head form. The underhead shoulder on the Style B head form is mandatory and all other head dimensions are common to both the Style A and Style B head forms.

^b This size is not specified for Type III square recessed flat countersunk heads; Type II cross recess is not specified for any size.

All dimensions in millimeters.

For dimension *B*, see [Table 1](#).

For dimension *L*, see [Table 6](#).

**Table 3. American National Standard Slotted, Cross and Square Recessed Oval Countersunk Head Metric Machine Screws
ANSI/ASME B18.6.7M-1985**

Nominal Screw Size and Thread Pitch	D _S		D _K			K	F	R _F	R		N		T	
	Body Diameter		Head Diameter			Head Side Height	Raised Head Height	Head Top Radius	Underhead Fillet Radius		Slot Width		Slot Depth	
			Theoretical Sharp		Actual				Max Ref	Max	Approx	Max	Min	Max
	Max	Min	Max	Min		Min	Max	Approx						
M2 × 0.4 ^a	2.00	1.65	4.4	4.1	3.5	1.2	0.5	5.0	0.8	0.4	0.7	0.5	1.0	0.8
M2.5 × 0.45	2.50	2.12	5.5	5.1	4.4	1.5	0.6	6.6	1.0	0.5	0.8	0.6	1.2	1.0
M3 × 0.5	3.00	2.58	6.3	5.9	5.2	1.7	0.7	7.4	1.2	0.6	1.0	0.8	1.5	1.2
M3.5 × 0.6	3.50	3.00	8.2	7.7	6.9	2.3	0.8	10.9	1.4	0.7	1.2	1.0	1.7	1.4
M4 × 0.7	4.00	3.43	9.4	8.9	8.0	2.7	1.0	11.6	1.6	0.8	1.5	1.2	1.9	1.6
M5 × 0.8	5.00	4.36	10.4	9.8	8.9	2.7	1.2	11.9	2.0	1.0	1.5	1.2	2.4	2.0
M6 × 1	6.00	5.21	12.6	11.9	10.9	3.3	1.4	14.9	2.4	1.2	1.9	1.6	2.8	2.4
M8 × 1.25	8.00	7.04	17.3	16.5	15.4	4.6	2.0	19.7	3.2	1.6	2.3	2.0	3.7	3.2
M10 × 1.5	10.00	8.86	20.0	19.2	17.8	5.0	2.3	22.9	4.0	2.0	2.8	2.5	4.4	3.8

^aThis size is not specified for Type III square recessed oval countersunk heads; Type II cross recess is not specified for any size.

All dimensions in millimeters.

For dimension *B*, see [Table 1](#).

For dimension *L*, see [Table 6](#).

**Table 4. American National Standard Slotted and Cross and Square Recessed Pan Head Metric Machine Screws
ANSI/ASME B18.6.7M-1985**

Nominal Screw Size and Thread Pitch	Ds		DK		Slotted		Cross and Square Recess		DA	R	N	T	W			
					K		R1							Transition Dia	Radius	
	Body Diameter		Head Diameter		Head Height		Head Radius		Underhead Fillet		Slot Width		Slot Depth			Unslotted Head Thickness
	Max	Min	Max	Min	Max	Min	Max	Min	Ref	Max	Min	Max	Min	Max	Min	Max
M2 × 0.4 ^a	2.00	1.65	4.0	3.7	1.3	1.1	0.8	1.6	1.4	3.2	2.6	0.1	0.7	0.5	0.5	0.4
M2.5 × 0.45	2.50	2.12	5.0	4.7	1.5	1.3	1.0	2.1	1.9	4.0	3.1	0.1	0.8	0.6	0.6	0.5
M3 × 0.5	3.00	2.58	5.6	5.3	1.8	1.6	1.2	2.4	2.2	5.0	3.6	0.1	1.0	0.8	0.7	0.7
M3.5 × 0.6	3.50	3.00	7.0	6.6	2.1	1.9	1.4	2.6	2.3	6.0	4.1	0.1	1.2	1.0	0.8	0.8
M4 × 0.7	4.00	3.43	8.0	7.6	2.4	2.2	1.6	3.1	2.8	6.5	4.7	0.2	1.5	1.2	1.0	0.9
M5 × 0.8	5.00	4.36	9.5	9.1	3.0	2.7	2.0	3.7	3.4	8.0	5.7	0.2	1.5	1.2	1.2	1.2
M6 × 1	6.00	5.21	12.0	11.5	3.6	3.3	2.5	4.6	4.3	10.0	6.8	0.3	1.9	1.6	1.4	1.4
M8 × 1.25	8.00	7.04	16.0	15.5	4.8	4.5	3.2	6.0	5.6	13.0	9.2	0.4	2.3	2.0	1.9	1.9
M10 × 1.5	10.00	8.86	20.0	19.4	6.0	5.7	4.0	7.5	7.1	16.0	11.2	0.4	2.8	2.5	2.4	2.4

^aThis size not specified for Type III square recessed pan heads; Type II cross recess is not specified for any size.

All dimensions in millimeters.

For dimension *B*, see [Table 1](#).

For dimension *L*, see [Table 6](#).

Table 5. American National Standard Hex and Hex Flange Head Metric Machine Screws ANSI/ASME B18.6.7M-1985

Hex Head									
Nominal Screw Size and Thread Pitch	D_S		S^a		E^a	K		D_A	R
	Body Diameter		Hex Width Across Flats		Hex Width Across Corners	Head Height		Underhead Fillet	
	Max	Min	Max	Min	Min	Max	Min	Transition Dia	Radius
M2 × 0.4	2.00	1.65	3.20	3.02	3.38	1.6	1.3	2.6	0.1
M2.5 × 0.45	2.50	2.12	4.00	3.82	4.28	2.1	1.8	3.1	0.1
M3 × 0.5	3.00	2.58	5.00	4.82	5.40	2.3	2.0	3.6	0.1
M3.5 × 0.6	3.50	3.00	5.50	5.32	5.96	2.6	2.3	4.1	0.1
M4 × 0.7	4.00	3.43	7.00	6.78	7.59	3.0	2.6	4.7	0.2
M5 × 0.8	5.00	4.36	8.00	7.78	8.71	3.8	3.3	5.7	0.2
M6 × 1	6.00	5.21	10.00	9.78	10.95	4.7	4.1	6.8	0.3
M8 × 1.25	8.00	7.04	13.00	12.73	14.26	6.0	5.2	9.2	0.4
M10 × 1.5	10.00	8.86	16.00	15.73	17.62	7.5	6.5	11.2	0.4
M12 × 1.75	12.00	10.68	18.00	17.73	19.86	9.0	7.8	13.2	0.4
M10 × 1.5 ^b	10.00	8.86	15.00	14.73	16.50	7.5	6.5	11.2	0.4

^aDimensions across flats and across corners of the head are measured at the point of maximum metal. Taper of sides of head (angle between one side and the axis) shall not exceed 2° or 0.10 mm, whichever is greater, the specified width across flats being the large dimension.

^bThe M10 size screws having heads with 15 mm width across flats are not ISO Standard. Unless M10 size screws with 15 mm width across flats are specifically ordered, M10 size screws with 16 mm width across flats shall be furnished.

Table 5. (Continued) American National Standard Hex and Hex Flange Head Metric Machine Screws ANSI/ASME B18.6.7M-1985

Hex Flange Head													
Nominal Screw Size and Thread Pitch	Body Diameter, D_s		Hex Width Across Flats, S^a		Hex Width Across Corners, E^a	Flange Diameter, D_C		Overall Head Height, K	Hex Height, K_1	Flange Edge Thickness, C^b	Flange Top Fillet Radius, R_1	Underhead Fillet	
	Max	Min	Max	Min		Max	Min					Max Transition Dia, D_A	Min Radius, R
M2 × 0.4	2.00	1.65	3.00	2.84	3.16	4.5	4.1	2.2	1.3	0.3	0.1	2.6	0.1
M2.5 × 0.45	2.50	2.12	3.20	3.04	3.39	5.4	5.0	2.7	1.6	0.3	0.2	3.1	0.1
M3 × 0.5	3.00	2.58	4.00	3.84	4.27	6.4	5.9	3.2	1.9	0.4	0.2	3.6	0.1
M3.5 × 0.6	3.50	3.00	5.00	4.82	5.36	7.5	6.9	3.8	2.4	0.5	0.2	4.1	0.1
M4 × 0.7	4.00	3.43	5.50	5.32	5.92	8.5	7.8	4.3	2.8	0.6	0.2	4.7	0.2
M5 × 0.8	5.00	4.36	7.00	6.78	7.55	10.6	9.8	5.4	3.5	0.7	0.3	5.7	0.2
M6 × 1	6.00	5.21	8.00	7.78	8.66	12.8	11.8	6.7	4.2	1.0	0.4	6.8	0.3
M8 × 1.25	8.00	7.04	10.00	9.78	10.89	16.8	15.5	8.6	5.6	1.2	0.5	9.2	0.4
M10 × 1.5	10.00	8.86	13.00	12.72	14.16	21.0	19.3	10.7	7.0	1.4	0.6	11.2	0.4
M12 × 1.75	12.00	10.68	15.00	14.72	16.38	24.8	23.3	13.7	8.4	1.8	0.7	13.2	0.4

^aDimensions across flats and across corners of the head are measured at the point of maximum metal. Taper of sides of head (angle between one side and the axis) shall not exceed 2° or 0.10 mm, whichever is greater, the specified width across flats being the large dimension.

^bThe contour of the edge at periphery of flange is optional provided the minimum flange thickness is maintained at the minimum flange diameter. The top surface of flange may be straight or slightly rounded (convex) upward.

All dimensions in millimeters.

A slight rounding of all edges of the hexagon surfaces of indented hex heads is permissible provided the diameter of the bearing circle is not less than the equivalent of 90 per cent of the specified minimum width across flats dimension.

Heads may be indented, trimmed, or fully upset at the option of the manufacturer.

For dimension B , see [Table 1](#).

For dimension L , see [Table 6](#).

Table 6. Recommended Nominal Screw Lengths for Metric Machine Screws

Nominal Screw Length	Nominal Screw Size									
	M2	M2.5	M3	M3.5	M4	M5	M6	M8	M10	M12
2.5	PH									
3	A	PH								
4	A	A	PH							
5	A	A	A	PH	PH					
6	A	A	A	A	A	PH				
8	A	A	A	A	A	A	A			
10	A	A	A	A	A	A	A	A		
13	A	A	A	A	A	A	A	A	A	
16	A	A	A	A	A	A	A	A	A	H
20	A	A	A	A	A	A	A	A	A	H
25		A	A	A	A	A	A	A	A	H
30			A	A	A	A	A	A	A	H
35				A	A	A	A	A	A	H
40					A	A	A	A	A	H
45						A	A	A	A	H
50						A	A	A	A	H
55							A	A	A	H
60							A	A	A	H
65								A	A	H
70								A	A	H
80								A	A	H
90									A	H

All dimensions in millimeters.

¹The nominal screw lengths included between the heavy lines are recommended for the respective screw sizes and screw head styles as designated by the symbols.

A — Signifies screws of all head styles covered in this standard.

P — Signifies pan head screws.

H — Signifies hex and hex flange head screws.

**Table 7. Clearance Holes for Metric Machine Screws
ANSI/ASME B18.6.7M-1985 Appendix**

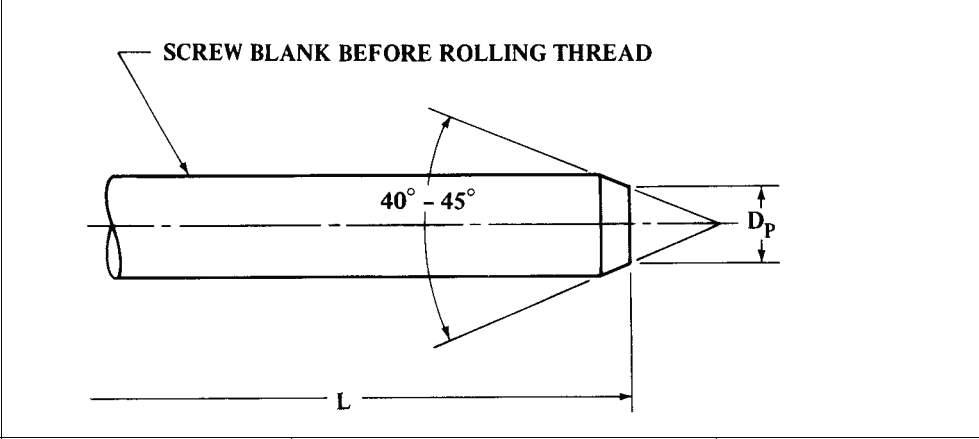
Nominal Screw Size	Basic Clearance Hole Diameter ^a		
	Close Clearance ^b	Normal Clearance (Preferred) ^b	Loose Clearance ^b
M2	2.20	2.40	2.60
M2.5	2.70	2.90	3.10
M3	3.20	3.40	3.60
M3.5	3.70	3.90	4.20
M4	4.30	4.50	4.80
M5	5.30	5.50	5.80
M6	6.40	6.60	7.00
M8	8.40	9.00	10.00
M10	10.50	11.00	12.00
M12	13.00	13.50	14.50

^aThe values given in this table are minimum limits. The recommended plus tolerances are as follows: for clearance hole diameters over 1.70 to and including 5.80 mm, plus 0.12, 0.20, and 0.30 mm for close, normal, and loose clearances, respectively; for clearance hole diameters over 5.80 to 14.50 mm, plus 0.18, 0.30, and 0.45 mm for close, normal, and loose clearances, respectively.

^bNormal clearance hole sizes are preferred. Close clearance hole sizes are for situations such as critical alignment of assembled components, wall thickness, or other limitations which necessitate the use of a minimal hole. Countersinking or counterboring at the fastener entry side may be necessary for the proper seating of the head. Loose clearance hole sizes are for applications where maximum adjustment capability between the components being assembled is necessary.

All dimensions in millimeters.

Table 8. American National Standard Header Points for Metric Machine Screws Before Threading ANSI/ASME B18.6.7M-1985



Nominal Screw Size and Thread Pitch	D_p		L^a
	Point Diameter		Nominal Screw Length
	Max	Min	Max
M2 × 0.4	1.33	1.21	13
M2.5 × 0.45	1.73	1.57	13
M3 × 0.5	2.12	1.93	16
M3.5 × 0.6	2.46	2.24	20
M4 × 0.7	2.80	2.55	25
M5 × 0.8	3.60	3.28	30
M6 × 1	4.25	3.85	40
M8 × 1.25	5.82	5.30	40
M10 × 1.5	7.36	6.71	40
M12 × 1.75	8.90	8.11	45

^a Header points apply to these nominal lengths or shorter. The pointing of longer lengths may require machining to the dimensions specified.

All dimensions in millimeters.

The edge of the point may be rounded and the end of point need not be flat nor perpendicular to the axis of screw shank.

British Machine Screws

Many of these classifications of fasteners are covered in British Standards B.S. 57:1951, "B.A. Screws, Bolts and Nuts"; BS 450:1958 (obsolescent), "Machine Screws and Machine Screw Nuts (BSW and BSF Threads)"; B.S. 1981:1953, "Unified Machine Screws and Machine Screw Nuts"; BS 2827:1957 (obsolescent):1957, "Machine Screw Nuts, Pressed Type (B.A. and Whitworth Form Threads)"; B.S. 3155:1960, "American Machine Screws and Nuts in Sizes Below $\frac{1}{4}$ inch Diameter"; and BS 4183:1967 (obsolescent), "Machine Screws and Machine Screw Nuts, Metric Series." At a conference organized by the British Standards Institution in 1965 at which the major sectors of British industry were represented, a policy statement was approved that urged British firms to regard the traditional screw thread systems—Whitworth, B.A. and BSF—as obsolescent, and to make the internationally-agreed ISO metric thread their first choice (with ISO Unified thread as second choice) for all future designs. It is recognized that some sections of British industry already using ISO inch (Unified) screw threads may find it necessary, for various reasons, to continue with their use for some time: Whitworth and B.A. threads should, however, be superseded by ISO metric threads in preference to an intermediate

change to ISO inch threads. Fasteners covered by B.S. 57, B.S. 450 and BS 2827:1957 (obsolescent) eventually would be superseded and replaced by fasteners specified by B.S. 4183.

British Standard Whitworth (BSW) and Fine (BSF) Machine Screws.—British Standard BS 450:1958 (obsolescent) covers machine screws and nuts with British Standard Whitworth and British Standard Fine threads. All the various heads in common use in both slotted and recessed forms are covered. Head shapes are shown on page 1676 and dimensions on page 1679. It is intended that this standard will eventually be superseded by B.S. 4183, “Machine Screws and Machine Screw Nuts, Metric Series.”

British Standard Machine Screws and Machine Screw Nuts, Metric Series.—British Standard BS 4183:1967 (obsolescent) gives dimensions and tolerances for: countersunk head, raised countersunk head, and cheese head slotted head screws in a diameter range from M1 (1 mm) to M20 (20 mm); pan head slotted head screws in a diameter range from M2.5 (2.5 mm) to M10 (10 mm); countersunk head and raised countersunk head recessed head screws in a diameter range from M2.5 (2.5 mm) to M12 (12 mm); pan head recessed head screws in a diameter range from M2.5 (2.5 mm) to M10 (10 mm); and square and hexagon machine screw nuts in a diameter range from M1.6 (1.6 mm) to M10 (10 mm). Mechanical properties are also specified for steel, brass and aluminum alloy machine screws and machine screw nuts in this standard.

Material: The materials from which the screws and nuts are manufactured have a tensile strength not less than the following: steel, 40 kgf/mm² (392 N/mm²); brass, 32 kgf/mm² (314 N/mm²); and aluminum alloy, 32 kgf/mm² (314 N/mm²). The unit, kgf/mm² is in accordance with ISO DR 911 and the unit in parentheses has the relationship, 1 kgf = 9.80665 Newtons. These minimum strengths are applicable to the finished products. Steel machine screws conform to the requirements for strength grade designation 4.8. The strength grade designation system for machine screws consists of two figures, the first is $\frac{1}{10}$ of the minimum tensile strength in kgf/mm², the second is $\frac{1}{10}$ of the ratio between the yield stress and the minimum tensile strength expressed as a percentage: $\frac{1}{10}$ minimum tensile strength of 40 kgf/mm² gives the symbol “4”; $\frac{1}{10}$ ratio $\frac{\text{yield stress}}{\text{minimum tensile strength}} \% = \frac{1}{10} \times \frac{32}{40} \times 100/1 = “8”$; giving the strength grade designation “4.8.” Multiplication of these two figures gives the minimum yield stress in kgf/mm².

Coating of Screws and Nuts: It is recommended that the coating comply with the appropriate part of BS 3382. “Electroplated Coatings on Threaded Components.”

Screw Threads: Screw threads are ISO metric coarse pitch series threads in accordance with B.S. 3643. “ISO Metric Screw Threads,” Part 1, “Thread Data and Standard Thread Series.” The external threads used for screws conform to tolerance Class 6g limits (medium fit) as given in B.S. 3643, “ISO Metric Screw Threads,” Part 2, “Limits and Tolerances for Coarse Pitch Series Threads.” The internal threads used for nuts conform to tolerance Class 6H limits (medium fit) as given in B.S. 3643: Part 2.

Nominal Lengths of Screws: For countersunk head screws the nominal length is the distance from the upper surface of the head to the extreme end of the shank, including any chamfer, radius, or cone point. For raised countersunk head screws the nominal length is the distance from the upper surface of the head (excluding the raised portion) to the extreme end of the shank, including any chamfer, radius, or cone point. For pan and cheese head screws the nominal length is the distance from the underside of the head to the extreme end of the shank, including any chamfer, radius, or cone point. Standard nominal lengths and tolerances are given in Table 5.

Lengths of Thread on Screws: The length of thread is the distance from the end of the screw (including any chamfer, radius, or cone point) to the leading face of a nut without countersink which has been screwed as far as possible onto the screw by hand. The minimum thread length is shown in the following table:

Nominal Thread Dia., d^a	M1	M1.2	(M1.4)	M1.6	M2	(M2.2)	M2.5	M3	(M3.5)	M4
Thread Length b (Min.)	^b	^b	^b	15	16	17	18	19	20	22
Nominal Thread Dia., d^a	(M4.5)	M5	M6	M8	M10	M12	(M14)	M16	(M18)	M20
Thread Length b (Min.)	24	25	28	34	40	46	52	58	64	70

^a Items shown in parentheses are non-preferred.

^b Threaded up to the head.

All dimensions are in millimeters.

Screws of nominal thread diameter M1, M1.2 and M1.4 and screws of larger diameters that are too short for the above thread lengths are threaded as far as possible up to the head.

In these screws the length of unthreaded shank under the head does not exceed $1\frac{1}{2}$ pitches for lengths up to twice the diameter and 2 pitches for longer lengths, and is defined as the distance from the leading face of a nut that has been screwed as far as possible onto the screw by hand to: 1) the junction of the basic major diameter and the countersunk portion of the head on countersunk and raised countersunk heads; and 2) the underside of the head on other types of heads.

Diameter of Unthreaded Shank on Screws: The diameter of the unthreaded portion of the shank on screws is not greater than the basic major diameter of the screw thread and not less than the minimum effective diameter of the screw thread. The diameter of the unthreaded portion of shank is closely associated with the method of manufacture; it will generally be nearer the major diameter of the thread for turned screws and nearer the effective diameter for those produced by cold heading.

Radius Under the Head of Screws: The radius under the head of pan and cheese head screws runs smoothly into the face of the head and shank without any step or discontinuity. A true radius is not essential providing that the curve is smooth and lies wholly within the maximum radius. Any radius under the head of countersunk head screws runs smoothly into the conical bearing surface of the head and the shank without any step or discontinuity. The radius values given in [Tables 1](#) and [2](#) are regarded as the maximum where the shank diameter is equal to the major diameter of the thread and minimum where the shank diameter is approximately equal to the effective diameter of the thread.

Table 1. British Standard Slotted Countersunk Head Machine Screws—Metric Series BS 4183:1967 (obsolescent)

Nominal Size d^a	Head Diameter D		Head Height k		Radius r^b	Thread Length b	Thread Run-out a	Flushness Tolerance ^c	Slot Width n		Slot Depth t	
	Max. (Theor. Sharp) $2d$	Min. $1.75d$	Max. $0.5d$	Min. $0.45d$		Min.	Max. $2p^d$		Max.	Max.	Min.	Max. $0.3d$
M1	2.00	1.75	0.50	0.45	0.1	e	0.50	...	0.45	0.31	0.30	0.20
M1.2	2.40	2.10	0.60	0.54	0.1	e	0.50	...	0.50	0.36	0.36	0.24
(M1.4)	2.80	2.45	0.70	0.63	0.1	e	0.60	...	0.50	0.36	0.42	0.28
M1.6	3.20	2.80	0.80	0.72	0.1	15.0	0.70	...	0.60	0.46	0.48	0.32
M2.0	4.00	3.50	1.00	0.90	0.1	16.0	0.80	...	0.70	0.56	0.60	0.40
(M2.2)	4.40	3.85	1.10	0.99	0.1	17.0	0.90	...	0.80	0.66	0.66	0.44
M2.5	5.00	4.38	1.25	1.12	0.1	18.0	0.90	0.10	0.80	0.66	0.75	0.50
M3	6.00	5.25	1.50	1.35	0.1	19.0	1.00	0.12	1.00	0.86	0.90	0.60
(M3.5)	7.00	6.10	1.75	1.57	0.2	20.0	1.20	0.13	1.00	0.86	1.05	0.70
M4	8.00	7.00	2.00	1.80	0.2	22.0	1.40	0.15	1.20	1.06	1.20	0.80
(M4.5)	9.00	7.85	2.25	2.03	0.2	24.0	1.50	0.17	1.20	1.06	1.35	0.90
M5	10.00	8.75	2.50	2.25	0.2	25.0	1.60	0.19	1.51	1.26	1.50	1.00
M6	12.00	10.50	3.00	2.70	0.25	28.0	2.00	0.23	1.91	1.66	1.80	1.20
M8	16.00	14.00	4.00	3.60	0.4	34.0	2.50	0.29	2.31	2.06	2.40	1.60
M10	20.00	17.50	5.00	4.50	0.4	40.0	3.00	0.37	2.81	2.56	3.00	2.00
M12	24.00	21.00	6.00	5.40	0.6	46.0	3.50	0.44	3.31	3.06	3.60	2.40
(M14)	28.00	24.50	7.00	6.30	0.6	52.0	4.00	0.52	3.31	3.06	4.20	2.80
M16	32.00	28.00	8.00	7.20	0.6	58.0	4.00	0.60	4.37	4.07	4.80	3.20
(M18)	36.00	31.50	9.00	8.10	0.6	64.0	5.00	0.67	4.37	4.07	5.40	3.60
M20	40.00	35.00	10.00	9.00	0.8	70.0	5.00	0.75	5.37	5.07	6.00	4.00

^a Nominal sizes shown in parentheses are non-preferred.

^b See *Radius Under the Head of Screws* description in text.

^c See *Dimensions of 90-Degree Countersunk Head Screws* description in text.

^d See text following table in *Lengths of Thread on Screws* description in text.

^e Threaded up to head.

All dimensions are given in millimeters. For dimensional notation, see diagram on page 1672. Recessed head screws are also standard and are available. For dimensions see British Standard.

Table 2. British Standard Slotted Raised Countersunk Head Machine Screws—Metric Series BS 4183:1967 (obsolescent)

Nominal Size d^a	Head Diameter D		Head Height k		Radius Under Head r^b	Thread Length b	Thread Run-out a	Height of Raised Portion f	Head Radius R	Slot Width n		Slot Depth t					
	Max. (Theor. Sharp) $2d$	Min. $1.75d$	Max. $0.5d$	Min. $0.45d$						Min.	Max. $2p^c$	Nom. $0.25d$	Nom.	Max.	Min.	Max. $0.5d$	Min. $0.4d$
M1	2.00	1.75	0.50	0.45	0.1	d	0.50	0.25	2.0	0.45	0.31	0.50	0.40				
M1.2	2.40	2.10	0.60	0.54	0.1	d	0.50	0.30	2.5	0.50	0.36	0.60	0.48				
(M1.4)	2.80	2.45	0.70	0.63	0.1	d	0.60	0.35	2.5	0.50	0.36	0.70	0.56				
M1.6	3.20	2.80	0.80	0.72	0.1	15.0	0.70	0.40	3.0	0.60	0.46	0.80	0.64				
M2.0	4.00	3.50	1.00	0.90	0.1	16.0	0.80	0.50	4.0	0.70	0.56	1.00	0.80				
(M2.2)	4.40	3.85	1.10	0.99	0.1	17.0	0.90	0.55	4.0	0.80	0.66	1.10	0.88				
M2.5	5.00	4.38	1.25	1.12	0.1	18.0	0.90	0.60	5.0	0.80	0.66	1.25	1.00				
M3	6.00	5.25	1.50	1.35	0.1	19.0	1.00	0.75	6.0	1.00	0.86	1.50	1.20				
(M3.5)	7.00	6.10	1.75	1.57	0.2	20.0	1.20	0.90	6.0	1.00	0.86	1.75	1.40				
M4	8.00	7.00	2.00	1.80	0.2	22.0	1.40	1.00	8.0	1.20	1.06	2.00	1.60				
(M4.5)	9.00	7.85	2.25	2.03	0.2	24.0	1.50	1.10	8.0	1.20	1.06	2.25	1.80				
M5	10.00	8.75	2.50	2.25	0.2	25.0	1.60	1.25	10.0	1.51	1.26	2.50	2.00				
M6	12.00	10.50	3.00	2.70	0.25	28.0	2.00	1.50	12.0	1.91	1.66	3.00	2.40				
M8	16.00	14.00	4.00	3.60	0.4	34.0	2.50	2.00	16.0	2.31	2.06	4.00	3.20				
M10	20.00	17.50	5.00	4.50	0.4	40.0	3.00	2.50	20.0	2.81	2.56	5.00	4.00				
M12	24.00	21.00	6.00	5.40	0.6	46.0	3.50	3.00	25.0	3.31	3.06	6.00	4.80				
(M14)	28.00	24.50	7.00	6.30	0.6	52.0	4.00	3.50	25.0	3.31	3.06	7.00	5.60				
M16	32.00	28.00	8.00	7.20	0.6	58.0	4.00	4.00	32.0	4.37	4.07	8.00	6.40				
(M18)	36.00	31.50	9.00	8.10	0.6	64.0	5.00	4.50	32.0	4.37	4.07	9.00	7.20				
M20	40.00	35.00	10.00	9.00	0.8	70.0	5.00	5.00	40.0	5.37	5.07	10.00	8.00				

^aNominal sizes shown in parentheses are non-preferred.

^bSee *Radius Under the Head of Screws* description in text.

^cSee text following table in *Lengths of Thread on Screws* description in text.

^dThreaded up to head.

All dimensions are given in millimeters. For dimensional notation see diagram on page 1672. Recessed head screws are also standard and available. For dimensions see British Standard.

Ends of Screws: When screws are made with rolled threads, the “lead” formed by the thread rolling operation is normally regarded as providing the necessary chamfer and no other machining is necessary. The ends of screws with cut threads are normally finished with a chamfer conforming to the dimension in Fig. 1a through Fig. 1d. At the option of the manufacturer, the ends of screws smaller than M6 (6-mm diameter) may be finished with a radius approximately equal to $1\frac{1}{4}$ times the nominal diameter of the shank. When cone point ends are required, they should have the dimensions given in Fig. 1a through Fig. 1d.

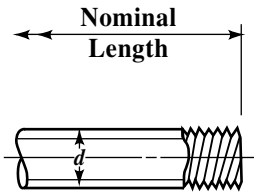
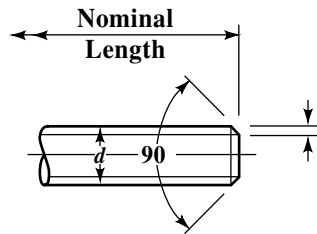


Fig. 1a. Rolled Thread End (Approximate Form as Rolled)



Cut Thread Chamfered End

Fig. 1b. Chamfer to Extend to Slightly Below the Minor Dia.

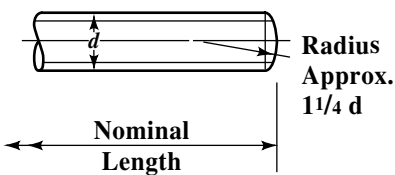


Fig. 1c. Cut Thread Radiused End (Permissible on Sizes Below M6 Dia.)

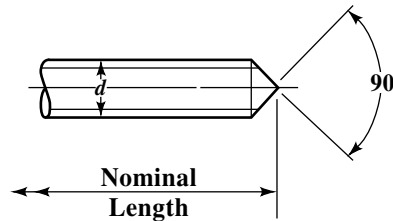


Fig. 1d. Cone Pointed End (Permissible on Cut or Rolled Thread Screws, but Regarded as "Special")

Dimensions of 90-Degree Countersunk Head Screws: One of the appendices to this British Standard states that countersunk head screws should fit into the countersunk hole with as great a degree of flushness as possible. To achieve this condition, it is necessary for the dimensions of both the head of the screw and the countersunk hole to be controlled within prescribed limits. The maximum or design size of the head is controlled by a theoretical diameter to a sharp corner and the minimum head angle of 90 degrees. The minimum head size is controlled by a minimum head diameter, the maximum head angle of 92 degrees and a flushness tolerance (see Fig. 2). The edge of the head may be flat or rounded, as shown in Fig. 3.

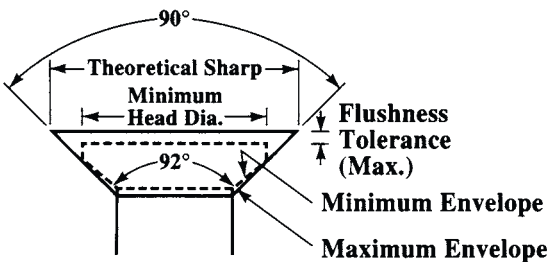


Fig. 2. Head Configuration

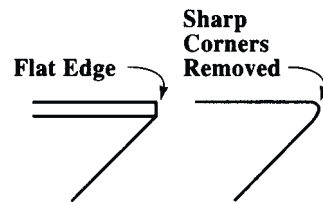
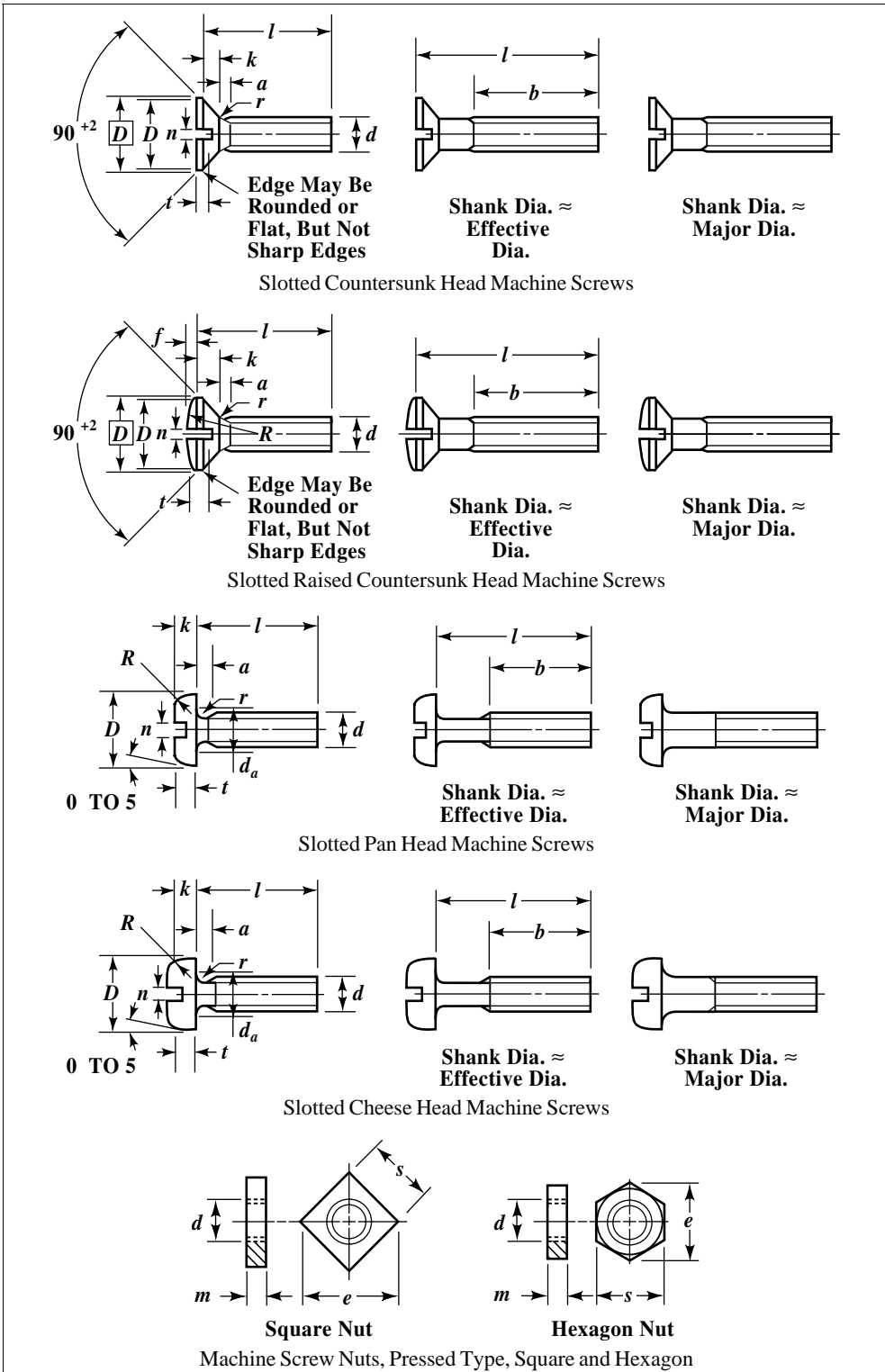


Fig. 3. Edge Configuration

British Standard Machine Screws and Machine Screw Nuts—Metric Series



For dimensions, see [Tables 1](#) through [5](#).

**Table 3. British Standard Slotted Pan Head Machine Screws—
Metric Series BS 4183:1967 (obsolescent)**

Nominal Size d^a	Head Diameter D		Head Height k		Head Radius R	Radius Under Head r	Transition Diameter d_a
	Max. $2d$	Min.	Max. $0.6d$	Min.	Max $0.4d$	Min.	Max.
M2.5	5.00	4.70	1.50	1.36	1.00	0.10	3.10
M3	6.00	5.70	1.80	1.66	1.20	0.10	3.60
(M3.5)	7.00	6.64	2.10	1.96	1.40	0.20	4.30
M4	8.00	7.64	2.40	2.26	1.60	0.20	4.70
(M4.5)	9.00	8.64	2.70	2.56	1.80	0.20	5.20
M5	10.00	9.64	3.00	2.86	2.00	0.20	5.70
M6	12.00	11.57	3.60	3.42	2.50	0.25	6.80
M8	16.00	15.57	4.80	4.62	3.20	0.40	9.20
M10	20.00	19.48	6.00	5.82	4.00	0.40	11.20

^a Nominal sizes shown in parentheses are non-preferred.

Nominal Size d^a	Thread Length b	Thread Run-out a	Slot Width n		Slot Depth t	
	Min.	Max. $2p^b$	Max.	Min.	Max. $0.6k$	Min. $0.4k$
M2.5	18.00	0.90	0.80	0.66	0.90	0.60
M3	19.00	1.00	1.00	0.86	1.08	0.72
(M3.5)	20.00	1.20	1.00	0.86	1.26	0.84
M4	22.00	1.40	1.20	1.06	1.44	0.96
(M4.5)	24.00	1.50	1.20	1.06	1.62	1.08
M5	25.00	1.60	1.51	1.26	1.80	1.20
M6	28.00	2.00	1.91	1.66	2.16	1.44
M8	34.00	2.50	2.31	2.06	2.88	1.92
M10	40.00	3.00	2.81	2.56	3.60	2.40

^a Nominal sizes shown in parentheses are non-preferred.

^b See *Lengths of Thread on Screws* on page 1668.

All dimensions are in millimeters. For dimensional notation, see diagram on page 1672. Recessed head screws are also standard and available. For dimensions, see British Standard.

Table 4. British Standard Slotted Cheese Head Machine Screws—Metric Series BS 4183:1967 (obsolescent)

Nominal Size d^n	Head Diameter D		Head Height k		Radius r^b	Transition Diameter d_a	Thread Length b	Thread Run-out a	Slot Width n		Slot Depth t	
	Max.	Min.	Max.	Min.	Min.	Max.	Min.	Max. ^c	Max.	Min.	Max.	Min.
M1	2.00	1.75	0.70	0.56	0.10	1.30	b	0.50	0.45	0.31	0.44	0.30
M1.2	2.30	2.05	0.80	0.66	0.10	1.50	b	0.50	0.50	0.36	0.49	0.35
(M1.4)	2.60	2.35	0.90	0.76	0.10	1.70	b	0.60	0.50	0.36	0.60	0.40
M1.6	3.00	2.75	1.00	0.86	0.10	2.00	15.00	0.70	0.60	0.46	0.65	0.45
M2	3.80	3.50	1.30	1.16	0.10	2.60	16.00	0.80	0.70	0.56	0.85	0.60
(M2.2)	4.00	3.70	1.50	1.36	0.10	2.80	17.00	0.90	0.80	0.66	1.00	0.70
M2.5	4.50	4.20	1.60	1.46	0.10	3.10	18.00	0.90	0.80	0.66	1.00	0.70
M3	5.50	5.20	2.00	1.86	0.10	3.60	19.00	1.00	1.00	0.86	1.30	0.90
(M3.5)	6.00	5.70	2.40	2.26	0.10	4.10	20.00	1.20	1.00	0.86	1.40	1.00
M4	7.00	6.64	2.60	2.46	0.20	4.70	22.00	1.40	1.20	1.06	1.60	1.20
(M4.5)	8.00	7.64	3.10	2.92	0.20	5.20	24.00	1.50	1.20	1.06	1.80	1.40
M5	8.50	8.14	3.30	3.12	0.20	5.70	25.00	1.60	1.51	1.26	2.00	1.50
M6	10.00	9.64	3.90	3.72	0.25	6.80	28.00	2.00	1.91	1.66	2.30	1.80
M8	13.00	12.57	5.00	4.82	0.40	9.20	34.00	2.50	2.31	2.06	2.80	2.30
M10	16.00	15.57	6.00	5.82	0.40	11.20	40.00	3.00	2.81	2.56	3.20	2.70
M12	18.00	17.57	7.00	6.78	0.60	14.20	46.00	3.50	3.31	3.06	3.80	3.20
(M14)	21.00	20.48	8.00	7.78	0.60	16.20	52.00	4.00	3.31	3.06	4.20	3.60
M16	24.00	23.48	9.00	8.78	0.60	18.20	58.00	4.00	4.37	4.07	4.60	4.00
(M18)	27.00	26.48	10.00	9.78	0.60	20.20	64.00	5.00	4.37	4.07	5.10	4.50
M20	30.00	29.48	11.00	10.73	0.80	22.40	70.00	5.00	5.27	5.07	5.60	5.00

^aNominal sizes shown in parentheses are non-preferred.

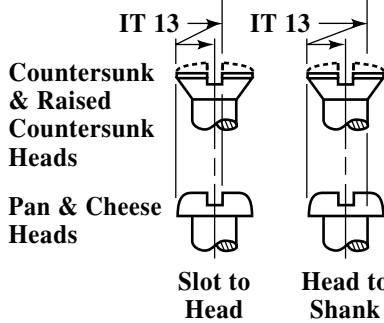
^bThreaded up to head.

^cSee text following table in *Lengths of Thread on Screws* description in text.

All dimensions are given in millimeters. For dimensional notation, see diagram on page 1672.

General Dimensions: The general dimensions and tolerances for screws and nuts are given in the accompanying tables. Although slotted screw dimensions are given, recessed head screws are also standard and available. Dimensions of recessed head screws are given in BS 4183:1967 (obsolescent).

Table 5. British Standard Machine Screws and Nuts — Metric Series BS 4183:1967 (obsolescent)

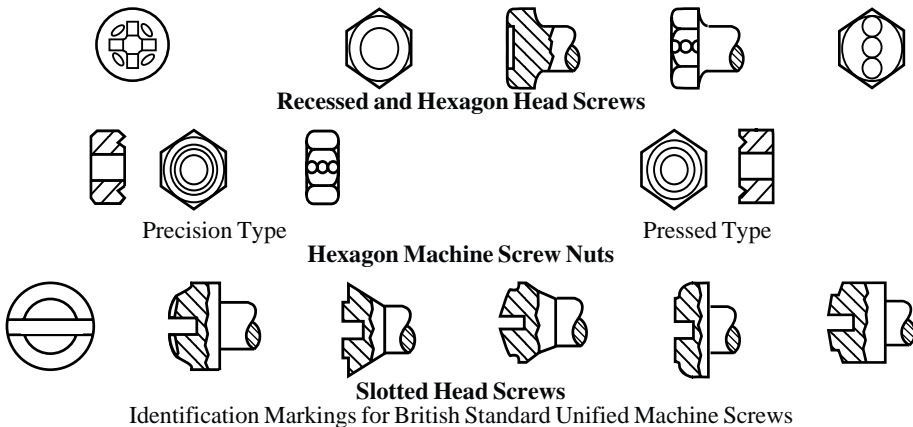
Concentricity Tolerances			Nominal Lengths and Tolerances on Length for Machine Screws				Dimensions of Machine Screw Nuts, Pressed Type, Square and Hexagon			
 <p>IT 13 IT 13</p> <p>Countersunk & Raised Countersunk Heads</p> <p>Pan & Cheese Heads</p> <p>Slot to Head Head to Shank</p>	Head to Shank and Slot to Head (IT 13)		Nominal Length ^a	Tolerance	Nominal Length ^a	Tolerance	Nominal Size d^a	Width Across		
	Countersunk, Raised Csk., and Pan Heads	Cheese Heads						Flats s		Corners e
Nominal Size d^a							Max.	Min.	Square	
M1, M1.2, (M1.4)	0.14	0.14	1.5	±0.12	45	±0.50	M1.6	3.2	3.02	4.5
M1.6	0.18	0.14	2	±0.12	50	±0.060	M2	4.0	3.82	5.7
M2, (M2.2), M2.5, M3	0.18	0.18	2.5	±0.20	55	±0.60	(M2.2)	4.5	4.32	6.4
(M3.5)	0.22	0.18	3	±0.20	60	±0.60	(M2.5)	5.0	4.82	7.1
M4, (M4.5), M5	0.22	0.22	4	±0.24	65	±0.60	M3	5.5	5.32	7.8
M6	0.27	0.22	5	±0.24	70	±0.60	(M3.5)	6.0	5.82	8.5
M8	0.27	0.27	6	±0.24	75	±0.60	M4	7.0	6.78	9.9
M10, M12	0.33	0.27	(7)	±0.29	80	±0.60	M5	8.0	7.78	11.3
(M14)	0.33	0.33	8	±0.29	85	±0.70	M6	10.0	9.78	14.1
M16, (M18), M20	0.39	0.33	(9)	±0.29	90	±0.70	M8	13.0	12.73	18.4
			10	±0.29	(95)	±0.70	M10	17.0	16.73	24.0
			(11)	±0.35	100	±0.70				
			12	±0.35	(105)	±0.70				
			14	±0.35	110	±0.70				
			16	±0.35	(115)	±0.70				
			(18)	±0.35	120	±0.70				
			20	±0.42	(125)	±0.70				
			(22)	±0.42	130	±0.80				
			25	±0.42	140	±0.80				
			(28)	±0.42	150	±0.80				
			30	±0.42	160	±0.80				
			(38)	±0.50	190	±0.925				
			40	±0.50	200	±0.925				

^aNominal sizes and lengths shown in parentheses are non-preferred.

All dimensions are given in millimeters. For dimensional notation, see diagram on page 1672.

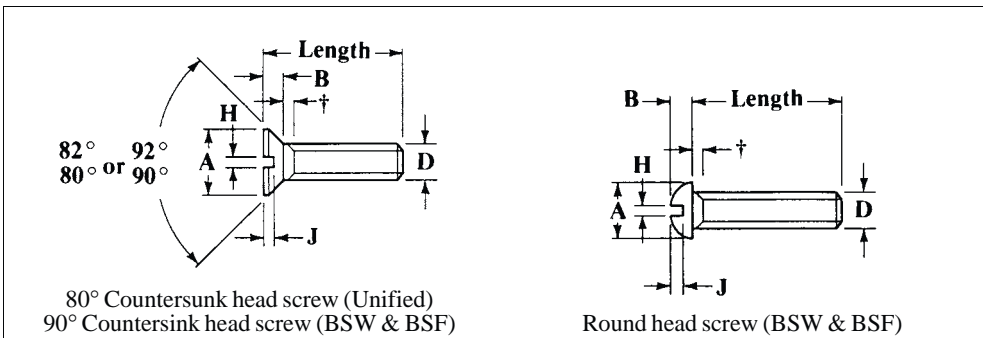
British Unified Machine Screws and Nuts.—British Standard B.S. 1981:1953 covers certain types of machine screws and machine screw nuts for which agreement has been reached with the United States and Canada as to general dimensions for interchangeability. These types are: countersunk, raised-countersunk, pan, and raised-cheese head screws with slotted or recessed heads; small hexagon head screws; and precision and pressed nuts. All have Unified threads. Head shapes are shown on page 1676 and dimensions are given on page 1678.

Identification: As revised by Amendment No. 1 in February 1955, this standard now requires that the above-mentioned screws and nuts that conform to this standard should have a distinguishing feature applied to identify them as Unified. All *recessed head screws* are to be identified as Unified by a groove in the form of four arcs of a circle in the upper surface of the head. All *hexagon head screws* are to be identified as Unified by: 1) a circular recess in the upper surface of the head; 2) a continuous line of circles indented on one or more of the flats of the hexagon and parallel to the screw axis; and 3) at least two contiguous circles indented on the upper surface of the head. All *machine screw nuts* of the pressed type shall be identified as Unified by means of the application of a groove indented in one face of the nut approximately midway between the major diameter of the thread and flats of the square or hexagon. *Slotted head screws* shall be identified as Unified either by a circular recess or by a circular platform or raised portion on the upper surface of the head. *Machine screw nuts* of the *precision type* shall be identified as Unified by either a groove indented on one face of the front approximately midway between the major diameter of the thread and the flats of the hexagon or a continuous line of circles indented on one or more of the flats of the hexagon and parallel to the nut axis.



Identification Markings for British Standard Unified Machine Screws

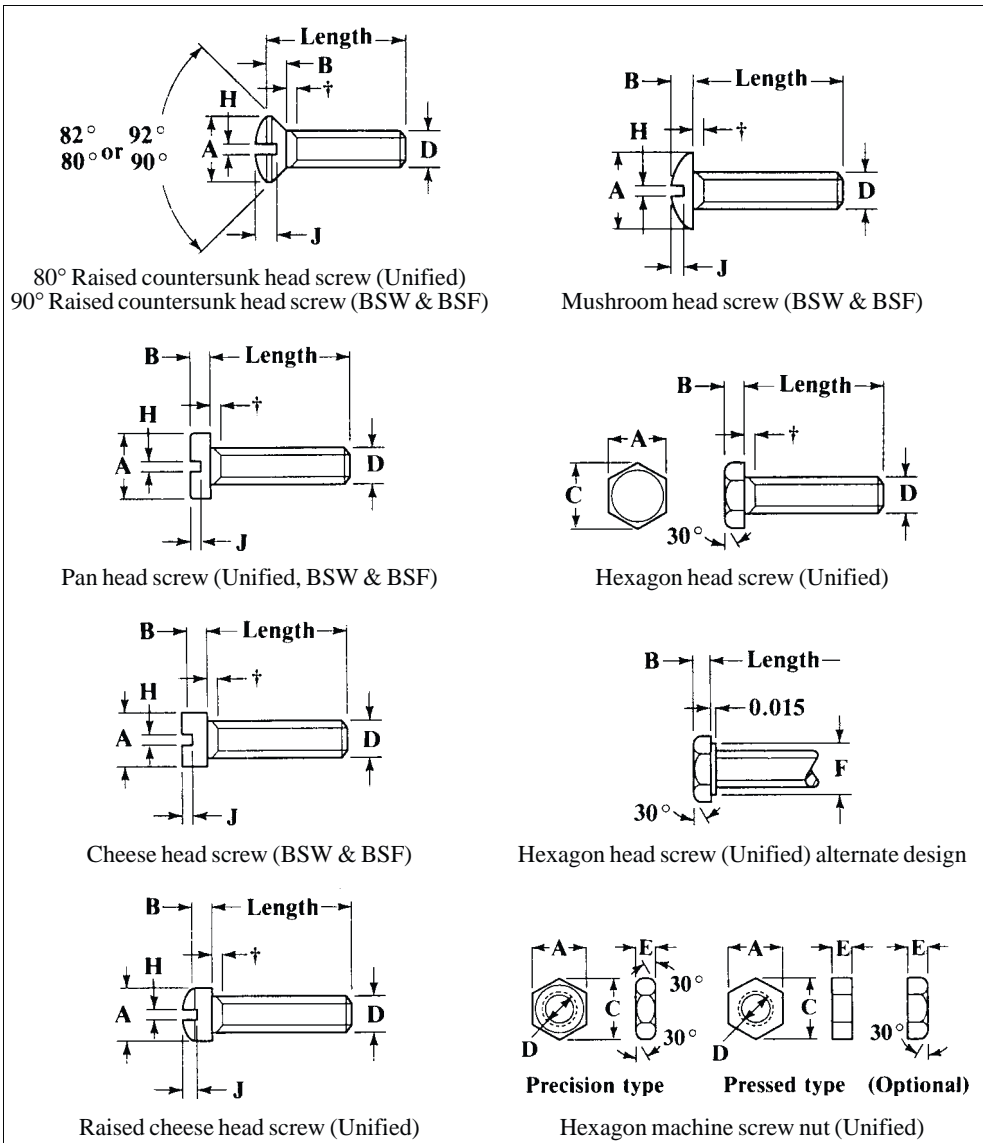
British Standard Machine Screws and Nuts
B.S. 450:1958 (obsolescent) and B.S. 1981:1953



80° Countersunk head screw (Unified)
 90° Countersink head screw (BSW & BSF)

Round head screw (BSW & BSF)

British Standard Machine Screws and Nuts (Continued)
B.S. 450:1958 (obsolescent) and B.S. 1981:1953



*Countersinks to suit the screws should have a maximum angle of 80° (Unified) or 90° (BSF and BSW) with a negative tolerance.

†Unified countersunk and raised countersunk head screws 2 inches long and under are threaded right up to the head. Other Unified, BSW and BSF machine screws 2 inches long and under have an unthread shank equal to twice the pitch. All Unified, BSW and BSF machine screws longer than 2 inches have a minimum thread length of 1¾ inches.

British Standard Unified Machine Screws and Nuts B.S. 1981:1953 (R2004)

Nom. Size of Screw	Basic Dia. <i>D</i>	Threads per Inch		Dia. of Head <i>A</i>		Depth of Head <i>B</i>		Width of Slot <i>H</i>		Depth of Slot <i>J</i>
		UNC	UNF	Max.	Min.	Max.	Min.	Max.	Min.	
80° Countersunk Head Screws^{a,b}										
4	0.112	40	...	0.211	0.194	0.067	...	0.039	0.031	0.025
6	0.138	32	...	0.260	0.242	0.083	...	0.048	0.039	0.031
8	0.164	32	...	0.310	0.291	0.100	...	0.054	0.045	0.037
10	0.190	24 ^c	32	0.359	0.339	0.116	...	0.060	0.050	0.044
1/4	0.250	20	28	0.473	0.450	0.153	...	0.075	0.064	0.058
5/16	0.3125	18	24	0.593	0.565	0.191	...	0.084	0.072	0.073
3/8	0.375	16	24	0.712	0.681	0.230	...	0.094	0.081	0.086
7/16	0.4375	14	20	0.753	0.719	0.223	...	0.094	0.081	0.086
1/2	0.500	13	20	0.808	0.770	0.223	...	0.106	0.091	0.086
5/8	0.625	11	18	1.041	0.996	0.298	...	0.133	0.116	0.113
3/4	0.750	10	16	1.275	1.223	0.372	...	0.149	0.131	0.141
Pan Head Screws^b										
4	0.112	40	...	0.219	0.205	0.068	0.058	0.039	0.031	0.036
6	0.138	32	...	0.270	0.256	0.082	0.072	0.048	0.039	0.044
8	0.164	32	...	0.322	0.306	0.096	0.085	0.054	0.045	0.051
10	0.190	24 ^c	32	0.373	0.357	0.110	0.099	0.060	0.050	0.059
1/4	0.250	20	28	0.492	0.473 ^d	0.144	0.130	0.075	0.064	0.079
5/16	0.3125	18	24	0.615	0.594	0.178	0.162	0.084	0.072	0.101
3/8	0.375	16	24	0.740	0.716	0.212	0.195	0.094	0.081	0.122
7/16	0.4375	14	20	0.863	0.838	0.247	0.227	0.094	0.081	0.133
1/2	0.500	13	20	0.987	0.958	0.281	0.260	0.106	0.091	0.152
5/8	0.625	11	18	1.125	1.090	0.350	0.325	0.133	0.116	0.189
3/4	0.750	10	16	1.250	1.209	0.419	0.390	0.149	0.131	0.226
Raised Cheese-Head Screws^b										
4	0.112	40	...	0.183	0.166	0.107	0.088	0.039	0.031	0.042
6	0.138	32	...	0.226	0.208	0.132	0.111	0.048	0.039	0.053
8	0.164	32	...	0.270	0.250	0.156	0.133	0.054	0.045	0.063
10	0.190	24 ^c	32	0.313	0.292	0.180	0.156	0.060	0.050	0.074
1/4	0.250	20	28	0.414	0.389	0.237	0.207	0.075	0.064	0.098
5/16	0.3125	18	24	0.518	0.490	0.295	0.262	0.084	0.072	0.124
3/8	0.375	16	24	0.622	0.590	0.355	0.315	0.094	0.081	0.149
7/16	0.4375	14	20	0.625	0.589	0.368	0.321	0.094	0.081	0.153
1/2	0.500	13	20	0.750	0.710	0.412	0.362	0.106	0.091	0.171
5/8	0.625	11	18	0.875	0.827	0.521	0.461	0.133	0.116	0.217
3/4	0.750	10	16	1.000	0.945	0.612	0.542	0.149	0.131	0.254

^a All dimensions, except *J*, given for the No. 4 to 3/8-inch sizes, incl., also apply to all the 80° Raised Countersunk Head Screws given in the Standard.

^b Also available with recessed heads.

^c Non-preferred.

^d By arrangement may also be 0.468.

Nom. Size	Basic Dia. <i>D</i>	Threads per Inch		Width Across			H'd Depth <i>B</i> Nut Thick. <i>E</i>		Wash. Face Dia. <i>F</i>	
		UNC	UNF	Flats <i>A</i>	Min.	Corners <i>C</i>	Max.	Min.	Max.	Min.
Hexagon Head Screws										
4	0.112	40	...	0.1875	0.1835	0.216	0.060	0.055	0.183	0.173
6	0.138	32	...	0.2500	0.2450	0.289	0.080	0.074	0.245	0.235
8	0.164	32	...	0.2500	0.2450	0.289	0.110	0.104	0.245	0.235
10	0.190	24 ^c	32	0.3125	0.3075	0.361	0.120	0.113	0.307	0.297
Hexagon Machine Screw Nuts—Precision Type										
4	0.112	40	...	0.1875	0.1835	0.216	0.098	0.087
6	0.138	32	...	0.2500	0.2450	0.269	0.114	0.102
8	0.164	32	...	0.3125	0.3075	0.361	0.130	0.117
10	0.190	24 ^c	...	0.3125	0.3075	0.361	0.130	0.117
Hexagon Machine Screw Nuts—Pressed Type										
4	0.112	40	...	0.2500	0.2410	0.289	0.087	0.077
6	0.138	32	...	0.3125	0.3020	0.361	0.114	0.102
8	0.164	32	...	0.3438	0.3320	0.397	0.130	0.117
10	0.190	24 ^c	32	0.3750	0.3620	0.433	0.130	0.117
1/4	0.250	20	28	0.4375	0.4230	0.505	0.193	0.178
5/16	0.3125	18	24	0.5625	0.5450	0.649	0.225	0.208
3/8	0.375	16	24	0.6250	0.6070	0.722	0.257	0.239

All dimensions in inches. See page 1676 for a pictorial representation and letter dimensions.

British Standard Whitworth (BSW) and Fine (BSF) Machine Screws
BS 450:1958 (obsolescent)

	Nom. Size of Screw	Basic Dia. <i>D</i>	Threads per Inch		Dia. of Head <i>A</i>		Depth of Head <i>B</i>		Width of Slot <i>H</i>		Depth of Slot <i>J</i>
			BSW	BSF	Max.	Min.	Max.	Min.	Max.	Min.	
90° Countersunk Head Screws ^{a,b}	1/8	0.1250	40	...	0.219	0.201	0.056	...	0.039	0.032	0.027
	3/16	0.1875	24	32 ^c	0.328	0.307	0.084	...	0.050	0.042	0.041
	7/32	0.2188	...	28 ^c	0.383	0.360	0.098	...	0.055	0.046	0.048
	1/4	0.2500	20	26	0.438	0.412	0.113	...	0.061	0.051	0.055
	5/16	0.3125	18	22	0.547	0.518	0.141	...	0.071	0.061	0.069
	3/8	0.3750	16	20	0.656	0.624	0.169	...	0.082	0.072	0.083
	7/16	0.4375	14	18	0.766	0.729	0.197	...	0.093	0.082	0.097
	1/2	0.5000	12	16	0.875	0.835	0.225	...	0.104	0.092	0.111
	9/16	0.5625	12 ^c	16 ^c	0.984	0.941	0.253	...	0.115	0.103	0.125
	5/8	0.6250	11	14	1.094	1.046	0.281	...	0.126	0.113	0.138
3/4	0.7500	10	12	1.312	1.257	0.338	...	0.148	0.134	0.166	
Round Head Screws ^b	1/8	0.1250	40	...	0.219	0.206	0.087	0.082	0.039	0.032	0.048
	3/16	0.1875	24	32 ^c	0.328	0.312 ^d	0.131	0.124	0.050	0.042	0.072
	7/32	0.2188	...	28 ^c	0.383	0.365	0.153	0.145	0.055	0.046	0.084
	1/4	0.2500	20	26	0.438	0.417	0.175	0.165	0.061	0.051	0.096
	5/16	0.3125	18	22	0.547	0.524	0.219	0.207	0.071	0.061	0.120
	3/8	0.3750	16	20	0.656	0.629	0.262	0.249	0.082	0.072	0.144
	7/16	0.4375	14	18	0.766	0.735	0.306	0.291	0.093	0.082	0.168
	1/2	0.5000	12	16	0.875	0.840	0.350	0.333	0.104	0.092	0.192
	9/16	0.5625	12 ^c	16 ^c	0.984	0.946	0.394	0.375	0.115	0.103	0.217
	5/8	0.6250	11	14	1.094	1.051	0.437	0.417	0.126	0.113	0.240
3/4	0.7500	10	12	1.312	1.262	0.525	0.500	0.148	0.134	0.288	
Pan Head Screws ^b	1/8	0.1250	40	...	0.245	0.231	0.075	0.065	0.039	0.032	0.040
	3/16	0.1875	24	32 ^c	0.373	0.375	0.110	0.099	0.050	0.042	0.061
	7/32	0.2188	...	28 ^c	0.425	0.407	0.125	0.112	0.055	0.046	0.069
	1/4	0.2500	20	26	0.492	0.473 ^e	0.144	0.130	0.061	0.051	0.078
	5/16	0.3125	18	22	0.615	0.594	0.178	0.162	0.071	0.061	0.095
	3/8	0.3750	16	20	0.740	0.716	0.212	0.195	0.082	0.072	0.112
	7/16	0.4375	14	18	0.863	0.838	0.247	0.227	0.093	0.082	0.129
	1/2	0.5000	12	16	0.987	0.958	0.281	0.260	0.104	0.092	0.145
	9/16	0.5625	12 ^c	16 ^c	1.031	0.999	0.315	0.293	0.115	0.103	0.162
	5/8	0.6250	11	14	1.125	1.090	0.350	0.325	0.126	0.113	0.179
3/4	0.7500	10	12	1.250	1.209	0.419	0.390	0.148	0.134	0.213	
Cheese Head Screws ^b	1/8	0.1250	40	...	0.188	0.180	0.087	0.082	0.039	0.032	0.039
	3/16	0.1875	24	32 ^c	0.281	0.270	0.131	0.124	0.050	0.042	0.059
	7/32	0.2188	...	28 ^c	0.328	0.315	0.153	0.145	0.055	0.046	0.069
	1/4	0.2500	20	26	0.375	0.360	0.175	0.165	0.061	0.051	0.079
	5/16	0.3125	18	22	0.469	0.450	0.219	0.207	0.071	0.061	0.098
	3/8	0.3750	16	20	0.562	0.540	0.262	0.249	0.082	0.072	0.118
	7/16	0.4375	14	18	0.656	0.630	0.306	0.291	0.093	0.082	0.138
	1/2	0.5000	12	16	0.750	0.720	0.350	0.333	0.104	0.092	0.157
	9/16	0.5625	12 ^c	16 ^c	0.844	0.810	0.394	0.375	0.115	0.103	0.177
	5/8	0.6250	11	14	0.938	0.900	0.437	0.417	0.126	0.113	0.197
3/4	0.7500	10	12	1.125	1.080	0.525	0.500	0.148	0.134	0.236	
Mushroom Head Screws ^b	1/8	0.1250	40	...	0.289	0.272	0.078	0.066	0.043	0.035	0.040
	3/16	0.1875	24	32 ^c	0.448	0.425	0.118	0.103	0.060	0.050	0.061
	1/4	0.2500	20	26	0.573	0.546	0.150	0.133	0.075	0.064	0.079
	5/16	0.3125	18	22	0.698	0.666	0.183	0.162	0.084	0.072	0.096
	3/8	0.3750	16	20	0.823	0.787	0.215	0.191	0.094	0.081	0.112

^a All dimensions, except *J*, given for the 1/8-through 3/8-inch sizes also apply to all the 90° Raised Countersunk Head Screw dimensions given in the Standard.

^b These screws are also available with recessed heads; dimensions of recess are not given here but may be found in the Standard.

^c Non-preferred size; avoid use whenever possible.

^d By arrangement may also be 0.309.

^e By arrangement may also be 0.468.

All dimensions in inches.

See diagram on page 1676 for a pictorial representation of screws and letter dimensions.

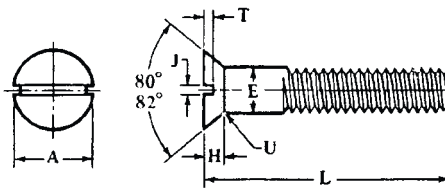
CAP AND SET SCREWS

Slotted Head Cap Screws.—American National Standard ANSI/ASME B18.6.2-1998 is intended to cover the complete general and dimensional data for the various styles of slotted head cap screws as well as square head and slotted headless set screws (see page 1687). Reference should be made to this Standard for information or data not found in the following text or tables.

Length of Thread: The length of complete (full form) thread on cap screws is equal to twice the basic screw diameter plus 0.250 in. with a plus tolerance of 0.188 in. or an amount equal to $2\frac{1}{2}$ times the pitch of the thread, whichever is greater. Cap screws of lengths too short to accommodate the minimum thread length have full form threads extending to within a distance equal to $2\frac{1}{2}$ pitches (threads) of the head.

Designation: Slotted head cap screws are designated by the following data in the sequence shown: Nominal size (fraction or decimal equivalent); threads per inch; screw length (fraction or decimal equivalent); product name; material; and protective finish, if required. Examples: $\frac{1}{2}$ -13 \times 3 Slotted Round Head Cap Screw, SAE Grade 2 Steel, Zinc Plated. .750-16 \times 2.25 Slotted Flat Countersunk Head Cap Screw, Corrosion Resistant Steel.

**Table 1. American National Standard Slotted Flat Countersunk Head Cap Screws
ANSI/ASME B18.6.2-1998 (R2010)**



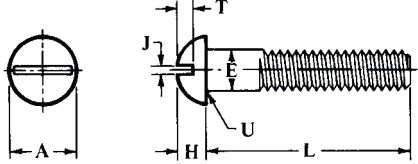
Nominal Size ^a or Basic Screw Dia.	Body Dia., E		Head Dia., A		Head Hgt., H	Slot Width, J		Slot Depth, T		Fillet Rad., U	
			Edge Sharp	Edge Rnd'd. or Flat		Max.	Min.	Max.	Min.		
	Max.	Min.	Max.	Min.	Ref.	Max.	Min.	Max.	Min.	Max.	
$\frac{1}{4}$	0.2500	.2500	.2450	.500	.452	.140	.075	.064	.068	.045	.100
$\frac{5}{16}$	0.3125	.3125	.3070	.625	.567	.177	.084	.072	.086	.057	.125
$\frac{3}{8}$	0.3750	.3750	.3690	.750	.682	.210	.094	.081	.103	.068	.150
$\frac{7}{16}$	0.4375	.4375	.4310	.812	.736	.210	.094	.081	.103	.068	.175
$\frac{1}{2}$	0.5000	.5000	.4930	.875	.791	.210	.106	.091	.103	.068	.200
$\frac{9}{16}$	0.5625	.5625	.5550	1.000	.906	.244	.118	.102	.120	.080	.225
$\frac{5}{8}$	0.6250	.6250	.6170	1.125	1.020	.281	.133	.116	.137	.091	.250
$\frac{3}{4}$	0.7500	.7500	.7420	1.375	1.251	.352	.149	.131	.171	.115	.300
$\frac{7}{8}$	0.8750	.8750	.8660	1.625	1.480	.423	.167	.147	.206	.138	.350
1	1.0000	1.0000	.9900	1.875	1.711	.494	.188	.166	.240	.162	.400
$1\frac{1}{8}$	1.1250	1.1250	1.1140	2.062	1.880	.529	.196	.178	.257	.173	.450
$1\frac{1}{4}$	1.2500	1.2500	1.2390	2.312	2.110	.600	.211	.193	.291	.197	.500
$1\frac{3}{8}$	1.3750	1.3750	1.3630	2.562	2.340	.665	.226	.208	.326	.220	.550
$1\frac{1}{2}$	1.5000	1.5000	1.4880	2.812	2.570	.742	.258	.240	.360	.244	.600

^a When specifying a nominal size in decimals, the zero preceding the decimal point is omitted as is any zero in the fourth decimal place.

All dimensions are in inches.

Threads: Threads are Unified Standard Class 2A; UNC, UNF and 8 UN Series or UNRC, UNRF, and 8 UNR Series.

**Table 2. American National Standard Slotted Round Head Cap Screws
ANSI/ASME B18.6.2-1998 (R2010)**



Nom. Size ^a or Basic Screw Diameter	Body Diameter, <i>E</i>		Head Diameter, <i>A</i>		Head Height, <i>H</i>		Slot Width, <i>J</i>		Slot Depth, <i>T</i>		
	Max.	Min.	Max.	Min.	Max.	Min.	Max.	Min.	Max.	Min.	
¼	0.2500	.2500	.2450	.437	.418	.191	.175	.075	.064	.117	.097
⅕	0.3125	.3125	.3070	.562	.540	.245	.226	.084	.072	.151	.126
⅜	0.3750	.3750	.3690	.625	.603	.273	.252	.094	.081	.168	.138
7/16	0.4375	.4375	.4310	.750	.725	.328	.302	.094	.081	.202	.167
½	0.5000	.5000	.4930	.812	.786	.354	.327	.106	.091	.218	.178
9/16	0.5625	.5625	.5550	.937	.909	.409	.378	.118	.102	.252	.207
5/8	0.6250	.6250	.6170	1.000	.970	.437	.405	.133	.116	.270	.220
¾	0.7500	.7500	.7420	1.250	1.215	.546	.507	.149	.131	.338	.278

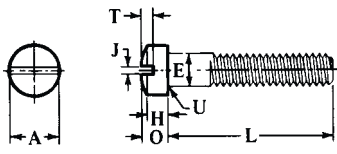
^a When specifying a nominal size in decimals, the zero preceding the decimal point is omitted as is any zero in the fourth decimal place.

All dimensions are in inches.

Fillet Radius, U: For fillet radius see footnote to table below.

Threads: Threads are Unified Standard Class 2A; UNC, UNF and 8 UN Series or UNRC, UNRF and 8 UNR Series.

**Table 3. American National Standard Slotted Fillister Head Cap Screws
ANSI/ASME B18.6.2-1998 (R2010)**



Nom. Size ^a or Basic Screw Dia.	Body Dia., <i>E</i>		Head Dia., <i>A</i>		Head Side Height, <i>H</i>		Total Head Height, <i>O</i>		Slot Width, <i>J</i>		Slot Depth, <i>T</i>		
	Max.	Min.	Max.	Min.	Max.	Min.	Max.	Min.	Max.	Min.	Max.	Min.	
¼	0.2500	.2500	.2450	.375	.363	.172	.157	.216	.194	.075	.064	.097	.077
⅕	0.3125	.3125	.3070	.437	.424	.203	.186	.253	.230	.084	.072	.115	.090
⅜	0.3750	.3750	.3690	.562	.547	.250	.229	.314	.284	.094	.081	.142	.112
7/16	0.4375	.4375	.4310	.625	.608	.297	.274	.368	.336	.094	.081	.168	.133
½	0.5000	.5000	.4930	.750	.731	.328	.301	.413	.376	.106	.091	.193	.153
9/16	0.5625	.5625	.5550	.812	.792	.375	.346	.467	.427	.118	.102	.213	.168
5/8	0.6250	.6250	.6170	.875	.853	.422	.391	.521	.478	.133	.116	.239	.189
¾	0.7500	.7500	.7420	1.000	.976	.500	.466	.612	.566	.149	.131	.283	.223
7/8	0.8750	.8750	.8660	1.125	1.098	.594	.556	.720	.668	.167	.147	.334	.264
1	1.0000	1.0000	.9900	1.312	1.282	.656	.612	.803	.743	.188	.166	.371	.291

^a When specifying nominal size in decimals, the zero preceding the decimal point is omitted as is any zero in the fourth decimal place.

All dimensions are in inches.

Fillet Radius, U: The fillet radius is as follows: For screw sizes ¼ to ⅜ incl., .031 max. and .016 min.; 7/16 to 9/16, incl., .047 max., .016 min.; and for 5/8 to 1, incl., .062 max., .031 min.

Threads: Threads are Unified Standard Class 2A; UNC, UNF and 8 UN Series or UNRC, UNRF and 8 UNR Series.

Table 4. American National Standard Hexagon and Spline Socket Head Cap Screws ANSI/ASME B18.3-1998

Nominal Size	Body Diameter, <i>D</i>		Head Diameter, <i>A</i>		Head Height, <i>H</i>		Spline Socket ^a Size, <i>M</i>	Nom. Hex. Socket Size, <i>J</i>		Fillet Ext., <i>F</i>	Key Engagement ^a , <i>T</i>
	Max	Min	Max	Min	Max	Min		Max	Max		
0	0.0600	0.0568	0.096	0.091	0.060	0.057	0.060	0.050	0.007	0.025	
1	0.0730	0.0695	0.118	0.112	0.073	0.070	0.072	1/16 0.062	0.007	0.031	
2	0.0860	0.0822	0.140	0.134	0.086	0.083	0.096	5/64 0.078	0.008	0.038	
3	0.0990	0.0949	0.161	0.154	0.099	0.095	0.096	5/64 0.078	0.008	0.044	
4	0.1120	0.1075	0.183	0.176	0.112	0.108	0.111	3/32 0.094	0.009	0.051	
5	0.1250	0.1202	0.205	0.198	0.125	0.121	0.111	3/32 0.094	0.010	0.057	
6	0.1380	0.1329	0.226	0.218	0.138	0.134	0.133	7/64 0.109	0.010	0.064	
8	0.1640	0.1585	0.270	0.262	0.164	0.159	0.168	9/64 0.141	0.012	0.077	
10	0.1900	0.1840	0.312	0.303	0.190	0.185	0.183	5/32 0.156	0.014	0.090	
1/4	0.2500	0.2435	0.375	0.365	0.250	0.244	0.216	3/16 0.188	0.014	0.120	
5/16	0.3125	0.3053	0.469	0.457	0.312	0.306	0.291	1/4 0.250	0.017	0.151	
3/8	0.3750	0.3678	0.562	0.550	0.375	0.368	0.372	5/16 0.312	0.020	0.182	
7/16	0.4375	0.4294	0.656	0.642	0.438	0.430	0.454	3/8 0.375	0.023	0.213	
1/2	0.5000	0.4919	0.750	0.735	0.500	0.492	0.454	3/8 0.375	0.026	0.245	
5/8	0.6250	0.6163	0.938	0.921	0.625	0.616	0.595	1/2 0.500	0.032	0.307	
3/4	0.7500	0.7406	1.125	1.107	0.750	0.740	0.620	5/8 0.625	0.039	0.370	
7/8	0.8750	0.8647	1.312	1.293	0.875	0.864	0.698	3/4 0.750	0.044	0.432	
1	1.0000	0.9886	1.500	1.479	1.000	0.988	0.790	3/4 0.750	0.050	0.495	
1 1/8	1.1250	1.1086	1.688	1.665	1.125	1.111	...	7/8 0.875	0.055	0.557	
1 1/4	1.2500	1.2336	1.875	1.852	1.250	1.236	...	7/8 0.875	0.060	0.620	
1 3/8	1.3750	1.3568	2.062	2.038	1.375	1.360	...	1 1.000	0.065	0.682	
1 1/2	1.5000	1.4818	2.250	2.224	1.500	1.485	...	1 1.000	0.070	0.745	
1 3/4	1.7500	1.7295	2.625	2.597	1.750	1.734	...	1 1/4 1.250	0.080	0.870	
2	2.0000	1.9780	3.000	2.970	2.000	1.983	...	1 1/2 1.500	0.090	0.995	
2 1/4	2.2500	2.2280	3.375	3.344	2.250	2.232	...	1 3/4 1.750	0.100	1.120	
2 1/2	2.5000	2.4762	3.750	3.717	2.500	2.481	...	1 3/4 1.750	0.110	1.245	
2 3/4	2.7500	2.7262	4.125	4.090	2.750	2.730	...	2 2.000	0.120	1.370	
3	3.0000	2.9762	4.500	4.464	3.000	2.979	...	2 1/4 2.250	0.130	1.495	
3 1/4	3.2500	3.2262	4.875	4.837	3.250	3.228	...	2 1/4 2.250	0.140	1.620	
3 1/2	3.5000	3.4762	5.250	5.211	3.500	3.478	...	2 3/4 2.750	0.150	1.745	
3 3/4	3.7500	3.7262	5.625	5.584	3.750	3.727	...	2 3/4 2.750	0.160	1.870	
4	4.0000	3.9762	6.000	5.958	4.000	3.976	...	3 3.000	0.170	1.995	

^a Key engagement depths are minimum. Spline socket sizes are nominal.

All dimensions in inches. The body length L_B of the screw is the length of the unthreaded cylindrical portion of the shank. The length of thread, L_T , is the distance from the extreme point to the last complete (full form) thread. Standard length increments for screw diameters up to 1 inch are 1/16 inch for lengths 1/8 through 1/4 inch, 1/8 inch for lengths 1/4 through 1 inch, 1/4 inch for lengths 1 through 3 1/2 inches, 1/2 inch for lengths 3 1/2 through 7 inches, 1 inch for lengths 7 through 10 inches and for diameters over 1 inch are 1/2 inch for lengths 1 through 7 inches, 1 inch for lengths 7 through 10 inches, and 2 inches for lengths over 10 inches.

Heads may be plain or knurled, and chamfered to an angle E of 30 to 45 degrees with the surface of the flat. The thread conforms to the Unified Standard with radius root, Class 3A UNRC and UNRF for screw sizes No. 0 through 1 inch inclusive, Class 2A UNRC and UNRF for over 1 inch through 1 1/2 inches inclusive, and Class 2A UNRC for larger sizes. Socket dimensions are given in Table 11. For details not shown, including materials, see ANSI/ASME B18.3-1998.

Table 5. Drill and Counterbore Sizes For Socket Head Cap Screws (1960 Series)

Nominal Size or Basic Screw Diameter	Nominal Drill Size					Counterbore Diameter	Countersink Diameter ^a		
	Close Fit ^b		Normal Fit ^c		A			B	C
	Number or Fractional Size	Decimal Size	Number or Fractional Size	Decimal Size					
0	0.0600	51	0.067	49	0.073	1/8	0.074		
1	0.0730	46	0.081	43	0.089	5/32	0.087		
2	0.0860	3/32	0.094	36	0.106	3/16	0.102		
3	0.0990	36	0.106	31	0.120	7/32	0.115		
4	0.1120	1/8	0.125	29	0.136	7/32	0.130		
5	0.1250	9/64	0.141	23	0.154	1/4	0.145		
6	0.1380	23	0.154	18	0.170	9/32	0.158		
8	0.1640	15	0.180	10	0.194	5/16	0.188		
10	0.1900	5	0.206	2	0.221	3/8	0.218		
1/4	0.2500	17/64	0.266	9/32	0.281	7/16	0.278		
5/16	0.3125	21/64	0.328	11/32	0.344	17/32	0.346		
3/8	0.3750	25/64	0.391	13/32	0.406	5/8	0.415		
7/16	0.4375	29/64	0.453	15/32	0.469	23/32	0.483		
1/2	0.5000	33/64	0.516	17/32	0.531	13/16	0.552		
5/8	0.6250	41/64	0.641	21/32	0.656	1	0.689		
3/4	0.7500	49/64	0.766	25/32	0.781	13/16	0.828		
7/8	0.8750	57/64	0.891	29/32	0.906	13/8	0.963		
1	1.0000	1 1/64	1.016	1 1/32	1.031	1 5/8	1.100		
1 1/4	1.2500	1 3/32	1.281	1 5/16	1.312	2	1.370		
1 1/2	1.5000	1 7/32	1.531	1 9/16	1.562	2 3/8	1.640		
1 3/4	1.7500	1 25/32	1.781	1 13/16	1.812	2 3/4	1.910		
2	2.0000	2 1/32	2.031	2 1/16	2.062	3 1/8	2.180		

^a *Countersink:* It is considered good practice to countersink or break the edges of holes which are smaller than $(D \text{ Max} + 2F \text{ Max})$ in parts having a hardness which approaches, equals or exceeds the screw hardness. If such holes are not countersunk, the heads of screws may not seat properly or the sharp edges on holes may deform the fillets on screws thereby making them susceptible to fatigue in applications involving dynamic loading. The countersink or corner relief, however, should not be larger than is necessary to insure that the fillet on the screw is cleared.

^b *Close Fit:* The close fit is normally limited to holes for those lengths of screws which are threaded to the head in assemblies where only one screw is to be used or where two or more screws are to be used and the mating holes are to be produced either at assembly or by matched and coordinated tooling.

^c *Normal Fit:* The normal fit is intended for screws of relatively long length or for assemblies involving two or more screws where the mating holes are to be produced by conventional tolerancing methods. It provides for the maximum allowable eccentricity of the longest standard screws and for certain variations in the parts to be fastened, such as: deviations in hole straightness, angularity between the axis of the tapped hole and that of the hole for the shank, differences in center distances of the mating holes, etc.

All dimensions in inches.

Source: Appendix to American National Standard ANSI/ASME B18.3-1998.

Table 6. American National Standard Hexagon and Spline Socket Flat Countersunk Head Cap Screws ANSI/ASME B18.3-1998

Nominal Size	Body Diameter		Head Diameter		Head-Height	Spline Socket Size	Hexagon Socket Size	Key Engagement
			Theoretical Sharp	Abs. Min.	Reference		Nom.	Min.
	Max.	Min.	Max.	Min.		<i>M</i>	<i>J</i>	<i>T</i>
	<i>D</i>		<i>A</i>		<i>H</i>		<i>J</i>	<i>T</i>
0	0.0600	0.0568	0.138	0.117	0.044	0.048	0.035	0.025
1	0.0730	0.0695	0.168	0.143	0.054	0.060	0.050	0.031
2	0.0860	0.0822	0.197	0.168	0.064	0.060	0.050	0.038
3	0.0990	0.0949	0.226	0.193	0.073	0.072	1/16	0.044
4	0.1120	0.1075	0.255	0.218	0.083	0.072	1/16	0.055
5	0.1250	0.1202	0.281	0.240	0.090	0.096	5/64	0.061
6	0.1380	0.1329	0.307	0.263	0.097	0.096	5/64	0.066
8	0.1640	0.1585	0.359	0.311	0.112	0.111	3/32	0.076
10	0.1900	0.1840	0.411	0.359	0.127	0.145	1/8	0.087
1/4	0.2500	0.2435	0.531	0.480	0.161	0.183	5/32	0.111
3/16	0.3125	0.3053	0.656	0.600	0.198	0.216	3/16	0.135
3/8	0.3750	0.3678	0.781	0.720	0.234	0.251	7/32	0.159
7/16	0.4375	0.4294	0.844	0.781	0.234	0.291	1/4	0.159
1/2	0.5000	0.4919	0.938	0.872	0.251	0.372	5/16	0.172
5/8	0.6250	0.6163	1.188	1.112	0.324	0.454	3/8	0.220
3/4	0.7500	0.7406	1.438	1.355	0.396	0.454	1/2	0.220
7/8	0.8750	0.8647	1.688	1.604	0.468	...	5/16	0.248
1	1.0000	0.9886	1.938	1.841	0.540	...	3/8	0.297
1 1/8	1.1250	1.1086	2.188	2.079	0.611	...	3/4	0.325
1 1/4	1.2500	1.2336	2.438	2.316	0.683	...	7/8	0.358
1 3/8	1.3750	1.3568	2.688	2.553	0.755	...	7/8	0.402
1 1/2	1.5000	1.4818	2.938	2.791	0.827	...	1	0.435

All dimensions in inches.

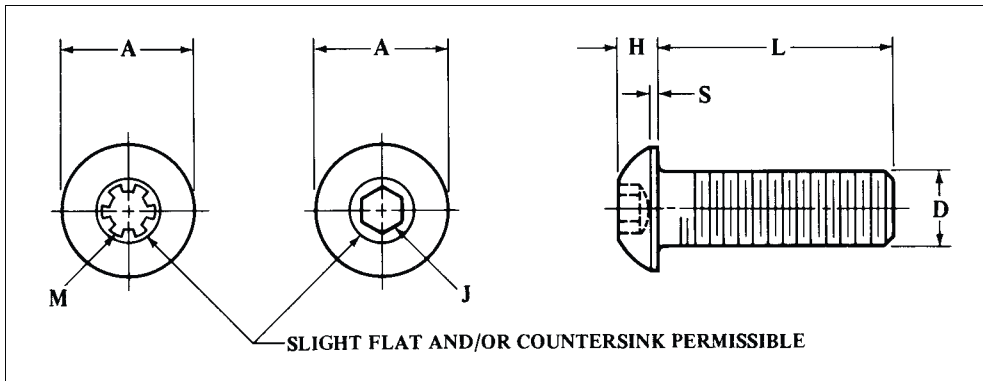
The body of the screw is the unthreaded cylindrical portion of the shank where not threaded to the head; the shank being the portion of the screw from the point of juncture of the conical bearing surface and the body to the flat of the point. The length of thread L_T is the distance measured from the extreme point to the last complete (full form) thread.

Standard length increments of No. 0 through 1-inch sizes are as follows: 1/16 inch for nominal screw lengths of 1/8 through 1/4 inch; 1/8 inch for lengths of 1/4 through 1 inch; 1/4 inch for lengths of 1 inch through 3 1/2 inches; 1/2 inch for lengths of 3 1/2 through 7 inches; and 1 inch for lengths of 7 through 10 inches, incl. For screw sizes over 1 inch, length increments are: 1/2 inch for nominal screw lengths of 1 inch through 7 inches; 1 inch for lengths of 7 through 10 inches; and 2 inches for lengths over 10 inches.

Threads shall be Unified external threads with radius root; Class 3A UNRC and UNRF series for sizes No. 0 through 1 inch and Class 2A UNRC and UNRF series for sizes over 1 inch to 1 1/2 inches, incl.

For manufacturing details not shown, including materials, see American National Standard ANSI/ASME B18.3-1998 Socket dimensions are given in [Table 11](#).

Table 7. American National Standard Hexagon Socket and Spline Socket Button Head Cap Screws ANSI/ASME B18.3-1998



Nominal Size	Screw Diameter	Head Diameter		Head Height		Head Side Height	Spline Socket Size ^a	Hexagon Socket Size ^a	Standard Length
	Basic	Max.	Min.	Max.	Min.	Ref.	Nom.	Nom.	Max.
	<i>D</i>	<i>A</i>		<i>H</i>		<i>S</i>	<i>M</i>	<i>J</i>	<i>L</i>
0	0.0600	0.114	0.104	0.032	0.026	0.010	0.048	0.035	1/2
1	0.0730	0.139	0.129	0.039	0.033	0.010	0.060	0.050	1/2
2	0.0860	0.164	0.154	0.046	0.038	0.010	0.060	0.050	1/2
3	0.0990	0.188	0.176	0.052	0.044	0.010	0.072	1/16	1/2
4	0.1120	0.213	0.201	0.059	0.051	0.015	0.072	1/16	1/2
5	0.1250	0.238	0.226	0.066	0.058	0.015	0.096	5/64	1/2
6	0.1380	0.262	0.250	0.073	0.063	0.015	0.096	5/64	5/8
8	0.1640	0.312	0.298	0.087	0.077	0.015	0.111	3/32	3/4
10	0.1900	0.361	0.347	0.101	0.091	0.020	0.145	1/8	1
1/4	0.2500	0.437	0.419	0.132	0.122	0.031	0.183	5/32	1
5/16	0.3125	0.547	0.527	0.166	0.152	0.031	0.216	3/16	1
3/8	0.3750	0.656	0.636	0.199	0.185	0.031	0.251	7/32	1 1/4
1/2	0.5000	0.875	0.851	0.265	0.245	0.046	0.372	5/16	2
5/8	0.6250	1.000	0.970	0.331	0.311	0.062	0.454	3/8	2

^a Socket dimensions are given in Table 11.

All dimensions in inches.

These cap screws have been designed and recommended for light fastening applications. They are not suggested for use in critical high-strength applications where socket head cap screws should normally be used.

Standard length increments for socket button head cap screws are as follows: 1/16 inch for nominal screw lengths of 1/8 through 1/4 inch, 1/8 inch for nominal screw lengths of 1/4 through 1 inch, and 1/4 inch for nominal screw lengths of 1 inch through 2 inches. Tolerances on lengths are -0.03 inch for lengths up to 1 inch inclusive. For lengths from 1 through 2 inches, inclusive, length tolerances are -0.04 inch.

The thread conforms to the Unified standard, Class 3A, with radius root, UNRC and UNRF.

To prevent interference, American National Standard ANSI/ASME B18.3.4M-1986 gives metric dimensional and general requirements for a lower head profile hexagon socket button head cap screw. Because of its design, wrenchability and other design factors are reduced; therefore, B18.3.4M should be reviewed carefully. Available only in metric sizes and with metric threads.

For manufacturing details, including materials, not shown, see American National Standard ANSI/ASME B18.3-1998

**Table 8. American National Standard Hexagon Socket Head Shoulder Screws
ANSI/ASME B18.3-1998**

Nominal Size	Shoulder Diameter		Head Diameter		Head Height		Head Side Height	Nominal Thread Size	Thread Length
	Max.	Min.	Max.	Min.	Max.	Min.	Min.		
	D		A		H		S	D ₁	E
¼	0.2480	0.2460	0.375	0.357	0.188	0.177	0.157	10-24	0.375
⅝ ₁₆	0.3105	0.3085	0.438	0.419	0.219	0.209	0.183	¼-20	0.438
⅜	0.3730	0.3710	0.562	0.543	0.250	0.240	0.209	⅝ ₁₆ -18	0.500
½	0.4980	0.4960	0.750	0.729	0.312	0.302	0.262	⅜-16	0.625
⅝ ₈	0.6230	0.6210	0.875	0.853	0.375	0.365	0.315	½-13	0.750
¾	0.7480	0.7460	1.000	0.977	0.500	0.490	0.421	⅝ ₈ -11	0.875
1	0.9980	0.9960	1.312	1.287	0.625	0.610	0.527	¾-10	1.000
1¼	1.2480	1.2460	1.750	1.723	0.750	0.735	0.633	⅞-9	1.125
1½	1.4980	1.4960	2.125	2.095	1.000	0.980	0.842	1⅝-7	1.500
1¾	1.7480	1.7460	2.375	2.345	1.125	1.105	0.948	1¾-7	1.750
2	1.9980	1.9960	2.750	2.720	1.250	1.230	1.054	1½-6	2.000

Nominal Size	Thread Neck Diameter		Thread Neck Width	Shoulder Neck Dia.	Shoulder Neck Width	Thread Neck Fillet		Head Fillet Extension Above D	Hexagon Socket Size
	Max.	Min.	Max.	Min.	Max.	Max.	Min.	Max.	Nom.
	G		I	K	F	N		M	J
¼	0.142	0.133	0.083	0.227	0.093	0.023	0.017	0.014	⅝ ₈
⅝ ₁₆	0.193	0.182	0.100	0.289	0.093	0.028	0.022	0.017	⅝ ₃₂
⅜	0.249	0.237	0.111	0.352	0.093	0.031	0.025	0.020	⅝ ₁₆
½	0.304	0.291	0.125	0.477	0.093	0.035	0.029	0.026	¼
⅝ ₈	0.414	0.397	0.154	0.602	0.093	0.042	0.036	0.032	⅝ ₁₆
¾	0.521	0.502	0.182	0.727	0.093	0.051	0.045	0.039	⅝ ₈
1	0.638	0.616	0.200	0.977	0.125	0.055	0.049	0.050	½
1¼	0.750	0.726	0.222	1.227	0.125	0.062	0.056	0.060	⅝ ₈
1½	0.964	0.934	0.286	1.478	0.125	0.072	0.066	0.070	⅝ ₈
1¾	1.089	1.059	0.286	1.728	0.125	0.072	0.066	0.080	1
2	1.307	1.277	0.333	1.978	0.125	0.102	0.096	0.090	1¼

All dimensions are in inches. The shoulder is the enlarged, unthreaded portion of the screw. Standard length increments for shoulder screws are: ⅝ inch for nominal screw lengths of ¼ through ¾ inch; ¼ inch for lengths above ¾ through 5 inches; and ½ inch for lengths over 5 inches. The thread conforms to the Unified Standard Class 3A, UNC. Hexagon socket sizes for the respective shoulder screw sizes are the same as for set screws of the same nominal size (see Table 7) except for shoulder screw size 1 inch, socket size is ½ inch, for screw size 1 ½ inches, socket size is ⅝ inch, and for screw size 2 inches, socket size is 1 ¼ inches. For details not shown, including materials, see ANSI/ASME B18.3-1998.

**Table 9. American National Standard Slotted Headless Set Screws
ANSI/ASME B18.6.2-1998 (R2010)**

Nominal Size ^a or Basic Screw Diameter		Slot Width, <i>J</i>		Slot Depth, <i>T</i>		Cup and Flat Point Dia., <i>C</i>		Dog Point Dia., <i>P</i>		Point Length			
										Dog, <i>Q</i>		Half Dog, <i>Q1</i>	
		Max.	Min.	Max.	Min.	Max.	Min.	Max.	Min.	Max.	Min.	Max.	Min.
0	0.0600	.014	.010	.020	.016	.033	.027	.040	.037	.032	.028	.017	.013
1	0.0730	.016	.012	.020	.016	.040	.033	.049	.045	.040	.036	.021	.017
2	0.0860	.018	.014	.025	.019	.047	.039	.057	.053	.046	.042	.024	.020
3	0.0990	.020	.016	.028	.022	.054	.045	.066	.062	.052	.048	.027	.023
4	0.1120	.024	.018	.031	.025	.061	.051	.075	.070	.058	.054	.030	.026
5	0.1250	.026	.020	.036	.026	.067	.057	.083	.078	.063	.057	.033	.027
6	0.1380	.028	.022	.040	.030	.074	.064	.092	.087	.073	.067	.038	.032
8	0.1640	.032	.026	.046	.036	.087	.076	.109	.103	.083	.077	.043	.037
10	0.1900	.035	.029	.053	.043	.102	.088	.127	.120	.095	.085	.050	.040
12	0.2160	.042	.035	.061	.051	.115	.101	.144	.137	.115	.105	.060	.050
¼	0.2500	.049	.041	.068	.058	.132	.118	.156	.149	.130	.120	.068	.058
⅜	0.3125	.055	.047	.083	.073	.172	.156	.203	.195	.161	.151	.083	.073
½	0.3750	.068	.060	.099	.089	.212	.194	.250	.241	.193	.183	.099	.089
⅝	0.4375	.076	.068	.114	.104	.252	.232	.297	.287	.224	.214	.114	.104
¾	0.5000	.086	.076	.130	.120	.291	.270	.344	.334	.255	.245	.130	.120
⅞	0.5625	.096	.086	.146	.136	.332	.309	.391	.379	.287	.275	.146	.134
1	0.6250	.107	.097	.161	.151	.371	.347	.469	.456	.321	.305	.164	.148
1 ¼	0.7500	.134	.124	.193	.183	.450	.425	.562	.549	.383	.367	.196	.180

^a When specifying a nominal size in decimals a zero preceding the decimal point or any zero in the fourth decimal place is omitted.

All dimensions are in inches.

Crown Radius, *I*: The crown radius has the same value as the basic screw diameter to three decimal places.

Oval Point Radius, *R*: Values of the oval point radius according to nominal screw size are: For a screw size of 0, a radius of .045; 1, .055; 2, .064; 3, .074; 4, .084; 5, .094; 6, .104; 8, .123; 10, .142; 12, .162; ¼, .188; ⅜, .234; ½, .281; ⅝, .328; ¾, .375; ⅞, .422; 1, .469; and for 1 ¼, .562.

Cone Point Angle, *Y*: The cone point angle is $90^\circ \pm 2^\circ$ for the following nominal lengths, or longer, shown according to screw size: For nominal size 0, a length of ⅝; 1, ⅜; 2, ¼; 3, ⅛; 4, ⅜; 5, ⅜; 6, ⅜; 8, ¼; 10, ¼; 12, ⅜; ¼, ⅜; ⅝, ⅜; ¾, ⅜; 1, ½; 1 ¼, ½; 1 ½, ⅜; 1 ¾, ⅜; 2, ¾; and for 2 ¼, ¾. For shorter screws, the cone point angle is $118^\circ \pm 2^\circ$.

Point Angle *X*: The point angle is $45^\circ, +5^\circ, -0^\circ$, for screws of nominal lengths, or longer, as given just above for cone point angle, and 30° , min. for shorter screws.

Threads: are Unified Standard Class 2A; UNC and UNF Series or UNRC and UNRF Series.

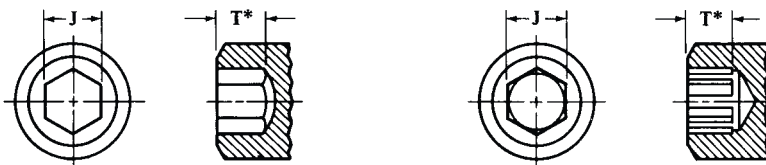
**Table 10. American National Standard Hexagon and Spline Socket Set Screw
Optional Cup Points ANSI/ASME B18.3-1998**

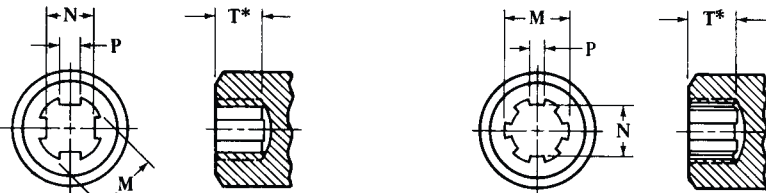
Nom. Size	Point Dia.		Point Dia.		Point Dia.		Point Length	
	Max.	Min.	Max.	Min.	Max.	Min.	Max.	Min.
	C		C1		C2		S	
0	0.033	0.027	0.032	0.027	0.027	0.022	0.007	0.004
1	0.040	0.033	0.038	0.033	0.035	0.030	0.008	0.005
2	0.047	0.039	0.043	0.038	0.043	0.038	0.010	0.007
3	0.054	0.045	0.050	0.045	0.051	0.046	0.011	0.007
4	0.061	0.051	0.056	0.051	0.059	0.054	0.013	0.008
5	0.067	0.057	0.062	0.056	0.068	0.063	0.014	0.009
6	0.074	0.064	0.069	0.062	0.074	0.068	0.017	0.012
8	0.087	0.076	0.082	0.074	0.090	0.084	0.021	0.016
10	0.102	0.088	0.095	0.086	0.101	0.095	0.024	0.019
¼	0.132	0.118	0.125	0.114	0.156	0.150	0.027	0.022
⅕ ₁₆	0.172	0.156	0.156	0.144	0.190	0.185	0.038	0.033
⅜	0.212	0.194	0.187	0.174	0.241	0.236	0.041	0.036
7 ₁₆	0.252	0.232	0.218	0.204	0.286	0.281	0.047	0.042
½	0.291	0.270	0.250	0.235	0.333	0.328	0.054	0.049
⅝	0.371	0.347	0.312	0.295	0.425	0.420	0.067	0.062
¾	0.450	0.425	0.375	0.357	0.523	0.518	0.081	0.076
7 ₈	0.530	0.502	0.437	0.418
1	0.609	0.579	0.500	0.480
1⅛	0.689	0.655	0.562	0.542
1¼	0.767	0.733	0.625	0.605
1⅜	0.848	0.808	0.687	0.667
1½	0.926	0.886	0.750	0.730
1¾	1.086	1.039	0.875	0.855
2	1.244	1.193	1.000	0.980

All dimensions are in inches.

The cup point types shown are those available from various manufacturers.

Table 11. American National Standard Hexagon and Spline Sockets
ANSI/ASME B18.3-1998

											
BROACHED SOCKET HEXAGON SOCKETS											
Nominal Socket Size	Socket Width Across Flats		Nominal Socket Size	Socket Width Across Flats		Nominal Socket Size	Socket Width Across Flats		Nominal Socket Size	Socket Width Across Flats	
	Max.	Min.		Max.	Min.		Max.	Min.		Max.	Min.
	J			J			J			J	
0.028	0.0285	0.0280	$\frac{1}{64}$	0.1426	0.1406	$\frac{7}{16}$	0.4420	0.4375	$1\frac{1}{4}$	1.2750	1.2500
0.035	0.0355	0.0350	$\frac{5}{32}$	0.1587	0.1562	$\frac{1}{2}$	0.5050	0.5000	$1\frac{1}{2}$	1.5300	1.5000
0.050	0.0510	0.0500	$\frac{3}{16}$	0.1900	0.1875	$\frac{5}{16}$	0.5680	0.5625	$1\frac{3}{4}$	1.7850	1.7500
$\frac{1}{16}$	0.0635	0.0625	$\frac{7}{32}$	0.2217	0.2187	$\frac{3}{8}$	0.6310	0.6250	2	2.0400	2.0000
$\frac{3}{64}$	0.0791	0.0781	$\frac{1}{4}$	0.2530	0.2500	$\frac{3}{4}$	0.7570	0.7500	$2\frac{1}{4}$	2.2950	2.2500
$\frac{3}{32}$	0.0952	0.0937	$\frac{5}{16}$	0.3160	0.3125	$\frac{7}{8}$	0.8850	0.8750	$2\frac{3}{4}$	2.8050	2.7500
$\frac{1}{8}$	0.1111	0.1094	$\frac{3}{8}$	0.3790	0.3750	1	1.0200	1.0000	3	3.0600	3.0000
$\frac{1}{8}$	0.1270	0.1250

											
SPLINE SOCKETS											
Nominal Socket Size	Number of Teeth	Socket Major Diameter		Socket Minor Diameter		Width of Tooth					
		Max.	Min.	Max.	Min.	Max.	Min.				
		M		N		P					
0.033	4	0.0350	0.0340	0.0260	0.0255	0.0120	0.0115				
0.048	6	0.050	0.049	0.041	0.040	0.011	0.010				
0.060	6	0.062	0.061	0.051	0.050	0.014	0.013				
0.072	6	0.074	0.073	0.064	0.063	0.016	0.015				
0.096	6	0.098	0.097	0.082	0.080	0.022	0.021				
0.111	6	0.115	0.113	0.098	0.096	0.025	0.023				
0.133	6	0.137	0.135	0.118	0.116	0.030	0.028				
0.145	6	0.149	0.147	0.128	0.126	0.032	0.030				
0.168	6	0.173	0.171	0.150	0.147	0.036	0.033				
0.183	6	0.188	0.186	0.163	0.161	0.039	0.037				
0.216	6	0.221	0.219	0.190	0.188	0.050	0.048				
0.251	6	0.256	0.254	0.221	0.219	0.060	0.058				
0.291	6	0.298	0.296	0.254	0.252	0.068	0.066				
0.372	6	0.380	0.377	0.319	0.316	0.092	0.089				
0.454	6	0.463	0.460	0.386	0.383	0.112	0.109				
0.595	6	0.604	0.601	0.509	0.506	0.138	0.134				
0.620	6	0.631	0.627	0.535	0.531	0.149	0.145				
0.698	6	0.709	0.705	0.604	0.600	0.168	0.164				
0.790	6	0.801	0.797	0.685	0.681	0.189	0.185				

All dimensions are in inches.

* Socket depths, *T*, for various screw types are given in the standard but are not shown here.

Where sockets are chamfered, the depth of chamfer shall not exceed 10 per cent of the nominal socket size for sizes up to and including $\frac{1}{16}$ inch for hexagon sockets and 0.060 for spline sockets, and 7.5 per cent for larger sizes.

Table 12. American National Standard Square Head Set Screws
ANSI/ASME B18.6.2-1998 (R2010)

Nominal Size* or Basic Screw Diameter	Cup and Flat Point Diams., C		Dog and Half Dog Point Diams., P		Point Length				Oval Point Rad., R	
	Max.	Min.	Max.	Min.	Dog, Q		Half Dog, Q1			
					Max.	Min.	Max.	Min.		
10	0.1900	.102	.088	.127	.120	.095	.085	.050	.040	.142
1/4	0.2500	.132	.118	.156	.149	.130	.120	.068	.058	.188
5/16	0.3125	.172	.156	.203	.195	.161	.151	.083	.073	.234
3/8	0.3750	.212	.194	.250	.241	.193	.183	.099	.089	.281
7/16	0.4375	.252	.232	.297	.287	.224	.214	.114	.104	.328
1/2	0.500	.291	.270	.344	.334	.255	.245	.130	.120	.375
9/16	0.5625	.332	.309	.391	.379	.287	.275	.146	.134	.422
5/8	0.6250	.371	.347	.469	.456	.321	.305	.164	.148	.469
3/4	0.7500	.450	.425	.562	.549	.383	.367	.196	.180	.562
7/8	0.8750	.530	.502	.656	.642	.446	.430	.227	.211	.656
1	1.0000	.609	.579	.750	.734	.510	.490	.260	.240	.750
1 1/8	1.1250	.689	.655	.844	.826	.572	.552	.291	.271	.844
1 1/4	1.2500	.767	.733	.938	.920	.635	.615	.323	.303	.938
1 3/8	1.3750	.848	.808	1.031	1.011	.698	.678	.354	.334	1.031
1 1/2	1.5000	.926	.886	1.125	1.105	.760	.740	.385	.365	1.125

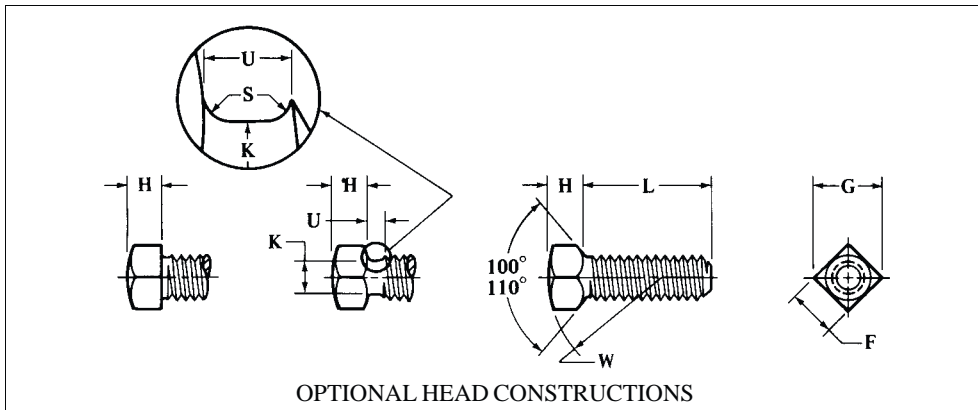
All dimensions are in inches.

*Threads: Threads are Unified Standard Class 2A; UNC, UNF and 8 UN Series or UNRC, UNRF and 8 UNR Series.

Length of Thread: Square head set screws have complete (full form) threads extending over that portion of the screw length which is not affected by the point. For the respective constructions, threads extend into the neck relief, to the conical underside of head, or to within one thread (as measured with a thread ring gage) from the flat underside of the head. Threads through angular or crowned portions of points have fully formed roots with partial crests.

*When specifying a nominal size in decimals, the zero preceding the decimal point is omitted as is any zero in the fourth decimal place.

Table 13. American National Standard Square Head Set Screws
ANSI/ASME B18.6.2-1998 (R2010)



OPTIONAL HEAD CONSTRUCTIONS

Nominal Size or Basic Screw Diameter	Width Across Flats, <i>F</i>		Width Across Corners, <i>G</i>		Head Height, <i>H</i>		Neck Relief Diameter, <i>K</i>		Neck Relief Fillet Rad., <i>S</i>	Neck Relief Width, <i>U</i>	Head Rad., <i>W</i>
	Max.	Min.	Max.	Min.	Max.	Min.	Max.	Min.	Max.	Min.	Min.
10	0.1900	.188 .180	.265 .247	.148 .134	.145 .140	.027	.083	0.48			
¼	0.2500	.250 .241	.354 .331	.196 .178	.185 .170	.032	.100	0.62			
⅝ ₁₆	0.3125	.312 .302	.442 .415	.245 .224	.240 .225	.036	.111	0.78			
⅜	0.3750	.375 .362	.530 .497	.293 .270	.294 .279	.041	.125	0.94			
7 ₁₆	0.4375	.438 .423	.619 .581	.341 .315	.345 .330	.046	.143	1.09			
½	0.5000	.500 .484	.707 .665	.389 .361	.400 .385	.050	.154	1.25			
9 ₁₆	0.5625	.562 .545	.795 .748	.437 .407	.454 .439	.054	.167	1.41			
⅝	0.6250	.625 .606	.884 .833	.485 .452	.507 .492	.059	.182	1.56			
¾	0.7500	.750 .729	1.060 1.001	.582 .544	.620 .605	.065	.200	1.88			
7 ₈	0.8750	.875 .852	1.237 1.170	.678 .635	.731 .716	.072	.222	2.19			
1	1.0000	1.000 .974	1.414 1.337	.774 .726	.838 .823	.081	.250	2.50			
1 1 ₈	1.1250	1.125 1.096	1.591 1.505	.870 .817	.939 .914	.092	.283	2.81			
1 ¼	1.2500	1.250 1.219	1.768 1.674	.966 .908	1.064 1.039	.092	.283	3.12			
1 ⅜	1.3750	1.375 1.342	1.945 1.843	1.063 1.000	1.159 1.134	.109	.333	3.44			
1 ½	1.5000	1.500 1.464	2.121 2.010	1.159 1.091	1.284 1.259	.109	.333	3.75			

Designation: Square head set screws are designated by the following data in the sequence shown: Nominal size (number, fraction or decimal equivalent); threads per inch; screw length (fraction or decimal equivalent); product name; point style; material; and protective finish, if required. Examples: ¼ - 20 × ¾ Square Head Set Screw, Flat Point, Steel, Cadmium Plated. .500 - 13 × 1.25 Square Head Set Screw, Cone Point, Corrosion Resistant Steel.

Cone Point Angle, *Y*: For the following nominal lengths, or longer, shown according to nominal size, the cone point angle is 90° ± 2°: For size No. 10, ¼, ¼, 5₁₆, 5₁₆, 3₈, 3₈, 7₁₆, 7₁₆, ½, ½, 9₁₆, 9₁₆, 5₈, 5₈, ¾, ¾, 7₈, 7₈, 1, 1, 1 1₈, 1 1₈, 1 ¼, 1 ¼, 1 ½, 1 ½, 1 ¾, 1 ¾; and for 1 ½, 1 ¾. For shorter screws the cone point angle is 118° ± 2°.

Point Types: Unless otherwise specified, square head set screws are supplied with cup points. Cup points as furnished by some manufacturers may be externally or internally knurled. Where so specified by the purchaser, screws have cone, dog, half-dog, flat or oval points as given on the following page.

Point Angle, *X*: The point angle is 45°, + 5°, - 0° for screws of the nominal lengths, or longer, given just above for cone point angle, and 30° min. for shorter lengths.

Table 14. Applicability of Hexagon and Spline Keys and Bits

Nominal Key or Bit Size	Cap Screws 1960 Series	Flat Countersunk Head Cap Screws	Button Head Cap Screws	Shoulder Screws	Set Screws
	Nominal Screw Sizes				
HEXAGON KEYS AND BITS					
0.028	0
0.035	...	0	0	...	1 & 2
0.050	0	1 & 2	1 & 2	...	3 & 4
$\frac{1}{16}$ 0.062	1	3 & 4	3 & 4	...	5 & 6
$\frac{5}{64}$ 0.078	2 & 3	5 & 6	5 & 6	...	8
$\frac{3}{32}$ 0.094	4 & 5	8	8	...	10
$\frac{7}{64}$ 0.109	6
$\frac{1}{8}$ 0.125	...	10	10	$\frac{1}{4}$	$\frac{1}{4}$
$\frac{9}{64}$ 0.141	8
$\frac{5}{32}$ 0.156	10	$\frac{1}{4}$	$\frac{1}{4}$	$\frac{5}{16}$	$\frac{5}{16}$
$\frac{3}{16}$ 0.188	$\frac{1}{4}$	$\frac{5}{16}$	$\frac{5}{16}$	$\frac{3}{8}$	$\frac{3}{8}$
$\frac{7}{32}$ 0.219	...	$\frac{3}{8}$	$\frac{3}{8}$...	$\frac{7}{16}$
$\frac{1}{4}$ 0.250	$\frac{5}{16}$	$\frac{7}{16}$...	$\frac{1}{2}$	$\frac{1}{2}$
$\frac{5}{16}$ 0.312	$\frac{3}{8}$	$\frac{1}{2}$	$\frac{1}{2}$	$\frac{5}{8}$	$\frac{5}{8}$
$\frac{3}{8}$ 0.375	$\frac{7}{16}$ & $\frac{1}{2}$	$\frac{5}{8}$	$\frac{5}{8}$	$\frac{3}{4}$	$\frac{3}{4}$
$\frac{7}{16}$ 0.438
$\frac{1}{2}$ 0.500	$\frac{5}{8}$	$\frac{3}{4}$...	1	$\frac{7}{8}$
$\frac{9}{16}$ 0.562	...	$\frac{7}{8}$	1 & $1\frac{1}{8}$
$\frac{5}{8}$ 0.625	$\frac{3}{4}$	1	...	$1\frac{1}{4}$	$1\frac{1}{4}$ & $1\frac{3}{8}$
$\frac{3}{4}$ 0.750	$\frac{7}{8}$ & 1	$1\frac{1}{8}$	$1\frac{1}{2}$
$\frac{7}{8}$ 0.875	$1\frac{1}{8}$ & $1\frac{1}{4}$	$1\frac{1}{4}$ & $1\frac{3}{8}$...	$1\frac{1}{2}$...
1 1.000	$1\frac{3}{8}$ & $1\frac{1}{2}$	$1\frac{1}{2}$...	$1\frac{3}{4}$	$1\frac{3}{4}$ & 2
$1\frac{1}{4}$ 1.250	$1\frac{3}{4}$	2	...
$1\frac{1}{2}$ 1.500	2
$1\frac{3}{4}$ 1.750	$2\frac{1}{4}$ & $2\frac{1}{2}$
2 2.000	$2\frac{3}{4}$
$2\frac{1}{4}$ 2.250	3 & $3\frac{1}{4}$
$2\frac{3}{4}$ 2.750	$3\frac{1}{2}$ & $3\frac{3}{4}$
3 3.000	4
SPLINE KEYS AND BITS					
0.033	0 & 1
0.048	...	0	0	...	2 & 3
0.060	0	1 & 2	1 & 2	...	4
0.072	1	3 & 4	3 & 4	...	5 & 6
0.096	2 & 3	5 & 6	5 & 6	...	8
0.111	4 & 5	8	8	...	10
0.133	6
0.145	...	10	10	...	$\frac{1}{4}$
0.168	8
0.183	10	$\frac{1}{4}$	$\frac{1}{4}$...	$\frac{5}{16}$
0.216	$\frac{1}{4}$	$\frac{5}{16}$	$\frac{5}{16}$...	$\frac{3}{8}$
0.251	...	$\frac{3}{8}$	$\frac{3}{8}$...	$\frac{7}{16}$
0.291	$\frac{5}{16}$	$\frac{7}{16}$	$\frac{1}{2}$
0.372	$\frac{3}{8}$	$\frac{1}{2}$	$\frac{1}{2}$...	$\frac{5}{8}$
0.454	$\frac{7}{16}$ & $\frac{1}{2}$	$\frac{5}{8}$ & $\frac{3}{4}$	$\frac{5}{8}$...	$\frac{3}{4}$
0.595	$\frac{5}{8}$	$\frac{7}{8}$
0.620	$\frac{3}{4}$
0.698	$\frac{7}{8}$
0.790	1

Source: Appendix to American National Standard ANSI/ASME B18.3-1998.

Table 15. ANSI Hexagon and Spline Socket Set Screws ANSI/ASME B18.3-1998

Nominal Size or Basic Screw Diameter	Socket Size		Cup and Flat Point Diameters		Half Dog Point		Oval Point Radius	Min. Key Engagement Depth		Lgth. Limit for Angle
	Hex.	Spl.	Cup and Flat Point Diameters		Dia.	Lgth.	Basic	Min. Key Engagement Depth		Y ^b
	Nom.	Nom.	Max.	Min.	Max.	Max.		Hex.	Spl.	
	J	M	C		P	Q	R	T _H ^a	T _S ^a	
0	0.0600	0.028	0.033	0.033	0.040	0.017	0.045	0.050	0.026	0.09
1	0.0730	0.035	0.033	0.040	0.049	0.021	0.055	0.060	0.035	0.09
2	0.0860	0.035	0.048	0.047	0.039	0.057	0.024	0.064	0.040	0.13
3	0.0990	0.050	0.048	0.054	0.045	0.066	0.027	0.074	0.040	0.13
4	0.1120	0.050	0.060	0.061	0.051	0.075	0.030	0.084	0.045	0.19
5	0.1250	1/16	0.072	0.067	0.057	0.083	0.033	0.094	0.055	0.19
6	0.1380	1/16	0.072	0.074	0.064	0.092	0.038	0.104	0.055	0.19
8	0.1640	5/64	0.096	0.087	0.076	0.109	0.043	0.123	0.080	0.25
10	0.1900	3/32	0.111	0.102	0.088	0.127	0.049	0.142	0.080	0.25
1/4	0.2500	1/8	0.145	0.132	0.118	0.156	0.067	0.188	0.125	0.31
5/16	0.3125	5/32	0.183	0.172	0.156	0.203	0.082	0.234	0.156	0.38
3/8	0.3750	3/16	0.216	0.212	0.194	0.250	0.099	0.281	0.188	0.44
7/16	0.4375	7/32	0.251	0.252	0.232	0.297	0.114	0.328	0.219	0.50
1/2	0.5000	1/4	0.291	0.291	0.270	0.344	0.130	0.375	0.250	0.57
5/8	0.6250	5/16	0.372	0.371	0.347	0.469	0.164	0.469	0.312	0.75
3/4	0.7500	3/8	0.454	0.450	0.425	0.562	0.196	0.562	0.375	0.88
7/8	0.8750	1/2	0.595	0.530	0.502	0.656	0.227	0.656	0.500	1.00
1	1.0000	9/16	...	0.609	0.579	0.750	0.260	0.750	0.562	1.13
1 1/8	1.1250	5/8	...	0.689	0.655	0.844	0.291	0.844	0.562	1.25
1 1/4	1.2500	3/4	...	0.767	0.733	0.938	0.323	0.938	0.625	1.50
1 3/8	1.3750	7/8	...	0.848	0.808	1.031	0.354	1.031	0.625	1.63
1 1/2	1.5000	1	...	0.926	0.886	1.125	0.385	1.125	0.750	1.75
1 3/4	1.7500	1	...	1.086	1.039	1.312	0.448	1.321	1.000	2.00
2	2.0000	1	...	1.244	1.193	1.500	0.510	1.500	1.000	2.25

^a Reference should be made to the Standard for shortest optimum nominal lengths to which the minimum key engagement depths T_H and T_S apply.

^b Cone point angle Y is 90 degrees plus or minus 2 degrees for these nominal lengths or longer and 118 degrees plus or minus 2 degrees for shorter nominal lengths.

All dimensions are in inches. The thread conforms to the Unified Standard, Class 3A, UNC and UNF series. The socket depth T is included in the Standard and some are shown here. The nominal length L of all socket type set screws is the total or overall length. For nominal screw lengths of 1/16 through 3/16 inch (0 through 3 sizes incl.) the standard length increment is 0.06 inch; for lengths 1/8 through 1 inch the increment is 1/8 inch; for lengths 1 through 2 inches the increment is 1/4 inch; for lengths 2 through 6 inches the increment is 1/2 inch; for lengths 6 inches and longer the increment is 1 inch. Socket dimensions are given in Table 11.

Length Tolerance: The allowable tolerance on length L for all set screws of the socket type is ± 0.01 inch for set screws up to 5/8 inch long; ± 0.02 inch for screws over 5/8 to 2 inches long; ± 0.03 inch for screws over 2 to 6 inches long and ± 0.06 inch for screws over 6 inches long. Socket dimensions are given in Table 11.

For manufacturing details, including materials, not shown, see American National Standard ANSI/ASME B18.3-1998.

British Standard Hexagon Socket Screws — Metric Series.—The first five parts of British Standard BS 4168: 1981 provide specifications for hexagon socket head cap screws and hexagon socket set screws.

Hexagon Socket Head Cap Screws: The dimensional data in **Table 1** are based upon BS 4168: Part 1: 1981. These screws are available in stainless steel and alloy steel, the latter having class 12.9 properties as specified in BS 6104:Part 1. When ordering these screws, the designation “Hexagon socket head cap screw BS 4168 M5 × 20-12.9” would mean, as an example, a cap screw having a thread size of $d = M5$, nominal length $l = 20$ mm, and property class 12.9. Alloy steel cap screws are furnished with a black oxide finish (thermal or chemical); stainless steel cap screws with a plain finish. Combinations of thread size, nominal length, and length of thread are shown in **Table 2**; the screw threads in these combinations are in the ISO metric coarse pitch series specified in BS 3643 with tolerances in the 5g6g class. (See Metric Screw Threads in Index.)

Hexagon Socket Set Screws: Part 2 of B.S. 4168:1981 specifies requirements for hexagon socket set screws with flat point having ISO metric threads, and diameters from 1.6 mm up to and including 24 mm. The dimensions of these set screws along with those of cone-point, dog-point, and cup-point set screws in accord, respectively, with Parts 3, 4, and 5 of the Standard are given in **Table 3** and the accompanying illustration. All of these set screws are available in either steel processed to mechanical properties class 45H B.S. 6104:Part 3; or stainless steel processed to mechanical properties described in B.S. 6105. Steel set screws are furnished with black oxide (thermal or chemical) finish; stainless steel set screws are furnished plain. The tolerances applied to the threads of these set screws are for ISO product grade A, based on ISO 4759/1-1978 “Tolerances for fasteners — Part 1: Bolts, screws, and nuts with thread diameters greater than or equal to 1.6 mm and less than or equal to 150 mm and product grades A, B, and C.”

Hexagon socket set screws are designated by the type, the thread size, nominal length, and property class. As an example, for a flat-point set screw of thread size $d = M6$, nominal length $l = 12$ mm, and property class 45H:

Hexagon socket set screw flat point BS 4168 M6 × 12-45H

British Standard Hexagon Socket Countersunk and Button Head Screws — Metric Series: British Standard BS 4168:1967 provides a metric series of hexagon socket countersunk and button head screws. The dimensions of these screws are given in **Table 4**. The revision of this Standard will constitute Parts 6 and 8 of BS 4168.

British Standards for Mechanical Properties of Fasteners: B.S. 6104: Part 1:1981 specifies mechanical properties for bolts, screws, and studs with nominal diameters up to and including 39 mm of any triangular ISO thread and made of carbon or alloy steel. It does not apply to set screws and similar threaded fasteners. Part 2 of this Standard specifies the mechanical properties of set screws and similar fasteners, not under tensile stress, in the range from M1.6 up to and including M39 and made of carbon or alloy steel.

B.S. 6105:1981 provides specifications for bolts, screws, studs, and nuts made from austenitic, ferritic, and martensitic grades of corrosion-resistant steels. This Standard applies only to fastener components after completion of manufacture with nominal diameters from M1.6 up to and including M39. These Standards are not described further here. Copies may be obtained from the British Standards Institution, 2 Park Street, London W1A 2BS and also from the American National Standards Institute, 25 West 43rd Street, New York, N.Y. 10036.

Table 1. British Standard Hexagon Socket Head Cap Screws—Metric Series
BS 4168:Part 1:1981 (obsolescent)

Nominal Size, ^a <i>d</i>	Body Diameter, <i>D</i>		Head Diameter, <i>A</i>			Head Height, <i>H</i>		Hexagon Socket Size, <i>J</i> ^b	Key Engagement, <i>K</i>	Wall Thickness, <i>W</i>	Fillet	
	Max	Min	Max ^c	Max ^d	Min	Max	Min				Min	Rad., <i>F</i>
								Min	Max			
M1.6	1.6	1.46	3	3.14	2.86	1.6	1.46	1.5	0.7	0.55	0.1	2
M2	2	1.86	3.8	3.98	3.62	2	1.86	1.5	1	0.55	0.1	2.6
M2.5	2.5	2.36	4.5	4.68	4.32	2.5	2.36	2	1.1	0.85	0.1	3.1
M3	3	2.86	5.5	5.68	5.32	3	2.86	2.5	1.3	1.15	0.1	3.6
M4	4	3.82	7	7.22	6.78	4	3.82	3	2	1.4	0.2	4.7
M5	5	4.82	8.5	8.72	8.28	5	4.82	4	2.5	1.9	0.2	5.7
M6	6	5.82	10	10.22	9.78	6	5.70	5	3	2.3	0.25	6.8
M8	8	7.78	13	13.27	12.73	8	7.64	6	4	3.3	0.4	9.2
M10	10	9.78	16	16.27	15.73	10	9.64	8	5	4	0.4	11.2
M12	12	11.73	18	18.27	17.73	12	11.57	10	6	4.8	0.6	14.2
(M14)	14	13.73	21	21.33	20.67	14	13.57	12	7	5.8	0.6	16.2
M16	16	15.73	24	24.33	23.67	16	15.57	14	8	6.8	0.6	18.2
M20	20	19.67	30	30.33	29.67	20	19.48	17	10	8.6	0.8	22.4
M24	24	23.67	36	36.39	35.61	24	23.48	19	12	10.4	0.8	26.4
M30	30	29.67	45	45.39	44.61	30	29.48	22	15.5	13.1	1	33.4
M36	36	35.61	54	54.46	53.54	36	35.38	27	19	15.3	1	39.4

^aThe size shown in () is non-preferred.

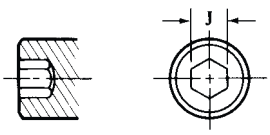
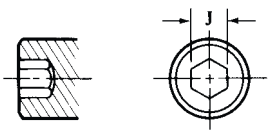
^b See Table 2 for min/max.

^c For plain heads.

^d For knurled heads.

All dimensions are given in millimeters.

Table 2. British Standard Hexagon Socket Screws — Metric Series
BS 4168:Part 1:1981 (obsolescent)

Dimensions of Hexagon Sockets					
					
	Max.	Min.		Max.	Min.
1.5	1.545	1.52	6	6.095	6.02
2.0	2.045	2.02	8	8.115	8.025
2.5	2.56	2.52	10	10.115	10.025
3	3.08	3.02	12	12.142	12.032
4	4.095	4.02	14	14.142	14.032
5	5.095	5.02	17	17.23	17.05
...	19	19.275	19.065

Association of Nominal and Thread Lengths for Each Thread Size																	
Nominal Length, <i>L</i>	Nominal Thread Size, <i>D</i>								Nominal Length, <i>L</i>	Nominal Thread Size, <i>D</i>							
	M1.6	M2	M2.5	M3	M4	M5	M6	M8		M10	M12	(M14)	M16	M20	M24	M30	M36
2.5									16								
3									20								
4									25								
5									30								
6									35								
8									40								
10									45								
12									50								
16									55								
20									60								
25									65								
30									70								
35									80								
40									90								
45									100								
50									110								
55									120								
60									130								
65									140								
70									150								
80									160								
...	180								
...	200								
<i>b</i> (ref)	15	16	17	18	20	22	24	28	<i>b</i> (ref)	32	36	40	44	52	60	72	84

All dimensions are in millimeters.

The popular lengths are those between the stepped solid lines. Lengths above the shaded areas are threaded to the head within 3 pitch lengths (*3P*). Lengths within and below the shaded areas have values of $L_{g,max}$ and L_s (see Table 1) given by the formulas: $L_{g,max} = L_{nom} - b_{ref}$, and $L_{s,min} = L_{g,max} - 5P$.

**Table 3. British Standard Hexagon Socket Set Screws — Metric Series
BS 4168:Parts 2, 3, 4, and 5:1994**

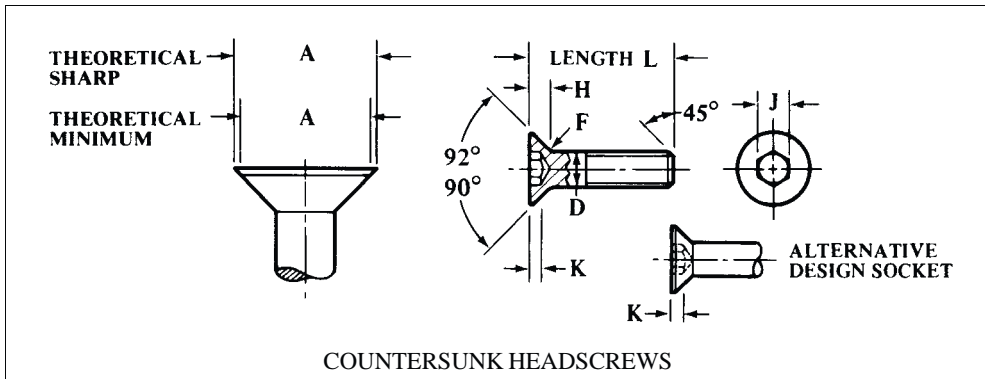
Nom. Size, <i>d</i>	Pitch, <i>P</i>	Socket Size, <i>s</i>	Depth of Key Engagement, <i>r</i> ^a		Range of Popular Lengths				Length of Dog on Dog Point Screws ^b					End Diameters			
					Flat Point	Cone Point	Dog Point	Cup Point	Short Dog, <i>z</i>		Long Dog, <i>z</i>		b	Flat Point, <i>d_z</i>	Cone Point <i>d_t</i>	Dog Point, <i>d_p</i>	Cup Point, <i>d_c</i>
									min	max	min	max					
M1.6	0.35	0.7	0.7	1.5	2-8	2-8	2-8	2-8	0.4	0.65	0.8	1.05	2.5	0.8	0	0.8	0.8
M2	0.4	0.9	0.8	1.7	2-10	2-10	2.5-10	2-10	0.5	0.75	1.0	1.25	3.0	1.0	0	1.0	1.0
M2.5	0.45	1.3	1.2	2.0	2-12	2.5-12	3-12	2-12	0.63	0.88	1.25	1.5	4	1.5	0	1.5	1.2
M3	0.5	1.5	1.2	2.0	2-16	2.5-16	4-16	2.5-16	0.75	1.0	1.5	1.75	5	2.0	0	2.0	1.4
M4	0.7	2.0	1.5	2.5	2.5-20	3-20	5-20	3-20	1.0	1.25	2.0	2.25	6	2.5	0	2.5	2.0
M5	0.8	2.5	2.0	3.0	3-25	4-25	6-25	4-25	1.25	1.5	2.5	2.75	6	3.5	0	3.5	2.5
M6	1.0	3.0	2.0	3.5	4-30	5-30	8-30	5-30	1.5	1.75	3.0	3.25	8	4.0	1.5	4.0	3.0
M8	1.25	4.0	3.0	5.0	5-40	6-40	8-40	6-40	2.0	2.25	4.0	4.3	10	5.5	2.0	5.5	5.0
M10	1.5	5.0	4.0	6.0	6-50	8-50	10-50	8-50	2.5	2.75	5.0	5.3	12	7.0	2.5	7.0	6.0
M12	1.75	6.0	4.8	8.0	8-60	10-60	12-60	10-60	3.0	3.25	6.0	6.3	16	8.5	3.0	8.5	8.0
M16	2.0	8.0	6.4	10.0	10-60	12-60	16-60	12-60	4.0	4.3	8.0	8.36	20	12.0	4.0	12.0	10.0
M20	2.5	10.0	8.0	12.0	12-60	16-60	20-60	16-60	5.0	5.3	10.0	10.36	25	15.0	5.0	15.0	14.0
M24	3.0	12.0	10.0	15.0	16-60	20-60	25-60	20-60	6.0	6.3	12.0	12.43	30	18.0	6.0	18.0	16.0

^aThe smaller of the two *t* min. values applies to certain short-length set screws. These short-length screws are those whose length is approximately equal to the diameter of the screw. The larger *t* min. values apply to longer-length screws.

^bA dog point set screw having a nominal length equal to or less than the length shown in the (*) column of the table is supplied with length *z* shown in the short dog column. For set screws of lengths greater than shown in the (*) column, *z* for long dogs applies.

All dimensions are in millimeters. For dimensional notation, see diagram, page 1699.

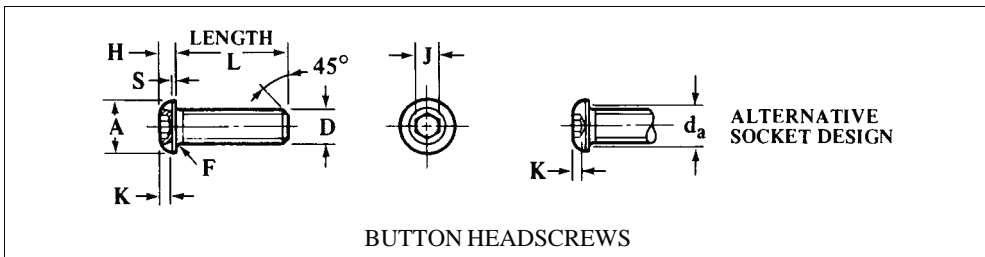
Table 4. British Standard Hexagon Socket Countersunk and Button Head Screws — Metric Series BS 4168:1967



COUNTERSUNK HEADSCREWS

Nom. Size ^a	Body Diameter, D		Head Diameter, A		Head Height, H		Hexagon Socket Size, J	Key Engagement, K	Fillet Radius, F
	Max.	Min.	Theor. Sharp Max.	Absolute Min.	Ref.	Flushness Tolerance	Nom.	Min.	Max.
M3	3.00	2.86	6.72	5.82	1.86	0.20	2.00	1.05	0.40
M4	4.00	3.82	8.96	7.78	2.48	0.20	2.50	1.49	0.40
M5	5.00	4.82	11.20	9.78	3.10	0.20	3.00	1.86	0.40
M6	6.00	5.82	13.44	11.73	3.72	0.20	4.00	2.16	0.60
M8	8.00	7.78	17.92	15.73	4.96	0.24	5.00	2.85	0.70
M10	10.00	9.78	22.40	19.67	6.20	0.30	6.00	3.60	0.80
M12	12.00	11.73	26.88	23.67	7.44	0.36	8.00	4.35	1.10
(M14)	14.00	13.73	30.24	26.67	8.12	0.40	10.00	4.65	1.10
M16	16.00	15.73	33.60	29.67	8.80	0.45	10.00	4.89	1.10
(M18)	18.00	17.73	36.96	32.61	9.48	0.50	12.00	5.25	1.10
M20	20.00	19.67	40.32	35.61	10.16	0.54	12.00	5.45	1.10

^a Sizes shown in parentheses are non-preferred.

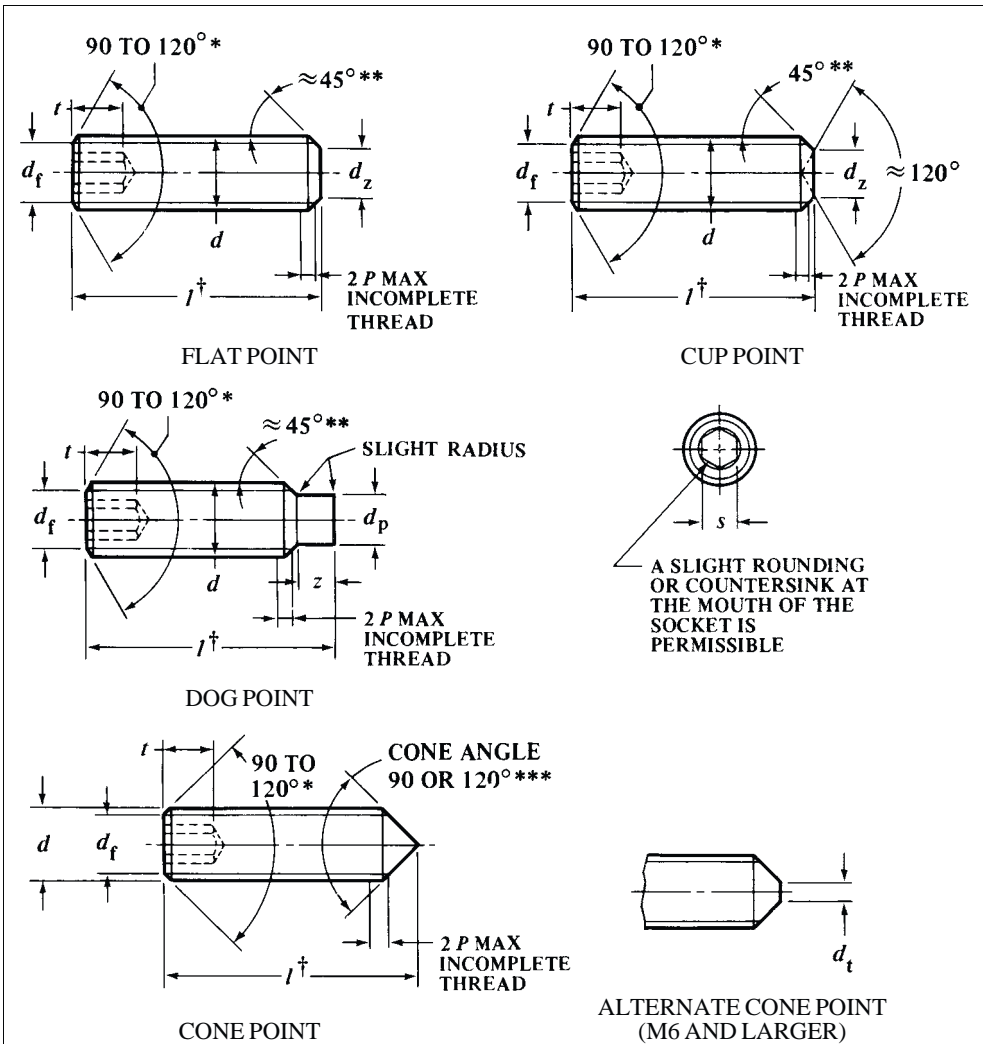


BUTTON HEADSCREWS

Nom. Size, D	Head Diameter, A		Head Height, H		Head Side Height, S	Hexagon Socket Size, J	Key Engagement, K	Fillet Radius	
	Max.	Min.	Max.	Min.	Ref.	Nom.	Min.	F	d_a
M3	5.50	5.32	1.60	1.40	0.38	2.00	1.04	0.10	3.60
M4	7.50	7.28	2.10	1.85	0.38	2.50	1.30	0.20	4.70
M5	9.50	9.28	2.70	2.45	0.50	3.00	1.56	0.20	5.70
M6	10.50	10.23	3.20	2.95	0.80	4.00	2.08	0.25	6.80
M8	14.00	13.73	4.30	3.95	0.80	5.00	2.60	0.40	9.20
M10	18.00	17.73	5.30	4.95	0.80	6.00	3.12	0.40	11.20
M12	21.00	20.67	6.40	5.90	0.80	8.00	4.16	0.60	14.20

All dimensions are given in millimeters.

British Standard Hexagon Socket Set Screws — Metric Series
BS 4168:Parts 2, 3, 4, and 5:1994



*The 120° angle is mandatory for short-length screws shown in the Standard. Short-length screws are those whose length is, approximately, equal to the diameter of the screw.

**The 45° angle applies only to that portion of the point below the root diameter, d_f , of the thread.

***The cone angle applies only to the portion of the point below the root diameter, d_f , of the thread and shall be 120° for certain short lengths listed in the Standard. All other lengths have a 90° cone angle.

†The popular length ranges of these set screws are listed in [Table 3](#). These lengths have been selected from the following nominal lengths: 2, 2.5, 3, 4, 6, 8, 10, 12, 16, 20, 25, 30, 35, 40, 45, 50, 55, and 60 millimeters.

Holding Power of Set-screws.—While the amount of power a set-screw of given size will transmit without slipping (when used for holding a pulley, gear, or other part from turning relative to a shaft) varies somewhat according to the physical properties of both set-screw and shaft and other variable factors, experiments have shown that the safe holding force in pounds for different diameters of set-screws should be approximately as follows: For 1/4-inch (6.35 mm) diameter set-screws the safe holding force is 100 pounds (445 N), for 3/8-inch (9.5 mm) diameter set-screws the safe holding force is 250 pounds (1112 N),

for 1/2-inch (12.7 mm) diameter set-screws the safe holding force is 500 pounds (2224 N), for 3/4-inch (19 mm) diameter set-screws the safe holding force is 1300 pounds (5783 N), and for 1-inch (25.4 mm) diameter set-screws the safe holding force is 2500 pounds (11121 N).

The power or torque that can be safely transmitted by a set-screw may be determined from the formulas, $P = (DNd^{2.3}) \div 50$; or $T = 1250Dd^{2.3}$ in which P is the horsepower transmitted; T is the torque in inch-pounds transmitted; D is the shaft diameter in inches; N is the speed of the shaft in revolutions per minute; and d is the diameter of the set-screw in inches.

Example: How many 1/2-inch diameter set-screws would be required to transmit 3 horsepower at a shaft speed of 1000 rpm if the shaft diameter is 1 inch?

Using the first formula given above, the power transmitted by a single 1/2-inch diameter set-screw is determined: $P = [1 \times 1000 \times (1/2)^{2.3}] \div 50 = 4.1$ hp. Therefore a single 1/2-inch diameter set-screw is sufficient.

Example: In the previous example, how many 3/8-inch diameter set-screws would be required? $P = [1 \times 1000 \times (3/8)^{2.3}] \div 50 = 2.1$ hp. Therefore two 3/8-inch diameter set-screws are required.

Table 5. British Standard Whitworth (BSW) and British Standard Fine (BSF) Bright Square Head Set-Screws (With Flat Chamfered Ends)

Nominal Size and Max. Dia., Inches	Number of Threads per Inch		No. 1 Standard		No. 2 Standard		No. 3 Standard	
			Width Across Flats A	Depth of Head B	Width Across Flats C	Depth of Head D	Width Across Flats E	Depth of Head F
	BSW	BSF						
1/4	20	26	0.250	0.250	0.313	0.250	0.375	0.250
5/16	18	22	0.313	0.313	0.375	0.313	0.438	0.313
3/8	16	20	0.375	0.375	0.438	0.375	0.500	0.375
7/16	14	18	0.438	0.438	0.500	0.438	0.625	0.438
1/2	12	16	0.500	0.500	0.563	0.500	0.750	0.500
5/8	11	14	0.625	0.625	0.750	0.625	0.875	0.625
3/4	10	12	0.750	0.750	0.875	0.750	1.000	0.750
7/8	9	11	0.875	0.875	1.000	0.875	1.125	0.875
1	8	10	1.000	1.000	1.125	1.000	1.250	1.000

* Depth of Head B , D and F same as for Width Across Flats, No. 1 Standard.

Dimensions A , B , C , D , E , and F are in inches.

SELF-THREADING SCREWS

ANSI Standard Sheet Metal, Self-Tapping, and Metallic Drive Screws.—**Table 1** shows the various types of “self-tapping” screw threads covered by the ANSI B18.6.4-1981 (R1991) standard. (Metric thread forming and thread cutting tapping screws are discussed beginning on page 1716). ANSI designations are also shown. Types A, AB, B, BP and C when turned into a hole of proper size form a thread by a displacing action. Types D, F, G, T, BF and BT when turned into a hole of proper size form a thread by a cutting action. Type U when driven into a hole of proper size forms a series of multiple threads by a displacing action. These screws have the following descriptions and applications:

Type A: Spaced-thread screw with gimlet point primarily for use in light sheet metal, resin-impregnated plywood, and asbestos compositions. This type is no longer recommended. Use Type AB in new designs and whenever possible substitute for Type A in existing designs.

Type AB: Spaced-thread screw with same pitches as Type B but with gimlet point, primarily for similar uses as for Type A.

Type B: Spaced-thread screw with a blunt point with pitches generally somewhat finer than Type A. Used for thin metal, non-ferrous castings, plastics, resin-impregnated plywood, and asbestos compositions.

Type BP: Spaced-thread screw, the same as Type B but having a conical point extending beyond incomplete entering threads. Used for piercing fabrics or in assemblies where holes are misaligned.

Type C: Screws having machine screw diameter-pitch combinations with threads approximately Unified Form and with blunt tapered points. Used where a machine screw thread is preferable to the spaced-thread types of thread forming screws. Also useful when chips from machine screw thread-cutting screws are objectionable. In view of the declining use of Type C screws, which in general require high driving torques, in favor of more efficient designs of thread tapping screws, they are not recommended for new designs.

Types D, F, G, and T: Thread-cutting screws with threads approximating machine screw threads, with blunt point, and with tapered entering threads having one or more cutting edges and chip cavities. The tapered threads of the Type F may be complete or incomplete at the producer's option; all other types have incomplete tapered threads. These screws can be used in materials such as aluminum, zinc, and lead die-castings; steel sheets and shapes; cast iron; brass; and plastics.

Types BF and BT: Thread-cutting screws with spaced threads as in Type B, with blunt points, and one or more cutting grooves. Used in plastics, asbestos, and other similar compositions.

Type U: Multiple-threaded drive screw with large helix angle, having a pilot point, for use in metal and plastics. This screw is forced into the work by pressure and is intended for making permanent fastenings.

ANSI Standard Head Types for Tapping and Metallic Drive Screws: Many of the head types used with “self-tapping” screw threads are similar to the head types of American National Standard machine screws shown in the section with that heading.

Round Head: The round head has a semi-elliptical top surface and a flat bearing surface. Because of the superior slot driving characteristics of pan head screws over round head screws, and the overlap in dimensions of cross recessed pan heads and round heads, it is recommended that pan head screws be used in new designs and wherever possible substituted in existing designs.

Undercut Flat and Oval Countersunk Heads: For short lengths, 82-degree and oval countersunk head tapping screws have heads undercut to 70 per cent of normal side height to afford greater length of thread on the screws.

Flat Countersunk Head: The flat countersunk head has a flat top surface and a conical bearing surface with a head angle for one design of approximately 82 degrees and for another design of approximately 100 degrees. Because of its limited usage and in the interest of curtailing product varieties, the 100-degree flat countersunk head is considered non-preferred.

Oval Countersunk Head: The oval countersunk head has a rounded top surface and a conical bearing surface with a head angle of approximately 82 degrees.

Flat and Oval Countersunk Trim Heads: Flat and oval countersunk trim heads are similar to the 82-degree flat and oval countersunk heads except that the size of head for a given size screw is one (large trim head) or two (small trim head) sizes smaller than the regular flat and oval countersunk head size. Oval countersunk trim heads have a definite radius where the curved top surface meets the conical bearing surface. Trim heads are furnished only in cross recessed types.

Pan Head: The slotted pan head has a flat top surface rounded into cylindrical sides and a flat bearing surface. The recessed pan head has a rounded top and a flat bearing surface. This head type is now preferred to the round head.

Fillister Head: The fillister head has a rounded top surface, cylindrical sides, and a flat bearing surface.

Hex Head: The hex head has a flat or indented top surface, six flat sides, and a flat bearing surface. Because the slotted hex head requires a secondary operation in manufacture which often results in burrs at the extremity of the slot that interfere with socket wrench engagement and the wrenching capability of the hex far exceeds that of the slot, it is not recommended for new designs.

Hex Washer Head: The hex washer head has an indented top surface and six flat sides formed integrally with a flat washer that projects beyond the sides and provides a flat bearing surface. Because the slotted hex washer head requires a secondary operation in manufacture which often results in burrs at the extremity of the slot that often interferes with socket wrench engagement and because the wrenching capability of the hex far exceeds that of the slot in the indented head, it is not recommended for new designs.

Truss Head: The truss head has a low rounded top surface with a flat bearing surface, the diameter of which for a given screw size is larger than the diameter of the corresponding round head. In the interest of product simplification and recognizing that the truss head is an inherently weak design, it is not recommended for new designs.

Method of Designation.—Tapping screws are designated by the following data in the sequence shown: Nominal size (number, fraction or decimal equivalent); threads per inch; nominal length (fraction or decimal equivalent); point type; product name, including head type and driving provision; material; and protective finish, if required.

Examples:

$\frac{1}{4}$ -14 \times 1 $\frac{1}{2}$ Type AB Slotted Pan Head Tapping Screw, Steel, Nickel Plated

6-32 \times $\frac{3}{4}$ Type T, Type 1A Cross Recessed Pan Head Tapping Screw, Corrosion Resistant Steel

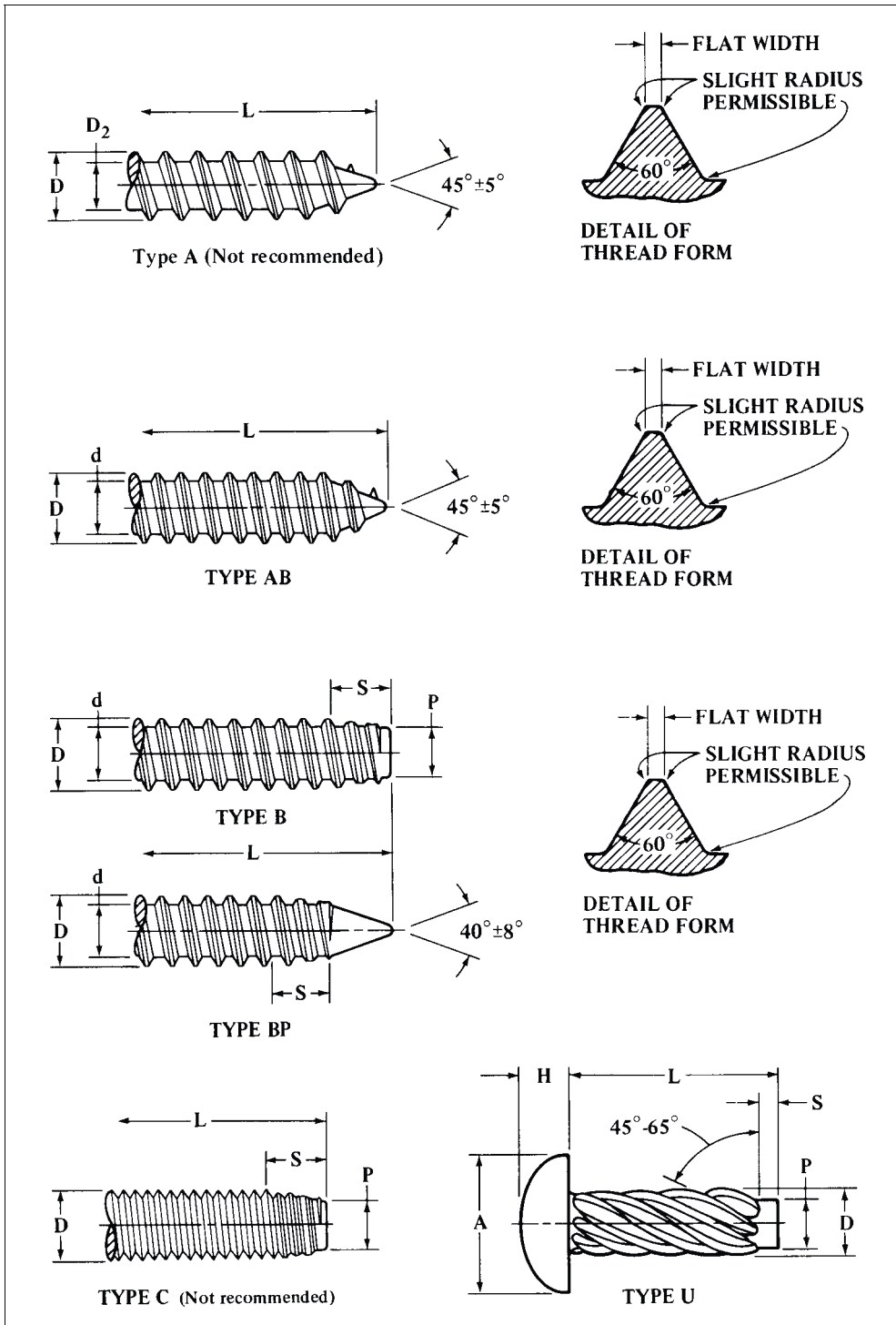
0.375-16 \times 1.50 Type D, Washer Head Tapping Screw, Steel

Metallic Drive Screws: Type U metallic drive screws are designated by the following data in the sequence shown: Nominal size (number, fraction, or decimal equivalent); nominal length (fraction or decimal equivalent); product name, including head type; material; and protective finish, if required. Examples:

10 \times $\frac{5}{16}$ Round Head Metallic Drive Screw, Steel

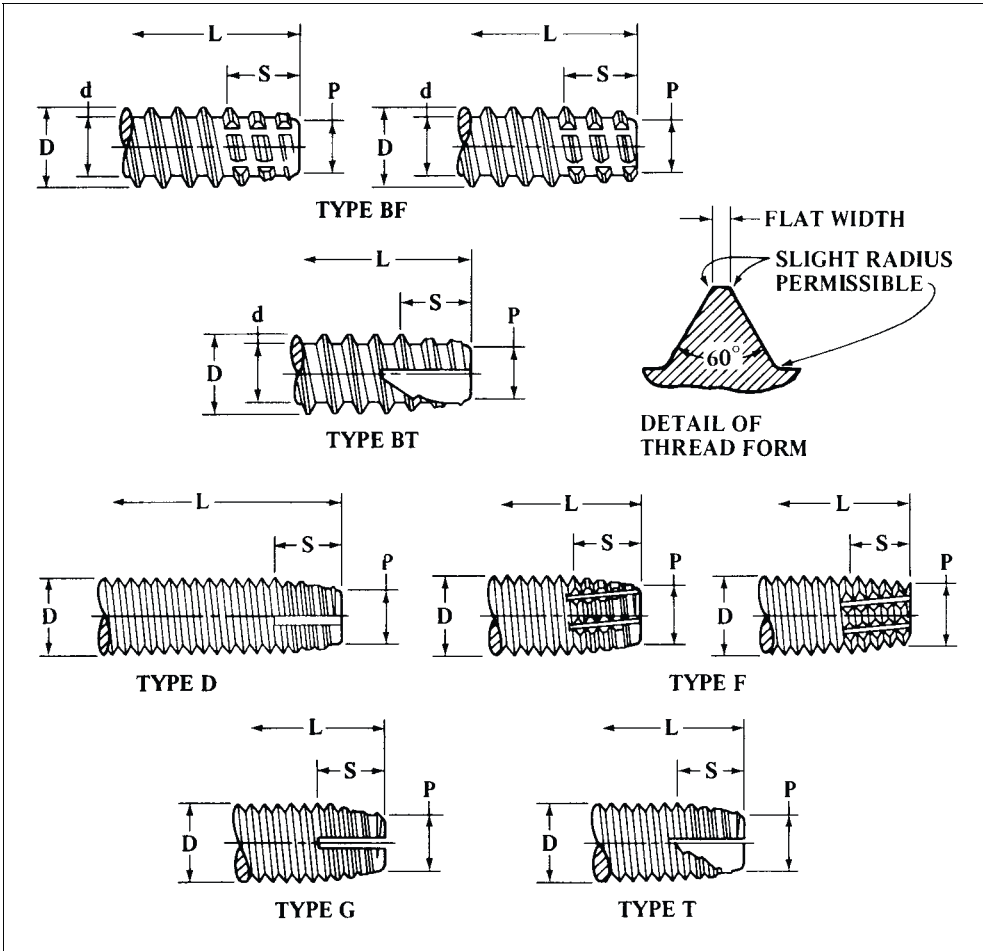
0.312 \times 0.50 Round Head Metallic Drive Screw, Steel, Zinc Plated

Table 1. ANSI Standard Threads and Points for Thread Forming Self-Tapping Screws ANSI B18.6.4-1981 (R1991)



See Tables 3, 5, and 6 for thread data.

Table 2. ANSI Standard Threads and Points for Thread Cutting Self-Tapping Screws ANSI B18.6.4-1981 (R1991)



See [Tables 5](#) and [7](#) for thread data.

Cross Recesses.—Type I cross recess has a large center opening, tapered wings, and blunt bottom, with all edges relieved or rounded. Type IA cross recess has a large center opening, wide straight wings, and blunt bottom, with all edges relieved or rounded. Type II consists of two intersecting slots with parallel sides converging to a slightly truncated apex at the bottom of the recess. Type III has a square center opening, slightly tapered side walls, and a conical bottom, with top edges relieved or rounded.

Table 3. ANSI Standard Cross Recesses for Self-Tapping Screws ANSI B18.6.4-1981 (R1991) and Metric Thread Forming and Thread Cutting Tapping Screws ANSI/ASME B18.6.5M-1986

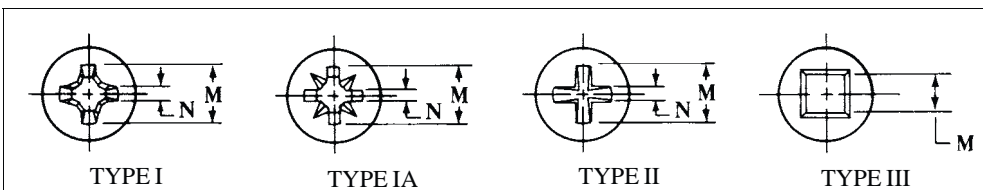


Table 4. ANSI Standard Thread and Point Dimensions for Types AB, A and U Thread Forming Tapping Screws ANSI B18.6.4-1981 (R1991)

Type AB (Formerly BA)								
Nominal Size or Basic Screw Diameter	Threads per inch	D		d		L		
		Major Diameter		Minor Diameter		Minimum Practical Screw Lengths		
		Max.	Min.	Max.	Min.	90° Heads	Csk. Heads	
0 0.0600	48	0.060	0.054	0.036	0.033	1/8	3/32	
1 0.0730	42	0.075	0.069	0.049	0.046	5/32	3/16	
2 0.0860	32	0.088	0.082	0.064	0.060	3/16	7/32	
3 0.0990	28	0.101	0.095	0.075	0.071	3/16	1/4	
4 0.1120	24	0.114	0.108	0.086	0.082	7/32	5/32	
5 0.1250	20	0.130	0.123	0.094	0.090	1/4	5/16	
6 0.1380	20	0.139	0.132	0.104	0.099	5/32	11/32	
7 0.1510	19	0.154	0.147	0.115	0.109	5/16	3/8	
8 0.1640	18	0.166	0.159	0.122	0.116	5/16	3/8	
10 0.1900	16	0.189	0.182	0.141	0.135	3/8	7/16	
12 0.2160	14	0.215	0.208	0.164	0.157	7/16	21/32	
1/4 0.2500	14	0.246	0.237	0.192	0.185	1/2	19/32	
5/16 0.3125	12	0.315	0.306	0.244	0.236	5/8	3/4	
3/8 0.3750	12	0.380	0.371	0.309	0.299	3/4	29/32	
7/16 0.4375	10	0.440	0.429	0.359	0.349	7/8	1 1/32	
1/2 0.5000	10	0.504	0.493	0.423	0.413	1	1 5/32	

Type A								
Nominal Size ^a Basic Screw Diameter	Threads per inch	D		d		L		
		Major Diameter		Minor Diameter		These Lengths or Shorter —Use Type AB		
		Max.	Min.	Max.	Min.	90° Heads	Csk. Heads	
0 0.0600	40	0.060	0.057	0.042	0.039	1/8	3/16	
1 0.0730	32	0.075	0.072	0.051	0.048	1/8	3/16	
2 0.0860	32	0.088	0.084	0.061	0.056	5/32	3/16	
3 0.0990	28	0.101	0.097	0.076	0.071	3/16	7/32	
4 0.1120	24	0.114	0.110	0.083	0.078	3/16	1/4	
5 0.1250	20	0.130	0.126	0.095	0.090	3/16	1/4	
6 0.1380	18	0.141	0.136	0.102	0.096	1/4	5/16	
7 0.1510	16	0.158	0.152	0.114	0.108	5/16	3/8	
8 0.1640	15	0.168	0.162	0.123	0.116	3/8	7/16	
10 0.1900	12	0.194	0.188	0.133	0.126	3/8	1/2	
12 0.2160	11	0.221	0.215	0.162	0.155	7/16	9/16	
14 0.2420	10	0.254	0.248	0.185	0.178	1/2	5/8	
16 0.2680	10	0.280	0.274	0.197	0.189	9/16	3/4	
18 0.2940	9	0.306	0.300	0.217	0.209	5/8	13/16	
20 0.3200	9	0.333	0.327	0.234	0.226	11/16	13/16	
24 0.3720	9	0.390	0.383	0.291	0.282	3/4	1	

^a Where specifying nominal size in decimals, zeros preceding decimal and in fourth place are omitted.

Type U Metallic Drive Screws											
Nom. Size	No. of Starts	Out. Dia.		Pilot Dia.		Nom. Size	No. of Starts	Out. Dia.		Pilot Dia.	
		Max.	Min.	Max.	Min.			Max.	Min.	Max.	Min.
00	6	0.060	0.057	0.049	0.046	8	8	0.167	0.162	0.136	0.132
0	6	0.075	0.072	0.063	0.060	10	8	0.182	0.177	0.150	0.146
2	8	0.100	0.097	0.083	0.080	12	8	0.212	0.206	0.177	0.173
4	7	0.116	0.112	0.096	0.092	14	9	0.242	0.236	0.202	0.198
6	7	0.140	0.136	0.116	0.112	5/16	11	0.315	0.309	0.272	0.267
7	8	0.154	0.150	0.126	0.122	3/8	12	0.378	0.371	0.334	0.329

All dimensions are in inches. See Table 1 for thread diagrams.

Sizes shown in bold face type are preferred. Type A screws are no longer recommended.

Table 5. ANSI Standard Thread and Point Dimensions for B and BP Thread Forming and BF and BT Thread Cutting Tapping Screws ANSI B18.6.4-1981 (R1991)

THREAD FORMING TYPES B AND BP													
Nominal Size ^a or Basic Screw Diameter	Thds per Inch ^b	D		d		P		S		L			
		Major Diameter		Minor Diameter		Point Diameter ^c		Point Taper Length ^d		Minimum Practical Nominal Screw Lengths			
		Max	Min	Max	Min	Max	Min	Max	Min	Type B		Type BP	
										90° Heads	Csk Heads	90° Heads	Csk Heads
0 0.0600	48	0.060	0.054	0.036	0.033	0.031	0.027	0.042	0.031	1/8	1/8	5/32	3/16
1 0.0730	42	0.075	0.069	0.049	0.046	0.044	0.040	0.048	0.036	1/8	5/32	3/16	7/32
2 0.0860	32	0.088	0.082	0.064	0.060	0.058	0.054	0.062	0.047	5/32	3/16	1/4	9/32
3 0.0990	28	0.101	0.095	0.075	0.071	0.068	0.063	0.071	0.054	3/16	7/32	5/32	3/16
4 0.1120	24	0.114	0.108	0.086	0.082	0.079	0.074	0.083	0.063	3/16	1/4	5/16	11/32
5 0.1250	20	0.130	0.123	0.094	0.090	0.087	0.082	0.100	0.075	7/32	5/32	11/32	13/32
6 0.1380	20	0.139	0.132	0.104	0.099	0.095	0.089	0.100	0.075	1/4	9/32	3/8	7/16
7 0.1510	19	0.154	0.147	0.115	0.109	0.105	0.099	0.105	0.079	1/4	5/16	13/32	15/32
8 0.1640	18	0.166	0.159	0.122	0.116	0.112	0.106	0.111	0.083	5/32	11/32	7/16	1/2
10 0.1900	16	0.189	0.182	0.141	0.135	0.130	0.123	0.125	0.094	5/16	3/8	1/2	19/32
12 0.2160	14	0.215	0.208	0.164	0.157	0.152	0.145	0.143	0.107	11/32	7/16	9/16	21/32
1/4 0.2500	14	0.246	0.237	0.192	0.185	0.179	0.171	0.143	0.107	3/8	1/2	21/32	3/4
5/16 0.3125	12	0.315	0.306	0.244	0.236	0.230	0.222	0.167	0.125	15/32	19/32	27/32	31/32
3/8 0.3750	12	0.380	0.371	0.309	0.299	0.293	0.285	0.167	0.125	17/32	11/16	15/16	1 1/8
7/16 0.4375	10	0.440	0.429	0.359	0.349	0.343	0.335	0.200	0.150	5/8	25/32	1 1/8	1 1/4
1/2 0.5000	10	0.504	0.493	0.423	0.413	0.407	0.399	0.200	0.150	11/16	27/32	1 1/4	1 13/32

^a Where specifying nominal size in decimals, zeros preceding decimal and in the fourth decimal place shall be omitted.

^b The width of flat at crest of thread shall not exceed 0.004 inch for sizes up to No. 8, inclusive, and 0.006 inch for larger sizes.

^c Point diameters specified apply to screw threads before roll threading.

^d Points of screws are tapered and fluted or slotted. The flute on Type BT screws has an included angle of 90 to 95 degrees and the thread cutting edge is located above the axis of the screw. Flutes and slots extend through first full form thread beyond taper except for Type BF screw on which tapered threads may be complete at manufacturer's option and flutes may be one pitch short of first full form thread.

THREAD CUTTING TYPES BF AND BT ^d													
Nominal Size ^a or Basic Screw Diameter	Thds per Inch ^b	D		d		P		S		L			
		Major Diameter		Minor Diameter		Point Diameter ^c		Point Taper Length ^d		Minimum Practical Nominal Screw Lengths			
		Max	Min	Max	Min	Max	Min	Max	Min	Type B		Type BP	
										90° Heads	Csk Heads	90° Heads	Csk Heads
0 0.0600	48	0.060	0.054	0.036	0.033	0.031	0.027	0.042	0.031	1/8	1/8	5/32	3/16
1 0.0730	42	0.075	0.069	0.049	0.046	0.044	0.040	0.048	0.036	1/8	5/32	3/16	7/32
2 0.0860	32	0.088	0.082	0.064	0.060	0.058	0.054	0.062	0.047	5/32	3/16	1/4	9/32
3 0.0990	28	0.101	0.095	0.075	0.071	0.068	0.063	0.071	0.054	3/16	7/32	5/32	3/16
4 0.1120	24	0.114	0.108	0.086	0.082	0.079	0.074	0.083	0.063	3/16	1/4	5/16	11/32
5 0.1250	20	0.130	0.123	0.094	0.090	0.087	0.082	0.100	0.075	7/32	5/32	11/32	13/32
6 0.1380	20	0.139	0.132	0.104	0.099	0.095	0.089	0.100	0.075	1/4	9/32	3/8	7/16
7 0.1510	19	0.154	0.147	0.115	0.109	0.105	0.099	0.105	0.079	1/4	5/16	13/32	15/32
8 0.1640	18	0.166	0.159	0.122	0.116	0.112	0.106	0.111	0.083	5/32	11/32	7/16	1/2
10 0.1900	16	0.189	0.182	0.141	0.135	0.130	0.123	0.125	0.094	5/16	3/8	1/2	19/32
12 0.2160	14	0.215	0.208	0.164	0.157	0.152	0.145	0.143	0.107	11/32	7/16	9/16	21/32
1/4 0.2500	14	0.246	0.237	0.192	0.185	0.179	0.171	0.143	0.107	3/8	1/2	21/32	3/4
5/16 0.3125	12	0.315	0.306	0.244	0.236	0.230	0.222	0.167	0.125	15/32	19/32	27/32	31/32
3/8 0.3750	12	0.380	0.371	0.309	0.299	0.293	0.285	0.167	0.125	17/32	11/16	15/16	1 1/8
7/16 0.4375	10	0.440	0.429	0.359	0.349	0.343	0.335	0.200	0.150	5/8	25/32	1 1/8	1 1/4
1/2 0.5000	10	0.504	0.493	0.423	0.413	0.407	0.399	0.200	0.150	11/16	27/32	1 1/4	1 13/32

All dimensions are in inches. See Tables 1 and 2 for thread diagrams.

Table 6. Thread and Point Dimensions for Type C Thread Forming Tapping Screws (ANSI B18.6.4-1981, R1991 Appendix)

Nominal Size ^a or Basic Screw Diameter	Threads per inch	D		P		S				L			
		Major Diameter		Point Diameter ^b		Point Taper Length ^c				Determinant Lengths for Point Taper ^c		Minimum Practical Nominal Screw Lengths	
		Max	Min	Max	Min	For Short Screws		For Long Screws		90° Heads	Csk Heads	90° Heads	Csk Heads
						Max	Min	Max	Min				
2 0.0860	56	0.0860	0.0813	0.068	0.061	0.062	0.045	0.080	0.062	3/32	3/16	3/32	3/16
2 0.0860	64	0.0860	0.0816	0.070	0.064	0.055	0.039	0.070	0.055	1/8	3/16	1/8	5/32
3 0.0990	48	0.0990	0.0938	0.078	0.070	0.073	0.052	0.094	0.073	3/16	7/32	3/32	7/32
3 0.0990	56	0.0990	0.0942	0.081	0.074	0.062	0.045	0.080	0.062	5/32	3/16	5/32	3/16
4 0.1120	40	0.1120	0.1061	0.087	0.078	0.088	0.062	0.112	0.088	7/32	1/4	3/16	1/4
4 0.1120	48	0.1120	0.1068	0.091	0.083	0.073	0.052	0.094	0.073	3/16	7/32	3/32	7/32
5 0.1250	40	0.1250	0.1191	0.100	0.091	0.088	0.062	0.112	0.088	7/32	9/32	3/16	1/4
5 0.1250	44	0.1250	0.1195	0.102	0.094	0.080	0.057	0.102	0.080	3/16	1/4	3/16	1/4
6 0.1380	32	0.1380	0.1312	0.107	0.096	0.109	0.078	0.141	0.109	1/4	5/16	1/4	5/16
6 0.1380	40	0.1380	0.1321	0.113	0.104	0.088	0.062	0.112	0.088	7/32	9/32	3/16	1/4
8 0.1640	32	0.1640	0.1571	0.132	0.122	0.109	0.078	0.141	0.109	1/4	11/32	1/4	5/16
8 0.1640	36	0.1640	0.1577	0.136	0.126	0.097	0.069	0.125	0.097	7/32	5/16	7/32	5/16
10 0.1900	24	0.1900	0.1818	0.148	0.135	0.146	0.104	0.188	0.146	11/32	7/16	3/16	13/32
10 0.1900	32	0.1900	0.1831	0.158	0.148	0.109	0.078	0.141	0.109	1/4	11/32	1/4	5/16
12 0.2160	24	0.2160	0.2078	0.174	0.161	0.146	0.104	0.188	0.146	11/32	7/16	3/16	13/32
12 0.2160	28	0.2160	0.2085	0.180	0.168	0.125	0.089	0.161	0.125	5/16	13/32	3/32	3/8
1/4 0.2500	20	0.2500	0.2408	0.200	0.184	0.175	0.125	0.225	0.175	13/32	17/32	3/8	1/2
1/4 0.2500	28	0.2500	0.2425	0.214	0.202	0.125	0.089	0.161	0.125	3/16	13/32	3/32	3/8
5/16 0.3125	18	0.3125	0.3026	0.257	0.239	0.194	0.139	0.250	0.194	15/32	19/32	7/16	9/16
5/16 0.3125	24	0.3125	0.3042	0.271	0.257	0.146	0.104	0.188	0.146	11/32	15/32	3/16	15/32
3/8 0.3750	16	0.3750	0.3643	0.312	0.293	0.219	0.156	0.281	0.219	1/2	11/16	15/32	5/8
3/8 0.3750	24	0.3750	0.3667	0.333	0.319	0.146	0.104	0.188	0.146	11/32	1/2	3/16	1/2
7/16 0.4375	14	0.4375	0.4258	0.366	0.344	0.250	0.179	0.321	0.250	19/32	3/4	3/16	23/32
7/16 0.4375	20	0.4375	0.4281	0.387	0.371	0.175	0.125	0.225	0.175	13/32	9/16	3/8	17/32
1/2 0.5000	13	0.5000	0.4876	0.423	0.399	0.269	0.192	0.346	0.269	3/8	25/32	19/32	3/4
1/2 0.5000	20	0.5000	0.4906	0.450	0.433	0.175	0.125	0.225	0.175	13/32	9/16	3/8	17/32

^a Where specifying nominal size in decimals, zeros preceding decimal and in the fourth decimal place shall be omitted.

^b The tabulated values apply to screw blanks before roll threading.

^c Screws of these nominal lengths and shorter shall have point taper length specified above for short screws. Longer lengths shall have point taper length specified for long screws.

All dimensions are in inches. See **Table 1** for thread diagrams. Type C is not recommended for new designs.

Tapered threads shall have unfinished crests.

Table 7. ANSI Standard Thread and Point Dimensions for Types D, F, G, and T Thread Cutting Tapping Screws ANSI B18.6.4-1981 (R1991)

Nominal Size ^a or Basic Screw Diameter	Threads per inch	D		P		S				L				
		Major Diameter		Point Diameter ^b		Point Taper Length ^c				Determinant Lengths for Point Taper ^c		Minimum Practical Nominal Screw Lengths		
		Max	Min	Max	Min	For Short Screws		For Long Screws		90° Heads	Csk Heads	90° Heads	Csk Heads	
						Max	Min	Max	Min					
2	0.0860	56	0.0860	0.0813	0.068	0.061	0.062	0.045	0.080	0.062	5/32	3/16	5/32	3/16
2	0.0860	64	0.0860	0.0816	0.070	0.064	0.055	0.039	0.070	0.055	1/8	3/16	1/8	5/32
3	0.0990	48	0.0990	0.0938	0.078	0.070	0.073	0.052	0.094	0.073	3/16	7/32	5/32	7/32
3	0.0990	56	0.0990	0.0942	0.081	0.074	0.062	0.045	0.080	0.062	5/32	3/16	5/32	3/16
4	0.1120	40	0.1120	0.1061	0.087	0.078	0.088	0.062	0.112	0.088	7/32	1/4	3/16	1/4
4	0.1120	48	0.1120	0.1068	0.091	0.083	0.073	0.052	0.094	0.073	3/16	7/32	5/32	7/32
5	0.1250	40	0.1250	0.1191	0.100	0.091	0.088	0.062	0.112	0.088	7/32	3/16	1/4	1/4
5	0.1250	44	0.1250	0.1195	0.102	0.094	0.080	0.057	0.102	0.080	3/16	1/4	3/16	1/4
6	0.1380	32	0.1380	0.1312	0.107	0.096	0.109	0.078	0.141	0.109	1/4	5/16	1/4	5/16
6	0.1380	40	0.1380	0.1321	0.113	0.104	0.088	0.062	0.112	0.088	7/32	3/16	3/16	1/4
8	0.1640	32	0.1640	0.1571	0.132	0.122	0.109	0.078	0.141	0.109	1/4	11/32	1/4	5/16
8	0.1640	36	0.1640	0.1577	0.136	0.126	0.097	0.069	0.125	0.097	7/32	5/16	7/32	9/32
10	0.1900	24	0.1900	0.1818	0.148	0.135	0.146	0.104	0.188	0.146	11/32	7/16	5/16	13/32
10	0.1900	32	0.1900	0.1831	0.158	0.148	0.109	0.078	0.141	0.109	1/4	11/32	1/4	5/16
12	0.2160	24	0.2160	0.2078	0.174	0.161	0.146	0.104	0.188	0.146	11/32	7/16	5/16	13/32
12	0.2160	28	0.2160	0.2085	0.180	0.168	0.125	0.089	0.161	0.125	5/16	13/32	9/32	3/8
1/4	0.2500	20	0.2500	0.2408	0.200	0.184	0.175	0.125	0.225	0.175	13/32	17/32	3/8	1/2
1/4	0.2500	28	0.2500	0.2425	0.214	0.202	0.125	0.089	0.161	0.125	5/16	13/32	3/8	3/8
5/16	0.3125	18	0.3125	0.3026	0.257	0.239	0.194	0.139	0.250	0.194	15/32	19/32	7/16	9/16
5/16	0.3125	24	0.3125	0.3042	0.271	0.257	0.146	0.104	0.188	0.146	11/32	15/32	5/16	15/32
3/8	0.3750	16	0.3750	0.3643	0.312	0.293	0.219	0.156	0.281	0.219	1/2	11/16	5/16	5/8
3/8	0.3750	24	0.3750	0.3667	0.333	0.319	0.146	0.104	0.188	0.146	11/32	1/2	5/16	1/2
7/16	0.4375	14	0.4375	0.4258	0.366	0.344	0.250	0.179	0.321	0.250	19/32	3/4	9/16	23/32
7/16	0.4375	20	0.4375	0.4281	0.387	0.371	0.175	0.125	0.225	0.175	13/32	9/16	3/8	17/32
1/2	0.5000	13	0.5000	0.4876	0.423	0.399	0.269	0.192	0.346	0.269	5/8	25/32	19/32	3/4
1/2	0.5000	20	0.5000	0.4906	0.450	0.433	0.175	0.125	0.225	0.175	13/32	9/16	3/8	17/32

^a Where specifying nominal size in decimals, zeros preceding decimal and in the fourth decimal place shall be omitted.

^b The tabulated values apply to screw blanks before roll threading.

^c Screws of these nominal lengths and shorter shall have point taper length specified above for short screws. Longer lengths shall have point taper length specified for long screws.

All dimensions are in inches. See Table 2 for thread diagrams.

Type "Type D" otherwise designated "Type 1."

Type "Type T" otherwise designated "Type 23."

Table 8. Approximate Hole Sizes for Type A Steel Thread Forming Screws

In Steel, Stainless Steel, Monel Metal, Brass, and Aluminum Sheet Metal									
Screw Size	Metal Thickness	Hole Size		Drill Size	Screw Size	Metal Thickness	Hole Size		Drill Size
		Pierced or Extruded	Drilled or Clean Punched				Pierced or Extruded	Drilled or Clean Punched	
4	0.015	...	0.086	44	8	0.024	0.136	0.125	1/8
	0.018	...	0.086	44		0.030	0.136	0.125	1/8
	0.024	0.098	0.094	42		0.036	0.136	0.125	1/8
	0.030	0.098	0.094	42		0.048	0.136	0.128	30
	0.036	0.098	0.098	40		0.018	...	0.136	29
6	0.015	...	0.104	37	10	0.024	0.157	0.136	29
	0.018	...	0.104	37		0.030	0.157	0.136	29
	0.024	0.111	0.104	37		0.036	0.157	0.136	29
	0.030	0.111	0.104	37		0.048	0.157	0.149	25
	0.036	0.111	0.106	36		0.024	...	0.161	20
7	0.015	...	0.116	32	12	0.030	0.185	0.161	20
	0.018	...	0.116	32		0.036	0.185	0.161	20
	0.024	0.120	0.116	32		0.048	0.185	0.161	20
	0.030	0.120	0.116	32		0.024	...	0.185	13
	0.036	0.120	0.116	32		0.030	0.209	0.189	12
8	0.048	0.120	0.120	31	14	0.036	0.209	0.191	11
	0.018	...	0.125	1/8		0.048	0.209	0.196	9

In Plywood (Resin Impregnated)						In Asbestos Compositions					
Screw Size	Hole Size	Drill Size	Min. Mat'l Thickness	Penetration in Blind Holes		Screw Size	Hole Size	Drill Size	Min. Mat'l Thickness	Penetration in Blind Holes	
				Min.	Max.					Min.	Max.
4	0.098	40	0.188	0.250	0.750	4	0.094	42	0.188	0.250	0.750
6	0.110	35	0.188	0.250	0.750	6	0.106	36	0.188	0.250	0.750
7	0.128	30	0.250	0.312	0.750	7	0.125	1/8	0.250	0.312	0.750
8	0.140	28	0.250	0.312	0.750	8	0.136	29	0.250	0.312	0.750
10	0.170	18	0.312	0.375	1.000	10	0.161	20	0.312	0.375	1.000
12	0.189	12	0.312	0.375	1.000	12	0.185	13	0.312	0.375	1.000
14	0.228	1	0.438	0.500	1.000	14	0.213	3	0.438	0.500	1.000

Type A is not recommended, use Type AB.

See footnote at bottom of Table 9.

Table 9. Approximate Hole Sizes for Type C Steel Thread Forming Screws

In Sheet Steel											
Screw Size	Metal Thickness	Hole Size	Drill Size	Screw Size	Metal Thickness	Hole Size	Drill Size	Screw Size	Metal Thickness	Hole Size	Drill Size
4-40	0.037	0.094	42	10-24	0.037	0.154	23	1/4-20	0.037	0.221	2
	0.048	0.094	42		0.048	0.161	20		0.048	0.221	2
	0.062	0.096	41		0.062	0.166	19		0.062	0.228	1
	0.075	0.100	39		0.075	0.170	18		0.075	0.234	A
	0.105	0.102	38		0.105	0.173	17		0.105	0.234	A
	0.134	0.102	38		0.134	0.177	16		0.134	0.236	6mm
6-32	0.037	0.113	33	10-32	0.037	0.170	18	1/4-28	0.037	0.224	5.7mm
	0.048	0.116	32		0.048	0.170	18		0.048	0.228	1
	0.062	0.116	32		0.062	0.170	18		0.062	0.232	5.9mm
	0.075	0.122	3.1mm		0.075	0.173	17		0.075	0.234	A
	0.105	0.125	1/8		0.105	0.177	16		0.105	0.238	B
	0.134	0.125	1/8		0.134	0.177	16		0.134	0.238	B
8-32	0.037	0.136	29	12-24	0.037	0.189	12	5/16-18	0.037	0.290	L
	0.048	0.144	27		0.048	0.194	10		0.048	0.290	L
	0.062	0.144	27		0.062	0.194	10		0.062	0.290	L
	0.075	0.147	26		0.075	0.199	8		0.075	0.295	M
	0.105	0.150	25		0.105	0.199	8		0.105	0.295	M
	0.134	0.150	25		0.134	0.199	8		0.134	0.295	M

All dimensions are in inches except drill sizes. It may be necessary to vary the hole size to suit a particular application.

Type C is not recommended for new designs.

Table 10. Approximate Pierced or Extruded Hole Sizes for Types AB, B, and BP Steel Thread Forming Screws

Screw Size	Metal Thickness	Pierced or Extruded Hole Size	Screw Size	Metal Thickness	Pierced or Extruded Hole Size	Screw Size	Metal Thickness	Pierced or Extruded Hole Size	
In Steel, Stainless Steel, Monel Metal, and Brass Sheet Metal									
4	0.015	0.086	7	0.024	0.120	10	0.030	0.157	
	0.018	0.086		0.030	0.120		0.036	0.157	
	0.024	0.098		0.036	0.120		0.048	0.157	
	0.030	0.098		12	0.048		0.120	0.024	0.185
	0.036	0.098			0.018		0.136	0.030	0.185
6	0.015	0.111	8	0.024	0.136	1/4	0.036	0.185	
	0.018	0.111		0.030	0.136		0.048	0.185	
	0.024	0.111		0.036	0.136		0.030	0.209	
	0.030	0.111		0.048	0.136	0.036	0.209		
7	0.036	0.111	10	0.018	0.157	...	0.048	0.209	
	0.036	0.111		0.024	0.157		
In Aluminum Alloy Sheet Metal									
4	0.024	0.086	6	0.048	0.111	8	0.036	0.136	
	0.030	0.086		0.024	0.120		0.048	0.136	
	0.036	0.086	7	0.030	0.120	10	0.024	0.157	
	0.048	0.086		0.036	0.120		0.030	0.157	
6	0.024	0.111	8	0.048	0.120	...	0.036	0.157	
	0.030	0.111		0.024	0.136		0.048	0.157	
	0.036	0.111		0.030	0.136		

All dimensions are in inches except whole number screw and drill sizes.

Since conditions differ widely, it may be necessary to vary the hole size to suit a particular application.

Table 11. Drilled Hole Sizes for Types AB, B, and BP Steel Thread Forming Screws

Screw Size	Hole Size	Drill Size	Min. Mat'l Thickness	Penetration in Blind Holes		Screw Size	Hole Size	Drill Size	Min. Mat'l Thickness	Penetration in Blind Holes	
				Min.	Max.					Min.	Max.
In Plywood (Resin Impregnated)						In Asbestos Compositions					
2	0.073	49	0.125	0.188	0.500	2	0.076	48	0.125	0.188	0.500
4	0.100	39	0.188	0.250	0.625	4	0.101	38	0.188	0.250	0.625
6	0.125	1/8	0.188	0.250	0.625	6	0.120	31	0.188	0.250	0.625
7	0.136	29	0.188	0.250	0.750	7	0.136	29	0.250	0.312	0.750
8	0.144	27	0.188	0.250	0.750	8	0.147	26	0.312	0.375	0.750
10	0.173	17	0.250	0.312	1.000	10	0.166	19	0.312	0.375	1.000
12	0.194	10	0.312	0.375	1.000	12	0.196	9	0.312	0.375	1.000
1/4	0.228	1	0.312	0.375	1.000	1/4	0.228	1	0.438	0.500	1.000
In Aluminum, Magnesium, Zinc, Brass, and Bronze Castings ^a						In Phenol Formaldehyde Plastics ^a					
2	0.078	47	...	0.125	...	2	0.078	47	...	0.188	...
4	0.104	37	...	0.188	...	4	0.100	39	...	0.250	...
6	0.128	30	...	0.250	...	6	0.128	30	...	0.250	...
7	0.144	27	...	0.250	...	7	0.136	29	...	0.250	...
8	0.152	24	...	0.250	...	8	0.150	25	...	0.312	...
10	0.177	16	...	0.250	...	10	0.177	16	...	0.312	...
12	0.199	8	...	0.281	...	12	0.199	8	...	0.375	...
1/4	0.234	1/64	...	0.312	...	1/4	0.234	1/64	...	0.375	...
In Cellulose Acetate and Nitrate, and Acrylic and Styrene Resins ^a											
2	0.078	47	...	0.188	...	8	0.144	27	...	0.312	...
4	0.094	42	...	0.250	...	10	0.170	18	...	0.312	...
6	0.120	31	...	0.250	...	12	0.191	11	...	0.375	...
7	0.128	30	...	0.250	...	1/4	0.221	2	...	0.375	...

^aData below apply to Types B and BP only.

All dimensions are in inches except whole number screw and drill sizes.

Since conditions differ widely, it may be necessary to vary the hole size to suit a particular application.

Table 12a. Approximate Drilled or Clean-Punched Hole Sizes for Types AB, B, and BP Steel Thread Forming Screws

Screw Size	Metal Thickness	Hole Size	Drill Size	Screw Size	Metal Thickness	Hole Size	Drill Size	Screw Size	Metal Thickness	Hole Size	Drill Size		
In Steel, Stainless Steel, Monel Metal, and Brass Sheet Metal													
2	0.015	0.064	52	7	0.018	0.116	32	10	0.125	0.170	18		
	0.018	0.064	52		0.024	0.116	32		0.135	0.170	18		
	0.024	0.067	51		0.030	0.116	32		0.164	0.173	17		
	0.030	0.070	50		0.036	0.116	32	12	0.024	0.166	19		
	0.036	0.073	49		0.048	0.120	31		0.030	0.166	19		
	0.048	0.073	49		0.060	0.128	30		0.036	0.166	19		
4	0.060	0.076	48	0.075	0.136	29	1/4	0.048	0.170	18			
	0.015	0.086	44	0.105	0.140	28		0.060	0.177	16			
	0.018	0.086	44	8	0.024	0.125		1/8	0.075	0.182	14		
	0.024	0.089	43		0.030	0.125		1/8	0.105	0.185	13		
	0.030	0.094	42		0.036	0.125		1/8	0.125	0.196	9		
	0.036	0.094	42	0.048	0.128	30		0.135	0.196	9			
	0.048	0.096	41	0.060	0.136	29		0.164	0.201	7			
	0.060	0.100	39	0.075	0.140	28		1/4	0.030	0.194 ^a	10 ^a		
0.075	0.102	38	0.105	0.150	25	0.036	0.194 ^a		10 ^a				
6	0.015	0.104	37	0.125	0.150	25	0.048		0.194 ^a	10 ^a			
	0.018	0.104	37	0.135	0.152	24	0.060	0.199 ^a	8 ^a				
	0.024	0.106	36	10	0.024	0.144	27	0.075	0.204 ^a	6 ^a			
	0.030	0.106	36		0.030	0.144	27	0.105	0.209	4			
	0.036	0.110	35		0.036	0.147	26	0.125	0.228	1			
	0.048	0.111	34	0.048	0.152 ^a	24 ^a	0.135	0.228	1				
	0.060	0.116	32	0.060	0.152 ^a	24 ^a	0.164	0.234	15/64				
	0.075	0.120	31	0.075	0.157	22	0.187	0.234	15/64				
0.105	0.128	30	0.105	0.161	20	0.194	0.234	15/64					
In Aluminum Alloy Sheet Metal													
2	0.024	0.064	52	7	0.060	0.120	31	10	0.164	0.159	21		
	0.030	0.064	52		0.075	0.128	30		0.200	0.166	19		
	0.036	0.064	52		0.105	0.136	29		to				
	0.048	0.067	51		0.128	0.136	29		0.375				
0.060	0.070	50	to										
4	0.030	0.086	44	8	0.250	0.116	32	12	0.048	0.161	20		
	0.036	0.086	44		0.030				0.116	32	0.060	0.166	19
	0.048	0.086	44		0.036				0.120	31	0.075	0.173	17
	0.060	0.089	43		0.048				0.128	30	0.105	0.180	15
	0.075	0.089	43		0.060				0.136	29	0.125	0.182	14
	0.105	0.094	42		0.075				0.140	28	0.135	0.182	14
6	0.030	0.104	37	10	0.075	0.140	28	1/4	0.164	0.189	12		
	0.036	0.104	37		0.105	0.147	26		0.200	0.196	9		
	0.048	0.104	37		0.125	0.147	26		to				
	0.060	0.106	36		0.135	0.149	25		0.375				
	0.075	0.110	35		0.162	0.152	24		0.060	0.199	8		
	0.105	0.111	34		to								
7	0.128	120	31	10	0.375	0.144	27	1/4	0.075	0.201	7		
	to				0.048	0.144	27		0.105	0.204	6		
	250				0.060	0.144	27		0.125	0.209	4		
	0.030				0.113	33	0.135		0.154	23	0.135	0.209	4
0.036	0.113	33	10	0.075	0.147	26	1/4	0.164	0.213	3			
0.048	0.116	32		0.105	0.147	26		0.187	0.213	3			
7	0.030	0.113		33	0.125	0.154		23	0.194	0.221	2		
					0.135	0.154		23	0.200	228	1		
to	0.375												

^aFor Types B and BP only; for Type AB see concluded Table 12b following.

Since conditions differ widely, it may be necessary to vary the hole size to suit a particular application. Hole sizes for metal thicknesses above 0.075 inch are for Types B and BP only.

Table 12b. Supplementary Data for Types AB Thread Forming Screws in Steel, Stainless Steel, Monel Metal, and Brass Sheet Metal

Screw Size	Metal Thickness	Hole Size	Drill Size	Screw Size	Metal Thickness	Hole Size	Drill Size	Screw Size	Metal Thickness	Hole Size	Drill Size
In Steel, Stainless Steel, Monel Metal, and Brass Sheet Metal											
10	0.018	0.144	27	1/4	0.018	0.196	9	1/4	0.048	0.205	5
10	0.048	0.149	25	1/4	0.024	0.196	9	1/4	0.060	0.228	1
10	0.060	0.154	23	1/4	0.030	0.196	9	1/4	0.075	0.232	5.9 mm
...	1/4	0.036	0.196	9

All dimensions are in inches except numbered screw and drill sizes.

Table 13. Approximate Hole Sizes for Types D, F, G, and T Steel Thread Cutting Screws in Sheet Metals

Screw Size	Thickness	Steel		Aluminum Alloy		Screw Size	Thickness	Steel		Aluminum Alloy		
		Hole Size	Drill Size	Hole Size	Drill Size			Hole Size	Drill Size	Hole Size	Drill Size	
2-56	0.050	0.073	49	0.070	50	8-32	0.187	0.150	25	0.147	26	
	0.060	0.073	49	0.073	49		0.250	0.150	25	0.150	25	
	0.083	0.073	49	0.073	49		0.312	0.150	25	0.150	25	
	0.109	0.073	49	0.073	49	10-24	0.050	0.152	24	0.150	25	
	0.125	0.076	48	0.073	49		0.060	0.154	23	0.152	24	
	0.140	0.076	48	0.073	49		0.083	0.161	20	0.154	23	
3-48	0.050	0.081	46	0.078	5/64		0.109	0.161	20	0.157	22	
	0.060	0.081	46	0.081	46		0.125	0.166	19	0.159	21	
	0.083	0.082	45	0.082	45		0.140	0.170	18	0.161	20	
	0.109	0.086	44	0.082	45	0.187	0.173	17	0.166	19		
	0.125	0.086	44	0.082	45	0.250	0.173	17	0.172	1/64		
	0.140	0.086	44	0.086	44	0.312	0.173	17	0.173	17		
4-40	0.050	0.089	43	0.089	43	10-32	0.050	0.159	21	0.161	20	
	0.060	0.089	43	0.089	43		0.060	0.166	19	0.161	20	
	0.083	0.094	42	0.089	43		0.083	0.166	19	0.161	20	
	0.109	0.096	41	0.094	42		0.109	0.170	18	0.166	19	
	0.125	0.098	40	0.094	42		0.125	0.170	18	0.166	19	
	0.140	0.098	40	0.094	42		0.140	0.170	18	0.166	19	
5-40	0.050	0.106	36	0.102	38	12-24	0.187	0.177	16	0.172	1/64	
	0.060	0.106	36	0.102	38		0.250	0.177	16	0.177	16	
	0.083	0.106	36	0.104	37		0.312	0.177	16	0.177	16	
	0.109	0.106	36	0.104	37		0.375	0.177	16	0.177	16	
	0.125	0.109	3/64	0.106	36		0.060	0.180	15	0.177	16	
	0.140	0.110	35	0.106	36		0.083	0.182	14	0.180	15	
6-32	0.187	0.116	32	0.110	35	1/4-20	0.109	0.219	3/32	0.209	4	
	0.250	0.116	32	0.113	33		0.125	0.221	2	0.213	3	
	8-32	0.050	0.110	35	0.109		3/64	0.140	0.221	2	0.213	3
		0.060	0.113	33	0.109		3/64	0.187	0.228	1	0.221	2
		0.083	0.116	32	0.111		34	0.250	0.228	1	0.228	1
		0.109	0.116	32	0.113		33	0.312	0.228	1	0.228	1
0.125		0.116	32	0.116	32	0.375	0.228	1	0.228	1		
0.140		0.120	31	0.116	32	0.500	0.199	8	0.199	8		
8-32	0.187	0.125	1/8	0.120	31	1/4-20	0.083	0.213	3	0.206	5	
	0.250	0.125	1/8	0.125	1/8		0.109	0.219	3/32	0.209	4	
	0.050	0.136	29	0.136	29		0.125	0.221	2	0.213	3	
	0.060	0.140	28	0.136	29		0.140	0.221	2	0.213	3	
	0.083	0.140	28	0.136	29		0.187	0.228	1	0.221	2	
	0.109	0.144	27	0.140	28		0.250	0.228	1	0.228	1	
0.125	0.144	27	0.140	28	0.312	0.228	1	0.228	1			
0.140	0.147	26	0.144	27	0.375	0.228	1	0.228	1			
						0.500	0.228	1	0.228	1		

Table 13. Approximate Hole Sizes for Types D, F, G, and T Steel Thread Cutting Screws in Sheet Metals

Screw Size	Thick-ness	Steel		Aluminum Alloy		Screw Size	Thick-ness	Steel		Aluminum Alloy	
		Hole Size	Drill Size	Hole Size	Drill Size			Hole Size	Drill Size	Hole Size	Drill Size
1/4-28	0.083	0.221	2	0.219	7/32	5/16-24	0.187	0.295	M	0.290	L
	0.109	0.228	1	0.221	2		0.250	0.295	M	0.295	M
	0.125	0.228	1	0.221	2		0.312	0.295	M	0.295	M
	0.140	0.234	A	0.221	2		0.375	0.295	M	0.295	M
	0.187	0.234	15/64	0.228	1	0.500	0.295	M	0.295	M	
	0.250	0.234	15/64	0.234	15/64	3/8-16	0.125	0.339	R	0.328	21/64
	0.312	0.234	15/64	0.234	15/64		0.140	0.339	R	0.332	Q
	0.375	0.234	15/64	0.234	15/64		0.187	0.348	S	0.339	R
0.500	0.234	15/64	0.234	15/64	0.250		0.358	T	0.348	S	
5/16-18	0.109	0.277	J	0.266	H	3/8-24	0.312	0.358	T	0.348	S
	0.125	0.277	J	0.272	I		0.375	0.358	T	0.348	S
	0.140	0.281	9/32	0.272	I		0.500	0.358	T	0.348	S
	0.187	0.290	L	0.281	K		0.125	0.348	S	0.344	11/32
	0.250	0.290	L	0.290	L	0.140	0.348	S	0.344	11/32	
	0.312	0.290	L	0.290	L	0.187	0.358	T	0.348	S	
	0.375	0.290	L	0.290	L	0.250	0.358	T	0.358	T	
	0.500	0.290	L	0.290	L	0.312	0.358	T	0.358	T	
5/16-24	0.109	0.290	L	0.281	K	0.375	0.358	T	0.358	T	
	0.125	0.290	L	0.281	9/32	0.500	0.358	T	0.358	T	
	0.140	0.290	L	0.281	9/32	

All dimensions are in inches except numbered drill and screw sizes. It may be necessary to vary the hole size to suit a particular application.

Table 14. Approximate Hole Sizes for Types D, F, G, and T Steel Thread Cutting Screws in Cast Metals and Plastics

Screw Size	Thick-ness	Cast Iron		Zinc and Aluminum ^a		Screw Size	Thick-ness	Cast Iron		Zinc and Aluminum ^a	
		Hole Size	Drill Size	Hole Size	Drill Size			Hole Size	Drill Size	Hole Size	Drill Size
2-56	0.050	0.076	48	0.073	49	5-40	0.083	0.113	33	0.106	36
	0.060	0.076	48	0.073	49		0.109	0.113	33	0.110	35
	0.083	0.076	48	0.076	48		0.125	0.116	32	0.110	35
	0.109	0.078	5/64	0.076	48		0.140	0.116	32	0.110	35
	0.125	0.078	5/64	0.076	48		0.187	0.116	32	0.111	34
	0.140	0.078	5/64	0.076	48		0.250	0.116	32	0.113	33
3-48	0.050	0.089	43	0.082	45	6-32	0.050	0.120	31	0.116	32
	0.060	0.089	43	0.082	45		0.060	0.120	31	0.120	31
	0.083	0.089	43	0.082	45		0.083	0.125	1/8	0.120	31
	0.109	0.089	43	0.086	44		0.109	0.125	1/8	0.120	31
	0.125	0.089	43	0.089	43		0.125	0.125	1/8	0.120	31
	0.140	0.094	42	0.089	43		0.140	0.125	1/8	0.120	31
	0.187	0.094	42	0.089	43		0.187	0.128	30	0.120	31
4-40	0.050	0.100	39	0.090	41	8-32	0.250	0.128	30	0.120	31
	0.060	0.100	39	0.096	41		0.050	0.147	26	0.144	27
	0.083	0.102	38	0.096	41		0.060	0.150	25	0.144	27
	0.109	0.102	38	0.096	41		0.083	0.150	25	0.144	27
	0.125	0.102	38	0.100	39		0.109	0.150	25	0.144	27
	0.140	0.102	38	0.100	39		0.125	0.150	25	0.147	26
5-40	0.187	0.104	37	0.100	39	0.140	0.150	25	0.147	26	
	0.050	0.111	34	0.106	36	0.187	0.154	23	0.147	26	
	0.060	0.111	34	0.106	36	0.250	0.154	23	0.150	25	
						0.312	0.154	23	0.150	25	

Table 14. Approximate Hole Sizes for Types D, F, G, and T Steel Thread Cutting Screws in Cast Metals and Plastics

Screw Size	Thick-ness	Cast Iron		Zinc and Aluminum ^a		Screw Size	Thick-ness	Cast Iron		Zinc and Aluminum ^a		
		Hole Size	Drill Size	Hole Size	Drill Size			Hole Size	Drill Size	Hole Size	Drill Size	
10-24	0.050	0.170	18	0.161	20	1/4-28	0.083	0.234	A	0.228	I	
	0.060	0.170	18	0.166	19		0.109	0.234	15/64	0.228	I	
	0.083	0.172	1 1/64	0.166	19		0.125	0.234	15/64	0.228	I	
	0.109	0.173	17	0.166	19		0.140	0.234	15/64	0.228	I	
	0.125	0.173	17	0.166	19		0.187	0.238	B	0.228	I	
	0.140	0.173	17	0.166	19		0.250	0.238	B	0.234	A	
	0.187	0.177	16	0.170	18		0.312	0.238	B	0.234	A	
	0.250	0.177	16	0.170	18		0.375	0.238	B	0.234	15/64	
	0.312	0.177	16	0.172	1 1/64		0.500	0.238	B	0.234	15/64	
10-32	0.050	0.173	17	0.170	18	5/16-18	0.109	0.290	L	0.277	J	
	0.060	0.173	17	0.170	18		0.125	0.290	L	0.281	K	
	0.083	0.177	16	0.172	1 1/64		0.140	0.290	L	0.281	K	
	0.109	0.177	16	0.172	1 1/64		0.187	0.295	M	0.281	3/32	
	0.125	0.177	16	0.172	1 1/64		0.250	0.295	M	0.281	3/32	
	0.140	0.177	16	0.172	1 1/64		0.312	0.295	M	0.290	L	
	0.187	0.180	15	0.172	1 1/64		0.375	0.295	M	0.290	L	
	0.250	0.180	15	0.173	17		0.500	0.295	M	0.290	L	
	0.312	0.180	15	0.173	17		5/16-24	0.109	0.295	M	0.290	L
0.375	0.180	15	0.177	16	0.125	0.295		M	0.290	L		
12-24	0.060	0.196	9	0.189	12	0.140		0.295	M	0.290	L	
	0.083	0.199	8	0.191	11	0.187		0.302	N	0.290	L	
	0.109	0.199	8	0.191	11	0.250		0.302	N	0.290	L	
	0.125	0.199	8	0.191	11	0.312		0.302	N	0.295	M	
	0.140	0.199	8	0.194	10	0.375		0.302	N	0.295	M	
	0.187	0.203	13/64	0.194	10	0.500		0.302	N	0.295	M	
	0.250	0.204	6	0.196	9	3/8-16		0.125	0.348	S	0.339	R
	0.312	0.204	6	0.196	9		0.140	0.348	S	0.339	R	
	0.375	0.204	6	0.199	8		0.187	0.348	S	0.339	R	
0.500	0.204	6	0.199	8	0.250		0.348	S	0.344	1 1/32		
1/4-20	0.083	0.228	1	0.219	3/32		0.312	0.348	S	0.344	1 1/32	
	0.109	0.228	1	0.219	7/32		0.375	0.348	S	0.348	S	
	0.125	0.228	1	0.221	2		0.500	0.348	S	0.348	S	
	0.140	0.228	1	0.221	2		3/8-24	0.125	0.358	T	0.348	S
	0.187	0.234	15/64	0.221	2			0.140	0.358	T	0.348	S
	0.250	0.234	15/64	0.228	1	0.187		0.358	T	0.348	S	
	0.312	0.234	15/64	0.228	1	0.250		0.358	T	0.358	T	
	0.375	0.234	15/64	0.228	1	0.312		0.358	T	0.358	T	
	0.500	0.234	15/64	0.228	1	0.375		0.358	T	0.358	T	
					0.500	0.358		T	0.358	T		

^aDie Castings

Screw Size	Phenol Formaldehyde ^a				Cellulose Acetate, Cellulose Nitrate, Acrylic Resin, and Styrene Resin ^a			
	Hole Size	Drill Size	Depth of Penetration		Hole Size	Drill Size	Depth of Penetration	
			Min	Max			Min	Max
2-56	0.078	5/64	0.219	0.375	0.076	48	0.219	0.375
3-48	0.089	43	0.219	0.375	0.086	44	0.219	0.375
4-40	0.098	40	0.250	0.312	0.093	42	0.250	0.312
5-40	0.113	33	0.250	0.438	0.110	35	0.250	0.438
6-32	0.116	32	0.250	0.312	0.116	32	0.250	0.312
8-32	0.144	27	0.312	0.500	0.144	27	0.312	0.500
10-24	0.161	20	0.375	0.500	0.161	20	0.375	0.500
10-32	0.166	19	0.375	0.500	0.166	19	0.375	0.500
1/4-20	0.228	1	0.375	0.625	0.228	1	0.375	1.000

^aPlastics

For footnotes see Table 13.

Table 15. Approximate Hole Sizes for Types BF and BT Steel Thread Cutting Screws in Cast Metals

In Die Cast Zinc and Aluminum							
Screw Size	Thickness	Hole Size	Drill Size	Screw Size	Thickness	Hole Size	Drill Size
2	0.060	0.073	49	10	0.125	0.166	19
	0.083	0.073	49		0.140	0.166	19
	0.109	0.076	48		0.188	0.166	19
	0.125	0.076	48		0.250	0.170	18
	0.140	0.076	48		0.312	0.172	1 1/64
3	0.060	0.086	44	12	0.375	0.172	1 1/64
	0.083	0.086	44		0.125	0.191	11
	0.109	0.086	44		0.140	0.191	11
	0.125	0.086	44		0.188	0.191	11
	0.140	0.089	43		0.250	0.196	9
4	0.188	0.089	43	1/4	0.312	0.196	9
	0.109	0.098	40		0.375	0.196	9
	0.125	0.100	39		0.125	0.221	2
	0.140	0.100	39		0.140	0.221	2
	0.188	0.100	39		0.188	0.221	2
5	0.250	0.102	38	5/16	0.250	0.228	1
	0.109	0.111	34		0.312	0.228	1
	0.125	0.111	34		0.375	0.228	1
	0.140	0.113	33		0.125	0.281	K
	0.188	0.113	33		0.140	0.281	K
6	0.250	0.116	32	3/8	0.188	0.281	K
	0.125	0.120	31		0.250	0.281	K
	0.140	0.120	31		0.312	0.290	L
	0.188	0.120	31		0.375	0.290	L
	0.250	0.125	1/8		0.125	0.344	1 1/32
8	0.312	0.125	1/8	3/8	0.140	0.344	1 1/32
	0.125	0.149	25		0.188	0.344	1 1/32
	0.140	0.149	25		0.250	0.344	1 1/32
	0.188	0.149	25		0.312	0.348	S
	0.250	0.152	24		0.375	0.348	S
	0.312	0.152	24	

All dimensions are in inches except numbered drill and screw sizes. It may be necessary to vary the hole size to suit a particular application.

Table 16. Approximate Hole Size for Types BF and BT Steel Thread Cutting Screws in Plastics

Screw Size	Phenol Formaldehyde				Cellulose Acetate, Cellulose Nitrate, Acrylic Resin and Styrene Resin			
	Hole Size	Drill Size	Depth of Penetration		Hole Size	Drill Size	Depth of Penetration	
			Min	Max			Min	Max
2	0.078	5/64	0.094	0.250	0.076	48	0.094	0.250
3	0.089	43	0.125	0.312	0.089	43	0.125	0.312
4	0.104	37	0.125	0.312	0.100	39	0.125	0.312
5	0.116	32	0.188	0.375	0.113	33	0.188	0.375
6	0.125	1/8	0.188	0.375	0.120	31	0.188	0.375
8	0.147	26	0.250	0.500	0.144	27	0.250	0.500
10	0.170	18	0.312	0.625	0.166	19	0.312	0.625
12	0.194	10	0.375	0.625	0.189	12	0.375	0.625
1/4	0.228	1	0.375	0.750	0.221	2	0.375	0.750

For footnotes see above table.

Table 17. Approximate Hole Sizes for Type U Hardened Steel Metallic Drive Screws

In Ferrous and Non-Ferrous Castings, Sheet Metals, Plastics, Plywood (Resin-Impregnated) and Fiber								
Screw Size	Hole Size	Drill Size	Screw Size	Hole Size	Drill Size	Screw Size	Hole Size	Drill Size
00	.052	55	6	.120	31	12	.191	11
0	.067	51	7	.136	29	14	.221	2
2	.086	44	8	.144	27	$\frac{3}{16}$.295	M
4	.104	37	10	.161	20	$\frac{3}{8}$.358	T

All dimensions are in inches except whole number screw and drill sizes and letter drill sizes.

**Table 18. ANSI Standard Torsional Strength Requirements for Tapping Screws
ANSI B18.6.4-1981 (R1991)**

Nom. Screw Size	Type A	Types AB, B, BF, BP, and BT	Types C, D, F, G, and T		Nom-Screw Size	Type A	Types AB, B, BF, BP, and BT	Types C, D, F, G, and T	
			Coarse Thread	Fine Thread				Coarse Thread	Fine Thread
2	4	4	5	6	$\frac{1}{4}$...	142	140	179
3	9	9	9	10	16	152
4	12	13	13	15	18	196
5	18	18	18	20	$\frac{3}{16}$...	290	306	370
6	24	24	23	27	20	250
7	30	30	24	492
8	39	39	42	47	$\frac{3}{8}$...	590	560	710
10	48	56	56	74	$\frac{7}{16}$...	620	700	820
12	83	88	93	108	$\frac{1}{2}$...	1020	1075	1285
14	125

Torsional strength data are in pound-inches.

Self-tapping Thread Inserts.—Self-tapping screw thread inserts are essentially hard bushings with internal and external threads. The internal threads conform to Unified and American standard classes 2B and 3B, depending on the type of insert used. The external thread has cutting edges on the end that provide the self-tapping feature. These inserts may be used in magnesium, aluminum, cast iron, zinc, plastics, and other materials. Self-tapping inserts are made of case-hardened carbon steel, stainless steel, and brass, the brass type being designed specifically for installation in wood.

Screw Thread Inserts.—Screw thread inserts are helically formed coils of diamond-shaped stainless steel or phosphor bronze wire that screw into a threaded hole to form a mating internal thread for a screw or stud. These inserts provide a convenient means of repairing stripped-out threads and are also used to provide stronger threads in soft materials such as aluminum, zinc die castings, wood, magnesium, etc. than can be obtained by direct tapping of the base metal involved.

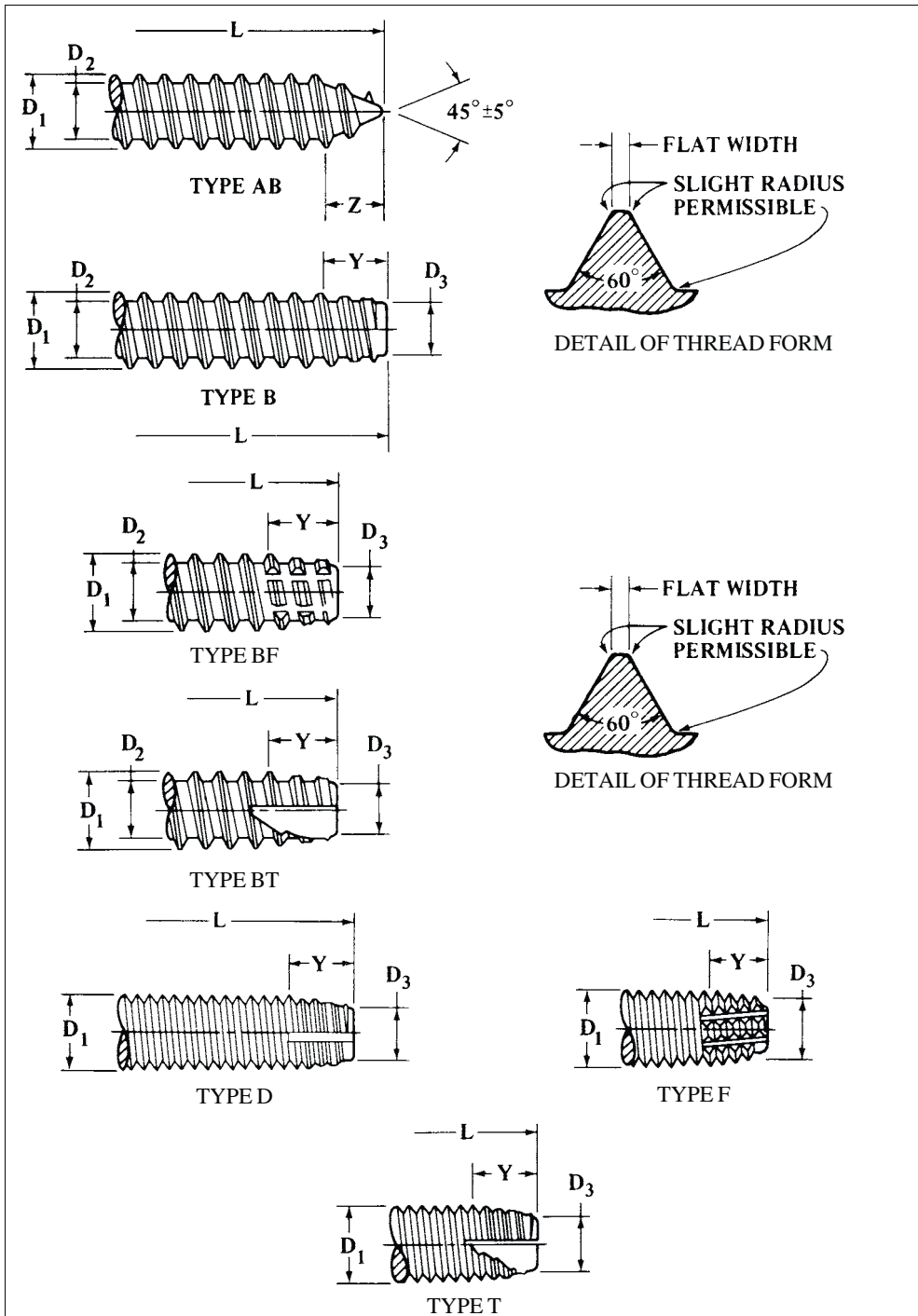
According to the Heli-Coil Corp., conventional design practice in specifying boss diameters or edge distances can usually be applied since the major diameter of a hole tapped to receive a thread insert is not much larger than the major diameter of thread the insert provides.

Screw thread inserts are available in thread sizes from 4-40 to 1½-6 inch National and Unified Coarse Thread Series and in 6-40 to 1½-12 sizes in the fine-thread series. When used in conjunction with appropriate taps and gages, screw thread inserts will meet requirements of 2, 2B, 3, and 3B thread classes.

ANSI Standard Metric Thread Forming and Thread Cutting Tapping Screws.—

Table 1 shows the various types of metric thread forming and thread cutting screw threads covered by the standard ANSI/ASME B18.6.5M-1986. The designations of the American National Standards Institute are shown.

Table 1. ANSI Standard Threads and Points for Metric Thread Forming and Thread Cutting Tapping Screws ANSI/ASME B18.6.5M-1986



See [Tables 3](#) and [4](#) for thread data.

Thread Forming Tapping Screws: These types are generally for application in materials where large internal stresses are permissible or desirable, to increase resistance to loosening. These screws have the following descriptions and applications:

Type AB: Spaced thread screw with gimlet point primarily intended for use in thin metal, resin impregnated plywood, and asbestos compositions.

Type B: Spaced thread screw with a blunt point that has tapered entering threads with unfinished crests and same pitches as Type AB. Used for thin metal, nonferrous castings, resin impregnated plywood, certain resilient plastics, and asbestos compositions.

Thread Cutting Tapping Screws: These screws are generally for application in materials where disruptive internal stresses are undesirable or where excessive driving torques are encountered with thread forming tapping screws. These screws have the following descriptions and applications:

Types BF and BT: Spaced threads with blunt point and tapered entering threads having unfinished crests, as on Type B, with one or more cutting edges or chip cavities, intended for use in plastics, asbestos compositions, and other similar materials.

Types D, F, and T: Tapping screws with threads of machine screw diameter-pitch combinations (metric coarse thread series) approximating a 60 degree basic thread form (not necessarily conforming to any standard thread profile) with a blunt point and tapered entering threads with unfinished crests and having one or more cutting edges and chip cavities, intended for use in materials such as aluminum, zinc, and lead die castings; steel sheets and shapes; cast iron; brass; and plastics.

ANSI Standard Head Types for Metric Thread Forming and Cutting Tapping Screws.—The head types covered by ANSI/ASME B18.6.5M-1986 include those commonly applicable to metric tapping screws and are described as follows:

Flat Countersunk Head: The flat countersunk head has a flat top surface and a conical bearing surface with a head angle of 90 to 92 degrees.

Oval Countersunk Head: The oval countersunk head has a rounded top surface and a conical bearing surface with a head angle of 90 to 92 degrees.

Pan Head: The slotted pan head has a flat top surface rounding into cylindrical sides and a flat bearing surface. The recessed pan head has a rounded top surface blending into cylindrical sides and a flat bearing surface.

Hex Head: The hex head has a flat or indented top surface, six flat sides, and a flat bearing surface.

Hex Flange Head: The hex flange head has a flat or indented top surface and six flat sides formed integrally with a frustroconical or slightly rounded (convex) flange that projects beyond the sides and provides a flat bearing surface.

Method of Designation.—Metric tapping screws are designated with the following data, preferably in the sequence shown: Nominal size; thread pitch; nominal length; thread and point type; product name, including head style and driving provision; material; and protective finish, if required.

Examples:

6.3 × 1.8 × 30 Type AB, Slotted Pan Head Tapping Screw, Steel, Zinc Plated

6 × 1 × 20 Type T, Type 1A Cross Recessed Pan Head Tapping Screw, Corrosion Resistant Steel

4.2 × 1.4 × 13 Type BF, Type 1 Cross Recessed Oval Countersunk Head Tapping Screw, Steel, Chromium Plated

10 × 1.5 × 40 Type D, Hex Flange Head Tapping Screw, Steel

**Table 2. Recommended Nominal Screw Lengths for Metric Tapping Screws
ANSI/ASME B18.6.5M-1986**

Nominal Screw Length	Nominal Screw Size for Types AB, B, BF, and BT									
	2.2	-	2.9	3.5	4.2	4.8	5.5	6.3	8	9.5
	Nominal Screw Size for Types D, F, and T									
	2	2.5	3	3.5	4	5	-	6	8	10
4	PH	PH								
5	PH	PH								
6	A	A	PH							
8	A	A	A	PH	PH					
10	A	A	A	A	A	PH				
13	A	A	A	A	A	A	A	PH		
16		A	A	A	A	A	A	A	PH	
20				A	A	A	A	A	A	PH
25				A	A	A	A	A	A	A
30						A	A	A	A	A
35						A	A	A	A	A
40							A	A	A	A
45								A	A	A
50									A	A
55										A
60										A

Table 3. ANSI Standard Thread and Point Dimensions for Types AB and B Metric Thread Forming Tapping Screws ANSI/ASME B18.6.5M-1986

Nominal Screw Size and Thread Pitch ^a	Basic Screw Diameter	Basic Thread Pitch	D ₁		D ₂		D ₃		Y		Z	L			
			Thread Major Diameter		Thread Minor Diameter		Point Diameter ^b		Point Taper Length Type B ^c		Point Length Factor Type AB	Min. Practical Nominal Screw Length ^d			
												Type AB		Type B	
			Ref ^e	Ref ^e	Max	Min	Max	Min	Max	Min	Max	Min	Ref ^f	Note 7	Note 8
2.2 × 0.8	2.184	0.79	2.24	2.10	1.63	1.52	1.47	1.37	1.6	1.2	2.0	4	6	4	5
2.9 × 1	2.845	1.06	2.90	2.76	2.18	2.08	2.01	1.88	2.1	1.6	2.6	6	7	5	7
3.5 × 1.3	3.505	1.27	3.53	3.35	2.64	2.51	2.41	2.26	2.5	1.9	3.2	7	9	6	8
4.2 × 1.4	4.166	1.41	4.22	4.04	3.10	2.95	2.84	2.69	2.8	2.1	3.7	8	10	7	10
4.8 × 1.6	4.826	1.59	4.80	4.62	3.58	3.43	3.30	3.12	3.2	2.4	4.3	9	12	8	11
5.5 × 1.8	5.486	1.81	5.46	5.28	4.17	3.99	3.86	3.68	3.6	2.7	5.0	11	14	9	12
6.3 × 1.8	6.350	1.81	6.25	6.03	4.88	4.70	4.55	4.34	3.6	2.7	6.0	12	16	10	13
8 × 2.1	7.938	2.12	8.00	7.78	6.20	5.99	5.84	5.64	4.2	3.2	7.5	16	20	12	17
9.5 × 2.1	9.525	2.12	9.65	9.43	7.85	7.59	7.44	7.24	4.2	3.2	8.0	19	24	14	19

^a The body diameter (unthreaded portion) is not less than the minimum minor diameter nor greater than the maximum major diameter of the thread.

^b The tabulated values shall apply to screw blanks prior to roll threading.

^c The tabulated maximum limits are equal to approximately two times the thread pitch.

^d Lengths shown are theoretical minimums and are intended to assist the user in the selection of appropriate short screw lengths. Refer to Table 2 for recommended diameter-length combinations.

^e Basic screw diameter and basic thread pitch shall be used for calculation purposes wherever these factors appear in formulations for dimensions.

^f The minimum effective grip length on Type AB tapping screws shall be determined by subtracting the point length factor from the minimum screw length.

All dimensions are in millimeters. See Table 1 for thread diagrams.

⁷ Pan, hex, and hex flange heads.

⁸ Flat and oval countersunk heads.

Table 4. ANSI Standard Thread and Point Dimensions for Types BF, BT, D, F, and T Metric Thread Cutting Tapping Screws ANSI/ASME B18.6.5M-1986

Types BF and BT												
Nominal Screw Size and Thread Pitch	Basic Screw Diameter	Basic Thread Pitch	D ₁		D ₂		D ₃		Y		L	
			Thread Major Diameter		Thread Minor Diameter		Point Diameter ^a		Point Taper Length Type B ^b		Minimal Practical Nominal Screw Length ^c	
			Ref ^d	Ref ^d	Max	Min	Max	Min	Max	Min	Max	Min
2.2 × 0.8	2.184	0.79	2.24	2.10	1.63	1.52	1.47	1.37	1.6	1.2	4	5
2.9 × 1	2.845	1.06	2.90	2.76	2.18	2.08	2.01	1.88	2.1	1.6	5	7
3.5 × 1.3	3.505	1.27	3.53	3.35	2.64	2.51	2.41	2.26	2.5	1.9	6	8
4.2 × 1.4	4.166	1.41	4.22	4.04	3.10	2.95	2.84	2.69	2.8	2.1	7	10
4.8 × 1.6	4.826	1.59	4.80	4.62	3.58	3.43	3.30	3.12	3.2	2.4	8	11
5.5 × 1.8	5.486	1.81	5.46	5.28	4.17	3.99	3.86	3.68	3.6	2.7	9	12
6.3 × 1.8	6.350	1.81	6.25	6.03	4.88	4.70	4.55	4.34	3.6	2.7	10	13
8 × 2.1	7.938	2.12	8.00	7.78	6.20	5.99	5.84	5.64	4.2	3.2	12	17
9.5 × 2.1	9.525	2.12	9.65	9.43	7.85	7.59	7.44	7.24	4.2	3.2	14	19

^a The tabulated values apply to screw blanks prior to roll threading.

^b The tabulated maximum limits are equal to approximately two times the thread pitch.

^c Lengths shown are theoretical minimums and are intended to assist in the selection of appropriate short screw lengths. See Table 2 for recommended length-diameter combinations. For Types D, F, and T, shorter screws are available with the point length reduced to the limits tabulated for short screws.

^d Basic screw diameter and basic thread pitch are used for calculation purposes whenever these factors appear in formulations for dimensions.

Types D, F, T												
Nominal Screw Size and Thread Pitch	D ₁		D ₃		D ₅	Y				L		
	Thread Major Diameter		Point Diameter ^a		Body Diameter ^a	Point Taper Length				Minimum Practical Nominal Screw Length ^c		
	Max	Min	Max	Min	Min	For Short Screws		For Long Screws ^b		Pan, Hex and Hex Flange Heads	Flat and Oval Csunk Heads	
2 × 0.4	2.00	1.88	1.45	1.39	1.65	1.4	1.0	1.8	1.4	4	5	
2.5 × 0.45	2.50	2.37	1.88	1.82	2.12	1.6	1.1	2.0	1.6	4	6	
3 × 0.5	3.00	2.87	2.32	2.26	2.58	1.8	1.3	2.3	1.8	5	6	
3.5 × 0.6	3.50	3.35	2.68	2.60	3.00	2.1	1.5	2.7	2.1	5	8	
4 × 0.7	4.00	3.83	3.07	2.97	3.43	2.5	1.8	3.2	2.5	6	9	
5 × 0.8	5.00	4.82	3.94	3.84	4.36	2.8	2.0	3.6	2.8	7	10	
6 × 1	6.00	5.79	4.69	4.55	5.21	3.5	2.5	4.5	3.5	9	12	
8 × 1.25	8.00	7.76	6.40	6.24	7.04	4.4	3.1	5.6	4.4	11	16	
10 × 1.5	10.00	9.73	8.08	7.88	8.86	5.3	3.8	6.8	5.3	13	18	

^a Minimum limits for body diameter (unthreaded portion) are tabulated for convenient reference. For Types BF and BT, the body diameter is not less than the minimum minor diameter nor greater than the maximum major diameter of the thread.

^b Long screws are screws of nominal lengths equal to or longer than those listed under L.

All dimensions are in millimeters. See Table 1 for thread diagrams.

Material and Heat Treatment.—Tapping screws are normally fabricated from carbon steel and are suitably processed to meet the performance and test requirements outlined in the standard, B18.6.5M. Tapping screws may also be made from corrosion resistant steel, Monel, brass, and aluminum alloys. The materials, properties, and performance characteristics applicable to such screws should be mutually agreed upon between the manufacturer and the purchaser.

**Table 5. Clearance Holes for Metric Tapping Screws
ANSI/ASME B18.6.5M-1986 Appendix**

Nominal Screw Size and Thread Pitch	Basic Clearance Hole Diameter ^a			Nominal Screw Size and Thread Pitch	Basic Clearance Hole Diameter ^a		
	Close Clearance ^b	Normal Clearance (Preferred) ^b	Loose Clearance ^b		Close Clearance ^b	Normal Clearance (Preferred) ^b	Loose Clearance ^b
Types AB, B, BF, and BT				Types D, F, and T			
2.2 × 0.8	2.40	2.60	2.80	2 × 0.4	2.20	2.40	2.60
2.9 × 1	3.10	3.30	3.50	2.5 × 0.45	2.70	2.90	3.10
3.5 × 1.3	3.70	3.90	4.20	3 × 0.5	3.20	3.40	3.60
4.2 × 1.4	4.50	4.70	5.00	3.5 × 0.6	3.70	3.90	4.20
4.8 × 1.6	5.10	5.30	5.60	4 × 0.7	4.30	4.50	4.80
5.5 × 1.8	5.90	6.10	6.50	5 × 0.8	5.30	5.50	5.80
6.3 × 1.8	6.70	6.90	7.30	6 × 1	6.40	6.60	7.00
8 × 2.1	8.40	9.00	10.00	8 × 1.25	8.40	9.00	10.00
9.5 × 2.1	10.00	10.50	11.50	10 × 1.5	10.50	11.00	12.00

^a The values given in this table are minimum limits. The recommended plus tolerances are as follows: for clearance hole diameters over 1.70 to and including 5.80 mm, plus 0.12, 0.20, and 0.30 mm for close, normal, and loose clearances, respectively; over 5.80 to and including 14.50 mm, plus 0.18, 0.30, and 0.45 mm for close, normal, and loose clearances, respectively.

^b Normal clearance hole sizes are preferred. Close clearance hole sizes are for situations such as critical alignment of assembled components, wall thickness, or other limitations that necessitate the use of a minimal hole. Countersinking or counterboring at the fastener entry side may be necessary for the proper seating of the head. Loose clearance hole sizes are for applications where maximum adjustment capability between the components being assembled is necessary.

All dimensions are in millimeters.

Approximate Installation Hole Sizes for Metric Tapping Screws.—The approximate hole sizes given in **Tables 7 through 9** provide general guidance in selecting holes for installing the respective types of metric thread forming and thread cutting tapping screws in various commonly used materials. Types AB, B, BF, and BT metric tapping screws are covered in these tables; hole sizes for Types D, F, and T metric thread cutting tapping screws are still under development.

**Table 6. Approximate Pierced or Extruded Hole Sizes for Steel
Types AB and B Metric Thread Forming Tapping Screws**

Nominal Screw Size and Thread Pitch	Metal Thickness	Hole Size	Nominal Screw Size and Thread Pitch	Metal Thickness	Hole Size	Nominal Screw Size and Thread Pitch	Metal Thickness	Hole Size
In Steel, Stainless Steel, Monel, and Brass Sheet Metal								
2.9 × 1	0.38	2.18	4.2 × 1.4	0.46	3.45	5.5 × 1.8	0.61	4.70
	0.46	2.18		0.61	3.45		0.76	4.70
	0.61	2.49		0.76	3.45		0.91	4.70
	0.76	2.49		0.91	3.45		1.22	4.70
	0.91	2.49		1.22	3.45	
3.5 × 1.3	0.38	2.82	4.8 × 1.6	0.46	3.99	6.3 × 1.8	0.76	5.31
	0.46	2.82		0.61	3.99		0.91	5.31
	0.61	2.82		0.76	3.99		1.22	5.31
	0.76	2.82		0.91	3.99	
	0.91	2.82		1.22	3.99	
In Aluminum Alloy								
2.9 × 1	0.61	2.18	3.5 × 1.3	0.91	2.82	4.8 × 1.6	0.61	3.99
	0.76	2.18		1.22	2.82		0.76	3.99
	0.91	2.18	4.2 × 1.4	0.61	3.45		0.91	3.99
	1.22	2.18		0.76	3.45		1.22	3.99
3.5 × 1.3	0.61	2.82	4.2 × 1.4	0.91	3.45	
	0.76	2.82		1.22	3.45	

All dimensions are in millimeters.

Table 7. Approximate Drilled or Clean-Punched Hole Sizes for Steel Type AB Metric Thread Forming Tapping Screws in Sheet Metal

Nominal Screw Size and Thread Pitch	Metal Thickness	Hole Size	Drill Size ^a	Nominal Screw Size and Thread Pitch	Metal Thickness	Hole Size	Drill Size ^a	Nominal Screw Size and Thread Pitch	Metal Thickness	Hole Size	Drill Size ^a
In Steel, Stainless Steel, Monel, and Brass Sheet Metal											
2.2 × 0.8	0.38	1.63	52	3.5 × 1.3	0.61	2.69	36	4.8 × 1.6	1.22	3.78	25
	0.46	1.63	52		0.76	2.69	36		1.52	3.91	23
	0.61	1.70	51		0.91	2.79	35		1.90	3.99	22
	0.76	1.78	50		1.22	2.82	34	5.5 × 1.8	0.46
	0.91	1.85	49		1.52	2.95	32		0.61	4.22	19
	1.22	1.85	49		1.90	3.05	31		0.76	4.22	19
	1.52	1.93	48		0.46		0.91	4.22	19
2.9 × 1	0.38	2.18	44	4.2 × 1.4	0.61	3.18	...	5.5 × 1.8	1.22	4.32	18
	0.46	2.18	44		0.76	3.18	...		1.52	4.50	16
	0.61	2.26	43		0.91	3.18	...		1.90	4.62	14
	0.76	2.39	42		1.22	3.25	30	6.3 × 1.8	0.46	4.98	9
	0.91	2.39	42		1.52	3.45	29		0.61	4.98	9
	1.22	2.44	41		1.90	3.56	28		0.76	4.98	9
	1.52	2.54	39	0.46	3.66	27	0.91		4.98	9	
3.5 × 1.3	0.38	2.64	37	4.8 × 1.6	0.61	3.66	27	6.3 × 1.8	1.22	5.21	W
	0.46	2.64	37		0.76	3.66	27		1.52	5.79	1
	0.91	2.64	37		0.91	3.73	26		1.90	5.89	...
In Aluminum Alloy Sheet Metal											
2.2 × 0.8	0.38	3.5 × 1.3	0.61	4.8 × 1.6	1.22	3.66	27
	0.46		0.76	2.64	37		1.52	3.66	27
	0.61	1.63	52		0.91	2.64	37		1.90	3.73	26
	0.76	1.63	52		1.22	2.64	37	5.5 × 1.8	0.46
	0.91	1.63	52		1.52	2.69	36		0.61
	1.22	1.70	51		1.90	2.79	35		0.76
	1.52	1.78	50		0.46		0.91
2.9 × 1	0.38	4.2 × 1.4	0.61	5.5 × 1.8	1.22	4.09	20
	0.46		0.76	2.95	32		1.52	4.22	19
	0.61		0.91	3.05	31		1.90	4.39	17
	0.76	2.18	44		1.22	3.25	30	6.3 × 1.8	0.46
	0.91	2.18	44		1.52	3.45	29		0.61
	1.22	2.18	44		1.90	3.56	28		0.76
	1.52	2.26	43	0.46	0.91		
3.5 × 1.3	0.38	4.8 × 1.6	0.61	6.3 × 1.8	1.22
	0.46		0.76		1.52	5.05	8
	0.91		0.91	3.66	27		1.90	5.11	7

^a Customary drill size references have been retained where the metric hole diameters are direct conversions of their decimal inch equivalents.

All dimensions are in millimeters except drill sizes.

Table 8. Approximate Hole Sizes for Steel Type AB Metric Thread Forming Tapping Screws in Plywoods and Asbestos

Nominal Screw Size and Thread Pitch	Hole Size	Drill Size ^a	Min Mat'l Thickness	Penetration in Blind Holes		Hole Size	Drill Size ^a	Min Mat'l Thickness	Penetration in Blind Holes	
				Min	Max				Min	Max
In Plywood (Resin Impregnated)						In Asbestors Compositions				
2.2 × 0.8	1.85	49	3.18	4.78	12.70	1.93	48	3.18	4.78	12.70
2.9 × 1	2.54	39	4.78	6.35	15.88	2.57	38	4.78	6.35	15.88
3.5 × 1.3	3.18	...	4.78	6.35	15.88	3.05	31	4.78	6.35	15.88
4.2 × 1.4	3.66	27	4.78	6.35	19.05	3.73	26	7.92	9.52	19.05
4.8 × 1.6	4.39	17	6.35	7.92	25.40	4.22	19	7.92	9.52	25.40
5.5 × 1.8	4.93	10	7.92	9.52	25.40	4.98	9	7.92	9.52	25.40
6.3 × 1.8	5.79	1	7.92	9.52	25.40	5.79	1	11.13	12.70	25.40

^a Customary drill size references have been retained where the metric hole diameters are direct conversions of their decimal inch equivalents.

All dimensions are in millimeters except drill sizes.

Table 9. Approximate Hole Sizes for Steel Type B Metric Thread Forming Tapping Screws in Plywoods, Asbestos, and Plastics

Nominal Screw Size and Thread Pitch	Hole Size	Drill Size ^a	Min Mat'l Thick-ness	Penetration in Blind Holes		Nominal Screw Size and Thread Pitch	Hole Size	Drill Size ^a	Min Mat'l Thick-ness	Penetration in Blind Holes	
				Min	Max					Min	Max
In Plywood (Resin Impregnated)											
2.2 × 0.8	1.85	49	3.18	4.78	12.70	4.8 × 1.6	4.39	17	6.35	7.92	25.40
2.9 × 1	2.54	39	4.78	6.35	15.88	5.5 × 1.8	4.93	10	7.92	9.52	25.40
3.5 × 1.3	3.18	...	4.78	6.35	15.88	6.3 × 1.8	5.79	1	7.92	9.52	25.40
4.2 × 1.4	3.66	27	4.78	6.35	19.05

^a Customary drill size references have been retained where the metric hole diameters are direct conversions of their decimal inch equivalents.

Nominal Screw Size and Thread Pitch	Hole Size	Drill Size ^a	Min Mat'l Thickness	Penetration in Blind Holes	
				Min	Max
In Asbestos Compositions					
2.2 × 0.8	1.93	48	3.18	4.78	12.70
2.9 × 1	2.57	38	4.78	6.35	15.88
3.5 × 1.3	3.05	31	4.78	6.35	15.88
4.2 × 1.4	3.73	26	7.92	9.52	19.05
4.8 × 1.6	4.22	19	7.92	9.52	25.40
5.5 × 1.8	4.98	9	7.92	9.52	25.40
6.3 × 1.8	5.79	1	11.13	12.70	25.40

Nominal Screw Size and Thread Pitch	Hole Size	Drill Size ^a	Min Penetration in Blind Holes	Hole Size	Drill Size ^a	Min Penetration in Blind Holes
2.2 × 0.8	1.98	47	4.78	1.98	47	4.78
2.9 × 1	2.54	39	6.35	2.39	42	6.35
3.5 × 1.3	3.25	30	6.35	3.05	32	6.35
4.2 × 1.4	3.81	25	7.92	3.66	27	7.92
4.8 × 1.6	4.50	16	7.92	4.32	18	7.92
5.5 × 1.8	5.05	8	9.52	4.85	11	9.52
6.3 × 1.8	5.94	...	9.52	5.61	2	9.52

All dimensions are in millimeters except drill sizes.

Table 10. Approximate Drilled or Clean-Punched Hole Sizes for Steel Type B Metric Thread Forming Tapping Screws in Sheet Metal and Cast Metals

Nominal Screw Size and Thread Pitch	Metal Thickness	Hole Size	Drill Size ^a	Nominal Screw Size and Thread Pitch	Metal Thickness	Hole Size	Drill Size ^a	Nominal Screw Size and Thread Pitch	Metal Thickness	Hole Size	Drill Size ^a			
In Steel, Stainless Steel, Monel, and Brass Sheet Metal														
2.2 × 0.8	0.38	1.63	52	3.5 × 1.3	1.90	3.05	31	5.5 × 1.8	0.61	4.22	19			
	0.46	1.63	52		2.67	3.25	30		0.76	4.22	19			
	0.61	1.70	51	4.2 × 1.4	0.61	3.18	...		0.91	4.22	19			
	0.76	1.78	50		0.76	3.18	...		1.22	4.32	18			
	0.91	1.85	49		0.91	3.18	...		1.52	4.50	16			
	1.22	1.85	49		1.22	3.25	30		1.90	4.62	14			
1.52	1.93	48	1.52		3.45	29	2.67	4.70	13					
2.9 × 1	0.38	2.18	44		4.8 × 1.6	1.90	3.56	28	6.3 × 1.8	3.18	4.98	9		
	0.46	2.18	44	2.67		3.81	25	3.43		4.98	9			
	0.61	2.26	43	3.18		3.81	25	4.17		5.11	7			
	0.76	2.39	42	3.43		3.86	24	0.76		4.93	10			
	0.91	2.39	42	0.61		3.66	27	0.91		4.93	10			
	1.22	2.44	41	0.76		3.66	27	1.22		4.93	10			
3.5 × 1.3	1.52	2.54	39	4.8 × 1.6	0.91	3.73	26	6.3 × 1.8	1.52	5.05	8			
	1.90	2.59	38		1.22	3.86	24		1.90	5.18	6			
	0.38	2.64	37		1.52	3.86	24		2.67	5.31	4			
	0.46	2.64	37		1.90	3.99	22		3.18	5.79	1			
	0.61	2.69	36		2.67	4.09	20		3.43	5.79	1			
	0.76	2.69	36		3.18	4.32	18		4.17	5.94	...			
3.5 × 1.3	0.91	2.79	35	4.8 × 1.6	3.43	4.32	18	6.3 × 1.8	4.75	5.94	...			
	1.22	2.82	34		4.17	4.39	17		4.93	5.94	...			
	1.52	2.95	32		In Aluminum Alloy Sheet Metal									
	2.2 × 0.8	0.61	1.63		52	4.2 × 1.4	0.76		2.95	32	5.5 × 1.8	1.22	4.09	20
		0.76	1.63		52		0.91		3.05	31		1.52	4.22	19
		0.91	1.63		52		1.22		3.25	30		1.90	4.39	17
1.22		1.70	51	1.52	3.45		29	2.67	4.57	15				
2.9 × 1	1.52	1.78	50	4.8 × 1.6	1.90	3.56	28	6.3 × 1.8	3.18	4.62	14			
	0.76	2.18	44		2.67	3.73	26		3.43	4.62	14			
	0.91	2.18	44		3.18	3.73	26		4.17	4.80	12			
	1.22	2.18	44		3.43	3.78	25		5.08					
	1.52	2.26	43		4.11				to					
	1.90	2.26	43		to				9.52	4.98	9			
3.5 × 1.3	2.67	2.39	42	4.8 × 1.6	9.52	3.86	24	6.3 × 1.8	1.52	5.05	8			
	0.76	2.64	37		0.91	3.66	27		1.90	5.11	7			
	0.91	2.64	37		1.22	3.66	27		2.67	5.18	6			
	1.22	2.64	37		1.52	3.66	27		3.18	5.31	4			
	1.52	2.69	36		1.90	3.73	26		3.43	5.31	4			
	1.90	2.79	35		2.67	3.73	26		4.17	5.41	3			
	2.67	2.82	34		3.18	3.91	23		4.75	5.41	3			
	3.25				3.43	3.91	23		4.93	5.61	2			
	to				4.17	4.04	21		5.08					
	6.25	3.05	31		5.08	to			to					
			9.52	4.22	19	9.52	5.79	1						

^a Customary drill size references have been retained where the metric hole diameters are direct conversions of their decimal inch equivalents.

In Aluminum, Magnesium, Zinc, Brass, and Bronze Cast Metals							
Nominal Screw Size and Thread Pitch	Hole Size	Drill Size ^a	Min Penetration in Blind Holes	Nominal Screw Size and Thread Pitch	Hole Size	Drill Size ^a	Min Penetration in Blind Holes
2.2 × 0.8	1.98	47	3.18	4.8 × 1.6	4.50	16	6.35
2.9 × 1	2.64	37	4.78	5.5 × 1.8	5.05	8	7.14
3.5 × 1.3	3.25	30	6.35	6.3 × 1.8	5.94	4	7.92
4.2 × 1.4	3.86	24	6.35

All dimensions are in millimeters, except drill sizes.

Table 11. Approximate Hole Sizes for Steel Types BF and BT Metric Thread Cutting Tapping Screws for Cast Metals and Plastics

Nominal Screw Size and Thread Pitch	Material Thickness	Hole Size	Drill Size ^a	Nominal Screw Size and Thread Pitch	Material Thickness	Hole Size	Drill Size ^a
In Die Cast Zinc and Aluminum							
2.2 × 0.8	1.52	1.85	49	3.5 × 1.3	3.18	3.05	31
	2.11	1.85	49		3.56	3.05	31
	2.77	1.93	48		4.78	3.05	31
	3.18	1.93	48		6.35	3.18	...
	3.56	1.93	48		7.92	3.18	...
2.9 × 1	2.77	2.49	40	4.2 × 1.4	3.18	3.78	25
	3.18	2.54	39		3.56	3.78	25
	3.56	2.54	39		4.78	3.78	25
	4.78	2.54	39		6.35	3.86	24
	6.35	2.59	38		7.92	3.86	24
4.8 × 1.6	3.18	4.22	19	6.3 × 1.8	6.35	5.79	1
	3.56	4.22	19		7.92	5.79	1
	4.78	4.22	19	8 × 2.1	9.52	5.79	1
	6.35	4.32	18		3.18	7.14	K
	7.92	4.37	...	3.56	7.14	K	
	9.52	4.37	...	4.78	7.14	K	
5.5 × 1.8	3.18	4.85	11	9.5 × 2.1	6.35	7.14	K
	3.56	4.85	11		7.92	7.37	L
	4.78	4.85	11	9.52	7.37	L	
	6.35	4.98	9	3.18	8.74	...	
	7.92	4.98	9	3.56	8.74	...	
	9.52	4.98	9	4.78	8.74	...	
6.3 × 1.8	3.18	5.61	2	9.5 × 2.1	6.35	8.74	...
	3.56	5.61	2		7.92	8.84	S
	4.78	5.61	2		9.52	8.84	S
Nominal Screw Size and Thread Pitch		Hole Size	Drill Size ^a	Depth of Penetration			
				Min		Max	
In Phenol Formaldehyde							
2.2 × 0.8		1.98		...		6.35	
2.9 × 1.0		2.64		37		7.92	
3.5 × 1.3		3.18		...		9.52	
4.2 × 1.4		3.73		26		12.70	
4.8 × 1.6		4.32		18		15.88	
5.5 × 1.8		4.93		10		15.88	
6.3 × 1.8		5.79		1		19.05	
In Cellulose Acetate and Nitrate, Acrylic and Styrene Resins							
2.2 × 0.8		1.93		48		6.35	
2.9 × 1.0		2.54		39		7.92	
3.5 × 1.3		3.05		31		9.52	
4.2 × 1.4		3.66		27		12.70	
4.8 × 1.6		4.22		19		15.88	
5.5 × 1.8		4.80		12		15.88	
6.3 × 1.8		5.61		2		19.05	

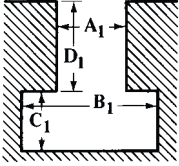
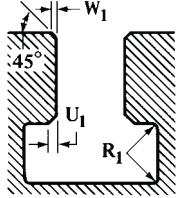
^a Customary drill size references have been retained where the metric hole sizes are direct conversions of their decimal inch equivalents.

All dimensions are in millimeters except drill sizes.

The finish (plating or coating) on metric tapping screws and the material composition and hardness of the mating component are factors that affect assembly torques in individual applications. Although the recommended installation hole sizes given in **Tables 7 through 9** were based on the use of plain unfinished carbon steel metric tapping screws, experience has shown that the specified holes are also suitable for screws having most types of commercial finishes. However, owing to various finishes providing different degrees of lubricity, some adjustment of installation torques may be necessary to suit individual applications. Also, where exceptionally heavy finishes are involved or screws are to be assembled into materials of higher hardness, some deviation from the specified hole sizes may be required to provide optimum assembly. The necessity and extent of such deviations can best be determined by experiment in the particular assembly environment.

T-SLOTS, BOLTS, AND NUTS

Table 1. American National Standard T-Slots ANSI/ASME B5.1M-1985 (R2009)

T-SLOTS																							
 <p>Basic Dimensions</p>										 <p>Suggested Approximate Dimensions For Rounding Or Breaking Of Corners</p>													
Nominal T-Bolt Size ^a		Width of Throat A_1^b		Width of Headspace B_1				Depth of Headspace C_1				Depth of Throat D_1				Rounding or Breaking of Corners ^c							
				inch		mm		inch		mm		inch		mm		inch			mm				
inch	mm	inch	mm	min	max	min	max	min	max	min	max	min	max	min	max	min	max	R_1 max	W_1 max	U_1 max	R_1 max	W_1 max	U_1 max
	4		5			10	11			3	3.5			4.5	7						0.5	0.8	0.8
	5		6			11	12.5			5	6			5	8						0.5	0.8	0.8
0.250	6	0.282	8	0.500	0.562	14.5	16	0.203	0.234	7	8	0.125	0.375	7	11	0.02	0.02	0.03	0.03	0.5	0.8	0.8	
0.312	8	0.344	10	0.594	0.656	16	18	0.234	0.266	7	8	0.156	0.438	9	14	0.02	0.03	0.03	0.03	0.5	0.8	0.8	
0.375	10	0.438	12	0.719	0.781	19	21	0.297	0.328	8	9	0.219	0.562	11	17	0.02	0.03	0.03	0.03	0.5	0.8	0.8	
0.500	12	0.562	14	0.906	0.969	23	25	0.359	0.391	9	11	0.312	0.688	12	19	0.02	0.03	0.03	0.03	0.5	0.8	0.8	
0.625	16	0.688	18	1.188	1.250	30	32	0.453	0.484	12	14	0.438	0.875	16	24	0.03	0.03	0.05	0.05	0.8	0.8	1.3	
0.750	20	0.812	22	1.375	1.469	37	40	0.594	0.625	16	18	0.562	1.062	20	29	0.03	0.03	0.05	0.05	0.8	0.8	1.3	
1.000	24	1.062	28	1.750	1.844	46	50	0.781	0.828	20	22	0.750	1.250	26	36	0.03	0.06	0.05	0.05	0.8	1.5	1.3	
1.250	30	1.312	36	2.125	2.219	56	60	1.031	1.094	25	28	1.000	1.562	33	46	0.03	0.06	0.05	0.05	0.8	1.5	1.3	
1.500	36	1.562	42	2.562	2.656	68	72	1.281	1.344	32	35	1.250	1.938	39	53	0.03	0.06	0.05	0.05	0.8	1.5	1.3	
	42		48			80	85			36	40			44	59					1.5	2.5	2	
	48		54			90	95			40	44			50	66					1.5	2.5	2	

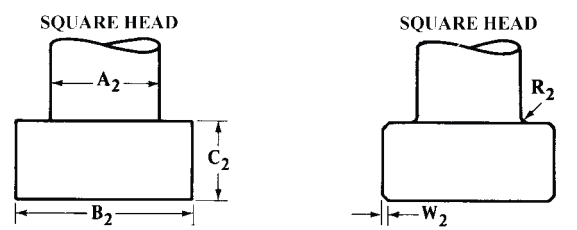
^a Width of tongue (tenon) to be used with the above T-Slots will be found in the complete standard, B5.1M.

^b Throat dimensions are basic. When slots are intended to be used for holding only, tolerances can be 0.0 + 0.010 inch or H12 Metric (ISO/R286); when intended for location, tolerance can be 0.0 + 0.001 inch or H8 Metric (see page 653).

^c Corners of T-Slots may be square or may be rounded or broken to the indicated maximum dimensions at the manufacturer's option.

For the dimensions of tongue seats, inserted tongues, and solid tongues refer to the complete standard, B5.1M.

Table 2. American National Standard T-Bolts ANSI/ASME B5.1M-1985 (R2009)

T-BOLTS																
																
Nominal T-Bolt Size and Thread A_2^{ab}		Bolt Head Dimensions										Rounding of Corners ^c				
		Width Across Flats B_2				Width Across Corners		Height C_2				R_2		W_2		
inch UNC-2A	metric ISO ^d	inch		mm		inch max	mm max	inch		mm		inch max	mm max	inch max	mm max	
		max	min	max	min			max	min	max	min					
	M4			9	8.5		12.7			2.5	2.1		0.3		0.5	
	M5			10	9.5		14.1			4	3.6		0.3		0.5	
0.250-20	M6	0.469	0.438	13	12	0.663	18.4	0.156	0.141	6	5.6	0.02	0.5	0.03	0.8	
0.312-18	M8	0.562	0.531	15	14	0.796	21.2	0.188	0.172	6	5.6	0.02	0.5	0.03	0.8	
0.375-16	M10	0.688	0.656	18	17	0.972	25.5	0.250	0.234	7	6.6	0.02	0.5	0.03	0.8	
0.500-13	M12	0.875	0.844	22	21	1.238	31.1	0.312	0.297	8	7.6	0.02	0.5	0.06	1.5	
0.625-11	M16	1.125	1.094	28	27	1.591	39.6	0.406	0.391	10	9.6	0.03	0.8	0.06	1.5	
0.750-10	M20	1.312	1.281	34	33	1.856	48.1	0.531	0.500	14	13.2	0.03	0.8	0.06	1.5	
1.000-8	M24	1.688	1.656	43	42	2.387	60.8	0.688	0.656	18	17.2	0.03	0.8	0.06	1.5	
1.250-7	M30	2.062	2.031	53	52	2.917	75	0.938	0.906	23	22.2	0.03	0.8	0.06	1.5	
1.500-6	M36	2.500	2.469	64	63	3.536	90.5	1.188	1.156	28	27.2	0.03	0.8	0.06	1.5	
	75			74		106.1	32			30.5	1					2
	85			84		120.2	36			34.5	1					2

^aFor inch tolerances for thread diameters of bolts or studs and for threads see page 1817.

^bT-slots to be used with these bolts will be found in Table 1.

^cCorners of T-bolts may be square or may be rounded or broken to the indicated maximum dimensions at the manufacturer's option.

^dMetric thread grade and tolerance position is 5g 6g (see page 1885).

Table 3. American National Standard T-Nuts ANSI/ASME B5.1M-1985 (R2009)

Nominal T-Bolt Size ^a		Width of Tongue A ₃				Tap for Stud ^b E ₃		Width of Nut B ₃				Height of Nut C ₃				Total Thickness Including Tongue ^c K ₃		Length of Nut ^c L ₃		Rounding of Corners				
																				R ₃		W ₃		
		inch	mm	max	min	max	min	inch	mm	max	min	max	min	max	min	max	min	inch	mm	inch	mm	inch	mm	inch
0.250	4	UNC-3B	ISO ^d
	5
	6
0.312	8	0.330	0.320	8.7	8.5	0.250-20	M6	0.562	0.531	15	14	0.188	0.172	6	5.6	0.281	9	0.562	18	0.02	0.5	0.03	0.8	0.8
0.375	10	0.418	0.408	11	10.75	0.312-18	M8	0.688	0.656	18	17	0.250	0.234	7	6.6	0.375	10.5	0.688	20	0.02	0.5	0.03	0.8	0.8
0.500	12	0.543	0.533	13.5	13.25	0.375-1	6M10	0.875	0.844	22	21	0.312	0.297	8	7.6	0.531	12	0.875	23	0.02	0.5	0.06	1.5	1.5
0.625	16	0.668	0.658	17.25	17	0.500-13	M12	1.125	1.094	28	27	0.406	0.391	10	9.6	0.625	15	1.125	27	0.03	0.8	0.06	1.5	1.5
0.750	20	0.783	0.773	20.5	20.25	0.625-11	M16	1.312	1.281	34	33	0.531	0.500	14	13.2	0.781	21	1.312	35	0.03	0.8	0.06	1.5	1.5
1.000	24	1.033	1.018	26.5	26	0.750-10	M20	1.688	1.656	43	42	0.688	0.656	18	17.2	1.000	27	1.688	46	0.03	0.8	0.06	1.5	1.5
1.250	30	1.273	1.258	33	32.5	1.000-8	M24	2.062	2.031	53	52	0.938	0.906	23	22.2	1.312	34	2.062	53	0.03	0.8	0.06	1.5	1.5
1.500	36	1.523	1.508	39.25	38.75	1.250-7	M30	2.500	2.469	64	63	1.188	1.156	28	27.2	1.625	42	2.500	65	0.03	0.8	0.06	1.5	1.5
	42			46.75	46.25		M36			75	74			32	30.5		48		75		1		2	2
	48			52.5	51.75		M42			85	84			36	34.5		54		85		1		2	2

^aT-slot dimensions to fit the above nuts will be found in Table 1.

^bFor tolerances of inch threads see page 1817.

^cNo tolerances are given for "Total Thickness" or "Nut Length" as they need not be held to close limits.

^dMetric tapped thread grade and tolerance position is 5H (see page 1885).

RIVETS AND RIVETED JOINTS

Riveted Joint Design

Classes and Types of Riveted Joints.—Riveted joints may be classified by application as: 1) pressure vessel; 2) structural; and 3) machine member.

For information and data concerning joints for pressure vessels such as boilers, reference should be made to standard sources such as the ASME Boiler Code. The following sections will cover only structural and machine-member riveted joints.

Basically there are two kinds of riveted joints, the *lap-joint* and the *butt-joint*. In the ordinary *lap-joint*, the plates overlap each other and are held together by one or more rows of rivets. In the *butt-joint*, the plates being joined are in the same plane and are joined by means of a cover plate or butt strap, which is riveted to both plates by one or more rows of rivets. The term *single riveting* means one row of rivets in a lap-joint or one row on each side of a butt-joint; *double riveting* means two rows of rivets in a lap-joint or two rows on each side of the joint in butt riveting. Joints are also triple and quadruple riveted. Lap-joints may also be made with inside or outside cover plates. Types of lap and butt joints are illustrated in the tables on starting at page 1733.

General Design Considerations for Riveted Joints.—Factors to be considered in the design or specification of a riveted joint are: type of joint; spacing of rivets; type and size of rivet; type and size of hole; and rivet material.

Spacing of Rivets: The spacing between rivet centers is called *pitch* and between row center lines, *back pitch* or *transverse pitch*. The distance between centers of rivets nearest each other in adjacent rows is called *diagonal pitch*. The distance from the edge of the plate to the center line of the nearest row of rivets is called *margin*.

Examination of a riveted joint made up of several rows of rivets will reveal that after progressing along the joint a given distance, the rivet pattern or arrangement is repeated. (For a butt joint, the length of a *repeating section* is usually equal to the *long pitch* or pitch of the rivets in the outer row, that is the row farthest from the edge of the joint.) For structural and machine-member joints, the proper pitch may be determined by making the tensile strength of the plate over the length of the repeating section, that is the distance between rivets in the outer row, equal to the total shear strength of the rivets in the repeating section. Minimum pitch and diagonal pitch are also governed by the clearance required for the hold-on (Dolly bar) and rivet set. Dimensions for different sizes of hold-ons and rivet sets are given in the table on page 1738.

When fastening thin plate, it is particularly important to maintain accurate spacing to avoid buckling.

Size and Type of Rivets: The rivet diameter d commonly falls between $d = 1.2\sqrt{t}$ and $d = 1.4\sqrt{t}$, where t is the thickness of the plate. Dimensions for various types of American Standard large ($\frac{1}{2}$ -inch diameter and up) rivets and small solid rivets are shown in tables that follow. It may be noted that countersunk heads are not as strong as other types.

Size and Type of Hole: Rivet holes may be punched, punched and reamed, or drilled. Rivet holes are usually made $\frac{1}{16}$ inch (1.6 mm) larger in diameter than the nominal diameter of the rivet although in some classes of work in which the rivet is driven cold, as in automatic machine riveting, the holes are reamed to provide minimum clearance so that the rivet fills the hole completely.

When holes are punched in heavy steel plate, there may be considerable loss of strength unless the holes are reamed to remove the inferior metal immediately surrounding them. This results in the diameter of the punched hole being increased by from $\frac{1}{16}$ to $\frac{1}{8}$ inch (1.6 to 3.2 mm). Annealing after punching tends to restore the strength of the plate in the vicinity of the holes.

Rivet Material: Rivets for structural and machine-member purposes are usually made of wrought iron or soft steel, but for aircraft and other applications where light weight or resistance to corrosion is important, copper, aluminum alloy, Monel, Inconel, etc., may be used as rivet material.

Simplified Design Assumptions: In the design of riveted joints, a simplified treatment is frequently used in which the following assumptions are made:

- 1) The load is carried equally by the rivets.
- 2) No combined stresses act on a rivet to cause failure.
- 3) The shearing stress in a rivet is uniform across the cross-section under question.
- 4) The load that would cause failure in single shear would have to be doubled to cause failure in double shear.
- 5) The bearing stress of rivet and plate is distributed equally over the projected area of the rivet.
- 6) The tensile stress is uniform in the section of metal between the rivets.

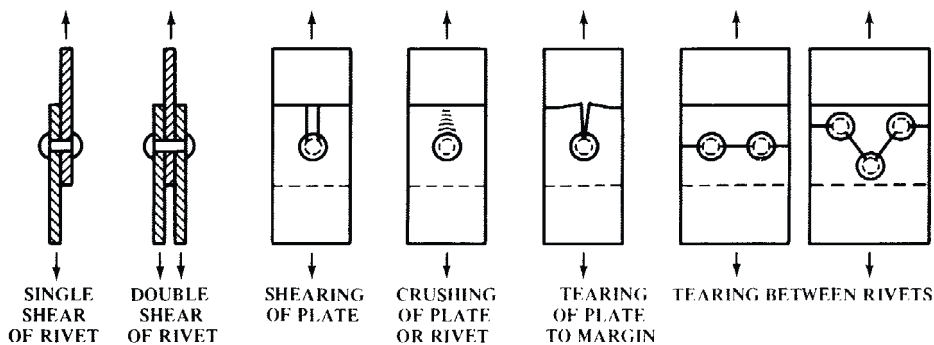
Failure of Riveted Joints.—Rivets may fail by:

- 1) Shearing through one cross-section (single shear)
- 2) Shearing through two cross-sections (double shear)
- 3) Crushing

Plates may fail by:

- 4) Shearing along two parallel lines extending from opposite sides of the rivet hole to the edge of the plate
- 5) Tearing along a single line from middle of rivet hole to edge of plate
- 6) Crushing
- 7) Tearing between adjacent rivets (tensile failure) in the same row or in adjacent rows

Types 4 and 5 failures are caused by rivets being placed too close to the edge of the plate. These types of failure are avoided by placing the center of the rivet at a minimum of one and one-half times the rivet diameter away from the edge.



Types of Rivet and Plate Failure

Failure due to tearing on a diagonal between rivets in adjacent rows when the pitch is four times the rivet diameter or less is avoided by making the transverse pitch one and three-quarters times the rivet diameter.

Theoretical versus Actual Riveted Joint Failure: If it is assumed that the rivets are placed the suggested distance from the edge of the plate and each row the suggested distance from another row, then the failure of a joint is most likely to occur as a result of shear failure of the rivets, bearing failure (crushing) of the plate or rivets, or tensile failure of the plate, alone or in combination depending on the makeup of the joints.

Joint failure in actuality is more complex than this. Rivets do not undergo pure shear especially in lap-joints where rivets are subjected to single shear. The rivet, in this instance, would be subject to a combination of tensile and shearing stresses and it would fail because

of combined stresses, not a single stress. Furthermore, the shearing stress is usually considered to be distributed evenly over the cross-section, which is also not the case.

Rivets that are usually driven hot contract on cooling. This contraction in the length of the rivet draws the plates together and sets up a stress in the rivet estimated to be equal in magnitude to the yield point of the rivet steel. The contraction in the diameter of the rivet results in a little clearance between the rivet and the hole in the plate. The tightness in the plates caused by the contraction in length of the rivet gives rise to a condition in which quite a sizeable frictional force would have to be overcome before the plates would slip over one another and subject the rivets to a shearing force. It is European practice to design joints for resistance to this slipping. It has been found, however, that the strength-basis designs obtained in American and English practice are not very different from European designs.

Allowable Stresses.—The design stresses for riveted joints are usually set by codes, practices, or specifications. The American Institute of Steel Construction issues specifications for the design, fabrication, and erection of structural steel for buildings in which the allowable stress permitted in tension for structural steel and rivets is specified at 20,000 pounds per square inch, the allowable bearing stress for rivets is 40,000 psi in double shear and 32,000 psi in single shear, and the allowable shearing stress for rivets is 15,000 psi. The American Society of Mechanical Engineers in its Boiler Code lists the following ultimate stresses: tensile, 55,000 psi; shearing, 44,000 psi; compressive or bearing, 95,000 psi. The design stresses usually are one-fifth of these, that is tensile, 11,000 psi; shearing, 8800 psi; compressive or bearing, 19,000 psi. In machine design work, values close to these or somewhat lower are commonly used.

Analysis of Joint Strength.—The following examples and strength analyses of riveted joints are based on the six previously outlined *Simplified Design Assumptions*.

Example 1: Consider a 12-inch section of single-riveted lap-joint made up with plates of $\frac{1}{4}$ -inch thickness and six rivets, $\frac{5}{8}$ inch in diameter. Assume that rivet holes are $\frac{1}{16}$ inch larger in diameter than the rivets. In this joint, the entire load is transmitted from one plate to the other by means of the rivets. Each plate and the six rivets carry the entire load. The safe tensile load L and the efficiency η may be determined in the following way: Design stresses of 8500 psi for shear, 20,000 psi for bearing, and 10,000 psi for tension are arbitrarily assigned and it is assumed that the rivets will not tear or shear through the plate to the edge of the joint.

a) The safe tensile load L based on single shear of the rivets is equal to the number of rivets n times the cross-sectional area of one rivet A_r , times the allowable shearing stress S_s , or

$$L = n \times A_r \times S_s = 6 \times \frac{\pi}{4} (0.625)^2 \times 8500 = 15,647 \text{ pounds}$$

b) The safe tensile load L based on bearing stress is equal to the number of rivets n times the projected bearing area of the rivet A_b (diameter times thickness of plate) times the allowable bearing stress S_c or $L = n \times A_b \times S_c = 6 \times (0.625 \times 0.25) \times 20,000 = 18,750$ pounds.

c) The safe load L based on the tensile stress is equal to the net cross-sectional area of the plate between rivet holes A_p , times the allowable tensile stress S_t or

$$L = A_p \times S_t = 0.25 [12 - 6(0.625 + 0.0625)] \times 10,000 = 19,688 \text{ pounds.}$$

The safe tensile load for the joint would be the least of the three loads just computed or 15,647 pounds and the efficiency η would be equal to this load divided by the tensile strength of the section of plate under consideration, if it were unperforated or

$$\eta = \frac{15,647}{12 \times 0.25 \times 10,000} \times 100 = 52.2 \text{ per cent}$$

Example 2: Under consideration is a 12-inch section of double-riveted butt-joint with main plates $\frac{1}{2}$ inch thick and two cover plates each $\frac{5}{16}$ inch thick. There are 3 rivets in the inner row and 2 on the outer and their diameters are $\frac{7}{8}$ inch. Assume that the diameter of the

rivet holes is $\frac{1}{16}$ inch larger than that of the rivets. The rivets are so placed that the main plates will not tear diagonally from one rivet row to the others nor will they tear or fail in shear out to their edges. The safe tensile load L and the efficiency η may be determined in the following way: Design stresses for 8500 psi for shear, 20,000 psi for bearing, and 10,000 psi for tension are arbitrarily assigned.

a) The safe tensile load L based on double shearing of the rivets is equal to the number of rivets n times the number of shearing planes per rivet times the cross-sectional area of one rivet A_r times the allowable shearing stress S_s or

$$L = n \times 2 \times A_r \times S_s = 5 \times 2 \times \frac{\pi}{4} (0.875)^2 \times 8500 = 51,112 \text{ pounds}$$

b) The safe tensile load L based on bearing stress is equal to the number of rivets n times the projected bearing area of the rivet A_b (diameter times thickness of plate) times the allowable bearing stress S_c or $L = n \times A_b \times S_c = 5 \times (0.875 \times 0.5) \times 20,000 = 43,750$ pounds.

(Cover plates are not considered since their combined thickness is $\frac{1}{4}$ inch greater than the main plate thickness.)

c) The safe tensile load L based on the tensile stress is equal to the net cross-sectional area of the plate between the two rivets in the outer row A_p times the allowable tensile stress S_t or $L = A_p \times S_t = 0.5[12 - 2(0.875 + 0.0625)] \times 10,000 = 50,625$ pounds.

In completing the analysis, the sum of the load that would cause tearing between rivets in the three-hole section plus the load carried by the two rivets in the two-hole section is also investigated. The sum is necessary because if the joint is to fail, it must fail at both sections simultaneously. The least safe load that can be carried by the two rivets of the two-hole section is based on the bearing stress (see the foregoing calculations).

1) The safe tensile load L based on the bearing strength of two rivets of the two-hole section is $L = n \times A_b \times S_c = 2 \times (0.875 \times 0.5) \times 20,000 = 17,500$ pounds.

2) The safe tensile load L based on the tensile strength of the main plate between holes in the three-hole section is $L \times A_p \times S_t = 0.5[12 - 3(0.875 + 0.0625)] \times 10,000 = 45,938$ pounds.

The total safe tensile load based on this combination is $17,500 + 45,938 = 63,438$ pounds, which is greater than any of the other results obtained.

The safe tensile load for the joint would be the least of the loads just computed or 43,750 pounds and the efficiency η would be equal to this load divided by the tensile strength of the section of plate under consideration, if it were unperforated or

$$\eta = \frac{43,750}{0.5 \times 12 \times 10,000} \times 100 = 72.9 \text{ per cent}$$

Formulas for Riveted Joint Design.—A riveted joint may fail by shearing through the rivets (single or double shear), crushing the rivets, tearing the plate between the rivets, crushing the plate or by a combination of two or more of the foregoing causes. Rivets placed too close to the edge of the plate may tear or shear the plate out to the edge but this type of failure is avoided by placing the center of the rivet 1.5 times the rivet diameter away from the edge.

The efficiency of a riveted joint is equal to the strength of the joint divided by the strength of the unriveted plate, expressed as a percentage.

In the following formulas, let

d = diameter of holes t = thickness of plate t_c = thickness of cover plates

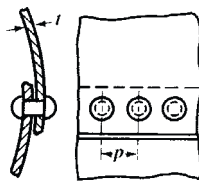
p = pitch of inner row of rivets P = pitch of outer row of rivets

S_s = shear stress for rivets S_t = tensile stress for plates

S_c = compressive or bearing stress for rivets or plates

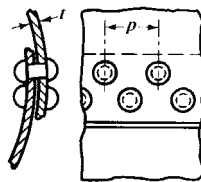
In the joint examples that follow, dimensions are usually specified in inches and stresses in pounds per square inch. See page 1731 for a discussion of allowable stresses that may be used in calculating the strengths given by the formulas. The design stresses are usually set by codes, practices, or specifications.

Single-Riveted Lap-Joint



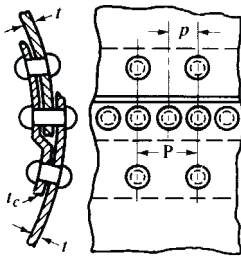
- (1) Resistance to shearing one rivet = $\frac{\pi d^2}{4} S_s$
- (2) Resistance to tearing plate between rivets = $(p - D)tS_t$
- (3) Resistance to crushing rivet or plate = dtS_c

Double-Riveted Lap-Joint



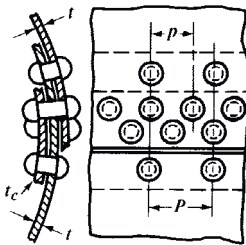
- (1) Resistance to shearing two rivets = $\frac{2\pi d^2}{4} S_s$
- (2) Resistance to tearing between two rivets = $(p - D)tS_t$
- (3) Resistance to crushing in front of two rivets = $2dtS_c$

Single-Riveted Lap-Joint with Inside Cover Plate



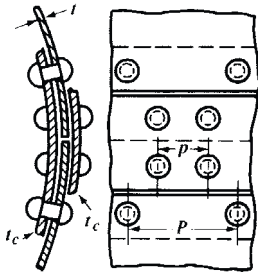
- (1) Resistance to tearing between outer row of rivets = $(P - D)tS_t$
- (2) Resistance to tearing between inner row of rivets, and shearing outer row of rivets = $(P - 2D)tS_t + \frac{\pi d^2}{4} S_s$
- (3) Resistance to shearing three rivets = $\frac{3\pi d^2}{4} S_s$
- (4) Resistance to crushing in front of three rivets = $3tS_c$
- (5) Resistance to tearing at inner row of rivets, and crushing in front of one rivet in outer row = $(P - 2D)tS_t + tS_c$

Double-Riveted Lap-Joint with Inside Cover Plate



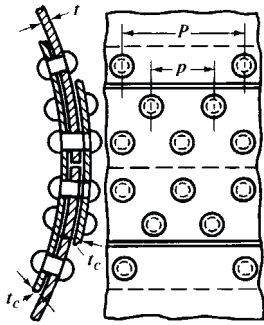
- (1) Resistance to tearing at outer row of rivets = $(P - D)tS_t$
- (2) Resistance to shearing four rivets = $\frac{4\pi d^2}{4} S_s$
- (3) Resistance to tearing at inner row and shearing outer row of rivets = $(P - 1\frac{1}{2}D)tS_t + \frac{\pi d^2}{4} S_s$
- (4) Resistance to crushing in front of four rivets = $4tS_c$
- (5) Resistance to tearing at inner row of rivets, and crushing in front of one rivet = $(P - 1\frac{1}{2}D)tS_t + tS_c$

Double-Riveted Butt-Joint



- (1) Resistance to tearing at outer row of rivets = $(P - D)tS_t$
- (2) Resistance to shearing two rivets in double shear and one in single shear = $\frac{5\pi d^2}{4} S_s$
- (3) Resistance to tearing at inner row of rivets and shearing one rivet of the outer row = $(P - 2D)tS_t + \frac{\pi d^2}{4} S_s$
- (4) Resistance to crushing in front of three rivets = $3tdS_c$
- (5) Resistance to tearing at inner row of rivets, and crushing in front of one rivet in outer row = $(P - 2D)tS_t + tdS_c$

Triple-Riveted Butt-Joint



- (1) Resistance to tearing at outer row of rivets = $(P - D)tS_t$
- (2) Resistance to shearing four rivets in double shear and one in single shear = $\frac{9\pi d^2}{4} S_s$
- (3) Resistance to tearing at middle row of rivets and shearing one rivet = $(P - 2D)tS_t + \frac{\pi d^2}{4} S_s$
- (4) Resistance to crushing in front of four rivets and shearing one rivet = $4dtS_c + \frac{\pi d^2}{4} S_s$
- (5) Resistance to crushing in front of five rivets = $4dtS_c + dt_cS_c$

American National Standard Rivets

Standards for rivets published by the American National Standards Institute and the British Standards Institution are as follows:

American National Standard Large Rivets.—The types of rivets covered by this standard (ANSI B18.1.2-1972 (R2006)) are shown on pages 1736, 1737, and 1738. It may be noted, however, that when specified, the swell neck included in this standard is applicable to all standard large rivets except the flat countersunk head and oval countersunk head types. Also shown are the hold-on (dolly bar) and rivet set impression dimensions (see page 1738). All standard large rivets have fillets under the head not exceeding an 0.062-inch radius. The length tolerances for these rivets are given as follows: through 6 inches in length, 1/2- and 5/8-inch diameters, ±0.03 inch; 3/4- and 7/8-inch diameters, ±0.06-inch; and 1-through 1 3/4-inch diameters, ±0.09 inch. For rivets over 6 inches in length, 1/2- and 5/8-inch diameters, ±0.06 inch; 3/4- and 7/8-inch diameters, ±0.12 inch; and 1- through 1 3/4-inch diameters, ±0.19 inch. Steel and wrought iron rivet materials appear in ASTM Specifications A31, A131, A152, and A502.

American National Standard Small Solid Rivets.—The types of rivets covered by this standard, ANSI/ASME B18.1.1-1972 (R2006), are shown on pages 1739 through 1741. In addition, the standard gives the dimensions of 60-degree flat countersunk head rivets used to assemble ledger plates and guards for mower cutter bars, but these are not shown. As the heads of standard rivets are not machined or trimmed, the circumference may be somewhat irregular and edges may be rounded or flat. Rivets other than countersunk types are furnished with a definite fillet under the head, whose radius should not exceed 10 per cent of the maximum shank diameter or 0.03 inch, whichever is the smaller. With regard to head dimensions, tolerances shown in the dimensional tables are applicable to rivets produced

Rivet Lengths for Forming Round and Countersunk Heads^a

Grip in Inches	To Form Round Head							Grip in Inches	To Form Countersunk Head						
	Diameter of Rivet in Inches								Diameter of Rivet in Inches						
	1/2	5/8	3/4	7/8	1	1 1/8	1 1/4		1/2	5/8	3/4	7/8	1	1 1/8	1 1/4
Length of Rivet in Inches								Length of Rivet in Inches							
1/2	1 5/8	1 7/8	1 7/8	2	2 1/8	1/2	1	1	1 1/8	1 1/4	1 1/4
5/8	1 3/4	2	2	2 1/8	2 1/4	5/8	1 1/8	1 1/4	1 3/8	1 3/8	1 3/8
3/4	1 7/8	2 1/8	2 1/8	2 1/4	2 3/8	3/4	1 3/8	1 3/8	1 3/8	1 1/2	1 1/2
7/8	2	2 1/4	2 1/4	2 3/8	2 1/2	7/8	1 1/2	1 1/2	1 1/2	1 3/8	1 3/8
1	2 1/4	2 3/8	2 3/8	2 1/2	2 5/8	2 3/4	2 7/8	1	1 5/8	1 5/8	1 5/8	1 3/4	1 3/4	1 7/8	1 7/8
1 1/8	2 3/8	2 1/2	2 1/2	2 5/8	2 3/4	2 7/8	3	1 1/8	1 3/4	1 3/4	1 7/8	1 7/8	1 7/8	2	2
1 1/4	2 1/2	2 5/8	2 5/8	2 3/4	2 7/8	3	3 1/8	1 1/4	2	2	2	2	2	2 1/8	2 1/8
1 3/8	2 5/8	2 3/4	2 3/4	2 7/8	3	3 3/8	3 1/4	1 3/8	2 1/8	2 1/8	2 1/8	2 1/4	2 1/4	2 3/8	2 3/8
1 1/2	2 7/8	3	3	3 1/8	3 1/4	3 3/8	3 1/2	1 1/2	2 1/4	2 1/4	2 1/4	2 3/8	2 3/8	2 1/2	2 1/2
1 5/8	3	3 1/8	3 1/8	3 1/4	3 3/8	3 1/2	3 1/2	1 5/8	2 3/8	2 3/8	2 3/8	2 1/2	2 1/2	2 5/8	2 5/8
1 3/4	3 1/8	3 1/4	3 1/4	3 1/2	3 5/8	3 3/4	3 3/4	1 3/4	2 5/8	2 5/8	2 5/8	2 5/8	2 5/8	2 3/4	2 3/4
1 7/8	3 1/4	3 3/8	3 3/8	3 5/8	3 3/4	3 7/8	3 7/8	1 7/8	2 3/4	2 3/4	2 3/4	2 3/4	2 3/4	2 7/8	2 7/8
2	3 1/2	3 1/2	3 3/8	3 3/4	3 7/8	4	4	2	2 7/8	2 7/8	2 7/8	2 7/8	2 7/8	3	3
2 1/8	3 3/8	3 3/8	3 3/4	3 7/8	4	4 1/8	4 1/8	2 1/8	3 1/8	3	3	3	3	3 3/8	3 3/8
2 1/4	3 3/4	3 3/8	3 3/8	4	4 1/8	4 1/4	4 1/4	2 1/4	3 1/4	3 1/8	3 1/8	3 1/8	3 1/4	3 1/4	3 1/4
2 3/8	4	4	4	4 1/8	4 1/4	4 3/8	4 3/8	2 3/8	3 3/8	3 3/8	3 3/8	3 3/8	3 3/8	3 3/8	3 3/8
2 1/2	4 1/8	4 1/8	4 1/8	4 1/4	4 3/8	4 1/2	4 1/2	2 1/2	3 1/2	3 1/2	3 1/2	3 1/2	3 1/2	3 3/8	3 3/8
2 5/8	4 1/4	4 1/4	4 1/4	4 3/8	4 1/2	4 5/8	4 5/8	2 5/8	3 3/4	3 3/8	3 5/8	3 5/8	3 3/8	3 3/4	3 3/4
2 3/4	4 3/8	4 3/8	4 3/8	4 1/2	4 5/8	4 3/4	4 3/4	2 3/4	3 3/8	3 3/4	3 3/4	3 3/4	3 3/4	3 7/8	3 7/8
2 7/8	4 3/8	4 3/8	4 3/8	4 5/8	4 3/4	4 7/8	5	2 7/8	4	3 7/8	3 7/8	3 7/8	3 7/8	4	4
3	...	4 3/4	4 3/4	4 7/8	5	5	5	3	...	4 1/8	4 1/8	4 1/8	4 1/8	4 1/8	4 1/8
3 1/8	...	4 7/8	4 7/8	5	5 1/8	5 1/4	5 1/4	3 1/8	...	4 1/4	4 1/4	4 1/4	4 1/4	4 1/4	4 1/4
3 1/4	...	5	5	5 1/8	5 1/4	5 3/8	5 3/8	3 1/4	...	4 3/8	4 3/8	4 3/8	4 3/8	4 3/8	4 3/8
3 3/8	...	5 1/8	5 1/8	5 1/4	5 3/8	5 1/2	5 1/2	3 3/8	...	4 1/2	4 1/2	4 1/2	4 1/2	4 1/2	4 1/2
3 1/2	...	5 3/8	5 3/8	5 3/8	5 1/2	5 5/8	5 5/8	3 1/2	...	4 5/8	4 5/8	4 5/8	4 5/8	4 5/8	4 5/8
3 3/8	...	5 1/2	5 1/2	5 1/2	5 3/8	5 3/4	5 3/4	3 3/8	...	4 3/4	4 3/4	4 3/4	4 3/4	4 7/8	4 7/8
3 3/4	...	5 5/8	5 5/8	5 5/8	5 3/4	5 7/8	5 7/8	3 3/4	...	5	5	5	5	5	5
3 7/8	...	5 3/4	5 3/4	5 7/8	5 7/8	6	6	3 7/8	...	5 1/8	5 1/8	5 1/8	5 1/8	5 1/8	5 1/8
4	5 7/8	6	6	6 1/4	6 1/4	4	5 1/4	5 1/4	5 1/4	5 1/4	5 1/4
4 1/8	6	6 1/8	6 1/4	6 3/8	6 3/8	4 1/8	5 3/8	5 3/8	5 3/8	5 3/8	5 3/8
4 1/4	6 1/8	6 1/4	6 1/2	6 1/2	6 1/2	4 1/4	5 1/2	5 1/2	5 1/2	5 1/2	5 1/2
4 3/8	6 3/8	6 1/2	6 1/2	6 3/8	6 3/8	4 3/8	5 5/8	5 5/8	5 5/8	5 5/8	5 5/8
4 1/2	6 1/2	6 3/8	6 3/8	6 3/4	6 3/4	4 1/2	5 3/4	5 3/4	5 3/4	5 3/4	5 3/4
4 5/8	6 5/8	6 3/4	6 3/4	6 3/4	6 7/8	4 5/8	6	6	6	6	6
4 3/4	6 3/4	6 3/8	6 7/8	7	7	4 3/4	6 1/8	6 1/8	6 1/8	6 1/8	6 1/8
4 7/8	6 7/8	7	7	7 1/8	7 1/8	4 7/8	6 1/4	6 1/4	6 1/4	6 1/4	6 1/4
5	7 1/8	7 1/8	7 1/4	7 1/4	5	6 3/8	6 3/8	6 3/8	6 3/8
5 1/8	7 1/4	7 1/4	7 3/8	7 3/8	5 1/8	6 1/2	6 1/2	6 1/2	6 1/2
5 1/4	7 3/8	7 3/8	7 1/2	7 1/2	5 1/4	6 3/8	6 3/8	6 3/8	6 3/8
5 3/8	7 3/8	7 3/8	7 3/4	7 3/4	5 3/8	6 3/4	6 3/4	6 3/4	6 3/4
5 1/2	7 3/4	7 3/4	7 7/8	7 7/8	5 1/2	6 7/8	6 7/8	6 7/8	6 7/8
5 3/8	7 7/8	7 7/8	8	8	5 3/8	7	7	7	7
5 3/4	8	8	8 1/8	8 1/8	5 3/4	7 1/4	7 1/4	7 1/4	7 1/4
5 7/8	8 1/8	8 1/8	8 1/4	8 1/4	5 7/8	7 3/8	7 3/8	7 3/8	7 3/8

^a As given by the American Institute of Steel Construction. Values may vary from standard practice of individual fabricators and should be checked against the fabricator's standard.

Table 1a. American National Standard Large Rivets ANSI B18.1.2-1972 (R2006)

Body Diameter ^a <i>D</i>		Head Dia. <i>A</i>		Head Depth <i>H</i>	Oval Crown Height ^a <i>C</i>	Oval Crown Radius ^a <i>G</i>		
Nominal ^a	Max.	Min.	Max. ^b	Min. ^c	Ref.			
1/2	0.500	0.520	0.478	0.936	0.872	0.260	0.095	1.125
5/8	0.625	0.655	0.600	1.194	1.112	0.339	0.119	1.406
3/4	0.750	0.780	0.725	1.421	1.322	0.400	0.142	1.688
7/8	0.875	0.905	0.850	1.647	1.532	0.460	0.166	1.969
1	1.000	1.030	0.975	1.873	1.745	0.520	0.190	2.250
1 1/8	1.125	1.160	1.098	2.114	1.973	0.589	0.214	2.531
1 1/4	1.250	1.285	1.223	2.340	2.199	0.650	0.238	2.812
1 3/8	1.375	1.415	1.345	2.567	2.426	0.710	0.261	3.094
1 1/2	1.500	1.540	1.470	2.793	2.652	0.771	0.285	3.375
1 5/8	1.625	1.665	1.588	3.019	2.878	0.831	0.309	3.656
1 3/4	1.750	1.790	1.713	3.262	3.121	0.901	0.332	3.938

^aAll dimensions are given in inches. Basic dimension as manufactured. For tolerances see table footnote on page 1734. The following formulas give basic dimensions for manufactured shapes: *Flat Countersunk Head*, $A = 1.810D$; $H = 1.192(\text{Max } A - D)/2$; included angle Q of head = 78 degrees. *Oval Countersunk Head*, $A = 1.810D$; $H = 1.192(\text{Max } A - D)/2$; included angle of head = 78 degrees. Length L is measured parallel to the rivet axis, from the extreme end to the intersection of the head top surface with the head diameter for countersunk head-type rivets.

^bSharp edged head.

^cRounded or flat edged irregularly shaped head (heads are not machined or trimmed).

by the normal cold heading process. Unless otherwise specified, rivets should have plain sheared ends that should be at right angles within 2 degrees to the axis of the rivet and be reasonably flat. When so specified by the user, rivets may have the standard header points shown on page 1736. Rivets may be made of ASTM Specification A31, Grade A steel; or may adhere to SAE Recommended Practice, Mechanical and Chemical Requirements for Nonthreaded Fasteners—SAE J430, Grade 0. When specified, rivets may be made of other materials.

ANSI/ASME B18.1.3M-1983 (R2001), Metric Small Solid Rivets, provides data for small, solid rivets with flat, round, and flat countersunk heads in metric dimensions. The main series of rivets has body diameters, in millimeters, of 1.6, 2, 2.5, 3, 4, 5, 6, 8, 10, and 12. A secondary series (nonpreferred) consists of sizes, 1, 1.2, 1.4, 3.5, 7, 9, and 11 millimeters.

British Standard Rivets

British Standard Rivets for General Engineering.—Dimensions in metric units of rivets for general engineering purposes are given in this British Standard, BS 4620:1970, which is based on ISO Recommendation ISO/R 1051. The snap head rivet dimensions of 14 millimeters and above are taken from the German Standard DIN 124, Round Head Rivets for Steel Structures. The shapes of heads have been restricted to those in common use in the United Kingdom. Table 3b shows the rivet dimensions. Table 3a shows a tentative

Table 1b. American National Standard Large Rivets— ANSI B18.1.2-1972 (R2006)

Nom. Body Dia. D^a	Head Dia. A		Height H		Head Dia. A		Height H		
	Mfd. ^b	Driven ^c	Mfd. ^b	Driven ^c	Mfd. ^b	Driven ^c	Mfd. ^{b,d}	Driven ^{c,d}	
Button Head					High Button Head (Acorn)				
1/2	0.875	0.922	0.375	0.344	0.781	0.875	0.500	0.375	
5/8	1.094	1.141	0.469	0.438	0.969	1.062	0.594	0.453	
3/4	1.312	1.375	0.562	0.516	1.156	1.250	0.688	0.531	
7/8	1.531	1.594	0.656	0.609	1.344	1.438	0.781	0.609	
1	1.750	1.828	0.750	0.688	1.531	1.625	0.875	0.688	
1 1/8	1.969	2.062	0.844	0.781	1.719	1.812	0.969	0.766	
1 1/4	2.188	2.281	0.938	0.859	1.906	2.000	1.062	0.844	
1 3/8	2.406	2.516	1.031	0.953	2.094	2.188	1.156	0.938	
1 1/2	2.625	2.734	1.125	1.031	2.281	2.375	1.250	1.000	
1 5/8	2.844	2.969	1.219	1.125	2.469	2.562	1.344	1.094	
1 3/4	3.062	3.203	1.312	1.203	2.656	2.750	1.438	1.172	
Cone Head					Pan Head				
1/2	0.875	0.922	0.438	0.406	0.800	0.844	0.350	0.328	
5/8	1.094	1.141	0.547	0.516	1.000	1.047	0.438	0.406	
3/4	1.312	1.375	0.656	0.625	1.200	1.266	0.525	0.484	
7/8	1.531	1.594	0.766	0.719	1.400	1.469	0.612	0.578	
1	1.750	1.828	0.875	0.828	1.600	1.687	0.700	0.656	
1 1/8	1.969	2.063	0.984	0.938	1.800	1.891	0.788	0.734	
1 1/4	2.188	2.281	1.094	1.031	2.000	2.094	0.875	0.812	
1 3/8	2.406	2.516	1.203	1.141	2.200	2.312	0.962	0.906	
1 1/2	2.625	2.734	1.312	1.250	2.400	2.516	1.050	0.984	
1 5/8	2.844	2.969	1.422	1.344	2.600	2.734	1.138	1.062	
1 3/4	3.062	3.203	1.531	1.453	2.800	2.938	1.225	1.141	

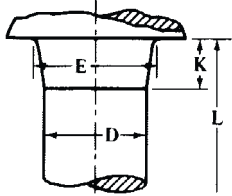
^a Tolerance for diameter of body is plus and minus from nominal and for 1/2-in. size equals +0.020, -0.022; for sizes 5/8 to 1-in., incl., equals +0.030, -0.025; for sizes 1 1/8 and 1 1/4-in. equals +0.035; -0.027; for sizes 1 3/8 and 1 1/2-in. equals +0.040, -0.030; for sizes 1 5/8 and 1 3/4-in. equals +0.040, -0.037.

^b Note 1. Basic dimensions of head as manufactured. All dimensions are given in inches. The following formulas give the basic dimensions for manufactured shapes: *Button Head*, $A = 1.750D$; $H = 0.750D$; $G = 0.885 D$. *High Button Head*, $A = 1.500D + 0.031$; $H = 0.750D + 0.125$; $F = 0.750D + 0.281$; $G = 0.750D - 0.281$. *Cone Head*, $A = 1.750D$; $B = 0.938D$; $H = 0.875D$. *Pan Head*, $A = 1.600D$; $B = 1.000D$; $H = 0.700D$. Length L is measured parallel to the rivet axis, from the extreme end to the bearing surface plane for flat bearing surface head type rivets, or to the intersection of the head top surface with the head diameter for countersunk head-type rivets.

^c Note 2. Dimensions of manufactured head after driving and also of driven head.

^d Note 3. Slight flat permissible within the specified head-height tolerance.

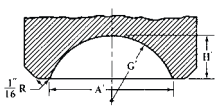
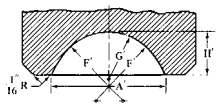
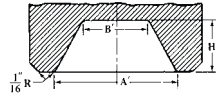
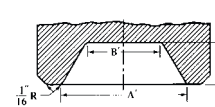
Table 1c. American National Standard Large Rivets ANSI B18.1.2-1972 (R2006)

 <p>Swell Neck</p>	Swell Neck ^a						
	Body Diameter <i>D</i>				Diameter Under Head <i>E</i>		Neck Length <i>K</i> ^b
	Nominal ^b	Max.	Min.	Max. (Basic)	Min.		
	1/2	0.500	0.520	0.478	0.563	0.543	0.250
5/8	0.625	0.655	0.600	0.688	0.658	0.312	
3/4	0.750	0.780	0.725	0.813	0.783	0.375	
7/8	0.875	0.905	0.850	0.938	0.908	0.438	
1	1.000	1.030	0.975	1.063	1.033	0.500	
1 1/8	1.125	1.160	1.098	1.188	1.153	0.562	
1 1/4	1.250	1.285	1.223	1.313	1.278	0.625	
1 3/8	1.375	1.415	1.345	1.438	1.398	0.688	
1 1/2	1.500	1.540	1.470	1.563	1.523	0.750	
1 5/8	1.625	1.665	1.588	1.688	1.648	0.812	
1 3/4	1.750	1.790	1.713	1.813	1.773	0.875	

^a The swell neck is applicable to all standard forms of large rivets except the flat countersunk and oval countersunk head types.

^b All dimensions are given in inches. The following formulas give basic dimensions for manufactured shapes: *Swell Neck*, $E = D + 0.063$; $K = 0.500D$. Length *L* is measured parallel to the rivet axis, from the extreme end to the bearing surface plane for flat bearing surface head-type rivets. Basic dimension as manufactured. For tolerances see table footnote on page 1734.

American National Standard Dimensions for Hold-On (Dolly Bar) and Rivet Set Impression ANSI B18.1.2-1972 (R2006)

Rivet Body Dia. ^a	 <p>Button Head</p>			 <p>High Button Head</p>				 <p>Cone Head</p>			 <p>Pan Head</p>		
	A'	H'	G'	A'	H'	F'	G'	A'	B'	H'	A'	B'	H'
	1/2	0.906	0.312	0.484	0.859	0.344	0.562	0.375	0.891	0.469	0.391	0.812	0.500
5/8	1.125	0.406	0.594	1.047	0.422	0.672	0.453	1.109	0.594	0.484	1.031	0.625	0.375
3/4	1.344	0.484	0.719	1.234	0.500	0.797	0.531	1.328	0.703	0.578	1.234	0.750	0.453
7/8	1.578	0.562	0.844	1.422	0.578	0.922	0.609	1.562	0.828	0.688	1.438	0.875	0.531
1	1.812	0.641	0.953	1.609	0.656	1.031	0.688	1.781	0.938	0.781	1.641	1.000	0.609
1 1/8	2.031	0.719	1.078	1.797	0.719	1.156	0.766	2.000	1.063	0.875	1.844	1.125	0.688
1 1/4	2.250	0.797	1.188	1.984	0.797	1.266	0.844	2.219	1.172	0.969	2.047	1.250	0.766
1 3/8	2.469	0.875	1.312	2.172	0.875	1.406	0.938	2.453	1.297	1.078	2.250	1.375	0.844
1 1/2	2.703	0.953	1.438	2.344	0.953	1.500	1.000	2.672	1.406	1.172	2.453	1.500	0.906
1 5/8	2.922	1.047	1.547	2.531	1.031	1.641	1.094	2.891	1.531	1.266	2.656	1.625	0.984
1 3/4	3.156	1.125	1.672	2.719	1.109	1.750	1.172	3.109	1.641	1.375	2.875	1.750	1.063

^a All dimensions are given in inches.

range of preferred nominal lengths as given in an appendix to the Standard. It is stated that these lengths will be reviewed in the light of usage. The rivets are made by cold or hot forging methods from mild steel, copper, brass, pure aluminum, aluminum alloys, or other suitable metal. It is stated that the radius under the head of a rivet shall run smoothly into the face of the head and shank without step or discontinuity.

Table 2a. American National Standard Small Solid Rivets
ANSI/ASME B18.1.1-1972 (R2006) and Appendix

Truss Head Rivets ^a													
Shank Dia., ^b <i>D</i>		Head Dimensions					Shank Dia., ^b <i>D</i>		Head Dimensions				
		Dia., <i>A</i>		Height, <i>H</i>		Rad. <i>R</i>			Dia., <i>A</i>		Height, <i>H</i>		Rad. <i>R</i>
Nominal	Max.	Min.	Max.	Min.	Approx.	Nominal	Max.	Min.	Max.	Min.	Approx.		
$\frac{3}{32}$	0.094	0.226	0.206	0.038	0.026	0.239	$\frac{9}{32}$	0.281	0.661	0.631	0.103	0.085	0.706
$\frac{1}{8}$	0.125	0.297	0.277	0.048	0.036	0.314	$\frac{5}{16}$	0.312	0.732	0.702	0.113	0.095	0.784
$\frac{5}{32}$	0.156	0.368	0.348	0.059	0.045	0.392	$\frac{11}{32}$	0.344	0.806	0.776	0.124	0.104	0.862
$\frac{3}{16}$	0.188	0.442	0.422	0.069	0.055	0.470	$\frac{3}{8}$	0.375	0.878	0.848	0.135	0.115	0.942
$\frac{7}{32}$	0.219	0.515	0.495	0.080	0.066	0.555	$\frac{13}{32}$	0.406	0.949	0.919	0.145	0.123	1.028
$\frac{1}{4}$	0.250	0.590	0.560	0.091	0.075	0.628	$\frac{7}{16}$	0.438	1.020	0.990	0.157	0.135	1.098

^a All dimensions in inches except where otherwise noted. Length tolerance of rivets is + or - .016 inch. Approximate proportions of rivets: $A = 2.300 \times D$, $H = 0.330 \times D$, $R = 2.512 \times D$.

^b Tolerances on the nominal shank diameter in inches are given for the following body diameter ranges: $\frac{3}{32}$ to $\frac{5}{32}$, plus 0.002, minus 0.004; $\frac{3}{16}$ to $\frac{1}{4}$, plus 0.003, minus 0.006; $\frac{9}{32}$ to $\frac{11}{32}$, plus 0.004, minus 0.008; and $\frac{3}{8}$ to $\frac{7}{16}$, plus 0.005, minus 0.010.

Coopers Rivets											
Size No. ^a	Shank Diameter, <i>D</i>		Head Diameter, <i>A</i>		Head Height, <i>H</i>		Point Dimensions ^b		Length, <i>L</i>		
	Max.	Min.	Max.	Min.	Max.	Min.	Dia., <i>P</i>		Max.	Min.	
							Nom.	Length, <i>Q</i>			
1 lb	0.111	0.105	0.291	0.271	0.045	0.031	Not Pointed		0.249	0.219	
1 1/4 lb	0.122	0.116	0.324	0.302	0.050	0.036	Not Pointed		0.285	0.255	
1 1/2 lb	0.132	0.126	0.324	0.302	0.050	0.036	Not Pointed		0.285	0.255	
1 3/4 lb	0.136	0.130	0.324	0.302	0.052	0.034	Not Pointed		0.318	0.284	
2 lb	0.142	0.136	0.355	0.333	0.056	0.038	Not Pointed		0.322	0.288	
3 lb	0.158	0.152	0.386	0.364	0.058	0.040	0.123	0.062	0.387	0.353	
4 lb	0.168	0.159	0.388	0.362	0.058	0.040	0.130	0.062	0.418	0.388	
5 lb	0.183	0.174	0.419	0.393	0.063	0.045	0.144	0.062	0.454	0.420	
6 lb	0.206	0.197	0.482	0.456	0.073	0.051	0.160	0.094	0.498	0.457	
7 lb	0.223	0.214	0.513	0.487	0.076	0.054	0.175	0.094	0.561	0.523	
8 lb	0.241	0.232	0.546	0.516	0.081	0.059	0.182	0.094	0.597	0.559	
9 lb	0.248	0.239	0.578	0.548	0.085	0.063	0.197	0.094	0.601	0.563	
10 lb	0.253	0.244	0.578	0.548	0.085	0.063	0.197	0.094	0.632	0.594	
12 lb	0.263	0.251	0.580	0.546	0.086	0.060	0.214	0.094	0.633	0.575	
14 lb	0.275	0.263	0.611	0.577	0.091	0.065	0.223	0.094	0.670	0.612	
16 lb	0.285	0.273	0.611	0.577	0.089	0.063	0.223	0.094	0.699	0.641	
18 lb	0.285	0.273	0.642	0.608	0.108	0.082	0.230	0.125	0.749	0.691	
20 lb	0.316	0.304	0.705	0.671	0.128	0.102	0.250	0.125	0.769	0.711	
3/8 in.	0.380	0.365	0.800	0.762	0.136	0.106	0.312	0.125	0.840	0.778	

^a All dimensions in inches except where otherwise noted. Size numbers in pounds refer to the approximate weight of 1000 rivets.

^b When specified American National Standard Small Solid Rivets may be obtained with points. Point dimensions for belt and coopers rivets are given in the accompanying tables. Formulas for calculating point dimensions of other rivets are given alongside the right diagram in Table 2a.

Table 2b. American National Standard Small Solid Rivets
ANSI/ASME B18.1.1-1972 (R2006)

Size No. ^a	Shank Diameter, <i>E</i>		Head Dia., <i>A</i>		Head Height, <i>H</i>		Length, <i>L</i>		
	Max.	Min.	Max.	Min.	Max.	Min.	Nom.	Max.	Min.
6 oz.	0.081	0.075	0.213	0.193	0.028	0.016	1/8	0.135	0.115
8 oz.	0.091	0.085	0.225	0.205	0.036	0.024	5/32	0.166	0.146
10 oz.	0.097	0.091	0.250	0.230	0.037	0.025	11/64	0.182	0.162
12 oz.	0.107	0.101	0.265	0.245	0.037	0.025	3/16	0.198	0.178
14 oz.	0.111	0.105	0.275	0.255	0.038	0.026	3/16	0.198	0.178
1 lb	0.113	0.107	0.285	0.265	0.040	0.028	13/64	0.213	0.193
1 1/4 lb	0.122	0.116	0.295	0.275	0.045	0.033	7/32	0.229	0.209
1 1/2 lb	0.132	0.126	0.316	0.294	0.046	0.034	15/64	0.244	0.224
1 3/4 lb	0.136	0.130	0.331	0.309	0.049	0.035	1/4	0.260	0.240
2 lb	0.146	0.140	0.341	0.319	0.050	0.036	17/64	0.276	0.256
2 1/2 lb	0.150	0.144	0.311	0.289	0.069	0.055	9/32	0.291	0.271
3 lb	0.163	0.154	0.329	0.303	0.073	0.059	5/16	0.323	0.303
3 1/2 lb	0.168	0.159	0.348	0.322	0.074	0.060	21/64	0.338	0.318
4 lb	0.179	0.170	0.368	0.342	0.076	0.062	11/32	0.354	0.334
5 lb	0.190	0.181	0.388	0.362	0.084	0.070	3/8	0.385	0.365
6 lb	0.206	0.197	0.419	0.393	0.090	0.076	25/64	0.401	0.381
7 lb	0.223	0.214	0.431	0.405	0.094	0.080	13/32	0.416	0.396
8 lb	0.227	0.218	0.475	0.445	0.101	0.085	7/16	0.448	0.428
9 lb	0.241	0.232	0.490	0.460	0.103	0.087	29/64	0.463	0.443
10 lb	0.241	0.232	0.505	0.475	0.104	0.088	15/32	0.479	0.459
12 lb	0.263	0.251	0.532	0.498	0.108	0.090	1/2	0.510	0.490
14 lb	0.288	0.276	0.577	0.543	0.113	0.095	33/64	0.525	0.505
16 lb	0.304	0.292	0.597	0.563	0.128	0.110	17/32	0.541	0.521
18 lb	0.347	0.335	0.706	0.668	0.156	0.136	19/32	0.603	0.583

^a All dimensions in inches. Size numbers refer to the approximate weight of 1000 rivets.

Size No. ^b	Shank Diameter, <i>E</i>		Head Dia., <i>A</i>		Head Height, <i>H</i>		Point Dimensions ^c	
	Max.	Min.	Max.	Min.	Max.	Min.	Dia., <i>P</i>	Length, <i>Q</i>
							Nominal	Nominal
14	0.085	0.079	0.260	0.240	0.042	0.030	0.065	0.078
13	0.097	0.091	0.322	0.302	0.051	0.039	0.073	0.078
12	0.111	0.105	0.353	0.333	0.054	0.040	0.083	0.078
11	0.122	0.116	0.383	0.363	0.059	0.045	0.097	0.078
10	0.136	0.130	0.417	0.395	0.065	0.047	0.109	0.094
9	0.150	0.144	0.448	0.426	0.069	0.051	0.122	0.094
8	0.167	0.161	0.481	0.455	0.072	0.054	0.135	0.094
7	0.183	0.174	0.513	0.487	0.075	0.056	0.151	0.125
6	0.206	0.197	0.606	0.580	0.090	0.068	0.165	0.125
5	0.223	0.214	0.700	0.674	0.105	0.083	0.185	0.125
4	0.241	0.232	0.921	0.893	0.138	0.116	0.204	0.141

^a All dimensions in inches. Length tolerance on belt rivets is plus 0.031 inch, minus 0 inch.

^b Size number refers to the Stub's iron wire gage number of the stock used in the shank of the rivet.

^c Note: American National Standard Small Solid Rivets may be obtained with or without points. Point proportions are given in the diagram in Table 2a.

Table 2c. American National Standard Small Solid Rivets ANSI/ASME B18.1.1-1972 (R2006) and Appendix

Shank Diameter		Flat Head ^a		Flat Countersunk Head ^a		Button Head ^a					Pan Head ^a											
		Head Dimensions		Head Dimensions		Head Dimensions		Head Dimensions			Head Dimensions		Radii									
Nominal	E	Dia., A		Height, H		Dia., A Sharp		Height ^b H Ref.	Dia., A		Height, H		Radius, R Approx.	Dia., A		Height, H		Radii				
		Max.	Min.	Max.	Min.	Max. ^c	Min. ^d		Max.	Min.	Max.	Min.		Max.	Min.	Max.	Min.	Approximate				
1/16	0.062	0.064	0.059	0.140	0.120	0.027	0.017	0.118	0.110	0.027	0.122	0.102	0.052	0.042	0.055	0.118	0.098	0.040	0.030	0.019	0.052	0.217
3/32	0.094	0.096	0.090	0.200	0.180	0.038	0.026	0.176	0.163	0.040	0.182	0.162	0.077	0.065	0.084	0.173	0.153	0.060	0.048	0.030	0.080	0.326
1/8	0.125	0.127	0.121	0.260	0.240	0.048	0.036	0.235	0.217	0.053	0.235	0.215	0.100	0.088	0.111	0.225	0.205	0.078	0.066	0.039	0.106	0.429
5/32	0.156	0.158	0.152	0.323	0.301	0.059	0.045	0.293	0.272	0.066	0.290	0.268	0.124	0.110	0.138	0.279	0.257	0.096	0.082	0.049	0.133	0.535
3/16	0.188	0.191	0.182	0.387	0.361	0.069	0.055	0.351	0.326	0.079	0.348	0.322	0.147	0.133	0.166	0.334	0.308	0.114	0.100	0.059	0.159	0.641
7/32	0.219	0.222	0.213	0.453	0.427	0.080	0.065	0.413	0.384	0.094	0.405	0.379	0.172	0.158	0.195	0.391	0.365	0.133	0.119	0.069	0.186	0.754
1/4	0.250	0.253	0.244	0.515	0.485	0.091	0.075	0.469	0.437	0.106	0.460	0.430	0.196	0.180	0.221	0.444	0.414	0.151	0.135	0.079	0.213	0.858
9/32	0.281	0.285	0.273	0.579	0.545	0.103	0.085	0.528	0.491	0.119	0.518	0.484	0.220	0.202	0.249	0.499	0.465	0.170	0.152	0.088	0.239	0.963
5/16	0.312	0.316	0.304	0.641	0.607	0.113	0.095	0.588	0.547	0.133	0.572	0.538	0.243	0.225	0.276	0.552	0.518	0.187	0.169	0.098	0.266	1.070
11/32	0.344	0.348	0.336	0.705	0.667	0.124	0.104	0.646	0.602	0.146	0.630	0.592	0.267	0.247	0.304	0.608	0.570	0.206	0.186	0.108	0.292	1.176
3/8	0.375	0.380	0.365	0.769	0.731	0.135	0.115	0.704	0.656	0.159	0.684	0.646	0.291	0.271	0.332	0.663	0.625	0.225	0.205	0.118	0.319	1.286
13/32	0.406	0.411	0.396	0.834	0.790	0.146	0.124	0.763	0.710	0.172	0.743	0.699	0.316	0.294	0.358	0.719	0.675	0.243	0.221	0.127	0.345	1.392
7/16	0.438	0.443	0.428	0.896	0.852	0.157	0.135	0.823	0.765	0.186	0.798	0.754	0.339	0.317	0.387	0.772	0.728	0.261	0.239	0.137	0.372	1.500

^a All dimensions in inches. Length tolerance of all rivets is plus or minus 0.016 inch. Approximate proportions of rivets: flat head, $A = 2.00 \times D$, $H = 0.33 D$; flat countersunk head, $A = 1.850 \times D$, $H = 0.425 \times D$; button head, $A = 1.750 \times D$, $H = 0.750 \times D$, $R = 0.885 \times D$; pan head, $A = 1.720 \times D$, $H = 0.570 \times D$, $R1 = 0.314 \times D$, $R2 = 0.850 \times D$, $R3 = 3.430 \times D$. Note: ANSI Small Solid Rivets may be obtained with or without points. Point proportions are given in the diagram in Table 2a.

^b Given for reference purposes only. Variations in this dimension are controlled by the head and shank diameters and the included angle of the head.

^c Tabulated maximum values calculated on basic diameter of rivet and 92° included angle extended to a sharp edge.

^d Minimum of rounded or flat-edged irregular-shaped head. Rivet heads are not machined or trimmed and the circumference may be irregular and edges rounded or flat.

In this Standard, **Tables 3a** and **3b**, the following definitions apply: 1) *Nominal diameter*: The diameter of the shank; 2) *Nominal length of rivets other than countersunk or raised countersunk rivets*: The length from the underside of the head to the end of the shank; 3) *Nominal length of countersunk and raised countersunk rivets*: The distance from the periphery of the head to the end of the rivet measured parallel to the axis of the rivet; and 4) *Manufactured head*: The head on the rivet as received from the manufacturer.

Table 3a. Tentative Range of Lengths for Rivets Appendix to BS 4620:1970 (1998)

Nom. Shank Dia.	Nominal Length																				
	3	4	5	6	8	10	12	14	16	(18)	20	(22)	25	(28)	30	(32)	35	(38)	40	45	...
1	●	●	●	●	●	●	●	●	●	...	●
1.2	●	●	●	●	●	●	●	●	●	...	●
1.6	●	●	●	●	●	●	●	●	●	●	...	●	●
2	●	●	●	●	●	●	●	●	●	...	●	●	●
2.5	●	●	●	●	●	●	●	●	●	...	●	●	●
3	...	●	●	●	●	●	●	●	●	●	●	●	●
(3.5)
4	●	●	●	●	●	●	...	●	●	●
5	●	●	●	●	●	●	●	●	●	●	●	●	...	●	●
6	●	●	●	●	●	●	●	●	●	●	●	●	...	●	●	...	●	...
Nom. Shank Dia.	Nominal Length																				
	10	12	14	16	(18)	20	(22)	25	(28)	30	(32)	35	(38)	40	45	50	55	60	65	70	75
(7)
8	●	●	●	●	●	●	●	●	●	...	●	●	...	●	●
10	●	●	●	●	●	●	●	...	●	●	...	●	●
12	●	...	●	...	●	...	●	...	●	●
(14)
16	●	●	●	●	●	●	...	●
Nom. Shank Dia.	Nominal Length																				
	45	50	55	60	65	70	75	80	85	90	(95)	100	(105)	110	(115)	120	(125)	130	140	150	160
(18)
20	●	●	●
(22)
24	●	...	●	...	●	●	...	●
(27)
30	●	●	...	●	...	●	...	●
(33)
36	●	...	●	...	●	...	●
(39)	●	...	●	●	●	●	●

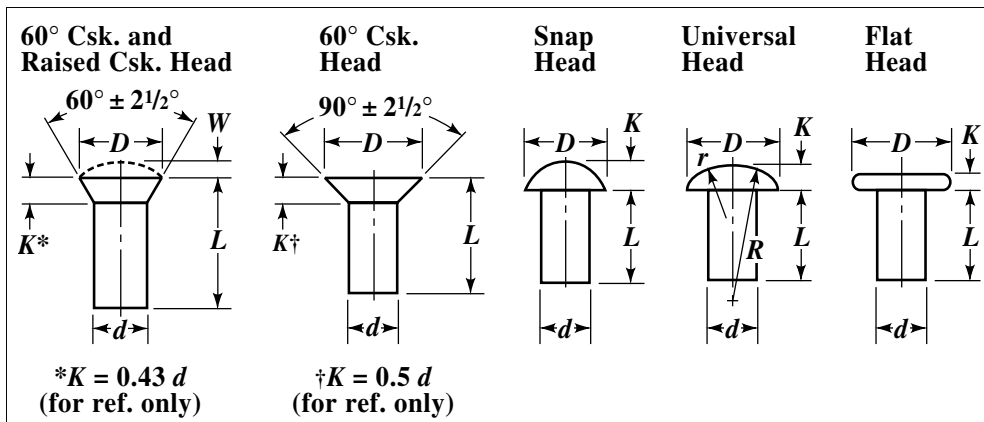
All dimensions are in millimeters.

Note: Sizes and lengths shown in parenthesis are nonpreferred and should be avoided if possible.

British Standard Small Rivets for General Purposes.—Dimensions of small rivets for general purposes are given in British Standard 641:1951 and are shown in **Table 4** on page 1744. In addition, the standard lists the standard lengths of these rivets, gives the dimensions of washers to be used with countersunk head rivets (140°), indicates that the rivets may be made from mild steel, copper, brass, and a range of aluminum alloys and pure aluminum specified in B.S. 1473, and gives the dimensions of Coopers’ flat head rivets ½ inch in diameter and below, in an appendix. In all types of rivets, except those with countersunk heads, there is a small radius or chamfer at the junction of the head and the shank.

British Standard Dimensions of Rivets (½ to 1¾ inch diameter).—The dimensions of rivets covered in BS 275:1927 (obsolescent) are given on page 1745 and do not apply to boiler rivets. With regard to this standard the terms “nominal diameter” and “standard diameter” are synonymous. The term “tolerance” refers to the variation from the nominal diameter of the rivet and not to the difference between the diameter under the head and the diameter near the point.

Table 3b. British Standard Rivets for General Engineering Purposes
BS 4620:1970 (1998)



Hot Forged Rivets									
Nom. Shank Dia. ^a <i>d</i>	Tol. on Dia. <i>d</i>	60° Csk. and Raised Csk. Head		Snap Head		Universal Head			
		Head Dimensions							
		Nom. Dia. <i>D</i>	Height of Raise <i>W</i>	Nom. Dia. <i>D</i>	Nom. Depth <i>K</i>	Nom. Dia. <i>D</i>	Nom. Depth <i>K</i>	Rad. <i>R</i>	Rad. <i>r</i>
(14)	±0.43	21	2.8	22	9	28	5.6	42	8.4
16		24	3.2	25	10	32	6.4	48	9.6
(18)		27	3.6	28	11.5	36	7.2	54	11
20	±0.52	30	4.0	32	13	40	8.0	60	12
(22)		33	4.4	36	14	44	8.8	66	13
24		36	4.8	40	16	48	9.6	72	14
(27)	±0.62	40	5.4	43	17	54	10.8	81	16
30		45	6.0	48	19	60	12.0	90	18
(33)		50	6.6	53	21	66	13.2	99	20
36		55	7.2	58	23	72	14.4	108	22
(39)		59	7.8	62	25	78	15.6	117	23

Cold Forged Rivets										
Nom. Shank Dia. ^a <i>d</i>	Tol. on Dia. <i>d</i>	90° Csk. Head	Snap Head		Universal Head				Flat Head	
		Head Dimensions								
		Nom. Dia. <i>D</i>	Nom. Dia. <i>D</i>	Nom. Dia. <i>K</i>	Nom. Dia. <i>D</i>	Nom. Depth <i>K</i>	Rad. <i>R</i>	Rad. <i>r</i>	Nom. Dia. <i>D</i>	Nom. Depth <i>K</i>
1	±0.07	2	1.8	0.6	2	0.4	3.0	0.6	2	0.25
1.2		2.4	2.1	0.7	2.4	0.5	3.6	0.7	2.4	0.3
1.6		3.2	2.8	1.0	3.2	0.6	4.8	1.0	3.2	0.4
2		4	3.5	1.2	4	0.8	6.0	1.2	4	0.5
2.5		5	4.4	1.5	5	1.0	7.5	1.5	5	0.6
3		6	5.3	1.8	6	1.2	9.0	1.8	6	0.8
(3.5)	±0.09	7	6.1	2.1	7	1.4	10.5	2.1	7	0.9
4		8	7	2.4	8	1.6	12	2.4	8	1.0
5		10	8.8	3.0	10	2.0	15	3.0	10	1.3
6		12	10.5	3.6	12	2.4	18	3.6	12	1.5
(7)	±0.11	14	12.3	4.2	14	2.8	21	4.2	14	1.8
8		16	14	4.8	16	3.2	24	4.8	16	2
10		20	18	6.0	20	4.0	30	6	20	2.5
12	±0.14	24	21	7.2	24	4.8	36	7.2
(14)		...	25	8.4	28	5.6	42	8.4
16		...	28	9.6	32	6.4	48	9.6

^aAll dimensions are in millimeters. Sizes shown in parentheses are nonpreferred.

Table 4. British Standard Small Rivets for General Purposes
BS 641:1951 (obsolescent)

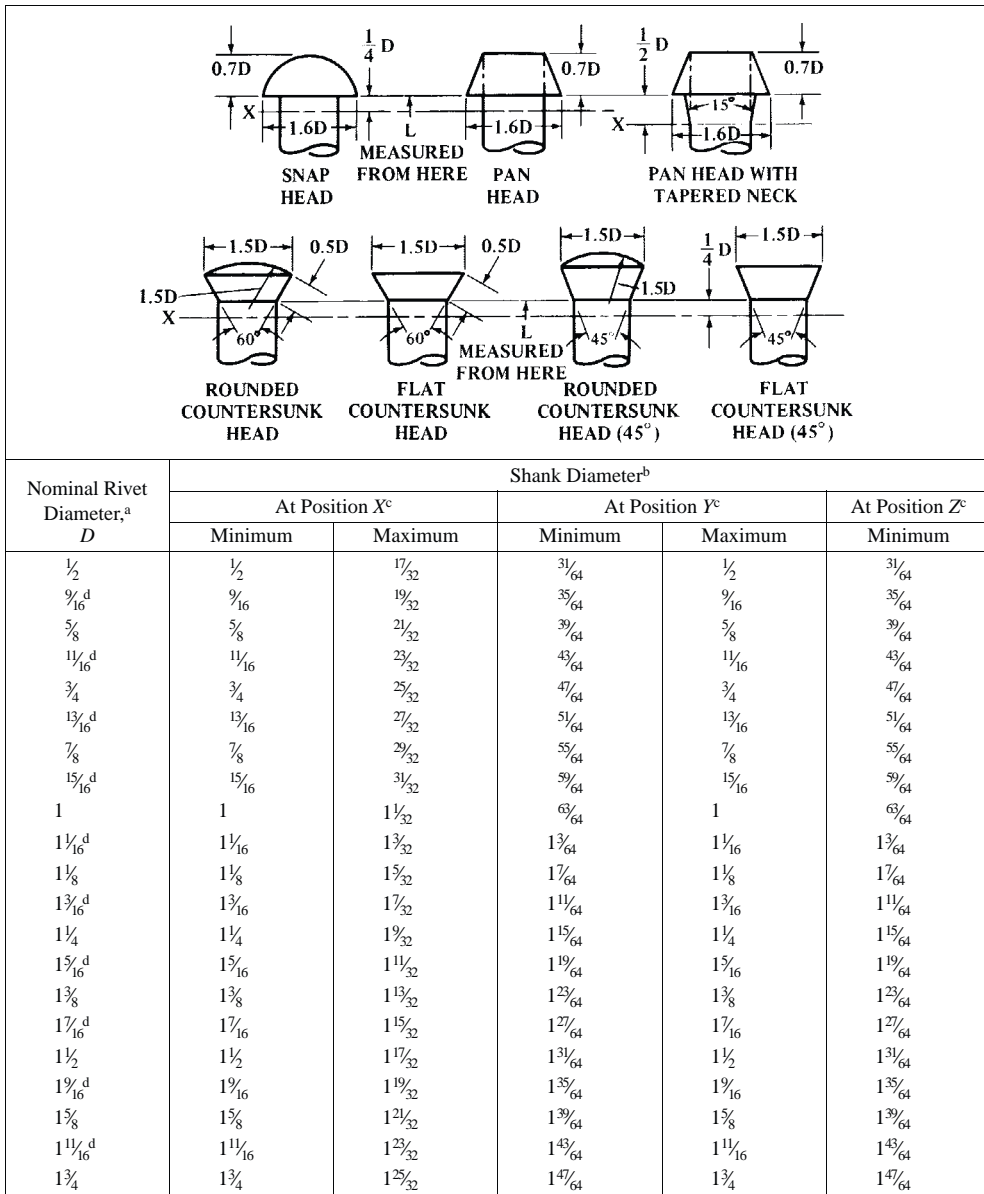
Nom. Dia. ^a <i>D</i>	Snap (or Round Head)			Mushroom Head			Flat Head		Countersunk Head (90°)		Countersunk Head (120°)	
	Head Dimensions											
	Dia. <i>A</i>	Ht. <i>H</i>	Rad. <i>R</i>	Dia. <i>A</i>	Ht. <i>H</i>	Rad. <i>R</i>	Dia. <i>A</i>	Ht. <i>H</i>	Dia. <i>A</i>	Ht. <i>H</i>	Dia. <i>A</i>	Ht. <i>H</i>
1/16	0.109	0.047	0.055	0.141	0.031	0.095	0.125	0.016	0.125	0.031
3/32	0.164	0.070	0.083	0.211	0.047	0.142	0.188	0.023	0.188	0.047
1/8	0.219	0.094	0.111	0.281	0.063	0.189	0.250	0.031	0.250	0.063	0.250	0.036
5/32	0.273	0.117	0.138	0.352	0.078	0.237	0.313	0.039	0.313	0.078
3/16	0.328	0.141	0.166	0.422	0.094	0.284	0.375	0.047	0.375	0.094	0.375	0.054
1/4	0.438	0.188	0.221	0.563	0.125	0.379	0.500	0.063	0.500	0.125	0.500	0.073
5/16	0.547	0.234	0.277	0.703	0.156	0.474	0.625	0.078	0.625	0.156	0.625	0.091
3/8	0.656	0.281	0.332	0.844	0.188	0.568	0.750	0.094	0.750	0.188	0.750	0.109
7/16	0.766	0.328	0.387	0.984	0.219	0.663	0.875	0.109	0.875	0.219

Nominal Diameter <i>D</i>	Pan Head		Countersunk Head (60°)		Countersunk Head (140°)			Countersunk Head Reaper		Snap (or Round) Head Reaper		
	Head Dimensions											
	Inch	Gage No. ^b	Dia. <i>A</i>	Ht. <i>H</i>	Dia. <i>A</i>	Ht. <i>H</i>	Dia. <i>A</i>	Ht. <i>H</i>	Dia. <i>E</i>	Dia. <i>A</i>	Ht. <i>H</i>	Dia. <i>A</i>
0.104	12	0.286	0.042	0.082
0.116	11	0.319	0.046	0.092
0.128	10	0.352	0.051	0.101
0.144	9	0.396	0.058	0.114
0.160	8	0.440	0.064	0.126
0.176	7	0.484	0.070	0.139
3/16	...	0.300	0.131	0.328	0.122
0.192	6	0.528	0.077	0.152	0.317	0.062	0.307	0.115
0.202	0.333	0.066	0.323	0.121
0.212	5	0.583	0.085	0.167	0.350	0.069	0.339	0.127
0.232	4	0.638	0.093	0.183	0.383	0.075	0.371	0.139
1/4	...	0.400	0.175	0.438	0.162	0.688	0.100	0.198
0.252	3	0.416	0.082	0.403	0.151
5/16	...	0.500	0.219	0.547	0.203	0.859	0.125	0.247
3/8	...	0.600	0.263	0.656	0.244	10.031	0.150	0.296
7/16	...	0.700	0.306	0.766	0.284

^a All dimensions in inches unless specified otherwise.

^b Gage numbers are British Standard Wire Gage (S.W.G.) numbers.

Head Dimensions and Diameters of British Standard Rivets
BS 275:1927 (obsolescent)



^a All dimensions that are tabulated are given in inches. This standard does not apply to Boiler Rivets

^b Tolerances of the rivet diameter are as follows: at position X, plus $\frac{1}{32}$ inch, minus zero; at position Y, plus zero, minus $\frac{1}{64}$ inch; at position Z, minus $\frac{1}{64}$ inch but in no case shall the difference between the diameters at positions X and Y exceed $\frac{1}{32}$ inch, nor shall the diameter of the shank between positions X and Y be less than the minimum diameter specified at position Y.

^c The location of positions Y and Z are as follows: Position Y is located $\frac{1}{2}D$ from the end of the rivet for rivet lengths 5 diameters long and under. For longer rivets, position Y is located $4\frac{1}{2}D$ from the head of the rivet. Position Z (found only on rivets longer than $5D$) is located $\frac{1}{2}D$ from the end of the rivet.

^d At the recommendation of the British Standards Institution, these sizes are to be dispensed with wherever possible.

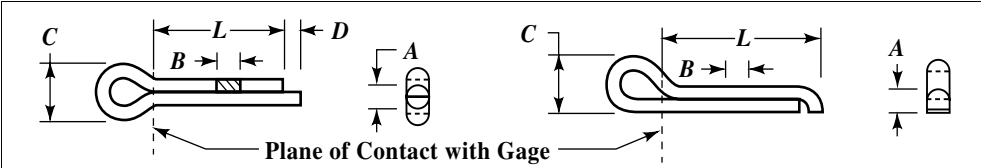
PINS AND STUDS

Dowel-Pins.—Dowel-pins are used either to retain parts in a fixed position or to preserve alignment. Under normal conditions a properly fitted dowel-pin is subjected solely to shearing strain, and this strain occurs only at the junction of the surfaces of the two parts which are being held by the dowel-pin. It is seldom necessary to use more than two dowel-pins for holding two pieces together and frequently one is sufficient. For parts that have to be taken apart frequently, and where driving out of the dowel-pins would tend to wear the holes, and also for very accurately constructed tools and gages that have to be taken apart, or that require to be kept in absolute alignment, the taper dowel-pin is preferable. The taper dowel-pin is most commonly used for average machine work, but the straight type is given the preference on tool and gage work, except where extreme accuracy is required, or where the tool or gage is to be subjected to rough handling.

The size of the dowel-pin is governed by its application. For locating nests, gage plates, etc., pins from $\frac{1}{8}$ to $\frac{3}{16}$ inch (3.2-4.8 mm) in diameter are satisfactory. For locating dies, the diameter of the dowel-pin should never be less than $\frac{1}{4}$ inch (6.35 mm); the general rule is to use dowel-pins of the same size as the screws used in fastening the work. The length of the dowel-pin should be about one and one-half to two times its diameter in each plate or part to be doweled.

When hardened cylindrical dowel-pins are inserted in soft parts, ream the hole about 0.001 inch (0.025 mm) smaller than the dowel-pin. If the doweled parts are hardened, grind (or lap) the hole 0.0002 to 0.0003 inch (0.005-0.0076 mm) under size. The hole should be ground or lapped straight, that is, without taper or “bell-mouth.”

American National Standard Cotter Pins ANSI B18.8.1-1972 (R1994)

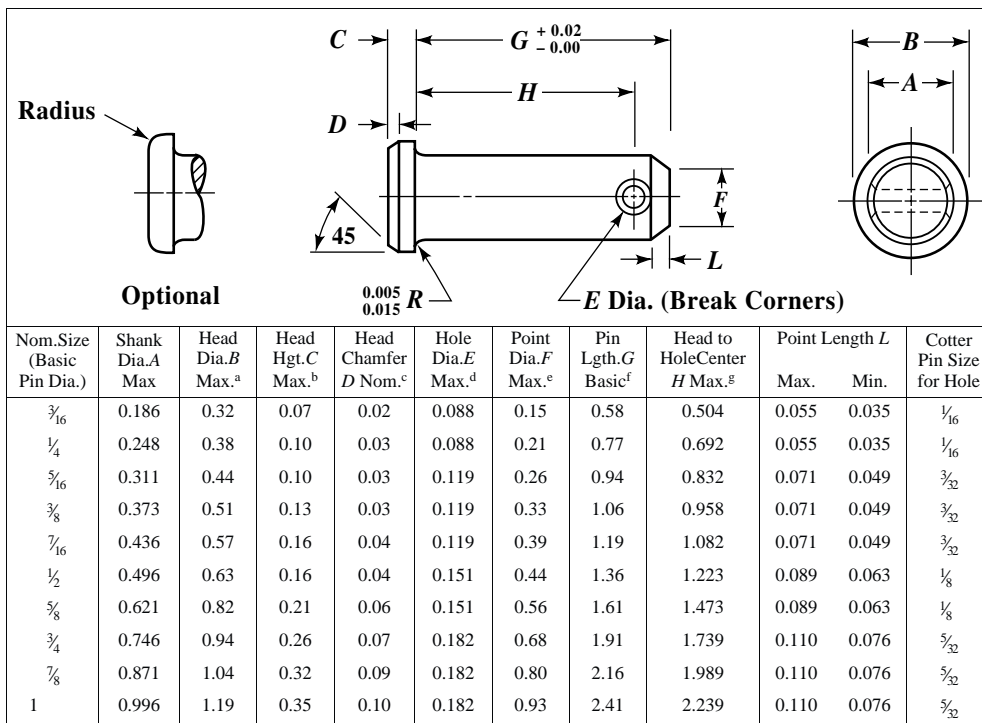


Nom. Size	Dia. A ^a & Width B Max.	Wire Width B Min.	Head Dia. C Min.	Prong Length D Min.	Hole Size	Nom. Size	Dia. A ^a & Width B Max.	Wire Width B Min.	Head Dia. C Min.	Prong Length D Min.	Hole Size
$\frac{1}{32}$	0.032	0.022	0.06	0.01	0.047	$\frac{3}{16}$	0.176	0.137	0.38	0.09	0.203
$\frac{3}{64}$	0.048	0.035	0.09	0.02	0.062	$\frac{7}{32}$	0.207	0.161	0.44	0.10	0.234
$\frac{1}{16}$	0.060	0.044	0.12	0.03	0.078	$\frac{1}{4}$	0.225	0.176	0.50	0.11	0.266
$\frac{5}{64}$	0.076	0.057	0.16	0.04	0.094	$\frac{5}{16}$	0.280	0.220	0.62	0.14	0.312
$\frac{3}{32}$	0.090	0.069	0.19	0.04	0.109	$\frac{3}{8}$	0.335	0.263	0.75	0.16	0.375
$\frac{7}{64}$	0.104	0.080	0.22	0.05	0.125	$\frac{7}{16}$	0.406	0.320	0.88	0.20	0.438
$\frac{1}{8}$	0.120	0.093	0.25	0.06	0.141	$\frac{1}{2}$	0.473	0.373	1.00	0.23	0.500
$\frac{9}{64}$	0.134	0.104	0.28	0.06	0.156	$\frac{5}{8}$	0.598	0.472	1.25	0.30	0.625
$\frac{5}{32}$	0.150	0.116	0.31	0.07	0.172	$\frac{3}{4}$	0.723	0.572	1.50	0.36	0.750

^a Tolerances are: -0.004 inch for the $\frac{1}{32}$ - to $\frac{3}{16}$ -inch sizes, incl.; -0.005 inch for the $\frac{7}{32}$ - to $\frac{5}{16}$ -inch sizes, incl.; -0.006 inch for the $\frac{3}{8}$ - to $\frac{1}{2}$ -inch sizes, incl.; and -0.008 inch for the $\frac{5}{8}$ - and $\frac{3}{4}$ -inch sizes. Note: Tolerances for length are: up to 1 inch \pm 0.030 inch, over 1 inch \pm 0.060 inch.

All dimensions are in inches.

American National Standard Clevis Pins ANSI B18.8.1-1972 (R1994)



^aTolerance is -0.05 inch.

^bTolerance is -0.02 inch.

^cTolerance is ±0.01 inch.

^dTolerance is -0.015 inch.

^eTolerance is -0.01 inch.

^fLengths tabulated are intended for use with standard clevises, without spacers. When other lengths are required, it is recommended that they be limited wherever possible to nominal lengths in 0.06-inch increments.

^gTolerance is -0.020 inch.

All dimensions are in inches.

British Standard for Metric Series Dowel Pins.—Steel parallel dowel pins specified in British Standard 1804:Part 2:1968 are divided into three grades which provide different degrees of pin accuracy.

Grade 1 is a precision ground pin made from En 32A or En 32B low carbon steel (BS 970) or from high carbon steel to BS 1407 or BS 1423. Pins below 4 mm diameter are unhardened. Those of 4 mm diameter and above are hardened to a minimum of 750 HV 30 in accordance with BS 427, but if they are made from steels to BS 1407 or BS 1423 then the hardness shall be within the range 600 to 700 HV 30, in accordance with BS 427. The values of other hardness scales may be used in accordance with BS 860.

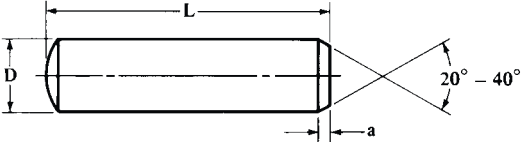
Grade 2 is a ground pin made from any of the steels used for Grade 1. The pins are normally supplied unhardened, unless a different condition is agreed on between the purchaser and supplier.

Grade 3 pins are made from En 1A free cutting steel (BS 970) and are supplied with a machined, bright rolled or drawn finish. They are normally supplied unhardened unless a different condition is agreed on between the purchaser and supplier.

Pins of any grade may be made from different steels in accordance with BS 970, by mutual agreement between the purchaser and manufacturer. If steels other than those in the

standard range are used, the hardness of the pins shall also be decided on by mutual agreement between purchaser and supplier. As shown in the illustration at the head of the accompanying table, one end of each pin is chamfered to provide a lead. The other end may be similarly chamfered, or domed.

British Standard Parallel Steel Dowel Pins — Metric Series *BS 1804: Part 2: 1968*



Nom. Length <i>L</i> , mm	Nominal Diameter <i>D</i> , mm													
	1	1.5	2	2.5	3	4	5	6	8	10	12	16	20	25
	Chamfer <i>a</i> max, mm													
	0.3	0.3	0.3	0.4	0.45	0.6	0.75	0.9	1.2	1.5	1.8	2.5	3	4
Standard Sizes														
4	•	•												
6	•	•	•	•										
8	•	•	•	•	•									
10		•	•	•	•	•								
12		•	•	•	•	•	•							
16			•	•	•	•	•	•						
20				•	•	•	•	•	•					
25					•	•	•	•	•	•				
30						•	•	•	•	•	•			
35							•	•	•	•	•	•		
40							•	•	•	•	•	•	•	
45								•	•	•	•	•	•	•
50									•	•	•	•	•	•
60										•	•	•	•	•
70											•	•	•	•
80												•	•	•
90													•	•
100														•
110														•
120														•

Limits of Tolerance on Diameter							
Grade ^a		1		2		3	
Tolerance Zone		m5		h7		h11	
Nom. Dia., mm		Limits of Tolerance, 0.001 mm					
Over	To & Incl.						
	3	+7	+2	0	-12 ^b	0	-60
3	6	+9	+4	0	-12	0	-75
6	10	+12	+6	0	-15	0	-90
10	14	+15	+7	0	-18	0	-110
14	18	+15	+7	0	-18	0	-110
18	24	+17	+8	0	-21	0	-130
24	30	+17	+8	0	-21	0	-130

^a The limits of tolerance for grades 1 and 2 dowel pins have been chosen to provide satisfactory assembly when used in standard reamed holes (H7 and H8 tolerance zones). If the assembly is not satisfactory, refer to B.S. 1916: Part 1, Limits and Fits for Engineering, and select a different class of fit.

^b This tolerance is larger than that given in BS 1916, and has been included because the use of a closer tolerance would involve precision grinding by the manufacturer, which is uneconomic for a grade 2 dowel pin.

The tolerance limits on the overall length of all grades of dowel pin up to and including 50 mm long are +0.5, -0.0 mm, and for pins over 50 mm long are +0.8, -0.0 mm. The Standard specifies that the roughness of the cylindrical surface of grades 1 and 2 dowel pins, when assessed in accordance with BS 1134, shall not be greater than 0.4 μm CLA (16 CLA).

Table 1. American National Standard Hardened Ground Machine Dowel Pins ANSI/ASME B18.8.2-1995

Nominal Size ^a or Nominal Pin Diameter	Pin Diameter, A						Point Diameter, B		Crown Height, C	Crown Radius, R		Range of Preferred Lengths, ^b L	Single Shear Load, for Carbon or Alloy Steel, Calculated lb	Suggested Hole Diameter ^c	
	Standard Series Pins			Oversize Series Pins			Max	Min	Max	Min	Max			Min	
	Basic	Max	Min	Basic	Max	Min									
1/16	0.0625	0.0627	0.0628	0.0626	0.0635	0.0636	0.0634	0.058	0.048	0.020	0.008	3/16-3/4	400	0.0625	0.0620
5/64 ^d	0.0781	0.0783	0.0784	0.0782	0.0791	0.0792	0.0790	0.074	0.064	0.026	0.010	...	620	0.0781	0.0776
3/32	0.0938	0.0940	0.0941	0.0939	0.0948	0.0949	0.0947	0.089	0.079	0.031	0.012	5/16-1	900	0.0937	0.0932
1/8	0.1250	0.1252	0.1253	0.1251	0.1260	0.1261	0.1259	0.120	0.110	0.041	0.016	3/8-2	1,600	0.1250	0.1245
5/32 ^d	0.1562	0.1564	0.1565	0.1563	0.1572	0.1573	0.1571	0.150	0.140	0.052	0.020	...	2,500	0.1562	0.1557
3/16	0.1875	0.1877	0.1878	0.1876	0.1885	0.1886	0.1884	0.180	0.170	0.062	0.023	1/2-2	3,600	0.1875	0.1870
1/4	0.2500	0.2502	0.2503	0.2501	0.2510	0.2511	0.2509	0.240	0.230	0.083	0.031	1/2-2 1/2	6,400	0.2500	0.2495
5/16	0.3125	0.3127	0.3128	0.3126	0.3135	0.3136	0.3134	0.302	0.290	0.104	0.039	1/2-2 1/2	10,000	0.3125	0.3120
3/8	0.3750	0.3752	0.3753	0.3751	0.3760	0.3761	0.3759	0.365	0.350	0.125	0.047	1/2-3	14,350	0.3750	0.3745
7/16	0.4375	0.4377	0.4378	0.4376	0.4385	0.4386	0.4384	0.424	0.409	0.146	0.055	7/8-3	19,550	0.4375	0.4370
1/2	0.5000	0.5002	0.5003	0.5001	0.5010	0.5011	0.5009	0.486	0.471	0.167	0.063	3/4-1-4	25,500	0.5000	0.4995
5/8	0.6250	0.6252	0.6253	0.6251	0.6260	0.6261	0.6259	0.611	0.595	0.208	0.078	1 1/4-5	39,900	0.6250	0.6245
3/4	0.7500	0.7502	0.7503	0.7501	0.7510	0.7511	0.7509	0.735	0.715	0.250	0.094	1 1/2-6	57,000	0.7500	0.7495
7/8	0.8750	0.8752	0.8753	0.8751	0.8760	0.8761	0.8759	0.860	0.840	0.293	0.109	2,2 1/2-6	78,000	0.8750	0.8745
1	1.0000	1.0002	1.0003	1.0001	1.0010	1.0011	1.0009	0.980	0.960	0.333	0.125	2,2 1/2-5,6	102,000	1.0000	0.9995

DOWEL PINS

1749

^a Where specifying nominal size as basic diameter, zeros preceding decimal and in the fourth decimal place are omitted.
^b Lengths increase in 1/16-inch steps up to 3/8 inch, in 1/8-inch steps from 3/8 inch to 1 inch, in 1/4-inch steps from 1 inch to 2 1/2 inches, and in 1/2-inch steps above 2 1/2 inches. Tolerance on length is ±0.010 inch.
^c These hole sizes have been commonly used for press fitting Standard Series machine dowel pins into materials such as mild steels and cast iron. In soft materials such as aluminum or zinc die castings, hole size limits are usually decreased by 0.0005 inch to increase the press fit.
^d Nonpreferred sizes, not recommended for use in new designs.
 All dimensions are in inches.

If a dowel pin is driven into a blind hole where no provision is made for releasing air, the worker assembling the pin may be endangered, and damage may be caused to the associated component, or stresses may be set up. The appendix of the Standard describes one method of overcoming this problem by providing a small flat surface along the length of a pin to permit the release of air.

For purposes of marking, the Standard states that each package or lot of dowel pins shall bear the manufacturer's name or trademark, the BS number, and the grade of pin.

American National Standard Hardened Ground Machine Dowel Pins.—Hardened ground machine dowel pins are furnished in two diameter series: Standard Series having basic diameters 0.0002 inch over the nominal diameter, intended for initial installations; and Oversize Series having basic diameters 0.001 inch over the nominal diameter, intended for replacement use.

Preferred Lengths and Sizes: The preferred lengths and sizes in which these pins are normally available are given in **Table 1**. Other sizes and lengths are produced as required by the purchaser.

Effective Length: The effective length, L_e , must not be less than 75 per cent of the overall length of the pin.

Shear Strength: Single shear strength values are listed in **Table 1**. Prior versions of ANSI/ASME B18.8.2-1995 had listed double shear load minimum values and had specified a minimum single shear strength of 130,000 psi. See ANSI/ASME B18.8.2-1995, Appendix B for a description of the double shear test.

Designation: These pins are designated by the following data in the sequence shown: Product name (noun first), including pin series, nominal pin diameter (fraction or decimal equivalent), length (fraction or decimal equivalent), material, and protective finish, if required.

Examples: Pins, Hardened Ground Machine Dowel — Standard Series, $\frac{3}{8} \times 1\frac{1}{2}$, Steel, Phosphate Coated.

Pins, Hardened Ground Machine Dowel — Oversize Series, 0.625×2.500 , Steel

Installation Precaution: Pins should not be installed by striking or hammering and when installing with a press, a shield should be used and safety glasses worn.

American National Standard Hardened Ground Production Dowel Pins.—Hardened ground production dowel pins have basic diameters that are 0.0002 inch over the nominal pin diameter.

Preferred Lengths and Sizes: The preferred lengths and sizes in which these pins are available are given in **Table 2**. Other sizes and lengths are produced as required by the purchaser.

Shear Strength: Single shear strength values are listed in **Table 2**. Prior versions of ANSI/ASME B18.8.2-1995 had listed double shear load minimum values and had specified a minimum single shear strength of 102,000 psi. See ANSI/ASME B18.8.2-1995, Appendix B for a description of the double shear test.

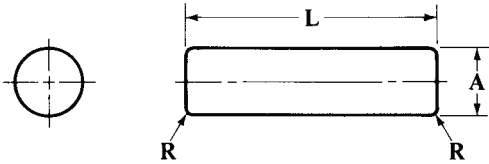
Ductility: These standard pins are sufficiently ductile to withstand being pressed into holes 0.0005 inch smaller than the nominal pin diameter in hardened steel without cracking or shattering.

Designation: These pins are designated by the following data in the sequence shown: Product name (noun first), nominal pin diameter (fraction or decimal equivalent), length (fraction or decimal equivalent), material, and protective finish, if required.

Examples: Pins, Hardened Ground Production Dowel, $\frac{1}{8} \times \frac{3}{4}$, Steel, Phosphate Coated

Pins, Hardened Ground Production Dowel, 0.375×1.500 , Steel

Table 2. American National Standard Hardened Ground Production Dowel Pins
ANSI/ASME B18.8.2-1995



Nominal Size ^a or Nominal Pin Diameter	Pin Diameter, A			Corner Radius, R		Range of Preferred Lengths, ^b L	Single Shear Load, Calculated, lb	Suggested Hole Diameter ^c	
	Basic	Max	Min	Max	Min			Max	Min
1/16	0.0625	0.0627	0.0628	0.0626	0.020	0.010	395	0.0625	0.0620
3/32	0.0938	0.0939	0.0940	0.0938	0.020	0.010	700	0.0937	0.0932
7/64	0.1094	0.1095	0.1096	0.1094	0.020	0.010	950	0.1094	0.1089
1/8	0.1250	0.1252	0.1253	0.1251	0.020	0.010	1,300	0.1250	0.1245
5/32	0.1562	0.1564	0.1565	0.1563	0.020	0.010	2,050	0.1562	0.1557
3/16	0.1875	0.1877	0.1878	0.1876	0.020	0.010	2,950	0.1875	0.1870
7/32	0.2188	0.2189	0.2190	0.2188	0.020	0.010	3,800	0.2188	0.2183
1/4	0.2500	0.2502	0.2503	0.2501	0.020	0.010	5,000	0.2500	0.2495
5/16	0.3125	0.3127	0.3128	0.3126	0.020	0.010	8,000	0.3125	0.3120
3/8	0.3750	0.3752	0.3753	0.3751	0.020	0.010	11,500	0.3750	0.3745

^a Where specifying nominal pin size in decimals, zeros preceding decimal and in the fourth decimal place are omitted.

^b Lengths increase in 1/16-inch steps up to 1 inch, in 1/8-inch steps from 1 inch to 2 inches and then are 2 1/4, 2 1/2, and 3 inches.

^c These hole sizes have been commonly used for press fitting production dowel pins into materials such as mild steels and cast iron. In soft materials such as aluminum or zinc die castings, hole size limits are usually decreased by 0.0005 inch to increase the press fit.

All dimensions are in inches.

American National Standard Unhardened Ground Dowel Pins.—Unhardened ground dowel pins are normally produced by grinding the outside diameter of commercial wire or rod material to size. Consequently, the maximum diameters of the pins, as specified in Table 3, are below the minimum commercial stock sizes by graduated amounts from 0.0005 inch on the 1/16-inch nominal pin size to 0.0028 inch on the 1-inch nominal pin size.

Preferred Lengths and Sizes: The preferred lengths and sizes in which unhardened ground pins are normally available are given in Table 3. Other sizes and lengths are produced as required by the purchaser.

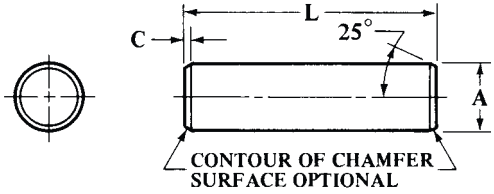
Shear Strength: These pins must have a single shear strength of 64,000 psi minimum for pins made from steel and 40,000 psi minimum for pins made from brass and must be capable of withstanding the minimum double shear loads given in Table 3 when tested in accordance with the procedure outlined in ANSI/ASME B18.8.2-1995, Appendix B.

Designation: These pins are designated by the following data in the order shown: Product name (noun first), nominal pin diameter (fraction or decimal equivalent), length (fraction or decimal equivalent), material, and protective finish, if required.

Examples: Pins, Unhardened Ground Dowel, 1/8 × 3/4, Steel

Pins, Unhardened Ground Dowel, 0.250 × 2.500, Steel, Zinc Plated

Table 3. American National Standard Unhardened Ground Dowel Pins
ANSI/ASME B18.8.2-1995



Nominal Size ^a or Basic Pin Diameter	Pin Diameter, A		Chamfer Length, C		Range of Preferred Lengths, ^b L	Suggested Hole Diameter ^c		Double Shear Load Min, lb.		
	Max	Min	Max	Min		Max	Min	Carbon- Steel	Brass	
1/16	0.0625	0.0600	0.0595	0.025	0.005	1/4-1	0.0595	0.0580	350	220
3/32	0.0938	0.0912	0.0907	0.025	0.005	1/4-1 1/2	0.0907	0.0892	820	510
^d 7/64	0.1094	0.1068	0.1063	0.025	0.005	...	0.1062	0.1047	1,130	710
1/8	0.1250	0.1223	0.1218	0.025	0.005	1/4-2	0.1217	0.1202	1,490	930
5/32	0.1562	0.1535	0.1530	0.025	0.005	1/4-2	0.1528	0.1513	2,350	1,470
3/16	0.1875	0.1847	0.1842	0.025	0.005	1/4-2	0.1840	0.1825	3,410	2,130
7/32	0.2188	0.2159	0.2154	0.025	0.005	1/4-2	0.2151	0.2136	4,660	2,910
1/4	0.2500	0.2470	0.2465	0.025	0.005	1/4-1 1/2, 1 3/4, 2-2 1/2	0.2462	0.2447	6,120	3,810
5/16	0.3125	0.3094	0.3089	0.040	0.020	5/16-1 1/2, 1 3/4, 2-2 1/2	0.3085	0.3070	9,590	5,990
3/8	0.3750	0.3717	0.3712	0.040	0.020	3/8-1 1/2, 1 3/4, 2-2 1/2	0.3708	0.3693	13,850	8,650
7/16	0.4375	0.4341	0.4336	0.040	0.020	7/16-5/8, 3/4, 7/8-1 1/2, 1 3/4, 2-2 1/2	0.4331	0.4316	18,900	11,810
1/2	0.5000	0.4964	0.4959	0.040	0.020	1/2, 5/8, 3/4, 7/8, 1-1 1/2, 1 3/4, 2-3	0.4954	0.4939	24,720	15,450
5/8	0.6250	0.6211	0.6206	0.055	0.035	5/8, 3/4, 7/8, 1-1 1/2, 1 3/4, 2, 2 1/2-4	0.6200	0.6185	38,710	24,190
3/4	0.7500	0.7458	0.7453	0.055	0.035	3/4, 7/8, 1, 1 1/4, 1 1/2, 1 3/4, 2, 2 1/2-4	0.7446	0.7431	55,840	34,900
7/8	0.8750	0.8705	0.8700	0.070	0.050	7/8, 1, 1 1/4, 1 1/2, 1 3/4, 2, 2 1/2-4	0.8692	0.8677	76,090	47,550
1	1.0000	0.9952	0.9947	0.070	0.050	1, 1 1/4, 1 1/2, 1 3/4, 2, 2 1/2-4	0.9938	0.9923	99,460	62,160

^a Where specifying pin size in decimals, zeros preceding decimal and in the fourth decimal place are omitted.

^b Lengths increase in 1/16-inch increments from 1/4 to 1 inch, in 1/8-inch increments from 1 inch to 2 inches, and in 1/4-inch increments from 2 to 2 1/2 inches, and in 1/2-inch increments from 2 1/2 to 4 inches.

^c These hole sizes have been found to be satisfactory for press fitting pins into mild steel and cast and malleable irons. In soft materials such as aluminum alloys or zinc die castings, hole size limits are usually decreased by 0.0005 inch to increase the press fit.

^d Nonpreferred size, not recommended for use in new designs.

All dimensions are in inches.

American National Standard Straight Pins.—The diameter of both chamfered and square end straight pins is that of the commercial wire or rod from which the pins are made. The tolerances shown in Table 4 are applicable to carbon steel and some deviations in the diameter limits may be necessary for pins made from other materials.

**Table 4. American National Standard Chamfered and Square End Straight Pins
ANSI/ASME B18.8.2-1995**

CHAMFERED STRAIGHT PIN					SQUARE END STRAIGHT PIN						
Nominal Size ^a or Basic Pin Diameter	Pin Diameter, A		Chamfer Length, C		Nominal Size ^b or Basic Pin Diameter	Pin Diameter, A		Chamfer Length, C			
	Max	Min	Max	Min		Max	Min	Max	Min		
1/16	0.062	0.0625	0.0605	0.025	0.005	3/16	0.312	0.3125	0.3105	0.040	0.020
3/32	0.094	0.0937	0.0917	0.025	0.00	3/8	0.375	0.3750	0.3730	0.040	0.020
7/64	0.109	0.1094	0.1074	0.025	0.005	7/16	0.438	0.4375	0.4355	0.040	0.020
1/8	0.125	0.1250	0.1230	0.025	0.005	1/2	0.500	0.5000	0.4980	0.040	0.020
5/32	0.156	0.1562	0.1542	0.025	0.005	5/8	0.625	0.6250	0.6230	0.055	0.035
3/16	0.188	0.1875	0.1855	0.025	0.005	3/4	0.750	0.7500	0.7480	0.055	0.035
7/32	0.219	0.2187	0.2167	0.025	0.005	7/8	0.875	0.8750	0.8730	0.055	0.035
1/4	0.250	0.2500	0.2480	0.025	0.005	1	1.000	1.0000	0.9980	0.055	0.035

^aWhere specifying nominal size in decimals, zeros preceding decimal point are omitted.

^bWhere specifying nominal size in decimals, zeros preceding decimal point are omitted.

All dimensions are in inches.

Length Increments: Lengths are as specified by the purchaser; however, it is recommended that nominal pin lengths be limited to increments of not less than 0.062 inch.

Material: Straight pins are normally made from cold drawn steel wire or rod having a maximum carbon content of 0.28 per cent. Where required, pins may also be made from corrosion resistant steel, brass, or other metals.

Designation: Straight pins are designated by the following data, in the sequence shown: Product name (noun first), nominal size (fraction or decimal equivalent), material, and protective finish, if required.

Examples: Pin, Chamfered Straight, 1/8 × 1.500, Steel

Pin, Square End Straight, 0.250 × 2.250, Steel, Zinc Plated

American National Standard Taper Pins.—Taper pins have a uniform taper over the pin length with both ends crowned. Most sizes are supplied in commercial and precision classes, the latter having generally tighter tolerances and being more closely controlled in manufacture.

Diameters: The major diameter of both commercial and precision classes of pins is the diameter of the large end and is the basis for pin size. The diameter at the small end is computed by multiplying the nominal length of the pin by the factor 0.02083 and subtracting the result from the basic pin diameter. See also [Table 5](#).

Taper: The taper on commercial class pins is 0.250 ± 0.006 inch per foot and on the precision class pins is 0.250 ± 0.004 inch per foot of length.

Materials: Unless otherwise specified, taper pins are made from SAE 1211 steel or cold drawn SAE 1212 or 1213 steel or equivalents, and no mechanical property requirements apply.

Hole Sizes: Under most circumstances, holes for taper pins require taper reaming. Sizes and lengths of taper pins for which standard reamers are available are given in [Table 6](#). Drilling specifications for taper pins are given below.

Designation: Taper pins are designated by the following data in the sequence shown: Product name (noun first), class, size number (or decimal equivalent), length (fraction or three-place decimal equivalent), material, and protective finish, if required.

Examples: Pin, Taper (Commercial Class) No. $0 \times \frac{3}{4}$, Steel

Pin, Taper (Precision Class) 0.219×1.750 , Steel, Zinc Plated

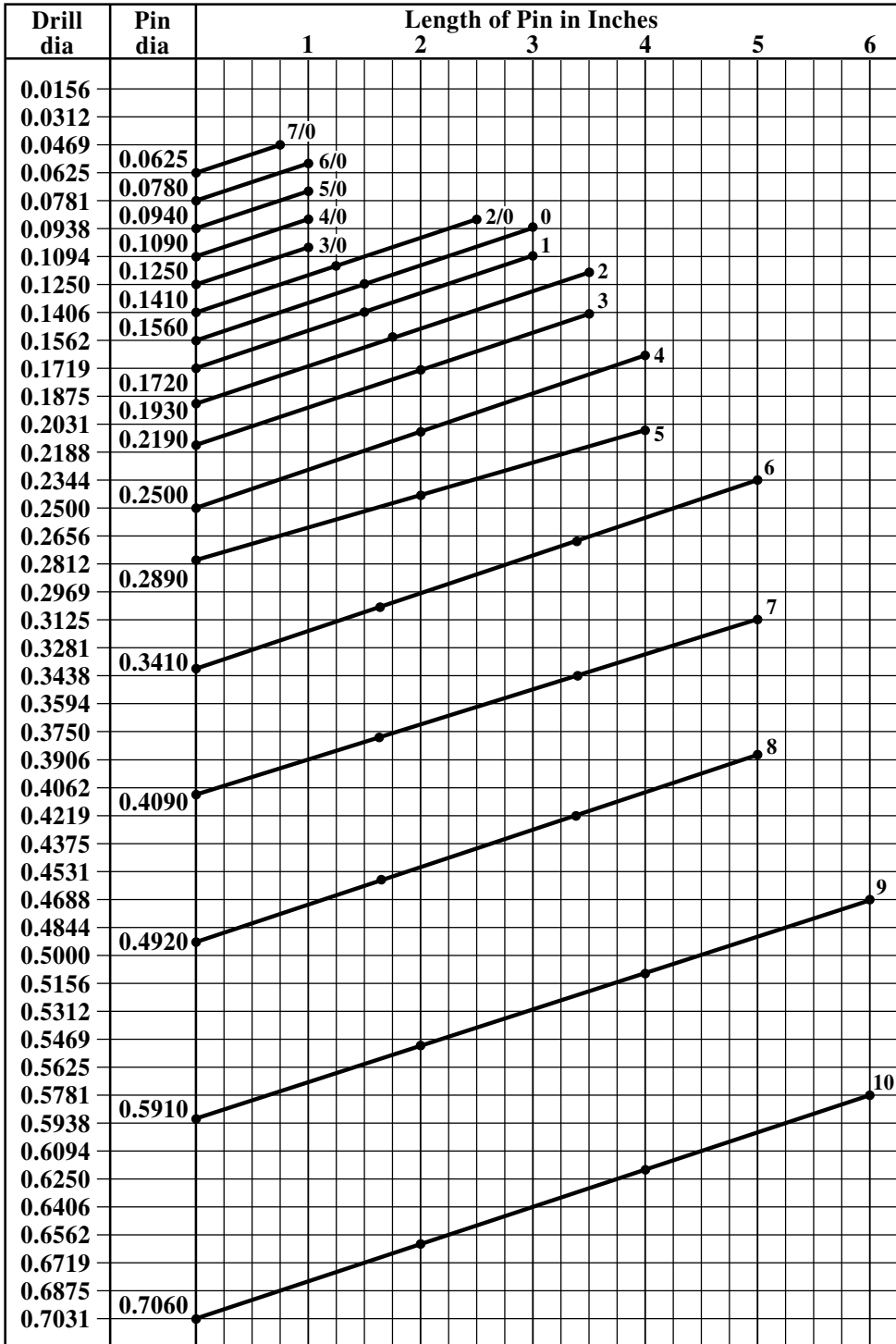
Table 5. Nominal Diameter at Small Ends of Standard Taper Pins

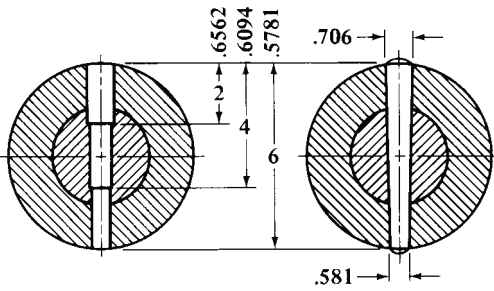
Pin Length in inches	Pin Number and Small End Diameter for Given Length										
	0	1	2	3	4	5	6	7	8	9	10
$\frac{3}{4}$	0.140	0.156	0.177	0.203	0.235	0.273	0.325	0.393	0.476	0.575	0.690
1	0.135	0.151	0.172	0.198	0.230	0.268	0.320	0.388	0.471	0.570	0.685
$1\frac{1}{4}$	0.130	0.146	0.167	0.192	0.224	0.263	0.315	0.382	0.466	0.565	0.680
$1\frac{1}{2}$	0.125	0.141	0.162	0.187	0.219	0.258	0.310	0.377	0.460	0.560	0.675
$1\frac{3}{4}$	0.120	0.136	0.157	0.182	0.214	0.252	0.305	0.372	0.455	0.554	0.669
2	0.114	0.130	0.151	0.177	0.209	0.247	0.299	0.367	0.450	0.549	0.664
$2\frac{1}{4}$	0.109	0.125	0.146	0.172	0.204	0.242	0.294	0.362	0.445	0.544	0.659
$2\frac{1}{2}$	0.104	0.120	0.141	0.166	0.198	0.237	0.289	0.356	0.440	0.539	0.654
$2\frac{3}{4}$	0.099	0.115	0.136	0.161	0.193	0.232	0.284	0.351	0.434	0.534	0.649
3	0.094	0.110	0.131	0.156	0.188	0.227	0.279	0.346	0.429	0.528	0.643
$3\frac{1}{4}$	0.151	0.182	0.221	0.273	0.340	0.424	0.523	0.638
$3\frac{1}{2}$	0.146	0.177	0.216	0.268	0.335	0.419	0.518	0.633
$3\frac{3}{4}$	0.141	0.172	0.211	0.263	0.330	0.414	0.513	0.628
4	0.136	0.167	0.206	0.258	0.326	0.409	0.508	0.623
$4\frac{1}{4}$	0.131	0.162	0.201	0.253	0.321	0.403	0.502	0.617
$4\frac{1}{2}$	0.125	0.156	0.195	0.247	0.315	0.398	0.497	0.612
5	0.146	0.185	0.237	0.305	0.389	0.487	0.602
$5\frac{1}{2}$	0.294	0.377	0.476	0.591
6	0.284	0.367	0.466	0.581

Drilling Specifications for Taper Pins.—When helically fluted taper pin reamers are used, the diameter of the through hole drilled prior to reaming is equal to the diameter at the small end of the taper pin. (See [Table 5](#).) However, when straight fluted taper reamers are to be used, it may be necessary, for long pins, to step drill the hole before reaming, the number and sizes of the drills to be used depending on the depth of the hole (pin length).

To determine the number and sizes of step drills required: Find the length of pin to be used at the top of the chart on page 1755 and follow this length down to the intersection with that heavy line which represents the size of taper pin (see taper pin numbers at the right-hand end of each heavy line). If the length of pin falls between the first and second dots, counting from the left, only one drill is required. Its size is indicated by following the nearest horizontal line from the point of intersection (of the pin length) on the heavy line over to the drill diameter values at the left. If the intersection of pin length comes between the second and third dots, then two drills are required. The size of the smaller drill then corresponds to the intersection of the pin length and the heavy line and the larger is the corresponding drill diameter for the intersection of one-half this length with the heavy line. Should the pin length fall between the third and fourth dots, three drills are required. The smallest drill will have a diameter corresponding to the intersection of the total pin length with the heavy line, the next in size will have a diameter corresponding to the intersection of two-thirds of this length with the heavy line and the largest will have a diameter corresponding to the intersection of one-third of this length with the heavy line. Where the intersection falls between two drill sizes, use the smaller.

Chart to Facilitate Selection of Number and Sizes of Drills for Step-Drilling Prior to Taper Reaming





Examples: For a No. 10 taper pin 6-inches long, three drills would be used, of the sizes and for the depths shown in the accompanying diagram.

For a No. 10 taper pin 3-inches long, two drills would be used because the 3-inch length falls between the second and third dots. The first or through drill will be 0.6406 inch and the second drill, 0.6719 inch for a depth of 1½ inches.

Table 6. American National Standard Taper Pins ANSI/ASME B18.8.2-1995

Pin Size Number and Basic Pin Dia. ^a		Major Diameter (Large End), A				End Crown Radius, R		Range of Lengths, ^b L	
		Commercial Class		Precision Class		Max	Min	Stand. Reamer Avail. ^c	Other
		Max	Min	Max	Min				
7/0	0.0625	0.0638	0.0618	0.0635	0.0625	0.072	0.052	...	1/4-1
6/0	0.0780	0.0793	0.0773	0.0790	0.0780	0.088	0.068	...	1/4-1/2
5/0	0.0940	0.0953	0.0933	0.0950	0.0940	0.104	0.084	1/4-1	1 1/4-1 1/2
4/0	0.1090	0.1103	0.1083	0.1100	0.1090	0.119	0.099	1/4-1	1 1/2-2
3/0	0.1250	0.1263	0.1243	0.1260	0.1250	0.135	0.115	1/4-1	1 1/2-2
2/0	0.1410	0.1423	0.1403	0.1420	0.1410	0.151	0.131	1/2-1 1/4	1 1/2-2 1/2
0	0.1560	0.1573	0.1553	0.1570	0.1560	0.166	0.146	1/2-1 1/4	1 1/2-3
1	0.1720	0.1733	0.1713	0.1730	0.1720	0.182	0.162	3/4-1 1/4	1 1/2-3
2	0.1930	0.1943	0.1923	0.1940	0.1930	0.203	0.183	3/4-1 1/2	1 3/4-3
3	0.2190	0.2203	0.2183	0.2200	0.2190	0.229	0.209	3/4-1 3/4	2-4
4	0.2500	0.2513	0.2493	0.2510	0.2500	0.260	0.240	3/4-2	2 1/2-4
5	0.2890	0.2903	0.2883	0.2900	0.2890	0.299	0.279	1-2 1/2	2 3/4-6
6	0.3410	0.3423	0.3403	0.3420	0.3410	0.351	0.331	1 1/4-3	3 1/4-6
7	0.4090	0.4103	0.4083	0.4100	0.4090	0.419	0.399	1 1/4-3 3/4	4-8
8	0.4920	0.4933	0.4913	0.4930	0.4920	0.502	0.482	1 1/4-4 1/2	4 3/4-8
9	0.5910	0.5923	0.5903	0.5920	0.5910	0.601	0.581	1 1/4-5 1/4	5 1/2-8
10	0.7060	0.7073	0.7053	0.7070	0.7060	0.716	0.696	1 1/2-6	6 1/4-8
11	0.8600	0.8613	0.8593	0.870	0.850	...	2-8
12	1.0320	1.0333	1.0313	1.042	1.022	...	2-9
13	1.2410	1.2423	1.2403	1.251	1.231	...	3-11
14	1.5210	1.5223	1.5203	1.531	1.511	...	3-13

^a When specifying nominal pin size in decimals, zeros preceding the decimal and in the fourth decimal place are omitted.

^b Lengths increase in 1/8-inch steps up to 1 inch and in 1/4-inch steps above 1 inch.

^c Standard reamers are available for pin lengths in this column.

All dimensions are in inches.

For nominal diameters, B, see Table 5.

American National Standard Grooved Pins.—These pins have three equally spaced longitudinal grooves and an expanded diameter over the crests of the ridges formed by the material displaced when the grooves are produced. The grooves are aligned with the axes of the pins. There are seven types of grooved pins as shown in the illustration on page 1758.

Standard Sizes and Lengths: The standard sizes and lengths in which grooved pins are normally available are given in Table 7.

Materials: Grooved pins are normally made from cold drawn low carbon steel wire or rod. Where additional performance is required, carbon steel pins may be supplied surface hardened and heat treated to a hardness consistent with the performance requirements. Pins may also be made from alloy steel, corrosion resistant steel, brass, Monel and other non-ferrous metals having chemical properties as agreed upon between manufacturer and purchaser.

Performance Requirements: Grooved pins are required to withstand the minimum double shear loads given in [Table 7](#) for the respective materials shown, when tested in accordance with the Double Shear Testing of Pins as set forth in ANSI/ASME B18.8.2-1995, Appendix B.

Hole Sizes: To obtain maximum product retention under average conditions, it is recommended that holes for the installation of grooved pins be held as close as possible to the limits shown in [Table 7](#). The minimum limits correspond to the drill size, which is the same as the basic pin diameter. The maximum limits are generally suitable for length-diameter ratios of not less than 4 to 1 nor greater than 10 to 1. For smaller length-to-diameter ratios, the hole should be held closer to the minimum limits where retention is critical. Conversely for larger ratios where retention requirements are less important, it may be desirable to increase the hole diameters beyond the maximum limits shown.

Designation: Grooved pins are designated by the following data in the sequence shown: Product name (noun first) including type designation, nominal size (number, fraction or decimal equivalent), length (fraction or decimal equivalent), material, including specification or heat treatment where necessary, protective finish, if required.

Examples: Pin, Type A Grooved, $\frac{3}{32} \times \frac{3}{4}$, Steel, Zinc Plated

Pin, Type F Grooved, 0.250×1.500 , Corrosion Resistant Steel

American National Standard Grooved T-Head Cotter Pins and Round Head Grooved Drive Studs.—The cotter pins have a T-head and the studs a round head. Both pins and studs have three equally spaced longitudinal grooves and an expanded diameter over the crests of the raised ridges formed by the material displaced when the grooves are formed.

Standard Sizes and Lengths: The standard sizes and range of standard lengths are given in [Tables 8](#) and [9](#).

Material: Unless otherwise specified these pins are made from low carbon steel. Where so indicated by the purchaser they may be made from corrosion resistant steel, brass or other non-ferrous alloys.

Hole Sizes: To obtain optimum product retention under average conditions, it is recommended that holes for the installation of grooved T-head cotter pins and grooved drive studs be held as close as possible to the limits tabulated. The minimum limits given correspond to the drill size, which is equivalent to the basic shank diameter. The maximum limits shown are generally suitable for length-diameter ratios of not less than 4 to 1 and not greater than 10 to 1. For smaller length-to-diameter ratios, the holes should be held closer to minimum limits where retention is critical. Conversely, for larger length-to-diameter ratios or where retention requirements are not essential, it may be desirable to increase the hole diameter beyond the maximum limits shown.

Designation: Grooved T-head cotter pins and round head grooved drive studs are designated by the following data, in the order shown: Product name (noun first), nominal size (number, fraction or decimal equivalent), length (fraction or decimal equivalent), material including specification or heat treatment where necessary, and protective finish, if required.

Examples: Pin, Grooved T-Head Cotter, $\frac{1}{4} \times 1\frac{1}{4}$, Steel, Zinc Plated

Drive Stud, Round Head Grooved, No. 10 $\times \frac{1}{2}$, Corrosion Resistant Steel

Table 7. American National Standard Grooved Pins ANSI/ASME B18.8.2-1995

Nominal Size or Basic Pin Diameter	Pin Diameter, ^a A		Pilot Length, C	Chamfer Length, ^b D	Crown Height, ^b E		Crown Radius, ^b F		Neck Width, G		Shoulder Length, H		Neck Radius, J	Neck Diameter, K		Range of Standard Lengths ^c	
	Max	Min	Ref	Min	Max	Min	Max	Min	Max	Min	Max	Min	Ref	Max	Min		
1/32 ^d	0.0312	0.0312	0.0302	0.015	1/8-1/2	
3/64 ^d	0.0469	0.0469	0.0459	0.031	1/8-3/8	
1/16	0.0625	0.0625	0.0615	0.031	0.016	0.0115	0.0015	0.088	0.068	1/8-1	
5/64 ^d	0.0781	0.0781	0.0771	0.031	0.016	0.0137	0.0037	0.104	0.084	1/4-1	
3/32	0.0938	0.0938	0.0928	0.031	0.016	0.0141	0.0041	0.135	0.115	0.038	0.028	0.041	0.031	0.016	0.067	0.057	1/4-1 1/4
7/64 ^d	0.1094	0.1094	0.1074	0.031	0.016	0.0160	0.0060	0.150	0.130	0.038	0.028	0.041	0.031	0.016	0.082	0.072	1/4-1 1/4
1/8	0.1250	0.1250	0.1230	0.031	0.016	0.0180	0.0080	0.166	0.146	0.069	0.059	0.041	0.031	0.031	0.088	0.078	1/4-1 1/2
5/32	0.1563	0.1563	0.1543	0.062	0.031	0.0220	0.0120	0.198	0.178	0.069	0.059	0.057	0.047	0.031	0.109	0.099	3/8-2
3/16	0.1875	0.1875	0.1855	0.062	0.031	0.0230	0.0130	0.260	0.240	0.069	0.059	0.057	0.047	0.031	0.130	0.120	3/8-2 1/4
1/2	0.2188	0.2188	0.2168	0.062	0.031	0.0270	0.0170	0.291	0.271	0.101	0.091	0.072	0.062	0.047	0.151	0.141	1/2-3
3/32	0.2500	0.2500	0.2480	0.062	0.031	0.0310	0.0210	0.322	0.302	0.101	0.091	0.072	0.062	0.047	0.172	0.162	1/2-3 1/4
1/4	0.3125	0.3125	0.3105	0.094	0.047	0.0390	0.0290	0.385	0.365	0.132	0.122	0.104	0.094	0.062	0.214	0.204	3/8-3 1/2
3/8	0.3750	0.3750	0.3730	0.094	0.047	0.0440	0.0340	0.479	0.459	0.132	0.122	0.135	0.125	0.062	0.255	0.245	3/4-4 1/4
7/16	0.4375	0.4375	0.4355	0.094	0.047	0.0520	0.0420	0.541	0.521	0.195	0.185	0.135	0.125	0.094	0.298	0.288	7/8-4 1/2
1/2	0.5000	0.5000	0.4980	0.094	0.047	0.0570	0.0470	0.635	0.615	0.195	0.185	0.135	0.125	0.094	0.317	0.307	1-4 1/2

^a For expanded diameters, B, see ANSI/ASME B18.8.2-1995.

^b Pins in 1/32- and 3/64-inch sizes of any length and all sizes of 1/4-inch nominal length or shorter are not crowned or chamfered.

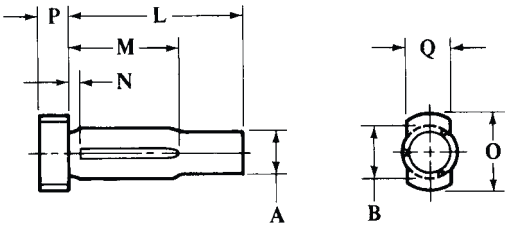
^c Standard lengths increase in 1/8-inch steps from 1/8 to 1 inch, and in 1/4-inch steps above 1 inch. Standard lengths for the 1/32-, 3/64-, 1/16-, and 5/64-inch sizes and the 1/4-inch length for the 3/32-, 7/64-, and 1/8-inch sizes do not apply to Type G grooved pins.

^d Non-stock items, not recommended for new designs.

Pin Material	Nominal Pin Size															
	1/32	3/64	1/16	5/64	3/32	7/64	1/8	5/32	3/16	7/32	1/4	5/16	3/8	7/16	1/2	
Steels	Double Shear Load, Min, lb															
Low Carbon	100	220	410	620	890	1,220	1,600	2,300	3,310	4,510	5,880	7,660	11,000	15,000	19,600	
Alloy (R _c 40 - 48 hardness)	180	400	720	1,120	1,600	2,180	2,820	4,520	6,440	8,770	11,500	17,900	26,000	35,200	46,000	
Corrosion Resistant	140	300	540	860	1,240	1,680	2,200	3,310	4,760	6,480	8,460	12,700	18,200	24,800	32,400	
Brass	60	140	250	390	560	760	990	1,540	2,220	3,020	3,950	6,170	9,050	12,100	15,800	
Recommended Hole Sizes for Unplated Pins (The minimum drill size is the same as the pin size. See also text on page 1757.)																
Maximum Diameter	0.0324	0.0482	0.0640	0.0798	0.0956	0.1113	0.1271	0.1587	0.1903	0.2219	0.2534	0.3166	0.3797	0.4428	0.5060	
Minimum Diameter	0.0312	0.0469	0.0625	0.0781	0.0938	0.1094	0.1250	0.1563	0.1875	0.2188	0.2500	0.3125	0.3750	0.4375	0.5000	

All dimensions are in inches.

**Table 8. American National Standard Grooved T-Head Cotter Pins
ANSI/ASME B18.8.2-1995**



Nominal Size ^a or Basic Shank Dia.	Shank Diameter, <i>A</i>		Length, <i>N</i>	Head Dia., <i>O</i>			Head Height, <i>P</i>		Head Width, <i>Q</i>		Range of Standard Lengths, ^b <i>L</i>	Recommended Hole Size	
	Max	Min	Max	Max	Min	Max	Min	Max	Min	Max		Min	
$\frac{5}{32}$	0.156	0.154	0.150	0.08	0.26	0.24	0.11	0.09	0.18	0.15	$\frac{3}{4}$ - $1\frac{1}{8}$	0.161	0.156
$\frac{3}{16}$	0.187	0.186	0.182	0.09	0.30	0.28	0.13	0.11	0.22	0.18	$\frac{3}{4}$ - $1\frac{1}{4}$	0.193	0.187
$\frac{1}{4}$	0.250	0.248	0.244	0.12	0.40	0.38	0.17	0.15	0.28	0.24	1- $1\frac{1}{2}$	0.257	0.250
$\frac{5}{16}$	0.312	0.310	0.305	0.16	0.51	0.48	0.21	0.19	0.34	0.30	$1\frac{1}{8}$ -2	0.319	0.312
$\frac{3}{8}$	0.359	0.358	0.353	0.18	0.57	0.54	0.24	0.22	0.38	0.35	$1\frac{1}{4}$ -2	0.366	0.359
$\frac{1}{2}$	0.500	0.498	0.493	0.25	0.79	0.76	0.32	0.30	0.54	0.49	2-3	0.508	0.500

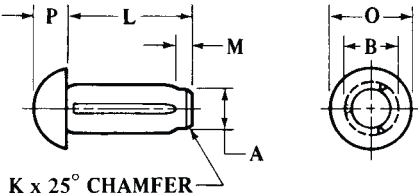
^a When specifying nominal size in decimals, zeros preceding decimal point and in the fourth decimal place are omitted.

^b Lengths increase in $\frac{1}{8}$ -inch steps from $\frac{3}{4}$ to $1\frac{1}{4}$ inch and in $\frac{1}{4}$ -inch steps above $1\frac{1}{4}$ inches. For groove length, *M*, dimensions see ANSI/ASME B18.8.2-1995.

All dimensions are in inches.

For expanded diameter, *B*, dimensions, see ANSI/ASME B18.8.2-1995.

**Table 9. American National Standard Round Head Grooved Drive Studs
ANSI/ASME B18.8.2-1995**



Stud Size Number and Basic Shank Diameter ^a	Shank Diameter, <i>A</i>		Head Diameter, <i>O</i>		Head Height, <i>P</i>		Range of Standard Lengths, ^b <i>L</i>	Recommended Hole Size		Drill Size	
	Max	Min	Max	Min	Max	Min		Max	Min		
0	0.067	0.067	0.065	0.130	0.120	0.050	0.040	$\frac{1}{8}$ - $\frac{1}{4}$	0.0686	0.0670	51
2	0.086	0.086	0.084	0.162	0.146	0.070	0.059	$\frac{1}{8}$ - $\frac{1}{4}$	0.0877	0.0860	44
4	0.104	0.104	0.102	0.211	0.193	0.086	0.075	$\frac{3}{16}$ - $\frac{5}{16}$	0.1059	0.1040	37
6	0.120	0.120	0.118	0.260	0.240	0.103	0.091	$\frac{1}{4}$ - $\frac{3}{8}$	0.1220	0.1200	31
7	0.136	0.136	0.134	0.309	0.287	0.119	0.107	$\frac{5}{16}$ - $\frac{1}{2}$	0.1382	0.1360	29
8	0.144	0.144	0.142	0.309	0.287	0.119	0.107	$\frac{3}{8}$ - $\frac{5}{8}$	0.1463	0.1440	27
10	0.161	0.161	0.159	0.359	0.334	0.136	0.124	$\frac{3}{8}$ - $\frac{5}{8}$	0.1636	0.1610	20
12	0.196	0.196	0.194	0.408	0.382	0.152	0.140	$\frac{1}{2}$ - $\frac{3}{4}$	0.1990	0.1960	9
14	0.221	0.221	0.219	0.457	0.429	0.169	0.156	$\frac{1}{2}$ - $\frac{3}{4}$	0.2240	0.2210	2
16	0.250	0.250	0.248	0.472	0.443	0.174	0.161	$\frac{1}{2}$	0.2534	0.2500	$\frac{1}{4}$

^a Where specifying nominal size in decimals, zeros preceding decimal point and in the fourth decimal place are omitted.

^b Lengths increase in $\frac{1}{16}$ -inch steps from $\frac{1}{8}$ to $\frac{3}{8}$ inch and in $\frac{1}{8}$ -inch steps above $\frac{3}{8}$ inch.

All dimensions are in inches.

For pilot length, *M*, and expanded diameter, *B*, dimensions see ANSI/ASME B18.8.2-1995.

Table 10. American National Standard Slotted Type Spring Pins
ANSI/ASME B18.8.2-1995

Nominal Size ^a or Basic Pin Diameter	Average Pin Diameter, A		Chamfer Dia., B	Chamfer Length, C		Stock Thickness, F	Recommended Hole Size		Material			Range of Practical Lengths ^b	
	Max	Min		Max	Min		Basic	Max	Min	SAE 1070 - 1095 and SAE 51420	SAE 30302 and 30304		Beryllium Copper
1/16	0.062	0.069	0.066	0.059	0.028	0.007	0.012	0.065	0.062	430	250	270	3/16-1
5/64	0.078	0.086	0.083	0.075	0.032	0.008	0.018	0.081	0.078	800	460	500	3/16-1 1/2
3/32	0.094	0.103	0.099	0.091	0.038	0.008	0.022	0.097	0.094	1,150	670	710	3/16-1 1/2
1/8	0.125	0.135	0.131	0.122	0.044	0.008	0.028	0.129	0.125	1,875	1,090	1,170	5/16-2
9/64	0.141	0.149	0.145	0.137	0.044	0.008	0.028	0.144	0.140	2,175	1,260	1,350	3/8-2
5/32	0.156	0.167	0.162	0.151	0.048	0.010	0.032	0.160	0.156	2,750	1,600	1,725	7/16-2 1/2
3/16	0.188	0.199	0.194	0.182	0.055	0.011	0.040	0.192	0.187	4,150	2,425	2,600	1/2-2 1/2
7/32	0.219	0.232	0.226	0.214	0.065	0.011	0.048	0.224	0.219	5,850	3,400	3,650	1/2-3
1/4	0.250	0.264	0.258	0.245	0.065	0.012	0.048	0.256	0.250	7,050	4,100	4,400	1/2-3 1/2
5/16	0.312	0.330	0.321	0.306	0.080	0.014	0.062	0.318	0.312	10,800	6,300	6,750	3/4-4
3/8	0.375	0.395	0.385	0.368	0.095	0.016	0.077	0.382	0.375	16,300	9,500	10,200	3/4, 7/8, 1, 1 1/4, 1 1/2, 1 3/4, 2-4
7/16	0.438	0.459	0.448	0.430	0.095	0.017	0.077	0.445	0.437	19,800	11,500	12,300	1, 1 1/4, 1 1/2, 1 3/4, 2-4
1/2	0.500	0.524	0.513	0.485	0.110	0.025	0.094	0.510	0.500	27,100	15,800	17,000	1 1/4, 1 1/2, 1 3/4, 2-4
5/8	0.625	0.653	0.640	0.608	0.125	0.030	0.125	0.636	0.625	46,000	18,800	...	2-6
3/4	0.750	0.784	0.769	0.730	0.150	0.030	0.150	0.764	0.750	66,000	23,200	...	2-6

^a Where specifying nominal size in decimals, zeros preceding decimal point are omitted.

^b Length increments are 1/16 inch from 1/8 to 1 inch; 1/8 inch from 1 inch to 2 inches; and 1/4 inch from 2 inches to 6 inches.

All dimensions are in inches.

American National Standard Spring Pins.—These pins are made in two types: one type has a slot throughout its length; the other is shaped into a coil.

Preferred Lengths and Sizes: The preferred lengths and sizes in which these pins are normally available are given in **Tables 10** and **11**.

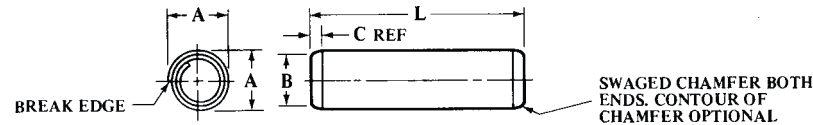
Materials: Spring pins are normally made from SAE 1070-1095 carbon steel, SAE 6150H alloy steel, SAE types 51410 through 51420, 30302 and 30304 corrosion resistant steels, and beryllium copper alloy, heat treated or cold worked to attain the hardness and performance characteristics set forth in ANSI/ASME B18.8.2-1995.

Designation: Spring pins are designated by the following data in the sequence shown:

Examples: Pin, Coiled Spring, 1/4 × 1 1/4, Standard Duty, Steel, Zinc Plated

Pin, Slotted Spring, 1/2 × 3, Steel, Phosphate Coated

Table 11. American National Standard Coiled Type Spring Pins ANSI/ASME B18.8.2-1995



Nominal Size or Basic Pin Diameter	Pin Diameter, A						Chamfer		Pin Diameter, A				SAE Material Number					
	Standard Duty		Heavy Duty		Light Duty		Dia., B	Length, C	Recommended Hole Size		1070-1095 and 51420	30302 and 30304	1070-1095 and 51420	30302 and 30304	1070-1095 and 51420	30302 and 30304		
	Max	Min	Max	Min	Max	Min			Max	Min	Double Shear Load, Min, lb			Standard Duty		Heavy Duty		Light Duty
1/32	0.031	0.035	0.033	0.029	0.024	0.032	0.031	90 ^a	65	
	0.039	0.044	0.041	0.037	0.024	0.040	0.039	135 ^a	100	
3/64	0.047	0.052	0.049	0.045	0.024	0.048	0.046	190 ^a	145	
	0.052	0.057	0.054	0.050	0.024	0.053	0.051	250 ^a	190	
1/16	0.062	0.072	0.067	0.070	0.066	0.073	0.067	0.059	0.028	0.065	0.061	330	265	475	360	205	160	
5/64	0.078	0.088	0.083	0.086	0.082	0.089	0.083	0.075	0.032	0.081	0.077	550	425	800	575	325	250	
3/32	0.094	0.105	0.099	0.103	0.098	0.106	0.099	0.091	0.038	0.097	0.093	775	600	1,150	825	475	360	
7/64	0.109	0.120	0.114	0.118	0.113	0.121	0.114	0.106	0.038	0.112	0.108	1,050	825	1,500	1,150	650	500	
1/8	0.125	0.138	0.131	0.136	0.130	0.139	0.131	0.121	0.044	0.129	0.124	1,400	1,100	2,000	1,700	825	650	
5/32	0.156	0.171	0.163	0.168	0.161	0.172	0.163	0.152	0.048	0.160	0.155	2,200	1,700	3,100	2,400	1,300	1,000	
3/16	0.188	0.205	0.196	0.202	0.194	0.207	0.196	0.182	0.055	0.192	0.185	3,150	2,400	4,500	3,500	1,900	1,450	
7/32	0.219	0.238	0.228	0.235	0.226	0.240	0.228	0.214	0.065	0.224	0.217	4,200	3,300	5,900	4,600	2,600	2,000	
1/4	0.250	0.271	0.260	0.268	0.258	0.273	0.260	0.243	0.065	0.256	0.247	5,500	4,300	7,800	6,200	3,300	2,600	
5/16	0.312	0.337	0.324	0.334	0.322	0.339	0.324	0.304	0.080	0.319	0.308	8,700	6,700	12,000	9,300	5,200	4,000	
3/8	0.375	0.403	0.388	0.400	0.386	0.405	0.388	0.366	0.095	0.383	0.370	12,600	9,600	18,000	14,000	
7/16	0.438	0.469	0.452	0.466	0.450	0.471	0.452	0.427	0.095	0.446	0.431	17,000	13,300	23,500	18,000	
1/2	0.500	0.535	0.516	0.532	0.514	0.537	0.516	0.488	0.110	0.510	0.493	22,500	17,500	32,000	25,000	
5/8	0.625	0.661	0.642	0.658	0.640	0.613	0.125	0.635	0.618	35,000 ^b	...	48,000 ^b	
3/4	0.750	0.787	0.768	0.784	0.766	0.738	0.150	0.760	0.743	50,000 ^b	...	70,000 ^b	

^a Sizes 1/32 inch through 0.052 inch are not available in SAE 1070-1095 carbon steel.

^b Sizes 3/8 inch and larger are produced from SAE 6150H alloy steel, not SAE 1070-1095 carbon steel. Practical lengths, L, for sizes 1/32 through 0.052 inch are 1/8 through 5/8 inch and for the 1/64-inch size, 1/4 through 1 3/4 inches. For lengths of other sizes see Table 10.

All dimensions are in inches.

RETAINING RINGS

Retaining Rings.—The purpose of a retaining ring is to act as an artificial shoulder that will retain an object in a housing (internal ring), as shown in Fig. 1, or on a shaft (external ring). Two types of retaining ring are common, the stamped ring and the spiral-wound ring. The stamped type of retaining ring, or snap ring, is stamped from tempered sheet metal and has a nonuniform cross-section. The typical spiral-wound retaining ring has a uniform cross-section and is made up of two or more turns of coiled, spring-tempered steel, although one-turn spiral-wound rings are common. Spiral-wound retaining rings provide a continuous gapless shoulder to a housing or shaft. Most stamped rings can only be installed at or near the end of a shaft or housing. The spiral-wound design generally requires installation from the end of a shaft or housing. Both types, stamped and spiral, are usually installed into grooves on the shaft or housing.

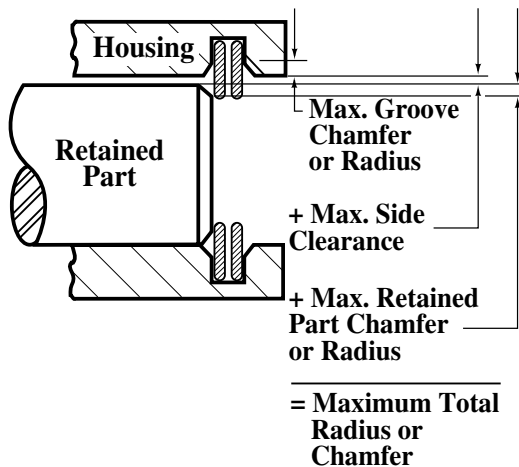


Fig. 1. Typical Retaining Ring Installation Showing Maximum Total Radius or Chamfer (Courtesy Spirolox Retaining Rings)

In the section that follows, Tables 1 through 6 give dimensions and data on general-purpose tapered and reduced cross-section metric retaining rings (stamped type) covered by ANSI B27.7-1977, R2010. Tables 1 and 4 cover Type 3AM1 tapered external retaining rings, Tables 2 and 5 cover Type 3BM1 tapered internal rings, and Tables 3 and 6 cover Type 3CM1 reduced cross-section external rings. Tables 7 through 10 cover inch sizes of internal and external spiral retaining rings corresponding to MIL-R-27426 Types A (external) and B (internal), Class 1 (medium duty) and Class 2 (heavy duty). Tables 11 through 17 cover stamped retaining rings in inch sizes.

Table 1. American National Standard Metric Tapered Retaining Rings — Basic External Series — 3AM1 ANSI B27.7-1977, R2010

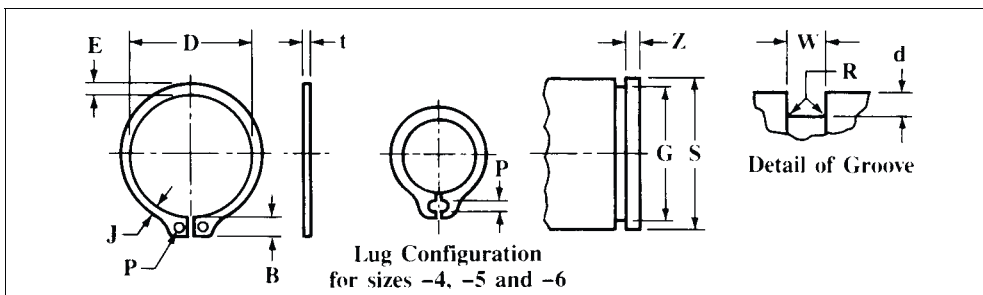


Table 1. (Continued) American National Standard Metric Tapered Retaining Rings — Basic External Series — 3AM1 ANSI B27.7-1977, R2010

Shaft Dia.	Ring		Groove				Shaft Diam	Ring		Groove			
	Free Dia.	Thickness	Dia.	Width	Depth	Edge Margin		Free Dia.	Thickness	Dia.	Width	Depth	Edge Margin
<i>S</i>	<i>D</i>	<i>t</i>	<i>G</i>	<i>W</i>	<i>d</i> ref	<i>Z</i> min	<i>S</i>	<i>D</i>	<i>t</i>	<i>G</i>	<i>W</i>	<i>d</i> ref	<i>Z</i> min
4	3.60	0.25	3.80	0.32	0.1	0.3	36	33.25	1.3	33.85	1.4	1.06	3.2
5	4.55	0.4	4.75	0.5	0.13	0.4	38	35.20	1.3	35.8	1.4	1.10	3.3
6	5.45	0.4	5.70	0.5	0.15	0.5	40	36.75	1.6	37.7	1.75	1.15	3.4
7	6.35	0.6	6.60	0.7	0.20	0.6	42	38.80	1.6	39.6	1.75	1.20	3.6
8	7.15	0.6	7.50	0.7	0.25	0.8	43	39.65	1.6	40.5	1.75	1.25	3.8
9	8.15	0.6	8.45	0.7	0.28	0.8	45	41.60	1.6	42.4	1.75	1.30	3.9
10	9.00	0.6	9.40	0.7	0.30	0.9	46	42.55	1.6	43.3	1.75	1.35	4.0
11	10.00	0.6	10.35	0.7	0.33	1.0	48	44.40	1.6	45.2	1.75	1.40	4.2
12	10.85	0.6	11.35	0.7	0.33	1.0	50	46.20	1.6	47.2	1.75	1.40	4.2
13	11.90	0.9	12.30	1.0	0.35	1.0	52	48.40	2.0	49.1	2.15	1.45	4.3
14	12.90	0.9	13.25	1.0	0.38	1.2	54	49.9	2.0	51.0	2.15	1.50	4.5
15	13.80	0.9	14.15	1.0	0.43	1.3	55	50.6	2.0	51.8	2.15	1.60	4.8
16	14.70	0.9	15.10	1.0	0.45	1.4	57	52.9	2.0	53.8	2.15	1.60	4.8
17	15.75	0.9	16.10	1.0	0.45	1.4	58	53.6	2.0	54.7	2.15	1.65	4.9
18	16.65	1.1	17.00	1.2	0.50	1.5	60	55.8	2.0	56.7	2.15	1.65	4.9
19	17.60	1.1	17.95	1.2	0.53	1.6	62	57.3	2.0	58.6	2.15	1.70	5.1
20	18.35	1.1	18.85	1.2	0.58	1.7	65	60.4	2.0	61.6	2.15	1.70	5.1
21	19.40	1.1	19.80	1.2	0.60	1.8	68	63.1	2.0	64.5	2.15	1.75	5.3
22	20.30	1.1	20.70	1.2	0.65	1.9	70	64.6	2.4	66.4	2.55	1.80	5.4
23	21.25	1.1	21.65	1.2	0.67	2.0	72	66.6	2.4	68.3	2.55	1.85	5.5
24	22.20	1.1	22.60	1.2	0.70	2.1	75	69.0	2.4	71.2	2.55	1.90	5.7
25	23.10	1.1	23.50	1.2	0.75	2.3	78	72.0	2.4	74.0	2.55	2.00	6.0
26	24.05	1.1	24.50	1.2	0.75	2.3	80	74.2	2.4	75.9	2.55	2.05	6.1
27	24.95	1.3	25.45	1.4	0.78	2.3	82	76.4	2.4	77.8	2.55	2.10	6.3
28	25.80	1.3	26.40	1.4	0.80	2.4	85	78.6	2.4	80.6	2.55	2.20	6.6
30	27.90	1.3	28.35	1.4	0.83	2.5	88	81.4	2.8	83.5	2.95	2.25	6.7
32	29.60	1.3	30.20	1.4	0.90	2.7	90	83.2	2.8	85.4	2.95	2.30	6.9
34	31.40	1.3	32.00	1.4	1.00	3.0	95	88.1	2.8	90.2	2.95	2.40	7.2
35	32.30	1.3	32.90	1.4	1.05	3.1	100	92.5	2.8	95.0	2.95	2.50	7.5

All dimensions are in millimeters. Sizes -4, -5, and -6 are available in beryllium copper only.

These rings are designated by series symbol and shaft diameter, thus: for a 4 mm diameter shaft, 3AM1-4; for a 20 mm diameter shaft, 3AM1-20; etc.

Ring Free Diameter Tolerances: For ring sizes -4 through -6, +0.05, -0.10 mm; for sizes -7 through -12, +0.05, -0.15 mm; for sizes -13 through -26, +0.15, -0.25 mm; for sizes -27 through -38, +0.25, -0.40 mm; for sizes -40 through -50, +0.35, -0.50 mm; for sizes -52 through -62, +0.35, -0.65 mm; and for sizes -65 through -100, +0.50, -0.75 mm.

Groove Diameter Tolerances: For ring sizes -4 through -6, -0.08 mm; for sizes -7 through -10, -0.10 mm; for sizes -11 through -15, -0.12 mm; for sizes -16 through -26, -0.15 mm; for sizes -27 through -36, -0.20 mm; for sizes -38 through -55, -0.30 mm; and for sizes -57 through -100, -0.40 mm.

Groove Diameter F.I.M. (full indicator movement) or maximum allowable deviation of concentricity between groove and shaft: For ring sizes -4 through -6, 0.03 mm; for ring sizes -7 through -12, 0.05 mm; for sizes -13 through -28, 0.10 mm; for sizes -30 through -55, 0.15 mm; and for sizes -57 through -100, 0.20 mm.

Groove Width Tolerances: For ring size -4, +0.05 mm; for sizes -5 and -6, +0.10 mm, for sizes -7 through -38, +0.15 mm; and for sizes -40 through -100, +0.20 mm.

Groove Maximum Bottom Radii, R: For ring sizes -4 through -6, none; for sizes -7 through -18, 0.1 mm; for sizes -19 through -30, 0.2 mm; for sizes -32 through -50, 0.3 mm; and for sizes -52 through -100, 0.4 mm. For manufacturing details not shown, including materials, see ANSI B27.7-1977, R2010.

Table 2. American National Standard Metric Tapered Retaining Rings — Basic Internal Series — 3BM1 ANSI B27.7-1977, R2010

Shaft Dia.	Ring		Groove				Shaft Dia.	Ring		Groove			
	Free Dia.	Thickness	Dia.	Width	Depth	Edge Margin		Free Dia.	Thickness	Dia.	Width	Depth	Edge Margin
S	D	t	G	W	d ref	Z min	S	D	t	G	W	d ref	Z min
8	8.80	0.4	8.40	0.5	0.2	0.6	65	72.2	2.4	69.0	2.55	2.00	6.0
9	10.00	0.6	9.45	0.7	0.23	0.7	68	75.7	2.4	72.2	2.55	2.10	6.3
10	11.10	0.6	10.50	0.7	0.25	0.8	70	77.5	2.4	74.4	2.55	2.20	6.6
11	12.20	0.6	11.60	0.7	0.3	0.9	72	79.6	2.4	76.5	2.55	2.25	6.7
12	13.30	0.6	12.65	0.7	0.33	1.0	75	83.3	2.4	79.7	2.55	2.35	7.1
13	14.25	0.9	13.70	1.0	0.35	1.1	78	86.8	2.8	82.8	2.95	2.40	7.2
14	15.45	0.9	14.80	1.0	0.40	1.2	80	89.1	2.8	85.0	2.95	2.50	7.5
15	16.60	0.9	15.85	1.0	0.43	1.3	82	91.1	2.8	87.2	2.95	2.60	7.8
16	17.70	0.9	16.90	1.0	0.45	1.4	85	94.4	2.8	90.4	2.95	2.70	8.1
17	18.90	0.9	18.00	1.0	0.50	1.5	88	97.9	2.8	93.6	2.95	2.80	8.4
18	20.05	0.9	19.05	1.0	0.53	1.6	90	100.0	2.80	95.7	2.95	2.85	8.6
19	21.10	0.9	20.10	1.0	0.55	1.7	92	102.2	2.8	97.8	2.95	2.90	8.7
20	22.25	0.9	21.15	1.0	0.57	1.7	95	105.6	2.8	101.0	2.95	3.00	9.0
21	23.30	0.9	22.20	1.0	0.60	1.8	98	109.0	2.8	104.2	2.95	3.10	9.3
22	24.40	1.1	23.30	1.2	0.65	1.9	100	110.7	2.8	106.3	2.95	3.15	9.5
23	25.45	1.1	24.35	1.2	0.67	2.0	102	112.4	2.8	108.4	2.95	3.20	9.6
24	26.55	1.1	25.4	1.2	0.70	2.1	105	115.8	2.8	111.5	2.95	3.25	9.8
25	27.75	1.1	26.6	1.2	0.80	2.4	108	119.2	2.8	114.6	2.95	3.30	9.9
26	28.85	1.1	27.7	1.2	0.85	2.6	110	120.8	2.8	116.7	2.95	3.35	10.1
27	29.95	1.3	28.8	1.4	0.90	2.7	115	126.0	2.8	121.9	2.95	3.45	10.4
28	31.10	1.3	29.8	1.4	0.90	2.7	120	132.4	2.8	127.0	2.95	3.50	10.5
30	33.40	1.3	31.9	1.4	0.95	2.9	125	137.1	2.8	132.1	2.95	3.55	10.7
32	35.35	1.3	33.9	1.4	0.95	2.9	130	142.5	2.8	137.2	2.95	3.60	10.8
34	37.75	1.3	36.1	1.4	1.05	3.2	135	148.5	3.2	142.3	3.40	3.65	11.0
35	38.75	1.3	37.2	1.4	1.10	3.3	140	154.1	3.2	147.4	3.40	3.70	11.1
36	40.00	1.3	38.3	1.4	1.15	3.5	145	159.5	3.2	152.5	3.40	3.75	11.3
37	41.05	1.3	39.3	1.4	1.15	3.5	150	164.5	3.2	157.6	3.40	3.80	11.4
38	42.15	1.3	40.4	1.4	1.20	3.6	155	168.8	3.2	162.7	3.40	3.85	11.6
40	44.25	1.6	42.4	1.75	1.20	3.6	160	175.1	4.0	167.8	4.25	3.90	11.7
42	46.60	1.6	44.5	1.75	1.25	3.7	165	180.3	4.0	172.9	4.25	3.95	11.9
45	49.95	1.6	47.6	1.75	1.30	3.9	170	185.6	4.0	178.0	4.25	4.00	12.0
46	51.05	1.6	48.7	1.75	1.35	4.0	175	191.3	4.0	183.2	4.25	4.10	12.3
47	52.15	1.6	49.8	1.75	1.40	4.2	180	196.6	4.0	188.4	4.25	4.20	12.6
48	53.30	1.6	50.9	1.75	1.45	4.3	185	202.7	4.8	193.6	5.10	4.30	12.9
50	55.35	1.6	53.1	1.75	1.55	4.6	190	207.7	4.8	198.8	5.10	4.40	13.2
52	57.90	2.0	55.3	2.15	1.65	5.0	200	217.8	4.8	209.0	5.10	4.50	13.5
55	61.10	2.0	58.4	2.15	1.70	5.1	210	230.3	4.8	219.4	5.10	4.70	14.1
57	63.25	2.0	60.5	2.15	1.75	5.3	220	240.5	4.8	230.0	5.10	5.00	15.0
58	64.4	2.0	61.6	2.15	1.80	5.4	230	251.4	4.8	240.6	5.10	5.30	15.9
60	66.8	2.0	63.8	2.15	1.90	5.7	240	262.3	4.8	251.0	5.10	5.50	16.5
62	68.6	2.0	65.8	2.15	1.90	5.7	250	273.3	4.8	261.4	5.10	5.70	17.1
63	69.9	2.0	66.9	2.15	1.95	5.9

All dimensions are in millimeters.

These rings are designated by series symbol and shaft diameter, thus: for a 9 mm diameter shaft, 3BM1-9; for a 22 mm diameter shaft, 3BM1-22; etc.

Ring Free Diameter Tolerances: For ring sizes -8 through -20, +0.25, -0.13 mm; for sizes -21 through -26, +0.40, -0.25 mm; for sizes -27 through -38, +0.65, -0.50 mm; for sizes -40 through -50, +0.90, -0.65 mm; for sizes -52 through -75, +1.00, -0.75 mm; for sizes -78 through -92, +1.40,

-1.40 mm; for sizes -95 through -155, +1.65, -1.65 mm; for sizes -160 through -180, +2.05, -2.05 mm; and for sizes -185 through -250, +2.30, -2.30 mm.

Groove Diameter Tolerances: For ring sizes -8 and -9, +0.06 mm; for sizes -10 through -18, +0.10 mm; for sizes -19 through -28, +0.15 mm; for sizes -30 through -50, +0.20 mm; for sizes -52 through -98, +0.30; for sizes -100 through -160, +0.40 mm; and for sizes -165 through -250, +0.50 mm.

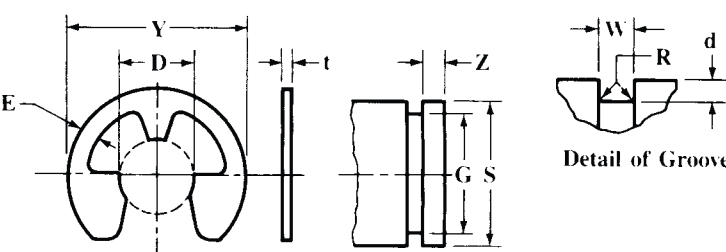
Groove Diameter F.I.M. (full indicator movement) or maximum allowable deviation of concentricity between groove and shaft: For ring sizes -8 through -10, 0.03 mm; for sizes -11 through -15, 0.05 mm; for sizes -16 through -25, 0.10 mm; for sizes -26 through -45, 0.15 mm; for sizes -46 through -80, 0.20 mm; for sizes -82 through -150, 0.25 mm; and for sizes -155 through -250, 0.30 mm.

Groove Width Tolerances: For ring size -8, +0.10 mm; for sizes -9 through -38, +0.15 mm; for sizes -40 through -130, +0.20 mm; and for sizes -135 through -250, +0.25 mm.

Groove Maximum Bottom Radii: For ring sizes -8 through -17, 0.1 mm; for sizes -18 through -30, 0.2 mm; for sizes -32 through -55, 0.3 mm; and for sizes -56 through -250, 0.4 mm.

For manufacturing details not shown, including materials, see ANSI B27.7-1977, R2010.

Table 3. American National Standard Metric Reduced Cross Section Retaining Rings — E Ring External Series — 3CM1 ANSI B27.7-1977, R2010



Shaft Dia. <i>S</i>	Ring			Groove				Shaft Dia. <i>S</i>	Ring			Groove			
	Free Dia.	Thickness	Outer Dia.	Dia.	Width	Depth	Edge Margin		Free Dia.	Thickness	Outer Dia.	Dia.	Width	Depth	Edge Margin
	<i>D</i>	<i>t</i>	<i>Y</i> nom	<i>G</i>	<i>W</i>	<i>d</i> ref	<i>Z</i> min		<i>D</i>	<i>t</i>	<i>Y</i> nom	<i>G</i>	<i>W</i>	<i>d</i> ref	<i>Z</i> min
1	0.64	0.25	2.0	0.72	0.32	0.14	0.3	11	8.55	0.9	17.4	8.90	1.0	1.05	2.1
2	1.30	0.25	4.0	1.45	0.32	0.28	0.6	12	9.20	1.1	18.6	9.60	1.2	1.20	2.4
3	2.10	0.4	5.6	2.30	0.5	0.35	0.7	13	9.95	1.1	20.3	10.30	1.2	1.35	2.7
4	2.90	0.6	7.2	3.10	0.7	0.45	0.9	15	11.40	1.1	22.8	11.80	1.2	1.60	3.2
5	3.70	0.6	8.5	3.90	0.7	0.55	1.1	16	12.15	1.1	23.8	12.50	1.2	1.75	3.5
6	4.70	0.6	11.1	4.85	0.7	0.58	1.2	18	13.90	1.3	27.2	14.30	1.4	1.85	3.7
7	5.25	0.6	13.4	5.55	0.7	0.73	1.5	20	15.60	1.3	30.0	16.00	1.4	2.00	4.0
8	6.15	0.6	14.6	6.40	0.7	0.80	1.6	22	17.00	1.3	33.0	17.40	1.4	2.30	4.6
9	6.80	0.9	15.8	7.20	1.0	0.90	1.8	25	19.50	1.3	37.1	20.00	1.4	2.50	5.0
10	7.60	0.9	16.8	8.00	1.0	1.00	2.0

All dimensions are in millimeters. Size -1 is available in beryllium copper only.

These rings are designated by series symbol and shaft diameter, thus: for a 2 mm diameter shaft, 3CM1-2; for a 13 mm shaft, 3CMI -13; etc.

Ring Free Diameter Tolerances: For ring sizes -1 through -7, +0.03, -0.08 mm; for sizes -8 through -13, +0.05, -0.10 mm; and for sizes -15 through -25, +0.10, -0.15 mm.

Groove Diameter Tolerances: For ring sizes -1 and -2, -0.05 mm; for sizes -3 through -6, -0.08; for sizes -7 through -11, -0.10 mm; for sizes -12 through -18, -0.15 mm; and for sizes -20 through -25, -0.20 mm.

Groove Diameter F.I.M. (Full Indicator Movement) or maximum allowable deviation of concentricity between groove and shaft: For ring sizes -1 through -3, 0.04 mm; for -4 through -6, 0.05 mm; for -7 through -10, 0.08 mm; for -11 through -25, 0.10 mm.

Groove Width Tolerances: For ring sizes -1 and -2, +0.05 mm; for size -3, +0.10 mm; and for sizes -4 through -25, +0.15 mm.

Groove Maximum Bottom Radii: For ring sizes -1 and -2, 0.05 mm; for -3 through -7, 0.15 mm; for -8 through -13, 0.25 mm; and for -15 through -25, 0.4 mm.

For manufacturing details not shown, including materials, see ANSI B27.7-1977, R2010.

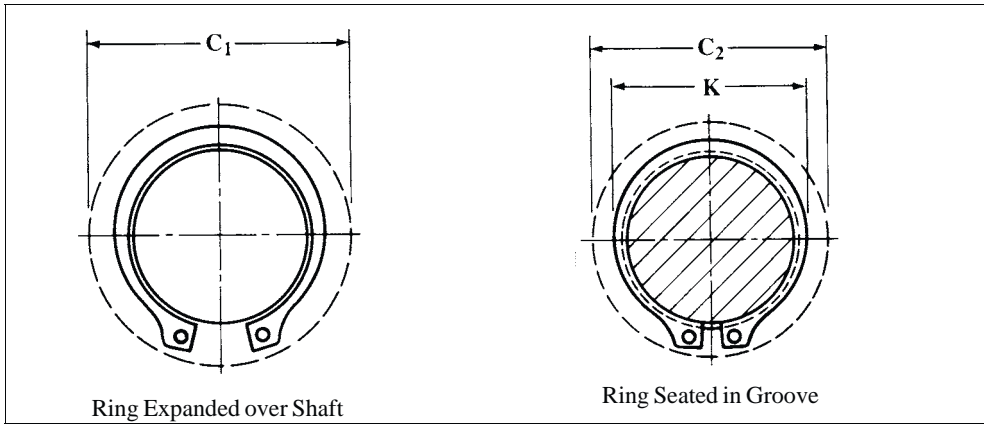


Table 4. American National Standard Metric Basic External Series 3AM1 Retaining Rings, Checking and Performance Data ANSI B27.7-1977, R2010

Ring Series and Size No.	Clearance Dia.		Gaging Diameter ^a	Allowable Thrust Loads Sharp Corner Abutment		Maximum Allowable Corner Radii and Chamfers		Allowable Assembly Speed ^b
	Ring Over Shaft	Ring in Groove		P_r^c	P_g^d	R max	Ch max	
3AM1	C_1	C_2	K max	P_r^c	P_g^d	R max	Ch max	...
No.	mm	mm	mm	kN	kN	mm	mm	rpm
-4 ^a	7.0	6.8	4.90	0.6	0.2	0.35	0.25	70 000
-5 ^a	8.2	7.9	5.85	1.1	0.3	0.35	0.25	70 000
-6 ^a	9.1	8.8	6.95	1.4	0.4	0.35	0.25	70 000
-7	12.3	11.8	8.05	2.6	0.7	0.45	0.3	60 000
-8	13.6	13.0	9.15	3.1	1.0	0.5	0.35	55 000
-9	14.5	13.8	10.35	3.5	1.2	0.6	0.35	48 000
-10	15.5	14.7	11.50	3.9	1.5	0.7	0.4	42 000
-11	16.4	15.6	12.60	4.3	1.8	0.75	0.45	38 000
-12	17.4	16.6	13.80	4.7	2.0	0.8	0.45	34 000
-13	19.7	18.8	15.05	7.5	2.2	0.8	0.5	31 000
-14	20.7	19.7	15.60	8.1	2.6	0.9	0.5	28 000
-15	21.7	20.6	17.20	8.7	3.2	1.0	0.6	27 000
-16	22.7	21.6	18.35	9.3	3.5	1.1	0.6	25 000
-17	23.7	22.6	19.35	9.9	4.0	1.1	0.6	24 000
-18	26.2	25.0	20.60	16.0	4.4	1.2	0.7	23 000
-19	27.2	25.9	21.70	16.9	4.9	1.2	0.7	21 500
-20	28.2	26.8	22.65	17.8	5.7	1.2	0.7	20 000
-21	29.2	27.7	23.80	18.6	6.2	1.3	0.7	19 000
-22	30.3	28.7	24.90	19.6	7.0	1.3	0.8	18 500
-23	31.3	29.6	26.00	20.5	7.6	1.3	0.8	18 000
-24	34.1	32.4	27.15	21.4	8.2	1.4	0.8	17 500
-25	35.1	33.3	28.10	22.3	9.2	1.4	0.8	17 000
-26	36.0	34.2	29.25	23.2	9.6	1.5	0.9	16 500
-27	37.8	35.9	30.35	28.4	10.3	1.5	0.9	16 300
-28	38.8	36.9	31.45	28.4	11.0	1.6	1.0	15 800
-30	40.8	38.8	33.6	31.6	12.3	1.6	1.0	15 000
-32	42.8	40.7	35.9	33.6	14.1	1.7	1.0	14 800
-34	44.9	42.5	37.9	36	16.7	1.7	1.1	14 000

**Table 4. American National Standard Metric Basic External Series
3AM1 Retaining Rings, Checking and Performance Data ANSI B27.7-1977, R2010**

Ring Series and Size No.	Clearance Dia.		Gaging Diameter ^a	Allowable Thrust Loads Sharp Corner Abutment		Maximum Allowable Corner Radii and Chamfers		Allowable Assembly Speed ^b
	Ring Over Shaft	Ring in Groove		P_r^c	P_g^d	R max	Ch max	
3AM1	C_1	C_2	K max	P_r^c	P_g^d	R max	Ch max	...
No.	mm	mm	mm	kN	kN	mm	mm	rpm
-35	45.9	43.4	39.0	37	18.1	1.8	1.1	13 500
-36	48.6	46.1	40.2	38	18.9	1.9	1.2	13 300
-38	50.6	48.0	42.5	40	20.5	2.0	1.2	12 700
-40	54.0	51.3	44.5	52	22.6	2.1	1.2	12 000
-42	56.0	53.2	46.9	54	24.8	2.2	1.3	11 000
-43	57.0	54.0	47.9	55	26.4	2.3	1.4	10 800
-45	59.0	55.9	50.0	58	28.8	2.3	1.4	10 000
-46	60.0	56.8	50.9	59	30.4	2.4	1.4	9 500
-48	62.4	59.1	53.0	62	33	2.4	1.4	8 800
-50	64.4	61.1	55.2	64	35	2.4	1.4	8 000
-52	67.6	64.1	57.4	84	37	2.5	1.5	7 700
-54	69.6	66.1	59.5	87	40	2.5	1.5	7 500
-55	70.6	66.9	60.4	89	44	2.5	1.5	7 400
-57	72.6	68.9	62.7	91	45	2.6	1.5	7 200
-58	73.6	69.8	63.6	93	46	2.6	1.6	7 100
-60	75.6	71.8	65.8	97	49	2.6	1.6	7 000
-62	77.6	73.6	67.9	100	52	2.7	1.6	6 900
-65	80.6	76.6	71.2	105	54	2.8	1.7	6 700
-68	83.6	79.5	74.5	110	58	2.9	1.7	6 500
-70	88.1	83.9	76.4	136	62	2.9	1.7	6 400
-72	90.1	85.8	78.5	140	65	2.9	1.7	6 200
-75	93.1	88.7	81.7	147	69	3.0	1.8	5 900
-78	95.4	92.1	84.6	151	76	3.0	1.8	5 600
-80	97.9	93.1	87.0	155	80	3.1	1.9	5 400
-82	100.0	95.1	89.0	159	84	3.2	1.9	5 200
-85	103.0	97.9	92.1	165	91	3.2	1.9	5 000
-88	107.0	100.8	95.1	199	97	3.2	1.9	4 800
-90	109.0	103.6	97.1	204	101	3.2	1.9	4 500
-95	114.0	108.6	102.7	215	112	3.4	2.1	4 350
-100	119.5	113.7	108.0	227	123	3.5	2.1	4 150

^a For checking when ring is seated in groove.

^b These values have been calculated for steel rings.

^c These values apply to rings made from SAE 1060-1090 steels and PH 15-7 Mo stainless steel used on shafts hardened to R_c 50 minimum, with the exception of sizes -4, -5, and -6 which are supplied in beryllium copper only. Values for other sizes made from beryllium copper can be calculated by multiplying the listed values by 0.75. The values listed include a safety factor of 4.

^d These values are for all standard rings used on low carbon steel shafts. They include a safety factor of 2.

Maximum allowable assembly loads with R max or Ch max are: For rings sizes -4, 0.2 kN; for sizes -5 and -6, 0.5 kN; for sizes -7 through -12, 2.1 kN; for sizes -13 through -17, 4.0 kN; for sizes -18 through -26, 6.0 kN; for sizes -27 through -38, 8.6 kN; for sizes -40 through -50, 13.2 kN; for sizes -52 through -68, 22.0 kN; for sizes -70 through -85, 32 kN; and for sizes -88 through -100, 47 kN.

Source: Appendix to American National Standard ANSI B27.7-1977, R2010.

Table 5. American National Standard Metric Basic Internal Series 3BMI Retaining Rings — Checking and Performance Data ANSI B27.7-1977, R2010

Ring Series and Size No.	Clearance Dia.		Gaging Diameter ^a	Allowable Thrust Loads Sharp Corner Abutment		Maximum Allowable Corner Radii and Chamfers	
	Ring in Bore	Ring in Groove		P_r^b	P_g^c	R_{max}	Ch_{max}
3BMI No.	C_1 mm	C_2 mm	A min mm	kN	kN	mm	mm
-8	4.4	4.8	1.40	2.4	1.0	0.4	0.3
-9	4.6	5.0	1.50	4.4	1.2	0.5	0.35
-10	5.5	6.0	1.85	4.9	1.5	0.5	0.35
-11	5.7	6.3	1.95	5.4	2.0	0.6	0.4
-12	6.7	7.3	2.25	5.8	2.4	0.6	0.4
-13	6.8	7.5	2.35	8.9	2.6	0.7	0.5
-14	6.9	7.7	2.65	9.7	3.2	0.7	0.5
-15	7.9	8.7	2.80	10.4	3.7	0.7	0.5
-16	8.8	9.7	2.80	11.0	4.2	0.7	0.5
-17	9.8	10.8	3.35	11.7	4.9	0.75	0.6
-18	10.3	11.3	3.40	12.3	5.5	0.75	0.6
-19	11.4	12.5	3.40	13.1	6.0	0.8	0.65
-20	11.6	12.7	3.8	13.7	6.6	0.9	0.7
-21	12.6	13.8	4.2	14.5	7.3	0.9	0.7
-22	13.5	14.8	4.3	22.5	8.3	0.9	0.7
-23	14.5	15.9	4.9	23.5	8.9	1.0	0.8
-24	15.5	16.9	5.2	24.8	9.7	1.0	0.8
-25	16.5	18.1	6.0	25.7	11.6	1.0	0.8
-26	17.5	19.2	5.7	26.8	12.7	1.2	1.0
-27	17.4	19.2	5.9	33	14.0	1.2	1.0
-28	18.2	20.0	6.0	34	14.6	1.2	1.0
-30	20.0	21.9	6.0	37	16.5	1.2	1.0
-32	22.0	23.9	7.3	39	17.6	1.2	1.0
-34	24.0	26.1	7.6	42	20.6	1.2	1.0
-35	25.0	27.2	8.0	43	22.3	1.2	1.0
-36	26.0	28.3	8.3	44	23.9	1.2	1.0
-37	27.0	29.3	8.4	45	24.6	1.2	1.0
-38	28.0	30.4	8.6	46	26.4	1.2	1.0
-40	29.2	31.6	9.7	62	27.7	1.7	1.3
-42	29.7	32.2	9.0	65	30.2	1.7	1.3
-45	32.3	34.9	9.6	69	33.8	1.7	1.3
-46	33.3	36.0	9.7	71	36	1.7	1.3
-47	34.3	37.1	10.0	72	38	1.7	1.3
-48	35.0	37.9	10.5	74	40	1.7	1.3
-50	36.9	40.0	12.1	77	45	1.7	1.3
-52	38.6	41.9	11.7	99	50	2.0	1.6
-55	40.8	44.2	11.9	105	54	2.0	1.6
-57	42.2	45.7	12.5	109	58	2.0	1.6

Table 5. American National Standard Metric Basic Internal Series 3BMI Retaining Rings — Checking and Performance Data ANSI B27.7-1977, R2010

-58	43.2	46.8	13.0	111	60	2.0	1.6
-60	45.5	49.3	12.7	115	66	2.0	1.6
-62	47.0	50.8	14.0	119	68	2.0	1.6
-63	47.8	51.7	14.2	120	71	2.0	1.6
-65	49.4	53.4	14.2	149	75	2.0	1.6
-68	52.0	56.2	14.4	156	82	2.3	1.8
-70	53.8	58.2	16.1	161	88	2.3	1.8
-72	55.9	60.4	17.4	166	93	2.3	1.8
-75	58.2	62.9	16.8	172	101	2.3	1.8
-78	61.2	66.0	17.6	209	108	2.5	2.0
-80	63.0	68.0	17.2	215	115	2.5	2.0
-82	63.5	68.7	18.8	220	122	2.6	2.1
-85	66.8	72.2	19.1	228	131	2.6	2.1
-88	69.6	75.2	20.4	236	141	2.8	2.2
-90	71.6	77.3	21.4	241	147	2.8	2.2
-92	73.6	79.4	22.2	247	153	2.9	2.4
-95	76.7	82.7	22.6	255	164	3.0	2.5
-98	78.3	84.5	22.6	263	174	3.0	2.5
-100	80.3	86.6	24.1	269	181	3.1	2.5
-102	82.2	88.6	25.5	273	187	3.2	2.6
-105	85.1	91.6	26.0	281	196	3.3	2.6
-108	88.1	94.7	26.4	290	205	3.5	2.7
-110	88.4	95.1	27.5	295	212	3.6	2.8
-115	93.2	100.1	29.4	309	227	3.7	2.9
-120	98.2	105.2	27.2	321	241	3.9	3.1
-125	103.1	110.2	30.3	335	255	4.0	3.2
-130	108.0	115.2	31.0	349	269	4.0	3.2
-135	110.4	117.7	30.4	415	283	4.3	3.4
-140	115.3	122.7	30.4	429	298	4.3	3.4
-145	120.4	127.9	31.6	444	313	4.3	3.4
-150	125.3	132.9	33.5	460	327	4.3	3.4
-155	130.4	138.1	37.0	475	343	4.3	3.4
-160	133.8	141.6	35.0	613	359	4.5	3.6
-165	138.7	146.6	33.1	632	374	4.6	3.7
-170	143.6	151.6	38.2	651	390	4.6	3.7
-175	146.0	154.2	37.7	670	403	4.8	3.8
-180	151.4	159.8	39.0	690	434	5.0	4.0
-185	154.7	163.3	37.3	851	457	5.1	4.1
-190	159.5	168.3	35.0	873	480	5.3	4.3
-200	169.2	178.2	43.9	919	517	5.4	4.3
-210	177.5	186.9	40.6	965	566	5.8	4.6
-220	184.1	194.1	38.3	1000	608	6.1	4.9
-230	194.0	204.6	49.0	1060	686	6.3	5.1
-240	200.4	211.4	45.4	1090	725	6.6	5.3
-250	210.0	221.4	53.0	1150	808	6.7	5.4

^a For checking when ring is seated in groove.

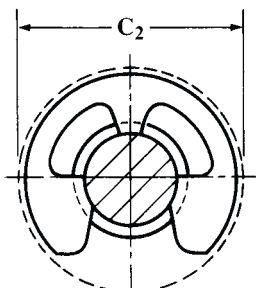
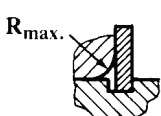
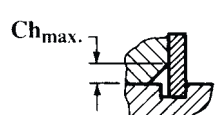
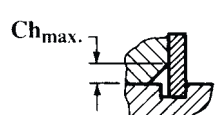
^b These values apply to rings made from SAE 1060-1090 steels and PH 15-7 Mo stainless steel used in bores hardened to R_c 50 minimum. Values for rings made from beryllium copper can be calculated by multiplying the listed values by 0.75. The values listed include a safety factor of 4.

^c These values are for standard rings used in low carbon steel bores. They include a safety factor of 2.

Maximum allowable assembly loads for R max or Ch max are: For ring size -8, 0.8 kN; for sizes -9 through -12, 2.0 kN; for sizes -13 through -21, 4.0 kN; for sizes -22 through -26, 7.4 kN; for sizes -27 through -38, 10.8 kN; for sizes -40 through -50, 17.4 kN; for sizes -52 through -63, 27.4 kN; for size -65, 42.0 kN; for sizes -68 through -72, 39 kN; for sizes -75 through -130, 54 kN; for sizes -135 through -155, 67 kN; for sizes -160 through -180, 102 kN; and for sizes -185 through -250, 151 kN.

Source: Appendix to American National Standard ANSI B27.7-1977, R2010.

Table 6. American National Standard Metric E-Type External Series 3CM1 Retaining Rings — Checking and Performance Data ANSI B27.7-1977, R2010

						
Ring Seated in Groove		Max. Allowable Radius of Retained Part				
						
Max. Allowable Chamfer of Retained Part						
Ring Series and Size No.	Clearance Diameter	Allowable Thrust Loads Sharp Corner Abutment		Maximum Allowable Corner Radii and Chamfers		Allowable Assembly Speed ^a
	Ring in Groove	P_r^b	P_g^c	$R \text{ max}$	$Ch \text{ max}$	
3CM1	C_2	kN	kN	mm	mm	...
No.	mm					rpm
-1	2.2	0.06	0.02	0.4	0.25	40 000
-2	4.3	0.13	0.09	0.8	0.5	40 000
-3	6.0	0.3	0.17	1.1	0.7	34 000
-4	7.6	0.7	0.3	1.6	1.2	31 000
-5	8.9	0.9	0.4	1.6	1.2	27 000
-6	11.5	1.1	0.6	1.6	1.2	25 000
-7	14.0	1.2	0.8	1.6	1.2	23 000
-8	15.1	1.4	1.0	1.7	1.3	21 500
-9	16.5	3.0	1.3	1.7	1.3	19 500
-10	17.5	3.4	1.6	1.7	1.3	18 000
-11	18.0	3.7	1.9	1.7	1.3	16 500
-12	19.3	4.9	2.3	1.9	1.4	15 000
-13	21.0	5.4	2.9	2.0	1.5	13 000
-15	23.5	6.2	4.0	2.0	1.5	11 500
-16	24.5	6.6	4.5	2.0	1.5	10 000
-18	27.9	8.7	5.4	2.1	1.6	9 000
-20	30.7	9.8	6.5	2.2	1.7	8 000
-22	33.7	10.8	8.1	2.2	1.7	7 000
-25	37.9	12.2	10.1	2.4	1.9	5 000

^a These values have been calculated for steel rings.

^b These values apply to rings made from SAE 1060-1090 steels and PH 15-7 Mo stainless steel used on shafts hardened to R_c 50 minimum, with the exception of size -1 which is supplied in beryllium copper only. Values for other sizes made from beryllium copper can be calculated by multiplying the listed values by 0.75. The values listed include a safety factor of 4.

^c These values apply to all standard rings used on low carbon steel shafts. They include a safety factor of 2.

Maximum allowable assembly loads with $R \text{ max}$ or $Ch \text{ max}$ are as follows:

Ring Size No.	Maximum Allowable Load, kN	Ring Size No.	Maximum Allowable Load, kN	Ring Size No.	Maximum Allowable Load, kN
-1	0.06	-8	1.4	-16	6.6
-2	0.13	-9	3.0	-18	8.7
-3	0.3	-10	3.4	-20	9.8
-4	0.7	-11	3.7	-22	10.8
-5	0.9	-12	4.9	-25	12.2
-6	1.1	-13	5.4
-7	1.2	-15	6.2

Source: Appendix to American National Standard ANSI B27.7-1977, R2010.

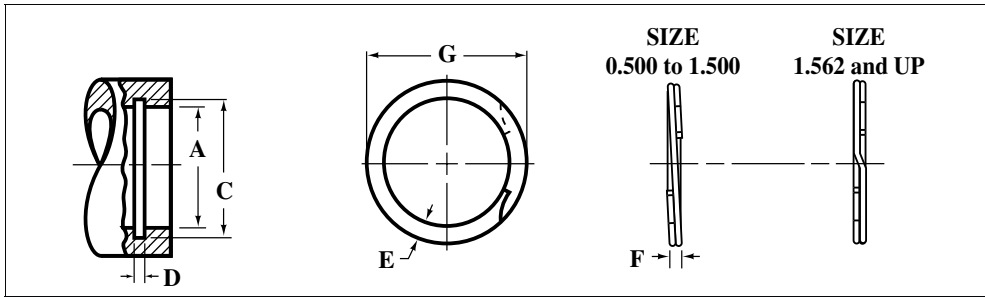


Table 7. Medium Duty Internal Spiral Retaining Rings MIL-R-27426

Bore Dia. A	Ring		Groove		Static Thrust Load (lb)		Bore Dia. A	Ring		Groove		Static Thrust Load (lb)			
	Dia. G	Wall E	Dia. C	Width D	Ring			Dia. G	Wall E	Dia. C	Width D	Ring		Groove	
					Ring	Groove						Ring	Groove		
0.500	0.532	0.045	0.526	0.030	2000	405	3.437	3.574	0.188	3.543	0.068	27660	18240		
0.512	0.544	0.045	0.538	0.030	2050	420	3.500	3.636	0.188	3.606	0.068	28170	18575		
0.531	0.564	0.045	0.557	0.030	2130	455	3.543	3.684	0.198	3.653	0.068	28520	19515		
0.562	0.594	0.045	0.588	0.030	2250	495	3.562	3.703	0.198	3.672	0.068	28670	19620		
0.594	0.626	0.045	0.619	0.030	2380	535	3.625	3.769	0.198	3.737	0.068	29180	20330		
0.625	0.658	0.045	0.651	0.030	2500	610	3.687	3.832	0.198	3.799	0.068	29680	20675		
0.656	0.689	0.045	0.682	0.030	2630	670	3.740	3.885	0.198	3.852	0.068	30100	20975		
0.687	0.720	0.045	0.713	0.030	2750	725	3.750	3.894	0.198	3.862	0.068	30180	21030		
0.718	0.751	0.045	0.744	0.030	2870	790	3.812	3.963	0.208	3.930	0.068	30680	22525		
0.750	0.790	0.065	0.782	0.036	3360	800	4.437	4.611	0.238	4.573	0.068	35710	30215		
0.777	0.817	0.065	0.808	0.036	3480	835	4.500	4.674	0.238	4.636	0.068	36220	30645		
0.781	0.821	0.065	0.812	0.036	3500	840	4.527	4.701	0.238	4.663	0.068	36440	30830		
0.812	0.853	0.065	0.843	0.036	3640	915	4.562	4.737	0.238	4.698	0.079	36720	31065		
0.843	0.889	0.065	0.880	0.036	3780	1155	4.625	4.803	0.250	4.765	0.079	43940	32420		
0.866	0.913	0.065	0.903	0.036	3880	1250	4.687	4.867	0.250	4.827	0.079	44530	32855		
0.875	0.922	0.065	0.912	0.036	3920	1250	4.724	4.903	0.250	4.864	0.079	44880	33115		
0.906	0.949	0.065	0.939	0.036	4060	1335	4.750	4.930	0.250	4.890	0.079	45130	33300		
0.938	0.986	0.065	0.975	0.036	4200	1430	4.812	4.993	0.250	4.952	0.079	45710	33735		
0.968	1.025	0.075	1.015	0.042	4340	1950	4.875	5.055	0.250	5.015	0.079	46310	34175		
0.987	1.041	0.075	1.030	0.042	4420	1865	4.921	5.102	0.250	5.061	0.079	46750	34495		
1.000	1.054	0.075	1.043	0.042	4480	1910	4.937	5.122	0.250	5.081	0.079	46900	35595		
1.023	1.078	0.075	1.066	0.042	5470	1660	5.000	5.185	0.250	5.144	0.079	47500	36050		
1.031	1.084	0.075	1.074	0.042	5510	1650	5.118	5.304	0.250	5.262	0.079	48620	36905		
1.062	1.117	0.075	1.104	0.042	5680	1745	5.125	5.311	0.250	5.269	0.079	48690	36955		
1.093	1.147	0.075	1.135	0.042	5840	1820	5.250	5.436	0.250	5.393	0.079	49880	37590		
1.125	1.180	0.075	1.167	0.042	6010	1935	5.375	5.566	0.250	5.522	0.079	51050	39565		
1.156	1.210	0.075	1.198	0.042	6180	2020	5.500	5.693	0.250	5.647	0.079	52250	40485		
1.188	1.249	0.085	1.236	0.048	7380	2115	5.511	5.703	0.250	5.658	0.079	52350	40565		
1.218	1.278	0.085	1.266	0.048	7570	2195	5.625	5.818	0.250	5.772	0.079	53440	41405		
1.250	1.312	0.085	1.298	0.048	7770	2510	5.708	5.909	0.250	5.861	0.079	54230	43730		
1.281	1.342	0.085	1.329	0.048	7960	2425	5.750	5.950	0.250	5.903	0.079	54630	44050		
1.312	1.374	0.085	1.360	0.048	8150	2532	5.875	6.077	0.250	6.028	0.079	55810	45010		
1.343	1.408	0.085	1.395	0.048	8340	2875	5.905	6.106	0.250	6.058	0.079	56100	45240		
1.375	1.442	0.095	1.427	0.048	8540	3070	6.000	6.202	0.312	6.153	0.079	57000	45965		
1.406	1.472	0.095	1.458	0.048	8740	3180	6.125	6.349	0.312	6.297	0.094	69500	52750		
1.437	1.504	0.095	1.489	0.048	8930	3330	6.250	6.474	0.312	6.422	0.094	70920	53825		
1.456	1.523	0.095	1.508	0.048	9050	3410	6.299	6.524	0.312	6.471	0.094	71480	54250		
1.468	1.535	0.095	1.520	0.048	9120	3460	6.375	6.601	0.312	6.547	0.094	72340	54905		
1.500	1.567	0.095	1.552	0.048	9320	3605	6.500	6.726	0.312	6.672	0.094	73760	55980		
1.562	1.634	0.108	1.617	0.056	10100	3590	6.625	6.863	0.312	6.807	0.094	75180	60375		
1.574	1.649	0.108	1.633	0.056	10180	3640	6.692	6.931	0.312	6.874	0.094	75940	60985		
1.625	1.701	0.108	1.684	0.056	10510	3875	6.750	6.987	0.312	6.932	0.094	76590	61515		
1.653	1.730	0.108	1.712	0.056	10690	4020	6.875	7.114	0.312	7.057	0.094	78010	62655		
1.687	1.768	0.118	1.750	0.056	10910	4510	7.000	7.239	0.312	7.182	0.094	79430	63790		
1.750	1.834	0.118	1.813	0.056	11310	4895	7.086	7.337	0.312	7.278	0.094	80410	68125		
1.813	1.894	0.118	1.875	0.056	11720	5080	7.125	7.376	0.312	7.317	0.094	80850	68500		

Table 7. Medium Duty Internal Spiral Retaining Rings MIL-R-27426

Bore Dia. A	Ring		Groove		Static Thrust Load (lb)		Bore Dia. A	Ring		Groove		Static Thrust Load (lb)	
	Dia. G	Wall E	Dia. C	Width D	Ring	Groove		Dia. G	Wall E	Dia. C	Width D	Ring	Groove
1.850	1.937	0.118	1.917	0.056	11960	5735	7.250	7.501	0.312	7.442	0.094	82270	69700
1.875	1.960	0.118	1.942	0.056	12120	5825	7.375	7.628	0.312	7.567	0.094	83690	70900
1.938	2.025	0.118	2.005	0.056	12530	6250	7.480	7.734	0.312	7.672	0.094	84880	71910
2.000	2.091	0.128	2.071	0.056	12930	7090	7.500	7.754	0.312	7.692	0.094	85110	72105
2.047	2.138	0.128	2.118	0.056	13230	7275	7.625	7.890	0.312	7.827	0.094	86520	77125
2.062	2.154	0.128	2.132	0.056	13330	7225	7.750	8.014	0.312	7.952	0.094	87940	78390
2.125	2.217	0.128	2.195	0.056	13740	7450	7.875	8.131	0.312	8.077	0.094	89360	79655
2.165	2.260	0.138	2.239	0.056	14000	8020	8.000	8.266	0.312	8.202	0.094	90780	80920
2.188	2.284	0.138	2.262	0.056	14150	8105	8.250	8.528	0.375	8.462	0.094	93620	87575
2.250	2.347	0.138	2.324	0.056	14550	8335	8.267	8.546	0.375	8.479	0.094	93810	87755
2.312	2.413	0.138	2.390	0.056	14950	9030	8.464	8.744	0.375	8.676	0.094	96040	89850
2.375	2.476	0.138	2.453	0.056	15350	9275	8.500	8.780	0.375	8.712	0.094	96450	90230
2.437	2.543	0.148	2.519	0.056	15760	10005	8.750	9.041	0.375	8.972	0.094	99290	97265
2.440	2.546	0.148	2.522	0.056	15780	10015	8.858	9.151	0.375	9.080	0.094	100520	98465
2.500	2.606	0.148	2.582	0.056	16160	10625	9.000	9.293	0.375	9.222	0.094	102130	100045
2.531	2.641	0.148	2.617	0.056	16360	10900	9.055	9.359	0.375	9.287	0.094	102750	105190
2.562	2.673	0.148	2.648	0.056	16560	11030	9.250	9.555	0.375	9.482	0.094	104960	107455
2.625	2.736	0.148	2.711	0.056	16970	11305	9.448	9.755	0.375	9.680	0.094	107210	109755
2.677	2.789	0.158	2.767	0.056	17310	12065	9.500	9.806	0.375	9.732	0.094	107800	110360
2.688	2.803	0.158	2.778	0.056	17380	12115	9.750	10.068	0.375	9.992	0.094	110640	118145
2.750	2.865	0.158	2.841	0.056	17780	12530	10.000	10.320	0.375	10.242	0.094	113470	121175
2.813	2.929	0.158	2.903	0.056	18190	12675	10.250	10.582	0.375	10.502	0.094	116310	129340
2.834	2.954	0.168	2.928	0.056	18320	13340	10.500	10.834	0.375	10.752	0.094	119150	132490
2.875	2.995	0.168	2.969	0.056	18590	13530	10.750	11.095	0.375	11.012	0.094	121980	141030
2.937	3.058	0.168	3.031	0.056	18990	13825	11.000	11.347	0.375	11.262	0.094	124820	144310
2.952	3.073	0.168	3.046	0.056	19090	13890	3.875	4.025	0.208	3.993	0.068	30680	22525
3.000	3.122	0.168	3.096	0.068	24150	14420	3.938	4.089	0.208	4.056	0.068	31700	23265
3.062	3.186	0.168	3.158	0.068	24640	14720	4.000	4.157	0.218	5.124	0.068	32190	24835
3.125	3.251	0.178	3.223	0.068	25150	15335	4.063	4.222	0.218	4.187	0.068	32700	25225
3.149	3.276	0.178	3.247	0.068	25340	15450	4.125	4.284	0.218	4.249	0.068	33200	25610
3.187	3.311	0.178	3.283	0.068	25650	15640	4.188	4.347	0.218	4.311	0.068	33710	25795
3.250	3.379	0.178	3.350	0.068	26160	16270	4.250	4.416	0.228	4.380	0.068	34210	27665
3.312	3.446	0.188	3.416	0.068	26660	17245	4.312	4.479	0.228	4.442	0.068	34710	28065
3.346	3.479	0.188	3.450	0.068	26930	17425	4.330	4.497	0.228	4.460	0.068	34850	28185
3.375	3.509	0.188	3.479	0.068	27160	17575	4.375	4.543	0.228	4.505	0.068	32210	28475

Source: Spirolox Retaining Rings, RR Series. All dimensions are in inches. Depth of groove $d = (C - A)/2$. Standard material: carbon spring steel (SAE 1070-1090).

Ring Thickness, F: For shaft sizes 0.500 through 0.718, 0.025; for sizes 0.750 through 0.938, 0.031; for sizes 0.968 through 1.156, 0.037; for sizes 1.188 through 1.500, 0.043; for sizes 1.562 through 2.952, 0.049; for sizes 3.000 through 4.562, 0.061; for sizes 4.625 through 6.000, 0.072; for sizes 6.125 through 11.000, 0.086.

Ring Free Diameter Tolerances: For housing sizes 0.500 through 1.031, +0.013, -0.000; for sizes 1.062 through 1.500, +0.015, -0.000; for sizes 1.562 through 2.047, +0.020, -0.000; for sizes 2.062 through 3.000, +0.025, -0.000; for sizes 3.062 through 4.063, +0.030, -0.000; for sizes 4.125 through 5.125, +0.035, -0.000; for sizes 5.250 through 6.125, +0.045, -0.000; for sizes 6.250 through 7.125, +0.055, -0.000; for sizes 7.250 through 11.000, +0.065, -0.000.

Ring Thickness Tolerances: Thickness indicated is for unplated rings; add 0.002 to upper thickness tolerance for plated rings. For housing sizes 0.500 through 1.500, ± 0.002 ; for sizes 1.562 through 4.562, ± 0.003 ; for sizes 4.625 through 11.000, ± 0.004 .

Groove Diameter Tolerances: For housing sizes 0.500 through 0.750, ± 0.002 ; for sizes 0.777 through 1.031, ± 0.003 ; for sizes 1.062 through 1.500, ± 0.004 ; for sizes 1.562 through 2.047, ± 0.005 ; for sizes 2.062 through 5.125, ± 0.006 ; for sizes 5.250 through 6.000, ± 0.007 ; for sizes 6.125 through 11.000, ± 0.008 .

Groove Width Tolerances: For housing sizes 0.500 through 1.156, +0.003, -0.000; for sizes 1.188 through 2.952, +0.004, -0.000; for sizes 3.000 through 6.000, +0.005, -0.000; for sizes 6.125 through 11.000, +0.006, -0.000.

Table 8. Medium Duty External Spiral Retaining Rings MIL-R-27426

Shaft Dia. A	Ring		Groove		Static Thrust Load (lb)		Shaft Dia. A	Ring		Groove		Static Thrust Load (lb)	
	Dia. G	Wall E	Dia. C	Width D	Ring	Groove		Dia. G	Wall E	Dia. C	Width D	Ring	Groove
0.500	0.467	0.045	0.474	0.030	2000	550	3.343	3.210	0.188	3.239	0.068	26910	17410
0.531	0.498	0.045	0.505	0.030	2130	640	3.375	3.242	0.188	3.271	0.068	27160	17570
0.551	0.518	0.045	0.525	0.030	2210	700	3.437	3.301	0.188	3.331	0.068	27660	18240
0.562	0.529	0.045	0.536	0.030	2250	730	3.500	3.363	0.188	3.394	0.068	28170	18580
0.594	0.561	0.045	0.569	0.030	2380	740	3.543	3.402	0.198	3.433	0.068	28520	19510
0.625	0.585	0.055	0.594	0.030	2500	970	3.562	3.422	0.198	3.452	0.068	28670	19620
0.656	0.617	0.055	0.625	0.030	2630	1020	3.625	3.483	0.198	3.515	0.068	29180	19970
0.669	0.629	0.055	0.638	0.030	2680	1040	3.687	3.543	0.198	3.575	0.068	29680	20680
0.687	0.647	0.055	0.656	0.030	2750	1060	3.740	3.597	0.198	3.628	0.068	30100	20970
0.718	0.679	0.055	0.687	0.030	2870	1110	3.750	3.606	0.198	3.638	0.068	30180	21030
0.750	0.710	0.065	0.719	0.036	3360	1100	3.812	3.668	0.198	3.700	0.068	30680	21380
0.781	0.741	0.065	0.750	0.036	3500	1210	3.875	3.724	0.208	3.757	0.068	31190	22890
0.812	0.771	0.065	0.781	0.036	3640	1260	3.938	3.784	0.208	3.820	0.068	31700	23270
0.843	0.803	0.065	0.812	0.036	3780	1310	4.000	3.842	0.218	3.876	0.068	32190	24840
0.875	0.828	0.065	0.838	0.036	3920	1620	4.063	3.906	0.218	3.939	0.068	32700	25230
0.906	0.860	0.065	0.869	0.036	4060	1680	4.125	3.967	0.218	4.000	0.068	33200	25820
0.937	0.889	0.065	0.900	0.036	4200	1740	4.134	3.975	0.218	4.010	0.068	33270	25670
0.968	0.916	0.075	0.925	0.042	5180	2080	4.188	4.030	0.218	4.058	0.068	33710	27260
0.984	0.930	0.075	0.941	0.042	5260	2120	4.250	4.084	0.228	4.120	0.068	34210	27660
1.000	0.946	0.075	0.957	0.042	5350	2150	4.312	4.147	0.218	4.182	0.068	34710	28070
1.023	0.968	0.075	0.980	0.042	5470	2200	4.331	4.164	0.218	4.200	0.068	34860	28410
1.031	0.978	0.075	0.988	0.042	5510	2220	4.375	4.208	0.218	4.245	0.068	35210	28480
1.062	1.007	0.075	1.020	0.042	5680	2230	4.437	4.271	0.218	4.307	0.068	35710	28880
1.093	1.040	0.075	1.051	0.042	5840	2300	4.500	4.326	0.238	4.364	0.068	36220	30640
1.125	1.070	0.075	1.083	0.042	6010	2370	4.562	4.384	0.250	4.422	0.079	43340	31980
1.156	1.102	0.075	1.114	0.042	6180	2430	4.625	4.447	0.250	4.485	0.079	43940	32420
1.188	1.127	0.085	1.140	0.048	7380	2850	4.687	4.508	0.250	4.457	0.079	44530	32860
1.218	1.159	0.085	1.170	0.048	7570	2930	4.724	4.546	0.250	4.584	0.079	44880	33120
1.250	1.188	0.085	1.202	0.048	7770	3000	4.750	4.571	0.250	4.610	0.079	45130	33300
1.281	1.221	0.085	1.233	0.048	7960	3080	4.812	4.633	0.250	4.672	0.079	45710	33730
1.312	1.251	0.095	1.264	0.048	8150	3150	4.875	4.695	0.250	4.735	0.079	46310	34170
1.343	1.282	0.095	1.295	0.048	8340	3230	4.937	4.757	0.250	4.797	0.079	46900	34610
1.375	1.308	0.095	1.323	0.048	8540	3580	5.000	4.820	0.250	4.856	0.079	47500	36050
1.406	1.340	0.095	1.354	0.048	8740	3660	5.118	4.934	0.250	4.974	0.079	48620	36900
1.437	1.370	0.095	1.385	0.048	8930	3740	5.125	4.939	0.250	4.981	0.079	48690	36950
1.468	1.402	0.095	1.416	0.048	9120	3820	5.250	5.064	0.250	5.107	0.079	49880	37590
1.500	1.433	0.095	1.448	0.048	9320	3910	5.375	5.187	0.250	5.228	0.079	51060	39560
1.562	1.490	0.108	1.507	0.056	10100	4300	5.500	5.308	0.250	5.353	0.079	52250	40480
1.575	1.503	0.108	1.520	0.056	10190	4340	5.511	5.320	0.250	5.364	0.079	52350	40560
1.625	1.549	0.108	1.566	0.056	10510	4800	5.625	5.433	0.250	5.478	0.079	53440	41400

Table 8. Medium Duty External Spiral Retaining Rings MIL-R-27426

1.687	1.610	0.118	1.628	0.056	10910	4980	5.750	5.550	0.250	5.597	0.079	54630	44050
1.750	1.673	0.118	1.691	0.056	11310	5170	5.875	5.674	0.250	5.722	0.079	55810	45010
1.771	1.690	0.118	1.708	0.056	11450	5590	5.905	5.705	0.250	5.752	0.079	56100	45240
1.813	1.730	0.118	1.749	0.056	11720	5810	6.000	5.798	0.250	5.847	0.079	57000	45970
1.875	1.789	0.128	1.808	0.056	12120	6290	6.125	5.903	0.312	5.953	0.094	69500	52750
1.938	1.844	0.128	1.861	0.056	12530	7470	6.250	6.026	0.312	6.078	0.094	70920	53830
1.969	1.882	0.128	1.902	0.056	12730	6610	6.299	6.076	0.312	6.127	0.094	71480	54250
2.000	1.909	0.128	1.992	0.056	12930	7110	6.375	6.152	0.312	6.203	0.094	72340	54900
2.062	1.971	0.128	2.051	0.056	13330	7870	6.500	6.274	0.312	6.328	0.094	73760	55980
2.125	2.029	0.128	2.082	0.056	13740	7990	6.625	6.390	0.312	6.443	0.094	75180	60380
2.156	2.060	0.138	2.091	0.056	13940	8020	6.750	6.513	0.312	6.568	0.094	76590	61515
2.188	2.070	0.138	2.113	0.056	14150	8220	6.875	6.638	0.312	6.693	0.094	78010	62650
2.250	2.092	0.138	2.176	0.056	14550	8340	7.000	6.761	0.312	6.818	0.094	79430	63790
2.312	2.153	0.138	2.234	0.056	14950	9030	7.125	6.877	0.312	6.933	0.094	80850	68500
2.362	2.211	0.138	2.284	0.056	15270	9230	7.250	6.999	0.312	7.058	0.094	82270	69700
2.375	2.273	0.138	2.297	0.056	15350	9280	7.375	7.125	0.312	7.183	0.094	83690	70900
2.437	2.331	0.148	2.355	0.056	15760	10000	7.500	7.250	0.312	7.308	0.094	85110	72100
2.500	2.394	0.148	2.418	0.056	16160	10260	7.625	7.363	0.312	7.423	0.094	86520	77120
2.559	2.449	0.148	2.473	0.056	16540	11020	7.750	7.486	0.312	7.548	0.094	87940	78390
2.562	2.452	0.148	2.476	0.056	16560	11030	7.875	7.611	0.312	7.673	0.094	89360	79650
2.625	2.514	0.148	2.539	0.056	16970	11300	8.000	7.734	0.312	7.798	0.094	90780	80920
2.688	2.572	0.158	2.597	0.056	17380	12250	8.250	7.972	0.375	8.038	0.094	93620	87580
2.750	2.635	0.158	2.660	0.056	17780	12390	8.500	8.220	0.375	8.288	0.094	96450	90230
2.813	2.696	0.168	2.722	0.056	18190	12820	8.750	8.459	0.375	8.528	0.094	99290	97270
2.875	2.755	0.168	2.781	0.056	18590	13530	9.000	8.707	0.375	8.778	0.094	102130	100050
2.937	2.817	0.168	2.843	0.056	18990	13820	9.250	8.945	0.375	9.018	0.094	104960	107560
2.952	2.831	0.168	2.858	0.056	19090	13890	9.500	9.194	0.375	9.268	0.094	107800	110360
3.000	2.877	0.168	2.904	0.068	24150	14420	9.750	9.432	0.375	9.508	0.094	110640	118150
3.062	2.938	0.168	2.966	0.068	24640	14720	10.000	9.680	0.375	9.758	0.094	113470	121180
3.125	3.000	0.178	3.027	0.068	25150	15335	10.250	9.918	0.375	9.998	0.094	116310	129340
3.149	3.023	0.178	3.051	0.068	25340	15450	10.500	10.166	0.375	10.248	0.094	119150	132490
3.187	3.061	0.178	3.089	0.068	25650	15640	10.750	10.405	0.375	10.488	0.094	121980	141030
3.250	3.121	0.178	3.150	0.068	26160	16270	11.000	10.653	0.375	10.738	0.094	124820	144310
3.312	3.180	0.188	3.208	0.068	26660	17250							

Source: Spirolox Retaining Rings, RS Series. All dimensions are in inches.

Depth of groove $d = (A - C)/2$. Standard material: carbon spring steel (SAE 1070-1090).

Ring Thickness, F : For shaft sizes 0.500 through 0.718, 0.025; for sizes 0.750 through 0.937, 0.031; for sizes 0.968 through 1.156, 0.037; for sizes 1.188 through 1.500, 0.043; for sizes 1.562 through 2.952, 0.049; for sizes 3.000 through 4.500, 0.061; for sizes 4.562 through 6.000, 0.072; for sizes 6.125 through 11.000, 0.086.

Ring Free Diameter Tolerances: For shaft sizes 0.500 through 1.031, +0.000, +0.000, -0.013; for sizes 1.062 through 1.500, +0.000, -0.015; for sizes 1.562 through 2.125, +0.000, -0.020; for sizes 2.156 through 2.688, +0.000, -0.025; for sizes 2.750 through 3.437, +0.000, -0.030; for sizes 3.500 through 5.125, +0.000, -0.040; for sizes 5.250 through 6.125, +0.000, -0.050; for sizes 6.250 through 7.375, +0.000, -0.060; for sizes 7.500 through 11.000, +0.000, -0.070.

Ring Thickness Tolerances: Thickness indicated is for unplated rings; add 0.002 to upper tolerance for plated rings. For shaft sizes 0.500 through 1.500, ± 0.002 ; for sizes 1.562 through 4.500, ± 0.003 ; for sizes 4.562 through 11.000, ± 0.004 .

Groove Diameter Tolerances: For shaft sizes 0.500 through 0.562, ± 0.002 ; for sizes 0.594 through 1.031, ± 0.003 ; for sizes 1.062 through 1.500, ± 0.004 ; for sizes 1.562 through 2.000, ± 0.005 ; for sizes 2.062 through 5.125, ± 0.006 ; for sizes 5.250 through 6.000, ± 0.007 ; for sizes 6.125 through 11.000, ± 0.008 .

Groove Width Tolerances: For shaft sizes 0.500 through 1.156, +0.003, -0.000; for sizes 1.188 through 2.952, +0.004, -0.000; for sizes 3.000 through 6.000, +0.005, -0.000; for sizes 6.125 through 11.000, +0.006, -0.000.

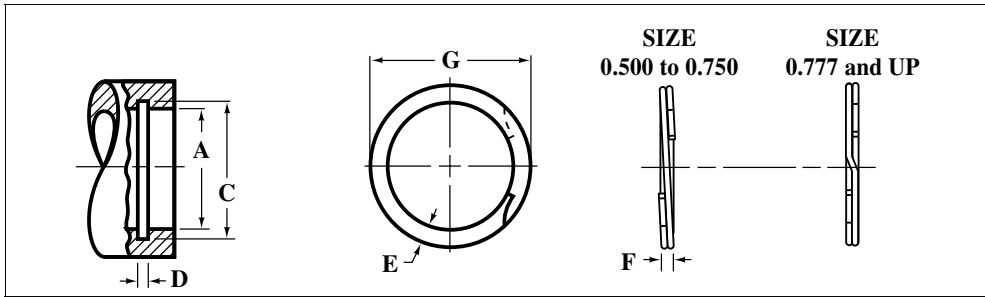


Table 9. Heavy Duty Internal Spiral Retaining Rings MIL-R-27426

Bore Dia. A	Ring		Groove		Static Thrust Load (lb)		Bore Dia. A	Ring		Groove		Static Thrust Load (lb)	
	Dia. G	Wall E	Dia. C	Width D	Ring	Groove		Dia. G	Wall E	Dia. C	Width D	Ring	Groove
0.500	0.538	0.045	0.530	0.039	2530	310	3.543	3.781	0.281	3.755	0.120	49420	28250
0.512	0.550	0.045	0.542	0.039	2590	325	3.562	3.802	0.281	3.776	0.120	49680	28815
0.562	0.605	0.055	0.596	0.039	2840	455	3.625	3.868	0.281	3.841	0.120	50560	30160
0.625	0.675	0.055	0.655	0.039	3160	655	3.750	4.002	0.312	3.974	0.120	52310	33720
0.688	0.743	0.065	0.732	0.039	3480	965	3.875	4.136	0.312	4.107	0.120	54050	37250
0.750	0.807	0.065	0.796	0.039	3790	1065	3.938	4.203	0.312	4.174	0.120	54930	39045
0.777	0.836	0.075	0.825	0.046	4720	1026	4.000	4.270	0.312	4.240	0.120	55790	41025
0.812	0.873	0.075	0.862	0.046	4930	1150	4.125	4.369	0.312	4.339	0.120	57540	38495
0.866	0.931	0.075	0.920	0.046	5260	1395	4.250	4.501	0.312	4.470	0.120	59280	41955
0.875	0.943	0.085	0.931	0.046	5310	1520	4.330	4.588	0.312	4.556	0.120	60400	44815
0.901	0.972	0.085	0.959	0.046	5470	1675	4.500	4.768	0.312	4.735	0.120	62770	50290
0.938	1.013	0.085	1.000	0.046	5690	1925	4.625	4.899	0.312	4.865	0.120	64510	54155
1.000	1.080	0.085	1.066	0.046	6070	2310	4.750	5.030	0.312	4.995	0.120	66260	58270
1.023	1.105	0.085	1.091	0.046	6210	2480	5.000	5.297	0.312	5.260	0.120	69740	65095
1.062	1.138	0.103	1.130	0.056	7010	1940	5.250	5.559	0.350	5.520	0.139	83790	68315
1.125	1.205	0.103	1.197	0.056	7420	2280	5.375	5.690	0.350	5.650	0.139	85780	72840
1.188	1.271	0.103	1.262	0.056	7840	2615	5.500	5.810	0.350	5.770	0.139	87780	74355
1.250	1.339	0.103	1.330	0.056	8250	3110	5.750	6.062	0.350	6.020	0.139	91770	77735
1.312	1.406	0.118	1.396	0.056	8650	3650	6.000	6.314	0.350	6.270	0.139	95760	81120
1.375	1.471	0.118	1.461	0.056	9070	4075	6.250	6.576	0.380	6.530	0.174	122520	80655
1.439	1.539	0.118	1.528	0.056	9490	4670	6.500	6.838	0.380	6.790	0.174	127420	90295
1.456	1.559	0.118	1.548	0.056	9600	4890	6.625	6.974	0.380	6.925	0.174	129870	92060
1.500	1.605	0.118	1.594	0.056	9900	5275	6.750	7.105	0.380	7.055	0.174	132320	102475
1.562	1.675	0.128	1.658	0.068	12780	4840	7.000	7.366	0.380	7.315	0.174	137220	110410
1.625	1.742	0.128	1.725	0.068	13290	5415	7.250	7.628	0.418	7.575	0.209	170370	103440
1.653	1.772	0.128	1.755	0.068	13520	5695	7.500	7.895	0.418	7.840	0.209	176240	115780
1.688	1.810	0.128	1.792	0.068	13810	6070	7.750	8.157	0.418	8.100	0.209	182120	127270
1.750	1.876	0.128	1.858	0.068	14320	7635	8.000	8.419	0.418	8.360	0.209	187990	139370
1.812	1.940	0.128	1.922	0.068	14820	7305	8.250	8.680	0.437	8.620	0.209	193870	152695
1.850	1.981	0.158	1.962	0.068	15130	7960	8.500	8.942	0.437	8.880	0.209	199740	161735
1.875	2.008	0.158	1.989	0.068	15340	8305	8.750	9.209	0.437	9.145	0.209	205620	173065
1.938	2.075	0.158	2.056	0.068	15850	9125	9.000	9.471	0.437	9.405	0.209	211490	182515
2.000	2.142	0.158	2.122	0.068	16360	10040	9.250	9.737	0.437	9.669	0.209	217370	194070
2.062	2.201	0.168	2.186	0.086	21220	8280	9.500	10.000	0.500	9.930	0.209	223240	204550

Table 9. Heavy Duty Internal Spiral Retaining Rings MIL-R-27426

Bore Dia. A	Ring		Groove		Static Thrust Load (lb)		Bore Dia. A	Ring		Groove		Static Thrust Load (lb)	
	Dia. G	Wall E	Dia. C	Width D	Ring	Groove		Dia. G	Wall E	Dia. C	Width D	Ring	Groove
2.125	2.267	0.168	2.251	0.086	21870	8935	9.750	10.260	0.500	10.189	0.209	229120	214325
2.188	2.334	0.168	2.318	0.086	22520	9745	10.000	10.523	0.500	10.450	0.209	234990	225330
2.250	2.399	0.168	2.382	0.086	23160	10455	10.250	10.786	0.500	10.711	0.209	240870	236605
2.312	2.467	0.200	2.450	0.086	23790	11700	10.500	11.047	0.500	10.970	0.209	246740	247110
2.357	2.535	0.200	2.517	0.086	24440	12715	10.750	11.313	0.500	11.234	0.209	252620	260530
2.440	2.602	0.200	2.584	0.086	25110	13550	11.000	11.575	0.500	11.495	0.209	258490	272645
2.500	2.667	0.200	2.648	0.086	25730	14640	11.250	11.838	0.500	11.756	0.209	264360	285040
2.531	2.700	0.200	2.681	0.086	26050	15185	11.500	12.102	0.562	12.018	0.209	270240	298285
2.562	2.733	0.225	2.714	0.103	29940	12775	11.750	12.365	0.562	12.279	0.209	276120	311240
2.625	2.801	0.225	2.781	0.103	30680	13780	12.000	12.628	0.562	12.540	0.209	281990	324475
2.688	2.868	0.225	2.848	0.103	31410	14775	12.250	12.891	0.562	12.801	0.209	287860	337980
2.750	2.934	0.225	2.914	0.103	32140	15790	12.500	13.154	0.562	13.063	0.209	293740	352390
2.813	3.001	0.225	2.980	0.103	32870	16845	12.750	13.417	0.562	13.324	0.209	299610	366460
2.834	3.027	0.225	3.006	0.103	33120	17595	13.000	13.680	0.662	13.585	0.209	305490	380805
2.875	3.072	0.225	3.051	0.103	33600	18505	13.250	13.943	0.662	13.846	0.209	311360	395430
3.000	3.204	0.225	3.182	0.103	35060	20795	13.500	14.207	0.662	14.108	0.209	317240	411000
3.062	3.271	0.281	3.248	0.120	42710	18735	13.750	14.470	0.662	14.369	0.209	323110	426185
3.125	3.338	0.281	3.315	0.120	43590	19865	14.000	14.732	0.662	14.630	0.209	328990	441645
3.157	3.371	0.281	3.348	0.120	44020	20345	14.250	14.995	0.662	14.891	0.209	334860	457380
3.250	3.470	0.281	3.446	0.120	45330	22120	14.500	15.259	0.750	15.153	0.209	340740	474120
3.346	3.571	0.281	3.546	0.120	46670	23905	14.750	15.522	0.750	15.414	0.209	346610	490415
3.469	3.701	0.281	3.675	0.120	48390	26405	15.000	15.785	0.750	15.675	0.209	352490	506990
3.500	3.736	0.281	3.710	0.120	48820	27370							

Source: Spirolox Retaining Rings, RRN Series. All dimensions are in inches. Depth of groove $d = (C - A)/2$. Thickness indicated is for unplated rings; add 0.002 to upper thickness tolerance for plated rings. Standard material: carbon spring steel (SAE 1070-1090).

Ring Thickness, F: For housing sizes 0.500 through 0.750, 0.035; for sizes 0.777 through 1.023, 0.042; for sizes 1.062 through 1.500, 0.050; for sizes 1.562 through 2.000, 0.062; for sizes 2.062 through 2.531, 0.078; for sizes 2.562 through 3.000, 0.093; for sizes 3.062 through 5.000, 0.111; for sizes 5.250 through 7.000, 0.156; for sizes 7.250 through 15.000, 0.187.

Ring Free Diameter Tolerances: For housing sizes 0.500 through 1.500, +0.013, -0.000; for sizes 1.562 through 2.000, +0.020, -0.000; for sizes 2.062 through 2.531, +0.025, -0.000; for sizes 2.562 through 3.000, +0.030, -0.000; for sizes 3.062 through 5.000, +0.035, -0.000; for sizes 5.250 through 6.000, +0.050, -0.000; for sizes 6.250 through 7.000, +0.055, -0.000; for sizes 7.250 through 10.500, +0.070, -0.000; for sizes 10.750 through 12.750, +0.120, -0.000; for sizes 13.000 through 15.000, +0.140, -0.000.

Ring Thickness Tolerances: For housing sizes 0.500 through 1.500, ± 0.002 ; for sizes 1.562 through 5.000, ± 0.003 ; for sizes 5.250 through 6.000, ± 0.004 ; for sizes 6.250 through 15.000, ± 0.005 .

Groove Diameter Tolerances: For housing sizes 0.500 through 0.750, ± 0.002 ; for sizes 0.777 through 1.023, ± 0.003 ; for sizes 1.062 through 1.500, ± 0.004 ; for sizes 1.562 through 2.000, ± 0.005 ; for sizes 2.062 through 5.000, ± 0.006 ; for sizes 5.250 through 6.000, ± 0.007 ; for sizes 6.250 through 10.500, ± 0.008 ; for sizes 10.750 through 12.500, ± 0.010 ; for sizes 12.750 through 15.000, ± 0.012 .

Groove Width Tolerances: For housing sizes 0.500 through 1.023, +0.003, -0.000; for sizes 1.062 through 2.000, +0.004, -0.000; for sizes 2.062 through 5.000, +0.005, -0.000; for sizes 5.250 through 6.000, +0.006, -0.000; for sizes 6.250 through 7.000, +0.008, -0.000; for sizes 7.250 through 15.000, +0.008, -0.000.

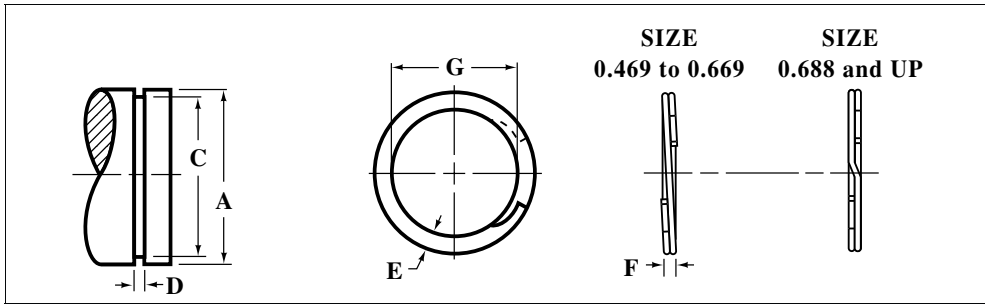


Table 10. Heavy Duty External Spiral Retaining Rings MIL-R-27426

Shaft Dia. A	Ring		Groove		Static Thrust Load (lb)		Shaft Dia. A	Ring		Groove		Static Thrust Load (lb)	
	Dia. G	Wall E	Dia. C	Width D	Ring	Groove		Dia. G	Wall E	Dia. C	Width D	Ring	Groove
0.469	0.439	0.045	0.443	0.029	1880	510	3.500	3.293	0.270	3.316	0.120	48820	32250
0.500	0.464	0.050	0.468	0.039	2530	440	3.543	3.333	0.270	3.357	0.120	49420	33000
0.551	0.514	0.050	0.519	0.039	2790	540	3.625	3.411	0.270	3.435	0.120	50560	34490
0.562	0.525	0.050	0.530	0.039	2840	560	3.687	3.469	0.270	3.493	0.120	51430	35820
0.594	0.554	0.050	0.559	0.039	3000	700	3.750	3.527	0.270	3.552	0.120	52310	37180
0.625	0.583	0.055	0.588	0.039	3160	820	3.875	3.647	0.270	3.673	0.120	54050	39190
0.669	0.623	0.055	0.629	0.039	3380	1070	3.938	3.708	0.270	3.734	0.120	54930	40230
0.688	0.641	0.065	0.646	0.046	4170	960	4.000	3.765	0.270	3.792	0.120	55790	41660
0.750	0.698	0.065	0.704	0.046	4550	1250	4.250	4.037	0.270	4.065	0.120	59280	39370
0.781	0.727	0.065	0.733	0.046	4740	1430	4.375	4.161	0.270	4.190	0.120	61020	40530
0.812	0.756	0.065	0.762	0.046	4930	1620	4.500	4.280	0.270	4.310	0.120	62770	42810
0.875	0.814	0.075	0.821	0.046	5310	2000	4.750	4.518	0.270	4.550	0.120	66260	47570
0.938	0.875	0.075	0.882	0.046	5690	2440	5.000	4.756	0.270	4.790	0.120	69740	52580
0.984	0.919	0.085	0.926	0.046	5970	2790	5.250	4.995	0.350	5.030	0.139	83790	57830
1.000	0.932	0.085	0.940	0.046	6070	2950	5.500	5.228	0.350	5.265	0.139	87780	64720
1.023	0.953	0.085	0.961	0.046	6210	3170	5.750	5.466	0.350	5.505	0.139	91770	70540
1.062	0.986	0.103	0.998	0.056	7010	2810	6.000	5.705	0.350	5.745	0.139	95760	76610
1.125	1.047	0.103	1.059	0.056	7420	2890	6.250	5.938	0.418	5.985	0.174	122520	82930
1.188	1.105	0.103	1.118	0.056	7840	3450	6.500	6.181	0.418	6.225	0.174	127420	89510
1.250	1.163	0.103	1.176	0.056	8250	4110	6.750	6.410	0.418	6.465	0.174	132320	96330
1.312	1.218	0.118	1.232	0.056	8650	4810	7.000	6.648	0.418	6.705	0.174	137220	103400
1.375	1.277	0.118	1.291	0.056	9070	5650	7.250	6.891	0.418	6.942	0.174	142130	111810
1.438	1.336	0.118	1.350	0.056	9490	6340	7.500	7.130	0.437	7.180	0.209	176240	120170
1.500	1.385	0.118	1.406	0.056	9900	7060	7.750	7.368	0.437	7.420	0.209	182120	128060
1.562	1.453	0.128	1.468	0.068	12780	6600	8.000	7.606	0.437	7.660	0.209	187990	136200
1.625	1.513	0.128	1.529	0.068	13290	7330	8.250	7.845	0.437	7.900	0.209	193870	144590
1.687	1.573	0.128	1.589	0.068	13800	8190	8.500	8.083	0.437	8.140	0.209	199740	153220
1.750	1.633	0.128	1.650	0.068	14320	8760	8.750	8.324	0.437	8.383	0.209	205620	160800
1.771	1.651	0.128	1.669	0.068	14490	9040	9.000	8.560	0.500	8.620	0.209	211490	171250
1.812	1.690	0.128	1.708	0.068	14820	9440	9.250	8.798	0.500	8.860	0.209	217370	180640
1.875	1.751	0.158	1.769	0.068	15340	9950	9.500	9.036	0.500	9.100	0.209	223240	190280
1.969	1.838	0.158	1.857	0.068	16110	11040	9.750	9.275	0.500	9.338	0.209	229120	201140
2.000	1.867	0.158	1.886	0.068	16360	11420	10.000	9.508	0.500	9.575	0.209	234990	212810
2.062	1.932	0.168	1.946	0.086	21220	11820	10.250	9.745	0.500	9.814	0.209	240870	223780
2.125	1.989	0.168	2.003	0.086	21870	12980	10.500	9.984	0.500	10.054	0.209	246740	234490
2.156	2.018	0.168	2.032	0.086	22190	13390	10.750	10.221	0.500	10.293	0.209	252620	246000
2.250	2.105	0.168	2.120	0.086	23160	14650	11.000	10.459	0.500	10.533	0.209	258490	257230
2.312	2.163	0.168	2.178	0.086	23790	15510	11.250	10.692	0.500	10.772	0.209	264360	269270
2.375	2.223	0.200	2.239	0.086	24440	16170	11.500	10.934	0.562	11.011	0.209	270240	281590
2.437	2.283	0.200	2.299	0.086	25080	16840	11.750	11.171	0.562	11.250	0.209	276120	294180
2.500	2.343	0.200	2.360	0.086	25730	17530	12.000	11.410	0.562	11.490	0.209	281990	306450
2.559	2.402	0.200	2.419	0.086	26340	17940	12.250	11.647	0.562	11.729	0.209	287860	319580
2.625	2.464	0.200	2.481	0.086	27020	18930	12.500	11.885	0.562	11.969	0.209	293740	332360
2.687	2.523	0.200	2.541	0.086	27650	19640	12.750	12.124	0.562	12.208	0.209	299610	346030

Table 10. Heavy Duty External Spiral Retaining Rings MIL-R-27426

Shaft Dia. A	Ring		Groove		Static Thrust Load (lb)		Shaft Dia. A	Ring		Groove		Static Thrust Load (lb)	
	Dia. G	Wall E	Dia. C	Width D	Ring	Groove		Dia. G	Wall E	Dia. C	Width D	Ring	Groove
2.750	2.584	0.225	2.602	0.103	32140	20380	13.000	12.361	0.662	12.448	0.209	305490	359330
2.875	2.702	0.225	2.721	0.103	33600	22170	13.250	12.598	0.662	12.687	0.209	311360	373530
2.937	2.760	0.225	2.779	0.103	34320	23240	13.500	12.837	0.662	12.927	0.209	317240	387340
3.000	2.818	0.225	2.838	0.103	35060	24340	13.750	13.074	0.662	13.166	0.209	323110	402090
3.062	2.878	0.225	2.898	0.103	35780	25140	14.000	13.311	0.662	13.405	0.209	328990	417110
3.125	2.936	0.225	2.957	0.103	36520	26290	14.250	13.548	0.662	13.644	0.209	334860	432410
3.156	2.965	0.225	2.986	0.103	36880	26860	14.500	13.787	0.750	13.884	0.209	340740	447250
3.250	3.054	0.225	3.076	0.103	37980	28320	14.750	14.024	0.750	14.123	0.209	346610	463090
3.344	3.144	0.225	3.166	0.103	39080	29800	15.000	14.262	0.750	14.363	0.209	352490	478450
3.437	3.234	0.225	3.257	0.103	40170	30980							

Source: Spirolox Retaining Rings, RSN Series. All dimensions are in inches. Depth of groove $d = (A - C)/2$. Thickness indicated is for unplated rings; add 0.002 to upper tolerance for plated rings. Standard material: carbon spring steel (SAE 1070-1090).

Ring Thickness, F: For shaft size 0.469, 0.025; for sizes 0.500 through 0.669, 0.035; for sizes 0.688 through 1.023, 0.042; for sizes 1.062 through 1.500, 0.050; for sizes 1.562 through 2.000, 0.062; for sizes 2.062 through 2.687, 0.078; for sizes 2.750 through 3.437, 0.093; for sizes 3.500 through 5.000, 0.111; for sizes 5.250 through 6.000, 0.127; for sizes 6.250 through 7.250, 0.156; for sizes 7.500 through 15.000, 0.187.

Ring Free Diameter Tolerances: For shaft sizes 0.469 through 1.500, +0.000, -0.013; for sizes 1.562 through 2.000, +0.000, -0.020; for sizes 2.062 through 2.687, +0.000, -0.025; for sizes 2.750 through 3.437, +0.000, -0.030; for sizes 3.500 through 5.000, +0.000, -0.035; for sizes 5.250 through 6.000, +0.000, -0.050; for sizes 6.250 through 7.000, +0.000, -0.060; for sizes 7.250 through 10.000, +0.000, -0.070; for sizes 10.250 through 12.500, +0.000, -0.090; for sizes 12.750 through 15.000, +0.000, -0.110.

Ring Thickness Tolerances: For shaft sizes 0.469 through 1.500, ± 0.002 ; for sizes 1.562 through 5.000, ± 0.003 ; for sizes 5.250 through 6.000, ± 0.004 ; for sizes 6.250 through 15.000, ± 0.005 .

Groove Diameter Tolerances: For shaft sizes 0.469 through 0.562, ± 0.002 ; for sizes 0.594 through 1.023, ± 0.003 ; for sizes 1.062 through 1.500, ± 0.004 ; for sizes 1.562 through 2.000, ± 0.005 ; for sizes 2.062 through 5.000, ± 0.006 ; for sizes 5.250 through 6.000, ± 0.007 ; for sizes 6.250 through 10.000, ± 0.008 ; for sizes 10.250 through 12.500, ± 0.010 ; for sizes 12.750 through 15.000, ± 0.012 .

Groove Width Tolerances: For shaft sizes 0.469 through 1.023, +0.003, -0.000; for sizes 1.062 through 2.000, +0.004, -0.000; for sizes 2.062 through 5.000, +0.005, -0.000; for sizes 5.250 through 6.000, +0.006; -0.000; for sizes 6.250 through 7.250, +0.008, -0.000; for sizes 7.500 through 15.000, +0.008, -0.000.

Thrust Load Capacity: The most important criterion in determining which ring is best suited for a specific application is thrust load capacity. The strength of the retaining ring and groove must both be considered when analyzing the thrust load capacity of an application to determine whether the groove or the retaining ring is likely to fail first. When a retaining ring application fails, the fault will usually be with the groove, unless the groove material is of very high strength.

Ring Material: The standard materials for spiral-wound retaining rings are SAE 1070 to 1090 carbon spring steels and 18-8 type 302 stainless steels. The 1070 to 1090 carbon spring steels provide high-strength retaining rings at low cost. Type 302 stainless steel withstands ordinary rusting. Other materials are used for specialized applications, such as the type 316 stainless frequently used in the food industry. For high-temperature use, superalloy A286 rings can be used at up to 900°F (482 °C) and Inconel X-750 at up to 1200°F (649 °C). Other materials, such as 316 stainless steel, 17-7PH and Inconel stainless steels are sometimes used for special-purpose and custom-made rings. Standard ring are typically supplied uncoated, however, special finishes such as cadmium, phosphate, zinc, or black oxide coatings for carbon spring steel rings and passivation of stainless steel rings are available.

Table 11. Important Dimensions of Inch Series External Retaining Rings
MS 16624

Lugs: D = 0.125 to 0.236 Lugs: D = 4.25 to 8.00

Shaft Dia. D	Ring		Groove			Shaft Dia. D	Ring		Groove		
	Dia. A	Thick. T	Dia. G	Width W	Margin E		Dia. A	Thick. T	Dia. G	Width W	Margin E
0.125	0.112	0.010	0.117	0.012	0.012	1.812	1.675	0.062	1.708	0.068	0.156
0.156	0.142	0.010	0.146	0.012	0.015	1.875	1.735	0.062	1.769	0.068	0.159
0.188	0.168	0.015	0.175	0.018	0.018	1.969	1.819	0.062	1.857	0.068	0.168
0.197	0.179	0.015	0.185	0.018	0.018	2.000	1.850	0.062	1.886	0.068	0.171
0.219	0.196	0.015	0.205	0.018	0.021	2.062	1.906	0.078	1.946	0.086	0.174
0.236	0.215	0.015	0.222	0.018	0.021	2.125	1.964	0.078	2.003	0.086	0.183
0.250	0.225	0.025	0.230	0.029	0.030	2.156	1.993	0.078	2.032	0.086	0.186
0.276	0.250	0.025	0.255	0.029	0.030	2.250	2.081	0.078	2.120	0.086	0.195
0.281	0.256	0.025	0.261	0.029	0.030	2.312	2.139	0.078	2.178	0.086	0.201
0.312	0.281	0.025	0.290	0.029	0.033	2.375	2.197	0.078	2.239	0.086	0.204
0.344	0.309	0.025	0.321	0.029	0.033	2.438	2.255	0.078	2.299	0.086	0.207
0.354	0.320	0.025	0.330	0.029	0.036	2.500	2.313	0.078	2.360	0.086	0.210
0.375	0.338	0.025	0.352	0.029	0.036	2.559	2.377	0.078	2.419	0.086	0.210
0.394	0.354	0.025	0.369	0.029	0.036	2.625	2.428	0.078	2.481	0.086	0.216
0.406	0.366	0.025	0.382	0.029	0.036	2.688	2.485	0.078	2.541	0.086	0.219
0.438	0.395	0.025	0.412	0.029	0.039	2.750	2.543	0.093	2.602	0.103	0.222
0.469	0.428	0.025	0.443	0.029	0.039	2.875	2.659	0.093	2.721	0.103	0.231
0.500	0.461	0.035	0.468	0.039	0.048	2.938	2.717	0.093	2.779	0.103	0.237
0.551	0.509	0.035	0.519	0.039	0.048	3.000	2.775	0.093	2.838	0.103	0.243
0.562	0.521	0.035	0.530	0.039	0.048	3.062	2.832	0.093	2.898	0.103	0.246
0.594	0.550	0.035	0.559	0.039	0.051	3.125	2.892	0.093	2.957	0.103	0.252
0.625	0.579	0.035	0.588	0.039	0.054	3.156	2.920	0.093	2.986	0.103	0.255
0.669	0.621	0.035	0.629	0.039	0.060	3.250	3.006	0.093	3.076	0.103	0.261
0.672	0.621	0.035	0.631	0.039	0.060	3.346	3.092	0.093	3.166	0.103	0.270
0.688	0.635	0.042	0.646	0.046	0.063	3.438	3.179	0.093	3.257	0.103	0.270
0.750	0.693	0.042	0.704	0.046	0.069	3.500	3.237	0.109	3.316	0.120	0.276
0.781	0.722	0.042	0.733	0.046	0.072	3.543	3.277	0.109	3.357	0.120	0.279
0.812	0.751	0.042	0.762	0.046	0.075	3.625	3.352	0.109	3.435	0.120	0.285
0.844	0.780	0.042	0.791	0.046	0.080	3.688	3.410	0.109	3.493	0.120	0.291
0.875	0.810	0.042	0.821	0.046	0.081	3.750	3.468	0.109	3.552	0.120	0.297
0.938	0.867	0.042	0.882	0.046	0.084	3.875	3.584	0.109	3.673	0.120	0.303
0.984	0.910	0.042	0.926	0.046	0.087	3.938	3.642	0.109	3.734	0.120	0.306
1.000	0.925	0.042	0.940	0.046	0.090	4.000	3.700	0.109	3.792	0.120	0.312
1.023	0.946	0.042	0.961	0.046	0.093	4.250	3.989	0.109	4.065	0.120	0.276
1.062	0.982	0.050	0.998	0.056	0.096	4.375	4.106	0.109	4.190	0.120	0.276
1.125	1.041	0.050	1.059	0.056	0.099	4.500	4.223	0.109	4.310	0.120	0.285
1.188	1.098	0.050	1.118	0.056	0.105	4.750	4.458	0.109	4.550	0.120	0.300
1.250	1.156	0.050	1.176	0.056	0.111	5.000	4.692	0.109	4.790	0.120	0.315
1.312	1.214	0.050	1.232	0.056	0.120	5.250	4.927	0.125	5.030	0.139	0.330
1.375	1.272	0.050	1.291	0.056	0.126	5.500	5.162	0.125	5.265	0.139	0.351
1.438	1.333	0.050	1.350	0.056	0.132	5.750	5.396	0.125	5.505	0.139	0.366
1.500	1.387	0.050	1.406	0.056	0.141	6.000	5.631	0.125	5.745	0.139	0.381
1.562	1.446	0.062	1.468	0.068	0.141	6.250	5.866	0.156	5.985	0.174	0.396
1.625	1.503	0.062	1.529	0.068	0.144	6.500	6.100	0.156	6.225	0.174	0.411
1.687	1.560	0.062	1.589	0.068	0.147	6.750	6.335	0.156	6.465	0.174	0.426
1.750	1.618	0.062	1.650	0.068	0.150	7.000	6.570	0.156	6.705	0.174	0.441
1.772	1.637	0.062	1.669	0.068	0.153	7.500	7.009	0.187	7.180	0.209	0.480

Source: Industrial Retaining Rings, 3100 Series. All dimensions are in inches. Depth of groove $d = (D - G)/2$. Thickness indicated is for unplated rings; for most plated rings, the maximum ring thickness will not exceed the minimum groove width (W) minus 0.0002 inch. Standard material: carbon spring steel (SAE 1060-1090).

Ring Free Diameter Tolerances: For shaft sizes 0.125 through 0.250, +0.002, -0.004; for sizes 0.276 through 0.500, +0.002, -0.005; for sizes 0.551 through 1.023, +0.005, -0.010; for sizes 1.062 through 1.500, +0.010, -0.015; for sizes 1.562 through 2.000, +0.013, -0.020; for sizes 2.062 through 2.500, +0.015, -0.025; for sizes 2.559 through 5.000, +0.020, -0.030; for sizes 5.250 through 6.000, +0.020, -0.040; for sizes 6.250 through 6.750, +0.020, -0.050; for sizes 7.000 and 7.500, +0.050, -0.130.

Ring Thickness Tolerances: For shaft sizes 0.125 and 0.156, ±0.001; for sizes 0.188 through 1.500, ±0.002; for sizes 1.562 through 5.000, ±0.003; for sizes 5.250 through 6.000, ±0.004; for sizes 6.250 through 7.500, ±0.005.

Groove Diameter Tolerances: For shaft sizes 0.125 through 0.250, ±0.0015; for sizes 0.276 through 0.562, ±0.002; for sizes 0.594 through 1.023, ±0.003; for sizes 1.062 through 1.500, ±0.004; for sizes 1.562 through 2.000, ±0.005; for sizes 2.062 through 5.000, ±0.006; for sizes 5.250 through 6.000, ±0.007; for sizes 6.250 through 7.500, ±0.008.

Groove Width Tolerances: For shaft sizes 0.125 through 0.236, +0.002, -0.000; for sizes 0.250 through 1.023, +0.003, -0.000; for sizes 1.062 through 2.000, +0.004, -0.000; for sizes 2.062 through 5.000, +0.005, -0.000; for sizes 5.250 through 6.000, +0.006, -0.000; for sizes 6.250 through 7.500, +0.008, -0.000.

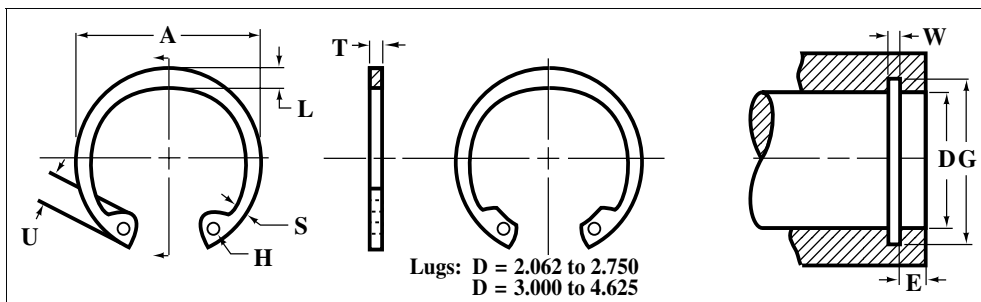


Table 12. Important Dimensions of Inch Series Internal Retaining Rings

Housing Dia. D	Ring		Groove			Housing Dia. D	Ring		Groove		
	Dia. A	Thick. T	Dia. G	Width W	Margin E		Dia. A	Thick. T	Dia. G	Width W	Margin E
0.250	0.280	0.015	0.268	0.018	0.027	2.500	2.775	0.078	2.648	0.086	0.222
0.312	0.346	0.015	0.330	0.018	0.027	2.531	2.775	0.078	2.681	0.086	0.225
0.375	0.415	0.025	0.397	0.029	0.033	2.562	2.844	0.093	2.714	0.103	0.228
0.438	0.482	0.025	0.461	0.029	0.036	2.625	2.910	0.093	2.781	0.103	0.234
0.453	0.498	0.025	0.477	0.029	0.036	2.677	2.980	0.093	2.837	0.103	0.240
0.500	0.548	0.035	0.530	0.039	0.045	2.688	2.980	0.093	2.848	0.103	0.240
0.512	0.560	0.035	0.542	0.039	0.045	2.750	3.050	0.093	2.914	0.103	0.246
0.562	0.620	0.035	0.596	0.039	0.051	2.812	3.121	0.093	2.980	0.103	0.252
0.625	0.694	0.035	0.665	0.039	0.060	2.835	3.121	0.093	3.006	0.103	0.255
0.688	0.763	0.035	0.732	0.039	0.066	2.875	3.191	0.093	3.051	0.103	0.264
0.750	0.831	0.035	0.796	0.039	0.069	2.953	3.325	0.093	3.135	0.103	0.273
0.777	0.859	0.042	0.825	0.046	0.072	3.000	3.325	0.093	3.182	0.103	0.273
0.812	0.901	0.042	0.862	0.046	0.075	3.062	3.418	0.109	3.248	0.120	0.279
0.866	0.961	0.042	0.920	0.046	0.081	3.125	3.488	0.109	3.315	0.120	0.285
0.875	0.971	0.042	0.931	0.046	0.084	3.149	3.523	0.109	3.341	0.120	0.288
0.901	1.000	0.042	0.959	0.046	0.087	3.156	3.523	0.109	3.348	0.120	0.288
0.938	1.041	0.042	1.000	0.046	0.093	3.250	3.623	0.109	3.446	0.120	0.294
1.000	1.111	0.042	1.066	0.046	0.099	3.346	3.734	0.109	3.546	0.120	0.300
1.023	1.136	0.042	1.091	0.046	0.102	3.469	3.857	0.109	3.675	0.120	0.309
1.062	1.180	0.050	1.130	0.056	0.102	3.500	3.890	0.109	3.710	0.120	0.315

Table 12. Important Dimensions of Inch Series Internal Retaining Rings

Housing Dia. D	Ring		Groove			Housing Dia. D	Ring		Groove		
	Dia. A	Thick. T	Dia. G	Width W	Margin E		Dia. A	Thick. T	Dia. G	Width W	Margin E
1.125	1.249	0.050	1.197	0.056	0.108	3.543	3.936	0.109	3.755	0.120	0.318
1.181	1.319	0.050	1.255	0.056	0.111	3.562	3.936	0.109	3.776	0.120	0.321
1.188	1.319	0.050	1.262	0.056	0.111	3.625	4.024	0.109	3.841	0.120	0.324
1.250	1.388	0.050	1.330	0.056	0.120	3.740	4.157	0.109	3.964	0.120	0.336
1.259	1.388	0.050	1.339	0.056	0.120	3.750	4.157	0.109	3.974	0.120	0.336
1.312	1.456	0.050	1.396	0.056	0.126	3.875	4.291	0.109	4.107	0.120	0.348
1.375	1.526	0.050	1.461	0.056	0.129	3.938	4.358	0.109	4.174	0.120	0.354
1.378	1.526	0.050	1.464	0.056	0.129	4.000	4.424	0.109	4.240	0.120	0.360
1.438	1.596	0.050	1.528	0.056	0.135	4.125	4.558	0.109	4.365	0.120	0.360
1.456	1.616	0.050	1.548	0.056	0.138	4.250	4.691	0.109	4.490	0.120	0.360
1.500	1.660	0.050	1.594	0.056	0.141	4.331	4.756	0.109	4.571	0.120	0.360
1.562	1.734	0.062	1.658	0.068	0.144	4.500	4.940	0.109	4.740	0.120	0.360
1.575	1.734	0.062	1.671	0.068	0.144	4.625	5.076	0.109	4.865	0.120	0.360
1.625	1.804	0.062	1.725	0.068	0.150	4.724	5.213	0.109	4.969	0.120	0.366
1.653	1.835	0.062	1.755	0.068	0.153	4.750	5.213	0.109	4.995	0.120	0.366
1.688	1.874	0.062	1.792	0.068	0.156	5.000	5.485	0.109	5.260	0.120	0.390
1.750	1.942	0.062	1.858	0.068	0.162	5.250	5.770	0.125	5.520	0.139	0.405
1.812	2.012	0.062	1.922	0.068	0.165	5.375	5.910	0.125	5.650	0.139	0.405
1.850	2.054	0.062	1.962	0.068	0.168	5.500	6.066	0.125	5.770	0.139	0.405
1.875	2.054	0.062	1.989	0.068	0.171	5.750	6.336	0.125	6.020	0.139	0.405
1.938	2.141	0.062	2.056	0.068	0.177	6.000	6.620	0.125	6.270	0.139	0.405
2.000	2.210	0.062	2.122	0.068	0.183	6.250	6.895	0.156	6.530	0.174	0.420
2.047	2.280	0.078	2.171	0.086	0.186	6.500	7.170	0.156	6.790	0.174	0.435
2.062	2.280	0.078	2.186	0.086	0.186	6.625	7.308	0.156	6.925	0.174	0.450
2.125	2.350	0.078	2.251	0.086	0.189	6.750	7.445	0.156	7.055	0.174	0.456
2.165	2.415	0.078	2.295	0.086	0.195	7.000	7.720	0.156	7.315	0.174	0.471
2.188	2.415	0.078	2.318	0.086	0.195	7.250	7.995	0.187	7.575	0.209	0.486
2.250	2.490	0.078	2.382	0.086	0.198	7.500	8.270	0.187	7.840	0.209	0.510
2.312	2.560	0.078	2.450	0.086	0.207	7.750	8.545	0.187	8.100	0.209	0.525
2.375	2.630	0.078	2.517	0.086	0.213	8.000	8.820	0.187	8.360	0.209	0.540
2.440	2.702	0.078	2.584	0.086	0.216	8.250	9.095	0.187	8.620	0.209	0.555

Source: Industrial Retaining Rings, 3000 Series. All dimensions are in inches. Depth of groove $d = (G - D)/2$. Thickness indicated is for unplated rings. Standard material: carbon spring steel (SAE 1060-1090).

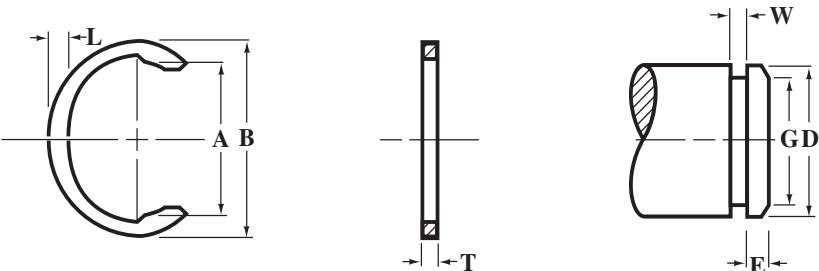
Ring Free Diameter Tolerances: For housing sizes 0.250 through 0.777, +0.010, -0.005; for sizes 0.812 through 1.023, +0.015, -0.010; for sizes 1.062 through 1.500, +0.025, -0.020; for sizes 1.562 through 2.000, +0.035, -0.025; for sizes 2.047 through 3.000, +0.040, -0.030; for sizes 3.062 through 3.625, ± 0.055 ; for sizes 3.740 through 6.000, ± 0.065 ; for sizes 6.250 through 7.000, ± 0.080 ; for sizes 7.250 through 8.250, ± 0.090 .

Ring Thickness Tolerances: For housing sizes 0.250 through 1.500, ± 0.002 ; for sizes 1.562 through 5.000, ± 0.003 ; for sizes 5.250 through 6.000, ± 0.004 ; for sizes 6.250 through 8.250, ± 0.005 .

Groove Diameter Tolerances: For housing sizes 0.250 and 0.312, ± 0.001 ; for sizes 0.375 through 0.750, ± 0.002 ; for sizes 0.777 through 1.023 ± 0.003 ; for sizes 1.062 through 1.500, ± 0.004 ; for sizes 1.562 through 2.000, ± 0.005 ; for sizes 2.047 through 5.000 ± 0.006 ; for sizes 5.250 through 6.000, ± 0.007 ; for sizes 6.250 through 8.250, ± 0.008 .

Groove Width Tolerances: For housing sizes 0.250 and 0.312, +0.002, -0.000; for sizes 0.375 through 1.023, +0.003, -0.000; for sizes 1.062 through 2.000, +0.004, -0.000; for sizes 2.047 through 5.000, +0.005; -0.000; for sizes 5.250 through 6.000, +0.006, -0.000; for sizes 6.250 through 8.250, +0.008, -0.000.

Table 13. Important Dimensions of Inch Series External Retaining Rings MS16632



Shaft Diameter D	Ring			Groove			^a Static Thrust Load (lb)	
	Free Dia. A	Thickness T	Diameter B	Diameter G	Width W	Margin E	Ring	Groove
	0.125	0.102	0.015	0.164	0.106	0.018	0.020	85
0.156	0.131	0.015	0.205	0.135	0.018	0.020	110	55
0.188	0.161	0.015	0.245	0.165	0.018	0.022	130	70
0.219	0.187	0.025	0.275	0.193	0.029	0.026	260	100
0.236	0.203	0.025	0.295	0.208	0.029	0.028	280	115
0.250	0.211	0.025	0.311	0.220	0.029	0.030	295	130
0.281	0.242	0.025	0.344	0.247	0.029	0.034	330	170
0.312	0.270	0.025	0.376	0.276	0.029	0.036	370	200
0.375	0.328	0.025	0.448	0.335	0.029	0.040	440	265
0.406	0.359	0.025	0.485	0.364	0.029	0.042	480	300
0.437	0.386	0.025	0.516	0.393	0.029	0.044	515	340
0.500	0.441	0.035	0.581	0.450	0.039	0.050	825	440
0.562	0.497	0.035	0.653	0.507	0.039	0.056	930	550
0.625	0.553	0.035	0.715	0.563	0.039	0.062	1030	690
0.687	0.608	0.042	0.780	0.619	0.046	0.068	1700	820
0.750	0.665	0.042	0.845	0.676	0.046	0.074	1850	985
0.812	0.721	0.042	0.915	0.732	0.046	0.080	2010	1150
0.875	0.777	0.042	0.987	0.789	0.046	0.086	2165	1320
0.937	0.830	0.042	1.054	0.843	0.046	0.094	2320	1550
1.000	0.887	0.042	1.127	0.900	0.046	0.100	2480	1770
1.125	0.997	0.050	1.267	1.013	0.056	0.112	3300	2200
1.188	1.031	0.050	1.321	1.047	0.056	0.140	3500	2900
1.250	1.110	0.050	1.410	1.126	0.056	0.124	3600	2700
1.375	1.220	0.050	1.550	1.237	0.056	0.138	4000	3300
1.500	1.331	0.050	1.691	1.350	0.056	0.150	4400	4000
1.750	1.555	0.062	1.975	1.576	0.068	0.174	6400	5300
2.000	1.777	0.062	2.257	1.800	0.068	0.200	7300	7000

^a Thrust Load Safety Factors: Ring, 4; groove, 2. Groove wall thrust loads are for grooves machined in cold-rolled steel with a tensile yield strength of 45,000 psi; for other shaft materials, the thrust load varies proportionally with the yield strength.

Source: Industrial Retaining Rings, 2000 Series. All dimensions are in inches. Depth of groove $d = (D - G)/2$. Standard material: carbon spring steel (SAE 1060-1090). Thickness indicated is for unplated rings; for most plated rings with shaft sizes less than 1.000 inch, the maximum thickness will not exceed the minimum groove width (W) minus 0.0002 inch; for larger rings, the ring thickness may increase by 0.002 inch.

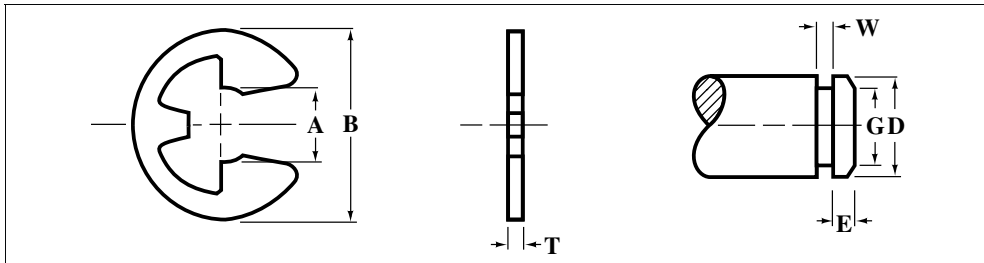
Groove Maximum Bottom Radii: For shaft diameters less than 0.500 inch, 0.005 inch; for shaft sizes 0.500 through 1.000 inch, 0.010 inch; all larger sizes, 0.015 inch.

Ring Free Diameter Tolerances: For shaft sizes 0.125 through 0.188, +0.002, -0.004; for sizes 0.219 through 0.437, +0.003, -0.005; for sizes 0.500 through 0.625, ±0.006; for sizes 0.687 through 1.000, ±0.007; for sizes 1.125 through 1.500, ±0.008; for sizes 1.750 and 2.000, ±0.010.

Ring Thickness Tolerances: For shaft sizes 0.125 through 1.500, ±0.002; for sizes 1.750 and 2.000, ±0.003.

Groove Diameter Tolerances: For shaft sizes 0.125 through 0.188, ±0.0015; for sizes 0.219 through 0.437, ±0.002; for sizes 0.500 through 1.000, ±0.003; for sizes 1.125 through 1.500, ±0.004; for sizes 1.750 and 2.000, ±0.005.

Groove Width Tolerances: For shaft sizes 0.125 through 0.188, +0.002, -0.000; for sizes 0.219 through 1.000, +0.003, -0.000; for sizes 1.125 through 2.000, +0.004, -0.000.

Table 14. Important Dimensions of Inch Series External Retaining Rings MS16633


Shaft Diameter D	Ring			Groove			^a Static Thrust Load (lb)	
	Free Dia. A	Thickness T	Diameter B	Diameter G	Width W	Margin E	Ring	Groove
	0.040	0.025	0.010	0.079	0.026	0.012	0.014	13
0.062	0.051	0.010	0.140	0.052	0.012	0.010	20	7
0.062 ^a	0.051	0.010	0.156	0.052	0.012	0.010	20	7
0.062 ^b	0.051	0.020	0.187	0.052	0.023	0.010	40	7
0.094	0.073	0.015	0.187	0.074	0.018	0.020	45	20
0.094	0.069	0.015	0.230	0.074	0.018	0.020	45	20
0.110	0.076	0.015	0.375	0.079	0.018	0.030	55	40
0.125	0.094	0.015	0.230	0.095	0.018	0.030	65	45
0.140	0.100	0.015	0.203	0.102	0.018	0.038	70	60
0.140 ^c	0.108	0.015	0.250	0.110	0.018	0.030	70	45
0.140 ^d	0.102	0.025	0.270	0.105	0.029	0.034	150	55
0.156	0.114	0.025	0.282	0.116	0.029	0.040	165	70
0.172	0.125	0.025	0.312	0.127	0.029	0.044	180	90
0.188	0.145	0.025	0.335	0.147	0.029	0.040	195	90
0.188	0.122	0.025	0.375	0.125	0.029	0.062	195	135
0.218	0.185	0.025	0.437	0.188	0.029	0.030	225	75
0.250	0.207	0.025	0.527	0.210	0.029	0.040	260	115
0.312	0.243	0.025	0.500	0.250	0.029	0.062	325	225
0.375	0.300	0.035	0.660	0.303	0.039	0.072	685	315
0.437	0.337	0.035	0.687	0.343	0.039	0.094	800	485
0.437	0.375	0.035	0.600	0.380	0.039	0.058	800	290
0.500	0.392	0.042	0.800	0.396	0.046	0.104	1100	600
0.625	0.480	0.042	0.940	0.485	0.046	0.140	1370	1040
0.744	0.616	0.050	1.000	0.625	0.056	0.118	1940	1050
0.750	0.616	0.050	1.000	0.625	0.056	0.124	1960	1100
0.750	0.574	0.050	1.120	0.580	0.056	0.170	1960	1500
0.875	0.668	0.050	1.300	0.675	0.056	0.200	2200	2050
0.985	0.822	0.050	1.500	0.835	0.056	0.148	2570	1710
1.000	0.822	0.050	1.500	0.835	0.056	0.164	2620	1900
1.188	1.066	0.062	1.626	1.079	0.068	0.108	3400	1500
1.375	1.213	0.062	1.875	1.230	0.068	0.144	4100	2300

^a Thrust Load Safety Factors: Ring 3; groove, 2.

Source: Industrial Retaining Rings, 1000 Series. All dimensions are in inches. Depth of groove $d = (D - G)/2$. Standard material: carbon spring steel (SAE 1060 -1090). Thickness indicated is for unplated rings; for most plated rings with shaft sizes less than 0.625, the maximum ring thickness will not exceed the minimum groove width (W) minus 0.0002 inch; for larger rings, the thickness may increase by 0.002 inch.

Groove Maximum Bottom Radii: For shaft sizes 0.040 and 0.062, 0.003 inch; for sizes 0.094 through 0.250, 0.005 inch; for sizes 0.312 through 0.437, 0.010 inch; for sizes 0.500 through 1.375, 0.015 inch.

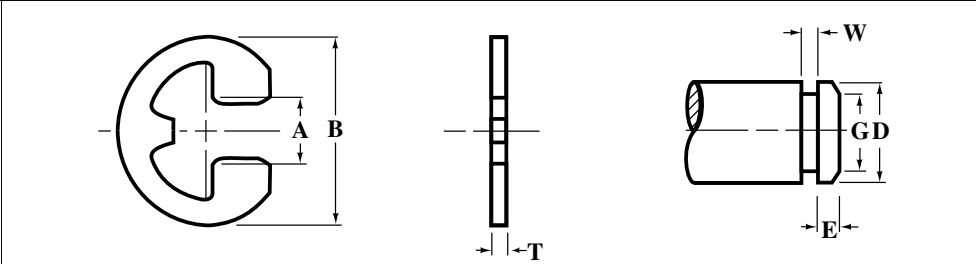
Ring Free Diameter Tolerances: For shaft sizes 0.040 through 0.250, +0.001, -0.003; for sizes 0.312 through 0.500, +0.002, -0.004; for sizes 0.625 through 1.000, +0.003, -0.005; for sizes 1.188 and 1.375, +0.006, -0.010.

Ring Thickness Tolerances: For shaft sizes 0.040 and 0.062^a, ± 0.001 ; for sizes 0.062^b through 1.000, ± 0.002 ; for sizes 1.188 and 1.375, ± 0.003 .

Groove Diameter Tolerances: For shaft sizes 0.040 through 0.218, +0.002, -0.000; for sizes 0.250 through 1.000, +0.003, -0.000; for sizes 1.188 and 1.375, +0.005, -0.000.

Groove Width Tolerances: For shaft sizes 0.040 through 0.140^c, +0.002, -0.000; for sizes 0.140^d through 1.000, +0.003, -0.000; for sizes 1.188 and 1.375, +0.004, -0.000.

Table 15. Dimensions of Inch Series External Retaining Rings MS3215



Shaft Diameter D	Ring			Groove			*Static Thrust Load (lb)	
	Free Dia. A	Thickness T	Diameter B	Diameter G	Width W	Margin E	Ring	Groove
0.094	0.072	0.015	0.206	0.074	0.018	0.020	55	13
0.125	0.093	0.015	0.270	0.095	0.018	0.030	75	25
0.156	0.113	0.025	0.335	0.116	0.029	0.040	150	40
0.188	0.143	0.025	0.375	0.147	0.029	0.040	180	50
0.219	0.182	0.025	0.446	0.188	0.029	0.031	215	50
0.250	0.204	0.025	0.516	0.210	0.029	0.040	250	75
0.312	0.242	0.025	0.588	0.250	0.029	0.062	300	135
0.312	0.242	0.035	0.588	0.250	0.039	0.062	420	135
0.375	0.292	0.035	0.660	0.303	0.039	0.072	520	190
0.438	0.332	0.035	0.746	0.343	0.039	0.096	600	285
0.500	0.385	0.042	0.810	0.396	0.046	0.104	820	360
0.562	0.430	0.042	0.870	0.437	0.046	0.124	930	480

^a Thrust Load Safety Factors: Ring, 3; groove, 2.

Source: Industrial Retaining Rings, 1200 Series. All dimensions are in inches. Depth of groove $d = (D - G)/2$. Standard material: carbon spring steel (SAE 1060-1090). Thickness indicated is for unplated rings; for most plated rings the maximum thickness will not exceed the minimum groove width (W) minus 0.0002 inch.

Groove Maximum Bottom Radii: For shaft sizes 0.250 and smaller, 0.005 inch; for sizes 0.312 through 0.438, 0.010 inch; for sizes 0.500 and 0.562, 0.015 inch. **Ring Free Diameter Tolerances:** For shaft sizes 0.094 through 0.156, +0.001, -0.003; for sizes 0.188 through 0.312, ±0.003; for sizes 0.375 through 0.562, ±0.004. **Ring Thickness Tolerances:** For all shaft sizes, ±0.002. **Groove Diameter Tolerances:** For shaft sizes 0.094 through 0.188, +0.002, -0.000; for sizes 0.219 and 0.250, ±0.002; for sizes 0.312 through 0.562, ±0.003. **Groove Width Tolerances:** For shaft sizes 0.094 and 0.125, +0.002, -0.000; for sizes 0.156 through 0.562, +0.003, -0.000.

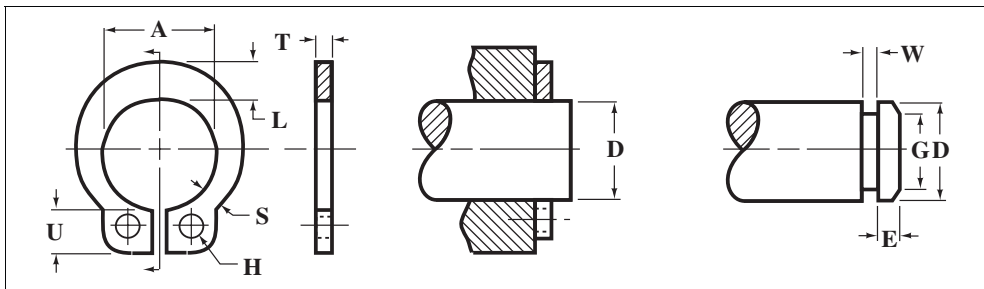
Thrust Load Capacity: The thrust load capacities shown in the tables of this section include safety factors. Usually, a safety factor of 2 is used for groove thrust load calculations when the load is applied through a retained part and groove with both having sharp corners and where the minimum side clearance exists between the retained part and the shaft or bore. Groove thrust load values in the tables of this section are based on these conditions. A safety factor of 3 is usual for calculations of thrust load capacity based on ring shear.

Ideally, the corner of a retained part in contact with a retaining ring should have square corners and contact the ring as closely as possible to the shaft or housing. The tabulated thrust capacities assume that minimum clearances exist between the retained part and shaft or housing, that the groove and retained part have square corners, and that contact between the retained part and the ring occurs close to the shaft or housing. If these conditions apply, the tabulated thrust loads apply. If the application does not meet the previous conditions but the side clearances, radii, and chamfers are less than the maximum total radius or chamfer of Fig. 1, then the thrust load capacity must be reduced by dividing the tabulated value by 2. The maximum total radius is given by $0.5(b - d)$ and the maximum total chamfer by $0.375(b - d)$, where b is the radial wall thickness, and d is the groove depth. The recommended maximum total radius or chamfer specifications are intended to be used as

guidelines by the designer, and to ensure the ring application will withstand published and calculated values of static thrust loads.

In analyzing the retaining ring loading conditions, a static, uniformly applied load is usually assumed. Dynamic and eccentric loads, however, are frequently encountered. Eccentric loading occurs when the load is concentrated on a small portion of the ring, such as may be caused by incorrectly machined surfaces, cocking of the retained part, and axial misalignment of parts. Conditions leading to eccentric loading on the ring should be avoided. In addition to the factors that affect the static thrust capacity, applications in which shock or impact loading occurs must be evaluated very carefully and tested in service to assess the effect of the mass and velocity of the retained part striking the ring. Vibration caused by impact loading can also cause the ring to fail if the resonant frequency of the system (retaining ring application) coincides with the resonant frequency of the retaining ring.

Table 16. Dimensions of Inch Series Self-Locking External Retaining Rings



Shaft Diameter		Ring		Optical Groove			^a Static Thrust Load (lb)				
Min. D	Max. D	Free Dia. A	Thickness T	Diameter G	Width W	Margin E	Ring	Groove			
0.078	0.080	0.074	0.025	The use of grooves with these shaft sizes is not suggested.			10	0			
0.092	0.096	0.089	0.025				10	0			
0.123	0.127	0.120	0.025				20	0			
0.134	0.138	0.130	0.025				20	0			
0.154	0.158	0.150	0.025				22	0			
0.185	0.189	0.181	0.035				25	0			
0.248	0.252	0.238	0.035				0.240	0.041	0.030	35	90
0.310	0.316	0.298	0.042				0.303	0.048	0.030	50	110
0.373	0.379	0.354	0.042				0.361	0.048	0.030	55	185
0.434	0.440	0.412	0.050				0.419	0.056	0.030	60	280
0.497	0.503	0.470	0.050	0.478	0.056	0.040	65	390			
0.622	0.628	0.593	0.062	0.599	0.069	0.045	85	570			
0.745	0.755	0.706	0.062	0.718	0.069	0.050	90	845			

^a Thrust Load Safety Factors: Ring, 1; groove, 2.

Source: Industrial Retaining Rings, 7100 Series. All dimensions are in inches. Depth of groove $d = (D - G)/2$. Standard material: carbon spring steel (SAE 1060-1090). Thickness indicated is for unplated rings; for plated, phosphate coated, and stainless steel rings, the maximum ring thickness may be exceeded by 0.002 inch.

Ring Free Diameter Tolerances: For shaft sizes 0.078 through 0.138, +0.002, -0.003; for sizes 0.154 through 0.252, +0.002, -0.004; for sizes 0.310 through 0.440, +0.003, -0.005; for sizes 0.497 through 0.755, +0.004, -0.006. Ring Thickness Tolerances: For shaft sizes 0.078 through 0.158, ±0.002; for sizes 0.185 through 0.503, ±0.003; for sizes 0.622 through 0.755, ±0.004. Groove Diameter Tolerances: For shaft sizes less than 0.248, grooves are not recommended; for other sizes, grooves are optional. For shaft sizes 0.248 through 0.316, +0.005, -0.0015; for sizes 0.373 through 0.628, +0.001, -0.002; for sizes 0.745 and 0.755, +0.002, -0.003. Groove Width Tolerances: For shaft sizes 0.248 through 0.379, +0.003, -0.000; for sizes 0.434 through 0.755, +0.004, -0.000.

Table 17. Inch Series Internal and External Self-Locking Retaining Rings

Internal						External					
Housing		Ring Dimensions			Static Thrust Load	Shaft		Ring Dimensions			Static Thrust Load
Min. D	Max. D	Thick. T	Dia. D	Margin E		Min. D	Max. D	Thick. T	Dia. D	Margin E	
0.311	0.313	0.010	0.136	0.040	80	0.093	0.095	0.010	0.250	0.040	15
0.374	0.376	0.010	0.175	0.040	75	0.124	0.126	0.010	0.325	0.040	20
0.437	0.439	0.010	0.237	0.040	70	0.155	0.157	0.010	0.356	0.040	25
0.498	0.502	0.010	0.258	0.040	60	0.187	0.189	0.010	0.387	0.040	35
0.560	0.564	0.010	0.312	0.040	50	0.218	0.220	0.010	0.418	0.040	35
0.623	0.627	0.010	0.390	0.040	45	0.239	0.241	0.015	0.460	0.060	35
0.748	0.752	0.015	0.500	0.060	75	0.249	0.251	0.010	0.450	0.040	40
0.873	0.877	0.015	0.625	0.060	70	0.311	0.313	0.010	0.512	0.040	40
0.936	0.940	0.015	0.687	0.060	70	0.374	0.376	0.010	0.575	0.040	40
0.998	1.002	0.015	0.750	0.060	70	0.437	0.440	0.015	0.638	0.060	50
1.248	1.252	0.015	0.938	0.060	60	0.498	0.502	0.015	0.750	0.060	50
1.436	1.440	0.015	1.117	0.060	60	0.560	0.564	0.015	0.812	0.060	50
1.498	1.502	0.015	1.188	0.060	60	0.623	0.627	0.015	0.875	0.060	50
						0.748	0.752	0.015	1.000	0.060	50
						0.873	0.877	0.015	1.125	0.060	55
						0.998	1.002	0.015	1.250	0.060	60

Source: Industrial Retaining Rings, 6000 Series (internal) and 6100 Series (external). All dimensions are in inches, thrust loads are in pounds. Thickness indicated is for unplated rings. Standard material: carbon spring steel (SAE 1060-1090).

Internal Rings: Thrust loads are for rings made of standard material inserted into cold-rolled, low-carbon housing. **Ring Thickness Tolerances:** For housing sizes 0.311 through 0.627, ±0.001; for sizes 0.748 through 1.502, ±0.002. **Ring Diameter Tolerances:** For housing sizes 0.311 through 0.439, ±0.005; for sizes 0.498 through 1.502, ±0.010.

External Rings: Thrust loads are for rings made of standard material installed onto cold-rolled, low-carbon shafts. **Ring Thickness Tolerances:** For shaft sizes 0.093 through 0.220, ±0.001; for size 0.239, ±0.002; for sizes 0.249 through 0.376, ±0.001; for sizes 0.437 through 1.002, ±0.002. **Ring Diameter Tolerances:** For shaft sizes 0.093 through 0.502, ±0.005; for sizes 0.560 through 1.002, ±0.010.

Centrifugal Capacity: Proper functioning of a retaining ring depends on the ring remaining seated on the groove bottom. External rings “cling” to the groove bottom because the ring ID is slightly smaller than the diameter at the bottom of the groove. Ring speed should be kept below the allowable steady-state speed of the ring, or self-locking rings specially designed for high-speed applications should be used, otherwise an external ring can lose its grip on the groove. Applications of large retaining rings that tend to spin in their grooves when subjected to sudden acceleration or deceleration of the retained part can benefit from a ring with more “cling” (i.e., a smaller interior diameter) as long as the stress of installation is within permissible limits. Special rings are also available that lock into a hole in the bottom of the groove, thereby preventing rotation. The following equation can be used to determine the allowable steady-state speed *N* of an external spiral retaining ring:

$$N = \sqrt{\frac{0.466 C_1 E^3 \times 10^{12}}{R_n^3 (1 + C_1) (R_o^3 - R_i^3)}} \quad (1)$$

where the speed N is in revolutions per minute, C_1 is the minimum ring cling to groove bottom, E is the ring radial wall, R_n is the free neutral ring radius, R_o is the free outside ring radius, and R_i is the free inside ring radius, all in inches. For external spiral rings, the minimum ring cling is given by: $C_1 = (C - G)/G$, where C is the mean groove diameter in inches, and G is the maximum ring free ID in inches.

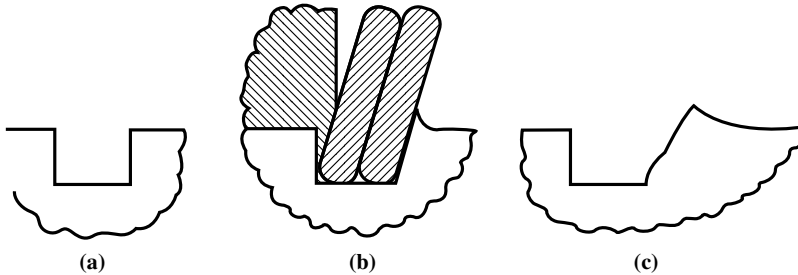


Fig. 2. Localized Groove Yielding under Load. (a) Groove Profile before Loading; (b) Localized Yielding of Retained Part and Groove under Load; (c) Groove Profile after Loading beyond Thrust Capacity (Courtesy Spirolox Retaining Rings)

Rotation between Parts: The use of spiral-wound rings to retain a rotating part should be limited to applications with rotation in only one direction. The ring should be matched so that the rotation tends to wind the spring into the groove. External rings should be wound in the direction of rotation of the retained part but internal rings should be wound against the direction of rotation of the rotating part. Failure to observe these precautions will cause the ring to wind out of the groove. Spiral-wound rings can be obtained with either right-hand (normal rotation) or left-hand (reverse rotation) wound configurations. Stamped retaining rings do not have these limitations, and may be used for applications that require rotation of the retained part, regardless of the direction of rotation.

Retaining Ring Failure.—Failure of a retaining ring application can result from failure of the ring itself, failure of the groove, or both. If a ring fails, the cause is likely to be from shearing of the ring. Shear failure occurs when a ring is installed in a groove and loaded by a retained part with both the groove and the retained part having a compressive yield strength greater than 45,000 psi (310 MPa); or when the load is applied through a retained part and groove, both having sharp corners and line-to-line contact; or when the ring is too thin in section compared with its diameter. To examine the possibility of ring shear, the allowable thrust P_s , based on the shear strength of the ring material, is given by

$$P_s = \frac{\pi D t S_s}{K} \quad (2)$$

where P_s is in lb_f (N), D is the shaft or housing diameter in inches (mm), t is the ring thickness in inches (mm), S_s is the shear strength of the ring material in lb/in^2 (N/mm^2), and K is the factor of safety.

Groove Failure: The most common type of groove failure is yielding of the groove material that occurs when the thrust load, applied through the retaining ring against the corner of the groove, exceeds the compressive yield strength of the groove. This yielding of the groove results from a low compressive yield strength of the groove material, and allows the ring to tilt and come out of the groove, as illustrated in Fig. 2(b).

When dishing of a ring occurs as a result of yielding in the groove material, a bending moment across the cross-section of the ring generates a tensile stress that is highest at the interior diameter of the ring. If the maximum stress is greater than the yield strength of the

ring material, the ring ID will grow and the ring will become permanently dished in shape. To determine the thrust load capacity of a ring based on groove deformation, the allowable angle of ring deflection must be calculated, then the thrust load based on groove yield can be determined. However, for spiral-wound rings, the thrust load P_G that initiates the onset of groove deformation can be estimated from the following:

$$P_G = \frac{\pi D d S_y}{K} \quad (3)$$

where P_G is given in lb_f (N), D is the shaft or housing diameter in inches (mm), d is the groove depth in inches (mm), S_y is the yield strength of the groove material in lb/in^2 (N/mm^2), and K is the safety factor. For stamped rings, estimate P_G by multiplying Equation (3) by the fraction of the groove circumference that contacts the ring.

The thrust load capacity of a particular retaining ring application can be increased by changing the workpiece material that houses the groove. Increasing the yield strength of the groove material increases the thrust load capacity of the retaining ring application. However, increasing the strength of the groove material may cause the failure mechanism to shift from groove deformation to ring shear. Therefore, use the lower of the values obtained from Equations (2) and (3) for the allowable thrust load.

Groove Design and Machining: In most applications, grooves are located near the end of a shaft or housing bore to facilitate installation and removal of the rings. The groove is normally located a distance at least two to three times the groove depth from the end of the shaft or bore. If the groove is too close to the end of the shaft or bore, the groove may shear or yield. The following equation can be used to determine the minimum safe distance Y of a groove from the end of a shaft or housing:

$$Y = \frac{K P_t}{\pi D S_c} \quad (4)$$

where K is the factor of safety, P_t is the thrust load on the groove in pounds (N), S_c is the shear strength of the groove material in lb/in^2 (N/mm^2), and D is the shaft or housing diameter in inches (mm).

A properly designed and machined groove is just as important in a retaining ring application as the ring itself. The walls of grooves should be perpendicular to the shaft or bore diameter; the grooves should have square corners on the top edges, and radii at the bottom, within the tolerances specified by the manufacturers, as shown in Fig. 1 (page 1763). Test data indicate that the ultimate thrust capacity for both static and dynamic loading conditions is greatly affected if these groove requirements are not met. For spiral-wound rings, the maximum bottom groove radius is 0.005 inch (0.127 mm) for rings up to 1.000 inch (25.4 mm) free diameter, and 0.010 inch (0.254 mm) for larger rings, internal or external. For stamped rings, the maximum bottom groove radius varies with ring size and style.

Table 18. Retaining Ring Standards

Military	
MIL-R-21248B	MS-16633 Open-type external uniform cross-section
	MS-16634 Open-type external uniform cross-section cylindrically
	MS-3215 Open-type external tapered cross-section
	MS-16632 Crescent-type external
	MS-16625 Internal
	MS-16629 Internal cylindrically bowed
	MS-16624 Closed-type external tapered cross-section

Table 18. Retaining Ring Standards (Continued)

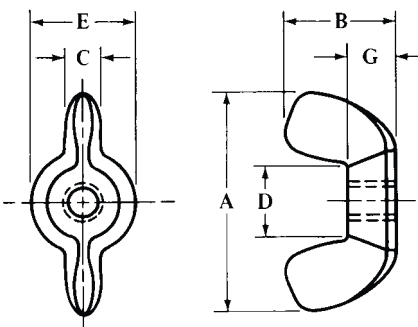
Military	
MIL-R-21248B	MS-16628 Closed-type external tapered cross-section cylindrically bowed
	MS-16627 Internal inverted
	MS-16626 Closed-type external tapered cross-section
	MS-90707 Self-locking external tapered cross-section
	MS-3217 External heavy-duty tapered cross-section
MIL-R-27426	Uniform cross-section spiral retaining rings, Type 1-External, Type 2-Internal
Acrospace Standard	
AS 3215	Ring, Retaining—Spiral, Internal, Heavy Duty, Stainless Steel
AS 3216	Ring, Retaining—Spiral, External, Heavy Duty, Stainless Steel
AS 3217	Ring, Retaining—Spiral, Internal, Light Duty, Stainless Steel
AS 3218	Ring, Retaining—Spiral, External, Light Duty, Stainless Steel
AS 3219	Ring, Wound, Dimensional and Acceptance Standard for Spiral Wound Retaining Rings
ANSI	
B27.6-1972, R2010	General Purpose Uniform Cross-Section Spiral Retaining Rings
B27.7-1977, R2010	General Purpose Tapered and Reduced Cross-Section Retaining Rings (Metric)
B27.8M-1977, R1999	General Purpose Metric Tapered and Reduced Cross-Section Retaining Rings
	Type 3DM1—Heavy Duty External Rings
	Type 3EM1—Reinforced “E” Rings
	Type 3FM1—“C” Type Rings
ANSI/SAE	
MA4016	Ring, Retaining—External Spiral Wound, Heavy and Medium Duty, Crescent, Metric
MA4017	Ring, Retaining—External Spiral Wound, Heavy and Medium Duty, Crescent, Metric
MA4020	Ring, Retaining—External Tapered, Type 1, Class 2, AMS 5520, Metric
MA4021	Ring, Retaining—Internal Tapered, Type 1, Class 1, AMS 5520, Metric
MA4029	Ring, Retaining—Internal, Beveled, Tapered, Type 2, Class 1, AMS 5520, Metric
MA4030	Ring, Retaining—External, Reinforced E-Ring, Type 1, Class 3, AMS 5520, Metric
MA4035	Rings, Retaining—Spiral Wound, Uniform Section, Corrosion Resistant, Procurement Specification for, Metric
MA4036	Ring, Retaining—Tapered Width, Uniform Thickness, Corrosion Resistant, Procurement Specification for, Metric
DIN	
DIN 471, 472, 6799, 984, 5417, 7993	Standards for normal and heavy type, internal and external retaining rings and retaining washers
LN 471, 472, 6799	Aerospace standards for internal and external retaining rings

WING NUTS, WING SCREWS, AND THUMB SCREWS

Wing Nuts.—A wing nut is a nut having wings designed for manual turning without driver or wrench. As covered by ANSI B18.17-1968 (R1983) wing nuts are classified first, by type on the basis of the method of manufacture; and second, by style on the basis of design characteristics. They consist of:

Type A: Type A wing nuts are cold forged or cold formed solid nuts having wings of moderate height. In some sizes they are produced in regular, light, and heavy series to best suit the requirements of specific applications. Dimensions are given in **Table 1**.

**Table 1. American National Standard Type A Wing Nuts
ANSI B18.17-1968, R1983**



Nominal Size or Basic Major Diameter of Thread ^a	Thds. per Inch	Series ^b	Nut Blank Size (Ref)	A		B		C		D		E		G	
				Wing Spread		Wing Height		Wing Thick.		Between Wings		Boss Dia.		Boss Height	
				Max	Min	Max	Min	Max	Min	Max	Min	Max	Min	Max	Min
3 (0.0990)	48, 56	Hvy.	AA	0.72	0.59	0.41	0.28	0.11	0.07	0.21	0.17	0.33	0.29	0.14	0.10
4 (0.1120)	40, 38	Hvy.	AA	0.72	0.59	0.41	0.28	0.11	0.07	0.21	0.17	0.33	0.29	0.14	0.10
5 (0.1250)	40, 44	Lgt.	AA	0.72	0.59	0.41	0.28	0.11	0.07	0.21	0.17	0.33	0.29	0.14	0.10
		Hvy.	A	0.91	0.78	0.47	0.34	0.14	0.10	0.27	0.22	0.43	0.39	0.18	0.14
6 (0.1380)	32, 40	Lgt.	AA	0.72	0.59	0.41	0.28	0.11	0.07	0.21	0.17	0.33	0.29	0.14	0.10
		Hvy.	A	0.91	0.78	0.47	0.34	0.14	0.10	0.27	0.22	0.43	0.39	0.18	0.14
8 (0.1640)	32, 36	Lgt.	A	0.91	0.78	0.47	0.34	0.14	0.10	0.27	0.22	0.43	0.39	0.18	0.14
		Hvy.	B	1.10	0.97	0.57	0.43	0.18	0.14	0.33	0.26	0.50	0.45	0.22	0.17
10 (0.1900)	24, 32	Lgt.	A	0.91	0.78	0.47	0.34	0.14	0.10	0.27	0.22	0.43	0.39	0.18	0.14
		Hvy.	B	1.10	0.97	0.57	0.43	0.18	0.14	0.33	0.26	0.50	0.45	0.22	0.17
12 (0.2160)	24, 28	Lgt.	B	1.10	0.97	0.57	0.43	0.18	0.14	0.33	0.26	0.50	0.45	0.22	0.17
		Hvy.	C	1.25	1.12	0.66	0.53	0.21	0.17	0.39	0.32	0.58	0.51	0.25	0.20
¼ (0.2500)	20, 28	Lgt.	B	1.10	0.97	0.57	0.43	0.18	0.14	0.39	0.26	0.50	0.45	0.22	0.17
		Hvy.	D	1.44	1.31	0.79	0.65	0.24	0.20	0.48	0.42	0.70	0.64	0.30	0.26
⅕ (0.3125)	18, 24	Lgt.	C	1.25	1.12	0.66	0.53	0.21	0.17	0.39	0.32	0.58	0.51	0.25	0.20
		Hvy.	D	1.44	1.31	0.79	0.65	0.24	0.20	0.48	0.42	0.70	0.64	0.30	0.26
⅜ (0.3750)	16, 24	Lgt.	D	1.44	1.31	0.79	0.65	0.24	0.20	0.48	0.42	0.70	0.64	0.30	0.26
		Hvy.	E	1.94	1.81	1.00	0.87	0.33	0.26	0.65	0.54	0.93	0.86	0.39	0.35
⅞ (0.4375)	14, 20	Lgt.	E	1.94	1.81	1.00	0.87	0.33	0.26	0.65	0.54	0.93	0.86	0.39	0.35
		Hvy.	F	2.76	2.62	1.44	1.31	0.40	0.34	0.90	0.80	1.19	1.13	0.55	0.51
½ (0.5000)	13, 20	Lgt.	E	1.94	1.81	1.00	0.87	0.33	0.26	0.65	0.54	0.93	0.86	0.39	0.35
		Hvy.	F	2.76	2.62	1.44	1.31	0.40	0.34	0.90	0.80	1.19	1.13	0.55	0.51
⅝ (0.5625)	12, 18	Hvy.	F	2.76	2.62	1.44	1.31	0.40	0.34	0.90	0.80	1.19	1.13	0.55	0.51
		Hvy.	F	2.76	2.62	1.44	1.31	0.40	0.34	0.90	0.80	1.19	1.13	0.55	0.51
¾ (0.7500)	10, 16	Hvy.	F	2.76	2.62	1.44	1.31	0.40	0.34	0.90	0.80	1.19	1.13	0.55	0.51

^a Where specifying nominal size in decimals, zeros in the fourth decimal place are omitted.

^b Lgt. = Light; Hvy. = Heavy; Reg. = Regular. Sizes shown in **bold face** are preferred.

All dimensions in inches.

Type B: Type B wing nuts are hot forged solid nuts available in two wing styles: Style 1, having wings of moderate height; and Style 2, having high wings. Dimensions are given in Table 2.

**Table 2. American National Standard Type B Wing Nuts
ANSI B18.17-1968, R1983**

		STYLE 1				STYLE 2							
Nominal Size or Basic Major Diameter of Thread ^a	Thds. per Inch	A		B		C		D		E		G	
		Wing Spread		Wing Height		Wing Thick.		Between Wings		Boss Dia.		Boss Height	
		Max	Min	Max	Min	Max	Min	Max	Min	Max	Min	Max	Min
Type B, Style 1													
5 (0.1250)	40	0.78	0.72	0.36	0.30	0.13	0.10	0.28	0.22	0.31	0.28	0.22	0.16
10 (0.1900)	24	0.97	0.91	0.45	0.39	0.15	0.12	0.34	0.28	0.39	0.36	0.28	0.22
¼ (0.2500)	20	1.16	1.09	0.56	0.50	0.17	0.14	0.41	0.34	0.47	0.44	0.34	0.28
⅕ (0.3125)	18	1.44	1.38	0.67	0.61	0.18	0.15	0.50	0.44	0.55	0.52	0.41	0.34
⅜ (0.3750)	16	1.72	1.66	0.80	0.73	0.20	0.17	0.59	0.53	0.63	0.60	0.47	0.41
⅞ (0.4375)	14	2.00	1.94	0.91	0.84	0.21	0.18	0.69	0.62	0.71	0.68	0.53	0.47
½ (0.5000)	13	2.31	2.22	1.06	0.94	0.23	0.20	0.78	0.69	0.79	0.76	0.62	0.50
⅝ (0.5625)	12	2.59	2.47	1.17	1.05	0.25	0.21	0.88	0.78	0.88	0.84	0.69	0.56
⅝ (0.6250)	11	2.84	2.72	1.31	1.19	0.27	0.23	0.94	0.84	0.96	0.92	0.75	0.62
¾ (0.7500)	10	3.31	3.19	1.52	1.39	0.29	0.25	1.10	1.00	1.12	1.08	0.88	0.75
Type B, Style 2													
5 (0.1250)	40	0.81	0.75	0.62	0.56	0.12	0.09	0.28	0.22	0.31	0.28	0.22	0.16
10 (0.1900)	24	1.01	0.95	0.78	0.72	0.14	0.11	0.35	0.29	0.39	0.36	0.28	0.22
¼ (0.2500)	20	1.22	1.16	0.94	0.88	0.16	0.13	0.41	0.35	0.47	0.44	0.34	0.28
⅕ (0.3125)	18	1.43	1.37	1.09	1.03	0.17	0.14	0.48	0.42	0.55	0.52	0.41	0.34
⅜ (0.3750)	16	1.63	1.57	1.25	1.19	0.18	0.15	0.55	0.49	0.63	0.60	0.47	0.41
⅞ (0.4375)	14	1.90	1.84	1.42	1.36	0.19	0.16	0.62	0.56	0.71	0.68	0.53	0.47
½ (0.5000)	13	2.13	2.04	1.58	1.45	0.20	0.17	0.69	0.60	0.79	0.76	0.62	0.50
⅝ (0.5625)	12	2.40	2.28	1.75	1.62	0.22	0.18	0.76	0.67	0.88	0.84	0.69	0.56
⅝ (0.6250)	11	2.60	2.48	1.91	1.78	0.23	0.19	0.83	0.74	0.96	0.92	0.75	0.62
¾ (0.7500)	10	3.02	2.90	2.22	2.09	0.24	0.20	0.97	0.88	1.12	1.08	0.88	0.75

^a Where specifying nominal size in decimals, zeros in the fourth decimal place are omitted.

All dimensions in inches.

Table 3. American National Standard Type C Wing Nuts ANSI B18.17-1968, R1983

Nominal Size or Basic Major Diameter of Thread ^a	Thds. per Inch	Series	Nut Blank Size (Ref)	A		B		C		D		E		F		G	
				Wing Spread		Wing Height		Wing Thick.		Between Wings		Boss Dia.		Boss Dia.		Boss Height	
				Max	Min	Max	Min	Max	Min	Max	Min	Max	Min	Max	Min	Max	Min
Type C, Style 1																	
4 (0.1120)	40	Reg.	AA	0.66	0.64	0.36	0.35	0.11	0.09	0.18	0.16	0.27	0.25	0.32	0.30	0.16	0.14
5 (0.1250)	40	Reg.	AA	0.66	0.64	0.36	0.35	0.11	0.09	0.18	0.16	0.27	0.25	0.32	0.30	0.16	0.14
6 (0.1380)	32	Reg.	AA	0.66	0.64	0.36	0.35	0.11	0.09	0.18	0.16	0.27	0.25	0.32	0.30	0.16	0.14
		Hvy.	A	0.85	0.83	0.43	0.42	0.14	0.12	0.29	0.27	0.38	0.36	0.41	0.40	0.20	0.18
8 (0.1640)	32	Reg.	A	0.85	0.83	0.43	0.42	0.14	0.12	0.29	0.27	0.38	0.36	0.41	0.40	0.20	0.18
10 (0.1900)	24, 32	Reg.	A	0.85	0.83	0.43	0.42	0.14	0.12	0.29	0.27	0.38	0.36	0.41	0.40	0.20	0.18
12 (0.2160)	24	Reg.	A	0.85	0.83	0.43	0.42	0.14	0.12	0.29	0.27	0.38	0.36	0.41	0.40	0.20	0.18
		Hvy.	B	1.08	1.05	0.57	0.53	0.16	0.14	0.32	0.30	0.44	0.42	0.48	0.46	0.23	0.21
¼ (0.2500)	20, 28	Reg.	B	1.08	1.05	0.57	0.53	0.16	0.14	0.32	0.30	0.44	0.42	0.48	0.46	0.23	0.21
⅜ (0.3125)	18, 24	Reg.	C	1.23	1.20	0.64	0.62	0.20	0.18	0.39	0.35	0.50	0.49	0.57	0.55	0.26	0.24
⅝ (0.3750)	16, 24	Reg.	D	1.45	1.42	0.74	0.72	0.23	0.21	0.46	0.42	0.62	0.60	0.69	0.67	0.29	0.27
		Reg.	E	1.89	1.86	0.91	0.90	0.29	0.28	0.67	0.65	0.75	0.73	0.83	0.82	0.38	0.37
⅞ (0.4375)	14, 20	Reg.	EH	1.89	1.86	0.93	0.91	0.34	0.33	0.63	0.62	0.81	0.79	0.89	0.87	0.42	0.40
		Hvy.	EH	1.89	1.86	0.91	0.90	0.29	0.28	0.67	0.65	0.75	0.73	0.83	0.82	0.38	0.37
½ (0.5000)	13, 20	Hvy.	EH	1.89	1.86	0.93	0.91	0.34	0.33	0.63	0.62	0.81	0.79	0.89	0.87	0.42	0.40
Type C, Style 2																	
5 (0.1250)	40	0.82	0.80	0.25	0.23	0.09	0.08	0.21	0.19	0.26	0.24	0.17	0.15
6 (0.1380)	32	0.82	0.80	0.25	0.23	0.09	0.08	0.21	0.19	0.26	0.24	0.17	0.15
8 (0.1640)	32	1.01	0.99	0.28	0.27	0.11	0.09	0.29	0.28	0.36	0.34	0.19	0.18
10 (0.1900)	24, 32	1.01	0.99	0.28	0.27	0.11	0.09	0.29	0.28	0.36	0.34	0.19	0.18
12 (0.2160)	24	1.20	1.18	0.32	0.31	0.12	0.11	0.38	0.37	0.44	0.43	0.22	0.20
¼ (0.2500)	20	1.20	1.18	0.32	0.31	0.12	0.11	0.38	0.37	0.44	0.43	0.22	0.20
⅜ (0.3125)	18	1.51	1.49	0.36	0.35	0.14	0.12	0.44	0.43	0.51	0.49	0.24	0.23
⅝ (0.3750)	16	1.89	1.86	0.58	0.55	0.20	0.17	0.44	0.43	0.63	0.62	0.37	0.35
Type C, Style 3																	
5 (0.1250)	40	0.92	0.89	0.70	0.67	0.16	0.15	0.26	0.24	0.38	0.36	0.25	0.24
6 (0.1380)	32	0.92	0.89	0.70	0.67	0.16	0.15	0.26	0.24	0.38	0.36	0.25	0.24
8 (0.1640)	32	0.92	0.89	0.70	0.67	0.16	0.15	0.26	0.24	0.38	0.36	0.25	0.24
10 (0.1900)	24, 32	1.14	1.12	0.85	0.83	0.19	0.17	0.32	0.30	0.44	0.42	0.29	0.27
12 (0.2160)	24	1.14	1.12	0.85	0.83	0.19	0.17	0.32	0.30	0.44	0.42	0.29	0.27
¼ (0.2500)	20	1.14	1.12	0.85	0.83	0.19	0.17	0.32	0.30	0.44	0.42	0.29	0.27
⅜ (0.3125)	18	1.29	1.27	1.04	1.02	0.23	0.22	0.39	0.36	0.50	0.49	0.35	0.34
⅝ (0.3750)	16	1.51	1.49	1.20	1.18	0.27	0.25	0.45	0.42	0.62	0.60	0.43	0.42

^a Where specifying nominal size in decimals, zeros in the fourth decimal place are omitted.

All dimensions in inches. Sizes shown in **bold face** are preferred.

Type C: Type C wing nuts are die cast solid nuts and are available in three wing styles: Style 1, having wings of moderate height; Style 2, having low wings; and Style 3, having high wings. In some sizes, the Style 1 nuts are produced in regular, light, and heavy series to best suit the requirements of specific applications. Dimensions are given in **Table 3**.

Table 4. American National Standard Type D Wing Nuts ANSI B18.17-1968, R1983

			A		B		C		D	E		G	H	T	
Nominal Size or Basic Major Diameter of Thread ^a	Thds. per Inch	Series ^b	Wing Spread		Wing Height		Wing Thick.		Between Wings	Boss Dia.		Boss Hgt.	Wall Hgt.	Stock Thick.	
			Max	Min	Max	Min	Max	Min	Min	Max	Min	Min	Max	Min	
Type D, Style 1															
8 (0.1640)	32, 36	...	0.78	0.72	0.40	0.34	0.18	0.14	0.25	0.41	0.35	0.08	0.12	0.04	0.03
10 (0.1900)	24, 32	...	0.91	0.85	0.47	0.41	0.21	0.17	0.34	0.53	0.47	0.10	0.12	0.04	0.03
12 (0.2160)	24, 28	...	1.09	1.03	0.47	0.41	0.21	0.17	0.34	0.53	0.47	0.10	0.12	0.05	0.04
¼ (0.2500)	20, 28	...	1.11	1.05	0.50	0.44	0.25	0.21	0.34	0.62	0.56	0.11	0.12	0.05	0.04
⅝ (0.3125)	18, 24	...	1.30	1.24	0.59	0.53	0.30	0.26	0.46	0.73	0.67	0.14	0.18	0.06	0.05
⅞ (0.3750)	16, 24	...	1.41	1.34	0.67	0.61	0.34	0.30	0.69	0.83	0.77	0.16	0.18	0.06	0.05
Type D, Style 2															
5 (0.1250)	40	Reg.	1.03	0.97	0.25	0.19	0.19	0.13	0.30	0.40	0.34	0.07	0.09	0.04	0.03
6 (0.1380)	32	Reg.	1.03	0.97	0.25	0.19	0.19	0.13	0.30	0.40	0.34	0.08	0.09	0.04	0.03
8 (0.1640)	32	Reg.	1.03	0.97	0.25	0.19	0.19	0.13	0.30	0.40	0.34	0.08	0.09	0.04	0.03
10 (0.1900)	24, 32	Reg. Hvy.	1.40	1.34	0.34	0.28	0.25	0.18	0.32	0.53	0.47	0.09	0.16	0.05	0.04
12 (0.2160)	24	Reg.	1.21	1.16	0.28	0.26	0.31	0.25	0.60	0.61	0.55	0.11	0.13	0.05	0.04
¼ (0.2500)	20	Reg.	1.21	1.16	0.28	0.26	0.31	0.25	0.60	0.61	0.55	0.11	0.13	0.05	0.04
Type D, Style 3															
10 (0.1900)	24, 32	Lgt. Reg.	1.31	1.25	0.48	0.42	0.29	0.23	0.47	0.65	0.59	0.08	0.12	0.04	0.03
		Reg.	1.40	1.34	0.53	0.47	0.25	0.19	0.50	0.75	0.69	0.08	0.14	0.04	0.03
12 (0.2160)	24	Reg.	1.28	1.22	0.40	0.34	0.23	0.17	0.59	0.73	0.67	0.11	0.12	0.04	0.03
		Lgt. Reg.	1.28	1.22	0.40	0.34	0.23	0.17	0.59	0.73	0.67	0.11	0.12	0.04	0.03
¼ (0.2500)	20	Reg. Hvy.	1.78	1.72	0.66	0.60	0.31	0.25	0.70	1.03	0.97	0.14	0.17	0.06	0.04
		Hvy.	1.47	1.40	0.50	0.44	0.37	0.31	0.66	1.03	0.97	0.14	0.14	0.08	0.06
⅝ (0.3125)	18	Reg.	1.78	1.72	0.66	0.60	0.31	0.25	0.70	1.03	0.97	0.14	0.17	0.06	0.04
		Hvy.	1.47	1.40	0.50	0.44	0.37	0.31	0.66	1.03	0.97	0.14	0.14	0.08	0.06

^a Where specifying nominal size in decimals, zeros in the fourth decimal place are omitted.

^b Lgt. = Light; Hvy. = Heavy; Reg. = Regular.

All dimensions in inches.

Type D: Type D wing nuts are stamped sheet metal nuts and are available in three styles: Style 1, having wings of moderate height; Style 2, having low wings; and Style 3, having wings of moderate height and a larger bearing surface. In some sizes, Styles 2 and 3 are produced in regular, light, and heavy series to best suit the requirements of specific applications. Dimensions are given in Table 4.

Specification of Wing Nuts.—When specifying wing nuts, the following data should be included in the designation and should appear in the following sequence: nominal size (number, fraction or decimal equivalent), threads per inch, type, style and/or series, material, and finish.

Examples: 10—32 Type A Wing Nut, Regular Series, Steel, Zinc Plated.

0.250—20 Type C Wing Nut, Style 1, Zinc Alloy, Plain.

Threads for Wing Nuts.—Threads are in conformance with the ANSI Standard Unified Thread, Class 2B for all types of wing nuts except type D which have a modified Class 2B thread. Because of the method of manufacture, the minor diameter of the thread in type D

nuts may be somewhat larger than the Unified Thread Class 2B maximum but shall in no case exceed the minimum pitch diameter.

Materials and Finish for Wing Nuts.—Types A, B, and D wing nuts are normally supplied as specified by the user in carbon steel, brass or corrosion resistant steel of good quality and adaptable to the manufacturing process. Type C wing nuts are made from die cast zinc alloy. Unless otherwise specified, wing nuts are supplied with a plain (unplated or uncoated) finish.

Wing Screws.—A wing screw is a screw having a wing-shaped head designed for manual turning without a driver or wrench. As covered by ANSI B18.17-1968 (R1983) wing screws are classified first, by type on the basis of the method of manufacture, and second, by style on the basis of design characteristics. They consist of the following:

Type A: Type A wing screws are of two-piece construction having cold formed or cold forged wing portions of moderate height. In some sizes they are produced in regular, light, and heavy series to best suit the requirements of specific applications. Dimensions are given in [Table 5](#).

Type B: Type B wing screws are of hot forged one-piece construction available in two wing styles: Style 1, having wings of moderate height; and Style 2, having high wings. Dimensions are given in [Table 5](#).

Type C: Type C wing screws are available in two styles: Style 1, of a one-piece die cast construction having wings of moderate height; and Style 2, of a two-piece construction having a die cast wing portion of moderate height. Dimensions are given in [Table 6](#).

Type D: Type D wing screws are of two-piece welded construction having stamped sheet metal wing portions of moderate height. Dimensions are given in [Table 6](#).

Materials for Wing Screws and Thumb Screws: Type A wing screws are normally supplied in carbon steel with the shank portion case hardened. When so specified, they also may be made from corrosion resistant steel, brass or other materials as agreed upon by the manufacturer and user.

Type B wing screws are normally made from carbon steel but also may be made from corrosion resistant steel, brass or other materials.

Type C, Style 1, wing screws are supplied only in die cast zinc alloy. Type C, Style 2, wing screws have the wing portion made from die cast zinc alloy with the shank portion normally made from carbon steel. Where so specified, the shank portion may be made from corrosion resistant steel, brass or other materials as agreed upon by the manufacturer and user.

Type D wing screws are normally supplied in carbon steel but also may be made from corrosion resistant steel, brass or other materials.

Thumb screws of all types are normally made from a good commercial quality of carbon steel having a maximum ultimate tensile strength of 48,000 psi (331 MPa). Where so specified, carbon steel thumb screws are case hardened. They are also made from corrosion resistant steel, brass, and other materials as agreed upon by the manufacturer and user.

Unless otherwise specified, wing screws and thumb screws are supplied with a plain (unplated or uncoated) finish.

Thumb Screws.—A thumb screw is a screw having a flattened head designed for manual turning without a driver or wrench. As covered by ANSI B18.17-1968 (R1983) thumb screws are classified by type on the basis of design characteristics. They consist of the following:

Type A: Type A thumb screws are forged one-piece screws having a shoulder under the head and are available in two series: regular and heavy. Dimensions are given in [Table 7](#).

Type B: Type B thumb screws are forged one-piece screws without a shoulder and are available in two series: regular and heavy. Dimensions are given in [Table 7](#).

Table 5. American National Standard Types A and B Wing Screws
ANSI B18.17-1968, R1983

Nominal Size or Basic Major Diameter ^a	Thds. per Inch	Series ^b	Head Blank size (Ref)	A		B		C		E		G		L	
				Wing Spread		Wing Height		Wing Thick.		Boss Dia.		Boss Height.		Practical Screw Lengths	
				Max	Min	Max	Min	Max	Min	Max	Min	Max	Min	Max	Min
Type A															
4 (0.1120)	40	Hvy.	AA	0.72	0.59	0.41	0.28	0.11	0.07	0.33	0.29	0.14	0.10	0.75	0.25
6 (0.1380)	32	Lgt.	AA	0.72	0.59	0.41	0.28	0.11	0.07	0.33	0.29	0.14	0.10	} 0.75	0.25
		Hvy.	A	0.91	0.78	0.47	0.34	0.14	0.10	0.43	0.39	0.18	0.14		
8 (0.1640)	32	Lgt.	A	0.91	0.78	0.47	0.34	0.14	0.10	0.43	0.39	0.18	0.14	} 0.75	0.38
		Hvy.	B	1.10	0.97	0.57	0.43	0.18	0.14	0.50	0.45	0.22	0.17		
10 (0.1900)	24, 32	Lgt.	A	0.91	0.78	0.47	0.34	0.14	0.10	0.43	0.39	0.18	0.14	} 1.00	0.38
		Hvy.	B	1.10	0.97	0.57	0.43	0.18	0.14	0.50	0.45	0.22	0.17		
12 (0.2160)	24	Lgt.	B	1.10	0.97	0.57	0.43	0.18	0.14	0.50	0.45	0.22	0.17	} 1.00	0.38
		Hvy.	C	1.25	1.12	0.66	0.53	0.21	0.17	0.58	0.51	0.25	0.20		
		Lgt.	B	1.10	0.97	0.57	0.43	0.18	0.14	0.50	0.45	0.22	0.17		
¼ (0.2500)	20	Lgt.	B	1.10	0.97	0.57	0.43	0.18	0.14	0.50	0.45	0.22	0.17	} 1.50	0.50
		Reg.	C	1.25	1.12	0.66	0.53	0.21	0.17	0.58	0.51	0.25	0.20		
		Hvy.	D	1.44	1.31	0.79	0.65	0.24	0.20	0.70	0.64	0.30	0.26		
⅕ (0.3125)	18	Lgt.	C	1.25	1.12	0.66	0.53	0.21	0.17	0.58	0.51	0.25	0.20	} 1.50	0.50
		Reg.	D	1.44	1.31	0.79	0.65	0.24	0.20	0.70	0.64	0.30	0.26		
		Hvy.	E	1.94	1.81	1.00	0.87	0.33	0.26	0.93	0.86	0.39	0.35		
⅜ (0.3750)	16	Lgt.	D	1.44	1.31	0.79	0.65	0.24	0.20	0.70	0.64	0.30	0.26	} 2.00	0.75
		Reg.	E	1.94	1.81	1.00	0.87	0.33	0.26	0.93	0.86	0.39	0.35		
		Hvy.	F	2.76	2.62	1.44	1.31	0.40	0.34	1.19	1.13	0.55	0.51		
⅞ (0.4375)	14	Lgt.	E	1.94	1.81	1.00	0.87	0.33	0.26	0.93	0.86	0.39	0.35	} 4.00	1.00
		Hvy.	F	2.76	2.62	1.44	1.31	0.40	0.34	1.19	1.13	0.55	0.51		
		Lgt.	E	1.94	1.81	1.00	0.87	0.33	0.26	0.93	0.86	0.39	0.35		
½ (0.5000)	13	Lgt.	E	1.94	1.81	1.00	0.87	0.33	0.26	0.93	0.86	0.39	0.35	} 4.00	1.00
		Hvy.	F	2.76	2.62	1.44	1.31	0.40	0.34	1.19	1.13	0.55	0.51		
		Lgt.	E	1.94	1.81	1.00	0.87	0.33	0.26	0.93	0.86	0.39	0.35		
⅝ (0.6250)	11	Hvy.	F	2.76	2.62	1.44	1.31	0.40	0.34	1.19	1.13	0.55	0.51	4.00	1.25
Type B, Style 1															
10 (0.1900)	24	0.97	0.91	0.45	0.39	0.15	0.12	0.39	0.36	0.28	0.22	2.00	0.50
¼ (0.2500)	20	1.16	1.09	0.56	0.50	0.17	0.14	0.47	0.44	0.34	0.28	3.00	0.50
⅕ (0.3125)	18	1.44	1.38	0.67	0.61	0.18	0.15	0.55	0.52	0.41	0.34	3.00	0.50
⅜ (0.3750)	16	1.72	1.66	0.80	0.73	0.20	0.17	0.63	0.60	0.47	0.41	4.00	0.50
⅞ (0.4375)	14	2.00	1.94	0.91	0.84	0.21	0.18	0.71	0.68	0.53	0.47	3.00	1.00
½ (0.5000)	13	2.31	2.22	1.06	0.94	0.23	0.20	0.79	0.76	0.62	0.50	3.00	1.00
⅝ (0.6250)	11	2.84	2.72	1.31	1.19	0.27	0.23	0.96	0.92	0.75	0.62	2.50	1.00
Type B, Style 2															
10 (0.1900)	24	1.01	0.95	0.78	0.72	0.14	0.11	0.39	0.36	0.28	0.22	1.25	0.50
¼ (0.2500)	20	1.22	1.16	0.94	0.88	0.16	0.13	0.47	0.44	0.34	0.28	2.00	0.50
⅕ (0.3125)	18	1.43	1.37	1.09	1.03	0.17	0.14	0.55	0.52	0.41	0.34	2.00	0.50
⅜ (0.3750)	16	1.63	1.57	1.25	1.19	0.18	0.15	0.63	0.60	0.47	0.41	2.00	0.50

All dimensions in inches. Sizes shown in **bold face** are preferred.

¹Plain point, unless alternate point from styles shown in Table 8 is specified by user.

^a Where specifying nominal size in decimals, zeros in the fourth decimal place are omitted.

^b Hvy. = Heavy; Lgt. = Light; Reg. = Regular.

Table 6. American National Standard Types C and D Wing Screws
ANSI B18.17-1968, R1983

Nominal Size or Basic Screw Diameter ^a	Thds. per Inch	A		B		C		E		F		G		L	
		Wing Spread		Wing Height		Wing Thick.		Boss Dia.		Boss Dia.		Height		Practical Screw Lengths	
		Max	Min	Max	Min	Max	Min	Max	Min	Max	Min	Max	Min	Max	Min
Type C, Style 1															
6 (0.1380)	32	0.85	0.83	0.45	0.43	0.15	0.12	0.41	0.39	0.12	0.07	0.75	0.25
8 (0.1640)	32	0.85	0.83	0.45	0.43	0.15	0.12	0.41	0.39	0.12	0.07	1.00	0.38
10 (0.1900)	24, 32	0.85	0.83	0.45	0.43	0.15	0.12	0.41	0.39	0.12	0.07	1.25	0.38
1/4 (0.2500)	20	1.08	1.05	0.56	0.53	0.17	0.14	0.46	0.44	0.12	0.07	1.50	0.50
5/16 (0.3125)	18	1.23	1.20	0.64	0.62	0.22	0.19	0.51	0.49	0.14	0.10	1.50	0.50
3/8 (0.3750)	16	1.45	1.42	0.74	0.72	0.24	0.21	0.63	0.62	0.15	0.12	1.50	0.50
Type C, Style 2															
6 (0.1380)	32	0.85	0.83	0.43	0.42	0.14	0.12	0.38	0.36	0.41	0.40	0.20	0.18	1.00	0.25
8 (0.1640)	32	0.85	0.83	0.43	0.42	0.14	0.12	0.38	0.36	0.41	0.40	0.20	0.18	1.00	0.38
10 (0.1900)	24, 32	0.85	0.83	0.43	0.42	0.14	0.12	0.38	0.36	0.41	0.40	0.20	0.18	2.00	0.38
1/4 (0.2500)	20	1.08	1.05	0.57	0.53	0.16	0.14	0.44	0.42	0.48	0.46	0.23	0.21	2.50	0.50
5/16 (0.3125)	18	1.23	1.20	0.64	0.62	0.20	0.18	0.50	0.49	0.57	0.55	0.26	0.24	3.00	0.50
3/8 (0.3750)	16	1.45	1.42	0.74	0.72	0.23	0.21	0.62	0.60	0.69	0.67	0.29	0.27	3.00	0.75
7/16 (0.4375)	14	1.89	1.86	0.91	0.90	0.29	0.28	0.75	0.73	0.83	0.82	0.38	0.37	4.00	1.00
1/2 (0.5000)	13	1.89	1.86	0.91	0.90	0.29	0.28	0.75	0.73	0.83	0.82	0.38	0.37	4.00	1.00
Type D															
6 (0.1380)	32	0.78	0.72	0.40	0.34	0.18	0.12	0.35	0.31	0.40	0.34	0.21	0.14	0.75	0.25
8 (0.1640)	32	0.78	0.72	0.40	0.34	0.18	0.12	0.35	0.31	0.40	0.34	0.21	0.14	0.75	0.38
10 (0.1900)	24	0.90	0.84	0.46	0.40	0.21	0.15	0.35	0.31	0.53	0.47	0.22	0.16	1.00	0.38
12 (0.2160)	24	1.09	1.03	0.46	0.40	0.26	0.20	0.44	0.39	0.61	0.55	0.24	0.18	1.00	0.38
1/4 (0.2500)	20	1.09	1.03	0.46	0.40	0.26	0.20	0.47	0.43	0.61	0.55	0.24	0.18	1.50	0.50
5/16 (0.3125)	18	1.31	1.25	0.62	0.56	0.29	0.23	0.57	0.53	0.68	0.62	0.29	0.23	1.50	0.50
3/8 (0.3750)	16	1.31	1.25	0.62	0.56	0.29	0.23	0.63	0.59	0.68	0.62	0.29	0.23	2.00	0.75

All dimensions in inches.

¹Plain point, unless alternate point from styles shown in Table 8 is specified by user.

^aWhere specifying nominal size in decimals, zeros in the fourth decimal place are omitted.

Wing Screw and Thumb Screw Designation.—When specifying wing and thumb screws, the following data should be included in the designation and should appear in the following sequence: nominal size (number, fraction or decimal equivalent), threads per inch, length (fractions or decimal equivalents), type, style and/or series, point (if other than plain point), materials, and finish.

Examples: 10—32 × 1¼ Thumb Screw, Type A, Regular, Steel, Zinc Plated.

0.375—16 × 2.00, Wing Screw, Type B, Style 2, Steel, Cadmium Plated.

0.250—20 × 1.50, Wing Screw, Type C, Style 2, Zinc Alloy Wings, Steel Shank, Brass Plated.

Table 7. American National Standard Types A and B Thumb Screws
ANSI B18.17-1968, R1983

		TYPE A				TYPE B							
		REGULAR		HEAVY		REGULAR				HEAVY			
Nominal Size or Basic Screw Diameter ^a	Thds. per Inch	A		B		C		C'		E		L	
		Head Width		Head Height		Head Thick.		Head Thick.		Shoulder Diameter		Practical Screw Lengths	
		Max	Min	Max	Min	Max	Min	Max	Min	Max	Min	Max	Min
Type A, Regular													
6 (0.1380)	32	0.31	0.29	0.33	0.31	0.05	0.04	0.25	0.23	0.75	0.25
8 (0.1640)	32	0.36	0.34	0.38	0.36	0.06	0.05	0.31	0.29	0.75	0.38
10 (0.1900)	24, 32	0.42	0.40	0.48	0.46	0.06	0.05	0.35	0.32	1.00	0.38
12 (0.2160)	24	0.48	0.46	0.54	0.52	0.06	0.05	0.40	0.38	1.00	0.38
¼ (0.2500)	20	0.55	0.52	0.64	0.61	0.07	0.05	0.47	0.44	1.50	0.50
⅜ (0.3125)	18	0.70	0.67	0.78	0.75	0.09	0.07	0.59	0.56	1.50	0.50
½ (0.3750)	16	0.83	0.80	0.95	0.92	0.11	0.09	0.76	0.71	2.00	0.75
Type A, Heavy													
10 (0.1900)	24	0.89	0.83	0.84	0.72	0.18	0.16	0.10	0.08	0.33	0.31	2.00	0.50
¼ (0.2500)	20	1.05	0.99	0.94	0.81	0.24	0.22	0.10	0.08	0.40	0.38	3.00	0.50
⅜ (0.3125)	18	1.21	1.15	1.00	0.88	0.27	0.25	0.11	0.09	0.46	0.44	4.00	0.50
½ (0.3750)	16	1.41	1.34	1.16	1.03	0.30	0.28	0.11	0.09	0.55	0.53	4.00	0.50
⅞ (0.4375)	14	1.59	1.53	1.22	1.09	0.36	0.34	0.13	0.11	0.71	0.69	2.50	1.00
1 (0.5000)	13	1.81	1.72	1.28	1.16	0.40	0.38	0.14	0.12	0.83	0.81	3.00	1.00
Type B, Regular													
6 (0.1380)	32	0.45	0.43	0.28	0.26	0.08	0.06	0.03	0.02	1.00	0.25
8 (0.1640)	32	0.51	0.49	0.32	0.30	0.09	0.07	0.04	0.02	1.00	0.38
10 (0.1900)	24, 32	0.58	0.54	0.39	0.36	0.10	0.08	0.05	0.03	2.00	0.38
12 (0.2160)	24	0.71	0.67	0.45	0.43	0.11	0.09	0.05	0.03	2.00	0.38
¼ (0.2500)	20	0.83	0.80	0.52	0.48	0.16	0.14	0.06	0.03	2.50	0.50
⅜ (0.3125)	18	0.96	0.91	0.64	0.60	0.17	0.14	0.09	0.06	3.00	0.50
½ (0.3750)	16	1.09	1.03	0.71	0.67	0.22	0.18	0.11	0.08	3.00	0.75
⅞ (0.4375)	14	1.40	1.35	0.96	0.91	0.27	0.24	0.14	0.11	4.00	1.00
1 (0.5000)	13	1.54	1.46	1.09	1.03	0.33	0.29	0.15	0.11	4.00	1.00
Type B, Heavy													
10 (0.1900)	24	0.89	0.83	0.78	0.66	0.18	0.16	0.08	0.06	2.00	0.50
¼ (0.2500)	20	1.05	0.99	0.81	0.72	0.24	0.22	0.11	0.09	3.00	0.50
⅜ (0.3125)	18	1.21	1.15	0.88	0.78	0.27	0.25	0.11	0.09	4.00	0.50
½ (0.3750)	16	1.41	1.34	0.94	0.84	0.30	0.28	0.14	0.12	4.00	0.50
⅞ (0.4375)	14	1.59	1.53	1.00	0.91	0.36	0.34	0.14	0.12	3.00	1.00
1 (0.5000)	13	1.81	1.72	1.09	0.97	0.40	0.38	0.18	0.16	3.00	1.00

^aWhere specifying nominal size in decimals, zeroes in fourth decimal place are omitted.

All dimensions in inches.

¹Plain point, unless alternate point from styles shown in Table 8 is specified by user.

Lengths of Wing and Thumb Screws.—The length of wing or thumb screws is measured parallel to the axis of the screw from the intersection of the head or shoulder with the shank to the extreme point of the screw. Standard length increments are as follows: For

sizes No. 4 through ¼ inch and for nominal lengths of 0.25 to 0.75 inch, 0.12-inch increments; from 0.75- to 1.50-inch lengths, 0.25-inch increments; and for 1.50- to 3.00-inch lengths, 0.50-inch increments. For sizes ⅝ through ½ inch and for 0.50- to 1.50-inch lengths, 0.25-inch increments; for 1.50- to 3.00-inch lengths, 0.50-inch increments; and for 3.00- to 4.00-inch lengths, 1.00-inch increments.

Threads for Wing Screws and Thumb Screws.—Threads for all types of wing screws and thumb screws are in conformance with ANSI Standard Unified Thread, Class 2A. For threads with an additive finish the Class 2A maximum diameters apply to an unplated screw or to a screw before plating, whereas the basic diameters (Class 2A maximum diameters plus the allowance) apply to a screw after plating. All types of wing and thumb screws should have complete (full form) threads extending as close to the head or shoulder as practicable.

Points for Wing and Thumb Screws.—Wing and thumb screws are normally supplied with plain points (sheared ends). Where so specified, these screws may be obtained with cone, cup, dog, flat or oval points as shown in Table 8.

Table 8. American National Standard Alternate Points for Wing and Thumb Screws ANSI B18.17-1968, R1983

Nominal Size or Basic Screw Diameter ^a	O		P		Q		R	
	Cup and Flat Point Diameter		Dog Point ^b				Oval Point Radius	
	Max	Min	Diameter		Length		Max	Min
4 (0.1120)	0.061	0.051	0.075	0.070	0.061	0.051	0.099	0.084
6 (0.1380)	0.074	0.064	0.092	0.087	0.075	0.065	0.140	0.109
8 (0.1640)	0.087	0.076	0.109	0.103	0.085	0.075	0.156	0.125
10 (0.1900)	0.102	0.088	0.127	0.120	0.095	0.085	0.172	0.141
12 (0.2160)	0.115	0.101	0.144	0.137	0.115	0.105	0.188	0.156
¼ (0.2500)	0.132	0.118	0.156	0.149	0.130	0.120	0.219	0.188
⅝ (0.3125)	0.172	0.156	0.203	0.195	0.161	0.151	0.256	0.234
⅜ (0.3750)	0.212	0.194	0.250	0.241	0.193	0.183	0.312	0.281
⅞ (0.4375)	0.252	0.232	0.297	0.287	0.224	0.214	0.359	0.328
½ (0.5000)	0.291	0.270	0.344	0.334	0.255	0.245	0.406	0.375
⅝ (0.6250)	0.371	0.347	0.469	0.456	0.321	0.305	0.500	0.469

^a Where specifying nominal size in decimals, zeros in the fourth decimal place are omitted.

^b The axis of dog points shall not be eccentric with the axis of the screw by more than 3 per cent of the basic screw diameter or 0.005 in., whichever is the smaller.

All dimensions in inches.

¹The external point angles specified shall apply to those portions of the angles which lie below the thread root diameter, it being recognized the angle within the thread profile may be varied due to the manufacturing processes.

ANSI Flat, Pan, and Oval Head Wood Screws ANSI B18.6.1-1981 (R2008)

Nominal Size	Threads per inch	<i>D</i> ^a		<i>J</i>		<i>A</i>		<i>B</i>		<i>P</i>	<i>H</i>
		Basic Dia. of Screw	Width of Slot		Head Diameter		Head Diameter		Head Radius	Height of Head	
			Max.	Min.	Max., Sharp Edge	Min., Edge Rounded or Flat	Max.	Min.			
0	32	.060	.023	.016	.119	.099	.116	.104	.020	.035	
1	28	.073	.026	.019	.146	.123	.142	.130	.025	.043	
2	26	.086	.031	.023	.172	.147	.167	.155	.035	.051	
3	24	.099	.035	.027	.199	.171	.193	.180	.037	.059	
4	22	.112	.039	.031	.225	.195	.219	.205	.042	.067	
5	20	.125	.043	.035	.252	.220	.245	.231	.044	.075	
6	18	.138	.048	.039	.279	.244	.270	.256	.046	.083	
7	16	.151	.048	.039	.305	.268	.296	.281	.049	.091	
8	15	.164	.054	.045	.332	.292	.322	.306	.052	.100	
9	14	.177	.054	.045	.358	.316	.348	.331	.056	.108	
10	13	.190	.060	.050	.385	.340	.373	.357	.061	.116	
12	11	.216	.067	.056	.438	.389	.425	.407	.078	.132	
14	10	.242	.075	.064	.507	.452	.492	.473	.087	.153	
16	9	.268	.075	.064	.544	.485	.528	.508	.094	.164	
18	8	.294	.084	.072	.635	.568	.615	.594	.099	.191	
20	8	.320	.084	.072	.650	.582	.631	.608	.121	.196	
24	7	.372	.094	.081	.762	.685	.740	.716	.143	.230	

^a *Diameter Tolerance*: Equals + 0.004 in. and - 0.007 in. for cut threads. For rolled thread body diameter tolerances, see ANSI 18.6.1-1981 (R1997).

Nominal Size	Threads per Inch	<i>O</i>		<i>K</i>		<i>T</i>		<i>U</i>		<i>V</i>	
		Tot. Hgt. of Head		Height of Head		Depth of Slot		Depth of Slot		Depth of Slot	
		Max.	Min.	Max.	Min.	Max.	Min.	Max.	Min.	Max.	Min.
0	32	.056	.041	.039	.031	.015	.010	.022	.014	.030	.025
1	28	.068	.052	.046	.038	.019	.012	.027	.018	.038	.031
2	26	.080	.063	.053	.045	.023	.015	.031	.022	.045	.037
3	24	.092	.073	.060	.051	.027	.017	.035	.027	.052	.043
4	22	.104	.084	.068	.058	.030	.020	.040	.030	.059	.049
5	20	.116	.095	.075	.065	.034	.022	.045	.034	.067	.055
6	18	.128	.105	.082	.072	.038	.024	.050	.037	.074	.060
7	16	.140	.116	.089	.079	.041	.027	.054	.041	.081	.066
8	15	.152	.126	.096	.085	.045	.029	.058	.045	.088	.072
9	14	.164	.137	.103	.092	.049	.032	.063	.049	.095	.078
10	13	.176	.148	.110	.099	.053	.034	.068	.053	.103	.084
12	11	.200	.169	.125	.112	.060	.039	.077	.061	.117	.096
14	10	.232	.197	.144	.130	.070	.046	.087	.070	.136	.112
16	9	.248	.212	.153	.139	.075	.049	.093	.074	.146	.120
18	8	.290	.249	.178	.162	.083	.054	.106	.085	.171	.141
20	8	.296	.254	.182	.166	.090	.059	.108	.087	.175	.144
24	7	.347	.300	.212	.195	.106	.070	.124	.100	.204	.168

All dimensions in inches. The edge of flat and oval head screws may be flat or rounded. Wood screws are also available with Types I, IA, and II recessed heads. Consult the standard for recessed head dimensions. *The length of the thread, *L_T*, on wood screws having cut threads shall be equivalent to approximately two-thirds of the nominal length of the screw. For rolled threads, *L_T* shall be at least four times the basic screw diameter or two-thirds of the nominal screw length, whichever is greater. Screws of nominal lengths that are too short to accommodate the minimum thread length shall have threads extending as close to the underside of the head as practicable.

Pilot Hole Drill Sizes for Wood Screws

Work Material	Wood Screw Size						
	2	4	6	8	10	12	14
Hardwood	3/64	1/16	5/64	3/32	7/64	1/8	9/64
Softwood	1/32	3/64	1/16	5/64	3/32	7/64	1/8

TABLE OF CONTENTS
THREADS AND THREADING

<p style="text-align: center;">SCREW THREAD SYSTEMS</p>	<p style="text-align: center;">CALCULATING THREAD DIMENSIONS</p>
<p>1806 Screw Thread Forms</p> <p>1806 V-Thread, Sharp V-thread</p> <p>1806 US Standard Screw Thread</p> <p>1806 Unified Screw Thread Forms</p> <p>1807 International Metric Thread</p> <p>1808 ISO Metric Thread System</p> <p>1808 Definitions of Screw Threads</p>	<p>1865 Introduction</p> <p>1865 Metric Application</p> <p>1865 Purpose</p> <p>1866 Calculating And Rounding</p> <p>1866 Rounding of Decimal Values</p> <p>1866 Calculations from Formulas</p> <p>1867 Examples</p> <p>1867 Inch Screw Threads</p> <p>1867 Metric Screw Threads</p> <p>1867 Thread Form Constants</p>
<p style="text-align: center;">UNIFIED SCREW THREADS</p>	<p style="text-align: center;">METRIC SCREW THREADS</p>
<p>1813 American Standard for Unified Screw Threads</p> <p>1813 Thread Form</p> <p>1814 Internal and External Screw Thread Design Profile</p> <p>1814 Thread Series</p> <p>1815 Inch Screw Thread</p> <p>1816 Diameter-Pitch Combination</p> <p>1817 Standard Series Combinations</p> <p>1844 Coarse-Thread Series</p> <p>1845 Fine-Thread Series</p> <p>1845 Extra-Fine-Thread Series</p> <p>1846 Constant Pitch Series</p> <p>1847 4-Thread Series</p> <p>1848 6-Thread Series</p> <p>1849 8-Thread Series</p> <p>1850 12-Thread Series</p> <p>1851 16-Thread Series</p> <p>1852 20-Thread Series</p> <p>1853 28-Thread Series</p> <p>1854 Thread Classes</p> <p>1854 Coated 60-deg. Threads</p> <p>1856 Screw Thread Selection</p> <p>1856 Pitch Diameter Tolerance</p> <p>1856 Screw Thread Designation</p> <p>1857 Designating Coated Threads</p> <p>1857 Designating UNS Threads</p> <p>1857 Hole Sizes for Tapping</p> <p>1857 Minor Diameter Tolerance</p> <p>1858 Unified Miniature Screw Thread</p> <p>1858 Basic Thread Form</p> <p>1859 Design Thread Form</p> <p>1860 Design Form Dimensions</p> <p>1860 Formulas for Basic Dimensions</p> <p>1861 Limits of Size and Tolerances</p> <p>1862 Minimum Root Flats</p> <p>1863 UNJ Profile</p> <p>1863 British Standard UNJ Threads</p> <p>1863 ASME UNJ Thread Form</p> <p>1864 UNJ Basic Profile Dimensions</p>	<p>1878 M Profile Metric Screw Threads</p> <p>1878 Comparison with Inch Threads</p> <p>1878 Interchangeability</p> <p>1878 Definitions</p> <p>1879 Basic M Profile</p> <p>1879 M Crest and Root Form</p> <p>1880 General Symbols</p> <p>1880 M Profile Screw Thread Series</p> <p>1880 Mechanical Fastener Coarse Pitch</p> <p>1881 M Profile Data</p> <p>1882 Limits and Fits</p> <p>1886 Limits for Coated Threads</p> <p>1888 Dimensional Effect of Coating</p> <p>1888 Formulas for M Profile</p> <p>1892 Tolerance Grade Comparisons</p> <p>1892 M Profile Limiting Dimension</p> <p>1893 Internal Metric Thread</p> <p>1895 External Metric Thread</p> <p>1900 MJ Profile Metric Screw Threads</p> <p>1900 Diameter-Pitch Combinations</p> <p>1903 Trapezoidal Metric Thread</p> <p>1903 Comparison of ISO and DIN</p> <p>1910 ISO Miniature Screw Threads</p> <p>1910 British Standard Metric Threads</p> <p>1910 Basic Profile Dimensions</p> <p>1911 Tolerance System</p> <p>1911 Fundamental Deviations</p> <p>1912 Tolerance Grades</p> <p>1912 Tolerance Positions</p> <p>1912 Tolerance Classes</p> <p>1913 Lengths of Thread Engagements</p> <p>1913 Design Profiles</p> <p>1913 M Designation</p> <p>1914 Fundamental Deviation Formulas</p> <p>1915 Crest Diameter Tolerance</p>

TABLE OF CONTENTS
THREADS AND THREADING

METRIC SCREW THREADS

(Continued)

- 1915 Limits and Tolerances, Table
- 1918 Diameter/Pitch Combinations
- 1918 Limits and Tolerances
- 1919 Diameter/Pitch Table
- 1920 Comparison of Thread Systems

ACME SCREW THREADS

- 1921 General Purpose Acme Threads
- 1921 Acme Thread Form
- 1923 Acme Thread Abbreviations
- 1923 Designation
- 1923 Basic Dimensions
- 1923 Formulas for Diameters
- 1923 Limiting Dimensions
- 1923 Single-Start Screw Thread Data
- 1923 Pitch Diameter Allowances
- 1923 Multiple Start Acme Threads
- 1928 Pitch Diameter Tolerances
- 1928 Centralizing Acme Threads
- 1930 Basic Dimensions
- 1930 Formulas for Diameters
- 1930 Limiting Dimensions
- 1931 Screw Thread Data
- 1932 Allowances
- 1933 Tolerances
- 1933 Designation
- 1939 Minor Diameter Centralizing
- 1939 Stub Acme Threads
- 1939 Basic Dimensions
- 1939 Formulas for Diameters
- 1939 Limiting Dimensions
- 1939 Stub Acme Thread Designations
- 1942 Alternative Stub Acme Threads
- 1942 Former 60-Degree Stub Thread
- 1944 Square Thread

BUTTRESS THREADS

- 1945 Threads of Buttress Form
- 1945 British Standard Buttress Threads
- 1945 Lowenherz or Löwenherz Thread
- 1946 Buttress Inch Screw Threads
- 1946 Pitch Combinations
- 1946 Basic Dimensions
- 1946 Symbols and Form
- 1947 Buttress Thread Tolerances
- 1948 Buttress Thread Form
- 1951 Allowances
- 1952 Buttress Thread Designations

WHITWORTH THREADS

- 1953 British Standard Whitworth (BSW) and Fine (BSF) Threads
- 1953 Standard Thread Form
- 1953 Whitworth Standard Thread Form
- 1953 Tolerance Formulas
- 1954 Basic Dimensions

PIPE AND HOSE THREADS

- 1956 American National Pipe Threads
- 1956 Thread Designation and Notation
- 1956 Taper Pipe Thread
- 1957 Basic Dimensions
- 1958 Length of Engagement
- 1958 Tolerances on Thread Elements
- 1959 Limits on Crest and Root
- 1960 Pipe Couplings
- 1960 Railing Joint
- 1960 Straight Pipe Threads
- 1960 Mechanical Joints
- 1962 Dryseal Pipe Thread
- 1962 Limits on Crest and Root
- 1962 Types of Dryseal Pipe Thread
- 1962 Limitation of Assembly
- 1964 Tap Drill Sizes
- 1964 Special Dryseal Threads
- 1965 Limitations for Combinations
- 1965 British Standard Pipe Threads
- 1965 Non-pressure-tight Joints
- 1966 Basic Sizes
- 1966 Pressure-tight Joints
- 1967 Limits of Size
- 1968 Hose Coupling Screw Threads
- 1970 Screw Thread Length
- 1970 Fire Hose Connection
- 1971 Basic Dimensions
- 1972 Limits of Size

OTHER THREADS

- 1973 Interference-Fit Threads
- 1974 Design and Application Data
- 1975 External Thread Dimension
- 1975 Internal Thread Dimension
- 1976 Engagement Lengths
- 1977 Allowances for Coarse Thread
- 1977 Tolerances for Coarse Thread
- 1978 Variations in Lead and Diameter
- 1979 Spark Plug Threads
- 1980 Lamp Base and Socket Threads

TABLE OF CONTENTS
THREADS AND THREADING

<p style="text-align: center;">OTHER THREADS</p> <p><i>(Continued)</i></p> <p>1981 Instrument & Microscope Threads</p> <p>1981 British Association Thread</p> <p>1982 Instrument Makers' Screw Thread</p> <p>1982 Microscope Objective Thread</p> <p>1985 Swiss Screw Thread</p> <p>1986 Historical and Miscellaneous</p> <p>1986 Aero-Thread</p> <p>1986 Briggs Pipe Thread</p> <p>1986 Casing Thread</p> <p>1987 Cordeaux Thread</p> <p>1987 Dardelet Thread</p> <p>1987 "Drunken" Thread</p> <p>1987 Echols Thread</p> <p>1987 French Thread (S.F.)</p> <p>1987 Harvey Grip Thread</p> <p>1988 Lloyd & Lloyd Thread</p> <p>1988 Lock-Nut Pipe Thread</p> <p>1988 Philadelphia Carriage Bolt Thread</p> <p>1988 SAE Standard Screw Thread</p> <p>1988 Sellers Screw Thread</p> <p>1988 Worm Threads</p>	<p style="text-align: center;">MEASURING SCREW THREADS</p> <p><i>(Continued)</i></p> <p>2005 Taper Screw Threads</p> <p>2006 Buttress Threads</p> <p>2007 Thread Gages</p> <p>2007 Thread Gage Classification</p> <p>2007 Gages for Unified Inch Threads</p> <p>2010 Thread Forms of Gages</p> <p>2010 Building Up Worn Plug Gages</p> <p>2010 Thread Gage Tolerances</p> <p>2012 Tolerances for Cylindrical Gages</p> <p>2014 Formulas for Limits</p>
<p style="text-align: center;">MEASURING SCREW THREADS</p> <p>1989 Measuring Screw Threads</p> <p>1989 Pitch and Lead of Screw Threads</p> <p>1989 Thread Micrometers</p> <p>1990 Ball-point Micrometers</p> <p>1990 Three-wire Method</p> <p>1991 Classes of Formulas</p> <p>1991 Screw Thread Profiles</p> <p>1991 Accuracy of Formulas</p> <p>1992 Best Wire Sizes</p> <p>1993 Measuring Wire Accuracy</p> <p>1993 Measuring or Contact Pressure</p> <p>1993 Three-Wire Formulas</p> <p>1994 NIST General Formula</p> <p>1995 Formulas for Pitch Diameters</p> <p>1995 Effect of Small Thread Angle</p> <p>1997 Dimensions Over Wires</p> <p>1997 Formula Including Lead Angle</p> <p>1998 Measuring Whitworth Threads</p> <p>1999 Buckingham Exact Formula</p> <p>2000 Accuracy of Formulas</p> <p>Acme and Stub Acme Thread</p> <p>2001 Checking Pitch Diameter</p> <p>2001 Checking Thread Thickness</p> <p>2002 Wire Sizes</p> <p>2002 Checking Thread Angle</p> <p>2003 Best Wire Diameters</p>	<p style="text-align: center;">TAPPING AND THREAD CUTTING</p> <p>2015 Selection of Taps</p> <p>2017 Tap Rake Angles</p> <p>2017 Cutting Speed</p> <p>2017 Tapping Specific Materials</p> <p>2020 Other Tapping Lubricants</p> <p>2020 Diameter of Tap Drill</p> <p>2021 Hole Size Limits</p> <p>2029 Tap Drill Sizes</p> <p>2030 Tap Drills and Clearance Drills</p> <p>2030 Tolerances of Tapped Holes</p> <p>2031 Hole Sizes before Tapping</p> <p>2032 Miniature Screw Threads</p> <p>2033 Tapping Drill Sizes</p> <p>2033 ISO Metric Threads</p> <p>2034 Clearance Holes</p> <p>2035 Cold Form Tapping</p> <p>2036 Core Hole Sizes</p> <p>2037 Tap Drill Sizes</p> <p>2037 Removing a Broken Tap</p> <p>2037 Tap Drills for Pipe Taps</p> <p>2037 Power for Pipe Taps</p> <p>2038 High-Speed CNC Tapping</p> <p>2039 Coolant for Tapping</p> <p>2039 Combined Drilling and Tapping</p> <p>2040 Relief Angles for Cutting Tools</p> <p>2042 Lathe Change Gears</p> <p>2042 Change Gears for Thread Cutting</p> <p>2042 Compound Gearing</p> <p>2042 Fractional Threads</p> <p>2043 Change Gears for Metric Pitches</p> <p>2043 Change Gears, Fractional Ratios</p> <p>2044 Quick-Change Gearbox Output</p> <p>2046 Finding Accurate Gear Ratios</p> <p>2046 Lathe Change-gears</p> <p>2047 Relieving Helical-Fluted Hobs</p>

TABLE OF CONTENTS
THREADS AND THREADING

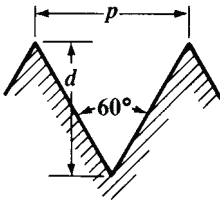
<p style="text-align: center;">THREAD ROLLING</p> <p>2048 Thread-Rolling Machine</p> <p>2048 Flat-Die Type</p> <p>2048 Cylindrical-Die Type</p> <p>2048 Rate of Production</p> <p>2049 Precision Thread Rolling</p> <p>2049 Steels for Thread Rolling</p> <p>2049 Diameter of Blank</p> <p>2050 Automatic Screw Machines</p> <p>2050 Factors Governing the Diameter</p> <p>2050 Diameter of Threading Roll</p> <p>2050 Kind of Thread on Roll</p> <p>2051 Application of Thread Roll</p> <p>2051 Tolerances on Wire for Thread Rolling</p> <p>2051 Thread Rolling Speeds and Feeds</p>	<p style="text-align: center;">THREAD MILLING</p> <p><i>(Continued)</i></p> <p>2063 Change Gears for Different Leads</p> <p>2073 Lead of Helix</p> <p>2076 Change Gears and Angles</p> <p style="padding-left: 20px;">Determining Helix Angle</p> <p>2077 For Given Lead and Diameter</p> <p>2078 For Given Angle</p> <p>2078 For Given Lead</p> <p>2078 For Lead Given DP and Teeth</p> <p>2078 Determine Lead of Tooth</p>
<p style="text-align: center;">THREAD GRINDING</p> <p>2053 Thread Grinding</p> <p>2053 Wheels for Thread Grinding</p> <p>2053 Single-Edge Wheel</p> <p>2054 Edges for Roughing and Finishing</p> <p>2054 Multi-ribbed Wheels</p> <p>2055 Ribbed Wheel for Fine Pitches</p> <p>2055 Solid Grinding Threads</p> <p>2055 Number of Wheel Passes</p> <p>2055 Wheel and Work Rotation</p> <p>2056 Wheel Speeds</p> <p>2056 Work Speeds</p> <p>2056 Truing Grinding Wheels</p> <p>2056 Wheel Hardness or Grade</p> <p>2057 Grain Size</p> <p>2057 Grinding by Centerless Method</p> <p>2057 Principle of Centerless Grinding</p>	<p style="text-align: center;">SIMPLE, COMPOUND, DIFFERENTIAL, AND BLOCK INDEXING</p> <p>2079 Milling Machine Indexing</p> <p>2079 Hole Circles</p> <p>2079 Holes in Brown & Sharpe</p> <p>2079 Holes in Cincinnati</p> <p>2079 Simple Indexing</p> <p>2080 Compound Indexing</p> <p>2081 Simple and Compound Indexing</p> <p>2086 Angular Indexing</p> <p>2086 Tables for Angular Indexing</p> <p>2087 Angle of One Hole Moves</p> <p>2088 Accurate Angular Indexing</p> <p>2103 Indexing for Small Angles</p> <p>2104 Differential Indexing</p> <p>2104 Ratio of Gearing</p> <p>2105 To Find the Indexing Movement</p> <p>2105 Use of Idler Gears</p> <p>2105 Compound Gearing</p> <p>2106 Check Number of Divisions</p> <p>2107 Simple and Different Indexing</p> <p>2113 Indexing Movements of Plate</p> <p>2114 Indexing High Numbers</p> <p>2117 Indexing Tables</p> <p>2117 Block or Multiple Indexing</p> <p>2119 60-Tooth Worm Indexing</p> <p>2120 Linear Indexing for Rack Cutting</p> <p>2120 Linear Indexing Movements</p> <p>2121 Counter Milling</p>
<p style="text-align: center;">THREAD MILLING</p> <p>2058 Thread Milling</p> <p>2058 Single-cutter Method</p> <p>2058 Multiple-cutter Method</p> <p>2059 Planetary Method</p> <p>2059 Classes of Work</p> <p>2060 Pitches of Die-cut Threads</p> <p>2060 Changing Pitch of Screw</p> <p>2060 Helical Milling</p> <p>2060 Lead of a Milling Machine</p> <p>2061 Change Gears for Helical Milling</p> <p>2061 Short-lead Milling</p> <p>2061 Helix</p> <p>2062 Helix Angles</p>	

SCREW THREAD SYSTEMS

Screw Thread Forms

Of the various screw thread forms which have been developed, the most used are those having symmetrical sides inclined at equal angles with a vertical center line through the thread apex. Present-day examples of such threads would include the Unified, the Whitworth and the Acme forms. One of the early forms was the Sharp V which is now used only occasionally. Symmetrical threads are relatively easy to manufacture and inspect and hence are widely used on mass-produced general-purpose threaded fasteners of all types. In addition to general-purpose fastener applications, certain threads are used to repeatedly move or translate machine parts against heavy loads. For these so-called translation threads a stronger form is required. The most widely used translation thread forms are the square, the Acme, and the buttress. Of these, the square thread is the most efficient, but it is also the most difficult to cut owing to its parallel sides and it cannot be adjusted to compensate for wear. Although less efficient, the Acme form of thread has none of the disadvantages of the square form and has the advantage of being somewhat stronger. The buttress form is used for translation of loads in one direction only because of its non-symmetrical form and combines the high efficiency and strength of the square thread with the ease of cutting and adjustment of the Acme thread.

V-Thread, Sharp V-thread.—The sides of the thread form an angle of 60 degrees with each other. The top and bottom or root of this thread form are theoretically sharp, but in actual practice the thread is made with a slight flat, owing to the difficulty of producing a perfectly sharp edge and because of the tendency of such an edge to wear away or become battered. This flat is usually equal to about one twenty-fifth of the pitch, although there is no generally recognized standard.



Owing to the difficulties connected with the V-thread, the tap manufacturers agreed in 1909 to discontinue the making of sharp V-thread taps, except when ordered. One advantage of the V-thread is that the same cutting tool may be used for all pitches, whereas, with the American Standard form, the width of the point or the flat varies according to the pitch.

The V-thread is regarded as a good form where a steam-tight joint is necessary, and many of the taps used on locomotive work have this form of thread. Some modified V-threads, for locomotive boiler taps particularly, have a depth of $0.8 \times$ pitch.

The American Standard screw thread is used largely in preference to the sharp V-thread because it has several advantages; see *American Standard for Unified Screw Threads*. If p = pitch of thread, and d depth of thread, then

$$d = p \times \cos 30 \text{ deg.} = 0.866 \times p = \frac{0.866}{\text{No. of threads per inch}}$$

United States Standard Screw Thread.—William Sellers of Philadelphia, in a paper read before the Franklin Institute in 1864, originally proposed the screw thread system that later became known as the U. S. Standard system for screw threads. A report was made to the United States Navy in May, 1868, in which the Sellers system was recommended as a standard for the Navy Department, which accounts for the name of U. S. Standard. The American Standard Screw Thread system is a further development of the United States Standard. The thread form which is known as the American (National) form is the same as the United States Standard form. See *American Standard for Unified Screw Threads*.

American National and Unified Screw Thread Forms.—The American National form (formerly known as the United States Standard) was used for many years for most screws, bolts, and miscellaneous threaded products produced in the United States. The American

National Standard for Unified Screw Threads now in use includes certain modifications of the former standard as is explained below and on page 1813. The basic profile is shown in Fig. 1 and is identical for both UN and UNR screw threads. In this figure H is the height of a sharp V-thread, P is the pitch, D and d are the basic major diameters, D_2 and d_2 are the basic pitch diameters, and D_1 and d_1 are the basic minor diameters. Capital letters are used to designate the internal thread dimensions (D , D_2 , D_1), and lowercase letters to designate the external thread dimensions (d , d_2 , d_1). Definitions of *Basic Size* and *Basic Profile of Thread* are given on page 1808.

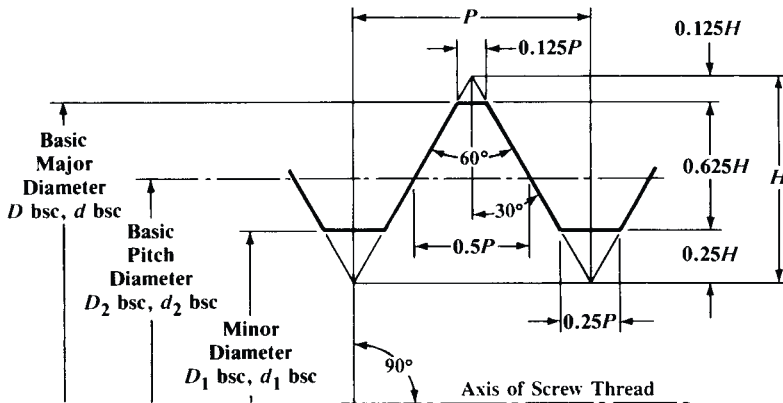
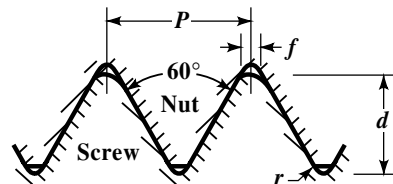


Fig. 1. Basic Profile of UN and UNF Screw Threads

In the past, other symbols were used for some of the thread dimensions illustrated above. These symbols were changed to conform with current practice in nomenclature as defined in ANSI/ASME B1.7M, "Nomenclature, Definitions, and Letter Symbols for Screw Threads." The symbols used above are also in accordance with terminology and symbols used for threads of the ISO metric thread system.

International Metric Thread System.—The *Système Internationale* (S.I.) Thread was adopted at the International Congress for the standardization of screw threads held in Zurich in 1898. The thread form is similar to the American standard (formerly U.S. Standard), excepting the depth which is greater. There is a clearance between the root and mating crest fixed at a maximum of $\frac{1}{16}$ the height of the fundamental triangle or $0.054 \times$ pitch. A rounded root profile is recommended. The angle in the plane of the axis is 60 degrees and the crest has a flat like the American standard equal to $0.125 \times$ pitch. This system formed the basis of the normal metric series (ISO threads) of many European countries, Japan, and many other countries, including metric thread standards of the United States.

$$\begin{aligned} \text{Depth } d &= 0.7035 P \text{ max.}; 0.6855 P \text{ min.} \\ \text{Flat } f &= 0.125 P \\ \text{Radius } r &= 0.0633 P \text{ max.}; 0.054 P \text{ min.} \\ \text{Tap drill dia} &= \text{major dia.} - \text{pitch} \end{aligned}$$

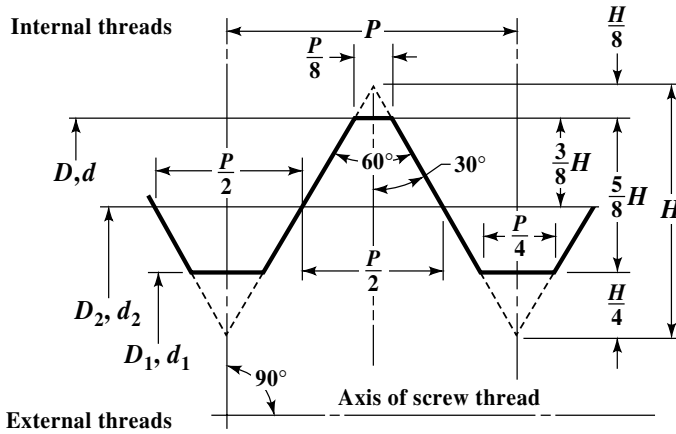


International Metric Fine Thread: The International Metric Fine Thread form of thread is the same as the International system but the pitch for a given diameter is smaller.

German Metric Thread Form: The German metric thread form is like the International Standard but the thread depth $= 0.6945 P$. The root radius is the same as the maximum for the International Standard or $0.0633 P$.

ISO Metric Thread System.—ISO refers to the International Organization for Standardization, a worldwide federation of national standards bodies (for example, the American National Standards Institute is the ISO national body representing the United States) that develops standards on a very wide variety of subjects.

The basic profile of ISO metric threads is specified in ISO 68 and shown in Fig. 2. The basic profile of this thread is very similar to that of the Unified thread, and as previously discussed, H is the height of a sharp V-thread, P is the pitch, D and d are the basic major diameters, D_2 and d_2 are the basic pitch diameters, and D_1 and d_1 are the basic minor diameters. Here also, capital letters designate the internal thread dimensions (D, D_2, D_1), and lowercase letters designate the external thread dimensions (d, d_2, d_1). This metric thread is discussed in detail in the section *METRIC SCREW THREADS* starting on page 1878.



$$H = \frac{\sqrt{3}}{2} \times P = 0.866025404P$$

$$0.125H = 0.108253175P \quad 0.250H = 0.216506351P \quad 0.375H = 0.324759526P \quad 0.625H = 0.541265877P$$

Fig. 2. ISO 68 Basic Profile

Definitions of Screw Threads

The following definitions are based on American National Standard ANSI/ASME B1.7M-1984 (R2001) “Nomenclature, Definitions, and Letter Symbols for Screw Threads,” and refer to both straight and taper threads.

Actual Size: An actual size is a measured size.

Allowance: An allowance is the prescribed difference between the design (maximum material) size and the basic size. It is numerically equal to the absolute value of the ISO term *fundamental deviation*.

Axis of Thread: Thread axis is coincident with the axis of its pitch cylinder or cone.

Basic Profile of Thread: The basic profile of a thread is the cyclical outline, in an axial plane, of the permanently established boundary between the provinces of the external and internal threads. All deviations are with respect to this boundary.

Basic Size: The basic size is that size from which the limits of size are derived by the application of allowances and tolerances.

Bilateral Tolerance: This is a tolerance in which variation is permitted in both directions from the specified dimension.

Black Crest Thread: This is a thread whose crest displays an unfinished cast, rolled, or forged surface.

Blunt Start Thread: “Blunt start” designates the removal of the incomplete thread at the starting end of the thread. This is a feature of threaded parts that are repeatedly assembled

by hand, such as hose couplings and thread plug gages, to prevent cutting of hands and crossing of threads. It was formerly known as a Higbee cut.

Chamfer: This is a conical surface at the starting end of a thread.

Class of Thread: The class of a thread is an alphanumeric designation to indicate the standard grade of tolerance and allowance specified for a thread.

Clearance Fit: This is a fit having limits of size so prescribed that a clearance always results when mating parts are assembled at their maximum material condition.

Complete Thread: The complete thread is that thread whose profile lies within the size limits. (See also *Effective Thread* and *Length of Complete Thread*.) *Note:* Formerly in pipe thread terminology this was referred to as “the perfect thread” but that term is no longer considered desirable.

Crest: This is that surface of a thread which joins the flanks of the thread and is farthest from the cylinder or cone from which the thread projects.

Crest Truncation: This is the radial distance between the sharp crest (crest apex) and the cylinder or cone that would bound the crest.

Depth of Thread Engagement: The depth (or height) of thread engagement between two coaxially assembled mating threads is the radial distance by which their thread forms overlap each other.

Design Size: This is the basic size with allowance applied, from which the limits of size are derived by the application of a tolerance. If there is no allowance, the design size is the same as the basic size.

Deviation: Deviation is a variation from an established dimension, position, standard, or value. In ISO usage, it is the algebraic difference between a size (actual, maximum, or minimum) and the corresponding basic size. The term deviation does not necessarily indicate an error. (See also *Error*.)

Deviation, Fundamental (ISO term): For standard threads, the fundamental deviation is the upper or lower deviation closer to the basic size. It is the upper deviation *es* for an external thread and the lower deviation *EI* for an internal thread. (See also *Allowance* and *Tolerance Position*.)

Deviation, Lower (ISO term): The algebraic difference between the minimum limit of size and the basic size. It is designated *EI* for internal and *ei* for external thread diameters.

Deviation, Upper (ISO term): The algebraic difference between the maximum limit of size and the basic size. It is designated *ES* for internal and *es* for external thread diameters.

Dimension: A numerical value expressed in appropriate units of measure and indicated on drawings along with lines, symbols, and notes to define the geometrical characteristic of an object.

Effective Size: See *Pitch Diameter, Functional Diameter*.

Effective Thread: The effective (or useful) thread includes the complete thread, and those portions of the incomplete thread which are fully formed at the root but not at the crest (in taper pipe threads it includes the so-called black crest threads); thus excluding the vanish thread.

Error: The algebraic difference between an observed or measured value beyond tolerance limits, and the specified value.

External Thread: A thread on a cylindrical or conical external surface.

Fit: Fit is the relationship resulting from the designed difference, before assembly, between the sizes of two mating parts which are to be assembled.

Flank: The flank of a thread is either surface connecting the crest with the root. The flank surface intersection with an axial plane is theoretically a straight line.

Flank Angle: The flank angles are the angles between the individual flanks and the perpendicular to the axis of the thread, measured in an axial plane. A flank angle of a symmetrical thread is commonly termed the half-angle of thread.

Flank Diametral Displacement: In a boundary profile defined system, flank diametral displacement is twice the radial distance between the straight thread flank segments of the

maximum and minimum boundary profiles. The value of flank diametral displacement is equal to pitch diameter tolerance in a pitch line reference thread system.

Height of Thread: The height (or depth) of thread is the distance, measured radially, between the major and minor cylinders or cones, respectively.

Helix Angle: On a straight thread, the helix angle is the angle made by the helix of the thread and its relation to the thread axis. On a taper thread, the helix angle at a given axial position is the angle made by the conical spiral of the thread with the axis of the thread. The helix angle is the complement of the lead angle. (See also page 2062 for diagram.)

Higbee Cut: See *Blunt Start Thread*.

Imperfect Thread: See *Incomplete Thread*.

Included Angle: This is the angle between the flanks of the thread measured in an axial plane.

Incomplete Thread: A threaded profile having either crests or roots or both, not fully formed, resulting from their intersection with the cylindrical or end surface of the work or the vanish cone. It may occur at either end of the thread.

Interference Fit: A fit having limits of size so prescribed that an interference always results when mating parts are assembled.

Internal Thread: A thread on a cylindrical or conical internal surface.

Lead: Lead is the axial distance between two consecutive points of intersection of a helix by a line parallel to the axis of the cylinder on which it lies, i.e., the axial movement of a threaded part rotated one turn in its mating thread.

Lead Angle: On a straight thread, the lead angle is the angle made by the helix of the thread at the pitch line with a plane perpendicular to the axis. On a taper thread, the lead angle at a given axial position is the angle made by the conical spiral of the thread with the perpendicular to the axis at the pitch line.

Lead Thread: That portion of the incomplete thread that is fully formed at the root but not fully formed at the crest that occurs at the entering end of either an external or internal thread.

Left-hand Thread: A thread is a left-hand thread if, when viewed axially, it winds in a counterclockwise and receding direction. Left-hand threads are designated LH.

Length of Complete Thread: The axial length of a thread section having full form at both crest and root but also including a maximum of two pitches at the start of the thread which may have a chamfer or incomplete crests.

Length of Thread Engagement: The length of thread engagement of two mating threads is the axial distance over which the two threads, each having full form at both crest and root, are designed to contact. (See also *Length of Complete Thread*.)

Limits of Size: The applicable maximum and minimum sizes.

Major Clearance: The radial distance between the root of the internal thread and the crest of the external thread of the coaxially assembled design forms of mating threads.

Major Cone: The imaginary cone that would bound the crests of an external taper thread or the roots of an internal taper thread.

Major Cylinder: The imaginary cylinder that would bound the crests of an external straight thread or the roots of an internal straight thread.

Major Diameter: On a straight thread the major diameter is that of the major cylinder. On a taper thread the major diameter at a given position on the thread axis is that of the major cone at that position. (See also *Major Cylinder* and *Major Cone*.)

Maximum Material Condition: (MMC): The condition where a feature of size contains the maximum amount of material within the stated limits of size. For example, minimum internal thread size or maximum external thread size.

Minimum Material Condition: (Least Material Condition (LMC)): The condition where a feature of size contains the least amount of material within the stated limits of size. For example, maximum internal thread size or minimum external thread size.

Minor Clearance: The radial distance between the crest of the internal thread and the root of the external thread of the coaxially assembled design forms of mating threads.

Minor Cone: The imaginary cone that would bound the roots of an external taper thread or the crests of an internal taper thread.

Minor Cylinder: The imaginary cylinder that would bound the roots of an external straight thread or the crests of an internal straight thread.

Minor Diameter: On a straight thread the minor diameter is that of the minor cylinder. On a taper thread the minor diameter at a given position on the thread axis is that of the minor cone at that position. (See also *Minor Cylinder* and *Minor Cone*.)

Multiple-Start Thread: A thread in which the lead is an integral multiple, other than one, of the pitch.

Nominal Size: Designation used for general identification.

Parallel Thread: See *Screw Thread*.

Partial Thread: See *Vanish Thread*.

Pitch: The pitch of a thread having uniform spacing is the distance measured parallel with its axis between corresponding points on adjacent thread forms in the same axial plane and on the same side of the axis. Pitch is equal to the lead divided by the number of thread starts. †

Pitch Cone: The pitch cone is an imaginary cone of such apex angle and location of its vertex and axis that its surface would pass through a taper thread in such a manner as to make the widths of the thread ridge and the thread groove equal. It is, therefore, located equidistantly between the sharp major and minor cones of a given thread form. On a theoretically perfect taper thread, these widths are equal to one-half the basic pitch. (See also *Axis of Thread* and *Pitch Diameter*.)

Pitch Cylinder: The pitch cylinder is an imaginary cylinder of such diameter and location of its axis that its surface would pass through a straight thread in such a manner as to make the widths of the thread ridge and groove equal. It is, therefore, located equidistantly between the sharp major and minor cylinders of a given thread form. On a theoretically perfect thread these widths are equal to one-half the basic pitch. (See also *Axis of Thread* and *Pitch Diameter*.)

Pitch Diameter: On a straight thread the pitch diameter is the diameter of the pitch cylinder. On a taper thread the pitch diameter at a given position on the thread axis is the diameter of the pitch cone at that position. *Note:* When the crest of a thread is truncated beyond the pitch line, the pitch diameter and pitch cylinder or pitch cone would be based on a theoretical extension of the thread flanks.

Pitch Diameter, Functional Diameter: The functional diameter is the pitch diameter of an enveloping thread with perfect pitch, lead, and flank angles and having a specified length of engagement. It includes the cumulative effect of variations in lead (pitch), flank angle, taper, straightness, and roundness. Variations at the thread crest and root are excluded. Other, nonpreferred terms are *virtual diameter*, *effective size*, *virtual effective diameter*, and *thread assembly diameter*.

Pitch Line: The generator of the cylinder or cone specified in *Pitch Cylinder* and *Pitch Cone*.

Right-hand Thread: A thread is a right-hand thread if, when viewed axially, it winds in a clockwise and receding direction. A thread is considered to be right-hand unless specifically indicated otherwise.

Root: That surface of the thread which joins the flanks of adjacent thread forms and is immediately adjacent to the cylinder or cone from which the thread projects.

Root Truncation: The radial distance between the sharp root (root apex) and the cylinder or cone that would bound the root. See also *Sharp Root (Root Apex)*.

Runout: As applied to screw threads, unless otherwise specified, runout refers to circular runout of major and minor cylinders with respect to the pitch cylinder. Circular runout, in accordance with ANSI Y14.5M, controls cumulative variations of circularity and coaxiality. Runout includes variations due to eccentricity and out-of-roundness. The amount of runout is usually expressed in terms of full indicator movement (FIM).

Screw Thread: A screw thread is a continuous and projecting helical ridge usually of uniform section on a cylindrical or conical surface.

Sharp Crest (Crest Apex): The apex formed by the intersection of the flanks of a thread when extended, if necessary, beyond the crest.

Sharp Root (Root Apex): The apex formed by the intersection of the adjacent flanks of adjacent threads when extended, if necessary, beyond the root.

Standoff: The axial distance between specified reference points on external and internal taper thread members or gages, when assembled with a specified torque or under other specified conditions.

Straight Thread: A straight thread is a screw thread projecting from a cylindrical surface.

Taper Thread: A taper thread is a screw thread projecting from a conical surface.

Tensile Stress Area: The tensile stress area is an arbitrarily selected area for computing the tensile strength of an externally threaded fastener so that the fastener strength is consistent with the basic material strength of the fastener. It is typically defined as a function of pitch diameter and/or minor diameter to calculate a circular cross section of the fastener correcting for the notch and helix effects of the threads.


Thread: A thread is a portion of a screw thread encompassed by one pitch. On a single-start thread it is equal to one turn. (See also *Threads per Inch* and *Turns per Inch*.)

Thread Angle: See *Included Angle*.

Thread Runout: See *Vanish Thread*.

Thread Series: Thread Series are groups of diameter/pitch combinations distinguished from each other by the number of threads per inch applied to specific diameters.

Thread Shear Area: The thread shear area is the total ridge cross-sectional area intersected by a specified cylinder with diameter and length equal to the mating thread engagement. Usually the cylinder diameter for external thread shearing is the minor diameter of the internal thread and for internal thread shearing it is the major diameter of the external thread.

 *Threads per Inch:* The number of threads per inch is the reciprocal of the axial pitch in inches.

Tolerance: The total amount by which a specific dimension is permitted to vary. The tolerance is the difference between the maximum and minimum limits.

Tolerance Class: (metric): The tolerance class (metric) is the combination of a tolerance position with a tolerance grade. It specifies the allowance (fundamental deviation), pitch diameter tolerance (flank diametral displacement), and the crest diameter tolerance.

Tolerance Grade: (metric): The tolerance grade (metric) is a numerical symbol that designates the tolerances of crest diameters and pitch diameters applied to the design profiles.

Tolerance Limit: The variation, positive or negative, by which a size is permitted to depart from the design size.

Tolerance Position: (metric): The tolerance position (metric) is a letter symbol that designates the position of the tolerance zone in relation to the basic size. This position provides the allowance (fundamental deviation).

Total Thread: Includes the complete and all the incomplete thread, thus including the vanish thread and the lead thread.

Transition Fit: A fit having limits of size so prescribed that either a clearance or an interference may result when mating parts are assembled.

Turns per Inch: The number of turns per inch is the reciprocal of the lead in inches.

Unilateral Tolerance: A tolerance in which variation is permitted in one direction from the specified dimension.

Vanish Thread: (Partial Thread, Washout Thread, or Thread Runout): That portion of the incomplete thread which is not fully formed at the root or at crest and root. It is produced by the chamfer at the starting end of the thread forming tool.

Virtual Diameter: See *Pitch Diameter, Functional Diameter*.

Washout Thread: See *Vanish Thread*.

UNIFIED SCREW THREADS

American Standard for Unified Screw Threads

American Standard B1.1-1949 was the first American standard to cover those Unified Thread Series agreed upon by the United Kingdom, Canada, and the United States to obtain screw thread interchangeability among these three nations. These Unified threads are now the basic American standard for fastening types of screw threads. In relation to previous American practice, Unified threads have substantially the same thread form and are mechanically interchangeable with the former American National threads of the same diameter and pitch.

The principal differences between the two systems lie in: 1) application of allowances; 2) variation of tolerances with size; 3) difference in amount of pitch diameter tolerance on external and internal threads; and 4) differences in thread designation.

In the Unified system an allowance is provided on both the Classes 1A and 2A external threads whereas in the American National system only the Class I external thread has an allowance. Also, in the Unified system, the pitch diameter tolerance of an internal thread is 30 per cent greater than that of the external thread, whereas they are equal in the American National system.

Revised Standard.—The revised screw thread standard ANSI/ASME B1.1-1989 (R2008) is much the same as that of ANSI B1.1-1982. The latest symbols in accordance with ANSI/ASME B1.7M-1984 (R2001) Nomenclature, are used. Acceptability criteria are described in ANSI/ASME B1.3M-1992 (R2001), Screw Thread Gaging Systems for Dimensional Acceptability, Inch or Metric Screw Threads (UN, UNR, UNJ, M, and MJ).

Where the letters U, A or B do not appear in the thread designations, the threads conform to the outdated American National screw threads.

Advantages of Unified Threads.—The Unified standard is designed to correct certain production difficulties resulting from the former standard. Often, under the old system, the tolerances of the product were practically absorbed by the combined tool and gage tolerances, leaving little for a working tolerance in manufacture. Somewhat greater tolerances are now provided for nut threads. As contrasted with the old “classes of fit” 1, 2, and 3, for each of which the pitch diameter tolerance on the external and internal threads were equal, the Classes 1B, 2B, and 3B (internal) threads in the new standard have, respectively, a 30 per cent larger pitch diameter tolerance than the 1A, 2A, and 3A (external) threads. Relatively more tolerance is provided for fine threads than for coarse threads of the same pitch. Where previous tolerances were more liberal than required, they were reduced.

Thread Form.—The Design Profiles for Unified screw threads, shown on page 1814, define the maximum material condition for external and internal threads with no allowance and are derived from the Basic Profile, shown on page 1807.

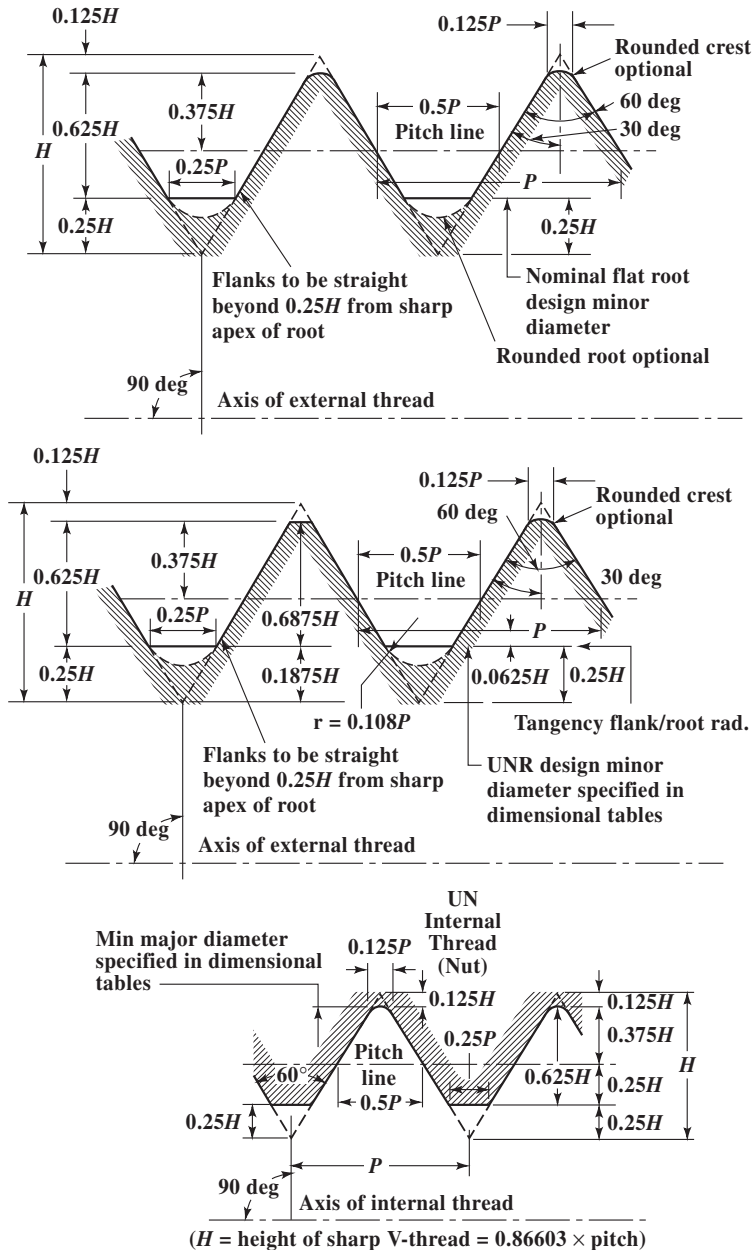
UN External Screw Threads: A flat root contour is specified, but it is necessary to provide for some threading tool crest wear, hence a rounded root contour cleared beyond the $0.25P$ flat width of the Basic Profile is optional.

UNR External Screw Threads: To reduce the rate of threading tool crest wear and to improve fatigue strength of a flat root thread, the Design Profile of the UNR thread has a smooth, continuous, non-reversing contour with a radius of curvature not less than $0.108P$ at any point and blends tangentially into the flanks and any straight segment. At the maximum material condition, the point of tangency is specified to be at a distance not less than $0.625H$ (where H is the height of a sharp V-thread) below the basic major diameter.

UN and UNR External Screw Threads: The Design Profiles of both UN and UNR external screw threads have flat crests. However, in practice, product threads are produced with partially or completely rounded crests. A rounded crest tangent at $0.125P$ flat is shown as an option on page 1814.

UN Internal Screw Thread: In practice it is necessary to provide for some threading tool crest wear, therefore the root of the Design Profile is rounded and cleared beyond the $0.125P$ flat width of the Basic Profile. There is no internal UNR screw thread.

American National Standard Unified Internal and External Screw Thread Design Profiles (Maximum Material Condition)



Thread Series.—Thread series are groups of diameter-pitch combinations distinguished from each other by the numbers of threads per inch applied to a specific diameter. The various diameter-pitch combinations of eleven standard series are shown in Table 2. The limits of size of threads in the eleven standard series together with certain selected combinations of diameter and pitch, as well as the symbols for designating the various threads, are given in Table 3. (Text continues on page 1844)

Table 1. American Standard Unified Inch Screw Thread Form Data

Threads per Inch <i>n</i>	Pitch <i>P</i>	Depth of Sharp V-Thread 0.86603 <i>P</i>	Depth of Int. Thd. and UN Ext. Thd. ^a 0.54127 <i>P</i>	Depth of UNR Ext. Thd. 0.59539 <i>P</i>	Truncation of Ext. Thd. Root 0.21651 <i>P</i>	Truncation of UNR Ext. Thd. Root ^b 0.16238 <i>P</i>	Truncation of Ext. Thd. Crest 0.10825 <i>P</i>	Truncation of Int. Thd. Root 0.10825 <i>P</i>	Truncation of Int. Thd. Crest 0.2165 <i>P</i>	Flat at Ext. Thd. Crest and Int. Thd. Root 0.125 <i>P</i>	Basic Flat at Int. Thd. Crest ^c 0.25 <i>P</i>	Maximum Ext. Thd. Root Radius 0.14434 <i>P</i>	Addendum of Ext. Thd. 0.32476 <i>P</i>
80	0.01250	0.01083	0.00677	0.00744	0.00271	0.00203	0.00135	0.00135	0.00271	0.00156	0.00312	0.00180	0.00406
72	0.01389	0.01203	0.00752	0.00827	0.00301	0.00226	0.00150	0.00150	0.00301	0.00174	0.00347	0.00200	0.00451
64	0.01563	0.01353	0.00846	0.00930	0.00338	0.00254	0.00169	0.00169	0.00338	0.00195	0.00391	0.00226	0.00507
56	0.01786	0.01546	0.00967	0.01063	0.00387	0.00290	0.00193	0.00193	0.00387	0.00223	0.00446	0.00258	0.00580
48	0.02083	0.01804	0.01128	0.01240	0.00451	0.00338	0.00226	0.00226	0.00451	0.00260	0.00521	0.00301	0.00677
44	0.02273	0.01968	0.01230	0.01353	0.00492	0.00369	0.00246	0.00246	0.00492	0.00284	0.00568	0.00328	0.00738
40	0.02500	0.02165	0.01353	0.01488	0.00541	0.00406	0.00271	0.00271	0.00541	0.00312	0.00625	0.00361	0.00812
36	0.02778	0.02406	0.01504	0.01654	0.00601	0.00451	0.00301	0.00301	0.00601	0.00347	0.00694	0.00401	0.00902
32	0.03125	0.02706	0.01691	0.01861	0.00677	0.00507	0.00338	0.00338	0.00677	0.00391	0.00781	0.00451	0.01015
28	0.03571	0.03093	0.01933	0.02126	0.00773	0.00580	0.00387	0.00387	0.00773	0.00446	0.00893	0.00515	0.01160
27	0.03704	0.03208	0.02005	0.02205	0.00802	0.00601	0.00401	0.00401	0.00802	0.00463	0.00926	0.00535	0.01203
24	0.04167	0.03608	0.02255	0.02481	0.00902	0.00677	0.00451	0.00451	0.00902	0.00521	0.01042	0.00601	0.01353
20	0.05000	0.04330	0.02706	0.02977	0.01083	0.00812	0.00541	0.00541	0.01083	0.00625	0.01250	0.00722	0.01624
18	0.05556	0.04811	0.03007	0.03308	0.01203	0.00902	0.00601	0.00601	0.01203	0.00694	0.01389	0.00802	0.01804
16	0.06250	0.05413	0.03383	0.03721	0.01353	0.01015	0.00677	0.00677	0.01353	0.00781	0.01562	0.00902	0.02030
14	0.07143	0.06186	0.03866	0.04253	0.01546	0.01160	0.00773	0.00773	0.01546	0.00893	0.01786	0.01031	0.02320
13	0.07692	0.06662	0.04164	0.04580	0.01655	0.01249	0.00833	0.00833	0.01665	0.00962	0.01923	0.01110	0.02498
12	0.08333	0.07217	0.04511	0.04962	0.01804	0.01353	0.00902	0.00902	0.01804	0.01042	0.02083	0.01203	0.02706
11½	0.08696	0.07531	0.04707	0.05177	0.01883	0.01412	0.00941	0.00941	0.01883	0.01087	0.02174	0.01255	0.02824
11	0.09091	0.07873	0.04921	0.05413	0.01968	0.01476	0.00984	0.00984	0.01968	0.01136	0.02273	0.01312	0.02952
10	0.10000	0.08660	0.05413	0.05954	0.02165	0.01624	0.01083	0.01083	0.02165	0.01250	0.02500	0.01443	0.03248
9	0.11111	0.09623	0.06014	0.06615	0.02406	0.01804	0.01203	0.01203	0.02406	0.01389	0.02778	0.01604	0.03608
8	0.12500	0.10825	0.06766	0.07442	0.02706	0.02030	0.01353	0.01353	0.02706	0.01562	0.03125	0.01804	0.04059
7	0.14286	0.12372	0.07732	0.08506	0.03093	0.02320	0.01546	0.01546	0.03093	0.01786	0.03571	0.02062	0.04639
6	0.16667	0.14434	0.09021	0.09923	0.03608	0.02706	0.01804	0.01804	0.03608	0.02083	0.04167	0.02406	0.05413
5	0.20000	0.17321	0.10825	0.11908	0.04330	0.03248	0.02165	0.02165	0.04330	0.02500	0.05000	0.02887	0.06495
4½	0.22222	0.19245	0.12028	0.13231	0.04811	0.03608	0.02406	0.02406	0.04811	0.02778	0.05556	0.03208	0.07217
4	0.25000	0.21651	0.13532	0.14885	0.05413	0.04059	0.02706	0.02706	0.05413	0.03125	0.06250	0.03608	0.08119

^a Also depth of thread engagement.

^b Design profile.

^c Also basic flat at external UN thread root.

All dimensions are in inches.

Table 2. Diameter-Pitch Combinations for Standard Series of Threads (UN/UNR)

Sizes ^a No. or Inches	Basic Major Dia. Inches	Threads per Inch											
		Series with Graded Pitches			Series with Uniform (Constant) Pitches								
		Coarse UNC	Fine ^b UNF	Extra fine ^c UNEF	4-UN	6-UN	8-UN	12-UN	16-UN	20-UN	28-UN	32-UN	
0	0.0600	...	80	Series designation shown indicates the UN thread form; however, the UNR thread form may be specified by substituting UNR in place of UN in all designations for external threads.									
(1)	0.0730	64	72										
2	0.0860	56	64										
(3)	0.0990	48	56										
4	0.1120	40	48										
5	0.1250	40	44										
6	0.1380	32	40										
8	0.1640	32	36										
10	0.1900	24	32										
(12)	0.2160	24	28										
$\frac{1}{4}$	0.2500	20	28	UNC	
$\frac{3}{16}$	0.3125	18	24	32	20	28	UNEF	
$\frac{3}{8}$	0.3750	16	24	32	UNC	20	28	UNEF	
$\frac{7}{16}$	0.4375	14	20	28	16	UNF	UNEF	32	
$\frac{1}{2}$	0.5000	13	20	28	16	UNF	UNEF	32	
$\frac{9}{16}$	0.5625	12	18	24	UNC	16	20	28	32	
$\frac{5}{8}$	0.6250	11	18	24	12	16	20	28	32	
($1\frac{1}{16}$)	0.6875	24	12	16	20	28	32	
$\frac{3}{4}$	0.7500	10	16	20	12	UNF	UNEF	28	32	
($1\frac{3}{16}$)	0.8125	20	12	16	UNEF	28	32	
$\frac{7}{8}$	0.8750	9	14	20	12	16	UNEF	28	32	
($1\frac{5}{16}$)	0.9375	20	12	16	UNEF	28	32	
1	1.0000	8	12	20	UNC	UNF	16	UNEF	28	32	
($1\frac{1}{16}$)	1.0625	18	8	12	16	20	28	...	
$1\frac{1}{8}$	1.1250	7	12	18	8	UNF	16	20	28	...	
($1\frac{3}{16}$)	1.1875	18	8	12	16	20	28	...	
$1\frac{1}{4}$	1.2500	7	12	18	8	UNF	16	20	28	...	
$1\frac{5}{16}$	1.3125	18	8	12	16	20	28	...	
$1\frac{3}{8}$	1.3750	6	12	18	...	UNC	8	UNF	16	20	28	...	
($1\frac{7}{16}$)	1.4375	18	...	6	8	12	16	20	28	...	
$1\frac{1}{2}$	1.5000	6	12	18	...	UNC	8	UNF	16	20	28	...	
($1\frac{9}{16}$)	1.5625	18	...	6	8	12	16	20	
$1\frac{5}{8}$	1.6250	18	...	6	8	12	16	20	
($1\frac{11}{16}$)	1.6875	18	...	6	8	12	16	20	
$1\frac{3}{4}$	1.7500	5	6	8	12	16	20	
($1\frac{13}{16}$)	1.8125	6	8	12	16	20	
$1\frac{7}{8}$	1.8750	6	8	12	16	20	
($1\frac{15}{16}$)	1.9375	6	8	12	16	20	
2	2.0000	4½	6	8	12	16	20	
($2\frac{1}{8}$)	2.1250	6	8	12	16	20	
$2\frac{1}{4}$	2.2500	4½	6	8	12	16	20	
($2\frac{3}{8}$)	2.3750	6	8	12	16	20	
$2\frac{1}{2}$	2.5000	4	UNC	6	8	12	16	20	
($2\frac{5}{8}$)	2.6250	4	6	8	12	16	20	
$2\frac{3}{4}$	2.7500	4	UNC	6	8	12	16	20	
($2\frac{7}{8}$)	2.8750	4	6	8	12	16	20	
3	3.0000	4	UNC	6	8	12	16	20	
($3\frac{1}{8}$)	3.1250	4	6	8	12	16	
$3\frac{1}{4}$	3.2500	4	UNC	6	8	12	16	
($3\frac{3}{8}$)	3.3750	4	6	8	12	16	
$3\frac{1}{2}$	3.5000	4	UNC	6	8	12	16	
($3\frac{5}{8}$)	3.6250	4	6	8	12	16	
$3\frac{3}{4}$	3.7500	4	UNC	6	8	12	16	
($3\frac{7}{8}$)	3.8750	4	6	8	12	16	
4	4.0000	4	UNC	6	8	12	16	

^a Sizes shown in parentheses are secondary sizes. Primary sizes of $4\frac{1}{4}$, $4\frac{1}{2}$, $4\frac{3}{4}$, 5, $5\frac{1}{4}$, $5\frac{1}{2}$, $5\frac{3}{4}$ and 6 inches also are in the 4, 6, 8, 12, and 16 thread sizes; secondary sizes of $4\frac{1}{8}$, $4\frac{3}{8}$, $4\frac{5}{8}$, $4\frac{7}{8}$, $5\frac{1}{8}$, $5\frac{3}{8}$, $5\frac{5}{8}$, and $5\frac{7}{8}$ also are in the 4, 6, 8, 12, and 16 thread series.

^b For diameters over $1\frac{1}{2}$ inches, use 12-thread series.

^c For diameters over $1\frac{1}{16}$ inches, use 16-thread series.

For UNR thread form substitute UNR for UN for external threads only.

Table 3. Standard Series and Selected Combinations — Unified Screw Threads

Nominal Size, Threads per Inch, and Series Designation ^a	External ^b								Internal ^b					
	Class	Allowance	Major Diameter			Pitch Diameter		UNR Minor Dia., ^c Max (Ref.)	Class	Minor Diameter		Pitch Diameter		Major Diameter
			Max ^d	Min	Min ^e	Max ^d	Min			Min	Max	Min	Max	
0-80 UNF	2A	0.0005	0.0595	0.0563	—	0.0514	0.0496	0.0446	2B	0.0465	0.0514	0.0519	0.0542	0.0600
	3A	0.0000	0.0600	0.0568	—	0.0519	0.0506	0.0451	3B	0.0465	0.0514	0.0519	0.0536	0.0600
1-64 UNC	2A	0.0006	0.0724	0.0686	—	0.0623	0.0603	0.0538	2B	0.0561	0.0623	0.0629	0.0655	0.0730
	3A	0.0000	0.0730	0.0692	—	0.0629	0.0614	0.0544	3B	0.0561	0.0623	0.0629	0.0648	0.0730
1-72 UNF	2A	0.0006	0.0724	0.0689	—	0.0634	0.0615	0.0559	2B	0.0580	0.0635	0.0640	0.0665	0.0730
	3A	0.0000	0.0730	0.0695	—	0.0640	0.0626	0.0565	3B	0.0580	0.0635	0.0640	0.0659	0.0730
2-56 UNC	2A	0.0006	0.0854	0.0813	—	0.0738	0.0717	0.0642	2B	0.0667	0.0737	0.0744	0.0772	0.0860
	3A	0.0000	0.0860	0.0819	—	0.0744	0.0728	0.0648	3B	0.0667	0.0737	0.0744	0.0765	0.0860
2-64 UNF	2A	0.0006	0.0854	0.0816	—	0.0753	0.0733	0.0668	2B	0.0691	0.0753	0.0759	0.0786	0.0860
	3A	0.0000	0.0860	0.0822	—	0.0759	0.0744	0.0674	3B	0.0691	0.0753	0.0759	0.0779	0.0860
3-48 UNC	2A	0.0007	0.0983	0.0938	—	0.0848	0.0825	0.0734	2B	0.0764	0.0845	0.0855	0.0885	0.0990
	3A	0.0000	0.0990	0.0945	—	0.0855	0.0838	0.0741	3B	0.0764	0.0845	0.0855	0.0877	0.0990
3-56 UNF	2A	0.0007	0.0983	0.0942	—	0.0867	0.0845	0.0771	2B	0.0797	0.0865	0.0874	0.0902	0.0990
	3A	0.0000	0.0990	0.0949	—	0.0874	0.0858	0.0778	3B	0.0797	0.0865	0.0874	0.0895	0.0990
4-40 UNC	2A	0.0008	0.1112	0.1061	—	0.0950	0.0925	0.0814	2B	0.0849	0.0939	0.0958	0.0991	0.1120
	3A	0.0000	0.1120	0.1069	—	0.0958	0.0939	0.0822	3B	0.0849	0.0939	0.0958	0.0982	0.1120
4-48 UNF	2A	0.0007	0.1113	0.1068	—	0.0978	0.0954	0.0864	2B	0.0894	0.0968	0.0985	0.1016	0.1120
	3A	0.0000	0.1120	0.1075	—	0.0985	0.0967	0.0871	3B	0.0894	0.0968	0.0985	0.1008	0.1120
5-40 UNC	2A	0.0008	0.1242	0.1191	—	0.1080	0.1054	0.0944	2B	0.0979	0.1062	0.1088	0.1121	0.1250
	3A	0.0000	0.1250	0.1199	—	0.1088	0.1069	0.0952	3B	0.0979	0.1062	0.1088	0.1113	0.1250
5-44 UNF	2A	0.0007	0.1243	0.1195	—	0.1095	0.1070	0.0972	2B	0.1004	0.1079	0.1102	0.1134	0.1250
	3A	0.0000	0.1250	0.1202	—	0.1102	0.1083	0.0979	3B	0.1004	0.1079	0.1102	0.1126	0.1250
6-32 UNC	2A	0.0008	0.1372	0.1312	—	0.1169	0.1141	0.1000	2B	0.104	0.114	0.1177	0.1214	0.1380
	3A	0.0000	0.1380	0.1320	—	0.1177	0.1156	0.1008	3B	0.1040	0.1140	0.1177	0.1204	0.1380
6-40 UNF	2A	0.0008	0.1372	0.1321	—	0.1210	0.1184	0.1074	2B	0.111	0.119	0.1218	0.1252	0.1380
	3A	0.0000	0.1380	0.1329	—	0.1218	0.1198	0.1082	3B	0.1110	0.1186	0.1218	0.1243	0.1380
8-32 UNC	2A	0.0009	0.1631	0.1571	—	0.1428	0.1399	0.1259	2B	0.130	0.139	0.1437	0.1475	0.1640
	3A	0.0000	0.1640	0.1580	—	0.1437	0.1415	0.1268	3B	0.1300	0.1389	0.1437	0.1465	0.1640
8-36 UNF	2A	0.0008	0.1632	0.1577	—	0.1452	0.1424	0.1301	2B	0.134	0.142	0.1460	0.1496	0.1640
	3A	0.0000	0.1640	0.1585	—	0.1460	0.1439	0.1309	3B	0.1340	0.1416	0.1460	0.1487	0.1640

UNIFIED SCREW THREADS

1817

Table 3. (Continued) Standard Series and Selected Combinations — Unified Screw Threads

Nominal Size, Threads per Inch, and Series Designation ^a	External ^b								Internal ^b					
	Class	Allow- ance	Major Diameter			Pitch Diameter		UNR Minor Dia., ^c Max (Ref.)	Class	Minor Diameter		Pitch Diameter		Major Diameter
			Max ^d	Min	Min ^e	Max ^d	Min			Min	Max	Min	Max	Min
10-24 UNC	2A	0.0010	0.1890	0.1818	—	0.1619	0.1586	0.1394	2B	0.145	0.156	0.1629	0.1672	0.1900
	3A	0.0000	0.1900	0.1828	—	0.1629	0.1604	0.1404	3B	0.1450	0.1555	0.1629	0.1661	0.1900
10-28 UNS	2A	0.0010	0.1890	0.1825	—	0.1658	0.1625	0.1464	2B	0.151	0.160	0.1668	0.1711	0.1900
10-32 UNF	2A	0.0009	0.1891	0.1831	—	0.1688	0.1658	0.1519	2B	0.156	0.164	0.1697	0.1736	0.1900
	3A	0.0000	0.1900	0.1840	—	0.1697	0.1674	0.1528	3B	0.1560	0.1641	0.1697	0.1726	0.1900
10-36 UNS	2A	0.0009	0.1891	0.1836	—	0.1711	0.1681	0.1560	2B	0.160	0.166	0.1720	0.1759	0.1900
10-40 UNS	2A	0.0009	0.1891	0.1840	—	0.1729	0.1700	0.1592	2B	0.163	0.169	0.1738	0.1775	0.1900
10-48 UNS	2A	0.0008	0.1892	0.1847	—	0.1757	0.1731	0.1644	2B	0.167	0.172	0.1765	0.1799	0.1900
10-56 UNS	2A	0.0007	0.1893	0.1852	—	0.1777	0.1752	0.1681	2B	0.171	0.175	0.1784	0.1816	0.1900
12-24 UNC	2A	0.0010	0.2150	0.2078	—	0.1879	0.1845	0.1654	2B	0.171	0.181	0.1889	0.1933	0.2160
	3A	0.0000	0.2160	0.2088	—	0.1889	0.1863	0.1664	3B	0.1710	0.1807	0.1889	0.1922	0.2160
12-28 UNF	2A	0.0010	0.2150	0.2085	—	0.1918	0.1886	0.1724	2B	0.177	0.186	0.1928	0.1970	0.2160
	3A	0.0000	0.2160	0.2095	—	0.1928	0.1904	0.1734	3B	0.1770	0.1857	0.1928	0.1959	0.2160
12-32 UNEF	2A	0.0009	0.2151	0.2091	—	0.1948	0.1917	0.1779	2B	0.182	0.190	0.1957	0.1998	0.2160
	3A	0.0000	0.2160	0.2100	—	0.1957	0.1933	0.1788	3B	0.1820	0.1895	0.1957	0.1988	0.2160
12-36 UNS	2A	0.0009	0.2151	0.2096	—	0.1971	0.1941	0.1821	2B	0.186	0.192	0.1980	0.2019	0.2160
12-40 UNS	2A	0.0009	0.2151	0.2100	—	0.1989	0.1960	0.1835	2B	0.189	0.195	0.1998	0.2035	0.2160
12-48 UNS	2A	0.0008	0.2152	0.2107	—	0.2017	0.1991	0.1904	2B	0.193	0.198	0.2025	0.2059	0.2160
12-56 UNS	2A	0.0007	0.2153	0.2112	—	0.2037	0.2012	0.1941	2B	0.197	0.201	0.2044	0.2076	0.2160
¼-20 UNC	1A	0.0011	0.2489	0.2367	—	0.2164	0.2108	0.1894	1B	0.196	0.207	0.2175	0.2248	0.2500
	2A	0.0011	0.2489	0.2408	0.2367	0.2164	0.2127	0.1894	2B	0.196	0.207	0.2175	0.2224	0.2500
	3A	0.0000	0.2500	0.2419	—	0.2175	0.2147	0.1905	3B	0.1960	0.2067	0.2175	0.2211	0.2500
¼-24 UNS	2A	0.0011	0.2489	0.2417	—	0.2218	0.2181	0.1993	2B	0.205	0.215	0.2229	0.2277	0.2500
¼-27 UNS	2A	0.0010	0.2490	0.2423	—	0.2249	0.2214	0.2049	2B	0.210	0.219	0.2259	0.2304	0.2500
¼-28 UNF	1A	0.0010	0.2490	0.2392	—	0.2258	0.2208	0.2064	1B	0.211	0.220	0.2268	0.2333	0.2500
	2A	0.0010	0.2490	0.2425	—	0.2258	0.2225	0.2064	2B	0.211	0.220	0.2268	0.2311	0.2500
	3A	0.0000	0.2500	0.2435	—	0.2268	0.2243	0.2074	3B	0.2110	0.2190	0.2268	0.2300	0.2500
¼-32 UNEF	2A	0.0010	0.2490	0.2430	—	0.2287	0.2255	0.2118	2B	0.216	0.224	0.2297	0.2339	0.2500
	3A	0.0000	0.2500	0.2440	—	0.2297	0.2273	0.2128	3B	0.2160	0.2229	0.2297	0.2328	0.2500

Table 3. (Continued) Standard Series and Selected Combinations — Unified Screw Threads

Nominal Size, Threads per Inch, and Series Designation ^a	External ^b								Internal ^b					
	Class	Allowance	Major Diameter			Pitch Diameter		UNR Minor Dia., ^c Max (Ref.)	Class	Minor Diameter		Pitch Diameter		Major Diameter
			Max ^d	Min	Min ^e	Max ^d	Min			Min	Max	Min	Max	
¼-36 UNS	2A	0.0009	0.2491	0.2436	—	0.2311	0.2280	0.2161	2B	0.220	0.226	0.2320	0.2360	0.2500
¼-40 UNS	2A	0.0009	0.2491	0.2440	—	0.2329	0.2300	0.2193	2B	0.223	0.229	0.2338	0.2376	0.2500
¼-48 UNS	2A	0.0008	0.2492	0.2447	—	0.2357	0.2330	0.2243	2B	0.227	0.232	0.2365	0.2401	0.2500
¼-56 UNS	2A	0.0008	0.2492	0.2451	—	0.2376	0.2350	0.2280	2B	0.231	0.235	0.2384	0.2417	0.2500
⅕ ₁₆ -18 UNC	1A	0.0012	0.3113	0.2982	—	0.2752	0.2691	0.2452	1B	0.252	0.265	0.2764	0.2843	0.3125
	2A	0.0012	0.3113	0.3026	0.2982	0.2752	0.2712	0.2452	2B	0.252	0.265	0.2764	0.2817	0.3125
	3A	0.0000	0.3125	0.3038	—	0.2764	0.2734	0.2464	3B	0.2520	0.2630	0.2764	0.2803	0.3125
⅕ ₁₆ -20 UN	2A	0.0012	0.3113	0.3032	—	0.2788	0.2748	0.2518	2B	0.258	0.270	0.2800	0.2852	0.3125
	3A	0.0000	0.3125	0.3044	—	0.2800	0.2770	0.2530	3B	0.2580	0.2680	0.2800	0.2839	0.3125
⅕ ₁₆ -24 UNF	1A	0.0011	0.3114	0.3006	—	0.2843	0.2788	0.2618	1B	0.267	0.277	0.2854	0.2925	0.3125
	2A	0.0011	0.3114	0.3042	—	0.2843	0.2806	0.2618	2B	0.267	0.277	0.2854	0.2902	0.3125
	3A	0.0000	0.3125	0.3053	—	0.2854	0.2827	0.2629	3B	0.2670	0.2754	0.2854	0.2890	0.3125
⅕ ₁₆ -27 UNS	2A	0.0010	0.3115	0.3048	—	0.2874	0.2839	0.2674	2B	0.272	0.281	0.2884	0.2929	0.3125
⅕ ₁₆ -28 UN	2A	0.0010	0.3115	0.3050	—	0.2883	0.2849	0.2689	2B	0.274	0.282	0.2893	0.2937	0.3125
	3A	0.0000	0.3125	0.3060	—	0.2893	0.2867	0.2699	3B	0.2740	0.2807	0.2893	0.2926	0.3125
⅕ ₁₆ -32 UNEF	2A	0.0010	0.3115	0.3055	—	0.2912	0.2880	0.2743	2B	0.279	0.286	0.2922	0.2964	0.3125
	3A	0.0000	0.3125	0.3065	—	0.2922	0.2898	0.2753	3B	0.2790	0.2847	0.2922	0.2953	0.3125
⅕ ₁₆ -36 UNS	2A	0.0009	0.3116	0.3061	—	0.2936	0.2905	0.2785	2B	0.282	0.289	0.2945	0.2985	0.3125
⅕ ₁₆ -40 UNS	2A	0.0009	0.3116	0.3065	—	0.2954	0.2925	0.2818	2B	0.285	0.291	0.2963	0.3001	0.3125
⅕ ₁₆ -48 UNS	2A	0.0008	0.3117	0.3072	—	0.2982	0.2955	0.2869	2B	0.290	0.295	0.2990	0.3026	0.3125
⅜-16 UNC	1A	0.0013	0.3737	0.3595	—	0.3331	0.3266	0.2992	1B	0.307	0.321	0.3344	0.3429	0.3750
	2A	0.0013	0.3737	0.3643	0.3595	0.3331	0.3287	0.2992	2B	0.307	0.321	0.3344	0.3401	0.3750
	3A	0.0000	0.3750	0.3656	—	0.3344	0.3311	0.3005	3B	0.3070	0.3182	0.3344	0.3387	0.3750
⅜-18 UNS	2A	0.0013	0.3737	0.3650	—	0.3376	0.3333	0.3076	2B	0.315	0.328	0.3389	0.3445	0.3750
⅜-20 UN	2A	0.0012	0.3738	0.3657	—	0.3413	0.3372	0.3143	2B	0.321	0.332	0.3425	0.3479	0.3750
	3A	0.0000	0.3750	0.3669	—	0.3425	0.3394	0.3155	3B	0.3210	0.3297	0.3425	0.3465	0.3750

Table 3. (Continued) Standard Series and Selected Combinations — Unified Screw Threads

Nominal Size, Threads per Inch, and Series Designation ^a	External ^b								Internal ^b					
	Class	Allowance	Major Diameter			Pitch Diameter		UNR Minor Dia., ^c Max (Ref.)	Class	Minor Diameter		Pitch Diameter		Major Diameter
			Max ^d	Min	Min ^e	Max ^d	Min			Min	Max	Min	Max	Min
$\frac{3}{8}$ -24 UNF	1A	0.0011	0.3739	0.3631	—	0.3468	0.3411	0.3243	1B	0.330	0.340	0.3479	0.3553	0.3750
	2A	0.0011	0.3739	0.3667	—	0.3468	0.3430	0.3243	2B	0.330	0.340	0.3479	0.3528	0.3750
$\frac{3}{8}$ -24 UNF	3A	0.0000	0.3750	0.3678	—	0.3479	0.3450	0.3254	3B	0.3300	0.3372	0.3479	0.3516	0.3750
$\frac{3}{8}$ -27 UNS	2A	0.0011	0.3739	0.3672	—	0.3498	0.3462	0.3298	2B	0.335	0.344	0.3509	0.3556	0.3750
$\frac{3}{8}$ -28 UN	2A	0.0011	0.3739	0.3674	—	0.3507	0.3471	0.3313	2B	0.336	0.345	0.3518	0.3564	0.3750
	3A	0.0000	0.3750	0.3685	—	0.3518	0.3491	0.3324	3B	0.3360	0.3426	0.3518	0.3553	0.3750
$\frac{3}{8}$ -32 UNEF	2A	0.0010	0.3740	0.3680	—	0.3537	0.3503	0.3368	2B	0.341	0.349	0.3547	0.3591	0.3750
	3A	0.0000	0.3750	0.3690	—	0.3547	0.3522	0.3378	3B	0.3410	0.3469	0.3547	0.3580	0.3750
$\frac{3}{8}$ -36 UNS	2A	0.0010	0.3740	0.3685	—	0.3560	0.3528	0.3409	2B	0.345	0.352	0.3570	0.3612	0.3750
$\frac{3}{8}$ -40 UNS	2A	0.0009	0.3741	0.3690	—	0.3579	0.3548	0.3443	2B	0.348	0.354	0.3588	0.3628	0.3750
0.390-27 UNS	2A	0.0011	0.3889	0.3822	—	0.3648	0.3612	0.3448	2B	0.350	0.359	0.3659	0.3706	0.3900
$\frac{7}{16}$ -14 UNC	1A	0.0014	0.4361	0.4206	—	0.3897	0.3826	0.3511	1B	0.360	0.376	0.3911	0.4003	0.4375
	2A	0.0014	0.4361	0.4258	0.4206	0.3897	0.3850	0.3511	2B	0.360	0.376	0.3911	0.3972	0.4375
	3A	0.0000	0.4375	0.4272	—	0.3911	0.3876	0.3525	3B	0.3600	0.3717	0.3911	0.3957	0.4375
$\frac{7}{16}$ -16 UN	2A	0.0014	0.4361	0.4267	—	0.3955	0.3909	0.3616	2B	0.370	0.384	0.3969	0.4028	0.4375
	3A	0.0000	0.4375	0.4281	—	0.3969	0.3935	0.3630	3B	0.3700	0.3800	0.3969	0.4014	0.4375
$\frac{7}{16}$ -18 UNS	2A	0.0013	0.4362	0.4275	—	0.4001	0.3958	0.3701	2B	0.377	0.390	0.4014	0.4070	0.4375
$\frac{7}{16}$ -20 UNF	1A	0.0013	0.4362	0.4240	—	0.4037	0.3975	0.3767	1B	0.383	0.395	0.4050	0.4131	0.4375
	2A	0.0013	0.4362	0.4281	—	0.4037	0.3995	0.3767	2B	0.383	0.395	0.4050	0.4104	0.4375
	3A	0.0000	0.4375	0.4294	—	0.4050	0.4019	0.3780	3B	0.3830	0.3916	0.4050	0.4091	0.4375
$\frac{7}{16}$ -24 UNS	2A	0.0011	0.4364	0.4292	—	0.4093	0.4055	0.3868	2B	0.392	0.402	0.4104	0.4153	0.4375
$\frac{7}{16}$ -27 UNS	2A	0.0011	0.4364	0.4297	—	0.4123	0.4087	0.3923	2B	0.397	0.406	0.4134	0.4181	0.4375
$\frac{7}{16}$ -28 UNEF	2A	0.0011	0.4364	0.4299	—	0.4132	0.4096	0.3938	2B	0.399	0.407	0.4143	0.4189	0.4375
	3A	0.0000	0.4375	0.4310	—	0.4143	0.4116	0.3949	3B	0.3990	0.4051	0.4143	0.4178	0.4375
	2A	0.0010	0.4365	0.4305	—	0.4162	0.4128	0.3993	2B	0.404	0.411	0.4172	0.4216	0.4375
$\frac{7}{16}$ -32 UN	2A	0.0010	0.4365	0.4305	—	0.4162	0.4128	0.3993	2B	0.404	0.411	0.4172	0.4216	0.4375
	3A	0.0000	0.4375	0.4315	—	0.4172	0.4147	0.4003	3B	0.4040	0.4094	0.4172	0.4205	0.4375

Table 3. (Continued) Standard Series and Selected Combinations — Unified Screw Threads

Nominal Size, Threads per Inch, and Series Designation ^a	External ^b								Internal ^b					
	Class	Allow- ance	Major Diameter			Pitch Diameter		UNR Minor Dia., ^c Max (Ref.)	Class	Minor Diameter		Pitch Diameter		Major Diameter
			Max ^d	Min	Min ^e	Max ^d	Min			Min	Max	Min	Max	
1/2-12 UNS	2A	0.0016	0.4984	0.4870	—	0.4443	0.4389	0.3992	2B	0.410	0.428	0.4459	0.4529	0.5000
	3A	0.0000	0.5000	0.4886	—	0.4459	0.4419	0.4008	3B	0.4100	0.4223	0.4459	0.4511	0.5000
1/2-13 UNC	1A	0.0015	0.4985	0.4822	—	0.4485	0.4411	0.4069	1B	0.417	0.434	0.4500	0.4597	0.5000
	2A	0.0015	0.4985	0.4876	0.4822	0.4485	0.4435	0.4069	2B	0.417	0.434	0.4500	0.4565	0.5000
	3A	0.0000	0.5000	0.4891	—	0.4500	0.4463	0.4084	3B	0.4170	0.4284	0.4500	0.4548	0.5000
1/2-14 UNS	2A	0.0015	0.4985	0.4882	—	0.4521	0.4471	0.4135	2B	0.423	0.438	0.4536	0.4601	0.5000
1/2-16 UN	2A	0.0014	0.4986	0.4892	—	0.4580	0.4533	0.4241	2B	0.432	0.446	0.4594	0.4655	0.5000
	3A	0.0000	0.5000	0.4906	—	0.4594	0.4559	0.4255	3B	0.4320	0.4419	0.4594	0.4640	0.5000
1/2-18 UNS	2A	0.0013	0.4987	0.4900	—	0.4626	0.4582	0.4326	2B	0.440	0.453	0.4639	0.4697	0.5000
1/2-20 UNF	1A	0.0013	0.4987	0.4865	—	0.4662	0.4598	0.4392	1B	0.446	0.457	0.4675	0.4759	0.5000
	2A	0.0013	0.4987	0.4906	—	0.4662	0.4619	0.4392	2B	0.446	0.457	0.4675	0.4731	0.5000
	3A	0.0000	0.5000	0.4919	—	0.4675	0.4643	0.4405	3B	0.4460	0.4537	0.4675	0.4717	0.5000
1/2-24 UNS	2A	0.0012	0.4988	0.4916	—	0.4717	0.4678	0.4492	2B	0.455	0.465	0.4729	0.4780	0.5000
1/2-27 UNS	2A	0.0011	0.4989	0.4922	—	0.4748	0.4711	0.4548	2B	0.460	0.469	0.4759	0.4807	0.5000
1/2-28 UNEF	2A	0.0011	0.4989	0.4924	—	0.4757	0.4720	0.4563	2B	0.461	0.470	0.4768	0.4816	0.5000
	3A	0.0000	0.5000	0.4935	—	0.4768	0.4740	0.4574	3B	0.4610	0.4676	0.4768	0.4804	0.5000
	2A	0.0010	0.4990	0.4930	—	0.4787	0.4752	0.4618	2B	0.466	0.474	0.4797	0.4842	0.5000
1/2-32 UN	3A	0.0000	0.5000	0.4940	—	0.4797	0.4771	0.4628	3B	0.4660	0.4719	0.4797	0.4831	0.5000
	1A	0.0016	0.5609	0.5437	—	0.5068	0.4990	0.4617	1B	0.472	0.490	0.5084	0.5186	0.5625
5/16-12 UNC	2A	0.0016	0.5609	0.5495	0.5437	0.5068	0.5016	0.4617	2B	0.472	0.490	0.5084	0.5152	0.5625
	3A	0.0000	0.5625	0.5511	—	0.5084	0.5045	0.4633	3B	0.4720	0.4843	0.5084	0.5135	0.5625
	2A	0.0015	0.5610	0.5507	—	0.5146	0.5096	0.4760	2B	0.485	0.501	0.5161	0.5226	0.5625
5/16-14 UNS	2A	0.0015	0.5610	0.5507	—	0.5146	0.5096	0.4760	2B	0.485	0.501	0.5161	0.5226	0.5625
5/16-16 UN	2A	0.0014	0.5611	0.5517	—	0.5205	0.5158	0.4866	2B	0.495	0.509	0.5219	0.5280	0.5625
	3A	0.0000	0.5625	0.5531	—	0.5219	0.5184	0.4880	3B	0.4950	0.5040	0.5219	0.5265	0.5625
5/16-18 UNF	1A	0.0014	0.5611	0.5480	—	0.5250	0.5182	0.4950	1B	0.502	0.515	0.5264	0.5353	0.5625
	2A	0.0014	0.5611	0.5524	—	0.5250	0.5205	0.4950	2B	0.502	0.515	0.5264	0.5323	0.5625
	3A	0.0000	0.5625	0.5538	—	0.5264	0.5230	0.4964	3B	0.5020	0.5106	0.5264	0.5308	0.5625

UNIFIED SCREW THREADS

1821

Table 3. (Continued) Standard Series and Selected Combinations — Unified Screw Threads

Nominal Size, Threads per Inch, and Series Designation ^a	External ^b								Internal ^b					
	Class	Allowance	Major Diameter			Pitch Diameter		UNR Minor Dia., ^c Max (Ref.)	Class	Minor Diameter		Pitch Diameter		Major Diameter
			Max ^d	Min	Min ^e	Max ^d	Min			Min	Max	Min	Max	Min
$\frac{1}{16}$ -20 UN	2A	0.0013	0.5612	0.5531	—	0.5287	0.5245	0.5017	2B	0.508	0.520	0.5300	0.5355	0.5625
	3A	0.0000	0.5625	0.5544	—	0.5300	0.5268	0.5030	3B	0.5080	0.5162	0.5300	0.5341	0.5625
$\frac{1}{16}$ -24 UNEF	2A	0.0012	0.5613	0.5541	—	0.5342	0.5303	0.5117	2B	0.517	0.527	0.5354	0.5405	0.5625
	3A	0.0000	0.5625	0.5553	—	0.5354	0.5325	0.5129	3B	0.5170	0.5244	0.5354	0.5392	0.5625
$\frac{1}{16}$ -27 UNS	2A	0.0011	0.5614	0.5547	—	0.5373	0.5336	0.5173	2B	0.522	0.531	0.5384	0.5432	0.5625
$\frac{1}{16}$ -28 UN	2A	0.0011	0.5614	0.5549	—	0.5382	0.5345	0.5188	2B	0.524	0.532	0.5393	0.5441	0.5625
	3A	0.0000	0.5625	0.5560	—	0.5393	0.5365	0.5199	3B	0.5240	0.5301	0.5393	0.5429	0.5625
$\frac{1}{16}$ -32 UN	2A	0.0010	0.5615	0.5555	—	0.5412	0.5377	0.5243	2B	0.529	0.536	0.5422	0.5467	0.5625
	3A	0.0000	0.5625	0.5565	—	0.5422	0.5396	0.5253	3B	0.5290	0.5344	0.5422	0.5456	0.5625
$\frac{5}{8}$ -11 UNC	1A	0.0016	0.6234	0.6052	—	0.5644	0.5561	0.5152	1B	0.527	0.546	0.5660	0.5767	0.6250
	2A	0.0016	0.6234	0.6113	0.6052	0.5644	0.5589	0.5152	2B	0.527	0.546	0.5660	0.5732	0.6250
	3A	0.0000	0.6250	0.6129	—	0.5660	0.5619	0.5168	3B	0.5270	0.5391	0.5660	0.5714	0.6250
$\frac{5}{8}$ -12 UN	2A	0.0016	0.6234	0.6120	—	0.5693	0.5639	0.5242	2B	0.535	0.553	0.5709	0.5780	0.6250
	3A	0.0000	0.6250	0.6136	—	0.5709	0.5668	0.5258	3B	0.5350	0.5463	0.5709	0.5762	0.6250
$\frac{5}{8}$ -14 UNS	2A	0.0015	0.6235	0.6132	—	0.5771	0.5720	0.5385	2B	0.548	0.564	0.5786	0.5852	0.6250
$\frac{5}{8}$ -16 UN	2A	0.0014	0.6236	0.6142	—	0.5830	0.5782	0.5491	2B	0.557	0.571	0.5844	0.5906	0.6250
	3A	0.0000	0.6250	0.6156	—	0.5844	0.5808	0.5505	3B	0.5570	0.5662	0.5844	0.5890	0.6250
$\frac{5}{8}$ -18 UNF	1A	0.0014	0.6236	0.6105	—	0.5875	0.5805	0.5575	1B	0.565	0.578	0.5889	0.5980	0.6250
	2A	0.0014	0.6236	0.6149	—	0.5875	0.5828	0.5575	2B	0.565	0.578	0.5889	0.5949	0.6250
	3A	0.0000	0.6250	0.6163	—	0.5889	0.5854	0.5589	3B	0.5650	0.5730	0.5889	0.5934	0.6250
$\frac{5}{8}$ -20 UN	2A	0.0013	0.6237	0.6156	—	0.5912	0.5869	0.5642	2B	0.571	0.582	0.5925	0.5981	0.6250
	3A	0.0000	0.6250	0.6169	—	0.5925	0.5893	0.5655	3B	0.5710	0.5787	0.5925	0.5967	0.6250
$\frac{5}{8}$ -24 UNEF	2A	0.0012	0.6238	0.6166	—	0.5967	0.5927	0.5742	2B	0.580	0.590	0.5979	0.6031	0.6250
	3A	0.0000	0.6250	0.6178	—	0.5979	0.5949	0.5754	3B	0.5800	0.5869	0.5979	0.6018	0.6250
$\frac{5}{8}$ -27 UNS	2A	0.0011	0.6239	0.6172	—	0.5998	0.5960	0.5798	2B	0.585	0.594	0.6009	0.6059	0.6250
$\frac{5}{8}$ -28 UN	2A	0.0011	0.6239	0.6174	—	0.6007	0.5969	0.5813	2B	0.586	0.595	0.6018	0.6067	0.6250
	3A	0.0000	0.6250	0.6185	—	0.6018	0.5990	0.5824	3B	0.5860	0.5926	0.6018	0.6055	0.6250

Table 3. (Continued) Standard Series and Selected Combinations — Unified Screw Threads

Nominal Size, Threads per Inch, and Series Designation ^a	External ^b								Internal ^b					
	Class	Allow- ance	Major Diameter			Pitch Diameter		UNR Minor Dia., ^c Max (Ref.)	Class	Minor Diameter		Pitch Diameter		Major Diameter
			Max ^d	Min	Min ^e	Max ^d	Min			Min	Max	Min	Max	Min
$\frac{5}{8}$ -32 UN	2A	0.0011	0.6239	0.6179	—	0.6036	0.6000	0.5867	2B	0.591	0.599	0.6047	0.6093	0.6250
	3A	0.0000	0.6250	0.6190	—	0.6047	0.6020	0.5878	3B	0.5910	0.5969	0.6047	0.6082	0.6250
$\frac{1}{16}$ -12 UN	2A	0.0016	0.6859	0.6745	—	0.6318	0.6264	0.5867	2B	0.597	0.615	0.6334	0.6405	0.6875
	3A	0.0000	0.6875	0.6761	—	0.6334	0.6293	0.5883	3B	0.5970	0.6085	0.6334	0.6387	0.6875
$\frac{1}{16}$ -16 UN	2A	0.0014	0.6861	0.6767	—	0.6455	0.6407	0.6116	2B	0.620	0.634	0.6469	0.6531	0.6875
	3A	0.0000	0.6875	0.6781	—	0.6469	0.6433	0.6130	3B	0.6200	0.6284	0.6469	0.6515	0.6875
$\frac{1}{16}$ -20 UN	2A	0.0013	0.6862	0.6781	—	0.6537	0.6494	0.6267	2B	0.633	0.645	0.6550	0.6606	0.6875
	3A	0.0000	0.6875	0.6794	—	0.6550	0.6518	0.6280	3B	0.6330	0.6412	0.6550	0.6592	0.6875
$\frac{1}{16}$ -24 UNEF	2A	0.0012	0.6863	0.6791	—	0.6592	0.6552	0.6367	2B	0.642	0.652	0.6604	0.6656	0.6875
	3A	0.0000	0.6875	0.6803	—	0.6604	0.6574	0.6379	3B	0.6420	0.6494	0.6604	0.6643	0.6875
$\frac{1}{16}$ -28 UN	2A	0.0011	0.6864	0.6799	—	0.6632	0.6594	0.6438	2B	0.649	0.657	0.6643	0.6692	0.6875
	3A	0.0000	0.6875	0.6810	—	0.6643	0.6615	0.6449	3B	0.6490	0.6551	0.6643	0.6680	0.6875
$\frac{1}{16}$ -32 UN	2A	0.0011	0.6864	0.6804	—	0.6661	0.6625	0.6492	2B	0.654	0.661	0.6672	0.6718	0.6875
	3A	0.0000	0.6875	0.6815	—	0.6672	0.6645	0.6503	3B	0.6540	0.6594	0.6672	0.6707	0.6875
$\frac{3}{4}$ -10 UNC	1A	0.0018	0.7482	0.7288	—	0.6832	0.6744	0.6291	1B	0.642	0.663	0.6850	0.6965	0.7500
	2A	0.0018	0.7482	0.7353	0.7288	0.6832	0.6773	0.6291	2B	0.642	0.663	0.6850	0.6927	0.7500
	3A	0.0000	0.7500	0.7371	—	0.6850	0.6806	0.6309	3B	0.6420	0.6545	0.6850	0.6907	0.7500
$\frac{3}{4}$ -12 UN	2A	0.0017	0.7483	0.7369	—	0.6942	0.6887	0.6491	2B	0.660	0.678	0.6959	0.7031	0.7500
	3A	0.0000	0.7500	0.7386	—	0.6959	0.6918	0.6508	3B	0.6600	0.6707	0.6959	0.7013	0.7500
$\frac{3}{4}$ -14 UNS	2A	0.0015	0.7485	0.7382	—	0.7021	0.6970	0.6635	2B	0.673	0.688	0.7036	0.7103	0.7500
$\frac{3}{4}$ -16 UNF	1A	0.0015	0.7485	0.7343	—	0.7079	0.7004	0.6740	1B	0.682	0.696	0.7094	0.7192	0.7500
	2A	0.0015	0.7485	0.7391	—	0.7079	0.7029	0.6740	2B	0.682	0.696	0.7094	0.7159	0.7500
	3A	0.0000	0.7500	0.7406	—	0.7094	0.7056	0.6755	3B	0.6820	0.6908	0.7094	0.7143	0.7500
$\frac{3}{4}$ -18 UNS	2A	0.0014	0.7486	0.7399	—	0.7125	0.7079	0.6825	2B	0.690	0.703	0.7139	0.7199	0.7500
$\frac{3}{4}$ -20 UNEF	2A	0.0013	0.7487	0.7406	—	0.7162	0.7118	0.6892	2B	0.696	0.707	0.7175	0.7232	0.7500
	3A	0.0000	0.7500	0.7419	—	0.7175	0.7142	0.6905	3B	0.6960	0.7037	0.7175	0.7218	0.7500
$\frac{3}{4}$ -24 UNS	2A	0.0012	0.7488	0.7416	—	0.7217	0.7176	0.6992	2B	0.705	0.715	0.7229	0.7282	0.7500
$\frac{3}{4}$ -27 UNS	2A	0.0012	0.7488	0.7421	—	0.7247	0.7208	0.7047	2B	0.710	0.719	0.7259	0.7310	0.7500

Table 3. (Continued) Standard Series and Selected Combinations — Unified Screw Threads

Nominal Size, Threads per Inch, and Series Designation ^a	External ^b								Internal ^b					
	Class	Allow- ance	Major Diameter			Pitch Diameter		UNR Minor Dia., ^c Max (Ref.)	Class	Minor Diameter		Pitch Diameter		Major Diameter
			Max ^d	Min	Min ^e	Max ^d	Min			Min	Max	Min	Max	Min
$\frac{3}{4}$ -28 UN	2A	0.0012	0.7488	0.7423	—	0.7256	0.7218	0.7062	2B	0.711	0.720	0.7268	0.7318	0.7500
	3A	0.0000	0.7500	0.7435	—	0.7268	0.7239	0.7074	3B	0.7110	0.7176	0.7268	0.7305	0.7500
$\frac{3}{4}$ -32 UN	2A	0.0011	0.7489	0.7429	—	0.7286	0.7250	0.7117	2B	0.716	0.724	0.7297	0.7344	0.7500
	3A	0.0000	0.7500	0.7440	—	0.7297	0.7270	0.7128	3B	0.7160	0.7219	0.7297	0.7333	0.7500
$\frac{13}{16}$ -12 UN	2A	0.0017	0.8108	0.7994	—	0.7567	0.7512	0.7116	2B	0.722	0.740	0.7584	0.7656	0.8125
	3A	0.0000	0.8125	0.8011	—	0.7584	0.7543	0.7133	3B	0.7220	0.7329	0.7584	0.7638	0.8125
$\frac{13}{16}$ -16 UN	2A	0.0015	0.8110	0.8016	—	0.7704	0.7655	0.7365	2B	0.745	0.759	0.7719	0.7782	0.8125
	3A	0.0000	0.8125	0.8031	—	0.7719	0.7683	0.7380	3B	0.7450	0.7533	0.7719	0.7766	0.8125
$\frac{13}{16}$ -20 UNEF	2A	0.0013	0.8112	0.8031	—	0.7787	0.7743	0.7517	2B	0.758	0.770	0.7800	0.7857	0.8125
	3A	0.0000	0.8125	0.8044	—	0.7800	0.7767	0.7530	3B	0.7580	0.7662	0.7800	0.7843	0.8125
$\frac{13}{16}$ -28 UN	2A	0.0012	0.8113	0.8048	—	0.7881	0.7843	0.7687	2B	0.774	0.782	0.7893	0.7943	0.8125
	3A	0.0000	0.8125	0.8060	—	0.7893	0.7864	0.7699	3B	0.7740	0.7801	0.7893	0.7930	0.8125
$\frac{13}{16}$ -32 UN	2A	0.0011	0.8114	0.8054	—	0.7911	0.7875	0.7742	2B	0.779	0.786	0.7922	0.7969	0.8125
	3A	0.0000	0.8125	0.8065	—	0.7922	0.7895	0.7753	3B	0.7790	0.7844	0.7922	0.7958	0.8125
$\frac{7}{8}$ -9 UNC	1A	0.0019	0.8731	0.8523	—	0.8009	0.7914	0.7408	1B	0.755	0.778	0.8028	0.8151	0.8750
	2A	0.0019	0.8731	0.8592	0.8523	0.8009	0.7946	0.7408	2B	0.755	0.778	0.8028	0.8110	0.8750
	3A	0.0000	0.8750	0.8611	—	0.8028	0.7981	0.7427	3B	0.7550	0.7681	0.8028	0.8089	0.8750
$\frac{7}{8}$ -10 UNS	2A	0.0018	0.8732	0.8603	—	0.8082	0.8022	0.7542	2B	0.767	0.788	0.8100	0.8178	0.8750
$\frac{7}{8}$ -12 UN	2A	0.0017	0.8733	0.8619	—	0.8192	0.8137	0.7741	2B	0.785	0.803	0.8209	0.8281	0.8750
	3A	0.0000	0.8750	0.8636	—	0.8209	0.8168	0.7758	3B	0.7850	0.7948	0.8209	0.8263	0.8750
$\frac{7}{8}$ -14 UNF	1A	0.0016	0.8734	0.8579	—	0.8270	0.8189	0.7884	1B	0.798	0.814	0.8286	0.8392	0.8750
	2A	0.0016	0.8734	0.8631	—	0.8270	0.8216	0.7884	2B	0.798	0.814	0.8286	0.8356	0.8750
	3A	0.0000	0.8750	0.8647	—	0.8286	0.8245	0.7900	3B	0.7980	0.8068	0.8286	0.8339	0.8750
$\frac{7}{8}$ -16 UN	2A	0.0015	0.8735	0.8641	—	0.8329	0.8280	0.7900	2B	0.807	0.821	0.8344	0.8407	0.8750
	3A	0.0000	0.8750	0.8656	—	0.8344	0.8308	0.8005	3B	0.8070	0.8158	0.8344	0.8391	0.8750
$\frac{7}{8}$ -18 UNS	2A	0.0014	0.8736	0.8649	—	0.8375	0.8329	0.8075	2B	0.815	0.828	0.8389	0.8449	0.8750
$\frac{7}{8}$ -20 UNEF	2A	0.0013	0.8737	0.8656	—	0.8412	0.8368	0.8142	2B	0.821	0.832	0.8425	0.8482	0.8750
	3A	0.0000	0.8750	0.8669	—	0.8425	0.8392	0.8155	3B	0.8210	0.8287	0.8425	0.8468	0.8750

Table 3. (Continued) Standard Series and Selected Combinations — Unified Screw Threads

Nominal Size, Threads per Inch, and Series Designation ^a	External ^b								Internal ^b					
	Class	Allow- ance	Major Diameter			Pitch Diameter		UNR Minor Dia., ^c Max (Ref.)	Class	Minor Diameter		Pitch Diameter		Major Diameter
			Max ^d	Min	Min ^e	Max ^d	Min			Min	Max	Min	Max	Min
$\frac{7}{8}$ -24 UNS	2A	0.0012	0.8738	0.8666	—	0.8467	0.8426	0.8242	2B	0.830	0.840	0.8479	0.8532	0.8750
$\frac{7}{8}$ -27 UNS	2A	0.0012	0.8738	0.8671	—	0.8497	0.8458	0.8297	2B	0.835	0.844	0.8509	0.8560	0.8750
$\frac{7}{8}$ -28 UN	2A	0.0012	0.8738	0.8673	—	0.8506	0.8468	0.8312	2B	0.836	0.845	0.8518	0.8568	0.8750
	3A	0.0000	0.8750	0.8685	—	0.8518	0.8489	0.8324	3B	0.8360	0.8426	0.8518	0.8555	0.8750
$\frac{7}{8}$ -32 UN	2A	0.0011	0.8739	0.8679	—	0.8536	0.8500	0.8367	2B	0.841	0.849	0.8547	0.8594	0.8750
	3A	0.0000	0.8750	0.8690	—	0.8547	0.8520	0.8378	3B	0.8410	0.8469	0.8547	0.8583	0.8750
$\frac{15}{16}$ -12 UN	2A	0.0017	0.9358	0.9244	—	0.8817	0.8760	0.8366	2B	0.847	0.865	0.8834	0.8908	0.9375
	3A	0.0000	0.9375	0.9261	—	0.8834	0.8793	0.8383	3B	0.8470	0.8575	0.8834	0.8889	0.9375
$\frac{15}{16}$ -16 UN	2A	0.0015	0.9360	0.9266	—	0.8954	0.8904	0.8615	2B	0.870	0.884	0.8969	0.9034	0.9375
	3A	0.0000	0.9375	0.9281	—	0.8969	0.8932	0.8630	3B	0.8700	0.8783	0.8969	0.9018	0.9375
$\frac{15}{16}$ -20 UNEF	2A	0.0014	0.9361	0.9280	—	0.9036	0.8991	0.8766	2B	0.883	0.895	0.9050	0.9109	0.9375
	3A	0.0000	0.9375	0.9294	—	0.9050	0.9016	0.8780	3B	0.8830	0.8912	0.9050	0.9094	0.9375
$\frac{15}{16}$ -28 UN	2A	0.0012	0.9363	0.9298	—	0.9131	0.9091	0.8937	2B	0.899	0.907	0.9143	0.9195	0.9375
	3A	0.0000	0.9375	0.9310	—	0.9143	0.9113	0.8949	3B	0.8990	0.9051	0.9143	0.9182	0.9375
$\frac{15}{16}$ -32 UN	2A	0.0011	0.9364	0.9304	—	0.9161	0.9123	0.8992	2B	0.904	0.911	0.9172	0.9221	0.9375
	3A	0.0000	0.9375	0.9315	—	0.9172	0.9144	0.9003	3B	0.9040	0.9094	0.9172	0.9209	0.9375
1-8 UNC	1A	0.0020	0.9980	0.9755	—	0.9168	0.9067	0.8492	1B	0.865	0.890	0.9188	0.9320	1.0000
	2A	0.0020	0.9980	0.9830	0.9755	0.9168	0.9100	0.8492	2B	0.865	0.890	0.9188	0.9276	1.0000
	3A	0.0000	1.0000	0.9850	—	0.9188	0.9137	0.8512	3B	0.8650	0.8797	0.9188	0.9254	1.0000
1-10 UNS	2A	0.0018	0.9982	0.9853	—	0.9332	0.9270	0.8792	2B	0.892	0.913	0.9350	0.9430	1.0000
	1A	0.0018	0.9982	0.9810	—	0.9441	0.9353	0.8990	1B	0.910	0.928	0.9459	0.9573	1.0000
1-12 UNF	2A	0.0018	0.9982	0.9868	—	0.9441	0.9382	0.8990	2B	0.910	0.928	0.9459	0.9535	1.0000
	3A	0.0000	1.0000	0.9886	—	0.9459	0.9415	0.9008	3B	0.9100	0.9198	0.9459	0.9516	1.0000
	1A	0.0017	0.9983	0.9828	—	0.9519	0.9435	0.9132	1B	0.923	0.938	0.9536	0.9645	1.0000
1-14 UNS ^f	2A	0.0017	0.9983	0.9880	—	0.9519	0.9463	0.9132	2B	0.923	0.938	0.9536	0.9609	1.0000
	3A	0.0000	1.0000	0.9897	—	0.9536	0.9494	0.9149	3B	0.9230	0.9315	0.9536	0.9590	1.0000
	2A	0.0015	0.9985	0.9891	—	0.9579	0.9529	0.9240	2B	0.932	0.946	0.9594	0.9659	1.0000
1-16 UN	3A	0.0000	1.0000	0.9906	—	0.9594	0.9557	0.9255	3B	0.9320	0.9408	0.9594	0.9643	1.0000
	2A	0.0014	0.9986	0.9899	—	0.9625	0.9578	0.9325	2B	0.940	0.953	0.9639	0.9701	1.0000

UNIFIED SCREW THREADS

1825

Table 3. (Continued) Standard Series and Selected Combinations — Unified Screw Threads

Nominal Size, Threads per Inch, and Series Designation ^a	External ^b								Internal ^b					
	Class	Allow- ance	Major Diameter			Pitch Diameter		UNR Minor Dia., ^c Max (Ref.)	Class	Minor Diameter		Pitch Diameter		Major Diameter
			Max ^d	Min	Min ^e	Max ^d	Min			Min	Max	Min	Max	Min
1-20 UNEF	2A	0.0014	0.9986	0.9905	—	0.9661	0.9616	0.9391	2B	0.946	0.957	0.9675	0.9734	1.0000
	3A	0.0000	1.0000	0.9919	—	0.9675	0.9641	0.9405	3B	0.9460	0.9537	0.9675	0.9719	1.0000
1-24 UNS	2A	0.0013	0.9987	0.9915	—	0.9716	0.9674	0.9491	2B	0.955	0.965	0.9729	0.9784	1.0000
1-27 UNS	2A	0.0012	0.9988	0.9921	—	0.9747	0.9707	0.9547	2B	0.960	0.969	0.9759	0.9811	1.0000
1-28 UN	2A	0.0012	0.9988	0.9923	—	0.9756	0.9716	0.9562	2B	0.961	0.970	0.9768	0.9820	1.0000
	3A	0.0000	1.0000	0.9935	—	0.9768	0.9738	0.9574	3B	0.9610	0.9676	0.9768	0.9807	1.0000
1-32 UN	2A	0.0011	0.9989	0.9929	—	0.9786	0.9748	0.9617	2B	0.966	0.974	0.9797	0.9846	1.0000
	3A	0.0000	1.0000	0.9940	—	0.9797	0.9769	0.9628	3B	0.9660	0.9719	0.9797	0.9834	1.0000
1¹/₁₆-8 UN	2A	0.0020	1.0605	1.0455	—	0.9793	0.9725	0.9117	2B	0.927	0.952	0.9813	0.9902	1.0625
	3A	0.0000	1.0625	1.0475	—	0.9813	0.9762	0.9137	3B	0.9270	0.9422	0.9813	0.9880	1.0625
1¹/₁₆-12 UN	2A	0.0017	1.0608	1.0494	—	1.0067	1.0010	0.9616	2B	0.972	0.990	1.0084	1.0158	1.0625
	3A	0.0000	1.0625	1.0511	—	1.0084	1.0042	0.9633	3B	0.9720	0.9823	1.0084	1.0139	1.0625
1¹/₁₆-16 UN	2A	0.0015	1.0610	1.0516	—	1.0204	1.0154	0.9865	2B	0.995	1.009	1.0219	1.0284	1.0625
	3A	0.0000	1.0625	1.0531	—	1.0219	1.0182	0.9880	3B	0.9950	1.0033	1.0219	1.0268	1.0625
1¹/₁₆-18 UNEF	2A	0.0014	1.0611	1.0524	—	1.0250	1.0203	0.9950	2B	1.002	1.015	1.0264	1.0326	1.0625
	3A	0.0000	1.0625	1.0538	—	1.0264	1.0228	0.9964	3B	1.0020	1.0105	1.0264	1.0310	1.0625
1¹/₁₆-20 UN	2A	0.0014	1.0611	1.0530	—	1.0286	1.0241	1.0016	2B	1.008	1.020	1.0300	1.0359	1.0625
	3A	0.0000	1.0625	1.0544	—	1.0300	1.0266	1.0030	3B	1.0080	1.0162	1.0300	1.0344	1.0625
1¹/₁₆-28 UN	2A	0.0012	1.0613	1.0548	—	1.0381	1.0341	1.0187	2B	1.024	1.032	1.0393	1.0445	1.0625
	3A	0.0000	1.0625	1.0560	—	1.0393	1.0363	1.0199	3B	1.0240	1.0301	1.0393	1.0432	1.0625
	1A	0.0022	1.1228	1.0982	—	1.0300	1.0191	0.9527	1B	0.970	0.998	1.0322	1.0463	1.1250
1¹/₈-7 UNC	2A	0.0022	1.1228	1.1064	1.0982	1.0300	1.0228	0.9527	2B	0.970	0.998	1.0322	1.0416	1.1250
	3A	0.0000	1.1250	1.1086	—	1.0322	1.0268	0.9549	3B	0.9700	0.9875	1.0322	1.0393	1.1250
	2A	0.0021	1.1229	1.1079	1.1004	1.0417	1.0348	0.9741	2B	0.990	1.015	1.0438	1.0528	1.1250
1¹/₈-8 UN	3A	0.0000	1.1250	1.1100	—	1.0438	1.0386	0.9762	3B	0.9900	1.0047	1.0438	1.0505	1.1250
	2A	0.0018	1.1232	1.1103	—	1.0582	1.0520	1.0042	2B	1.017	1.038	1.0600	1.0680	1.1250
1¹/₈-10 UNS	1A	0.0018	1.1232	1.1060	—	1.0691	1.0601	1.0240	1B	1.035	1.053	1.0709	1.0826	1.1250
	2A	0.0018	1.1232	1.1118	—	1.0691	1.0631	1.0240	2B	1.035	1.053	1.0709	1.0787	1.1250
1¹/₈-12 UNF	3A	0.0000	1.1250	1.1136	—	1.0709	1.0664	1.0258	3B	1.0350	1.0448	1.0709	1.0768	1.1250

Table 3. (Continued) Standard Series and Selected Combinations — Unified Screw Threads

Nominal Size, Threads per Inch, and Series Designation ^a	External ^b								Internal ^b					
	Class	Allow- ance	Major Diameter			Pitch Diameter		UNR Minor Dia., ^c Max (Ref.)	Class	Minor Diameter		Pitch Diameter		Major Diameter
			Max ^d	Min	Min ^e	Max ^d	Min			Min	Max	Min	Max	Min
1/8-14 UNS	2A	0.0016	1.1234	1.1131	—	1.0770	1.0717	1.0384	2B	1.048	1.064	1.0786	1.0855	1.1250
1/8-16 UN	2A	0.0015	1.1235	1.1141	—	1.0829	1.0779	1.0490	2B	1.057	1.071	1.0844	1.0909	1.1250
	3A	0.0000	1.1250	1.1156	—	1.0844	1.0807	1.0505	3B	1.0570	1.0658	1.0844	1.0893	1.1250
1/8-18 UNEF	2A	0.0014	1.1236	1.1149	—	1.0875	1.0828	1.0575	2B	1.065	1.078	1.0889	1.0951	1.1250
	3A	0.0000	1.1250	1.1163	—	1.0889	1.0853	1.0589	3B	1.0650	1.0730	1.0889	1.0935	1.1250
1/8-20 UN	2A	0.0014	1.1236	1.1155	—	1.0911	1.0866	1.0641	2B	1.071	1.082	1.0925	1.0984	1.1250
	3A	0.0000	1.1250	1.1169	—	1.0925	1.0891	1.0655	3B	1.0710	1.0787	1.0925	1.0969	1.1250
1/8-24 UNS	2A	0.0013	1.1237	1.1165	—	1.0966	1.0924	1.0742	2B	1.080	1.090	1.0979	1.1034	1.1250
1/8-28 UN	2A	0.0012	1.1238	1.1173	—	1.1006	1.0966	1.0812	2B	1.086	1.095	1.1018	1.1070	1.1250
	3A	0.0000	1.1250	1.1185	—	1.1018	1.0988	1.0824	3B	1.0860	1.0926	1.1018	1.1057	1.1250
3/16-8 UN	2A	0.0021	1.1854	1.1704	—	1.1042	1.0972	1.0366	2B	1.052	1.077	1.1063	1.1154	1.1875
3/16-12 UN	3A	0.0000	1.1875	1.1725	—	1.1063	1.1011	1.0387	3B	1.0520	1.0672	1.1063	1.1131	1.1875
	2A	0.0017	1.1858	1.1744	—	1.1317	1.1259	1.0866	2B	1.097	1.115	1.1334	1.1409	1.1875
3/16-16 UN	3A	0.0000	1.1875	1.1761	—	1.1334	1.1291	1.0883	3B	1.0970	1.1073	1.1334	1.1390	1.1875
	2A	0.0015	1.1860	1.1766	—	1.1454	1.1403	1.1115	2B	1.120	1.134	1.1469	1.1535	1.1875
3/16-18 UNEF	3A	0.0000	1.1875	1.1781	—	1.1469	1.1431	1.1130	3B	1.1200	1.1283	1.1469	1.1519	1.1875
	2A	0.0015	1.1860	1.1773	—	1.1499	1.1450	1.1199	2B	1.127	1.140	1.1514	1.1577	1.1875
3/16-20 UN	3A	0.0000	1.1875	1.1788	—	1.1514	1.1478	1.1214	3B	1.1270	1.1355	1.1514	1.1561	1.1875
	2A	0.0014	1.1861	1.1780	—	1.1536	1.1489	1.1266	2B	1.133	1.145	1.1550	1.1611	1.1875
3/16-28 UN	3A	0.0000	1.1875	1.1794	—	1.1550	1.1515	1.1280	3B	1.1330	1.1412	1.1550	1.1595	1.1875
	2A	0.0012	1.1863	1.1798	—	1.1631	1.1590	1.1437	2B	1.149	1.157	1.1643	1.1696	1.1875
1/4-7 UNC	3A	0.0000	1.1875	1.1810	—	1.1643	1.1612	1.1449	3B	1.1490	1.1551	1.1643	1.1683	1.1875
	1A	0.0022	1.2478	1.2232	—	1.1550	1.1439	1.0777	1B	1.095	1.123	1.1572	1.1716	1.2500
1/4-8 UN	2A	0.0022	1.2478	1.2314	1.2232	1.1550	1.1476	1.0777	2B	1.095	1.123	1.1572	1.1668	1.2500
	3A	0.0000	1.2500	1.2336	—	1.1572	1.1517	1.0799	3B	1.0950	1.1125	1.1572	1.1644	1.2500
1/4-10 UN	2A	0.0021	1.2479	1.2329	1.2254	1.1667	1.1597	1.0991	2B	1.115	1.140	1.1688	1.1780	1.2500
	3A	0.0000	1.2500	1.2350	—	1.1688	1.1635	1.1012	3B	1.1150	1.1297	1.1688	1.1757	1.2500
1/4-10 UNS	2A	0.0019	1.2481	1.2352	—	1.1831	1.1768	1.1291	2B	1.142	1.163	1.1850	1.1932	1.2500

UNIFIED SCREW THREADS

1827

Table 3. (Continued) Standard Series and Selected Combinations — Unified Screw Threads

Nominal Size, Threads per Inch, and Series Designation ^a	External ^b								Internal ^b					
	Class	Allow- ance	Major Diameter			Pitch Diameter		UNR Minor Dia., ^c Max (Ref.)	Class	Minor Diameter		Pitch Diameter		Major Diameter
			Max ^d	Min	Min ^e	Max ^d	Min			Min	Max	Min	Max	Min
1¼-12 UNF	1A	0.0018	1.2482	1.2310	—	1.1941	1.1849	1.1490	1B	1.160	1.178	1.1959	1.2079	1.2500
	2A	0.0018	1.2482	1.2368	—	1.1941	1.1879	1.1490	2B	1.160	1.178	1.1959	1.2039	1.2500
	3A	0.0000	1.2500	1.2386	—	1.1959	1.1913	1.1508	3B	1.1600	1.1698	1.1959	1.2019	1.2500
1¼-14 UNS	2A	0.0016	1.2484	1.2381	—	1.2020	1.1966	1.1634	2B	1.173	1.188	1.2036	1.2106	1.2500
1¼-16 UN	2A	0.0015	1.2485	1.2391	—	1.2079	1.2028	1.1740	2B	1.182	1.196	1.2094	1.2160	1.2500
	3A	0.0000	1.2500	1.2406	—	1.2094	1.2056	1.1755	3B	1.1820	1.1908	1.2094	1.2144	1.2500
	2A	0.0015	1.2485	1.2398	—	1.2124	1.2075	1.1824	2B	1.190	1.203	1.2139	1.2202	1.2500
1¼-18 UNEF	3A	0.0000	1.2500	1.2413	—	1.2139	1.2103	1.1839	3B	1.1900	1.1980	1.2139	1.2186	1.2500
	2A	0.0014	1.2486	1.2405	—	1.2161	1.2114	1.1891	2B	1.196	1.207	1.2175	1.2236	1.2500
	3A	0.0000	1.2500	1.2419	—	1.2175	1.2140	1.1905	3B	1.1960	1.2037	1.2175	1.2220	1.2500
1¼-20 UN	2A	0.0013	1.2487	1.2415	—	1.2216	1.2173	1.1991	2B	1.205	1.215	1.2229	1.2285	1.2500
1¼-24 UNS	2A	0.0012	1.2488	1.2423	—	1.2256	1.2215	1.2062	2B	1.211	1.220	1.2268	1.2321	1.2500
	3A	0.0000	1.2500	1.2435	—	1.2268	1.2237	1.2074	3B	1.2110	1.2176	1.2268	1.2308	1.2500
	2A	0.0021	1.3104	1.2954	—	1.2292	1.2221	1.1616	2B	1.177	1.202	1.2313	1.2405	1.3125
1½-8 UN	3A	0.0000	1.3125	1.2975	—	1.2313	1.2260	1.1637	3B	1.1770	1.1922	1.2313	1.2382	1.3125
	2A	0.0017	1.3108	1.2994	—	1.2567	1.2509	1.2116	2B	1.222	1.240	1.2584	1.2659	1.3125
	3A	0.0000	1.3125	1.3011	—	1.2584	1.2541	1.2133	3B	1.2220	1.2323	1.2584	1.2640	1.3125
1½-12 UN	2A	0.0015	1.3110	1.3016	—	1.2704	1.2653	1.2365	2B	1.245	1.259	1.2719	1.2785	1.3125
	3A	0.0000	1.3125	1.3031	—	1.2719	1.2681	1.2380	3B	1.2450	1.2533	1.2719	1.2769	1.3125
	2A	0.0015	1.3110	1.3023	—	1.2749	1.2700	1.2449	2B	1.252	1.265	1.2764	1.2827	1.3125
1½-16 UN	3A	0.0000	1.3125	1.3038	—	1.2764	1.2728	1.2464	3B	1.2520	1.2605	1.2764	1.2811	1.3125
	2A	0.0014	1.3111	1.3030	—	1.2786	1.2739	1.2516	2B	1.258	1.270	1.2800	1.2861	1.3125
	3A	0.0000	1.3125	1.3044	—	1.2800	1.2765	1.2530	3B	1.2580	1.2662	1.2800	1.2845	1.3125
1½-18 UNEF	2A	0.0012	1.3113	1.3048	—	1.2881	1.2840	1.2687	2B	1.274	1.282	1.2893	1.2946	1.3125
	3A	0.0000	1.3125	1.3060	—	1.2893	1.2862	1.2699	3B	1.2740	1.2801	1.2893	1.2933	1.3125
	2A	0.0024	1.3726	1.3453	—	1.2643	1.2523	1.1742	1B	1.195	1.225	1.2667	1.2822	1.3750
1½-20 UN	2A	0.0024	1.3726	1.3544	1.3453	1.2643	1.2563	1.1742	2B	1.195	1.225	1.2667	1.2771	1.3750
	3A	0.0000	1.3750	1.3568	—	1.2667	1.2607	1.1766	3B	1.1950	1.2146	1.2667	1.2745	1.3750
	1A	0.0024	1.3726	1.3453	—	1.2643	1.2523	1.1742	1B	1.195	1.225	1.2667	1.2822	1.3750
1¾-6 UNC	2A	0.0024	1.3726	1.3544	1.3453	1.2643	1.2563	1.1742	2B	1.195	1.225	1.2667	1.2771	1.3750
	3A	0.0000	1.3750	1.3568	—	1.2667	1.2607	1.1766	3B	1.1950	1.2146	1.2667	1.2745	1.3750

Table 3. (Continued) Standard Series and Selected Combinations — Unified Screw Threads

Nominal Size, Threads per Inch, and Series Designation ^a	External ^b								Internal ^b					
	Class	Allow- ance	Major Diameter			Pitch Diameter		UNR Minor Dia., ^c Max (Ref.)	Class	Minor Diameter		Pitch Diameter		Major Diameter
			Max ^d	Min	Min ^e	Max ^d	Min			Min	Max	Min	Max	Min
1 $\frac{3}{8}$ -8 UN	2A	0.0022	1.3728	1.3578	1.3503	1.2916	1.2844	1.2240	2B	1.240	1.265	1.2938	1.3031	1.3750
	3A	0.0000	1.3750	1.3600	—	1.2938	1.2884	1.2262	3B	1.2400	1.2547	1.2938	1.3008	1.3750
1 $\frac{3}{8}$ -10 UNS	2A	0.0019	1.3731	1.3602	—	1.3081	1.3018	1.2541	2B	1.267	1.288	1.3100	1.3182	1.3750
1 $\frac{3}{8}$ -12 UNF	1A	0.0019	1.3731	1.3559	—	1.3190	1.3096	1.2739	1B	1.285	1.303	1.3209	1.3332	1.3750
	2A	0.0019	1.3731	1.3617	—	1.3190	1.3127	1.2739	2B	1.285	1.303	1.3209	1.3291	1.3750
	3A	0.0000	1.3750	1.3636	—	1.3209	1.3162	1.2758	3B	1.2850	1.2948	1.3209	1.3270	1.3750
1 $\frac{3}{8}$ -14 UNS	2A	0.0016	1.3734	1.3631	—	1.3270	1.3216	1.2884	2B	1.298	1.314	1.3286	1.3356	1.3750
1 $\frac{3}{8}$ -16 UN	2A	0.0015	1.3735	1.3641	—	1.3329	1.3278	1.2990	2B	1.307	1.321	1.3344	1.3410	1.3750
	3A	0.0000	1.3750	1.3656	—	1.3344	1.3306	1.3005	3B	1.3070	1.3158	1.3344	1.3394	1.3750
1 $\frac{3}{8}$ -18 UNEF	2A	0.0015	1.3735	1.3648	—	1.3374	1.3325	1.3074	2B	1.315	1.328	1.3389	1.3452	1.3750
	3A	0.0000	1.3750	1.3663	—	1.3389	1.3353	1.3089	3B	1.3150	1.3230	1.3389	1.3436	1.3750
1 $\frac{3}{8}$ -20 UN	2A	0.0014	1.3736	1.3655	—	1.3411	1.3364	1.3141	2B	1.321	1.332	1.3425	1.3486	1.3750
	3A	0.0000	1.3750	1.3669	—	1.3425	1.3390	1.3155	3B	1.3210	1.3287	1.3425	1.3470	1.3750
1 $\frac{3}{8}$ -24 UNS	2A	0.0013	1.3737	1.3665	—	1.3466	1.3423	1.3241	2B	1.330	1.340	1.3479	1.3535	1.3750
1 $\frac{3}{8}$ -28 UN	2A	0.0012	1.3738	1.3673	—	1.3506	1.3465	1.3312	2B	1.336	1.345	1.3518	1.3571	1.3750
	3A	0.0000	1.3750	1.3685	—	1.3518	1.3487	1.3324	3B	1.3360	1.3426	1.3518	1.3558	1.3750
1 $\frac{7}{16}$ -6 UN	2A	0.0024	1.4351	1.4169	—	1.3268	1.3188	1.2367	2B	1.257	1.288	1.3292	1.3396	1.4375
	3A	0.0000	1.4375	1.4193	—	1.3292	1.3232	1.2391	3B	1.2570	1.2771	1.3292	1.3370	1.4375
1 $\frac{7}{16}$ -8 UN	2A	0.0022	1.4353	1.4203	—	1.3541	1.3469	1.2865	2B	1.302	1.327	1.3563	1.3657	1.4375
	3A	0.0000	1.4375	1.4225	—	1.3563	1.3509	1.2887	3B	1.3020	1.3172	1.3563	1.3634	1.4375
1 $\frac{7}{16}$ -12 UN	2A	0.0018	1.4357	1.4243	—	1.3816	1.3757	1.3365	2B	1.347	1.365	1.3834	1.3910	1.4375
	3A	0.0000	1.4375	1.4261	—	1.3834	1.3790	1.3383	3B	1.3470	1.3573	1.3834	1.3891	1.4375
1 $\frac{7}{16}$ -16 UN	2A	0.0016	1.4359	1.4265	—	1.3953	1.3901	1.3614	2B	1.370	1.384	1.3969	1.4037	1.4375
	3A	0.0000	1.4375	1.4281	—	1.3969	1.3930	1.3630	3B	1.3700	1.3783	1.3969	1.4020	1.4375
1 $\frac{7}{16}$ -18 UNEF	2A	0.0015	1.4360	1.4273	—	1.3999	1.3949	1.3699	2B	1.377	1.390	1.4014	1.4079	1.4375
	3A	0.0000	1.4375	1.4288	—	1.4014	1.3977	1.3714	3B	1.3770	1.3855	1.4014	1.4062	1.4375
1 $\frac{7}{16}$ -20 UN	2A	0.0014	1.4361	1.4280	—	1.4036	1.3988	1.3766	2B	1.383	1.395	1.4050	1.4112	1.4375
	3A	0.0000	1.4375	1.4294	—	1.4050	1.4014	1.3780	3B	1.3830	1.3912	1.4050	1.4096	1.4375

UNIFIED SCREW THREADS

1829

Table 3. (Continued) Standard Series and Selected Combinations — Unified Screw Threads

Nominal Size, Threads per Inch, and Series Designation ^a	External ^b								Internal ^b					
	Class	Allow- ance	Major Diameter			Pitch Diameter		UNR Minor Dia., ^c Max (Ref.)	Class	Minor Diameter		Pitch Diameter		Major Diameter
			Max ^d	Min	Min ^e	Max ^d	Min			Min	Max	Min	Max	Min
1 $\frac{1}{16}$ -28 UN	2A	0.0013	1.4362	1.4297	—	1.4130	1.4088	1.3936	2B	1.399	1.407	1.4143	1.4198	1.4375
	3A	0.0000	1.4375	1.4310	—	1.4143	1.4112	1.3949	3B	1.3990	1.4051	1.4143	1.4184	1.4375
1 $\frac{1}{2}$ -6 UNC	1A	0.0024	1.4976	1.4703	—	1.3893	1.3772	1.2992	1B	1.320	1.350	1.3917	1.4075	1.5000
	2A	0.0024	1.4976	1.4794	1.4703	1.3893	1.3812	1.2992	2B	1.320	1.350	1.3917	1.4022	1.5000
	3A	0.0000	1.5000	1.4818	—	1.3917	1.3856	1.3016	3B	1.3200	1.3396	1.3917	1.3996	1.5000
1 $\frac{1}{2}$ -8 UN	2A	0.0022	1.4978	1.4828	1.4753	1.4166	1.4093	1.3490	2B	1.365	1.390	1.4188	1.4283	1.5000
	3A	0.0000	1.5000	1.4850	—	1.4188	1.4133	1.3512	3B	1.3650	1.3797	1.4188	1.4259	1.5000
1 $\frac{1}{2}$ -10 UNS	2A	0.0019	1.4981	1.4852	—	1.4331	1.4267	1.3791	2B	1.392	1.413	1.4350	1.4433	1.5000
1 $\frac{1}{2}$ -12 UNF	1A	0.0019	1.4981	1.4809	—	1.4440	1.4344	1.3989	1B	1.410	1.428	1.4459	1.4584	1.5000
	2A	0.0019	1.4981	1.4867	—	1.4440	1.4376	1.3989	2B	1.410	1.428	1.4459	1.4542	1.5000
	3A	0.0000	1.5000	1.4886	—	1.4459	1.4411	1.4008	3B	1.4100	1.4198	1.4459	1.4522	1.5000
1 $\frac{1}{2}$ -14 UNS	2A	0.0017	1.4983	1.4880	—	1.4519	1.4464	1.4133	2B	1.423	1.438	1.4536	1.4608	1.5000
1 $\frac{1}{2}$ -16 UN	2A	0.0016	1.4984	1.4890	—	1.4578	1.4526	1.4239	2B	1.432	1.446	1.4594	1.4662	1.5000
	3A	0.0000	1.5000	1.4906	—	1.4594	1.4555	1.4255	3B	1.4320	1.4408	1.4594	1.4645	1.5000
	2A	0.0015	1.4985	1.4898	—	1.4624	1.4574	1.4324	2B	1.440	1.452	1.4639	1.4704	1.5000
1 $\frac{1}{2}$ -18 UNEF	3A	0.0000	1.5000	1.4913	—	1.4639	1.4602	1.4339	3B	1.4400	1.4480	1.4639	1.4687	1.5000
	2A	0.0014	1.4986	1.4905	—	1.4661	1.4613	1.4391	2B	1.446	1.457	1.4675	1.4737	1.5000
1 $\frac{1}{2}$ -20 UN	3A	0.0000	1.5000	1.4919	—	1.4675	1.4639	1.4405	3B	1.4460	1.4537	1.4675	1.4721	1.5000
	2A	0.0013	1.4987	1.4915	—	1.4716	1.4672	1.4491	2B	1.455	1.465	1.4729	1.4787	1.5000
1 $\frac{1}{2}$ -24 UNS	2A	0.0013	1.4987	1.4922	—	1.4755	1.4713	1.4561	2B	1.461	1.470	1.4768	1.4823	1.5000
1 $\frac{9}{16}$ -6 UN	3A	0.0000	1.5000	1.4935	—	1.4768	1.4737	1.4574	3B	1.4610	1.4676	1.4768	1.4809	1.5000
	2A	0.0024	1.5601	1.5419	—	1.4518	1.4436	1.3617	2B	1.382	1.413	1.4542	1.4648	1.5625
	3A	0.0000	1.5625	1.5443	—	1.4542	1.4481	1.3641	3B	1.3820	1.4021	1.4542	1.4622	1.5625
1 $\frac{9}{16}$ -8 UN	2A	0.0022	1.5603	1.5453	—	1.4791	1.4717	1.4115	2B	1.427	1.452	1.4813	1.4909	1.5625
	3A	0.0000	1.5625	1.5475	—	1.4813	1.4758	1.4137	3B	1.4270	1.4422	1.4813	1.4885	1.5625
1 $\frac{9}{16}$ -12 UN	2A	0.0018	1.5607	1.5493	—	1.5066	1.5007	1.4615	2B	1.472	1.490	1.5084	1.5160	1.5625
	3A	0.0000	1.5625	1.5511	—	1.5084	1.5040	1.4633	3B	1.4720	1.4823	1.5084	1.5141	1.5625

Table 3. (Continued) Standard Series and Selected Combinations — Unified Screw Threads

Nominal Size, Threads per Inch, and Series Designation ^a	External ^b								Internal ^b					
	Class	Allow- ance	Major Diameter			Pitch Diameter		UNR Minor Dia., ^c Max (Ref.)	Class	Minor Diameter		Pitch Diameter		Major Diameter
			Max ^d	Min	Min ^e	Max ^d	Min			Min	Max	Min	Max	Min
1/16-16 UN	2A	0.0016	1.5609	1.5515	—	1.5203	1.5151	1.4864	2B	1.495	1.509	1.5219	1.5287	1.5625
	3A	0.0000	1.5625	1.5531	—	1.5219	1.5180	1.4880	3B	1.4950	1.5033	1.5219	1.5270	1.5625
1/16-18 UNEF	2A	0.0015	1.5610	1.5523	—	1.5249	1.5199	1.4949	2B	1.502	1.515	1.5264	1.5329	1.5625
	3A	0.0000	1.5625	1.5538	—	1.5264	1.5227	1.4964	3B	1.5020	1.5105	1.5264	1.5312	1.5625
1/16-20 UN	2A	0.0014	1.5611	1.5530	—	1.5286	1.5238	1.5016	2B	1.508	1.520	1.5300	1.5362	1.5625
	3A	0.0000	1.5625	1.5544	—	1.5300	1.5264	1.5030	3B	1.5080	1.5162	1.5300	1.5346	1.5625
5/8-6 UN	2A	0.0025	1.6225	1.6043	—	1.5142	1.5060	1.4246	2B	1.445	1.475	1.5167	1.5274	1.6250
	3A	0.0000	1.6250	1.6068	—	1.5167	1.5105	1.4271	3B	1.4450	1.4646	1.5167	1.5247	1.6250
5/8-8 UN	2A	0.0022	1.6228	1.6078	1.6003	1.5416	1.5342	1.4784	2B	1.490	1.515	1.5438	1.5535	1.6250
	3A	0.0000	1.6250	1.6100	—	1.5438	1.5382	1.4806	3B	1.4900	1.5047	1.5438	1.5510	1.6250
5/8-10 UNS	2A	0.0019	1.6231	1.6102	—	1.5581	1.5517	1.5041	2B	1.517	1.538	1.5600	1.5683	1.6250
	2A	0.0018	1.6232	1.6118	—	1.5691	1.5632	1.5240	2B	1.535	1.553	1.5709	1.5785	1.6250
5/8-12 UN	3A	0.0000	1.6250	1.6136	—	1.5709	1.5665	1.5258	3B	1.5350	1.5448	1.5709	1.5766	1.6250
	2A	0.0017	1.6233	1.6130	—	1.5769	1.5714	1.5383	2B	1.548	1.564	1.5786	1.5858	1.6250
5/8-16 UN	2A	0.0016	1.6234	1.6140	—	1.5828	1.5776	1.5489	2B	1.557	1.571	1.5844	1.5912	1.6250
	3A	0.0000	1.6250	1.6156	—	1.5844	1.5805	1.5505	3B	1.5570	1.5658	1.5844	1.5895	1.6250
5/8-18 UNEF	2A	0.0015	1.6235	1.6148	—	1.5874	1.5824	1.5574	2B	1.565	1.578	1.5889	1.5954	1.6250
	3A	0.0000	1.6250	1.6163	—	1.5889	1.5852	1.5589	3B	1.5650	1.5730	1.5889	1.5937	1.6250
5/8-20 UN	2A	0.0014	1.6236	1.6155	—	1.5911	1.5863	1.5641	2B	1.571	1.582	1.5925	1.5987	1.6250
	3A	0.0000	1.6250	1.6169	—	1.5925	1.5889	1.5655	3B	1.5710	1.5787	1.5925	1.5971	1.6250
5/8-24 UNS	2A	0.0013	1.6237	1.6165	—	1.5966	1.5922	1.5741	2B	1.580	1.590	1.5979	1.6037	1.6250
	2A	0.0025	1.6850	1.6668	—	1.5767	1.5684	1.4866	2B	1.507	1.538	1.5792	1.5900	1.6875
1 1/16-6 UN	3A	0.0000	1.6875	1.6693	—	1.5792	1.5730	1.4891	3B	1.5070	1.5271	1.5792	1.5873	1.6875
	2A	0.0022	1.6853	1.6703	—	1.6041	1.5966	1.5365	2B	1.552	1.577	1.6063	1.6160	1.6875
1 1/16-8 UN	3A	0.0000	1.6875	1.6725	—	1.6063	1.6007	1.5387	3B	1.5520	1.5672	1.6063	1.6136	1.6875
	2A	0.0018	1.6857	1.6743	—	1.6316	1.6256	1.5865	2B	1.597	1.615	1.6334	1.6412	1.6875
1 1/16-12 UN	3A	0.0000	1.6875	1.6761	—	1.6334	1.6289	1.5883	3B	1.5970	1.6073	1.6334	1.6392	1.6875

UNIFIED SCREW THREADS

1831

Table 3. (Continued) Standard Series and Selected Combinations — Unified Screw Threads

Nominal Size, Threads per Inch, and Series Designation ^a	External ^b								Internal ^b					
	Class	Allow- ance	Major Diameter			Pitch Diameter		UNR Minor Dia., ^c Max (Ref.)	Class	Minor Diameter		Pitch Diameter		Major Diameter
			Max ^d	Min	Min ^e	Max ^d	Min			Min	Max	Min	Max	Min
1 ¹¹ / ₁₆ -16 UN	2A	0.0016	1.6859	1.6765	—	1.6453	1.6400	1.6114	2B	1.620	1.634	1.6469	1.6538	1.6875
	3A	0.0000	1.6875	1.6781	—	1.6469	1.6429	1.6130	3B	1.6200	1.6283	1.6469	1.6521	1.6875
1 ¹¹ / ₁₆ -18 UNEF	2A	0.0015	1.6860	1.6773	—	1.6499	1.6448	1.6199	2B	1.627	1.640	1.6514	1.6580	1.6875
	3A	0.0000	1.6875	1.6788	—	1.6514	1.6476	1.6214	3B	1.6270	1.6355	1.6514	1.6563	1.6875
1 ¹¹ / ₁₆ -20 UN	2A	0.0015	1.6860	1.6779	—	1.6535	1.6487	1.6265	2B	1.633	1.645	1.6550	1.6613	1.6875
	3A	0.0000	1.6875	1.6794	—	1.6550	1.6514	1.6280	3B	1.6330	1.6412	1.6550	1.6597	1.6875
1 ³ / ₄ -5 UNC	1A	0.0027	1.7473	1.7165	—	1.6174	1.6040	1.5092	1B	1.534	1.568	1.6201	1.6375	1.7500
	2A	0.0027	1.7473	1.7268	1.7165	1.6174	1.6085	1.5092	2B	1.534	1.568	1.6201	1.6317	1.7500
	3A	0.0000	1.7500	1.7295	—	1.6201	1.6134	1.5119	3B	1.5340	1.5575	1.6201	1.6288	1.7500
1 ³ / ₄ -6 UN	2A	0.0025	1.7475	1.7293	—	1.6392	1.6309	1.5491	2B	1.570	1.600	1.6417	1.6525	1.7500
	3A	0.0000	1.7500	1.7318	—	1.6417	1.6354	1.5516	3B	1.5700	1.5896	1.6417	1.6498	1.7500
1 ³ / ₄ -8 UN	2A	0.0023	1.7477	1.7327	1.7252	1.6665	1.6590	1.5989	2B	1.615	1.640	1.6688	1.6786	1.7500
	3A	0.0000	1.7500	1.7350	—	1.6688	1.6632	1.6012	3B	1.6150	1.6297	1.6688	1.6762	1.7500
1 ³ / ₄ -10 UNS	2A	0.0019	1.7481	1.7352	—	1.6831	1.6766	1.6291	2B	1.642	1.663	1.6850	1.6934	1.7500
1 ³ / ₄ -12 UN	2A	0.0018	1.7482	1.7368	—	1.6941	1.6881	1.6490	2B	1.660	1.678	1.6959	1.7037	1.7500
	3A	0.0000	1.7500	1.7386	—	1.6959	1.6914	1.6508	3B	1.6600	1.6698	1.6959	1.7017	1.7500
1 ³ / ₄ -14 UNS	2A	0.0017	1.7483	1.7380	—	1.7019	1.6963	1.6632	2B	1.673	1.688	1.7036	1.7109	1.7500
1 ³ / ₄ -16 UN	2A	0.0016	1.7484	1.7390	—	1.7078	1.7025	1.6739	2B	1.682	1.696	1.7094	1.7163	1.7500
	3A	0.0000	1.7500	1.7406	—	1.7094	1.7054	1.6755	3B	1.6820	1.6908	1.7094	1.7146	1.7500
1 ³ / ₄ -18 UNS	2A	0.0015	1.7485	1.7398	—	1.7124	1.7073	1.6824	2B	1.690	1.703	1.7139	1.7205	1.7500
1 ³ / ₄ -20 UN	2A	0.0015	1.7485	1.7404	—	1.7160	1.7112	1.6890	2B	1.696	1.707	1.7175	1.7238	1.7500
	3A	0.0000	1.7500	1.7419	—	1.7175	1.7139	1.6905	3B	1.6960	1.7037	1.7175	1.7222	1.7500
1 ¹³ / ₁₆ -6 UN	2A	0.0025	1.8100	1.7918	—	1.7017	1.6933	1.6116	2B	1.632	1.663	1.7042	1.7151	1.8125
	3A	0.0000	1.8125	1.7943	—	1.7042	1.6979	1.6141	3B	1.6320	1.6521	1.7042	1.7124	1.8125
1 ¹³ / ₁₆ -8 UN	2A	0.0023	1.8102	1.7952	—	1.7290	1.7214	1.6614	2B	1.677	1.702	1.7313	1.7412	1.8125
	3A	0.0000	1.8125	1.7975	—	1.7313	1.7256	1.6637	3B	1.6770	1.6922	1.7313	1.7387	1.8125
1 ¹³ / ₁₆ -12 UN	2A	0.0018	1.8107	1.7993	—	1.7566	1.7506	1.7115	2B	1.722	1.740	1.7584	1.7662	1.8125
	3A	0.0000	1.8125	1.8011	—	1.7584	1.7539	1.7133	3B	1.7220	1.7323	1.7584	1.7642	1.8125

Table 3. (Continued) Standard Series and Selected Combinations — Unified Screw Threads

Nominal Size, Threads per Inch, and Series Designation ^a	External ^b								Internal ^b					
	Class	Allow- ance	Major Diameter			Pitch Diameter		UNR Minor Dia., ^c Max (Ref.)	Class	Minor Diameter		Pitch Diameter		Major Diameter
			Max ^d	Min	Min ^e	Max ^d	Min			Min	Max	Min	Max	Min
1 ¹³ / ₁₆ -16 UN	2A	0.0016	1.8109	1.8015	—	1.7703	1.7650	1.7364	2B	1.745	1.759	1.7719	1.7788	1.8125
	3A	0.0000	1.8125	1.8031	—	1.7719	1.7679	1.7380	3B	1.7450	1.7533	1.7719	1.7771	1.8125
1 ¹³ / ₁₆ -20 UN	2A	0.0015	1.8110	1.8029	—	1.7785	1.7737	1.7515	2B	1.758	1.770	1.7800	1.7863	1.8125
	3A	0.0000	1.8125	1.8044	—	1.7800	1.7764	1.7530	3B	1.7580	1.7662	1.7800	1.7847	1.8125
1 ⁷ / ₈ -6 UN	2A	0.0025	1.8725	1.8543	—	1.7642	1.7558	1.6741	2B	1.695	1.725	1.7667	1.7777	1.8750
	3A	0.0000	1.8750	1.8568	—	1.7667	1.7604	1.6766	3B	1.6950	1.7146	1.7667	1.7749	1.8750
1 ⁷ / ₈ -8 UN	2A	0.0023	1.8727	1.8577	1.8502	1.7915	1.7838	1.7239	2B	1.740	1.765	1.7938	1.8038	1.8750
	3A	0.0000	1.8750	1.8600	—	1.7938	1.7881	1.7262	3B	1.7400	1.7547	1.7938	1.8013	1.8750
1 ⁷ / ₈ -10 UNS	2A	0.0019	1.8731	1.8602	—	1.8081	1.8016	1.7541	2B	1.767	1.788	1.8100	1.8184	1.8750
1 ⁷ / ₈ -12 UN	2A	0.0018	1.8732	1.8618	—	1.8191	1.8131	1.7740	2B	1.785	1.803	1.8209	1.8287	1.8750
	3A	0.0000	1.8750	1.8636	—	1.8209	1.8164	1.7758	3B	1.7850	1.7948	1.8209	1.8267	1.8750
1 ⁷ / ₈ -14 UNS	2A	0.0017	1.8733	1.8630	—	1.8269	1.8213	1.7883	2B	1.798	1.814	1.8286	1.8359	1.8750
1 ⁷ / ₈ -16 UN	2A	0.0016	1.8734	1.8640	—	1.8328	1.8275	1.7989	2B	1.807	1.821	1.8344	1.8413	1.8750
	3A	0.0000	1.8750	1.8656	—	1.8344	1.8304	1.8005	3B	1.8070	1.8158	1.8344	1.8396	1.8750
1 ⁷ / ₈ -18 UNS	2A	0.0015	1.8735	1.8648	—	1.8374	1.8323	1.8074	2B	1.815	1.828	1.8389	1.8455	1.8750
1 ⁷ / ₈ -20 UN	2A	0.0015	1.8735	1.8654	—	1.8410	1.8362	1.8140	2B	1.821	1.832	1.8425	1.8488	1.8750
	3A	0.0000	1.8750	1.8669	—	1.8425	1.8389	1.8155	3B	1.8210	1.8287	1.8425	1.8472	1.8750
1 ¹⁵ / ₁₆ -6 UN	2A	0.0026	1.9349	1.9167	—	1.8266	1.8181	1.7365	2B	1.757	1.788	1.8292	1.8403	1.9375
	3A	0.0000	1.9375	1.9193	—	1.8292	1.8228	1.7391	3B	1.7570	1.7771	1.8292	1.8375	1.9375
1 ¹⁵ / ₁₆ -8 UN	2A	0.0023	1.9352	1.9202	—	1.8540	1.8463	1.7864	2B	1.802	1.827	1.8563	1.8663	1.9375
	3A	0.0000	1.9375	1.9225	—	1.8563	1.8505	1.7887	3B	1.8020	1.8172	1.8563	1.8638	1.9375
1 ¹⁵ / ₁₆ -12 UN	2A	0.0018	1.9357	1.9243	—	1.8816	1.8755	1.8365	2B	1.847	1.865	1.8834	1.8913	1.9375
	3A	0.0000	1.9375	1.9261	—	1.8834	1.8789	1.8383	3B	1.8470	1.8573	1.8834	1.8893	1.9375
1 ¹⁵ / ₁₆ -16 UN	2A	0.0016	1.9359	1.9265	—	1.8953	1.8899	1.8614	2B	1.870	1.884	1.8969	1.9039	1.9375
	3A	0.0000	1.9375	1.9281	—	1.8969	1.8929	1.8630	3B	1.8700	1.8783	1.8969	1.9021	1.9375
1 ¹⁵ / ₁₆ -20 UN	2A	0.0015	1.9360	1.9279	—	1.9035	1.8986	1.8765	2B	1.883	1.895	1.9050	1.9114	1.9375
	3A	0.0000	1.9375	1.9294	—	1.9050	1.9013	1.8780	3B	1.8830	1.8912	1.9050	1.9098	1.9375

UNIFIED SCREW THREADS

1833

Table 3. (Continued) Standard Series and Selected Combinations — Unified Screw Threads

Nominal Size, Threads per Inch, and Series Designation ^a	External ^b								Internal ^b					
	Class	Allow- ance	Major Diameter			Pitch Diameter		UNR Minor Dia., ^c Max (Ref.)	Class	Minor Diameter		Pitch Diameter		Major Diameter
			Max ^d	Min	Min ^e	Max ^d	Min			Min	Max	Min	Max	Min
2-4½ UNC	1A	0.0029	1.9971	1.9641	—	1.8528	1.8385	1.7324	1B	1.759	1.795	1.8557	1.8743	2.0000
	2A	0.0029	1.9971	1.9751	1.9641	1.8528	1.8433	1.7324	2B	1.759	1.795	1.8557	1.8681	2.0000
	3A	0.0000	2.0000	1.9780	—	1.8557	1.8486	1.7353	3B	1.7590	1.7861	1.8557	1.8650	2.0000
2-6 UN	2A	0.0026	1.9974	1.9792	—	1.8891	1.8805	1.7990	2B	1.820	1.850	1.8917	1.9028	2.0000
	3A	0.0000	2.0000	1.9818	—	1.8917	1.8853	1.8016	3B	1.8200	1.8396	1.8917	1.9000	2.0000
2-8 UN	2A	0.0023	1.9977	1.9827	1.9752	1.9165	1.9087	1.8489	2B	1.865	1.890	1.9188	1.9289	2.0000
	3A	0.0000	2.0000	1.9850	—	1.9188	1.9130	1.8512	3B	1.8650	1.8797	1.9188	1.9264	2.0000
2-10 UNS	2A	0.0020	1.9980	1.9851	—	1.9330	1.9265	1.8790	2B	1.892	1.913	1.9350	1.9435	2.0000
2-12 UN	2A	0.0018	1.9982	1.9868	—	1.9441	1.9380	1.8990	2B	1.910	1.928	1.9459	1.9538	2.0000
	3A	0.0000	2.0000	1.9886	—	1.9459	1.9414	1.9008	3B	1.9100	1.9198	1.9459	1.9518	2.0000
2-14 UNS	2A	0.0017	1.9983	1.9880	—	1.9519	1.9462	1.9133	2B	1.923	1.938	1.9536	1.9610	2.0000
2-16 UN	2A	0.0016	1.9984	1.9890	—	1.9578	1.9524	1.9239	2B	1.932	1.946	1.9594	1.9664	2.0000
	3A	0.0000	2.0000	1.9906	—	1.9594	1.9554	1.9255	3B	1.9320	1.9408	1.9594	1.9646	2.0000
2-18 UNS	2A	0.0015	1.9985	1.9898	—	1.9624	1.9573	1.9324	2B	1.940	1.953	1.9639	1.9706	2.0000
2-20 UN	2A	0.0015	1.9985	1.9904	—	1.9660	1.9611	1.9390	2B	1.946	1.957	1.9675	1.9739	2.0000
	3A	0.0000	2.0000	1.9919	—	1.9675	1.9638	1.9405	3B	1.9460	1.9537	1.9675	1.9723	2.0000
2½-16 UNS	2A	0.0016	2.0609	2.0515	—	2.0203	2.0149	1.9864	2B	1.995	2.009	2.0219	2.0289	2.0625
	3A	0.0000	2.0625	2.0531	—	2.0219	2.0179	1.9880	3B	1.9950	2.0033	2.0219	2.0271	2.0625
2½-6 UN	2A	0.0026	2.1224	2.1042	—	2.0141	2.0054	1.9240	2B	1.945	1.975	2.0167	2.0280	2.1250
	3A	0.0000	2.1250	2.1068	—	2.0167	2.0102	1.9266	3B	1.9450	1.9646	2.0167	2.0251	2.1250
2½-8 UN	2A	0.0024	2.1226	2.1076	2.1001	2.0414	2.0335	1.9738	2B	1.990	2.015	2.0438	2.0540	2.1250
	3A	0.0000	2.1250	2.1100	—	2.0438	2.0379	1.9762	3B	1.9900	2.0047	2.0438	2.0515	2.1250
2½-12 UN	2A	0.0018	2.1232	2.1118	—	2.0691	2.0630	2.0240	2B	2.035	2.053	2.0709	2.0788	2.1250
	3A	0.0000	2.1250	2.1136	—	2.0709	2.0664	2.0258	3B	2.0350	2.0448	2.0709	2.0768	2.1250
2½-16 UN	2A	0.0016	2.1234	2.1140	—	2.0828	2.0774	2.0489	2B	2.057	2.071	2.0844	2.0914	2.1250
	3A	0.0000	2.1250	2.1156	—	2.0844	2.0803	2.0505	3B	2.0570	2.0658	2.0844	2.0896	2.1250
2½-20 UN	2A	0.0015	2.1235	2.1154	—	2.0910	2.0861	2.0640	2B	2.071	2.082	2.0925	2.0989	2.1250
	3A	0.0000	2.1250	2.1169	—	2.0925	2.0888	2.0655	3B	2.0710	2.0787	2.0925	2.0973	2.1250

Table 3. (Continued) Standard Series and Selected Combinations — Unified Screw Threads

Nominal Size, Threads per Inch, and Series Designation ^a	External ^b								Internal ^b					
	Class	Allow- ance	Major Diameter			Pitch Diameter		UNR Minor Dia., ^c Max (Ref.)	Class	Minor Diameter		Pitch Diameter		Major Diameter
			Max ^d	Min	Min ^e	Max ^d	Min			Min	Max	Min	Max	Min
2 ³ / ₁₆ -16 UNS	2A	0.0016	2.1859	2.1765	—	2.1453	2.1399	2.1114	2B	2.120	2.134	2.1469	2.1539	2.1875
	3A	0.0000	2.1875	2.1781	—	2.1469	2.1428	2.1130	3B	2.1200	2.1283	2.1469	2.1521	2.1875
2 ¹ / ₄ -4 ¹ / ₂ UNC	1A	0.0029	2.2471	2.2141	—	2.1028	2.0882	1.9824	1B	2.009	2.045	2.1057	2.1247	2.2500
	2A	0.0029	2.2471	2.2251	2.2141	2.1028	2.0931	1.9824	2B	2.009	2.045	2.1057	2.1183	2.2500
	3A	0.0000	2.2500	2.2280	—	2.1057	2.0984	1.9853	3B	2.0090	2.0361	2.1057	2.1152	2.2500
2 ¹ / ₄ -6 UN	2A	0.0026	2.2474	2.2292	—	2.1391	2.1303	2.0490	2B	2.070	2.100	2.1417	2.1531	2.2500
	3A	0.0000	2.2500	2.2318	—	2.1417	2.1351	2.0516	3B	2.0700	2.0896	2.1417	2.1502	2.2500
2 ¹ / ₄ -8 UN	2A	0.0024	2.2476	2.2326	2.2251	2.1664	2.1584	2.0988	2B	2.115	2.140	2.1688	2.1792	2.2500
	3A	0.0000	2.2500	2.2350	—	2.1688	2.1628	2.1012	3B	2.1150	2.1297	2.1688	2.1766	2.2500
2 ¹ / ₄ -10 UNS	2A	0.0020	2.2480	2.2351	—	2.1830	2.1765	2.1290	2B	2.142	2.163	2.1850	2.1935	2.2500
2 ¹ / ₄ -12 UN	2A	0.0018	2.2482	2.2368	—	2.1941	2.1880	2.1490	2B	2.160	2.178	2.1959	2.2038	2.2500
	3A	0.0000	2.2500	2.2386	—	2.1959	2.1914	2.1508	3B	2.1600	2.1698	2.1959	2.2018	2.2500
2 ¹ / ₄ -14 UNS	2A	0.0017	2.2483	2.2380	—	2.2019	2.1962	2.1633	2B	2.173	2.188	2.2036	2.2110	2.2500
2 ¹ / ₄ -16 UN	2A	0.0016	2.2484	2.2390	—	2.2078	2.2024	2.1739	2B	2.182	2.196	2.2094	2.2164	2.2500
	3A	0.0000	2.2500	2.2406	—	2.2094	2.2053	2.1755	3B	2.1820	2.1908	2.2094	2.2146	2.2500
	2A	0.0015	2.2485	2.2398	—	2.2124	2.2073	2.1824	2B	2.190	2.203	2.2139	2.2206	2.2500
2 ¹ / ₄ -18 UNS	2A	0.0015	2.2485	2.2404	—	2.2160	2.2111	2.1890	2B	2.196	2.207	2.2175	2.2239	2.2500
2 ¹ / ₄ -20 UN	3A	0.0000	2.2500	2.2419	—	2.2175	2.2137	2.1905	3B	2.1960	2.2037	2.2175	2.2223	2.2500
	2A	0.0017	2.3108	2.3014	—	2.2702	2.2647	2.2363	2B	2.245	2.259	2.2719	2.2791	2.3125
	3A	0.0000	2.3125	2.3031	—	2.2719	2.2678	2.2380	3B	2.2450	2.2533	2.2719	2.2773	2.3125
2 ³ / ₈ -6 UN	2A	0.0027	2.3723	2.3541	—	2.2640	2.2551	2.1739	2B	2.195	2.226	2.2667	2.2782	2.3750
	3A	0.0000	2.3750	2.3568	—	2.2667	2.2601	2.1766	3B	2.1950	2.2146	2.2667	2.2753	2.3750
2 ³ / ₈ -8 UN	2A	0.0024	2.3726	2.3576	—	2.2914	2.2833	2.2238	2B	2.240	2.265	2.2938	2.3043	2.3750
	3A	0.0000	2.3750	2.3600	—	2.2938	2.2878	2.2262	3B	2.2400	2.2547	2.2938	2.3017	2.3750
2 ³ / ₈ -12 UN	2A	0.0019	2.3731	2.3617	—	2.3190	2.3128	2.2739	2B	2.285	2.303	2.3209	2.3290	2.3750
	3A	0.0000	2.3750	2.3636	—	2.3209	2.3163	2.2758	3B	2.2850	2.2948	2.3209	2.3269	2.3750
2 ³ / ₈ -16 UN	2A	0.0017	2.3733	2.3639	—	2.3327	2.3272	2.2988	2B	2.307	2.321	2.3344	2.3416	2.3750
	3A	0.0000	2.3750	2.3656	—	2.3344	2.3303	2.3005	3B	2.3070	2.3158	2.3344	2.3398	2.3750

UNIFIED SCREW THREADS

1835

Table 3. (Continued) Standard Series and Selected Combinations — Unified Screw Threads

Nominal Size, Threads per Inch, and Series Designation ^a	External ^b								Internal ^b					
	Class	Allow- ance	Major Diameter			Pitch Diameter		UNR Minor Dia., ^c Max (Ref.)	Class	Minor Diameter		Pitch Diameter		Major Diameter
			Max ^d	Min	Min ^e	Max ^d	Min			Min	Max	Min	Max	Min
2 $\frac{3}{8}$ -20 UN	2A	0.0015	2.3735	2.3654	—	2.3410	2.3359	2.3140	2B	2.321	2.332	2.3425	2.3491	2.3750
	3A	0.0000	2.3750	2.3669	—	2.3425	2.3387	2.3155	3B	2.3210	2.3287	2.3425	2.3475	2.3750
2 $\frac{7}{16}$ -16 UNS	2A	0.0017	2.4358	2.4264	—	2.3952	2.3897	2.3613	2B	2.370	2.384	2.3969	2.4041	2.4375
	3A	0.0000	2.4375	2.4281	—	2.3969	2.3928	2.3630	3B	2.3700	2.3783	2.3969	2.4023	2.4375
2 $\frac{1}{2}$ -4 UNC	1A	0.0031	2.4969	2.4612	—	2.3345	2.3190	2.1992	1B	2.229	2.267	2.3376	2.3578	2.5000
	2A	0.0031	2.4969	2.4731	2.4612	2.3345	2.3241	2.1992	2B	2.229	2.267	2.3376	2.3511	2.5000
	3A	0.0000	2.5000	2.4762	—	2.3376	2.3298	2.2023	3B	2.2290	2.2594	2.3376	2.3477	2.5000
2 $\frac{1}{2}$ -6 UN	2A	0.0027	2.4973	2.4791	—	2.3890	2.3800	2.2989	2B	2.320	2.350	2.3917	2.4033	2.5000
	3A	0.0000	2.5000	2.4818	—	2.3917	2.3850	2.3016	3B	2.3200	2.3396	2.3917	2.4004	2.5000
2 $\frac{1}{2}$ -8 UN	2A	0.0024	2.4976	2.4826	2.4751	2.4164	2.4082	2.3488	2B	2.365	2.390	2.4188	2.4294	2.5000
	3A	0.0000	2.5000	2.4850	—	2.4188	2.4127	2.3512	3B	2.3650	2.3797	2.4188	2.4268	2.5000
2 $\frac{1}{2}$ -10 UNS	2A	0.0020	2.4980	2.4851	—	2.4330	2.4263	2.3790	2B	2.392	2.413	2.4350	2.4437	2.5000
2 $\frac{1}{2}$ -12 UN	2A	0.0019	2.4981	2.4867	—	2.4440	2.4378	2.3989	2B	2.410	2.428	2.4459	2.4540	2.5000
	3A	0.0000	2.5000	2.4886	—	2.4459	2.4413	2.4008	3B	2.4100	2.4198	2.4459	2.4519	2.5000
2 $\frac{1}{2}$ -14 UNS	2A	0.0017	2.4983	2.4880	—	2.4519	2.4461	2.4133	2B	2.423	2.438	2.4536	2.4612	2.5000
2 $\frac{1}{2}$ -16 UN	2A	0.0017	2.4983	2.4889	—	2.4577	2.4522	2.4238	2B	2.432	2.446	2.4594	2.4666	2.5000
	3A	0.0000	2.5000	2.4906	—	2.4594	2.4553	2.4255	3B	2.4320	2.4408	2.4594	2.4648	2.5000
2 $\frac{1}{2}$ -18 UNS	2A	0.0016	2.4984	2.4897	—	2.4623	2.4570	2.4323	2B	2.440	2.453	2.4639	2.4708	2.5000
2 $\frac{1}{2}$ -20 UN	2A	0.0015	2.4985	2.4904	—	2.4660	2.4609	2.4390	2B	2.446	2.457	2.4675	2.4741	2.5000
	3A	0.0000	2.5000	2.4919	—	2.4675	2.4637	2.4405	3B	2.4460	2.4537	2.4675	2.4725	2.5000
2 $\frac{5}{8}$ -6 UN	2A	0.0027	2.6223	2.6041	—	2.5140	2.5050	2.4239	2B	2.445	2.475	2.5167	2.5285	2.6250
	3A	0.0000	2.6250	2.6068	—	2.5167	2.5099	2.4266	3B	2.4450	2.4646	2.5167	2.5255	2.6250
2 $\frac{5}{8}$ -8 UN	2A	0.0025	2.6225	2.6075	—	2.5413	2.5331	2.4737	2B	2.490	2.515	2.5438	2.5545	2.6250
	3A	0.0000	2.6250	2.6100	—	2.5438	2.5376	2.4762	3B	2.4900	2.5047	2.5438	2.5518	2.6250
2 $\frac{5}{8}$ -12 UN	2A	0.0019	2.6231	2.6117	—	2.5690	2.5628	2.5239	2B	2.535	2.553	2.5709	2.5790	2.6250
	3A	0.0000	2.6250	2.6136	—	2.5709	2.5663	2.5258	3B	2.5350	2.5448	2.5709	2.5769	2.6250
2 $\frac{5}{8}$ -16 UN	2A	0.0017	2.6233	2.6139	—	2.5827	2.5772	2.5488	2B	2.557	2.571	2.5844	2.5916	2.6250
	3A	0.0000	2.6250	2.6156	—	2.5844	2.5803	2.5505	3B	2.5570	2.5658	2.5844	2.5898	2.6250

Table 3. (Continued) Standard Series and Selected Combinations — Unified Screw Threads

Nominal Size, Threads per Inch, and Series Designation ^a	External ^b								Internal ^b					
	Class	Allow- ance	Major Diameter			Pitch Diameter		UNR Minor Dia., ^c Max (Ref.)	Class	Minor Diameter		Pitch Diameter		Major Diameter
			Max ^d	Min	Min ^e	Max ^d	Min			Min	Max	Min	Max	
2 $\frac{5}{8}$ -20 UN	2A	0.0015	2.6235	2.6154	—	2.5910	2.5859	2.5640	2B	2.571	2.582	2.5925	2.5991	2.6250
	3A	0.0000	2.6250	2.6169	—	2.5925	2.5887	2.5655	3B	2.5710	2.5787	2.5925	2.5975	2.6250
2 $\frac{3}{4}$ -4 UNC	1A	0.0032	2.7468	2.7111	—	2.5844	2.5686	2.4491	1B	2.479	2.517	2.5876	2.6082	2.7500
	2A	0.0032	2.7468	2.7230	2.7111	2.5844	2.5739	2.4491	2B	2.479	2.517	2.5876	2.6013	2.7500
	3A	0.0000	2.7500	2.7262	—	2.5876	2.5797	2.4523	3B	2.4790	2.5094	2.5876	2.5979	2.7500
2 $\frac{3}{4}$ -6 UN	2A	0.0027	2.7473	2.7291	—	2.6390	2.6299	2.5489	2B	2.570	2.600	2.6417	2.6536	2.7500
	3A	0.0000	2.7500	2.7318	—	2.6417	2.6349	2.5516	3B	2.5700	2.5896	2.6417	2.6506	2.7500
2 $\frac{3}{4}$ -8 UN	2A	0.0025	2.7475	2.7325	2.7250	2.6663	2.6580	2.5987	2B	2.615	2.640	2.6688	2.6796	2.7500
	3A	0.0000	2.7500	2.7350	—	2.6688	2.6625	2.6012	3B	2.6150	2.6297	2.6688	2.6769	2.7500
2 $\frac{3}{4}$ -10 UNS	2A	0.0020	2.7480	2.7351	—	2.6830	2.6763	2.6290	2B	2.642	2.663	2.6850	2.6937	2.7500
2 $\frac{3}{4}$ -12 UN	2A	0.0019	2.7481	2.7367	—	2.6940	2.6878	2.6489	2B	2.660	2.678	2.6959	2.7040	2.7500
	3A	0.0000	2.7500	2.7386	—	2.6959	2.6913	2.6508	3B	2.6600	2.6698	2.6959	2.7019	2.7500
2 $\frac{3}{4}$ -14 UNS	2A	0.0017	2.7483	2.7380	—	2.7019	2.6961	2.6633	2B	2.673	2.688	2.7036	2.7112	2.7500
2 $\frac{3}{4}$ -16 UN	2A	0.0017	2.7483	2.7389	—	2.7077	2.7022	2.6738	2B	2.682	2.696	2.7094	2.7166	2.7500
	3A	0.0000	2.7500	2.7406	—	2.7094	2.7053	2.6755	3B	2.6820	2.6908	2.7094	2.7148	2.7500
	2A	0.0016	2.7484	2.7397	—	2.7123	2.7070	2.6823	2B	2.690	2.703	2.7139	2.7208	2.7500
2 $\frac{3}{4}$ -20 UN	2A	0.0015	2.7485	2.7404	—	2.7160	2.7109	2.6890	2B	2.696	2.707	2.7175	2.7241	2.7500
	3A	0.0000	2.7500	2.7419	—	2.7175	2.7137	2.6905	3B	2.6960	2.7037	2.7175	2.7225	2.7500
2 $\frac{7}{8}$ -6 UN	2A	0.0028	2.8722	2.8540	—	2.7639	2.7547	2.6738	2B	2.695	2.725	2.7667	2.7787	2.8750
	3A	0.0000	2.8750	2.8568	—	2.7667	2.7598	2.6766	3B	2.6950	2.7146	2.7667	2.7757	2.8750
2 $\frac{7}{8}$ -8 UN	2A	0.0025	2.8725	2.8575	—	2.7913	2.7829	2.7237	2B	2.740	2.765	2.7938	2.8048	2.8750
	3A	0.0000	2.8750	2.8600	—	2.7938	2.7875	2.7262	3B	2.7400	2.7547	2.7938	2.8020	2.8750
2 $\frac{7}{8}$ -12 UN	2A	0.0019	2.8731	2.8617	—	2.8190	2.8127	2.7739	2B	2.785	2.803	2.8209	2.8291	2.8750
	3A	0.0000	2.8750	2.8636	—	2.8209	2.8162	2.7758	3B	2.7850	2.7948	2.8209	2.8271	2.8750
2 $\frac{7}{8}$ -16 UN	2A	0.0017	2.8733	2.8639	—	2.8327	2.8271	2.7988	2B	2.807	2.821	2.8344	2.8417	2.8750
	3A	0.0000	2.8750	2.8656	—	2.8344	2.8302	2.8005	3B	2.8070	2.8158	2.8344	2.8399	2.8750
2 $\frac{7}{8}$ -20 UN	2A	0.0016	2.8734	2.8653	—	2.8409	2.8357	2.8139	2B	2.821	2.832	2.8425	2.8493	2.8750
	3A	0.0000	2.8750	2.8669	—	2.8425	2.8386	2.8155	3B	2.8210	2.8287	2.8425	2.8476	2.8750

UNIFIED SCREW THREADS

1837

Table 3. (Continued) Standard Series and Selected Combinations — Unified Screw Threads

Nominal Size, Threads per Inch, and Series Designation ^a	External ^b								Internal ^b					
	Class	Allow- ance	Major Diameter			Pitch Diameter		UNR Minor Dia., ^c Max (Ref.)	Class	Minor Diameter		Pitch Diameter		Major Diameter
			Max ^d	Min	Min ^e	Max ^d	Min			Min	Max	Min	Max	Min
3-4 UNC	1A	0.0032	2.9968	2.9611	—	2.8344	2.8183	2.6991	1B	2.729	2.767	2.8376	2.8585	3.0000
	2A	0.0032	2.9968	2.9730	2.9611	2.8344	2.8237	2.6991	2B	2.729	2.767	2.8376	2.8515	3.0000
	3A	0.0000	3.0000	2.9762	—	2.8376	2.8296	2.7023	3B	2.7290	2.7594	2.8376	2.8480	3.0000
3-6 UN	2A	0.0028	2.9972	2.9790	—	2.8889	2.8796	2.7988	2B	2.820	2.850	2.8917	2.9038	3.0000
	3A	0.0000	3.0000	2.9818	—	2.8917	2.8847	2.8016	3B	2.8200	2.8396	2.8917	2.9008	3.0000
3-8 UN	2A	0.0026	2.9974	2.9824	2.9749	2.9162	2.9077	2.8486	2B	2.865	2.890	2.9188	2.9299	3.0000
	3A	0.0000	3.0000	2.9850	—	2.9188	2.9124	2.8512	3B	2.8650	2.8797	2.9188	2.9271	3.0000
3-10 UNS	2A	0.0020	2.9980	2.9851	—	2.9330	2.9262	2.8790	2B	2.892	2.913	2.9350	2.9439	3.0000
3-12 UN	2A	0.0019	2.9981	2.9867	—	2.9440	2.9377	2.8989	2B	2.910	2.928	2.9459	2.9541	3.0000
	3A	0.0000	3.0000	2.9886	—	2.9459	2.9412	2.9008	3B	2.9100	2.9198	2.9459	2.9521	3.0000
3-14 UNS	2A	0.0018	2.9982	2.9879	—	2.9518	2.9459	2.9132	2B	2.923	2.938	2.9536	2.9613	3.0000
3-16 UN	2A	0.0017	2.9983	2.9889	—	2.9577	2.9521	2.9238	2B	2.932	2.946	2.9594	2.9667	3.0000
	3A	0.0000	3.0000	2.9906	—	2.9594	2.9552	2.9255	3B	2.9320	2.9408	2.9594	2.9649	3.0000
3-18 UNS	2A	0.0016	2.9984	2.9897	—	2.9623	2.9569	2.9323	2B	2.940	2.953	2.9639	2.9709	3.0000
3-20 UN	2A	0.0016	2.9984	2.9903	—	2.9659	2.9607	2.9389	2B	2.946	2.957	2.9675	2.9743	3.0000
	3A	0.0000	3.0000	2.9919	—	2.9675	2.9636	2.9405	3B	2.9460	2.9537	2.9675	2.9726	3.0000
3 1/8-6 UN	2A	0.0028	3.1222	3.1040	—	3.0139	3.0045	2.9238	2B	2.945	2.975	3.0167	3.0289	3.1250
	3A	0.0000	3.1250	3.1068	—	3.0167	3.0097	2.9266	3B	2.9450	2.9646	3.0167	3.0259	3.1250
3 1/8-8 UN	2A	0.0026	3.1224	3.1074	—	3.0412	3.0326	2.9736	2B	2.990	3.015	3.0438	3.0550	3.1250
	3A	0.0000	3.1250	3.1100	—	3.0438	3.0374	2.9762	3B	2.9900	3.0047	3.0438	3.0522	3.1250
3 1/8-12 UN	2A	0.0019	3.1231	3.1117	—	3.0690	3.0627	3.0239	2B	3.035	3.053	3.0709	3.0791	3.1250
	3A	0.0000	3.1250	3.1136	—	3.0709	3.0662	3.0258	3B	3.0350	3.0448	3.0709	3.0771	3.1250
3 1/8-16 UN	2A	0.0017	3.1233	3.1139	—	3.0827	3.0771	3.0488	2B	3.057	3.071	3.0844	3.0917	3.1250
	3A	0.0000	3.1250	3.1156	—	3.0844	3.0802	3.0505	3B	3.0570	3.0658	3.0844	3.0899	3.1250
3 1/4 UNC	1A	0.0033	3.2467	3.2110	—	3.0843	3.0680	2.9490	1B	2.979	3.017	3.0876	3.1088	3.2500
	2A	0.0033	3.2467	3.2229	3.2110	3.0843	3.0734	2.9490	2B	2.979	3.017	3.0876	3.1017	3.2500
	3A	0.0000	3.2500	3.2262	—	3.0876	3.0794	2.9523	3B	2.9790	3.0094	3.0876	3.0982	3.2500
3 1/4-6 UN	2A	0.0028	3.2472	3.2290	—	3.1389	3.1294	3.0488	2B	3.070	3.100	3.1417	3.1540	3.2500
	3A	0.0000	3.2500	3.2318	—	3.1417	3.1346	3.0516	3B	3.0700	3.0896	3.1417	3.1509	3.2500

Table 3. (Continued) Standard Series and Selected Combinations — Unified Screw Threads

Nominal Size, Threads per Inch, and Series Designation ^a	External ^b								Internal ^b					
	Class	Allow- ance	Major Diameter			Pitch Diameter		UNR Minor Dia., ^c Max (Ref.)	Class	Minor Diameter		Pitch Diameter		Major Diameter
			Max ^d	Min	Min ^e	Max ^d	Min			Min	Max	Min	Max	Min
3/4-8 UN	2A	0.0026	3.2474	3.2324	3.2249	3.1662	3.1575	3.0986	2B	3.115	3.140	3.1688	3.1801	3.2500
	3A	0.0000	3.2500	3.2350	—	3.1688	3.1623	3.1012	3B	3.1150	3.1297	3.1688	3.1773	3.2500
3/4-10 UNS	2A	0.0020	3.2480	3.2351	—	3.1830	3.1762	3.1290	2B	3.142	3.163	3.1850	3.1939	3.2500
3/4-12 UN	2A	0.0019	3.2481	3.2367	—	3.1940	3.1877	3.1489	2B	3.160	3.178	3.1959	3.2041	3.2500
	3A	0.0000	3.2500	3.2386	—	3.1959	3.1912	3.1508	3B	3.1600	3.1698	3.1959	3.2041	3.2500
3/4-14 UNS	2A	0.0018	3.2482	3.2379	—	3.2018	3.1959	3.1632	2B	3.173	3.188	3.2036	3.2113	3.2500
3/4-16 UN	2A	0.0017	3.2483	3.2389	—	3.2077	3.2021	3.1738	2B	3.182	3.196	3.2094	3.2167	3.2500
	3A	0.0000	3.2500	3.2406	—	3.2094	3.2052	3.1755	3B	3.1820	3.1908	3.2094	3.2149	3.2500
3/4-18 UNS	2A	0.0016	3.2484	3.2397	—	3.2123	3.2069	3.1823	2B	3.190	3.203	3.2139	3.2209	3.2500
3/8-6 UN	2A	0.0029	3.3721	3.3539	—	3.2638	3.2543	3.1737	2B	3.195	3.225	3.2667	3.2791	3.3750
	3A	0.0000	3.3750	3.3568	—	3.2667	3.2595	3.1766	3B	3.1950	3.2146	3.2667	3.2760	3.3750
3/8-8 UN	2A	0.0026	3.3724	3.3574	—	3.2912	3.2824	3.2236	2B	3.240	3.265	3.2938	3.3052	3.3750
	3A	0.0000	3.3750	3.3600	—	3.2938	3.2872	3.2262	3B	3.2400	3.2547	3.2938	3.3023	3.3750
3/8-12 UN	2A	0.0019	3.3731	3.3617	—	3.3190	3.3126	3.2739	2B	3.285	3.303	3.3209	3.3293	3.3750
	3A	0.0000	3.3750	3.3636	—	3.3209	3.3161	3.2758	3B	3.2850	3.2948	3.3209	3.3272	3.3750
3/8-16 UN	2A	0.0017	3.3733	3.3639	—	3.3327	3.3269	3.2988	2B	3.307	3.321	3.3344	3.3419	3.3750
	3A	0.0000	3.3750	3.3656	—	3.3344	3.3301	3.3005	3B	3.3070	3.3158	3.3344	3.3400	3.3750
3/2-4 UNC	1A	0.0033	3.4967	3.4610	—	3.3343	3.3177	3.1990	1B	3.229	3.267	3.3376	3.3591	3.5000
	2A	0.0033	3.4967	3.4729	3.4610	3.3343	3.3233	3.1990	2B	3.229	3.267	3.3376	3.3519	3.5000
	3A	0.0000	3.5000	3.4762	—	3.3376	3.3293	3.2023	3B	3.2290	3.2594	3.3376	3.3484	3.5000
3/2-6 UN	2A	0.0029	3.4971	3.4789	—	3.3888	3.3792	3.2987	2B	3.320	3.350	3.3917	3.4042	3.5000
	3A	0.0000	3.5000	3.4818	—	3.3917	3.3845	3.3016	3B	3.3200	3.3396	3.3917	3.4011	3.5000
3/2-8 UN	2A	0.0026	3.4974	3.4824	3.4749	3.4162	3.4074	3.3486	2B	3.365	3.390	3.4188	3.4303	3.5000
	3A	0.0000	3.5000	3.4850	—	3.4188	3.4122	3.3512	3B	3.3650	3.3797	3.4188	3.4274	3.5000
3/2-10 UNS	2A	0.0021	3.4979	3.4850	—	3.4329	3.4260	3.3789	2B	3.392	3.413	3.4350	3.4440	3.5000
3/2-12 UN	2A	0.0019	3.4981	3.4867	—	3.4440	3.4376	3.3989	2B	3.410	3.428	3.4459	3.4543	3.5000
	3A	0.0000	3.5000	3.4886	—	3.4459	3.4411	3.4008	3B	3.4100	3.4198	3.4459	3.4522	3.5000

UNIFIED SCREW THREADS

1839

Table 3. (Continued) Standard Series and Selected Combinations — Unified Screw Threads

Nominal Size, Threads per Inch, and Series Designation ^a	External ^b								Internal ^b					
	Class	Allow- ance	Major Diameter			Pitch Diameter		UNR Minor Dia., ^c Max (Ref.)	Class	Minor Diameter		Pitch Diameter		Major Diameter
			Max ^d	Min	Min ^e	Max ^d	Min			Min	Max	Min	Max	
3½-14 UNS	2A	0.0018	3.4982	3.4879	—	3.4518	3.4457	3.4132	2B	3.423	3.438	3.4536	3.4615	3.5000
3½-16 UN	2A	0.0017	3.4983	3.4889	—	3.4577	3.4519	3.4238	2B	3.432	3.446	3.4594	3.4669	3.5000
	3A	0.0000	3.5000	3.4906	—	3.4594	3.4551	3.4255	3B	3.4320	3.4408	3.4594	3.4650	3.5000
3½-18 UNS	2A	0.0017	3.4983	3.4896	—	3.4622	3.4567	3.4322	2B	3.440	3.453	3.4639	3.4711	3.5000
3⅝-6 UN	2A	0.0029	3.6221	3.6039	—	3.5138	3.5041	3.4237	2B	3.445	3.475	3.5167	3.5293	3.6250
	3A	0.0000	3.6250	3.6068	—	3.5167	3.5094	3.4266	3B	3.4450	3.4646	3.5167	3.5262	3.6250
3⅝-8 UN	2A	0.0027	3.6223	3.6073	—	3.5411	3.5322	3.4735	2B	3.490	3.515	3.5438	3.5554	3.6250
	3A	0.0000	3.6250	3.6100	—	3.5438	3.5371	3.4762	3B	3.4900	3.5047	3.5438	3.5525	3.6250
3⅝-12 UN	2A	0.0019	3.6231	3.6117	—	3.5690	3.5626	3.5239	2B	3.535	3.553	3.5709	3.5793	3.6250
	3A	0.0000	3.6250	3.6136	—	3.5709	3.5661	3.5258	3B	3.5350	3.5448	3.5709	3.5772	3.6250
3⅝-16 UN	2A	0.0017	3.6233	3.6139	—	3.5827	3.5769	3.5488	2B	3.557	3.571	3.5844	3.5919	3.6250
	3A	0.0000	3.6250	3.6156	—	3.5844	3.5801	3.5505	3B	3.5570	3.5658	3.5844	3.5900	3.6250
3¾-4 UNC	1A	0.0034	3.7466	3.7109	—	3.5842	3.5674	3.4489	1B	3.479	3.517	3.5876	3.6094	3.7500
	2A	0.0034	3.7466	3.7228	3.7109	3.5842	3.5730	3.4489	2B	3.479	3.517	3.5876	3.6021	3.7500
	3A	0.0000	3.7500	3.7262	—	3.5876	3.5792	3.4523	3B	3.4790	3.5094	3.5876	3.5985	3.7500
3¾-6 UN	2A	0.0029	3.7471	3.7289	—	3.6388	3.6290	3.5487	2B	3.570	3.600	3.6417	3.6544	3.7500
	3A	0.0000	3.7500	3.7318	—	3.6417	3.6344	3.5516	3B	3.5700	3.5896	3.6417	3.6512	3.7500
3¾-8 UN	2A	0.0027	3.7473	3.7323	3.7248	3.6661	3.6571	3.5985	2B	3.615	3.640	3.6688	3.6805	3.7500
	3A	0.0000	3.7500	3.7350	—	3.6688	3.6621	3.6012	3B	3.6150	3.6297	3.6688	3.6776	3.7500
3¾-10 UNS	2A	0.0021	3.7479	3.7350	—	3.6829	3.6760	3.6289	2B	3.642	3.663	3.6850	3.6940	3.7500
3¾-12 UN	2A	0.0019	3.7481	3.7367	—	3.6940	3.6876	3.6489	2B	3.660	3.678	3.6959	3.7043	3.7500
	3A	0.0000	3.7500	3.7386	—	3.6959	3.6911	3.6508	3B	3.6600	3.6698	3.6959	3.7022	3.7500
3¾-14 UNS	2A	0.0018	3.7482	3.7379	—	3.7018	3.6957	3.6632	2B	3.673	3.688	3.7036	3.7115	3.7500
3¾-16 UN	2A	0.0017	3.7483	3.7389	—	3.7077	3.7019	3.6738	2B	3.682	3.696	3.7094	3.7169	3.7500
	3A	0.0000	3.7500	3.7406	—	3.7094	3.7051	3.6755	3B	3.6820	3.6908	3.7094	3.7150	3.7500
3¾-18 UNS	2A	0.0017	3.7483	3.7396	—	3.7122	3.7067	3.6822	2B	3.690	3.703	3.7139	3.7211	3.7500

Table 3. (Continued) Standard Series and Selected Combinations — Unified Screw Threads

Nominal Size, Threads per Inch, and Series Designation ^a	External ^b								Internal ^b					
	Class	Allow- ance	Major Diameter			Pitch Diameter		UNR Minor Dia., ^c Max (Ref.)	Class	Minor Diameter		Pitch Diameter		Major Diameter
			Max ^d	Min	Min ^e	Max ^d	Min			Min	Max	Min	Max	Min
3/8-6 UN	2A	0.0030	3.8720	3.8538	—	3.7637	3.7538	3.6736	2B	3.695	3.725	3.7667	3.7795	3.8750
	3A	0.0000	3.8750	3.8568	—	3.7667	3.7593	3.6766	3B	3.6950	3.7146	3.7667	3.7763	3.8750
3/8-8 UN	2A	0.0027	3.8723	3.8573	—	3.7911	3.7820	3.7235	2B	3.740	3.765	3.7938	3.8056	3.8750
	3A	0.0000	3.8750	3.8600	—	3.7938	3.7870	3.7262	3B	3.7400	3.7547	3.7938	3.8026	3.8750
3/8-12 UN	2A	0.0020	3.8730	3.8616	—	3.8189	3.8124	3.7738	2B	3.785	3.803	3.8209	3.8294	3.8750
	3A	0.0000	3.8750	3.8636	—	3.8209	3.8160	3.7758	3B	3.7850	3.7948	3.8209	3.8273	3.8750
3/8-16 UN	2A	0.0018	3.8732	3.8638	—	3.8326	3.8267	3.7987	2B	3.807	3.821	3.8344	3.8420	3.8750
	3A	0.0000	3.8750	3.8656	—	3.8344	3.8300	3.8005	3B	3.8070	3.8158	3.8344	3.8401	3.8750
4-4 UNC	1A	0.0034	3.9966	3.9609	—	3.8342	3.8172	3.6989	1B	3.729	3.767	3.8376	3.8597	4.0000
	2A	0.0034	3.9966	3.9728	3.9609	3.8342	3.8229	3.6989	2B	3.729	3.767	3.8376	3.8523	4.0000
	3A	0.0000	4.0000	3.9762	—	3.8376	3.8291	3.7023	3B	3.7290	3.7594	3.8376	3.8487	4.0000
4-6 UN	2A	0.0030	3.9970	3.9788	—	3.8887	3.8788	3.7986	2B	3.820	3.850	3.8917	3.9046	4.0000
	3A	0.0000	4.0000	3.9818	—	3.8917	3.8843	3.8016	3B	3.8200	3.8396	3.8917	3.9014	4.0000
4-8 UN	2A	0.0027	3.9973	3.9823	3.9748	3.9161	3.9070	3.8485	2B	3.865	3.890	3.9188	3.9307	4.0000
	3A	0.0000	4.0000	3.9850	—	3.9188	3.9120	3.8512	3B	3.8650	3.8797	3.9188	3.9277	4.0000
4-10 UNS	2A	0.0021	3.9979	3.9850	—	3.9329	3.9259	3.8768	2B	3.892	3.913	3.9350	3.9441	4.0000
4-12 UN	2A	0.0020	3.9980	3.9866	—	3.9439	3.9374	3.8988	2B	3.910	3.928	3.9459	3.9544	4.0000
	3A	0.0000	4.0000	3.9886	—	3.9459	3.9410	3.9008	3B	3.9100	3.9198	3.9459	3.9523	4.0000
4-14 UNS	2A	0.0018	3.9982	3.9879	—	3.9518	3.9456	3.9132	2B	3.923	3.938	3.9536	3.9616	4.0000
4-16 UN	2A	0.0018	3.9982	3.9888	—	3.9576	3.9517	3.9237	2B	3.932	3.946	3.9594	3.9670	4.0000
	3A	0.0000	4.0000	3.9906	—	3.9594	3.9550	3.9255	3B	3.9320	3.9408	3.9594	3.9651	4.0000
4 1/4-10 UNS	2A	0.0021	4.2479	4.2350	—	4.1829	4.1759	4.1289	2B	4.142	4.163	4.1850	4.1941	4.2500
4 1/4-12 UN	2A	0.0020	4.2480	4.2366	—	4.1939	4.1874	4.1488	2B	4.160	4.178	4.1959	4.2044	4.2500
	3A	0.0000	4.2500	4.2386	—	4.1959	4.1910	4.1508	3B	4.1600	4.1698	4.1959	4.2023	4.2500
4 1/4-14 UNS	2A	0.0018	4.2482	4.2379	—	4.2018	4.1956	4.1632	2B	4.173	4.188	4.2036	4.2116	4.2500
4 1/4-16 UN	2A	0.0018	4.2482	4.2388	—	4.2076	4.2017	4.1737	2B	4.182	4.196	4.2094	4.2170	4.2500
	3A	0.0000	4.2500	4.2406	—	4.2094	4.2050	4.1755	3B	4.1820	4.1900	4.2094	4.2151	4.2500
4 1/2-10 UNS	2A	0.0021	4.4979	4.4850	—	4.4329	4.4259	4.3789	2B	4.392	4.413	4.4350	4.4441	4.5000

UNIFIED SCREW THREADS

1841

Table 3. (Continued) Standard Series and Selected Combinations — Unified Screw Threads

Nominal Size, Threads per Inch, and Series Designation ^a	External ^b								Internal ^b					
	Class	Allow- ance	Major Diameter			Pitch Diameter		UNR Minor Dia., ^c Max (Ref.)	Class	Minor Diameter		Pitch Diameter		Major Diameter
			Max ^d	Min	Min ^e	Max ^d	Min			Min	Max	Min	Max	Min
4½-12 UN	2A	0.0020	4.4980	4.4866	—	4.4439	4.4374	4.3988	2B	4.410	4.428	4.4459	4.4544	4.5000
	3A	0.0000	4.5000	4.4886	—	4.4459	4.4410	4.4008	3B	4.4100	4.4198	4.4459	4.4523	4.5000
4½-14 UNS	2A	0.0018	4.4982	4.4879	—	4.4518	4.4456	4.4132	2B	4.423	4.438	4.4536	4.4616	4.5000
4½-16 UN	2A	0.0018	4.4982	4.4888	—	4.4576	4.4517	4.4237	2B	4.432	4.446	4.4594	4.4670	4.5000
	3A	0.0000	4.5000	4.4906	—	4.4594	4.4550	4.4255	3B	4.4320	4.4408	4.4594	4.4651	4.5000
4¾-10 UNS	2A	0.0022	4.7478	4.7349	—	4.6828	4.6756	4.6288	2B	4.642	4.663	4.6850	4.6944	4.7500
4¾-12 UN	2A	0.0020	4.7480	4.7366	—	4.6939	4.6872	4.6488	2B	4.660	4.678	4.6959	4.7046	4.7500
	3A	0.0000	4.7500	4.7386	—	4.6959	4.6909	4.6508	3B	4.6600	4.6698	4.6959	4.7025	4.7500
4¾-14 UNS	2A	0.0019	4.7481	4.7378	—	4.7017	4.6953	4.6631	2B	4.673	4.688	4.7036	4.7119	4.7500
	3A	0.0000	4.7500	4.7388	—	4.7076	4.7015	4.6737	3B	4.682	4.696	4.7094	4.7173	4.7500
5.00-10 UNS	2A	0.0022	4.9978	4.9849	—	4.9328	4.9256	4.8788	2B	4.892	4.913	4.9350	4.9444	5.0000
	3A	0.0000	5.0000	4.9886	—	4.9439	4.9372	4.8988	3B	4.910	4.928	4.9459	4.9546	5.0000
5.00-12 UN	2A	0.0020	4.9980	4.9866	—	4.9459	4.9409	4.9008	2B	4.9100	4.9198	4.9459	4.9525	5.0000
	3A	0.0000	5.0000	4.9906	—	4.9517	4.9453	4.9131	3B	4.923	4.938	4.9536	4.9619	5.0000
5.00-14 UNS	2A	0.0019	4.9981	4.9878	—	4.9576	4.9515	4.9237	2B	4.932	4.946	4.9594	4.9673	5.0000
	3A	0.0000	5.0000	4.9906	—	4.9594	4.9549	4.9255	3B	4.9320	4.9408	4.9594	4.9653	5.0000
5½-10 UNS	2A	0.0022	5.2478	5.2349	—	5.1829	5.1756	5.1288	2B	5.142	5.163	5.1850	5.1944	5.2500
	3A	0.0000	5.2500	5.2386	—	5.1939	5.1872	5.1488	3B	5.160	5.178	5.1959	5.2046	5.2500
5½-12 UN	2A	0.0020	5.2480	5.2366	—	5.1959	5.1909	5.1508	2B	5.1600	5.1698	5.1959	5.2025	5.2500
	3A	0.0000	5.2500	5.2386	—	5.2017	5.1953	5.1631	3B	5.173	5.188	5.2036	5.2119	5.2500
5½-14 UNS	2A	0.0019	5.2481	5.2378	—	5.2076	5.2015	5.1737	2B	5.182	5.196	5.2094	5.2173	5.2500
	3A	0.0000	5.2500	5.2406	—	5.2094	5.2049	5.1755	3B	5.1820	5.1908	5.2094	5.2153	5.2500
5½-16 UN	2A	0.0018	5.2482	5.2388	—	5.4328	5.4256	5.3788	2B	5.392	5.413	5.4350	5.4444	5.5000
	3A	0.0000	5.2500	5.2406	—	5.4439	5.4372	5.3988	3B	5.410	5.428	5.4459	5.4546	5.5000
5½-10 UNS	2A	0.0022	5.4978	5.4849	—	5.4459	5.4409	5.4008	2B	5.4100	5.4198	5.4459	5.4525	5.5000
	3A	0.0000	5.5000	5.4886	—	5.4517	5.4453	5.4131	3B	5.423	5.438	5.4536	5.4619	5.5000
5½-12 UN	2A	0.0020	5.4980	5.4866	—	5.4517	5.4453	5.4131	2B	5.423	5.438	5.4536	5.4619	5.5000
	3A	0.0000	5.5000	5.4886	—	5.4517	5.4453	5.4131	3B	5.423	5.438	5.4536	5.4619	5.5000
5½-14 UNS	2A	0.0019	5.4981	5.4878	—	5.4517	5.4453	5.4131	2B	5.423	5.438	5.4536	5.4619	5.5000

Table 3. (Continued) Standard Series and Selected Combinations — Unified Screw Threads

Nominal Size, Threads per Inch, and Series Designation ^a	External ^b								Internal ^b					
	Class	Allow- ance	Major Diameter			Pitch Diameter		UNR Minor Dia., ^c Max (Ref.)	Class	Minor Diameter		Pitch Diameter		Major Diameter
			Max ^d	Min	Min ^e	Max ^d	Min			Min	Max	Min	Max	Min
5½-16 UN	2A	0.0018	5.4982	5.4888	—	5.4576	5.4515	5.4237	2B	5.432	5.446	5.4594	5.4673	5.5000
	3A	0.0000	5.5000	5.4906	—	5.4594	5.4549	5.4255	3B	5.4320	5.4408	5.4594	5.4653	5.5000
5¾-10 UNS	2A	0.0022	5.7478	5.7349	—	5.6828	5.6754	5.6288	2B	5.642	5.663	5.6850	5.6946	5.7500
5¾-12 UN	2A	0.0021	5.7479	5.7365	—	5.6938	5.6869	5.6487	2B	5.660	5.678	5.6959	5.7049	5.7500
	3A	0.0000	5.7500	5.7386	—	5.6959	5.6907	5.6508	3B	5.6600	5.6698	5.6959	5.7026	5.7500
5¾-14 UNS	2A	0.0020	5.7480	5.7377	—	5.7016	5.6951	5.6630	2B	5.673	5.688	5.7036	5.7121	5.7500
5¾-16 UN	2A	0.0019	5.7481	5.7387	—	5.7075	5.7013	5.6736	2B	5.682	5.696	5.7094	5.7175	5.7500
	3A	0.0000	5.7500	5.7406	—	5.7094	5.7047	5.6755	3B	5.6820	5.6908	5.7094	5.7155	5.7500
6-10 UNS	2A	0.0022	5.9978	5.9849	—	5.9328	5.9254	5.8788	2B	5.892	5.913	5.9350	5.9446	6.0000
6-14 UNS	2A	0.0020	5.9980	5.9877	—	5.9516	5.9451	5.9130	2B	5.923	5.938	5.9536	5.9621	6.0000
6-12 UN	2A	0.0021	5.9979	5.9865	—	5.9438	5.9369	5.8987	2B	5.910	5.928	5.9459	5.9549	6.0000
	3A	0.0000	6.0000	5.9886	—	5.9459	5.9407	5.9008	3B	5.9100	5.9198	5.9459	5.9526	6.0000
6-16 UN	2A	0.0019	5.9981	5.9887	—	5.9575	5.9513	5.9236	2B	5.932	5.946	5.9594	5.9675	6.0000
	3A	0.0000	6.0000	5.9906	—	5.9594	5.9547	5.9255	3B	5.9320	5.9408	5.9594	5.9655	6.0000

^a Use UNR designation instead of UN wherever UNR thread form is desired for external use.

^b Regarding combinations of thread classes, see text on page 1854.

^c UN series external thread maximum minor diameter is basic for Class 3A and basic minus allowance for Classes 1A and 2A.

^d For Class 2A threads having an additive finish the maximum is increased, by the allowance, to the basic size, the value being the same as for Class 3A.

^e For unfinished hot-rolled material not including standard fasteners with rolled threads.

^f Formerly NF, tolerances and allowances are based on one diameter length of engagement.

All dimensions in inches.

Use UNS threads only if Standard Series do not meet requirements (see pages 1814, 1846, and 1857). For additional sizes above 4 inches see ASME/ANSI B1.1-1989 (R2008).

Coarse-Thread Series: This series, UNC/UNRC, is the one most commonly used in the bulk production of bolts, screws, nuts and other general engineering applications. It is also used for threading into lower tensile strength materials such as cast iron, mild steel and softer materials (bronze, brass, aluminum, magnesium and plastics) to obtain the optimum resistance to stripping of the internal thread. It is applicable for rapid assembly or disassembly, or if corrosion or slight damage is possible.

Table 4a. Coarse-Thread Series, UNC and UNRC — Basic Dimensions

Sizes No. or Inches	Basic Major Dia., <i>D</i>	Thds. per Inch, <i>n</i>	Basic Pitch Dia., ^a <i>D</i> ₂	Minor Diameter		Lead Angle λ at Basic P.D.		Area of Minor Dia. at <i>D</i> -2 <i>h</i> _b	Tensile Stress Area ^b
				Ext. Thds., ^c <i>d</i> ₃ (Ref.)	Int. Thds., ^d <i>D</i> ₁	Deg.	Min		
	Inches	Inches	Inches	Sq. In.	Sq. In.				
1 (0.073)^e	0.0730	64	0.0629	0.0544	0.0561	4	31	0.00218	0.00263
2 (0.086)	0.0860	56	0.0744	0.0648	0.0667	4	22	0.00310	0.00370
3 (0.099)^e	0.0990	48	0.0855	0.0741	0.0764	4	26	0.00406	0.00487
4 (0.112)	0.1120	40	0.0958	0.0822	0.0849	4	45	0.00496	0.00604
5 (0.125)	0.1250	40	0.1088	0.0952	0.0979	4	11	0.00672	0.00796
6 (0.138)	0.1380	32	0.1177	0.1008	0.1042	4	50	0.00745	0.00909
8 (0.164)	0.1640	32	0.1437	0.1268	0.1302	3	58	0.01196	0.0140
10 (0.190)	0.1900	24	0.1629	0.1404	0.1449	4	39	0.01450	0.0175
12 (0.216)^e	0.2160	24	0.1889	0.1664	0.1709	4	1	0.0206	0.0242
$\frac{1}{4}$	0.2500	20	0.2175	0.1905	0.1959	4	11	0.0269	0.0318
$\frac{5}{16}$	0.3125	18	0.2764	0.2464	0.2524	3	40	0.0454	0.0524
$\frac{3}{8}$	0.3750	16	0.3344	0.3005	0.3073	3	24	0.0678	0.0775
$\frac{7}{16}$	0.4375	14	0.3911	0.3525	0.3602	3	20	0.0933	0.1063
$\frac{1}{2}$	0.5000	13	0.4500	0.4084	0.4167	3	7	0.1257	0.1419
$\frac{9}{16}$	0.5625	12	0.5084	0.4633	0.4723	2	59	0.162	0.182
$\frac{5}{8}$	0.6250	11	0.5660	0.5168	0.5266	2	56	0.202	0.226
$\frac{3}{4}$	0.7500	10	0.6850	0.6309	0.6417	2	40	0.302	0.334
$\frac{7}{8}$	0.8750	9	0.8028	0.7427	0.7547	2	31	0.419	0.462
1	1.0000	8	0.9188	0.8512	0.8647	2	29	0.551	0.606
1$\frac{1}{8}$	1.1250	7	1.0322	0.9549	0.9704	2	31	0.693	0.763
1$\frac{1}{4}$	1.2500	7	1.1572	1.0799	1.0954	2	15	0.890	0.969
1$\frac{3}{8}$	1.3750	6	1.2667	1.1766	1.1946	2	24	1.054	1.155
1$\frac{1}{2}$	1.5000	6	1.3917	1.3016	1.3196	2	11	1.294	1.405
1$\frac{3}{4}$	1.7500	5	1.6201	1.5119	1.5335	2	15	1.74	1.90
2	2.0000	4$\frac{1}{2}$	1.8557	1.7353	1.7594	2	11	2.30	2.50
2$\frac{1}{4}$	2.2500	4$\frac{1}{2}$	2.1057	1.9853	2.0094	1	55	3.02	3.25
2$\frac{1}{2}$	2.5000	4	2.3376	2.2023	2.2294	1	57	3.72	4.00
2$\frac{3}{4}$	2.7500	4	2.5876	2.4523	2.4794	1	46	4.62	4.93
3	3.0000	4	2.8376	2.7023	2.7294	1	36	5.62	5.97
3$\frac{1}{4}$	3.2500	4	3.0876	2.9523	2.9794	1	29	6.72	7.10
3$\frac{1}{2}$	3.5000	4	3.3376	3.2023	3.2294	1	22	7.92	8.33
3$\frac{3}{4}$	3.7500	4	3.5876	3.4523	3.4794	1	16	9.21	9.66
4	4.0000	4	3.8376	3.7023	3.7294	1	11	10.61	11.08

^aBritish: Effective Diameter.

^bSee formula, pages 1528 and 1536.

^cDesign form for UNR threads. (See figure on page 1814.)

^dBasic minor diameter.

^eSecondary sizes.

Fine-Thread Series: This series, UNF/UNRF, is suitable for the production of bolts, screws, and nuts and for other applications where the Coarse series is not applicable. External threads of this series have greater tensile stress area than comparable sizes of the Coarse series. The Fine series is suitable when the resistance to stripping of both external

and mating internal threads equals or exceeds the tensile load carrying capacity of the externally threaded member (see page 1536). It is also used where the length of engagement is short, where a smaller lead angle is desired, where the wall thickness demands a fine pitch, or where finer adjustment is needed.

Table 4b. Fine-Thread Series, UNF and UNRF — Basic Dimensions

Sizes No. or Inches	Basic Major Dia., <i>D</i>	Thds. per Inch, <i>n</i>	Basic Pitch Dia., ^a <i>D</i> ₂	Minor Diameter		Lead Angle λ at Basic P.D.		Area of Minor Dia. at <i>D</i> -2 <i>h</i> _p	Tensile Stress Area ^b
				Ext. Thds., ^c <i>d</i> ₃ (Ref.)	Int. Thds., ^d <i>D</i> ₁	Deg.	Min		
	Inches	Inches	Inches	Inches	Sq. In.			Sq. In.	
0 (0.060)	0.0600	80	0.0519	0.0451	0.0465	4	23	0.00151	0.00180
1 (0.073)^e	0.0730	72	0.0640	0.0565	0.0580	3	57	0.00237	0.00278
2 (0.086)	0.0860	64	0.0759	0.0674	0.0691	3	45	0.00339	0.00394
3 (0.099)^e	0.0990	56	0.0874	0.0778	0.0797	3	43	0.00451	0.00523
4 (0.112)	0.1120	48	0.0985	0.0871	0.0894	3	51	0.00566	0.00661
5 (0.125)	0.1250	44	0.1102	0.0979	0.1004	3	45	0.00716	0.00830
6 (0.138)	0.1380	40	0.1218	0.1082	0.1109	3	44	0.00874	0.01015
8 (0.164)	0.1640	36	0.1460	0.1309	0.1339	3	28	0.01285	0.01474
10 (0.190)	0.1900	32	0.1697	0.1528	0.1562	3	21	0.0175	0.0200
12 (0.216)^e	0.2160	28	0.1928	0.1734	0.1773	3	22	0.0226	0.0258
1/4	0.2500	28	0.2268	0.2074	0.2113	2	52	0.0326	0.0364
5/16	0.3125	24	0.2854	0.2629	0.2674	2	40	0.0524	0.0580
3/8	0.3750	24	0.3479	0.3254	0.3299	2	11	0.0809	0.0878
7/16	0.4375	20	0.4050	0.3780	0.3834	2	15	0.1090	0.1187
1/2	0.5000	20	0.4675	0.4405	0.4459	1	57	0.1486	0.1599
9/16	0.5625	18	0.5264	0.4964	0.5024	1	55	0.189	0.203
5/8	0.6250	18	0.5889	0.5589	0.5649	1	43	0.240	0.256
3/4	0.7500	16	0.7094	0.6763	0.6823	1	36	0.351	0.373
7/8	0.8750	14	0.8286	0.7900	0.7977	1	34	0.480	0.509
1	1.0000	12	0.9459	0.9001	0.9098	1	36	0.625	0.663
1 1/8	1.1250	12	1.0709	1.0258	1.0348	1	25	0.812	0.856
1 1/4	1.2500	12	1.1959	1.1508	1.1598	1	16	1.024	1.073
1 3/8	1.3750	12	1.3209	1.2758	1.2848	1	9	1.260	1.315
1 1/2	1.5000	12	1.4459	1.4008	1.4098	1	3	1.521	1.581

^a British: Effective Diameter.

^b See formula, pages 1528 and 1536.

^c Design form for UNR threads. (See figure on page 1814.)

^d Basic minor diameter.

^e Secondary sizes.

Extra-Fine-Thread Series: This series, UNEF/UNREF, is applicable where even finer pitches of threads are desirable, as for short lengths of engagement and for thin-walled tubes, nuts, ferrules, or couplings. It is also generally applicable under the conditions stated above for the fine threads. See Table 4c.

Fine Threads for Thin-Wall Tubing: Dimensions for a 27-thread series, ranging from 1/4- to 1-inch nominal size, also are included in Table 3. These threads are recommended for general use on thin-wall tubing. The minimum length of complete thread is one-third of the basic major diameter plus 5 threads (+ 0.185 in.).

Selected Combinations: Thread data are tabulated in Table 3 for certain additional selected special combinations of diameter and pitch, with pitch diameter tolerances based on a length of thread engagement of 9 times the pitch. The pitch diameter limits are applicable to a length of engagement of from 5 to 15 times the pitch. (This provision should not be confused with the lengths of thread on mating parts, as they may exceed the length of engagement by a considerable amount.) Thread symbols are UNS and UNRS.

Table 4c. Extra-Fine-Thread Series, UNEF and UNREF — Basic Dimensions

Sizes No. or Inches	Basic Major Dia., <i>D</i>	Thds. per Inch, <i>n</i>	Basic Pitch Dia., ^a <i>D</i> ₂	Minor Diameter		Lead Angle λ at Basic P.D.		Area of Minor Dia. at <i>D</i> - 2 <i>h</i> _b	Tensile Stress Area ^b
				Ext. Thds., ^c <i>d</i> ₃ (Ref.)	Int. Thds., ^d <i>D</i> ₁				
	Inches	Inches	Inches	Inches	Inches	Deg.	Min	Sq. In.	Sq. In.
12 (0.216)^e	0.2160	32	0.1957	0.1788	0.1822	2	55	0.0242	0.0270
$\frac{1}{4}$	0.2500	32	0.2297	0.2128	0.2162	2	29	0.0344	0.0379
$\frac{5}{16}$	0.3125	32	0.2922	0.2753	0.2787	1	57	0.0581	0.0625
$\frac{3}{8}$	0.3750	32	0.3547	0.3378	0.3412	1	36	0.0878	0.0932
$\frac{7}{16}$	0.4375	28	0.4143	0.3949	0.3988	1	34	0.1201	0.1274
$\frac{1}{2}$	0.5000	28	0.4768	0.4574	0.4613	1	22	0.162	0.170
$\frac{9}{16}$	0.5625	24	0.5354	0.5129	0.5174	1	25	0.203	0.214
$\frac{5}{8}$	0.6250	24	0.5979	0.5754	0.5799	1	16	0.256	0.268
$1\frac{1}{16}^e$	0.6875	24	0.6604	0.6379	0.6424	1	9	0.315	0.329
$\frac{3}{4}$	0.7500	20	0.7175	0.6905	0.6959	1	16	0.369	0.386
$1\frac{3}{16}^e$	0.8125	20	0.7800	0.7530	0.7584	1	10	0.439	0.458
$\frac{7}{8}$	0.8750	20	0.8425	0.8155	0.8209	1	5	0.515	0.536
$1\frac{5}{16}^e$	0.9375	20	0.9050	0.8780	0.8834	1	0	0.598	0.620
1	1.0000	20	0.9675	0.9405	0.9459	0	57	0.687	0.711
$1\frac{1}{16}^e$	1.0625	18	1.0264	0.9964	1.0024	0	59	0.770	0.799
$1\frac{1}{8}$	1.1250	18	1.0889	1.0589	1.0649	0	56	0.871	0.901
$1\frac{3}{16}^e$	1.1875	18	1.1514	1.1214	1.1274	0	53	0.977	1.009
$1\frac{1}{4}$	1.2500	18	1.2139	1.1839	1.1899	0	50	1.090	1.123
$1\frac{5}{16}^e$	1.3125	18	1.2764	1.2464	1.2524	0	48	1.208	1.244
$1\frac{3}{8}$	1.3750	18	1.3389	1.3089	1.3149	0	45	1.333	1.370
$1\frac{7}{16}^e$	1.4375	18	1.4014	1.3714	1.3774	0	43	1.464	1.503
$1\frac{1}{2}$	1.5000	18	1.4639	1.4339	1.4399	0	42	1.60	1.64
$1\frac{9}{16}^e$	1.5625	18	1.5264	1.4964	1.5024	0	40	1.74	1.79
$1\frac{5}{8}$	1.6250	18	1.5889	1.5589	1.5649	0	38	1.89	1.94
$1\frac{11}{16}^e$	1.6875	18	1.6514	1.6214	1.6274	0	37	2.05	2.10

^a British: Effective Diameter.

^b See formula, pages 1528 and 1536.

^c Design form for UNR threads. (See figure on page 1814.)

^d Basic minor diameter.

^e Secondary sizes.

Other Threads of Special Diameters, Pitches, and Lengths of Engagement: Thread data for special combinations of diameter, pitch, and length of engagement not included in selected combinations are also given in the Standard but are not given here. Also, when design considerations require non-standard pitches or extreme conditions of engagement not covered by the tables, the allowance and tolerances should be derived from the formulas in the Standard. The thread symbol for such special threads is UNS.

Constant Pitch Series.—The various constant-pitch series, UN, with 4, 6, 8, 12, 16, 20, 28 and 32 threads per inch, given in Table 3, offer a comprehensive range of diameter-pitch combinations for those purposes where the threads in the Coarse, Fine, and Extra-Fine series do not meet the particular requirements of the design.

When selecting threads from these constant-pitch series, preference should be given wherever possible to those tabulated in the 8-, 12-, or 16-thread series.

8-Thread Series: The 8-thread series (8-UN) is a uniform-pitch series for large diameters. Although originally intended for high-pressure-joint bolts and nuts, it is now widely used as a substitute for the Coarse-Thread Series for diameters larger than 1 inch.

12-Thread Series: The 12-thread series (12-UN) is a uniform pitch series for large diameters requiring threads of medium-fine pitch. Although originally intended for boiler practice, it is now used as a continuation of the Fine-Thread Series for diameters larger than 1½ inches.

16-Thread Series: The 16-thread series (16-UN) is a uniform pitch series for large diameters requiring fine-pitch threads. It is suitable for adjusting collars and retaining nuts, and also serves as a continuation of the Extra-fine Thread Series for diameters larger than 1¼ inches.

4-, 6-, 20-, 28-, and 32-Thread Series: These thread series have been used more or less widely in industry for various applications where the Standard Coarse, Fine or Extra-fine Series were not as applicable. They are now recognized as Standard Unified Thread Series in a specified selection of diameters for each pitch (see Table 2).

Whenever a thread in a constant-pitch series also appears in the UNC, UNF, or UNEF series, the symbols and tolerances for limits of size of UNC, UNF, or UNEF series are applicable, as will be seen in Tables 2 and 3. (Text continues on page 1854)

Table 5a. 4-Thread Series, 4-UN and 4-UNR — Basic Dimensions

Sizes		Basic Major Dia., <i>D</i>	Basic Pitch Dia., ^a <i>D</i> ₂	Minor Diameter		Lead Angle λ at Basic P.D.		Area of Minor Dia. at <i>D</i> - 2 <i>h</i> _b	Tensile Stress Area ^b
Primary	Secondary			Ext. Thds., ^c <i>d</i> _{3s} (Ref.)	Int. Thds., ^d <i>D</i> ₁	Deg.	Min.		
Inches	Inches	Inches	Inches	Inches	Inches			Sq. In.	Sq. In.
2½ ^e	2⅝	2.5000	2.3376	2.2023	2.2294	1	57	3.72	4.00
		2.6250	2.4626	2.3273	2.3544	1	51	4.16	4.45
2¾ ^e	2⅞	2.7500	2.5876	2.4523	2.4794	1	46	4.62	4.93
		2.8750	2.7126	2.5773	2.6044	1	41	5.11	5.44
3 ^e	3⅛	3.0000	2.8376	2.7023	2.7294	1	36	5.62	5.97
		3.1250	2.9626	2.8273	2.8544	1	32	6.16	6.52
3¼ ^e	3⅜	3.2500	3.0876	2.9523	2.9794	1	29	6.72	7.10
		3.3750	3.2126	3.0773	3.1044	1	25	7.31	7.70
3½ ^e	3⅝	3.5000	3.3376	3.2023	3.2294	1	22	7.92	8.33
		3.6250	3.4626	3.3273	3.3544	1	19	8.55	9.00
3¾ ^e	3⅞	3.7500	3.5876	3.4523	3.4794	1	16	9.21	9.66
		3.8750	3.7126	3.5773	3.6044	1	14	9.90	10.36
4 ^e	4⅛	4.0000	3.8376	3.7023	3.7294	1	11	10.61	11.08
		4.1250	3.9626	3.8273	3.8544	1	9	11.34	11.83
4¼	4⅜	4.2500	4.0876	3.9523	3.9794	1	7	12.10	12.61
		4.3750	4.2126	4.0773	4.1044	1	5	12.88	13.41
4½	4⅝	4.5000	4.3376	4.2023	4.2294	1	3	13.69	14.23
		4.6250	4.4626	4.3273	4.3544	1	1	14.52	15.1
4¾	4⅞	4.7500	4.5876	4.4523	4.4794	1	0	15.4	15.9
		4.8750	4.7126	4.5773	4.6044	0	58	16.3	16.8
5	5⅛	5.0000	4.8376	4.7023	4.7294	0	57	17.2	17.8
		5.1250	4.9626	4.8273	4.8544	0	55	18.1	18.7
5¼	5⅜	5.2500	5.0876	4.9523	4.9794	0	54	19.1	19.7
		5.3750	5.2126	5.0773	5.1044	0	52	20.0	20.7
5½	5⅝	5.5000	5.3376	5.2023	5.2294	0	51	21.0	21.7
		5.6250	5.4626	5.3273	5.3544	0	50	22.1	22.7
5¾	5⅞	5.7500	5.5876	5.4523	5.4794	0	49	23.1	23.8
		5.8750	5.7126	5.5773	5.6044	0	48	24.2	24.9
6		6.0000	5.8376	5.7023	5.7294	0	47	25.3	26.0

^aBritish: Effective Diameter.

^bSee formula, pages 1528 and 1536.

^cDesign form for UNR threads. (See figure on page 1814).

^dBasic minor diameter.

^eThese are standard sizes of the UNC series.

Table 5b. 6-Thread Series, 6-UN and 6-UNR—Basic Dimensions

Sizes		Basic Major Dia., <i>D</i>	Basic Pitch Dia., ^a <i>D</i> ₂	Minor Diameter		Lead Angle λ at Basic P.D.		Area of Minor Dia. at $D - 2h_b$	Tensile Stress Area ^b
Primary	Secondary			Ext. Thds., ^c <i>d</i> ₃ (Ref.)	Int. Thds., ^d <i>D</i> ₁	Deg.	Min.		
Inches	Inches	Inches	Inches	Inches	Inches	Deg.	Min.	Sq. In.	Sq. In.
1 $\frac{3}{8}$ ^e		1.3750	1.2667	1.1766	1.1946	2	24	1.054	1.155
	1 $\frac{7}{16}$	1.4375	1.3292	1.2391	1.2571	2	17	1.171	1.277
1 $\frac{1}{2}$ ^e		1.5000	1.3917	1.3016	1.3196	2	11	1.294	1.405
	1 $\frac{9}{16}$	1.5625	1.4542	1.3641	1.3821	2	5	1.423	1.54
1 $\frac{5}{8}$		1.6250	1.5167	1.4271	1.4446	2	0	1.56	1.68
	1 $\frac{11}{16}$	1.6875	1.5792	1.4891	1.5071	1	55	1.70	1.83
1 $\frac{3}{4}$		1.7500	1.6417	1.5516	1.5696	1	51	1.85	1.98
	1 $\frac{13}{16}$	1.8125	1.7042	1.6141	1.6321	1	47	2.00	2.14
1 $\frac{7}{8}$		1.8750	1.7667	1.6766	1.6946	1	43	2.16	2.30
	1 $\frac{15}{16}$	1.9375	1.8292	1.7391	1.7571	1	40	2.33	2.47
2		2.0000	1.8917	1.8016	1.8196	1	36	2.50	2.65
	2 $\frac{1}{8}$	2.1250	2.0167	1.9266	1.9446	1	30	2.86	3.03
2 $\frac{1}{4}$		2.2500	2.1417	2.0516	2.0696	1	25	3.25	3.42
	2 $\frac{3}{8}$	2.3750	2.2667	2.1766	2.1946	1	20	3.66	3.85
2 $\frac{1}{2}$		2.5000	2.3917	2.3016	2.3196	1	16	4.10	4.29
	2 $\frac{5}{8}$	2.6250	2.5167	2.4266	2.4446	1	12	4.56	4.76
2 $\frac{3}{4}$		2.7500	2.6417	2.5516	2.5696	1	9	5.04	5.26
	2 $\frac{7}{8}$	2.8750	2.7667	2.6766	2.6946	1	6	5.55	5.78
3		3.0000	2.8917	2.8016	2.8196	1	3	6.09	6.33
	3 $\frac{1}{8}$	3.1250	3.0167	2.9266	2.9446	1	0	6.64	6.89
3 $\frac{1}{4}$		3.2500	3.1417	3.0516	3.0696	0	58	7.23	7.49
	3 $\frac{3}{8}$	3.3750	3.2667	3.1766	3.1946	0	56	7.84	8.11
3 $\frac{1}{2}$		3.5000	3.3917	3.3016	3.3196	0	54	8.47	8.75
	3 $\frac{5}{8}$	3.6250	3.5167	3.4266	3.4446	0	52	9.12	9.42
3 $\frac{3}{4}$		3.7500	3.6417	3.5516	3.5696	0	50	9.81	10.11
	3 $\frac{7}{8}$	3.8750	3.7667	3.6766	3.6946	0	48	10.51	10.83
4		4.0000	3.8917	3.8016	3.8196	0	47	11.24	11.57
	4 $\frac{1}{8}$	4.1250	4.0167	3.9266	3.9446	0	45	12.00	12.33
4 $\frac{1}{4}$		4.2500	4.1417	4.0516	4.0696	0	44	12.78	13.12
	4 $\frac{3}{8}$	4.3750	4.2667	4.1766	4.1946	0	43	13.58	13.94
4 $\frac{1}{2}$		4.5000	4.3917	4.3016	4.3196	0	42	14.41	14.78
	4 $\frac{5}{8}$	4.6250	4.5167	4.4266	4.4446	0	40	15.3	15.6
4 $\frac{3}{4}$		4.7500	4.6417	4.5516	4.5696	0	39	16.1	16.5
	4 $\frac{7}{8}$	4.8750	4.7667	4.6766	4.6946	0	38	17.0	17.5
5		5.0000	4.8917	4.8016	4.8196	0	37	18.0	18.4
	5 $\frac{1}{8}$	5.1250	5.0167	4.9266	4.9446	0	36	18.9	19.3
5 $\frac{1}{4}$		5.2500	5.1417	5.0516	5.0696	0	35	19.9	20.3
	5 $\frac{3}{8}$	5.3750	5.2667	5.1766	5.1946	0	35	20.9	21.3
5 $\frac{1}{2}$		5.5000	5.3917	5.3016	5.3196	0	34	21.9	22.4
	5 $\frac{5}{8}$	5.6250	5.5167	5.4266	5.4446	0	33	23.0	23.4
5 $\frac{3}{4}$		5.7500	5.6417	5.5516	5.5696	0	32	24.0	24.5
	5 $\frac{7}{8}$	5.8750	5.7667	5.6766	5.6946	0	32	25.1	25.6
6		6.0000	5.8917	5.8016	5.8196	0	31	26.3	26.8

^a British: Effective Diameter.

^b See formula, pages 1528 and 1536.

^c Design form for UNR threads. (See figure on page 1814).

^d Basic minor diameter.

^e These are standard sizes of the UNC series.

Table 5c. 8-Thread Series, 8-UN and 8-UNR—Basic Dimensions

Sizes		Basic Major Dia., D	Basic Pitch Dia., ^a D_2	Minor Diameter		Lead Angle λ at Basic P.D.		Area of Minor Dia. at $D - 2h_b$	Tensile Stress Area ^b
Primary	Secondary			Ext.Thds., ^c d_3 (Ref.)	Int.Thds., ^d D_1	Deg.	Min.		
Inches	Inches	Inches	Inches	Inches	Inches	Deg.	Min.	Sq. In.	Sq. In.
1 ^e		1.0000	0.9188	0.8512	0.8647	2	29	0.551	0.606
	1 ¹ / ₁₆	1.0625	0.9813	0.9137	0.9272	2	19	0.636	0.695
1 ¹ / ₈		1.1250	1.0438	0.9792	0.9897	2	11	0.728	0.790
	1 ³ / ₁₆	1.1875	1.1063	1.0387	1.0522	2	4	0.825	0.892
1 ¹ / ₄		1.2500	1.1688	1.1012	1.1147	1	57	0.929	1.000
	1 ⁵ / ₁₆	1.3125	1.2313	1.1637	1.1772	1	51	1.039	1.114
1 ³ / ₈		1.3750	1.2938	1.2262	1.2397	1	46	1.155	1.233
	1 ⁷ / ₁₆	1.4375	1.3563	1.2887	1.3022	1	41	1.277	1.360
1 ¹ / ₂		1.5000	1.4188	1.3512	1.3647	1	36	1.405	1.492
	1 ⁹ / ₁₆	1.5625	1.4813	1.4137	1.4272	1	32	1.54	1.63
1 ⁵ / ₈		1.6250	1.5438	1.4806	1.4897	1	29	1.68	1.78
	1 ¹¹ / ₁₆	1.6875	1.6063	1.5387	1.5522	1	25	1.83	1.93
1 ³ / ₄		1.7500	1.6688	1.6012	1.6147	1	22	1.98	2.08
	1 ¹³ / ₁₆	1.8125	1.7313	1.6637	1.6772	1	19	2.14	2.25
1 ⁷ / ₈		1.8750	1.7938	1.7262	1.7397	1	16	2.30	2.41
	1 ¹⁵ / ₁₆	1.9375	1.8563	1.7887	1.8022	1	14	2.47	2.59
2		2.0000	1.9188	1.8512	1.8647	1	11	2.65	2.77
	2 ¹ / ₈	2.1250	2.0438	1.9762	1.9897	1	7	3.03	3.15
2 ¹ / ₄		2.2500	2.1688	2.1012	2.1147	1	3	3.42	3.56
	2 ³ / ₈	2.3750	2.2938	2.2262	2.2397	1	0	3.85	3.99
2 ¹ / ₂		2.5000	2.4188	2.3512	2.3647	0	57	4.29	4.44
	2 ⁵ / ₈	2.6250	2.5438	2.4762	2.4897	0	54	4.76	4.92
2 ³ / ₄		2.7500	2.6688	2.6012	2.6147	0	51	5.26	5.43
	2 ⁷ / ₈	2.8750	2.7938	2.7262	2.7397	0	49	5.78	5.95
3		3.0000	2.9188	2.8512	2.8647	0	47	6.32	6.51
	3 ¹ / ₈	3.1250	3.0438	2.9762	2.9897	0	45	6.89	7.08
3 ¹ / ₄		3.2500	3.1688	3.1012	3.1147	0	43	7.49	7.69
	3 ³ / ₈	3.3750	3.2938	3.2262	3.2397	0	42	8.11	8.31
3 ¹ / ₂		3.5000	3.4188	3.3512	3.3647	0	40	8.75	8.96
	3 ⁵ / ₈	3.6250	3.5438	3.4762	3.4897	0	39	9.42	9.64
3 ³ / ₄		3.7500	3.6688	3.6012	3.6147	0	37	10.11	10.34
	3 ⁷ / ₈	3.8750	3.7938	3.7262	3.7397	0	36	10.83	11.06
4		4.0000	3.9188	3.8512	3.8647	0	35	11.57	11.81
	4 ¹ / ₈	4.1250	4.0438	3.9762	3.9897	0	34	12.34	12.59
4 ¹ / ₄		4.2500	4.1688	4.1012	4.1147	0	33	13.12	13.38
	4 ³ / ₈	4.3750	4.2938	4.2262	4.2397	0	32	13.94	14.21
4 ¹ / ₂		4.5000	4.4188	4.3512	4.3647	0	31	14.78	15.1
	4 ⁵ / ₈	4.6250	4.5438	4.4762	4.4897	0	30	15.6	15.9
4 ³ / ₄		4.7500	4.6688	4.6012	4.6147	0	29	16.5	16.8
	4 ⁷ / ₈	4.8750	4.7938	4.7262	4.7397	0	29	17.4	17.7
5		5.0000	4.9188	4.8512	4.8647	0	28	18.4	18.7
	5 ¹ / ₈	5.1250	5.0438	4.9762	4.9897	0	27	19.3	19.7
5 ¹ / ₄		5.2500	5.1688	5.1012	5.1147	0	26	20.3	20.7
	5 ³ / ₈	5.3750	5.2938	5.2262	5.2397	0	26	21.3	21.7
5 ¹ / ₂		5.5000	5.4188	5.3512	5.3647	0	25	22.4	22.7
	5 ⁵ / ₈	5.6250	5.5438	5.4762	5.4897	0	25	23.4	23.8
5 ³ / ₄		5.7500	5.6688	5.6012	5.6147	0	24	24.5	24.9
	5 ⁷ / ₈	5.8750	5.7938	5.7262	5.7397	0	24	25.6	26.0
6		6.0000	5.9188	5.8512	5.8647	0	23	26.8	27.1

^a British: Effective Diameter.

^b See formula, pages 1528 and 1536.

^c Design form for UNR threads. (See figure on page 1814).

^d Basic minor diameter.

^e This is a standard size of the UNC series.

Table 5d. 12-Thread series, 12-UN and 12-UNR—Basic Dimensions

Sizes		Basic Major Dia., <i>D</i>	Basic Pitch Dia., ^a <i>D</i> ₂	Minor Diameter		Lead Angle λ at Basic P.D.		Area of Minor Dia. at $D - 2h_p$ Sq. In.	Tensile Stress Area ^b Sq. In.
Primary	Secondary			Ext. Thds., ^c <i>d</i> ₃ (Ref.)	Int. Thds., ^d <i>D</i> ₁	Deg.	Min.		
Inches	Inches	Inches	Inches	Inches	Inches	Deg.	Min.	Sq. In.	Sq. In.
9/16 ^e		0.5625	0.5084	0.4633	0.4723	2	59	0.162	0.182
5/8		0.6250	0.5709	0.5258	0.5348	2	40	0.210	0.232
	11/16	0.6875	0.6334	0.5883	0.5973	2	24	0.264	0.289
3/4		0.7500	0.6959	0.6508	0.6598	2	11	0.323	0.351
	13/16	0.8125	0.7584	0.7133	0.7223	2	0	0.390	0.420
7/8		0.8750	0.8209	0.7758	0.7848	1	51	0.462	0.495
	15/16	0.9375	0.8834	0.8383	0.8473	1	43	0.540	0.576
1 ^e		1.0000	0.9459	0.9008	0.9098	1	36	0.625	0.663
	1 1/16	1.0625	1.0084	0.9633	0.9723	1	30	0.715	0.756
1 1/8 ^e		1.1250	1.0709	1.0258	1.0348	1	25	0.812	0.856
	1 3/16	1.1875	1.1334	1.0883	1.0973	1	20	0.915	0.961
1 1/4 ^e		1.2500	1.1959	1.1508	1.1598	1	16	1.024	1.073
	1 5/16	1.3125	1.2584	1.2133	1.2223	1	12	1.139	1.191
1 3/8		1.3750	1.3209	1.2758	1.2848	1	9	1.260	1.315
	1 7/16	1.4375	1.3834	1.3383	1.3473	1	6	1.388	1.445
1 1/2 ^e		1.5000	1.4459	1.4008	1.4098	1	3	1.52	1.58
	1 9/16	1.5625	1.5084	1.4633	1.4723	1	0	1.66	1.72
1 5/8		1.6250	1.5709	1.5258	1.5348	0	58	1.81	1.87
	1 11/16	1.6875	1.6334	1.5883	1.5973	0	56	1.96	2.03
1 3/4		1.7500	1.6959	1.6508	1.6598	0	54	2.12	2.19
	1 13/16	1.8125	1.7584	1.7133	1.7223	0	52	2.28	2.35
1 7/8		1.8750	1.8209	1.7758	1.7848	0	50	2.45	2.53
	1 15/16	1.9375	1.8834	1.8383	1.8473	0	48	2.63	2.71
2		2.0000	1.9459	1.9008	1.9098	0	47	2.81	2.89
	2 1/8	2.1250	2.0709	2.0258	2.0348	0	44	3.19	3.28
2 1/4		2.2500	2.1959	2.1508	2.1598	0	42	3.60	3.69
	2 3/8	2.3750	2.3209	2.2758	2.2848	0	39	4.04	4.13
2 1/2		2.5000	2.4459	2.4008	2.4098	0	37	4.49	4.60
	2 5/8	2.6250	2.5709	2.5258	2.5348	0	35	4.97	5.08
2 3/4		2.7500	2.6959	2.6508	2.6598	0	34	5.48	5.59
	2 7/8	2.8750	2.8209	2.7758	2.7848	0	32	6.01	6.13
3		3.0000	2.9459	2.9008	2.9098	0	31	6.57	6.69
	3 1/8	3.1250	3.0709	3.0258	3.0348	0	30	7.15	7.28
3 1/4		3.2500	3.1959	3.1508	3.1598	0	29	7.75	7.89
	3 3/8	3.3750	3.3209	3.2758	3.2848	0	27	8.38	8.52
3 1/2		3.5000	3.4459	3.4008	3.4098	0	26	9.03	9.18
	3 5/8	3.6250	3.5709	3.5258	3.5348	0	26	9.71	9.86
3 3/4		3.7500	3.6959	3.6508	3.6598	0	25	10.42	10.57
	3 7/8	3.8750	3.8209	3.7758	3.7848	0	24	11.14	11.30
4		4.0000	3.9459	3.9008	3.9098	0	23	11.90	12.06
	4 1/8	4.1250	4.0709	4.0258	4.0348	0	22	12.67	12.84
4 1/4		4.2500	4.1959	4.1508	4.1598	0	22	13.47	13.65
	4 3/8	4.3750	4.3209	4.2758	4.2848	0	21	14.30	14.48
4 1/2		4.5000	4.4459	4.4008	4.4098	0	21	15.1	15.3
	4 5/8	4.6250	4.5709	4.5258	4.5348	0	20	16.0	16.2
4 3/4		4.7500	4.6959	4.6508	4.6598	0	19	16.9	17.1
	4 7/8	4.8750	4.8209	4.7758	4.7848	0	19	17.8	18.0
5		5.0000	4.9459	4.9008	4.9098	0	18	18.8	19.0
	5 1/8	5.1250	5.0709	5.0258	5.0348	0	18	19.8	20.0
5 1/4		5.2500	5.1959	5.1508	5.1598	0	18	20.8	21.0
	5 3/8	5.3750	5.3209	5.2758	5.2848	0	17	21.8	22.0
5 1/2		5.5000	5.4459	5.4008	5.4098	0	17	22.8	23.1
	5 5/8	5.6250	5.5709	5.5258	5.5348	0	16	23.9	24.1
5 3/4		5.7500	5.6959	5.6508	5.6598	0	16	25.0	25.2
	5 7/8	5.8750	5.8209	5.7758	5.7848	0	16	26.1	26.4
6		6.0000	5.9459	5.9008	5.9098	0	15	27.3	27.5

^a British: Effective Diameter.

^b See formula, pages 1528 and 1536.

^c Design form for UNR threads. (See figure on page 1814.)

^d Basic minor diameter.

^e These are standard sizes of the UNC or UNF Series.

Table 5e. 16-Thread Series, 16-UN and 16-UNR—Basic Dimensions

Sizes		Basic Major Dia., D	Basic Pitch Dia., D_2	Minor Diameter		Lead Angle λ at Basic P.D.		Area of Minor Dia. at $D - 2h_b$	Tensile Stress Area ^b
Primary	Secondary			Ext. Thds., ^c d_3 (Ref.)	Int. Thds., ^d D_1	Deg.	Min.		
Inches	Inches	Inches	Inches	Inches	Inches	Deg.	Min.	Sq. In.	Sq. In.
3/8		0.3750	0.3344	0.3005	0.3073	3	24	0.0678	0.0775
7/16		0.4375	0.3969	0.3630	0.3698	2	52	0.0997	0.1114
1/2		0.5000	0.4594	0.4255	0.4323	2	29	0.1378	0.151
9/16		0.5625	0.5219	0.4880	0.4948	2	11	0.182	0.198
5/8		0.6250	0.5844	0.5505	0.5573	1	57	0.232	0.250
	11/16	0.6875	0.6469	0.6130	0.6198	1	46	0.289	0.308
3/4		0.7500	0.7094	0.6755	0.6823	1	36	0.351	0.373
	13/16	0.8125	0.7719	0.7380	0.7448	1	29	0.420	0.444
7/8		0.8750	0.8344	0.8005	0.8073	1	22	0.495	0.521
	15/16	0.9375	0.8969	0.8630	0.8698	1	16	0.576	0.604
1		1.0000	0.9594	0.9255	0.9323	1	11	0.663	0.693
	1 1/16	1.0625	1.0219	0.9880	0.9948	1	7	0.756	0.788
1 1/8		1.1250	1.0844	1.0505	1.0573	1	3	0.856	0.889
	1 3/16	1.1875	1.1469	1.1130	1.1198	1	0	0.961	0.997
1 1/4		1.2500	1.2094	1.1755	1.1823	0	57	1.073	1.111
	1 5/16	1.3125	1.2719	1.2380	1.2448	0	54	1.191	1.230
1 3/8		1.3750	1.3344	1.3005	1.3073	0	51	1.315	1.356
	1 7/16	1.4375	1.3969	1.3630	1.3698	0	49	1.445	1.488
1 1/2		1.5000	1.4594	1.4255	1.4323	0	47	1.58	1.63
	1 9/16	1.5625	1.5219	1.4880	1.4948	0	45	1.72	1.77
1 5/8		1.6250	1.5844	1.5505	1.5573	0	43	1.87	1.92
	1 11/16	1.6875	1.6469	1.6130	1.6198	0	42	2.03	2.08
1 3/4		1.7500	1.7094	1.6755	1.6823	0	40	2.19	2.24
	1 13/16	1.8125	1.7719	1.7380	1.7448	0	39	2.35	2.41
1 7/8		1.8750	1.8344	1.8005	1.8073	0	37	2.53	2.58
	1 15/16	1.9375	1.8969	1.8630	1.8698	0	36	2.71	2.77
2		2.0000	1.9594	1.9255	1.9323	0	35	2.89	2.95
	2 1/8	2.1250	2.0844	2.0505	2.0573	0	33	3.28	3.35
2 1/4		2.2500	2.2094	2.1755	2.1823	0	31	3.69	3.76
	2 3/8	2.3750	2.3344	2.3005	2.3073	0	29	4.13	4.21
2 1/2		2.5000	2.4594	2.4255	2.4323	0	28	4.60	4.67
	2 5/8	2.6250	2.5844	2.5505	2.5573	0	26	5.08	5.16
2 3/4		2.7500	2.7094	2.6755	2.6823	0	25	5.59	5.68
	2 7/8	2.8750	2.8344	2.8005	2.8073	0	24	6.13	6.22
3		3.0000	2.9594	2.9255	2.9323	0	23	6.69	6.78
	3 1/8	3.1250	3.0844	3.0505	3.0573	0	22	7.28	7.37
3 1/4		3.2500	3.2094	3.1755	3.1823	0	21	7.89	7.99
	3 3/8	3.3750	3.3344	3.3005	3.3073	0	21	8.52	8.63
3 1/2		3.5000	3.4594	3.4255	3.4323	0	20	9.18	9.29
	3 5/8	3.6250	3.5844	3.5505	3.5573	0	19	9.86	9.98
3 3/4		3.7500	3.7094	3.6755	3.6823	0	18	10.57	10.69
	3 7/8	3.8750	3.8344	3.8005	3.8073	0	18	11.30	11.43
4		4.0000	3.9594	3.9255	3.9323	0	17	12.06	12.19
	4 1/8	4.1250	4.0844	4.0505	4.0573	0	17	12.84	12.97
4 1/4		4.2500	4.2094	4.1755	4.1823	0	16	13.65	13.78
	4 3/8	4.3750	4.3344	4.3005	4.3073	0	16	14.48	14.62
4 1/2		4.5000	4.4594	4.4255	4.4323	0	15	15.34	15.5
	4 5/8	4.6250	4.5844	4.5505	4.5573	0	15	16.2	16.4
4 3/4		4.7500	4.7094	4.6755	4.6823	0	15	17.1	17.3
	4 7/8	4.8750	4.8344	4.8005	4.8073	0	14	18.0	18.2
5		5.0000	4.9594	4.9255	4.9323	0	14	19.0	19.2
	5 1/8	5.1250	5.0844	5.0505	5.0573	0	13	20.0	20.1
5 1/4		5.2500	5.2094	5.1755	5.1823	0	13	21.0	21.1
	5 3/8	5.3750	5.3344	5.3005	5.3073	0	13	22.0	22.2

Table 5e. (Continued) 16-Thread Series, 16-UN and 16-UNR—Basic Dimensions

Sizes		Basic Major Dia., D	Basic Pitch Dia., ^a D_2	Minor Diameter		Lead Angle λ at Basic P.D.		Area of Minor Dia. at $D - 2h_b$	Tensile Stress Area ^b
Primary	Secondary			Ext. Thds., ^c d_3 (Ref.)	Int. Thds., ^d D_1	Deg.	Min.		
5½	5⅝	5.5000	5.4594	5.4255	5.4323	0	13	23.1	23.2
		5.6250	5.5844	5.5505	5.5573	0	12	24.1	24.3
5¾	5⅝	5.7500	5.7094	5.6755	5.6823	0	12	25.2	25.4
		5.8750	5.8344	5.8005	5.8073	0	12	26.4	26.5
6		6.0000	5.9594	5.9255	5.9323	0	11	27.5	27.7

^a British: Effective Diameter.

^b See formula, pages 1528 and 1536.

^c Design form for UNR threads. (See figure on page 1814).

^d Basic minor diameter.

^e These are standard sizes of the UNC or UNF Series.

Table 5f. 20-Thread Series, 20-UN and 20-UNR—Basic Dimensions

Sizes		Basic Major Dia., D	Basic Pitch Dia., ^a D_2	Minor Diameter		Lead Angle λ at Basic P.D.		Area of Minor Dia. at $D - 2h_b$	Tensile Stress Area ^b
Primary	Secondary			Ext. Thds., ^c d_3 (Ref.)	Int. Thds., ^d D_1	Deg.	Min.		
¼ ^e		0.2500	0.2175	0.1905	0.1959	4	11	0.0269	0.0318
		0.3125	0.2800	0.2530	0.2584	3	15	0.0481	0.0547
⅜		0.3750	0.3425	0.3155	0.3209	2	40	0.0755	0.0836
		0.4375	0.4050	0.3780	0.3834	2	15	0.1090	0.1187
½ ^e		0.5000	0.4675	0.4405	0.4459	1	57	0.1486	0.160
		0.5625	0.5300	0.5030	0.5084	1	43	0.194	0.207
⅝		0.6250	0.5925	0.5655	0.5709	1	32	0.246	0.261
		0.6875	0.6550	0.6280	0.6334	1	24	0.304	0.320
¾ ^e	1¼ ₁₆	0.7500	0.7175	0.6905	0.6959	1	16	0.369	0.386
		0.8125	0.7800	0.7530	0.7584	1	10	0.439	0.458
7⁄8 ^e	1⅜ ₁₆	0.8750	0.8425	0.8155	0.8209	1	5	0.515	0.536
		0.9375	0.9050	0.8780	0.8834	1	0	0.0.598	0.620
1 ^e	1½ ₁₆	1.0000	0.9675	0.9405	0.9459	0	57	0.687	0.711
		1.0625	1.0300	1.0030	1.0084	0	53	0.782	0.807
1⅛	1⅜ ₁₆	1.1250	1.0925	1.0655	1.0709	0	50	0.882	0.910
		1.1875	1.1550	1.1280	1.1334	0	47	0.990	1.018
1¼ ₁₄	1⅝ ₁₆	1.2500	1.2175	1.1905	1.1959	0	45	1.103	1.133
		1.3125	1.2800	1.2530	1.2584	0	43	1.222	1.254
1⅜	1⅞ ₁₆	1.3750	1.3425	1.3155	1.3209	0	41	1.348	1.382
		1.4375	1.4050	1.3780	1.3834	0	39	1.479	1.51
1½	1⅞ ₁₆	1.5000	1.4675	1.4405	1.4459	0	37	1.62	1.65
		1.5625	1.5300	1.5030	1.5084	0	36	1.76	1.80
1⅝	1⅞ ₁₆	1.6250	1.5925	1.5655	1.5709	0	34	1.91	1.95
		1.6875	1.6550	1.6280	1.6334	0	33	2.07	2.11
1¾	1⅞ ₁₆	1.7500	1.7175	1.6905	1.6959	0	32	2.23	2.27
		1.8125	1.7800	1.7530	1.7584	0	31	2.40	2.44
1⅞	1⅞ ₁₆	1.8750	1.8425	1.8155	1.8209	0	30	2.57	2.62
		1.9375	1.9050	1.8780	1.8834	0	29	2.75	2.80
2	2⅞ ₁₆	2.0000	1.9675	1.9405	1.9459	0	28	2.94	2.99
		2.1250	2.0925	2.0655	2.0709	0	26	3.33	3.39
2¼	2⅞ ₁₆	2.2500	2.2175	2.1905	2.1959	0	25	3.75	3.81
		2.3750	2.3425	2.3155	2.3209	0	23	4.19	4.25
2½	2⅞ ₁₆	2.5000	2.4675	2.4405	2.4459	0	22	4.66	4.72
		2.6250	2.5925	2.5655	2.5709	0	21	5.15	5.21
2¾	2⅞ ₁₆	2.7500	2.7175	2.6905	2.6959	0	20	5.66	5.73
		2.8750	2.8425	2.8155	2.8209	0	19	6.20	6.27
3		3.0000	2.9675	2.9405	2.9459	0	18	6.77	6.84

^a British: Effective Diameter.

^b See formula, pages 1528 and 1536.

^c Design form for UNR threads. (See figure on page 1814.)

^d Basic minor diameter.

^e These are standard sizes of the UNC, UNF, or UNEF Series.

Table 5g. 28-Thread Series, 28-UN and 28-UNR — Basic Dimensions

Sizes		Basic Major Dia., D	Basic Pitch Dia., ^a D ₂	Minor Diameter		Lead Angel λ at Basic P.D.		Area of Minor Dia. at D - 2h _b	Tensile Stress Area ^b
Primary	Secondary			Ext. Thds., ^c d ₃ (Ref.)	Int. Thds., ^d D ₁	Deg.	Min.		
Inches	Inches	Inches	Inches	Inches	Inches	Deg.	Min.	Sq. In.	Sq. In.
	12 (0.216)^e	0.2160	0.1928	0.1734	0.1773	3	22	0.0226	0.0258
$\frac{1}{4}$ ^e		0.2500	0.2268	0.2074	0.2113	2	52	0.0326	0.0364
$\frac{5}{16}$		0.3125	0.2893	0.2699	0.2738	2	15	0.0556	0.0606
$\frac{3}{8}$		0.3750	0.3518	0.3324	0.3363	1	51	0.0848	0.0909
$\frac{7}{16}$ ^e		0.4375	0.4143	0.3949	0.3988	1	34	0.1201	0.1274
$\frac{1}{2}$		0.5000	0.4768	0.4574	0.4613	1	22	0.162	0.170
$\frac{9}{16}$		0.5625	0.5393	0.5199	0.5238	1	12	0.209	0.219
$\frac{5}{8}$		0.6250	0.6018	0.5824	0.5863	1	5	0.263	0.274
	$\frac{11}{16}$	0.6875	0.6643	0.6449	0.6488	0	59	0.323	0.335
$\frac{3}{4}$		0.7500	0.7268	0.7074	0.7113	0	54	0.389	0.402
	$\frac{13}{16}$	0.8125	0.7893	0.7699	0.7738	0	50	0.461	0.475
$\frac{7}{8}$		0.8750	0.8518	0.8324	0.8363	0	46	0.539	0.554
	$\frac{15}{16}$	0.9375	0.9143	0.8949	0.8988	0	43	0.624	0.640
1		1.0000	0.9768	0.9574	0.9613	0	40	0.714	0.732
	$\frac{1}{16}$	1.0625	1.0393	1.0199	1.0238	0	38	0.811	0.830
$\frac{1}{8}$		1.1250	1.1018	1.0824	1.0863	0	35	0.914	0.933
	$\frac{1}{4}$	1.1875	1.1643	1.1449	1.1488	0	34	1.023	1.044
$\frac{1}{4}$		1.2500	1.2268	1.2074	1.2113	0	32	1.138	1.160
	$\frac{1}{8}$	1.3125	1.2893	1.2699	1.2738	0	30	1.259	1.282
$\frac{1}{8}$		1.3750	1.3518	1.3324	1.3363	0	29	1.386	1.411
	$\frac{1}{16}$	1.4375	1.4143	1.3949	1.3988	0	28	1.52	1.55
$\frac{1}{2}$		1.5000	1.4768	1.4574	1.4613	0	26	1.66	1.69

^a British: Effective Diameter.

^b See formula, pages 1528 and 1536.

^c Design form for UNR threads. (See figure on page 1814.)

^d Basic minor diameter.

^e These are standard sizes of the UNF or UNEF Series.

Table 5h. 32-Thread Series, 32-UN and 32-UNR — Basic Dimensions

Sizes		Basic Major Dia., ^a D	Basic Pitch Dia., ^a D ₂	Minor Diameter		Lead Angel λ at Basic P.D.		Area of Minor Dia. at D - 2h _b	Tensile Stress Area ^b	
Primary	Secondary			Ext. Thds., ^c d ₃ (Ref.)	Int. Thds., ^d D ₁	Deg.	Min.			
Inches	Inches	Inches	Inches	Inches	Inches	Deg.	Min.	Sq. In.	Sq. In.	
6 (0.138)^e	12 (0.216)^e	0.1380	0.1177	0.1008	0.1042	4	50	0.00745	0.00909	
8 (0.164)^e		0.1640	0.1437	0.1268	0.1302	3	58	0.01196	0.0140	
10 (0.190)^e		0.1900	0.1697	0.1528	0.1562	3	21	0.01750	0.0200	
		0.2160	0.1957	0.1788	0.1822	2	55	0.0242	0.0270	
$\frac{1}{4}$		0.2500	0.2297	0.2128	0.2162	2	29	0.0344	0.0379	
$\frac{5}{16}$ ^e		0.3125	0.2922	0.2753	0.2787	1	57	0.0581	0.0625	
$\frac{3}{8}$ ^e		0.3750	0.3547	0.3378	0.3412	1	36	0.0878	0.0932	
$\frac{7}{16}$		0.4375	0.4172	0.4003	0.4037	1	22	0.1237	0.1301	
$\frac{1}{2}$		0.5000	0.4797	0.4628	0.4662	1	11	0.166	0.173	
$\frac{9}{16}$		0.5625	0.5422	0.5253	0.5287	1	3	0.214	0.222	
$\frac{5}{8}$		0.6250	0.6047	0.5878	0.5912	0	57	0.268	0.278	
		$\frac{11}{16}$	0.6875	0.6672	0.6503	0.6537	0	51	0.329	0.339
$\frac{3}{4}$			0.7500	0.7297	0.7128	0.7162	0	47	0.395	0.407
		$\frac{13}{16}$	0.8125	0.7922	0.7753	0.7787	0	43	0.468	0.480
$\frac{7}{8}$			0.8750	0.8547	0.8378	0.8412	0	40	0.547	0.560
		$\frac{15}{16}$	0.9375	0.9172	0.9003	0.9037	0	37	0.632	0.646
1		1.0000	0.9797	0.9628	0.9662	0	35	0.723	0.738	

^a British: Effective Diameter.

^b See formula, pages 1528 and 1536.

^c Design form for UNR threads. (See figure on page 1814.)

^d Basic minor diameter.

^e These are standard sizes of the UNC, UNF, or UNEF Series.

Thread Classes.—Thread classes are distinguished from each other by the amounts of tolerance and allowance. Classes identified by a numeral followed by the letters A and B are derived from certain Unified formulas (not shown here) in which the pitch diameter tolerances are based on increments of the basic major (nominal) diameter, the pitch, and the length of engagement. These formulas and the class identification or symbols apply to all of the Unified threads.

Classes 1A, 2A, and 3A apply to external threads only, and Classes 1B, 2B, and 3B apply to internal threads only. The disposition of the tolerances, allowances, and crest clearances for the various classes is illustrated on page 1855.

Classes 2A and 2B: Classes 2A and 2B are the most commonly used for general applications, including production of bolts, screws, nuts, and similar fasteners.

The maximum diameters of Class 2A (external) uncoated threads are less than basic by the amount of the allowance. The allowance minimizes galling and seizing in high-cycle wrench assembly, or it can be used to accommodate plated finishes or other coating. However, for threads with additive finish, the maximum diameters of Class 2A may be exceeded by the amount of the allowance, for example, the 2A maximum diameters apply to an unplated part or to a part before plating whereas the basic diameters (the 2A maximum diameter plus allowance) apply to a part after plating. The minimum diameters of Class 2B (internal) threads, whether or not plated or coated, are basic, affording no allowance or clearance in assembly at maximum metal limits.

Class 2AG: Certain applications require an allowance for rapid assembly to permit application of the proper lubricant or for residual growth due to high-temperature expansion. In these applications, when the thread is coated and the 2A allowance is not permitted to be consumed by such coating, the thread class symbol is qualified by G following the class symbol.

Classes 3A and 3B: Classes 3A and 3B may be used if closer tolerances are desired than those provided by Classes 2A and 2B. The maximum diameters of Class 3A (external) threads and the minimum diameters of Class 3B (internal) threads, whether or not plated or coated, are basic, affording no allowance or clearance for assembly of maximum metal components.

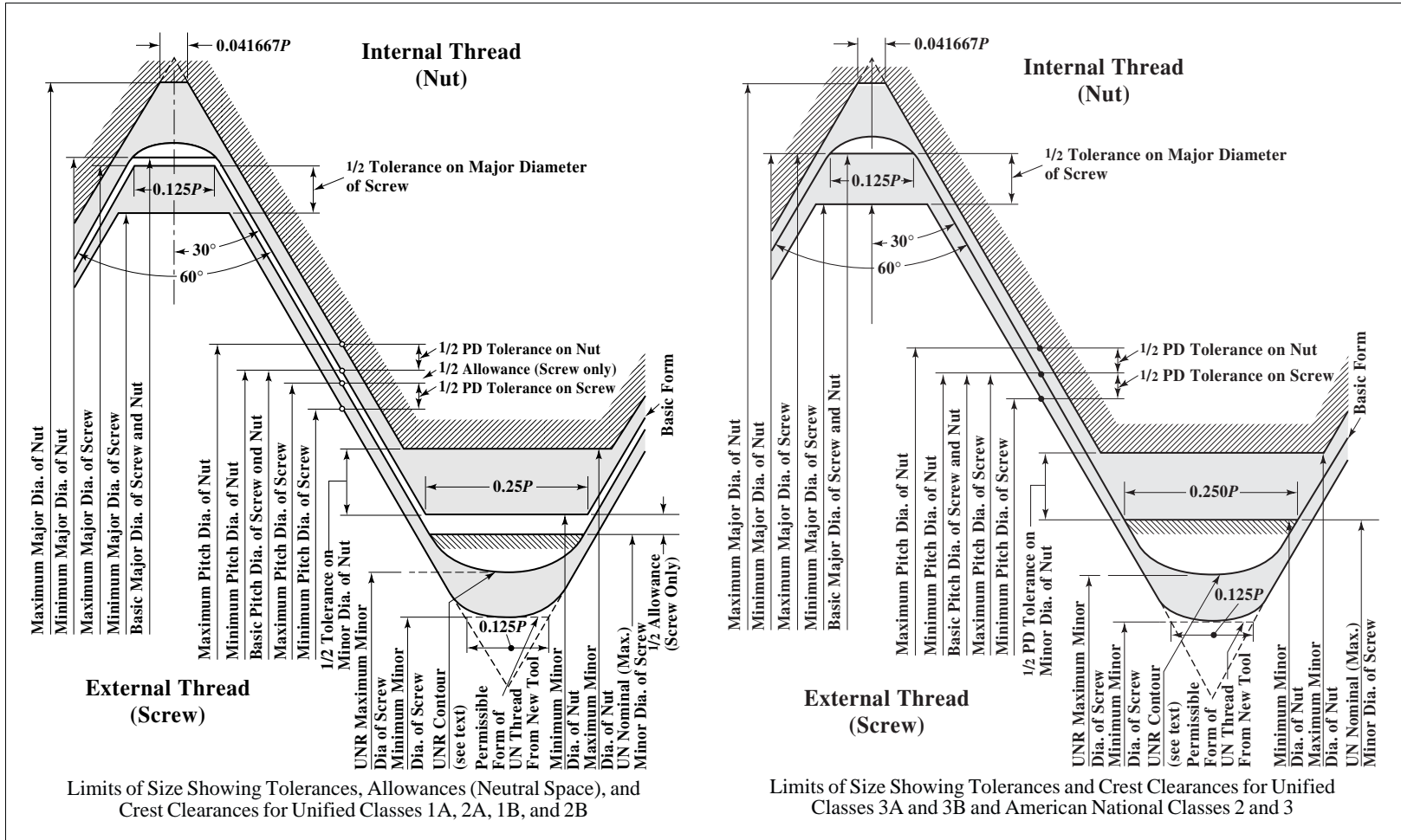
Classes 1A and 1B: Classes 1A and 1B threads replaced American National Class 1. These classes are intended for ordnance and other special uses. They are used on threaded components where quick and easy assembly is necessary and where a liberal allowance is required to permit ready assembly, even with slightly bruised or dirty threads.

Maximum diameters of Class 1A (external) threads are less than basic by the amount of the same allowance as applied to Class 2A. For the intended applications in American practice the allowance is not available for plating or coating. Where the thread is plated or coated, special provisions are necessary. The minimum diameters of Class 1B (internal) threads, whether or not plated or coated, are basic, affording no allowance or clearance for assembly with maximum metal external thread components having maximum diameters which are basic.

Coated 60-deg. Threads.—Although the Standard does not make recommendations for thicknesses of, or specify limits for coatings, it does outline certain principles that will aid mechanical interchangeability if followed whenever conditions permit.

To keep finished threads within the limits of size established in the Standard, external threads should not exceed basic size after plating and internal threads should not be below basic size after plating. This recommendation does not apply to threads coated by certain commonly used processes such as hot-dip galvanizing where it may not be required to maintain these limits.

Class 2A provides both a tolerance and an allowance. Many thread requirements call for coatings such as those deposited by electro-plating processes and, in general, the 2A allow-



ance provides adequate undercut for such coatings. There may be variations in thickness and symmetry of coating resulting from commercial processes but after plating the threads should be accepted by a basic Class 3A size GO gage and a Class 2A gage as a NOT-GO gage. Class 1A provides an allowance which is maintained for both coated and uncoated product, i.e., it is not available for coating.

Class 3A does not include an allowance so it is suggested that the limits of size before plating be reduced by the amount of the 2A allowance whenever that allowance is adequate.

No provision is made for overcutting internal threads as coatings on such threads are not generally required. Further, it is very difficult to deposit a significant thickness of coating on the flanks of internal threads. Where a specific thickness of coating is required on an internal thread, it is suggested that the thread be overcut so that the thread as coated will be accepted by a GO thread plug gage of basic size.

This Standard ASME/ANSI B1.1-1989 (R2008) specifies limits of size that pertain whether threads are coated or uncoated. Only in Class 2A threads is an allowance available to accommodate coatings. Thus, in all classes of internal threads and in all Class 1A, 2AG, and 3A external threads, limits of size must be adjusted to provide suitable provision for the desired coating.

For further information concerning dimensional accommodation of coating or plating for 60-degree threads, see Section 7, ASME/ANSI B1.1-1989 (R2008).

Screw Thread Selection — Combination of Classes.—Whenever possible, selection should be made from [Table 2](#), Standard Series Unified Screw Threads, preference being given to the Coarse- and Fine- thread Series. If threads in the standard series do not meet the requirements of design, reference should be made to the selected combinations in [Table 3](#). The third expedient is to compute the limits of size from the tolerance tables or tolerance increment tables given in the Standard. The fourth and last resort is calculation by the formulas given in the Standard.

The requirements for screw thread fits for specific applications depend on end use and can be met by specifying the proper combinations of thread classes for the components. For example, a Class 2A external thread may be used with a Class 1B, 2B, or 3B internal thread.

Pitch Diameter Tolerances, All Classes.—The pitch diameter tolerances in [Table 3](#) for all classes of the UNC, UNF, 4-UN, 6-UN, and 8-UN series are based on a length of engagement equal to the basic major (nominal) diameter and are applicable for lengths of engagement up to $1\frac{1}{2}$ diameters.

The pitch diameter tolerances used in [Table 3](#) for all classes of the UNEF, 12-UN, 16-UN, 20-UN, 28-UN, and 32-UN series and the UNS series, are based on a length of engagement of 9 pitches and are applicable for lengths of engagement of from 5 to 15 pitches.

Screw Thread Designation.—The basic method of designating a screw thread is used where the standard tolerances or limits of size based on the standard length of engagement are applicable. The designation specifies in sequence the nominal size, number of threads per inch, thread series symbol, thread class symbol, and the gaging system number per ASME/ANSI B1.3M. The nominal size is the basic major diameter and is specified as the fractional diameter, screw number, or their decimal equivalent. Where decimal equivalents are used for size callout, they shall be interpreted as being nominal size designations only and shall have no dimensional significance beyond the fractional size or number designation. The symbol LH is placed after the thread class symbol to indicate a left-hand thread:

Examples:

$\frac{1}{4}$ -20 UNC-2A (21) or 0.250-20 UNC-2A (21)

10-32 UNF-2A (22) or 0.190-32 UNF-2A (22)
 $\frac{7}{16}$ -20 UNRF-2A (23) or 0.4375-20 UNRF-2A (23)
 2-12 UN-2A (21) or 2.000-12 UN-2A (21)
 $\frac{1}{4}$ -20 UNC-3A-LH (21) or 0.250-20 UNC-3A-LH (21)

For uncoated standard series threads these designations may optionally be supplemented by the addition of the pitch diameter limits of size.

Example:

$\frac{1}{4}$ -20 UNC-2A (21)

PD 0.2164-0.2127 (Optional for uncoated threads)

Designating Coated Threads.—For coated (or plated) Class 2A external threads, the basic (max) major and basic (max) pitch diameters are given followed by the words AFTER COATING. The major and pitch diameter limits of size before coating are also given followed by the words BEFORE COATING.

Example:

$\frac{3}{4}$ -10 UNC-2A (21)

^aMajor dia 0.7500 max } AFTER COATING
 PD 0.6850 max

^bMajor dia 0.7482-0.7353 } BEFORE COATING
 PD 0.6832-0.6773 }

^aMajor and PD values are equal to basic and correspond to those in [Table 3](#) for Class 3A.

^bMajor and PD limits are those in [Table 3](#) for Class 2A.

Certain applications require an allowance for rapid assembly, to permit application of a proper lubricant, or for residual growth due to high-temperature expansion. In such applications where the thread is to be coated and the 2A allowance is not permitted to be consumed by such coating, the thread class symbol is qualified by the addition of the letter G (symbol for allowance) following the class symbol, and the maximum major and maximum pitch diameters are reduced below basic size by the amount of the 2A allowance and followed by the words AFTER COATING. This arrangement ensures that the allowance is maintained. The major and pitch diameter limits of size before coating are also given followed by SPL and BEFORE COATING. For information concerning the designating of this and other special coating conditions reference should be made to American National Standard ASME/ANSI B1.1-1989 (R2008).

Designating UNS Threads.—UNS screw threads that have special combinations of diameter and pitch with tolerance to Unified formulation have the basic form designation set out first followed always by the limits of size.

Designating Multiple Start Threads.—If a screw thread is of multiple start, it is designated by specifying in sequence the nominal size, pitch (in decimals or threads per inch) and lead (in decimals or fractions).

Other Special Designations.—For other special designations including threads with modified limits of size or with special lengths of engagement, reference should be made to American National Standard ASME/ANSI B1.1-1989 (R2008).

Hole Sizes for Tapping.—Hole size limits for tapping Classes 1B, 2B, and 3B threads of various lengths of engagement are given in [Table 2](#) on page 2021.

Internal Thread Minor Diameter Tolerances.—Internal thread minor diameter tolerances in [Table 3](#) are based on a length of engagement equal to the nominal diameter. For general applications these tolerances are suitable for lengths of engagement up to $1\frac{1}{2}$ diameters. However, some thread applications have lengths of engagement which are greater than $1\frac{1}{2}$ diameters or less than the nominal diameter. For such applications it may be advantageous to increase or decrease the tolerance, respectively, as explained in the Tapping Section.

American Standard for Unified Miniature Screw Threads

This American Standard (B1.10-1958, R1988) introduces a new series to be known as Unified Miniature Screw Threads and intended for general purpose fastening screws and similar uses in watches, instruments, and miniature mechanisms. Use of this series is recommended on all new products in place of the many improvised and unsystematized sizes now in existence which have never achieved broad acceptance nor recognition by standardization bodies. The series covers a diameter range from 0.30 to 1.40 millimeters (0.0118 to 0.0551 inch) and thus supplements the Unified and American thread series which begins at 0.060 inch (number 0 of the machine screw series). It comprises a total of fourteen sizes which, together with their respective pitches, are those endorsed by the American-British-Canadian Conference of April 1955 as the basis for a Unified standard among the inch-using countries, and coincide with the corresponding range of sizes in ISO (International Organization for Standardization) Recommendation No. 68. Additionally, it utilizes thread forms which are compatible in all significant respects with both the Unified and ISO basic thread profiles. Thus, threads in this series are interchangeable with the corresponding sizes in both the American-British-Canadian and ISO standardization programs.

Basic Form of Thread.—The basic profile by which the design forms of the threads covered by this standard are governed is shown in Table 1. The thread angle is 60 degrees and except for basic height and depth of engagement which are $0.52p$, instead of $0.54127p$, the basic profile for this thread standard is identical with the Unified and American basic thread form. The selection of 0.52 as the exact value of the coefficient for the height of this basic form is based on practical manufacturing considerations and a plan evolved to simplify calculations and achieve more precise agreement between the metric and inch dimensional tables.

Products made to this standard will be interchangeable with products made to other standards which allow a maximum depth of engagement (or combined addendum height) of $0.54127p$. The resulting difference is negligible (only 0.00025 inch for the coarsest pitch) and is completely offset by practical considerations in tapping, since internal thread heights exceeding $0.52p$ are avoided in these (Unified Miniature) small thread sizes in order to reduce excessive tap breakage.

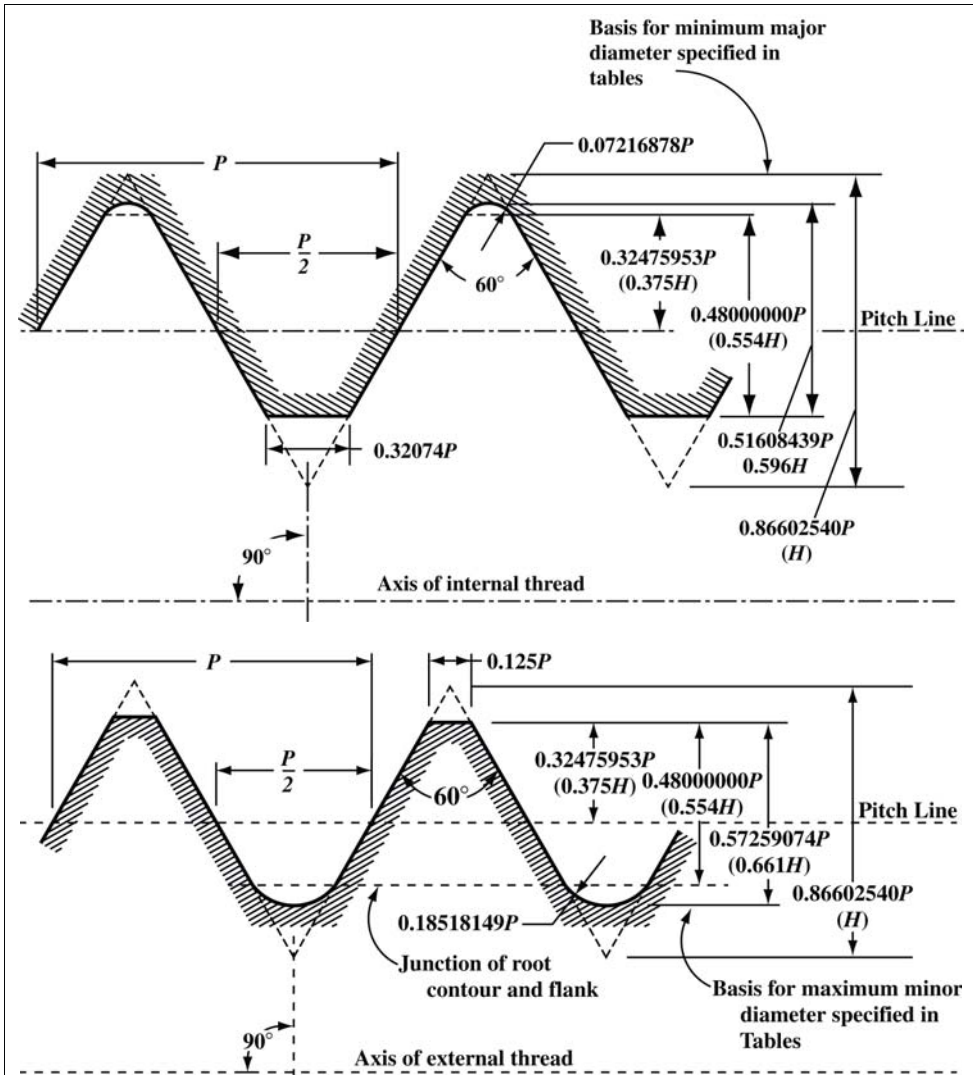
Design Forms of Threads.—The design (maximum material) forms of the external and internal threads are shown in Table 2. These forms are derived from the basic profile shown in Table 1 by the application of clearances for the crests of the addenda at the roots of the mating dedendum forms. Basic and design form dimensions are given in Table 3.

Nominal Sizes: The thread sizes comprising this series and their respective pitches are shown in the first two columns of Table 5. The fourteen sizes shown in Table 5 have been systematically distributed to provide a uniformly proportioned selection over the entire range. They are separated alternately into two categories: The sizes shown in bold type are selections made in the interest of simplification and are those to which it is recommended that usage be confined wherever the circumstances of design permit. Where these sizes do not meet requirements the intermediate sizes shown in light type are available.

Table 1. Unified Miniature Screw Threads — Basic Thread Form

	Formulas for Basic Thread Form Metric units (millimeters) are used in all formulas		
	Thread Element	Symbol	Formula
Angle of thread	2α	60°	
Half angle of thread	α	30°	
Pitch of thread	p		
No. of threads per inch	n	$25.4/p$	
Height of sharp V thread	H	$0.86603p$	
Addendum of basic thread	h_{ab}	$0.32476p$	
Height of basic thread	h_b	$0.52p$	

Table 2. Unified Miniature Screw Threads — Design Thread Form



Formulas for Design Thread Form (maximum material)^a

External Thread			Internal Thread		
Thread Element	Symbol	Formula	Thread Element	Symbol	Formula
Addendum	h_{as}	$0.32476p$	Height of engagement	h_e	$0.52p$
Height	h_s	$0.60p$	Height of thread	h_n	$0.556p$
Flat at crest	F_{cs}	$0.125p$	Flat at crest	F_{cn}	$0.27456p$
Radius at root	r_{rs}	$0.158p$ (approx)	Radius at root	r_{rn}	$0.072p$ (approx)

^a Metric units (millimeters) are used in all formulas.

Table 3. Unified Miniature Screw Threads—Basic and Design Form Dimensions

Basic Thread Form					External Thread Design Form			Internal Thread Design Form		
Threads per inch n^a	Pitch p	Height of Sharp V $H = 0.86603p$	Height $h_b = 0.52p$	Addendum $h_{ab} = h_{as} = 0.32476p$	Height $h_s = 0.60p$	Flat at Crest $F_{cs} = 0.125p$	Radius at Root $r_{rs} = 0.158p$	Height $h_n = 0.556p$	Flat at Crest $F_{cn} = 0.27456p$	Radius at Root $r_{rn} = 0.072p$
Millimeter Dimensions										
...	.080	.0693	.0416	.0260	.048	.0100	.0126	.0445	.0220	.0058
...	.090	.0779	.0468	.0292	.054	.0112	.0142	.0500	.0247	.0065
...	.100	.0866	.0520	.0325	.060	.0125	.0158	.0556	.0275	.0072
...	.125	.1083	.0650	.0406	.075	.0156	.0198	.0695	.0343	.0090
...	.150	.1299	.0780	.0487	.090	.0188	.0237	.0834	.0412	.0108
...	.175	.1516	.0910	.0568	.105	.0219	.0277	.0973	.0480	.0126
...	.200	.1732	.1040	.0650	.120	.0250	.0316	.1112	.0549	.0144
...	.225	.1949	.1170	.0731	.135	.0281	.0356	.1251	.0618	.0162
...	.250	.2165	.1300	.0812	.150	.0312	.0395	.1390	.0686	.0180
...	.300	.2598	.1560	.0974	.180	.0375	.0474	.1668	.0824	.0216
Inch Dimensions										
317½	.003150	.00273	.00164	.00102	.00189	.00039	.00050	.00175	.00086	.00023
282¾	.003543	.00307	.00184	.00115	.00213	.00044	.00056	.00197	.00097	.00026
254	.003937	.00341	.00205	.00128	.00236	.00049	.00062	.00219	.00108	.00028
203½	.004921	.00426	.00256	.00160	.00295	.00062	.00078	.00274	.00135	.00035
169⅓	.005906	.00511	.00307	.00192	.00354	.00074	.00093	.00328	.00162	.00043
145⅓	.006890	.00597	.00358	.00224	.00413	.00086	.00109	.00383	.00189	.00050
127	.007874	.00682	.00409	.00256	.00472	.00098	.00124	.00438	.00216	.00057
112¾	.008858	.00767	.00461	.00288	.00531	.00111	.00140	.00493	.00243	.00064
101⅓	.009843	.00852	.00512	.00320	.00591	.00123	.00156	.00547	.00270	.00071
84¾	.011811	.01023	.00614	.00384	.00709	.00148	.00187	.00657	.00324	.00085

^aIn Tables 5 and 6 these values are shown rounded to the nearest whole number.

Table 4. Unified Miniature Screw Threads — Formulas for Basic and Design Dimensions and Tolerances

Formulas for Basic Dimensions	
D = Basic Major Diameter and Nominal Size in millimeters; p = Pitch in millimeters; E = Basic Pitch Diameter in millimeters = $D - 0.64952p$; and K = Basic Minor Diameter in millimeters = $D - 1.04p$	
Formulas for Design Dimensions (Maximum Material)	
External Thread	Internal Thread
D_s = Major Diameter = D	D_n = Major Diameter = $D + 0.072p$
E_s = Pitch Diameter = E	E_n = Pitch Diameter = E
K_s = Minor Diameter = $D - 1.20p$	K_n = Minor Diameter = K
Formulas for Tolerances on Design Dimensions ^a	
External Thread (-)	Internal Thread (+)
Major Diameter Tol., $0.12p + 0.006$	^b Major Diameter Tol., $0.168p + 0.008$
Pitch Diameter Tol., $0.08p + 0.008$	Pitch Diameter Tol., $0.08p + 0.008$
^c Minor Diameter Tol., $0.16p + 0.008$	Minor Diameter Tol., $0.32p + 0.012$

^aThese tolerances are based on lengths of engagement of $\frac{2}{3}D$ to $1\frac{1}{2}D$.

^bThis tolerance establishes the maximum limit of the major diameter of the internal thread. In practice, this limit is applied to the threading tool (tap) and not gaged on the product. Values for this tolerance are, therefore, not given in Table 5.

^cThis tolerance establishes the minimum limit of the minor diameter of the external thread. In practice, this limit is applied to the threading tool and only gaged on the product in confirming new tools. Values for this tolerance are, therefore, not given in Table 5.

Metric units (millimeters) apply in all formulas. Inch tolerances are not derived by direct conversion of the metric values. They are the differences between the rounded off limits of size in inch units.

Table 5. Unified Miniature Screw Threads — Limits of Size and Tolerances

Size Designation ^a	Pitch mm	External Threads						Internal Threads						Lead Angle at Basic Pitch Diam.		Sectional Area at Minor Diam. at D — 1.28p sq mm
		Major Diam.		Pitch Diam.		Minor Diam.		Minor Diam.		Pitch Diam.		Major Diam.				
		Max ^b	Min	Max ^b	Min	Max ^c	Min ^d	Min ^b	Max	Min ^b	Max	Min ^e	Max ^d	deg	min	sq in
0.30 UNM	0.080	0.300	0.284	0.248	0.234	0.204	0.183	0.217	0.254	0.248	0.262	0.306	0.327	5	52	0.0307
0.35 UNM	0.090	0.350	0.333	0.292	0.277	0.242	0.220	0.256	0.297	0.292	0.307	0.356	0.380	5	37	0.0433
0.40 UNM	0.100	0.400	0.382	0.335	0.319	0.280	0.256	0.296	0.340	0.335	0.351	0.407	0.432	5	26	0.0581
0.45 UNM	0.100	0.450	0.432	0.385	0.369	0.330	0.306	0.346	0.390	0.385	0.401	0.457	0.482	4	44	0.0814
0.50 UNM	0.125	0.500	0.479	0.419	0.401	0.350	0.322	0.370	0.422	0.419	0.437	0.509	0.538	5	26	0.0908
0.55 UNM	0.125	0.550	0.529	0.469	0.451	0.400	0.372	0.420	0.472	0.469	0.487	0.559	0.588	4	51	0.1195
0.60 UNM	0.150	0.600	0.576	0.503	0.483	0.420	0.388	0.444	0.504	0.503	0.523	0.611	0.644	5	26	0.1307
0.70 UNM	0.175	0.700	0.673	0.586	0.564	0.490	0.454	0.518	0.586	0.586	0.608	0.713	0.750	5	26	0.1780
0.80 UNM	0.200	0.800	0.770	0.670	0.646	0.560	0.520	0.592	0.668	0.670	0.694	0.814	0.856	5	26	0.232
0.90 UNM	0.225	0.900	0.867	0.754	0.728	0.630	0.586	0.666	0.750	0.754	0.780	0.916	0.962	5	26	0.294
1.00 UNM	0.250	1.000	0.964	0.838	0.810	0.700	0.652	0.740	0.832	0.838	0.866	1.018	1.068	5	26	0.363
1.10 UNM	0.250	1.100	1.064	0.938	0.910	0.800	0.752	0.840	0.932	0.938	0.966	1.118	1.168	4	51	0.478
1.20 UNM	0.250	1.200	1.164	1.038	1.010	0.900	0.852	0.940	1.032	1.038	1.066	1.218	1.268	4	23	0.608
1.40 UNM	0.300	1.400	1.358	1.205	1.173	1.040	0.984	1.088	1.196	1.205	1.237	1.422	1.480	4	32	0.811
	Thds. per in.	inch	inch	inch	inch	inch	inch	inch	inch	inch	inch	inch	inch	deg	min	sq in
0.30 UNM	318	0.0118	0.0112	0.0098	0.0092	0.0080	0.0072	0.0085	0.0100	0.0098	0.0104	0.0120	0.0129	5	52	0.0000475
0.35 UNM	282	0.0138	0.0131	0.0115	0.0109	0.0095	0.0086	0.0101	0.0117	0.0115	0.0121	0.0140	0.0149	5	37	0.0000671
0.40 UNM	254	0.0157	0.0150	0.0132	0.0126	0.0110	0.0101	0.0117	0.0134	0.0132	0.0138	0.0160	0.0170	5	26	0.0000901
0.45 UNM	254	0.0177	0.0170	0.0152	0.0145	0.0130	0.0120	0.0136	0.0154	0.0152	0.0158	0.0180	0.0190	4	44	0.0001262
0.50 UNM	203	0.0197	0.0189	0.0165	0.0158	0.0138	0.0127	0.0146	0.0166	0.0165	0.0172	0.0200	0.0212	5	26	0.0001407
0.55 UNM	203	0.0217	0.0208	0.0185	0.0177	0.0157	0.0146	0.0165	0.0186	0.0185	0.0192	0.0220	0.0231	4	51	0.0001852
0.60 UNM	169	0.0236	0.0227	0.0198	0.0190	0.0165	0.0153	0.0175	0.0198	0.0198	0.0206	0.0240	0.0254	5	26	0.000203
0.70 UNM	145	0.0276	0.0265	0.0231	0.0222	0.0193	0.0179	0.0204	0.0231	0.0231	0.0240	0.0281	0.0295	5	26	0.000276
0.80 UNM	127	0.0315	0.0303	0.0264	0.0254	0.0220	0.0205	0.0233	0.0263	0.0264	0.0273	0.0321	0.0325	5	26	0.000360
0.90 UNM	113	0.0354	0.0341	0.0297	0.0287	0.0248	0.0231	0.0262	0.0295	0.0297	0.0307	0.0361	0.0379	5	26	0.000456
1.00 UNM	102	0.0394	0.0380	0.0330	0.0319	0.0276	0.0257	0.0291	0.0327	0.0330	0.0341	0.0401	0.0420	5	26	0.000563
1.10 UNM	102	0.0433	0.0419	0.0369	0.0358	0.0315	0.0296	0.0331	0.0367	0.0369	0.0380	0.0440	0.0460	4	51	0.000741
1.20 UNM	102	0.0472	0.0458	0.0409	0.0397	0.0354	0.0335	0.0370	0.0406	0.0409	0.0420	0.0480	0.0499	4	23	0.000943
1.40 UNM	85	0.0551	0.0535	0.0474	0.0462	0.0409	0.0387	0.0428	0.0471	0.0474	0.0487	0.0560	0.0583	4	32	0.001257

^a Sizes shown in bold type are preferred.

^b This is also the basic dimension.

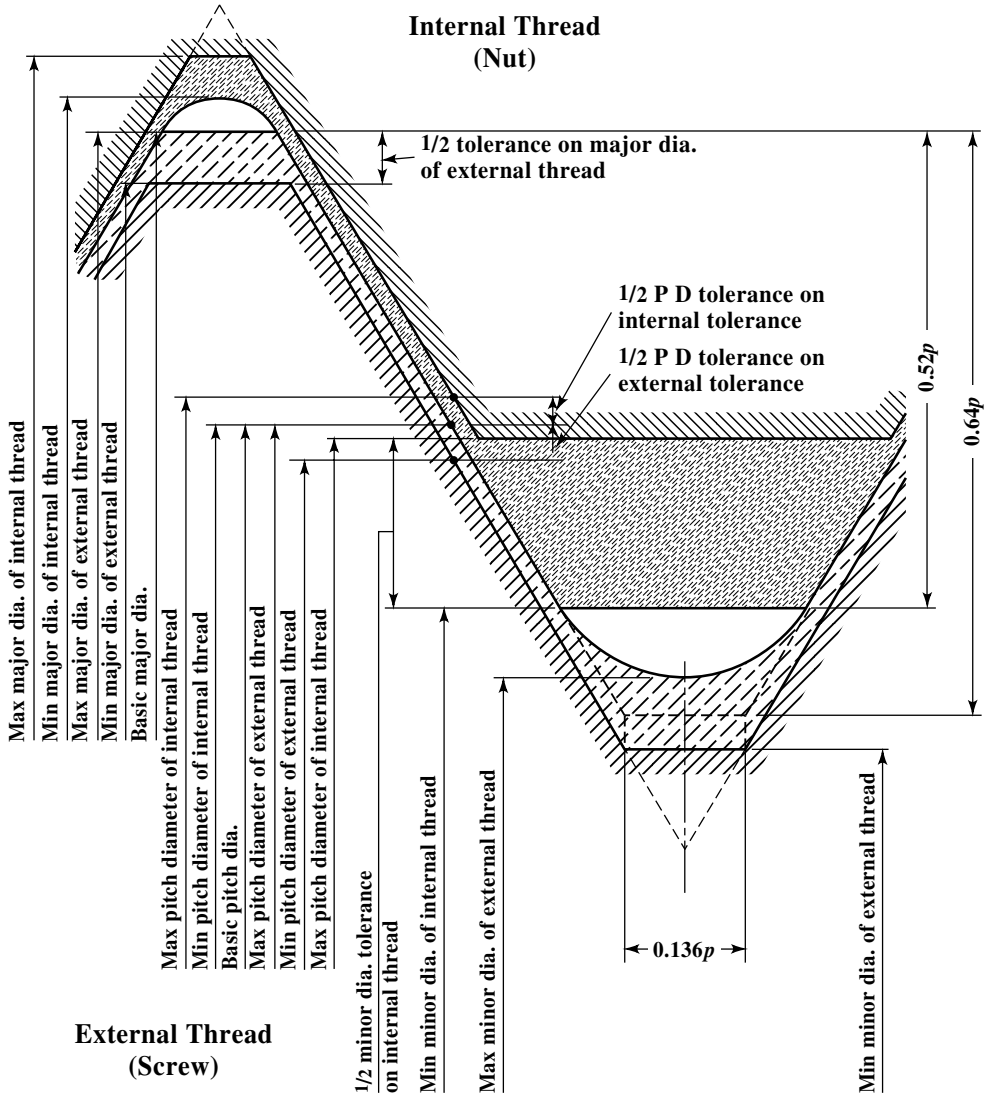
^c This limit, in conjunction with root form shown in Table 2, is advocated for use when optical projection methods of gaging are employed. For mechanical gaging the minimum minor diameter of the internal thread is applied.

^d This limit is provided for reference only. In practice, the form of the threading tool is relied upon for this limit.

^e This limit is provided for reference only, and is not gaged. For gaging, the maximum major diameter of the external thread is applied.

**Table 6. Unified Miniature Screw Threads—
Minimum Root Flats for External Threads**

Pitch mm	No. of Threads Per Inch	Thread Height for Min. Flat at Root $0.64p$		Minimum Flat at Root $F_{rs} = 0.136p$	
		mm	Inch	mm	Inch
0.080	318	0.0512	0.00202	0.0109	0.00043
0.090	282	0.0576	0.00227	0.0122	0.00048
0.100	254	0.0640	0.00252	0.0136	0.00054
0.125	203	0.0800	0.00315	0.0170	0.00067
0.150	169	0.0960	0.00378	0.0204	0.00080
0.175	145	0.1120	0.00441	0.0238	0.00094
0.200	127	0.1280	0.00504	0.0272	0.00107
0.225	113	0.1440	0.00567	0.0306	0.00120
0.250	102	0.1600	0.00630	0.0340	0.00134
0.300	85	0.1920	0.00756	0.0408	0.00161



Limits of Size: Formulas used to determine limits of size are given in [Table 4](#); the limits of size are given in [Table 5](#). The diagram on page [1862](#) illustrates the limits of size and [Table 6](#) gives values for the minimum flat at the root of the external thread shown on the diagram.

Classes of Threads: The standard establishes one class of thread with zero allowance on all diameters. When coatings of a measurable thickness are required, they should be included within the maximum material limits of the threads since these limits apply to both coated and uncoated threads.

Hole Sizes for Tapping: Suggested hole sizes are given in the Tapping Section.

Unified Screw Threads of UNJ Basic Profile

British Standard UNJ Threads.—This British Standard BS 4084: 1978 arises from a request originating from within the British aircraft industry and is based upon specifications for Unified screw threads and American military standard MIL-S-8879.

These UNJ threads, having an enlarged root radius, were introduced for applications requiring high fatigue strength where working stress levels are high, in order to minimize size and weight, as in aircraft engines, airframes, missiles, space vehicles and similar designs where size and weight are critical. To meet these requirements the root radius of external Unified threads is controlled between appreciably enlarged limits, the minor diameter of the mating internal threads being appropriately increased to insure the necessary clearance. The requirement for high strength is further met by restricting the tolerances for UNJ threads to the highest classes, Classes 3A and 3B, of Unified screw threads.

The standard, not described further here, contains both a coarse and a fine pitch series of threads. BS 4084: 1978 is technically identical to ISO 3161-1977 except for Appendix A.

ASME Unified Inch Screw Threads, UNJ Form.—The ASME B1.15-1995 standard is similar to Military Specification MIL-S-8879, and equivalent to ISO 3161-1977 for thread Classes 3A and 3B. Basic profile dimensions are given in [Table 1](#), page [1864](#).

The ASME B1.15-1995 standard establishes the basic profile for the UNJ thread form, specifies a system of designation, lists the standard series of diameter-pitch combinations for diameters from 0.060 to 6.00 inches, and specifies limiting dimensions and tolerances. It specifies the characteristics of the UNJ inch series of threads having 0.15011*P* to 0.18042*P* designated radius at the root of the external thread, and also having the minor diameter of the external and internal threads increased above the ASME B1.1 UN and UNR thread forms to accommodate the external thread maximum root radius.

UNJ threads are similar to UN threads except for a large radius in the root, or minor diameter, of the external thread. The radius eliminates sharp corners in the minor diameter of the bolt to increase the stripping strength. The fillets or radius in sharp corners increases strength at stress points where cracking or failure may occur due to change in temperature, heavy loads, or vibration. Other dimensions are the same as the UN thread.

Because the radius on the external thread increases the minor diameter of the bolt, the internal thread, or nut, is modified accordingly to permit assembly. The minor diameter of the internal thread is enlarged to clear the radius. This is the only change to the internal thread. All other dimensions are the same as standard Unified threads. Different types of tap drill sizes are required to produce UNJ thread. All tooling for external threads, thread rolls, and chasers must be made to produce a radius at the minor diameter. All runout or incomplete threads shall have a radius also.

Thread conforming to the ASME B1.1 UN profile and the UNJ profile are not interchangeable because of possible interference between the UNJ external thread minor diameter and the UN internal thread minor diameter. However, the UNJ internal thread will assemble with the UN external thread.

Table 1. Basic Profile Dimensions UNJ Threads ASME B1.15-1995

Threads per inch <i>n</i>	Pitch $P = 1/n$	Pitch Line $0.5P$	Flat at Internal Thread Crest $0.3125P$	Flat at Internal Thread Root and External Thread Crest $0.125P$	Height of Sharp V Thread $H = 0.866025P$	Height of Internal Thread and Depth of Thread Engagement $0.5625H = 0.487139P$	Addendum of External Thread $0.375H = 0.324760P$	Truncation of Internal Thread Crest $0.3125H = 0.270633P$	Truncation of Internal Thread Root and External Thread Crest $0.125H = 0.108253P$	Half Addendum of External Thread (REF. ONLY) $0.1875H = 0.16238P$
80	0.012500	0.006250	0.00391	0.00156	0.010825	0.00609	0.00406	0.00338	0.00135	0.00203
72	0.013889	0.006944	0.00434	0.00174	0.012028	0.00677	0.00451	0.00376	0.00150	0.00226
64	0.015625	0.007813	0.00488	0.00195	0.013532	0.00761	0.00507	0.00423	0.00169	0.00254
56	0.017857	0.008929	0.00558	0.00223	0.015465	0.00870	0.00580	0.00483	0.00193	0.00290
48	0.020833	0.010417	0.00651	0.00260	0.018042	0.01015	0.00677	0.00564	0.00226	0.00338
44	0.022727	0.011364	0.00710	0.00284	0.019682	0.01107	0.00738	0.00615	0.00246	0.00369
40	0.025000	0.012500	0.00781	0.00313	0.021651	0.01218	0.00812	0.00677	0.00271	0.00406
36	0.027778	0.013889	0.00868	0.00347	0.024056	0.01353	0.00902	0.00752	0.00301	0.00451
32	0.031250	0.015625	0.00977	0.00391	0.027063	0.01522	0.01015	0.00846	0.00338	0.00507
28	0.035714	0.017857	0.01116	0.00446	0.030929	0.01740	0.01160	0.00967	0.00387	0.00580
24	0.041667	0.020833	0.01302	0.00521	0.036084	0.02030	0.01353	0.01128	0.00451	0.00677
20	0.050000	0.025000	0.01563	0.00625	0.043301	0.02436	0.01624	0.01353	0.00541	0.00812
18	0.055556	0.027778	0.01736	0.00694	0.048113	0.02706	0.01804	0.01504	0.00601	0.00902
16	0.062500	0.031250	0.01953	0.00781	0.054127	0.03045	0.02030	0.01691	0.00677	0.01015
14	0.071429	0.035714	0.02232	0.00893	0.061859	0.03480	0.02320	0.01933	0.00773	0.01160
12	0.083333	0.041667	0.02604	0.01042	0.072169	0.04059	0.02706	0.02255	0.00902	0.01353
11	0.090909	0.045455	0.02841	0.01136	0.078730	0.04429	0.02952	0.02460	0.00984	0.01476
10	0.100000	0.050000	0.03125	0.01250	0.086603	0.04871	0.03248	0.02706	0.01083	0.01624
9	0.111111	0.055556	0.03472	0.01389	0.096225	0.05413	0.03608	0.03007	0.01203	0.01804
8	0.125000	0.062500	0.03906	0.01563	0.108253	0.06089	0.04060	0.03383	0.01353	0.02030
7	0.142857	0.071429	0.04464	0.01786	0.123718	0.06959	0.04639	0.03866	0.01546	0.02320
6	0.166667	0.083333	0.05208	0.02083	0.144338	0.08119	0.05413	0.04511	0.01804	0.02706
5	0.200000	0.100000	0.06250	0.02500	0.173205	0.09743	0.06495	0.05413	0.02165	0.03248
4.5	0.222222	0.111111	0.06944	0.02778	0.192450	0.10825	0.07217	0.06014	0.02406	0.03608
4	0.250000	0.125000	0.07813	0.03125	0.216506	0.12178	0.08119	0.06766	0.02706	0.04060

CALCULATING THREAD DIMENSIONS

Introduction

The purpose of the ASME B1.30 standard is to establish uniform and specific practices for calculating and rounding the numeric values used for inch and metric screw thread design data dimensions only. No attempt has been made to establish a policy of rounding actual thread characteristics measured by the manufacturer or user of thread gages. Covered is the *Standard Rounding Policy** regarding the last figure or decimal place to be retained by a numeric value and the number of decimal places to be retained by values used in intermediate calculations of thread design data dimensions. Values calculated to this ASME B1.30 Standard for inch and metric screw thread design data dimensions may vary slightly from values shown in existing issues of ASME B1 screw thread standards and are to take precedence in all new or future revisions of ASME B1 standards as applicable except as noted in following paragraph.

Metric Application.—Allowances (fundamental deviations) and tolerances for metric M and MJ screw threads are based upon formulas which appear in applicable standards. Values of allowances for standard tolerance positions and values of tolerances for standard tolerance grades are tabulated in these standards for a selection of pitches. Rounding rules specified in ASME B1.30 have not been applied to these values but have followed practices of the International Organization for Standardization (ISO). For pitches which are not included in the tables, standard formulas and the rounding rules specified herein are applicable.

ISO rounding practices, for screw thread tolerances and allowances, use rounding to the nearest values in the R40 series of numbers in accordance with ISO 3 (see page 674). In some cases, the rounded values have been adjusted to produce a smooth progression. Since the ISO rounded values have been standardized internationally, for metric screw threads, it would lead to confusion if tolerances and allowances were recalculated using B1.30 rules for use in the USA. B1.30 rounding rules are, therefore, only applicable to special threads where tabulated values do not exist in ISO standards. Values calculated using the ISO R40 series values may differ from those calculated using B1.30. In such a case the special thread values generated using B1.30 take precedence.

Purpose.—Thread dimensions calculated from published formulas frequently may not yield the exact values published in the standards. The difference in most cases are due to rounding policy.

The ASME B1.30 standard specifies that pitch, P , values shall be rounded to eight decimal places. In **Example 1** that follows on page 1867, the pitch of 28 threads per inch, 0.03571429, is correct; using $\frac{1}{28}$ or 0.0357 or 0.0357142856 instead of 0.03571429 will not produce values that conform to values calculated according this standard.

The rounding rules specified by the standard are not uniform, and vary by feature. Pitch is held to eight decimal places, maximum major diameter to four decimal places, and tolerances to six decimal places. In order to maintain same screw dimensions, everybody has to follow the same rounding practice.

Basic profile of UN and UNF screw threads are shown on **Fig. 1**. Here we show two example of detail calculations of UNEF and UNS External and Internal thread, where all the ins and outs of rounding policy, formulas, and detail description is provided for better understanding, and individual to find out accurate dimensions.

* It is recognized that ASME B1.30 is not in agreement with other published documents, e.g., ASME SI-9, *Guide for Metrication of Codes and Standards SI (Metric) Units*, and IEEE/ASTM SI 10, *Standard for Metric Practice*. The rounding practices used in the forenamed documents are designed to produce even distribution of numerical values. The purpose of this document is to define the most practical and common used method of rounding numerical thread form values. Application of this method is far more practical in the rounding of thread form values.

Calculating and Rounding Dimensions

Rounding of Decimal Values.—The following rounding practice represents the method to be used in new or future revisions of ASME B1 thread standards.

Rounding Policy: When the figure next beyond the last figure or place retained is less than 5, the figure in the last place retained is kept unchanged.

Example:

1.012342	1.01234
1.012342	1.0123
1.012342	1.012

When the figure next beyond the last figure or place retained is greater than 5, the figure in the last place retained is increased by 1.

Example:

1.56789	1.5679
1.56789	1.568
1.56789	1.57

When the figure next beyond the last figure or place retained is 5, and:

- 1) There are no figures, or only zeros, beyond the 5, the last figure should be increased by 1.

Example:

1.01235	1.0124
1.0123500	1.0124
1.012345	1.01235
1.01234500	1.01235

- 2) If the 5 next beyond the figure in the last place to be retained is followed by any figures other than zero, the figure in the last place retained should be increased by 1.

Example:

1.0123501	1.0124
1.0123599	1.0124
1.01234501	1.01235
1.01234599	1.01235

The final rounded value is obtained from the most precise value available and not from a series of successive rounding. For example, 0.5499 should be rounded to 0.550, 0.55 and 0.5 (not 0.6), since the most precise value available is less than 0.55. Similarly, 0.5501 should be rounded as 0.550, 0.55 and 0.6, since the most precise value available is more than 0.55. In the case of 0.5500 rounding should be 0.550, 0.55 and 0.6, since the most precise value available is 0.5500.

Calculations from Formulas, General Rules.—1) Values for pitch and constants derived from a function of pitch are used out to eight decimal places for inch series. The eight place values are obtained by rounding their truncated ten place values.

Seven decimal place values for metric series constants are derived by rounding their truncated nine place values.

Values used in intermediate calculations are rounded to two places beyond the number of decimal places retained for the final value, see [Tables 1](#) and [7](#).

- 2) Rounding to the final value is the last step in a calculation.

Example 1, Rounding Inch Series:

$$n = 28 \text{ threads per inch} \quad P = \frac{1}{n} = \frac{1}{28}$$

$$P = 0.0357142857 \quad (\text{calculated and truncated to 10 places})$$

$$P = 0.03571429 \quad (\text{rounded to 8 places})$$

Table 1. Number of Decimal Places Used in Calculations

Units	Pitch	Constants	Intermediate	Final
Inch	8	8	6	4
Metric	as designated	7	5	3

3) For inch screw thread dimensions, four decimal places are required for the final values of pitch diameter, major diameter, and minor diameter with the exception of Class 1B and 2B internal thread minor diameters for thread sizes 0.138 and larger.

The final values for the allowances and tolerances applied to thread elements are expressed to four decimal places except for external thread pitch diameter tolerance, Td_2 , which is expressed to six decimal places.

Minor Diameter Exceptions for Internal Threads:

Minimum Minor Diameter: All classes are calculated and then rounded off to the nearest 0.001 inch and expressed in three decimal places for sizes 0.138 inch and larger. For Class 3B, a zero is added to yield four decimal places.

Maximum Minor Diameter: All classes are calculated before rounding, then rounded for Classes 1B and 2B to the nearest 0.001 in. for sizes 0.138 in. and larger. Class 3B values are rounded to four decimal places.

4) Metric screw threads are dimensioned in millimeters. The final values of pitch diameter, major diameter, minor diameter, allowance and thread element tolerances are expressed to three decimal places.

5) Values containing multiple trailing zeros out to the required number of decimal places can be expressed by displaying only two of them beyond the last significant digit.

Example: 20 threads per inch has a pitch equal to 0.05000000 and can be expressed as 0.0500.

Examples

Inch Screw Threads.—The formulas in the examples for inch screw threads are based on those listed in ASME B1.1, *Unified Inch Screw Threads*. Table 3 and Table 4 are based on a size that when converted from a fraction to a decimal will result in a number that has only four decimal places. Table 5 and Table 6 are based on a size that when converted will result in a number with infinite numbers of digits after the decimal point. Fig. 1 is provided for reference.

Metric Screw Threads.—The formulas for metric screw threads are based on those listed in ASME B1.13M, *Metric Screw Threads*. The calculation of size limits for standard diameter/pitch combinations listed in both ISO 261 and ASME B1.13M use the tabulated values for allowances and tolerances (in accordance with ISO 965-1). The constant values differ from those used for inch screw threads, in accordance with the policy of rounding of this standard, because metric limits of size are expressed to only three decimal places rather than four.

Thread Form Constants.—For thread form data see Table 2. The number of decimal places and the manner in which they are listed should be consistent. Thread form constants printed in older thread standards are based on a function of thread height (H) or pitch (P). The equivalent of the corresponding function is also listed. There are some constants that would require these values to 8 or 7 decimal places before they would round to equivalent

values. For standardization the tabulated listing of thread values based on a function of pitch has been established, with thread height used as a reference only All thread calculations are to be performed using a function of pitch (P), rounded to 8 decimal places for inch series and as designated for metric series, not a function of thread height (H). Thread height is to be used for reference only. See Table 7.

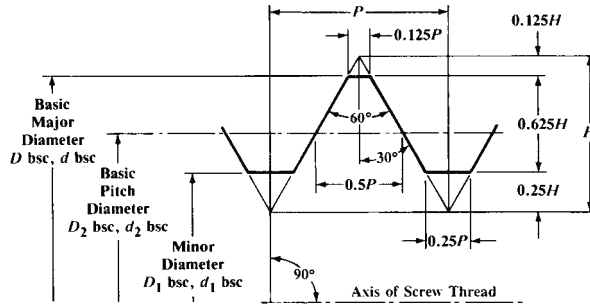


Fig. 1. Basic Profile of UN and UNF Screw Threads

Table 2. Thread Form Data

Constant for Inch Series (8-place)	Reference Values		Constant for Metric Series (7-place)
0.04811252P	$\frac{1}{18} H$	0.0556H	0.0481125P
0.05412659P	$\frac{1}{16} H$	0.0625H	0.0541266P
0.08660254P	$\frac{1}{10} H$	0.1000H	0.0866025P
0.09622504P	$\frac{1}{9} H$	0.1111H	0.0962250P
0.10825318P	$\frac{1}{8} H$	0.1250H	0.1082532P
0.12990381P	$\frac{3}{20} H$	0.1500H	0.1299038P
0.14433757P	$\frac{1}{6} H$	0.1667H	0.1443376P
0.16237976P	$\frac{3}{16} H$	0.1875H	0.1623798P
0.21650635P	$\frac{1}{4} H$	0.2500H	0.2165064P
0.28867513P	$\frac{1}{3} H$	0.3333H	0.2886751P
0.32475953P	$\frac{3}{8} H$	0.3750H	0.3247595P
0.36084392P	$\frac{5}{12} H$	0.4167H	0.3608439P
0.39692831P	$\frac{11}{24} H$	0.4583H	0.3969283P
0.43301270P	$\frac{1}{2} H$	0.5000H	0.4330127P
0.48713929P	$\frac{9}{16} H$	0.5625H	0.4871393P
0.54126588P	$\frac{5}{8} H$	0.6250H	0.5412659P
0.57735027P	$\frac{2}{3} H$	0.6667H	0.5773503P
0.59539246P	$\frac{11}{16} H$	0.6875H	0.5953925P
0.61343466P	$\frac{17}{24} H$	0.7083H	0.6134347P
0.61602540P	...	0.7113H	0.6160254P
0.64951905P	$\frac{3}{4} H$	0.7500H	0.6495191P
0.72168783P	$\frac{5}{6} H$	0.8333H	0.7216878P
0.79385662P	$\frac{11}{12} H$	0.9167H	0.7938566P
0.86602540P	H	1.0000H	0.8660254P
1.08253175P	$\frac{5}{4} H$	1.2500H	1.0825318P
1.19078493P	$\frac{11}{8} H$	1.3750H	1.1907849P
1.22686932P	$\frac{17}{12} H$	1.4167H	1.2268693P

Table 3. External Inch Screw Thread Calculations for 1/2-28 UNEF-2A

Characteristic Description	Calculation	Notes
Basic major diameter, d_{bsc}	$d_{bsc} = \frac{1}{2} = 0.5 = 0.5000$	d_{bsc} is rounded to four decimal places
Pitch, P	$P = \frac{1}{28} = 0.035714285714 = 0.03571429$	P is rounded to eight decimal places
Maximum external major diameter (d_{max}) = basic major diameter (d_{bsc}) – allowance (es)	$d_{max} = d_{bsc} - es$	es is the basic allowance
Basic major diameter (d_{bsc})	$d_{bsc} = 0.5000$	d_{bsc} is rounded to four decimal places
Allowance (es)	$es = 0.300 \times Td_2$ for Class 2A	Td_2 is the pitch diameter tolerance for Class 2A
External pitch diameter tolerance Td_2	$Td_2 = 0.0015D^{\frac{1}{3}} + 0.0015\sqrt{LE} + 0.015P^{\frac{2}{3}}$ $= 0.0015 \times 0.5^{\frac{1}{3}} + 0.0015\sqrt{9 \times 0.03571429} + 0.015(0.03571429)^{\frac{2}{3}}$ $= 0.001191 + 0.000850 + 0.001627 = 0.003668$	$LE = 9P$ (length of engagement) Td_2 is rounded to six decimal places
Allowance (es)	$es = 0.300 \times 0.003668 = 0.0011004 = 0.0011$	es is rounded to four decimal places
Maximum external major diameter (d_{max})	$d_{max} = d_{base} - es = 0.5000 - 0.0011 = 0.4989$	d_{max} is rounded to four decimal places
Minimum external major diameter (d_{min}) = maximum external major diameter (d_{max}) – major diameter tolerance (Td)	$d_{min} = d_{max} - Td$	Td is the major diameter tolerance
Major diameter tolerance (Td)	$Td = 0.060\sqrt[3]{P^2} = 0.060 \times \sqrt[3]{0.03571429^2}$ $= 0.060 \times \sqrt[3]{0.001276} = 0.060 \times 0.108463$ $= 0.00650778 = 0.0065$	Td is rounded to four decimal places

Table 3. (Continued) External Inch Screw Thread Calculations for 1/2-28 UNEF-2A

Characteristic Description	Calculation	Notes
Minimum external major diameter (d_{min})	$d_{min} = d_{max} - Td = 0.4989 - 0.006508$ $= 0.492392 = 0.4924$	d_{min} is rounded to four decimal places
Maximum external pitch diameter (d_{2max}) = maximum external major diameter (d_{max}) – twice the external thread addendum (h_{as})	$d_{2max} = d_{max} - 2 \times h_{as}$	h_{as} = external thread addendum
External thread addendum	$h_{as} = \frac{0.64951905P}{2}$ $2h_{as} = 0.64951905P$ $2h_{as} = 0.64951905 \times 0.03571429 = 0.02319711$ $= 0.023197$	$2h_{as}$ is rounded to six decimal places
Maximum external pitch diameter (d_{2max})	$d_{2max} = d_{max} - 2 \times h_{as} = 0.4989 - 0.23197$ $= 0.475703 = 0.4757$	d_{2max} is rounded to four decimal places
Minimum external pitch diameter (d_{2min}) = maximum external pitch diameter (d_{2max}) – external pitch diameter tolerance (Td_2)	$d_{2min} = d_{2max} - Td_2$	Td_2 = external pitch diameter tolerance (see previous Td_2 calculation in this table)
Minimum external pitch diameter (d_{2min})	$d_{2min} = d_{2max} - Td_2 = 0.4757 - 0.003668$ $= 0.472032 = 0.4720$	d_{2min} is rounded to four decimal places
Maximum external UNR minor diameter (d_{3max}) = maximum external major diameter (d_{max}) – double height of external UNR thread $2h_s$	$d_{3max} = d_{max} - 2 \times h_s$	h_s = external UNR thread height,
External UNR thread height ($2h_s$)	$2h_s = 1.19078493P = 1.19078493 \times 0.03571429$ $= 0.042528$	$2h_s$ rounded to six decimal places
Maximum external UNR minor diameter (d_{3max})	$d_{3max} = d_{max} - 2 \times h_s = 0.4989 - 0.042528$ $= 0.456372 = 0.4564$	d_{3max} is rounded to four decimal places

Table 3. (Continued) External Inch Screw Thread Calculations for 1/2-28 UNEF-2A

Characteristic Description	Calculation	Notes
Maximum external UN minor diameter (d_{1max}) = maximum external major diameter (d_{max}) – double height of external UN thread $2h_s$	$d_{1max} = d_{max} - 2 \times h_s$	For UN threads, $2h_s = 2h_n$
Double height of external UN thread $2h_s$	$2h_s = 1.08253175P$ $= 1.08253175 \times 0.03571429 = 0.03866185$ $= 0.038662$	$2h_s$ is rounded to six decimal places
Maximum external UN minor diameter (d_{1max})	$d_{1max} = d_{max} - 2 \times h_s$ $= 0.4989 - 0.038662 = 0.460238 = 0.4602$	d_{1max} is rounded to four decimal places

Table 4. Internal Inch Screw Thread Calculations for 1/2-28 UNEF-2B

Characteristic Description	Calculation	Notes
Basic major diameter, d_{bsc}	$d_{bsc} = \frac{1}{2} = 0.5 = 0.5000$	d_{bsc} is rounded to four decimal places
Pitch, P	$P = \frac{1}{28} = 0.035714285714 = 0.03571429$	P is rounded to eight decimal places
Minimum internal minor diameter (D_{1min}) = basic major diameter (D_{bsc}) – double height of external UN thread $2h_n$	$D_{1min} = D_{bsc} - 2h_n$	$2h_n$ is the double height of external UN thread
Double height of external UN thread $2h_s$	$2h_n = 1.08253175P = 1.08253175 \times 0.03571429$ $= 0.03866185 = 0.038662$	$2h_n$ is rounded to six decimal places
Minimum internal major diameter (D_{1min})	$D_{1min} = D_{bsc} - 2 \times h_n = 0.5000 - 0.038662$ $= 0.461338 = 0.461$	For class 2B the value is rounded to three decimal places to obtain the final values

Table 4. (Continued) Internal Inch Screw Thread Calculations for 1/2-28 UNEF-2B

Characteristic Description	Calculation	Notes
Maximum internal minor diameter (D_{1max}) = minimum internal minor diameter (D_{1min}) + internal minor diameter tolerance TD_1	$D_{1max} = D_{1min} + TD_1$	D_{1min} is rounded to six decimal places
Internal minor diameter tolerance TD_1	$TD_1 = 0.25P - 0.40P^2$ $= 0.25 \times 0.03571429 - 0.40 \times 0.03571429^2$ $= 0.008929 - 0.000510 = 0.008419 = 0.003127$	TD_1 is rounded to four decimal places.
Maximum internal minor diameter (D_{1max})	$D_{1max} = D_{1min} + TD_1 = 0.461338 + 0.008419$ $= 0.469757 = 0.470$	For the Class 2B thread D_{1max} is rounded to three decimal places to obtain final values. Other sizes and classes are expressed in a four decimal places
Minimum internal pitch diameter (D_{2min}) = basic major diameter (D_{bsc}) – twice the external thread addendum (h_b)	$D_{2min} = D_{bsc} - h_b$	h_b = external thread addendum
External thread addendum (h_b)	$h_b = 0.64951905P = 0.64951905 \times 0.03571429$ $= 0.02319711 = 0.023197$	h_b is rounded to six decimal places
Minimum internal pitch diameter (D_{2min})	$D_{2min} = D_{bsc} - h_b = 0.5000 - 0.023197$ $= 0.476803 = 0.4768$	D_{2min} is rounded to four decimal places
Maximum internal pitch diameter (D_{2max}) = minimum internal pitch diameter (D_{2min}) + internal pitch diameter tolerance (TD_2)	$D_{2max} = D_{2min} + TD_2$	TD_2 = external pitch diameter tolerance
External pitch diameter tolerance TD_2	$TD_2 = 1.30 \times (Td_2 \text{ for Class 2A}) = 1.30 \times 0.003668$ $= 0.0047684 = 0.0048$	Constant 1.30 is for this Class 2B example, and will be different for Classes 1B and 3B. Td_2 for Class 2A (see Table 3) is rounded to six decimal places. TD_2 is rounded 4 to places
Maximum internal pitch diameter (D_{2max})	$D_{2max} = D_{2min} + TD_2 = 0.4768 + 0.0048 = 0.4816$	D_{2max} is rounded to four decimal places

Table 4. (Continued) Internal Inch Screw Thread Calculations for 1/2-28 UNEF-2B

Characteristic Description	Calculation	Notes
Minimum internal major diameter (D_{min}) = basic major diameter (D_{bsc})	$D_{min} = D_{bsc} = 0.5000$	D_{min} is rounded to four decimal places

Table 5. External Inch Screw Thread Calculations for 19/64-36 UNS-2A

Characteristic Description	Calculation	Notes
Basic major diameter, d_{bsc}	$d_{bsc} = \frac{19}{64} = 0.296875 = 0.2969$	d_{bsc} is rounded to four decimal places
Pitch, P	$P = \frac{1}{36} = 0.0277777777778 = 0.02777778$	P is rounded to eight decimal places
Maximum external major diameter (d_{max}) = basic major diameter (d_{bsc}) – allowance (es)	$d_{max} = d_{bsc} - es$	
Allowance (es)	$es = 0.300 \times Td_2$ for Class 2A	Td_2 is Pitch diameter tolerance for Class 2A
External pitch diameter tolerance, Td_2	$Td_2 = 0.0015D^{1/3} + 0.0015\sqrt{LE} + 0.015P^{2/3}$ $= 0.0015 \times 0.2969^{1/3} + 0.0015\sqrt{9 \times 0.02777778} + 0.015(0.02777778)^{2/3}$ $= 0.001000679 + 0.00075 + 0.001375803 = 0.003126482$ $= 0.003127$	$LE = 9P$ (length of engagement) Td_2 is rounded to six decimal places
Allowance (es)	$es = 0.300 \times 0.003127 = 0.0009381 = 0.0009$	es is rounded to four decimal places
Maximum external major diameter (d_{max})	$d_{max} = d_{bsc} - es = 0.2969 - 0.0009 = 0.2960$	d_{max} is rounded to four decimal places

Table 5. (Continued) External Inch Screw Thread Calculations for $19/64$ -36 UNS-2A

Characteristic Description	Calculation	Notes
Minimum external major diameter (d_{min}) = maximum external major diameter (d_{max}) – major diameter tolerance (Td)	$d_{min} = d_{max} - Td$	Td is the major diameter tolerance
Major diameter tolerance (Td)	$Td = 0.060 \sqrt[3]{P^2} = 0.060 \times \sqrt[3]{0.02777778^2}$ $= 0.060 \times \sqrt[3]{0.000772} = 0.060 \times 0.091736$ $= 0.00550416 = 0.0055$	Td is rounded to four decimal places
Minimum external major diameter (d_{min})	$d_{min} = d_{max} - Td = 0.2960 - 0.0055 = 0.2905$	d_{min} is rounded to four decimal places
Maximum external pitch diameter (d_{2max}) = maximum external major diameter (d_{max}) – twice the external thread addendum	$d_{2max} = d_{max} - 2 \times h_{as}$	h_{as} = external thread addendum
External thread addendum	$h_{as} = \frac{0.64951905P}{2} \quad 2h_{as} = 0.64951905P$ $2h_{as} = 0.64951905 \times 0.02777778 = 0.0180421972$ $= 0.018042$	h_{as} is rounded to six decimal places
Maximum external pitch diameter (d_{2max})	$d_{2max} = d_{max} - 2h_{as} = 0.2960 - 0.018042$ $= 0.277958 = 0.2780$	d_{2max} is rounded to four decimal places
Minimum external pitch diameter (d_{2min}) = maximum external pitch diameter (d_{2max}) – external pitch diameter tolerance (Td_2)	$d_{2min} = d_{2max} - Td_2$	Td_2 = external pitch diameter tolerance (see previous Td_2 calculation in this table)
Minimum external pitch diameter (d_{2min})	$d_{2min} = d_{2max} - Td_2 = 0.2780 - 0.003127$ $= 0.274873 = 0.2749$	d_{2min} is rounded to four decimal places

Table 5. (Continued) External Inch Screw Thread Calculations for 19/64-36 UNS-2A

Characteristic Description	Calculation	Notes
Maximum external UNR minor diameter (d_{3max}) = maximum external major diameter (d_{max}) – double height of external UNR thread $2h_s$	$d_{3max} = d_{max} - 2h_s$	h_s = external UNR thread height,
External UNR thread height	$2h_s = 1.19078493P = 1.19078493 \times 0.02777778$ $= 0.033077362 = 0.033077$	$2h_s$ is rounded to six decimal places
Maximum external UNR minor diameter (d_{3max})	$d_{3max} = d_{max} - 2h_s = 0.2960 - 0.033077$ $= 0.262923 = 0.2629$	d_{3max} is rounded to four decimal places
Maximum external UN minor diameter (d_{1max}) = maximum external major diameter (d_{max}) – double height of external UN thread $2h_s$	$d_{1max} = d_{max} - 2 \times h_s$	For UN threads, $2h_s = 2h_n$
Double height of external UN thread $2h_s$	$2h_s = 1.08253175P = 1.08253175 \times 0.02777778$ $= 0.030070329 = 0.030070$	For UN threads, $2h_s = 2h_n$ $2h_s$ is rounded to six decimal places
Maximum external UN minor diameter (d_{1max})	$d_{1max} = d_{max} - 2h_s = 0.2960 - 0.030070$ $= 0.265930 = 0.2659$	Maximum external UN minor diameter is rounded to four decimal places

Table 6. Internal Inch Screw Thread Calculations for 19/64-28 UNS-2B

Characteristic Description	Calculation	Notes
Minimum internal minor diameter (D_{1min}) = basic major diameter (D_{bsc}) – double height of external UN thread $2h_n$	$D_{1min} = D_{bsc} - 2h_n$	$2h_n$ is the double height of external UN threads
Basic major diameter (D_{bsc})	$D_{bsc} = \frac{19}{64} = 0.296875 = 0.2969$	This is the final value of basic major diameter (given) and rounded to four decimal places

Table 6. (Continued) Internal Inch Screw Thread Calculations for $19/64$ -28 UNS-2B

Characteristic Description	Calculation	Notes
Double height of external UN thread $2h_s$	$2h_n = 1.08253175P = 1.08253175 \times 0.02777778$ $= 0.030070329 = 0.030070$	P is rounded to eight decimal places
Minimum internal major diameter (D_{1min})	$D_{1min} = D_{bsc} - 2h_n = 0.2969 - 0.030070$ $= 0.266830 = 0.267$	For class 2B the value is rounded to three decimal places to obtain the final value, other sizes and classes are expressed in a four place decimal.
Maximum internal minor diameter (D_{1max}) = minimum internal minor diameter (D_{1min}) + internal minor diameter tolerance TD_1	$D_{1max} = D_{1min} + TD_1$	D_{1min} is rounded to six decimal places
Internal minor diameter tolerance TD_1	$TD_1 = 0.25P - 0.40P^2$ $= 0.25 \times 0.02777778 - 0.40 \times 0.02777778^2$ $= 0.006944 - 0.000309 = 0.006635 = 0.0066$	TD_1 is rounded to four decimal places.
Maximum internal minor diameter (D_{1max})	$D_{1max} = D_{1min} + TD_1 = 0.266830 + 0.006635$ $= 0.273465 = 0.273$	For Class 2B thread the value is rounded to three decimal places to obtain the final values. Other sizes and classes are expressed in a four decimal places
Minimum internal pitch diameter (D_{2min}) = basic major diameter (D_{bsc}) – twice the external thread addendum (h_b)	$D_{2min} = D_{1max} - h_b$	h_b = external thread addendum
External thread addendum	$h_b = 0.64951905P = 0.64951905 \times 0.02777778$ $= 0.018042197 = 0.018042$	h_b is rounded to six decimal places
Minimum internal pitch diameter (D_{2min})	$D_{2min} = D_{bsc} - h_b = 0.2969 - 0.018042$ $= 0.278858 = 0.2789$	D_{2min} is rounded to four decimal places

Table 6. (Continued) Internal Inch Screw Thread Calculations for 19/64-28 UNS-2B

Characteristic Description	Calculation	Notes
Maximum internal pitch diameter (D_{2max}) = minimum internal pitch diameter (D_{2min}) + internal pitch diameter tolerance (TD_2)	$D_{2max} = D_{2min} + TD_2$	TD_2 = external pitch diameter tolerance
External pitch diameter tolerance TD_2	$TD_2 = 1.30 \times (Td_2 \text{ for Class 2A})$ $= 1.30 \times 0.003127 = 0.0040651 = 0.0041$	The constant 1.30 is for this Class 2B example, and will be different for Classes 1B and 3B. Td_2 for Class 2A (see calculation, Table 5) is rounded to six decimal places
Maximum internal pitch diameter (D_{2max})	$D_{2max} = D_{2min} + TD_2 = 0.2789 + 0.0041 = 0.2830$	D_{2max} is rounded to four decimal places
Minimum internal major diameter (D_{min}) = basic major diameter (D_{bsc})	$D_{min} = D_{bsc} = 0.2969$	D_{min} is rounded to four decimal places

Table 7. Number of Decimal Places for Intermediate and Final Calculations of Thread Characteristics

Symbol	Dimensions	Intermediate		Final		Symbol	Dimensions	Intermediate		Final	
		Inch	Metric	Inch	Metric			Inch	Metric	Inch	Metric
d	Major diameter, external thread	4	3	LE	Length of thread engagement	6	N/A
D	Major diameter, internal thread	4	3	P	Pitch	8	Note ^a
d_2	Pitch diameter, external thread	4	3	Td	Major diameter tolerance	4	3
D_2	Pitch diameter, internal thread	4	3	TD_2	Pitch diameter tolerance, external thread	6	3
d_1	Minor diameter, external thread	4	3	TD_2	Pitch diameter tolerance, internal thread	4	3
d_3	Minor diameter, rounded root external thread	4	3	TD_1	Minor diameter tolerance, internal thread	4	3
D_1	Minor diameter, internal threads for sizes 0.138 and larger for Classes 1B and 2B only	3	N/A	$h_b = 2h_{as}$	Twice the external thread addendum	6	N/A
D_1	Minor diameter, internal threads for sizes smaller than 0.138 for Classes 1B and 2B, and all sizes for Class 3B	4	N/A	$2h_s$	Double height of UNR external thread	6	N/A
D_1	Minor diameter, internal metric thread	N/A	3	$2h_n$	Double height of internal thread and UN external thread	6	N/A
es	Allowance at major pitch and minor diameters of external thread	3		Twice the external thread addendum	6	N/A

^aMetric pitches are not calculated. They are stated in the screw thread designation and are to be used out to the number of decimal places as stated.

Note: Constants based on a function of P are rounded to an 8-place decimal for inch threads and a 7-place decimal for metric threads.

METRIC SCREW THREADS

American National Standard Metric Screw Threads M Profile

American National Standard ANSI/ASME B1.13M-2005 describes a system of metric threads for general fastening purposes in mechanisms and structures. The standard is in basic agreement with ISO screw standards and resolutions, as of the date of publication, and features detailed information for diameter-pitch combinations selected as to preferred standard sizes. This Standard contains general metric standards for a 60-degree symmetrical screw thread with a basic ISO 68 designated profile.

Application Comparison with Inch Threads.—The metric M profile threads of tolerance class 6H/6g (see page 1885) are intended for metric applications where the inch class 2A/2B have been used. At the minimum material limits, the 6H/6g results in a looser fit than the 2A/2B. Tabular data are also provided for a tighter tolerance fit external thread of class 4g6g which is approximately equivalent to the inch class 3A but with an allowance applied. It may be noted that a 4H5H/4h6h fit is approximately equivalent to class 3A/3B fit in the inch system.

Interchangeability with Other System Threads.—Threads produced to this Standard ANSI/ASME B1.13M are fully interchangeable with threads conforming to other National Standards that are based on ISO 68 basic profile and ISO 965/1 tolerance practices.

Threads produced to this Standard should be mechanically interchangeable with those produced to ANSI B1.18M-1982 (R1987) “Metric Screw Threads for Commercial Mechanical Fasteners—Boundary Profile Defined,” of the same size and tolerance class. However, there is a possibility that some parts may be accepted by conventional gages used for threads made to ANSI/ASME B1.13M and rejected by the Double-NOT-GO gages required for threads made to ANSI B1.18M.

Threads produced in accordance with M profile and MJ profile ANSI/ASME B1.21M design data will assemble with each other. However, external MJ threads will encounter interference on the root radii with internal M thread crests when both threads are at maximum material condition.

Definitions.—The following definitions apply to metric screw threads — M profile.

Allowance: The minimum nominal clearance between a prescribed dimension and its basic dimension. Allowance is not an ISO metric screw thread term but it is numerically equal to the absolute value of the ISO term *fundamental deviation*.

Basic Thread Profile: The cyclical outline in an axial plane of the permanently established boundary between the provinces of the external and internal threads. All deviations are with respect to this boundary. (See Figs. 1 and 5.)

Bolt Thread (External Thread): The term used in ISO metric thread standards to describe all external threads. All symbols associated with external threads are designated with lower case letters. This Standard uses the term external threads in accordance with United States practice.

Clearance: The difference between the size of the internal thread and the size of the external thread when the latter is smaller.

Crest Diameter: The major diameter of an external thread and the minor diameter of an internal thread.

Design Profiles: The maximum material profiles permitted for external and internal threads for a specified tolerance class. (See Figs. 2 and 3.)

Deviation: An ISO term for the algebraic difference between a given size (actual, measured, maximum, minimum, etc.) and the corresponding basic size. The term deviation does not necessarily indicate an error.

Fit: The relationship existing between two corresponding external and internal threads with respect to the amount of clearance or interference which is present when they are assembled.

Fundamental Deviation: For Standard threads, the deviation (upper or lower) closer to the basic size. It is the upper deviation, es , for an external thread and the lower deviation, ei , for an internal thread. (See Fig. 5.)

Limiting Profiles: The limiting M profile for internal threads is shown in Fig. 6. The limiting M profile for external threads is shown in Fig. 7.

Lower Deviation: The algebraic difference between the minimum limit of size and the corresponding basic size.

Nut Thread (Internal Thread): A term used in ISO metric thread standards to describe all internal threads. All symbols associated with internal threads are designated with upper case letters. This Standard uses the term *internal thread* in accordance with United States practice.

Tolerance: The total amount of variation permitted for the size of a dimension. It is the difference between the maximum limit of size and the minimum limit of size (i.e., the algebraic difference between the upper deviation and the lower deviation). The tolerance is an absolute value without sign. Tolerance for threads is applied to the design size in the direction of the minimum material. On external threads the tolerance is applied negatively. On internal threads the tolerance is applied positively.

Tolerance Class: The combination of a tolerance position with a tolerance grade. It specifies the allowance (fundamental deviation) and tolerance for the pitch and major diameters of external threads and pitch and minor diameters of internal threads.

Tolerance Grade: A numerical symbol that designates the tolerances of crest diameters and pitch diameters applied to the design profiles.

Tolerance Position: A letter symbol that designates the position of the tolerance zone in relation to the basic size. This position provides the allowance (fundamental deviation).

Upper Deviation: The algebraic difference between the maximum limit of size and the corresponding basic size.

Basic M Profile.—The basic M thread profile also known as ISO 68 basic profile for metric screw threads is shown in Fig. 1 with associated dimensions listed in Table 3.

Design M Profile for Internal Thread.—The design M profile for the internal thread at maximum material condition is the basic ISO 68 profile. It is shown in Fig. 2 with associated thread data listed in Table 3.

Design M Profile for External Thread.—The design M profile for the external thread at the no allowance maximum material condition is the basic ISO 68 profile except where a rounded root is required. For the standard $0.125P$ minimum radius, the ISO 68 profile is modified at the root with a $0.17783H$ truncation blending into two arcs with radii of $0.125P$ tangent to the thread flanks as shown in Fig. 3 with associated thread data in Table 3.

M Crest and Root Form.—The form of crest at the major diameter of the external thread is flat, permitting corner rounding. The external thread is truncated $0.125H$ from a sharp crest. The form of the crest at the minor diameter of the internal thread is flat. It is truncated $0.25H$ from a sharp crest.

The crest and root tolerance zones at the major and minor diameters will permit rounded crest and root forms in both external and internal threads.

The root profile of the external thread must lie within the “section lined” tolerance zone shown in Fig. 4. For the rounded root thread, the root profile must lie within the “section lined” rounded root tolerance zone shown in Fig. 4. The profile must be a continuous, smoothly blended non-reversing curve, no part of which has a radius of less than $0.125P$, and which is tangential to the thread flank. The profile may comprise tangent flank arcs that are joined by a tangential flat at the root.

The root profile of the internal thread must not be smaller than the basic profile. The maximum major diameter must not be sharp.

General Symbols.—The general symbols used to describe the metric screw thread forms are shown in [Table 1](#).

**Table 1. American National Standard Symbols for Metric Threads
ANSI/ASME B1.13M-2005**

Symbol	Explanation
D	Major Diameter Internal Thread
D_1	Minor Diameter Internal Thread
D_2	Pitch Diameter Internal Thread
d	Major Diameter External Thread
d_1	Minor Diameter External Thread
d_2	Pitch Diameter External Thread
d_3	Rounded Form Minor Diameter External Thread
P	Pitch
r	External Thread Root Radius
T	Tolerance
T_{D1}, T_{D2}	Tolerances for D_1, D_2
T_d, T_{d2}	Tolerances for d, d_2
ES	Upper Deviation, Internal Thread [Equals the Allowance (Fundamental Deviation) Plus the Tolerance]. See Fig. 5 .
EI	Lower Deviation, Internal Thread Allowance (Fundamental Deviation). See Fig. 5 .
G, H	Letter Designations for Tolerance Positions for Lower Deviation, Internal Thread
g, h	Letter Designations for Tolerance Positions for Upper Deviation, External Thread
es	Upper Deviation, External Thread Allowance (Fundamental Deviation). See Fig. 5 . In the ISO system es is always negative for an allowance fit or zero for no allowance.
ei	Lower Deviation, External Thread [Equals the Allowance (Fundamental Deviation) Plus the Tolerance]. See Fig. 5 . In the ISO system ei is always negative for an allowance fit.
H	Height of Fundamental Triangle
LE	Length of Engagement
LH	Left Hand Thread

Standard M Profile Screw Thread Series.—The standard metric screw thread series for general purpose equipment's threaded components design and mechanical fasteners is a *coarse thread* series. Their diameter/pitch combinations are shown in [Table 4](#). These diameter/pitch combinations are the preferred sizes and should be the first choice as applicable. Additional *fine pitch* diameter/pitch combinations are shown in [Table 5](#).

**Table 2. American National Standard General Purpose and Mechanical Fastener
Coarse Pitch Metric Thread—M Profile Series ANSI/ASME B1.13M-2005**

Nom.Size	Pitch	Nom.Size	Pitch	Nom.Size	Pitch	Nom.Size	Pitch
1.6	0.35	6	1	22	2.5 ^a	56	5.5
2	0.4	8	1.25	24	3	64	6
2.5	0.45	10	1.5	27	3 ^a	72	6 ^b
3	0.5	12	1.75	30	3.5	80	6 ^b
3.5	0.6	14	2	36	4	90	6 ^b
4	0.7	16	2	42	4.5	100	6 ^b
5	0.8	20	2.5	48	5

^a For high strength structural steel fasteners only.

^b Designated as part of 6 mm fine pitch series in ISO 261.

All dimensions are in millimeters.

Table 3. American National Standard Metric Thread — M Profile Data ANSI/ASME B1.13M-2005

Pitch <i>P</i>	Truncation of Internal Thread Root and External Thread Crest $\frac{H}{8}$ 0.1082532 <i>P</i>	Addendum of Internal Thread and Truncation of Internal Thread $\frac{H}{4}$ 0.2165064 <i>P</i>	Dedendum of Internal Thread and Addendum External Thread $\frac{3}{8}H$ 0.3247595 <i>P</i>	Difference ^a $\frac{H}{2}$ 0.4330127 <i>P</i>	Height of Internal Thread and Depth of Thread Engagement $\frac{5}{8}H$ 0.5412659 <i>P</i>	Difference ^b 0.711325 <i>H</i> 0.6160254 <i>P</i>	Twice the External Thread Addendum $\frac{3}{4}H$ 0.6495191 <i>P</i>	Difference ^c $\frac{11}{12}H$ 0.7938566 <i>P</i>	Height of Sharp V-Thread <i>H</i> 0.8660254 <i>P</i>	Double Height of Internal Thread $\frac{5}{4}H$ 1.0825318 <i>P</i>
0.2	0.02165	0.04330	0.06495	0.08660	0.10825	0.12321	0.12990	0.15877	0.17321	0.21651
0.25	0.02706	0.05413	0.08119	0.10825	0.13532	0.15401	0.16238	0.19846	0.21651	0.27063
0.3	0.03248	0.06495	0.09743	0.12990	0.16238	0.18481	0.19486	0.23816	0.25981	0.32476
0.35	0.03789	0.07578	0.11367	0.15155	0.18944	0.21561	0.22733	0.27785	0.30311	0.37889
0.4	0.04330	0.08660	0.12990	0.17321	0.21651	0.24541	0.25981	0.31754	0.34641	0.43301
0.45	0.04871	0.09743	0.14614	0.19486	0.24357	0.27721	0.29228	0.35724	0.38971	0.48714
0.5	0.05413	0.10825	0.16238	0.21651	0.27063	0.30801	0.32476	0.39693	0.43301	0.54127
0.6	0.06495	0.12990	0.19486	0.25981	0.32476	0.36962	0.38971	0.47631	0.51962	0.64952
0.7	0.07578	0.15155	0.22733	0.30311	0.37889	0.43122	0.45466	0.55570	0.60622	0.75777
0.75	0.08119	0.16238	0.24357	0.32476	0.40595	0.46202	0.48714	0.59539	0.64952	0.81190
0.8	0.08660	0.17321	0.25981	0.34641	0.43301	0.49282	0.51962	0.63509	0.69282	0.86603
1	0.10825	0.21651	0.32476	0.43301	0.54127	0.61603	0.64952	0.79386	0.86603	1.08253
1.25	0.13532	0.27063	0.40595	0.54127	0.67658	0.77003	0.81190	0.99232	1.08253	1.35316
1.5	0.16238	0.32476	0.48714	0.64952	0.81190	0.92404	0.97428	1.19078	1.29904	1.62380
1.75	0.18944	0.37889	0.56833	0.75777	0.94722	1.07804	1.13666	1.38925	1.51554	1.89443
2	0.21651	0.43301	0.64952	0.86603	1.08253	1.23205	1.29904	1.58771	1.73205	2.16506
2.5	0.27063	0.54127	0.81190	1.08253	1.35316	1.54006	1.62380	1.98464	2.16506	2.70633
3	0.32476	0.64652	0.97428	1.29904	1.62380	1.84808	1.94856	2.38157	2.59808	3.24760
3.5	0.37889	0.75777	1.13666	1.51554	1.89443	2.15609	2.27332	2.77850	3.03109	3.78886
4	0.43301	0.86603	1.29904	1.73205	2.16506	2.46410	2.59808	3.17543	3.46410	4.33013
4.5	0.48714	0.97428	1.46142	1.94856	2.43570	2.72721	2.92284	3.57235	3.89711	4.87139
5	0.54127	1.08253	1.62380	2.16506	2.70633	3.08013	3.24760	3.96928	4.33013	5.41266
5.5	0.59539	1.19079	1.78618	2.38157	2.97696	3.38814	3.57236	4.36621	4.76314	5.95392
6	0.64952	1.29904	1.94856	2.59808	3.24760	3.69615	3.89711	4.76314	5.19615	6.49519
8	0.86603	1.73205	2.59808	3.46410	4.33013	4.92820	5.19615	6.35085	6.92820	8.66025

^a Difference between max theoretical pitch diameter and max minor diameter of external thread and between min theoretical pitch diameter and min minor diameter of internal thread.

^b Difference between min theoretical pitch diameter and min design minor diameter of external thread for 0.125*P* root radius.

^c Difference between max major diameter and max theoretical pitch diameter of internal thread.

All dimensions are in millimeters.

**Table 4. American National Standard Minimum Rounded Root Radius—
M Profile Series ANSI/ASME B1.13M-2005**

Pitch <i>P</i>	Min. Root Radius, 0.125 <i>P</i>	Pitch <i>P</i>	Min. Root Radius, 0.125 <i>P</i>	Pitch <i>P</i>	Min. Root Radius, 0.125 <i>P</i>	Pitch <i>P</i>	Min. Root Radius, 0.125 <i>P</i>
0.2	0.025	0.6	0.075	1.5	0.188	4	0.500
0.25	0.031	0.7	0.088	1.75	0.219	4.5	0.563
0.3	0.038	0.75	0.094	2	0.250	5	0.625
0.35	0.044	0.8	0.100	2.5	0.313	5.5	0.688
0.4	0.050	1	0.125	3	0.375	6	0.750
0.45	0.056	1.25	0.156	3.5	0.438	8	1.000
0.5	0.063

All dimensions are in millimeters.

**Table 5. American National Standard Fine Pitch Metric Thread—M Profile Series
ANSI/ASME B1.13M-2005**

Nom. Size	Pitch			Nom. Size	Pitch			Nom. Size	Pitch			
8	1	27	...	2	...	56	...	2	105	2
10	0.75	1.0	1.25	30	1.5	2	...	60	1.5	...	110	2
12	1	1.5	1.25	33	...	2	...	64	...	2	120	2
14	...	1.5	...	35	1.5	65	1.5	...	130	2
15	1	36	...	2	...	70	1.5	...	140	2
16	...	1.5	...	39	...	2	...	72	...	2	150	2
17	1	40	1.5	75	1.5	...	160	3
18	...	1.5	...	42	...	2	...	80	1.5	2	170	3
20	1	1.5	...	45	1.5	85	...	2	180	3
22	...	1.5	...	48	...	2	...	90	...	2	190	3
24	...	2	...	50	1.5	95	...	2	200	3
25	1.5	55	1.5	100	...	2		

All dimensions are in millimeters.

Limits and Fits for Metric Screw Threads — M Profile.—The International (ISO) metric tolerance system is based on a system of limits and fits. The limits of the tolerances on the mating parts together with their allowances (fundamental deviations) determine the fit of the assembly. For simplicity the system is described for cylindrical parts (see *British Standard for Metric ISO Limits and Fits* starting on page 662) but in this Standard it is applied to screw threads. Holes are equivalent to internal threads and shafts to external threads.

Basic Size: This is the zero line or surface at assembly where the interface of the two mating parts have a common reference.*

Upper Deviation: This is the algebraic difference between the maximum limit of size and the basic size. It is designated by the French term “écart supérieur” (ES for internal and *es* for external threads).

Lower Deviation: This is the algebraic difference between the minimum limit of size and the basic size. It is designated by the French term “écart inférieur” (*EI* for internal and *ei* for external threads).

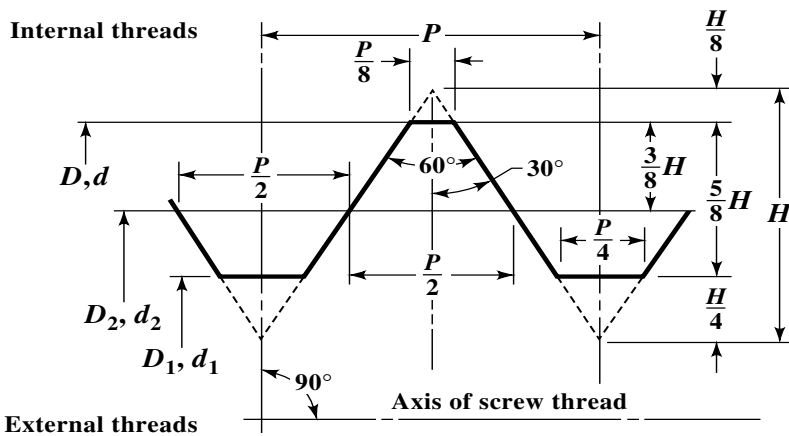
Fundamental Deviations (Allowances): These are the deviations which are closest to the basic size. In the accompanying figure they would be *EI* and *es*.

*“Basic,” when used to identify a particular dimension in this Standard, such as basic major diameter, refers to the h/H tolerance position (zero fundamental deviation) value.

Tolerance: The tolerance is defined by a series of numerical grades. Each grade provides numerical values for the various nominal sizes corresponding to the standard tolerance for that grade.

In the schematic diagram the tolerance for the external thread is shown as negative. Thus the tolerance plus the fit define the lower deviation (*ei*). The tolerance for the mating internal thread is shown as positive. Thus the tolerance plus the fit defines the upper deviation (*ES*).

Fits: Fits are determined by the fundamental deviations assigned to the mating parts and may be positive or negative. The selected fits can be clearance, transition, or interference. To illustrate the fits schematically, a zero line is drawn to represent the basic size as shown in Fig. 5. By convention, the external thread lies below the zero line and the internal thread lies above it (except for interference fits). This makes the fundamental deviation negative for the external thread and equal to its upper deviation (*es*). The fundamental deviation is positive for the internal thread and equal to its lower deviation (*EI*).



$$H = \frac{\sqrt{3}}{2} \times P = 0.866025P$$

$$0.125H = 0.108253P \quad 0.250H = 0.216506P \quad 0.375H = 0.324760P \quad 0.625H = 0.541266P$$

Fig. 1. Basic M Thread Profile (ISO 68 Basic Profile)

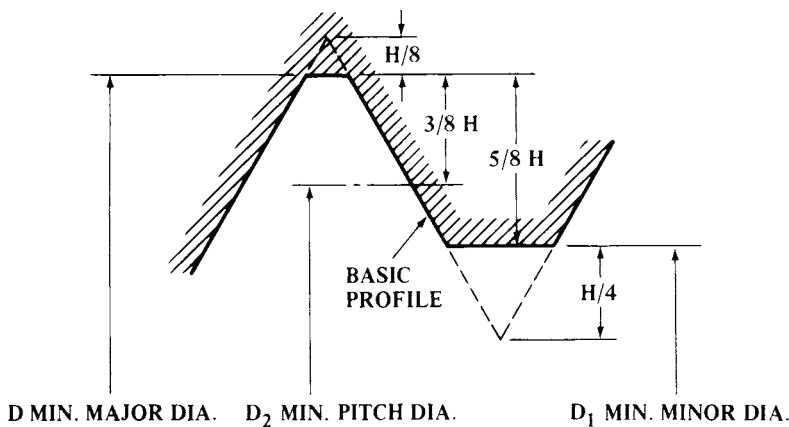


Fig. 2. Internal Thread Design M Profile with No Allowance (Fundamental Deviation) (Maximum Material Condition). For Dimensions see Table 3

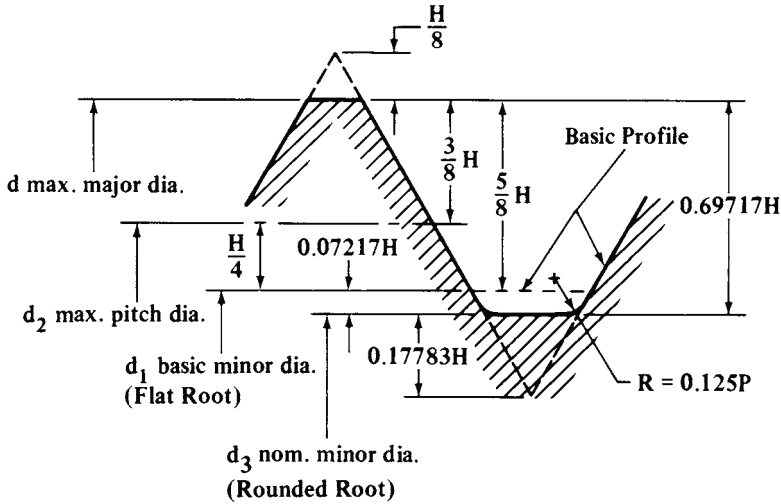


Fig. 3. External Thread Design M Profile with No Allowance (Fundamental Deviation) (Flanks at Maximum Material Condition). For Dimensions see Table 3

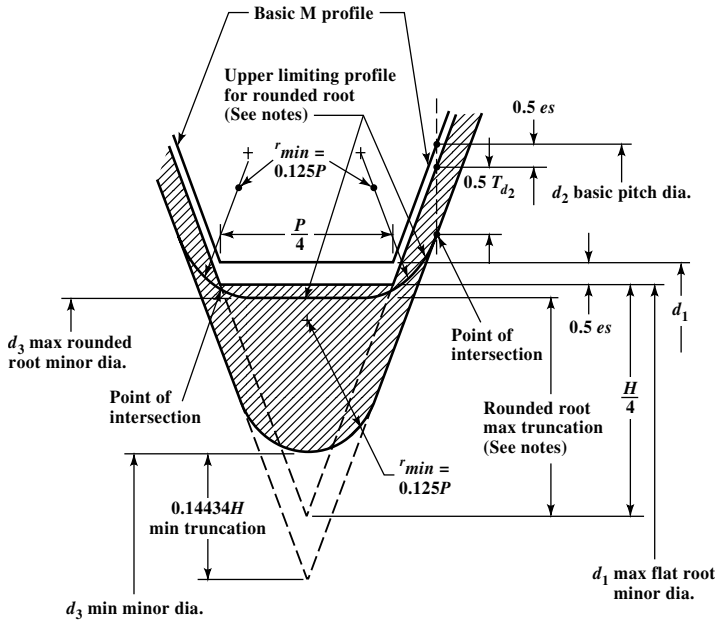


Fig. 4. M Profile, External Thread Root, Upper and Lower Limiting Profiles for $r_{min} = 0.125P$ and for Flat Root (Shown for Tolerance Position g)

Notes:

- 1) "Section lined" portions identify tolerance zone and unshaded portions identify allowance (fundamental deviation).
- 2) The upper limiting profile for rounded root is not a design profile; rather it indicates the limiting acceptable condition for the rounded root which will pass a GO thread gage.
- 3) Max truncation = $\frac{H}{4} - r_{min} \left(1 - \cos \left[60^\circ - \arccos \left(1 - \frac{T_{d2}}{4r_{min}} \right) \right] \right)$

where

- H = Height of fundamental triangle
- r_{min} = Minimum external thread root radius
- T_{d2} = Tolerance on pitch diameter of external thread

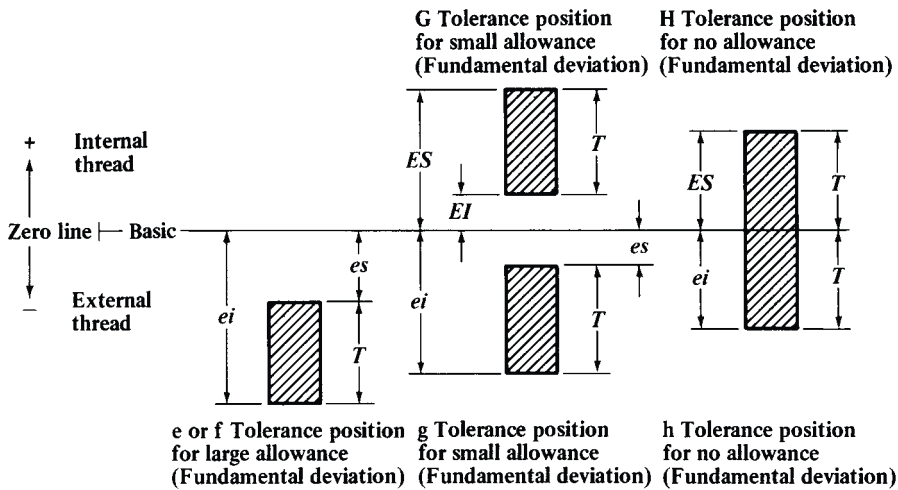


Fig. 5. Metric Tolerance System for Screw Threads

Tolerance Grade: This is indicated by a number. The system provides for a series of tolerance grades for each of the four screw thread parameters: minor diameter, internal thread, D_1 ; major diameter, external thread, d ; pitch diameter, internal thread, D_2 ; and pitch diameter, external thread, d_2 . The tolerance grades for this Standard ANSI B1.13M were selected from those given in ISO 965/1.

Dimension	Tolerance Grades	Table
D_1	4, 5, <u>6</u> , 7, 8	Table 8
d	4, <u>6</u> , 8	Table 9
D_2	4, 5, <u>6</u> , 7, 8	Table 10
d_2	3, <u>4</u> , 5, <u>6</u> , 7, 8, 9	Table 11

Note: The underlined tolerance grades are used with normal length of thread engagement.

Tolerance Position: This position is the allowance (fundamental deviation) and is indicated by a letter. A capital letter is used for internal threads and a lower case letter for external threads. The system provides a series of tolerance positions for internal and external threads. The underlined letters are used in this Standard:

Internal threads	G, <u>H</u>	Table 6
External threads	e, f, <u>g</u> , h	Table 6

Designations of Tolerance Grade, Tolerance Position, and Tolerance Class: The tolerance grade is given first followed by the tolerance position, thus 4g or 5H. To designate the tolerance class the grade and position of the pitch diameter is shown first followed by that for the major diameter in the case of the external thread or that for the minor diameter in the case of the internal thread, thus 4g6g for an external thread and 5H6H for an internal thread. If the two grades and positions are identical, it is not necessary to repeat the symbols, thus 4g, alone, stands for 4g4g and 5H, alone, stands for 5H5H.

Lead and Flank Angle Tolerances: For acceptance of lead and flank angles of product screw threads, see Section 10 of ANSI/ASME B1.13M-2005.

Short and Long Lengths of Thread Engagement when Gaged with Normal Length Contacts: For short lengths of thread engagement, LE, reduce the pitch diameter tolerance of the external thread by one tolerance grade number. For long lengths of thread engagement, LE, increase the allowance (fundamental deviation) at the pitch diameter of the external thread. Examples of tolerance classes required for normal, short, and long gage length contacts are given in the following table.

For lengths of thread engagement classified as normal, short, and long, see Table 7.

Table 6. American National Standard Allowance (Fundamental Deviation) for Internal and External Metric Threads ISO 965/1 ANSI/ASME B1.13M-2005

Pitch <i>P</i>	Allowance (Fundamental Deviation) ^a					
	Internal Thread <i>D</i> ₂ , <i>D</i> ₁		External Thread <i>d</i> , <i>d</i> ₂			
	<i>G</i>	<i>H</i> ^b	<i>e</i>	<i>f</i>	<i>g</i> ^c	<i>h</i>
	<i>El</i>	<i>El</i>	<i>es</i>	<i>es</i>	<i>es</i>	<i>es</i>
0.2	+0.017	0	-0.017	0
0.25	+0.018	0	-0.018	0
0.3	+0.018	0	-0.018	0
0.35	+0.019	0	...	-0.034	-0.019	0
0.4	+0.019	0	...	-0.034	-0.019	0
0.45	+0.020	0	...	-0.035	-0.020	0
0.5	+0.020	0	-0.050	-0.036	-0.020	0
0.6	+0.021	0	-0.053	-0.036	-0.021	0
0.7	+0.022	0	-0.056	-0.038	-0.022	0
0.75	+0.022	0	-0.056	-0.038	-0.022	0
0.8	+0.024	0	-0.060	-0.038	-0.024	0
1	+0.026	0	-0.060	-0.040	-0.026	0
1.25	+0.028	0	-0.063	-0.042	-0.028	0
1.5	+0.032	0	-0.067	-0.045	-0.032	0
1.75	+0.034	0	-0.071	-0.048	-0.034	0
2	+0.038	0	-0.071	-0.052	-0.038	0
2.5	+0.042	0	-0.080	-0.058	-0.042	0
3	+0.048	0	-0.085	-0.063	-0.048	0
3.5	+0.053	0	-0.090	-0.070	-0.053	0
4	+0.060	0	-0.095	-0.075	-0.060	0
4.5	+0.063	0	-0.100	-0.080	-0.063	0
5	+0.071	0	-0.106	-0.085	-0.071	0
5.5	+0.075	0	-0.112	-0.090	-0.075	0
6	+0.080	0	-0.118	-0.095	-0.080	0
8	+0.100	0	-0.140	-0.118	-0.100	0

All dimensions are in millimeters.

^a Allowance is the absolute value of fundamental deviation.

^b Tabulated in this standard for M internal threads.

^c Tabulated in this standard for M external threads.

Normal LE	Short LE	Long LE
6g	5g6g	6e6g
4g6g	3g6g	4e6g
6h ^a	5h6h	6g6h
4h6h ^a	3h6h	4g6h
6H	5H	6G
4H6H	3H6H	4G6G

^a Applies to maximum material functional size (GO thread gage) for plated 6g and 4g6g class threads, respectively.

Material Limits for Coated Threads.—Unless otherwise specified, size limits for standard external tolerance classes 6g and 4g6g apply prior to coating. The external thread allowance may thus be used to accommodate the coating thickness on coated parts, provided that the maximum coating thickness is no more than $\frac{1}{4}$ of the allowance. Thus, a 6g thread after coating is subject to acceptance using a basic size 6h GO thread gage and a 4g6g thread, a 4h6h or 6h GO thread gage. Minimum material, LO, or NOT-GO gages would be 6g and 4g6g, respectively. Where the external thread has no allowance or the allowance must be maintained after coating, and for standard internal threads, sufficient

Table 7. American National Standard Length of Metric Thread Engagement
ISO 965/1 and ANSI/ASME B1.13M-2005

Basic Major Diameter d_{bsc}		Pitch P	Length of Thread Engagement			
			Short LE	Normal LE		Long LE
Over	Up to and incl.		Up to and incl.	Over	Up to and incl.	Over
1.5	2.8	0.2	0.5	0.5	1.5	1.5
		0.25	0.6	0.6	1.9	1.9
		0.35	0.8	0.8	2.6	2.6
		0.4	1	1	3	3
		0.45	1.3	1.3	3.8	3.8
2.8	5.6	0.35	1	1	3	3
		0.5	1.5	1.5	4.5	4.5
		0.6	1.7	1.7	5	5
		0.7	2	2	6	6
		0.75	2.2	2.2	6.7	6.7
5.6	11.2	0.8	2.5	2.5	7.5	7.5
		0.75	2.4	2.4	7.1	7.1
		1	3	3	9	9
		1.25	4	4	12	12
11.2	22.4	1.5	5	5	15	15
		1	3.8	3.8	11	11
		1.25	4.5	4.5	13	13
		1.5	5.6	5.6	16	16
		1.75	6	6	18	18
22.4	45	2	8	8	24	24
		2.5	10	10	30	30
		1	4	4	12	12
		1.5	6.3	6.3	19	19
		2	8.5	8.5	25	25
		3	12	12	36	36
45	90	3.5	15	15	45	45
		4	18	18	53	53
		4.5	21	21	63	63
		1.5	7.5	7.5	22	22
		2	9.5	9.5	28	28
		3	15	15	45	45
		4	19	19	56	56
90	180	5	24	24	71	71
		5.5	28	28	85	85
		6	32	32	95	95
		2	12	12	36	36
		3	18	18	53	53
		4	24	24	71	71
180	355	6	36	36	106	106
		8	45	45	132	132
		3	20	20	60	60
		4	26	26	80	80
		6	40	40	118	118
		8	50	50	150	150

All dimensions are in millimeters.

allowance must be provided prior to coating to ensure that finished product threads do not exceed the maximum material limits specified. For thread classes with tolerance position H or h , coating allowances in accordance with Table 6 for position G or g , respectively, should be applied wherever possible.

Dimensional Effect of Coating.—On a cylindrical surface, the effect of coating is to change the diameter by twice the coating thickness. On a 60-degree thread, however, since the coating thickness is measured perpendicular to the thread surface while the pitch diameter is measured perpendicular to the thread axis, the effect of a uniformly coated flank on the pitch diameter is to change it by four times the thickness of the coating on the flank.

External Thread with No Allowance for Coating: To determine gaging limits before coating for a uniformly coated thread, decrease: 1) maximum pitch diameter by four times maximum coating thickness; 2) minimum pitch diameter by four times minimum coating thickness; 3) maximum major diameter by two times maximum coating thickness; and 4) minimum major diameter by two times minimum coating thickness.

External Thread with Only Nominal or Minimum Thickness Coating: If no coating thickness tolerance is given, it is recommended that a tolerance of plus 50 per cent of the nominal or minimum thickness be assumed.

Then, to determine before coating gaging limits for a uniformly coated thread, decrease:

1) maximum pitch diameter by six times coating thickness; 2) minimum pitch diameter by four times coating thickness; 3) maximum major diameter by three times coating thickness; and 4) minimum major diameter by two times coating thickness.

Adjusted Size Limits: It should be noted that the before coating material limit tolerances are less than the tolerance after coating. This is because the coating tolerance consumes some of the product tolerance. In cases there may be insufficient pitch diameter tolerance available in the before coating condition so that additional adjustments and controls will be necessary.

Strength: On small threads (5 mm and smaller) there is a possibility that coating thickness adjustments will cause base material minimum material conditions which may significantly affect strength of externally threaded parts. Limitations on coating thickness or part redesign may then be necessary.

Internal Threads: Standard internal threads provide no allowance for coating thickness.

To determine before coating, gaging limits for a uniformly coated thread, increase:

1) minimum pitch diameter by four times maximum coating thickness, if specified, or by six times minimum or nominal coating thickness when a tolerance is not specified; 2) maximum pitch diameter by four times minimum or nominal coating thickness; 3) minimum minor diameter by two times maximum coating thickness, if specified, or by three times minimum or nominal coating thickness; and 4) maximum minor diameter by two times minimum or nominal coating thickness.

Other Considerations: It is essential to review all possibilities adequately and consider limitations in the threading and coating production processes before finally deciding on the coating process and the allowance required to accommodate the coating. A no-allowance thread after coating must not transgress the basic profile and is, therefore, subject to acceptance using a basic (tolerance position H/h) size GO thread gage.

Formulas for M Profile Screw Thread Limiting Dimensions.—The limiting dimensions for M profile screw threads are calculated from the following formulas.

Internal Threads:

Min major dia. = basic major dia. + *EI* (Table 6)

Min pitch dia. = basic major dia. - 0.6495191*P* (Table 3) + *EI* for *D*₂ (Table 6)

Max pitch dia. = min pitch dia. + *TD*₂ (Table 10)

Max major dia. = max pitch dia. + 0.7938566*P* (Table 3)

Min minor dia. = min major dia. - 1.0825318*P* (Table 3)

Max minor dia. = min minor dia. + *TD*₁ (Table 8)

External Threads:

Max major dia. = basic major dia. - *es* (Table 6) (Note that *es* is an absolute value.)

Min major dia. = max major dia. - *Td* (Table 9)

Max pitch dia. = basic major dia. - 0.6495191*P* (Table 3) - *es* for *d*₂ (Table 6)

Min pitch dia. = max pitch dia. - *Td*₂ (Table 11)

Max flat form minor dia. = max pitch dia. - 0.433013*P* (Table 3)

Max rounded root minor dia. = max pitch dia. - 2 × max trunc. (See Fig. 4)

Min rounded root minor dia. = min pitch dia. - 0.616025*P* (Table 3)

Min root radius = 0.125*P*

Table 8. ANSI Standard Minor Diameter Tolerances of Internal Metric Threads *TD*₁ ISO 965/1 ANSI/ASME B1.13M-2005

Pitch <i>P</i>	Tolerance Grade				
	4	5	6 ^a	7	8
0.2	0.038
0.25	0.045	0.056
0.3	0.053	0.067	0.085
0.35	0.063	0.080	0.100
0.4	0.071	0.090	0.112
0.45	0.080	0.100	0.125
0.5	0.090	0.112	0.140	0.180	...
0.6	0.100	0.125	0.160	0.200	...
0.7	0.112	0.140	0.180	0.224	...
0.75	0.118	0.150	0.190	0.236	...
0.8	0.125	0.160	0.200	0.250	0.315
1	0.150	0.190	0.236	0.300	0.375
1.25	0.170	0.212	0.265	0.335	0.425
1.5	0.190	0.236	0.300	0.375	0.475
1.75	0.212	0.265	0.335	0.425	0.530
2	0.236	0.300	0.375	0.475	0.600
2.5	0.280	0.355	0.450	0.560	0.710
3	0.315	0.400	0.500	0.630	0.800
3.5	0.355	0.450	0.560	0.710	0.900
4	0.375	0.475	0.600	0.750	0.950
4.5	0.425	0.530	0.670	0.850	1.060
5	0.450	0.560	0.710	0.900	1.120
5.5	0.475	0.600	0.750	0.950	1.180
6	0.500	0.630	0.800	1.000	1.250
8	0.630	0.800	1.000	1.250	1.600

^a Tabulated in this standard for M internal threads.

All dimensions are in millimeters.

Table 9. ANSI Standard Major Diameter Tolerances of External Metric Threads, T_d ISO 965/1 ANSI/ASME B1.13M-2005

Pitch P	Tolerance Grade			Pitch P	Tolerance Grade		
	4	6 ^a	8		4	6 ^a	8
0.2	0.036	0.056	...	1.5	0.150	0.236	0.375
0.25	0.042	0.067	...	1.75	0.170	0.265	0.425
0.3	0.048	0.075	...	2	0.180	0.280	0.450
0.35	0.053	0.085	...	2.5	0.212	0.335	0.530
0.4	0.060	0.095	...	3	0.236	0.375	0.600
0.45	0.063	0.100	...	3.5	0.265	0.425	0.670
0.5	0.067	0.106	...	4	0.300	0.475	0.750
0.6	0.080	0.125	...	4.5	0.315	0.500	0.800
0.7	0.090	0.140	...	5	0.335	0.530	0.850
0.75	0.090	0.140	...	5.5	0.355	0.560	0.900
0.8	0.095	0.150	0.236	6	0.375	0.600	0.950
1	0.112	0.180	0.280	8	0.450	0.710	1.180
1.25	0.132	0.212	0.335

^aTabulated in this standard for M internal threads.

All dimensions are in millimeters.

Table 10. ANSI Standard Pitch-Diameter Tolerances of Internal Metric Thread, TD_2 ISO 965/1 ANSI/ASME B1.13M-2005

Basic Major Diameter, D		Pitch P	Tolerance Grade				
Over	Up to and incl.		4	5	6 ^a	7	8
1.5	2.8	0.2	0.042
		0.25	0.048	0.060
		0.35	0.053	0.067	0.085
		0.4	0.056	0.071	0.090
		0.45	0.060	0.075	0.095
2.8	5.6	0.35	0.056	0.071	0.090
		0.5	0.063	0.080	0.100	0.125	...
		0.6	0.071	0.090	0.112	0.140	...
		0.7	0.075	0.095	0.118	0.150	...
		0.75	0.075	0.095	0.118	0.150	...
5.6	11.2	0.8	0.080	0.100	0.125	0.160	0.200
		0.75	0.085	0.106	0.132	0.170	...
		1	0.095	0.118	0.150	0.190	0.236
		1.25	0.100	0.125	0.160	0.200	0.250
		1.5	0.112	0.140	0.180	0.224	0.280
11.2	22.4	1	0.100	0.125	0.160	0.200	0.250
		1.25	0.112	0.140	0.180	0.224	0.280
		1.5	0.118	0.150	0.190	0.236	0.300
		1.75	0.125	0.160	0.200	0.250	0.315
		2	0.132	0.170	0.212	0.265	0.335
		2.5	0.140	0.180	0.224	0.280	0.355
22.4	45	1	0.106	0.132	0.170	0.212	...
		1.5	0.125	0.160	0.200	0.250	0.315
		2	0.140	0.180	0.224	0.280	0.355
		3	0.170	0.212	0.265	0.335	0.425
		3.5	0.180	0.224	0.280	0.355	0.450
		4	0.190	0.236	0.300	0.375	0.475
		4.5	0.200	0.250	0.315	0.400	0.500
45	90	1.5	0.132	0.170	0.212	0.265	0.335
		2	0.150	0.190	0.236	0.300	0.375
		3	0.180	0.224	0.280	0.355	0.450
		4	0.200	0.250	0.315	0.400	0.500
		5	0.212	0.265	0.335	0.425	0.530
		5.5	0.224	0.280	0.355	0.450	0.560
6	0.236	0.300	0.375	0.475	0.600		

Table 10. (Continued) ANSI Standard Pitch-Diameter Tolerances of Internal Metric Thread, TD_2 ISO 965/1 ANSI/ASME B1.13M-2005

Basic Major Diameter, D		Pitch P	Tolerance Grade				
Over	Up to and incl.		4	5	6 ^a	7	8
90	180	2	0.160	0.200	0.250	0.315	0.400
		3	0.190	0.236	0.300	0.375	0.475
		4	0.212	0.265	0.335	0.425	0.530
		6	0.250	0.315	0.400	0.500	0.630
		8	0.280	0.355	0.450	0.560	0.710
180	355	3	0.212	0.265	0.335	0.425	0.530
		4	0.236	0.300	0.375	0.475	0.600
		6	0.265	0.335	0.425	0.530	0.670
		8	0.300	0.375	0.475	0.600	0.750

^a Tabulated in this standard for M threads.

All dimensions are in millimeters.

Table 11. ANSI Standard Pitch-Diameter Tolerances of External Metric Threads, Td_2 ISO 965/1 ANSI/ASME B1.13M-2005

Basic Major Diameter, d		Pitch P	Tolerance Grade						
Over	Up to and incl.		3	4 ^a	5	6 ^a	7	8	9
1.5	2.8	0.2	0.025	0.032	0.040	0.050
		0.25	0.028	0.036	0.045	0.056
		0.35	0.032	0.040	0.050	0.063	0.080
		0.4	0.034	0.042	0.053	0.067	0.085
		0.45	0.036	0.045	0.056	0.071	0.090
2.8	5.6	0.35	0.034	0.042	0.053	0.067	0.085
		0.5	0.038	0.048	0.060	0.075	0.095
		0.6	0.042	0.053	0.067	0.085	0.106
		0.7	0.045	0.056	0.071	0.090	0.112
		0.75	0.045	0.056	0.071	0.090	0.112
		0.8	0.048	0.060	0.075	0.095	0.118	0.150	0.190
5.6	11.2	0.75	0.050	0.063	0.080	0.100	0.125
		1	0.056	0.071	0.090	0.112	0.140	0.180	0.224
		1.25	0.060	0.075	0.095	0.118	0.150	0.190	0.236
		1.5	0.067	0.085	0.106	0.132	0.170	0.212	0.265
11.2	22.4	1	0.060	0.075	0.095	0.118	0.150	0.190	0.236
		1.25	0.067	0.085	0.106	0.132	0.170	0.212	0.265
		1.5	0.071	0.090	0.112	0.140	0.180	0.224	0.280
		1.75	0.075	0.095	0.118	0.150	0.190	0.236	0.300
		2	0.080	0.100	0.125	0.160	0.200	0.250	0.315
		2.5	0.085	0.106	0.132	0.170	0.212	0.265	0.335
22.4	45	1	0.063	0.080	0.100	0.125	0.160	0.200	0.250
		1.5	0.075	0.095	0.118	0.150	0.190	0.236	0.300
		2	0.085	0.106	0.132	0.170	0.212	0.265	0.335
		3	0.100	0.125	0.160	0.200	0.250	0.315	0.400
		3.5	0.106	0.132	0.170	0.212	0.265	0.335	0.425
		4	0.112	0.140	0.180	0.224	0.280	0.355	0.450
		4.5	0.118	0.150	0.190	0.236	0.300	0.375	0.475
45	90	1.5	0.080	0.100	0.125	0.160	0.200	0.250	0.315
		2	0.090	0.112	0.140	0.180	0.224	0.280	0.355
		3	0.106	0.132	0.170	0.212	0.265	0.335	0.425
		4	0.118	0.150	0.190	0.236	0.300	0.375	0.475
		5	0.125	0.160	0.200	0.250	0.315	0.400	0.500
		5.5	0.132	0.170	0.212	0.265	0.335	0.425	0.530
		6	0.140	0.180	0.224	0.280	0.355	0.450	0.560
		6	0.140	0.180	0.224	0.280	0.355	0.450	0.560
90	180	2	0.095	0.118	0.150	0.190	0.236	0.300	0.375
		3	0.112	0.140	0.180	0.224	0.280	0.355	0.450
		4	0.125	0.160	0.200	0.250	0.315	0.400	0.500
		6	0.150	0.190	0.236	0.300	0.375	0.475	0.600
		8	0.170	0.212	0.265	0.335	0.425	0.530	0.670

Table 11. (Continued) ANSI Standard Pitch-Diameter Tolerances of External Metric Threads, Td_2 ISO 965/1 ANSI/ASME B1.13M-2005

Basic Major Diameter, d		Pitch P	Tolerance Grade						
Over	Up to and incl.		3	4 ^a	5	6 ^a	7	8	9
180	355	3	0.125	0.160	0.200	0.250	0.315	0.400	0.500
		4	0.140	0.180	0.224	0.280	0.355	0.450	0.560
		6	0.160	0.200	0.250	0.315	0.400	0.500	0.630
		8	0.180	0.224	0.280	0.355	0.450	0.560	0.710

^aTabulated in this Standard for M threads.

All dimensions are in millimeters.

Tolerance Grade Comparisons.—The approximate ratios of the tolerance grades shown in Tables 8, 9, 10, and 11 in terms of Grade 6 are as follows:

Minor Diameter Tolerance of Internal Thread: Grade 6 is TD_1 (Table 8); Grade 4 is 0.63 TD_1 (6); Grade 5 is 0.8 TD_1 (6); Grade 7 is 1.25 TD_1 (6); and Grade 8 is 1.6 TD_1 (6).

Pitch Diameter Tolerance of Internal Thread: Td_2 (Table 10): Grade 4 is 0.85 Td_2 (6); Grade 5 is 1.06 Td_2 (6); Grade 6 is 1.32 Td_2 (6); Grade 7 is 1.7 Td_2 (6); and Grade 8 is 2.12 Td_2 (6). It should be noted that these ratios are in terms of the Grade 6 pitch diameter tolerance for the external thread.

Major Diameter Tolerance of External Thread: $Td(6)$ (Table 9): Grade 4 is 0.63 Td (6); and Grade 8 is 1.6 Td (6).

Pitch Diameter Tolerance of External Thread: Td_2 (Table 11): Grade 3 is 0.5 Td_2 (6); Grade 4 is 0.63 Td_2 (6); Grade 5 is 0.8 Td_2 (6); Grade 7 is 1.25 Td_2 (6); Grade 8 is 1.6 Td_2 (6); and Grade 9 is 2 Td_2 (6).

Standard M Profile Screw Threads, Limits of Size.—The limiting M profile for internal threads is shown in Fig. 6 with associated dimensions for standard sizes in Table 12. The limiting M profiles for external threads are shown in Fig. 7 with associated dimensions for standard sizes in Table 13.

If the required values are not listed in these tables, they may be calculated using the data in Tables 3, 6, 7, 8, 9, 10, and 11 together with the preceding formulas. If the required data are not included in any of the tables listed above, reference should be made to Sections 6 and 9.3 of ANSI/ASME B1.13M, which gives design formulas.

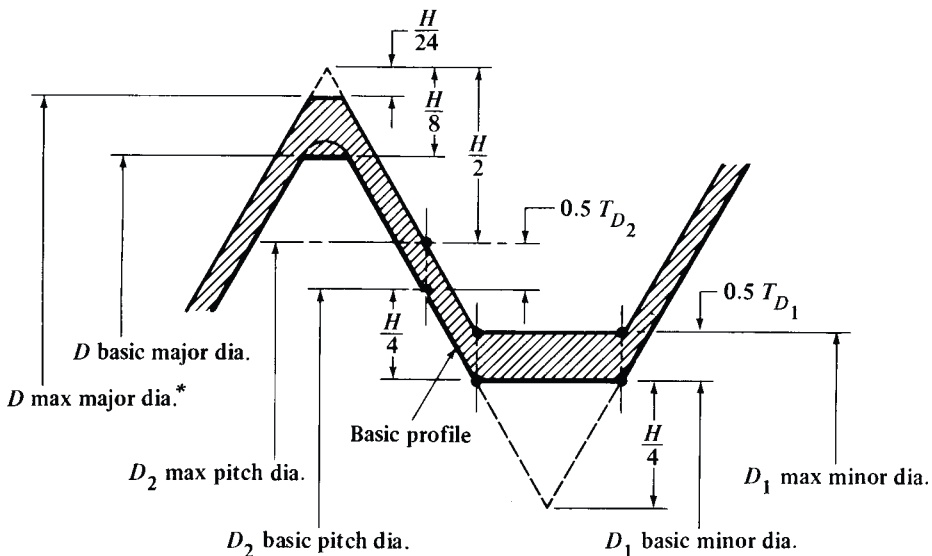


Fig. 6. Internal Thread — Limiting M Profile. Tolerance Position H

Note: "Section Lined" portions identify tolerance zone.

*Dimension D in Fig. 6 is used in the design of tools, etc. For internal threads it is not normally specified. Generally, major diameter acceptance is based on maximum material condition gaging.

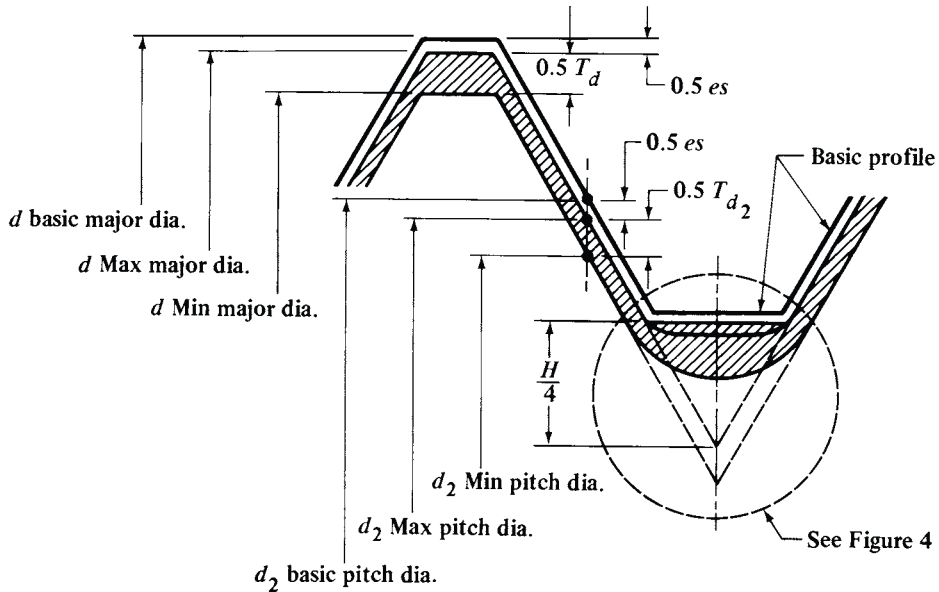


Fig. 7. External Thread — Limiting M Profile. Tolerance Position g

Note: "Section Lined" portions identify tolerance zone and unshaded portions identify allowance (fundamental deviation.)

Table 12. Internal Metric Thread - M Profile Limiting Dimensions, ANSI/ASME B1.13M-2005

Basic Thread Designation	Toler. Class	Minor Diameter D_1		Pitch Diameter D_2			Major Diameter D	
		Min	Max	Min	Max	Tol	Min	Max ^a
M1.6 × 0.35	6H	1.221	1.321	1.373	1.458	0.085	1.600	1.736
M2 × 0.4	6H	1.567	1.679	1.740	1.830	0.090	2.000	2.148
M2.5 × 0.45	6H	2.013	2.138	2.208	2.303	0.095	2.500	2.660
M3 × 0.5	6H	2.459	2.599	2.675	2.775	0.100	3.000	3.172
M3.5 × 0.6	6H	2.850	3.010	3.110	3.222	0.112	3.500	3.698
M4 × 0.7	6H	3.242	3.422	3.545	3.663	0.118	4.000	4.219
M5 × 0.8	6H	4.134	4.334	4.480	4.605	0.125	5.000	5.240
M6 × 1	6H	4.917	5.153	5.350	5.500	0.150	6.000	6.294
M8 × 1.25	6H	6.647	6.912	7.188	7.348	0.160	8.000	8.340
M8 × 1	6H	6.917	7.153	7.350	7.500	0.150	8.000	8.294
M10 × 0.75	6H	9.188	9.378	9.513	9.645	0.132	10.000	10.240
M10 × 1	6H	8.917	9.153	9.350	9.500	0.150	10.000	10.294
M10 × 1.5	6H	8.376	8.676	9.026	9.206	0.180	10.000	10.397
M10 × 1.25	6H	8.647	8.912	9.188	9.348	0.160	10.000	10.340
M12 × 1.75	6H	10.106	10.441	10.863	11.063	0.200	12.000	12.452
M12 × 1.5	6H	10.376	10.676	11.026	11.216	0.190	12.000	12.407
M12 × 1.25	6H	10.647	10.912	11.188	11.368	0.180	12.000	12.360
M12 × 1	6H	10.917	11.153	11.350	11.510	0.160	12.000	12.304
M14 × 2	6H	11.835	12.210	12.701	12.913	0.212	14.000	14.501
M14 × 1.5	6H	12.376	12.676	13.026	13.216	0.190	14.000	14.407
M15 × 1	6H	13.917	14.153	14.350	14.510	0.160	15.000	15.304
M16 × 2	6H	13.835	14.210	14.701	14.913	0.212	16.000	16.501
M16 × 1.5	6H	14.376	14.676	15.026	15.216	0.190	16.000	16.407
M17 × 1	6H	15.917	16.153	16.350	16.510	0.160	17.000	17.304
M18 × 1.5	6H	16.376	16.676	17.026	17.216	0.190	18.000	18.407
M20 × 2.5	6H	17.294	17.744	18.376	18.600	0.224	20.000	20.585
M20 × 1.5	6H	18.376	18.676	19.026	19.216	0.190	20.000	20.407



**Table 12. (Continued) Internal Metric Thread - M Profile Limiting Dimensions,
ANSI/ASME B1.13M-2005**

Basic Thread Designation	Toler. Class	Minor Diameter D_1		Pitch Diameter D_2			Major Diameter D	
		Min	Max	Min	Max	Tol	Min	Max ^a
M20 × 1	6H	18.917	19.153	19.350	19.510	0.160	20.000	20.304
M22 × 2.5	6H	19.294	19.744	20.376	20.600	0.224	22.000	22.585
M22 × 1.5	6H	20.376	20.676	21.026	21.216	0.190	22.000	22.407
M24 × 3	6H	20.752	21.252	22.051	22.316	0.265	24.000	24.698
M24 × 2	6H	21.835	22.210	22.701	22.925	0.224	24.000	24.513
M25 × 1.5	6H	23.376	23.676	24.026	24.226	0.200	25.000	25.417
M27 × 3	6H	23.752	24.252	25.051	25.316	0.265	27.000	27.698
M27 × 2	6H	24.835	25.210	25.701	25.925	0.224	27.000	27.513
M30 × 3.5	6H	26.211	26.771	27.727	28.007	0.280	30.000	30.786
M30 × 2	6H	27.835	28.210	28.701	28.925	0.224	30.000	30.513
M30 × 1.5	6H	28.376	28.676	29.026	29.226	0.200	30.000	30.417
M33 × 2	6H	30.835	31.210	31.701	31.925	0.224	33.000	33.513
M35 × 1.5	6H	33.376	33.676	34.026	34.226	0.200	35.000	35.417
M36 × 4	6H	31.670	32.270	33.402	33.702	0.300	36.000	36.877
M36 × 2	6H	33.835	34.210	34.701	34.925	0.224	36.000	36.513
M39 × 2	6H	36.835	37.210	37.701	37.925	0.224	39.000	39.513
M40 × 1.5	6H	38.376	38.676	39.026	39.226	0.200	40.000	40.417
M42 × 4.5	6H	37.129	37.799	39.077	39.392	0.315	42.000	42.964
M42 × 2	6H	39.835	40.210	40.701	40.925	0.224	42.000	42.513
M45 × 1.5	6H	43.376	43.676	44.026	44.226	0.200	45.000	45.417
M48 × 5	6H	42.587	43.297	44.752	45.087	0.335	48.000	49.056
M48 × 2	6H	45.835	46.210	46.701	46.937	0.236	48.000	48.525
M50 × 1.5	6H	48.376	48.676	49.026	49.238	0.212	50.000	50.429
M55 × 1.5	6H	53.376	53.676	54.026	54.238	0.212	55.000	55.429
M56 × 5.5	6H	50.046	50.796	52.428	52.783	0.355	56.000	57.149
M56 × 2	6H	53.835	54.210	54.701	54.937	0.236	56.000	56.525
M60 × 1.5	6H	58.376	58.676	59.026	59.238	0.212	60.000	60.429
M64 × 6	6H	57.505	58.305	60.103	60.478	0.375	64.000	65.241
M64 × 2	6H	61.835	62.210	62.701	62.937	0.236	64.000	64.525
M65 × 1.5	6H	63.376	63.676	64.026	64.238	0.212	65.000	65.429
M70 × 1.5	6H	68.376	68.676	69.026	69.238	0.212	70.000	70.429
M72 × 6	6H	65.505	66.305	68.103	68.478	0.375	72.000	73.241
M72 × 2	6H	69.835	70.210	70.701	70.937	0.236	72.000	72.525
M75 × 1.5	6H	73.376	73.676	74.026	74.238	0.212	75.000	75.429
M80 × 6	6H	73.505	74.305	76.103	76.478	0.375	80.000	81.241
M80 × 2	6H	77.835	78.210	78.701	78.937	0.236	80.000	80.525
M80 × 1.5	6H	78.376	78.676	79.026	79.238	0.212	80.000	80.429
M85 × 2	6H	82.835	83.210	83.701	83.937	0.236	85.000	85.525
M90 × 6	6H	83.505	84.305	86.103	86.478	0.375	90.000	91.241
M90 × 2	6H	87.835	88.210	88.701	88.937	0.236	90.000	90.525
M95 × 2	6H	92.835	93.210	93.701	93.951	0.250	95.000	95.539
M100 × 6	6H	93.505	94.305	96.103	96.503	0.400	100.000	101.266
M100 × 2	6H	97.835	98.210	98.701	98.951	0.250	100.000	100.539
M105 × 2	6H	102.835	103.210	103.701	103.951	0.250	105.000	105.539
M110 × 2	6H	107.835	108.210	108.701	108.951	0.250	110.000	110.539
M120 × 2	6H	117.835	118.210	118.701	118.951	0.250	120.000	120.539
M130 × 2	6H	127.835	128.210	128.701	128.951	0.250	130.000	130.539
M140 × 2	6H	137.835	138.210	138.701	138.951	0.250	140.000	140.539
M150 × 2	6H	147.835	148.210	148.701	148.951	0.250	150.000	150.539
M160 × 3	6H	156.752	157.252	158.051	158.351	0.300	160.000	160.733
M170 × 3	6H	166.752	167.252	168.051	168.351	0.300	170.000	170.733
M180 × 3	6H	176.752	177.252	178.051	178.351	0.300	180.000	180.733
M190 × 3	6H	186.752	187.252	188.051	188.386	0.335	190.000	190.768
M200 × 3	6H	196.752	197.252	198.051	198.386	0.335	200.000	200.768

^a This reference dimension is used in design of tools, etc., and is not normally specified. Generally, major diameter acceptance is based upon maximum material condition gaging.

All dimensions are in millimeters.

Table 13. External Metric Thread—M Profile Limiting Dimensions *ANSI/ASME B1.13M-2005*

Basic Thread Designation	Tol. Class	Allowance ^a <i>e_s</i>	Major Diameter ^b <i>d</i>		Pitch Diameter ^{b c} <i>d₂</i>			Minor Dia. ^b <i>d₁</i>	Minor Dia. ^d <i>d₃</i>
			Max.	Min.	Max.	Min.	Tol.	Max.	Min.
M1.6 × 0.35	6g	0.019	1.581	1.496	1.354	1.291	0.063	1.202	1.075
M1.6 × 0.35	6h	0.000	1.600	1.515	1.373	1.310	0.063	1.221	1.094
M1.6 × 0.35	4g6g	0.019	1.581	1.496	1.354	1.314	0.040	1.202	1.098
M2 × 0.4	6g	0.019	1.981	1.886	1.721	1.654	0.067	1.548	1.408
M2 × 0.4	6h	0.000	2.000	1.905	1.740	1.673	0.067	1.567	1.427
M2 × 0.4	4g6g	0.019	1.981	1.886	1.721	1.679	0.042	1.548	1.433
M2.5 × 0.45	6g	0.020	2.480	2.380	2.188	2.117	0.071	1.993	1.840
M2.5 × 0.45	6h	0.000	2.500	2.400	2.208	2.137	0.071	2.013	1.860
M2.5 × 0.45	4g6g	0.020	2.480	2.380	2.188	2.143	0.045	1.993	1.866
M3 × 0.5	6g	0.020	2.980	2.874	2.655	2.580	0.075	2.438	2.272
M3 × 0.5	6h	0.000	3.000	2.894	2.675	2.600	0.075	2.458	2.292
M3 × 0.5	4g6g	0.020	2.980	2.874	2.655	2.607	0.048	2.438	2.299
M3.5 × 0.6	6g	0.021	3.479	3.354	3.089	3.004	0.085	2.829	2.634
M3.5 × 0.6	6h	0.000	3.500	3.375	3.110	3.025	0.085	2.850	2.655
M3.5 × 0.6	4g6g	0.021	3.479	3.354	3.089	3.036	0.053	2.829	2.666
M4 × 0.7	6g	0.022	3.978	3.838	3.523	3.433	0.090	3.220	3.002
M4 × 0.7	6h	0.000	4.000	3.860	3.545	3.455	0.090	3.242	3.024
M4 × 0.7	4g6g	0.022	3.978	3.838	3.523	3.467	0.056	3.220	3.036
M5 × 0.8	6g	0.024	4.976	4.826	4.456	4.361	0.095	4.110	3.868
M5 × 0.8	6h	0.000	5.000	4.850	4.480	4.385	0.095	4.134	3.892
M5 × 0.8	4g6g	0.024	4.976	4.826	4.456	4.396	0.060	4.110	3.903
M6 × 1	6g	0.026	5.974	5.794	5.324	5.212	0.112	4.891	4.596
M6 × 1	6h	0.000	6.000	5.820	5.350	5.238	0.112	4.917	4.622
M6 × 1	4g6g	0.026	5.974	5.794	5.324	5.253	0.071	4.891	4.637
M8 × 1.25	6g	0.028	7.972	7.760	7.160	7.042	0.118	6.619	6.272
M8 × 1.25	6h	0.000	8.000	7.788	7.188	7.070	0.118	6.647	6.300
M8 × 1.25	4g6g	0.028	7.972	7.760	7.160	7.085	0.075	6.619	6.315
M8 × 1	6g	0.026	7.974	7.794	7.324	7.212	0.112	6.891	6.596
M8 × 1	6h	0.000	8.000	7.820	7.350	7.238	0.112	6.917	6.622
M8 × 1	4g6g	0.026	7.974	7.794	7.324	7.253	0.071	6.891	6.637
M10 × 1.5	6g	0.032	9.968	9.732	8.994	8.862	0.132	8.344	7.938
M10 × 1.5	6h	0.000	10.000	9.764	9.026	8.894	0.132	8.376	7.970
M10 × 1.5	4g6g	0.032	9.968	9.732	8.994	8.909	0.085	8.344	7.985
M10 × 1.25	6g	0.028	9.972	9.760	9.160	9.042	0.118	8.619	8.272
M10 × 1.25	6h	0.000	10.000	9.788	9.188	9.070	0.118	8.647	8.300
M10 × 1.25	4g6g	0.028	9.972	9.760	9.160	9.085	0.075	8.619	8.315
M10 × 1	6g	0.026	9.974	9.794	9.324	9.212	0.112	8.891	8.596
M10 × 1	6h	0.000	10.000	9.820	9.350	9.238	0.112	8.917	8.622
M10 × 1	4g6g	0.026	9.974	9.794	9.324	9.253	0.071	8.891	8.637
M10 × 0.75	6g	0.022	9.978	9.838	9.491	9.391	0.100	9.166	8.929
M10 × 0.75	6h	0.000	10.000	9.860	9.513	9.413	0.100	9.188	8.951
M10 × 0.75	4g6g	0.022	9.978	9.838	9.491	9.428	0.063	9.166	8.966
M12 × 1.75	6g	0.034	11.966	11.701	10.829	10.679	0.150	10.071	9.601
M12 × 1.75	6h	0.000	12.000	11.735	10.863	10.713	0.150	10.105	9.635
M12 × 1.75	4g6g	0.034	11.966	11.701	10.829	10.734	0.095	10.071	9.656
M12 × 1.5	6g	0.032	11.968	11.732	10.994	10.854	0.140	10.344	9.930
M12 × 1.5	6h	0.000	12.000	11.764	11.026	10.886	0.140	10.376	9.962
M12 × 1.5	4g6g	0.032	11.968	11.732	10.994	10.904	0.090	10.344	9.980
M12 × 1.25	6g	0.028	11.972	11.760	11.160	11.028	0.132	10.619	10.258
M12 × 1.25	6h	0.000	12.000	11.788	11.188	11.056	0.132	10.647	10.286
M12 × 1.25	4g6g	0.028	11.972	11.760	11.160	11.075	0.085	10.619	10.305
M12 × 1	6g	0.026	11.974	11.794	11.324	11.206	0.118	10.891	10.590
M12 × 1	6h	0.000	12.000	11.820	11.350	11.232	0.118	10.917	10.616
M12 × 1	4g6g	0.026	11.974	11.794	11.324	11.249	0.075	10.891	10.633
M14 × 2	6g	0.038	13.962	13.682	12.663	12.503	0.160	11.797	11.271
M14 × 2	6h	0.000	14.000	13.720	12.701	12.541	0.160	11.835	11.309
M14 × 2	4g6g	0.038	13.962	13.682	12.663	12.563	0.100	11.797	11.331
M14 × 1.5	6g	0.032	13.968	13.732	12.994	12.854	0.140	12.344	11.930
M14 × 1.5	6h	0.000	14.000	13.764	13.026	12.886	0.140	12.376	11.962
M14 × 1.5	4g6g	0.032	13.968	13.732	12.994	12.904	0.090	12.344	11.980
M15 × 1	6g	0.026	14.974	14.794	14.324	14.206	0.118	13.891	13.590
M15 × 1	6h	0.000	15.000	14.820	14.350	14.232	0.118	13.917	13.616
M15 × 1	4g6g	0.026	14.974	14.794	14.324	14.249	0.075	13.891	13.633



Table 13. (Continued) External Metric Thread—M Profile Limiting Dimensions ANSI/ASME B1.13M-2005

Basic Thread Designation	Tol. Class	Allowance ^a <i>e_s</i>	Major Diameter ^b <i>d</i>		Pitch Diameter ^{b,c} <i>d₂</i>			Minor Dia. ^b <i>d₁</i>	Minor Dia. ^d <i>d₃</i>
			Max.	Min.	Max.	Min.	Tol.	Max.	Min.
M16 × 2	6g	0.038	15.962	15.682	14.663	14.503	0.160	13.797	13.271
M16 × 2	6h	0.000	16.000	15.720	14.701	14.541	0.160	13.835	13.309
M16 × 2	4g6g	0.038	15.962	15.682	14.663	14.563	0.100	13.797	13.331
M16 × 1.5	6g	0.032	15.968	15.732	14.994	14.854	0.140	14.344	13.930
M16 × 1.5	6h	0.000	16.000	15.764	15.026	14.886	0.140	14.376	13.962
M16 × 1.5	4g6g	0.032	15.968	15.732	14.994	14.904	0.090	14.344	13.980
M17 × 1	6g	0.026	16.974	16.794	16.324	16.206	0.118	15.891	15.590
M17 × 1	6h	0.000	17.000	16.820	16.350	16.232	0.118	15.917	15.616
M17 × 1	4g6g	0.026	16.974	16.794	16.324	16.249	0.075	15.891	15.633
M18 × 1.5	6g	0.032	17.968	17.732	16.994	16.854	0.140	16.344	15.930
M18 × 1.5	6h	0.000	18.000	17.764	17.026	16.886	0.140	16.376	15.962
M18 × 1.5	4g6g	0.032	17.968	17.732	16.994	16.904	0.090	16.344	15.980
M20 × 2.5	6g	0.042	19.958	19.623	18.334	18.164	0.170	17.251	16.624
M20 × 2.5	6h	0.000	20.000	19.665	18.376	18.206	0.170	17.293	16.666
M20 × 2.5	4g6g	0.042	19.958	19.623	18.334	18.228	0.106	17.251	16.688
M20 × 1.5	6g	0.032	19.968	19.732	18.994	18.854	0.140	18.344	17.930
M20 × 1.5	6h	0.000	20.000	19.764	19.026	18.886	0.140	18.376	17.962
M20 × 1.5	4g6g	0.032	19.968	19.732	18.994	18.904	0.090	18.344	17.980
M20 × 1	6g	0.026	19.974	19.794	19.324	19.206	0.118	18.891	18.590
M20 × 1	6h	0.000	20.000	19.820	19.350	19.232	0.118	18.917	18.616
M20 × 1	4g6g	0.026	19.974	19.794	19.324	19.249	0.075	18.891	18.633
M22 × 2.5	6g	0.042	21.958	21.623	20.334	20.164	0.170	19.251	18.624
M22 × 2.5	6h	0.000	22.000	21.665	20.376	20.206	0.170	19.293	18.666
M22 × 1.5	6g	0.032	21.968	21.732	20.994	20.854	0.140	20.344	19.930
M22 × 1.5	6h	0.000	22.000	21.764	21.026	20.886	0.140	20.376	19.962
M22 × 1.5	4g6g	0.032	21.968	21.732	20.994	20.904	0.090	20.344	19.980
M24 × 3	6g	0.048	23.952	23.577	22.003	21.803	0.200	20.704	19.955
M24 × 3	6h	0.000	24.000	23.625	22.051	21.851	0.200	20.752	20.003
M24 × 3	4g6g	0.048	23.952	23.577	22.003	21.878	0.125	20.704	20.030
M24 × 2	6g	0.038	23.962	23.682	22.663	22.493	0.170	21.797	21.261
M24 × 2	6h	0.000	24.000	23.720	22.701	22.531	0.170	21.835	21.299
M24 × 2	4g6g	0.038	23.962	23.682	22.663	22.557	0.106	21.797	21.325
M25 × 1.5	6g	0.032	24.968	24.732	23.994	23.844	0.150	23.344	22.920
M25 × 1.5	6h	0.000	25.000	24.764	24.026	23.876	0.150	23.376	22.952
M25 × 1.5	4g6g	0.032	24.968	24.732	23.994	23.899	0.095	23.344	22.975
M27 × 3	6g	0.048	26.952	26.577	25.003	24.803	0.200	23.704	22.955
M27 × 3	6h	0.000	27.000	26.625	25.051	24.851	0.200	23.752	23.003
M27 × 2	6g	0.038	26.962	26.682	25.663	25.493	0.170	24.797	24.261
M27 × 2	6h	0.000	27.000	26.720	25.701	25.531	0.170	24.835	24.299
M27 × 2	4g6g	0.038	26.962	26.682	25.663	25.557	0.106	24.797	24.325
M30 × 3.5	6g	0.053	29.947	29.522	27.674	27.462	0.212	26.158	25.306
M30 × 3.5	6h	0.000	30.000	29.575	27.727	27.515	0.212	26.211	25.359
M30 × 3.5	4g6g	0.053	29.947	29.522	27.674	27.542	0.132	26.158	25.386
M30 × 2	6g	0.038	29.962	29.682	28.663	28.493	0.170	27.797	27.261
M30 × 2	6h	0.000	30.000	29.720	28.701	28.531	0.170	27.835	27.299
M30 × 2	4g6g	0.038	29.962	29.682	28.663	28.557	0.106	27.797	27.325
M30 × 1.5	6g	0.032	29.968	29.732	28.994	28.844	0.150	28.344	27.920
M30 × 1.5	6h	0.000	30.000	29.764	29.026	28.876	0.150	28.376	27.952
M30 × 1.5	4g6g	0.032	29.968	29.732	28.994	28.899	0.095	28.344	27.975
M33 × 2	6g	0.038	32.962	32.682	31.663	31.493	0.170	30.797	30.261
M33 × 2	6h	0.000	33.000	32.720	31.701	31.531	0.170	30.835	30.299
M33 × 2	4g6g	0.038	32.962	32.682	31.663	31.557	0.106	30.797	30.325
M35 × 1.5	6g	0.032	34.968	34.732	33.994	33.844	0.150	33.344	32.920
M35 × 1.5	6h	0.000	35.000	34.764	34.026	33.876	0.150	33.376	32.952
M36 × 4	6g	0.060	35.940	35.465	33.342	33.118	0.224	31.610	30.654
M36 × 4	6h	0.000	36.000	35.525	33.402	33.178	0.224	31.670	30.714
M36 × 4	4g6g	0.060	35.940	35.465	33.342	33.202	0.140	31.610	30.738
M36 × 2	6g	0.038	35.962	35.682	34.663	34.493	0.170	33.797	33.261
M36 × 2	6h	0.000	36.000	35.720	34.701	34.531	0.170	33.835	33.299
M36 × 2	4g6g	0.038	35.962	35.682	34.663	34.557	0.106	33.797	33.325
M39 × 2	6g	0.038	38.962	38.682	37.663	37.493	0.170	36.797	36.261
M39 × 2	6h	0.000	39.000	38.720	37.701	37.531	0.170	36.835	36.299
M39 × 2	4g6g	0.038	38.962	38.682	37.663	37.557	0.106	36.797	36.325
M40 × 1.5	6g	0.032	39.968	39.732	38.994	38.844	0.150	38.344	37.920

Table 13. (Continued) External Metric Thread—M Profile Limiting Dimensions ANSI/ASME B1.13M-2005

Basic Thread Designation	Tol. Class	Allowance ^a <i>es</i>	Major Diameter ^b <i>d</i>		Pitch Diameter ^{b c} <i>d</i> ₂			Minor Dia. ^b <i>d</i> ₁	Minor Dia. ^d <i>d</i> ₃
			Max.	Min.	Max.	Min.	Tol.	Max.	Min.
M40 × 1.5	6h	0.000	40.000	39.764	39.026	38.876	0.150	38.376	37.952
M40 × 1.5	4g6g	0.032	39.968	39.732	38.994	38.899	0.095	38.344	37.975
M42 × 4.5	6g	0.063	41.937	41.437	39.014	38.778	0.236	37.065	36.006
M42 × 4.5	6h	0.000	42.000	41.500	39.077	38.841	0.236	37.128	36.069
M42 × 4.5	4g6g	0.063	41.937	41.437	39.014	38.864	0.150	37.065	36.092
M42 × 2	6g	0.038	41.962	41.682	40.663	40.493	0.170	39.797	39.261
M42 × 2	6h	0.000	42.000	41.720	40.701	40.531	0.170	39.835	39.299
M42 × 2	4g6g	0.038	41.962	41.682	40.663	40.557	0.106	39.797	39.325
M45 × 1.5	6g	0.032	44.968	44.732	43.994	43.844	0.150	43.344	42.920
M45 × 1.5	6h	0.000	45.000	44.764	44.026	43.876	0.150	43.376	42.952
M45 × 1.5	4g6g	0.032	44.968	44.732	43.994	43.899	0.095	43.344	42.975
M48 × 5	6g	0.071	47.929	47.399	44.681	44.431	0.250	42.516	41.351
M48 × 5	6h	0.000	48.000	47.470	44.752	44.502	0.250	42.587	41.422
M48 × 5	4g6g	0.071	47.929	47.399	44.681	44.521	0.160	42.516	41.441
M48 × 2	6g	0.038	47.962	47.682	46.663	46.483	0.180	45.797	45.251
M48 × 2	6h	0.000	48.000	47.720	46.701	46.521	0.180	45.835	45.289
M48 × 2	4g6g	0.038	47.962	47.682	46.663	46.551	0.112	45.797	45.319
M50 × 1.5	6g	0.032	49.968	49.732	48.994	48.834	0.160	48.344	47.910
M50 × 1.5	6h	0.000	50.000	49.764	49.026	48.866	0.160	48.376	47.942
M50 × 1.5	4g6g	0.032	49.968	49.732	48.994	48.894	0.100	48.344	47.970
M55 × 1.5	6g	0.032	54.968	54.732	53.994	53.834	0.160	53.344	52.910
M55 × 1.5	6h	0.000	55.000	54.764	54.026	53.866	0.160	53.376	52.942
M55 × 1.5	4g6g	0.032	54.968	54.732	53.994	53.894	0.100	53.344	52.970
M56 × 5.5	6g	0.075	55.925	55.365	52.353	52.088	0.265	49.971	48.700
M56 × 5.5	6h	0.000	56.000	55.440	52.428	52.163	0.265	50.046	48.775
M56 × 5.5	4g6g	0.075	55.925	55.365	52.353	52.183	0.170	49.971	48.795
M56 × 2	6g	0.038	55.962	55.682	54.663	54.483	0.180	53.797	53.251
M56 × 2	6h	0.000	56.000	55.720	54.701	54.521	0.180	53.835	53.289
M56 × 2	4g6g	0.038	55.962	55.682	54.663	54.551	0.112	53.797	53.319
M60 × 1.5	6g	0.032	59.968	59.732	58.994	58.834	0.160	58.344	57.910
M60 × 1.5	6h	0.000	60.000	59.764	59.026	58.866	0.160	58.376	57.942
M60 × 1.5	4g6g	0.032	59.968	59.732	58.994	58.894	0.100	58.344	57.970
M64 × 6	6g	0.080	63.920	63.320	60.023	59.743	0.280	57.425	56.047
M64 × 6	6h	0.000	64.000	63.400	60.103	59.823	0.280	57.505	56.127
M64 × 6	4g6g	0.080	63.920	63.320	60.023	59.843	0.180	57.425	56.147
M64 × 2	6g	0.038	63.962	63.682	62.663	62.483	0.180	61.797	61.251
M64 × 2	6h	0.000	64.000	63.720	62.701	62.521	0.180	61.835	61.289
M64 × 2	4g6g	0.038	63.962	63.682	62.663	62.551	0.112	61.797	61.319
M65 × 1.5	6g	0.032	64.968	64.732	63.994	63.834	0.160	63.344	62.910
M65 × 1.5	6h	0.000	65.000	64.764	64.026	63.866	0.160	63.376	62.942
M65 × 1.5	4g6g	0.032	64.968	64.732	63.994	63.894	0.100	63.344	62.970
M70 × 1.5	6g	0.032	69.968	69.732	68.994	68.834	0.160	68.344	67.910
M70 × 1.5	6h	0.000	70.000	69.764	69.026	68.866	0.160	68.376	67.942
M70 × 1.5	4g6g	0.032	69.968	69.732	68.994	68.894	0.100	68.344	67.970
M72 × 6	6g	0.080	71.920	71.320	68.023	67.743	0.280	65.425	64.047
M72 × 6	6h	0.000	72.000	71.400	68.103	67.823	0.280	65.505	64.127
M72 × 6	4g6g	0.080	71.920	71.320	68.023	67.843	0.180	65.425	64.147
M72 × 2	6g	0.038	71.962	71.682	70.663	70.483	0.180	69.797	69.251
M72 × 2	6h	0.000	72.000	71.720	70.701	70.521	0.180	69.835	69.289
M72 × 2	4g6g	0.038	71.962	71.682	70.663	70.551	0.112	69.797	69.319
M75 × 1.5	6g	0.032	74.968	74.732	73.994	73.834	0.160	73.344	72.910
M75 × 1.5	6h	0.000	75.000	74.764	74.026	73.866	0.160	73.376	72.942
M75 × 1.5	4g6g	0.032	74.968	74.732	73.994	73.894	0.100	73.344	72.970
M80 × 6	6g	0.080	79.920	79.320	76.023	75.743	0.280	73.425	72.047
M80 × 6	6h	0.000	80.000	79.400	76.103	75.823	0.280	73.505	72.127
M80 × 6	4g6g	0.080	79.920	79.320	76.023	75.843	0.180	73.425	72.147
M80 × 2	6g	0.038	79.962	79.682	78.663	78.483	0.180	77.797	77.251
M80 × 2	6h	0.000	80.000	79.720	78.701	78.521	0.180	77.835	77.289
M80 × 2	4g6g	0.038	79.962	79.682	78.663	78.551	0.112	77.797	77.319
M80 × 1.5	6g	0.032	79.968	79.732	78.994	78.834	0.160	78.344	77.910
M80 × 1.5	6h	0.000	80.000	79.764	79.026	78.866	0.160	78.376	77.942
M80 × 1.5	4g6g	0.032	79.968	79.732	78.994	78.894	0.100	78.344	77.970
M85 × 2	6g	0.038	84.962	84.682	83.663	83.483	0.180	82.797	82.251
M85 × 2	6h	0.000	85.000	84.720	83.701	83.521	0.180	82.835	82.289

Table 13. (Continued) External Metric Thread—M Profile Limiting Dimensions ANSI/ASME B1.13M-2005

Basic Thread Designation	Tol. Class	Allowance ^a <i>es</i>	Major Diameter ^b <i>d</i>		Pitch Diameter ^{b c} <i>d</i> ₂			Minor Dia. ^b <i>d</i> ₁	Minor Dia. ^d <i>d</i> ₃
			Max.	Min.	Max.	Min.	Tol.	Max.	Min.
M85 × 2	4g6g	0.038	84.962	84.682	83.663	83.551	0.112	82.797	82.319
M90 × 6	6g	0.080	89.920	89.320	86.023	85.743	0.280	83.425	82.047
M90 × 6	6h	0.000	90.000	89.400	86.103	85.823	0.280	83.505	82.127
M90 × 6	4g6g	0.080	89.920	89.320	86.023	85.843	0.180	83.425	82.147
M90 × 2	6g	0.038	89.962	89.682	88.663	88.483	0.180	87.797	87.251
M90 × 2	6h	0.000	90.000	89.720	88.701	88.521	0.180	87.835	87.289
M90 × 2	4g6g	0.038	89.962	89.682	88.663	88.551	0.112	87.797	87.319
M95 × 2	6g	0.038	94.962	94.682	93.663	93.473	0.190	92.797	92.241
M95 × 2	6h	0.000	95.000	94.720	93.701	93.511	0.190	92.835	92.279
M95 × 2	4g6g	0.038	94.962	94.682	93.663	93.545	0.118	92.797	92.313
M100 × 6	6g	0.080	99.920	99.320	96.023	95.723	0.300	93.425	92.027
M100 × 6	6h	0.000	100.000	99.400	96.103	95.803	0.300	93.505	92.107
M100 × 6	4g6g	0.080	99.920	99.320	96.023	95.833	0.190	93.425	92.137
M100 × 2	6g	0.038	99.962	99.682	98.663	98.473	0.190	97.797	97.241
M100 × 2	6h	0.000	100.000	99.720	98.701	98.511	0.190	97.835	97.279
M100 × 2	4g6g	0.038	99.962	99.682	98.663	98.545	0.118	97.797	97.313
M105 × 2	6g	0.038	104.962	104.682	103.663	103.473	0.190	102.797	102.241
M105 × 2	6h	0.000	105.000	104.720	103.701	103.511	0.190	102.835	102.279
M105 × 2	4g6g	0.038	104.962	104.682	103.663	103.545	0.118	102.797	102.313
M110 × 2	6g	0.038	109.962	109.682	108.663	108.473	0.190	107.797	107.241
M110 × 2	6h	0.000	110.000	109.720	108.701	108.511	0.190	107.835	107.279
M110 × 2	4g6g	0.038	109.962	109.682	108.663	108.545	0.118	107.797	107.313
M120 × 2	6g	0.038	119.962	119.682	118.663	118.473	0.190	117.797	117.241
M120 × 2	6h	0.000	120.000	119.720	118.701	118.511	0.190	117.835	117.279
M120 × 2	4g6g	0.038	119.962	119.682	118.663	118.545	0.118	117.797	117.313
M130 × 2	6g	0.038	129.962	129.682	128.663	128.473	0.190	127.797	127.241
M130 × 2	6h	0.000	130.000	129.720	128.701	128.511	0.190	127.835	127.279
M130 × 2	4g6g	0.038	129.962	129.682	128.663	128.545	0.118	127.797	127.313
M140 × 2	6g	0.038	139.962	139.682	138.663	138.473	0.190	137.797	137.241
M140 × 2	6h	0.000	140.000	139.720	138.701	138.511	0.190	137.835	137.279
M140 × 2	4g6g	0.038	139.962	139.682	138.663	138.545	0.118	137.797	137.313
M150 × 2	6g	0.038	149.962	149.682	148.663	148.473	0.190	147.797	147.241
M150 × 2	6h	0.000	150.000	149.720	148.701	148.511	0.190	147.835	147.279
M150 × 2	4g6g	0.038	149.962	149.682	148.663	148.545	0.118	147.797	147.313
M160 × 3	6g	0.048	159.952	159.577	158.003	157.779	0.224	156.704	155.931
M160 × 3	6h	0.000	160.000	159.625	158.051	157.827	0.224	156.752	155.979
M160 × 3	4g6g	0.048	159.952	159.577	158.003	157.863	0.140	156.704	156.015
M170 × 3	6g	0.048	169.952	169.577	168.003	167.779	0.224	166.704	165.931
M170 × 3	6h	0.000	170.000	169.625	168.051	167.827	0.224	166.752	165.979
M170 × 3	4g6g	0.048	169.952	169.577	168.003	167.863	0.140	166.704	166.015
M180 × 3	6g	0.048	179.952	179.577	178.003	177.779	0.224	176.704	175.931
M180 × 3	6h	0.000	180.000	179.625	178.051	177.827	0.224	176.752	175.979
M180 × 3	4g6g	0.048	179.952	179.577	178.003	177.863	0.140	176.704	176.015
M190 × 3	6g	0.048	189.952	189.577	188.003	187.753	0.250	186.704	185.905
M190 × 3	6h	0.000	190.000	189.625	188.051	187.801	0.250	186.752	185.953
M190 × 3	4g6g	0.048	189.952	189.577	188.003	187.843	0.160	186.704	185.995
M200 × 3	6g	0.048	199.952	199.577	198.003	197.753	0.250	196.704	195.905
M200 × 3	6h	0.000	200.000	199.625	198.051	197.801	0.250	196.752	195.953
M200 × 3	4g6g	0.048	199.952	199.577	198.003	197.843	0.160	196.704	195.995

^a *es* is an absolute value.

^b Coated threads with tolerance classes 6g or 4g6g, see *Material Limits for Coated Threads*, 1886.

^c Functional diameter size includes the effects of all variations in pitch diameter, thread form, and profile. The variations in the individual thread characteristics such as flank angle, lead, taper, and roundness on a given thread, cause the measurements of the pitch diameter and functional diameter to vary from one another on most threads. The pitch diameter and the functional diameter on a given thread are equal to one another only when the thread form is perfect. When required to inspect either the pitch diameter, the functional diameter, or both, for thread acceptance, use the same limits of size for the appropriate thread size and class.

^d Dimension used in the design of tools, etc.; in dimensioning external threads it is not normally specified. Generally, minor diameter acceptance is based on maximum material condition gaging.

All dimensions are in millimeters.

Metric Screw Thread Designations.—Metric screw threads are identified by the letter (M) for the thread form profile, followed by the nominal diameter size and the pitch expressed in millimeters, separated by the sign (×) and followed by the tolerance class separated by a dash (–) from the pitch.

The simplified international practice for designating coarse pitch M profile metric screw threads is to leave off the pitch. Thus a M14×2 thread is designated just M14. However, to prevent misunderstanding, it is mandatory to use the value for pitch in all designations.

Thread acceptability gaging system requirements of ANSI B1.3M may be added to the thread size designation as noted in the examples (numbers in parentheses) or as specified in pertinent documentation, such as the drawing or procurement document.

Unless otherwise specified in the designation, the screw thread is right hand.

Examples: External thread of M profile, right hand: M6×1–4g6g (22)
Internal thread of M profile, right hand: M6×1–5H6H (21)

Designation of Left Hand Thread: When a left hand thread is specified, the tolerance class designation is followed by a dash and LH.

Example: M6×1–5H6H–LH (23)

Designation for Identical Tolerance Classes: If the two tolerance class designations for a thread are identical, it is not necessary to repeat the symbols.

Example: M6×1–6H (21)

Designation Using All Capital Letters: When computer and teletype thread designations use all capital letters, the external or internal thread may need further identification. Thus the tolerance class is followed by the abbreviations EXT or INT in capital letters.

Examples: M6×1–4G6G EXT; M6×1–6H INT

Designation for Thread Fit: A fit between mating threads is indicated by the internal thread tolerance class followed by the external thread tolerance class and separated by a slash.

Examples: M6×1–6H/6g; M6×1–6H/4g6g

Designation for Rounded Root External Thread: The M profile with a minimum root radius of 0.125P on the external thread is desirable for all threads but is mandatory for threaded mechanical fasteners of ISO 898/I property class 8.8 (minimum tensile strength 800 MPa) and stronger. No special designation is required for these threads. Other parts requiring a 0.125P root radius must have that radius specified.

When a special rounded root is required, its external thread designation is suffixed by the minimum root radius value in millimeters and the letter R.

Example: M42×4.5–6g–0.63R

Designation of Threads Having Modified Crests: Where the limits of size of the major diameter of an external thread or the minor diameter of an internal thread are modified, the thread designation is suffixed by the letters MOD followed by the modified diameter limits.

Examples:

External thread M profile, major diameter reduced 0.075 mm. M6×1–4h6h MOD Major dia = 5.745–5.925 MOD	Internal thread M profile, minor diameter increased 0.075 mm. M6×1–4H5H MOD Minor dia = 5.101–5.291 MOD
---	---

Designation of Special Threads: Special diameter-pitch threads developed in accordance with this Standard ANSI/ASME B1.13M are identified by the letters SPL following the tolerance class. The limits of size for the major diameter, pitch diameter, and minor diameter are specified below this designation.

Examples:

External thread	Internal thread
M6.5 × 1 – 4h6h – SPL (22)	M6.5 × 1 – 4H5H – SPL (23)
Major dia = 6.320 – 6.500	Major dia = 6.500 min
Pitch dia = 5.779 – 5.850	Pitch dia = 5.850 – 5.945
Minor dia = 5.163 – 5.386	Minor dia = 5.417 – 5.607

Designation of Multiple Start Threads: When a thread is required with a multiple start, it is designated by specifying sequentially: M for metric thread, nominal diameter size, × L for lead, lead value, dash, P for pitch, pitch value, dash, tolerance class, parenthesis, script number of starts, and the word starts, close parenthesis.

Examples: M16 × L4 – P2 – 4h6h (TWO STARTS)
M14 × L6 – P2 – 6H (THREE STARTS)

Designation of Coated or Plated Threads: In designating coated or plated M threads the tolerance class should be specified as after coating or after plating. If no designation of after coating or after plating is specified, the tolerance class applies before coating or plating in accordance with ISO practice. After plating, the thread must not transgress the maximum material limits for the tolerance position H/h.

Examples: M6 × 1 – 6h AFTER COATING or AFTER PLATING
M6 × 1 – 6g AFTER COATING or AFTER PLATING

Where the tolerance position G/g is insufficient relief for the application to hold the threads within product limits, the coating or plating allowance may be specified as the maximum and minimum limits of size for minor and pitch diameters of internal threads or major and pitch diameters for external threads before coating or plating.

Example: Allowance on external thread M profile based on 0.010 mm minimum coating thickness.

M6 × 1 – 4h6h – AFTER COATING
BEFORE COATING
Major dia = 5.780 – 5.940
Pitch dia = 5.239 – 5.290

Metric Screw Threads—MJ Profile

The MJ screw thread is intended for aerospace metric threaded parts and for other highly stressed applications requiring high temperature or high fatigue strength, or for “no allowance” applications. The MJ profile thread is a hard metric version similar to the UNJ inch standards, ANSI/ASME B1.15 and MIL-S-8879. The MJ profile thread has a 0.15011*P* to 0.180424*P* controlled root radius in the external thread and the internal thread minor diameter truncated to accommodate the external thread maximum root radius.

First issued in 1978, the American National Standard ANSI/ASME B1.21M-1997 establishes the basic triangular profile for the MJ form of thread; gives a system of designations; lists the standard series of diameter-pitch combinations for diameters from 1.6 to 200 mm; and specifies limiting dimensions and tolerances. Changes included in the 1997 revision are the addition of tolerance class 4G6G and 4G5G/4g6g comparable to ANSI/ASME B1.15 (UNJ thread); the addition of tolerance class 6H/6g comparable to ANSI/ASME B1.13M; and changes in the rounding procedure as set forth in ANSI/ASME B1.30M.

Diameter-Pitch Combinations.—This Standard includes a selected series of diameter-pitch combinations of threads taken from International Standard ISO 261 plus some additional sizes in the constant pitch series. These are given in [Table 1](#). It also includes the standard series of diameter-pitch combinations for aerospace screws, bolts, nuts, and fluid system fittings as shown in [Table 2](#).

**Table 1. ANSI Standard Metric Screw Threads MJ Profile
Diameter-Pitch Combinations ANSI/ASME B1.21M-1997 (R2003)**

Nominal Diameter		Pitches		Nominal Diameter		Pitches	
Choices		Coarse	Fine	Choices		Coarse	Fine
1st	2nd			1st	2nd		
1.6	...	0.35	52	...	3, 2, 1.5
...	1.8	0.35	...	55	3, 2, 1.5
2.0	...	0.4	56	5.5	3, 2, 1.5
...	2.2	0.45	58	...	3, 2, 1.5
2.5	...	0.45	...	60	3, 2, 1.5
3	...	0.5	62	...	3, 2, 1.5
3.5	...	0.6	64	6	3, 2, 1.5
4	...	0.7	...	65	3, 2, 1.5
...	4.5	0.75	68	...	3, 2, 1.5
5	...	0.8	...	70	3, 2, 1.5
6	...	1	0.75	...	72	6	3, 2, 1.5
7	...	1	0.75	75	3, 2, 1.5
8	...	1.25	1, 0.75	...	76	...	3, 2, 1.5
...	9	1.25	1, 0.75	...	78	...	3 ^a , 2, 1.5 ^a
10	...	1.5	1.25, 1, 0.75	80	...	6	3, 2, 1.5
...	11	1.5	1.25 ^b , 1, 0.75	...	82	...	3 ^a , 2, 1.5 ^a
12	...	1.75	1.5, 1.25, 1	85	3, 2, 1.5 ^a
14	...	2	1.5, 1.25 ^c , 1	90	...	6	3, 2, 1.5 ^a
...	15	...	1.5, 1	95	3, 2, 1.5 ^a
16	...	2	1.5, 1	100	...	6	3, 2, 1.5 ^a
...	17	...	1.5, 1	105	3, 2, 1.5 ^a
18	...	2.5	2, 1.5, 1	110	3, 2, 1.5 ^a
20	...	2.5	2, 1.5, 1	...	115	...	3, 2, 1.5 ^a
22	...	2.5	2, 1.5, 1	120	3, 2, 1.5 ^a
24	...	3	2, 1.5, 1	...	125	...	3, 2, 1.5 ^a
...	25	...	2, 1.5, 1	130	3, 2, 1.5 ^a
...	26	...	1.5	...	135	...	3, 2, 1.5 ^a
27	...	3	2, 1.5, 1	140	3, 2, 1.5 ^a
...	28	...	2, 1.5, 1	...	145	...	3, 2, 1.5 ^a
30	...	3.5	3, 2, 1.5, 1	150	3, 2, 1.5 ^a
...	32	...	2, 1.5	...	155	...	3
33	3, 2, 1.5	160	3
...	35	...	1.5	...	165	...	3
36	...	4	3, 2, 1.5	170	3
...	38	...	1.5	...	175	...	3
39	3, 2, 1.5	180	3
...	40	...	3, 2, 1.5	...	185	...	3
.	42	4.5	3, 2, 1.5	190	3
45	3, 2, 1.5	...	195	...	3
...	48	5	3, 2, 1.5	200	3
50	3, 2, 1.5

^a Not included in ISO 261.

^b Only for aircraft control cable fittings.

^c Only for spark plugs for engines.

All dimensions are in millimeters. Pitches in parentheses () are to be avoided as far as possible.

Table 2. ANSI Standard Metric Screw Threads MJ Profile, Diameter-Pitch Combinations for Aerospace ANSI/ASME B1.21M-1997 (R2003)

Aerospace Screws, Bolts and Nuts								Aerospace Fluid System Fittings					
Nom. Size ^a	Pitch	Nom. Size	Pitch	Nom. Size	Pitch	Nom. Size	Pitch	Nom. Size	Pitch	Nom. Size	Pitch	Nom. Size	Pitch
1.6	0.35	5	0.8	14	1.5	27	2	8	1	20	1.5	36	1.5
2	0.4	6	1	16	1.5	30	2	10	1	22	1.5	39	1.5
2.5	0.45	7	1	18	1.5	33	2	12	1.25	24	1.5	42	2
3	0.5	8	1	20	1.5	36	2	14	1.5	27	1.5	48	2
3.5	0.6	10	1.25	22	1.5	39	2	16	1.5	30	1.5	50	2
4	0.7	12	1.25	24	2	18	1.5	33	1.5

All dimensions are in millimeters.

^a For threads smaller than 1.6 mm nominal size, use miniature screw threads (ANSI B1.10M).

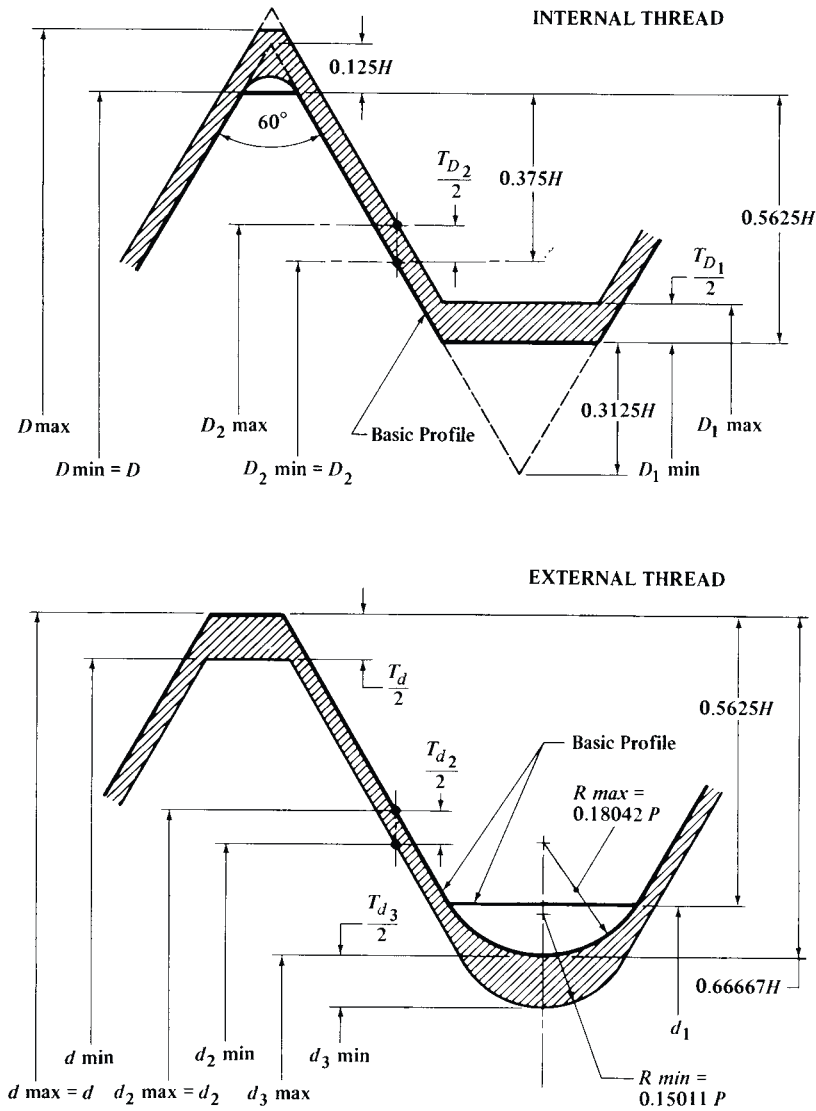


Fig. 1. Internal MJ Thread Basic and Design Profiles (Top) and External MJ Thread Basic and Design Profiles (Bottom) Showing Tolerance Zones

Tolerances: The thread tolerance system is based on ISO 965/1, *Metric Screw thread System of Tolerance Positions and Grades*. Tolerances are positive for internal threads and negative for external threads, that is, in the direction of minimum material.

For aerospace applications, except for fluid fittings, tolerance classes 4H5H or 4G6G and 4g6g should be used. These classes approximate classes 3B/3A in the inch system. Aerospace fluid fittings use classes 4H5H or 4H6H and 4g6g.

Tolerance classes 4G5G or 4G6G and 4g6g are provided for use when thread allowances are required. These classes provide a slightly tighter fit than the inch classes 2B/2A at minimum material condition.

Additional tolerance classes 6H/6g are included in this Standard to provide appropriate product selection based on general applications. These classes and the selection of standard diameter/pitch combinations are the same as those provided for the M profile metric screw threads in ANSI/ASME B1.13M. Classes 6H/6g result in a slightly looser fit than inch classes 2B/2A at minimum material condition.

Symbols: Standard symbols appearing in Fig. 1 are:

D = Basic major diameter of internal thread

D_2 = Basic pitch diameter of internal thread

D_1 = Basic minor diameter of internal thread

d = Basic major diameter of external thread

d_2 = Basic pitch diameter of external thread

d_1 = Basic minor diameter of internal thread

d_3 = Diameter to bottom of external thread root radius

H = Height of fundamental triangle

P = Pitch

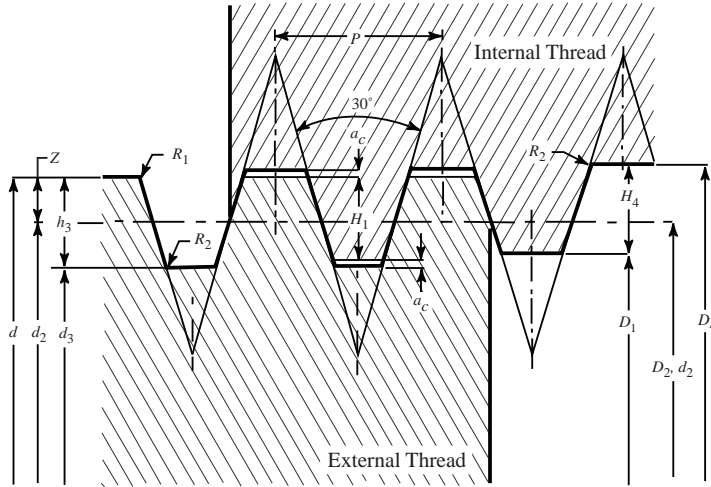
Basic Designations: The aerospace metric screw thread is designated by the letters “MJ” to identify the metric J thread form, followed by the nominal size and pitch in millimeters (separated by the sign “×”) and followed by the tolerance class (separated by a dash from the pitch). Unless otherwise specified in the designation, the thread helix is right hand.

Example: MJ6 × 1 – 4h6h

For further details concerning limiting dimensions, allowances for coating and plating, modified and special threads, etc., reference should be made to the Standard.

Trapezoidal Metric Thread

Comparison of ISO and DIN Standards.—ISO metric trapezoidal screw threads standard, ISO 2904-1977, describes the system of general purpose metric threads for use in mechanisms and structures. The standard is in basic agreement with trapezoidal metric thread DIN 103. The DIN 103 standard applies a particular pitch for a particular diameter of thread, but the ISO standard applies a variety of pitches for a particular diameter. In ISO 2904-1977, the same clearance is applied to both the major diameter and minor diameter, but in DIN 103 the clearance in the minor diameter is two or three times greater than clearance in the major diameter. A comparison of DIN 103 is given in Table 1.



Metric Trapezoidal Thread, ISO 2904

Terminology: The term "bolt threads" is used for external screw threads, the term "nut threads" for internal screw threads.

Calculation: The value given in the International standards have been calculated by using the following formulas:

$$\begin{aligned}
 H_1 &= 0.5P & H_4 &= H_1 + a_c = 0.5P + a_c & H_3 &= H_1 + a_c = 0.5P + a_c \\
 D_4 &= d + 2a_c & Z &= 0.25P = H_1/2 & D_1 &= d - 2H_1 = d - p \\
 D_3 &= D - 2h_3 & d_2 &= D_2 = d - 2Z = d - 0.5P & R_{1max.} &= 0.5a_c & R_{2max.} &= a_c
 \end{aligned}$$

where a_c = clearance on the crest; D = major diameter for nut threads; D_2 = pitch diameter for nut threads; D_1 = minor diameter for nut threads; d = major diameter for bolt threads = nominal diameter; d_2 = pitch diameter for bolt threads; d_3 = minor diameter for bolt threads; h_1 = Height of overlapping; h_4 = height of nut threads; h_3 = height of bolt threads; and, P = pitch.

Table 1. Comparison of ISO Metric Trapezoidal Screw Thread ISO 2904-1977 and Trapezoidal Metric Screw Thread DIN 103

	ISO 2904	DIN 103	Comment
Nominal Diameter	D	D_s	
Pitch	p	p	Same
Clearances (Bolt Circle)	a_c	b	Same
Clearances (Nut Circle)	a_c	a	Not same
Height of Overlapping	h_1	h_e	Same
Bolt Circle			
	$h_3 = 0.50P + a_c$	$h_s = 0.50P + a$	Same
	$h_{as} = 0.25p$	$z = 0.25p$	Same
Minor diameter for external thread	$D_3 = d - 2h_3$	$k_s = d - 2h_s$	Same
Pitch diameter for external thread	$D_2 = d - 2h_{as}$	$d_2 = d - 2z$	Same
Nut Circle			
Basic major diameter for nut thread	$D_4 = d + 2a_c$	$d_n = d + a + b$	Not same
Height of internal thread	$h_4 = h_3$	$h_n = h_3 + a$	Not same
Minor diameter of internal thread	$D_1 = D - 2h_1$	$K_n = D_n - 2h_n$	Not same

Table 2. ISO Metric Trapezoidal Screw Thread ISO 2904-1977

Nominal Diameter, d			Pitch, P	Pitch Diam. $d_2 = D_2$	Major Diam. D_4	Minor Diameter	
						d_3	D_1
8			1.5	7.250	8.300	6.200	6.500
			2	8.000	9.500	6.500	7.000
	9		1.5	8.250	9.300	7.200	7.500
			2	8.000	9.500	6.500	7.000
10			1.5	9.250	10.300	8.200	8.500
			2	9.000	10.500	7.500	8.000
	11		2	10.000	11.500	8.500	9.000
			3	9.500	11.500	7.500	8.000
12			2	11.000	12.500	9.500	10.000
			3	10.500	12.500	8.500	9.000
	14		2	13.000	14.500	11.500	12.000
			3	12.500	14.500	10.500	11.000
16			2	15.000	16.500	13.500	14.000
			3	14.500	16.500	12.500	13.000
	18		2	17.000	18.500	15.500	16.000
			4	16.000	18.500	13.500	14.000
20			2	19.000	20.500	17.500	18.000
			4	18.000	20.500	15.500	16.000
	22		3	20.500	22.500	18.500	19.000
			5	19.500	22.500	16.500	17.000
			8	18.000	23.000	13.000	14.000
24			3	22.500	24.500	20.500	21.000
			5	21.500	24.500	18.500	19.000
			8	20.000	25.000	15.000	16.000
	26		3	24.500	26.500	22.500	23.000
			5	23.500	26.500	20.500	21.000
			8	22.000	27.000	17.000	18.000
28			3	26.500	28.500	24.500	25.000
			5	25.500	28.500	22.500	23.000
			8	24.000	29.000	19.000	20.000
	30		3	28.500	30.500	26.500	27.000
			6	27.000	31.000	23.000	24.000
			10	25.000	31.000	19.000	20.000
32			3	30.500	32.500	28.500	29.000
			6	29.000	33.000	25.000	26.000
			10	27.000	33.000	21.000	22.000
	34		3	32.500	34.500	30.500	31.000
			6	31.000	35.000	27.000	28.000
			10	29.000	35.000	23.000	24.000
36			3	34.500	36.500	32.500	33.000
			6	33.000	37.000	29.000	30.000
			10	31.000	37.000	25.000	26.000
	38		3	36.500	38.500	34.500	35.000
			7	34.500	39.000	30.000	31.000
			10	33.000	39.000	27.000	28.000
40			3	38.500	40.500	36.500	37.000
			7	36.500	41.000	32.000	33.000
			10	35.000	41.000	29.000	30.000

Table 2. (Continued) ISO Metric Trapezoidal Screw Thread ISO 2904-1977

Nominal Diameter, d			Pitch, P	Pitch Diam. $d_2 = D_2$	Major Diam. D_4	Minor Diameter	
						d_3	D_1
42			3	40.500	42.500	38.500	39.000
			7	38.500	43.000	34.000	35.000
			10	37.000	43.000	31.000	32.000
44			3	42.500	44.500	40.500	41.000
			7	40.500	45.000	36.000	37.000
			12	38.000	45.000	31.000	32.000
46			3	44.500	46.500	42.500	43.000
			8	42.000	47.000	37.000	38.000
			12	40.000	47.000	33.000	34.000
48			3	46.500	48.500	44.500	45.000
			8	44.000	49.000	39.000	40.000
			12	42.000	49.000	35.000	36.000
50			3	48.500	50.500	46.500	47.000
			8	46.000	51.000	41.000	42.000
			12	44.000	51.000	37.000	38.000
52			3	50.500	52.500	48.500	49.000
			8	48.000	53.000	43.000	44.000
			12	46.000	53.000	39.000	40.000
55			3	53.500	55.500	51.500	52.000
			9	50.500	56.000	45.000	46.000
			14	48.000	57.000	39.000	41.000
60			3	58.500	60.500	56.500	57.000
			9	55.500	61.000	50.000	51.000
			14	53.000	62.000	44.000	46.000
65			4	63.000	65.500	60.500	61.000
			10	60.000	66.000	54.000	55.000
			16	57.000	67.000	47.000	49.000
70			4	68.000	70.500	65.500	66.000
			10	65.000	71.000	59.000	60.000
			16	62.000	72.000	52.000	54.000
75			4	73.000	75.500	70.500	71.000
			10	70.000	76.000	64.000	65.000
			16	67.000	77.000	57.000	59.000
80			4	78.000	80.500	75.500	76.000
			10	75.000	81.000	69.000	70.000
			16	72.000	82.000	62.000	64.000
85			4	83.000	85.500	80.500	81.000
			12	79.000	86.000	72.000	73.000
			18	76.000	87.000	65.000	67.000
90			4	88.000	90.500	85.500	86.000
			12	84.000	91.000	77.000	78.000
			18	81.000	92.000	70.000	72.000
95			4	93.000	95.500	90.500	91.000
			12	89.000	96.000	82.000	83.000
95			18	86.000	97.000	75.000	77.000
			4	98.000	100.500	95.500	96.000
100			12	94.000	101.000	87.000	88.000
			20	90.000	102.000	78.000	80.000

Table 2. (Continued) ISO Metric Trapezoidal Screw Thread ISO 2904-1977

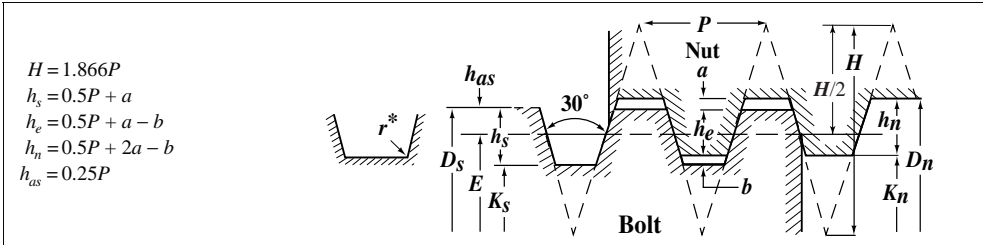
Nominal Diameter, d			Pitch, P	Pitch Diam. $d_2 = D_2$	Major Diam. D_4	Minor Diameter	
						d_3	D_1
105			4	103.000	105.500	100.500	101.000
			12	103.000	106.000	92.000	93.000
			20	95.000	107.000	83.000	85.000
110			4	108.000	110.500	105.500	106.000
			12	104.000	111.000	97.000	98.000
			20	100.000	112.000	88.000	90.000
115			6	112.000	116.000	108.000	109.000
			14	112.000	117.000	99.000	101.000
			22	104.000	117.000	91.000	93.000
120			6	117.000	121.000	113.000	114.000
			14	113.000	122.000	104.000	106.000
			22	109.000	122.000	96.000	98.000
125			6	122.000	126.000	118.000	119.000
			14	122.000	127.000	109.000	111.000
			22	114.000	127.000	101.000	103.000
130			6	127.000	131.000	123.000	124.000
			14	123.000	132.000	114.000	116.000
			22	119.000	132.000	106.000	108.000
135			6	132.000	136.000	128.000	129.000
			14	132.000	137.000	119.000	121.000
			24	123.000	137.000	109.000	111.000
140			6	137.000	141.000	133.000	134.000
			14	133.000	142.000	124.000	126.000
			24	128.000	142.000	114.000	116.000
145			6	142.000	146.000	138.000	139.000
			14	142.000	147.000	129.000	131.000
			24	133.000	147.000	119.000	121.000
150			6	147.000	151.000	143.000	144.000
			16	142.000	152.000	132.000	134.000
			24	138.000	152.000	124.000	126.000
155			6	152.000	156.000	148.000	149.000
			16	152.000	157.000	137.000	139.000
			24	143.000	157.000	129.000	131.000
160			6	157.000	161.000	153.000	154.000
			16	152.000	162.000	142.000	144.000
			28	146.000	162.000	130.000	132.000
165			6	162.000	166.000	158.000	159.000
			16	162.000	167.000	147.000	149.000
			28	151.000	167.000	135.000	137.000
170			6	167.000	171.000	163.000	164.000
			16	162.000	172.000	152.000	154.000
			28	156.000	172.000	140.000	142.000
175			8	171.000	176.000	166.000	167.000
			16	171.000	177.000	157.000	159.000
			28	161.000	177.000	145.000	147.000
180			8	176.000	181.000	171.000	172.000
			18	171.000	182.000	160.000	162.000
			28	166.000	182.000	150.000	152.000

Table 2. (Continued) ISO Metric Trapezoidal Screw Thread ISO 2904-1977

Nominal Diameter, d			Pitch, P	Pitch Diam. $d_2 = D_2$	Major Diam. D_4	Minor Diameter	
						d_3	D_1
185			8	181.000	186.000	176.000	177.000
			18	181.000	187.000	165.000	167.000
			32	169.000	187.000	151.000	153.000
190			8	186.000	191.000	181.000	182.000
			18	181.000	192.000	170.000	172.000
			32	174.000	192.000	156.000	158.000
195			8	191.000	196.000	186.000	187.000
			18	191.000	197.000	175.000	177.000
			32	179.000	197.000	161.000	163.000
200			8	196.000	201.000	191.000	192.000
			18	191.000	202.000	180.000	182.000
			32	184.000	202.000	166.000	168.000
210			8	206.000	211.000	201.000	202.000
			20	200.000	212.000	188.000	190.000
			36	192.000	212.000	172.000	174.000
220			8	216.000	221.000	211.000	212.000
			20	210.000	222.000	198.000	200.000
			36	202.000	222.000	182.000	184.000
230			8	226.000	231.000	221.000	222.000
			20	220.000	232.000	208.000	210.000
			36	212.000	232.000	192.000	194.000
240			8	236.000	241.000	231.000	232.000
			22	229.000	242.000	216.000	218.000
			36	222.000	242.000	202.000	204.000
250			12	244.000	251.000	237.000	238.000
			22	239.000	252.000	226.000	228.000
			40	230.000	252.000	208.000	210.000
260			12	254.000	261.000	247.000	248.000
			22	249.000	262.000	236.000	238.000
			40	240.000	262.000	218.000	220.000
270			12	264.000	271.000	257.000	258.000
			24	258.000	272.000	244.000	246.000
			40	250.000	272.000	228.000	230.000
280			12	274.000	281.000	267.000	268.000
			24	268.000	282.000	254.000	256.000
			40	260.000	282.000	238.000	240.000
290			12	284.000	291.000	277.000	278.000
			24	278.000	292.000	264.000	266.000
			44	268.000	292.000	244.000	246.000
300			12	294.000	301.000	287.000	288.000
			24	288.000	302.000	274.000	276.000
			44	278.000	302.000	254.000	256.000

All dimensions in millimeters

Trapezoidal Metric Thread — Preferred Basic Sizes *DIN 103*



Nom. & Major Diam. of Bolt, D_s	Pitch, P	Pitch Diam., E	Depth of Engagement, h_e	Clearance		Bolt		Nut		
				a	b	Minor Diam., K_s	Depth of Thread, h_s	Major Diam., D_n	Minor Diam., K_n	Depth of Thread, h_n
10	3	8.5	1.25	0.25	0.5	6.5	1.75	10.5	7.5	1.50
12	3	10.5	1.25	0.25	0.5	8.5	1.75	12.5	9.5	1.50
14	4	12	1.75	0.25	0.5	9.5	2.25	14.5	10.5	2.00
16	4	14	1.75	0.25	0.5	11.5	2.25	16.5	12.5	2.00
18	4	16	1.75	0.25	0.5	13.5	2.25	18.5	14.5	2.00
20	4	18	1.75	0.25	0.5	15.5	2.25	20.5	16.5	2.00
22	5	19.5	2	0.25	0.75	16.5	2.75	22.5	18	2.00
24	5	21.5	2	0.25	0.75	18.5	2.75	24.5	20	2.25
26	5	23.5	2	0.25	0.75	20.5	2.75	26.5	22	2.25
28	5	25.5	2	0.25	0.75	22.5	2.75	28.5	24	2.25
30	6	27	2.5	0.25	0.75	23.5	3.25	30.5	25	2.75
32	6	29	2.5	0.25	0.75	25.5	3.25	32.5	27	2.75
36	6	33	2.5	0.25	0.75	29.5	3.25	36.5	31	2.75
40	7	36.5	3	0.25	0.75	32.5	3.75	40.5	34	3.25
44	7	40.5	3	0.25	0.75	36.5	3.75	44.5	38	3.25
48	8	44	3.5	0.25	0.75	39.5	4.25	48.5	41	3.75
50	8	46	3.5	0.25	0.75	41.5	4.25	50.5	43	3.75
52	8	48	3.5	0.25	0.75	43.5	4.25	52.5	45	3.75
55	9	50.5	4	0.25	0.75	45.5	4.75	55.5	47	4.25
60	9	55.5	4	0.25	0.75	50.5	4.75	60.5	52	4.25
65	10	60	4.5	0.25	0.75	54.5	5.25	65.5	56	4.75
70	10	65	4.5	0.25	0.75	59.5	5.25	70.5	61	4.75
75	10	70	4.5	0.25	0.75	64.5	5.25	75.5	66	4.75
80	10	75	4.5	0.25	0.75	69.5	5.25	80.5	71	4.75
85	12	79	5.5	0.25	0.75	72.5	6.25	85.5	74	5.75
90	12	84	5.5	0.25	0.75	77.5	6.25	90.5	79	5.75
95	12	89	5.5	0.25	0.75	82.5	6.25	95.5	84	5.75
100	12	94	5.5	0.25	0.75	87.5	6.25	100.5	89	5.75
110	12	104	5.5	0.25	0.75	97.5	6.25	110.5	99	5.75
120	14	113	6	0.5	1.5	105	7.5	121	108	6.5
130	14	123	6	0.5	1.5	115	7.5	131	118	6.5
140	14	133	6	0.5	1.5	125	7.5	141	128	6.5
150	16	142	7	0.5	1.5	133	8.5	151	136	7.5
160	16	152	7	0.5	1.5	143	8.5	161	146	7.5
170	16	162	7	0.5	1.5	153	8.5	171	156	7.5
180	18	171	8	0.5	1.5	161	9.5	181	164	8.5
190	18	181	8	0.5	1.5	171	9.5	191	174	8.5
200	18	191	8	0.5	1.5	181	9.5	201	184	8.5
210	20	200	9	0.5	1.5	189	10.5	211	192	9.5
220	20	210	9	0.5	1.5	199	10.5	221	202	9.5
230	20	220	9	0.5	1.5	209	10.5	231	212	9.5
240	22	229	10	0.5	1.5	217	11.5	241	220	10.5
250	22	239	10	0.5	1.5	227	11.5	251	230	10.5
260	22	249	10	0.5	1.5	237	11.5	261	240	10.5
270	24	258	11	0.5	1.5	245	12.5	271	248	11.5
280	24	268	11	0.5	1.5	255	12.5	281	258	11.5
290	24	278	11	0.5	1.5	265	12.5	291	268	11.5
300	26	287	12	0.5	1.5	273	13.5	301	276	12.5

All dimensions are in millimeters.

*Roots are rounded to a radius, r , equal to 0.25 mm for pitches of from 3 to 12 mm inclusive and 0.5 mm for pitches of from 14 to 26 mm inclusive for power transmission.

ISO Miniature Screw Threads

ISO Miniature Screw Threads, Basic Form *ISO/R 1501:1970*

Pitch P	$H = 0.866025P$	$0.554256H = 0.48P$	$0.375H = 0.324760P$	$0.320744H = 0.320744P$	$0.125H = 0.108253P$
0.08	0.069282	0.038400	0.025981	0.022222	0.008660
0.09	0.077942	0.043200	0.029228	0.024999	0.009743
0.1	0.086603	0.048000	0.032476	0.027777	0.010825
0.125	0.108253	0.060000	0.040595	0.034722	0.013532
0.15	0.129904	0.072000	0.048714	0.041666	0.016238
0.175	0.151554	0.084000	0.056833	0.048610	0.018944
0.2	0.173205	0.096000	0.064952	0.055554	0.021651
0.225	0.194856	0.108000	0.073071	0.062499	0.024357
0.25	0.216506	0.120000	0.081190	0.069443	0.027063
0.3	0.259808	0.144000	0.097428	0.083332	0.032476

ISO Miniature Screw Threads, Basic Dimensions *ISO/R 1501:1970*

Nominal Diameter	Pitch P	Major Diameter D, d	Pitch Diameter D_2, d_2	Minor Diameter D_1, d_1
0.30	0.080	0.300000	0.248039	0.223200
0.35	0.090	0.350000	0.291543	0.263600
0.40	0.100	0.400000	0.335048	0.304000
0.45	0.100	0.450000	0.385048	0.354000
0.50	0.125	0.500000	0.418810	0.380000
0.55	0.125	0.550000	0.468810	0.430000
0.60	0.150	0.600000	0.502572	0.456000
0.70	0.175	0.700000	0.586334	0.532000
0.80	0.200	0.800000	0.670096	0.608000
0.90	0.225	0.900000	0.753858	0.684000
1.00	0.250	1.000000	0.837620	0.760000
1.10	0.250	1.100000	0.937620	0.860000
1.20	0.250	1.200000	1.037620	0.960000
1.40	0.300	1.400000	1.205144	1.112000

D and d dimensions refer to the nut (internal) and screw (external) threads, respectively.

British Standard ISO Metric Screw Threads

BS 3643:Part 1:1981 (R2004) provides principles and basic data for ISO metric screw threads. It covers single-start, parallel screw threads of from 1 to 300 millimeters in diameter. Part 2 of the Standard gives the specifications for selected limits of size.

Basic Profile.—The ISO basic profile for triangular screw threads is shown in Fig. 1. and basic dimensions of this profile are given in Table 1.

**Table 1. British Standard ISO Metric Screw Threads
Basic Profile Dimensions BS 3643:1981 (R2004)**

Pitch P	$H = 0.86603P$	$\frac{5}{8}H = 0.54127P$	$\frac{3}{8}H = 0.32476P$	$H/4 = 0.21651P$	$H/8 = 0.10825P$
0.2	0.173 205	0.108 253	0.064 952	0.043 301	0.021 651
0.25	0.216 506	0.135 316	0.081 190	0.054 127	0.027 063
0.3	0.259 808	0.162 380	0.097 428	0.064 952	0.032 476
0.35	0.303 109	0.189 443	0.113 666	0.075 777	0.037 889
0.4	0.346 410	0.216 506	0.129 904	0.086 603	0.043 301
0.45	0.389 711	0.243 570	0.146 142	0.097 428	0.048 714
0.5	0.433 013	0.270 633	0.162 380	0.108 253	0.054 127
0.6	0.519 615	0.324 760	0.194 856	0.129 904	0.064 952
0.7	0.606 218	0.378 886	0.227 322	0.151 554	0.075 777

**Table 1. (Continued) British Standard ISO Metric Screw Threads
Basic Profile Dimensions BS 3643:1981 (R2004)**

Pitch <i>P</i>	$H =$ 0.086603 <i>P</i>	$\frac{5}{8}H =$ 0.54127 <i>P</i>	$\frac{3}{8}H =$ 0.32476 <i>P</i>	$H/4 =$ 0.21651 <i>P</i>	$H/8 =$ 0.10825 <i>P</i>
0.75	0.649 519	0.405 949	0.243 570	0.162 380	0.081 190
0.8	0.692 820	0.433 013	0.259 808	0.173 205	0.086 603
1	0.866 025	0.541 266	0.324 760	0.216 506	0.108 253
1.25	1.082 532	0.676 582	0.405 949	0.270 633	0.135 316
1.5	1.299 038	0.811 899	0.487 139	0.324 760	0.162 380
1.75	1.515 544	0.947 215	0.568 329	0.378 886	0.189 443
2	1.732 051	1.082 532	0.649 519	0.433 013	0.216 506
2.5	2.165 063	1.353 165	0.811 899	0.541 266	0.270 633
3	2.598 076	1.623 798	0.974 279	0.649 519	0.324 760
3.5	3.031 089	1.894 431	1.136 658	0.757 772	0.378 886
4	3.464 102	2.165 063	1.299 038	0.866 025	0.433 013
4.5	3.897 114	2.435 696	1.461 418	0.974 279	0.487 139
5	4.330 127	2.706 329	1.623 798	1.082 532	0.541 266
5.5	4.763 140	2.976 962	1.786 177	1.190 785	0.595 392
6	5.196 152	3.247 595	1.948 557	1.299 038	0.649 519
8 ^a	6.928 203	4.330 127	2.598 076	1.732 051	0.866 025

^aThis pitch is not used in any of the ISO metric standard series.
All dimensions are given in millimeters.

Tolerance System.—The tolerance system defines *tolerance classes* in terms of a combination of a *tolerance grade* (figure) and a *tolerance position* (letter). The tolerance position is defined by the distance between the basic size and the nearest end of the tolerance zone, this distance being known as the *fundamental deviation*, EI, in the case of internal threads, and es in the case of external threads. These tolerance positions with respect to the basic size (zero line) are shown in Fig. 2 and fundamental deviations for nut and bolt threads are given in Table 2.

Table 2. Fundamental Deviations for Nut Threads and Bolt Threads

Pitch <i>P</i> mm	Nut Thread <i>D</i> ₂ , <i>D</i> ₁		Bolt Thread <i>d</i> , <i>d</i> ₂				Pitch <i>P</i> mm	Nut Thread <i>D</i> ₂ , <i>D</i> ₁		Bolt Thread <i>d</i> , <i>d</i> ₂			
	Tolerance Position							Tolerance Position					
	G	H	e	f	g	h		G	H	e	f	g	h
	Fundamental Deviation							Fundamental Deviation					
	EI	EI	es	es	es	es		EI	EI	es	es	es	es
	μm	μm	μm	μm	μm	μm		μm	μm	μm	μm	μm	μm
0.2	+17	0	-17	0	1.25	+28	0	-63	-42	-28	0
0.25	+18	0	-18	0	1.5	+32	0	-67	-45	-32	0
0.3	+18	0	-18	0	1.75	+34	0	-71	-48	-34	0
0.35	+19	0	...	-34	-19	0	2	+38	0	-71	-52	-38	0
0.4	+19	0	...	-34	-19	0	2.5	+42	0	-80	-58	-42	0
0.45	+20	0	...	-35	-20	0	3	+48	0	-85	-63	-48	0
0.5	+20	0	-50	-36	-20	0	3.5	+53	0	-90	-70	-53	0
0.6	+21	0	-53	-36	-21	0	4	+60	0	-95	-75	-60	0
0.7	+22	0	-56	-38	-22	0	4.5	+63	0	-100	-80	-63	0
0.75	+22	0	-56	-38	-22	0	5	+71	0	-106	-85	-71	0
0.8	+24	0	-60	-38	-24	0	5.5	+75	0	-112	-90	-75	0
1	+26	0	-60	-40	-26	0	6	+80	0	-118	-95	-80	0

See Figs. 1 and 2 for meaning of symbols.

Tolerance Grades.—Tolerance grades specified in the Standard for each of the four main screw thread diameters are as follows:

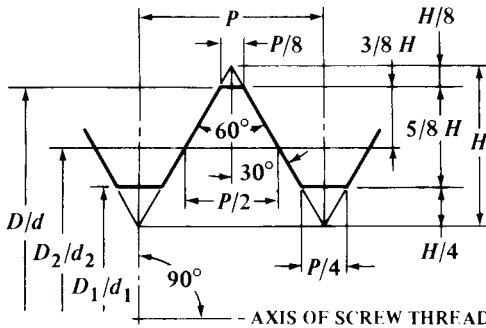
Minor diameter of nut threads (D_1): tolerance grades 4, 5, 6, 7, and 8.

Major diameter of bolt threads (d): tolerance grades 4, 6, and 8.

Pitch diameter of nut threads (D_2): tolerance grades 4, 5, 6, 7, and 8.

Pitch diameter of bolt threads (d_2): tolerance grades 3, 4, 5, 6, 7, 8, and 9.

Tolerance Positions.—Tolerance positions are G and H for nut threads and e, f, g, and h for bolt threads. The relationship of these tolerance position identifying letters to the amount of fundamental deviation is shown in [Table 2](#).



- D = maj. diam. of internal thread;
- d = maj. diam. of external th
- D_2 = pitch diam. of internal thread;
- d_2 = pitch diam. of internal thread;
- D_1 = minor diam. of internal thread;
- d_1 = minor diam. of external thread;
- P = Pitch;
- H = height of fundamental angle;

Fig. 1. Basic Profile of ISO Metric Thread

Tolerance Classes.—To reduce the number of gages and tools, the Standard specifies that the tolerance positions and classes shall be chosen from those listed in [Table 3](#) for short, normal, and long lengths of thread engagement. The following rules apply for the choice of tolerance quality: *Fine*: for precision threads when little variation of fit character is needed; *Medium*: for general use; and *Coarse*: for cases where manufacturing difficulties can arise as, for example, when threading hot-rolled bars and long blind holes. If the actual length of thread engagement is unknown, as in the manufacturing of standard bolts, normal is recommended.

Table 3. Tolerance Classes^{a,b,c} for Nuts and Bolts

Tolerance Classes for Nuts											
Tolerance Quality	Tolerance Position G			Tolerance Position H							
	Short	Normal	Long	Short	Normal	Long					
Fine	4H ^b	5H ^b	6H ^b					
Medium	5G ^a	6G ^c	7G ^c	5H ^a	6H ^{a,d}	7H ^a					
Coarse	...	7G ^c	8G ^c	...	7H ^b	8H ^b					

Tolerance Classes for Bolts												
Tolerance Quality	Tolerance Position e			Tolerance Position f			Tolerance Position g			Tolerance Position h		
	Short	Normal	Long	Short	Normal	Long	Short	Normal	Long	Short	Normal	Long
Fine	3h4h ^c	4h ^a	5h4h ^c
Medium	...	6e ^a	7e6e ^c	...	6f ^a	...	5g6g ^c	6g ^{a,d}	7g6g ^c	5h6h ^c	6h ^b	7h6h ^c
Coarse	8g ^b	9g8g ^c

^a First choice.

^b Second choice.

^c Third choice; these are to be avoided.

^d For commercial nut and bolt threads.

Note: See [Table 4](#) for short, normal, and long categories. Any of the recommended tolerance classes for nuts can be combined with any of the recommended tolerance classes for bolts with the exception of sizes M1.4 and smaller for which the combination 5H/6h or finer shall be chosen. However, to guarantee a sufficient overlap, the finished components should preferably be made to form the fits H/g, H/h, or G/h.

Table 4. Lengths of Thread Engagements for Short, Normal, and Long Categories

Basic Major Diameter <i>d</i>		Pitch <i>P</i>	Short	Normal		Long	Basic Major Diameter <i>d</i>		Pitch <i>P</i>	Short	Normal		Long
Over	Up to and Incl.		Length of Thread Engagement				Over	Up to and Incl.		Length of Thread Engagement			
			Up to and Incl.	Over	Up to and Incl.	Over				Up to and Incl.	Over	Up to and Incl.	Over
0.99	1.4	0.2	0.5	0.5	1.4	1.4	22.4	45	1	4	4	12	12
		0.25	0.6	0.6	1.7	1.7			1.5	6.3	6.3	19	19
		0.3	0.7	0.7	2	2			2	8.5	8.5	25	25
1.4	2.8	0.2	0.5	0.5	1.5	1.5			3	12	12	36	36
		0.25	0.6	0.6	1.9	1.9			3.5	15	15	45	45
		0.35	0.8	0.8	2.6	2.6			4	18	18	53	53
		0.4	1	1	3	3			4.5	21	21	63	63
		0.45	1.3	1.3	3.8	3.8			1.5	7.5	7.5	22	22
2.8	5.6	0.35	1	1	3	3			2	9.5	9.5	28	28
		0.5	1.5	1.5	4.5	4.5			3	15	15	45	45
		0.6	1.7	1.7	5	5			4	19	19	56	56
		0.7	2	2	6	6			5	24	24	71	71
		0.75	2.2	2.2	6.7	6.7	5.5	28	28	85	85		
		0.8	2.5	2.5	7.5	7.5	6	32	32	95	95		
5.6	11.2	0.75	2.4	2.4	7.1	7.1	2	12	12	36	36		
		1	3	3	9	9	3	18	18	53	53		
		1.25	4	4	12	12	4	24	24	71	71		
		1.5	5	5	15	15	6	36	36	106	106		
11.2	22.4	1	3.8	3.8	11	11	3	20	20	60	60		
		1.25	4.5	4.5	13	13	4	26	26	80	80		
		1.5	5.6	5.6	16	16	6	40	40	118	118		
		1.75	6	6	18	18							
		2	8	8	24	24							
		2.5	10	10	30	30							

All dimensions are given in millimeters

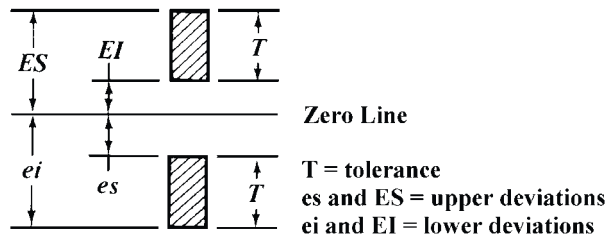


Fig. 2. Tolerance Positions with Respect to Zero Line (Basic Size)

Design Profiles.—The design profiles for ISO metric internal and external screw threads are shown in Fig. 3. These represent the profiles of the threads at their maximum metal condition. It may be noted that the root of each thread is deepened so as to clear the basic flat crest of the other thread. The contact between the thread is thus confined to their sloping flanks. However, for nut threads as well as bolt threads, the actual root contours shall not at any point violate the basic profile.

Designation.—Screw threads complying with the requirements of the Standard shall be designated by the letter M followed by values of the nominal diameter and of the pitch, expressed in millimeters, and separated by the sign ×. *Example:* M6×0.75. The absence of the indication of pitch means that a coarse pitch is specified.

The complete designation of a screw thread consists of a designation for the thread system and size, and a designation for the crest diameter tolerance. Each class designation consists of: a figure indicating the tolerance grade; and a letter indicating the tolerance

position, capital for nuts, lower case for bolts. If the two class designations for a thread are the same (one for the pitch diameter and one for the crest diameter), it is not necessary to repeat the symbols. As examples, a bolt thread designated M10-6g signifies a thread of 10 mm nominal diameter in the Coarse Thread Series having a tolerance class 6g for both pitch and major diameters. A designation M10 × 1-5g6g signifies a bolt thread of 10 mm nominal diameter having a pitch of 1 mm, a tolerance class 5g for pitch diameter, and a tolerance class 6g for major diameter. A designation M10-6H signifies a nut thread of 10 mm diameter in the Coarse Thread Series having a tolerance class 6H for both pitch and minor diameters.

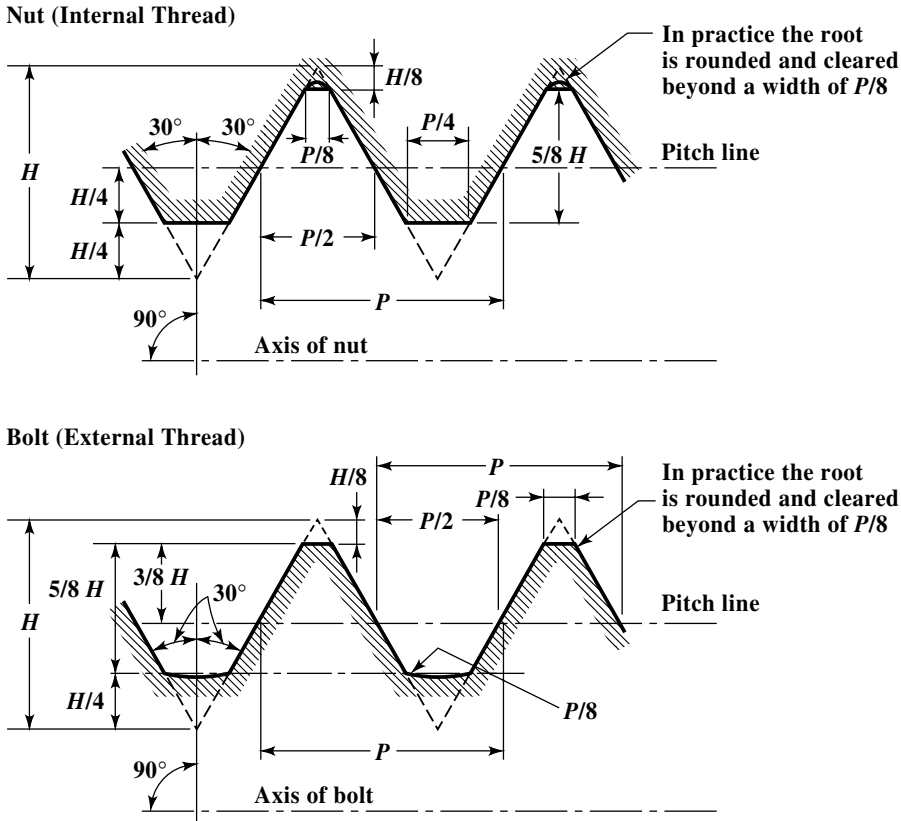


Fig. 3. Maximum Material Profiles for Internal and External Threads

A fit between mating parts is indicated by the nut thread tolerance class followed by the bolt thread tolerance class separated by an oblique stroke. *Examples:* M6-6H/6g and M20 × 2-6H/5g6g. For coated threads, the tolerances apply to the parts before coating, unless otherwise specified. After coating, the actual thread profile shall not at any point exceed the maximum material limits for either tolerance position H or h.

Fundamental Deviation Formulas.—The formulas used to calculate the fundamental deviations in Table 2 are:

$$EI_G = +(15 + 11P)$$

$$EI_H = 0$$

$$es_e = -(50 + 11P) \text{ except for threads with } P \leq 0.45 \text{ mm}$$

$$es_f = -(30 + 11P)$$

$$es_g = -(15 + 11P)$$

$$es_h = 0$$

In these formulas, EI and es are expressed in micrometers and P is in millimeters.

Crest Diameter Tolerance Formulas.—The tolerances for the major diameter of bolt threads (T_d), grade 6, in Table 5, were calculated from the formula:

$$T_d(6) = 180 \sqrt[3]{P^2} - \frac{3.15}{\sqrt{P}}$$

In this formula, $T_d(6)$ is in micrometers and P is in millimeters. For tolerance grades 4 and 8: $T_d(4) = 0.63 T_d(6)$ and $T_d(8) = 1.6 T_d(6)$, respectively.

The tolerances for the minor diameter of nut threads (T_{D1}), grade 6, in Table 5, were calculated as follows:

For pitches 0.2 to 0.8 mm, $T_{D1}(6) = 433P - 190P^{1.22}$.

For pitches 1 mm and coarser, $T_{D1}(6) = 230P^{0.7}$.

In these formulas, $T_{D1}(6)$ is in micrometers and P is in millimeters. For tolerance grades 4, 5, 7, and 8: $T_{D1}(4) = 0.63 T_{D1}(6)$; $T_{D1}(5) = 0.8 T_{D1}(6)$; $T_{D1}(7) = 1.25 T_{D1}(6)$; and $T_{D1}(8) = 1.6 T_{D1}(6)$, respectively.

Table 5. British Standard ISO Metric Screw Threads: Limits and Tolerances for Finished Uncoated Threads for Normal Lengths of Engagement BS 3643: Part 2: 1981

Nominal Diameter ^a	Pitch		External Threads (Bolts)						Internal Threads (Nuts) ^b							
	Coarse	Fine	Tol. Class	Fund. dev.	Major Dia.		Pitch Dia.		Minor Dia	Tol. Class	Major Dia.		Pitch Dia.		Minor Dia	
					Max	Tol(-)	Max	Tol(-)	Min		Min	Max	Tol(-)	Max	Tol(-)	
	1	0.25	0.2	4h	0	1.000	0.036	0.870	0.030	0.717	4H	1.000	0.910	0.040	0.821	0.038
6g				0.017	0.983	0.056	0.853	0.048	0.682							
1.1	0.25	0.2	4h	0	1.100	0.042	0.938	0.034	0.750	4H	1.100	0.983	0.045	0.874	0.045	
			6g	0.018	1.082	0.067	0.920	0.053	0.713	5H	1.100	0.994	0.056	0.885	0.056	
1.2	0.25	0.2	4h	0	1.200	0.042	1.038	0.034	0.850	4H	1.200	1.083	0.045	0.974	0.045	
			6g	0.017	1.183	0.056	1.053	0.048	0.882	5H	1.200	1.094	0.056	0.985	0.056	
1.4	0.3	0.2	4h	0	1.400	0.036	1.270	0.030	1.117	4H	1.400	1.310	0.040	1.221	0.038	
			6g	0.017	1.383	0.056	1.253	0.048	1.082							
1.6	0.35	0.2	4h	0	1.600	0.036	1.470	0.032	1.315	4H	1.600	1.512	0.042	1.421	0.038	
			6g	0.017	1.583	0.056	1.453	0.050	1.280							
1.8	0.35	0.2	4h	0	1.800	0.036	1.670	0.032	1.515	4H	1.800	1.712	0.042	1.621	0.038	
			6g	0.017	1.783	0.056	1.653	0.050	1.480							
2	0.4	0.25	4h	0	2.000	0.042	1.838	0.036	1.648	4H	2.000	1.886	0.048	1.774	0.045	
			6g	0.018	1.982	0.067	1.820	0.056	1.610	5H	2.000	1.898	0.060	1.785	0.056	
2.2	0.45	0.25	4h	0	2.200	0.042	2.038	0.036	1.848	4H	2.200	2.086	0.048	1.974	0.045	
			6g	0.018	2.182	0.067	2.020	0.056	1.810	5H	2.200	2.098	0.060	1.985	0.056	
2.2	0.45	0.25	4h	0	2.200	0.063	1.908	0.045	1.585	4H	2.200	1.968	0.060	1.793	0.080	
			6g	0.020	2.180	0.100	1.888	0.071	1.539	5H	2.200	1.983	0.075	1.813	0.100	
2.2	0.45	0.25	4h	0	2.200	0.063	1.908	0.045	1.585	4H	2.200	1.968	0.060	1.793	0.080	
			6g	0.020	2.180	0.100	1.888	0.071	1.539	5H	2.200	1.983	0.075	1.813	0.100	

Table 5. (Continued) British Standard ISO Metric Screw Threads: Limits and Tolerances for Finished Uncoated Threads for Normal Lengths of Engagement BS 3643: Part 2: 1981

Nominal Diameter ^a	Pitch		External Threads (Bolts)						Internal Threads (Nuts) ^b							
	Course	Fine	Tol. Class	Fund. dev.	Major Dia.		Pitch Dia.		Minor Dia	Tol. Class	Major Dia.		Pitch Dia.		Minor Dia	
					Max	Tol(-)	Max	Tol(-)			Min	Min	Max	Tol(-)	Max	Tol(-)
2.5	0.35	6g	4h	0	2.500	0.053	2.273	0.040	2.017	4H	2.500	2.326	0.053	2.184	0.063	
			6g	0.019	2.481	0.085	2.254	0.063	1.975	5H	2.500	2.340	0.067	2.201	0.080	
			6H	2.500	2.358	0.085	2.221	0.100								
	0.45	6g	4h	0	2.500	0.063	2.208	0.045	1.885	4H	2.500	2.268	0.060	2.093	0.080	
			6g	0.020	2.480	0.100	2.188	0.071	1.839	5H	2.500	2.283	0.075	2.113	0.100	
			6H	2.500	2.303	0.095	2.138	0.125								
3	0.35	6g	4h	0	3.000	0.053	2.773	0.042	2.515	4H	3.000	2.829	0.056	2.684	0.063	
			6g	0.019	2.981	0.085	2.754	0.067	2.471	5H	3.000	2.844	0.071	2.701	0.080	
			6H	3.000	2.863	0.090	2.721	0.100								
	0.5	6g	4h	0	3.000	0.067	2.675	0.048	2.319	5H	3.000	2.755	0.080	2.571	0.112	
			6g	0.020	2.980	0.106	2.655	0.075	2.272	6H	3.000	2.775	0.100	2.599	0.140	
			7H	3.000	2.800	0.125	2.639	0.180								
3.5	0.35	6g	4h	0	3.500	0.053	3.273	0.042	3.015	4H	3.500	3.329	0.056	3.184	0.063	
			6g	0.019	3.481	0.085	3.254	0.067	2.971	5H	3.500	3.344	0.071	3.201	0.080	
			6H	3.500	3.363	0.090	3.221	0.100								
	0.6	6g	4h	0	3.500	0.080	3.110	0.053	2.688	5H	3.500	3.200	0.090	2.975	0.125	
			6g	0.021	3.479	0.125	3.089	0.085	2.635	6H	3.500	3.222	0.112	3.010	0.160	
			7H	3.500	3.250	0.140	3.050	0.200								
4	0.5	6g	4h	0	4.000	0.067	3.675	0.048	3.319	5H	4.000	3.755	0.080	3.571	0.112	
			6g	0.020	3.980	0.106	3.655	0.075	3.272	6H	4.000	3.775	0.100	3.599	0.140	
			7H	4.000	3.800	0.125	3.639	0.180								
	0.7	6g	4h	0	4.000	0.090	3.545	0.056	3.058	5H	4.000	3.640	0.095	3.382	0.140	
			6g	0.022	3.978	0.140	3.523	0.090	3.002	6H	4.000	3.663	0.118	3.422	0.180	
			7H	4.000	3.695	0.150	3.466	0.224								
4.5	0.5	6g	4h	0	4.500	0.067	4.175	0.048	3.819	5H	4.500	4.255	0.080	4.071	0.112	
			6g	0.020	4.480	0.106	4.155	0.075	3.772	6H	4.500	4.275	0.100	4.099	0.140	
			7H	4.500	4.300	0.125	4.139	0.180								
	0.75	6g	4h	0	4.500	0.090	4.013	0.056	3.495	5H	4.500	4.108	0.095	3.838	0.150	
			6g	0.022	4.478	0.140	3.991	0.090	3.439	6H	4.500	4.131	0.118	3.878	0.190	
			7H	4.500	4.163	0.150	3.924	0.236								
5	0.5	6g	4h	0	5.000	0.067	4.675	0.048	4.319	5H	5.000	4.755	0.080	4.571	0.112	
			6g	0.020	4.980	0.106	4.655	0.075	4.272	6H	5.000	4.775	0.100	4.599	0.140	
			7H	5.000	4.800	0.125	4.639	0.180								
	0.8	6g	4h	0	5.000	0.095	4.480	0.060	3.927	5H	5.000	4.580	0.100	4.294	0.160	
			6g	0.024	4.976	0.150	4.456	0.095	3.868	6H	5.000	4.605	0.125	4.334	0.200	
			7H	5.000	4.640	0.160	4.384	0.250								
5.5	0.5	6g	4h	0	5.500	0.067	5.175	0.048	4.819	5H	5.500	5.255	0.080	5.071	0.112	
			6g	0.020	5.480	0.106	5.155	0.075	4.772	6H	5.500	5.275	0.100	5.099	0.140	
			7H	5.500	5.300	0.125	5.139	0.180								
	0.75	6g	4h	0	6.000	0.090	5.513	0.063	4.988	5H	6.000	5.619	0.106	5.338	0.150	
			6g	0.022	5.978	0.140	5.491	0.100	4.929	6H	6.000	5.645	0.132	5.378	0.190	
			7H	6.000	5.683	0.170	5.424	0.236								
6	1	6g	4h	0	6.000	0.112	5.350	0.071	4.663	5H	6.000	5.468	0.118	5.107	0.190	
			6g	0.026	5.974	0.180	5.324	0.112	4.597	6H	6.000	5.500	0.150	5.153	0.236	
			8g	0.026	5.974	0.280	5.324	0.180	4.528	7H	6.000	5.540	0.190	5.217	0.300	
	0.75	6g	4h	0	7.000	0.090	6.513	0.063	5.988	5H	7.000	6.619	0.106	6.338	0.150	
			6g	0.022	6.978	0.140	6.491	0.100	5.929	6H	7.000	6.645	0.132	6.378	0.190	
			7H	7.000	6.683	0.170	6.424	0.236								
7	1	6g	4h	0	7.000	0.112	6.350	0.071	5.663	5H	7.000	6.468	0.118	6.107	0.190	
			6g	0.026	6.974	0.180	6.324	0.112	5.596	6H	7.000	6.500	0.150	6.153	0.236	
			8g	0.026	6.974	0.280	6.324	0.180	5.528	7H	7.000	6.540	0.190	6.217	0.300	
	1.25	6g	4h	0	8.000	0.132	7.188	0.075	6.343	5H	8.000	7.313	0.125	6.859	0.212	
			6g	0.028	7.972	0.212	7.160	0.118	6.272	6H	8.000	7.348	0.160	6.912	0.265	
			8g	0.028	7.972	0.335	7.160	0.190	6.200	7H	8.000	7.388	0.200	6.982	0.335	

Table 5. (Continued) British Standard ISO Metric Screw Threads: Limits and Tolerances for Finished Uncoated Threads for Normal Lengths of Engagement BS 3643: Part 2: 1981

Nominal Diameter ^a	Pitch		External Threads (Bolts)						Internal Threads (Nuts) ^b							
	Course	Fine	Tol. Class	Fund dev.	Major Dia.		Pitch Dia.		Minor Dia	Tol. Class	Major Dia.		Pitch Dia.		Minor Dia	
					Max	Tol(-)	Max	Tol(-)	Min		Min	Max	Tol(-)	Max	Tol(-)	
					4h	6g	8g	4h	6g		8g	5H	6H	7H	5H	6H
9	1.25		4h	0	9.000	0.132	8.188	0.075	7.343	5H	9.000	8.313	0.125	7.859	0.212	
			6g	0.028	8.972	0.212	8.160	0.008	7.272	6H	9.000	8.348	0.160	7.912	0.265	
			8g	0.028	8.972	0.335	8.160	0.190	7.200	7H	9.000	8.388	0.200	7.982	0.335	
10	1.25		4h	0	10.000	0.132	9.188	0.075	8.343	5H	10.000	9.313	0.125	8.859	0.212	
			6g	0.028	9.972	0.212	9.160	0.118	8.272	6H	10.000	9.348	0.160	8.912	0.265	
			8g	0.028	9.972	0.335	9.160	0.190	8.200	7H	10.000	9.388	0.200	8.982	0.335	
	1.5		4h	0	10.000	0.150	9.026	0.085	8.018	5H	10.000	9.166	0.140	8.612	0.236	
			6g	0.032	9.968	0.236	8.994	0.132	7.938	6H	10.000	9.206	0.180	8.676	0.300	
			8g	0.032	9.968	0.375	8.994	0.212	7.858	7H	10.000	9.250	0.224	8.751	0.375	
11	1.5		4h	0	11.000	0.150	10.026	0.085	9.018	5H	11.000	10.166	0.140	9.612	0.236	
			6g	0.032	10.968	0.236	9.994	0.132	8.938	6H	11.000	10.206	0.180	9.676	0.300	
			8g	0.032	10.968	0.375	9.994	0.212	8.858	7H	11.000	10.250	0.224	9.751	0.375	
12	1.25		4h	0	12.000	0.132	11.188	0.085	10.333	5H	12.000	11.328	0.140	10.859	0.212	
			6g	0.028	11.972	0.212	11.160	0.132	10.257	6H	12.000	11.398	0.180	10.912	0.265	
			8g	0.028	11.972	0.335	11.160	0.212	10.177	7H	12.000	11.412	0.224	10.985	0.335	
	1.75		4h	0	12.000	0.170	10.863	0.095	9.692	5H	12.000	11.023	0.160	10.371	0.265	
			6g	0.034	11.966	0.265	10.829	0.150	9.602	6H	12.000	11.063	0.200	10.441	0.335	
			8g	0.034	11.966	0.425	10.829	0.236	9.516	7H	12.000	11.113	0.250	10.531	0.425	
14	1.5		4h	0	14.000	0.150	13.026	0.090	12.012	5H	14.000	13.176	0.150	12.612	0.236	
			6g	0.032	13.968	0.236	12.994	0.140	11.930	6H	14.000	13.216	0.190	12.676	0.300	
			8g	0.032	13.968	0.375	12.994	0.224	11.846	7H	14.000	13.262	0.236	12.751	0.375	
	2		4h	0	14.000	0.180	12.701	0.100	11.369	5H	14.000	12.871	0.170	12.135	0.300	
			6g	0.038	13.962	0.280	12.663	0.160	11.271	6H	14.000	12.913	0.212	12.210	0.375	
			8g	0.038	13.962	0.450	12.663	0.250	11.181	7H	14.000	12.966	0.265	12.310	0.475	
16	1.5		4h	0	16.000	0.150	15.026	0.090	14.012	5H	16.000	15.176	0.150	14.612	0.236	
			6g	0.032	15.968	0.236	14.994	0.140	13.930	6H	16.000	15.216	0.190	14.676	0.300	
			8g	0.032	15.968	0.375	14.994	0.224	13.846	7H	16.000	15.262	0.236	14.751	0.375	
	2		4h	0	16.000	0.180	14.701	0.100	13.369	5H	16.000	14.871	0.170	14.135	0.300	
			6g	0.038	15.962	0.280	14.663	0.160	13.271	6H	16.000	14.913	0.212	14.210	0.375	
			8g	0.038	15.962	0.450	14.663	0.250	13.181	7H	16.000	14.966	0.265	14.310	0.475	
18	1.5		4h	0	18.000	0.150	17.026	0.090	16.012	5H	18.000	17.176	0.150	16.612	0.236	
			6g	0.032	17.968	0.236	16.994	0.140	15.930	6H	18.000	17.216	0.190	16.676	0.300	
			8g	0.032	17.968	0.375	16.994	0.224	15.846	7H	18.000	17.262	0.236	16.751	0.375	
	2.5		4h	0	18.000	0.212	16.376	0.106	14.730	5H	18.000	16.556	0.180	15.649	0.355	
			6g	0.042	17.958	0.335	16.334	0.170	14.624	6H	18.000	16.600	0.224	15.774	0.450	
			8g	0.042	17.958	0.530	16.334	0.265	14.529	7H	18.000	16.656	0.280	15.854	0.560	
20	1.5		4h	0	20.000	0.150	19.026	0.090	18.012	5H	20.000	19.176	0.150	18.612	0.236	
			6g	0.032	19.968	0.236	18.994	0.140	17.930	6H	20.000	0.190	19.262	0.236	18.751	
			8g	0.032	19.968	0.375	18.994	0.224	17.846	7H	20.000	19.262	0.236	18.751	0.375	
	2.5		4h	0	20.000	0.212	18.376	0.106	16.730	5H	20.000	18.556	0.180	17.649	0.355	
			6g	0.042	19.958	0.335	18.334	0.170	16.624	6H	20.000	18.600	0.224	17.744	0.450	
			8g	0.042	19.958	0.530	18.334	0.265	16.529	7H	20.000	18.650	0.280	17.854	0.560	
22	1.5		4h	0	22.000	0.150	21.026	0.090	20.012	5H	22.000	21.176	0.150	20.612	0.236	
			6g	0.032	21.968	0.236	20.994	0.140	19.930	6H	22.000	21.216	0.190	20.676	0.300	
			8g	0.032	21.968	0.375	20.994	0.224	19.846	7H	22.000	21.262	0.236	20.751	0.375	
	2.5		4h	0	22.000	0.212	20.376	0.106	18.730	5H	22.000	20.556	0.180	19.649	0.355	
			6g	0.042	21.958	0.335	20.334	0.170	18.624	6H	22.000	20.600	0.224	19.744	0.450	
			8g	0.042	21.958	0.530	20.334	0.265	18.529	7H	22.000	20.656	0.280	19.854	0.560	
24	2		4h	0	24.000	0.180	22.701	0.106	21.363	5H	24.000	22.881	0.180	22.135	0.300	
			6g	0.038	23.962	0.280	22.663	0.170	21.261	6H	24.000	22.925	0.224	22.210	0.375	
			8g	0.038	23.962	0.450	22.663	0.265	21.166	7H	24.000	22.981	0.280	22.310	0.475	
	3		4h	0	24.000	0.236	22.051	0.125	20.078	5H	24.000	22.263	0.212	21.152	0.400	
			6g	0.048	23.952	0.375	22.003	0.200	19.955	6H	24.000	22.316	0.265	21.252	0.500	
			8g	0.048	23.952	0.600	22.003	0.315	19.840	7H	24.000	22.386	0.335	21.382	0.630	
27	2		4h	0	27.000	0.180	25.701	0.106	24.363	5H	27.000	25.881	0.180	25.135	0.300	
			6g	0.038	26.962	0.280	25.663	0.170	24.261	6H	27.000	25.925	0.224	25.210	0.375	
			8g	0.038	26.962	0.450	25.663	0.265	24.166	7H	27.000	25.981	0.280	25.310	0.475	
	3		4h	0	27.000	0.236	25.051	0.125	23.078	5H	27.000	25.263	0.212	24.152	0.400	
			6g	0.048	26.952	0.375	25.003	0.200	22.955	6H	27.000	25.316	0.265	24.252	0.500	
			8g	0.048	26.952	0.600	25.003	0.315	22.840	7H	27.000	25.386	0.335	24.382	0.630	

Table 5. (Continued) British Standard ISO Metric Screw Threads: Limits and Tolerances for Finished Uncoated Threads for Normal Lengths of Engagement BS 3643: Part 2: 1981

Nominal Diameter ^a	Pitch		External Threads (Bolts)							Internal Threads (Nuts) ^b						
	Course	Fine	Tol. Class	Fund. dev.	Major Dia.		Pitch Dia.		Minor Dia.	Tol. Class	Major Dia.		Pitch Dia.		Minor Dia.	
					Max	Tol(-)	Max	Tol(-)	Min		Min	Max	Tol(-)	Max	Tol(-)	
					4h	6g	8g	5H	6H		7H	30.000	28.881	0.180	28.135	0.300
30	2		4h	0	30.000	0.180	28.701	0.106	27.363	5H	30.000	28.881	0.180	28.135	0.300	
			6g	0.038	29.962	0.280	28.663	0.170	27.261	6H	30.000	27.925	0.224	28.210	0.375	
			8g	0.038	29.962	0.450	28.663	0.265	27.166	7H	30.000	28.981	0.280	28.310	0.475	
	3.5		4h	0	30.000	0.265	27.727	0.132	25.439	5H	30.000	27.951	0.224	26.661	0.450	
			6g	0.053	29.947	0.425	27.674	0.212	25.305	6H	30.000	28.007	0.280	26.771	0.560	
			8g	0.053	29.947	0.670	27.674	0.335	25.183	7H	30.000	28.082	0.355	26.921	0.710	
33	2		4h	0	33.000	0.180	31.701	0.106	30.363	5H	33.000	31.881	0.180	31.135	0.300	
			6g	0.038	32.962	0.280	31.663	0.170	30.261	6H	33.000	31.925	0.224	31.210	0.375	
			8g	0.038	32.962	0.450	30.663	0.265	30.166	7H	33.000	31.981	0.280	31.310	0.475	
	3.5		4h	0	33.000	0.265	30.727	0.132	28.438	5H	33.000	30.951	0.224	29.661	0.450	
			6g	0.053	32.947	0.425	30.674	0.212	28.305	6H	33.000	31.007	0.280	29.771	0.560	
			8g	0.053	32.947	0.670	30.674	0.335	28.182	7H	33.000	31.082	0.355	29.921	0.710	
36	4		4h	0	36.000	0.300	33.402	0.140	30.798	5H	36.000	33.638	0.236	32.145	0.475	
			6g	0.060	35.940	0.475	33.342	0.224	30.654	6H	36.000	33.702	0.300	32.270	0.600	
			8g	0.060	35.940	0.750	33.342	0.355	30.523	7H	36.000	33.777	0.375	32.420	0.750	
39	4		4h	0	39.000	0.300	36.402	0.140	33.798	5H	39.000	36.638	0.236	35.145	0.475	
			6g	0.060	38.940	0.475	36.342	0.224	33.654	6H	39.000	36.702	0.300	35.270	0.600	
			8g	0.060	38.940	0.750	36.342	0.355	33.523	7H	39.000	36.777	0.375	35.420	0.750	

^a This table provides coarse- and fine-pitch series data for threads listed in Table 6 for first, second, and third choices. For constant-pitch series and for larger sizes than are shown, refer to the Standard.

^b The fundamental deviation for internal threads (nuts) is zero for threads in this table.

All dimensions are in millimeters.

Diameter/Pitch Combinations.—Part 1 of BS 3643 provides a choice of diameter/pitch combinations shown here in Table 6. The use of first-choice items is preferred but if necessary, second, then third choice combinations may be selected. If pitches finer than those given in Table 6 are necessary, only the following pitches should be used: 3, 2, 1.5, 1, 0.75, 0.5, 0.35, 0.25, and 0.2 mm. When selecting such pitches it should be noted that there is increasing difficulty in meeting tolerance requirements as the diameter is increased for a given pitch. It is suggested that diameters greater than the following should not be used with the pitches indicated:

Pitch, mm	0.5	0.75	1	1.5	2	3
Maximum Diameter, mm	22	33	80	150	200	300

In cases where it is necessary to use a thread with a pitch larger than 6 mm, in the diameter range of 150 to 300 mm, the 8 mm pitch should be used.

Limits and Tolerances for Finished Uncoated Threads.—Part 2 of BS 3643 specifies the fundamental deviations, tolerances, and limits of size for the tolerance classes 4H, 5H, 6H, and 7H for internal threads (nuts) and 4h, 6g, and 8g for external threads (bolts) for coarse-pitch series within the range of 1 to 68 mm; fine-pitch series within the range of 1 to 33 mm; and constant pitch series within the range of 8 to 300 mm diameter.

The data in Table 5 provide the first, second, and third choice combinations shown in Table 6 except that constant-pitch series threads are omitted. For diameters larger than shown in Table 5, and for constant-pitch series data, refer to the Standard.

**Table 6. British Standard ISO Metric Screw Threads —
Diameter/Pitch Combinations BS 3643:Part 1:1981 (R2004)**

Nominal Diameter			Coarse Pitch	Fine Pitch	Constant Pitch	Nominal Diameter			Constant Pitch
Choices						Choices			
1st	2nd	3rd				1st	2nd	3rd	
1	0.25	0.2	70	6, 4, 3, 2, 1.5
...	1.1	...	0.25	0.2	...	72	6, 4, 3, 2, 1.5
1.2	0.25	0.2	75	4, 3, 2, 1.5
...	1.4	...	0.3	0.2	76	...	6, 4, 3, 2, 1.5
1.6	0.35	0.2	78	2
...	1.8	...	0.35	0.2	...	80	6, 4, 3, 2, 1.5
2.0	0.4	0.25	82	2
...	2.2	...	0.45	0.25	85	...	6, 4, 3, 2
2.5	0.45	0.35	...	90	6, 4, 3, 2
3	0.5	0.35	95	...	6, 4, 3, 2
...	3.5	...	0.6	0.35	...	100	6, 4, 3, 2
4	0.7	0.5	105	...	6, 4, 3, 2
...	4.5	...	0.75	0.5	...	110	6, 4, 3, 2
5	0.8	0.5	115	...	6, 4, 3, 2
...	...	5.5	...	(0.5)	120	...	6, 4, 3, 2
6	1	0.75	...	125	6, 4, 3, 2
...	7	...	1	0.75	130	...	6, 4, 3, 2
8	1.25	1	0.75	135	6, 4, 3, 2
...	...	9	1.25	...	1, 0.75	140	6, 4, 3, 2
10	1.5	1.25	1, 0.75	145	6, 4, 3, 2
...	...	11	1.5	...	1, 0.75	150	6, 4, 3, 2
12	1.75	1.25	1.5, 1	155	6, 4, 3
...	14	...	2	1.5	1.25 ^a , 1	160	6, 4, 3
...	...	15	1.5, 1	165	6, 4, 3
16	2	1.5	1	...	170	...	6, 4, 3
...	...	17	1.5, 1	175	6, 4, 3
...	18	...	2.5	1.5	2, 1	180	6, 4, 3
20	2.5	1.5	2, 1	185	6, 4, 3
...	22	...	2.5	1.5	2, 1	...	190	...	6, 4, 3
24	3	2	1.5, 1	195	6, 4, 3
...	...	25	2, 1.5, 1	200	6, 4, 3
...	...	26	1.5	205	6, 4, 3
...	27	...	3	2	1.5, 1	...	210	...	6, 4, 3
...	...	28	2, 1.5, 1	215	6, 4, 3
30	3.5	2	(3), 1.5, 1	220	6, 4, 3
...	...	32	2, 1.5	225	6, 4, 3
...	33	...	3.5	2	(3), 1.5	230	6, 4, 3
...	...	35 ^b	1.5	235	6, 4, 3
36	4	...	3, 2, 1.5	...	240	...	6, 4, 3
...	...	38	1.5	245	6, 4, 3
...	39	...	4	...	3, 2, 1.5	250	6, 4, 3
...	...	40	3, 2, 1.5	255	6, 4
42	45	...	4.5	...	4, 3, 2, 1.5	...	260	...	6, 4
48	5	...	4, 3, 2, 1.5	265	6, 4
...	...	50	3, 2, 1.5	270	6, 4
...	52	...	5	...	4, 3, 2, 1.5	275	6, 4
...	...	55	4, 3, 2, 1.5	280	6, 4
56	5.5	...	4, 3, 2, 1.5	285	6, 4
...	...	58	4, 3, 2, 1.5	290	6, 4
...	60	...	5.5	...	4, 3, 2, 1.5	295	6, 4
...	...	62	4, 3, 2, 1.5	...	300	...	6, 4
64	6	...	4, 3, 2, 1.5
...	...	65	4, 3, 2, 1.5
...	68	...	6	...	4, 3, 2, 1.5

^aOnly for spark plugs for engines.

^bOnly for locking nuts for bearings.

All dimensions are in millimeters. Pitches in parentheses () are to be avoided as far as possible.

Comparison of Metric Thread Systems

Metric Series Threads — A comparison of Maximum Metal Dimensions of British (*BS 1095*), French (*NF E03-104*), German (*DIN 13*), and Swiss (*VSM 12003*) Systems

Nominal Size and Major Bolt Diam.	Pitch	Pitch Diam.	Bolt				Nut				
			Minor Diameter				Major Diameter			Minor Diameter	
			British	French	German	Swiss	British & German	French	Swiss	French, German & Swiss	British
6	1	5.350	4.863	4.59	4.700	4.60	6.000	6.108	6.100	4.700	4.863
7	1	6.350	5.863	5.59	5.700	5.60	7.000	7.108	7.100	5.700	5.863
8	1.25	7.188	6.579	6.24	6.376	6.25	8.000	8.135	8.124	6.376	6.579
9	1.25	8.188	7.579	7.24	7.376	7.25	9.000	9.135	9.124	7.376	7.579
10	1.5	9.026	8.295	7.89	8.052	7.90	10.000	10.162	10.150	8.052	8.295
11	1.5	10.026	9.295	8.89	9.052	8.90	11.000	11.162	11.150	9.052	9.295
12	1.75	10.863	10.011	9.54	9.726	9.55	12.000	12.189	12.174	9.726	10.011
14	2	12.701	11.727	11.19	11.402	11.20	14.000	14.216	14.200	11.402	11.727
16	2	14.701	13.727	13.19	13.402	13.20	16.000	16.216	16.200	13.402	13.727
18	2.5	16.376	15.158	14.48	14.752	14.50	18.000	18.270	18.250	14.752	15.158
20	2.5	18.376	17.158	16.48	16.752	16.50	20.000	20.270	20.250	16.752	17.158
22	2.5	20.376	19.158	18.48	18.752	18.50	22.000	22.270	22.250	18.752	19.158
24	3	22.051	20.590	19.78	20.102	19.80	24.000	24.324	24.300	20.102 ^a	20.590
27	3	25.051	23.590	22.78	23.102	22.80	27.000	27.324	27.300	23.102 ^b	23.590
30	3.5	27.727	26.022	25.08	25.454	25.10	30.000	30.378	30.350	25.454	26.022
33	3.5	30.727	29.022	28.08	28.454	28.10	33.000	33.378	33.350	28.454	29.022
36	4	33.402	31.453	30.37	30.804	30.40	36.000	36.432	36.400	30.804	31.453
39	4	36.402	34.453	33.37	33.804	33.40	39.000	39.432	39.400	33.804	34.453
42	4.5	39.077	36.885	35.67	36.154	35.70	42.000	42.486	42.450	36.154	36.885
45	4.5	42.077	39.885	38.67	39.154	38.70	45.000	45.486	45.450	39.154	39.885
48	5	41.752	42.316	40.96	41.504	41.00	48.000	48.540	48.500	41.504	42.316
52	5	48.752	46.316	44.96	45.504	45.00	52.000	52.540	52.500	45.504	46.316
56	5.5	52.428	49.748	48.26	48.856	48.30	56.000	56.594	56.550	48.856	49.748
60	5.5	56.428	53.748	52.26	52.856	52.30	60.000	60.594	60.550	52.856	53.748

^aThe value shown is given in the German Standard; the value in the French Standard is 20.002; and in the Swiss Standard, 20.104.

^bThe value shown is given in the German Standard; the value in the French Standard is 23.002; and in the Swiss Standard, 23.104.

All dimensions are in mm.

ACME SCREW THREADS

American National Standard Acme Screw Threads

This American National Standard ASME/ANSI B1.5-1997 is a revision of American Standard ANSI B1.5-1988 and provides for two general applications of Acme threads, namely, General Purpose and Centralizing.

The limits and tolerances in this standard relate to single-start Acme threads, and may be used, if considered suitable, for multi-start Acme threads, which provide fast relative traversing motion when this is necessary. For information on additional allowances for multi-start Acme threads, see later section on page 1923.

General Purpose Acme Threads.—Three classes of General Purpose threads, 2G, 3G, and 4G, are provided in the standard, each having clearance on all diameters for free movement, and may be used in assemblies with the internal thread rigidly fixed and movement of the external thread in a direction perpendicular to its axis limited by its bearing or bearings. It is suggested that external and internal threads of the same class be used together for general purpose assemblies, Class 2G being the preferred choice. If less backlash or end play is desired, Classes 3G and 4G are provided. Class 5G is not recommended for new designs.

Thread Form: The accompanying Fig. 1 shows the thread form of these General Purpose threads, and the formulas accompanying the figure determine their basic dimensions. Table 1 gives the basic dimensions for the most generally used pitches.

Angle of Thread: The angle between the sides of the thread, measured in an axial plane, is 29 degrees. The line bisecting this 29-degree angle shall be perpendicular to the axis of the screw thread.

Thread Series: A series of diameters and associated pitches is recommended in the Standard as preferred. These diameters and pitches have been chosen to meet present needs with the fewest number of items in order to reduce to a minimum the inventory of both tools and gages. This series of diameters and associated pitches is given in Table 3.

Chamfers and Fillets: General Purpose external threads may have the crest corner chamfered to an angle of 45 degrees with the axis to a maximum width of $P/15$, where P is the pitch. This corresponds to a maximum depth of chamfer flat of $0.0945P$.

Basic Diameters: The max major diameter of the external thread is basic and is the nominal major diameter for all classes. The min pitch diameter of the internal thread is basic and is equal to the basic major diameter minus the basic height of the thread, h . The basic minor diameter is the min minor diameter of the internal thread. It is equal to the basic major diameter minus twice the basic thread height, $2h$.

Length of Engagement: The tolerances specified in this standard are applicable to lengths of engagement not exceeding twice the nominal major diameter.

Major and Minor Diameter Allowances: A minimum diametral clearance is provided at the minor diameter of all external threads by establishing the maximum minor diameter 0.020 inch below the basic minor diameter of the nut for pitches of 10 threads per inch and coarser, and 0.010 inch for finer pitches. A minimum diametral clearance at the major diameter is obtained by establishing the minimum major diameter of the internal thread 0.020 inch above the basic major diameter of the screw for pitches of 10 threads per inch and coarser, and 0.010 inch for finer pitches.

Major and Minor Diameter Tolerances: The tolerance on the external thread major diameter is $0.05P$, where P is the pitch, with a minimum of 0.005 inch. The tolerance on the internal thread major diameter is 0.020 inch for 10 threads per inch and coarser and 0.010 for finer pitches. The tolerance on the external thread minor diameter is $1.5 \times$ pitch diameter tolerance. The tolerance on the internal thread minor diameter is $0.05P$ with a minimum of 0.005 inch.

**ANSI General Purpose Acme Thread Form ASME/ANSI B1.5-1997 (R2009),
and Stub Acme Screw Thread Form ASME/ANSI B1.8-1988 (R2006)**

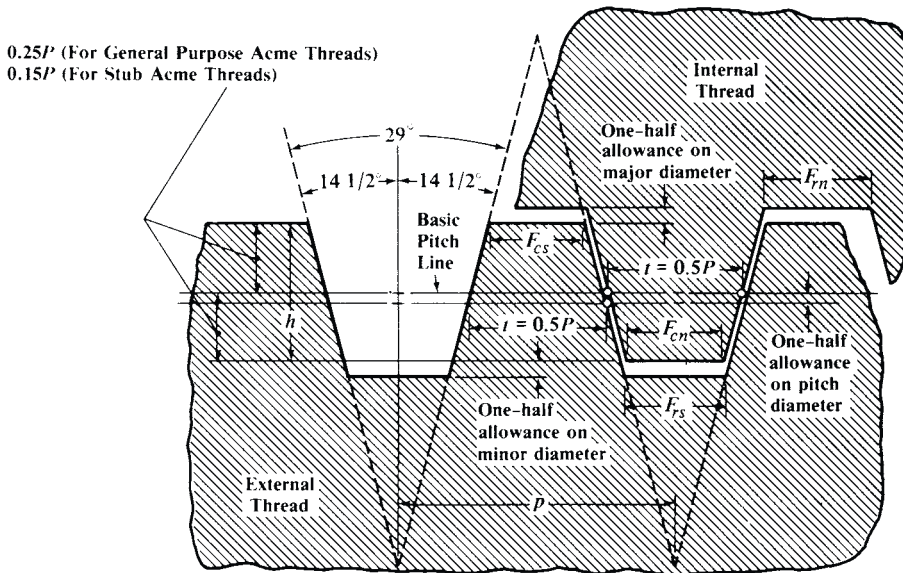


Fig. 1. General Purpose and Stub Acme Thread Forms

Formulas for Basic Dimensions of General Purpose and Stub Acme Screw Threads

General Purpose	Stub Acme Threads
Pitch = $P = 1 \div \text{No. threads per inch, } n$	Pitch = $P = 1 \div \text{No. threads per inch, } n$
Basic thread height $h = 0.5P$	Basic thread height $h = 0.3P$
Basic thread thickness $t = 0.5P$	Basic thread thickness $t = 0.5P$
Basic flat at crest $F_{cn} = 0.3707P$ (internal thread)	Basic flat at crest $F_{cn} = 0.4224P$ (internal thread)
Basic flat at crest $F_{cs} = 0.3707P - 0.259 \times$ (pitch dia. allowance on ext. thd.)	Basic flat at crest $F_{cs} = 0.4224P - 0.259 \times$ (pitch dia. allowance on ext. thread)
$F_m = 0.3707P - 0.259 \times$ (major dia. allowance on internal thread)	$F_m = 0.4224P - 0.259 \times$ (major dia. allowance on internal thread)
$F_{rs} = 0.3707P - 0.259 \times$ (minor dia. allowance on ext. thread - pitch dia. allowance on ext. thread)	$F_{rs} = 0.4224P - 0.259 \times$ (minor dia. allowance on ext. thread - pitch dia. allowance on ext. thread)

Pitch Diameter Allowances and Tolerances: Allowances on the pitch diameter of General Purpose Acme threads are given in Table 4. Pitch diameter tolerances are given in Table 5. The ratios of the pitch diameter tolerances of Classes 2G, 3G, and 4G, General Purpose threads are 3.0, 1.4, and 1, respectively.

An increase of 10 per cent in the allowance is recommended for each inch, or fraction thereof, that the length of engagement exceeds two diameters.

Application of Tolerances: The tolerances specified are designed to ensure interchangeability and maintain a high grade of product. The tolerances on diameters of the internal thread are plus, being applied from minimum sizes to above the minimum sizes. The tolerances on diameters of the external thread are minus, being applied from the maximum sizes to below the maximum sizes. The pitch diameter (or thread thickness) tolerances for an external or internal thread of a given class are the same. The thread thickness tolerance is 0.259 times the pitch diameter tolerance.

Limiting Dimensions: Limiting dimensions of General Purpose Acme screw threads in the recommended series are given in [Table 2b](#). These limits are based on the formulas in [Table 2a](#).

For combinations of pitch and diameter other than those in the recommended series, the formulas in [Table 2a](#) and the data in [Tables 4](#) and [5](#) make it possible to readily determine the limiting dimensions required.

A diagram showing the disposition of allowances, tolerances, and crest clearances for General Purpose Acme threads appears on page [1922](#).

Stress Area of General Purpose Acme Threads: For computing the tensile strength of the thread section, the minimum stress area based on the mean of the minimum pitch diameter d_2 min. and the minimum minor diameter d_1 min. of the external thread is used:

$$\text{Stress Area} = 3.1416 \left(\frac{d_2 \text{ min.} + d_1 \text{ min.}}{4} \right)^2$$

where d_2 min. and d_1 min. may be computed by Formulas 4 and 6, [Table 2a](#) or taken from [Table 2b](#).

Shear Area of General Purpose Acme Threads: For computing the shear area per inch length of engagement of the external thread, the maximum minor diameter of the internal thread D_1 max., and the minimum pitch diameter of the external thread d_2 min., [Table 2b](#) or Formulas 12 and 4, [Table 2a](#), are used:

$$\text{Shear Area} = 3.1416 D_1 \text{ max.} [0.5 + n \tan 14\frac{1}{2}^\circ (d_2 \text{ min.} - D_1 \text{ max.})]$$

Acme Thread Abbreviations.—The following abbreviations are recommended for use on drawings and in specifications, and on tools and gages:

ACME = Acme threads
 G = General Purpose
 C = Centralizing
 P = pitch
 L = lead
 LH = left hand

Designation of General Purpose Acme Threads.—The examples listed below are given here to show how General Purpose Acme threads are designated on drawings and tools:

1.750-4 ACME-2G indicates a General Purpose Class 2G Acme thread of 1.750-inch major diameter, 4 threads per inch, single thread, right hand. The same thread, but left hand, is designated 1.750-4 ACME-2G-LH.

2.875-0.4P-0.8L-ACME-3G indicates a General Purpose Class 3G Acme thread of 2.875-inch major diameter, pitch 0.4 inch, lead 0.8 inch, double thread, right hand.

Multiple Start Acme Threads.—The tabulated diameter-pitch data with allowances and tolerances relate to single-start threads. These data, as tabulated, may be and often are used for two-start Class 2G threads but this usage generally requires reduction of the full working tolerances to provide a greater allowance or clearance zone between the mating threads to assure satisfactory assembly.

When the class of thread requires smaller working tolerances than the 2G class or when threads with 3, 4, or more starts are required, some additional allowances or increased tolerances or both may be needed to ensure adequate working tolerances and satisfactory assembly of mating parts.

It is suggested that the allowances shown in [Table 4](#) be used for all external threads and that allowances be applied to internal threads in the following ratios: for two-start threads,

Table 1. American National Standard General Purpose Acme Screw Thread Form — Basic Dimensions ASME/ANSI B1.5-1997 (R2009)

Thds. per Inch <i>n</i>	Pitch, $P = 1/n$	Height of Thread (Basic), $h = P/2$	Total Height of Thread, $h_s = P/2 + \frac{1}{2}$ allowance ^a	Thread Thickness (Basic), $t = P/2$	Width of Flat	
					Crest of Internal Thread (Basic), $F_{cn} = 0.3707P$	Root of Internal Thread, $F_{rn} = 0.3707P - 0.259 \times$ allowance ^a
16	0.06250	0.03125	0.0362	0.03125	0.0232	0.0206
14	0.07143	0.03571	0.0407	0.03571	0.0265	0.0239
12	0.08333	0.04167	0.0467	0.04167	0.0309	0.0283
10	0.10000	0.05000	0.0600	0.05000	0.0371	0.0319
8	0.12500	0.06250	0.0725	0.06250	0.0463	0.0411
6	0.16667	0.08333	0.0933	0.08333	0.0618	0.0566
5	0.20000	0.10000	0.1100	0.10000	0.0741	0.0689
4	0.25000	0.12500	0.1350	0.12500	0.0927	0.0875
3	0.33333	0.16667	0.1767	0.16667	0.1236	0.1184
2½	0.40000	0.20000	0.2100	0.20000	0.1483	0.1431
2	0.50000	0.25000	0.2600	0.25000	0.1853	0.1802
1½	0.66667	0.33333	0.3433	0.33333	0.2471	0.2419
1⅓	0.75000	0.37500	0.3850	0.37500	0.2780	0.2728
1	1.00000	0.50000	0.5100	0.50000	0.3707	0.3655

All dimensions are in inches.

^a Allowance is 0.020 inch for 10 threads per inch and coarser, and 0.010 inch for finer threads.

Table 2a. American National Standard General Purpose Acme Single-Start Screw Threads — Formulas for Determining Diameters ASME/ANSI B1.5-1997 (R2009)

<p>D = Basic Major Diameter and Nominal Size, in Inches. P = Pitch = 1 ÷ Number of Threads per Inch. E = Basic Pitch Diameter = $D - 0.5P$ K = Basic Minor Diameter = $D - P$</p>	
No.	External Threads (Screws)
1	Major Dia., Max. = D
2	Major Dia., Min. = D minus 0.05 P^a but not less than 0.005.
3	Pitch Dia., Max. = E minus allowance from Table 4.
4	Pitch Dia., Min. = Pitch Dia., Max. (Formula 3) minus tolerance from Table 5.
5	Minor Dia., Max. = K minus 0.020 for 10 threads per inch and coarser and 0.010 for finer-pitches.
6	Minor Dia., Min. = Minor Dia., Max. (Formula 5) minus 1.5 × pitch diameter tolerance from Table 5.
Internal Threads (Nuts)	
7	Major Dia., Min. = D plus 0.020 for 10 threads per inch and coarser and 0.010 for finer pitches.
8	Major Dia., Max. = Major Dia., Min. (Formula 7) plus 0.020 for 10 threads per inch and coarser and 0.010 for finer pitches.
9	Pitch Dia., Min. = E
10	Pitch Dia., Max. = Pitch Dia., Min. (Formula 9) plus tolerance from Table 5.
11	Minor Dia., Min. = K
12	Minor Dia., Max. = Minor Dia., Min. (Formula 11) plus 0.05 P^a but not less than 0.005.

^a If P is between two recommended pitches listed in Table 3, use the coarser of the two pitches in this formula instead of the actual value of P .

Table 2b. Limiting Dimensions of ANSI General Purpose Acme Single-Start Screw Threads ASME/ANSI B1.5-1988

Nominal Diameter, D		$\frac{1}{4}$	$\frac{5}{16}$	$\frac{3}{8}$	$\frac{7}{16}$	$\frac{1}{2}$	$\frac{5}{8}$	$\frac{3}{4}$	$\frac{7}{8}$	1	$1\frac{1}{8}$	$1\frac{1}{4}$	$1\frac{3}{8}$
Threads per Inch ^a		16	14	12	12	10	8	6	6	5	5	5	4
Limiting Dimensions		External Threads											
Classes 2G, 3G, and 4G	Max (D)	0.2500	0.3125	0.3750	0.4375	0.5000	0.6250	0.7500	0.8750	1.0000	1.1250	1.2500	1.3750
	Major Diameter	0.2450	0.3075	0.3700	0.4325	0.4950	0.6188	0.7417	0.8667	0.9900	1.1150	1.2400	1.3625
Classes 2G, 3G, and 4G	Minor Diameter	0.1775	0.2311	0.2817	0.3442	0.3800	0.4800	0.5633	0.6883	0.7800	0.9050	1.0300	1.1050
	Class 2G, Minor Diameter	0.1618	0.2140	0.2632	0.3253	0.3594	0.4570	0.5372	0.6615	0.7509	0.8753	0.9998	1.0720
Class 3G, Minor Diameter	0.1702	0.2231	0.2730	0.3354	0.3704	0.4693	0.5511	0.6758	0.7664	0.8912	1.0159	1.0896	
Class 4G, Minor Diameter	0.1722	0.2254	0.2755	0.3379	0.3731	0.4723	0.5546	0.6794	0.7703	0.8951	1.0199	1.0940	
Class 2G, Pitch Diameter	Max	0.2148	0.2728	0.3284	0.3909	0.4443	0.5562	0.6598	0.7842	0.8920	1.0165	1.1411	1.2406
	Min	0.2043	0.2614	0.3161	0.3783	0.4306	0.5408	0.6424	0.7663	0.8726	0.9967	1.1210	1.2188
Class 3G, Pitch Diameter	Max	0.2158	0.2738	0.3296	0.3921	0.4458	0.5578	0.6615	0.7861	0.8940	1.0186	1.1433	1.2430
	Min	0.2109	0.2685	0.3238	0.3862	0.4394	0.5506	0.6534	0.7778	0.8849	1.0094	1.1339	1.2327
Class 4G, Pitch Diameter	Max	0.2168	0.2748	0.3309	0.3934	0.4472	0.5593	0.6632	0.7880	0.8960	1.0208	1.1455	1.2453
	Min	0.2133	0.2710	0.3268	0.3892	0.4426	0.5542	0.6574	0.7820	0.8895	1.0142	1.1388	1.2380
		Internal Threads											
Classes 2G, 3G, and 4G	Min	0.2600	0.3225	0.3850	0.4475	0.5200	0.6450	0.7700	0.8950	1.0200	1.1450	1.2700	1.3950
	Major Diameter	0.2700	0.3325	0.3950	0.4575	0.5400	0.6650	0.7900	0.9150	1.0400	1.1650	1.2900	1.4150
Classes 2G, 3G, and 4G	Minor Diameter	0.1875	0.2411	0.2917	0.3542	0.4000	0.5000	0.5833	0.7083	0.8000	0.9250	1.0500	1.1250
	Class 2G, Pitch Diameter	0.1925	0.2461	0.2967	0.3592	0.4050	0.5062	0.5916	0.7166	0.8100	0.9350	1.0600	1.1375
Class 3G, Pitch Diameter	Min	0.2188	0.2768	0.3333	0.3958	0.4500	0.5625	0.6667	0.7917	0.9000	1.0250	1.1500	1.2500
	Max	0.2293	0.2882	0.3456	0.4084	0.4637	0.5779	0.6841	0.8096	0.9194	1.0448	1.1701	1.2720
Class 4G, Pitch Diameter	Min	0.2188	0.2768	0.3333	0.3958	0.4500	0.5625	0.6667	0.7917	0.9000	1.0250	1.1500	1.2500
	Max	0.2237	0.2821	0.3391	0.4017	0.4564	0.5697	0.6748	0.8000	0.9091	1.0342	1.1594	1.2603
Class 4G, Pitch Diameter	Min	0.2188	0.2768	0.3333	0.3958	0.4500	0.5625	0.6667	0.7917	0.9000	1.0250	1.1500	1.2500
	Max	0.2223	0.2806	0.3374	0.4000	0.4546	0.5676	0.6725	0.7977	0.9065	1.0316	1.1567	1.2573

ACME SCREW THREADS

1925

Table 2b. (Continued) Limiting Dimensions of ANSI General Purpose Acme Single-Start Screw Threads ASME/ANSI B1.5-1988

Nominal Diameter, <i>D</i>		1½	1¾	2	2¼	2½	2¾	3	3½	4	4½	5
		Threads per Inch ^a										
Limiting Dimensions		External Threads										
Classes 2G, 3G, and 4G Major Diameter	Max (<i>D</i>)	1.5000	1.7500	2.0000	2.2500	2.5000	2.7500	3.0000	3.5000	4.0000	4.5000	5.0000
	Min	1.4875	1.7375	1.9875	2.2333	2.4833	2.7333	2.9750	3.4750	3.9750	4.4750	4.9750
Classes 2G, 3G, and 4G Minor Diameter	Max	1.2300	1.4800	1.7300	1.8967	2.1467	2.3967	2.4800	2.9800	3.4800	3.9800	4.4800
	Min	1.1965	1.4456	1.6948	1.8572	2.1065	2.3558	2.4326	2.9314	3.4302	3.9291	4.4281
Class 2G, Minor Diameter	Min	1.2144	1.4640	1.7136	1.8783	2.1279	2.3776	2.4579	2.9574	3.4568	3.9563	4.4558
Class 3G, Minor Diameter	Min	1.2189	1.4686	1.7183	1.8835	2.1333	2.3831	2.4642	2.9638	3.4634	3.9631	4.4627
Class 2G, Pitch Diameter	Max	1.3652	1.6145	1.8637	2.0713	2.3207	2.5700	2.7360	3.2350	3.7340	4.2330	4.7319
	Min	1.3429	1.5916	1.8402	2.0450	2.2939	2.5427	2.7044	3.2026	3.7008	4.1991	4.6973
Class 3G, Pitch Diameter	Max	1.3677	1.6171	1.8665	2.0743	2.3238	2.5734	2.7395	3.2388	3.7380	4.2373	4.7364
	Min	1.3573	1.6064	1.8555	2.0620	2.3113	2.5607	2.7248	3.2237	3.7225	4.2215	4.7202
Class 4G, Pitch Diameter	Max	1.3701	1.6198	1.8693	2.0773	2.3270	2.5767	2.7430	3.2425	3.7420	4.2415	4.7409
	Min	1.3627	1.6122	1.8615	2.0685	2.3181	2.5676	2.7325	3.2317	3.7309	4.2302	4.7294
Limiting Dimensions		Internal Threads										
Classes 2G, 3G, and 4G Major Diameter	Min	1.5200	1.7700	2.0200	2.2700	2.5200	2.7700	3.0200	3.5200	4.0200	4.5200	5.0200
	Max	1.5400	1.7900	2.0400	2.2900	2.5400	2.7900	3.0400	3.5400	4.0400	4.5400	5.0400
Classes 2G, 3G, and 4G Minor Diameter	Min	1.2500	1.5000	1.7500	1.9167	2.1667	2.4167	2.5000	3.0000	3.5000	4.0000	4.5000
	Max	1.2625	1.5125	1.7625	1.9334	2.1834	2.4334	2.5250	3.0250	3.5250	4.0250	4.5250
Class 2G, Pitch Diameter	Min	1.3750	1.6250	1.8750	2.0833	2.3333	2.5833	2.7500	3.2500	3.7500	4.2500	4.7500
	Max	1.3973	1.6479	1.8985	2.1096	2.3601	2.6106	2.7816	3.2824	3.7832	4.2839	4.7846
Class 3G, Pitch Diameter	Min	1.3750	1.6250	1.8750	2.0833	2.3333	2.5833	2.7500	3.2500	3.7500	4.2500	4.7500
	Max	1.3854	1.6357	1.8860	2.0956	2.3458	2.5960	2.7647	3.2651	3.7655	4.2658	4.7662
Class 4G, Pitch Diameter	Min	1.3750	1.6250	1.8750	2.0833	2.3333	2.5833	2.7500	3.2500	3.7500	4.2500	4.7500
	Max	1.3824	1.6326	1.8828	2.0921	2.3422	2.5924	2.7605	3.2608	3.7611	4.2613	4.7615

^a All other dimensions are given in inches. The selection of threads per inch is arbitrary and for the purpose of establishing a standard.

Table 3. General Purpose Acme Single-Start Screw Thread Data ASME/ANSI B1.5-1988

Identification		Basic Diameters			Thread Data							
Nominal Sizes (All Classes)	Threads per Inch, ^a <i>n</i>	Classes 2G, 3G, and 4G			Pitch, <i>P</i>	Thickness at Pitch Line, <i>t</i> = <i>P</i> /2	Basic Height of Thread, <i>h</i> = <i>P</i> /2	Basic Width of Flat, <i>F</i> = 0.3707 <i>P</i>	Lead Angle λ at Basic Pitch Diameter ^a Classes 2G, 3G, and 4G		Shear Area ^b Class 3G	Stress Area ^c Class 3G
		Major Diameter, <i>D</i>	Pitch Diameter, <i>D</i> ₂ = <i>D</i> - <i>h</i>	Minor Diameter, <i>D</i> ₁ = <i>D</i> - 2 <i>h</i>					Deg	Min		
1/4	16	0.2500	0.2188	0.1875	0.06250	0.03125	0.03125	0.0232	5	12	0.350	0.0285
5/16	14	0.3125	0.2768	0.2411	0.07143	0.03571	0.03571	0.0265	4	42	0.451	0.0474
3/8	12	0.3750	0.3333	0.2917	0.08333	0.04167	0.04167	0.0309	4	33	0.545	0.0699
7/16	12	0.4375	0.3958	0.3542	0.08333	0.04167	0.04167	0.0309	3	50	0.660	0.1022
1/2	10	0.5000	0.4500	0.4000	0.10000	0.05000	0.05000	0.0371	4	3	0.749	0.1287
5/8	8	0.6250	0.5625	0.5000	0.12500	0.06250	0.06250	0.0463	4	3	0.941	0.2043
3/4	6	0.7500	0.6667	0.5833	0.16667	0.08333	0.08333	0.0618	4	33	1.108	0.2848
7/8	6	0.8750	0.7917	0.7083	0.16667	0.08333	0.08333	0.0618	3	50	1.339	0.4150
1	5	1.0000	0.9000	0.8000	0.20000	0.10000	0.10000	0.0741	4	3	1.519	0.5354
1 1/8	5	1.1250	1.0250	0.9250	0.20000	0.10000	0.10000	0.0741	3	33	1.751	0.709
1 1/4	5	1.2500	1.1500	1.0500	0.20000	0.10000	0.10000	0.0741	3	10	1.983	0.907
1 3/8	4	1.3750	1.2500	1.1250	0.25000	0.12500	0.12500	0.0927	3	39	2.139	1.059
1 1/2	4	1.5000	1.3750	1.2500	0.25000	0.12500	0.12500	0.0927	3	19	2.372	1.298
1 3/4	4	1.7500	1.6250	1.5000	0.25000	0.12500	0.12500	0.0927	2	48	2.837	1.851
2	4	2.0000	1.8750	1.7500	0.25000	0.12500	0.12500	0.0927	2	26	3.301	2.501
2 1/4	3	2.2500	2.0833	1.9167	0.33333	0.16667	0.16667	0.1236	2	55	3.643	3.049
2 1/2	3	2.5000	2.3333	2.1667	0.33333	0.16667	0.16667	0.1236	2	36	4.110	3.870
2 3/4	3	2.7500	2.5833	2.4167	0.33333	0.16667	0.16667	0.1236	2	21	4.577	4.788
3	2	3.0000	2.7500	2.5000	0.50000	0.25000	0.25000	0.1853	3	19	4.786	5.27
3 1/2	2	3.5000	3.2500	3.0000	0.50000	0.25000	0.25000	0.1853	2	48	5.73	7.50
4	2	4.0000	3.7500	3.5000	0.50000	0.25000	0.25000	0.1853	2	26	6.67	10.12
4 1/2	2	4.5000	4.2500	4.0000	0.50000	0.25000	0.25000	0.1853	2	9	7.60	13.13
5	2	5.0000	4.7500	4.5000	0.50000	0.25000	0.25000	0.1853	1	55	8.54	16.53

^a All other dimensions are given in inches.

^b Per inch length of engagement of the external thread in line with the minor diameter crests of the internal thread. Figures given are the minimum shear area based on max *D*₁ and min *d*₂.

^c Figures given are the minimum stress area based on the mean of the minimum minor and pitch diameters of the external thread. See formulas for shear area and stress area on page 1923.

Table 4. American National Standard General Purpose Acme Single-Start Screw Threads — Pitch Diameter Allowances ASME/ANSI B1.5-1988

Nominal Size Range ^a		Allowances on External Threads ^b			Nominal Size Range ^a		Allowances on External Threads ^b		
Above	To and Including	Class 2G ^c , 0.008 \sqrt{D}	Class 3G, 0.006 \sqrt{D}	Class 4G, 0.004 \sqrt{D}	Above	To and Including	Class 2G ^c , 0.008 \sqrt{D}	Class 3G, 0.006 \sqrt{D}	Class 4G, 0.004 \sqrt{D}
0	$\frac{3}{16}$	0.0024	0.0018	0.0012	$\frac{1}{16}$	$\frac{1}{16}$	0.0098	0.0073	0.0049
$\frac{3}{16}$	$\frac{5}{16}$	0.0040	0.0030	0.0020	$\frac{1}{16}$	$\frac{1}{8}$	0.0105	0.0079	0.0052
$\frac{5}{16}$	$\frac{7}{16}$	0.0049	0.0037	0.0024	$\frac{1}{8}$	$\frac{2}{8}$	0.0113	0.0085	0.0057
$\frac{7}{16}$	$\frac{9}{16}$	0.0057	0.0042	0.0028	$\frac{2}{8}$	$\frac{3}{8}$	0.0120	0.0090	0.0060
$\frac{9}{16}$	$\frac{11}{16}$	0.0063	0.0047	0.0032	$\frac{3}{8}$	$\frac{2}{8}$	0.0126	0.0095	0.0063
$\frac{11}{16}$	$\frac{13}{16}$	0.0069	0.0052	0.0035	$\frac{2}{8}$	$\frac{2}{8}$	0.0133	0.0099	0.0066
$\frac{13}{16}$	$\frac{15}{16}$	0.0075	0.0056	0.0037	$\frac{2}{8}$	$\frac{3}{4}$	0.0140	0.0105	0.0070
$\frac{15}{16}$	$1\frac{1}{16}$	0.0080	0.0060	0.0040	$\frac{3}{4}$	$\frac{3}{4}$	0.0150	0.0112	0.0075
$1\frac{1}{16}$	$1\frac{3}{16}$	0.0085	0.0064	0.0042	$\frac{3}{4}$	$\frac{4}{4}$	0.0160	0.0120	0.0080
$1\frac{3}{16}$	$1\frac{5}{16}$	0.0089	0.0067	0.0045	$\frac{4}{4}$	$\frac{4}{4}$	0.0170	0.0127	0.0085
$1\frac{5}{16}$	$1\frac{7}{16}$	0.0094	0.0070	0.0047	$\frac{4}{4}$	$5\frac{1}{2}$	0.0181	0.0136	0.0091

All dimensions in inches. It is recommended that the sizes given in Table 3 be used whenever possible.

^a The values in columns for Classes 2G, 3G, and 4G are to be used for any size within the nominal size range shown. These values are calculated from the mean of the range.

^b An increase of 10 per cent in the allowance is recommended for each inch, or fraction thereof, that the length of engagement exceeds two diameters.

^c Allowances for the 2G Class of thread in this table also apply to American National Standard Stub Acme threads ASME/ANSI B 1.8-1988.

50 per cent of the allowances shown in the Class 2G, 3G and 4G columns of Table 4; for three-start threads, 75 per cent of these allowances; and for four-start threads, 100 per cent of these same values.

These values will provide for a 0.25-16 ACME-2G thread size, 0.002, 0.003, and 0.004 inch additional clearance for 2-, 3-, and 4-start threads, respectively. For a 5-2 ACME-3G thread size the additional clearances would be 0.0091, 0.0136, and 0.0181 inch, respectively. GO thread plug gages and taps would be increased by these same values. To maintain the same working tolerances on multi-start threads, the pitch diameter of the NOT GO thread plug gage would also be increased by these same values.

For multi-start threads with more than four starts, it is believed that the 100 per cent allowance provided by the above procedures would be adequate as index spacing variables would generally be no greater than on a four-start thread.

In general, for multi-start threads of Classes 2G, 3G, and 4G the percentages would be applied, usually, to allowances for the same class, respectively. However, where exceptionally good control over lead, angle, and spacing variables would produce close to theoretical values in the product, it is conceivable that these percentages could be applied to Class 3G or Class 4G allowances used on Class 2G internally threaded product. Also, these percentages could be applied to Class 4G allowances used on Class 3G internally threaded product. It is not advocated that any change be made in externally threaded products.

Designations for gages or tools for internal threads could cover allowance requirements as follows:

GO and NOT GO thread plug gages for: 2.875-0.4P-0.8L-ACME-2G with 50 per cent of the 4G internal thread allowance.

Centralizing Acme Threads.—The three classes of Centralizing Acme threads in American National Standard ASME/ANSI B1.5-1988, designated as 2C, 3C, and 4C, have limited clearance at the major diameters of internal and external threads so that a bearing at the major diameters maintains approximate alignment of the thread axis and prevents wedging

Table 5. American National Standard General Purpose Acme Single-Start Screw Threads — Pitch Diameter Tolerances ASME/ANSI B1.5-1988

Nom. Dia., ^a <i>D</i>	Class of Thread			Nom. Dia., ^a <i>D</i>	Class of Thread		
	2G ^b	3G	4G		2G ^b	3G	4G
	Diameter Increment				Diameter Increment		
	$0.006\sqrt{D}$	$0.0028\sqrt{D}$	$0.002\sqrt{D}$		$0.006\sqrt{D}$	$0.0028\sqrt{D}$	$0.002\sqrt{D}$
1/4	.00300	.00140	.00100	1 1/2	.00735	.00343	.00245
5/16	.00335	.00157	.00112	1 3/4	.00794	.00370	.00265
3/8	.00367	.00171	.00122	2	.00849	.00396	.00283
7/16	.00397	.00185	.00132	2 1/4	.00900	.00420	.00300
1/2	.00424	.00198	.00141	2 1/2	.00949	.00443	.00316
5/8	.00474	.00221	.00158	2 3/4	.00995	.00464	.00332
3/4	.00520	.00242	.00173	3	.01039	.00485	.00346
7/8	.00561	.00262	.00187	3 1/2	.01122	.00524	.00374
1	.00600	.00280	.00200	4	.01200	.00560	.00400
1 1/8	.00636	.00297	.00212	4 1/2	.01273	.00594	.00424
1 1/4	.00671	.00313	.00224	5	.01342	.00626	.00447
1 3/8	.00704	.00328	.00235

Thds. per Inch, ^c <i>n</i>	Class of Thread			Thds. per Inch, ^c <i>n</i>	Class of Thread		
	2G ^b	3G	4G		2G ^b	3G	4G
	Pitch Increment				Pitch Increment		
	$0.030\sqrt{1/n}$	$0.014\sqrt{1/n}$	$0.010\sqrt{1/n}$		$0.030\sqrt{1/n}$	$0.014\sqrt{1/n}$	$0.010\sqrt{1/n}$
16	.00750	.00350	.00250	4	.01500	.00700	.00500
14	.00802	.00374	.00267	3	.01732	.00808	.00577
12	.00866	.00404	.00289	2 1/2	.01897	.00885	.00632
10	.00949	.00443	.00316	2	.02121	.00990	.00707
8	.01061	.00495	.00354	1 1/2	.02449	.01143	.00816
6	.01225	.00572	.00408	1 1/3	.02598	.01212	.00866
5	.01342	.00626	.00447	1	.03000	.01400	.01000

For any particular size of thread, the pitch diameter tolerance is obtained by adding the *diameter increment* from the upper half of the table to the *pitch increment* from the lower half of the table. Example: A 1/4-16 Acme-2G thread has a pitch diameter tolerance of 0.00300 + 0.00750 = 0.0105 inch.

The equivalent tolerance on thread thickness is 0.259 times the pitch diameter tolerance.

^a For a nominal diameter between any two tabulated nominal diameters, use the diameter increment for the larger of the two tabulated nominal diameters.

^b Columns for the 2G Class of thread in this table also apply to American National Standard Stub Acme threads, ASME/ANSI B1.8-1988 (R2006).

^c All other dimensions are given in inches.

on the flanks of the thread. An alternative series having centralizing control on the *minor* diameter is described on page 1939. For any combination of the three classes of threads covered in this standard some end play or backlash will result. Classes 5C and 6C are not recommended for new designs.

Application: These three classes together with the accompanying specifications are for the purpose of ensuring the interchangeable manufacture of Centralizing Acme threaded parts. Each user is free to select the classes best adapted to his particular needs. It is suggested that external and internal threads of the same class be used together for centralizing assemblies, Class 2C providing the maximum end play or backlash. If less backlash or end play is desired, Classes 3C and 4C are provided. The requirement for a centralizing fit is that the sum of the major diameter tolerance plus the major diameter allowance on the internal thread, and the major diameter tolerance on the external thread shall equal or be less than the pitch diameter allowance on the external thread. A Class 2C external thread, which has a larger pitch diameter allowance than either a Class 3C or 4C, can be used interchangeably with a Class 2C, 3C, or 4C internal thread and fulfill this requirement. Simi-

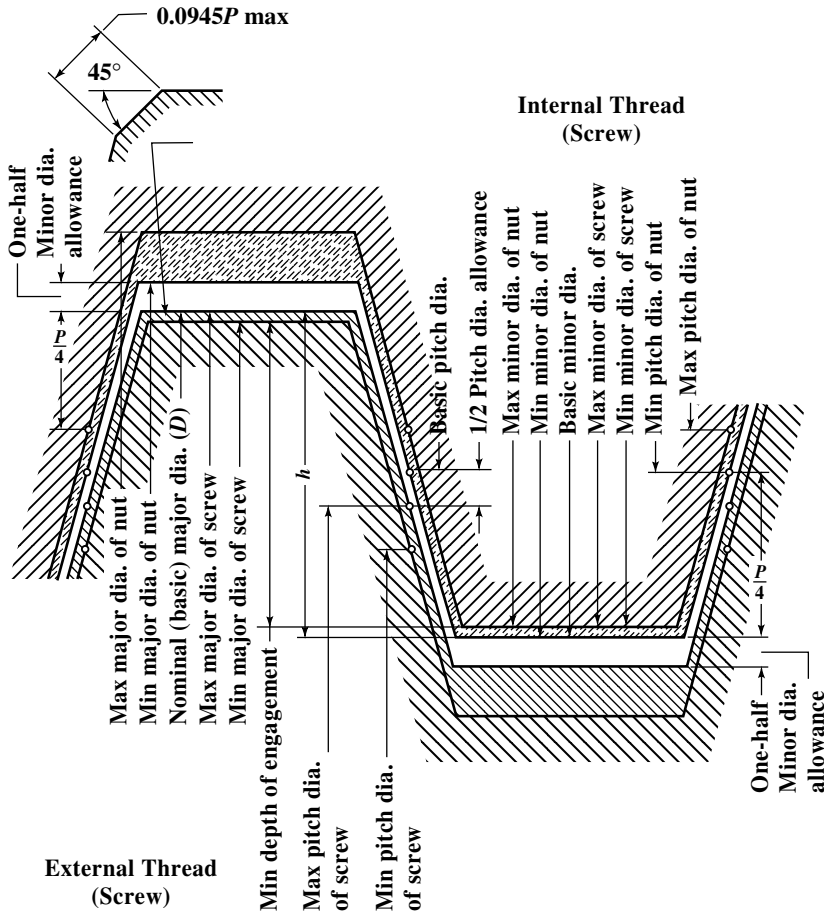


Fig. 2. Disposition of Allowances, Tolerances, and Crest Clearances for General Purpose Single-start Acme Threads (All Classes)

larly, a Class 3C external thread can be used interchangeably with a Class 3C or 4C internal thread, but only a Class 4C internal thread can be used with a Class 4C external thread.

Thread Form: The thread form is the same as the General Purpose Acme Thread and is shown in Fig. 3. The formulas in Table 7 determine the basic dimensions, which are given in Table 6 for the most generally used pitches.

Angle of Thread: The angle between the sides of the thread measured in an axial plane is 29 degrees. The line bisecting this 29-degree angle shall be perpendicular to the axis of the thread.

Chamfers and Fillets: External threads have the crest corners chamfered at an angle of 45 degrees with the axis to a minimum depth of $P/20$ and a maximum depth of $P/15$. These modifications correspond to a minimum width of chamfer flat of $0.0707P$ and a maximum width of $0.0945P$ (see Table 6, columns 6 and 7).

External threads for Classes 2C, 3C, and 4C may have a fillet at the minor diameter not greater than $0.1P$

Thread Series: A series of diameters and pitches is recommended in the Standard as preferred. These diameters and pitches have been chosen to meet present needs with the fewest number of items in order to reduce to a minimum the inventory of both tools and gages. This series of diameters and associated pitches is given in Table 9.

Table 6. American National Standard Centralizing Acme Screw Thread Form — Basic Dimensions ASME/ANSI B1.5-1988

Thds per Inch, n	Pitch, P	Height of Thread (Basic), $h = P/2$	Total Height of Thread (All External Threads) $h_s = h + \frac{1}{2}$ allowance ^a	Thread Thickness (Basic), $t = P/2$	45-Deg Chamfer Crest of External Threads		Max Fillet Radius, Root of Tapped Hole, $0.06P$	Fillet Radius at Min or Diameter of Screws Max (All) $0.10P$
					Min Depth, $0.05P$	Min Width of Chamfer Flat, $0.0707P$		
16	0.06250	0.03125	0.0362	0.03125	0.0031	0.0044	0.0038	0.0062
14	0.07143	0.03571	0.0407	0.03571	0.0036	0.0050	0.0038	0.0071
12	0.08333	0.04167	0.0467	0.04167	0.0042	0.0059	0.0050	0.0083
10	0.10000	0.05000	0.0600	0.05000	0.0050	0.0071	0.0060	0.0100
8	0.12500	0.06250	0.0725	0.06250	0.0062	0.0088	0.0075	0.0125
6	0.16667	0.08333	0.0933	0.08333	0.0083	0.0119	0.0100	0.0167
5	0.20000	0.10000	0.1100	0.10000	0.0100	0.0141	0.0120	0.0200
4	0.25000	0.12500	0.1350	0.12500	0.0125	0.0177	0.0150	0.0250
3	0.33333	0.16667	0.1767	0.16667	0.0167	0.0236	0.0200	0.0333
2½	0.40000	0.20000	0.2100	0.20000	0.0200	0.0283	0.0240	0.0400
2	0.50000	0.25000	0.2600	0.25000	0.0250	0.0354	0.0300	0.0500
1½	0.66667	0.33333	0.3433	0.33333	0.0330	0.0471	0.0400	0.0667
1¼	0.75000	0.37500	0.3850	0.37500	0.0380	0.0530	0.0450	0.0750
1	1.00000	0.50000	0.5100	0.50000	0.0500	0.0707	0.0600	0.1000

All dimensions in inches. See Fig. 3.

^a Allowance is 0.020 inch for 10 or less threads per inch and 0.010 inch for more than 10 threads per inch.

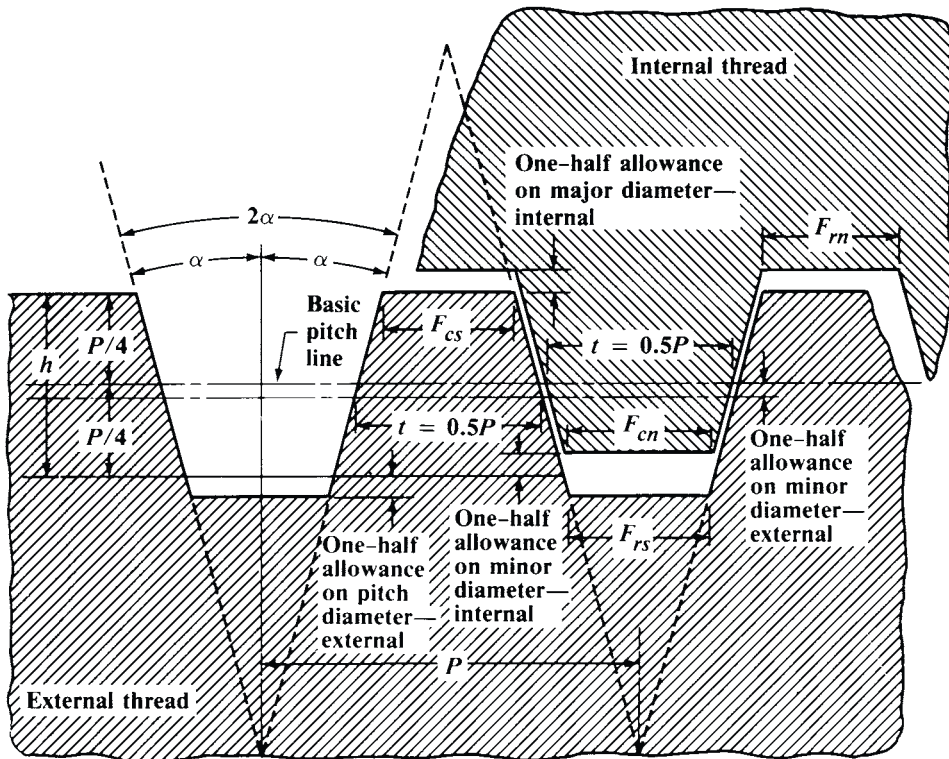


Fig. 3. Centralizing Acme Screw Thread Form

Basic Diameters: The maximum major diameter of the external thread is basic and is the nominal major diameter for all classes.

Table 7. Formulas for Finding Basic Dimensions of Centralizing Acme Screw Threads

Pitch = $P = 1 \div$ No. threads per inch, n :	Basic thread height $h = 0.5P$
Basic thread thickness $t = 0.5P$	
Basic flat at crest $F_{en} = 0.3707P + 0.259 \times$ (minor diameter allowance on internal threads) (internal thread)	
Basic flat at crest $F_{es} = 0.3707P - 0.259 \times$ (pitch diameter allowance on external thread) (external thread)	
$F_{rn} = 0.3707P - 0.259 \times$ (major dia. allowance on internal thread)	
$F_{rs} = 0.3707P - 0.259 \times$ (minor dia. allowance on external thread — pitch dia. allowance on external thread)	

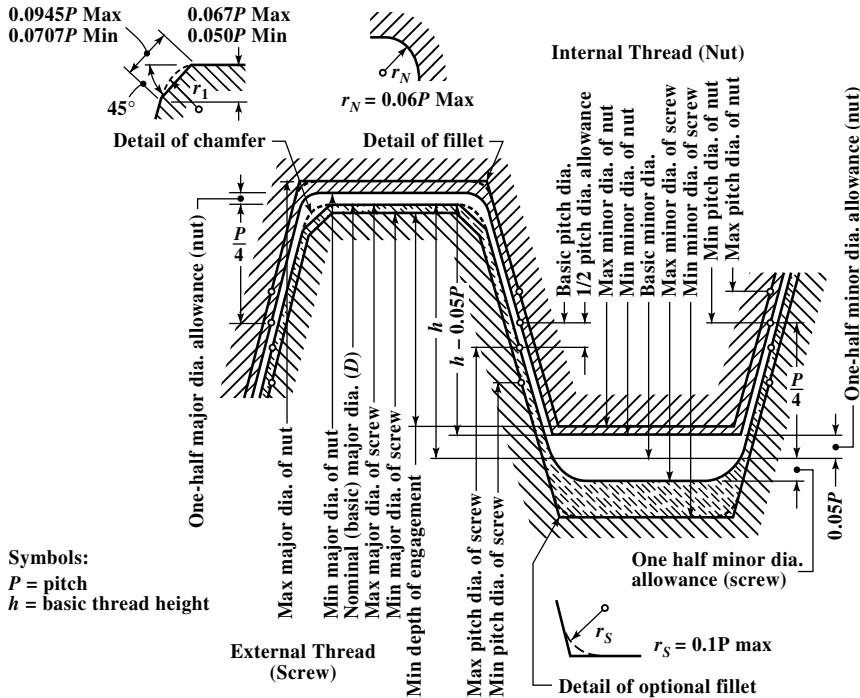


Fig. 4. Disposition of Allowances, Tolerances, and Crest Clearances for Centralizing Single-Start Acme Threads—Classes 2C, 3C, and 4C

The minimum pitch diameter of the internal thread is basic for all classes and is equal to the basic major diameter D minus the basic height of thread, h . The minimum minor diameter of the internal thread for all classes is $0.1P$ above basic.

Length of Engagement: The tolerances specified in this Standard are applicable to lengths of engagement not exceeding twice the nominal major diameter.

Pitch Diameter Allowances: Allowances applied to the pitch diameter of the external thread for all classes are given in Table 10.

Major and Minor Diameter Allowances: A minimum diametral clearance is provided at the minor diameter of all external threads by establishing the maximum minor diameter 0.020 inch below the basic minor diameter for 10 threads per inch and coarser, and 0.010 inch for finer pitches and by establishing the minimum minor diameter of the internal thread $0.1P$ greater than the basic minor diameter.

A minimum diametral clearance at the major diameter is obtained by establishing the minimum major diameter of the internal thread $0.001 \sqrt{D}$ above the basic major diameter. These allowances are shown in Table 12.

Table 8a. American National Standard Centralizing Acme Single-Start Screw Threads — Formulas for Determining Diameters ASME/ANSI B1.5-1988

D = Nominal Size or Diameter in Inches P = Pitch = 1 ÷ Number of Threads per Inch	
No.	Classes 2C, 3C, and 4C External Threads (Screws)
1	Major Dia., Max = D (Basic).
2	Major Dia., Min = D minus tolerance from Table 12, columns 7, 8, or 10.
3	Pitch Dia., Max = Int. Pitch Dia., Min (Formula 9) minus allowance from the appropriate Class 2C, 3C, or 4C column of Table 10.
4	Pitch Dia., Min = Ext. Pitch Dia., Max (Formula 3) minus tolerance from Table 11.
5	Minor Dia., Max = D minus P minus allowance from Table 12, column 3.
6	Minor Dia., Min = Ext. Minor Dia., Max (Formula 5) minus $1.5 \times$ Pitch Dia. tolerance from Table 11.
Classes 2C, 3C, and 4C Internal Threads (Nuts)	
7	Major Dia., Min = D plus allowance from Table 12, column 4.
8	Major Dia., Max = Int. Major Dia., Min (Formula 7) plus tolerance from Table 12, columns 7, 9, or 11.
9	Pitch Dia., Min = D minus $P/2$ (Basic).
10	Pitch Dia., Max = Int. Pitch Dia., Min (Formula 9) plus tolerance from Table 11.
11	Minor Dia., Min = D minus $0.9P$.
12	Minor Dia., Max = Int. Minor Dia., Min (Formula 11) plus tolerance from Table 12, column 6.

Major and Minor Diameter Tolerances: The tolerances on the major and minor diameters of the external and internal threads are listed in Table 12 and are based upon the formulas given in the column headings.

An increase of 10 per cent in the allowance is recommended for each inch or fraction thereof that the length of engagement exceeds two diameters.

For information on gages for Centralizing Acme threads the Standard ASME/ANSI B1.5 should be consulted.

Pitch Diameter Tolerances: Pitch diameter tolerances for Classes 2C, 3C and 4C for various practicable combinations of diameter and pitch are given in Table 11. The ratios of the pitch diameter tolerances of Classes 2C, 3C, and 4C are 3.0, 1.4, and 1, respectively.

Application of Tolerances: The tolerances specified are such as to insure interchangeability and maintain a high grade of product. The tolerances on the diameters of internal threads are plus, being applied from the minimum sizes to above the minimum sizes. The tolerances on the diameters of external threads are minus, being applied from the maximum sizes to below the maximum sizes. The pitch diameter tolerances for an external or internal thread of a given class are the same.

Limiting Dimensions: Limiting dimensions for Centralizing Acme threads in the preferred series of diameters and pitches are given in Tables 8b and 8c. These limits are based on the formulas in Table 8a.

For combinations of pitch and diameter other than those in the preferred series the formulas in Tables 8b and 8c and the data in the tables referred to therein make it possible to readily determine the limiting dimension required.

Designation of Centralizing Acme Threads.—The following examples are given to show how these Acme threads are designated on drawings, in specifications, and on tools and gages:

Example, 1.750-6-ACME-4C: Indicates a Centralizing Class 4C Acme thread of 1.750-inch major diameter, 0.1667-inch pitch, single thread, right-hand.

Table 8b. Limiting Dimensions of American National Standard Centralizing Acme Single-Start Screw Threads, Classes 2C, 3C, and 4C ASME/ANSI B1.5-1988

Nominal Diameter, <i>D</i>		½	⅝	¾	⅞	1	1⅛	1¼	1⅜	1½
		Threads per Inch ^a	10	8	6	6	5	5	5	4
Limiting Dimensions		External Threads								
Classes 2C, 3C, and 4C, Major Diameter	Max	0.5000	0.6250	0.7500	0.8750	1.0000	1.1250	1.2500	1.3750	1.5000
Class 2C, Major Diameter	Min	0.4975	0.6222	0.7470	0.8717	0.9965	1.1213	1.2461	1.3709	1.4957
Class 3C, Major Diameter	Min	0.4989	0.6238	0.7487	0.8736	0.9985	1.1234	1.2483	1.3732	1.4982
Class 4C, Major Diameter	Min	0.4993	0.6242	0.7491	0.8741	0.9990	1.1239	1.2489	1.3738	1.4988
Classes 2C, 3C, and 4C, Minor Diameter	Max	0.3800	0.4800	0.5633	0.6883	0.7800	0.9050	1.0300	1.1050	1.2300
Class 2C, Minor Diameter	Min	0.3594	0.4570	0.5371	0.6615	0.7509	0.8753	0.9998	1.0719	1.1965
Class 3C, Minor Diameter	Min	0.3704	0.4693	0.5511	0.6758	0.7664	0.8912	1.0159	1.0896	1.2144
Class 4C, Minor Diameter	Min	0.3731	0.4723	0.5546	0.6794	0.7703	0.8951	1.0199	1.0940	1.2188
Class 2C, Pitch Diameter	Max	0.4443	0.5562	0.6598	0.7842	0.8920	1.0165	1.1411	1.2406	1.3652
	Min	0.4306	0.5408	0.6424	0.7663	0.8726	0.9967	1.1210	1.2186	1.3429
Class 3C, Pitch Diameter	Max	0.4458	0.5578	0.6615	0.7861	0.8940	1.0186	1.1433	1.2430	1.3677
	Min	0.4394	0.5506	0.6534	0.7778	0.8849	1.0094	1.1339	1.2327	1.3573
Class 4C, Pitch Diameter	Max	0.4472	0.5593	0.6632	0.7880	0.8960	1.0208	1.1455	1.2453	1.3701
	Min	0.4426	0.5542	0.6574	0.7820	0.8895	1.0142	1.1388	1.2380	1.3627
		Internal Threads								
Classes 2C, 3C, and 4C, Major Diameter	Min	0.5007	0.6258	0.7509	0.8759	1.0010	1.1261	1.2511	1.3762	1.5012
Classes 2C and 3C, Major Diameter	Max	0.5032	0.6286	0.7539	0.8792	1.0045	1.1298	1.2550	1.3803	1.5055
Class 4C, Major Diameter	Max	0.5021	0.6274	0.7526	0.8778	1.0030	0.1282	1.2533	1.3785	1.5036
Classes 2C, 3C, and 4C, Minor Diameter	Min	0.4100	0.5125	0.6000	0.7250	0.8200	0.9450	0.0700	1.1500	1.2750
	Max	0.04150	0.5187	0.6083	0.7333	0.8300	0.9550	1.0800	1.1625	1.2875
Class 2C, Pitch Diameter	Min	0.4500	0.5625	0.6667	0.7917	0.9000	1.0250	1.1500	1.2500	1.3750
	Max	0.4637	0.5779	0.6841	0.8096	0.9194	1.0448	1.1701	1.2720	1.3973
Class 3C, Pitch Diameter	Min	0.4500	0.5625	0.6667	0.7917	0.9000	1.0250	1.1500	1.2500	1.3750
	Max	0.4564	0.5697	0.6748	0.8000	0.9091	1.0342	1.1594	1.2603	1.3854
Class 4C, Pitch Diameter	Min	0.4500	0.5625	0.6667	0.7917	0.9000	1.0250	1.1500	1.2500	1.3750
	Max	0.4546	0.5676	0.6725	0.7977	0.9065	1.0316	1.1567	1.2573	1.3824

Table 8c. Limiting Dimensions of American National Standard Centralizing Acme Single-Start Screw Threads, Classes 2C, 3C, and 4C ASME/ANSI B1.5-1988

Nominal Diameter, <i>D</i>		1¾	2	2¼	2½	2¾	3	3½ ₂₁₂	4	4½	5
Threads per Inch ^a		4	4	3	3	3	2	2	2	2	2
Limiting Dimensions		External Threads									
Classes 2C, 3C, and 4C, Major Diameter	Max	1.7500	2.0000	2.2500	2.5000	2.7500	3.0000	3.5000	4.0000	4.5000	5.0000
Class 2C, Major Diameter	Min	1.7454	1.9951	2.2448	2.4945	2.7442	2.9939	3.4935	3.9930	4.4926	4.9922
Class 3C, Major Diameter	Min	1.7480	1.9979	2.2478	2.4976	2.7475	2.9974	3.4972	3.9970	4.4968	4.9966
Class 4C, Major Diameter	Min	1.7487	1.9986	2.2485	2.4984	2.7483	2.9983	3.4981	3.9980	4.4979	4.9978
Classes 2C, 3C, and 4C, Minor Diameter	Max	1.4800	1.7300	1.8967	2.1467	2.3967	2.4800	2.9800	3.4800	3.9800	4.4800
Class 2C, Minor Diameter	Min	1.4456	1.6948	1.8572	2.1065	2.3558	2.4326	2.9314	3.4302	3.9291	4.4281
Class 3C, Minor Diameter	Min	1.4640	1.7136	1.8783	2.1279	2.3776	2.4579	2.9574	3.4568	3.9563	4.4558
Class 4C, Minor Diameter	Min	1.4685	1.7183	1.8835	2.1333	2.3831	2.4642	2.9638	3.4634	3.9631	4.4627
Class 2C, Pitch Diameter	Max	1.6145	1.8637	2.0713	2.3207	2.5700	2.7360	3.2350	3.7340	4.2330	4.7319
	Min	1.5916	1.8402	2.0450	2.2939	2.5427	2.7044	3.2026	3.7008	4.1991	4.6973
Class 3C, Pitch Diameter	Max	1.6171	1.8665	2.0743	2.3238	2.5734	2.7395	3.2388	3.7380	4.2373	4.7364
	Min	1.6064	1.8555	2.0620	2.3113	2.5607	2.7248	3.2237	3.7225	4.2215	4.7202
Class 4C, Pitch Diameter	Max	1.6198	1.8693	2.0773	2.3270	2.5767	2.7430	3.2425	3.7420	4.2415	4.7409
	Min	1.6122	1.8615	2.0685	2.3181	2.5676	2.7325	3.2317	3.7309	4.2302	4.7294
		Internal Threads									
Classes 2C, 3C, and 4C, Major Diameter	Min	1.7513	2.0014	2.2515	2.5016	2.7517	3.0017	3.5019	4.0020	4.5021	5.0022
Classes 2C and 3C, Major Diameter	Max	1.7559	2.0063	2.2567	2.5071	2.7575	3.0078	3.5084	4.0090	4.5095	5.0100
Class 4C, Major Diameter	Max	1.7539	2.0042	2.2545	2.5048	2.7550	3.0052	3.5056	4.0060	4.5063	5.0067
Classes 2C, 3C, and 4C, Minor Diameter	Min	1.5250	1.7750	1.9500	2.2000	2.4500	2.5500	3.0500	3.5500	4.0500	4.5500
	Max	1.5375	1.7875	1.9667	2.2167	2.4667	2.5750	3.0750	3.5750	4.0750	4.5750
Class 2C, Pitch Diameter	Min	1.6250	1.8750	2.0833	2.3333	2.5833	2.7500	3.2500	3.7500	4.2500	4.7500
	Max	1.6479	1.8985	2.1096	2.3601	2.6106	2.7816	3.2824	3.7832	4.2839	4.7846
Class 3C, Pitch Diameter	Min	1.6250	1.8750	2.0833	2.3333	2.5833	2.7500	3.2500	3.7500	4.2500	4.7500
	Max	1.6357	1.8860	2.0956	2.3458	2.5960	2.7647	3.2651	3.7655	4.2658	4.7662
Class 4C Pitch Diameter	Min	1.6250	1.8750	2.0833	2.3333	2.5833	2.7500	3.2500	3.7500	4.2500	4.7500
	Max	1.6326	1.8828	2.0921	2.3422	2.5924	2.7605	3.2608	3.7611	4.2613	4.7615

^a All other dimensions are in inches. The selection of threads per inch is arbitrary and for the purpose of establishing a standard.

Table 9. American National Standard Centralizing Acme Single-Start Screw Thread Data ASME/ANSI B1.5-1988

Identification		Diameters			Thread Data					
Nominal Sizes (All Classes)	Threads per Inch, ^a <i>n</i>	Centralizing, Classes 2C, 3C, and 4C			Pitch, <i>P</i>	Thickness at Pitch Line, <i>t = P/2</i>	Basic Height of Thread, <i>h = P/2</i>	Basic Width of Flat, <i>F = 0.3707P</i>	Lead Angle λ at Basic Pitch Diameter ^a Centralizing Classes 2C, 3C, and 4C,	
		Basic Major Diameter, <i>D</i>	Pitch Diameter, <i>D₂ = (D - h)</i>	Minor Diameter, <i>D₁ = (D - 2h)</i>					Deg	Min
1/4	16	0.2500	0.2188	0.1875	0.06250	0.03125	0.03125	0.0232	5	12
5/16	14	0.3125	0.2768	0.2411	0.07143	0.03571	0.03571	0.0265	4	42
3/8	12	0.3750	0.3333	0.2917	0.08333	0.04167	0.04167	0.0309	4	33
7/16	12	0.4375	0.3958	0.3542	0.08333	0.04167	0.04167	0.0309	3	50
1/2	10	0.5000	0.4500	0.4000	0.10000	0.05000	0.05000	0.0371	4	3
5/8	8	0.6250	0.5625	0.5000	0.12500	0.06250	0.06250	0.0463	4	3
3/4	6	0.7500	0.6667	0.5833	0.16667	0.08333	0.08333	0.0618	4	33
7/8	6	0.8750	0.7917	0.7083	0.16667	0.08333	0.08333	0.0618	3	50
1	5	1.0000	0.9000	0.8000	0.20000	0.10000	0.10000	0.0741	4	3
1 1/8	5	1.1250	1.0250	0.9250	0.20000	0.10000	0.10000	0.0741	3	33
1 1/4	5	1.2500	1.1500	1.0500	0.20000	0.10000	0.10000	0.0741	3	10
1 3/8	4	1.3750	1.2500	1.1250	0.25000	0.12500	0.12500	0.0927	3	39
1 1/2	4	1.5000	1.3750	1.2500	0.25000	0.12500	0.12500	0.0927	3	19
1 3/4	4	1.7500	1.6250	1.5000	0.25000	0.12500	0.12500	0.0927	2	48
2	4	2.0000	1.8750	1.7500	0.25000	0.12500	0.12500	0.0927	2	26
2 1/4	3	2.2500	2.0833	1.9167	0.33333	0.16667	0.16667	0.1236	2	55
2 1/2	3	2.5000	2.3333	2.1667	0.33333	0.16667	0.16667	0.1236	2	36
2 3/4	3	2.7500	2.5833	2.4167	0.33333	0.16667	0.16667	0.1236	2	21
3	2	3.0000	2.7500	2.5000	0.50000	0.25000	0.25000	0.1853	3	19
3 1/2	2	3.5000	3.2500	3.0000	0.50000	0.25000	0.25000	0.1853	2	48
4	2	4.0000	3.7500	3.5000	0.50000	0.25000	0.25000	0.1853	2	26
4 1/2	2	4.5000	4.2500	4.0000	0.50000	0.25000	0.25000	0.1853	2	9
5	2	5.0000	4.7500	4.5000	0.50000	0.25000	0.25000	0.1853	1	55

^a All other dimensions are given in inches.

Table 10. American National Standard Centralizing Acme Single-Start Screw Threads — Pitch Diameter Allowances ASME/ANSI B1.5-1988

Nominal Size Range ^a		Allowances on External Threads ^b			Nominal Size Range ^a		Allowances on External Threads ^b		
Above	To and Including	Centralizing			Above	To and Including	Centralizing		
		Class 2C, 0.008√D	Class 3C, 0.006√D	Class 4C, 0.004√D			Class 2C, 0.008√D	Class 3C, 0.006√D	Class 4C, 0.004√D
0	3/16	0.0024	0.0018	0.0012	1 7/16	1 7/16	0.0098	0.0073	0.0049
3/16	5/16	0.0040	0.0030	0.0020	1 9/16	1 7/8	0.0105	0.0079	0.0052
5/16	7/16	0.0049	0.0037	0.0024	1 7/8	2 1/8	0.0113	0.0085	0.0057
7/16	9/16	0.0057	0.0042	0.0028	2 1/8	2 3/8	0.0120	0.0090	0.0060
9/16	1 1/16	0.0063	0.0047	0.0032	2 3/8	2 5/8	0.0126	0.0095	0.0063
1 1/16	1 3/16	0.0069	0.0052	0.0035	2 5/8	2 7/8	0.0133	0.0099	0.0066
1 3/16	1 5/16	0.0075	0.0056	0.0037	2 7/8	3 1/4	0.0140	0.0105	0.0070
1 5/16	1 7/16	0.0080	0.0060	0.0040	3 1/4	3 3/4	0.0150	0.0112	0.0075
1 7/16	1 9/16	0.0085	0.0064	0.0042	3 3/4	4 1/4	0.0160	0.0120	0.0080
1 9/16	1 11/16	0.0089	0.0067	0.0045	4 1/4	4 3/4	0.0170	0.0127	0.0085
1 11/16	1 13/16	0.0094	0.0070	0.0047	4 3/4	5 1/2	0.0181	0.0136	0.0091

All dimensions are given in inches.

It is recommended that the sizes given in Table 9 be used whenever possible.

^a The values in columns for Classes 2C, 3C, and 4C are to be used for any size within the nominal size range columns. These values are calculated from the mean of the range.

^b An increase of 10 per cent in the allowance is recommended for each inch, or fraction thereof, that the length of engagement exceeds two diameters.

Table 11. American National Standard Centralizing Acme Single-Start Screw Threads — Pitch Diameter Tolerances ASME/ANSI B1.5-1988

Nom. Dia. ^a D	Class of Thread and Diameter Increment			Nom. Dia. ^a D	Class of Thread and Diameter Increment		
	2C	3C	4C		2C	3C	4C
	0.006√D	0.0028√D	0.002√D		0.006√D	0.0028√D	0.002√D
1/4	.00300	.00140	.00100	1 1/2	.00735	.00343	.00245
5/16	.00335	.00157	.00112	1 3/4	.00794	.00370	.00265
3/8	.00367	.00171	.00122	2	.00849	.00396	.00283
7/16	.00397	.00185	.00132	2 1/4	.00900	.00420	.00300
1/2	.00424	.00198	.00141	2 1/2	.00949	.00443	.00316
5/8	.00474	.00221	.00158	2 3/4	.00995	.00464	.00332
3/4	.00520	.00242	.00173	3	.01039	.00485	.00346
7/8	.00561	.00262	.00187	3 1/2	.01122	.00524	.00374
1	.00600	.00280	.00200	4	.01200	.00560	.00400
1 1/8	.00636	.00297	.00212	4 1/2	.01273	.00594	.00424
1 1/4	.00671	.00313	.00224	5	.01342	.00626	.00447
1 3/8	.00704	.00328	.00235

Thds. per Inch, n	Class of Thread and Pitch Increment			Thds. per Inch, n	Class of Thread and Pitch Increment		
	2C	3C	4C		2C	3C	4C
	0.030√1/n	0.014√1/n	0.010√1/n		0.030√1/n	0.014√1/n	0.010√1/n
16	.00750	.00350	.00250	4	.01500	.00700	.00500
14	.00802	.00374	.00267	3	.01732	.00808	.00577
12	.00866	.00404	.00289	2 1/2	.01897	.00885	.00632
10	.00949	.00443	.00316	2	.02121	.00990	.00707
8	.01061	.00495	.00354	1 1/2	.02449	.01143	.00816
6	.01225	.00572	.00408	1 1/3	.02598	.01212	.00866
5	.01342	.00626	.00447	1	.03000	.01400	.01000

All dimensions are given in inches.

For any particular size of thread, the pitch diameter tolerance is obtained by adding the diameter increment from the upper half of the table to the pitch increment from the lower half of the table. Example: A 0.250-16-ACME-2C thread has a pitch diameter tolerance of 0.00300 + 0.00750 = 0.0105 inch.

The equivalent tolerance on thread thickness is 0.259 times the pitch diameter tolerance.

^a For a nominal diameter between any two tabulated nominal diameters, use the diameter increment for the larger of the two tabulated nominal diameters.

Table 12. American National Standard Centralizing Acme Single-Start Screw Threads — Tolerances and Allowances for Major and Minor Diameters ASME/ANSI B1.5-1988

Size (Nom.)	Thds ^a per Inch	Allowance From Basic Major and Minor Diameters (All Classes)			Tolerance on Minor Diam., ^{b, c} All Internal Threads, (Plus 0.05P)	Tolerance on Major Diameter Plus on Internal, Minus on External Threads				
		Minor Diam., ^d All External Threads (Minus)	Internal Thread			Class 2C	Class 3C		Class 4C	
			Major Diam., ^e (Plus $0.0010 \sqrt{D}$)	Minor Diam., ^d (Plus 0.1P)		External and Internal Threads, $0.0035 \sqrt{D}$	External Thread, $0.0015 \sqrt{D}$	Internal Thread, $0.0035 \sqrt{D}$	External Thread, $0.0010 \sqrt{D}$	Internal Thread, $0.0020 \sqrt{D}$
1/4	16	0.010	0.0005	0.0062	0.0050	0.0017	0.0007	0.0017	0.0005	0.0010
5/16	14	0.010	0.0006	0.0071	0.0050	0.0020	0.0008	0.0020	0.0006	0.0011
3/8	12	0.010	0.0006	0.0083	0.0050	0.0021	0.0009	0.0021	0.0006	0.0012
7/16	12	0.010	0.0007	0.0083	0.0050	0.0023	0.0010	0.0023	0.0007	0.0013
1/2	10	0.020	0.0007	0.0100	0.0050	0.0025	0.0011	0.0025	0.0007	0.0014
5/8	8	0.020	0.0008	0.0125	0.0062	0.0028	0.0012	0.0028	0.0008	0.0016
3/4	6	0.020	0.0009	0.0167	0.0083	0.0030	0.0013	0.0030	0.0009	0.0017
7/8	6	0.020	0.0009	0.0167	0.0083	0.0033	0.0014	0.0033	0.0009	0.0019
1	5	0.020	0.0010	0.0200	0.0100	0.0035	0.0015	0.0035	0.0010	0.0020
1 1/8	5	0.020	0.0011	0.0200	0.0100	0.0037	0.0016	0.0037	0.0011	0.0021
1 1/4	5	0.020	0.0011	0.0200	0.0100	0.0039	0.0017	0.0039	0.0011	0.0022
1 3/8	4	0.020	0.0012	0.0250	0.0125	0.0041	0.0018	0.0041	0.0012	0.0023
1 1/2	4	0.020	0.0012	0.0250	0.0125	0.0043	0.0018	0.0043	0.0012	0.0024
1 3/4	4	0.020	0.0013	0.0250	0.0125	0.0046	0.0020	0.0046	0.0013	0.0026
2	4	0.020	0.0014	0.0250	0.0125	0.0049	0.0021	0.0049	0.0014	0.0028
2 1/4	3	0.020	0.0015	0.0333	0.0167	0.0052	0.0022	0.0052	0.0015	0.0030
2 1/2	3	0.020	0.0016	0.0333	0.0167	0.0055	0.0024	0.0055	0.0016	0.0032
2 3/4	3	0.020	0.0017	0.0333	0.0167	0.0058	0.0025	0.0058	0.0017	0.0033
3	2	0.020	0.0017	0.0500	0.0250	0.0061	0.0026	0.0061	0.0017	0.0035
3 1/2	2	0.020	0.0019	0.0500	0.0250	0.0065	0.0028	0.0065	0.0019	0.0037
4	2	0.020	0.0020	0.0500	0.0250	0.0070	0.0030	0.0070	0.0020	0.0040
4 1/2	2	0.020	0.0021	0.0500	0.0250	0.0074	0.0032	0.0074	0.0021	0.0042
5	2	0.020	0.0022	0.0500	0.0250	0.0078	0.0034	0.0078	0.0022	0.0045

^a All other dimensions are given in inches. Intermediate pitches take the values of the next coarser pitch listed. Values for intermediate diameters should be calculated from the formulas in column headings, but ordinarily may be interpolated.

^b To avoid a complicated formula and still provide an adequate tolerance, the pitch factor is used as a basis, with the minimum tolerance set at 0.005 in.

^c Tolerance on minor diameter of all external threads is $1.5 \times$ pitch diameter tolerance.

^d The minimum clearance at the minor diameter between the internal and external thread is the sum of the values in columns 3 and 5.

^e The minimum clearance at the major diameter between the internal and external thread is equal to column 4.

Example, 1.750-6-ACME-4C-LH: Indicates the same thread left-hand.

Example, 2.875-0.4P-0.8L-ACME-3C (Two Start): Indicates a Centralizing Class 3C Acme thread with 2.875-inch major diameter, 0.4-inch pitch, 0.8-inch lead, double thread, right-hand.

Example, 2.500-0.3333P-0.6667L-ACME-4C (Two Start): Indicates a Centralizing Class 4C Acme thread with 2.500-inch nominal major diameter (basic major diameter 2.500 inches), 0.3333-inch pitch, 0.6667-inch lead, double thread, right-hand. The same thread left-hand would have LH at the end of the designation.

Acme Centralizing Threads—Alternative Series with Minor Diameter Centralizing Control.—When Acme centralizing threads are produced in single units or in very small quantities (and principally in sizes larger than the range of commercial taps and dies) where the manufacturing process employs cutting tools (such as lathe cutting), it may be economically advantageous and therefore desirable to have the centralizing control of the mating threads located at the *minor diameters*.

Particularly under the above-mentioned type of manufacturing, the two advantages cited for minor diameter centralizing control over centralizing control at the major diameters of the mating threads are: 1) Greater ease and faster checking of machined thread dimensions. It is much easier to measure the minor diameter (root) of the external thread and the mating minor diameter (crest or bore) of the internal thread than it is to determine the major diameter (root) of the internal thread and the major diameter (crest or turn) of the external thread; and 2) better manufacturing control of the machined size due to greater ease of checking.

In the event that minor diameter centralizing is necessary, recalculate all thread dimensions, reversing major and minor diameter allowances, tolerances, radii, and chamfer.

American National Standard Stub Acme Threads.—This American National Standard ASME/ANSI B1.8-1988 (R2006) provides a Stub Acme screw thread for those unusual applications where, due to mechanical or metallurgical considerations, a coarse-pitch thread of shallow depth is required. The fit of Stub Acme threads corresponds to the Class 2G General Purpose Acme thread in American National Standard ANSI B1.5-1988. For a fit having less backlash, the tolerances and allowances for Classes 3G or 4G General Purpose Acme threads may be used.

Thread Form: The thread form and basic formulas for Stub Acme threads are given on page 1922 and the basic dimensions in Table 13.

Allowances and Tolerances: The major and minor diameter allowances for Stub Acme threads are the same as those given for General Purpose Acme threads on page 1921.

Pitch diameter allowances for Stub Acme threads are the same as for Class 2G General Purpose Acme threads and are given in Table 4. Pitch diameter tolerances for Stub Acme threads are the same as for Class 2G General Purpose Acme threads given in Table 5.

Limiting Dimensions: Limiting dimensions of American Standard Stub Acme threads may be determined by using the formulas given in Table 14a, or directly from Table 14b. The diagram below shows the limits of size for Stub Acme threads.

Thread Series: A preferred series of diameters and pitches for General Purpose Acme threads (Table 15) is recommended for Stub Acme threads.

Stub Acme Thread Designations.—The method of designation for Standard Stub Acme threads is illustrated in the following examples: 0.500-20 Stub Acme indicates a ½-inch major diameter, 20 threads per inch, right hand, single thread, Standard Stub Acme thread. The designation 0.500-20 Stub Acme-LH indicates the same thread except that it is left hand.

Table 13. American National Standard Stub Acme Screw Thread Form — Basic Dimensions ASME/ANSI B1.8-1988 (R2006)

Thds. per Inch ^a <i>n</i>	Pitch, <i>P</i> = 1/ <i>n</i>	Height of Thread (Basic), 0.3 <i>P</i>	Total Height of Thread, 0.3 <i>P</i> + ½ allowance ^b	Thread Thickness (Basic), <i>P</i> /2	Width of Flat	
					Crest of Internal Thread (Basic), 0.4224 <i>P</i>	Root of Internal Thread, 0.4224 <i>P</i> - 0.259 × allowance ^b
16	0.06250	0.01875	0.0238	0.03125	0.0264	0.0238
14	0.07143	0.02143	0.0264	0.03571	0.0302	0.0276
12	0.08333	0.02500	0.0300	0.04167	0.0352	0.0326
10	0.10000	0.03000	0.0400	0.05000	0.0422	0.0370
9	0.11111	0.03333	0.0433	0.05556	0.0469	0.0417
8	0.12500	0.03750	0.0475	0.06250	0.0528	0.0476
7	0.14286	0.04285	0.0529	0.07143	0.0603	0.0551
6	0.16667	0.05000	0.0600	0.08333	0.0704	0.0652
5	0.20000	0.06000	0.0700	0.10000	0.0845	0.0793
4	0.25000	0.07500	0.0850	0.12500	0.1056	0.1004
3½	0.28571	0.08571	0.0957	0.14286	0.1207	0.1155
3	0.33333	0.10000	0.1100	0.16667	0.1408	0.1356
2½	0.40000	0.12000	0.1300	0.20000	0.1690	0.1638
2	0.50000	0.15000	0.1600	0.25000	0.2112	0.2060
1½	0.66667	0.20000	0.2100	0.33333	0.2816	0.2764
1½	0.75000	0.22500	0.2350	0.37500	0.3168	0.3116
1	1.00000	0.30000	0.3100	0.50000	0.4224	0.4172

^a All other dimensions in inches. See Fig. 1, page 1922.

^b Allowance is 0.020 inch for 10 or less threads per inch and 0.010 inch for more than 10 threads per inch.

Table 14a. American National Standard Stub Acme Single-Start Screw Threads — Formulas for Determining Diameters ASME/ANSI B1.8-1988 (R2006)

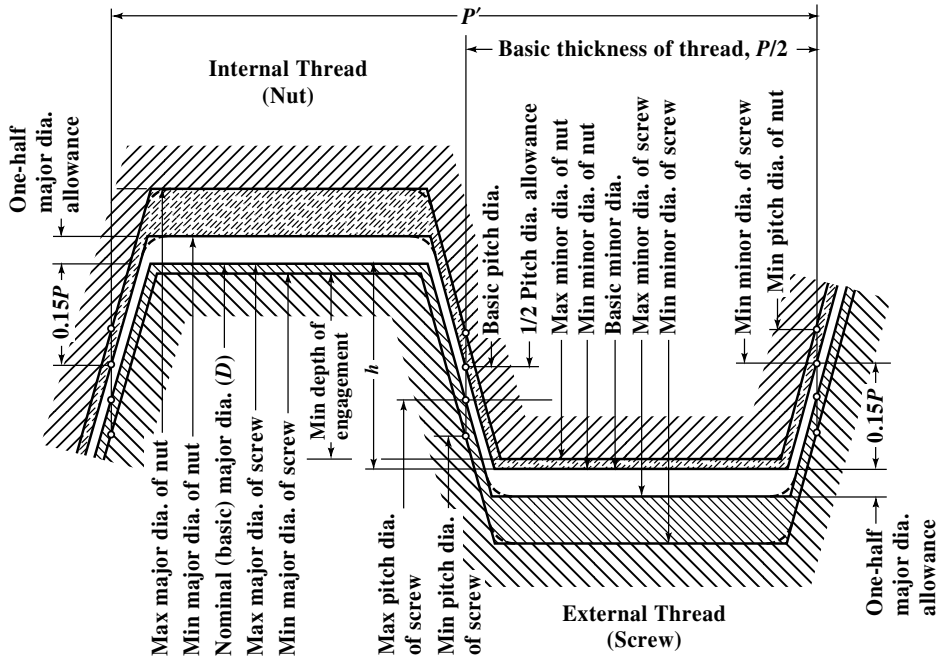
D = Basic Major Diameter and Nominal Size in Inches D_2 = Basic Pitch Diameter = $D - 0.3P$ D_1 = Basic Minor Diameter = $D - 0.6P$	
No.	External Threads (Screws)
1	Major Dia., Max = D .
2	Major Dia., Min. = D minus 0.05 <i>P</i> .
3	Pitch Dia., Max. = D_2 minus allowance from the appropriate Class 2G column, Table 4.
4	Pitch Dia., Min. = Pitch Dia., Max. (Formula 3) minus Class 2G tolerance from Table 5.
5	Minor Dia., Max. = D_1 minus 0.020 for 10 threads per inch and coarser and 0.010 for finer pitches.
6	Minor Dia., Min. = Minor Dia., Max. (Formula 5) minus Class 2G pitch diameter tolerance from Table 5.
Internal Threads (Nuts)	
7	Major Dia., Min. = D plus 0.020 for 10 threads per inch and coarser and 0.010 for finer pitches.
8	Major Dia., Max. = Major Dia., Min. (Formula 7) plus Class 2G pitch diameter tolerance from Table 5.
9	Pitch Dia., Min. = $D_2 = D - 0.3P$
10	Pitch Dia., Max. = Pitch Dia., Min. (Formula 9) plus Class 2G tolerance from Table 5.
11	Minor Dia., Min. = $D_1 = D - 0.6P$
12	Minor Dia., Max = Minor Dia., Min. (Formula 11) plus 0.05 <i>P</i> .

Table 14b. Limiting Dimensions for American National Standard Stub Acme Single-Start Screw Threads ASME/ANSI B1.8-1988 (R2006)

Nominal Diameter, <i>D</i>		1/4	5/16	3/8	7/16	1/2	5/8	3/4	7/8	1	1 1/8	1 1/4	1 3/8
Threads per Inch ^a		16	14	12	12	10	8	6	6	5	5	5	4
Limiting Dimensions		External Threads											
Major Dia.	{ Max (<i>D</i>)	0.2500	0.3125	0.3750	0.4375	0.5000	0.6250	0.7500	0.8750	1.0000	1.1250	1.2500	1.3750
	{ Min	0.2469	0.3089	0.3708	0.4333	0.4950	0.6188	0.7417	0.8667	0.9900	1.1150	1.2400	1.3625
Pitch Dia.	{ Max	0.2272	0.2871	0.3451	0.4076	0.4643	0.5812	0.6931	0.8175	0.9320	1.0565	1.1811	1.2906
	{ Min	0.2167	0.2757	0.3328	0.3950	0.4506	0.5658	0.6757	0.7996	0.9126	1.0367	1.1610	1.2686
Minor Dia.	{ Max	0.2024	0.2597	0.3150	0.3775	0.4200	0.5300	0.6300	0.7550	0.8600	0.9850	1.1100	1.2050
	{ Min	0.1919	0.2483	0.3027	0.3649	0.4063	0.5146	0.6126	0.7371	0.8406	0.9652	1.0899	1.1830
Limiting Dimensions		Internal Threads											
Major Dia.	{ Min	0.2600	0.3225	0.3850	0.4475	0.5200	0.6450	0.7700	0.8950	1.0200	1.1450	1.2700	1.3950
	{ Max	0.2705	0.3339	0.3973	0.4601	0.5337	0.6604	0.7874	0.9129	1.0394	1.1648	1.2901	1.4170
Pitch Dia.	{ Min	0.2312	0.2911	0.3500	0.4125	0.4700	0.5875	0.7000	0.8250	0.9400	1.0650	1.1900	1.3000
	{ Max	0.2417	0.3025	0.3623	0.4251	0.4837	0.6029	0.7174	0.8429	0.9594	1.0848	1.2101	1.3220
Minor Dia.	{ Min	0.2125	0.2696	0.3250	0.3875	0.4400	0.5500	0.6500	0.7750	0.8800	1.0050	1.1300	1.2250
	{ Max	0.2156	0.2732	0.3292	0.3917	0.4450	0.5562	0.6583	0.7833	0.8900	1.0150	1.1400	1.2375
Nominal Diameter, <i>D</i>		1 1/2	1 3/4	2	2 1/4	2 1/2	2 3/4	3	3 1/2	4	4 1/2	5	
Threads per Inch ^a		4	4	4	3	3	3	2	2	2	2	2	
Limiting Dimensions		External Threads											
Major Dia.	{ Max (<i>D</i>)	1.5000	1.7500	2.0000	2.2500	2.5000	2.7500	3.0000	3.5000	4.0000	4.5000	5.0000	
	{ Min	1.4875	1.7375	1.9875	2.2333	2.4833	2.7333	2.9750	3.4750	3.9750	4.4750	4.9750	
Pitch Dia.	{ Max	1.4152	1.6645	1.9137	2.1380	2.3874	2.6367	2.8360	3.3350	3.8340	4.3330	4.8319	
	{ Min	1.3929	1.6416	1.8902	2.1117	2.3606	2.6094	2.8044	3.3026	3.8008	4.2991	4.7973	
Minor Dia.	{ Max	1.3300	1.5800	1.8300	2.0300	2.2800	2.5300	2.6800	3.1800	3.6800	4.1800	4.6800	
	{ Min	1.3077	1.5571	1.8065	2.0037	2.2532	2.5027	2.6484	3.1476	3.6468	4.1461	4.6454	
Limiting Dimensions		Internal Threads											
Major Dia.	{ Min	1.5200	1.7700	2.0200	2.2700	2.5200	2.7700	3.0200	3.5200	4.0200	4.5200	5.0200	
	{ Max	1.5423	1.7929	2.0435	2.2963	2.5468	2.7973	3.0516	3.5524	4.0532	4.5539	5.0546	
Pitch Dia.	{ Min	1.4250	1.6750	1.9250	2.1500	2.4000	2.6500	2.8500	3.3500	3.8500	4.3500	4.8500	
	{ Max	1.4473	1.6979	1.9485	2.1763	2.4268	2.6773	2.8816	3.3824	3.8832	4.3839	4.8846	
Minor Dia.	{ Min	1.3500	1.6000	1.8500	2.0500	2.3000	2.5500	2.7000	3.2000	3.7000	4.2000	4.7000	
	{ Max	1.3625	1.6125	1.8625	2.0667	2.3167	2.5667	2.7250	3.2250	3.7250	4.2250	4.7250	

ALTERNATIVE STUB ACME SCREW THREADS

1941



Limits of Size, Allowances, Tolerances, and Crest Clearances for American National Standard Stub Acme Threads

Alternative Stub Acme Threads.—Since one Stub Acme thread form may not meet the requirements of all applications, basic data for two of the other commonly used forms are included in the appendix of the American Standard for Stub Acme Threads. These so-called Modified Form 1 and Modified Form 2 threads utilize the same tolerances and allowances as Standard Stub Acme threads and have the same major diameter and basic thread thickness at the pitchline ($0.5P$). The basic height of Form 1 threads, h , is $0.375P$; for Form 2 it is $0.250P$. The basic width of flat at the crest of the internal thread is $0.4030P$ for Form 1 and $0.4353P$ for Form 2.

The pitch diameter and minor diameter for Form 1 threads will be smaller than similar values for the Standard Stub Acme Form and for Form 2 they will be larger owing to the differences in basic thread height h . Therefore, in calculating the dimensions of Form 1 and Form 2 threads using Formulas 1 through 12 in Table 14a, it is only necessary to substitute the following values in applying the formulas: For Form 1, $D_2 = D - 0.375P$, $D_1 = D - 0.75P$; for Form 2, $D_2 = D - 0.25P$, $D_1 = D - 0.5P$.

Thread Designation: These threads are designated in the same manner as Standard Stub Acme threads except for the insertion of either M1 or M2 after “Acme.” Thus, 0.500-20 Stub Acme M1 for a Form 1 thread; and 0.500-20 Stub Acme M2 for a Form 2 thread.

Former 60-Degree Stub Thread.—Former American Standard B1.3-1941 included a 60-degree stub thread for use where design or operating conditions could be better satisfied by the use of this thread, or other modified threads, than by Acme threads. Data for 60-Degree Stub thread form are given in the accompanying diagram.

Table 15. Stub Acme Screw Thread Data ASME/ANSI B1.8-1988 (R2006)

Identification		Basic Diameters			Thread Data					
Nominal Sizes	Threads per Inch, ^a <i>n</i>	Major Diameter, <i>D</i>	Pitch Diameter, <i>D</i> ₂ = <i>D</i> - <i>h</i>	Minor Diameter, <i>D</i> ₁ = <i>D</i> - 2 <i>h</i>	Pitch, <i>P</i>	Thread Thickness at Pitch Line, <i>t</i> = <i>P</i> /2	Basic Thread Height, <i>h</i> = 0.3 <i>P</i>	Basic Width of Flat, 0.4224 <i>P</i>	Lead Angle at Basic Pitch Diameter	
									Deg	Min
1/4	16	0.2500	0.2312	0.2125	0.06250	0.03125	0.01875	0.0264	4	54
5/16	14	0.3125	0.2911	0.2696	0.07143	0.03572	0.02143	0.0302	4	28
3/8	12	0.3750	0.3500	0.3250	0.08333	0.04167	0.02500	0.0352	4	20
7/16	12	0.4375	0.4125	0.3875	0.08333	0.04167	0.02500	0.0352	3	41
1/2	10	0.5000	0.4700	0.4400	0.10000	0.05000	0.03000	0.0422	3	52
5/8	8	0.6250	0.5875	0.5500	0.12500	0.06250	0.03750	0.0528	3	52
3/4	6	0.7500	0.7000	0.6500	0.16667	0.08333	0.05000	0.0704	4	20
7/8	6	0.8750	0.8250	0.7750	0.16667	0.08333	0.05000	0.0704	3	41
1	5	1.0000	0.9400	0.8800	0.20000	0.10000	0.06000	0.0845	3	52
1 1/8	5	1.1250	1.0650	1.0050	0.20000	0.10000	0.06000	0.0845	3	25
1 1/4	5	1.2500	1.1900	1.1300	0.20000	0.10000	0.06000	0.0845	3	4
1 3/8	4	1.3750	1.3000	1.2250	0.25000	0.12500	0.07500	0.1056	3	30
1 1/2	4	1.5000	1.4250	1.3500	0.25000	0.12500	0.07500	0.1056	3	12
1 3/4	4	1.7500	1.6750	1.6000	0.25000	0.12500	0.07500	0.1056	2	43
2	4	2.0000	1.9250	1.8500	0.25000	0.12500	0.07500	0.1056	2	22
2 1/4	3	2.2500	2.1500	2.0500	0.33333	0.16667	0.10000	0.1408	2	50
2 1/2	3	2.5000	2.4000	2.3000	0.33333	0.16667	0.10000	0.1408	2	32
2 3/4	3	2.7500	2.6500	2.5500	0.33333	0.16667	0.10000	0.1408	2	18
3	2	3.0000	2.8500	2.7000	0.50000	0.25000	0.15000	0.2112	3	12
3 1/2	2	3.5000	3.3500	3.2000	0.50000	0.25000	0.15000	0.2112	2	43
4	2	4.0000	3.8500	3.7000	0.50000	0.25000	0.15000	0.2112	2	22
4 1/2	2	4.5000	4.3500	4.2000	0.50000	0.25000	0.15000	0.2112	2	6
5	2	5.0000	4.8500	4.7000	0.50000	0.25000	0.15000	0.2112	1	53

^a All other dimensions are given in inches.

BUTTRESS THREADS

Threads of Buttress Form

The buttress form of thread has certain advantages in applications involving exceptionally high stresses along the thread axis in one direction only. The contacting flank of the thread, which takes the thrust, is referred to as the *pressure flank* and is so nearly perpendicular to the thread axis that the radial component of the thrust is reduced to a minimum. Because of the small radial thrust, this form of thread is particularly applicable where tubular members are screwed together, as in the case of breech mechanisms of large guns and airplane propeller hubs.

Fig. 1a shows a common form. The front or load-resisting face is perpendicular to the axis of the screw and the thread angle is 45 degrees. According to one rule, the pitch $P = 2 \times$ screw diameter $\div 15$. The thread depth d may equal $\frac{3}{4} \times$ pitch, making the flat $f = \frac{1}{8} \times$ pitch. Sometimes depth d is reduced to $\frac{2}{3} \times$ pitch, making $f = \frac{1}{6} \times$ pitch.

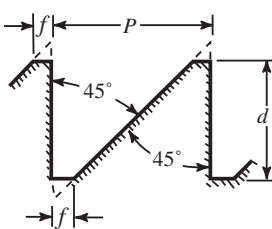


Fig. 1a.

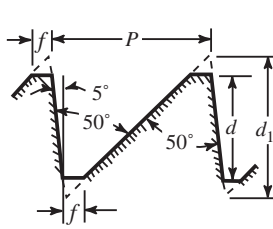


Fig. 1b.

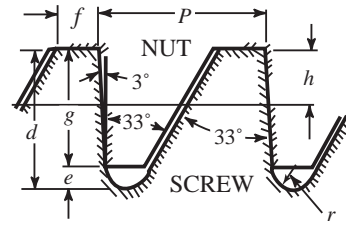


Fig. 1c.

The load-resisting side or flank may be inclined an amount (Fig. 1b) ranging usually from 1 to 5 degrees to avoid cutter interference in milling the thread. With an angle of 5 degrees and an included thread angle of 50 degrees, if the width of the flat f at both crest and root equals $\frac{1}{8} \times$ pitch, then the thread depth equals $0.69 \times$ pitch or $\frac{3}{4} d_1$.

The saw-tooth form of thread illustrated by Fig. 1c is known in Germany as the "Sägengewinde" and in Italy as the "Fillettatura a dente di Sega." Pitches are standardized from 2 millimeters up to 48 millimeters in the German and Italian specifications. The front face inclines 3 degrees from the perpendicular and the included angle is 33 degrees.

The thread depth d for the screw = $0.86777 \times$ pitch P . The thread depth g for the nut = $0.75 \times$ pitch. Dimension $h = 0.341 \times P$. The width f of flat at the crest of the thread on the screw = $0.26384 \times$ pitch. Radius r at the root = $0.12427 \times$ pitch. The clearance space $e = 0.11777 \times$ pitch.

British Standard Buttress Threads BS 1657: 1950.—Specifications for buttress threads in this standard are similar to those in the American Standard (see page 1946) except: 1) A basic depth of thread of $0.4p$ is used instead of $0.6p$; 2) Sizes below 1 inch are not included; 3) Tolerances on major and minor diameters are the same as the pitch diameter tolerances, whereas in the American Standard separate tolerances are provided; however, provision is made for smaller major and minor diameter tolerances when crest surfaces of screws or nuts are used as datum surfaces, or when the resulting reduction in depth of engagement must be limited; and 4) Certain combinations of large diameters with fine pitches are provided that are not encouraged in the American Standard.

Lowenherz or Löwenherz Thread.—The Lowenherz thread is intended for the fine screws of instruments and is based on the metric system. The Löwenherz thread has flats at the top and bottom the same as the U.S. standard buttress form, but the angle is 53 degrees 8 minutes. The depth equals $0.75 \times$ the pitch, and the width of the flats at the top and bottom is equal to $0.125 \times$ the pitch. This screw thread used for measuring instruments, optical apparatus, etc., especially in Germany.

Löwenherz Thread

Diameter		Pitch, Millimeters	Approximate No. of Threads per Inch	Diameter		Pitch, Millimeters	Approximate No. of Threads per Inch
Millimeters	Inches			Millimeters	Inches		
1.0	0.0394	0.25	101.6	9.0	0.3543	1.30	19.5
1.2	0.0472	0.25	101.6	10.0	0.3937	1.40	18.1
1.4	0.0551	0.30	84.7	12.0	0.4724	1.60	15.9
1.7	0.0669	0.35	72.6	14.0	0.5512	1.80	14.1
2.0	0.0787	0.40	63.5	16.0	0.6299	2.00	12.7
2.3	0.0905	0.40	63.5	18.0	0.7087	2.20	11.5
2.6	0.1024	0.45	56.4	20.0	0.7874	2.40	10.6
3.0	0.1181	0.50	50.8	22.0	0.8661	2.80	9.1
3.5	0.1378	0.60	42.3	24.0	0.9450	2.80	9.1
4.0	0.1575	0.70	36.3	26.0	1.0236	3.20	7.9
4.5	0.1772	0.75	33.9	28.0	1.1024	3.20	7.9
5.0	0.1968	0.80	31.7	30.0	1.1811	3.60	7.1
5.5	0.2165	0.90	28.2	32.0	1.2599	3.60	7.1
6.0	0.2362	1.00	25.4	36.0	1.4173	4.00	6.4
7.0	0.2756	1.10	23.1	40.0	1.5748	4.40	5.7
8.0	0.3150	1.20	21.1

American National Standard Buttress Inch Screw Threads

The buttress form of thread has certain advantages in applications involving exceptionally high stresses along the thread axis in one direction only. As the thrust side (load flank) of the standard buttress thread is made very nearly perpendicular to the thread axis, the radial component of the thrust is reduced to a minimum. On account of the small radial thrust, the buttress form of thread is particularly applicable when tubular members are screwed together. Examples of actual applications are the breech assemblies of large guns, airplane propeller hubs, and columns for hydraulic presses.

7°/45° Buttress Thread Form.—In selecting the form of thread recommended as standard, ANSI B1.9-1973 (R2007), manufacture by milling, grinding, rolling, or other suitable means, has been taken into consideration. All dimensions are in inches.

Form of Thread: The form of the buttress thread is shown in the accompanying **Figs. 2a** and **2b**, and has the following characteristics:

- a) A load flank angle, measured in an axial plane, of 7 degrees from the normal to the axis.
- b) A clearance flank angle, measured in an axial plane, of 45 degrees from the normal to the axis.
- c) Equal truncations at the crests of the external and internal threads such that the basic height of thread engagement (assuming no allowance) is equal to 0.6 of the pitch
- d) Equal radii, at the roots of the external and internal basic thread forms tangential to the load flank and the clearance flank. (There is, in practice, almost no chance that the thread forms will be achieved strictly as basically specified, that is, as true radii.) When specified, equal flat roots of the external and internal thread may be supplied.

Table 1. American National Standard Diameter—Pitch Combinations for 7°/45° Buttress Threads ANSI B1.9-1973 (R2007)

Preferred Nominal Major Diameters, Inches	Threads per Inch ^a	Preferred Nominal Major Diameters, Inches	Threads per Inch ^a
0.5, 0.625, 0.75	(20, 16, 12)	4.5, 5, 5.5, 6	12, 10, 8, (6, 5, 4), 3
0.875, 1.0	(16, 12, 10)	7, 8, 9, 10	10, 8, 6, (5, 4, 3), 2.5, 2
1.25, 1.375, 1.5	16, (12, 10, 8), 6	11, 12, 14, 16	10, 8, 6, 5, (4, 3, 2.5), 2, 1.5, 1.25
1.75, 2, 2.25, 2.5	16, 12, (10, 8, 6), 5, 4	18, 20, 22, 24	8, 6, 5, 4, (3, 2.5, 2), 1.5, 1.25, 1
2.75, 3, 3.5, 4	16, 12, 10, (8, 6, 5), 4		

^a Preferred threads per inch are in parentheses.

**Table 2. American National Standard Inch Buttress Screw Threads—
Basic Dimensions ANSI B1.9-1973 (R2007)**

Thds. ^a per Inch	Pitch, p	Basic Height of Thread, $h = 0.6p$	Height of Sharp-V Thread, $H =$ $0.89064p$	Crest Truncation, $f =$ $0.14532p$	Height of Thread, h_s or $h_n =$ $0.66271p$	Max. Root Trunca- tion, ^b $s =$ $0.0826p$	Max. Root Radius, ^c $r =$ $0.0714p$	Width of Flat at Crest, $F =$ $0.16316p$
20	0.0500	0.0300	0.0445	0.0073	0.0331	0.0041	0.0036	0.0082
16	0.0625	0.0375	0.0557	0.0091	0.0414	0.0052	0.0045	0.0102
12	0.0833	0.0500	0.0742	0.0121	0.0552	0.0069	0.0059	0.0136
10	0.1000	0.0600	0.0891	0.0145	0.0663	0.0083	0.0071	0.0163
8	0.1250	0.0750	0.1113	0.0182	0.0828	0.0103	0.0089	0.0204
6	0.1667	0.1000	0.1484	0.0242	0.1105	0.0138	0.0119	0.0271
5	0.2000	0.1200	0.1781	0.0291	0.1325	0.0165	0.0143	0.0326
4	0.2500	0.1500	0.2227	0.0363	0.1657	0.0207	0.0179	0.0408
3	0.3333	0.2000	0.2969	0.0484	0.2209	0.0275	0.0238	0.0543
2½	0.4000	0.2400	0.3563	0.0581	0.2651	0.0330	0.0286	0.0653
2	0.5000	0.3000	0.4453	0.0727	0.3314	0.0413	0.0357	0.0816
1½	0.6667	0.4000	0.5938	0.0969	0.4418	0.0551	0.0476	0.1088
1¼	0.8000	0.4800	0.7125	0.1163	0.5302	0.0661	0.0572	0.1305
1	1.0000	0.6000	0.8906	0.1453	0.6627	0.0826	0.0714	0.1632

^aAll other dimensions are in inches.

^bMinimum root truncation is one-half of maximum.

^cMinimum root radius is one-half of maximum.

Buttress Thread Tolerances.—Tolerances from basic size on external threads are applied in a minus direction and on internal threads in a plus direction.

Pitch Diameter Tolerances: The following formula is used for determining the pitch diameter product tolerance for Class 2 (standard grade) external or internal threads:

$$\text{PD tolerance} = 0.002 \sqrt[3]{D} + 0.00278 \sqrt{L_e} + 0.00854 \sqrt{p}$$

where D = basic major diameter of external thread (assuming no allowance)

L_e = length of engagement

p = pitch of thread

When the length of engagement is taken as $10p$, the formula reduces to

$$0.002 \sqrt[3]{D} + 0.0173 \sqrt{p}$$

It is to be noted that this formula relates specifically to Class 2 (standard grade) PD tolerances. Class 3 (precision grade) PD tolerances are two-thirds of Class 2 PD tolerances. Pitch diameter tolerances based on this latter formula, for various diameter pitch combinations, are given in [Table 4](#).

Functional Size: Deviations in lead and flank angle of product threads increase the functional size of an external thread and decrease the functional size of an internal thread by the cumulative effect of the diameter equivalents of these deviations. The functional size of all buttress product threads shall not exceed the maximum-material limit.

Tolerances on Major Diameter of External Thread and Minor Diameter of Internal Thread: Unless otherwise specified, these tolerances should be the same as the pitch diameter tolerance for the class used.

Tolerances on Minor Diameter of External Thread and Major Diameter of Internal Thread: It will be sufficient in most instances to state only the maximum minor diameter of the external thread and the minimum major diameter of the internal thread without any tol-

ANSI BUTTRESS THREADS

Form of American National Standard 7°/45° Buttress Thread with 0.6p Basic Height of Thread Engagement

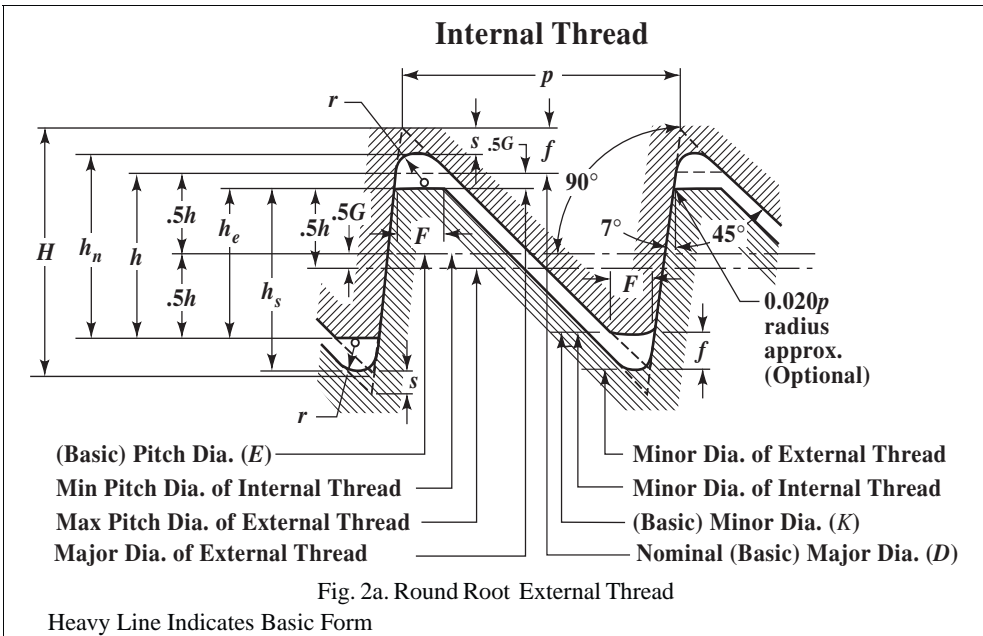


Fig. 2a. Round Root External Thread

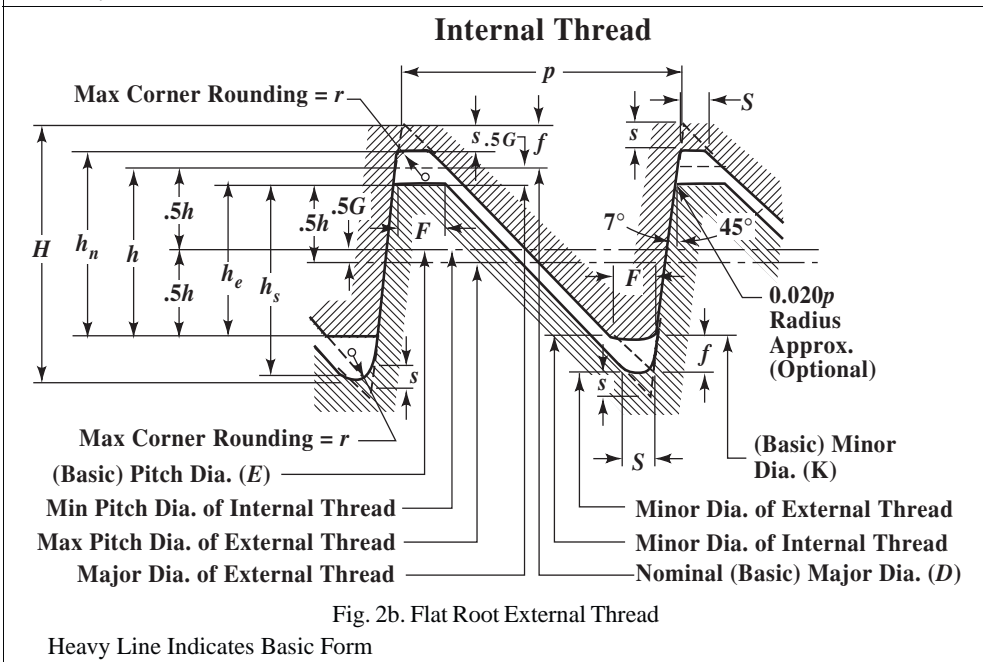


Fig. 2b. Flat Root External Thread

erance. However, the root truncation from a sharp V should not be greater than $0.0826p$ nor less than $0.0413p$.

Lead and Flank Angle Deviations for Class 2: The deviations in lead and flank angles may consume the entire tolerance zone between maximum and minimum material product limits given in [Table 4](#).

Diameter Equivalents for Variations in Lead and Flank Angles for Class 3: The combined diameter equivalents of variations in lead (including helix deviations), and flank

Table 3. American National Standard Buttress Inch Screw Thread Symbols and Form

Thread Element	Max. Material (Basic)	Min. Material
Pitch	p	
Height of sharp-V thread	$H = 0.89064p$	
Basic height of thread engagement	$h = 0.6p$	
Root radius (theoretical)(see footnote ^a)	$r = 0.07141p$	Min. $r = 0.0357p$
Root truncation	$s = 0.0826p$	Min. $s = 0.5$; Max. $s = 0.0413p$
Root truncation for flat root form	$s = 0.0826p$	Min. $s = 0.5$; Max. $s = 0.0413p$
Flat width for flat root form	$S = 0.0928p$	Min. $S = 0.0464p$
Allowance	G (see text)	
Height of thread engagement	$h_e = h - 0.5G$	Min. $h_e = \text{Max. } h_e - [0.5 \text{ tol. on major dia. external thread} + 0.5 \text{ tol. on minor dia. internal thread}]$.
Crest truncation	$f = 0.14532p$	
Crest width	$F = 0.16316p$	
Major diameter	D	
Major diameter of internal thread	$D_n = D + 0.12542p$	Max. $D_n = \text{Max. pitch dia. of internal thread} + 0.80803p$
Major diameter of external thread	$D_s = D - G$	Min. $D_s = D - G - D \text{ tol.}$
Pitch diameter	E	
Pitch diameter of internal thread (see footnote ^b)	$E_n = D - h$	Max. $E_n = D - h + PD \text{ tol.}$
Pitch diameter of external thread (see footnote ^c)	$E_s = D - h - G$	Min. $E_s = D - h - G - PD \text{ tol.}$
Minor diameter	K	
Minor diameter of external thread	$K_s = D - 1.32542p - G$	Min. $K_s = \text{Min. pitch dia. of external thread} - 0.80803p$
Minor diameter of internal thread	$K_n = D - 2h$	Min. $K_n = D - 2h + K \text{ tol.}$
Height of thread of internal thread	$h_n = 0.66271p$	
Height of thread of external thread	$h_s = 0.66271p$	
Pitch diameter increment for lead	ΔE_l	
Pitch diameter increment for 45° clearance flank angle	$\Delta E\alpha_1$	
Pitch diameter increment for 7° load flank angle	$\Delta E\alpha_2$	
Length of engagement	L_e	

^a Unless the flat root form is specified, the rounded root form of the external and internal thread shall be a continuous, smoothly blended curve within the zone defined by $0.07141p$ maximum to $0.0357p$ minimum radius. The resulting curve shall have no reversals or sudden angular variations, and shall be tangent to the flanks of the thread. There is, in practice, almost no chance that the rounded thread form will be achieved strictly as basically specified, that is, as a true radius.

^b The pitch diameter X tolerances for GO and NOT GO threaded plug gages are applied to the internal product limits for E_n and Max. E_n .

^c The pitch diameter W tolerances for GO and NOT GO threaded setting plug gages are applied to the external product limits for E_s and Min. E_s .

Table 4. American National Standard Buttress Inch Screw Threads Tolerances Class 2 (Standard Grade) and Class 3 (Precision Grade) ANSI B1.9-1973 (R2007)

Thds. per Inch	Pitch, ^a <i>p</i> Inch	Basic Major Diameter, Inch									Pitch ^b Increment, $0.0173 \sqrt{p}$ Inch
		From 0.5 thru 0.7	Over 0.7 thru 1.0	Over 1.0 thru 1.5	Over 1.5 thru 2.5	Over 2.5 thru 4	Over 4 thru 6	Over 6 thru 10	Over 10 thru 16	Over 16 thru 24	
		Tolerance on Major Diameter of External Thread, Pitch Diameter of External and Internal Threads, and Minor Diameter of Internal Thread, Inch									
Class 2, Standard Grade											
20	0.0500	.005600387
16	0.0625	.0060	.0062	.0065	.0068	.007300432
12	0.0833	.0067	.0069	.0071	.0075	.0080	.008400499
10	0.10000074	.0076	.0080	.0084	.0089	.0095	.010200547
8	0.12500083	.0086	.0091	.0095	.0101	.0108	.0115	.00612
6	0.16670092	.0096	.0100	.0105	.0111	.0118	.0125	.00706
5	0.20000103	.0107	.0112	.0117	.0124	.0132	.00774
4	0.25000112	.0116	.0121	.0127	.0134	.0141	.00865
3	0.33330134	.0140	.0147	.0154	.00999
2.5	0.40000149	.0156	.0164	.01094
2.0	0.50000162	.0169	.0177	.01223
1.5	0.66670188	.0196	.01413
1.25	0.80000202	.0209	.01547
1.0	1.00000227	.01730
Diameter Increment, ^c $0.002 \sqrt[3]{D}$.00169	.00189	.00215	.00252	.00296	.00342	.00400	.00470	.00543	
Class 3, Precision Grade											
20	0.0500	.0037	
16	0.0625	.0040	.0042	.0043	.0046	.0049	
12	0.0833	.0044	.0046	.0048	.0050	.0053	.0056	
10	0.10000049	.0051	.0053	.0056	.0059	.0063	.0068	
8	0.12500055	.0058	.0061	.0064	.0067	.0072	.0077	
6	0.16670061	.0064	.0067	.0070	.0074	.0078	.0083	
5	.020000068	.0071	.0074	.0078	.0083	.0088	
4	0.25000074	.0077	.0080	.0084	.0089	.0094	
3	.033330089	.0093	.0098	.0103	
2.5	0.40000100	.0104	.0109	
2.0	0.50000108	.0113	.0118	
1.5	0.66670126	.0130	
1.25	0.80000135	.0139	
1.0	1.00000152	

^aFor threads with pitches not shown in this table, pitch increment to be used in tolerance formula is to be determined by use of formula PD Tolerance = $0.002 \sqrt[3]{D} + 0.00278 \sqrt{L_e} + 0.00854 \sqrt{p}$, where: *D* = basic major diameter of external thread (assuming no allowance), *L_e* = length of engagement, and *p* = pitch of thread. This formula relates specifically to Class 2 (standard grade) PD tolerances. Class 3 (precision grade) PD tolerances are two-thirds of Class 2 PD tolerances. See text

^bWhen the length of engagement is taken as 10*p*, the formula reduces to: $0.002 \sqrt[3]{D} + 0.0173 \sqrt{p}$

^cDiameter *D*, used in diameter increment formula, is based on the average of the range. angle for Class 3, shall not exceed 50 percent of the Class 2 pitch diameter tolerances given in Table 4.

Tolerances on Taper and Roundness: There are no requirements for taper and roundness for Class 2 buttress screw threads.

The major and minor diameters of Class 3 buttress threads shall not taper nor be out of round to the extent that specified limits for major and minor diameter are exceeded. The taper and out-of-roundness of the pitch diameter for Class 3 buttress threads shall not exceed 50 per cent of the pitch-diameter tolerances.

Allowances for Easy Assembly.—An allowance (clearance) should be provided on all external threads to secure easy assembly of parts. The amount of the allowance is deducted from the nominal major, pitch, and minor diameters of the external thread when the maximum material condition of the external thread is to be determined.

The minimum internal thread is basic.

The amount of the allowance is the same for both classes and is equal to the Class 3 pitch-diameter tolerance as calculated by the formulas previously given. The allowances for various diameter-pitch combinations are given in **Table 5**.

Table 5. American National Standard External Thread Allowances for Classes 2 and 3 Buttress Inch Screw Threads ANSI B1.9-1973 (R2007)

Threads per Inch	Pitch, p Inch	Basic Major Diameter, Inch								
		From 0.5 thru 0.7	Over 0.7 thru 1.0	Over 1.0 thru 1.5	Over 1.5 thru 2.5	Over 2.5 thru 4	Over 4 thru 6	Over 6 thru 10	Over 10 thru 16	Over 16 thru 24
		Allowance on Major, Minor and Pitch Diameters of External Thread, Inch								
20	0.0500	.0037
16	0.0625	.0040	.0042	.0043	.0046	.0049
12	0.0833	.0044	.0046	.0048	.0050	.0053	.0056
10	0.10000049	.0051	.0053	.0056	.0059	.0063	.0068
8	0.12500055	.0058	.0061	.0064	.0067	.0072	.0077
6	0.16670061	.0064	.0067	.0070	.0074	.0078	.0083
5	0.20000068	.0071	.0074	.0078	.0083	.0088
4	0.25000074	.0077	.0080	.0084	.0089	.0094
3	0.33330089	.0093	.0098	.0103
2.5	0.40000100	.0104	.0109
2.0	0.50000108	.0113	.0118
1.5	0.66670126	.0130
1.25	0.80000135	.0139
1.0	1.00000152

Example Showing Dimensions for a Typical Buttress Thread.—The dimensions for a 2-inch diameter, 4 threads per inch, Class 2 buttress thread with flank angles of 7 degrees and 45 degrees are

$$h = \text{basic thread height} = 0.1500 \text{ (Table 2)}$$

$$h_s = h_n = \text{height of thread in external and internal threads} = 0.1657 \text{ (Table 2)}$$

$$G = \text{pitch-diameter allowance on external thread} = 0.0074 \text{ (Table 5)}$$

$$\text{Tolerance on PD of external and internal threads} = 0.0112 \text{ (Table 4)}$$

$$\text{Tolerance on major diameter of external thread and minor diameter of internal thread} = 0.0112 \text{ (Table 4)}$$

Internal Thread:

$$\text{Basic Major Diameter: } D = 2.0000$$

$$\text{Min. Major Diameter: } D - 2h + 2h_n = 2.0314 \text{ (see Table 2)}$$

$$\text{Min. Pitch Diameter: } D - h = 1.8500 \text{ (see Table 2)}$$

$$\text{Max. Pitch Diameter: } D - h + \text{PD Tolerance} = 1.8612 \text{ (see Table 4)}$$

$$\text{Min. Minor Diameter: } D - 2h = 1.7000 \text{ (see Table 2)}$$

$$\text{Max. Minor Diameter: } D - 2h + \text{Minor Diameter Tolerance} = 1.7112 \text{ (see Table 4)}$$

External Thread:

Max. Major Diameter: $D - G = 1.9926$ (see [Table 5](#))

Min. Major Diameter: $D - G - \text{Major Diameter Tolerance} = 1.9814$ (see [Tables 4 and 5](#))

Max. Pitch Diameter: $D - h - G = 1.8426$ (see [Tables 2 and 5](#))

Min. Pitch Diameter: $D - h - G - PD \text{ Tolerance} = 1.8314$ (see [Table 4](#))

Max. Minor Diameter: $D - G - 2h_s = 1.6612$ (see [Tables 2 and 5](#))

Buttress Thread Designations.—When only the designation, BUTT is used, the thread is “pull” type buttress (external thread pulls) with the clearance flank leading and the 7-degree pressure flank following. When the designation, PUSH-BUTT is used, the thread is a push type buttress (external thread pushes) with the 7-degree load flank leading and the 45-degree clearance flank following. Whenever possible this description should be confirmed by a simplified view showing thread angles on the drawing of the product that has the buttress thread.

Standard Buttress Threads: A buttress thread is considered to be standard when:

- 1) opposite flank angles are 7-degrees and 45-degrees; 2) basic thread height is $0.6p$;
- 3) tolerances and allowances are as shown in [Tables 4 and 5](#); and 4) length of engagement is $10p$ or less.

Thread Designation Abbreviations: In thread designations on drawings, tools, gages, and in specifications, the following abbreviations and letters are to be used:

BUTT	for buttress thread, pull type	
PUSH-BUTT	for buttress thread, push type	
LH	for left-hand thread (Absence of LH indicates that the thread is a right-hand thread.)	
P	for pitch	
L	for lead	
A	for external thread	<i>Note:</i> Absence of A or B after thread class indicates that designation covers both the external and internal threads.
B	for internal thread	
Le	for length of thread engagement	
SPL	for special	
FL	for flat root thread	
E	for pitch diameter	
TPI	for threads per inch	
THD	for thread	

Designation Sequence for Buttress Inch Screw Threads: When designating single-start standard buttress threads the nominal size is given first, the threads per inch next, then PUSH if the internal member is to push, but nothing if it is to pull, then the class of thread (2 or 3), then whether external (A) or internal (B), then LH if left-hand, but nothing if right-hand, and finally FL if a flat root thread, but nothing if a radiused root thread; thus, 2.5-8 BUTT-2A indicates a 2.5 inch, 8 threads per inch buttress thread, Class 2 external, right-hand, internal member to pull, with radiused root of thread. The designation 2.5-8 PUSH-BUTT-2A-LH-FL signifies a 2.5 inch size, 8 threads per inch buttress thread with internal member to push, Class 2 external, left-hand, and flat root.

A multiple-start standard buttress thread is similarly designated but the pitch is given instead of the threads per inch, followed by the lead and the number of starts is indicated in parentheses after the class of thread. Thus, 10-0.25P-0.5L - BUTT-3B (2 start) indicates a 10-inch thread with 4 threads per inch, 0.5 inch lead, buttress form with internal member to pull, Class 3 internal, 2 starts, with radiused root of thread.

WHITWORTH THREADS

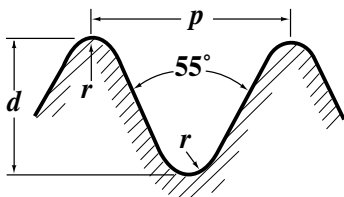
British Standard Whitworth (BSW) and British Standard Fine (BSF) Threads

The BSW is the Coarse Thread series and the BSF is the Fine Thread series of British Standard 84:1956—Parallel Screw Threads of Whitworth Form. The dimensions given in the tables on the following pages for the major, effective, and minor diameters are, respectively, the maximum limits of these diameters for bolts and the minimum limits for nuts. Formulas for the tolerances on these diameters are given in the table below.

Whitworth Standard Thread Form.—This thread form is used for the British Standard Whitworth (BSW) and British Standard Fine (BSF) screw threads. More recently, both threads have been known as parallel screw threads of Whitworth form. With standardization of the Unified thread, the Whitworth thread form is expected to be used only for replacements or spare parts. Tables of British Standard Parallel Screw Threads of Whitworth Form will be found on the following pages; tolerance formulas are given in the table below. The form of the thread is shown by the diagram. If p = pitch, d = depth of thread, r = radius at crest and root, and n = number of threads per inch, then

$$d = \frac{1}{3}p \times \cot 27^\circ 30' = 0.640327p = 0.640327 \div n$$

$$r = 0.137329p = 0.137329 \div n$$



It is recommended that stainless steel bolts of nominal size $\frac{3}{4}$ inch and below should not be made to Close Class limits but rather to Medium or Free Class limits. Nominal sizes above $\frac{3}{4}$ inch should have maximum and minimum limits 0.001 inch smaller than the values obtained from the table.

Tolerance Classes : Close Class bolts. Applies to screw threads requiring a fine snug fit, and should be used only for special work where refined accuracy of pitch and thread form are particularly required. *Medium Class bolts and nuts.* Applies to the better class of ordinary interchangeable screw threads. *Free Class bolts.* Applies to the majority of bolts of ordinary commercial quality. *Normal Class nuts.* Applies to ordinary commercial quality nuts; this class is intended for use with Medium or Free Class bolts.

Table 1. Tolerance Formulas for BSW and BSF Threads

	Class or Fit	Tolerance in inches ^a (+ for nuts, - for bolts)		
		Major Dia.	Effective Dia.	Minor Dia.
Bolts	Close	$\frac{2}{3}T + 0.01 \sqrt{p}$	$\frac{2}{3}T$	$\frac{2}{3}T + 0.013 \sqrt{p}$
	Medium	$T + 0.01 \sqrt{p}$	T	$T + 0.02 \sqrt{p}$
	Free	$\frac{3}{2}T + 0.01 \sqrt{p}$	$\frac{3}{2}T$	$\frac{3}{2}T + 0.02 \sqrt{p}$
Nuts	Close	...	$\frac{2}{3}T$	} { 0.2p + 0.004 ^b 0.2p + 0.005 ^c 0.2p + 0.007 ^d
	Medium	...	T	
	Normal	...	$\frac{3}{2}T$	

^aThe symbol $T = 0.002 \sqrt[3]{D} + 0.003 \sqrt{L} + 0.005 \sqrt{p}$, where D = major diameter of thread in inches; L = length of engagement in inches; p = pitch in inches. The symbol p signifies pitch.

^bFor 26 threads per inch and finer.

^cFor 24 and 22 threads per inch.

^dFor 20 threads per inch and coarser.

Table 2. Threads of Whitworth Form—Basic Dimensions

$p = 1 \div n$ $H = 0.960491p$ $H/6 = 0.160082p$ $h = 0.640327p$ $e = 0.0739176p$ $r = 0.137329p$						
Threads per Inch	Pitch	Triangular Height	Shortening	Depth of Thread	Depth of Rounding	Radius
<i>n</i>	<i>p</i>	<i>H</i>	<i>H/6</i>	<i>h</i>	<i>e</i>	<i>r</i>
72	0.013889	0.013340	0.002223	0.008894	0.001027	0.001907
60	0.016667	0.016009	0.002668	0.010672	0.001232	0.002289
56	0.017857	0.017151	0.002859	0.011434	0.001320	0.002452
48	0.020833	0.020010	0.003335	0.013340	0.001540	0.002861
40	0.025000	0.024012	0.004002	0.016008	0.0011848	0.003433
36	0.027778	0.026680	0.004447	0.017787	0.002053	0.003815
32	0.031250	0.030015	0.005003	0.020010	0.002310	0.004292
28	0.035714	0.034303	0.005717	0.022869	0.002640	0.004905
26	0.038462	0.036942	0.006157	0.024628	0.002843	0.005282
24	0.041667	0.040020	0.006670	0.026680	0.003080	0.005722
22	0.045455	0.043659	0.007276	0.029106	0.003366	0.006242
20	0.050000	0.048025	0.008004	0.032016	0.003696	0.006866
19	0.052632	0.050553	0.008425	0.033702	0.003890	0.007228
18	0.055556	0.053361	0.008893	0.035574	0.004107	0.007629
16	0.062500	0.060031	0.010005	0.040020	0.004620	0.008583
14	0.071429	0.068607	0.011434	0.045738	0.005280	0.009809
12	0.083333	0.080041	0.013340	0.053361	0.006160	0.011444
11	0.090909	0.087317	0.014553	0.058212	0.006720	0.012484
10	0.100000	0.096049	0.016008	0.064033	0.007392	0.013733
9	0.111111	0.106721	0.017787	0.071147	0.008213	0.015259
8	0.125000	0.120061	0.020010	0.080041	0.009240	0.017166
7	0.142857	0.137213	0.022869	0.091475	0.010560	0.019618
6	0.166667	0.160082	0.026680	0.106721	0.012320	0.022888
5	0.200000	0.192098	0.032016	0.128065	0.014784	0.027466
4.5	0.222222	0.213442	0.035574	0.142295	0.016426	0.030518
4	0.250000	0.240123	0.040020	0.160082	0.018479	0.034332
3.5	0.285714	0.274426	0.045738	0.182951	0.021119	0.039237
3.25	0.307692	0.295536	0.049256	0.197024	0.022744	0.042255
3	0.333333	0.320164	0.053361	0.213442	0.024639	0.045776
2.875	0.347826	0.334084	0.055681	0.222722	0.025710	0.047767
2.75	0.363636	0.349269	0.058212	0.232846	0.026879	0.049938
2.625	0.380952	0.365901	0.060984	0.243934	0.028159	0.052316
2.5	0.400000	0.384196	0.064033	0.256131	0.029567	0.054932

Dimensions are in inches.

Allowances: Only Free Class and Medium Class bolts have an allowance. For nominal sizes of 3/4 inch down to 1/4 inch, the allowance is 30 per cent of the Medium Class bolt effective-diameter tolerance (0.3T); for sizes less than 1/4 inch, the allowance for the 1/4-inch size applies. Allowances are applied minus from the basic bolt dimensions; the tolerances are then applied to the reduced dimensions.

Table 3. British Standard Whitworth (BSW) and British Standard Fine (BSF) Screw Thread Series—Basic Dimensions *BS 84:1956 (obsolescent)*

Nominal Size, Inches	Threads per Inch	Pitch, Inches	Depth of Thread, Inches	Major Diameter, Inches	Effective Diameter, Inches	Minor Diameter, Inches	Area at Bottom of Thread, Sq. in.	Tap Drill Dia.
Coarse Thread Series (BSW)								
$\frac{1}{8}$ ^a	40	0.02500	0.0160	0.1250	0.1090	0.9030	0.0068	2.55 mm
$\frac{3}{16}$	24	0.04167	0.0267	0.1875	0.1608	0.1341	0.0141	3.70 mm
$\frac{1}{4}$	20	0.05000	0.0320	0.2500	0.2180	0.1860	0.0272	5.10 mm
$\frac{5}{16}$	18	0.05556	0.0356	0.3125	0.2769	0.2413	0.0457	6.50 mm
$\frac{3}{8}$	16	0.06250	0.0400	0.3750	0.3350	0.2950	0.0683	7.90 mm
$\frac{7}{16}$	14	0.07143	0.0457	0.4375	0.3918	0.3461	0.0941	9.30 mm
$\frac{1}{2}$	12	0.08333	0.0534	0.5000	0.4466	0.3932	0.1214	10.50 mm
$\frac{9}{16}$ ^a	12	0.08333	0.0534	0.5625	0.5091	0.4557	0.1631	12.10 mm
$\frac{5}{8}$	11	0.09091	0.0582	0.6250	0.5668	0.5086	0.2032	13.50 mm
$\frac{11}{16}$ ^a	11	0.09091	0.0582	0.6875	0.6293	0.5711	0.2562	15.00 mm
$\frac{3}{4}$	10	0.10000	0.0640	0.7500	0.6860	0.6220	0.3039	16.25 mm
$\frac{7}{8}$	9	0.11111	0.0711	0.8750	0.8039	0.7328	0.4218	19.25 mm
1	8	0.12500	0.0800	1.0000	0.9200	0.8400	0.5542	22.00 mm
$1\frac{1}{8}$	7	0.14286	0.0915	1.1250	1.0335	0.9420	0.6969	24.75 mm
$1\frac{1}{4}$	7	0.14286	0.0915	1.2500	1.1585	1.0670	0.8942	28.00 mm
$1\frac{1}{2}$	6	0.16667	0.1067	1.5000	1.3933	1.2866	1.3000	33.50 mm
$1\frac{3}{4}$	5	0.20000	0.1281	1.7500	1.6219	1.4938	1.7530	39.00 mm
2	4.5	0.22222	0.1423	2.0000	1.8577	1.7154	2.3110	44.50 mm
$2\frac{1}{4}$	4	0.25000	0.1601	2.2500	2.0899	1.9298	2.9250	
$2\frac{1}{2}$	4	0.25000	0.1601	2.5000	2.3399	2.1798	3.7320	
$2\frac{3}{4}$	3.5	0.28571	0.1830	2.7500	2.5670	2.3840	4.4640	Tap drill diameters shown in this column are recommended sizes listed in BS 1157:1975 and provide from 77 to 87% of full thread.
3	3.5	0.28571	0.1830	3.0000	2.8170	2.6340	5.4490	
$3\frac{1}{2}$ ^a	3.25	0.30769	0.1970	3.2500	3.0530	2.8560	6.4060	
$3\frac{1}{2}$	3.25	0.30769	0.1970	3.5000	3.3030	3.1060	7.5770	
$3\frac{3}{4}$ ^a	3	0.33333	0.2134	3.7500	3.5366	3.3232	8.6740	
4	3	0.33333	0.2134	4.0000	3.7866	3.5732	10.0300	
$4\frac{1}{2}$	2.875	0.34783	0.2227	4.5000	4.2773	4.0546	12.9100	
5	2.75	0.36364	0.2328	5.0000	4.7672	4.5344	16.1500	
$5\frac{1}{2}$	2.625	0.38095	0.2439	5.5000	5.2561	5.0122	19.7300	
6	2.5	0.40000	0.2561	6.0000	5.7439	5.4878	23.6500	
Fine Thread Series (BSF)								
$\frac{3}{16}$ ^{a, b}	32	0.03125	0.0200	0.1875	0.1675	0.1475	0.0171	4.00 mm
$\frac{7}{32}$ ^a	28	0.03571	0.0229	0.2188	0.1959	0.1730	0.0235	4.60 mm
$\frac{1}{4}$	26	0.03846	0.0246	0.2500	0.2254	0.2008	0.0317	5.30 mm
$\frac{9}{32}$ ^a	26	0.03846	0.0246	0.2812	0.2566	0.2320	0.0423	6.10 mm
$\frac{5}{16}$	22	0.04545	0.0291	0.3125	0.2834	0.2543	0.0508	6.80 mm
$\frac{3}{8}$	20	0.05000	0.0320	0.3750	0.3430	0.3110	0.0760	8.30 mm
$\frac{7}{16}$	18	0.05556	0.0356	0.4375	0.4019	0.3363	0.1054	9.70 mm
$\frac{1}{2}$	16	0.06250	0.0400	0.5000	0.4600	0.4200	0.1385	11.10 mm
$\frac{9}{16}$	16	0.06250	0.0400	0.5625	0.5225	0.4825	0.1828	12.70 mm
$\frac{5}{8}$	14	0.07143	0.0457	0.6250	0.5793	0.5336	0.2236	14.00 mm
$\frac{11}{16}$ ^a	14	0.07143	0.0457	0.6875	0.6418	0.5961	0.2791	15.50 mm
$\frac{3}{4}$	12	0.08333	0.0534	0.7500	0.6966	0.6432	0.3249	16.75 mm
$\frac{7}{8}$	11	0.09091	0.0582	0.8750	0.8168	0.7586	0.4520	19.75 mm
1	10	0.10000	0.0640	1.0000	0.9360	0.8720	0.5972	22.75 mm
$1\frac{1}{8}$	9	0.11111	0.0711	1.1250	1.0539	0.9828	0.7586	25.50 mm
$1\frac{1}{4}$	9	0.11111	0.0711	1.2500	1.1789	1.1078	0.9639	28.50 mm
$1\frac{3}{8}$ ^a	8	0.12500	0.0800	1.3750	1.2950	1.2150	1.1590	31.50 mm
$1\frac{1}{2}$	8	0.12500	0.0800	1.5000	1.4200	1.3400	1.4100	34.50 mm
$1\frac{5}{8}$ ^a	8	0.12500	0.0800	1.6250	1.5450	1.4650	1.6860	
$1\frac{3}{4}$	7	0.14286	0.0915	1.7500	1.6585	1.5670	1.9280	
2	7	0.14286	0.0915	2.0000	1.9085	1.8170	2.5930	Tap drill sizes listed in this column are recommended sizes shown in BS 1157:1975 and provide from 78 to 88% of full thread.
$2\frac{1}{4}$	6	0.16667	0.1067	2.2500	2.1433	2.0366	3.2580	
$2\frac{1}{2}$	6	0.16667	0.1067	2.5000	2.3933	2.2866	4.1060	
$2\frac{3}{4}$	6	0.16667	0.1067	2.7500	2.6433	2.5366	5.0540	
3	5	0.20000	0.1281	3.0000	2.8719	2.7438	5.9130	
$3\frac{1}{4}$	5	0.20000	0.1281	3.2500	3.1219	2.9938	7.0390	
$3\frac{1}{2}$	4.5	0.22222	0.1423	3.5000	3.3577	3.2154	8.1200	
$3\frac{3}{4}$	4.5	0.22222	0.1423	3.7500	3.6077	3.4654	9.4320	
4	4.5	0.22222	0.1423	4.0000	3.8577	3.7154	10.8400	
$4\frac{1}{4}$	4	0.25000	0.1601	4.2500	4.0899	3.9298	12.1300	

^a To be dispensed with wherever possible.

^b The use of number 2 BA threads is recommended in place of 3/16-inch BSF thread, see page 1981.

PIPE AND HOSE THREADS

The types of threads used on pipe and pipe fittings may be classed according to their intended use: 1) threads that when assembled with a sealer will produce a pressure-tight joint; 2) threads that when assembled without a sealer will produce a pressure-tight joint; 3) threads that provide free- and loose-fitting mechanical joints without pressure tightness; and 4) threads that produce rigid mechanical joints without pressure tightness.

American National Standard Pipe Threads

American National Standard pipe threads described in the following paragraphs provide taper and straight pipe threads for use in various combinations and with certain modifications to meet these specific needs.

Thread Designation and Notation.—American National Standard Pipe Threads are designated by specifying in sequence the nominal size, number of threads per inch, and the symbols for the thread series and form, as: $\frac{3}{8}$ —18 NPT. The symbol designations are as follows: NPT—American National Standard Taper Pipe Thread; NPTR—American National Standard Taper Pipe Thread for Railing Joints; NPSC—American National Standard Straight Pipe Thread for Couplings; NPSM—American National Standard Straight Pipe Thread for Free-fitting Mechanical Joints; NPSL—American National Standard Straight Pipe Thread for Loose-fitting Mechanical Joints with Locknuts; and NPSH—American National Standard Straight Pipe Thread for Hose Couplings.

American National Standard Taper Pipe Threads.—The basic dimensions of the ANSI Standard taper pipe thread are given in [Table 1a](#).

Form of Thread: The angle between the sides of the thread is 60 degrees when measured in an axial plane, and the line bisecting this angle is perpendicular to the axis. The depth of the truncated thread is based on factors entering into the manufacture of cutting tools and the making of tight joints and is given by the formulas in [Table 1a](#) or the data in [Table 2](#) obtained from these formulas. Although the standard shows flat surfaces at the crest and root of the thread, some rounding may occur in commercial practice, and it is intended that the pipe threads of product shall be acceptable when crest and root of the tools or chasers lie within the limits shown in [Table 2](#).

Pitch Diameter Formulas: In the following formulas, which apply to the ANSI Standard taper pipe thread, E_0 = pitch diameter at end of pipe; E_1 = pitch diameter at the large end of the internal thread and at the gaging notch; D = outside diameter of pipe; L_1 = length of hand-tight or normal engagement between external and internal threads; L_2 = basic length of effective external taper thread; and p = pitch = $1 \div$ number of threads per inch.

$$E_0 = D - (0.05D + 1.1)p$$

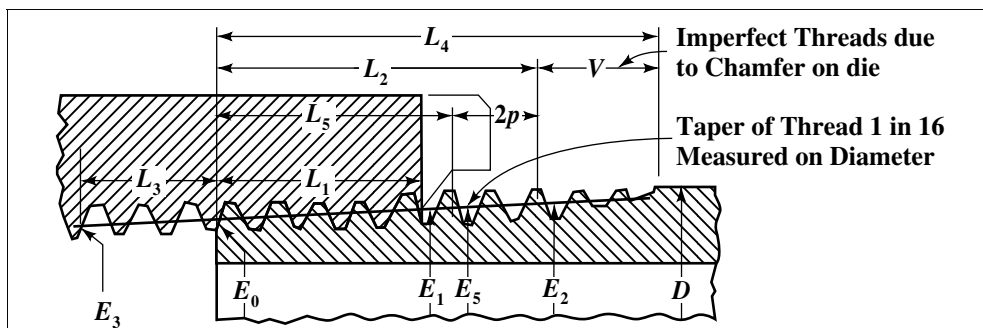
$$E_1 = E_0 + 0.0625L_1$$

Thread Length: The formula for L_2 determines the length of the effective thread and includes approximately two usable threads that are slightly imperfect at the crest. The normal length of engagement, L_1 , between external and internal taper threads, when assembled by hand, is controlled by the use of the gages.

$$L_2 = (0.80D + 6.8)p$$

Taper: The taper of the thread is 1 in 16, or 0.75 inch per foot, measured on the diameter and along the axis. The corresponding half-angle of taper or angle with the center line is 1 degree, 47 minutes.

**Table 1a. Basic Dimensions, American National Standard Taper Pipe Threads, NPT
ANSI/ASME B1.20.1-1983 (R2006)**



For all dimensions, see corresponding reference letter in table.

Angle between sides of thread is 60 degrees. Taper of thread, on diameter, is $\frac{3}{4}$ inch per foot. Angle of taper with center line is $1^{\circ}47'$.

The basic maximum thread height, h , of the truncated thread is $0.8 \times$ pitch of thread. The crest and root are truncated a minimum of $0.033 \times$ pitch for all pitches. For maximum depth of truncation, see Table 2.

Nominal Pipe Size	Outside Dia. of Pipe, D	Threads per Inch, n	Pitch of Thread, p	Pitch Diameter at Beginning of External Thread, E_0	Handtight Engagement		Effective Thread, External	
					Length, ^a L_1	Dia., ^b E_1	Length, ^c L_2	Dia., E_2
					Inch		Inch	
$\frac{1}{16}$	0.3125	27	0.03704	0.27118	0.160	0.28118	0.2611	0.28750
$\frac{1}{8}$	0.405	27	0.03704	0.36351	0.1615	0.37360	0.2639	0.38000
$\frac{1}{4}$	0.540	18	0.05556	0.47739	0.2278	0.49163	0.4018	0.50250
$\frac{3}{8}$	0.675	18	0.05556	0.61201	0.240	0.62701	0.4078	0.63750
$\frac{1}{2}$	0.840	14	0.07143	0.75843	0.320	0.77843	0.5337	0.79179
$\frac{3}{4}$	1.050	14	0.07143	0.96768	0.339	0.98887	0.5457	1.00179
1	1.315	$11\frac{1}{2}$	0.08696	1.21363	0.400	1.23863	0.6828	1.25630
$1\frac{1}{4}$	1.660	$11\frac{1}{2}$	0.08696	1.55713	0.420	1.58338	0.7068	1.60130
$1\frac{1}{2}$	1.900	$11\frac{1}{2}$	0.08696	1.79609	0.420	1.82234	0.7235	1.84130
2	2.375	$11\frac{1}{2}$	0.08696	2.26902	0.436	2.29627	0.7565	2.31630
$2\frac{1}{2}$	2.875	8	0.12500	2.71953	0.682	2.76216	1.1375	2.79062
3	3.500	8	0.12500	3.34062	0.766	3.38850	1.2000	3.41562
$3\frac{1}{2}$	4.000	8	0.12500	3.83750	0.821	3.88881	1.2500	3.91562
4	4.500	8	0.12500	4.33438	0.844	4.38712	1.3000	4.41562
5	5.563	8	0.12500	5.39073	0.937	5.44929	1.4063	5.47862
6	6.625	8	0.12500	6.44609	0.958	6.50597	1.5125	6.54062
8	8.625	8	0.12500	8.43359	1.063	8.50003	1.7125	8.54062
10	10.750	8	0.12500	10.54531	1.210	10.62094	1.9250	10.66562
12	12.750	8	0.12500	12.53281	1.360	12.61781	2.1250	12.66562
14 OD	14.000	8	0.12500	13.77500	1.562	13.87262	2.2500	13.91562
16 OD	16.000	8	0.12500	15.76250	1.812	15.87575	2.4500	15.91562
18 OD	18.000	8	0.12500	17.75000	2.000	17.87500	2.6500	17.91562
20 OD	20.000	8	0.12500	19.73750	2.125	19.87031	2.8500	19.91562
24 OD	24.000	8	0.12500	23.71250	2.375	23.86094	3.2500	23.91562

^a Also length of thin ring gage and length from gaging notch to small end of plug gage.

^b Also pitch diameter at gaging notch (handtight plane).

^c Also length of plug gage.

**Table 1b. Basic Dimensions, American National Standard Taper Pipe Threads, NPT
ANSI/ASME B1.20.1-1983 (R2006)**

Nominal Pipe Size	Wrench Makeup Length for Internal Thread		Vanish Thread, (3.47 thds.), V	Overall Length External Thread, L_4	Nominal Perfect External Threads ^a		Height of Thread, h	Basic Minor Dia. at Small End of Pipe, ^b K_0
	Length, ^c L_3	Dia., E_3			Length, L_5	Dia., E_5		
1/16	0.1111	0.26424	0.1285	0.3896	0.1870	0.28287	0.02963	0.2416
1/8	0.1111	0.35656	0.1285	0.3924	0.1898	0.37537	0.02963	0.3339
1/4	0.1667	0.46697	0.1928	0.5946	0.2907	0.49556	0.04444	0.4329
3/8	0.1667	0.60160	0.1928	0.6006	0.2967	0.63056	0.04444	0.5676
1/2	0.2143	0.74504	0.2478	0.7815	0.3909	0.78286	0.05714	0.7013
3/4	0.2143	0.95429	0.2478	0.7935	0.4029	0.99286	0.05714	0.9105
1	0.2609	1.19733	0.3017	0.9845	0.5089	1.24543	0.06957	1.1441
1 1/4	0.2609	1.54083	0.3017	1.0085	0.5329	1.59043	0.06957	1.4876
1 1/2	0.2609	1.77978	0.3017	1.0252	0.5496	1.83043	0.06957	1.7265
2	0.2609	2.25272	0.3017	1.0582	0.5826	2.30543	0.06957	2.1995
2 1/2	0.2500 ^d	2.70391	0.4337	1.5712	0.8875	2.77500	0.100000	2.6195
3	0.2500 ^d	3.32500	0.4337	1.6337	0.9500	3.40000	0.100000	3.2406
3 1/2	0.2500	3.82188	0.4337	1.6837	1.0000	3.90000	0.100000	3.7375
4	0.2500	4.31875	0.4337	1.7337	1.0500	4.40000	0.100000	4.2344
5	0.2500	5.37511	0.4337	1.8400	1.1563	5.46300	0.100000	5.2907
6	0.2500	6.43047	0.4337	1.9462	1.2625	6.52500	0.100000	6.3461
8	0.2500	8.41797	0.4337	2.1462	1.4625	8.52500	0.100000	8.3336
10	0.2500	10.52969	0.4337	2.3587	1.6750	10.65000	0.100000	10.4453
12	0.2500	12.51719	0.4337	2.5587	1.8750	12.65000	0.100000	12.4328
14 OD	0.2500	13.75938	0.4337	2.6837	2.0000	13.90000	0.100000	13.6750
16 OD	0.2500	15.74688	0.4337	2.8837	2.2000	15.90000	0.100000	15.6625
18 OD	0.2500	17.73438	0.4337	3.0837	2.4000	17.90000	0.100000	17.6500
20 OD	0.2500	19.72188	0.4337	3.2837	2.6000	19.90000	0.100000	19.6375
24 OD	0.2500	23.69688	0.4337	3.6837	3.0000	23.90000	0.100000	23.6125

^a The length L_5 from the end of the pipe determines the plane beyond which the thread form is imperfect at the crest. The next two threads are perfect at the root. At this plane the cone formed by the crests of the thread intersects the cylinder forming the external surface of the pipe. $L_5 = L_2 - 2p$.

^b Given as information for use in selecting tap drills.

^c Three threads for 2-inch size and smaller; two threads for larger sizes.

^d Military Specification MIL—P—7105 gives the wrench makeup as three threads for 3 in. and smaller. The E_3 dimensions are then as follows: Size 2 1/2 in., 2.69609 and size 3 in., 3.31719.

All dimensions given in inches.

Increase in diameter per thread is equal to $0.0625/n$.

The basic dimensions of the ANSI Standard Taper Pipe Thread are given in inches to four or five decimal places. While this implies a greater degree of precision than is ordinarily attained, these dimensions are the basis of gage dimensions and are so expressed for the purpose of eliminating errors in computations.

Engagement Between External and Internal Taper Threads.—The normal length of engagement between external and internal taper threads when screwed together handtight is shown as L_1 in **Table 1a**. This length is controlled by the construction and use of the pipe thread gages. It is recognized that in special applications, such as flanges for high-pressure work, longer thread engagement is used, in which case the pitch diameter E_1 (**Table 1a**) is maintained and the pitch diameter E_0 at the end of the pipe is proportionately smaller.

Tolerances on Thread Elements.—The maximum allowable variation in the commercial product (manufacturing tolerance) is one turn large or small from the basic dimensions.

The permissible variations in thread elements on steel products and all pipe made of steel, wrought iron, or brass, exclusive of butt-weld pipe, are given in **Table 3**. This table is a

guide for establishing the limits of the thread elements of taps, dies, and thread chasers. These limits may be required on product threads.

On pipe fittings and valves (not steel) for steam pressures 300 pounds and below, it is intended that plug and ring gage practice as set up in the Standard ANSI/ASME B1.20.1 will provide for a satisfactory check of accumulated variations of taper, lead, and angle in such product. Therefore, no tolerances on thread elements have been established for this class.

For service conditions where a more exact check is required, procedures have been developed by industry to supplement the regulation plug and ring method of gaging.

Table 2. Limits on Crest and Root of American National Standard External and Internal Taper Pipe Threads, NPT ANSI/ASME B1.20.1-1983 (R2006)

Threads per Inch	Height of Sharp V Thread, <i>H</i>	Height of Pipe Thread, <i>h</i>		Truncation, <i>f</i>		Width of Flat, <i>F</i> , Equivalent to Truncation	
		Max.	Min.	Min.	Max.	Min.	Max.
27	0.03208	0.02963	0.02496	0.0012	0.0036	0.0014	0.0041
18	0.04811	0.04444	0.03833	0.0018	0.0049	0.0021	0.0057
14	0.06186	0.05714	0.05071	0.0024	0.0056	0.0027	0.0064
11½	0.07531	0.06957	0.06261	0.0029	0.0063	0.0033	0.0073
8	0.10825	0.10000	0.09275	0.0041	0.0078	0.0048	0.0090

All dimensions are in inches and are given to four or five decimal places only to avoid errors in computations, not to indicate required precision.

Table 3. Tolerances on Taper, Lead, and Angle of Pipe Threads of Steel Products and All Pipe of Steel, Wrought Iron, or Brass ANSI/ASME B1.20.1-1983 (R2006) (Exclusive of Butt-Weld Pipe)

Nominal Pipe Size	Threads per Inch	Taper on Pitch Line (¾ in./ft)		Lead in Length of Effective Threads	60 Degree Angle of Threads, Degrees
		Max.	Min.		
1/16, 1/8	27	+1/8	-1/16	±0.003	± 2½
1/4, 3/8	18	+1/8	-1/16	±0.003	±2
1/2, 3/4	14	+1/8	-1/16	±0.003 ^a	±2
1, 1¼, 1½, 2	11½	+1/8	-1/16	±0.003 ^a	±1½
2½ and larger	8	+1/8	-1/16	±0.003 ^a	±1½

^a The tolerance on lead shall be ± 0.003 in. per inch on any size threaded to an effective thread length greater than 1 in.

For tolerances on height of thread, see Table 2.

The limits specified in this table are intended to serve as a guide for establishing limits of the thread elements of taps, dies, and thread chasers. These limits may be required on product threads.

Table 4. Internal Threads in Pipe Couplings, NPSC for Pressure-tight Joints with Lubricant or Sealer ANSI/ASME B1.20.1-1983 (R2006)

Nom. Pipe Size	Thds. per Inch	Minor ^a Dia.	Pitch Diameter ^b		Nom. Pipe Size	Thds. per Inch	Minor ^a Dia.	Pitch Diameter ^b	
		Min.	Min.	Max.			Min.	Min.	Max.
1/8	27	0.340	0.3701	0.3771	1 1/2	11 1/2	1.745	1.8142	1.8305
1/4	18	0.442	0.4864	0.4968	2	11 1/2	2.219	2.2881	2.3044
3/8	18	0.577	0.6218	0.6322	2 1/2	8	2.650	2.7504	2.7739
1/2	14	0.715	0.7717	0.7851	3	8	3.277	3.3768	3.4002
3/4	14	0.925	0.9822	0.9956	3 1/2	8	3.777	3.8771	3.9005
1	11 1/2	1.161	1.2305	1.2468	4	8	4.275	4.3754	4.3988
1 1/4	11 1/2	1.506	1.5752	1.5915

^a As the ANSI Standard Pipe Thread form is maintained, the major and minor diameters of the internal thread vary with the pitch diameter. All dimensions are given in inches.

^b The actual pitch diameter of the straight tapped hole will be slightly smaller than the value given when gaged with a taper plug gage as called for in ANSI/ASME B1.20.1.

Railing Joint Taper Pipe Threads, NPTR.—Railing joints require a rigid mechanical thread joint with external and internal taper threads. The external thread is basically the same as the ANSI Standard Taper Pipe Thread, except that sizes 1/2 through 2 inches are shortened by 3 threads and sizes 2 1/2 through 4 inches are shortened by 4 threads to permit the use of the larger end of the pipe thread. A recess in the fitting covers the last scratch or imperfect threads on the pipe.

Straight Pipe Threads in Pipe Couplings, NPSC.—Threads in pipe couplings made in accordance with the ANSI/ASME B1.20.1 specifications are straight (parallel) threads of the same thread form as the ANSI Standard Taper Pipe Thread. They are used to form pressure-tight joints when assembled with an ANSI Standard external taper pipe thread and made up with lubricant or sealant. These joints are recommended for comparatively low pressures only.

Straight Pipe Threads for Mechanical Joints, NPSM, NPSL, and NPSH.—While external and internal taper pipe threads are recommended for pipe joints in practically every service, there are mechanical joints where straight pipe threads are used to advantage. Three types covered by ANSI/ASME B1.20.1 are:

Loose-fitting Mechanical Joints With Locknuts (External and Internal), NPSL: This thread is designed to produce a pipe thread having the largest diameter that it is possible to cut on standard pipe. The dimensions of these threads are given in Table 5. It will be noted that the maximum major diameter of the external thread is slightly greater than the nominal outside diameter of the pipe. The normal manufacturer's variation in pipe diameter provides for this increase.

Loose-fitting Mechanical Joints for Hose Couplings (External and Internal), NPSH:

Hose coupling joints are ordinarily made with straight internal and external loose-fitting threads. There are several standards of hose threads having various diameters and pitches. One of these is based on the ANSI Standard pipe thread and by the use of this thread series, it is possible to join small hose couplings in sizes 1/2 to 4 inches, inclusive, to ends of standard pipe having ANSI Standard External Pipe Threads, using a gasket to seal the joints. For the hose coupling thread dimensions see *ANSI Standard Hose Coupling Screw Threads* starting on page 1968.

Free-fitting Mechanical Joints for Fixtures (External and Internal), NPSM: Standard iron, steel, and brass pipe are often used for special applications where there are no internal pressures. Where straight thread joints are required for mechanical assemblies, straight pipe threads are often found more suitable or convenient. Dimensions of these threads are given in Table 5.

Table 5. American National Standard Straight Pipe Threads for Mechanical Joints, NPSM and NPSL ANSI/ASME B1.20.1-1983 (R2006)

Nominal Pipe Size	Threads per Inch	External Thread				Internal Thread				
		Allowance	Major Diameter		Pitch Diameter		Minor Diameter		Pitch Diameter	
			Max. ^a	Min.	Max.	Min.	Min. ^a	Max.	Min. ^b	Max.
Free-fitting Mechanical Joints for Fittings—NPSM										
1/8	27	0.0011	0.397	0.390	0.3725	0.3689	0.358	0.364	0.3736	0.3783
1/4	18	0.0013	0.526	0.517	0.4903	0.4859	0.468	0.481	0.4916	0.4974
3/8	18	0.0014	0.662	0.653	0.6256	0.6211	0.603	0.612	0.6270	0.6329
1/2	14	0.0015	0.823	0.813	0.7769	0.7718	0.747	0.759	0.7784	0.7851
3/4	14	0.0016	1.034	1.024	0.9873	0.9820	0.958	0.970	0.9889	0.9958
1	11 1/2	0.0017	1.293	1.281	1.2369	1.2311	1.201	1.211	1.2386	1.2462
1 1/4	11 1/2	0.0018	1.638	1.626	1.5816	1.5756	1.546	1.555	1.5834	1.5912
1 1/2	11 1/2	0.0018	1.877	1.865	1.8205	1.8144	1.785	1.794	1.8223	1.8302
2	11 1/2	0.0019	2.351	2.339	2.2944	2.2882	2.259	2.268	2.2963	2.3044
2 1/2	8	0.0022	2.841	2.826	2.7600	2.7526	2.708	2.727	2.7622	2.7720
3	8	0.0023	3.467	3.452	3.3862	3.3786	3.334	3.353	3.3885	3.3984
3 1/2	8	0.0023	3.968	3.953	3.8865	3.8788	3.835	3.848	3.8888	3.8988
4	8	0.0023	4.466	4.451	4.3848	4.3771	4.333	4.346	4.3871	4.3971
5	8	0.0024	5.528	5.513	5.4469	5.4390	5.395	5.408	5.4493	5.4598
6	8	0.0024	6.585	6.570	6.5036	6.4955	6.452	6.464	6.5060	6.5165
Loose-fitting Mechanical Joints for Locknut Connections—NPSL										
1/8	27	...	0.409	...	0.3840	0.3805	0.362	...	0.3863	0.3898
1/4	18	...	0.541	...	0.5038	0.4986	0.470	...	0.5073	0.5125
3/8	18	...	0.678	...	0.6409	0.6357	0.607	...	0.6444	0.6496
1/2	14	...	0.844	...	0.7963	0.7896	0.753	...	0.8008	0.8075
3/4	14	...	1.054	...	1.0067	1.0000	0.964	...	1.0112	1.0179
1	11 1/2	...	1.318	...	1.2604	1.2523	1.208	...	1.2658	1.2739
1 1/4	11 1/2	...	1.663	...	1.6051	1.5970	1.553	...	1.6106	1.6187
1 1/2	11 1/2	...	1.902	...	1.8441	1.8360	1.792	...	1.8495	1.8576
2	11 1/2	...	2.376	...	2.3180	2.3099	2.265	...	2.3234	2.3315
2 1/2	8	...	2.877	...	2.7934	2.7817	2.718	...	2.8012	2.8129
3	8	...	3.503	...	3.4198	3.4081	3.344	...	3.4276	3.4393
3 1/2	8	...	4.003	...	3.9201	3.9084	3.845	...	3.9279	3.9396
4	8	...	4.502	...	4.4184	4.4067	4.343	...	4.4262	4.4379
5	8	...	5.564	...	5.4805	5.4688	5.405	...	5.4884	5.5001
6	8	...	6.620	...	6.5372	6.5255	6.462	...	6.5450	6.5567
8	8	...	8.615	...	8.5313	8.5196	8.456	...	8.5391	8.5508
10	8	...	10.735	...	10.6522	10.6405	10.577	...	10.6600	10.6717
12	8	...	12.732	...	12.6491	12.6374	12.574	...	12.6569	12.6686

^a As the ANSI Standard Straight Pipe Thread form of thread is maintained, the major and the minor diameters of the internal thread and the minor diameter of the external thread vary with the pitch diameter. The major diameter of the external thread is usually determined by the diameter of the pipe. These theoretical diameters result from adding the depth of the truncated thread ($0.666025 \times p$) to the maximum pitch diameters, and it should be understood that commercial pipe will not always have these maximum major diameters.

^b This is the same as the pitch diameter at end of internal thread, E_1 Basic. (See Table 1a.)

All dimensions are given in inches.

Notes for Free-fitting Fixture Threads: The minor diameters of external threads and major diameters of internal threads are those as produced by commercial straight pipe dies and commercial ground straight pipe taps.

The major diameter of the external thread has been calculated on the basis of a truncation of $0.10825p$, and the minor diameter of the internal thread has been calculated on the basis of a truncation of $0.21651p$, to provide no interference at crest and root when product is gaged with gages made in accordance with the Standard.

Notes for Loose-fitting Locknut Threads: The locknut thread is established on the basis of retaining the greatest possible amount of metal thickness between the bottom of the thread and the inside of the pipe. In order that a locknut may fit loosely on the externally threaded part, an allowance equal to the “increase in pitch diameter per turn” is provided, with a tolerance of $1\frac{1}{2}$ turns for both external and internal threads.

American National Standard Dryseal Pipe Threads for Pressure-Tight Joints.—

Dryseal pipe threads are based on the USA (American) pipe thread; however, they differ in that they are designed to seal pressure-tight joints without the necessity of using sealing compounds. To accomplish this, some modification of thread form and greater accuracy in manufacture is required. The roots of both the external and internal threads are truncated slightly more than the crests, i.e., roots have wider flats than crests so that metal-to-metal contact occurs at the crests and roots coincident with, or prior to, flank contact. Thus, as the threads are assembled by wrenching, the roots of the threads crush the sharper crests of the mating threads. This sealing action at both major and minor diameters tends to prevent spiral leakage and makes the joints pressure-tight without the necessity of using sealing compounds, provided that the threads are in accordance with standard specifications and tolerances and are not damaged by galling in assembly. The control of crest and root truncation is simplified by the use of properly designed threading tools. Also, it is desirable that both external and internal threads have full thread height for the length of hand engagement. Where not functionally objectionable, the use of a compatible lubricant or sealant is permissible to minimize the possibility of galling. This is desirable in assembling Dryseal pipe threads in refrigeration and other systems to effect a pressure-tight seal. The crest and root of Dryseal pipe threads may be slightly rounded, but are acceptable if they lie within the truncation limits given in **Table 6**.

Table 6. American National Standard Dryseal Pipe Threads—Limits on Crest and Root Truncation ANSI B1.20.3-1976 (R2008)

Threads Per Inch	Height of Sharp V Thread (<i>H</i>)	Truncation							
		Minimum				Maximum			
		At Crest		At Root		At Crest		At Root	
		Formula	Inch	Formula	Inch	Formula	Inch	Formula	Inch
27	0.03208	$0.047p$	0.0017	$0.094p$	0.0035	$0.094p$	0.0035	$0.140p$	0.0052
18	0.04811	$0.047p$	0.0026	$0.078p$	0.0043	$0.078p$	0.0043	$0.109p$	0.0061
14	0.06180	$0.036p$	0.0026	$0.060p$	0.0043	$0.060p$	0.0043	$0.085p$	0.0061
11½	0.07531	$0.040p$	0.0035	$0.060p$	0.0052	$0.060p$	0.0052	$0.090p$	0.0078
8	0.10825	$0.042p$	0.0052	$0.055p$	0.0069	$0.055p$	0.0069	$0.076p$	0.0095

All dimensions are given in inches. In the formulas, p = pitch.

Types of Dryseal Pipe Thread.—American National Standard ANSI B1.20.3-1976 (R2008) covers four types of standard Dryseal pipe threads:

NPTF, Dryseal USA (American) Standard Taper Pipe Thread

PTF-SAE SHORT, Dryseal SAE Short Taper Pipe Thread

NPSF, Dryseal USA (American) Standard Fuel Internal Straight Pipe Thread

NPSI, Dryseal USA (American) Standard Intermediate Internal Straight Pipe Thread

Table 7. Recommended Limitation of Assembly among the Various Types of Dryseal Threads

External Dryseal Thread		For Assembly with Internal Dryseal Thread	
Type	Description	Type	Description
1	NPTF (tapered), ext thd	1	NPTF (tapered), int thd
		2 ^{a,b}	PTF-SAE SHORT (tapered), int thd
		3 ^{a,c}	NPSF (straight), int thd
		4 ^{a,c,d}	NPSI (straight), int thd
2 ^{a,e}	PTF-SAE SHORT (tapered) ext thd	4	NPSI (straight), int thd
		1	NPTF (tapered), int thd

^a Pressure-tight joints without the use of a sealant can best be ensured where both components are threaded with NPTF (full length threads), since theoretically interference (sealing) occurs at all threads, but there are two less threads engaged than for NPTF assemblies. When straight internal threads are used, there is interference only at one thread depending on ductility of materials.

^b PTF-SAE SHORT internal threads are primarily intended for assembly with type 1-NPTF external threads. They are not designed for, and at extreme tolerance limits may not assemble with, type 2-PTF-SAE SHORT external threads.

^c There is no external straight Dryseal thread.

^d NPSI internal threads are primarily intended for assembly with type 2-PTF-SAE SHORT external threads but will also assemble with full length type 1 NPTF external threads.

^e PTF-SAE SHORT external threads are primarily intended for assembly with type 4-NPSI internal threads but can also be used with type 1-NPTF internal threads. They are not designed for, and at extreme tolerance limits may not assemble with, type 2-PTF-SAE SHORT internal threads or type 3-NPSF internal threads.

An assembly with straight internal pipe threads and taper external pipe threads is frequently more advantageous than an all taper thread assembly, particularly in automotive and other allied industries where economy and rapid production are major considerations. Dryseal threads are not used in assemblies in which both components have straight pipe threads.

NPTF Threads: This type applies to both external and internal threads and is suitable for pipe joints in practically every type of service. Of all Dryseal pipe threads, NPTF external and internal threads mated are generally conceded to be superior for strength and seal since they have the longest length of thread and, theoretically, interference (sealing) occurs at every engaged thread root and crest. Use of tapered internal threads, such as NPTF or PTF-SAE SHORT in hard or brittle materials having thin sections will minimize the possibility of fracture.

There are two classes of NPTF threads. Class 1 threads are made to interfere (seal) at root and crest when mated, but inspection of crest and root truncation is not required. Consequently, Class 1 threads are intended for applications where close control of tooling is required for conformance of truncation or where sealing is accomplished by means of a sealant applied to the threads.

Class 2 threads are theoretically identical to those made to Class 1, however, inspection of root and crest truncation is required. Consequently, where a sealant is not used, there is more assurance of a pressure-tight seal for Class 2 threads than for Class 1 threads.

PTF-SAE SHORT Threads: External threads of this type conform in all respects with NPTF threads except that the thread length has been shortened by eliminating one thread from the small (entering) end. These threads are designed for applications where clearance is not sufficient for the full length of the NPTF threads or for economy of material where the full thread length is not necessary.

Internal threads of this type conform in all respects with NPTF threads, except that the thread length has been shortened by eliminating one thread from the large (entry) end. These threads are designed for thin materials where thickness is not sufficient for the full thread length of the NPTF threads or for economy in tapping where the full thread length is not necessary.

Pressure-tight joints without the use of lubricant or sealer can best be ensured where mating components are both threaded with NPTF threads. This should be considered before specifying PTF-SAE SHORT external or internal threads.

NPSF Threads: Threads of this type are straight (cylindrical) instead of tapered and are internal only. They are more economical to produce than tapered internal threads, but when assembled do not offer as strong a guarantee of sealing since root and crest interference will not occur for all threads. NPSF threads are generally used with soft or ductile materials which will tend to adjust at assembly to the taper of external threads, but may be used in hard or brittle materials where the section is thick.

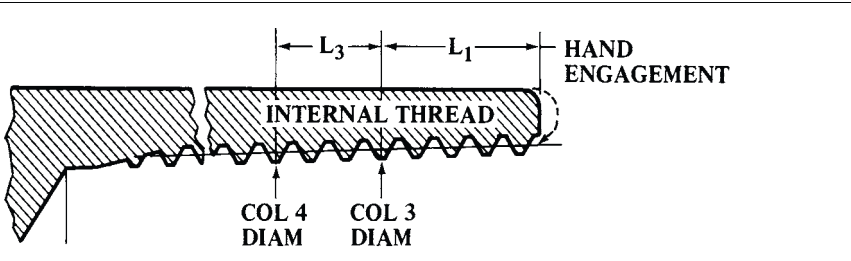
NPSI Threads: Threads of this type are straight (cylindrical) instead of tapered, are internal only and are slightly larger in diameter than NPSF threads but have the same tolerance and thread length. They are more economical to produce than tapered threads and may be used in hard or brittle materials where the section is thick or where there is little expansion at assembly with external taper threads. As with NPSF threads, NPSI threads when assembled do not offer as strong a guarantee of sealing as do tapered internal threads.

For more complete specifications for production and acceptance of Dryseal pipe threads, see ANSI B1.20.3 (Inch) and ANSI B1.20.4 (Metric Translation), and for gaging and inspection, see ANSI B1.20.5 (Inch) and ANSI B1.20.6M (Metric Translation).

Designation of Dryseal Pipe Threads: The standard Dryseal pipe threads are designated by specifying in sequence nominal size, thread series symbol, and class:

Examples: 1/8-27 NPTF-1; 1/8-27 PTF-SAE SHORT; and 3/8-18 NPTF-1 AFTER PLATING.

Table 8. Suggested Tap Drill Sizes for Internal Dryseal Pipe Threads



Size	Probable Drill Oversize Cut (Mean)	Taper Pipe Thread				Straight Pipe Thread		
		Minor Diameter At Distance		Drill Size ^a		Minor Diameter		Drill Size ^a
		L ₁ From Large End	L ₁ + L ₃ From Large End	Without Reamer	With Reamer	NPSF	NPSI	
1/16-27	0.0038	0.2443	0.2374	“C” (0.242)	“A” (0.234)	0.2482	0.2505	“D” (0.246)
1/8-27	0.0044	0.3367	0.3298	“Q” (0.332)	2 1/64 (0.328)	0.3406	0.3429	“R” (0.339)
1/4-18	0.0047	0.4362	0.4258	7/16 (0.438)	27/64 (0.422)	0.4422	0.4457	7/16 (0.438)
3/8-18	0.0049	0.5708	0.5604	9/16 (0.562)	9/16 (0.563)	0.5776	0.5811	37/64 (0.578)
1/2-14	0.0051	0.7034	0.6901	45/64 (0.703)	11/16 (0.688)	0.7133	0.7180	45/64 (0.703)
3/4-14	0.0060	0.9127	0.8993	29/32 (0.906)	57/64 (0.891)	0.9238	0.9283	59/64 (0.922)
1-11 1/2	0.0080	1.1470	1.1307	1 1/64 (1.141)	1 1/8 (1.125)	1.1600	1.1655	1 5/32 (1.156)
1 1/4-11 1/2	0.0100	1.4905	1.4742	1 31/64 (1.484)	1 15/32 (1.469)
1 1/2-11 1/2	0.0120	1.7295	1.7132	1 23/32 (1.719)	1 45/64 (1.703)
2-11 1/2	0.0160	2.2024	2.1861	2 3/16 (2.188)	2 11/64 (2.172)
2 1/2-8	0.0180	2.6234	2.6000	2 29/64 (2.609)	2 37/64 (2.578)
3-8	0.0200	3.2445	3.2211	3 15/64 (3.234)	3 13/64 (3.203)

^a Some drill sizes listed may not be standard drills.

All dimensions are given in inches.

Special Dryseal Threads.—Where design limitations, economy of material, permanent installation, or other limiting conditions prevail, consideration may be given to using a special Dryseal thread series.

Dryseal Special Short Taper Pipe Thread, PTF-SPL SHORT: Threads of this series conform in all respects to PTF-SAE SHORT threads except that the full thread length has been further shortened by eliminating one thread at the small end of internal threads or one thread at the large end of external threads.

Dryseal Special Extra Short Taper Pipe Thread, PTF-SPL EXTRA SHORT: Threads of this series conform in all respects to PTF-SAE SHORT threads except that the full thread length has been further shortened by eliminating two threads at the small end of internal threads or two threads at the large end of external threads.

Limitations of Assembly: Table 9 applies where Dryseal Special Short or Extra Short Taper Pipe Threads are to be assembled as special combinations.

Table 9. Assembly Limitations for Special Combinations of Dryseal Threads

Thread	May Assemble with ^a	May Assemble with ^b
PTF SPL SHORT EXTERNAL PTF SPL EXTRA SHORT EXTERNAL	PTF-SAE SHORT INTERNAL NPSF INTERNAL PTF SPL SHORT INTERNAL PTF SPL EXTRA SHORT INTERNAL	NPTF or NPSI INTERNAL
PTF SPL SHORT INTERNAL PTF SPL EXTRA SHORT INTERNAL	PTF-SAE SHORT EXTERNAL	NPTF EXTERNAL

^a Only when the external thread or the internal thread or both are held closer than the standard tolerance, the external thread toward the minimum and the internal thread toward the maximum pitch diameter to provide a minimum of one turn hand engagement. At extreme tolerance limits the shortened full-thread lengths reduce hand engagement and the threads may not start to assemble.

^b Only when the internal thread or the external thread or both are held closer than the standard tolerance, the internal thread toward the minimum and the external thread toward the maximum pitch diameter to provide a minimum of two turns for wrench make-up and sealing. At extreme tolerance limits the shortened full-thread lengths reduce wrench make-up and the threads may not seal.

Dryseal Fine Taper Thread Series, F-PTF: The need for finer pitches for nominal pipe sizes has brought into use applications of 27 threads per inch to $\frac{1}{4}$ - and $\frac{3}{8}$ -inch pipe sizes. There may be other needs that require finer pitches for larger pipe sizes. It is recommended that the existing threads per inch be applied to the next larger pipe size for a fine thread series, thus: $\frac{1}{4}$ -27, $\frac{3}{8}$ -27, $\frac{1}{2}$ -18, $\frac{3}{4}$ -18, 1-14, $1\frac{1}{4}$ -14, $1\frac{1}{2}$ -14, and 2-14. This series applies to external and internal threads of full length and is suitable for applications where threads finer than NPTF are required.

Dryseal Special Diameter-Pitch Combination Series, SPL-PTF: Other applications of diameter-pitch combinations have come into use where taper pipe threads are applied to nominal size thin wall tubing. These combinations are: $\frac{1}{2}$ -27, $\frac{5}{8}$ -27, $\frac{3}{4}$ -27, $\frac{7}{8}$ -27, and 1-27. This series applies to external and internal threads of full length and is applicable to thin wall nominal diameter outside tubing.

Designation of Special Dryseal Pipe Threads: The designations used for these special dryseal pipe threads are as follows:

$\frac{1}{8}$ -27 PTF-SPL SHORT

$\frac{1}{8}$ -27 PTF-SPL EXTRA SHORT

$\frac{1}{2}$ -27 SPL PTF, OD 0.500

Note that in the last designation the OD of tubing is given.

British Standard Pipe Threads

British Standard Pipe Threads for Non-pressure-tight Joints.—The threads in BS 2779:1973, “Specifications for Pipe Threads where Pressure-tight Joints are not Made on the Threads”, are Whitworth form parallel fastening threads that are generally used for fastening purposes such as the mechanical assembly of component parts of fittings, cocks and valves. They are not suitable where pressure-tight joints are made on the threads.

The crests of the basic Whitworth thread form may be truncated to certain limits of size given in the Standard except on internal threads, when they are likely to be assembled with external threads conforming to the requirements of BS 21 “British Standard Pipe Threads for Pressure-tight Joints” (see page 1966).

For external threads two classes of tolerance are provided and for internal, one class. The two classes of tolerance for external threads are Class A and Class B. For economy of manufacture the class B fit should be chosen whenever possible. The class A is reserved for those applications where the closer tolerance is essential. Class A tolerance is an entirely negative value, equivalent to the internal thread tolerance. Class B tolerance is an entirely negative value twice that of class A tolerance. Tables showing limits and dimensions are given in the Standard.

The thread series specified in this Standard shall be designated by the letter "G". A typical reference on a drawing might be "G $\frac{1}{2}$ ", for internal thread; "G $\frac{1}{2}$ A", for external thread, class A; and "G $\frac{1}{2}$ B", for external thread, class B. Where no class reference is stated for external threads, that of class B will be assumed. The designation of truncated threads shall have the addition of the letter "T" to the designation, i.e., G $\frac{1}{2}$ T and G $\frac{1}{2}$ BT.

**British Standard Pipe Threads (Non-pressure-tight Joints)
Metric and Inch Basic Sizes BS 2779:1973**

Nominal Size, Inches	Threads per Inch ^a	Depth of Thread	Major Diameter	Pitch Diameter	Minor Diameter	Nominal Size, Inches	Threads per Inch ^a	Depth of Thread	Major Diameter	Pitch Diameter	Minor Diameter
$\frac{1}{16}$	28 {	0.581 <i>0.0229</i>	7.723 <i>0.3041</i>	7.142 <i>0.2812</i>	6.561 <i>0.2583</i>	$1\frac{3}{4}$	11 {	1.479 <i>0.0582</i>	53.746 <i>2.1160</i>	52.267 <i>2.0578</i>	50.788 <i>1.9996</i>
$\frac{1}{8}$	28 {	0.581 <i>0.0229</i>	9.728 <i>0.3830</i>	9.147 <i>0.3601</i>	8.566 <i>0.3372</i>	2	11 {	1.479 <i>0.0582</i>	59.614 <i>2.3470</i>	58.135 <i>2.2888</i>	56.656 <i>2.2306</i>
$\frac{1}{4}$	19 {	0.856 <i>0.0337</i>	13.157 <i>0.5180</i>	12.301 <i>0.4843</i>	11.445 <i>0.4506</i>	$2\frac{1}{4}$	11 {	1.479 <i>0.0582</i>	65.710 <i>2.5870</i>	64.231 <i>2.5288</i>	62.752 <i>2.4706</i>
$\frac{3}{8}$	19 {	0.856 <i>0.0337</i>	16.662 <i>0.6560</i>	15.806 <i>0.6223</i>	14.950 <i>0.5886</i>	$2\frac{1}{2}$	11 {	1.479 <i>0.0582</i>	75.184 <i>2.9600</i>	73.705 <i>2.9018</i>	72.226 <i>2.8436</i>
$\frac{1}{2}$	14 {	1.162 <i>0.0457</i>	20.955 <i>0.8250</i>	19.793 <i>0.7793</i>	18.631 <i>0.7336</i>	$2\frac{3}{4}$	11 {	1.479 <i>0.0582</i>	81.534 <i>3.2100</i>	80.055 <i>3.1518</i>	78.576 <i>3.0936</i>
$\frac{5}{8}$	14 {	1.162 <i>0.0457</i>	22.911 <i>0.9020</i>	21.749 <i>0.8563</i>	20.587 <i>0.8106</i>	3	11 {	1.479 <i>0.0582</i>	87.884 <i>3.4600</i>	86.405 <i>3.4018</i>	84.926 <i>3.3336</i>
$\frac{3}{4}$	14 {	1.162 <i>0.0457</i>	26.441 <i>1.0410</i>	25.279 <i>0.9953</i>	24.117 <i>0.9496</i>	$3\frac{1}{2}$	11 {	1.479 <i>0.0582</i>	100.330 <i>3.9500</i>	98.851 <i>3.8918</i>	97.372 <i>3.8336</i>
$\frac{7}{8}$	14 {	1.162 <i>0.0457</i>	30.201 <i>1.1890</i>	29.039 <i>1.1433</i>	27.877 <i>1.0976</i>	4	11 {	1.479 <i>0.0582</i>	113.030 <i>4.4500</i>	111.551 <i>4.3918</i>	110.072 <i>4.3336</i>
1	11 {	1.479 <i>0.0582</i>	33.249 <i>1.3090</i>	31.770 <i>1.2508</i>	30.291 <i>1.1926</i>	$4\frac{1}{2}$	11 {	1.479 <i>0.0582</i>	125.730 <i>4.9500</i>	124.251 <i>4.8918</i>	122.772 <i>4.8336</i>
$1\frac{1}{8}$	11 {	1.479 <i>0.0582</i>	37.897 <i>1.4920</i>	36.418 <i>1.4338</i>	34.939 <i>1.3756</i>	5	11 {	1.479 <i>0.0582</i>	138.430 <i>5.4500</i>	136.951 <i>5.3918</i>	135.472 <i>5.3336</i>
$1\frac{1}{4}$	11 {	1.479 <i>0.0582</i>	41.910 <i>1.6500</i>	40.431 <i>1.5918</i>	38.952 <i>1.5336</i>	$5\frac{1}{2}$	11 {	1.479 <i>0.0582</i>	151.130 <i>5.9500</i>	149.651 <i>5.8918</i>	148.172 <i>5.8336</i>
$1\frac{1}{2}$	11 {	1.479 <i>0.0582</i>	47.803 <i>1.8820</i>	46.324 <i>1.8238</i>	44.845 <i>1.7656</i>	6	11 {	1.479 <i>0.0582</i>	163.830 <i>6.4500</i>	162.351 <i>6.3918</i>	160.872 <i>6.3336</i>

^a The thread pitches in millimeters are as follows: 0.907 for 28 threads per inch, 1.337 for 19 threads per inch, 1.814 for 14 threads per inch, and 2.309 for 11 threads per inch.

Each basic metric dimension is given in roman figures (nominal sizes excepted) and each basic inch dimension is shown in italics directly beneath it.

British Standard Pipe Threads for Pressure-tight Joints.—The threads in BS 21:1973, "Specification for Pipe Threads where Pressure-tight Joints are Made on the Threads", are based on the Whitworth thread form and are specified as:

1) *Jointing threads*: These relate to pipe threads for joints made pressure-tight by the mating of the threads; they include taper external threads for assembly with either taper or parallel internal threads (parallel external pipe threads are not suitable as jointing threads).

2) *Longscrew threads*: These relate to parallel external pipe threads used for longscrews (connectors) specified in BS 1387 where a pressure-tight joint is achieved by the compression of a soft material onto the surface of the external thread by tightening a back nut against a socket.

**British Standard External and Internal Pipe Threads (Pressure-tight Joints)
Metric and Inch Dimensions and Limits of Size BS 21:1973**

Nominal Size	No. of Threads per Inch ^a		Basic Diameters at Gage Plane			Gage Length		Number of Useful Threads on Pipe for Basic Gage Length ^b	Tolerance + and -	
			Major	Pitch	Minor	Basic	Tolerance (+ and -)		Gage Plane to Face of Int. Taper Thread	On Diameter of Parallel Int. Threads
1/16	28	{	7.723	7.142	6.561	(4 3/8)	(1)	(7 1/8)	(1 1/4)	0.071
			<i>0.304</i>	<i>0.2812</i>	<i>0.2583</i>	4.0	0.9	6.5	1.1	<i>0.0028</i>
1/8	28	{	9.728	9.147	8.566	(4 3/8)	(1)	(7 1/8)	(1 1/4)	0.071
			<i>0.383</i>	<i>0.3601</i>	<i>0.3372</i>	4.0	0.9	6.5	1.1	<i>0.0028</i>
1/4	19	{	13.157	12.301	11.445	(4 1/2)	(1)	(7 1/4)	(1 1/4)	0.104
			<i>0.518</i>	<i>0.4843</i>	<i>0.4506</i>	6.0	1.3	9.7	1.7	<i>0.0041</i>
3/8	19	{	16.662	15.806	14.950	(4 3/4)	(1)	(7 1/2)	(1 1/4)	0.104
			<i>0.656</i>	<i>0.6223</i>	<i>0.5886</i>	6.4	1.3	10.1	1.7	<i>0.0041</i>
1/2	14	{	20.955	19.793	18.631	(4 1/2)	(1)	(7 1/4)	(1 1/4)	0.142
			<i>0.825</i>	<i>0.7793</i>	<i>0.7336</i>	8.2	1.8	13.2	2.3	<i>0.0056</i>
3/4	14	{	26.441	25.279	24.117	(5 1/4)	(1)	(8)	(1 1/4)	0.142
			<i>1.041</i>	<i>0.9953</i>	<i>0.9496</i>	9.5	1.8	14.5	2.3	<i>0.0056</i>
1	11	{	33.249	31.770	30.291	(4 1/2)	(1)	(7 1/4)	(1 1/4)	0.180
			<i>1.309</i>	<i>1.2508</i>	<i>1.1926</i>	10.4	2.3	16.8	2.9	<i>0.0071</i>
1 1/4	11	{	41.910	40.431	38.952	(5 1/2)	(1)	(8 1/4)	(1 1/4)	0.180
			<i>1.650</i>	<i>1.5918</i>	<i>1.5336</i>	12.7	2.3	19.1	2.9	<i>0.0071</i>
1 1/2	11	{	47.803	46.324	44.845	(5 1/2)	(1)	(8 1/4)	(1 1/4)	0.180
			<i>1.882</i>	<i>1.8238</i>	<i>1.7656</i>	12.7	2.3	19.1	2.9	<i>0.0071</i>
2	11	{	59.614	58.135	56.656	(6 3/8)	(1)	(10 1/8)	(1 1/4)	0.180
			<i>2.347</i>	<i>2.2888</i>	<i>2.2306</i>	15.9	2.3	23.4	2.9	<i>0.0071</i>
2 1/2	11	{	75.184	73.705	72.226	(7 1/16)	(1 1/2)	(11 1/16)	(1 1/2)	0.216
			<i>2.960</i>	<i>2.9018</i>	<i>2.8436</i>	17.5	3.5	26.7	3.5	<i>0.0085</i>
3	11	{	87.884	86.405	84.926	(8 15/16)	(1 1/2)	(12 15/16)	(1 1/2)	0.216
			<i>3.460</i>	<i>3.4018</i>	<i>3.3436</i>	20.6	3.5	29.8	3.5	<i>0.0085</i>
4	11	{	113.030	111.551	110.072	(11)	(1 1/2)	(15 1/2)	(1 1/2)	0.216
			<i>4.450</i>	<i>4.3918</i>	<i>4.3336</i>	25.4	3.5	35.8	3.5	<i>0.0085</i>
5	11	{	138.430	136.951	135.472	(12 3/8)	(1 1/2)	(17 3/8)	(1 1/2)	0.216
			<i>5.450</i>	<i>5.3918</i>	<i>5.3336</i>	28.6	3.5	40.1	3.5	<i>0.0085</i>
6	11	{	163.830	162.351	160.872	(12 3/8)	(1 1/2)	(17 3/8)	(1 1/2)	0.216
			<i>6.450</i>	<i>6.3918</i>	<i>6.3336</i>	28.6	3.5	40.1	3.5	<i>0.0085</i>

^a In the Standard BS 21:1973 the thread pitches in millimeters are as follows: 0.907 for 28 threads per inch, 1.337 for 19 threads per inch, 1.814 for 14 threads per inch, and 2.309 for 11 threads per inch.

^b This is the minimum number of useful threads on the pipe for the basic gage length; for the maximum and minimum gage lengths, the minimum numbers of useful threads are, respectively, greater and less by the amount of tolerance in the column to the left. The design of internally threaded parts shall make allowance for receiving pipe ends of up to the minimum number of useful threads corresponding to the maximum gage length; the minimum number of useful *internal* threads shall be no less than 80 per cent of the minimum number of useful external threads for the minimum gage length.

Each basic metric dimension is given in roman figures (nominal sizes excepted) and each basic inch dimension is shown in italics directly beneath it. Figures in () are numbers of turns of thread with metric linear equivalents given beneath. Taper of taper thread is 1 in 16 on diameter.

Hose Coupling Screw Threads

ANSI Standard Hose Coupling Screw Threads.—Threads for hose couplings, valves, and all other fittings used in direct connection with hose intended for domestic, industrial, and general service in sizes $\frac{1}{2}$, $\frac{5}{8}$, $\frac{3}{4}$, 1, $1\frac{1}{4}$, $1\frac{1}{2}$, 2, $2\frac{1}{2}$, 3, $3\frac{1}{2}$, and 4 inches are covered by American National Standard ANSI/ASME B1.20.7-1991 These threads are designated as follows:

- NH — Standard hose coupling threads of full form as produced by cutting or rolling.
- NHR — Standard hose coupling threads for garden hose applications where the design utilizes thin walled material which is formed to the desired thread.
- NPSH — Standard straight hose coupling thread series in sizes $\frac{1}{2}$ to 4 inches for joining to American National Standard taper pipe threads using a gasket to seal the joint.

Thread dimensions are given in **Table 1** and thread lengths in **Table 2**.

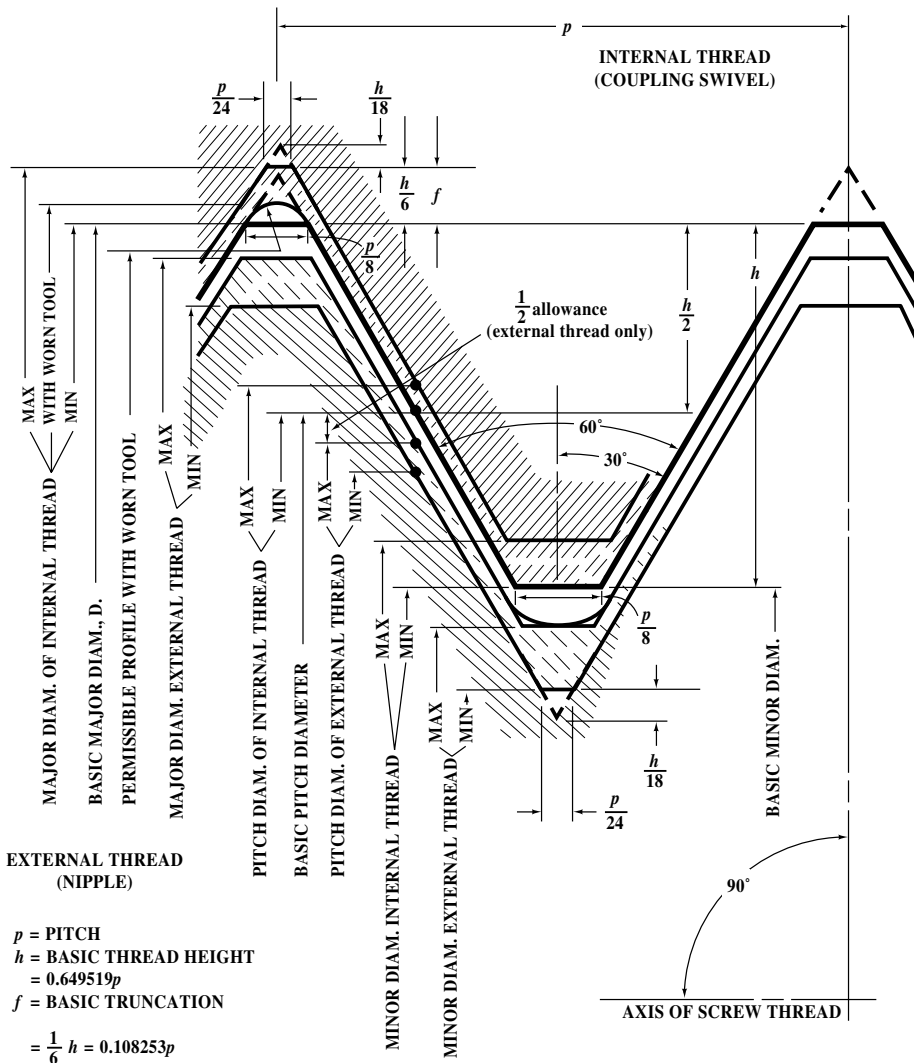


Fig. 1. Thread Form for ANSI Standard Hose Coupling Threads, NPSH, NH, and NHR. Heavy Line Shows Basic Size.

**Table 1. ANSI Standard Hose Coupling Threads for NPSH, NH, and NHR Nipples and Coupling Swivels
ANSI/ASME B1.20.7-1991 (R2008)**

Nominal Size of Hose	Threads per Inch	Thread Designation	Pitch	Basic Height of Thread	Nipple (External) Thread					Coupling (Internal) Thread				
					Major Dia.		Pitch Dia.		Minor Dia.	Minor Dia.		Pitch Dia.		Major Dia.
					Max.	Min.	Max.	Min.	Max.	Min.	Max.	Min.	Max.	Min.
1/2, 5/8, 3/4	11.5	.75-11.5NH	.08696	.05648	1.0625	1.0455	1.0060	0.9975	0.9495	0.9595	0.9765	1.0160	1.0245	1.0725
1/2, 5/8, 3/4	11.5	.75-11.5NHR	.08696	.05648	1.0520	1.0350	1.0100	0.9930	0.9495	0.9720	0.9930	1.0160	1.0280	1.0680
1/2	14	.5-14NPSH	.07143	.04639	0.8248	0.8108	0.7784	0.7714	0.7320	0.7395	0.7535	0.7859	0.7929	0.8323
3/4	14	.75-14NPSH	.07143	.04639	1.0353	1.0213	0.9889	0.9819	0.9425	0.9500	0.9640	0.9964	1.0034	1.0428
1	11.5	1-11.5NPSH	.08696	.05648	1.2951	1.2781	1.2396	1.2301	1.1821	1.1921	1.2091	1.2486	1.2571	1.3051
1 1/4	11.5	1.25-11.5NPSH	.08696	.05648	1.6399	1.6229	1.5834	1.5749	1.5269	1.5369	1.5539	1.5934	1.6019	1.6499
1 1/2	11.5	1.5-11.5 NPSH	.08696	.05648	1.8788	1.8618	1.8223	1.8138	1.7658	1.7758	1.7928	1.8323	1.8408	1.8888
2	11.5	2-11.5NPSH	.08696	.05648	2.3528	2.3358	2.2963	2.2878	2.2398	2.2498	2.2668	2.3063	2.3148	2.3628
2 1/2	8	2.5-8NPSH	.12500	.08119	2.8434	2.8212	2.7622	2.7511	2.6810	2.6930	2.7152	2.7742	2.7853	2.8554
3	8	3-8NPSH	.12500	.08119	3.4697	3.4475	3.3885	3.3774	3.3073	3.3193	3.3415	3.4005	3.4116	3.4817
3 1/2	8	3.5-8NPSH	.12500	.08119	3.9700	3.9478	3.8888	3.8777	3.8076	3.8196	3.8418	3.9008	3.9119	3.9820
4	8	4-8NPSH	.12500	.08119	4.4683	4.4461	4.3871	4.3760	4.3059	4.3179	4.3401	4.3991	4.4102	4.4803
4	6	4-6NH (SPL)	.16667	.10825	4.9082	4.8722	4.7999	4.7819	4.6916	4.7117	4.7477	4.8200	4.8380	4.9283

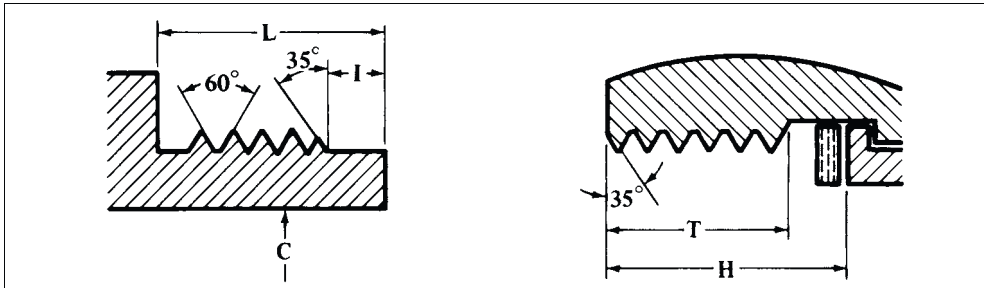
All dimensions are given in inches.

Dimensions given for the maximum minor diameter of the nipple are figured to the intersection of the worn tool arc with a centerline through crest and root. The minimum minor diameter of the nipple shall be that corresponding to a flat at the minor diameter of the minimum nipple equal to 1/2p, and may be determined by subtracting 0.7939p from the minimum pitch diameter of the nipple. (See Fig. 1)

Dimensions given for the minimum major diameter of the coupling correspond to the basic flat, 1/8p, and the profile at the major diameter produced by a worn tool must not fall below the basic outline. The maximum major diameter of the coupling shall be that corresponding to a flat at the major diameter of the maximum coupling equal to 1/2p and may be determined by adding 0.7939p to the maximum pitch diameter of the coupling. (See Fig. 1)

NH and NHR threads are used for garden hose applications. NPSH threads are used for steam, air and all other hose connections to be made up with standard pipe threads. NH (SPL) threads are used for marine applications.

Table 2. ANSI Standard Hose Coupling Screw Thread Lengths
ANSI/ASME B1.20.7-1991 (R2008)



Nominal Size of Hose	Threads per Inch	I.D. of Nipple, C	Approx. O.D. of Ext. Thd.	Length of Nipple, L	Length of Pilot, I	Depth of Coupl., H	Coupl. Thd. Length, T	Approx. No. Thds. in Length T
1/2, 5/8, 3/4	11.5	25/32	1 1/16	9/16	1/8	17/32	3/8	4 1/4
1/2, 5/8, 3/4	11.5	25/32	1 1/16	9/16	1/8	17/32	3/8	4 1/4
1/2	14	17/32	1 3/16	1/2	1/8	15/32	5/16	4 1/4
3/4	14	25/32	1 1/32	9/16	1/8	17/32	3/8	5 1/4
1	11.5	1 1/32	1 9/32	9/16	5/32	17/32	3/8	4 1/4
1 1/4	11.5	1 9/32	1 5/8	5/8	5/32	19/32	15/32	5 1/2
1 1/2	11.5	1 17/32	1 7/8	5/8	5/32	19/32	15/32	5 1/2
2	11.5	2 1/32	2 1 1/32	3/4	3/16	23/32	19/32	6 3/4
2 1/2	8	2 17/32	2 27/32	1	1/4	15/16	11/16	5 1/2
3	8	3 1/32	3 15/32	1 1/8	1/4	1 1/16	13/16	6 1/2
3 1/2	8	3 17/32	3 31/32	1 1/8	1/4	1 1/16	13/16	6 1/2
4	8	4 1/32	4 15/32	1 1/8	1/4	1 1/16	13/16	6 1/2
4	6	4	4 29/32	1 1/8	5/16	1 1/16	3/4	4 1/2

All dimensions are given in inches. For thread designation see [Table 1](#).

American National Fire Hose Connection Screw Thread.—This thread is specified in the National Fire Protection Association's Standard NFPA No. 194-1974. It covers the dimensions for screw thread connections for fire hose couplings, suction hose couplings, relay supply hose couplings, fire pump suction, discharge valves, fire hydrants, nozzles, adaptors, reducers, caps, plugs, wyes, siamese connections, standpipe connections, and sprinkler connections.

Form of Thread: The basic form of thread is as shown in [Fig. 1](#). It has an included angle of 60 degrees and is truncated top and bottom. The flat at the root and crest of the basic thread form is equal to 1/8 (0.125) times the pitch in inches. The height of the thread is equal to 0.649519 times the pitch. The outer ends of both external and internal threads are terminated by the blunt start or "Higbee Cut" on full thread to avoid crossing and mutilation of thread.

Thread Designation: The thread is designated by specifying in sequence the nominal size of the connection, number of threads per inch followed by the thread symbol NH.

Thus, .75-8NH indicates a nominal size connection of 0.75 inch diameter with 8 threads per inch.

Basic Dimensions: The basic dimensions of the thread are as given in **Table 1**.

Table 1. Basic Dimensions of NH Threads NFPA 1963-1993 Edition

Nom. Size	Threads per Inch (tpi)	Thread Designation	Pitch, <i>p</i>	Basic Thread Height, <i>h</i>	Minimum Internal Thread Dimensions		
					Min. Minor Dia.	Basic Pitch Dia.	Basic Major Dia.
¾	8	0.75-8 NH	0.12500	0.08119	1.2246	1.3058	1.3870
1	8	1-8 NH	0.12500	0.08119	1.2246	1.3058	1.3870
1½	9	1.5-9 NH	0.11111	0.07217	1.8577	1.9298	2.0020
2½	7.5	2.5-7.5 NH	0.13333	0.08660	2.9104	2.9970	3.0836
3	6	3-6 NH	0.16667	0.10825	3.4223	3.5306	3.6389
3½	6	3.5-6 NH	0.16667	0.10825	4.0473	4.1556	4.2639
4	4	4-4 NH	0.25000	0.16238	4.7111	4.8735	5.0359
4½	4	4.5-4 NH	0.25000	0.16238	5.4611	5.6235	5.7859
5	4	5-4 NH	0.25000	0.16238	5.9602	6.1226	6.2850
6	4	6-4 NH	0.25000	0.16238	6.7252	6.8876	7.0500
Nom. Size	Threads per Inch (tpi)	Thread Designation	Pitch, <i>p</i>	External Thread Dimensions (Nipple)			
				Allowance	Max. Major Dia.	Max. Pitch Dia.	Max Minor Dia.
¾	8	0.75-8 NH	0.12500	0.0120	1.3750	1.2938	1.2126
1	8	1-8 NH	0.12500	0.0120	1.3750	1.2938	1.2126
1½	9	1.5-9 NH	0.11111	0.0120	1.9900	1.9178	1.8457
2½	7.5	2.5-7.5 NH	0.13333	0.0150	3.0686	2.9820	2.8954
3	6	3-6 NH	0.16667	0.0150	3.6239	3.5156	3.4073
3½	6	3.5-6 NH	0.16667	0.0200	4.2439	4.1356	4.0273
4	4	4-4 NH	0.25000	0.0250	5.0109	4.8485	4.6861
4½	4	4.5-4 NH	0.25000	0.0250	5.7609	5.5985	5.4361
5	4	5-4 NH	0.25000	0.0250	6.2600	6.0976	5.9352
6	4	6-4 NH	0.25000	0.0250	7.0250	6.8626	6.7002

All dimensions are in inches.

Thread Limits of Size: Limits of size for NH external threads are given in **Table 2**. Limits of size for NH internal threads are given in **Table 3**.

Tolerances: The pitch-diameter tolerances for mating external and internal threads are the same. Pitch-diameter tolerances include lead and half-angle deviations. Lead deviations consuming one-half of the pitch-diameter tolerance are 0.0032 inch for ¾-, 1-, and 1½-inch sizes; 0.0046 inch for 2½-inch size; 0.0052 inch for 3-, and 3½-inch sizes; and 0.0072 inch for 4-, 4½-, 5-, and 6-inch sizes. Half-angle deviations consuming one-half of the pitch-diameter tolerance are 1 degree, 42 minutes for ¾- and 1-inch sizes; 1 degree, 54 minutes for 1½-inch size; 2 degrees, 17 minutes for 2½-inch size; 2 degrees, 4 minutes for 3- and 3½-inch size; and 1 degree, 55 minutes for 4-, 4½-, 5-, and 6-inch sizes.

Tolerances for the external threads are:

Major diameter tolerance = 2 × pitch-diameter tolerance

Minor diameter tolerance = pitch-diameter tolerance + 2*h*/9

The minimum minor diameter of the external thread is such as to result in a flat equal to one-third of the *p*/8 basic flat, or *p*/24, at the root when the pitch diameter of the external thread is at its minimum value. The maximum minor diameter is basic, but may be such as results from the use of a worn or rounded threading tool. The maximum minor diameter is shown in **Fig. 1** and is the diameter upon which the minor diameter tolerance formula shown above is based.

Tolerances for the internal threads are:

Minor diameter tolerance = $2 \times$ pitch-diameter tolerance

The minimum minor diameter of the internal thread is such as to result in a basic flat, $p/8$, at the crest when the pitch diameter of the thread is at its minimum value.

Major diameter tolerance = pitch-diameter tolerance - $2h/9$

Table 2. Limits of Size and Tolerances for NH External Threads (Nipples)
NFPA 1963, 1993 Edition

Nom. Size	Threads per Inch (tpi)	External Thread (Nipple)						
		Major Diameter			Pitch Diameter			Minor ^a Dia.
		Max.	Min.	Toler.	Max.	Min.	Toler.	Max.
$\frac{3}{4}$	8	1.3750	1.3528	0.0222	1.2938	1.2827	0.0111	1.2126
1	8	1.3750	1.3528	0.0222	1.2938	1.2827	0.0111	1.2126
$1\frac{1}{2}$	9	1.9900	1.9678	0.0222	1.9178	1.9067	0.0111	1.8457
$2\frac{1}{2}$	7.5	3.0686	3.0366	0.0320	2.9820	2.9660	0.0160	2.8954
3	6	3.6239	3.5879	0.0360	3.5156	3.4976	0.0180	3.4073
$3\frac{1}{2}$	6	4.2439	4.2079	0.0360	4.1356	4.1176	0.0180	4.0273
4	4	5.0109	4.9609	0.0500	4.8485	4.8235	0.0250	4.6861
$4\frac{1}{2}$	4	5.7609	5.7109	0.0500	5.5985	5.5735	0.0250	5.4361
5	4	6.2600	6.2100	0.0500	6.0976	6.0726	0.0250	5.9352
6	4	7.0250	6.9750	0.0500	6.8626	6.8376	0.0250	6.7002

^aDimensions given for the maximum minor diameter of the nipple are figured to the intersection of the worn tool arc with a center line through crest and root. The minimum minor diameter of the nipple shall be that corresponding to a flat at the minor diameter of the minimum nipple equal to $p/24$ and may be determined by subtracting $11h/9$ (or $0.7939p$) from the minimum pitch diameter of the nipple.

All dimensions are in inches.

Table 3. Limits of Size and Tolerances for NH Internal Threads (Couplings)
NFPA 1963, 1993 Edition

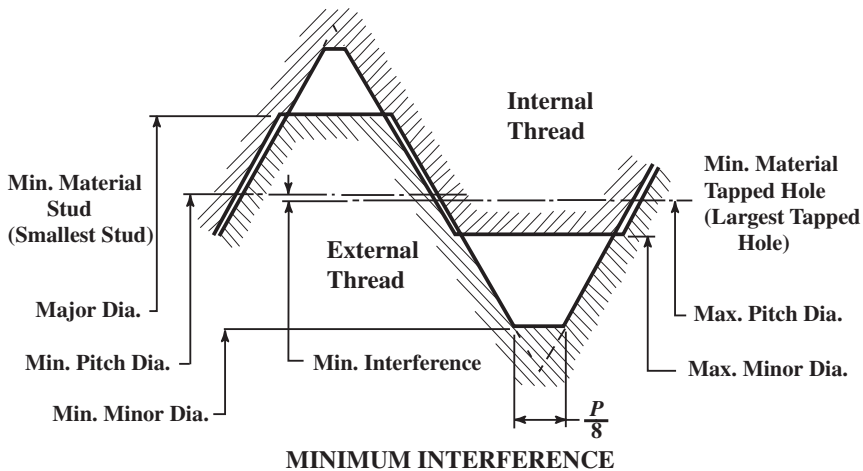
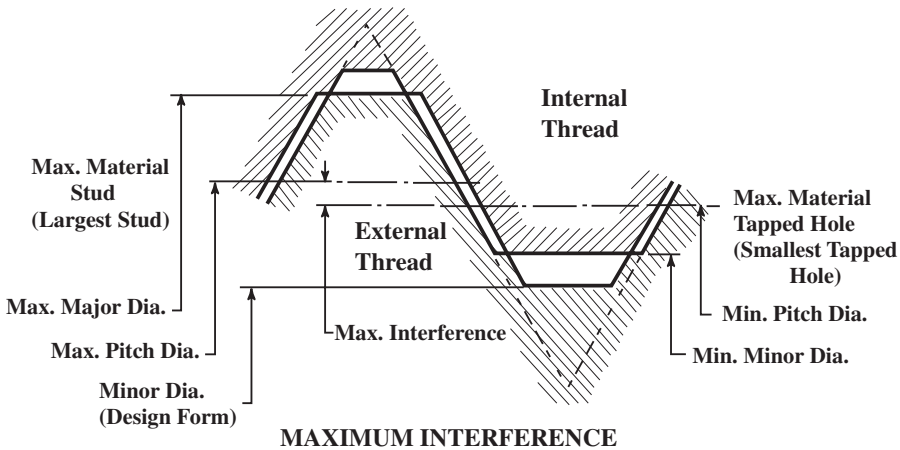
Nom. Size	Threads per Inch (tpi)	Internal Thread (Coupling)						
		Minor Diameter			Pitch Diameter			Major ^a Dia.
		Min.	Max.	Toler.	Min.	Max.	Toler.	Min.
$\frac{3}{4}$	8	1.2246	1.2468	0.0222	1.3058	1.3169	0.0111	1.3870
1	8	1.2246	1.2468	0.0222	1.3058	1.3169	0.0111	1.3870
$1\frac{1}{2}$	9	1.8577	1.8799	0.0222	1.9298	1.9409	0.0111	2.0020
$2\frac{1}{2}$	7.5	2.9104	2.9424	0.0320	2.9970	3.0130	0.0160	3.0836
3	6	3.4223	3.4583	0.0360	3.5306	3.5486	0.0180	3.6389
$3\frac{1}{2}$	6	4.0473	4.0833	0.0360	4.1556	4.1736	0.0180	4.2639
4	4	4.7111	4.7611	0.0500	4.8735	4.8985	0.0250	5.0359
$4\frac{1}{2}$	4	5.4611	5.5111	0.0500	5.6235	5.6485	0.0250	5.7859
5	4	5.9602	6.0102	0.0500	6.1226	6.1476	0.0250	6.2850
6	4	6.7252	6.7752	0.0500	6.8876	6.9126	0.0250	7.0500

^aDimensions for the minimum major diameter of the coupling correspond to the basic flat ($p/8$), and the profile at the major diameter produced by a worn tool must not fall below the basic outline. The maximum major diameter of the coupling shall be that corresponding to a flat at the major diameter of the maximum coupling equal to $p/24$ and may be determined by adding $11h/9$ (or $0.7939p$) to the maximum pitch diameter of the coupling.

All dimensions are in inches.

Gages and Gaging: Full information on gage dimensions and the use of gages in checking the NH thread are given in NFPA Standard No. 1963, 1993 Edition, published by the National Fire Protection Association, Batterymarch Park, Quincy, MA 02269.

The information and data taken from this standard are reproduced with the permission of the NFPA.



Note: Plastic flow of interference metal into cavities at major and minor diameters is not illustrated.

Maximum and Minimum Material Limits for Class 5 Interference-Fit Thread

Design and Application Data for Class 5 Interference-Fit Threads.—Following are conditions of usage and inspection on which satisfactory application of products made to dimensions in [Tables 1, 2, and 3](#) are based.

Thread Designations: The following thread designations provide a means of distinguishing the American Standard Class 5 Threads from the tentative Class 5 and alternate Class 5 threads, specified in Handbook H28. They also distinguish between external and internal American Standard Class 5 Threads.

Class 5 External Threads are designated as follows:

NC-5 HF—For driving in hard ferrous material of hardness over 160 BHN.

NC-5 CSF—For driving in copper alloy and soft ferrous material of 160 BHN or less.

NC-5 ONF—For driving in other nonferrous material (nonferrous materials other than copper alloys), any hardness.

Class 5 Internal Threads are designated as follows:

NC-5 IF—Entire ferrous material range.

NC-5 INF—Entire nonferrous material range.

**Table 1. External Thread Dimensions for Class 5 Interference-Fit Threads
ANSI/ASME B1.12-1987 (R2008)**

Nominal Size	Major Diameter, Inches						Pitch Diameter, Inches		Minor Diameter, Inches
	NC-5 HF for driving in ferrous material with hardness greater than 160 BHN $L_e = 1\frac{1}{4}$ Diam.		NC-5 CSF for driving in brass and ferrous material with hardness equal to or less than 160 BHN $L_e = 1\frac{1}{4}$ Diam.		NC-5 ONF for driving in nonferrous except brass (any hardness) $L_e = 2\frac{1}{2}$ Diam.				
	Max	Min	Max	Min	Max	Min	Max	Min	
0.2500-20	0.2470	0.2418	0.2470	0.2418	0.2470	0.2418	0.2230	0.2204	0.1932
0.3125-18	0.3080	0.3020	0.3090	0.3030	0.3090	0.3030	0.2829	0.2799	0.2508
0.3750-16	0.3690	0.3626	0.3710	0.3646	0.3710	0.3646	0.3414	0.3382	0.3053
0.4375-14	0.4305	0.4233	0.4330	0.4258	0.4330	0.4258	0.3991	0.3955	0.3579
0.5000-13	0.4920	0.4846	0.4950	0.4876	0.4950	0.4876	0.4584	0.4547	0.4140
0.5625-12	0.5540	0.5460	0.5575	0.5495	0.5575	0.5495	0.5176	0.5136	0.4695
0.6250-11	0.6140	0.6056	0.6195	0.6111	0.6195	0.6111	0.5758	0.5716	0.5233
0.7500-10	0.7360	0.7270	0.7440	0.7350	0.7440	0.7350	0.6955	0.6910	0.6378
0.8750- 9	0.8600	0.8502	0.8685	0.8587	0.8685	0.8587	0.8144	0.8095	0.7503
1.0000- 8	0.9835	0.9727	0.9935	0.9827	0.9935	0.9827	0.9316	0.9262	0.8594
1.1250- 7	1.1070	1.0952	1.1180	1.1062	1.1180	1.1062	1.0465	1.0406	0.9640
1.2500- 7	1.2320	1.2200	1.2430	1.2312	1.2430	1.2312	1.1715	1.1656	1.0890
1.3750- 6	1.3560	1.3410	1.3680	1.3538	1.3680	1.3538	1.2839	1.2768	1.1877
1.5000- 6	1.4810	1.4670	1.4930	1.4788	1.4930	1.4788	1.4089	1.4018	1.3127

Based on external threaded members being steel ASTM A-325 (SAE Grade 5) or better. L_e = length of engagement.

**Table 2. Internal Thread Dimensions for Class 5 Interference-Fit Threads
ANSI/ASME B1.12-1987 (R2008)**

Nominal Size	NC-5 IF Ferrous Material			NC-5 INF Nonferrous Material			Pitch Diameter		Major Diam.
	Minor Diam. ^a		Tap Drill	Minor Diam. ^a		Tap Drill			
	Min	Max		Min	Max		Min	Max	
0.2500-20	0.196	0.206	0.2031	0.196	0.206	0.2031	0.2175	0.2201	0.2532
0.3125-18	0.252	0.263	0.2610	0.252	0.263	0.2610	0.2764	0.2794	0.3161
0.3750-16	0.307	0.318	0.3160	0.307	0.318	0.3160	0.3344	0.3376	0.3790
0.4375-14	0.374	0.381	0.3750	0.360	0.372	0.3680	0.3911	0.3947	0.4421
0.5000-13	0.431	0.440	0.4331	0.417	0.429	0.4219	0.4500	0.4537	0.5050
0.5625-12	0.488	0.497	0.4921	0.472	0.485	0.4844	0.5084	0.5124	0.5679
0.6250-11	0.544	0.554	0.5469	0.527	0.540	0.5313	0.5660	0.5702	0.6309
0.7500-10	0.667	0.678	0.6719	0.642	0.655	0.6496	0.6850	0.6895	0.7565
0.8750- 9	0.777	0.789	0.7812	0.755	0.769	0.7656	0.8028	0.8077	0.8822
1.0000- 8	0.890	0.904	0.8906	0.865	0.880	0.8750	0.9188	0.9242	1.0081
1.1250- 7	1.000	1.015	1.0000	0.970	0.986	0.9844	1.0322	1.0381	1.1343
1.2500- 7	1.125	1.140	1.1250	1.095	1.111	1.1094	1.1572	1.1631	1.2593
1.3750- 6	1.229	1.247	1.2344	1.195	1.213	1.2031	1.2667	1.2738	1.3858
1.5000- 6	1.354	1.372	1.3594	1.320	1.338	1.3281	1.3917	1.3988	1.5108

^a Fourth decimal place is 0 for all sizes.

All dimensions are in inches, unless otherwise specified.

Externally Threaded Products: Points of externally threaded components should be chamfered or otherwise reduced to a diameter below the minimum minor diameter of the thread. The limits apply to bare or metallic coated parts. The threads should be free from excessive nicks, burrs, chips, grit or other extraneous material before driving.

Table 3. Torques, Interferences, and Engagement Lengths for Class 5 Interference-Fit Threads ANSI/ASME B1.12-1987 (R2008)

Nominal Size	Interference on Pitch Diameter		Engagement Lengths, External Thread Lengths and Tapped Hole Depths ^a						Torque at $1-\frac{1}{2}D$ Engagement in Ferrous Material	
			In Brass and Ferrous			In Nonferrous Except Brass				
	Max	Min	L_e	T_s	T_h min	L_e	T_s	T_h min	Max, lb-ft	Min, lb-ft
0.2500-20	.0055	.0003	0.312	0.375 + .125 - 0	0.375	0.625	0.688 + .125 - 0	0.688	12	3
0.3125-18	.0065	.0005	0.391	0.469 + .139 - 0	0.469	0.781	0.859 + .139 - 0	0.859	19	6
0.3750-16	.0070	.0006	0.469	0.562 + .156 - 0	0.562	0.938	1.031 + .156 - 0	1.031	35	10
0.4375-14	.0080	.0008	0.547	0.656 + .179 - 0	0.656	1.094	1.203 + .179 - 0	1.203	45	15
0.5000-13	.0084	.0010	0.625	0.750 + .192 - 0	0.750	1.250	1.375 + .192 - 0	1.375	75	20
0.5625-12	.0092	.0012	0.703	0.844 + .208 - 0	0.844	1.406	1.547 + .208 - 0	1.547	90	30
0.6250-11	.0098	.0014	0.781	0.938 + .227 - 0	0.938	1.562	1.719 + .227 - 0	1.719	120	37
0.7500-10	.0105	.0015	0.938	1.125 + .250 - 0	1.125	1.875	2.062 + .250 - 0	2.062	190	60
0.8750- 9	.0016	.0018	1.094	1.312 + .278 - 0	1.312	2.188	2.406 + .278 - 0	2.406	250	90
1.0000- 8	.0128	.0020	1.250	1.500 + .312 - 0	1.500	2.500	2.750 + .312 - 0	2.750	400	125
1.1250- 7	.0143	.0025	1.406	1.688 + .357 - 0	1.688	2.812	3.094 + .357 - 0	3.095	470	155
1.2500- 7	.0143	.0025	1.562	1.875 + .357 - 0	1.875	3.125	3.438 + .357 - 0	3.438	580	210
1.3750- 6	.0172	.0030	1.719	2.062 + .419 - 0	2.062	3.438	3.781 + .419 - 0	3.781	705	250
1.5000- 6	.0172	.0030	1.875	2.250 + .419 - 0	2.250	3.750	4.125 + .419 - 0	4.125	840	325

^a L_e = Length of engagement. T_s = External thread length of full form thread. T_h = Minimum depth of full form thread in hole.

All dimensions are inches.

Materials for Externally Threaded Products: The length of engagement, depth of thread engagement and pitch diameter in Tables 1, 2, and 3 are designed to produce adequate torque conditions when heat-treated medium-carbon steel products, ASTM A-325 (SAE Grade 5) or better, are used. In many applications, case-carburized and nonheat-treated medium-carbon steel products of SAE Grade 4 are satisfactory. SAE Grades 1 and 2, may be usable under certain conditions. This standard is not intended to cover the use of products made of stainless steel, silicon bronze, brass or similar materials. When such materials are used, the tabulated dimensions will probably require adjustment based on pilot experimental work with the materials involved.

Lubrication: For driving in ferrous material, a good lubricant sealer should be used, particularly in the hole. A non-carbonizing type of lubricant (such as a rubber-in-water dispersion) is suggested. The lubricant must be applied to the hole and it may be applied to the male member. In applying it to the hole, care must be taken so that an excess amount of lubricant will not cause the male member to be impeded by hydraulic pressure in a blind hole. Where sealing is involved, the lubricant selected should be insoluble in the medium being sealed.

For driving, in nonferrous material, lubrication may not be needed. The use of medium gear oil for driving in aluminum is recommended. American research has observed that the minor diameter of lubricated tapped holes in non-ferrous materials may tend to close in, that is, be reduced in driving; whereas with an unlubricated hole the minor diameter may tend to open up.

Driving Speed: This standard makes no recommendation for driving speed. Some opinion has been advanced that careful selection and control of driving speed is desirable to obtain optimum results with various combinations of surface hardness and roughness. Experience with threads made to this standard may indicate what limitations should be placed on driving speeds.

Table 4. Allowances for Coarse Thread Series ANSI/ASME B1.12-1987 (R2008)

TPI	Difference between Nom. Size and Max Major Diam of NC-5 HF ^a	Difference between Nom. Size and Max Major Diam. of NC-5 CSF or NC-5 ONF ^a	Difference between Basic Minor Diam. and Min Minor Diam. of NC-5 IF ^a	Difference between Basic Minor Diam. and Min Minor Diam. of NC-5 INF	Max PD Inteference or Neg Allowance, Ext Thread ^b	Difference between Max Minor Diam. and Basic Minor Diam., Ext Thread
20	0.0030	0.0030	0.000	0.000	0.0055	0.0072
18	0.0045	0.0035	0.000	0.000	0.0065	0.0080
16	0.0060	0.0040	0.000	0.000	0.0070	0.0090
14	0.0070	0.0045	0.014	0.000	0.0080	0.0103
13	0.0080	0.0050	0.014	0.000	0.0084	0.0111
12	0.0085	0.0050	0.016	0.000	0.0092	0.0120
11	0.0110	0.0055	0.017	0.000	0.0098	0.0131
10	0.0140	0.0060	0.019	0.000	0.0105	0.0144
9	0.0150	0.0065	0.022	0.000	0.0116	0.0160
8	0.0165	0.0065	0.025	0.000	0.0128	0.0180
7	0.0180	0.0070	0.030	0.000	0.0143	0.0206
6	0.0190	0.0070	0.034	0.000	0.0172	0.0241

^a The allowances in these columns were obtained from industrial research data.

^b Negative allowance is the difference between the basic pitch diameter and pitch diameter value at maximum material condition.

All dimensions are in inches.

The difference between basic major diameter and internal thread minimum major diameter is $0.075H$ and is tabulated in [Table 5](#).

Table 5. Tolerances for Pitch Diameter, Major Diameter, and Minor Diameter for Coarse Thread Series ANSI/ASME B1.12-1987 (R2008)

TPI	PD Tolerance for Ext and Int Threads ^a	Major Diam. Tolerance for Ext Thread ^b	Minor Diam. Tolerance for Int Thread NC-5 IF	Minor Diam. Tolerance for Int Thread NC-5 INF ^c	Tolerance $0.075H$ or $0.065P$ for Tap Major Diam.
20	0.0026	0.0052	0.010	0.010	0.0032
18	0.0030	0.0060	0.011	0.011	0.0036
16	0.0032	0.0064	0.011	0.011	0.0041
14	0.0036	0.0072	0.008	0.012	0.0046
13	0.0037	0.0074	0.008	0.012	0.0050
12	0.0040	0.0080	0.009	0.013	0.0054
11	0.0042	0.0084	0.010	0.013	0.0059
10	0.0045	0.0090	0.011	0.014	0.0065
9	0.0049	0.0098	0.012	0.014	0.0072
8	0.0054	0.0108	0.014	0.015	0.0093
7	0.0059	0.0118	0.015	0.015	0.0093
6	0.0071	0.0142	0.018	0.018	0.0108

^a National Class 3 pitch diameter tolerance from ASA B1.1-1960.

^b Twice the NC-3 pitch diameter tolerance.

^c National Class 3 minor diameter tolerance from ASA B1.1-1960.

All dimensions are in inches.

Relation of Driving Torque to Length of Engagement: Torques increase directly as the length of engagement and this increase is proportionately more rapid as size increases. The standard does not establish recommended breakloose torques.

Surface Roughness: Surface roughness is not a required measurement. Roughness between 63 and 125 μin . Ra is recommended. Surface roughness greater than 125 μin . Ra may encourage galling and tearing of threads. Surfaces with roughness less than 63 μin . Ra may hold insufficient lubricant and wring or weld together.

Lead and Angle Variations: The lead variation values tabulated in **Table 6** are the maximum variations from specified lead between any two points not farther apart than the length of the standard GO thread gage. Flank angle variation values tabulated in **Table 7** are maximum variations from the basic 30° angle between thread flanks and perpendiculars to the thread axis. The application of these data in accordance with ANSI/ASME B1.3M, the screw thread gaging system for dimensional acceptability, is given in the Standard. Lead variation does not change the volume of displaced metal, but it exerts a cumulative unilateral stress on the pressure side of the thread flank. Control of the difference between pitch diameter size and functional diameter size to within one-half the pitch diameter tolerance will hold lead and angle variables to within satisfactory limits. Both the variations may produce unacceptable torque and faulty assemblies.

Table 6. Maximum Allowable Variations in Lead and Maximum Equivalent Change in Functional Diameter ANSI/ASME B1.12-1987 (R2008)

Nominal Size	External and Internal Threads	
	Allowable Variation in Axial Lead (Plus or Minus)	Max Equivalent Change in Functional Diam. (Plus for Ext, Minus for Int)
0.2500-20	0.0008	0.0013
0.3125-18	0.0009	0.0015
0.3750-16	0.0009	0.0016
0.4375-14	0.0010	0.0018
0.5000-13	0.0011	0.0018
0.5625-12	0.0012	0.0020
0.6250-11	0.0012	0.0021
0.7500-10	0.0013	0.0022
0.8750- 9	0.0014	0.0024
1.0000- 8	0.0016	0.0027
1.1250- 7	0.0017	0.0030
1.2500- 7	0.0017	0.0030
1.3750- 6	0.0020	0.0036
1.5000- 6	0.0020	0.0036

All dimensions are in inches.

Note: The equivalent change in functional diameter applies to total effect of form errors.

Maximum allowable variation in lead is permitted only when all other form variations are zero.

For sizes not tabulated, maximum allowable variation in lead is equal to 0.57735 times one-half the pitch diameter tolerance.

Table 7. Maximum Allowable Variation in 30° Basic Half-Angle of External and Internal Screw Threads ANSI/ASME B1.12-1987 (R2008)

TPI	Allowable Variation in Half-Angle of Thread (Plus or Minus)	TPI	Allowable Variation in Half-Angle of Thread (Plus or Minus)	TPI	Allowable Variation in Half-Angle of Thread (Plus or Minus)
32	1° 30'	14	0° 55'	8	0° 45'
28	1° 20'	13	0° 55'	7	0° 45'
27	1° 20'	12	0° 50'	6	0° 40'
24	1° 15'	11½	0° 50'	5	0° 40'
20	1° 10'	11	0° 50'	4½	0° 40'
18	1° 05'	10	0° 50'	4	0° 40'
16	1° 00'	9	0° 50'

Spark Plug Threads

British Standard for Spark Plugs BS 45:1972 (withdrawn).—This revised British Standard refers solely to spark plugs used in automobiles and industrial spark ignition internal combustion engines. The basic thread form is that of the ISO metric (see page 1912). In assigning tolerances to the threads of the spark plug and the tapped holes, full consideration has been given to the desirability of achieving the closest possible measure of interchangeability between British spark plugs and engines, and those made to the standards of other ISO Member Bodies.

Basic Thread Dimensions for Spark Plug and Tapped Hole in Cylinder Head

Nom. Size	Pitch	Thread	Major Dia.		Pitch Dia.		Minor Dia.	
			Max.	Min.	Max.	Min.	Max.	Min.
14	1.25	Plug	13.937 ^a	13.725	13.125	12.993	12.402	12.181
14	1.25	Hole		14.00	13.368	13.188	12.912	12.647
18	1.5	Plug	17.933 ^a	17.697	16.959	16.819	16.092	15.845
18	1.5	Hole		18.00	17.216	17.026	16.676	16.376

^a Not specified

All dimensions are given in millimeters.

The tolerance grades for finished spark plugs and corresponding tapped holes in the cylinder head are: for 14 mm size, 6e for spark plugs and 6H for tapped holes which gives a minimum clearance of 0.063 mm; and for 18 mm size, 6e for spark plugs and 6H for tapped holes which gives a minimum clearance of 0.067 mm.

These minimum clearances are intended to prevent the possibility of seizure, as a result of combustion deposits on the bare threads, when removing the spark plugs and applies to both ferrous and non-ferrous materials. These clearances are also intended to enable spark plugs with threads in accordance with this standard to be fitted into existing holes.

SAE Spark-Plug Screw Threads.—The SAE Standard includes the following sizes: $\frac{7}{8}$ -inch nominal diameter with 18 threads per inch; 18-millimeter nominal diameter with a 1.5-millimeter pitch; 14-millimeter nominal diameter with a 1.25-millimeter pitch; 10-millimeter nominal diameter with a 1.0 millimeter pitch; $\frac{3}{8}$ -inch nominal diameter with 24 threads per inch; and $\frac{1}{4}$ -inch nominal diameter with 32 threads per inch. During manufacture, in order to keep the wear on the threading tools within permissible limits, the threads in the spark plug GO (ring) gage should be truncated to the maximum minor diameter of the spark plug; and in the tapped hole GO (plug) gage to the minimum major diameter of the tapped hole.

SAE Standard Threads for Spark Plugs

Size ^a Nom. × Pitch	Major Diameter		Pitch Diameter		Minor Diameter	
	Max.	Min.	Max.	Min.	Max.	Min.
Spark Plug Threads, mm (inches)						
M18 × 1.5	17.933 (0.07060)	17.803 (0.7009)	16.959 (0.6677)	16.853 (0.6635)	16.053 (0.6320)	...
M14 × 1.25	13.868 (0.5460)	13.741 (0.5410)	13.104 (0.5159)	12.997 (0.5117)	12.339 (0.4858)	...
M12 × 1.25	11.862 (0.4670)	11.735 (0.4620)	11.100 (0.4370)	10.998 (0.4330)	10.211 (0.4020)	...
M10 × 1.0	9.974 (0.3927)	9.794 (0.3856)	9.324 (0.3671)	9.212 (0.3627)	8.747 (0.3444)	...

SAE Standard Threads for Spark Plugs (Continued)

Size ^a Nom. × Pitch	Major Diameter		Pitch Diameter		Minor Diameter	
	Max.	Min.	Max.	Min.	Max.	Min.
Tapped Hole Threads, mm (inches)						
M18 × 1.5	...	18.039 (0.7102)	17.153 (0.6753)	17.026 (0.6703)	16.426 (0.6467)	16.266 (0.6404)
M14 × 1.25	...	14.034 (0.5525)	13.297 (0.5235)	13.188 (0.5192)	12.692 (0.4997)	12.499 (0.4921)
M12 × 1.25	...	12.000 (0.4724)	11.242 (0.4426)	11.188 (0.4405)	10.559 (0.4157)	10.366 (0.4081)
M10 × 1.0	...	10.000 (0.3937)	9.500 (0.3740)	9.350 (0.3681)	9.153 (0.3604)	8.917 (0.3511)

^aM14 and M18 are preferred for new applications.

In order to keep the wear on the threading tools within permissible limits, the threads in the spark plug GO (ring) gage shall be truncated to the maximum minor diameter of the spark plug, and in the tapped hole GO (plug) gage to the minimum major diameter of the tapped hole. The plain plug gage for checking the minor diameter of the tapped hole shall be the minimum specified. The thread form is that of the ISO metric (see page 1912).

Reprinted with permission © 1990 Society of Automotive Engineers, Inc.

Lamp Base and Electrical Fixture Threads

Lamp Base and Socket Shell Threads.—The “American Standard” threads for lamp base and socket shells are sponsored by the American Society of Mechanical Engineers, the National Electrical Manufacturers’ Association and by most of the large manufacturers of products requiring rolled threads on sheet metal shells or parts, such as lamp bases, fuse plugs, attachment plugs, etc. There are five sizes, designated as the “miniature size,” the “candelabra size,” the “intermediate size,” the “medium size” and the “mogul size.”

Rolled Threads for Screw Shells of Electric Sockets and Lamp Bases— American Standard

Male or Base Screw Shells Before Assembly								
Size	Threads per Inch	Pitch <i>P</i>	Depth of Thread <i>D</i>	Radius Crest Root <i>R</i>	Major Dia.		Minor Diam.	
					Max. <i>A</i>	Min. <i>a</i>	Max. <i>B</i>	Min. <i>b</i>
Miniature	14	0.07143	0.020	0.0210	0.375	0.370	0.335	0.330
Candelabra	10	0.10000	0.025	0.0312	0.465	0.460	0.415	0.410
Intermediate	9	0.11111	0.027	0.0353	0.651	0.645	0.597	0.591
Medium	7	0.14286	0.033	0.0470	1.037	1.031	0.971	0.965
Mogul	4	0.25000	0.050	0.0906	1.555	1.545	1.455	1.445
Socket Screw Shells Before Assembly								
Miniature	14	0.07143	0.020	0.0210	0.3835	0.3775	0.3435	0.3375
Candelabra	10	0.10000	0.025	0.0312	0.476	0.470	0.426	0.420
Intermediate	9	0.11111	0.027	0.0353	0.664	0.657	0.610	0.603
Medium	7	0.14286	0.033	0.0470	1.053	1.045	0.987	0.979
Mogul	4	0.25000	0.050	0.0906	1.577	1.565	1.477	1.465

All dimensions are in inches.

Base Screw Shell Gage Tolerances: Threaded ring gages—"Go," Max. thread size to minus 0.0003 inch; "Not Go," Min. thread size to plus 0.0003 inch. Plain ring gages—"Go," Max. thread O.D. to minus 0.0002 inch; "Not Go," Min. thread O.D. to plus 0.0002 inch.

Socket Screw Shell Gages: Threaded plug gages—"Go," Min. thread size to plus 0.0003 inch; "Not Go," Max. thread size to minus 0.0003 inch. Plain plug gages—"Go," Min. minor dia. to plus 0.0002 inch; "Not Go," Max. minor dia. to minus 0.0002 inch.

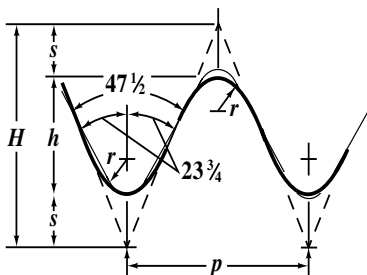
Check Gages for Base Screw Shell Gages: Threaded plugs for checking threaded ring gages—"Go," Max. thread size to minus 0.0003 inch; "Not Go," Min. thread size to plus 0.0003 inch.

Electric Fixture Thread.—The special straight electric fixture thread consists of a straight thread of the same pitches as the American standard pipe thread, and having the regular American or U. S. standard form; it is used for caps, etc. The male thread is smaller, and the female thread larger than those of the special straight-fixture pipe threads. The male thread assembles with a standard taper female thread, while the female thread assembles with a standard taper male thread. This thread is used when it is desired to have the joint "make up" on a shoulder. The gages used are straight-threaded limit gages.

Instrument and Microscope Threads

British Association Standard Thread (BA).—This form of thread is similar to the Whitworth thread in that the root and crest are rounded (see illustration). The angle, however, is only 47 degrees 30 minutes and the radius of the root and crest are proportionately larger. This thread is used in Great Britain and, to some extent, in other European countries for very small screws. Its use in the United States is practically confined to the manufacture of tools for export. This thread system was originated in Switzerland as a standard for watch and clock screws, and it is sometimes referred to as the "Swiss small screw thread standard." See also *Swiss Screw Thread*.

This screw thread system is recommended by the British Standards Institution for use in preference to the BSW and BSF systems for all screws smaller than $\frac{1}{4}$ inch except that the use of the "0" BA thread be discontinued in favor of the $\frac{1}{4}$ -in. BSF. It is further recommended that in the selection of sizes, preference be given to even numbered BA sizes. The thread form is shown by the diagram.



British Association Thread

$$H = 1.13634 \times p$$

$$h = 0.60000 \times p$$

$$r = 0.18083 \times p$$

$$s = 0.26817 \times p$$

It is a symmetrical V-thread, of $47\frac{1}{2}$ degree included angle, having its crests and roots rounded with equal radii, such that the basic depth of the thread is 0.6000 of the pitch. Where p = pitch of thread, H = depth of V-thread, h = depth of BA thread, r = radius at root and crest of thread, and s = root and crest truncation.

**British Association (BA) Standard Thread, Basic Dimensions
BS 93:1951 (obsolescent)**

Designation Number	Pitch, mm	Depth of Thread, mm	Bolt and Nut			Radius, mm	Threads per Inch (approx.)
			Major Diameter, mm	Effective Diameter, mm	Minor Diameter, mm		
0	1.0000	0.600	6.00	5.400	4.80	0.1808	25.4
1	0.9000	0.540	5.30	4.760	4.22	0.1627	28.2
2	0.8100	0.485	4.70	4.215	3.73	0.1465	31.4
3	0.7300	0.440	4.10	3.660	3.22	0.1320	34.8
4	0.6600	0.395	3.60	3.205	2.81	0.1193	38.5
5	0.5900	0.355	3.20	2.845	2.49	0.1067	43.0
6	0.5300	0.320	2.80	2.480	2.16	0.0958	47.9
7	0.4800	0.290	2.50	2.210	1.92	0.0868	52.9
8	0.4300	0.260	2.20	1.940	1.68	0.0778	59.1
9	0.3900	0.235	1.90	1.665	1.43	0.0705	65.1
10	0.3500	0.210	1.70	1.490	1.28	0.0633	72.6
11	0.3100	0.185	1.50	1.315	1.13	0.0561	82.0
12	0.2800	0.170	1.30	1.130	0.96	0.0506	90.7
13	0.2500	0.150	1.20	1.050	0.90	0.0452	102
14	0.2300	0.140	1.00	0.860	0.72	0.0416	110
15	0.2100	0.125	0.90	0.775	0.65	0.0380	121
16	0.1900	0.115	0.79	0.675	0.56	0.0344	134

Tolerances and Allowances: Two classes of bolts and one for nuts are provided: *Close Class bolts* are intended for precision parts subject to stress, no allowance being provided between maximum bolt and minimum nut sizes. *Normal Class bolts* are intended for general commercial production and general engineering use; for sizes 0 to 10 BA, an allowance of 0.025 mm is provided.

Tolerance Formulas for British Association (BA) Screw Threads

	Class or Fit	Tolerance (+ for nuts, - for bolts)		
		Major Dia.	Effective Dia.	Minor Dia.
Bolts	Close Class 0 to 10 BA incl.	0.15 <i>p</i> mm	0.08 <i>p</i> + 0.02 mm	0.16 <i>p</i> + 0.04 mm
	Normal Class 0 to 10 BA incl.	0.20 <i>p</i> mm	0.10 <i>p</i> + 0.025 mm	0.20 <i>p</i> + 0.05 mm
	Normal Class 11 to 16 BA incl.	0.25 <i>p</i> mm	0.10 <i>p</i> + 0.025 mm	0.20 <i>p</i> + 0.05 mm
Nuts	All Classes		0.12 <i>p</i> + 0.03 mm	0.375 <i>p</i> mm

In these formulas, *p* = pitch in millimeters.

Instrument Makers' Screw Thread System.—The standard screw system of the Royal Microscopical Society of London, also known as the “Society Thread,” is employed for microscope objectives and the nose pieces of the microscope into which these objectives screw. The form of the thread is the standard Whitworth form. The number of threads per inch is 36. There is one size only. The maximum pitch diameter of the objective is 0.7804 inch and the minimum pitch diameter of the nose-piece is 0.7822 inch. The dimensions are as follows:

Male thread	outside dia. root dia.	max., 0.7982 inch max., 0.7626 inch	min., 0.7952 inch min., 0.7596 inch
Female thread	root of thread top of thread	max., 0.7674 inch max., 0.8030 inch	min., 0.7644 inch min., 0.8000 inch

The Royal Photographic Society Standard Screw Thread ranges from 1-inch diameter upward. For screws less than 1 inch, the Microscopical Society Standard is used. The British Association thread is another thread system employed on instruments abroad.

American Microscope Objective Thread (AMO).—The standard, ANSI B1.11-1958 (R2011), describes the American microscope objective thread, AMO, the screw thread form used for mounting a microscope objective assembly to the body or lens turret of a microscope. This screw thread is also recommended for other microscope optical assem-

bles as well as related applications such as photomicrographic equipment. It is based on, and intended to be interchangeable with, the screw thread produced and adopted many years ago by the Royal Microscopical Society of Great Britain, generally known as the RMS thread. While the standard is almost universally accepted as the basic standard for microscope objective mountings, formal recognition has been extremely limited.

The basic thread possesses the overall British Standard Whitworth form. (See *Whitworth Standard Thread Form* starting on page 1953). However, the actual design thread form implementation is based on the WWII era ASA B1.6-1944 “Truncated Whitworth Form” in which the rounded crests and roots are removed. ASA B1.6-1944 was withdrawn in 1951, however, ANSI B1.11-1958 (R2011) is still active for new design.

Design Requirements of Microscope Objective Threads: Due to the inherent longevity of optical equipment and the repeated use to which the objective threads are subjected, the following factors should be considered when designing microscope objective threads:

Adequate clearance to afford protection against binding due to the presence of foreign particles or minor crest damage.

Sufficient depth of thread engagement to assure security in the short lengths of engagement commonly encountered.

Allowances for limited eccentricities so that centralization and squareness of the objective are not influenced by such errors in manufacture.

Deviation from the Truncated Whitworth Thread Form: Although ANSI B1.11-1958 (R2011) is based on the withdrawn ASA B1.6-1944 truncated Whitworth standard, the previously described design requirements necessitate a deviation from the truncated Whitworth thread form. Some of the more significant modifications are:

A larger allowance on the pitch diameter of the external thread.

Smaller tolerances on the major diameter of the external thread and minor diameter of the internal thread.

The provision of allowances on the major and minor diameters of the external thread.

Thread Overview: The thread is a single start type. There is only one class of thread based on a basic major diameter of 0.800 in. and a pitch, p , of 0.027778 inch (36 threads per inch). The AMO thread shall be designated on drawings, tools and gages as “0.800-36 AMO.” Thread nomenclature, definitions and terminology are based on ANSI B1.7-1965 (R1972), “Nomenclature, Threads, and Letter Symbols for Screw Threads.”

It should also be noted that ISO 8038-1:1997 “Screw threads for objectives and related nosepieces” is also based on the 0.800 inch, 36 tpi RMS thread form.

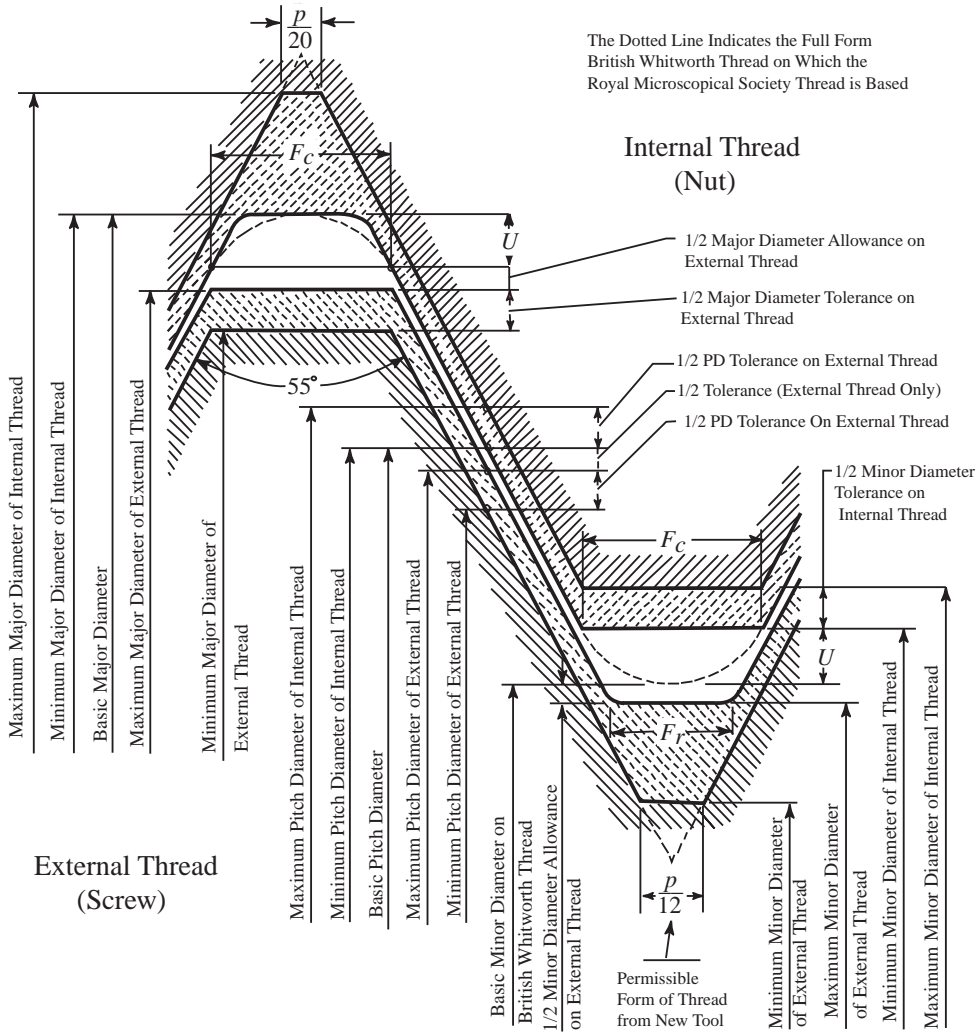
Tolerances and Allowances: Tolerances are given in Table 2. A positive allowance (minimum clearance) of 0.0018 in. is provided for the pitch diameter E , major diameter D , and minor diameter, K

If interchangeability with full-form Whitworth threads is not required, the allowances for the major and minor diameters are not necessary, because the forms at the root and crest are truncated. In these cases, either both limits or only the maximum limit of the major and minor diameters may be increased by the amount of the allowance, 0.0018 inch.

Lengths of Engagement: The tolerances specified in Table 2 are applicable to lengths of engagement ranging from $\frac{1}{8}$ in. to $\frac{3}{8}$ inch, approximately 15% to 50% of the basic diameter. Microscope objective assemblies generally have a length of engagement of $\frac{1}{8}$ inch. Lengths exceeding these limits are seldom employed and not covered in this standard.

Gage testing: Recommended ring and plug testing gage dimensions for the 0.800-36 AMO thread size can be found in ANSI B1.11-1958 (R2011), Appendix.

Dimensional Terminology: Because the active standard ANSI B1.11-1958 (R2011) is based on the withdrawn ASA Truncated Whitworth standard, dimensional nomenclature is described below.



Tolerances, Allowances and Crest Clearances for Microscope Objective Thread (AMO)
ANSI B1.11-1958 (R2011)

Table 1. Definitions, Formulas, Basic and Design Dimensions
ANSI B1.11-1958 (R2011)

Symbol	Property	Formula	Dimension
Basic Thread Form			
α	Half angle of thread	...	27°30'
2α	Included angle of thread	...	55°00'
n	Number of threads per inch	...	36
p	Pitch	$1/n$	0.027778
H	Height of fundamental triangle	$0.960491p$	0.026680
h_b	Height of basic thread	$0.640327p$	0.0178
r	Radius at crest and root of British Standard Whitworth basic thread (not used)	$0.137329p$	0.0038

Table 1. (Continued) Definitions, Formulas, Basic and Design Dimensions
ANSI B1.11-1958 (R2011)

Symbol	Property	Formula	Dimension
Design Thread Form			
k	Height of truncated Whitworth thread	$h_b - U = 0.566410p$	0.0157
F_c	Width of flat at crest	$0.243624p$	0.0068
F_r	Width of flat at root	$0.166667p$	0.0046
U	Basic truncation of crest from basic Whitworth form	$0.073917p$	0.00205
Basic and Design Sizes			
D	Major diameter, nominal and basic	...	0.800
D_n	Major diameter of internal thread	D	0.800
D_s	Major diameter of external thread ^a	$D - 2U - G$	0.7941
E	Pitch (effective) diameter, basic	$D - h_b$	0.7822
E_n	Pitch (effective) diameter of internal thread	$D - h_b$	0.7822
E_s	Pitch (effective) diameter of external thread ^b	$D - h_b - G$	0.7804
K	Minor diameter, basic	$D - 2h_b$	0.7644
K_n	Minor diameter of internal thread	$D - 2k$	0.7685
K_s	Minor diameter of external thread ^a	$D - 2h_b - G$	0.7626
G	Allowance at pitch (effective) diameter ^{a, b}	...	0.0018

^a An allowance equal to that on the pitch diameter is also provided on the major and minor diameters of the external thread for additional clearance and centralizing.

^b Allowance (minimum clearance) on pitch (effective) diameter is the same as the British RMS thread.

All dimensions are in inches.

Table 2. Limits of Size and Tolerances — 0.800-36 AMO Thread
ANSI B1.11-1958 (R2011)

Element	Major Diameter, D			Pitch Diameter, E			Minor Diameter, K		
	Max.	Min.	Tol.	Max.	Min.	Tol.	Max.	Min.	Tol.
External thread	0.7941	0.7911	0.0030	0.7804	0.7774	0.0030	0.7626	0.7552 ^a	...
Internal thread	0.8092 ^b	0.8000	...	0.7852	0.7822	0.0030	0.7715	0.7865	0.0030

^a Extreme minimum minor diameter produced by a new threading tool having a minimum flat of $p/12 = 0.0023$ inch. This minimum diameter is not controlled by gages but by the form of the threading tool.

^b Extreme maximum major diameter produced by a new threading tool having a minimum flat of $p/20 = 0.0014$ inch. This maximum diameter is not controlled by gages but by the form of the threading tool.

Tolerances on the internal thread are applied in a plus direction from the basic and design size and tolerances on the external thread are applied in a minus direction from its design (maximum material) size.

All dimensions are in inches.

Swiss Screw Thread.—This is a thread system originated in Switzerland as a standard for screws used in watch and clock making. The angle between the two sides of the thread is 47 degrees 30 minutes, and the top and bottom of the thread are rounded. This system has been adopted by the British Association as a standard for small screws, and is known as the British Association thread. See *British Association Standard Thread (BA)* on page 1981.

Historical and Miscellaneous Threads

Aero-Thread.—The name “Aero-thread” has been applied to a patented screw thread system that is specially applicable in cases where the nut or internally threaded part is made from a soft material, such as aluminum or magnesium alloy, for the sake of obtaining lightness, as in aircraft construction, and where the screw is made from a high-strength steel to provide strength and good wearing qualities. The nut or part containing the internal thread has a 60-degree truncated form of thread. See Fig. 1. The screw, or stud, is provided with a semi-circular thread form, as shown. Between the screw and the nut there is an intermediary part known as a thread lining or insert, which is made in the form of a helical spring, so that it can be screwed into the nut. The stud, in turn, is then screwed into the thread formed by the semicircular part of the thread insert. When the screw is provided with a V-form of thread, like the American Standard, frequent loosening and tightening of the screw would cause rapid wear of the softer metal from which the nut is made; furthermore, all the threads might not have an even bearing on the mating threads. By using a thread insert which is screwed into the nut permanently, and which is made from a reasonably hard material like phosphor bronze, good wearing qualities are obtained. Also, the bearing or load is evenly distributed over all the threads of the nut since the insert, being in the form of a spring, can adjust itself to bear on all of the thread surfaces.

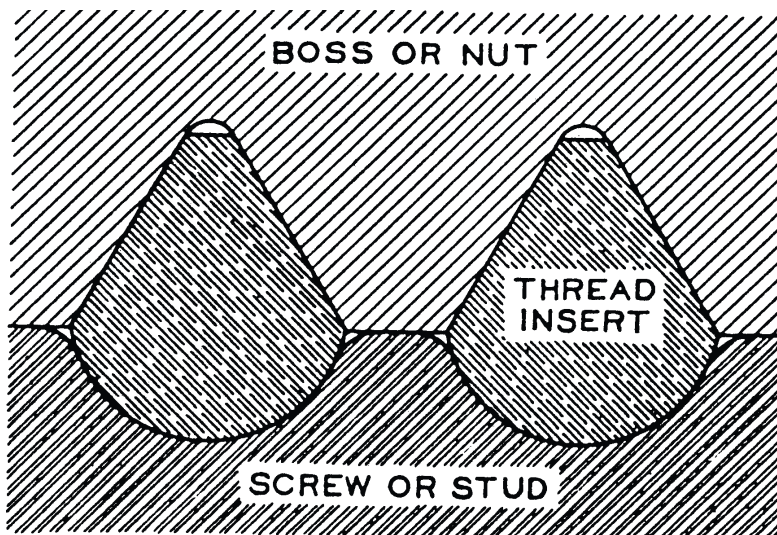


Fig. 1. The Basic Thread Form Used in the Aero-Thread System

Briggs Pipe Thread.—The Briggs pipe thread (now known as the American Standard) is used for threaded pipe joints and is the standard for this purpose in the United States. It derives its name from Robert Briggs.

Casing Thread.—The standard casing thread of the American Petroleum Institute has an included angle of 60 degrees and a taper of $\frac{3}{4}$ inch per foot.

The fourteen casing sizes listed in the 1942 revision have outside diameters ranging from $4\frac{1}{2}$ to 20 inches. All sizes have 8 threads per inch.

Rounded Thread Form: Threads for casing sizes up to $13\frac{3}{8}$ inches, inclusive, have rounded crests and roots, and the depth, measured perpendicular to the axis of the pipe, equals $0.626 \times \text{pitch} - 0.007 = 0.07125$ inch.

Truncated Form: Threads for the 16- and 20-inch casing sizes have flat crests and roots. The depth equals $0.760 \times \text{pitch} = 0.0950$ inch. This truncated form is designated in the A.P.I. Standard as a “sharp thread.”

Cordeaux Thread.—The Cordeaux screw thread derives its name from John Henry Cordeaux, an English telegraph inspector who obtained a patent for this thread in 1877. This thread is used for connecting porcelain insulators with their stalks by means of a screw thread on the stalk and a corresponding thread in the insulator. The thread is approximately a Whitworth thread, 6 threads per inch, the diameters most commonly used being $\frac{5}{8}$ or $\frac{3}{4}$ inch outside diameter of thread; $\frac{5}{8}$ inch is almost universally used for telegraph purposes, while a limited number of $\frac{3}{4}$ -inch sizes are used for large insulators.

Dardelet Thread.—The Dardelet patented self-locking thread is designed to resist vibrations and remain tight without auxiliary locking devices. The locking surfaces are the tapered root of the bolt thread and the tapered crest of the nut thread. The nut is free to turn until seated tightly against a resisting surface, thus causing it to shift from the free position (indicated by dotted lines) to the locking position. The locking is due to a wedging action between the tapered crest of the nut thread and the tapered root or binding surface of the bolt thread. This self-locking thread is also applied to set-screws and cap-screws. The holes must, of course, be threaded with Dardelet taps. The abutment sides of the Dardelet thread carry the major part of the tensile load. The nut is unlocked simply by turning it backward with a wrench. The Dardelet thread can either be cut or rolled, using standard equipment provided with tools, taps, dies, or rolls made to suit the Dardelet thread profile. The included thread angle is 29 degrees; depth $E = 0.3P$; maximum axial movement = $0.28P$. The major internal thread diameter (standard series) equals major external thread diameter plus 0.003 inch except for $\frac{1}{4}$ -inch size which is plus 0.002 inch. The width of both external and internal threads at pitch line equals $0.36P$.

“Drunken” Thread.—A “drunken” thread, according to prevalent usage of this expression by machinists, etc., is a thread that does not coincide with a true helix or advance uniformly. This irregularity in a taper thread may be due to the fact that in taper turning with the tailstock set over, the work does not turn with a uniform angular velocity, while the cutting tool is advancing along the work longitudinally with a uniform linear velocity. The change in the pitch and the irregularity of the thread is so small as to be imperceptible to the eye, if the taper is slight, but as the tapers increase to, say, $\frac{3}{4}$ inch per foot or more, the errors become more pronounced. To avoid this defect, a taper attachment should be used for taper thread cutting.

Echols Thread.—Chip room is of great importance in machine taps and taper taps where the cutting speed is high and always in one direction. The tap as well as the nut to be threaded is liable to be injured, if ample space for the chips to pass away from the cutting edges is not provided. A method of decreasing the number of cutting edges, as well as increasing the amount of chip room, is embodied in the “Echols thread,” where every alternate tooth is removed. If a tap has an even number of flutes, the removal of every other tooth in the lands will be equivalent to the removal of the teeth of a continuous thread. It is, therefore, necessary that taps provided with this thread be made with an odd number of lands, so that removing the tooth in alternate lands may result in removing every other tooth in each individual land. Machine taps are often provided with the Echols thread.

French Thread (S.F.).—The French thread has the same form and proportions as the American Standard (formerly U. S. Standard). This French thread is being displaced gradually by the International Metric Thread System.

Harvey Grip Thread.—The characteristic feature of this thread is that one side inclines 44 degrees from a line at right angles to the axis, whereas the other side has an inclination of only 1 degree. This form of thread is sometimes used when there is considerable resistance or pressure in an axial direction and when it is desirable to reduce the radial or bursting pressure on the nut as much as possible. See *BUTTRESS THREADS*.

Lloyd & Lloyd Thread.—The Lloyd & Lloyd screw thread is the same as the regular Whitworth screw thread in which the sides of the thread form an angle of 55 degrees with one another. The top and bottom of the thread are rounded.

Lock-Nut Pipe Thread.—The lock-nut pipe thread is a straight thread of the largest diameter which can be cut on a pipe. Its form is identical with that of the American or Briggs standard taper pipe thread. In general, “Go” gages only are required. These consist of a straight-threaded plug representing the minimum female lock-nut thread, and a straight-threaded ring representing the maximum male lock-nut thread. This thread is used only to hold parts together, or to retain a collar on the pipe. It is never used where a tight threaded joint is required.

Philadelphia Carriage Bolt Thread.—This is a screw thread for carriage bolts which is somewhat similar to a square thread, but having rounded corners at the top and bottom. The sides of the thread are inclined to an inclusive angle of $3\frac{1}{2}$ degrees. The width of the thread at the top is 0.53 times the pitch.

SAE Standard Screw Thread.—The screw thread standard of the Society of Automotive Engineers (SAE) is intended for use in the automotive industries of the United States. The SAE Standard includes a Coarse series, a Fine series, an 8-thread series, a 12-thread series, a 16-thread series, an Extra-fine series, and a Special-pitch series. The Coarse and Fine series, and also the 8-, 12- and 16-thread series, are exactly the same as corresponding series in the American Standard. The Extra-fine and Special-pitch series are SAE Standards only.

The American Standard thread *form* (or the form previously known as the U. S. Standard) is applied to all SAE Standard screw threads. The Extra-fine series has a total of six pitches ranging from 32 down to 16 threads per inch. The 16 threads per inch in the Extra-fine series, applies to all diameters from $1\frac{3}{4}$ up to 6 inches. This Extra-fine series is intended for use on relatively light sections; on parts requiring fine adjustment; where jar and vibration are important factors; when the thickness of a threaded section is relatively small as in tubing, and where assembly is made without the use of wrenches.

The SAE Special pitches include some which are finer than any in the Extra-fine series. The special pitches apply to a range of diameters extending from No. 10 (0.1900 inch) up to 6 inches. Each diameter has a range of pitches varying from five to eight. For example, a $\frac{1}{4}$ -inch diameter has six pitches ranging from 24 to 56 threads per inch, whereas a 6-inch diameter has eight pitches ranging from 4 to 16 threads per inch. These various SAE Standard series are intended to provide adequate screw thread specifications for all uses in the automotive industries.

Sellers Screw Thread.—The Sellers screw thread, later known as the ‘United States standard thread,’ and now as the “American Standard,” is the most commonly used screw thread in the United States. It was originated by William Sellers, of Philadelphia, and first proposed by him in a paper read before the Franklin Institute, in April, 1864. In 1868, it was adopted by the United States Navy and has since become the generally accepted standard screw thread in the United States.

Worm Threads.—The included angle of worm threads range from 29° to 60° ; for single-threaded worms 29° is common; multiple-threaded type must have larger helix and thread angles to avoid excessive under-cutting in hobbing the worm-wheel teeth. AGMA recommends 40° included thread angle for triple- and quadruple-thread worms, but many speed reducers and transmissions have 60° thread angles. The 29° angle is the same as the Acme thread, but worm thread depth is greater and widths of the flats at the top and bottom are less. If lead angle is larger than 20° , an increase in included thread angle is desirable. Worm gearing reaches maximum efficiency when lead angle is 45° , thus explaining the 60° thread angle. Thread parts of a 29° worm thread are: p = pitch; d = depth of thread = $0.6866p$; t = width, top of thread = $0.335p$; b = width, bottom of thread = $0.310p$.

MEASURING SCREW THREADS

Measuring Screw Threads

Pitch and Lead of Screw Threads.—The *pitch* of a screw thread is the distance from the center of one thread to the center of the next thread. This applies no matter whether the screw has a single, double, triple or quadruple thread. The *lead* of a screw thread is the distance the nut will move forward on the screw if it is turned around one full revolution. In a single-threaded screw, the pitch and lead are equal, because the nut would move forward the distance from one thread to the next, if turned around once. In a double-threaded screw, the nut will move forward two threads, or twice the pitch, so that in this case the lead equals twice the pitch. In a triple-threaded screw, the lead equals three times the pitch, and so on.

The word “pitch” is often, although improperly, used to denote the *number of threads per inch*. Screws are spoken of as having a 12-pitch thread, when twelve threads per inch is what is really meant. The number of threads per inch equals 1 divided by the pitch, or expressed as a formula:

$$\text{Number of threads per inch} = \frac{1}{\text{pitch}}$$

The pitch of a screw equals 1 divided by the number of threads per inch, or:

$$\text{Pitch} = \frac{1}{\text{number of threads per inch}}$$

If the number of threads per inch equals 16, the pitch = $\frac{1}{16}$. If the pitch equals 0.05, the number of threads equals $1 \div 0.05 = 20$. If the pitch is $\frac{2}{5}$ inch, the number of threads per inch equals $1 \div \frac{2}{5} = 2 \frac{1}{2}$.

Confusion is often caused by the indefinite designation of multiple-thread screws (double, triple, quadruple, etc.). The expression, “four threads per inch, triple,” for example, is not to be recommended. It means that the screw is cut with four triple threads or with twelve threads per inch, if the threads are counted by placing a scale alongside the screw. To cut this screw, the lathe would be geared to cut four threads per inch, but they would be cut only to the depth required for twelve threads per inch. The best expression, when a multiple-thread is to be cut, is to say, in this case, “ $\frac{1}{4}$ inch lead, $\frac{1}{12}$ inch pitch, triple thread.” For single-threaded screws, only the number of threads per inch and the form of the thread are specified. The word “single” is not required.

Measuring Screw Thread Pitch Diameters by Thread Micrometers.—As the pitch or angle diameter of a tap or screw is the most important dimension, it is necessary that the pitch diameter of screw threads be measured, in addition to the outside diameter.

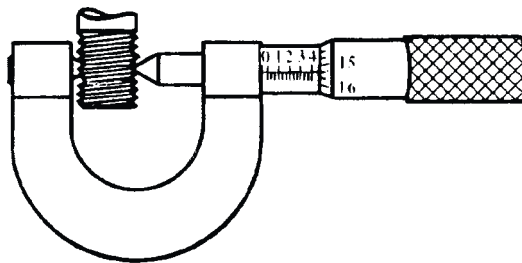


Fig. 1.

One method of measuring in the angle of a thread is by means of a special screw thread micrometer, as shown in the accompanying engraving, Fig. 1. The fixed anvil is W-shaped to engage two thread flanks, and the movable point is cone-shaped so as to enable it to enter the space between two threads, and at the same time be at liberty to revolve. The contact

points are on the sides of the thread, as they necessarily must be in order that the pitch diameter may be determined. The cone-shaped point of the measuring screw is slightly rounded so that it will not bear in the bottom of the thread. There is also sufficient clearance at the bottom of the V-shaped anvil to prevent it from bearing on the top of the thread. The movable point is adapted to measuring all pitches, but the fixed anvil is limited in its capacity. To cover the whole range of pitches, from the finest to the coarsest, a number of fixed anvils are therefore required.

To find the theoretical pitch diameter, which is measured by the micrometer, subtract twice the addendum of the thread from the standard outside diameter. The addendum of the thread for the American and other standard threads is given in the section on screw thread systems.

Ball-point Micrometers.—If standard plug gages are available, it is not necessary to actually measure the pitch diameter, but merely to compare it with the standard gage. In this case, a ball-point micrometer, as shown in Fig. 2, may be employed. Two types of ball-point micrometers are ordinarily used. One is simply a regular plain micrometer with ball points made to slip over both measuring points. (See B, Fig. 2.) This makes a kind of combination plain and ball-point micrometer, the ball points being easily removed. These ball points, however, do not fit solidly on their seats, even if they are split, as shown, and are apt to cause errors in measurements. The best, and, in the long run, the cheapest, method is to use a regular micrometer arranged as shown at A. Drill and ream out both the end of the measuring screw or spindle and the anvil, and fit ball points into them as shown. Care should be taken to have the ball point in the spindle run true. The holes in the micrometer spindle and anvil and the shanks on the points are tapered to insure a good fit. The hole *H* in spindle *G* is provided so that the ball point can be easily driven out when a change for a larger or smaller size of ball point is required.

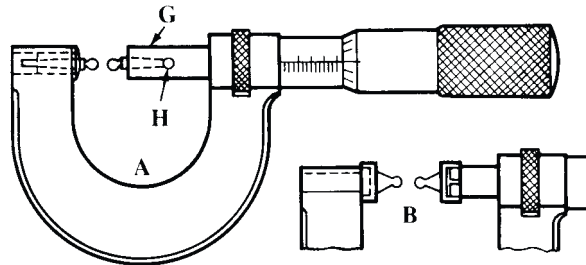


Fig. 2.

A ball-point micrometer may be used for comparing the *angle* of a screw thread, with that of a gage. This can be done by using different sizes of ball points, comparing the size first near the root of the thread, then (using a larger ball point) at about the point of the pitch diameter, and finally near the top of the thread (using in the latter case, of course, a much larger ball point). If the gage and thread measurements are the same at each of the three points referred to, this indicates that the thread angle is correct.

Measuring Screw Threads by Three-wire Method.—The *effective* or *pitch diameter* of a screw thread may be measured very accurately by means of some form of micrometer and three wires of equal diameter. This method is extensively used in checking the accuracy of threaded plug gages and other precision screw threads. Two of the wires are placed in contact with the thread on one side and the third wire in a position diametrically opposite as illustrated by the diagram, (see table “*Formulas for Checking Pitch Diameters of Screw Threads* on page 1995”) and the dimension over the wires is determined by means of a micrometer. An ordinary micrometer is commonly used but some form of “floating micrometer” is preferable, especially for measuring thread gages and other precision work. The floating micrometer is mounted upon a compound slide so that it can move freely in directions parallel or at right angles to the axis of the screw, which is held in a hor-

izontal position between adjustable centers. With this arrangement the micrometer is held constantly at right angles to the axis of the screw so that only one wire on each side may be used instead of having two on one side and one on the other, as is necessary when using an ordinary micrometer. The pitch diameter may be determined accurately if the correct micrometer reading for wires of a given size is known.

Classes of Formulas for Three-Wire Measurement.—Various formulas have been established for checking the pitch diameters of screw threads by measurement over wires of known size. These formulas differ with regard to their simplicity or complexity and resulting accuracy. They also differ in that some show what measurement M over the wires should be to obtain a given pitch diameter E , whereas others show the value of the pitch diameter E for a given measurement M .

Formulas for Finding Measurement M : In using a formula for finding the value of measurement M , the required pitch diameter E is inserted in the formula. Then, in cutting or grinding a screw thread, the actual measurement M is made to conform to the calculated value of M . Formulas for finding measurement M may be modified so that the basic major or outside diameter is inserted in the formula instead of the pitch diameter; however, the pitch-diameter type of formula is preferable because the pitch diameter is a more important dimension than the major diameter.

Formulas for Finding Pitch Diameters E : Some formulas are arranged to show the value of the pitch diameter E when measurement M is known. Thus, the value of M is first determined by measurement and then is inserted in the formula for finding the corresponding pitch diameter E . This type of formula is useful for determining the pitch diameter of an existing thread gage or other screw thread in connection with inspection work. The formula for finding measurement M is more convenient to use in the shop or tool room in cutting or grinding new threads, because the pitch diameter is specified on the drawing and the problem is to find the value of measurement M for obtaining that pitch diameter.

General Classes of Screw Thread Profiles.—Thread profiles may be divided into three general classes or types as follows:

Screw Helicoid: Represented by a screw thread having a straight-line profile in the axial plane. Such a screw thread may be cut in a lathe by using a straight-sided single-point tool, provided the top surface lies in the axial plane.

Involute Helicoid: Represented either by a screw thread or a helical gear tooth having an involute profile in a plane perpendicular to the axis. A rolled screw thread, theoretically at least, is an exact involute helicoid.

Intermediate Profiles: An intermediate profile that lies somewhere between the screw helicoid and the involute helicoid will be formed on a screw thread either by milling or grinding with a straight-sided wheel set in alignment with the thread groove. The resulting form will approach closely the involute helicoid form. In milling or grinding a thread, the included cutter or wheel angle may either equal the standard thread angle (which is always measured in the axial plane) or the cutter or wheel angle may be reduced to approximate, at least, the thread angle in the normal plane. In practice, all these variations affect the three-wire measurement.

Accuracy of Formulas for Checking Pitch Diameters by Three-Wire Method.—The exact measurement M for a given pitch diameter depends upon the lead angle, the thread angle, and the profile or cross-sectional shape of the thread. As pointed out in the preceding paragraph, the profile depends upon the method of cutting or forming the thread. In a milled or ground thread, the profile is affected not only by the cutter or wheel angle, but also by the diameter of the cutter or wheel; hence, because of these variations, an absolutely exact and reasonably simple general formula for measurement M cannot be established; however, if the lead angle is low, as with a standard single-thread screw, and especially if the thread angle is high like a 60-degree thread, simple formulas that are not arranged to compensate for the lead angle are used ordinarily and meet most practical

requirements, particularly in measuring 60-degree threads. If lead angles are large enough to greatly affect the result, as with most multiple threads (especially Acme or 29-degree worm threads), a formula should be used that compensates for the lead angle sufficiently to obtain the necessary accuracy.

The formulas that follow include 1) a very simple type in which the effect of the lead angle on measurement M is entirely ignored. This simple formula usually is applicable to the measurement of 60-degree single-thread screws, except possibly when gage-making accuracy is required; 2) formulas that do include the effect of the lead angle but, nevertheless, are approximations and not always suitable for the higher lead angles when extreme accuracy is required; and 3) formulas for the higher lead angles and the most precise classes of work.

Where approximate formulas are applied consistently in the measurement of both thread plug gages and the thread "setting plugs" for ring gages, interchangeability might be secured, assuming that such approximate formulas were universally employed.

Wire Sizes for Checking Pitch Diameters of Screw Threads.—In checking screw threads by the 3-wire method, the general practice is to use measuring wires of the so-called "best size." The "best-size" wire is one that contacts at the pitch line or midslope of the thread because then the measurement of the pitch diameter is least affected by an error in the thread angle. In the following formula for determining approximately the "best-size" wire or the diameter for pitch-line contact, A = one-half included angle of thread in the axial plane.

$$\text{Best-size wire} = \frac{0.5 \times \text{pitch}}{\cos A} = 0.5 \text{ pitch} \times \sec A$$

For 60-degree threads, this formula reduces to

$$\text{Best-size wire} = 0.57735 \times \text{pitch}$$

Diameters of Wires for Measuring American Standard and British Standard Whitworth Screw Threads

Threads per Inch	Pitch, Inch	Wire Diameters for American Standard Threads			Wire Diameters for Whitworth Standard Threads		
		Max.	Min.	Pitch-Line Contact	Max.	Min.	Pitch-Line Contact
4	0.2500	0.2250	0.1400	0.1443	0.1900	0.1350	0.1409
4½	0.2222	0.2000	0.1244	0.1283	0.1689	0.1200	0.1253
5	0.2000	0.1800	0.1120	0.1155	0.1520	0.1080	0.1127
5½	0.1818	0.1636	0.1018	0.1050	0.1382	0.0982	0.1025
6	0.1667	0.1500	0.0933	0.0962	0.1267	0.0900	0.0939
7	0.1428	0.1283	0.0800	0.0825	0.1086	0.0771	0.0805
8	0.1250	0.1125	0.0700	0.0722	0.0950	0.0675	0.0705
9	0.1111	0.1000	0.0622	0.0641	0.0844	0.0600	0.0626
10	0.1000	0.0900	0.0560	0.0577	0.0760	0.0540	0.0564
11	0.0909	0.0818	0.0509	0.0525	0.0691	0.0491	0.0512
12	0.0833	0.0750	0.0467	0.0481	0.0633	0.0450	0.0470
13	0.0769	0.0692	0.0431	0.0444	0.0585	0.0415	0.0434
14	0.0714	0.0643	0.0400	0.0412	0.0543	0.0386	0.0403
16	0.0625	0.0562	0.0350	0.0361	0.0475	0.0337	0.0352
18	0.0555	0.0500	0.0311	0.0321	0.0422	0.0300	0.0313
20	0.0500	0.0450	0.0280	0.0289	0.0380	0.0270	0.0282
22	0.0454	0.0409	0.0254	0.0262	0.0345	0.0245	0.0256
24	0.0417	0.0375	0.0233	0.0240	0.0317	0.0225	0.0235
28	0.0357	0.0321	0.0200	0.0206	0.0271	0.0193	0.0201
32	0.0312	0.0281	0.0175	0.0180	0.0237	0.0169	0.0176
36	0.0278	0.0250	0.0156	0.0160	0.0211	0.0150	0.0156
40	0.0250	0.0225	0.0140	0.0144	0.0190	0.0135	0.0141

These formulas are based upon a thread groove of zero lead angle because ordinary variations in the lead angle have little effect on the wire diameter and it is desirable to use one wire size for a given pitch regardless of the lead angle. A theoretically correct solution for finding the *exact* size for pitch-line contact involves the use of cumbersome indeterminate equations with solution by successive trials. The accompanying table gives the wire sizes for both American Standard (formerly, U.S. Standard) and the Whitworth Standard Threads. The following formulas for determining wire diameters do not give the extreme theoretical limits, but the smallest and largest practicable sizes. The diameters in the table are based upon these approximate formulas.

	Smallest wire diameter = $0.56 \times \text{pitch}$
American Standard	Largest wire diameter = $0.90 \times \text{pitch}$
	Diameter for pitch-line contact = $0.57735 \times \text{pitch}$
	Smallest wire diameter = $0.54 \times \text{pitch}$
Whitworth	Largest wire diameter = $0.76 \times \text{pitch}$
	Diameter for pitch-line contact = $0.56369 \times \text{pitch}$

Measuring Wire Accuracy.—A set of three measuring wires should have the same diameter within 0.0002 (5.08 μm) inch. To measure the pitch diameter of a screw-thread gage to an accuracy of 0.0001 inch (2.54 μm) by means of wires, it is necessary to know the wire diameters to 0.00002 (0.51 μm) inch. If the diameters of the wires are known only to an accuracy of 0.0001 (2.54 μm) inch, an accuracy better than 0.0003 (7.62 μm) inch in the measurement of pitch diameter cannot be expected. The wires should be accurately finished hardened steel cylinders of the maximum possible hardness without being brittle. The hardness should not be less than that corresponding to a Knoop indentation number of 630. A wire of this hardness can be cut with a file only with difficulty. The surface should not be rougher than the equivalent of a deviation of 3 microinches (0.0762 μm) from a true cylindrical surface.

Measuring or Contact Pressure.—In measuring screw threads or screw-thread gages by the 3-wire method, variations in contact pressure will result in different readings. The effect of a variation in contact pressure in measuring threads of fine pitches is indicated by the difference in readings obtained with pressures of 2 and 5 pounds (0.91 and 2.27 kg) in checking a thread plug gage having 24 threads per inch. The reading over the wires with 5 pounds (2.27 kg) pressure was 0.00013 inch (3.302 μm) less than with 2 pounds (0.91 kg) pressure. For pitches finer than 20 threads per inch (0.05 inch or 1.27 mm pitch), a pressure of 16 ounces (0.45 kg) is recommended by the National Bureau of Standards, now National Institute of Standards and Technology (NIST). For pitches of 20 threads per inch and coarser, a pressure of 2 $\frac{1}{2}$ pounds (1.13 kg) is recommended.

For Acme threads, the wire presses against the sides of the thread with a pressure of approximately twice that of the measuring instrument. To limit the tendency of the wires to wedge in between the sides of an Acme thread, it is recommended that pitch-diameter measurements be made at 1 pound on 8 threads per inch and finer, and at 2 $\frac{1}{2}$ pounds for pitches coarser than 8 threads per inch (0.125 inch or 3.175 mm pitch).

Approximate Three-Wire Formulas That Do Not Compensate for Lead Angle.—A general formula in which the effect of lead angle is ignored is as follows (see accompanying notation used in formulas):

$$M = E - T \cot A + W(1 + \csc A) \quad (1)$$

This formula can be simplified for any given thread angle and pitch. To illustrate, because $T = 0.5P$, $M = E - 0.5P \cot 30^\circ + W(1 + 2)$, for a 60-degree thread, such as the American Standard,

$$M = E - 0.866025P + 3W$$

The accompanying table contains these simplified formulas for different standard threads. Two formulas are given for each. The upper one is used when the measurement over wires, M , is known and the corresponding pitch diameter, E , is required; the lower formula gives the measurement M for a specified value of pitch diameter. These formulas are sufficiently accurate for checking practically all standard 60-degree single-thread screws because of the low lead angles, which vary from $1^\circ 11'$ to $4^\circ 31'$ in the American Standard Coarse-Thread Series.

Bureau of Standards (now NIST) General Formula.—**Formula (2)**, which follows, compensates quite largely for the effect of the lead angle. It is from the National Bureau of Standards Handbook H 28 (1944), now FED-STD-H28. The formula, however, as here given has been arranged for finding the value of M (instead of E).

$$M = E - T \cot A + W(1 + \csc A + 0.5 \tan^2 B \cos A \cot A) \quad (2)$$

This expression is also found in ANSI/ASME B1.2-1983 (R2007). The Bureau of Standards uses **Formula (2)** in preference to **Formula (1)** when the value of $0.5W \tan^2 B \cos A \cot A$ exceeds 0.00015, with the larger lead angles. If this test is applied to American Standard 60-degree threads, it will show that **Formula (1)** is generally applicable; but for 29-degree Acme or worm threads, **Formula (2)** (or some other that includes the effect of lead angle) should be employed.

Notation Used in Formulas for Checking Pitch Diameters by Three-Wire Method

A = one-half included thread angle in the axial plane

A_n = one-half included thread angle in the normal plane or in plane perpendicular to sides of thread = one-half included angle of cutter when thread is milled ($\tan A_n = \tan A \times \cos B$). (Note: Included angle of milling cutter or grinding wheel may equal the nominal included angle of thread, or may be reduced to whatever normal angle is required to make the thread angle standard in the axial plane. In either case, A_n = one-half cutter angle.)

B = lead angle at pitch diameter = helix angle of thread as measured from a plane perpendicular to the axis, $\tan B = L \div 3.1416E$

D = basic major or outside diameter

E = pitch diameter (basic, maximum, or minimum) for which M is required, or pitch diameter corresponding to measurement M

F = angle required in **Formulas (4b)**, **(4d)**, and **(4e)**

G = angle required in **Formula (4)**

H = helix angle at pitch diameter and measured from axis = $90^\circ - B$ or $\tan H = \cot B$

H_b = helix angle at R_b measured from axis

L = lead of thread = pitch $P \times$ number of threads S

M = dimension over wires

P = pitch = $1 \div$ number of threads per inch

R_b = radius required in **Formulas (4)** and **(4e)**

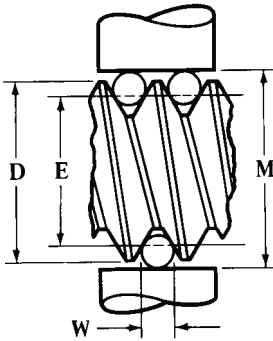
S = number of "starts" or threads on a multiple-threaded worm or screw

$T = 0.5P$ = width of thread in axial plane at diameter E

T_a = arc thickness on pitch cylinder in plane perpendicular to axis

W = wire or pin diameter

Formulas for Checking Pitch Diameters of Screw Threads



The formulas below do not compensate for the effect of the lead angle upon measurement M , but they are sufficiently accurate for checking standard single-thread screws unless exceptional accuracy is required. See accompanying information on effect of lead angle; also matter relating to measuring wire sizes, accuracy required for such wires, and contact or measuring pressure.

The approximate best wire size for pitch-line contact may be obtained by the formula

$$W = 0.5 \times \text{pitch} \times \sec \frac{1}{2} \text{ included thread angle}$$

For 60-degree threads, $W = 0.57735 \times \text{pitch}$.

Form of Thread	Formulas for determining measurement M corresponding to correct pitch diameter and the pitch diameter E corresponding to a given measurement over wires. ^a
American National Standard Unified	When measurement M is known, $E = M + 0.86603P - 3W$ When pitch diameter E is used in formula, $M = E - 0.86603P + 3W$ The American Standard formerly was known as U.S. Standard.
British Standard Whitworth	When measurement M is known, $E = M + 0.9605P - 3.1657W$ When pitch diameter E is used in formula, $M = E - 0.9605P + 3.1657W$
British Association Standard	When measurement M is known, $E = M + 1.1363P - 3.4829W$ When pitch diameter E is used in formula, $M = E - 1.1363P + 3.4829W$
Lowenherz Thread	When measurement M is known, $E = M + P - 3.2359W$ When pitch diameter E is used in formula, $M = E - P + 3.2359W$
Sharp V-Thread	When measurement M is known, $E = M + 0.86603P - 3W$ When pitch diameter E is used in formula, $M = E - 0.86603P + 3W$
International Standard	Use the formula above for the American National Standard Unified Thread.
Pipe Thread	See accompanying paragraph on <i>Buckingham Exact Involute Helicoid Formula Applied to Screw Threads</i> .
Acme and Worm Threads	See Buckingham Formulas page 1999; also <i>Three-wire Measurement of Acme and Stub Acme Thread Pitch Diameter</i> .
Buttress Form of Thread	Different forms of buttress threads are used. See paragraph on <i>Three-Wire Method Applied to Buttress Threads</i> .

^aThe wires must be lapped to a uniform diameter and it is very important to insert in the rule or formula the wire diameter as determined by precise means of measurement. Any error will be multiplied. See paragraph on *Wire Sizes for Checking Pitch Diameters of Screw Threads* on page 1992.

Why Small Thread Angle Affects Accuracy of Three-Wire Measurement.—In measuring or checking Acme threads, or any others having a comparatively small thread angle A , it is particularly important to use a formula that compensates largely, if not entirely, for the effect of the lead angle, especially in all gage and precision work. The effect of the lead angle on the position of the wires and upon the resulting measurement M is much greater in a 29-degree thread than in a higher thread angle such, for example, as a 60-degree thread. This effect results from an increase in the cotangent of the thread angle as this angle becomes smaller. The reduction in the width of the thread groove in the normal plane due

to the lead angle causes a wire of given size to rest higher in the groove of a thread having a small thread angle *A* (like a 29-degree thread) than in the groove of a thread with a larger angle (like a 60-degree American Standard).

Acme Threads: Three-wire measurements of high accuracy require the use of **Formula (4)**. For most measurements, however, **Formula (2)** or **(3)** gives satisfactory results. The table on page 2002 lists suitable wire sizes for use in **Formulas (2)** and **(4)**.

Values of Constants Used in Formulas for Measuring Pitch Diameters of Screws by the Three-wire System

No. of Threads per Inch	American Standard Unified and Sharp V-Thread 0.866025 <i>P</i>	Whitworth Thread 0.9605 <i>P</i>	No. of Threads per Inch	American Standard Unified and Sharp V-Thread 0.866025 <i>P</i>	Whitworth Thread 0.9605 <i>P</i>
2¼	0.38490	0.42689	18	0.04811	0.05336
2⅜	0.36464	0.40442	20	0.04330	0.04803
2½	0.34641	0.38420	22	0.03936	0.04366
2⅝	0.32992	0.36590	24	0.03608	0.04002
2¾	0.31492	0.34927	26	0.03331	0.03694
2⅞	0.30123	0.33409	28	0.03093	0.03430
3	0.28868	0.32017	30	0.02887	0.03202
3¼	0.26647	0.29554	32	0.02706	0.03002
3½	0.24744	0.27443	34	0.02547	0.02825
4	0.21651	0.24013	36	0.02406	0.02668
4½	0.19245	0.21344	38	0.02279	0.02528
5	0.17321	0.19210	40	0.02165	0.02401
5½	0.15746	0.17464	42	0.02062	0.02287
6	0.14434	0.16008	44	0.01968	0.02183
7	0.12372	0.13721	46	0.01883	0.02088
8	0.10825	0.12006	48	0.01804	0.02001
9	0.09623	0.10672	50	0.01732	0.01921
10	0.08660	0.09605	52	0.01665	0.01847
11	0.07873	0.08732	56	0.01546	0.01715
12	0.07217	0.08004	60	0.01443	0.01601
13	0.06662	0.07388	64	0.01353	0.01501
14	0.06186	0.06861	68	0.01274	0.01412
15	0.05774	0.06403	72	0.01203	0.01334
16	0.05413	0.06003	80	0.01083	0.01201

Constants Used for Measuring Pitch Diameters of Metric Screws by the Three-wire System

Pitch in mm	0.866025 <i>P</i> in Inches	<i>W</i> in Inches	Pitch in mm	0.866025 <i>P</i> in Inches	<i>W</i> in Inches	Pitch in mm	0.866025 <i>P</i> in Inches	<i>W</i> in Inches
0.2	0.00682	0.00455	0.75	0.02557	0.01705	3.5	0.11933	0.07956
0.25	0.00852	0.00568	0.8	0.02728	0.01818	4	0.13638	0.09092
0.3	0.01023	0.00682	1	0.03410	0.02273	4.5	0.15343	0.10229
0.35	0.01193	0.00796	1.25	0.04262	0.02841	5	0.17048	0.11365
0.4	0.01364	0.00909	1.5	0.05114	0.03410	5.5	0.18753	0.12502
0.45	0.01534	0.01023	1.75	0.05967	0.03978	6	0.20457	0.13638
0.5	0.01705	0.01137	2	0.06819	0.04546	8	0.30686	0.18184
0.6	0.02046	0.01364	2.5	0.08524	0.05683
0.7	0.02387	0.01591	3	0.10229	0.06819

This table may be used for American National Standard Metric Threads. The formulas for American Standard Unified Threads on page 1995 are used. In the table above, the values of 0.866025*P* and *W* are in inches so that the values for *E* and *M* calculated from the formulas on page 1995 are also in inches.

Dimensions Over Wires of Given Diameter for Checking Screw Threads of American National Form (U.S. Standard) and the V-Form

Dia. of Thread	No. of Threads per Inch	Wire Dia. Used	Dimension over Wires		Dia. of Thread	No. of Threads per Inch	Wire Dia. Used	Dimension over Wires	
			V-Thread	U.S. Thread				V-Thread	U.S. Thread
1/4	18	0.035	0.2588	0.2708	7/8	8	0.090	0.9285	0.9556
1/4	20	0.035	0.2684	0.2792	7/8	9	0.090	0.9525	0.9766
1/4	22	0.035	0.2763	0.2861	7/8	10	0.090	0.9718	0.9935
1/4	24	0.035	0.2828	0.2919	15/16	8	0.090	0.9910	1.0181
5/16	18	0.035	0.3213	0.3333	15/16	9	0.090	1.0150	1.0391
5/16	20	0.035	0.3309	0.3417	1	8	0.090	1.0535	1.0806
5/16	22	0.035	0.3388	0.3486	1	9	0.090	1.0775	1.1016
5/16	24	0.035	0.3453	0.3544	1 1/8	7	0.090	1.1476	1.1785
3/8	16	0.040	0.3867	0.4003	1 1/4	7	0.090	1.2726	1.3035
3/8	18	0.040	0.3988	0.4108	1 3/8	6	0.150	1.5363	1.5724
3/8	20	0.040	0.4084	0.4192	1 1/2	6	0.150	1.6613	1.6974
7/16	14	0.050	0.4638	0.4793	1 5/8	5 1/2	0.150	1.7601	1.7995
7/16	16	0.050	0.4792	0.4928	1 3/4	5	0.150	1.8536	1.8969
1/2	12	0.050	0.5057	0.5237	1 7/8	5	0.150	1.9786	2.0219
1/2	13	0.050	0.5168	0.5334	2	4 1/2	0.150	2.0651	2.1132
1/2	14	0.050	0.5263	0.5418	2 1/4	4 1/2	0.150	2.3151	2.3632
9/16	12	0.050	0.5682	0.5862	2 1/2	4	0.150	2.5170	2.5711
9/16	14	0.050	0.5888	0.6043	2 3/4	4	0.150	2.7670	2.28211
5/8	10	0.070	0.6618	0.6835	3	3 1/2	0.200	3.1051	3.1670
5/8	11	0.070	0.6775	0.6972	3 1/4	3 1/2	0.200	3.3551	3.4170
5/8	12	0.070	0.6907	0.7087	3 1/2	3 1/4	0.250	3.7171	3.7837
11/16	10	0.070	0.7243	0.7460	3 3/4	3	0.250	3.9226	3.9948
11/16	11	0.070	0.7400	0.7597	4	3	0.250	4.1726	4.2448
3/4	10	0.070	0.7868	0.8085	4 1/4	2 7/8	0.250	4.3975	4.4729
3/4	11	0.070	0.8025	0.8222	4 1/2	2 3/4	0.250	4.6202	4.6989
3/4	12	0.070	0.8157	0.8337	4 3/4	2 5/8	0.250	4.8402	4.9227
13/16	9	0.070	0.8300	0.8541	5	2 1/2	0.250	5.0572	5.1438
13/16	10	0.070	0.8493	0.8710

Buckingham Simplified Formula which Includes Effect of Lead Angle.—The **Formula (3)** which follows gives very accurate results for the lower lead angles in determining measurement *M*. However, if extreme accuracy is essential, it may be advisable to use the involute helicoid formulas as explained later.

$$M = E + W(1 + \sin A_n) \quad (3) \quad \text{where} \quad W = \frac{T \times \cos B}{\cos A_n} \quad (3a)$$

Theoretically correct equations for determining measurement *M* are complex and cumbersome to apply. **Formula (3)** combines simplicity with a degree of accuracy which meets all but the most exacting requirements, particularly for lead angles below 8 or 10 degrees and the higher thread angles. However, the wire diameter used in **Formula (3)** must conform to that obtained by **Formula (3a)** to permit a direct solution or one not involving indeterminate equations and successive trials.

Application of Buckingham Formula: In the application of **Formula (3)** to screw or worm threads, two general cases are to be considered.

Case 1: The screw thread or worm is to be milled with a cutter having an included angle equal to the nominal or standard thread angle that is assumed to be the angle in the axial plane. For example, a 60-degree cutter is to be used for milling a thread. In this case, the

Table for Measuring Whitworth Standard Threads by the Three-wire Method

Dia. of Thread	No. of Threads per Inch	Dia. of Wire Used	Dia. Measured over Wires	Dia. of Thread	No. of Threads per Inch	Dia. of Wire Used	Dia. Measured over Wires
$\frac{1}{8}$	40	0.018	0.1420	$2\frac{1}{4}$	4	0.150	2.3247
$\frac{3}{16}$	24	0.030	0.2158	$2\frac{3}{8}$	4	0.150	2.4497
$\frac{1}{4}$	20	0.035	0.2808	$2\frac{1}{2}$	4	0.150	2.5747
$\frac{5}{16}$	18	0.040	0.3502	$2\frac{5}{8}$	4	0.150	2.6997
$\frac{3}{8}$	16	0.040	0.4015	$2\frac{3}{4}$	$3\frac{1}{2}$	0.200	2.9257
$\frac{7}{16}$	14	0.050	0.4815	$2\frac{7}{8}$	$3\frac{1}{2}$	0.200	3.0507
$\frac{1}{2}$	12	0.050	0.5249	3	$3\frac{1}{2}$	0.200	3.1757
$\frac{9}{16}$	12	0.050	0.5874	$3\frac{1}{8}$	$3\frac{1}{2}$	0.200	3.3007
$\frac{5}{8}$	11	0.070	0.7011	$3\frac{1}{4}$	$3\frac{1}{4}$	0.200	3.3905
$\frac{11}{16}$	11	0.070	0.7636	$3\frac{3}{8}$	$3\frac{1}{4}$	0.200	3.5155
$\frac{3}{4}$	10	0.070	0.8115	$3\frac{1}{2}$	$3\frac{1}{4}$	0.200	3.6405
$\frac{13}{16}$	10	0.070	0.8740	$3\frac{5}{8}$	$3\frac{1}{4}$	0.200	3.7655
$\frac{7}{8}$	9	0.070	0.9187	$3\frac{3}{4}$	3	0.200	3.8495
$\frac{15}{16}$	9	0.070	0.9812	$3\frac{7}{8}$	3	0.200	3.9745
1	8	0.090	1.0848	4	3	0.200	4.0995
$1\frac{1}{16}$	8	0.090	1.1473	$4\frac{1}{8}$	3	0.200	4.2245
$1\frac{1}{8}$	7	0.090	1.1812	$4\frac{1}{4}$	$2\frac{7}{8}$	0.250	4.4846
$1\frac{3}{16}$	7	0.090	1.2437	$4\frac{3}{8}$	$2\frac{7}{8}$	0.250	4.6096
$1\frac{1}{4}$	7	0.090	1.3062	$4\frac{1}{2}$	$2\frac{7}{8}$	0.250	4.7346
$1\frac{5}{16}$	7	0.090	1.3687	$4\frac{5}{8}$	$2\frac{7}{8}$	0.250	4.8596
$1\frac{3}{8}$	6	0.120	1.4881	$4\frac{3}{4}$	$2\frac{3}{4}$	0.250	4.9593
$1\frac{7}{16}$	6	0.120	1.5506	$4\frac{7}{8}$	$2\frac{3}{4}$	0.250	5.0843
$1\frac{1}{2}$	6	0.120	1.6131	5	$2\frac{3}{4}$	0.250	5.2093
$1\frac{9}{16}$	6	0.120	1.6756	$5\frac{1}{8}$	$2\frac{3}{4}$	0.250	5.3343
$1\frac{5}{8}$	5	0.120	1.6847	$5\frac{1}{4}$	$2\frac{5}{8}$	0.250	5.4316
$1\frac{11}{16}$	5	0.120	1.7472	$5\frac{3}{8}$	$2\frac{5}{8}$	0.250	5.5566
$1\frac{3}{4}$	5	0.120	1.8097	$5\frac{1}{2}$	$2\frac{5}{8}$	0.250	5.6816
$1\frac{13}{16}$	5	0.120	1.8722	$5\frac{5}{8}$	$2\frac{5}{8}$	0.250	5.8066
$1\frac{7}{8}$	$4\frac{1}{2}$	0.150	1.9942	$5\frac{3}{4}$	$2\frac{1}{2}$	0.250	5.9011
$1\frac{15}{16}$	$4\frac{1}{2}$	0.150	2.0567	$5\frac{7}{8}$	$2\frac{1}{2}$	0.250	6.0261
2	$4\frac{1}{2}$	0.150	2.1192	6	$2\frac{1}{2}$	0.250	6.1511
$2\frac{1}{8}$	$4\frac{1}{2}$	0.150	2.2442

All dimensions are given in inches.

thread angle in the plane of the axis will exceed 60 degrees by an amount increasing with the lead angle. This variation from the standard angle may be of little or no practical importance if the lead angle is small or if the mating nut (or teeth in worm gearing) is formed to suit the thread as milled.

Case 2: The screw thread or worm is to be milled with a cutter reduced to whatever normal angle is equivalent to the standard thread angle in the axial plane. For example, a 29-degree Acme thread is to be milled with a cutter having some angle smaller than 29 degrees (the reduction increasing with the lead angle) to make the thread angle standard in the plane of the axis. Theoretically, the milling cutter angle should always be corrected to suit the normal angle; but if the lead angle is small, such correction may be unnecessary.

If the thread is cut in a lathe to the standard angle as measured in the axial plane, Case 2 applies in determining the pin size W and the overall measurement M .

In solving all problems under Case 1, angle A_n used in **Formulas (3)** and **(3a)** equals one-half the included angle of the milling cutter.

When Case 2 applies, angle A_n for milled threads also equals one-half the included angle of the cutter, but the cutter angle is reduced and is determined as follows:

$$\tan A_n = \tan A \times \cos B$$

The included angle of the cutter or the normal included angle of the thread groove = $2A_n$. Examples 1 and 2, which follow, illustrate Cases 1 and 2.

Example 1 (Case 1): Take, for example, an Acme screw thread that is milled with a cutter having an included angle of 29 degrees; consequently, the angle of the thread exceeds 29 degrees in the axial section.

The outside or major diameter is 3 inches; the pitch, $\frac{1}{2}$ inch; the lead, 1 inch; the number of threads or “starts,” 2. Find pin size W and measurement M .

Pitch diameter $E = 2.75$; $T = 0.25$; $L = 1.0$; $A_n = 14.50^\circ$ $\tan A_n = 0.258618$; $\sin A_n = 0.25038$; and $\cos A_n = 0.968148$.

$$\tan B = \frac{1.0}{3.1416 \times 2.75} = 0.115749 \quad B = 6.6025^\circ$$

$$W = \frac{0.25 \times 0.993368}{0.968148} = 0.25651 \text{ inch}$$

$$M = 2.75 + 0.25651 \times (1 + 0.25038) = 3.0707 \text{ inches}$$

Note: This value of M is only 0.0001 inch larger than that obtained by using the very accurate involute helicoid **Formula (4)** discussed on the following page.

Example 2 (Case 2): A triple-threaded worm has a pitch diameter of 2.481 inches, pitch of 1.5 inches, lead of 4.5 inches, lead angle of 30 degrees, and nominal thread angle of 60 degrees in the axial plane. Milling cutter angle is to be reduced. $T = 0.75$ inch; $\cos B = 0.866025$; and $\tan A = 0.57735$. Again use **Formula (3)** to see if it is applicable.

$\tan A_n = \tan A \times \cos B = 0.57735 \times 0.866025 = 0.5000$; hence $A_n = 26.565^\circ$, making the included cutter angle 53.13° , thus $\cos A_n = 0.89443$ and $\sin A_n = 0.44721$.

$$W = \frac{0.75 \times 0.866025}{0.89443} = 0.72618 \text{ inch}$$

$$M = 2.481 + 0.72618 \times (1 + 0.44721) = 3.532 \text{ inches}$$

Note: If the value of measurement M is determined by using the following **Formula (4)** it will be found that $M = 3.515 +$ inches; hence the error equals $3.532 - 3.515 = 0.017$ inch approximately, which indicates that **Formula (3)** is not accurate enough here. The application of this simpler **Formula (3)** will depend upon the lead angle and thread angle (as previously explained) and upon the class of work.

Buckingham Exact Involute Helicoid Formula Applied to Screw Threads.—When extreme accuracy is required in finding measurement M for obtaining a given pitch diameter, the equations that follow, although somewhat cumbersome to apply, have the merit of providing a direct and very accurate solution; consequently, they are preferable to the indeterminate equations and successive trial solutions heretofore employed when extreme precision is required. These equations are exact for involute helical gears and, consequently, give theoretically correct results when applied to a screw thread of the involute helicoidal form; they also give very close approximations for threads having intermediate profiles.

Helical Gear Equation Applied to Screw Thread Measurement: In applying the helical gear equations to a screw thread, use either the axial or normal thread angle and the lead angle of the helix. To keep the solution on a practical basis, either thread angle A or A_n , as the case may be, is assumed to equal the cutter angle of a milled thread. Actually, the pro-

file of a milled thread will have some curvature in both axial and normal sections; hence angles A and A_n represent the angular approximations of these slightly curved profiles. The equations that follow give the values needed to solve the screw thread problem as a helical gear problem.

$$M = \frac{2R_b}{\cos G} + W \quad (4)$$

$$\tan F = \frac{\tan A}{\tan B} = \frac{\tan A_n}{\sin B} \quad (4a) \quad R_b = \frac{E}{2} \cos F \quad (4b)$$

$$T_a = \frac{T}{\tan B} \quad (4c) \quad \tan H_b = \cos F \times \tan H \quad (4d)$$

$$\text{inv } G = \frac{T_a}{E} + \text{inv } F + \frac{W}{2R_b \cos H_b} - \frac{\pi}{S} \quad (4e)$$

The tables of involute functions starting on page 111 provide values for angles from 14 to 51 degrees, used for gear calculations. The formula for involute functions on page 110 may be used to extend this table as required.

✦ *Example 3:* To illustrate the application of **Formula (4)** and the supplementary formulas, assume that the number of starts $S = 6$; pitch diameter $E = 0.6250$; normal thread angle $A_n = 20^\circ$; lead of thread $L = 0.864$ inch; $T = 0.072$; $W = 0.07013$ inch.

$$\tan B = \frac{L}{\pi E} = \frac{0.864}{1.9635} = 0.44003 \quad B = 23.751^\circ$$

$$\text{Helix angle } H = 90^\circ - 23.751^\circ = 66.249^\circ$$

$$\tan F = \frac{\tan A_n}{\sin B} = \frac{0.36397}{0.40276} = 0.90369 \quad F = 42.104^\circ$$

$$R_b = \frac{E}{2} \cos F = \frac{0.6250}{2} \times 0.74193 = 0.23185$$

$$T_a = \frac{T}{\tan B} = \frac{0.072}{0.44003} = 0.16362$$

$$\tan H_b = \cos F \tan H = 0.74193 \times 2.27257 = 1.68609 \quad H_b = 59.328^\circ$$

The involute function of G is found next by **Formula (4e)**.

$$\text{inv } G = \frac{0.16362}{0.625} + 0.16884 + \frac{0.07013}{2 \times 0.23185 \times 0.51012} - \frac{3.1416}{6} = 0.20351$$

Since 0.20351 is outside the values for involute functions given in the tables on pages 111 through 114 use the formula for involute functions on page 110 to extend these tables as required. It will be found that 44 deg. 21 min. or 44.350 degrees is the angular equivalent of 0.20351; hence, $G = 44.350$ degrees.

$$M = \frac{2R_b}{\cos G} + W = \frac{2 \times 0.23185}{0.71508} + 0.07013 = 0.71859 \text{ inch}$$

Accuracy of Formulas (3) and (4) Compared.—With the involute helicoid **Formula (4)** any wire size that makes contact with the flanks of the thread may be used; however, in the preceding example, the wire diameter W was obtained by **Formula (3a)** in order to compare **Formula (4)** with (3). If Example (3) is solved by **Formula (3)**, $M = 0.71912$; hence the difference between the values of M obtained with **Formulas (3) and (4)** equals $0.71912 - 0.71859 = 0.00053$ inch. The included thread angle in this case is 40 degrees. If **Formulas**

(3) and (4) are applied to a 29-degree thread, the difference in measurements M or the error resulting from the use of Formulas (3) will be larger. For example, with an Acme thread having a lead angle of about 34 degrees, the difference in values of M obtained by the two formulas equals 0.0008 inch.

Three-wire Measurement of Acme and Stub Acme Thread Pitch Diameter.—For single- and multiple-start Acme and Stub Acme threads having lead angles of less than 5 degrees, the approximate three-wire formula given on page 1993 and the best wire size taken from the table on page 2002 may be used.

Multiple-start Acme and Stub Acme threads commonly have a lead angle of greater than 5 degrees. For these, a direct determination of the actual pitch diameter is obtained by using the formula: $E = M - (C + c)$ in conjunction with the table on page 2003. To enter the table, the lead angle B of the thread to be measured must be known. It is found by the formula: $\tan B = L \div 3.1416E_1$ where L is the lead of the thread and E_1 is the nominal pitch diameter. The best wire size is now found by taking the value of w_1 as given in the table for lead angle B , with interpolation, and dividing it by the number of threads per inch. The value of $(C + c)_1$ given in the table for lead angle B is also divided by the number of threads per inch to get $(C + c)$. Using the best size wires, the actual measurement over wires M is made and the actual pitch diameter E found by using the formula: $E = M - (C + c)$.

Example: For a 5 tpi, 4-start Acme thread with a 13.952° lead angle, using three 0.10024-inch wires, $M = 1.1498$ inches, hence $E = 1.1498 - 0.1248 = 1.0250$ inches.

Under certain conditions, a wire may contact one thread flank at two points, and it is then advisable to substitute balls of the same diameter as the wires.

Checking Thickness of Acme Screw Threads.—In some instances it may be preferable to check the thread thickness instead of the pitch diameter, especially if there is a thread thickness tolerance.

A direct method, applicable to the larger pitches, is to use a vernier gear-tooth caliper for measuring the thickness in the *normal* plane of the thread. This measurement, for an American Standard General Purpose Acme thread, should be made at a distance below the *basic* outside diameter equal to $p/4$. The thickness at this basic pitch-line depth and in the axial plane should be $p/2 - 0.259 \times$ the pitch diameter allowance from the table on page 1923 with a tolerance of *minus* $0.259 \times$ the pitch diameter tolerance from the table on page 1928. The thickness in the normal plane or plane of measurement is equal to the thickness in the axial plane multiplied by the cosine of the helix angle. The helix angle may be determined from the formula:

$$\text{tangent of helix angle} = \text{lead of thread} \div (3.1416 \times \text{pitch diameter})$$

Three-Wire Method for Checking Thickness of Acme Threads.—The application of the 3-wire method of checking the thickness of an Acme screw thread is included in the Report of the National Screw Thread Commission. In applying the 3-wire method for checking thread thickness, the procedure is the same as in checking pitch diameter (see *Three-wire Measurement of Acme and Stub Acme Thread Pitch Diameter*), although a different formula is required. Assume that D = basic major diameter of screw; M = measurement over wires; W = diameter of wires; S = tangent of helix angle at pitch line; P = pitch; T = thread thickness at depth equal to $0.25P$.

$$T = 1.12931 \times P + 0.25862 \times (M - D) - W \times (1.29152 + 0.48407S^2)$$

This formula transposed to show the correct measurement M equivalent to a given required thread thickness is as follows:

$$M = D + \frac{W \times (1.29152 + 0.48407S^2) + T - 1.12931 \times P}{0.25862}$$

**Wire Sizes for Three-Wire Measurement of Acme Threads
with Lead Angles of Less than 5 Degrees**

Threads per Inch	Best Size	Max.	Min.	Threads per Inch	Best Size	Max.	Min.
1	0.51645	0.65001	0.48726	5	0.10329	0.13000	0.09745
1 $\frac{1}{3}$	0.38734	0.48751	0.36545	6	0.08608	0.10834	0.08121
1 $\frac{1}{2}$	0.34430	0.43334	0.32484	8	0.06456	0.08125	0.06091
2	0.25822	0.32501	0.24363	10	0.05164	0.06500	0.04873
2 $\frac{1}{2}$	0.20658	0.26001	0.19491	12	0.04304	0.05417	0.04061
3	0.17215	0.21667	0.16242	14	0.03689	0.04643	0.03480
4	0.12911	0.16250	0.12182	16	0.03228	0.04063	0.03045

Wire sizes are based upon zero helix angle. Best size = $0.51645 \times \text{pitch}$; maximum size = $0.650013 \times \text{pitch}$; minimum size = $0.487263 \times \text{pitch}$.

Example: An Acme General Purpose thread, Class 2G, has a 5-inch basic major diameter, 0.5-inch pitch, and 1-inch lead (double thread). Assume the wire size is 0.258 inch. Determine measurement M for a thread thickness T at the basic pitch line of 0.2454 inch. (T is the maximum thickness at the basic pitch line and equals $0.5P$, the basic thickness, $-0.259 \times$ allowance from Table 4, page 1928.)

$$M = 5 + \frac{0.258 \times [1.29152 + 0.48407 \times (0.06701)^2] + 0.2454 - 1.12931 \times 0.5}{0.25862}$$

$$= 5.056 \text{ inches}$$

Testing Angle of Thread by Three-Wire Method.—The error in the angle of a thread may be determined by using sets of wires of two diameters, the measurement over the two sets of wires being followed by calculations to determine the amount of error, assuming that the angle cannot be tested by comparison with a standard plug gage, known to be correct. The diameter of the small wires for the American Standard thread is usually about 0.6 times the pitch and the diameter of the large wires, about 0.9 times the pitch. The total difference between the measurements over the large and small sets of wires is first determined. If the thread is an American Standard or any other form having an included angle of 60 degrees, the difference between the two measurements should equal three times the difference between the diameters of the wires used. Thus, if the wires are 0.116 and 0.076 inch in diameter, respectively, the difference equals $0.116 - 0.076 = 0.040$ inch. Therefore, the difference between the micrometer readings for a standard angle of 60 degrees equals $3 \times 0.040 = 0.120$ inch for this example. If the angle is incorrect, the amount of error may be determined by the following formula, which applies to any thread regardless of angle:

$$\sin a = \frac{A}{B - A}$$

where A = difference in diameters of the large and small wires used

B = total difference between the measurements over the large and small wires

a = one-half the included thread angle

Example: The diameter of the large wires used for testing the angle of a thread is 0.116 inch and of the small wires 0.076 inch. The measurement over the two sets of wires shows a total difference of 0.122 inch instead of the correct difference, 0.120 inch, for a standard angle of 60 degrees when using the sizes of wires mentioned. The amount of error is determined as follows:

$$\sin a = \frac{0.040}{0.122 - 0.040} = \frac{0.040}{0.082} = 0.4878$$

A table of sines shows that this value (0.4878) is the sine of 29 degrees 12 minutes, approximately. Therefore, the angle of the thread is 58 degrees 24 minutes or 1 degree 36 minutes less than the standard angle.

Best Wire Diameters and Constants for Three-wire Measurement of Acme and Stub Acme Threads with Large Lead Angles, 1-inch Axial Pitch

Lead angle, B , deg.	1-start threads		2-start threads		Lead angle, B , deg.	2-start threads		3-start threads	
	w_1	$(C + c)_1$	w_1	$(C + c)_1$		w_1	$(C + c)_1$	w_1	$(C + c)_1$
5.0	0.51450	0.64311	0.51443	0.64290	10.0	0.50864	0.63518	0.50847	0.63463
5.1	0.51442	0.64301	0.51435	0.64279	10.1	0.50849	0.63498	0.50381	0.63442
5.2	0.51435	0.64291	0.51427	0.64268	10.2	0.50834	0.63478	0.50815	0.63420
5.3	0.51427	0.64282	0.51418	0.64256	10.3	0.50818	0.63457	0.50800	0.63399
5.4	0.51419	0.64272	0.51410	0.64245	10.4	0.50802	0.63436	0.50784	0.63378
5.5	0.51411	0.64261	0.51401	0.64233	10.5	0.40786	0.63416	0.50768	0.63356
5.6	0.51403	0.64251	0.51393	0.64221	10.6	0.50771	0.63395	0.50751	0.63333
5.7	0.51395	0.64240	0.51384	0.64209	10.7	0.50755	0.63375	0.50735	0.63311
5.8	0.51386	0.64229	0.51375	0.64196	10.8	0.50739	0.53354	0.50718	0.63288
5.9	0.51377	0.64218	0.51366	0.64184	10.9	0.50723	0.63333	0.50701	0.63265
6.0	0.51368	0.64207	0.51356	0.64171	11.0	0.50707	0.63313	0.50684	0.63242
6.1	0.51359	0.64195	0.51346	0.64157	11.1	0.50691	0.63292	0.50667	0.63219
6.2	0.51350	0.64184	0.51336	0.64144	11.2	0.50674	0.63271	0.50649	0.63195
6.3	0.51340	0.64172	0.41327	0.64131	11.3	0.50658	0.63250	0.50632	0.63172
6.4	0.51330	0.64160	0.51317	0.64117	11.4	0.50641	0.63228	0.50615	0.63149
6.5	0.51320	0.64147	0.51306	0.64103	11.5	0.50623	0.63206	0.50597	0.63126
6.6	0.51310	0.64134	0.51296	0.64089	11.6	0.50606	0.63184	0.50579	0.63102
6.7	0.51300	0.64122	0.51285	0.64075	11.7	0.50589	0.63162	0.50561	0.63078
6.8	0.51290	0.64110	0.51275	0.64061	11.8	0.50571	0.63140	0.50544	0.63055
6.9	0.51280	0.64097	0.51264	0.64046	11.9	0.50553	0.63117	0.50526	0.63031
7.0	0.51270	0.64085	0.51254	0.64032	12.0	0.50535	0.63095	0.50507	0.63006
7.1	0.51259	0.64072	0.51243	0.64017	12.1	0.50517	0.63072	0.50488	0.62981
7.2	0.51249	0.64060	0.51232	0.64002	12.2	0.50500	0.63050	0.50470	0.62956
7.3	0.51238	0.64047	0.51221	0.63987	12.3	0.50482	0.63027	0.50451	0.62931
7.4	0.51227	0.64034	0.51209	0.63972	12.4	0.50464	0.63004	0.50432	0.62906
7.5	0.51217	0.64021	0.51198	0.63957	12.5	0.50445	0.62981	0.50413	0.62881
7.6	0.51206	0.64008	0.51186	0.63941	12.6	0.50427	0.62958	0.50394	0.62856
7.7	0.51196	0.63996	0.51174	0.63925	12.7	0.50408	0.62934	0.50375	0.62830
7.8	0.51186	0.63983	0.51162	0.63909	12.8	0.50389	0.62911	0.50356	0.62805
7.9	0.51175	0.63970	0.51150	0.63892	12.9	0.50371	0.62888	0.50336	0.62779
8.0	0.51164	0.63957	0.51138	0.63876	13.0	0.50352	0.62865		
8.1	0.51153	0.63944	0.51125	0.63859	13.1	0.50333	0.62841		
8.2	0.51142	0.63930	0.51113	0.63843	13.2	0.50313	0.62817		
8.3	0.51130	0.63916	0.51101	0.63827	13.3	0.50293	0.62792		
8.4	0.51118	0.63902	0.51088	0.63810	13.4	0.50274	0.62778		
8.5	0.51105	0.63887	0.51075	0.63793	13.5	0.50254	0.62743		
8.6	0.51093	0.63873	0.51062	0.63775	13.6	0.50234	0.62718		
8.7	0.51081	0.63859	0.51049	0.63758	13.7	0.50215	0.62694		
8.8	0.51069	0.63845	0.51035	0.63740	13.8	0.50195	0.62670		
8.9	0.51057	0.63831	0.51022	0.63722	13.9	0.50175	0.62645		
9.0	0.51044	0.63817	0.51008	0.63704	14.0	0.50155	0.62621		
9.1	0.51032	0.63802	0.50993	0.63685	14.1	0.50135	0.62596		
9.2	0.51019	0.63788	0.50979	0.63667	14.2	0.50115	0.62571		
9.3	0.51006	0.63774	0.50965	0.63649	14.3	0.50094	0.62546		
9.4	0.50993	0.63759	0.50951	0.63630	14.4	0.50073	0.62520		
9.5	0.50981	0.63744	0.50937	0.63612	14.5	0.50051	0.62494		
9.6	0.50968	0.63730	0.50922	0.63593	14.6	0.50030	0.62468		
9.7	0.50955	0.63715	0.50908	0.63574	14.7	0.50009	0.62442		
9.8	0.50941	0.63700	0.50893	0.63555	14.8	0.49988	0.62417		
9.9	0.50927	0.63685	0.50879	0.63537	14.9	0.49966	0.62391		
10.0	0.50913	0.63670	0.50864	0.63518	15.0	0.49945	0.62365		

For these 3-start thread values see table on following page.

All dimensions are in inches.

Values given for w_1 and $(C + c)_1$ in table are for 1-inch pitch axial threads. For other pitches, divide table values by number of threads per inch.

Courtesy of Van Keuren Co.

Best Wire Diameters and Constants for Three-wire Measurement of Acme and Stub Acme Threads with Large Lead Angles—1-inch Axial Pitch

Lead angle, B , deg.	3-start threads		4-start threads		Lead angle, B , deg.	3-start threads		4-start threads	
	w_1	$(C + c)_1$	w_1	$(C + c)_1$		w_1	$(C + c)_1$	w_1	$(C + c)_1$
13.0	0.50316	0.62752	0.50297	0.62694	18.0	0.49154	0.61250	0.49109	0.61109
13.1	0.50295	0.62725	0.50277	0.62667	18.1	0.49127	0.61216	0.49082	0.61073
13.2	0.50275	0.62699	0.50256	0.62639	18.2	0.49101	0.61182	0.49054	0.61037
13.3	0.50255	0.62672	0.50235	0.62611	18.3	0.49074	0.61148	0.49027	0.61001
13.4	0.50235	0.62646	0.50215	0.62583	18.4	0.49047	0.61114	0.48999	0.60964
13.5	0.50214	0.62619	0.50194	0.62555	18.5	0.49020	0.61080	0.48971	0.60928
13.6	0.50194	0.62592	0.50173	0.62526	18.6	0.48992	0.61045	0.48943	0.60981
13.7	0.50173	0.62564	0.50152	0.62498	18.7	0.48965	0.61011	0.48915	0.60854
13.8	0.50152	0.62537	0.50131	0.62469	18.8	0.48938	0.60976	0.48887	0.60817
13.9	0.50131	0.62509	0.50109	0.62440	18.9	0.48910	0.60941	0.48859	0.60780
14.0	0.50110	0.62481	0.50087	0.62411	19.0	0.48882	0.60906	0.48830	0.60742
14.1	0.50089	0.62453	0.50065	0.62381	19.1	0.48854	0.60871	0.48800	0.60704
14.2	0.50068	0.62425	0.50043	0.62351	19.2	0.48825	0.60835	0.48771	0.60666
14.3	0.50046	0.62397	0.50021	0.62321	19.3	0.48797	0.60799	0.48742	0.60628
14.4	0.50024	0.62368	0.49997	0.62291	19.4	0.48769	0.60764	0.48713	0.60590
14.5	0.50003	0.62340	0.49977	0.62262	19.5	0.48741	0.60729	0.48684	0.60552
14.6	0.49981	0.62312	0.49955	0.62232	19.6	0.48712	0.60693	0.48655	0.60514
14.7	0.49959	0.62283	0.49932	0.62202	19.7	0.48683	0.60657	0.48625	0.60475
14.8	0.49936	0.62253	0.49910	0.62172	19.8	0.48655	0.60621	0.48596	0.60437
14.9	0.49914	0.62224	0.49887	0.62141	19.9	0.48626	0.60585	0.48566	0.60398
15.0	0.49891	0.62195	0.49864	0.62110	20.0	0.48597	0.60549	0.48536	0.60359
15.1	0.49869	0.62166	0.49842	0.62080	20.1	0.48506	0.60320
15.2	0.49846	0.62137	0.49819	0.62049	20.2	0.48476	0.60281
15.3	0.49824	0.62108	0.49795	0.62017	20.3	0.48445	0.60241
15.4	0.42801	0.62078	0.49771	0.61985	20.4	0.48415	0.60202
15.5	0.49778	0.62048	0.49747	0.61953	20.5	0.48384	0.60162
15.6	0.49754	0.62017	0.49723	0.61921	20.6	0.48354	0.60123
15.7	0.49731	0.61987	0.49699	0.61889	20.7	0.48323	0.60083
15.8	0.49707	0.61956	0.49675	0.61857	20.8	0.48292	0.60042
15.9	0.49683	0.61926	0.49651	0.61825	20.9	0.48261	0.60002
16.0	0.49659	0.61895	0.49627	0.61793	21.0	0.48230	0.59961
16.1	0.49635	0.61864	0.49602	0.61760	21.1	0.48198	0.49920
16.2	0.49611	0.61833	0.49577	0.61727	21.2	0.48166	0.59879
16.3	0.49586	0.61801	0.49552	0.61694	21.3	0.48134	0.59838
16.4	0.49562	0.61770	0.49527	0.61661	21.4	0.48103	0.59797
16.5	0.49537	0.61738	0.49502	0.61628	21.5	0.48071	0.59756
16.6	0.49512	0.61706	0.49476	0.61594	21.6	0.48040	0.59715
16.7	0.49488	0.61675	0.49451	0.61560	21.7	0.48008	0.59674
16.8	0.40463	0.61643	0.49425	0.61526	21.8	0.47975	0.59632
16.9	0.49438	0.61611	0.49400	0.61492	21.9	0.47943	0.59590
17.0	0.49414	0.61580	0.49375	0.61458	22.0	0.47910	0.59548
17.1	0.49389	0.61548	0.49349	0.61424	22.1	0.47878	0.59507
17.2	0.49363	0.61515	0.49322	0.61389	22.2	0.47845	0.59465
17.3	0.49337	0.61482	0.49296	0.61354	22.3	0.47812	0.59422
17.4	0.49311	0.61449	0.49269	0.61319	22.4	0.47778	0.59379
17.5	0.49285	0.61416	0.49243	0.61284	22.5	0.47745	0.59336
17.6	0.49259	0.61383	0.49217	0.61250	22.6	0.47711	0.52993
17.7	0.49233	0.61350	0.49191	0.61215	22.7	0.47677	0.59250
17.8	0.49206	0.61316	0.49164	0.61180	22.8	0.47643	0.59207
17.9	0.49180	0.61283	0.49137	0.61144	22.9	0.47610	0.59164
...	23.0	0.47577	0.59121

All dimensions are in inches.

Values given for w_1 and $(C + c)_1$ in table are for 1-inch pitch axial threads. For other pitches divide table values by number of threads per inch.

Courtesy of Van Keuren Co.

Measuring Taper Screw Threads by Three-Wire Method.—When the 3-wire method is used in measuring a taper screw thread, the measurement is along a line that is not perpendicular to the axis of the screw thread, the inclination from the perpendicular equaling one-half the included angle of the taper. The formula that follows compensates for this inclination resulting from contact of the measuring instrument surfaces, with two wires on one side and one on the other. The taper thread is measured over the wires in the usual manner except that the single wire must be located in the thread at a point where the effective diameter is to be checked (as described more fully later). The formula shows the dimension equivalent to the correct pitch diameter at this given point. The general formula for taper screw threads follows:

$$M = \frac{E - (\cot a)/2N + W(1 + \csc a)}{\sec b}$$

where M = measurement over the 3 wires

E = pitch diameter

a = one-half the angle of the thread

N = number of threads per inch

W = diameter of wires; and

b = one-half the angle of taper.

This formula is not theoretically correct but it is accurate for screw threads having tapers of $\frac{3}{4}$ inch per foot or less. This general formula can be simplified for a given thread angle and taper. The simplified formula following (in which P = pitch) is for an American National Standard pipe thread:

$$M = \frac{E - (0.866025 \times P) + 3 \times W}{1.00049}$$

Standard pitch diameters for pipe threads will be found in the section “American Pipe Threads,” which also shows the location, or distance, of this pitch diameter from the end of the pipe. In using the formula for finding dimension M over the wires, the single wire is placed in whatever part of the thread groove locates it at the point where the pitch diameter is to be checked. The wire must be accurately located at this point. The other wires are then placed on each side of the thread that is diametrically opposite the single wire. If the pipe thread is straight or without taper,

$$M = E - (0.866025 \times P) + 3 \times W$$

Application of Formula to Taper Pipe Threads: To illustrate the use of the formula for taper threads, assume that dimension M is required for an American Standard 3-inch pipe thread gage. [Table 1a](#) starting on page 1957 shows that the 3-inch size has 8 threads per inch, or a pitch of 0.125 inch, and a pitch diameter at the gaging notch of 3.3885 inches. Assume that the wire diameter is 0.07217 inch: Then when the pitch diameter is correct

$$M = \frac{3.3885 - (0.866025 \times 0.125) + 3 \times 0.07217}{1.00049} = 3.495 \text{ inches}$$

Pitch Diameter Equivalent to a Given Measurement Over the Wires: The formula following may be used to check the pitch diameter at any point along a tapering thread when measurement M over wires of a given diameter is known. In this formula, E = the effective or pitch diameter at the position occupied by the single wire. The formula is not theoretically correct but gives very accurate results when applied to tapers of $\frac{3}{4}$ inch per foot or less.

$$E = 1.00049 \times M + (0.866025 \times P) - 3 \times W$$

Example: Measurement M = 3.495 inches at the gaging notch of a 3-inch pipe thread and the wire diameter = 0.07217 inch. Then

$$E = 1.00049 \times 3.495 + (0.866025 \times 0.125) - 3 \times 0.07217 = 3.3885 \text{ inches}$$

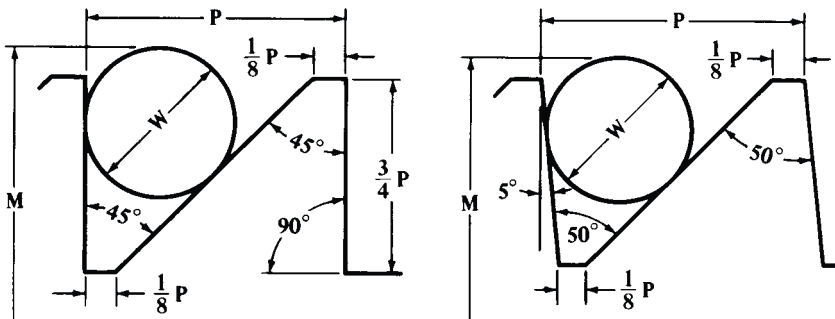
Pitch Diameter at Any Point Along Taper Screw Thread: When the pitch diameter in any position along a tapering thread is known, the pitch diameter at any other position may be determined as follows:

Multiply the distance (measured along the axis) between the location of the known pitch diameter and the location of the required pitch diameter, by the taper per inch or by 0.0625 for American National Standard pipe threads. Add this product to the known diameter, if the required diameter is at a large part of the taper, or subtract if the required diameter is smaller.

Example: The pitch diameter of a 3-inch American National Standard pipe thread is 3.3885 at the gaging notch. Determine the pitch diameter at the small end. The table starting on page 1957 shows that the distance between the gaging notch and the small end of a 3-inch pipe is 0.77 inch. Hence the pitch diameter at the small end = $3.3885 - (0.77 \times 0.0625) = 3.3404$ inches.

Three-Wire Method Applied to Buttress Threads.—The angles of buttress threads vary somewhat, especially on the front or load-resisting side. **Formula (1)**, which follows, may be applied to any angles required. In this formula, M = measurement over wires when pitch diameter E is correct; A = included angle of thread and thread groove; a = angle of front face or load-resisting side, measured from a line perpendicular to screw thread axis; P = pitch of thread; and W = wire diameter.

$$M = E - \left[\frac{P}{\tan a + \tan(A - a)} \right] + W \left[1 + \cos\left(\frac{A}{2} - a\right) \times \csc\frac{A}{2} \right] \quad (1)$$



For given angles A and a , this general formula may be simplified as shown by **Formulas (3)** and **(4)**. These simplified formulas contain constants with values depending upon angles A and a .

Wire Diameter: The wire diameter for obtaining pitch-line contact at the back of a buttress thread may be determined by the following general **Formula (2)**:

$$W = P \left(\frac{\cos a}{1 + \cos A} \right) \quad (2)$$

45-Degree Buttress Thread: The buttress thread shown by the diagram at the left, has a front or load-resisting side that is perpendicular to the axis of the screw. Measurement M equivalent to a correct pitch diameter E may be determined by **Formula (3)**:

$$M = E - P + (W \times 3.4142) \quad (3)$$

Wire diameter W for pitch-line contact at back of thread = $0.586 \times$ pitch.

50-Degree Buttress Thread with Front-face Inclination of 5 Degrees: This buttress thread form is illustrated by the diagram at the right. Measurement M equivalent to the correct pitch diameter E may be determined by **Formula (4)**:

$$M = E - (P \times 0.91955) + (W \times 3.2235) \quad (4)$$

Wire diameter W for pitch-line contact at back of thread = $0.606 \times$ pitch. If the width of flat at crest and root = $\frac{1}{8} \times$ pitch, depth = $0.69 \times$ pitch.

American National Standard Buttress Threads ANSI B1.9-1973: This buttress screw thread has an included thread angle of 52 degrees and a front face inclination of 7 degrees. Measurements M equivalent to a pitch diameter E may be determined by **Formula (5)**:

$$M = E - 0.89064P + 3.15689W + c \quad (5)$$

The wire angle correction factor c is less than 0.0004 inch for recommended combinations of thread diameters and pitches and may be neglected. Use of wire diameter $W = 0.54147P$ is recommended.

Measurement of Pitch Diameter of Thread Ring Gages.—The application of direct methods of measurement to determine the pitch diameter of thread ring gages presents serious difficulties, particularly in securing proper contact pressure when a high degree of precision is required. The usual practice is to fit the ring gage to a master setting plug. When the thread ring gage is of correct lead, angle, and thread form, within close limits, this method is quite satisfactory and represents standard American practice. It is the only method available for small sizes of threads. For the larger sizes, various more or less satisfactory methods have been devised, but none of these have found wide application.

Screw Thread Gage Classification.—Screw thread gages are classified by their degree of accuracy, that is, by the amount of tolerance afforded the gage manufacturer and the wear allowance, if any.

There are also three classifications according to use: 1) Working gages for controlling production; 2) inspection gages for rejection or acceptance of the finished product; and 3) reference gages for determining the accuracy of the working and inspection gages.

American National Standard for Gages and Gaging for Unified Inch Screw Threads ANSI/ASME B1.2-1983 (R2007).—This standard covers gaging methods for conformance of Unified Screw threads and provides the essential specifications for applicable gages required for unified inch screw threads.

The standard includes the following gages for *Product Internal Thread*:

GO Working Thread Plug Gage for inspecting the maximum-material GO functional limit.

NOT GO (HI) Thread Plug Gage for inspecting the NOT GO (HI) functional diameter limit.

Thread Snap Gage—GO Segments or Rolls for inspecting the maximum-material GO functional limit.

Thread Snap Gage—NOT GO (HI) Segments or Rolls for inspecting the NOT GO (HI) functional diameter limit.

Thread Snap Gages—Minimum Material: Pitch Diameter Cone Type and Vee and Thread Groove Diameter Type for inspecting the minimum-material limit pitch diameter.

Thread-Setting Solid Ring Gage for setting internal thread indicating and snap gages.

Plain Plug, Snap, and Indicating Gages for checking the minor diameter of internal threads.

Snap and Indicating Gages for checking the major diameter of internal threads.

Functional Indicating Thread Gage for inspecting the maximum-material GO functional limit and size and the NOT GO (HI) functional diameter limit and size.

Minimum-Material Indicating Thread Gage for inspecting the minimum-material limit and size.

Indicating Runout Thread Gage for inspecting runout of the minor diameter to pitch diameter.

In addition to these gages for product internal threads, the Standard also covers differential gaging and such instruments as pitch micrometers, thread-measuring balls, optical comparator and toolmaker's microscope, profile tracing instrument, surface roughness measuring instrument, and roundness measuring equipment.

The Standard includes the following gages for *Product External Thread*:

GO Working Thread Ring Gage for inspecting the maximum-material GO functional limit.

NOT GO (LO) Thread Ring Gage for inspecting the NOT GO (LO) functional diameter limit.

Thread Snap Gage—GO Segments or Rolls for inspecting the maximum-material GO functional limit.

Thread Snap Gage—NOT GO (LO) Segments or Rolls for inspecting the NOT GO (LO) functional diameter limit.

Thread Snap Gages—Cone and Vee Type and Minimum Material Thread Groove Diameter Type for inspecting the minimum-material pitch diameter limit.

Plain Ring and Snap Gages for checking the major diameter.

Snap Gage for checking the minor diameter.

Functional Indicating Thread Gage for inspecting the maximum-material GO functional limit and size and the NOT GO (LO) functional diameter limit and size.

Minimum-Material Indicating Thread Gage for inspecting the minimum-material limit and size.

Indicating Runout Gage for inspecting the runout of the major diameter to the pitch diameter.

WTolerance Thread-Setting Plug Gage for setting adjustable thread ring gages, checking solid thread ring gages, setting thread snap limit gages, and setting indicating thread gages.

Plain Check Plug Gage for Thread Ring Gage for verifying the minor diameter limits of thread ring gages after the thread rings have been properly set with the applicable thread-setting plug gages.

Indicating Plain Diameter Gage for checking the major diameter.

Indicating Gage for checking the minor diameter.

In addition to these gages for product external threads, the Standard also covers differential gaging and such instruments as thread micrometers, thread-measuring wires, optical comparator and toolmaker's microscope, profile tracing instrument, electromechanical lead tester, helical path attachment used with GO type thread indicating gage, helical path analyzer, surface roughness measuring equipment, and roundness measuring equipment.

The standard lists the following for use of Threaded and Plain Gages for verification of product internal threads:

Tolerance: Unless otherwise specified all thread gages which directly check the product thread shall be X tolerance for all classes.

GO Thread Plug Gages: GO thread plug gages must enter and pass through the full threaded length of the product freely. The GO thread plug gage is a cumulative check of all thread elements except the minor diameter.

NOT GO (HI) Thread Plug Gages: NOT GO (HI) thread plug gages when applied to the product internal thread may engage only the end threads (which may not be representative of the complete thread). Entering threads on product are incomplete and permit gage to start. Starting threads on NOT GO (HI) plugs are subject to greater wear than the remaining threads. Such wear in combination with the incomplete product threads permits further entry of the gage. NOT GO (HI) functional diameter is acceptable when the NOT GO (HI) thread plug gage applied to the product internal thread does not enter more than three complete turns. The gage should not be forced. Special requirements such as exceptionally thin or ductile material, small number of threads, etc., may necessitate modification of this practice.

GO and NOT GO Plain Plug Gages for Minor Diameter of Product Internal Thread: (Recommended in Class Z tolerance.) GO plain plug gages must completely enter and pass through the length of the product without force. NOT GO cylindrical plug gage must not enter.

The standard lists the following for use of Thread Gages for verification of product external threads:

GO Thread Ring Gages: Adjustable GO thread ring gages must be set to the applicable W tolerance setting plugs to assure they are within specified limits. The product thread must freely enter the GO thread ring gage for the entire length of the threaded portion. The GO thread ring gage is a cumulative check of all thread elements except the major diameter.

NOT GO (LO) Thread Ring Gages: NOT GO (LO) thread ring gages must be set to the applicable W tolerance setting plugs to assure that they are within specified limits. NOT GO (LO) thread ring gages when applied to the product external thread may engage only the end threads (which may not be representative of the complete product thread)

Starting threads on NOT GO (LO) rings are subject to greater wear than the remaining threads. Such wear in combination with the incomplete threads at the end of the product thread permit further entry in the gage. NOT GO (LO) functional diameter is acceptable when the NOT GO (LO) thread ring gage applied to the product external thread does not pass over the thread more than three complete turns. The gage should not be forced. Special requirements such as exceptionally thin or ductile material, small number of threads, etc., may necessitate modification of this practice.

GO and NOT GO Plain Ring and Snap Gages for Checking Major Diameter of Product External Thread: The GO gage must completely receive or pass over the major diameter of the product external thread to ensure that the major diameter does not exceed the maximum-material-limit. The NOT GO gage must not pass over the major diameter of the product external thread to ensure that the major diameter is not less than the minimum-material-limit.

Limitations concerning the use of gages are given in the standard as follows:

Product threads accepted by a gage of one type may be verified by other types. It is possible, however, that parts which are near either rejection limit may be accepted by one type and rejected by another. Also, it is possible for two individual limit gages of the same type to be at the opposite extremes of the gage tolerances permitted, and borderline product threads accepted by one gage could be rejected by another. For these reasons, a product screw thread is considered acceptable when it passes a test by any of the permissible gages in ANSI B1.3 for the gaging system that are within the tolerances.

Gaging large product external and internal threads equal to above 6.25-inch nominal size with plain and threaded plug and ring gages presents problems for technical and economic reasons. In these instances, verification may be based on use of modified snap or indicating gages or measurement of thread elements. Various types of gages or measuring

devices in addition to those defined in the Standard are available and acceptable when properly correlated to this Standard. Producer and user should agree on the method and equipment used.

Thread Forms of Gages.—Thread forms of gages for product internal and external threads are given in [Table 1](#). The Standard ANSI/ASME B1.2-1983 (R2007) also gives illustrations of the thread forms of truncated thread setting plug gages, the thread forms of full-form thread setting plug gages, the thread forms of solid thread setting ring gages, and an illustration that shows the chip groove and removal of partial thread.

Building Up Worn Plug Gages.—Plug gages which have been worn under size can be built up by chromium plating and then lapped to size. Any amount of metal up to 0.004 or 0.005 inch can be added to a worn gage. Chromium oxide is used in lapping chromium plated gages, or other parts, to size and for polishing. When the chromium plating of a plug gage has worn under size, it may be removed by subjecting it to the action of muriatic acid. The gage is then built up again by chromium plating and lapped to size. When removing the worn plating the gage should be watched carefully and the action of the acid stopped as soon as the plating has been removed in order to avoid the roughening effect of the acid on the steel.

Thread Gage Tolerances.—Gage tolerances of thread plug and ring gages, thread setting plugs, and setting rings for Unified screw threads, designated as W and X tolerances, are given in [Table 4](#). W tolerances represent the highest commercial grade of accuracy and workmanship, and are specified for thread setting gages; X tolerances are larger than W tolerances and are used for product inspection gages. Tolerances for plain gages are given in [Table 2](#).

Determining Size of Gages: The three-wire method of determining pitch diameter size of plug gages is recommended for gages covered by American National Standard B1.2, described in Appendix B of the 1983 issue of that Standard.

Size limit adjustments of thread ring and external thread snap gages are determined by their fit on their respective calibrated setting plugs. Indicating gages and thread gages for product external threads are controlled by reference to appropriate calibrated setting plugs.

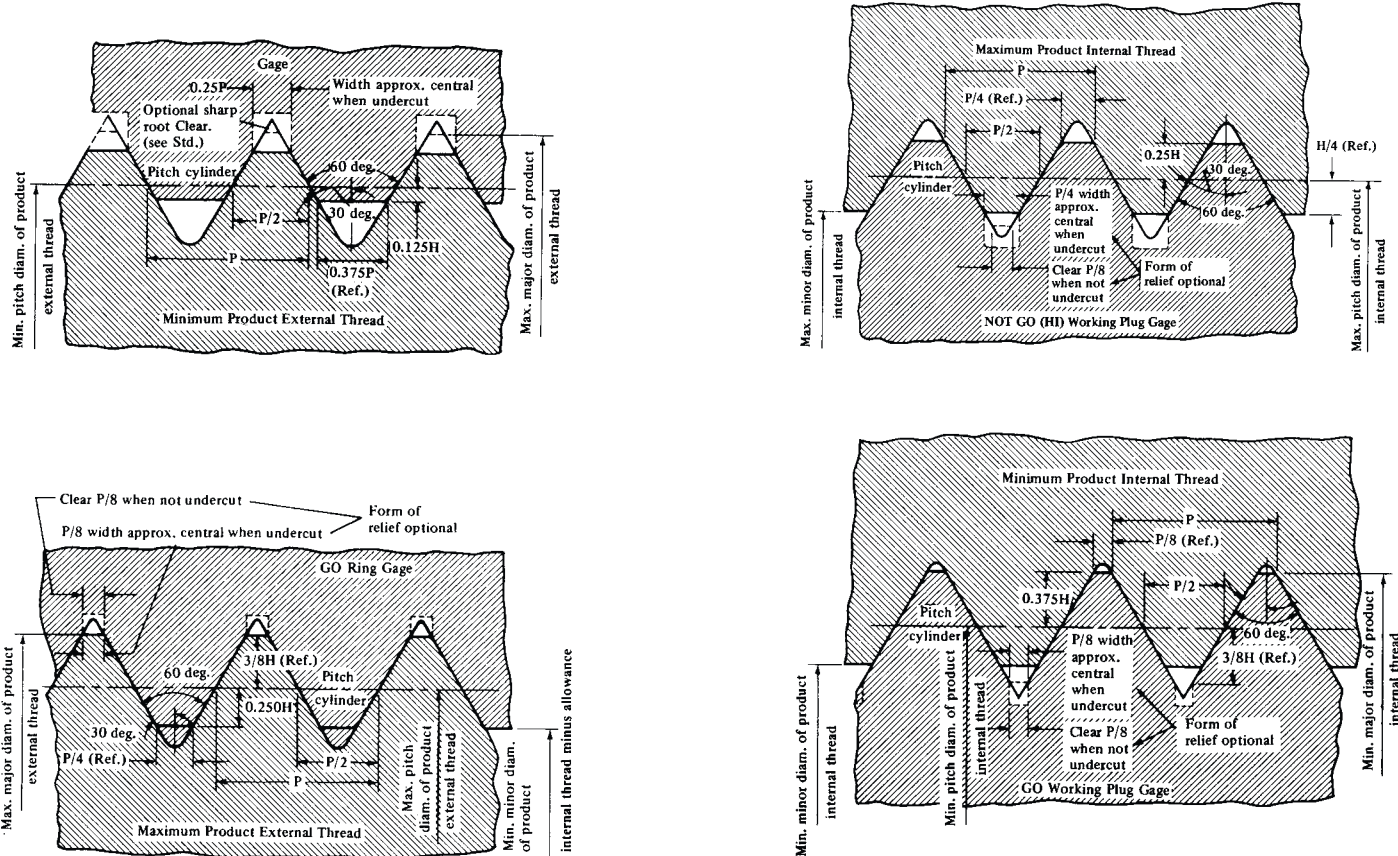
Size limit adjustments of internal thread snap gages are determined by their fit on their respective calibrated setting rings. Indicating gages and other adjustable thread gages for product internal threads are controlled by reference to appropriate calibrated setting rings or by direct measuring methods.

Interpretation of Tolerances: Tolerances on lead, half-angle, and pitch diameter are variations which may be taken independently for each of these elements and may be taken to the extent allowed by respective tabulated dimensional limits. The tabulated tolerance on any one element must not be exceeded, even though variations in the other two elements are smaller than the respective tabulated tolerances.

Direction of Tolerance on Gages: At the maximum-material limit (GO), the dimensions of all gages used for final conformance gaging are to be within limits of size of the product thread. At the functional diameter limit, using NOT GO (HI and LO) thread gages, the standard practice is to have the gage tolerance within the limits of size of the product thread.

Formulas for Limits of Gages: Formulas for limits of American National Standard Gages for Unified screw threads are given in [Table 5](#). Some constants which are required to determine gage dimensions are tabulated in [Table 3](#).

Table 1. Thread Forms of Gages for Product Internal and External Threads



**Table 2. American National Standard Tolerances for Plain Cylindrical Gages
ANSI/ASME B1.2-1983 (R2007)**

Size Range		Tolerance Class ^a				
Above	To and Including	XX	X	Y	Z	ZZ
Tolerance						
0.020	0.825	.00002	.00004	.00007	.00010	.00020
0.825	1.510	.00003	.00006	.00009	.00012	.00024
1.510	2.510	.00004	.00008	.00012	.00016	.00032
2.510	4.510	.00005	.00010	.00015	.00020	.00040
4.510	6.510	.000065	.00013	.00019	.00025	.00050
6.510	9.010	.00008	.00016	.00024	.00032	.00064
9.010	12.010	.00010	.00020	.00030	.00040	.00080

^a Tolerances apply to actual diameter of plug or ring. Apply tolerances as specified in the Standard. Symbols XX, X, Y, Z, and ZZ are standard gage tolerance classes.

All dimensions are given in inches.

**Table 3. Constants for Computing Thread Gage Dimensions
ANSI/ASME B1.2-1983 (R2007)**

Threads per Inch	Pitch, <i>p</i>	$0.060\sqrt[3]{p^2} + 0.017p$.05 <i>p</i>	.087 <i>p</i>	Height of Sharp V-Thread, <i>H</i> = .866025 <i>p</i>	<i>H</i> /2 = .43301 <i>p</i>	<i>H</i> /4 = .216506 <i>p</i>
80	.012500	.0034	.00063	.00109	.010825	.00541	.00271
72	.013889	.0037	.00069	.00122	.012028	.00601	.00301
64	.015625	.0040	.00078	.00136	.013532	.00677	.00338
56	.017857	.0044	.00089	.00155	.015465	.00773	.00387
48	.020833	.0049	.00104	.00181	.018042	.00902	.00451
44	.022727	.0052	.00114	.00198	.019682	.00984	.00492
40	.025000	.0056	.00125	.00218	.021651	.01083	.00541
36	.027778	.0060	.00139	.00242	.024056	.01203	.00601
32	.031250	.0065	.00156	.00272	.027063	.01353	.00677
28	.035714	.0071	.00179	.00311	.030929	.01546	.00773
27	.037037	.0073	.00185	.00322	.032075	.01604	.00802
24	.041667	.0079	.00208	.00361	.036084	.01804	.00902
20	.050000	.0090	.00250	.00435	.043301	.02165	.01083
18	.055556	.0097	.00278	.00483	.048113	.02406	.01203
16	.062500	.0105	.00313	.00544	.054127	.02706	.01353
14	.071429	.0115	.00357	.00621	.061859	.03093	.01546
13	.076923	.0122	.00385	.00669	.066617	.03331	.01665
12	.083333	.0129	.00417	.00725	.072169	.03608	.01804
11½	.086957	.0133	.00435	.00757	.075307	.03765	.01883
11	.090909	.0137	.00451	.00791	.078730	.03936	.01968
10	.100000	.0146	.00500	.00870	.086603	.04330	.02165
9	.111111	.0158	.00556	.00967	.096225	.04811	.02406
8	.125000	.0171	.00625	.01088	.108253	.05413	.02706
7	.142857	.0188	.00714	.01243	.123718	.06186	.03093
6	.166667	.0210	.00833	.01450	.144338	.07217	.03608
5	.200000	.0239	.01000	.01740	.173205	.08660	.04330
4½	.222222	.0258	.01111	.01933	.192450	.09623	.04811
4	.250000	.0281	.01250	.02175	.216506	.10825	.05413

All dimensions are given in inches unless otherwise specified.

Table 4. American National Standard Tolerance for GO, HI, and LO Thread Gages for Unified Inch Screw Thread

Thds. per Inch	Tolerance on Lead ^a		Tol. on Thread Half-angle (±), minutes	Tol. on Major and Minor Diams. ^b			Tolerance on Pitch Diameter ^b				
	To & incl. ½ in. Dia.	Above ½ in. Dia.		To & incl. ½ in. Dia.	Above ½ to 4 in. Dia.	Above 4 in. Dia.	To & incl. ½ in. Dia.	Above ½ to 1 ½ in. Dia.	Above 1 ½ to 4 in. Dia.	Above 4 to 8 in. Dia.	Above 8 to 12 in. ^c Dia.
W GAGES											
80, 72	.0001	.00015	20	.0003	.00030001	.00015
64	.0001	.00015	20	.0003	.00040001	.00015
56	.0001	.00015	20	.0003	.00040001	.00015	.0002
48	.0001	.00015	18	.0003	.00040001	.00015	.0002
44, 40	.0001	.00015	15	.0003	.00040001	.00015	.0002
36	.0001	.00015	12	.0003	.00040001	.00015	.0002
32	.0001	.00015	12	.0003	.0005	.0007	.0001	.00015	.0002	.00025	.0003
28, 27	.00015	.00015	8	.0005	.0005	.0007	.0001	.00015	.0002	.00025	.0003
24, 20	.00015	.00015	8	.0005	.0005	.0007	.0001	.00015	.0002	.00025	.0003
18	.00015	.00015	8	.0005	.0005	.0007	.0001	.00015	.0002	.00025	.0003
16	.00015	.00015	8	.0006	.0006	.0009	.0001	.0002	.00025	.0003	.0004
14, 13	.0002	.0002	6	.0006	.0006	.0009	.00015	.0002	.00025	.0003	.0004
12	.0002	.0002	6	.0006	.0006	.0009	.00015	.0002	.00025	.0003	.0004
11½	.0002	.0002	6	.0006	.0006	.0009	.00015	.0002	.00025	.0003	.0004
11	.0002	.0002	6	.0006	.0006	.0009	.00015	.0002	.00025	.0003	.0004
1000025	60006	.00090002	.00025	.0003	.0004
900025	60007	.00110002	.00025	.0003	.0004
800025	50007	.00110002	.00025	.0003	.0004
70003	50007	.00110002	.00025	.0003	.0004
60003	50008	.00130002	.00025	.0003	.0004
50003	40008	.001300025	.0003	.0004
4½0003	40008	.001300025	.0003	.0004
40003	40009	.001500025	.0003	.0004
X GAGES											
80, 72	.0002	.0002	30	.0003	.00030002	.0002
64	.0002	.0002	30	.0004	.00040002	.0002
56, 48	.0002	.0002	30	.0004	.00040002	.0002	.0003
44, 40	.0002	.0002	20	.0004	.00040002	.0002	.0003
36	.0002	.0002	20	.0004	.00040002	.0002	.0003
32, 28	.0003	.0003	15	.0005	.0005	.0007	.0003	.0003	.0004	.0005	.0006
27, 24	.0003	.0003	15	.0005	.0005	.0007	.0003	.0003	.0004	.0005	.0006
20	.0003	.0003	15	.0005	.0005	.0007	.0003	.0003	.0004	.0005	.0006
18	.0003	.0003	10	.0005	.0005	.0007	.0003	.0003	.0004	.0005	.0006
16, 14	.0003	.0003	10	.0006	.0006	.0009	.0003	.0003	.0004	.0006	.0008
13, 12	.0003	.0003	10	.0006	.0006	.0009	.0003	.0003	.0004	.0006	.0008
11½	.0003	.0003	10	.0006	.0006	.0009	.0003	.0003	.0004	.0006	.0008
11, 10	.0003	.0003	10	.0006	.0006	.0009	.0003	.0003	.0004	.0006	.0008
9	.0003	.0003	10	.0007	.0007	.0011	.0003	.0003	.0004	.0006	.0008
8, 7	.0004	.0004	5	.0007	.0007	.0011	.0004	.0004	.0005	.0006	.0008
6	.0004	.0004	5	.0008	.0008	.0013	.0004	.0004	.0005	.0006	.0008
5, 4½	.0004	.0004	5	.0008	.0008	.00130005	.0006	.0008
4	.0004	.0004	5	.0009	.0009	.00150005	.0006	.0008

^a Allowable variation in lead between any two threads not farther apart than the length of the standard gage as shown in ANSI B47.1. The tolerance on lead establishes the width of a zone, measured parallel to the axis of the thread, within which the actual helical path must lie for the specified length of the thread. Measurements are taken from a fixed reference point, located at the start of the first full thread, to a sufficient number of positions along the entire helix to detect all types of lead variations. The amounts that these positions vary from their basic (theoretical) positions are recorded with due respect to sign. The greatest variation in each direction (±) is selected, and the sum of their values, disregarding sign, must not exceed the tolerance limits specified for W gages.

^b Tolerances apply to designated size of thread. The application of the tolerances is specified in the Standard.

^c Above 12 in. the tolerance is directly proportional to the tolerance given in this column below, in the ratio of the diameter to 12 in.

All dimensions are given in inches unless otherwise specified.

Table 5. Formulas for Limits of American National Standard Gages for Unified Inch Screw Threads ANSI/ASME B1.2-1983 (R2007)

No.	Thread Gages for External Threads
1	GO Pitch Diameter = Maximum pitch diameter of external thread. Gage tolerance is <i>minus</i> .
2	GO Minor Diameter = Maximum pitch diameter of external thread minus $H/2$. Gage tolerance is <i>minus</i> .
3	NOT GO (LO) Pitch Diameter (for plus tolerance gage) = Minimum pitch diameter of external thread. Gage tolerance is <i>plus</i> .
4	NOT GO (LO) Minor Diameter = Minimum pitch diameter of external thread minus $H/4$. Gage tolerance is <i>plus</i> .
Plain Gages for Major Diameter of External Threads	
5	GO = Maximum major diameter of external thread. Gage tolerance is <i>minus</i> .
6	NOT GO = Minimum major diameter of external thread. Gage tolerance is <i>plus</i> .
Thread Gages for Internal Threads	
7	GO Major Diameter = Minimum major diameter of internal thread. Gage tolerance is <i>plus</i> .
8	GO Pitch Diameter = Minimum pitch diameter of internal thread. Gage tolerance is <i>plus</i> .
9	NOT GO (HI) Major Diameter = Maximum pitch diameter of internal thread plus $H/2$. Gage tolerance is <i>minus</i> .
10	NOT GO (HI) Pitch Diameter = Maximum pitch diameter of internal thread. Gage tolerance is <i>minus</i> .
Plain Gages for Minor Diameter of Internal Threads	
11	GO = Minimum minor diameter of internal thread. Gage tolerance is <i>plus</i> .
12	NOT GO = Maximum minor diameter of internal thread. Gage tolerance is <i>minus</i> .
Full Form and Truncated Setting Plugs	
13	GO Major Diameter (Truncated Portion) = Maximum major diameter of external thread (= minimum major diameter of full portion of GO setting plug) minus $(0.060\sqrt[3]{p^2} + 0.017p)$. Gage tolerance is <i>minus</i> .
14	GO Major Diameter (Full Portion) = Maximum major diameter of external thread. Gage tolerance is <i>plus</i> .
15	GO Pitch Diameter = Maximum pitch diameter of external thread. Gage tolerance is <i>minus</i> .
16	^a NOT GO (LO) Major Diameter (Truncated Portion) = Minimum pitch diameter of external thread plus $H/2$. Gage tolerance is <i>minus</i> .
17	NOT GO (LO) Major Diameter (Full Portion) = Maximum major diameter of external thread provided major diameter crest width shall not be less than 0.001 in. (0.0009 in. truncation). Apply W tolerance <i>plus</i> for maximum size except that for 0.001 in. crest width apply tolerance <i>minus</i> . For the 0.001 in. crest width, major diameter is equal to maximum major diameter of external thread plus $0.216506p$ minus the sum of external thread pitch diameter tolerance and 0.0017 in.
18	NOT GO (LO) Pitch Diameter = Minimum pitch diameter of external thread. Gage tolerance is <i>plus</i> .
Solid Thread-setting Rings for Snap and Indicating Gages	
19	^b GO Pitch Diameter = Minimum pitch diameter of internal thread. W gage tolerance is <i>plus</i> .
20	GO Minor Diameter = Minimum minor diameter of internal thread. W gage tolerance is <i>minus</i> .
21	^b NOT GO (HI) Pitch Diameter = Maximum pitch diameter of internal thread. W gage tolerance is <i>minus</i> .
22	NOT GO (HI) Minor Diameter = Maximum minor diameter of internal thread. W gage tolerance is <i>minus</i> .

^aTruncated portion is required when optional sharp root profile is used.

^bTolerances greater than W tolerance for pitch diameter are acceptable when internal indicating or snap gage can accommodate a greater tolerance and when agreed upon by supplier and user.

See data in Screw Thread Systems section for symbols and dimensions of Unified Screw Threads.

TAPPING AND THREAD CUTTING

Selection of Taps.—For most applications, a standard tap supplied by the manufacturer can be used, but some jobs may require special taps. A variety of standard taps can be obtained. In addition to specifying the size of the tap it is necessary to be able to select the one most suitable for the application at hand.

The elements of standard taps that are varied are: the number of flutes; the type of flute, whether straight, spiral pointed, or spiral fluted; the chamfer length; the relief of the land, if any; the tool steel used to make the tap; and the surface treatment of the tap.

Details regarding the nomenclature of tap elements are given in the section *TAPS* starting on page 904, along with a listing of the standard sizes available.

Factors to consider in selecting a tap include: the method of tapping, by hand or by machine; the material to be tapped and its heat treatment; the length of thread, or depth of the tapped hole; the required tolerance or class of fit; and the production requirement and the type of machine to be used.

The diameter of the hole must also be considered, although this action is usually only a matter of design and the specification of the tap drill size.

Method of Tapping: The term *hand tap* is used for both hand and machine taps, and almost all taps can be applied by the hand or machine method. While any tap can be used for hand tapping, those having a concentric land without the relief are preferable. In hand tapping the tool is reversed periodically to break the chip, and the heel of the land of a tap with a concentric land (without relief) will cut the chip off cleanly or any portion of it that is attached to the work, whereas a tap with an eccentric or con-eccentric relief may leave a small burr that becomes wedged between the relieved portion of the land and the work. This wedging creates a pressure towards the cutting face of the tap that may cause it to chip; it tends to roughen the threads in the hole, and it increases the overall torque required to turn the tool. When tapping by machine, however, the tap is usually turned only in one direction until the operation is complete, and an eccentric or con-eccentric relief is often an advantage.

Chamfer Length: Three types of hand taps, used both for hand and machine tapping, are available, and they are distinguished from each other by the length of chamfer. *Taper taps* have a chamfer angle that reduces the height about 8-10 teeth; *plug taps* have a chamfer angle with 3-5 threads reduced in height; and *bottoming taps* have a chamfer angle with 1½ threads reduced in height. Since the teeth that are reduced in height do practically all the cutting, the chip load or chip thickness per tooth will be least for a taper tap, greater for a plug tap, and greatest for a bottoming tap.

For most through hole tapping applications it is necessary to use only a plug type tap, which is also most suitable for blind holes where the tap drill hole is deeper than the required thread. If the tap must bottom in a blind hole, the hole is usually threaded first with a plug tap and then finished with a bottoming tap to catch the last threads in the bottom of the hole. Taper taps are used on materials where the chip load per tooth must be kept to a minimum. However, taper taps should not be used on materials that have a strong tendency to work harden, such as the austenitic stainless steels.

Spiral Point Taps: Spiral point taps offer a special advantage when machine tapping through holes in ductile materials because they are designed to handle the long continuous chips that form and would otherwise cause a disposal problem. An angular gash is ground at the point or end of the tap along the face of the chamfered threads or lead teeth of the tap. This gash forms a left-hand helix in the flutes adjacent to the lead teeth which causes the chips to flow ahead of the tap and through the hole. The gash is usually formed to produce a rake angle on the cutting face that increases progressively toward the end of the tool. Since the flutes are used primarily to provide a passage for the cutting fluid, they are usually made narrower and shallower thereby strengthening the tool. For tapping thin work-

pieces short fluted spiral point taps are recommended. They have a spiral point gash along the cutting teeth; the remainder of the threaded portion of the tap has no flute. Most spiral pointed taps are of plug type; however, spiral point bottoming taps are also made.

Spiral Fluted Taps: Spiral fluted taps have a helical flute; the helix angle of the flute may be between 15 and 52 degrees and the hand of the helix is the same as that of the threads on the tap. The spiral flute and the rake that it forms on the cutting face of the tap combine to induce the chips to flow backward along the helix and out of the hole. Thus, they are ideally suited for tapping blind holes and they are available as plug and bottoming types. A higher spiral angle should be specified for tapping very ductile materials; when tapping harder materials, chipping at the cutting edge may result and the spiral angle must be reduced.

Holes having a pronounced interruption such as a groove or a keyway can be tapped with spiral fluted taps. The land bridges the interruption and allows the tap to cut relatively smoothly.

Serial Taps and Close Tolerance Threads: For tapping holes to close tolerances a set of serial taps is used.

They are usually available in sets of three: the No. 1 tap is undersize and is the first rougher; the No. 2 tap is of intermediate size and is the second rougher; and the No. 3 tap is used for finishing.

The different taps are identified by one, two, and three annular grooves in the shank adjacent to the square. For some applications involving finer pitches only two serial taps are required. Sets are also used to tap hard or tough materials having a high tensile strength, deep blind holes in normal materials, and large coarse threads. A set of more than three taps is sometimes required to produce threads of coarse pitch. Threads to some commercial tolerances, such as American Standard Unified 2B, or ISO Metric 6H, can be produced in one cut using a ground tap; sometimes even closer tolerances can be produced with a single tap. Ground taps are recommended for all close tolerance tapping operations. For much ordinary work, cut taps are satisfactory and more economical than ground taps.

Tap Steels: Most taps are made from high speed steel. The type of tool steel used is determined by the tap manufacturer and is usually satisfactory when correctly applied except in a few exceptional cases. Typical grades of high speed steel used to make taps are M-1, M-2, M-3, M-42, etc. Carbon tool steel taps are satisfactory where the operating temperature of the tap is low and where a high resistance to abrasion is not required as in some types of hand tapping.

Surface Treatment: The life of high speed steel taps can sometimes be increased significantly by treating the surface of the tap. A very common treatment is oxide coating, which forms a thin metallic oxide coating on the tap that has lubricity and is somewhat porous to absorb and retain oil. This coating reduces the friction between the tap and the work and it makes the surface virtually impervious to rust. It does not increase the hardness of the surface but it significantly reduces or prevents entirely galling, or the tendency of the work material to weld or stick to the cutting edge and to other areas on the tap with which it is in contact. For this reason oxide coated taps are recommended for metals that tend to gall and stick such as non-free cutting low carbon steels and soft copper. It is also useful for tapping other steels having higher strength properties.

Nitriding provides a very hard and wear resistant case on high speed steel. Nitrided taps are especially recommended for tapping plastics; they have also been used successfully on a variety of other materials including high strength high alloy steels. However, some caution must be used in specifying nitrided taps because the nitride case is very brittle and may have a tendency to chip.

Chrome plating has been used to increase the wear resistance of taps but its application has been limited because of the high cost and the danger of hydrogen embrittlement which can cause cracks to form in the tool. A flash plate of about .0001 in. or less in thickness is applied to the tap. Chrome-plated taps have been used successfully to tap a variety of fer-

rous and nonferrous materials including plastics, hard rubber, mild steel, and tool steel. Other surface treatments that have been used successfully to a limited extent are vapor blasting and liquid honing.

Rake Angle: For the majority of applications in both ferrous and nonferrous materials the rake angle machined on the tap by the manufacturer is satisfactory. This angle is approximately 5 to 7 degrees. In some instances it may be desirable to alter the rake angle of the tap to obtain beneficial results and **Table 1** provides a guide that can be used. In selecting a rake angle from this table, consideration must be given to the size of the tap and the strength of the land. Most standard taps are made with a curved face with the rake angle measured as a chord between the crest and root of the thread. The resulting shape is called a hook angle.

Table 1. Tap Rake Angles for Tapping Different Materials

Material	Rake Angle, Degrees	Material	Rake Angle, Degrees
Cast Iron	0-3	Aluminum	8-20
Malleable Iron	5-8	Brass	2-7
Steel		Naval Brass	5-8
AISI 1100 Series	5-12	Phosphor Bronze	5-12
Low Carbon (up to .25 per cent)	5-12	Tobin Bronze	5-8
Medium Carbon, Annealed (.30 to .60 per cent)	5-10	Manganese Bronze	5-12
Heat Treated, 225-283 Brinell (.30 to .60 per cent)	0-8	Magnesium	10-20
High Carbon and High Speed	0-5	Monel	9-12
Stainless	8-15	Copper	10-18
Titanium	5-10	Zinc Die Castings	10-15
		Plastic	
		Thermoplastic	5-8
		Thermosetting	0-3
		Hard Rubber	0-3

Cutting Speed.—The cutting speed for machine tapping is treated in detail on page 1071. It suffices to say here that many variables must be considered in selecting this cutting speed and any tabulation may have to be modified greatly. Where cutting speeds are mentioned in the following section, they are intended only to provide a guideline to show the possible range of speeds that could be used.

Tapping Specific Materials.—The work material has a great influence on the ease with which a hole can be tapped. For production work, in many instances, modified taps are recommended; however, for toolroom or short batch work, standard hand taps can be used on most jobs, providing reasonable care is taken when tapping. The following concerns the tapping of metallic materials; information on the tapping of plastics is given on page 601.

Low Carbon Steel (Less than 0.15% C): These steels are very soft and ductile resulting in a tendency for the work material to tear and to weld to the tap. They produce a continuous chip that is difficult to break and spiral pointed taps are recommended for tapping through holes; for blind holes a spiral fluted tap is recommended. To prevent galling and welding, a liberal application of a sulfur base or other suitable cutting fluid is essential and the selection of an oxide coated tap is very helpful.

Low Carbon Steels (0.15 to 0.30% C): The additional carbon in these steels is beneficial as it reduces the tendency to tear and to weld; their machinability is further improved by cold drawing. These steels present no serious problems in tapping provided a suitable cutting fluid is used. An oxide coated tap is recommended, particularly in the lower carbon range.

Medium Carbon Steels (0.30 to 0.60% C): These steels can be tapped without too much difficulty, although a lower cutting speed must be used in machine tapping. The cutting speed is dependent on carbon content and heat treatment. Steels that have a higher carbon content must be tapped more slowly, especially if the heat treatment has produced a pearlitic microstructure. The cutting speed and ease of tapping is significantly improved by heat treating to produce a spheroidized microstructure. A suitable cutting fluid must be used.

High Carbon Steels (More than 0.6% C): Usually these materials are tapped in the annealed or normalized condition although sometimes tapping is done after hardening and tempering to a hardness below 55 Rc. Recommendations for tapping after hardening and tempering are given under High Tensile Strength Steels. In the annealed and normalized condition these steels have a higher strength and are more abrasive than steels with a lower carbon content; thus, they are more difficult to tap. The microstructure resulting from the heat treatment has a significant effect on the ease of tapping and the tap life, a spheroidite structure being better in this respect than a pearlitic structure. The rake angle of the tap should not exceed 5 degrees and for the harder materials a concentric tap is recommended. The cutting speed is considerably lower for these steels and an activated sulfur-chlorinated cutting fluid is recommended.

Alloy Steels: This classification includes a wide variety of steels, each of which may be heat treated to have a wide range of properties. When annealed and normalized they are similar to medium to high carbon steels and usually can be tapped without difficulty, although for some alloy steels a lower tapping speed may be required. Standard taps can be used and for machine tapping a con-eccentric relief may be helpful. A suitable cutting fluid must be used.

High-Tensile Strength Steels: Any steel that must be tapped after being heat treated to a hardness range of 40-55 Rc is included in this classification. Low tap life and excessive tap breakage are characteristics of tapping these materials; those that have a high chromium content are particularly troublesome. Best results are obtained with taps that have concentric lands, a rake angle that is at or near zero degrees, and 6 to 8 chamfered threads on the end to reduce the chip load per tooth. The chamfer relief should be kept to a minimum. The load on the tap should be kept to a minimum by every possible means, including using the largest possible tap drill size; keeping the hole depth to a minimum; avoidance of bottoming holes; and, in the larger sizes, using fine instead of coarse pitches. Oxide coated taps are recommended although a nitrided tap can sometimes be used to reduce tap wear. An active sulfur-chlorinated oil is recommended as a cutting fluid and the tapping speed should not exceed about 10 feet per minute (3.0 m/min).

Stainless Steels: Ferritic and martensitic type stainless steels are somewhat like alloy steels that have a high chromium content, and they can be tapped in a similar manner, although a slightly slower cutting speed may have to be used. Standard rake angle oxide coated taps are recommended and a cutting fluid containing molybdenum disulphide is helpful to reduce the friction in tapping. Austenitic stainless steels are very difficult to tap because of their high resistance to cutting and their great tendency to work harden. A work-hardened layer is formed by a cutting edge of the tap and the depth of this layer depends on the severity of the cut and the sharpness of the tool. The next cutting edge must penetrate below the work-hardened layer, if it is to be able to cut. Therefore, the tap must be kept sharp and each succeeding cutting edge on the tool must penetrate below the work-hardened layer formed by the preceding cutting edge. For this reason, a taper tap should not be used, but rather a plug tap having 3-5 chamfered threads. To reduce the rubbing of the lands, an eccentric or con-eccentric relieved land should be used and a 10-15 degree rake angle is recommended. A tough continuous chip is formed that is difficult to break. To control this chip, spiral pointed taps are recommended for through holes and low-helix angle spiral fluted taps for blind holes. An oxide coating on the tap is very helpful and a sulfur-chlorinated mineral lard oil is recommended, although heavy duty soluble oils have also been used successfully.

Free Cutting Steels: There are large numbers of free cutting steels, including free cutting stainless steels, which are also called free machining steels. Sulfur, lead, or phosphorus are added to these steels to improve their machinability. Free machining steels are always easier to tap than their counterparts that do not have the free machining additives. Tool life is usually increased and a somewhat higher cutting speed can be used. The type of tap recommended depends on the particular type of free machining steel and the nature of the tapping operation; usually a standard tap can be used.

High Temperature Alloys: These are cobalt or nickel base nonferrous alloys that cut like austenitic stainless steel, but are often even more difficult to machine. The recommendations given for austenitic stainless steel also apply to tapping these alloys but the rake angle should be 0 to 10 degrees to strengthen the cutting edge. For most applications a nitrided tap or one made from M41, M42, M43, or M44 steel is recommended. The tapping speed is usually in the range of 5-10 ft/min (1.5-3.0 m/min).

Titanium and Titanium Alloys: Titanium and its alloys have a low specific heat and a pronounced tendency to weld on to the tool material; therefore, oxide coated taps are recommended to minimize galling and welding. The rake angle of the tap should be from 6 to 10 degrees. To minimize the contact between the work and the tap an eccentric or con-eccentric relief land should be used. Taps having interrupted threads are sometimes helpful. Pure titanium is comparatively easy to tap but the alloys are very difficult. The cutting speed depends on the composition of the alloy and may vary from 10-40 ft/min (3.0-12.2 m/min). Special cutting oils are recommended for tapping titanium.

Gray Cast Iron: The microstructure of gray cast iron can vary, even within a single casting, and compositions are used that vary in tensile strength from about 20,000-60,000 psi (138-414 MPa) and 160 to 250 Bhn. Thus, cast iron is not a single material, although in general it is not difficult to tap. The cutting speed may vary from 90 ft/min (27.4 m/min) for the softer grades to 30 ft/min (9.1 m/min) for the harder grades. The chip is discontinuous and straight fluted taps should be used for all applications. Oxide coated taps are helpful and gray cast iron can usually be tapped dry, although water soluble oils and chemical emulsions are sometimes used.

Malleable Cast Iron: Commercial malleable cast irons are also available having a rather wide range of properties, although within a single casting they tend to be quite uniform. They are relatively easy to tap and standard taps can be used. The cutting speed for ferritic cast irons is 60-90 ft/min (18.3-27.4 m/min), for pearlitic malleable irons 40-50 ft/min (12.2-15.2 m/min), and for martensitic malleable irons 30-35 ft/min (9.1-10.7 m/min). A soluble oil cutting fluid is recommended except for martensitic malleable iron where a sulfur base oil may work better.

Ductile or Nodular Cast Iron: Several classes of nodular iron are used having a tensile strength varying from 60,000-120,000 psi (414-827 MPa). Moreover, the microstructure in a single casting and in castings produced at different times vary rather widely. The chips are easily controlled but have some tendency to weld to the faces and flanks of cutting tools. For this reason oxide coated taps are recommended. The cutting speed may vary from 15 fpm (4.6 m/min) for the harder martensitic ductile irons to 60 fpm (18.3 m/min) for the softer ferritic grades. A suitable cutting fluid should be used.

Aluminum: Aluminum and aluminum alloys are relatively soft materials that have little resistance to cutting. The danger in tapping these alloys is that the tap will ream the hole instead of cutting threads, or that it will cut a thread eccentric to the hole. For these reasons, extra care must be taken when aligning the tap and starting the thread. For production tapping a spiral pointed tap is recommended for through holes and a spiral fluted tap for blind holes; preferably these taps should have a 10 to 15 degree rake angle. A lead screw tapping machine is helpful in cutting accurate threads. A heavy duty soluble oil or a light base mineral oil should be used as a cutting fluid.

Copper Alloys: Most copper alloys are not difficult to tap, except beryllium copper and a few other hard alloys. Pure copper is difficult because of its ductility and the ductile continuous chip formed, which can be hard to control. However, with reasonable care and the use of medium heavy duty mineral lard oil it can be tapped successfully. Red brass, yellow brass, and similar alloys containing not more than 35 per cent zinc produce a continuous chip. While straight fluted taps can be used for hand tapping these alloys, machine tapping should be done with spiral pointed or spiral fluted taps for through and blind holes respectively. Naval brass, leaded brass, and cast brasses produce a discontinuous chip and a straight fluted tap can be used for machine tapping. These alloys exhibit a tendency to close in on the tap and sometimes an interrupted thread tap is used to reduce the resulting jamming effect. Beryllium copper and the silicon bronzes are the strongest of the copper alloys. Their strength combined with their ability to work harden can cause difficulties in tapping. For these alloys plug type taps should be used and the taps should be kept as sharp as possible. A medium or heavy duty water soluble oil is recommended as a cutting fluid.

Other Tapping Lubricants.—The power required in tapping varies considerably with different lubricants. The following lubricants reduce the resistance to the cut when threading forged nuts and hexagon drawn material: stearine oil, lard oil, sperm oil, rape oil, and 10 per cent graphite with 90 per cent tallow. A mixture of cutting emulsion (soluble oil) with water reduces resistance to threading action well. A few emulsions are almost as good as animal and vegetable oils, but the emulsion used plays an important part; the majority of emulsions do not give good results. A large volume of lubricant gives somewhat better results than a small quantity, especially in the case of the thinner oils. Kerosene, turpentine, and graphite proved unsuitable for tapping steel. Mineral oils not mixed with animal and vegetable oils, and ordinary lubricating and machine oils, are wholly unsuitable.

For aluminum, kerosene is recommended. For tapping cast iron use a strong solution of emulsion; oil has a tendency to make cast-iron chips clog in the flutes, preventing the lubricant from reaching the tap cutting teeth. For tapping copper, milk is a good lubricant.

Diameter of Tap Drill.—Tapping troubles are sometimes caused by tap drills that are too small in diameter. The tap drill should not be smaller than is necessary to give the required strength to the thread as even a very small decrease in the diameter of the drill will increase the torque required and the possibility of broken taps. Tests have shown that any increase in the percentage of full thread over 60 per cent does not significantly increase the strength of the thread. Often, a 55 to 60 per cent thread is satisfactory, although 75 per cent threads are commonly used to provide an extra measure of safety. The present thread specifications do not always allow the use of the smaller thread depths. However, the specification given on a part drawing must be adhered to and may require smaller minor diameters than might otherwise be recommended.

The depth of the thread in the tapped hole is dependent on the length of thread engagement and on the material. In general, when the engagement length is more than one and one-half times the nominal diameter a 50 or 55 per cent thread is satisfactory. Soft ductile materials permit a slightly larger tapping hole than brittle materials such as gray cast iron.

It must be remembered that a twist drill is a roughing tool that may be expected to drill slightly oversize and that some variations in the size of the tapping holes are almost inevitable. When a closer control of the hole size is required it must be reamed. Reaming is recommended for the larger thread diameters and for some fine pitch threads.

For threads of Unified form (see *American National and Unified Screw Thread Forms* on page 1806) the selection of tap drills is covered in the section *Factors Influencing Minor Diameter Tolerances of Tapped Holes* on page 2030, and the hole size limits are given in Table 2. Tap drill sizes for American National Form threads based on 75 per cent of full thread depth are given in Tables 3 and 4. For smaller-size threads the use of slightly larger drills, if permissible, will reduce tap breakage. The selection of tap drills for these threads also may be based on the hole size limits given in Table 2 for Unified threads that take lengths of engagement into account. (*Text continues on page 2030.*)

Table 2. Recommended Hole Size Limits Before Tapping Unified Threads

Thread Size	Classes 1B and 2B								Class 3B							
	Length of Engagement (D = Nominal Size of Thread)															
	To and Including $\frac{1}{3}D$		Above $\frac{1}{3}D$ to $\frac{2}{3}D$		Above $\frac{2}{3}D$ to $1\frac{1}{2}D$		Above $1\frac{1}{2}D$ to $3D$		To and Including $\frac{1}{3}D$		Above $\frac{1}{3}D$ to $\frac{2}{3}D$		Above $\frac{2}{3}D$ to $1\frac{1}{2}D$		Above $1\frac{1}{2}D$ to $3D$	
	Recommended Hole Size Limits															
	Min ^a	Max	Min	Max	Min	Max ^b	Min	Max	Min ^a	Max	Min	Max	Min	Max ^b	Min	Max
0-80	0.0465	0.0500	0.0479	0.0514	0.0479	0.0514	0.0479	0.0514	0.0465	0.0500	0.0479	0.0514	0.0479	0.0514	0.0479	0.0514
1-64	0.0561	0.0599	0.0585	0.0623	0.0585	0.0623	0.0585	0.0623	0.0561	0.0599	0.0585	0.0623	0.0585	0.0623	0.0585	0.0623
1-72	0.0580	0.0613	0.0596	0.0629	0.0602	0.0635	0.0602	0.0635	0.0580	0.0613	0.0596	0.0629	0.0602	0.0635	0.0602	0.0635
2-56	0.0667	0.0705	0.0686	0.0724	0.0699	0.0737	0.0699	0.0737	0.0667	0.0705	0.0686	0.0724	0.0699	0.0737	0.0699	0.0737
2-64	0.0691	0.0724	0.0707	0.0740	0.0720	0.0753	0.0720	0.0753	0.0691	0.0724	0.0707	0.0740	0.0720	0.0753	0.0720	0.0753
3-48	0.0764	0.0804	0.0785	0.0825	0.0805	0.0845	0.0806	0.0846	0.0764	0.0804	0.0785	0.0825	0.0805	0.0845	0.0806	0.0846
3-56	0.0797	0.0831	0.0814	0.0848	0.0831	0.0865	0.0833	0.0867	0.0797	0.0831	0.0814	0.0848	0.0831	0.0865	0.0833	0.0867
4-40	0.0849	0.0894	0.0871	0.0916	0.0894	0.0939	0.0902	0.0947	0.0849	0.0894	0.0871	0.0916	0.0894	0.0939	0.0902	0.0947
4-48	0.0894	0.0931	0.0912	0.0949	0.0931	0.0968	0.0939	0.0976	0.0894	0.0931	0.0912	0.0949	0.0931	0.0968	0.0939	0.0976
5-40	0.0979	0.1020	0.1000	0.1041	0.1021	0.1062	0.1036	0.1077	0.0979	0.1020	0.1000	0.1041	0.1021	0.1062	0.1036	0.1077
5-44	0.1004	0.1042	0.1023	0.1060	0.1042	0.1079	0.1060	0.1097	0.1004	0.1042	0.1023	0.1060	0.1042	0.1079	0.1060	0.1097
6-32	0.104	0.109	0.106	0.112	0.109	0.114	0.112	0.117	0.1040	0.1091	0.1066	0.1115	0.1091	0.1140	0.1115	0.1164
6-40	0.111	0.115	0.113	0.117	0.115	0.119	0.117	0.121	0.1110	0.1148	0.1128	0.1167	0.1147	0.1186	0.1166	0.1205
8-32	0.130	0.134	0.132	0.137	0.134	0.139	0.137	0.141	0.1300	0.1345	0.1324	0.1367	0.1346	0.1389	0.1367	0.1410
8-36	0.134	0.138	0.136	0.140	0.138	0.142	0.140	0.144	0.1340	0.1377	0.1359	0.1397	0.1378	0.1416	0.1397	0.1435
10-24	0.145	0.150	0.148	0.154	0.150	0.156	0.152	0.159	0.1450	0.1502	0.1475	0.1528	0.1502	0.1555	0.1528	0.1581
10-32	0.156	0.160	0.158	0.162	0.160	0.164	0.162	0.166	0.1560	0.1601	0.1581	0.1621	0.1601	0.1641	0.1621	0.1661
12-24	0.171	0.176	0.174	0.179	0.176	0.181	0.178	0.184	0.1710	0.1758	0.1733	0.1782	0.1758	0.1807	0.1782	0.1831
12-28	0.177	0.182	0.179	0.184	0.182	0.186	0.184	0.188	0.1770	0.1815	0.1794	0.1836	0.1815	0.1857	0.1836	0.1878
12-32	0.182	0.186	0.184	0.188	0.186	0.190	0.188	0.192	0.1820	0.1858	0.1837	0.1877	0.1855	0.1895	0.1873	0.1913
$\frac{1}{4}$ -20	0.196	0.202	0.199	0.204	0.202	0.207	0.204	0.210	0.1960	0.2013	0.1986	0.2040	0.2013	0.2067	0.2040	0.2094
$\frac{1}{4}$ -28	0.211	0.216	0.213	0.218	0.216	0.220	0.218	0.222	0.2110	0.2152	0.2131	0.2171	0.2150	0.2190	0.2169	0.2209
$\frac{1}{4}$ -32	0.216	0.220	0.218	0.222	0.220	0.224	0.222	0.226	0.2160	0.2196	0.2172	0.2212	0.2189	0.2229	0.2206	0.2246
$\frac{1}{4}$ -36	0.220	0.224	0.221	0.225	0.224	0.226	0.225	0.228	0.2200	0.2243	0.2199	0.2243	0.2214	0.2258	0.2229	0.2273
$\frac{5}{16}$ -18	0.252	0.259	0.255	0.262	0.259	0.265	0.262	0.268	0.2520	0.2577	0.2551	0.2604	0.2577	0.2630	0.2604	0.2657
$\frac{5}{16}$ -24	0.267	0.272	0.270	0.275	0.272	0.277	0.275	0.280	0.2670	0.2714	0.2694	0.2734	0.2714	0.2754	0.2734	0.2774
$\frac{5}{16}$ -32	0.279	0.283	0.281	0.285	0.283	0.286	0.285	0.289	0.2790	0.2817	0.2792	0.2832	0.2807	0.2847	0.2822	0.2862
$\frac{5}{16}$ -36	0.282	0.286	0.284	0.288	0.285	0.289	0.287	0.291	0.2820	0.2863	0.2824	0.2863	0.2837	0.2877	0.2850	0.2890
$\frac{3}{8}$ -16	0.307	0.314	0.311	0.318	0.314	0.321	0.318	0.325	0.3070	0.3127	0.3101	0.3155	0.3128	0.3182	0.3155	0.3209

TAPPING

2021

Table 2. (Continued) Recommended Hole Size Limits Before Tapping Unified Threads

Thread Size	Classes 1B and 2B								Class 3B							
	Length of Engagement (D = Nominal Size of Thread)															
	To and Including $\frac{1}{3}D$		Above $\frac{1}{3}D$ to $\frac{2}{3}D$		Above $\frac{2}{3}D$ to $1\frac{1}{2}D$		Above $1\frac{1}{2}D$ to $3D$		To and Including $\frac{1}{3}D$		Above $\frac{1}{3}D$ to $\frac{2}{3}D$		Above $\frac{2}{3}D$ to $1\frac{1}{2}D$		Above $1\frac{1}{2}D$ to $3D$	
	Recommended Hole Size Limits															
	Min ^a	Max	Min	Max	Min	Max ^b	Min	Max	Min ^a	Max	Min	Max	Min	Max ^b	Min	Max
$\frac{3}{8}$ -24	0.330	0.335	0.333	0.338	0.335	0.340	0.338	0.343	0.3300	0.3336	0.3314	0.3354	0.3332	0.3372	0.3351	0.3391
$\frac{3}{8}$ -32	0.341	0.345	0.343	0.347	0.345	0.349	0.347	0.351	0.3410	0.3441	0.3415	0.3455	0.3429	0.3469	0.3444	0.3484
$\frac{3}{8}$ -36	0.345	0.349	0.346	0.350	0.347	0.352	0.349	0.353	0.3450	0.3488	0.3449	0.3488	0.3461	0.3501	0.3474	0.3514
$\frac{7}{16}$ -14	0.360	0.368	0.364	0.372	0.368	0.376	0.372	0.380	0.3600	0.3660	0.3630	0.3688	0.3659	0.3717	0.3688	0.3746
$\frac{7}{16}$ -20	0.383	0.389	0.386	0.391	0.389	0.395	0.391	0.397	0.3830	0.3875	0.3855	0.3896	0.3875	0.3916	0.3896	0.3937
$\frac{7}{16}$ -28	0.399	0.403	0.401	0.406	0.403	0.407	0.406	0.410	0.3990	0.4020	0.3995	0.4035	0.4011	0.4051	0.4017	0.4067
$\frac{1}{2}$ -13	0.417	0.426	0.421	0.430	0.426	0.434	0.430	0.438	0.4170	0.4225	0.4196	0.4254	0.4226	0.4284	0.4255	0.4313
$\frac{1}{2}$ -12	0.410	0.414	0.414	0.424	0.414	0.428	0.424	0.433	0.4100	0.4161	0.4129	0.4192	0.4160	0.4223	0.4192	0.4255
$\frac{1}{2}$ -20	0.446	0.452	0.449	0.454	0.452	0.457	0.454	0.460	0.4460	0.4498	0.4477	0.4517	0.4497	0.4537	0.4516	0.4556
$\frac{1}{2}$ -28	0.461	0.467	0.463	0.468	0.466	0.470	0.468	0.472	0.4610	0.4645	0.4620	0.4660	0.4636	0.4676	0.4652	0.4692
$\frac{9}{16}$ -12	0.472	0.476	0.476	0.486	0.476	0.490	0.486	0.495	0.4720	0.4783	0.4753	0.4813	0.4783	0.4843	0.4813	0.4873
$\frac{9}{16}$ -18	0.502	0.509	0.505	0.512	0.509	0.515	0.512	0.518	0.5020	0.5065	0.5045	0.5086	0.5065	0.5106	0.5086	0.5127
$\frac{9}{16}$ -24	0.517	0.522	0.520	0.525	0.522	0.527	0.525	0.530	0.5170	0.5209	0.5186	0.5226	0.5204	0.5244	0.5221	0.5261
$\frac{9}{16}$ -28	0.524	0.528	0.526	0.531	0.528	0.532	0.531	0.535	0.5240	0.5270	0.5245	0.5285	0.5261	0.5301	0.5277	0.5317
$\frac{5}{8}$ -11	0.527	0.536	0.532	0.541	0.536	0.546	0.541	0.551	0.5270	0.5328	0.5298	0.5360	0.5329	0.5391	0.5360	0.5422
$\frac{5}{8}$ -12	0.535	0.544	0.540	0.549	0.544	0.553	0.549	0.558	0.5350	0.5406	0.5377	0.5435	0.5405	0.5463	0.5434	0.5492
$\frac{5}{8}$ -18	0.565	0.572	0.568	0.575	0.572	0.578	0.575	0.581	0.5650	0.5690	0.5670	0.5711	0.5690	0.5730	0.5711	0.5752
$\frac{5}{8}$ -24	0.580	0.585	0.583	0.588	0.585	0.590	0.588	0.593	0.5800	0.5834	0.5811	0.5851	0.5829	0.5869	0.5846	0.5886
$\frac{5}{8}$ -28	0.586	0.591	0.588	0.593	0.591	0.595	0.593	0.597	0.5860	0.5895	0.5870	0.5910	0.5886	0.5926	0.5902	0.5942
$\frac{1}{4}$ -12	0.597	0.606	0.602	0.611	0.606	0.615	0.611	0.620	0.5970	0.6029	0.6001	0.6057	0.6029	0.6085	0.6057	0.6113
$\frac{1}{4}$ -24	0.642	0.647	0.645	0.650	0.647	0.652	0.650	0.655	0.6420	0.6459	0.6436	0.6476	0.6454	0.6494	0.6471	0.6511
$\frac{3}{4}$ -10	0.642	0.653	0.647	0.658	0.653	0.663	0.658	0.668	0.6420	0.6481	0.6449	0.6513	0.6481	0.6545	0.6513	0.6577
$\frac{3}{4}$ -12	0.660	0.669	0.665	0.674	0.669	0.678	0.674	0.683	0.6600	0.6652	0.6626	0.6680	0.6653	0.6707	0.6680	0.6734
$\frac{3}{4}$ -16	0.682	0.689	0.686	0.693	0.689	0.696	0.693	0.700	0.6820	0.6866	0.6844	0.6887	0.6865	0.6908	0.6886	0.6929
$\frac{3}{4}$ -20	0.696	0.702	0.699	0.704	0.702	0.707	0.704	0.710	0.6960	0.6998	0.6977	0.7017	0.6997	0.7037	0.7016	0.7056
$\frac{3}{4}$ -28	0.711	0.716	0.713	0.718	0.716	0.720	0.718	0.722	0.7110	0.7145	0.7120	0.7160	0.7136	0.7176	0.7152	0.7192
$\frac{1}{2}$ -12	0.722	0.731	0.727	0.736	0.731	0.740	0.736	0.745	0.7220	0.7276	0.7250	0.7303	0.7276	0.7329	0.7303	0.7356

Table 2. (Continued) Recommended Hole Size Limits Before Tapping Unified Threads

Thread Size	Classes 1B and 2B								Class 3B							
	Length of Engagement (D = Nominal Size of Thread)															
	To and Including $\frac{1}{3}D$		Above $\frac{1}{3}D$ to $\frac{2}{3}D$		Above $\frac{2}{3}D$ to $1\frac{1}{2}D$		Above $1\frac{1}{2}D$ to $3D$		To and Including $\frac{1}{3}D$		Above $\frac{1}{3}D$ to $\frac{2}{3}D$		Above $\frac{2}{3}D$ to $1\frac{1}{2}D$		Above $1\frac{1}{2}D$ to $3D$	
	Recommended Hole Size Limits															
	Min ^a	Max	Min	Max	Min	Max ^b	Min	Max	Min ^a	Max	Min	Max	Min	Max ^b	Min	Max
$\frac{13}{16}$ -16	0.745	0.752	0.749	0.756	0.752	0.759	0.756	0.763	0.7450	0.7491	0.7469	0.7512	0.7490	0.7533	0.7511	0.7554
$\frac{13}{16}$ -20	0.758	0.764	0.761	0.766	0.764	0.770	0.766	0.772	0.7580	0.7623	0.7602	0.7642	0.7622	0.7662	0.7641	0.7681
$\frac{7}{8}$ -9	0.755	0.767	0.761	0.773	0.767	0.778	0.773	0.785	0.7550	0.7614	0.7580	0.7647	0.7614	0.7681	0.7647	0.7714
$\frac{7}{8}$ -12	0.785	0.794	0.790	0.799	0.794	0.803	0.799	0.808	0.7850	0.7900	0.7874	0.7926	0.7900	0.7952	0.7926	0.7978
$\frac{7}{8}$ -14	0.798	0.806	0.802	0.810	0.806	0.814	0.810	0.818	0.7980	0.8022	0.8000	0.8045	0.8023	0.8068	0.8045	0.8090
$\frac{7}{8}$ -16	0.807	0.814	0.811	0.818	0.814	0.821	0.818	0.825	0.8070	0.8116	0.8094	0.8137	0.8115	0.8158	0.8136	0.8179
$\frac{7}{8}$ -20	0.821	0.827	0.824	0.829	0.827	0.832	0.829	0.835	0.8210	0.8248	0.8227	0.8267	0.8247	0.8287	0.8266	0.8306
$\frac{7}{8}$ -28	0.836	0.840	0.838	0.843	0.840	0.845	0.843	0.847	0.8360	0.8395	0.8370	0.8410	0.8386	0.8426	0.8402	0.8442
$\frac{15}{16}$ -12	0.847	0.856	0.852	0.861	0.856	0.865	0.861	0.870	0.8470	0.8524	0.8499	0.8550	0.8524	0.8575	0.8550	0.8601
$\frac{15}{16}$ -16	0.870	0.877	0.874	0.881	0.877	0.884	0.881	0.888	0.8700	0.8741	0.8719	0.8762	0.8740	0.8783	0.8761	0.8804
$\frac{15}{16}$ -20	0.883	0.889	0.886	0.891	0.889	0.895	0.891	0.897	0.8830	0.8873	0.8852	0.8892	0.8872	0.8912	0.8891	0.8931
1-8	0.865	0.878	0.871	0.884	0.878	0.890	0.884	0.896	0.8650	0.8722	0.8684	0.8759	0.8722	0.8797	0.8760	0.8835
1-12	0.910	0.919	0.915	0.924	0.919	0.928	0.924	0.933	0.9100	0.9148	0.9123	0.9173	0.9148	0.9198	0.9173	0.9223
1-14	0.923	0.931	0.927	0.934	0.931	0.938	0.934	0.942	0.9230	0.9271	0.9249	0.9293	0.9271	0.9315	0.9293	0.9337
1-16	0.932	0.939	0.936	0.943	0.939	0.946	0.943	0.950	0.9320	0.9366	0.9344	0.9387	0.9365	0.9408	0.9386	0.9429
1-20	0.946	0.952	0.949	0.954	0.952	0.957	0.954	0.960	0.9460	0.9498	0.9477	0.9517	0.9497	0.9537	0.9516	0.9556
1-28	0.961	0.966	0.963	0.968	0.966	0.970	0.968	0.972	0.9610	0.9645	0.9620	0.9660	0.9636	0.9676	0.9652	0.9692
$1\frac{1}{16}$ -12	0.972	0.981	0.977	0.986	0.981	0.990	0.986	0.995	0.9720	0.9773	0.9748	0.9798	0.9773	0.9823	0.9798	0.9848
$1\frac{1}{16}$ -16	0.995	1.002	0.999	1.055	1.002	1.009	1.055	1.013	0.9950	0.9991	0.9969	1.0012	0.9990	1.0033	1.0011	1.0054
$1\frac{1}{16}$ -18	1.002	1.009	1.005	1.012	1.009	1.015	1.012	1.018	1.0020	1.0065	1.0044	1.0085	1.0064	1.0105	1.0085	1.0126
$1\frac{1}{8}$ -7	0.970	0.984	0.977	0.991	0.984	0.998	0.991	1.005	0.9700	0.9790	0.9747	0.9833	0.9789	0.9875	0.9832	0.9918
$1\frac{1}{8}$ -8	0.990	1.003	0.996	1.009	1.003	1.015	1.009	1.021	0.9900	0.9972	0.9934	1.0009	0.9972	1.0047	1.0010	1.0085
$1\frac{1}{8}$ -12	1.035	1.044	1.040	1.049	1.044	1.053	1.049	1.058	1.0350	1.0398	1.0373	1.0423	1.0398	1.0448	1.0423	1.0473
$1\frac{1}{8}$ -16	1.057	1.064	1.061	1.068	1.064	1.071	1.068	1.075	1.0570	1.0616	1.0594	1.0637	1.0615	1.0658	1.0636	1.0679
$1\frac{1}{8}$ -18	1.065	1.072	1.068	1.075	1.072	1.078	1.075	1.081	1.0650	1.0690	1.0669	1.0710	1.0689	1.0730	1.0710	1.0751
$1\frac{1}{8}$ -20	1.071	1.077	1.074	1.079	1.077	1.082	1.079	1.085	1.0710	1.0748	1.0727	1.0767	1.0747	1.0787	1.0766	1.0806
$1\frac{1}{8}$ -28	1.086	1.091	1.088	1.093	1.091	1.095	1.093	1.097	1.0860	1.0895	1.0870	1.0910	1.0886	1.0926	1.0902	1.0942
$1\frac{3}{16}$ -12	1.097	1.106	1.102	1.111	1.106	1.115	1.111	1.120	1.0970	1.1023	1.0998	1.1048	1.1023	1.1073	1.1048	1.1098

Table 2. (Continued) Recommended Hole Size Limits Before Tapping Unified Threads

Thread Size	Classes 1B and 2B								Class 3B							
	Length of Engagement (D = Nominal Size of Thread)															
	To and Including $\frac{1}{3}D$		Above $\frac{1}{3}D$ to $\frac{2}{3}D$		Above $\frac{2}{3}D$ to $1\frac{1}{2}D$		Above $1\frac{1}{2}D$ to $3D$		To and Including $\frac{1}{3}D$		Above $\frac{1}{3}D$ to $\frac{2}{3}D$		Above $\frac{2}{3}D$ to $1\frac{1}{2}D$		Above $1\frac{1}{2}D$ to $3D$	
	Recommended Hole Size Limits															
	Min ^a	Max	Min	Max	Min	Max ^b	Min	Max	Min ^a	Max	Min	Max	Min	Max ^b	Min	Max
1 $\frac{3}{16}$ -16	1.120	1.127	1.124	1.131	1.127	1.134	1.131	1.138	1.1200	1.1241	1.1219	1.1262	1.1240	1.1283	1.1261	1.1304
1 $\frac{3}{16}$ -18	1.127	1.134	1.130	1.137	1.134	1.140	1.137	1.143	1.1270	1.1315	1.1294	1.1335	1.1314	1.1355	1.1335	1.1376
1 $\frac{1}{4}$ -7	1.095	1.109	1.102	1.116	1.109	1.123	1.116	1.130	1.0950	1.1040	1.0997	1.1083	1.1039	1.1125	1.1082	1.1168
1 $\frac{1}{4}$ -8	1.115	1.128	1.121	1.134	1.128	1.140	1.134	1.146	1.1150	1.1222	1.1184	1.1259	1.1222	1.1297	1.1260	1.1335
1 $\frac{1}{4}$ -12	1.160	1.169	1.165	1.174	1.169	1.178	1.174	1.183	1.1600	1.1648	1.1623	1.1673	1.1648	1.1698	1.1673	1.1723
1 $\frac{1}{2}$ -16	1.182	1.189	1.186	1.193	1.189	1.196	1.193	1.200	1.1820	1.1866	1.1844	1.1887	1.1865	1.1908	1.1886	1.1929
1 $\frac{1}{2}$ -18	1.190	1.197	1.193	1.200	1.197	1.203	1.200	1.206	1.1900	1.1940	1.1919	1.1960	1.1939	1.1980	1.1960	1.2001
1 $\frac{3}{4}$ -20	1.196	1.202	1.199	1.204	1.202	1.207	1.204	1.210	1.1960	1.1998	1.1977	1.2017	1.1997	1.2037	1.2016	1.2056
1 $\frac{5}{16}$ -12	1.222	1.231	1.227	1.236	1.231	1.240	1.236	1.245	1.2220	1.2273	1.2248	1.2298	1.2273	1.2323	1.2298	1.2348
1 $\frac{5}{16}$ -16	1.245	1.252	1.249	1.256	1.252	1.259	1.256	1.263	1.2450	1.2491	1.2469	1.2512	1.2490	1.2533	1.2511	1.2554
1 $\frac{5}{16}$ -18	1.252	1.259	1.256	1.262	1.259	1.265	1.262	1.268	1.2520	1.2565	1.2544	1.2585	1.2564	1.2605	1.2585	1.2626
1 $\frac{3}{8}$ -6	1.195	1.210	1.203	1.221	1.210	1.225	1.221	1.239	1.1950	1.2046	1.1996	1.2096	1.2046	1.2146	1.2096	1.2196
1 $\frac{3}{8}$ -8	1.240	1.253	1.246	1.259	1.253	1.265	1.259	1.271	1.2400	1.2472	1.2434	1.2509	1.2472	1.2547	1.2510	1.2585
1 $\frac{3}{8}$ -12	1.285	1.294	1.290	1.299	1.294	1.303	1.299	1.308	1.2850	1.2898	1.2873	1.2923	1.2898	1.2948	1.2923	1.2973
1 $\frac{3}{8}$ -16	1.307	1.314	1.311	1.318	1.314	1.321	1.318	1.325	1.3070	1.3116	1.3094	1.3137	1.3115	1.3158	1.3136	1.3179
1 $\frac{3}{8}$ -18	1.315	1.322	1.318	1.325	1.322	1.328	1.325	1.331	1.3150	1.3190	1.3169	1.3210	1.3189	1.3230	1.3210	1.3251
1 $\frac{7}{16}$ -12	1.347	1.354	1.350	1.361	1.354	1.365	1.361	1.370	1.3470	1.3523	1.3498	1.3548	1.3523	1.3573	1.3548	1.3598
1 $\frac{7}{16}$ -16	1.370	1.377	1.374	1.381	1.377	1.384	1.381	1.388	1.3700	1.3741	1.3719	1.3762	1.3740	1.3783	1.3761	1.3804
1 $\frac{7}{16}$ -18	1.377	1.384	1.380	1.387	1.384	1.390	1.387	1.393	1.3770	1.3815	1.3794	1.3835	1.3814	1.3855	1.3835	1.3876
1 $\frac{1}{2}$ -6	1.320	1.335	1.328	1.346	1.335	1.350	1.346	1.364	1.3200	1.3296	1.3246	1.3346	1.3296	1.3396	1.3346	1.3446
1 $\frac{1}{2}$ -8	1.365	1.378	1.371	1.384	1.378	1.390	1.384	1.396	1.3650	1.3722	1.3684	1.3759	1.3722	1.3797	1.3760	1.3835
1 $\frac{1}{2}$ -12	1.410	1.419	1.4155	1.424	1.419	1.428	1.424	1.433	1.4100	1.4148	1.4123	1.4173	1.4148	1.4198	1.4173	1.4223
1 $\frac{1}{2}$ -16	1.432	1.439	1.436	1.443	1.439	1.446	1.443	1.450	1.4320	1.4366	1.4344	1.4387	1.4365	1.4408	1.4386	1.4429
1 $\frac{1}{2}$ -18	1.440	1.446	1.443	1.450	1.446	1.452	1.450	1.456	1.4400	1.4440	1.4419	1.4460	1.4439	1.4480	1.4460	1.4501
1 $\frac{3}{4}$ -20	1.446	1.452	1.449	1.454	1.452	1.457	1.454	1.460	1.4460	1.4498	1.4477	1.4517	1.4497	1.4537	1.4516	1.4556
1 $\frac{9}{16}$ -16	1.495	1.502	1.499	1.506	1.502	1.509	1.506	1.513	1.4950	1.4991	1.4969	1.5012	1.4990	1.5033	1.5011	1.5054
1 $\frac{9}{16}$ -18	1.502	1.509	1.505	1.512	1.509	1.515	1.512	1.518	1.5020	1.5065	1.5044	1.5085	1.5064	1.5105	1.5085	1.5126

Table 2. (Continued) Recommended Hole Size Limits Before Tapping Unified Threads

Thread Size	Classes 1B and 2B								Class 3B							
	Length of Engagement ($D = \text{Nominal Size of Thread}$)															
	To and Including $\frac{1}{3}D$		Above $\frac{1}{3}D$ to $\frac{2}{3}D$		Above $\frac{2}{3}D$ to $1\frac{1}{2}D$		Above $1\frac{1}{2}D$ to $3D$		To and Including $\frac{1}{3}D$		Above $\frac{1}{3}D$ to $\frac{2}{3}D$		Above $\frac{2}{3}D$ to $1\frac{1}{2}D$		Above $1\frac{1}{2}D$ to $3D$	
	Recommended Hole Size Limits															
	Min ^a	Max	Min	Max	Min	Max ^b	Min	Max	Min ^a	Max	Min	Max	Min	Max ^b	Min	Max
1 $\frac{3}{8}$ -8	1.490	1.498	1.494	1.509	1.498	1.515	1.509	1.521	1.4900	1.4972	1.4934	1.5009	1.4972	1.5047	1.5010	1.5085
1 $\frac{5}{8}$ -12	1.535	1.544	1.540	1.549	1.544	1.553	1.549	1.558	1.5350	1.5398	1.5373	1.5423	1.5398	1.5448	1.5423	1.5473
1 $\frac{5}{8}$ -16	1.557	1.564	1.561	1.568	1.564	1.571	1.568	1.575	1.5570	1.5616	1.5594	1.5637	1.5615	1.5658	1.5636	1.5679
1 $\frac{3}{4}$ -18	1.565	1.572	1.568	1.575	1.572	1.578	1.575	1.581	1.5650	1.5690	1.5669	1.5710	1.5689	1.5730	1.5710	1.5751
1 $\frac{1}{16}$ -18	1.620	1.627	1.624	1.631	1.627	1.634	1.631	1.638	1.6200	1.6241	1.6219	1.6262	1.6240	1.6283	1.6261	1.6304
1 $\frac{1}{16}$ -16	1.627	1.634	1.630	1.637	1.634	1.640	1.637	1.643	1.6270	1.6315	1.6294	1.6335	1.6314	1.6355	1.6335	1.6376
1 $\frac{3}{4}$ -5	1.534	1.551	1.543	1.560	1.551	1.568	1.560	1.577	1.5340	1.5455	1.5395	1.5515	1.5455	1.5575	1.5515	1.5635
1 $\frac{3}{4}$ -8	1.615	1.628	1.621	1.634	1.628	1.640	1.634	1.646	1.6150	1.6222	1.6184	1.6259	1.6222	1.6297	1.6260	1.6335
1 $\frac{3}{4}$ -12	1.660	1.669	1.665	1.674	1.669	1.678	1.674	1.683	1.6600	1.6648	1.6623	1.6673	1.6648	1.6698	1.6673	1.6723
1 $\frac{3}{4}$ -16	1.682	1.689	1.686	1.693	1.689	1.696	1.693	1.700	1.6820	1.6866	1.6844	1.6887	1.6865	1.6908	1.6886	1.6929
1 $\frac{3}{4}$ -20	1.696	1.702	1.699	1.704	1.702	1.707	1.704	1.710	1.6960	1.6998	1.6977	1.7017	1.6997	1.7037	1.7016	1.7056
1 $\frac{3}{16}$ -16	1.745	1.752	1.749	1.756	1.752	1.759	1.756	1.763	1.7450	1.7491	1.7469	1.7512	1.7490	1.7533	1.7511	1.7554
1 $\frac{7}{8}$ -8	1.740	1.752	1.746	1.759	1.752	1.765	1.759	1.771	1.7400	1.7472	1.7434	1.7509	1.7472	1.7547	1.7510	1.7585
1 $\frac{7}{8}$ -12	1.785	1.794	1.790	1.799	1.794	1.803	1.799	1.808	1.7850	1.7898	1.7873	1.7923	1.7898	1.7948	1.7923	1.7973
1 $\frac{7}{8}$ -16	1.807	1.814	1.810	1.818	1.814	1.821	1.818	1.825	1.8070	1.8116	1.8094	1.8137	1.8115	1.8158	1.8136	1.8179
1 $\frac{5}{16}$ -16	1.870	1.877	1.874	1.881	1.877	1.884	1.881	1.888	1.8700	1.8741	1.8719	1.8762	1.8740	1.8783	1.8761	1.8804
2-4 $\frac{1}{2}$	1.759	1.777	1.768	1.786	1.777	1.795	1.786	1.804	1.7590	1.7727	1.7661	1.7794	1.7728	1.7861	1.7794	1.7927
2-8	1.865	1.878	1.871	1.884	1.878	1.890	1.884	1.896	1.8650	1.8722	1.8684	1.8759	1.8722	1.8797	1.8760	1.8835
2-12	1.910	1.919	1.915	1.924	1.919	1.928	1.924	1.933	1.9100	1.9148	1.9123	1.9173	1.9148	1.9198	1.9173	1.9223
2-16	1.932	1.939	1.936	1.943	1.939	1.946	1.943	1.950	1.9320	1.9366	1.9344	1.9387	1.9365	1.9408	1.9386	1.9429
2-20	1.946	1.952	1.949	1.954	1.952	1.957	1.954	1.960	1.9460	1.9498	1.9477	1.9517	1.9497	1.9537	1.9516	1.9556
2 $\frac{1}{16}$ -16	1.995	2.002	2.000	2.006	2.002	2.009	2.006	2.012	1.9950	1.9991	1.9969	2.0012	1.9990	2.0033	2.0011	2.0054
2 $\frac{1}{8}$ -8	1.990	2.003	1.996	2.009	2.003	2.015	2.009	2.021	1.9900	1.9972	1.9934	2.0009	1.9972	2.0047	2.0010	2.0085
2 $\frac{1}{8}$ -12	2.035	2.044	2.040	2.049	2.044	2.053	2.049	2.058	2.0350	2.0398	2.0373	2.0423	2.0398	2.0448	2.0423	2.0473
2 $\frac{1}{8}$ -16	2.057	2.064	2.061	2.068	2.064	2.071	2.068	2.075	2.0570	2.0616	2.0594	2.0637	2.0615	2.0658	2.0636	2.0679
2 $\frac{3}{16}$ -16	2.120	2.127	2.124	2.131	2.127	2.134	2.131	2.138	2.1200	2.1241	2.1219	2.1262	2.1240	2.1283	2.1261	2.1304
2 $\frac{1}{4}$ -4 $\frac{1}{2}$	2.009	2.027	2.018	2.036	2.027	2.045	2.036	2.054	2.0090	2.0227	2.0161	2.0294	2.0228	2.0361	2.0294	2.0427

Table 2. (Continued) Recommended Hole Size Limits Before Tapping Unified Threads

Thread Size	Classes 1B and 2B								Class 3B							
	Length of Engagement ($D =$ Nominal Size of Thread)															
	To and Including $\frac{1}{3}D$		Above $\frac{1}{3}D$ to $\frac{2}{3}D$		Above $\frac{2}{3}D$ to $1\frac{1}{2}D$		Above $1\frac{1}{2}D$ to $3D$		To and Including $\frac{1}{3}D$		Above $\frac{1}{3}D$ to $\frac{2}{3}D$		Above $\frac{2}{3}D$ to $1\frac{1}{2}D$		Above $1\frac{1}{2}D$ to $3D$	
	Recommended Hole Size Limits															
	Min ^a	Max	Min	Max	Min	Max ^b	Min	Max	Min ^a	Max	Min	Max	Min	Max ^b	Min	Max
2¼-8	2.115	2.128	2.121	2.134	2.128	2.140	2.134	2.146	2.1150	2.1222	2.1184	2.1259	2.1222	2.1297	2.1260	2.1335
2½-12	2.160	2.169	2.165	2.174	2.169	2.178	2.174	2.182	2.1600	2.1648	2.1623	2.1673	2.1648	2.1698	2.1673	2.1723
2¼-16	2.182	2.189	2.186	2.193	2.189	2.196	2.193	2.200	2.1820	2.1866	2.1844	2.1887	2.1865	2.1908	2.1886	2.1929
2½-20	2.196	2.202	2.199	2.204	2.202	2.207	2.204	2.210	2.1960	2.1998	2.1977	2.2017	2.1997	2.2037	2.2016	2.2056
2⅝-16	2.245	2.252	2.249	2.256	2.252	2.259	2.256	2.263	2.2450	2.2491	2.2469	2.2512	2.2490	2.2533	2.2511	2.2554
2¾-12	2.285	2.294	2.290	2.299	2.294	2.303	2.299	2.308	2.2850	2.2898	2.2873	2.2923	2.2898	2.2948	2.2923	2.2973
2¾-16	2.307	2.314	2.311	2.318	2.314	2.321	2.318	2.325	2.3070	2.3116	2.3094	2.3137	2.3115	2.3158	2.3136	2.3179
2⅞-16	2.370	2.377	2.374	2.381	2.377	2.384	2.381	2.388	2.3700	2.3741	2.3719	2.3762	2.3740	2.3783	2.3761	2.3804
2½-4	2.229	2.248	2.238	2.258	2.248	2.267	2.258	2.277	2.2290	2.2444	2.2369	2.2519	2.2444	2.2594	2.2519	2.2669
2½-8	2.365	2.378	2.371	2.384	2.378	2.390	2.384	2.396	2.3650	2.3722	2.3684	2.3759	2.3722	2.3797	2.3760	2.3835
2½-12	2.410	2.419	2.415	2.424	2.419	2.428	2.424	2.433	2.4100	2.4148	2.4123	2.4173	2.4148	2.4198	2.4173	2.4223
2½-16	2.432	2.439	2.436	2.443	2.439	2.446	2.443	2.450	2.4320	2.4366	2.4344	2.4387	2.4365	2.4408	2.4386	2.4429
2½-20	2.446	2.452	2.449	2.454	2.452	2.457	2.454	2.460	2.4460	2.4498	2.4478	2.4517	2.4497	2.4537	2.4516	2.4556
2¾-12	2.535	2.544	2.540	2.549	2.544	2.553	2.549	2.558	2.5350	2.5398	2.5373	2.5423	2.5398	2.5448	2.5423	2.5473
2⅝-16	2.557	2.564	2.561	2.568	2.564	2.571	2.568	2.575	2.5570	2.5616	2.5594	2.5637	2.5615	2.5658	2.5636	2.5679
2¾-4	2.479	2.498	2.489	2.508	2.498	2.517	2.508	2.527	2.4790	2.4944	2.4869	2.5019	2.4944	2.5094	2.5019	2.5169
2¾-8	2.615	2.628	2.621	2.634	2.628	2.640	2.634	2.644	2.6150	2.6222	2.6184	2.6259	2.6222	2.6297	2.6260	2.6335
2¾-12	2.660	2.669	2.665	2.674	2.669	2.678	2.674	2.683	2.6600	2.6648	2.6623	2.6673	2.6648	2.6698	2.6673	2.6723
2¾-16	2.682	2.689	2.686	2.693	2.689	2.696	2.693	2.700	2.6820	2.6866	2.6844	2.6887	2.6865	2.6908	2.6886	2.6929
2⅞-12	2.785	2.794	2.790	2.809	2.794	2.803	2.809	2.808	2.7850	2.7898	2.7873	2.7923	2.7898	2.7948	2.7923	2.7973
2⅞-16	2.807	2.814	2.811	2.818	2.814	2.821	2.818	2.825	2.8070	2.8116	2.8094	2.8137	2.8115	2.8158	2.8136	2.8179
3-4	2.729	2.748	2.739	2.758	2.748	2.767	2.758	2.777	2.7290	2.7444	2.7369	2.7519	2.7444	2.7594	2.7519	2.7669
3-8	2.865	2.878	2.871	2.884	2.878	2.890	2.884	2.896	2.8650	2.8722	2.8684	2.8759	2.8722	2.8797	2.8760	2.8835
3-12	2.910	2.919	2.915	2.924	2.919	2.928	2.924	2.933	2.9100	2.9148	2.9123	2.9173	2.9148	2.9198	2.9173	2.9223
3-16	2.932	2.939	2.936	2.943	2.939	2.946	2.943	2.950	2.9320	2.9366	2.9344	2.9387	2.9365	2.9408	2.9386	2.9429
3⅛-12	3.035	3.044	3.040	3.049	3.044	3.053	3.049	3.058	3.0350	3.0398	3.0373	3.0423	3.0398	3.0448	3.0423	3.0473
3⅛-16	3.057	3.064	3.061	3.068	3.064	3.071	3.068	3.075	3.0570	3.0616	3.0594	3.0637	3.0615	3.0658	3.0636	3.0679

Table 2. (Continued) Recommended Hole Size Limits Before Tapping Unified Threads

Thread Size	Classes 1B and 2B								Class 3B							
	Length of Engagement (D = Nominal Size of Thread)															
	To and Including $\frac{1}{3}D$		Above $\frac{1}{3}D$ to $\frac{2}{3}D$		Above $\frac{2}{3}D$ to $1\frac{1}{2}D$		Above $1\frac{1}{2}D$ to $3D$		To and Including $\frac{1}{3}D$		Above $\frac{1}{3}D$ to $\frac{2}{3}D$		Above $\frac{2}{3}D$ to $1\frac{1}{2}D$		Above $1\frac{1}{2}D$ to $3D$	
	Recommended Hole Size Limits															
	Min ^a	Max	Min	Max	Min	Max ^b	Min	Max	Min ^a	Max	Min	Max	Min	Max ^b	Min	Max
3/4-4	2.979	2.998	2.989	3.008	2.998	3.017	3.008	3.027	2.9790	2.9944	2.9869	3.0019	2.9944	3.0094	3.0019	3.0169
3/4-8	3.115	3.128	3.121	3.134	3.128	3.140	3.134	3.146	3.1150	3.1222	3.1184	3.1259	3.1222	3.1297	3.1260	3.1335
3/4-12	3.160	3.169	3.165	3.174	3.169	3.178	3.174	3.183	3.1600	3.1648	3.1623	3.1673	3.1648	3.1698	3.1673	3.1723
3/4-16	3.182	3.189	3.186	3.193	3.189	3.196	3.193	3.200	3.1820	3.1866	3.1844	3.1887	3.1865	3.1908	3.1886	3.1929
3/8-12	3.285	3.294	3.290	3.299	3.294	3.303	3.299	3.299	3.2850	3.2898	3.2873	3.2923	3.2898	3.2948	3.2923	3.2973
3/8-16	3.307	3.314	3.311	3.318	3.314	3.321	3.317	3.325	3.3070	3.3116	3.3094	3.3137	3.3115	3.3158	3.3136	3.3179
3/2-4	3.229	3.248	3.239	3.258	3.248	3.267	3.258	3.277	3.2290	3.2444	3.2369	3.2519	3.2444	3.2594	3.2519	3.2669
3/2-8	3.365	3.378	3.371	3.384	3.378	3.390	3.384	3.396	3.3650	3.3722	3.3684	3.3759	3.3722	3.3797	3.3760	3.3835
3/2-12	3.410	3.419	3.415	3.424	3.419	3.428	3.424	3.433	3.4100	3.4148	3.4123	3.4173	3.4148	3.4198	3.4173	3.4223
3/2-16	3.432	3.439	3.436	3.443	3.439	3.446	3.443	3.450	3.4320	3.4366	3.4344	3.4387	3.4365	3.4408	3.4386	3.4429
3/8-12	3.535	3.544	3.544	3.549	3.544	3.553	3.549	3.553	3.5350	3.5398	3.5373	3.5423	3.5398	3.5448	3.5423	3.5473
3/8-16	3.557	3.564	3.561	3.568	3.567	3.571	3.568	3.575	3.5570	3.5616	3.5594	3.5637	3.5615	3.5658	3.5636	3.5679
3/4-4	3.479	3.498	3.489	3.508	3.498	3.517	3.508	3.527	3.4790	3.4944	3.4869	3.5019	3.4944	3.5094	3.5019	3.5169
3/4-8	3.615	3.628	3.615	3.634	3.628	3.640	3.634	3.646	3.6150	3.6222	3.6184	3.6259	3.6222	3.6297	3.6260	3.6335
3/4-12	3.660	3.669	3.665	3.674	3.669	3.678	3.674	3.683	3.6600	3.6648	3.6623	3.6673	3.6648	3.6698	3.6673	3.6723
3/2-16	3.682	3.689	3.686	3.693	3.689	3.696	3.693	3.700	3.6820	3.6866	3.6844	3.6887	3.6865	3.6908	3.6886	3.6929
3/8-12	3.785	3.794	3.790	3.799	3.794	3.803	3.799	3.808	3.7850	3.7898	3.7873	3.7923	3.7898	3.7948	3.7923	3.7973
3/8-16	3.807	3.814	3.811	3.818	3.814	3.821	3.818	3.825	3.8070	3.8116	3.8094	3.8137	3.8115	3.8158	3.8136	3.8179
4-4	3.729	3.748	3.739	3.758	3.748	3.767	3.758	3.777	3.7290	3.7444	3.7369	3.7519	3.7444	3.7594	3.7519	3.7669
4-8	3.865	3.878	3.871	3.884	3.878	3.890	3.884	3.896	3.8650	3.8722	3.8684	3.8759	3.8722	3.8797	3.8760	3.8835
4-12	3.910	3.919	3.915	3.924	3.919	3.928	3.924	3.933	3.9100	3.9148	3.9123	3.9173	3.9148	3.9198	3.9173	3.9223
4-16	3.932	3.939	3.936	3.943	3.939	3.946	3.943	3.950	3.9320	3.9366	3.9344	3.9387	3.9365	3.9408	3.9386	3.9429
4 1/4-4	3.979	3.998	3.989	4.008	3.998	4.017	4.008	4.027	3.9790	3.9944	3.9869	4.0019	3.9944	4.0094	4.0019	4.0169
4 1/4-8	4.115	4.128	4.121	4.134	4.128	4.140	4.134	4.146	4.1150	4.1222	4.1184	4.1259	4.1222	4.1297	4.1260	4.1335
4 1/4-12	4.160	4.169	4.165	4.174	4.169	4.178	4.174	4.183	4.1600	4.1648	4.1623	4.1673	4.1648	4.1698	4.1673	4.1723
4 1/4-16	4.182	4.189	4.186	4.193	4.189	4.196	4.193	4.200	4.1820	4.1866	4.1844	4.1887	4.1865	4.1908	4.1886	4.1929
4 1/2-4	4.229	4.248	4.239	4.258	4.248	4.267	4.258	4.277	4.2290	4.2444	4.2369	4.2519	4.2444	4.2594	4.2519	4.2669

TAPPING

2027

Table 2. (Continued) Recommended Hole Size Limits Before Tapping Unified Threads

Thread Size	Classes 1B and 2B								Class 3B							
	Length of Engagement ($D =$ Nominal Size of Thread)															
	To and Including $\frac{1}{3}D$		Above $\frac{1}{3}D$ to $\frac{2}{3}D$		Above $\frac{2}{3}D$ to $1\frac{1}{2}D$		Above $1\frac{1}{2}D$ to $3D$		To and Including $\frac{1}{3}D$		Above $\frac{1}{3}D$ to $\frac{2}{3}D$		Above $\frac{2}{3}D$ to $1\frac{1}{2}D$		Above $1\frac{1}{2}D$ to $3D$	
	Recommended Hole Size Limits															
	Min ^a	Max	Min	Max	Min	Max ^b	Min	Max	Min ^a	Max	Min	Max	Min	Max ^b	Min	Max
4½-8	4.365	4.378	4.371	4.384	4.378	4.390	4.384	4.396	4.3650	4.3722	4.3684	4.3759	4.3722	4.3797	4.3760	4.3835
4½-12	4.410	4.419	4.419	4.424	4.419	4.428	4.424	4.433	4.4100	4.4148	4.4123	4.4173	4.4148	4.4198	4.4173	4.4223
4½-16	4.432	4.439	4.437	4.444	4.439	4.446	4.444	4.455	4.4320	4.4366	4.4344	4.4387	4.4365	4.4408	4.4386	4.4429
4¾-8	4.615	4.628	4.621	4.646	4.628	4.640	4.646	4.646	4.6150	4.6222	4.6184	4.6259	4.6222	4.6297	4.6260	4.6335
4¾-12	4.660	4.669	4.665	4.674	4.669	4.678	4.674	4.683	4.6600	4.6648	4.6623	4.6673	4.6648	4.6698	4.6673	4.6723
4¾-16	4.682	4.689	4.686	4.693	4.689	4.696	4.693	4.700	4.6820	4.6866	4.6844	4.6887	4.6865	4.6908	4.6886	4.6929
5-8	4.865	4.878	4.871	4.884	4.878	4.890	4.884	4.896	4.8650	4.8722	4.8684	4.8759	4.8722	4.8797	4.8760	4.8835
5-12	4.910	4.919	4.915	4.924	4.919	4.928	4.924	4.933	4.9100	4.9148	4.9123	4.9173	4.9148	4.9198	4.9173	4.9223
5-16	4.932	4.939	4.936	4.943	4.939	4.946	4.943	4.950	4.9320	4.9366	4.9344	4.9387	4.9365	4.9408	4.9386	4.9429
5½-8	5.115	5.128	5.121	5.134	5.128	5.140	5.134	5.146	5.1150	5.1222	5.1184	5.1259	5.1222	5.1297	5.1260	5.1335
5½-12	5.160	5.169	5.165	5.174	5.169	5.178	5.174	5.183	5.1600	5.1648	5.1623	5.1673	5.1648	5.1698	5.1673	5.1723
5½-16	5.182	5.189	5.186	5.193	5.189	5.196	5.193	5.200	5.1820	5.1866	5.1844	5.1887	5.1865	5.1908	5.1886	5.1929
5¾-8	5.365	5.378	5.371	5.384	5.378	5.390	5.384	5.396	5.3650	5.3722	5.3684	5.3759	5.3722	5.3797	5.3760	5.3835
5¾-12	5.410	5.419	5.415	5.424	5.419	5.428	5.424	5.433	5.4100	5.4148	5.4123	5.4173	5.4148	5.4198	5.4173	5.4223
5¾-16	5.432	5.439	5.436	5.442	5.439	5.446	5.442	5.450	5.4320	5.4366	5.4344	5.4387	5.4365	5.4408	5.4386	5.4429
5¾-8	5.615	5.628	5.621	5.634	5.628	5.640	5.634	5.646	5.6150	5.6222	5.6184	5.6259	5.6222	5.6297	5.6260	5.6335
5¾-12	5.660	5.669	5.665	5.674	5.669	5.678	5.674	5.683	5.6600	5.6648	5.6623	5.6673	5.6648	5.6698	5.6673	5.6723
5¾-16	5.682	5.689	5.686	5.693	5.689	5.696	5.693	5.700	5.6820	5.6866	5.6844	5.6887	5.6865	5.6908	5.6886	5.6929
6-8	5.865	5.878	5.871	5.896	5.878	5.890	5.896	5.896	5.8650	5.8722	5.8684	5.8759	5.8722	5.8797	5.8760	5.8835
6-12	5.910	5.919	5.915	5.924	5.919	5.928	5.924	5.933	5.9100	5.9148	5.9123	5.9173	5.9148	5.9198	5.9173	5.9223
6-16	5.932	5.939	5.935	5.943	5.939	5.946	5.943	5.950	5.9320	5.9366	5.9344	5.9387	5.9365	5.9408	5.9386	5.9429

^a This is the minimum minor diameter specified in the thread tables, page 1817.

^b This is the maximum minor diameter specified in the thread tables, page 1817.

All dimensions are in inches.

For basis of recommended hole size limits see accompanying text.

As an aid in selecting suitable drills, see the listing of American Standard drill sizes starting on page 868 in the twist drill section. For amount of expected drill over-size, see page 897.

Table 3. Tap Drill Sizes for Threads of American National Form

Screw Thread		Commercial Tap Drills ^a		Screw Thread		Commercial Tap Drills ^a	
Outside Diam. Pitch	Root Diam.	Size or Number	Decimal Equiv.	Outside Diam. Pitch	Root Diam.	Size or Number	Decimal Equiv.
1/16-64	0.0422	3/64	0.0469	27	0.4519	15/32	0.4687
72	0.0445	3/64	0.0469	5/16-12	0.4542	3/64	0.4844
3/64-60	0.0563	1/16	0.0625	18	0.4903	33/64	0.5156
72	0.0601	52	0.0635	27	0.5144	17/32	0.5312
3/32-48	0.0667	49	0.0730	5/8-11	0.5069	17/32	0.5312
50	0.0678	49	0.0730	12	0.5168	35/64	0.5469
7/64-48	0.0823	43	0.0890	18	0.5528	37/64	0.5781
1/8-32	0.0844	3/32	0.0937	27	0.5769	19/32	0.5937
40	0.0925	38	0.1015	11/16-11	0.5694	19/32	0.5937
9/64-40	0.1081	32	0.1160	16	0.6063	5/8	0.6250
5/32-32	0.1157	1/8	0.1250	3/4-10	0.6201	21/32	0.6562
36	0.1202	30	0.1285	12	0.6418	43/64	0.6719
11/64-32	0.1313	9/64	0.1406	16	0.6688	11/16	0.6875
3/16-24	0.1334	26	0.1470	27	0.7019	23/32	0.7187
32	0.1469	22	0.1570	13/16-10	0.6826	23/32	0.7187
13/64-24	0.1490	20	0.1610	7/8-9	0.7307	49/64	0.7656
7/32-24	0.1646	16	0.1770	12	0.7668	51/64	0.7969
32	0.1782	12	0.1890	14	0.7822	13/16	0.8125
15/64-24	0.1806	10	0.1935	18	0.8028	53/64	0.8281
1/4-20	0.1850	7	0.2010	27	0.8269	27/32	0.8437
24	0.1959	4	0.2090	15/16-9	0.7932	53/64	0.8281
27	0.2019	3	0.2130	1-8	0.8376	7/8	0.8750
28	0.2036	3	0.2130	12	0.8918	59/64	0.9219
32	0.2094	7/32	0.2187	14	0.9072	15/16	0.9375
3/16-18	0.2403	F	0.2570	27	0.9519	31/32	0.9687
20	0.2476	17/64	0.2656	1 1/8-7	0.9394	63/64	0.9844
24	0.2584	I	0.2720	12	1.0168	13/64	1.0469
27	0.2644	J	0.2770	1 1/4-7	1.0644	17/64	1.1094
32	0.2719	9/32	0.2812	12	1.1418	11 1/64	1.1719
3/8-16	0.2938	5/16	0.3125	1 3/8-6	1.1585	17/32	1.2187
20	0.3100	21/64	0.3281	12	1.2668	19/64	1.2969
24	0.3209	Q	0.3320	1 1/2-6	1.2835	11 1/32	1.3437
27	0.3269	R	0.3390	12	1.3918	127/64	1.4219
7/16-14	0.3447	U	0.3680	1 5/8-5 1/2	1.3888	129/64	1.4531
20	0.3726	25/64	0.3906	1 3/4-5	1.4902	19/16	1.5625
24	0.3834	X	0.3970	1 7/8-5	1.6152	11 1/16	1.6875
27	0.3894	Y	0.4040	2-4 1/2	1.7113	125/32	1.7812
1/2-12	0.3918	27/64	0.4219	2 1/8-4 1/2	1.8363	129/32	1.9062
13	0.4001	27/64	0.4219	2 1/4-4 1/2	1.9613	2 1/32	2.0312
20	0.4351	29/64	0.4531	2 3/8-4	2.0502	2 1/8	2.1250
24	0.4459	29/64	0.4531	2 1/2-4	2.1752	2 1/4	2.2500

^a These tap drill diameters allow approximately 75 per cent of a full thread to be produced. For small thread sizes in the first column, the use of drills to produce the larger hole sizes shown in Table 2 will reduce defects caused by tap problems and breakage.

Table 4. Tap Drills and Clearance Drills for Machine Screws with American National Thread Form

Size of Screw		No. of Threads per Inch	Tap Drills		Clearance Hole Drills			
No. or Diam.	Decimal Equiv.		Drill Size	Decimal Equiv.	Close Fit		Free Fit	
					Drill Size	Decimal Equiv.	Drill Size	Decimal Equiv.
0	.060	80	$\frac{3}{64}$.0469	52	.0635	50	.0700
1	.073	64	53	.0595	48	.0760	46	.0810
		72	53	.0595				
2	.086	56	50	.0700	43	.0890	41	.0960
		64	50	.0700				
3	.099	48	47	.0785	37	.1040	35	.1100
		56	45	.0820				
4	.112	36 ^a	44	.0860	32	.1160	30	.1285
		40	43	.0890				
		48	42	.0935				
5	.125	40	38	.1015	30	.1285	29	.1360
		44	37	.1040				
6	.138	32	36	.1065	27	.1440	25	.1495
		40	33	.1130				
8	.164	32	29	.1360	18	.1695	16	.1770
		36	29	.1360				
10	.190	24	25	.1495	9	.1960	7	.2010
		32	21	.1590				
12	.216	24	16	.1770	2	.2210	1	.2280
		28	14	.1820				
14	.242	20 ^a	10	.1935	D	.2460	F	.2570
		24 ^a	7	.2010				
$\frac{1}{4}$.250	20	7	.2010	F	.2570	H	.2660
		28	3	.2130				
$\frac{5}{16}$.3125	18	F	.2570	P	.3230	Q	.3320
		24	I	.2720				
$\frac{3}{8}$.375	16	$\frac{3}{16}$.3125	W	.3860	X	.3970
		24	Q	.3320				
$\frac{7}{16}$.4375	14	U	.3680	$\frac{29}{64}$.4531	$\frac{15}{32}$.4687
		20	$\frac{25}{64}$.3906				
$\frac{1}{2}$.500	13	$\frac{27}{64}$.4219	$\frac{33}{64}$.5156	$\frac{17}{32}$.5312
		20	$\frac{29}{64}$.4531				

^a These screws are not in the American Standard but are from the former A.S.M.E. Standard.

The size of the tap drill hole for any desired percentage of full thread depth can be calculated by the formulas below. In these formulas the Per Cent Full Thread is expressed as a decimal; e.g., 75 per cent is expressed as .75. The tap drill size is the size nearest to the calculated hole size.

✦ For American Unified Thread form:

$$\text{Hole Size} = \text{Basic Major Diameter} - \frac{1.08253 \times \text{Per Cent Full Thread}}{\text{Number of Threads per Inch}}$$

✦ For ISO Metric threads (all dimensions in millimeters):

$$\text{Hole Size} = \text{Basic Major Diameter} - (1.08253 \times \text{Pitch} \times \text{Per Cent Full Thread})$$

The constant 1.08253 in the above equation represents $5H/8$ where H is the height of a sharp V-thread (see page 1806). (The pitch is taken to be 1.)

Factors Influencing Minor Diameter Tolerances of Tapped Holes.—As stated in the Unified screw thread standard, the principle practical factors that govern minor diameter tolerances of internal threads are tapping difficulties, particularly tap breakage in the small sizes, availability of standard drill sizes in the medium and large sizes, and depth (radial) of engagement. Depth of engagement is related to the stripping strength of the thread assembly, and thus also, to the length of engagement. It also has an influence on the tendency toward disengagement of the threads on one side when assembly is eccentric. The amount of possible eccentricity is one-half of the sum of the pitch diameter allowance and toler-

ances on both mating threads. For a given pitch, or height of thread, this sum increases with the diameter, and accordingly this factor would require a decrease in minor diameter tolerance with increase in diameter. However, such decrease in tolerance would often require the use of special drill sizes; therefore, to facilitate the use of standard drill sizes, for any given pitch the minor diameter tolerance for Unified thread classes 1B and 2B threads of $\frac{1}{4}$ inch diameter and larger is constant, in accordance with a formula given in the American Standard for Unified Screw Threads.

Effect of Length of Engagement of Minor Diameter Tolerances: There may be applications where the lengths of engagement of mating threads is relatively short or the combination of materials used for mating threads is such that the maximum minor diameter tolerance given in the Standard (based on a length of engagement equal to the nominal diameter) may not provide the desired strength of the fastening. Experience has shown that for lengths of engagement less than $\frac{2}{3}D$ (the minimum thickness of standard nuts) the minor diameter tolerance may be reduced without causing tapping difficulties. In other applications the length of engagement of mating threads may be long because of design considerations or the combination of materials used for mating threads. As the threads engaged increase in number, a shallower depth of engagement may be permitted and still develop stripping strength greater than the external thread breaking strength. Under these conditions the maximum tolerance given in the Standard should be increased to reduce the possibility of tapping difficulties. The following paragraphs indicate how the aforementioned considerations were taken into account in determining the minor diameter limits for various lengths of engagement given in [Table 2](#).

Recommended Hole Sizes before Tapping.—Recommended hole size limits before threading to provide for optimum strength of fastenings and tapping conditions are shown in [Table 2](#) for classes 1B, 2B, and 3B. The hole size limit before threading, and the tolerances between them, are derived from the minimum and maximum minor diameters of the internal thread given in the dimensional tables for Unified threads in the screw thread section using the following rules:

1) For lengths of engagement in the range to and including $\frac{1}{3}D$, where D equals nominal diameter, the minimum hole size will be equal to the minimum minor diameter of the internal thread and the maximum hole size will be larger by one-half the minor diameter tolerance.

2) For the range from $\frac{1}{3}D$ to $\frac{2}{3}D$, the minimum and maximum hole sizes will each be one quarter of the minor diameter tolerance larger than the corresponding limits for the length of engagement to and including $\frac{1}{3}D$.

3) For the range from $\frac{2}{3}D$ to $1\frac{1}{2}D$ the minimum hole size will be larger than the minimum minor diameter of the internal thread by one-half the minor diameter tolerance and the maximum hole size will be equal to the maximum minor diameter.

4) For the range from $1\frac{1}{2}D$ to $3D$ the minimum and maximum hole sizes will each be one-quarter of the minor diameter tolerance of the internal thread larger than the corresponding limits for the $\frac{2}{3}D$ to $1\frac{1}{2}D$ length of engagement.

From the foregoing it will be seen that the difference between limits in each range is the same and equal to one-half of the minor diameter tolerance given in the Unified screw thread dimensional tables. This is a general rule, except that the minimum differences for sizes below $\frac{1}{4}$ inch are equal to the minor diameter tolerances calculated on the basis of lengths of engagement to and including $\frac{1}{3}D$. Also, for lengths of engagement greater than $\frac{1}{3}D$ and for sizes $\frac{1}{4}$ inch and larger the values are adjusted so that the difference between limits is never less than 0.004 inch.

For diameter-pitch combinations other than those given in [Table 2](#), the foregoing rules should be applied to the tolerances given in the dimensional tables in the screw thread sec-

tion or the tolerances derived from the formulas given in the Standard to determine the hole size limits.

Selection of Tap Drills: In selecting standard drills to produce holes within the limits given in **Table 2** it should be recognized that drills have a tendency to cut oversize. The material on page 897 may be used as a guide to the expected amount of oversize.

Table 5. Unified Miniature Screw Threads—Recommended Hole Size Limits Before Tapping

Thread Size		Internal Threads		Lengths of Engagement					
Designation	Pitch mm	Minor Diameter Limits		To and including $\frac{2}{3}D$		Above $\frac{2}{3}D$ to $1\frac{1}{2}D$		Above $1\frac{1}{2}D$ to $3D$	
		Min mm	Max mm	Min mm	Max mm	Recommended Hole Size Limits			
						Min mm	Max mm	Min mm	Max mm
0.30 UNM	0.080	0.217	0.254	0.226	0.240	0.236	0.254	0.245	0.264
0.35 UNM	0.090	0.256	0.297	0.267	0.282	0.277	0.297	0.287	0.307
0.40 UNM	0.100	0.296	0.340	0.307	0.324	0.318	0.340	0.329	0.351
0.45 UNM	0.100	0.346	0.390	0.357	0.374	0.368	0.390	0.379	0.401
0.50 UNM	0.125	0.370	0.422	0.383	0.402	0.396	0.422	0.409	0.435
0.55 UNM	0.125	0.420	0.472	0.433	0.452	0.446	0.472	0.459	0.485
0.60 UNM	0.150	0.444	0.504	0.459	0.482	0.474	0.504	0.489	0.519
0.70 UNM	0.175	0.518	0.586	0.535	0.560	0.552	0.586	0.569	0.603
0.80 UNM	0.200	0.592	0.668	0.611	0.640	0.630	0.668	0.649	0.687
0.90 UNM	0.225	0.666	0.750	0.687	0.718	0.708	0.750	0.729	0.771
1.00 UNM	0.250	0.740	0.832	0.763	0.798	0.786	0.832	0.809	0.855
1.10 UNM	0.250	0.840	0.932	0.863	0.898	0.886	0.932	0.909	0.955
1.20 UNM	0.250	0.940	1.032	0.963	0.998	0.986	1.032	1.009	1.055
1.40 UNM	0.300	1.088	1.196	1.115	1.156	1.142	1.196	1.169	1.223
Designation	Thds. per in.	inch	inch	inch	inch	inch	inch	inch	inch
0.30 UNM	318	0.0085	0.0100	0.0089	0.0095	0.0093	0.0100	0.0096	0.0104
0.35 UNM	282	0.0101	0.0117	0.0105	0.0111	0.0109	0.0117	0.0113	0.0121
0.40 UNM	254	0.0117	0.0134	0.0121	0.0127	0.0125	0.0134	0.0130	0.0138
0.45 UNM	254	0.0136	0.0154	0.0141	0.0147	0.0145	0.0154	0.0149	0.0158
0.50 UNM	203	0.0146	0.0166	0.0150	0.0158	0.0156	0.0166	0.0161	0.0171
0.55 UNM	203	0.0165	0.0186	0.0170	0.0178	0.0176	0.0186	0.0181	0.0191
0.60 UNM	169	0.0175	0.0198	0.0181	0.0190	0.0187	0.0198	0.0193	0.0204
0.70 UNM	145	0.0204	0.0231	0.0211	0.0221	0.0217	0.0231	0.0224	0.0237
0.80 UNM	127	0.0233	0.0263	0.0241	0.0252	0.0248	0.0263	0.0256	0.0270
0.90 UNM	113	0.0262	0.0295	0.0270	0.0283	0.0279	0.0295	0.0287	0.0304
1.00 UNM	102	0.0291	0.0327	0.0300	0.0314	0.0309	0.0327	0.0319	0.0337
1.10 UNM	102	0.0331	0.0367	0.0340	0.0354	0.0349	0.0367	0.0358	0.0376
1.20 UNM	102	0.0370	0.0406	0.0379	0.0393	0.0388	0.0406	0.0397	0.0415
1.40 UNM	85	0.0428	0.0471	0.0439	0.0455	0.0450	0.0471	0.0460	0.0481

As an aid in selecting suitable drills, see the listing of American Standard drill sizes in the twist drill section. Thread sizes in heavy type are preferred sizes.

Hole Sizes for Tapping Unified Miniature Screw Threads.—**Table 5** indicates the hole size limits recommended for tapping. These limits are derived from the internal thread minor diameter limits given in the American Standard for Unified Miniature Screw Threads ASA B1.10-1958 and are disposed so as to provide the optimum conditions for tapping. The maximum limits are based on providing a functionally adequate fastening for the most common applications, where the material of the externally threaded member is of a strength essentially equal to or greater than that of its mating part. In applications where, because of considerations other than the fastening, the screw is made of an appreciably

weaker material, the use of smaller hole sizes is usually necessary to extend thread engagement to a greater depth on the external thread. Recommended minimum hole sizes are greater than the minimum limits of the minor diameters to allow for the spin-up developed in tapping.

In selecting drills to produce holes within the limits given in [Table 5](#) it should be recognized that drills have a tendency to cut oversize. The material on [page 897](#) may be used as a guide to the expected amount of oversize.

British Standard Tapping Drill Sizes for Screw and Pipe Threads.—British Standard BS 1157:1975 (2004) provides recommendations for tapping drill sizes for use with fluted taps for various ISO metric, Unified, British Standard fine, British Association, and British Standard Whitworth screw threads as well as British Standard parallel and taper pipe threads.

Table 6. British Standard Tapping Drill Sizes for ISO Metric Coarse Pitch Series Threads BS 1157:1975 (2004)

Nom. Size and Thread Diam.	Standard Drill Sizes ^a				Nom. Size and Thread Diam.	Standard Drill Sizes ^a			
	Recommended		Alternative			Recommended		Alternative	
	Size	Theoretical Radial Engagement with Ext. Thread (Per Cent)	Size	Theoretical Radial Engagement with Ext. Thread (Per Cent)		Size	Theoretical Radial Engagement with Ext. Thread (Per Cent)	Size	Theoretical Radial Engagement with Ext. Thread (Per Cent)
M 1	0.75	81.5	0.78	71.7	M 12	10.20	83.7	10.40	74.5 ^b
M 1.1	0.85	81.5	0.88	71.7	M 14	12.00	81.5	12.20	73.4 ^b
M 1.2	0.95	81.5	0.98	71.7	M 16	14.00	81.5	14.25	71.3 ^c
M 1.4	1.10	81.5	1.15	67.9	M 18	15.50	81.5	15.75	73.4 ^c
M 1.6	1.25	81.5	1.30	69.9	M 20	17.50	81.5	17.75	73.4 ^c
M 1.8	1.45	81.5	1.50	69.9	M 22	19.50	81.5	19.75	73.4 ^c
M 2	1.60	81.5	1.65	71.3	M 24	21.00	81.5	21.25	74.7 ^b
M 2.2	1.75	81.5	1.80	72.5	M 27	24.00	81.5	24.25	74.7 ^b
M 2.5	2.05	81.5	2.10	72.5	M 30	26.50	81.5	26.75	75.7 ^b
M 3	2.50	81.5	2.55	73.4	M 33	29.50	81.5	29.75	75.7 ^b
M 3.5	2.90	81.5	2.95	74.7	M 36	32.00	81.5
M 4	3.30	81.5	3.40	69.9 ^b	M 39	35.00	81.5
M 4.5	3.70	86.8	3.80	76.1	M 42	37.50	81.5
M 5	4.20	81.5	4.30	71.3 ^b	M 45	40.50	81.5
M 6	5.00	81.5	5.10	73.4	M 48	43.00	81.5
M 7	6.00	81.5	6.10	73.4	M 52	47.00	81.5
M 8	6.80	78.5	6.90	71.7 ^b	M 56	50.50	81.5
M 9	7.80	78.5	7.90	71.7 ^b	M 60	54.50	81.5
M 10	8.50	81.5	8.60	76.1	M 64	58.00	81.5
M 11	9.50	81.5	9.60	76.1	M 68	62.00	81.5

^a These tapping drill sizes are for fluted taps only.

^b For tolerance class 6H and 7H threads only.

^c For tolerance class 7H threads only.

Drill sizes are given in millimeters.

In the accompanying [Table 6](#), recommended and alternative drill sizes are given for producing holes for ISO metric coarse pitch series threads. These coarse pitch threads are suitable for the large majority of general-purpose applications, and the limits and tolerances for internal coarse threads are given in the table starting on [page 1919](#). It should be noted that [Table 6](#) is for fluted taps only since a fluteless tap will require for the same screw thread a different size of twist drill than will a fluted tap. When tapped, holes produced with drills of the recommended sizes provide for a theoretical radial engagement with the external thread of about 81 per cent in most cases. Holes produced with drills of the alternative sizes provide for a theoretical radial engagement with the external thread of about 70 to 75

per cent. In some cases, as indicated in **Table 6**, the alternative drill sizes are suitable only for medium (6H) or for free (7H) thread tolerance classes.

When relatively soft material is being tapped, there is a tendency for the metal to be squeezed down towards the root of the tap thread, and in such instances, the minor diameter of the tapped hole may become smaller than the diameter of the drill employed. Users may wish to choose different tapping drill sizes to overcome this problem or for special purposes, and reference can be made to the pages mentioned above to obtain the minor diameter limits for internal pitch series threads.

Reference should be made to this standard BS 1157:1975 (2004) for recommended tapping hole sizes for other types of British Standard screw threads and pipe threads.

Table 7. British Standard Metric Bolt and Screw Clearance Holes BS 4186: 1967

Nominal Thread Diameter	Clearance Hole Sizes			Nominal Thread Diameter	Clearance Hole Sizes		
	Close Fit Series	Medium Fit Series	Free Fit Series		Close Fit Series	Medium Fit Series	Free Fit Series
1.6	1.7	1.8	2.0	52.0	54.0	56.0	62.0
2.0	2.2	2.4	2.6	56.0	58.0	62.0	66.0
2.5	2.7	2.9	3.1	60.0	62.0	66.0	70.0
3.0	3.2	3.4	3.6	64.0	66.0	70.0	74.0
4.0	4.3	4.5	4.8	68.0	70.0	74.0	78.0
5.0	5.3	5.5	5.8	72.0	74.0	78.0	82.0
6.0	6.4	6.6	7.0	76.0	78.0	82.0	86.0
7.0	7.4	7.6	8.0	80.0	82.0	86.0	91.0
8.0	8.4	9.0	10.0	85.0	87.0	91.0	96.0
10.0	10.5	11.0	12.0	90.0	93.0	96.0	101.0
12.0	13.0	14.0	15.0	95.0	98.0	101.0	107.0
14.0	15.0	16.0	17.0	100.0	104.0	107.0	112.0
16.0	17.0	18.0	19.0	105.0	109.0	112.0	117.0
18.0	19.0	20.0	21.0	110.0	114.0	117.0	122.0
20.0	21.0	22.0	24.0	115.0	119.0	122.0	127.0
22.0	23.0	24.0	26.0	120.0	124.0	127.0	132.0
24.0	25.0	26.0	28.0	125.0	129.0	132.0	137.0
27.0	28.0	30.0	32.0	130.0	134.0	137.0	144.0
30.0	31.0	33.0	35.0	140.0	144.0	147.0	155.0
33.0	34.0	36.0	38.0	150.0	155.0	158.0	165.0
36.0	37.0	39.0	42.0
39.0	40.0	42.0	45.0
42.0	43.0	45.0	48.0
45.0	46.0	48.0	52.0
48.0	50.0	52.0	56.0

All dimensions are given in millimeters.

British Standard Clearance Holes for Metric Bolts and Screws.—The dimensions of the clearance holes specified in this British Standard BS 4186:1967 have been chosen in such a way as to require the use of the minimum number of drills. The recommendations cover three series of clearance holes, namely close fit (H 12), medium fit (H 13), and free fit (H 14) and are suitable for use with bolts and screws specified in the following metric British Standards: BS 3692, ISO metric precision hexagon bolts, screws, and nuts; BS 4168, Hexagon socket screws and wrench keys; BS 4183, Machine screws and machine screw nuts; and BS 4190, ISO metric black hexagon bolts, screws, and nuts. The sizes are in accordance with those given in ISO Recommendation R273, and the range has been extended up to 150 millimeters diameter in accordance with an addendum to that recommendation. The selection of clearance holes sizes to suit particular design requirements

can of course be dependent upon many variable factors. It is however felt that the medium fit series should suit the majority of general purpose applications. In the Standard, limiting dimensions are given in a table which is included for reference purposes only, for use in instances where it may be desirable to specify tolerances.

To avoid any risk of interference with the radius under the head of bolts and screws, it is necessary to countersink slightly all recommended clearance holes in the close and medium fit series. Dimensional details for the radius under the head of fasteners made according to BS 3692 are given on page 1631; those for fasteners to BS 4168 are given on page 1695; those to BS 4183 are given on pages 1669 through 1673.

Cold Form Tapping.—Cold form taps do not have cutting edges or conventional flutes; the threads on the tap form the threads in the hole by displacing the metal in an extrusion or swaging process. The threads thus produced are stronger than conventionally cut threads because the grains in the metal are unbroken and the displaced metal is work hardened. The surface of the thread is burnished and has an excellent finish. Although chip problems are eliminated, cold form tapping does displace the metal surrounding the hole and countersinking or chamfering before tapping is recommended. Cold form tapping is not recommended if the wall thickness of the hole is less than two-thirds of the nominal diameter of the thread. If possible, blind holes should be drilled deep enough to permit a cold form tap having a four thread lead to be used as this will require less torque, produce less burr surrounding the hole, and give a greater tool life.

The operation requires 0 to 50 per cent more torque than conventional tapping, and the cold form tap will pick up its own lead when entering the hole; thus, conventional tapping machines and tapping heads can be used. Another advantage is the better tool life obtained. The best results are obtained by using a good lubricating oil instead of a conventional cutting oil.

The method can be applied only to relatively ductile metals, such as low-carbon steel, leaded steels, austenitic stainless steels, wrought aluminum, low-silicon aluminum die casting alloys, zinc die casting alloys, magnesium, copper, and ductile copper alloys. A higher than normal tapping speed can be used, sometimes by as much as 100 per cent.

Conventional tap drill sizes should not be used for cold form tapping because the metal is displaced to form the thread. The cold formed thread is stronger than the conventionally tapped thread, so the thread height can be reduced to 60 per cent without much loss of strength; however, the use of a 65 per cent thread is strongly recommended. The following formula is used to calculate the theoretical hole size for cold form tapping:

$$\text{Theoretical hole size} = \text{basic tap O.D.} - \frac{0.0068 \times \text{per cent of full thread}}{\text{threads per inch}}$$

The theoretical hole size and the tap drill sizes for American Unified threads are given in Table 8, and Table 9 lists drills for ISO metric threads. Sharp drills should be used to prevent cold working the walls of the hole, especially on metals that are prone to work hardening. Such damage may cause the torque to increase, possibly stopping the machine or breaking the tap. On materials that can be die cast, cold form tapping can be done in cored holes provided the correct core pin size is used. The core pins are slightly tapered, so the theoretical hole size should be at the position on the pin that corresponds to one-half of the required engagement length of the thread in the hole. The core pins should be designed to form a chamfer on the hole to accept the vertical extrusion.

Table 8. Theoretical and Tap Drill or Core Hole Sizes for Cold Form Tapping Unified Threads

Tap Size	Threads Per Inch	Percentage of Full Thread								
		75			65			55		
		Theor. Hole Size	Nearest Drill Size	Dec. Equiv.	Theor. Hole Size	Nearest Drill Size	Dec. Equiv.	Theor. Hole Size	Nearest Drill Size	Dec. Equiv.
0	80	0.0536	1.35 mm	0.0531	0.0545	0.0554	54	0.055
1	64	0.0650	1.65 mm	0.0650	0.0661	0.0672	51	0.0670
	72	0.0659	1.65 mm	0.0650	0.0669	1.7 mm	0.0669	0.0679	51	0.0670
2	56	0.0769	1.95 mm	0.0768	0.0781	$\frac{5}{64}$	0.0781	0.0794	2.0 mm	0.0787
	64	0.0780	$\frac{5}{64}$	0.0781	0.0791	2.0 mm	0.0787	0.0802
3	48	0.0884	2.25 mm	0.0886	0.0898	43	0.089	0.0913	2.3 mm	0.0906
	56	0.0889	43	0.089	0.0911	2.3 mm	0.0906	0.0924	2.35 mm	0.0925
4	40	0.0993	2.5 mm	0.0984	0.1010	39	0.0995	0.1028	2.6 mm	0.1024
	48	0.0104	38	0.1015	0.1028	2.6 mm	0.1024	0.1043	37	0.1040
5	40	0.1123	34	0.1110	0.1140	33	0.113	0.1158	32	0.1160
	44	0.1134	33	0.113	0.1150	2.9 mm	0.1142	0.1166	32	...
6	32	0.1221	3.1 mm	0.1220	0.1243	0.1264	3.2 mm	0.1260
	40	0.1253	$\frac{1}{8}$	0.1250	0.1270	3.2 mm	0.1260	0.1288	30	0.1285
8	32	0.1481	3.75 mm	0.1476	0.1503	25	0.1495	0.1524	24	0.1520
	36	0.1498	25	0.1495	0.1518	24	0.1520	0.1537	3.9 mm	0.1535
10	24	0.1688	0.1717	$\frac{11}{64}$	0.1719	0.1746	17	0.1730
	32	0.1741	17	0.1730	0.1763	0.1784	4.5 mm	0.1772
12	24	0.1948	10	0.1935	0.1977	5.0 mm	0.1968	0.2006	5.1 mm	0.2008
	28	0.1978	5.0 mm	0.1968	0.2003	8	0.1990	0.2028
$\frac{1}{4}$	20	0.2245	5.7 mm	0.2244	0.2280	1	0.2280	0.2315
	28	0.2318	0.2343	A	0.2340	0.2368	6.0 mm	0.2362
$\frac{5}{16}$	18	0.2842	7.2 mm	0.2835	0.2879	7.3 mm	0.2874	0.2917	7.4 mm	0.2913
	24	0.2912	7.4 mm	0.2913	0.2941	M	0.2950	0.2969	$\frac{19}{64}$	0.2969
$\frac{3}{8}$	16	0.3431	$\frac{11}{32}$	0.3437	0.3474	S	0.3480	0.3516
	24	0.3537	9.0 mm	0.3543	0.3566	0.3594	$\frac{23}{64}$	0.3594
$\frac{7}{16}$	14	0.4011	0.4059	$\frac{13}{32}$	0.4062	0.4108
	20	0.4120	Z	0.413	0.4154	0.4188
$\frac{1}{2}$	13	0.4608	0.4660	0.4712	12 mm	0.4724
	20	0.4745	0.4779	0.4813
$\frac{9}{16}$	12	0.5200	0.5257	0.5313	$\frac{17}{32}$	0.5312
	18	0.5342	13.5 mm	0.5315	0.5380	0.5417
$\frac{5}{8}$	11	0.5787	$\frac{37}{64}$	0.5781	0.5848	0.5910	15 mm	0.5906
	18	0.5976	$\frac{19}{32}$	0.5937	0.6004	0.6042
$\frac{3}{4}$	10	0.6990	0.7058	$\frac{45}{64}$	0.7031	0.7126
	16	0.7181	$\frac{23}{32}$	0.7187	0.7224	0.7266

Table 9. Tap Drill or Core Hole Sizes for Cold Form Tapping ISO Metric Threads

Nominal Size of Tap	Pitch	Recommended Tap Drill Size
1.6 mm	0.35 mm	1.45 mm
1.8 mm	0.35 mm	1.65 mm
2.0 mm	0.40 mm	1.8 mm
2.2 mm.	0.45 mm	2.0 mm
2.5 mm	0.45 mm	2.3 mm
3.0 mm	0.50 mm	2.8 mm ^a
3.5 mm	0.60 mm	3.2 mm
4.0 mm	0.70 mm	3.7 mm
4.5 mm	0.75 mm	4.2 mm ^a
5.0 mm	0.80 mm	4.6 mm
6.0 mm	1.00 mm	5.6 mm ^a
7.0 mm	1.00 mm	6.5 mm
8.0 mm	1.25 mm	7.4 mm
10.0 mm	1.50 mm	9.3 mm

^a These diameters are the nearest stocked drill sizes and not the theoretical hole size, and may not produce 60 to 75 per cent full thread.

The sizes are calculated to provide 60 to 75 per cent of full thread.

Removing a Broken Tap.—Broken taps can be removed by electrodischarge machining (EDM), and this method is recommended when available. When an EDM machine is not available, broken taps may be removed by using a tap extractor, which has fingers that enter the flutes of the tap; the tap is backed out of the hole by turning the extractor with a wrench. Sometimes the injection of a small amount of a proprietary solvent into the hole will be helpful. A solvent can be made by diluting about one part nitric acid with five parts water. The action of the proprietary solvent or the diluted nitric acid on the steel loosens the tap so that it can be removed with pliers or with a tap extractor. The hole should be washed out afterwards so that the acid will not continue to work on the part. Another method is to add, by electric arc welding, additional metal to the shank of the broken tap, above the level of the hole. Care must be taken to prevent depositing metal on the threads in the tapped hole. After the shank has been built up, the head of a bolt or a nut is welded to it and then the tap may be backed out.

Tap Drills for Pipe Taps

Size of Tap	Drills for Briggs Pipe Taps	Drills for Whitworth Pipe Taps	Size of Tap	Drills for Briggs Pipe Taps	Drills for Whitworth Pipe Taps	Size of Tap	Drills for Briggs Pipe Taps	Drills for Whitworth Pipe Taps
1/8	11/32	5/16	1 1/4	1 1/2	1 15/32	3 1/4	...	3 1/2
1/4	7/16	27/64	1 1/2	1 23/32	1 25/32	3 1/2	3 3/4	3 3/4
3/8	19/32	9/16	1 3/4	...	1 15/16	3 3/4	...	4
1/2	23/32	1 1/16	2	2 3/16	2 5/32	4	4 1/4	4 1/4
5/8	...	25/32	2 1/4	...	2 13/32	4 1/2	4 3/4	4 3/4
3/4	15/16	29/32	2 1/2	2 5/8	2 25/32	5	5 5/16	5 1/4
7/8	...	1 1/16	2 3/4	...	3 1/32	5 1/2	...	5 3/4
1	1 5/32	1 1/8	3	3 1/4	3 3/32	6	6 3/8	6 1/4

All dimensions are in inches.

To secure the best results, the hole should be reamed before tapping with a reamer having a taper of 3/4 inch per foot.

Power for Pipe Taps.—The power required for driving pipe taps is given in the following table, which includes nominal pipe tap sizes from 2 to 8 inches.

The holes to be tapped were reamed with standard pipe tap reamers before tapping. The horsepower recorded was read off just before the tap was reversed. The table gives the net horsepower, deductions being made for the power required to run the machine without a load. The material tapped was cast iron, except in two instances, where cast steel was tapped. It will be seen that nearly double the power is required for tapping cast steel. The

power varies, of course, with the conditions. More power than that indicated in the table will be required if the cast iron is of a harder quality or if the taps are not properly relieved. The taps used in these experiments were of the inserted-blade type, the blades being made of high-speed steel.

Power Required for Pipe Taps

Nominal Tap Size		Rev. per Min.	Net Power		Thickness of Metal		Nominal Tap Size		Rev. per Min.	Net Power		Thickness of Metal	
inch	mm		H.P.	kW	inch	mm	inch	mm		H.P.	kW	inch	mm
2	50.80	40	4.24	3.16	1/8	28.58	3 1/2	88.90	25.6	7.20	5.37	1 3/4	44.45
2 1/2	63.50	40	5.15	3.84	1/8	28.58	4	101.60	18	6.60	4.92	2	50.80
*2 1/2	63.50	38.5	9.14	6.81	1/8	28.58	5	127.00	18	7.70	5.74	2	50.80
3	76.20	40	5.75	4.29	1/8	28.58	6	152.40	17.8	8.80	6.56	2	50.80
*3	76.20	38.5	9.70	7.23	1/8	28.58	8	203.20	14	7.96	5.93	2 1/2	63.50

^aTapping cast steel; other tests in cast iron.

High-Speed CNC Tapping.—Tapping speed depends on the type of material being cut, the type of cutting tool, the speed and rigidity of the machine, the rigidity of the part-holding fixture, and the proper use of coolants and cutting fluids. When tapping, each revolution of the tool feeds the tap a distance equal to the thread pitch. Both spindle speed and feed per revolution must be accurately controlled so that changes in spindle speed result in a corresponding change in feed rate. If the feed/rev is not right, a stripped thread or broken tap will result. NC/CNC machines equipped with the *synchronous tapping* feature are able to control the tap feed as a function of spindle speed. These machines can use rigid-type tap holders or automatic tapping attachments and are able to control depth very accurately. Older NC machines that are unable to reliably coordinate spindle speed and feed must use a tension-compression type tapping head that permits some variation of the spindle speed while still letting the tap feed at the required rate.

CNC machines capable of synchronous tapping accurately coordinate feed rate and rotational speed so that the tap advances at the correct rate regardless of the spindle speed. A canned tapping cycle (see *Right Hand Thread (G84)* and *Left Hand Thread (G74)* on page 1297 in the *CNC NUMERICAL CONTROL PROGRAMMING* section) usually controls the operation, and feed and speed are set by the machine operator or part programmer. Synchronized tapping requires reversing the tapping spindle twice for each hole tapped, once after finishing the cut and again at the end of the cycle. Because the rotating mass is fairly large (motor, spindle, chuck or tap holder, and tap), the acceleration and deceleration of the tap are rather slow and a lot of time is lost by this process. The frequent changes in cutting speed during the cut also accelerate tap wear and reduce tap life.

A self-reversing tapping attachment has a forward drive that rotates in the same direction as the machine spindle, a reverse drive that rotates in the opposite direction, and a neutral position in between the two. When a hole is tapped, the spindle feeds at a slightly slower rate than the tap to keep the forward drive engaged until the tap reaches the bottom of the hole. Through holes are tapped by feeding to the desired depth and then retracting the spindle, which engages the tapping-head reverse drive and backs the tap out of the hole—the spindle does not need to be reversed. For tapping blind holes, the spindle is fed to a depth equal to the thread depth minus the self-feed of the tapping attachment. When the spindle is retracted (without reversing), the tap continues to feed forward a short distance (the tapping head self-feed distance) before the reverse drive engages and reverse drives the tap out of the hole. The depth can be controlled to within about 1/4 revolution of the tap. The tapping cycle normally used for the self-reversing tap attachment is a standard boring cycle with feed return and no dwell. A typical programming cycle is illustrated with a G85 block on page 1297. The inward feed is set to about 95 per cent of the normal tapping feed (i.e.,

95 per cent of the pitch per revolution). Because the tap is lightweight, tap reversal is almost instantaneous and tapping speed is very fast compared with synchronous tapping.

Tapping speeds are usually given in surface feet per minute (sfm) or the equivalent feet per minute (fpm or ft/min), so a conversion is necessary to get the spindle speed in revolutions per minute. The tapping speed in rpm depends on the diameter of the tap, and is given by the following formula:

$$\text{rpm} = \frac{\text{sfm} \times 12}{d \times 3.14159} = \frac{\text{sfm} \times 3.82}{d}$$

where d is the nominal diameter of the tap in inches. As indicated previously, the feed in in/rev is equal to the thread pitch and is independent of the cutting speed. The feed rate in inches per minute is found by dividing the tapping speed in rpm by the number of threads per inch, or by multiplying the speed in rpm by the pitch or feed per revolution:

$$\text{feed rate (in/min)} = \frac{\text{rpm}}{\text{threads per inch}} = \text{rpm} \times \text{thread pitch} = \text{rpm} \times \text{feed/rev}$$

Example: If the recommended tapping speed for 1020 steel is given as 45 to 60 sfm, find the required spindle speed and feed rate for tapping a 1/4-20 UNF thread in 1020 steel.

Assuming that the machine being used is in good condition and rigid, and the tap is sharp, use the higher rate of 60 sfm and calculate the required spindle speed and feed rate as follows:

$$\text{speed} = \frac{60 \times 3.82}{0.25} = 916.8 \approx 920 \text{ rpm} \quad \text{feed rate} = \frac{920}{20} = 46 \text{ in/min}$$

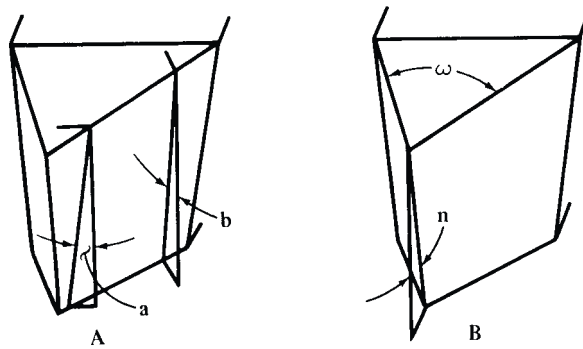
Coolant for Tapping.—Proper use of through-the-tap high-pressure coolant/lubricant can result in increased tap life, increased speed and feed, and more accurate threads. In most chip-cutting processes, cutting fluid is used primarily as a coolant, with lubrication being a secondary but important benefit. Tapping, however, requires a cutting fluid with lubricity as the primary property and coolant as a secondary benefit. Consequently, the typical blend of 5 per cent coolant concentrate to 95 per cent water is too low for best results. An increased percentage of concentrate in the blend helps the fluid to cling to the tap, providing better lubrication at the cutting interface. A method of increasing the tap lubrication qualities without changing the concentration of the primary fluid blend is to use a cutting fluid dispenser controlled by an M code different from that used to control the high-pressure flood coolant (for example, use an M08 code in addition to M07). The secondary coolant-delivery system applies a small amount of an edge-type cutting fluid (about a drop at a time) directly onto the tap-cutting surfaces providing the lubrication needed for cutting. The edge-type fluid applied in this way clings to the tap, increasing the lubrication effect and ensuring that the cutting fluid becomes directly involved in the cutting action at the shear zone.

High-pressure coolant fed through the tap is important in many high-volume tapping applications. The coolant is fed directly through the spindle or tool holder to the cutting zone, greatly improving the process of chip evacuation and resulting in better thread quality. High-pressure through-the-tap coolant flushes blind holes before the tap enters and can remove chips from the holes after tapping is finished. The flushing action prevents chip recutting by forcing chips through the flutes and back out of the hole, improving the surface of the thread and increasing tap life. By improving lubrication and reducing heat and friction, the use of high-pressure coolant may result in increased tap life up to five times that of conventional tapping and may permit speed and feed increases that reduce overall cycle time.

Combined Drilling and Tapping.—A special tool that drills and taps in one operation can save a lot of time by reducing setup and eliminating a secondary operation in some

applications. A combination drill and tap can be used for through holes if the length of the fluted drill section is greater than the material thickness, but cannot be used for drilling and tapping blind holes because the tip (drill point) must cut completely through the material before the tapping section begins to cut threads. Drilling and tapping depths up to twice the tool diameter are typical. Determine the appropriate speed by starting the tool at the recommended speed for the tap size and material, and adjust the speed higher or lower to suit the application. Feed during tapping is dependent on the thread pitch. NC/CNC programs can use a fast drilling speed and a slower tapping speed to combine both operations into one and minimize cutting time.

Relief Angles for Single-Point Thread Cutting Tools.—The surface finish on threads cut with single-point thread cutting tools is influenced by the relief angles on the tools. The leading and trailing cutting edges that form the sides of the thread, and the cutting edge at the nose of the tool must all be provided with an adequate amount of relief. Moreover, it is recommended that the effective relief angle, a_e , for all of these cutting edges be made equal, although the practice in some shops is to use slightly less relief at the trailing cutting edge. While too much relief may weaken the cutting edge, causing it to chip, an inadequate amount of relief will result in rough threads and in a shortened tool life. Other factors that influence the finish produced on threads include the following: the work material; the cutting speed; the cutting fluid used; the method used to cut the thread; and, the condition of the cutting edge.



Two similar diagrams showing relationships of various relief angles of thread cutting tools

Relief angles on single-point thread cutting tools are often specified on the basis of experience. While this method may give satisfactory results in many instances, better results can usually be obtained by calculating these angles, using the formulas provided further on. When special high helix angle threads are to be cut, the magnitude of the relief angles should always be calculated. These calculations are based on the effective relief angle, a_e ; this is the angle between the flank of the tool and the sloping sides of the thread, measured in a direction parallel to the axis of the thread. Recommended values of this angle are 8 to 14 degrees for high speed steel tools, and 5 to 10 degrees for cemented carbide tools. The larger values are recommended for cutting threads on soft and gummy materials, and the smaller values are for the harder materials, which inherently take a better surface finish. Harder materials also require more support below the cutting edges, which is provided by using a smaller relief angle. These values are recommended for the relief angle below the cutting edge at the nose without any further modification. The angles below the leading and trailing side cutting edges are modified, using the formulas provided. The angles b and b' are the relief angles actually ground on the tool below the leading and trailing side cutting edges respectively; they are measured perpendicular to the side cutting edges. When designing or grinding the thread cutting tool, it is sometimes helpful to know the magnitude of the angle, n , for which a formula is provided. This angle would occur only in the event that the tool were ground to a sharp point. It is the angle of the edge formed by the intersection of the flank surfaces.

$$\tan \phi = \frac{\text{lead of thread}}{\pi K} \qquad \tan \phi' = \frac{\text{lead of thread}}{\pi D}$$

$$a = a_e + \phi$$

$$a' = a_e - \phi'$$

$$\tan b = \tan a \cos \frac{1}{2}\omega$$

$$\tan b' = \tan a' \cos \frac{1}{2}\omega$$

$$\tan n = \frac{\tan a - \tan a'}{2 \tan \frac{1}{2}\omega}$$

where θ = helix angle of thread at minor diameter

θ' = helix angle of thread at major diameter

K = minor diameter of thread

D = major diameter of thread

a = side relief angle parallel to thread axis at leading edge of tool

a' = side relief angle parallel to thread axis at trailing edge of tool

a_e = effective relief angle

b = side relief angle perpendicular to leading edge of tool

b' = side relief angle perpendicular to trailing edge of tool

ω = included angle of thread cutting tool

n = nose angle resulting from intersection of flank surfaces

Example: Calculate the relief angles and the nose angle n for a single-point thread cutting tool that is to be used to cut a 1-inch diameter, 5-threads-per-inch, double Acme thread. The lead of this thread is $2 \times 0.200 = 0.400$ inch. The included angle ω of this thread is 29 degrees, the minor diameter K is 0.780 inch, and the effective relief angle a_e below all cutting edges is to be 10 degrees.

$$\tan \phi = \frac{\text{lead of thread}}{\pi K} = \frac{0.400}{\pi \times 0.780}$$

$$\phi = 9.27^\circ (9^\circ 16')$$

$$\tan \phi' = \frac{\text{lead of thread}}{\pi D} = \frac{0.400}{\pi \times 1.000}$$

$$\phi' = 7.26^\circ (7^\circ 15')$$

$$a = a_e + \phi = 10^\circ + 9.27^\circ = 19.27^\circ$$

$$a' = a_e - \phi' = 10^\circ - 7.26^\circ = 2.74^\circ$$

$$\tan b = \tan a \cos \frac{1}{2}\omega = \tan 19.27 \cos 14.5$$

$$b = 18.70^\circ (18^\circ 42')$$

$$\tan b' = \tan a' \cos \frac{1}{2}\omega = \tan 2.74 \cos 14.5$$

$$b' = 2.65^\circ (2^\circ 39')$$

$$\tan n = \frac{\tan a - \tan a'}{2 \tan \frac{1}{2}\omega} = \frac{\tan 19.27 - \tan 2.74}{2 \tan 14.5}$$

$$n = 30.26^\circ (30^\circ 16')$$

Lathe Change Gears

Change Gears for Thread Cutting.—To determine the change gears to use for cutting a thread of given pitch, first find what number of threads per inch will be cut when gears of the same size are placed on the lead screw and spindle stud, either by trial or by referring to the index plate; then multiply this number, called the “lathe screw constant,” by some trial number to obtain the number of teeth in the gear for the spindle stud, and multiply the threads per inch to be cut by the *same* trial number to obtain the number of teeth in the gear for the lead screw. Expressing this rule as a formula:

$$\frac{\text{Trial number} \times \text{lathe screw constant}}{\text{Trial number} \times \text{threads per inch to be cut}} = \frac{\text{teeth in gear on spindle stud}}{\text{teeth in gear on lead screw}}$$

For example, suppose the available change gears supplied with the lathe have 24, 28, 32, 36 teeth, etc., the number increasing by 4 up to 100, and that 10 threads per inch are to be cut in a lathe having a lathe screw constant of 6; then, if the screw constant is written as the numerator, the number of threads per inch to be cut as the denominator of a fraction, and both numerator and denominator are multiplied by some trial number, say, 4, it is found that gears having 24 and 40 teeth can be used. Thus:

$$\frac{6}{10} = \frac{6 \times 4}{10 \times 4} = \frac{24}{40}$$

The 24-tooth gear goes on the spindle stud and the 40-toothgear on the lead screw.

The lathe screw constant is, of course, equal to the number of threads per inch on the lead screw, provided the spindle stud and spindle are geared in the ratio of 1 to 1, which, however, is not always so.

Compound Gearing.—To find the change gears used in compound gearing, place the screw constant as the numerator and the number of threads per inch to be cut as the denominator of a fraction; resolve both numerator and denominator into two factors each, and multiply each “pair” of factors by the same number, until values are obtained representing suitable numbers of teeth for the change gears. (One factor in the numerator and one in the denominator make a “pair” of factors.)

Example:— $1\frac{3}{4}$ threads per inch are to be cut in a lathe having a screw constant of 8; the available gears have 24, 28, 32, 36, 40 teeth. etc., increasing by 4 up to 100. Following the rule:

$$\frac{8}{1\frac{3}{4}} = \frac{2 \times 4}{1 \times 1\frac{3}{4}} = \frac{(2 \times 36) \times (4 \times 16)}{(1 \times 36) \times (1\frac{3}{4} \times 16)} = \frac{72 \times 64}{36 \times 28}$$

The gears having 72 and 64 teeth are the *driving* gears and those with 36 and 28 teeth are the *driven* gears.

Fractional Threads.—Sometimes the lead of a thread is given as a fraction of an inch instead of stating the number of threads per inch. For example, a thread may be required to be cut, having $\frac{3}{8}$ inch lead. The expression “ $\frac{3}{8}$ inch lead” should first be transformed to “number of threads per inch.” The number of threads per inch (the thread being single) equals:

$$\frac{1}{\frac{3}{8}} = 1 \div \frac{3}{8} = \frac{8}{3} = 2\frac{2}{3}$$

To find the change gears to cut $2\frac{2}{3}$ threads per inch in a lathe having a screw constant 8 and change gears ranging from 24 to 100 teeth, increasing in increments of 4, proceed as below:

$$\frac{8}{2\frac{2}{3}} = \frac{2 \times 4}{1 \times 2\frac{2}{3}} = \frac{(2 \times 36) \times (4 \times 24)}{(1 \times 36) \times (2\frac{2}{3} \times 24)} = \frac{72 \times 96}{36 \times 64}$$

Change Gears for Metric Pitches.—When screws are cut in accordance with the metric system, it is the usual practice to give the lead of the thread in millimeters, instead of the number of threads per unit of measurement. To find the change gears for cutting metric threads, when using a lathe having an inch lead screw, first determine the number of threads per inch corresponding to the given lead in millimeters. Suppose a thread of 3 millimeters lead is to be cut in a lathe having an inch lead screw and a screw constant of 6. As there are 25.4 millimeters per inch, the number of threads per inch will equal $25.4 \div 3$. Place the screw constant as the numerator, and the number of threads per inch to be cut as the denominator:

$$\frac{6}{\frac{25.4}{3}} = 6 \div \frac{25.4}{3} = \frac{6 \times 3}{25.4}$$

The numerator and denominator of this fractional expression of the change gear ratio is next multiplied by some trial number to determine the size of the gears. The first whole number by which 25.4 can be multiplied so as to get a whole number as the result is 5. Thus, $25.4 \times 5 = 127$. Hence, one gear having 127 teeth is always used when cutting metric threads with an inch lead screw. The other gear required has 90 teeth. Thus:

$$\frac{6 \times 3 \times 5}{25.4 \times 5} = \frac{90}{127}$$

Therefore, the following rule can be used to find the change gears for cutting metric pitches with an inch lead screw:

Rule: Place the lathe screw constant multiplied by the lead of the required thread in millimeters multiplied by 5 as the numerator of the fraction and 127 as the denominator. The product of the numbers in the numerator equals the number of teeth for the spindle-stud gear, and 127 is the number of teeth for the lead-screw gear.

If the lathe has a metric pitch lead screw, and a screw having a given number of threads per inch is to be cut, first find the “metric screw constant” of the lathe or the lead of thread in millimeters that would be cut with change gears of equal size on the lead screw and spindle stud; then the method of determining the change gears is simply the reverse of the one already explained for cutting a metric thread with an inch lead screw.

Rule: To find the change gears for cutting inch threads with a metric lead screw, place 127 in the numerator and the threads per inch to be cut, multiplied by the metric screw constant multiplied by 5 in the denominator; 127 is the number of teeth on the spindle-stud gear and the product of the numbers in the denominator equals the number of teeth in the lead-screw gear.

Threads per Inch Obtained with a Given Combination of Gears.—To determine the number of threads per inch that will be obtained with a given combination of gearing, multiply the lathe screw constant by the number of teeth in the *driven* gear (or by the product of the numbers of teeth in both driven gears of compound gearing), and divide the product thus obtained by the number of teeth in the *driving* gear (or by the product of the two driving gears of a compound train). The quotient equals the number of threads per inch.

Change Gears for Fractional Ratios.—When gear ratios cannot be expressed exactly in whole numbers that are within the range of ordinary gearing, the combination of gearing required for the fractional ratio may be determined quite easily, often by the “cancellation method.” To illustrate this method, assume that the speeds of two gears are to be in the ratio of 3.423 to 1. The number 3.423 is first changed to $\frac{3423}{1000}$ to clear it of decimals. Then, in order to secure a fraction that can be reduced, 3423 is changed to 3420;

$$\frac{3420}{1000} = \frac{342}{100} = \frac{3 \times 2 \times 57}{2 \times 50} = \frac{3 \times 57}{1 \times 50}$$

Then, multiplying $\frac{3}{1}$ by some trial number, say, 24, the following gear combination is obtained:

$$\frac{72}{24} \times \frac{57}{50} = \frac{4104}{1200} = \frac{3.42}{1}$$

As the desired ratio is 3.423 to 1, there is an error of 0.003. When the ratios are comparatively simple, the cancellation method is not difficult and is frequently used; but by the logarithmic method to be described, more accurate results are usually possible.

Modifying the Quick-Change Gearbox Output.—On most modern lathes, the gear train connecting the headstock spindle with the lead screw contains a quick-change gearbox. Instead of using different change gears, it is only necessary to position the handles of the gearbox to adjust the speed ratio between the spindle and the lead screw in preparation for cutting a thread. However, a thread sometimes must be cut for which there is no quick-change gearbox setting. It is then necessary to modify the normal, or standard, gear ratio between the spindle and the gearbox by installing modifying change gears to replace the standard gears normally used. Metric and other odd pitch threads can be cut on lathes that have an inch thread lead screw and a quick-change gearbox having only settings for inch threads by using modifying-change gears in the gear train. Likewise, inch threads and other odd pitch threads can be cut on metric lead-screw lathes having a gearbox on which only metric thread settings can be made. Modifying-change gears also can be used for cutting odd pitch threads on lathes having a quick-change gearbox that has both inch and metric thread settings.

The sizes of the modifying-change gears can be calculated by formulas to be given later; they depend on the thread to be cut and on the setting of the quick-change gearbox. Many different sets of gears can be found for each thread to be cut. It is recommended that several calculations be made in order to find the set of gears that is most suitable for installation on the lathe. The modifying-change gear formulas that follow are based on the type of lead screw, i.e., whether the lead screw has inch or metric threads.

Metric Threads on Inch Lead-Screw Lathes: A 127-tooth translating gear must be used in the modifying-change gear train in order to be able to cut metric threads on inch lead-screw lathes. The formula for calculating the modifying change gears is:

$$\frac{5 \times \text{gearbox setting in thds/in.} \times \text{pitch in mm to be cut}}{127} = \frac{\text{driving gears}}{\text{driven gears}}$$

The numerator and denominator of this formula are multiplied by equal numbers, called trial numbers, to find the gears. If suitable gears cannot be found with one set, then another set of equal trial numbers is used. (Because these numbers are equal, such as 15/15 or 24/24, they are equal to the number one when thought of as a fraction; their inclusion has the effect of multiplying the formula by one, which does not change its value.) It is necessary to select the gearbox setting in threads per inch that must be used to cut the metric thread when using the gears calculated by the formula. One method is to select a quick-change gearbox setting that is close to the actual number of metric threads in a 1-inch length, called the equivalent threads per inch, which can be calculated by the following formula: Equivalent thds/in. = 25.4 ÷ pitch in millimeters to be cut.

Example: Select the quick-change gearbox setting and calculate the modifying change gears required to set up a lathe having an inch-thread lead screw in order to cut an M12 × 1.75 metric thread.

$$\begin{aligned} \text{Equivalent thds/in.} &= \frac{25.4}{\text{pitch in mm to be cut}} = \frac{25.4}{1.75} = 1.45 \text{ (use 14 thds/in.)} \\ \frac{5 \times \text{gearbox setting in thds/in.} \times \text{pitch in mm to be cut}}{127} &= \frac{5 \times 14 \times 1.75}{127} \\ &= \frac{(24) \times 5 \times 14 \times 1.75}{(24) \times 127} = \frac{(5 \times 14) \times (24 \times 1.75)}{24 \times 127} \\ &= \frac{70 \times 42}{24 \times 127} = \frac{\text{driving gears}}{\text{driven gears}} \end{aligned}$$

Odd Inch Pitch Threads: The calculation of the modifying change gears used for cutting odd pitch threads that are specified by their pitch in inches involves the sizes of the standard gears, which can be found by counting their teeth. Standard gears are those used to enable the lathe to cut the thread for which the gearbox setting is made; they are the gears that are normally used. The threads on worms used with worm gears are among the odd pitch threads that can be cut by this method. As before, it is usually advisable to calculate the actual number of threads per inch of the odd pitch thread and to select a gearbox setting that is close to this value. The following formula is used to calculate the modifying-change gears to cut odd inch pitch threads:

$$\begin{aligned} \frac{\text{Standard driving gear} \times \text{pitch to be cut in inches} \times \text{gearbox setting in thds/in.}}{\text{Standard driven gear}} \\ = \frac{\text{driving gears}}{\text{driven gears}} \end{aligned}$$

Example: Select the quick-change gearbox setting and calculate the modifying change gears required to cut a thread having a pitch equal to 0.195 inch. The standard driving and driven gears both have 48 teeth. To find equivalent threads per inch:

$$\frac{\text{Thds}}{\text{in.}} = \frac{1}{\text{pitch}} = \frac{1}{0.195} = 5.13 \quad (\text{use 5 thds/in.})$$

$$\begin{aligned} \frac{\text{Standard driving gear} \times \text{pitch to be cut in inches} \times \text{gearbox setting in thds/in.}}{\text{Standard driven gear}} \\ = \frac{48 \times 0.195 \times 5}{48} = \frac{(1000) \times 0.195 \times 5}{(1000)} = \frac{195 \times 5}{500 \times 2} = \frac{39 \times 5}{100 \times 2} = \frac{39 \times 5 \times (8)}{50 \times 2 \times 2 \times (8)} \\ = \frac{39 \times 40}{50 \times 32} = \frac{\text{driving gears}}{\text{driven gears}} \end{aligned}$$

It will be noted that in the second step above, 1000/1000 has been substituted for 48/48. This substitution does not change the ratio. The reason for this substitution is that $1000 \times 0.195 = 195$, a whole number. Actually, $200/200$ might have been substituted because $200 \times 0.195 = 39$, also a whole number.

The procedure for calculating the modifying gears using the following formulas is the same as illustrated by the two previous examples.

Odd Threads per Inch on Inch Lead Screw Lathes:

$$\frac{\text{Standard driving gear} \times \text{gearbox setting in thds/in.}}{\text{Standard driven gear} \times \text{thds/in. to be cut}} = \frac{\text{driving gears}}{\text{driven gears}}$$

Inch Threads on Metric Lead Screw Lathes:

$$\frac{127}{5 \times \text{gearbox setting in mm pitch} \times \text{thds/in. to be cut}} = \frac{\text{driving gears}}{\text{driven gears}}$$

Odd Metric Pitch Threads on Metric Lead Screw Lathes:

$$\frac{\text{Standard driving gear} \times \text{mm pitch to be cut}}{\text{Standard driven gear} \times \text{gearbox setting in mm pitch}} = \frac{\text{driving gears}}{\text{driven gears}}$$

Finding Accurate Gear Ratios.—Tables included in the 23rd and earlier editions of this handbook furnished a series of logarithms of gear ratios as a quick means of finding ratios for all gear combinations having 15 to 120 teeth. The ratios thus determined could be factored into sets of 2, 4, 6, or any other even numbers of gears to provide a desired overall ratio.

Although the method of using logarithms of gear ratios provides results of suitable accuracy for many gear-ratio problems, it does not provide a systematic means of evaluating whether other, more accurate ratios are available. In critical applications, especially in the design of mechanisms using reduction gear trains, it may be desirable to find many or all possible ratios to meet a specified accuracy requirement. The methods best suited to such problems use *Continued Fractions* and *Conjugate Fractions* as explained starting on pages 11 and illustrated in the worked-out example on page 13 for a set of four change gears.

As an example, if an overall reduction of 0.31416 is required, a fraction must be found such that the factors of the numerator and denominator may be used to form a four-gear reduction train in which no gear has more than 120 teeth. By using the method of conjugate fractions discussed on page 12, the ratios listed above, and their factors are found to be successively closer approximations to the required overall gear ratio.

Ratio	Numerator Factors	Denominator	Error Factors
11/35	11	5 × 7	+0.00013
16/51	2 × 2 × 2 × 2	3 × 17	-0.00043
27/86	3 × 3 × 3	2 × 43	-0.00021
38/121	2 × 19	11 × 11	-0.00011
49/156	7 × 7	2 × 2 × 3 × 13	-0.00006
82/261	2 × 41	3 × 3 × 29	+0.00002
224/713	2 × 2 × 2 × 2 × 2 × 7	23 × 31	+0.000005
437/1391	19 × 23	13 × 107	+0.000002
721/2295	7 × 103	3 × 3 × 3 × 5 × 17	+0.000001
1360/4329	2 × 2 × 2 × 2 × 17	3 × 3 × 13 × 53	+0.0000003
1715/5459	5 × 7 × 7 × 7	53 × 103	+0.0000001
3927/12500	3 × 7 × 11 × 17	2 × 2 × 5 × 5 × 5 × 5 × 5	0

Lathe Change-gears.—To calculate the change gears to cut any pitch on a lathe, the “constant” of the machine must be known. For any lathe, the ratio $C:L$ = driver:driven gear, in which C = constant of machine and L = threads per inch.

For example, to find the change gears required to cut 1.7345 threads per inch on a lathe having a constant of 4, the formula:

$$\frac{C}{L} = \frac{4}{1.7345} = 2.306140$$

may be used. The method of conjugate fractions shown on page 12 will find the ratio, $113/49 = 2.306122$, which is closer than any other having suitable factors. This ratio is in error by only $2.306140 - 2.306122 = 0.000018$. Therefore, the driver should have 113 teeth and the driven gear 49 teeth.

Relieving Helical-Fluted Hobs.—Relieving hobs that have been fluted at right angles to the thread is another example of approximating a required change-gear ratio. The usual method is to change the angle of the helical flutes to agree with previously calculated change-gears. The ratio between the hob and the relieving attachment is expressed in the formula:

$$\frac{N}{(C \times \cos^2 \alpha)} = \frac{\text{driver}}{\text{driven}} \text{ gears}$$

and

$$\tan \alpha = \frac{P}{H_c}$$

in which: N = number of flutes in hob; α = helix angle of thread from plane perpendicular to axis; C = constant of relieving attachment; P = axial lead of hob; and H_c = hob pitch circumference, = 3.1416 times pitch diameter.

The constant of the relieving attachment is found on its index plate and is determined by the number of flutes that require equal gears on the change-gear studs. These values will vary with different makes of lathes.

For example, what four change-gears can be used to relieve a helical-fluted worm-gear hob, of 24 diametral pitch, six starts, 13 degrees, 41 minutes helix angle of thread, with eleven helical flutes, assuming a relieving attachment having a constant of 4 is to be used?

$$\frac{N}{(C \times \cos^2 \alpha)} = \frac{11}{(4 \times \cos^2 13^\circ 41')} = \frac{11}{(4 \times 0.944045)} = 2.913136$$

Using the conjugate fractions method discussed on page 12, the following ratios are found to provide factors that are successively closer approximations to the required change-gear ratio 2.913136.

<i>Numerator/Denominator</i>	<i>Ratio</i>	<i>Error</i>
67 × 78 / (39 × 46)	2.913043	-0.000093
30 × 47 / (22 × 22)	2.913223	+0.000087
80 × 26 / (21 × 34)	2.913165	+0.000029
27 × 82 / (20 × 38)	2.913158	+0.000021
55 × 75 / (24 × 59)	2.913136	+0.0000004
74 × 92 / (57 × 41)	2.913136	+0.00000005

THREAD ROLLING

Screw threads may be formed by rolling either by using some type of thread-rolling machine or by equipping an automatic screw machine or turret lathe with a suitable threading roll. If a thread-rolling machine is used, the unthreaded screw, bolt, or other "blank" is placed (either automatically or by hand) between dies having thread-shaped ridges that sink into the blank, and by displacing the metal, form a thread of the required shape and pitch. The thread-rolling process is applied where bolts, screws, studs, threaded rods, etc., are required in large quantities. Screw threads that are within the range of the rolling process may be produced more rapidly by this method than in any other way. Because of the cold-working action of the dies, the rolled thread is 10 to 20 per cent stronger than a cut or ground thread, and the increase may be much higher for fatigue resistance. Other advantages of the rolling process are that no stock is wasted in forming the thread, and the surface of a rolled thread is harder than that of a cut thread, thus increasing wear resistance.

Thread-Rolling Machine of Flat-Die Type.—One type of machine that is used extensively for thread rolling is equipped with a pair of flat or straight dies. One die is stationary and the other has a reciprocating movement when the machine is in use. The ridges on these dies, which form the screw thread, incline at an angle equal to the helix angle of the thread. In making dies for precision thread rolling, the threads may be formed either by milling and grinding after heat treatment, or by grinding "from the solid" after heat treating. A vitrified wheel is used.

In a thread-rolling machine, thread is formed in one passage of the work, which is inserted at one end of the dies, either by hand or automatically, and then rolls between the die faces until it is ejected at the opposite end. The relation between the position of the dies and a screw thread being rolled is such that the top of the thread-shaped ridge of one die, at the point of contact with the screw thread, is directly opposite the bottom of the thread groove in the other die at the point of contact. Some form of mechanism ensures starting the blank at the right time and square with the dies.

Thread-Rolling Machine of Cylindrical-Die Type.—With machines of this type, the blank is threaded while being rolled between two or three cylindrical dies (depending upon the type of machine) that are pressed into the blank at a rate of penetration adjusted to the hardness of the material, or wall thickness in threading operations on tubing or hollow parts. The dies have ground, or ground and lapped, threads and a pitch diameter that is a multiple of the pitch diameter of the thread to be rolled. As the dies are much larger in diameter than the work, a multiple thread is required to obtain the same lead angle as that of the work. The thread may be formed in one die revolution or even less, or several revolutions may be required (as in rolling hard materials) to obtain a gradual rate of penetration equivalent to that obtained with flat or straight dies if extended to a length of possibly 15 or 20 feet (4.6 or 6 m). Provisions for accurately adjusting or matching the thread rolls to bring them into proper alignment with each other are important features of these machines.

Two-Roll Type of Machine: With a two-roll type of machine, the work is rotated between two horizontal power-driven threading rolls and is supported by a hardened rest bar on the lower side. One roll is fed inward by hydraulic pressure to a depth that is governed automatically.

Three-Roll Type of Machine: With this machine, the blank to be threaded is held in a "floating position" while being rolled between three cylindrical dies that, through toggle arms, are moved inward at a predetermined rate of penetration until the required pitch diameter is obtained. The die movement is governed by a cam driven through change gears selected to give the required cycle of squeeze, dwell, and release.

Rate of Production.—Production rates in thread rolling depend upon the type of machine, the size of both machine and work, and whether the parts to be threaded are inserted by hand or automatically. A reciprocating flat die type of machine, applied to ordinary steels, may thread 30 or 40 parts per minute in diameters ranging from about $\frac{5}{8}$ to $1\frac{1}{8}$

inch (15.875–28.575 mm), and 150 to 175 per minute in machine screw sizes from No. 10 (.190 inch) to No. 6 (.138 inch). In the case of heat-treated alloy steels in the usual hardness range of 26 to 32 Rockwell C, the production may be 30 or 40 per minute or less. With a cylindrical die type of machine, which is designed primarily for precision work and hard metals, 10 to 30 parts per minute are common production rates, the amount depending upon the hardness of material and allowable rate of die penetration per work revolution. These production rates are intended as a general guide only. The diameters of rolled threads usually range from the smallest machine screw sizes up to 1 or 1½ inches (25.4 or 38.1 mm), depending upon the type and size of machine.

Precision Thread Rolling.—Both flat and cylindrical dies are used in aeronautical and other plants for precision work. With accurate dies and blank diameters held to close limits, it is practicable to produce rolled threads for American Standard Class 3 and Class 4 fits. The blank sizing may be by centerless grinding or by means of a die in conjunction with the heading operations. The blank should be round, and, as a general rule, the diameter tolerance should not exceed $\frac{1}{2}$ to $\frac{2}{3}$ the pitch diameter tolerance. The blank diameter should range from the correct size (which is close to the pitch diameter, but should be determined by actual trial), down to the allowable minimum, the tolerance being minus to insure a correct pitch diameter, even though the major diameter may vary slightly. Precision thread rolling has become an important method of threading alloy steel studs and other threaded parts, especially in aeronautical work where precision and high-fatigue resistance are required. Micrometer screws are also an outstanding example of precision thread rolling. This process has also been applied in tap making, although it is the general practice to finish rolled taps by grinding when the Class 3 and Class 4 fits are required.

Steels for Thread Rolling.—Steels vary from soft low-carbon types for ordinary screws and bolts, to nickel, nickel-chromium and molybdenum steels for aircraft studs, bolts, etc., or for any work requiring exceptional strength and fatigue resistance. Typical SAE alloy steels are No. 2330, 3135, 3140, 4027, 4042, 4640 and 6160. The hardness of these steels after heat-treatment usually ranges from 26 to 32 Rockwell C, with tensile strengths varying from 130,000 to 150,000 psi (896–1034 MPa). While harder materials might be rolled, grinding is more practicable when the hardness exceeds 40 Rockwell C. Thread rolling is applicable not only to a wide range of steels but for non-ferrous materials, especially if there is difficulty in cutting due to “tearing” the threads.

Diameter of Blank for Thread Rolling.—The diameter of the screw blank or cylindrical part upon which a thread is to be rolled should be less than the outside screw diameter by an amount that will just compensate for the metal that is displaced and raised above the original surface by the rolling process. The increase in diameter is approximately equal to the depth of one thread. While there are rules and formulas for determining blank diameters, it may be necessary to make slight changes in the calculated size in order to secure a well-formed thread. The blank diameter should be verified by trial, especially when rolling accurate screw threads. Some stock offers greater resistance to displacement than other stock, owing to the greater hardness or tenacity of the metal. The following figures may prove useful in establishing trial sizes. The blank diameters for screws varying from $\frac{1}{4}$ to $\frac{1}{2}$ inch are from 0.002 to 0.0025 inch (50.8–63.5 μm) larger than the pitch diameter, and for screws varying from $\frac{1}{2}$ to 1 inch (12.7–25.4 mm) or larger, the blank diameters are from 0.0025 to .003 inch (63.5–76.2 μm) larger than the pitch diameter. Blanks which are slightly less than the pitch diameter are intended for bolts, screws, etc., which are to have a comparatively free fit. Blanks for this class of work may vary from 0.002 to 0.003 inch (50.8–76.2 μm) less than the pitch diameter for screw thread sizes varying from $\frac{1}{4}$ to $\frac{1}{2}$ inch (6.35–12.7 mm), and from 0.003 to 0.005 inch (76.2–127 μm) less than the pitch diameter for sizes above $\frac{1}{2}$ inch. If the screw threads are smaller than $\frac{1}{4}$ inch, the blanks are usually from 0.001 to 0.0015 inch (25.4–38.1 μm) less than the pitch diameter for ordinary grades of work.

Thread Rolling in Automatic Screw Machines.—Screw threads are sometimes rolled in automatic screw machines and turret lathes when the thread is behind a shoulder so that it cannot be cut with a die. In such cases, the advantage of rolling the thread is that a second operation is avoided. A circular roll is used for rolling threads in screw machines. The roll may be presented to the work either in a tangential direction or radially, either method producing a satisfactory thread. In the former case, the roll gradually comes into contact with the periphery of the work and completes the thread as it passes across the surface to be threaded. When the roll is held in a radial position, it is simply forced against one side until a complete thread is formed. The method of applying the roll may depend upon the relation between the threading operation and other machining operations. Thread rolling in automatic screw machines is generally applied only to brass and other relatively soft metals, owing to the difficulty of rolling threads in steel. Thread rolls made of chrome-nickel steel containing from 0.15 to 0.20 per cent of carbon have given fairly good results, however, when applied to steel. A 3 per cent nickel steel containing about 0.12 per cent carbon has also proved satisfactory for threading brass.

Factors Governing the Diameter of Thread Rolling.—The threading roll used in screw machines may be about the same diameter as the screw thread, but for sizes smaller than, say, $\frac{3}{4}$ inch (19.05 mm), the roll diameter is some multiple of the thread diameter minus a slight amount to obtain a better rolling action. When the diameters of the thread and roll are practically the same, a single-threaded roll is used to form a single thread on the screw. If the diameter of the roll is made double that of the screw, in order to avoid using a small roll, then the roll must have a double thread. If the thread roll is three times the size of the screw thread, a triple thread is used, and so on. These multiple threads are necessary when the roll diameter is some multiple of the work, in order to obtain corresponding helix angles on the roll and work.

Diameter of Threading Roll.—The pitch diameter of a threading roll having a single thread is slightly less than the pitch diameter of the screw thread to be rolled, and in the case of multiple-thread rolls, the pitch diameter is not an exact multiple of the screw thread pitch diameter but is also reduced somewhat. The amount of reduction recommended by one screw machine manufacturer is given by the formula shown at the end of this paragraph. A description of the terms used in the formula is given as follows: D = pitch diameter of threading roll, d = pitch diameter of screw thread, N = number of single threads or “starts” on the roll (this number is selected with reference to diameter of roll desired), T = single depth of thread:

$$D = N\left(d - \frac{T}{2}\right) - T$$

Example: Find, by using above formula, the pitch diameter of a double-thread roll for rolling a $\frac{1}{2}$ -inch American standard screw thread. Pitch diameter $d = 0.4500$ inch and thread depth $T = 0.0499$ inch.

$$D = 2\left(0.4500 - \frac{0.0499}{2}\right) - 0.0499 = 0.8001 \text{ inch}$$

Kind of Thread on Roll and Its Shape.—The thread (or threads) on the roll should be left hand for rolling a right-hand thread, and *vice versa*. The roll should be wide enough to overlap the part to be threaded, provided there are clearance spaces at the ends, which should be formed if possible. The thread on the roll should be sharp on top for rolling an American (National) standard form of thread, so that less pressure will be required to displace the metal when rolling the thread. The bottom of the thread groove on the roll may also be left sharp or it may have a flat. If the bottom is sharp, the roll is sunk only far enough into the blank to form a thread having a flat top, assuming that the thread is the American form. The number of threads on the roll (whether double, triple, quadruple, etc.) is

selected, as a rule, so that the diameter of the thread roll will be somewhere between $1\frac{1}{4}$ and $2\frac{1}{4}$ inches (31.75–57.15 mm). In making a thread roll, the ends are beveled at an angle of 45 degrees, to prevent the threads on the ends of the roll from chipping. Precautions should be taken in hardening, because, if the sharp edges are burnt, the roll will be useless. Thread rolls are usually lapped after hardening, by holding them on an arbor in the lathe and using emery and oil on a piece of hard wood. To give good results a thread roll should fit closely in the holder. If the roll is made to fit loosely, it will mar the threads.

Application of Thread Roll.—The shape of the work and the character of the operations necessary to produce it, govern, to a large extent, the method employed in applying the thread roll. Some of the points to consider are as follows:

- 1) Diameter of the part to be threaded.
- 2) Location of the part to be threaded.
- 3) Length of the part to be threaded.
- 4) Relation that the thread rolling operation bears to the other operations.
- 5) Shape of the part to be threaded, whether straight, tapered or otherwise.
- 6) Method of applying the support.

When the diameter to be rolled is much smaller than the diameter of the shoulder preceding it, a cross-slide knurl-holder should be used. If the part to be threaded is not behind a shoulder, a holder on the swing principle should be used. When the work is long (greater in length than two-and-one-half times its diameter) a swing roll-holder should be employed, carrying a support. When the work can be cut off after the thread is rolled, a cross-slide roll-holder should be used. The method of applying the support to the work also governs to some extent the method of applying the thread roll. When no other tool is working at the same time as the thread roll, and when there is freedom from chips, the roll can be held more rigidly by passing it under instead of over the work. When passing the roll over the work, there is a tendency to raise the cross-slide. Where the part to be threaded is tapered, the roll can best be presented to the work by holding it in a cross-slide roll-holder.

Tolerances on Wire for Thread Rolling.—The wire mills will accept a tolerance specification of plus or minus 0.002 inch (50.8 μm) on the diameter. It is particularly important that this tolerance be maintained on stock used for long screws of small diameter. On screws of short length the material will flow, and if the wire is over size little trouble will be experienced, but in the case of screws having a length greater than ten times their diameter, the material will be confined, and “burning” will take place, if the tolerance is greater than that specified. If the wire is slightly under size, the rolled threads will have a ragged appearance due to the fact that the crest is not fully formed. On screws under the No. 10-24 size, a tolerance of plus or minus 0.001 inch should be adhered to in order to ensure good results.

Speeds and Feeds for Thread Rolling.—When the thread roll is made from high-carbon steel and used on brass, a surface speed as high as 200 feet per minute can be used. However, better results are obtained by using a lower speed than this. When the roll is held in a holder attached to the cross-slide, and is presented either tangentially or radially to the work, a considerably higher speed can be used than if it is held in a swing tool. This is due to the lack of rigidity in a holder of the swing type. The feeds to be used when a cross-slide roll-holder is used are given in the upper half of the table “Feeds for Thread Rolling;” the lower half of the table gives the feeds for thread rolling with swing tools. These feeds are applicable for rolling threads without a support, when the root diameter of the blank is not less than five times the double depth of the thread. When the root diameter is less than this, a support should be used. A support should also be used when the width of the roll is more than two-and-one-half times the smallest diameter of the piece to be rolled, irrespective of the pitch of the thread. When the smallest diameter of the piece to be rolled is much less than the root diameter of the thread, the smallest diameter should be taken as the deciding factor for the feed to be used.

Feeds for Thread Rolling

Root Diam. of Blank	Number of Threads per Inch													
	72	64	56	48	44	40	36	32	28	24	22	20	18	14
	Cross-slide Holders — Feed per Revolution in Inches													
1/8	0.0045	0.0040	0.0035	0.0030	0.0025	0.0020	0.0015	0.0010
3/16	0.0050	0.0045	0.0040	0.0035	0.0030	0.0025	0.0020	0.0015	0.0005
1/4	0.0055	0.0050	0.0045	0.0040	0.0035	0.0030	0.0025	0.0020	0.0010	0.0005	0.0005
5/16	0.0060	0.0055	0.0050	0.0045	0.0040	0.0035	0.0030	0.0025	0.0015	0.0010	0.0010	0.0005	0.0005
3/8	0.0065	0.0060	0.0055	0.0050	0.0045	0.0040	0.0035	0.0030	0.0020	0.0015	0.0015	0.0010	0.0010	0.0005
7/16	0.0070	0.0065	0.0060	0.0055	0.0050	0.0045	0.0040	0.0035	0.0025	0.0020	0.0020	0.0015	0.0015	0.0010
1/2	0.0075	0.0070	0.0065	0.0060	0.0055	0.0050	0.0045	0.0040	0.0030	0.0025	0.0025	0.0020	0.0020	0.0015
5/8	0.0080	0.0075	0.0070	0.0065	0.0060	0.0055	0.0050	0.0045	0.0035	0.0030	0.0030	0.0025	0.0025	0.0020
3/4	0.0085	0.0080	0.0075	0.0070	0.0065	0.0060	0.0055	0.0050	0.0040	0.0035	0.0035	0.0030	0.0030	0.0025
7/8	0.0090	0.0085	0.0080	0.0075	0.0070	0.0065	0.0060	0.0055	0.0045	0.0040	0.0040	0.0035	0.0035	0.0030
1	0.0095	0.0090	0.0085	0.0080	0.0075	0.0070	0.0065	0.0060	0.0050	0.0045	0.0045	0.0040	0.0040	0.0035
Root Diam.	Swing Holders — Feed per Revolution in Inches													
1/8	0.0025	0.0020	0.0015	0.0010	0.0005
3/16	0.0028	0.0025	0.0020	0.0015	0.0008	0.0005
1/4	0.0030	0.0030	0.0025	0.0020	0.0010	0.0010	0.0005	0.0005	0.0005
5/16	0.0035	0.0035	0.0030	0.0025	0.0015	0.0015	0.0010	0.0010	0.0010	0.0010	0.0005
3/8	0.0040	0.0040	0.0035	0.0030	0.0020	0.0020	0.0015	0.0015	0.0015	0.0010	0.0005	0.0005	0.0005
7/16	0.0045	0.0045	0.0040	0.0035	0.0030	0.0025	0.0020	0.0020	0.0020	0.0020	0.0015	0.0010	0.0010
1/2	0.0048	0.0048	0.0045	0.0040	0.0035	0.0030	0.0025	0.0025	0.0025	0.0025	0.0020	0.0015	0.0015	0.0005
5/8	0.0050	0.0050	0.0048	0.0043	0.0040	0.0035	0.0030	0.0030	0.0030	0.0028	0.0025	0.0020	0.0020	0.0010
3/4	0.0055	0.0052	0.0050	0.0045	0.0043	0.0040	0.0035	0.0035	0.0035	0.0030	0.0028	0.0025	0.0022	0.0013
7/8	0.0058	0.0055	0.0052	0.0048	0.0045	0.0043	0.0040	0.0038	0.0032	0.0030	0.0028	0.0025	0.0022	0.0015
1	0.0060	0.0058	0.0054	0.0050	0.0048	0.0047	0.0043	0.0040	0.0035	0.0032	0.0030	0.0028	0.0025	0.0018

THREAD GRINDING

Thread grinding is employed for precision tool and gage work and also in producing certain classes of threaded parts.

Thread grinding may be utilized 1) because of the accuracy and finish obtained; 2) hardness of material to be threaded; and 3) economy in grinding certain classes of screw threads when using modern machines, wheels, and thread-grinding oils.

In some cases pre-cut threads are finished by grinding; but usually, threads are ground "from the solid," being formed entirely by the grinding process. Examples of work include thread gages and taps of steel and tungsten carbide, hobs, worms, lead-screws, adjusting or traversing screws, alloy steel studs, etc. Grinding is applied to external, internal, straight, and tapering threads, and to various thread forms.

Accuracy Obtainable by Thread Grinding.—With single-edge or single-ribbed wheels it is possible to grind threads on gages to a degree of accuracy that requires but very little lapping to produce a so-called "master" thread gage. As far as lead is concerned, some thread grinding machine manufacturers guarantee to hold the lead within 0.0001 inch per inch (or mm per mm) of thread; and while it is not guaranteed that a higher degree of accuracy for lead is obtainable, it is known that threads have been ground to closer tolerances than this on the lead. Pitch diameter accuracies for either Class 3 or Class 4 fits are obtainable according to the grinding method used; with single-edge wheels, the thread angle can be ground to an accuracy of within two or three minutes in half the angle.

Wheels for Thread Grinding.—The wheels used for steel have an aluminous abrasive and, ordinarily, either a resinoid bond or a vitrified bond. The general rule is to use resinoid wheels when extreme tolerances are not required, and it is desirable to form the thread with a minimum number of passes, as in grinding threaded machine parts, such as studs, adjusting screws which are not calibrated, and for some classes of taps. *Resinoid wheels*, as a rule, will hold a fine edge longer than a vitrified wheel but they are more flexible and, consequently, less suitable for accurate work, especially when there is lateral grinding pressure that causes wheel deflection. *Vitrified wheels* are utilized for obtaining extreme accuracy in thread form and lead because they are very rigid and not easily deflected by side pressure in grinding. This rigidity is especially important in grinding pre-cut threads on such work as gages, taps and lead-screws. The progressive lead errors in long lead-screws, for example, might cause an increasing lateral pressure that would deflect a resinoid wheel. Vitrified wheels are also recommended for internal grinding.

Diamond Wheels: Diamond wheels set in a rubber or plastic bond are also used for thread grinding, especially for grinding threads in carbide materials and in other hardened alloys. Thread grinding is now being done successfully on a commercial basis on both taps and gages made from carbides. Gear hobs made from carbides have also been tested with successful results. Diamond wheels are dressed by means of silicon-carbide grinding wheels which travel past the diamond-wheel thread form at the angle required for the flanks of the thread to be ground. The action of the dressing wheels is, perhaps, best described as a "scrubbing" of the bond which holds the diamond grits. Obviously, the silicon-carbide wheels do not dress the diamonds, but they loosen the bond until the diamonds not wanted drop out.

Thread Grinding with Single-Edge Wheel.—With this type of wheel, the edge is trued to the cross-sectional shape of the thread groove. The wheel, when new, may have a diameter of 18 or 20 inches (45.7 or 50.8 cm) and, when grinding a thread, the wheel is inclined to align it with the thread groove. On some machines, lead variations are obtained by means of change-gears which transmit motion from the work-driving spindle to the lead-screw. Other machines are so designed that a lead-screw is selected to suit the lead of thread to be ground and transmits motion directly to the work-driving spindle.

Wheels with Edges for Roughing and Finishing.—The “three-ribbed” type of wheel has a roughing edge or rib which removes about two-thirds of the metal. This is followed by an intermediate rib which leaves about 0.005 inch (127 μm) for the third or finishing rib. The accuracy obtained with this triple-edge type compares with that of a single-edge wheel, which means that it may be used for the greatest accuracy obtainable in thread grinding.

When the accuracy required makes it necessary, this wheel can be inclined to the helix angle of the thread, the same as is the single-edge wheel.

The three-ribbed wheel is recommended not only for precision work but for grinding threads which are too long for the multi-ribbed wheel referred to later. It is also well adapted to tap grinding, because it is possible to dress a portion of the wheel adjacent to the finish rib for the purpose of grinding the outside diameter of the thread, as indicated in Fig. 1. Furthermore, the wheel can be dressed for grinding or relieving both crests and flanks at the same time.

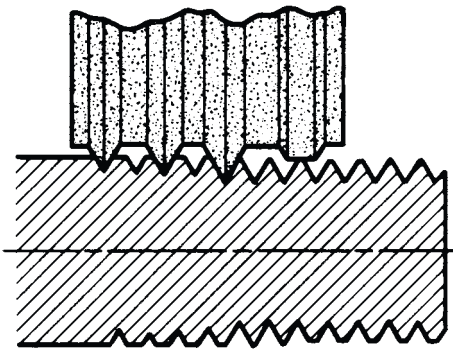


Fig. 1. Wheel with Edges for Roughing and Finishing

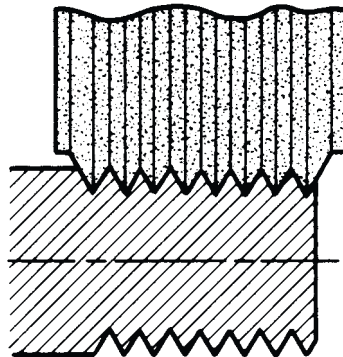


Fig. 2. Multi-ribbed Type of Thread-grinding Wheel

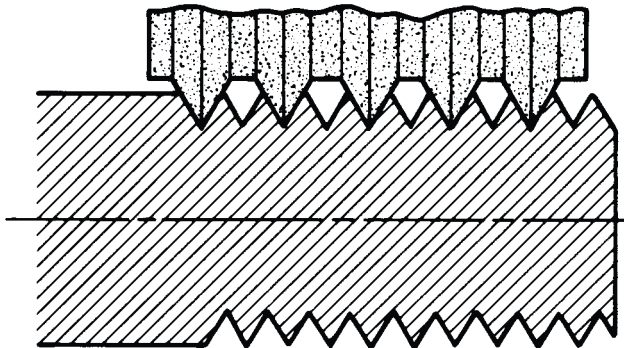


Fig. 3. Alternate-ribbed Wheel for Grinding the Finer Pitches

Multi-ribbed Wheels.—This type of wheel is employed when rapid production is more important than extreme accuracy, which means that it is intended primarily for the grinding of duplicate parts in manufacturing. A wheel $1\frac{1}{4}$ to 2 inches (3.175–5.08 cm) wide has formed upon its face a series of annular thread-shaped ridges (see Fig. 2); hence, if the length of the thread is not greater than the wheel width, a thread may be ground in one work revolution plus about one-half revolution for feeding in and withdrawing the wheel. The principle of operation is the same as that of thread milling with a multiple type cutter. This type of wheel is not inclined to the lead angle. To obtain a Class 3 fit, the lead angle should not exceed 4 degrees.

It is not practicable to use this form of wheel on thread pitches where the root is less than 0.007 inch (177.8 μm) wide, because of difficulties in wheel dressing. When this method can be applied, it is the fastest means known of producing threads in hardened materials. It is not recommended, however, that thread gages, taps, and work of this character be ground with multi-ribbed wheels. The single-ribbed wheel has a definite field for accurate, small-lot production.

It is necessary, in multi-ribbed grinding, to use more horsepower than is required for single-ribbed wheel grinding. Coarse threads, in particular, may require a wheel motor with two or three times more horsepower than would be necessary for grinding with a single-ribbed wheel.

Alternate-ribbed Wheel for Fine Pitches.—The spacing of ribs on this type of wheel (Fig. 3) equals twice the pitch, so that during the first revolution every other thread groove section is being ground; consequently, about two and one-half work revolutions are required for grinding a complete thread, but the better distribution of cooling oil and resulting increase in work speeds makes this wheel very efficient. This alternate-type of wheel is adapted for grinding threads of fine pitch. Since these wheels cannot be tipped to the helix angle of the thread, they are not recommended for anything closer than Class 3 fits. The “three-ribbed” wheels referred to in a previous paragraph are also made in the alternate type for the finer pitches.

Grinding Threads “from the Solid”.—The process of forming threads entirely by grinding, or without preliminary cutting, is applied both in the manufacture of certain classes of threaded parts and also in the production of precision tools, such as taps and thread gages. For example, in airplane engine manufacture, certain parts are heat-treated and then the threads are ground “from the solid,” thus eliminating distortion. Minute cracks are sometimes found at the roots of threads that were cut and then hardened, or ground from the solid. Steel threads of coarse pitch that are to be surface hardened, may be rough threaded by cutting, then hardened and finally corrected by grinding. Many ground thread taps are produced by grinding from the solid after heat-treatment. Hardening high-speed steel taps before the thread is formed will make sure there are no narrow or delicate crests to interfere with the application of the high temperature required for uniform hardness and the best steel structure.

Number of Wheel Passes.—The number of cuts or passes for grinding from the solid depends upon the type of wheel and accuracy required. In general, threads of 12 or 14 per inch and finer may be ground in one pass of a single-edge wheel unless the “unwrapped” thread length is much greater than normal. Unwrapped length = pitch circumference \times total number of thread turns, approximately. For example, a thread gage $1\frac{1}{4}$ inches long with 24 threads per inch would have an unwrapped length equal to $30 \times$ pitch circumference. (If more convenient, outside circumference may be used instead of pitch circumference.) Assume that there are 6 or 7 feet of unwrapped length on a screw thread having 12 threads per inch. In this case, one pass might be sufficient for a Class 3 fit, whereas two passes might be recommended for a Class 4 fit. When two passes are required, too deep a roughing cut may break down the narrow edge of the wheel. To prevent this, try a roughing cut depth equal to about two-thirds the total thread depth, thus leaving one-third for the finishing cut.

Wheel and Work Rotation.—When a screw thread, on the side being ground, is moving *upward* or *against* the grinding wheel rotation, less heat is generated and the grinding operation is more efficient than when wheel and work are moving in the same direction on the grinding side; however, to avoid running a machine idle during its return stroke, many screw threads are ground during both the forward and return traversing movements, by reversing the work rotation at the end of the forward stroke. For this reason, thread grinders generally are equipped so that both forward and return work speeds may be changed; they may also be designed to accelerate the return movement when grinding in one direction only.

Wheel Speeds.—Wheel speeds should always be limited to the maximum specified on the wheel by the manufacturer. According to the American National Standard Safety Code, resinoid and vitrified wheels are limited to 12,000 surface feet per minute (3657 m/min); however, according to Norton Co., the most efficient speeds are from 9,000 to 10,000 (2743–3048 m/min) for resinoid wheels and 7,500 to 9,500 (2286–2896 m/min) for vitrified wheels. Only tested wheels recommended by the wheel manufacturer should be used. After a suitable surface speed has been established, it should be maintained by increasing the rpm of the wheel, as the latter is reduced in diameter by wear.

Since thread grinding wheels work close to the limit of their stock-removing capacity, some adjustment of the wheel or work speed may be required to get the best results. If the wheel speed is too slow for a given job and excessive heat is generated, try an increase in speed, assuming that such increase is within the safety limits. If the wheel is too soft and the edge wears excessively, again an increase in wheel speed will give the effect of a harder wheel and result in better form-retaining qualities.

Work Speeds.—The work speed usually ranges from 3 to 10 fpm (0.9–3.0 m/min). In grinding with a comparatively heavy feed, and a minimum number of passes, the speed may not exceed $2\frac{1}{2}$ or 3 fpm (0.76–0.9 m/min). If very light feeds are employed, as in grinding hardened high-speed steel, the work speed may be much higher than 3 fpm (0.9 m/min) and should be determined by test. If excessive heat is generated by removing stock too rapidly, a work speed reduction is one remedy. If a wheel is working below its normal capacity, an increase in work speed would prevent dulling of the grains and reduce the tendency to heat or “burn” the work. An increase in work speed and reduction in feed may also be employed to prevent burning while grinding hardened steel.

Truing Grinding Wheels.—Thread grinding wheels are trued both to maintain the required thread form and also an efficient grinding surface. Thread grinders ordinarily are equipped with precision truing devices which function automatically. One type automatically dresses the wheel and also compensates for the slight amount removed in dressing, thus automatically maintaining size control of the work. While truing the wheel, a small amount of grinding oil should be used to reduce diamond wear. Light truing cuts are advisable, especially in truing resinoid wheels which may be deflected by excessive truing pressure. A master former for controlling the path followed by the truing diamond may require a modified profile to prevent distortion of the thread form, especially when the lead angles are comparatively large. Such modification usually is not required for 60-degree threads when the pitches for a given diameter are standard because then the resulting lead angles are less than $4\frac{1}{2}$ degrees. In grinding Acme threads or 29-degree worm threads having lead angles greater than 4 or 5 degrees, modified formers may be required to prevent a bulge in the thread profile. The highest point of this bulge is approximately at the pitch line. A bulge of about 0.001 inch (25.4 μ m) may be within allowable limits on some commercial worms but precision worms for gear hobbers, etc., require straight flanks in the axial plane.

Crushing Method: Thread grinding wheels are also dressed or formed by the crushing method, which is used in connection with some types of thread grinding machines. When this method is used, the annular ridge or ridges on the wheel are formed by a hardened steel cylindrical dresser or crusher. The crusher has a series of smooth annular ridges which are shaped and spaced like the thread that is to be ground. During the wheel dressing operation, the crusher is positively driven instead of the grinding wheel, and the ridges on the wheel face are formed by the rotating crusher being forced inward.

Wheel Hardness or Grade.—Wheel hardness or grade selection is based upon a compromise between efficient cutting and durability of the grinding edge. Grade selection depends on the bond and the character of the work. The following general recommendations are based upon Norton grading.

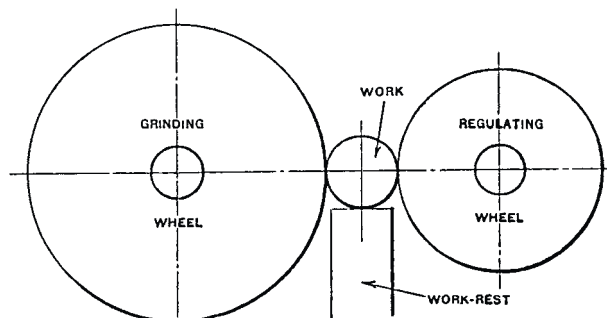
Vitrified wheels usually range from J to M, and resinoid wheels from R to U. For heat-treated screws or studs and the Unified Standard Thread, try the following. For 8 to 12

threads per inch, grade S resinoid wheel; for 14 to 20 threads per inch, grade T resinoid; for 24 threads per inch and finer, grades T or U resinoid. For high-speed steel taps 4 to 12 threads per inch, grade J vitrified or S resinoid; 14 to 20 threads per inch, grade K vitrified or T resinoid; 24 to 36 threads per inch, grade M vitrified or T resinoid.

Grain Size.—A thread grinding wheel usually operates close to its maximum stock-removing capacity, and the narrow edge which forms the root of the thread is the most vulnerable part. In grain selection, the general rule is to use the coarsest grained wheel that will hold its form while grinding a reasonable amount of work. Pitch of thread and quality of finish are two governing factors. Thus, to obtain an exceptionally fine finish, the grain size might be smaller than is needed to retain the edge profile. The usual grain sizes range from 120 to 150. For heat-treated screws and studs with Unified Standard Threads, 100 to 180 is the usual range. For precision screw threads of very fine pitch, the grain size may range from 220 to 320. For high-speed steel taps, the usual range is from 150 to 180 for Unified Standard Threads, and from 80 to 150 for pre-cut Acme threads.

Thread Grinding by Centerless Method.—Screw threads may be ground from the solid by the centerless method. A centerless thread grinder is similar in its operating principle to a centerless grinder designed for general work, in that it has a grinding wheel, a regulating or feed wheel (with speed adjustments), and a work-rest. Adjustments are provided to accommodate work of different sizes and for varying the rates of feed. The grinding wheel is a multi-ribbed type, being a series of annular ridges across the face. These ridges conform in pitch and profile with the thread to be ground. The grinding wheel is inclined to suit the helix or lead angle of the thread. In grinding threads on such work as socket type set-screws, the blanks are fed automatically and passed between the grinding and regulating wheels in a continuous stream. To illustrate production possibilities, hardened socket set-screws of ¼-20 size may be ground from the solid at the rate of 60 to 70 per minute and with the wheel operating continuously for 8 hours without redressing. The lead errors of centerless ground screw threads may be limited to 0.0005 inch per inch (or mm per mm) or even less by reducing the production rate. The pitch diameter tolerances are within 0.0002 to 0.0003 inch (5.08–7.62 μm) of the basic size. The grain size for the wheel is selected with reference to the pitch of the thread, the following sizes being recommended: For 11 to 13 threads per inch, 150; for 16 threads per inch, 180; for 18 to 20 threads per inch, 220; for 24 to 28 threads per inch, 320; for 40 threads per inch, 400.

Principle of Centerless Grinding.—Centerless grinding is the grinding of cylindrical work without supporting it on centers in the usual way. Two abrasive wheels are mounted so that their peripheries face each other, one of the wheels having its axis so arranged that it can be swung out of parallel with the axis of the other wheel by varying amounts, as required. Between these two abrasive wheels is a work-supporting member equipped with suitable guides. The grinding wheel forces the work downward against the work-rest and also against the regulating wheel. The latter imparts a uniform rotation to the work which has the same peripheral speed as the regulating wheel, the speed of which is adjustable.



Principle of the Centerless Grinding Process

THREAD MILLING

Single-cutter Method.—Usually, when a single point cutter is used, the axis of the cutter is inclined an amount equal to the lead angle of the screw thread, in order to locate the cutter in line with the thread groove at the point where the cutting action takes place. Tangent of lead angle = lead of screw thread ÷ pitch circumference of screw.

The helical thread groove is generated by making as many turns around the workpiece diameter as there are pitches in the length of thread to be cut. For example, a 16-pitch thread, 1 inch long, would require 16 turns of the cutter around the work. The single cutter process is especially applicable to the milling of large screw threads of coarse pitch, and either single or multiple threads.

The cutter should revolve as fast as possible without dulling the cutting edges excessively, in order to mill a smooth thread and prevent the unevenness that would result with a slow-moving cutter, on account of the tooth spaces. As the cutter rotates, the part on which a thread is to be milled is also revolved, but at a very slow rate (a few inches per minute), since this rotation of the work is practically a feeding movement. The cutter is ordinarily set to the full depth of the thread groove and finishes a single thread in one passage, although deep threads of coarse pitch may require two or even three cuts. For fine pitches and short threads, the multiple-cutter method (described in the next paragraph) usually is preferable, because it is more rapid. The milling of taper screw threads may be done on a single-cutter type of machine by traversing the cutter laterally as it feeds along in a lengthwise direction, the same as when using a taper attachment on a lathe.

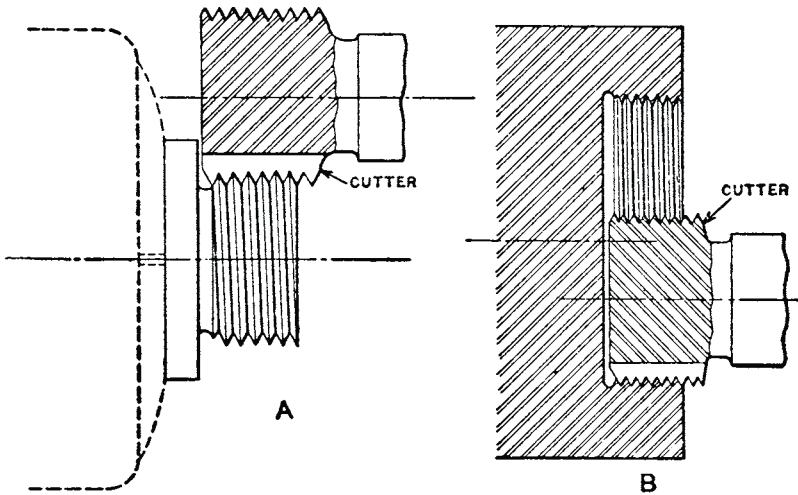
Multiple-cutter Method.—The multiple cutter for thread milling is practically a series of single cutters, although formed of one solid piece of steel, at least so far as the cutter proper is concerned. The rows of teeth do not lie in a helical path, like the teeth of a hob or tap, but they are annular or without lead. If the cutter had helical teeth the same as a gear hob, it would have to be geared to revolve in a certain fixed ratio with the screw being milled, but a cutter having annular teeth may rotate at any desired cutting speed, while the screw blank is rotated slowly to provide a suitable rate of feed. (The multiple thread milling cutters used are frequently called “hobs,” but the term hob should be applied only to cutters having a helical row of teeth like a gear-cutting hob.)

The object in using a multiple cutter instead of a single cutter is to finish a screw thread complete in approximately one revolution of the work, a slight amount of over-travel being allowed to insure milling the thread to the full depth where the end of cut joins the starting point. The cutter which is at least one and one half or two threads or pitches wider than the thread to be milled, is fed in to the full thread depth and then either the cutter or screw blank is moved in a lengthwise direction a distance equal to the lead of the thread during one revolution of the work.

The multiple cutter is used for milling comparatively short threads and coarse, medium or fine pitches. The accompanying illustration shows typical examples of external and internal work for which the multiple-cutter type of thread milling has proved very efficient, although its usefulness is not confined to shoulder work and “blind” holes.

In using multiple cutters either for internal or external thread milling, the axis of the cutter is set parallel with the axis of the work, instead of inclining the cutter to suit the lead angle of the thread, as when using a single cutter. Theoretically, this is not the correct position for a cutter, since each cutting edge is revolving in a plane at right angles to the screw's axis while milling a thread groove of helical form. However, as a general rule, interference between the cutter and the thread, does not result a decided change in the standard thread form. Usually the deviation is very slight and may be disregarded except when milling threads which incline considerably relative to the axis like a thread of multiple form and large lead angle. Multiple cutters are suitable for external threads having lead angles under $3\frac{1}{2}$ degrees and for internal threads having lead angles under $2\frac{1}{2}$ degrees. Threads which have steeper sides or smaller included angles than the American Standard or Whitworth

forms have greater limitations on the maximum helix angle and may have to be milled with a single point cutter tilted to the helix angle, assuming that the milling process is preferable to other methods. For instance, in milling an Acme thread which has an included angle between the sides of 29 degrees, there might be considerable interference if a multiple cutter were used, unless the screw thread diameter were large enough in proportion to the pitch to prevent such interference. If an attempt were made to mill a square thread with a multiple cutter, the results would be unsatisfactory owing to the interference.



Examples of External and Internal Thread Milling with a Multiple Thread Milling Cutter

Interference between the cutter and work is more pronounced when milling internal threads, because the cutter does not clear itself so well. It is preferable to use as small a cutter as practicable, either for internal or external work, not only to avoid interference, but to reduce the strain on the driving mechanism. Some thread milling cutters, known as “topping cutters,” are made for milling the outside diameter of the thread as well as the angular sides and root, but most are made non-tapping.

Planetary Method.—The planetary method of thread milling is similar in principle to planetary milling. The part to be threaded is held stationary and the thread milling cutter, while revolving about its own axis, is given a planetary movement around the work in order to mill the thread in one planetary revolution. The machine spindle and the cutter which is held by it is moved longitudinally for thread milling, an amount equal to the thread lead during one planetary revolution. This operation is applicable to both internal and external threads. Other advantages: Thread milling is frequently accompanied by milling operations on other adjoining surfaces, and may be performed with conventional and planetary methods. For example, a machine may be used for milling a screw thread and a concentric cylindrical surface simultaneously. When the milling operation begins, the cutter-spindle feeds the cutter in to the right depth and the planetary movement then begins, thus milling the thread and the cylindrical surface. Thin sharp starting edges are eliminated on threads milled by this method and the thread begins with a smooth gradual approach. One design of machine will mill internal and external threads simultaneously. These threads may be of the same hand or one may be right hand and the other left hand. The threads may also be either of the same pitch or of a different pitch, and either straight or tapered.

Classes of Work for Thread Milling Machines.—Thread milling machines are used in preference to lathes or taps and dies for certain threading operations.

There are four general reasons why a thread milling machine may be preferred:

- 1) Because the pitch of the thread is too coarse for cutting with a die; 2) because the milling process is more efficient than using a single-point tool in a lathe; 3) to secure a smoother and more accurate thread than would be obtained with a tap or die; and
- 4) because the thread is so located relative to a shoulder or other surface that the milling method is superior, if not the only practicable way.

A thread milling machine having a single cutter is especially adapted for coarse pitches, multiple-threaded screws, or any form or size of thread requiring the removal of a relatively large amount of metal, particularly if the pitch of the thread is large in proportion to the screw diameter, since the torsional strain due to the milling process is relatively small. Thread milling often gives a higher rate of production, and a thread is usually finished by means of a single turn of the multiple thread milling cutter around the thread diameter. The multiple-cutter type of thread milling machine frequently comes into competition with dies and taps, and especially self-opening dies and collapsing taps. The use of a multiple cutter is desirable when a thread must be cut close to a shoulder or to the bottom of a shallow recess, although the usefulness of the multiple cutter is not confined to shoulder work and "blind" holes.

Maximum Pitches of Die-cut Threads.—Dies of special design could be constructed for practically any pitch, if the screw blank were strong enough to resist the cutting strains and the size and cost of the die were immaterial; but, as a general rule, when the pitch is coarser than four or five threads per inch, the difficulty of cutting threads with dies increases rapidly, although in a few cases some dies are used successfully on screw threads having two or three threads per inch or less. Much depends upon the design of the die, the finish or smoothness required, and the relation between the pitch of the thread and the diameter of the screw. When the screw diameter is relatively small in proportion to the pitch, there may be considerable distortion due to the twisting strains set up when the thread is being cut. If the number of threads per inch is only one or two less than the standard number for a given diameter, a screw blank ordinarily will be strong enough to permit the use of a die.

Changing Pitch of Screw Thread Slightly.—A very slight change in the pitch of a screw thread may be necessary as, for example, when the pitch of a tap is increased a small amount to compensate for shrinkage in hardening. One method of obtaining slight variations in pitch is by means of a taper attachment. This attachment is set at an angle and the work is located at the same angle by adjusting the tailstock center. The result is that the tool follows an angular path relative to the movement of the carriage and, consequently, the pitch of the thread is increased slightly, the amount depending upon the angle to which the work and taper attachment are set. The cosine of this angle, for obtaining a given increase in pitch, equals the standard pitch (which would be obtained with the lathe used in the regular way) divided by the increased pitch necessary to compensate for shrinkage.

Example: If the pitch of a $\frac{3}{4}$ -inch American standard screw is to be increased from 0.100 to 0.1005, the cosine of the angle to which the taper attachment and work should be set is found as follows:

$$\text{Cosine of required angle} = \frac{0.100}{0.1005} = 0.9950$$

which is the cosine of 5 degrees 45 minutes, nearly.

Change Gears for Helical Milling

Lead of a Milling Machine.—If gears with an equal number of teeth are placed on the table feed-screw and the worm-gear stud, then the *lead of the milling machine* is the distance the table will travel while the index spindle makes one complete revolution. This distance is a constant used in figuring the change gears.

The lead of a helix or “spiral” is the distance, measured along the axis of the work, in which the helix makes one full turn around the work. The lead of the milling machine may, therefore, also be expressed as the lead of the helix that will be cut when gears with an equal number of teeth are placed on the feed-screw and the worm-gear stud, and an idler of suitable size is interposed between the gears.

Rule: To find the lead of a milling machine, place equal gears on the worm-gear stud and on the feed-screw, and multiply the number of revolutions made by the feed-screw to produce one revolution of the index head spindle, by the lead of the thread on the feed-screw. Expressing the rule given as a formula:

$$\text{lead of milling machine} = \frac{\text{rev. of feed-screw for one revolution of index spindle with equal gears}}{\text{lead of feed-screw}} \times \text{lead of feed-screw}$$

Assume that it is necessary to make 40 revolutions of the feed-screw to turn the index head spindle one complete revolution, when the gears are equal, and that the lead of the thread on the feed-screw of the milling machine is $\frac{1}{4}$ inch (6.35 mm); then the lead of the machine equals $40 \times \frac{1}{4}$ inch = 10 inches. In metric units, the lead is $40 \times 6.35 = 254$ mm.

Change Gears for Helical Milling.—To find the change gears to be used in the compound train of gears for helical milling, place the lead of the helix to be cut in the numerator and the lead of the milling machine in the denominator of a fraction; divide numerator and denominator into two factors each; and multiply each “pair” of factors by the *same* number until suitable numbers of teeth for the change gears are obtained. (One factor in the numerator and one in the denominator are considered as one “pair” in this calculation.)

Example: Assume that the lead of a machine is 10 inches, and that a helix having a 48-inch lead is to be cut. Following the method explained:

$$\frac{48}{10} = \frac{6 \times 8}{2 \times 5} = \frac{(6 \times 12) \times (8 \times 8)}{(2 \times 12) \times (5 \times 8)} = \frac{72 \times 64}{24 \times 40}$$

The gear having 72 teeth is placed on the worm-gear stud and meshes with the 24-tooth gear on the intermediate stud. On the same intermediate stud is then placed the gear having 64 teeth, which is driven by the gear having 40 teeth placed on the feed-screw. This makes the gears having 72 and 64 teeth the driven gears, and the gears having 24 and 40 teeth the driving gears. In general, for compound gearing, the following formula may be used:

$$\frac{\text{lead of helix to be cut}}{\text{lead of machine}} = \frac{\text{product of driven gears}}{\text{product of driving gears}}$$

Short-lead Milling.—If the lead to be milled is exceptionally short, the drive may be direct from the table feed-screw to the dividing head spindle to avoid excessive load on feed-screw and change-gears. If the table feed-screw has 4 threads per inch (usual standard), then

$$\text{Change-gear ratio} = \frac{\text{Lead to be milled}}{0.25} = \frac{\text{Driven gears}}{\text{Driving gears}}$$

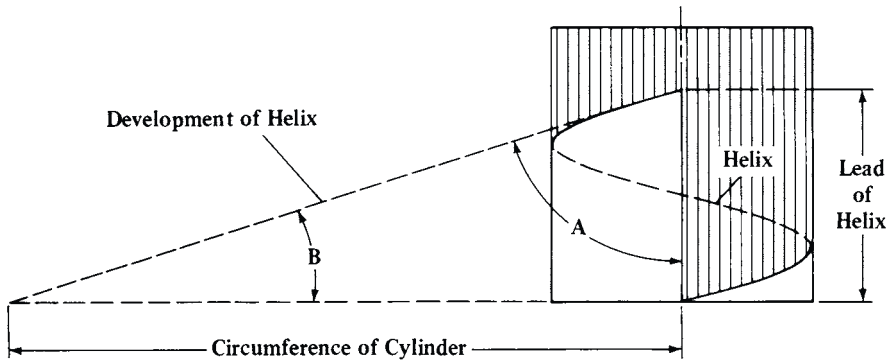
For indexing, the number of teeth on the spindle change-gear should be some multiple of the number of divisions required, to permit indexing by disengaging and turning the gear.

Helix.—A helix is a curve generated by a point moving about a cylindrical surface (real or imaginary) at a constant rate in the direction of the cylinder's axis. The curvature of a screw thread is one common example of a helical curve.

Lead of Helix: The lead of a helix is the distance that it advances in an axial direction, in one complete turn about the cylindrical surface. To illustrate, the lead of a screw thread

equals the distance that a thread advances in one turn; it also equals the distance that a nut would advance in one turn.

Development of Helix: If one turn of a helical curve were unrolled onto a plane surface (as shown by diagram), the helix would become a straight line forming the hypotenuse of a right angle triangle. The length of one side of this triangle would equal the circumference of the cylinder with which the helix coincides, and the length of the other side of the triangle would equal the lead of the helix.



Helix Angles.—The triangular development of a helix has one angle *A* subtended by the circumference of the cylinder, and another angle *B* subtended by the lead of the helix. The term “helix angle” applies to angle *A*. For example, the helix angle of a helical gear, according to the general usage of the term, is always angle *A*, because this is the angle used in helical gear-designing formulas. Helix angle *A* would also be applied in milling the helical teeth of cutters, reamers, etc. Angle *A* of a gear or cutter tooth is a measure of its inclination relative to the axis of the gear or cutter.

Lead Angle: Angle *B* is applied to screw threads and worm threads and is referred to as the lead angle of the screw thread or worm. This angle *B* is a measure of the inclination of a screw thread from a plane that is perpendicular to the screw thread axis. Angle *B* is called the “lead angle” because it is subtended by the lead of the thread, and to distinguish it from the term “helix angle” as applied to helical gears.

Finding Helix Angle of Helical Gear: A helical gear tooth has an infinite number of helix angles, but the angle at the pitch diameter or mid-working depth is the one required in gear designing and gear cutting. This angle *A*, relative to the axis of the gear, is found as follows:

$$\tan \text{ helix angle} = \frac{3.1416 \times \text{pitch diameter of gear}}{\text{Lead of gear tooth}}$$

Finding Lead Angle of Screw Thread: The lead or helix angle at the pitch diameter of a screw thread usually is required when, for example, a thread milling cutter must be aligned with the thread. This angle measured from a plane perpendicular to the screw thread axis, is found as follows:

$$\tan \text{ lead angle} = \frac{\text{Lead of screw thread}}{3.1416 \times \text{pitch diameter of screw thread}}$$

Change Gears for Different Leads—0.670 Inch to 2.658 Inches

Lead in Inches	Driven	Driver	Driven	Driver	Lead in Inches	Driven	Driver	Driven	Driver	Lead in Inches	Driven	Driver	Driven	Driver
	Gear on Worm	First Gear on Stud	Second Gear on Stud	Gear on Screw		Gear on Worm	First Gear on Stud	Second Gear on Stud	Gear on Screw		Gear on Worm	First Gear on Stud	Second Gear on Stud	Gear on Screw
0.670	24	86	24	100	1.711	28	72	44	100	2.182	24	44	40	100
0.781	24	86	28	100	1.714	24	56	40	100	2.188	24	48	28	64
0.800	24	72	24	100	1.744	24	64	40	86	2.193	24	56	44	86
0.893	24	86	32	100	1.745	24	44	32	100	2.200	24	48	44	100
0.930	24	72	24	86	1.750	28	64	40	100	2.222	24	48	32	72
1.029	24	56	24	100	1.776	24	44	28	86	2.233	40	86	48	100
1.042	28	86	32	100	1.778	32	72	40	100	2.238	28	64	44	86
1.047	24	64	24	86	1.786	24	86	64	100	2.240	28	40	32	100
1.050	24	64	28	100	1.800	24	64	48	100	2.250	24	40	24	64
1.067	24	72	32	100	1.809	28	72	40	86	2.274	32	72	44	86
1.085	24	72	28	86	1.818	24	44	24	72	2.286	32	56	40	100
1.116	24	86	40	100	1.823	28	86	56	100	2.292	24	64	44	72
1.196	24	56	24	86	1.860	28	56	32	86	2.326	32	64	40	86
1.200	24	48	24	100	1.861	24	72	48	86	2.333	28	48	40	100
1.221	24	64	28	86	1.867	28	48	32	100	2.338	24	44	24	56
1.228	24	86	44	100	1.875	24	48	24	64	2.344	28	86	72	100
1.240	24	72	32	86	1.886	24	56	44	100	2.368	28	44	32	86
1.250	24	64	24	72	1.905	24	56	32	72	2.381	32	86	64	100
1.302	28	86	40	100	1.919	24	64	44	86	2.386	24	44	28	64
1.309	24	44	24	100	1.920	24	40	32	100	2.392	24	56	48	86
1.333	24	72	40	100	1.925	28	64	44	100	2.400	28	56	48	100
1.340	24	86	48	100	1.944	24	48	28	72	2.424	24	44	32	72
1.371	24	56	32	100	1.954	24	40	28	86	2.431	28	64	40	72
1.395	24	48	24	86	1.956	32	72	44	100	2.442	24	32	28	86
1.400	24	48	28	100	1.990	28	72	44	86	2.445	40	72	44	100
1.429	24	56	24	72	1.993	24	56	40	86	2.450	28	64	56	100
1.440	24	40	24	100	2.000	24	40	24	72	2.456	44	86	48	100
1.458	24	64	28	72	2.009	24	86	72	100	2.481	32	72	48	86
1.467	24	72	44	100	2.030	24	44	32	86	2.489	32	72	56	100
1.488	32	86	40	100	2.035	28	64	40	86	2.500	24	48	28	56
1.500	24	64	40	100	2.036	28	44	32	100	2.514	32	56	44	100
1.522	24	44	24	86	2.045	24	44	24	64	2.532	28	72	56	86
1.550	24	72	40	86	2.047	40	86	44	100	2.537	24	44	40	86
1.563	24	86	56	100	2.057	24	28	24	100	2.546	28	44	40	100
1.595	24	56	32	86	2.067	32	72	40	86	2.558	32	64	44	86
1.600	24	48	32	100	2.083	24	64	40	72	2.567	28	48	44	100
1.607	24	56	24	64	2.084	28	86	64	100	2.571	24	40	24	56
1.628	24	48	28	86	2.093	24	64	48	86	2.593	28	48	32	72
1.637	32	86	44	100	2.100	24	64	56	100	2.605	28	40	32	86
1.650	24	64	44	100	2.121	24	44	28	72	2.618	24	44	48	100
1.667	24	56	28	72	2.133	24	72	64	100	2.619	24	56	44	72
1.674	24	40	24	86	2.143	24	56	32	64	2.625	24	40	28	64
1.680	24	40	28	100	2.171	24	72	56	86	2.640	24	40	44	100
1.706	24	72	44	86	2.178	28	72	56	100	2.658	32	56	40	86

Change Gears for Different Leads—2.667 Inches to 4.040 Inches

Lead in Inches	Driven	Driver	Driven	Driver	Lead in Inches	Driven	Driver	Driven	Driver	Lead in Inches	Driven	Driver	Driven	Driver
	Gear on Worm	First Gear on Stud	Second Gear on Stud	Gear on Screw		Gear on Worm	First Gear on Stud	Second Gear on Stud	Gear on Screw		Gear on Worm	First Gear on Stud	Second Gear on Stud	Gear on Screw
2.667	40	72	48	100	3.140	24	86	72	64	3.588	72	56	24	86
2.674	28	64	44	72	3.143	40	56	44	100	3.600	72	48	24	100
2.678	24	56	40	64	3.150	28	100	72	64	3.618	56	72	40	86
2.679	32	86	72	100	3.175	32	56	40	72	3.636	24	44	32	48
2.700	24	64	72	100	3.182	28	44	32	64	3.637	48	44	24	72
2.713	28	48	40	86	3.189	32	56	48	86	3.646	40	48	28	64
2.727	24	44	32	64	3.190	24	86	64	56	3.655	40	56	44	86
2.743	24	56	64	100	3.198	40	64	44	86	3.657	64	56	32	100
2.750	40	64	44	100	3.200	28	100	64	56	3.663	72	64	28	86
2.778	32	64	40	72	3.214	24	56	48	64	3.667	40	48	44	100
2.791	28	56	48	86	3.225	24	100	86	64	3.673	24	28	24	56
2.800	24	24	28	100	3.241	28	48	40	72	3.684	44	86	72	100
2.812	24	32	24	64	3.256	24	24	28	86	3.686	86	56	24	100
2.828	28	44	32	72	3.267	28	48	56	100	3.704	32	48	40	72
2.843	40	72	44	86	3.273	24	40	24	44	3.721	24	24	32	86
2.845	32	72	64	100	3.275	44	86	64	100	3.733	48	72	56	100
2.849	28	64	56	86	3.281	24	32	28	64	3.750	24	32	24	48
2.857	24	48	32	56	3.300	44	64	48	100	3.763	86	64	28	100
2.865	44	86	56	100	3.308	32	72	64	86	3.771	44	56	48	100
2.867	86	72	24	100	3.333	32	64	48	72	3.772	24	28	44	100
2.880	24	40	48	100	3.345	28	100	86	72	3.799	56	48	28	86
2.894	28	72	64	86	3.349	40	86	72	100	3.809	24	28	32	72
2.909	32	44	40	100	3.360	56	40	24	100	3.810	64	56	24	72
2.917	24	64	56	72	3.383	32	44	40	86	3.818	24	40	28	44
2.924	32	56	44	86	3.403	28	64	56	72	3.819	40	64	44	72
2.933	44	72	48	100	3.409	24	44	40	64	3.822	86	72	32	100
2.934	32	48	44	100	3.411	32	48	44	86	3.837	24	32	44	86
2.946	24	56	44	64	3.422	44	72	56	100	3.840	64	40	24	100
2.960	28	44	40	86	3.428	24	40	32	56	3.850	44	64	56	100
2.977	40	86	64	100	3.429	40	28	24	100	3.876	24	72	100	86
2.984	28	48	44	86	3.438	24	48	44	64	3.889	32	64	56	72
3.000	24	40	28	56	3.488	40	64	48	86	3.896	24	44	40	56
3.030	24	44	40	72	3.491	64	44	24	100	3.907	56	40	24	86
3.044	24	44	48	86	3.492	32	56	44	72	3.911	44	72	64	100
3.055	28	44	48	100	3.500	40	64	56	100	3.920	28	40	56	100
3.056	32	64	44	72	3.520	32	40	44	100	3.927	72	44	24	100
3.070	24	40	44	86	3.535	28	44	40	72	3.929	32	56	44	64
3.080	28	40	44	100	3.552	56	44	24	86	3.977	28	44	40	64
3.086	24	56	72	100	3.556	40	72	64	100	3.979	44	72	56	86
3.101	40	72	48	86	3.564	56	44	28	100	3.987	24	28	40	86
3.111	28	40	32	72	3.565	28	48	44	72	4.000	24	40	32	48
3.117	24	44	32	56	3.571	24	48	40	56	4.011	28	48	44	64
3.125	28	56	40	64	3.572	48	86	64	100	4.019	72	86	48	100
3.126	48	86	56	100	3.582	44	40	28	86	4.040	32	44	40	72

Change Gears for Different Leads—4.059 Inches to 5.568 Inches

Lead in Inches	Driven	Driver	Driven	Driver	Lead in Inches	Driven	Driver	Driven	Driver	Lead in Inches	Driven	Driver	Driven	Driver
	Gear on Worm	First Gear on Stud	Second Gear on Stud	Gear on Screw		Gear on Worm	First Gear on Stud	Second Gear on Stud	Gear on Screw		Gear on Worm	First Gear on Stud	Second Gear on Stud	Gear on Screw
4.059	32	44	48	86	4.567	72	44	24	86	5.105	28	48	56	64
4.060	64	44	24	86	4.572	40	56	64	100	5.116	44	24	24	86
4.070	28	32	40	86	4.582	72	44	28	100	5.119	86	56	24	72
4.073	64	44	28	100	4.583	44	64	48	72	5.120	64	40	32	100
4.074	32	48	44	72	4.584	32	48	44	64	5.133	56	48	44	100
4.091	24	44	48	64	4.651	40	24	24	86	5.134	44	24	28	100
4.093	32	40	44	86	4.655	64	44	32	100	5.142	72	56	40	100
4.114	48	28	24	100	4.667	28	40	32	48	5.143	24	28	24	40
4.125	24	40	44	64	4.675	24	28	24	44	5.156	44	32	24	64
4.135	40	72	64	86	4.687	40	32	24	64	5.160	86	40	24	100
4.144	56	44	28	86	4.688	56	86	72	100	5.168	100	72	32	86
4.167	28	48	40	56	4.691	86	44	24	100	5.185	28	24	32	72
4.186	72	64	32	86	4.714	44	40	24	56	5.186	64	48	28	72
4.200	48	64	56	100	4.736	64	44	28	86	5.195	32	44	40	56
4.242	28	44	32	48	4.762	40	28	24	72	5.209	100	64	24	72
4.253	64	56	32	86	4.773	24	32	28	44	5.210	64	40	28	86
4.264	40	48	44	86	4.778	86	72	40	100	5.226	86	64	28	72
4.267	64	48	32	100	4.784	72	56	32	86	5.233	72	64	40	86
4.278	28	40	44	72	4.785	48	28	24	86	5.236	72	44	32	100
4.286	24	28	24	48	4.800	48	24	24	100	5.238	44	28	24	72
4.300	86	56	28	100	4.813	44	40	28	64	5.250	24	32	28	40
4.320	72	40	24	100	4.821	72	56	24	64	5.256	86	72	44	100
4.341	48	72	56	86	4.849	32	44	48	72	5.280	48	40	44	100
4.342	64	48	28	86	4.861	40	32	28	72	5.303	28	44	40	48
4.361	100	64	24	86	4.884	48	64	56	86	5.316	40	28	32	86
4.363	24	40	32	44	4.889	32	40	44	72	5.328	72	44	28	86
4.364	40	44	48	100	4.898	24	28	32	56	5.333	40	24	32	100
4.365	40	56	44	72	4.900	56	32	28	100	5.347	44	64	56	72
4.375	24	24	28	64	4.911	40	56	44	64	5.348	44	32	28	72
4.386	24	28	44	86	4.914	86	56	32	100	5.357	40	28	24	64
4.400	24	24	44	100	4.950	56	44	28	72	5.358	64	86	72	100
4.444	64	56	28	72	4.961	64	48	32	86	5.375	86	64	40	100
4.465	64	40	24	86	4.978	56	72	64	100	5.400	72	32	24	100
4.466	48	40	32	86	4.984	100	56	24	86	5.413	64	44	32	86
4.477	44	32	28	86	5.000	24	24	28	56	5.426	40	24	28	86
4.479	86	64	24	72	5.017	86	48	28	100	5.427	40	48	56	86
4.480	56	40	32	100	5.023	72	40	24	86	5.444	56	40	28	72
4.500	72	64	40	100	5.029	44	28	32	100	5.455	48	44	28	56
4.522	100	72	28	86	5.040	72	40	28	100	5.469	40	32	28	64
4.537	56	48	28	72	5.074	40	44	48	86	5.473	86	44	28	100
4.545	24	44	40	48	5.080	64	56	32	72	5.486	64	28	24	100
4.546	28	44	40	56	5.088	100	64	28	86	5.500	44	40	24	48
4.548	44	72	64	86	5.091	56	44	40	100	5.556	40	24	24	72
4.558	56	40	28	86	5.093	40	48	44	72	5.568	56	44	28	64

Change Gears for Different Leads—5.581 Inches to 7.500 Inches

Lead in Inches	Driven	Driver	Driven	Driver	Lead in Inches	Driven	Driver	Driven	Driver	Lead in Inches	Driven	Driver	Driven	Driver
	Gear on Worm	First Gear on Stud	Second Gear on Stud	Gear on Screw		Gear on Worm	First Gear on Stud	Second Gear on Stud	Gear on Screw		Gear on Worm	First Gear on Stud	Second Gear on Stud	Gear on Screw
5.581	64	32	24	86	6.172	72	28	24	100	6.825	86	56	32	72
5.582	48	24	24	86	6.202	40	24	32	86	6.857	32	28	24	40
5.600	56	24	24	100	6.222	64	40	28	72	6.875	44	24	24	64
5.625	48	32	24	64	6.234	32	28	24	44	6.880	86	40	32	100
5.657	56	44	32	72	6.250	24	24	40	64	6.944	100	48	24	72
5.698	56	32	28	86	6.255	86	44	32	100	6.945	100	56	28	72
5.714	48	28	24	72	6.279	72	64	48	86	6.968	86	48	28	72
5.730	40	48	44	64	6.286	44	40	32	56	6.977	48	32	40	86
5.733	86	48	32	100	6.300	72	32	28	100	6.982	64	44	48	100
5.756	72	64	44	86	6.343	100	44	24	86	6.984	44	28	32	72
5.759	86	56	24	64	6.350	40	28	32	72	7.000	28	24	24	40
5.760	72	40	32	100	6.364	56	44	24	48	7.013	72	44	24	56
5.788	64	72	56	86	6.379	64	28	24	86	7.040	64	40	44	100
5.814	100	64	32	86	6.396	44	32	40	86	7.071	56	44	40	72
5.818	64	44	40	100	6.400	64	24	24	100	7.104	56	44	48	86
5.833	28	24	24	48	6.417	44	40	28	48	7.106	100	72	44	86
5.847	64	56	44	86	6.429	24	28	24	32	7.111	64	40	32	72
5.848	44	28	32	86	6.450	86	64	48	100	7.130	44	24	28	72
5.861	72	40	28	86	6.460	100	72	40	86	7.143	40	28	32	64
5.867	44	24	32	100	6.465	64	44	32	72	7.159	72	44	28	64
5.893	44	32	24	56	6.482	56	48	40	72	7.163	56	40	44	86
5.912	86	64	44	100	6.512	56	24	24	86	7.167	86	40	24	72
5.920	56	44	40	86	6.515	86	44	24	72	7.176	72	28	24	86
5.926	64	48	32	72	6.534	56	24	28	100	7.200	72	24	24	100
5.952	100	56	24	72	6.545	48	40	24	44	7.268	100	64	40	86
5.954	64	40	32	86	6.548	44	48	40	56	7.272	64	44	28	56
5.969	44	24	28	86	6.563	56	32	24	64	7.273	32	24	24	44
5.972	86	48	24	72	6.578	72	56	44	86	7.292	56	48	40	64
5.980	72	56	40	86	6.600	48	32	44	100	7.310	44	28	40	86
6.000	48	40	28	56	6.645	100	56	32	86	7.314	64	28	32	100
6.016	44	32	28	64	6.667	64	48	28	56	7.326	72	32	28	86
6.020	86	40	28	100	6.689	86	72	56	100	7.330	86	44	24	64
6.061	40	44	32	48	6.697	100	56	24	64	7.333	44	24	40	100
6.077	100	64	28	72	6.698	72	40	32	86	7.334	44	40	32	48
6.089	72	44	32	86	6.719	86	48	24	64	7.347	48	28	24	56
6.109	56	44	48	100	6.720	56	40	48	100	7.371	86	56	48	100
6.112	24	24	44	72	6.735	44	28	24	56	7.372	86	28	24	100
6.122	40	28	24	56	6.750	72	40	24	64	7.400	100	44	28	86
6.125	56	40	28	64	6.757	86	56	44	100	7.408	40	24	32	72
6.137	72	44	24	64	6.766	64	44	40	86	7.424	56	44	28	48
6.140	48	40	44	86	6.784	100	48	28	86	7.442	64	24	24	86
6.143	86	56	40	100	6.806	56	32	28	72	7.465	86	64	40	72
6.160	56	40	44	100	6.818	40	32	24	44	7.467	64	24	28	100
6.171	72	56	48	100	6.822	44	24	32	86	7.500	48	24	24	64

Change Gears for Different Leads—7.525 Inches to 9.598 Inches

Lead in Inches	Driven	Driver	Driven	Driver	Lead in Inches	Driven	Driver	Driven	Driver	Lead in Inches	Driven	Driver	Driven	Driver
	Gear on Worm	First Gear on Stud	Second Gear on Stud	Gear on Screw		Gear on Worm	First Gear on Stud	Second Gear on Stud	Gear on Screw		Gear on Worm	First Gear on Stud	Second Gear on Stud	Gear on Screw
7.525	86	32	28	100	8.140	56	32	40	86	8.800	48	24	44	100
7.543	48	28	44	100	8.145	64	44	56	100	8.838	100	44	28	72
7.576	100	44	24	72	8.148	64	48	44	72	8.839	72	56	44	64
7.597	56	24	28	86	8.149	44	24	32	72	8.909	56	40	28	44
7.601	86	44	28	72	8.163	40	28	32	56	8.929	100	48	24	56
7.611	72	44	40	86	8.167	56	40	28	48	8.930	64	40	48	86
7.619	64	48	32	56	8.182	48	32	24	44	8.953	56	32	44	86
7.620	64	28	24	72	8.186	64	40	44	86	8.959	86	48	28	56
7.636	56	40	24	44	8.212	86	64	44	72	8.960	64	40	56	100
7.639	44	32	40	72	8.229	72	28	32	100	8.980	44	28	32	56
7.644	86	72	64	100	8.250	44	32	24	40	9.000	48	32	24	40
7.657	56	32	28	64	8.306	100	56	40	86	9.044	100	72	56	86
7.674	72	48	44	86	8.312	64	44	32	56	9.074	56	24	28	72
7.675	48	32	44	86	8.333	40	24	24	48	9.091	40	24	24	44
7.679	86	48	24	56	8.334	40	24	28	56	9.115	100	48	28	64
7.680	64	40	48	100	8.361	86	40	28	72	9.134	72	44	48	86
7.700	56	32	44	100	8.372	72	24	24	86	9.137	100	56	44	86
7.714	72	40	24	56	8.377	86	44	24	56	9.143	64	40	32	56
7.752	100	48	32	86	8.400	72	24	28	100	9.164	72	44	56	100
7.778	32	24	28	48	8.437	72	32	24	64	9.167	44	24	24	48
7.792	40	28	24	44	8.457	100	44	32	86	9.210	72	40	44	86
7.813	100	48	24	64	8.484	32	24	28	44	9.214	86	40	24	56
7.815	56	40	48	86	8.485	64	44	28	48	9.260	100	48	32	72
7.818	86	44	40	100	8.485	56	44	32	48	9.302	48	24	40	86
7.838	86	48	28	64	8.506	64	28	32	86	9.303	56	28	40	86
7.855	72	44	48	100	8.523	100	44	24	64	9.333	64	40	28	48
7.857	44	24	24	56	8.527	44	24	40	86	9.334	32	24	28	40
7.872	44	28	32	64	8.532	86	56	40	72	9.351	48	28	24	44
7.875	72	40	28	64	8.534	64	24	32	100	9.375	48	32	40	64
7.883	86	48	44	100	8.552	86	44	28	64	9.382	86	44	48	100
7.920	72	40	44	100	8.556	56	40	44	72	9.385	86	56	44	72
7.936	100	56	32	72	8.572	64	32	24	56	9.406	86	40	28	64
7.954	40	32	28	44	8.572	48	24	24	56	9.428	44	28	24	40
7.955	56	44	40	64	8.594	44	32	40	64	9.429	48	40	44	56
7.963	86	48	32	72	8.600	86	24	24	100	9.460	86	40	44	100
7.974	48	28	40	86	8.640	72	40	48	100	9.472	64	44	56	86
7.994	100	64	44	86	8.681	100	64	40	72	9.524	40	28	32	48
8.000	64	32	40	100	8.682	64	24	28	86	9.545	72	44	28	48
8.021	44	32	28	48	8.687	86	44	32	72	9.546	56	32	24	44
8.035	72	56	40	64	8.721	100	32	24	86	9.547	56	44	48	64
8.063	86	40	24	64	8.727	48	40	32	44	9.549	100	64	44	72
8.081	64	44	40	72	8.730	44	28	40	72	9.556	86	40	32	72
8.102	100	48	28	72	8.750	28	24	24	32	9.569	72	28	32	86
8.119	64	44	48	86	8.772	48	28	44	86	9.598	86	56	40	64

Change Gears for Different Leads—9.600 Inches to 12.375 Inches

Lead in Inches	Driven	Driver	Driven	Driver	Lead in Inches	Driven	Driver	Driven	Driver	Lead in Inches	Driven	Driver	Driven	Driver
	Gear on Worm	First Gear on Stud	Second Gear on Stud	Gear on Screw		Gear on Worm	First Gear on Stud	Second Gear on Stud	Gear on Screw		Gear on Worm	First Gear on Stud	Second Gear on Stud	Gear on Screw
9.600	72	24	32	100	10.370	64	24	28	72	11.314	72	28	44	100
9.625	44	32	28	40	10.371	64	48	56	72	11.363	100	44	24	48
9.643	72	32	24	56	10.390	40	28	32	44	11.401	86	44	28	48
9.675	86	64	72	100	10.417	100	32	24	72	11.429	32	24	24	28
9.690	100	48	40	86	10.419	64	40	56	86	11.454	72	40	28	44
9.697	64	48	32	44	10.451	86	32	28	72	11.459	44	24	40	64
9.723	40	24	28	48	10.467	72	32	40	86	11.467	86	24	32	100
9.741	100	44	24	56	10.473	72	44	64	100	11.512	72	32	44	86
9.768	72	48	56	86	10.476	44	24	32	56	11.518	86	28	24	64
9.773	86	44	24	48	10.477	48	28	44	72	11.520	72	40	64	100
9.778	64	40	44	72	10.500	56	32	24	40	11.574	100	48	40	72
9.796	64	28	24	56	10.558	86	56	44	64	11.629	100	24	24	86
9.818	72	40	24	44	10.571	100	44	40	86	11.638	64	40	32	44
9.822	44	32	40	56	10.606	56	44	40	48	11.667	56	24	24	48
9.828	86	28	32	100	10.631	64	28	40	86	11.688	72	44	40	56
9.844	72	32	28	64	10.655	72	44	56	86	11.695	64	28	44	86
9.900	72	32	44	100	10.659	100	48	44	86	11.719	100	32	24	64
9.921	100	56	40	72	10.667	64	40	48	72	11.721	72	40	56	86
9.923	64	24	32	86	10.694	44	24	28	48	11.728	86	40	24	44
9.943	100	44	28	64	10.713	40	28	24	32	11.733	64	24	44	100
9.954	86	48	40	72	10.714	48	32	40	56	11.757	86	32	28	64
9.967	100	56	48	86	10.750	86	40	24	48	11.785	72	48	44	56
9.968	100	28	24	86	10.800	72	32	48	100	11.786	44	28	24	32
10.000	56	28	24	48	10.853	56	24	40	86	11.825	86	32	44	100
10.033	86	24	28	100	10.859	86	44	40	72	11.905	100	28	24	72
10.046	72	40	48	86	10.909	72	44	32	48	11.938	56	24	44	86
10.057	64	28	44	100	10.913	100	56	44	72	11.944	86	24	24	72
10.078	86	32	24	64	10.937	56	32	40	64	11.960	72	28	40	86
10.080	72	40	56	100	10.945	86	44	56	100	12.000	48	24	24	40
10.101	100	44	32	72	10.949	86	48	44	72	12.031	56	32	44	64
10.159	64	28	32	72	10.972	64	28	48	100	12.040	86	40	56	100
10.175	100	32	28	86	11.000	44	24	24	40	12.121	40	24	32	44
10.182	64	40	28	44	11.021	72	28	24	56	12.153	100	32	28	72
10.186	44	24	40	72	11.057	86	56	72	100	12.178	72	44	64	86
10.209	56	24	28	64	11.111	40	24	32	48	12.216	86	44	40	64
10.228	72	44	40	64	11.137	56	32	28	44	12.222	44	24	32	48
10.233	48	24	44	86	11.160	100	56	40	64	12.245	48	28	40	56
10.238	86	28	24	72	11.163	72	24	32	86	12.250	56	32	28	40
10.267	56	24	44	100	11.169	86	44	32	56	12.272	72	32	24	44
10.286	48	28	24	40	11.198	86	48	40	64	12.277	100	56	44	64
10.312	48	32	44	64	11.200	56	24	48	100	12.286	86	28	40	100
10.313	72	48	44	64	11.225	44	28	40	56	12.318	86	48	44	64
10.320	86	40	48	100	11.250	72	24	24	64	12.343	72	28	48	100
10.336	100	72	64	86	11.313	64	44	56	72	12.375	72	40	44	64

Change Gears for Different Leads—12.403 Inches to 16.000 Inches

Lead in Inches	Driven	Driver	Driven	Driver	Lead in Inches	Driven	Driver	Driven	Driver	Lead in Inches	Driven	Driver	Driven	Driver
	Gear on Worm	First Gear on Stud	Second Gear on Stud	Gear on Screw		Gear on Worm	First Gear on Stud	Second Gear on Stud	Gear on Screw		Gear on Worm	First Gear on Stud	Second Gear on Stud	Gear on Screw
12.403	64	24	40	86	13.438	86	24	24	64	14.668	44	24	32	40
12.444	64	40	56	72	13.469	48	28	44	56	14.694	72	28	32	56
12.468	64	28	24	44	13.500	72	32	24	40	14.743	86	28	48	100
12.500	40	24	24	32	13.514	86	28	44	100	14.780	86	40	44	64
12.542	86	40	28	48	13.566	100	24	28	86	14.800	100	44	56	86
12.508	86	44	64	100	13.611	56	24	28	48	14.815	64	24	40	72
12.558	72	32	48	86	13.636	48	32	40	44	14.849	56	24	28	44
12.571	64	40	44	56	13.643	64	24	44	86	14.880	100	48	40	56
12.572	44	28	32	40	13.650	86	28	32	72	14.884	64	28	56	86
12.600	72	32	56	100	13.672	100	32	28	64	14.931	86	32	40	72
12.627	100	44	40	72	13.682	86	40	28	44	14.933	64	24	56	100
12.686	100	44	48	86	13.713	64	40	48	56	14.950	100	56	72	86
12.698	64	28	40	72	13.715	64	28	24	40	15.000	48	24	24	32
12.727	64	32	28	44	13.750	44	24	24	32	15.050	86	32	56	100
12.728	56	24	24	44	13.760	86	40	64	100	15.150	100	44	32	48
12.732	100	48	44	72	13.889	100	24	24	72	15.151	100	44	48	72
12.758	64	28	48	86	13.933	86	48	56	72	15.202	86	44	56	72
12.791	100	40	44	86	13.935	86	24	28	72	15.238	64	28	48	72
12.798	86	48	40	56	13.953	72	24	40	86	15.239	64	28	32	48
12.800	64	28	56	100	13.960	86	44	40	56	15.272	56	40	48	44
12.834	56	40	44	48	13.968	64	28	44	72	15.278	44	24	40	48
12.857	72	28	32	64	14.000	56	24	24	40	15.279	100	40	44	72
12.858	48	28	24	32	14.025	72	44	48	56	15.306	100	28	24	56
12.900	86	32	48	100	14.026	72	28	24	44	15.349	72	24	44	86
12.963	56	24	40	72	14.063	72	32	40	64	15.357	86	28	24	48
12.987	100	44	32	56	14.071	86	44	72	100	15.429	72	40	48	56
13.020	100	48	40	64	14.078	86	48	44	56	15.469	72	32	44	64
13.024	56	24	48	86	14.142	72	40	44	56	15.480	86	40	72	100
13.030	86	44	32	48	14.204	100	44	40	64	15.504	100	48	64	86
13.062	64	28	32	56	14.260	56	24	44	72	15.556	64	32	56	72
13.082	100	64	72	86	14.286	40	24	24	28	15.584	48	28	40	44
13.090	72	40	32	44	14.318	72	32	28	44	15.625	100	24	24	64
13.096	44	28	40	48	14.319	72	44	56	64	15.636	86	40	32	44
13.125	72	32	28	48	14.322	100	48	44	64	15.677	86	32	28	48
13.139	86	40	44	72	14.333	86	40	32	48	15.714	44	24	24	28
13.157	72	28	44	86	14.352	72	28	48	86	15.750	72	32	28	40
13.163	86	28	24	56	14.400	72	24	48	100	15.767	86	24	44	100
13.200	72	24	44	100	14.536	100	32	40	86	15.873	100	56	64	72
13.258	100	44	28	48	14.545	64	24	24	44	15.874	100	28	32	72
13.289	100	28	32	86	14.583	56	32	40	48	15.909	100	40	28	44
13.333	64	24	24	48	14.584	40	24	28	32	15.925	86	48	64	72
13.393	100	56	48	64	14.651	72	32	56	86	15.926	86	24	32	72
13.396	72	40	64	86	14.659	86	44	48	64	15.989	100	32	44	86
13.437	86	32	28	56	14.667	64	40	44	48	16.000	64	24	24	40

Change Gears for Different Leads—16.042 Inches to 21.39 Inches

Lead in Inches	Driven	Driver	Driven	Driver	Lead in Inches	Driven	Driver	Driven	Driver	Lead in Inches	Driven	Driver	Driven	Driver
	Gear on Worm	First Gear on Stud	Second Gear on Stud	Gear on Screw		Gear on Worm	First Gear on Stud	Second Gear on Stud	Gear on Screw		Gear on Worm	First Gear on Stud	Second Gear on Stud	Gear on Screw
16.042	56	24	44	64	17.442	100	32	48	86	19.350	86	32	72	100
16.043	44	24	28	32	17.454	64	40	48	44	19.380	100	24	40	86
16.071	72	32	40	56	17.500	56	24	24	32	19.394	64	24	32	44
16.125	86	32	24	40	17.550	86	28	32	56	19.444	40	24	28	24
16.204	100	24	28	72	17.677	100	44	56	72	19.480	100	28	24	44
16.233	100	44	40	56	17.679	72	32	44	56	19.531	100	32	40	64
16.280	100	40	56	86	17.778	64	24	32	48	19.535	72	24	56	86
16.288	86	44	40	48	17.858	100	24	24	56	19.545	86	24	24	44
16.296	64	24	44	72	17.917	86	24	32	64	19.590	64	28	48	56
16.327	64	28	40	56	17.918	86	24	24	48	19.635	72	40	48	44
16.333	56	24	28	40	17.959	64	28	44	56	19.642	100	40	44	56
16.364	72	24	24	44	18.000	72	24	24	40	19.643	44	28	40	32
16.370	100	48	44	56	18.181	56	28	40	44	19.656	86	28	64	100
16.423	86	32	44	72	18.182	48	24	40	44	19.687	72	32	56	64
16.456	72	28	64	100	18.229	100	32	28	48	19.710	86	40	44	48
16.500	72	40	44	48	18.273	100	28	44	86	19.840	100	28	40	72
16.612	100	28	40	86	18.285	64	28	32	40	19.886	100	44	56	64
16.623	64	28	32	44	18.333	56	28	44	48	19.887	100	32	28	44
16.667	56	28	40	48	18.367	72	28	40	56	19.908	86	24	40	72
16.722	86	40	56	72	18.428	86	28	24	40	19.934	100	28	48	86
16.744	72	24	48	86	18.476	86	32	44	64	20.00	72	24	32	48
16.752	86	44	48	56	18.519	100	24	32	72	20.07	86	24	56	100
16.753	86	28	24	44	18.605	100	40	64	86	20.09	100	56	72	64
16.797	86	32	40	64	18.663	100	64	86	72	20.16	86	48	72	64
16.800	72	24	56	100	18.667	64	24	28	40	20.20	100	44	64	72
16.875	72	32	48	64	18.700	72	44	64	56	20.35	100	32	56	86
16.892	86	40	44	56	18.750	100	32	24	40	20.36	64	40	56	44
16.914	100	44	64	86	18.750	72	32	40	48	20.41	100	28	32	56
16.969	64	44	56	48	18.770	86	28	44	72	20.42	56	24	28	32
16.970	64	24	28	44	18.812	86	32	28	40	20.45	72	32	40	44
17.045	100	32	24	44	18.858	48	28	44	40	20.48	86	48	64	56
17.046	100	44	48	64	18.939	100	44	40	48	20.57	72	40	64	56
17.062	86	28	40	72	19.029	100	44	72	86	20.63	72	32	44	48
17.101	86	44	56	64	19.048	40	24	32	28	20.74	64	24	56	72
17.102	86	32	28	44	19.090	56	32	48	44	20.78	64	28	40	44
17.141	64	32	48	56	19.091	72	24	28	44	20.83	100	32	48	72
17.143	64	28	24	32	19.096	100	32	44	72	20.90	86	32	56	72
17.144	48	24	24	28	19.111	86	40	64	72	20.93	100	40	72	86
17.188	100	40	44	64	19.136	72	28	64	86	20.95	64	28	44	48
17.200	86	32	64	100	19.197	86	32	40	56	21.00	56	32	48	40
17.275	86	56	72	64	19.200	72	24	64	100	21.12	86	32	44	56
17.361	100	32	40	72	19.250	56	32	44	40	21.32	100	24	44	86
17.364	64	24	56	86	19.285	72	32	48	56	21.33	100	56	86	72
17.373	86	44	64	72	19.286	72	28	24	32	21.39	44	24	28	24

Change Gears for Different Leads—21.43 Inches to 32.09 Inches

Lead in Inches	Driven	Driver	Driven	Driver	Lead in Inches	Driven	Driver	Driven	Driver	Lead in Inches	Driven	Driver	Driven	Driver
	Gear on Worm	First Gear on Stud	Second Gear on Stud	Gear on Screw		Gear on Worm	First Gear on Stud	Second Gear on Stud	Gear on Screw		Gear on Worm	First Gear on Stud	Second Gear on Stud	Gear on Screw
21.43	100	40	48	56	24.88	100	72	86	48	28.05	72	28	48	44
21.48	100	32	44	64	24.93	64	28	48	44	28.06	100	28	44	56
21.50	86	24	24	40	25.00	72	24	40	48	28.13	100	40	72	64
21.82	72	44	64	48	25.08	86	24	28	40	28.15	86	28	44	48
21.88	100	40	56	64	25.09	86	40	56	48	28.29	72	28	44	40
21.90	86	24	44	72	25.13	86	44	72	56	28.41	100	32	40	44
21.94	86	28	40	56	25.14	64	28	44	40	28.57	100	56	64	40
21.99	86	44	72	64	25.45	64	44	56	32	28.64	72	44	56	32
22.00	64	32	44	40	25.46	100	24	44	72	28.65	100	32	44	48
22.04	72	28	48	56	25.51	100	28	40	56	28.67	86	40	64	48
22.11	86	28	72	100	25.57	100	64	72	44	29.09	64	24	48	44
22.22	100	40	64	72	25.60	86	28	40	48	29.17	100	40	56	48
22.34	86	44	64	56	25.67	56	24	44	40	29.22	100	56	72	44
22.40	86	32	40	48	25.71	72	24	48	56	29.32	86	48	72	44
22.50	72	24	48	64	25.72	72	24	24	28	29.34	64	24	44	40
22.73	100	24	24	44	25.80	86	24	72	100	29.39	72	28	64	56
22.80	86	48	56	44	25.97	100	44	64	56	29.56	86	32	44	40
22.86	64	24	24	28	26.04	100	32	40	48	29.76	100	28	40	48
22.91	72	44	56	40	26.06	86	44	64	48	29.86	100	40	86	72
22.92	100	40	44	48	26.16	100	32	72	86	29.90	100	28	72	86
22.93	86	24	64	100	26.18	72	40	64	44	30.00	56	28	48	32
23.04	86	56	72	48	26.19	44	24	40	28	30.23	86	32	72	64
23.14	100	24	40	72	26.25	72	32	56	48	30.30	100	48	64	44
23.26	100	32	64	86	26.33	86	28	48	56	30.48	64	24	32	28
23.33	64	32	56	48	26.52	100	44	56	48	30.54	100	44	86	64
23.38	72	28	40	44	26.58	100	28	64	86	30.56	44	24	40	24
23.44	100	48	72	64	26.67	64	28	56	48	30.61	100	28	48	56
23.45	86	40	48	44	26.79	100	48	72	56	30.71	86	24	48	56
23.52	86	32	56	64	26.88	86	28	56	64	30.72	86	24	24	28
23.57	72	28	44	48	27.00	72	32	48	40	30.86	72	28	48	40
23.81	100	48	64	56	27.13	100	24	56	86	31.01	100	24	64	86
23.89	86	32	64	72	27.15	100	44	86	72	31.11	64	24	56	48
24.00	64	40	72	48	27.22	56	24	28	24	31.25	100	28	56	64
24.13	86	28	44	56	27.27	100	40	48	44	31.27	86	40	64	44
24.19	86	40	72	64	27.30	86	28	64	72	31.35	86	32	56	48
24.24	64	24	40	44	27.34	100	32	56	64	31.36	86	24	28	32
24.31	100	32	56	72	27.36	86	40	56	44	31.43	64	28	44	32
24.43	86	32	40	44	27.43	64	28	48	40	31.50	72	32	56	40
24.44	44	24	32	24	27.50	56	32	44	28	31.75	100	72	64	28
24.54	72	32	48	44	27.64	86	40	72	56	31.82	100	44	56	40
24.55	100	32	44	56	27.78	100	32	64	72	31.85	86	24	64	72
24.57	86	40	64	56	27.87	86	24	56	72	31.99	100	56	86	48
24.64	86	24	44	64	27.92	86	28	40	44	32.00	64	28	56	40
24.75	72	32	44	40	28.00	100	64	86	48	32.09	56	24	44	32

Change Gears for Different Leads—32.14 Inches to 60.00 Inches

Lead in Inches	Driven	Driver	Driven	Driver	Lead in Inches	Driven	Driver	Driven	Driver	Lead in Inches	Driven	Driver	Driven	Driver
	Gear on Worm	First Gear on Stud	Second Gear on Stud	Gear on Screw		Gear on Worm	First Gear on Stud	Second Gear on Stud	Gear on Screw		Gear on Worm	First Gear on Stud	Second Gear on Stud	Gear on Screw
32.14	100	56	72	40	38.20	100	24	44	48	46.07	86	28	72	48
32.25	86	48	72	40	38.39	100	40	86	56	46.67	64	24	56	32
32.41	100	24	56	72	38.57	72	28	48	32	46.88	100	32	72	48
32.47	100	28	40	44	38.89	56	24	40	24	47.15	72	24	44	28
32.58	86	24	40	44	38.96	100	28	48	44	47.62	100	28	64	48
32.73	72	32	64	44	39.09	86	32	64	44	47.78	86	24	64	48
32.74	100	28	44	48	39.29	100	28	44	40	47.99	100	32	86	56
32.85	86	24	44	48	39.42	86	24	44	40	48.00	72	24	64	40
33.00	72	24	44	40	39.49	86	28	72	56	48.38	86	32	72	40
33.33	100	24	32	40	39.77	100	32	56	44	48.61	100	24	56	48
33.51	86	28	48	44	40.00	72	24	64	48	48.86	100	40	86	44
33.59	100	64	86	40	40.18	100	32	72	56	48.89	64	24	44	24
33.79	86	28	44	40	40.31	86	32	72	48	49.11	100	28	44	32
33.94	64	24	56	44	40.72	100	44	86	48	49.14	86	28	64	40
34.09	100	48	72	44	40.82	100	28	64	56	49.27	86	24	44	32
34.20	86	44	56	32	40.91	100	40	72	44	49.77	100	24	86	72
34.29	72	48	64	28	40.95	86	28	64	48	50.00	100	28	56	40
34.38	100	32	44	40	40.96	86	24	32	28	50.17	86	24	56	40
34.55	86	32	72	56	41.14	72	28	64	40	50.26	86	28	72	44
34.72	100	24	40	48	41.25	72	24	44	32	51.14	100	32	72	44
34.88	100	24	72	86	41.67	100	32	64	48	51.19	86	24	40	28
34.90	100	56	86	44	41.81	86	24	56	48	51.43	72	28	64	32
35.00	72	24	56	48	41.91	64	24	44	28	51.95	100	28	64	44
35.10	86	28	64	56	41.99	100	32	86	64	52.12	86	24	64	44
35.16	100	32	72	64	42.00	72	24	56	40	52.50	72	24	56	32
35.18	86	44	72	40	42.23	86	28	44	32	53.03	100	24	56	44
35.36	72	32	44	28	42.66	100	28	86	72	53.33	64	24	56	28
35.56	64	24	32	24	42.78	56	24	44	24	53.57	100	28	72	48
35.71	100	32	64	56	42.86	100	28	48	40	53.75	86	24	48	32
35.72	100	24	24	28	43.00	86	32	64	40	54.85	100	28	86	56
35.83	86	32	64	48	43.64	72	24	64	44	55.00	72	24	44	24
36.00	72	32	64	40	43.75	100	32	56	40	55.28	86	28	72	40
36.36	100	44	64	40	43.98	86	32	72	44	55.56	100	24	32	24
36.46	100	48	56	32	44.44	64	24	40	24	55.99	100	24	86	64
36.67	48	24	44	24	44.64	100	28	40	32	56.25	100	32	72	40
36.86	86	28	48	40	44.68	86	28	64	44	56.31	86	24	44	28
37.04	100	24	64	72	44.79	100	40	86	48	57.14	100	28	64	40
37.33	100	32	86	72	45.00	72	28	56	32	57.30	100	24	44	32
37.40	72	28	64	44	45.45	100	32	64	44	57.33	86	24	64	40
37.50	100	48	72	40	45.46	100	28	56	44	58.33	100	24	56	40
37.63	86	32	56	40	45.61	86	24	56	44	58.44	100	28	72	44
37.88	100	24	40	44	45.72	64	24	48	28	58.64	86	24	72	44
38.10	64	24	40	28	45.84	100	24	44	40	59.53	100	24	40	28
38.18	72	24	56	44	45.92	100	28	72	56	60.00	72	24	64	32

Lead of Helix for Given Helix Angle Relative to Axis, When Diameter = 1

Deg.	0'	6'	12'	18'	24'	30'	36'	42'	48'	54'	60'
0	Inf.	1800.001	899.997	599.994	449.993	359.992	299.990	257.130	224.986	199.983	179.982
1	179.982	163.616	149.978	138.438	128.545	119.973	112.471	105.851	99.967	94.702	89.964
2	89.964	85.676	81.778	78.219	74.956	71.954	69.183	66.617	64.235	62.016	59.945
3	59.945	58.008	56.191	54.485	52.879	51.365	49.934	48.581	47.299	46.082	44.927
4	44.927	43.827	42.780	41.782	40.829	39.918	39.046	38.212	37.412	36.645	35.909
5	35.909	35.201	34.520	33.866	33.235	32.627	32.040	31.475	30.928	30.400	29.890
6	29.890	29.397	28.919	28.456	28.008	27.573	27.152	26.743	26.346	25.961	25.586
7	25.586	25.222	24.868	24.524	24.189	23.863	23.545	23.236	22.934	22.640	22.354
8	22.354	22.074	21.801	21.535	21.275	21.021	20.773	20.530	20.293	20.062	19.835
9	19.835	19.614	19.397	19.185	18.977	18.773	18.574	18.379	18.188	18.000	17.817
10	17.817	17.637	17.460	17.287	17.117	16.950	16.787	16.626	16.469	16.314	16.162
11	16.162	16.013	15.866	15.722	15.581	15.441	15.305	15.170	15.038	14.908	14.780
12	14.780	14.654	14.530	14.409	14.289	14.171	14.055	13.940	13.828	13.717	13.608
13	13.608	13.500	13.394	13.290	13.187	13.086	12.986	12.887	12.790	12.695	12.600
14	12.600	12.507	12.415	12.325	12.237	12.148	12.061	11.975	11.890	11.807	11.725
15	11.725	11.643	11.563	11.484	11.405	11.328	11.252	11.177	11.102	11.029	10.956
16	10.956	10.884	10.813	10.743	10.674	10.606	10.538	10.471	10.405	10.340	10.276
17	10.276	10.212	10.149	10.086	10.025	9.964	9.904	9.844	9.785	9.727	9.669
18	9.669	9.612	9.555	9.499	9.444	9.389	9.335	9.281	9.228	9.176	9.124
19	9.124	9.072	9.021	8.971	8.921	8.872	8.823	8.774	8.726	8.679	8.631
20	8.631	8.585	8.539	8.493	8.447	8.403	8.358	8.314	8.270	8.227	8.184
21	8.184	8.142	8.099	8.058	8.016	7.975	7.935	7.894	7.855	7.815	7.776
22	7.776	7.737	7.698	7.660	7.622	7.584	7.547	7.510	7.474	7.437	7.401
23	7.401	7.365	7.330	7.295	7.260	7.225	7.191	7.157	7.123	7.089	7.056
24	7.056	7.023	6.990	6.958	6.926	6.894	6.862	6.830	6.799	6.768	6.737
25	6.737	6.707	6.676	6.646	6.617	6.586	6.557	6.528	6.499	6.470	6.441
26	6.441	6.413	6.385	6.357	6.329	6.300	6.274	6.246	6.219	6.192	6.166
27	6.166	6.139	6.113	6.087	6.061	6.035	6.009	5.984	5.959	5.933	5.908
28	5.908	5.884	5.859	5.835	5.810	5.786	5.762	5.738	5.715	5.691	5.668
29	5.668	5.644	5.621	5.598	5.575	5.553	5.530	5.508	5.486	5.463	5.441

Lead of Helix for Given Helix Angle Relative to Axis, When Diameter = 1(Continued)

Deg.	0'	6'	12'	18'	24'	30'	36'	42'	48'	54'	60'
30	5.441	5.420	5.398	5.376	5.355	5.333	5.312	5.291	5.270	5.249	5.228
31	5.228	5.208	5.187	5.167	5.147	5.127	5.107	5.087	5.067	5.047	5.028
32	5.028	5.008	4.989	4.969	4.950	4.931	4.912	4.894	4.875	4.856	4.838
33	4.838	4.819	4.801	4.783	4.764	4.746	4.728	4.711	4.693	4.675	4.658
34	4.658	4.640	4.623	4.605	4.588	4.571	4.554	4.537	4.520	4.503	4.487
35	4.487	4.470	4.453	4.437	4.421	4.404	4.388	4.372	4.356	4.340	4.324
36	4.324	4.308	4.292	4.277	4.261	4.246	4.230	4.215	4.199	4.184	4.169
37	4.169	4.154	4.139	4.124	4.109	4.094	4.079	4.065	4.050	4.036	4.021
38	4.021	4.007	3.992	3.978	3.964	3.950	3.935	3.921	3.907	3.893	3.880
39	3.880	3.866	3.852	3.838	3.825	3.811	3.798	3.784	3.771	3.757	3.744
40	3.744	3.731	3.718	3.704	3.691	3.678	3.665	3.652	3.640	3.627	3.614
41	3.614	3.601	3.589	3.576	3.563	3.551	3.538	3.526	3.514	3.501	3.489
42	3.489	3.477	3.465	3.453	3.440	3.428	3.416	3.405	3.393	3.381	3.369
43	3.369	3.358	3.346	3.334	3.322	3.311	3.299	3.287	3.276	3.265	3.253
44	3.253	3.242	3.231	3.219	3.208	3.197	3.186	3.175	3.164	3.153	3.142
45	3.142	3.131	3.120	3.109	3.098	3.087	3.076	3.066	3.055	3.044	3.034
46	3.034	3.023	3.013	3.002	2.992	2.981	2.971	2.960	2.950	2.940	2.930
47	2.930	2.919	2.909	2.899	2.889	2.879	2.869	2.859	2.849	2.839	2.829
48	2.829	2.819	2.809	2.799	2.789	2.779	2.770	2.760	2.750	2.741	2.731
49	2.731	2.721	2.712	2.702	2.693	2.683	2.674	2.664	2.655	2.645	2.636
50	2.636	2.627	2.617	2.608	2.599	2.590	2.581	2.571	2.562	2.553	2.544
51	2.544	2.535	2.526	2.517	2.508	2.499	2.490	2.481	2.472	2.463	2.454
52	2.454	2.446	2.437	2.428	2.419	2.411	2.402	2.393	2.385	2.376	2.367
53	2.367	2.359	2.350	2.342	2.333	2.325	2.316	2.308	2.299	2.291	2.282
54	2.282	2.274	2.266	2.257	2.249	2.241	2.233	2.224	2.216	2.208	2.200
55	2.200	2.192	2.183	2.175	2.167	2.159	2.151	2.143	2.135	2.127	2.119
56	2.119	2.111	2.103	2.095	2.087	2.079	2.072	2.064	2.056	2.048	2.040
57	2.040	2.032	2.025	2.017	2.009	2.001	1.994	1.986	1.978	1.971	1.963
58	1.963	1.955	1.948	1.940	1.933	1.925	1.918	1.910	1.903	1.895	1.888
59	1.888	1.880	1.873	1.865	1.858	1.851	1.843	1.836	1.828	1.821	1.814

Lead of Helix for Given Helix Angle Relative to Axis, When Diameter = 1(Continued)

Deg.	0'	6'	12'	18'	24'	30'	36'	42'	48'	54'	60'
60	1.814	1.806	1.799	1.792	1.785	1.777	1.770	1.763	1.756	1.749	1.741
61	1.741	1.734	1.727	1.720	1.713	1.706	1.699	1.692	1.685	1.677	1.670
62	1.670	1.663	1.656	1.649	1.642	1.635	1.628	1.621	1.615	1.608	1.601
63	1.601	1.594	1.587	1.580	1.573	1.566	1.559	1.553	1.546	1.539	1.532
64	1.532	1.525	1.519	1.512	1.505	1.498	1.492	1.485	1.478	1.472	1.465
65	1.465	1.458	1.452	1.445	1.438	1.432	1.425	1.418	1.412	1.405	1.399
66	1.399	1.392	1.386	1.379	1.372	1.366	1.359	1.353	1.346	1.340	1.334
67	1.334	1.327	1.321	1.314	1.308	1.301	1.295	1.288	1.282	1.276	1.269
68	1.269	1.263	1.257	1.250	1.244	1.237	1.231	1.225	1.219	1.212	1.206
69	1.206	1.200	1.193	1.187	1.181	1.175	1.168	1.162	1.156	1.150	1.143
70	1.143	1.137	1.131	1.125	1.119	1.112	1.106	1.100	1.094	1.088	1.082
71	1.082	1.076	1.069	1.063	1.057	1.051	1.045	1.039	1.033	1.027	1.021
72	1.021	1.015	1.009	1.003	0.997	0.991	0.985	0.978	0.972	0.966	0.960
73	0.960	0.954	0.948	0.943	0.937	0.931	0.925	0.919	0.913	0.907	0.901
74	0.901	0.895	0.889	0.883	0.877	0.871	0.865	0.859	0.854	0.848	0.842
75	0.842	0.836	0.830	0.824	0.818	0.812	0.807	0.801	0.795	0.789	0.783
76	0.783	0.777	0.772	0.766	0.760	0.754	0.748	0.743	0.737	0.731	0.725
77	0.725	0.720	0.714	0.708	0.702	0.696	0.691	0.685	0.679	0.673	0.668
78	0.668	0.662	0.656	0.651	0.645	0.639	0.633	0.628	0.622	0.616	0.611
79	0.611	0.605	0.599	0.594	0.588	0.582	0.577	0.571	0.565	0.560	0.554
80	0.554	0.548	0.543	0.537	0.531	0.526	0.520	0.514	0.509	0.503	0.498
81	0.498	0.492	0.486	0.481	0.475	0.469	0.464	0.458	0.453	0.447	0.441
82	0.441	0.436	0.430	0.425	0.419	0.414	0.408	0.402	0.397	0.391	0.386
83	0.386	0.380	0.375	0.369	0.363	0.358	0.352	0.347	0.341	0.336	0.330
84	0.330	0.325	0.319	0.314	0.308	0.302	0.297	0.291	0.286	0.280	0.275
85	0.275	0.269	0.264	0.258	0.253	0.247	0.242	0.236	0.231	0.225	0.220
86	0.220	0.214	0.209	0.203	0.198	0.192	0.187	0.181	0.176	0.170	0.165
87	0.165	0.159	0.154	0.148	0.143	0.137	0.132	0.126	0.121	0.115	0.110
88	0.110	0.104	0.099	0.093	0.088	0.082	0.077	0.071	0.066	0.060	0.055
89	0.055	0.049	0.044	0.038	0.033	0.027	0.022	0.016	0.011	0.005	0.000

Leads, Change Gears and Angles for Helical Milling

Lead of Helix, Inches	Change Gears				Diameter of Work, Inches											
	Gear on Work	First Gear on Stud	Second Gear on Stud	Gear on Screw	1/8	1/4	3/8	1/2	5/8	3/4	7/8	1	1 1/4	1 1/2		
					Approximate Angles for Milling Machine Table											
0.67	24	86	24	100	30 1/4		
0.78	24	86	28	100	26	44 1/2		
0.89	24	86	32	100	23 1/2	41		
1.12	24	86	40	100	19	34 1/2		
1.34	24	86	48	100	16	30 1/4	41 1/2		
1.46	24	64	28	72	14 3/4	28	38 1/2		
1.56	24	86	56	100	13 3/4	26 1/2	37		
1.67	24	64	32	72	12 3/4	25	34 3/4	43 1/4		
1.94	32	64	28	72	11 1/4	21 3/4	31	39	45		
2.08	24	64	40	72	10 1/4	20 1/2	29 1/2	37	43 1/4		
2.22	32	56	28	72	9 3/4	19 1/4	27 1/2	35	41 1/4		
2.50	24	64	48	72	8 3/4	17	25	32	38	43 1/4		
2.78	40	56	28	72	8	15 1/2	23	29 1/2	35 1/4	40 1/2	44 3/4		
2.92	24	64	56	72	7 1/2	15	21 3/4	28 1/4	34	39	43 1/4		
3.24	40	48	28	72	6 3/4	13 1/4	19 3/4	25 3/4	31 1/4	36	40 1/2	44 1/4		
3.70	40	48	32	72	6	11 3/4	17 1/2	23	28	32 1/2	36 1/2	40 1/2		
3.89	56	48	24	72	5 1/2	11 1/4	16 3/4	22	26 3/4	31 1/4	35 1/4	39		
4.17	40	72	48	64	5 1/4	10 1/2	15 3/4	20 1/2	25 1/4	29 1/2	33 1/2	37	43 1/4	...		
4.46	48	40	32	86	4 3/4	9 3/4	14 3/4	19 1/4	23 3/4	27 3/4	31 1/2	35	41 1/2	...		
4.86	40	64	56	72	4 1/2	9	13 1/2	17 3/4	22	25 3/4	29 1/2	33	39	44 1/4		
5.33	48	40	32	72	4	8 1/4	12 1/4	16 1/2	20 1/4	23 3/4	27 1/4	30 1/2	36 1/2	41 1/2		
5.44	56	40	28	72	4	8	12	16	20	23 1/2	26 3/4	30	36	41		
6.12	56	40	28	64	3 1/2	7 1/4	11	14 1/2	17 3/4	21	24 1/4	27	33	37 3/4		
6.22	56	40	32	72	3 1/2	7	10 3/4	14 1/4	17 1/2	20 3/4	23 3/4	26 3/4	32 1/2	37 1/4		
6.48	56	48	40	72	3 1/4	6 3/4	10 1/4	13 1/2	16 3/4	20	23	25 3/4	31 1/2	36 1/4		
6.67	64	48	28	56	3 1/4	6 1/2	10	13 1/4	16 1/2	19 1/2	22 1/2	25 1/4	30 3/4	35 1/4		
7.29	56	48	40	64	3	6 1/4	9 1/4	12 1/4	15	18	20 1/2	23 1/2	28 1/2	33		
7.41	64	48	40	72	3	6	9	12	14 3/4	17 3/4	20 1/4	22 3/4	28 1/4	32 1/2		
7.62	64	48	32	56	2 3/4	5 3/4	8 3/4	11 1/2	14 1/2	17 1/4	19 3/4	22 1/4	27 1/2	32		
8.33	48	32	40	72	2 1/2	5 1/4	8	10 1/2	13 1/4	15 3/4	18 1/4	20 1/2	25 1/2	29 1/2		
8.95	86	48	28	56	2 1/2	5	7 1/2	10	12 1/2	14 3/4	17	19 1/4	24	28		
9.33	56	40	48	72	2 1/4	4 3/4	7 1/4	9 1/2	11 3/4	14	16 1/4	18 1/2	23	27		
9.52	64	48	40	56	2 1/4	4 1/2	7	9 1/4	11 1/2	13 3/4	16	18 1/4	22 1/2	26 1/2		
10.29	72	40	32	56	2	4 1/4	6 1/2	8 3/4	10 3/4	12 3/4	15	17 1/4	21	24 3/4		
10.37	64	48	56	72	2	4 1/4	6 1/2	8 1/2	10 1/2	12 1/4	14 3/4	17	20 3/4	24 1/2		
10.50	48	40	56	64	2	4 1/4	6 1/4	8 1/2	10 1/2	12 1/2	14 1/2	16 3/4	20 1/2	24 1/4		
10.67	64	40	48	72	2	4	6 1/4	8 1/4	10 1/4	12 1/4	14 1/4	16 1/2	20 1/4	24		
10.94	56	32	40	64	2	4	6	8 1/4	10 1/4	12	14	16 1/4	20	23 1/2		
11.11	64	32	40	72	2	4	6	8	10	11 3/4	13 3/4	16	19 3/4	23		
11.66	56	32	48	72	1 3/4	3 3/4	5 3/4	7 1/2	9 1/2	11 1/4	13 1/4	15 1/4	18 3/4	22		
12.00	72	40	32	48	1 3/4	3 3/4	5 1/2	7 1/4	9 1/4	11	12 3/4	15	18 1/4	21 1/2		
13.12	56	32	48	64	1 1/2	3 1/2	5 1/4	6 3/4	8 1/2	10 1/4	11 3/4	13 1/2	16 3/4	20		
13.33	56	28	48	72	1 1/2	3 1/4	5	6 1/2	8 1/4	10	11 1/2	13 1/4	16 1/2	19 1/2		
13.71	64	40	48	56	1 1/2	3 1/4	4 3/4	6 1/2	8	9 3/4	11 1/4	13	16	19		
15.24	64	28	48	72	1 1/2	3	4 1/2	5 3/4	7 1/4	8 3/4	10 1/4	11 3/4	14 1/2	17 1/4		
15.56	64	32	56	72	1 1/4	2 3/4	4 1/4	5 3/4	7 1/4	8 3/4	10	11 1/2	14 1/4	17		
15.75	56	64	72	40	1 1/4	2 3/4	4 1/4	5 1/2	7	8 1/2	9 3/4	11 1/4	14	16 3/4		
16.87	72	32	48	64	1 1/4	2 1/2	4	5 1/4	6 3/4	7 3/4	9 1/4	10 1/2	13 1/4	15 3/4		
17.14	64	32	48	56	1 1/4	2 1/2	4	5 1/4	6 1/2	7 3/4	9	10 1/4	13	15 1/2		
18.75	72	32	40	48	1	2 1/4	3 1/2	4 3/4	6	7 1/4	8 1/4	9 1/2	12	14 1/4		
19.29	72	32	48	56	1	2 1/4	3 1/2	4 1/2	5 3/4	7	8	9 1/4	11 1/2	13 3/4		
19.59	64	28	48	56	1	2 1/4	3 1/4	4 1/2	5 3/4	6 3/4	8	9 1/4	11 1/2	13 1/2		
19.69	72	32	56	64	1	2 1/4	3 1/4	4 1/2	5 3/4	6 3/4	8	9	11 1/2	13 1/2		
21.43	72	24	40	56	1	2	3 1/4	4 1/4	5 1/4	6 1/4	7 1/2	8 1/2	10 1/2	12 1/2		
22.50	72	28	56	64	1	2	3	4	5	6	7	8	10	12		
23.33	64	32	56	48	1	2	3	4	5	5 3/4	6 3/4	7 3/4	9 3/4	11 1/2		
26.25	72	24	56	64	1	1 3/4	2 3/4	3 1/2	4 1/4	5	6	7	8 1/2	10 1/4		
26.67	64	28	56	48	3/4	1 3/4	2 1/4	3 1/2	4 1/4	5	6	6 3/4	8 1/2	10		
28.00	64	32	56	40	3/4	1 3/4	2 1/2	3 1/4	4	4 3/4	5 3/4	6 1/2	8	9 1/2		
30.86	72	28	48	40	3/4	1 1/2	2 1/4	3	3 3/4	4 1/2	5	5 3/4	7 1/4	8 3/4		

Leads, Change Gears and Angles for Helical Milling

Lead of Helix, Inches	Change Gears				Diameter of Work, Inches									
	Gear on Worm	First Gear on Stud	Second Gear on Stud	Gear on Screw	1¾	2	2¼	2½	2¾	3	3¼	3½	3¾	4
					Approximate Angles for Milling Machine Table									
6.12	56	40	28	64	42
6.22	56	40	32	72	41½
6.48	56	48	40	72	40¼	44¼
6.67	64	48	28	56	39½	43½
7.29	56	48	40	64	37	41	44¼
7.41	64	48	40	72	36½	40¼	43¾
7.62	64	48	32	56	36	39½	43
8.33	48	32	40	72	33½	37	40½	43½
8.95	86	48	28	56	31¾	35¼	38½	41¼	44
9.33	56	40	48	72	30½	34	37¼	40¼	43
9.52	64	48	40	56	30	33½	36½	39½	42¼	45
10.29	72	40	32	56	28¼	31½	34½	37½	40	42½	45
10.37	64	48	56	72	28	31¼	34¼	37¼	39¾	42¼	44¾
10.50	48	40	56	64	27¾	31	34	36¾	39½	42	44¼
10.67	64	40	48	72	27¼	30½	33½	36½	39	41½	43¾
10.94	56	32	40	64	26¾	30	33	35¾	38¼	40¾	43
11.11	64	32	40	72	26½	29½	32½	35¼	38	40¼	42½	44¾
11.66	56	32	48	72	25¼	28½	31¼	34	36½	39	41¼	43½
12.00	72	40	32	48	24¾	27¾	30½	33¼	35¾	38	40¼	42½	44¾	...
13.12	56	32	48	64	22¾	25¾	28¼	31	33¼	35¾	37¾	40	42	43¾
13.33	56	28	48	72	22½	25½	28	30½	33	35¼	37½	39½	41½	43¼
13.71	64	40	48	56	22	24¾	27¼	30	32¼	34½	36½	38¾	40¾	42½
15.24	64	28	48	72	20	22½	25	27¼	29½	31¾	34	35¾	37¾	39½
15.56	64	32	56	72	19½	22	24½	27	29	31¼	33¼	35¼	37	39
15.75	56	64	72	40	19¼	21¾	24¼	26½	28¾	31	33	35	36¾	38½
16.87	72	32	48	64	18¼	20½	22¾	25	27	29¼	31¼	33¼	35	36½
17.14	64	32	48	56	17¾	20¼	22¼	24¾	26¾	29	30¾	32¾	34½	36
18.75	72	32	40	48	16¾	18½	20¾	22¾	25	26¾	28½	30¼	32	33¾
19.29	72	32	48	56	16	18¼	20¼	22¼	24	26	28	29¾	31½	33
19.59	64	28	48	56	15¾	18	20	22	23¾	25¾	27½	29¼	31	32¾
19.69	72	32	56	64	15¾	17¾	20	21¾	23¾	25½	27½	29¼	31	32½
21.43	72	24	40	56	14½	16½	18½	20¼	22	23¾	25½	27¼	29	30¼
22.50	72	28	56	64	13¾	15¾	17½	19¼	21	22¾	24½	26	27¾	29¼
23.33	64	32	56	48	13¼	15¼	17	18¾	20¼	22	23½	25¼	27	28¼
26.25	72	24	56	64	12	13½	15	16¾	18¼	19¾	21¼	22¾	24¼	25½
26.67	64	28	56	48	11¾	13¼	14¾	16½	18	19½	21	22¼	23¾	25¼
28.00	64	32	56	40	11¼	12¾	14¼	15¾	17¼	18¾	20	21½	22¾	24
30.86	72	28	48	40	10	11½	13	14¼	15½	17	18½	19½	21	22
31.50	72	32	56	40	10	11¼	12¾	14	15¼	16½	18	19¼	20½	21¾
36.00	72	32	64	40	8¾	10	11	12¼	13½	14¾	16	17	18¼	19¼
41.14	72	28	64	40	7¾	8¾	9¾	10¾	11¾	13	14	15	16	17
45.00	72	28	56	32	7	8	9	10	11	11¾	12¾	13¾	14¾	15½
48.00	72	24	64	40	6½	7½	8½	9¼	10¼	11¼	12	13	13¾	14½
51.43	72	28	64	32	6	7¾	8¾	9½	10½	11¼	12	12¾	13¾	14½
60.00	72	24	64	32	5¼	6	6¾	7½	8¼	9	9½	10¼	11	11¾
68.57	72	24	64	28	4¼	5¼	5¾	6½	7¼	8	8½	9	9¾	10¼

Helix Angle for Given Lead and Diameter.—The table on this and the preceding page gives helix angles (relative to axis) equivalent to a range of leads and diameters. The expression “Diameter of Work” at the top of the table might mean pitch diameter or outside diameter, depending upon the class of work. Assume, for example, that a plain milling cutter 4 inches in diameter is to have helical teeth and a helix angle of about 25 degrees is desired. The table shows that this angle will be obtained approximately by using change-gears that will give a lead of 26.67 inches. As the outside diameter of the cutter is 4 inches,

the helix angle of $25\frac{1}{4}$ degrees is at the top of the teeth. The angles listed for different diameters are used in setting the table of a milling machine. In milling a right-hand helix (or cutter teeth that turn to the right as seen from the end of the cutter), swivel the right-hand end of the machine table toward the rear, and, inversely, for a left-hand helix, swivel the left-hand end of the table toward the rear. The angles in the table are based upon the following formula:

$$\cot \text{ helix angle relative to axis} = \frac{\text{lead of helix}}{3.1416 \times \text{diameter}}$$

Lead of Helix for Given Angle.—The lead of a helix or “spiral” for given angles measured with the axis of the work is given in the table, starting on page 2073, for a diameter of 1. For other diameters, lead equals the value found in the table multiplied by the given diameter. Suppose the angle is 55 degrees, and the diameter 5 inches; what would be the lead? By referring to the table starting on page 2073, it is found that the lead for a diameter of 1 and an angle of 55 degrees 0 minutes equals 2.200. Multiply this value by 5; $5 \times 2.200 = 11$ inches, which is the required lead. If the lead and diameter are given, and the angle is wanted, divide the given lead by the given diameter, thus obtaining the lead for a diameter equal to 1; then find the angle corresponding to this lead in the table. If the lead and angle are given, and the diameter is wanted, divide the lead by the value in the table for the angle.

Helix Angle for Given Lead and Pitch Radius.—To determine the helix angle for a helical gear, knowing the pitch radius and the lead, use the formula:

$$\tan \psi = 2\pi R/L$$

where ψ = helix angle

R = pitch radius of gear, and

L = lead of tooth

Example:

$$R = 3.000, L = 21.000, \tan \psi = (2 \times 3.1416 \times 3.000)/21.000 = 0.89760$$

$$\therefore \psi = 41.911 \text{ degrees}$$

Helix Angle and Lead, Given Normal DP and Numbers of Teeth.—When N_1 = number of teeth in pinion, N_2 = number of teeth in gear, P_n = normal diametral pitch, C = center distance, ψ = helix angle, L_1 = lead of pinion, and L_2 = lead of gear, then:

$$\cos \psi = \frac{N_1 + N_2}{2P_n C}, \quad L_1 = \frac{\pi N_1}{P_n \sin \psi}, \quad L_2 = \frac{\pi N_2}{P_n \sin \psi}$$

$$P_n = 6, \quad N_1 = 18, \quad N_2 = 30, \quad C = 4.500$$

$$\cos \psi = \frac{18 + 30}{2 \times 6 \times 4.5} = 0.88889, \therefore \psi = 27.266^\circ, \text{ and } \sin \psi = 0.45812$$

$$L_1 = \frac{3.1416 \times 18}{6 \times 0.45812} = 20.5728, \text{ and } L_2 = \frac{3.1416 \times 30}{6 \times 0.45812} = 34.2880$$

Lead of Tooth Given Pitch Radius and Helix Angle.—To determine the lead of the tooth for a helical gear, given the helix angle and the pitch radius, the formula becomes:
 $L = 2\pi R/\tan \psi$.

$$\psi = 22.5^\circ, \quad \therefore \tan \psi = 0.41421, \quad R = 2.500.$$

$$L = \frac{2 \times 3.1416 \times 2.500}{0.41421} = 37.9228$$

SIMPLE, COMPOUND, DIFFERENTIAL, AND BLOCK INDEXING

Milling Machine Indexing.—Positioning a workpiece at a precise angle or interval of rotation for a machining operation is called indexing. A dividing head is a milling machine attachment that provides this fine control of rotational positioning through a combination of a crank-operated worm and worm gear, and one or more indexing plates with several circles of evenly spaced holes to measure partial turns of the worm crank. The indexing crank carries a movable indexing pin that can be inserted into and withdrawn from any of the holes in a given circle with an adjustment provided for changing the circle that the indexing pin tracks.

Hole Circles.—The Brown & Sharpe dividing head has three standard indexing plates, each with six circles of holes as listed in the table below.

Numbers of Holes in Brown & Sharpe Standard Indexing Plates

Plate Number	Numbers of Holes					
1	15	16	17	18	19	20
2	21	23	27	29	31	33
3	37	39	41	43	47	49

Dividing heads of Cincinnati Milling Machine design have two-sided, standard, and high-number plates with the numbers of holes shown in the following table.

Numbers of Holes in Cincinnati Milling Machine Standard Indexing Plates

Side	Standard Plate										
1	24	25	28	30	34	37	38	39	41	42	43
2	46	47	49	51	53	54	57	58	59	62	66
	High-Number Plates										
A	30	48	69	91	99	117	129	147	171	177	189
B	36	67	81	97	111	127	141	157	169	183	199
C	34	46	79	93	109	123	139	153	167	181	197
D	32	44	77	89	107	121	137	151	163	179	193
E	26	42	73	87	103	119	133	149	161	175	191
F	28	38	71	83	101	113	131	143	159	173	187

Some dividing heads provide for *Direct Indexing* through the attachment of a special indexing plate directly to the main spindle where a separate indexing pin engages indexing holes in the plate. The worm is disengaged from the worm gear during this quick method of indexing, which is mostly used for common, small-numbered divisions such as six, used in machining hexagonal forms for bolt heads and nuts, for instance.

Simple Indexing.—Also called *Plain Indexing* or *Indirect Indexing*, simple indexing is based on the ratio between the worm and the worm gear, which is usually, but not always, 40:1. All the tables in this section are based on a 40:1 gear ratio, except for [Table 8](#) on page [2119](#) that gives indexing movements for dividing heads utilizing a 60:1 gear ratio.

The number of turns of the indexing crank needed for each indexing movement to produce a specified number of evenly spaced divisions is equal to the number of turns of the crank that produce exactly one full turn of the main spindle, divided by the specified number of divisions required for the workpiece. The accompanying tables in this section provide data for the indexing movements to meet most division requirements, and include the simple indexing movements along with the more complex movements for divisions that are not available through simple indexing. The fractional entries in the tables are deliberately not reduced to lowest terms. Thus, the numerator represents the number of holes to be moved on the circle of holes specified by the denominator.

Setting up for an indexing job includes setting the sector arms to the fractional part of a turn required for each indexing movement to avoid the need to count holes each time. The current location of the indexing pin in the circle of holes to be used is always hole zero when counting the number of holes to be moved. The wormshaft hub carrying the dividing plate may also carry one or two sets of sector arms, each of which can be used to define two arcs of holes. As shown at the right in the drawing of a typical dividing head at the top of the table *Simple and Differential Indexing with Browne & Sharpe Indexing Plates* on page 2107, these sector arms can make up an inner arc, A, and an outer arc, B. The inner arc is used most often, but some indexing movements require the use of the outer arc.

Example: With a worm/worm gear ratio of 40:1 making 35 divisions requires each indexing movement to be $40 \div 35 = 1 \frac{1}{7}$ turns: one full turn of the indexing crank plus one-seventh of a full turn more. A full turn is easily achieved using any circle of holes, but to continue the indexing movement to completion for this example requires a circle in which the number of holes is evenly divisible by 7. The Brown & Sharpe dividing head has a 21-hole circle on plate 2 and a 49-hole circle on plate 3. Either circle could be used because $3/21$ and $7/49$ both equal $1/7$ th. The Cincinnati dividing head standard plate has a 28-hole circle on the first side and a 49-hole circle on the second side and again, either $4/28$ or $7/49$ could be used for the fractional part of a turn needed for 35 divisions. In selecting among equivalent indexing solutions, the one with the smallest number of holes in the fractional part of a turn is generally preferred (except that if an indexing plate with an alternate solution is already mounted on the dividing head, the alternate should be used to avoid switching indexing plates).

Compound Indexing.—Compound indexing is used to obtain divisions that are not available by simple indexing. Two simple indexing movements are used with different circles of holes on an indexing plate that is not bolted to the dividing head frame so that it is free to rotate on the worm shaft. A second, stationary indexing pin arrangement is clamped or otherwise fixed to the frame of the dividing head to hold the indexing plate in position except during the second portion of the compound indexing movement. If available, a double set of low-profile sector arms would improve the ease and reliability of this method. Sector arms for the innermost circle of an indexing movement should not reach as far as the outermost circle of the movement, and sector arms for the outermost circle should be full length. Positioning the outermost circle sector arms may have to wait until the indexing pin on the innermost circle is withdrawn, and may sometimes coincide with the position of that pin. The indexing pin on the crank is set to track the innermost of the two circles in the compound movement and the stationary indexing pin is set to track the outermost circle. Some divisions are only available using adjacent circles, so the intercircle spacing may become a constraining factor in the design or evaluation of a stationary pin arrangement.

The first part of the indexing movement is performed as in simple indexing by withdrawing the indexing pin on the crank arm from its hole in the indexing plate, rotating the crank to its next position, and reinserting the indexing pin in the new hole. For the second part of the movement, the stationary indexing pin is released from its hole in the indexing plate, and with the crank indexing pin seated in its hole, the crank is used to turn the crank arm and indexing plate together to the next position for reinserting the stationary pin into its new hole.

There are two possibilities for the separate movements in compound indexing: they may both be in the same direction of rotation, referred to as *positive compounding* and indicated in the table by a plus (+) sign between the two indexing movements, or they may be in opposite directions of rotation, referred to as *negative compounding* and indicated in the table by a minus (–) sign between the two indexing movements. In positive compounding, it does not matter whether the rotation is clockwise or counterclockwise, as long as it is the same throughout the job. In negative compounding, there will be one clockwise movement and one counterclockwise movement for each unit of the division. The mathematical difference is in whether the two fractional turns are to be added together or whether one is to

be subtracted from the other. Operationally, this difference is important because of the backlash, or free play, between the worm and the worm gear of the dividing head. In positive compounding, this play is always taken up because the worm is turned continually in the same direction. In negative compounding, however, the direction of each turn is always opposite that of the previous turn, requiring each portion of each division to be started by backing off a few holes to allow the play to be taken up before the movement to the next position begins.

The **Tables 1a** and **1b**, *Simple and Compound Indexing with Brown & Sharpe Plates*, give indexing movements for all divisions up to and including 250 with plain dividing heads of the Brown & Sharpe design. All the simple indexing movements, and many of the compound indexing movements, are exact for the divisions they provide. There remains a substantial number of divisions for which the indexing movements are approximate. For these divisions, the indexing movements shown come very close to the target number, but the price of getting close is increased length and complexity of the indexing movements. The table shows all divisions that can be obtained through simple indexing and all divisions for which exact compound indexing movements are available. Approximate movements are only used when it is necessary to obtain a division that would otherwise not be available. The approximate indexing movements usually involve multiple revolutions of the workpiece, with successive revolutions filling in spaces left during earlier turns.

Table 1a. Simple and Compound Indexing with Brown & Sharpe Plates

Number of Divisions	Whole Turns	Fractions of a Turn	Number of Divisions	Whole Turns	Fractions of a Turn	Number of Divisions	Whole Turns	Fractions of a Turn
2	20	...	15	2	26/39	33	1	7/33
3	13	5/15	16	2	8/16	34	1	3/17
3	13	7/21	17	2	6/17	35	1	3/21
3	13	13/39	18	2	4/18	35	1	7/49
4	10	...	18	2	6/27	36	1	2/18
5	8	...	19	2	2/19	36	1	3/27
6	6	10/15	20	2	...	37	1	3/37
6	6	14/21	21	1	19/21	38	1	1/19
6	6	26/39	22	1	27/33	39	1	1/39
7	5	15/21	23	1	17/23	40	1	...
8	5	...	24	1	10/15	41	...	40/41
9	4	8/18	24	1	14/21	42	...	20/21
9	4	12/27	24	1	26/39	43	...	40/43
10	4	...	25	1	9/15	44	...	30/33
11	3	21/33	26	1	21/39	45	...	16/18
12	3	5/15	27	1	13/27	45	...	24/27
12	3	7/21	28	1	9/21	46	...	20/23
12	3	13/39	29	1	11/29	47	...	40/47
13	3	3/39	30	1	5/15	48	...	15/18
14	2	18/21	30	1	7/21	49	...	40/49
14	2	42/49	30	1	13/39	50	...	12/15
15	2	10/15	31	1	9/31			
15	2	14/21	32	1	4/16			

Table 1b. Simple and Compound Indexing with Brown & Sharpe Plates

Target Divisions	Indexing Movements	Workpiece Revolutions	Precise Number of Divisions	Diameter at Which Error = 0.001	Target Divisions	Indexing Movements	Workpiece Revolutions	Precise Number of Divisions	Diameter at Which Error = 0.001
51	10/15 + 2/17	1	51.00000	Exact	57	5/15 + 7/19	1	57.00000	Exact
51 ^a	7 ⁴ / ₄₇ + 37/49	11	51.00005	322.55	57 ^a	4 ⁴ / ₄₇ + 3/49	7	56.99991	205.26
52	30/39	1	52.00000	Exact	58	20/29	1	58.00000	Exact
53	26/29 + 19/31	2	52.99926	22.89	59	18/37 + 9/47	1	58.99915	22.14
53	14/43 + 4 ⁵ / ₄₇	7	52.99991	180.13	59	4 ² / ₄₃ + 1/47	6	59.00012	154.39
53 ^a	5 ⁴³ / ₄₇ + 43/49	9	53.00006	263.90	59 ^a	7 ¹⁰ / ₄₇ + 12/49	11	58.99971	64.51
54	20/27	1	54.00000	Exact	59	5 ¹⁵ / ₃₇ + 3 ² / ₄₉	13	58.99994	300.09
55	24/33	1	55.00000	Exact	60	10/15	1	60.00000	Exact
56	15/21	1	56.00000	Exact	60	14/21	1	60.00000	Exact
56	35/49	1	56.00000	Exact	60	26/39	1	60.00000	Exact

Table 1b. (Continued) Simple and Compound Indexing with Brown & Sharpe Plates

Target Divisions	Indexing Movements	Workpiece Revolutions	Precise Number of Divisions	Diameter at Which Error = 0.001	Target Divisions	Indexing Movements	Workpiece Revolutions	Precise Number of Divisions	Diameter at Which Error = 0.001
61	$2\frac{3}{43} + 26/47$	4	60.99981	102.93	94	20/47	1	94.00000	Exact
61 ^a	$3\frac{42}{47} + 2/49$	6	60.99989	175.94	95	8/19	1	95.00000	Exact
61 ^a	$4\frac{31}{41} + 2/49$	8	61.00009	204.64	96 ^a	$3/18 + 5/20$	1	96.00000	Exact
62	20/31	1	62.00000	Exact	97	$15/41 + 2/43$	1	97.00138	22.45
63	$11/21 + 3/27$	1	63.00000	Exact	97	$1\frac{42}{43} + 4/47$	5	97.00024	128.66
63 ^a	$4\frac{19}{29} + 14/33$	8	62.99938	32.49	97 ^a	$3\frac{27}{41} + 43/49$	11	96.99989	281.37
64	10/16	1	64.00000	Exact	98	20/49	1	98.00000	Exact
65	24/39	1	65.00000	Exact	99 ^a	$6/27 + 6/33$	1	99.00000	Exact
66	20/33	1	66.00000	Exact	100	6/15	1	100.00000	Exact
67	$29/37 + 16/39$	2	66.99942	36.75	101	$1\frac{33}{43} + 10/47$	5	100.99950	64.33
67	$2\frac{27}{41} + 16/49$	5	67.00017	127.90	101	$2\frac{27}{37} + 2/47$	7	100.99979	154.99
67	$4\frac{31}{43} + 2\frac{25}{49}$	11	67.00007	295.10	101 ^a	$3\frac{32}{43} + 30/49$	11	101.00011	295.10
68	10/17	1	68.00000	Exact	102	$5/15 + 1/17$	1	102.00000	Exact
69	$14/21 - 2/23$	1	69.00000	Exact	102 ^a	$3\frac{17}{43} + 45/49$	11	102.00022	147.55
69 ^a	$19/23 + 11/33$	2	69.00000	Exact	103 ^a	$1\frac{8}{43} + 18/49$	4	103.00031	107.31
70	12/21	1	70.00000	Exact	103	$2\frac{22}{37} + 21/41$	8	103.00021	154.52
70	28/49	1	70.00000	Exact	103	$4\frac{32}{37} + 9/49$	13	103.00011	300.09
71	$35/37 + 32/43$	3	71.00037	60.77	104	15/39	1	104.00000	Exact
71 ^a	$2\frac{34}{41} + 27/49$	6	70.99985	153.48	105	8/21	1	105.00000	Exact
71	$4\frac{25}{39} + 2\frac{28}{41}$	13	70.99991	264.67	106	$1\frac{7}{39} + 29/41$	5	105.99934	50.90
72	10/18	1	72.00000	Exact	106	$2\frac{12}{41} + 15/43$	7	105.99957	78.57
72	15/27	1	72.00000	Exact	106 ^a	$2\frac{28}{41} + 23/49$	9	106.00029	115.11
73	$5/43 + 48/49$	2	73.00130	17.88	107	$23/43 + 10/47$	2	107.00199	17.15
73	$2\frac{19}{43} + 14/47$	5	72.99982	128.66	107 ^a	$1\frac{12}{31} + 31/33$	7	107.00037	91.18
73	$2\frac{28}{47} + 3\frac{48}{49}$	12	73.00007	351.87	107	$2\frac{28}{41} + 3/47$	8	106.99983	196.28
73 ^a	$5\frac{28}{47} + 48/49$	12	73.00007	351.87	107	$3\frac{38}{39} + 22/43$	12	106.99987	256.23
74	20/37	1	74.00000	Exact	108	10/27	1	108.00000	Exact
75	8/15	1	75.00000	Exact	109	$1\frac{3}{21} + 2/23$	4	108.99859	24.60
76	10/19	1	76.00000	Exact	109	$1\frac{24}{37} + 26/47$	6	108.99974	132.85
77 ^a	$9/21 + 3/33$	1	77.00000	Exact	109 ^a	$2\frac{19}{39} + 4/49$	7	108.99980	170.32
78	20/39	1	78.00000	Exact	110	12/33	1	110.00000	Exact
79	$17/37 + 26/47$	2	79.00057	44.28	111	$1/37 + 13/39$	1	111.00000	Exact
79 ^a	$2\frac{42}{43} + 3/49$	6	79.00016	160.96	111 ^a	$3\frac{29}{47} + 17/49$	11	111.00011	322.55
79	$4\frac{34}{39} + 9/47$	10	79.00011	233.38	112 ^a	$3\frac{10}{31} + 20/33$	11	111.99801	17.91
80	8/16	1	80.00000	Exact	112	$33/43 + 2\frac{21}{47}$	9	112.00123	28.95
81	$10/43 + 37/49$	2	80.99952	53.65	112	$14/37 + 4\frac{46}{47}$	15	112.00086	41.52
81	$3\frac{47}{47} + 13/49$	7	80.99987	205.26	112	$9\frac{14}{37} + 46/47$	29	112.00044	80.26
81 ^a	$4\frac{41}{41} + 40/49$	10	80.99990	255.79	113	$14/37 - 1/41$	1	112.99814	19.32
81	$5\frac{11}{37} + 1\frac{6}{39}$	13	81.00009	300.09	113	$2\frac{28}{41} + 7/47$	8	112.99982	196.28
82	20/41	1	82.00000	Exact	113 ^a	$2\frac{29}{47} + 31/49$	9	112.99986	263.90
83	$1\frac{11}{29} + 17/31$	4	83.00058	45.79	113	$4\frac{29}{37} + 3/49$	13	113.00012	300.09
83 ^a	$2\frac{45}{47} + 44/49$	8	83.00034	78.19	114 ^a	$10/15 - 6/19$	1	114.00000	Exact
83	$3\frac{17}{27} + 7/31$	8	82.99969	85.26	114	$1\frac{35}{37} + 25/49$	7	113.99955	80.79
83	$5\frac{17}{37} + 31/41$	12	83.00011	231.78	115	8/23	1	115.00000	Exact
84	10/21	1	84.00000	Exact	116	10/29	1	116.00000	Exact
85	8/17	1	85.00000	Exact	117	$1\frac{16}{41} + 15/47$	5	117.00061	61.34
86	20/43	1	86.00000	Exact	117	$7\frac{1}{47} - 9/49$	20	117.00006	586.45
87	$14/21 - 6/29$	1	87.00000	Exact	117 ^a	$6\frac{1}{47} + 40/49$	20	117.00006	586.45
87	$17/29 + 11/33$	2	87.00000	Exact	118 ^a	$1\frac{8}{39} + 24/49$	5	117.99938	60.83
88	15/33	1	88.00000	Exact	118	$30/41 + 2\frac{15}{47}$	9	117.99966	110.41
89	$1\frac{29}{37} + 19/41$	5	88.99971	96.58	119	$15/43 + 31/47$	3	118.99902	38.60
89	$2\frac{22}{37} + 5/49$	6	88.99980	138.50	119 ^a	$2\frac{23}{23} + 17/33$	8	119.00049	77.31
89 ^a	$2\frac{28}{39} + 43/49$	8	89.00015	194.65	119	$3\frac{31}{37} + 25/47$	13	118.99987	287.84
90	8/18	1	90.00000	Exact	120	5/15	1	120.00000	Exact
90	12/27	1	90.00000	Exact	120	7/21	1	120.00000	Exact
91 ^a	$6/39 + 14/49$	1	91.00000	Exact	120	13/39	1	120.00000	Exact
92	10/23	1	92.00000	Exact	121	$8/37 + 38/49$	3	121.00111	34.63
93	$7/21 + 3/31$	1	93.00000	Exact	121 ^a	$14/47 + 34/49$	3	120.99825	21.99
93 ^a	$3/31 + 11/33$	1	93.00000	Exact	121	$1\frac{1}{43} + 2\frac{10}{47}$	10	120.99985	257.32

Table 1b. (Continued) Simple and Compound Indexing with Brown & Sharpe Plates

Target Divisions	Indexing Movements	Workpiece Revolutions	Precise Number of Divisions	Diameter at Which Error = 0.001	Target Divisions	Indexing Movements	Workpiece Revolutions	Precise Number of Divisions	Diameter at Which Error = 0.001
122	$1\frac{1}{41} + 14/47$	5	122.00063	61.34	147	13/39 - 3/49	1	147.00000	Exact
122	$41/43 + 2\frac{3}{49}$	11	122.00026	147.55	147 ^a	13/39 + 37/49	4	147.00000	Exact
122 ^a	$2\frac{4}{43} + 32/49$	11	122.00026	147.55	148	10/37	1	148.00000	Exact
123	$26/39 - 14/41$	1	123.00000	Exact	149	$28/41 + 6/49$	3	148.99876	38.37
123 ^a	$1\frac{1}{43} + 17/49$	5	123.00058	67.07	149	$1\frac{7}{39} + 7/43$	5	149.00044	106.76
124	10/31	1	124.00000	Exact	149 ^a	$2\frac{2}{43} + 41/49$	11	149.00032	147.55
125	$41/43 + 16/49$	4	124.99815	21.46	149	$26/37 + 2\frac{37}{47}$	13	148.99984	287.84
125	$1\frac{3}{41} + 37/49$	8	125.00097	40.93	150	4/15	1	150.00000	Exact
125	$2\frac{3}{43} + 8/47$	7	125.00110	36.03	151	$5/37 + 31/47$	3	150.99855	33.21
125	$3/41 + 3\frac{2}{47}$	11	125.00074	53.98	151 ^a	$42/43 + 43/49$	7	151.00077	62.60
126	$2/21 + 6/27$	1	126.00000	Exact	151	$6/37 + 35/39$	4	151.00065	73.49
126	$2\frac{1}{19} + 13/20$	11	125.99849	26.61	151	$2\frac{2}{43} + 20/47$	11	151.00017	283.05
127	$2/39 + 42/47$	3	126.99769	17.50	152	5/19	1	152.00000	Exact
127	$2\frac{6}{37} + 2/47$	7	127.00052	77.50	153	$10/18 - 5/17$	1	153.00000	Exact
127 ^a	$2\frac{2}{39} + 12/49$	9	127.00018	218.98	153 ^a	$1\frac{4}{47} + 45/49$	11	153.00015	322.55
128	5/16	1	128.00000	Exact	154 ^a	$1/21 + 7/33$	1	154.00000	Exact
129	$13/39 - 1/43$	1	129.00000	Exact	155	8/31	1	155.00000	Exact
129 ^a	$5\frac{2}{41} + 15/49$	19	128.99966	121.50	156	10/39	1	156.00000	Exact
130	12/39	1	130.00000	Exact	157	$18/47 - 5/39$	1	157.00214	23.34
131	$5/37 + 8/47$	1	130.99812	22.14	157	$22/47 + 27/49$	4	157.00043	117.29
131 ^a	$2\frac{4}{43} + 21/49$	11	130.99901	42.16	157 ^a	$2\frac{2}{31} + 2/33$	11	157.00035	143.28
131	$4/37 + 1\frac{1}{43}$	5	131.00041	101.29	157	$22/41 + 2\frac{3}{49}$	13	157.00030	166.27
131	$2\frac{2}{43} + 20/47$	10	130.99984	257.32	158 ^a	$4\frac{5}{43} + 34/49$	19	157.99901	50.97
132	10/33	1	132.00000	Exact	158	$1\frac{1}{39} + 8/49$	5	157.99917	60.83
133	$1/37 + 27/47$	2	133.00191	22.14	158	$1\frac{2}{39} + 23/43$	9	158.00052	96.09
133	$12/31 + 17/33$	3	133.00108	39.08	159	$14/37 + 27/43$	4	159.00062	81.03
133 ^a	$2\frac{3}{29} + 17/33$	11	133.00063	67.02	159	$1\frac{1}{43} + 15/47$	7	158.99972	180.13
133	$1\frac{3}{29} + 19/31$	8	133.00046	91.57	159 ^a	$2\frac{7}{37} + 16/49$	10	159.00022	230.84
134	$4/29 + 25/33$	3	134.00233	18.28	160	4/16	1	160.00000	Exact
134	$1\frac{1}{43} + 37/47$	7	133.99953	90.06	161	$9/23 - 3/21$	1	161.00000	Exact
134 ^a	$3\frac{2}{47} + 15/49$	13	134.00022	190.60	161 ^a	$1\frac{1}{39} + 48/49$	9	161.00164	31.28
135	8/27	1	135.00000	Exact	162	$28/47 - 15/43$	1	162.00401	12.87
136	5/17	1	136.00000	Exact	162	$1\frac{3}{39} - 2/49$	7	161.99818	28.39
137	$9/37 + 31/49$	3	137.00252	17.31	162 ^a	$3\frac{0}{39} + 47/49$	7	161.99818	28.39
137	$11/41 + 1\frac{3}{49}$	7	136.99951	89.53	162	$2\frac{8}{23} + 25/29$	13	161.99907	55.20
137	$17/43 + 2\frac{4}{49}$	11	137.00015	295.10	163	$18/49 - 5/41$	1	163.00203	25.58
137 ^a	$2\frac{7}{43} + 40/49$	11	137.00015	295.10	163	$19/37 + 22/47$	4	162.99941	88.57
138	$7/21 - 1/23$	1	138.00000	Exact	163 ^a	$2\frac{7}{37} + 25/49$	11	162.99959	126.96
138 ^a	$18/23 + 22/33$	5	138.00000	Exact	163	$2\frac{3}{47} + 26/49$	13	162.99986	381.20
139	$23/41 + 13/43$	3	139.00131	33.67	164	10/41	1	164.00000	Exact
139	$1\frac{3}{39} + 9/41$	7	139.00031	142.51	165	8/33	1	165.00000	Exact
139	$3\frac{1}{43} + 6/47$	12	138.99986	308.79	166	$20/29 + 17/33$	5	166.00173	30.46
139 ^a	$2\frac{2}{37} + 24/49$	11	138.99983	253.92	166 ^a	$1\frac{1}{43} + 12/49$	7	165.99887	46.95
140	6/21	1	140.00000	Exact	166	$2\frac{2}{41} + 7/43$	11	166.00043	123.46
141	$29/47 - 13/39$	1	141.00000	Exact	167 ^a	$2\frac{1}{29} + 4/33$	9	166.99952	109.66
141 ^a	$1\frac{3}{29} + 22/49$	8	141.00069	64.88	167	$23/43 + 9/49$	3	167.00132	40.24
142	$23/39 + 12/47$	3	142.00129	35.01	167	$6/37 + 39/49$	4	167.00058	92.34
142	$18/41 + 2\frac{3}{47}$	11	141.99967	134.94	167	$2\frac{2}{37} + 20/43$	13	167.00040	131.67
142 ^a	$4\frac{1}{47} + 10/49$	15	141.99979	219.92	168	5/21	1	168.00000	Exact
143 ^a	$36/47 + 31/49$	5	142.99907	48.87	169	$1/41 + 22/49$	2	169.00105	51.16
143	$13/37 + 20/41$	3	143.00079	57.95	169 ^a	$1\frac{3}{37} + 13/49$	9	169.00052	103.88
143	$1\frac{1}{27} + 20/31$	8	143.00053	85.26	170	4/17	1	170.00000	Exact
144	5/18	1	144.00000	Exact	171	$8/18 - 4/19$	1	171.00000	Exact
145	8/29	1	145.00000	Exact	171 ^a	$1\frac{2}{47} + 1/49$	7	170.99973	205.26
146	$16/41 - 5/43$	1	146.00414	11.22	172	10/43	1	172.00000	Exact
146	$3/37 + 1\frac{1}{49}$	7	145.99942	80.79	173	$27/37 + 8/41$	4	173.00071	77.26
146 ^a	$1\frac{3}{37} + 41/49$	7	145.99942	80.79	173 ^a	$1\frac{7}{43} + 11/49$	6	173.00034	160.96
146	$28/37 + 2\frac{3}{41}$	13	146.00037	125.55					

Table 1b. (Continued) Simple and Compound Indexing with Brown & Sharpe Plates

Target Divisions	Indexing Movements	Workpiece Revolutions	Precise Number of Divisions	Diameter at Which Error = 0.001	Target Divisions	Indexing Movements	Workpiece Revolutions	Precise Number of Divisions	Diameter at Which Error = 0.001
174	7/21 - 3/29	1	174.00000	Exact	199	16/41 + 10/47	3	199.00172	36.80
174 ^a	14/29 + 22/33	5	174.00000	Exact	199	26/37 + 13/43	5	198.99937	101.29
175	3/37 + 26/43	3	174.99542	12.15	199 ^a	1 ¹² / ₄₁ + 45/49	11	199.00045	140.69
175 ^a	1 ⁴ / ₃₁ + 8/33	6	174.99644	15.63	199	1 ⁴ / ₄₃ + 31/47	13	199.00019	334.52
175	1 ³ / ₃₇ + 5/39	6	174.99747	22.05	200	3/15	1	200.00000	Exact
175	2 ³ / ₄₁ + 15/47	11	175.00103	53.98	201	27/37 + 13/49	5	200.99778	28.85
176 ^a	1 ¹⁴ / ₄₃ + 13/49	7	176.00239	23.47	201	1 ¹⁸ / ₄₁ + 27/49	10	201.00050	127.90
176	2 ¹⁸ / ₃₇ + 22/47	13	175.99844	35.98	201 ^a	2 ¹⁸ / ₄₇ + 10/49	13	201.00034	190.60
177	6/37 + 3/47	1	176.99746	22.14	201	2 ⁵ / ₄₁ + 20/43	13	200.99978	291.81
177	1 ¹⁷ / ₃₇ + 6/49	7	177.00139	40.40	202	24/37 + 14/41	5	201.99734	24.14
177 ^a	2 ¹⁹ / ₄₇ + 4/49	11	176.99913	64.51	202 ^a	3 ¹⁹ / ₄₁ + 6/49	17	201.99911	72.47
178	1 ¹⁶ / ₃₉ + 7/43	7	177.99848	37.37	202	1/43 + 2 ²⁷ / ₄₉	13	201.99853	43.59
178 ^a	3 ²⁸ / ₄₇ + 11/49	17	177.99955	124.62	203	14/29 - 6/21	1	203.00000	Exact
178	2 ¹¹ / ₄₁ + 32/49	13	177.99966	166.27	203 ^a	1 ²³ / ₃₉ + 9/49	9	202.99793	31.28
179	20/37 - 13/41	1	178.99705	19.31	204	9/17 - 5/15	1	204.00000	Exact
179	14/39 + 23/43	4	178.99933	85.41	204 ^a	2 ²¹ / ₄₁ + 3/49	13	203.99922	83.13
179 ^a	1 ³¹ / ₄₇ + 36/49	11	179.00018	322.55	205	8/41	1	205.00000	Exact
180	4/18	1	180.00000	Exact	206	1/41 + 24/43	3	205.99805	33.67
180	6/27	1	180.00000	Exact	206	2 ⁸ / ₃₉ + 15/47	13	205.99957	151.70
181	20/37 + 6/49	3	180.99834	34.63	206 ^a	2 ³¹ / ₃₉ + 2/49	15	206.00072	91.24
181 ^a	2 ⁸ / ₄₃ + 12/49	11	180.99961	147.55	207	5/23 + 15/27	4	207.00000	Exact
181	39/41 + 28/47	7	180.99966	171.75	207 ^a	2 ⁸ / ₄₁ + 25/49	14	206.99908	71.62
181	2 ³ / ₃₉ + 21/47	12	180.99979	280.06	208	8/43 + 38/49	5	207.99605	16.77
182 ^a	3/39 + 7/49	1	182.00000	Exact	208 ^a	1 ¹⁹ / ₄₇ + 16/49	9	207.99799	32.99
183	8/29 + 5/31	2	183.00254	22.89	208	3 ³⁵ / ₄₃ + 11/49	21	208.00094	70.42
183	1/43 + 40/47	4	182.99943	102.93	209 ^a	9/41 + 8/49	2	208.99870	51.16
183 ^a	1 ²¹ / ₄₁ + 8/49	8	183.00028	204.64	209	1 ³⁶ / ₄₁ + 18/43	12	208.99975	269.37
184	5/23	1	184.00000	Exact	210	4/21	1	210.00000	Exact
185	8/37	1	185.00000	Exact	211 ^a	1 ²⁸ / ₃₉ + 18/49	11	211.00125	53.53
186	17/31 - 7/21	1	186.00000	Exact	211	35/37 + 9/47	6	211.00101	66.42
186 ^a	3/31 + 11/33	2	186.00000	Exact	211	1 ¹⁰ / ₃₇ + 17/39	9	210.99919	82.68
187	19/37 + 5/39	3	186.99784	27.56	211	1 ³³ / ₄₁ + 31/47	13	211.00021	318.96
187 ^a	1 ³⁰ / ₄₇ + 14/49	8	186.99822	33.51	212	34/39 + 22/49	7	211.99683	21.29
187	21/23 + 10/27	6	187.00125	47.44	212	1 ⁵ / ₄₃ + 47/49	11	212.00091	73.77
187	1 ³⁸ / ₄₃ + 12/47	10	186.99977	257.32	212 ^a	3 ⁴ / ₄₇ + 6/49	17	211.99946	124.62
188	10/47	1	188.00000	Exact	213 ^a	1 ¹⁹ / ₃₉ + 2/49	8	212.99896	64.88
189	7/27 - 1/21	1	189.00000	Exact	213	14/37 + 44/47	7	213.00087	77.50
189 ^a	1 ²⁶ / ₄₁ + 34/49	11	189.00150	40.20	213	2 ³⁶ / ₃₇ + 9/41	17	213.00021	328.36
190	4/19	1	190.00000	Exact	214	7/39 + 37/49	5	213.99776	30.41
191	1/21 + 18/31	3	191.00244	24.87	214 ^a	2 ⁹ / ₄₇ + 30/49	15	214.00031	219.92
191 ^a	1 ³⁸ / ₄₇ + 14/49	10	191.00145	41.89	215	8/43	1	215.00000	Exact
191	34/37 + 5/39	5	190.99934	91.86	216	5/27	1	216.00000	Exact
191	28/39 + 45/47	8	190.99967	186.71	217	12/21 - 12/31	1	217.00000	Exact
192	5/15 - 2/16	1	192.00000	Exact	217 ^a	2 ²³ / ₄₃ + 16/49	13	217.00139	49.82
192 ^a	1 ²⁹ / ₄₁ + 37/49	11	191.99826	35.17	218	14/39 + 9/47	3	217.99802	35.01
193 ^a	5/37 + 34/49	4	193.00067	92.34	218 ^a	22/47 + 40/49	7	217.99865	51.31
193	29/39 + 12/41	5	192.99940	101.80	218	19/37 + 1 ³¹ / ₃₉	13	218.00116	59.71
194	41/43 + 24/49	7	194.00197	31.30	219	24/39 + 14/47	5	218.99642	19.45
194 ^a	1 ²² / ₃₇ + 33/49	11	193.99805	31.74	219 ^a	2 ²⁹ / ₄₃ + 39/49	19	218.99891	63.71
194	1 ²³ / ₃₇ + 11/47	9	194.00062	99.64	219	1 ² / ₃₇ + 11/49	7	218.99914	80.79
194	2 ⁸ / ₄₇ + 25/49	13	193.99968	190.60	219	2 ¹¹ / ₄₁ + 41/49	17	218.99968	217.42
195	8/39	1	195.00000	Exact	220	6/33	1	220.00000	Exact
196	10/49	1	196.00000	Exact	221	26/37 + 1/47	4	221.00079	88.57
197	17/37 - 10/39	1	196.99659	18.37	221 ^a	5/47 + 48/49	6	220.99960	175.94
197	19/39 + 5/41	3	197.00205	30.54	221	3 ⁴ / ₄₁ + 25/43	21	220.99985	471.39
197 ^a	1 ³⁹ / ₄₃ + 16/49	11	196.99958	147.55	222	19/37 - 13/39	1	222.00000	Exact
198 ^a	3/27 + 3/33	1	198.00000	Exact	222 ^a	1 ⁸ / ₄₃ + 39/49	11	222.00192	36.89

Table 1b. (Continued) Simple and Compound Indexing with Brown & Sharpe Plates

Target Divisions	Indexing Movements	Workpiece Revolutions	Precise Number of Divisions	Diameter at Which Error = 0.001	Target Divisions	Indexing Movements	Workpiece Revolutions	Precise Number of Divisions	Diameter at Which Error = 0.001
223	6/37 + 36/49	25	223.00123	57.71	239	1/37 + 12/39	2	239.00621	12.25
223	1 ²⁶ / ₃₇ + 38/47	14	222.99977	309.98	239	32/39 + 9/49	6	238.99948	145.99
223 ^a	2 ²⁹ / ₄₃ + 13/49	16	222.99983	429.23	239 ^a	1 ²³ / ₄₃ + 15/49	11	238.99974	295.10
223	3 ¹¹ / ₄₁ + 15/47	20	223.00014	490.71	239	2 ³ / ₄₁ + 26/43	16	239.00021	359.16
224	1 ¹³ / ₃₇ + 11/43	9	223.99687	22.79	240	3/18	1	240.00000	Exact
224	2 ¹⁹ / ₃₉ + 11/41	15	224.00187	38.17	241	4/39 + 17/43	3	241.00599	12.81
224 ^a	2 ⁹ / ₂₃ + 2/33	13	223.99546	15.70	241	26/41 + 17/47	6	241.00052	147.21
224	3 ⁵ / ₄₃ + 13/47	19	223.99883	61.11	241 ^a	1 ¹ / ₄₁ + 23/49	9	240.99967	230.21
225	1/15 + 2/18	1	225.00000	Exact	241	1 ²⁵ / ₃₇ + 35/43	15	240.99975	303.86
225 ^a	1/18 + 6/20	2	225.00000	Exact	242	4/37 + 19/49	3	242.00222	34.63
226	28/37 + 5/39	5	225.99843	45.93	242	1 ³⁷ / ₃₉ + 26/49	15	242.00084	91.24
226 ^a	1 ³⁸ / ₃₉ + 16/49	13	225.99955	158.16	242 ^a	1 ²³ / ₄₁ + 45/49	15	241.99960	191.85
227	9/39 + 14/47	3	226.99690	23.34	242	2 ²² / ₃₉ + 39/43	21	241.99966	224.20
227	1 ¹¹ / ₃₇ + 25/39	11	227.00036	202.10	243	22/37 + 3/47	4	243.00437	17.71
227 ^a	3 ³ / ₄₃ + 5/49	18	226.99985	482.89	243	32/41 + 2/47	5	243.00126	61.34
228	5/15 - 3/19	1	228.00000	Exact	243 ^a	29/41 + 46/49	10	242.99970	255.79
229	7/39 + 34/49	5	228.99940	121.66	244	36/39 + 11/49	7	243.99453	14.19
229 ^a	1 ¹⁹ / ₄₁ + 31/49	12	229.00024	306.95	244	1 ¹⁹ / ₃₇ + 8/39	9	244.00188	41.34
229	2 ³⁸ / ₄₁ + 20/43	19	229.00017	426.50	244	2 ¹⁵ / ₃₁ + 10/33	17	243.99860	55.36
230	4/23	1	230.00000	Exact	244 ^a	1 ²⁸ / ₃₇ + 2/43	11	244.00139	55.71
231 ^a	3/21 + 1/33	1	231.00000	Exact	245	8/49	1	245.00000	Exact
232	5/29	1	232.00000	Exact	246	13/39 - 7/41	1	246.00000	Exact
233	2/37 + 31/49	4	232.99598	18.47	246 ^a	6/43 + 33/49	5	246.00117	67.07
233 ^a	1 ³⁶ / ₄₇ + 6/49	11	233.00069	107.52	247	17/37 + 21/41	6	247.00136	57.59
233	21/37 + 26/41	7	233.00055	135.21	247	15/43 + 1 ⁴⁵ / ₄₉	14	247.00021	375.58
233	1 ²³ / ₃₇ + 41/43	15	232.99976	303.86	247 ^a	1 ¹⁵ / ₄₃ + 45/49	14	247.00021	375.58
234 ^a	2 ²¹ / ₂₉ + 6/33	17	234.00216	34.52	248	5/31	1	248.00000	Exact
234	8/41 + 31/47	5	234.00121	61.34	249	20/37 + 5/49	4	248.99571	18.47
234	2 ¹⁷ / ₄₃ + 24/47	17	233.99966	218.72	249	10/37 + 1 ⁴⁶ / ₄₇	14	249.00026	309.98
235	8/47	1	235.00000	Exact	249	4/43 + 2 ⁴⁷ / ₄₉	19	249.00016	509.72
236	22/37 + 29/49	7	236.00186	40.40	249 ^a	2 ⁴ / ₄₃ + 47/49	19	249.00016	509.72
236 ^a	2 ³ / ₄₃ + 9/49	17	236.00066	114.02	250	1 ⁸ / ₄₁ + 12/49	9	249.99654	23.02
237	1 ⁷ / ₃₉ + 7/41	8	236.99861	54.29	250 ^a	1 ⁹ / ₃₇ + 41/49	13	250.00265	30.01
237	1 ²⁶ / ₃₇ + 6/39	11	236.99888	67.37	250	2 ² / ₄₃ + 33/49	17	250.00174	45.61
237	12/47 + 1 ⁴⁶ / ₄₉	13	236.99980	381.20	250	3 ¹⁶ / ₄₇ + 48/49	27	249.99899	79.17
237 ^a	1 ¹² / ₄₇ + 46/49	13	236.99980	381.20
238	7/37 + 28/43	5	237.99551	16.88
238	1/43 + 1 ²³ / ₄₇	9	237.99804	38.60
238 ^a	2 ³ / ₃₁ + 14/33	15	237.99922	97.69
238	2 ¹⁷ / ₃₉ + 4/47	15	238.00043	175.04

^a Requires only the outer most circle of holes on indexing plate.

The greater spacing between successive machining operations may be used to advantage to spread out and reduce the effects of heat generation on the workpiece. The number of workpiece revolutions required by an approximation is shown in the table in the column to the right of the indexing movements. The table gives two or three choices for each division requiring approximate movements.

Two measures of the closeness of each approximation are provided to aid in the trade-off between complexity and precision. The first measure is the precise number of divisions that a set of indexing movements produces, offering a direct comparison of the degree of approximation. However, the difference between the precise number of divisions and the target number of divisions is angular in nature, so the error introduced by an approximation depends on the size of the circle being divided. The second measure of closeness reflects this characteristic by expressing the degree of approximation as the diameter at which the error is equal to 0.001. This second measure is unitless, so that taking the error as 0.001 inch means that the entries in that column are to be taken as diameters in inches, but the

measure works as well with 0.001 centimeter and diameters in centimeters. The measure can also be used to calculate the error of approximation at a given diameter. Divide the given diameter by the value of the measure and multiply the result by 0.001 to determine the amount of error that using an approximation will introduce.

Example: A gear is to be cut with 127 teeth at 16 diametral pitch using a Brown & Sharpe plain dividing head. The indexing table gives three approximations for 127 divisions. The pitch diameter of a 16 DP gear with 127 teeth is about 7.9 inches, so the calculated error of approximation for the three choices would be about $(7.9 \div 17.5) \times 0.001 = 0.00045$ inch, $(7.9 \div 77.5) \times 0.001 = 0.00010$ inch, and $(7.9 \div 218.98) \times 0.001 = 0.000036$ inch. Considering the increased potential for operator error with longer indexing movements and such other factors as may be appropriate, assume that the first of the three approximations is selected. Plate 3 is mounted on the worm shaft of the dividing head but not bolted to the frame. A double set of sector arms is installed, if available; otherwise, the single pair of sector arms is installed. The indexing pin on the crank arm is set to track the 39-hole circle. The stationary indexing pin is installed and set to track the 47-hole circle. If only one pair of sector arms is used, it is used for the 42/47 movement and is set for 0-42 holes using the outer arc. Six holes should be showing in the inner arc on the 47-hole circle (the zero-hole, the 42-hole, and four extra holes). The second set of sector arms is set for 0-2 holes on the 39-hole circle using the inner arc (three holes showing). If there is no second pair of sector arms, this is a short enough movement to do freehand without adding much risk of error.

Angular Indexing.—The plain dividing head with a 40:1 gear ratio will rotate the main spindle and the workpiece 9 degrees for each full turn of the indexing crank, and therefore 1 degree for movements of 2/18 or 3/27 on Brown & Sharpe dividing heads and 6/54 on heads of Cincinnati design. To find the indexing movement for an angle, divide that angle, in degrees, by 9 to get the number of full turns and the remainder, if any. If the remainder, expressed in minutes, is evenly divisible by 36, 33.75, 30, 27, or 20, then the quotient is the number of holes to be moved on the 15-, 16-, 18-, 20-, or 27-hole circles, respectively, to obtain the fractional turn required (or evenly divisible by 22.5, 21.6, 18, 16.875, 15, 11.25, or 10 for the number of holes to be moved on the 24-, 25-, 30-, 32-, 36-, 48-, or 54-hole circles, respectively, for the standard and high number plates of a Cincinnati dividing head). If none of these divisions is even, it is not possible to index the angle (exactly) by this method.

Example: An angle of $61^{\circ} 48'$ is required. Expressed in degrees, this angle is 61.8° , which when divided by 9 equals 6 with a remainder of 7.8° , or $468'$. Division of 468 by 20, 27, 30, 33.75, and 36 reveals an even division by 36, yielding 13. The indexing movement for $61^{\circ} 48'$ is six full turns plus 13 holes on the 15-hole circle.

Tables for Angular Indexing.—Table 2, headed *Angular Values of One-Hole Moves*, provides the angular movement obtained with a move of one hole in each of the indexing circles available on standard Brown & Sharpe and Cincinnati plates, for a selection of angles that can be approximated with simple indexing.

Table 3, titled *Accurate Angular Indexing*, provides the simple and compound indexing movements to obtain the full range of fractional turns with the standard indexing plates of both the Brown & Sharpe and Cincinnati dividing heads. Compound indexing movements depend on the presence of specific indexing circles on the same indexing plate, so some movements may not be available with plates of different configurations. To use the table to index an angle, first convert the angle to seconds and then divide the number of seconds in the angle by 32,400 (the number of seconds in 9 degrees, which is one full turn of the indexing crank). The whole-number portion of the quotient gives the number of full turns of the indexing crank, and the decimal fraction of the quotient gives the fractional turn required.

Table 2. Angular Values of One-Hole Moves for B&S and Cincinnati Index Plates

Holes in Circle	Angle in Minutes	Holes in Circle	Angle in Minutes	Holes in Circle	Angle in Minutes
15	36.000	53	10.189	129	4.186
16	33.750	54	10.000	131	4.122
17	31.765	57	9.474	133	4.060
18	30.000	58	9.310	137	3.942
19	28.421	59	9.153	139	3.885
20	27.000	62	8.710	141	3.830
21	25.714	66	8.182	143	3.776
23	23.478	67	8.060	147	3.673
24	22.500	69	7.826	149	3.624
25	21.600	71	7.606	151	3.576
26	20.769	73	7.397	153	3.529
27	20.000	77	7.013	157	3.439
28	19.286	79	6.835	159	3.396
29	18.621	81	6.667	161	3.354
30	18.000	83	6.506	163	3.313
31	17.419	87	6.207	167	3.234
32	16.875	89	6.067	169	3.195
33	16.364	91	5.934	171	3.158
34	15.882	93	5.806	173	3.121
36	15.000	97	5.567	175	3.086
37	14.595	99	5.455	177	3.051
38	14.211	101	5.347	179	3.017
39	13.846	103	5.243	181	2.983
41	13.171	107	5.047	183	2.951
42	12.857	109	4.954	187	2.888
43	12.558	111	4.865	189	2.857
44	12.273	113	4.779	191	2.827
46	11.739	117	4.615	193	2.798
47	11.489	119	4.538	197	2.741
48	11.250	121	4.463	199	2.714
49	11.020	123	4.390
51	10.588	127	4.252

Use **Table 3** to locate the indexing movement for the decimal fraction nearest to the decimal fraction of the quotient for which there is an entry in the column for the dividing head to be used. If the decimal fraction of the quotient is close to the midpoint between two table entries, calculate the mathematical value of the two indexing movements to more decimal places to make the closeness determination.

Example: Movement through an angle of $31^{\circ} 27' 50''$ is required. Expressed in seconds, this angle $113270''$, which, divided by 32,400, equals 3.495987. The indexing movement is three full turns of the crank plus a fractional turn of 0.495987. The nearest **Table 3** entry is for 0.4960, which requires a compound indexing movement of 8 holes on the 23-hole circle plus 4 holes on the 27-hole circle in the same direction. Checking the value of these movements shows that $\frac{8}{23} + \frac{4}{27} = 0.347826 + 0.148148 = 0.495974$, which, multiplied by 32,400, = 16,069.56, or $4^{\circ} 27' 49.56''$ from the fractional turn. Adding the 27° from three full turns gives a total movement of $31^{\circ} 27' 49.56''$.

Table 3. Accurate Angular Indexing

Part of a Turn	B&S, Becker, HendeY, K&T, & Rockford	Cincinnati and LeBlond	Part of a Turn	B&S, Becker, HendeY, K&T, & Rockford	Cincinnati and LeBlond
0.0010	12/49 – 10/41	15/51 – 17/58	0.0370	13/43 – 13/49	6/51 – 5/62
0.0020	24/49 – 20/41	23/51 – 22/49	0.0370	1/27	2/54
0.0030	8/23 – 10/29	7/39 – 6/34	0.0377	...	2/53
0.0040	1/41 – 1/49	4/66 – 3/53	0.0380	13/41 – 12/43	12/49 – 12/58
0.0050	4/39 – 4/41	3/24 – 3/25	0.0390	15/29 – 11/23	9/54 – 6/47
0.0060	9/29 – 7/23	18/51 – 17/49	0.0392	...	2/51
0.0070	11/31 – 8/23	5/46 – 6/59	0.0400	9/41 – 7/39	1/25
0.0080	2/41 – 2/49	10/49 – 10/51	0.0408	2/49	2/49
0.0090	1/23 – 1/29	8/24 – 12/37	0.0410	20/41 – 21/47	21/43 – 17/38
0.0100	8/39 – 8/41	6/24 – 6/25	0.0417	...	1/24
0.0110	6/39 – 7/49	11/59 – 10/57	0.0420	8/47 – 5/39	23/59 – 16/46
0.0120	9/47 – 7/39	15/49 – 15/51	0.0426	2/47	2/47
0.0130	2/33 – 1/21	3/54 – 2/47	0.0430	7/21 – 9/31	8/59 – 5/54
0.0140	19/47 – 16/41	10/46 – 12/59	0.0435	1/23	2/46
0.0150	8/29 – 6/23	9/24 – 9/25	0.0440	17/43 – 13/37	17/57 – 15/59
0.0152	...	1/66	0.0450	11/49 – 7/39	3/24 – 2/25
0.0160	18/49 – 13/37	20/49 – 20/51	0.0455	...	3/66
0.0161	...	1/62	0.0460	8/37 – 8/47	19/39 – 15/34
0.0169	...	1/59	0.0465	2/43	2/43
0.0170	15/41 – 15/43	9/49 – 11/66	0.0470	8/49 – 5/43	26/66 – 17/49
0.0172	...	1/58	0.0476	1/21	2/42
0.0175	...	1/57	0.0480	11/47 – 8/43	13/51 – 12/58
0.0180	9/39 – 10/47	11/42 – 10/41	0.0484	...	3/62
0.0185	...	1/54	0.0488	2/41	2/41
0.0189	...	1/53	0.0490	14/43 – 13/47	8/47 – 8/66
0.0190	7/37 – 8/47	6/49 – 6/58	0.0500	1/20	2/24 – 1/30
0.0196	...	1/51	0.0508	...	3/59
0.0200	16/39 – 16/41	3/30 – 2/25	0.0510	2/17 – 1/15	16/54 – 13/53
0.0204	1/49	1/49	0.0513	2/39	2/39
0.0210	3/43 – 2/41	15/46 – 18/59	0.0517	...	3/58
0.0213	1/47	1/47	0.0520	19/37 – 18/39	6/46 – 4/51
0.0217	...	1/46	0.0526	1/19	2/38
0.0220	12/37 – 13/43	22/59 – 20/57	0.0526	...	3/57
0.0230	4/37 – 4/47	3/47 – 2/49	0.0530	14/47 – 12/49	1/54 + 2/58
0.0233	1/43	1/43	0.0540	17/47 – 12/39	12/53 – 10/58
0.0238	...	1/42	0.0541	2/37	2/37
0.0240	18/47 – 14/39	23/58 – 19/51	0.0550	4/41 – 2/47	9/24 – 8/25
0.0244	1/41	1/41	0.0556	1/18	3/54
0.0250	2/16 – 2/20	2/30 – 1/24	0.0560	13/49 – 9/43	7/38 – 5/39
0.0256	1/39	1/39	0.0566	...	3/53
0.0260	4/33 – 2/21	3/46 – 2/51	0.0570	13/29 – 9/23	18/49 – 18/58
0.0263	...	1/38	0.0580	19/41 – 15/37	7/53 – 4/54
0.0270	3/23 – 3/29	6/53 – 5/58	0.0588	1/17	2/34
0.0270	1/37	1/37	0.0588	...	3/51
0.0280	17/43 – 18/49	20/46 – 24/59	0.0590	11/41 – 9/43	21/49 – 17/46
0.0290	11/37 – 11/41	4/49 – 3/57	0.0600	4/39 – 2/47	3/30 – 1/25
0.0294	...	1/34	0.0606	2/33	4/66
0.0300	2/39 – 1/47	7/25 – 6/24	0.0610	7/37 – 5/39	5/51 – 2/54
0.0303	1/33	2/66	0.0612	3/49	3/49
0.0310	13/39 – 13/43	13/34 – 13/37	0.0620	17/43 – 13/39	11/37 – 8/34
0.0320	11/37 – 13/49	8/37 – 7/38	0.0625	1/16	...
0.0323	1/31	2/62	0.0630	2/21 – 1/31	5/59 – 1/46
0.0330	11/49 – 9/47	11/49 – 9/47	0.0638	3/47	3/47
0.0333	...	1/30	0.0640	23/49 – 15/37	10/51 – 7/53
0.0339	...	2/59	0.0645	2/31	4/62
0.0340	18/49 – 13/39	18/49 – 17/51	0.0650	5/43 – 2/39	11/25 – 9/24
0.0345	1/29	2/58	0.0652	...	3/46
0.0350	13/41 – 11/39	4/25 – 3/24	0.0660	22/49 – 18/47	22/49 – 18/47
0.0351	...	2/57	0.0667	1/15	2/30
0.0357	...	1/28	0.0670	5/39 – 3/49	19/49 – 17/53
0.0360	18/39 – 20/47	21/41 – 20/42	0.0678	...	4/59

Table 3. (Continued) Accurate Angular Indexing

Part of a Turn	B&S, Becker, Hendeny, K&T, & Rockford	Cincinnati and LeBlond	Part of a Turn	B&S, Becker, Hendeny, K&T, & Rockford	Cincinnati and LeBlond
0.0680	9/39 – 7/43	23/51 – 18/47	0.0980	...	5/51
0.0690	2/29	4/58	0.0990	1/29 + 2/31	20/47 – 16/49
0.0690	12/37 – 12/47	7/66 – 2/54	0.1000	2/20	3/30
0.0698	3/43	3/43	0.1010	6/27 – 4/33	18/59 – 10/49
0.0700	8/33 – 5/29	8/25 – 6/24	0.1017	...	6/59
0.0702	...	4/57	0.1020	6/47 – 1/39	11/54 – 6/59
0.0710	17/43 – 12/37	11/58 – 7/59	0.1020	5/49	5/49
0.0714	...	2/28	0.1026	4/39	4/39
0.0714	...	3/42	0.1030	21/49 – 14/43	18/57 – 10/47
0.0720	7/47 – 3/39	10/49 – 7/53	0.1034	...	6/58
0.0730	9/37 – 8/47	1/47 + 3/58	0.1035	3/29	...
0.0732	3/41	3/41	0.1040	21/41 – 20/49	15/62 – 8/58
0.0740	23/49 – 17/43	19/42 – 14/37	0.1050	11/41 – 8/49	12/25 – 9/24
0.0741	2/27	4/54	0.1053	2/19	4/38
0.0750	2/16 – 1/20	1/24 + 1/30	0.1053	...	6/57
0.0755	...	4/53	0.1060	1/27 + 2/29	2/54 + 4/58
0.0758	...	5/66	0.1061	...	7/66
0.0760	17/47 – 14/49	24/49 – 24/58	0.1064	5/47	5/47
0.0769	3/39	3/39	0.1070	10/37 – 8/49	2/51 + 4/59
0.0770	...	9/46 – 7/59	0.1071	...	3/28
0.0771	6/37 – 4/47	...	0.1080	1/23 + 2/31	24/53 – 20/58
0.0780	13/39 – 12/47	9/46 – 6/51	0.1081	4/37	4/37
0.0784	...	4/51	0.1087	...	5/46
0.0789	...	3/38	0.1090	8/47 – 3/49	25/58 – 19/59
0.0790	20/37 – 18/39	21/39 – 17/37	0.1100	2/41 + 3/49	9/25 – 6/24
0.0800	9/37 – 8/49	2/25	0.1110	15/49 – 8/41	32/59 – 22/51
0.0806	...	5/62	0.1111	3/27	6/54
0.0810	9/23 – 9/29	17/47 – 16/57	0.1111	2/18	...
0.0811	3/37	3/37	0.1120	23/41 – 22/49	23/47 – 20/53
0.0816	4/49	4/49	0.1129	...	7/62
0.0820	5/47 – 1/41	4/38 – 1/43	0.1130	13/41 – 10/49	1/49 + 5/54
0.0830	4/23 – 3/33	8/46 – 6/66	0.1132	...	6/53
0.0833	...	2/24	0.1140	7/43 – 2/41	22/58 – 13/49
0.0840	8/43 – 5/49	8/47 – 5/58	0.1150	13/31 – 7/23	6/25 – 3/24
0.0847	...	5/59	0.1160	6/29 – 3/33	14/53 – 8/54
0.0850	9/17 – 8/18	3/24 – 1/25	0.1163	5/43	5/43
0.0851	4/47	4/47	0.1170	5/33 – 1/29	5/59 + 2/62
0.0860	13/31 – 7/21	16/59 – 10/54	0.1176	2/17	4/34
0.0862	...	5/58	0.1176	...	6/51
0.0870	2/23	4/46	0.1180	6/23 – 3/21	27/59 – 18/53
0.0870	5/33 – 2/31	21/54 – 16/53	0.1186	...	7/59
0.0877	...	5/57	0.1190	10/29 – 7/31	4/47 + 2/59
0.0880	8/37 – 5/39	28/57 – 25/62	0.1190	...	5/42
0.0882	...	3/34	0.1200	8/39 – 4/47	3/25
0.0890	6/37 – 3/41	22/53 – 15/46	0.1207	...	7/58
0.0900	22/49 – 14/39	6/24 – 4/25	0.1210	21/43 – 18/49	26/53 – 17/46
0.0909	3/33	6/66	0.1212	4/33	8/66
0.0910	23/49 – 14/37	21/51 – 17/53	0.1220	5/41	5/41
0.0920	4/31 – 1/27	4/34 – 1/39	0.1220	23/47 – 18/49	10/51 – 4/54
0.0926	...	5/54	0.1224	6/49	6/49
0.0930	15/29 – 14/33	5/34 – 2/37	0.1228	...	7/57
0.0930	4/43	4/43	0.1230	10/49 – 3/37	1/59 + 7/66
0.0940	23/47 – 17/43	15/49 – 14/66	0.1240	2/23 + 1/27	18/34 – 15/37
0.0943	...	5/53	0.1250	2/16	3/24
0.0950	5/43 – 1/47	9/24 – 7/25	0.1260	24/47 – 15/39	10/59 – 2/46
0.0952	2/21	4/42	0.1270	22/43 – 15/39	1/46 + 6/57
0.0960	11/39 – 8/43	11/39 – 8/43	0.1277	6/47	6/47
0.0968	3/31	6/62	0.1280	7/37 – 3/49	33/62 – 19/47
0.0970	22/43 – 17/41	12/59 – 5/47	0.1282	5/39	5/39
0.0976	4/41	4/41	0.1290	10/27 – 7/29	24/59 – 15/54
0.0980	7/27 – 5/31	16/47 – 16/66	0.1290	4/31	8/62

Table 3. (Continued) Accurate Angular Indexing

Part of a Turn	B&S, Becker, Hendeny, K&T, & Rockford	Cincinnati and LeBlond	Part of a Turn	B&S, Becker, Hendeny, K&T, & Rockford	Cincinnati and LeBlond
0.1296	...	7/54	0.1613	5/31	10/62
0.1300	10/43 - 4/39	6/24 - 3/25	0.1620	3/39 + 4/47	25/57 - 13/47
0.1304	3/23	6/46	0.1622	6/37	6/37
0.1310	3/43 + 3/49	8/49 - 2/62	0.1628	7/43	7/43
0.1316	...	5/38	0.1630	10/29 - 6/33	22/47 - 18/59
0.1320	11/47 - 5/49	11/47 - 5/49	0.1633	8/49	8/49
0.1321	...	7/53	0.1640	10/47 - 2/41	8/38 - 2/43
0.1330	8/29 - 3/21	2/37 + 3/38	0.1650	2/47 + 6/49	3/24 + 1/25
0.1333	2/15	4/30	0.1660	8/23 - 6/33	16/46 - 12/66
0.1340	7/17 - 5/18	19/53 - 11/49	0.1667	3/18	4/24
0.1350	10/43 - 4/41	9/24 - 6/25	0.1667	...	5/30
0.1351	5/37	5/37	0.1667	...	7/42
0.1356	...	8/59	0.1667	...	9/54
0.1360	5/16 - 3/17	11/47 - 5/51	0.1667	...	11/66
0.1364	...	9/66	0.1670	16/39 - 9/37	19/53 - 9/47
0.1370	3/41 + 3/47	10/47 - 5/66	0.1680	16/43 - 10/49	26/57 - 17/59
0.1373	...	7/51	0.1690	5/39 + 2/49	10/46 - 3/62
0.1379	4/29	8/58	0.1695	...	10/59
0.1380	23/47 - 13/37	18/39 - 11/34	0.1698	...	9/53
0.1390	28/49 - 16/37	16/38 - 11/39	0.1700	6/23 - 3/33	6/24 - 2/25
0.1395	6/43	6/43	0.1702	8/47	8/47
0.1400	8/49 - 1/43	1/25 + 3/30	0.1707	7/41	7/41
0.1404	...	8/57	0.1710	15/49 - 5/37	15/47 - 8/54
0.1410	11/47 - 4/43	12/66 - 2/49	0.1720	1/39 + 6/41	32/59 - 20/54
0.1420	8/49 - 1/47	21/57 - 12/53	0.1724	5/29	10/58
0.1429	...	4/28	0.1730	9/41 - 2/31	9/41 - 2/43
0.1429	3/21	6/42	0.1739	4/23	8/46
0.1429	7/49	7/49	0.1740	10/33 - 4/31	21/53 - 12/54
0.1430	10/47 - 3/43	24/51 - 19/58	0.1750	2/16 + 1/20	1/24 + 4/30
0.1440	19/43 - 14/47	20/49 - 14/53	0.1754	...	10/57
0.1450	9/47 - 2/43	15/24 - 12/25	0.1760	2/37 + 5/41	2/37 + 5/41
0.1452	...	9/62	0.1765	3/17	6/34
0.1460	26/49 - 15/39	2/47 + 6/58	0.1765	...	9/51
0.1463	6/41	6/41	0.1770	5/39 + 2/41	14/49 - 5/46
0.1470	4/21 - 1/23	16/41 - 9/37	0.1774	...	11/62
0.1471	...	5/34	0.1780	23/41 - 18/47	6/49 + 3/54
0.1480	4/19 - 1/16	9/37 - 4/42	0.1786	...	5/28
0.1481	4/27	8/54	0.1790	11/21 - 10/29	19/51 - 12/62
0.1489	7/47	7/47	0.1795	7/39	7/39
0.1490	12/31 - 5/21	11/49 - 4/53	0.1800	11/47 - 2/37	2/25 + 3/30
0.1500	3/20	7/30 - 2/24	0.1810	11/37 - 5/43	18/38 - 12/41
0.1509	...	8/53	0.1818	6/33	12/66
0.1510	22/47 - 13/41	25/59 - 18/66	0.1820	9/39 - 2/41	21/46 - 14/51
0.1515	5/33	10/66	0.1830	5/17 - 2/18	33/58 - 22/57
0.1520	11/41 - 5/43	16/62	0.1837	9/49	9/49
0.1522	...	7/46	0.1840	8/31 - 2/27	19/62 - 6/49
0.1525	...	9/59	0.1842	...	7/38
0.1530	10/27 - 5/23	13/54 - 5/57	0.1850	4/37 + 3/39	14/25 - 9/24
0.1538	6/39	6/39	0.1852	5/27	10/54
0.1540	10/37 - 5/43	5/58 + 4/59	0.1860	1/29 + 5/33	18/47 - 13/66
0.1550	8/37 - 3/49	7/25 - 3/24	0.1860	8/43	8/43
0.1552	...	9/58	0.1864	...	11/59
0.1560	4/21 - 1/29	1/49 + 8/59	0.1870	16/49 - 6/43	24/57 - 11/47
0.1569	...	8/51	0.1875	3/16	...
0.1570	15/47 - 6/37	31/59 - 21/57	0.1880	12/29 - 7/31	30/49 - 28/66
0.1579	3/19	6/38	0.1887	...	10/53
0.1579	...	9/57	0.1890	13/29 - 7/27	23/58 - 11/53
0.1580	3/37 + 3/39	3/34 + 3/43	0.1892	7/37	7/37
0.1590	20/43 - 15/49	3/54 + 6/58	0.1897	...	11/58
0.1600	18/37 - 16/49	4/25	0.1900	10/43 - 2/47	11/25 - 6/24
0.1610	9/39 - 3/43	9/39 - 3/43	0.1905	4/21	8/42

Table 3. (Continued) Accurate Angular Indexing

Part of a Turn	B&S, Becker, Hende, K&T, & Rockford	Cincinnati and LeBlond	Part of a Turn	B&S, Becker, Hende, K&T, & Rockford	Cincinnati and LeBlond
0.1910	17/39 – 12/49	21/57 – 11/62	0.2222	4/18	...
0.1915	9/47	9/47	0.2222	6/27	12/54
0.1920	7/41 + 1/47	12/57 – 1/54	0.2230	15/31 – 6/23	11/46 – 1/62
0.1930	...	11/57	0.2240	5/41 + 5/49	15/38 – 7/41
0.1930	10/19 – 5/15	19/59 – 8/62	0.2241	...	13/58
0.1935	6/31	12/62	0.2245	11/49	11/49
0.1940	7/41 + 1/43	14/43 – 5/38	0.2250	2/16 + 2/20	3/24 + 3/30
0.1950	1/23 + 5/33	8/25 – 3/24	0.2258	7/31	14/62
0.1951	8/41	8/41	0.2260	7/39 + 2/43	2/49 + 10/54
0.1957	...	9/46	0.2264	...	12/53
0.1960	21/49 – 10/43	34/66 – 15/47	0.2270	7/27 – 1/31	14/54 – 2/62
0.1961	...	10/51	0.2273	...	15/66
0.1970	...	13/66	0.2280	11/39 – 2/37	23/49 – 14/58
0.1970	21/39 – 14/41	11/47 – 2/54	0.2281	...	13/57
0.1980	2/29 + 4/31	17/49 – 7/47	0.2290	18/39 – 10/43	29/51 – 18/53
0.1990	5/37 + 3/47	27/59 – 15/58	0.2300	7/37 + 2/49	12/25 – 6/24
0.2000	3/15	5/25	0.2308	9/39	9/39
0.2000	4/20	6/30	0.2310	28/49 – 16/47	26/59 – 13/62
0.2010	11/39 – 3/37	8/49 + 2/53	0.2320	20/41 – 11/43	26/57 – 13/58
0.2020	23/41 – 14/39	23/41 – 14/39	0.2326	10/43	10/43
0.2030	2/37 + 7/47	19/62 – 6/58	0.2330	27/47 – 14/41	25/62 – 8/47
0.2034	...	12/59	0.2333	...	7/30
0.2037	...	11/54	0.2340	24/41 – 13/37	2/54 + 13/66
0.2040	12/47 – 2/39	18/51 – 7/47	0.2340	11/47	11/47
0.2041	10/49	10/49	0.2350	11/27 – 5/29	9/25 – 3/24
0.2050	13/37 – 6/41	3/24 + 2/25	0.2353	4/17	8/34
0.2051	8/39	8/39	0.2353	...	12/51
0.2059	...	7/34	0.2360	10/39 – 1/49	29/66 – 12/59
0.2060	15/43 – 7/49	12/53 – 1/49	0.2368	...	9/38
0.2069	6/29	12/58	0.2370	23/37 – 15/39	23/37 – 15/39
0.2070	19/41 – 10/39	19/41 – 10/39	0.2373	...	14/59
0.2075	...	11/53	0.2380	2/43 + 9/47	34/57 – 19/53
0.2080	15/31 – 8/29	13/58 – 1/62	0.2381	5/21	10/42
0.2083	...	5/24	0.2390	24/43 – 15/47	12/62 + 3/66
0.2090	16/33 – 8/29	8/46 + 2/57	0.2391	...	11/46
0.2093	9/43	9/43	0.2400	3/43 + 8/47	6/25
0.2097	...	13/62	0.2407	...	13/54
0.2100	22/37 – 15/39	6/24 – 1/25	0.2410	19/47 – 8/49	17/47 – 7/58
0.2105	4/19	8/38	0.2414	7/29	14/58
0.2105	...	12/57	0.2419	...	15/62
0.2110	22/41 – 14/43	22/41 – 14/43	0.2420	21/37 – 14/43	12/46 – 1/53
0.2120	2/27 – 4/29	4/54 + 8/58	0.2424	8/33	16/66
0.2121	7/33	14/66	0.2430	29/49 – 15/43	4/47 + 9/57
0.2128	10/47	10/47	0.2432	9/37	9/37
0.2130	23/49 – 10/39	2/30 + 6/41	0.2439	10/41	10/41
0.2140	20/37 – 16/49	12/51 – 1/47	0.2440	13/49 – 1/47	30/53 – 19/59
0.2143	...	6/28	0.2449	12/49	12/49
0.2143	...	9/42	0.2450	13/37 – 5/47	3/24 + 3/25
0.2150	11/43 – 2/49	9/24 – 4/25	0.2453	...	13/53
0.2157	...	11/51	0.2456	...	14/57
0.2160	2/23 + 4/31	25/51 – 17/62	0.2460	20/49 – 6/37	11/37 – 2/39
0.2162	8/37	8/37	0.2470	10/37 – 1/43	29/49 – 20/58
0.2170	11/41 – 2/39	28/59 – 17/66	0.2480	4/23 + 2/27	26/49 – 13/46
0.2174	5/23	10/46	0.2490	10/37 – 1/47	17/43 – 6/41
0.2180	3/31 + 4/33	21/59 – 8/58	0.2500	4/16	6/24
0.2190	11/23 – 7/27	3/47 + 9/58	0.2500	5/20	7/28
0.2195	9/41	9/41	0.2510	2/15 + 2/17	34/66 – 14/53
0.2200	4/41 + 6/49	3/25 + 3/30	0.2520	24/43 – 15/49	22/49 – 13/66
0.2203	...	13/59	0.2530	7/37 + 3/47	11/53 + 3/66
0.2210	18/49 – 6/41	21/47 – 14/62	0.2540	26/49 – 13/47	2/46 + 12/57
0.2220	25/41 – 19/49	7/51 + 5/59	0.2542	...	15/59

Table 3. (Continued) Accurate Angular Indexing

Part of a Turn	B&S, Becker, Hendey, K&T, & Rockford	Cincinnati and LeBlond	Part of a Turn	B&S, Becker, Hendey, K&T, & Rockford	Cincinnati and LeBlond
0.2549	...	13/51	0.2857	...	12/42
0.2550	4/21 + 2/31	9/24 - 3/25	0.2857	...	8/28
0.2553	12/47	12/47	0.2860	20/47 - 6/43	20/58 - 3/51
0.2558	11/43	11/43	0.2870	7/41 + 5/43	20/42 - 7/37
0.2560	13/33 - 4/29	9/47 + 4/62	0.2879	...	19/66
0.2564	10/39	10/39	0.2880	19/43 - 6/39	19/43 - 6/39
0.2570	20/39 - 11/43	8/53 + 7/66	0.2881	...	17/59
0.2576	...	17/66	0.2890	1/21 + 7/29	16/46 - 3/51
0.2580	15/29 - 7/27	24/54 - 11/59	0.2895	...	11/38
0.2581	8/31	16/62	0.2900	23/43 - 12/49	6/24 + 1/25
0.2586	...	15/58	0.2903	9/31	18/62
0.2590	24/49 - 9/39	16/42 - 5/41	0.2910	5/39 + 7/43	7/49 + 8/54
0.2593	7/27	14/54	0.2917	...	7/24
0.2600	20/43 - 8/39	4/25 + 3/30	0.2920	9/39 + 3/49	35/57 - 19/59
0.2609	6/23	12/46	0.2927	12/41	12/41
0.2610	15/33 - 6/31	5/53 + 9/54	0.2930	17/39 - 7/49	28/53 - 12/51
0.2619	...	11/42	0.2931	...	17/58
0.2620	18/37 - 11/49	16/51 - 3/58	0.2940	8/21 - 2/23	14/57 + 3/62
0.2630	13/41 - 2/37	13/46 - 1/51	0.2941	5/17	10/34
0.2632	5/19	10/38	0.2941	...	15/51
0.2632	...	15/57	0.2950	18/37 - 9/47	9/24 - 2/25
0.2640	22/47 - 10/49	22/47 - 10/49	0.2960	21/41 - 8/37	29/57 - 10/47
0.2642	...	14/53	0.2963	8/27	16/54
0.2647	...	9/34	0.2970	3/29 + 6/31	13/47 + 1/49
0.2650	8/37 + 2/41	15/24 - 9/25	0.2973	11/37	11/37
0.2653	13/49	13/49	0.2979	14/47	14/47
0.2660	8/27 - 1/33	28/51 - 15/53	0.2980	11/21 - 7/31	12/37 - 1/38
0.2667	...	8/30	0.2982	...	17/57
0.2670	18/37 - 9/41	19/47 - 7/51	0.2990	19/43 - 7/49	19/43 - 4/28
0.2680	8/18 - 3/17	27/49 - 15/53	0.3000	6/20	9/30
0.2683	11/41	11/41	0.3010	1/41 + 13/47	19/54 - 3/59
0.2690	2/18 + 3/19	6/54 + 9/57	0.3019	...	16/53
0.2700	16/27 - 10/31	13/25 - 6/24	0.3020	7/29 + 2/33	23/62 - 4/58
0.2703	10/37	10/37	0.3023	13/43	13/43
0.2710	2/43 + 11/49	1/28 + 8/34	0.3030	15/39 - 4/49	25/57 - 8/59
0.2712	...	16/59	0.3030	10/33	20/66
0.2720	14/37 - 5/47	17/59 - 1/62	0.3040	16/31 - 7/33	33/59 - 12/47
0.2727	9/33	18/66	0.3043	7/23	14/46
0.2730	1/16 + 4/19	18/34 - 10/39	0.3050	1/31 + 9/33	15/24 - 8/25
0.2740	6/41 + 6/47	26/59 - 9/54	0.3051	...	18/59
0.2742	...	17/62	0.3060	17/31 - 8/33	33/54 - 18/59
0.2745	...	14/51	0.3061	15/49	15/49
0.2750	2/16 + 3/20	5/24 + 2/30	0.3065	...	19/62
0.2759	8/29	16/58	0.3070	18/37 - 7/39	1/53 + 17/59
0.2760	12/31 - 3/27	13/43 - 1/38	0.3077	12/39	12/39
0.2766	13/47	13/47	0.3080	5/41 + 8/43	16/49 - 1/54
0.2770	11/27 - 3/23	18/28 - 15/41	0.3090	1/43 + 14/49	19/30 - 12/37
0.2778	5/18	15/54	0.3095	...	13/42
0.2780	5/23 + 2/33	17/39 - 6/38	0.3100	16/37 - 6/49	14/25 - 6/24
0.2790	16/29 - 9/33	14/47 - 1/53	0.3103	9/29	18/58
0.2791	12/43	12/43	0.3110	3/39 + 11/47	19/46 - 5/49
0.2800	16/49 - 2/43	7/25	0.3120	8/21 - 2/29	2/49 + 16/59
0.2807	...	16/57	0.3125	5/16	...
0.2810	3/39 + 10/49	17/57 - 1/58	0.3130	9/37 + 3/43	4/24 + 6/41
0.2820	5/27 + 3/31	24/66 - 4/49	0.3137	...	16/51
0.2821	11/39	11/39	0.3140	12/27 - 3/23	14/47 + 1/62
0.2826	...	13/46	0.3148	...	17/54
0.2830	14/43 - 2/47	15/53	0.3150	26/41 - 15/47	21/24 - 14/25
0.2840	21/47 - 7/43	37/66 - 13/47	0.3158	...	12/38
0.2850	15/43 - 3/47	3/24 + 4/25	0.3158	...	18/57
0.2857	14/49	14/49	0.3160	6/37 + 6/39	6/34 + 6/43

Table 3. (Continued) Accurate Angular Indexing

Part of a Turn	B&S, Becker, Hendeny, K&T, & Rockford	Cincinnati and LeBlond	Part of a Turn	B&S, Becker, Hendeny, K&T, & Rockford	Cincinnati and LeBlond
0.3170	11/18 – 5/17	34/59 – 14/54	0.3485	...	23/66
0.3171	13/41	13/41	0.3488	15/43	15/43
0.3180	22/37 – 13/47	6/54 + 12/58	0.3490	11/29 – 1/33	2/47 + 19/62
0.3182	...	21/66	0.3500	7/20	6/24 + 3/30
0.3190	6/27 + 3/31	3/34 + 9/39	0.3509	...	20/57
0.3191	15/47	15/47	0.3510	13/27 – 3/23	25/53 – 7/58
0.3200	16/47 – 1/49	8/25	0.3514	13/37	13/37
0.3208	...	17/53	0.3519	...	19/54
0.3210	25/49 – 7/37	10/59 + 10/66	0.3520	4/37 + 10/41	24/62 – 2/57
0.3214	...	9/28	0.3529	6/17	12/34
0.3220	18/39 – 6/43	18/39 – 6/43	0.3529	...	18/51
0.3220	...	19/59	0.3530	4/37 + 12/49	31/59 – 10/58
0.3226	10/31	20/62	0.3540	14/37 – 1/41	22/59 – 1/53
0.3230	21/41 – 7/37	21/41 – 7/37	0.3548	11/31	22/62
0.3235	...	11/34	0.3550	10/43 + 6/49	12/25 – 3/24
0.3240	3/23 + 6/31	21/47 – 7/57	0.3559	...	21/59
0.3243	12/37	12/37	0.3560	5/41 + 11/47	12/49 + 6/54
0.3250	2/16 + 4/20	3/24 + 5/25	0.3570	20/43 – 4/37	20/43 – 4/37
0.3256	14/43	14/43	0.3571	...	10/28
0.3260	21/49 – 4/39	23/59 – 3/47	0.3571	...	15/42
0.3261	...	15/46	0.3580	14/37 – 1/49	38/62 – 13/51
0.3265	16/49	16/49	0.3585	...	19/53
0.3270	24/49 – 7/43	17/58 + 2/59	0.3590	14/39	14/39
0.3276	...	19/58	0.3600	22/47 – 4/37	9/25
0.3280	26/41 – 15/49	15/51 + 2/59	0.3610	9/23 – 1/33	18/46 – 2/66
0.3290	5/21 + 3/33	23/43 – 7/34	0.3617	17/47	17/47
0.3300	4/47 + 12/49	6/24 + 2/25	0.3620	15/27 – 6/31	17/41 – 2/38
0.3310	17/31 – 5/23	23/59 – 3/51	0.3621	...	21/58
0.3320	28/43 – 15/47	30/59 – 9/51	0.3630	23/49 – 5/47	25/53 – 5/46
0.3330	7/43 + 8/47	36/51 – 22/59	0.3636	12/33	24/66
0.3333	5/15	8/24	0.3640	26/47 – 7/37	25/62 – 2/51
0.3333	6/18	10/30	0.3650	28/47 – 9/39	3/24 + 6/25
0.3333	7/21	13/39	0.3659	...	15/41
0.3333	9/27	14/42	0.3660	10/17 – 4/18	13/57 + 8/58
0.3333	11/33	17/51	0.3667	...	11/30
0.3333	13/39	18/54	0.3670	5/27 + 6/33	13/49 + 6/59
0.3333	...	19/57	0.3673	18/49	18/49
0.3333	...	22/66	0.3680	16/31 – 4/27	31/66 – 6/59
0.3340	7/41 + 8/49	29/47 – 15/53	0.3684	7/19	14/38
0.3350	21/37 – 10/43	9/24 – 1/25	0.3684	...	21/57
0.3360	28/41 – 17/49	9/46 + 8/57	0.3690	30/49 – 9/37	21/62 + 2/66
0.3370	2/39 + 14/49	33/57 – 15/62	0.3696	...	17/46
0.3380	10/23 – 3/31	25/62 – 3/46	0.3700	30/47 – 11/41	6/24 + 3/25
0.3387	...	21/62	0.3704	10/27	20/54
0.3390	19/49 – 2/41	20/59	0.3710	32/49 – 11/39	23/62
0.3396	...	18/53	0.3720	2/29 + 10/33	34/57 – 11/49
0.3400	25/49 – 8/47	6/25 + 3/30	0.3721	16/43	16/43
0.3404	16/47	16/47	0.3725	...	19/51
0.3410	12/27 – 3/29	22/46 – 7/51	0.3729	...	22/59
0.3415	14/41	14/41	0.3730	30/47 – 13/49	21/49 – 3/54
0.3420	4/21 + 5/33	25/62 – 3/49	0.3740	32/49 – 12/43	5/46 + 13/49
0.3421	...	13/38	0.3750	6/16	9/24
0.3430	13/23 – 6/27	37/57 – 15/49	0.3760	5/21 + 4/29	11/49 + 10/66
0.3440	2/39 + 12/41	14/54 + 5/59	0.3770	13/37 + 1/39	20/51 – 1/66
0.3448	...	20/58	0.3774	...	20/53
0.3450	2/23 + 8/31	15/24 – 7/25	0.3780	13/27 – 3/29	31/53 – 12/58
0.3460	18/41 – 4/43	18/41 – 4/43	0.3784	14/37	14/37
0.3469	17/49	17/49	0.3788	...	25/66
0.3470	7/31 + 4/33	7/38 + 7/43	0.3790	8/37 + 7/43	8/37 + 7/43
0.3478	8/23	16/46	0.3793	11/29	22/58
0.3480	20/33 – 8/31	31/59 – 11/62	0.3800	20/43 – 4/47	7/25 + 3/30

Table 3. (Continued) Accurate Angular Indexing

Part of a Turn	B&S, Becker, Hendeny, K&T, & Rockford	Cincinnati and LeBlond	Part of a Turn	B&S, Becker, Hendeny, K&T, & Rockford	Cincinnati and LeBlond
0.3810	8/21	16/42	0.4120	18/41 – 1/37	24/53 – 2/49
0.3810	19/47 – 1/43	8/51 + 13/58	0.4130	2/39 + 17/47	19/46
0.3820	25/49 – 5/39	40/62 – 15/57	0.4138	12/29	24/58
0.3824	...	13/34	0.4140	19/39 – 3/41	19/39 – 3/41
0.3830	18/47	18/47	0.4146	17/41	17/41
0.3830	27/43 – 12/49	37/58 – 13/51	0.4150	18/33 – 3/23	9/24 + 1/25
0.3840	27/43 – 10/41	27/43 – 10/41	0.4151	...	22/53
0.3846	15/39	15/39	0.4160	21/39 – 6/49	41/62 – 13/53
0.3850	15/37 – 1/49	15/24 – 6/25	0.4167	...	10/24
0.3860	1/37 + 14/39	22/57	0.4170	26/37 – 14/49	10/38 + 6/39
0.3870	3/17 + 4/19	16/39 – 1/43	0.4180	8/21 + 1/27	16/46 + 4/57
0.3871	12/31	24/62	0.4186	18/43	18/43
0.3878	19/49	19/49	0.4190	18/39 – 2/47	31/46 – 13/51
0.3880	14/41 + 2/43	18/53 + 3/62	0.4194	13/31	26/62
0.3889	7/18	21/54	0.4200	24/49 – 3/43	8/25 + 3/30
0.3890	17/41 – 1/39	24/53 – 3/47	0.4210	1/39 + 17/43	23/49 – 3/62
0.3898	...	23/59	0.4211	8/19	16/38
0.3900	2/23 + 10/33	16/25 – 6/24	0.4211	...	24/57
0.3902	16/41	16/41	0.4220	15/29 – 2/21	3/41 + 15/43
0.3910	14/31 – 2/33	29/66 – 3/62	0.4230	24/43 – 5/37	20/54 + 3/57
0.3913	9/23	18/46	0.4237	...	25/59
0.3920	14/33 – 1/31	17/47 + 2/66	0.4240	4/27 + 8/29	41/62 – 14/59
0.3922	...	20/51	0.4242	14/33	28/66
0.3929	...	11/28	0.4250	6/16 + 1/20	7/24 + 4/30
0.3930	1/39 + 18/49	28/46 – 11/51	0.4255	20/47	20/47
0.3939	13/33	26/66	0.4259	...	23/54
0.3940	3/39 + 13/41	24/53 – 3/51	0.4260	27/41 – 10/43	28/57 – 3/46
0.3947	...	15/38	0.4270	27/39 – 13/49	29/59 – 4/62
0.3950	26/37 – 12/39	13/25 – 3/24	0.4280	12/43 + 7/47	33/57 – 8/53
0.3953	17/43	17/43	0.4286	9/21	12/28
0.3960	4/29 + 8/31	33/47 – 15/49	0.4286	21/49	18/42
0.3962	...	21/53	0.4286	...	21/49
0.3966	...	23/58	0.4290	30/47 – 9/43	21/51 + 1/58
0.3970	25/41 – 10/47	7/57 + 17/62	0.4300	22/43 – 4/49	17/25 – 6/24
0.3980	3/16 + 4/19	28/58 – 5/59	0.4310	11/39 + 7/47	25/58
0.3990	7/39 + 9/41	6/37 + 9/38	0.4314	...	22/51
0.4000	6/15	10/25	0.4320	4/23 + 8/31	28/62 – 1/51
0.4000	8/20	12/30	0.4324	16/37	16/37
0.4010	2/37 + 17/49	27/62 – 2/58	0.4330	5/37 + 14/47	26/42 – 8/43
0.4020	5/43 + 14/49	16/49 + 4/53	0.4333	...	13/30
0.4030	26/49 – 6/47	30/47 – 12/51	0.4340	5/31 + 9/33	23/53
0.4032	...	25/62	0.4348	10/23	20/46
0.4035	...	23/57	0.4350	21/31 – 8/33	14/25 – 3/24
0.4040	11/39 + 5/41	11/39 + 5/41	0.4355	...	27/62
0.4043	19/47	19/47	0.4359	...	17/39
0.4048	...	17/42	0.4360	6/31 + 8/33	42/59 – 16/58
0.4050	29/41 – 13/43	3/24 + 7/25	0.4370	27/39 – 12/47	31/49 – 9/46
0.4054	15/37	15/37	0.4375	7/16	...
0.4060	21/47 – 2/49	17/58 + 7/62	0.4380	13/27 – 1/23	24/57 + 1/59
0.4068	...	24/59	0.4386	...	25/57
0.4070	9/19 – 1/15	7/47 + 16/62	0.4390	18/43 + 1/49	34/59 – 7/51
0.4074	11/27	22/54	0.4390	18/41	18/41
0.4080	16/37 – 1/41	2/54 + 23/62	0.4394	...	29/66
0.4082	20/49	20/49	0.4400	8/41 + 12/49	11/25
0.4090	15/39 + 1/41	15/39 + 1/41	0.4407	...	26/59
0.4091	...	27/66	0.4410	10/37 + 7/41	10/37 + 7/41
0.4100	1/37 + 18/47	6/24 + 4/25	0.4412	...	15/34
0.4103	16/39	16/39	0.4419	19/43	19/43
0.4110	9/41 + 9/47	7/34 + 8/39	0.4420	18/33 – 3/29	34/62 – 5/47
0.4118	7/17	14/34	0.4430	4/39 + 16/47	20/51 + 3/59
0.4118	...	21/51	0.4440	9/41 + 11/49	14/51 + 10/59

Table 3. (Continued) Accurate Angular Indexing

Part of a Turn	B&S, Becker, Hendey, K&T, & Rockford	Cincinnati and LeBlond	Part of a Turn	B&S, Becker, Hendey, K&T, & Rockford	Cincinnati and LeBlond
0.4444	12/27	24/54	0.4737	...	27/57
0.4444	8/18	...	0.4740	9/37 + 9/39	9/34 + 9/43
0.4450	7/37 + 11/43	3/24 + 8/25	0.4746	...	28/59
0.4460	11/23 - 1/31	22/46 - 2/62	0.4750	6/16 + 2/20	9/24 + 3/30
0.4468	21/47	21/47	0.4760	4/43 + 18/47	15/53 + 11/57
0.4470	6/21 + 5/31	14/49 + 10/62	0.4762	10/21	20/42
0.4474	...	17/38	0.4770	26/43 - 6/47	30/47 - 10/62
0.4480	10/41 + 10/49	27/41 - 8/38	0.4780	12/31 + 3/33	24/62 + 6/66
0.4483	13/29	26/58	0.4783	11/23	22/46
0.4490	22/49	22/49	0.4790	22/39 - 4/47	10/53 + 18/62
0.4490	20/39 - 3/47	14/57 + 12/59	0.4800	16/39 + 3/43	12/25
0.4500	9/20	6/24 + 6/30	0.4810	14/41 + 6/43	22/58 + 6/59
0.4510	...	23/51	0.4815	13/27	26/54
0.4510	5/15 + 2/17	42/62 - 12/53	0.4820	33/49 - 9/47	19/46 + 4/58
0.4516	14/31	28/62	0.4828	14/29	28/58
0.4520	14/39 + 4/43	4/49 + 20/54	0.4830	27/39 - 9/43	27/39 - 9/43
0.4524	...	19/42	0.4839	15/31	30/62
0.4528	...	24/53	0.4840	5/37 + 15/43	24/46 - 2/53
0.4530	3/23 + 10/31	16/59 + 12/66	0.4848	16/33	32/66
0.4540	14/27 - 2/31	1/54 + 27/62	0.4850	24/47 - 1/39	3/24 + 9/25
0.4545	15/33	30/66	0.4860	13/43 + 9/49	43/62 - 11/53
0.4550	25/47 - 3/39	9/24 + 2/25	0.4865	18/37	18/37
0.4560	9/37 + 10/47	17/62 + 12/66	0.4870	15/37 + 4/49	26/43 - 4/34
0.4561	...	26/57	0.4872	19/39	19/39
0.4565	...	21/46	0.4878	20/41	20/41
0.4570	4/37 + 15/43	27/39 - 8/34	0.4880	8/29 + 7/33	5/46 + 22/58
0.4576	...	27/59	0.4884	21/43	21/43
0.4580	27/49 - 4/43	20/53 + 5/62	0.4890	28/43 - 6/37	19/47 + 5/59
0.4583	...	11/24	0.4894	23/47	23/47
0.4590	35/49 - 12/47	18/51 + 7/66	0.4898	24/49	24/49
0.4595	17/37	17/37	0.4900	13/21 - 4/31	6/24 + 6/25
0.4600	16/41 + 3/43	9/25 + 3/30	0.4902	...	25/51
0.4610	13/39 + 6/47	22/34 - 8/43	0.4906	...	26/53
0.4615	18/39	18/39	0.4910	15/39 + 5/47	21/46 + 2/58
0.4620	15/47 + 7/49	36/62 - 7/59	0.4912	...	28/57
0.4630	...	25/54	0.4915	...	29/59
0.4630	...	10/46 + 14/57	0.4920	25/37 - 9/49	17/46 + 6/49
0.4631	9/21 + 1/29	...	0.4930	8/41 + 14/47	21/53 + 6/62
0.4634	19/41	19/41	0.4940	33/49 - 7/39	14/46 + 11/58
0.4640	21/43 - 1/41	32/58 - 5/57	0.4950	5/29 + 10/31	9/24 + 3/25
0.4643	...	13/28	0.4960	8/23 + 4/27	20/53 + 7/59
0.4650	21/37 - 4/39	15/24 - 4/25	0.4970	33/47 - 8/39	7/46 + 20/58
0.4651	20/43	20/43	0.4980	20/37 - 2/47	29/41 - 9/43
0.4655	...	27/58	0.4990	26/41 - 5/37	26/41 - 5/37
0.4660	13/41 + 7/47	31/47 - 12/62	0.5000	8/16	12/24
0.4667	7/15	14/30	0.5000	9/18	14/28
0.4670	19/37 - 2/43	25/34 - 11/41	0.5000	10/20	15/30
0.4677	...	29/62	0.5000	...	17/34
0.4680	11/27 + 2/33	3/49 + 24/59	0.5000	...	19/38
0.4681	22/47	22/47	0.5000	...	21/42
0.4690	8/23 + 4/33	35/49 - 13/53	0.5000	...	23/46
0.4694	23/49	23/49	0.5000	...	27/54
0.4697	...	31/66	0.5000	...	29/58
0.4700	19/29 - 5/27	18/25 - 6/24	0.5000	...	31/62
0.4706	8/17	16/34	0.5000	...	33/66
0.4706	...	24/51	0.5010	5/37 + 15/41	37/51 - 11/49
0.4710	12/39 + 8/49	12/47 + 11/51	0.5020	17/37 + 2/47	25/53 + 2/66
0.4717	...	25/53	0.5030	8/39 + 14/47	16/49 + 9/51
0.4720	20/39 - 2/49	31/53 - 7/62	0.5040	5/43 + 19/49	37/66 - 3/53
0.4730	6/39 + 15/47	29/59 - 1/54	0.5050	21/31 - 5/29	15/24 - 3/25
0.4737	9/19	18/38	0.5060	7/39 + 16/49	22/53 + 6/66

Table 3. (Continued) Accurate Angular Indexing

Part of a Turn	B&S, Becker, HendeY, K&T, & Rockford	Cincinnati and LeBlond	Part of a Turn	B&S, Becker, HendeY, K&T, & Rockford	Cincinnati and LeBlond
0.5070	33/47 – 8/41	28/46 – 6/59	0.5370	...	29/54
0.5080	12/37 + 9/49	41/66 – 6/53	0.5370	...	6/51 + 26/62
0.5085	...	30/59	0.5371	17/41 + 6/49	...
0.5088	...	29/57	0.5380	4/18 + 6/19	12/49 + 17/58
0.5090	24/39 – 5/47	27/51 – 1/49	0.5385	21/39	21/39
0.5094	...	27/53	0.5390	26/39 – 6/47	34/51 – 6/47
0.5098	...	26/51	0.5400	25/41 – 3/43	6/25 + 9/30
0.5100	8/21 + 4/31	18/24 – 6/25	0.5405	20/37	20/37
0.5102	25/49	25/49	0.5410	12/47 + 14/49	2/38 + 21/43
0.5106	24/47	24/47	0.5417	...	13/24
0.5110	6/37 + 15/43	26/49 – 1/51	0.5420	4/43 + 22/49	7/46 + 23/59
0.5116	22/43	22/43	0.5424	...	32/59
0.5120	21/29 – 7/33	45/66 – 9/53	0.5430	33/43 – 11/49	22/54 + 8/59
0.5122	21/41	21/41	0.5435	...	25/46
0.5128	20/39	20/39	0.5439	...	31/57
0.5130	22/37 – 4/49	30/54 – 2/47	0.5440	4/37 + 17/39	4/37 + 17/39
0.5135	19/37	19/37	0.5450	3/39 + 22/47	15/24 – 2/25
0.5140	30/43 – 9/49	33/46 – 12/59	0.5455	18/33	36/66
0.5150	1/39 + 23/47	16/25 – 3/24	0.5460	13/27 + 2/31	2/34 + 19/39
0.5152	17/33	34/66	0.5470	21/31 – 3/23	32/49 – 7/66
0.5160	28/43 – 5/37	37/59 – 6/54	0.5472	...	29/53
0.5161	16/31	32/62	0.5476	...	23/42
0.5170	13/39 + 9/49	9/49 + 17/51	0.5480	12/41 + 12/47	25/39 – 4/43
0.5172	15/29	30/58	0.5484	17/31	34/62
0.5180	9/47 + 16/49	31/41 – 10/42	0.5490	10/15 – 2/17	8/47 + 25/66
0.5185	14/27	28/54	0.5490	...	28/51
0.5190	27/41 – 6/43	6/49 + 23/58	0.5500	11/20	6/24 + 9/30
0.5200	3/41 + 21/47	13/25	0.5510	19/39 + 3/47	31/53 – 2/59
0.5210	17/39 + 4/47	41/59 – 8/46	0.5510	...	27/49
0.5217	12/23	24/46	0.5517	16/29	32/58
0.5220	19/31 – 3/33	14/47 + 13/58	0.5520	31/41 – 10/49	29/46 – 4/51
0.5230	17/43 + 6/47	14/49 + 14/59	0.5526	...	21/38
0.5238	11/21	22/42	0.5530	15/21 – 5/31	28/54 + 2/58
0.5240	29/47 – 4/43	32/51 – 6/58	0.5532	26/47	26/47
0.5250	6/16 + 3/20	7/24 + 7/30	0.5540	12/23 + 1/31	12/53 + 19/58
0.5254	...	31/59	0.5550	1/41 + 26/49	17/25 – 3/24
0.5260	28/37 – 9/39	26/46 – 2/51	0.5556	10/18	30/54
0.5263	10/19	20/38	0.5556	15/27	...
0.5263	...	30/57	0.5560	32/41 – 11/49	35/47 – 10/53
0.5270	32/47 – 6/39	6/53 + 24/58	0.5570	22/41 + 1/49	18/49 + 11/58
0.5280	19/39 + 2/49	35/59 – 3/46	0.5580	3/29 + 15/33	7/53 + 23/54
0.5283	...	28/53	0.5581	24/43	24/43
0.5290	18/37 + 2/47	30/53 – 2/54	0.5588	...	19/34
0.5294	9/17	18/34	0.5590	27/37 – 7/41	43/59 – 9/53
0.5294	...	27/51	0.5593	...	33/59
0.5300	5/27 + 10/29	6/24 + 7/25	0.5600	37/49 – 8/41	14/25
0.5303	...	35/66	0.5606	...	37/66
0.5306	26/49	26/49	0.5610	23/41	23/41
0.5310	15/23 – 4/33	24/37 – 4/34	0.5610	4/23 + 12/31	5/51 + 25/54
0.5319	25/47	25/47	0.5614	...	32/57
0.5320	7/27 + 9/33	5/51 + 23/53	0.5620	1/23 + 14/27	9/34 + 11/37
0.5323	...	33/62	0.5625	9/16	...
0.5330	18/37 + 2/43	16/46 + 10/54	0.5630	12/39 + 12/47	22/46 + 5/59
0.5333	8/15	16/30	0.5640	25/33 – 6/31	41/49 – 18/66
0.5340	28/41 – 7/47	37/51 – 9/47	0.5641	22/39	22/39
0.5345	...	31/58	0.5645	...	35/62
0.5349	23/43	23/43	0.5650	10/31 + 8/33	3/24 + 11/25
0.5350	16/37 + 4/39	9/24 + 4/25	0.5652	13/23	26/46
0.5357	...	15/28	0.5660	4/39 + 19/41	9/46 + 20/54
0.5360	1/41 + 22/43	5/49 + 23/53	0.5660	...	30/53
0.5366	22/41	22/41	0.5667	...	17/30

Table 3. (Continued) Accurate Angular Indexing

Part of a Turn	B&S, Becker, Hendey, K&T, & Rockford	Cincinnati and LeBlond	Part of a Turn	B&S, Becker, Hendey, K&T, & Rockford	Cincinnati and LeBlond
0.5670	33/47 – 5/37	25/47 + 2/57	0.5970	6/47 + 23/49	13/58 + 22/59
0.5676	21/37	21/37	0.5980	35/49 – 5/43	16/47 + 17/66
0.5680	23/31 – 4/23	21/47 + 8/66	0.5990	17/37 + 6/43	23/49 + 7/54
0.5686	...	29/51	0.6000	9/15	15/25
0.5690	...	33/58	0.6000	12/20	18/30
0.5690	28/39 – 7/47	42/59 – 7/49	0.6010	32/41 – 7/39	32/41 – 7/39
0.5700	21/43 + 4/49	6/24 + 8/25	0.6020	13/16 – 4/19	20/47 + 9/51
0.5710	9/43 + 17/47	39/57 – 6/53	0.6030	16/41 + 10/47	24/49 + 6/53
0.5714	12/21	16/28	0.6034	...	35/58
0.5714	28/49	24/42	0.6038	...	32/53
0.5714	...	28/49	0.6040	23/31 – 4/29	21/58 + 15/62
0.5720	31/43 – 7/47	40/58 – 6/51	0.6047	...	26/43
0.5730	12/39 + 13/49	23/57 + 10/59	0.6050	11/37 + 12/39	3/24 + 12/25
0.5740	14/41 + 10/43	23/37 – 2/42	0.6053	...	23/38
0.5741	...	31/54	0.6060	28/41 – 3/39	29/54 + 4/58
0.5745	27/47	27/47	0.6061	20/33	40/66
0.5750	3/15 + 6/16	9/24 + 6/30	0.6070	31/49 – 1/39	23/47 + 6/51
0.5758	19/33	38/66	0.6071	...	17/28
0.5760	21/29 – 4/27	24/49 + 5/58	0.6078	...	31/51
0.5763	...	34/59	0.6080	1/31 + 19/33	24/53 + 9/58
0.5770	5/37 + 19/43	32/46 – 7/59	0.6087	14/23	28/46
0.5780	2/21 + 14/29	25/49 + 4/59	0.6090	17/31 + 2/33	40/59 – 4/58
0.5789	11/19	22/38	0.6098	25/41	25/41
0.5789	...	33/57	0.6100	23/33 – 2/23	6/24 + 9/25
0.5790	26/43 – 1/39	38/62 – 2/59	0.6102	...	36/59
0.5800	3/43 + 25/49	12/25 + 3/30	0.6110	1/39 + 24/41	5/28 + 16/37
0.5806	18/31	36/62	0.6111	...	33/54
0.5810	21/39 + 2/47	18/53 + 14/58	0.6120	27/41 – 2/43	29/39 – 5/38
0.5814	25/43	25/43	0.6122	30/49	30/49
0.5820	6/21 + 8/27	23/38 – 1/43	0.6129	19/31	38/62
0.5830	11/37 + 14/49	8/46 + 27/66	0.6130	15/19 – 3/17	1/49 + 32/54
0.5833	...	14/24	0.6140	25/39 – 1/37	36/49 – 7/58
0.5840	18/39 + 6/49	13/57 + 21/59	0.6140	...	35/57
0.5849	...	31/53	0.6150	22/37 + 1/49	9/24 + 6/25
0.5850	3/23 + 15/33	15/24 – 1/25	0.6154	24/39	24/39
0.5854	24/41	24/41	0.6160	10/41 + 16/43	14/53 + 19/54
0.5860	20/39 + 3/41	17/54 + 16/59	0.6170	12/37 + 12/41	5/59 + 33/62
0.5862	17/29	34/58	0.6170	29/47	29/47
0.5870	...	27/46	0.6176	...	21/34
0.5870	30/47 – 2/39	37/53 – 6/54	0.6180	5/39 + 24/49	3/53 + 32/57
0.5880	1/37 + 23/41	28/57 + 6/62	0.6190	1/43 + 28/47	17/53 + 17/57
0.5882	10/17	20/34	0.6190	13/21	26/42
0.5882	...	30/51	0.6200	23/43 + 4/47	8/25 + 9/30
0.5890	32/41 – 9/47	8/46 + 22/53	0.6207	...	36/58
0.5897	23/39	23/39	0.6210	29/37 – 7/43	6/46 + 26/53
0.5900	29/47 – 1/37	18/24 – 4/25	0.6212	...	41/66
0.5909	...	39/66	0.6216	23/37	23/37
0.5910	24/39 – 1/41	40/59 – 4/46	0.6220	14/27 + 3/29	15/53 + 20/59
0.5918	29/49	29/49	0.6226	...	33/53
0.5920	21/37 + 1/41	21/34 – 1/39	0.6230	24/37 – 1/39	24/37 – 1/39
0.5926	16/27	32/54	0.6240	5/29 + 14/31	4/49 + 32/59
0.5930	1/15 + 10/19	22/34 – 2/37	0.6250	10/16	15/24
0.5932	...	35/59	0.6260	12/43 + 17/49	21/46 + 10/59
0.5940	6/29 + 12/31	15/49 + 19/66	0.6270	17/47 + 13/49	24/46 + 6/57
0.5946	22/37	22/37	0.6271	...	37/59
0.5950	12/41 + 13/43	18/25 – 3/24	0.6275	...	32/51
0.5952	...	25/42	0.6279	27/43	27/43
0.5957	28/47	28/47	0.6280	23/33 – 2/29	28/47 + 2/62
0.5960	28/39 – 5/41	15/51 + 16/53	0.6290	11/39 + 17/49	12/54 + 24/59
0.5965	...	34/57	0.6290	...	39/62
0.5968	...	37/62	0.6296	17/27	34/54

Table 3. (Continued) Accurate Angular Indexing

Part of a Turn	B&S, Becker, Hendeny, K&T, & Rockford	Cincinnati and LeBlond	Part of a Turn	B&S, Becker, Hendeny, K&T, & Rockford	Cincinnati and LeBlond
0.6300	11/41 + 17/47	18/24 - 3/25	0.6610	...	39/59
0.6304	...	29/46	0.6613	...	41/62
0.6310	9/37 + 19/49	8/49 + 29/62	0.6620	13/23 + 3/31	36/53 - 1/58
0.6316	12/19	24/38	0.6630	35/49 - 2/39	11/39 + 16/42
0.6316	...	36/57	0.6640	13/41 + 17/49	33/51 + 1/59
0.6320	12/37 + 12/39	12/34 + 12/43	0.6650	16/37 + 10/43	15/24 + 1/25
0.6327	31/49	31/49	0.6660	34/41 - 8/49	21/51 + 15/59
0.6330	13/27 + 5/33	14/51 + 19/53	0.6667	10/15	16/24
0.6333	...	19/30	0.6667	12/18	20/30
0.6340	7/17 + 4/18	25/37 - 1/24	0.6667	14/21	26/39
0.6341	26/41	26/41	0.6667	18/27	28/42
0.6350	9/39 + 19/47	19/25 - 3/24	0.6667	22/33	34/51
0.6360	7/37 + 21/47	12/54 + 24/58	0.6667	26/39	36/54
0.6364	21/33	42/66	0.6667	...	38/57
0.6370	5/47 + 26/49	10/47 + 28/66	0.6667	...	44/66
0.6379	...	37/58	0.6670	24/41 + 4/49	5/51 + 33/58
0.6380	12/27 + 6/31	6/34 + 18/39	0.6680	14/41 + 16/49	11/47 + 23/53
0.6383	30/47	30/47	0.6690	5/23 + 14/31	10/46 + 28/62
0.6390	14/23 + 1/33	28/39 - 3/38	0.6700	37/49 - 4/47	18/24 - 2/25
0.6400	4/37 + 25/47	16/25	0.6710	9/21 + 8/33	15/47 + 19/54
0.6410	...	45/66 - 2/49	0.6720	15/41 + 15//49	7/54 + 32//59
0.6410	25/39	25/39	0.6724	...	39/58
0.6415	...	34/53	0.6730	7/43 + 25//49	42/57 - 3//47
0.6420	23/37 + 1/49	20/59 + 20/66	0.6735	33/49	33/49
0.6429	...	18/28	0.6739	...	31/46
0.6429	...	27/42	0.6740	4/39 + 28/49	21/53 + 15/54
0.6430	41/37 - 20/43	24/51 + 10/58	0.6744	29/43	29/43
0.6440	31/43 - 3/39	31/43 - 3/39	0.6750	10/16 + 1/20	9/24 + 9/30
0.6441	...	38/59	0.6757	25/37	25/37
0.6450	33/43 - 6/49	3/24 + 13/25	0.6760	20/23 - 6/31	43/62 - 1/57
0.6452	20/31	40/62	0.6765	...	23/34
0.6460	23/37 + 1/41	2/47 + 35/58	0.6770	7/37 + 20/41	26/53 + 11/59
0.6470	8/39 + 19/43	24/47 + 9/66	0.6774	21/31	42/62
0.6471	11/17	22/34	0.6780	...	40/59
0.6471	...	33/51	0.6780	21/39 + 6/43	6/49 + 30/54
0.6480	31/41 - 4/37	43/57 - 5/47	0.6786	...	19/28
0.6481	...	35/54	0.6790	7/37 + 24/49	19/51 + 19/62
0.6486	24/37	24/37	0.6792	...	36/53
0.6490	3/23 + 14/27	8/30 + 13/34	0.6800	31/47 + 1/49	17/25
0.6491	...	37/57	0.6809	32/47	32/47
0.6500	13/20	6/24 + 12/30	0.6810	21/27 - 3/31	29/41 - 1/38
0.6510	18/29 + 1/33	25/59 + 15/66	0.6818	...	45/66
0.6512	...	28/43	0.6820	15/37 + 13/47	37/51 - 2/46
0.6515	...	43/66	0.6829	28/41	28/41
0.6520	8/31 + 13/33	46/59 - 6/47	0.6830	5/17 + 7/18	35/57 + 4/58
0.6522	15/23	30/46	0.6840	31/37 - 6/39	13/47 + 22/54
0.6530	24/31 - 4/33	22/54 + 14/57	0.6842	13/19	26/38
0.6531	32/49	32/49	0.6842	...	39/57
0.6540	23/41 + 4/43	34/58 + 4/59	0.6850	15/41 + 15/47	3/24 + 14/25
0.6550	23/31 - 2/23	9/24 + 7/25	0.6852	...	37/54
0.6552	19/29	38/58	0.6860	3/23 + 15/27	19/49 + 17/57
0.6560	29/41 - 2/39	23/24 - 13/43	0.6863	...	35/51
0.6570	10/23 + 6/27	20/46 + 12/54	0.6870	28/37 - 3/43	36/51 - 1/53
0.6579	...	25/38	0.6875	11/16	...
0.6580	10/21 + 6/33	20/34 + 3/43	0.6880	13/21 + 2/29	30/49 + 5/66
0.6585	27/41	27/41	0.6890	36/47 - 3/39	42/53 - 6/58
0.6590	15/27 + 3/29	3/54 + 35/58	0.6897	20/29	40/58
0.6596	31/47	31/47	0.6900	21/37 + 6/49	6/24 + 11/25
0.6600	8/47 + 24/49	9/25 + 9/30	0.6905	...	29/42
0.6604	...	35/53	0.6910	35/49 - 1/43	21/57 + 20/62
0.6610	2/41 + 30/49	34/57 + 4/62	0.6920	35/43 - 5/41	35/43 - 5/41

Table 3. (Continued) Accurate Angular Indexing

Part of a Turn	B&S, Becker, Hendey, K&T, & Rockford	Cincinnati and LeBlond	Part of a Turn	B&S, Becker, Hendey, K&T, & Rockford	Cincinnati and LeBlond
0.6923	27/39	27/39	0.7234	...	34/47
0.6930	19/37 + 7/39	19/37 + 7/39	0.7240	3/27 + 19/31	34/41 - 4/38
0.6935	...	43/62	0.7241	21/29	42/58
0.6939	34/49	34/49	0.7250	2/16 + 12/20	7/24 + 13/30
0.6940	10/23 + 7/27	14/38 + 14/43	0.7255	...	37/51
0.6949	...	41/59	0.7258	...	45/62
0.6950	24/33 - 1/31	9/24 + 8/25	0.7260	34/41 - 6/47	2/49 + 37/54
0.6957	16/23	32/46	0.7270	15/19 - 1/16	14/54 + 29/62
0.6960	15/31 + 7/33	32/47 + 1/66	0.7273	24/33	48/66
0.6970	...	46/66	0.7280	23/37 + 5/47	23/49 + 15/58
0.6970	24/39 + 4/49	24/51 + 12/53	0.7288	...	43/59
0.6977	30/43	30/43	0.7290	38/49 - 2/43	12/47 + 27/57
0.6980	22/29 - 2/33	4/47 + 38/62	0.7297	27/37	27/37
0.6981	...	37/53	0.7300	11/27 + 10/31	6/24 + 12/25
0.6990	34/47 - 1/41	14/58 + 27/59	0.7310	15/37 + 14/43	26/59 + 18/62
0.7000	14/20	21/30	0.7317	30/41	30/41
0.7010	24/43 + 7/49	28/47 + 6/57	0.7320	20/37 + 9/47	26/57 + 16/58
0.7018	...	40/57	0.7330	19/37 + 9/41	39/47 - 6/62
0.7020	10/21 + 7/31	7/37 + 20/39	0.7333	11/15	22/30
0.7021	33/47	33/47	0.7340	6/21 + 13/29	26/49 + 12/59
0.7027	26/37	26/37	0.7347	36/49	36/49
0.7030	25/31 - 3/29	23/58 + 19/62	0.7350	29/37 - 2/41	9/24 + 9/25
0.7037	19/27	38/54	0.7353	...	25/34
0.7040	8/37 + 20/41	47/59 - 5/54	0.7358	...	39/53
0.7050	19/37 + 9/47	15/24 + 2/25	0.7360	25/47 + 10/49	47/59 - 4/66
0.7059	12/17	24/34	0.7368	14/19	28/38
0.7059	...	36/51	0.7368	...	42/57
0.7060	18/37 + 9/41	38/58 + 3/59	0.7370	2/37 + 28/41	13/49 + 25/53
0.7069	...	41/58	0.7380	19/37 + 11/49	31/47 + 4/51
0.7070	6/39 + 26/47	7/30 + 18/38	0.7381	...	31/42
0.7073	29/41	29/41	0.7390	6/31 + 18/33	12/62 + 36/66
0.7080	30/39 - 3/49	13/58 + 30/62	0.7391	17/23	34/46
0.7083	...	17/24	0.7400	8/39 + 23/43	6/25 + 15/30
0.7090	34/39 - 7/43	31/46 + 2/57	0.7407	20/27	40/54
0.7097	22/31	44/62	0.7410	9/39 + 25/49	49/57 - 7/59
0.7100	20/43 + 12/49	18/24 - 1/25	0.7414	...	43/58
0.7105	...	27/38	0.7419	23/31	46/62
0.7110	22/29 - 1/21	33/39 - 5/37	0.7420	17/39 + 15/49	28/51 + 11/57
0.7119	...	42/59	0.7424	...	49/66
0.7120	6/39 + 24/43	31/54 + 8/58	0.7430	19/39 + 11/43	1/53 + 42/58
0.7121	...	47/66	0.7436	...	29/39
0.7130	27/43 + 4/47	17/30 + 6/41	0.7440	4/29 + 20/33	27/49 + 11/57
0.7140	6/43 + 27/47	45/57 - 4/53	0.7442	32/43	32/43
0.7143	15/21	20/28	0.7447	35/47	35/47
0.7143	35/49	30/42	0.7450	17/21 - 2/31	15/24 + 3/25
0.7143	...	35/49	0.7451	...	38/51
0.7150	28/43 + 3/47	21/25 - 3/24	0.7458	...	44/59
0.7160	2/47 + 33/49	25/51 + 14/62	0.7460	13/47 + 23/49	2/59 + 47/66
0.7170	...	38/53	0.7470	23/41 + 8/43	29/49 + 9/58
0.7170	29/43 + 2/47	28/59 + 16/66	0.7480	19/43 + 15/49	10/53 + 33/59
0.7174	...	33/46	0.7490	13/15 - 2/17	36/47 - 1/59
0.7179	28/39	28/39	0.7500	12/16	18/24
0.7180	22/27 - 3/31	21/58 + 21/59	0.7500	15/20	21/28
0.7190	39/49 - 3/39	12/57 + 30/59	0.7510	11/23 + 9/33	39/53 + 1/66
0.7193	...	41/57	0.7520	19/23 - 2/27	39/57 + 4/59
0.7200	2/43 + 33/49	18/25	0.7530	23/39 + 8/49	11/53 + 36/66
0.7209	31/43	31/43	0.7540	6/37 + 29/49	25/46 + 12/57
0.7210	13/29 + 9/33	21/47 + 17/62	0.7544	...	43/57
0.7220	18/23 - 2/33	13/46 + 29/66	0.7547	...	40/53
0.7222	13/18	39/54	0.7550	24/37 + 5/47	21/24 - 3/25
0.7230	6/29 + 16/31	11/46 + 30/62	0.7551	37/49	37/49

Table 3. (Continued) Accurate Angular Indexing

Part of a Turn	B&S, Becker, Hendeny, K&T, & Rockford	Cincinnati and LeBlond	Part of a Turn	B&S, Becker, Hendeny, K&T, & Rockford	Cincinnati and LeBlond
0.7560	1/47 + 36/49	9/47 + 35/62	0.7860	17/37 + 16/49	49/58 - 3/51
0.7561	31/41	31/41	0.7870	10/39 + 26/49	30/37 - 1/42
0.7568	28/37	28/37	0.7872	37/47	37/47
0.7570	15/43 + 20/49	8/53 + 40/66	0.7879	26/33	52/66
0.7576	25/33	50/66	0.7880	6/39 + 26/41	45/51 - 5/53
0.7580	16/37 + 14/43	48/59 - 3/54	0.7890	19/41 + 14/43	37/49 + 2/59
0.7581	...	47/62	0.7895	...	30/38
0.7586	22/29	44/58	0.7895	...	45/57
0.7590	28/47 + 8/49	36/41 - 5/42	0.7900	15/37 + 15/39	18/24 + 1/25
0.7593	...	41/54	0.7903	...	49/62
0.7600	39/47 - 3/43	19/25	0.7907	34/43	34/43
0.7609	...	35/46	0.7910	8/29 + 17/33	7/49 + 35/54
0.7610	19/43 + 15/47	34/51 + 5/53	0.7917	...	19/24
0.7619	16/21	32/42	0.7920	8/29 + 16/31	4/47 + 41/58
0.7620	38/47 - 2/43	16/51 + 26/58	0.7925	...	42/53
0.7627	...	45/59	0.7930	10/39 + 22/41	7/47 + 38/59
0.7630	14/37 + 15/39	36/46 - 1/51	0.7931	23/29	46/58
0.7632	...	29/38	0.7940	28/43 + 7/49	14/57 + 34/62
0.7640	29/39 + 1/49	27/57 + 18/62	0.7941	...	27/34
0.7647	13/17	26/34	0.7949	31/39	31/39
0.7647	...	39/51	0.7950	24/37 + 6/41	21/24 - 2/25
0.7650	16/27 + 5/29	3/24 + 16/25	0.7959	39/49	39/49
0.7660	36/47	36/47	0.7960	2/39 + 35/47	18/37 + 13/42
0.7660	13/37 + 17/41	4/37 + 25/38	0.7963	...	43/54
0.7667	...	23/30	0.7966	...	47/59
0.7670	14/41 + 20/47	31/38 - 2/41	0.7970	40/47 - 2/37	13/53 + 32/58
0.7674	33/43	33/43	0.7980	14/39 + 18/41	33/51 + 8/53
0.7680	21/41 + 11/43	21/41 + 11/43	0.7990	3/37 + 28/39	10/28 + 19/43
0.7690	16/47 + 21/49	15/54 + 28/57	0.8000	12/15	20/25
0.7692	30/39	30/39	0.8000	16/20	24/30
0.7700	14/23 + 5/31	6/24 + 13/25	0.8010	32/37 - 3/47	10/47 + 30/51
0.7710	21/39 + 10/43	48/59 - 2/47	0.8020	27/31 - 2/29	54/62 - 4/58
0.7719	...	44/57	0.8030	18/39 + 14/41	18/39 + 14/41
0.7720	2/37 + 28/39	2/37 + 28/39	0.8030	...	53/66
0.7727	...	51/66	0.8039	...	41/51
0.7730	20/27 + 1/31	1/34 + 29/39	0.8040	10/43 + 28/49	32/49 + 8/53
0.7736	...	41/53	0.8043	...	37/46
0.7740	32/39 - 2/43	32/39 - 2/43	0.8049	33/41	33/41
0.7742	24/31	48/62	0.8050	22/23 - 5/33	3/24 + 17/25
0.7750	6/16 + 8/20	9/24 + 12/30	0.8060	34/41 - 1/43	13/47 + 27/51
0.7755	38/49	38/49	0.8065	50/62	50/62
0.7759	...	45/58	0.8070	5/15 + 9/19	15/58 + 34/62
0.7760	36/41 - 5/49	5/51 + 40/59	0.8070	...	46/57
0.7770	6/23 + 16/31	47/59 - 1/51	0.8080	19/21 - 3/31	22/39 + 10/41
0.7778	14/18	42/54	0.8085	38/47	38/47
0.7778	21/27	...	0.8090	22/39 + 12/49	28/53 + 16/57
0.7780	16/41 + 19/49	41/47 - 5/53	0.8095	...	34/42
0.7790	6/41 + 31/49	49/57 - 5/62	0.8100	33/43 + 2/47	6/24 + 14/25
0.7797	...	46/59	0.8103	...	47/58
0.7800	28/37 + 1/43	17/25 + 3/30	0.8108	30/37	30/37
0.7805	32/41	32/41	0.8110	7/27 + 16/29	34/53 + 10/59
0.7810	12/23 + 7/27	17/57 + 28/58	0.8113	...	43/53
0.7820	28/31 - 4/33	45/49 - 9/66	0.8120	17/29 + 7/31	34/58 + 14/62
0.7826	18/23	36/46	0.8125	13/16	...
0.7830	13/31 + 12/33	23/46 + 15/53	0.8130	6/43 + 33/49	16/24 + 6/41
0.7838	29/37	29/37	0.8136	...	48/59
0.7840	21/23 - 4/31	34/47 + 4/66	0.8140	35/43	35/43
0.7843	...	40/51	0.8140	28/33 - 1/29	14/47 + 32/62
0.7850	32/43 + 2/49	15/24 + 4/25	0.8148	22/27	44/54
0.7857	...	22/28	0.8150	22/47 + 17/49	9/24 + 11/25
0.7857	...	33/42	0.8158	...	31/38

Table 3. (Continued) Accurate Angular Indexing

Part of a Turn	B&S, Becker, Hendeny, K&T, & Rockford	Cincinnati and LeBlond	Part of a Turn	B&S, Becker, Hendeny, K&T, & Rockford	Cincinnati and LeBlond
0.8160	5/37 + 32/47	23/34 + 6/43	0.8478	...	39/46
0.8163	40/49	40/49	0.8480	30/41 + 5/43	31/59 + 20/62
0.8170	12/17 + 2/18	13/54 + 34/59	0.8485	28/33	56/66
0.8180	30/39 + 2/41	33/54 + 12/58	0.8490	13/41 + 25/47	2/47 + 50/62
0.8182	27/33	54/66	0.8491	...	45/53
0.8190	26/37 + 5/43	20/34 + 9/39	0.8500	17/20	18/24 + 3/30
0.8200	28/39 + 5/49	8/25 + 15/30	0.8510	5/21 + 19/31	22/37 + 10/39
0.8205	32/39	32/39	0.8511	40/47	40/47
0.8210	10/21 + 10/29	10/59 + 43/66	0.8519	23/27	46/54
0.8214	...	23/28	0.8520	1/16 + 15/19	55/62 - 2/57
0.8220	18/41 + 18/47	11/57 + 39/62	0.8529	...	29/34
0.8226	...	51/62	0.8530	17/21 + 1/23	19/58 + 31/59
0.8230	34/39 - 2/41	4/49 + 43/58	0.8537	35/41	35/41
0.8235	14/17	28/34	0.8540	15/39 + 23/49	54/62 - 1/59
0.8235	...	42/51	0.8548	...	53/62
0.8240	15/37 + 18/43	19/53 + 27/58	0.8550	19/37 + 14/41	9/24 + 12/25
0.8246	...	47/57	0.8560	24/43 + 14/47	37/53 + 9/57
0.8250	6/16 + 9/20	7/24 + 16/30	0.8570	3/43 + 37/47	51/57 - 2/53
0.8260	4/31 + 23/33	39/62 + 13/66	0.8571	18/21	24/28
0.8261	19/23	38/46	0.8571	42/49	36/42
0.8270	32/41 + 2/43	46/58 + 2/59	0.8571	...	42/49
0.8276	24/29	48/58	0.8580	25/43 + 13/47	38/51 + 7/62
0.8280	35/41 - 1/39	35/41 - 1/39	0.8590	11/27 + 14/31	22/54 + 28/62
0.8290	5/37 + 34/49	10/34 + 23/43	0.8596	...	49/57
0.8293	34/41	34/41	0.8600	1/43 + 41/49	9/25 + 15/30
0.8298	39/47	39/47	0.8605	37/43	37/43
0.8300	17/23 + 3/33	18/24 + 2/25	0.8610	16/37 + 21/49	18/46 + 31/66
0.8302	...	44/53	0.8620	13/37 + 24/47	17/38 + 17/41
0.8305	...	49/59	0.8621	25/29	50/58
0.8310	34/39 - 2/49	39/49 + 2/57	0.8627	...	44/51
0.8320	27/43 + 10/49	27/53 + 20/62	0.8630	38/41 - 3/47	18/46 + 25/53
0.8330	9/37 + 23/39	42/47 - 4/66	0.8636	...	57/66
0.8333	15/18	20/24	0.8640	11/16 + 3/17	56/62 - 2/51
0.8333	...	25/30	0.8644	...	51/59
0.8333	...	35/42	0.8649	32/37	32/37
0.8333	...	45/54	0.8650	4/41 + 33/43	15/24 + 6/25
0.8333	...	55/66	0.8660	10/17 + 5/18	13/57 + 37/58
0.8340	15/23 + 6/33	20/38 + 12/39	0.8667	13/15	26/30
0.8350	43/49 - 2/47	21/24 - 1/25	0.8670	3/21 + 21/29	28/54 + 23/66
0.8360	2/41 + 37/47	32/46 + 8/57	0.8679	...	46/53
0.8367	41/49	41/49	0.8680	36/47 + 5/49	53/59 - 2/66
0.8370	19/29 + 6/33	33/57 + 16/62	0.8684	...	33/38
0.8372	...	36/43	0.8690	40/43 - 3/49	39/47 + 2/51
0.8378	...	31/37	0.8696	20/23	40/46
0.8380	7/39 + 27/41	20/46 + 25/62	0.8700	4/39 + 33/43	18/24 + 3/25
0.8387	26/31	52/62	0.8704	...	47/54
0.8390	30/39 + 3/43	3/49 + 42/54	0.8710	27/31	54/62
0.8400	19/37 + 16/49	21/25	0.8710	17/27 + 7/29	31/51 + 15/57
0.8410	23/43 + 15/49	44/51 - 1/46	0.8718	34/39	34/39
0.8420	34/37 - 3/39	46/49 - 6/62	0.8720	30/37 + 3/49	26/58 + 25/59
0.8421	16/19	32/38	0.8723	41/47	41/47
0.8421	...	48/57	0.8730	15/39 + 21/43	21/49 + 24/54
0.8430	6/37 + 32/47	9/47 + 43/66	0.8740	15/39 + 23/47	5/53 + 46/59
0.8431	...	43/51	0.8750	14/16	21/24
0.8440	17/21 + 1/29	41/54 + 5/59	0.8760	21/23 - 1/27	48/57 + 2/59
0.8448	...	49/58	0.8770	3/37 + 39/49	37/51 + 10/66
0.8450	29/37 + 3/49	3/24 + 18/25	0.8772	...	50/57
0.8460	27/37 + 5/43	22/54 + 25/57	0.8776	43/49	43/49
0.8462	33/39	33/39	0.8780	24/47 + 18/49	31/53 + 17/58
0.8470	5/23 + 17/27	26/38 + 7/43	0.8780	36/41	36/41
0.8475	...	50/59	0.8788	...	58/66

Table 3. (Continued) Accurate Angular Indexing

Part of a Turn	B&S, Becker, Hendey, K&T, & Rockford	Cincinnati and LeBlond	Part of a Turn	B&S, Becker, Hendey, K&T, & Rockford	Cincinnati and LeBlond
0.8790	22/43 + 18/49	52/58 - 1/57	0.9110	31/37 + 3/41	31/37 + 3/41
0.8793	...	51/58	0.9118	...	31/34
0.8800	31/39 + 4/47	22/25	0.9120	26/37 + 9/43	52/43 - 11/37
0.8810	...	37/42	0.9123	...	52/57
0.8810	19/29 + 7/31	8/51 + 42/58	0.9130	2/31 + 28/33	35/62 + 23/66
0.8814	...	52/59	0.9130	21/23	42/46
0.8820	20/37 + 14/41	42/57 + 9/62	0.9138	...	53/58
0.8824	15/17	30/34	0.9140	7/21 + 18/31	42/47 + 1/49
0.8824	...	45/51	0.9149	43/47	43/47
0.8830	27/41 + 11/49	7/51 + 44/59	0.9150	8/17 + 8/18	21/24 + 1/25
0.8837	38/43	38/43	0.9153	...	54/59
0.8840	23/29 + 3/33	37/47 + 6/62	0.9160	35/43 + 5/49	40/53 + 10/62
0.8850	7/23 + 18/31	3/24 + 19/25	0.9167	...	22/24
0.8860	38/41 - 2/49	38/59 + 15/62	0.9170	19/23 + 3/33	29/38 + 6/39
0.8868	...	47/53	0.9180	1/41 + 42/47	39/46 + 4/57
0.8870	28/41 + 10/49	34/51 + 13/59	0.9184	45/49	45/49
0.8871	...	55/62	0.9189	34/37	34/37
0.8880	18/41 + 22/49	28/51 + 20/59	0.9190	14/23 + 9/29	8/46 + 38/51
0.8889	16/18	48/54	0.9194	...	57/62
0.8889	24/27	...	0.9200	28/37 + 8/49	23/25
0.8890	8/41 + 34/49	53/57 - 2/49	0.9210	17/37 + 18/39	23/49 + 28/62
0.8900	39/41 - 3/49	6/24 + 16/25	0.9211	...	35/38
0.8910	29/41 + 9/49	52/57 - 1/47	0.9216	...	47/51
0.8913	...	41/46	0.9220	26/39 + 12/47	10/34 + 27/43
0.8919	33/37	33/37	0.9229	31/37 + 4/47	...
0.8920	19/41 + 21/49	17/47 + 35/66	0.9230	...	29/54 + 22/57
0.8929	...	25/28	0.9231	36/39	36/39
0.8930	27/37 + 8/49	5/46 + 40/51	0.9240	15/41 + 24/43	45/59 + 10/62
0.8936	42/47	42/47	0.9242	...	61/66
0.8939	...	59/66	0.9245	...	49/53
0.8940	27/29 - 1/27	28/49 + 20/62	0.9250	14/16 + 1/20	7/24 + 19/30
0.8947	17/19	34/38	0.9259	25/27	50/54
0.8947	...	51/57	0.9260	17/43 + 26/49	2/51 + 47/53
0.8950	30/41 + 8/49	9/24 + 13/25	0.9268	38/41	38/41
0.8960	20/41 + 20/49	8/47 + 45/62	0.9270	28/37 + 8/47	29/59 + 27/62
0.8966	26/29	52/58	0.9280	3/39 + 40/47	47/57 + 6/58
0.8970	14/43 + 28/49	7/57 + 48/62	0.9286	...	26/28
0.8974	35/39	35/39	0.9286	...	39/42
0.8980	44/49	44/49	0.9290	12/37 + 26/43	16/53 + 37/59
0.8980	1/39 + 41/47	28/57 + 24/59	0.9298	...	53/57
0.8983	...	53/59	0.9300	5/29 + 25/33	6/24 + 17/25
0.8990	8/39 + 34/49	42/51 + 4/53	0.9302	40/43	40/43
0.9000	18/20	27/30	0.9310	25/37 + 12/47	7/30 + 30/43
0.9010	28/29 - 2/31	27/58 + 27/62	0.9310	27/29	54/58
0.9020	20/27 + 5/31	46/51	0.9320	30/39 + 7/43	59/62 + 1/51
0.9020	...	29/53 + 22/62	0.9322	...	55/59
0.9024	37/41	37/41	0.9330	34/39 + 3/49	5/42 + 35/43
0.9030	17/41 + 21/43	17/41 + 21/43	0.9333	14/15	28/30
0.9032	28/31	56/62	0.9340	1/37 + 39/43	56/59 - 1/66
0.9040	17/41 + 23/47	7/53 + 44/57	0.9348	...	43/46
0.9048	19/21	38/42	0.9350	2/39 + 38/43	9/24 + 14/25
0.9050	38/43 + 1/47	15/24 + 7/25	0.9355	29/31	58/62
0.9057	...	48/53	0.9360	15/37 + 26/49	13/58 + 42/59
0.9060	17/43 + 24/47	17/58 + 38/62	0.9362	44/47	44/47
0.9070	39/43	39/43	0.9370	19/21 + 1/31	29/53 + 23/59
0.9070	14/29 + 14/33	7/47 + 47/62	0.9375	15/16	...
0.9074	...	49/54	0.9380	13/39 + 26/43	21/46 + 26/54
0.9080	1/27 + 27/31	29/54 + 23/62	0.9388	46/49	46/49
0.9090	14/37 + 26/49	8/53 + 47/62	0.9390	30/37 + 5/39	30/37 + 5/39
0.9091	30/33	60/66	0.9394	31/33	62/66
0.9100	14/39 + 27/49	18/24 + 4/25	0.9400	35/39 + 2/47	16/25 + 9/30

Table 3. (Continued) Accurate Angular Indexing

Part of a Turn	B&S, Becker, Hendeny, K&T, & Rockford	Cincinnati and LeBlond	Part of a Turn	B&S, Becker, Hendeny, K&T, & Rockford	Cincinnati and LeBlond
0.9410	30/41 + 9/43	25/47 + 27/66	0.9670	9/47 + 38/49	8/34 + 30/41
0.9412	16/17	32/34	0.9677	30/31	60/62
0.9412	...	48/51	0.9680	26/37 + 13/49	2/46 + 49/53
0.9420	15/37 + 22/41	42/47 + 3/62	0.9690	26/39 + 13/43	5/51 + 54/62
0.9430	9/23 + 16/29	12/49 + 37/53	0.9697	32/33	64/66
0.9434	...	50/53	0.9700	12/23 + 13/29	6/24 + 18/25
0.9440	9/43 + 36/49	26/46 + 25/66	0.9706	...	33/34
0.9444	17/18	51/54	0.9710	26/37 + 11/41	14/46 + 34/51
0.9450	37/41 + 2/47	15/24 + 8/25	0.9720	26/43 + 18/49	31/53 + 24/62
0.9459	35/37	35/37	0.9730	36/37	36/37
0.9460	12/39 + 30/47	22/46 + 29/62	0.9730	20/23 + 3/29	26/54 + 29/59
0.9470	33/47 + 12/49	14/49 + 41/62	0.9737	...	37/38
0.9474	18/19	36/38	0.9740	16/21 + 7/33	26/34 + 9/43
0.9474	...	54/57	0.9744	38/39	38/39
0.9480	18/37 + 18/39	11/38 + 27/41	0.9750	10/16 + 7/20	13/24 + 13/30
0.9483	...	55/58	0.9756	40/41	40/41
0.9487	37/39	37/39	0.9760	14/39 + 29/47	10/49 + 44/57
0.9490	1/15 + 15/17	13/47 + 39/58	0.9762	...	41/42
0.9492	...	56/59	0.9767	42/43	42/43
0.9500	19/20	6/24 + 21/30	0.9770	33/37 + 4/47	30/47 + 21/62
0.9510	29/43 + 13/47	41/53 + 11/62	0.9780	25/37 + 13/43	25/37 + 13/43
0.9512	39/41	39/41	0.9783	...	45/46
0.9516	...	59/62	0.9787	46/47	46/47
0.9520	8/43 + 36/47	30/53 + 22/57	0.9790	13/23 + 12/29	10/53 + 49/62
0.9524	20/21	40/42	0.9796	48/49	48/49
0.9530	5/43 + 41/49	16/59 + 45/66	0.9800	23/39 + 16/41	17/25 + 9/30
0.9535	41/43	41/43	0.9804	...	50/51
0.9540	29/37 + 8/47	28/54 + 27/62	0.9810	22/43 + 23/49	51/58 + 6/59
0.9545	...	63/66	0.9811	...	52/53
0.9550	7/39 + 38/49	21/24 + 2/25	0.9815	...	53/54
0.9560	13/37 + 26/43	13/37 + 26/43	0.9820	30/39 + 10/47	19/46 + 33/58
0.9565	22/23	44/46	0.9825	...	56/57
0.9570	14/21 + 9/31	21/47 + 25/49	0.9828	...	57/58
0.9574	45/47	45/47	0.9830	26/41 + 15/43	45/57 + 12/62
0.9580	5/39 + 39/47	20/53 + 36/62	0.9831	...	58/59
0.9583	...	23/24	0.9839	...	61/62
0.9590	21/41 + 21/47	18/51 + 40/66	0.9840	13/37 + 31/49	1/46 + 51/53
0.9592	47/49	47/49	0.9848	...	65/66
0.9600	7/39 + 32/41	24/25	0.9850	6/23 + 21/29	15/24 + 9/25
0.9608	...	49/51	0.9860	16/23 + 9/31	42/53 + 12/62
0.9610	11/23 + 14/29	5/34 + 35/43	0.9870	15/21 + 9/33	13/34 + 26/43
0.9620	28/41 + 12/43	52/59 + 5/62	0.9880	7/39 + 38/47	5/46 + 51/58
0.9623	...	51/53	0.9890	33/39 + 7/49	20/39 + 20/42
0.9630	26/27	52/54	0.9900	10/29 + 20/31	18/24 + 6/25
0.9630	30/43 + 13/49	1/51 + 50/53	0.9910	22/23 + 1/29	21/46 + 31/58
0.9640	21/39 + 20/47	52/57 + 3/58	0.9920	39/41 + 2/49	40/53 + 14/59
0.9643	...	27/28	0.9930	8/23 + 20/31	21/53 + 37/62
0.9649	...	55/57	0.9940	7/23 + 20/29	14/46 + 40/58
0.9650	11/39 + 28/41	3/24 + 21/25	0.9950	35/39 + 4/41	21/24 + 3/25
0.9655	28/29	56/58	0.9960	40/41 + 1/49	43/46 + 3/49
0.9660	13/39 + 31/49	15/39 + 25/43	0.9970	15/23 + 10/29	30/46 + 20/58
0.9661	...	57/59	0.9980	20/41 + 25/49	12/51 + 45/59
0.9667	...	29/30	0.9990	10/41 + 37/49	6/51 + 52/59

Approximate Indexing for Small Angles.—To find *approximate* indexing movements for small angles, such as the remainder from the method discussed in *Angular Indexing* starting on page 2086, on a dividing head with a 40:1 worm-gear ratio, divide 540 by the number of minutes in the angle, and then divide the number of holes in each of the available indexing circles by this quotient. The result that is closest to a whole number is the best approximation of the angle for a simple indexing movement and is the number of holes to be moved in the corresponding circle of holes. If the angle is greater than 9 degrees, the

whole number will be greater than the number of holes in the circle, indicating that one or more full turns of the crank are required. Dividing by the number of holes in the indicated circle of holes will reduce the required indexing movement to the number of full turns, and the remainder will be the number of holes to be moved for the fractional turn. If the angle is less than about 11 minutes, it cannot be indexed by simple indexing with standard B & S plates (the corresponding angle for standard plates on a Cincinnati head is about 8 minutes, and for Cincinnati high number plates, 2.7 minutes. See [Tables 5, 6a, and 6b](#) for indexing movements with Cincinnati standard and high number plates).

Example: An angle of $7^{\circ} 25'$ is to be indexed. Expressed in minutes, it is $445'$ and 540 divided by 445 equals 1.213483 . The indexing circles available on standard B & S plates are 15, 16, 17, 18, 19, 20, 21, 23, 27, 29, 31, 33, 37, 39, 41, 43, 47, and 49. Each of these numbers is divided by 1.213483 and the closest to a whole number is found to be $17 \div 1.213483 = 14.00926$. The best approximation for a simple indexing movement to obtain $7^{\circ} 25'$ is 14 holes on the 17-hole circle.

Differential Indexing.—This method is the same, in principle, as compound indexing (see *Compound Indexing* on page 2080), but differs from the latter in that the index plate is rotated by suitable gearing that connects it to the spiral-head spindle. This rotation or differential motion of the index plate takes place when the crank is turned, the plate moving either in the same direction as the crank or opposite to it, as may be required. The result is that the *actual* movement of the crank, at every indexing, is either greater or less than its movement with relation to the index plate. The differential method makes it possible to obtain almost any division by using only one circle of holes for that division and turning the index crank in one direction, as with plain indexing.

The gears to use for turning the index plate the required amount (when gears are required) are shown by [Tables 4a and 4b](#), *Simple and Differential Indexing with Browne & Sharpe Indexing Plates*, which shows what divisions can be obtained by plain indexing, and when it is necessary to use gears and the differential system. For example, if 50 divisions are required, the 20-hole index circle is used and the crank is moved 16 holes, but no gears are required. For 51 divisions, a 24-tooth gear is placed on the wormshaft and a 48-tooth gear on the spindle. These two gears are connected by two idler gears having 24 and 44 teeth, respectively.

To illustrate the principle of differential indexing, suppose a dividing head is to be geared for 271 divisions. [Table 4b](#) calls for a gear on the wormshaft having 56 teeth, a spindle gear with 72 teeth, and a 24-tooth idler to rotate the index plate in the same direction as the crank. The sector arms should be set to give the crank a movement of 3 holes in the 21-hole circle. If the spindle and the index plate were not connected through gearing, 280 divisions would be obtained by successively moving the crank 3 holes in the 21-hole circle, but the gears cause the index plate to turn in the same direction as the crank at such a rate that, when 271 indexings have been made, the work is turned one complete revolution. Therefore, we have 271 divisions instead of 280, the number being reduced because the total movement of the crank, for each indexing, is equal to the movement relative to the index plate, *plus* the movement of the plate itself when, as here, the crank and plate rotate in the same direction.

If they were rotated in opposite directions, the crank would have a total movement equal to the amount it turned relative to the plate, *minus* the plate's movement. Sometimes it is necessary to use compound gearing to move the index plate the required amount for each turn of the crank. The differential method cannot be used in connection with helical or spiral milling because the spiral head is then geared to the leadscrew of the machine.

Finding Ratio of Gearing for Differential Indexing.—To find the ratio of gearing for differential indexing, first select some approximate number A of divisions either greater or less than the required number N . For example, if the required number N is 67, the approximate number A might be 70. Then, if 40 turns of the index crank are required for 1 revolu-

tion of the spindle, the gearing ratio $R = (A - N) \times 40/A$. If the approximate number A is less than N , the formula is the same as above except that $A - N$ is replaced by $N - A$.

Example: Find the gearing ratio and indexing movement for 67 divisions.

$$\text{If } A = 70, \text{ gearing ratio} = (70 - 67) \times \frac{40}{70} = \frac{12}{7} = \frac{\text{gear on spindle (driver)}}{\text{gear on worm (driven)}}$$

The fraction $12/7$ is raised to obtain a numerator and a denominator to match gears that are available. For example, $12/7 = 48/28$.

Various combinations of gearing and index circles are possible for a given number of divisions. The index numbers and gear combinations in the accompanying **Tables 4a** and **4b** apply to a given series of index circles and gear-tooth numbers. The approximate number A on which any combination is based may be determined by dividing 40 by the fraction representing the indexing movement. For example, the approximate number used for 109 divisions equals $40 \div 6/16$, or $40 \times 16/6 = 106 \frac{2}{3}$. If this approximate number is inserted in the preceding formula, it will be found that the gear ratio is $7/8$, as shown in the table.

Second Method of Determining Gear Ratio: In illustrating a somewhat different method of obtaining the gear ratio, 67 divisions will again be used. If 70 is selected as the approximate number, then $40/70 = 4/7$ or $12/21$ turn of the index crank will be required. If the crank is indexed four-sevenths of a turn, sixty-seven times, it will make $4/7 \times 67 = 38 \frac{2}{7}$ revolutions. This number is $1 \frac{5}{7}$ turns less than the 40 required for one revolution of the work (indicating that the gearing should be arranged to rotate the index plate in the same direction as the index crank to increase the indexing movement). Hence the gear ratio $1 \frac{5}{7} = 12/7$.

To Find the Indexing Movement.—The indexing movement is represented by the fraction $40/A$. For example, if 70 is the approximate number A used in calculating the gear ratio for 67 divisions, then, to find the required movement of the index crank, reduce $40/70$ to any fraction of equal value and having as denominator any number equal to the number of holes available in an index circle.

$$\text{To illustrate, } \frac{40}{70} = \frac{4}{7} = \frac{12}{21} = \frac{\text{number of holes indexed}}{\text{number of holes in index circle}}$$

Use of Idler Gears.—In differential indexing, idler gears are used to rotate the index plate in the same direction as the index crank, thus *increasing* the resulting indexing movement, or to rotate the index plate in the opposite direction, thus *reducing* the resulting indexing movement.

Example 1: If the approximate number A is *greater* than the required number of divisions N , simple gearing will require one idler, and compound gearing, no idler. Index plate and crank rotate in the same direction.

Example 2: If the approximate number A is *less* than the required number of divisions N , simple gearing requires two idlers, and compound gearing, one idler. Index plate and crank rotate in opposite directions.

When Compound Gearing Is Required.—It is sometimes necessary, as shown in the table, to use a train of four gears to obtain the required ratio with the gear-tooth numbers that are available.

Example: Find the gear combination and indexing movement for 99 divisions, assuming that an approximate number A of 100 is used.

$$\text{Ratio} = (100 - 99) \times \frac{40}{100} = \frac{4}{10} = \frac{4 \times 1}{5 \times 2} = \frac{32}{40} \times \frac{28}{56}$$

The final numbers here represent available gear sizes. The gears having 32 and 28 teeth are the drivers (gear on spindle and first gear on stud), and gears having 40 and 56 teeth are

driven (second gear on stud and gear on wormshaft). The indexing movement is represented by the fraction $\frac{40}{100}$, which is reduced to $\frac{2}{5}$, the 20-hole index circle being used here.

Example: Determine the gear combination to use for indexing 53 divisions. If 56 is used as an approximate number (possibly after one or more trial solutions to find an approximate number and resulting gear ratio coinciding with available gears):

$$\text{Gearing ratio} = (56 - 53) \times \frac{40}{56} = \frac{15}{7} = \frac{3 \times 5}{1 \times 7} = \frac{72 \times 40}{24 \times 56}$$

The tooth numbers above the line here represent *gear on spindle* and *first gear on stud*. The tooth numbers below the line represent *second gear on stud* and *gear on wormshaft*.

$$\text{Indexing movement} = \frac{40}{56} = \frac{5}{7} = \frac{5 \times 7}{7 \times 7} = \frac{35 \text{ holes}}{49\text{-hole circle}}$$

To Check the Number of Divisions Obtained with a Given Gear Ratio and Index Movement.—Invert the fraction representing the indexing movement. Let C = this inverted fraction and R = gearing ratio.

Example 1: If simple gearing with one idler, or compound gearing with no idler, is used: number of divisions $N = 40C - RC$.

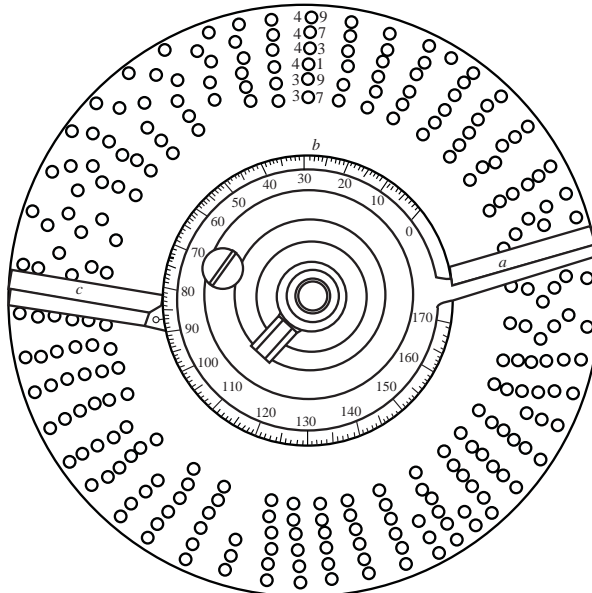
For instance, if the gear ratio is $\frac{12}{7}$, there is simple gearing and one idler, and the indexing movement is $\frac{12}{21}$, making the inverted fraction $C, \frac{21}{12}$; find the number of divisions N .

$$N = \left(40 \times \frac{21}{12}\right) - \left(\frac{12}{7} \times \frac{21}{12}\right) = 70 - \frac{21}{7} = 67$$

Example 2: If simple gearing with two idlers, or compound gearing with one idler, is used: number of divisions $N = 40C + RC$.

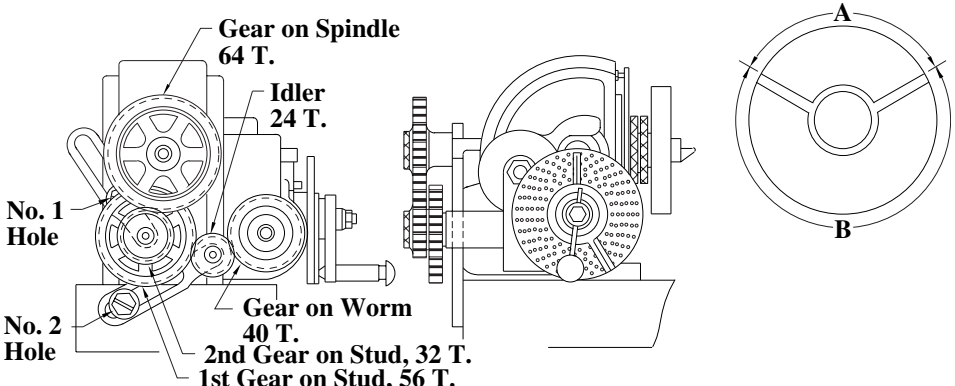
For instance, if the gear ratio is $\frac{7}{8}$, two idlers are used with simple gearing, and the indexing movement is 6 holes in the 16-hole circle, then number of divisions:

$$N = \left(40 \times \frac{16}{6}\right) + \left(\frac{7}{8} \times \frac{16}{6}\right) = 109$$



Sector Graduations

Table 4a. Simple and Differential Indexing with Browne & Sharpe Indexing Plates



Geared for 107 Divisions

No. of Div.	Index Circle	No. of Turns of Crank	Graduation on Sector	No. of Div.	Index Circle	No. of Turns of Crank	Graduation on Sector	Gear on Worm	No. 1 Hole		Gear on Spindle	Idlers	
									First Gear on Stud	Second Gear on Stud		No. 1 Hole	No. 2 Hole
2	Any	20	...	33	33	1 $\frac{1}{3}$	41	<p><i>Note:</i> The data in columns labeled Graduation on Sector refer to a graduated dial that accompanies the sector arms on some dividing heads, page 2106. The graduated sector ring eliminates the requirement of counting holes and thereby lessens the possibility of error. Graduations in table indicate setting for sector arms when index crank moves through arc A, except figures marked *, when crank moves through arc B.</p> <p><i>Differential Indexing</i> Certain divisions such as 51, 53, 57, etc., require the use of differential indexing. In differential indexing, change gears are used to transmit motion from the main spindle of the dividing head to the index plate, which turns (either in the same direction as the index plate or in the opposite direction) whatever amount is required to obtain the correct indexing movement.</p> <p>The numbers in the columns below represent numbers of teeth for the change gears necessary to give the divisions required. Where no numbers are shown simple indexing, which does not require change gears, is used.</p>					
3	39	13 $\frac{13}{39}$	65	34	17	1 $\frac{3}{17}$	33						
4	Any	10	...	35	49	1 $\frac{7}{49}$	26						
5	Any	8	...	36	27	1 $\frac{3}{27}$	21						
6	39	6 $\frac{26}{39}$	132	37	37	1 $\frac{3}{37}$	15						
7	49	5 $\frac{38}{49}$	140	38	19	1 $\frac{1}{19}$	9						
8	Any	5	...	39	39	1 $\frac{1}{39}$	3						
9	27	4 $\frac{12}{27}$	88	40	Any	1	...						
10	Any	4	...	41	41	40/41	3*						
11	33	3 $\frac{21}{33}$	126	42	21	20/21	9*						
12	39	3 $\frac{13}{39}$	65	43	43	40/43	12*						
13	39	3 $\frac{13}{39}$	14	44	33	30/33	17*						
14	49	2 $\frac{42}{49}$	169	45	27	24/27	21*						
15	39	2 $\frac{27}{39}$	132	46	23	20/23	172						
16	20	2 $\frac{10}{20}$	98	47	47	40/47	168						
17	17	2 $\frac{9}{17}$	69	48	18	15/18	165						
18	27	2 $\frac{9}{27}$	43	49	49	40/49	161						
19	19	2 $\frac{7}{19}$	19	50	20	16/20	158						
20	Any	2	...	51	17	14/17	33*						
21	21	1 $\frac{19}{21}$	18*	52	39	30/39	152						
22	33	1 $\frac{27}{33}$	161	53	49	35/49	140						
23	23	1 $\frac{17}{23}$	147	54	27	20/27	147						
24	39	1 $\frac{26}{39}$	132	55	33	24/33	144						
25	20	1 $\frac{12}{20}$	118	56	49	35/49	140						
26	39	1 $\frac{21}{39}$	106	57	21	15/21	142						
27	27	1 $\frac{13}{27}$	95	58	29	20/29	136						
28	49	1 $\frac{21}{49}$	83	59	39	26/39	132						
29	29	1 $\frac{11}{29}$	75	60	39	26/39	132						
30	39	1 $\frac{13}{39}$	65	61	39	26/39	132						
31	31	1 $\frac{1}{31}$	56	62	31	20/31	127						
32	20	1 $\frac{1}{20}$	48	63	39	26/39	132						
								Differential Gears					
24	48	24	44								
...								
56	40	24	72								
...								
...								
56	40	24	44								
...								
48	32	44	...								
...								
48	32	24	44								
...								
24	48	24	44								

**Table 4b. Simple and Differential Indexing
Browne & Sharpe Indexing Plates**

No. of Divisions	Index Circle	No. of Turns of Crank	Graduation on Sector ^a	Gear on Worm	No. 1 Hole		Gear on Spindle	Idlers	
					First Gear on Stud	Second Gear on Stud		No. 1 Hole	No. 2 Hole ^b
64	16	10/16	123
65	39	24/39	121
66	33	20/33	120
67	21	12/21	113	28	48	44	...
68	17	10/17	116
69	20	12/20	118	40	56	24	44
70	49	28/49	112
71	18	10/18	109	72	40	24	...
72	27	15/27	110
73	21	12/21	113	28	48	24	44
74	37	20/37	107
75	15	8/15	105
76	19	10/19	103
77	20	10/20	98	32	48	44	...
78	39	20/39	101
79	20	10/20	98	48	24	44	...
80	20	10/20	98
81	20	10/20	98	48	24	24	44
82	41	20/41	96
83	20	10/20	98	32	48	24	44
84	21	10/21	94
85	17	8/17	92
86	43	20/48	91
87	15	7/15	92	40	24	24	44
88	33	15/33	89
89	18	8/18	87	72	32	44	...
90	27	12/27	88
91	39	18/39	91	24	48	24	44
92	23	10/23	86
93	18	8/18	87	24	32	24	44
94	47	20/47	83
95	19	8/19	82
96	21	9/21	85	28	32	24	44
97	20	8/20	78	40	48	44	...
98	49	20/49	79
99	20	8/20	78	56	28	40	32
100	20	8/20	78
101	20	8/20	78	72	24	40	48	...	24
102	20	8/20	78	40	32	24	44
103	20	8/20	78	40	48	24	44
104	39	15/39	75
105	21	8/21	75
106	43	16/43	73	86	24	24	48
107	20	8/20	78	40	56	32	64	...	24
108	27	10/27	73
109	16	6/16	73	32	28	24	44
110	33	12/33	71
111	39	13/39	65	24	72	32	...
112	39	13/39	65	24	64	44	...
113	39	13/39	65	24	56	44	...
114	39	13/39	65	24	48	44	...
115	23	8/23	68
116	29	10/29	68
117	39	13/39	65	24	24	56	...
118	39	13/39	65	48	32	44	...
119	39	13/39	65	72	24	44	...
120	39	13/39	65
121	39	13/39	65	72	24	24	44
122	39	13/39	65	48	32	24	44
123	39	13/39	65	24	24	24	44
124	31	10/31	63

**Table 4b. (Continued) Simple and Differential Indexing
Browne & Sharpe Indexing Plates**

No. of Divisions	Index Circle	No. of Turns of Crank	Graduation on Sector ^a	Gear on Worm	No. 1 Hole		Gear on Spindle	Idlers	
					First Gear on Stud	Second Gear on Stud		No. 1 Hole	No. 2 Hole ^b
125	39	13/39	65	24	40	24	44
126	39	13/39	65	24	48	24	44
127	39	13/39	65	24	56	24	44
128	16	5/16	61
129	39	13/39	65	24	72	24	44
130	39	12/39	60
131	20	6/20	58	40	28	44	...
132	33	10/33	59
133	21	6/21	56	24	48	44	...
134	21	6/21	56	28	48	44	...
135	27	8/27	58
136	17	5/17	57
137	21	6/21	56	28	24	56	...
138	21	6/21	56	56	32	44	...
139	21	6/21	56	56	32	48	24
140	49	14/49	55
141	18	5/18	54	48	40	44	...
142	21	6/21	56	56	32	24	44
143	21	6/21	56	28	24	24	44
144	18	5/18	54
145	29	8/29	54
146	21	6/21	56	28	48	24	44
147	21	6/21	56	24	48	24	44
148	37	10/37	53
149	21	6/21	56	28	72	24	44
150	15	4/15	52
151	20	5/20	48	32	72	44	...
152	19	5/19	51
153	20	5/20	48	32	56	44	...
154	20	5/20	48	32	48	44	...
155	31	8/31	50
156	39	10/39	50
157	20	5/20	48	32	24	56	...
158	20	5/20	48	48	24	44	...
159	20	5/20	48	64	32	56	28
160	20	5/20	48
161	20	5/20	48	64	32	56	28	...	24
162	20	5/20	48	48	24	24	44
163	20	5/20	48	32	24	24	44
164	41	10/41	47
165	33	8/33	47
166	20	5/20	48	32	48	24	44
167	20	5/20	48	32	56	24	44
168	21	5/21	47
169	20	5/20	48	32	72	24	44
170	17	4/17	45
171	21	5/21	47	56	40	24	44
172	43	10/43	44
173	18	4/18	43	72	56	32	64
174	18	4/18	43	24	32	56	...
175	18	4/18	43	72	40	32	64
176	18	4/18	43	72	24	24	64
177	18	4/18	43	72	48	24	...
178	18	4/18	43	72	32	44	...
179	18	4/18	43	72	24	48	32
180	18	4/18	43
181	18	4/18	43	72	24	48	32	...	24
182	18	4/18	43	72	32	24	44
183	18	4/18	43	48	32	24	44
184	23	5/23	42
185	37	8/37	42

**Table 4b. (Continued) Simple and Differential Indexing
Browne & Sharpe Indexing Plates**

No. of Divisions	Index Circle	No. of Turns of Crank	Graduation on Sector ^a	Gear on Worm	No. 1 Hole		Gear on Spindle	Idlers	
					First Gear on Stud	Second Gear on Stud		No. 1 Hole	No. 2 Hole ^b
186	18	4/18	43	48	64	24	44
187	18	4/18	43	72	48	24	56	...	24
188	47	10/47	40
189	18	4/18	43	32	64	24	44
190	19	4/19	40
191	20	4/20	38	40	72	24	...
192	20	4/20	38	40	64	44	...
193	20	4/20	38	40	56	44	...
194	20	4/20	38	40	48	44	...
195	39	8/39	39
196	49	10/49	38
197	20	4/20	38	40	24	56	...
198	20	4/20	38	56	28	40	32
199	20	4/20	38	100	40	64	32
200	20	4/20	38
201	20	4/20	38	72	24	40	24	...	24
202	20	4/20	38	72	24	40	48	...	24
203	20	4/20	38	40	24	24	44
204	20	4/20	38	40	32	24	44
204	20	4/20	38	40	32	24	44
205	41	8/41	37
206	20	4/20	38	40	48	24	44
207	20	4/20	38	40	56	24	44
208	20	4/20	38	40	64	24	44
209	20	4/20	38	40	72	24	44
210	21	4/21	37
211	16	3/16	36	64	28	44	...
212	43	8/43	35	86	24	24	48
213	27	5/27	36	72	40	44	...
214	20	4/20	38	40	56	32	64	...	24
215	43	8/43	35
216	27	5/27	36
217	21	4/21	37	48	64	24	44
218	16	3/16	36	64	56	24	44
219	21	4/21	37	28	48	24	44
220	33	6/33	35
221	17	3/17	33	24	24	56	...
222	18	3/18	32	24	72	44	...
223	43	8/43	35	86	8	24	64	...	24
224	18	3/18	32	24	64	44	...
225	27	5/27	36	24	40	24	44
226	18	3/18	32	24	56	44	...
227	49	8/49	30	56	64	28	72
228	18	3/18	32	24	48	44	...
229	18	3/18	32	24	44	48	...
230	23	4/23	34
231	18	3/18	32	32	48	44	...
232	29	5/29	33
233	18	3/18	32	48	56	44	...
234	18	3/18	32	24	24	56	...
235	47	8/47	32
236	18	3/18	32	48	32	44	...
237	18	3/18	32	48	24	44	...
238	18	3/18	32	72	24	44	...
239	18	3/18	32	72	24	64	32
240	18	3/18	32
241	18	3/18	32	72	24	64	32	...	24
242	18	3/18	32	72	24	24	44
243	18	3/18	32	64	32	24	44
244	18	3/18	32	48	32	24	44
245	49	8/49	30

**Table 4b. (Continued) Simple and Differential Indexing
Browne & Sharpe Indexing Plates**

No. of Divisions	Index Circle	No. of Turns of Crank	Graduation on Sector ^a	Gear on Worm	No. 1 Hole		Gear on Spindle	Idlers	
					First Gear on Stud	Second Gear on Stud		No. 1 Hole	No. 2 Hole ^b
246	18	3/18	32	24	24	24	44
247	18	3/18	32	48	56	24	44
248	31	5/31	31
249	18	3/18	32	32	48	24	44
250	18	3/18	32	24	40	24	44
251	18	3/18	32	48	44	32	64	...	24
252	18	3/18	32	24	48	24	44
253	33	5/33	29	24	40	56	...
254	18	3/18	32	24	56	24	44
255	18	3/18	32	48	40	24	72	...	24
256	18	3/18	32	24	64	24	44
257	49	8/49	30	56	48	28	64	...	24
258	43	7/43	31	32	64	24	44
259	21	3/21	28	24	72	44	...
260	39	6/39	29
261	29	4/29	26	48	64	24	72
262	20	3/20	28	40	28	44	...
263	49	8/49	30	56	64	28	72	...	24
264	33	5/33	29
265	21	3/21	28	56	40	24	72
266	21	3/21	28	32	64	44	...
267	27	4/27	28	72	32	44	...
268	21	3/21	28	28	48	44	...
269	20	3/20	28	64	32	40	28	...	24
270	27	4/27	28
271	21	3/21	28	56	24	24	72
272	21	3/21	28	56	64	24	...
273	21	3/21	28	24	24	56	...
274	21	3/21	28	56	48	44	...
275	21	3/21	28	56	40	44	...
276	21	3/21	28	56	32	44	...
277	21	3/21	28	56	24	44	...
278	21	3/21	28	56	32	48	24
279	27	4/27	28	24	32	24	44
280	49	7/49	26
281	21	3/21	28	72	24	56	24	...	24
282	43	6/43	26	86	24	24	56
283	21	3/21	28	56	24	24	44
284	21	3/21	28	56	32	24	44
285	21	3/21	28	56	40	24	44
286	21	3/21	28	56	48	24	44
287	21	3/21	28	24	24	24	44
288	21	3/21	28	28	32	24	44
289	21	3/21	28	56	24	24	72	...	24
290	29	4/29	26
291	15	2/15	25	40	48	44	...
292	21	3/21	28	28	48	24	44
293	15	2/15	25	48	32	40	56
294	21	3/21	28	24	48	24	44
295	15	2/15	25	48	32	44	...
296	37	5/37	26
297	33	4/33	23	28	48	24	56
298	21	3/21	28	28	72	24	44
299	23	3/23	25	24	24	56	...
300	15	2/15	25
301	43	6/43	26	24	48	24	44
302	16	2/16	24	32	72	24	...
303	15	2/15	25	72	24	40	48	...	24
304	16	2/16	24	24	48	44	...
305	15	2/15	25	48	32	24	44
306	15	2/15	25	40	32	24	44

**Table 4b. (Continued) Simple and Differential Indexing
Browne & Sharpe Indexing Plates**

No. of Divisions	Index Circle	No. of Turns of Crank	Graduation on Sector ^a	Gear on Worm	No. 1 Hole		Gear on Spindle	Idlers	
					First Gear on Stud	Second Gear on Stud		No. 1 Hole	No. 2 Hole ^b
307	15	2/15	25	72	48	40	56	...	24
308	16	2/16	24	32	48	44	...
309	15	2/15	25	40	48	24	44
310	31	4/31	24
311	16	2/16	24	64	24	24	72
312	39	5/39	24
313	16	2/16	24	32	28	56	...
314	16	2/16	24	32	24	56	...
315	16	2/16	24	64	40	24	...
316	16	2/16	24	64	32	44	...
317	16	2/16	24	64	24	44	...
318	16	2/16	24	56	28	48	24
319	29	4/29	26	48	64	24	72	...	24
320	16	2/16	24
321	16	2/16	24	72	24	64	24	...	24
322	23	3/23	25	32	64	24	44
323	16	2/16	24	64	24	24	44
324	16	2/16	24	64	32	24	44
325	16	2/16	24	64	40	24	44
326	16	2/16	24	32	24	24	44
327	16	2/16	24	32	28	24	44
328	41	5/41	23
329	16	2/16	24	64	24	24	72	...	24
330	33	4/33	23
331	16	2/16	24	64	44	24	48	...	24
332	16	2/16	24	32	48	24	44
333	18	2/18	21	24	72	44	...
334	16	2/16	24	32	56	24	44
335	33	4/33	23	72	48	44	40	...	24
336	16	2/16	24	32	64	24	44
337	43	5/43	21	86	40	32	56
338	16	2/16	24	32	72	24	44
339	18	2/18	21	24	56	44	...
340	17	2/17	22
341	43	5/43	21	86	24	32	40
342	18	2/18	21	32	64	44	...
343	15	2/15	25	40	64	24	86	...	24
344	43	5/43	21
345	18	2/18	21	24	40	56	...
346	18	2/18	21	72	56	32	64
347	43	5/43	21	86	24	32	40	...	24
348	18	2/18	21	24	32	56	...
349	18	2/18	21	72	44	24	48
350	18	2/18	21	72	40	32	64
351	18	2/18	21	24	24	56	...
352	18	2/18	21	72	24	24	64
353	18	2/18	21	72	24	24	56
354	18	2/18	21	72	48	24	...
355	18	2/18	21	72	40	24	...
356	18	2/18	21	72	32	24	...
357	18	2/18	21	72	24	44	...
358	18	2/18	21	72	32	48	24
359	43	5/43	21	86	48	32	100	...	24
360	18	2/18	21
361	19	2/19	19	32	64	44	...
362	18	2/18	21	72	28	56	32	...	24
363	18	2/18	21	72	24	24	44
364	18	2/18	21	72	32	24	44

^a See Note on page 2107.^b On B & S numbers 1, 1½, and 2 machines, number 2 hole is in the machine table. On numbers 3 and 4 machines, number 2 hole is in the head.

**Table 5. Indexing Movements for Standard Index Plate
Cincinnati Milling Machine**

The standard index plate indexes all numbers up to and including 60; all even numbers and those divisible by 5 up to 120; and all divisions listed below up to 400. This plate is drilled on both sides, and has holes as follows: First side: 24, 25, 28, 30, 34, 37, 38, 39, 41, 42, 43. Second side: 46, 47, 49, 51, 53, 54, 57, 58, 59, 62, 66.												
No. of Divisions	Index Plate Circle	No. of Turns	No. of Holes	No. of Divisions	Index Plate Circle	No. of Holes	No. of Divisions	Index Plate Circle	No. of Holes	No. of Divisions	Index Plate Circle	No. of Holes
2	Any	20	...	44	66	60	104	39	15	205	41	8
3	24	13	8	45	54	48	105	42	16	210	42	8
4	Any	10	...	46	46	40	106	53	20	212	53	10
5	Any	8	...	47	47	40	108	54	20	215	43	8
6	24	6	16	48	24	20	110	66	24	216	54	10
7	28	5	20	49	49	40	112	28	10	220	66	12
8	Any	5	...	50	25	20	114	57	20	224	28	5
9	54	4	24	51	51	40	115	46	16	228	57	10
10	Any	4	...	52	39	30	116	58	20	230	46	8
11	66	3	42	53	53	40	118	59	20	232	58	10
12	24	3	8	54	54	40	120	66	22	235	47	8
13	39	3	3	55	66	48	124	62	20	236	59	10
14	49	2	42	56	28	20	125	25	8	240	66	11
15	24	2	16	57	57	40	130	39	12	245	49	8
16	24	2	12	58	58	40	132	66	20	248	62	10
17	34	2	12	59	59	40	135	54	16	250	25	4
18	54	2	12	60	42	28	136	34	10	255	51	8
19	38	2	4	62	62	40	140	28	8	260	39	6
20	Any	2	...	64	24	15	144	54	15	264	66	10
21	42	1	38	65	39	24	145	58	16	270	54	8
22	66	1	54	66	66	40	148	37	10	272	34	5
23	46	1	34	68	34	20	150	30	8	280	28	4
24	24	1	16	70	28	16	152	38	10	290	58	8
25	25	1	15	72	54	30	155	62	16	296	37	5
26	39	1	21	74	37	20	156	39	10	300	30	4
27	54	1	26	75	30	16	160	28	7	304	38	5
28	42	1	18	76	38	20	164	41	10	310	62	8
29	58	1	22	78	39	20	165	66	16	312	39	5
30	24	1	8	80	34	17	168	42	10	320	24	3
31	62	1	18	82	41	20	170	34	8	328	41	5
32	28	1	7	84	42	20	172	43	10	330	66	8
33	66	1	14	85	34	16	176	66	15	336	42	5
34	34	1	6	86	43	20	180	54	12	340	34	4
35	28	1	4	88	66	30	184	46	10	344	43	5
36	54	1	6	90	54	24	185	37	8	360	54	6
37	37	1	3	92	46	20	188	47	10	368	46	5
38	38	1	2	94	47	20	190	38	8	370	37	4
39	39	1	1	95	38	16	192	24	5	376	47	5
40	Any	1	...	96	24	10	195	39	8	380	38	4
41	41	...	40	98	49	20	196	49	10	390	39	4
42	42	...	40	100	25	10	200	30	6	392	49	5
43	43	...	40	102	51	20	204	51	10	400	30	3

**Table 6a. Indexing Movements for High Numbers
Cincinnati Milling Machine**

This set of 3 index plates indexes all numbers up to and including 200; all even numbers and those divisible by 5 up to and including 400. The plates are drilled on each side, making six sides A, B, C, D, E and F. <i>Example:</i> —It is required to index 35 divisions. The preferred side is F, since this requires the least number of holes; but should one of plates D, A or E be in place, either can be used, thus avoiding the changing of plates.														
No. of Divisions	Side	Circle	Turns	Holes	No. of Divisions	Side	Circle	Turns	Holes	No. of Divisions	Side	Circle	Turns	Holes
2	Any	Any	20	15	C	93	2	62	28	D	77	1	33
3	A	30	13	10	15	F	159	2	106	28	A	91	1	39
3	B	36	13	12	16	E	26	2	13	29	E	87	1	33
3	E	42	13	14	16	F	28	2	14	30	A	30	1	10
3	C	93	13	31	16	A	30	2	15	30	B	36	1	12
3	F	159	13	53	16	D	32	2	16	30	E	42	1	14
4	Any	Any	10	16	C	34	2	17	30	C	93	1	31
5	Any	Any	8	16	B	36	2	18	30	F	159	1	53
6	A	30	6	20	17	C	34	2	12	31	C	93	1	27
6	B	36	6	24	17	E	119	2	42	32	F	28	1	7
6	E	42	6	28	17	C	153	2	54	32	D	32	1	8
6	C	93	6	62	17	F	187	2	66	32	B	36	1	9
6	F	159	6	106	18	B	36	2	8	32	A	48	1	12
7	F	28	5	20	18	A	99	2	22	33	A	99	1	21
7	E	42	5	30	18	C	153	2	34	34	C	34	1	6
7	D	77	5	55	19	F	38	2	4	34	E	119	1	21
7	A	91	5	65	19	E	133	2	14	34	F	187	1	33
8	Any	Any	5	19	A	171	2	18	35	F	28	1	4
9	B	36	4	16	20	Any	Any	2	35	D	77	1	11
9	A	99	4	44	21	E	42	1	38	35	A	91	1	13
9	C	153	4	68	21	A	147	1	133	35	E	119	1	17
10	Any	Any	4	22	D	44	1	36	36	B	36	1	4
11	D	44	3	28	22	A	99	1	81	36	A	99	1	11
11	A	99	3	63	22	F	143	1	117	36	C	153	1	17
11	F	143	3	91	23	C	46	1	34	37	B	111	1	9
12	A	30	3	10	23	A	69	1	51	38	F	38	1	2
12	B	36	3	12	23	E	161	1	119	38	E	133	1	7
12	E	42	3	14	24	A	30	1	20	38	A	171	1	9
12	C	93	3	31	24	B	36	1	24	39	A	117	1	3
12	F	159	3	53	24	E	42	1	28	40	Any	Any	1
13	E	26	3	2	24	C	93	1	62	41	C	123	120
13	A	91	3	7	24	F	159	1	106	42	E	42	40
13	F	143	3	11	25	A	30	1	18	42	A	147	140
13	B	169	3	13	25	E	175	1	105	43	A	129	120
14	F	28	2	24	26	F	26	1	14	44	D	44	40
14	E	42	2	36	26	A	91	1	49	44	A	99	90
14	D	77	2	66	26	B	169	1	91	44	F	143	130
14	A	91	2	78	27	B	81	1	39	45	B	36	32
15	A	30	2	20	27	A	189	1	91	45	A	99	88
15	B	36	2	24	28	F	28	1	12	45	C	153	136
15	E	42	2	28	28	E	42	1	18	46	C	46	40

**Table 6b. Indexing Movements for High Numbers
Cincinnati Milling Machine**

No. of Division	Side	Circle	Holes	No. of Divisions	Side	Circle	Holes	No. of Division	Side	Circle	Holes
46	A	69	60	70	E	119	68	96	B	36	15
46	E	161	140	71	F	71	40	96	A	48	20
47	B	141	120	72	B	36	20	97	B	97	40
48	A	30	25	72	A	117	65	98	A	147	60
48	B	36	30	72	C	153	85	99	A	99	40
49	A	147	120	73	E	73	40	100	A	30	12
50	A	30	24	74	B	111	60	100	E	175	70
50	E	175	140	75	A	30	16	101	F	101	40
51	C	153	120	76	F	38	20	102	C	153	60
52	E	26	20	76	E	133	70	103	E	103	40
52	A	91	70	76	A	171	90	104	E	26	10
52	F	143	110	77	D	77	40	104	A	91	35
52	B	169	130	78	A	117	60	104	F	143	55
53	F	159	120	79	C	79	40	104	B	169	65
54	B	81	60	80	E	26	13	105	E	42	16
54	A	189	140	80	F	28	14	105	A	147	56
55	D	44	32	80	A	30	15	106	F	159	60
55	F	143	104	80	D	32	16	107	D	107	40
56	F	28	20	80	C	34	17	108	B	81	30
56	E	42	30	80	B	36	18	108	A	189	70
56	D	77	55	80	E	42	21	109	C	109	40
56	A	91	65	81	B	81	40	110	D	44	16
57	A	171	120	82	C	123	60	110	A	99	36
58	E	87	60	83	F	83	40	110	F	143	52
59	A	177	120	84	E	42	20	111	B	111	40
60	A	30	20	84	A	147	70	112	F	28	10
60	B	36	24	85	C	34	16	112	E	42	15
60	E	42	28	85	E	119	56	113	F	113	40
60	F	159	106	85	F	187	88	114	A	171	60
61	B	183	120	86	A	129	60	115	C	46	16
62	C	93	60	87	E	87	40	115	A	69	24
63	A	189	120	88	D	44	20	115	E	161	56
64	D	32	20	88	A	99	45	116	E	87	30
64	A	48	30	88	F	143	65	117	A	117	40
65	E	26	16	89	D	89	40	118	A	177	60
65	A	91	56	90	B	36	16	119	E	119	40
65	F	143	88	90	A	99	44	120	A	30	10
65	B	169	104	90	C	153	68	120	B	36	12
66	A	99	60	91	A	91	40	120	E	42	14
67	B	67	40	92	C	46	20	120	C	93	31
68	C	34	20	92	A	69	30	120	F	159	53
68	E	119	70	92	E	161	70	121	D	121	40
68	F	187	110	93	C	93	40	122	B	183	60
69	A	69	40	94	B	141	60	123	C	123	40
70	F	28	16	95	F	38	16	124	C	93	30
70	D	42	24	95	E	133	56	125	E	175	56
70	A	91	52	95	A	171	72	126	A	189	60
127	B	127	40	160	A	48	12	198	A	99	20
128	D	32	10	161	E	161	40	199	B	199	40
128	A	48	15	162	B	81	20	200	A	30	6
129	A	129	40	163	D	163	40	200	E	175	35
130	E	26	8	164	C	123	30	202	F	101	20
130	A	91	28	165	A	99	24	204	C	153	30
130	F	143	44	166	F	83	20	205	C	123	24
130	B	169	52	167	C	167	40	206	E	103	20
131	F	131	40	168	E	42	10	208	E	26	5
132	A	99	30	168	A	147	35	210	E	42	8
133	E	133	40	169	B	169	40	210	A	147	28
134	B	67	20	170	C	34	8	212	F	159	30
135	B	81	24	170	E	119	28	214	D	107	20
135	A	189	56	170	F	187	44	215	A	129	24
136	C	34	10	171	A	171	40	216	B	81	15
136	E	119	35	172	A	129	30	216	A	189	35

**Table 6b. (Continued) Indexing Movements for High Numbers
Cincinnati Milling Machine**

No. of Division	Side	Circle	Holes	No. of Divisions	Side	Circle	Holes	No. of Division	Side	Circle	Holes
137	D	137	40	173	F	173	40	218	C	109	20
138	A	69	20	174	E	87	20	220	D	44	8
139	C	139	40	175	E	175	40	220	A	99	18
140	F	28	8	176	D	44	10	220	F	143	26
140	E	42	12	177	A	177	40	222	B	111	20
140	D	77	22	178	D	89	20	224	F	28	5
140	A	91	26	179	D	179	40	226	F	113	20
141	B	141	40	180	B	36	8	228	A	171	30
142	F	71	20	180	A	99	22	230	C	46	8
143	F	143	40	180	C	153	34	230	A	69	12
144	B	36	10	181	C	181	40	230	E	161	28
145	E	87	24	182	A	91	20	232	E	87	15
146	E	73	20	183	B	183	40	234	A	117	20
147	A	147	40	184	C	46	10	235	B	141	24
148	B	111	30	184	A	69	15	236	A	177	30
149	E	149	40	184	E	161	35	238	E	119	20
150	A	30	8	185	B	111	24	240	A	30	5
151	D	151	40	186	C	93	20	240	B	36	6
152	F	38	10	187	F	187	40	240	E	42	7
152	E	133	35	188	B	141	30	240	A	48	8
152	A	171	45	189	A	189	40	242	D	121	20
153	C	153	40	190	F	38	8	244	B	183	30
154	D	77	20	190	E	133	28	245	A	147	24
155	C	93	24	190	A	171	36	246	C	123	20
156	A	117	30	191	E	191	40	248	C	93	15
157	B	157	40	192	A	48	10	250	E	175	28
158	C	79	20	193	D	193	40	252	A	189	30
159	F	159	40	194	B	97	20	254	B	127	20
160	F	28	7	195	A	117	24	255	C	153	24
160	D	32	8	196	A	147	30	256	D	32	5
160	B	36	9	197	C	197	40	258	A	129	20
260	E	26	4	304	F	38	5	354	A	177	20
260	A	91	14	305	B	183	24	355	F	71	8
260	F	143	22	306	C	153	20	356	D	89	10
260	B	169	26	308	D	77	10	358	D	179	20
262	F	131	20	310	C	93	12	360	B	36	4
264	A	99	15	312	A	117	15	360	A	99	11
265	F	159	24	314	B	157	20	360	C	153	17
266	E	133	20	315	A	189	24	362	C	181	20
268	B	67	10	316	C	79	10	364	A	91	10
270	B	81	12	318	F	159	20	365	E	73	8
270	A	189	28	320	D	32	4	366	B	183	20
272	C	34	5	320	A	48	6	368	C	46	5
274	D	137	20	322	E	161	20	370	B	111	12
276	A	69	10	324	B	81	10	372	C	93	10
278	C	139	20	326	D	163	20	374	F	187	20
280	F	28	4	328	C	123	15	376	B	141	15
280	E	42	6	330	A	99	12	378	A	189	20
280	D	77	11	332	F	83	10	380	F	38	4
280	A	91	13	334	C	167	20	380	E	133	14
282	B	141	20	335	B	67	8	380	A	171	18
284	F	71	10	336	E	42	5	382	E	191	20
285	A	171	24	338	B	169	20	384	A	48	5
286	F	143	20	340	C	34	4	385	D	77	8
288	B	36	5	340	E	119	14	386	D	193	20
290	E	87	12	340	F	187	22	388	B	97	10
292	E	73	10	342	A	171	20	390	A	117	12
294	A	147	20	344	A	129	15	392	A	147	15
295	A	177	24	345	A	69	8	394	C	197	20
296	B	111	15	346	F	173	20	395	C	79	8
298	E	149	20	348	E	87	10	396	A	99	10
300	A	30	4	350	E	175	20	398	B	199	20
302	D	151	20	352	D	44	5	400	A	30	3

Indexing Tables.—Indexing tables are usually circular, with a flat, T-slotted table, 12 to 24 in. (30.5–61 cm) in diameter, to which workpieces can be clamped. The flat table surface may be horizontal, universal, or angularly adjustable. The table can be turned continuously through 360° about an axis normal to the surface. Rotation is through a worm drive with a graduated scale, and a means of angular readout is provided. Indexed locations to 0.25° with accuracy of ± 0.1 second can be obtained from mechanical means, or greater accuracy from an autocollimator or sine-angle attachment built into the base, or under numerical control. Provision is made for locking the table at any angular position while a machining operation is being performed.

Power for rotation of the table during machining can be transmitted, as with a dividing head, for cutting a continuous, spiral scroll, for instance. The indexing table is usually more rigid and can be used with larger workpieces than the dividing head.

Block or Multiple Indexing for Gear Cutting.—With the block system of indexing, numbers of teeth are indexed at one time, instead of cutting the teeth consecutively, and the gear is revolved several times before all the teeth are finished. For example, when cutting a gear having 25 teeth, the indexing mechanism is geared to index four teeth at once (see Table 7) and the first time around, six widely separated tooth spaces are cut. The second time around, the cutter is one tooth behind the spaces originally milled. On the third indexing, the cutter has dropped back another tooth, and the gear in question is thus finished by indexing it through four cycles.

The various combinations of change gears to use for block or multiple indexing are given in the accompanying Table 7. The advantage claimed for block indexing is that the heat generated by the cutter (especially when cutting cast iron gears of coarse pitch) is distributed more evenly about the rim and is dissipated to a greater extent, thus avoiding distortion due to local heating and permitting higher speeds and feeds to be used.

Table 7 gives values for use with Brown & Sharpe automatic gear cutting machines, but the gears for any other machine equipped with a similar indexing mechanism can be calculated easily. Assume, for example, that a gear cutter requires the following change gears for indexing a certain number of teeth: driving gears having 20 and 30 teeth, respectively, and driven gears having 50 and 60 teeth.

Then if it is desired to cut, for instance, every fifth tooth, multiply the fractions $20/60$ and $30/50$ by 5. Then $20/60 \times 30/50 \times 5/1 = 1/1$. In this instance, the blank could be divided so that every fifth space was cut, by using gears of equal size. The number of teeth in the gear and the number of teeth indexed in each block must not have a common factor.

Table 7. Block or Multiple Indexing for Gear Cutting

Number of Teeth to be Cut	Number Indexed at Once	1st Driver	1st Follower	2nd Driver	2nd Follower	Turns of Locking Disk	Number of Teeth to be Cut	Number Indexed at Once	1st Driver	1st Follower	2nd Driver	2nd Follower	Turns of Locking Disk
25	4	100	50	72	30	4	36	5	100	48	80	40	4
26	3	100	50	90	52	4	37	5	100	30	90	74	4
27	2	100	50	60	54	4	38	5	100	30	90	76	4
28	3	100	50	90	56	4	39	5	100	30	90	78	4
29	3	100	50	90	58	4	40	3	100	50	90	80	4
30	7	100	30	84	40	4	41	5	100	30	90	82	4
31	3	100	50	90	62	4	42	5	100	30	90	84	4
32	3	100	50	90	64	4	43	5	100	30	90	86	4
33	4	100	50	80	44	4	44	5	100	30	90	88	4
34	3	100	50	90	68	4	45	7	100	50	70	30	4
35	4	100	50	96	56	4	46	5	100	30	90	92	4

Table 7. (Continued) Block or Multiple Indexing for Gear Cutting

Number of Teeth to be Cut	Number Indexed at Once	1st Driver	1st Follower	2nd Driver	2nd Follower	Turns of Locking Disk	Number of Teeth to be Cut	Number Indexed at Once	1st Driver	1st Follower	2nd Driver	2nd Follower	Turns of Locking Disk
47	5	100	30	90	94	4	119	3	100	70	72	68	2
48	5	100	30	90	96	4	120	7	100	50	70	40	2
49	5	100	30	90	98	4	121	4	60	66	96	44	2
50	7	100	50	84	40	4	123	7	100	30	84	82	2
51	4	100	30	96	68	2	124	5	100	60	90	62	2
52	5	100	30	90	52	2	125	7	100	50	84	50	2
54	5	100	30	90	54	2	126	5	100	50	50	42	2
55	4	100	50	96	44	2	128	5	100	60	90	64	2
56	5	100	30	90	56	2	129	7	100	30	84	86	2
57	4	100	30	96	76	2	130	7	100	50	84	52	2
58	5	100	30	90	58	2	132	5	100	88	80	40	2
60	7	100	30	84	40	2	133	4	100	70	96	76	2
62	5	100	30	90	62	2	134	5	100	60	90	67	2
63	5	100	30	80	56	2	135	7	100	50	84	54	2
64	5	100	30	90	64	2	136	5	100	60	90	68	2
65	4	100	50	96	52	2	138	5	100	92	80	40	2
66	5	100	44	80	40	2	140	3	50	50	90	70	2
67	5	100	30	90	67	2	141	5	100	94	80	40	2
68	5	100	30	90	68	2	143	6	90	66	96	52	2
69	5	100	46	80	40	2	144	5	100	60	90	72	2
70	3	100	50	90	70	2	145	6	100	50	72	58	2
72	5	100	30	90	72	2	147	5	100	98	80	40	2
74	5	100	30	90	74	2	148	5	100	60	90	74	2
75	7	100	30	84	50	2	150	7	100	60	84	50	2
76	5	100	30	90	76	2	152	5	100	60	90	76	2
77	4	100	70	96	44	2	153	5	100	68	80	60	2
78	5	100	30	90	78	2	154	5	100	56	72	66	2
80	3	100	50	90	80	2	155	6	100	50	72	62	2
81	7	100	30	84	52	2	156	5	100	60	90	78	2
82	5	100	30	90	82	2	160	7	100	50	84	64	2
84	5	100	30	90	84	2	161	5	100	70	60	46	2
85	4	100	50	96	68	2	162	7	100	60	84	52	2
86	5	100	30	90	86	2	164	5	100	60	90	82	2
87	7	100	30	84	58	2	165	7	100	50	84	66	2
88	5	100	30	90	88	2	168	5	100	60	90	84	2
90	7	100	30	70	50	2	169	6	96	52	90	78	2
91	3	100	70	72	52	2	170	7	100	50	84	68	2
92	5	100	30	90	92	2	171	5	70	42	80	76	2
93	7	100	30	84	62	2	172	5	100	60	90	86	2
94	5	100	30	90	94	2	174	7	100	60	84	58	2
95	4	100	50	96	76	2	175	8	100	50	96	70	2
96	5	100	30	90	96	2	176	5	100	60	90	88	2
98	5	100	30	90	98	2	180	7	100	60	70	50	2
99	10	100	30	80	44	2	182	9	90	56	96	52	2
100	7	100	50	84	40	2	184	5	100	60	90	92	2
102	5	100	30	60	68	2	185	6	100	50	72	74	2
104	5	100	60	90	52	2	186	7	100	60	84	62	2
105	4	100	70	96	60	2	187	5	100	44	48	68	2
108	7	100	30	70	60	2	188	5	100	60	90	94	2
110	7	100	50	84	44	2	189	5	100	60	80	84	2
111	5	100	74	80	40	2	190	7	100	50	84	76	2
112	5	100	60	90	56	2	192	5	100	60	90	96	2
114	7	100	30	84	76	2	195	7	100	50	84	78	2
115	8	100	50	96	46	2	196	5	100	60	90	98	2
116	5	100	60	90	58	2	198	7	100	50	70	66	2
117	8	100	30	96	78	2	200	7	60	60	84	40	2

Table 8. Indexing Movements for 60-Tooth Worm-Wheel Dividing Head

Divisions	Index Circle	No. of Turns	No. of Holes	Divisions	Index Circle	No. of Turns	No. of Holes	Divisions	Index Circle	No. of Holes	Divisions	Index Circle	No. of Holes
2	Any	30	..	50	60	1	12	98	49	30	146	73	30
3	Any	20	..	51	17	1	3	99	33	20	147	49	20
4	Any	15	..	52	26	1	4	100	60	36	148	37	15
5	Any	12	..	53	53	1	7	101	101	60	149	149	60
6	Any	10	..	54	27	1	3	102	17	10	150	60	24
7	21	8	12	55	33	1	3	103	103	60	151	151	60
8	26	7	13	56	28	1	2	104	26	15	152	76	30
9	21	6	14	57	19	1	1	105	21	12	153	51	20
10	Any	6	..	58	29	1	1	106	53	30	154	77	30
11	33	5	15	59	59	1	1	107	107	60	155	31	12
12	Any	5	..	60	Any	1	..	108	27	15	156	26	10
13	26	4	16	61	61	..	60	109	109	60	157	157	60
14	21	4	6	62	31	..	30	110	33	18	158	79	30
15	Any	4	..	63	21	..	20	111	37	20	159	53	20
16	28	3	21	64	32	..	30	112	28	15	160	32	12
17	17	3	9	65	26	..	24	113	113	60	161	161	60
18	21	3	7	66	33	..	30	114	19	10	162	27	10
19	19	3	3	67	67	..	60	115	23	12	163	163	60
20	Any	3	..	68	17	..	15	116	29	15	164	41	15
21	21	2	18	69	23	..	20	117	39	20	165	33	12
22	33	2	24	70	21	..	18	118	59	30	166	83	30
23	23	2	14	71	71	..	60	119	119	60	167	167	60
24	26	2	13	72	60	..	50	120	26	13	168	28	10
25	60	2	24	73	73	..	60	121	121	60	169	169	60
26	26	2	8	74	37	..	30	122	61	30	170	17	6
27	27	2	6	75	60	..	48	123	41	20	171	57	20
28	21	2	3	76	19	..	15	124	31	15	172	43	15
29	29	2	2	77	77	..	60	125	100	48	173	173	60
30	Any	2	..	78	26	..	20	126	21	10	174	29	10
31	31	1	29	79	79	..	60	127	127	60	175	35	12
32	32	1	28	80	28	..	21	128	32	15	176	44	15
33	33	1	27	81	27	..	20	129	43	20	177	59	20
34	17	1	13	82	41	..	30	130	26	12	178	89	30
35	21	1	15	83	83	..	60	131	131	60	179	179	60
36	21	1	14	84	21	..	15	132	33	15	180	21	7
37	37	1	23	85	17	..	12	133	133	60	181	181	60
38	19	1	11	86	43	..	30	134	67	30	182	91	30
39	26	1	14	87	29	..	20	135	27	12	183	61	20
40	26	1	13	88	44	..	30	136	68	30	184	46	15
41	41	1	19	89	89	..	60	137	137	60	185	37	12
42	21	1	9	90	21	..	14	138	23	10	186	31	10
43	43	1	17	91	91	..	60	139	139	60	187	187	60
44	33	1	12	92	23	..	15	140	21	9	188	47	15
45	21	1	7	93	31	..	20	141	47	20	189	63	20
46	23	1	7	94	47	..	30	142	71	30	190	19	6
47	47	1	13	95	19	..	12	143	143	60	191	191	60
48	28	1	7	96	32	..	20	144	60	25	192	32	10
49	49	1	11	97	97	..	60	145	29	12	193	193	60

Linear Indexing for Rack Cutting.—When racks are cut on a milling machine, two general methods of linear indexing are used. One is by using the graduated dial on the feed-screw and the other is by using an indexing attachment. The accompanying Table 9 shows the indexing movements when the first method is employed. This table applies to milling machines having feed-screws with the usual lead of $\frac{1}{4}$ inch (6.35 mm) and 250 dial graduations each equivalent to 0.001 inch (25.4 μ m) of table movement.

$$\text{Actual rotation of feed-screw} = \frac{\text{Linear pitch of rack}}{\text{Lead of feed-screw}}$$

Multiply *decimal* part of turn (obtained by above formula) by 250, to obtain dial reading for fractional part of indexing movement, assuming that dial has 250 graduations.

Table 9. Linear Indexing Movements for Cutting Rack Teeth on a Milling Machine

Pitch of Rack Teeth		Indexing, Movement		Pitch of Rack Teeth		Indexing, Movement	
Diametral Pitch	Linear or Circular	No. of Whole Turns	No. of 0.001 Inch Divisions	Diametral Pitch	Linear or Circular	No. of Whole Turns	No. of 0.001 Inch Divisions
2	1.5708	6	70.8	12	0.2618	1	11.8
2 $\frac{1}{4}$	1.3963	5	146.3	13	0.2417	0	241.7
2 $\frac{1}{2}$	1.2566	5	6.6	14	0.2244	0	224.4
2 $\frac{3}{4}$	1.1424	4	142.4	15	0.2094	0	208.4
3	1.0472	4	47.2	16	0.1963	0	196.3
3 $\frac{1}{2}$	0.8976	3	147.6	17	0.1848	0	184.8
4	0.7854	3	35.4	18	0.1745	0	174.8
5	0.6283	2	128.3	19	0.1653	0	165.3
6	0.5263	2	23.6	20	0.1571	0	157.1
7	0.4488	1	198.8	22	0.1428	0	142.8
8	0.3927	1	142.7	24	0.1309	0	130.9
9	0.3491	1	99.1	26	0.1208	0	120.8
10	0.3142	1	64.2	28	0.1122	0	112.2
11	0.2856	1	35.6	30	0.1047	0	104.7

These movements are for table feed-screws having the usual lead of $\frac{1}{4}$ inch

Note: The linear pitch of the rack equals the circular pitch of gear or pinion which is to mesh with the rack. The table gives both standard diametral pitches and their equivalent linear or circular pitches.

Example: Find indexing movement for cutting rack to mesh with a pinion of 10 diametral pitch.

Indexing movement equals 1 whole turn of feed-screw plus 64.2 thousandths or divisions on feed-screw dial. The feed-screw may be turned this fractional amount by setting dial back to its zero position for each indexing (without backward movement of feed-screw), or, if preferred, 64.2 (in this example) may be added to each successive dial position as shown below.

Dial reading for second position = $64.2 \times 2 = 128.4$ (complete movement = 1 turn \times 64.2 additional divisions by turning feed-screw until dial reading is 128.4).

Third dial position = $64.2 \times 3 = 192.6$ (complete movement = 1 turn + 64.2 additional divisions by turning until dial reading is 192.6).

Fourth position = $64.2 \times 4 - 250 = 6.8$ (1 turn + 64.2 additional divisions by turning feed-screw until dial reading is 6.8 divisions past the zero mark); or, to simplify operation, set dial back to zero for fourth indexing (without moving feed-screw) and then repeat settings for the three previous indexings or whatever number can be made before making a complete turn of the dial.

Counter Milling.—Changing the direction of a linear milling operation by a specific angle requires a linear offset before changing the angle of cut. This compensates for the radius of the milling cutters, as illustrated in Figs. 1a and 1b.

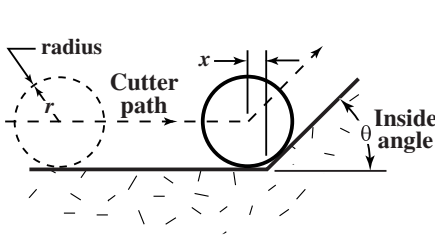


Fig. 1a. Inside Milling

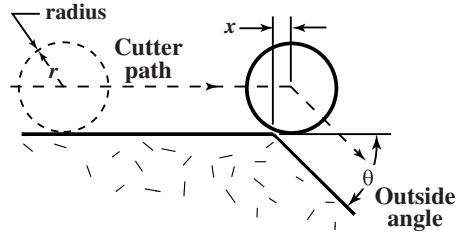


Fig. 1b. Outside Milling

For inside cuts the offset is subtracted from the point at which the cutting direction changes (Fig. 1a), and for outside cuts the offset is added to the point at which the cutting direction changes (Fig. 1b). The formula for the offset is

$$x = rM$$

where x = offset distance; r = radius of the milling cutter; and, M = the multiplication factor ($M = \tan \frac{\theta}{2}$). The value of M for certain angles can be found in Table 10.

Table 10. Offset Multiplication Factors

Deg°	M	Deg°	M	Deg°	M	Deg°	M	Deg°	M
1°	0.00873	19°	0.16734	37°	0.33460	55°	0.52057	73°	0.73996
2°	0.01746	20°	0.17633	38°	0.34433	56°	0.53171	74°	0.75355
3°	0.02619	21°	0.18534	39°	0.35412	57°	0.54296	75°	0.76733
4°	0.03492	22°	0.19438	40°	0.36397	58°	0.55431	76°	0.78129
5°	0.04366	23°	0.20345	41°	0.37388	59°	0.56577	77°	0.79544
6°	0.05241	24°	0.21256	42°	0.38386	60°	0.57735	78°	0.80978
7°	0.06116	25°	0.22169	43°	0.39391	61°	0.58905	79°	0.82434
8°	0.06993	26°	0.23087	44°	0.40403	62°	0.60086	80°	0.83910
9°	0.07870	27°	0.24008	45°	0.41421	63°	0.61280	81°	0.85408
10°	0.08749	28°	0.24933	46°	0.42447	64°	0.62487	82°	0.86929
11°	0.09629	29°	0.25862	47°	0.43481	65°	0.63707	83°	0.88473
12°	0.10510	30°	0.26795	48°	0.44523	66°	0.64941	84°	0.90040
13°	0.11394	31°	0.27732	49°	0.45573	67°	0.66189	85°	0.91633
14°	0.12278	32°	0.28675	50°	0.46631	68°	0.67451	86°	0.93252
15°	0.13165	33°	0.29621	51°	0.47698	69°	0.68728	87°	0.94896
16°	0.14054	34°	0.30573	52°	0.48773	70°	0.70021	88°	0.96569
17°	0.14945	35°	0.31530	53°	0.49858	71°	0.71329	89°	0.98270
18°	0.15838	36°	0.32492	54°	0.50953	72°	0.72654	90°	1.00000

Multiply factor M by the tool radius r to determine the offset dimension

TABLE OF CONTENTS
GEARS, SPLINES, AND CAMS

GEARS AND GEARING	GEARS AND GEARING
2125 Definitions of Gear Terms	2160 Gear Blanks
2129 Sizes and Shape of Gear Teeth	2161 Spur and Helical Gear Data
2129 Nomenclature of Gear Teeth	2163 Backlash
2130 Properties of the Involute Curve	2163 Determining Amount of Backlash
2130 Diametral and Circular Pitch Systems	2164 Helical and Herringbone Gearing
2131 Formulas for Spur Gear	2165 Bevel and Hypoid Gears
2132 Gear Tooth Forms and Parts	2166 Providing Backlash
2134 Gear Tooth Parts	2166 Excess Depth of Cut
2135 Tooth Proportions	2166 Control of Backlash Allowances
2136 Fine Pitch Tooth Parts	2167 Measurement of Backlash
2136 American Spur Gear Standards	2168 Control of Backlash
2137 Formulas for Tooth Parts	2168 Allowance and Tolerance
2137 Fellows Stub Tooth	2169 Angular Backlash in Gears
2137 Basic Gear Dimensions	2169 Inspection of Gears
2138 Formulas for Outside and Root Diameters	2169 Pressure for Fine-Pitch Gears
2141 Tooth Thickness Allowance	2170 Internal Gearing
2141 Circular Pitch for Given Center Distance	2170 Internal Spur Gears
2141 Circular Thickness of Tooth	2170 Methods of Cutting Internal Gears
2145 Chordal Addendum	2170 Formed Cutters for Internal Gears
2146 Addendums and Tooth Thicknesses	2170 Arc Thickness of Gear Tooth
2146 Enlarged Pinion	2170 Arc Thickness of Pinion Tooth
2147 Caliper Measurement of Gear Tooth	2170 Relative Sizes of Internal Gear
2148 Involute Gear Milling Cutter	2171 Rules for Internal Gears
2148 Circular Pitch in Gears	2172 British Standard for Spur and Helical Gears
2148 Increasing Pinion Diameter	2173 Addendum Modification
2150 Finishing Gear Milling Cutters	
2151 Increase in Dedendum	HYPOID AND BEVEL GEARING
2151 Dimensions Required	2176 Hypoid Gears
2152 Tooth Proportions for Pinions	2177 Bevel Gearing
2154 Minimum Number of Teeth	2177 Types of Bevel Gears
2154 Gear to Mesh with Enlarged Pinion	2179 Applications of Bevel and Hypoid Gears
2154 Standard Center-distance	2179 Design of Bevel Gear Blanks
2154 Enlarged Center-distance	2180 Mountings for Bevel Gears
2155 Contact Diameter	2180 Cutting Bevel Gear Teeth
2156 Contact Ratio	2181 Nomenclature for Bevel Gears
2156 Lowest Point of Single Tooth Contact	2181 Formulas for Dimensions
2156 Maximum Hob Tip Radius	2185 Numbers of Formed Cutters
2157 Undercut Limit	2187 Selecting Formed Cutters
2157 Highest Point of Single Tooth Contact	2188 Offset of Cutter
2157 True Involute Form Diameter	2188 Adjusting the Gear Blank
2158 Profile Checker Settings	2189 Circular Thickness, Chordal Thickness
	2190 Steels Used for Bevel Gear

TABLE OF CONTENTS
GEARS, SPLINES, AND CAMS

<p style="text-align: center;">WORM GEARING</p> <p>2191 Standard Design for Fine-pitch 2191 Formulas for Wormgears 2193 Materials for Worm Gearing 2194 Single-thread Worms Gears 2194 Multi-thread Worm Gears 2194 Worm-Gear Cutting</p>	<p style="text-align: center;">CHECKING GEAR SIZES</p> <p>2221 Checking External Spur Gear Sizes 2222 Measurement Over Wires 2226 Checking Internal Spur Gear 2235 Measurements for Checking Helical Gears using Wires 2236 Checking Spur Gear Size 2238 Formula for Chordal Dimension</p>
<p style="text-align: center;">HELICAL GEARING</p> <p>2195 Helical Gear Calculations 2195 Rules and Formulas 2195 Determining Direction of Thrust 2196 Determining Helix Angles 2196 Pitch of Cutter to be Used 2199 Shafts at Right Angles, Center Distance Approximate 2200 Shafts at Right Angles, Center Distance Exact 2203 Shafts at Any Angle, Center Distance Exact 2204 Selecting Cutter for Milling Helical Gears 2205 Factors for Selecting Cutters 2205 Outside and Pitch Diameters 2205 Milling the Helical Teeth 2206 Fine-Pitch Helical Gears 2207 Center Distance with no Backlash 2208 Change-gears for Hobbing 2210 Helical Gear Hobbing 2210 Herringbone Gears 2210 General Classes of Problems</p>	<p style="text-align: center;">GEAR MATERIALS</p> <p>2240 Gearing Material 2240 Classification of Gear Steels 2240 Use of Casehardening Steels 2240 Use of “Thru-Hardening” Steels 2240 Heat-Treatment for Machining 2241 Making Pinion Harder 2241 Forged and Rolled Carbon Steels 2241 Compositions 2241 Forged and Rolled Alloy Steels 2242 Compositions 2242 Steel Castings for Gears 2242 Compositions 2242 Effect of Alloying Metals 2243 Sintered Materials 2243 Steels for Industrial Gearing 2243 Bronze and Brass Gear Castings 2245 Materials for Worm Gearing 2246 Non-metallic Gears 2246 Power-Transmitting Capacity 2246 Safe Working Stresses 2247 Preferred Pitch 2247 Bore Sizes 2247 Preferred Pitches 2247 Keyway Stresses 2248 Invention of Gear Teeth 2249 Calculating Replacement 2249 Spur Gears 2251 Helical Gears</p>
<p style="text-align: center;">OTHER GEAR TYPES</p> <p>2211 Elliptic Gears 2211 Planetary Gearing 2211 Direction of Rotation 2211 Compound Drive 2211 Planetary Bevel Gears 2212 Ratios of Epicyclic Gearing 2215 Ratchet Gearing 2215 Types of Ratchet Gearing 2216 Shape of Ratchet Wheel Teeth 2216 Pitch of Ratchet Wheel Teeth 2217 Module System Gear Design 2217 German Standard Tooth Form 2218 Tooth Dimensions 2219 Rules for Module System 2220 Equivalent Diametral Pitches, Circular Pitches</p>	<p style="text-align: center;">SPLINES AND SERRATIONS</p> <p>2252 Involute Splines 2252 American National Standard 2253 Terms 2254 Types of Involute Spline 2256 Tooth Proportions 2256 Symbols 2257 Formulas for Basic Dimensions 2258 Basic Dimensions 2258 Tooth Numbers</p>

TABLE OF CONTENTS
GEARS, SPLINES, AND CAMS

SPLINES AND SERRATIONS	CAMS AND CAM DESIGN
<i>(Continued)</i>	
2258 Types and Classes of Fits	2284 Classes of Cams
2258 Classes of Tolerances	2284 Cam Follower Systems
2259 Maximum Tolerances	2285 Displacement Diagrams
2260 Fillets and Chamfers	2290 Modified Constant Velocity Cam
2261 Spline Variations	2290 Cam Profile Determination
2261 Effect of Spline Variations	2293 Pressure Angle and Radius of Curvature
2261 Effective and Actual Dimensions	2294 Cam Size for a Radial Follower
2262 Space Width and Tooth Thickness Limits	2296 Cam Size for Swinging Roller Follower
2262 Effective and Actual Dimensions	2297 Formulas for Calculating Pressure Angles
2263 Combinations of Spline Types	2299 Radius of Curvature
2263 Interchangeability	2301 Cam Forces, Contact Stresses, and Materials
2263 Drawing Data	2306 Calculation of Contact Stresses
2265 Spline Data and Reference Dimensions	2307 Layout of Cylinder Cams
2265 Estimating Key and Spline Sizes	2307 Shape of Rolls for Cylinder Cams
2266 Formulas for Torque Capacity	2308 Cam Milling
2267 Spline Application Factors	2309 Cutting Uniform Motion Cams
2267 Load Distribution Factors	
2268 Fatigue-Life Factors	
2268 Wear Life Factors	
2268 Allowable Shear Stresses	
2269 Crowned Splines for Large Misalignments	
2270 Fretting Damage to Splines	
2270 Inspection Methods	
2271 Inspection with Gages	
2271 Measurements with Pins	
2272 Metric Module Splines	
2273 Comparison of Symbols	
2273 Formulas for Dimensions and Tolerances	
2276 Tooth Thickness Modification	
2276 Machining Tolerances	
2276 Tooth Thickness Total Tolerance	
2277 Selected Fit Classes Data	
2278 Straight Splines	
2278 British Standard Straight Splines	
2279 Splines Fittings	
2280 Standard Splined Fittings	
2281 Dimensions of Standard Splines	
2282 Polygon-type Shaft Connections	

GEARS AND GEARING

External spur gears are cylindrical gears with straight teeth cut parallel to the axes. Gears transmit drive between parallel shafts. Tooth loads produce no axial thrust. Excellent at moderate speeds but tend to be noisy at high speeds. Shafts rotate in opposite directions.

Internal spur gears provide compact drive arrangements for transmitting motion between parallel shafts rotating in the same direction.

Helical gears are cylindrical gears with teeth cut at an angle to the axes. Provides drive between shafts rotating in opposite directions, with superior load carrying capacity and quietness than spur gears. Tooth loads produce axial thrust.

Crossed helical gears are helical gears that mesh together on non-parallel axes.

Straight bevel gears have teeth that are radial toward the apex and are of conical form. Designed to operate on intersecting axes, bevel gears are used to connect two shafts on intersecting axes. The angle between the shafts equals the angle between the two axes of the meshing teeth. End thrust developed under load tends to separate the gears.

Spiral bevel gears have curved oblique teeth that contact each other smoothly and gradually from one end of a tooth to the other. Meshing is similar to that of straight bevel gears but is smoother and quieter in use. Left hand spiral teeth incline away from the axis in an anti-clockwise direction looking on small end of pinion or face of gear, right-hand teeth incline away from axis in clockwise direction. The hand of spiral of the pinion is always opposite to that of the gear and is used to identify the hand of the gear pair. Used to connect two shafts on intersecting axes as with straight bevel gears. The spiral angle does not affect the smoothness and quietness of operation or the efficiency but does affect the direction of the thrust loads created. A left-hand spiral pinion driving clockwise when viewed from the large end of the pinion creates an axial thrust that tends to move the pinion out of mesh.

Zerol bevel gears have curved teeth lying in the same general direction as straight bevel teeth but should be considered to be spiral bevel gears with zero spiral angle.

Hypoid bevel gears are a cross between spiral bevel gears and worm gears. The axes of hypoid bevel gears are non-intersecting and non-parallel. The distance between the axes is called the offset. The offset permits higher ratios of reduction than is practicable with other bevel gears. Hypoid bevel gears have curved oblique teeth on which contact begins gradually and continues smoothly from one end of the tooth to the other.

Worm gears are used to transmit motion between shafts at right angles, that do not lie in a common plane and sometimes to connect shafts at other angles. Worm gears have line tooth contact and are used for power transmission, but the higher the ratio the lower the efficiency.

Definitions of Gear Terms.—The following terms are commonly applied to the various classes of gears:

Active face width is the dimension of the tooth face width that makes contact with a mating gear.

Addendum is the radial or perpendicular distance between the pitch circle and the top of the tooth.

Arc of action is the arc of the pitch circle through which a tooth travels from the first point of contact with the mating tooth to the point where contact ceases.

Arc of approach is the arc of the pitch circle through which a tooth travels from the first point of contact with the mating tooth to the pitch point.

Arc of recession is the arc of the pitch circle through which a tooth travels from its contact with a mating tooth at the pitch point until contact ceases.

Axial pitch is the distance parallel to the axis between corresponding sides of adjacent teeth.

Axial plane is the plane that contains the two axes in a pair of gears. In a single gear the axial plane is any plane containing the axis and any given point.

Axial thickness is the distance parallel to the axis between two pitch line elements of the same tooth.

Backlash is the shortest distance between the non-driving surfaces of adjacent teeth when the working flanks are in contact.

Base circle is the circle from which the involute tooth curve is generated or developed.

Base helix angle is the angle at the base cylinder of an involute gear that the tooth makes with the gear axis.

Base pitch is the circular pitch taken on the circumference of the base circles, or the distance along the line of action between two successive and corresponding involute tooth profiles. The *normal base pitch* is the base pitch in the normal plane and the *axial base pitch* is the base pitch in the axial plane.

Base tooth thickness is the distance on the base circle in the plane of rotation between involutes of the same pitch.

Bottom land is the surface of the gear between the flanks of adjacent teeth.

Center distance is the shortest distance between the non-intersecting axes of mating gears, or between the parallel axes of spur gears and parallel helical gears, or the crossed axes of crossed helical gears or worm gears.

Central plane is the plane perpendicular to the gear axis in a worm gear, which contains the common perpendicular of the gear and the worm axes. In the usual arrangement with the axes at right angles, it contains the worm axis.

Chordal addendum is the radial distance from the circular thickness chord to the top of the tooth, or the height from the top of the tooth to the chord subtending the circular thickness arc.

Chordal thickness is the length of the chord subtended by the circular thickness arc. The dimension obtained when a gear tooth caliper is used to measure the tooth thickness at the pitch circle.

Circular pitch is the distance on the circumference of the pitch circle, in the plane of rotation, between corresponding points of adjacent teeth. The length of the arc of the pitch circle between the centers or other corresponding points of adjacent teeth.

Circular thickness is the thickness of the tooth on the pitch circle in the plane of rotation, or the length of arc between the two sides of a gear tooth measured on the pitch circle.

Clearance is the radial distance between the top of a tooth and the bottom of a mating tooth space, or the amount by which the dedendum in a given gear exceeds the addendum of its mating gear.

Contact diameter is the smallest diameter on a gear tooth with which the mating gear makes contact.

Contact ratio is the ratio of the arc of action in the plane of rotation to the circular pitch, and is sometimes thought of as the average number of teeth in contact. This ratio is obtained most directly as the ratio of the length of action to the base pitch.

Contact ratio - face is the ratio of the face advance to the circular pitch in helical gears.

Contact ratio - total is the ratio of the sum of the arc of action and the face advance to the circular pitch.

Contact stress is the maximum compressive stress within the contact area between mating gear tooth profiles. Also called the Hertz stress.

Cycloid is the curve formed by the path of a point on a circle as it rolls along a straight line. When such a circle rolls along the outside of another circle the curve is called an *epicycloid*, and when it rolls along the inside of another circle it is called a *hypocycloid*. These curves are used in defining the former American Standard composite Tooth Form.

Dedendum is the radial or perpendicular distance between the pitch circle and the bottom of the tooth space.

Diametral pitch is the ratio of the number of teeth to the number of inches in the pitch diameter in the plane of rotation, or the number of gear teeth to each inch of pitch diameter. Normal diametral pitch is the diametral pitch as calculated in the normal plane, or the diametral pitch divided by the cosine of the helix angle.

Efficiency is the torque ratio of a gear set divided by its gear ratio.

Equivalent pitch radius is the radius of curvature of the pitch surface at the pitch point in a plane normal to the pitch line element.

Face advance is the distance on the pitch circle that a gear tooth travels from the time pitch point contact is made at one end of the tooth until pitch point contact is made at the other end.

Fillet radius is the radius of the concave portion of the tooth profile where it joins the bottom of the tooth space.

Fillet stress is the maximum tensile stress in the gear tooth fillet.

Flank of tooth is the surface between the pitch circle and the bottom land, including the gear tooth fillet.

Gear ratio is the ratio between the numbers of teeth in mating gears.

Helical overlap is the effective face width of a helical gear divided by the gear axial pitch.

Helix angle is the angle that a helical gear tooth makes with the gear axis at the pitch circle, unless specified otherwise.

Hertz stress, see *Contact stress*.

Highest point of single tooth contact (HPSTC) is the largest diameter on a spur gear at which a single tooth is in contact with the mating gear.

Interference is the contact between mating teeth at some point other than along the line of action.

Internal diameter is the diameter of a circle that coincides with the tops of the teeth of an internal gear.

Internal gear is a gear with teeth on the inner cylindrical surface.

Involute is the curve generally used as the profile of gear teeth. The curve is the path of a point on a straight line as it rolls along a convex base curve, usually a circle.

Land The top land is the top surface of a gear tooth and the *bottom land* is the surface of the gear between the fillets of adjacent teeth.

Lead is the axial advance of the helix in one complete turn, or the distance along its own axis on one revolution if the gear were free to move axially.

Length of action is the distance on an involute line of action through which the point of contact moves during the action of the tooth profile.

Line of action is the portion of the common tangent to the base cylinders along which contact between mating involute teeth occurs.

Lowest point of single tooth contact (LPSTC) is the smallest diameter on a spur gear at which a single tooth is in contact with its mating gear. Gear set contact stress is determined with a load placed on the pinion at this point.

Module is the ratio of the pitch diameter to the number of teeth, normally the ratio of pitch diameter in mm to the number of teeth. Module in the inch system is the ratio of the pitch diameter in inches to the number of teeth.

Normal plane is a plane normal to the tooth surfaces at a point of contact and perpendicular to the pitch plane.

Number of teeth is the number of teeth contained in a gear.

Outside diameter is the diameter of the circle that contains the tops of the teeth of external gears.

Pitch is the distance between similar, equally-spaced tooth surfaces in a given direction along a given curve or line.

Pitch circle is the circle through the pitch point having its center at the gear axis.

Pitch diameter is the diameter of the pitch circle. The operating pitch diameter is the pitch diameter at which the gear operates.

Pitch plane is the plane parallel to the axial plane and tangent to the pitch surfaces in any pair of gears. In a single gear, the pitch plane may be any plane tangent to the pitch surfaces.

Pitch point is the intersection between the axes of the line of centers and the line of action.

Plane of rotation is any plane perpendicular to a gear axis.

Pressure angle is the angle between a tooth profile and a radial line at its pitch point. In involute teeth, the pressure angle is often described as the angle between the line of action and the line tangent to the pitch circle. *Standard pressure angles* are established in connection with standard tooth proportions. A given pair of involute profiles will transmit smooth motion at the same velocity ratio when the center distance is changed. Changes in center distance in gear design and gear manufacturing operations may cause changes in pitch diameter, pitch and pressure angle in the same gears under different conditions. Unless otherwise specified, the pressure angle is the *standard pressure angle at the standard pitch diameter*. The *operating pressure angle* is determined by the center distance at which a pair of gears operate. In oblique teeth such as helical and spiral designs, the pressure angle is specified in the transverse, normal or axial planes.

Principle reference planes are pitch plane, axial plane and transverse plane, all intersecting at a point and mutually perpendicular.

Rack: A rack is a gear with teeth spaced along a straight line, suitable for straight line motion. A basic rack is a rack that is adopted as the basis of a system of interchangeable gears. Standard gear tooth dimensions are often illustrated on an outline of a basic rack.

Roll angle is the angle subtended at the center of a base circle from the origin of an involute to the point of tangency of a point on a straight line from any point on the same involute. The radian measure of this angle is the tangent of the pressure angle of the point on the involute.

Root diameter is the diameter of the circle that contains the roots or bottoms of the tooth spaces.

Tangent plane is a plane tangent to the tooth surfaces at a point or line of contact.

Tip relief is an arbitrary modification of a tooth profile where a small amount of material is removed from the involute face of the tooth surface near the tip of the gear tooth.

Tooth face is the surface between the pitch line element and the tooth tip.

Tooth surface is the total tooth area including the flank of the tooth and the tooth face.

Total face width is the dimensional width of a gear blank and may exceed the effective face width as with a double-helical gear where the total face width includes any distance separating the right-hand and left-hand helical gear teeth.

Transverse plane is a plane that is perpendicular to the axial plane and to the pitch plane. In gears with parallel axes, the transverse plane and the plane of rotation coincide.

Trochoid is the curve formed by the path of a point on the extension of a radius of a circle as it rolls along a curve or line. A trochoid is also the curve formed by the path of a point on a perpendicular to a straight line as the straight line rolls along the convex side of a base curve. By the first definition, a trochoid is derived from the *cycloid*, by the second definition it is derived from the *involute*.

True involute form diameter is the smallest diameter on the tooth at which the point of tangency of the involute tooth profile exists. Usually this position is the point of tangency of the involute tooth profile and the fillet curve, and is often referred to as the TIF diameter.

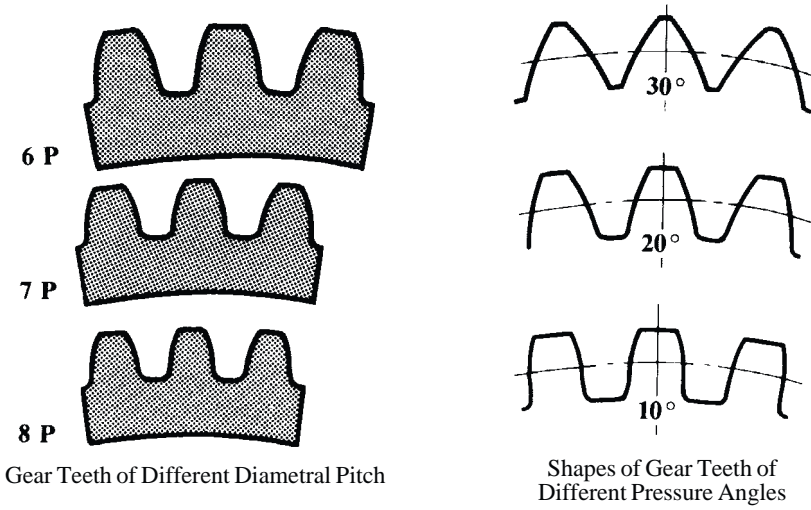
Undercut is a condition in generated gear teeth when any part of the fillet curve lies inside a line drawn at a tangent to the working profile at its lowest point. Undercut may be introduced deliberately to facilitate shaving operations, as in pre-shaving.

Whole depth is the total depth of a tooth space, equal to the addendum plus the dedendum and equal to the working depth plus clearance.

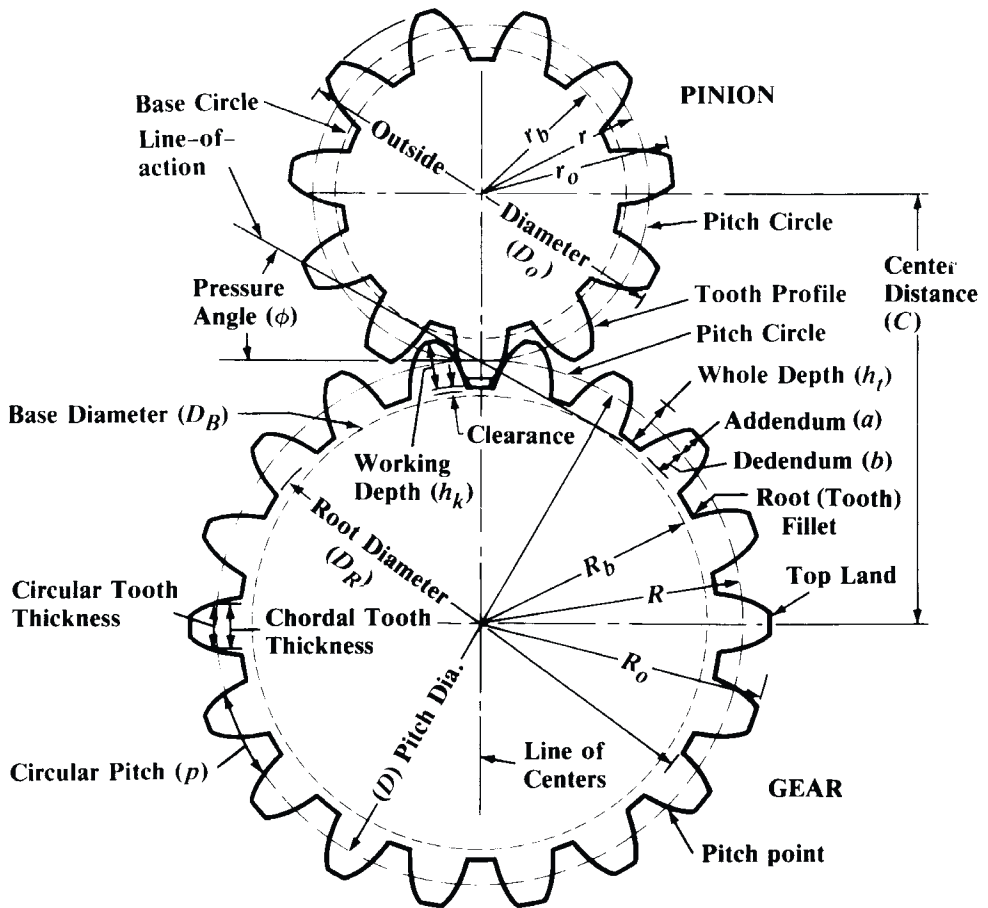
Working depth is the depth of engagement of two gears, or the sum of their addendums. The standard working distance is the depth to which a tooth extends into the tooth space of a mating gear when the center distance is standard.

Definitions of gear terms are given in AGMA Standards 112.05, 115.01, and 116.01 entitled "Terms, Definitions, Symbols and Abbreviations," "Reference Information—Basic Gear Geometry," and "Glossary—Terms Used in Gearing," respectively; obtainable from American Gear Manufacturers Assn., 500 Montgomery St., Alexandria, VA 22314.

Comparative Sizes and Shape of Gear Teeth



Nomenclature of Gear Teeth



Terms Used in Gear Geometry from Table 1 on page 2131

Properties of the Involute Curve.—The involute curve is used almost exclusively for gear-tooth profiles, because of the following important properties.

1) The form or shape of an involute curve depends upon the diameter of the base circle from which it is derived. (If a taut line were unwound from the circumference of a circle—the *base circle* of the involute—the end of that line or any point on the unwound portion, would describe an involute curve.)

2) If a gear tooth of involute curvature acts against the involute tooth of a mating gear while rotating at a uniform rate, the angular motion of the driven gear will also be uniform, even though the center-to-center distance is varied.

3) The relative rate of motion between driving and driven gears having involute tooth curves is established by the diameters of their base circles.

4) Contact between intermeshing involute teeth on a driving and driven gear is along a straight line that is tangent to the two base circles of these gears. This is the *line of action*.

5) The point where the line of action intersects the common center-line of the mating involute gears, establishes the radii of the pitch circles of these gears; hence true pitch circle diameters are affected by a change in the center distance. (Pitch diameters obtained by dividing the number of teeth by the diametral pitch apply when the center distance equals the total number of teeth on both gears divided by twice the diametral pitch.)

6) The pitch diameters of mating involute gears are directly proportional to the diameters of their respective base circles; thus, if the base circle of one mating gear is three times as large as the other, the pitch circle diameters will be in the same ratio.

7) The angle between the line of action and a line perpendicular to the common center-line of mating gears, is the *pressure angle*; hence the pressure angle is affected by any change in the center distance.

8) When an involute curve acts against a straight line (as in the case of an involute pinion acting against straight-sided rack teeth), the straight line is tangent to the involute and perpendicular to its line of action.

9) The pressure angle, in the case of an involute pinion acting against straight-sided rack teeth, is the angle between the line of action and the line of the rack's motion. If the involute pinion rotates at a uniform rate, movement of the rack will also be uniform.

Nomenclature:

- ϕ = Pressure Angle
 a = Addendum a_G = Addendum of Gear a_p = Addendum of Pinion
 b = Dedendum
 c = Clearance
 C = Center Distance
 D = Pitch Diameter D_G = Pitch Diameter of Gear D_p = Pitch Diameter of Pinion
 D_B = Base Circle Diameter D_O = Outside Diameter D_R = Root Diameter
 F = Face Width
 h_k = Working Depth of Tooth h_t = Whole Depth of Tooth
 m_G = Gear Ratio
 N = Number of Teeth N_G = Number of Teeth in Gear N_p = Number of Teeth in Pinion
 p = Circular Pitch P = Diametral Pitch

Diametral and Circular Pitch Systems.—Gear tooth system standards are established by specifying the tooth proportions of the basic rack. The diametral pitch system is applied to most of the gearing produced in the United States. If gear teeth are larger than about one diametral pitch, it is common practice to use the circular pitch system. The circular pitch system is also applied to cast gearing and it is commonly used in connection with the design and manufacture of worm gearing.

Pitch Diameters Obtained with Diametral Pitch System.—The diametral pitch system is arranged to provide a series of standard tooth sizes, the principle being similar to the standardization of screw thread pitches. Inasmuch as there must be a whole number of

teeth on each gear, the increase in pitch diameter per tooth varies according to the pitch. For example, the pitch diameter of a gear having, say, 20 teeth of 4 diametral pitch, will be 5 inches; 21 teeth, 5¼ inches; and so on, the increase in diameter for each additional tooth being equal to ¼ inch for 4 diametral pitch. Similarly, for 2 diametral pitch the variations for successive numbers of teeth would equal ½ inch, and for 10 diametral pitch the variations would equal 1/10 inch, etc. Where a given center distance must be maintained and no standard diametral pitch can be used, gears should be designed with reference to the gear set center distance procedure discussed in *Gears for Given Center Distance and Ratio* starting on page 2139.

Table 1. Formulas for Dimensions of Standard Spur Gears

To Find	Formula	To Find	Formula
Base Circle Diameter	$D_B = D \cos \phi$ (1)	Number of Teeth	$N = P \times D$ (2a)
Circular Pitch	$p = \frac{3.1416D}{N}$ (3a)		$N = \frac{3.1416D}{p}$ (3b)
	$p = \frac{3.1416}{P}$ (3c)	Outside Diameter (Full-depth Teeth)	$D_O = \frac{N+2}{P}$ (4a)
Center Distance	$C = \frac{N_P(m_G + 1)}{2P}$ (5a)		$D_O = \frac{(N+2)p}{3.1416}$ (5b)
	$C = \frac{D_P + D_G}{2}$ (5c)	Outside Diameter (American Standard Stub Teeth)	$D_O = \frac{N+1.6}{P}$ (6a)
	$C = \frac{N_G + N_P}{2P}$ (6b)		$D_O = \frac{(N+1.6)p}{3.1416}$ (6c)
	$C = \frac{(N_G + N_P)p}{6.2832}$ (6d)	Outside Diameter	$D_O = D + 2a$ (7)
Diametral Pitch	$P = \frac{3.1416}{p}$ (8a)	Pitch Diameter	$D = \frac{N}{P}$ (9a)
	$P = \frac{N}{D}$ (9b)		$D = \frac{Np}{3.1416}$ (9c)
	$P = \frac{N_P(m_G + 1)}{2C}$ (9d)	Root Diameter ^a	$D_R = D - 2b$ (10)
Gear Ratio	$m_G = \frac{N_G}{N_P}$ (11)	Whole Depth	$a + b$ (12)
		Working Depth	$a_G + a_P$ (13)

^a See also formulas in Tables 2 and 4 on pages 2131 and 2135.

Table 2. Formulas for Tooth Parts, 20- and 25-degree Involute Full-depth Teeth ANSI Coarse Pitch Spur Gear Tooth Forms ANSI B6.1-1968 (R1974)

To Find	Diametral Pitch, P, Known	Circular Pitch, p, Known
Addendum	$a = 1.000 \div P$	$a = 0.3183 \times p$
Dedendum (Preferred)	$b = 1.250 \div P$	$b = 0.3979 \times p$
(Shaved or Ground Teeth) ^a	$b = 1.350 \div P$	$b = 0.4297 \times p$
Working Depth	$h_k = 2.000 \div P$	$h_k = 0.6366 \times p$
Whole Depth (Preferred)	$h_t = 2.250 \div P$	$h_t = 0.7162 \times p$
(Shaved or Ground Teeth)	$h_t = 2.350 \div P$	$h_t = 0.7480 \times p$
Clearance (Preferred) ^b	$c = 0.250 \div P$	$c = 0.0796 \times p$

Table 2. (Continued) Formulas for Tooth Parts, 20- and 25-degree Involute Full-depth Teeth ANSI Coarse Pitch Spur Gear Tooth Forms ANSI B6.1-1968 (R1974)

To Find	Diametral Pitch, P , Known	Circular Pitch, p , Known
(Shaved or Ground Teeth)	$c = 0.350 \div P$	$c = 0.1114 \times p$
Fillet Radius (Rack) ^c	$r_f = 0.300 \div P$	$r_f = 0.0955 \times p$
Pitch Diameter	$D = N \div P$	$D = 0.3183 \times N \times p$
Outside Diameter	$D_O = (N + 2) \div P$	$D_O = 0.3183 \times (N + 2)p$
Root Diameter (Preferred)	$D_R = (N - 2.5) \div P$	$D_R = 0.3183 \times (N - 2.5)p$
(Shaved or Ground Teeth)	$D_R = (N - 2.7) \div P$	$D_R = 0.3183 \times (N - 2.7)p$
Circular Thickness—Basic	$t = 1.5708 \div P$	$t = p \div 2$

^a When gears are preshaved cut on a gear shaper the dedendum will usually need to be increased to $1.40/P$ to allow for the higher fillet trochoid produced by the shaper cutter. This is of particular importance on gears of few teeth or if the gear blank configuration requires the use of a small diameter shaper cutter, in which case the dedendum may need to be increased to as much as $1.45/P$. This should be avoided on highly loaded gears where the consequently reduced J factor will increase gear tooth stress excessively.

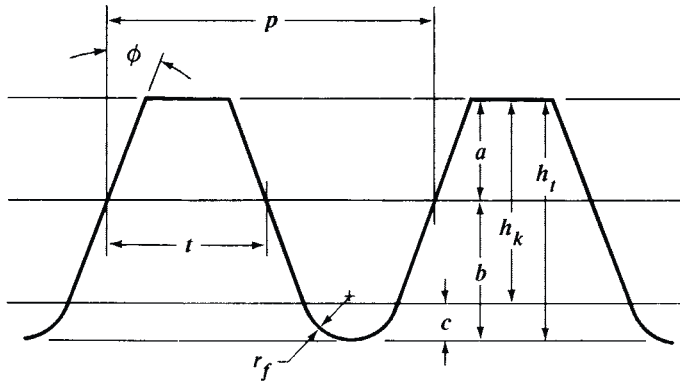
^b A minimum clearance of $0.157/P$ may be used for the basic 20-degree and 25-degree pressure angle rack in the case of shallow root sections and use of existing hobs or cutters. However, whenever less than standard clearance is used, the location of the TIF diameter should be determined by the method shown in *True Involute Form Diameter* starting on page 2157. The TIF diameter must be less than the Contact Diameter determined by the method shown on page 2155.

^c The fillet radius of the basic rack should not exceed $0.235/P$ for a 20-degree pressure angle rack or $0.270/P$ for a 25-degree pressure angle rack for a clearance of $0.157/P$. The basic rack fillet radius must be *reduced* for teeth with a 25-degree pressure angle having a clearance in excess of $0.250/P$.

American National Standard Coarse Pitch Spur Gear Tooth Forms.—The American National Standard (ANSI B6.1-1968, R1974) provides tooth proportion information on two involute spur gear forms. These two forms are identical except that one has a pressure angle of 20 degrees and a minimum allowable tooth number of 18 while the other has a pressure angle of 25 degrees and a minimum allowable tooth number of 12. (For pinions with fewer teeth, see tooth proportions for long addendum pinions and their mating short addendum gears in Tables 7 through 9d starting on page 2146.) A gear tooth standard is established by specifying the tooth proportions of the basic rack. Gears made to this standard will thus be conjugate with the specified rack and with each other. The basic rack forms for the 20-degree and 25-degree standard are shown on the following page; basic formulas for these proportions as a function of the gear diametral pitch and also of the circular pitch are given in Table 2. Tooth parts data are given in Table 3.

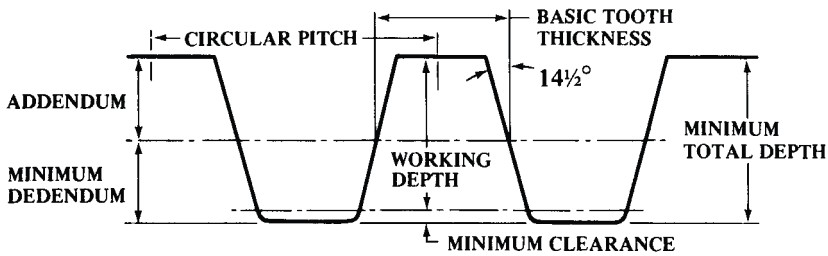
In recent years the established standard of almost universal use is the ANSI 20-degree standard spur gear form. It provides a gear with good strength and without fillet undercut in pinions of as few as eighteen teeth. Some more recent applications have required a tooth form of even greater strength and fewer teeth than eighteen. This requirement has stimulated the establishment of the ANSI 25-degree standard. This 25-degree form will give greater tooth strength than the 20-degree standard, will provide pinions of as few as twelve teeth without fillet undercut and will provide a lower contact compressive stress for greater gear set surface durability.

American National Standard and Former American Standard Gear Tooth Forms
ANSI B6.1-1968, (R1974) and ASA B6.1-1932

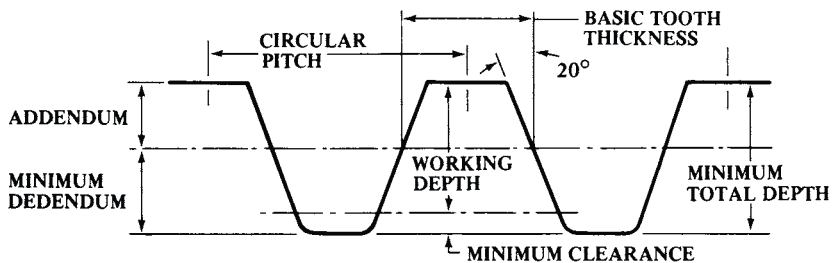


- a = addendum
- b = dedendum
- c = clearance
- h_k = working depth
- h_t = whole depth
- p = circular pitch
- r_f = fillet radius of basic rack
- t = circular tooth thickness — basic
- ϕ = pressure angle

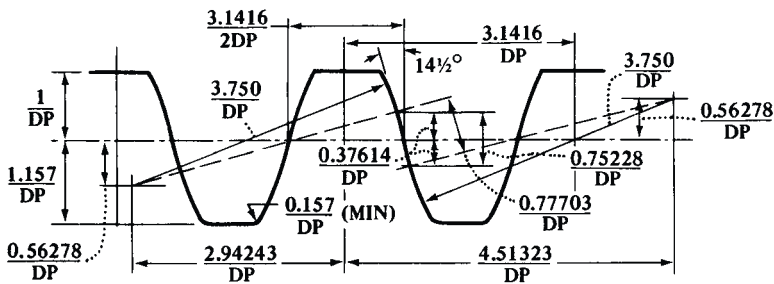
Basic Rack of the 20-Degree and 25-Degree Full-Depth Involute Systems



Basic Rack of the 14½-Degree Full-Depth Involute System



Basic Rack of the 20-Degree Stub Involute System



Approximation of Basic Rack for the 14½-Degree Composite System

**Table 3. Gear Tooth Parts for American National Standard Coarse Pitch
20- and 25-Degree Pressure Angle Gears**

Dia. Pitch	Circ. Pitch	Stand. Addend. ^a	Stand. Dedend.	Spec. Dedend. ^b	Min. Dedend.	Stand. F. Rad.	Min. F. Rad.
<i>P</i>	<i>p</i>	<i>a</i>	<i>b</i>	<i>b</i>	<i>b</i>	<i>r_f</i>	<i>r_f</i>
0.3142	10.	3.1831	3.9789	4.2972	3.6828	0.9549	0.4997
0.3307	9.5	3.0239	3.7799	4.0823	3.4987	0.9072	0.4748
0.3491	9.	2.8648	3.5810	3.8675	3.3146	0.8594	0.4498
0.3696	8.5	2.7056	3.3820	3.6526	3.1304	0.8117	0.4248
0.3927	8.	2.5465	3.1831	3.4377	2.9463	0.7639	0.3998
0.4189	7.5	2.3873	2.9842	3.2229	2.7621	0.7162	0.3748
0.4488	7.	2.2282	2.7852	3.0080	2.5780	0.6685	0.3498
0.4833	6.5	2.0690	2.5863	2.7932	2.3938	0.6207	0.3248
0.5236	6.	1.9099	2.3873	2.5783	2.2097	0.5730	0.2998
0.5712	5.5	1.7507	2.1884	2.3635	2.0256	0.5252	0.2749
0.6283	5.	1.5915	1.9894	2.1486	1.8414	0.4775	0.2499
0.6981	4.5	1.4324	1.7905	1.9337	1.6573	0.4297	0.2249
0.7854	4.	1.2732	1.5915	1.7189	1.4731	0.3820	0.1999
0.8976	3.5	1.1141	1.3926	1.5040	1.2890	0.3342	0.1749
1.	3.1416	1.0000	1.2500	1.3500	1.1570	0.3000	0.1570
1.25	2.5133	0.8000	1.0000	1.0800	0.9256	0.2400	0.1256
1.5	2.0944	0.6667	0.8333	0.9000	0.7713	0.2000	0.1047
1.75	1.7952	0.5714	0.7143	0.7714	0.6611	0.1714	0.0897
2.	1.5708	0.5000	0.6250	0.6750	0.5785	0.1500	0.0785
2.25	1.3963	0.4444	0.5556	0.6000	0.5142	0.1333	0.0698
2.5	1.2566	0.4000	0.5000	0.5400	0.4628	0.1200	0.0628
2.75	1.1424	0.3636	0.4545	0.4909	0.4207	0.1091	0.0571
3.	1.0472	0.3333	0.4167	0.4500	0.3857	0.1000	0.0523
3.25	0.9666	0.3077	0.3846	0.4154	0.3560	0.0923	0.0483
3.5	0.8976	0.2857	0.3571	0.3857	0.3306	0.0857	0.0449
3.75	0.8378	0.2667	0.3333	0.3600	0.3085	0.0800	0.0419
4.	0.7854	0.2500	0.3125	0.3375	0.2893	0.0750	0.0392
4.5	0.6981	0.2222	0.2778	0.3000	0.2571	0.0667	0.0349
5.	0.6283	0.2000	0.2500	0.2700	0.2314	0.0600	0.0314
5.5	0.5712	0.1818	0.2273	0.2455	0.2104	0.0545	0.0285
6.	0.5236	0.1667	0.2083	0.2250	0.1928	0.0500	0.0262
6.5	0.4833	0.1538	0.1923	0.2077	0.1780	0.0462	0.0242
7.	0.4488	0.1429	0.1786	0.1929	0.1653	0.0429	0.0224
7.5	0.4189	0.1333	0.1667	0.1800	0.1543	0.0400	0.0209
8.	0.3927	0.1250	0.1563	0.1687	0.1446	0.0375	0.0196
8.5	0.3696	0.1176	0.1471	0.1588	0.1361	0.0353	0.0185
9.	0.3491	0.1111	0.1389	0.1500	0.1286	0.0333	0.0174
9.5	0.3307	0.1053	0.1316	0.1421	0.1218	0.0316	0.0165
10.	0.3142	0.1000	0.1250	0.1350	0.1157	0.0300	0.0157
11.	0.2856	0.0909	0.1136	0.1227	0.1052	0.0273	0.0143
12.	0.2618	0.0833	0.1042	0.1125	0.0964	0.0250	0.0131
13.	0.2417	0.0769	0.0962	0.1038	0.0890	0.0231	0.0121
14.	0.2244	0.0714	0.0893	0.0964	0.0826	0.0214	0.0112
15.	0.2094	0.0667	0.0833	0.0900	0.0771	0.0200	0.0105
16.	0.1963	0.0625	0.0781	0.0844	0.0723	0.0188	0.0098
17.	0.1848	0.0588	0.0735	0.0794	0.0681	0.0176	0.0092
18.	0.1745	0.0556	0.0694	0.0750	0.0643	0.0167	0.0087
19.	0.1653	0.0526	0.0658	0.0711	0.0609	0.0158	0.0083
20.	0.1571	0.0500	0.0625	0.0675	0.0579	0.0150	0.0079

^aWhen using equal addendums on pinion and gear the minimum number of teeth on the pinion is 18 and the minimum total number of teeth in the pair is 36 for 20-degree full depth involute tooth form and 12 and 24, respectively, for 25-degree full depth tooth form.

^bThe dedendum in this column is used when the gear tooth is shaved. It allows for the higher fillet cut by a protuberance hob.

The working depth is equal to twice the addendum.

The whole depth is equal to the addendum plus the dedendum.

Table 4. Tooth Proportions for Fine-Pitch Involute Spur and Helical Gears of 14½-, 20-, and 25-Degree Pressure Angle ANSI B6.7-1977

Item	Spur	Helical
Addendum, a	$\frac{1.000}{P}$	$\frac{1.000}{P_n}$
Dedendum, b	$\frac{1.200}{P} + 0.002$ (min.)	$\frac{1.200}{P_n} + 0.002$ (min.)
Working Depth, h_k	$\frac{2.000}{P}$	$\frac{2.000}{P_n}$
Whole Depth, h_t	$\frac{2.200}{P} + 0.002$ (min.)	$\frac{2.200}{P_n} + 0.002$ (min.)
Clearance, c (Standard)	$\frac{0.200}{P} + 0.002$ (min.)	$\frac{0.200}{P_n} + 0.002$ (min.)
(Shaved or Ground Teeth)	$\frac{0.350}{P} + 0.002$ (min.)	$\frac{0.350}{P_n} + 0.002$ (min.)
Tooth Thickness, t At Pitch Diameter	$t = \frac{1.5708}{P}$	$t_n = \frac{1.5708}{P_n}$
Circular Pitch, p	$p = \frac{\pi D}{N}$ or $\frac{\pi d}{n}$ or $\frac{\pi}{P}$	$p_n = \frac{\pi}{P_n}$
Pitch Diameter Pinion, d	$\frac{n}{P}$	$\frac{n}{P_n \cos \psi}$
Gear, D	$\frac{N}{P}$	$\frac{N}{P_n \cos \psi}$
Outside Diameter Pinion, d_o	$\frac{n+2}{P}$	$\frac{1}{P_n} \left(\frac{n}{\cos \psi} + 2 \right)$
Gear, D_o	$\frac{N+2}{P}$	$\frac{1}{P_n} \left(\frac{N}{\cos \psi} + 2 \right)$
Center Distance, C	$\frac{N+n}{2P}$	$\frac{N+n}{2P_n \cos \psi}$
All dimensions are in inches. P = Transverse Diametral Pitch P_n = Normal Diametral Pitch t_n = Normal Tooth Thickness at Pitch Diameter p_n = Normal Circular Pitch		ψ = Helix Angle n = Number of pinion teeth N = Number of gear teeth

American National Standard Tooth Proportions for Fine-Pitch Involute Spur and Helical Gears.—The proportions of spur gears in this Standard (ANSI B6.7-1977) follow closely ANSI B6.1-1968, R1974, “Tooth Proportions for Coarse-Pitch Involute Spur Gears.” The main difference between fine-pitch and coarse-pitch gears is the greater clearance specified for fine-pitch gears. The increased clearance provides for any foreign material that may tend to accumulate at the bottoms of the teeth and also the relatively larger fillet radius resulting from proportionately greater wear on the tips of fine-pitch cutting tools.

Pressure Angle: The standard pressure angle for fine-pitch gears is 20 degrees and is recommended for most applications. For helical gears this pressure angle applies in the *normal* plane. In certain cases, notably sintered or molded gears, or in gearing where greatest strength and wear resistance are desired, a 25-degree pressure angle may be required. However, pressure angles greater than 20 degrees tend to require use of generating tools

having very narrow point widths, and higher pressure angles require closer control of center distance when backlash requirements are critical.

In those cases where consideration of angular position or backlash is critical and both pinion and gear contain relatively large numbers of teeth, a $14\frac{1}{2}$ -degree pressure angle may be desirable. In general, pressure angles less than 20 degrees require greater amounts of tooth modification to avoid undercutting problems and are limited to larger total numbers of teeth in pinion and gear when operating at a standard center distance. Information Sheet B in the Standard provides tooth proportions for both $14\frac{1}{2}$ - and 25-degree pressure angle fine-pitch gears. **Table 4** provides tooth proportions for fine-pitch spur and helical gears with $14\frac{1}{2}$ -, 20-, and 25-degree pressure angles, and **Table 5** provides tooth parts.

Diametral Pitches: Diametral pitches preferred are: 20, 24, 32, 40, 48, 64, 72, 80, 96, and 120.

**Table 5. American National Standard Fine Pitch Standard Gear Tooth Parts—
 $14\frac{1}{2}$ -, 20-, and 25-Degree Pressure Angles**

Diametral Pitch	Circular Pitch	Circular Thickness	Standard Addend.	Standard Dedend.	Special Dedend. ^a
P	p	t	a	b	b
20	0.1571	0.0785	0.0500	0.0620	0.0695
24	0.1309	0.0654	0.0417	0.0520	0.0582
32	0.0982	0.0491	0.0313	0.0395	0.0442
40	0.0785	0.0393	0.0250	0.0320	0.0358
48	0.0654	0.0327	0.0208	0.0270	0.0301
64	0.0491	0.0245	0.0156	0.0208	0.0231
72	0.0436	0.0218	0.0139	0.0187	0.0208
80	0.0393	0.0196	0.0125	0.0170	0.0189
96	0.0327	0.0164	0.0104	0.0145	0.0161
120	0.0262	0.0131	0.0083	0.0120	0.0132

^aBased upon clearance for shaved or ground teeth.

The working depth is equal to twice the addendum. The whole depth is equal to the addendum plus the dedendum. For minimum number of teeth see page 2154.

Other American Spur Gear Standards.—An appended information sheet in the American National Standard ANSI B6.1-1968, R1974 provides tooth proportion information for three spur gear forms with the notice that they are “not recommended for new designs.” These forms are therefore considered to be obsolescent but the information is given on their proportions because they have been used widely in the past. These forms are the $14\frac{1}{2}$ -degree full depth form, the 20-degree stub involute form and the $14\frac{1}{2}$ -degree composite form which were covered in the former American Standard (ASA B6.1-1932). The basic rack for the $14\frac{1}{2}$ -degree full depth form is shown on page 2132; basic formulas for these proportions are given in **Table 6**.

Table 6. Formulas for Tooth Parts—Former American Standard Spur Gear Tooth Forms ASA B6.1-1932

To Find	Diametral Pitch, P Known	Circular Pitch, p Known
14½-Degree Involute Full-depth Teeth		
Addendum	$a = 1.000 \div P$	$a = 0.3183 \times p$
Minimum Dedendum	$b = 1.157 \div P$	$b = 0.3683 \times p$
Working Depth	$h_k = 2.000 \div P$	$h_k = 0.6366 \times p$
Minimum Whole Depth	$h_t = 2.157 \div P$	$h_t = 0.6866 \times p$
Basic Tooth Thickness on Pitch Line	$t = 1.5708 \div P$	$t = 0.500 \times p$
Minimum Clearance	$c = 0.157 \div P$	$c = 0.050 \times p$
20-Degree Involute Stub Teeth		
Addendum	$a = 0.800 \div P$	$a = 0.2546 \times p$
Minimum Dedendum	$b = 1.000 \div P$	$b = 0.3183 \times p$
Working Depth	$h_k = 1.600 \div P$	$h_k = 0.5092 \times p$
Minimum Whole Depth	$h_t = 1.800 \div P$	$h_t = 0.5729 \times p$
Basic Tooth Thickness on Pitch Line	$t = 1.5708 \div P$	$t = 0.500 \times p$
Minimum Clearance	$c = 0.200 \div P$	$c = 0.0637 \times p$

Note: Radius of fillet equals $1\frac{1}{3} \times$ clearance for 14½-degree full-depth teeth and $1\frac{1}{2} \times$ clearance for 20-degree full-depth teeth.

Note: A suitable working tolerance should be considered in connection with all minimum recommendations.

Fellows Stub Tooth.—The system of stub gear teeth introduced by the Fellows Gear Shaper Co. is based upon the use of two diametral pitches. One diametral pitch, say, 8, is used as the basis for obtaining the dimensions for the addendum and dedendum, while another diametral pitch, say, 6, is used for obtaining the dimensions of the thickness of the tooth, the number of teeth, and the pitch diameter. Teeth made according to this system are designated as $\frac{6}{8}$ pitch, $\frac{12}{14}$ pitch, etc., the numerator in this fraction indicating the pitch determining the thickness of the tooth and the number of teeth, and the denominator, the pitch determining the depth of the tooth. The clearance is made greater than in the ordinary gear-tooth system and equals $0.25 \div$ denominator of the diametral pitch. The pressure angle is 20 degrees.

This type of stub gear tooth is now used infrequently. For information as to the tooth part dimensions see 18th and earlier editions of Machinery's Handbook.

Basic Gear Dimensions.—The basic dimensions for all involute spur gears may be obtained using the formulas shown in Table 1. This table is used in conjunction with Table 3 to obtain dimensions for coarse pitch gears and Table 5 to obtain dimensions for fine pitch standard spur gears. To obtain the dimensions of gears that are specified at a standard circular pitch, the equivalent diametral pitch is first calculated by using the formula in Table 1. If the required number of teeth in the pinion (N_p) is less than the minimum specified in either Table 3 or Table 5, whichever is applicable, the gears must be proportioned by the long and short addendum method shown on page 2148.

**Formulas for Outside and Root Diameters of Spur Gears that are
Finish-hobbed, Shaped, or Pre-shaved**

		Notation
D = Pitch Diameter		a = Standard Addendum
D_O = Outside Diameter		b = Standard Minimum Dedendum
D_R = Root Diameter		b_s = Standard Dedendum
P = Diametral Pitch		b_{ps} = Dedendum for Pre-shaving
14½-, 20-, And 25-degree Involute Full-depth Teeth (19 <i>P</i> and coarser) ^a		
$D_O = D + 2a = \frac{N}{P} + \left(2 \times \frac{1}{P}\right)$		
$D_R = D - 2b = \frac{N}{P} - \left(2 \times \frac{1.157}{P}\right)$		(Hobbed) ^b
$D_R = D - 2b_s = \frac{N}{P} - \left(2 \times \frac{1.25}{P}\right)$		(Shaped) ^c
$D_R = D - 2b_{ps} = \frac{N}{P} - \left(2 \times \frac{1.35}{P}\right)$		(Pre-shaved) ^d
$D_R = D - 2b_{ps} = \frac{N}{P} - \left(2 \times \frac{1.40}{P}\right)$		(Pre-shaved) ^e
20-degree Involute Fine-pitch Full-depth Teeth (20 <i>P</i> and finer)		
$D_O = D + 2a = \frac{N}{P} + \left(2 \times \frac{1}{P}\right)$		
$D_R = D - 2b = \frac{N}{P} - 2\left(\frac{1.2}{P} + 0.002\right)$		(Hobbed or Shaped) ^f
$D_R = D - 2b_{ps} = \frac{N}{P} - 2\left(\frac{1.35}{P} + 0.002\right)$		(Pre-shaved) ^g
20-degree Involute Stub Teeth ^a		
$D_O = D + 2a = \frac{N}{P} + \left(2 \times \frac{0.8}{P}\right)$		
$D_R = D - 2b = \frac{N}{P} - \left(2 \times \frac{1}{P}\right)$		(Hobbed)
$D_R = D - 2b_{ps} = \frac{N}{P} - \left(2 \times \frac{1.35}{P}\right)$		(Pre-shaved)

^a 14½-degree full-depth and 20-degree stub teeth are not recommended for new designs.

^b According to ANSI B6.1-1968 a minimum clearance of $0.157/P$ may be used for the basic 20-degree and 25-degree pressure angle rack in the case of shallow root sections and the use of existing hobs and cutters.

^c According to ANSI B6.1-1968 the preferred clearance is $0.250/P$.

^d According to ANSI B6.1-1968 the clearance for teeth which are shaved or ground is $0.350/P$.

^e When gears are pre shave cut on a gear shaper the dedendum will usually need to be increased to $1.40/P$ to allow for the higher fillet trochoid produced by the shaper cutter; this is of particular importance on gears of few teeth or if the gear blank configuration requires the use of a small diameter shaper cutter, in which case the dedendum may need to be increased to as much as $1.45/P$. This should be avoided on highly loaded gears where the consequently reduced *J* factor will increase gear tooth stress excessively.

^f According to ANSI B6.7-1967 the standard clearance is $0.200/P + 0.002$ (min.).

^g According to ANSI B6.7-1967 the clearance for shaved or ground teeth is $0.350/P + 0.002$ (min.).

Gears for Given Center Distance and Ratio.—When it is necessary to use a pair of gears of given ratio at a specified center distance C_1 , it may be found that no gears of standard diametral pitch will satisfy the center distance requirement. Gears of standard diametral pitch P may need to be redesigned to operate at other than their standard pitch diameter D and standard pressure angle ϕ . The diametral pitch P_1 at which these gears will operate is

$$P_1 = \frac{N_P + N_G}{2C_1} \tag{1}$$

where N_P = number of teeth in pinion

N_G = number of teeth in gear

and their operating pressure angle ϕ_1 is

$$\phi_1 = \arccos\left(\frac{P_1}{P} \cos \phi\right) \tag{2}$$

Thus although the pair of gears are cut to a diametral pitch P and a pressure angle ϕ , they operate as standard gears of diametral pitch P_1 and pressure angle ϕ_1 . The pitch P and pressure angle ϕ should be chosen so that ϕ_1 lies between about 18 and 25 degrees.

The operating pitch diameters of the pinion D_{P1} and of the gear D_{G1} are

$$D_{P1} = \frac{N_P}{P_1} \tag{3a} \quad \text{and} \quad D_{G1} = \frac{N_G}{P_1} \tag{3b}$$

The base diameters of the pinion D_{PB1} and of the gear D_{GB1} are

$$D_{PB1} = D_{P1} \cos \phi_1 \tag{4a} \quad \text{and} \quad D_{GB1} = D_{G1} \cos \phi_1 \tag{4b}$$

The basic tooth thickness, t_1 , at the operating pitch diameter for both pinion and gear is

$$t_1 = \frac{1.5708}{P_1} \tag{5}$$

The root diameters of the pinion D_{PR1} and gear D_{GR1} and the corresponding outside diameters D_{PO1} and D_{GO1} are not standard because each gear is to be cut with a cutter that is not standard for the operating pitch diameters D_{P1} and D_{G1} .

The root diameters are

$$D_{PR1} = \frac{N_P}{P} - 2b_{P1} \tag{6a} \quad \text{and} \quad D_{GR1} = \frac{N_G}{P} - 2b_{G1} \tag{6b}$$

where
$$b_{P1} = b_c - \left(\frac{t_{P2} - 1.5708/P}{2 \tan \phi}\right) \tag{7a}$$

and
$$b_{G1} = b_c - \frac{t_{G2} - 1.5708/P}{2 \tan \phi} \tag{7b}$$

where b_c is the hob or cutter addendum for the pinion and gear.

The tooth thicknesses of the pinion t_{P2} and the gear t_{G2} are

$$t_{P2} = \frac{N_P}{P} \left(\frac{1.5708}{N_P} + \text{inv } \phi_1 - \text{inv } \phi\right) \tag{8a}$$

$$t_{G2} = \frac{N_G}{P} \left(\frac{1.5708}{N_G} + \text{inv } \phi_1 - \text{inv } \phi \right) \quad (8b)$$

The outside diameter of the pinion D_{PO} and the gear D_{GO} are

$$D_{PO} = 2 \times C_1 - D_{GR1} - 2(b_c - 1/P) \quad (9a)$$

and $D_{GO} = 2 \times C_1 - D_{PR1} - 2(b_c - 1/P) \quad (9b)$

✦ *Example:* Design gears of 8 diametral pitch, 20-degree pressure angle, and 28 and 88 teeth to operate at 7.50-inch center distance. The gears are to be cut with a hob of 0.169-inch addendum.

$$P_1 = \frac{28 + 88}{2 \times 7.50} = 7.7333 \quad (1)$$

$$\phi_1 = \arccos\left(\frac{7.7333}{8} \times 0.93969\right) = 24.719^\circ \quad (2)$$

$$D_{P1} = \frac{28}{7.7333} = 3.6207 \text{ in.} \quad (3a)$$

and $D_{G1} = \frac{88}{7.7333} = 11.3794 \text{ in.} \quad (3b)$

$$D_{PB1} = 3.6207 \times 0.90837 = 3.2889 \text{ in.} \quad (4a)$$

and $D_{GB1} = 11.3794 \times 0.90837 = 10.3367 \text{ in.} \quad (4b)$

$$t_1 = \frac{1.5708}{7.7333} = 0.20312 \text{ in.} \quad (5)$$

$$D_{PR1} = \frac{28}{8} - 2 \times 0.1016 = 3.2968 \text{ in.} \quad (6a)$$

and $D_{GR1} = \frac{88}{8} - 2 \times (-0.0428) = 11.0856 \text{ in.} \quad (6b)$

$$b_{P1} = 0.169 - \left(\frac{0.2454 - 1.5708/8}{2 \times 0.36397} \right) = 0.1016 \text{ in.} \quad (7a)$$

$$b_{G1} = 0.169 - \left(\frac{0.3505 - 1.5708/8}{2 \times 0.36397} \right) = -0.0428 \text{ in.} \quad (7b)$$

$$t_{P2} = \frac{28}{8} \left(\frac{1.5708}{28} + 0.028922 - 0.014904 \right) = 0.2454 \text{ in.} \quad (8a)$$

$$t_{G2} = \frac{88}{8} \left(\frac{1.5708}{88} + 0.028922 - 0.014904 \right) - 0.3505 \text{ in.} \quad (8b)$$

$$D_{PO1} = 2 \times 7.50 - 11.0856 - 2(0.169 - 1/8) = 3.8264 \text{ in.} \quad (9a)$$

$$D_{GO1} = 2 \times 7.50 - 3.2968 - 2(0.169 - 1/8) = 11.6152 \text{ in.} \quad (9b)$$


Tooth Thickness Allowance for Shaving.—Proper stock allowance is important for good results in shaving operations. If too much stock is left for shaving, the life of the shaving tool is reduced and, in addition, shaving time is increased. The following figures represent the amount of stock to be left on the teeth for removal by shaving under average conditions: For diametral pitches of 2 to 4, a thickness of 0.003 to 0.004 inch (0.0762–0.1016 mm)—one-half on each side of the tooth; for 5 to 6 diametral pitch, 0.0025 to 0.0035 inch (0.0635–0.0889 mm); for 7 to 10 diametral pitch, 0.002 to 0.003 inch (0.0508–0.0762 mm); for 11 to 14 diametral pitch, 0.0015 to 0.0020 inch (0.0381–0.0508 mm); for 16 to 18 diametral pitch, 0.001 to 0.002 inch (0.0254–0.0508 mm); for 20 to 48 diametral pitch, 0.0005 to 0.0015 inch (0.0127–0.0381 mm); and for 52 to 72 diametral pitch, 0.0003 to 0.0007 inch (0.00762–0.01778 mm).

The thickness of the gear teeth may be measured in several ways to determine the amount of stock left on the sides of the teeth to be removed by shaving. If it is necessary to measure the tooth thickness during the preshaving operation while the gear is in the gear shaper or hobbing machine, a gear tooth caliper or pins would be employed. Caliper methods of measuring gear teeth are explained in detail on page 2147 for measurements over single teeth, and on page 2236 for measurements over two or more teeth.

When the preshaved gear can be removed from the machine for checking, the center distance method may be employed. In this method, the preshaved gear is meshed without backlash with a gear of standard tooth thickness and the increase in center distance over standard is noted. The amount of total tooth thickness over standard on the preshaved gear can then be determined by the formula: $t_2 = 2 \tan \phi \times d$, where t_2 = amount that the total thickness of the tooth exceeds the standard thickness, ϕ = pressure angle, and d = amount that the center distance between the two gears exceeds the standard center distance.

Circular Pitch for Given Center Distance and Ratio.—When it is necessary to use a pair of gears of given ratio at a specified center distance, it may be found that no gears of standard diametral pitch will satisfy the center distance requirement. Hence, circular pitch gears may be selected. To find the required circular pitch p , when the center distance C and total number of teeth N in both gears are known, use the following formula:

$$p = \frac{C \times 6.2832}{N}$$

Example: A pair of gears having a ratio of 3 is to be used at a center distance of 10.230 inches. If one gear has 60 teeth and the other 20, what must be their circular pitch? 

$$p = \frac{10.230 \times 6.2832}{60 + 20} = 0.8035 \text{ inch}$$

Circular Thickness of Tooth when Outside Diameter is Standard.—For a full-depth or stub tooth gear of standard outside diameter, the tooth thickness on the pitch circle (circular thickness or arc thickness) is found by the following formula:

$$t = \frac{1.5708}{P}$$

where t = circular thickness and P = diametral pitch. In Fellows stub tooth gears the diametral pitch used is the numerator of the pitch fraction (for example, 6 if the pitch is 6/8).

Example 1: Find the tooth thickness on the pitch circle of a 14½-degree full-depth tooth of 12 diametral pitch.

$$t = 1.5708/12 = 0.1309 \text{ inch}$$

Example 2: Find the tooth thickness on the tooth circle of a 20-degree full-depth involute tooth having a diametral pitch of 5.

$$t = \frac{1.5708}{5} = 0.31416, \text{ say } 0.3142 \text{ inch}$$

The tooth thickness on the pitch circle can be determined very accurately by means of measurement over wires which are located in tooth spaces that are diametrically opposite or as nearly diametrically opposite as possible. Where measurement over wires is not feasible, the circular or arc tooth thickness can be used in determining the chordal thickness which is the dimension measured with a gear tooth caliper.

Circular Thickness of Tooth when Outside Diameter has been Enlarged.—When the outside diameter of a small pinion is not standard but is enlarged to avoid undercut and to improve tooth action, the teeth are located farther out radially relative to the standard pitch diameter and consequently the circular tooth thickness at the standard pitch diameter is increased. To find this increased arc thickness the following formula is used, where t = tooth thickness; e = amount outside diameter is increased over standard; ϕ = pressure angle; and p = circular pitch at the standard pitch diameter.

$$t = \frac{p}{2} + e \tan \phi$$

Example: The outside diameter of a pinion having 10 teeth of 5 diametral pitch and a pressure angle of $14\frac{1}{2}$ degrees is to be increased by 0.2746 inch. The circular pitch equivalent to 5 diametral pitch is 0.6283 inch. Find the arc tooth thickness at the standard pitch diameter.

$$t = \frac{0.6283}{2} + (0.2746 \times \tan 14\frac{1}{2}^\circ)$$

$$t = 0.3142 + (0.2746 \times 0.25862) = 0.3852 \text{ inch}$$

Circular Thickness of Tooth when Outside Diameter has been Reduced.—If the outside diameter of a gear is reduced, as is frequently done to maintain the standard center distance when the outside diameter of the mating pinion is increased, the circular thickness of the gear teeth at the standard pitch diameter will be reduced. This decreased circular thickness can be found by the following formula where t = circular thickness at the standard pitch diameter; e = amount outside diameter is reduced under standard; ϕ = pressure angle; and p = circular pitch.

$$t = \frac{p}{2} - e \tan \phi$$

Example: The outside diameter of a gear having a pressure angle of $14\frac{1}{2}$ degrees is to be reduced by 0.2746 inch or an amount equal to the increase in diameter of its mating pinion. The circular pitch is 0.6283 inch. Determine the circular tooth thickness at the standard pitch diameter.

$$t = \frac{0.6283}{2} - (0.2746 \times \tan 14\frac{1}{2}^\circ)$$

$$t = 0.3142 - (0.2746 \times 0.25862) = 0.2432 \text{ inch}$$

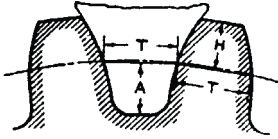
Chordal Thickness of Tooth when Outside Diameter is Standard.—To find the chordal or straight line thickness of a gear tooth the following formula can be used where t_c = chordal thickness; D = pitch diameter; and N = number of teeth.

$$t_c = D \sin\left(\frac{90^\circ}{N}\right)$$

Example: A pinion has 15 teeth of 3 diametral pitch; the pitch diameter is equal to $15 \div 3$ or 5 inches. Find the chordal thickness at the standard pitch diameter.

$$t_c = 5 \sin\left(\frac{90^\circ}{15}\right) = 5 \sin 6^\circ = 5 \times 0.10453 = 0.5226 \text{ inch}$$

Chordal Thicknesses and Chordal Addenda of Milled, Full-depth Gear Teeth and of Gear Milling Cutters



T = chordal thickness of gear tooth and cutter tooth at pitch line;
 H = chordal addendum for full-depth gear tooth;
 A = chordal addendum of cutter = $(2.157 \div \text{diametral pitch}) - H$
 $= (0.6866 \times \text{circular pitch}) - H$.

Diametral Pitch	Dimension	Number of Gear Cutter, and Corresponding Number of Teeth							
		No. 1 135 Teeth	No. 2 55 Teeth	No. 3 35 Teeth	No. 4 26 Teeth	No. 5 21 Teeth	No. 6 17 Teeth	No. 7 14 Teeth	No. 8 12 Teeth
1	T	1.5707	1.5706	1.5702	1.5698	1.5694	1.5686	1.5675	1.5663
	H	1.0047	1.0112	1.0176	1.0237	1.0294	1.0362	1.0440	1.0514
1½	T	1.0471	1.0470	1.0468	1.0465	1.0462	1.0457	1.0450	1.0442
	H	0.6698	0.6741	0.6784	0.6824	0.6862	0.6908	0.6960	0.7009
2	T	0.7853	0.7853	0.7851	0.7849	0.7847	0.7843	0.7837	0.7831
	H	0.5023	0.5056	0.5088	0.5118	0.5147	0.5181	0.5220	0.5257
2½	T	0.6283	0.6282	0.6281	0.6279	0.6277	0.6274	0.6270	0.6265
	H	0.4018	0.4044	0.4070	0.4094	0.4117	0.4144	0.4176	0.4205
3	T	0.5235	0.5235	0.5234	0.5232	0.5231	0.5228	0.5225	0.5221
	H	0.3349	0.3370	0.3392	0.3412	0.3431	0.3454	0.3480	0.3504
3½	T	0.4487	0.4487	0.4486	0.4485	0.4484	0.4481	0.4478	0.4475
	H	0.2870	0.2889	0.2907	0.2919	0.2935	0.2954	0.2977	0.3004
4	T	0.3926	0.3926	0.3926	0.3924	0.3923	0.3921	0.3919	0.3915
	H	0.2511	0.2528	0.2544	0.2559	0.2573	0.2590	0.2610	0.2628
5	T	0.3141	0.3141	0.3140	0.3139	0.3138	0.3137	0.3135	0.3132
	H	0.2009	0.2022	0.2035	0.2047	0.2058	0.2072	0.2088	0.2102
6	T	0.2618	0.2617	0.2617	0.2616	0.2615	0.2614	0.2612	0.2610
	H	0.1674	0.1685	0.1696	0.1706	0.1715	0.1727	0.1740	0.1752
7	T	0.2244	0.2243	0.2243	0.2242	0.2242	0.2240	0.2239	0.2237
	H	0.1435	0.1444	0.1453	0.1462	0.1470	0.1480	0.1491	0.1502
8	T	0.1963	0.1963	0.1962	0.1962	0.1961	0.1960	0.1959	0.1958
	H	0.1255	0.1264	0.1272	0.1279	0.1286	0.1295	0.1305	0.1314
9	T	0.1745	0.1745	0.1744	0.1744	0.1743	0.1743	0.1741	0.1740
	H	0.1116	0.1123	0.1130	0.1137	0.1143	0.1151	0.1160	0.1168
10	T	0.1570	0.1570	0.1570	0.1569	0.1569	0.1568	0.1567	0.1566
	H	0.1004	0.1011	0.1017	0.1023	0.1029	0.1036	0.1044	0.1051
11	T	0.1428	0.1428	0.1427	0.1427	0.1426	0.1426	0.1425	0.1424
	H	0.0913	0.0919	0.0925	0.0930	0.0935	0.0942	0.0949	0.0955
12	T	0.1309	0.1309	0.1308	0.1308	0.1308	0.1307	0.1306	0.1305
	H	0.0837	0.0842	0.0848	0.0853	0.0857	0.0863	0.0870	0.0876
14	T	0.1122	0.1122	0.1121	0.1121	0.1121	0.1120	0.1119	0.1118
	H	0.0717	0.0722	0.0726	0.0731	0.0735	0.0740	0.0745	0.0751
16	T	0.0981	0.0981	0.0981	0.0981	0.0980	0.0980	0.0979	0.0979
	H	0.0628	0.0632	0.0636	0.0639	0.0643	0.0647	0.0652	0.0657
18	T	0.0872	0.0872	0.0872	0.0872	0.0872	0.0871	0.0870	0.0870
	H	0.0558	0.0561	0.0565	0.0568	0.0571	0.0575	0.0580	0.0584
20	T	0.0785	0.0785	0.0785	0.0785	0.0784	0.0784	0.0783	0.0783
	H	0.0502	0.0505	0.0508	0.0511	0.0514	0.0518	0.0522	0.0525

**Chordal Thicknesses and Chordal Addenda of Milled, Full-depth
Gear Teeth and of Gear Milling Cutters**

Circular Pitch	Dimension	Number of Gear Cutter, and Corresponding Number of Teeth							
		No. 1 135 Teeth	No. 2 55 Teeth	No. 3 35 Teeth	No. 4 26 Teeth	No. 5 21 Teeth	No. 6 17 Teeth	No. 7 14 Teeth	No. 8 12 Teeth
¼	T	0.1250	0.1250	0.1249	0.1249	0.1249	0.1248	0.1247	0.1246
	H	0.0799	0.0804	0.0809	0.0814	0.0819	0.0824	0.0830	0.0836
⅕	T	0.1562	0.1562	0.1562	0.1561	0.1561	0.1560	0.1559	0.1558
	H	0.0999	0.1006	0.1012	0.1018	0.1023	0.1030	0.1038	0.1045
⅙	T	0.1875	0.1875	0.1874	0.1873	0.1873	0.1872	0.1871	0.1870
	H	0.1199	0.1207	0.1214	0.1221	0.1228	0.1236	0.1245	0.1254
⅚	T	0.2187	0.2187	0.2186	0.2186	0.2185	0.2184	0.2183	0.2181
	H	0.1399	0.1408	0.1416	0.1425	0.1433	0.1443	0.1453	0.1464
½	T	0.2500	0.2500	0.2499	0.2498	0.2498	0.2496	0.2495	0.2493
	H	0.1599	0.1609	0.1619	0.1629	0.1638	0.1649	0.1661	0.1673
⅗	T	0.2812	0.2812	0.2811	0.2810	0.2810	0.2808	0.2806	0.2804
	H	0.1799	0.1810	0.1821	0.1832	0.1842	0.1855	0.1868	0.1882
⅘	T	0.3125	0.3125	0.3123	0.3123	0.3122	0.3120	0.3118	0.3116
	H	0.1998	0.2012	0.2023	0.2036	0.2047	0.2061	0.2076	0.2091
⅙	T	0.3437	0.3437	0.3436	0.3435	0.3434	0.3432	0.3430	0.3427
	H	0.2198	0.2213	0.2226	0.2239	0.2252	0.2267	0.2283	0.2300
¾	T	0.3750	0.3750	0.3748	0.3747	0.3747	0.3744	0.3742	0.3740
	H	0.2398	0.2414	0.2428	0.2443	0.2457	0.2473	0.2491	0.2509
⅚	T	0.4062	0.4062	0.4060	0.4059	0.4059	0.4056	0.4054	0.4050
	H	0.2598	0.2615	0.2631	0.2647	0.2661	0.2679	0.2699	0.2718
⅞	T	0.4375	0.4375	0.4373	0.4372	0.4371	0.4368	0.4366	0.4362
	H	0.2798	0.2816	0.2833	0.2850	0.2866	0.2885	0.2906	0.2927
⅞	T	0.4687	0.4687	0.4685	0.4684	0.4683	0.4680	0.4678	0.4674
	H	0.2998	0.3018	0.3035	0.3054	0.3071	0.3092	0.3114	0.3137
1	T	0.5000	0.5000	0.4998	0.4997	0.4996	0.4993	0.4990	0.4986
	H	0.3198	0.3219	0.3238	0.3258	0.3276	0.3298	0.3322	0.3346
1⅛	T	0.5625	0.5625	0.5623	0.5621	0.5620	0.5617	0.5613	0.5610
	H	0.3597	0.3621	0.3642	0.3665	0.3685	0.3710	0.3737	0.3764
1¼	T	0.6250	0.6250	0.6247	0.6246	0.6245	0.6241	0.6237	0.6232
	H	0.3997	0.4023	0.4047	0.4072	0.4095	0.4122	0.4152	0.4182
1⅝	T	0.6875	0.6875	0.6872	0.6870	0.6869	0.6865	0.6861	0.6856
	H	0.4397	0.4426	0.4452	0.4479	0.4504	0.4534	0.4567	0.4600
1½	T	0.7500	0.7500	0.7497	0.7495	0.7494	0.7489	0.7485	0.7480
	H	0.4797	0.4828	0.4857	0.4887	0.4914	0.4947	0.4983	0.5019
1¾	T	0.8750	0.8750	0.8746	0.8744	0.8743	0.8737	0.8732	0.8726
	H	0.5596	0.5633	0.5666	0.5701	0.5733	0.5771	0.5813	0.5855
2	T	1.0000	1.0000	0.9996	0.9994	0.9992	0.9986	0.9980	0.9972
	H	0.6396	0.6438	0.6476	0.6516	0.6552	0.6596	0.6644	0.6692
2¼	T	1.1250	1.1250	1.1246	1.1242	1.1240	1.1234	1.1226	1.1220
	H	0.7195	0.7242	0.7285	0.7330	0.7371	0.7420	0.7474	0.7528
2½	T	1.2500	1.2500	1.2494	1.2492	1.2490	1.2482	1.2474	1.2464
	H	0.7995	0.8047	0.8095	0.8145	0.8190	0.8245	0.8305	0.8365
3	T	1.5000	1.5000	1.4994	1.4990	1.4990	1.4978	1.4970	1.4960
	H	0.9594	0.9657	0.9714	0.9774	0.9828	0.9894	0.9966	1.0038

Chordal Thickness of Tooth when Outside Diameter is Special.—When the outside diameter is larger or smaller than standard the chordal thickness at the standard pitch diameter is found by the following formula where t_c = chordal thickness at the standard pitch diameter D ; t = circular thickness at the standard pitch diameter of the enlarged pinion or reduced gear being measured.

$$t_c = t - \frac{t^3}{6 \times D^2}$$

Example 1: The outside diameter of a pinion having 10 teeth of 5 diametral pitch has been enlarged by 0.2746 inch. This enlargement has increased the circular tooth thickness at the standard pitch diameter (as determined by the formula previously given) to 0.3852 inch. Find the equivalent chordal thickness.

$$t_c = 0.3852 - \frac{0.3852^3}{6 \times 2^2} = 0.3852 - 0.0024 = 0.3828 \text{ inch}$$

(The error introduced by rounding the circular thickness to three significant figures before cubing it only affects the fifth decimal place in the result.)

Example 2: A gear having 30 teeth is to mesh with the pinion in **Example 1** and is reduced so that the circular tooth thickness at the standard pitch diameter is 0.2432 inch. Find the equivalent chordal thickness.

$$t_c = 0.2432 - \frac{0.2432^3}{6 \times 6^2} = 0.2432 - 0.00007 = 0.2431 \text{ inch}$$

Chordal Addendum.—In measuring the chordal thickness, the vertical scale of a gear tooth caliper is set to the chordal or “corrected” addendum to locate the caliper jaws at the pitch line (see *Method of setting a gear tooth caliper* on page 2148). The simplified formula which follows may be used in determining the chordal addendum either when the addendum is standard for full-depth or stub teeth or when the addendum is either longer or shorter than standard as in case of an enlarged pinion or a gear which is to mesh with an enlarged pinion and has a reduced addendum to maintain the standard center distance. If a_c = chordal addendum; a = addendum; and t = circular thickness of tooth at pitch diameter D ; then,

$$a_c = a + \frac{t^2}{4D}$$

Example 1: The outside diameter of an 8 diametral pitch 14-tooth pinion with 20-degree full-depth teeth is to be increased by using an enlarged addendum of $1.234 \div 8 = 0.1542$ inch (see **Table 7** on page 2146). The basic tooth thickness of the enlarged pinion is $1.741 \div 8 = 0.2176$ inch. What is the chordal addendum?

$$\text{Chordal addendum} = 0.1542 + \frac{0.2176^2}{4 \times (14 \div 8)} = 0.1610 \text{ inch}$$

Example 2: The outside diameter of a $14\frac{1}{2}$ -degree pinion having 12 teeth of 2 diametral pitch is to be enlarged 0.624 inch to avoid undercut (see **Table 8** on page 2146), thus increasing the addendum from 0.5000 to 0.8120 inch and the arc thickness at the pitch line from 0.7854 to 0.9467 inch. Then,

$$\text{Chordal addendum of pinion} = 0.8120 + \frac{0.9467^2}{4 \times (12 \div 2)} = 0.8493 \text{ inch}$$

Table 7. Addendums and Tooth Thicknesses for Coarse-Pitch Long-Addendum Pinions and their Mating Short-Addendum Gears—20- and 25-degree Pressure Angles ANSI B6.1-1968 (R1974)

Number of Teeth in Pinion	Addendum		Basic Tooth Thickness		Number of Teeth in Gear
	Pinion	Gear	Pinion	Gear	
N_P	a_P	a_G	t_P	t_G	N_G (min)
20-Degree Involute Full Depth Tooth Form (Less than 20 Diametral Pitch)					
10	1.468	.532	1.912	1.230	25
11	1.409	.591	1.868	1.273	24
12	1.351	.649	1.826	1.315	23
13	1.292	.708	1.783	1.358	22
14	1.234	.766	1.741	1.400	21
15	1.175	.825	1.698	1.443	20
16	1.117	.883	1.656	1.486	19
17	1.058	.942	1.613	1.529	18
25-Degree Involute Full Depth Tooth Form (Less than 20 Diametral Pitch)					
10	1.184	.816	1.742	1.399	15
11	1.095	.905	1.659	1.482	14

All values are for 1 diametral pitch. For any other sizes of teeth all linear dimensions should be divided by the diametral pitch. Basic tooth thicknesses do not include an allowance for backlash.

Table 8. Enlarged Pinion and Reduced Gear Dimensions to Avoid Interference Coarse Pitch 14½-degree Involute Full Depth Teeth

Number of Pinion Teeth	Changes in Pinion and Gear Diameters	Circular Tooth Thickness		Min. No. of Teeth in Mating Gear	
		Pinion	Mating Gear	To Avoid Undercut	For Full Involute Action
10	1.3731	1.9259	1.2157	54	27
11	1.3104	1.9097	1.2319	53	27
12	1.2477	1.8935	1.2481	52	28
13	1.1850	1.8773	1.2643	51	28
14	1.1223	1.8611	1.2805	50	28
15	1.0597	1.8449	1.2967	49	28
16	0.9970	1.8286	1.3130	48	28
17	0.9343	1.8124	1.3292	47	28
18	0.8716	1.7962	1.3454	46	28
19	0.8089	1.7800	1.3616	45	28
20	0.7462	1.7638	1.3778	44	28
21	0.6835	1.7476	1.3940	43	28
22	0.6208	1.7314	1.4102	42	27
23	0.5581	1.7151	1.4265	41	27
24	0.4954	1.6989	1.4427	40	27
25	0.4328	1.6827	1.4589	39	26
26	0.3701	1.6665	1.4751	38	26
27	0.3074	1.6503	1.4913	37	26
28	0.2447	1.6341	1.5075	36	25
29	0.1820	1.6179	1.5237	35	25
30	0.1193	1.6017	1.5399	34	24
31	0.0566	1.5854	1.5562	33	24

All dimensions are given in inches and are for 1 diametral pitch. For other pitches divide tabular values by desired diametral pitch.

Add to the standard outside diameter of the pinion the amount given in the second column of the table divided by the desired diametral pitch, and (to maintain standard center distance) subtract the same amount from the outside diameter of the mating gear. Long addendum pinions will mesh with standard gears, but the center distance will be greater than standard.

Example 3: The outside diameter of the mating gear for the pinion in [Example 3](#) is to be reduced 0.624 inch. The gear has 60 teeth and the addendum is reduced from 0.5000 to 0.1881 inch (to maintain the standard center distance), thus reducing the arc thickness to 0.6240 inch. Then,

$$\text{Chordal addendum of gear} = 0.1881 + \frac{0.6240^2}{4 \times (60 \div 2)} = 0.1913 \text{ inch}$$

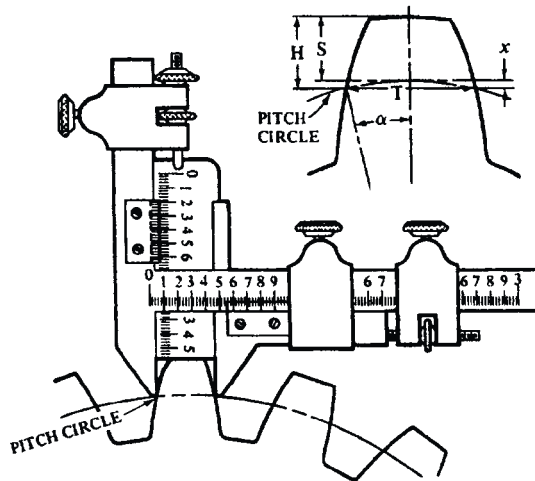
When a gear addendum is reduced as much as the mating pinion addendum is enlarged, the minimum number of gear teeth required to prevent undercutting depends upon the enlargement of the mating pinion. To illustrate, if a $14\frac{1}{2}$ -degree pinion with 13 teeth is enlarged 1.185 inches, then the reduced mating gear should have a minimum of 51 teeth to avoid undercut (see [Table 8](#) on page [2146](#)).

Tables for Chordal Thicknesses and Chordal Addenda of Milled, Full-depth Teeth.—Two convenient tables for checking gears with milled, full-depth teeth are given on pages [2143](#) and [2144](#). The first shows chordal thicknesses and chordal addenda for the lowest number of teeth cut by gear cutters Nos. 1 through 8, and for the commonly used diametral pitches. The second gives similar data for commonly used circular pitches. In each case the data shown are accurate for the number of gear teeth indicated, but are approximate for other numbers of teeth within the range of the cutter under which they appear in the table. For the higher diametral pitches and lower circular pitches, the error introduced by using the data for any tooth number within the range of the cutter under which it appears is comparatively small. The chordal thicknesses and chordal addenda for gear cutters Nos. 1 through 8 of the more commonly used diametral and circular pitches can be obtained from the table and formulas on pages [2143](#) and [2144](#).

Caliper Measurement of Gear Tooth.—In cutting gear teeth, the general practice is to adjust the cutter or hob until it grazes the outside diameter of the blank; the cutter is then sunk to the total depth of the tooth space plus whatever slight additional amount may be required to provide the necessary play or backlash between the teeth. (For recommendations concerning backlash and excess depth of cut required, see [Backlash](#) starting on page [2163](#).) If the outside diameter of the gear blank is correct, the tooth thickness should also be correct after the cutter has been sunk to the depth required for a given pitch and backlash. However, it is advisable to check the tooth thickness by measuring it, and the vernier gear-tooth caliper (see following illustration) is commonly used in measuring the thickness.

The vertical scale of this caliper is set so that when it rests upon the top of the tooth as shown, the lower ends of the caliper jaws will be at the height of the pitch circle; the horizontal scale then shows the chordal thickness of the tooth at this point. If the gear is being cut on a milling machine or with the type of gear-cutting machine employing a formed milling cutter, the tooth thickness is checked by first taking a trial cut for a short distance at one side of the blank; then the gear blank is indexed for the next space and another cut is taken far enough to mill the full outline of the tooth. The tooth thickness is then measured.

Before the gear-tooth caliper can be used, it is necessary to determine the correct chordal thickness and also the chordal addendum (or “corrected addendum” as it is sometimes called). The vertical scale is set to the chordal addendum, thus locating the ends of the jaws at the height of the pitch circle. The rules or formulas to use in determining the chordal thickness and chordal addendum will depend upon the outside diameter of the gear; for example, if the outside diameter of a small pinion is enlarged to avoid undercut and improve the tooth action, this must be taken into account in figuring the chordal thickness and chordal addendum as shown by the accompanying rules. The detail of a gear tooth included with the gear-tooth caliper illustration, represents the chordal thickness T , the addendum S , and the chordal addendum H . For the caliper measurements over two or more teeth see [Checking Spur Gear Size by Chordal Measurement Over Two or More Teeth](#) starting on page [2236](#).



Method of setting a gear tooth caliper

Selection of Involute Gear Milling Cutter for a Given Diametral Pitch and Number of Teeth.—When gear teeth are cut by using formed milling cutters, the cutter must be selected to suit both the pitch and the number of teeth, because the shapes of the tooth spaces vary according to the number of teeth. For instance, the tooth spaces of a small pinion are not of the same shape as the spaces of a large gear of equal pitch. Theoretically, there should be a different formed cutter for every tooth number, but such refinement is unnecessary in practice. The involute formed cutters commonly used are made in series of eight cutters for each diametral pitch (see *Series of Involute, Finishing Gear Milling Cutters for Each Pitch*). The shape of each cutter in this series is correct for a certain number of teeth only, but it can be used for other numbers within the limits given. For instance, a No. 6 cutter may be used for gears having from 17 to 20 teeth, but the tooth outline is correct only for 17 teeth or the lowest number in the range, which is also true of the other cutters listed. When this cutter is used for a gear having, say, 19 teeth, too much material is removed from the upper surfaces of the teeth, although the gear meets ordinary requirements. When greater accuracy of tooth shape is desired to ensure smoother or quieter operation, an intermediate series of cutters having half-numbers may be used provided the number of gear teeth is between the number listed for the regular cutters (see *Series of Involute, Finishing Gear Milling Cutters for Each Pitch*).

Involute gear milling cutters are designed to cut a composite tooth form, the center portion being a true involute while the top and bottom portions are cycloidal. This composite form is necessary to prevent tooth interference when milled mating gears are meshed with each other. Because of their composite form, milled gears will not mate satisfactorily enough for high grade work with those of generated, full-involute form. Composite form hobs are available, however, which will produce generated gears that mesh with those cut by gear milling cutters.

Metric Module Gear Cutters: The accompanying table for selecting the cutter number to be used to cut a given number of teeth may be used also to select metric module gear cutters except that the numbers are designated in reverse order. For example, cutter No. 1, in the metric module system, is used for 12-13 teeth, cutter No. 2 for 14-16 teeth, etc.

Increasing Pinion Diameter to Avoid Undercut or Interference.—On coarse-pitch pinions with small numbers of teeth (10 to 17 for 20-degree and 10 and 11 for 25-degree pressure angle involute tooth forms) undercutting of the tooth profile or fillet interference with the tip of the mating gear can be avoided by making certain changes from the standard tooth proportions that are specified in [Table 3](#) on page 2134. These changes consist essen-

Circular Pitch in Gears—Pitch Diameters, Outside Diameters, and Root Diameters

For any particular circular pitch and number of teeth, use the table as shown in the example to find the pitch diameter, outside diameter, and root diameter. *Example:* Pitch diameter for 57 teeth of 6-inch circular pitch = 10 × pitch diameter given under factor for 5 teeth plus pitch diameter given under factor for 7 teeth. (10 × 9.5493) + 13.3690 = 108.862 inches.

Outside diameter of gear equals pitch diameter plus outside diameter factor from next-to-last column in table = 108.862 + 3.8197 = 112.682 inches.

Root diameter of gear equals pitch diameter minus root diameter factor from last column in table = 108.862 – 4.4194 = 104.443 inches.

Circular Pitch in Inches	Factor for Number of Teeth									Outside Dia. Factor	Root Diameter Factor
	1	2	3	4	5	6	7	8	9		
	Pitch Diameter Corresponding to Factor for Number of Teeth										
6	1.9099	3.8197	5.7296	7.6394	9.5493	11.4591	13.3690	15.2788	17.1887	3.8197	4.4194
5½	1.7507	3.5014	5.2521	7.0028	8.7535	10.5042	12.2549	14.0056	15.7563	3.5014	4.0511
5	1.5915	3.1831	4.7746	6.3662	7.9577	9.5493	11.1408	12.7324	14.3239	3.1831	3.6828
4½	1.4324	2.8648	4.2972	5.7296	7.1620	8.5943	10.0267	11.4591	12.8915	2.8648	3.3146
4	1.2732	2.5465	3.8197	5.0929	6.3662	7.6394	8.9127	10.1859	11.4591	2.5465	2.9463
3½	1.1141	2.2282	3.3422	4.4563	5.5704	6.6845	7.7986	8.9127	10.0267	2.2282	2.5780
3	0.9549	1.9099	2.8648	3.8197	4.7746	5.7296	6.6845	7.6394	8.5943	1.9099	2.2097
2½	0.7958	1.5915	2.3873	3.1831	3.9789	4.7746	5.5704	6.3662	7.1620	1.5915	1.8414
2	0.6366	1.2732	1.9099	2.5465	3.1831	3.8197	4.4563	5.0929	5.7296	1.2732	1.4731
1¾	0.5968	1.1937	1.7905	2.3873	2.9841	3.5810	4.1778	4.7746	5.3715	1.1937	1.3811
1¾	0.5570	1.1141	1.6711	2.2282	2.7852	3.3422	3.8993	4.4563	5.0134	1.1141	1.2890
1⅝	0.5173	1.0345	1.5518	2.0690	2.5863	3.1035	3.6208	4.1380	4.6553	1.0345	1.1969
1½	0.4775	0.9549	1.4324	1.9099	2.3873	2.8648	3.3422	3.8197	4.2972	0.9549	1.1049
1⅙	0.4576	0.9151	1.3727	1.8303	2.2878	2.7454	3.2030	3.6606	4.1181	0.9151	1.0588
1⅝	0.4377	0.8754	1.3130	1.7507	2.1884	2.6261	3.0637	3.5014	3.9391	0.8754	1.0128
1⅝	0.4178	0.8356	1.2533	1.6711	2.0889	2.5067	2.9245	3.3422	3.7600	0.8356	0.9667
1¼	0.3979	0.7958	1.1937	1.5915	1.9894	2.3873	2.7852	3.1831	3.5810	0.7958	0.9207
1⅙	0.3780	0.7560	1.1340	1.5120	1.8900	2.2680	2.6459	3.0239	3.4019	0.7560	0.8747
1⅝	0.3581	0.7162	1.0743	1.4324	1.7905	2.1486	2.5067	2.8648	3.2229	0.7162	0.8286
1⅙	0.3382	0.6764	1.0146	1.3528	1.6910	2.0292	2.3674	2.7056	3.0438	0.6764	0.7826
1	0.3183	0.6366	0.9549	1.2732	1.5915	1.9099	2.2282	2.5465	2.8648	0.6366	0.7366
15/16	0.2984	0.5968	0.8952	1.1937	1.4921	1.7905	2.0889	2.3873	2.6857	0.5968	0.6905
7/8	0.2785	0.5570	0.8356	1.1141	1.3926	1.6711	1.9496	2.2282	2.5067	0.5570	0.6445
13/16	0.2586	0.5173	0.7759	1.0345	1.2931	1.5518	1.8104	2.0690	2.3276	0.5173	0.5985
¾	0.2387	0.4475	0.7162	0.9549	1.1937	1.4324	1.6711	1.9099	2.1486	0.4475	0.5524
11/16	0.2188	0.4377	0.6565	0.8754	1.0942	1.3130	1.5319	1.7507	1.9695	0.4377	0.5064
2/5	0.2122	0.4244	0.6366	0.8488	1.0610	1.2732	1.4854	1.6977	1.9099	0.4244	0.4910
3/8	0.1989	0.3979	0.5968	0.7958	0.9947	1.1937	1.3926	1.5915	1.7905	0.3979	0.4604
9/16	0.1790	0.3581	0.5371	0.7162	0.8952	1.0743	1.2533	1.4324	1.6114	0.3581	0.4143
½	0.1592	0.3183	0.4775	0.6366	0.7958	0.9549	1.1141	1.2732	1.4324	0.3183	0.3683
7/16	0.1393	0.2785	0.4178	0.5570	0.6963	0.8356	0.9748	1.1141	1.2533	0.2785	0.3222
3/8	0.1194	0.2387	0.3581	0.4775	0.5968	0.7162	0.8356	0.9549	1.0743	0.2387	0.2762
½	0.1061	0.2122	0.3183	0.4244	0.5305	0.6366	0.7427	0.8488	0.9549	0.2122	0.2455
5/16	0.0995	0.1989	0.2984	0.3979	0.4974	0.5968	0.6963	0.7958	0.8952	0.1989	0.2302
¼	0.0796	0.1592	0.2387	0.3183	0.3979	0.4775	0.5570	0.6366	0.7162	0.1592	0.1841
3/16	0.0597	0.1194	0.1790	0.2387	0.2984	0.3581	0.4178	0.4775	0.5371	0.1194	0.1381
1/8	0.0398	0.0796	0.1194	0.1592	0.1989	0.2387	0.2785	0.3183	0.3581	0.0796	0.0921
1/16	0.0199	0.0398	0.0597	0.0796	0.0995	0.1194	0.1393	0.1592	0.1790	0.0398	0.0460

tially in increasing the addendum and hence the outside diameter of the pinion and decreasing the addendum and hence the outside diameter of the mating gear. These changes in outside diameters of pinion and gear do not change the velocity ratio or the procedures in cutting the teeth on a hobbing machine or generating type of shaper or planer.

Data in **Table 7** on page 2146 are taken from ANSI Standard B6.1-1968, reaffirmed 1974, and show for 20-degree and 25-degree full-depth standard tooth forms, respectively, the addendums and tooth thicknesses for long addendum pinions and their mating short addendum gears when the number of teeth in the pinion is as given. Similar data for former

standard $14\frac{1}{2}$ -degree full-depth teeth (20 diametral pitch and coarser) are given in [Table 8](#) on page [2146](#).

Example: A 14-tooth, 20-degree pressure angle pinion of 6 diametral pitch is to be enlarged. What will be the outside diameters of the pinion and a 60-tooth mating gear? If the mating gear is to have the minimum number of teeth to avoid undercut, what will be its outside diameter?

$$D_o(\text{ pinion}) = \frac{N_P}{P} + 2a = \frac{14}{6} + 2\left(\frac{1.234}{6}\right) = 2.745 \text{ inches}$$

$$D_o(\text{ gear}) = \frac{N_G}{P} + 2a = \frac{60}{6} + 2\left(\frac{0.766}{6}\right) = 10.255 \text{ inches}$$

For a mating gear with minimum number of teeth to avoid undercut:

$$D_o(\text{ gear}) = \frac{N_G}{P} + 2a = \frac{21}{6} + 2\left(\frac{0.766}{6}\right) = 3.755 \text{ inches}$$

Series of Involute, Finishing Gear Milling Cutters for Each Pitch

Number of Cutter	Will cut Gears from	Number of Cutter	Will cut Gears from
1	135 teeth to a rack	5	21 to 25 teeth
2	55 to 134 teeth	6	17 to 20 teeth
3	35 to 54 teeth	7	14 to 16 teeth
4	26 to 34 teeth	8	12 to 13 teeth
The regular cutters listed above are used ordinarily.			
The cutters listed below (an intermediate series having half numbers) may be used when greater accuracy of tooth shape is essential in cases where the number of teeth is between the numbers for which the regular cutters are intended.			
Number of Cutter	Will cut Gears from	Number of Cutter	Will cut Gears from
$1\frac{1}{2}$	80 to 134 teeth	$5\frac{1}{2}$	19 to 20 teeth
$2\frac{1}{2}$	42 to 54 teeth	$6\frac{1}{2}$	15 to 16 teeth
$3\frac{1}{2}$	30 to 34 teeth	$7\frac{1}{2}$	13 teeth
$4\frac{1}{2}$	23 to 25 teeth

Roughing cutters are made with No. 1 form only. Dimensions of roughing and finishing cutters are given on page [828](#). Dimensions of cutters for bevel gears are given on page [829](#).

Enlarged Fine-Pitch Pinions: American Standard ANSI B6.7-1977, Information Sheet A provides a different system for 20-degree pressure angle pinion enlargement than is used for coarse-pitch gears. Pinions with 11 through 23 teeth (9 through 14 teeth for 25-degree pressure angle) are enlarged so that a standard tooth thickness rack with addendum $1.05/P$ will start contact 5° of roll above the base circle radius. The use of $1.05/P$ for the addendum allows for center distance variation and eccentricity of the mating gear outside diameter; the 5° roll angle avoids the fabrication of the involute in the troublesome area near the base circle.

Pinions with less than 11 teeth (9 teeth for 25-degree pressure angle) are enlarged to the extent that the highest point of undercut coincides with the start of contact with the standard rack described previously. The height of undercut considered is that produced by a sharp-cornered 120 pitch hob. Pinions with less than 13 teeth (11 teeth for 25-degree pressure angle) are truncated to provide a top land of $0.275/P$. Data for enlarged pinions may be found in [Tables 9a, 9b, 9c, and 9d](#).

Table 9a. Increase in Dedendum, Δ for 20 -, and 25 -Degree Pressure Angle Fine-Pitch Enlarged Pinions and Reduced Gears ANSI B6.7-1977

Diametral Pitch, <i>P</i>	Δ	Diametral Pitch, <i>P</i>	Δ	Diametral Pitch, <i>P</i>	Δ	Diametral Pitch, <i>P</i>	Δ	Diametral Pitch, <i>P</i>	Δ
20	0.0000	32	0.0007	48	0.0012	72	0.0015	96	0.0016
24	0.0004	40	0.0010	64	0.0015	80	0.0015	120	0.0017

Δ = increase in standard dedendum to provide increased clearance. See footnote to Table 9d.

Table 9b. Dimensions Required when Using Enlarged, Fine-pitch, 14½-Degree Pressure Angle Pinions ANSI B6.7-1977, Information Sheet B

Enlarged Pinion			Standard Center-distance System (Long and Short Addendum)				Enlarged Center-distance System		
			Reduced Mating Gear			Contact Ratio, <i>n</i> Mating with <i>N</i>	Enlarged Pinion Mating with St'd. Gear	Two Equal Enlarged Mating Pinions ^a	Contact Ratio of Two Equal Enlarged Mating Pinions
No. of Teeth <i>n</i>	Outside Diameter	Cir. Tooth Thickness at Standard Pitch Dia.	Decrease in Standard Outside Dia. ^b	Cir. Tooth Thickness at Standard Pitch Dia.	Recommended Minimum No. of Teeth <i>N</i>				
10	13.3731	1.9259	1.3731	1.2157	54	1.831	0.6866	1.3732	1.053
11	14.3104	1.9097	1.3104	1.2319	53	1.847	0.6552	1.3104	1.088
12	15.2477	1.8935	1.2477	1.2481	52	1.860	0.6239	1.2477	1.121
13	16.1850	1.8773	1.1850	1.2643	51	1.873	0.5925	1.1850	1.154
14	17.1223	1.8611	1.1223	1.2805	50	1.885	0.5612	1.2223	1.186
15	18.0597	1.8448	1.0597	1.2967	49	1.896	0.5299	1.0597	1.217
16	18.9970	1.8286	0.9970	1.3130	48	1.906	0.4985	0.9970	1.248
17	19.9343	1.8124	0.9343	1.3292	47	1.914	0.4672	0.9343	1.278
18	20.8716	1.7962	0.8716	1.3454	46	1.922	0.4358	0.8716	1.307
19	21.8089	1.7800	0.8089	1.3616	45	1.929	0.4045	0.8089	1.336
20	22.7462	1.7638	0.7462	1.3778	44	1.936	0.3731	0.7462	1.364
21	23.6835	1.7476	0.6835	1.3940	43	1.942	0.3418	0.6835	1.392
22	24.6208	1.7314	0.6208	1.4102	42	1.948	0.3104	0.6208	1.419
23	25.5581	1.7151	0.5581	1.4265	41	1.952	0.2791	0.5581	1.446
24	26.4954	1.6989	0.4954	1.4427	40	1.956	0.2477	0.4954	1.472
25	27.4328	1.6827	0.4328	1.4589	39	1.960	0.2164	0.4328	1.498
26	28.3701	1.6665	0.3701	1.4751	38	1.963	0.1851	0.3701	1.524
27	29.3074	1.6503	0.3074	1.4913	37	1.965	0.1537	0.3074	1.549
28	30.2447	1.6341	0.2448	1.5075	36	1.967	0.1224	0.2448	1.573
29	31.1820	1.6179	0.1820	1.5237	35	1.969	0.0910	0.1820	1.598
30	32.1193	1.6017	0.1193	1.5399	34	1.970	0.0597	0.1193	1.622
31	33.0566	1.5854	0.0566	1.5562	33	1.971	0.0283	0.0566	1.646

^a If enlarged mating pinions are of unequal size, the center distance is increased by an amount equal to one-half the sum of their increase over standard outside diameters. Data in this column are not given in the standard.

^b To maintain standard center distance when using an enlarged pinion, the mating gear diameter must be decreased by the amount of the pinion enlargement.

All dimensions are given in inches and are for 1 diametral pitch. For other pitches divide tabulated dimensions by the diametral pitch.

**Table 9c. Tooth Proportions Recommended for Enlarging Fine-Pitch Pinions of 20-Degree Pressure Angle—
20 Diametral Pitch and Finer ANSI B6.7-1977**

Enlarged Pinion Dimensions					Enlarged C.D. System Pinion Mating with Standard Gear		Standard Center Distance (Long and Short Addendums) Reduced Gear Dimensions				
Number of Teeth, ^a <i>n</i>	Outside Diameter, <i>D_{oP}</i>	Addendum, <i>a_P</i>	Basic Tooth Thickness, <i>t_P</i>	Dedendum Based on 20 Pitch, ^b <i>b_P</i>	Contact Ratio Two Equal Pinions	Contact Ratio with a 24-Tooth Gear	Addendum, <i>a_G</i>	Basic Tooth Thickness, <i>t_G</i>	Dedendum Based on 20 Pitch, ^b <i>b_G</i>	Recommended Minimum No. of Teeth, <i>N</i>	Contact Ratio <i>n</i> Mating with <i>N</i>
7	10.0102	1.5051	2.14114	0.4565	0.697	1.003	0.2165	1.00045	2.0235	42	1.079
8	11.0250	1.5125	2.09854	0.5150	0.792	1.075	0.2750	1.04305	1.9650	40	1.162
9	12.0305	1.5152	2.05594	0.5735	0.893	1.152	0.3335	1.08565	1.9065	39	1.251
10	13.0279	1.5140	2.01355	0.6321	0.982	1.211	0.3921	1.12824	1.8479	38	1.312
11	14.0304	1.5152	1.97937	0.6787	1.068	1.268	0.4387	1.16222	1.8013	37	1.371
12	15.0296	1.5148	1.94703	0.7232	1.151	1.322	0.4832	1.19456	1.7568	36	1.427
13	15.9448	1.4724	1.91469	0.7676	1.193	1.353	0.5276	1.22690	1.7124	35	1.457
14	16.8560	1.4280	1.88235	0.8120	1.232	1.381	0.5720	1.25924	1.6680	34	1.483
15	17.7671	1.3836	1.85001	0.8564	1.270	1.408	0.6164	1.29158	1.6236	33	1.507
16	18.6782	1.3391	1.81766	0.9009	1.323	1.434	0.6609	1.32393	1.5791	32	1.528
17	19.5894	1.2947	1.78532	0.9453	1.347	1.458	0.7053	1.35627	1.5347	31	1.546
18	20.5006	1.2503	1.75298	0.9897	1.385	1.482	0.7497	1.38861	1.4903	30	1.561
19	21.4116	1.2058	1.72064	1.0342	1.423	1.505	0.7942	1.42095	1.4458	29	1.574
20	22.3228	1.1614	1.68839	1.0786	1.461	1.527	0.8386	1.45320	1.4014	28	1.584
21	23.2340	1.1170	1.65595	1.1230	1.498	1.548	0.8830	1.48564	1.3570	27	1.592
22	24.1450	1.0725	1.62361	1.1675	1.536	1.568	0.9275	1.51798	1.3125	26	1.598
23	25.0561	1.0281	1.59127	1.2119	1.574	1.588	0.9719	1.55032	1.2681	25	1.601
24	26.0000	1.0000	1.57080	1.2400	1.602	1.602	1.0000	1.57080	1.2400	24	1.602

^a Caution should be exercised in the use of pinions above the horizontal lines. They should be checked for suitability, particularly in the areas of contact ratio (less than 1.2 is not recommended), center distance, clearance, and tooth strength.

^b The actual dedendum is calculated by dividing the values in this column by the desired diametral pitch and then adding to the result an amount Δ found in Table 9a. As an example, a 20-degree pressure angle 7-tooth pinion meshing with a 42-tooth gear would have, for 24 diametral pitch, a dedendum of $0.4565 \div 24 + 0.0004 = 0.0194$. The 42-tooth gear would have a dedendum of $2.0235 \div 24 + 0.004 = 0.0847$ inch.

All dimensions are given in inches.

**Table 9d. Tooth Proportions Recommended for Enlarging Fine-Pitch Pinions of 25-Degree Pressure Angle—
20 Diametral Pitch and Finer ANSI B6.7-1977, Information Sheet B**

Enlarged Pinion Dimensions					Enlarged C.D. System Pinion Mating with Standard Gear		Standard Center Distance (Long and Short Addendums) Reduced Gear Dimensions					
Number of Teeth, ^a <i>n</i>	Outside Diameter, <i>D_{oP}</i>	Addendum, <i>a_P</i>	Basic Tooth Thickness, <i>t_P</i>	Dedendum Based on 20 Pitch, Dedendum Based on 20 Pitch, ^b <i>b_P</i>	Contact Ratio Two Equal Pinions	Contact Ratio with a 15-Tooth Gear	Addendum, <i>a_G</i>	Basic Tooth Thickness, <i>t_G</i>	Dedendum Based on 20 Pitch, ^b <i>b_G</i>	Recommended Minimum No. of Teeth, <i>N</i>	Contact Ratio <i>n</i> Mating with <i>N</i>	
6	8.7645	1.3822	2.18362	0.5829	0.696	0.954	0.3429	0.95797	1.8971	24	1.030	
7	9.7253	1.3626	2.10029	0.6722	0.800	1.026	0.4322	1.04130	1.8078	23	1.108	
8	10.6735	1.3368	2.01701	0.7616	0.904	1.094	0.5216	1.12459	1.7184	22	1.177	
9	11.6203	1.3102	1.94110	0.8427	1.003	1.156	0.6029	1.20048	1.6371	20	1.234	
10	12.5691	1.2846	1.87345	0.9155	1.095	1.211	0.6755	1.26814	1.5645	19	1.282	
11	13.5039	1.2520	1.80579	0.9880	1.183	1.261	0.7480	1.33581	1.4920	18	1.322	
12	14.3588	1.1794	1.73813	1.0606	1.231	1.290	0.8206	1.40346	1.4194	17	1.337	
13	15.2138	1.1069	1.67047	1.1331	1.279	1.317	0.8931	1.47112	1.3469	16	1.347	
14	16.0686	1.0343	1.60281	1.2057	1.328	1.343	0.9657	1.53878	1.2743	15	1.352	
15	17.0000	1.0000	1.57030	1.2400	1.358	1.358	1.0000	1.57080	1.2400	15	1.358	

^a Caution should be exercised in the use of pinions above the horizontal lines. They should be checked for suitability, particularly in the areas of contact ratio (less than 1.2 is not recommended), center distance, clearance, and tooth strength.

^b The actual dedendum is calculated by dividing the values in this column by the desired diametral pitch and then adding to the result an amount Δ found in Table 9a. As an example, a 20-degree pressure angle 7-tooth pinion meshing with a 42-tooth gear would have, for 24 diametral pitch, a dedendum of $0.4565 \div 24 + 0.0004 = 0.0194$. The 42-tooth gear would have a dedendum of $2.0235 \div 24 + 0.004 = 0.0847$ inch.

All dimensions are given in inches.

All values are for 1 diametral pitch. For any other sizes of teeth, all linear dimensions should be divided by the diametral pitch.

Note: The tables in the ANSI B6.7-1977 standard also specify Form Diameter, Roll Angle to Form Diameter, and Top Land. These are not shown here. The top land is in no case less than $0.275/P$. The form diameters and the roll angles to form diameter shown in the Standard are the values which should be met with a standard hob when generating the tooth thicknesses shown in the tables. These form diameters provides more than enough length of involute profile for any mating gear smaller than a rack. However, since these form diameters are based on gear tooth generation using standard hobs, they should impose little or no hardship on manufacture except in cases of the most critical quality levels. In such cases, form diameter specifications and master gear design should be based upon actual mating conditions.

Minimum Number of Teeth to Avoid Undercutting by Hob.—The data in the above tables give tooth proportions for low numbers of teeth to avoid interference between the gear tooth tip and the pinion tooth flank. Consideration must also be given to possible undercutting of the pinion tooth flank by the hob used to cut the pinion. The minimum number of teeth N_{\min} of standard proportion that may be cut without undercut is:

$N_{\min} = 2P \csc^2 \phi [a_H - r_t (1 - \sin \phi)]$ where: a_H = cutter addendum; r_t = radius at cutter tip or corners; ϕ = cutter pressure angle; and P = diametral pitch.

Gear to Mesh with Enlarged Pinion.—Data in the fifth column of **Table 8** show minimum number of teeth in a mating gear which can be cut with hob or rack type cutter without undercut, when outside diameter of gear has been reduced an amount equal to the pinion enlargement to retain the standard center distance. To calculate N for the gear, insert addendum a of enlarged mating pinion in the formula $N = 2a \times \csc^2 \phi$.

Example: A gear is to mesh with a 24-tooth pinion of 1 diametral pitch which has been enlarged 0.4954 inch, as shown by the table. The pressure angle is $14\frac{1}{2}$ degrees. Find minimum number of teeth N for reduced gear.

$$\text{Pinion addendum} = 1 + (0.4954 \div 2) = 1.2477$$

$$\text{Hence, } N = 2 \times 1.2477 \times 15.95 = 39.8 \text{ (use 40)}$$

In the case of fine pitch gears with reduced outside diameters, the recommended minimum numbers of teeth given in **Tables 9b**, **9c**, and **9d**, are somewhat more than the minimum numbers required to prevent undercutting and are based upon studies made by the *American Gear Manufacturers Association*.

Standard Center-distance System for Enlarged Pinions.—In this system, sometimes referred to as “long and short addendums,” the center distance is made standard for the numbers of teeth in pinion and gear. The outside diameter of the gear is decreased by the same amount that the outside of the pinion is enlarged.

The advantages of this system are: 1) No change in center distance or ratio is required; 2) The operating pressure angle remains standard; and 3) A slightly greater contact ratio is obtained than when the center distance is increased.

The disadvantages are 1) The gears as well as the pinion must be changed from standard dimensions; 2) Pinions having fewer than the minimum number of teeth to avoid undercut cannot be satisfactorily meshed together; and 3) In most cases where gear trains include idler gears, the standard center-distance system cannot be used.

Enlarged Center-distance System for Enlarged Pinions.—If an enlarged pinion is meshed with another enlarged pinion or with a gear of standard outside diameter, the center distance must be increased. For fine-pitch gears, it is usually satisfactory to increase the center distance by an amount equal to one-half of the enlargements (see eighth column of **Table 9b**). This is an approximation as theoretically there is a slight increase in backlash.

The advantages of this system are: 1) Only the pinions need be changed from the standard dimensions; 2) Pinions having fewer than 18 teeth may engage other pinions in this range; 3) The pinion tooth, which is the weaker member, is made stronger by the enlargement; and 4) The tooth contact stress, which controls gear durability, is lowered by being moved away from the pinion base circle.

The disadvantages are: 1) Center distances must be enlarged over the standard; 2) The operating pressure angle increases slightly with different combinations of pinions and gears, which is usually not important; and 3) The contact ratio is slightly smaller than that obtained with the standard center-distance system.

This consideration is of minor importance as in the worst case the loss is approximately only 6 per cent.

Enlarged Pinions Meshing without Backlash: When two enlarged pinions are to mesh without backlash, their center distance will be greater than the standard and less than that

for the enlarged center-distance system. This center distance may be calculated by the formulas given in the following section.

Center Distance at Which Modified Mating Spur Gears Will Mesh with No Backlash.—When the tooth thickness of one or both of a pair of mating spur gears has been increased or decreased from the standard value ($\pi + 2P$), the center distance at which they will mesh tightly (without backlash) may be calculated from the following formulas:

$$\text{inv } \phi_1 = \text{inv } \phi + \frac{P(t + T) - \pi}{n + N} \quad C = \frac{n + N}{2P} \quad C_1 = \frac{\cos \phi}{\cos \phi_1} \times C$$

In these formulas, P = diametral pitch; n = number of teeth in pinion; N = number of teeth in gear; t and T are the actual tooth thicknesses of the pinion and gear, respectively, on their standard pitch circles; $\text{inv } \phi$ = involute function of standard pressure angle of gears; C = standard center distance for the gears; C_1 = center distance at which the gears mesh without backlash; and $\text{inv } \phi_1$ = involute function of operating pressure angle when gears are meshed tightly at center distance C_1 .

Example: Calculate the center distance for no backlash when an enlarged 10-tooth pinion of 100 diametral pitch and 20-degree pressure angle is meshed with a standard 30-tooth gear, the circular tooth thickness of the pinion and gear, respectively, being 0.01873 and 0.015708 inch. From the table of involute functions, page 111, $\text{inv } 20\text{-degrees} = 0.014904$. Therefore,

$$\text{inv } \phi_1 = \text{inv } 20^\circ + \frac{100(0.01873 + 0.015708) - \pi}{(10 + 30)} = 0.014904 + \frac{0.34438 - 0.31416}{4}$$

$$\text{inv } \phi_1 = 0.022459 \quad \text{then, from the involute table} \quad \phi_1 = 22^\circ 49'$$

$$C = \frac{n + N}{2P} = \frac{10 + 30}{2 \times 100} = 0.2000 \text{ inch}$$

$$C_1 = \frac{\cos 20^\circ}{\cos 22^\circ 49'} \times 0.2000 = \frac{0.93969}{0.92175} \times 0.2000 = 0.2039 \text{ inch}$$

Contact Diameter.—For two meshing gears it is important to know the contact diameter of each. A first gear with number of teeth, n , and outside diameter, d_o , meshes at a standard center distance with a second gear with number of teeth, N , and outside diameter, D_o ; both gears have a diametral pitch, P , and pressure angle, ϕ , a , A , b , and B are unnamed angles used only in the calculations. The contact diameter, d_c , is found by a three-step calculation that can be done by hand using a trigonometric table and a logarithmic table or a desk calculator. Slide rule calculation is not recommended because it is not accurate enough to give good results. The three-step formulas to find the contact diameter, d_c , of the first gear are:

$$\cos A = \frac{N \cos \phi}{D_o \times P} \tag{1}$$

$$\tan b = \tan \phi - \frac{N}{n} (\tan A - \tan \phi) \tag{2}$$

$$d_c = \frac{n \cos \phi}{P \cos b} \tag{3}$$

Similarly the three-step formulas to find the contact diameter, D_c , of the second gear are:

$$\cos a = \frac{n \cos \phi}{d_o \times P} \tag{4}$$

$$\tan B = \tan \phi - \frac{n}{N}(\tan a - \tan \phi) \quad (5)$$

$$D_c = \frac{N \cos \phi}{P \cos B} \quad (6)$$

Contact Ratio.—The contact ratio of a pair of mating spur gears must be well over 1.0 to assure a smooth transfer of load from one pair of teeth to the next pair as the two gears rotate under load. Because of a reduction in contact ratio due to such factors as tooth deflection, tooth spacing errors, tooth tip breakage, and outside diameter and center distance tolerances, the contact ratio of gears for power transmission as a general rule should not be less than about 1.4. A contact ratio of as low as 1.15 may be used in extreme cases, provided the tolerance effects mentioned above are accounted for in the calculation. The formula for determining the contact ratio, m_f , using the nomenclature in the previous section is:

$$m_f = \frac{N}{6.28318}(\tan A - \tan B) \quad (7a)$$

or

$$m_f = \frac{N}{6.28318}(\tan a - \tan b) \quad (7b)$$

or

$$m_f = \frac{\sqrt{R_0^2 - R_B^2} + \sqrt{r_0^2 - r_B^2} - C \sin \theta}{P \cos \theta} \quad (7c)$$

where R_0 = outside radius of first gear; R_B = base radius of first gear; r_0 = outside radius of second gear; r_B = base radius of second gear; C = center distance; I = pressure angle; and, p = circular pitch.

Both formulas [Equations \(4a\)](#) and [Equations \(5b\)](#) should give the same answer. It is good practice to use both formulas as a check on the previous calculations.

Lowest Point of Single Tooth Contact.—This diameter on the pinion (sometimes referred to as LPSTC) is used to find the maximum contact compressive stress (sometimes called the Hertz Stress) of a pair of mating spur gears. The two-step formulas for determining this pinion diameter, d_L , using the same nomenclature as in the previous sections with c and C as unnamed angles used only in the calculations are:

$$\tan c = \tan a - \frac{6.28318}{n} \quad (8)$$

$$d_L = \frac{n \cos \phi}{P \cos c} \quad (9)$$

In some cases it is necessary to have a plot of the compressive stress over the whole cycle of contact; in this case the LPSTC for the gear is required also. The similar two-step formulas for this gear diameter are:

$$\tan C = \tan A - \frac{6.28318}{N} \quad (10)$$

$$D_L = \frac{N \cos \phi}{P \cos C} \quad (11)$$

Maximum Hob Tip Radius.—The standard gear tooth proportions given by the formulas in [Table 2](#) on page 2131 provide a specified size for the rack fillet radius in the general form of (a constant) \times (pitch). For any given standard this constant may vary up to a maximum

which it is geometrically impossible to exceed; this maximum constant, r_c (max), is found by the formula:

$$r_c \text{ (max)} = \frac{0.785398 \cos \phi - b \sin \phi}{1 - \sin \phi} \quad (12)$$

where b is the similar constant in the specified formula for the gear dedendum. The hob tip radius of any standard hob to finish cut any standard gear may vary from zero up to this limiting value.

Undercut Limit for Hobbed Involute Gears.—It is well to avoid designing and specifying gears that will have a hobbled trochoidal fillet that undercuts the involute gear tooth profile. This should be avoided because it may cause the involute profile to be cut away up to a point above the required contact diameter with the mating gear so that involute action is lost and the contact ratio reduced to a level that may be too low for proper conjugate action. An undercut fillet will also weaken the beam strength and thus raise the fillet tensile stress of the gear tooth. To assure that the hobbled gear tooth will not have an undercut fillet, the following formula must be satisfied:

$$\frac{b - r_c}{\sin \phi} + r_c \leq 0.5n \sin \phi \quad (13)$$

where b is the dedendum constant; r_c is the hob or rack tip radius constant; n is the number of teeth in the gear; and ϕ is the gear and hob pressure angle. If the gear is not standard or the hob does not roll at the gear pitch diameter, this formula can not be applied and the determination of the expected existence of undercut becomes a considerably more complicated procedure.

Highest Point of Single Tooth Contact.—This diameter is used to place the maximum operating load for the determination of the gear tooth fillet stress. The two-step formulas for determining this diameter, d_H , of the pinion using the same nomenclature as in the previous sections with d and D as unnamed angles used only in the calculations are:

$$\tan d = \tan b + \frac{6.28318}{n} \quad (14)$$

$$d_H = \frac{n \cos \phi}{P \cos d} \quad (15)$$

Similarly for the gear:

$$\tan D = \tan B + \frac{6.28318}{N} \quad (16)$$

$$D_H = \frac{N \cos \phi}{P \cos D} \quad (17)$$

True Involute Form Diameter.—The point on the gear tooth at which the fillet and the involute profile are tangent to each other should be determined to assure that it lies at a smaller diameter than the required contact diameter with the mating gear. If the TIF diameter is larger than the contact diameter, then fillet interference will occur with severe damage to the gear tooth profile and rough action of the gear set. This two-step calculation is made by using the following two formulas with e and E as unnamed angles used only in the calculations:

$$\tan e = \tan \phi - \frac{4}{n} \left(\frac{b - r_c}{\sin 2\phi} + \frac{r_c}{2 \cos \phi} \right) \quad (18)$$

$$d_{TIF} = \frac{n \cos \phi}{P \cos e} \quad (19)$$

As in the previous sections, ϕ is the pressure angle of the gear; n is the number of teeth in the pinion; b is the dedendum constant, r_c is the rack or hob tip radius constant, P is the gear diametral pitch and d_{TIF} is the true involute form diameter.

Similarly, for the mating gear:

$$\tan E = \tan \phi - \frac{4}{N} \left(\frac{b - r_c}{\sin 2\phi} + \frac{r_c}{2 \cos \phi} \right) \quad (20)$$

$$D_{TIF} = \frac{N \cos \phi}{P \cos E} \quad (21)$$

where N is number of teeth in this mating gear and D_{TIF} is the true involute form diameter.

Profile Checker Settings.—The actual tooth profile tolerance will need to be determined on high performance gears that operate either at high unit loads or at high pitch-line velocity. This is done on an involute checker, a machine which requires two settings, the gear base radius and the roll angle in degrees to significant points on the involute. From the smallest diameter outward these significant points are: TIF, Contact Diameter, LPSTC, Pitch Diameter, HPSTC, and Outside Diameter.

The base radius is:

$$R_b = \frac{N \cos \phi}{2P} \quad (22)$$

The roll angle, in degrees, at any point is equal to the tangent of the pressure angle at that point multiplied by 57.2958. The following table shows the tangents to be used at each significant diameter.

Significant Point on Tooth Profile	Pinion	Gear	For Computation
TIF	$\tan e$	$\tan E$	(See Formulas (18) & (20))
Contact Dia.	$\tan b$	$\tan B$	(See Formulas (2) & (5))
LPSTC	$\tan c$	$\tan C$	(See Formulas (8) & (10))
Pitch Dia.	$\tan \phi$	$\tan \phi$	(ϕ = Pressure angle)
HPSTC	$\tan d$	$\tan D$	(See Formulas (14) & (16))
Outside Dia.	$\tan a$	$\tan A$	(See Formulas (4) & (1))

✦ *Example:* Find the significant diameters, contact ratio and hob tip radius for a 10-diametral pitch, 23-tooth, 20-degree pressure angle pinion of 2.5-inch outside diameter if it is to mesh with a 31-tooth gear of 3.3-inch outside diameter.

Thus: $n = 23$

$$d_o = 2.5$$

$$P = 10$$

$$N = 31$$

$$D_o = 3.3$$

$$\phi = 20^\circ$$

1) Pinion contact diameter, d_c

$$\begin{aligned}\cos A &= \frac{31 \times 0.93969}{3.3 \times 10} \\ &= 0.88274 \quad A = 28^\circ 1' 30''\end{aligned}\quad (1)$$

$$\begin{aligned}\tan b &= 0.36397 - \frac{31}{23}(0.53227 - 0.36397) \\ &= 0.13713 \quad b = 7^\circ 48' 26''\end{aligned}\quad (2)$$

$$\begin{aligned}d_c &= \frac{23 \times 0.93969}{10 \times 0.99073} \\ &= 2.1815 \text{ inches}\end{aligned}\quad (3)$$

2) Gear contact diameter, D_c

$$\begin{aligned}\cos a &= \frac{23 \times 0.93963}{2.5 \times 10} \\ &= 0.86452 \quad a = 30^\circ 10' 20''\end{aligned}\quad (4)$$

$$\begin{aligned}\tan B &= 0.36397 - \frac{23}{31}(0.58136 - 0.36937) \\ &= 0.20267 \quad B = 11^\circ 27' 26''\end{aligned}\quad (5)$$

$$\begin{aligned}D_c &= \frac{31 \times 0.93969}{10 \times 0.98000} \\ &= 2.9725 \text{ inches}\end{aligned}\quad (6)$$

3) Contact ratio, m_f

$$\begin{aligned}m_f &= \frac{31}{6.28318}(0.53227 - 0.20267) \\ &= 1.626\end{aligned}\quad (7a)$$

$$\begin{aligned}m_f &= \frac{23}{6.28318}(0.58136 - 0.13713) \\ &= 1.626\end{aligned}\quad (7b)$$

4) Pinion LPSTC, d_L

$$\begin{aligned}\tan c &= 0.58136 - \frac{6.28318}{23} \\ &= 0.30818 \quad c = 17^\circ 7' 41''\end{aligned}\quad (8)$$

$$\begin{aligned}d_L &= \frac{23 \times 0.93969}{10 \times 0.95565} \\ &= 2.2616 \text{ inches}\end{aligned}\quad (9)$$

5) Gear LPSTC, D_L

$$\begin{aligned}\tan C &= 0.53227 - \frac{6.28318}{31} \\ &= 0.32959 \quad C = 18^\circ 14' 30''\end{aligned}\quad (10)$$

$$\begin{aligned}D_L &= \frac{31 \times 0.93969}{10 \times 0.94974} \\ &= 3.0672 \text{ inches}\end{aligned}\quad (11)$$

6) Maximum permissible hob tip radius, r_c (max). The dedendum factor is 1.25.

$$r_c \text{ (max)} = \frac{0.785398 \times 0.93969 - 1.25 \times 0.34202}{1 - 0.34202} \quad (12)$$

$$= 0.4719 \text{ inch}$$

7) If the hob tip radius r_c is 0.30, determine if the pinion involute is undercut.

$$\frac{1.25 - 0.30}{0.34202} + 0.30 \leq 0.5 \times 23 \times 0.34202 \quad (13)$$

$$3.0776 < 3.9332$$

8) therefore there is no involute undercut.

9) Pinion HPSTC, d_H

$$\tan d = 0.13713 + \frac{6.28318}{23} \quad (14)$$

$$= 0.41031 \quad d = 22^\circ 18' 32''$$

$$d_H = \frac{23 \times 0.93969}{10 \times 0.92515} \quad (15)$$

$$= 2.3362 \text{ inches}$$

10) Gear HPSTC, D_H

$$\tan D = 0.20267 + \frac{6.28318}{31} \quad (16)$$

$$= 0.40535 \quad D = 22^\circ 3' 55''$$

$$D_H = \frac{31 \times 0.93969}{10 \times 0.92676} \quad (17)$$

$$= 3.1433 \text{ inches}$$

11) Pinion TIF diameter, d_{TIF}

$$\tan e = 0.36397 - \frac{4}{23} \left(\frac{1.25 - 0.30}{0.64279} + \frac{0.30}{2 \times 0.93969} \right) \quad (18)$$

$$= 0.07917 \quad e = 4^\circ 31' 36''$$

$$d_{TIF} = \frac{23 \times 0.93969}{10 \times 0.99688} \quad (19)$$

$$= 2.1681 \text{ inches}$$

12) Gear TIF diameter, D_{TIF}

$$\tan E = 0.36397 - \frac{4}{31} \left(\frac{1.25 - 0.30}{0.64279} + \frac{0.30}{2 \times 0.93969} \right) \quad (20)$$

$$= 0.15267 \quad E = 8^\circ 40' 50''$$

$$D_{TIF} = \frac{31 \times 0.93969}{10 \times 0.98855} = 2.9468 \text{ inches} \quad (21)$$

Gear Blanks for Fine-pitch Gears.—The accuracy to which gears can be produced is considerably affected by the design of the gear blank and the accuracy to which the various surfaces of the blank are machined. The following recommendations should not be regarded as inflexible rules, but rather as minimum average requirements for gear-blank quality compatible with the expected quality class of the finished gear.

Design of Gear Blanks: The accuracy to which gears can be produced is affected by the design of the blank, so the following points of design should be noted: 1) Gears designed with a hole should have the hole large enough that the blank can be adequately supported during machining of the teeth and yet not so large as to cause distortion; 2) Face widths should be wide enough, in proportion to outside diameters, to avoid springing and to permit obtaining flatness in important surfaces; 3) Short bore lengths should be avoided wherever possible. It is feasible, however, to machine relatively thin blanks in stacks, provided the surfaces are flat and parallel to each other; 4) Where gear blanks with hubs are to be designed, attention should be given to the wall sections of the hubs. Too thin a section will not permit proper clamping of the blank during machining operations and may also affect proper mounting of the gear; and 5) Where pinions or gears integral with their shafts are to be designed, deflection of the shaft can be minimized by having the shaft length and shaft diameter well proportioned to the gear or pinion diameter. The foregoing general principles may also be useful when applied to blanks for coarser pitch gears.

Specifying Spur and Helical Gear Data on Drawings.—The data that may be shown on drawings of spur and helical gears falls into three groups: The first group consists of data basic to the design of the gear; the second group consists of data used in manufacturing and inspection; and the third group consists of engineering reference data. The accompanying table may be used as a checklist for the various data which may be placed on gear drawings and the sequence in which they should appear.

Explanation of Terms Used in Gear Specifications: 1) Number of teeth is the number of teeth in 360 deg of gear circumference. In a sector gear, both the actual number of teeth in the sector and the theoretical number of teeth in 360 deg should be given.

2) Diametral pitch is the ratio of the number of teeth in the gear to the number of inches in the standard pitch diameter. It is used in this standard as a nominal specification of tooth size.

- a) Normal diametral pitch is the diametral pitch in the normal plane.
- b) Transverse diametral pitch is the diametral pitch in the transverse plane.
- c) Module is the ratio of the number of teeth in the gear to the number of mm in the standard pitch diameter.
- d) Normal module is the module measured in the normal plane.
- e) Transverse module is the module measured in the transverse plane.

3) Pressure angle is the angle between the gear tooth profile and a radial line at the pitch point. It is used in this standard to specify the pressure angle of the basic rack used in defining the gear tooth profile.

- a) Normal pressure angle is the pressure angle in the normal plane.
- b) Transverse pressure angle is the pressure angle in the transverse plane.

4) Helix angle is the angle between the pitch helix and an element of the pitch cylinder, unless otherwise specified.

- a) Hand of helix is the direction in which the teeth twist as they recede from an observer along the axis. A right hand helix twists clockwise and a left hand helix twists counterclockwise.

5) Standard pitch diameter is the diameter of the pitch circle. It equals the number of teeth divided by the transverse diametral pitch.

6) Tooth form may be specified as standard addendum, long addendum, short addendum, modified involute or special. If a modified involute or special tooth form is required, a detailed view should be shown on the drawing. If a special tooth form is specified, roll angles must be supplied (see page 2158).

7) Addendum is the radial distance between the standard pitch circle and the outside circle. The actual value depends on the specification of outside diameter.

8) Whole depth is the total radial depth of the tooth space. The actual value is dependent on the specification of outside diameter and root diameter.

9) Maximum calculated circular thickness on the standard pitch circle is the tooth thickness which will provide the desired minimum backlash when the gear is assembled in mesh with its mate on minimum center distance. Control may best be exerted by testing in tight mesh with a master which integrates all errors in the several teeth in mesh through the arc of action as explained on page 2169. This value is independent of the effect of runout.

a) Maximum calculated *normal* circular thickness is the circular tooth thickness in the normal plane which satisfies requirements explained in (9).

10) Gear testing radius is the distance from its axis of rotation to the standard pitch line of a standard master when in intimate contact under recommended pressure on a variable-center-distance running gage. Maximum testing radius should be calculated to provide the maximum circular tooth thickness specified in (9) when checked as explained on page 2169. This value is affected by the runout of the gear. Tolerance on testing radius must be equal to or greater than the total composite error permitted by the quality class specified in (11).

11) Quality class is specified for convenience when talking or writing about the accuracy of the gear.

12) Maximum total composite error, and 13) Maximum tooth-to-tooth composite error. Actual tolerance values (12 and 13) permitted by the quality class (11) are specified in inches to provide machine operator or inspector with tolerances required to inspect the gear.

14) Testing pressure recommendations are given on page 2169. Incorrect testing pressure will result in incorrect measurement of testing radius.

15) Master specifications by tool or code number may be required to call for the use of a special master gear when tooth thickness deviates excessively from standard.

16) Measurement over two 0.xxxx diameter pins may be specified to assist the manufacturing department in determining size at machine for setup only.

17) Outside diameter is usually shown on the drawing of the gear together with other blank dimensions so that it will not be necessary for machine operators to search gear tooth data for this dimension. Since outside diameter is also frequently used in the manufacture and inspection of the teeth, it may be included in the data block with other tooth specifications if preferred. To permit use of topping hobs for cutting gears on which the tooth thickness has been modified from standard, the outside diameter should be related to the specified gear testing radius (10).

18) Maximum root diameter is specified to assure adequate clearance for the outside diameter of the mating gear. This dimension is usually considered acceptable if the gear is checked with a master and meets specifications (10) through (13).

19) Active profile diameter of a gear is the smallest diameter at which the mating gear tooth profile can make contact. Because of difficulties involved in checking, this specification is not recommended for gears finer than 48 pitch.

20) Surface roughness on active profile surfaces may be specified in microinches to be checked by instrument up to about 32 pitch, or by visual comparison in the finer pitch ranges. It is difficult to determine accurately the surface roughness of fine pitch gears. For many commercial applications surface roughness may be considered acceptable on gears which meet the maximum tooth-to-tooth-error specification (13).

21) Mating gear part number may be shown as a convenient reference. If the gear is used in several applications, all mating gears may be listed but usual practice is to record this information in a reference file.

22) Number of teeth in mating gear, and 23) Minimum operating center distance. This information is often specified to eliminate the necessity of getting prints of the mating gear and assemblies for checking the design specifications, interference, backlash, determination of master gear specification, and acceptance or rejection of gears made out of tolerance.

Data for Spur and Helical Gear Drawings

Type of Data	Min. Spur Gear Data	Min. Helical Gear-Data	Add'l Optional Data	Item Number ^a	Data ^a
Basic Specifications	•	•		1	Number of teeth
	•			2	Diametral pitch or module
		•		2a	Normal diametral pitch or module
			•	2b	Transverse diametral pitch or module
	•			3	Pressure angle
		•		3a	Normal pressure angle
			•	3b	Transverse pressure angle
		•		4	Helix angle
		•		4a	Hand of helix
	•	•		5	Standard pitch diameter
	•	•		6	Tooth form
			•	7	Addendum
			•	8	Whole depth
Manufacturing and Inspection	•			9	Max. calc. circular thickness on std. pitch circle
		•		9a	Max. calc. normal circular thickness on std.pitch circle
			•	10	Roll angles
	•	•		11	A.G.M.A. quality class
	•	•		12	Max. total composite error
	•	•		13	Max. tooth-to-tooth composite error
			•	14	Testing pressure (Ounces)
	•	•		15	Master specification
	•	•	•	16	Meas. over two .xxxx dia. pins (For setup only)
			•	17	Outside diameter (Preferably shown on drawing of gear)
			•	18	Max. root diameter
Engineering Reference			•	19	Active profile diameter
			•	20	Surface roughness of active profile
			•	21	Mating gear part number
			•	22	Number of teeth in mating gear
			•	23	Minimum operating center distance

^a An item-by-item explanation of the terms used in this table is given beginning on page 2161.

Backlash

In general, backlash in gears is play between mating teeth. For purposes of measurement and calculation, backlash is defined as the amount by which a tooth space exceeds the thickness of an engaging tooth. It does not include the effect of center-distance changes of the mountings and variations in bearings. When not otherwise specified, numerical values of backlash are understood to be given on the pitch circles. The general purpose of backlash is to prevent gears from jamming together and making contact on both sides of their teeth simultaneously. Lack of backlash may cause noise, overloading, overheating of the gears and bearings, and even seizing and failure.

Excessive backlash is objectionable, particularly if the drive is frequently reversing, or if there is an overrunning load as in cam drives. On the other hand, specification of an unnecessarily small amount of backlash allowance will increase the cost of gears, because errors in runout, pitch, profile, and mounting must be held correspondingly smaller. Backlash does not affect involute action and usually is not detrimental to proper gear action.

Determining Proper Amount of Backlash.—In specifying proper backlash and tolerances for a pair of gears, the most important factor is probably the maximum permissible amount of runout in both gear and pinion (or worm). Next are the allowable errors in profile, pitch, tooth thickness, and helix angle. Backlash between a pair of gears will vary as successive teeth make contact because of the effect of composite tooth errors, particularly runout, and errors in the gear center distances and bearings.

Other important considerations are speed and space for lubricant film. Slow-moving gears, in general, require the least backlash. Fast-moving fine-pitch gears are usually lubri-

cated with relatively light oil, but if there is insufficient clearance for an oil film, and particularly if oil trapped at the root of the teeth cannot escape, heat and excessive tooth loading will occur.

Heat is a factor because gears may operate warmer, and, therefore, expand more, than the housings. The heat may result from oil churning or from frictional losses between the teeth, at bearings or oil seals, or from external causes. Moreover, for the same temperature rise, the material of the gears—for example, bronze and aluminum—may expand more than the material of the housings, usually steel or cast iron.

The higher the helix angle or spiral angle, the more transverse backlash is required for a given normal backlash. The transverse backlash is equal to the normal backlash divided by the cosine of the helix angle.

In designs employing normal pressure angles higher than 20 degrees, special consideration must be given to backlash, because more backlash is required on the pitch circles to obtain a given amount of backlash in a direction normal to the tooth profiles.

Errors in boring the gear housings, both in center distance and alignment, are of extreme importance in determining allowance to obtain the backlash desired. The same is true in the mounting of the gears, which is affected by the type and adjustment of bearings, and similar factors. Other influences in backlash specification are heat treatment subsequent to cutting the teeth, lapping operations, need for recutting, and reduction of tooth thickness through normal wear.

Minimum backlash is necessary for timing, indexing, gun-sighting, and certain instrument gear trains. If the operating speed is very low and the necessary precautions are taken in the manufacture of such gear trains, the backlash may be held to extremely small limits. However, the specification of “zero backlash,” so commonly stipulated for gears of this nature, usually involves special and expensive techniques, and is difficult to obtain.

Table 1. AGMA Recommended Backlash Range for Coarse-Pitch Spur, Helical, and Herringbone Gearing

Center Distance (Inches)	Normal Diametral Pitches				
	0.5-1.99	2-3.49	3.5-5.99	6-9.99	10-19.99
	Backlash, Normal Plane, Inches ^a				
Up to 5005-.015
Over 5 to 10010-.020	.010-.020
Over 10 to 20020-.030	.015-.025	.010-.020
Over 20 to 30030-.040	.025-.030	.020-.030	...
Over 30 to 40	.040-.060	.035-.045	.030-.040	.025-.035	...
Over 40 to 50	.050-.070	.040-.055	.035-.050	.030-.040	...
Over 50 to 80	.060-.080	.045-.065	.040-.060
Over 80 to 100	.070-.095	.050-.080
Over 100 to 120	.080-.110

^a Suggested backlash, on nominal centers, measured after rotating to the point of closest engagement. For helical and herringbone gears, divide above values by the cosine of the helix angle to obtain the transverse backlash.

The above backlash tolerances contain allowance for gear expansion due to differential in the operating temperature of the gearing and their supporting structure. The values may be used where the operating temperatures are up to 70 deg F higher than the ambient temperature.

For most gearing applications the recommended backlash ranges will provide proper running clearance between engaging teeth of mating gears. Deviation below the minimum or above the maximum values shown, which do not affect operational use of the gearing, should not be cause for rejection.

Definite backlash tolerances on coarse-pitch gearing are to be considered binding on the gear manufacturer only when agreed upon in writing.

Some applications may require less backlash than shown in the above table. In such cases the amount and tolerance should be by agreement between manufacturer and purchaser.

Recommended Backlash: In the following tables American Gear Manufacturers Association recommendations for backlash ranges for various kinds of gears are given.* For purposes of measurement and calculation, backlash is defined as the amount by which a tooth space exceeds the thickness of an engaging tooth. When not otherwise specified, numerical values of backlash are understood to be measured at the tightest point of mesh on the pitch circle in a direction normal to the tooth surface when the gears are mounted in their specified position.

Coarse-Pitch Gears:: Table 1 gives the recommended backlash range for coarse-pitch spur, helical and herringbone gearing. Because backlash for helical and herringbone gears is more conveniently measured in the normal plane, Table 1 has been prepared to show backlash in the normal plane for coarse-pitch helical and herringbone gearing and in the transverse plane for spur gears. To obtain backlash in the transverse plane for helical and herringbone gears, divide the normal plane backlash in Table 1 by the cosine of the helix angle.

Table 2. AGMA Recommended Backlash Range for Bevel and Hypoid Gears

Diametral Pitch	Normal Backlash, Inch		Diametral Pitch	Normal Backlash, Inch	
	Quality Numbers 7 through 13	Quality Numbers 3 through 6		Quality Numbers 7 through 13	Quality Numbers 3 through 6
1.00 to 1.25	0.020-0.030	0.045-0.065	5.00 to 6.00	0.005-0.007	0.006-0.013
1.25 to 1.50	0.018-0.026	0.035-0.055	6.00 to 8.00	0.004-0.006	0.005-0.010
1.50 to 1.75	0.016-0.022	0.025-0.045	8.00 to 10.00	0.003-0.005	0.004-0.008
1.75 to 2.00	0.014-0.018	0.020-0.040	10.00 to 16.00	0.002-0.004	0.003-0.005
2.00 to 2.50	0.012-0.016	0.020-0.030	16.00 to 20.00	0.001-0.003	0.002-0.004
2.50 to 3.00	0.010-0.013	0.015-0.025	20 to 50	0.000-0.002	0.000-0.002
3.00 to 3.50	0.008-0.011	0.012-0.022	50 to 80	0.000-0.001	0.000-0.001
3.50 to 4.00	0.007-0.009	0.010-0.020	80 and finer	0.000-0.0007	0.000-0.0007
4.00 to 5.00	0.006-0.008	0.008-0.016

Measured at tightest point of mesh

The backlash tolerances given in this table contain allowances for gear expansion due to a differential in the operating temperature of the gearing and their supporting structure. The values may be used where the operating temperature is up to 70 °F higher (39 °C higher) than the ambient temperature. These backlash values will provide proper running clearances for most gear applications.

The following important factors must be considered in establishing backlash tolerances:

- a) Center distance tolerance; b) Parallelism of gear axes; c) Side runout or wobble;
- d) Tooth thickness tolerance; e) Pitch line runout tolerance; f) Profile tolerance; g) Pitch tolerance; h) Lead tolerance; i) Types of bearings and subsequent wear; j) Deflection under load; k) Gear tooth wear; l) Pitch line velocity; m) Lubrication requirements; and
- n) Thermal expansion of gears and housing.

A tight mesh may result in objectionable gear sound, increased power losses, overheating, rupture of the lubricant film, overloaded bearings and premature gear failure. However, it is recognized that there are some gearing applications where a tight mesh (zero backlash) may be required.

Specifying unnecessarily close backlash tolerances will increase the cost of the gearing. It is obvious from the above summary that the desired amount of backlash is difficult to evaluate. It is, therefore, recommended that when a designer, user or purchaser includes a reference to backlash in a gearing specification and drawing, consultation be arranged with the manufacturer.

* Extracted from Gear Classification Manual, AGMA 390.03 with permission of the publisher, the American Gear Manufacturers Association, 1500 King St., Alexandria, VA 22314.

Bevel and Hypoid Gears: Table 2 gives similar backlash range values for bevel and hypoid gears. These are values based upon average conditions for general purpose gearing, but may require modification to meet specific needs.

Backlash on bevel and hypoid gears can be controlled to some extent by axial adjustment of the gears during assembly. However, due to the fact that actual adjustment of a bevel or hypoid gear in its mounting will alter the amount of backlash, it is imperative that the amount of backlash cut into the gears during manufacture is not excessive. Bevel and hypoid gears must always be capable of operation without interference when adjusted for zero backlash. This requirement is imposed by the fact that a failure of the axial thrust bearing might permit the gears to operate under this condition. Therefore, bevel and hypoid gears should never be designed to operate with normal backlash in excess of $0.080/P$ where P is diametral pitch.

Fine-Pitch Gears: Table 3 gives similar backlash range values for fine-pitch spur, helical and herringbone gearing.

Providing Backlash.—In order to obtain the amount of backlash desired, it is necessary to decrease tooth thicknesses. However, because of manufacturing and assembling inaccuracies not only in the gears but also in other parts, the allowances made on tooth thickness almost always must exceed the desired amount of backlash. Since the amounts of these allowances depend on the closeness of control exercised on all manufacturing operations, no general recommendations for them can be given.

It is customary to make half the allowance for backlash on the tooth thickness of each gear of a pair, although there are exceptions. For example, on pinions having very low numbers of teeth it is desirable to provide all the allowance on the mating gear, so as not to weaken the pinion teeth. In worm gearing, ordinary practice is to provide all of the allowance on the worm which is usually made of a material stronger than that of the worm gear.

In some instances the backlash allowance is provided in the cutter, and the cutter is then operated at the standard tooth depth. In still other cases, backlash is obtained by setting the distance between two tools for cutting the two sides of the teeth, as in straight bevel gears, or by taking side cuts, or by changing the center distance between the gears in their mountings. In spur and helical gearing, backlash allowance is usually obtained by sinking the cutter deeper into the blank than the standard depth. The accompanying table gives the excess depth of cut for various pressure angles.

Excess Depth of Cut E to Provide Backlash Allowance

Distribution of Backlash	Pressure Angle ϕ , Degrees				
	$14\frac{1}{2}$	$17\frac{1}{2}$	20	25	30
Excess Depth of Cut E to Obtain Circular Backlash B^a					
All on One Gear	$1.93B$	$1.59B$	$1.37B$	$1.07B$	$0.87B$
One-half on Each Gear	$0.97B$	$0.79B$	$0.69B$	$0.54B$	$0.43B$
Excess Depth of Cut E to Obtain Backlash B_b Normal to Tooth Profile ^b					
All on One Gear	$2.00B_b$	$1.66B_b$	$1.46B_b$	$1.18B_b$	$1.99B_b$
One-half on Each Gear	$1.00B_b$	$0.83B_b$	$0.73B_b$	$0.59B_b$	$0.50B_b$

^a Circular backlash is the amount by which the width of a tooth space is greater than the thickness of the engaging tooth on the pitch circles. As described in pages 2163 and 2167 this is what is meant by backlash unless otherwise specified.

^b Backlash measured normal to the tooth profile by inserting a feeler gage between meshing teeth; to convert to circular backlash, $B = B_b \div \cos \phi$.

Control of Backlash Allowances in Production.—Measurement of the tooth thickness of gears is perhaps the simplest way of controlling backlash allowances in production.

There are several ways in which this may be done including: 1) chordal thickness measurements as described on page 2145; 2) caliper measurements over two or more teeth as described on page 2236; and 3) measurements over wires.

In this last method, first the theoretical measurement over wires when the backlash allowance is zero is determined by the method described on page 2221; then the amount this measurement must be reduced to obtain a desired backlash allowance is taken from the table on page 2235.

It should be understood, as explained in the section *Measurement of Backlash* that merely making tooth thickness allowances will not guarantee the amount of backlash in the ready-to-run assembly of two or more gears. Manufacturing limitations will introduce such gear errors as runout, pitch error, profile error, and lead error, and gear-housing errors in both center distance and alignment. All of these make the backlash of the assembled gears different from that indicated by tooth thickness measurements on the individual gears.

Measurement of Backlash.—Backlash is commonly measured by holding one gear of a pair stationary and rocking the other back and forth. The movement is registered by a dial indicator having its pointer or finger in a plane of rotation at or near the pitch diameter and in a direction parallel to a tangent to the pitch circle of the moving gear. If the direction of measurement is normal to the teeth, or other than as specified above, it is recommended that readings be converted to the plane of rotation and in a tangent direction at or near the pitch diameter, for purposes of standardization and comparison.

In spur gears, parallel helical gears, and bevel gears, it is immaterial whether the pinion or gear is held stationary for the test. In crossed helical and hypoid gears, readings may vary according to which member is stationary; hence, it is customary to hold the pinion stationary and measure on the gear.

In some instances, backlash is measured by thickness gages or feelers. A similar method utilizes a soft lead wire inserted between the teeth as they pass through mesh. In both methods, it is likewise recommended that readings be converted to the plane of rotation and in a tangent direction at or near the pitch diameter, taking into account the normal pressure angle, and the helix angle or spiral angle of the teeth.

Sometimes backlash in parallel helical or herringbone gears is checked by holding the gear stationary, and moving the pinion axially back and forth, readings being taken on the face or shaft of the pinion, and converted to the plane of rotation by calculation. Another method consists of meshing a pair of gears tightly together on centers and observing the variation from the specified center distance. Such readings should also be converted to the plane of rotation and in a tangent direction at or near the pitch diameter for the reasons previously given.

Measurements of backlash may vary in the same pair of gears, depending on accuracy of manufacturing and assembling. Incorrect tooth profiles will cause a change of backlash at different phases of the tooth action. Eccentricity may cause a substantial difference between maximum and minimum backlash at different positions around the gears. In stating amounts of backlash, it should always be remembered that merely making allowances on tooth thickness does not guarantee the minimum amount of backlash that will exist in assembled gears.

Fine-Pitch Gears: The measurement of backlash of fine-pitch gears, when assembled, cannot be made in the same manner and by the same techniques employed for gears of coarser pitches. In the very fine pitches, it is virtually impossible to use indicating devices for measuring backlash. Sometimes a toolmaker's microscope is used for this purpose to good advantage on very small mechanisms.

Another means of measuring backlash in fine-pitch gears is to attach a beam to one of the shafts and measure the angular displacement in inches when one member is held stationary. The ratio of the length of the beam to the nominal pitch radius of the gear or pinion to which the beam is attached gives the approximate ratio of indicator reading to circular backlash. Because of the limited means of measuring backlash between a pair of fine-pitch gears, gear centers and tooth thickness of the gears when cut must be held to very close lim-

its. Tooth thickness of fine-pitch spur and helical gears can best be checked on a variable-center-distance fixture using a master gear. When checked in this manner, tooth thickness change = $2 \times$ center distance change \times tangent of transverse pressure angle, approximately.

Control of Backlash in Assemblies.—Provision is often made for adjusting one gear relative to the other, thereby affording complete control over backlash at initial assembly and throughout the life of the gears. Such practice is most common in bevel gearing. It is fairly common in spur and helical gearing when the application permits slight changes between shaft centers. It is practical in worm gearing only for single thread worms with low lead angles. Otherwise faulty contact results.

Another method of controlling backlash quite common in bevel gears and less common in spur and helical gears is to match the high and low spots of the runout gears of one to one ratio and mark the engaging teeth at the point where the runout of one gear cancels the runout of the mating gear.

Table 3. AGMA Backlash Allowance and Tolerance for Fine-Pitch Spur, Helical and Herringbone Gearing

Backlash Designation	Normal Diametral Pitch Range	Tooth Thinning to Obtain Backlash ^a		Resulting Approximate Backlash (per Mesh) Normal Plane ^b Inch
		Allowance, per Gear, Inch	Tolerance, per Gear, Inch	
A	20 thru 45	.002	0 to .002	.004 to .008
	46 thru 70	.0015	0 to .002	.003 to .007
	71 thru 90	.001	0 to .00175	.002 to .0055
	91 thru 200	.00075	0 to .00075	.0015 to .003
B	20 thru 60	.001	0 to .001	.002 to .004
	61 thru 120	.00075	0 to .00075	.0015 to .003
	121 thru 200	.0005	0 to .0005	.001 to .002
C	20 thru 60	.0005	0 to .0005	.001 to .002
	61 thru 120	.00035	0 to .0004	.0007 to .0015
	121 thru 200	.0002	0 to .0003	.0004 to .001
D	20 thru 60	.00025	0 to .00025	.0005 to .001
	61 thru 120	.0002	0 to .0002	.0004 to .0008
	121 thru 200	.0001	0 to .0001	.0002 to .0004
E	20 thru 60	Zero ^c	0 to .00025	0 to .0005
	61 thru 120		0 to .0002	0 to .0004
	121 thru 200		0 to .0001	0 to .0002

^a These dimensions are shown primarily for the benefit of the gear manufacturer and represent the amount that the thickness of teeth should be reduced in the pinion and gear below the standard calculated value, to provide for backlash in the mesh. In some cases, particularly with pinions involving small numbers of teeth, it may be desirable to provide for total backlash by thinning the teeth in the gear member only by twice the allowance value shown in column (3). In this case both members will have the tolerance shown in column (4). In some cases, particularly in meshes with a small number of teeth, backlash may be achieved by an increase in basic center at distance. In such cases, neither member is reduced by the allowance shown in column (3).

^b These dimensions indicate the approximate backlash that will occur in a mesh in which each of the mating pairs of gears have the teeth thinned by the amount referred to in Note 1, and are meshed on theoretical centers.

^c Backlash in gear sets can also be achieved by increasing the center distance above nominal and using the teeth at standard tooth thickness. Class E backlash designation infers gear sets operating under these conditions.

Backlash in gears is the play between mating tooth surfaces. For purposes of measurement and calculation, backlash is defined as the amount by which a tooth space exceeds the thickness of an engaging tooth. When not otherwise specified, numerical values of backlash are understood to be measured at the tightest point of mesh on the pitch circle in a direction normal to the tooth surface when the gears are mounted in their specified position.

Allowance is the basic amount that a tooth is thinned from basic calculated circular tooth thickness to obtain the required backlash class.

Tolerance is the total permissible variation in the circular thickness of the teeth.

Angular Backlash in Gears.—When the backlash on the pitch circles of a meshing pair of gears is known, the angular backlash or angular play corresponding to this backlash may be computed from the following formulas.

$$\theta_D = \frac{6875B}{D} \text{ minutes} \quad \theta_d = \frac{6875B}{d} \text{ minutes}$$

In these formulas, B = backlash between gears, in inches; D = pitch diameter of larger gear, in inches; d = pitch diameter of smaller gear, in inches; θ_D = angular backlash or angular movement of larger gear in minutes when smaller gear is held fixed and larger gear rocked back and forth; and θ_d = angular backlash or angular movement of smaller gear, in minutes, when the larger gear is held fixed and the smaller gear rocked back and forth.

Inspection of Gears.—Perhaps the most widely used method of determining relative accuracy in a gear is to rotate the gear through at least one complete revolution in intimate contact with a master gear of known accuracy. The gear to be tested and the master gear are mounted on a variable-center-distance fixture and the resulting radial displacements or changes in center distance during rotation of the gear are measured by a suitable device. Except for the effect of backlash, this so-called “composite check” approximates the action of the gear under operating conditions and gives the combined effect of the following errors: runout; pitch error; tooth-thickness variation; profile error; and lateral runout (sometimes called wobble).

Tooth-to-Tooth Composite Error, illustrated below, is the error that shows up as flicker on the indicator of a variable-center-distance fixture as the gear being tested is rotated from tooth to tooth in intimate contact with the master gear. Such flicker shows the combined or composite effect of circular pitch error, tooth-thickness variation, and profile error.

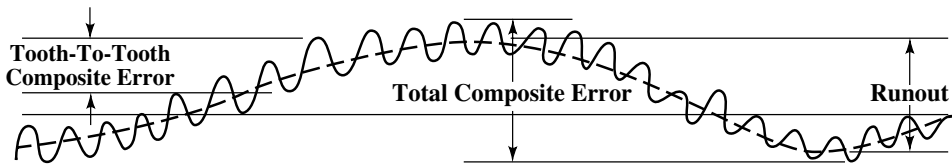


Diagram Showing Nature of Composite Errors

Total Composite Error, shown above, is made up of runout, wobble, and the tooth-to-tooth composite error; it is the total center-distance displacement read on the indicating device of the testing fixture, as shown in the accompanying diagram.

Pressure for Composite Checking of Fine-Pitch Gears.—In using a variable-center-distance fixture, excessive pressure on fine-pitch gears of narrow face width will result in incorrect readings due to deflection of the teeth. Based on tests, the following checking pressures are recommended for gears of 0.100-inch face width: 20 to 29 diametral pitch, 28 ounces; 30 to 39 pitch, 24 ounces; 40 to 49 pitch, 20 ounces; 50 to 59 pitch, 16 ounces; 60 to 79 pitch, 12 ounces; 80 to 99 pitch, 8 ounces, 100 to 149 pitch, 4 ounces; and 150 and finer pitches, 2 ounces, minimum. These recommended checking pressures are based on the use of antifriction mountings for the movable head of the checking fixture and include the pressure of the indicating device. For face widths less than 0.100 inch, the recommended pressures should be reduced proportionately; for larger widths, no increase is necessary although the force may be increased safely in the proper proportion.

Internal Gearing

Internal Spur Gears.—An internal gear may be proportioned like a standard spur gear turned “outside in” or with addendum and dedendum in reverse positions; however, to avoid interference or improve the tooth form and action, the internal diameter of the gear should be increased and the outside diameter of the mating pinion is also made larger than the size based upon standard or conventional tooth proportions. The extent of these enlargements will be illustrated by means of examples given following table, *Rules for Internal Gears – 20-degree Full-Depth Teeth*. The 20-degree involute full-depth tooth form is recommended for internal gears; the 20-degree stub tooth and the 14½-degree full-depth tooth are also used.

Methods of Cutting Internal Gears.—Internal spur gears are cut by methods similar in principle to those employed for external spur gears.

They may be cut by one of the following methods: 1) By a generating process, as when using a Fellows gear shaper; 2) by using a formed cutter and milling the teeth; 3) by planing, using a machine of the template or form-copying type (especially applicable to gears of large pitch); and 4) by using a formed tool that reproduces its shape and is given a planing action either on a slotting or a planing type of machine.

Internal gears frequently have a web at one side that limits the amount of clearance space at the ends of the teeth. Such gears may be cut readily on a gear shaper. The most practical method of cutting very large internal gears is on a planer of the form-copying type. A regular spur gear planer is equipped with a special tool holder for locating the tool in the position required for cutting internal teeth.

Formed Cutters for Internal Gears.—When formed cutters are used, a special cutter usually is desirable, because the tooth spaces of an internal gear are not the same shape as the tooth spaces of external gearing having the same pitch and number of teeth. This difference is because an internal gear is a spur gear “turned outside in.” According to one rule, the standard No. 1 cutter for external gearing may be used for internal gears of 4 diametral pitch and finer, when there are 60 or more teeth. This No. 1 cutter, as applied to external gearing, is intended for all gears having from 135 teeth to a rack. The finer the pitch and the larger the number of teeth, the better the results obtained with a No. 1 cutter. The standard No. 1 cutter is considered satisfactory for jobbing work, and usually when the number of gears to be cut does not warrant obtaining a special cutter, although the use of the No. 1 cutter is not practicable when the number of teeth in the pinion is large in proportion to the number of teeth in the internal gear.

Arc Thickness of Internal Gear Tooth.—*Rule:* If internal diameter of an internal gear is enlarged as determined by Rules 1 and 2 for Internal Diameters (see *Rules for Internal Gears – 20-degree Full-Depth Teeth*), the arc tooth thickness at the pitch circle equals 1.3888 divided by the diametral pitch, assuming a pressure angle of 20 degrees.

Arc Thickness of Pinion Tooth.—*Rule:* If the pinion for an internal gear is larger than conventional size (see Outside Diameter of Pinion for Internal Gear, under *Rules for Internal Gears – 20-degree Full-Depth Teeth*), then the arc tooth thickness on the pitch circle equals 1.7528 divided by the diametral pitch, assuming a pressure angle of 20 degrees.

Note: For chordal thickness and chordal addendum, see rules and formulas for spur gears.

Relative Sizes of Internal Gear and Pinion.—If a pinion is too large or too near the size of its mating internal gear, serious interference or modification of the tooth shape may occur.

Rule: For internal gears having a 20-degree pressure angle and full-depth teeth, the difference between the numbers of teeth in gear and pinion should not be less than 12. For teeth of stub form, the smallest difference should be 7 or 8 teeth. For a pressure angle of 14½ degrees, the difference in tooth numbers should not be less than 15.

Rules for Internal Gears – 20-degree Full-Depth Teeth

To Find	Rule
Pitch Diameter	<p><i>Rule:</i> To find the pitch diameter of an internal gear, divide the number of internal gear teeth by the diametral pitch. The pitch diameter of the mating pinion also equals the number of pinion teeth divided by the diametral pitch, the same as for external spur gears.</p>
Internal Diameter (Enlarged to Avoid Interference)	<p><i>Rule 1:</i> For internal gears to mesh with pinions having 16 teeth or more, subtract 1.2 from the number of teeth and divide the remainder by the diametral pitch.</p> <p><i>Example:</i> An internal gear has 72 teeth of 6 diametral pitch and the mating pinion has 18 teeth; then</p> $\text{Internal diameter} = \frac{72 - 1.2}{6} = 11.8 \text{ inches}$ <p><i>Rule 2:</i> If circular pitch is used, subtract 1.2 from the number of internal gear teeth, multiply the remainder by the circular pitch, and divide the product by 3.1416.</p>
Internal Diameter (Based upon Spur Gear Reversed)	<p><i>Rule:</i> If the internal gear is to be designed to conform to a spur gear turned outside in, subtract 2 from the number of teeth and divide the remainder by the diametral pitch to find the internal diameter.</p> <p><i>Example:</i> (Same as Example above.)</p> $\text{Internal diameter} = \frac{72 - 2}{6} = 11.666 \text{ inches}$
Outside Diameter of Pinion for Internal Gear	<p><i>Note:</i> If the internal gearing is to be proportioned like standard spur gearing, use the rule or formula previously given for spur gears in determining the outside diameter. The rule and formula following apply to a pinion that is enlarged and intended to mesh with an internal gear enlarged as determined by the preceding Rules 1 and 2 above.</p> <p><i>Rule:</i> For pinions having 16 teeth or more, add 2.5 to the number of pinion teeth and divide by the diametral pitch.</p> <p><i>Example 1:</i> A pinion for driving an internal gear is to have 18 teeth (full depth) of 6 diametral pitch; then</p> $\text{Outside diameter} = \frac{18 + 2.5}{6} = 3.416 \text{ inches}$ <p>By using the rule for external spur gears, the outside diameter = 3.333 inches.</p>
Center Distance	<p><i>Rule:</i> Subtract the number of pinion teeth from the number of internal gear teeth and divide the remainder by two times the diametral pitch.</p>
Tooth Thickness	<p>See paragraphs, <i>Arc Thickness of Internal Gear Tooth</i> and <i>Effect of Diameter of Cutting on Profile and Pressure Angle of Worms</i>, on previous page.</p>

British Standard for Spur and Helical Gears

British Standard For Spur And Helical Gears.—BS 436: Part 1: 1967: Spur and Helical Gears, Basic Rack Form, Pitches and Accuracy for Diametral Pitch Series, now has sections concerned with basic requirements for general tooth form, standard pitches, accuracy and accuracy testing procedures, and the showing of this information on engineering drawings to make sure that the gear manufacturer receives the required data. The latest form of the standard complies with ISO agreements. The standard pitches are in accordance with ISO R54, and the basic rack form and its modifications are in accordance with the ISO R53 “Basic Rack of Cylindrical Gears for General Engineering and for Heavy Engineering Standard”.

Five grades of gear accuracy in previous versions are replaced by grades 3 to 12 of the draft ISO Standard. Grades 1 and 2 cover master gears that are not dealt with here. BS 436: Part 1: 1967 is a companion to the following British Standards:

BS 235 “Gears for Traction”

BS 545 “Bevel Gears (Machine Cut)”

BS 721 “Worm Gearing”

BS 821 “Iron Castings for Gears and Gear Blanks (Ordinary, Medium and High Grade)”

BS 978 “Fine Pitch Gears” Part 1, “Involute, Spur and Helical Gears”; Part 2, “Cycloidal Gears” (with addendum 1, PD 3376: “Double Circular Arc Type Gears.”; Part 3, “Bevel Gears”

BS 1807 “Gears for Turbines and Similar Drives” Part 1, “Accuracy” Part 2, “Tooth Form and Pitches”

BS 2519 “Glossary of Terms for Toothed Gearing”

BS 3027 “Dimensions for Worm Gear Units”

BS 3696 “Master Gears”

Part 1 of BS 436 applies to external and internal involute spur and helical gears on parallel shafts and having normal diametral pitch of 20 or coarser. The basic rack and tooth form are specified, also first and second preference standard pitches and fundamental tolerances that determine the grades of gear accuracy, and requirements for terminology and notation.

These requirements include: center distance a ; reference circle diameter d , for pinion d_1 and wheel d_2 ; tip diameter d_a for pinion d_{a1} and wheel d_{a2} ; center distance modification coefficient γ ; face width b for pinion b_1 and wheel b_2 ; addendum modification coefficient x ; for pinion x_1 and wheel x_2 ; length of arc l ; diametral pitch P_d ; normal diametral pitch p_n ; transverse pitch p_t ; number of teeth z , for pinion z_1 and wheel z_2 ; helix angle at reference cylinder β ; pressure angle at reference cylinder α ; normal pressure angle at reference cylinder α_n ; transverse pressure angle at reference cylinder α_t ; and transverse pressure angle, working, α_{tw} .

The basic rack tooth profile has a pressure angle of 20. The Standard permits the total tooth depth to be varied within 2.25 to 2.40, so that the root clearance can be increased within the limits of 0.25 to 0.040 to allow for variations in manufacturing processes; and the root radius can be varied within the limits of 0.25 to 0.39. Tip relief can be varied within the limits shown at the right in the illustration.

Standard normal diametral pitches P_n , BS 436 Part 1:1967, are in accordance with ISO R54. The preferred series, rather than the second choice, should be used where possible. Preferred normal diametral pitches for spur and helical gears (second choices in parentheses) are: 20 (18), 16 (14), 12 (11), 10 (9), 8 (7), 6 (5.5), 5 (4.5), 4 (3.5), 3 (2.75), 2.5 (2.25), 2 (1.75), 1.5, 1.25, and 1.

Information to be Given on Drawings: British Standard BS 308, “Engineering Drawing Practice”, specifies data to be included on drawings of spur and helical gears. For all gears the data should include: number of teeth, normal diametral pitch, basic rack tooth form, axial pitch, tooth profile modifications, blank diameter, reference circle diameter, and helix angle at reference cylinder (0 for straight spur gears), tooth thickness at reference cyl-

inder, grade of gear, drawing number of mating gear, working center distance, and backlash.

For single helical gears, the above data should be supplemented with hand and lead of the tooth helix; and for double helical gears, with the hand in relation to a specific part of the face width and the lead of tooth helix.

Inspection instructions should be included, care being taken to avoid conflicting requirements for accuracy of individual elements, and single- and dual-flank testing. Supplementary data covering specific design, manufacturing and inspection requirements or limitations may be needed, together with other dimensions and tolerances, material, heat treatment, hardness, case depth, surface texture, protective finishes, and drawing scale.

Addendum Modification to Involute Spur and Helical Gears.—The British Standards Institute guide PD 6457:1970 contains certain design recommendations aimed at making it possible to use standard cutting tools for some sizes of gears. Essentially, the guide covers addendum modification and includes formulas for both English and metric units.

Addendum Modification is an enlargement or reduction of gear tooth dimensions that results from displacement of the reference plane of the generating rack from its normal position. The displacement is represented by the coefficient X, X1, or X2, where X is the equivalent dimension for gears of unit module or diametral pitch. The addendum modification establishes a datum tooth thickness at the reference circle of the gear but does not necessarily establish the height of either the reference addendum or the working addendum. In any pair of gears, the datum tooth thicknesses are those that always give zero backlash at the meshing center distance. Normal practice requires allowances for backlash for all unmodified gears.

Taking full advantage of the adaptability of the involute system allows various tooth design features to be obtained. Addendum modification has the following applications: avoiding undercut tooth profiles; achieving optimum tooth proportions and control of the proportion of receding to approaching contact; adapting a gear pair to a predetermined center distance without recourse to non-standard pitches; and permitting use of a range of working pressure angles using standard geometry tools.

BS 436, Part 3:1986 “Spur and Helical Gears”.—This part provides methods for calculating contact and root bending stresses for metal involute gears, and is somewhat similar to the ANSI/AGMA Standard for calculating stresses in pairs of involute spur or helical gears. Stress factors covered in the British Standard include the following:

Tangential Force is the nominal force for contact and bending stresses.

Zone Factor accounts for the influence of tooth flank curvature at the pitch point on Hertzian stress.

Contact Ratio Factor takes account of the load-sharing influence of the transverse contact ratio and the overlap ratio on the specific loading.

Elasticity Factor takes into account the influence of the modulus of elasticity of the material and of Poisson's ratio on the Hertzian stress.

Basic Endurance Limit for contact makes allowance for the surface hardness.

Material Quality covers the quality of the material used.

Lubricant Influence, Roughness, and Speed The lubricant viscosity, surface roughness and pitch line speed affect the lubricant film thickness, which in turn, affects the Hertzian stresses.

Work Hardening Factor accounts for the increase in surface durability due to the meshing action.

Size Factor covers the possible influences of size on the material quality and its response to manufacturing processes.

Life Factor accounts for the increase in permissible stresses when the number of stress cycles is less than the endurance life.

Application Factor allows for load fluctuations from the mean load or loads in the load histogram caused by sources external to the gearing.

Dynamic Factor allows for load fluctuations arising from contact conditions at the gear mesh.

Load Distribution accounts for the increase in local load due to maldistribution of load across the face of the gear tooth caused by deflections, alignment tolerances and helix modifications.

Minimum Demanded and Actual Safety Factor The minimum demanded safety factor is agreed between the supplier and the purchaser. The actual safety factor is calculated.

Geometry Factors allow for the influence of the tooth form, the effect of the fillet and the helix angle on the nominal bending stress for the application of load at the highest point of single pair tooth contact.

Sensitivity Factor allows for the sensitivity of the gear material to the presence of notches such as the root fillet.

Surface Condition Factor accounts for reduction of the endurance limit due to flaws in the material and the surface roughness of the tooth root fillets.

ISO TC/600.— The ISO TC/600 Standard is similar to BS 436, Part 3:1986, but is far more comprehensive. For general gear design, the ISO Standard provides a complicated method of arriving at a conclusion similar to that reached by the less complex British Standard. Factors additional to the above that are included in the ISO Standard include the following

Application Factor account for dynamic overloads from sources external to the gearing.

Dynamic Factor allows for internally generated dynamic loads caused by vibrations of the pinion and wheel against each other.

Load Distribution makes allowance for the effects of non-uniform distribution of load across the face width, depending on the mesh alignment error of the loaded gear pair and the mesh stiffness.

Transverse Load Distribution Factor takes into account the effect of the load distribution on gear tooth contact stresses.

Gear Tooth Stiffness Constants are defined as the load needed to deform one or several meshing gear teeth having 1 mm face width, by an amount of 1 μm (0.00004 in).

Allowable Contact Stress is the permissible Hertzian pressure on the gear tooth face.

Minimum demanded and Calculated Safety Factors The minimum demanded safety factor is agreed between the supplier and the customer. The calculated safety factor is the actual safety factor of the gear pair.

Zone Factor accounts for the influence on the Hertzian pressure of the tooth flank curvature at the pitch point.

Elasticity Factor takes account of the influence of the material properties such as the modulus of elasticity and Poisson's ratio.

Contact Ratio Factor accounts for the influence of the transverse contact ratio and the overlap ratio on the specific surface load of the gears.

Helix Angle Factor makes allowance for influence of helix angle on surface durability.

Endurance Limit is the limit of repeated Hertzian stresses that can be permanently endured by a given material

Life Factor takes account of a higher permissible Hertzian stress if only limited durability is demanded.

Lubrication Film Factor The film of lubricant between the tooth flanks influences the surface load capacity. Factors include the oil viscosity, pitch line velocity and roughness of the tooth flanks.

Work Hardening Factor takes account of the increase in surface durability due to meshing a steel wheel with a hardened pinion having smooth tooth surfaces.

Coefficient of Friction The mean value of the local coefficient of friction depends on the lubricant, surface roughness, the lay of surface irregularities, material properties of the tooth flanks, and the force and size of tangential velocities.

Bulk Temperature Thermal Flash Factor is dependent on moduli of elasticity and thermal contact coefficients of pinion and wheel materials and geometry of the line of action.

Welding Factor Accounts for different tooth materials and heat treatments.

Geometrical Factor is defined as a function of the gear ratio and the dimensionless parameter on the line of action.

Integral Temperature Criterion The integral temperature of the gears depends on the lubricant viscosity and tendency toward cuffing and scoring of the gear materials.

Examination of the above factors shows the similarity in the approach of the British and the ISO Standards to that of the ANSI/AGMA Standards. Slight variations in the methods used to calculate the factors will result in different allowable stress figures. Experimental work using some of the stressing formulas has shown wide variations and designers must continue to rely on experience to arrive at satisfactory results.

Standards Nomenclature

All standards are referenced and identified throughout this book by an alphanumeric prefix which designates the organization that administered the development work on the standard, and followed by a standards number.

All standards are reviewed by the relevant committees at regular time intervals, as specified by the overseeing standards organization, to determine whether the standard should be confirmed (reissued without changes other than correction of typographical errors), updated, or removed from service.

The following is for example use only. ANSI B18.8.2-1984, R1994 is a standard for Taper, Dowel, Straight, Grooved, and Spring Pins. ANSI refers to the American National Standards Institute that is responsible for overseeing the development or approval of the standard, and B18.8.2 is the number of the standard. The first date, 1984, indicates the year in which the standard was issued, and the sequence R1994 indicates that this standard was reviewed and reaffirmed in that 1994. The current designation of the standard, ANSI/ASME B18.8.2-1995, indicates that it was revised in 1995; it is ANSI approved; and, ASME (American Society of Mechanical Engineers) was the standards body responsible for development of the standard. This standard is sometimes also designated ASME B18.8.2-1995.

ISO (International Organization for Standardization) standards use a slightly different format, for example, ISO 5127-1:1983. The entire ISO reference number consists of a prefix ISO, a serial number, and the year of publication.

Aside from content, ISO standards differ from American National standards in that they often smaller focused documents, which in turn reference other standards or other parts of the same standard. Unlike the numbering scheme used by ANSI, ISO standards related to a particular topic often do not carry sequential numbers nor are they in consecutive series.

British Standards Institute standards use the following format: BS 1361: 1971 (1986). The first part is the organization prefix BS, followed by the reference number and the date of issue. The number in parenthesis is the date that the standard was most recently reconfirmed. British Standards may also be designated *withdrawn* (no longer to be used) and *obsolescent* (going out of use, but may be used for servicing older equipment).

Organization	Web Address	Organization	Web Address
ISO (International Organization for Standardization)	www.iso.ch	JIS (Japanese Industrial Standards)	www.jisc.org
IEC (International Electrotechnical Commission)	www.iec.ch	ASME (American Society of Mechanical Engineers)	www.asme.org
ANSI (American National Standards Institute)	www.ansi.org	SAE (Society of Automotive Engineers)	www.sae.org
BSI (British Standards Institute)	www.bsi-inc.org	SME (Society of Manufacturing Engineers)	www.sme.org

HYPOID AND BEVEL GEARING

Hypoid Gears

Hypoid gears are offset and in effect, are spiral gears whose axes do not intersect but are staggered by an amount decided by the application. Due to the offset, contact between the teeth of the two gears does not occur along a surface line of the cones as it does with spiral bevels having intersecting axes, but along a curve in space inclined to the surface line. The basic solids of the hypoid gear members are not cones, as in spiral bevels, but are hyperboloids of revolution which cannot be projected into the common plane of ordinary flat gears, thus the name hypoid. The visualization of hypoid gears is based on an imaginary flat gear which is a substitute for the theoretically correct helical surface. If certain rules are observed during the calculations to fix the gear dimensions, the errors that result from the use of an imaginary flat gear as an approximation are negligible.

The staggered axes result in meshing conditions that are beneficial to the strength and running properties of the gear teeth. A uniform sliding action takes place between the teeth, not only in the direction of the tooth profile but also longitudinally, producing ideal conditions for movement of lubricants. With spiral gears, great differences in sliding motion arise over various portions of the tooth surface, creating vibration and noise. Hypoid gears are almost free from the problems of differences in these sliding motions and the teeth also have larger curvature radii in the direction of the profile. Surface pressures are thus reduced so that there is less wear and quieter operation.

The teeth of hypoid gears are 1.5 to 2 times stronger than those of spiral bevel gears of the same dimensions, made from the same material. Certain limits must be imposed on the dimensions of hypoid gear teeth so that their proportions can be calculated in the same way as they are for spiral bevel gears. The offset must not be larger than 1/7th of the ring gear outer diameter, and the tooth ratio must not be much less than 4 to 1. Within these limits, the tooth proportions can be calculated in the same way as for spiral bevel gears and the radius of lengthwise curvature can be assumed in such a way that the normal module is a maximum at the center of the tooth face width to produce stabilized tooth bearings.

If the offset is larger or the ratio is smaller than specified above, a tooth form must be selected that is better adapted to the modified meshing conditions. In particular, the curvature of the tooth length curve must be determined with other points in view. The limits are only guidelines since it is impossible to account for all other factors involved, including the pitch line speed of the gears, lubrication, loads, design of shafts and bearings, and the general conditions of operation.

Of the three different designs of hypoid bevel gears now available, the most widely used, especially in the automobile industry, is the Gleason system. Two other hypoid gear systems have been introduced by Oerlikon (Swiss) and Klingelnberg (German). All three methods use the involute gear form, but they have teeth with differing curvatures, produced by the cutting method. Teeth in the Gleason system are arc shaped and their depth tapers. Both the European systems are designed to combine rolling with the sideways motion of the teeth and use a constant tooth depth. Oerlikon uses an epicycloidal tooth form and Klingelnberg uses a true involute form.

With their circular accurate tooth face curves, Gleason hypoid gears are produced with multi-bladed face milling cutters. The gear blank is rolled relative to the rotating cutter to make one inter-tooth groove, then the cutter is withdrawn and returned to its starting position while the blank is indexed into the position for cutting the next tooth. Both roughing and finishing cutters are kept parallel to the tooth root lines, which are at an angle to the gear pitch line. Depending on this angularity, plus the spiral angle, a correction factor must be calculated for both the leading and trailing faces of the gear tooth.

In operation, the convex faces of the teeth on one gear always bear on the concave faces of the teeth on the mating gear. For correct meshing between the pinion and gear wheel, the

spiral angles should not vary over the full face width. The tooth form generated is a logarithmic spiral and, as a compromise, the cutter radius is made equal to the mean radius of a corresponding logarithmic spiral.

The involute tooth face curves of the Klingelnberg system gears have constant-pitch teeth cut by (usually) a single-start taper hob. The machine is set up to rotate both the cutter and the gear blank at the correct relative speeds. The surface of the hob is set tangential to a circle radius, which is the gear base circle, from which all the parallel involute curves are struck. To keep the hob size within reasonable dimensions, the cone must lie a minimum distance within the teeth and this requirement governs the size of the module.

Both the module and the tooth depth are constant over the full face width and the spiral angle varies. The cutting speed variations, especially with regard to crown wheels, over the cone surface of the hob, make it difficult to produce a uniform surface finish on the teeth, so a finishing cut is usually made with a truncated hob which is tilted to produce the required amount of crowning automatically, for correct tooth marking and finishing. The dependence of the module, spiral angle and other features on the base circle radius, and the need for suitable hob proportions restrict the gear dimensions and the system cannot be used for gears with a low or zero angle. However, gears can be cut with a large root radius giving teeth of high strength. The favorable geometry of the tooth form gives quieter running and tolerance of inaccuracies in assembly.

Teeth of gears made by the Oerlikon system have elongated epicycloidal form, produced with a face-type rotating cutter. Both the cutter and the gear blank rotate continuously, with no indexing. The cutter head has separate groups of cutters for roughing, outside cutting and inside cutting so that tooth roots and flanks are cut simultaneously, but the feed is divided into two stages. As stresses are released during cutting, there is some distortion of the blank and this distortion will usually be worse for a hollow crown wheel than for a solid pinion.

All the heavy cuts are taken during the first stages of machining with the Oerlikon system and the second stage is used to finish the tooth profile accurately, so distortion effects are minimized. As with the Klingelnberg process, the Oerlikon system produces a variation in spiral angle and module over the width of the face, but unlike the Klingelnberg method, the tooth length curve is cycloidal. It is claimed that, under load, the tilting force in an Oerlikon gear set acts at a point 0.4 times the distance from the small diameter end of the gear and not in the mid-tooth position as in other gear systems, so that the radius is obviously smaller and the tilting moment is reduced, resulting in lower loading of the bearings.

Gears cut by the Oerlikon system have tooth markings of different shape than gears cut by other systems, showing that more of the face width of the Oerlikon tooth is involved in the load-bearing pattern. Thus, the surface loading is spread over a greater area and becomes lighter at the points of contact.

Bevel Gearing

Types of Bevel Gears.—Bevel gears are conical gears, that is, gears in the shape of cones, and are used to connect shafts having intersecting axes. Hypoid gears are similar in general form to bevel gears, but operate on axes that are offset. With few exceptions, most bevel gears may be classified as being either of the straight-tooth type or of the curved-tooth type. The latter type includes spiral bevels, Zerol bevels, and hypoid gears. The following is a brief description of the distinguishing characteristics of the different types of bevel gears.

Straight Bevel Gears: The teeth of this most commonly used type of bevel gear are straight but their sides are tapered so that they would intersect the axis at a common point called the pitch cone apex if extended inward. The face cone elements of most straight bevel gears, however, are now made parallel to the root cone elements of the mating gear to obtain uniform clearance along the length of the teeth. The face cone elements of such

gears, therefore, would intersect the axis at a point inside the pitch cone. Straight bevel gears are the easiest to calculate and are economical to produce.

Straight bevel gear teeth may be generated for full-length contact or for localized contact. The latter are slightly convex in a lengthwise direction so that some adjustment of the gears during assembly is possible and small displacements due to load deflections can occur without undesirable load concentration on the ends of the teeth. This slight lengthwise rounding of the tooth sides need not be computed in the design but is taken care of automatically in the cutting operation on the newer types of bevel gear generators.

Zerol Bevel Gears: The teeth of Zerol bevel gears are curved but lie in the same general direction as the teeth of straight bevel gears. They may be thought of as spiral bevel gears of zero spiral angle and are manufactured on the same machines as spiral bevel gears. The face cone elements of Zerol bevel gears do not pass through the pitch cone apex but instead are approximately parallel to the root cone elements of the mating gear to provide uniform tooth clearance. The root cone elements also do not pass through the pitch cone apex because of the manner in which these gears are cut. Zerol bevel gears are used in place of straight bevel gears when generating equipment of the spiral type but not the straight type is available, and may be used when hardened bevel gears of high accuracy (produced by grinding) are required.

Spiral Bevel Gears: Spiral bevel gears have curved oblique teeth on which contact begins gradually and continues smoothly from end to end. They mesh with a rolling contact similar to straight bevel gears. As a result of their overlapping tooth action, however, spiral bevel gears will transmit motion more smoothly than straight bevel or Zerol bevel gears, reducing noise and vibration that become especially noticeable at high speeds.

One of the advantages associated with spiral bevel gears is the complete control of the localized tooth contact. By making a slight change in the radii of curvature of the mating tooth surfaces, the amount of surface over which tooth contact takes place can be changed to suit the specific requirements of each job. Localized tooth contact promotes smooth, quiet running spiral bevel gears, and permits some mounting deflections without concentrating the load dangerously near either end of the tooth. Permissible deflections established by experience are given under the heading *Mountings for Bevel Gears*.

Because their tooth surfaces can be ground, spiral bevel gears have a definite advantage in applications requiring hardened gears of high accuracy. The bottoms of the tooth spaces and the tooth profiles may be ground simultaneously, resulting in a smooth blending of the tooth profile, the tooth fillet, and the bottom of the tooth space. This feature is important from a strength standpoint because it eliminates cutter marks and other surface interruptions that frequently result in stress concentrations.

Hypoid Gears: In general appearance, hypoid gears resemble spiral bevel gears, except that the axis of the pinion is offset relative to the gear axis. If there is sufficient offset, the shafts may pass one another thus permitting the use of a compact straddle mounting on the gear and pinion. Whereas a spiral bevel pinion has equal pressure angles and symmetrical profile curvatures on both sides of the teeth, a hypoid pinion properly conjugate to a mating gear having equal pressure angles on both sides of the teeth must have nonsymmetrical profile curvatures for proper tooth action. In addition, to obtain equal arcs of motion for both sides of the teeth, it is necessary to use unequal pressure angles on hypoid pinions. Hypoid gears are usually designed so that the pinion has a larger spiral angle than the gear. The advantage of such a design is that the pinion diameter is increased and is stronger than a corresponding spiral bevel pinion. This diameter increment permits the use of comparatively high ratios without the pinion becoming too small to allow a bore or shank of adequate size. The sliding action along the lengthwise direction of their teeth in hypoid gears is a function of the difference in the spiral angles on the gear and pinion. This sliding effect makes such gears even smoother running than spiral bevel gears. Grinding of hypoid gears can be accomplished on the same machines used for grinding spiral bevel and Zerol bevel gears.

Applications of Bevel and Hypoid Gears.—Bevel and hypoid gears may be used to transmit power between shafts at practically any angle and speed. The particular type of gearing best suited for a specific job, however, depends on the mountings and the operating conditions.

Straight and Zerol Bevel Gears: For peripheral speeds up to 1000 feet per minute (305 m/min), where maximum smoothness and quietness are not the primary consideration, straight and Zerol bevel gears are recommended. For such applications, plain bearings may be used for radial and axial loads, although the use of antifriction bearings is always preferable. Plain bearings permit a more compact and less expensive design, which is one reason why straight and Zerol bevel gears are much used in differentials. This type of bevel gearing is the simplest to calculate and set up for cutting, and is ideal for small lots where fixed charges must be kept to a minimum.

Zerol bevel gears are recommended in place of straight bevel gears where hardened gears of high accuracy are required, because Zerol gears may be ground; and when only spiral-type equipment is available for cutting bevel gears.

Spiral Bevel and Hypoid Gears: Spiral bevel and hypoid gears are recommended for applications where peripheral speeds exceed 1000 feet per minute (305 m/min) or 1000 revolutions per minute. In many instances, they may be used to advantage at lower speeds, particularly where extreme smoothness and quietness are desired. For peripheral speeds above 8000 feet per minute (2438 m/min), ground gears should be used.

For large reduction ratios the use of spiral and hypoid gears will reduce the overall size of the installation because the continuous pitch line contact of these gears makes it practical to obtain smooth performance with a smaller number of teeth in the pinion than is possible with straight or Zerol bevel gears.

Hypoid gears are recommended for industrial applications: when maximum smoothness of operation is desired; for high reduction ratios where compactness of design, smoothness of operation, and maximum pinion strength are important; and for nonintersecting shafts.

Bevel and hypoid gears may be used for both speed-reducing and speed-increasing drives. In speed-increasing drives, however, the ratio should be kept as low as possible and the pinion mounted on antifriction bearings; otherwise bearing friction will cause the drive to lock.

Notes on the Design of Bevel Gear Blanks.—The quality of any finished gear is dependent, to a large degree, on the design and accuracy of the gear blank. A number of factors that affect manufacturing economy as well as performance must be considered.

A gear blank should be designed to avoid localized stresses and serious deflections within itself. Sufficient thickness of metal should be provided under the roots of gear teeth to give them proper support. As a general rule, the amount of metal under the root should equal the whole depth of the tooth; this metal depth should be maintained under the small ends of the teeth as well as under the middle. On webless-type ring gears, the minimum stock between the root line and the bottom of tap drill holes should be one-third the tooth depth. For heavily loaded gears, a preliminary analysis of the direction and magnitude of the forces is helpful in the design of both the gear and its mounting. Rigidity is also necessary for proper chucking when cutting the teeth. For this reason, bores, hubs, and other locating surfaces must be in proper proportion to the diameter and pitch of the gear. Small bores, thin webs, or any condition that necessitates excessive overhang in cutting should be avoided.

Other factors to be considered are the ease of machining and, in gears that are to be hardened, proper design to ensure the best hardening conditions. It is desirable to provide a locating surface of generous size on the backs of gears. This surface should be machined or ground square with the bore and is used both for locating the gear axially in assembly and for holding it when the teeth are cut. The front clamping surface must, of course, be flat and parallel to the back surface. In connection with cutting the teeth on Zerol bevel, spiral

bevel, and hypoid gears, clearance must be provided for face-mill type cutters; front and rear hubs should not intersect the extended root line of the gear or they will interfere with the path of the cutter. In addition, there must be enough room in the front of the gear for the clamp nut that holds the gear on the arbor, or in the chuck, while cutting the teeth. The same considerations must be given to straight bevel gears that are to be generated using a circular-type cutter instead of reciprocating tools.

Mountings for Bevel Gears.—Rigid mountings should be provided for bevel gears to keep the displacements of the gears under operating loads within recommended limits. To align gears properly, care should be taken to ensure accurately machined mountings, properly fitted keys, and couplings that run true and square.

As a result of deflection tests on gears and their mountings, and having observed these same units in service, the *Gleason Works* recommends that the following allowable deflections be used for gears from 6 to 15 inches (15.24–38.10 cm) in diameter: neither the pinion nor the gear should lift or depress more than 0.003 inch (0.076 mm) at the center of the face width; the pinion should not yield axially more than 0.003 inch (0.076 mm) in either direction; and the gear should not yield axially more than 0.003 inch (0.076 mm) in either direction on 1 to 1 ratio gears (miter gears), or near miters, or more than 0.010 inch (0.25 mm) away from the pinion on higher ratios.

When deflections exceed these limits, additional problems are involved in obtaining satisfactory gears. It becomes necessary to narrow and shorten the tooth contacts to suit the more flexible mounting. These changes decrease the bearing area, raise the unit tooth pressure, and reduce the number of teeth in contact, resulting in increased noise and the danger of surface failure as well as tooth breakage.

Spiral bevel and hypoid gears in general should be mounted on antifriction bearings in an oil-tight case. Designs for a given set of conditions may use plain bearings for radial and thrust loads, maintaining gears in satisfactory alignment is usually more easily accomplished with ball or roller bearings.

Bearing Spacing and Shaft Stiffness: Bearing spacing and shaft stiffness are extremely important if gear deflections are to be minimized. For both straddle mounted and overhung mounted gears the spread between bearings should never be less than 70 per cent of the pitch diameter of the gear. On overhung mounted gears the spread should be at least $2\frac{1}{2}$ times the overhang and, in addition, the shaft diameter should be equal to or preferably greater than the overhang to provide sufficient shaft stiffness. When two spiral bevel or hypoid gears are mounted on the same shaft, the axial thrust should be taken at one place only and near the gear where the greater thrust is developed. Provision should be made for adjusting both the gear and pinion axially in assembly. Details on how this may be accomplished are given in the *Gleason Works* booklet, "Assembling Bevel Gears."

Cutting Bevel Gear Teeth.—A correctly formed bevel gear tooth has the same sectional shape throughout its length, but on a uniformly diminishing scale from the large to the small end. The only way to obtain this correct form is by using a generating type of bevel gear cutting machine. This accounts, in part, for the extensive use of generating type gear cutting equipment in the production of bevel gears.

Bevel gears too large to be cut by generating equipment—100 inches (254 cm) or over in diameter—may be produced by a form-copying type of gear planer. A template or former is used to mechanically guide a single cutting tool in the proper path to cut the profile of the teeth. Since the tooth profile produced by this method is dependent on the contour of the template used, it is possible to produce tooth profiles to suit a variety of requirements.

Although generating methods are to be preferred, there are still some cases where straight bevel gears are produced by milling. Milled gears cannot be produced with the accuracy of generated gears and generally are not suitable for use in high-speed applications or where angular motion must be transmitted with a high degree of accuracy. Milled gears are used chiefly as replacement gears in certain applications, and gears which are

subsequently to be finished on generating type equipment are sometimes roughed out by milling. Formulas and methods used for the cutting of bevel gears are given in the latter part of this section.

In producing gears by generating methods, the tooth curvature is generated from a straight-sided cutter or tool having an angle equal to the required pressure angle. This tool represents the side of a crown gear tooth. The teeth of a true involute crown gear, however, have sides which are very slightly curved. If the curvature of the cutting tool conforms to that of the involute crown gear, an involute form of bevel gear tooth will be obtained. The use of a straight-sided tool is more practical and results in a very slight change of tooth shape to what is known as the "octoid" form. Both the octoid and involute forms of bevel gear tooth give theoretically correct action.

Bevel gear teeth, like those for spur gears, differ as to pressure angle and tooth proportions. The whole depth and the addendum at the large end of the tooth may be the same as for a spur gear of equal pitch. Most bevel gears, however, both of the straight tooth and spiral-bevel types, have lengthened pinion addendums and shortened gear addendums as in the case of some spur gears, the amount of departure from equal addendums varying with the ratio of gearing. Long addendums on the pinion are used principally to avoid undercut and to increase tooth strength. In addition, where long and short addendums are used, the tooth thickness of the gear is decreased and that of the pinion increased to provide a better balance of strength. See the Gleason Works System for straight and spiral bevel gears and also the British Standard.

Nomenclature for Bevel Gears.—The accompanying diagram, *Fig. 1a, Bevel Gear Nomenclature*, illustrates various angles and dimensions referred to in describing bevel gears. In connection with the face angles shown in the diagram, it should be noted that the face cones are made parallel to the root cones of the mating gears to provide uniform clearance along the length of the teeth. See also *Fig. 1b*, page 2183.

American Standard for Bevel Gears.—American Standard ANSI/AGMA 2005-B88, Design Manual for Bevel Gears, replaces AGMA Standards 202.03, 208.03, 209.04, and 330.01, and provides standards for design of straight, zerol, and spiral bevel gears and hypoid gears with information on fabrication, inspection, and mounting. The information covers preliminary design, drawing formats, materials, rating, strength, inspection, lubrication, mountings, and assembly. Blanks for standard taper, uniform depth, duplex taper, and tilted root designs are included so that the material applies to users of Gleason, Klingelnberg, and Oerlikon gear cutting machines.

Formulas for Dimensions of Milled Bevel Gears.—As explained earlier, most bevel gears are produced by generating methods. Even so, there are applications for which it may be desired to cut a pair of mating bevel gears by using rotary formed milling cutters. Examples of such applications include replacement gears for certain types of equipment and gears for use in experimental developments.

The tooth proportions of milled bevel gears differ in some respects from those of generated gears, the principal difference being that for milled bevel gears the tooth thicknesses of pinion and gear are made equal, and the addendum and dedendum of the pinion are respectively the same as those of the gear. The rules and formulas in the accompanying table may be used to calculate the dimensions of milled bevel gears with shafts at a right angle, an acute angle, and an obtuse angle.

In the accompanying diagrams, *Figs. 1a* and *1b*, and list of notations, the various terms and symbols applied to milled bevel gears are as indicated.

N = number of teeth

P = diametral pitch

p = circular pitch

α = pitch cone angle and edge angle

Σ = angle between shafts

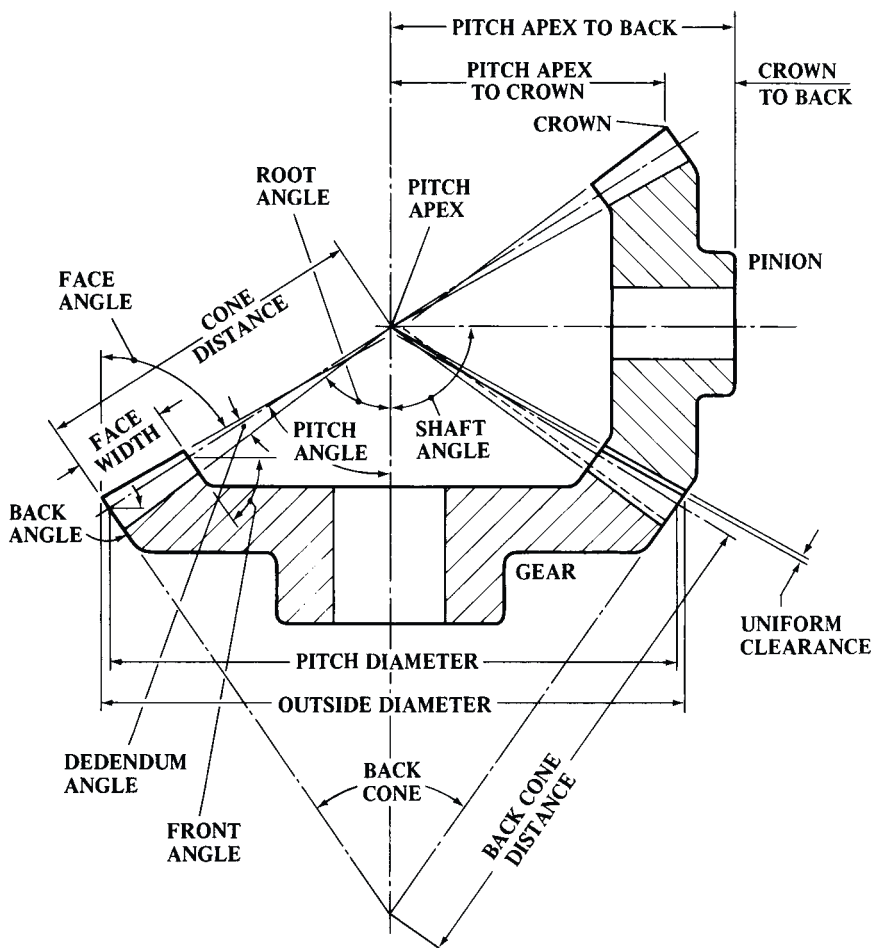


Fig. 1a. Bevel Gear Nomenclature

- D = pitch diameter
 S = addendum
 $S+A$ = dedendum (A = clearance)
 W = whole depth of tooth
 T = thickness of tooth at pitch line
 C = pitch cone radius
 F = width of face
 s = addendum at small end of tooth
 t = thickness of tooth at pitch line at small end
 θ = addendum angle
 ϕ = dedendum angle
 γ = face angle = pitch cone angle + addendum angle
 δ = angle of compound rest
 ζ = cutting angle
 K = angular addendum
 O = outside diameter
 J = vertex distance
 j = vertex distance at small end
 N' = number of teeth for which to select cutter

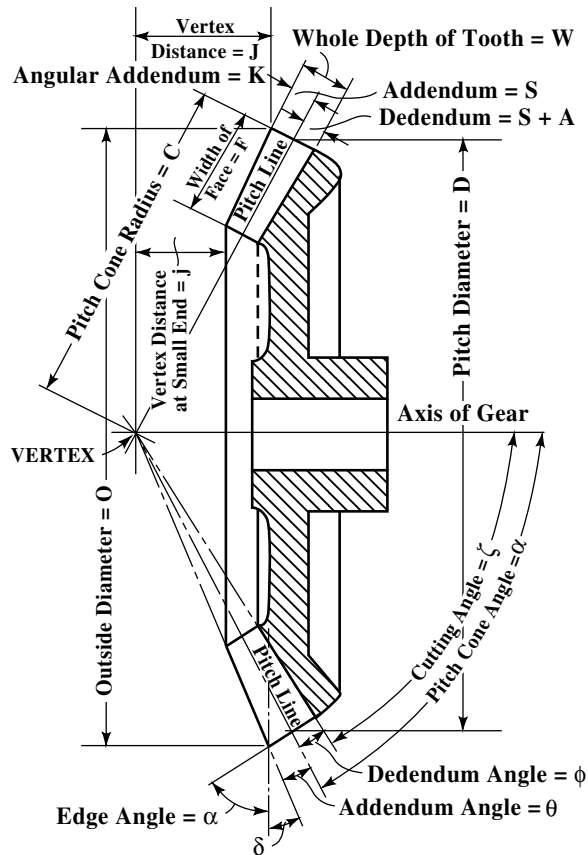


Fig. 1b. Bevel Gear Nomenclature

The formulas for milled bevel gears should be modified to make the clearance at the bottom of the teeth uniform instead of tapering toward the vertex. If this recommendation is followed, then the cutting angle (root angle) should be determined by subtracting the *addendum* angle from the pitch cone angle instead of subtracting the dedendum angle as in the formula given in the table.

Rules and Formulas for Calculating Dimensions of Milled Bevel Gears

To Find	Rule	Formula
Pitch Cone Angle of Pinion	Divide the sine of the shaft angle by the sum of the cosine of the shaft angle and the quotient obtained by dividing the number of teeth in the gear by the number of teeth in the pinion; this gives the tangent. <i>Note:</i> For shaft angles greater than 90° the cosine is negative.	$\tan \alpha_p = \frac{\sin \Sigma}{\frac{N_G}{N_P} + \cos \Sigma}$ For 90° shaft angle, $\tan \alpha_p = \frac{N_P}{N_G}$
Pitch Cone Angle of Gear	Subtract the pitch cone angle of the pinion from the shaft angle.	$\alpha_G = \Sigma - \alpha_p$
Pitch Diameter	Divide the number of teeth by the diametral pitch.	$D = N \div P$



Rules and Formulas for Calculating Dimensions of Milled Bevel Gears(Continued)

To Find	Rule	Formula	
These dimensions are the same for both gear and pinion.	Addendum	Divide 1 by the diametral pitch.	$S = 1 \div P$
	Dedendum	Divide 1.157 by the diametral pitch.	$S + A = 1.157 \div P$
	Whole Depth of Tooth	Divide 2.157 by the diametral pitch.	$W = 2.157 \div P$
	Thickness of Tooth at Pitch Line	Divide 1.571 by the diametral pitch.	$T = 1.571 \div P$
	Pitch Cone Radius	Divide the pitch diameter by twice the sine of the pitch cone angle.	$C = \frac{D}{2 \times \sin \alpha}$
	Addendum of Small End of Tooth	Subtract the width of face from the pitch cone radius, divide the remainder by the pitch cone radius and multiply by the addendum.	$s = S \times \frac{C - F}{C}$
	Thickness of Tooth at Pitch Line at Small End	Subtract the width of face from the pitch cone radius, divide the remainder by the pitch cone radius and multiply by the thickness of the tooth at pitch line.	$t = T \times \frac{C - F}{C}$
	Addendum Angle	Divide the addendum by the pitch cone radius to get the tangent.	$\tan \theta = \frac{S}{C}$
	Dedendum Angle	Divide the dedendum by the pitch cone radius to get the tangent.	$\tan \phi = \frac{S + A}{C}$
	Face Width (Max.)	Divide the pitch cone radius by 3 or divide 8 by the diametral pitch, whichever gives the smaller value.	$F = \frac{C}{3}$ or $F = \frac{8}{P}$
	Circular Pitch	Divide 3.1416 by the diametral pitch.	$\rho = 3.1416 \div P$
Face Angle	Add the addendum angle to the pitch cone angle	$\gamma = \alpha + \theta$	
Compound Rest Angle for Turning Blank	Subtract both the pitch cone angle and the addendum angle from 90 degrees.	$\delta = 90^\circ - \alpha - \theta$	
Cutting Angle	Subtract the dedendum angle from the pitch cone angle.	$\zeta = \alpha - \phi$	
Angular Addendum	Multiply the addendum by the cosine of the pitch cone angle.	$K = S \times \cos \alpha$	
Outside Diameter	Add twice the angular addendum to the pitch diameter.	$O = D + 2K$	
Vertex or Apex Distance	Multiply one-half the outside diameter by the cotangent of the face angle.	$J = \frac{O}{2} \times \cot \gamma$	
Vertex Distance at Small End of Tooth	Subtract the width of face from the pitch cone radius; divide the remainder by the pitch cone radius and multiply by the apex distance.	$j = J \times \frac{C - F}{C}$	
Number of Teeth for which to Select Cutter	Divide the number of teeth by the cosine of the pitch cone angle.	$N' = \frac{N}{\cos \alpha}$	

Numbers of Formed Cutters Used to Mill Teeth in Mating Bevel Gear and Pinion with Shafts at Right Angles

		Number of Teeth in Pinion																
		12	13	14	15	16	17	18	19	20	21	22	23	24	25	26	27	28
Number of Teeth in Gear	12	7-7
	13	6-7	6-6
	14	5-7	6-6	6-6
	15	5-7	5-6	5-6	5-5
	16	4-7	5-7	5-6	5-6	5-5
	17	4-7	4-7	4-6	5-6	5-5	5-5
	18	4-7	4-7	4-6	4-6	4-5	4-5	5-5
	19	3-7	4-7	4-6	4-6	4-6	4-5	4-5	4-4
	20	3-7	3-7	4-6	4-6	4-6	4-5	4-5	4-4	4-4
	21	3-8	3-7	3-7	3-6	4-6	4-5	4-5	4-5	4-4	4-4
	22	3-8	3-7	3-7	3-6	3-6	3-5	4-5	4-5	4-4	4-4	4-4
	23	3-8	3-7	3-7	3-6	3-6	3-5	3-5	3-5	3-4	4-4	4-4	4-4
	24	3-8	3-7	3-7	3-6	3-6	3-6	3-5	3-5	3-4	3-4	3-4	4-4	4-4
	25	2-8	2-7	3-7	3-6	3-6	3-6	3-5	3-5	3-5	3-4	3-4	3-4	4-4	3-3
	26	2-8	2-7	3-7	3-6	3-6	3-6	3-5	3-5	3-5	3-4	3-4	3-4	3-4	3-3	3-3
	27	2-8	2-7	2-7	2-6	3-6	3-6	3-5	3-5	3-5	3-4	3-4	3-4	3-4	3-4	3-3	3-3	...
	28	2-8	2-7	2-7	2-6	2-6	3-6	3-5	3-5	3-5	3-4	3-4	3-4	3-4	3-4	3-3	3-3	3-3
	29	2-8	2-7	2-7	2-7	2-6	2-6	3-5	3-5	3-5	3-4	3-4	3-4	3-4	3-4	3-3	3-3	3-3
	30	2-8	2-7	2-7	2-7	2-6	2-6	2-5	2-5	3-5	3-5	3-4	3-4	3-4	3-4	3-4	3-3	3-3
	31	2-8	2-7	2-7	2-7	2-6	2-6	2-6	2-5	2-5	2-5	3-4	3-4	3-4	3-4	3-4	3-3	3-3
	32	2-8	2-7	2-7	2-7	2-6	2-6	2-6	2-5	2-5	2-5	2-5	2-4	2-4	3-4	3-4	3-4	3-3
	33	2-8	2-8	2-7	2-7	2-6	2-6	2-6	2-5	2-5	2-5	2-5	2-4	2-4	2-4	3-4	3-4	3-3
	34	2-8	2-8	2-7	2-7	2-6	2-6	2-6	2-5	2-5	2-5	2-5	2-4	2-4	2-4	2-4	2-4	3-3
	35	2-8	2-8	2-7	2-7	2-6	2-6	2-6	2-5	2-5	2-5	2-5	2-4	2-4	2-4	2-4	2-4	2-3
	36	2-8	2-8	2-7	2-7	2-6	2-6	2-6	2-5	2-5	2-5	2-5	2-5	2-4	2-4	2-4	2-4	2-3
	37	2-8	2-8	2-7	2-7	2-6	2-6	2-6	2-5	2-5	2-5	2-5	2-5	2-4	2-4	2-4	2-4	2-3
	38	2-8	2-8	2-7	2-7	2-6	2-6	2-6	2-5	2-5	2-5	2-5	2-5	2-4	2-4	2-4	2-4	2-4
	39	2-8	2-8	2-7	2-7	2-6	2-6	2-6	2-5	2-5	2-5	2-5	2-5	2-4	2-4	2-4	2-4	2-4
	40	1-8	2-8	2-7	2-7	2-6	2-6	2-6	2-5	2-5	2-5	2-5	2-5	2-4	2-4	2-4	2-4	2-4
	41	1-8	1-8	2-7	2-7	2-6	2-6	2-6	2-6	2-5	2-5	2-5	2-5	2-4	2-4	2-4	2-4	2-4
	42	1-8	1-8	2-7	2-7	2-6	2-6	2-6	2-6	2-5	2-5	2-5	2-5	2-4	2-4	2-4	2-4	2-4
	43	1-8	1-8	1-7	2-7	2-6	2-6	2-6	2-6	2-5	2-5	2-5	2-5	2-4	2-4	2-4	2-4	2-4
	44	1-8	1-8	1-7	1-7	2-6	2-6	2-6	2-6	2-5	2-5	2-5	2-5	2-4	2-4	2-4	2-4	2-4
	45	1-8	1-8	1-7	1-7	1-6	2-6	2-6	2-6	2-5	2-5	2-5	2-5	2-4	2-4	2-4	2-4	2-4
	46	1-8	1-8	1-7	1-7	1-7	2-6	2-6	2-6	2-5	2-5	2-5	2-5	2-4	2-4	2-4	2-4	2-4
	47	1-8	1-8	1-7	1-7	1-7	1-6	2-6	2-6	2-5	2-5	2-5	2-5	2-4	2-4	2-4	2-4	2-4
	48	1-8	1-8	1-7	1-7	1-7	1-6	1-6	2-6	2-5	2-5	2-5	2-5	2-4	2-4	2-4	2-4	2-4
	49	1-8	1-8	1-7	1-7	1-7	1-6	1-6	1-6	2-5	2-5	2-5	2-5	2-4	2-4	2-4	2-4	2-4
	50	1-8	1-8	1-7	1-7	1-7	1-6	1-6	1-6	2-5	2-5	2-5	2-5	2-4	2-4	2-4	2-4	2-4
	51	1-8	1-8	1-7	1-7	1-7	1-6	1-6	1-6	1-5	2-5	2-5	2-5	2-4	2-4	2-4	2-4	2-4
	52	1-8	1-8	1-7	1-7	1-7	1-6	1-6	1-6	1-5	1-5	2-5	2-5	2-4	2-4	2-4	2-4	2-4
	53	1-8	1-8	1-7	1-7	1-7	1-6	1-6	1-6	1-5	1-5	1-5	2-5	2-4	2-4	2-4	2-4	2-4
	54	1-8	1-8	1-7	1-7	1-7	1-6	1-6	1-6	1-5	1-5	1-5	1-5	2-4	2-4	2-4	2-4	2-4
	55	1-8	1-8	1-7	1-7	1-7	1-6	1-6	1-6	1-5	1-5	1-5	1-5	1-4	2-4	2-4	2-4	2-4

Numbers of Formed Cutters Used to Mill Teeth in Mating Bevel Gear and Pinion with Shafts at Right Angles (Continued)

		Number of Teeth in Pinion																
		12	13	14	15	16	17	18	19	20	21	22	23	24	25	26	27	28
Number of Teeth in Gear	56	1-8	1-8	1-7	1-7	1-6	1-6	1-6	1-6	1-5	1-5	1-5	1-5	1-4	1-4	2-4	2-4	2-4
	57	1-8	1-8	1-7	1-7	1-6	1-6	1-6	1-6	1-5	1-5	1-5	1-5	1-4	1-4	1-4	2-4	2-4
	58	1-8	1-8	1-7	1-7	1-6	1-6	1-6	1-6	1-5	1-5	1-5	1-5	1-4	1-4	1-4	1-4	2-4
	59	1-8	1-8	1-7	1-7	1-6	1-6	1-6	1-6	1-5	1-5	1-5	1-5	1-5	1-4	1-4	1-4	1-4
	60	1-8	1-8	1-7	1-7	1-6	1-6	1-6	1-6	1-5	1-5	1-5	1-5	1-5	1-4	1-4	1-4	1-4
	61	1-8	1-8	1-7	1-7	1-6	1-6	1-6	1-6	1-5	1-5	1-5	1-5	1-5	1-4	1-4	1-4	1-4
	62	1-8	1-8	1-7	1-7	1-6	1-6	1-6	1-6	1-5	1-5	1-5	1-5	1-5	1-4	1-4	1-4	1-4
	63	1-8	1-8	1-7	1-7	1-6	1-6	1-6	1-6	1-5	1-5	1-5	1-5	1-5	1-4	1-4	1-4	1-4
	64	1-8	1-8	1-7	1-7	1-6	1-6	1-6	1-6	1-5	1-5	1-5	1-5	1-5	1-4	1-4	1-4	1-4
	65	1-8	1-8	1-7	1-7	1-7	1-6	1-6	1-6	1-6	1-5	1-5	1-5	1-5	1-4	1-4	1-4	1-4
	66	1-8	1-8	1-7	1-7	1-7	1-6	1-6	1-6	1-6	1-5	1-5	1-5	1-5	1-4	1-4	1-4	1-4
	67	1-8	1-8	1-7	1-7	1-7	1-6	1-6	1-6	1-6	1-5	1-5	1-5	1-5	1-4	1-4	1-4	1-4
	68	1-8	1-8	1-7	1-7	1-7	1-6	1-6	1-6	1-6	1-5	1-5	1-5	1-5	1-4	1-4	1-4	1-4
	69	1-8	1-8	1-7	1-7	1-7	1-6	1-6	1-6	1-6	1-5	1-5	1-5	1-5	1-4	1-4	1-4	1-4
	70	1-8	1-8	1-7	1-7	1-7	1-6	1-6	1-6	1-6	1-5	1-5	1-5	1-5	1-4	1-4	1-4	1-4
	71	1-8	1-8	1-7	1-7	1-7	1-6	1-6	1-6	1-6	1-5	1-5	1-5	1-5	1-4	1-4	1-4	1-4
	72	1-8	1-8	1-7	1-7	1-7	1-6	1-6	1-6	1-6	1-5	1-5	1-5	1-5	1-4	1-4	1-4	1-4
	73	1-8	1-8	1-7	1-7	1-7	1-6	1-6	1-6	1-6	1-5	1-5	1-5	1-5	1-4	1-4	1-4	1-4
	74	1-8	1-8	1-7	1-7	1-7	1-6	1-6	1-6	1-6	1-5	1-5	1-5	1-5	1-4	1-4	1-4	1-4
	75	1-8	1-8	1-7	1-7	1-7	1-6	1-6	1-6	1-6	1-5	1-5	1-5	1-5	1-4	1-4	1-4	1-4
	76	1-8	1-8	1-7	1-7	1-7	1-6	1-6	1-6	1-6	1-5	1-5	1-5	1-5	1-4	1-4	1-4	1-4
	77	1-8	1-8	1-7	1-7	1-7	1-6	1-6	1-6	1-6	1-5	1-5	1-5	1-5	1-4	1-4	1-4	1-4
	78	1-8	1-8	1-7	1-7	1-7	1-6	1-6	1-6	1-6	1-5	1-5	1-5	1-5	1-4	1-4	1-4	1-4
	79	1-8	1-8	1-7	1-7	1-7	1-6	1-6	1-6	1-6	1-5	1-5	1-5	1-5	1-4	1-4	1-4	1-4
	80	1-8	1-8	1-7	1-7	1-7	1-6	1-6	1-6	1-6	1-5	1-5	1-5	1-5	1-4	1-4	1-4	1-4
	81	1-8	1-8	1-7	1-7	1-7	1-6	1-6	1-6	1-6	1-5	1-5	1-5	1-5	1-4	1-4	1-4	1-4
	82	1-8	1-8	1-7	1-7	1-7	1-6	1-6	1-6	1-6	1-5	1-5	1-5	1-5	1-4	1-4	1-4	1-4
	83	1-8	1-8	1-7	1-7	1-7	1-6	1-6	1-6	1-6	1-5	1-5	1-5	1-5	1-4	1-4	1-4	1-4
	84	1-8	1-8	1-7	1-7	1-7	1-6	1-6	1-6	1-6	1-5	1-5	1-5	1-5	1-4	1-4	1-4	1-4
	85	1-8	1-8	1-7	1-7	1-7	1-6	1-6	1-6	1-6	1-5	1-5	1-5	1-5	1-4	1-4	1-4	1-4
	86	1-8	1-8	1-7	1-7	1-7	1-6	1-6	1-6	1-6	1-5	1-5	1-5	1-5	1-4	1-4	1-4	1-4
	87	1-8	1-8	1-7	1-7	1-7	1-6	1-6	1-6	1-6	1-5	1-5	1-5	1-5	1-4	1-4	1-4	1-4
	88	1-8	1-8	1-7	1-7	1-7	1-6	1-6	1-6	1-6	1-5	1-5	1-5	1-5	1-4	1-4	1-4	1-4
	89	1-8	1-8	1-7	1-7	1-7	1-6	1-6	1-6	1-6	1-5	1-5	1-5	1-5	1-4	1-4	1-4	1-4
	90	1-8	1-8	1-7	1-7	1-7	1-6	1-6	1-6	1-6	1-5	1-5	1-5	1-5	1-4	1-4	1-4	1-4
	91	1-8	1-8	1-7	1-7	1-7	1-6	1-6	1-6	1-6	1-5	1-5	1-5	1-5	1-4	1-4	1-4	1-4
	92	1-8	1-8	1-7	1-7	1-7	1-6	1-6	1-6	1-6	1-5	1-5	1-5	1-5	1-4	1-4	1-4	1-4
	93	1-8	1-8	1-7	1-7	1-7	1-6	1-6	1-6	1-6	1-5	1-5	1-5	1-5	1-4	1-4	1-4	1-4
	94	1-8	1-8	1-7	1-7	1-7	1-6	1-6	1-6	1-6	1-5	1-5	1-5	1-5	1-4	1-4	1-4	1-4
	95	1-8	1-8	1-7	1-7	1-7	1-6	1-6	1-6	1-6	1-5	1-5	1-5	1-5	1-4	1-4	1-4	1-4
	96	1-8	1-8	1-7	1-7	1-7	1-6	1-6	1-6	1-6	1-5	1-5	1-5	1-5	1-4	1-4	1-4	1-4
	97	1-8	1-8	1-7	1-7	1-7	1-6	1-6	1-6	1-6	1-5	1-5	1-5	1-5	1-4	1-4	1-4	1-4
	98	1-8	1-8	1-7	1-7	1-7	1-6	1-6	1-6	1-6	1-5	1-5	1-5	1-5	1-4	1-4	1-4	1-4
	99	1-8	1-8	1-7	1-7	1-7	1-6	1-6	1-6	1-6	1-5	1-5	1-5	1-5	1-4	1-4	1-4	1-4
	100	1-8	1-8	1-7	1-7	1-7	1-6	1-6	1-6	1-6	1-5	1-5	1-5	1-5	1-4	1-4	1-4	1-4

Number of cutter for gear given first, followed by number for pinion. See text, page 2187

Selecting Formed Cutters for Milling Bevel Gears.—For milling 14½-degree pressure angle bevel gears, the standard cutter series furnished by manufacturers of formed milling cutters is commonly used. There are 8 cutters in the series for each diametral pitch to cover the full range from a 12-tooth pinion to a crown gear. The difference between formed cutters used for milling spur gears and those used for bevel gears is that bevel gear cutters are thinner because they must pass through the narrow tooth space at the small end of the bevel gear; otherwise the shape of the cutter and hence, the cutter number, are the same.

To select the proper number of cutter to be used when a bevel gear is to be milled, it is necessary, first, to compute what is called the “Number of Teeth, N' for which to Select Cutter.” This number of teeth can then be used to select the proper number of bevel gear cutter from the spur gear milling cutter table on page 2150. The value of N' may be computed using the last formula in the table on page 2183.

Example 1: What numbers of cutters are required for a pair of bevel gears of 4 diametral pitch and 70 degree shaft angle if the gear has 50 teeth and the pinion 20 teeth?

The pitch cone angle of the pinion is determined by using the first formula in the table on page 2183:

$$\tan \alpha_p = \frac{\sin \Sigma}{\frac{N_G}{N_p} + \cos \Sigma} = \frac{\sin 70^\circ}{\frac{50}{20} + \cos 70^\circ} = 0.33064; \alpha_p = 18^\circ 18'$$

The pitch cone angle of the gear is determined from the second formula in the table on page 2183:

$$\alpha_G = \Sigma - \alpha_p = 70^\circ - 18^\circ 18' = 51^\circ 42'$$

The numbers of teeth N' for which to select the cutters for the gear and pinion may now be determined from the last formula in the table on page 2183:

$$N' \text{ for the pinion} = \frac{N_p}{\cos \alpha_p} = \frac{20}{\cos 18^\circ 18'} = 21.1 \approx 21 \text{ teeth}$$

$$N' \text{ for the gear} = \frac{N_G}{\cos \alpha_G} = \frac{50}{\cos 51^\circ 42'} = 80.7 \approx 81 \text{ teeth}$$

From the table on page 2150 the numbers of the cutters for pinion and gear are found to be, respectively, 5 and 2.

Example 2: Required the cutters for a pair of bevel gears where the gear has 24 teeth and the pinion 12 teeth. The shaft angle is 90 degrees. As in the first example, the formulas given in the table on page 2183 will be used.

$$\tan \alpha_p = N_p \div N_G = 12 \div 24 = 0.5000 \text{ and } \alpha_p = 26^\circ 34'$$

$$\alpha_G = \Sigma - \alpha_p = 90^\circ - 26^\circ 34' = 63^\circ 26'$$

$$N' \text{ for pinion} = 12 \div \cos 26^\circ 34' = 13.4 \approx 13 \text{ teeth}$$

$$N' \text{ for gear} = 24 \div \cos 63^\circ 26' = 53.6 \approx 54 \text{ teeth}$$

And from the table on page 2150 the cutters for pinion and gear are found to be, respectively, 8 and 3.

Use of Table for Selecting Formed Cutters for Milling Bevel Gears.—The table beginning on page 2185 gives the numbers of cutters to use for milling various numbers of teeth in the gear and pinion. The table applies only to bevel gears with axes at right angles. Thus, in *Example 2* given above, the numbers of the cutters could have been obtained directly by entering the table with the actual numbers of teeth in the gear, 24, and the pinion, 12.

Offset of Cutter for Milling Bevel Gears.—When milling bevel gears with a rotary formed cutter, it is necessary to take two cuts through each tooth space with the gear blank slightly off center, first on one side and then on the other, to obtain a tooth of approximately the correct form. The gear blank is also rotated proportionately to obtain the proper tooth thickness at the large and small ends. The amount that the gear blank or cutter should be offset from the central position can be determined quite accurately by the use of the table *Factors for Obtaining Offset for Milling Bevel Gears* in conjunction with the following rule: Find the factor in the table corresponding to the number of cutter used and to the ratio of the pitch cone radius to the face width; then divide this factor by the diametral pitch and subtract the result from half the thickness of the cutter at the pitch line.

Factors for Obtaining Offset for Milling Bevel Gears

No. of Cutter	Ratio of Pitch Cone Radius to Width of Face $\left(\frac{C}{F}\right)$												
	$\frac{3}{1}$	$\frac{3\frac{1}{4}}{1}$	$\frac{3\frac{1}{2}}{1}$	$\frac{3\frac{3}{4}}{1}$	$\frac{4}{1}$	$\frac{4\frac{1}{4}}{1}$	$\frac{4\frac{1}{2}}{1}$	$\frac{4\frac{3}{4}}{1}$	$\frac{5}{1}$	$\frac{5\frac{1}{2}}{1}$	$\frac{6}{1}$	$\frac{7}{1}$	$\frac{8}{1}$
1	0.254	0.254	0.255	0.256	0.257	0.257	0.257	0.258	0.258	0.259	0.260	0.262	0.264
2	0.266	0.268	0.271	0.272	0.273	0.274	0.274	0.275	0.277	0.279	0.280	0.283	0.284
3	0.266	0.268	0.271	0.273	0.275	0.278	0.280	0.282	0.283	0.286	0.287	0.290	0.292
4	0.275	0.280	0.285	0.287	0.291	0.293	0.296	0.298	0.298	0.302	0.305	0.308	0.311
5	0.280	0.285	0.290	0.293	0.295	0.296	0.298	0.300	0.302	0.307	0.309	0.313	0.315
6	0.311	0.318	0.323	0.328	0.330	0.334	0.337	0.340	0.343	0.348	0.352	0.356	0.362
7	0.289	0.298	0.308	0.316	0.324	0.329	0.334	0.338	0.343	0.350	0.360	0.370	0.376
8	0.275	0.286	0.296	0.309	0.319	0.331	0.338	0.344	0.352	0.361	0.368	0.380	0.386

Note.—For obtaining offset by above table, use formula:

$$\text{Offset} = \frac{T}{2} - \frac{\text{factor from table}}{P}$$

P = diametral pitch of gear to be cut

T = thickness of cutter used, measured at pitch line

To illustrate, what would be the amount of offset for a bevel gear having 24 teeth, 6 diametral pitch, 30-degree pitch cone angle and $1\frac{1}{4}$ -inch face or tooth length? In order to obtain a factor from the table, the ratio of the pitch cone radius to the face width must be determined. The pitch cone radius equals the pitch diameter divided by twice the sine of the pitch cone angle = $4 \div (2 \times 0.5) = 4$ inches. As the face width is 1.25, the ratio is $4 \div 1.25$ or about $3\frac{1}{4}$ to 1. The factor in the table for this ratio is 0.280 with a No. 4 cutter, which would be the cutter number for this particular gear. The thickness of the cutter at the pitch line is measured by using a vernier gear tooth caliper. The depth $S + A$ (see Fig. 2; S = addendum; A = clearance) at which to take the measurement equals 1.157 divided by the diametral pitch; thus, $1.157 \div 6 = 0.1928$ inch. The cutter thickness at this depth will vary with different cutters and even with the same cutter as it is ground away, because formed bevel gear cutters are commonly provided with side relief. Assuming that the thickness is 0.1745 inch, and substituting the values in the formula given, we have:

$$\text{Offset} = \frac{0.1745}{2} = \frac{0.280}{6} = 0.0406 \text{ inch}$$

Adjusting the Gear Blank for Milling.—After the offset is determined, the blank is adjusted laterally by this amount, and the tooth spaces are milled around the blank. After having milled one side of each tooth to the proper dimensions, the blank is set over in the

opposite direction the same amount from a position central with the cutter, and is rotated to line up the cutter with a tooth space at the small end. A trial cut is then taken, which will leave the tooth being milled a little too thick, provided the cutter is thin enough—as it should be—to pass through the small end of the tooth space of the finished gear. This trial tooth is made the proper thickness by rotating the blank toward the cutter. To test the amount of offset, measure the tooth thickness (with a vernier caliper) at the large and small ends. The caliper should be set so that the addendum at the small end is in proper proportion to the addendum at the large end; that is, in the ratio, $(C - F)/C$ (see Fig. 2).

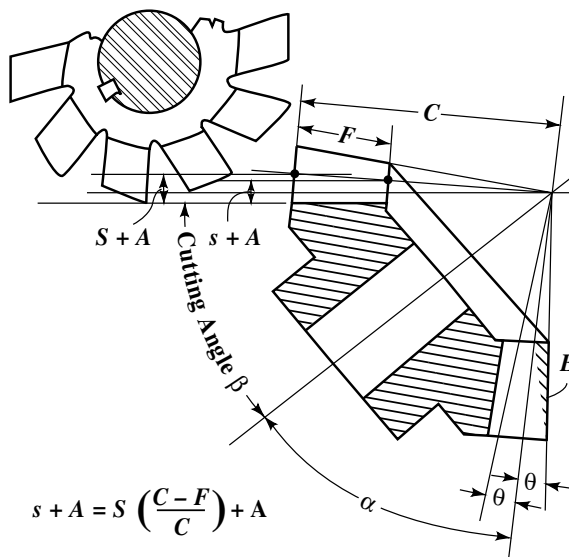


Fig. 2.

In taking these measurements, if the thicknesses at both ends (which should be in this same ratio) are too great, rotate the tooth toward the cutter and take trial cuts until the proper thickness at either the large or small end is obtained. If the large end of the tooth is the right thickness and the small end too thick, the blank was offset too much; inversely, if the small end is correct and the large end too thick, the blank was not set enough off center, and, either way, its position should be changed accordingly. The formula and table previously referred to will enable a properly turned blank to be set accurately enough for general work. The dividing head should be set to the cutting angle β (see Fig. 2), which is found by subtracting the addendum angle θ from the pitch cone angle α . After a bevel gear is cut by the method described, the sides of the teeth at the small end should be filed as indicated by the shade lines at E ; that is, by filing off a triangular area from the point of the tooth at the large end to the point at the small end, thence down to the pitch line and back diagonally to a point at the large end.

Circular Thickness, Chordal Thickness, and Chordal Addendum of Milled Bevel Gear Teeth.—In the formulas that follow, T = circular tooth thickness on pitch circle at large end of tooth; t = circular thickness at small end; T_c and t_c = chordal thickness at large and small ends, respectively; S_c and s_c = chordal addendum at large and small ends, respectively; D = pitch diameter at large end; and $C, F, P, S, s,$ and α are as defined on page 2181.

$$\begin{aligned}
 T &= \frac{1.5708}{P} & T_c &= T - \frac{T^3}{6D^2} & S_c &= S + \frac{T^2 \cos \alpha}{4D} \\
 t &= \frac{T(C - F)}{C} & t_c &= t - \frac{t^3}{6(D - 2F \sin \alpha)^2} & s_c &= s + \frac{t^2 \cos \alpha}{4(D - 2F \sin \alpha)}
 \end{aligned}$$

Typical Steels Used for Bevel Gear Applications

Carburizing Steels					
SAE or AISI No.	Type of Steel	Purchase Specifications			Remarks
		Preliminary Heat Treatment	Brinell Hard- ness Number	ASTM Grain Size	
1024	Manganese	Normalize			Low Alloy — oil quench limited to thin sections
2512	Nickel Alloy	Normalize — Anneal	163-228	5-8	Aircraft quality
3310 3312X	Nickel-Chromium	Normalize, then heat to 1450°F, cool in furnace. Reheat to 1170°F — cool in air	163-228	5-8	Used for maximum resistance to wear and fatigue
4028	Molybdenum	Normalize	163-217		Low Alloy
4615 4620	Nickel-Molybdenum	Normalize — 1700°F-1750°F	163-217	5-8	Good machining qualities. Well adapted to direct quench — gives tough core with minimum distortion
4815 4820	Nickel-Molybdenum	Normalize	163-241	5-8	For aircraft and heavily loaded service
5120	Chromium	Normalize	163-217	5-8	
8615 8620 8715 8720	Chromium-Nickel- Molybdenum	Normalize — cool at hammer	163-217	5-8	Used as an alternate for 4620
Oil Hardening and Flame Hardening Steels					
1141	Sulfurized free-cutting carbon steel	Normalize Heat-treated	179-228 255-269	5 or Coarser	Free-cutting steel used for unhardened gears, oil-treated gears, and for gears to be surface hardened where stresses are low
4140 4640	Chromium- Molybdenum Nickel- Molybdenum	For oil hardening, Normalize — Anneal For surface hardening, Normalize, reheat, quench, and draw	179-212 235-269 269-302 302-341		Used for heat-treated, oil-hardened, and surface-hardened gears. Machine qualities of 4640 are superior to 4140, and it is the preferred steel for flame hardening
6145	Chromium- Vanadium	Normalize— reheat, quench, and draw	235-269 269-302 302-341		Fair machining qualities. Used for surface hardened gears when 4640 is not available
8640 8739	Chromium-Nickel- Molybdenum	Same as for 4640			Used as an alternate for 4640
Nitriding Steels					
Nitralloy H & G	Special Alloy	Anneal	163-192		Normal hardness range for cutting is 20-28 Rockwell C

Other steels with qualities equivalent to those listed in the table may also be used.

WORM GEARING

Worm Gearing.—Worm gearing may be divided into two general classes, fine-pitch worm gearing, and coarse-pitch worm gearing. Fine-pitch worm gearing is segregated from coarse-pitch worm gearing for the following reasons:

1) Fine-pitch worms and wormgears are used largely to transmit motion rather than power. Tooth strength except at the coarser end of the fine-pitch range is seldom an important factor; durability and accuracy, as they affect the transmission of uniform angular motion, are of greater importance.

2) Housing constructions and lubricating methods are, in general, quite different for fine-pitch worm gearing.

3) Because fine-pitch worms and wormgears are so small, profile deviations and tooth bearings cannot be measured with the same accuracy as can those of coarse pitches.

4) Equipment generally available for cutting fine-pitch wormgears has restrictions which limit the diameter, the lead range, the degree of accuracy attainable, and the kind of tooth bearing obtainable.

5) Special consideration must be given to top lands in fine-pitch hardened worms and wormgear-cutting tools.

6) Interchangeability and high production are important factors in fine-pitch worm gearing; individual matching of the worm to the gear, as often practiced with coarse-pitch precision worms, is impractical in the case of fine-pitch worm drives.

American Standard Design for Fine-pitch Worm Gearing (ANSI B6.9-1977).—This standard is intended as a design procedure for fine-pitch worms and wormgears having axes at right angles. It covers cylindrical worms with helical threads, and wormgears hobbled for fully conjugate tooth surfaces. It does not cover helical gears used as wormgears.

Hobs: The hob for producing the gear is a duplicate of the mating worm with regard to tooth profile, number of threads, and lead. The hob differs from the worm principally in that the outside diameter of the hob is larger to allow for resharpening and to provide bottom clearance in the wormgear.

Pitches: Eight standard axial pitches have been established to provide adequate coverage of the pitch range normally required: 0.030, 0.040, 0.050, 0.065, 0.080, 0.100, 0.130, and 0.160 inch.

Axial pitch is used as a basis for this design standard because: 1) Axial pitch establishes lead which is a basic dimension in the production and inspection of worms; 2) the axial pitch of the worm is equal to the circular pitch of the gear in the central plane; and 3) only one set of change gears or one master lead cam is required for a given lead, regardless of lead angle, on commonly-used worm-producing equipment.

Lead Angles: Fifteen standard lead angles have been established to provide adequate coverage: 0.5, 1, 1.5, 2, 3, 4, 5, 7, 9, 11, 14, 17, 21, 25, and 30 degrees.

This series of lead angles has been standardized to: 1) Minimize tooling; 2) permit obtaining geometric similarity between worms of different axial pitch by keeping the same lead angle; and 3) take into account the production distribution found in fine-pitch worm gearing applications.

For example, most fine-pitch worms have either one or two threads. This requires smaller increments at the low end of the lead angle series. For the less frequently used thread numbers, proportionately greater increments at the high end of the lead angle series are sufficient.

Pressure Angle of Worm: A pressure angle of 20 degrees has been selected as standard for cutters and grinding wheels used to produce worms within the scope of this Standard because it avoids objectionable undercutting regardless of lead angle.

Table 1. Formulas for Proportions of American Standard Fine-pitch Worms and Wormgears ANSI B6.9-1977

<p style="text-align: center;">LETTER SYMBOLS</p> <p>P = Circular pitch of wormgear P = axial pitch of the worm, P_x, in the central plane P_x = Axial pitch of worm P_n = Normal circular pitch of worm and wormgear = $P_x \cos \lambda = P \cos \psi$ λ = Lead angle of worm ψ = Helix angle of wormgear n = Number of threads in worm N = Number of teeth in wormgear $N = nm_G$ m_G = Ratio of gearing = $N \div n$</p>	
---	--

Item	Formula	Item	Formula
WORM DIMENSIONS		WORMGEAR DIMENSIONS ^a	
Lead	$l = nP_x$	Pitch Diameter	$D = NP \div \pi = N\pi P_x \div \pi$
Pitch Diameter	$d = l \div (\pi \tan \lambda)$	Outside Diameter	$D_o = 2C - d + 2a$
Outside Diameter	$d_o = d + 2a$	Face Width	$F_{Gmin} = 1.125 \times \sqrt{(d_o + 2c)^2 - (d_o - 4a)^2}$
Safe Minimum Length of Threaded Portion of Worm ^b	$F_W = \sqrt{D_o^2 - D^2}$		
DIMENSIONS FOR BOTH WORM AND WORMGEAR			
Addendum	$a = 0.3183P_n$	Tooth thickness	$t_n = 0.5P_n$
Whole Depth	$h_t = 0.7003P_n + 0.002$	Approximate normal pressure angle ^c	$\phi_n = 20$ degrees
Working Depth	$h_k = 0.6366P_n$	Center distance	$C = 0.5(d + D)$
Clearance	$c = h_t - h_k$		

All dimensions in inches unless otherwise indicated.

^a Current practice for fine-pitch worm gearing does not require the use of throated blanks. This results in the much simpler blank shown in the diagram which is quite similar to that for a spur or helical gear. The slight loss in contact resulting from the use of non-throated blanks has little effect on the load-carrying capacity of fine-pitch worm gears. It is sometimes desirable to use topping hobs for producing wormgears in which the size relation between the outside and pitch diameters must be closely controlled. In such cases the blank is made slightly larger than D_o by an amount (usually from 0.010 to 0.020) depending on the pitch. Topped wormgears will appear to have a small throat which is the result of the hobbing operation. For all intents and purposes, the throating is negligible and a blank so made is not to be considered as being a throated blank.

^b This formula allows a sufficient length for fine-pitch worms.

^c As stated in the text on page 2191, the actual pressure angle will be slightly greater due to the manufacturing process.

Although the pressure angle of the cutter or grinding wheel used to produce the worm is 20 degrees, the normal pressure angle produced in the worm will actually be slightly greater, and will vary with the worm diameter, lead angle, and diameter of cutter or grinding wheel. A method for calculating the pressure angle change is given under the heading *Effect of Production Method on Worm Profile and Pressure Angle*.

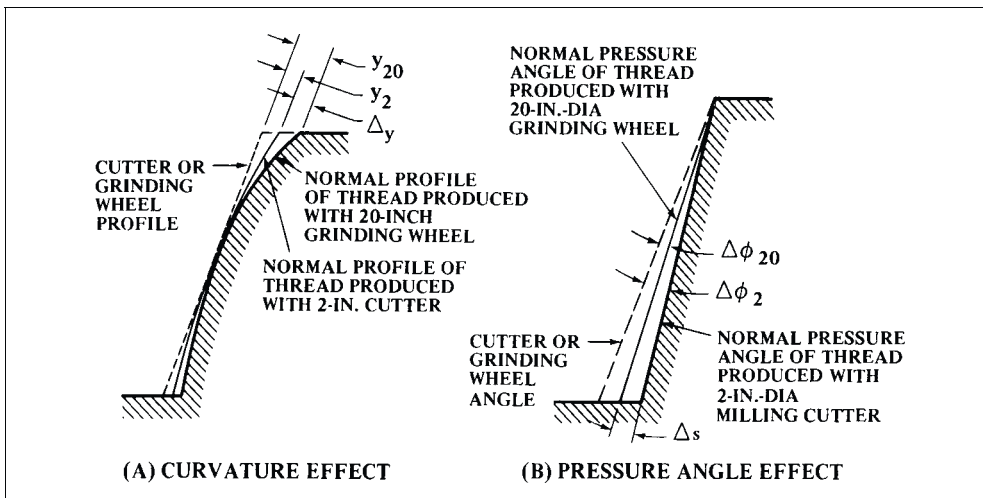
Pitch Diameter Range of Worms: The minimum recommended worm pitch diameter is 0.250 inch and the maximum is 2.000 inches.

Tooth Form of Worm and Wormgear: The shape of the worm thread in the normal plane is defined as that which is produced by a symmetrical double-conical cutter or grinding wheel having straight elements and an included angle of 40 degrees.

Because worms and wormgears are closely related to their method of manufacture, it is impossible to specify clearly the tooth form of the wormgear without referring to the mating worm. For this reason, worm specifications should include the method of manufacture and the diameter of cutter or grinding wheel used. Similarly, for determining the shape of the generating tool, information about the method of producing the worm threads must be given to the manufacturer if the tools are to be designed correctly.

The worm profile will be a curve that departs from a straight line by varying amounts, depending on the worm diameter, lead angle, and the cutter or grinding wheel diameter. A method for calculating this deviation is given in the Standard. The tooth form of the wormgear is understood to be made fully conjugate to the mating worm thread.

Effect of Diameter of Cutting on Profile and Pressure Angle of Worms



Effect of Production Method on Worm Profile and Pressure Angle.—In worm gearing, tooth bearing is usually used as the means of judging tooth profile accuracy since direct profile measurements on fine-pitch worms or wormgears is not practical. According to AGMA 370.01, Design Manual for Fine-Pitch Gearing, a minimum of 50 per cent initial area of contact is suitable for most fine-pitch worm gearing, although in some cases, such as when the load fluctuates widely, a more restricted initial area of contact may be desirable.

Except where single-pointed lathe tools, end mills, or cutters of special shape are used in the manufacture of worms, the pressure angle and profile produced by the cutter are different from those of the cutter itself. The amounts of these differences depend on several factors, namely, diameter and lead angle of the worm, thickness and depth of the worm thread, and diameter of the cutter or grinding wheel. The accompanying diagram shows the curvature and pressure angle effects produced in the worm by cutters and grinding wheels, and how the amount of variation in worm profile and pressure angle is influenced by the diameter of the cutting tool used.

Materials for Worm Gearing.—Worm gearing, especially for power transmission, should have steel worms and phosphor bronze wormgears. This combination is used extensively. The worms should be hardened and ground to obtain accuracy and a smooth finish.

The phosphor bronze wormgears should contain from 10 to 12 per cent of tin. The S.A.E. phosphor gear bronze (No. 65) contains 88-90% copper, 10-12% tin, 0.50% lead, 0.50%

zinc (but with a maximum total lead, zinc and nickel content of 1.0 per cent), phosphorous 0.10-0.30%, aluminum 0.005%. The S.A.E. nickel phosphor gear bronze (No. 65 + Ni) contains 87% copper, 11% tin, 2% nickel and 0.2% phosphorous.

Single-thread Worms Gears.—The ratio of the worm speed to the wormgear speed may range from 1.5 or even less up to 100 or more. Worm gearing having high ratios are not very efficient as transmitters of power; nevertheless high as well as low ratios often are required. Since the ratio equals the number of wormgear teeth divided by the number of threads or “starts” on the worm, single-thread worms are used to obtain a high ratio. As a general rule, a ratio of 50 is about the maximum recommended for a single worm and wormgear combination, although ratios up to 100 or higher are possible. When a high ratio is required, it may be preferable to use, in combination, two sets of worm gearing of the multi-thread type in preference to one set of the single-thread type in order to obtain the same total reduction and a higher combined efficiency.

Single-thread worms are comparatively inefficient because of the effect of the low lead angle; consequently, single-thread worms are not used when the primary purpose is to transmit power as efficiently as possible but they may be employed either when a large speed reduction with one set of gearing is necessary, or possibly as a means of adjustment, especially if “mechanical advantage” or self-locking are important factors.

Multi-thread Worm Gears.—When worm gearing is designed primarily for transmitting power efficiently, the lead angle of the worm should be as high as is consistent with other requirements and preferably between, say, 25 or 30 and 45 degrees. This means that the worm must be multi-threaded. To obtain a given ratio, some number of wormgear teeth divided by some number of worm threads must equal the ratio. Thus, if the ratio is 6, combinations such as the following might be used:

$$\frac{24}{4}, \frac{30}{5}, \frac{36}{6}, \frac{42}{7}$$

The numerators represent numbers of wormgear teeth and the denominators, the number of worm threads or “starts.” The number of wormgear teeth may not be an exact multiple of the number of threads on a multi-thread worm in order to obtain a “hunting tooth” action.

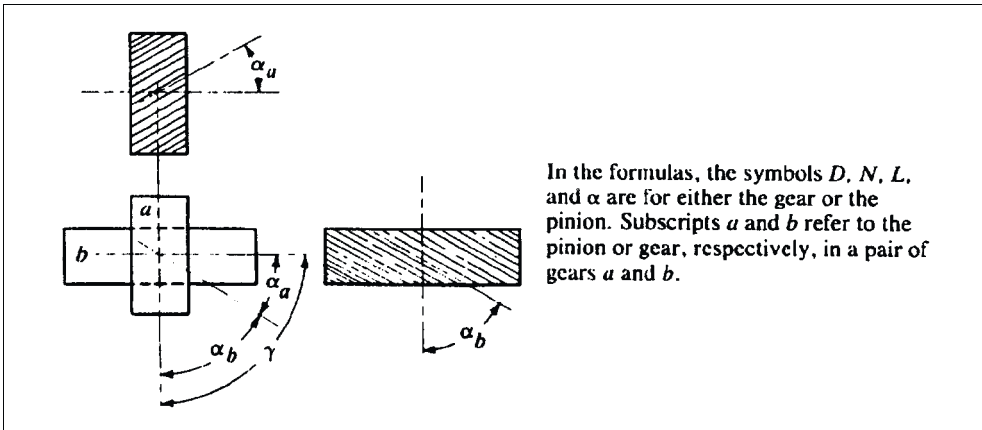
Number of Threads or “Starts” on Worm: The number of threads on the worm ordinarily varies from one to six or eight, depending upon the ratio of the gearing. As the ratio is increased, the number of worm threads is reduced, as a general rule. In some cases, however, the higher of two ratios may also have a larger number of threads. For example, a ratio of $6\frac{1}{2}$ would have 5 threads whereas a ratio of $6\frac{2}{3}$ would have 6 threads. Whenever the ratio is fractional, the number of threads on the worm equals the denominator of the fractional part of the ratio.

Worm-Gear Cutting.—The machines used for cutting worm-gears include ordinary milling machines, gear-hobbing machines of the type adapted to cutting either spur, spiral, or worm gearing, and special machines designed expressly for cutting worm-gears. The general methods employed are (1) cutting by using a straight hob and a radial feeding movement between hob and gear blank; (2) cutting by feeding a fly cutter tangentially with relation to the worm gear blank; and (3) cutting by feeding a tapering hob tangentially. The fly-cutter method is slow as compared with hobbing but it has two decided advantages: First, a very simple and inexpensive cutter may be used instead of an expensive hob. This is of great importance when the number of worm-gears is not large enough to warrant making a hob. Second, with the fly-cutter method, it is possible to produce worm-gears having more accurate teeth than are obtainable by the use of a straight hob. Taper hobs are especially adapted for cutting worm-gears that are to mesh with worms having large helix angles; they are also preferable for worm-gears having large face widths in proportion to the worm diameter. Worm-gear teeth are generated more accurately with a taper hob than with a straight hob that is given a radial feeding movement.

HELICAL GEARING

Basic Rules and Formulas for Helical Gear Calculations.—The rules and formulas in the following table and elsewhere in this article are basic to helical gear calculations. The notation used in the formulas is: P_n = normal diametral pitch of cutter; D = pitch diameter; N = number of teeth; α = helix angle; γ = center angle or angle between shafts; C = center distance; N' = number of teeth for which to select a formed cutter for milled teeth; L = lead of tooth helix; S = addendum; W = whole depth; T_n = normal tooth thickness at pitch line; and O = outside diameter.

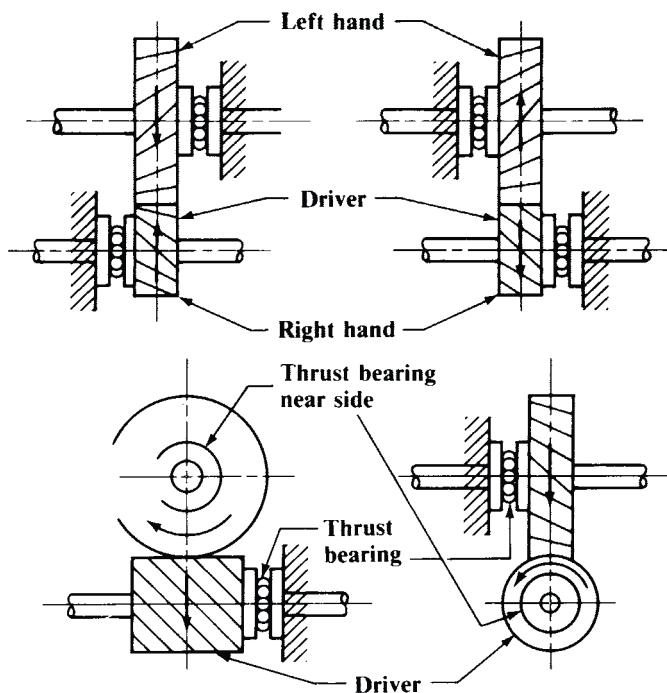
Rules and Formulas for Helical Gear Calculations



No.	To Find	Rule	Formula
1	Pitch Diameter	Divide the number of teeth by the product of the normal diameter pitch and the cosine of the helix angle.	$D = \frac{N}{P_n \cos \alpha}$
2	Center Distance	Add together the two pitch diameters and divide by 2.	$C = \frac{D_a + D_b}{2}$
3	Lead of Tooth Helix	Multiply the pitch diameter by 3.1416 by the cotangent of the helix angle.	$L = \pi D \cot \alpha$
4	Addendum	Divide 1 by the normal diametral pitch.	$S = \frac{1}{P_n}$
5	Whole Depth of tooth	Divide 2.157 by the normal diametral pitch.	$W = \frac{2.157}{P_n}$
6	Normal Tooth Thickness at Pitch Line	Divide 1.5708 by the normal diametral pitch.	$T_n = \frac{1.5708}{P_n}$
7	Outside Diameter	Add twice the addendum to the pitch diameter.	$O = D + 2S$

Determining Direction of Thrust.—The first step in helical gear design is to determine the desired direction of the thrust. When the direction of the thrust has been determined and the relative positions of the driver and driven gears are known, then the direction of helix (right- or left-hand) may be found from the accompanying thrust diagrams, *Directions of Rotation and Resulting Thrust for Parallel Shaft and 90 Degree Shaft Angle Helical Gears*. The diagrams show the directions of rotation and the resulting thrust for parallel-

shaft and 90-degree shaft angle helical gears. The thrust bearings are located so as to take the thrust caused by the tooth loads. The direction of the thrust depends on the direction of the helix, the relative positions of driver and driven gears, and the direction of rotation. The thrust may be changed to the opposite direction by changing any one of the three conditions, namely, by changing the hand of the helix, by reversing the direction of rotation, or by exchanging of driver and driven gear positions.



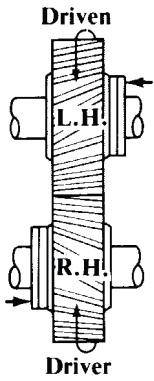
Directions of Rotation and Resulting Thrust for Parallel Shaft and 90 Degree Shaft Angle Helical Gears

Determining Helix Angles.—The following rules should be observed for helical gears with shafts at any given angle. If each helix angle is less than the shaft angle, then the sum of the helix angles of the two gears will equal the angle between the shafts, and the helix angle is of the same hand for both gears; if the helix angle of one of the gears is larger than the shaft angle, then the difference between the helix angles of the two gears will be equal to the shaft angle, and the gears will be of opposite hand.

Pitch of Cutter to be Used.—The thickness of the cutter at the pitchline for cutting helical gears should equal one-half the *normal* circular pitch. The normal pitch varies with the helix angle, hence, the helix angle must be considered when selecting a cutter. The cutter should be of the same pitch as the *normal* diametral pitch of the gear. This normal pitch is found by dividing the transverse diametral pitch of the gear by the cosine of the helix angle. To illustrate, if the pitch diameter of a helical gear is 6.718 and there are 38 teeth having a helix angle of 45 degrees, the transverse diametral pitch equals 38 divided by 6.718 = 5.656; then the normal diametral pitch equals 5.656 divided by 0.707 = 8. A cutter, then, of 8 diametral pitch is the one to use for this particular gear.

Helical gears should preferably be cut on a generating-type gear cutting machine such as a hobber or shaper. Milling machines are used in some shops when hobbers or shapers are not available or when single, replacement gears are being made. In such instances, the pitch of the formed cutter used in milling a helical gear must not only conform to the normal diametral pitch of the gear, but the cutter number must also be determined. See *Selecting Cutter for Milling Helical Gears* starting on page 2204.

1. Shafts Parallel, Center Distance Approximate.—Given or assumed:



- 1) Position of gear having right- or left-hand helix, depending upon rotation and direction in which thrust is to be received
- 2) C_a = approximate center distance
- 3) P_n = normal diametral pitch
- 4) N = number of teeth in large gear
- 5) n = number of teeth in small gear
- 6) α = angle of helix

To find:

$$1) D = \text{pitch diameter of large gear} = \frac{N}{P_n \cos \alpha}$$

$$2) d = \text{pitch diameter of small gear} = \frac{n}{P_n \cos \alpha}$$

$$3) O = \text{outside diameter of large gear} = D + \frac{2}{P_n}$$

$$4) o = \text{outside diameter of small gear} = d + \frac{2}{P_n}$$

$$5) T = \text{number of teeth marked on formed milling cutter (large gear)} = \frac{N}{\cos^3 \alpha}$$

$$6) t = \text{number of teeth marked on formed milling cutter (small gear)} = \frac{n}{\cos^3 \alpha}$$

$$7) L = \text{lead of helix on large gear} = \pi D \cot \alpha$$

$$8) l = \text{lead of helix on small gear} = \pi d \cot \alpha$$

$$9) C = \text{center distance (if not right, vary } \alpha) = \frac{1}{2}(D + d)$$

Example: Given or assumed: 1) See illustration; 2) $C_a = 17$ inches; 3) $P_n = 2$; 4) $N = 48$; 5) $n = 20$; and 6) $\alpha = 20$.

To find:

$$1) D = \frac{N}{P_n \cos \alpha} = \frac{48}{2 \times 0.9397} = 25.541 \text{ inches}$$

$$2) d = \frac{n}{P_n \cos \alpha} = \frac{20}{2 \times 0.9397} = 10.642 \text{ inches}$$

$$3) O = \frac{2}{P_n} = 25.541 + \frac{2}{2} = 26.541 \text{ inches}$$

$$4) o = d + \frac{2}{P_n} = 10.642 + \frac{2}{2} = 11.642 \text{ inches}$$

$$5) T = \frac{N}{\cos^3 \alpha} = \frac{48}{(0.9397)^3} = 57.8, \text{ say } 58 \text{ teeth}$$

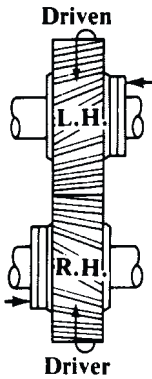
$$6) t = \frac{n}{\cos^3 \alpha} = \frac{20}{(0.9397)^3} = 24.1, \text{ say } 24 \text{ teeth}$$

$$7) L = \pi D \cot \alpha = 3.1416 \times 25.541 \times 2.747 = 220.42 \text{ inches}$$

$$8) l = \pi d \cot \alpha = 3.1416 \times 10.642 \times 2.747 = 91.84 \text{ inches}$$

$$9) C = \frac{1}{2}(D + d) = \frac{1}{2}(25.541 + 10.642) = 18.091 \text{ inches}$$

2. Shafts Parallel, Center Distance Exact.—Given or assumed:



- 1) Position of gear having right- or left-hand helix, depending upon rotation and direction in which thrust is to be received
- 2) C = exact center distance
- 3) P_n = normal diametral pitch (pitch of cutter)
- 4) N = number of teeth in large gear
- 5) n = number of teeth in small gear

To find:

$$1) \cos \alpha = \frac{N + n}{2P_n C}$$

$$2) D = \text{pitch diameter of large gear} = \frac{N}{P_n \cos \alpha}$$

$$3) d = \text{pitch diameter of small gear} = \frac{n}{P_n \cos \alpha}$$

$$4) O = \text{outside diameter of large gear} = D + \frac{2}{P_n}$$

$$5) o = \text{outside diameter of small gear} = d + \frac{2}{P_n}$$

$$6) T = \text{number of teeth marked on formed milling cutter (large gear)} = \frac{N}{\cos^3 \alpha}$$

$$7) t = \text{number of teeth marked on formed milling cutter (small gear)} = \frac{n}{\cos^3 \alpha}$$

$$8) L = \text{lead of helix (large gear)} = \pi D \cot \alpha$$

$$9) l = \text{lead of helix (small gear)} = \pi d \cot \alpha$$

Example: Given or assumed: 1) See illustration; 2) $C = 18.75$ inches; 3) $P_n = 4$; 4) $N = 96$; and 5) $n = 48$.

$$1) \cos \alpha = \frac{N + n}{2P_n C} = \frac{96 + 48}{2 \times 4 \times 18.75} = 0.96, \text{ or } \alpha = 16^\circ 16'$$

$$2) D = \frac{N}{P_n \cos \alpha} = \frac{96}{4 \times 0.96} = 25 \text{ inches}$$

$$3) d = \frac{n}{P_n \cos \alpha} = \frac{48}{4 \times 0.96} = 12.5 \text{ inches}$$

$$4) O = D + \frac{2}{P_n} = 25 + \frac{2}{4} = 25.5 \text{ inches}$$

$$5) o = d + \frac{2}{P_n} = 12.5 + \frac{2}{4} = 13 \text{ inches}$$

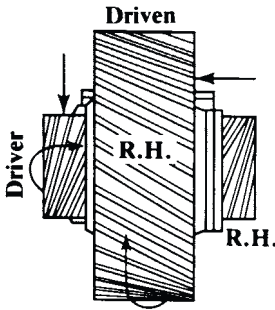
$$6) T = \frac{N}{\cos^3 \alpha} = \frac{96}{(0.96)^3} = 108 \text{ teeth}$$

$$7) t = \frac{n}{\cos^3 \alpha} = \frac{48}{(0.96)^3} = 54 \text{ teeth}$$

$$8) L = \pi D \cot \alpha = 3.1416 \times 25 \times 3.427 = 269.15 \text{ inches}$$

$$9) l = \pi d \cot \alpha = 3.1416 \times 12.5 \times 3.427 = 134.57 \text{ inches}$$

3. Shafts at Right Angles, Center Distance Approximate.—Sum of helix angles of gear and pinion must equal 90 degrees.



Given or assumed:

- 1) Position of gear having right- or left-hand helix, depending on rotation and direction in which thrust is to be received
- 2) C_a = approximate center distance
- 3) P_n = normal diametral pitch (pitch of cutter)
- 4) R = ratio of gear to pinion size

5) n = number of teeth in pinion = $\frac{1.41 C_a P_n}{R + 1}$ for 45 degrees;

and $\frac{2 C_a P_n \cos \alpha \cos \beta}{R \cos \beta + \cos \alpha}$ for any angle

6) N = number of teeth in gear = nR

7) α = angle of helix of gear

8) β = angle of helix of pinion

To find:

a) When helix angles are 45 degrees,

1) D = pitch diameter of gear = $\frac{N}{0.70711 P_n}$

2) d = pitch diameter of pinion = $\frac{n}{0.70711 P_n}$

3) O = outside diameter of gear = $D + \frac{2}{P_n}$

4) o = outside diameter of pinion = $d + \frac{2}{P_n}$

5) T = number of formed cutter (gear) = $\frac{N}{0.353}$

6) t = number of formed cutter (pinion) = $\frac{n}{0.353}$

7) L = lead of helix of gear = πD

8) l = lead of helix of pinion = πd

9) C = center distance (exact) = $\frac{D + d}{2}$

b) When helix angles are other than 45 degrees

1) $D = \frac{N}{P_n \cos \alpha}$ 2) $d = \frac{n}{P_n \cos \beta}$ 3) $T = \frac{N}{\cos^3 \alpha}$

4) $t = \frac{n}{\cos^3 \beta}$ 5) $L = \pi D \cot \alpha$ 6) $l = \pi d \cot \beta$

Example: Given or assumed: 1) See illustration; 2) $C_a = 3.2$ inches; 3) $P_n = 10$; and 4) $R = 1.5$.

5) $n = \frac{1.41 C_a P_n}{R + 1} = \frac{1.41 \times 3.2 \times 10}{1.5 + 1} = \text{say } 18 \text{ teeth.}$

6) $N = nR = 18 \times 1.5 = 27 \text{ teeth; 7) } \alpha = 45 \text{ degrees; and 8) } \beta = 45 \text{ degrees.}$

To find:

$$1) D = \frac{N}{0.70711 P_n} = \frac{27}{0.70711 \times 10} = 3.818 \text{ inches}$$

$$2) d = \frac{n}{0.70711 P_n} = \frac{18}{0.70711 \times 10} = 2.545 \text{ inches}$$

$$3) O = D + \frac{2}{P_n} = 3.818 + \frac{2}{10} = 4.018 \text{ inches}$$

$$4) o = d + \frac{2}{P_n} = 2.545 + \frac{2}{10} = 2.745 \text{ inches}$$

$$5) T = \frac{N}{0.353} = \frac{27}{0.353} = 76.5, \text{ say } 76 \text{ teeth}$$

$$6) t = \frac{n}{0.353} = \frac{18}{0.353} = 51 \text{ teeth}$$

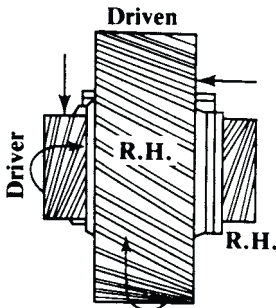
$$7) L = \pi D = 3.1416 \times 3.818 = 12 \text{ inches}$$

$$8) l = \pi d = 3.1416 \times 2.545 = 8 \text{ inches}$$

$$9) C = \frac{D+d}{2} = \frac{3.818 + 2.545}{2} = 3.182 \text{ inches}$$



4A. Shafts at Right Angles, Center Distance Exact.—Gears have same direction of helix. Sum of the helix angles will equal 90 degrees.



Given or assumed:

- 1) Position of gear having right- or left-hand helix depending on rotation and direction in which thrust is to be received
- 2) P_n = normal diametral pitch (pitch of cutter)
- 3) R = ratio of number of teeth in large gear to number of teeth in small gear
- 4) α_a = approximate helix angle of large gear
- 5) C = exact center distance

To find:

- 1) n = number of teeth in small gear nearest = $2 CP_n \sin \alpha_a \div 1 + R \tan \alpha_a$
- 2) N = number of teeth in large gear = Rn
- 3) α = exact helix angle of large gear, found by trial from $R \sec \alpha + \operatorname{cosec} \alpha = 2 CP_n \div n$
- 4) β = exact helix angle of small gear = $90^\circ - \alpha$
- 5) D = pitch diameter of large gear = $\frac{N}{P_n \cos \alpha}$
- 6) d = pitch diameter of small gear = $\frac{n}{P_n \cos \beta}$
- 7) O = outside diameter of large gear = $D + \frac{2}{P_n}$

8) $o = \text{outside diameter of small gear} = d + \frac{2}{P_n}$

9) N' and n' = numbers of teeth marked on cutters for large and small gears (see page 2204)

10) $L = \text{lead of helix on large gear} = \pi D \cot \alpha$

11) $l = \text{lead of helix on small gear} = \pi d \cot \beta$

Example: Given or assumed: 1) See illustration; 2) $P_n = 8$; 3) $R = 3$; 4) $\alpha_a = 45$ degrees; and 5) $C = 10$ in.

To find:

1) $n = \frac{2CP_n \sin \alpha_a}{1 + R \tan \alpha_a} = \frac{2 \times 10 \times 8 \times 0.70711}{1 + 3} = 28.25$, say 28 teeth

2) $N = Rn = 3 \times 28 = 84$ teeth

3) $R \sec \alpha + \operatorname{cosec} \alpha = \frac{2CP_n}{n} = \frac{2 \times 10 \times 8}{28} = 5.714$, or $\alpha = 46^\circ 6'$

4) $\beta = 90^\circ - \alpha = 90^\circ - 46^\circ 6' = 43^\circ 54'$

5) $D = \frac{N}{P_n \cos \alpha} = \frac{84}{8 \times 0.6934} = 15.143$ inches

6) $d = \frac{n}{P_n \cos \beta} = \frac{28}{8 \times 0.72055} = 4.857$ inches

7) $O = D + \frac{2}{P_n} = 15.143 + 0.25 = 15.393$ inches

8) $o = d + \frac{2}{P_n} = 4.857 + 0.25 = 5.107$ inches

9) $N' = 275$; $n' = 94$ (see page 2204)

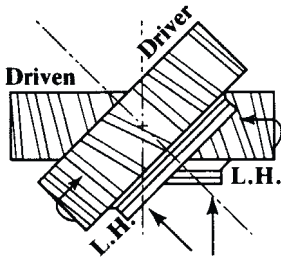
10) $L = \pi D \cot \alpha = 3.1416 \times 15.143 \times 0.96232 = 45.78$ inches

11) $l = \pi d \cot \beta = 3.1416 \times 4.857 \times 1.0392 = 15.857$ inches

4B. Shafts at Right Angles, Any Ratio, Helix Angle for Minimum Center Distance.—

Diagram similar to 4A. Gears have same direction of helix. The sum of the helix angles will equal 90 degrees.

For any given ratio of gearing R there is a helix angle α for the larger gear and a helix angle $\beta = 90^\circ - \alpha$ for the smaller gear that will make the center distance C a minimum. Helix angle α is found from the formula $\cot \alpha = R^{1/3}$. As an example, using the data found in Case 4A, helix angles α and β for minimum center distance would be: $\cot \alpha = R^{1/3} = 1.4422$; $\alpha = 34^\circ 44'$ and $\beta = 90^\circ - 34^\circ 44' = 55^\circ 16'$. Using these helix angles, $D = 12.777$; $d = 6.143$; and $C = 9.460$ from the formulas for D and d given under Case 4A.



5. Shafts at Any Angle, Center Distance Approximate.— The sum of the helix angles of the two gears equals the shaft angle, and the gears are of the same hand, if each angle is less than the shaft angle. The difference between the helix angles equals the shaft angle, and the gears are of opposite hand, if either angle is greater than the shaft angle.

Given or assumed:

- 1) Hand of helix, depending on rotation and direction in which thrust is to be received
- 2) C_a = center distance
- 3) P_n = normal diametral pitch (pitch of cutter)

$$4) R = \text{ratio of gear to pinion} = \frac{N}{n}$$

$$5) \alpha = \text{angle of helix, gear}$$

$$6) \beta = \text{angle of helix, pinion}$$

$$7) n = \text{number of teeth in pinion nearest } \frac{2C_a P_n \cos \alpha \cos \beta}{R \cos \beta + \cos \alpha} \text{ for any angle}$$

$$\text{and } \frac{2C_a P_n \cos \alpha}{R + 1} \text{ when both angles are equal}$$

$$8) N = \text{number of teeth in gear} = Rn$$

To find:

$$1) D = \text{pitch diameter of gear} = \frac{N}{P_n \cos \alpha}$$

$$2) d = \text{pitch diameter of pinion} = \frac{n}{P_n \cos \beta}$$

$$3) O = \text{outside diameter of gear} = D + \frac{2}{P_n}$$

$$4) o = \text{outside diameter of pinion} = d + \frac{2}{P_n}$$

$$5) T = \text{number of teeth marked on cutter for gear} = \frac{N}{\cos^3 \alpha}$$

$$6) t = \text{number of teeth marked on cutter for pinion} = \frac{n}{\cos^3 \beta}$$

$$7) L = \text{lead of helix on gear} = \pi D \cot \alpha$$

$$8) l = \text{lead of helix on pinion} = \pi d \cot \beta$$

$$9) C = \text{actual center distance} = \frac{D + d}{2}$$

Example: Given or assumed (angle of shafts, 60 degrees):

$$1) \text{ See illustration } 2) C_a = 12 \text{ inches } 3) P_n = 8$$

$$4) R = 4 \quad 5) \alpha = 30 \text{ degrees } 6) \beta = 30 \text{ degrees}$$

$$7) n = \frac{2C_a P_n \cos \alpha}{R + 1} = \frac{2 \times 12 \times 8 \times 0.86603}{4 + 1} = 33 \text{ teeth}$$

$$8) N = 4 \times 33 = 132 \text{ teeth}$$

To find:

$$1) D = \frac{N}{P_n \cos \alpha} = \frac{132}{8 \times 0.86603} = 19.052 \text{ inches}$$

$$2) d = \frac{n}{P_n \cos \beta} = \frac{33}{8 \times 0.86603} = 4.763 \text{ inches}$$

$$3) O = D + \frac{2}{P_n} = 19.052 + \frac{2}{8} = 19.302 \text{ inches}$$

$$4) o = d + \frac{2}{P_n} = 4.763 + \frac{2}{8} = 5.013 \text{ inches}$$

$$5) T = \frac{N}{\cos^3 \alpha} = \frac{132}{0.65} = 203 \text{ teeth}$$

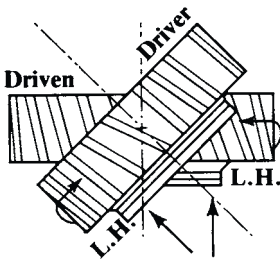
$$6) t = \frac{n}{\cos^3 \beta} = \frac{33}{0.65} = 51 \text{ teeth}$$

$$7) L = \pi D \cot \alpha = \pi \times 19.052 \times 1.732 = 103.66 \text{ inches}$$

$$8) l = \pi d \cot \beta = \pi \times 4.763 \times 1.732 = 25.92 \text{ inches}$$

$$9) C = \frac{D + d}{2} = \frac{19.052 + 4.763}{2} = 11.9075 \text{ inches}$$

6. Shafts at Any Angle, Center Distance Exact.—The sum of the helix angles of



the two gears equals the shaft angle, and the gears are of the same hand, if each angle is less than the shaft angle. The difference between the helix angles equals the shaft angle, and the gears are of opposite hand, if either angle is greater than the shaft angle.

Given or assumed:

1) Hand of helix, depending on rotation and direction in which thrust is to be received

2) C = center distance

3) P_n = normal diametral pitch (pitch of cutter)

4) α_a = approximate helix angle of gear

5) β_a = approximate helix angle of pinion

6) R = ratio of gear to pinion size = $\frac{N}{n}$

7) n = number of pinion teeth nearest $\frac{2CP_n \cos \alpha_a \cos \beta_a}{R \cos \beta_a + \cos \alpha_a}$

8) N = number of gear teeth = Rn

To find:

1) α and β , exact helix angles, found by trial from $R \sec \alpha + \sec \beta = \frac{2CP_n}{n}$

$$2) D = \text{pitch diameter of gear} = \frac{N}{P_n \cos \alpha}$$

$$3) d = \text{pitch diameter of pinion} = \frac{n}{P_n \cos \beta}$$

$$4) O = \text{outside diameter of gear} = D + \frac{2}{P_n}$$

$$5) o = \text{outside diameter of pinion} = d + \frac{2}{P_n}$$

6) N' = number of teeth marked on formed cutter for gear (see below)

7) n' = number of teeth marked on formed cutter for pinion (see below)

8) L = lead of helix on gear = $\pi D \cot \alpha$

9) l = lead of helix on pinion = $\pi d \cot \beta$

Selecting Cutter for Milling Helical Gears.—The proper milling cutter to use for *spur* gears depends on the pitch of the teeth and also upon the number of teeth as explained on page 2148 but a cutter for milling helical gears is not selected with reference to the actual number of teeth in the gear, as in spur gearing, but rather with reference to a calculated number N' that takes into account the effect on the tooth profile of lead angle, normal diametral pitch, and cutter diameter.

In the helical gearing examples starting on page 2197 the number of teeth N' on which to base the selection of the cutter has been determined using the approximate formula $N' = N \div \cos^3 \alpha$ or $N' = N \sec^3 \alpha$, where N = the actual number of teeth in the helical gear and α = the helix angle. However, the use of this formula may, where a combination of high helix angle and low tooth number is involved, result in the selection of a higher number of cutter than should actually be used for greatest accuracy. This condition is most likely to occur when the aforementioned formula is used to calculate N' for gears of high helix angle and low number of teeth.

To avoid the possibility of error in choice of cutter number, the following formula, which gives theoretically correct results for all combinations of helix angle and tooth numbers, is to be preferred:

$$N' = N \sec^3 \alpha + P_n D_c \tan^2 \alpha \quad (1)$$

where: N' = number of teeth on which to base selection of cutter number from table on page 2150; N = actual number of teeth in helical gear; α = helix angle; P_n = normal diametral pitch of gear and cutter; and D_c = pitch diameter of cutter.

To simplify calculations, **Formula (1)** may be written as follows:

$$N' = NK + QK' \quad (2)$$

In this formula, K , K' and Q are constants obtained from the tables on page 2205.

Example: Helix angle = 30 degrees; number of teeth in helical gear = 15; and normal diametral pitch = 20. From the tables on page 2205 K , K' , and Q are, respectively, 1.540, 0.333, and 37.80.

$$\begin{aligned} N' &= (15 \times 1.540) + (37.80 \times 0.333) = 23.10 + 12.60 \\ &= 35.70, \text{ say, } 36 \end{aligned}$$

Hence, from page 2150 select a number 3 cutter. Had the approximate formula been used, then a number 5 cutter would have been selected on the basis of $N' = 23$.

Factors for Selecting Cutters for Milling Helical Gears

Helix Angle, α	K	K'	Helix Angle, α	K	K'	Helix Angle, α	K	K'	Helix Angle, α	K	K'
0	1.000	0	16	1.127	0.082	32	1.640	0.390	48	3.336	1.233
1	1.001	0	17	1.145	0.093	33	1.695	0.422	49	3.540	1.323
2	1.002	0.001	18	1.163	0.106	34	1.755	0.455	50	3.767	1.420
3	1.004	0.003	19	1.182	0.119	35	1.819	0.490	51	4.012	1.525
4	1.007	0.005	20	1.204	0.132	36	1.889	0.528	52	4.284	1.638
5	1.011	0.008	21	1.228	0.147	37	1.963	0.568	53	4.586	1.761
6	1.016	0.011	22	1.254	0.163	38	2.044	0.610	54	4.925	1.894
7	1.022	0.015	23	1.282	0.180	39	2.130	0.656	55	5.295	2.039
8	1.030	0.020	24	1.312	0.198	40	2.225	0.704	56	5.710	2.198
9	1.038	0.025	25	1.344	0.217	41	2.326	0.756	57	6.190	2.371
10	1.047	0.031	26	1.377	0.238	42	2.436	0.811	58	6.720	2.561
11	1.057	0.038	27	1.414	0.260	43	2.557	0.870	59	7.321	2.770
12	1.068	0.045	28	1.454	0.283	44	2.687	0.933	60	8.000	3.000
13	1.080	0.053	29	1.495	0.307	45	2.828	1	61	8.780	3.254
14	1.094	0.062	30	1.540	0.333	46	2.983	1.072	62	9.658	3.537
15	1.110	0.072	31	1.588	0.361	47	3.152	1.150	63	10.687	3.852

$K = 1 \div \cos^3 \alpha = \sec^3 \alpha; K' = \tan^2 \alpha$

Outside and Pitch Diameters of Standard Involute-form Milling Cutters

Normal Diametral Pitch, P_n	Outside Dia., D_o	Pitch Dia., D_c	$Q = P_n D_c$	Normal Diametral Pitch, P_n	Outside Dia., D_o	Pitch Dia., D_c	$Q = P_n D_c$	Normal Diametral Pitch, P_n	Outside Dia., D_o	Pitch Dia., D_c	$Q = P_n D_c$
1	8.500	6.18	6.18	6	3.125	2.76	16.56	20	2.000	1.89	37.80
1¼	7.750	5.70	7.12	7	2.875	2.54	17.78	24	1.750	1.65	39.60
1½	7.000	5.46	8.19	8	2.875	2.61	20.88	28	1.750	1.67	46.76
1¾	6.500	5.04	8.82	9	2.750	2.50	22.50	32	1.750	1.68	53.76
2	5.750	4.60	9.20	10	2.375	2.14	21.40	36	1.750	1.69	60.84
2½	5.750	4.83	12.08	12	2.250	2.06	24.72	40	1.750	1.70	68.00
3	4.750	3.98	11.94	14	2.125	1.96	27.44	48	1.750	1.70	81.60
4	4.250	3.67	14.68	16	2.125	1.98	31.68
5	3.750	3.29	16.45	18	2.000	1.87	33.66

Pitch diameters shown in the table are computed from the formula: $D_c = D_o - 2(1.57 \div P_n)$. This same formula may be used to compute the pitch diameter of a non-standard outside diameter cutter when the normal diametral pitch P_n and the outside diameter D_o are known.

Milling the Helical Teeth.—The teeth of a helical gear are proportioned from the normal pitch and not the circular pitch. The whole depth of the tooth can be found by dividing 2.157 by the normal diametral pitch of the gear, which corresponds to the pitch of the cut-

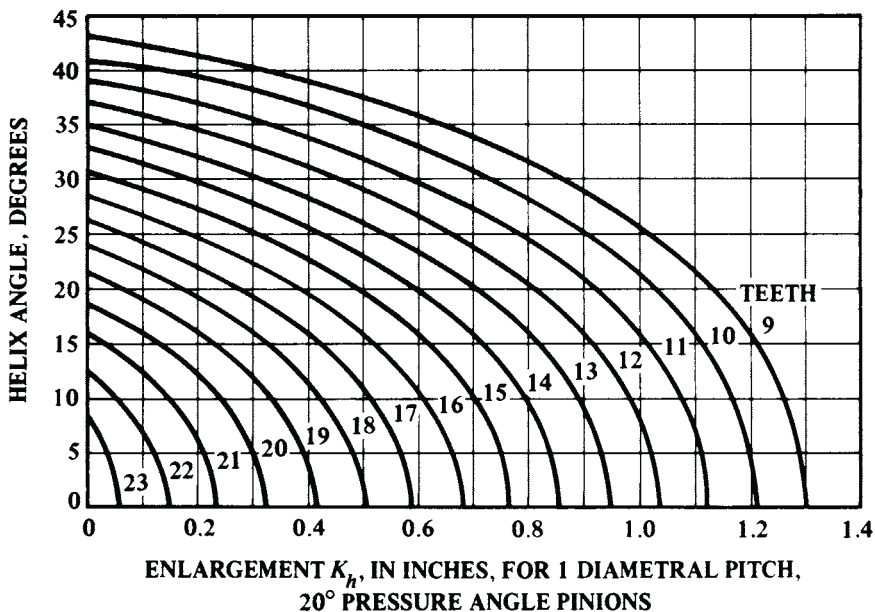
ter. The thickness of the tooth at the pitch line equals 1.571 divided by the normal diametral pitch. After a tooth space has been milled, the cutter should be prevented from dragging through it when being returned for another cut. This can be done by lowering the blank slightly, or by stopping the machine and turning the cutter to such a position that the teeth will not touch the work. If the gear has teeth coarser than 10 or 12 diametral pitch, it is well to take a roughing and a finishing cut. When pressing a helical gear blank on the arbor, it should be remembered that it is more likely to slip when being milled than a spur gear, because the pressure of the cut, being at an angle, tends to rotate the blank on the arbor.

Angular Position of Table: When cutting a helical gear on a milling machine, the table is set to the helix angle of the gear. If the lead of the helical gear is known, but not the helix angle, the helix angle is determined by multiplying the pitch diameter of the gear by 3.1416 and dividing this product by the lead; the result is the tangent of the lead angle which may be obtained from trigonometric tables or a calculator.

American National Standard Fine-Pitch Teeth For Helical Gears.—This Standard, ANSI B6.7-1977, provides a 20-degree tooth form for both spur and helical gears of 20 diametral pitch and finer. Formulas for tooth parts are given on page 2135.

Enlargement of Helical Pinions, 20-Degree Normal Pressure Angle: Formula (4) and the accompanying graph are based on the use of hobs having sharp corners at their top lands. Pinions cut by shaper cutters may not require as much modification as indicated by (4) or the graph. The number 2.1 appearing in (4) results from the use of a standard tooth thickness rack having an addendum of $1.05/P_n$ which will start contact at a roll angle 5 degrees above the base radius. The roll angle of 5 degrees is also reflected in Formula (4).

To avoid undercutting of the teeth and to provide more favorable contact conditions near the base of the tooth, it is recommended that helical pinions with less than 24 teeth be enlarged in accordance with the following graph and formulas. As with enlarged spur pinions, when an enlarged helical pinion is used it is necessary either to reduce the diameter of the mating gear or to increase the center distance. In the formulas that follow, ϕ_n = normal pressure angle; ϕ_t = transverse pressure angle; ψ = helix angle of pinion; P_n = normal diametral pitch; P_t = transverse diametral pitch; d = pitch diameter of pinion; d_o = outside diameter of enlarged pinion, K_h = enlargement for full depth pinions of 1 normal diametral pitch; and n = number of teeth in pinion.



To eliminate the need for making the calculations indicated in **Formulas (3) and (4)**, the accompanying graph may be used to obtain the value of K_h directly for full-depth pinions of 20-degree normal pressure angle.

$$P_t = P_n \cos \psi \tag{1}$$

$$d = n \div P_t \tag{2}$$

$$\tan \psi_t = \tan \phi_n \div \cos \psi \tag{3}$$

$$K_h = 2.1 - \frac{n}{\cos \psi} (\sin \phi_t - \cos \phi_t \tan 5^\circ) \sin \phi_t \tag{3}$$

$$d_o = d + \frac{2 + K_h}{P_n} \tag{4}$$

$$d_o = d + \frac{2 + K_h}{P_n} \tag{5}$$

Example: Find the outside diameter of a helical pinion having 12 teeth, 32 normal diametral pitch, 20-degree pressure angle, and 18-degree helix angle.

$$P_t = P_n \cos \psi = 32 \cos 18^\circ = 32 \times 0.95106 = 30.4339$$

$$d = n \div P_t = 12 \div 30.4339 = 0.3943 \text{ inch}$$

$$K_h = 0.851 \text{ (from graph)}$$

$$d_o = 0.3943 + \frac{2 + 0.851}{32} = 0.4834$$

Center Distance at Which Modified Mating Helical Gears Will Mesh with no Backlash.—If the helical pinion in the previous example on page 2207 had been made to standard dimensions, that is, not enlarged, and was in tight mesh with a standard 24-tooth mating gear, the center distance for tight mesh could be calculated from the formula on page 2135:

$$C = \frac{n + N}{2P_n \cos \psi} = \frac{12 + 24}{2 \times 32 \times \cos 18^\circ} = 0.5914 \text{ inch} \tag{1}$$

However, if the pinion is enlarged as in the example and meshed with the same standard 24-tooth gear, then the center distance for tight mesh will be increased. To calculate the new center distance, the following formulas and calculations are required:

First, calculate the transverse pressure angle ϕ_t using **Formula (2)**:

$$\tan \phi_t = \tan \phi_n \div \cos \psi = \tan 20^\circ \div \cos 18^\circ = 0.38270 \tag{2}$$

and from a calculator the angle ϕ_t is found to be $20^\circ 56' 30''$. In the table on page 111, $\text{inv } \phi_t$ is found to be 0.017196, and the cosine from a calculator as 0.93394.

Using **Formula (3)**, calculate the pressure angle ϕ at which the gears are in tight mesh:

$$\text{inv } \phi = \text{inv } \phi_t + \frac{(t_{nP} + t_{nG}) - \pi}{n + N} \tag{3}$$

In this formula, the value for t_{nP} for 1 diametral pitch is that found in **Table 9c** on page 2152, for a 12-tooth pinion, in the fourth column: 1.94703. The value of t_{nG} for 1 diametral pitch for a standard gear is always 1.5708.

$$\text{inv } \phi = 0.017196 + \frac{(1.94703 + 1.5708) - \pi}{12 + 24} = 0.027647$$

From the table on page 112, or a calculator, 0.027647 is the involute of $24^\circ 22' 7''$ and the cosine corresponding to this angle is 0.91091.

Finally, using **Formula (4)**, the center distance for tight mesh, C' is found:

$$C' = \frac{C \cos \phi_t}{\cos \phi} = \frac{0.5914 \times 0.93394}{0.91091} = 0.606 \text{ inch} \tag{4}$$

Change-gears for Helical Gear Hobbing.—If a gear-hobbing machine is not equipped with a differential, there is a fixed relation between the index and feed gears and it is necessary to compensate for even slight errors in the index gear ratio, to avoid excessive lead errors. This may be done readily (as shown by the example to follow) by modifying the ratio of the feed gears slightly, thus offsetting the index gear error and making very accurate leads possible.

Machine Without Differential: The formulas which follow may be applied in computing the index gear ratio.

R = index-gear ratio

L = lead of gear, inches

F = feed per gear revolution, inch

K = machine constant

T = number of threads on hob

N = number of teeth on gear

P_n = normal diametral pitch

P_{nc} = normal circular pitch

A = helix angle, relative to axis

M = feed gear constant

$$R = \frac{L \div F}{(L \div F) \pm 1} \times \frac{KT}{N} = \frac{L}{L \pm F} \times \frac{KT}{N} = \frac{\text{Driving gear sizes}}{\text{Driven gear sizes}} \quad (1)$$

Use minus (–) sign in **Formulas (1) and (2)** when gear and hob are the same “hand” and plus (+) sign when they are of opposite hand; when *climb* hobbing is to be used, reverse this rule.

$$R = \frac{KT}{N \pm \frac{P_n \times \sin A \times F}{\pi}} = \frac{KT}{N \pm \frac{\sin A \times F}{P_{nc}}} \quad (2)$$

$$\text{Ratio of feed gears} = \frac{F}{M} \quad F = \frac{L(NR - KT)}{NR} \quad (3)$$

$$L = \frac{FNR}{(NR - KT)} = \text{lead obtained with available index and feed gears} \quad (4)$$

Note: If gear and hob are of opposite hand, then in **Formulas (3) and (4)** change $(NR - KT)$ to $(KT - NR)$. This change is also made if gear and hob are of same hand but *climb* hobbing is used.

Example: A right-hand helical gear with 48 teeth of 10 normal diametral pitch, has a lead of 44.0894 inches. The feed is to be 0.035 inch, with whatever slight adjustment may be necessary to compensate for the error in available index gears. $K = 30$ and $M = 0.075$. A single-thread right-hand hob is to be used.

$$R = \frac{44.0894}{44.0894 - 0.035} \times \frac{30 \times 1}{48} = 0.62549654$$

Using the method of *Conjugate Fractions* beginning on page 12, several suitable ratios close to 0.62549654 were found. One of these, $(34 \times 53)/(43 \times 67) = 0.625477264839$ will be used as the index ratio. Other usable ratios and their decimal values were found to be as follows:

$$\begin{aligned} \frac{32 \times 38}{27 \times 72} &= 0.6255144 & \frac{27 \times 42}{42 \times 37} &= 0.62548263 \\ \frac{44 \times 29}{34 \times 60} &= 0.6254902 & \frac{26 \times 97}{96 \times 42} &= 0.62549603 \\ \frac{20 \times 41}{23 \times 57} &= 0.62547674 \end{aligned}$$

Index ratio error = $0.62549654 - 0.62547726 = 0.00001928$.

Now use **Formula (3)** to find slight change required in rate of feed. This change compensates sufficiently for the error in available index gears.

Change in Feed Rate: Insert in **Formula (3)** obtainable index ratio.

$$F = \frac{44.0894 \times (48 \times 0.62547726 - 30)}{48 \times 0.62547726} = 0.0336417$$

$$\text{Modified feed gear ratio} = \frac{F}{M} = \frac{0.0336417}{0.075} = 0.448556$$

$$\text{Log } 0.448556 = \bar{1}.651817 \quad \text{log of reciprocal} = 0.348183$$

To find close approximation to modified feed gear ratio, proceed as in finding suitable gears for index ratio, thus obtaining $\frac{106}{71} \times \frac{112}{75}$. Inverting, modified feed gear ratio =

$$\frac{71}{106} \times \frac{75}{112} = 0.448534.$$

Modified feed $F =$ obtainable modified feed ratio $\times M = 0.448534 \times 0.075 = 0.03364$ inch. If the feed rate is not modified, even a small error in the index gear ratio may result in an excessive lead error.

Checking Accuracy of Lead: The modified feed and obtainable index ratio are inserted in **Formula (4)**. Desired lead = 44.0894 inches. Lead obtained = 44.087196 inches; hence the computed error = $44.0894 - 44.087196 = 0.002204$ inch or about 0.00005 inch per inch of lead.

Machine with Differential: If a machine is equipped with a differential, the *lead gears* are computed in order to obtain the required helix angle and lead. The instructions of the hobbing machine manufacturer should be followed in computing the lead gears, because the ratio formula is affected by the location of the differential gears. If these gears are *ahead* of the index gears, the lead gear ratio is not affected by a change in the number of teeth to be cut (see **Formula (5)**); hence, the same lead gears are used when, for example, a gear and pinion are cut on the same machine. In the formulas which follow, the notation is the same as previously given, with these exceptions: $R_d =$ lead gear ratio for machine with differential; $P_a =$ axial or linear pitch of helical gear = distance from center of one tooth to center of next tooth measured parallel to gear axis = total lead $L \div$ number of teeth N .

$$R_d = \frac{P_a \times T}{K} = \frac{L \times T}{N \times K} = \frac{\pi \times \text{cosec} A \times T}{P_n \times K} = \frac{\text{Driven gear sizes}}{\text{Driving gear sizes}} \quad (5)$$

The number of hob threads T is included in the formula because double-thread hobs are used sometimes, especially for roughing in order to reduce the hobbing time. Lead gears having a ratio sufficiently close to the required ratio may be determined by using the table of gear ratio logarithms as previously described in connection with the non-differential type of machine. When using a machine equipped with a differential, the effect of a lead-gear ratio error upon the lead of the gear is small in comparison with the effect of an index gear error when using a non-differential type of machine. The lead obtained with a given or

obtainable lead gear ratio may be determined by the following formula: $L = (R_d NK) \div T$. In this formula, R_d represents the ratio obtained with available gears. If the given lead is 44.0894 inches, as in the preceding example, then the desired ratio as obtained with **Formula (5)** would be 0.9185292 if $K = 1$. Assume that the lead gears selected by using logs of ratios have a ratio of 0.9184704; then this ratio error of 0.0000588 would result in a computed lead error of only 0.000065 inch per inch.

Formula (5), as mentioned, applies to machines having the differential located *ahead* of the index gears. If the differential is located after the index gears, it is necessary to change lead gears whenever the index gears are changed for hobbing a different number of teeth, as indicated by the following formula which gives the lead gear ratio. In this formula, $D =$ pitch diameter.

$$R_d = \frac{L \times T}{K} = \frac{D \times \pi \times T}{K \times \tan A} = \frac{\text{Driven gear sizes}}{\text{Driving gear sizes}} \quad (6)$$

General Remarks on Helical Gear Hobbing.—In cutting teeth having large angles, it is desirable to have the direction of helix of the hob the same as the direction of helix of the gear, or in other words, the gear and the hob of the same “hand.” Then the direction of the cut will come against the movement of the blank. At ordinary angles, however, one hob will cut both right- and left-hand gears. In setting up the hobbing machine for helical gears, care should be taken to see that the vertical feed does not trip until the machine has been stopped or the hob has fed down past the finished gear.

Herringbone Gears

Double helical or herringbone gears are commonly used in parallel-shaft transmissions, especially when a smooth, continuous action (due to the gradual overlapping engagement of the teeth) is essential, as in high-speed drives where the pitch-line velocity may range from about 1000 to 3000 feet per minute (305–914 m/min) in commercial gearing and up to 12,000 feet per minute (3658 m/min) or higher in more specialized installations. These relatively high speeds are encountered in marine reduction gears, in certain speed-reducing and speed-increasing units, and in various other transmissions, particularly in connection with steam turbine and electric motor drives.

General Classes of Helical Gear Problems.—There are two general classes of problems. In one, the problem is to design gears capable of transmitting a given amount of power at a given speed, safely and without excessive wear; hence, the required proportions must be determined. In the second, the proportions and speed are known and the power-transmitting capacity is required. The first is the more difficult and common problem.

Causes of Herringbone Gear Failures.—Where failure occurs in a herringbone gear transmission, it is rarely due to tooth breakage but usually to excessive wear or sub-surface failures, such as pitting and spalling; hence, it is common practice to base the design of such gears upon durability, or upon tooth pressures which are within the allowable limits for wear. In this connection, it seems to have been well established by tests of both spur gears and herringbone gears, that there is a critical surface pressure value for teeth having given physical properties and coefficient of friction. According to these tests, pressures above the critical value result in rapid wear and a short gear life, whereas when pressures are below the critical, wear is negligible. The yield point or endurance limit of the material marks the critical loading point, and in practical designing a reasonable factor of safety would, of course, be employed.

OTHER GEAR TYPES

Elliptic Gears

Gears of this type provide simple means of obtaining a quick-return motion but they present a rather cumbersome manufacturing problem and, as a general rule, it is preferable to obtain quick-return motions by some other type of mechanism. When elliptic gears are used, the two gears that mesh with each other must be equal in size, and each gear must revolve about one of the foci of the ellipse forming the pitch line, as indicated by the diagram, in Fig. 1. By the use of elliptic gears so mounted, it is possible to obtain a variable motion of the driven shaft, because the gear on the driving shaft, while revolving one half of a revolution, will engage with only a small portion of the circumference of the driven gear, while during the other half of its revolution, the driving gear will engage with a great deal more than one-half of the total number of teeth in the driven gear; hence, the cutting stroke of a machine tool, for example, may be made to have a slow motion, while the return stroke is at a rapid rate. The ellipse has two points, each of which is called a *focus*, located as indicated at *A* and *B*. The sum of the distance between the foci and the elliptic curve is constant at all points and is equal to the longer or major axis of the ellipse. On account of this peculiarity of the ellipse, two equal ellipses can be made to mesh with each other during a complete revolution about their axes, if one is mounted on a shaft at its focus *A* and the other at its focus *B*.

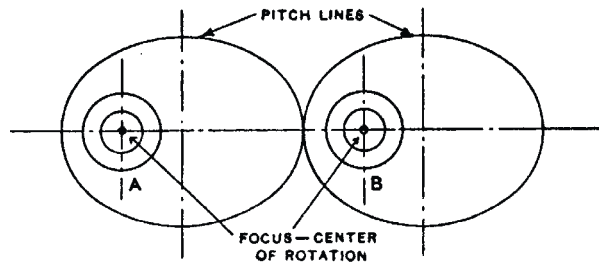


Fig. 1. General Arrangement of Elliptic Gears.

Planetary Gearing

Planetary or epicyclic gearing provides means of obtaining a compact design of transmission, with driving and driven shafts in line, and a large speed reduction when required. Typical arrangements of planetary gearing are shown by the following diagrams which are accompanied by speed ratio formulas. When planetary gears are arranged as shown by Figs. 5, 6, 9 and 12, the speed of the follower relative to the driver is increased, whereas Figs. 7, 8, 10, and 11 illustrate speed-reducing mechanisms.

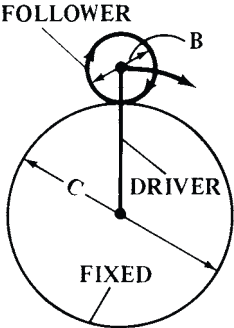
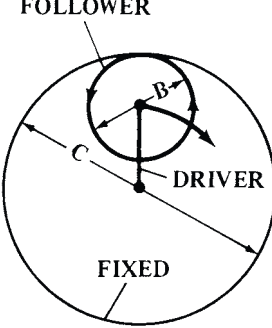
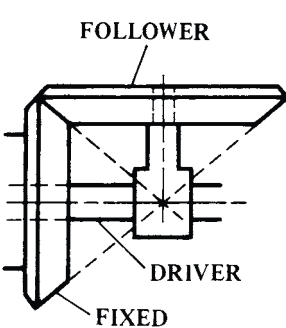
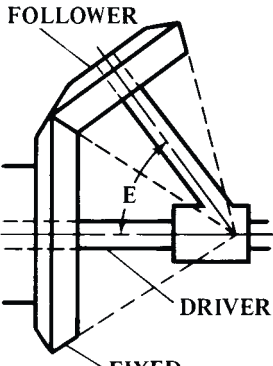
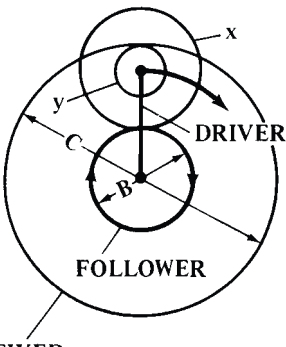
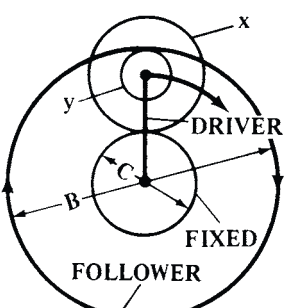
Direction of Rotation.—In using the following formulas, if the final result is preceded by a minus sign (negative), this indicates that the driver and follower will rotate in opposite directions; otherwise, both will rotate in the same direction.

Compound Drive.—The formulas accompanying Figs. 19 through 22 are for obtaining the speed ratios when there are *two* driving members rotating at different speeds. For example, in Fig. 19, the central shaft with its attached link is one driver. The internal gear *z*, instead of being fixed, is also rotated. In Fig. 22, if $z = 24$, $B = 60$ and $S = 3\frac{1}{2}$, with both drivers rotating in the same direction, then $F = 0$, thus indicating, in this case, the point where a larger value of *S* will reverse follower rotation.

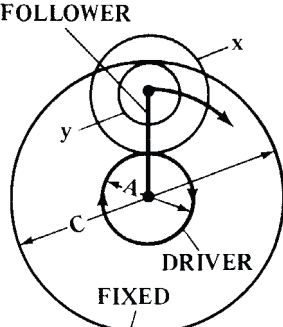
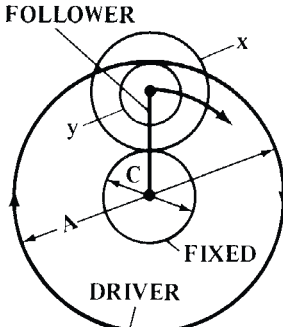
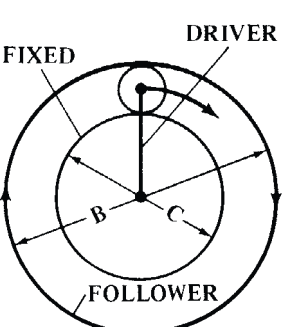
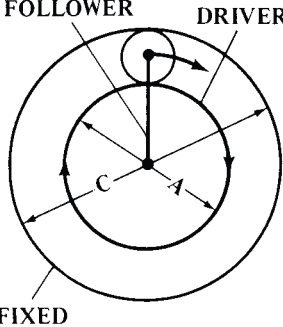
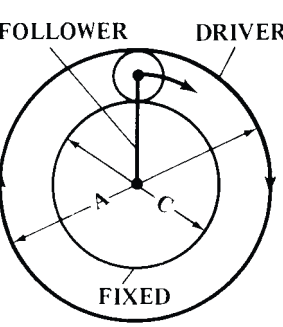
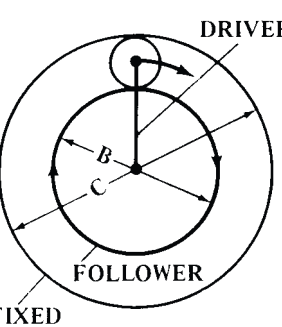
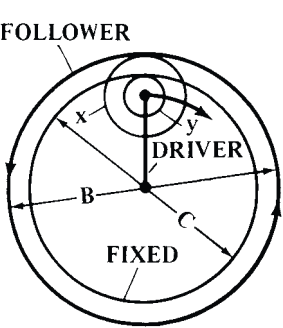
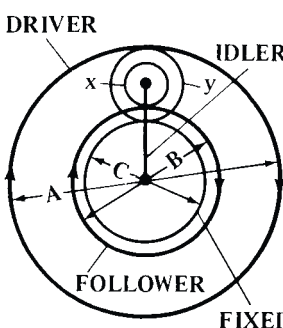
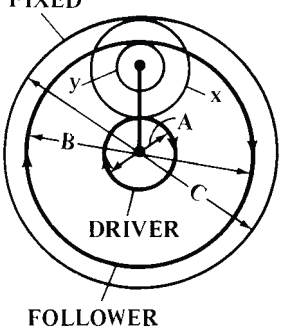
Planetary Bevel Gears.—Two forms of planetary gears of the bevel type are shown in Figs. 23 and 24. The planet gear in Fig. 23 rotates about a fixed bevel gear at the center of which is the driven shaft. Fig. 24 illustrates the Humpage reduction gear. This is sometimes referred to as cone-pulley back-gearing because of its use within the cone pulleys of certain types of machine tools.

Ratios of Planetary or Epicyclic Gearing

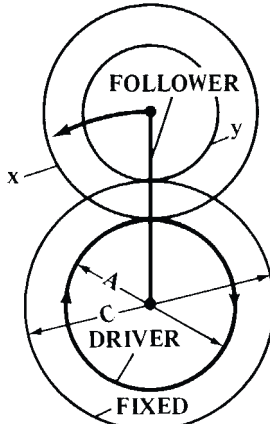
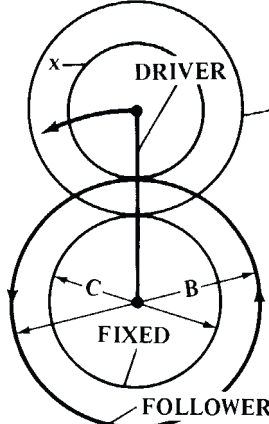
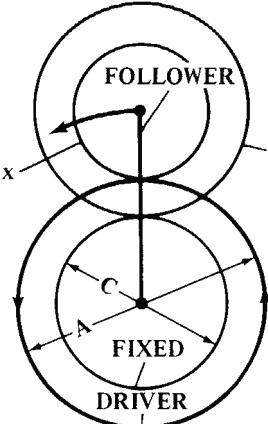
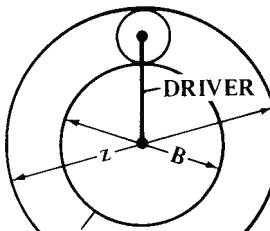
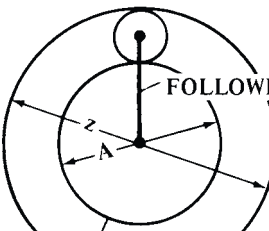
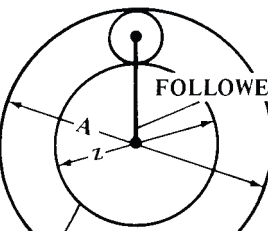
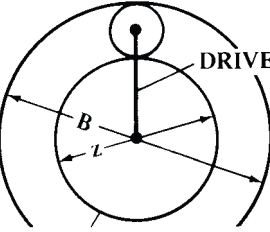
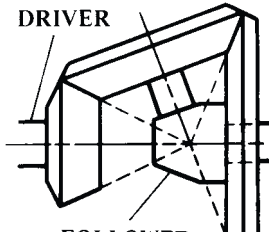
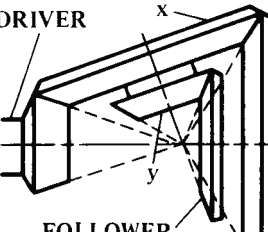
D = rotation of *driver* per revolution of follower or driven member
 F = rotation of *follower* or driven member per revolution of driver. (In Figs. 1 through 4, F = rotation of planet type follower about its axis.)
 A = size of driving gear (use either number of teeth or pitch diameter). Note: When follower derives its motion both from A and from a secondary driving member, A = size of *initial* driving gear, and formula gives speed relationship between A and follower.
 B = size of *driven gear or follower* (use either pitch diameter or number of teeth)
 C = size of *fixed gear* (use either pitch diameter or number of teeth)
 x = size of *planet gear* as shown by diagram (use either pitch diameter or number of teeth)
 y = size of *planet gear* as shown by diagram (use either pitch diameter or number of teeth)
 z = size of secondary or *auxiliary driving gear*, when follower derives its motion from two driving members
 S = rotation of *secondary driver*, per revolution of *initial driver*. S is negative when secondary and initial drivers rotate in opposite directions. (Formulas in which S is used, give speed relationship between follower and the initial driver.)
 Note: In all cases, if D is known, $F = 1 \div D$, or, if F is known, $D = 1 \div F$.

 <p>Fig. 1. $F = 1 + \frac{C}{B}$</p>	 <p>Fig. 2. $F = 1 - \frac{C}{B}$</p>	 <p>Fig. 3. $F = \frac{C}{B}$</p>
 <p>Fig. 4. $F = \cos E + \frac{C}{B}$</p>	 <p>Fig. 5. $F = 1 + \frac{x \times C}{y \times B}$</p>	 <p>Fig. 6. $F = 1 + \frac{y \times C}{x \times B}$</p>

Ratios of Planetary or Epicyclic Gearing

 <p>Fig. 7.</p> $D = 1 + \frac{x \times C}{y \times A}$	 <p>Fig. 8.</p> $D = 1 + \frac{y \times C}{x \times A}$	 <p>Fig. 9.</p> $F = 1 + \frac{C}{B}$
 <p>Fig. 10.</p> $D = 1 + \frac{C}{A}$	 <p>Fig. 11.</p> $D = 1 + \frac{C}{A}$	 <p>Fig. 12.</p> $F = 1 + \frac{C}{B}$
 <p>Fig. 13.</p> $F = 1 - \left(\frac{C \times x}{y \times B} \right)$	 <p>Fig. 14.</p> $D = \frac{1 + \frac{C}{A}}{1 - \left(\frac{C \times x}{y \times B} \right)}$	 <p>Fig. 15.</p> $D = \frac{1 + \frac{C}{A}}{1 - \left(\frac{C \times y}{x \times B} \right)}$

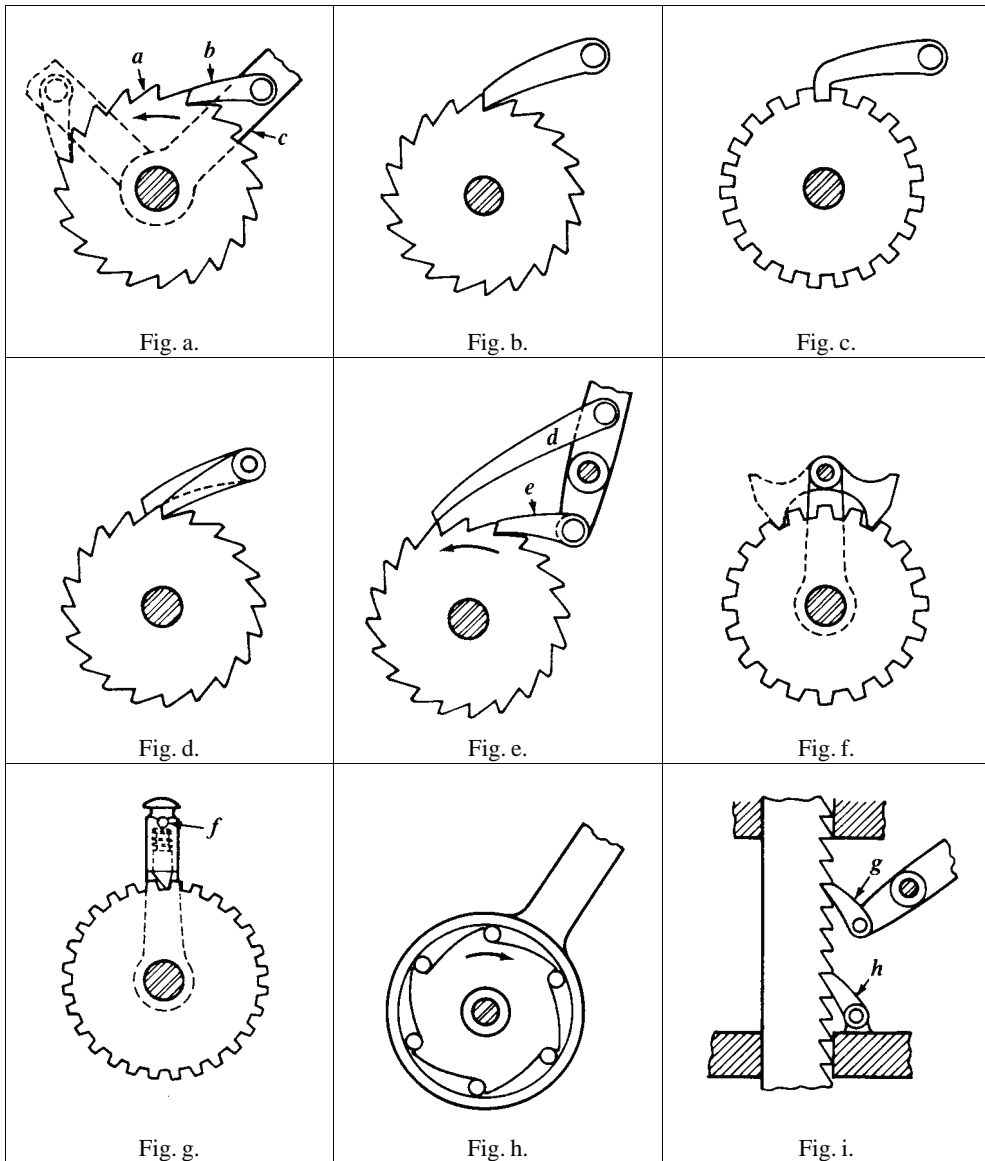
Ratios of Planetary or Epicyclic Gearing

 <p>Fig. 16.</p> $D = 1 - \left(\frac{C \times x}{y \times A} \right)$	 <p>Fig. 17.</p> $F = 1 - \left(\frac{C \times x}{y \times B} \right)$	 <p>Fig. 18.</p> $D = 1 - \left(\frac{C \times x}{y \times A} \right)$
 <p>Fig. 19.</p> $F = 1 + \frac{z \times (1 - S)}{B}$	 <p>Fig. 20.</p> $D = \frac{A + z}{A + (S \times z)}$	 <p>Fig. 21.</p> $D = \frac{A + z}{A + (S \times z)}$
 <p>Fig. 22.</p> $F = 1 + \frac{z \times (1 - S)}{B}$	 <p>Fig. 23.</p> $D = 1 + \frac{C}{A}$	 <p>Fig. 24.</p> $D = \frac{1 + \frac{C}{A}}{1 - \left(\frac{C \times y}{x \times B} \right)}$

Ratchet Gearing

Ratchet gearing may be used to transmit intermittent motion, or its only function may be to prevent the ratchet wheel from rotating backward. Ratchet gearing of this latter form is commonly used in connection with hoisting mechanisms of various kinds, to prevent the hoisting drum or shaft from rotating in a reverse direction under the action of the load.

Types of Ratchet Gearing



Ratchet gearing in its simplest form consists of a toothed ratchet wheel *a* (see Fig. a), and a pawl or detent *b*, and it may be used to transmit intermittent motion or to prevent relative motion between two parts except in one direction. The pawl *b* is pivoted to lever *c* which, when given an oscillating movement, imparts an intermittent rotary movement to ratchet wheel *a*. Fig. b illustrates another application of the ordinary ratchet and pawl mechanism. In this instance, the pawl is pivoted to a stationary member and its only function is to prevent the ratchet wheel from rotating backward. With the stationary design, illustrated at

Fig. c, the pawl prevents the ratchet wheel from rotating in either direction, so long as it is in engagement with the wheel.

The principle of *multiple-pawl ratchet gearing* is illustrated at **Fig. d**, which shows the use of two pawls. One of these pawls is longer than the other, by an amount equal to one-half the pitch of the ratchet-wheel teeth, so that the practical effect is that of reducing the pitch one-half. By placing a number of driving pawls side by side and proportioning their lengths according to the pitch of the teeth, a very fine feed can be obtained with a ratchet wheel of comparatively coarse pitch.

This method of obtaining a fine feed from relatively coarse-pitch ratchets may be preferable to the use of single ratchets of fine pitch which, although providing the feed required, may have considerably weaker teeth.

The type of ratchet gearing shown at **Fig. e** is sometimes employed to impart a rotary movement to the ratchet wheel for both the forward and backward motions of the lever to which the two pawls are attached.

A simple form of *reversing ratchet* is illustrated at **Fig. f**. The teeth of the wheel are so shaped that either side may be used for driving by simply changing the position of the double-ended pawl, as indicated by the full and dotted lines.

Another form of reversible ratchet gearing for shapers is illustrated at **Fig. g**. The pawl, in this case, instead of being a pivoted latch, is in the form of a plunger which is free to move in the direction of its axis, but is normally held into engagement with the ratchet wheel by a small spring. When the pawl is lifted and turned one-half revolution, the driving face then engages the opposite sides of the teeth and the ratchet wheel is given an intermittent rotary motion in the opposite direction.

The *frictional type* of ratchet gearing differs from the designs previously referred to, in that there is no positive engagement between the driving and driven members of the ratchet mechanism, the motion being transmitted by frictional resistance. One type of frictional ratchet gearing is illustrated at **Fig. h**. Rollers or balls are placed between the ratchet wheel and an outer ring which, when turned in one direction, causes the rollers or balls to wedge between the wheel and ring as they move up the inclined edges of the teeth.

Fig. i illustrates one method of utilizing ratchet gearing for moving the driven member in a straight line, as in the case of a lifting jack. The pawl *g* is pivoted to the operating lever of the jack and does the lifting, whereas the pawl *h* holds the load while the lifting pawl *g* is being returned preparatory to another lifting movement.

Shape of Ratchet Wheel Teeth.—When designing ratchet gearing, it is important to so shape the teeth that the pawl will remain in engagement when a load is applied. The faces of the teeth which engage the end of the pawl should be in such relation with the center of the pawl pivot that a line perpendicular to the face of the engaging tooth will pass somewhere between the center of the ratchet wheel and the center of the pivot about which the pawl swings. This is true if the pawl *pushes* the ratchet wheel, or if the ratchet wheel *pushes* the pawl. However, if the pawl *pulls* the ratchet wheel or if the ratchet wheel *pulls* the pawl, the perpendicular from the face of the ratchet teeth should fall outside the pawl pivot center. Ratchet teeth may be either cut by a milling cutter having the correct angle, or hobbled in a gear-hobbing machine by the use of a special hob.

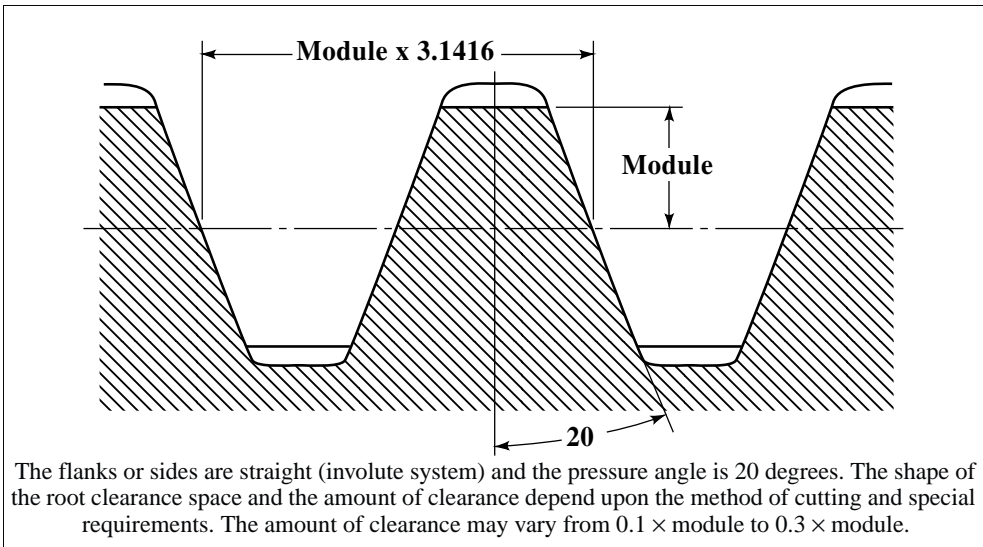
Pitch of Ratchet Wheel Teeth.—The pitch of ratchet wheels used for holding suspended loads may be calculated by the following formula, in which P = circular pitch, in inches (mm), measured at the outside circumference; M = turning moment acting upon the ratchet wheel shaft, in inch-pounds (N-mm); L = length of tooth face (thickness of ratchet gear), in inches (millimeters); S = safe stress (for steel, 2500 pounds per square inch or 17 MPa when subjected to shock, and 4000 pounds per square inch or 28 MPa when not subjected to shock); N = number of teeth in ratchet wheel; F = a factor the value of which is 50 for ratchet gears with 12 teeth or less, 35 for gears having from 12 to 20 teeth, and 20 for gears having over 20 teeth:

$$P = \sqrt{\frac{FM}{LSN}}$$

This formula has been used in the calculation of ratchet gears for crane design.

Gear Design Based upon Module System.—The *module* of a gear is equal to the pitch diameter divided by the number of teeth, whereas *diametral pitch* is equal to the number of teeth divided by the pitch diameter. The module system (see accompanying table and diagram) is in general use in countries that have adopted the metric system; hence, the term module is usually understood to mean the pitch diameter *in millimeters* divided by the number of teeth. The module system, however, may also be based on inch measurements and then it is known as the English module to avoid confusion with the metric module. Module is an actual dimension, whereas diametral pitch is only a ratio. Thus, if the pitch diameter of a gear is 50 millimeters and the number of teeth 25, the module is 2, which means that there are 2 millimeters of pitch diameter for each tooth. The table *Tooth Dimensions Based Upon Module System* shows the relation among module, diametral pitch, and circular pitch.

German Standard Tooth Form for Spur and Bevel Gears DIN 867



To Find	Module Known	Circular Pitch Known
Addendum	Equals module	0.31823 × Circular pitch
Dedendum	1.157 × module* 1.167 × module**	0.3683 × Circular pitch* 0.3714 × Circular pitch**
Working Depth	2 × module	0.6366 × Circular pitch
Total Depth	2.157 × module* 2.167 × module**	0.6866 × Circular pitch* 0.6898 × Circulate pitch**
Tooth Thickness on Pitch Line	1.5708 × module	0.5 × Circular pitch

Formulas for dedendum and total depth, marked (*) are used when clearance equals 0.157 × module. Formulas marked (**) are used when clearance equals one-sixth module. It is common practice among American cutter manufacturers to make the clearance of metric or module cutters equal to 0.157 × module.

Tooth Dimensions Based Upon Module System

Module, <i>DIN</i> Standard Series	Equivalent Diametral Pitch	Circular Pitch		Addendum, Millimeters	Dedendum, Millimeters ^a	Whole Depth, ^a Millimeters	Whole Depth, ^b Millimeters
		Millimeters	Inches				
0.3	84.667	0.943	0.0371	0.30	0.35	0.650	0.647
0.4	63.500	1.257	0.0495	0.40	0.467	0.867	0.863
0.5	50.800	1.571	0.0618	0.50	0.583	1.083	1.079
0.6	42.333	1.885	0.0742	0.60	0.700	1.300	1.294
0.7	36.286	2.199	0.0865	0.70	0.817	1.517	1.510
0.8	31.750	2.513	0.0989	0.80	0.933	1.733	1.726
0.9	28.222	2.827	0.1113	0.90	1.050	1.950	1.941
1	25.400	3.142	0.1237	1.00	1.167	2.167	2.157
1.25	20.320	3.927	0.1546	1.25	1.458	2.708	2.697
1.5	16.933	4.712	0.1855	1.50	1.750	3.250	3.236
1.75	14.514	5.498	0.2164	1.75	2.042	3.792	3.774
2	12.700	6.283	0.2474	2.00	2.333	4.333	4.314
2.25	11.289	7.069	0.2783	2.25	2.625	4.875	4.853
2.5	10.160	7.854	0.3092	2.50	2.917	5.417	5.392
2.75	9.236	8.639	0.3401	2.75	3.208	5.958	5.932
3	8.466	9.425	0.3711	3.00	3.500	6.500	6.471
3.25	7.815	10.210	0.4020	3.25	3.791	7.041	7.010
3.5	7.257	10.996	0.4329	3.50	4.083	7.583	7.550
3.75	6.773	11.781	0.4638	3.75	4.375	8.125	8.089
4	6.350	12.566	0.4947	4.00	4.666	8.666	8.628
4.5	5.644	14.137	0.5566	4.50	5.25	9.750	9.707
5	5.080	15.708	0.6184	5.00	5.833	10.833	10.785
5.5	4.618	17.279	0.6803	5.50	6.416	11.916	11.864
6	4.233	18.850	0.7421	6.00	7.000	13.000	12.942
6.5	3.908	20.420	0.8035	6.50	7.583	14.083	14.021
7	3.628	21.991	0.8658	7.	8.166	15.166	15.099
8	3.175	25.132	0.9895	8.	9.333	17.333	17.256
9	2.822	28.274	1.1132	9.	10.499	19.499	19.413
10	2.540	31.416	1.2368	10.	11.666	21.666	21.571
11	2.309	34.558	1.3606	11.	12.833	23.833	23.728
12	2.117	37.699	1.4843	12.	14.000	26.000	25.884
13	1.954	40.841	1.6079	13.	15.166	28.166	28.041
14	1.814	43.982	1.7317	14.	16.332	30.332	30.198
15	1.693	47.124	1.8541	15.	17.499	32.499	32.355
16	1.587	50.266	1.9790	16.	18.666	34.666	34.512
18	1.411	56.549	2.2263	18.	21.000	39.000	38.826
20	1.270	62.832	2.4737	20.	23.332	43.332	43.142
22	1.155	69.115	2.7210	22.	25.665	47.665	47.454
24	1.058	75.398	2.9685	24.	28.000	52.000	51.768
27	0.941	84.823	3.339	27.	31.498	58.498	58.239
30	0.847	94.248	3.711	30.	35.000	65.000	64.713
33	0.770	103.673	4.082	33.	38.498	71.498	71.181
36	0.706	113.097	4.453	36.	41.998	77.998	77.652
39	0.651	122.522	4.824	39.	45.497	84.497	84.123
42	0.605	131.947	5.195	42.	48.997	90.997	90.594
45	0.564	141.372	5.566	45.	52.497	97.497	97.065
50	0.508	157.080	6.184	50.	58.330	108.330	107.855
55	0.462	172.788	6.803	55.	64.163	119.163	118.635
60	0.423	188.496	7.421	60.	69.996	129.996	129.426
65	0.391	204.204	8.040	65.	75.829	140.829	140.205
70	0.363	219.911	8.658	70.	81.662	151.662	150.997
75	0.339	235.619	9.276	75.	87.495	162.495	161.775

^a Dedendum and total depth when clearance = $0.1666 \times$ module, or one-sixth module.

^b Total depth equivalent to American standard full-depth teeth. (Clearance = $0.157 \times$ module.)

Rules for Module System of Gearing

To Find	Rule
Metric Module	<p><i>Rule 1:</i> To find the metric module, divide the pitch diameter in millimeters by the number of teeth.</p> <p><i>Example 1:</i> The pitch diameter of a gear is 200 millimeters and the number of teeth, 40; then</p> $\text{Module} = \frac{200}{40} = 5$ <p><i>Rule 2:</i> Multiply circular pitch in millimeters by 0.3183.</p> <p><i>Example 2:</i> (Same as Example 1. Circular pitch of this gear equals 15.708 millimeters.)</p> $\text{Module} = 15.708 \times 0.3183 = 5$ <p><i>Rule 3:</i> Divide outside diameter in millimeters by the number of teeth plus 2.</p>
English Module	<p><i>Note:</i> The module system is usually applied when gear dimensions are expressed in millimeters, but module may also be based on inch measurements.</p> <p><i>Rule:</i> To find the English module, divide pitch diameter in inches by the number of teeth.</p> <p><i>Example:</i> A gear has 48 teeth and a pitch diameter of 12 inches.</p> $\text{Module} = \frac{12}{48} = \frac{1}{4} \text{ module or 4 diametral pitch}$
Metric Module Equivalent to Diametral Pitch	<p><i>Rule:</i> To find the metric module equivalent to a given diametral pitch, divide 25.4 by the diametral pitch.</p> <p><i>Example:</i> Determine metric module equivalent to 10 diametral pitch.</p> $\text{Equivalent module} = \frac{25.4}{10} = 2.54$ <p><i>Note:</i> The nearest standard module is 2.5.</p>
Diametral Pitch Equivalent to Metric Module	<p><i>Rule:</i> To find the diametral pitch equivalent to a given module, divide 25.4 by the module. (25.4 = number of millimeters per inch.)</p> <p><i>Example:</i> The module is 12; determine equivalent diametral pitch.</p> $\text{Equivalent diametral pitch} = \frac{25.4}{12} = 2.117$ <p><i>Note:</i> A diametral pitch of 2 is the nearest <i>standard</i> equivalent.</p>
Pitch Diameter	<p><i>Rule:</i> Multiply number of teeth by module.</p> <p><i>Example:</i> The metric module is 8 and the gear has 40 teeth; then</p> $D = 40 \times 8 = 320 \text{ millimeters} = 12.598 \text{ inches}$
Outside Diameter	<p><i>Rule:</i> Add 2 to the number of teeth and multiply sum by the module.</p> <p><i>Example:</i> A gear has 40 teeth and module is 6. Find outside or blank diameter.</p> $\text{Outside diameter} = (40 + 2) \times 6 = 252 \text{ millimeters}$

For tooth dimensions, see table *Tooth Dimensions Based Upon Module System*; also formulas in *German Standard Tooth Form for Spur and Bevel Gears DIN 867*.

**Equivalent Diametral Pitches, Circular Pitches, and Metric Modules
Commonly Used Pitches and Modules in Bold Type**

Diametral Pitch	Circular Pitch, Inches	Module Millimeters	Diametral Pitch	Circular Pitch, Inches	Module Millimeters	Diametral Pitch	Circular Pitch, Inches	Module Millimeters
$\frac{1}{2}$	6.2832	50.8000	2.2848	$1\frac{3}{8}$	11.1170	10.0531	$\frac{5}{16}$	2.5266
0.5080	6.1842	50	2.3091	1.3605	11	10.1600	0.3092	2 $\frac{1}{2}$
0.5236	6	48.5104	2 $\frac{1}{2}$	1.2566	10.1600	11	0.2856	2.3091
0.5644	5.5658	45	2.5133	1 $\frac{1}{4}$	10.1063	12	0.2618	2.1167
0.5712	5 $\frac{1}{2}$	44.4679	2.5400	1.2368	10	12.5664	$\frac{1}{4}$	2.0213
0.6283	5	40.4253	2 $\frac{3}{4}$	1.1424	9.2364	12.7000	0.2474	2
0.6350	4.9474	40	2.7925	1 $\frac{1}{8}$	9.0957	13	0.2417	1.9538
0.6981	4 $\frac{1}{2}$	36.3828	2.8222	1.1132	9	14	0.2244	1.8143
0.7257	4.3290	35	3	1.0472	8.4667	15	0.2094	1.6933
$\frac{3}{4}$	4.1888	33.8667	3.1416	1	8.0851	16	0.1963	1.5875
0.7854	4	32.3403	3.1750	0.9895	8	16.7552	$\frac{3}{16}$	1.5160
0.8378	3 $\frac{3}{4}$	30.3190	3.3510	$\frac{15}{16}$	7.5797	16.9333	0.1855	1 $\frac{1}{2}$
0.8467	3.7105	30	3 $\frac{1}{2}$	0.8976	7.2571	17	0.1848	1.4941
0.8976	3 $\frac{1}{2}$	28.2977	3.5904	$\frac{7}{8}$	7.0744	18	0.1745	1.4111
0.9666	3 $\frac{1}{4}$	26.2765	3.6286	0.8658	7	19	0.1653	1.3368
1	3.1416	25.4000	3.8666	$\frac{13}{16}$	6.5691	20	0.1571	1.2700
1.0160	3.0921	25	3.9078	0.8040	6 $\frac{1}{2}$	22	0.1428	1.1545
1.0472	3	24.2552	4	0.7854	6.3500	24	0.1309	1.0583
1.1424	2 $\frac{3}{4}$	22.2339	4.1888	$\frac{3}{4}$	6.0638	25	0.1257	1.0160
1 $\frac{1}{4}$	2.5133	20.3200	4.2333	0.7421	6	25.1328	$\frac{1}{8}$	1.0106
1.2566	2 $\frac{1}{2}$	20.2127	4.5696	$\frac{11}{16}$	5.5585	25.4000	0.1237	1
1.2700	2.4737	20	4.6182	0.6803	5 $\frac{1}{2}$	26	0.1208	0.9769
1.3963	2 $\frac{1}{4}$	18.1914	5	0.6283	5.0800	28	0.1122	0.9071
1.4111	2.2263	18	5.0265	$\frac{5}{8}$	5.0532	30	0.1047	0.8467
1 $\frac{1}{2}$	2.0944	16.9333	5.0800	0.6184	5	32	0.0982	0.7937
1.5708	2	16.1701	5.5851	$\frac{9}{16}$	4.5478	34	0.0924	0.7470
1.5875	1.9790	16	5.6443	0.5566	4 $\frac{1}{2}$	36	0.0873	0.7056
1.6755	1 $\frac{7}{8}$	15.1595	6	0.5236	4.2333	38	0.0827	0.6684
1.6933	1.8553	15	6.2832	$\frac{1}{2}$	4.0425	40	0.0785	0.6350
1 $\frac{3}{4}$	1.7952	14.5143	6.3500	0.4947	4	42	0.0748	0.6048
1.7952	1 $\frac{3}{4}$	14.1489	7	0.4488	3.6286	44	0.0714	0.5773
1.8143	1.7316	14	7.1808	$\frac{7}{16}$	3.5372	46	0.0683	0.5522
1.9333	1 $\frac{5}{8}$	13.1382	7.2571	0.4329	3 $\frac{1}{2}$	48	0.0654	0.5292
1.9538	1.6079	13	8	0.3927	3.1750	50	0.0628	0.5080
2	1.5708	12.7000	8.3776	$\frac{3}{8}$	3.0319	50.2656	$\frac{1}{16}$	0.5053
2.0944	1 $\frac{1}{2}$	12.1276	8.4667	0.3711	3	50.8000	0.0618	$\frac{1}{2}$
2.1167	1.4842	12	9	0.3491	2.8222	56	0.0561	0.4536
2 $\frac{1}{4}$	1.3963	11.2889	10	0.3142	2.5400	60	0.0524	0.4233

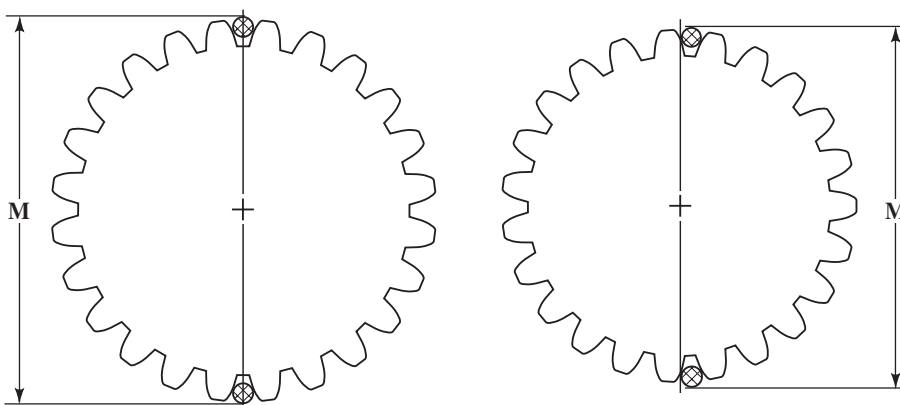
The module of a gear is the pitch diameter divided by the number of teeth. The module may be expressed in any units; but when no units are stated, it is understood to be in millimeters. The metric module, therefore, equals the pitch diameter in millimeters divided by the number of teeth. To find the metric module equivalent to a given diametral pitch, divide 25.4 by the diametral pitch. To find the diametral pitch equivalent to a given module, divide 25.4 by the module. (25.4 = number of millimeters per inch.)

CHECKING GEAR SIZES

Checking Gear Size by Measurement Over Wires or Pins

The wire or pin method of checking gear sizes is accurate, easily applied, and especially useful in shops with limited inspection equipment. Two cylindrical wires or pins of predetermined diameter are placed in diametrically opposite tooth spaces (see diagram). If the gear has an odd number of teeth, the wires are located as nearly opposite as possible, as shown by the diagram at the right. The overall measurement M is checked by using any sufficiently accurate method of measurement. The value of measurement M when the pitch diameter is correct can be determined easily and quickly by means of the calculated values in the accompanying tables.

Measurements for Checking External Spur Gears when Wire Diameter Equals 1.728 Divided by Diametral Pitch.—Tables 1 and 2 give measurements M , in inches, for checking the pitch diameters of external spur gears of 1 diametral pitch. For any other diametral pitch, divide the measurement given in the table by whatever diametral pitch is required. The result shows what measurement M should be when the pitch diameter is correct and there is no allowance for backlash. The procedure for obtaining a given amount of backlash will be explained later. Tables 1 through 4 inclusive are based on wire sizes conforming to the Van Keuren standard. For external spur gears, the wire size equals 1.728 divided by the diametral pitch. The wire diameters for various diametral pitches will be found in the left-hand section of Table 5.



Even Number of Teeth: Table 1 is for even numbers of teeth. To illustrate the use of the table, assume that a spur gear has 32 teeth of 4 diametral pitch and a pressure angle of 20 degrees. Table 1 shows that the measurement for 1 diametral pitch is 34.4130; hence, for 4 diametral pitch, the measurement equals $34.4130 \div 4 = 8.6032$ inches. This dimension is the measurement over the wires when the pitch diameter is correct, provided there is no allowance for backlash. The wire diameter here equals $1.728 \div 4 = 0.432$ inch (Table 5).

Measurement for even numbers of teeth above 170 and not in Table 1 may be determined as shown by the following example: Assume that number of teeth = 240 and pressure angle = $14\frac{1}{2}$ degrees; then, for 1 diametral pitch, figure at left of decimal point = given No. of teeth + 2 = $240 + 2 = 242$. Figure at right of decimal point lies between decimal values given in table for 200 teeth and 300 teeth and is obtained by interpolation. Thus, $240 - 200 = 40$ (change to 0.40); $0.5395 - 0.5321 = 0.0074$ = difference between decimal values for 300 and 200 teeth; hence, decimal required = $0.5321 + (0.40 \times 0.0074) = 0.53506$. Total dimension = 242.53506 divided by the diametral pitch required.

Odd Number of Teeth: Table 2 is for odd numbers of teeth. Measurement for odd numbers above 171 and not in Table 2 may be determined as shown by the following example: Assume that number of teeth = 335 and pressure angle = 20 degrees; then, for 1 diametral

pitch, figure at left of decimal point = given No. of teeth + 2 = 335 + 2 = 337. Figure at right of decimal point lies between decimal values given in table for 301 and 401 teeth. Thus, $335 - 301 = 34$ (change to 0.34); $0.4565 - 0.4538 = 0.0027$; hence, decimal required = $0.4538 + (0.34 \times 0.0027) = 0.4547$. Total dimension = 337.4547.

**Table 1. Checking External Spur Gear Sizes
by Measurement Over Wires**

EVEN NUMBERS OF TEETH					
Dimensions in table are for 1 diametral pitch and Van Keuren standard wire sizes. For any other diametral pitch, divide dimension in table by given pitch.					
Wire or pin diameter = $\frac{1.728}{\text{Diametral Pitch}}$					
No. of Teeth	Pressure Angle				
	14½°	17½°	20°	25°	30°
6	8.2846	8.2927	8.3032	8.3340	8.3759
8	10.3160	10.3196	10.3271	10.3533	10.3919
10	12.3399	12.3396	12.3445	12.3667	12.4028
12	14.3590	14.3552	14.3578	14.3768	14.4108
14	16.3746	16.3677	16.3683	16.3846	16.4169
16	18.3877	18.3780	18.3768	18.3908	18.4217
18	20.3989	20.3866	20.3840	20.3959	20.4256
20	22.4087	22.3940	22.3900	22.4002	22.4288
22	24.4172	24.4004	24.3952	24.4038	24.4315
24	26.4247	26.4060	26.3997	26.4069	26.4339
26	28.4314	28.4110	28.4036	28.4096	28.4358
28	30.4374	30.4154	30.4071	30.4120	30.4376
30	32.4429	32.4193	32.4102	32.4141	32.4391
32	34.4478	34.4228	34.4130	34.4159	34.4405
34	36.4523	36.4260	36.4155	36.4176	36.4417
36	38.4565	38.4290	38.4178	38.4191	38.4428
38	40.4603	40.4317	40.4198	40.4205	40.4438
40	42.4638	42.4341	42.4217	42.4217	42.4447
42	44.4671	44.4364	44.4234	44.4228	44.4455
44	46.4701	46.4385	46.4250	46.4239	46.4463
46	48.4729	48.4404	48.4265	48.4248	48.4470
48	50.4756	50.4422	50.4279	50.4257	50.4476
50	52.4781	52.4439	52.4292	52.4265	52.4482
52	54.4804	54.4454	54.4304	54.4273	54.4487
54	56.4826	56.4469	56.4315	56.4280	56.4492
56	58.4847	58.4483	58.4325	58.4287	58.4497
58	60.4866	60.4496	60.4335	60.4293	60.4501
60	62.4884	62.4509	62.4344	62.4299	62.4506
62	64.4902	64.4520	64.4352	64.4304	64.4510
64	66.4918	66.4531	66.4361	66.4309	66.4513
66	68.4933	68.4542	68.4369	68.4314	68.4517
68	70.4948	70.4552	70.4376	70.4319	70.4520
70	72.4963	72.4561	72.4383	72.4323	72.4523
72	74.4977	74.4570	74.4390	74.4327	74.4526
74	76.4990	76.4578	76.4396	76.4331	76.4529
76	78.5002	78.4586	78.4402	78.4335	78.4532
78	80.5014	80.4594	80.4408	80.4339	80.4534
80	82.5026	82.4601	82.4413	82.4342	82.4536
82	84.5037	84.4608	84.4418	84.4345	84.4538
84	86.5047	86.4615	86.4423	86.4348	86.4540
86	88.5057	88.4621	88.4428	88.4351	88.4542
88	90.5067	90.4627	90.4433	90.4354	90.4544

**Table 1. (Continued) Checking External Spur Gear Sizes
by Measurement Over Wires**

EVEN NUMBERS OF TEETH					
Dimensions in table are for 1 diametral pitch and Van Keuren standard wire sizes. For any other diametral pitch, divide dimension in table by given pitch.					
Wire or pin diameter = $\frac{1.728}{\text{Diametral Pitch}}$					
No. of Teeth	Pressure Angle				
	14½°	17½°	20°	25°	30°
90	92.5076	92.4633	92.4437	92.4357	92.4546
92	94.5085	94.4639	94.4441	94.4359	94.4548
94	96.5094	96.4644	96.4445	96.4362	96.4550
96	98.5102	98.4649	98.4449	98.4364	98.4552
98	100.5110	100.4655	100.4453	100.4367	100.4554
100	102.5118	102.4660	102.4456	102.4369	102.4555
102	104.5125	104.4665	104.4460	104.4370	104.4557
104	106.5132	106.4669	106.4463	106.4372	106.4558
106	108.5139	108.4673	108.4466	108.4374	108.4560
108	110.5146	110.4678	110.4469	110.4376	110.4561
110	112.5152	112.4682	112.4472	112.4378	112.4562
112	114.5159	114.4686	114.4475	114.4380	114.4563
114	116.5165	116.4690	116.4478	116.4382	116.4564
116	118.5171	118.4693	118.4481	118.4384	118.4565
118	120.5177	120.4697	120.4484	120.4385	120.4566
120	122.5182	122.4701	122.4486	122.4387	122.4567
122	124.5188	124.4704	124.4489	124.4388	124.4568
124	126.5193	126.4708	126.4491	126.4390	126.4569
126	128.5198	128.4711	128.4493	128.4391	128.4570
128	130.5203	130.4714	130.4496	130.4393	130.4571
130	132.5208	132.4717	132.4498	132.4394	132.4572
132	134.5213	134.4720	134.4500	134.4395	134.4573
134	136.5217	136.4723	136.4502	136.4397	136.4574
136	138.5221	138.4725	138.4504	138.4398	138.4575
138	140.5226	140.4728	140.4506	140.4399	140.4576
140	142.5230	142.4730	142.4508	142.4400	142.4577
142	144.5234	144.4733	144.4510	144.4401	144.4578
144	146.5238	146.4736	146.4512	146.4402	146.4578
146	148.5242	148.4738	148.4513	148.4403	148.4579
148	150.5246	150.4740	150.4515	150.4404	150.4580
150	152.5250	152.4742	152.4516	152.4405	152.4580
152	154.5254	154.4745	154.4518	154.4406	154.4581
154	156.5257	156.4747	156.4520	156.4407	156.4581
156	158.5261	158.4749	158.4521	158.4408	158.4582
158	160.5264	160.4751	160.4523	160.4409	160.4582
160	162.5267	162.4753	162.4524	162.4410	162.4583
162	164.5270	164.4755	164.4526	164.4411	164.4584
164	166.5273	166.4757	166.4527	166.4411	166.4584
166	168.5276	168.4759	168.4528	168.4412	168.4585
168	170.5279	170.4760	170.4529	170.4413	170.4585
170	172.5282	172.4761	172.4531	172.4414	172.4586
180	182.5297	182.4771	182.4537	182.4418	182.4589
190	192.5310	192.4780	192.4542	192.4421	192.4591
200	202.5321	202.4786	202.4548	202.4424	202.4593
300	302.5395	302.4831	302.4579	302.4443	302.4606
400	402.5434	402.4854	402.4596	402.4453	402.4613
500	502.5458	502.4868	502.4606	502.4458	502.4619

**Table 2. Checking External Spur Gear Sizes
by Measurement Over Wires**

ODD NUMBERS OF TEETH					
Dimensions in table are for 1 diametral pitch and Van Keuren standard wire sizes. For any other diametral pitch, divide dimension in table by given pitch.					
Wire or pin diameter = $\frac{1.728}{\text{Diametral Pitch}}$					
No. of Teeth	Pressure Angle				
	14½°	17½°	20°	25°	30°
7	9.1116	9.1172	9.1260	9.1536	9.1928
9	11.1829	11.1844	11.1905	11.2142	11.2509
11	13.2317	13.2296	13.2332	13.2536	13.2882
13	15.2677	15.2617	15.2639	15.2814	15.3142
15	17.2957	17.2873	17.2871	17.3021	17.3329
17	19.3182	19.3072	19.3053	19.3181	19.3482
19	21.3368	21.3233	21.3200	21.3310	21.3600
21	23.3524	23.3368	23.3321	23.3415	23.3696
23	25.3658	25.3481	25.3423	25.3502	25.3775
25	27.3774	27.3579	27.3511	27.3576	27.3842
27	29.3876	29.3664	29.3586	29.3640	29.3899
29	31.3966	31.3738	31.3652	31.3695	31.3948
31	33.4047	33.3804	33.3710	33.3743	33.3991
33	35.4119	35.3863	35.3761	35.3786	35.4029
35	37.4185	37.3916	37.3807	37.3824	37.4063
37	39.4245	39.3964	39.3849	39.3858	39.4094
39	41.4299	41.4007	41.3886	41.3889	41.4120
41	43.4348	43.4047	43.3920	43.3917	43.4145
43	45.4394	45.4083	45.3951	45.3942	45.4168
45	47.4437	47.4116	47.3980	47.3965	47.4188
47	49.4477	49.4147	49.4007	49.3986	49.4206
49	51.4514	51.4175	51.4031	51.4006	51.4223
51	53.4547	53.4202	53.4053	53.4024	53.4239
53	55.4579	55.4227	55.4074	55.4041	55.4254
55	57.4609	57.4249	57.4093	57.4056	57.4267
57	59.4637	59.4271	59.4111	59.4071	59.4280
59	61.4664	61.4291	61.4128	61.4084	61.4292
61	63.4689	63.4310	63.4144	63.4097	63.4303
63	65.4712	65.4328	65.4159	65.4109	65.4313
65	67.4734	67.4344	67.4173	67.4120	67.4323
67	69.4755	69.4360	69.4186	69.4130	69.4332
69	71.4775	71.4375	71.4198	71.4140	71.4341
71	73.4795	73.4389	73.4210	73.4150	73.4349
73	75.4813	75.4403	75.4221	75.4159	75.4357
75	77.4830	77.4416	77.4232	77.4167	77.4364
77	79.4847	79.4428	79.4242	79.4175	79.4371
79	81.4863	81.4440	81.4252	81.4183	81.4378
81	83.4877	83.4451	83.4262	83.4190	83.4384
83	85.4892	85.4462	85.4271	85.4196	85.4390
85	87.4906	87.4472	87.4279	87.4203	87.4395
87	89.4919	89.4481	89.4287	89.4209	89.4400
89	91.4932	91.4490	91.4295	91.4215	91.4405
91	93.4944	93.4499	93.4303	93.4221	93.4410
93	95.4956	95.4508	95.4310	95.4227	95.4415

**Table 2. Checking External Spur Gear Sizes
by Measurement Over Wires**

ODD NUMBERS OF TEETH					
Dimensions in table are for 1 diametral pitch and Van Keuren standard wire sizes. For any other diametral pitch, divide dimension in table by given pitch.					
Wire or pin diameter = $\frac{1.728}{\text{Diametral Pitch}}$					
No. of Teeth	Pressure Angle				
	14½°	17½°	20°	25°	30°
95	97.4967	97.4516	97.4317	97.4232	97.4420
97	99.4978	99.4524	99.4323	99.4237	99.4424
99	101.4988	101.4532	101.4329	101.4242	101.4428
101	103.4998	103.4540	103.4335	103.4247	103.4432
103	105.5008	105.4546	105.4341	105.4252	105.4436
105	107.5017	107.4553	107.4346	107.4256	107.4440
107	109.5026	109.4559	109.4352	109.4260	109.4443
109	111.5035	111.4566	111.4357	111.4264	111.4447
111	113.5044	113.4572	113.4362	113.4268	113.4450
113	115.5052	115.4578	115.4367	115.4272	115.4453
115	117.5060	117.4584	117.4372	117.4275	117.4456
117	119.5068	119.4589	119.4376	119.4279	119.4459
119	121.5075	121.4594	121.4380	121.4282	121.4462
121	123.5082	123.4599	123.4384	123.4285	123.4465
123	125.5089	125.4604	125.4388	125.4288	125.4468
125	127.5096	127.4609	127.4392	127.4291	127.4471
127	129.5103	129.4614	129.4396	129.4294	129.4473
129	131.5109	131.4619	131.4400	131.4297	131.4476
131	133.5115	133.4623	133.4404	133.4300	133.4478
133	135.5121	135.4628	135.4408	135.4302	135.4480
135	137.5127	137.4632	137.4411	137.4305	137.4483
137	139.5133	139.4636	139.4414	139.4307	139.4485
139	141.5139	141.4640	141.4418	141.4310	141.4487
141	143.5144	143.4644	143.4421	143.4312	143.4489
143	145.5149	145.4648	145.4424	145.4315	145.4491
145	147.5154	147.4651	147.4427	147.4317	147.4493
147	149.5159	149.4655	149.4430	149.4319	149.4495
149	151.5164	151.4658	151.4433	151.4321	151.4497
151	153.5169	153.4661	153.4435	153.4323	153.4498
153	155.5174	155.4665	155.4438	155.4325	155.4500
155	157.5179	157.4668	157.4440	157.4327	157.4502
157	159.5183	159.4671	159.4443	159.4329	159.4504
159	161.5188	161.4674	161.4445	161.4331	161.4505
161	163.5192	163.4677	163.4448	163.4333	163.4507
163	165.5196	165.4680	165.4450	165.4335	165.4508
165	167.5200	167.4683	167.4453	167.4337	167.4510
167	169.5204	169.4686	169.4455	169.4338	169.4511
169	171.5208	171.4688	171.4457	171.4340	171.4513
171	173.5212	173.4691	173.4459	173.4342	173.4514
181	183.5230	183.4704	183.4469	183.4350	183.4520
191	193.5246	193.4715	193.4478	193.4357	193.4526
201	203.5260	203.4725	203.4487	203.4363	203.4532
301	303.5355	303.4790	303.4538	303.4402	303.4565
401	403.5404	403.4823	403.4565	403.4422	403.4582
501	503.5433	503.4843	503.4581	503.4434	503.4592

**Table 3. Checking Internal Spur Gear Sizes
by Measurement Between Wires**

EVEN NUMBERS OF TEETH					
Dimensions in table are for 1 diametral pitch and Van Keuren standard wire sizes. For any other diametral pitch, divide dimension in table by given pitch.					
Wire or pin diameter = $\frac{1.44}{\text{Diametral Pitch}}$					
No. of Teeth	Pressure Angle				
	14½°	17½°	20°	25°	30°
10	8.8337	8.7383	8.6617	8.5209	8.3966
12	10.8394	10.7404	10.6623	10.5210	10.3973
14	12.8438	12.7419	12.6627	12.5210	12.3978
16	14.8474	14.7431	14.6630	14.5210	14.3982
18	16.8504	16.7441	16.6633	16.5210	16.3985
20	18.8529	18.7449	18.6635	18.5211	18.3987
22	20.8550	20.7456	20.6636	20.5211	20.3989
24	22.8569	22.7462	22.6638	22.5211	22.3991
26	24.8585	24.7467	24.6639	24.5211	24.3992
28	26.8599	26.7471	26.6640	26.5211	26.3993
30	28.8612	28.7475	28.6641	28.5211	28.3994
32	30.8623	30.7478	30.6642	30.5211	30.3995
34	32.8633	32.7481	32.6642	32.5211	32.3995
36	34.8642	34.7483	34.6643	34.5212	34.3996
38	36.8650	36.7486	36.6642	36.5212	36.3996
40	38.8658	38.7488	38.6644	38.5212	38.3997
42	40.8665	40.7490	40.6644	40.5212	40.3997
44	42.8672	42.7492	42.6645	42.5212	42.3998
46	44.8678	44.7493	44.6645	44.5212	44.3998
48	46.8683	46.7495	46.6646	46.5212	46.3999
50	48.8688	48.7496	48.6646	48.5212	48.3999
52	50.8692	50.7497	50.6646	50.5212	50.3999
54	52.8697	52.7499	52.6647	52.5212	52.4000
56	54.8701	54.7500	54.6647	54.5212	54.4000
58	56.8705	56.7501	56.6648	56.5212	56.4001
60	58.8709	58.7502	58.6648	58.5212	58.4001
62	60.8712	60.7503	60.6648	60.5212	60.4001
64	62.8715	62.7504	62.6648	62.5212	62.4001
66	64.8718	64.7505	64.6649	64.5212	64.4001
68	66.8721	66.7505	66.6649	66.5212	66.4001
70	68.8724	68.7506	68.6649	68.5212	68.4001
72	70.8727	70.7507	70.6649	70.5212	70.4002
74	72.8729	72.7507	72.6649	72.5212	72.4002
76	74.8731	74.7508	74.6649	74.5212	74.4002
78	76.8734	76.7509	76.6649	76.5212	76.4002
80	78.8736	78.7509	78.6649	78.5212	78.4002
82	80.8738	80.7510	80.6649	80.5212	80.4002
84	82.8740	82.7510	82.6649	82.5212	82.4002
86	84.8742	84.7511	84.6650	84.5212	84.4002
88	86.8743	86.7511	86.6650	86.5212	86.4003
90	88.8745	88.7512	88.6650	88.5212	88.4003
92	90.8747	90.7512	90.6650	90.5212	90.4003
94	92.8749	92.7513	92.6650	92.5212	92.4003

**Table 3. Checking Internal Spur Gear Sizes
by Measurement Between Wires**

EVEN NUMBERS OF TEETH					
Dimensions in table are for 1 diametral pitch and Van Keuren standard wire sizes. For any other diametral pitch, divide dimension in table by given pitch.					
Wire or pin diameter = $\frac{1.44}{\text{Diametral Pitch}}$					
No. of Teeth	Pressure Angle				
	14½°	17½°	20°	25°	30°
96	94.8750	94.7513	94.6650	94.5212	94.4003
98	96.8752	96.7513	96.6650	96.5212	96.4003
100	98.8753	98.7514	98.6650	98.5212	98.4003
102	100.8754	100.7514	100.6650	100.5212	100.4003
104	102.8756	102.7514	102.6650	102.5212	102.4003
106	104.8757	104.7515	104.6650	104.5212	104.4003
108	106.8758	106.7515	106.6650	106.5212	106.4003
110	108.8759	108.7515	108.6651	108.5212	108.4004
112	110.8760	110.7516	110.6651	110.5212	110.4004
114	112.8761	112.7516	112.6651	112.5212	112.4004
116	114.8762	114.7516	114.6651	114.5212	114.4004
118	116.8763	116.7516	116.6651	116.5212	116.4004
120	118.8764	118.7517	118.6651	118.5212	118.4004
122	120.8765	120.7517	120.6651	120.5212	120.4004
124	122.8766	122.7517	122.6651	122.5212	122.4004
126	124.8767	124.7517	124.6651	124.5212	124.4004
128	126.8768	126.7518	126.6651	126.5212	126.4004
130	128.8769	128.7518	128.6652	128.5212	128.4004
132	130.8769	130.7518	130.6652	130.5212	130.4004
134	132.8770	132.7518	132.6652	132.5212	132.4004
136	134.8771	134.7519	134.6652	134.5212	134.4004
138	136.8772	136.7519	136.6652	136.5212	136.4004
140	138.8773	138.7519	138.6652	138.5212	138.4004
142	140.8773	140.7519	140.6652	140.5212	140.4004
144	142.8774	142.7519	142.6652	142.5212	142.4004
146	144.8774	144.7520	144.6652	144.5212	144.4004
148	146.8775	146.7520	146.6652	146.5212	146.4004
150	148.8775	148.7520	148.6652	148.5212	148.4005
152	150.8776	150.7520	150.6652	150.5212	150.4005
154	152.8776	152.7520	152.6652	152.5212	152.4005
156	154.8777	154.7520	154.6652	154.5212	154.4005
158	156.8778	156.7520	156.6652	156.5212	156.4005
160	158.8778	158.7520	158.6652	158.5212	158.4005
162	160.8779	160.7520	160.6652	160.5212	160.4005
164	162.8779	162.7521	162.6652	162.5212	162.4005
166	164.8780	164.7521	164.6652	164.5212	164.4005
168	166.8780	166.7521	166.6652	166.5212	166.4005
170	168.8781	168.7521	168.6652	168.5212	168.4005
180	178.8783	178.7522	178.6652	178.5212	178.4005
190	188.8785	188.7522	188.6652	188.5212	188.4005
200	198.8788	198.7523	198.6652	198.5212	198.4005
300	298.8795	298.7525	298.6654	298.5212	298.4005
400	398.8803	398.7527	398.6654	398.5212	398.4006
500	498.8810	498.7528	498.6654	498.5212	498.4006

**Table 4. Checking Internal Spur Gear Sizes
by Measurement Between Wires**

ODD NUMBERS OF TEETH					
Dimensions in table are for 1 diametral pitch and Van Keuren standard wire sizes. For any other diametral pitch, divide dimensions in table by given pitch.					
Wire or pin diameter = $\frac{1.44}{\text{Diametral Pitch}}$					
No. of Teeth	Pressure Angle				
	14½°	17½°	20°	25°	30°
7	5.6393	5.5537	5.4823	5.3462	5.2232
9	7.6894	7.5976	7.5230	7.3847	7.2618
11	9.7219	9.6256	9.5490	9.4094	9.2867
13	11.7449	11.6451	11.5669	11.4265	11.3040
15	13.7620	13.6594	13.5801	13.4391	13.3167
17	15.7752	15.6703	15.5902	15.4487	15.3265
19	17.7858	17.6790	17.5981	17.4563	17.3343
21	19.7945	19.6860	19.6045	19.4625	19.3405
23	21.8017	21.6918	21.6099	21.4676	21.3457
25	23.8078	23.6967	23.6143	23.4719	23.3501
27	25.8130	25.7009	25.6181	25.4755	25.3538
29	27.8176	27.7045	27.6214	27.4787	27.3571
31	29.8216	29.7076	29.6242	29.4814	29.3599
33	31.8251	31.7104	31.6267	31.4838	31.3623
35	33.8282	33.7128	33.6289	33.4860	33.3645
37	35.8311	35.7150	35.6310	35.4879	35.3665
39	37.8336	37.7169	37.6327	37.4896	37.3682
41	39.8359	39.7187	39.6343	39.4911	39.3698
43	41.8380	41.7203	41.6357	41.4925	41.3712
45	43.8399	43.7217	43.6371	43.4938	43.3725
47	45.8416	45.7231	45.6383	45.4950	45.3737
49	47.8432	47.7243	47.6394	47.4960	47.3748
51	49.8447	49.7254	49.6404	49.4970	49.3758
53	51.8461	51.7265	51.6414	51.4979	51.3768
55	53.8474	53.7274	53.6422	53.4988	53.3776
57	55.8486	55.7283	55.6431	55.4996	55.3784
59	57.8497	57.7292	57.6438	57.5003	57.3792
61	59.8508	59.7300	59.6445	59.5010	59.3799
63	61.8517	61.7307	61.6452	61.5016	61.3806
65	63.8526	63.7314	63.6458	63.5022	63.3812
67	65.8535	65.7320	65.6464	65.5028	65.3818
69	67.8543	67.7327	67.6469	67.5033	67.3823
71	69.8551	69.7332	69.6475	69.5038	69.3828
73	71.8558	71.7338	71.6480	71.5043	71.3833
75	73.8565	73.7343	73.6484	73.5048	73.3838
77	75.8572	75.7348	75.6489	75.5052	75.3842
79	77.8573	77.7352	77.6493	77.5056	77.3846
81	79.8584	79.7357	79.6497	79.5060	79.3850
83	81.8590	81.7361	81.6501	81.5064	81.3854
85	83.8595	83.7365	83.6505	83.5067	83.3858
87	85.8600	85.7369	85.6508	85.5071	85.3861
89	87.8605	87.7373	87.6511	87.5074	87.3864
91	89.8610	89.7376	89.6514	89.5077	89.3867
93	91.8614	91.7379	91.6517	91.5080	91.3870
95	93.8619	93.7383	93.6520	93.5082	93.3873
97	95.8623	95.7386	95.6523	95.5085	95.3876
99	97.8627	97.7389	97.6526	97.5088	97.3879
101	99.8631	99.7391	99.6528	99.5090	99.3881
103	101.8635	101.7394	101.6531	101.5093	101.3883
105	103.8638	103.7397	103.6533	103.5095	103.3886
107	105.8642	105.7399	105.6535	105.5097	105.3888
109	107.8645	107.7402	107.6537	107.5099	107.3890
111	109.8648	109.7404	109.6539	109.5101	109.3893

Table 4. Checking Internal Spur Gear Sizes by Measurement Between Wires

ODD NUMBERS OF TEETH					
Dimensions in table are for 1 diametral pitch and Van Keuren standard wire sizes. For any other diametral pitch, divide dimensions in table by given pitch.					
Wire or pin diameter = $\frac{1.44}{\text{Diametral Pitch}}$					
No. of Teeth	Pressure Angle				
	14½°	17½°	20°	25°	30°
113	111.8651	111.7406	111.6541	111.5103	111.3895
115	113.8654	113.7409	113.6543	113.5105	113.3897
117	115.8657	115.7411	115.6545	115.5107	115.3899
119	117.8660	117.7413	117.6547	117.5109	117.3900
121	119.8662	119.7415	119.6548	119.5110	119.3902
123	121.8663	121.7417	121.6550	121.5112	121.3904
125	123.8668	123.7418	123.6552	123.5114	123.3905
127	125.8670	125.7420	125.6554	125.5115	125.3907
129	127.8672	127.7422	127.6556	127.5117	127.3908
131	129.8675	129.7424	129.6557	129.5118	129.3910
133	131.8677	131.7425	131.6559	131.5120	131.3911
135	133.8679	133.7427	133.6560	133.5121	133.3913
137	135.8681	135.7428	135.6561	135.5123	135.3914
139	137.8683	137.7430	137.6563	137.5124	137.3916
141	139.8685	139.7431	139.6564	139.5125	139.3917
143	141.8687	141.7433	141.6565	141.5126	141.3918
145	143.8689	143.7434	143.6566	143.5127	143.3919
147	145.8691	145.7436	145.6568	145.5128	145.3920
149	147.8693	147.7437	147.6569	147.5130	147.3922
151	149.8694	149.7438	149.6570	149.5131	149.3923
153	151.8696	151.7439	151.6571	151.5132	151.3924
155	153.8698	153.7441	153.6572	153.5133	153.3925
157	155.8699	155.7442	155.6573	155.5134	155.3926
159	157.8701	157.7443	157.6574	157.5135	157.3927
161	159.8702	159.7444	159.6575	159.5136	159.3928
163	161.8704	161.7445	161.6576	161.5137	161.3929
165	163.8705	163.7446	163.6577	163.5138	163.3930
167	165.8707	165.7447	165.6578	165.5139	165.3931
169	167.8708	167.7448	167.6579	167.5139	167.3932
171	169.8710	169.7449	169.6580	169.5140	169.3933
181	179.8717	179.7453	179.6584	179.5144	179.3937
191	189.8721	189.7458	189.6588	189.5148	189.3940
201	199.8727	199.7461	199.6591	199.5151	199.3944
301	299.8759	299.7485	299.6612	299.5171	299.3965
401	399.8776	399.7496	399.6623	399.5182	399.3975
501	499.8786	499.7504	499.6629	499.5188	499.3981

Table 5. Van Keuren Wire Diameters for Gears

External Gears Wire Dia. = 1.728 ÷ D.P.				Internal Gears Wire Dia. = 1.44 ÷ D.P.			
D.P.	Dia.	D.P.	Dia.	D.P.	Dia.	D.P.	Dia.
2	0.86400	16	0.10800	2	0.72000	16	0.09000
2½	0.69120	18	0.09600	2½	0.57600	18	0.08000
3	0.57600	20	0.08640	3	0.48000	20	0.07200
4	0.43200	22	0.07855	4	0.36000	22	0.06545
5	0.34560	24	0.07200	5	0.28800	24	0.06000
6	0.28800	28	0.06171	6	0.24000	28	0.05143
7	0.24686	32	0.05400	7	0.20571	32	0.04500
8	0.21600	36	0.04800	8	0.18000	36	0.04000
9	0.19200	40	0.04320	9	0.16000	40	0.03600
10	0.17280	48	0.03600	10	0.14400	48	0.03000
11	0.15709	64	0.02700	11	0.13091	64	0.02250
12	0.14400	72	0.02400	12	0.12000	72	0.02000
14	0.12343	80	0.02160	14	0.10286	80	0.01800

Measurements for Checking Internal Gears when Wire Diameter Equals 1.44 Divided by Diametral Pitch.—Tables 3 and 4 give measurements between wires for checking internal gears of 1 diametral pitch. For any other diametral pitch, divide the measurement given in the table by the diametral pitch required. These measurements are based upon the Van Keuren standard wire size, which, for internal spur gears, equals 1.44 divided by the diametral pitch (see Table 5).

Even Number of Teeth: For an even number of teeth above 170 and not in Table 3, proceed as shown by the following example: Assume that the number of teeth = 380 and pressure angle is $14\frac{1}{2}$ degrees; then, for 1 diametral pitch, figure at left of decimal point = given number of teeth $- 2 = 380 - 2 = 378$. Figure at right of decimal point lies between decimal values given in table for 300 and 400 teeth and is obtained by interpolation. Thus, $380 - 300 = 80$ (change to 0.80); $0.8803 - 0.8795 = 0.0008$; hence, decimal required = $0.8795 + (0.80 \times 0.0008) 0.88014$. Total dimension = 378.88014.

Odd Number of Teeth: Table 4 is for internal gears having odd numbers of teeth. For tooth numbers above 171 and not in the table, proceed as shown by the following example: Assume that number of teeth = 337 and pressure angle is $14\frac{1}{2}$ degrees; then, for 1 diametral pitch, figure at left of decimal point = given No. of teeth $- 2 = 337 - 2 = 335$. Figure at right of decimal point lies between decimal values given in table for 301 and 401 teeth and is obtained by interpolation. Thus, $337 - 301 = 36$ (change to 0.36); $0.8776 - 0.8759 = 0.0017$; hence, decimal required = $0.8759 + (0.36 \times 0.0017) = 0.8765$. Total dimension = 335.8765.

Measurements for Checking External Spur Gears when Wire Diameter Equals 1.68 Divided by Diametral Pitch.—Tables 7 and 8 give measurements M , in inches, for checking the pitch diameters of external spur gears of 1 diametral pitch. For any other diametral pitch, divide the measurement given in the table by whatever diametral pitch is required. The result shows what measurement M should be when the pitch diameter is correct and there is no allowance for backlash. The procedure for checking for a given amount of backlash when the diameter of the measuring wires equals 1.68 divided by the diametral pitch is explained under a subsequent heading. Tables 7 and 8 are based upon wire sizes equal to 1.68 divided by the diametral pitch. The corresponding wire diameters for various diametral pitches are given in Table 6.

Table 6. Wire Diameters for Spur and Helical Gears Based upon 1.68 Constant

Diametral or Normal Diametral Pitch	Wire Diameter	Diametral or Normal Diametral Pitch	Wire Diameter	Diametral or Normal Diametral Pitch	Wire Diameter	Diametral or Normal Diametral Pitch	Wire Diameter
2	0.840	8	0.210	18	0.09333	40	0.042
$2\frac{1}{2}$	0.672	9	0.18666	20	0.084	48	0.035
3	0.560	10	0.168	22	0.07636	64	0.02625
4	0.420	11	0.15273	24	0.070	72	0.02333
5	0.336	12	0.140	28	0.060	80	0.021
6	0.280	14	0.120	32	0.0525
7	0.240	16	0.105	36	0.04667

Pin diameter = $1.68 \div$ diametral pitch for spur gears and $1.68 \div$ normal diametral pitch for helical gears.

To find measurement M of an external spur gear using wire sizes equal to 1.68 inches divided by the diametral pitch, the same method is followed in using Tables 7 and 8 as that outlined for Tables 1 and 2.

**Table 7. Checking External Spur Gear Sizes
by Measurement Over Wires**

EVEN NUMBERS OF TEETH					
Dimensions in table are for 1 diametral pitch and 1.68-inch series wire sizes (a Van Keuren standard). For any other diametral pitch, divide dimension in table by given pitch.					
Wire or pin diameter = $\frac{1.68}{\text{Diametral Pitch}}$					
No. of Teeth	Pressure Angle				
	14½°	17½°	20°	25°	30°
6	8.1298	8.1442	8.1600	8.2003	8.2504
8	10.1535	10.1647	10.1783	10.2155	10.2633
10	12.1712	12.1796	12.1914	12.2260	12.2722
12	14.1851	14.1910	14.2013	14.2338	14.2785
14	16.1964	16.2001	16.2091	16.2397	16.2833
16	18.2058	18.2076	18.2154	18.2445	18.2871
18	20.2137	20.2138	20.2205	20.2483	20.2902
20	22.2205	22.2190	22.2249	22.2515	22.2927
22	24.2265	24.2235	24.2286	24.2542	24.2949
24	26.2317	26.2275	26.2318	26.2566	26.2967
26	28.2363	28.2309	28.2346	28.2586	28.2982
28	30.2404	30.2339	30.2371	30.2603	30.2996
30	32.2441	32.2367	32.2392	32.2619	32.3008
32	34.2475	34.2391	34.2412	34.2632	34.3017
34	36.2505	36.2413	36.2430	36.2644	36.3026
36	38.2533	38.2433	38.2445	38.2655	38.3035
38	40.2558	40.2451	40.2460	40.2666	40.3044
40	42.2582	42.2468	42.2473	42.2675	42.3051
42	44.2604	44.2483	44.2485	44.2683	44.3057
44	46.2624	46.2497	46.2496	46.2690	46.3063
46	48.2642	48.2510	48.2506	48.2697	48.3068
48	50.2660	50.2522	50.2516	50.2704	50.3073
50	52.2676	52.2534	52.2525	52.2710	52.3078
52	54.2691	54.2545	54.2533	54.2716	54.3082
54	56.2705	56.2555	56.2541	56.2721	56.3086
56	58.2719	58.2564	58.2548	58.2726	58.3089
58	60.2731	60.2572	60.2555	60.2730	60.3093
60	62.2743	62.2580	62.2561	62.2735	62.3096
62	64.2755	64.2587	64.2567	64.2739	64.3099
64	66.2765	66.2594	66.2572	66.2742	66.3102
66	68.2775	68.2601	68.2577	68.2746	68.3104
68	70.2785	70.2608	70.2582	70.2749	70.3107
70	72.2794	72.2615	72.2587	72.2752	72.3109
72	74.2803	74.2620	74.2591	74.2755	74.3111
74	76.2811	76.2625	76.2596	76.2758	76.3113
76	78.2819	78.2631	78.2600	78.2761	78.3115
78	80.2827	80.2636	80.2604	80.2763	80.3117
80	82.2834	82.2641	82.2607	82.2766	82.3119
82	84.2841	84.2646	84.2611	84.2768	84.3121
84	86.2847	86.2650	86.2614	86.2771	86.3123
86	88.2854	88.2655	88.2617	88.2773	88.3124
88	90.2860	90.2659	90.2620	90.2775	90.3126
90	92.2866	92.2662	92.2624	92.2777	92.3127
92	94.2872	94.2666	94.2626	94.2779	94.3129
94	96.2877	96.2670	96.2629	96.2780	96.3130
96	98.2882	98.2673	98.2632	98.2782	98.3131
98	100.2887	100.2677	100.2635	100.2784	100.3132
100	102.2892	102.2680	102.2638	102.2785	102.3134
102	104.2897	104.2683	104.2640	104.2787	104.3135

Table 7. Checking External Spur Gear Sizes by Measurement Over Wires

EVEN NUMBERS OF TEETH					
Dimensions in table are for 1 diametral pitch and 1.68-inch series wire sizes (a Van Keuren standard). For any other diametral pitch, divide dimension in table by given pitch.					
Wire or pin diameter = $\frac{1.68}{\text{Diametral Pitch}}$					
No. of Teeth	Pressure Angle				
	14½°	17½°	20°	25°	30°
104	106.2901	106.2685	106.2642	106.2788	106.3136
106	108.2905	108.2688	108.2644	108.2789	108.3137
108	110.2910	110.2691	110.2645	110.2791	110.3138
110	112.2914	112.2694	112.2647	112.2792	112.3139
112	114.2918	114.2696	114.2649	114.2793	114.3140
114	116.2921	116.2699	116.2651	116.2794	116.3141
116	118.2925	118.2701	118.2653	118.2795	118.3142
118	120.2929	120.2703	120.2655	120.2797	120.3142
120	122.2932	122.2706	122.2656	122.2798	122.3143
122	124.2936	124.2708	124.2658	124.2799	124.3144
124	126.2939	126.2710	126.2660	126.2800	126.3145
126	128.2941	128.2712	128.2661	128.2801	128.3146
128	130.2945	130.2714	130.2663	130.2802	130.3146
130	132.2948	132.2716	132.2664	132.2803	132.3147
132	134.2951	134.2718	134.2666	134.2804	134.3147
134	136.2954	136.2720	136.2667	136.2805	136.3148
136	138.2957	138.2722	138.2669	138.2806	138.3149
138	140.2960	140.2724	140.2670	140.2807	140.3149
140	142.2962	142.2725	142.2671	142.2808	142.3150
142	144.2965	144.2727	144.2672	144.2808	144.3151
144	146.2967	146.2729	146.2674	146.2809	146.3151
146	148.2970	148.2730	148.2675	148.2810	148.3152
148	150.2972	150.2732	150.2676	150.2811	150.3152
150	152.2974	152.2733	152.2677	152.2812	152.3153
152	154.2977	154.2735	154.2678	154.2812	154.3153
154	156.2979	156.2736	156.2679	156.2813	156.3154
156	158.2981	158.2737	158.2680	158.2813	158.3155
158	160.2983	160.2739	160.2681	160.2814	160.3155
160	162.2985	162.2740	162.2682	162.2815	162.3155
162	164.2987	164.2741	164.2683	164.2815	164.3156
164	166.2989	166.2742	166.2684	166.2816	166.3156
166	168.2990	168.2744	168.2685	168.2816	168.3157
168	170.2992	170.2745	170.2686	170.2817	170.3157
170	172.2994	172.2746	172.2687	172.2818	172.3158
180	182.3003	182.2752	182.2691	182.2820	182.3160
190	192.3011	192.2757	192.2694	192.2823	192.3161
200	202.3018	202.2761	202.2698	202.2825	202.3163
300	302.3063	302.2790	302.2719	302.2839	302.3173
400	402.3087	402.2804	402.2730	402.2845	402.3178
500	502.3101	502.2813	502.2736	502.2850	502.3181

Allowance for Backlash: Tables 1, 2, 7, and 8 give measurements over wires when the pitch diameters are correct and there is no allowance for backlash or play between meshing teeth. Backlash is obtained by cutting the teeth somewhat deeper than standard, thus reducing the thickness. Usually, the teeth of both mating gears are reduced in thickness an amount equal to one-half of the total backlash desired. However, if the pinion is small, it is common practice to reduce the gear teeth the full amount of backlash and the pinion is made to standard size. The changes in measurements M over wires, for obtaining backlash in external spur gears, are listed in Table 9.

**Table 8. Checking External Spur Gear Sizes
by Measurement Over Wires**

ODD NUMBERS OF TEETH					
Dimensions in table are for 1 diametral pitch and 1.68-inch series wire sizes (a Van Keuren standard). For any other diametral pitch, divide dimension in table by given pitch.					
Wire or pin diameter = $\frac{1.68}{\text{Diametral Pitch}}$					
No. of Teeth	Pressure Angle				
	14½°	17 ½°	20°	25°	30°
5	6.8485	6.8639	6.8800	6.9202	6.9691
7	8.9555	8.9679	8.9822	9.0199	9.0675
9	11.0189	11.0285	11.0410	11.0762	11.1224
11	13.0615	13.0686	13.0795	13.1126	13.1575
13	15.0925	15.0973	15.1068	15.1381	15.1819
15	17.1163	17.1190	17.1273	17.1570	17.1998
17	19.1351	19.1360	19.1432	19.1716	19.2136
19	21.1505	21.1498	21.1561	21.1832	21.2245
21	23.1634	23.1611	23.1665	23.1926	23.2334
23	25.1743	25.1707	25.1754	25.2005	25.2408
25	27.1836	27.1788	27.1828	27.2071	27.2469
27	29.1918	29.1859	29.1892	29.2128	29.2522
29	31.1990	31.1920	31.1948	31.2177	31.2568
31	33.2053	33.1974	33.1997	33.2220	33.2607
33	35.2110	35.2021	35.2041	35.2258	35.2642
35	37.2161	37.2065	37.2079	37.2292	37.2674
37	39.2208	39.2104	39.2115	39.2323	39.2702
39	41.2249	41.2138	41.2147	41.2349	41.2726
41	43.2287	43.2170	43.2174	43.2374	43.2749
43	45.2323	45.2199	45.2200	45.2396	45.2769
45	47.2355	47.2226	47.2224	47.2417	47.2788
47	49.2385	49.2251	49.2246	49.2435	49.2805
49	51.2413	51.2273	51.2266	51.2452	51.2820
51	53.2439	53.2294	53.2284	53.2468	53.2835
53	55.2463	55.2313	55.2302	55.2483	55.2848
55	57.2485	57.2331	57.2318	57.2497	57.2861
57	59.2506	59.2348	59.2333	59.2509	59.2872
59	61.2526	61.2363	61.2347	61.2521	61.2883
61	63.2545	63.2378	63.2360	63.2532	63.2893
63	65.2562	65.2392	65.2372	65.2543	65.2902
65	67.2579	67.2406	67.2383	67.2553	67.2911
67	69.2594	69.2419	69.2394	69.2562	69.2920
69	71.2609	71.2431	71.2405	71.2571	71.2928
71	73.2623	73.2442	73.2414	73.2579	73.2935
73	75.2636	75.2452	75.2423	75.2586	75.2942
75	77.2649	77.2462	77.2432	77.2594	77.2949
77	79.2661	79.2472	79.2440	79.2601	79.2955
79	81.2673	81.2481	81.2448	81.2607	81.2961
81	83.2684	83.2490	83.2456	83.2614	83.2967
83	85.2694	85.2498	85.2463	85.2620	85.2972
85	87.2704	87.2506	87.2470	87.2625	87.2977
87	89.2714	89.2514	89.2476	89.2631	89.2982
89	91.2723	91.2521	91.2482	91.2636	91.2987
91	93.2732	93.2528	93.2489	93.2641	93.2991
93	95.2741	95.2534	95.2494	95.2646	95.2996

**Table 8. Checking External Spur Gear Sizes
by Measurement Over Wires**

ODD NUMBERS OF TEETH					
Dimensions in table are for 1 diametral pitch and 1.68-inch series wire sizes (a Van Keuren standard). For any other diametral pitch, divide dimension in table by given pitch.					
Wire or pin diameter = $\frac{1.68}{\text{Diametral Pitch}}$					
No. of Teeth	Pressure Angle				
	14½°	17 ½°	20°	25°	30°
95	97.2749	97.2541	97.2500	97.2650	97.3000
97	99.2757	99.2547	99.2506	99.2655	99.3004
99	101.2764	101.2553	101.2511	101.2659	101.3008
101	103.2771	103.2558	103.2516	103.2663	103.3011
103	105.2778	105.2563	105.2520	105.2667	105.3015
105	107.2785	107.2568	107.2525	107.2671	107.3018
107	109.2791	109.2573	109.2529	109.2674	109.3021
109	111.2798	111.2578	111.2533	111.2678	111.3024
111	113.2804	113.2583	113.2537	113.2681	113.3027
113	115.2809	115.2588	115.2541	115.2684	115.3030
115	117.2815	117.2592	117.2544	117.2687	117.3033
117	119.2821	119.2596	119.2548	119.2690	119.3036
119	121.2826	121.2601	121.2552	121.2693	121.3038
121	123.2831	123.2605	123.2555	123.2696	123.3041
123	125.2836	125.2608	125.2558	125.2699	125.3043
125	127.2841	127.2612	127.2562	127.2702	127.3046
127	129.2846	129.2615	129.2565	129.2704	129.3048
129	131.2851	131.2619	131.2568	131.2707	131.3050
131	133.2855	133.2622	133.2571	133.2709	133.3053
133	135.2859	135.2626	135.2574	135.2712	135.3055
135	137.2863	137.2629	137.2577	137.2714	137.3057
137	139.2867	139.3632	139.2579	139.2716	139.3059
139	141.2871	141.2635	141.2582	141.2718	141.3060
141	143.2875	143.2638	143.2584	143.2720	143.3062
143	145.2879	145.2641	145.2587	145.2722	145.3064
145	147.2883	147.2644	147.2589	147.2724	147.3066
147	149.2887	149.2647	149.2591	149.2726	149.3068
149	151.2890	151.2649	151.2594	151.2728	151.3069
151	153.2893	153.2652	153.2596	153.2730	153.3071
153	155.2897	155.2654	155.2598	155.2732	155.3073
155	157.2900	157.2657	157.2600	157.2733	157.3074
157	159.2903	159.2659	159.2602	159.2735	159.3076
159	161.2906	161.2661	161.2604	161.2736	161.3077
161	163.2909	163.2663	163.2606	163.2738	163.3078
163	165.2912	165.2665	165.2608	165.2740	165.3080
165	167.2915	167.2668	167.2610	167.2741	167.3081
167	169.2917	169.2670	169.2611	169.2743	169.3083
169	171.2920	171.2672	171.2613	171.2744	171.3084
171	173.2922	173.2674	173.2615	173.2746	173.3085
181	183.2936	183.2684	183.2623	183.2752	183.3091
191	193.2947	193.2692	193.2630	193.2758	193.3097
201	203.2957	203.2700	203.2636	203.2764	203.3101
301	303.3022	303.2749	303.2678	303.2798	303.3132
401	403.3056	403.2774	403.2699	403.2815	403.3147
501	503.3076	503.2789	503.2711	503.2825	503.3156

Table 9. Backlash Allowances for External and Internal Spur Gears

No. of Teeth	14½°		17½°		20°		25°		30°	
	Ext.	Int.	Ext.	Int.	Ext.	Int.	Ext.	Int.	Ext.	Int.
5	.0019	.0024	.0018	.0024	.0017	.0023	.0015	.0021	.0013	.0019
10	.0024	.0029	.0022	.0027	.0020	.0026	.0017	.0022	.0015	.0018
20	.0028	.0032	.0025	.0029	.0023	.0027	.0019	.0022	.0016	.0018
30	.0030	.0034	.0026	.0030	.0024	.0027	.0020	.0022	.0016	.0018
40	.0031	.0035	.0027	.0030	.0025	.0027	.0020	.0022	.0017	.0018
50	.0032	.0036	.0028	.0031	.0025	.0027	.0020	.0022	.0017	.0018
100	.0035	.0037	.0030	.0031	.0026	.0027	.0021	.0022	.0017	.0017
200	.0036	.0038	.0031	.0031	.0027	.0027	.0021	.0022	.0017	.0017

External Gears: For each 0.001 inch reduction in pitch-line tooth thickness, *reduce* measurement over wires obtained from **Tables 1, 2, 7, or 8** by the amount shown below.

Internal Gears: For each 0.001 inch reduction in pitch-line tooth thickness, *increase* measurement between wires obtained from **Tables 3 or 4** by the amounts shown below.

Backlash on pitch line equals double tooth thickness reduction when teeth of *both* mating gears are reduced. If teeth of *one* gear only are reduced, backlash on pitch line equals amount of reduction.

Example: For a 30-tooth, 10-diametral pitch, 20-degree pressure angle, external gear the measurement over wires from **Table 1** is $32.4102 \div 10$. For a backlash of 0.002 this measurement must be reduced by 2×0.0024 to 3.2362 or (3.2410 – 0.0048).

Measurements for Checking Helical Gears using Wires or Balls.—Helical gears may be checked for size by using one wire, or ball; two wires, or balls; and three wires, depending on the case at hand. Three wires may be used for measurement of either even or odd tooth numbers provided that the face width and helix angle of the gear permit the arrangement of two wires in adjacent tooth spaces on one side of the gear and a third wire on the opposite side. The wires should be held between flat, parallel plates. The measurement between these plates, and perpendicular to the gear axis, will be the same for both even and odd numbers of teeth because the axial displacement of the wires with the odd numbers of teeth does not affect the perpendicular measurement between the plates. The calculation of measurements over three wires is the same as described for measurements over two wires for even numbers of teeth.

Measurements over One Wire or One Ball for Even or Odd Numbers of Teeth: This measurement is calculated by the method for measurement over two wires for even numbers of teeth and the result divided by two to obtain the measurement from over the wire or ball to the center of the gear mounted on an arbor.

Measurement over Two Wires or Two Balls for Even Numbers of Teeth: The measurement over two wires (or two balls kept in the same plane by holding them against a surface parallel to the face of the gear) is calculated as follows: First, calculate the pitch diameter of the helical gear from the formula $D = \text{Number of teeth} \div \text{product of the normal diametral pitch and the cosine of the helix angle}$, $D = N \div (P_n \times \cos \psi)$. Next, calculate the number of teeth, N_e , there would be in a spur gear for it to have the same tooth curvature as the helical gear has in the normal plane: $N_e = N / \cos^3 \psi$. Next, refer to **Table 7** for spur gears with even tooth numbers and find, by interpolation, the *decimal* value of the constant for this number of teeth under the given *normal* pressure angle. Finally, add 2 to this decimal value and divide the sum by the normal diametral pitch P_n . The result of this calculation, added to the pitch diameter D , is the measurement over two wires or balls.

Example: A helical gear has 32 teeth of 6 normal diametral pitch, 20 degree pressure angle, and 23 degree helix angle. Determine the measurement over two wires, M , without allowance for backlash.

$D = 32 \div 6 \times \cos 23^\circ = 5.7939$; $N_e = 32 \div \cos^3 23^\circ = 41.027$; and in **Table 7**, fourth column, the decimal part of the measurement for 40 teeth is .2473 and that for 42 teeth is .2485. The

decimal part for 41.027 teeth is, by interpolation, $\frac{(41.027 - 40)}{(42 - 40)} \times (.2485 - .2473) + .2473 = 0.2479$; $(0.2479 + 2) \div 6 = 0.3747$; and $M = 0.3747 + 5.7939 = 6.1686$.

This measurement over wires or balls is based upon the use of $1.68/P_n$ wires or balls. If measurements over $1.728/P_n$ diameter wires or balls are preferred, use **Table 1** to find the decimal part described above instead of **Table 7**.

Measurement over Two Wires or Two Balls for Odd Numbers of Teeth: The procedure is similar to that for two wire or two ball measurement for even tooth numbers except that a correction is made in the final M value to account for the wires or balls not being diametrically opposite by one-half tooth interval. In addition, care must be taken to ensure that the balls or wires are kept in a plane of the gear's rotation as described previously.

Example: A helical gear has 13 teeth of 8 normal diametral pitch, $14\frac{1}{2}$ degree pressure angle, and 45 degree helix angle. Determine measurement M without allowance for backlash based upon the use of $1.728/P_n$ balls or wires.

As before, $D = 13/8 \times \cos 45^\circ = 2.2981$; $N_e = 13/\cos^3 45^\circ = 36.770$; and in the second column of **Table 1** the *decimal* part of the measurement for 36 teeth is .4565 and that for 38 teeth is .4603. The decimal part for 36.770 teeth is, by interpolation, $\frac{(36.770 - 36)}{(38 - 36)} \times (.4603 - .4565) + .4565 = 0.4580$; $(0.4580 + 2)/8 = 0.3073$; and $M = 0.3073 + 2.2981 = 2.6054$. This measurement is correct for three-wire measurements but, for two balls or wires held in the plane of rotation of the gear, M must be corrected as follows:

$$\begin{aligned} M \text{ corrected} &= (M - \text{Ball Diam.}) \times \cos(90^\circ/N) + \text{Ball Diam.} \\ &= (2.6054 - 1.728/8) \times \cos(90^\circ/13) + 1.728/8 = 2.5880 \end{aligned}$$

Checking Spur Gear Size by Chordal Measurement Over Two or More Teeth.—

Another method of checking gear sizes, that is generally available, is illustrated by the diagram accompanying **Table 10**. A vernier caliper is used to measure the distance M over two or more teeth. The diagram illustrates the measurement over two teeth (or with one intervening tooth space), but three or more teeth might be included, depending upon the pitch. The jaws of the caliper are merely held in contact with the sides or profiles of the teeth and perpendicular to the axis of the gear. Measurement M for involute teeth of the correct size is determined as follows

General Formula for Checking External and Internal Spur Gears by Measurement Over Wires: The following formulas may be used for pressure angles or wire sizes not covered by the tables. In these formulas, M = measurement *over* wires for external gears or measurement *between* wires for internal gears; D = pitch diameter; T = arc tooth thickness on pitch circle; W = wire diameter; N = number of gear teeth; A = pressure angle of gear; a = angle, the cosine of which is required in **Formulas (2)** and **(3)**.

First determine the involute function of angle a ($\text{inv } a$); then the corresponding angle a is found by referring to the tables of involute functions beginning on page **111**,

$$\text{inv } a = \text{inv } A \pm \frac{T}{D} \pm \frac{W}{D \cos A} \mp \frac{\pi}{N} \quad (1)$$

$$\text{For even numbers of teeth, } M = \frac{D \cos A}{\cos a} \pm W \quad (2)$$

$$\text{For odd numbers of teeth, } M = \left(\frac{D \cos A}{\cos a} \right) \left(\cos \frac{90^\circ}{N} \right) \pm W \quad (3)$$

Note: In **Formulas (1)**, **(2)**, and **(3)**, use the upper sign for *external* and the lower sign for *internal* gears wherever a \pm or \mp appears in the formulas.

Table 10. Chordal Measurements over Spur Gear Teeth of 1 Diametral Pitch

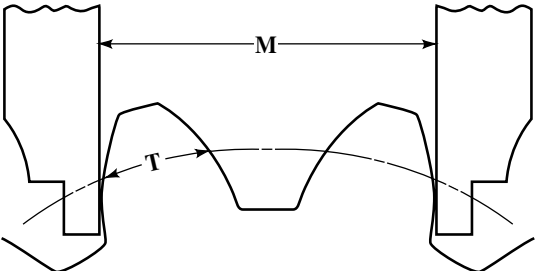
<p>Find value of M under pressure angle and opposite number of teeth; divide M by diametral pitch of gear to be measured and then subtract one-half total backlash to obtain a measurement M equivalent to given pitch and backlash. The number of teeth to gage or measure over is shown by Table 11.</p> 							
Number of Gear Teeth	M in Inches for 1 D.P.	Number of Gear Teeth	M in Inches for 1 D.P.	Number of Gear Teeth	M in Inches for 1 D.P.	Number of Gear Teeth	M in Inches for 1 D.P.
Pressure Angle, 14½ Degrees							
12	4.6267	37	7.8024	62	14.0197	87	20.2370
13	4.6321	38	10.8493	63	17.0666	88	23.2838
14	4.6374	39	10.8547	64	17.0720	89	23.2892
15	4.6428	40	10.8601	65	17.0773	90	23.2946
16	4.6482	41	10.8654	66	17.0827	91	23.2999
17	4.6536	42	10.8708	67	17.0881	92	23.3053
18	4.6589	43	10.8762	68	17.0934	93	23.3107
19	7.7058	44	10.8815	69	17.0988	94	23.3160
20	7.7112	45	10.8869	70	17.1042	95	23.3214
21	7.7166	46	10.8923	71	17.1095	96	23.3268
22	7.7219	47	10.8976	72	17.1149	97	23.3322
23	7.7273	48	10.9030	73	17.1203	98	23.3375
24	7.7326	49	10.9084	74	17.1256	99	23.3429
25	7.7380	50	10.9137	75	17.1310	100	23.3483
26	7.7434	51	13.9606	76	20.1779	101	26.3952
27	7.7488	52	13.9660	77	20.1833	102	26.4005
28	7.7541	53	13.9714	78	20.1886	103	26.4059
29	7.7595	54	13.9767	79	20.1940	104	26.4113
30	7.7649	55	13.9821	80	20.1994	105	26.4166
31	7.7702	56	13.9875	81	20.2047	106	26.4220
32	7.7756	57	13.9929	82	20.2101	107	26.4274
33	7.7810	58	13.9982	83	20.2155	108	26.4327
34	7.7863	59	14.0036	84	20.2208	109	26.4381
35	7.7917	60	14.0090	85	20.2262	110	26.4435
36	7.7971	61	14.0143	86	20.2316
Pressure Angle, 20 Degrees							
12	4.5963	30	10.7526	48	16.9090	66	23.0653
13	4.6103	31	10.7666	49	16.9230	67	23.0793
14	4.6243	32	10.7806	50	16.9370	68	23.0933
15	4.6383	33	10.7946	51	16.9510	69	23.1073
16	4.6523	34	10.8086	52	16.9650	70	23.1214
17	4.6663	35	10.8226	53	16.9790	71	23.1354
18	4.6803	36	10.8366	54	16.9930	72	23.1494
19	7.6464	37	13.8028	55	19.9591	73	26.1155
20	7.6604	38	13.8168	56	19.9731	74	26.1295
21	7.6744	39	13.8307	57	19.9872	75	26.1435
22	7.6884	40	13.8447	58	20.0012	76	26.1575
23	7.7024	41	13.8587	59	20.0152	77	26.1715
24	7.7165	42	13.8727	60	20.0292	78	26.1855
25	7.7305	43	13.8867	61	20.0432	79	26.1995
26	7.7445	44	13.9007	62	20.0572	80	26.2135
27	7.7585	45	13.9147	63	20.0712	81	26.2275
28	10.7246	46	16.8810	64	23.0373
29	10.7386	47	16.8950	65	23.0513

Table for Determining the Chordal Dimension: Table 10 gives the chordal dimensions for one diametral pitch when measuring over the number of teeth indicated in Table 11. To obtain any chordal dimension, it is simply necessary to divide chord M in the table (opposite the given number of teeth) by the diametral pitch of the gear to be measured and then subtract from the quotient one-half the total backlash between the mating pair of gears. In cases where a small pinion is used with a large gear and all of the backlash is to be obtained by reducing the gear teeth, the total amount of backlash is subtracted from the chordal dimension of the gear and nothing from the chordal dimension of the pinion. The application of the tables will be illustrated by an example.

Table 11. Number of Teeth Included in Chordal Measurement

Tooth Range for 14½° Pressure Angle	Tooth Range for 20° Pressure Angle	Number of Teeth to Gage Over	Tooth Range for 14½° Pressure Angle	Tooth Range for 20° Pressure Angle	Number of Teeth to Gage Over
12 to 18	12 to 18	2	63 to 75	46 to 54	6
19 to 37	19 to 27	3	76 to 87	55 to 63	7
38 to 50	28 to 36	4	88 to 100	64 to 72	8
51 to 62	37 to 45	5	101 to 110	73 to 81	9

This table shows the number of teeth to be included between the jaws of the vernier caliper in measuring dimension M as explained in connection with Table 10.

Example: Determine the chordal dimension for checking the size of a gear having 30 teeth of 5 diametral pitch and a pressure angle of 20 degrees. A total backlash of 0.008 inch is to be obtained by reducing equally the teeth of both mating gears.

Table 10 shows that chordal distance for 30 teeth of one diametral pitch and a pressure angle of 20 degrees is 10.7526 inches; one-half of the backlash equals 0.004 inch; hence,

$$\text{Chordal dimension} = \frac{10.7526}{5} - 0.004 = 2.1465 \text{ inches}$$

Table 11 shows that this is the chordal dimension when the vernier caliper spans four teeth, this being the number of teeth to gage over whenever gears of 20-degree pressure angle have any number of teeth from 28 to 36, inclusive.

If it is considered necessary to leave enough stock on the gear teeth for a shaving or finishing cut, this allowance is simply added to the chordal dimension of the finished teeth to obtain the required measurement over the teeth for the roughing operation. It may be advisable to place this chordal dimension for rough machining on the detail drawing.

Formula for Chordal Dimension M .—The required measurement M over spur gear teeth may be obtained by the following formula in which R = pitch radius of gear, A = pressure angle, T = tooth thickness along pitch circle, N = number of gear teeth, S = number of tooth spaces between caliper jaws, F = a factor depending on the pressure angle = 0.01109 for 14½°; = 0.01973 for 17½°; = 0.0298 for 20°; = 0.04303 for 22½°; = 0.05995 for 25°. This factor F equals twice the involute function of the pressure angle.

$$M = R \times \cos A \times \left(\frac{T}{R} + \frac{6.2832 \times S}{N} + F \right)$$

Example: A spur gear has 30 teeth of 6 diametral pitch and a pressure angle of 14½ degrees. Determine measurement M over three teeth, there being two intervening tooth spaces.

The pitch radius = 2½ inches, the arc tooth thickness equivalent to 6 diametral pitch is 0.2618 inch (if no allowance is made for backlash) and factor F for 14½ degrees = 0.01109 inch.

$$M = 2.5 \times 0.96815 \times \left(\frac{0.2618}{2.5} + \frac{6.2832 \times 2}{30} + 0.01109 \right) = 1.2941 \text{ inches}$$

Checking Enlarged Pinions by Measuring Over Pins or Wires.—When the teeth of small spur gears or pinions would be undercut if generated by an unmodified straight-sided rack cutter or hob, it is common practice to make the outside diameter larger than standard. The amount of increase in outside diameter varies with the pressure angle and number of teeth, as shown by [Table 7](#) on page 2146. The teeth are always cut to standard depth on a generating type of machine such as a gear hobber or gear shaper; and because the number of teeth and pitch are not changed, the pitch diameter also remains unchanged. The tooth thickness on the pitch circle, however, is increased and wire sizes suitable for standard gears are not large enough to extend above the tops of these enlarged gears or pinions; hence, the Van Keuren wire size recommended for these enlarged pinions equals 1.92 ÷ diametral pitch. [Table 12](#) gives measurements over wires of this size, for checking full-depth involute gears of 1 diametral pitch. For any other pitch, merely divide the measurement given in the table by the diametral pitch. [Table 12](#) applies to pinions that have been enlarged by the same amounts as given in [tables 7 and 8](#), starting on page 2146. These enlarged pinions will mesh with standard gears; but if the standard center distance is to be maintained, reduce the gear diameter below the standard size by as much as the pinion diameter is increased.

Table 12. Checking Enlarged Spur Pinions by Measurement Over Wires

Measurements over wires are given in table for 1 diametral pitch. For any other diametral pitch, divide measurement in table by given pitch. Wire size equals 1.92 ÷ diametral pitch.							
Number of Teeth	Outside or Major Diameter (Note 1)	Circular Tooth Thickness (Note 2)	Measurement Over Wires	Number of Teeth	Outside or Major Diameter (Note 1)	Circular Tooth Thickness (Note 2)	Measurement Over Wires
14½-degree full-depth involute teeth:				20-degree full-depth involute teeth:			
10	13.3731	1.9259	13.6186	10	12.936	1.912	13.5039
11	14.3104	1.9097	14.4966	11	13.818	1.868	14.3299
12	15.2477	1.8935	15.6290	12	14.702	1.826	15.4086
13	16.1850	1.8773	16.5211	13	15.584	1.783	16.2473
14	17.1223	1.8611	17.6244	14	16.468	1.741	17.2933
15	18.0597	1.8449	18.5260	15	17.350	1.698	18.1383
16	18.9970	1.8286	19.6075	16	18.234	1.656	19.1596
17	19.9343	1.8124	20.5156	17	19.116	1.613	20.0080
18	20.8716	1.7962	21.5806	<p><i>Note 1:</i> These enlargements, which are to improve the tooth form and avoid undercut, conform to those given in Tables 7 and 8, starting on page 2146 where data will be found on the minimum number of teeth in the mating gear.</p> <p><i>Note 2:</i> The circular or arc thickness is at the standard pitch diameter. The corresponding chordal thickness may be found as follows: Multiply arc thickness by 90 and then divide product by 3.1416 × pitch radius; find sine of angle thus obtained and multiply it by pitch diameter.</p>			
19	21.8089	1.7800	22.4934				
20	22.7462	1.7638	23.5451				
21	23.6835	1.7476	24.4611				
22	24.6208	1.7314	25.5018				
23	25.5581	1.7151	26.4201				
24	26.4954	1.6989	27.4515				
25	27.4328	1.6827	28.3718				
26	28.3701	1.6665	29.3952				
27	29.3074	1.6503	30.3168				
28	30.2447	1.6341	31.3333				
29	31.1820	1.6179	32.2558				
30	32.1193	1.6017	33.2661				
31	33.0566	1.5854	34.1889				

GEAR MATERIALS

Classification of Gear Steels.—Gear steels may be divided into two general classes — the plain carbon and the alloy steels. Alloy steels are used to some extent in the industrial field, but heat-treated plain carbon steels are far more common. The use of untreated alloy steels for gears is seldom, if ever, justified, and then, only when heat-treating facilities are lacking. The points to be considered in determining whether to use heat-treated plain carbon steels or heat-treated alloy steels are: Does the service condition or design require the superior characteristics of the alloy steels, or, if alloy steels are not required, will the advantages to be derived offset the additional cost? For most applications, plain carbon steels, heat-treated to obtain the best of their qualities for the service intended, are satisfactory and quite economical. The advantages obtained from using heat-treated alloy steels in place of heat-treated plain carbon steels are as follows:

- 1) Increased surface hardness and depth of hardness penetration for the same carbon content and quench.
- 2) Ability to obtain the same surface hardness with a less drastic quench and, in the case of some of the alloys, a lower quenching temperature, thus giving less distortion.
- 3) Increased toughness, as indicated by the higher values of yield point, elongation, and reduction of area.
- 4) Finer grain size, with the resulting higher impact toughness and increased wear resistance.
- 5) In the case of some of the alloys, better machining qualities or the possibility of machining at higher hardnesses.

Use of Casehardening Steels.—Each of the two general classes of gear steels may be further subdivided as follows: 1) Casehardening steels; 2) full-hardening steels; and 3) steels that are heat-treated and drawn to a hardness that will permit machining.

The first two — casehardening and full-hardening steels — are interchangeable for some kinds of service, and the choice is often a matter of personal opinion. Casehardening steels with their extremely hard, fine-grained (when properly treated) case and comparatively soft and ductile core are generally used when resistance to wear is desired. Casehardening alloy steels have a fairly tough core, but not as tough as that of the full-hardening steels. In order to realize the greatest benefits from the core properties, casehardened steels should be double-quenched. This is particularly true of the alloy steels, because the benefits derived from their use seldom justify the additional expense, unless the core is refined and toughened by a second quench. The penalty that must be paid for the additional refinement is increased distortion, which may be excessive if the shape or design does not lend itself to the casehardening process.

Use of “Thru-Hardening” Steels.—Thru-hardening steels are used when great strength, high endurance limit, toughness, and resistance to shock are required. These qualities are governed by the kind of steel and treatment used. Fairly high surface hardnesses are obtainable in this group, though not so high as those of the casehardening steels. For that reason, the resistance to wear is not so great as might be obtained, but when wear resistance combined with great strength and toughness is required, this type of steel is superior to the others. Thru-hardening steels become distorted to some extent when hardened, the amount depending upon the steel and quenching medium used. For that reason, thru-hardening steels are not suitable for high-speed gearing where noise is a factor, or for gearing where accuracy is of paramount importance, except, of course, in cases where grinding of the teeth is practicable. The medium and high-carbon percentages require an oil quench, but a water quench may be necessary for the lower carbon contents, in order to obtain the highest physical properties and hardness. The distortion, however, will be greater with the water quench.

Heat-Treatment that Permits Machining.—When the grinding of gear teeth is not practicable and a high degree of accuracy is required, hardened steels may be drawn or tem-

pered to a hardness that will permit the cutting of the teeth. This treatment gives a highly refined structure, great toughness, and, in spite of the low hardness, excellent wearing qualities. The lower strength is somewhat compensated for by the elimination of the increment loads due to the impacts which are caused by inaccuracies. When steels that have a low degree of hardness penetration from surface to core are treated in this manner, the design cannot be based on the physical properties corresponding to the hardness at the surface. Since the physical properties are determined by the hardness, the drop in hardness from surface to core will give lower physical properties at the root of the tooth, where the stress is greatest. The quenching medium may be either oil, water, or brine, depending on the steel used and hardness penetration desired. The amount of distortion, of course, is immaterial, because the machining is done after heat-treating.

Making Pinion Harder than Gear to Equalize Wear.—Beneficial results from a wear standpoint are obtained by making the pinion harder than the gear. The pinion, having a lesser number of teeth than the gear, naturally does more work per tooth, and the differential in hardness between the pinion and the gear (the amount being dependent on the ratio) serves to equalize the rate of wear. The harder pinion teeth correct the errors in the gear teeth to some extent by the initial wear and then seem to burnish the teeth of the gear and increase its ability to withstand wear by the greater hardness due to the cold-working of the surface. In applications where the gear ratio is high and there are no severe shock loads, a casehardened pinion running with an oil-treated gear, treated to a Brinell hardness at which the teeth may be cut after treating, is an excellent combination. The pinion, being relatively small, is distorted but little, and distortion in the gear is circumvented by cutting the teeth after treatment.

Forged and Rolled Carbon Steels for Gears.—These compositions cover steel for gears in three groups, according to heat treatment, as follows:

- a) case-hardened gears
- b) unhardened gears, not heat treated after machining
- c) hardened and tempered gears

Forged and rolled carbon gear steels are purchased on the basis of the requirements as to chemical composition specified in [Table 1](#). Class N steel will normally be ordered in ten point carbon ranges within these limits. Requirements as to physical properties have been omitted, but when they are called for the requirements as to carbon shall be omitted. The steels may be made by either or both the open hearth and electric furnace processes.

Table 1. Compositions of Forged and Rolled Carbon Steels for Gears

Heat Treatment	Class	Carbon	Manganese	Phosphorus	Sulfur
Case-hardened	C	0.15-0.25	0.40-0.70	0.045 max	0.055 max
Untreated	N	0.25-0.50	0.50-0.80	0.045 max	0.055 max
Hardened (or untreated)	H	0.40-0.50	0.40-0.70	0.045 max	0.055 max

Forged and Rolled Alloy Steels for Gears.—These compositions cover alloy steel for gears, in two classes according to heat treatment, as follows:

- a) casehardened gears
- b) hardened and tempered gears

Forged and rolled alloy gear steels are purchased on the basis of the requirements as to chemical composition specified in [Table 2](#). Requirements as to physical properties have been omitted. The steel shall be made by either or both the open hearth and electric furnace process.

Table 2. Compositions of Forged and Rolled Alloy Steels for Gears

Steel Specification	Chemical Composition ^a					
	C	Mn	Si	Ni	Cr	Mo
AISI 4130	0.28-0.30	0.40-0.60	0.20-0.35	...	0.80-1.1	0.15-0.25
AISI 4140	0.38-0.43	0.75-1.0	0.20-0.35	...	0.80-1.1	0.15-0.25
AISI 4340	0.38-0.43	0.60-0.80	0.20-0.35	1.65-2.0	0.70-90	0.20-0.30
AISI 4615	0.13-0.18	0.45-0.65	0.20-0.35	1.65-2.0	...	0.20-0.30
AISI 4620	0.17-0.22	0.45-0.65	0.20-0.35	1.65-2.0	...	0.20-0.30
AISI 8615	0.13-0.18	0.70-0.90	0.20-0.35	0.40-0.70	0.40-0.60	0.15-0.25
AISI 8620	0.18-0.23	0.70-0.90	0.20-0.35	0.40-0.70	0.40-0.60	0.15-0.25
AISI 9310	0.08-0.13	0.45-0.65	0.20-0.35	3.0-3.5	1.0-1.4	0.08-0.15
Nitralloy						
Type N ^b	0.20-0.27	0.40-0.70	0.20-0.40	3.2-3.8	1.0-1.3	0.20-0.30
135 Mod. ^b	0.38-0.45	0.40-0.70	0.20-0.40	...	1.4-1.8	0.30-0.45

^a C = carbon; Mn = manganese; Si = silicon; Ni = nickel; Cr = chromium, and Mo = molybdenum.

^b Both Nitralloy alloys contain aluminum 0.85-1.2%

Steel Castings for Gears.—It is recommended that steel castings for cut gears be purchased on the basis of chemical analysis and that only two types of analysis be used, one for case-hardened gears and the other for both untreated gears and those which are to be hardened and tempered. The steel is to be made by the open hearth, crucible, or electric furnace processes. The converter process is not recognized. Sufficient risers must be provided to secure soundness and freedom from undue segregation. Risers should not be broken off the unannealed castings by force. Where risers are cut off with a torch, the cut should be at least one-half inch above the surface of the castings, and the remaining metal removed by chipping, grinding, or other noninjurious method.

Steel for use in gears should conform to the requirements for chemical composition indicated in **Table 3**. All steel castings for gears must be thoroughly normalized or annealed, using such temperature and time as will entirely eliminate the characteristic structure of unannealed castings.

Table 3. Compositions of Cast Steels for Gears

Steel Specification	Chemical Composition ^a			
	C	Mn	Si	
SAE-0022	0.12-0.22	0.50-0.90	0.60 Max.	May be carburized
SAE-0050	0.40-0.50	0.50-0.90	0.80 Max.	Hardenable 210-250

^a C = carbon; Mn = manganese; and Si = silicon.

Effect of Alloying Metals on Gear Steels.—The effect of the various alloying elements on steel are here summarized to assist in deciding on the particular kind of alloy steel to use for specific purposes. The characteristics outlined apply only to heat-treated steels. When the effect of the addition of an alloying element is stated, it is understood that reference is made to alloy steels of a given carbon content, compared with a plain carbon steel of the same carbon content.

Nickel: The addition of nickel tends to increase the hardness and strength, with but little sacrifice of ductility. The hardness penetration is somewhat greater than that of plain carbon steels. Use of nickel as an alloying element lowers the critical points and produces less distortion, due to the lower quenching temperature. The nickel steels of the case-hardening group carburize more slowly, but the grain growth is less.

Chromium: Chromium increases the hardness and strength over that obtained by the use of nickel, though the loss of ductility is greater. Chromium refines the grain and imparts a

greater depth of hardness. Chromium steels have a high degree of wear resistance and are easily machined in spite of the fine grain.

Manganese: When present in sufficient amounts to warrant the use of the term alloy, the addition of manganese is very effective. It gives greater strength than nickel and a higher degree of toughness than chromium. Owing to its susceptibility to cold-working, it is likely to flow under severe unit pressures. Up to the present time, it has never been used to any great extent for heat-treated gears, but is now receiving an increasing amount of attention.

Vanadium: Vanadium has a similar effect to that of manganese—increasing the hardness, strength, and toughness. The loss of ductility is somewhat more than that due to manganese, but the hardness penetration is greater than for any of the other alloying elements. Owing to the extremely fine-grained structure, the impact strength is high; but vanadium tends to make machining difficult.

Molybdenum: Molybdenum has the property of increasing the strength without affecting the ductility. For the same hardness, steels containing molybdenum are more ductile than any other alloy steels, and having nearly the same strength, are tougher; in spite of the increased toughness, the presence of molybdenum does not make machining more difficult. In fact, such steels can be machined at a higher hardness than any of the other alloy steels. The impact strength is nearly as great as that of the vanadium steels.

Chrome-Nickel Steels: The combination of the two alloying elements chromium and nickel adds the beneficial qualities of both. The high degree of ductility present in nickel steels is complemented by the high strength, finer grain size, deep hardening, and wear-resistant properties imparted by the addition of chromium. The increased toughness makes these steels more difficult to machine than the plain carbon steels, and they are more difficult to heat treat. The distortion increases with the amount of chromium and nickel.

Chrome-Vanadium Steels: Chrome-vanadium steels have practically the same tensile properties as the chrome-nickel steels, but the hardening power, impact strength, and wear resistance are increased by the finer grain size. They are difficult to machine and become distorted more easily than the other alloy steels.

Chrome-Molybdenum Steels: This group has the same qualities as the straight molybdenum steels, but the hardening depth and wear resistance are increased by the addition of chromium. This steel is very easily heat treated and machined.

Nickel-Molybdenum Steels: Nickel-molybdenum steels have qualities similar to chrome-molybdenum steel. The toughness is said to be greater, but the steel is somewhat more difficult to machine.

Sintered Materials.—For high production of low and moderately loaded gears, significant production cost savings may be effected by the use of a sintered metal powder. With this material, the gear is formed in a die under high pressure and then sintered in a furnace. The primary cost saving comes from the great reduction in labor cost of machining the gear teeth and other gear blank surfaces. The volume of production must be high enough to amortize the cost of the die and the gear blank must be of such a configuration that it may be formed and readily ejected from the die.

Bronze and Brass Gear Castings.—These specifications cover nonferrous metals for spur, bevel, and worm gears, bushings and flanges for composition gears. This material shall be purchased on the basis of chemical composition. The alloys may be made by any approved method.

Spur and Bevel Gears: For spur and bevel gears, hard cast bronze is recommended (ASTM B-10-18; SAE No. 62; and the well-known 88-10-2 mixture) with the following limits as to composition: Copper, 86 to 89; tin, 9 to 11; zinc, 1 to 3; lead (max), 0.20; iron (max), 0.06 per cent. Good castings made from this bronze should have the following minimum physical characteristics: Ultimate strength, 30,000 pounds per square inch; yield point, 15,000 pounds per square inch; elongation in 2 inches, 14 per cent.

Steels for Industrial Gearing

Material Specification	Hardness		Typical Heat Treatment, Characteristics, and Uses
	Case Rc	Core Bhn	
Case-Hardening Steels			
AISI 1020 AISI 1116	55-60	160-230	Carburize, harden, temper at 350°F. For gears that must be wear-resistant. Normalized material is easily machined. Core is ductile but has little strength.
AISI 4130 AISI 4140	50-55	270-370	Harden, temper at 900°F, Nitride. For parts requiring greater wear resistance than that of through-hardened steels but cannot tolerate the distortion of carburizing. Case is shallow, core is tough.
AISI 4615 AISI 4620	} 55-60	170-260	Carburize, harden, temper at 350°F. For gears requiring high fatigue resistance and strength. The 86xx series has better machinability. The 20 point steels are used for coarser teeth.
AISI 8615 AISI 8620	} 55-60	200-300	
AISI 9310	58-63	250-350	Carburize, harden, temper at 300°F. Primarily for aerospace gears that are highly loaded and operate at high pitch line velocity and for other gears requiring high reliability under extreme operating conditions. This material is not used at high temperatures.
Nitalloy N and Type 135 Mod. (15-N)	90-94	300-370	Harden, temper at 1200°F, Nitride. For gears requiring high strength and wear resistance that cannot tolerate the distortion of the carburizing process or that operate at high temperatures. Gear teeth are usually finished before nitriding. Care must be exercised in running nitrided gears together to avoid crazing of case-hardened surfaces.
Through-Hardening Steels			
AISI 1045 AISI 1140	24-40	...	Harden and temper to required hardness. Oil quench for lower hardness and water quench for higher hardness. For gears of medium and large size requiring moderate strength and wear resistance. Gears that must have consistent, solid sections to withstand quenching.
AISI 4140 AISI 4340	24-40	...	Harden (oil quench), temper to required hardness. For gears requiring high strength and wear resistance, and high shock loading resistance. Use 41xx series for moderate sections and 43xx series for heavy sections. Gears must have consistent, solid sections to withstand quenching.

Worm Gears: For bronze worm gears, two alternative analyses of phosphor bronze are recommended, SAE No. 65 and No. 63.

SAE No. 65 (called phosphor gear bronze) has the following composition: Copper, 88 to 90; tin, 10 to 12; phosphorus, 0.1 to 0.3; lead, zinc, and impurities (max) 0.5 per cent.

Good castings made of this alloy should have the following minimum physical characteristics: Ultimate strength, 35,000 pounds per square inch; yield point, 20,000 pounds per square inch; elongation in 2 inches, 10 per cent.

The composition of SAE No. 63 (called leaded gun metal) follows: copper, 86 to 89; tin, 9 to 11; lead, 1 to 2.5; phosphorus (max), 0.25; zinc and impurities (max), 0.50 per cent.

Good castings made of this alloy should have the following minimum physical characteristics: Ultimate strength, 30,000 pounds per square inch; yield point, 12,000 pounds per square inch; elongation in 2 inches, 10 per cent.

These alloys, especially No. 65, are adapted to chilling for hardness and refinement of grain. No. 65 is to be preferred for use with worms of great hardness and fine accuracy. No. 63 is to be preferred for use with unhardened worms.

Gear Bushings: For bronze bushings for gears, SAE No. 64 is recommended of the following analysis: copper, 78.5 to 81.5; tin, 9 to 11; lead, 9 to 11; phosphorus, 0.05 to 0.25; zinc (max), 0.75; other impurities (max), 0.25 per cent. Good castings of this alloy should have the following minimum physical characteristics: Ultimate strength, 25,000 pounds per square inch; yield point, 12,000 pounds per square inch; elongation in 2 inches, 8 per cent.

Flanges for Composition Pinions: For brass flanges for composition pinions ASTM B-30-32T, and SAE No. 40 are recommended. This is a good cast red brass of sufficient strength and hardness to take its share of load and wear when the design is such that the flanges mesh with the mating gear. The composition is as follows: copper, 83 to 86; tin, 4.5 to 5.5; lead, 4.5 to 5.5; zinc, 4.5 to 5.5; iron (max) 0.35; antimony (max), 0.25 per cent; aluminum, none. Good castings made from this alloy should have the following minimum physical characteristics: ultimate strength, 27,000 pounds per square inch; yield point, 12,000 pounds per square inch; elongation in 2 inches, 16 per cent.

Materials for Worm Gearing.—The Hamilton Gear & Machine Co. conducted an extensive series of tests on a variety of materials that might be used for worm gears, to ascertain which material is the most suitable. According to these tests chill-cast nickel-phosphor-bronze ranks first in resistance to wear and deformation. This bronze is composed of approximately 87.5 per cent copper, 11 per cent tin, 1.5 per cent nickel, with from 0.1 to 0.2 per cent phosphorus. The worms used in these tests were made from SAE-2315, 3½ per cent nickel steel, case-hardened, ground, and polished. The Shore scleroscope hardness of the worms was between 80 and 90. This nickel alloy steel was adopted after numerous tests of a variety of steels, because it provided the necessary strength, together with the degree of hardness required.

The material that showed up second best in these tests was a No. 65 SAE bronze. Navy bronze (88-10-2) containing 2 per cent zinc, with no phosphorus, and not chilled, performed satisfactorily at speeds of 600 revolutions per minute, but was not sufficiently strong at lower speeds. Red brass (85-5-5) proved slightly better at from 1500 to 1800 revolutions per minute, but would bend at lower speeds, before it would show actual wear.

Non-metallic Gearing.—Non-metallic or composition gearing is used primarily where quietness of operation at high speed is the first consideration. Non-metallic materials are also applied very generally to timing gears and numerous other classes of gearing. Rawhide was used originally for non-metallic gears, but other materials have been introduced that have important advantages. These later materials are sold by different firms under various trade names, such as Micarta, Textolite, Formica, Dilecto, Spauldite, Phenolite, Fibroc, Fabroil, Synthane, Celoron, etc. Most of these gear materials consist of layers of canvas or other material that is impregnated with plastics and forced together under hydraulic pressure, which, in conjunction with the application of heat, forms a dense rigid mass.

Although phenol resin gears in general are resilient, they are self-supporting and require no side plates or shrouds unless subjected to a heavy starting torque. The phenol resinoid element protects these gears from vermin and rodents.

The non-metallic gear materials referred to are generally assumed to have the power-transmitting capacity of cast iron. Although the tensile strength may be considerably less than that of cast iron, the resiliency of these materials enables them to withstand impact and

abrasion to a degree that might result in excessive wear of cast-iron teeth. Thus, composition gearing of impregnated canvas has often proved to be more durable than cast iron.

Application of Non-metallic Gears.—The most effective field of use for these non-metallic materials is for high-speed duty. At low speeds, when the starting torque may be high, or when the load may fluctuate widely, or when high shock loads may be encountered, these non-metallic materials do not always prove satisfactory. In general, non-metallic materials should not be used for pitch-line velocities below 600 feet per minute (3.05 m/s).

Tooth Form: The best tooth form for non-metallic materials is the 20-degree stub-tooth system. When only a single pair of gears is involved and the center distance can be varied, the best results will be obtained by making the non-metallic driving pinion of all-addendum form, and the driven metal gear with standard tooth proportions. Such a drive will carry from 50 to 75 per cent greater loads than one of standard tooth proportions.

Material for Mating Gear: For durability under load, the use of hardened steel (over 400 Brinell) for the mating metal gear appears to give the best results. A good second choice for the material of the mating member is cast iron. The use of brass, bronze, or soft steel (under 400 Brinell) as a material for the mating member of phenolic laminated gears leads to excessive abrasive wear.

Power-Transmitting Capacity of Non-metallic Gears.—The characteristics of gears made of phenolic laminated materials are so different from those of metal gears that they should be considered in a class by themselves. Because of the low modulus of elasticity, most of the effects of small errors in tooth form and spacing are absorbed at the tooth surfaces by the elastic deformation, and have but little effect on the strength of the gears.

If S = safe working stress for a given velocity lb/in² (MPa)

S_s = allowable static stress lb/in² (MPa)

V = pitch-line velocity in feet per minute (meter/s)

then, the recommended practice of the American Gear Manufacturers' Association,

$$S = S_s \times \left(\frac{150}{200 + V} + 0.25 \right) \text{ US Units} \quad S = S_s \times \left(\frac{0.76}{1.016 + V} + 0.25 \right) \text{ SI Units}$$

The value of S_s for phenolic laminated materials is given as 6000 lb/in² (41.36 MPa). The accompanying table gives the safe working stresses S for different pitch-line velocities. When the value of S is known, the horsepower capacity is determined by substituting the value of S for S_s in the appropriate equations in the section on power-transmitting capacity of plastics gears starting on page 604.

Safe Working Stresses for Non-metallic Gears

Pitch-Line Velocity, V		Safe Working Stress, S		Pitch-Line Velocity, V		Safe Working Stress, S		Pitch-Line Velocity, V		Safe Working Stress, S	
fpm	m/s	lb/in ²	MPa	fpm	m/s	lb/in ²	MPa	fpm	m/s	lb/in ²	MPa
600	3.05	2625	18.10	1800	9.14	1950	13.44	4000	20.32	1714	11.82
700	3.56	2500	17.24	2000	10.16	1909	13.16	4500	22.86	1691	11.66
800	4.06	2400	16.54	2200	11.18	1875	12.93	5000	25.40	1673	11.53
900	4.57	2318	15.98	2400	12.19	1846	12.73	5500	27.94	1653	11.40
1000	5.08	2250	15.51	2600	13.20	1821	12.56	6000	30.48	1645	11.34
1200	6.10	2143	14.78	2800	14.22	1800	12.41	6500	33.02	1634	11.27
1400	7.11	2063	14.22	3000	15.24	1781	12.28	7000	35.56	1622	11.18
1600	8.13	2000	13.79	3500	17.78	1743	12.02	7500	38.10	1617	11.15

The tensile strength of the phenolic laminated materials used for gears is slightly less than that of cast iron. These materials are far softer than any metal, and the modulus of elas-

ticity is about one-thirtieth that of steel. In other words, if the tooth load on a steel gear that causes a deformation of 0.001 inch (0.025 mm) were applied to the tooth of a similar gear made of phenolic laminated material, the tooth of the non-metallic gear would be deformed about $\frac{1}{32}$ inch (0.794 mm). Under these conditions, several things will happen. With all gears, regardless of the theoretical duration of contact, one tooth only will carry the load until the load is sufficient to deform the tooth the amount of the error that may be present. On metal gears, when the tooth has been deformed the amount of the error, the stresses set up in the materials may approach or exceed the elastic limit of the material. Hence, for standard tooth forms and those generated from standard basic racks, it is dangerous to calculate their strength as very much greater than that which can safely be carried on a single tooth. On gears made of phenolic laminated materials, on the other hand, the teeth will be deformed the amount of this normal error without setting up any appreciable stresses in the material, so that the load is actually supported by several teeth.

All materials have their own peculiar and distinct characteristics, so that under certain specific conditions, each material has a field of its own where it is superior to any other. Such fields may overlap to some extent, and only in such overlapping fields are different materials directly competitive. For example, steel is more or less ductile, has a high tensile strength, and a high modulus of elasticity. Cast iron, on the other hand, is not ductile, has a low tensile strength, but a high compressive strength, and a low modulus of elasticity. Hence, when stiffness and high tensile strength are essential, steel is far superior to cast iron. On the other hand, when these two characteristics are unimportant, but high compressive strength and a moderate amount of elasticity are essential, cast iron is superior to steel.

Preferred Pitch for Non-metallic Gears.—The pitch of the gear or pinion should bear a reasonable relation either to the power or speed or to the applied torque, as shown by the accompanying table. The upper half of this table is based upon horsepower (kw) transmitted at a given pitch-line velocity. The lower half gives the torque in pounds-feet (N-m) or the torque at a 1-foot (meter) radius. This torque T for any given horsepower (kw) and speed can be obtained from the following formulas:

$$T = \frac{5252 \times hp}{rpm} \text{ pound-feet} \quad T = \frac{9550 \times kw}{rpm} \text{ N-m}$$

Bore Sizes for Non-metallic Gears.—For plain phenolic laminated pinions, that is, pinions without metal end plates, a drive fit of 0.001 inch per inch (or mm/mm) of shaft diameter should be used. For shafts above 2.5 inches (63.5 mm) in diameter, the fit should be constant at 0.0025 to 0.003 inch (0.064–0.076 mm). When metal reinforcing end plates are used, the drive fit should conform to the same standards as used for metal.

The root diameter of a pinion of phenolic laminated type should be such that the minimum distance from the edge of the keyway to the root diameter will be at least equal to the depth of tooth.

Keyway Stresses for Non-metallic Gears.—The keyway stress should not exceed 3000 psi (20.68 MPa) on a plain phenolic laminated gear or pinion. The keyway stress is calculated by the formulas:

$$S = \frac{33,000 \times hp}{V \times A} \text{ psi} \quad S = \frac{1,000 \times kw}{V \times A} \text{ MPa}$$

where S = unit stress in pounds per square inch (newton per square meter)

hp = horsepower transmitted

kw = kilowatt power transmitted

V = peripheral speed of shaft in feet per minute (meter/sec)

A = square inch (square meter) area of keyway in pinion (length \times height)

If the keyway stress formula is expressed in terms of shaft radius r (inch or meter) and revolutions per minute, it will read:

Preferred Pitches for Non-metallic Gears
Applicable both to rawhide and the phenolic laminated types of materials

Diametral Pitch for Given Horsepower and Pitch Line Velocities					
Horsepower Transmitted	Pitch Line Velocity up to 1000 Feet per Minute	Pitch Line Velocity from 1000 to 2000 Feet per Minute	Pitch Line Velocity over 2000 Feet per Minute		
¼-1	8-10	10-12	12-16		
1-2	7-8	8-10	10-12		
2-3	6-7	7-8	8-10		
3-7½	5-6	6-7	7-8		
7½-10	4-5	5-6	6-7		
10-15	3-4	4-5	5-6		
15-25	2½-3	3-4	4-5		
25-60	2-2½	2½-3	3-4		
60-100	1¾-2	2-2½	2½-3		
100-150	1½-1¾	1¾-2	2-2½		

Torque in Pounds-feet for Given Diametral Pitch					
Diametral Pitch	Torque in Pounds-feet		Diametral Pitch	Torque in Pounds-feet	
	Minimum	Maximum		Minimum	Maximum
16	1	2	4	50	100
12	2	4	3	100	200
10	4	8	2½	200	450
8	8	15	2	450	900
6	15	30	1½	900	1800
5	30	50	1	1800	3500

$$S = \frac{63,000 \times \text{hp}}{\text{rpm} \times r \times A} \text{ psi} \qquad S = \frac{9550 \times \text{kw}}{\text{rpm} \times r \times A} \text{ N-m}$$

When the design is such that the keyway stresses exceed 3000 psi (20.68 MPa), metal reinforcing end plates may be used. Such end plates should not extend beyond the root diameter of the teeth. The distance from the outer edge of the retaining bolt to the root diameter of the teeth shall not be less than a full tooth depth. The use of drive keys should be avoided, but if required, metal end plates should be used on the pinion to take the wedging action of the key.

For phenolic laminated pinions, the face of the mating gear should be the same or slightly greater than the pinion face.

Invention of Gear Teeth.—The invention of gear teeth represents a gradual evolution from gearing of primitive form. The earliest evidence we have of an investigation of the problem of *uniform motion* from toothed gearing and the successful solution of that problem dates from the time of Olaf Roemer, the celebrated Danish astronomer, who, in the year 1674, proposed the epicycloidal form to obtain uniform motion. Evidently Robert Willis, professor at the University of Cambridge, was the first to make a practical application of the epicycloidal curve so as to provide for an interchangeable series of gears. Willis gives credit to Camus for conceiving the idea of interchangeable gears, but claims for himself its first application. The involute tooth was suggested as a theory by early scientists and mathematicians, but it remained for Willis to present it in a practical form. Perhaps the earliest conception of the application of this form of teeth to gears was by Philippe de Lahire, a Frenchman, who considered it, in theory, equally suitable with the epicycloidal

for tooth outlines. This was about 1695 and not long after Roemer had first demonstrated the epicycloidal form. The applicability of the involute had been further elucidated by Leonard Euler, a Swiss mathematician, born at Basel, 1707, who is credited by Willis with being the first to suggest it. Willis devised the Willis odontograph for laying out involute teeth.

A pressure angle of $14\frac{1}{2}$ degrees was selected for three different reasons. First, because the sine of $14\frac{1}{2}$ degrees is nearly $\frac{1}{4}$, making it convenient in calculation; second, because this angle coincided closely with the pressure angle resulting from the usual construction of epicycloidal gear teeth; third, because the angle of the straight-sided involute rack is the same as the 29-degree worm thread.

Calculating Replacement-Gear Dimensions from Simple Measurements.—The following Tables 1a, 1b, and 1c, provide formulas with which to calculate the dimensions needed to produce replacement spur, bevel, and helical gears when only the number of teeth, the outside diameter, and the tooth depth of the gear to be replaced are known.

For helical gears, exact helix angles can be obtained by the following procedure.

1) Using a common protractor, measure the approximate helix angle *A* at the approximate pitch line.

2) Place sample or its mating gear on the arbor of a gear hobbing machine.

3) Calculate the index and lead gears differentially for the angle obtained by the measurements, and set up the machine as though a gear is to be cut.

4) Attach a dial indicator on an adjustable arm to the vertical swivel head, with the indicator plunger in a plane perpendicular to the gear axis and in contact with the tooth face. Contact may be anywhere between the top and the root of the tooth.

5) With the power shut off, engage the starting lever and traverse the indicator plunger axially by means of the handwheel.

6) If angle *A* is correct, the indicator plunger will not move as it traverses the face width of the gear. If it does move from 0, note the amount. Divide the amount of movement by the width of the gear to obtain the tangent of the angle by which to correct angle *A*, plus or minus, depending on the direction of indicator movement.

Table 1a. Formulas for Calculating Spur Gear Dimensions

Tooth Form and Pressure Angle	Diametral Pitch <i>P</i>	Pitch Diameter <i>D</i>	Circular Pitch <i>P_c</i>	Outside Diameter <i>O</i>	Addendum <i>J</i>	Dedendum <i>K</i>	Whole Tooth Depth <i>W</i>	Clearance <i>K - J</i>	Tooth Thickness on Pitch Circle
American Standard $14\frac{1}{2}$ - and 20-degree full depth	$\frac{N + 2}{O}$	$\frac{N}{P}$	$\frac{3.1416}{P}$	$\frac{N + 2}{P}$	$\frac{1}{P}$	$\frac{1.157}{P}$	$\frac{2.157}{P}$	$\frac{0.157}{P}$	$\frac{1.5708}{P}$
American Standard 20-degree stub	$\frac{N + 1.6}{O}$	$\frac{N}{P}$	$\frac{3.1416}{P}$	$\frac{N + 1.6}{P}$	$\frac{0.8}{P}$	$\frac{1}{P}$	$\frac{1.8}{P}$	$\frac{0.2}{P}$	$\frac{1.5708}{P}$
Fellows 20-degree stub	See Note ^a	$\frac{N}{P_N}$	$\frac{3.1416}{P_N}$	$\frac{N}{P_N} + \frac{2}{P_D}$	$\frac{1}{P_D}$	$\frac{1.25}{P_D}$	$\frac{2.25}{P_D}$	$\frac{0.25}{P_D}$	$\frac{1.5708}{P_N}$

^a In the Fellows stub-tooth system, *P_N* = diametral pitch in numerator of stub-tooth designation and is used to determine circular pitch and number of teeth, and *P_D* = diametral pitch in the denominator of stub-tooth designation and is used to determine tooth depth.

N = number of teeth.

Table 1b. Formulas for Calculating Dimensions of Milled Bevel Gears — 90 degree Shafts^a

Tooth Form and Pressure Angle	Tangent of Pitch Cone Angle of Gear, $\tan A$	Tangent of Pitch Cone Angle of Pinion, $\tan a$	Diametral Pitch ^b of Both Gear and Pinion, P	Outside Diameter of Gear, O , or Pinion, o	Pitch-Cone Radius ^b or Cone Distance, E	Tangent of Addendum Angle ^b	Tangent of Dedendum Angle ^b	Cosine of Pitch-Cone Angle ^c of Gear, $\cos A$
American Standard 14½- and 20-degree full depth	$\frac{N_G}{N_P}$	$\frac{N_P}{N_G}$	$\frac{N_G + 2 \cos A}{O}$ or $\frac{N_P + 2 \cos a}{o}$	$\frac{N_G + 2 \cos A}{P}$ or $\frac{N_P + 2 \cos a}{P}$	$\frac{D}{2 \sin A}$ or $\frac{d}{2 \sin a}$	$\frac{2 \sin A}{N_a}$ or $\frac{2 \sin a}{N_p}$	$\frac{2.314 \sin A}{N_G}$ or $\frac{2.314 \sin a}{N_P}$	$\frac{(P \times O) - N_G}{2}$
American Standard 20-degree stub	$\frac{N_G}{N_P}$	$\frac{N_P}{N_G}$	$\frac{N_G + 1.6 \cos A}{O}$ or $\frac{N_P + 1.6 \cos a}{o}$	$\frac{N_G + 1.6 \cos A}{P}$ or $\frac{N_P + 1.6 \cos a}{P}$	$\frac{D}{2 \sin A}$ or $\frac{d}{2 \sin a}$	$\frac{1.6 \sin A}{N_G}$ or $\frac{1.6 \sin a}{N_P}$	$\frac{2 \sin A}{N_G}$ or $\frac{2 \sin a}{N_P}$	$\frac{(P \times O) - N_G}{1.6}$
Fellows 20-degree stub	$\frac{N_G}{N_P}$	$\frac{N_P}{N_G}$...	$\frac{N_G}{P_N} + \frac{2 \cos A}{P_D}$ or $\frac{N_P}{P_N} + \frac{2 \cos a}{P_D}$	$\frac{D}{2 \sin A}$ or $\frac{d}{2 \sin a}$	$\frac{2 P_N \sin A}{N_G \times P_D}$ or $\frac{2 P_N \sin a}{N_P \times P_D}$	$\frac{2.5 P_N \sin A}{N_G \times P_D}$ or $\frac{2.5 P_N \sin a}{N_P \times P_D}$	$\frac{P_D [(O \times P_N) - N_G]}{2 P_N}$

^aThese formulas do not apply to Gleason System Gearing.

^bThese values are the same for both gear and pinion.

^cThe same formulas apply to the pinion, substituting N_P for N_G and o for O .

N_G = number of teeth in gear; N_P = number of teeth in pinion; O = outside diameter of gear; o = outside diameter of pinion; D = pitch diameter of gear = $N_G \div P$; d = pitch diameter of pinion = $N_P \div P$; P_c = circular pitch; J = addendum; K = dedendum; W = whole depth.

See footnote in **Table 1a** for meaning of P_N and P_D . The tooth thickness on the pitch circle is found by means of the formulas in the last column under spur gears.

Table 1c. Formulas for Calculating Dimensions of Helical Gears

Tooth Form and Pressure Angle	Normal Diametral Pitch P_N	Diametral Pitch P	Outside Diameter of Blank O	Pitch Diameter D	Cosine of Helix Angle A	Addendum	Dedendum	Whole Depth
American Standard 14½- and 20-degree full depth	$\frac{N + 2 \cos A}{O \times \cos A}$ or $\frac{P}{\cos A}$	$P_N \cos A$ or $\frac{N + 2 \cos A}{O}$	$\frac{N + 2 \cos A}{P_N \cos A}$ or $\frac{N + 2 \cos A}{P}$	$\frac{N}{P_N \cos A}$ or $\frac{N}{P}$	$\frac{P}{P_N}$ or $\frac{N}{O \times P_N - 2}$	$\frac{1}{P_N}$ or $\frac{\cos A}{P}$	$\frac{1.157}{P_N}$ or $\frac{1.157 \cos A}{P}$	$\frac{2.157}{P_N}$ or $\frac{2.157 \cos A}{P}$
American Standard 20-degree stub	$\frac{N + 1.6 \cos A}{O \times \cos A}$ or $\frac{P}{\cos A}$	$P_n \cos A$ or $\frac{N + 1.6 \cos A}{O}$	$\frac{N + 1.6 \cos A}{P_N \cos A}$ or $\frac{N + 1.6 \cos A}{P}$	$\frac{N}{P_N \cos A}$ or $\frac{N}{P}$	$\frac{P}{P_N}$ or $\frac{N}{O \times P_N - 1.6}$	$\frac{0.8}{P_N}$ or $\frac{0.8 \cos A}{P}$	$\frac{1}{P_N}$ or $\frac{\cos A}{P}$	$\frac{1.8}{P_N}$ or $\frac{1.8 \cos A}{P}$
Fellows 20-degree stub	$\frac{N}{(P_N)_N \cos A} + \frac{2}{(P_N)_D}$	$\frac{N}{(P_N)_N \cos A}$	$\frac{N}{(P_N)_N \left(O - \frac{2}{(P_N)_D} \right)}$	$\frac{1}{(P_N)_D}$	$\frac{1.25}{(P_N)_D}$	$\frac{2.25}{(P_N)_D}$

P_N = normal diametral pitch = normal diametral pitch of cutter or hob used to cut teeth

P = diametral pitch

O = outside diameter of blank

D = pitch diameter

A = helix angle

N = number of teeth

$(P_N)_N$ = normal diametral pitch in numerator of stub-tooth designation, which determines thickness of tooth and number of teeth

$(P_N)_D$ = normal diametral pitch in denominator of stub-tooth designation, which determines the addendum, dedendum, and whole depth

SPLINES AND SERRATIONS

A splined shaft is one having a series of parallel keys formed integrally with the shaft and mating with corresponding grooves cut in a hub or fitting; this arrangement is in contrast to a shaft having a series of keys or feathers fitted into slots cut into the shaft. The latter construction weakens the shaft to a considerable degree because of the slots cut into it and consequently, reduces its torque-transmitting capacity.

Splined shafts are most generally used in three types of applications: 1) for coupling shafts when relatively heavy torques are to be transmitted without slippage; 2) for transmitting power to slidably-mounted or permanently-fixed gears, pulleys, and other rotating members; and 3) for attaching parts that may require removal for indexing or change in angular position.

Splines having straight-sided teeth have been used in many applications (see SAE Parallel Side Splines for Soft Broached Holes in Fittings); however, the use of splines with teeth of involute profile has steadily increased since 1) involute spline couplings have greater torque-transmitting capacity than any other type; 2) they can be produced by the same techniques and equipment as is used to cut gears; and 3) they have a self-centering action under load even when there is backlash between mating members.

Involute Splines

American National Standard Involute Splines*.—These splines or multiple keys are similar in form to internal and external involute gears. The general practice is to form the external splines either by hobbing, rolling, or on a gear shaper, and internal splines either by broaching or on a gear shaper. The internal spline is held to basic dimensions and the external spline is varied to control the fit. Involute splines have maximum strength at the base, can be accurately spaced and are self-centering, thus equalizing the bearing and stresses, and they can be measured and fitted accurately.

In American National Standard ANSI B92.1-1970 (R 1993), many features of the 1960 standard are retained; plus the addition of three tolerance classes, for a total of four. The term “involute serration,” formerly applied to involute splines with 45-degree pressure angle, has been deleted and the standard now includes involute splines with 30-, 37.5-, and 45-degree pressure angles. Tables for these splines have been rearranged accordingly. The term “serration” will no longer apply to splines covered by this Standard.

The Standard has only one fit class for all side fit splines; the former Class 2 fit. Class 1 fit has been deleted because of its infrequent use. The major diameter of the flat root side fit spline has been changed and a tolerance applied to include the range of the 1950 and the 1960 standards. The interchangeability limitations with splines made to previous standards are given later in the section entitled “Interchangeability.”

There have been no tolerance nor fit changes to the major diameter fit section.

The Standard recognizes the fact that proper assembly between mating splines is dependent only on the spline being within effective specifications from the tip of the tooth to the form diameter. Therefore, on side fit splines, the internal spline major diameter now is shown as a maximum dimension and the external spline minor diameter is shown as a minimum dimension. The minimum internal major diameter and the maximum external minor diameter must clear the specified form diameter and thus do not need any additional control.

The spline specification tables now include a greater number of tolerance level selections. These tolerance classes were added for greater selection to suit end product needs. The selections differ only in the tolerance as applied to space width and tooth thickness.

* See American National Standard ANSI B92.2M-1980 (R1989), Metric Module Involute Splines; also see page 2272.

The tolerance class used in ASA B5.15-1960 is the basis and is now designated as tolerance Class 5. The new tolerance classes are based on the following formulas:

$$\text{Tolerance Class 4} = \text{Tolerance Class 5} \times 0.71$$

$$\text{Tolerance Class 6} = \text{Tolerance Class 5} \times 1.40$$

$$\text{Tolerance Class 7} = \text{Tolerance Class 5} \times 2.00$$

All dimensions listed in this standard are for the finished part. Therefore, any compensation that must be made for operations that take place during processing, such as heat treatment, must be taken into account when selecting the tolerance level for manufacturing.

The standard has the same internal minimum effective space width and external maximum effective tooth thickness for all tolerance classes and has two types of fit. For tooth side fits, the minimum effective space width and the maximum effective tooth thickness are of equal value. This basic concept makes it possible to have interchangeable assembly between mating splines where they are made to this standard regardless of the tolerance class of the individual members. A tolerance class “mix” of mating members is thus allowed, which often is an advantage where one member is considerably less difficult to produce than its mate, and the “average” tolerance applied to the two units is such that it satisfies the design need. For instance, assigning a Class 5 tolerance to one member and Class 7 to its mate will provide an assembly tolerance in the Class 6 range. The maximum effective tooth thickness is less than the minimum effective space width for major diameter fits to allow for eccentricity variations.

In the event the fit as provided in this standard does not satisfy a particular design need and a specific amount of effective clearance or press fit is desired, the change should be made only to the external spline by a reduction or an increase in effective tooth thickness and a like change in actual tooth thickness. The minimum effective space width, in this standard, is always basic. The basic minimum effective space width should always be retained when special designs are derived from the concept of this standard.

Terms Applied to Involute Splines.—The following definitions of involute spline terms, here listed in alphabetical order, are given in the American National Standard. Some of these terms are illustrated in the diagram in [Table 6](#).

Active Spline Length (L_a) is the length of spline that contacts the mating spline. On sliding splines, it exceeds the length of engagement.

Actual Space Width (s) is the circular width on the pitch circle of any single space considering an infinitely thin increment of axial spline length.

Actual Tooth Thickness (t) is the circular thickness on the pitch circle of any single tooth considering an infinitely thin increment of axial spline length.

Alignment Variation is the variation of the effective spline axis with respect to the reference axis (see [Fig. 1c](#)).

Base Circle is the circle from which involute spline tooth profiles are constructed.

Base Diameter (D_b) is the diameter of the base circle.

Basic Space Width is the basic space width for 30-degree pressure angle splines; half the circular pitch. The basic space width for 37.5- and 45-degree pressure angle splines, however, is greater than half the circular pitch. The teeth are proportioned so that the external tooth, at its base, has about the same thickness as the internal tooth at the form diameter. This proportioning results in greater minor diameters than those of comparable involute splines of 30-degree pressure angle.

Circular Pitch (p) is the distance along the pitch circle between corresponding points of adjacent spline teeth.

Depth of Engagement is the radial distance from the minor circle of the internal spline to the major circle of the external spline, minus corner clearance and/or chamfer depth.

Diametral Pitch (P) is the number of spline teeth per inch of pitch diameter. The diametral pitch determines the circular pitch and the basic space width or tooth thickness. In conjunction with the number of teeth, it also determines the pitch diameter. (See also Pitch.)

Effective Clearance (c_v) is the effective space width of the internal spline minus the effective tooth thickness of the mating external spline.

Effective Space Width (S_v) of an internal spline is equal to the circular tooth thickness on the pitch circle of an imaginary perfect external spline that would fit the internal spline without looseness or interference considering engagement of the entire axial length of the spline. The minimum effective space width of the internal spline is always basic, as shown in Table 3. Fit variations may be obtained by adjusting the tooth thickness of the external spline.

Three Types of Involute Spline Variations

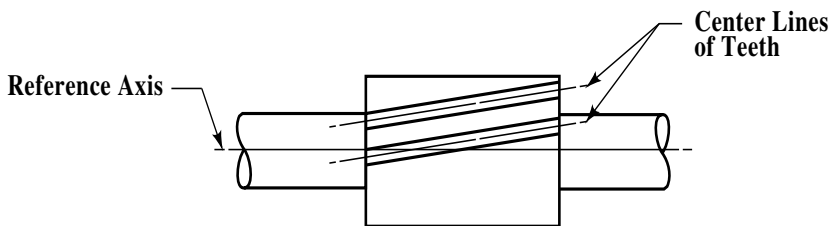


Fig. 1a. Lead Variation

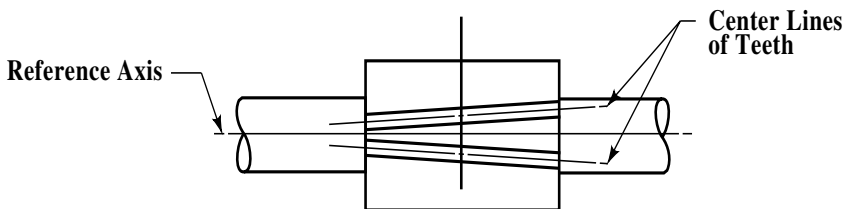


Fig. 1b. Parallelism Variation

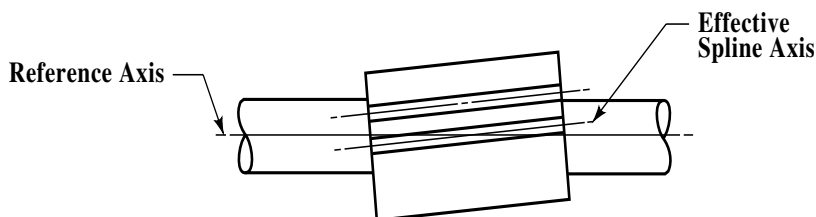


Fig. 1c. Alignment Variation

Effective Tooth Thickness (t_v) of an external spline is equal to the circular space width on the pitch circle of an imaginary perfect internal spline that would fit the external spline without looseness or interference, considering engagement of the entire axial length of the spline.

Effective Variation is the accumulated effect of the spline variations on the fit with the mating part.

External Spline is a spline formed on the outer surface of a cylinder.

Fillet is the concave portion of the tooth profile that joins the sides to the bottom of the space.

Fillet Root Splines are those in which a single fillet in the general form of an arc joins the sides of adjacent teeth.

Flat Root Splines are those in which fillets join the arcs of major or minor circles to the tooth sides.

Form Circle is the circle which defines the deepest points of involute form control of the tooth profile. This circle along with the tooth tip circle (or start of chamfer circle) determines the limits of tooth profile requiring control. It is located near the major circle on the internal spline and near the minor circle on the external spline.

Form Clearance (c_F) is the radial depth of involute profile beyond the depth of engagement with the mating part. It allows for looseness between mating splines and for eccentricities between the minor circle (internal), the major circle (external), and their respective pitch circles.

Form Diameter (D_{Fe} , D_{Fi}) the diameter of the form circle.

Internal Spline is a spline formed on the inner surface of a cylinder.

Involute Spline is one having teeth with involute profiles.

Lead Variation is the variation of the direction of the spline tooth from its intended direction parallel to the reference axis, also including parallelism and alignment variations (see Fig. 1a). *Note:* Straight (nonhelical) splines have an infinite lead.

Length of Engagement (L_q) is the axial length of contact between mating splines.

Machining Tolerance (m) is the permissible variation in actual space width or actual tooth thickness.

Major Circle is the circle formed by the outermost surface of the spline. It is the outside circle (tooth tip circle) of the external spline or the root circle of the internal spline.

Major Diameter (D_o , D_{ri}) is the diameter of the major circle.

Minor Circle is the circle formed by the innermost surface of the spline. It is the root circle of the external spline or the inside circle (tooth tip circle) of the internal spline.

Minor Diameter (D_{re} , D_i) is the diameter of the minor circle.

Nominal Clearance is the actual space width of an internal spline minus the actual tooth thickness of the mating external spline. It does not define the fit between mating members, because of the effect of variations.

Out of Roundness is the variation of the spline from a true circular configuration.

Parallelism Variation is the variation of parallelism of a single spline tooth with respect to any other single spline tooth (see Fig. 1b).

Pitch (P/P_s) is a combination number of a one-to-two ratio indicating the spline proportions; the upper or first number is the diametral pitch, the lower or second number is the stub pitch and denotes, as that fractional part of an inch, the basic radial length of engagement, both above and below the pitch circle.

Pitch Circle is the reference circle from which all transverse spline tooth dimensions are constructed.

Pitch Diameter (D) is the diameter of the pitch circle.

Pitch Point is the intersection of the spline tooth profile with the pitch circle.

Pressure Angle (ϕ) is the angle between a line tangent to an involute and a radial line through the point of tangency. Unless otherwise specified, it is the standard pressure angle.

Profile Variation is any variation from the specified tooth profile normal to the flank.

Spline is a machine element consisting of integral keys (spline teeth) or keyways (spaces) equally spaced around a circle or portion thereof.

Standard (Main) Pressure Angle (ϕ_D) is the pressure angle at the specified pitch diameter.

Stub Pitch (P_s) is a number used to denote the radial distance from the pitch circle to the major circle of the external spline and from the pitch circle to the minor circle of the internal spline. The stub pitch for splines in this standard is twice the diametral pitch.

Total Index Variation is the greatest difference in any two teeth (adjacent or otherwise) between the actual and the perfect spacing of the tooth profiles.

Total Tolerance ($m + \lambda$) is the machining tolerance plus the variation allowance.

Variation Allowance (λ) is the permissible effective variation.

Tooth Proportions.—There are 17 pitches: 2.5/5, 3/6, 4/8, 5/10, 6/12, 8/16, 10/20, 12/24, 16/32, 20/40, 24/48, 32/64, 40/80, 48/96, 64/128, 80/160, and 128/256. The numerator in this fractional designation is known as the diametral pitch and controls the pitch diameter; the denominator, which is always double the numerator, is known as the stub pitch and controls the tooth depth. For convenience in calculation, only the numerator is used in the formulas given and is designated as P . Diametral pitch, as in gears, means the number of teeth per inch of pitch diameter.

Table 1 shows the symbols and Table 2 the formulas for basic tooth dimensions of involute spline teeth of various pitches. Basic dimensions are given in Table 3.

**Table 1. American National Standard Involute Spline Symbols
ANSI B92.1-1970, R1993**

c_v	effective clearance	M_i	measurement between pins, internal spline
c_F	form clearance	N	number of teeth
D	pitch diameter	P	diametral pitch
D_b	base diameter	P_s	stub pitch
D_{ci}	pin contact diameter, internal spline	p	circular pitch
D_{ce}	pin contact diameter, external spline	r_f	fillet radius
D_{Fe}	form diameter, external spline	s	actual space width, circular
D_{Fi}	form diameter, internal spline	s_v	effective space width, circular
D_i	minor diameter, internal spline	s_c	allowable compressive stress, psi
D_o	major diameter, external spline	s_s	allowable shear stress, psi
D_{re}	minor diameter, external spline (root)	t	actual tooth thickness, circular
D_{ri}	major diameter, internal spline (root)	t_v	effective tooth thickness, circular
d_e	diameter of measuring pin for external spline	λ	variation allowance
d_i	diameter of measuring pin for internal spline	ϵ	involute roll angle
K_e	change factor for external spline	ϕ	pressure angle
K_i	change factor for internal spline	ϕ_D	standard pressure angle
L	spline length	ϕ_{ci}	pressure angle at pin contact diameter, internal spline
L_a	active spline length	ϕ_{ce}	pressure angle at pin contact diameter, external spline
L_g	length of engagement	ϕ_i	pressure angle at pin center, internal spline
m	machining tolerance	ϕ_e	pressure angle at pin center, external spline
M_e	measurement over pins, external spline	ϕ_F	pressure angle at form diameter

Table 2. Formulas for Involute Spline Basic Dimensions *ANSI B92.1-1970, R1993*

Term	Symbol	30 deg ϕ_D			37.5 deg ϕ_D	45 deg ϕ_D
		Flat Root Side Fit	Flat Root Major Dia Fit	Fillet Root Side Fit	Fillet Root Side Fit	Fillet Root Side Fit
		2.5/5 - 32/64 Pitch	3/6 - 16/32 Pitch	2.5/5 - 48/96 Pitch	2.5/5 - 48/96 Pitch	10/20 - 128/256 Pitch
Stub Pitch	P_s	$2P$	$2P$	$2P$	$2P$	$2P$
Pitch Diameter	D	N/P	N/P	N/P	N/P	N/P
Base Diameter	D_b	$D \cos \phi_D$	$D \cos \phi_D$	$D \cos \phi_D$	$D \cos \phi_D$	$D \cos \phi_D$
Circular Pitch	p	π/P	π/P	π/P	π/P	π/P
Minimum Effective Space Width	s_v	$\pi/(2P)$	$\pi/(2P)$	$\pi/(2P)$	$(0.5\pi + 0.1)/P$	$(0.5\pi + 0.2)/P$
Major Diameter, Internal	D_{ri}	$(N + 1.35)/P$	$(N + 1)/P$	$(N + 1.8)/P$	$(N + 1.6)/P$	$(N + 1.4)/P$
Major Diameter, External	D_o	$(N + 1)/P$	$(N + 1)/P$	$(N + 1)/P$	$(N + 1)/P$	$(N + 1)/P$
Minor Diameter, Internal	D_i	$(N - 1)/P$	$(N - 1)/P$	$(N - 1)/P$	$(N - 0.8)/P$	$(N - 0.6)/P$
Minor Dia. Ext.	2.5/5 thru 12/24 pitch	D_{re}	$(N - 1.35)/P$	$(N - 1.8)/P$	$(N - 1.3)/P$...
	16/32 pitch and finer			$(N - 2)/P$		
	10/20 pitch and finer			...		
Form Diameter, Internal	D_{Fi}	$(N + 1)/P + 2cF$	$(N + 0.8)/P - 0.004 + 2cF$	$(N + 1)/P + 2cF$	$(N + 1)/P + 2cF$	$(N + 1)/P + 2cF$
Form Diameter, External	D_{Fe}	$(N - 1)/P - 2cF$	$(N - 1)/P - 2cF$	$(N - 1)/P - 2cF$	$(N - 0.8)/P - 2cF$	$(N - 0.6)/P - 2cF$
Form Clearance (Radial)	c_F	0.001 D , with max of 0.010, min of 0.002				

$\pi = 3.1415927$

Note: All spline specification table dimensions in the standard are derived from these basic formulas by application of tolerances.



Table 3. Basic Dimensions for Involute Splines ANSI B92.1-1970, R1993

Pitch, P/P_s	Circular Pitch, p	Min Effective Space Width (BASIC), S_v min			Pitch, P/P_s	Circular Pitch, p	Min Effective Space Width (BASIC), S_v min		
		30 deg ϕ	37.5 deg ϕ	45 deg ϕ			30 deg ϕ	37.5 deg ϕ	45 deg ϕ
2.5/5	1.2566	0.6283	0.6683	...	20/40	0.1571	0.0785	0.0835	0.0885
3/6	1.0472	0.5236	0.5569	...	24/48	0.1309	0.0654	0.0696	0.0738
4/8	0.7854	0.3927	0.4177	...	32/64	0.0982	0.0491	0.0522	0.0553
5/10	0.6283	0.3142	0.3342	...	40/80	0.0785	0.0393	0.0418	0.0443
6/12	0.5236	0.2618	0.2785	...	48/96	0.0654	0.0327	0.0348	0.0369
8/16	0.3927	0.1963	0.2088	...	64/128	0.0491	0.0277
10/20	0.3142	0.1571	0.1671	0.1771	80/160	0.0393	0.0221
12/24	0.2618	0.1309	0.1392	0.1476	128/256	0.0246	0.0138
16/32	0.1963	0.0982	0.1044	0.1107

Tooth Numbers.—The American National Standard covers involute splines having tooth numbers ranging from 6 to 60 with a 30- or 37.5-degree pressure angle and from 6 to 100 with a 45-degree pressure angle. In selecting the number of teeth for a given spline application, it is well to keep in mind that there are no advantages to be gained by using odd numbers of teeth and that the diameters of splines with odd tooth numbers, particularly internal splines, are troublesome to measure with pins since no two tooth spaces are diametrically opposite each other.

Types and Classes of Involute Spline Fits.—Two types of fits are covered by the American National Standard for involute splines, the side fit, and the major diameter fit. Dimensional data for flat root side fit, flat root major diameter fit, and fillet root side fit splines are tabulated in this standard for 30-degree pressure angle splines; but for only the fillet root side fit for 37.5- and 45-degree pressure angle splines.

Side Fit: In the side fit, the mating members contact only on the sides of the teeth; major and minor diameters are clearance dimensions. The tooth sides act as drivers and centralize the mating splines.

Major Diameter Fit: Mating parts for this fit contact at the major diameter for centralizing. The sides of the teeth act as drivers. The minor diameters are clearance dimensions.

The major diameter fit provides a minimum effective clearance that will allow for contact and location at the major diameter with a minimum amount of location or centralizing effect by the sides of the teeth. The major diameter fit has only one space width and tooth thickness tolerance which is the same as side fit Class 5.

A fillet root may be specified for an external spline, even though it is otherwise designed to the flat root side fit or major diameter fit standard. An internal spline with a fillet root can be used only for the side fit.

Classes of Tolerances.—This standard includes four classes of tolerances on space width and tooth thickness. This has been done to provide a range of tolerances for selection to suit a design need. The classes are variations of the former single tolerance which is now Class 5 and are based on the formulas shown in the footnote of Table 4. All tolerance classes have the same minimum effective space width and maximum effective tooth thickness limits so that a mix of classes between mating parts is possible.

Table 4. Maximum Tolerances for Space Width and Tooth Thickness of Tolerance Class 5 Splines ANSI B92.1-1970, R1993 (Values shown in ten thousandths; 20 = 0.0020)

No. of Teeth	Pitch, P/P_s											
	2.5/5 and 3/6	4/8 and 5/10	6/12 and 8/16	10/20 and 12/24	16/32 and 20/40	24/48 thru 48/96	64/128 and 80/160	128/256				
<i>N</i>	Machining Tolerance, <i>m</i>											
10	15.8	14.5	12.5	12.0	11.7	11.7	9.6	9.5				
20	17.6	16.0	14.0	13.0	12.4	12.4	10.2	10.0				
30	18.4	17.5	15.5	14.0	13.1	13.1	10.8	10.5				
40	21.8	19.0	17.0	15.0	13.8	13.8	11.4	—				
50	23.0	20.5	18.5	16.0	14.5	14.5	—	—				
60	24.8	22.0	20.0	17.0	15.2	15.2	—	—				
70	—	—	—	18.0	15.9	15.9	—	—				
80	—	—	—	19.0	16.6	16.6	—	—				
90	—	—	—	20.0	17.3	17.3	—	—				
100	—	—	—	21.0	18.0	18.0	—	—				
<i>N</i>	Variation Allowance, λ											
10	23.5	20.3	17.0	15.7	14.2	12.2	11.0	9.8				
20	27.0	22.6	19.0	17.4	15.4	13.4	12.0	10.6				
30	30.5	24.9	21.0	19.1	16.6	14.6	13.0	11.4				
40	34.0	27.2	23.0	21.6	17.8	15.8	14.0	—				
50	37.5	29.5	25.0	22.5	19.0	17.0	—	—				
60	41.0	31.8	27.0	24.2	20.2	18.2	—	—				
70	—	—	—	25.9	21.4	19.4	—	—				
80	—	—	—	27.6	22.6	20.6	—	—				
90	—	—	—	29.3	23.8	21.8	—	—				
100	—	—	—	31.0	25.0	23.0	—	—				
<i>N</i>	Total Index Variation											
10	20	17	15	15	14	12	11	10				
20	24	20	18	17	15	13	12	11				
30	28	22	20	19	16	15	14	13				
40	32	25	22	20	18	16	15	—				
50	36	27	25	22	19	17	—	—				
60	40	30	27	24	20	18	—	—				
70	—	—	—	26	21	20	—	—				
80	—	—	—	28	22	21	—	—				
90	—	—	—	29	24	23	—	—				
100	—	—	—	31	25	24	—	—				
<i>N</i>	Profile Variation											
All	+7	+6	+5	+4	+3	+2	+2	+2				
	-10	-8	-7	-6	-5	-4	-4	-4				
Lead Variation												
L_g , in.	0.3	0.5	1	2	3	4	5	6	7	8	9	10
Variation	2	3	4	5	6	7	8	9	10	11	12	13

For other tolerance classes: Class 4 = $0.71 \times$ Tabulated value

Class 5 = As tabulated in table

Class 6 = $1.40 \times$ Tabulated value

Class 7 = $2.00 \times$ Tabulated value

Fillets and Chamfers.—Spline teeth may have either a flat root or a rounded fillet root.

Flat Root Splines: are suitable for most applications. The fillet that joins the sides to the bottom of the tooth space, if generated, has a varying radius of curvature. Specification of this fillet is usually not required. It is controlled by the form diameter, which is the diameter at the deepest point of the desired true involute form (sometimes designated as TIF).

When flat root splines are used for heavily loaded couplings that are not suitable for fillet root spline application, it may be desirable to minimize the stress concentration in the flat root type by specifying an approximate radius for the fillet.

Because internal splines are stronger than external splines due to their broad bases and high pressure angles at the major diameter, broaches for flat root internal splines are normally made with the involute profile extending to the major diameter.

Fillet Root Splines: are recommended for heavy loads because the larger fillets provided reduce the stress concentrations. The curvature along any generated fillet varies and cannot be specified by a radius of any given value.

External splines may be produced by generating with a pinion-type shaper cutter or with a hob, or by cutting with no generating motion using a tool formed to the contour of a tooth space. External splines are also made by cold forming and are usually of the fillet root design. Internal splines are usually produced by broaching, by form cutting, or by generating with a shaper cutter. Even when full-tip radius tools are used, each of these cutting methods produces a fillet contour with individual characteristics. Generated spline fillets are curves related to the prolate epicycloid for external splines and the prolate hypocycloid for internal splines. These fillets have a minimum radius of curvature at the point where the fillet is tangent to the external spline minor diameter circle or the internal spline major diameter circle and a rapidly increasing radius of curvature up to the point where the fillet comes tangent to the involute profile.

Chamfers and Corner Clearance: In major diameter fits, it is always necessary to provide corner clearance at the major diameter of the spline coupling. This clearance is usually effected by providing a chamfer on the top corners of the external member. This method may not be possible or feasible because of the following:

- a) If the external member is roll formed by plastic deformation, a chamfer cannot be provided by the process.
- b) A semitopping cutter may not be available.
- c) When cutting external splines with small numbers of teeth, a semitopping cutter may reduce the width of the top land to a prohibitive point.

In such conditions, the corner clearance can be provided on the internal spline, as shown in Fig. 2.

When this option is used, the form diameter may fall in the protuberance area.

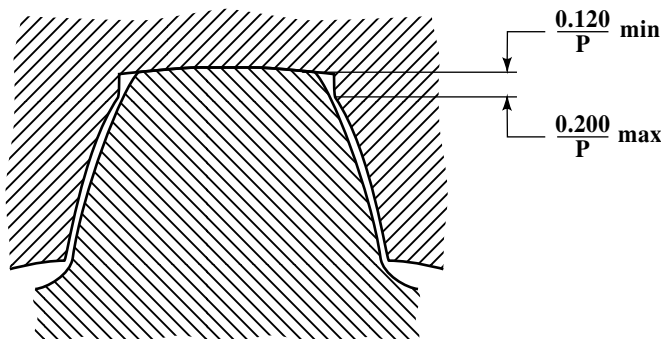


Fig. 2. Internal corner clearance.

Spline Variations.—The maximum allowable variations for involute splines are listed in [Table 4](#).

Profile Variation: The reference profile, from which variations occur, passes through the point used to determine the actual space width or tooth thickness. This is either the pitch point or the contact point of the standard measuring pins.

Profile variation is positive in the direction of the space and negative in the direction of the tooth. Profile variations may occur at any point on the profile for establishing effective fits and are shown in [Table 4](#).

Lead Variations: The lead tolerance for the total spline length applies also to any portion thereof unless otherwise specified.

Out of Roundness: This condition may appear merely as a result of index and profile variations given in [Table 4](#) and requires no further allowance. However, heat treatment and deflection of thin sections may cause out of roundness, which increases index and profile variations. Tolerances for such conditions depend on many variables and are therefore not tabulated. Additional tooth and/or space width tolerance must allow for such conditions.

Eccentricity: Eccentricity of major and minor diameters in relation to the effective diameter of side fit splines should not cause contact beyond the form diameters of the mating splines, even under conditions of maximum effective clearance. This standard does not establish specific tolerances.

Eccentricity of major diameters in relation to the effective diameters of major diameter fit splines should be absorbed within the maximum material limits established by the tolerances on major diameter and effective space width or effective tooth thickness.

If the alignment of mating splines is affected by eccentricity of locating surfaces relative to each other and/or the splines, it may be necessary to decrease the effective and actual tooth thickness of the external splines in order to maintain the desired fit condition. This standard does not include allowances for eccentric location.

Effect of Spline Variations.—Spline variations can be classified as index variations, profile variations, or lead variations.

Index Variations: These variations cause the clearance to vary from one set of mating tooth sides to another. Because the fit depends on the areas with minimum clearance, index variations reduce the effective clearance.

Profile Variations: Positive profile variations affect the fit by reducing effective clearance. Negative profile variations do not affect the fit but reduce the contact area.

Lead Variations: These variations will cause clearance variations and therefore reduce the effective clearance.

Variation Allowance: The effect of individual spline variations on the fit (effective variation) is less than their total, because areas of more than minimum clearance can be altered without changing the fit. The variation allowance is 60 percent of the sum of twice the positive profile variation, the total index variation and the lead variation for the length of engagement. The variation allowances in [Table 4](#) are based on a lead variation for an assumed length of engagement equal to one-half the pitch diameter. Adjustment may be required for a greater length of engagement.

Effective and Actual Dimensions.—Although each space of an internal spline may have the same width as each tooth of a perfect mating external spline, the two may not fit because of variations of index and profile in the internal spline. To allow the perfect external spline to fit in any position, all spaces of the internal spline must then be widened by the amount of interference. The resulting width of these tooth spaces is the *actual* space width of the internal spline. The *effective* space width is the tooth thickness of the perfect mating external spline. The same reasoning applied to an external spline that has variations of index and profile when mated with a perfect internal spline leads to the concept of effective

tooth thickness, which exceeds the actual tooth thickness by the amount of the effective variation.

The effective space width of the internal spline minus the effective tooth thickness of the external spline is the effective clearance and defines the fit of the mating parts. (This statement is strictly true only if high points of mating parts come into contact.) Positive effective clearance represents looseness or backlash. Negative effective clearance represents tightness or interference.

Space Width and Tooth Thickness Limits.—The variation of actual space width and actual tooth thickness within the machining tolerance causes corresponding variations of effective dimensions, so that there are four limit dimensions for each component part.

These variations are shown diagrammatically in Table 5.

Table 5. Specification Guide for Space Width and Tooth Thickness
ANSI B92.1-1970, R1993

Dimension of Variations, Clearances, and Tolerances on Part			Dimensioning Method		
Dimension	Effective	Actual	Standard	Alternatives	
				A	B
Space Width of Internal Spline			Required	Required	Ref.
			Ref.	Ref.	Ref.
			Ref.	Required	Required
			Required	Required	Required
Tooth Thickness of External Spline			Ref.	Required	Required
			Ref.	Ref.	Ref.
			Required	Required	Required
			Required	Required	Ref.

The minimum effective space width is always basic. The maximum effective tooth thickness is the same as the minimum effective space width except for the major diameter fit. The major diameter fit maximum effective tooth thickness is less than the minimum effective space width by an amount that allows for eccentricity between the effective spline and the major diameter. The permissible variation of the effective clearance is divided between the internal and external splines to arrive at the maximum effective space width and the minimum effective tooth thickness. Limits for the actual space width and actual tooth thickness are constructed from suitable variation allowances.

Use of Effective and Actual Dimensions.—Each of the four dimensions for space width and tooth thickness shown in Table 5 has a definite function.

Minimum Effective Space Width and Maximum Effective Tooth Thickness: These dimensions control the minimum effective clearance, and must always be specified.

Minimum Actual Space Width and Maximum Actual Tooth Thickness: These dimensions cannot be used for acceptance or rejection of parts. If the actual space width is less than the minimum without causing the effective space width to be undersized, or if the actual tooth thickness is more than the maximum without causing the effective tooth thickness to be oversized, the effective variation is less than anticipated; such parts are desirable and not defective. The specification of these dimensions as processing reference dimensions is optional. They are also used to analyze undersize effective space width or oversize effective tooth thickness conditions to determine whether or not these conditions are caused by excessive effective variation.

Maximum Actual Space Width and Minimum Actual Tooth Thickness: These dimensions control machining tolerance and limit the effective variation. The spread between

these dimensions, reduced by the effective variation of the internal and external spline, is the maximum effective clearance. Where the effective variation obtained in machining is appreciably less than the variation allowance, these dimensions must be adjusted in order to maintain the desired fit.

Maximum Effective Space Width and Minimum Effective Tooth Thickness: These dimensions define the maximum effective clearance but they do not limit the effective variation. They may be used, in addition to the maximum actual space width and minimum actual tooth thickness, to prevent the increase of maximum effective clearance due to reduction of effective variations. The notation “inspection optional” may be added where maximum effective clearance is an assembly requirement, but does not need absolute control. It will indicate, without necessarily adding inspection time and equipment, that the actual space width of the internal spline must be held below the maximum, or the actual tooth thickness of the external spline above the minimum, if machining methods result in less than the allowable variations. Where effective variation needs no control or is controlled by laboratory inspection, these limits may be substituted for maximum actual space width and minimum actual tooth thickness.

Combinations of Involute Spline Types.—Flat root side fit internal splines may be used with fillet root external splines where the larger radius is desired on the external spline for control of stress concentrations. This combination of fits may also be permitted as a design option by specifying for the minimum root diameter of the external, the value of the minimum root diameter of the fillet root external spline and noting this as “optional root.”

A design option may also be permitted to provide either flat root internal or fillet root internal by specifying for the maximum major diameter, the value of the maximum major diameter of the fillet root internal spline and noting this as “optional root.”

Interchangeability.—Splines made to this standard may interchange with splines made to older standards. Exceptions are listed below.

External Splines: These external splines will mate with older internal splines as follows:

Year	Major Dia. Fit	Flat Root Side Fit	Fillet Root Side Fit
1946	Yes	No (A) ^a	No (A)
1950 ^b	Yes (B)	Yes (B)	Yes (C)
1950 ^c	Yes (B)	No (A)	Yes (C)
1957 SAE	Yes	No (A)	Yes (C)
1960	Yes	No (A)	Yes (C)

^a For exceptions A, B, C, see the paragraph on *Exceptions* that follows.

^b Full dedendum.

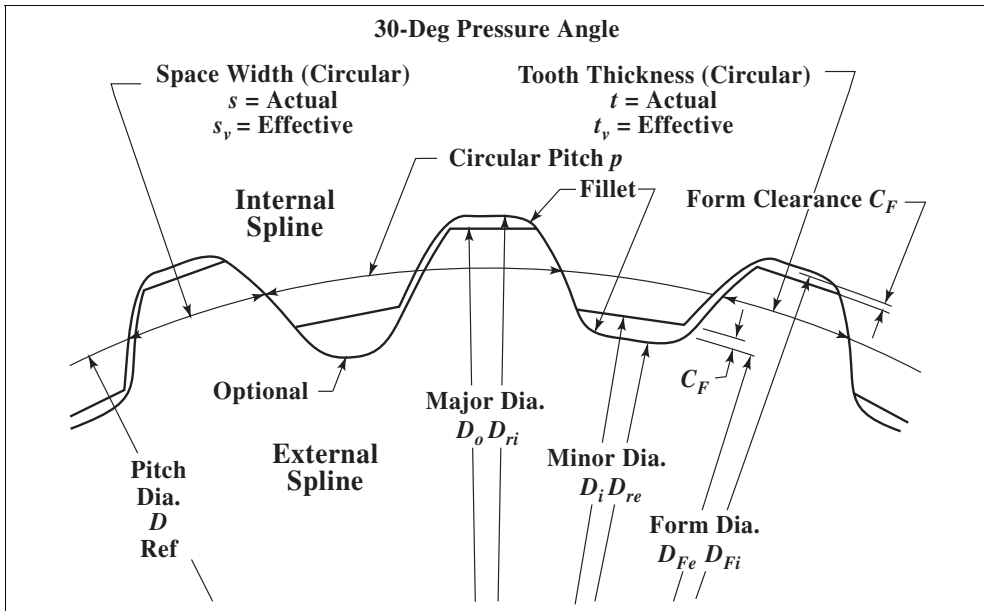
^c Short dedendum.

Internal Splines: These will mate with older external splines as follows:

Year	Major Dia. Fit	Flat Root Side Fit	Fillet Root Side Fit
1946	No (D) ^a	No (E)	No (D)
1950	Yes (F)	Yes	Yes (C)
1957 SAE	Yes (G)	Yes	Yes
1960	Yes (G)	Yes	Yes

^a For exceptions C, D, E, F, G, see the paragraph on *Exceptions* that follows.

Table 6. Spline Terms, Symbols, and Drawing Data, 30-Degree Pressure Angle, Flat Root Side Fit ANSI B92.1-1970, R1993



The fit shown is used in restricted areas (as with tubular parts with wall thickness too small to permit use of fillet roots, and to allow hobbing closer to shoulders, etc.) and for economy (when hobbing, shaping, etc., and using shorter broaches for the internal member).

Press fits are not tabulated because their design depends on the degree of tightness desired and must allow for such factors as the shape of the blank, wall thickness, material, hardness, thermal expansion, etc. Close tolerances or selective size grouping may be required to limit fit variations.

Drawing Data

Internal Involute Spline Data		External Involute Spline Data	
Flat Root Side Fit		Flat Root Side Fit	
Number of Teeth	xx	Number of Teeth	xx
Pitch	xx/xx	Pitch	xx/xx
Pressure Angle	30°	Pressure Angle	30°
Base Diameter	x.xxxxxx Ref	Base Diameter	x.xxxxxx Ref
Pitch Diameter	x.xxxxxx Ref	Pitch Diameter	x.xxxxxx Ref
Major Diameter	x.xxx max	Major Diameter	x.xxx/x.xxx
Form Diameter	x.xxx	Form Diameter	x.xxx
Minor Diameter	x.xxx/x.xxx	Minor Diameter	x.xxx min
Circular Space Width		Circular Tooth Thickness	
Max Actual	x.xxxx	Max Effective	x.xxxx
Min Effective	x.xxxx	Min Actual	x.xxxx
The following information may be added as required:		The following information may be added as required:	
Max Measurement Between Pins	x.xxx Ref	Min Measurement Over Pins	x.xxxx Ref
Pin Diameter	x.xxxx	Pin Diameter	x.xxxx

The above drawing data are required for the spline specifications. The standard system is shown; for alternate systems, see Table 5. Number of x's indicates number of decimal places normally used.

Exceptions:

a) The external major diameter, unless chamfered or reduced, may interfere with the internal form diameter on flat root side fit splines. Internal splines made to the 1957 and 1960 standards had the same dimensions as shown for the major diameter fit splines in this standard.

b) For 15 teeth or less, the minor diameter of the internal spline, unless chamfered, will interfere with the form diameter of the external spline.

c) For 9 teeth or less, the minor diameter of the internal spline, unless chamfered, will interfere with form diameter of the external spline.

d) The internal minor diameter, unless chamfered, will interfere with the external form diameter.

e) The internal minor diameter, unless chamfered, will interfere with the external form diameter.

f) For 10 teeth or less, the minimum chamfer on the major diameter of the external spline may not clear the internal form diameter.

g) Depending upon the pitch of the spline, the minimum chamfer on the major diameter may not clear the internal form diameter.

Drawing Data.—It is important that uniform specifications be used to show complete information on detail drawings of splines. Much misunderstanding will be avoided by following the suggested arrangement of dimensions and data as given in [Table 6](#). The number of x's indicates the number of decimal places normally used. With this tabulated type of spline specifications, it is usually not necessary to show a graphic illustration of the spline teeth.

Spline Data and Reference Dimensions.—Spline data are used for engineering and manufacturing purposes. Pitch and pressure angle are not subject to individual inspection.

As used in this standard, *reference* is an added notation or modifier to a dimension, specification, or note when that dimension, specification, or note is:

1) Repeated for drawing clarification.

2) Needed to define a nonfeature datum or basis from which a form or feature is generated.

3) Needed to define a nonfeature dimension from which other specifications or dimensions are developed.

4) Needed to define a nonfeature dimension at which toleranced sizes of a feature are specified.

5) Needed to define a nonfeature dimension from which control tolerances or sizes are developed or added as useful information.

Any dimension, specification, or note that is noted “REF” should not be used as a criterion for part acceptance or rejection.

Estimating Key and Spline Sizes and Lengths.—[Fig. 3](#) may be used to estimate the size of American Standard involute splines required to transmit a given torque. It also may be used to find the outside diameter of shafts used with single keys. After the size of the shaft is found, the proportions of the key can be determined from [Table 1](#) on page [2472](#).

Curve A is for flexible splines with teeth hardened to Rockwell C 55-65. For these splines, lengths are generally made equal to or somewhat greater than the pitch diameter for diameters below $1\frac{1}{4}$ inches; on larger diameters, the length is generally one-third to two-thirds the pitch diameter. Curve A also applies for a single key used as a fixed coupling, the length of the key being one to one and one-quarter times the shaft diameter. The stress in the shaft, neglecting stress concentration at the keyway, is about 7500 pounds per square inch. See also *Effect of Keyways on Shaft Strength* starting on page [301](#).

Curve B represents high-capacity single keys used as fixed couplings for stresses of 9500 pounds per square inch, neglecting stress concentration. Key-length is one to one and one-quarter times shaft diameter and both shaft and key are of moderately hard heat-treated

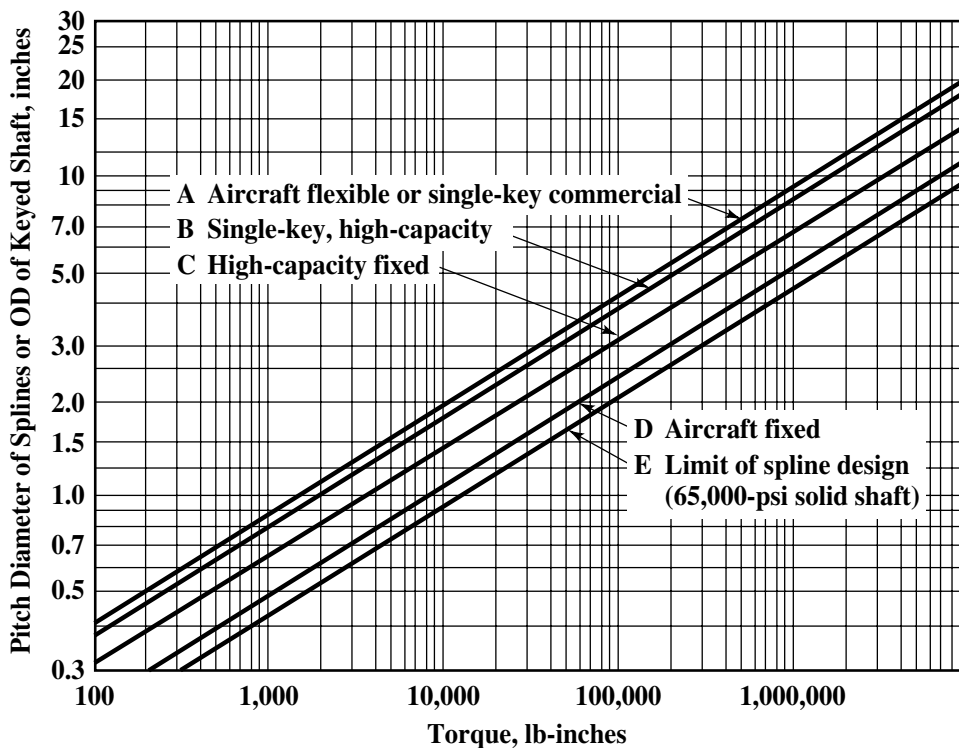


Fig. 3. Chart for Estimating Involute Spline Size Based on Diameter-Torque Relationships steel. This type of connection is commonly used to key commercial flexible couplings to motor or generator shafts.

Curve C is for multiple-key fixed splines with lengths of three-quarters to one and one-quarter times pitch diameter and shaft hardness of 200-300 BHN.

Curve D is for high-capacity splines with lengths one-half to one times the pitch diameter. Hardnesses up to Rockwell C 58 are common and in aircraft applications the shaft is generally hollow to reduce weight.

Curve E represents a solid shaft with 65,000 pounds per square inch shear stress. For hollow shafts with inside diameter equal to three-quarters of the outside diameter the shear stress would be 95,000 pounds per square inch.

Length of Splines: Fixed splines with lengths of one-third the pitch diameter will have the same shear strength as the shaft, assuming uniform loading of the teeth; however, errors in spacing of teeth result in only half the teeth being fully loaded. Therefore, for balanced strength of teeth and shaft the length should be two-thirds the pitch diameter. If weight is not important, however, this may be increased to equal the pitch diameter. In the case of flexible splines, long lengths do not contribute to load carrying capacity when there is misalignment to be accommodated. Maximum effective length for flexible splines may be approximated from Fig. 4.

Formulas for Torque Capacity of Involute Splines.—The formulas for torque capacity of 30-degree involute splines given in the following paragraphs are derived largely from an article “When Splines Need Stress Control” by D. W. Dudley, *Product Engineering*, Dec. 23, 1957.

In the formulas that follow the symbols used are as defined on page 2256 with the following additions: D_h = inside diameter of hollow shaft, inches; K_a = application factor from Table 7; K_m = load distribution factor from Table 8; K_f = fatigue life factor from Table 9; K_w

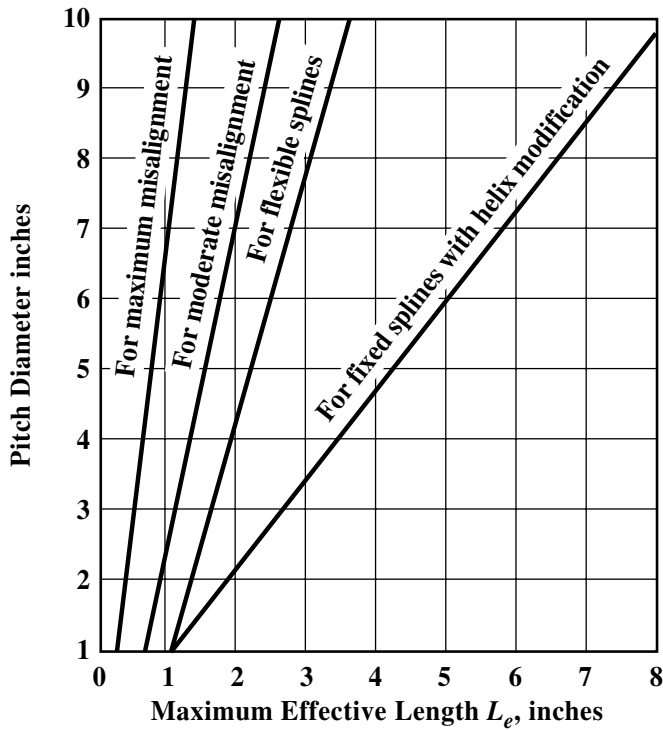


Fig. 4. Maximum Effective Length for Fixed and Flexible Splines = wear life factor from Table 10; L_e = maximum effective length from Fig. 4, to be used in stress formulas even though the actual length may be greater; T = transmitted torque, pound-inches. For fixed splines without helix modification, the effective length L_e should never exceed $5000 D^{3.5} \div T$.

Table 7. Spline Application Factors, K_a

Power Source	Type of Load			
	Uniform (Generator, Fan)	Light Shock (Oscillating Pumps, etc.)	Intermittent Shock (Actuating Pumps, etc.)	Heavy Shock (Punches, Shears, etc.)
Uniform (Turbine, Motor)	1.0	1.2	1.5	1.8
Light Shock (Hydraulic Motor)	1.2	1.3	1.8	2.1
Medium Shock (Internal Combustion, Engine)	2.0	2.2	2.4	2.8

Table 8. Load Distribution Factors, K_m , for Misalignment of Flexible Splines

Misalignment, inches per inch	Load Distribution Factor, K_m^a			
	1/2-in. Face Width	1-in. Face Width	2-in. Face Width	4-in. Face Width
0.001	1	1	1	1 1/2
0.002	1	1	1 1/2	2
0.004	1	1 1/2	2	2 1/2
0.008	1 1/2	2	2 1/2	3

^a For fixed splines, $K_m=1$.

For fixed splines, $K_m = 1$.

Table 9. Fatigue-Life Factors, K_f , for Splines

No. of Torque Cycles ^a	Fatigue-Life Factor, K_f	
	Unidirectional	Fully-reversed
1,000	1.8	1.8
10,000	1.0	1.0
100,000	0.5	0.4
1,000,000	0.4	0.3
10,000,000	0.3	0.2

^a A torque cycle consists of one start and one stop, not the number of revolutions.

Table 10. Wear Life Factors, K_w , for Flexible Splines

Number of Revolutions of Spline	Life Factor, K_w	Number of Revolutions of Spline	Life Factor, K_w
10,000	4.0	100,000,000	1.0
100,000	2.8	1,000,000,000	0.7
1,000,000	2.0	10,000,000,000	0.5
10,000,000	1.4

Wear life factors, unlike fatigue life factors given in Table 9, are based on the total number of revolutions of the spline, since each revolution of a flexible spline results in a complete cycle of rocking motion which contributes to spline wear.

Definitions: A *fixed* spline is one which is either shrink fitted or loosely fitted but piloted with rings at each end to prevent rocking of the spline which results in small axial movements that cause wear. A *flexible* spline permits some rocking motion such as occurs when the shafts are not perfectly aligned. This flexing or rocking motion causes axial movement and consequently wear of the teeth. Straight-toothed flexible splines can accommodate only small angular misalignments (less than 1 deg.) before wear becomes a serious problem. For greater amounts of misalignment (up to about 5 deg.), crowned splines are preferable to reduce wear and end-loading of the teeth.

Shear Stress Under Roots of External Teeth: For a transmitted torque T , the torsional shear stress induced in the shaft under the root diameter of an external spline is:

$$S_s = \frac{16TK_a}{\pi D_{re}^3 K_f} \quad \text{for a solid shaft} \quad (1)$$

$$S_s = \frac{16TD_{re}K_a}{\pi(D_{re}^4 - D_h^4)K_f} \quad \text{for a hollow shaft} \quad (2)$$

The computed stress should not exceed the values in Table 11.

Table 11. Allowable Shear, Compressive, and Tensile Stresses for Splines

Material	Hardness		Max. Allowable Stress			
			Shear Stress, psi	Compressive Stress, psi		Tensile Stress, psi
	Brinell	Rockwell C		Straight	Crowned	
Steel	160-200	—	20,000	1,500	6,000	22,000
	230-260	—	30,000	2,000	8,000	32,000
	302-351	33-38	40,000	3,000	12,000	45,000
Surface-hardened Steel	—	48-53	40,000	4,000	16,000	45,000
Case-hardened Steel	—	58-63	50,000	5,000	20,000	55,000
Through-hardened Steel (Aircraft Quality)	—	42-46	45,000	—	—	50,000

Shear Stress at the Pitch Diameter of Teeth: The shear stress at the pitch line of the teeth for a transmitted torque T is:

$$S_s = \frac{4TK_aK_m}{DNL_e tK_f} \quad (3)$$

The factor of 4 in (3) assumes that only half the teeth will carry the load because of spacing errors. For poor manufacturing accuracies, change the factor to 6.

The computed stress should not exceed the values in **Table 11**.

Compressive Stresses on Sides of Spline Teeth: Allowable compressive stresses on splines are very much lower than for gear teeth since non-uniform load distribution and misalignment result in unequal load sharing and end loading of the teeth.

$$\text{For flexible splines, } S_c = \frac{2TK_mK_a}{DNL_e hK_w} \quad (4)$$

$$\text{For fixed splines, } S_c = \frac{2TK_mK_a}{9DNL_e hK_f} \quad (5)$$

In these formulas, h is the depth of engagement of the teeth, which for flat root splines is $0.9/P$ and for fillet root splines is $1/P$, approximately.

The stresses computed from **Formulas (4) and (5)** should not exceed the values in **Table 11**.

Bursting Stresses on Splines: Internal splines may burst due to three kinds of tensile stress: 1) tensile stress due to the radial component of the transmitted load; 2) centrifugal tensile stress; and 3) tensile stress due to the tangential force at the pitch line causing bending of the teeth.

$$\text{Radial load tensile stress, } S_1 = \frac{T \tan \phi}{\pi D t_w L} \quad (6)$$

where t_w = wall thickness of internal spline = outside diameter of spline sleeve minus spline major diameter, all divided by 2. L = full length of spline.

$$\text{Centrifugal tensile stress, } S_2 = \frac{1.656 \times (\text{rpm})^2 (D_{oi}^2 + 0.212 D_{ri}^2)}{1,000,000} \quad (7)$$

where D_{oi} = outside diameter of spline sleeve.

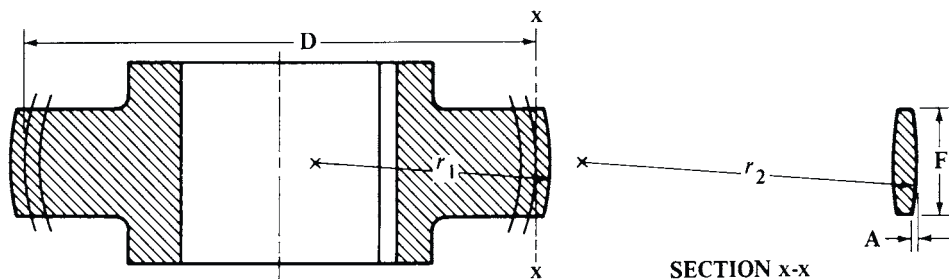
$$\text{Beam loading tensile stress, } S_3 = \frac{4T}{D^2 L_e Y} \quad (8)$$

In **Equation (8)**, Y is the Lewis form factor obtained from a tooth layout. For internal splines of 30-deg. pressure angle a value of $Y = 1.5$ is a satisfactory estimate. The factor 4 in (8) assumes that only half the teeth are carrying the load.

The total tensile stress tending to burst the rim of the external member is: $S_t = [K_a K_m (S_1 + S_3) + S_2]/K_f$; and should be less than those in **Table 11**.

Crowned Splines for Large Misalignments.—As mentioned on page 2268, crowned splines can accommodate misalignments of up to about 5 degrees. Crowned splines have considerably less capacity than straight splines of the same size if both are operating with precise alignment. However, when large misalignments exist, the crowned spline has greater capacity.

American Standard tooth forms may be used for crowned external members so that they may be mated with straight internal members of Standard form.



The accompanying diagram of a crowned spline shows the radius of the crown r_1 ; the radius of curvature of the crowned tooth, r_2 ; the pitch diameter of the spline, D ; the face width, F ; and the relief or crown height A at the ends of the teeth. The crown height A should always be made somewhat greater than one-half the face width multiplied by the tangent of the misalignment angle. For a crown height A , the approximate radius of curvature r_2 is $F^2 \div 8A$, and $r_1 = r_2 \tan \phi$, where ϕ is the pressure angle of the spline.

For a torque T , the compressive stress on the teeth is:

$$S_c = 2290 \sqrt{2T \div DNhr_2};$$

and should be less than the value in [Table 11](#).

Fretting Damage to Splines and Other Machine Elements.—Fretting is wear that occurs when cyclic loading, such as vibration, causes two surfaces in intimate contact to undergo small oscillatory motions with respect to each other. During fretting, high points or asperities of the mating surfaces adhere to each other and small particles are pulled out, leaving minute, shallow pits and a powdery debris. In steel parts exposed to air, the metallic debris oxidizes rapidly and forms a red, rustlike powder or sludge; hence, the coined designation “fretting corrosion.”

Fretting is mechanical in origin and has been observed in most materials, including those that do not oxidize, such as gold, platinum, and nonmetallics; hence, the corrosion accompanying fretting of steel parts is a secondary factor.

Fretting can occur in the operation of machinery subject to motion or vibration or both. It can destroy close fits; the debris may clog moving parts; and fatigue failure may be accelerated because stress levels to initiate fatigue in fretted parts are much lower than for undamaged material. Sites for fretting damage include interference fits; splined, bolted, keyed, pinned, and riveted joints; between wires in wire rope; flexible shafts and tubes; between leaves in leaf springs; friction clamps; small amplitude-of-oscillation bearings; and electrical contacts.

Vibration or cyclic loadings are the main causes of fretting. If these factors cannot be eliminated, greater clamping force may reduce movement but, if not effective, may actually worsen the damage. Lubrication may delay the onset of damage; hard plating or surface hardening methods may be effective, not by reducing fretting, but by increasing the fatigue strength of the material. Plating soft materials having inherent lubricity onto contacting surfaces is effective until the plating wears through.

Involute Spline Inspection Methods.—Spline gages are used for routine inspection of production parts.

Analytical inspection, which is the measurement of individual dimensions and variations, may be required:

- a) To supplement inspection by gages, for example, where NOT GO composite gages are used in place of NOT GO sector gages and variations must be controlled.
- b) To evaluate parts rejected by gages.
- c) For prototype parts or short runs where spline gages are not used.

d) To supplement inspection by gages where each individual variation must be restrained from assuming too great a portion of the tolerance between the minimum material actual and the maximum material effective dimensions.

Inspection with Gages.—A variety of gages is used in the inspection of involute splines.

Types of Gages: A composite spline gage has a full complement of teeth. A sector spline gage has two diametrically opposite groups of teeth. A sector plug gage with only two teeth per sector is also known as a “paddle gage.” A sector ring gage with only two teeth per sector is also known as a “snap ring gage.” A progressive gage is a gage consisting of two or more adjacent sections with different inspection functions. Progressive GO gages are physical combinations of GO gage members that check consecutively first one feature or one group of features, then their relationship to other features. GO and NOT GO gages may also be combined physically to form a progressive gage.

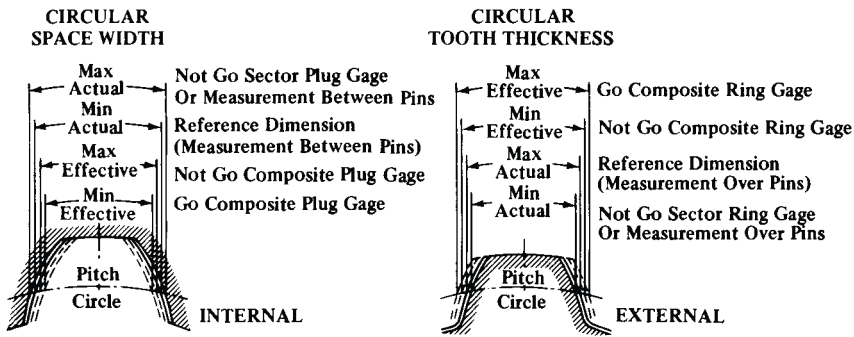


Fig. 5. Space width and tooth-thickness inspection.

GO and NOT GO Gages: GO gages are used to inspect maximum material conditions (maximum external, minimum internal dimensions). They may be used to inspect an individual dimension or the relationship between two or more functional dimensions. They control the minimum looseness or maximum interference.

NOT GO gages are used to inspect minimum material conditions (minimum external, maximum internal dimensions), thereby controlling the maximum looseness or minimum interference. Unless otherwise agreed upon, a product is acceptable only if the NOT GO gage does not enter or go on the part. A NOT GO gage can be used to inspect only one dimension. An attempt at simultaneous NOT GO inspection of more than one dimension could result in failure of such a gage to enter or go on (acceptance of part), even though all but one of the dimensions were outside product limits. In the event all dimensions are outside the limits, their relationship could be such as to allow acceptance.

Effective and Actual Dimensions: The effective space width and tooth thickness are inspected by means of an accurate mating member in the form of a composite spline gage.

The actual space width and tooth thickness are inspected with sector plug and ring gages, or by measurements with pins.

Measurements with Pins.—The actual space width of internal splines, and the actual tooth thickness of external splines, may be measured with pins. These measurements do not determine the fit between mating parts, but may be used as part of the analytic inspection of splines to evaluate the effective space width or effective tooth thickness by approximation.

Formulas for 2-Pin Measurement Between Pins: For measurement *between* pins of internal splines using the symbols given on page 2256:

1) Find involute of pressure angle at pin center:

$$\text{inv } \phi_i = \frac{s}{D} + \text{inv } \phi_d - \frac{d_i}{D_b}$$

2) Find the value of ϕ_i in degrees, in the involute function tables beginning on page 111. Find $\sec \phi_i = 1/\cosine \phi_i$ in the trig tables, pages 107 through 109, using interpolation to obtain higher accuracy.

3) Compute measurement, M_i , between pins:

For even numbers of teeth: $M_i = D_b \sec \phi_i - d_i$

For odd numbers of teeth: $M_i = (D_b \cos 90^\circ/N) \sec \phi_i - d_i$

where: $d_i = 1.7280/P$ for 30° and 37.5° standard pressure angle (ϕ_D) splines

$d_i = 1.9200/P$ for 45° pressure angle splines

Example: Find the measurement between pins for *maximum* actual space width of an internal spline of 30° pressure angle, tolerance class 4, $\frac{3}{6}$ diametral pitch, and 20 teeth.

The maximum actual space width to be substituted for s in Step 1 above is obtained as follows: In Table 5, page 2262, the maximum actual space width is the sum of the minimum effective space width (second column) and $\lambda + m$ (third column). The minimum effective space width s_v from Table 2, page 2257, is $\pi/2P = \pi/(2 \times 3)$. The values of λ and m from Table 4, page 2259, are, for a class 4 fit, $\frac{3}{6}$ diametral pitch, 20-tooth spline: $\lambda = 0.0027 \times 0.71 = 0.00192$; and $m = 0.00176 \times 0.71 = 0.00125$, so that $s = 0.52360 + 0.00192 + 0.00125 = 0.52677$.

Other values required for Step 1 are:

$$D = N \div P = 20 \div 3 = 6.66666$$

$$\text{inv } \phi_D = \text{inv } 30^\circ = 0.053751 \text{ from a calculator}$$

$$d_i = 1.7280/3 = 0.57600$$

$$D_b = D \cos \phi_D = 6.66666 \times 0.86603 = 5.77353$$

The computation is made as follows:

$$1) \text{inv } \phi_i = 0.52677/6.66666 + 0.053751 - 0.57600/5.77353 = 0.03300$$

$$2) \text{ From a calculator, } \phi_i = 25^\circ 46.18' \text{ and } \sec \phi_i = 1.11044$$

$$3) M_i = 5.77353 \times 1.11044 - 0.57600 = 5.8352 \text{ inches}$$

Formulas for 2-Pin Measurement Over Pins: For measurement *over* pins of external splines:

1) Find involute of pressure angle at pin center:

$$\text{inv } \phi_e = \frac{t}{D} + \text{inv } \phi_D + \frac{d_e}{D_b} - \frac{\pi}{N}$$

2) Find the value of ϕ_e and $\sec \phi_e$ from the involute function tables beginning on page 111.

3) Compute measurement, M_e , over pins:

For even numbers of teeth: $M_e = D_b \sec \phi_e + d_e$

For odd numbers of teeth: $M_e = (D_b \cos 90^\circ/N) \sec \phi_e + d_e$

where $d_e = 1.9200/P$ for all external splines

American National Standard Metric Module Splines.—ANSI B92.2M-1980 (R1989) is the American National Standards Institute version of the International Standards Organization involute spline standard. It is not a “soft metric” conversion of any previous, inch-based, standard,* and splines made to this hard metric version are not intended for use with components made to the B92.1 or other, previous standards. The ISO 4156 Standard from

* A “soft” conversion is one in which dimensions in inches, when multiplied by 25.4 will, after being appropriately rounded off, provide equivalent dimensions in millimeters. In a “hard” system the tools of production, such as hobs, do not bear a usable relation to the tools in another system; i.e., a 10 diametral pitch hob calculates to be equal to a 2.54 module hob in the metric module system, a hob that does not exist in the metric standard.

which this one is derived is the result of a cooperative effort between the ANSI B92 committee and other members of the ISO/TC 14-2 involute spline committee.

Many of the features of the previous standard, ANSI B92.1-1970 (R1993), have been retained such as: 30-, 37.5-, and 45-degree pressure angles; flat root and fillet root side fits; the four tolerance classes 4, 5, 6, and 7; tables for a single class of fit; and the effective fit concept.

Among the major differences are: use of modules of from 0.25 through 10 mm in place of diametral pitch; dimensions in millimeters instead of inches; the “basic rack”; removal of the major diameter fit; and use of ISO symbols in place of those used previously. Also, provision is made for calculating three defined clearance fits.

The Standard recognizes that proper assembly between mating splines is dependent only on the spline being within effective specifications from the tip of the tooth to the form diameter. Therefore, the internal spline major diameter is shown as a maximum dimension and the external spline minor diameter is shown as a minimum dimension. The minimum internal major diameter and the maximum external minor diameter must clear the specified form diameter and thus require no additional control. All dimensions are for the finished part; any compensation that must be made for operations that take place during processing, such as heat treatment, must be considered when selecting the tolerance level for manufacturing.

The Standard provides the same internal minimum effective space width and external maximum effective tooth thickness for all tolerance classes. This basic concept makes possible interchangeable assembly between mating splines regardless of the tolerance class of the individual members, and permits a tolerance class “mix” of mating members. This arrangement is often an advantage when one member is considerably less difficult to produce than its mate, and the “average” tolerance applied to the two units is such that it satisfies the design need. For example, by specifying Class 5 tolerance for one member and Class 7 for its mate, an assembly tolerance in the Class 6 range is provided.

If a fit given in this Standard does not satisfy a particular design need, and a specific clearance or press fit is desired, the change shall be made only to the external spline by a reduction of, or an increase in, the effective tooth thickness and a like change in the actual tooth thickness. The minimum effective space width is always basic and this basic width should always be retained when special designs are derived from the concept of this Standard.

Spline Terms and Definitions: The spline terms and definitions given for American National Standard ANSI B92.1-1970 (R1993) described in the preceding section, may be used in regard to ANSI B92.2M-1980 (R1989). The 1980 Standard utilizes ISO symbols in place of those used in the 1970 Standard; these differences are shown in [Table 12](#).

Dimensions and Tolerances: Dimensions and tolerances of splines made to the 1980 Standard may be calculated using the formulas given in [Table 13](#). These formulas are for metric module splines in the range of from 0.25 to 10 mm metric module of side-fit design and having pressure angles of 30-, 37.5-, and 45-degrees. The standard modules in the system are: 0.25; 0.5; 0.75; 1; 1.25; 1.5; 1.75; 2; 2.5; 3; 4; 5; 6; 8; and 10. The range of from 0.5 to 10 module applies to all splines except 45-degree fillet root splines; for these, the range of from 0.25 to 2.5 module applies.

Fit Classes: Four classes of side fit splines are provided: spline fit class H/h having a minimum effective clearance, $c_v = es = 0$; classes H/f, H/e, and H/d having tooth thickness modifications, es , of f , e , and d , respectively, to provide progressively greater effective clearance c_v . The tooth thickness modifications h , f , e , and d in [Table 14](#) are fundamental deviations selected from ISO R286, “ISO System of Limits and Fits.” They are applied to the external spline by shifting the tooth thickness total tolerance below the basic tooth thickness by the amount of the tooth thickness modification to provide a prescribed minimum effective clearance c_v .

Table 12. Comparison of Symbols Used in ANSI B92.2M-1980 (R1989) and Those in ANSI B92.1-1970, R1993

Symbol		Meaning of Symbol	Symbol		Meaning of Symbol
B92.2M	B92.1		B92.2M	B92.1	
c	...	theoretical clearance	m	...	module
c_v	c_v	effective clearance	...	P	diametral pitch
c_F	c_F	form clearance	...	P_s	stub pitch = $2P$
D	D	pitch diameter	P_b	...	base pitch
DB	D_b	base diameter	p	p	circular pitch
d_{ce}	D_{ce}	pin contact diameter, external spline	π	π	3.141592654
d_{ci}	D_{ci}	pin contact diameter, internal spline	r_{fe}	r_f	fillet rad., ext. spline
DEE	D_o	major diam., ext. spline	r_{fi}	r_f	fillet rad., int. spline
DEI	D_{ri}	major diam., int. spline	E_{bse}	s_v min	basic circular space width
DFE	D_{Fe}	form diam., ext. spline	E_{max}	s	max. actual circular space width
DFI	D_{Fi}	form diam., int. spline	E_{min}	s	min. actual circular space width
DIE	D_{re}	minor diam., ext. spline	EV	s_v	effective circular space width
DII	D_i	minor diam., int. spline	S_{bse}	t_v max	basic circular tooth thickness
DRE	d_e	pin diam., ext. spline	S_{max}	t	max. actual circular tooth thick.
DRI	d_i	pin diam., int. spline	S_{min}	t	min. actual circular tooth thick.
h_s	...	see Figs. 6a, 6b, 6c, and 6d	SV	t_v	effective circular tooth thick.
λ	λ	effective variation	α	ϕ	pressure angle
INV α	...	involute $\alpha = \tan \alpha - \text{arc } \alpha$	α_D	ϕ_D	standard pressure angle
KE	K_e	change factor, ext. spline	α_{ci}	ϕ_{ci}	press. angle at pin contact diameter, internal spline
KI	K_i	change factor, int. spline	α_{ce}	ϕ_{ce}	press. angle at pin contact diameter, external spline
g	L	spline length	α_i	ϕ_i	press. angle at pin center, internal spline
g_w	...	active spline length	α_e	ϕ_e	press. angle at pin center, external spline
$g\gamma$...	length of engagement	α_{Fe}	ϕ_F	press. angle at form diameter, external spline
T	m	machining tolerance	α_{Fi}	ϕ_F	press. angle at form diameter, internal spline
MRE	M_e	meas. over 2 pins, ext. spline	es	...	ext. spline cir. tooth thick. modification for required fit class= c_v min (Table 14)
MRI	M_i	meas. bet. 2 pins, int. spline	$h, f, e, \text{ or } d$...	tooth thick. size modifiers (called fundamental deviation in ISO R286), Table 14
Z	N	number of teeth	H	...	space width size modifier (called fundamental deviation in ISO R286), Table 14

**Table 13. Formulas for Dimensions and Tolerances for All Fit Classes—
Metric Module Involute Splines**

Term	Symbol	Formula			
		30-Degree Flat Root 0.5 to 10 module	30-Degree Fillet Root 0.5 to 10 module	37.5-Degree Fillet Root 0.5 to 10 module	45-Degree Fillet Root 0.25 to 2.5 module
Pitch Diameter	D	mZ			
Base Diameter	DB	$mZ \cos \alpha_D$			
Circular Pitch	p	πm			
Base Pitch	p_b	$\pi m \cos \alpha_D$			
Tooth Thick Mod	es	According to selected fit class, H/h, H/f, H/e, or H/d (see Table 14)			
Min Maj. Diam. Int	DEI min	$m(Z + 1.5)$	$m(Z + 1.8)$	$m(Z + 1.4)$	$m(Z + 1.2)$
Max Maj Diam. Int.	DEI max	DEI min + $(T + \lambda)/\tan \alpha_D$ (see Footnote ^a)			
Form Diam, Int.	DFI	$m(Z + 1) + 2c_F$	$m(Z + 1) + 2c_F$	$m(Z + 0.9) + 2c_F$	$m(Z + 0.8) + 2c_F$
Min Minor Diam, Int	DII min	$DFE + 2c_F$ (see Footnote ^b)			
Max Minor Diam, Int	DII max	DII min + $(0.2m^{0.667} - 0.01m^{-0.5})$ (see Footnote ^c)			
Cir Space Width, Basic	E_{bsc}	$0.5\pi m$			
Min Effective	EV min	$0.5\pi m$			
Max Actual	E max	EV min + $(T + \lambda)$ for classes 4, 5, 6, and 7 (see Table 15 for $T + \lambda$)			
Min Actual	E min	EV min + λ (see text on page 2276 for λ)			
Max Effective	EV max	E max - λ (see text on page 2276 for λ)			
Max Major Diam, Ext ^d	DEE max	$m(Z + 1) - es/\tan \alpha_D$	$m(Z + 1) - es/\tan \alpha_D$	$m(Z + 0.9) - es/\tan \alpha_D$	$m(Z + 0.8) - es/\tan \alpha_D$
Min Major Diam. Ext	DEE min	DEE max - $(0.2m^{0.667} - 0.01m^{-0.5})^c$			
Form Diam, External	DFE	$2 \times \sqrt{(0.5DB)^2 + \left[0.5D \sin \alpha_D - \frac{h_s + ((0.5es)/\tan \alpha_D)}{\sin \alpha_D}\right]^2}$			
Max Minor Diam, Ext ^d	DIE max	$m(Z - 1.5) - es/\tan \alpha_D$	$m(Z - 1.8) - es/\tan \alpha_D$	$m(Z - 1.4) - es/\tan \alpha_D$	$m(Z - 1.2) - es/\tan \alpha_D$
Min Minor Diam, Ext	DIE min	DIE max - $(T + \lambda)/\tan \alpha_D$ (see Footnote ^a)			
Cir Tooth Thick, Basic	S_{bsc}	$0.5\pi m$			
Max Effective	SV max	$S_{bsc} - es$			
Min Actual	S min	SV max - $(T + \lambda)$ for classes 4, 5, 6, and 7 (see Table 15 for $T + \lambda$)			
Max Actual	S max	SV max - λ (see text on page 2276 for λ)			
Min Effective	SV min	S min + λ (see text on page 2276 for λ)			
Total Tolerance on Circular Space Width or Tooth Thickness	$(T + \lambda)$	See formulas in Table 15			
Machining Tolerance on Circular Space Width or Tooth Thickness	T	$T = (T + \lambda)$ from Table 15 - λ from text on page 2276.			
Effective Variation Allowed on Circular Space Width or Tooth Thickness	λ	See text on page 2276.			
Form Clearance	c_F	$0.1m$			
Rack Dimension	h_s	$0.6m$ (see Fig. 6a)	$0.6m$ (see Fig. 6b)	$0.55m$ (see Fig. 6c)	$0.5m$ (see Fig. 6d)

^a Use $(T + \lambda)$ for class 7 from Table 15

^b For all types of fit, always use the DFE value corresponding to the H/h fit.

^c Values of $(0.2m^{0.667} - 0.01m^{-0.5})$ are as follows: for 10 module, 0.93; for 8 module, 0.80; for 6 module, 0.66; for 5 module, 0.58; for 4 module, 0.50; for 3 module, 0.41; for 2.5 module, 0.36; for 2 module, 0.31; for 1.75 module, 0.28; for 1.5 module, 0.25; for 1.25 module, 0.22; for 1 module, 0.19; for 0.75 module, 0.15; for 0.5 module, 0.11; and for 0.25 module, 0.06.

^d See Table 17 for values of $es/\tan \alpha_D$.

Table 14. Tooth Thickness Modification, es , for Selected Spline Fit Classes

Pitch Diameter in mm, D	External Splines ^a				Pitch Diameter in mm, D	External Splines ^a			
	Selected Fit Class					Selected Fit Class			
	d	e	f	h		d	e	f	h
	Tooth Thickness Modification (Reduction) Relative to Basic Tooth Thickness at Pitch Diameter, es , in mm					Tooth Thickness Modification (Reduction) Relative to Basic Tooth Thickness at Pitch Diameter, es , in mm			
≤ 3	0.020	0.014	0.006	0	> 120 to 180	0.145	0.085	0.043	0
> 3 to 6	0.030	0.020	0.010	0	> 180 to 250	0.170	0.100	0.050	0
> 6 to 10	0.040	0.025	0.013	0	> 250 to 315	0.190	0.110	0.056	0
> 10 to 18	0.050	0.032	0.016	0	> 315 to 400	0.210	0.125	0.062	0
> 18 to 30	0.065	0.040	0.020	0	> 400 to 500	0.230	0.135	0.068	0
> 30 to 50	0.080	0.050	0.025	0	> 500 to 630	0.260	0.145	0.076	0
> 50 to 80	0.100	0.060	0.030	0	> 630 to 800	0.290	0.160	0.080	0
> 80 to 120	0.120	0.072	0.036	0	> 800 to 1000	0.320	0.170	0.086	0

^a Internal splines are fit class H and have space width modification from basic space width equal to zero; thus, an H/h fit class has effective clearance $c_v = 0$.

Note: The values listed in this table are taken from ISO R286 and have been computed on the basis of the geometrical mean of the size ranges shown. Values in **boldface** type do not comply with any documented rule for rounding but are those used by ISO R286; they are used in this table to comply with established international practice.

Basic Rack Profiles: The basic rack profile for the standard pressure angle splines are shown in Figs. 6a, 6b, 6c, and 6d. The dimensions shown are for maximum material condition and for fit class H/h.

Spline Machining Tolerances and Variations.—The total tolerance ($T + \lambda$), Table 15, is the sum of Effective Variation, λ , and a Machining Tolerance, T .

Table 15. Space Width and Tooth Thickness Total Tolerance, $(T + \lambda)$, in Millimeters

Spline Tolerance Class	Formula for Total Tolerance, $(T + \lambda)$	Spline Tolerance Class	Formula for Total Tolerance, $(T + \lambda)$	In these formulas, i^* and i^{**} are tolerance units based upon pitch diameter and tooth thickness, respectively: $i^* = 0.001(0.45^3\sqrt{D} + 0.001D)$ for $D \leq 500$ mm $= 0.001(0.004D + 2.1)$ for $D > 500$ mm $i^{**} = 0.001(0.45^3\sqrt{S_{\text{bsc}}} + 0.001S_{\text{bsc}})$
4	$10i^* + 40i^{**}$	6	$25i^* + 100i^{**}$	
5	$16i^* + 64i^{**}$	7	$40i^* + 160i^{**}$	

Effective Variation: The effective variation, λ , is the combined effect that total index variation, positive profile variation, and tooth alignment variation has on the effective fit of mating involute splines. The effect of the individual variations is less than the sum of the allowable variations because areas of more than minimum clearance can have profile, tooth alignment, or index variations without changing the fit. It is also unlikely that these variations would occur in their maximum amounts simultaneously on the same spline. For this reason, total index variation, total profile variation, and tooth alignment variation are used to calculate the combined effect by the following formula:

$$\lambda = 0.6\sqrt{(F_p)^2 + (f_f)^2 + (F_\beta)^2} \text{ millimeters}$$

The above variation is based upon a length of engagement equal to one-half the pitch diameter of the spline; adjustment of λ may be required for a greater length of engagement. Formulas for values of F_p , f_f , and F_β used in the above formula are given in Table 16.

Table 16. Formulas for F_p , f_f , and F_β used to calculate λ

Spline Tolerance Class	Total Index Variation, in mm, F_p	Total Profile Variation, in mm, f_f	Total Lead Variation, in mm, F_β
4	$0.001(2.5\sqrt{mZ\pi/2} + 6.3)$	$0.001[1.6m(1 + 0.0125Z) + 10]$	$0.001(0.8\sqrt{g} + 4)$
5	$0.001(3.55\sqrt{mZ\pi/2} + 9)$	$0.001[2.5m(1 + 0.0125Z) + 16]$	$0.001(1.0\sqrt{g} + 5)$
6	$0.001(5\sqrt{mZ\pi/2} + 12.5)$	$0.001[4m(1 + 0.0125Z) + 25]$	$0.001(1.25\sqrt{g} + 6.3)$
7	$0.001(7.1\sqrt{mZ\pi/2} + 18)$	$0.001[6.3m(1 + 0.0125Z) + 40]$	$0.001(2\sqrt{g} + 10)$

g = length of spline in millimeters.

Table 17. Reduction, $es/\tan \alpha_D$, of External Spline Major and Minor Diameters Required for Selected Fit Classes

Pitch Diameter D in mm	Standard Pressure Angle, in Degrees									
	30	37.5	45	30	37.5	45	30	37.5	45	All
	Classes of Fit									
	d			e			f			h
$es/\tan \alpha_D$ in millimeters										
≤ 3	0.035	0.026	0.020	0.024	0.018	0.014	0.010	0.008	0.006	0
>3 to 6	0.052	0.039	0.030	0.035	0.026	0.020	0.017	0.013	0.010	0
> 6 to 10	0.069	0.052	0.040	0.043	0.033	0.025	0.023	0.017	0.013	0
> 10 to 18	0.087	0.065	0.050	0.055	0.042	0.032	0.028	0.021	0.016	0
> 18 to 30	0.113	0.085	0.065	0.069	0.052	0.040	0.035	0.026	0.020	0
> 30 to 50	0.139	0.104	0.080	0.087	0.065	0.050	0.043	0.033	0.025	0
> 50 to 80	0.173	0.130	0.100	0.104	0.078	0.060	0.052	0.039	0.030	0
> 80 to 120	0.208	0.156	0.120	0.125	0.094	0.072	0.062	0.047	0.036	0
> 120 to 180	0.251	0.189	0.145	0.147	0.111	0.085	0.074	0.056	0.043	0
> 180 to 250	0.294	0.222	0.170	0.173	0.130	0.100	0.087	0.065	0.050	0
> 250 to 315	0.329	0.248	0.190	0.191	0.143	0.110	0.097	0.073	0.056	0
> 315 to 400	0.364	0.274	0.210	0.217	0.163	0.125	0.107	0.081	0.062	0
> 400 to 500	0.398	0.300	0.230	0.234	0.176	0.135	0.118	0.089	0.068	0
> 500 to 630	0.450	0.339	0.260	0.251	0.189	0.145	0.132	0.099	0.076	0
> 630 to 800	0.502	0.378	0.290	0.277	0.209	0.160	0.139	0.104	0.080	0
> 800 to 1000	0.554	0.417	0.320	0.294	0.222	0.170	0.149	0.112	0.086	0

These values are used with the applicable formulas in Table 13.

Machining Tolerance: A value for machining tolerance may be obtained by subtracting the effective variation, λ , from the total tolerance ($T + \lambda$). Design requirements or specific processes used in spline manufacture may require a different amount of machining tolerance in relation to the total tolerance.

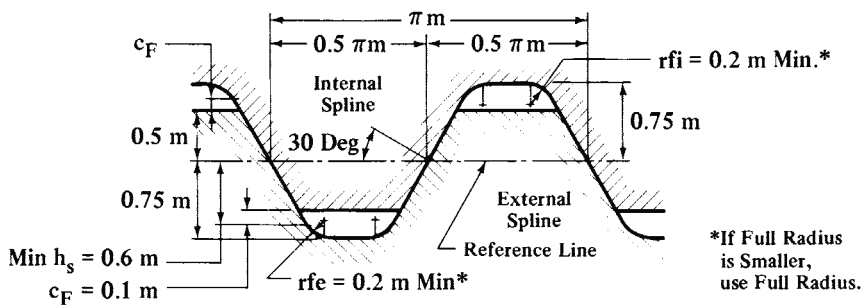


Fig. 6a. Profile of Basic Rack for 30° Flat Root Spline

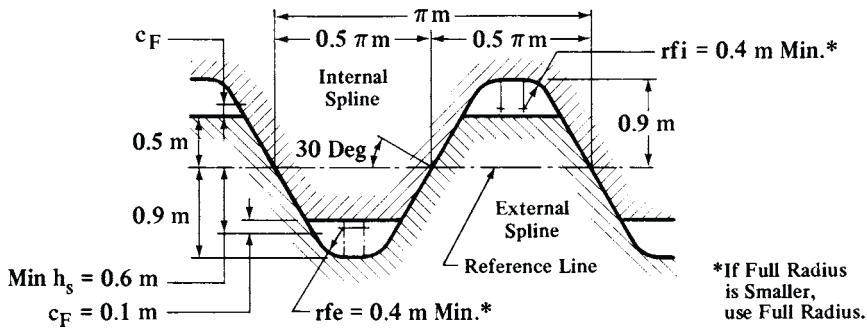


Fig. 6b. Profile of Basic Rack for 30° Fillet Root Spline

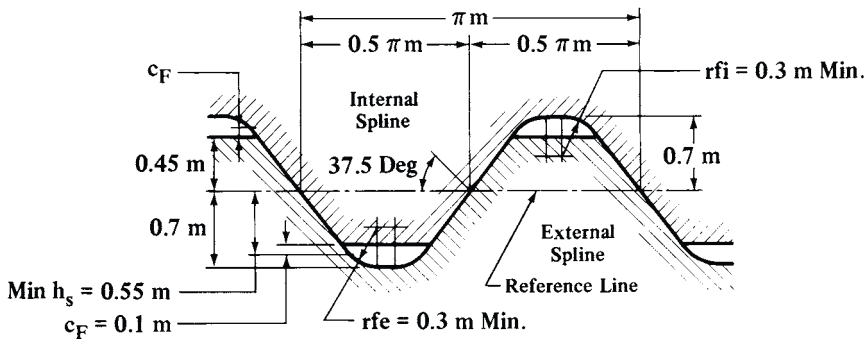


Fig. 6c. Profile of Basic Rack for 37.5° Fillet Root Spline

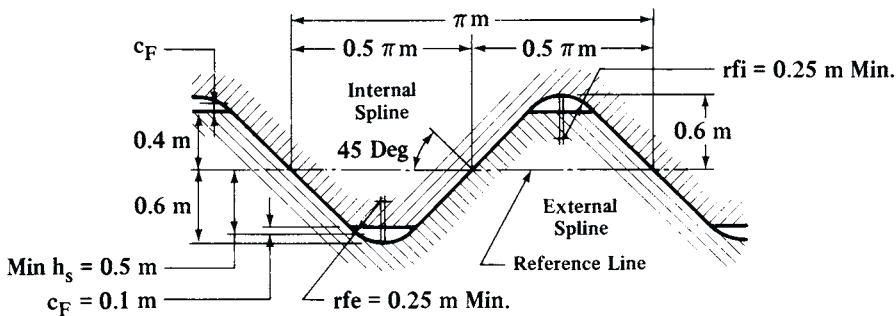


Fig. 6d. Profile of Basic Rack for 45° Fillet Root Spline

British Standard Straight Splines.—British Standard BS 2059:1953, “Straight-sided Splines and Serrations”, was introduced because of the widespread development and use of splines and because of the increasing use of involute splines it was necessary to provide a separate standard for straight-sided splines. BS 2059 was prepared on the hole basis, the hole being the constant member, and provide for different fits to be obtained by varying the size of the splined or serrated shaft. Part 1 of the standard deals with 6 splines only, irrespective of the shaft diameter, with two depths termed shallow and deep. The splines are bottom fitting with top clearance.

The standard contains three different grades of fit, based on the principle of variations in the diameter of the shaft at the root of the splines, in conjunction with variations in the widths of the splines themselves. Fit 1 represents the condition of closest fit and is designed for minimum backlash. Fit 2 has a positive allowance and is designed for ease of assembly, and Fit 3 has a larger positive allowance for applications that can accept such clearances.

all these splines allow for clearance on the sides of the splines (the widths), but in Fit 1, the minor diameters of the hole and the shaft may be of identical size.

Assembly of a splined shaft and hole requires consideration of the designed profile of each member, and this consideration should concentrate on the maximum diameter of the shafts and the widths of external splines, in association with the minimum diameter of the hole and the widths of the internal splineways. In other words, both internal and external splines are in the maximum metal condition. The accuracy of spacing of the splines will affect the quality of the resultant fit. If angular positioning is inaccurate, or the splines are not parallel with the axis, there will be interference between the hole and the shaft.

Part 2 of the Standard deals with straight-sided 90 serrations having nominal diameters from 0.25 to 6.0 inches. Provision is again made for three grades of fits, the basic constant being the serrated hole size. Variations in the fits of these serrations is obtained by varying the sizes of the serrations on the shaft, and the fits are related to flank bearing, the depth of engagement being constant for each size and allowing positive clearance at crest and root.

Fit 1 is an interference fit intended for permanent or semi-permanent assemblies. Heating to expand the internally-serrated member is needed for assembly. Fit 2 is a transition fit intended for assemblies that require accurate location of the serrated members, but must allow disassembly. In maximum metal conditions, heating of the outside member may be needed for assembly. Fit 3 is a clearance or sliding fit, intended for general applications.

Maximum and minimum dimensions for the various features are shown in the Standard for each class of fit. Maximum metal conditions presupposes that there are no errors of form such as spacing, alignment, or roundness of hole or shaft. Any compensation needed for such errors may require reduction of a shaft diameter or enlargement of a serrated bore, but the measured effective size must fall within the specified limits.

British Standard BS 3550:1963, "Involute Splines", is complementary to BS 2059, and the basic dimensions of all the sizes of splines are the same as those in the ANSI/ASME B5.15-1960, for major diameter fit and side fit. The British Standard uses the same terms and symbols and provides data and guidance for design of straight involute splines of 30 pressure angle, with tables of limiting dimensions. The standard also deals with manufacturing errors and their effect on the fit between mating spline elements. The range of splines covered is:

Side fit, flat root, 2.5/5.0 to 32/64 pitch, 6 to 60 splines.

Major diameter, flat root, 3.0/6.0 to 16/32 pitch, 6 to 60 splines.

Side fit, fillet root, 2.5/5.0 to 48/96 pitch, 6 to 60 splines.

British Standard BS 6186, Part 1:1981, "Involute Splines, Metric Module, Side Fit" is identical with sections 1 and 2 of ISO 4156 and with ANSI B92.2M-1980 (R1989) "Straight Cylindrical Involute Splines, Metric Module, Side Fit - Generalities, Dimensions and Inspection".

S.A.E. Standard Spline Fittings.—The S.A.E. spline fittings (Tables 18 through 21 inclusive) have become an established standard for many applications in the agricultural, automotive, machine tool, and other industries. The dimensions given, in inches, apply only to soft broached holes. Dimensions are illustrated in Figs. 7a, 7b, and 7c. The tolerances given may be readily maintained by usual broaching methods. The tolerances selected for the large and small diameters may depend upon whether the fit between the mating part, as finally made, is on the large or the small diameter. The other diameter, which is designed for clearance, may have a larger manufactured tolerance. If the final fit between the parts is on the sides of the spline only, larger tolerances are permissible for both the large and small diameters. The spline should not be more than 0.006 inch per foot out of parallel with respect to the shaft axis. No allowance is made for corner radii to obtain clearance. Radii at the corners of the spline should not exceed 0.015 inch.

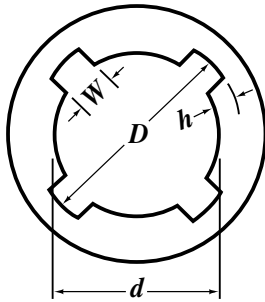


Fig. 7a. 4-Spline Fitting

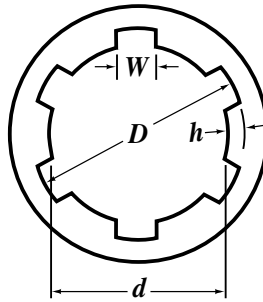


Fig. 7b. 6-Spline Fitting

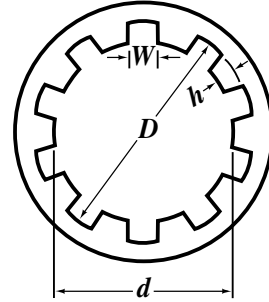


Fig. 7c. 10-Spline Fitting

Table 18. S.A.E. Standard 4-Spline Fittings

Nom. Diam.	For All Fits				4A—Permanent Fit				T^a	4B—To Slide—No Load				T^a
	D		W		d		h			d		h		
	Min.	Max.	Min.	Max.	Min.	Max.	Min.	Max.		Min.	Max.	Min.	Max.	
3/4	0.749	0.750	0.179	0.181	0.636	0.637	0.055	0.056	78	0.561	0.562	0.093	0.094	123
7/8	0.874	0.875	0.209	0.211	0.743	0.744	0.065	0.066	107	0.655	0.656	0.108	0.109	167
1	0.999	1.000	0.239	0.241	0.849	0.850	0.074	0.075	139	0.749	0.750	0.124	0.125	219
1 1/8	1.124	1.125	0.269	0.271	0.955	0.956	0.083	0.084	175	0.843	0.844	0.140	0.141	277
1 1/4	1.249	1.250	0.299	0.301	1.061	1.062	0.093	0.094	217	0.936	0.937	0.155	0.156	341
1 3/8	1.374	1.375	0.329	0.331	1.168	1.169	0.102	0.103	262	1.030	1.031	0.171	0.172	414
1 1/2	1.499	1.500	0.359	0.361	1.274	1.275	0.111	0.112	311	1.124	1.125	0.186	0.187	491
1 5/8	1.624	1.625	0.389	0.391	1.380	1.381	0.121	0.122	367	1.218	1.219	0.202	0.203	577
1 3/4	1.749	1.750	0.420	0.422	1.486	1.487	0.130	0.131	424	1.311	1.312	0.218	0.219	670
2	1.998	2.000	0.479	0.482	1.698	1.700	0.148	0.150	555	1.498	1.500	0.248	0.250	875
2 1/4	2.248	2.250	0.539	0.542	1.910	1.912	0.167	0.169	703	1.685	1.687	0.279	0.281	1106
2 1/2	2.498	2.500	0.599	0.602	2.123	2.125	0.185	0.187	865	1.873	1.875	0.310	0.312	1365
3	2.998	3.000	0.720	0.723	2.548	2.550	0.223	0.225	1249	2.248	2.250	0.373	0.375	1969

^a See note at end of Table 21.

Table 19. S.A.E. Standard 6-Spline Fittings

Nom. Diam.	For All Fits				6A—Permanent Fit			6B—To Slide—No Load			6C—To Slide Under Load		
	D		W		d		T^a	d		T^a	d		T^a
	Min.	Max.	Min.	Max.	Min.	Max.		Min.	Max.		Min.	Max.	
3/4	0.749	0.750	0.186	0.188	0.674	0.675	80	0.637	0.638	117	0.599	0.600	152
7/8	0.874	0.875	0.217	0.219	0.787	0.788	109	0.743	0.744	159	0.699	0.700	207
1	0.999	1.000	0.248	0.250	0.899	0.900	143	0.849	0.850	208	0.799	0.800	270
1 1/8	1.124	1.125	0.279	0.281	1.012	1.013	180	0.955	0.956	263	0.899	0.900	342
1 1/4	1.249	1.250	0.311	0.313	1.124	1.125	223	1.062	1.063	325	0.999	1.000	421
1 3/8	1.374	1.375	0.342	0.344	1.237	1.238	269	1.168	1.169	393	1.099	1.100	510
1 1/2	1.499	1.500	0.373	0.375	1.349	1.350	321	1.274	1.275	468	1.199	1.200	608
1 5/8	1.624	1.625	0.404	0.406	1.462	1.463	376	1.380	1.381	550	1.299	1.300	713
1 3/4	1.749	1.750	0.436	0.438	1.574	1.575	436	1.487	1.488	637	1.399	1.400	827
2	1.998	2.000	0.497	0.500	1.798	1.800	570	1.698	1.700	833	1.598	1.600	1080
2 1/4	2.248	2.250	0.560	0.563	2.023	2.025	721	1.911	1.913	1052	1.798	1.800	1367
2 1/2	2.498	2.500	0.622	0.625	2.248	2.250	891	2.123	2.125	1300	1.998	2.000	1688
3	2.998	3.000	0.747	0.750	2.698	2.700	1283	2.548	2.550	1873	2.398	2.400	2430

^a See note at end of Table 21.

Table 20. S.A.E. Standard 10-Spline Fittings

Nom. Diam.	For All Fits				10A—Permanent Fit			10B—To Slide, No Load			10C—To Slide Under Load		
	D		W		d		T ^a	d		T ^a	d		T ^a
	Min.	Max.	Min.	Max.	Min.	Max.		Min.	Max.		Min.	Max.	
3/4	0.749	0.750	0.115	0.117	0.682	0.683	120	0.644	0.645	183	0.607	0.608	241
7/8	0.874	0.875	0.135	0.137	0.795	0.796	165	0.752	0.753	248	0.708	0.709	329
1	0.999	1.000	0.154	0.156	0.909	0.910	215	0.859	0.860	326	0.809	0.810	430
1 1/8	1.124	1.125	0.174	0.176	1.023	1.024	271	0.967	0.968	412	0.910	0.911	545
1 1/4	1.249	1.250	0.193	0.195	1.137	1.138	336	1.074	1.075	508	1.012	1.013	672
1 3/8	1.374	1.375	0.213	0.215	1.250	1.251	406	1.182	1.183	614	1.113	1.114	813
1 1/2	1.499	1.500	0.232	0.234	1.364	1.365	483	1.289	1.290	732	1.214	1.215	967
1 5/8	1.624	1.625	0.252	0.254	1.478	1.479	566	1.397	1.398	860	1.315	1.316	1135
1 3/4	1.749	1.750	0.271	0.273	1.592	1.593	658	1.504	1.505	997	1.417	1.418	1316
2	1.998	2.000	0.309	0.312	1.818	1.820	860	1.718	1.720	1302	1.618	1.620	1720
2 1/4	2.248	2.250	0.348	0.351	2.046	2.048	1088	1.933	1.935	1647	1.821	1.823	2176
2 1/2	2.498	2.500	0.387	0.390	2.273	2.275	1343	2.148	2.150	2034	2.023	2.025	2688
3	2.998	3.000	0.465	0.468	2.728	2.730	1934	2.578	2.580	2929	2.428	2.430	3869
3 1/2	3.497	3.500	0.543	0.546	3.182	3.185	2632	3.007	3.010	3987	2.832	2.835	5266
4	3.997	4.000	0.621	0.624	3.637	3.640	3438	3.437	3.440	5208	3.237	3.240	6878
4 1/2	4.497	4.500	0.699	0.702	4.092	4.095	4351	3.867	3.870	6591	3.642	3.645	8705
5	4.997	5.000	0.777	0.780	4.547	4.550	5371	4.297	4.300	8137	4.047	4.050	10746
5 1/2	5.497	5.500	0.855	0.858	5.002	5.005	6500	4.727	4.730	9846	4.452	4.455	13003
6	5.997	6.000	0.933	0.936	5.457	5.460	7735	5.157	5.160	11718	4.857	4.860	15475

^a See note at end of Table 21.

Table 21. S.A.E. Standard 16-Spline Fittings

Nom. Diam.	For All Fits				16A—Permanent Fit			16B—To Slide—No Load			16C—To Slide Under Load		
	D		W		d		T ^a	d		T ^a	d		T ^a
	Min.	Max.	Min.	Max.	Min.	Max.		Min.	Max.		Min.	Max.	
2	1.997	2.000	0.193	0.196	1.817	1.820	1375	1.717	1.720	2083	1.617	1.620	2751
2 1/2	2.497	2.500	0.242	0.245	2.273	2.275	2149	2.147	2.150	3255	2.022	2.025	4299
3	2.997	3.000	0.291	0.294	2.727	2.730	3094	2.577	2.580	4687	2.427	2.430	6190
3 1/2	3.497	3.500	0.340	0.343	3.182	3.185	4212	3.007	3.010	6378	2.832	2.835	8426
4	3.997	4.000	0.389	0.392	3.637	3.640	5501	3.437	3.440	8333	3.237	3.240	11005
4 1/2	4.497	4.500	0.438	0.441	4.092	4.095	6962	3.867	3.870	10546	3.642	3.645	13928
5	4.997	5.000	0.487	0.490	4.547	4.550	8595	4.297	4.300	13020	4.047	4.050	17195
5 1/2	5.497	5.500	0.536	0.539	5.002	5.005	10395	4.727	4.730	15754	4.452	4.455	20806
6	5.997	6.000	0.585	0.588	5.457	5.460	12377	5.157	5.160	18749	4.857	4.860	24760

^a *Torque Capacity of Spline Fittings:* The torque capacities of the different spline fittings are given in the columns headed "T." The torque capacity, per inch of bearing length at 1000 pounds pressure per square inch on the sides of the spline, may be determined by the following formula, in which *T* = torque capacity in inch-pounds per inch of length, *N* = number of splines, *R* = mean radius or radial distance from center of hole to center of spline, *h* = depth of spline: $T = 1000NRh$

Table 22. Formulas for Determining Dimensions of S.A.E. Standard Splines

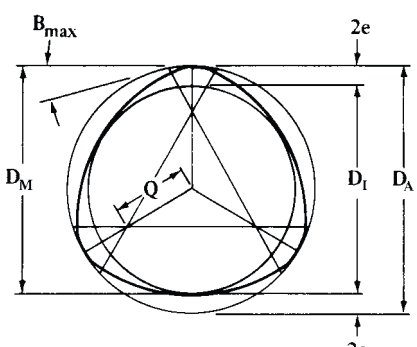
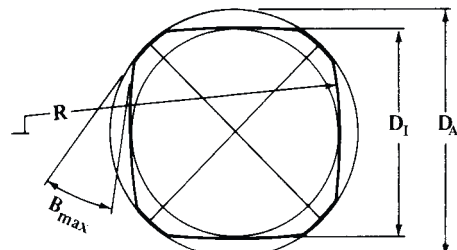
No. of Splines	W For All Fits	A Permanent Fit		B To Slide Without Load		C To Slide Under Load	
		h	d	h	d	h	d
Four	0.241D ^a	0.075D	0.850D	0.125D	0.750D
Six	0.250D	0.050D	0.900D	0.075D	0.850D	0.100D	0.800D
Ten	0.156D	0.045D	0.910D	0.070D	0.860D	0.095D	0.810D
Sixteen	0.098D	0.045D	0.910D	0.070D	0.860D	0.095D	0.810D

^aFour splines for fits *A* and *B* only.

The formulas in the table above give the maximum dimensions for *W*, *h*, and *d*, as listed in Tables 18 through 21 inclusive.

- ✦ **Polygon-Type Shaft Connections.**—Involute-form and straight-sided splines are used for both fixed and sliding connections between machine members such as shafts and gears. Polygon-type connections, so called because they resemble regular polygons but with curved sides, may be used similarly. German DIN Standards 32711 and 32712 include data for three- and four-sided metric polygon connections. Data for 11 of the sizes shown in those Standards, but converted to inch dimensions by Stoffel Polygon Systems, are given in the accompanying table.

Dimensions of Three- and Four-Sided Polygon-type Shaft Connections

Drawing for 3-sided Designs					Drawing for 4-sided Designs				
									
Three-Sided Designs					Four-Sided Designs				
Nominal Sizes			Design Data		Nominal Sizes			Design Data	
<i>D_A</i> (in.)	<i>D_I</i> (in.)	<i>e</i> (in.)	Area (in. ²)	<i>Z_p</i> (in. ³)	<i>D_A</i> (in.)	<i>D_I</i> (in.)	<i>e</i> (in.)	Area (in. ²)	<i>Z_p</i> (in. ³)
0.530	0.470	0.015	0.194	0.020	0.500	0.415	0.075	0.155	0.014
0.665	0.585	0.020	0.302	0.039	0.625	0.525	0.075	0.250	0.028
0.800	0.700	0.025	0.434	0.067	0.750	0.625	0.125	0.350	0.048
0.930	0.820	0.027	0.594	0.108	0.875	0.725	0.150	0.470	0.075
1.080	0.920	0.040	0.765	0.153	1.000	0.850	0.150	0.650	0.12
1.205	1.045	0.040	0.977	0.224	1.125	0.950	0.200	0.810	0.17
1.330	1.170	0.040	1.208	0.314	1.250	1.040	0.200	0.980	0.22
1.485	1.265	0.055	1.450	0.397	1.375	1.135	0.225	1.17	0.29
1.610	1.390	0.055	1.732	0.527	1.500	1.260	0.225	1.43	0.39
1.870	1.630	0.060	2.378	0.850	1.750	1.480	0.250	1.94	0.64
2.140	1.860	0.070	3.090	1.260	2.000	1.700	0.250	2.60	0.92

Dimensions *Q* and *R* shown on the diagrams are approximate and used only for drafting purposes: $Q \approx 7.5e$; $R \approx D_I/2 + 16e$.

Dimension $D_M = D_I + 2e$. Pressure angle B_{max} is approximately $344e/D_M$ degrees for three sides, and $299e/D_M$ degrees for four sides.

Tolerances: ISO H7 tolerances apply to bore dimensions. For shafts, g6 tolerances apply for sliding fits; k7 tolerances for tight fits.

Choosing Between Three- and Four-Sided Designs: Three-sided designs are best for applications in which no relative movement between mating components is allowed while torque is transmitted. If a hub is to slide on a shaft while under torque, four-sided designs, which have larger pressure angles B_{max} than those of three-sided designs, are better suited to sliding even though the axial force needed to move the sliding member is approximately 50 percent greater than for comparable involute spline connections.

Strength of Polygon Connections: In the formulas that follow,

H_w = hub width, inches H_t = hub wall thickness, inches

M_b = bending moment, lb-inch

M_t = torque, lb-inch

Z = section modulus, bending, in.³

= $0.098D_M^4/D_A$ for three sides = $0.15D_I^3$ for four sides

Z_p = polar section modulus, torsion, in.³

= $0.196D_M^4/D_A$ for three sides = $0.196D_I^3$ for four sides

D_A and D_M . See table footnotes.

S_b = bending stress, allowable, lb/in.²

S_s = shearing stress, allowable, lb/in.²

S_t = tensile stress, allowable, lb/in.²

For shafts, M_t (maximum) = $S_s Z_p$;

M_b (maximum) = $S_b Z$

For bores,

$$H_t(\text{minimum}) = K \sqrt{\frac{M_t}{S_t H_w}}$$

in which $K = 1.44$ for three sides except that if D_M is greater than 1.375 inches, then $K = 1.2$; $K = 0.7$ for four sides.

Failure may occur in the hub of a polygon connection if the hoop stresses in the hub exceed the allowable tensile stress for the material used. The radial force tending to expand the rim and cause tensile stresses is calculated from

$$\text{Radial Force, lb} = \frac{2M_t}{D_I n \tan(B_{max} + 11.3)}$$

This radial force acting at n points may be used to calculate the tensile stress in the hub wall using formulas from strength of materials.

Manufacturing: Polygon shaft profiles may be produced using conventional machining processes such as hobbing, shaping, contour milling, copy turning, and numerically controlled milling and grinding. Bores are produced using broaches, spark erosion, gear shapers with generating cutters of appropriate form, and, in some instances, internal grinders of special design. Regardless of the production methods used, points on both of the mating profiles may be calculated from the following equations:

$$X = (D_I/2 + e) \cos \alpha - e \cos n\alpha \cos \alpha - ne \sin n\alpha \sin \alpha$$

$$Y = (D_I/2 + e) \sin \alpha - e \cos n\alpha \sin \alpha + ne \sin n\alpha \cos \alpha$$

In these equations, α is the angle of rotation of the workpiece from any selected reference position; n is the number of polygon sides, either 3 or 4; D_I is the diameter of the inscribed circle shown on the diagram in the table; and e is the dimension shown on the diagram in the table and which may be used as a setting on special polygon grinding machines. The value of e determines the shape of the profile. A value of 0, for example, results in a circular shaft having a diameter of D_I . The values of e in the table were selected arbitrarily to provide suitable proportions for the sizes shown.

CAMS AND CAM DESIGN

Classes of Cams.—Cams may, in general, be divided into two classes: uniform motion cams and accelerated motion cams. The uniform motion cam moves the follower at the same rate of speed from the beginning to the end of the stroke; but as the movement is started from zero to the full speed of the uniform motion and stops in the same abrupt way, there is a distinct shock at the beginning and end of the stroke, if the movement is at all rapid. In machinery working at a high rate of speed, therefore, it is important that cams are so constructed that sudden shocks are avoided when starting the motion or when reversing the direction of motion of the follower.

The uniformly accelerated motion cam is suitable for moderate speeds, but it has the disadvantage of sudden changes in acceleration at the beginning, middle and end of the stroke. A cycloidal motion curve cam produces no abrupt changes in acceleration and is often used in high-speed machinery because it results in low noise, vibration and wear. The cycloidal motion displacement curve is so called because it can be generated from a cycloid which is the locus of a point of a circle rolling on a straight line.*

Cam Follower Systems.—The three most used cam and follower systems are radial and offset translating roller follower, **Figs. 1a** and **1b**; and the swinging roller follower, **Fig. 1c**. When the cam rotates, it imparts a translating motion to the roller followers in **Figs. 1a** and **1b** and a swinging motion to the roller follower in **Fig. 1c**. The motion of the follower is, of course, dependent on the shape of the cam; and the following section on displacement diagrams explains how a favorable motion is obtained so that the cam can rotate at high speed without shock.

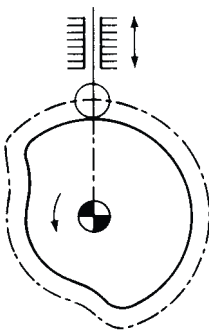


Fig. 1a. Radial Translating Roller Follower

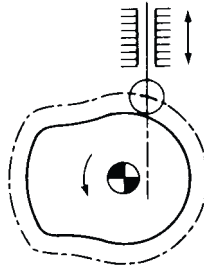


Fig. 1b. Offset Translating Roller Follower

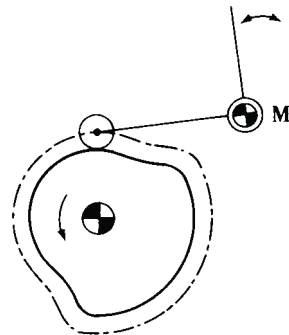


Fig. 1c. Swinging Roller Follower

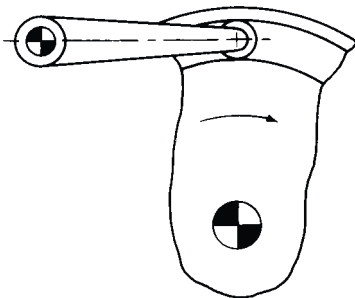


Fig. 2a. Closed-Track Cam

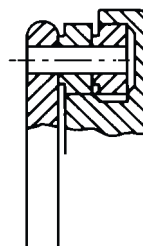


Fig. 2b. Closed-Track Cam With Two Rollers

The arrangements in **Figs. 1a**, **1b**, and **1c** show open-track cams. In **Figs. 2a** and **2b** the roller is forced to move in a closed track. Open-track cams build smaller than closed-track

* Jensen, P. W., *Cam Design and Manufacture*, Industrial Press Inc.

cams but, in general, springs are necessary to keep the roller in contact with the cam at all times. Closed-track cams do not require a spring and have the advantage of positive drive throughout the rise and return cycle. The positive drive is sometimes required as in the case where a broken spring would cause serious damage to a machine.

Displacement Diagrams.—Design of a cam begins with the displacement diagram. A simple displacement diagram is shown in Fig. 3. One cycle means one whole revolution of the cam; i.e., one cycle represents 360°. The horizontal distances T_1, T_2, T_3, T_4 are expressed in units of time (seconds); or radians or degrees. The vertical distance, h , represents the maximum “rise” or stroke of the follower.

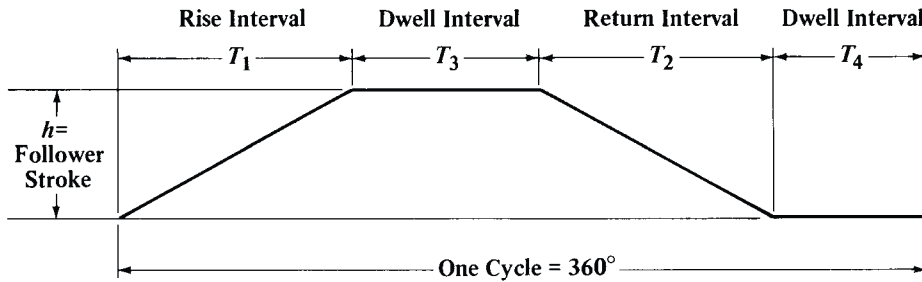


Fig. 3. A Simple Displacement Diagram

The displacement diagram of Fig. 3 is not a very favorable one because the motion from rest (the horizontal lines) to constant velocity takes place instantaneously and this means that accelerations become infinitely large at these transition points.

Types of Cam Displacement Curves: A variety of cam curves are available for moving the follower. In the following sections only the rise portions of the total time-displacement diagram are studied. The return portions can be analyzed in a similar manner. Complex cams are frequently employed which may involve a number of rise-dwell-return intervals in which the rise and return aspects are quite different. To analyze the action of a cam it is necessary to study its time-displacement and associated velocity and acceleration curves. The latter are based on the first and second time-derivatives of the equation describing the time-displacement curve:

$$y = \text{displacement} = f(t) \quad \text{or} \quad y = f(\phi)$$

$$v = \frac{dy}{dt} = \text{velocity} = \omega \frac{dy}{d\phi}$$

$$a = \frac{d^2y}{dt^2} = \text{acceleration} = \omega^2 \frac{d^2y}{d\phi^2}$$

Meaning of Symbols and Equivalent Relations

y = displacement of follower, inch (m)

h = maximum displacement of follower, inch (m)

t = time for cam to rotate through angle ϕ , sec, = ϕ/ω , sec

T = time for cam to rotate through angle β , sec, = β/ω , or $\beta/6N$, sec

ϕ = cam angle rotation for follower displacement y , degrees

β = cam angle rotation for total rise h , degrees

v = velocity of follower, in/sec (m/s)

a = follower acceleration, in/sec² (m/s²)

$$t/T = \phi/\beta$$

N = cam speed, rpm

ω = angular velocity of cam, degrees/sec = $\beta/T = \phi/t = d\phi/dt = 6N$

ω_R = angular velocity of cam, radians/sec = $\pi\omega/180$

- W = effective weight, lbs (kg)
- g = gravitational constant = 386 in./sec² (9.81 m/s²)
- $f(t)$ = means a function of t
- $f(\phi)$ = means a function of ϕ
- R_{min} = minimum radius to the cam pitch curve, inch (m)
- R_{max} = maximum radius to the cam pitch curve, inch (m)
- r_f = radius of cam follower roller, inch (m)
- ρ = radius of curvature of cam pitch curve (path of center of roller follower), inch (m)
- R_c = radius of curvature of actual cam surface, in., (m) = $\rho - r_f$ for convex surface;
= $\rho + r_f$ for concave surface.

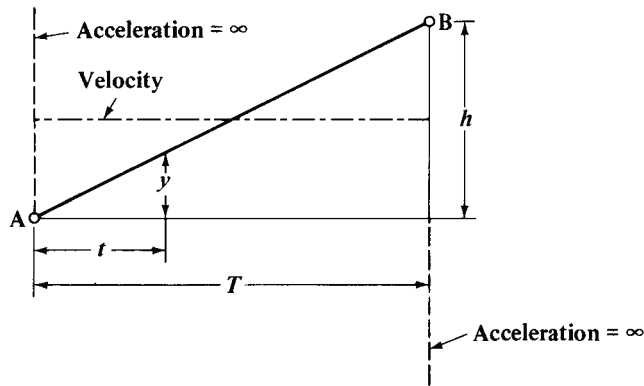


Fig. 4. Cam Displacement, Velocity, and Acceleration Curves for Constant Velocity Motion
Four displacement curves are of the greatest utility in cam design.

1. *Constant-Velocity Motion:* (Fig. 4)

$$y = h \frac{t}{T} \quad \text{or} \quad y = \frac{h\phi}{\beta} \quad (1a)$$

$$v = \frac{dy}{dt} = \frac{h}{T} \quad \text{or} \quad v = \frac{h\omega}{\beta} \quad (1b)$$

$$a = \frac{d^2y}{dt^2} = 0^* \quad (1c)$$

} $0 < t < T$

* Except at $t = 0$ and $t = T$ where the acceleration is theoretically infinite.

This motion and its disadvantages were mentioned previously. While in the unaltered form shown it is rarely used except in very crude devices, nevertheless, the advantage of uniform velocity is an important one and by modifying the start and finish of the follower stroke this form of cam motion can be utilized. Such modification is explained in the section *Displacement Diagram Synthesis* on page 2288.

2. *Parabolic Motion:* (Fig. 5)

For $0 \leq t \leq T/2$ and $0 \leq \phi \leq \beta/2$

For $T/2 \leq t \leq T$ and $\beta/2 \leq \phi \leq \beta$

$$y = 2h(t/T)^2 = 2h(\phi/\beta)^2 \quad (2a)$$

$$y = h[1 - 2(1 - t/T)^2] = h[1 - 2(1 - \phi/\beta)^2] \quad (2d)$$

$$v = 4ht/T^2 = 4h\omega\phi/\beta^2 \quad (2b)$$

$$v = 4h/T(1 - t/T) = (4h\omega/\beta)(1 - \phi/\beta) \quad (2e)$$

$$a = 4h/T^2 = 4h(\omega/\beta)^2 \quad (2c)$$

$$a = -4h/T^2 = -4h(\omega/\beta)^2 \quad (2f)$$

Examination of the above formulas shows that the velocity is zero when $t = 0$ and $y = 0$; and when $t = T$ and $y = h$.

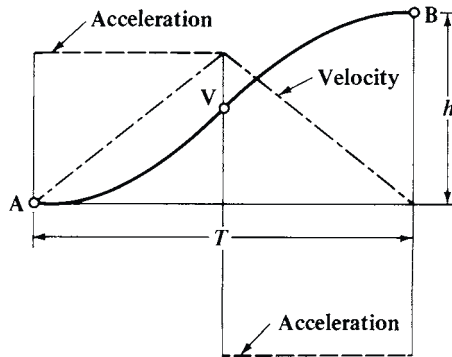


Fig. 5. Cam Displacement, Velocity, and Acceleration Curves for Parabolic Motion

The most important advantage of this curve is that for a given angle of rotation and rise it produces the smallest possible acceleration. However, because of the sudden changes in acceleration at the beginning, middle, and end of the stroke, shocks are produced. If the follower system were perfectly rigid with no backlash or flexibility, this would be of little significance. But such systems are mechanically impossible to build and a certain amount of impact is caused at each of these changeover points.

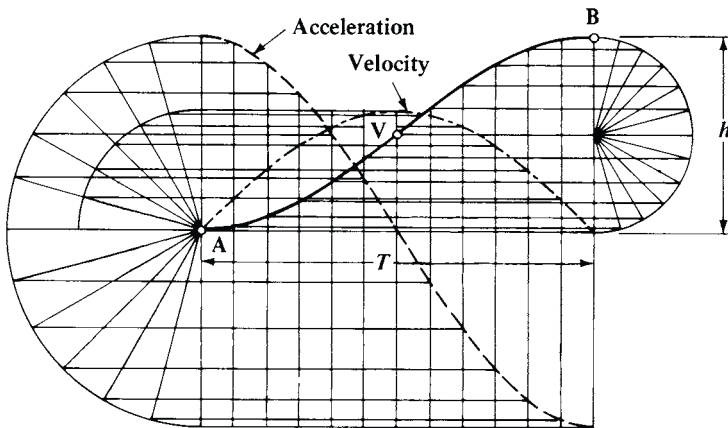


Fig. 6. Cam Displacement, Velocity, and Acceleration Curves for Simple Harmonic Motion

3. Simple Harmonic Motion: (Fig. 6)

$$y = \frac{h}{2} \left[1 - \cos\left(\frac{180^\circ t}{T}\right) \right] \quad \text{or} \quad y = \frac{h}{2} \left[1 - \cos\left(\frac{180^\circ \phi}{\beta}\right) \right] \quad (3a)$$

$$v = \frac{h}{2} \cdot \frac{\pi}{T} \sin\left(\frac{180^\circ t}{T}\right) \quad \text{or} \quad v = \frac{h}{2} \cdot \frac{\pi \omega}{\beta} \sin\left(\frac{180^\circ \phi}{\beta}\right) \quad (3b)$$

$$a = \frac{h}{2} \cdot \frac{\pi^2}{T^2} \cos\left(\frac{180^\circ t}{T}\right) \quad \text{or} \quad a = \frac{h}{2} \cdot \left(\frac{\pi \omega}{\beta}\right)^2 \cos\left(\frac{180^\circ \phi}{\beta}\right) \quad (3c)$$

} $0 \leq t \leq T$

Smoothness in velocity and acceleration during the stroke is the advantage inherent in this curve. However, the instantaneous changes in acceleration at the beginning and end of the stroke tend to cause vibration, noise, and wear. As can be seen from Fig. 6, the maximum acceleration values occur at the ends of the stroke. Thus, if inertia loads are to be overcome by the follower, the resulting forces cause stresses in the members. These forces are in many cases much larger than the externally applied loads.

4. Cycloidal Motion: (Fig. 7)

$$y = h \left[\frac{t}{T} - \frac{1}{2\pi} \sin \left(\frac{360^\circ t}{T} \right) \right] \quad \text{or} \quad y = h \left[\frac{\phi}{\beta} - \frac{1}{2\pi} \sin \left(\frac{360^\circ \phi}{\beta} \right) \right] \quad (4a)$$

$$v = \frac{h}{T} \left[1 - \cos \left(\frac{360^\circ t}{T} \right) \right] \quad \text{or} \quad v = \frac{h\omega}{\beta} \left[1 - \cos \left(\frac{360^\circ \phi}{\beta} \right) \right] \quad (4b) \quad \left. \vphantom{\frac{h}{T}} \right\} 0 \leq t \leq T$$

$$a = \frac{2\pi h}{T^2} \sin \left(\frac{360^\circ t}{T} \right) \quad \text{or} \quad a = \frac{2\pi h\omega^2}{\beta^2} \sin \left(\frac{360^\circ \phi}{\beta} \right) \quad (4c)$$

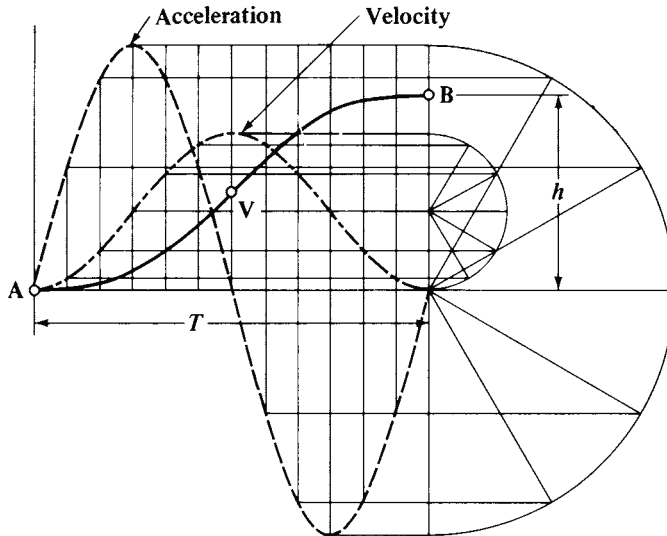


Fig. 7. Cam Displacement, Velocity, and Acceleration Curves for Cycloidal Motion

This time-displacement curve has excellent acceleration characteristics; there are no abrupt changes in its associated acceleration curve. The maximum value of the acceleration of the follower for a given rise and time is somewhat higher than that of the simple harmonic motion curve. In spite of this, the cycloidal curve is used often as a basis for designing cams for high-speed machinery because it results in low levels of noise, vibration, and wear.

Displacement Diagram Synthesis.—The straight-line graph shown in Fig. 3 has the important advantage of uniform velocity. This is so desirable that many cams based on this graph are used. To avoid impact at the beginning and end of the stroke, a modification is introduced at these points. There are many different types of modifications possible, ranging from a simple circular arc to much more complicated curves. One of the better curves used for this purpose is the parabolic curve given by Equation (2a). As seen from the derived time graphs, this curve causes the follower to begin a stroke with zero velocity but having a finite and constant acceleration. We must accept the necessity of acceleration, but effort should be made to hold it to a minimum.

Matching of Constant Velocity and Parabolic Motion Curves: By matching a parabolic cam curve to the beginning and end of a straight-line cam displacement diagram it is possible to reduce the acceleration from infinity to a finite constant value to avoid impact loads. As illustrated in Fig. 8, it can be shown that for any parabola the vertex of which is at O , the tangent to the curve at the point P intersects the line OQ at its midpoint. This means that the tangent at P represents the velocity of the follower at time X_0 as shown in Fig. 8. Since the tangent also represents the velocity of the follower over the constant velocity portion of the stroke, the transition from rest to the maximum velocity is accomplished with smoothness.

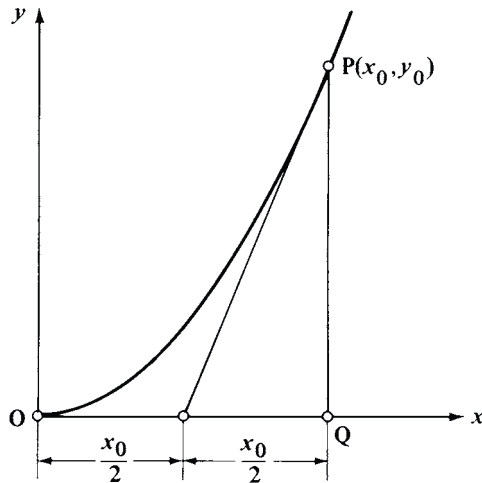


Fig. 8. The Tangent at P Bisects OQ, When Curve is a Parabola

Example: A cam follower is to rise $\frac{1}{4}$ in. with constant acceleration; $1\frac{1}{4}$ in. with constant velocity, over an angle of 50 degrees; and then $\frac{1}{2}$ in. with constant deceleration.

In Fig. 9 the three rise distances are laid out, $y_1 = \frac{1}{4}$ in., $y_2 = 1\frac{1}{4}$ in., $y_3 = \frac{1}{2}$ in., and horizontals drawn. Next, an arbitrary horizontal distance ϕ_2 proportional to 50 degrees is measured off and points A and B are located. The line AB is extended to M_1 and M_2 . By remembering that a tangent to a parabola, Fig. 8, will cut the abscissa axis at point $(X_0/2, 0)$ where X_0 is the abscissa of the point of tangency, the two values $\phi_1 = 20^\circ$ and $\phi_3 = 40^\circ$ will be found. Analytically,

$$\frac{M_1E}{\phi_2} = \frac{y_1}{y_2} \quad \frac{\frac{1}{2}\phi_1}{50^\circ} = \frac{0.25}{1.25} \quad \therefore \phi_1 = 20^\circ$$

$$\frac{FM_2}{\phi_2} = \frac{y_3}{y_2} \quad \frac{\frac{1}{2}\phi_3}{50^\circ} = \frac{0.50}{1.25} \quad \therefore \phi_3 = 40^\circ$$

In Fig. 9, the portions of the parabola have been drawn in; the details of this operation are as follows:

Assume that accuracy to the nearest thousandth of one inch is desired, and it is decided to plot values for every 5 degrees of cam rotation.

The formula for the acceleration portion of the parabolic curve is:

$$y = \frac{2h}{T^2}t^2 = 2h\left(\frac{\phi}{\beta}\right)^2 \tag{5}$$

Two different parabolas are involved in this example; one for accelerating the follower during a cam rotation of 20 degrees, the other for decelerating it in 40 degrees, these two being tangent, to opposite ends of the same line AB.

In Fig. 9 only the first half of a complete acceleration-deceleration parabolic curve is used to blend with the left end of the straight line AB. Therefore, in using the Formula (5) substitute $2y_1$ for h and $2\phi_1$ for β so that

$$y = \frac{2h\phi^2}{\beta^2} = \frac{(2)(2y_1)}{(2\phi_1)^2}\phi^2$$

For the right end of the straight line AB , the calculations are similar but, in using [Formula \(5\)](#), calculated y values are *subtracted* from the *total* rise of the cam ($y_1 + y_2 + y_3$) to obtain the follower displacement.

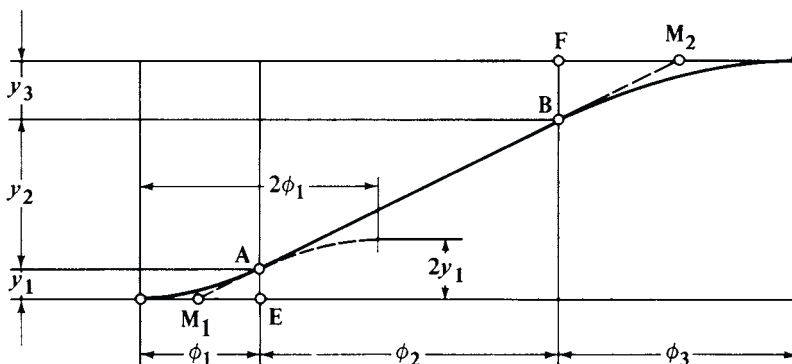


Fig. 9. Matching a Parabola at Each End of Straight Line Displacement Curve AB to Provide More Acceptable Acceleration and Deceleration

[Table 1](#) shows the computations and resulting values for the cam displacement diagram described. The calculations are shown in detail so that if equations are programmed for a digital computer, the results can be verified easily. Obviously, the intermediate points are not needed to draw the straight line, but when the cam profile is later to be drawn or cut, these values will be needed since they are to be measured on radial lines.

The matching procedure when using cycloidal motion is exactly the same as for parabolic motion, because parabolic and cycloidal motion have the same maximum velocity for equal rise (or return) and lift angle (or return angle).

Cam Profile Determination.—In the cam constructions that follow an artificial device called an *inversion* is used. This represents a mental concept which is very helpful in performing the graphical work. The construction of a cam profile requires the drawing of many positions of the cam with the follower in each case in its related location. However, instead of revolving the cam, it is assumed that the follower rotates around the *fixed* cam. It requires the drawing of many follower positions, but since this is done more or less diagrammatically, it is relatively simple.

As part of the inversion process, the direction of rotation is important. In order to preserve the correct sequence of events, the artificial rotation of the follower must be the reverse of the cam's prescribed rotation. Thus, in [Fig. 10](#) the cam rotation is counterclockwise, whereas the artificial rotation of the follower is clockwise.

Radial Translating Roller Follower: The time-displacement diagram for a cam with a radial translating roller follower is shown in [Fig. 10\(a\)](#). This diagram is read from left to right as follows: For 100 degrees of cam shaft rotation the follower rises h inches (AB), dwells in its upper position for 20 degrees (BC), returns over 180 degrees (CD), and finally dwells in its lowest position for 60 degrees (DE). Then the entire cycle is repeated.

[Fig. 10\(b\)](#) shows the cam construction layout with the cam pitch curve as a dot and dash line. To locate a point on this curve, take a point on the displacement curve, as $6'$ at the 60-degree position, and project this horizontally to point $6''$ on the 0-degree position of the cam construction diagram. Using the center of cam rotation, an arc is struck from point $6''$ to intercept the 60-degree position radial line which gives point $6'''$ on the cam pitch curve. It will be seen that the smaller circle in the cam construction layout has a radius R_{\min} equal

Table 1. Development of Modified Constant Velocity Cam with Parabolic Matching

Rise Angle	ϕ Degrees	Computation	Follower Displacement y	Explanation
$\phi_1 = 20^\circ$	0	0	0	$\beta = 40^\circ h = 0.500$ $y = \frac{(2)(0.500)}{(40)^2} \phi^2$ $= 0.000625 \phi^2$
	5	0.000625×5^2	0.016	
	10	0.00625×10^2	0.063	
	15	0.000625×15^2	0.141	
	20	0.000625×20^2	0.250	
$\phi_2 = 50^\circ$	25		0.375	1.250 in. divided into 10 uniform divisions
	30		0.500	
	35		0.625	
	40		0.750	
	45		0.875	
	50		1.000	
	55		1.125	
	60		1.250	
	65		1.375	
	70		1.500	
$\phi_3 = 40^\circ$	75	$2.000 - (0.0003125 \times 35^2)$	1.617	$\beta = 80^\circ, h = 1.000$ $y = 2 - \frac{(2)(1.000)}{(80^\circ)^2} (110^\circ - \phi)^2$ $= 2 - 0.0003125 (110^\circ - \phi)^2$ See footnote ^a
	80	$2.000 - (0.0003125 \times 30^2)$	1.719	
	85	$2.000 - (0.0003125 \times 25^2)$	1.805	
	90	$2.000 - (0.0003125 \times 20^2)$	1.875	
	95	$2.000 - (0.0003125 \times 15^2)$	1.930	
	100	$2.000 - (0.0003125 \times 10^2)$	1.969	
	105	$2.000 - (0.0003125 \times 5^2)$	1.992	
	110	$2.000 - (0.0003125 \times 0^2)$	2.000	

^a Since the deceleration portion of a parabolic cam is the same shape as the acceleration portion, but inverted, **Formula (5)** may be used to calculate the y values by substituting $2y_3$ for h and for β and the result subtracted from the total rise ($y_1 + y_2 + y_3$) to obtain the follower displacement.

to the smallest distance from the center of cam rotation to the pitch curve and, similarly, the larger circle has a radius R_{max} equal to the largest distance to the pitch curve. Thus, the difference in radii of these two circles is equal to the maximum rise h of the follower.

The cam pitch curve is also the actual profile or working surface when a knife-edged follower is used. To get the profile or working surface for a cam with a roller follower, a series of arcs with centers on the pitch curve and radii equal to the radius of the roller are drawn and the inner envelope drawn tangent to these arcs is the cam working surface or profile shown as a solid line in **Fig. 10(b)**.

Cam Grinding: The cams used on gas and gasoline motors, for operating the inlet and exhaust valves, are finished to the correct form by grinding. This grinding may be done in a regular cylindrical grinding machine by using a suitable cam grinding attachment. The general method of grinding cams is by so mounting the cam or camshaft that, while rotating, it will be moved toward and from the grinding wheel by a master cam, the movement causing the cam to be ground to the required form or contour. The master cam is in engagement with a roller which transmits motion to the work-holding fixture. It is evident that cam grinding first involves the generation of master cams, since these must be made to suit each different form of cam that is ground. In modern CNC cam grinding machines, downloaded master cam data replaces the “hard” master cam required on older manual machines.

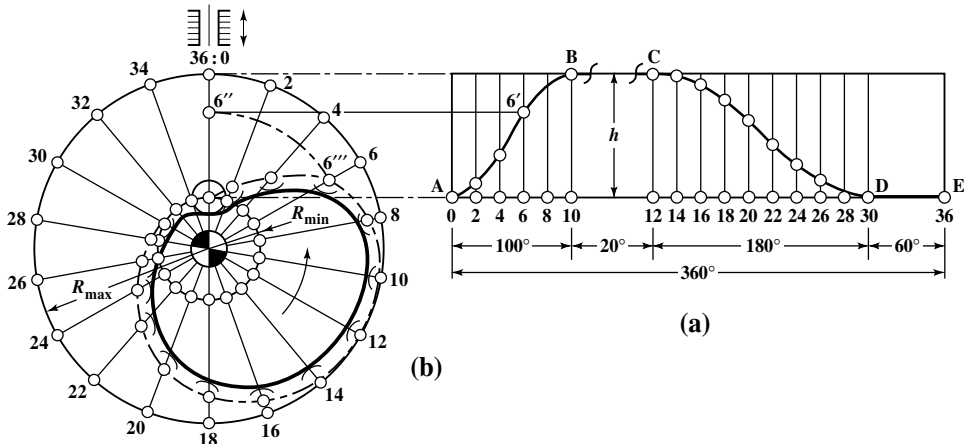


Fig. 10. (a) Time-Displacement Diagram for Cam to be Laid Out; (b) Construction of Contour of Cam With Radial Translating Roller Follower

Offset Translating Roller Follower: Given the time-displacement diagram Fig. 11 (a) and an offset follower. The construction of the cam in this case is very similar to the foregoing case and is shown in Fig. 11 (b). In this construction it will be noted that the angular position lines are not drawn radially from the cam shaft center but tangent to a circle having a radius equal to the amount of offset of the center line of the cam follower from the center of the cam shaft. For counterclockwise rotation of the cam, points 6', 6'', and 6''' are located in succession as indicated.

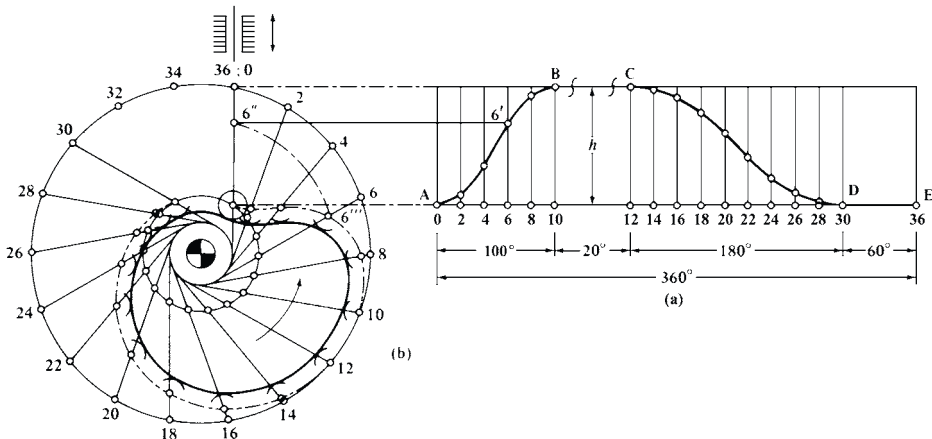


Fig. 11. (a) Time-Displacement Diagram for Cam to be Laid Out; (b) Construction of Contour of Cam With Offset Translating Roller Follower

Swinging Roller Follower: Given the time-displacement diagram Fig. 12 (a) and the length of the swinging follower arm L_f , it is required that the displacement of the follower center along the circular arc that it describes be equal to the corresponding displacements in the time-displacement diagram. If ϕ_0 is known, the displacement h of Fig. 12 (a) would be found from the formula $h = \pi\phi_0 L_f / 180^\circ$; otherwise the maximum rise h of the follower is stepped off on the arc drawn with M as a center and starting at a point on the R_{min} circle. Point M is the actual position of the pivot center of the swinging follower with respect to the cam shaft center. It is again required that the rotation of the cam be counterclockwise and therefore M is considered to have been rotated clockwise around the cam shaft center, whereby the points 2, 4, 6, etc., are obtained as shown in Fig. 12 (b). Around each of the pivot points, 2, 4, 6, etc., circular arcs whose radii equal L_f are drawn between the R_{min} and

R_{\max} circles giving the points $2', 4', 6',$ etc. The R_{\min} circle with center at the cam shaft center is drawn through the lowest position of the center of the roller follower and the R_{\max} circle through the highest position as shown. The different points on the pitch curve are now located. Point $6'''$, for instance, is found by stepping off the y_6 ordinate of the displacement diagram on arc $6'$ starting at the R_{\min} circle.

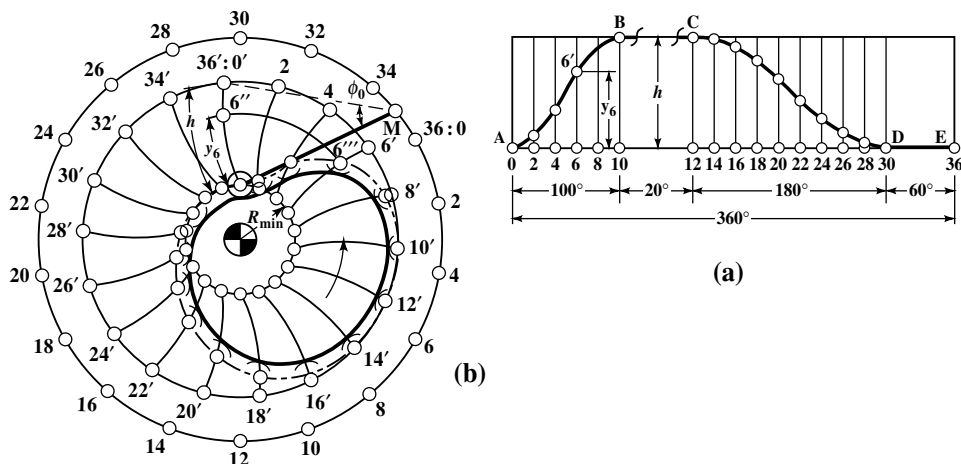


Fig. 12. (a) Time-Displacement Diagram for Cam to be Laid Out; (b) Construction of Contour of Cam With Swinging Roller Follower

Pressure Angle and Radius of Curvature.—The pressure angle at any point on the profile of a cam may be defined as the angle between the direction where the follower wants to go at that point and where the cam wants to push it. It is the angle between the tangent to the path of follower motion and the line perpendicular to the tangent of the cam profile at the point of cam-roller contact.

The size of the pressure angle is important because:

1) Increasing the pressure angle increases the side thrust and this increases the forces exerted on cam and follower.

2) Reducing the pressure angle increases the cam size and often this is not desirable because:

a) The size of the cam determines, to a certain extent, the size of the machine.

b) Larger cams require more precise cutting points in manufacturing and, therefore, an increase in cost.

c) Larger cams have higher circumferential speed and small deviations from the theoretical path of the follower cause additional acceleration, the size of which increases with the square of the cam size.

d) Larger cams mean more revolving weight and in high-speed machines this leads to increased vibrations in the machine.

e) The inertia of a large cam may interfere with quick starting and stopping.

The maximum pressure angle α_m should, in general, be kept at or below 30 degrees for translating-type followers and at or below 45 degrees for swinging-type followers. These values are on the conservative side and in many cases may be increased considerably, but beyond these limits trouble could develop and an analysis is necessary.

In the following, graphical methods are described by which a cam mechanism can be designed with translating or swinging roller followers having specified maximum pressure angles for rise and return. These methods are applicable to any kind of time-displacement diagram.

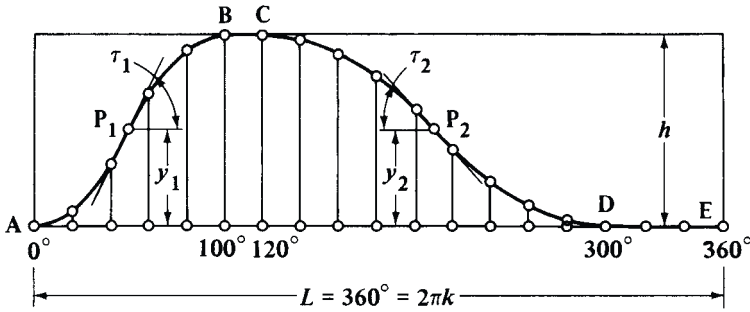


Fig. 13. Displacement Diagram

Determination of Cam Size for a Radial or an Offset Translating Follower.—Fig. 13 shows a time-displacement diagram. The maximum displacement is preferably made to scale, but the length of the abscissa, L , can be chosen arbitrarily. The distance L from 0 to 360 degrees is measured and is set equal to $2\pi k$ from which

$$k = \frac{L}{2\pi}$$

k is calculated and laid out as length E to M in Fig. 14.

In Fig. 13 the two points P_1 and P_2 having the maximum angles of slope, τ_1 , and τ_2 , are located by inspection. In this example y_1 and y_2 are of equal length.

Angles τ_1 and τ_2 are laid out as shown in Fig. 14, and the points of intersection with a perpendicular to EM at M determine Q_1 and Q_2 . The measured distances

$$MQ_1 = k \tan \tau_1 \quad \text{and} \quad MQ_2 = k \tan \tau_2$$

are laid out in Fig. 15, which is constructed as follows:

Draw a vertical line $R_u R_o$ of length h equal to the stroke of the roller follower, R_u being the lowest position and R_o the highest position of the center of the roller follower. From R_u lay out $R_u R_{y1} = y_1$ and $R_u R_{y2} = y_2$; these are equal lengths in this example. Next, if the rotation of the cam is counterclockwise, lay out $k \tan \tau_1$, to the left, $k \tan \tau_2$ to the right from points R_{y1} and R_{y2} , respectively, R_{y1} and R_{y2} being the same point in this case.

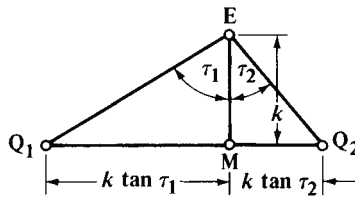


Fig. 14. Construction to Find $k \tan \tau_1$ and $k \tan \tau_2$

The specified maximum pressure angle α_1 is laid out at E_1 as shown, and a ray (line) $E_1 F_1$ is determined. Any point on this ray chosen as the cam shaft center will proportion the cam so that the pressure angle at a point on the cam profile corresponding to point P_1 , of the displacement diagram will be exactly α_1 .

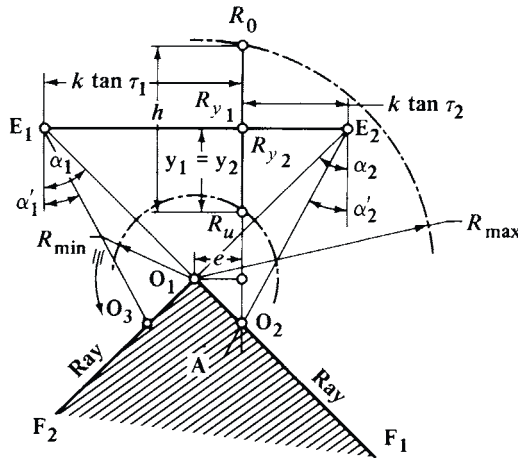


Fig. 15. Finding Proportions of Cam; Offset Translating Follower

The angle α_2 is laid out at E_2 as shown, and another ray E_2F_2 is determined. Similarly, any point on this ray chosen as the cam shaft center will proportion the cam so that the pressure angle at a point on the cam profile corresponding to point P_2 of the displacement diagram will be exactly α_2 .

Any point chosen within the cross-hatched area A as the cam center will yield a cam whose pressure angles at points corresponding to P_1 and P_2 will not exceed the specified values α_1 and α_2 respectively. If O_1 is chosen as the cam shaft center, the pressure angles on the cam profile corresponding to points P_1 and P_2 are exactly α_1 and α_2 , respectively. Selection of point O_1 also yields the smallest possible cam for the given requirements and requires an offset follower in which e is the offset distance.

If O_2 is chosen as the cam shaft center, a radial translating follower is obtained (zero offset). In that case, the pressure angle α_1 for the rise is unchanged, whereas the pressure angle for the return is changed from α_2 to α'_2 . That is, the pressure angle on the return stroke is reduced at the point P_2 . If point O_3 had been selected, then α_2 would remain unchanged but α_1 would be decreased and the offset, e , increased.

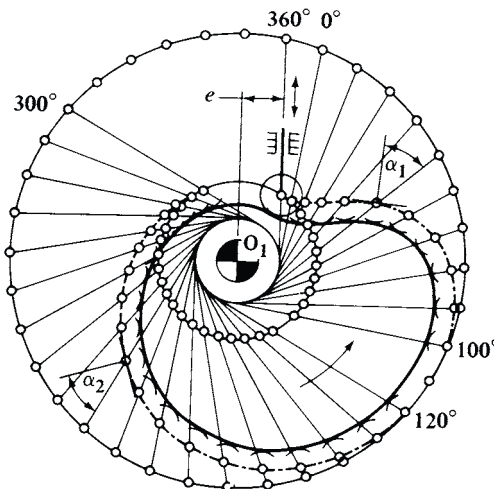


Fig. 16. Construction of Cam Contour; Offset Translating Follower

Fig. 16 shows the shape of the cam when O_1 from Fig. 15 is chosen as the cam shaft center, and it is seen that the pressure angle at a point on the cam profile corresponding to point P_1 is α_1 and at a point corresponding to point P_2 is α_2 .

In the foregoing, a cam mechanism has been so proportioned that the pressure angles α_1 and α_2 at points on the cam corresponding to points P_1 and P_2 were obtained. Even though P_1 and P_2 are the points of greatest slope on the displacement diagram, the pressure angles produced at some other points on the actual cam may be slightly greater.

However, if the pressure angles α_1 and α_2 are not to be exceeded at any point — i.e., they are to be maximum pressure angles — then P_1 and P_2 must be selected to be at the locations where these maximum pressure angles occur. If these locations are not known, then the graphical procedure described must be repeated, letting P_1 take various positions on the curve for rise (AB) and P_2 various positions on the return curve (CD) and then setting R_{\min} equal to the largest of the values determined from the various positions.

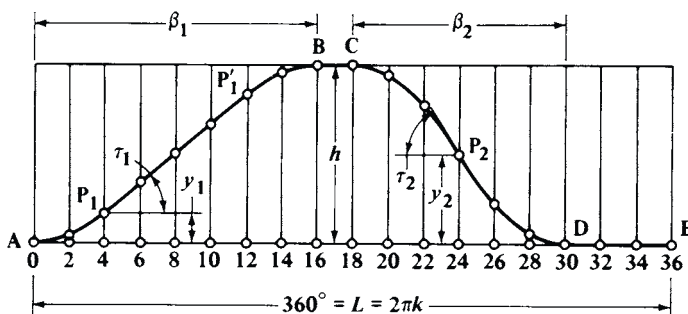


Fig. 17. Displacement Diagram

Determination of Cam Size for Swinging Roller Follower.—The proportioning of a cam with swinging roller follower having specific pressure angles at selected points follows the same procedure as that for a translating follower.

Example: Given the diagram for the roller displacement along its circular arc, Fig. 17 with $h = 1.95$ in., the periods of rise and fall, respectively, $\beta_1 = 160^\circ$ and $\beta_2 = 120^\circ$, the length of the swinging follower arm $L_f = 3.52$ in., rotation of the cam away from pivot point M , and pressure angles $\alpha_1 = \alpha_2 = 45^\circ$ (corresponding to the points P_1 and P_2 in the displacement diagram). Find the cam proportions.

Solution: Distances $k \tan \tau_1$ and $k \tan \tau_2$ are determined as in the previous example, Fig. 14. In Fig. 18, R_{y_1} is determined by making the distance $R_u R_{y_1} = y_1$ along the arc $R_u R_o$ and R_{y_2} by making $R_u R_{y_2} = y_2$. The arc $R_u R_o = h$ and R_u indicates the lowest position of the center of the swinging roller follower and R_o the highest position.

Because the cam (i.e., the surface of the cam as it passes under the follower roller) rotates away from pivot point M , $k \tan \tau_1$ is laid out away from M , that is, from R_{y_1} to E_1 and $k \tan \tau_2$ is laid out toward M from R_{y_2} to E_2 . Angle α_1 at E_1 determines one ray and α_2 at E_2 another ray, which together subtend an area A having the property that if the cam shaft center is chosen inside this area, the pressure angles at the points of the cam corresponding to P_1 and P_2 in the displacement diagram will not exceed the given values α_1 and α_2 , respectively. If the cam shaft center is chosen on the ray drawn from E_1 at an angle $\alpha_1 = 45^\circ$, the pressure angle α_1 on the cam profile corresponding to point P_1 will be exactly 45° , and if chosen on the ray from E_2 , the pressure angle α_2 corresponding to P_2 will be exactly 45° . If another point, O_2 for example, is chosen as the cam shaft center, the pressure angle corresponding to P_1 will be α'_1 and that corresponding to P_2 will be α_2 .

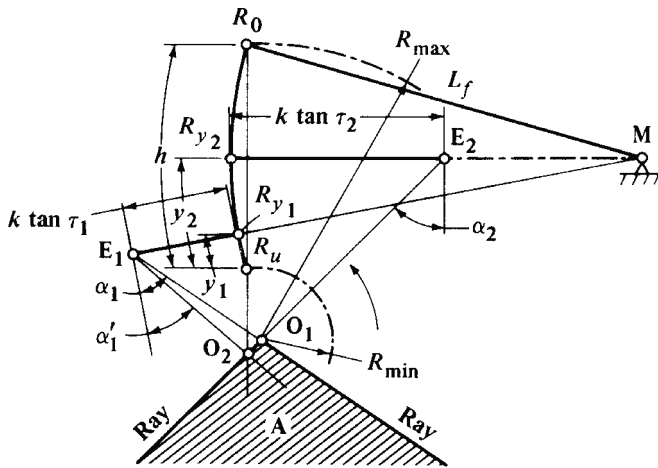


Fig. 18. Finding Proportions of Cam; Swinging Roller Follower (CCW Rotation)

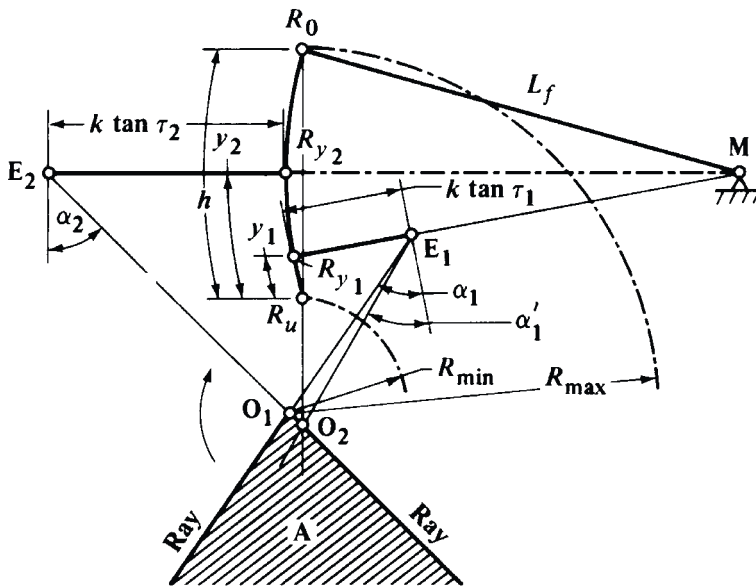


Fig. 19. Finding Proportions of Cam; Swinging Roller Follower (CW Rotation)

Fig. 19 shows the construction for rotation toward pivot point M (clockwise rotation of the cam in this case). The layout of the cam curve is made in a manner similar to that shown previously in Fig. 12.

In this example, the cam mechanism was so proportioned that the pressure angles at certain points (corresponding to P_1 and P_2) do not exceed certain specified values (namely α_1 and α_2).

To make sure that the pressure angle at *no point* along the cam profile exceeds the specified value, the previous procedure should be repeated for a series of points along the profile.

Formulas for Calculating Pressure Angles.—The graphical methods described previously are useful because they permit layout and measurement of pressure angles and radii of curvature of *any* cam profile. For cams of complicated profiles, and especially if the pro-

file cannot be represented by a simple formula, the graphical method may be the only practical solution. However, for some of the standard cam profiles utilizing *radial* translating roller followers, the following formulas may be used to determine key cam dimensions before laying out the cam. These formulas enable the designer to specify the maximum pressure angle (usually 30° or less) and, using the specified value, to calculate the minimum cam size that will satisfy the requirement.

The following symbols are in addition to those starting on page 2285.

α_{max} = specified maximum pressure angle, degrees

$R_{\alpha_{max}}$ = radius from cam center to point on pitch curve where α_{max} is located, inches (m)

ϕ_p = rise angle, in degrees, corresponding to α_{max} and $R_{\alpha_{max}}$

α = pressure angle at any selected point, degrees

R_α = radius from cam center to pitch curve at α , inches (m)

ϕ = rise angle, in degrees, corresponding to α and R_α

For Uniform Velocity Motion

$$\alpha = \arctan \left[\frac{180^\circ h}{\pi \beta R_\alpha} \right] \text{ at radius } R_\alpha \text{ to the pitch curve} \quad (6a)$$

$$\alpha_{max} = \arctan \left[\frac{180^\circ h}{\pi \beta R_{min}} \right] \text{ at radius } R_{min} \text{ of the pitch curve } (\phi=0^\circ). \quad (6b)$$

If α_{max} is specified, the minimum radius to the lowest point on the pitch curve, R_{min} , is:

$$R_{min} = \frac{180^\circ h}{\pi \beta \tan \alpha_{max}} \text{ which corresponds to } \phi=0^\circ. \quad (6c)$$

For Parabolic Motion

$$\alpha = \arctan \left[\frac{720^\circ h \phi}{\pi \beta^2 R_\alpha} \right] \text{ at radius } R_\alpha \text{ to the pitch curve at angle } \phi, \text{ where } 0 \leq \phi \leq \beta/2 \quad (7a)$$

$$\text{and } \alpha = \arctan \left[\frac{720^\circ h (1 - \phi/\beta)}{\pi \beta R_\alpha} \right] \text{ at radius } R_\alpha \text{ to pitch curve at angle } \phi, \text{ where } \beta/2 \leq \phi \leq \beta.$$

$$\alpha_{max} = \arctan \left[\frac{360^\circ h}{\pi \beta R_\alpha} \right] \text{ which occurs at } \phi=\beta/2 \text{ and } R_\alpha=R_{min}+h/2 \quad (7b)$$

If α_{max} is specified, then the minimum radius to the lowest point of the pitch curve is:

$$R_{min} = \left[\frac{360^\circ h}{\pi \beta \tan \alpha_{max}} - \frac{h}{2} \right] \text{ which corresponds to } \phi=0^\circ. \quad (7c)$$

For Simple Harmonic Motion

$$\alpha = \arctan \left[\frac{90^\circ h}{\beta R_\alpha} \sin \left(\frac{180^\circ \phi}{\beta} \right) \right] \text{ at radius } R_\alpha \text{ to the pitch curve at angle } \phi \quad (8a)$$

$$\phi_p = \left(\frac{\beta}{180^\circ} \right) \left[\operatorname{arccot} \left(\frac{\beta}{180^\circ} \tan \alpha_{max} \right) \right] = \phi \text{ where pressure angle } \alpha_{max} \text{ occurs} \quad (8b)$$

$$R_{\alpha_{max}} = \frac{h [\sin (180^\circ \phi_p / \beta)]^2}{2 \cos (180^\circ \phi_p / \beta)} \text{ at point where } \alpha=\alpha_{max} \text{ and } \phi=\phi_{max} \quad (8c)$$

$$R_{min} = R_{\alpha \max} - \frac{h}{2} \left[1 - \cos \left(\frac{180^\circ \phi_p}{\beta} \right) \right] \tag{8d}$$

For Cycloidal Motion

$$\alpha = \arctan \left[\frac{180^\circ}{\pi \beta R_\alpha} \left[1 - \cos \left(\frac{360^\circ \phi}{\beta} \right) \right] \right] \text{ at radius } R_\alpha \text{ to the pitch curve at angle } \phi \tag{9a}$$

$$\phi_p = \frac{\beta}{180^\circ} \left[\operatorname{arccot} \left(\frac{\beta \tan \alpha_{\max}}{360^\circ} \right) \right] = \text{value of } \phi \text{ where pressure angle } \alpha_{\max} \text{ occurs} \tag{9b}$$

$$R_{\alpha \max} = \frac{h}{2\pi} \frac{[1 - \cos(360^\circ \phi_p / \beta)]^2}{\sin(360^\circ \phi_p / \beta)} \text{ at point where } \alpha = \alpha_{\max} \text{ and } \phi = \phi_p \tag{9c}$$

$$R_{min} = R_{\alpha \max} - h \left[\frac{\phi_p}{\beta} - \frac{1}{2\pi} \sin \left(\frac{360^\circ \phi_p}{\beta} \right) \right] \tag{9d}$$

Radius of Curvature.—The minimum radius of curvature of a cam should be kept as large as possible (1) to prevent undercutting of the convex portion of the cam and (2) to prevent too high surface stresses. Figs. 20(a), (b) and (c) illustrate how undercutting occurs.

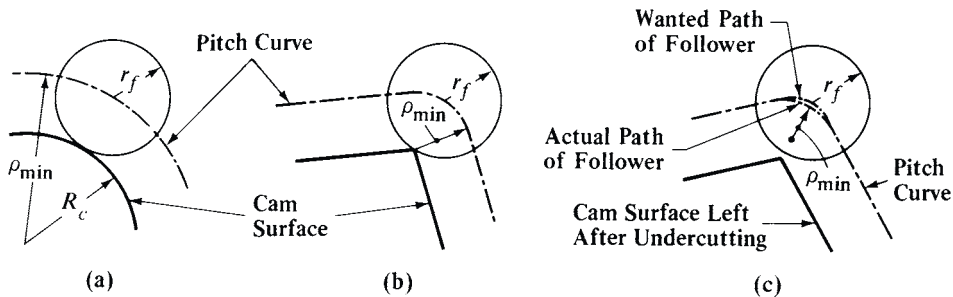


Fig. 20. (a) No Undercutting. (b) Sharp Corner on Cam. (c) Undercutting

In Fig. 20(a) the radius of curvature of the path of the follower is ρ_{min} and the cam will at that point have a radius of curvature $R_c = \rho_{min} - r_f$

In Fig. 20(b) $\rho_{min} = r_f$ and $R_c = 0$. Therefore, the actual cam will have a sharp corner which in most cases will result in too high surface stresses.

In Fig. 20(c) is shown the case where $\rho_{min} < r_f$. This case is not possible because undercutting will occur and the actual motion of the roller follower will deviate from the desired one as shown.

Undercutting cannot occur at the *concave* portion of the cam profile (working surface), but caution should be exerted in not making the radius of curvature equal to the radius of the roller follower. This condition would occur if there is a cusp on the displacement diagram which, of course, should always be avoided. To enable milling or grinding of *concave* portions of a cam profile, the radius of curvature of concave portions of the cam, $R_c = \rho_{min} + r_f$ must be larger than the radius of the cutter to be used.

The radius of curvature is used in calculating surface stresses (see following section), and may be determined by measurement on the cam layout or, in the case of radial translating followers, may be calculated using the formulas that follow. Although these formulas are exact for radial followers, they may be used for offset and swinging followers to obtain an approximation.

Based upon polar coordinates, the radius of curvature is:

$$\rho = \frac{\left[r^2 + \left(\frac{dr}{d\phi} \right)^2 \right]^{3/2}}{r^2 + 2 \left(\frac{dr}{d\phi} \right)^2 - r \left(\frac{d^2r}{d\phi^2} \right)} \quad (10)$$

*Positive values (+) indicate convex curve; negative values (-), concave.

In Equation (10), $r = (R_{\min} + y)$, where R_{\min} is the smallest radius to the pitch curve (see Fig. 12) and y is the displacement of the follower from its lowest position given in terms of ϕ , the angle of cam rotation. The following formulas for r , $dr/d\phi$, and $d^2r/d\phi^2$ may be substituted into Equation (10) to calculate the radius of curvature at any point of the cam pitch curve; however, to determine the possibility of undercutting of the convex portion of the cam, it is the minimum radius of curvature on the convex portion, ρ_{\min} , that is needed. The minimum radius of curvature occurs, generally, at the point of maximum *negative* acceleration.

Parabolic motion:

$$r = R_{\min} + h - 2h \left(1 - \frac{\phi}{\beta} \right)^2 \quad (11a)$$

$$\frac{dr}{d\phi} = \frac{720^\circ h}{\pi \beta} \left(1 - \frac{\phi}{\beta} \right) \quad (11b)$$

$$\frac{d^2r}{d\phi^2} = \frac{-4(180^\circ)^2 h}{\pi^2 \beta^2} \quad (11c)$$

$$\left. \begin{array}{l} (11a) \\ (11b) \\ (11c) \end{array} \right\} \frac{\beta}{2} \leq \phi \leq \beta$$

These equations are for the deceleration portion of the curve as explained in the footnote to Table 1.

The minimum radius of curvature can occur at either $\phi = \beta/2$ or at $\phi = \beta$, depending on the magnitudes of h , R_{\min} , and β . Therefore, to determine which is the case, make two calculations using Formula (10), one for $\phi = \beta/2$, and the other for $\phi = \beta$.

Simple harmonic motion:

$$r = R_{\min} + \frac{h}{2} \left[1 - \cos \left(\frac{180^\circ \phi}{\beta} \right) \right] \quad (12a)$$

$$\frac{dr}{d\phi} = \frac{180^\circ h}{2\beta} \sin \left(\frac{180^\circ \phi}{\beta} \right) \quad (12b)$$

$$\frac{d^2r}{d\phi^2} = \frac{(180^\circ)^2 h}{2\beta^2} \cos \left(\frac{180^\circ \phi}{\beta} \right) \quad (12c)$$

$$\left. \begin{array}{l} (12a) \\ (12b) \\ (12c) \end{array} \right\} 0 \leq \phi \leq \beta$$

The minimum radius of curvature can occur at either $\phi = \beta/2$ or at $\phi = \beta$, depending on the magnitudes of h , R_{\min} , and β . Therefore, to determine which is the case, make two calculations using Formula (10), one for $\phi = \beta/2$, and the other for $\phi = \beta$.

Cycloidal motion:

$$r = R_{\min} + h \left[\frac{\phi}{\beta} - \frac{1}{2\pi} \sin \left(\frac{360^\circ \phi}{\beta} \right) \right] \quad (13a)$$

$$\frac{dr}{d\phi} = \frac{180^\circ h}{\pi \beta} \left[1 - \cos \left(\frac{360^\circ \phi}{\beta} \right) \right] \quad (13b)$$

$$\left. \begin{array}{l} (13a) \\ (13b) \end{array} \right\} 0 \leq \phi \leq \beta$$

$$\frac{d^2r}{d\phi^2} = \frac{2(180^\circ)^2 h}{\pi\beta^2} \sin\left(\frac{360^\circ\phi}{\beta}\right) \quad (13c) \quad 0 \leq \phi \leq \beta$$

$$\rho_{\min} = \frac{[(R_{\min} + 0.91h)^2 + (180^\circ h/\pi\beta)^2]^{3/2}}{(R_{\min} + 0.91h)^2 + 2(180^\circ h/\pi\beta)^2 + (R_{\min} + 0.91h)[2(180^\circ)^2 h/\pi\beta^2]} \quad (13d)$$

(ρ_{\min} occurs near $\phi = 0.75\beta$.)

Example: Given $h = 1$ inch(m), $R_{\min} = 2.9$ inch(m), and $\beta = 60^\circ$. Find ρ_{\min} for parabolic motion, simple harmonic motion, and cycloidal motion.

Solution: $\rho_{\min} = 2.02$ inch(m) for parabolic motion, from Equation (10)

$\rho_{\min} = 1.8$ inch(m) for simple harmonic motion, from Equation (10)

$\rho_{\min} = 1.6$ inch(m) for cycloidal motion, from Equation (13d)

The value of ρ_{\min} on any cam may also be obtained by measurement on the layout of the cam using a compass.

Cam Forces, Contact Stresses, and Materials.—After a cam and follower configuration has been determined, the forces acting on the cam may be calculated or otherwise determined. Next, the stresses at the cam surface are calculated and suitable materials to withstand the stress are selected. If the calculated maximum stress is too great, it will be necessary to change the cam design.

Such changes may include: 1) increasing the cam size to decrease pressure angle and increase the radius of curvature; 2) changing to an offset or swinging follower to reduce the pressure angle; 3) reducing the cam rotation speed to reduce inertia forces; 4) increasing the cam rise angle, β , during which the rise, h , occurs; 5) increasing the thickness of the cam, provided that deflections of the follower are small enough to maintain uniform loading across the width of the cam; and 6) using a more suitable cam curve or modifying the cam curve at critical points.

Although parabolic motion seems to be the best with respect to minimizing the calculated maximum acceleration and, therefore, also the maximum acceleration forces, nevertheless, in the case of high speed cams, cycloidal motion yields the lower maximum acceleration forces. Thus, it can be shown that owing to the sudden change in acceleration (called *jerk* or *pulse*) in the case of parabolic motion, the actual forces acting on the cam are doubled and sometimes even tripled at high speed, whereas with cycloidal motion, owing to the gradually changing acceleration, the actual dynamic forces are only slightly higher than the theoretical. Therefore, the calculated force due to acceleration should be multiplied by at least a factor of 2 for parabolic and 1.05 for cycloidal motion to provide an allowance for the load-increasing effects of elasticity and backlash.

The main factors influencing cam forces are: 1) displacement and cam speed (forces due to acceleration); 2) dynamic forces due to backlash and flexibility; 3) linkage dimensions which affect weight and weight distribution; 4) pressure angle and friction forces; and 5) spring forces.

The main factors influencing stresses in cams are: 1) radius of curvature for cam and roller; and 2) materials.

Acceleration Forces: The formula for the force acting on a translating body given an acceleration a is:

$$R = \frac{Wa}{g} = \frac{Wa}{386} \quad (14)$$

In this formula, $g = 386$ inches/second squared, $a =$ acceleration of W in inches/second squared; $R =$ resultant of all the external forces (except friction) acting on the weight W . For cam analysis purposes, W , in pounds, consists of the weight of the follower, a portion of the

weight of the return spring ($1/3$), and the weight of the members of the external mechanism against which the follower pushes, for example, the weight of a piston:

$$W = W_f + \frac{1}{3}W_s + W_e \tag{15}$$

where W = equivalent single weight; W_f = follower weight; W_s = spring weight; and W_e = external weight, all in pounds.

Spring Forces: The return spring, K_s , shown in Fig. 21a must be strong enough to hold the follower against the cam at all times. At high cam speeds the main force attempting to separate the follower from the cam surface is the acceleration force R at the point of maximum *negative* acceleration. Thus, at that point the spring must exert a force F_s ,

$$F_s = R - W_f - F_e - F_f \tag{16}$$

where F_e = external force resisting motion of follower, and F_f = friction force from follower guide bushings and other sources.

When the follower is at its lowest position (R_{min} in Fig. 21a), it is usual practice to have the spring provide some estimated preload to account for “set” that takes place in a spring after repeated use and to prevent roller sliding at the start of movement.

The required spring constant, K_s , in pounds per inch of spring deflection is:

$$K_s = \frac{F_s - \text{preload}}{y_a} \tag{17}$$

where y_a = rise of cam from R_{min} to height at which maximum negative acceleration takes place.

The force, F_y , that the spring exerts at any height y above R_{min} is:

$$F_y = yK_s + \text{preload} \tag{18}$$

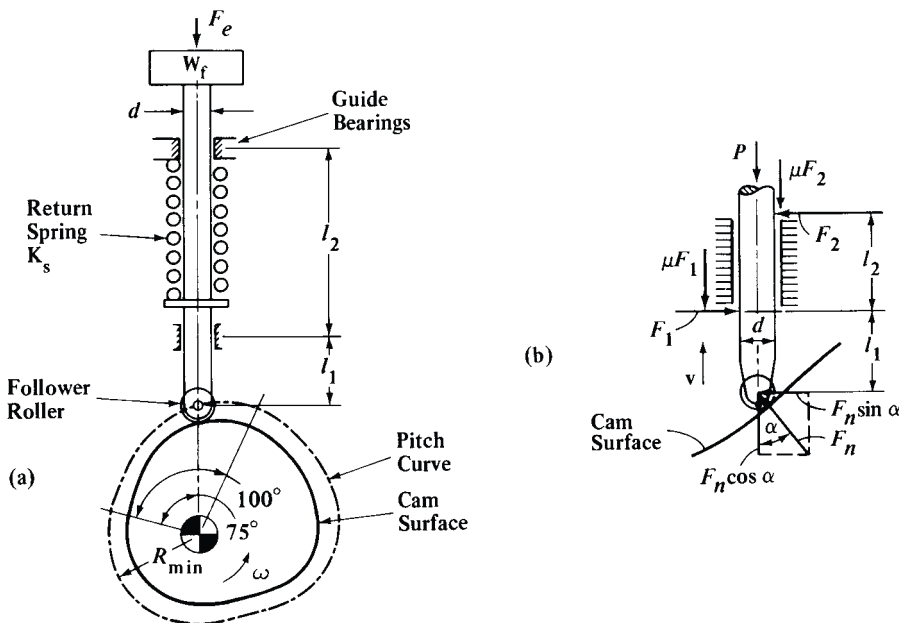


Fig. 21. (a) Radial Translating Follower and Cam System (b) Force Acting on a Translating Follower
Pressure Angle and Friction Forces: As shown in Fig. 21b, the pressure angle of the cam causes a sideways component $F_n \sin \alpha$ which produces friction forces μF_1 and μF_2 in the guide bushing. If the follower rod is too flexible, bending of the follower will increase

these friction forces. The effect of the friction forces and the pressure angle are taken into account in the formula,

$$F_n = \frac{P}{\cos \alpha - \frac{\mu \sin \alpha}{l_2}(2l_1 + l_2 - \mu d)} \quad (19a)$$

where μ = coefficient of friction in bushing; l_1, l_2 , and d are as shown in Fig. 21; and P = the sum of all the forces acting down against the upward motion of the follower (acceleration force + spring force + follower weight + external force)

$$P = \frac{W \times a}{386} + (yK_s + \text{preload}) + W_f + F_e \quad (19b)$$

Cam Torque: The follower pressing against the cam causes resisting torques during the rise period and assisting torques during the return period. The maximum value of the resisting torque determines the cam drive requirements. Instantaneous torque values may be calculated from

$$T_o = \frac{30vF_n \cos \alpha}{\pi N} = (R_{\min} + y)F_n \sin \alpha \quad (20)$$

in which T_o = instantaneous torque in pound-inches.

Example of Force Analysis: A radial translating follower system is shown in Fig. 21a. The follower is moved with cycloidal motion over a distance of 1 in. and an angle of lift $\beta = 100^\circ$. Cam speed $N = 900$ rpm. The weight of the follower mass, W_f , is 2 pounds. Both the spring weight W_s and the external weight W_e are negligible. The follower stem diameter is 0.75 in., $l_1 = 1.5$ in., $l_2 = 4$ in., coefficient of friction $\mu = 0.05$, external force $F_e = 10$ lbs, and the pressure angle is not to exceed 30° .

(a) What is the smallest radius R_{\min} to the pitch curve?

From Formula (9b) the rise angle ϕ_p to where the maximum pressure angle α_{\max} exists is:

$$\begin{aligned} \phi_p &= \frac{\beta}{180^\circ} \left[\operatorname{arccot} \left(\frac{\beta \tan \alpha_{\max}}{360^\circ} \right) \right] = \frac{100^\circ}{180^\circ} \left[\operatorname{arccot} \left(\frac{100^\circ \times \tan 30^\circ}{360^\circ} \right) \right] \\ &= 44.94^\circ = 45^\circ \end{aligned}$$

From Formula (9c) the radius, $R_{\alpha \max}$, at which the angle of rise is ϕ_p is:

$$R_{\alpha \max} = \frac{h}{2\pi} \frac{[1 - \cos(360^\circ \phi_p / \beta)]^2}{\sin(360^\circ \phi_p / \beta)} = \frac{1}{2\pi} \frac{[1 - \cos[(360^\circ \times 45^\circ) / 100^\circ]]^2}{\sin[(360^\circ \times 45^\circ) / 100^\circ]} = 1.96 \text{ in.}$$

From Formula (9d), R_{\min} is given by

$$\begin{aligned} R_{\min} &= R_{\alpha \max} - h \left[\frac{\phi_p}{\beta} - \frac{1}{2\pi} \sin \left(\frac{360^\circ \phi_p}{\beta} \right) \right] \\ &= 1.96 - 1 \times \left[\frac{45^\circ}{100^\circ} - \frac{1}{2\pi} \sin \left(\frac{360^\circ \times 45^\circ}{100^\circ} \right) \right] = 1.560 \text{ in.} \end{aligned}$$

The same results could have been obtained graphically. If this R_{\min} is too small, i.e., if the cam bore and hub require a larger cam, then R_{\min} can be increased, in which case the maximum pressure angle will be less than 30° .

(b) If the return spring K_s is specified to provide a preload of 36 lbs when the follower is at R_{\min} , what is the spring constant required to hold the follower on the cam throughout the cycle?

The follower tends to leave the cam at the point of maximum *negative* acceleration. Fig. 7 shows this to be at $\phi = \frac{3}{4}\beta = 75^\circ$.

From Formula (4c),

$$a = \frac{2\pi h \omega^2}{\beta^2} \sin\left(\frac{360^\circ \phi}{\beta}\right) = \frac{2\pi \times 1 \times (6 \times 900)^2}{(100^\circ)^2} \sin\left(\frac{360^\circ \times 75^\circ}{100^\circ}\right) = -18,300 \text{ in./sec}^2$$

From Formulas (14) and (15),

$$R = \frac{Wa}{386} = \frac{(W_f + \frac{1}{3}W_s + W_e)a}{386} = \frac{(2 + 0 + 0)(-18,300)}{386} = 95 \text{ lbs (upward)}$$

Using Formula (16) to determine the spring force F_s to hold the follower on the cam,

$$F_s = R - W_f - F_e - F_f$$

as stated on page 2301, the value of R in the above formula should be multiplied by 1.05 for cycloidal motion to provide a factor of safety for dynamic pulses. Thus,

$$F_s = 1.05R - W_f - F_e - F_f = 1.05 \times 95 - 2 - 10 - 0 = 88 \text{ lbs (downward)}$$

The spring constant from Formula (17) is:

$$K_s = \frac{F_s - \text{preload}}{y_a} = \frac{88 - 36}{y_a}$$

and, from Formula (4a) y_a is:

$$y_a = h \left[\frac{\phi}{\beta} - \frac{1}{2\pi} \sin\left(\frac{360^\circ \phi}{\beta}\right) \right] = 1 \times \left[\frac{75^\circ}{100^\circ} - \frac{1}{2\pi} \sin\left(\frac{360^\circ \times 75^\circ}{100^\circ}\right) \right] = 0.909 \text{ in.}$$

so that $K_s = (88 - 36)/0.909 = 57 \text{ lb/in.}$

(c) At the point where the pressure angle α_{\max} is 30° ($\phi = 45^\circ$) the rise of the follower is $1.96 - 1.56 = 0.40 \text{ in.}$ What is the normal force, F_n , on the cam? From Formulas (19a) and (19b)

$$F_n = \frac{Wa/386 + yK_s + \text{preload} + W_f + F_e}{\cos \alpha - \frac{\mu \sin \alpha}{l_2} (2l_1 + l_2 - \mu d)}$$

using $\phi = 45^\circ$, $h = 1 \text{ in.}$, $\beta = 100^\circ$, and $\omega = 6 \times 900$ in Formula (4c) gives $a = 5660 \text{ in./sec}^2$. So that, with $W = 2 \text{ lbs}$, $y = 0.4$, $K_s = 57$, preload = 36 lbs, $W_f = 2 \text{ lbs}$, $F_e = 10 \text{ lbs}$, $\alpha = 30^\circ$, $\mu = 0.05$, $l_1 = 1.5$, $l_2 = 4$, and $d = 0.75$,

$$F_n = \frac{(2 \times 5660)/386 + 0.4 \times 57 + 36 + 2}{\cos 30^\circ - \frac{0.05 \times \sin 30^\circ}{4} (2 \times 1.5 + 4 - 0.05 \times 0.75)} = 110 \text{ lbs}$$

Note: If the coefficient of friction had been assumed to be 0, then $F_n = 104$; on the other hand, if the follower is too flexible, so that sidewise bending occurs causing jamming in the bushing, the coefficient of friction may increase to, say, 0.5, in which case the calculated $F_n = 200 \text{ lbs}$.

(d) Assuming that in the manufacture of this cam that an error or “bump” resulting from a chattermark or as a result of poor blending occurred, and that this “bump” rose to a height of 0.001 in. in a 1° rise of the cam in the vicinity of $\phi = 45^\circ$. What effect would this bump have on the acceleration force R ?

One formula that may be used to calculate the change in acceleration caused by such a cam error is:

$$\Delta a = \pm 2e \left(\frac{6N}{\Delta\phi} \right)^2 \quad (21)$$

where Δa = change in acceleration,

e = error in inches,

$\Delta\phi$ = width of error in degrees. The plus (+) sign is used for a “bump” and the minus (–) sign for a dent or hollow in the surface

For $e = 0.001$, $\Delta\phi = 1^\circ$, and $N = 900$ rpm,

$$\Delta a = +2 \times 0.001 \left(\frac{6 \times 900}{1^\circ} \right)^2 = 58,320 \text{ in./sec}^2$$

which is 10 times the acceleration calculated for a perfect cam and would cause sufficient force F_n to damage the cam surface. On high speed cams, therefore, accuracy is of considerable importance.

(e) What is the cam torque at $\phi = 45^\circ$?

From **Formula (20)**,

$$\begin{aligned} T_o &= (R_{\min} + y)F_n \sin \alpha \\ &= (1.56 + 0.4) \times 110 \times \sin 30^\circ = 108 \text{ in.-lbs} \end{aligned}$$

(f) What is the radius of curvature at $\phi = 45^\circ$?

From **Formula (10)**,

$$\begin{aligned} \rho &= \frac{\left[r^2 + \left(\frac{dr}{d\phi} \right)^2 \right]^{3/2}}{r^2 + 2 \left(\frac{dr}{d\phi} \right)^2 - r \left(\frac{d^2r}{d\phi^2} \right)} \\ r &= R_{\min} + y = 1.56 + 0.4 = 1.96 \end{aligned}$$

From **Formula (13b)**,

$$\begin{aligned} \frac{dr}{d\phi} &= \frac{180^\circ h}{\pi \beta} \left[1 - \cos \left(\frac{360^\circ \phi}{\beta} \right) \right] = \frac{180^\circ \times 1}{\pi \times 100^\circ} \left[1 - \cos \left(\frac{360^\circ \times 45^\circ}{100^\circ} \right) \right] \\ &= 1.12 \end{aligned}$$

From **Formula (13c)**,

$$\begin{aligned} \frac{d^2r}{d\phi^2} &= \frac{2(180^\circ)^2 h}{\pi \beta^2} \sin \left(\frac{360^\circ \phi}{\beta} \right) = \frac{2 \times (180^\circ)^2 \times 1}{\pi \times (100^\circ)^2} \sin \left(\frac{360^\circ \times 45^\circ}{100^\circ} \right) \\ &= 0.64 \\ \rho &= \frac{[(1.96)^2 + (1.12)^2]^{3/2}}{(1.96)^2 + 2(1.12)^2 - 1.96 \times 0.64} = 2.26 \text{ in.} \end{aligned}$$

Calculation of Contact Stresses.—When a roller follower is loaded against a cam, the compressive stress developed at the surface of contact may be calculated from

$$S_c = 2290 \sqrt{\frac{F_n}{b} \left(\frac{1}{r_f} \pm \frac{1}{R_c} \right)} \quad (22)$$

for a steel roller against a steel cam. For a steel roller on a cast iron cam, use 1850 instead of 2290 in Equation (22).

S_c = maximum calculated compressive stress, psi

F_n = normal load, lb

b = width of cam, inch

R_c = radius of curvature of cam surface, inch

r_f = radius of roller follower, inch

The plus sign in (21) is used in calculating the maximum compressive stress when the roller is in contact with the convex portion of the cam profile and the minus sign is used when the roller is in contact with the concave portion. When the roller is in contact with the straight (flat) portion of the cam profile, $R_c = \infty$ and $1/R_c = 0$. In practice, the greatest compressive stress is most apt to occur when the roller is in contact with that part of the cam profile which is convex and has the smallest radius of curvature.

Example: Given the previous cam example, the radius of the roller $r_f = 0.25$ in., the convex radius of the cam $R_c = (2.26 - 0.25)$ in., the width of contact $b = 0.3$ in., and the normal load $F_n = 110$ lbs. Find the maximum surface compressive stress. From (21),

$$S_c = 2290 \sqrt{\frac{110}{0.3} \left(\frac{1}{0.25} + \frac{1}{2.01} \right)} = 93,000 \text{ psi}$$

This calculated stress should be less than the allowable stress for the material selected from Table 2.

Cam Materials: In considering materials for cams it is difficult to select any single material as being the best for every application. Often the choice is based on custom or the machinability of the material rather than its strength. However, the failure of a cam or roller is commonly due to fatigue, so that an important factor to be considered is the limiting wear load, which depends on the surface endurance limits of the materials used and the relative hardnesses of the mating surfaces.

Table 2. Cam Materials

Cam Materials for Use with Roller of Hardened Steel	Maximum Allowable Compressive Stress, psi
Gray-iron casting, ASTM A 48-48, Class 20, 160-190 Bhn, phosphate-coated	58,000
Gray-iron casting, ASTM A 339-51T, Grade 20, 140-160 Bhn	51,000
Nodular-iron casting, ASTM A 339-51T, Grade 80-60-03, 207-241 Bhn	72,000
Gray-iron casting, ASTM A 48-48, Class 30, 200-220 Bhn	65,000
Gray-iron casting, ASTM A 48-48, Class 35, 225-225 Bhn	78,000
Gray-iron casting, ASTM A 48-48, Class 30, heat treated (Austempered), 225-300 Bhn	90,000
SAE 1020 steel, 130-150 Bhn	82,000
SAE 4150 steel, heat treated to 270-300 Bhn, phosphate coated	20,000
SAE 4150 steel, heat treated to 270-300 Bhn	188,000
SAE 1020 steel, carburized to 0.045 in. depth of case, 50-58 Rc	226,000
SAE 1340 steel, induction hardened to 45-55 Rc	198,000
SAE 4340 steel, induction hardened to 50-55 Rc	226,000

Based on United Shoe Machinery Corp. data by Guy J. Talbourdet.

In Table 2 are given maximum permissible compressive stresses (surface endurance limits) for various cam materials when in contact with a roller of hardened steel. The stress values shown are based on 100,000,000 cycles or repetitions of stress for pure rolling. Where the repetitions of stress are considerably greater than 100,000,000, where there is appreciable misalignment, or where there is sliding, more conservative stress figures must be used.

Layout of Cylinder Cams.—In Fig. 22 is shown the development of a uniformly accelerated motion cam curve laid out on the surface of a cylindrical cam. This development is necessary for finding the projection on the cylindrical surface, as shown at *KL*. To construct the developed curve, first divide the base circle of the cylinder into, say, twelve equal parts. Set off these parts along line *ag*. Only one-half of the layout has been shown, as the other half is constructed in the same manner, except that the curve is here falling instead of rising. Divide line *aH* into the same number of divisions as the half circle, the divisions being in the proportion 1 : 3 : 5 : 5 : 3 : 1. Draw horizontal lines from these division points and vertical lines from *a, b, c*, etc. The intersections between the two sets of lines are points on the developed cam curve. These points are transferred to the cylindrical surface at the left by projection in the usual manner.

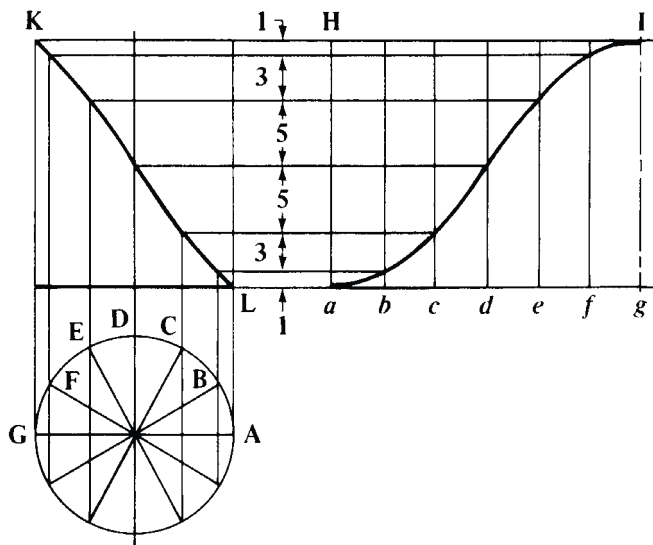


Fig. 22. Development of Cylindrical Cam

Shape of Rolls for Cylinder Cams.—The rolls for cylindrical cams working in a groove in the cam should be conical rather than cylindrical in shape, in order that they may rotate freely and without excessive friction. Fig. 23(a) shows a straight roll and groove, the action of which is faulty because of the varying surface speed at the top and bottom of the groove. Fig. 23(b) shows a roll with curved surface. For heavy work, however, the small bearing area is quickly worn down and the roll presses a groove into the side of the cam as well, thus destroying the accuracy of the movement and creating backlash. Fig. 23(c) shows the conical shape which permits a true rolling action in the groove. The amount of taper depends on the angle of spiral of the cam groove. As this angle, as a rule, is not constant for the whole movement, the roll and groove should be designed to meet the requirements on that section of the cam where the heaviest duty is performed. Frequently the cam groove is of a nearly even spiral angle for a considerable length. The method for determining the angle of the roll and groove to work correctly during the important part of the cycle is as follows:

In Fig. 23(d), *b* is the circumferential distance on the surface of the cam that includes the section of the groove for which correct rolling action is required. The throw of the cam for this circumferential movement is *a*. Line *OU* is the development of the movement of the

cam roll during the given part of the cycle, and c is the movement corresponding to b , but on a circle the diameter of which is equal to that of the cam at the bottom of the groove. With the same throw a as before, the line OV will be the development of the cam at the bottom of the groove. OU then is the length of the helix traveled by the top of the roll, while OV is the travel at the bottom of the groove. If, then, the top width and bottom width of the groove be made proportional to OU and OV , the groove will be properly proportioned.

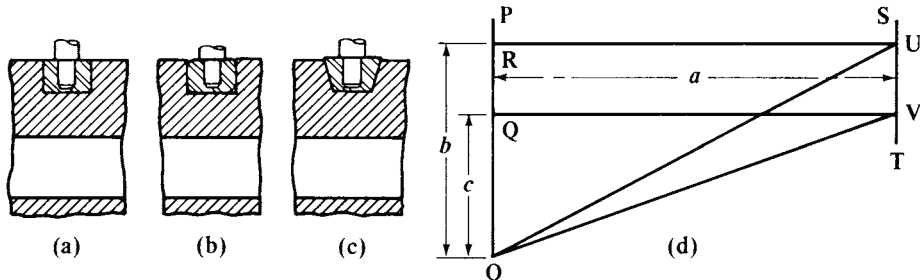


Fig. 23. Shape of Rolls for Cylinder Cams

Cam Milling.—Plate cams having a constant rise, such as are used on automatic screw machines, can be cut in a universal milling machine, with the spiral head set at an angle α , as shown by the illustration.

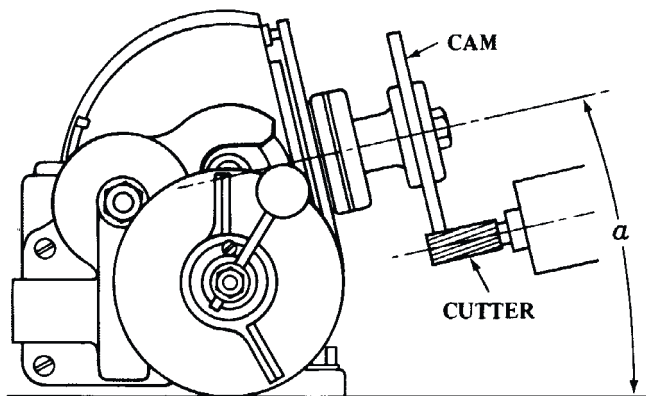


Fig. 24.

When the spiral head is set vertical, the “lead” of the cam (or its rise for one complete revolution) is the same as the lead for which the machine is geared; but when the spiral head and cutter are inclined, any lead or rise of the cam can be obtained, provided it is less than the lead for which the machine is geared, that is, less than the forward feed of the table for one turn of the spiral-head spindle. The cam lead, then, can be varied within certain limits by simply changing the inclination α of the spiral head and cutter. The following formula is for determining this angle of inclination, for a given rise of cam and with the machine geared for a lead, L , selected from the tables beginning on page 2063,

$$\sin \alpha = \frac{360^\circ \times r}{\phi \times L}$$

where α = angle to which index head and milling attachment are set from horizontal as shown in the accompanying diagram

r = rise of cam in given part of circumference

L = spiral lead for which milling machine is geared

ϕ = angle in which rise is required, expressed in degrees

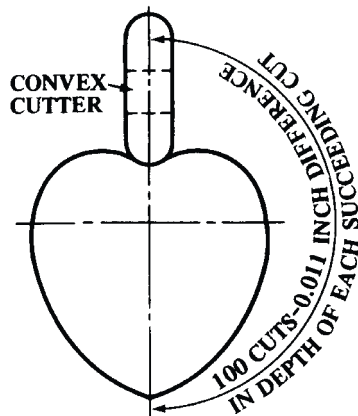
For example, suppose a cam is to be milled having a rise of 0.125 inch in 300 degrees and that the machine is geared for the smallest possible lead, or 0.670 inch; then:

$$\sin \alpha = \frac{360^\circ \times 0.125}{300^\circ \times 0.670} = 0.2239$$

which is the sine of $12^\circ 56'$. Therefore, to secure a rise of 0.125 inch with the machine geared for 0.670 inch lead, the spiral head is elevated to an angle of $12^\circ 56'$ and the vertical milling attachment is also swiveled around to locate the cutter in line with the spiral-head spindle, so that the edge of the finished cam will be parallel to its axis of rotation. In the example given, the lead used was 0.670. A larger lead, say 0.930, could have been selected from the table on page 2063. In that case, $\alpha = 9^\circ 17'$.

When there are several lobes on a cam, having different leads, the machine can be geared for a lead somewhat in excess of the greatest lead on the cam, and then all the lobes can be milled without changing the spiral head gearing, by simply varying the angle of the spiral head and cutter to suit the different cam leads. Whenever possible, it is advisable to mill on the under side of the cam, as there is less interference from chips; moreover, it is easier to see any lines that may be laid out on the cam face. To set the cam for a new cut, it is first turned back by operating the handle of the table feed screw, after which the index crank is disengaged from the plate and turned the required amount.

Simple Method for Cutting Uniform Motion Cams.—Some cams are laid out with dividers, machined and filed to the line; but for a cam that must advance a certain number of thousandths per revolution of spindle this method is not accurate. Cams are easily and accurately cut in the following manner.



Let it be required to make the heart cam shown in the illustration. The throw of this cam is 1.1 inch. Now, by setting the index on the milling machine to cut 200 teeth and also dividing 1.1 inch by 100, we find that we have 0.011 inch to recede from or advance towards the cam center for each cut across the cam. Placing the cam securely on an arbor, and the latter between the centers of the milling machine, and using a convex cutter set the proper distance from the center of the arbor, make the first cut across the cam. Then, by lowering the milling machine knee 0.011 inch and turning the index pin the proper number of holes on the index plate, take the next cut and so on.

TABLE OF CONTENTS
MACHINE ELEMENTS

PLAIN BEARINGS	BALL, ROLLER, AND NEEDLE BEARINGS
2314 Introduction 2314 Classes of Plain Bearings 2314 Types of Journal Bearings 2317 Hydrostatic Bearings 2317 Guide Bearings 2317 Modes of Bearing Operation 2319 Methods of Retaining Bearings 2319 Methods of Sealing 2321 Hardness and Surface Finish 2322 Machining Bores 2322 Methods of Lubrication 2323 Lubricant Selection 2325 Greases and Solid Lubricants 2326 Journal or Sleeve Bearings 2326 Grooving and Oil Feeding 2326 Heat Radiating Capacity 2327 Journal Bearing Design Notation 2329 Journal Bearing Lubrication 2330 Sleeve Bearing Pressure 2335 Use of Lubrication Analysis 2338 Thrust Bearings 2339 Design Notation 2340 Flat Plate Design 2345 Step Design 2347 Tapered Land Design 2352 Tilting Pad Thrust Bearing Design 2356 Plain Bearing Materials 2356 Properties of Bearing Materials 2357 Bearing and Bushing Alloys 2358 Babbitt or White Metal Alloys 2359 Copper-Lead 2359 Leaded Bronze and Tin-Bronze 2360 Aluminum 2360 Silver 2360 Cast Iron 2361 Sintered Bearings 2361 Plastics Bearings 2362 Wood 2362 Carbon-Graphite 2363 Sintered Copper- and Iron-Base	<div style="text-align: center;"><i>(Continued)</i></div> <hr style="border: 0.5px solid black;"/> 2370 Needle Bearings 2372 Plastics Bearings 2373 Flanged Housing Bearings 2373 Conventional Bearing Materials 2373 Cage Materials 2373 Method of Bearing Designation 2374 Bearing Tolerances 2375 Ball and Roller Bearings 2379 Thrust Bearings 2381 Needle Roller Bearings 2382 Shaft and Housing Fits 2387 Design and Installation 2387 Needle Roller Bearing Fitting 2390 Bearing Mounting Practice 2391 Alignment Tolerances 2391 Squareness and Alignment 2392 Soft Metal and Resilient Housings 2393 Quiet or Vibration-free Mountings 2393 General Mounting Precautions 2393 Seating Fits for Bearings 2393 Clamping and Retaining Methods 2398 Bearing Closures 2398 Bearing Fits 2398 Design Considerations 2398 Friction Losses 2399 Selection, Ball & Roller Bearings 2400 Method of Lubrication 2401 Type of Mounting 2401 Radial and Axial Clearance 2402 Bearing Handling Precautions 2403 Bearing Failures and Deficiencies 2403 Load Ratings and Fatigue Life 2403 Ball and Roller Bearing Life 2404 Ball Bearing Types Covered 2404 Limitations for Ball Bearings 2405 Ball Bearing Rating Life 2409 Roller Bearing Types Covered 2410 Roller Bearing Rating Life 2414 Life Adjustment Factors 2415 Ball Bearing Static Load Rating 2418 Equivalent Load
BALL, ROLLER, AND NEEDLE BEARINGS	
2365 Rolling Contact Bearings 2365 Types of Anti-friction Bearings 2366 Ball Bearings 2368 Roller Bearings 2369 Ball and Roller Thrust Bearings	

TABLE OF CONTENTS
MACHINE ELEMENTS

<p style="text-align: center;">LUBRICATION</p> <p>2420 Lubrication Theory</p> <p>2420 Film Thickness Ratio, λ</p> <p>2420 The Lubrication Film</p> <p>2423 Lubricants</p> <p>2424 Lubricating Oil</p> <p>2427 Composition of Oil</p> <p>2427 Mineral Based Oil</p> <p>2427 Oil Additives</p> <p>2429 Synthetic Based Oils</p> <p>2430 Temperature Effects on Oil</p> <p>2431 Lubricating Grease</p> <p>2433 Lubricant Application</p> <p>2433 Selecting a Suitable Lubricant</p> <p>2435 Oil Application</p> <p>2435 Grease Application</p> <p>2436 Lubrication Delivery Methods</p> <p>2438 Contamination Control</p> <p>2439 ISO Cleanliness Code</p> <p>2440 Water Contamination</p> <p>2441 Filtration Systems</p>	<p style="text-align: center;">KEYS AND KEYSEATS</p> <p><i>(Continued)</i></p> <p>2465 Tolerances Greater than Basic</p> <p>2465 Key Dimensions</p> <p>2466 Preferred Lengths and Tolerances</p> <p>2467 Keyway Dimensions</p> <p>2469 Material Requirements</p> <p>2469 Metric Woodruff Keys, Keyways</p> <p>2470 Dimensions for Woodruff Keys</p> <p>2471 Advantages of Woodruff Keys</p> <p>2471 Woodruff Keyway Dimensions</p> <p>2472 Inch Keys and Keyseats</p> <p>2472 Key Size Versus Shaft Diameter</p> <p>2475 Plain and Gib Head Keys</p> <p>2476 Fits for Parallel and Taper Keys</p> <p>2477 Key Chamfer</p> <p>2477 Tolerances for Electric Motors</p> <p>2477 Set Screws for Use Over Keys</p> <p>2477 Woodruff Keys and Keyseats</p> <p>2480 Keyseat Dimensions</p> <p>2482 Depths for Milling Keyseats</p> <p>2482 Depth of Keyseat</p> <p>2482 Keyseating Machines</p> <p>2482 Other Key Types</p> <p>2482 Effect of Keyways on Shaft Strength</p> <p>2482 British Standard Keys and Keyways</p> <p>2482 Cotters</p>
<p style="text-align: center;">COUPLINGS, CLUTCHES, BRAKES</p> <p>2443 Connecting Shafts</p> <p>2443 Safety Flange Coupling</p> <p>2444 Interference Fits</p> <p>2444 Double-cone Clamping Couplings</p> <p>2445 Flexible Couplings</p> <p>2445 The Universal Joint</p> <p>2446 Knuckle Joints</p> <p>2446 Friction Clutches</p> <p>2448 Formulas for Cone Clutches</p> <p>2450 Magnetic Clutches</p> <p>2450 Slipping Clutch/Couplings</p> <p>2450 Wrapped-spring Clutches</p> <p>2451 Positive Clutches</p> <p>2452 Cutting Clutch Teeth</p> <p>2455 Friction Brakes</p> <p>2455 Formulas for Band Brakes</p> <p>2457 Coefficient of Friction in Brakes</p> <p>2458 Formulas for Block Brakes</p> <p>2458 Friction Wheels</p>	<p style="text-align: center;">FLEXIBLE BELTS AND SHEAVES</p> <p>2484 Calculations for Belts and Pulleys</p> <p>2484 Diameters and Drive Ratios</p> <p>2484 Wrap Angles, Center Distance</p> <p>2484 Center Distances and Belt Length</p> <p>2485 Pulley Diameters and Speeds</p> <p>2486 Pulley Speed in Compound Drive</p> <p>2486 Belt Length in Three Pulleys</p> <p>2487 Power Transmitted by Belts</p> <p>2487 Measuring the Effective Length</p> <p>2487 Flat Belting</p> <p>2488 Flat Belt Pulleys</p> <p>2489 Narrow V-Belts</p> <p>2490 Standard Effective Lengths</p> <p>2491 Sheave and Groove Dimensions</p> <p>2493 Sheave Outside Diameters</p> <p>2495 Classical V-Belts</p> <p>2496 Standard Datum Length</p> <p>2497 Sheave and Groove Dimensions</p> <p>2502 Double V-Belts</p> <p>2503 Sheave and Groove Dimensions</p>
<p style="text-align: center;">KEYS AND KEYSEATS</p> <p>2460 Metric Keys and Keyways</p> <p>2460 Preferred Lengths and Tolerances</p> <p>2461 Key Dimensions and Tolerances</p> <p>2463 Keyway Dimensions, Tolerances</p>	

TABLE OF CONTENTS

MACHINE ELEMENTS

FLEXIBLE BELTS AND SHEAVES

(Continued)

2507	Allowable Tight Side Tension
2510	Tension Ratio, Arc of Contact
2510	Light Duty V-Belts
2510	Belt Cross Sections
2510	Belt Size Designation
2511	V-Belt Standard Dimensions
2512	Sheave and Groove Dimensions
2513	V-Ribbed Belts
2513	Nominal Dimensions
2514	Sheave and Groove Dimensions
2516	Standard Effective Lengths
2518	Variable Speed Belts
2518	Normal Dimensions
2519	Standard Belt Lengths
2520	Sheave and Groove Dimensions
2525	60 Degree V-Belts
2525	SAE Standard V-Belts
2525	SAE Belt and Pulley Dimensions
2525	Belt Storage and Handling
2527	Service Factors for V-belts
2528	Synchronous Belts
2529	Synchronous Belt Service Factors
2530	Tooth and Section Dimensions
2530	Pulley and Flange Dimensions
2531	Pitch Lengths and Tolerances
2532	Widths and Tolerances
2533	Pulley Diameters
2534	Pulley Tolerances
2535	Teeth in Mesh Factor
2536	Torque Rating
2536	Belt Width Factor

TRANSMISSION CHAINS

2537	Types of Chains
2537	Types of Roller Chains
2538	Roller Chain Nomenclature
2539	Transmission Roller Chain
2539	Standard Dimensions, Loads
2540	Roller Chain Numbers
2540	Types of Sprockets
2541	Attachments
2542	Sprocket Classes
2542	Keys, Keyways, and Set Screws
2542	Sprocket Diameters
2545	Profile Dimension
2546	Proportions of Sprockets
2547	Chain and Sprocket Selection
2547	Power Ratings for Roller Chain
2552	Max. Bore and Hub Diameter

2552	Sprocket Center Distance
2553	Center Distance of Chain Length
2553	Idler Sprockets
2553	Length of Driving Chain
2554	Tooth Form for Roller Chain
2555	Standard Hob Design
2556	Cutting Sprocket Tooth Form
2556	Standard Space Cutters
2557	Space Cutter Sizes
2557	Sprocket Materials
2558	Roller Chain Drive Ratings
2558	Service Factors
2559	Lubrication
2559	Installation and Alignment
2560	Design Procedure

BALL AND ACME LEADSCREWS

2561	Leadscrew Overview
2561	Ball Screws
2561	Acme Screws
2562	Leadscrew Design
2563	Ball Screw Selection
2564	Screws, Power Transmission

ELECTRIC MOTORS

2565	Classes of NEMA Standards
2565	Mounting Dimensions
2565	Integral-horsepower Motors
2566	Locked-rotor Torque
2567	Torque and Current Definitions
2567	Direction of Motor Rotation
2568	Pull-up Torque
2568	Types of Motors
2569	Shunt-wound Motor Drive
2570	Compound-wound Motors
2570	Types of Polyphase AC Motors
2570	Squirrel-cage Induction Motor
2571	Multiple-Speed Induction Motors
2571	Wound-Rotor Induction Motors
2571	High-Frequency Induction Motors
2571	Synchronous Motors
2572	Alternating-Current Motors
2573	Speed Reducers
2573	Factors Governing Motor Selection
2573	Speed, HP, Torque and Inertia
2574	Space Limitations
2576	Applications of DC Motors
2577	Polyphase AC Motors
2578	Electric Motor Maintenance

TABLE OF CONTENTS
MACHINE ELEMENTS

ADHESIVES AND SEALANTS	SHAFT ALIGNMENT
2580 Bonding Adhesives	2622 Introduction
2581 Two-Component Mix Adhesives	2622 Angular Misalignment
2583 Retaining Compounds	2622 Offset Misalignment
2584 Threadlocking	2623 Alignment with Dial Indicators
2584 Sealants	2623 Instruments and Methods
2585 Tapered Pipe-thread Sealing	2623 Runout Check
2586 Anaerobic Pipe Sealants	2625 Soft Legs
O-RINGS	2626 Mounting Dial Indicators
2588 Gland Depth	2627 Preparations
2590 Clearances and Groove Sizes	2628 Alignment Procedures
2591 Typical O-Ring Compounds	2629 Rim and Face Alignment
2592 Ring Materials	2633 Dial Indicator Arrangements
ROLLED STEEL, WIRE, SHEET-METAL, WIRE ROPE	2649 Method for Motors with Extra Feet
2593 Rolled Steel Sections	
2593 Angles Bent to Circular Shape	
2593 Hot-Rolled Structural Steel	
2594 Steel Wide-Flange	
2598 Steel S Sections	
2599 Steel Channels	
2600 Steel Angles with Equal Legs	
2601 Angles with Unequal Legs	
2603 Aluminum Structural Shapes	
2604 Wire and Sheet-Metal Gages	
2604 Wall Thicknesses of Tubing	
2607 Properties of Perforated Materials	
2608 Sheet-Metal Gages	
2610 Flat Metal Products	
2611 Preferred Metric Thicknesses	
2612 Letter and Number Drills	
2612 Wire Drawing History	
2612 Shaped Wire	
2613 Wire Rope	
2613 Wire Rope Construction	
2614 Properties of Wire Rope	
2615 Classes of Wire Rope	
2620 Sizes and Strengths	
2621 Safe Loads, Factors of Safety	

PLAIN BEARINGS

Introduction

On the following pages are given data and procedures for designing full-film or hydrodynamically lubricated bearings of the journal and thrust types. However, before proceeding to these design methods, it is thought useful to first review those bearing aspects concerning the types of bearings available; lubricants and lubrication methods; hardness and surface finish; machining methods; seals; retainers; and typical length-to-diameter ratios for various applications.

The following paragraphs preceding the design sections provide guidance in these matters and suggest modifications in allowable loads when other than full-film operating conditions exist in a bearing.

Classes of Plain Bearings.—Bearings that provide sliding contact between mating surfaces fall into three general classes: *radial bearings* that support rotating shafts or journals; *thrust bearings* that support axial loads on rotating members; and *guide or slipper bearings* that guide moving parts in a straight line. Radial sliding bearings, more commonly called sleeve bearings, may be of several types, the most usual being the plain full journal bearing, which has 360-degree contact with its mating journal, and the partial journal bearing, which has less than 180-degree contact. This latter type is used when the load direction is constant and has the advantages of simplicity, ease of lubrication, and reduced frictional loss.

The relative motions between the parts of plain bearings may take place: 1) as pure sliding without the benefit of a liquid or gaseous lubricating medium between the moving surfaces such as with the dry operation of nylon or Teflon; 2) with hydrodynamic lubrication in which a wedge or film buildup of lubricating medium is produced, with either whole or partial separation of the bearing surfaces; 3) with hydrostatic lubrication in which a lubricating medium is introduced under pressure between the mating surfaces causing a force opposite to the applied load and a lifting or separation of these surfaces; and 4) with a hybrid form or combination of hydrodynamic and hydrostatic lubrication.

Listed below are some of the advantages and disadvantages of sliding contact (plain) bearings as compared with rolling contact (antifriction) bearings.

Advantages: 1) require less space; 2) are quieter in operation; 3) are lower in cost, particularly in high-volume production; 4) have greater rigidity; and 5) their life is generally not limited by fatigue.

Disadvantages: 1) have higher frictional properties resulting in higher power consumption; 2) are more susceptible to damage from foreign material in lubrication system; 3) have more stringent lubrication requirements; and 4) are more susceptible to damage from interrupted lubrication supply.

Types of Journal Bearings.—Many types of journal bearing configurations have been developed; some of these are shown in Fig. 1.

Circumferential-groove bearings, Fig. 1(a), have an oil groove extending circumferentially around the bearing. The oil is maintained under pressure in the groove. The groove divides the bearing into two shorter bearings that tend to run at a slightly greater eccentricity. However, the advantage in terms of stability is slight, and this design is most commonly used in reciprocating-load main and connecting-rod bearings because of the uniformity of oil distribution.

Short cylindrical bearings are a better solution than the circumferential-groove bearing for high-speed, low-load service. Often the bearing can be shortened enough to increase the unit loading to a substantial value, causing the shaft to ride at a position of substantial eccentricity in the bearing. Experience has shown that instability rarely results when the shaft eccentricity is greater than 0.6. Very short bearings are not often used for this type of

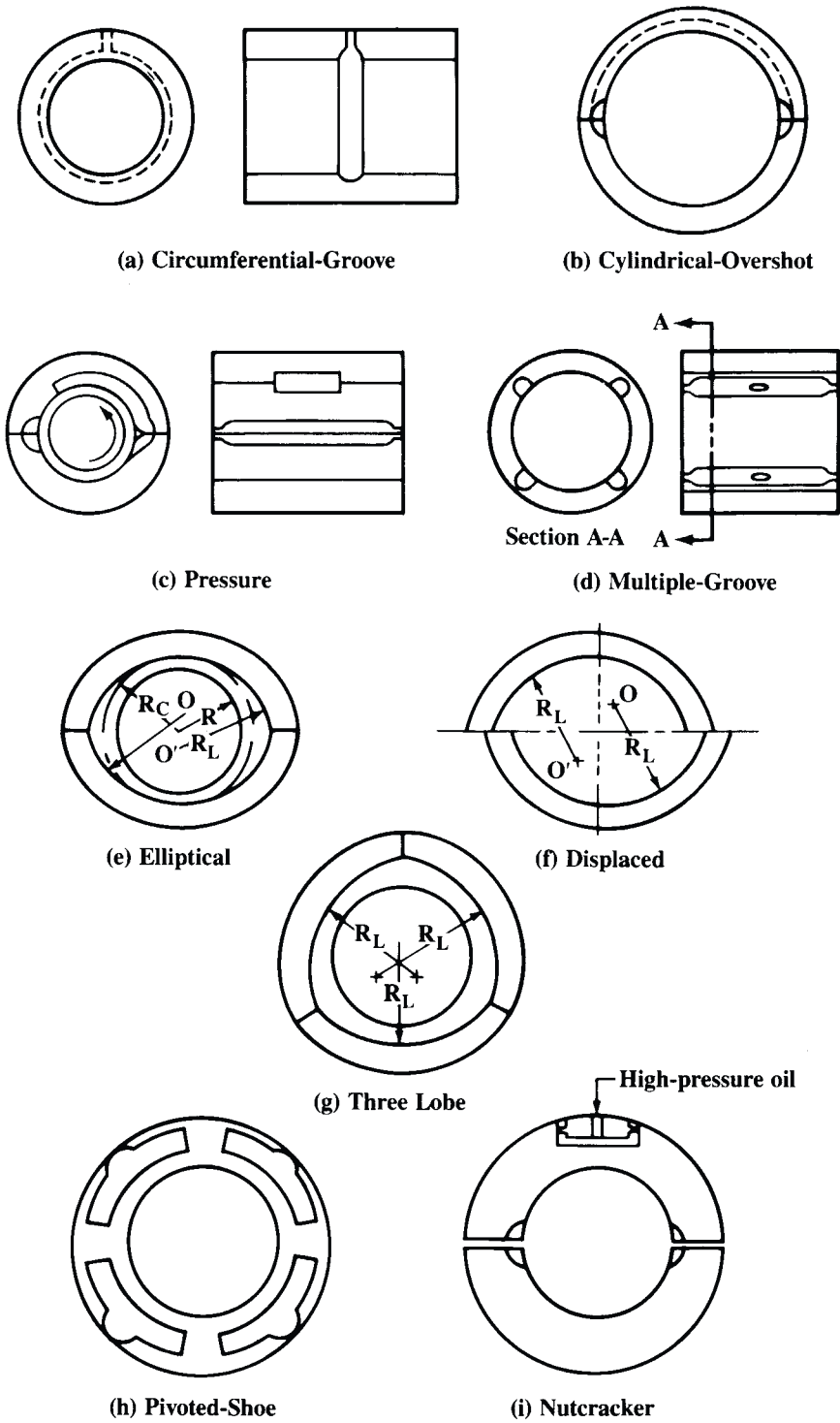


Fig. 1. Typical shapes of several types of pressure-fed bearings.

application, because they do not provide a high temporary rotating-load capacity in the event some unbalance should be created in the rotor during service.

Cylindrical-overshot bearings, Fig. 1(b), are used where surface speeds of 10,000 fpm or more exist, and where additional oil flow is desired to maintain a reasonable bearing temperature. This bearing has a wide circumferential groove extending from one axial oil groove to the other over the upper half of the bearing. Oil is usually admitted to the trailing-edge oil groove. An inlet orifice is used to control the oil flow. Cooler operation results from the elimination of shearing action over a large section of the upper half of the bearing and, to a great extent, from the additional flow of cool oil over the top half of the bearing.

Pressure bearings, Fig. 1(c), employ a groove over the top half of the bearing. The groove terminates at a sharp dam about 45 degrees beyond the vertical in the direction of shaft rotation. Oil is pumped into this groove by shear action from the rotation of the shaft and is then stopped by the dam. In high-speed operation, this situation creates a high oil pressure over the upper half of the bearing. The pressure created in the oil groove and surrounding upper half of the bearing increases the load on the lower half of the bearing. This self-generated load increases the shaft eccentricity. If the eccentricity is increased to 0.6 or greater, stable operation under high-speed, low-load conditions can result. The central oil groove can be extended around the lower half of the bearing, further increasing the effective loading. This design has one primary disadvantage: Dirt in the oil will tend to abrade the sharp edge of the dam and impair ability to create high pressures.

Multiple-groove bearings, Fig. 1(d), are sometimes used to provide increased oil flow. The interruptions in the oil film also appear to give this bearing some merit as a stable design.

Elliptical bearings, Fig. 1(e), are not truly elliptical, but are formed from two sections of a cylinder. This two-piece bearing has a large clearance in the direction of the split and a smaller clearance in the load direction at right angles to the split. At light loads, the shaft runs eccentric to both halves of the bearing, and hence, the elliptical bearing has a higher oil flow than the corresponding cylindrical bearing. Thus, the elliptical bearing will run cooler and will be more stable than a cylindrical bearing.

Elliptical-overshot bearings (not shown) are elliptical bearings in which the upper half is relieved by a wide oil groove connecting the axial oil grooves. They are analogous to cylindrical-overshot bearings.

Displaced elliptical bearings, Fig. 1(f), shift the centers of the two bearing arcs in both a horizontal and a vertical direction. This design has greater stiffness than a cylindrical bearing, in both horizontal and vertical directions, with substantially higher oil flow. It has not been extensively used, but offers the prospect of high stability and cool operation.

Three-lobe bearings, Fig. 1(g), are made up in cross section of three circular arcs. They are most effective as antioil whip bearings when the centers of curvature of each of the three lobes lie well outside the clearance circle that the shaft center can describe within the bearing. Three axial oil-feed grooves are used. It is a more difficult design to manufacture, because it is almost necessary to make it in three parts instead of two. The bore is machined with shims between each of the three parts. The shims are removed after machining is completed.

Pivoted-shoe bearings, Fig. 1(h), are one of the most stable bearings. The bearing surface is divided into three or more segments, each of which is pivoted at the center. In operation, each shoe tilts to form a wedge-shaped oil film, thus creating a force tending to push the shaft toward the center of the bearing. For single-direction rotation, the shoes are sometimes pivoted near one end and forced toward the shaft by springs.

Nutcracker bearings, Fig. 1(i), consist of two cylindrical half-bearings. The upper half-bearing is free to move in a vertical direction and is forced toward the shaft by a hydraulic cylinder. External oil pressure may be used to create load on the upper half of the bearing through the hydraulic cylinder. Or the high-pressure oil may be obtained from the lower half of the bearing by tapping a hole into the high-pressure oil film, thus creating a self-loading bearing. Either type can increase bearing eccentricity to the point where stable operation can be achieved.

Hydrostatic Bearings.—Hydrostatic bearings are used when operating conditions require full film lubrication that cannot be developed hydrodynamically. The hydrostatically lubricated bearing, either thrust or radial, is supplied with lubricant under pressure from an external source. Some advantages of the hydrostatic bearing over bearings of other types are: low friction; high load capacity; high reliability; high stiffness; and long life.

Hydrostatic bearings are used successfully in many applications including machine tools, rolling mills, and other heavily loaded slow-moving machinery. However, specialized techniques, including a thorough understanding of hydraulic components external to the bearing package is required. The designer is cautioned against use of this type of bearing without a full knowledge of all aspects of the problem. Determination of the operating performance of hydrostatic bearings is a specialized area of the lubrication field and is described in specialized reference books.

Guide Bearings.—This type of bearing is generally used as a positioning device or as a guide to linear motion such as in machine tools. Fig. 2 shows several examples of guide-way bearing designs. It is normal for this type of bearing to operate in the boundary lubrication region with either dry, dry film such as molybdenum disulfide (MoS_2) or tetrafluorethylene (TFE), grease, oil, or gaseous lubrication. Hydrostatic lubrication is often used to improve performance, reduce wear, and increase stability. This type of design uses pumps to supply air or gas under pressure to pockets designed to produce a bearing film and maintain complete separation of the sliding surfaces.

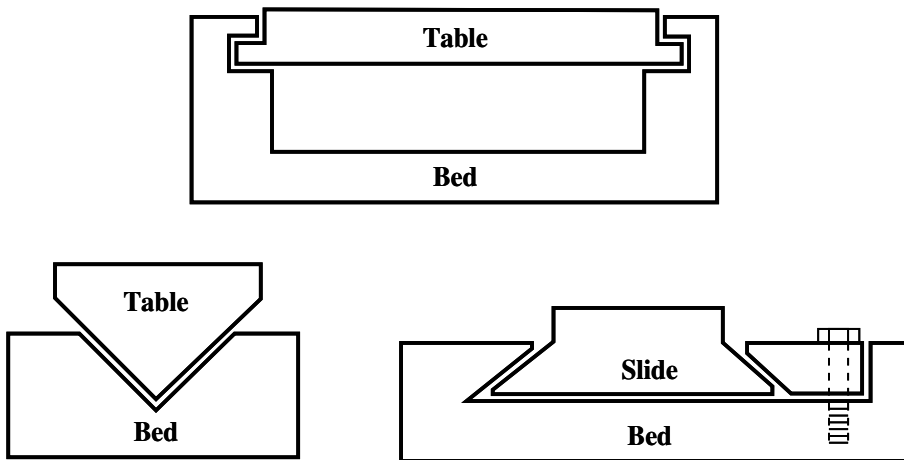


Fig. 2. Types of Guide Bearings

Design.—The design of a sliding bearing is generally accomplished in one of two ways:

1) a bearing operating under similar conditions is used as a model or basis from which the new bearing is designed; and 2) in the absence of any previous experience with similar bearings in similar environments, certain assumptions concerning operating conditions and requirements are made and a tentative design prepared based on general design parameters or rules of thumb. Detailed lubrication analysis is then performed to establish design and operating details and requirements.

Modes of Bearing Operation.—The load-carrying ability of a sliding bearing depends upon the kind of fluid film that is formed between its moving surfaces. The formation of this film is dependent, in part, on the design of the bearing and, in part, on the speed of rotation. The bearing has three modes or regions of operation designated as *full-film*, *mixed-film*, and *boundary* lubrication with effects on bearing friction, as shown in Fig. 3.

In terms of physical bearing operation these three modes may be further described as follows:

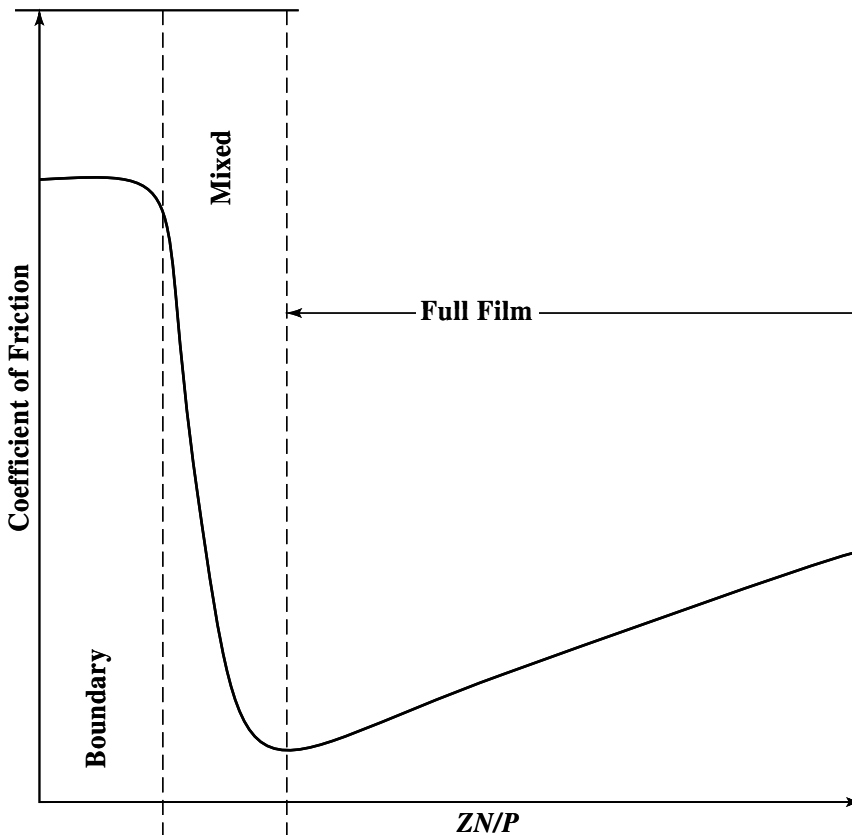


Fig. 3. Three modes of bearing operation.

1) Full-film, or hydrodynamic, lubrication produces a complete physical separation of the sliding surfaces resulting in low friction and long wear-free service life.

To promote full-film lubrication in hydrodynamic operation, the following parameters should be satisfied: a) Lubricant selected has the correct viscosity for the proposed operation; b) proper lubricant flow rates are maintained; c) proper design methods and considerations have been utilized; and d) surface velocity in excess of 25 fpm (7.62 m/min) is maintained.

When full-film lubrication is achieved, a coefficient of friction between 0.001 and 0.005 can be expected.

2) Mixed-film lubrication is a mode of operation between the full-film and boundary modes. With this mode, there is a partial separation of the sliding surfaces by the lubricant film; however, as in boundary lubrication, limitations on surface speed and wear will result. With this type of lubrication, a surface velocity in excess of 10 fpm (3.05 m/min) is required with resulting coefficients of friction of 0.02 to 0.08.

3) Boundary lubrication takes place when the sliding surfaces are rubbing together with only an extremely thin film of lubricant present. This type of operation is acceptable only in applications with oscillating or slow rotary motion. In complete boundary lubrication, the oscillatory or rotary motion is usually less than 10 feet per minute with resulting coefficients of friction of 0.08 to 0.14. These bearings are usually grease lubricated or periodically oil lubricated.

In starting up and accelerating to its operating point, a journal bearing passes through all three modes of operation. At rest, the journal and bearing are in contact, and thus when starting, the operation is in the boundary lubrication region. As the shaft begins to rotate more rapidly and the hydrodynamic film starts to build up, bearing operation enters the

region of mixed-film lubrication. When design speeds and loads are reached, the hydrodynamic action in a properly designed bearing will promote full-film lubrication.

Methods of Retaining Bearings.—Several methods are available to ensure that a bearing remains in place within a housing. Which method to use depends upon the particular application but requires first that the unit lends itself to convenient assembly and disassembly; additionally, the bearing wall should be of uniform thickness to avoid introduction of weak points in the construction that may lead to elastic or thermal distortion.

Press or Shrink Fit: One common and satisfactory technique for retaining the bearing is to press or shrink the bearing in the housing with an interference fit. This method permits the use of bearings having uniform wall thickness over the entire bearing length.

Standard bushings with finished inside and outside diameters are available in sizes up to approximately 5 inches (127 mm) inside diameter. Stock bushings are commonly provided 0.002 to 0.003 inch (50.8–76.2 μm) over nominal on outside diameter sizes of 3 inches (76.2 mm) or less. For diameters greater than 3 inches, outside diameters are 0.003 to 0.005 inch (76.2–127 μm) over nominal. Because these tolerances are built into standard bushings, the amount of press fit is controlled by the housing-bore size.

As a result of a press or shrink fit, the bore of the bearing material “closes in” by some amount. In general, this diameter decrease is approximately 70 to 100 per cent of the amount of the interference fit. Any attempt to accurately predict the amount of reduction, in an effort to avoid final clearance machining, should be avoided.

Shrink fits may be accomplished by chilling the bearing in a mixture of dry ice and alcohol, or in liquid air. These methods are easier than heating the housing and are preferred. Dry ice in alcohol has a temperature of -110°F (-79°C) and liquid air boils at -310°F (-190°C).

When a bearing is pressed into the housing, the driving force should be uniformly applied to the end of the bearing to avoid upsetting or peening of the bearing. Of equal importance, the mating surfaces must be clean, smoothly finished, and free of machining imperfections.

Keying Methods: A variety of methods can be used to fix the position of the bearing with respect to its housing by “keying” the two together. Possible keying methods are shown in Figs. 4a through 4f including: a) set screws; b) Woodruff keys; c) bolted bearing flanges; d) threaded bearings; e) dowel pins; and f) housing caps.

Factors to be considered when selecting one of these methods are as follows:

1) Maintaining uniform wall thickness of the bearing material, if possible, especially in the load-carrying region of the bearing.

2) Providing as much contact area as possible between bearing and housing. Mating surfaces should be clean, smooth, and free from imperfections to facilitate heat transfer.

3) Preventing any local deformation of the bearing that might result from the keying method. Machining after keying is recommended.

4) Considering the possibility of bearing distortion resulting from the effect of temperature changes on the particular keying method.

Methods of Sealing.—In applications where lubricants or process fluids are utilized in operation, provision must be made normally to prevent leakage to other areas. This provision is made by the use of static and dynamic type sealing devices. In general, three terms are used to describe the devices used for sealing:

Seal: A means of preventing migration of fluids, gases, or particles across a joint or opening in a container.

Packing: A dynamic seal, used where some form of relative motion occurs between rigid members of an assembly.

Gaskets: A static seal, used where there is no relative motion between joined parts.

Methods of Bearing Retention

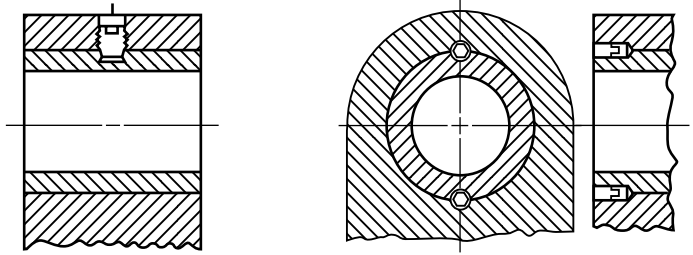


Fig. 4a. Set Screws

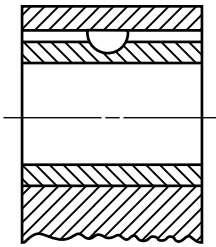


Fig. 4b. Woodruff Key

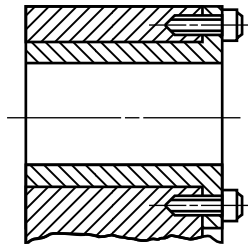


Fig. 4c. Bolts through Flange

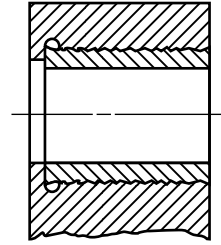


Fig. 4d. Bearing Screwed into Housing

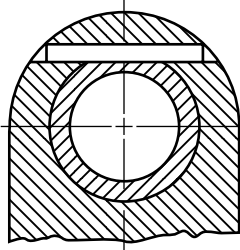


Fig. 4e. Dowel Pin

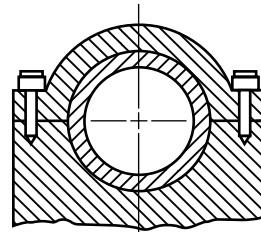


Fig. 4f. Housing Cap

Two major functions must be achieved by all sealing applications: prevent escape of fluid; and prevent migration of foreign matter from the outside.

The first determination in selecting the proper seal is whether the application is static or dynamic. To meet the requirements of a static application there must be no relative motion between the joining parts or between the seal and the mating part. If there is any relative motion, the application must be considered dynamic, and the seal selected accordingly.

Dynamic sealing requires control of fluids leaking between parts with relative motion. Two primary methods are used to this end: positive contact or rubbing seals; and controlled clearance noncontact seals.

Positive Contact or Rubbing Seals: These seals are used where positive containment of liquids or gases is required, or where the seal area is continuously flooded. If properly selected and applied, contact seals can provide zero leakage for most fluids. However, because they are sensitive to temperature, pressure, and speed, improper application can result in early failure. These seals are applicable to rotating and reciprocating shafts. In many assemblies, positive-contact seals are available as off-the-shelf items. In other instances, they are custom-designed to the special demands of a particular application. Custom design is offered by many seal manufacturers and, for extreme cases, probably offers the best solution to the sealing problem.

Controlled Clearance Noncontact Seals: Representative of the controlled-clearance seals, which includes all seals in which there is no rubbing contact between the rotating and

stationary members, are throttling bushings and labyrinths. Both types operate by fluid-throttling action in narrow annular or radial passages.

Clearance seals are frictionless and very insensitive to temperature and speed. They are chiefly effective as devices for limiting leakage rather than stopping it completely. Although they are employed as primary seals in many applications, the clearance seal also finds use as auxiliary protection in contact-seal applications. These seals are usually designed into the equipment by the designer himself, and they can take on many different forms.

Advantages of this seal are that friction is kept to an absolute minimum and there is no wear or distortion during the life of the equipment. However, there are two significant disadvantages: The seal has limited use when leakage rates are critical; and it becomes quite costly as the configuration becomes elaborate.

Static Seals: Static seals such as gaskets, “O” rings, and molded packings cover very broad ranges of both design and materials.

Some of the typical types are as follows: 1) Molded packings: a) lip type, and b) squeeze-molded; 2) simple compression packings; 3) diaphragm seals; 4) nonmetallic gaskets; 5) “O” rings; and 6) metallic gaskets and “O” rings.

Data on “O” rings are found starting on page 2587.

Detailed design information for specific products should be obtained directly from manufacturers.

Hardness and Surface Finish.—Even in well-lubricated full-film sleeve bearings, momentary contact between journal and bearing may occur under such conditions as starting, stopping, or overloading. In mixed-film and boundary-film lubricated sleeve bearings, continuous metal-to-metal contact occurs. Hence, to allow for any necessary wearing-in, the journal is usually made harder than the bearing material. This arrangement allows the effects of scoring or wearing to take place on the bearing, which is more easily replaced, rather than on the more expensive shaft. As a general rule, recommended Brinell (Bhn) hardness of the journal is at least 100 points harder than the bearing material.

The softer cast bronzes used for bearings are those with high lead content and very little tin. Such bronzes give adequate service in boundary- and mixed-film applications where full advantage is taken of their excellent “bearing” characteristics.

High-tin, low-lead content cast bronzes are the harder bronzes and these have high ultimate load-carrying capacity: higher journal hardnesses are required with these bearing bronzes. Aluminum bronze, for example, requires a journal hardness in the range of 550 to 600 Bhn.

In general, harder bearing materials require better alignment and more reliable lubrication to minimize local heat generation if and when the journal touches the shaft. Also, abrasives that find their way into the bearing are a problem for the harder bearing materials and greater care should be taken to exclude them.

Surface Finish: Whether bearing operation is complete boundary, mixed film, or fluid film, surface finishes of the journal and bearing must receive careful attention. In applications where operation is hydrodynamic or full-film, peak surface variations should be less than the expected minimum film thickness; otherwise, peaks on the journal surface will contact peaks on the bearing surface, with resulting high friction and temperature rise. Ranges of surface roughness obtained by various finishing methods are: boring, broaching, and reaming, 32 to 64 μ inches (0.813–1.626 μ m), rms; grinding, 16 to 64 μ inches (0.406–1.626 μ m), rms; and fine grinding, 4 to 16 μ inches (0.102–0.406 μ m), rms.

In general, the better surface finishes are required for full-film bearings operating at high eccentricity ratios because full-film lubrication must be maintained with small clearances, and metal-to-metal contact must be avoided. Also, the harder the material, the better the surface finish required. For boundary- and mixed-film applications, surface finish requirements may be somewhat relaxed because bearing wear-in will in time smooth the surfaces.

Fig. 5 is a general guide to the ranges required for bearing and journal surface finishes. Selecting a particular surface finish in each range can be simplified by observing the general rule that smoother finishes are required for the harder materials, for high loads, and for high speeds.

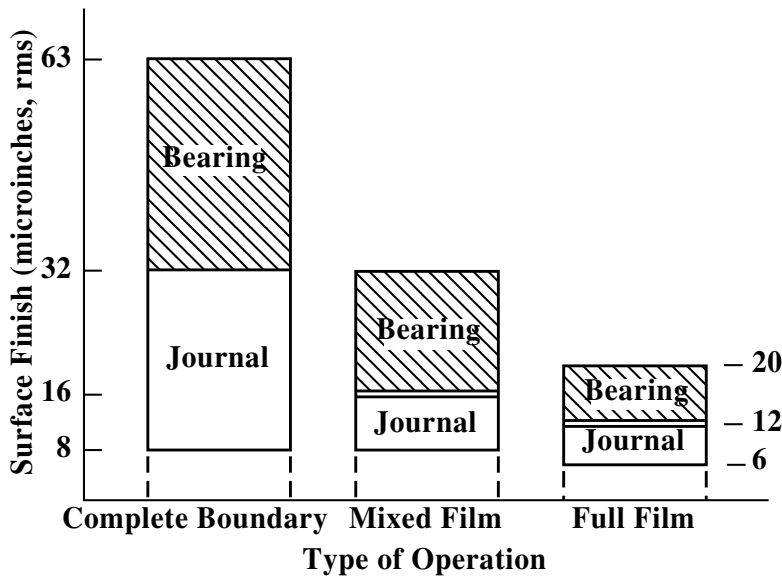


Fig. 5. Recommended ranges of surface finish for the three types of sleeve bearing operations.

Machining Bores.—The methods most commonly used in finishing journal bearing bores are boring, broaching, reaming, and burnishing.

Broaching is a rapid finishing method providing good size and alignment control when adequate piloting is possible. Soft babbitt materials are particularly compatible with the broaching method. A third finishing method, reaming, facilitates good size and alignment control when piloting is utilized. Reaming can be accomplished both manually or by machine, the machine method being preferred. Burnishing is a fast sizing operation that gives good alignment control, but does not give as good size control as the cutting methods. It is not recommended for soft materials such as babbitt. Burnishing has an ironing effect that gives added seating of the bushing outside diameter in the housing bore; consequently, it is often used for this purpose, especially on a $\frac{1}{32}$ -inch (0.794 mm) wall bushing, even if a further sizing operation is to be used subsequently.

Boring of journal bearings provides the best concentricity, alignment, and size control and is the finishing method of choice when close tolerances and clearances are desirable.

Methods of Lubrication.—There are numerous ways to supply lubricant to bearings. The more common of these are described in the following.

Pressure lubrication, in which an abundance of oil is fed to the bearing from a central groove, single or multiple holes, or axial grooves, is effective and efficient. The moving oil assists in flushing dirt from the bearing and helps keep the bearing cool. In fact, it removes heat faster than other lubricating methods and, therefore, permits thinner oil films and unimpaired load capacities. The oil-supply pressure needed for bushings carrying the basic load is directly proportional to the shaft speed, but for most installations, 50 psi (345 kPa) will be adequate.

Splash fed applies to a variety of intermittently lubricated bushings. It includes everything from bearings spattered with oil from the action of other moving parts to bearings regularly dipped in oil. Like oil bath lubrication, splash feeding is practical when the housing can be made oiltight and when the moving parts do not churn the oil. The fluctuating

nature of the load and the intermittent oil supply in splash fed applications requires the designer to use experience and judgment when determining the probable load capacity of bearings lubricated in this way.

Oil bath lubrication, in which the bushing is submerged in oil, is the most reliable of all methods except pressure lubrication. It is practical if the housing can be made oil tight, and if the shaft speed is not so great as to cause excessive churning of the oil.

Oil ring lubrication, in which oil is supplied to the bearing by a ring in contact with the shaft, will, within reasonable limits, bring enough oil to the bearing to maintain hydrodynamic lubrication. If the shaft speed is too low, little oil will follow the ring to the bearing; and, if the speed is too high, the ring speed will not keep pace with the shaft. Also, a ring revolving at high speed will lose oil by centrifugal force. For best results, the peripheral speed of the shaft should be between 200 and 2000 fpm (61 and 610 m/min). Safe load to achieve hydrodynamic lubrication should be one-half of that for pressure fed bearings. Unless the load is light, hydrodynamic lubrication is doubtful. The safe load, then, to achieve hydrodynamic lubrication, should be one-quarter of that of pressure fed bearings.

Wick or waste pack lubrication delivers oil to a bushing by the capillary action of a wick or waste pack; the amount delivered is proportional to the size of the wick or pack.

Lubricants: The value of an oil as a lubricant depends mainly on its film-forming capacity, that is, its capability to maintain a film of oil between the bearing surfaces. The film-forming capacity depends to a large extent on the viscosity of the oil, but this should not be understood to mean that oil of the highest viscosity is always the most suitable lubricant. For practical reasons, an oil of the lowest viscosity that will retain an unbroken oil film between the bearing surfaces is the most suitable for purposes of lubrication. A higher viscosity than that necessary to maintain the oil film results in a waste of power due to the expenditure of energy necessary to overcome the internal friction of the oil itself.

Fig. 6 provides representative values of viscosity in centipoises for SAE mineral oils. **Table 56a** on page 2698 is provided as a means of converting viscosities of other units to centipoises.

Grease packed in a cavity surrounding the bushing is less adequate than an oil system, but it has the advantage of being more or less permanent. Although hydrodynamic lubrication is possible under certain very favorable circumstances, boundary lubrication is the usual state.

Lubricant Selection.—In selecting lubricants for journal bearing operation, several factors must be considered: 1) type of operation (full, mixed, or boundary film) anticipated; 2) surface speed; and 3) bearing loading.

Fig. 7 combines these factors and facilitates general selection of the proper lubricant viscosity range.

As an example of using these curves, consider a lightly loaded bearing operating at 2000 rpm. At the bottom of the figure, locate 2000 rpm and move vertically to intersect the light-load full-film lubrication curve, which indicates an SAE 5 oil.

As a general rule-of-thumb, heavier oils are recommended for high loads and lighter oils for high speeds.

In addition, other than using conventional lubrication oils, journal bearings may be lubricated with greases or solid lubricants. Some of the reasons for use of these lubricants are to:

- 1) Lengthen the period between relubrication;
- 2) Avoid contaminating surrounding equipment or material with “leaking” lubricating oil;
- 3) Provide effective lubrication under extreme temperature ranges;
- 4) Provide effective lubrication in the presence of contaminating atmospheres; and
- 5) Prevent intimate metal-to-metal contact under conditions of high unit pressure which might destroy boundary lubricating films.

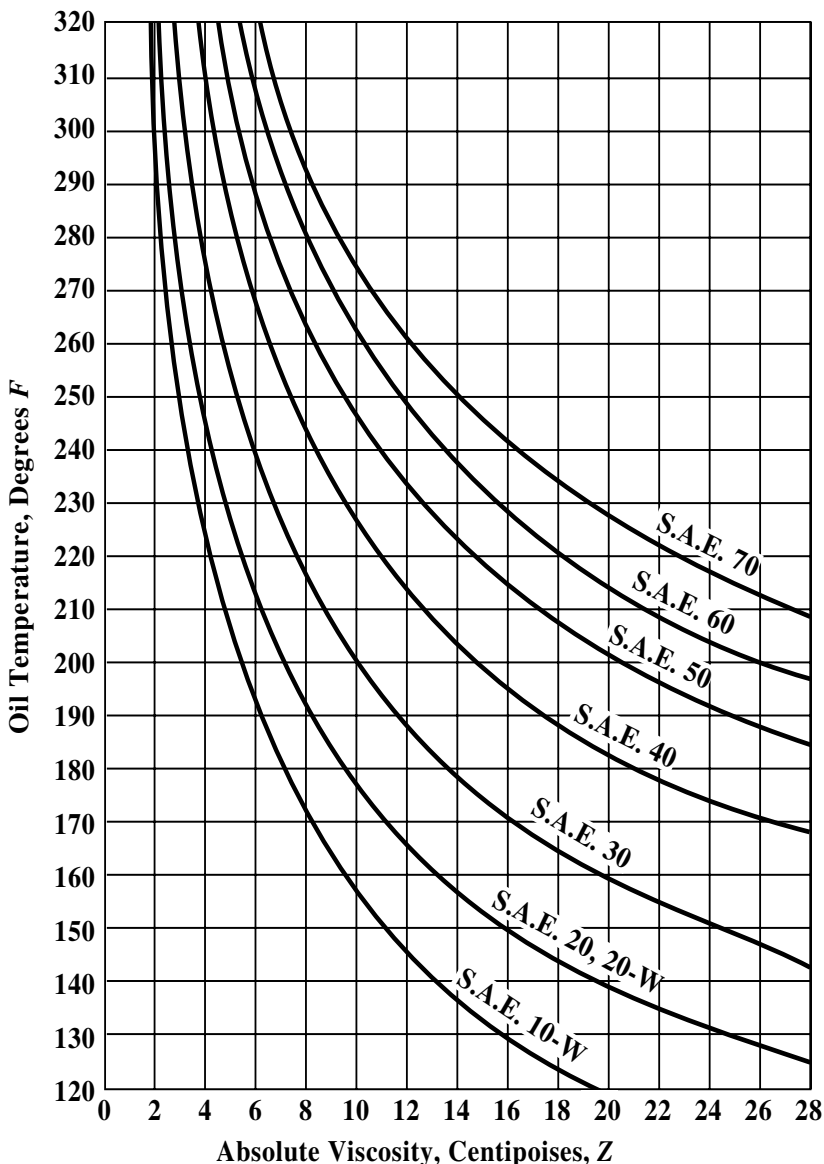


Fig. 6. Viscosity vs. Temperature—SAE oils.

Greases: Where full-film lubrication is not possible or is impractical for slow-speed fairly high-load applications, greases are widely used as bearing lubricants. Although full-film lubrication with grease is possible, it is not normally considered since an elaborate pumping system is required to continuously supply a prescribed amount of grease to the bearing. Bearings supplied with grease are usually lubricated periodically. Grease lubrication, therefore, implies that the bearing will operate under conditions of complete boundary lubrication and should be designed accordingly.

Lubricating greases are essentially a combination of a mineral lubricating oil and a thickening agent, which is usually a metallic soap. When suitably mixed, they make excellent bearing lubricants. There are many different types of greases which, in general, may be classified according to the soap base used. Information on commonly used greases is shown in [Table 1](#).

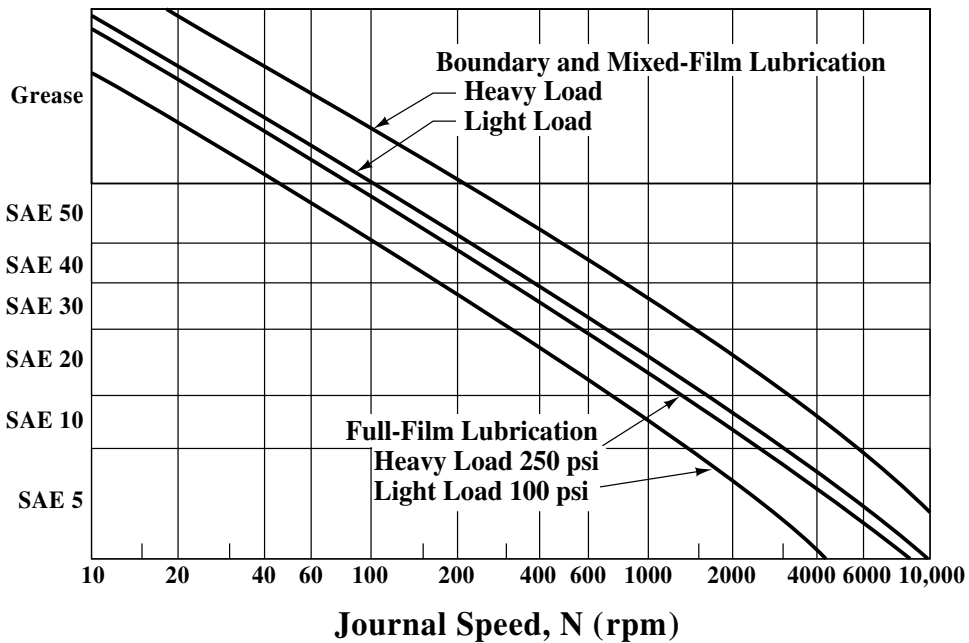


Fig. 7. Lubricant Selection Guide

Table 1. Commonly Used Greases and Solid Lubricants

Type	Operating Temperature		Load	Comments
	°F	°C		
Greases				
Calcium or lime soap	160	71	Moderate	...
Sodium soap	300	149	Wide	For wide speed range
Aluminum soap	180	82	Moderate	...
Lithium soap	300	149	Moderate	Good low temperature
Barium soap	350	177	Wide	...
Solid Lubricants				
Graphite	1000	538	Wide	...
Molybdenum disulfide	-100 to 750	-73 to 399	Wide	...

Synthetic greases are composed of normal types of soaps but use synthetic hydrocarbons instead of normal mineral oils. They are available in a range of consistencies in both water-soluble and insoluble types. Synthetic greases can accommodate a wide range of variation in operating temperature; however, recommendations on special-purpose greases should be obtained from the lubricant manufacturer.

Application of grease is accomplished by one of several techniques depending upon grease consistency. These classifications are shown in Table 2 along with typical methods of application. Grooves for grease are generally greater in width, up to 1.5 times, than for oil.

Coefficients of friction for grease-lubricated bearings range from 0.08 to 0.16, depending upon consistency of the grease, frequency of lubrication, and type of grease. An average value of 0.12 may be used for design purposes.

Solid Lubricants: The need for effective high-temperature lubricants led to the development of several solid lubricants. Essentially, solid lubricants may be described as low-shear-strength solid materials. Their function within a bronze bearing is to act as an intermediary material between sliding surfaces. Since these solids have very low shear

Table 2. NLGI Consistency Numbers

NLGI ^a Consistency No.	Consistency of Grease	Typical Method of Application
0	Semifluid	Brush or gun
1	Very soft	Pin-type cup or gun
2	Soft	Pressure gun or centralized pressure system
3	Light cup grease	Pressure gun or centralized pressure system
4	Medium cup grease	Pressure gun or centralized pressure system
5	Heavy cup grease	Pressure gun or hand
6	Block grease	Hand, cut to fit

^aNLGI is National Lubricating Grease Institute

strength, they shear more readily than the bearing material and thereby allow relative motion. So long as solid lubricant remains between the moving surfaces, effective lubrication is provided and friction and wear are reduced to acceptable levels.

Solid lubricants provide the most effective boundary films in terms of reduced friction, wear, and transfer of metal from one sliding component to the other. However, there is a significant deterioration in these desirable properties as the operating temperature of the boundary film approaches the melting point of the solid film. At this temperature the friction may increase by a factor of 5 to 10 and the rate of metal transfer may increase by as much as 1000. What occurs is that the molecules of the lubricant lose their orientation to the surface that exists when the lubricant is solid. As the temperature further increases, additional deterioration sets in with the friction increasing by some additional small amount but the transfer of metal accelerates by an additional factor of 20 or more. The final effect of too high temperature is the same as metal-to-metal contact without benefit of lubricant. These changes, which are due to the physical state of the lubricant, are reversed when cooling takes place.

The effects just described also partially explain why fatty acid lubricants are superior to paraffin base lubricants. The fatty acid lubricants react chemically with the metallic surfaces to form a metallic soap that has a higher melting point than the lubricant itself, the result being that the breakdown temperature of the film, now in the form of a metallic soap is raised so that it acts more like a solid film lubricant than a fluid film lubricant.

Journal or Sleeve Bearings

Although this type of bearing may take many shapes and forms, there are always three basic components: journal or shaft, bushing or bearing, and lubricant. Fig. 1 shows these components with the nomenclature generally used to describe a journal bearing: W = applied load, N = revolution, e = eccentricity of journal center to bearing center, θ = attitude angle, which is the angle between the applied load and the point of minimum film thickness, d = diameter of the shaft, c_d = bearing clearance, $d + c_d$ = diameter of the bearing and h_o = minimum film thickness.

Grooving and Oil Feeding.—Grooving in a journal bearing has two purposes:

- 1) to establish and maintain an efficient film of lubricant between the bearing moving surfaces and
- 2) to provide adequate bearing cooling

The obvious and only practical location for introducing lubricant to the bearing is in a region of low pressure. A typical pressure profile of a bearing is shown by Fig. 2. The arrow W shows the applied load. Typical grooving configurations used for journal bearings are shown in Figs. 3a through 3e.

Heat Radiating Capacity.—In a self-contained lubrication system for a journal bearing, the heat generated by bearing friction must be removed to prevent continued temperature

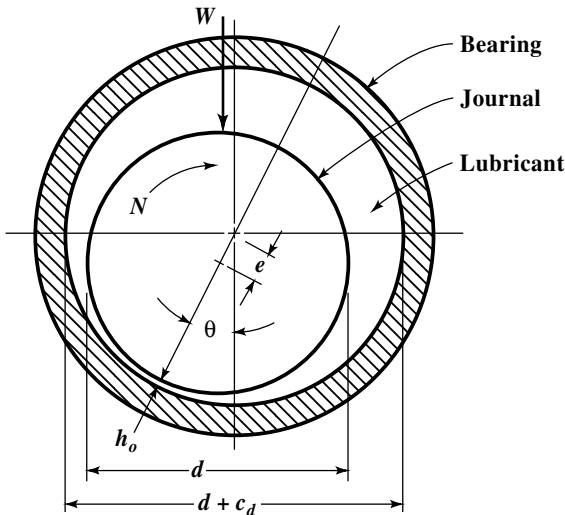


Fig. 1. Basic components of a journal bearing.

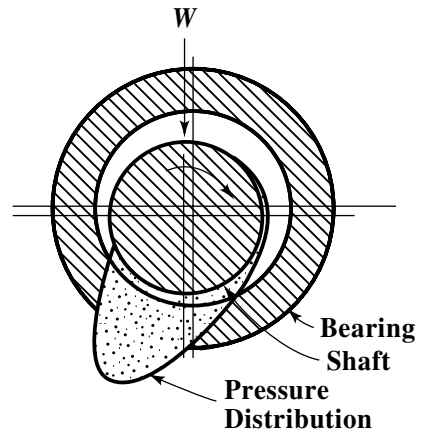


Fig. 2. Typical pressure profile of journal bearing.

Types of Journal Bearing Oil Grooving

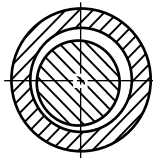


Fig. 3a. Single inlet hole

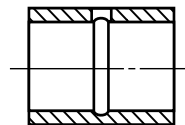


Fig. 3b. Circular groove

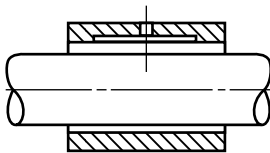


Fig. 3c. Straight axial groove

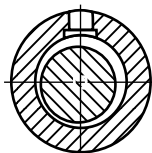


Fig. 3d. Straight axial groove with feeder groove

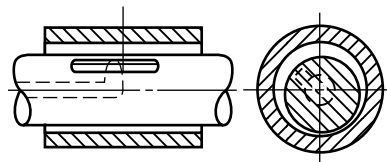
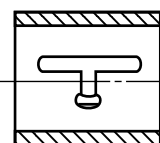
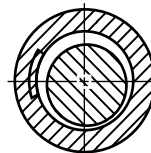


Fig. 3e. Straight axial groove in shaft

rise to an unsatisfactory level. The heat-radiating capacity H_R of the bearing in foot-pounds per minute may be calculated from the formula $H_R = Ld Ct_R$ in which C is a constant determined by O. Lasche, and t_R is temperature rise in degrees Fahrenheit.

Values for the product Ct_R may be found from the curves in Fig. 4 for various values of bearing temperature rise t_R and for three operating conditions. In this equation, L = total length of the bearing in inches and d = bearing diameter in inches.

Journal Bearing Design Notation.—The symbols used in the following step-by-step procedure for lubrication analysis and design of a plain sleeve or journal bearing are as follows:

c = specific heat of lubricant, Btu/lb/degree F

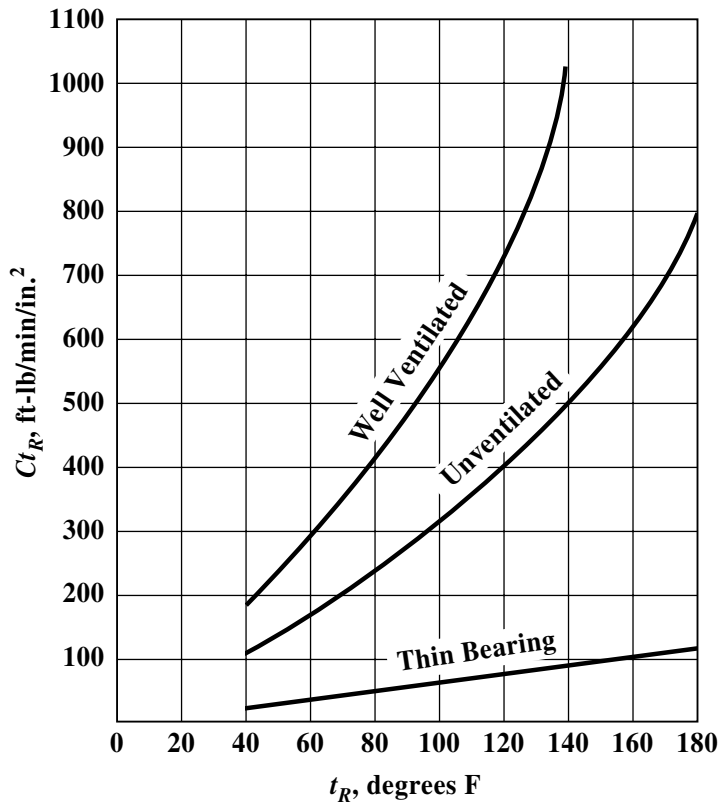


Fig. 4. Heat-radiating capacity factor, C_{tR} , vs. bearing temperature rise, t_R —journal bearings.

- c_d = diametral clearance, inches
- C_n = bearing capacity number
- d = journal diameter, inches
- e = eccentricity, inches
- h_o = minimum film thickness, inch
- K = constants
- l = bearing length as defined in Fig. 5, inches
- L = actual length of bearing, inches
- m = clearance modulus
- N = rpm
- p_b = unit load, psi
- p_s = oil supply pressure, psi
- P_f = friction horsepower
- P' = bearing pressure parameter
- q = flow factor
- Q_1 = hydrodynamic flow, gpm
- Q_2 = pressure flow, gpm
- Q = total flow, gpm
- Q_{new} = new total flow, gpm
- Q_R = total flow required, gpm
- r = journal radius, inches
- Δt = actual temperature rise of oil in bearing, °F
- Δt_a = assumed temperature rise of oil in bearing, °F
- Δt_{new} = new assumed temperature rise of oil in bearing, °F

- t_b = bearing operating temperature, °F
- t_m = oil inlet temperature, °F
- T_f = friction torque, inch-pounds/inch
- T' = torque parameter
- W = load, pounds
- X = factor
- Z = viscosity, centipoises
- ϵ = eccentricity ratio — ratio of eccentricity to radial clearance
- α = oil density, lbs/inch³

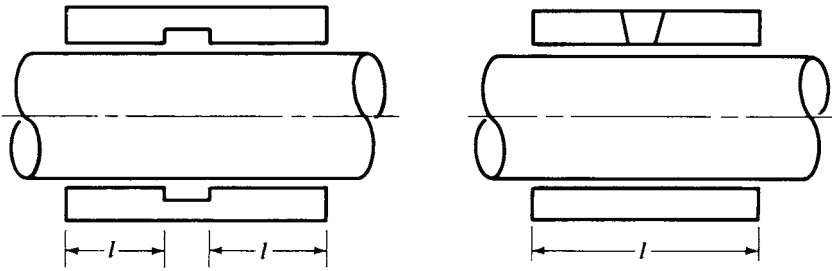


Fig. 5. Length, l , of bearing for circular groove type (left) and single inlet hole type (right).

Journal Bearing Lubrication Analysis.—The following procedure leads to a complete lubrication analysis which forms the basis for the bearing design.

1) *Diameter of bearing d* : This is usually determined by considering strength and/or deflection requirements for the shaft using principles of strength of materials.

2) *Length of bearing L* : This is determined by an assumed l/d ratio in which l may or may not be equal to the overall length, L (See Step 6). Bearing pressure and the possibility of edge loading due to shaft deflection and misalignment are factors to be considered. In general, shaft misalignment resulting from location tolerances and/or shaft deflections should be maintained below 0.0003 inch per inch of length.

3) *Bearing pressure p_b* : The unit load in pound per square inch is calculated from the formula:

$$p_b = \frac{W}{Kld}$$

where $K = 1$ for single oil hole

$K = 2$ for central groove

W = load, pounds

l = bearing length as defined in Fig. 5, inches

d = journal diameter, inches

Typical unit loads in service are shown in Table 3. These pressures can be used as a safe guide in selection. However, if space limitations impose a higher limit of loading, the complete lubrication analysis and evaluation of material properties will determine acceptability.

Table 3. Allowable Sleeve Bearing Pressures for Various Classes of Bearings

Types of Bearing or Kind of Service	Pressure ^a psi (MPa)	Types of Bearing or Kind of Service	Pressure ^a psi (MPa)
Electric Motor & Generator Bearings (General)	100–200 (0.69–1.38)	Diesel Engine Rod	1000–2000 (6.89–13.79)
Turbine & Reduction Gears	100–250 (0.69–1.72)	Wrist Pins	1800–2000 (12.41–13.79)
Heavy Line Shafting	100–150 (0.69–1.03)	Automotive, Main Bearings	500–700 (3.45–4.83)
Locomotive Axles	300–350 (2.07–2.41)	Automotive, Rod Bearings	1500–2500 (10.34–17.24)
Light Line Shafting	15–35 (0.103–0.241)	Centrifugal Pumps	80–100 (0.55–0.689)
Diesel Engine, Main	800–1500 (5.52–10.34)	Aircraft Rod Bearings	700–3000 (4.83–20.68)

^aThese pressures in psi (MPa) of area equal to length times diameter are intended as a general guide only. The allowable unit pressure depends upon operating conditions, especially in regard to lubrication, design of bearings, workmanship, velocity, and nature of load.

4) *Diametral clearance c_d* : This is selected on a trial basis from Fig. 6 which shows suggested diametral clearance ranges for various shaft sizes and for two speed ranges. These are *hot* or *operating* clearances so that thermal expansion of journal and bearing to these temperatures must be taken into consideration in establishing machining dimensions. The optimum operating clearance should be determined on the basis of a complete lubrication analysis (See paragraph following Step Item 23).

5) *Clearance modulus m* : This is calculated from the formula: $m = \frac{c_d}{d}$

6) *Length to diameter ratio l/d* : This is usually between 1 and 2; however, with the modern trend toward higher speeds and more compact units, lower ratios down to 0.3 are used. In shorter bearings there is a consequent reduction in load carrying capacity due to excessive end or side leakage of lubricant. In longer bearings there may be a tendency towards edge loading. Length l for a single oil feed hole is taken as the total length of the bearing as shown in Fig. 5. For a central oil groove length, l is taken as one-half the total length.

Typical l/d ratio's use for various types of applications are given in Table 4.

7) *Assumed operating temperature t_b* : A temperature rise of the lubricant as it passes through the bearing is assumed and the consequent operating temperature in degrees F is calculated from the formula:

$$t_b = t_{in} + \Delta t_a$$

where t_{in} = inlet temperature of oil in °F

Δt_a = assumed temperature rise of oil in bearing in °F. An initial assumption of 20°F is usually made.

8) *Viscosity of lubricant Z* : The viscosity in centipoises at the assumed bearing operating temperature is found from the curve in Fig. 6 which shows the viscosity of SAE grade oils versus temperature.

9) *Bearing pressure parameter P'* : This value is required to find the eccentricity ratio and is calculated from the formula:

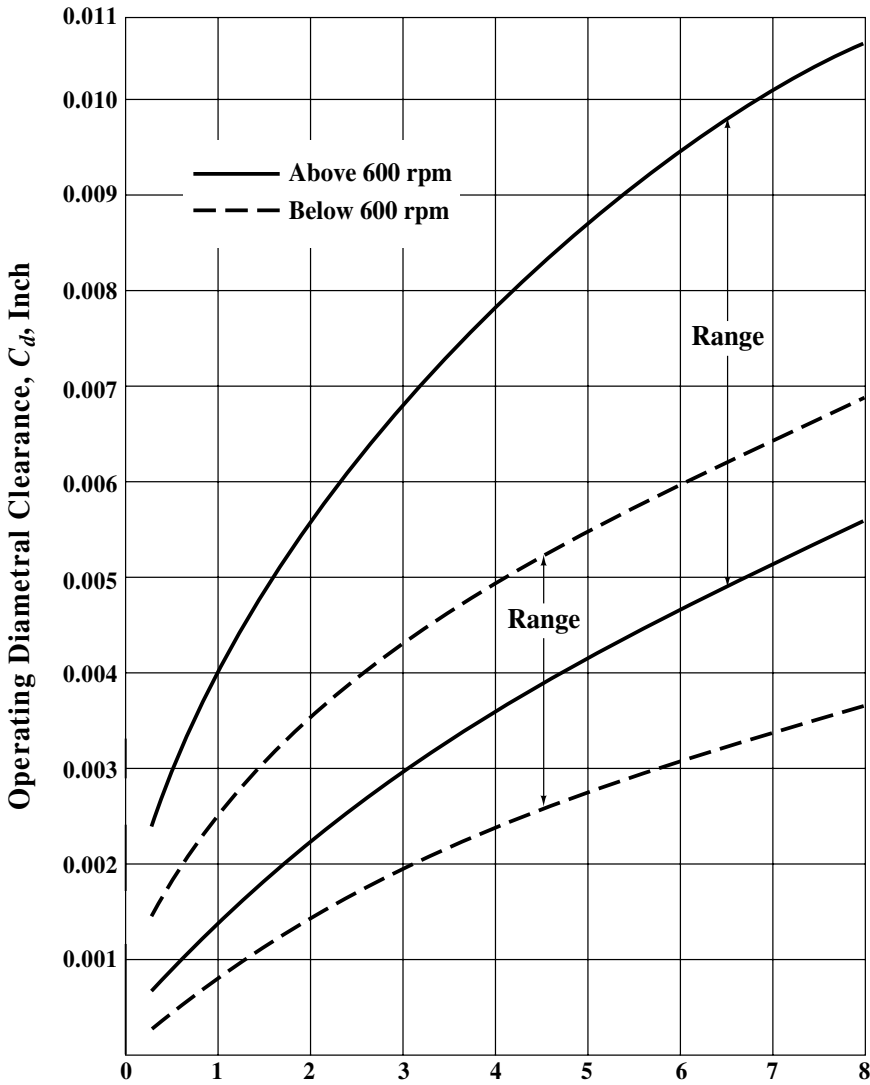


Fig. 6. Operating Diametral Clearance C_d vs. Journal Diameter d .

Table 4. Representative l/d Ratios

Type of Service	l/d	Type of Service	l/d
Gasoline and diesel engine		Light shafting	2.5 to 3.5
main bearings and crankpins	0.3 to 1.0	Heavy shafting	2.0 to 3.0
Generators and motors	1.2 to 2.5	Steam engine	
Turbogenerators	0.8 to 1.5	Main bearings	1.5 to 2.5
Machine tools	2.0 to 3.0	Crank and wrist pins	1.0 to 1.3

$$P' = \frac{6.9(1000m)^2 p_b}{ZN}$$

where $N = \text{rpm}$

10) *Eccentricity ratio* ϵ : Using P' and l/d , the value of $1/(1 - \epsilon)$ is determined from Fig. 7 and from this, ϵ can be determined.

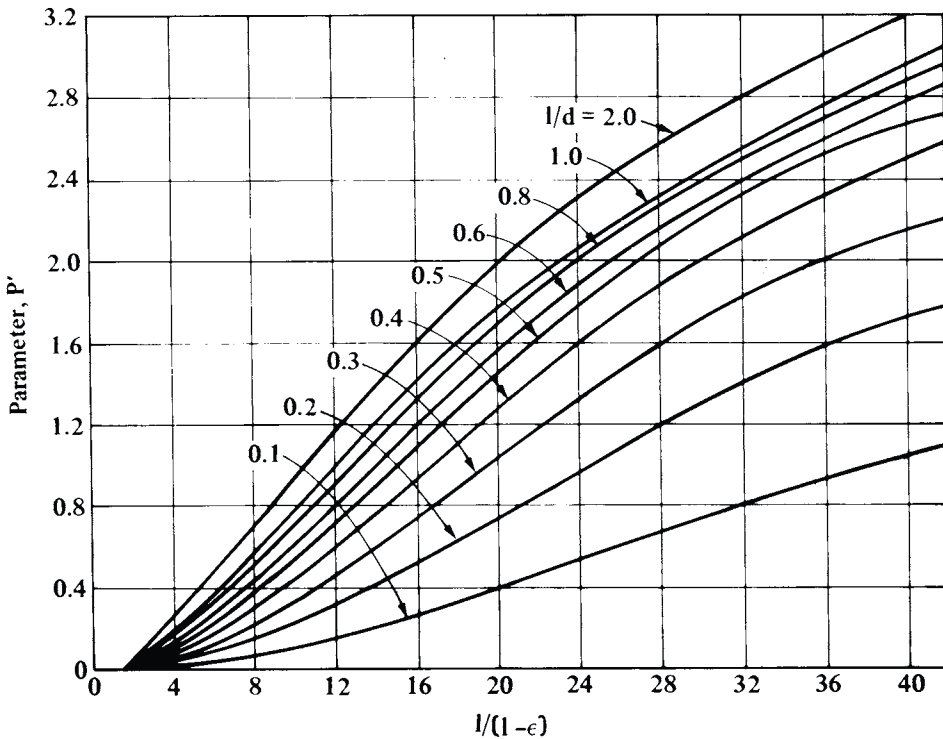


Fig. 7. Bearing parameter, P' , vs. eccentricity ratio, $1/(1-\epsilon)$ —journal bearings.

11) *Torque parameter T'* : This value is obtained from Fig. 8 or Fig. 9 using $1/(1-\epsilon)$ and l/d .

12) *Friction torque T* : This value is calculated from the formula:

$$T = \frac{T' r^2 Z N}{6900 (1000m)}$$

where r = journal radius, inches

13) *Friction horsepower P_f* : This value is calculated from the formula:

$$P_f = \frac{KTNI}{63,000}$$

where $K = 1$ for single oil hole, 2 for central groove.

14) *Factor X* : This factor is used in the calculation of the lubricant flow and can either be obtained from Table 5 or calculated from the formula:

$$X = 0.1837/\alpha c$$

where α = oil density in pounds per cubic inch

c = specific heat of lubricant in Btu/lb/°F

15) *Total flow of lubricant required Q_R* : This is calculated from the formula:

$$Q_R = \frac{X(P_f)}{\Delta t_a}$$

16) *Bearing capacity number C_n* : This value is needed to obtain the flow factor and is calculated from the formula:

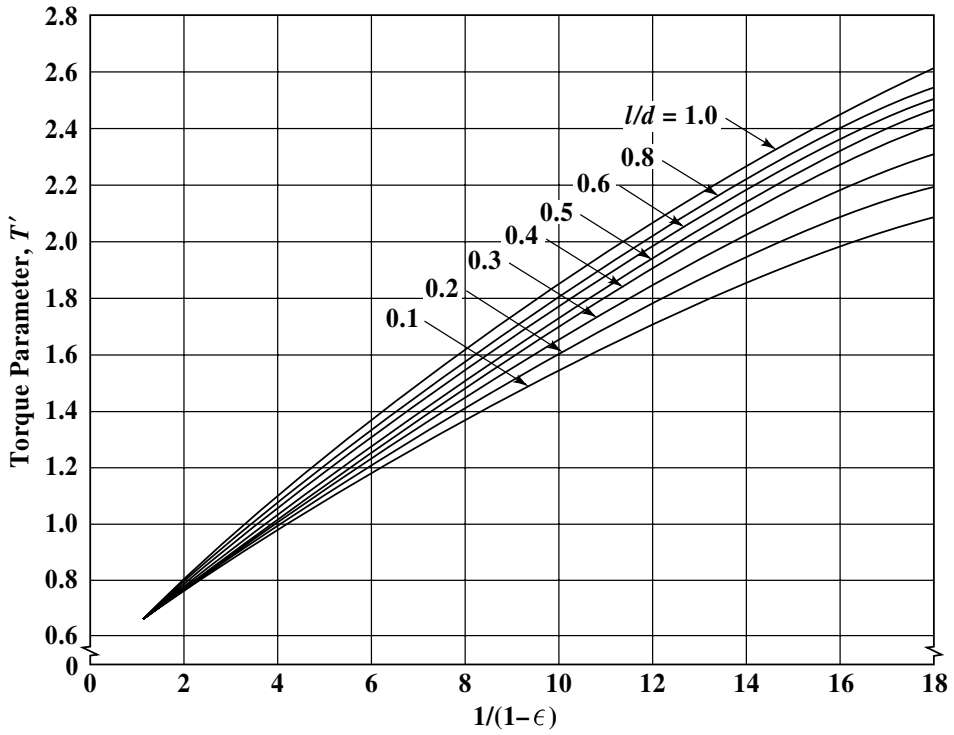


Fig. 8. Torque parameter, T' , vs. eccentricity ratio, $1/(1-\epsilon)$ — journal bearings.

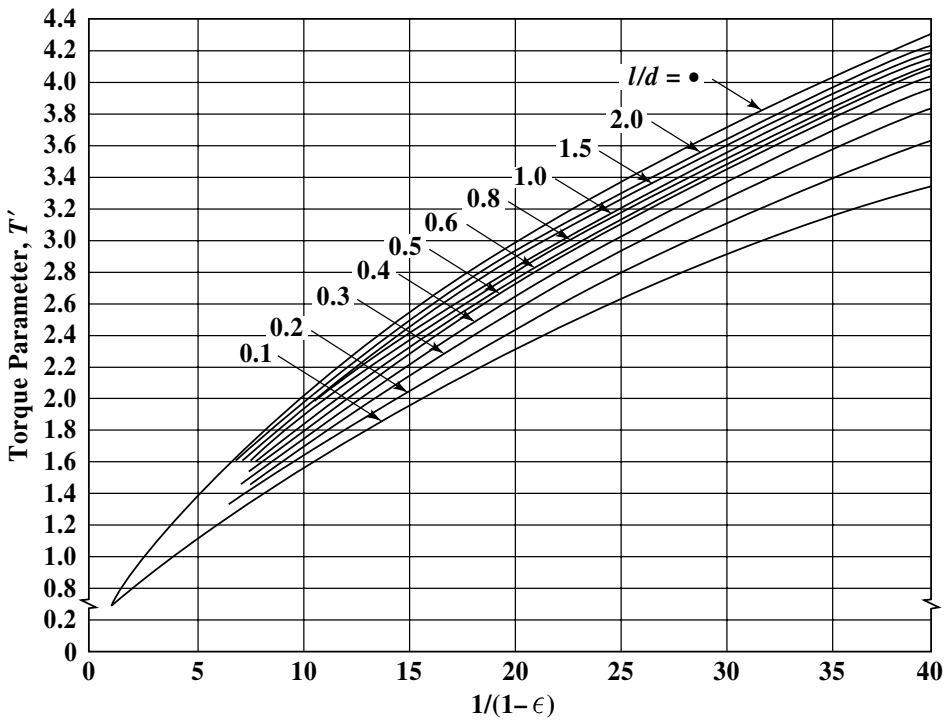


Fig. 9. Torque parameter, T' , vs eccentricity ratio, $1/(1-\epsilon)$ — journal bearings.

Table 5. X Factor vs. Temperature of Mineral Oils

Temperature	X Factor
100	12.9
150	12.4
200	12.1
250	11.8
300	11.5

$$C_n = \left(\frac{l}{d}\right)^2 / 60P'$$

17) *Flow factor q*: This value is obtained from the curve in Fig. 10.

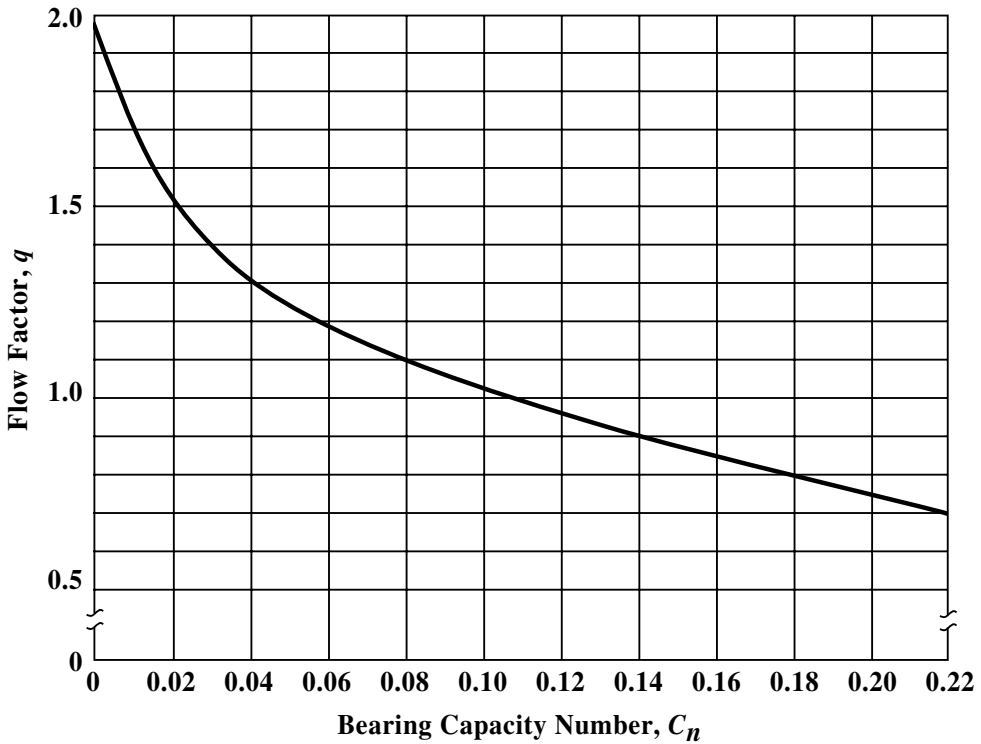


Fig. 10. Flow factor, q , vs. bearing capacity number, C_n —journal bearings.

18) *Hydrodynamic flow of lubricant Q_1* : This flow in gallons per minute is calculated from the formula:

$$Q_1 = \frac{Nlc_dqd}{294}$$

19) *Pressure flow of lubricant Q_2* : This flow in gallons per minute is calculated from the formula:

$$Q_2 = \frac{Kp_s c_d^3 d(1 + 1.5\epsilon^2)}{Zl}$$

where $K = 1.64 \times 10^5$ for single oil hole
 $K = 2.35 \times 10^5$ for central groove
 p_s = oil supply pressure

20) *Total flow of lubricant Q*: This value is obtained by adding the hydrodynamic flow and the pressure flow.

$$Q = Q_1 + Q_2$$

21) *Bearing temperature rise Δt*: This temperature rise in degrees F is obtained from the formula:

$$\Delta t = \frac{X(P_f)}{Q}$$

22) *Comparison of actual and assumed temperature rises*: At this point if Δt_a and Δt differ by more than 5 degrees F, Steps 7 through 22 are repeated using a Δt_{new} halfway between the former Δt_a and Δt .

23) *Minimum film thickness h_o* : When Step 22 has been satisfied, the minimum film thickness in inches is calculated from the formula: $h_o = \frac{1}{2}C_d(1 - \epsilon)$.

A new diametral clearance c_d is now assumed and Steps 5 through 23 are repeated. When this repetition has been done for a sufficient number of values for c_d , the full lubrication study is plotted as shown in Fig. 11. From this chart a working range of diametral clearance can be determined that optimizes film thickness, differential temperature, friction horsepower and oil flow.

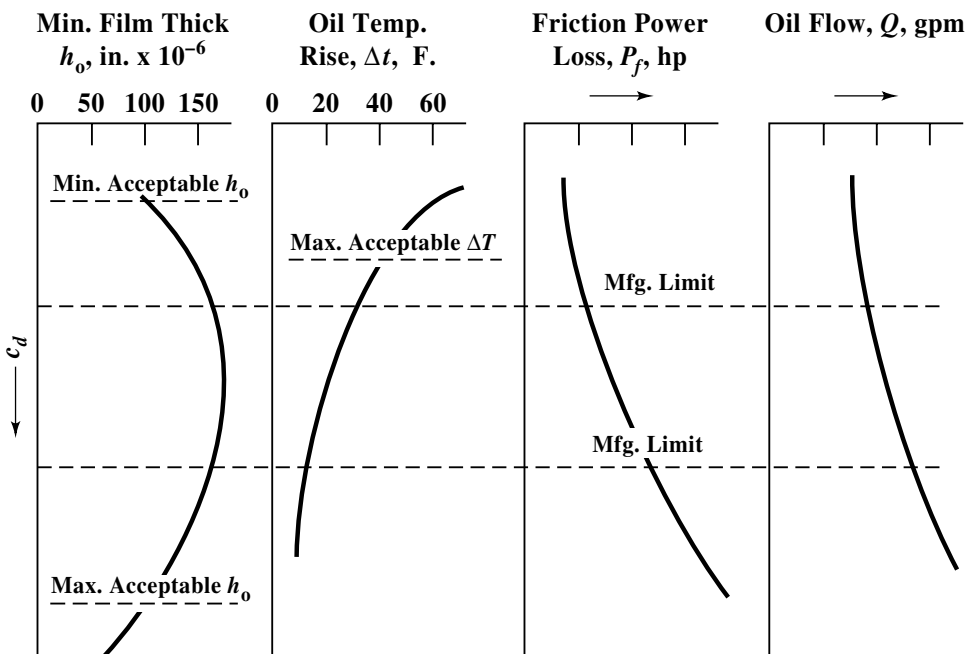


Fig. 11. Example of lubrication analysis curves for journal bearing.

Use of Lubrication Analysis.—Once the lubrication analysis has been completed and plotted as shown in Fig. 11, the following steps lead to the optimum bearing design, taking into consideration both basic operating requirements and requirements peculiar to the application.

1) Examine the curve (Fig. 11) for minimum film thickness and determine the acceptable range of diametral clearance, c_d , based on

- a) a minimum of 200×10^{-6} inches for small bearings under 1 inch diameter
- b) a minimum of 500×10^{-6} inches for bearings from 1 to 4 inches diameter

c) a minimum of 750×10^{-6} inches for larger bearings.

More conservative designs would increase these requirements

2) Determine the minimum acceptable c_d based on a maximum Δt of 40°F from the oil temperature rise curve (Fig. 11).

3) If there are no requirements for maintaining low friction horsepower and oil flow, the possible limits of diametral clearance are now defined.

4) The required manufacturing tolerances can now be placed within this band to optimize h_o as shown by Fig. 11.

5) If oil flow and power loss are a consideration, the manufacturing tolerances may then be shifted, within the range permitted by the requirements for h_o and Δt .

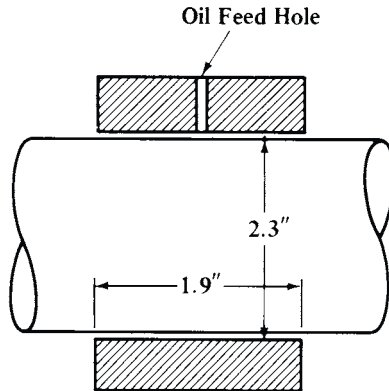


Fig. 12. Full journal bearing example design.

Example: A full journal bearing, Fig. 12, 2.3 inches in diameter and 1.9 inches long is to carry a load of 6000 pounds at 4800 rpm, using SAE 30 oil supplied at 200°F through a single oil hole at 30 psi. Determine the operating characteristics of this bearing as a function of diametral clearance.

1) *Diameter of bearing*, given as 2.3 inches.

2) *Length of bearing*, given as 1.9 inches.

3) *Bearing pressure:*

$$p_b = \frac{6000}{1 \times 1.9 \times 2.3} = 1372 \text{ lbs. per sq. in.}$$

4) *Diametral clearance:* Assume c_d is equal to 0.003 inch from Fig. 6 on page 2331 for first calculation.

5) *Clearance modulus:* $m = \frac{0.003}{2.3} = 0.0013$ inch

6) *Length-to-diameter ratio:*

$$\frac{l}{d} = \frac{1.9}{2.3} = 0.83$$

7) *Assumed operating temperature:* If the temperature rise Δt_a is assumed to be 20°F ,

$$t_b = 200 + 20 = 220^\circ\text{F}$$

8) *Viscosity of lubricant:* From Fig. 6 on page 2324, $Z = 7.7$ centipoises

9) *Bearing-pressure parameter:*

$$P' = \frac{6.9 \times 1.3^2 \times 1372}{7.7 \times 4800} = 0.43$$

10) *Eccentricity ratio:* From Fig. 7, $\frac{1}{1 - \epsilon} = 6.8$ and $\epsilon = 0.85$

11) *Torque parameter*: From Fig. 8, $T' = 1.46$

12) *Friction torque*:

$$T_f = \frac{1.46 \times 1.15^2 \times 7.7 \times 4800}{6900 \times 1.3} = 7.96 \text{ inch-pounds per inch}$$

13) *Friction horsepower*:

$$P_f = \frac{1 \times 7.96 \times 4800 \times 1.9}{63,000} = 1.15 \text{ horsepower}$$

14) *Factor X*: From Table 5, $X = 12$, approximately

15) *Total flow of lubricant required*:

$$Q_R = \frac{12 \times 1.15}{20} = 0.69 \text{ gallon per minute}$$

16) *Bearing-capacity number*:

$$C_n = \frac{0.83^2}{60 \times 0.43} = 0.027$$

17) *Flow factor*: From Fig. 10, $q = 1.43$

18) *Actual hydrodynamic flow of lubricant*:

$$Q_1 = \frac{4800 \times 1.9 \times 0.003 \times 1.43 \times 2.3}{294} = 0.306 \text{ gallon per minute}$$

19) *Actual pressure flow of lubricant*:

$$Q_2 = \frac{1.64 \times 10^5 \times 30 \times 0.003^3 \times 2.3 \times (1 + 1.5 \times 0.85^2)}{7.7 \times 1.9} = 0.044 \text{ gallon per min}$$

20) *Actual total flow of lubricant*:

$$Q = 0.306 + 0.044 = 0.350 \text{ gallon per minute}$$

21) *Actual bearing-temperature rise*:

$$\Delta t = \frac{12 \times 1.15}{0.350} = 39.4^\circ\text{F}$$

22) *Comparison of actual and assumed temperature rises*: Because Δt_a and Δt differ by more than 5°F , a new Δt_a , midway between these two, of 30°F is assumed and Steps 7 through 22 are repeated.

7a) *Assumed operating temperature*:

$$t_b = 200 + 30 = 230^\circ\text{F}$$

8a) *Viscosity of lubricant*: From Fig. 6, $Z = 6.8$ centipoises

9a) *Bearing-pressure parameter*:

$$P' = \frac{6.9 \times 1.3^2 \times 1372}{6.8 \times 4800} = 0.49$$

10a) *Eccentricity ratio*: From Fig. 7,

$$\frac{1}{1 - \epsilon} = 7.4$$

and $\epsilon = 0.86$

11a) *Torque parameter*: From Fig. 8, $T' = 1.53$

12a) *Friction torque*:

$$T_f = \frac{1.53 \times 1.15^2 \times 6.8 \times 4800}{6900 \times 1.3} = 7.36 \text{ inch-pounds per inch}$$

13a) *Friction horsepower*:

$$P_f = \frac{1 \times 7.36 \times 4800 \times 1.9}{63,000} = 1.07 \text{ horsepower}$$

14a) *Factor X*: From **Table 5**, $X = 11.9$ approximately

15a) *Total flow of lubricant required*:

$$Q_R = \frac{11.9 \times 1.07}{30} = 0.42 \text{ gallon per minute}$$

16a) *Bearing-capacity number*:

$$C_n = \frac{0.83^2}{60 \times 0.49} = 0.023$$

17a) *Flow factor*: From **Fig. 10**, $q = 1.48$

18a) *Actual hydrodynamic flow of lubricant*:

$$Q_1 = \frac{4800 \times 1.9 \times 0.003 \times 1.48 \times 2.3}{294} = 0.317 \text{ gallon per minute}$$

19a) *Pressure flow*:

$$Q_2 = \frac{1.64 \times 10^5 \times 30 \times 0.003^3 \times 2.3 \times (1 + 1.5 \times 0.86^2)}{6.8 \times 1.9} = 0.050 \text{ gallon per minute}$$

20a) *Actual flow of lubricant*:

$$Q_{\text{new}} = 0.317 + 0.050 = 0.367 \text{ gallon per minute}$$

21a) *Actual bearing-temperature rise*:

$$\Delta t = \frac{11.9 \times 1.06}{0.367} = 34.4^\circ\text{F}$$

22a) *Comparison of actual and assumed temperature rises*: Now Δt and Δt_a are within 5 degrees F.

23) *Minimum film thickness*:

$$h_o = \frac{0.003}{2} (1 - 0.86) = 0.00021 \text{ inch}$$

This analysis may now be repeated for other values of c_d determined from **Fig. 6** and a complete lubrication analysis performed and plotted as shown in **Fig. 11**. An operating range for c_d can then be determined to optimize minimum clearance, friction horsepower loss, lubricant flow, and temperature rise.

Thrust Bearings

As the name implies, thrust bearings are used either to absorb axial shaft loads or to position shafts axially. Brief descriptions of the normal designs for these bearings follow with approximate design methods for each. The generally accepted load ranges for these types of bearings are given in **Table 1** and the schematic configurations are shown in **Fig. 1**.

The parallel or flat plate thrust bearing is probably the most frequently used type. It is the simplest and lowest in cost of those considered; however, it is also the least capable of absorbing load, as can be seen from **Table 1**. It is most generally used as a positioning device where loads are either light or occasional.

The step bearing, like the parallel plate, is also a relatively simple design. This type of bearing will accept the normal range of thrust loads and lends itself to low-cost, high-volume production. However, this type of bearing becomes sensitive to alignment as its size increases.

The tapered land thrust bearing, as shown in **Table 1**, is capable of high load capacity. Where the step bearing is generally used for small sizes, the tapered land type can be used in larger sizes. However, it is more costly to manufacture and does require good alignment as size is increased.

The tilting pad or Kingsbury thrust bearing (as it is commonly referred to) is also capable of high thrust capacity. Because of its construction it is more costly, but it has the inherent advantage of being able to absorb significant amounts of misalignment.

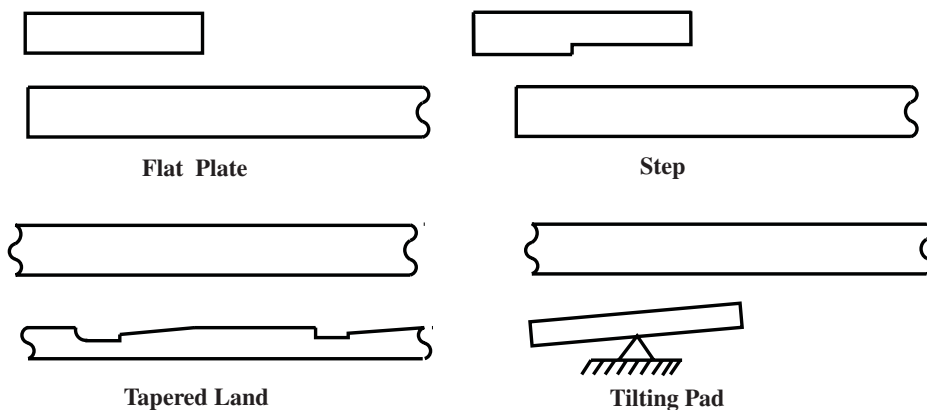


Fig. 1. Types of thrust bearings.

Table 1. Thrust Bearing Loads*

Type	Normal Unit Loads, Lb per Sq. In.	Maximum Unit Loads, Lb per Sq. In.
Parallel surface	<75	<150
Step	200	500
Tapered land	200	500
Tilting pad	200	500

Thrust Bearing Design Notation.—The symbols used in the design procedures that follow for flat plate, step, tapered land, and tilting pad thrust bearings are as follows:

- a = radial width of pad, inches
- b = circumferential length of pad at pitch line, inches
- b_2 = pad step length
- B = circumference of pitch circle, inches
- c = specific heat of oil, Btu/gal/°F
- D = diameter, inches
- e = depth of step, inch
- f = coefficient of friction
- g = depth of 45° chamfer, inches
- h = film thickness, inch
- i = number of pads
- J = power loss coefficient
- K = film thickness factor
- K_g = fraction of circumference occupied by the pads; usually, 0.8
- l = length of chamfer, inches
- M = horsepower per square inch
- N = revolutions per minute
- O = operating number
- p = bearing unit load, psi
- p_s = oil-supply pressure, psi
- P_f = friction horsepower
- Q = total flow, gpm

* Reproduced with permission from Wilcock and Booser, *Bearing Design and Applications*, McGraw-Hill Book Co., Copyright © 1957.

- Q_c = required flow per chamfer, gpm
 Q_c^o = uncorrected required flow per chamfer, gpm
 Q_F = film flow, gpm
 s = oil-groove width
 Δt = temperature rise, °F
 U = velocity, feet per minute
 V = effective width-to-length ratio for one pad
 W = applied load, pounds
 Y_G = oil-flow factor
 Y_L = leakage factor
 Y_S = shape factor
 Z = viscosity, centipoises
 α = dimensionless film-thickness factor
 δ = taper
 ξ = kinetic energy correction factor

Note: In the following, subscript 1 denotes inside diameter and subscript 2 denotes outside diameter. Subscript i denotes inlet and subscript o denotes outlet.

Flat Plate Thrust Bearing Design.—The following steps define the performance of a flat plate thrust bearing, one section of which is shown in Fig. 2. Although each bearing section is wedge shaped, as shown below right, for the purposes of design calculation, it is considered to be a rectangle with a length b equal to the circumferential length along the pitch line of the section being considered, and a width a equal to the difference in the external and internal radii.

General Parameters: a) From Table 1, the maximum unit load is between 75 and 100 pounds per square inch; and b) The outside diameter is usually between 1.5 and 2.5 times the inside diameter.

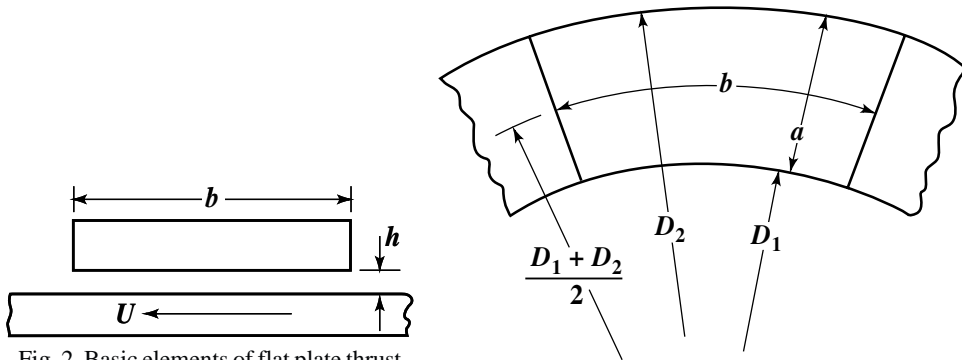


Fig. 2. Basic elements of flat plate thrust bearing.*

Basic elements of flat plate thrust bearing.*

- 1) *Inside diameter, D_1 .* Determined by shaft size and clearance.
- 2) *Outside diameter, D_2 .* Calculated by the formula

$$D_2 = \left(\frac{4W}{\pi K_g p} + D_1^2 \right)^{1/2}$$

where W = applied load, pounds

K_g = fraction of circumference occupied by pads; usually, 0.8

p = bearing unit load, psi

- 3) *Radial pad width, a .* Equal to one-half the difference between the inside and outside diameters.

$$a = \frac{D_2 - D_1}{2}$$

4) *Pitch line circumference, B.* Found from the pitch diameter.

$$B = \pi(D_2 - a)$$

5) *Number of pads, i.* Assume an oil groove width, s . If the length of pad is assumed to be optimum, i.e., equal to its width,

$$i_{\text{app}} = \frac{B}{a + s}$$

Take i as nearest even number.

6) *Length of pad, b.* If number of pads and oil groove width are known,

$$b = \frac{B - (i \times s)}{i}$$

7) *Actual unit load, p.* Calculated in pounds per square inch based on pad dimensions.

$$p = \frac{W}{iab}$$

8) *Pitch line velocity, U.* Found in feet per minute from

$$U = \frac{BN}{12}$$

where $N = \text{rpm}$

9) *Friction power loss, P_f .* Friction power loss is difficult to calculate for this type of bearing because there is no theoretical method of determining the operating film thickness. However, a good approximation can be made using Fig. 3. From this curve, the value of M , horsepower loss per square inch of bearing surface, can be obtained. The total power loss, P_f , is then calculated from

$$P_f = iabM$$

10) *Oil flow required, Q.* May be estimated in gallons per minute for a given temperature rise from

$$Q = \frac{42.4P_f}{c\Delta t}$$

where $c = \text{specific heat of oil in Btu/gal/}^\circ\text{F}$

$\Delta t = \text{temperature rise of the oil in } ^\circ\text{F}$

Note: A Δt of 50°F is an acceptable maximum.

Because there is no theoretical method of predicting the minimum film thickness in this type of bearing, only an approximation, based on experience, of the film flow can be made. For this reason and based on practical experience, it is desirable to have a minimum of one-half of the desired oil flow pass through the chamfer.

11) *Film flow, Q_F .* Calculated in gallons per minute from

$$Q_F = \frac{(1.5)(10^5)ih^3p_s}{Z_2}$$

where $V = \text{effective width-to-length ratio for one pad, } a/b$

$Z_2 = \text{oil viscosity at outlet temperature}$

$h = \text{film thickness}$

Note: Because h cannot be calculated, use $h = 0.002$ inch.

12) *Required flow per chamfer, Q_c .* Readily found from the formula

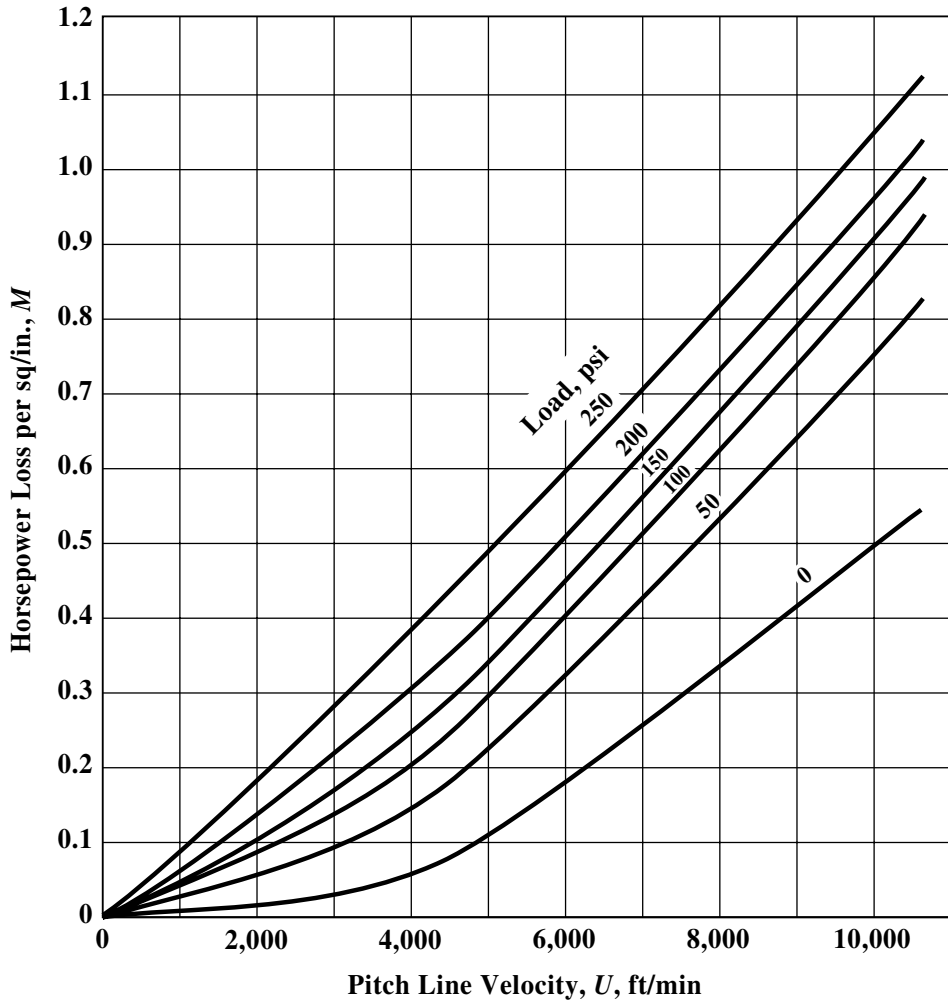


Fig. 3. Friction power loss, M , vs. peripheral speed, U — thrust bearings.^a

^a See footnote on page 2339.

$$Q_c = \frac{Q}{i}$$

13) *Kinetic energy correction factor*, ξ . Found by assuming a chamfer length l and entering Fig. 4 with a value $Z_2 l$ and Q_c .

14) *Uncorrected required flow per chamfer*, Q_c^0 . Found from the formula

$$Q_c^0 = \frac{Q_c}{\xi}$$

15) *Depth of chamfer*, g . Found from the formula

$$g = \sqrt[4]{\frac{Q_c^0 I Z_2}{4.74 \times 10^4 p_s}}$$



Example: Design a flat plate thrust bearing to carry 900 pounds load at 4000 rpm using an SAE 10 oil with a specific heat of 3.5 Btu/gal/°F at 120°F and 30-psi inlet conditions. The

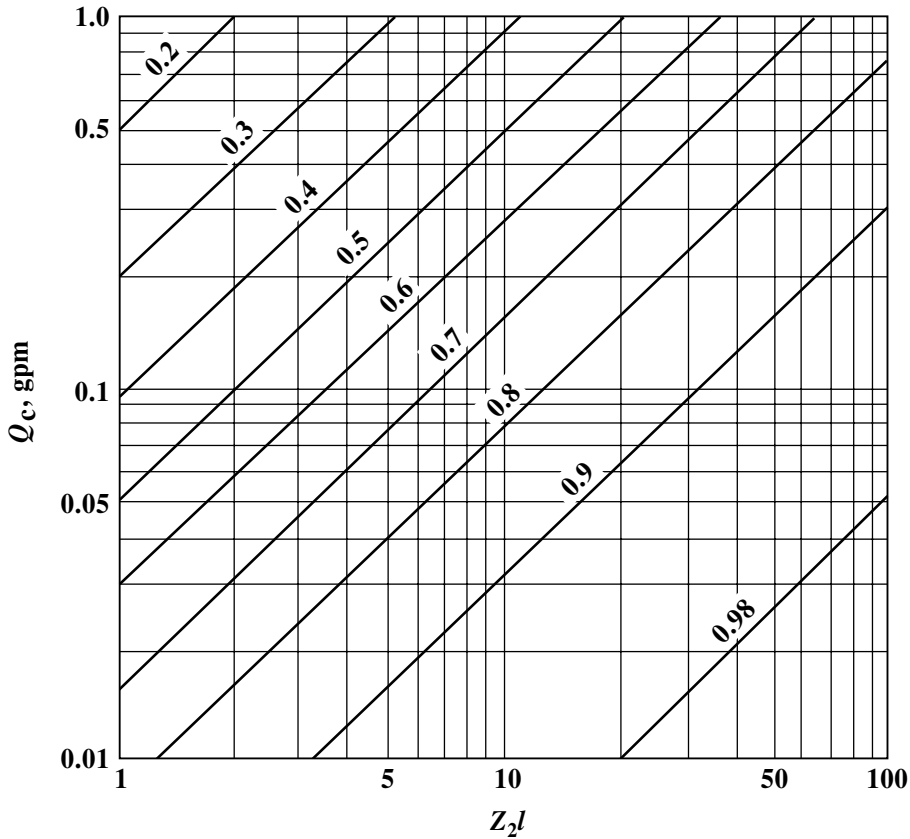


Fig. 4. Kinetic energy correction factor, ξ —thrust bearings.^a

^a See footnote on page 2339.

shaft is $2\frac{3}{4}$ inches in diameter and the temperature rise is not to exceed 40°F. Fig. 5 shows the final design of this bearing.

1) *Inside diameter.* Assumed to be 3 inches to clear shaft.

2) *Outside diameter.* Assuming a unit bearing load of 75 pounds per square inch from Table 1,

$$D_2 = \sqrt{\frac{4 \times 900}{\pi \times 0.8 \times 75}} + 3^2 = 5.30 \text{ inches}$$

Use $5\frac{1}{2}$ inches.

3) *Radial pad width.*

$$a = \frac{5.5 - 3}{2} = 1.25 \text{ inches}$$

4) *Pitch-line circumference.*

$$B = \pi \times 4.25 = 13.35 \text{ inches}$$

5) *Number of pads.* Assume an oil groove width of $\frac{3}{16}$ inch. If length of pad is assumed to be equal to width of pad, then

$$i_{\text{app}} = \frac{13.3}{1.25 + 0.1875} = 9+$$

If the number of pads, i , is taken as 10, then

$$6) \text{ Length of pad. } b = \frac{13.35 - (10 \times 0.1875)}{10} = 1.14 \text{ inches}$$

7) *Actual unit load.*

$$p = \frac{900}{10 \times 1.25 \times 1.14} = 63 \text{ psi}$$

8) *Pitch-line velocity.*

$$U = \frac{13.35 \times 4000}{12} = 4,430 \text{ ft per min.}$$

9) *Friction power loss.* From Fig. 3, $M = 0.19$

$$P_f = 10 \times 1.25 \times 1.14 \times 0.19 = 2.7 \text{ horsepower}$$

10) *Oil flow required.*

$$Q = \frac{42.4 \times 2.7}{3.5 \times 40} = 0.82 \text{ gallon per minute}$$

(Assuming a temperature rise of 40°F—the maximum allowable according to the given condition—then the assumed operating temperature will be 120°F + 40°F = 160°F and the oil viscosity Z_2 is found from Fig. 6 to be 9.6 centipoises.)

11) *Film flow.*

$$Q_F = \frac{1.5 \times 10^5 \times 10 \times 1 \times 0.002^3 \times 30}{9.6} = 0.038 \text{ gpm}$$

Because 0.038 gpm is a very small part of the required flow of 0.82 gpm, the bulk of the flow must be carried through the chamfers.

12) *Required flow per chamfer.* Assume that all the oil flow is to be carried through the chamfers.

$$Q_c = \frac{0.82}{10} = 0.082 \text{ gpm}$$

13) *Kinetic energy correction factor.* If l , the length of chamfer is made $\frac{1}{8}$ inch, then $Z_2 l = 9.6 \times \frac{1}{8} = 1.2$. Entering Fig. 4 with this value and $Q_c = 0.082$,

$$\xi = 0.44$$

14) *Uncorrected required oil flow per chamfer.*

$$Q_c^0 = \frac{0.082}{0.44} = 0.186 \text{ gpm}$$

15) *Depth of chamfer.*

$$g = \sqrt[4]{\frac{0.186 \times 0.125 \times 9.6}{4.74 \times 10^4 \times 30}}$$

$$g = 0.02 \text{ inch}$$

A schematic drawing of this bearing is shown in Fig. 5.

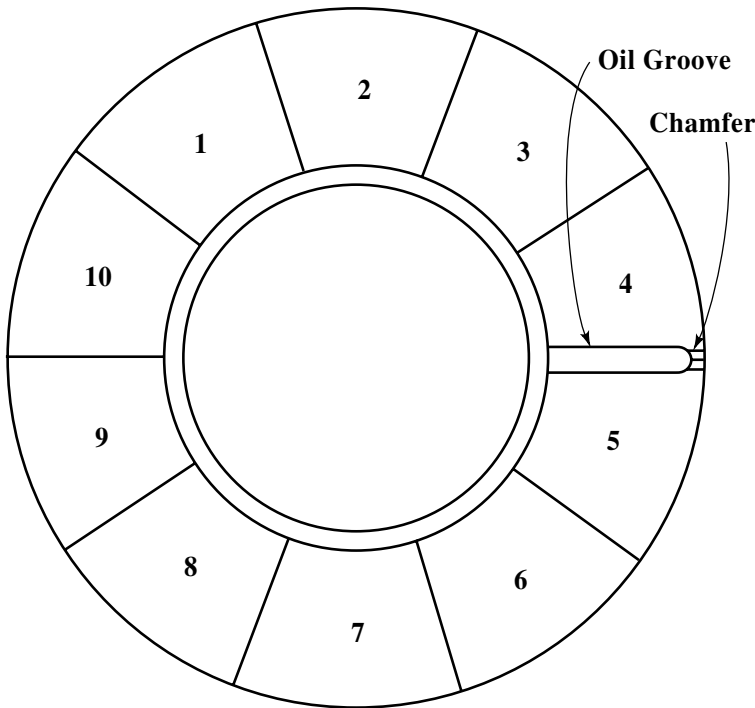


Fig. 5. Flat plate thrust bearing example design.*

Step Thrust Bearing Design.—The following steps define the performance of a step thrust bearing, one section of which is shown in Fig. 6.

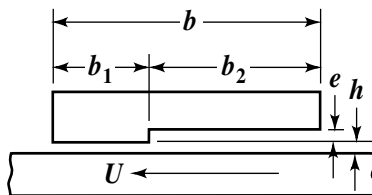


Fig. 6. Basic elements of step thrust bearing.*

Although each bearing section is wedge shaped, as shown at the right in Fig. 6, for the purposes of design calculation it is considered to be a rectangle with a length b equal to the circumferential length along the pitch line of the section being considered, and a width a equal to the difference in the external and internal radii.

General Parameters: For optimum proportions, $a = b$, $b_2 = 1.2b_1$, and $e = 0.7h$.

1) *Internal diameter, D_1 .* An internal diameter is assumed that is sufficient to clear the shaft.

2) *External diameter, D_2 .* A unit bearing pressure is assumed from Table 1 and the external diameter is then found from the formula

$$D_2 = \sqrt{\frac{4W}{\pi K_g p} + D_1^2}$$

3) *Radial pad width, a .* Equal to the difference between the external and internal radii.

$$a = \frac{D_2 - D_1}{2}$$

* See footnote on page 2339.

4) *Pitch-line circumference, B.* Found from the formula

$$B = \frac{\pi(D_1 + D_2)}{2}$$

5) *Number of pads, i.* Assume an oil groove width, s (0.062 inch may be taken as a minimum), and find the approximate number of pads, assuming the pad length is equal to a . Note that if a chamfer is found necessary to increase the oil flow (see Step 13), the oil groove width should be greater than the chamfer width.

$$i_{\text{app}} = \frac{B}{a + s}$$

Then i is taken as the nearest even number.

6) *Length of pad, b.* Readily determined from the number of pads and groove width.

$$b = \frac{B}{i} - s$$

7) *Pitch-line velocity, U.* Found in feet per minute from the formula $U = \frac{BN}{12}$

8) *Film thickness, h.* Found in inches from the formula

$$h = \sqrt{\frac{2.09 \times 10^{-9} i a^3 U Z}{W}}$$

9) *Depth of step, e.* According to the general parameter

$$e = 0.7h$$

10) *Friction power loss, P_f.* Found from the formula

$$P_f = \frac{7.35 \times 10^{-13} i a^2 U^2 Z}{h}$$

11) *Pad step length, b₂.* This distance, on the pitch line, from the leading edge of the pad to the step in inches is determined by the general parameters

$$b_2 = \frac{1.2b}{2.2}$$

12) *Hydrodynamic oil flow, Q.* Found in gallons per minute from the formula

$$Q = 6.65 \times 10^{-4} i a h U$$

13) *Temperature rise, Δt.* Found in degrees F from the formula

$$\Delta t = \frac{42.4 P_f}{c Q}$$

If the flow is insufficient, as indicated by too high a temperature rise, chamfers can be added to provide adequate flow as in Steps 12-15 of the flat plate thrust bearing design.



Example: Design a step thrust bearing for positioning a $\frac{7}{8}$ -inch diameter shaft operating with a 25-pound thrust load and a speed of 5,000 rpm. The lubricating oil has a viscosity of 25 centipoises at the operating temperature of 160 deg. F and has a specific heat of 3.4 Btu per gal. per deg. F.

1) *Internal diameter.* Assumed to be 1 inch to clear the shaft.

2) *External diameter.* Because the example is a positioning bearing with low total load, unit load will be negligible and the external diameter is not established by using the formula given in Step 2 of the procedure, but a convenient size is taken to give the desired overall bearing proportions.

$$D_2 = 3 \text{ inches}$$

3) *Radial pad width.*

$$a = \frac{3-1}{2} = 1 \text{ inch}$$

4) *Pitch-line circumference.*

$$B = \frac{\pi(3+1)}{2} = 6.28 \text{ inches}$$

5) *Number of pads.* Assuming a minimum groove width of 0.062 inch,

$$i_{\text{app}} = \frac{6.28}{1+0.062} = 5.9$$

Take $i = 6$.

6) *Length of pad.*

$$b = \frac{6.28}{6} - 0.062 = 0.985$$

7) *Pitch-line velocity.*

$$U = \frac{6.28 \times 5,000}{12} = 2,620 \text{ fpm}$$

8) *Film thickness.*

$$h = \sqrt{\frac{2.09 \times 10^{-9} \times 6 \times 1^3 \times 2,620 \times 25}{25}} = 0.0057 \text{ inch}$$

9) *Depth of step.*

$$e = 0.7 \times 0.0057 = 0.004 \text{ inch}$$

10) *Power loss.*

$$P_f = \frac{7.35 \times 10^{-13} \times 6 \times 1^2 \times 2,620^2 \times 25}{0.0057} = 0.133 \text{ hp}$$

11) *Pad step length.*

$$b_2 = \frac{1.2 \times 0.985}{2.2} = 0.537 \text{ inch}$$

12) *Total hydrodynamic oil flow.*

$$Q = 6.65 \times 10^{-4} \times 6 \times 1 \times 0.0057 \times 2,620 = 0.060 \text{ gpm}$$

13) *Temperature rise.*

$$\Delta t = \frac{42.4 \times 0.133}{3.4 \times 0.060} = 28^\circ \text{ F}$$

Tapered Land Thrust Bearing Design.—The following steps define the performance of a tapered land thrust bearing, one section of which is shown in Fig. 7. Although each bearing section is wedge shaped, as shown in Fig. 7, right, for the purposes of design calculation, it is considered to be a rectangle with a length b equal to the circumferential length along the pitch line of the section being considered and a width a equal to the difference in the external and internal radii.

General Parameters: Usually, the taper extends to only 80 per cent of the pad length with the remainder being flat, thus: $b_2 = 0.8b$ and $b_1 = 0.2b$.

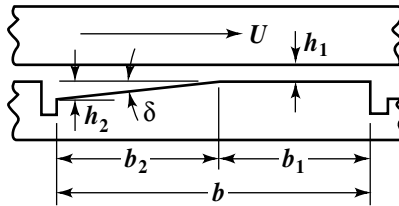


Fig. 7. Basic elements of tapered land thrust bearing.*

- 1) *Inside diameter, D_1* . Determined by shaft size and clearance.
- 2) *Outside diameter, D_2* . Calculated by the formula

$$D_2 = \left(\frac{4W}{\pi K_g P_a} + D_1^2 \right)^{1/2}$$

where $K_g = 0.8$ or 0.9 and $W =$ applied load, pounds

$P_a =$ assumed unit load from **Table 1**, page 2339

- 3) *Radial pad width, a* . Equal to one-half the difference between the inside and outside diameters.

$$a = \frac{D_2 - D_1}{2}$$

- 4) *Pitch-line circumference, B* . Found from the mean diameter:

$$B = \frac{\pi(D_1 + D_2)}{2}$$

- 5) *Number of pads, i* . Assume an oil groove width, s , and find the approximate number of pads, assuming the pad length is equal to a .

$$i_{\text{app}} = \frac{B}{a + s}$$

Then i is taken as the nearest even number.

- 6) *Length of pad, b* . Readily determined because the number of pads and groove width are known.

$$b = \frac{B - is}{i}$$

- 7) *Taper values, δ_1 and δ_2* . Can be taken from **Table 2**.

- 8) *Actual bearing unit load, p* . Calculated in pounds per square inch from the formula

$$p = \frac{W}{iab}$$

- 9) *Pitch-line velocity, U* . Found in feet per minute at the pitch circle from the formula

$$U = \frac{BN}{12}$$

where $N =$ rpm

- 10) *Oil leakage factor, Y_L* . Found either from **Fig. 8** which shows curves for Y_L as functions of the pad width a and length of land b or from the formula

$$Y_L = \frac{b}{1 + (\pi^2 b^2 / 12 a^2)}$$

- 11) *Film thickness factor, K* . Calculated using the formula

$$K = \frac{5.75 \times 10^6 p}{UY_L Z}$$

* See footnote on page 2339.

12) *Minimum film thickness, h.* Using the value of *K* just determined and the selected taper values δ_1 and δ_2 , *h* is found from Fig. 9. In general, *h* should be 0.001 inch for small bearings and 0.002 inch for larger and high-speed bearings.

13) *Friction power loss, P_f.* Using the film thickness *h*, the coefficient *J* can be obtained from Fig. 10. The friction loss in horsepower is then calculated from the formula

$$P_f = 8.79 \times 10^{-13} iabJU^2Z$$

14) *Required oil flow, Q.* May be estimated in gallons per minute for a given temperature rise Δ_t from the formula

$$Q = \frac{42.4P_f}{c\Delta t}$$

where *c* = specific heat of the oil in Btu/gal/°F

Note: A Δt of 50°F is an acceptable maximum.

15) *Shape factor, Y_s.* Needed to compute the actual oil flow and calculated from

$$Y_s = \frac{8ab}{D_2^2 - D_1^2}$$

16) *Oil flow factor, Y_G.* Found from Fig. 11 using *Y_s* and D_1/D_2 .

17) *Actual oil film flow, Q_F.* The amount of oil in gallons per minute that the bearing film will pass is calculated from the formula

$$Q_F = \frac{8.9 \times 10^{-4} i \delta_2 D_2^3 N Y_G Y_s^2}{D_2 - D_1}$$

18) If the flow is insufficient, the tapers can be increased or chamfers calculated to provide adequate flow, as in Steps 12-15 of the flat plate thrust bearing design procedure.

Example: Design a tapered land thrust bearing for 70,000 pounds at 3600 rpm. The shaft diameter is 6.5 inches. The oil inlet temperature is 110°F at 20 psi.

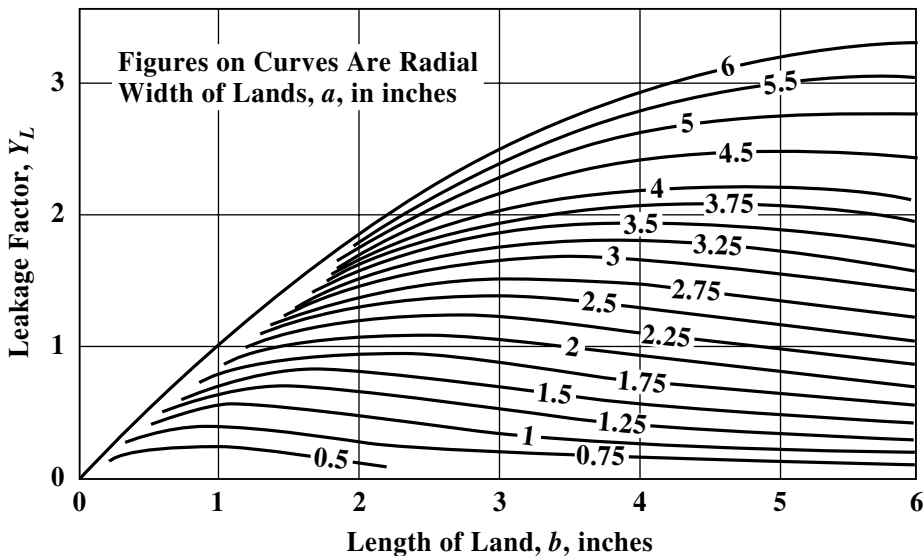


Fig. 8. Leakage factor, *Y_L*, vs. pad dimensions *a* and *b*—tapered land thrust bearings.*

* See footnote on page 2339.

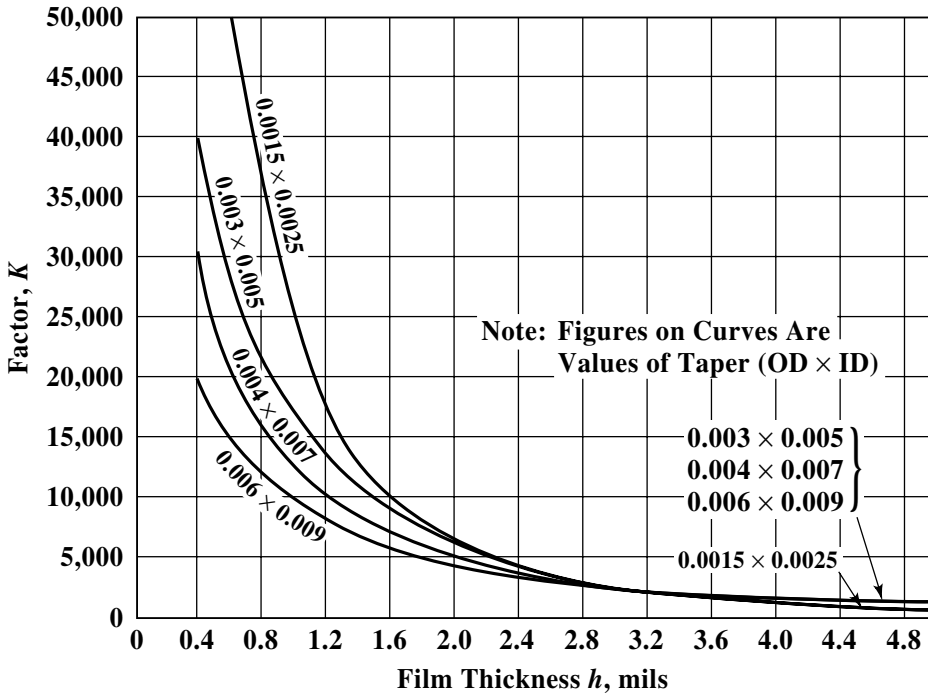


Fig. 9. Thickness, h , vs. factor K —tapered land thrust bearings.*

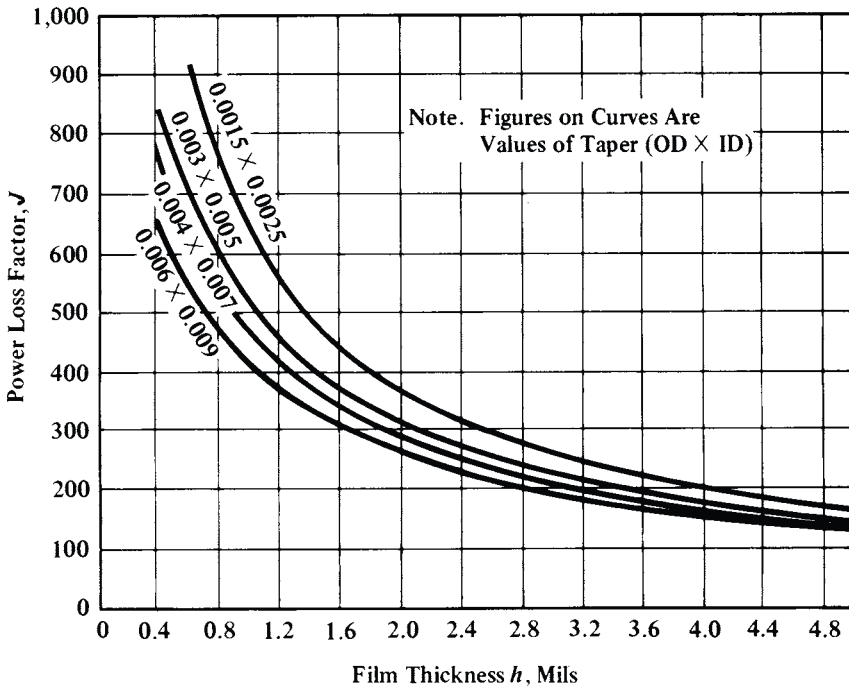


Fig. 10. Power-loss coefficient, J , vs. film thickness, h —tapered land thrust bearings.*

A maximum temperature rise of 50°F is acceptable and results in a viscosity of 18 centipoises. Use values of $K_g = 0.9$ and $c = 3.5$ Btu/gal/°F.

* See footnote on page 2339.

1) *Internal diameter.* Assume $D_1 = 7$ inches to clear shaft.

2) *External diameter.* Assume a unit bearing load p_a of 400 pounds per square inch from Table 1, then

$$D_2 = \sqrt{\frac{4 \times 70,000}{3.14 \times 0.9 \times 400} + 7^2} = 17.2 \text{ inches}$$

Round off to 17 inches.

3) *Radial pad width.*

$$a = \frac{17 - 7}{2} = 5 \text{ inches}$$

4) *Pitch-line circumference.*

$$B = \frac{3.14(17 + 7)}{2} = 37.7 \text{ inches}$$

5) *Number of pads.* Assume groove width of 0.5 inch, then

$$i_{app} = \frac{37.7}{5 + 0.5} = 6.85$$

Take $i = 6$.

6) *Length of pad.*

$$b = \frac{37.7 - 6 \times 0.5}{6} = 5.78 \text{ inches}$$

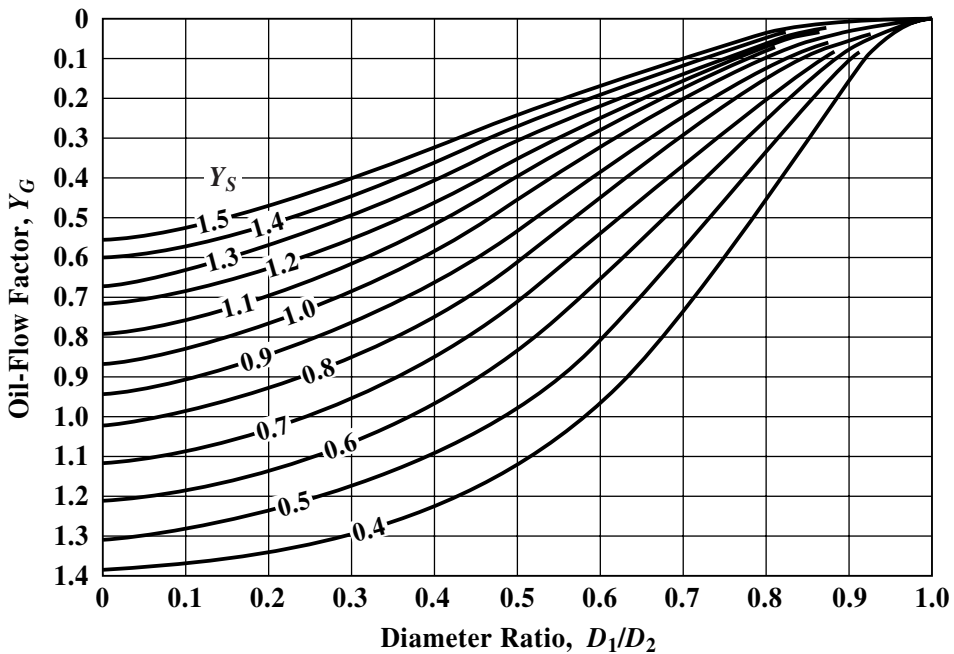


Fig. 11. Oil-flow factor, Y_G , vs. diameter ratio D_1/D_2 —tapered land bearings.*

7) *Taper values.* Interpolate in Table 2 to obtain

$$\delta_1 = 0.008 \text{ inch} \quad \text{and} \quad \delta_2 = 0.005 \text{ inch}$$

8) *Actual bearing unit load.*

$$p = \frac{70,000}{6 \times 5 \times 5.78} = 404 \text{ psi}$$

* See footnote on page 2339.

9) *Pitch-line velocity.*

$$U = \frac{37.7 \times 3600}{12} = 11,300 \text{ ft per min}$$

10) *Oil leakage factor.*

$$\text{From Fig. 8, } Y_L = 2.75$$

11) *Film-thickness factor.*

$$K = \frac{5.75 \times 10^6 \times 404}{11,300 \times 2.75 \times 18} = 4150$$

12) *Minimum film thickness.*

$$\text{From Fig. 9, } h = 2.2 \text{ mils}$$

13) *Friction power loss.* From Fig. 10, $J = 260$, then

$$P_f = 8.79 \times 10^{-13} \times 6 \times 5 \times 5.78 \times 260 \times 11,300^2 \times 18 = 91 \text{ hp}$$

14) *Required oil flow.*

$$Q = \frac{42.4 \times 91}{3.5 \times 50} = 22.0 \text{ gpm}$$

See footnote on page 2339.

15) *Shape factor.*

$$Y_S = \frac{8 \times 5 \times 5.78}{17^2 - 7^2} = 0.963$$

16) *Oil-flow factor.*

$$\text{From Fig. 11, } Y_G = 0.61$$

where $D_1/D_2 = 0.41$

17) *Actual oil film flow.*

$$Q_F = \frac{8.9 \times 10^{-4} \times 6 \times 0.005 \times 17^3 \times 3600 \times 0.61 \times 0.963^2}{17 - 7} = 26.7 \text{ gpm}$$

Because calculated film flow exceeds required oil flow, chamfers are not necessary. However, if film flow were less than required, suitable chamfers would be needed.

Table 2. Taper Values for Tapered Land Thrust Bearings

Pad Dimensions, Inches	Taper, Inch	
	$\delta_1 = h_2 - h_1$ (at ID)	$\delta_2 = h_2 - h_1$ (at OD)
$\frac{1}{2} \times \frac{1}{2}$	0.0025	0.0015
1×1	0.005	0.003
3×3	0.007	0.004
7×7	0.009	0.006

Tilting Pad Thrust Bearing Design.—The following steps define the performance of a tilting pad thrust bearing, one section of which is shown in Fig. 12. Although each bearing section is wedge shaped, as shown at the right below, for the purposes of design calculation, it is considered to be a rectangle with a length b equal to the circumferential length along the pitch line of the section being considered and a width a equal to the difference in the external and internal radii, as shown at left in Fig. 12. The location of the pivot shown in Fig. 12 is optimum. If shaft rotation in both directions is required, however, the pivot must be at the midpoint, which results in little or no detrimental effect on the performance.

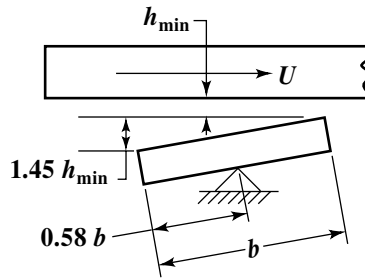


Fig. 12. Basic elements of tilting pad thrust bearing.*

- 1) *Inside diameter, D_1* . Determined by shaft size and clearance.
- 2) *Outside diameter, D_2* . Calculated from the formula

$$D_2 = \left(\frac{4W}{\pi K_g p} + D_1^2 \right)^{1/2}$$

where W = applied load, pounds

$$K_g = 0.8$$

p = unit load from **Table 1**

- 3) *Radial pad width, a* . Equal to one-half the difference between the inside and outside diameters:

$$a = \frac{D_2 - D_1}{2}$$

- 4) *Pitch-line circumference, B* . Found from the mean diameter:

$$B = \pi \left(\frac{D_1 + D_2}{2} \right)$$

- 5) *Number of pads, i* . The number of pads may be estimated from the formula

$$i = \frac{BK_g}{a}$$

Select the nearest even number.

- 6) *Length of pad, b* . Found from the formula

$$b \cong \frac{BK_g}{i}$$

- 7) *Pitch-line velocity, U* . Calculated in feet per minute from the formula

$$U = \frac{BN}{12}$$

- 8) *Bearing unit load, p* . Calculated from the formula

$$p = \frac{W}{iab}$$

- 9) *Operating number, O* . Calculated from the formula

$$O = \frac{1.45 \times 10^{-7} Z_2 U}{5pb}$$

10) where Z_2 = viscosity of oil at outlet temperature (inlet temperature plus assumed temperature rise through the bearing).

* See footnote on page 2339.

11) *Minimum film thickness, h_{\min}* . By using the operating number, the value of α = dimensionless film thickness is found from Fig. 13. Then the actual minimum film thickness is calculated from the formula:

$$h_{\min} = \alpha b$$

In general, this value should be 0.001 inch for small bearings and 0.002 inch for larger and high-speed bearings.

12) *Coefficient of friction, f* . Found from Fig. 14.

13) *Friction power loss, P_f* . This horsepower loss now is calculated by the formula

$$P_f = \frac{fWU}{33,000}$$

14) *Actual oil flow, Q* . This flow over the pad in gallons per minute is calculated from the formula

$$Q = 0.0591 \alpha i a b U$$

15) *Temperature rise, Δt* . Found from the formula

$$\Delta t = 0.0217 \frac{f p}{\alpha c}$$

where c = specific heat of oil in Btu/gal/°F

If the flow is insufficient, as indicated by too high a temperature rise, chamfers can be added to provide adequate flow, as in Steps 12-15 of the flat plate thrust bearing design.



Example: Design a tilting pad thrust bearing for 70,000 pounds thrust at 3600 rpm. The shaft diameter is 6.5 inches and a maximum OD of 15 inches is available. The oil inlet temperature is 110°F and the supply pressure is 20 pounds per square inch. A maximum temperature rise of 50°F is acceptable and results in a viscosity of 18 centipoises. Use a value of 3.5 Btu/gal/°F for c .

1) *Inside diameter.* Assume $D_1 = 7$ inches to clear shaft.

2) *Outside diameter.* Given maximum $D_2 = 15$ inches.

3) *Radial pad width.*

$$a = \frac{15 - 7}{2} = 4 \text{ inches}$$

4) *Pitch-line circumference.*

$$B = \pi \left(\frac{7 + 15}{2} \right) = 34.6 \text{ inches}$$

5) *Number of pads.*

$$i = \frac{34.6 \times 0.8}{4} = 6.9$$

Select 6 pads: $i = 6$.

6) *Length of pad.*

$$b = \frac{34.6 \times 0.8}{6} = 4.61 \text{ inches}$$

Make $b = 4.75$ inches.

7) *Pitch-line velocity.*

$$U = \frac{34.6 \times 3600}{12} = 10,400 \text{ ft/min}$$

8) *Bearing unit load.*

$$p = \frac{70,000}{6 \times 4 \times 4.75} = 614 \text{ psi}$$

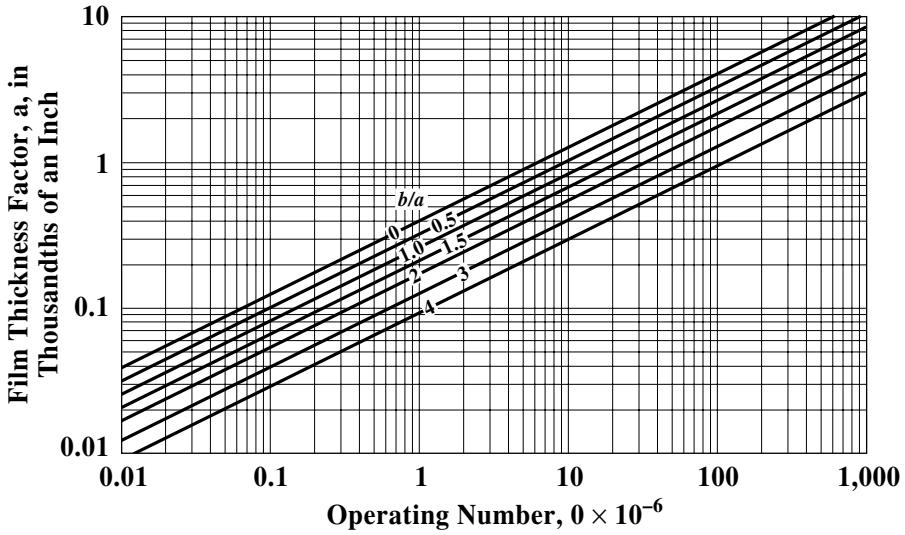


Fig. 13. Dimensionless minimum film thickness, α , vs. operating number, O —tilting pad thrust bearings.*

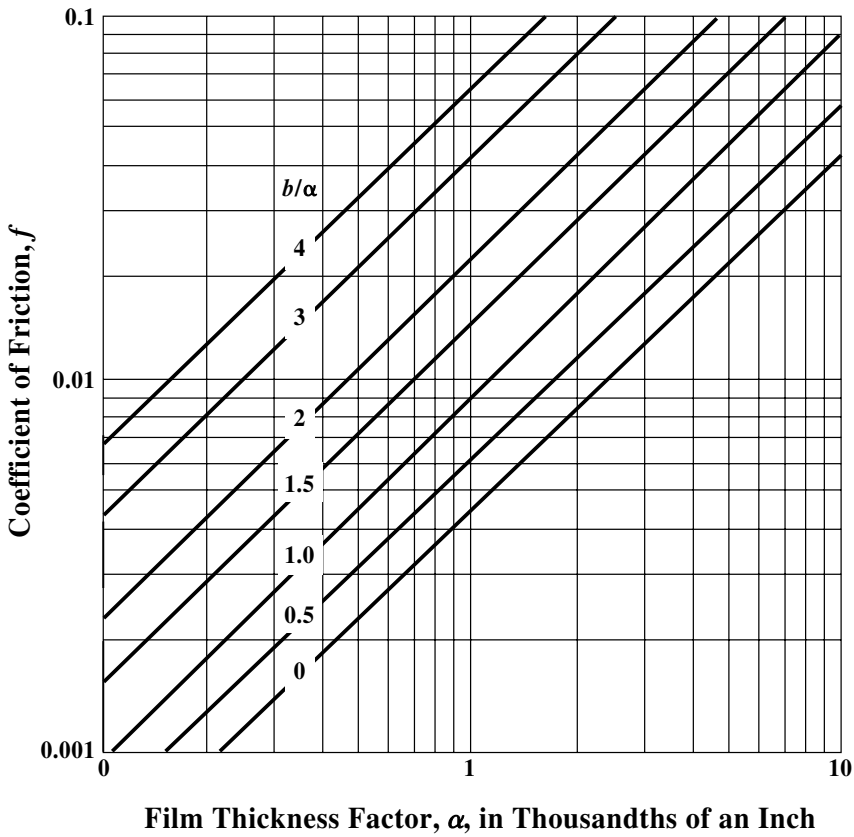


Fig. 14. Coefficient of friction f vs. dimensionless film thickness α for tilting pad thrust bearings with optimum pivot location.*

* See footnote on page 2339.

9) *Operating number.*

$$O = \frac{1.45 \times 10^{-7} \times 18 \times 10,400}{5 \times 614 \times 4.75} = 1.86 \times 10^{-6}$$

10) *Minimum film thickness.* From Fig. 13, $\alpha = 0.30 \times 10^{-3}$.

$$h_{\min} = 0.00030 \times 4.75 = 0.0014 \text{ inch}$$

11) *Coefficient of friction.* From Fig. 14, $f = 0.0036$.

12) *Friction power loss.*

$$P_f = \frac{0.0036 \times 70,000 \times 10,400}{33,000} = 79.4 \text{ hp}$$

13) *Oil flow.*

$$Q = 0.0591 \times 6 \times 0.30 \times 10^{-3} \times 4 \times 4.75 \times 10,400 = 21.02 \text{ gpm}$$

14) *Temperature rise.*

$$\Delta t = \frac{0.0217 \times 0.0036 \times 614}{0.30 \times 10^{-3} \times 3.5} = 45.7^\circ \text{F}$$

Because this temperature is less than the 50°F , which is considered as the acceptable maximum, the design is satisfactory.

Plain Bearing Materials

Materials used for sliding bearings cover a wide range of metals and nonmetals. To make the optimum selection requires a complete analysis of the specific application. The important general categories are: Babbitts, alkali-hardened lead, cadmium alloys, copper lead, aluminum bronze, silver, sintered metals, plastics, wood, rubber, and carbon graphite.

Properties of Bearing Materials.—For a material to be used as a plain bearing, it must possess certain physical and chemical properties that permit it to operate properly. If a material does not possess all of these characteristics to some degree, it will not function long as a bearing. It should be noted, however, that few, if any, materials are outstanding in all these characteristics. Therefore, the selection of the optimum bearing material for a given application is at best a compromise to secure the most desirable combination of properties required for that particular usage.

The seven properties generally acknowledged to be the most significant are: 1) Fatigue resistance; 2) Embeddability; 3) Compatibility; 4) Conformability; 5) Thermal conductivity; 6) Corrosion resistance; and 7) Load capacity.

These properties are described as follows:

1) *Fatigue resistance* is the ability of the bearing lining material to withstand repeated applications of stress and strain without cracking, flaking, or being destroyed by some other means.

2) *Embeddability* is the ability of the bearing lining material to absorb or embed within itself any of the larger of the small dirt particles present in a lubrication system. Poor embeddability permits particles circulating around the bearing to score both the bearing surface and the journal or shaft. Good embeddability will permit these particles to be trapped and forced into the bearing surface and out of the way where they can do no harm.

3) *Compatibility or anticorrosion tendencies* permit the shaft and bearing to “get along” with each other. It is the ability to resist galling or seizing under conditions of metal-to-metal contact such as at startup. This characteristic is most truly a bearing property, because contact between the bearing and shaft in good designs occurs only at startup.

4) *Conformability* is defined as malleability or as the ability of the bearing material to creep or flow slightly under load, as in the initial stages of running, to permit the shaft and bearing contours to conform with each other or to compensate for nonuniform loading caused by misalignment.

Table 1. Bearing and Bushing Alloys—Composition, Forms, Characteristics, and Applications *SAE General Information*

SAE No. and Alloy Grouping		Nominal Composition, Per cent	Form of Use (1), Characteristics (2), and Applications (3)
Sn-Base Alloys	11	Sn, 87.5; Sb, 6.75; Cu, 5.75	(1) Cast on steel, bronze, or brass backs, or directly in the bearing housing. (2) Soft, corrosion-resistant with moderate fatigue resistance. (3) Main and connecting-rod bearings; motor bushings. Operates with either hard or soft journal.
	12	Sn, 89; Sb, 7.5; Cu, 3.5	
Pb-Base Alloys	13	Pb, 84; Sb, 10; Sn, 6	(1) SAE 13 and 14 are cast on steel, bronze, or brass, or in the bearing housing; SAE 15 is cast on steel; and SAE 16 is cast into and on a porous sintered matrix, usually copper-nickel bonded to steel. (2) Soft, moderately fatigue-resistant, corrosion-resistant. (3) Main and connecting-rod bearings. Operates with hard or soft journal with good finish.
	14	Pb, 75; Sb, 15; Sn, 10	
	15	Pb, 83; Sb, 15; Sn, 14; As, 1	
	16	Pb, 92; Sb, 3.5; Sn, 4.5	
Pb-Sn Overlays	19	Pb, 90; Sn, 10	(1) Electrodeposited as a thin layer on copper-lead or silver bearings faces. (2) Soft, corrosion-resistant. Bearings so coated run satisfactorily against soft shafts throughout the life of the coating. (3) Heavy-duty, high-speed main and connecting-rod bearings.
	190	Pb, 93; Sn, 7	
Cu-Pb Alloys	49	Cu, 76; Pb, 24	(1) Cast or sintered on steel back with the exception of SAE 481, which is cast on steel back only. (2) Moderately hard. Somewhat subject to oil corrosion. Some oils minimize this; protection with overlay may be desirable. Fatigue resistance good to fairly good. Listed in order of decreasing hardness and fatigue resistance. (3) Main and connecting-rod bearings. The higher lead alloys can be used unplated against a soft shaft, although an overlay is helpful. The lower lead alloys may be used against a hard shaft, or with an overlay against a soft one.
	48	Cu, 70; Pb, 30	
	480	Cu, 65; Pb, 35	
	481	Cu, 60; Pb, 40	
Cu-Pb-Sn-Alloys	482	Cu, 67; Pb, 28; Sn, 5	(1) Steel-backed and lined with a structure combining sintered copper alloy matrix with corrosion-resistant lead alloy. (2) Moderately hard. Corrosion resistance improved over copper-leads of equal lead content without tin. Fatigue resistance fairly good. Listed in order of decreasing hardness and fatigue resistance. (3) Main and connecting-rod bearings. Generally used without overlay. SAE 484 and 485 may be used with hard or soft shaft, and a hardened or cast shaft is recommended for SAE 482.
	484	Cu, 55; Pb, 42; Sn, 3	
	485	Cu, 46; Pb, 51; Sn, 3	
Al-Base Alloys	770	Al, 91.75; Sn, 6.25; Cu, 1; Ni, 1	(1) SAE 770 cast in permanent molds; work-hardened to improve physical properties. SAE 780 and 782 usually bonded to steel back but is procurable in strip form without steel backing. SAE 781 usually bonded to steel back but can be produced as castings or wrought strip without steel back. (2) Hard, extremely fatigue-resistant, resistant to oil corrosion. (3) Main and connecting-rod bearings. Generally used with suitable overlay. SAE 781 and 782 also used for bushings and thrust bearings with or without overlay.
	780	Al, 91; Sn, 6; Si, 1.5; Cu, 1; Ni, 0.5	
	781	Al, 95; Si, 4; Cd, 1	
	782	Al, 95; Cu, 1; Ni, 1; Cd, 3	
Other Cu-Base Alloys	795	Cu, 90; Zn, 9.5; Sn, 0.5	(1) Wrought solid bronze, (2) Hard, strong, good fatigue resistance, (3) Intermediate-load oscillating motion such as tie-rods and brake shafts.
	791	Cu, 88; Zn, 4; Sn, 4; Pb, 4	
	793	Cu, 84; Pb, 8; Sn, 4; Zn, 4	
Other Cu-Base Alloys	798	Cu, 84; Pb, 8; Sn, 4; Zn, 4	(1) SAE 791, wrought solid bronze; SAE 793, cast on steel back; SAE 798, sintered on steel back. (2) General-purpose bearing material, good shock and load capacity. Resistant to high temperatures. Hard shaft desirable. Less score-resistant than higher lead alloys. (3) Medium to high loads. Transmission bushings and thrust washers. SAE 791 also used for piston pin and 793 and 798 for chassis bushings.
	792	Cu, 80; Sn, 10; Pb, 10	
	797	Cu, 80; Sn, 10; Pb, 10	
	794	Cu, 73.5; Pb, 23; Sn, 3.5	
Other Cu-Base Alloys	799	Cu, 73.5; Pb, 23; Sn, 3.5	(1) SAE 794, cast on steel back; SAE 799, sintered on steel back. (2) Higher lead content gives improved surface action for higher speeds but results in somewhat less corrosion resistance. (3) Intermediate load application for both oscillating and rotating shafts, that is, rocker-arm bushings, transmissions, and farm implements.

5) *High thermal conductivity* is required to absorb and carry away the heat generated in the bearing. This conductivity is most important, not in removing frictional heat generated in the oil film, but in preventing seizures due to hot spots caused by local asperity breakthroughs or foreign particles.

6) *Corrosion resistance* is required to resist attack by organic acids that are sometimes formed in oils at operating conditions.

7) *Load capacity or strength* is the ability of the material to withstand the hydrodynamic pressures exerted upon it during operation.

Babbitt or White Metal Alloys.—Many different bearing metal compositions are referred to as babbitt metals. The exact composition of the original babbitt metal is not known; however, the ingredients were probably tin, copper, and antimony in approximately the following percentages: 89.3, 3.6, and 7.1. Tin and lead-base babbitts are probably the best known of all bearing materials. With their excellent embeddability and compatibility characteristics under boundary lubrication, babbitt bearings are used in a wide range of applications including household appliances, automobile and diesel engines, railroad cars, electric motors, generators, steam and gas turbines, and industrial and marine gear units.

Table 2. White Metal Bearing Alloys—Composition and Properties
ASTM B23-83, reapproved 1988

ASTM Alloy ^a Number	Nominal Composition, Per Cent				Compressive Yield Point, ^b psi		Ultimate Compressive Strength, ^c psi		Brinell Hardness ^d		Melting Point °F	Proper Pouring Temperature, °F
	Sn	Sb	Pb	Cu	68 °F	212 °F	68 °F	212 °F	68 °F	212 °F		
1	91.0	4.5	...	4.5	4400	2650	12,850	6950	17.0	8.0	433	825
2	89.0	7.5	...	3.5	6100	3000	14,900	8700	24.5	12.0	466	795
3	83.33	8.33	...	8.33	6600	3150	17,600	9900	27.0	14.5	464	915
4	75.0	12.0	10.0	3.0	5550	2150	16,150	6900	24.5	12.0	363	710
5	65.0	15.0	18.0	2.0	5050	2150	15,050	6750	22.5	10.0	358	690
6	20.0	15.0	63.5	1.5	3800	2050	14,550	8050	21.0	10.5	358	655
7 ^e	10.0	15.0	bal.	...	3550	1600	15,650	6150	22.5	10.5	464	640
8 ^e	5.0	15.0	bal.	...	3400	1750	15,600	6150	20.0	9.5	459	645
10	2.0	15.0	83.0	...	3350	1850	15,450	5750	17.5	9.0	468	630
11	...	15.0	85.0	...	3050	1400	12,800	5100	15.0	7.0	471	630
12	...	10.0	90.0	...	2800	1250	12,900	5100	14.5	6.5	473	625
15 ^f	1.0	16.0	bal.	0.5	21.0	13.0	479	662
16	10.0	12.5	77.0	0.5	27.5	13.6	471	620
19	5.0	9.0	86.0	15,600	6100	17.7	8.0	462	620

^aData for ASTM alloys 1, 2, 3, 7, 8, and 15 appear in the Appendix of ASTM B23-83; the data for alloys 4, 5, 6, 10, 11, 12, 16, and 19 are given in ASTM B23-49. All values are for reference purposes only.

^bThe values for yield point were taken from stress-strain curves at the deformation of 0.125 per cent reduction of gage.

^cThe ultimate strength values were taken as the unit load necessary to produce a deformation of 25 per cent of the length of the specimen.

^dThese values are the average Brinell number of three impressions on each alloy using a 10-mm ball and a 500-kg load applied for 30 seconds.

^eAlso nominal arsenic, 0.45 per cent.

^fAlso nominal arsenic, 1 per cent.

The compression test specimens were cylinders 1.5 inches in length and 0.5 inch in diameter, machined from chill castings 2 inches in length and 0.75 inch in diameter. The Brinell tests were made on the bottom face of parallel machined specimens cast in a 2-inch diameter by 0.625-inch deep steel mold at room temperature.

Both the Society of Automotive Engineers and American Society for Testing and Materials have classified white metal bearing alloys. **Tables 1** and **2** give compositions and properties or characteristics for the two classifications.

In small bushings for fractional-horsepower motors and in automotive engine bearings, babbitt is generally used as a thin coating over a flat steel strip. After forming oil distribution grooves and drilling required holes, the strip is cut to size, rolled, and shaped into finished bearing. These bearings are available for shaft diameters from 0.5 to 5 inches (12.7–127 mm). Strip bearings are turned out by the millions yearly in highly automated factories and offer an excellent combination of low cost with good bearing properties.

For larger bearings in heavy-duty equipment, a thicker babbitt is cast on a rigid backing of steel or cast iron. Chemical and electrolytic cleaning of the bearing shell, thorough rinsing, tinning, and then centrifugal casting of the babbitt are desirable for sound bonding of the babbitt to the bearing shell. After machining, the babbitt layer is usually $\frac{1}{2}$ to $\frac{1}{4}$ inch (12.7–6.35 mm) thick.

Compared to other bearing materials, babbitts generally have lower load-carrying capacity and fatigue strength, are a little higher in cost, and require a more complicated design. Also, their strength decreases rapidly with increasing temperature. These shortcomings can be avoided by using an intermediate layer of high-strength, fatigue-resistant material that is placed between a steel backing and a thin babbitt surface layer. Such composite bearings frequently eliminate any need for using alternate materials having poorer bearing characteristics.

Tin babbitt is composed of 80 to 90 per cent tin to which is added about 3 to 8 per cent copper and 4 to 14 per cent antimony. An increase in copper or antimony produces increased hardness and tensile strength and decreased ductility. However, if the percentages of these alloys are increased above those shown in [Table 2](#), the resulting alloy will have decreased fatigue resistance. These alloys have very little tendency to cause wear to their journals because of their ability to embed dirt. They resist the corrosive effects of acids, are not prone to oil-film failure, and are easily bonded and cast. Two drawbacks are encountered from use of these alloys because they have low fatigue resistance and their hardness and strength drop appreciably at low temperatures.

Lead babbitt compositions generally range from 10 to 15 per cent antimony and up to 10 per cent tin in combination with the lead. Like tin-base babbitts, these alloys have little tendency to cause wear to their journals, embed dirt well, resist the corrosive effects of acids, are not prone to oil-film failure and are easily bonded and cast. Their chief disadvantages when compared with tin-base alloys are a rather lower strength and a susceptibility to corrosion.

Cadmium Base.—Cadmium alloy bearings have a greater resistance to fatigue than babbitt bearings, but their use is very limited due to their poor corrosion resistance. These alloys contain 1 to 15 per cent nickel, or 0.4 to 0.75 per cent copper, and 0.5 to 2.0 per cent silver. Their prime attribute is their high-temperature capability. The load-carrying capacity and relative basic bearing properties are shown in [Table 3](#).

Copper-Lead.—Copper-lead bearings are a binary mixture of copper and lead containing from 20 to 40 per cent lead. Lead is practically insoluble in copper, so a cast microstructure consists of lead pockets in a copper matrix. A steel backing is commonly used with this material and high volume is achieved either by continuous casting or by powder metallurgy techniques. This material is very often used with an overplate such as lead-tin and lead-tin-copper to increase basic bearing properties. [Table 3](#) provides comparisons of material properties.

The combination of good fatigue strength, high-load capacity, and high-temperature performance has resulted in extensive use of this material for heavy-duty main and connecting-rod bearings as well as moderate-load and speed applications in turbines and electric motors.

Leaded Bronze and Tin-Bronze.—Leaded and tin-bronzes contain up to 25 per cent lead or approximately 10 per cent tin, respectively. Cast leaded bronze bearings offer good compatibility, excellent casting, and easy machining characteristics, low cost, good struc-

Table 3. Properties of Bearing Alloys and Bearing Characteristics Ratings

Material	Recommended Shaft Hardness, Brinell	Load-Carrying Capacity, psi ^a	Maximum Operating Temp., °F ^b	Compatibility ^c	Conformability and Embeddability ^c	Corrosion Resistance ^c	Fatigue Strength ^c
Tin-Base Babbitt	150 or less	800 – 1500	300	1	1	1	5
Lead-Base Babbitt	150 or less	800 – 1200	300	1	1	3	5
Cadmium Base	200 – 250	1200 – 2000	500	1	2	5	4
Copper-Lead	300	1500 – 2500	350	2	2	5	3
Tin-Bronze	300 – 400	4000+	500+	3	5	2	1
Lead-Bronze	300	3000 – 4500	450 – 500	3	4	4	2
Aluminum	300	4000+	225 – 300	5	3	1	2
Silver-Overplate	300	4000+	500	2	3	1	1
Trimetal-Overplate	230 or less	2000 – 4000+	225 – 300	1	2	2	3

^a 1 psi = 6.8947 kPa.

^b Temp. in °C = (°F–32)/1.8.

^c Note: 1 is best; 5 is worst.

tural properties and high-load capacity, usefulness as a single material that requires neither a separate overlay nor a steel backing. Bronzes are available in standard bar stock, sand or permanent molds, investment, centrifugal or continuous casting. Leaded bronzes have better compatibility than tin-bronzes because the spheroids of lead smear over the bearing surface under conditions of inadequate lubrication. These alloys are generally a first choice at intermediate loads and speeds. **Table 3** provides comparisons of basic bearing properties of these materials.

Aluminum.—Aluminum bearings are either cast solid aluminum, aluminum with a steel backing, or aluminum with a suitable overlay. The aluminum is usually alloyed with small amounts of tin, silicon, cadmium, nickel, or copper, as shown in **Table 1**. An aluminum bearing alloy with 20 to 30 per cent tin alloy and up to 3 per cent copper has shown promise as a substitute for bronzes in some industrial applications.

These bearings are best suited for operation with hard journals. Owing to the high thermal expansion of the metal (resulting in diametral contraction when it is confined as a bearing in a rigid housing), large clearances are required, which tend to make the bearing noisy, especially on starting. Overlays of lead-tin, lead, or lead-tin-copper may be applied to aluminum bearings to facilitate their use with soft shafts.

Aluminum alloys are available with properties specifically designed for bearing applications, such as high load-carrying capacity, fatigue strength, and thermal conductivity, in addition to excellent corrosion resistance and low cost.

Silver.—Silver bearings were developed for and have an excellent record in heavy-duty applications such as aircraft master rod and diesel engine main bearings. Silver has a higher fatigue rating than any of the other bearing materials; the steel backing used with this material may show evidence of fatigue before the silver. The advent of overlays, or more commonly called overplates, made it possible for silver to be used as a bearing material. Silver by itself does not possess any of the desirable bearing qualities except high fatigue resistance and high thermal conductivity. The overlays such as lead, lead-tin, or lead-indium improve the embeddability and antiscoring properties of silver. The relative basic properties of this material, when used as an overplate, are shown in **Table 3**.

Cast Iron.—Cast iron is an inexpensive bearing material capable of operation at light loads and low speeds, i.e., up to 130 ft/min (40 m/min) and 150 lb/in² (1.03 MPa). These bearings must be well lubricated and have a rather large clearance so as to avoid scoring from particles torn from the cast iron that ride between bearing and journal. A journal hardness of between 150 – 250 Brinell has been found to be best when using cast-iron bearings.

Porous Metals.—Porous metal self-lubricating bearings are usually made by sintering metals such as plain or leaded bronze, iron, and stainless steel. The sintering produces a spongelike structure capable of absorbing fairly large quantities of oil, usually 10-35 per cent of the total volume. These bearings are used where lubrication supply is difficult, inadequate, or infrequent. This type of bearing should be flooded from time to time to resaturate the material. Another use of these porous materials is to meter a small quantity of oil to the bearings such as in drip feed systems. The general design operating characteristics of this class of materials are shown in [Table 4](#).

Table 4. Application Limits — Sintered Metal and Nonmetallic Bearings

Bearing Material	Load Capacity		Maximum Temperature		Surface Speed, V_{max} (max. fpm)	PV Limit $P =$ psi load $V =$ surface ft/min
	psi	kPa	°F	°C		
Acetal	1000	6895	180	82	1000	3000
Graphite (dry)	600	4137	750	399	2500	15,000
Graphite (lubricated)	600	4137	750	399	2500	150,000
Nylon, Polycarbonate	1000	6895	200	93	1000	3000
Nylon composite	400	204	...	16,000
Phenolics	6000	41369	200	93	2500	15,000
Porous bronze	4500	31026	160	71	1500	50,000
Porous iron	8000	55158	160	71	800	50,000
Porous metals	4000–8000	27579–55158	150	66	1500	50,000
Virgin Teflon (TFE)	500	3447	500	260	50	1000
Reinforced Teflon	2500	17237	500	260	1000	10,000–15,000
TFE fabric	60,000	413685	500	260	150	25,000
Rubber	50	345	150	66	4000	15,000
Maple & Lignum Vitae	2000	13790	150	66	2000	15,000

1 fpm = 0.3048 m/min; 1 psi = 6.8947 kPa;

[Tables 5a](#), [5b](#), and [5c](#) give the chemical compositions, permissible loads, interference fits, and running clearances of bronze-base and iron-base metal-powder sintered bearings that are specified in the ASTM specifications for oil-impregnated metal-powder sintered bearings (B438-83a and B439-83).

Plastics Bearings.—Plastics are finding increased use as bearing materials because of their resistance to corrosion, quiet operation, ability to be molded into many configurations, and their excellent compatibility, which minimizes or eliminates the need for lubrication. Many plastics are capable of operating as bearings, especially phenolic, tetrafluoroethylene (TFE), and polyamide (nylon) resins. The general application limits for these materials are shown in [Table 4](#).

Laminated Phenolics: These composite materials consist of cotton fabric, asbestos, or other fillers bonded with phenolic resin. They have excellent compatibility with various fluids as well as strength and shock resistance. However, precautions must be taken to maintain adequate bearing cooling because the thermal conductivity of these materials is low.

Nylon: This material has the widest use for small, lightly loaded applications. It has low frictional properties and requires no lubrication.

Teflon: This material, with its exceptional low coefficient of friction, self-lubricating characteristics, resistance to attack by almost any chemicals, and its wide temperature range, is one of the most interesting of the plastics for bearing use. High cost combined

with low load capacity cause Teflon to be selected mostly in modified form, where other less expensive materials have proved inadequate for design requirements.

Bearings made of laminated phenolics, nylon, or Teflon are all unaffected by acids and alkalis except if highly concentrated and therefore can be used with lubricants containing dilute acids or alkalis. Water is used to lubricate most phenolic laminate bearings but oil, grease, and emulsions of grease and water are also used. Water and oil are used as lubricants for nylon and Teflon bearings. Almost all types of plastic bearings absorb water and oil to some extent. In some the dimensional change caused by the absorption may be as much as three per cent in one direction. This means that bearings have to be treated before use so that proper clearances will be kept. This may be done by boiling in water, for water lubricated bearings. Boiling in water makes bearings swell the maximum amount. Clearances for phenolic bearings are kept at about 0.001 inch per inch (or mm per mm) of diameter on treated bearings. Partially lubricated or dry nylon bearings are given a clearance of 0.004 to 0.006 inches (101.6–152.4 μm) for a one-inch (25.4 mm) diameter bearing.

Rubber: Rubber bearings give excellent performance on propeller shafts and rudders of ships, hydraulic turbines, pumps, sand and gravel washers, dredges and other industrial equipment that handle water or slurries. The resilience of rubber helps to isolate vibration and provide quiet operation, allows running with relatively large clearances and helps to compensate for misalignment. In these bearings a fluted rubber structure is supported by a metal shell. The flutes or scallops in the rubber form a series of grooves through which lubricant or, as generally used, water and foreign material such as sand may pass through the bearing.

Wood.—Bearings made from such woods as lignum vitae, rock maple, or oak offer self-lubricating properties, low cost, and clean operation. However, they have frequently been displaced in recent years by various plastics, rubber and sintered-metal bearings. General applications are shown in [Table 4](#).

Carbon-Graphite.—Bearings of molded and machined carbon-graphite are used where regular maintenance and lubrication cannot be given. They are dimensionally stable over a wide range of temperatures, may be lubricated if desired, and are not affected by chemicals. These bearings may be used up to temperatures of 700 to 750°F (371–399°C) in air or 1200°F (649°C) in a non-oxidizing atmosphere, and generally are operated at a maximum load of 20 pounds per square inch. In some instances a metal or metal alloy is added to the carbon-graphite composition to improve such properties as compressive strength and density. The temperature limitation depends upon the melting point of the metal or alloy and the maximum load is generally 350 psi (2.4 MPa) when used with no lubrication or 600 psi (4.2 MPa) when used with lubrication.

Normal running clearances for both types of carbon-graphite bearings used with steel shafts and operating at a temperature of less than 200°F (93°C) are as follows: 0.001 inch (0.0254 mm) for bearings of 0.187 to 0.500-inch (4.75–12.7 mm) inside diameter, 0.002 inch (0.0508 mm) for bearings of 0.501 to 1.000-inch (12.73–25.4 mm) inside diameter, 0.003 inch (0.0762 mm) for bearings of 1.001 to 1.250-inch (25.43–31.75 mm) inside diameter, 0.004 inch (0.1016 mm) for bearings of 1.251 to 1.500-inch (31.77–38.1 mm) diameter, and 0.005 inch (0.127 mm) for bearings of 1.501 to 2.000-inch (38.13–50.8 mm) inside diameter. Speeds depend upon too many variables to list specifically so it can only be stated here that high loads require a low number of rpm and low loads permit a high number of rpm. Smooth journals are necessary in these bearings as rough ones tend to abrade the bearings quickly. Cast iron and hard chromium-plate steel shafts of 400 Brinell and over, and phosphor-bronze shafts over 135 Brinell are recommended.

**Table 5a. Copper- and Iron-Base Sintered Bearings (Oil Impregnated) —
ASTM B438-83a (R1989), B439-83 (R1989), and Appendices**

Chemical Requirements								
Alloying Elements ^a	Percentage Composition							
	Copper-Base Bearings				Iron-Base Bearings			
	Grade 1		Grade 2		Grades			
	Class A	Class B	Class A	Class B	1	2	3	4
Cu	87.5-99.5	87.5-90.5	87.5-90.5	87.5-90.5	7.0-11.0	18.0-22.0
Sn	9.5-10.5	9.5-10.5	9.5-10.5	9.5-10.5
Graphite	0.1 max.	1.75 max.	0.1 max.	1.75 max.
Pb	2.0-4.0	2.0-4.0
Fe	1.0 max.	1.0 max.	1.0 max.	1.0 max.	96.25 min.	95.9 min.	Balance ^b	Balance ^b
Comb. C ^c	0.25 max.	0.25-0.60
Si, max.	0.3	0.3
Al, max.	0.2	0.2
Others	0.5 max.	0.5 max.	1.0 max.	1.0 max.	3.0 max.	3.0 max.	3.0 max.	3.0 max.

^a Abbreviations used for the alloying elements are as follows: Cu, copper; Fe, iron; Sn, tin; Pb, lead; Zn, zinc; Ni, nickel; Sb, antimony; Si, silicon; Al, aluminum; and C, carbon.

^b Total of iron plus copper shall be 97 per cent, minimum.

^c Combined carbon (on basis of iron only) may be a metallographic estimate of the carbon in the iron.

Permissible Loads							
Copper-Base Bearings				Iron-Base Bearings			
Shaft Velocity, fpm	Grades 1 & 2			Shaft Velocity, fpm	Grades 1 & 2	Grades 3 & 4	
	Type 1	Type 2	Types 3 & 4				
	Max. Load, psi						Max. Load, psi
Slow and intermittent	3200	4000	4000	Slow and intermittent	3600	8000	
25	2000	2000	2000	25	1800	3000	
50 to 100	500	500	550	50 to 100	450	700	
Over 100 to 150	365	325	365	Over 100 to 150	300	400	
Over 150 to 200	280	250	280	Over 150 to 200	225	300	
Over 200		a	a	a	Over 200	a	

^a For shaft velocities over 200 fpm, the permissible loads may be calculated as follows: $P = 50,000/V$; where P = safe load, psi of projected area; and V = shaft velocity, fpm. With a shaft velocity of less than 50 fpm and a permissible load greater than 1,000 psi, an extreme pressure lubricant should be used; with heat dissipation and removal techniques, higher PV ratings can be obtained.

Clearances						
Press-Fit Clearances			Running Clearances ^a			
Copper- and Iron-Base			Copper-Base		Iron-Base	
Bearing OD	Min.	Max.	Shaft Size	Min. Clearance	Shaft Size	Min. Clearance
Up to 0.760	0.001	0.003	Up to 0.250	0.0003	Up to 0.760	0.0005
0.761-1.510	0.0015	0.004	0.250-0.760	0.0005	0.761-1.510	0.001
1.511-2.510	0.002	0.005	0.760-1.510	0.0010	1.511-2.510	0.0015
2.511-3.010	0.002	0.006	1.510-2.510	0.0015	Over 2.510	0.002
Over 3.010	0.002	0.007	Over 2.510	0.0020		

^a Only minimum recommended clearances are listed. It is assumed that ground steel shafting will be used and that all bearings will be oil-impregnated.

Table 5b. Copper- and Iron-Base Sintered Bearings (Oil Impregnated) —
ASTM B438-83a (R1989), B439-83 (R1989), and Appendices

Commercial Dimensional Tolerances ^{a,b}							
Diameter Tolerance		Length Tolerance		Diameter Tolerance		Length Tolerance	
Copper Base				Iron Base			
Inside or Outside Diameter	Total Diameter Tolerances	Length	Total Length Tolerances	Inside or Outside Diameter	Total Diameter Tolerances	Length	Total Length Tolerances
Up to 1	0.001	Up to 1.5	0.01	Up to 0.760	-0.001	Up to 1.495	0.01
1 to 1.5	0.0015	1.5 to 3	0.01	0.761-1.510	-0.0015	1.496-1.990	0.02
1.5 to 2	0.002	3 to 4.5	0.02	1.511-2.510	-0.002	1.991-2.990	0.02
2 to 2.5	0.0025	2.511-3.010	-0.003	2.991-4.985	0.03
2.5 to 3	0.003	3.011-4.010	-0.005
...	4.011-5.010	-0.005
...	5.011-6.010	-0.006

Concentricity Tolerance ^{a,b,c}					
Iron Base			Copper Base		
Outside Diameter	Max. Wall Thickness	Concentricity Tolerance	Outside Diameter	Length	Concentricity Tolerance
Up to 1.510	Up to 0.355	0.003	Up to 1	0 to 1	0.00
				1 to 2	0.004
1.511 to 2.010	Up to 0.505	0.004	1 to 2	2 to 3	0.005
				0 to 1	0.004
2.011 to 4.010	Up to 1.010	0.005	2 to 3	1 to 2	0.005
				2 to 3	0.006
4.011 to 5.010	Up to 1.510	0.006	2 to 3	0 to 1	0.005
				1 to 2	0.006
5.011 to 6.010	Up to 2.010	0.007		2 to 3	0.007

^a For copper-base bearings with 4-to-1 maximum-length-diameter ratio and a 24-to-1 maximum-length-to-wall-thickness ratio; bearings with greater ratios are not covered here.

^b For iron-base bearings with a 3-to-1 maximum-length-to-inside diameter ratio and a 20-to-1 maximum-length-to-wall-thickness ratio; bearings with greater ratios are not covered here.

^c Total indicator reading.

Table 5c. Copper- and Iron-Base Sintered Bearings (Oil Impregnated) —
ASTM B438-83a (R1989), B439-83 (R1989), and Appendices

Diameter Range	Flange and Thrust Bearings, Diameter, and Thickness Tolerances ^a				Parallellism ^a on Faces, max.			
	Flange Diameter Tolerance		Flange Thickness Tolerance		Copper Base		Iron Base	
	Standard	Special	Standard	Special	Standard	Special	Standard	Special
0 to 1½	±0.005	±0.0025	±0.005	±0.0025	0.003	0.002	0.005	0.003
Over 1½ to 3	±0.010	±0.005	±0.010	±0.007	0.004	0.003	0.007	0.005
Over 3 to 6	±0.025	±0.010	±0.015	±0.010	0.005	0.004	0.010	0.007

^a Standard and special tolerances are specified for diameters, thicknesses, and parallellism. Special tolerances should not be specified unless required because they require additional or secondary operations and, therefore, are costlier. Thrust bearings (¼ inch thickness, max.) have a standard thickness tolerance of ±0.005 inch and a special thickness tolerance of ±0.0025 inch for all diameters.

All dimensions in inches except where otherwise noted.

BALL, ROLLER, AND NEEDLE BEARINGS

Rolling Contact Bearings

Rolling contact bearings substitute a rolling element, ball or roller, for a hydrodynamic or hydrostatic fluid film to carry an impressed load without wear and with reduced friction. Because of their greatly reduced starting friction, when compared to the conventional journal bearing, they have acquired the common designation of “anti-friction” bearings. Although normally made with hardened rolling elements and races, and usually utilizing a separator to space the rolling elements and reduce friction, many variations are in use throughout the mechanical and electrical industries. The most common anti-friction bearing application is that of the deep-groove ball bearing with ribbon-type separator and sealed-grease lubrication used to support a shaft with radial and thrust loads in rotating equipment. This shielded or sealed bearing has become a standard and commonplace item ordered from a supplier's catalogue in much the same manner as nuts and bolts. Because of the simple design approach and the elimination of a separate lubrication system or device, this bearing is found in as many installations as the wick-fed or impregnated porous plain bushing.

Currently, a number of manufacturers produce a complete range of ball and roller bearings in a fully interchangeable series with standard dimensions, tolerances and fits as specified in Anti-Friction Bearing Manufacturers Association (AFBMA) Standards. Except for deep-groove ball bearings, performance standards are not so well defined and sizing and selection must be done in close conformance with the specific manufacturer's catalogue requirements. In general, desired functional features should be carefully gone over with the vendor's representatives.















Rolling contact bearings are made to high standards of accuracy and with close metallurgical control. Balls and rollers are normally held to diametral tolerances of .0001 inch (2.54 μm) or less within one bearing and are often used as “gage” blocks in routine toolroom operations. This accuracy is essential to the performance and durability of rolling-contact bearings and in limiting runout, providing proper radial and axial clearances, and ensuring smoothness of operation.

Because of their low friction, both starting and running, rolling-contact bearings are utilized to reduce the complexity of many systems that normally function with journal bearings. Aside from this advantage and that of precise radial and axial location of rotating elements, however, they also are desirable because of their reduced lubrication requirements and their ability to function during brief interruptions in normal lubrication.

In applying rolling-contact bearings it is well to appreciate that their life is limited by the fatigue life of the material from which they are made and is modified by the lubricant used. In rolling-contact fatigue, precise relationships among life, load, and design characteristics are not predictable, but a statistical function described as the “probability of survival” is used to relate them according to equations recommended by the AFBMA. Deviations from these formulas result when certain extremes in applications such as speed, deflection, temperature, lubrication, and internal geometry must be dealt with.

Types of Anti-friction Bearings.—The general types are usually determined by the shape of the rolling element, but many variations have been developed that apply conventional elements in unique ways. Thus it is well to know that special bearings can be procured with races adapted to specific applications, although this is not practical for other than high volume configurations or where the requirements cannot be met in a more economical manner. “Special” races are appreciably more expensive. Quite often, in such situations, races are made to incorporate other functions of the mechanism, or are “submerged” in the surrounding structure, with the rolling elements supported by a shaft or housing that has been hardened and finished in a suitable manner. Typical anti-friction bearing types are shown in [Tables 1a](#) through [1g](#).

Table 1a. Types of Rolling Element Bearings and Their Symbols

BALL BEARINGS, SINGLE ROW, RADIAL CONTACT					
Symbol	Description		Symbol	Description	
BC	Non-filling slot assembly		BH	Non-separable counter-bore assembly	
BL	Filling slot assembly		BM	Separable assembly	
BALL BEARINGS, SINGLE ROW, ANGULAR CONTACT ^a					
Symbol	Description		Symbol	Description	
BN	Non-separable Nominal contact angle: from above 10° to and including 22°		BAS	Separable inner ring Nominal contact angle: from above 22° to and including 32°	
BNS	Separable outer ring Nominal contact angle: from above 10° to and including 22°		BT	Non-separable Nominal contact angle: from above 32° to and including 45°	
BNT	Separable inner ring Nominal contact angle: from above 22° to and including 32°		BY	Two-piece outer ring	
BA	Non-separable Nominal contact angle: from above 22° to and including 32°		BZ	Two-piece inner ring	
BALL BEARINGS, SINGLE ROW, RADIAL CONTACT, SPHERICAL OUTSIDE SURFACE					
Symbol	Description		Symbol	Description	
BCA	Non-filling slot assembly		BLA	Filling slot assembly	

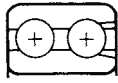
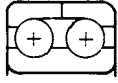
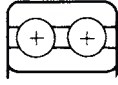
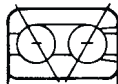
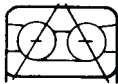
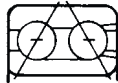
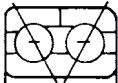
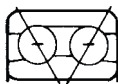
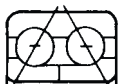
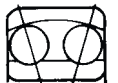
^aA line through the ball contact points forms an acute angle with a perpendicular to the bearing axis.

Types of Ball Bearings.—Most types of ball bearings originate from three basic designs: the single-row radial, the single-row angular contact, and the double-row angular contact.

Single-row Radial, Non-filling Slot: This is probably the most widely used ball bearing and is employed in many modified forms. It is also known as the “Conrad” type or “Deep-groove” type. It is a symmetrical unit capable of taking combined radial and thrust loads in which the thrust component is relatively high, but is not intended for pure thrust loads, however. Because this type is not self-aligning, accurate alignment between shaft and housing bore is required.

Single-row Radial, Filling Slot: This type is designed primarily to carry radial loads. Bearings of this type are assembled with as many balls as can be introduced by eccentric displacement of the rings, as in the non-filling slot type, and then several more balls are inserted through the loading slot, aided by a slight spreading of the rings and heat expansion of the outer ring, if necessary. This type of bearing will take a certain degree of thrust when in combination with a radial load but is not recommended where thrust loads exceed 60 per cent of the radial load.

Table 1b. Types of Rolling Element Bearings and Their Symbols

BALL BEARINGS, DOUBLE ROW, RADIAL CONTACT			
Symbol	Description	Symbol	Description
BF	Filling slot assembly 	BHA	Non-separable two-piece outer ring 
BK	Non-filling slot assembly 		
BALL BEARINGS, DOUBLE ROW, ANGULAR CONTACT ^a			
Symbol	Description	Symbol	Description
BD	Filling slot assembly Vertex of contact angles inside bearing 	BG	Non-filling slot assembly Vertex of contact angles outside bearing 
BE	Filling slot assembly Vertex of contact angles outside bearing 	BAA	Non-separable Vertex of contact angles inside bearing Two-piece outer ring 
BJ	Non-filling slot assembly Vertex of contact angles inside bearing 	BVV	Separable Vertex of contact angles outside bearing Two-piece inner ring 
BALL BEARINGS, DOUBLE ROW, SELF-ALIGNING ^a			
	Symbol	Description	
	BS	Raceway of outer ring spherical 	

^a A line through the ball contact points forms an acute angle with a perpendicular to the bearing axis.















Single-row Angular-contact: This type is designed for combined radial and thrust loads where the thrust component may be large and axial deflection must be confined within very close limits. A high shoulder on one side of the outer ring is provided to take the thrust, while the shoulder on the other side is only high enough to make the bearing non-separable. Except where used for a pure thrust load in one direction, this type is applied either in pairs (duplex) or one at each end of the shaft, opposed.

Double-row Bearings: These are, in effect, two single-row angular-contact bearings built as a unit with the internal fit between balls and raceway fixed at the time of bearing assembly. This fit is therefore not dependent upon mounting methods for internal rigidity. These bearings usually have a known amount of internal preload built in for maximum resistance to deflection under combined loads with thrust from either direction. Thus, with balls and races under compression before an external load is applied, due to this internal preload, the bearings are very effective for radial loads where bearing deflection must be minimized.

Other Types: Modifications of these basic types provide arrangements for self-sealing, location by snap ring, shielding, etc., but the fundamentals of mounting are not changed. A special type is the *self-aligning* ball bearing which can be used to compensate for an appreciable degree of misalignment between shaft and housing due to shaft deflections, mount-

ing inaccuracies, or other causes commonly encountered. With a single row of balls, alignment is provided by a spherical outer surface on the outer ring; with a double row of balls, alignment is provided by a spherical raceway on the outer ring. Bearings in the wide series have a considerable amount of thrust capacity.

Table 1c. Types of Rolling Element Bearings and Their Symbols

CYLINDRICAL ROLLER BEARING, SINGLE ROW, NON-LOCATING TYPE					
Symbol	Description				
RU	Inner ring without ribs Double-ribbed outer ring Inner ring separable		RNS	Double-ribbed inner ring Outer ring without ribs Outer ring separable Spherical outside surface	
RUP	Inner ring without ribs Double-ribbed outer ring with one loose rib Both rings separable		RAB	Inner ring without ribs Single-ribbed outer ring Both rings separable	
RUA	Inner ring without ribs Double-ribbed outer ring Inner ring separable Spher- ical outside surface		RM	Inner ring without ribs Rollers located by cage, end-rings or internal snap rings recesses in outer ring Inner ring separable	
RN	Double-ribbed inner ring Outer ring without ribs Outer ring separable		RNU	Inner ring without ribs Outer ring without ribs Both rings separable	
CYLINDRICAL ROLLER BEARINGS, SINGLE ROW, ONE-DIRECTION-LOCATING TYPE					
Symbol	Description				
RR	Single-ribbed inner-ring Outer ring with two internal snap rings Inner ring separable		RF	Double-ribbed inner ring Single-ribbed outer ring Outer ring separable	
RJ	Single-ribbed inner ring Double-ribbed outer ring Inner ring separable		RS	Single-ribbed inner ring Outer ring with one rib and one internal snap ring Inner ring separable	
RJP	Single-ribbed inner ring Double-ribbed outer ring with one loose rib Both rings separable		RAA	Single-ribbed inner ring Single-ribbed outer ring Both rings separable	





Types of Roller Bearings.—Types of roller bearings are distinguished by the design of rollers and raceways to handle axial, combined axial and thrust, or thrust loads.

Cylindrical Roller: These bearings have solid or helically wound hollow cylindrical rollers. The free ring may have a restraining flange to provide some restraint to endwise movement in one direction or may be without a flange so that the bearing rings may be displaced axially with respect to each other. Either rolls or roller path on the races may be slightly crowned to prevent edge loading under slight shaft misalignment. Low friction makes this type suitable for relatively high speeds.

Barrel Roller: These bearings have rollers that are barrel-shaped and symmetrical. They are furnished in both single- and double-row mountings. As with cylindrical roller bearings, the single-row mounting type has a low thrust capacity, but angular mounting of rolls in the double-row type permits its use for combined axial and thrust loads.

Spherical Roller: These bearings are usually furnished in a double-row, self-aligning mounting. Both rows of rollers have a common spherical outer raceway. The rollers are

Table 1d. Types of Rolling Element Bearings and Their Symbols

CYLINDRICAL ROLLER BEARINGS, SINGLE ROW, TWO-DIRECTION-LOCATING TYPE			
Symbol	Description		
RK	Double-ribbed inner ring Outer ring with two internal snap rings Non-separable		RY
			Double-ribbed inner ring Outer ring with one rib and one internal snap ring Non-separable
RC	Double-ribbed inner ring Double-ribbed outer ring Non-separable		RCS
RG	Inner ring, with one rib and one snap ring Double-ribbed outer ring Non-separable		
RP	Double-ribbed inner ring Double-ribbed outer ring with one loose rib Outer ring separable		RT
			Double-ribbed inner ring with one loose rib Double-ribbed outer ring Inner ring separable
CYLINDRICAL ROLLER BEARINGS			
Double Row Non-Locating Type		Double Row Two-Direction-Locating Type	
Symbol	Description	Symbol	Description
RA	Inner ring without ribs Three integral ribs on outer ring Inner ring separable	RB	Three integral ribs on inner ring Outer ring without ribs, with two internal snap rings Non-separable
RD	Three integral ribs on inner ring Outer ring without ribs Outer ring separable	Multi-Row Non-Locating Type	
		Symbol	Description
RE	Inner ring without ribs Outer rings without ribs, with two internal snap rings Inner ring separable	RV	Inner ring without ribs Double-ribbed outer ring (loose ribs) Both rings separable

barrel-shaped with one end smaller than the other to provide a small thrust to keep the rollers in contact with the center guide flange. This type of roller bearing has a high radial and thrust load carrying capacity with the ability to maintain this capacity under some degree of misalignment of shaft and bearing housing.

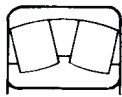

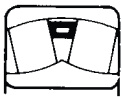
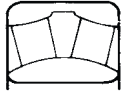








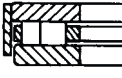
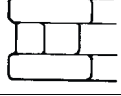
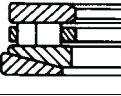
Tapered Roller: In this type, straight tapered rollers are held in accurate alignment by means of a guide flange on the inner ring. The basic characteristic of these bearings is that the apexes of the tapered working surfaces of both rollers and races, if extended, would coincide on the bearing axis. These bearings are separable. They have a high radial and thrust carrying capacity.

Types of Ball and Roller Thrust Bearings.—Are designed to take thrust loads alone or in combination with radial loads.

One-direction Ball Thrust: These bearings consist of a shaft ring and a flat or spherical housing ring with a single row of balls between. They are capable of carrying pure thrust loads in one direction only. They cannot carry any radial load.

Two-direction Ball Thrust: These bearings consist of a shaft ring with a ball groove in either side, two sets of balls, and two housing rings so arranged that thrust loads in either direction can be supported. No radial loads can be carried.

Table 1e. Types of Rolling Element Bearings and Their Symbols

SELF-ALIGNING ROLLER BEARINGS, DOUBLE ROW					
Symbol	Description	Symbol	Description		
SD	Three integral ribs on inner ring Raceway of outer ring spherical		SL	Raceway of outer ring spherical Rollers guided by the cage Two integral ribs on inner ring	
SE	Raceway of outer ring spherical Rollers guided by separate center guide ring in outer ring		SELF-ALIGNING ROLLER BEARINGS SINGLE ROW		
			Symbol	Description	
SW	Raceway of inner ring spherical		SR	Inner ring with ribs Raceway of outer ring spherical Radial contact	
SC	Raceway of outer ring spherical Rollers guided by separate axially floating guide ring on inner ring		SA	Raceway of outer ring spherical Angular contact	
			SB	Raceway of inner ring spherical Angular contact	
THRUST BALL BEARINGS					
Symbol	Description	Symbol	Description		
TA TB ^a	Single direction, grooved raceways, flat seats		TDA	Double direction, washers with grooved raceways, flat seats	
TBF ^a	Single direction, flat washers, flat seats				
THRUST ROLLER BEARINGS					
Symbol	Description	Symbol	Description		
TS	Single direction, aligning flat seats, spherical rollers		TPC ^a	Single direction, flat seats, flat races, outside band, cylindrical rollers	
TP	Single direction, flat seats, cylindrical rollers		TR ^a	Single direction, flat races, aligning seat with aligning washer, cylindrical rollers	

^a Inch dimensioned only.







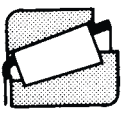
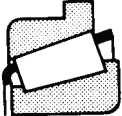
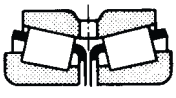

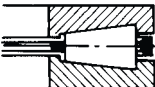
Spherical Roller Thrust: This type is similar in design to the radial spherical roller bearing except that it has a much larger contact angle. The rollers are barrel shaped with one end smaller than the other. This type of bearing has a very high thrust load carrying capacity and can also carry radial loads.

Tapered Roller Thrust: In this type the rollers are tapered and several different arrangements of housing and shaft are used.

Roller Thrust: In this type the rollers are straight and several different arrangements of housing and shaft are used.

Types of Needle Bearings.—Needle bearings are characterized by their relatively small size rollers, usually not above $\frac{1}{4}$ inch (6.35 mm) in diameter, and a relatively high ratio of length to diameter, usually ranging from about 3 to 1 and 10 to 1. Another feature that is

Table 1f. Types of Rolling Element Bearings and Their Symbols

TAPERED ROLLER BEARINGS — INCH			
Symbol	Description	Symbol	Description
TS	Single row 	TDI	Two row, double-cone single cups 
TDO	Two row, double-cup single-cone adjustable 	TNA	Two row, double-cup single cone nonadjustable 
TQD, TQI	Four row, cup adjusted 		
TAPERED ROLLER BEARINGS — METRIC			
Symbol	Description	Symbol	Description
TS	Single row, straight bore 	TSF	Single row, straight bore, flanged cup 
TDO	Double row, straight bore, two single cones, one double cup with lubrication hole and groove 	2TS	Double row, straight bore, two single cones, two single cups 
THRUST TAPERED ROLLER BARINGS			
	Symbol	Description	
	TT	Thrust bearings	

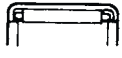



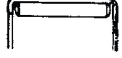



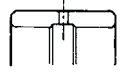
characteristic of several types of needle bearings is the absence of a cage or separator for retaining the individual rollers. Needle bearings may be divided into three classes: loose-roller, outer race and retained roller, and non-separable units.

Loose-roller: This type of bearing has no integral races or retaining members, the needles being located directly between the shaft and the outer bearing bore. Usually both shaft and outer bore bearing surfaces are hardened and retaining members that have smooth unbroken surfaces are provided to prevent endwise movement. Compactness and high radial load capacity are features of this type.

Outer Race and Retained Roller: There are two types of outer race and retained roller bearings. In the *Drawn Shell* type, the needle rollers are enclosed by a hardened shell that acts as a retaining member and as a hardened outer race. The needles roll directly on the shaft, the bearing surface of which should be hardened. The capacity for given roller length and shaft diameter is about two-thirds that of the loose roller type. It is mounted in the housing with a press fit.

In the *Machined Race* type, the outer race consists of a heavy machined member. Various modifications of this type provide heavy ends or faces for end location of the needle rollers, or open end construction with end washers for roller retention, or a cage that maintains alignment of the rollers and is itself held in place by retaining rings. An auxiliary outer member with spherical seat that holds the outer race may be provided for self-alignment.

Table 1g. Types of Rolling Element Bearings and Their Symbols

NEEDLE ROLLER BEARINGS, DRAWN CUP					
Symbol ^a	Description		Symbol ^a	Description	
NIB NB	Needle roller bearing, full complement, drawn cup, without inner ring		NIYM NYM	Needle roller bearing, full complement, rollers retained by lubricant, drawn cup, closed end, without inner ring	
NIBM NBM	Needle roller bearing, full complement, drawn cup, closed end, without inner ring		NIH NH	Needle roller bearing, with cage, drawn cup, without inner ring	
NIY NY	Needle roller bearing, full complement, rollers retained by lubricant, drawn cup, without inner ring		NIHM NHM	Needle roller bearing, with cage, drawn cup, closed end, without inner ring	
NEEDLE ROLLER BEARINGS			NEEDLE ROLLER AND CAGE ASSEMBLIES		
Symbol ^a	Description		Symbol ^a	Description	
NIA NA	Needle roller bearing, with cage, machined ring lubrication hole and groove in OD, without inner ring		NIM NM	Needle roller and cage assembly	
NEEDLE ROLLER BEARING INNER RINGS			Machined Ring Needle Roller Bearings Type NIA may be used with inch dimensioned inner rings, Type NIR, and Type NA may be used with metric dimensional inner rings, Type NR.		
Symbol ^a	Description				
NIR NR	Needle roller bearing inner ring, lubrication hole and groove in bore				

^a Symbols with I, as NIB, are inch-dimensioned, and those without the I, as NB, are metric dimensioned.

This type is applicable where split housings occur or where a press fit of the bearing into the housing is not possible.

Non-separable: This type consists of a non-separable unit of outer race, rollers and inner race. These bearings are used where high static or oscillating motion loads are expected as in certain aircraft components and where both outer and inner races are necessary.

Special or Unconventional Types.—Rolling contact bearings have been developed for many highly specialized applications. They may be constructed of non-corrosive materials, non-magnetic materials, plastics, ceramics, and even wood. Although the materials are chosen to adapt more conventional configurations to difficult applications or environments, even greater ingenuity has been applied in utilizing rolling contact for solving particular problems. Thus, linear or recirculating bearings are available to provide low friction, accurate location, and simplified lubrication features to such applications as machine ways, axial motion devices, jack-screws, steering linkages, collets, and chucks. This type of bearing utilizes the “full-complement” style of loading the rolling elements between “races” or ways without a cage and with each element advancing by the action of “races” in the loaded areas and by contact with the adjacent element in the unloaded areas. The “races” may not be cylindrical or bodies of revolution but plane surfaces, with suitable interruptions to free the rolling elements so that they can follow a return trough or slot back to the entry-point at the start of the “race” contact area. Combinations of radial and thrust bearings are available for the user with special requirements.

Plastics Bearings.—A more recent development has been the use of Acetal resin rollers and balls in applications where abrasive, corrosive and difficult-to-lubricate conditions exist. Although these bearings do not have the load carrying capacity nor the low friction factor of their hard steel counterparts, they do offer freedom from indentation, wear, and corrosion, while at the same time providing significant weight savings.

Of additional value are: 1) their resistance to indentation from shock loads or oscillation; and 2) their self-lubricating properties.

Usually these bearings are not available from stock, but must be designed and produced in accordance with the data made available by the plastics processor.

Pillow Block and Flanged Housing Bearings.—Of great interest to the shop man and particularly adaptable to “line-shafting” applications are a series of ball and roller bearings supplied with their own housings, adapters, and seals. Often called pre-mounted bearings, they come with a wide variety of flange mountings permitting location on faces parallel to or perpendicular to the shaft axis.

Inner races can be mounted directly on ground shafts, or can be adapter-mounted to “drill-rod” or to commercial shafting. For installations sensitive to imbalance and vibration, the use of accurately ground shaft seats is recommended.

Most pillow block designs incorporate self-aligning types of bearings so they do not require the precision mountings utilized with more normal bearing installations.

Conventional Bearing Materials.—Most rolling contact bearings are made with all load carrying members of full hard steel, either through- or case-hardened. For greater reliability this material is controlled and selected for cleanliness and alloying practices in conformity with rigid specifications in order to reduce anomalies and inclusions that could limit the useful fatigue life. Magnaflux inspection is employed to ensure that elements are free from both material defects and cracks. Likewise, a light etch is employed between rough and finish grinding to allow detection of burns due to heavy stock removal and associated decarburization in finished pieces.

Cage Materials.—Standard bearings are normally made with cages of free-machining brass or low carbon sulfurized steel. In high-speed applications or where lubrication may be intermittent or marginal, special materials may be employed. Iron-silicon-bronze, laminated phenolics, silver-plating, over-lays, solid-film baked-on coatings, carbon-graphite inserts, and, in extreme cases, sintered or even impregnated materials are used in separators.

Commercial bearings usually rely on stamped steel with or without a phosphate treatment; some low cost varieties are found with snap-in plastic or metallic cages.

So long as lubrication is adequate and speeds are both reasonable and steady, the materials and design of the cage are of secondary importance when compared with those of the rolling elements and their contacts with the races. In spite of this tolerance, a good portion of all rolling bearing failures encountered can be traced to cage failures resulting from inadequate lubrication. It can never be overemphasized that *no bearing can be designed to run continuously without lubrication!*

Standard Method of Bearing Designation.—The Anti-Friction Bearing Manufacturers Association has adopted a standard identification code that provides a specific designation for each different ball, roller, and needle bearing. Thus, for any given bearing, a uniform designation is provided for manufacturer and user alike, so that the confusion of different company designations can be avoided.

In this identification code there is a “basic number” for each bearing that consists of three elements: a one- to four-digit number to indicate the size of the bore in numbers of millimeters (metric series); a two- or three-letter symbol to indicate the type of bearing; and a two-digit number to identify the dimension series to which the bearing belongs.

In addition to this “basic number” other numbers and letters are added to designate type of tolerance, cage, lubrication, fit up, ring modification, addition of shields, seals, mounting accessories, etc. Thus, a complete designating symbol might be *50BC02JPXE0A10*, for example. The basic number is *50BC02* and the remainder is the supplementary number. For a radial bearing, this latter consists of up to four letters to indicate modification of design, one or two digits to indicate internal fit and tolerances, a letter to indicate lubricants and preservatives, and up to three digits to indicate special requirements.

For a thrust bearing the supplementary number would consist of two letters to indicate modifications of design, one digit to indicate tolerances, one letter to indicate lubricants and preservatives, and up to three digits to indicate special requirements.

For a needle bearing the supplementary number would consist of up to three letters indicating cage material or integral seal information or whether the outer ring has a crowned outside surface and one letter to indicate lubricants or preservatives.

Dimension Series: Annular ball, cylindrical roller, and self-aligning roller bearings are made in a series of different outside diameters for every given bore diameter and in a series of different widths for every given outside diameter. Thus, each of these bearings belongs to a dimension series that is designated by a two-digit number such as 02, 03, 04, etc. The first digit (8, 0, 1, 2, 3, 4, 5, 6 and 9) indicates the *width series* and the second digit (7, 8, 9, 0, 1, 2, 3, and 4) the *diameter series* to which the bearing belongs. Similar types of identification codes are used for ball and roller thrust bearings and needle roller bearings.

Bearing Tolerances

Ball and Roller Bearings.—In order to provide standards of precision for proper application of ball or roller bearings in all types of equipment, five classes of tolerances have been established by the Anti-Friction Bearing Manufacturers Association for ball bearings, three for cylindrical roller bearings and one for spherical roller bearings. These tolerances are given in [Tables 2, 3, 4, 5, and 6](#). They are designated as ABEC-1, ABEC-3, ABEC-5, ABEC-7 and ABEC-9 for ball bearings, the ABEC-9 being the most precise, RBEC-1, RBEC-3, and RBEC-5 for roller bearings. In general, bearings to specifications closer than ABEC-1 or RBEC-1 are required because of the need for very precise fits on shaft or housing, to reduce eccentricity or runout of shaft or supported part, or to permit operation at very high speeds. All five classes include tolerances for bore, outside diameter, ring width, and radial runouts of inner and outer rings. ABEC-5, ABEC-7 and ABEC-9 provide added tolerances for parallelism of sides, side runout and groove parallelism with sides.

Thrust Bearings.—Anti-Friction Bearing Manufacturers Association and American National Standard tolerance limits for metric single direction thrust ball and roller bearings are given in [Table 8](#). Tolerance limits for single direction thrust ball bearings, inch dimensioned are given in [Table 7](#), and for cylindrical thrust roller bearings, inch dimensioned in [Table 9](#).

Only one class of tolerance limits is established for metric thrust bearings.

Radial Needle Roller Bearings.—Tolerance limits for needle roller bearings, drawn cup, without inner ring, inch types NIB, NIBM, NIY, NIYM, NIH, and NIHM are given in [Table 10](#) and for metric types NB, NBM, NY, NYM, NH and NHM in [Table 11](#). Standard tolerance limits for needle roller bearings, with cage, machined ring, without inner ring, inch type NIA are given in [Table 12](#) and for needle roller bearings inner rings, inch type NIR in [Table 13](#).

Table 2. ABEC-1 and RBEC-1 Tolerance Limits for Metric Ball and Roller Bearings ANSI/ABMA 20-1987

Basic Inner Ring Bore Diameter, d		V_{dp} , ^a max			Δ_{dmp} ^b		K_{ia} ^c
mm		Diameter Series					
Over	Incl.	7,8,9	0,1	2,3,4	High	Low	max
2.5	10	10	8	6	0	-8	10
10	18	10	8	6	0	-8	10
18	30	13	10	8	0	-10	13
30	50	15	12	9	0	-12	15
50	80	19	19	11	0	-15	20
80	120	25	25	15	0	-20	25
120	180	31	31	19	0	-25	30
180	250	38	38	23	0	-30	40
250	315	44	44	26	0	-35	50
315	400	50	50	30	0	-40	60

^aBore diameter variation in a single radial plane.

^bSingle plane mean bore diameter deviation from basic. (For a basically tapered bore, Δ_{dmp} refers only to the theoretical small end of the bore.)

^cRadial runout of assembled bearing inner ring.

Basic Outer Ring Outside Diameter, D		V_{Dp} , ^a max				Δ_{Dmp} ^b		K_{ea} ^c
mm		Open Bearings		Capped Bearings ^d				
Over	Incl.	7,8,9	0,1	2,3,4	2,3,4	High	Low	max
6	18	10	8	6	10	0	-8	15
18	30	12	9	7	12	0	-9	15
30	50	14	11	8	16	0	-11	20
50	80	16	13	10	20	0	-13	25
80	120	19	19	11	26	0	-15	35
120	150	23	23	14	30	0	-18	40
150	180	31	31	19	38	0	-25	45
180	250	38	38	23	...	0	-30	50
250	315	44	44	26	...	0	-35	60
315	400	50	50	50	...	0	-40	70

^aOutside diameter variation in a single radial plane. Applies before mounting and after removal of internal or external snap ring.

^bSingle plane mean outside diameter deviation from basic.

^cRadial runout of assembled bearing outer ring.

^dNo values have been established for diameters series 7, 8, 9, 0, and 1.

Width Tolerances									
d		Δ_{Bs} ^a			d		Δ_{Bs} ^a		
mm		All	Normal	Modified ^b	mm		All	Normal	Modified ^b
Over	Incl.	High	Low		Over	Incl.	High	Low	
2.5	10	0	-120	-250	80	120	0	-200	-380
10	18	0	-120	-250	120	180	0	-250	-500
18	30	0	-120	-250	180	250	0	-300	-500
30	50	0	-120	-250	250	315	0	-350	-500
50	80	0	-150	-380	315	400	0	-400	-630

^aSingle inner ring width deviation from basic. Δ_{Cs} (single outer ring width deviation from basic) is identical to Δ_{Bs} of inner ring of same bearing.

^bRefers to the rings of single bearings made for paired or stack mounting.

All units are micrometers, unless otherwise indicated. For sizes beyond range of this table, see Standard. This table does not cover tapered roller bearings.

Table 3. ABEC-3 AND RBEC-3 Tolerance Limits for Metric Ball and Roller Bearings ANSI/ABMA 20-1987

Basic Inner Ring Bore Diameter, <i>d</i>		V_{dp} ^a max			Δ_{dmp} ^b		K_{ia} ^c
mm		Diameter Series					
Over	Incl.	7, 8, 9	0, 1	2, 3, 4	High	Low	max
2.5	10	9	7	5	0	-7	6
10	18	9	7	5	0	-7	7
18	30	10	8	6	0	-8	8
30	50	13	10	8	0	-10	10
50	80	15	15	9	0	-12	10
80	120	19	19	11	0	-15	13
120	180	23	23	14	0	-18	18
180	250	28	28	17	0	-22	20
250	315	31	31	19	0	-25	25
315	400	38	38	23	0	-30	30

^a Bore diameter variation in a single radial plane.

^b Single plane mean bore diameter deviation from basic. (For a basically tapered bore, Δ_{dmp} refers only to the theoretical small end of the bore.)

^c Radial runout of assembled bearing inner ring.

Basic Outer Ring Outside Outsides Diameter, <i>D</i>		V_{Dp} ^a max				Δ_{Dmp} ^b		K_{ea} ^c
mm		Open Bearings		Capped Bearings ^d				
Over	Incl.	7,8,9	0,1	2,3,4	2,3,4	High	Low	max
6	18	9	7	5	9	0	-7	8
18	30	10	8	6	10	0	-8	9
30	50	11	9	7	13	0	-9	10
50	80	14	11	8	16	0	-11	13
80	120	16	16	10	20	0	-13	18
120	150	19	19	11	25	0	-15	20
150	180	23	23	14	30	0	-18	23
180	250	25	25	15	...	0	-20	25
250	315	31	31	19	...	0	-25	30
315	400	35	35	21	...	0	-28	35

^a Outside diameter variation in a single radial plane. Applies before mounting and after removal of internal or external snap ring.

^b Single plane mean outside diameter deviation from basic.

^c Radial runout of assembled bearing outer ring.

^d No values have been established for diameter series 7, 8, 9, 0, and 1.

Width Tolerances									
<i>d</i>		Δ_{Bs} ^a			<i>d</i>		Δ_{Bs} ^a		
mm		All	Normal	Modified ^b	mm		All	Normal	Modified ^b
Over	Incl.	High	Low		Over	Incl.	High	Low	
2.5	10	0	-120	-250	80	120	0	-200	-380
10	18	0	-120	-250	120	180	0	-250	-500
18	30	0	-120	-250	180	250	0	-300	-500
30	50	0	-120	-250	250	315	0	-350	-500
50	80	0	-150	-380	315	400	0	-400	-630

^a Single inner ring width deviation from basic. Δ_{Cs} (single outer ring width deviation from basic) is identical to Δ_{Bs} of inner ring of same bearing.

^b Refers to the rings of single bearings made for paired or stack mounting.

All units are micrometers, unless otherwise indicated. For sizes beyond range of this table, see Standard. This table does not cover tapered roller bearings.

Table 4. ABEC-5 and RBEC-5 Tolerance Limits for Metric Ball and Roller Bearings ANSI/ABMA 20-1987

INNER RING												
Inner Ring Bore Basic Dia., d mm		V_{dp} , ^a max Diameter Series		Δ_{dmp} ^b		Radial Runout K_{ia}	Ref. Face Runout with Bore S_d	Axial Runout S_{ia} ^c	Width			
									Δ_{Bs} ^d			V_{Bs} ^e
Over	Incl.	7, 8, 9	0, 1, 2, 3, 4	Hig h	Low	max	max	max	All	Normal	Modified ^f	max
2.5	10	5	4	0	-5	4	7	7	0	-40	-250	5
10	18	5	4	0	-5	4	7	7	0	-80	-250	5
18	30	6	5	0	-6	4	8	8	0	-120	-250	5
30	50	8	6	0	-8	5	8	8	0	-120	-250	5
50	80	9	7	0	-9	5	8	8	0	-150	-250	6
80	120	10	8	0	-10	6	9	9	0	-200	-380	7
120	180	13	10	0	-13	8	10	10	0	-250	-380	8
180	250	15	12	0	-15	10	11	13	0	-300	-500	10

^a Bore (V_{dp}) and outside diameter (V_{Dp}) variation in a single radial plane.

^b Single plane mean bore (Δ_{dmp}) and outside diameter (Δ_{Dmp}) deviation from basic. (For a basically tapered bore, Δ_{dmp} refers only to the theoretical small end of the bore.)

^c Axial runout of assembled bearing with inner ring S_{ia} . Applies to groove-type ball bearings only.

^d Single bore (Δ_{Bs}) and outer ring (Δ_{Cs}) width variation.

^e Inner (V_{Bs}) and outer (V_{Cs}) ring width deviation from basic.

^f Applies to the rings of single bearings made for paired or stack mounting.

OUTER RING												
Basic Outer Ring Outside Dia., D mm		V_{Dp} , ^{aa} max Diameter Series		Δ_{Dmp} ^b		Radial Runout K_{ea}	Outside Cylindrical Surface Runout S_D ^b	Axial Runout S_{ea} ^c	Width			
									Δ_{Cs} ^d			V_{Cs} ^e
Over	Incl.	7, 8, 9	0, 1, 2, 3, 4	High	Low	max	max	max	High	Low	max	
6	18	5	4	0	-5	5	8	8			5	
18	30	6	5	0	-6	6	8	8			5	
30	50	7	5	0	-7	7	8	8			5	
50	80	9	7	0	-9	8	8	10			6	
80	120	10	8	0	-10	10	9	11			8	
120	150	11	8	0	-11	11	10	13			8	
150	180	13	10	0	-13	13	10	14			8	
180	250	15	11	0	-15	15	11	15			10	

^a No values have been established for capped bearings.

^b Outside cylindrical surface runout with outer ring reference face S_D

^c Axial runout of assembled bearing with outer ring S_{ea} .

All units are micrometers, unless otherwise indicated. For sizes beyond range of this table, see Standard. This table does not cover instrument bearings and tapered roller bearings.

Table 5. ABEC-7 Tolerance Limits for Metric Ball and Roller Bearings ANSI/ABMA 20-1987

INNER RING														
Inner Ring Bore Basic Diameter, d mm		V_{dp} ^a max Diameter Series		Δ_{dmp} ^b		Δ_{ds} ^c		Radial Runout K_{ia}	Ref. Face Runout with Bore S_d	Axial Runout S_{ia}^d	Width			
											Δ_{Bs} ^e		V_{Bs} ^f	
Over	Incl.	7, 8, 9	0, 1, 2, 3, 4	High	Low	High	Low	max	max	max	All	Nor-mal		Mod-ified ^g
2.5	10	4	3	0	-4	0	-4	2.5	3	3	0	-40	-250	2.5
10	18	4	3	0	-4	0	-4	2.5	3	3	0	-80	-250	2.5
18	30	5	4	0	-5	0	-5	3	4	4	0	-120	-250	2.5
30	50	6	5	0	-6	0	-6	4	4	4	0	-120	-250	3
50	80	7	5	0	-7	0	-7	4	5	5	0	-150	-250	4
80	120	8	6	0	-8	0	-8	5	5	5	0	-200	-380	4
120	180	10	8	0	-10	0	-10	6	6	7	0	-250	-380	5
180	250	12	9	0	-12	0	-12	8	7	8	0	-300	-500	6

- ^a Bore (V_{dp}) and outside diameter (V_{Dp}) variation in a single radial plane.
- ^b Single plane mean bore (Δ_{dmp}) and outside diameter (Δ_{Dmp}) deviation from basic. (For a basically tapered bore, Δ_{dmp} refers only to the theoretical small end of the bore.)
- ^c Single bore (Δ_{ds}) and outside diameter (Δ_{Ds}) deviations from basic. These deviations apply to diameter series 0, 1, 2, 3, and 4 only.
- ^d Axial run out of assembled bearing with inner ring S_{ia} . Applies to groove-type ball bearings only.
- ^e Single bore (Δ_{Bs}) and outer ring (Δ_{Cs}) width deviation from basic.
- ^f Inner (V_{Bs}) and outer (V_{Cs}) ring width variation.
- ^g Applies to the rings of single bearings made for paired or stack mounting.

OUTER RING													
Basic Outer Ring Outside Dia., D mm		V_{Dp} ^{aa} max Diameter Series		Δ_{Dmp} ^b		Δ_{Ds} ^c		Radial Runout K_{ea}	Surface Runout S_D^d	Axial Runout S_{ea}^e	Width		
											Δ_{Cs} ^f		V_{Cs} ^g
Over	Incl.	7, 8, 9	0, 1, 2, 3, 4	High	Low	High	Low	max	max	max	High	Low	
6	18	4	3	0	-4	0	-4	3	4	5	Identical to Δ_{Bs} of inner ring of same bearing		2.5
18	30	5	4	0	-5	0	-5	4	4	5			2.5
30	50	6	5	0	-6	0	-6	5	4	5			2.5
50	80	7	5	0	-7	0	-7	5	4	5			3
80	120	8	6	0	-8	0	-8	6	5	6			4
120	150	9	7	0	-9	0	-9	7	5	7			5
150	180	10	8	0	-10	0	-10	8	5	8			5
180	250	11	8	0	-11	0	-11	19	7	10		7	

- ^a No values have been established for capped bearings.
- ^b Single plane mean bore (Δ_{dmp}) and outside diameter (Δ_{Dmp}) deviation from basic. (For a basically tapered bore, Δ_{dmp} refers only to the theoretical small end of the bore.)
- ^c Single bore (Δ_{ds}) and outside diameter (Δ_{Ds}) deviations from basic. These deviations apply to diameter series 0, 1, 2, 3, and 4 only.
- ^d Outside cylindrical surface runout outer ring reference face S_D
- ^e Axial run out of assembled bearing with outer ring S_{ia} . Applies to groove-type ball bearings only.
- ^f Single bore (Δ_{Bs}) and outer ring (Δ_{Cs}) width deviation from basic.
- ^g Inner (V_{Bs}) and outer (V_{Cs}) ring width variation.

All units are micrometers, unless otherwise indicated. For sizes beyond range of this table, see Standard. This table does not cover instrument bearings.

Table 6. ABEC-9 Tolerance Limits for Metric Ball and Roller Bearing ANSI/ABMA 20-1987

INNER RING												
Inner Ring Bore Basic Dia., d mm		V_{dp} ^a max	Δ_{dmp} ^b		Δ_{ds} ^c		Radial Runout K_{ia}	Ref. Face Runout with Bore S_d	Axial Runout of Assembled Bearing with Inner Ring S_{ia}^d	Width		
Over	Incl.		max	High	Low	High				Low	max	max
2.5	10	2.5	0	-2.5	0	-2.5	1.5	1.5	1.5	0	-40	1.5
10	18	2.5	0	-2.5	0	-2.5	1.5	1.5	1.5	0	-80	1.5
18	30	2.5	0	-2.5	0	-2.5	2.5	1.5	2.5	0	-120	1.5
30	50	2.5	0	-2.5	0	-2.5	2.5	1.5	2.5	0	-120	1.5
50	80	4	0	-4	0	-4	2.5	1.5	2.5	0	-150	1.5
50	80	4	0	-4	0	-4	2.5	1.5	2.5	0	-150	1.5
80	120	5	0	-5	0	-5	2.5	2.5	2.5	0	-200	2.5
120	150	7	0	-7	0	-7	2.5	2.5	2.5	0	-250	2.5
150	180	7	0	-7	0	-7	5	4	5	0	-300	4
180	250	8	0	-8	0	-8	5	5	5	0	-350	5

^a Bore (V_{dp}) and outside diameter (V_{Dp}) variation in a single radial plane.

^b Single plane mean bore (Δ_{dmp}) and outside diameter (Δ_{Dmp}) deviation from basic. (For a basically tapered bore, Δ_{dmp} refers to the theoretical small end of the bore.)

^c Single bore diameter (Δ_{ds}) and outside diameter (Δ_{Ds}) deviation from basic.

^d Applies to groove-type ball bearings only.

^e Single bore (Δ_{Bs}) and outer ring (Δ_{Cs}) width variation from basic.

^f Inner (V_{Bs}) and outer (V_{Cs}) ring width variation.

OUTER RING												
Basic Outside Diameter, D mm		V_{Dp} ^{aa}	Δ_{Dmp} ^b		Δ_{Ds} ^c		Radial Runout K_{ea}	Outside Cylindrical Surface Runout with Outer Ring S_D	Axial Runout of Assembled Bearing with Outer Ring S_{ea}	Width		
Over	Incl.		max	High	Low	High				Low	max	max
6	18	2.5	0	-2.5	0	-2.5	1.5	1.5	1.5	Identical to Δ_{Bs} of inner ring of same bearing		1.5
18	30	4	0	-4	0	-4	2.5	1.5	2.5			1.5
30	50	4	0	-4	0	-4	2.5	1.5	2.5			1.5
50	80	4	0	-4	0	-4	4	1.5	4			1.5
80	120	5	0	-5	0	-5	5	2.5	5			1.5
120	150	5	0	-5	0	-5	5	2.5	5			1.5
150	180	7	0	-7	0	-7	5	2.5	5			2.5
180	250	8	0	-8	0	-8	7	4	7			4
250	315	8	0	-8	0	-8	7	5	7			5

^a No values have been established for capped bearings.

All units are micrometers, unless otherwise indicated. For sizes beyond range of this table, see Standard. This table does not cover instrument bearings.

Table 7. Tolerance Limits for Single Direction Ball Thrust Bearings—Inch Design ANSI/ABMA 24.2-1989 (R1999)

Bore Diameter ^a d , Inches		Single Plane Mean Bore Dia. Variation, d , Inch		Outside Diameter D , Inches		Single Plane Mean O.D. Variation, D , Inch	
Over	Incl.	High	Low	Over	Incl.	High	Low
0	6.7500	+0.005	0	0	5.3125	+0	-0.002
6.7500	20.0000	+0.010	0	5.3125	17.3750	+0	-0.003
...	17.3750	39.3701	+0	-0.004

^a Bore tolerance limits: For bore diameters 0 to 1.8125 inches, inclusive, +0.005, -0.005; over 1.8125 to 12.000 inches, inclusive, +0.010, -0.010; over 12.000 to 20.000, inclusive, +0.0150, -0.0150.

Table 8. AFBMA and American National Standard Tolerance Limits for Metric Single Direction Thrust Ball (Type TA) and Roller Type (Type TS) Bearings ANSI/ABMA 24.1-1989 (R1999)

Bore Dia. of Shaft Washer, <i>d</i>		Δd_{mp}^a		S_p, S_e^b	ΔT_{sMin}^c			Outside Dia. of Housing Washer, <i>D</i>		ΔD_{mp}^a	
mm		High	Low	Max	Max	Type TA	Type TS	Over	Incl.	High	Low
18	30	0	-10	10	20	-250	...	10	18	0	-11
30	50	0	-12	10	20	-250	-300	18	30	0	-13
50	80	0	-15	10	20	-300	-400	30	50	0	-16
80	120	0	-20	15	25	-300	-400	50	80	0	-19
120	180	0	-25	15	25	-400	-500	80	120	0	-22
180	250	0	-30	20	30	-400	-500	120	180	0	-25
250	315	0	-35	25	40	-400	-700	180	250	0	-30
315	400	0	-40	30	40	-500	-700	250	315	0	-35
400	500	0	-45	30	50	-500	-900	315	400	0	-40
500	630	0	-50	35	60	-600	-1200	400	500	0	-45

^a Single plane mean bore diameter deviation of central shaft washer (Δd_{mp}) and outside diameter (ΔD_{mp}) variation.

^b Raceway parallelism with the face, housing-mounted (S_e) and boremounted (S_p) race or washer.

^c Deviation of the actual bearing height.

All dimensions in micrometers, unless otherwise indicated. Tolerances are for normal tolerance class only. For sizes beyond the range of this table and for other tolerance class values, see Standard. All entries apply to type TA bearings; boldface entries also apply to type TS bearings.

Table 9. Tolerance Limits for Cylindrical Roller Thrust Bearings—Inch Design ANSI/ABMA 24.2-1989 (R1999)

Basic Bore Dia., <i>d</i>		Δd_{mp}^a		ΔT_s^b		Basic Outside dia., <i>D</i>		ΔD_{mp}^c	
Over	Incl.	Low	High	High	Low	Over	Incl.	High	Low
EXTRA LIGHT SERIES—TYPE TP									
0	0.9375	+0.040	+0.060	+0.050	-0.050	0	4.7188	+0	-0.030
0.9375	1.9375	+0.050	+0.070	+0.050	-0.050	4.7188	5.2188	+0	-0.030
1.9375	3.0000	+0.060	+0.080	+0.050	-0.050
3.0000	3.5000	+0.080	+0.100	-0.100	-0.100

^a Single plane mean bore diameter deviation.

^b Deviation of the actual bearing height, single direction bearing.

^c Single plane mean outside diameter deviation.

Basic Bore Diameter, <i>d</i>		Δd_{mp}^a		Basic Outside Diameter, <i>D</i>		Outside Dia., <i>D</i> Tolerance Limits		Basic Bore Diameter, <i>d</i>		ΔT_s	
Over	Incl.	High	Low	Over	Incl.	High	Low	Over	Incl.	High	Low
LIGHT SERIES—TYPE TP											
0	1.1870	+0	-0.005	0	2.8750	+0.005	-0	0	2.0000	+0	-0.06
1.1870	1.3750	+0	-0.006	2.8750	3.3750	+0.007	-0	2.0000	3.0000	+0	-0.08
1.3750	1.5620	+0	-0.007	3.3750	3.7500	+0.009	-0	3.0000	6.0000	+0	-0.10
1.5620	1.7500	+0	-0.008	3.7500	4.1250	+0.011	-0	6.0000	10.0000	+0	-0.15
1.7500	1.9370	+0	-0.009	4.1250	4.7180	+0.013	-0	10.0000	18.0000	+0	-0.20
1.9370	2.1250	+0	-0.010	4.7180	5.2180	+0.015	-0	18.0000	30.0000	+0	-0.25
2.1250	2.5000	+0	-0.011
2.5000	3.0000	+0	-0.012
3.0000	3.5000	+0	-0.013
HEAVY SERIES—TYPE TP											
2.0000	3.0000	+0	-0.010	5.0000	10.0000	+0.015	-0	0	2.000	+0	-0.06
3.0000	3.5000	+0	-0.012	10.0000	18.0000	+0.020	-0	2.000	3.000	+0	-0.08
3.5000	9.0000	+0	-0.015	18.0000	26.0000	+0.025	-0	3.000	6.000	+0	-0.10
9.0000	12.0000	+0	-0.018	26.0000	34.0000	+0.030	-0	6.000	10.000	+0	-0.15
12.0000	18.0000	+0	-0.020	34.0000	44.0000	+0.040	-0	10.000	18.000	+0	-0.20
18.0000	22.0000	+0	-0.025	18.000	30.000	+0	-0.25
22.0000	30.0000	+0	-0.03
TYPE TPC											
0	2.0156	+0.010	-0	2.5000	4.0000	+0.005	-0.005	0	2.0156	+0	-0.08
2.0156	3.0156	+0.010	-0.020	4.0000	6.0000	+0.006	-0.006	2.0156	3.0156	+0	-0.10
3.0156	6.0156	+0.015	-0.020	6.0000	10.0000	+0.010	-0.010	3.0156	6.0156	+0	-0.15
6.0156	10.1560	+0.015	-0.050	10.0000	18.0000	+0.012	-0.012	6.0156	10.1560	+0	-0.20

All dimensions are in inches. For Type TR bearings, see Standard.

Table 10. AFBMA and American National Standard Tolerance Limits for Needle Roller Bearings, Drawn Cup, Without Inner Ring — Inch Types NIB, NIBM, NIY, NIYM, NIH, and NIHM ANSI/ABMA 18.2-1982 (R1999)

Ring Gage Bore Diameter ^a			Basic Bore Diameter under Needle Rollers, F_w		Allowable Deviation from F_w ^a		Allowable Deviation from Width, B	
Basic Outside Diameter, D Inch		Deviation from D Inch	Inch		Inch		Inch	
Over	Incl.		Over	Incl.	Low	High	High	Low
0.1875	0.9375	+0.0005	0.1875	0.6875	+0.0015	+0.0024	+0	-0.0100
0.9375	4.0000	-0.0005	0.6875	1.2500	+0.0005	+0.0014	+0	-0.0100
For fitting and mounting practice see Table 19.			1.2500	1.3750	+0.0005	+0.0015	+0	-0.0100
			1.3750	1.6250	+0.0005	+0.0016	+0	-0.0100
			1.6250	1.8750	+0.0005	+0.0017	+0	-0.0100
			1.8750	2.0000	+0.0006	+0.0018	+0	-0.0100
			2.0000	2.5000	+0.0006	+0.0020	+0	-0.0100
			2.5000	3.5000	+0.0010	+0.0024	+0	-0.0100

^a The bore diameter under needle rollers can be measured only when bearing is pressed into a ring gage, which rounds and sizes the bearing.

Table 11. AFBMA and American National Standard Tolerance Limits for Needle Roller Bearings, Drawn Cup, Without Inner Ring — Metric Types NB, NBM, NY, NYM, NH, and NHM ANSI/ABMA 18.1-1982 (R1999)

Ring Gage Bore Diameter ^a			Basic Bore Diameter under Needle Rollers, F_w		Allowable Deviation from F_w ^a		Allowable Deviation from Width, B	
Basic Outside Diameter, D mm		Deviation from D Micrometers	mm		Micrometers		Micrometers	
Over	Incl.		Over	Incl.	Low	High	High	Low
6	10	-16	3	6	+10	+28	+0	-250
10	18	-20	6	10	+13	+31	+0	-250
30	50	-28	18	30	+20	+41	+0	-250
50	80	-33	30	50	+25	+50	+0	-250
...	50	70	+30	+60	+0	-250

^a The bore diameter under needle rollers can be measured only when bearing is pressed into a ring gage, which rounds and sizes the bearing.

For fitting and mounting practice, see Table 19.

Table 12. AFBMA and American National Standard Tolerance Limits for Needle Roller Bearings, With Cage, Machined Ring, Without Inner Ring— Inch Type NIA ANSI/ABMA 18.2-1982 (R1999)

Basic Outside Diameter, D		Allowable Deviation From D of Single Mean Diameter, D_{mp}		Basic Bore Diameter under Needle Rollers, F_w		Allowable Deviation from F_w		Allowable Deviation from Width, B	
Inch		Inch		Inch		Inch		Inch	
Over	Incl.	High	Low	Over	Incl.	Low	High	High	Low
0.7500	2.0000	+0	-0.0005	0.3150	0.7087	+0.0008	+0.0017	+0	-0.0050
2.0000	3.2500	+0	-0.0006	0.7087	1.1811	+0.0009	+0.0018	+0	-0.0050
3.2500	4.7500	+0	-0.0008	1.1811	1.6535	+0.0010	+0.0019	+0	-0.0050
4.7500	7.2500	+0	-0.0010	1.6535	1.9685	+0.0010	+0.0020	+0	-0.0050
				1.9685	2.7559	+0.0011	+0.0021	+0	-0.0050
7.2500	10.2500	+0	-0.0012	2.7559	3.1496	+0.0011	+0.0023	+0	-0.0050
10.2500	11.1250	+0	-0.0014	3.1496	4.0157	+0.0012	+0.0024	+0	-0.0050
...	4.0157	4.7244	+0.0012	+0.0026	+0	-0.0050
...	4.7244	6.2992	+0.0013	+0.0027	+0	-0.0050
...	6.2992	7.0866	+0.0013	+0.0029	+0	-0.0050
...	7.0866	7.8740	+0.0014	+0.0030	+0	-0.0050
...	7.8740	9.2520	+0.0014	+0.0032	+0	-0.0050

For fitting and mounting practice, see Table 20.

Table 13. AFBMA and American National Standard Tolerance Limits for Needle Roller Bearing Inner Rings—Inch Type NIR ANSI/ABMA 18.2-1982 (R1999)

Basic Outside Diameter, F		Allowable Deviation From F of Single Mean Diameter, F_{mp}		Basic Bore Diameter d		Allowable Deviation from d of Single Mean Diameter, d_{mp}		Allowable Deviation from Width, B	
Inch		Inch		Inch		Inch		Inch	
Over	Incl.	High	Low	Over	Incl.	High	Low	High	Low
0.3937	0.7087	-0.0005	-0.0009	0.3125	0.7500	+0	-0.0004	+0.0100	+0.0050
0.7087	1.0236	-0.0007	-0.0012	0.7500	2.0000	+0	-0.0005	+0.0100	+0.0050
1.0236	1.1811	-0.0009	-0.0014	2.0000	3.2500	+0	-0.0006	+0.0100	+0.0050
1.1811	1.3780	-0.0009	-0.0015	3.2500	4.2500	+0	-0.0008	+0.0100	+0.0050
1.3780	1.9685	-0.0010	-0.0016	4.2500	4.7500	+0	-0.0008	+0.0150	+0.0100
1.9685	3.1496	-0.0011	-0.0018	4.7500	7.0000	+0	-0.0010	+0.0150	+0.0100
3.1496	3.9370	-0.0013	-0.0022	7.0000	8.0000	+0	-0.0012	+0.0150	+0.0100
3.9370	4.7244	-0.0015	-0.0024
4.7244	5.5118	-0.0015	-0.0025
5.5118	7.0866	-0.0017	-0.0027
7.0866	8.2677	-0.0019	-0.0031
8.2677	9.2520	-0.0020	-0.0032

For fitting and mounting practice, see [Table 21](#).

Metric Radial Ball and Roller Bearing Shaft and Housing Fits.—To select the proper fits, it is necessary to consider the type and extent of the load, bearing type, and certain other design and performance requirements.

The required shaft and housing fits are indicated in [Tables 14](#) and [15](#). The terms “Light,” “Normal,” and “Heavy” loads refer to radial loads that are generally within the following limits, with some overlap (C being the Basic Load Rating computed in accordance with AFBMA-ANSI Standards):

Bearing Type	Radial Load		
	Light	Normal	Heavy
Ball	Up to $0.075C$	From $0.075C$ to $0.15C$	Over $0.15C$
Cylindrical Roller	Up to $0.075C$	From $0.075C$ to $0.2C$	Over $0.15C$
Spherical Roller	Up to $0.075C$	From $0.070C$ to $0.25C$	Over $0.15C$

Shaft Fits: [Table 14](#) indicates the initial approach to shaft fit selection. Note that for most normal applications where the shaft rotates and the radial load direction is constant, an interference fit should be used. Also, the heavier the load, the greater is the required interference. For stationary shaft conditions and constant radial load direction, the inner ring may be moderately loose on the shaft.

For pure thrust (axial) loading, heavy interference fits are not necessary; only a moderately loose to tight fit is needed.

The upper part of [Table 16](#) shows how the shaft diameters for various ANSI shaft limit classifications deviate from the basic bore diameters.

[Table 17](#) gives metric values for the shaft diameter and housing bore tolerance limits given in [Table 16](#).

The lower parts of [Tables 16](#) and [17](#) show how housing bores for various ANSI hole limit classifications deviate from the basic shaft outside diameters.

Table 14. Selection of Shaft Tolerance Classifications for Metric Radial Ball and Roller Bearings of ABEC-1 and RBEC-1 Tolerance Classes ANSI/ABMA 7-1995 (R2001)

Operating Conditions			Ball Bearings		Cylindrical Roller Bearings		Spherical Roller Bearings		Tolerance Symbol ^a
			mm	Inch	mm	Inch	mm	Inch	
Inner ring stationary in relation to the direction of the load.	All loads	Inner ring has to be easily displaceable	All diameters	All diameters	All diameters	All diameters	All diameters	All diameters	g6
		Inner ring does not have to be easily displaceable	All diameters	All diameters	All diameters	All diameters	All diameters	All diameters	h6
Direction of load indeterminate or the inner ring rotating in relation to the direction of the load.	Radial load:		Nominal Shaft Diameter						
	LIGHT	≤18 >18	≤0.71 >0.71	≤40 (40)–140 (140)–320 (320)–500 >500	≤1.57 (1.57)–5.51 (5.51)–12.6 (126)–19.7 >19.7	≤40 (40)–100 (100)–320 (320)–500 >500	≤1.57 (1.57)–3.94 (3.94)–12.6 (126)–19.7 >19.7	h5 j6 ^b k6 ^b m6 ^b n6 p6	
		NORMAL	≤18 >18	≤0.71 >0.71	≤40 (40)–100 (100)–140 (140)–320 (320)–500 >500	≤1.57 (1.57)–3.94 (3.94)–5.51 (5.51)–12.6 (12.6)–19.7 >19.7	≤40 (40)–65 (65)–100 (100)–140 (140)–280 (280)–500 >500	≤1.57 (1.57)–2.56 (2.56)–3.94 (3.94)–5.51 (5.51)–11.0 (11.0)–19.7 >19.7	j5 k5 m5 m6 n6 p6 r6 r7
			HEAVY	(18)–100 >100	(0.71)–3.94 >3.94	≤40 (40)–65 (65)–140 (140)–200 (200)–500 >500	≤1.57 (1.57)–2.56 (2.56)–5.51 (5.51)–7.87 (7.87)–19.7 >19.7	≤40 (40)–65 (65)–100 (100)–140 (140)–200 >200	≤1.57 (1.57)–2.56 (2.56)–3.94 (3.94)–5.51 (5.51)–7.87 >7.87
Pure Thrust Load			All diams.	All diams.	Consult Bearing Manufacturer				j6

^a For solid steel shafts. For hollow or nonferrous shafts, tighter fits may be needed.

^b When greater accuracy is required, use j5, k5, and m5 instead of j6, k6, and m6, respectively.

Numerical values are given in [Tables 16](#) and [17](#).

Table 15. Selection of Housing Tolerance Classifications for Metric Radial Ball and Roller Bearings of ABEC-1 and RBEC-1 Tolerance Classes

Design and Operating Conditions				Tolerance Classification ^a
Rotational Conditions	Loading	Outer Ring Axial Displacement Limitations	Other Conditions	
Outer ring stationary in relation to load direction	Light Normal and Heavy	Outer ring must be easily axially displaceable	Heat input through shaft	G7
			Housing split axially	H7 ^b
	Shock with temporary complete unloading	Transitional Range ^c	Housing not split axially	H6 ^b
Load direction is indeterminate	Light and normal			J6 ^b
	Normal and Heavy			
Outer ring rotating in relation to load direction	Heavy Shock	split housing not recommended	K6 ^b	
	Light		M6 ^b	
	Normal and Heavy	Outer ring need not be axially displaceable	N6 ^b	
Heavy	Thin wall housing not split		P6 ^b	

^a For cast iron or steel housings. For housings of nonferrous alloys tighter fits may be needed.

^b Where wider tolerances are permissible, use tolerance classifications P7, N7, M7, K7, J7, and H7, in place of P6, N6, M6, K6, J6, and H6, respectively.

^c The tolerance zones are such that the outer ring may be either tight or loose in the housing.

Table 16. AFBMA and American National Standard Shaft Diameter and Housing Bore Tolerance Limits ANSI/ABMA 7-1995 (R2001)

Allowable Deviations of Shaft Diameter from Basic Bore Diameter, Inch																
Inches		mm		g6	h6	h5	j5	j6	k5	k6	m5	m6	n6	p6	r6	r7
Over	Incl.	Over	Incl.													
Base Bore Diameter																
0.2362	0.3937	6	10	-0.002 -0.006	0 -0.004	0 -0.002	+0.002 -0.001	+0.003 -0.001	+0.003 0		+0.005 +0.002					
0.3937	0.7087	10	18	-0.002 -0.007	0 -0.004	0 -0.003	+0.002 -0.001	+0.003 -0.001	+0.004 0		+0.006 +0.003					
0.7087	1.1811	18	30	-0.003 -0.008	0 -0.005		+0.002 -0.002	+0.004 -0.002	+0.004 +0.001		+0.007 +0.003					
1.1811	1.9685	30	50	-0.004 -0.010	0 -0.006		+0.002 -0.002	+0.004 -0.002	+0.005 +0.001	+0.007 +0.001	+0.008 +0.004	+0.010 +0.004				
1.9685	3.1496	50	80	-0.004 -0.011	0 -0.007		+0.002 -0.003	+0.005 -0.003	+0.006 +0.001	+0.008 +0.001	+0.009 +0.004	+0.012 +0.004	+0.018 +0.009			
3.1496	4.7244	80	120	-0.005 -0.013	0 -0.009		+0.002 -0.004	+0.005 -0.004	+0.007 +0.001	+0.010 +0.001	+0.011 +0.005	+0.014 +0.005	+0.019 +0.010	+0.023 +0.015		
Allowable Deviations of Housing Bore from Basic Outside Diameter of Shaft, Inch																
Basic Outside Diameter				G7	H7	H6	J7	J6	K6	K7	M6	M7	N6	N7	P6	P7
0.7087	1.1811	18	30	+0.003 +0.011	0 +0.008	0 +0.005	-0.004 +0.005	-0.002 +0.003	-0.004 +0.001	-0.006 +0.002	-0.007 +0.002	-0.008 0	-0.009 -0.004	-0.011 -0.003	-0.012 -0.007	-0.014 -0.006
1.1811	1.9685	30	50	+0.004 +0.013	0 +0.010	0 +0.006	-0.004 +0.006	-0.002 +0.004	-0.005 +0.001	-0.007 +0.003	-0.008 -0.002	-0.010 0	-0.011 -0.005	-0.013 -0.003	-0.015 -0.008	-0.017 -0.007
1.9685	3.1496	50	80	+0.004 +0.016	0 +0.012	0 +0.007	-0.005 +0.007	-0.002 +0.005	-0.006 +0.002	-0.008 +0.004	-0.009 -0.002	-0.012 0	-0.013 -0.006	-0.015 -0.004	-0.018 -0.010	-0.020 -0.008
3.1496	4.7244	80	120	+0.005 +0.019	0 +0.014	0 +0.009	-0.005 +0.009	-0.002 +0.006	-0.007 +0.002	-0.010 +0.004	-0.011 -0.002	-0.014 0	-0.015 -0.006	-0.018 -0.004	-0.020 -0.012	-0.023 -0.009
4.7244	7.0866	120	180	+0.006 +0.021	0 +0.016	0 +0.010	-0.006 +0.010	-0.003 +0.007	-0.008 +0.002	-0.011 +0.005	-0.013 -0.003	-0.016 0	-0.018 -0.008	-0.020 -0.005	-0.024 -0.014	-0.027 -0.011
7.0866	9.8425	180	250	+0.006 +0.024	0 +0.018	0 +0.011	-0.006 +0.012	-0.003 +0.009	-0.009 +0.002	-0.013 +0.005	-0.015 -0.003	-0.018 0	-0.020 -0.009	-0.024 -0.006	-0.028 -0.016	-0.031 -0.013

Based on ANSI B4.1-1967 (R2009) Preferred Limits and Fits for Cylindrical Parts. Symbols g6, h6, etc., are shaft and G7, H7, etc., hole limits designations. For larger diameters and metric values see AFBMA Standard 7.

Table 17. AFBMA and American National Standard Shaft Diameter and Housing Bore Tolerance Limits ANSI/ABMA 7-1995 (R2001)

Allowable Deviations of Shaft Diameter from Basic Bore Diameter, mm																
Inches		mm		g6	h6	h5	j5	j6	k5	k6	m5	m6	n6	p6	r6	r7
Over	Incl.	Over	Incl.													
Base Bore Diameter																
0.2362	0.3937	6	10	-.005 -.014	0 -.009	0 -.006	+.004 -.002	+.007 -.002	+.007 -.001		+.012 +.006					
0.3937	0.7087	10	18	-.006 -.017	0 -.011	0 -.008	+.005 -.003	+.008 -.003	+.009 +.001		+.015 +.007					
0.7087	1.1811	18	30	-.007 -.020	0 -.013		+.005 -.004	+.009 -.004	+.011 +.002		+.017 +.008					
1.1811	1.9685	30	50	-.009 -.025	0 -.016		+.006 -.005	+.011 -.005	+.013 +.002	+.018 +.002	+.020 +.009	+.025 +.009				
1.9685	3.1496	50	80	-.010 -.029	0 -.019		+.006 -.007	+.012 -.007	+.015 +.002	+.021 +.002	+.024 +.011	+.030 +.011	+.039 +.020			
3.1496	4.7244	80	120	-.012 -.034	0 -.022		+.006 -.009	+.013 -.009	+.018 +.003	+.025 +.003	+.028 +.013	+.035 +.013	+.045 +.023	+.059 +.037		
Allowable Deviations of Housing Bore from Basic Outside Diameter of Shaft, mm																
Basic Outside Diameter				G7	H7	H6	J7	J6	K6	K7	M6	M7	N6	N7	P6	P7
.7086	1.1811	18	30	+.007 +.028	0 +.021	0 +.013	-.009 +.012	-.005 +.008	-.011 +.002	-.015 +.006	-.017 -.004	-.021 0	-.024 -.011	-.028 -.007	-.031 -.018	-.035 -.014
1.1811	1.9685	30	50	+.009 +.034	0 +.025	0 +.016	-.011 +.014	-.006 +.010	-.013 +.003	-.018 +.007	-.020 -.004	-.025 0	-.028 -.012	-.033 -.008	-.037 -.021	-.042 -.017
1.9685	3.1496	50	80	+.010 +.040	0 +.030	0 +.019	-.012 +.018	-.006 +.013	-.015 +.004	-.021 +.009	-.024 -.005	-.030 0	-.033 -.014	-.039 -.009	-.045 -.026	-.051 -.021
3.1496	4.7244	80	120	+.012 +.047	0 +.035	0 +.022	-.013 +.022	-.006 +.016	-.018 +.004	-.025 +.010	-.028 -.006	-.035 0	-.038 -.016	-.045 -.010	-.052 -.030	-.059 -.024
4.7244	7.0866	120	180	+.014 +.054	0 +.040	0 +.025	-.014 +.026	-.007 +.018	-.021 +.004	-.028 +.012	-.033 -.008	-.040 0	-.045 -.020	-.052 -.012	-.061 -.036	-.068 -.028
7.0866	9.8425	180	250	+.015 +.061	0 +.046	0 +.029	-.016 +.030	-.007 +.022	-.024 +.005	-.033 +.013	-.037 -.008	-.046 0	-.051 -.022	-.060 -.014	-.070 -.041	-.079 -.033

Based on ANSI B4.1-1967 (R2009) Preferred Limits and Fits for Cylindrical Parts. Symbols g6, h6, etc., are shaft and G7, H7, etc., hole limits designations. For larger diameters and metric values see AFBMA Standard 7.

Design and Installation Considerations.—Interference fitting will reduce bearing radial internal clearance, so it is recommended that prospective users consult bearing manufacturers to make certain that the required bearings are correctly specified to satisfy all mounting, environmental and other operating conditions and requirements. This check is particularly necessary where heat sources in associated parts may further diminish bearing clearances in operation.

Standard values of radial internal clearances of radial bearings are listed in AFBMA-ANSI Standard 20.

Allowance for Axial Displacement.—Consideration should be given to axial displacement of bearing components owing to thermal expansion or contraction of associated parts. Displacement may be accommodated either by the internal construction of the bearing or by allowing one of the bearing rings to be axially displaceable. For unusual applications consult bearing manufacturers.

Needle Roller Bearing Fitting and Mounting Practice.—The tolerance limits required for shaft and housing seat diameters for needle roller bearings with inner and outer rings as well as limits for raceway diameters where inner or outer rings or both are omitted and rollers operate directly upon these surfaces are given in Tables 18 through 21, inclusive. Unusual design and operating conditions may require a departure from these practices. In such cases, bearing manufacturers should be consulted.

Needle Roller Bearings, Drawn Cup: These bearings without inner ring, Types NIB, NB, NIBM, NBM, NIY, NY, NIYM, NYM, NIH, NH, NIHM, NHM, and Inner Rings, Type NIR depend on the housings into which they are pressed for their size and shape. Therefore, the housings must not only have the proper bore dimensions but also must have sufficient strength. Tables 18 and 19, show the bore tolerance limits for rigid housings such as those made from cast iron or steel of heavy radial section equal to or greater than the ring gage section given in AFBMA Standard 4, 1984. The bearing manufacturers should be consulted for recommendations if the housings must be of lower strength materials such as aluminum or even of steel of thin radial section. The shape of the housing bores should be such that when the mean bore diameter of a housing is measured in each of several radial planes, the maximum difference between these mean diameters should not exceed 0.0005 inch (0.013 mm) or one-half the housing bore tolerance limit, if smaller. Also, the radial deviation from circular form should not exceed 0.00025 inch (0.006 mm). The housing bore surface finish should not exceed 125 micro-inches (3.2 micrometers) arithmetical average.

Table 18. AFBMA and American National Standard Tolerance Limits for Shaft Raceway and Housing Bore Diameters—Needle Roller Bearings, Drawn Cup, Without Inner Ring, Inch Types NIB, NIBM, NIY, NIYM, NIH, and NIHM ANSI/ABMA 18.2-1982 (R1999)

Basic Bore Diameter under Needle Rollers, F_w		Shaft Raceway Diameter ^a Allowable Deviation from F_w		Basic Outside Diameter, D		Housing Bore Diameter ^a Allowable Deviation from D	
Inch		Inch		Inch		Inch	
Over	Incl.	High	Low	Over	Incl.	Low	High
OUTER RING STATIONARY RELATIVE TO LOAD							
0.1875	1.8750	+0	-0.0005	0.3750	4.0000	-0.0005	+0.0005
1.8750	3.5000	+0	-0.0006
OUTER RING ROTATING RELATIVE TO LOAD							
0.1875	1.8750	-0.0005	-0.0010	0.3750	4.0000	-0.0010	+0
1.8750	3.5000	-0.0005	-0.0011

^a See text for additional requirements.

For bearing tolerances, see Table 10.

**Table 19. AFBMA and American National Standard Tolerance Limits for Shaft Raceway and Housing Bore Diameters—Needle Roller Bearings, Drawn Cup, Without Inner Ring, Metric Types NB, NBM, NY, NYM, NH, and NHM
ANSI/ABMA 18.1-1982 (R1999)**

Basic Bore Diameter Under Needle Rollers, F_w				Shaft Raceway Diameter ^a Allowable Deviation from F_w		Basic Outside Diameter, D		Housing Bore Diameter- ^a Allowable Deviation from D			
OUTER RING STATIONARY RELATIVE TO LOAD											
mm		Inch		ANSI h6, Inch		mm		Inch		ANSI N7, Inch	
Over	Incl.	Over	Incl.	High	Low	Over	Incl.	Over	Incl.	Low	High
3	6	0.1181	0.2362	+0	-0.0003	6	10	0.2362	0.3937	-0.0007	-0.0002
6	10	0.2362	0.3937	+0	-0.0004	10	18	0.3937	0.7087	-0.0009	-0.0002
10	18	0.3937	0.7087	+0	-0.0004	18	30	0.7087	1.1811	-0.0011	-0.0003
18	30	0.7087	1.1811	+0	-0.0005	30	50	1.1811	1.9685	-0.0013	-0.0003
30	50	1.1811	1.9685	+0	-0.0006	50	80	1.9685	3.1496	-0.0015	-0.0004
50	80	1.9685	3.1496	+0	-0.0007
OUTER RING ROTATING RELATIVE TO LOAD											
mm		Inch		ANSI f6, Inch		mm		Inch		ANSI R7, Inch	
Over	Incl.	Over	Incl.	High	Low	Over	Incl.	Over	Incl.	Low	High
3	6	0.1181	0.2362	-0.0004	-0.0007	6	10	0.2362	0.3937	-0.0011	-0.0005
6	10	0.2362	0.3937	-0.0005	-0.0009	10	18	0.3937	0.7087	-0.0013	-0.0006
10	18	0.3937	0.7087	-0.0006	-0.0011	18	30	0.7087	1.1811	-0.0016	-0.0008
18	30	0.7087	1.1811	-0.0008	-0.0013	30	50	1.1811	1.9685	-0.0020	-0.0010
30	50	1.1811	1.9685	-0.0010	-0.0016	50	65	1.9685	2.5591	-0.0024	-0.0012
50	80	1.9685	3.1496	-0.0012	-0.0019	65	80	2.5591	3.1496	-0.0024	-0.0013

For bearing tolerances, see Table 11.

**Table 20. AFBMA and American National Standard Tolerance Limits for Shaft Raceway and Housing Bore Diameters—Needle Roller Bearings, With Cage, Machined Ring, Without Inner Ring, Inch Type NIA
ANSI/ABMA 18.2-1982 (R1999)**

Basic Bore Diameter under Needle Rollers, F_w		Shaft Raceway Diameter ^a Allowable Deviation from F_w		Basic Outside Diameter, D		Housing Bore Diameter ^a Allowable Deviation from D	
OUTER RING STATIONARY RELATIVE TO LOAD							
Inch		ANSI h6, Inch		Inch		ANSI H7, Inch	
Over	Incl.	High	Low	Over	Incl.	Low	High
0.2362	0.3937	+0	-0.0004	0.3937	0.7087	+0	+0.0007
0.3937	0.7087	+0	-0.0004	0.7087	1.1811	+0	+0.0008
0.7087	1.1811	+0	-0.0005	1.1811	1.9685	+0	+0.0010
1.1811	1.9685	+0	-0.0006	1.9685	3.1496	+0	+0.0012
1.9685	3.1496	+0	-0.0007	3.1496	4.7244	+0	+0.0014
3.1496	4.7244	+0	-0.0009	4.7244	7.0866	+0	+0.0016
4.7244	7.0866	+0	-0.0010	7.0866	9.8425	+0	+0.0018
7.0866	9.8425	+0	-0.0011	9.8425	12.4016	+0	+0.0020
OUTER RING ROTATING RELATIVE TO LOAD							
Inch		ANSI f6, Inch		Inch		ANSI N7, Inch	
Over	Incl.	High	Low	Over	Incl.	Low	High
0.2362	0.3937	-0.0005	-0.0009	0.3937	0.7087	-0.0009	-0.0002
0.3937	0.7087	-0.0006	-0.0011	0.7087	1.1811	-0.0011	-0.0003
0.7087	1.1811	-0.0008	-0.0013	1.1811	1.9685	-0.0013	-0.0003
1.1811	1.9685	-0.0010	-0.0016	1.9685	3.1496	-0.0015	-0.0004
1.9685	3.1496	-0.0012	-0.0019	3.1496	4.7244	-0.0018	-0.0004
3.1496	4.7244	-0.0014	-0.0023	4.7244	7.0866	-0.0020	-0.0005
4.7244	7.0866	-0.0016	-0.0027	7.0866	9.8425	-0.0024	-0.0006
7.0866	9.8425	-0.0020	-0.0031	9.8425	11.2205	-0.0026	-0.0006

^a See text for additional requirements.

For bearing tolerances, see Table 12.

Table 21. AFBMA and American National Standard Tolerance Limits for Shaft Diameters—Needle Roller Bearing Inner Rings, Inch Type NIR (Used with Bearing Type NIA) ANSI/ABMA 18.2-1982 (R1999)

Basic Bore, <i>d</i>		Shaft Diameter ^a			
		Shaft Rotating Relative to Load, Outer Ring Stationary Relative to Load Allowable Deviation from <i>d</i>		Shaft Stationary Relative to Load, Outer Ring Rotating Relative to Load Allowable Deviation from <i>d</i>	
Inch		ANSI m5, Inch		ANSI g6, Inch	
Over	Incl.	High	Low	High	Low
0.2362	0.3937	+0.0005	+0.0002	-0.0002	-0.0006
0.3937	0.7087	+0.0006	+0.0003	-0.0002	-0.0007
0.7087	1.1811	+0.0007	+0.0003	-0.0003	-0.0008
1.1811	1.9685	+0.0008	+0.0004	-0.0004	-0.0010
1.9685	3.1496	+0.0009	+0.0004	-0.0004	-0.0011
3.1496	4.7244	+0.0011	+0.0005	-0.0005	-0.0013
4.7244	7.0866	+0.0013	+0.0006	-0.0006	-0.0015
7.0866	9.8425	+0.0015	+0.0007	-0.0006	-0.0017

^a See text for additional requirements.

For inner ring tolerance limits, see [Table 13](#).

Most needle roller bearings do not use inner rings, but operate directly on the surfaces of shafts. When shafts are used as inner raceways, they should be made of bearing quality steel hardened to Rockwell C 58 minimum. [Tables 15](#) and [19](#) show the shaft raceway tolerance limits and [Table 21](#) shows the shaft seat tolerance limits when inner rings are used. However, whether the shaft surfaces are used as inner raceways or as seats for inner rings, the mean outside diameter of the shaft surface in each of several radial planes should be determined. The difference between these mean diameters should not exceed 0.0003 inch (0.008 mm) or one-half the diameter tolerance limit, if smaller. The radial deviation from circular form should not exceed 0.0001 inch (0.0025 mm), for diameters up to and including 1 in. (25.4 mm). Above one inch the allowable deviation is 0.0001 times the shaft diameter. The surface finish should not exceed 16 micro-inches (0.4 micrometer) arithmetical average. The housing bore and shaft diameter tolerance limits depend upon whether the load rotates relative to the shaft or the housing.

Needle Roller Bearing With Cage, Machined Ring, Without Inner Ring: The following covers needle roller bearings Type NIA and inner rings Type NIR. The shape of the housing bores should be such that when the mean bore diameter of a housing is measured in each of several radial planes, the maximum difference between these mean diameters does not exceed 0.0005 inch (0.013 mm) or one-half the housing bore tolerance limit, if smaller. Also, the radial deviation from circular form should not exceed 0.00025 inch (0.006 mm). The housing bore surface finish should not exceed 125 micro-inches (3.2 micrometers) arithmetical average. [Table 21](#) shows the housing bore tolerance limits.

When shafts are used as inner raceways their requirements are the same as those given above for Needle Roller Bearings, Drawn Cup. [Table 20](#) shows the shaft raceway tolerance limits and [Table 21](#) shows the shaft seat tolerance limits when inner rings are used.

Needle Roller and Cage Assemblies, Types NIM and NM: For information concerning boundary dimensions, tolerance limits, and fitting and mounting practice, reference should be made to ANSI/ABMA 18.1-1982 (R1999) and ANSI/ABMA 18.2-1982 (R1999).

Bearing Mounting Practice

Because of their inherent design and material rigidity, rolling contact bearings must be mounted with careful control of their alignment and runout. Medium-speed or slower (400,000 DN values or less where D is the bearing bore in millimeters and N is the bearing speed in revolutions per minute), and medium to light load (C/P values of 7 or greater where C is the bearing specific dynamic capacity in pounds and P is the average bearing load in pounds) applications can endure misalignments equivalent to those acceptable for high-capacity, precision journal bearings utilizing hard bearing materials such as silver, copper-lead, or aluminum. In no case, however, should the maximum shaft deflection exceed .001 inch per inch (or mm per mm) for well-crowned roller bearings, and .003 inch per inch (or mm per mm) for deep-groove ball-bearings. Except for self-aligning ball-bearings and spherical or barrel roller bearings, all other types require shaft alignments with deflections no greater than .0002 inch per inch (or mm per mm). With preloaded ball bearings, this same limit is recommended as a maximum. Close-clearance tapered bearings or thrust bearings of most types require the same shaft alignment also.

Of major importance for all bearings requiring good reliability, is the location of the races on the shaft and in the housing.

Assembly methods must insure: 1) that the faces are square, before the cavity is closed; 2) that the cover face is square to the shoulder and pulled in evenly; and 3) that it will be located by a face parallel to it when finally seated against the housing.

These requirements are shown in the accompanying [Table 22](#). In applications not controlled by automatic tooling with closely controlled fixtures and bolt torquing mechanisms, races should be checked for squareness by sweeping with a dial indicator mounted as shown below. For commercial applications with moderate life and reliability requirements, outer race runouts should be held to .0005 inch per inch (or mm per mm) of radius and inner race runout to .0004 inch per inch (or mm per mm) of radius. In preloaded and precision applications, these tolerances must be cut in half. In regard to the question of alignment, it must be recognized that rolling-contact bearings, being made of fully-hardened steel, do not wear in as may certain journal bearings when carefully applied and initially operated. Likewise, rolling contact bearings absorb relatively little deflection when loaded to C/P values of 6 or less. At such stress levels the rolling element-race deformation is generally not over .0002 inch (5.08 μm). Consequently, proper mounting and control of shaft deflections are imperative for reliable bearing performance. Aside from inadequate lubrication, these factors are the most frequent causes of premature bearing failures.

Mountings for Precision and Quiet-running Applications.—In applications of rolling-element bearings where vibration or smoothness of operation is critical, special precautions must be taken to eliminate those conditions which can serve to initiate radial and axial motions. These exciting forces can result in shaft excursions which are in resonance with shaft or housing components over a range of frequencies from well below shaft speed to as much as 100 times above it. The more sensitive the configuration, the greater is the need for precision bearings and mountings to be used.

Precision bearings are normally made to much closer tolerances than standard and therefore benefit from better finishing techniques. Special inspection operations are required, however, to provide races and rolling elements with smoothness and runouts compatible with the needs of the application. Similarly, shafts and housings must be carefully controlled.

Among the important elements to be controlled are shaft, race, and housing roundness; squareness of faces, diameters, shoulders, and rolling paths. Though not readily appreciated, grinding chatter, lobular and compensating out-of-roundness, waviness, and flats of less than 0.0005 inch (0.013 mm) deviation from the average or mean diameter can cause significant roughness. To detect these and insure the selection of good pieces, three-point electronic indicator inspection must be made. For ultra-precise or quiet applications,

pieces are often checked on a “Talyrond” or a similar continuous recording instrument capable of measuring to within a few millionths of an inch. Though this may seem extreme, it has been found that shaft deformities will be reflected through inner races shrunk onto them. Similarly, tight-fit outer races pick up significant deviations in housings. In many instrument and in missile guidance applications, such deviations and deformities may have to be limited to less than 0.00002 inch (0.508 μm).

In most of these precision applications, bearings are used with rolling elements controlled to less than 5 millionths of an inch deviation from roundness and within the same range for diameter.

Special attention is required both in housing design and in assembly of the bearing to shaft and housing. Housing response to axial excursions forced by bearing wobble (which in itself is a result of out-of-square mounting) has been found to be a major source of small electric and other rotating equipment noise and howl. Stiffer, more massive housings and careful alignment of bearing races can make significant improvements in applications where noise or vibration has been found to be objectionable.

Table 22. Commercial Application Alignment Tolerances

Feature	Location	Tolerance
Housing Face Runout	1	Square to shaft center within .0004 inch/inch of radius full indicator reading.
Outer Race Face Runout	2	Square to shaft center within .0004 inch/inch of radius full indicator reading and complementary to the housing runout (not opposed).
Inner Race Face Runout	3	Square to shaft center within .0003 inch/inch of radius full indicator reading.
Cover and Closure Mounting Face Parallelism	4 and 5	Parallel within .001.
Housing Mounting Face Parallelism	6	Parallel within .001

Squareness and Alignment.—In addition to the limits for roundness and wall variation of the races and their supports, squareness of end faces and shoulders must be closely controlled. Tolerances of .0001 inch (2.54 μm) full indicator reading per inch of diameter are normally required for end faces and shoulders, with appropriately selected limits for fillet eccentricities. The latter must also fall within specified limits for radii tolerances to prevent interference and the resulting cocking of the race. Reference should be made to the bearing dimension tables which list corner radii for typical bearings. Shoulders must also be of a sufficient height to insure proper support for the races, since they are of hardened steel and are less capable of absorbing shock loads and abuse. The general subject of squareness and alignment is of primary importance to the life of rolling element bearings.

The following recommendations for shaft and housing design are given by the New Departure Division of General Motors Corporation:*

“As a rule, there is little trouble experienced with inaccuracies in shafts. Bearings seats and locating shoulders are turned and ground to size with the shaft held on centers and, with ordinary care, there is small chance for serious out-of-roundness or taper. Shaft shoulders should present sufficient surface in contact with the bearing face to assure positive and accurate location.

“Where an undercut must be made for wheel runout in grinding a bearing seat, care should be exercised that no sharp corners are left, for it is at such points that fatigue is most likely to result in shaft breakage. It is best to undercut as little as possible and to have the undercut end in a fillet instead of a sharp corner.

“Where clamping nuts are to be used, it is important to cut the threads as true and square as possible in order to insure even pressure at all points on the bearing inner ring faces when the nuts are set up tight. It is also important not to cut threads so far into the bearing seat as to leave part of the inner ring unsupported or carried on the threads. Excessive deflection is usually the result of improperly designed or undersized machine parts. With a weak shaft, it is possible to seriously affect bearing operation through misalignment due to shaft deflection. Where shafts are comparatively long, the diameter between bearings must be great enough to properly resist bending. In general, the use of more than two bearings on a single shaft should be avoided, owing to the difficulty of securing accurate alignment. With bearings mounted close to each other, this can result in extremely heavy bearing loads.

“Design is as important as careful machining in construction of accurate bearing housings. There should be plenty of metal in the wall sections and large, thin areas should be avoided as much as possible, since they are likely to permit deflection of the boring tool when the housing is being finish-machined.

“Wherever possible, it is best to design a housing so that the radial load placed on the bearing is transmitted as directly as possible to the wall or rib supporting the housing. Diaphragm walls connecting an offset housing to the main wall or side of a machine are apt to deflect unless made thick and well braced.

“When two bearings are to be mounted opposed, but in separate housings, the housings should be so reinforced with fins or webs as to prevent deflection due to the axial load under which the bearings are opposed.

“Where housings are deep and considerable overhang of the boring tool is required, there is a tendency to produce out-of-roundness and taper, unless the tool is very rigid and light finishing cuts are taken. In a too roughly bored housing there is a possibility for the ridges of metal topeen down under load, thus eventually resulting in too loose a fit for the bearing outer ring.”

Soft Metal and Resilient Housings.—In applications relying on bearing housings made of soft materials (aluminum, magnesium, light sheet metal, etc.) or those which lose their fit because of differential thermal expansion, outer race mounting must be approached in a cautious manner. Of first importance is the determination of the possible consequences of race loosening and turning. In conjunction with this, the type of loading must be considered for it may serve to magnify the effect of race loosening. It must be remembered that generally, balancing processes do not insure zero unbalance at operating speeds, but rather an “acceptable” maximum. This force exerted by the rotating element on the outer race can initiate a precession which will aggravate the race loosening problem by causing further attrition through wear, pounding, and abrasion. Since this force is generally of an order greater than the friction forces in effect between the outer race, housing, and closures (retaining nuts also), no foolproof method can be recommended for securing outer races in housings which deform significantly under load or after appreciable service wear. Though

* New Departure Handbook. Vol. II — 1951.

many such “fixes” are offered, the only sure solution is to press the race into a housing of sufficient stiffness with the heaviest fit consistent with the installed and operating clearances. In many cases, inserts, or liners of cast iron or steel are provided to maintain the desired fit and increase useful life of both bearing and housing.

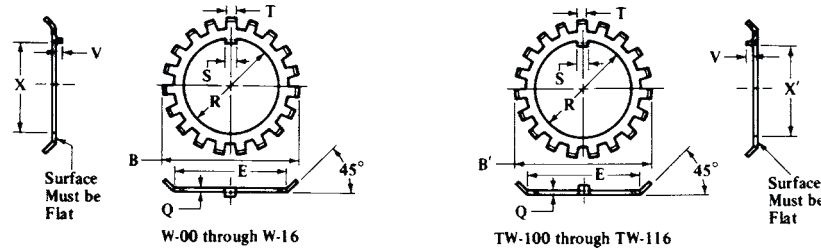
Quiet or Vibration-free Mountings.—In seeming contradiction is the approach to bearing mountings in which all shaft or rotating element excursions must be isolated from the frame, housing, or supporting structure. Here bearing outer races are often supported on elastomeric or metallic springs. Fundamentally, this is an isolation problem and must be approached with caution to insure solution of the primary bearing objective — location and restraint of the rotating body, as well as the reduction or elimination of the dynamic problem. Again, the danger of skidding rolling elements must be considered and reference to the resident engineers or sales engineers of the numerous bearing companies is recommended, as this problem generally develops requirements for special, or non-catalog-type bearings.

General Mounting Precautions.—Since the last operations involving the bearing application — mounting and closing — have such important effects on bearing performance, durability, and reliability, it must be cautioned that more bearings are abused or “killed” in this early stage of their life than wear out or “die” under conditions for which they were designed. Hammer and chisel “mechanics” invariably handle bearings as though no blow could be too hard, no dirt too abrasive, and no misalignment of any consequence. Proper tools, fixtures, and techniques are a must for rolling bearing application, and it is the responsibility of the design engineer to provide for this in his design, advisory notes, mounting instructions, and service manuals. Nicks, dents, scores, scratches, corrosion staining, and dirt must be avoided if reliability, long life, and smooth running are to be expected of rolling bearings. All manufacturers have pertinent service instructions available for the bearing user. These should be followed for best performance. In a later section, methods for inspecting bearings and descriptions of most common bearing deficiencies will be given.

Seating Fits for Bearings.—Anti-Friction Bearing Manufacturers Association (AFBMA) standard shaft and housing bearing seat tolerances are given in [Tables 13](#) through [18](#), inclusive.

Clamping and Retaining Methods.—Various methods of clamping bearings to prevent axial movement on the shaft are employed, one of the most common being a nut screwed on the end of the shaft and held in place by a tongued lock washer (see [Table 23](#)). The shaft thread for the clamping nut (see [Table 24](#)) should be cut in accurate relation to bearing seats and shoulders if bearing stresses are to be avoided. The threads used are of American National Form, Class 3; special diameters and data for these are given in [Tables 25](#) and [26](#). Where somewhat closer than average accuracy is required, the washers and locknut faces may be obtained ground for closer alignment with the threads. For a high degree of accuracy the shaft threads are ground and a more precise clamping means is employed. Where a bearing inner ring is to be clamped, it is important to provide a sufficiently high shoulder on the shaft to locate the bearing positively and accurately. If the difference between bearing bore and maximum shaft diameter gives a low shoulder which would enter the corner of the radius of the bearing, a shoulder ring that extends above the shoulder and well into the shaft corner is employed. A shoulder ring with snap wire fitting into a groove in the shaft is sometimes used where no locating shaft shoulder is present. A snap ring fitting into a groove is frequently employed to prevent endwise movement of the bearing away from the locating shoulder where tight clamping is not required. Such a retaining ring should not be used where a slot in the shaft surface might lead to fatigue failure. Snap rings are also used to locate the outer bearing ring in the housing. Dimensions of snap rings used for this latter purpose are given in AFBMA and ANSI standards.

Table 23. AFBMA Standard Lockwashers (Series W-00) for Ball Bearings and Cylindrical and Spherical Roller Bearings and (Series TW-100) for Tapered Roller Bearings. Inch Design.



Type W No.	Q	Type TW No.	Q	Tangs		Key						Bore R		Diameter		Dia. Over Tangs. Max.		
				No.	Width ^a	Project. ^a	Width S		X		X'		Min.	Max.	E	Tol.	B	B'
					T	V	Min.	Max.	Min.	Max.	Min.	Max.						
W-00	.032	TW-100	.032	9	.120	.031	.110	.120	.334	.359	.334	.359	.406	0.421	0.625	+0.015	0.875	0.891
W-01	.032	TW-101	.032	9	.120	.031	.110	.120	.412	.437	.412	.437	.484	.499	0.719	+0.015	1.016	1.031
W-02	.032	TW-102	.048	11	.120	.031	.110	.120	.529	.554	.513	.538	.601	.616	0.813	+0.015	1.156	1.156
W-03	.032	TW-103	.048	11	.120	.031	.110	.120	.607	.632	.591	.616	.679	.694	0.938	+0.015	1.328	1.344
W-04	.032	TW-104	.048	11	.166	.031	.156	.176	.729	.754	.713	.738	.801	.816	1.125	+0.015	1.531	1.563
W-05	.040	TW-105	.052	13	.166	.047	.156	.176	.909	.939	.897	.927	.989	1.009	1.281	+0.015	1.719	1.703
W-06	.040	TW-106	.052	13	.166	.047	.156	.176	1.093	1.128	1.081	1.116	1.193	1.213	1.500	+0.015	1.922	1.953
		TW-065	.052	15	.166156	.176	1.221	1.256	1.333	1.353	1.813	+0.015	...	2.234
W-07	.040	TW-107	.052	15	.166	.047	.156	.176	1.296	1.331	1.284	1.319	1.396	1.416	1.813	+0.015	2.250	2.250
W-08	.048	TW-108	.062	15	.234	.047	.250	.290	1.475	1.510	1.461	1.496	1.583	1.603	2.000	+0.030	2.469	2.484
W-09	.048	TW-109	.062	17	.234	.062	.250	.290	1.684	1.724	1.670	1.710	1.792	1.817	2.281	+0.030	2.734	2.719
W-10	.048	TW-110	.062	17	.234	.062	.250	.290	1.884	1.924	1.870	1.910	1.992	2.017	2.438	+0.030	2.922	2.922
W-11	.053	TW-111	.062	17	.234	.062	.250	.290	2.069	2.109	2.060	2.100	2.182	2.207	2.656	±0.030	3.109	3.094
W-12	.053	TW-112	.072	17	.234	.062	.250	.290	2.267	2.307	2.248	2.288	2.400	2.425	2.844	+0.030	3.344	3.328
W-13	.053	TW-113	.072	19	.234	.062	.250	.290	2.455	2.495	2.436	2.476	2.588	2.613	3.063	+0.030	3.578	3.563
W-14	.053	TW-114	.072	19	.234	.094	.250	.290	2.658	2.698	2.639	2.679	2.791	2.816	3.313	+0.030	3.828	3.813
W-15	.062	TW-115	.085	19	.328	.094	.250	.290	2.831	2.876	2.808	2.853	2.973	3.003	3.563	+0.030	4.109	4.047
W-16	.062	TW-116	.085	19	.328	.094	.313	.353	3.035	3.080	3.012	3.057	3.177	3.207	3.844	+0.030	4.375	4.391

^a *Tolerances:* On width, T , -0.010 inch for Types W-00 to W-03 and TW-100 to TW-103; -0.020 inch for W-04 to W-07 and TW-104 to TW-107; -0.030 inch for all others shown. On Projection V , $+0.031$ inch for all sizes up through W-13 and TW-113; $+0.062$ inch for all others shown.

All dimensions in inches. For dimensions in millimeters, multiply inch values by 25.4 and round result to two decimal places.

Data for sizes larger than shown are given in ANSI/AFBMA Standard 8.2-1991.

Table 24. AFBMA Standard Locknuts (Series N-00) for Ball Bearings and Cylindrical and Spherical Roller Bearings and (Series TN-00) for Tapered Roller Bearings. Inch Design.

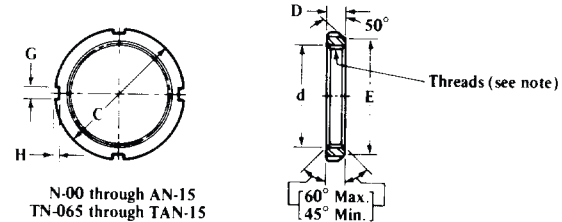
Runout and parallelism of faces measured on a tight fitting threaded arbor.

N-00 to N-06 = .002 Max.
N-07 to AN-15 = .004 Max.

TN-065 to TAN-15 = .002 Max.

Surface Finish Note

TN-065 to TN-11, 100μ in., max.
TN-12 to TAN-15, 120μ in., max.



N-00 through AN-15
TN-065 through TAN-15

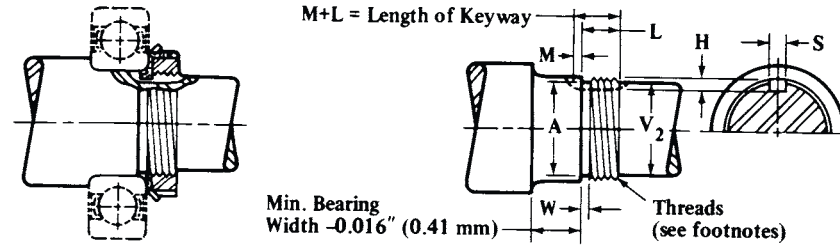
BB & RB Nut No.	TRB Nut No.	Thds. per Inch	Thread Minor Dia.		Thread Pitch Dia.		Thd. Major Dia. <i>d</i>	Outside Dia. <i>C</i>	Face Dia. <i>E</i>		Slot dimension			Thickness <i>D</i>	
			Min.	Max.	Min.	Max.			Min.	Max.	Width <i>G</i>		Height <i>H</i>	Min.	Max.
											Min.	Max.			
N-00	—	32	0.3572	0.3606	0.3707	0.3733	0.391	0.755	.605	.625	.120	.130	.073	.209	.229
N-01	—	32	0.4352	0.4386	0.4487	0.4513	0.469	0.880	.699	.719	.120	.130	.073	.303	.323
N-02	—	32	0.5522	0.5556	0.5657	0.5687	0.586	1.005	.793	.813	.120	.130	.104	.303	.323
N-03	—	32	0.6302	0.6336	0.6437	0.6467	0.664	1.130	.918	.938	.120	.130	.104	.334	.354
N-04	—	32	0.7472	0.7506	0.7607	0.7641	0.781	1.380	1.105	1.125	.178	.198	.104	.365	.385
N-05	—	32	0.9352	0.9386	0.9487	0.9521	0.969	1.568	1.261	1.281	.178	.198	.104	.396	.416
N-06	—	18	1.1129	1.1189	1.1369	1.1409	1.173	1.755	1.480	1.500	.178	.198	.104	.396	.416
	TN-065	18	1.2524	1.2584	1.2764	1.2804	1.312	2.068	1.793	1.813	.178	.198	.104	.428	.448
N-07	TN-07	18	1.3159	1.3219	1.3399	1.3439	1.376	2.068	1.793	1.813	.178	.198	.104	.428	.448
N-08	TN-08	18	1.5029	1.5089	1.5269	1.5314	1.563	2.255	1.980	2.000	.240	.260	.104	.428	.448
N-09	TN-09	18	1.7069	1.7129	1.7309	1.7354	1.767	2.536	2.261	2.281	.240	.260	.104	.428	.448
N-10	TN-10	18	1.9069	1.9129	1.9309	1.9354	1.967	2.693	2.418	2.438	.240	.260	.104	.490	.510
N-11	TN-11	18	2.0969	2.1029	2.1209	2.1260	2.157	2.974	2.636	2.656	.240	.260	.135	.490	.510
N-12	TN-12	18	2.2999	2.3059	2.3239	2.3290	2.360	3.161	2.824	2.844	.240	.260	.135	.521	.541
N-13	TN-13	18	2.4879	2.4949	2.5119	2.5170	2.548	3.380	3.043	3.063	.240	.260	.135	.553	.573
N-14	TN-14	18	2.6909	2.6969	2.7149	2.7200	2.751	3.630	3.283	3.313	.240	.260	.135	.553	.573
AN-15	TAN-15	12	2.8428	2.8518	2.8789	2.8843	2.933	3.880	3.533	3.563	.360	.385	.135	.584	.604

All dimensions in inches. For dimensions in millimeters, multiply inch values, except thread diameters, by 25.4 and round result to two decimal places.

Threads are American National form, Class 3.

Typical steels for locknuts are: AISI, C1015, C1018, C1020, C1025, C1035, C1117, C1118, C1212, C1213, and C1215. Minimum hardness, tensile strength, yield strength and elongation are given in ANSI/ABMA 8.2-1991 which also lists larger sizes of locknuts.

Table 25. AFBMA Standard for Shafts for Locknuts (series N-00) for Ball Bearings and Cylindrical and Spherical Roller Bearings. Inch Design.

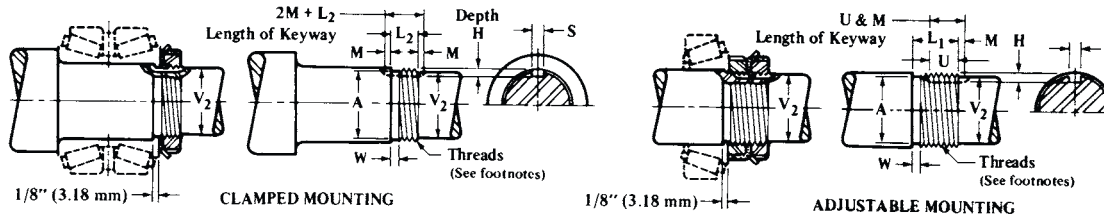


Locknut Number	Bearing Bore	V ₂ Max.	Threads ^a					Relief		Keyway		
			No. per inch	Major Dia.	Pitch Dia.	Minor Dia.	Length L	Dia. A	Width W	Depth H	Width S	M
				Max.	Max.	Max.	Max.	Max.	Max.	Max.	Min.	Min.
N-00	0.3937	0.312	32	0.391	0.3707	0.3527	0.297	0.3421	0.078	0.062	0.125	0.094
N-01	0.4724	0.406	32	0.469	0.4487	0.4307	0.391	0.4201	0.078	0.062	0.125	0.094
N-02	0.5906	0.500	32	0.586	0.5657	0.5477	0.391	0.5371	0.078	0.078	0.125	0.094
N-03	0.6693	0.562	32	0.664	0.6437	0.6257	0.422	0.6151	0.078	0.078	0.125	0.094
N-04	0.7874	0.719	32	0.781	0.7607	0.7427	0.453	0.7321	0.078	0.078	0.188	0.094
N-05	0.9843	0.875	32	0.969	0.9487	0.9307	0.484	0.9201	0.078	0.094	0.188	0.125
N-06	1.1811	1.062	18	1.173	1.1369	1.1048	0.484	1.0942	0.109	0.094	0.188	0.125
N-07	1.3780	1.250	18	1.376	1.3399	1.3078	0.516	1.2972	0.109	0.094	0.188	0.125
N-08	1.5748	1.469	18	1.563	1.5269	1.4948	0.547	1.4842	0.109	0.094	0.312	0.125
N-09	1.7717	1.688	18	1.767	1.7309	1.6988	0.547	1.6882	0.141	0.094	0.312	0.156
N-10	1.9685	1.875	18	1.967	1.9309	1.8988	0.609	1.8882	0.141	0.094	0.312	0.156
N-11	2.1654	2.062	18	2.157	2.1209	2.0888	0.609	2.0782	0.141	0.125	0.312	0.156
N-12	2.3622	2.250	18	2.360	2.3239	2.2918	0.641	2.2812	0.141	0.125	0.312	0.156
N-13	2.5591	2.438	18	2.548	2.5119	2.4798	0.672	2.4692	0.141	0.125	0.312	0.156
N-14	2.7559	2.625	18	2.751	2.7149	2.6828	0.672	2.6722	0.141	0.125	0.312	0.250
AN-15	2.9528	2.781	12	2.933	2.8789	2.8308	0.703	2.8095	0.172	0.125	0.312	0.250
AN-16	3.1496	3.000	12	3.137	3.0829	3.0348	0.703	3.0135	0.172	0.125	0.375	0.250

^aThreads are American National form Class 3.

All dimensions in inches. For dimensions in millimeters, multiply inch values, except thread diameters, by 25.4 and round result to two decimal places. See footnote to Table 26 for material other than stl. For sizes larger than shown, see ANSI/ABMA 8.2-1991.

Table 26. AFBMA Standard for Shafts for Tapered Roller Bearing Locknuts. Inch Design.



Locknut Number	Bearing Bore	V ₂ Max.	Threads ^a No. per inch	Threads ^a			Length		Relief		Keyway			
				Major Dia.	Pitch Dia.	Minor Dia.	L ₁	L ₂	Dia. A	Width W	Depth H	Width S	M	U
				Max.	Max.	Max.	Max.	Max.	Max.	Max.	Max.	Max.	Min.	Min.
N-00	0.3937	0.312	32	0.391	0.3707	0.3527	0.609	0.391	0.3421	0.078	0.094	0.125	0.094	0.469
N-01	0.4724	0.406	32	0.469	0.4487	0.4307	0.797	0.484	0.4201	0.078	0.094	0.125	0.094	0.562
N-02	0.5906	0.500	32	0.586	0.5657	0.5477	0.828	0.516	0.5371	0.078	0.094	0.125	0.094	0.594
N-03	0.6693	0.562	32	0.664	0.6437	0.6257	0.891	0.547	0.6151	0.078	0.078	0.125	0.094	0.625
N-04	0.7874	0.703	32	0.781	0.7607	0.7427	0.922	0.547	0.7321	0.078	0.094	0.188	0.094	0.625
N-05	0.9843	0.875	32	0.969	0.9487	0.9307	1.016	0.609	0.9201	0.078	0.125	0.188	0.125	0.719
N-06	1.1811	1.062	18	1.173	1.1369	1.1048	1.016	0.609	1.0942	0.109	0.125	0.188	0.125	0.719
TN-065	1.3750	1.188	18	1.312	1.2764	1.2443	1.078	0.641	1.2337	0.109	0.125	0.188	0.125	0.750
TN-07	1.3780	1.250	18	1.376	1.3399	1.3078	1.078	0.641	1.2972	0.109	0.125	0.188	0.125	0.750
TN-08	1.5748	1.438	18	1.563	1.5269	1.4948	1.078	0.641	1.4842	0.109	0.125	0.312	0.125	0.750
TN-09	1.7717	1.656	18	1.767	1.7309	1.6988	1.078	0.641	1.6882	0.141	0.125	0.312	0.156	0.781
TN-10	1.9685	1.859	18	1.967	1.9309	1.8988	1.203	0.703	1.882	0.141	0.125	0.312	0.156	0.844
TN-11	2.1654	2.047	18	2.157	2.1209	2.0888	1.203	0.703	2.0782	0.141	0.125	0.312	0.156	0.844
TN-12	2.3622	2.250	18	2.360	2.3239	2.2918	1.297	0.766	2.2812	0.141	0.156	0.312	0.156	0.906
TN-13	2.5591	2.422	18	2.548	2.5119	2.4798	1.359	0.797	2.4692	0.141	0.156	0.312	0.156	0.938
TN-14	2.7559	2.625	18	2.751	2.7149	2.6828	1.359	0.797	2.6722	0.141	0.156	0.312	0.250	1.000
TAN-15	2.9528	2.781	12	2.933	2.8789	2.8308	1.422	0.828	2.8095	0.172	0.188	0.312	0.250	1.031
TAN-16	3.1496	3.000	12	3.137	3.0829	3.0348	1.422	0.828	3.0135	0.172	0.188	0.375	0.250	1.031

^aThreads are American National form Class 3.

All dimensions in inches. For dimensions in millimeters, multiply inch values, except thread diameters, by 25.4 and round results to two decimal places. These data apply to steel. When either the nut or the shaft is made of stainless steel, aluminum, or other material having a tendency to seize, it is recommended that the maximum thread diameter of the shaft, both major and pitch, be reduced by 20 per cent of the pitch diameter tolerance listed in the Standard. For sizes larger than shown, see ANSI/ABMA 8.2-1991.

Bearing Closures.—Shields, seals, labyrinths, and slingers are employed to retain the lubricant in the bearing and to prevent the entry of dirt, moisture, or other harmful substances. The type selected for a given application depends upon the lubricant, shaft, speed, and the atmospheric conditions in which the unit is to operate. The shields or seals may be located in the bearing itself. Shields differ from seals in that they are attached to one bearing race but there is a definite clearance between the shield and the other, usually the inner, race. When a shielded bearing is placed in a housing in which the grease space has been filled, the bearing in running will tend to expel excess grease past the shields or to accept grease from the housing when the amount in the bearing itself is low.

Seals of leather, rubber, cork, felt, or plastic composition may be used. Since they must bear against the rotating member, excessive pressure should be avoided and some lubricant must be allowed to flow into the area of contact in order to prevent seizing and burning of the seal and scoring of the rotating member. Some seals are made up in the form of cartridges which can be pressed into the end of the bearing housing.

Leather seals may be used over a wide range of speeds. Although lubricant is best retained with a leather cupped inward toward the bearing, this arrangement is not suitable at high speeds due to danger of burning the leather. At high speeds where abrasive dust is present, the seal should be arranged with the leather cupped outward to lead some lubricant into the contact area. Only light pressure of leather against the shaft should be maintained.

Bearing Fits.—The slipping or creeping of a bearing ring on a rotating shaft or in a rotating housing occurs when the fit of the ring on the shaft or in the housing is loose. Such slipping or creeping action may cause rapid wear of both shaft and bearing ring when the surfaces are dry and highly loaded. To prevent this action the bearing is customarily mounted with the rotating ring a press fit and the stationary ring a push fit, the tightness or looseness depending upon the service intended. Thus, where shock or vibratory loads are to be encountered, fits should be made somewhat tighter than for ordinary service. The stationary ring, if correctly fitted, is allowed to creep very slowly so that prolonged stressing of one part of the raceway is avoided.

To facilitate the assembly of a bearing on a shaft it may become necessary to expand the inner ring by heating. This should be done in clean oil or in a temperature-controlled furnace at a temperature of between 200 and 250°F (93 to 121°C). The utmost care must be used to make sure that the temperature does not exceed 250°F, as overheating will tend to reduce the hardness of the rings. Prelubricated bearings should not be mounted by this method.

Design Considerations

Friction Losses in Rolling Element Bearings.—The static and kinematic torques of rolling element bearings are generally small and in many applications are not significant. Bearing torque is a measure of the frictional resistance of the bearing to rotation and is the sum of three components: the torque due to the applied load; the torque due to viscous forces in lubricated rolling element bearings; and the torque due to roller end motions, for example, thrust loads against flanges. The friction or torque data may be used to calculate power absorption or heat generation within the bearing and can be utilized in efficiency or system-cooling studies.

Empirical equations have been developed for each of the torque components. These equations are influenced by such factors as bearing load, lubrication environment, and bearing design parameters. These design parameters include sliding friction from contact between the rolling elements and separator surfaces or between adjacent rolling elements; rolling friction from material deformations during the passage of the rolling elements over the race path; skidding or sliding of the Hertzian contact; and windage friction as a function of speed.

Starting or breakaway torques are also of interest in some situations. Breakaway torques tend to be between 1.5 and 1.8 times the running or kinetic torques.

When evaluating the torque requirements of a system under design, it should be noted that other components of the bearing package, such as seals and closures, can increase the overall system torque significantly. Seal torques have been shown to vary from a fraction of the bearing torque to several times that torque. In addition, the torque values given can vary significantly when load, speed of rotation, temperature, or lubrication are outside normal ranges.

For small instrument bearings friction torque has implications more critical than for larger types of bearings. These bearings have three operating friction torques to consider: starting torque, normal running torque, and peak running torque. These torque levels may vary between manufacturers and among lots from a given manufacturer.

Instrument bearings are even more critically dependent on design features — radial play, retainer type, and race conformity — than larger bearings. Typical starting torque values for small bearings are given in the accompanying table, extracted from the New Departure General Catalog.

Finally, if accurate control of friction torque is critical to a particular application, tests of the selected bearings should be conducted to evaluate performance.

Starting Torque — ABEC7

Bearing Bore (in.)	Max. Starting Torque (g cm)	Thrust Load (g)	Minimum Radial Play Range (inches)	
			High Carbon Chrome Steel and All Miniatures	Stainless Steel Except Miniatures
0.125	0.10	75	0.0003-0.0005	—
	0.14	75	0.0002-0.0004	0.0004-0.0006
	0.18	75	0.0001-0.0003	0.0003-0.0005
	0.22	75	0.0001-0.0003	0.0001-0.0003
0.1875-0.312	0.40	400	0.0005-0.0008	—
	0.45	400	0.0004-0.0006	0.0005-0.0008
	0.50	400	0.0003-0.0005	0.0003-0.0005
	0.63	400	0.0001-0.0003	0.0002-0.0004
0.375	0.50	400	0.0005-0.0008	0.0008-0.0011
	0.63	400	0.0004-0.0006	0.0005-0.0008
	0.75	400	0.0003-0.0005	0.0004-0.0006
	0.95	400	0.0002-0.0004	0.0003-0.0005

Selection of Ball and Roller Bearings.—As compared with sleeve bearings, ball and roller bearings offer the following advantages: 1) Starting friction is low; 2) Less axial space is required; 3) Relatively accurate shaft alignment can be maintained; 4) Both radial and axial loads can be carried by certain types; 5) Angle of load application is not restricted; 6) Replacement is relatively easy; 7) Comparatively heavy overloads can be carried momentarily; 8) Lubrication is simple; and 9) Design and application can be made with the assistance of bearing supplier engineers.

In selecting a ball or roller bearing for a specific application five choices must be made:

- 1) the bearing series; 2) the type of bearing; 3) the size of bearing; 4) the method of lubrication; and 5) the type of mounting.

Naturally these considerations are modified or affected by the anticipated operating conditions, expected life, cost, and overhaul philosophy.

It is well to review the possible history of the bearing and its function in the machine it will be applied to, thus: 1) Will it be expected to endure removal and reapplication?; 2) Must it be free from maintenance attention during its useful life?; 3) Can wear of the housing or shaft be tolerated during the overhaul period?; 4) Must it be adjustable to take up wear, or to change shaft location?; 5) How accurately can the load spectrum be estimated?; and 6) Will it be relatively free from abuse in operation?.

Though many cautions could be pointed out, it should always be remembered that inadequate design approaches limit the utilization of rolling element bearings, reduce customer satisfaction, and reduce reliability. Time spent in this stage of design is the most rewarding effort of the bearing engineer, and here again he can depend on the bearing manufacturers' field organization for assistance.

Type: Where loads are low, ball bearings are usually less expensive than roller bearings in terms of unit-carrying capacity. Where loads are high, the reverse is usually true.

For a purely radial load, almost any type of radial bearing can be used, the actual choice being determined by other factors. To support a combination of thrust and radial loads, several types of bearings may be considered. If the thrust load component is large, it may be most economical to provide a separate thrust bearing. When a separate thrust bearing cannot be used due to high speed, lack of space, or other factors, the following types may be considered: angular contact ball bearing, deep groove ball bearing without filling slot, tapered roller bearing with steep contact angle, and self-aligning bearing of the wide type. If movement or deflection in an axial direction must be held to a minimum, then a separate thrust bearing or a preloaded bearing capable of taking considerable thrust load is required. To minimize deflection due to a moment in an axial plane, a rigid bearing such as a double row angular contact type with outwardly converging load lines is required. In such cases, the resulting stresses must be taken into consideration in determining the proper size of the bearing.

For shock loads or heavy loads of short duration, roller bearings are usually preferred.

Special bearing designs may be required where accelerations are usually high as in planetary or crank motions.

Where the problem of excessive shaft deflection or misalignment between shaft and housing is present, a self-aligning type of bearing may be a satisfactory solution.

It should be kept in mind that a great deal of difficulty can be avoided if standard types of bearings are used in preference to special designs, wherever possible.

Size: The size of bearing required for a given application is determined by the loads that are to be carried and, in some cases, by the amount of rigidity that is necessary to limit deflection to some specified amount.

The forces to which a bearing will be subjected can be calculated by the laws of engineering mechanics from the known loads, power, operating pressure, etc. Where loads are irregular, varying, or of unknown magnitude, it may be difficult to determine the actual forces. In such cases, empirical determination of such forces, based on extensive experience in bearing design, may be needed to attack the problem successfully. Where such experience is lacking, the bearing manufacturer should be consulted or the services of a bearing expert obtained.

If a ball or roller bearing is to be subjected to a combination of radial and thrust loads, an *equivalent radial load* is computed in the case of radial or angular type bearings and an *equivalent thrust load* is computed in the case of thrust bearings.

Method of Lubrication.—If speeds are high, relubrication difficult, the shaft angle other than horizontal, the application environment incompatible with normal lubrication, leakage cannot be tolerated; if other elements of the mechanism establish the lubrication requirements, bearing selection must be made with these criteria as controlling influences. Modern bearing types cover a wide selection of lubrication means. Though the most popular type is the “cartridge” type of sealed grease ball bearing, many applications have

requirements which dictate against them. Often, operating environments may subject bearings to temperatures too high for seals utilized in the more popular designs. If minute leakage or the accumulation of traces of dirt at seal lips cannot be tolerated by the application (as in baking industry machinery), then the selections of bearings must be made with other sealing and lubrication systems in mind.

High shaft speeds generally dictate bearing selection based on the need for cooling, the suppression of churning or aeration of conventional lubricants, and most important of all, the inherent speed limitations of certain bearing types. An example of the latter is the effect of cage design and of the roller-end thrust-flange contact on the lubrication requirements in commercial taper roller bearings, which limit the speed they can endure and the thrust load they can carry. Reference to the manufacturers' catalog and application-design manuals is recommended before making bearing selections.

See *Selecting a Suitable Lubricant* on page 2433 for more information on this topic.

Type of Mounting.—Many bearing installations are complicated because the best adapted type was not selected. Similarly, performance, reliability, and maintenance operations are restricted because the mounting was not thoroughly considered. There is no universally adaptable bearing for all needs. Careful reviews of the machine requirements should be made before designs are implemented. In many cases complicated machining, redundant shaft and housings, and use of an oversize bearing can be eliminated if the proper bearing in a well-thought-out mounting is chosen.

Advantage should be taken of the many race variations available in “standard” series of bearings. Puller grooves, tapered sleeves, ranged outer races, split races, fully demountable rolling-element and cage assemblies, flexible mountings, hydraulic removal features, relubrication holes and grooves, and many other innovations are available beyond the obvious advantages which are inherent in the basic bearing types.

Radial and Axial Clearance.—In designing the bearing mounting, a major consideration is to provide running clearances consistent with the requirements of the application. Race fits must be expected to absorb some of the original bearing clearance so that allowance should be made for approximately 80 per cent of the actual interference showing up in the diameter of the race. This will increase for heavy, stiff housings or for extra light series races shrunk onto solid shafts, while light metal housings (aluminum, magnesium, or sheet metal) and tubular shafts with wall sections less than the race wall thickness will cause a lesser change in the race diameter.

Where the application will impose heat losses through housing or shaft, or where a temperature differential may be expected, allowances must be made in the proper direction to insure proper operating clearance. Some compromises are required in applications where the indicated modification cannot be fully accommodated without endangering the bearing performance at lower speeds, during starting, or under lower temperature conditions than anticipated. Some leeway can be relied on with ball bearings since they can run with moderate preloads (0.0005 inch or 12.7 μm , max.) without affecting bearing life or temperature rise. Roller bearings, however, have a lesser tolerance for preloading, and must be carefully controlled to avoid overheating and resulting self-destruction.

In all critical applications axial and radial clearances should be checked with feeler gages or dial indicators to insure mounted clearances within tolerances established by the design engineer. Since chips, scores, race misalignment, shaft or housing denting, housing distortion, end cover (closure) off-squareness, and mismatch of rotor and housing axial dimensions can rob the bearing of clearance, careful checks of running clearance is recommended.

For precision applications, taper-sleeve mountings, opposed ball or tapered-roller bearings with adjustable or shimmed closures are employed to provide careful control of radial and/or axial clearances. This practice requires skill and experience as well as the initial assistance of the bearing manufacturer's field engineer.

Tapered bore bearings are often used in applications such as these, again requiring careful and well worked-out assembly procedures. They can be assembled on either tapered shafts or on adapter sleeves. Advancement of the inner race over the tapered shaft can be done either by controlled heating (to expand the race as required) or by the use of a hydraulic jack. The adapter sleeve is supplied with a lock-nut which is used to advance the race on the tapered sleeve. With the heavier fits normally required to effect the clearance changes compatible with such mountings, hydraulic removal devices are normally recommended.

For the conventional application, with standard fits, clearances provided in the standard bearing are suitable for normal operation. To insure that the design conditions are "normal," a careful review of the application requirements, environments, operating speed range, anticipated abuses, and design parameters must be made.

General Bearing Handling Precautions.—To insure that rolling element bearings are capable of achieving their design life and that they perform without objectionable noise, temperature rise, or shaft excursions, the following precautions are recommended:

1) Use the best bearing available for the application, consistent with the value of the application. Remember, the cost of the best bearing is generally small compared to the replacement costs of the rotating components that can be destroyed if a bearing fails or malfunctions.

2) If questions arise in designing the bearing application, seek out the assistance of the bearing manufacturer's representative.

3) Handle bearings with care, keeping them in the sealed, original container until ready to use.

4) Follow the manufacturer's instructions in handling and assembling the bearings.

5) Work with clean tools, clean dry hands, and in clean surroundings.

6) Do not wash or wipe bearings prior to installation unless special instructions or requirements have been established to do so.

7) Place unwrapped bearings on clean paper and keep them similarly covered until applied, if they cannot be kept in the original container.

8) Don't use wooden mallets, brittle or chipped tools, or dirty fixtures and tools in mounting bearings.

9) Don't spin uncleaned bearings, nor spin *any* bearing with an air blast.

10) Use care not to scratch or nick bearings.

11) Don't strike or press on race flanges.

12) Use adapters for mounting which provide uniform steady pressure rather than hammering on a drift or sleeve.

13) Insure that races are started onto shafts and into housings evenly so as to prevent cocking.

14) Inspect shafts and housings before mounting bearing to insure that proper fits will be maintained.

15) When removing bearings, clean housings, covers, and shafts before exposing the bearings. All dirt can be considered an abrasive, dangerous to the reuse of any rolling bearing.

16) Treat used bearings, which may be reused, as new ones.

17) Protect dismantled bearings from dirt and moisture.

18) Use clean, lint-free rags if bearings are wiped.

19) Wrap bearings in clean, oil-proof paper when not in use.

20) Use clean filtered, water-free Stoddard's solvent or flushing oil to clean bearings.

21) In heating bearings for mounting onto shafts, follow manufacturer's instructions.

22) In assembling bearings onto shafts *never* strike the outer race, or press on it to force the inner race. Apply the pressure on the inner race only. In dismantling follow the same precautions.

23) Do not press, strike, or otherwise force the seal or shield on factory-sealed bearings.

Bearing Failures, Deficiencies, and Their Origins.—The general classifications of failures and deficiencies requiring bearing removal are:

1) Overheating due to a) Inadequate or insufficient lubrication; b) Excessive lubrication; c) Grease liquefaction or aeration; d) Oil foaming; e) Abrasive or corrosive action due to contaminants in bearing; f) Distortion of housing due to warping, or out-of-round; g) Seal rubbing or failure; h) Inadequate or blocked scavenge oil passages; i) Inadequate bearing-clearance or bearing-preload; j) Race turning; k) Cage wear; and l) Shaft expansion-loss of bearing or seal clearance.

2) Vibration due to a) Dirt or chips in bearing; b) Fatigued race or rolling elements; c) Race turning; d) Rotor unbalance; e) Out-of-round shaft; f) Race misalignment; g) Housing resonance; h) Cage wear; i) Flats on races or rolling elements; j) Excessive clearance; k) Corrosion; l) False-brinelling or indentation of races; m) Electrical discharge (similar to corrosion effects); n) Mixed rolling element diameters; and o) Out-of-square rolling paths in races.

3) Turning on shaft due to a) Growth of race due to overheating; b) Fretting wear; c) Improper initial fit; d) Excessive shaft deflection; e) Initially coarse shaft finish; and f) Seal rub on inner race.

4) Binding of the shaft due to a) Lubricant breakdown; b) Contamination by abrasive or corrosive matter; c) Housing distortion or out-of-round pinching bearing; d) Uneven shimming of housing with loss of clearance; e) Tight rubbing seals; f) Preloaded bearings; g) Cocked races; h) Loss of clearance due to excessive tightening of adapter; i) Thermal expansion of shaft or housing; and j) Cage failure.

5) Noisy bearing due to a) Lubrication breakdown, inadequate lubrication, stiff grease; b) Contamination; c) Pinched bearing; d) Seal rubbing; e) Loss of clearance and preloading; f) Bearing slipping on shaft or in housing; g) Flatted roller or ball; h) Brinelling due to assembly abuse, handling, or shock loads; i) Variation in size of rolling elements; j) Out-of-round or lobular shaft; k) Housing bore waviness; and l) Chips or scores under bearing race seat.

6) Displaced shaft due to a) Bearing wear; b) Improper housing or closure assembly; c) Overheated and shifted bearing; d) Inadequate shaft or housing shoulder; e) Lubrication and cage failure permitting rolling elements to bunch; f) Loosened retainer nut or adapter; g) Excessive heat application in assembling inner race, causing growth and shifting on shaft; and h) Housing pounding out.

7) Lubricant leakage due to a) Overfilling of lubricant; b) Grease churning due to use of too soft a consistency; c) Grease deterioration due to excessive operating temperature; d) Operating life longer than grease life (grease breakdown, aeration, and purging); e) Seal wear; f) Wrong shaft attitude (bearing seals designed for horizontal mounting only); g) Seal failure; h) Clogged breather; i) Oil foaming due to churning or air flow through housing; j) Gasket (O-ring) failure or misapplication; k) Porous housing or closure; and l) Lubricator set at wrong flow rate.

Load Ratings and Fatigue Life

Ball and Roller Bearing Life.—The performance of ball and roller bearings is a function of many variables. These include the bearing design, the characteristics of the material from which the bearings are made, the way in which they are manufactured, as well as many variables associated with their application. The only sure way to establish the satisfactory operation of a bearing selected for a specific application is by actual performance in the application. As this is often impractical, another basis is required to estimate the suitability of a particular bearing for a given application. Two factors are taken into consideration: the bearing fatigue life, and its ability to withstand static loading.

Life Criterion: Even if a ball or roller bearing is properly mounted, adequately lubricated, protected from foreign matter and not subjected to extreme operating conditions, it

can ultimately fatigue. Under ideal conditions, the repeated stresses developed in the contact areas between the balls or rollers and the raceways eventually can result in the fatigue of the material which manifests itself with the spalling of the load-carrying surfaces. In most applications the fatigue life is the maximum useful life of a bearing.

Static Load Criterion: A static load is a load acting on a non-rotating bearing. Permanent deformations appear in balls or rollers and raceways under a static load of moderate magnitude and increase gradually with increasing load. The permissible static load is, therefore, dependent upon the permissible magnitude of permanent deformation. It has been found that for ball and roller bearings suitably manufactured from hardened alloy steel, deformations occurring under maximum contact stress of 4,000 megapascals (580,000 pounds per square inch) acting at the center of contact (in the case of roller bearings, of a uniformly loaded roller) do not greatly impair smoothness or friction. Depending on requirements for smoothness of operation, friction, or sound level, higher or lower static load limits may be tolerated.

Ball Bearing Types Covered.—AFBMA and American National Standard ANSI/ABMA 9-1990 sets forth the method of determining ball bearing Rating Life and Static Load Rating and covers the following types:

1) *Radial, deep groove and angular contact ball bearings* whose inner ring raceways have a cross-sectional radius not larger than 52 percent of the ball diameter and whose outer ring raceways have a cross-sectional radius not larger than 53 percent of the ball diameter.

2) *Radial, self-aligning ball bearings* whose inner ring raceways have cross-sectional radii not larger than 53 percent of the ball diameter.

3) *Thrust ball bearings* whose washer raceways have cross-sectional radii not larger than 54 percent of the ball diameter.

4) *Double row, radial and angular contact ball bearings* and double direction thrust ball bearings are presumed to be symmetrical.

Limitations for Ball Bearings.—The following limitations apply:

1) *Truncated contact area.* This standard* may not be safely applied to ball bearings subjected to loading which causes the contact area of the ball with the raceway to be truncated by the raceway shoulder. This limitation depends strongly on details of bearing design which are not standardized.

2) *Material.* This standard applies only to ball bearings fabricated from hardened good quality steel.

3) *Types.* The f_c factors specified in the basic load rating formulas are valid only for those ball bearing types specified above.

4) *Lubrication.* The Rating Life calculated according to this standard is based on the assumption that the bearing is adequately lubricated. The determination of adequate lubrication depends upon the bearing application.

5) *Ring support and alignment.* The Rating Life calculated according to this standard assumes that the bearing inner and outer rings are rigidly supported and the inner and outer ring axes are properly aligned.

6) *Internal clearance.* The radial ball bearing Rating Life calculated according to this standard is based on the assumption that only a nominal interior clearance occurs in the mounted bearing at operating speed, load and temperature.

7) *High speed effects.* The Rating Life calculated according to this standard does not account for high speed effects such as ball centrifugal forces and gyroscopic moments. These effects tend to diminish fatigue life. Analytical evaluation of these effects frequently requires the use of high speed digital computation devices and hence is not covered in the standard.

* All references to "standard" are to AFBMA and American National Standard "Load Ratings and Fatigue Life for Ball Bearings" ANSI/ABMA 9-1990.

8) *Groove radii.* If groove radii are smaller than those specified in the bearing types covered, the ability of a bearing to resist fatigue is not improved: however, it is diminished by the use of larger radii.

Ball Bearing Rating Life.—According to the Anti-Friction Bearing Manufacturers Association standards the Rating Life L_{10} of a group of apparently identical ball bearings is the life in millions of revolutions that 90 percent of the group will complete or exceed. For a single bearing, L_{10} also refers to the life associated with 90 percent reliability.

Radial and Angular Contact Ball Bearings: The magnitude of the Rating Life L_{10} in millions of revolutions, for a radial or angular contact ball bearing application is given by the formula:

$$L_{10} = \left(\frac{C}{P}\right)^3 \tag{1}$$

where C = basic load rating, newtons (pounds). See Formulas (2), (3a) and (3b)

P = equivalent radial load, newtons (pounds). See Formula (4)

Table 27. Values of f_c for Radial and Angular Contact Ball Bearings

$\frac{D \cos \alpha}{d_m}$	Single Row Radial Contact; Single and Double Row Angular Contact, Groove Type ^a		Double Row Radial Contact Groove Type		Self-Aligning	
	Metric ^b	Inch ^c	Metric ^b	Inch ^c	Metric ^b	Inch ^c
0.05	46.7	3550	44.2	3360	17.3	1310
0.06	49.1	3730	46.5	3530	18.6	1420
0.07	51.1	3880	48.4	3680	19.9	1510
0.08	52.8	4020	50.0	3810	21.1	1600
0.09	54.3	4130	51.4	3900	22.3	1690
0.10	55.5	4220	52.6	4000	23.4	1770
0.12	57.5	4370	54.5	4140	25.6	1940
0.14	58.8	4470	55.7	4230	27.7	2100
0.16	59.6	4530	56.5	4290	29.7	2260
0.18	59.9	4550	56.8	4310	31.7	2410
0.20	59.9	4550	56.8	4310	33.5	2550
0.22	59.6	4530	56.5	4290	35.2	2680
0.24	59.0	4480	55.9	4250	36.8	2790
0.26	58.2	4420	55.1	4190	38.2	2910
0.28	57.1	4340	54.1	4110	39.4	3000
0.30	56.0	4250	53.0	4030	40.3	3060
0.32	54.6	4160	51.8	3950	40.9	3110
0.34	53.2	4050	50.4	3840	41.2	3130
0.36	51.7	3930	48.9	3730	41.3	3140
0.38	50.0	3800	47.4	3610	41.0	3110
0.40	48.4	3670	45.8	3480	40.4	3070

^aA. When calculating the basic load rating for a unit consisting of two similar, single row, radial contact ball bearings, in a duplex mounting, the pair is considered as one, double row, radial contact ball bearing.

B. When calculating the basic load rating for a unit consisting of two, similar, single row, angular contact ball bearings in a duplex mounting, “face-to-face” or “back-to-back,” the pair is considered as one, double row, angular contact ball bearing.

C. When calculating the basic load rating for a unit consisting of two or more similar, single angular contact ball bearings mounted “in tandem,” properly manufactured and mounted for equal load distribution, the rating of the combination is the number of bearings to the 0.7 power times the rating of a single row ball bearing. If the unit may be treated as a number of individually interchangeable single row bearings, this footnote “C” does not apply.

^bUse to obtain C in newtons when D is given in mm.

^cUse to obtain C in pounds when D is given in inches.

Table 28. Values of X and Y for Computing Equivalent Radial Load P of Radial and Angular Contact Ball Bearings

Contact Angle, α	Table Entering Factors ^a			Single Row Bearings ^b			Double Row Bearings			
				$\frac{F_a}{F_r} > e$			$\frac{F_a}{F_r} \leq e$		$\frac{F_a}{F_r} > e$	
RADIAL CONTACT GROOVE BEARINGS										
	F_d/C_o	F_d/iZD^2		e	X	Y	X	Y	X	Y
		Metric Units	Inch Units							
0°	0.014	0.172	25	0.19		2.30				2.30
	0.028	0.345	50	0.22		1.99				1.99
	0.056	0.689	100	0.26		1.71				1.71
	0.084	1.03	150	0.28		1.56				1.55
	0.11	1.38	200	0.30	0.56	1.45	1	0	0.56	1.45
	0.17	2.07	300	0.34		1.31				1.31
	0.28	3.45	500	0.38		1.15				1.15
	0.42	5.17	750	0.42		1.04				1.04
	0.56	6.89	1000	0.44		1.00				1.00
ANGULAR CONTACT GROOVE BEARINGS										
	iF_d/C_o	F_d/ZD^2		e	X	Y	X	Y	X	Y
		Metric Units	Inch Units							
5°	0.014	0.172	25	0.23	For this type use the X, Y, and e values applicable to single row radial contact bearings			2.78	0.78	3.74
	0.028	0.345	50	0.26			2.40		3.23	
	0.056	0.689	100	0.30			2.07		2.78	
	0.085	1.03	150	0.34			1.87		2.52	
	0.11	1.38	200	0.36			1.75	1	2.36	
	0.17	2.07	300	0.40			1.58		2.13	
	0.28	3.45	500	0.45			1.39		1.87	
	0.42	5.17	750	0.50			1.26		1.69	
	0.56	6.89	1000	0.52			1.21		1.63	
10°	0.014	0.172	25	0.29		1.88		2.18		3.06
	0.029	0.345	50	0.32		1.71		1.98		2.78
	0.057	0.689	100	0.36		1.52		1.76		2.47
	0.086	1.03	150	0.38		1.41		1.63		2.20
	0.11	1.38	200	0.40	0.46	1.34	1	1.55	0.75	2.18
	0.17	2.07	300	0.44		1.23		1.42		2.00
	0.29	3.45	500	0.49		1.10		1.27		1.79
	0.43	5.17	750	0.54		1.01		1.17		1.64
	0.57	6.89	1000	0.54		1.00		1.16		1.63
15°	0.015	0.172	25	0.38		1.47		1.65		2.39
	0.029	0.345	50	0.40		1.40		1.57		2.28
	0.058	0.689	100	0.43		1.30		1.46		2.11
	0.087	1.03	150	0.46		1.23		1.38		2.00
	0.12	1.38	200	0.47	0.44	1.19	1	1.34	0.72	1.93
	0.17	2.07	300	0.50		1.12		1.26		1.82
	0.29	3.45	500	0.55		1.02		1.14		1.66
	0.44	5.17	750	0.56		1.00		1.12		1.63
	0.58	6.89	1000	0.56		1.00		1.12		1.63
20°	0.57	0.43	1.00	1	1.09	0.70	1.63
25°	0.68	0.41	0.87	1	0.92	0.67	1.41
30°	0.80	0.39	0.76	1	0.78	0.63	1.24
35°	0.95	0.37	0.66	1	0.66	0.60	1.07
40°	1.14	0.35	0.57	1	0.55	0.57	0.98
Self-aligning Ball Bearings				$1.5 \tan \alpha$	0.40	$0.4 \cot \alpha$	1	$0.42 \cot \alpha$	0.65	$0.65 \cot \alpha$

^a Symbol definitions are given on the following page.

^b For single row bearings when $F_d/F_r \leq e$, use $X = 1, Y = 0$. Two similar, single row, angular contact ball bearings mounted face-to-face or back-to-back are considered as one double row, angular contact bearing.

Values of X, Y, and e for a load or contact angle other than shown are obtained by linear interpolation. Values of X, Y, and e do not apply to filling slot bearings for applications in which ball-raceway

contact areas project substantially into the filling slot under load. Symbol Definitions: F_a is the applied axial load in newtons (pounds); C_o is the static load rating in newtons (pounds) of the bearing under consideration and is found by [Formula \(20\)](#); i is the number of rows of balls in the bearing; Z is the number of balls per row in a radial or angular contact bearing or the number of balls in a single row, single direction thrust bearing; D is the ball diameter in millimeters (inches); and F_r is the applied radial load in newtons (pounds).

For radial and angular contact ball bearings with balls not larger than 25.4 mm (1 inch) in diameter, C is found by the formula:

$$C = f_c(i \cos \alpha)^{0.7} Z^{2/3} D^{1.8} \tag{2}$$

and with balls larger than 25.4 mm (1 inch) in diameter C is found by the formula:

$$C = 3.647 f_c(i \cos \alpha)^{0.7} Z^{2/3} D^{1.4} \quad (\text{metric}) \tag{3a}$$

$$C = f_c(i \cos \alpha)^{0.7} Z^{2/3} D^{1.4} \quad (\text{inch}) \tag{3b}$$

where f_c = a factor which depends on the geometry of the bearing components, the accuracy to which the various bearing parts are made and the material. Values of f_c , are given in [Table 27](#)

i = number of rows of balls in the bearing

α = nominal contact angle, degrees

Z = number of balls per row in a radial or angular contact bearing

D = ball diameter, mm (inches)

The magnitude of the equivalent radial load, P , in newtons (pounds) for radial and angular contact ball bearings, under combined constant radial and constant thrust loads is given by the formula:

$$P = XF_r + YF_a \tag{4}$$

where F_r = the applied radial load in newtons (pounds)

F_a = the applied axial load in newtons (pounds)

X = radial load factor as given in [Table 30](#)

Y = axial load factor as given in [Table 30](#)

Thrust Ball Bearings: The magnitude of the Rating Life L_{10} in millions of revolutions for a thrust ball bearing application is given by the formula:

$$L_{10} = \left(\frac{C_a}{P_a} \right)^3 \tag{5}$$

where C_a = the basic load rating, newtons (pounds). See [Formulas \(6\) to \(10\)](#)

P_a = equivalent thrust load, newtons (pounds). See [Formula \(11\)](#)

For single row, single and double direction, thrust ball bearing with balls not larger than 25.4 mm (1 inch) in diameter, C_a is found by the formulas:

$$\text{for } \alpha = 90 \text{ degrees, } C_a = f_c Z^{2/3} D^{1.8} \tag{6}$$

$$\text{for } \alpha \neq 90 \text{ degrees, } C_a = f_c (\cos \alpha)^{0.7} Z^{2/3} D^{1.8} \tan \alpha \tag{7}$$

and with balls larger than 25.4 mm (1 inch) in diameter, C_a is found by the formulas:

$$\text{for } \alpha = 90 \text{ degrees, } C_a = 3.647 f_c Z^{2/3} D^{1.4} \quad (\text{metric}) \tag{8a}$$

$$C_a = f_c Z^{2/3} D^{1.4} \quad (\text{inch}) \tag{8b}$$

$$\text{for } \alpha \neq 90 \text{ degrees, } C_a = 3.647 f_c (\cos \alpha)^{0.7} Z^{2/3} D^{1.4} \tan \alpha \quad (\text{metric}) \tag{9a}$$

$$C_a = f_c (\cos \alpha)^{0.7} Z^{2/3} D^{1.4} \tan \alpha \quad (\text{inch}) \tag{9b}$$

where f_c = a factor which depends on the geometry of the bearing components, the accuracy to which the various bearing parts are made, and the material. Values of f_c are given in **Table 29**

Z = number of balls per row in a single row, single direction thrust ball bearing

D = ball diameter, mm (inches)

α = nominal contact angle, degrees

Table 29. Values of f_c for Thrust Ball Bearings

$\frac{D}{d_m}$	$\alpha = 90^\circ$		$D \cos \alpha$	$\alpha = 45^\circ$		$\alpha = 60^\circ$		$\alpha = 75^\circ$	
	Metric ^a	Inch ^b		Metric ^a	Inch ^b	Metric ^a	Inch ^b	Metric ^a	Inch ^b
0.01	36.7	2790	0.01	42.1	3200	39.2	2970	37.3	2840
0.02	45.2	3430	0.02	51.7	3930	48.1	3650	45.9	3490
0.03	51.1	3880	0.03	58.2	4430	54.2	4120	51.7	3930
0.04	55.7	4230	0.04	63.3	4810	58.9	4470	56.1	4260
0.05	59.5	4520	0.05	67.3	5110	62.6	4760	59.7	4540
0.06	62.9	4780	0.06	70.7	5360	65.8	4990	62.7	4760
0.07	65.8	5000	0.07	73.5	5580	68.4	5190	65.2	4950
0.08	68.5	5210	0.08	75.9	5770	70.7	5360	67.3	5120
0.09	71.0	5390	0.09	78.0	5920	72.6	5510	69.2	5250
0.10	73.3	5570	0.10	79.7	6050	74.2	5630	70.7	5370
0.12	77.4	5880	0.12	82.3	6260	76.6	5830
0.14	81.1	6160	0.14	84.1	6390	78.3	5950
0.16	84.4	6410	0.16	85.1	6470	79.2	6020
0.18	87.4	6640	0.18	85.5	6500	79.6	6050
0.20	90.2	6854	0.20	85.4	6490	79.5	6040
0.22	92.8	7060	0.22	84.9	6450
0.24	95.3	7240	0.24	84.0	6380
0.26	97.6	7410	0.26	82.8	6290
0.28	99.8	7600	0.28	81.3	6180
0.30	101.9	7750	0.30	79.6	6040
0.32	103.9	7900
0.34	105.8	8050

^a Use to obtain C_a in newtons when D is given in mm.

^b Use to obtain C_a in pounds when D is given in inches.

For thrust ball bearings with two or more rows of similar balls carrying loads in the same direction, the basic load rating, C_a , in newtons (pounds) is found by the formula:

$$C_a = (Z_1 + Z_2 + \dots + Z_n) \left[\left(\frac{Z_1}{C_{a1}} \right)^{10/3} + \left(\frac{Z_2}{C_{a2}} \right)^{10/3} + \dots + \left(\frac{Z_n}{C_{an}} \right)^{10/3} \right]^{-0.3} \tag{10}$$

where Z_1, Z_2, \dots, Z_n = number of balls in respective rows of a single-direction multi-row thrust ball bearing

$C_{a1}, C_{a2}, \dots, C_{an}$ = basic load rating per row of a single-direction, multi-row thrust ball bearing, each calculated as a single-row bearing with Z_1, Z_2, \dots, Z_n balls, respectively

The magnitude of the equivalent thrust load, P_a , in newtons (pounds) for thrust ball bearings with $\alpha \neq 90$ degrees under combined constant thrust and constant radial loads is found by the formula:

$$P_a = XF_r + YF_a \tag{11}$$

where F_r = the applied radial load in newtons (pounds)

F_a = the applied axial load in newtons (pounds)

X = radial load factor as given in **Table 30**

Y = axial load factor as given in **Table 30**

Table 30. Values of X and Y for Computing Equivalent Thrust Load P_a for Thrust Ball Bearings

Contact Angle α	e	Single Direction Bearings		Double Direction Bearings			
		$\frac{F_a}{F_r} > e$		$\frac{F_a}{F_r} \leq e$		$\frac{F_a}{F_r} > e$	
		X	Y	X	Y	X	Y
45°	1.25	0.66	1	1.18	0.59	0.66	1
60°	2.17	0.92	1	1.90	0.54	0.92	1
75°	4.67	1.66	1	3.89	0.52	1.66	1

For $\alpha = 90^\circ$, $F_r = 0$ and $Y = 1$.

Roller Bearing Types Covered.—This standard* applies to *cylindrical, tapered and self-aligning radial and thrust roller bearings* and to *needle roller bearings*. These bearings are presumed to be within the size ranges shown in the AFBMA dimensional standards, of good quality and produced in accordance with good manufacturing practice.

Roller bearings vary considerably in design and execution. Since small differences in relative shape of contacting surfaces may account for distinct differences in load carrying ability, this standard does not attempt to cover all design variations, rather it applies to basic roller bearing designs.

The following limitations apply:

1) *Truncated contact area.* This standard may not be safely applied to roller bearings subjected to application conditions which cause the contact area of the roller with the raceway to be severely truncated by the edge of the raceway or roller.

2) *Stress concentrations.* A cylindrical, tapered or self-aligning roller bearing must be expected to have a basic load rating less than that obtained using a value of f_c taken from Table 31 or 32 if, under load, a stress concentration is present in some part of the roller-raceway contact. Such stress concentrations occur in the center of nominal point contacts, at the contact extremities for line contacts and at inadequately blended junctions of a rolling surface profile. Stress concentrations can also occur if the rollers are not accurately guided such as in bearings without cages and bearings not having rigid integral flanges. Values of f_c given in Tables 31 and 32 are based upon bearings manufactured to achieve optimized contact. For no bearing type or execution will the factor f_c be greater than that obtained in Tables 31 and 32.

3) *Material.* This standard applies only to roller bearings fabricated from hardened, good quality steel.

4) *Lubrication.* Rating Life calculated according to this standard is based on the assumption that the bearing is adequately lubricated. Determination of adequate lubrication depends upon the bearing application.

5) *Ring support and alignment.* Rating Life calculated according to this standard assumes that the bearing inner and outer rings are rigidly supported, and that the inner and outer ring axes are properly aligned.

6) *Internal clearance.* Radial roller bearing Rating Life calculated according to this standard is based on the assumption that only a nominal internal clearance occurs in the mounted bearing at operating speed, load, and temperature.

7) *High speed effects.* The Rating Life calculated according to this standard does not account for high speed effects such as roller centrifugal forces and gyroscopic moments: These effects tend to diminish fatigue life. Analytical evaluation of these effects frequently requires the use of high speed digital computation devices and hence, cannot be included.

* All references to “standard” are to AFBMA and American National Standard “Load Ratings and Fatigue Life for Roller Bearings” ANSI/AFBMA Std 11-1990.

Table 31. Values of f_c for Radial Roller Bearings

$\frac{D \cos \alpha}{d_m}$	f_c		$\frac{D \cos \alpha}{d_m}$	f_c		$\frac{D \cos \alpha}{d_m}$	f_c	
	Metric ^a	Inch ^b		Metric ^a	Inch ^b		Metric ^a	Inch ^b
0.01	52.1	4680	0.18	88.8	7980	0.35	79.5	7140
0.02	60.8	5460	0.19	88.8	7980	0.36	78.6	7060
0.03	66.5	5970	0.20	88.7	7970	0.37	77.6	6970
0.04	70.7	6350	0.21	88.5	7950	0.38	76.7	6890
0.05	74.1	6660	0.22	88.2	7920	0.39	75.7	6800
0.06	76.9	6910	0.23	87.9	7890	0.40	74.6	6700
0.07	79.2	7120	0.24	87.5	7850	0.41	73.6	6610
0.08	81.2	7290	0.25	87.0	7810	0.42	72.5	6510
0.09	82.8	7440	0.26	86.4	7760	0.43	71.4	6420
0.10	84.2	7570	0.27	85.8	7710	0.44	70.3	6320
0.11	85.4	7670	0.28	85.2	7650	0.45	69.2	6220
0.12	86.4	7760	0.29	84.5	7590	0.46	68.1	6120
0.13	87.1	7830	0.30	83.8	7520	0.47	67.0	6010
0.14	87.7	7880	0.31	83.0	7450	0.48	65.8	5910
0.15	88.2	7920	0.32	82.2	7380	0.49	64.6	5810
0.16	88.5	7950	0.33	81.3	7300	0.50	63.5	5700
0.17	88.7	7970	0.34	80.4	7230

^a For $\alpha = 0^\circ$, $F_a = 0$ and $X = 1$.

^b Use to obtain C in pounds when l_{eff} and D are given in inches.

Table 32. Values of f_c for Thrust Roller Bearings

$\frac{D \cos \alpha}{d_m}$	$45^\circ < \alpha < 60^\circ$		$60^\circ < \alpha < 75^\circ$		$75^\circ \leq \alpha < 90^\circ$		$\frac{D}{d_m}$	$\alpha = 90^\circ$	
	f_c							f_c	
	Metric ^a	Inch ^b	Metric ^a	Inch ^b	Metric ^a	Inch ^b		Metric ^a	Inch ^b
0.01	109.7	9840	107.1	9610	105.6	9470	0.01	105.4	9500
0.02	127.8	11460	124.7	11180	123.0	11030	0.02	122.9	11000
0.03	139.5	12510	136.2	12220	134.3	12050	0.03	134.5	12100
0.04	148.3	13300	144.7	12980	142.8	12810	0.04	143.4	12800
0.05	155.2	13920	151.5	13590	149.4	13400	0.05	150.7	13200
0.06	160.9	14430	157.0	14080	154.9	13890	0.06	156.9	14100
0.07	165.6	14850	161.6	14490	159.4	14300	0.07	162.4	14500
0.08	169.5	15200	165.5	14840	163.2	14640	0.08	167.2	15100
0.09	172.8	15500	168.7	15130	166.4	14930	0.09	171.7	15400
0.10	175.5	15740	171.4	15370	169.0	15160	0.10	175.7	15900
0.12	179.7	16120	175.4	15730	173.0	15520	0.12	183.0	16300
0.14	182.3	16350	177.9	15960	175.5	15740	0.14	189.4	17000
0.16	183.7	16480	179.3	16080	0.16	195.1	17500
0.18	184.1	16510	179.7	16120	0.18	200.3	18000
0.20	183.7	16480	179.3	16080	0.20	205.0	18500
0.22	182.6	16380	0.22	209.4	18800
0.24	180.9	16230	0.24	213.5	19100
0.26	178.7	16030	0.26	217.3	19600
0.28	0.28	220.9	19900
0.30	0.30	224.3	20100

^a Use to obtain C_a in newtons when l_{eff} and D are given in mm.

^b Use to obtain C_a in pounds when l_{eff} and D are given in inches.

Roller Bearing Rating Life.—The Rating Life L_{10} of a group of apparently identical roller bearings is the life in millions of revolutions that 90 percent of the group will complete or exceed. For a single bearing, L_{10} also refers to the life associated with 90 percent reliability.

Radial Roller Bearings: The magnitude of the Rating Life, L_{10} , in millions of revolutions, for a radial roller bearing application is given by the formula:

$$L_{10} = \left(\frac{C}{P}\right)^{10/3} \tag{12}$$

where C = the basic load rating in newtons (pounds), see **Formula (13)**; and, P = equivalent radial load in newtons (pounds), see **Formula (14)**.

For radial roller bearings, C is found by the formula:

$$C = f_c (i l_{eff} \cos \alpha)^{7/9} Z^{3/4} D^{29/27} \tag{13}$$

where f_c = a factor which depends on the geometry of the bearing components, the accuracy to which the various bearing parts are made, and the material. Maximum values of f_c are given in **Table 31**

i = number of rows of rollers in the bearing

l_{eff} = effective length, mm (inches) α = nominal contact angle, degrees

Z = number of rollers per row in a radial roller bearing

D = roller diameter, mm (inches) (mean diameter for a tapered roller, major diameter for a spherical roller)

When rollers are longer than $2.5D$, a reduction in the f_c value must be anticipated. In this case, the bearing manufacturer may be expected to establish load ratings accordingly.

In applications where rollers operate directly on a shaft surface or a housing surface, such a surface must be equivalent in all respects to the raceway it replaces to achieve the basic load rating of the bearing.

When calculating the basic load rating for a unit consisting of two or more similar single-row bearings mounted “in tandem,” properly manufactured and mounted for equal load distribution, the rating of the combination is the number of bearings to the 7/9 power times the rating of a single-row bearing. If, for some technical reason, the unit may be treated as a number of individually interchangeable single-row bearings, this consideration does not apply.

The magnitude of the equivalent radial load, P , in newtons (pounds), for radial roller bearings, under combined constant radial and constant thrust loads is given by the formula:

$$P = XF_r + YF_a \tag{14}$$

where F_r = the applied radial load in newtons (pounds)

F_a = the applied axial load in newtons (pounds)

X = radial load factor as given in **Table 33**

Y = axial load factor as given in **Table 33**

Table 33. Values of X and Y for Computing Equivalent Radial Load P for Radial Roller Bearing

Bearing Type	$\frac{F_a}{F_r} \leq e$		$\frac{F_a}{F_r} > e$	
	X	Y	X	Y
Self-Aligning and Tapered Roller Bearings ^a $\alpha \neq 0^\circ$	Single Row Bearings			
	1	0	0.4	$0.4 \cot \alpha$
	Double Row Bearings ^a			
	1	$0.45 \cot \alpha$	0.67	$0.67 \cot \alpha$

^a For $\alpha = 0^\circ$, $F_a = 0$ and $X = 1$.

$e = 1.5 \tan \alpha$

Typical Bearing Life for Various Design Applications

Uses	Design life in hours	Uses	Design life in hours
Agricultural equipment	3000 - 6000	Gearing units	
Aircraft equipment	500 - 2000	Automotive	600 - 5000
Automotive		Multipurpose	8000 - 15000
Race car	500 - 800	Machine tools	20000
Light motor cycle	600 - 1200	Rail Vehicles	15000 - 25000
Heavy motor cycle	1000 - 2000	Heavy rolling mill	> 50000
Light cars	1000 - 2000	Machines	
Heavy cars	1500 - 2500	Beater mills	20000 - 30000
Light trucks	1500 - 2500	Briquette presses	20000 - 30000
Heavy trucks	2000 - 2500	Grinding spindles	1000 - 2000
Buses	2000 - 5000	Machine tools	10000 - 30000
Electrical		Mining machinery	4000 - 15000
Household appliances	1000 - 2000	Paper machines	50000 - 80000
Motors $\leq \frac{1}{2}$ hp	1000 - 2000	Rolling mills	
Motors ≤ 3 hp	8000 - 10000	Small cold mills	5000 - 6000
Motors, medium	10000 - 15000	Large multipurpose mills	8000 - 10000
Motors, large	20000 - 30000	Rail vehicle axle	
Elevator cables sheaves	40000 - 60000	Mining cars	5000
Mine ventilation fans	40000 - 50000	Motor rail cars	16000 - 20000
Propeller thrust bearings	15000 - 25000	Open-pit mining cars	20000 - 25000
Propeller shaft bearings	> 80000	Streetcars	20000 - 25000
Gear drives		Passenger cars	26000
Boat gearing units	3000 - 5000	Freight cars	35000
Gear drives	> 50000	Locomotive outer bearings	20000 - 25000
Ship gear drives	20000 - 30000	Locomotive inner bearings	30000 - 40000
Machinery for 8 hour service which are not always fully utilized	14000 - 20000	Machinery for short or intermittent operation where service interruption is of minor importance	4000 - 8000
Machinery for 8 hour service which are fully utilized	20000 - 30000	Machinery for intermittent service where reliable operation is of great importance	8000 - 14000
Machinery for continuous 24 hour service	50000 - 60000	Instruments and apparatus in frequent use	0 - 500

Roller bearings are generally designed to achieve optimized contact; however, they usually support loads other than the loading at which optimized contact is maintained. The $10/3$ exponent in Rating Life Formulas (12) and (15) was selected to yield satisfactory Rating Life estimates for a broad spectrum from light to heavy loading. When loading exceeds that which develops optimized contact, e.g., loading greater than $C/4$ to $C/2$ or $C_d/4$ to $C_d/2$, the user should consult the bearing manufacturer to establish the adequacy of the Rating Life formulas for the particular application.

Thrust Roller Bearings: The magnitude of the Rating Life, L_{10} , in millions of revolutions for a thrust roller bearing application is given by the formula:

$$L_{10} = \left(\frac{C_a}{P_a} \right)^{10/3} \quad (15)$$

where C_a = basic load rating, newtons (pounds). See Formulas (16) to (18)

P_a = equivalent thrust load, newtons (pounds). See Formula (19)

For single row, single and double direction, thrust roller bearings, the magnitude of the basic load rating, C_a , in newtons (pounds), is found by the formulas:

$$\text{for } \alpha = 90^\circ, C_a = f_c l_{eff}^{7/9} Z^{3/4} D^{29/27} \quad (16)$$

$$\text{for } \alpha \neq 90^\circ, C_a = f_c(l_{eff} \cos \alpha)^{7/9} Z^{3/4} D^{29/27} \tan \alpha \tag{17}$$

where f_c = a factor which depends on the geometry of the bearing components, the accuracy to which the various parts are made, and the material. Values of f_c are given in **Table 32**

l_{eff} = effective length, mm (inches)

Z = number of rollers in a single row, single direction, thrust roller bearing

D = roller diameter, mm (inches) (mean diameter for a tapered roller, major diameter for a spherical roller)

α = nominal contact angle, degrees

For thrust roller bearings with two or more rows of rollers carrying loads in the same direction the magnitude of C_a is found by the formula:

$$C_a = (Z_1 l_{eff1} + Z_2 l_{eff2} \dots Z_n l_{effn}) \left\{ \left[\frac{Z_1 l_{eff1}}{C_{a1}} \right]^{9/2} + \left[\frac{Z_2 l_{eff2}}{C_{a2}} \right]^{9/2} + \dots \left[\frac{Z_n l_{effn}}{C_{an}} \right]^{9/2} \right\}^{-2/9} \tag{18}$$

Where $Z_1, Z_2 \dots Z_n$ = the number of rollers in respective rows of a single direction, multi-row bearing

$C_{a1}, C_{a2} \dots C_{an}$ = the basic load rating per row of a single direction, multi-row, thrust roller bearing, each calculated as a single row bearing with $Z_1, Z_2 \dots Z_n$ rollers respectively

$l_{eff1}, l_{eff2} \dots l_{effn}$ = effective length, mm (inches), or rollers in the respective rows

In applications where rollers operate directly on a surface supplied by the user, such a surface must be equivalent in all respects to the washer raceway it replaces to achieve the basic load rating of the bearing.

In case the bearing is so designed that several rollers are located on a common axis, these rollers are considered as one roller of a length equal to the total effective length of contact of the several rollers. Rollers as defined above, or portions thereof which contact the same washer-raceway area, belong to one row.

When the ratio of the individual roller effective length to the pitch diameter (at which this roller operates) is too large, a reduction of the f_c value must be anticipated due to excessive slip in the roller-raceway contact.

When calculating the basic load rating for a unit consisting of two or more similar single row bearings mounted “in tandem,” properly manufactured and mounted for equal load distribution, the rating of the combination is defined by **Formula (18)**. If, for some technical reason, the unit may be treated as a number of individually interchangeable single-row bearings, this consideration does not apply.

The magnitude of the equivalent thrust load, P_a , in pounds, for thrust roller bearings with α not equal to 90 degrees under combined constant thrust and constant radial loads is given by the formula:

$$P_a = XF_r + YF_a \tag{19}$$

where F_r = applied radial load, newtons (pounds)

F_a = applied axial load, newtons (pounds)

X = radial load factor as given in **Table 34**

Y = axial load factor as given in **Table 34**

Table 34. Values of X and Y for Computing Equivalent Thrust Load P_a for Thrust Roller Bearings

Bearing Type	Single Direction Bearings		Double Direction Bearings			
	$\frac{F_a}{F_r} > e$		$\frac{F_a}{F_r} \leq e$		$\frac{F_a}{F_r} > e$	
	X	Y	X	Y	X	Y
Self-Aligning Tapered Thrust Roller Bearings ^a $\alpha \neq 0$	$\tan \alpha$	1	$1.5 \tan \alpha$	0.67	$\tan \alpha$	1

^aFor $\alpha = 90^\circ$, $F_r = 0$ and $Y = 1$.

$$e = 1.5 \tan \alpha$$

Life Adjustment Factors.—In certain applications of ball or roller bearings it is desirable to specify life for a reliability other than 90 per cent. In other cases the bearings may be fabricated from special bearing steels such as vacuum-degassed and vacuum-melted steels, and improved processing techniques. Finally, application conditions may indicate other than normal lubrication, load distribution, or temperature. For such conditions a series of life adjustment factors may be applied to the fatigue life formula. This is fully explained in AFBMA and American National Standard “Load Ratings and Fatigue Life for Ball Bearings” ANSI/AFBMA Std 9-1990 and AFBMA and American National Standard “Load Ratings and Fatigue Life for Roller Bearings” ANSI/AFBMA Std 11-1990. In addition to consulting these standards it may be advantageous to also obtain information from the bearing manufacturer.

Life Adjustment Factor for Reliability: For certain applications, it is desirable to specify life for a reliability greater than 90 per cent which is the basis of the Rating Life.

To determine the bearing life of ball or roller bearings for reliability greater than 90 per cent, the Rating Life must be adjusted by a factor a_1 such that $L_n = a_1 L_{10}$. For a reliability of 95 per cent, designated as L_5 , the life adjustment factor a_1 is 0.62; for 96 per cent, L_4 , a_1 is 0.53; for 97 per cent, L_3 , a_1 is 0.44; for 98 per cent, L_2 , a_1 is 0.33; and for 99 per cent, L_1 , a_1 is 0.21.

Life Adjustment Factor for Material: For certain types of ball or roller bearings which incorporate improved materials and processing, the Rating Life can be adjusted by a factor a_2 such that $L_{10}' = a_2 L_{10}$. Factor a_2 depends upon steel analysis, metallurgical processes, forming methods, heat treatment, and manufacturing methods in general. Ball and roller bearings fabricated from consumable vacuum remelted steels and certain other special analysis steels, have demonstrated extraordinarily long endurance. These steels are of exceptionally high quality, and bearings fabricated from these are usually considered special manufacture. Generally, a_2 values for such steels can be obtained from the bearing manufacturer. However, all of the specified limitations and qualifications for the application of the Rating Life formulas still apply.

Life Adjustment Factor for Application Condition: Application conditions which affect ball or roller bearing life include: 1) lubrication; 2) load distribution (including effects of clearance, misalignment, housing and shaft stiffness, type of loading, and thermal gradients); and 3) temperature.

Items 2 and 3 require special analytical and experimental techniques, therefore the user should consult the bearing manufacturer for evaluations and recommendations.

Operating conditions where the factor a_3 might be less than 1 include: a) exceptionally low values of Nd_m (rpm times pitch diameter, in mm); e.g., $Nd_m < 10,000$; b) lubricant viscosity at less than 70 SSU for ball bearings and 100 SSU for roller bearings at operating temperature; and c) excessively high operating temperatures.

When a_3 is less than 1 it may not be assumed that the deficiency in lubrication can be overcome by using an improved steel. When this factor is applied, $L_{10}' = a_3 L_{10}$.

In most ball and roller bearing applications, lubrication is required to separate the rolling surfaces, i.e., rollers and raceways, to reduce the retainer-roller and retainer-land friction and sometimes to act as a coolant to remove heat generated by the bearing.

Factor Combinations: A fatigue life formula embodying the foregoing life adjustment factors is $L_{10}' = a_1 a_2 a_3 L_{10}$. Indiscriminate application of the life adjustment factors in this formula may lead to serious overestimation of bearing endurance, since fatigue life is only one criterion for bearing selection. Care must be exercised to select bearings which are of sufficient size for the application.

Ball Bearing Static Load Rating.—For ball bearings suitably manufactured from hardened alloy steels, the static radial load rating is that uniformly distributed static radial bearing load which produces a maximum contact stress of 4,000 megapascals (580,000 pounds per square inch). In the case of a single row, angular contact ball bearing, the static radial load rating refers to the radial component of that load which causes a purely radial displacement of the bearing rings in relation to each other. The static axial load rating is that uniformly distributed static centric axial load which produces a maximum contact stress of 4,000 megapascals (580,000 pounds per square inch).

Radial and Angular Contact Groove Ball Bearings: The magnitude of the static load rating C_o in newtons (pounds) for radial ball bearings is found by the formula:

$$C_o = f_o i Z D^2 \cos \alpha \quad (20)$$

where f_o = a factor for different kinds of ball bearings given in [Table 35](#)

i = number of rows of balls in bearing

Z = number of balls per row

D = ball diameter, mm (inches)

α = nominal contact angle, degrees

This formula applies to bearings with a cross sectional raceway groove radius not larger than $0.52 D$ in radial and angular contact groove ball bearing inner rings and $0.53 D$ in radial and angular contact groove ball bearing outer rings and self-aligning ball bearing inner rings.

The load carrying ability of a ball bearing is not necessarily increased by the use of a smaller groove radius but is reduced by the use of a larger radius than those indicated above.

Radial or Angular Contact Ball Bearing Combinations: The basic static load rating for two similar single row radial or angular contact ball bearings mounted side by side on the same shaft such that they operate as a unit (duplex mounting) in “back-to-back” or “face-to-face” arrangement is two times the rating of one single row bearing.

The basic static radial load rating for two or more single row radial or angular contact ball bearings mounted side by side on the same shaft such that they operate as a unit (duplex or stack mounting) in “tandem” arrangement, properly manufactured and mounted for equal load distribution, is the number of bearings times the rating of one single row bearing.

Thrust Ball Bearings: The magnitude of the static load rating C_{oa} for thrust ball bearings is found by the formula:

$$C_{oa} = f_o Z D^2 \cos \alpha \quad (21)$$

where f_o = a factor given in [Table 35](#)

Z = number of balls carrying the load in one direction

D = ball diameter, mm (inches)

α = nominal contact angle, degrees

This formula applies to thrust ball bearings with a cross sectional raceway radius not larger than $0.54 D$. The load carrying ability of a bearing is not necessarily increased by use of a smaller radius, but is reduced by use of a larger radius.

Roller Bearing Static Load Rating: For roller bearings suitably manufactured from hardened alloy steels, the static radial load rating is that uniformly distributed static radial bearing load which produces a maximum contact stress of 4,000 megapascals (580,000 pounds per square inch) acting at the center of contact of the most heavily loaded rolling element. The static axial load rating is that uniformly distributed static centric axial load which produces a maximum contact stress of 4,000 megapascals (580,000 pounds per square inch) acting at the center of contact of each rolling element.

Table 35. f_0 for Calculating Static Load Rating for Ball Bearings

$\frac{D \cos \alpha}{d_m}$	Radial and Angular Contact Groove Type		Radial Self-Aligning		Thrust	
	Metric ^a	Inch ^b	Metric ^a	Inch ^b	Metric ^a	Inch ^b
0.00	12.7	1850	1.3	187	51.9	7730
0.01	13.0	1880	1.3	191	52.6	7620
0.02	13.2	1920	1.3	195	51.7	7500
0.03	13.5	1960	1.4	198	50.9	7380
0.04	13.7	1990	1.4	202	50.2	7280
0.05	14.0	2030	1.4	206	49.6	7190
0.06	14.3	2070	1.5	210	48.9	7090
0.07	14.5	2100	1.5	214	48.3	7000
0.08	14.7	2140	1.5	218	47.6	6900
0.09	14.5	2110	1.5	222	46.9	6800
0.10	14.3	2080	1.6	226	46.4	6730
0.11	14.1	2050	1.6	231	45.9	6660
0.12	13.9	2020	1.6	235	45.5	6590
0.13	13.6	1980	1.7	239	44.7	6480
0.14	13.4	1950	1.7	243	44.0	6380
0.15	13.2	1920	1.7	247	43.3	6280
0.16	13.0	1890	1.7	252	42.6	6180
0.17	12.7	1850	1.8	256	41.9	6070
0.18	12.5	1820	1.8	261	41.2	5970
0.19	12.3	1790	1.8	265	40.4	5860
0.20	12.1	1760	1.9	269	39.7	5760
0.21	11.9	1730	1.9	274	39.0	5650
0.22	11.6	1690	1.9	278	38.3	5550
0.23	11.4	1660	2.0	283	37.5	5440
0.24	11.2	1630	2.0	288	37.0	5360
0.25	11.0	1600	2.0	293	36.4	5280
0.26	10.8	1570	2.1	297	35.8	5190
0.27	10.6	1540	2.1	302	35.0	5080
0.28	10.4	1510	2.1	307	34.4	4980
0.29	10.3	1490	2.1	311	33.7	4890
0.30	10.1	1460	2.2	316	33.2	4810
0.31	9.9	1440	2.2	321	32.7	4740
0.32	9.7	1410	2.3	326	32.0	4640
0.33	9.5	1380	2.3	331	31.2	4530
0.34	9.3	1350	2.3	336	30.5	4420
0.35	9.1	1320	2.4	341	30.0	4350
0.36	8.9	1290	2.4	346	29.5	4270
0.37	8.7	1260	2.4	351	28.8	4170
0.38	8.5	1240	2.5	356	28.0	4060
0.39	8.3	1210	2.5	361	27.2	3950
0.40	8.1	1180	2.5	367	26.8	3880
0.41	8.0	1160	2.6	372	26.2	3800
0.42	7.8	1130	2.6	377	25.7	3720
0.43	7.6	1100	2.6	383	25.1	3640
0.44	7.4	1080	2.7	388	24.6	3560
0.45	7.2	1050	2.7	393	24.0	3480

Table 35. (Continued) f_o for Calculating Static Load Rating for Ball Bearings

$\frac{D \cos \alpha}{d_m}$	Radial and Angular Contact Groove Type		Radial Self-Aligning		Thrust	
	Metric ^a	Inch ^b	Metric ^a	Inch ^b	Metric ^a	Inch ^b
0.46	7.1	1030	2.8	399	23.5	3400
0.47	6.9	1000	2.8	404	22.9	3320
0.48	6.7	977	2.8	410	22.4	3240
0.49	6.6	952	2.9	415	21.8	3160
0.50	6.4	927	2.9	421	21.2	3080

^a Use to obtain C_o or C_{oa} in newtons when D is given in mm.

^b Use to obtain C_o or C_{oa} in pounds when D is given in inches.

Note: Based on modulus of elasticity = 2.07×10^5 megapascals (30×10^6 pounds per square inch) and Poisson's ratio = 0.3.

Radial Roller Bearings: The magnitude of the static load rating C_o in newtons (pounds) for radial roller bearings is found by the formulas:

$$C_o = 44 \left(1 - \frac{D \cos \alpha}{d_m} \right) i Z l_{eff} D \cos \alpha \quad (\text{metric}) \quad (22a)$$

$$C_o = 6430 \left(1 - \frac{D \cos \alpha}{d_m} \right) i Z l_{eff} D \cos \alpha \quad (\text{inch}) \quad (22b)$$

where D = roller diameter, mm (inches); mean diameter for a tapered roller and major diameter for a spherical roller

d_m = mean pitch diameter of the roller complement, mm (inches)

i = number of rows of rollers in bearing

Z = number of rollers per row

l_{eff} = effective length, mm (inches); overall roller length minus roller chamfers or minus grinding undercuts at the ring where contact is shortest

α = nominal contact angle, degrees

Radial Roller Bearing Combinations: The static load rating for two similar single row roller bearings mounted side by side on the same shaft such that they operate as a unit is two times the rating of one single row bearing.

The static radial load rating for two or more similar single row roller bearings mounted side by side on the same shaft such that they operate as a unit (duplex or stack mounting) in “tandem” arrangement, properly manufactured and mounted for equal load distribution, is the number of bearings times the rating of one single row bearing.

Thrust Roller Bearings: The magnitude of the static load rating C_{oa} in newtons (pounds) for thrust roller bearings is found by the formulas:

$$C_{oa} = 220 \left(1 - \frac{D \cos \alpha}{d_m} \right) Z l_{eff} D \sin \alpha \quad (\text{metric}) \quad (23a)$$

$$C_{oa} = 32150 \left(1 - \frac{D \cos \alpha}{d_m} \right) Z l_{eff} D \sin \alpha \quad (\text{inch}) \quad (23b)$$

where the symbol definitions are the same as for Formulas (22a) and (22b).

Thrust Roller Bearing Combination: The static axial load rating for two or more similar single direction thrust roller bearings mounted side by side on the same shaft such that they operate as a unit (duplex or stack mounting) in “tandem” arrangement, properly manufactured and mounted for equal load distribution, is the number of bearings times the rating of one single direction bearing. The accuracy of this formula decreases in the case of single direction bearings when $F_r > 0.44 F_a \cot \alpha$ where F_r is the applied radial load in newtons (pounds) and F_a is the applied axial load in newtons (pounds).

Ball Bearing Static Equivalent Load.—For ball bearings the static equivalent radial load is that calculated static radial load which produces a maximum contact stress equal in magnitude to the maximum contact stress in the actual condition of loading. The static equivalent axial load is that calculated static centric axial load which produces a maximum contact stress equal in magnitude to the maximum contact stress in the actual condition of loading.

Radial and Angular Contact Ball Bearings: The magnitude of the static equivalent radial load P_o in newtons (pounds) for radial and angular contact ball bearings under combined thrust and radial loads is the greater of:

$$P_o = X_o F_r + Y_o F_a \quad (24)$$

$$P_o = F_r \quad (25)$$

where X_o = radial load factor given in **Table 36**

Y_o = axial load factor given in **Table 36**

F_r = applied radial load, newtons (pounds)

F_a = applied axial load, newtons (pounds)

Table 36. Values of X_o and Y_o for Computing Static Equivalent Radial Load P_o of Ball Bearings

Contact Angle	Single Row Bearings ^a		Double Row Bearings	
	X_o	Y_o^b	X_o	Y_o^b
RADIAL CONTACT GROOVE BEARINGS ^{c,a}				
$\alpha = 0^\circ$	0.6	0.5	0.6	0.5
ANGULAR CONTACT GROOVE BEARINGS				
$\alpha = 15^\circ$	0.5	0.47	1	0.94
$\alpha = 20^\circ$	0.5	0.42	1	0.84
$\alpha = 25^\circ$	0.5	0.38	1	0.76
$\alpha = 30^\circ$	0.5	0.33	1	0.66
$\alpha = 35^\circ$	0.5	0.29	1	0.58
$\alpha = 40^\circ$	0.5	0.26	1	0.52
SELF-ALIGNING BEARINGS				
...	0.5	$0.22 \cot \alpha$	1	$0.44 \cot \alpha$

^a P_o is always $\geq F_r$.

^b Values of Y_o for intermediate contact angles are obtained by linear interpolation.

^c Permissible maximum value of F_a/C_o (where F_a is applied axial load and C_o is static radial load rating) depends on the bearing design (groove depth and internal clearance).

Thrust Ball Bearings: The magnitude of the static equivalent axial load P_{oa} in newtons (pounds) for thrust ball bearings with contact angle $\alpha \neq 90^\circ$ under combined radial and thrust loads is found by the formula:

$$P_{oa} = F_a + 2.3F_r \tan \alpha \quad (26)$$

where the symbol definitions are the same as for **Formulas (24) and (25)**. This formula is valid for all load directions in the case of double direction ball bearings. For single direction ball bearings, it is valid where $F_r/F_a \leq 0.44 \cot \alpha$ and gives a satisfactory but less conservative value of P_{oa} for F_r/F_a up to $0.67 \cot \alpha$.

Thrust ball bearings with $\alpha = 90^\circ$ can support axial loads only. The static equivalent load for this type of bearing is $P_{oa} = F_a$.

Roller Bearing Static Equivalent Load.—The static equivalent radial load for roller bearings is that calculated, static radial load which produces a maximum contact stress acting at the center of contact of a uniformly loaded rolling element equal in magnitude to the maximum contact stress in the actual condition of loading. The static equivalent axial load is that calculated, static centric axial load which produces a maximum contact stress acting

at the center of contact of a uniformly loaded rolling element equal in magnitude to the maximum contact stress in the actual condition of loading.

Radial Roller Bearings: The magnitude of the static equivalent radial load P_o in newtons (pounds) for radial roller bearings under combined radial and thrust loads is the greater of:

$$P_o = X_o F_r + Y_o F_a \tag{27}$$

$$P_o = F_r \tag{28}$$

where X_o = radial factor given in **Table 37**

Y_o = axial factor given in **Table 37**

F_r = applied radial load, newtons (pounds)

F_a = applied axial load, newtons (pounds)

Table 37. Values of X_o and Y_o for Computing Static Equivalent Radial Load P_o for Self-Aligning and Tapered Roller Bearings

Bearing Type	Single Row ^a		Double Row	
	X_o	Y_o	X_o	Y_o
Self-Aligning and Tapered $\alpha \neq 0$	0.5	$0.22 \cot \alpha$	1	$0.44 \cot \alpha$

^a P_o is always $\geq F_r$.

The static equivalent radial load for radial roller bearings with $\alpha = 0^\circ$ and subjected to radial load only is $P_{or} = F_r$.

Note: The ability of radial roller bearings with $\alpha = 0^\circ$ to support axial loads varies considerably with bearing design and execution. The bearing user should therefore consult the bearing manufacturer for recommendations regarding the evaluation of equivalent load in cases where bearings with $\alpha = 0^\circ$ are subjected to axial load.

Radial Roller Bearing Combinations: When calculating the static equivalent radial load for two similar single row angular contact roller bearings mounted side by side on the same shaft such that they operate as a unit (duplex mounting) in “back-to-back” or “face-to-face” arrangement, use the X_o and Y_o values for a double row bearing and the F_r and F_a values for the total loads on the arrangement.

When calculating the static equivalent radial load for two or more similar single row angular contact roller bearings mounted side by side on the same shaft such that they operate as a unit (duplex or stack mounting) in “tandem” arrangement, use the X_o and Y_o values for a single row bearing and the F_r and F_a values for the total loads on the arrangement.

Thrust Roller Bearings: The magnitude of the static equivalent axial load P_{oa} in newtons (pounds) for thrust roller bearings with contact angle $\alpha \neq 90^\circ$, under combined radial and thrust loads is found by the formula:

$$P_{oa} = F_a + 2.3F_r \tan \alpha \tag{29}$$

where F_a = applied axial load, newtons (pounds)

F_r = applied radial load, newtons (pounds)

α = nominal contact angle, degrees

The accuracy of this formula decreases for single direction thrust roller bearings when $F_r > 0.44 F_a \cot \alpha$.

Thrust Roller Bearing Combinations: When calculating the static equivalent axial load for two or more thrust roller bearings mounted side by side on the same shaft such that they operate as a unit (duplex or stack mounting) in “tandem” arrangement, use the F_r and F_a values for the total loads acting on the arrangement.

LUBRICATION

Lubrication Theory

Whenever a solid surface moves over another, it must overcome a resistive, opposing force known as *solid friction*. The first stage of solid friction, known as *static friction*, is the frictional resistance that must be overcome to initiate movement of a body at rest. The second stage of frictional resistance, known as *kinetic friction*, is the resistive force of a body in motion as it slides or rolls over another solid body. It is usually smaller in magnitude than static friction. Although friction varies according to applied load and solid surface roughness, it is unaffected by speed of motion and apparent contact surface area.

When viewed under a microscope a solid surface will appear rough with many *asperities* (peaks and valleys). When two solid surfaces interact without a lubricating medium, full metal-to-metal contact takes place in which the asperity peaks of one solid interfere with asperity peaks of the other solid. When any movement is initiated the asperities collide causing a rapid increase in heat and the metal peaks to adhere and weld to one another. If the force of motion is great enough the peaks will plow through each other's surface and the welded areas will shear causing surface degradation, or wear. In extreme cases, the resistance of the welded solid surfaces could be greater than the motive force causing mechanical seizure to take place.

Some mechanical systems designs, such as brakes, are designed to take advantage of friction. For other systems, such as bearings, this metal-to-metal contact state and level of wear is usually undesirable. To combat this level of solid friction, heat, wear, and consumed power, a suitable lubricating fluid or fluid film must be introduced as an intermediary between the two solid surfaces. Although lubricants themselves are not frictionless, the molecular resistive force of a gas or fluid in motion known as *fluid friction* is significantly less than *solid friction*. The level of fluid friction is dependent on the lubricant's *Viscosity* (see page 2425.)

Film Thickness Ratio, λ .—For all bearings, the working lubricant film thickness has a direct relationship to bearing life. The “working” or specific film thickness ratio lambda λ is defined by dividing the nominal film thickness by the surface roughness, as depicted in Fig. 1.

$$\lambda = \frac{T}{R} \quad (1)$$

where λ = Specific film thickness
 T = Nominal film thickness
 R = Surface roughness

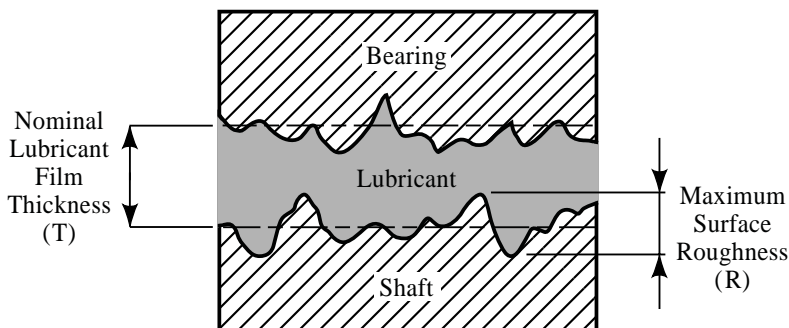


Fig. 1. Determining the Working Film Thickness Ratio Lambda

The Lubrication Film.—Whenever a plain journal style bearing operates with a fluid film, the coefficient of friction μ or extent of friction reduction will depend on which one of three lubricant film conditions exists between the facing surfaces.

Full Film Hydrodynamic Lubrication (HDL): HDL is the desired lubrication condition for plain style bearings in which both surfaces are fully separated by a working or specific film thickness λ , λ of more than 2 at the point of pressure distribution loading shown in Fig. 2. A fluid wedge is created in which the asperities will not collide. Both surfaces are said to be “metal-contact” free at all times.

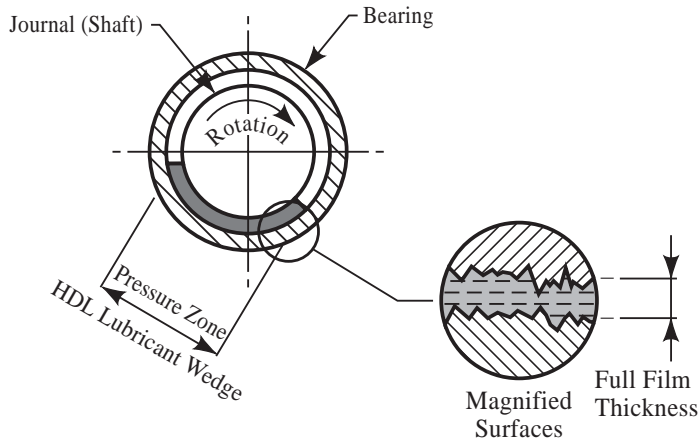


Fig. 2. HDL Hydrodynamic Lubrication of a Journal Bearing

As the shaft speed accelerates, rotation of the journal acts as a pump, forcing lubricant into the pressure distribution area. Providing the lubricant is of a high enough viscosity, the wedge-shaped lubricant channel will create a load-carrying pressure sufficient to completely separate the two surfaces and support the moving journal. Full film thickness will vary between 5 and 200 microns depending on speed, load, and viscosity. As the speed increases so does the lubricating action and ability to carry heavier loads. Inversely, slow speeds do not allow the lubricant wedge to form, causing breakdown of the hydrodynamic action and an undesirable *Boundary Layer Lubrication* state to prevail.

Boundary Layer Lubrication (BL): When a journal shaft is at rest in the bearing, any full film lubricant wedge has collapsed leaving a residual film of lubricant in its place, insufficient to prevent metal-to-metal contact from occurring. Upon subsequent start up, the bearing surfaces partially collide and ride on the thin lubricant film (start up conditions promote heavy wear). When lubricant supply is inadequate, or heavy loads coupled with low shaft speeds is the only design possible, the boundary layer lubrication must rely heavily on the composition of the lubricant to provide specific anti-wear and extreme pressure sacrificial additives, designed to retard premature wear. These surface-active additives act to form a thin surface laminate that prevents metal adhesion. Boundary layer lubrication also occurs when a lubricant of too low a viscosity is chosen.

Mixed Film Lubrication (MF): Mixed film lubrication state is generally encountered under shock load conditions when a minimum thickness hydrodynamic film momentarily breaks down or “thins out” into a boundary layer condition under severe shock load. Mixed film condition is also encountered as a shaft accelerates toward full speed and the film thickness transforms from boundary to full hydrodynamic condition. Choosing too light a viscosity lubricant can lead to momentary or full time mixed film condition. Mixed film condition is encountered when the specific film thickness λ is between 1 and 2.

Lubricating Film Transition: Boundary layer condition is encountered when the specific film thickness λ ratio is less than 1, mixed-film when the λ ratio is between 1 and 2, and hydrodynamic when the λ ratio is more than 2. Once the λ ratio surpasses 4, relative bearing life is increased four-fold as depicted in Fig. 3.

Lambda $\lambda < 1$	$1 < \text{Lambda } \lambda < 2$	$2 < \text{Lambda } \lambda < 4$
Boundary Layer Film Lubrication	Mixed Film Lubrication	Hydrodynamic Lubrication

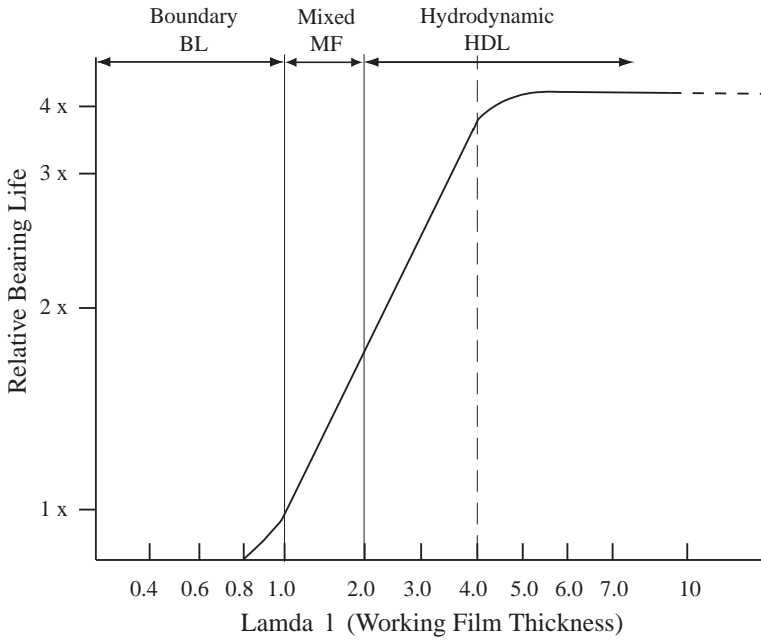


Fig. 3. The Relationship Between Film Thickness Ratio Lambda λ , and Bearing Life

To achieve long life while supporting heavy loads, a plain bearing must successfully manage the relationship between load, speed, and lubricant viscosity. If the load and speed change, the lubricant viscosity must be able to compensate for the change. This relationship is shown in the Stribeck or ZNP curve illustrated in Fig. 4. Choosing the correct lubricant viscosity allows the bearing to run in the favored hydrodynamic range producing a low coefficient of friction ranging from 0.002 to 0.005.

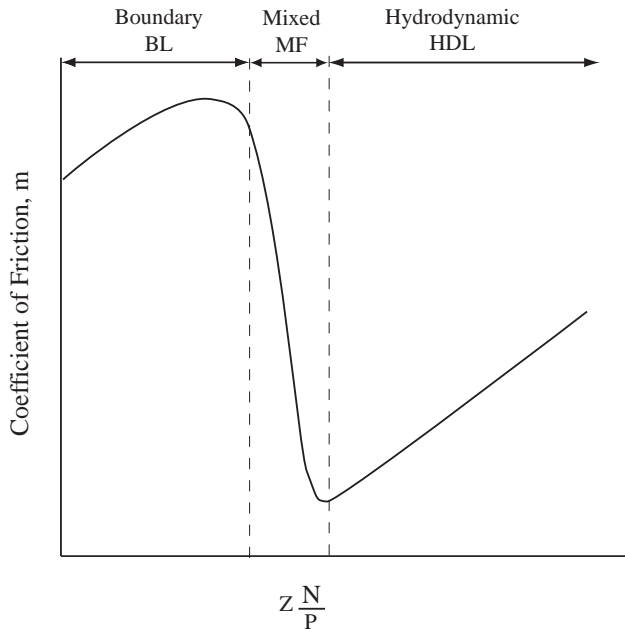


Fig. 4. Stribeck (ZNP) Curve

Rolling element bearings (point contact) and the rolling section of mating gear teeth (line contact) also favor full hydrodynamic lubrication film. They differ from sliding elements in that rolling elements require considerably less lubrication than their sliding counterparts and that the load is concentrated over a much smaller footprint on a non-conforming surface - small diameter ball or roller “rolling” over or within a much larger diameter raceway. As the ball or roller “rolls” through the load zone, the point of contact experiences a rapid pressure rise causing momentary micro distortion of both the rolling element and race. This area of deformation is named the *Hertzian Contact Area* (Fig. 5) and is analogous to the contact patch of a properly inflated tire on a moving vehicle. As the loaded section of rolling element moves out of the Hertzian contact area the deformed surface elastically returns to its original shape. The lubricant trapped in the Hertzian contact area benefits greatly from a phenomenon in which a lubricant under pressure will experience a dramatic rise in viscosity and act as a solid lubricant, allowing small amounts of lubricant to provide full film separation under extreme loading conditions. Under these conditions the hydrodynamic film is termed *elastohydrodynamic lubrication* (EHDL), and is unique to point/line contact situations typically found with rolling element bearings and mating gear teeth.

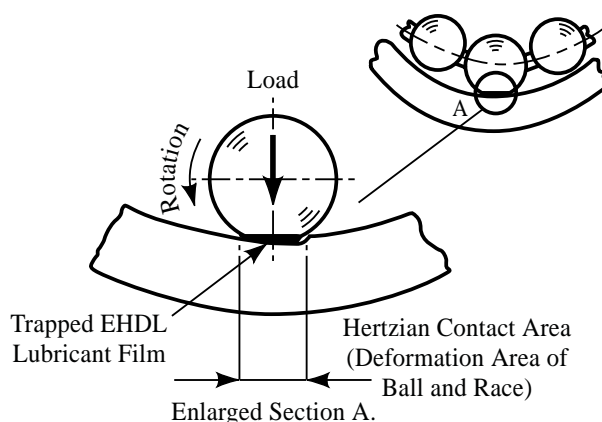


Fig. 5. Hertzian Contact Area Found in Rolling Element Bearing Surfaces

The wheels of industry run literally on a microfilm of lubricant; practical examples of typical oil film thicknesses expressed in machine dynamic clearance are stated in the following [Table 1](#).

Table 1. Typical Oil Film Thicknesses Expressed as Machine Dynamic Clearances.

Machine Component	Typical Clearance in Microns
Plain Journal Bearings	0.5 - 100
Rolling Element Bearings	0.1 - 3
Gears	0.1 - 1
Hydraulic Spool To Sleeve	1 - 4
Engine Piston Ring to Cylinder	0.3 - 7
Engine Rod Bearing (Plain)	0.5 - 20
Engine Main Bearing (Plain)	0.5 - 80
Pump Piston to Bore	5 - 40

1 micron = 0.00003937 inches; 25.4 microns = 0.001 inches.

Lubricants

A lubricant’s primary function is to reduce friction; in doing so it reduces wear and energy consumption. Secondary functions are to reduce temperature, impact shock, corrosion, and contamination.

A lubricant can be in liquid (oil), solid (grease), or gaseous (oil mist) form and can be formulated from animal, vegetable, hydrocarbon, or synthetic base oil stocks. Adding to each lubricant formulation numerous chemical thickeners, solids, and chemical additives, gives every single manufactured lubricant its own unique signature blend. Selection of lubricant style and type is arguably the most influential factor in assuring long bearing life.

In the 1970's, Dr. Ernest Rabinowicz of MIT performed a landmark study on the effects of lubrication on the Gross National Product (GNP) of the United States. The study concluded that at that time, US manufacturing companies spent over \$600 billion US annually to repair damage caused by friction-induced mechanical wear; more importantly, the study determined that over 70% of bearing loss of usefulness (failure) is directly attributable to surface degradation - a totally preventable condition. In his study, Rabinowicz determined there are four major contributors to surface degradation:

Corrosive Wear: All metallic-bearing surfaces will corrode if left unprotected from contact with water and corrosive acids. Water is introduced into lubricated environments from outside sources penetrating the sealed reservoir or bearing (washout, product contamination), or through condensation, causing ferrous metals to rust. Corrosive acids are produced when the lubricant becomes oxidized and suffers loss or breakdown of its corrosion inhibitor additive packages. Specifying and using a lubricant with rust inhibitors and corrosion-inhibitor additives, and replacing the lubricant in a timely manner when additives are depleted from the oil, will prevent corrosion.

Mechanical Wear by Adhesion: Adhesive wear occurs when a lubricant film separating two sliding surfaces fails to completely separate the two surfaces. Metal to metal contact occurs causing metal fragment transfer from one surface to the other. This transfer is commonly referred to as seizing, galling, scuffing, or scoring of surfaces. Correct lubricant viscosity and application frequency will significantly reduce or eliminate adhesive wear.

Mechanical Wear by Abrasion: Abrasive wear, sometimes referred to as *cutting wear*, is the result of hard particles (wear particles or introduced contaminant particles) bridging two moving surfaces, scraping and cutting either one surface (two body abrasion) or both bearing surfaces (three body abrasion). Controlling abrasive wear requires reduction of adhesive wear combined with contamination control of lubricant transfer, application, and filtration processes.

Mechanical Wear by Fatigue: Fatigue wear results when bridged wear particles cause small surface stress raisers (surface rippling) that eventually expand and break away from the parent metal as a spall (flake or splinter). Repeated cyclic stress at the damaged area accelerates the fatigue wear process. Correct lubricant viscosity choice and contamination control are essential to retard fatigue wear.

In all four types of wear, the primary solution for wear retardation lies in the correct choice of lubricant. Lubricants are categorized into two specific families - oil, and grease. The choice to use either oil or grease will depend upon temperature range, speed of rotation, environment, budget, machine design, bearing and seal design, which operating conditions.

Lubricating Oil.—For the majority of industrial applications requiring the separation of moving surfaces, the lubricant of choice continues to be petroleum based oil, also widely known as mineral oil. Although any liquid will provide a degree of lubrication, hydrocarbon based petroleum oils provide excellent surface wetting capabilities, water resistance, thermal stability, and sufficient fluid viscosity or “stiffness” to provide full film protection under load - all at an inexpensive price. By adding chemicals, metals, solids, and fillers, mineral base oil stock can be formulated into an infinite number of tailored lubricating products, including grease. These modified mineral oils can be formulated for virtually any industrial application and widen the lubricant's specification and capabilities even further. The fundamental defining property for all lubricating oils is *viscosity*, and is the starting point for choosing one specific lubricant over another.

Viscosity: The viscosity of a fluid is measured as its resistance to flow and shear; resistance caused by fluid friction is set up along the molecular shear planes of the lubricant as depicted in Fig. 6. Thin or light lubricants, such as machine and spindle oils shear at a faster rate than thick lubricants such as gear oils, and are said to be less viscous. Although lower viscosity oil is desirable for reducing energy (less drag), it likely would not be “stiff” or viscous enough to withstand the demands of a heavily loaded gearbox.

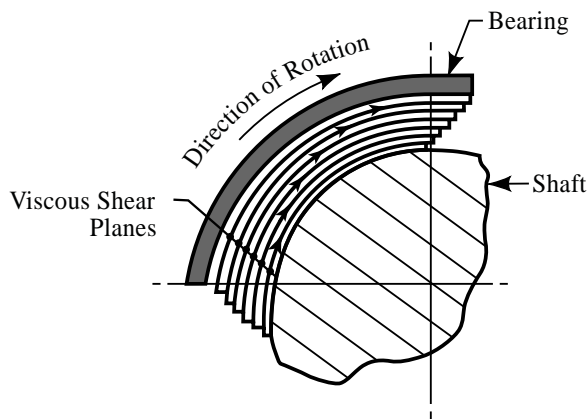


Fig. 6. Viscosity Shear Planes

Kinematic Viscosity: Oil viscosity is measured by a variety of classifications. The two generally accepted industrial standards are: Saybolt Universal Seconds - SUS (imperial measure), and ISO VG - Centistokes - cSt (metric measure). These two standards rate oil by their *kinematic viscosity* values. The ratings, based on a fluid temperature of 100° F (40° C) and 212° F (100° C), relate the time taken for a fluid to flow through a viscosimeter capillary apparatus and directly measure oil’s resistance to flow and shear by the forces of gravity. Other common viscosity classifications and comparison equivalents are shown in Table 2.

$$cSt = \frac{g/cc}{\eta(cP)} \quad @ 60^{\circ}F \quad (2)$$

Where h = Absolute or Dynamic Viscosity in centipoise

g/cc = Lubricant Density (Specific Gravity)

cSt = Kinematic Viscosity in centistokes

To convert cSt to SUS @ 100° F (40° C), multiply by 4.632

To convert cSt to SUS @ 210° F (100° C), multiply by 4.664

Absolute Viscosity: The *absolute* or *dynamic* viscosity is measured in Poise (metric) or CentiPoise (cP) and Reyn (imperial), where one Reyn is equivalent to 68,950 Poise. One-Poise is equivalent to a one-dyne force required to move a plane surface (shear plane) of unit area a distance of one centimeter with unit speed (one centimeter per second) over a second plane at a unit distance (one centimeter) from it. *Absolute viscosity* is calculated by multiplying the kinematic viscosity value by the density of the lubricant measured at the test temperature, and is the measure of oil’s resistance to flow and shear caused by internal friction. Absolute viscosity is the viscosity measured through oil analysis.

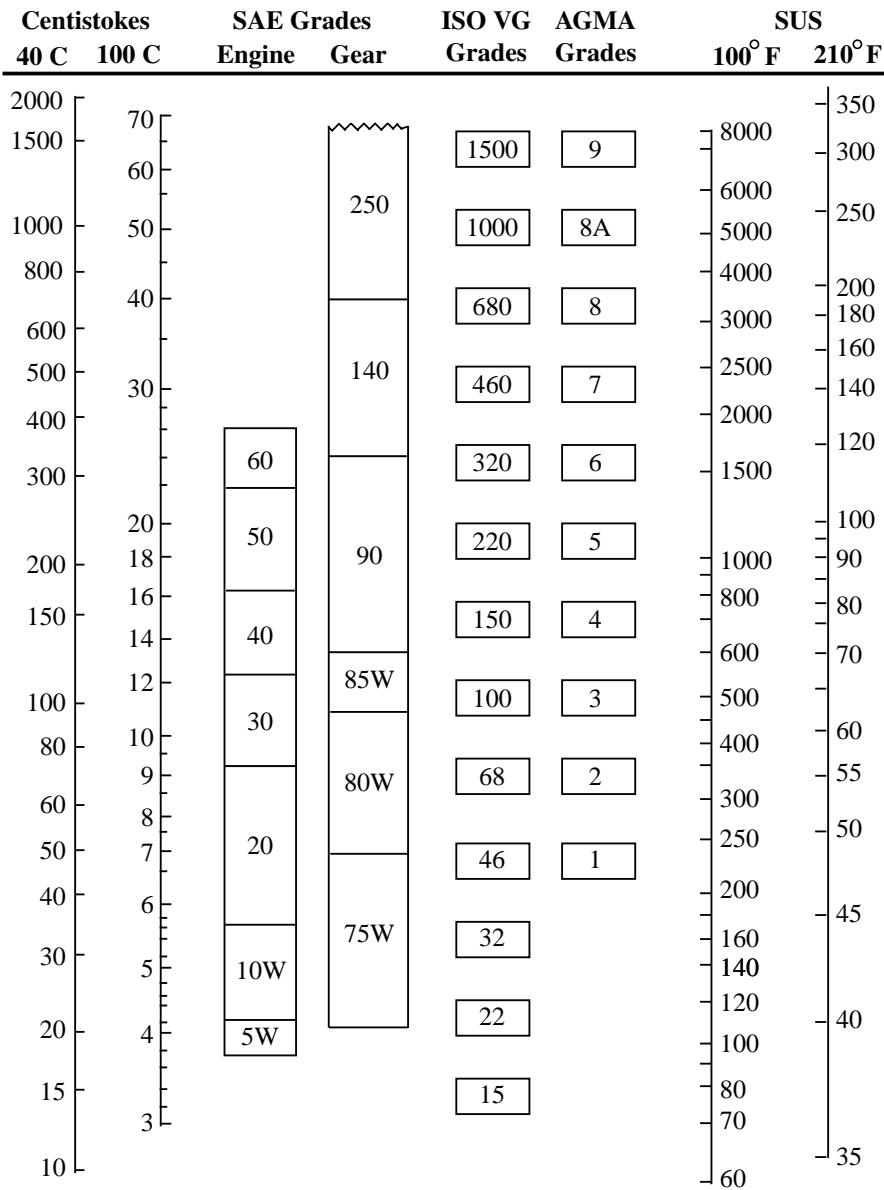
$$\eta(cP) = g/cc @ 60^{\circ}F \times cSt \quad (3)$$

Where h = Absolute or Dynamic Viscosity in centipoise

g/cc = Lubricant Density (specific gravity)

cSt = Kinematic viscosity in centistokes

Table 2. Viscosity Comparison Chart



Viscosities based on 95VI single grades relate horizontally. SAE - Society of Automotive Engineers (Automotive lubricants)
 SAE grades specified at 100 C. AGMA - American Gear Manufacturers Assn. (Gear lubricants)
 SAE W grades are also specified at low temperatures. ISO - International Standards Organization
 ISO and AGMA Grades specified at 40 C. SUS - Saybolt Universal Seconds

Viscosity Index (VI): Viscosity is dependent on temperature. As oil heats up it becomes thinner or less viscous. Inversely, as oil cools down it becomes thicker or more viscous. This phenomenon dictates that all oils will change their physical properties once they have achieved their working environment temperature. Therefore, before a lubricant viscosity choice can be made, its expected working environment temperature must be known. To engineer for this phenomena, oil is given a *Viscosity Index*, or *VI* rating, which defines the measure of a lubricant’s viscosity change due to temperature change. Higher VI ratings are more desirable, reflecting narrower viscosity change over a standard temperature range.

To determine a specific oil's VI rating, its kinematic viscosity is measured at 100° F (40° C) and 212° F (100° C), then its results are compared with two or more series of oils. VI values once ranged between 0 and 100, but recent developments in lubricant technology and additives have allowed this index to raise its upper limit and include a Very High Viscosity Index (VHVI) group. Lubricants are generally classified in four basic VI groups depicted in [Table 3](#).

Table 3. Viscosity Index Rating

VI rating	Viscosity Index Group
< 35	Low (LVI)
35 - 80	Medium (MVI)
80 - 110	High (HVI)
> 110	Very High (VHVI)

Composition of Oil.—Oil is composed of either a mineral (hydrocarbon based) or synthetic oil base stock to which is added a variety of organic and inorganic compounds that are dissolved or suspended as solids in the formulated oil. Depending on the end use condition the oil formulation is designed for, the additive package can represent between 1% up to 30% of the formulated oil volume.

Mineral Based Oil.—Mineral oils are refined from crude oil stocks. Depending on where the crude stock is found in the world, the oil can be paraffinic or naphthenic based.

Paraffinic based stocks are generally found in the Mid Continent USA, England's North Sea, and the Middle East. They contain a 60/30/10 mix of paraffin/naphthene/wax resulting in a very high VI rating up to 105. Because wax is present, they are known to have *wax pour point* in which the oil's flow is severely constricted or stopped by wax crystallization at lower temperatures. This type of base oil stock is preferred when blending high quality crankcase oils, hydraulic fluids, turbine oils, gear oils, and bearing oils.

Naphthenic based oil stocks are generally found in South America and the coastal regions of the USA. They contain a 25/75/trace mix of paraffin/naphthene/wax, resulting in a less stable VI rating up to 70. Because only a trace of wax is present they are known as *viscosity pour point oils* in which oil flow is restricted by increases in the lubricant's viscosity at low temperatures. Naphthenic oils have lower pour points, higher flash points, and better additive solvency than paraffinic oils. This type of base stock is preferred when blending locomotive oils, refrigerant, and compressor oils.

Oil Additives.—When contact is likely between two bearing surfaces the lubricant should be designed to mitigate the friction through the addition of engineered additives to the base oil. Every manufactured lubricant on the market has its own unique formulation. In effect, it is an engineered liquid, custom built to perform a specific a job in a specific environment. All additives are sacrificial and therefore careful attention to additive package levels through the use of oil analysis will tell the user exactly when to change the oil to prevent damage to the bearing or contact parts. Typically oil additives as shown in [Table 4](#) are used to enhance the existing base oil, add additional properties to the oil, and suppress any undesirable properties the base oil may have.

Table 4. Oil Additives

Enhancement Additives	New Property Additives	Suppressant Additives
Anti-oxidant	EP	
Corrosion Inhibitor	Anti-wear	Pour Point Depressant
Demulsifier	Detergent	Viscosity Improver
Anti-foam	Dispersant	

The additive package formulation will depend on the end use. [Table 5](#) references what oil type generally carries what additive package in its formulation.

Table 5. Additive Package by Oil Type Guide

Additive	Bear- ing Oil	Gear Oil	Turbine Oil	Hydraulic Oil	Compres- sor Oil	Crankcase Oil	Grease
Anti-oxidant	●	●	●	●	●	●	●
Corrosion Inhibitor	●	●	●	●	●	●	●
Demulsifier	●	●	●	●	●		
Anti-foam	●	●	●	●	●	●	
Extreme Pressure EP		●					●
Anti-wear	●	●		●	●	●	●
Detergent					●	●	
Dispersant					●	●	
Pour Point		● some		● some	● some	● some	
Viscosity Improver						●	

Anti-oxidants: Oxygen attacks the base oil, especially at higher temperatures, leading to the formation of sludge, tars, varnish, and corrosive acids. Anti-oxidant additives can improve the oxidation stability of the oil by more than 10 times; lubricants designed for higher operating temperatures will contain higher levels of antioxidants.

Corrosion Inhibitor or Antirust Agents : Used to form a protective shield against water on ferrous metals, and copper, tin, and lead based bearing metals. They also act to neutralize any corrosive acids that may attack the bearing materials.

Demulsifying Agents: Stop water from emulsifying with the oil.

Antifoaming Agents: When oil is moved quickly, these agents, usually silicon based compounds, act to retard the formation of air bubbles at the lubricant's surface; air bubbles contain oxygen that will attack the base oil and cause cavitation in pumps.

Extreme Pressure (EP) Additives: Additives such as sulphur, phosphorous, and chlorine are employed to "soften" bearing surfaces, allowing them to break away as small asperities without adhesive "tearing" when metal-to-metal contact is unavoidable. These additives can be detrimental to yellow metal bearing material.

Anti-wear Agents: Solids such as molybdenum disulphide (moly), graphite, and PTFE, are employed to assist as additional sliding agents when metal-to-metal contact occurs under heavy loads. See [Table 6](#).

Detergents are organic metallic soaps of barium, calcium, and magnesium, acting as chemical cleaners to keep surfaces free from deposits and neutralize harmful combustion acids.

Dispersants work in conjunction with detergents to chemically suspend the dirt particles in the oil and allow them to be extracted by the lubrication system filters.

Pour Point Depressants prevent the formation of wax crystals in paraffinic-based mineral oil at low temperatures allowing it to be more fluid at colder temperatures.

Viscosity Improvers : Sometimes a base oil of inferior quality will require thickeners to assist in achieving the specified viscosity levels over a varied temperature range. Viscosity improvers are also used to prevent the oil from thinning at higher temperatures allowing the manufacturer to build multi-grade lubricants that operate over wider temperature ranges. Viscosity improvers use long chain organic molecules such as polymethacrylates and ethylene propylene copolymers to retard the viscosity shearing and improve an oil's viscosity performance.

Table 6. Properties of Common Lubricant Solids Additives

Solid Additive	Color	Load Capability	Thermal Stability	Average Particle Size	Moisture Sensitivity
Molybdenum Disulphide	Grey-Black	> 100,000 (psi)	< 750° F	< 1 - 6 micron	Detrimental
Graphite	Grey-Black	< 50,000 (psi)	< 1200° F	2 - 10 micron	Necessary
Polytetrafluoroethylene PTFE	White	< 6,000 (psi)	< 500° F	< 1 micron	No Effect

1 micron = 0.00003937 inches; 1 psi = 6.8947 kPa; Temp. in °C = (°F-32)/1.8

Solids additives shown in **Table 6**, can be added to both mineral and synthetic base oil stocks. In certain high temperature and high-pressure conditions, solids can be mixed with a mineral spirits carrier and applied directly to the bearing surfaces as a dry solid lubricant. The volatile carrier flashes off with the heat and leaves a dry solid film on the bearing surface.

Synthetic Based Oils.—Originally developed to cope with extreme high temperature situations encountered in early jet engines, synthetic based oil differs from mineral based oil in that its base stock is man-made. Using a polymerization similar to that used in plastics manufacturing, synthetic based oils are scientifically designed with identifiable molecular structures, resulting in fluids with highly predictable properties.

Synthetic lubricants deliver many advantages; their stability under severe high and low temperature operating conditions enables equipment to operate in extreme conditions with a high degree of reliability. Although there are many different synthetic base stocks, industry is primarily served by the following five common synthetic lubricant types.

Poly-Alph-Olefins - PAOs: PAOs, **Table 7**, are often described as man-made mineral oils (synthesized hydrocarbons) and were amongst the first developed synthetic lubricants for popular use in automotive crankcase oils. They are formulated in a similar molecular structure to that of pure paraffin through the synthesis of ethylene gas molecules into a polymerized uniform structure. They have a wide range of uses that include crankcase oil, gear oil, compressor oil, and turbine oils.

Table 7. Poly-Alph-Olefins (PAOs)

Positive Features	Negative Features
Low pour point (down to -90° F or -68°C) High viscosity index, VI > 140 High viscosity range Good mineral oil compatibility Good seal compatibility Excellent corrosion stability	Cost (4-8 × mineral oil cost) Poor additive solubility Poor biodegradability

Poly-alkylene Glycols - PAGs: PAGs, **Table 8**, are also known as organic chemical Ucon fluids that possess excellent lubricity and a unique property that causes decomposed or oxidized products to volatilize (clean burn) or become soluble, resulting in no sludge, varnish, or damaging particles to be formed at high temperatures. PAG's are polymers of alkylene oxides and are used for compressor oils, hydraulic oils (water glycols), and severe duty gear oils.

Table 8. Polyalkylene Glycols (PAGs)

Positive Features	Negative Features
Low pour point (to -60° F or -51°C) High viscosity index, VI > 150 High viscosity range Fair seal compatibility Excellent biodegradability Do not produce sludge or varnish	Cost (4 - 8 × mineral oil cost) Poor mineral oil compatibility Poor PAO and synthetic ester based oil compatibility

Di-Basic Acid Esters - Di-Esters: Due to their high shear VI stability under extreme temperature, Di-Esters, **Table 9**, have become very popular in the aerospace industry. Formulated from the reaction between alcohol and acid-laden oxygen, Di-esters originally saw primary use in jet engine oils, but are now used mainly in high temperature compressor oils.

Table 9. Di-Basic Acid Esters (Di-esters)

Positive Features	Negative Features
Low pour point (to -80° F or -62°C) High viscosity index, VI > 150 High viscosity range Good mineral oil compatibility Good additive solvency	Cost (4 - 8 x mineral oil cost) Poor hydrolytic stability Poor seal compatibility Fair mineral oil compatibility Poor corrosion stability

Polyol-Esters: Due to their increased thermal stability over Di-esters, Polyol-Esters, **Table 10**, have now taken over as the preferred oils for gas turbines, jet engines, and 2-cycle oil applications.

Table 10. Polyol-Esters

Positive Features	Negative Features
Low pour point (to -95° F or -71°C) High viscosity index, VI > 160 High viscosity range Good oxidation stability Good mineral oil compatibility Good anti-wear properties Good additive solvency	Cost (10 - 15 × mineral oil cost) Poor hydrolytic stability Poor seal compatibility Fair mineral oil compatibility Poor corrosion stability

Silicones: Silicone lubricants, **Table 11**, are semi-inorganic compounds formulated to provide the stability of inorganic products, yet retain the versatility of organic products. Although they have poor lubricity, silicone lubricants find favor in lightly loaded instrument bearings and oils and situations requiring high temperature change and compatibility with plastics. Additives are added to the base stocks to enhance lubricant performance, just as with mineral oils.

Table 11. Silicone

Positive Features	Negative Features
Low pour point (to -95° F or -71°C) High viscosity index, VI > 250 Very High Viscosity range Very high flash point Good seal compatibility	High Cost (30 - 100 × mineral oil cost) Poor lubricity Poor seal compatibility Poor mineral oil compatibility Poor biodegradability Poor additive solvency

Temperature Effects on Oil .—Changes in temperature effect an oil's viscosity and its ability to maintain a load carrying hydrodynamic film as depicted in **Fig. 7**. With the exception of silicone-based fluids, which unfortunately have poor lubricating qualities, most oils suffer a dramatic drop in viscosity once the temperature surpasses 100° F (38° C).

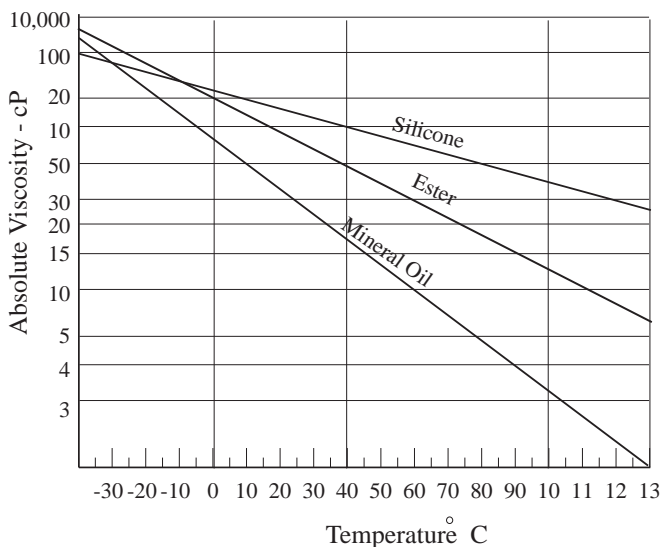


Fig. 7. Temperature Effect on Viscosity for Different Oils

Temperature affects not only the viscosity of the oil, it affects the condition and life expectancy of the oil as shown in Fig. 8. For every 17° F (10° C) increase in temperature, oxidation rates double and effective oil life is halved. Operating temperature is the leading indicator in determining oil change out frequencies

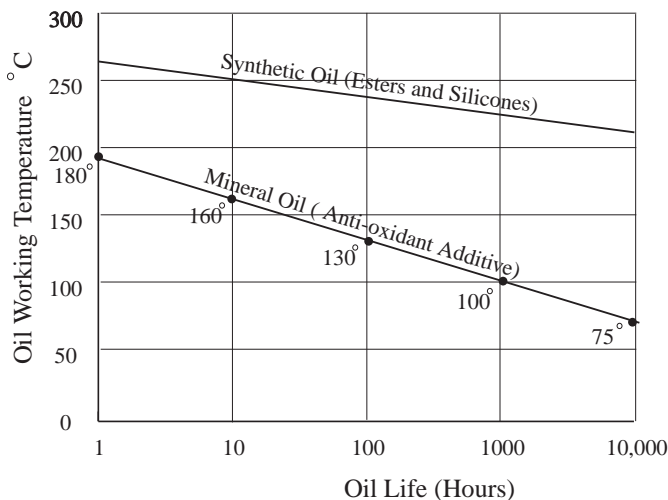


Fig. 8. Expected Oil Life at Varying Operating Temperatures.

Oxidation is the leading cause of lubricant failure. Fig. 9 shows typical upper and lower working limits for various lubricating oils.

Lubricating Grease.—In situations where the containment and continued application of lubricating oil is not practical, lubricating grease is widely used - most specifically in rolling element bearings requiring only periodic lubrication, and slow-speed, high-load boundary lubrication applications. Easier to retain than oil, grease offers lower lubricant losses and good sealing qualities. When utilized in an automatic delivery system, grease can provide full film lubrication.

Grease is a blended mix of the lubricating oil (mineral or synthetic - usually di-ester or silicone based), oil additive package, and fatty acids mixed with metallic alkaline soap to

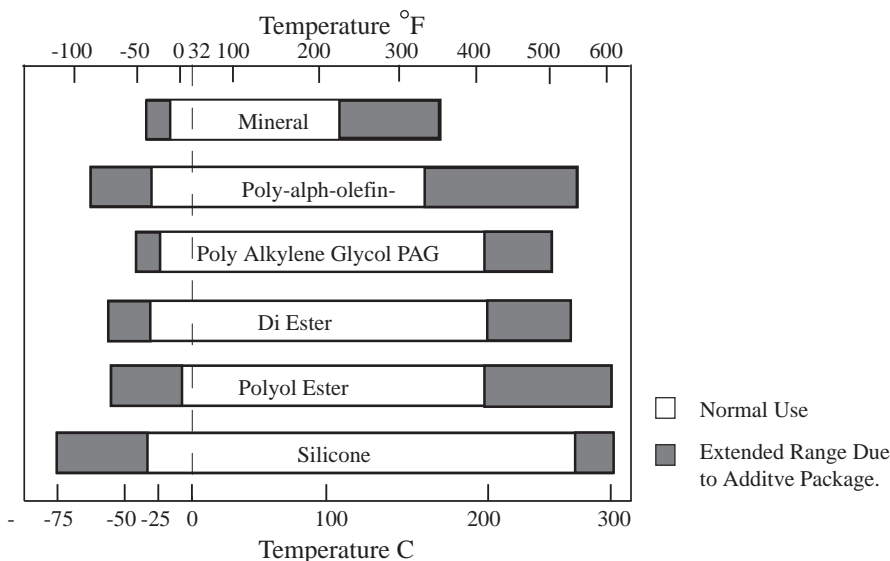


Fig. 9. Temperature Limit Guidelines for Oil.

form the thickening agent. Varying the oil, additive package, and soap blend produces many unique types of grease formulated for a variety of operating conditions. Greases are classified according to their soap base as depicted in Table 12.

Grease works in a similar way to a sponge; as the temperature of the grease rises, the oil bleeds from the soap filler and performs the lubricating function to the balls, raceways, and sliding surfaces. Inversely, once the grease cools down, the oil is soaked back up into the soap filler, which essentially acts as a semi-fluid container for the lubricating oil. An important step in selecting the correct grease is determining if the base oil viscosity is suitable for the application. For example, grease designed for heavily loaded, high temperature applications will probably use a heavy viscosity oil base, whereas general-purpose grease is more likely to use a medium viscosity oil base.

Table 12. Grease Types and Their Properties

Type	Appearance	Pump-ability	Heat Resistance	Temperature Range	Water Resistance	Compatibility with other greases
Calcium (Lime Soap)	Buttery	Fair	Fair	230° F (110° C)	Excellent	Excellent
Sodium (Soda Soap)	Fibrous	Fair	Very Good	250° F (120° C)	Poor	Good
Calcium Complex	Stringy	Fair	Good	350° F (175° C)	Very Good	Fair
Lithium	Buttery	Excellent	Good	350° F (175° C)	Excellent	Excellent
Aluminum Complex	Stringy	Good	Excellent	350° F (175° C)	Excellent	Poor
Lithium Complex	Buttery	Excellent	Excellent	375° F (190° C)	Very Good	Excellent
Barium	Fibrous	Very Good	Excellent	380° F (193° C)	Excellent	Fair
Bentonite (non-soap)	Buttery	Good	Excellent	500° F (260° C)	Good	Poor
Urea	Buttery	Good	Excellent	> 500° F (260° C)	Excellent	Excellent

Grease properties may change according to the additive package used

At sustained high temperatures, grease will soften substantially and could leak or drop from the bearing unless rated specifically for high temperature applications. High temperatures rapidly oxidize the lubricant causing the soap to harden; higher temperatures require more frequent application of grease. Lower temperatures can be just as detrimental because the grease “stiffens” considerably as temperatures near -20° F (-30° C). At this temperature the rolling elements no longer rotate and they drag across the raceway. Under heavier loads this effect causes “smearing” of the bearing surfaces leading to premature bearing failure. Grease temperature guidelines by type are shown in Fig. 10.

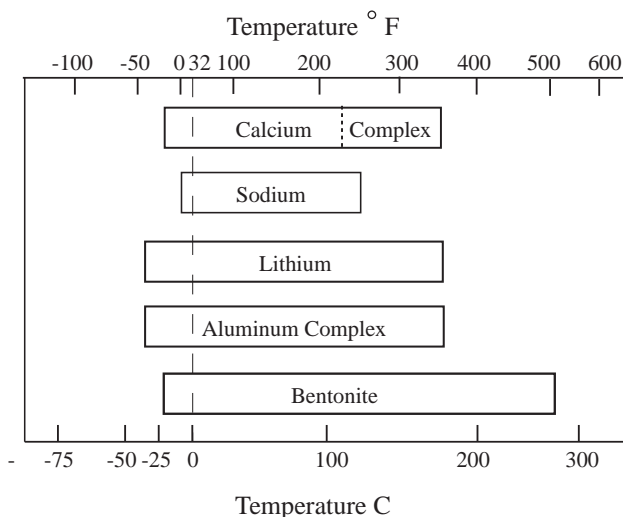


Fig. 10. Temperature Limit Guidelines for Grease

Grease Classification: The National Lubricating Grease Institute - NLGI, classifies grease according to a rating standard that measures the consistency of the grease. Using a penetrometer apparatus under laboratory conditions, a conical weight is dropped from a known height into the grease sample, and its depth of penetration is measured after a 5 second time period. The [Table 13](#) rating chart shows that stiffer greases are rated with a higher NLGI code than more fluid grease with higher levels of penetration. Grease consistency largely depends on the type and amount of soap thickener blended in the grease and the oil viscosity — **NOT** the base oil viscosity alone. Rolling element bearings will use grease in the NLGI 1 to 3 ranges. Centralized grease lubricating systems favor 0 to 2 NLGI rated grease.

Table 13. NLGI Grease Consistency Rating Chart

NLGI Rating	Description	Penetration Range (0.1mm@77° F)
6	Brick Hard	85 - 115
5	Very Stiff	130 - 160
4	Stiff	175 - 205
3	Medium	220 - 250
2	Medium Soft	265 - 295
1	Soft	310 - 340
0	Very Soft	355 - 385
00	Semi Fluid	400 - 430
000	Semi Fluid	445 - 475

Grease Additives: As with oil, grease will also contain solids additives such as graphite, molybdenum disulfide, and PTFE for use in extreme pressure and heavy wear conditions.

Lubricant Application

Selecting a Suitable Lubricant.—Selecting a suitable lubricant will depend on a number of factors such as type of operation (full film, boundary layer), temperature, speed, load, working environment, and machine design. Machine maintenance requirements and maintenance schedules are not always taken into account in the equipment engineering design process of the lubrication system(s). Careful assessment of the conditions and consultation with a lubricant manufacturer/provider must take place to determine the optimal lubricant choice for each specific application. [Table 14](#) offers general guidelines for lubricant choice

when operating conditions are known, and Fig. 11 offers lubricant viscosity guideline choices based on bearing speed in RPM. Once the initial lubricant choice is made, its viscosity must be checked against the specific operating temperature to ensure that the lubricant is suitable for speed, load, and temperature conditions.

Table 14. General Guidelines for Choosing a Preferred Lubricant Type

Condition	Oil	Grease	Solid
Clearances Designed for Oil	●		●
Clearances Designed for Grease		●	●
High Speed, Low Load	●		
Low Speed, High Load		●	
Low Speed Oscillating Load		●	●
High Temperature	●		
Full Film Applications	●	● ^a	
Boundary Layer Applications		●	●
Contaminated Working Environment		●	
Product Cannot Tolerate Leaks		●	●
Closed Gearbox	●		
Isolated Bearings		●	

^a Automated delivery system.

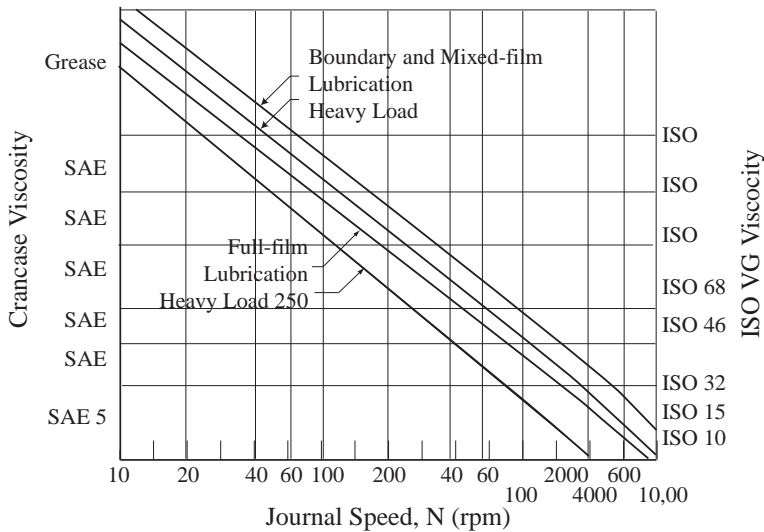


Fig. 11. Lubricant Viscosity Selection Guide based on Bearing Speed in RPM

Lubricant additives deliver different working characteristics to the lubricant. Knowing and documenting a machine or system’s lubricant application requirements will facilitate a consolidation of lubricant requirements and assist in determining the optimal lubricant additive package. Table 15 reviews typical lubricated components, and assigns priority guideline ratings against a number of important lubricant functional attributes. This information is a starting point when working with the lubricant manufacturer to enable consolidation of lubricant needs and choose lubricants with suitable additives.

Table 15. Priority Guideline Ratings of Lubricant Functional Attributes for Different Lubricated Components

Lubricant Attribute	Sliding Bearing	Rolling Bearing	Wire Rope, Chain, Open Gears	Closed Gears
Friction Reduction	1	2	1	2
Boundary Lubrication	1	2	2	3
Cooling Ability	2	2	0	3
Temperature Range	1	2	1	2
Corrosion Protection	1	2	2	1
Seal Out Contaminants	0	2	1	0

0 = Low Priority, 3 = High Priority

Oil Application.—Oil lubrication can be broken down into two major categories: terminating (total loss), and recirculating oil systems.

Terminating Oil Systems: Terminating oil systems are semi-automated and automated systems that dispense oil at a known rate to the bearing(s) and do not recover the oil. This system can be generally observed in use for lubricating plain bearings, gibs, and slide ways found in small to medium-sized machine tools. Reservoir oil is replenished with new oil on an “as used” basis.

Recirculating Oil Systems: Recirculating oil systems pump oil through the bearing(s) on a semi-continuous or continuous cycle, using the oil to cool the bearing as it lubricates. Depending on the system design the oil can be filtered prior to the pump suction inlet, on the pump discharge, and again on the gravity return to the oil storage reservoir.

Recirculating systems are used on every kind of small to very large equipment as long as the oil can be contained; reservoirs retain their original charge of oil, which is changed on a condition or time basis.

A simple method used by lubrication delivery system manufacturers for determining the bearing oil requirements under normal load and speed conditions uses a volumetric requirement over a specified time period (See [Table 16](#)), designated by:

$$V = A \times R \quad (4)$$

Where V = Oil volume in cubic centimeters, (cc)

A = Bearing contact surface area, (cm²)

R = Film thickness replenishment, (mm)

Table 16. Lubrication Film Replenishment Rate Guidelines for Oil and Grease

Lubricant Delivery Method	R - Film Thickness	Time
Automatic Terminating Oil	0.025mm (0.001 inch)	1 hour
Automatic Recirculating Oil	0.025mm (0.001 inch)	1 minute

Other closed system oiling methods exist: Gearbox splash systems employ a simple recirculative pickup/transfer of oil by a submerged gear tooth from an oil reservoir bath. Constant level oilers maintain a constant level of oil in a specially designed oil bath bearing housing. Using air over oil technology, oil can be misted and “rifled” into the bearing allowing very high speeds of over 20,000 rpm at light loads.

When replenishing oil reservoirs always use new clean oil of the exact same specification, from the same manufacturer. Mixing different oils of similar specification can cause additive packages to react with one another causing detriment to the bearings. If changing to a new oil specification or manufacturer consult with the new manufacturer for the correct change out procedure.

Grease Application.—Because grease is easy to retain in a bearing housing over a long period of time and because it acts as a seal against contaminants, most rolling element bearings are grease lubricated. For most applications a NLGI 1 or 2 rating grease is used. The

method of grease lubrication will depend on the greased bearing design; bearings can be hand-packed, manually-lubricated with a terminating style grease gun, or automatically greased.

Open rolling bearings are received with a rust inhibiting compound from new and must be pre packed on assembly - **DO NOT remove bearings from their packaging until ready to use**, and **DO NOT spin dry bearings as this will significantly degrade the life of the bearing**. Shielded or sealed bearings usually arrive pre-packed from the manufacturer - always specify your preferred grease to your bearing supplier when ordering. The initial amount of grease is determined by adjusting the volume according to the known speed and load. For operating temperatures above 180°F (80°C) the bearing is packed to 25% of the full pack volume. For temperatures below 180°F (80°C), the guideline for pack volume is shown in **Table 17** and is based on the bearing surface speed in operation calculated as:

$$dn \text{ or } Dn = SD \times \text{RPM} \quad (5)$$

where dn = Bearing surface speed factor, Metric, mm

Dn = Bearing surface speed factor, US Customary, in.

SD = Shaft Diameter of the bearing bore, mm or in.

RPM = Velocity, Rotations Per Minute at full speed

Table 17. Bearing Packing Guidelines

dn (mm)		Dn (in.)		% Full Pack
From	To	From	To	
0	50,000	0	2,000	100
50,000	100,000	2,000	4,000	75
100,000	150,000	4,000	6,000	50
150,000	200,000	6,000	8,000	33
200,000+		8,000+		25

For vibration applications, do not fill more than 60% of full pack

When hand packing, work the grease with fingers around all the rolling elements; the bearing can be dismantled to make for this operation easier. The grease should fill the immediate bearing area. Before renewing grease in an existing bearing, the bearing must be removed and washed in kerosene or any suitable degreasing product. Once clean, the bearing is lightly coated in mineral oil, being careful not to spin the bearing at this point. Once filled with the appropriate amount of grease in the bearing area, the bearing can be hand spun to fling off grease excess, which is wiped away with a lint-free clean cloth. Free spacing in the housing should be filled from 30% to 50%. Overfilling bearings with grease is the leading cause of bearing lubrication-related failures. Over greasing causes the lubricant to “churn,” which in turn “spikes” the bearing internal temperature, significantly reducing the bearing life using considerably more energy to overcome fluid friction. Bearings designed to be lubricated by a grease handgun or automated delivery system will have a grease port built into the bearing housing and raceway. Grease lubrication intervals will depend on temperature and speed. **Fig. 12** provides guidelines for renewing grease based on speed.

Bearings running at high temperature extremes will require more frequent application based on the temperature, load, speed, and type of grease used. When replenishing grease always use new clean grease of the exact same specification, from the same manufacturer. Mixing different greases can lead to compatibility problems causing detriment to the bearings. If changing to a new grease specification or manufacturer, consult with the new manufacturer for the correct change out procedure.

Lubrication Delivery Methods and Systems .—Numerous methods and systems are used to deliver oil and grease to bearing points. Automated centralized systems work on the premise of delivering a very small amount of lubrication on an almost continual basis,

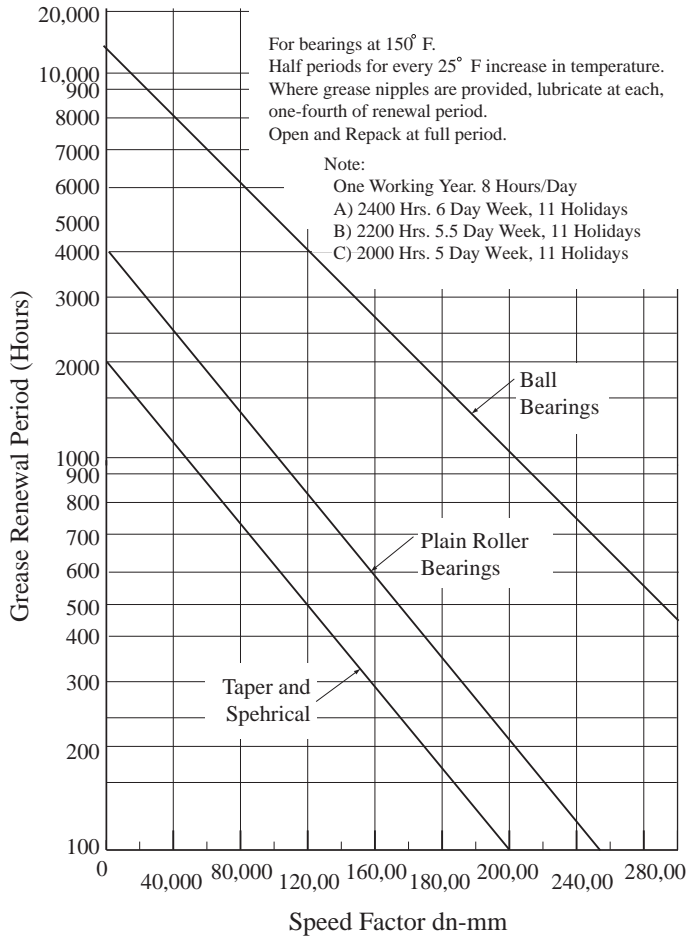


Fig. 12. Grease Renewal Period based on Running Time and Speed providing optimal full film lubrication to the bearing. Although more expensive initially, automated centralized systems are credited with significant savings by extending bearing life up to three times longer than manually lubricated bearings. They also reduce downtime in changing out bearings, reduce lubricant consumption, and reduce energy consumption. Table 18 compares the different types of methods and delivery systems and some of their features, and can be used as a guide in to determining a suitable lubrication delivery approach.

Table 18. Lubrication Method and System Comparison Guide

Feature	Hand Pack	Manual Gun	Single Point	Centralized Total Loss	Centralized Recirculating	Self Contained Splash/Bath	Gravity Fed
Oil		●	●	●	●	●	●
Grease	●	●	●	●			
Continuous Delivery			●		●	●	●
Cyclic Delivery		●		●			
Automatic Control			●	●	●		●
Manual Control	●	●		●			●
Positive Displacement		●	●	●	●		
Line Monitor Protection				●	●		
# Lube Points		Unlimited	Unlimited	20 Min.	200 Max.		20 Max.

Manual gun delivery systems are commonly known as grease guns and oil guns. These hand-dispensing devices are capable of delivering lubricant at pressures exceeding 15,000 psi (103 MPa), and must be used with extreme caution if the bearing seal is not to be compromised - especially when lubricating from a remote located grease nipple. Bearings manually lubricated with grease and oil guns are lubricated with significantly more lubricant and less frequent applications than automatic centralized lubricated bearings. Manual lubrication results in a high degree of bearing fluid friction and a significant lower life expectancy.

Single point lubricators are self-contained automatic dispensing units that house a lubricant reservoir and can dispense oil or grease to a single bearing or a small number of bearings through a manifold system. Earlier versions of the grease units employed a spring-loaded follower plate that dispensed against a bearing back pressure through a controllable bleed valve; while oil units used gravity (also known as gravity units) to allow oil to drip through a bleed valve at a controlled rate onto a brush or wick device touching the moving shaft or part. Both unit types are refillable and are still available. Modern day versions are mostly one-time-use units that employ programmable controlled battery operated positive displacement pumps, or electrochemical gas expandable bellows to move the lubricant to the bearing.

Centralized total loss systems employ a pump that can be automatically or manually activated to pump oil (solid or mist) or grease to a series of metering valves mounted at the lubrication point, or in a manifold device piped to the bearing point. These systems are capable of delivering a metered amount of lubricant on a cyclic basis to many hundreds of lubricant points simultaneously. Because the lubricant is not reclaimed at the bearing point, the pump reservoir must be filled with lubricant on a regular basis. This lubrication system is the most common type of found on industrial equipment.

Centralized oil recirculating systems are designed to continually pump a metered amount of oil through each bearing point. The oil is channeled back to the reservoir through a filter system and pumped out again through the distribution system.

Self contained bath and splash installations are “pick-up” type systems that employ oil in a reservoir filled to an engineered level that covers the lowest submersed gear teeth. As the gear moves it picks up the oil and transfers lubricant as each gear engages and disengages. Higher rpm speed causes the lubricant to be splashed high into the gearbox cavity so that it is distributed to all the internal devices.

Contamination Control

Before an oil lubricant gets to perform its lubrication function at the bearing point, it must often go through a torturous handling process where the oil must be transferred multiple times before it eventually resides in the final application reservoir. The lubricant is shipped from the refinery to the blending station, to the manufacturer’s bulk storage tank, to the supplier’s storage tank, to the barrel or pail, to the user’s storage facility, to the maintenance department, and finally to the machine’s reservoir. If the transfer equipment and storage tanks/devices are not dedicated to this exact lubricant type and scrupulously clean, and the oil is not filtered at every transfer point, the virgin oil will be contaminated when placed in the equipment reservoir.

In a study performed by the National Research Council of Canada on bearing failure in primary industries it was found that 82% of wear induced failure was particle induced failure from dirty lubricants, with the greatest wear caused by particles whose size equaled the oil film thickness. Perhaps the greatest contamination enemy for bearings is the ever present silt and its abrasive properties. Fig. 13 shows the Macpherson curve, which depicts the contaminant effect on roller bearing life based on contaminant micron size.

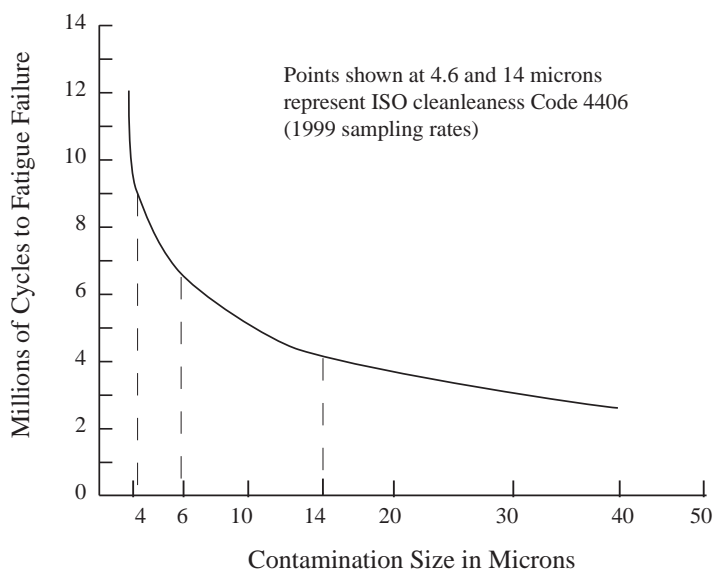


Fig. 13. Macpherson Contamination Effect Curve

The graph in Fig. 13 clearly shows the relationship between bearing life extension and contaminant size. By focusing on controlling contaminants less than 10 microns in size with quality filtration methods, expected bearing life is more than tripled.

ISO Cleanliness Code.—When performing a solids lubricant analysis and cleanliness testing, the ISO Cleanliness Code ISO4406 (1999) is used as a guide. The number of 4-micron, 6-micron, and 14-micron diameter particles in a one ml lubricant sample are counted and compared to a particle concentration range, (see Table 19), then assigned a cleanliness code number for each particle count size.

Table 19. ISO Cleanliness Code 4406 (1999)

Particles Per ml			Particles Per ml		
More Than	Up to and Including	Range Number (R)	More Than	Up to and Including	Range Number (R)
80000	160000	24	20	40	12
40000	80000	23	10	20	11
20000	40000	22	5	10	10
10000	20000	21	2.5	5	9
5000	10000	20	1.3	2.6	8
2500	5000	19	0.64	1,28	7
1300	2600	18	0.32	0.64	6
640	1280	17	0.16	0.32	5
320	640	16	0.08	0.16	4
160	320	15	0.04	0.08	3
80	160	14	0.02	0.04	2
40	80	13	0.01	0.02	1

Example: An ISO code of 21/19/17 would represent findings of between 10,000 to 20,000 4-micron sized particles per ml, between 2,500 and 5,000 6-micron sized particles per ml, and between 640 and 1,280 14-micron sized particles per ml; this sample would be considered very dirty.

Typical cleanliness targets for rolling element bearings would start at 16/14/12 or better, 17/15/12 or better for journal style bearings, 17/14/12 or better for industrial gearboxes, and 15/12 or better for hydraulic fluids.

A study conducted by the British Hydromechanics Research Association (BHRA) looked at the relationship between hydraulic fluid cleanliness and mean time between failure (MTBF), of over 100 hydraulic systems in a variety of industries over a three year period. The results are seen in Fig. 14 and show that systems that were successful in filtering out and excluding contaminants over 5 microns in size lasted tens of thousand of hours longer between system breakdowns.

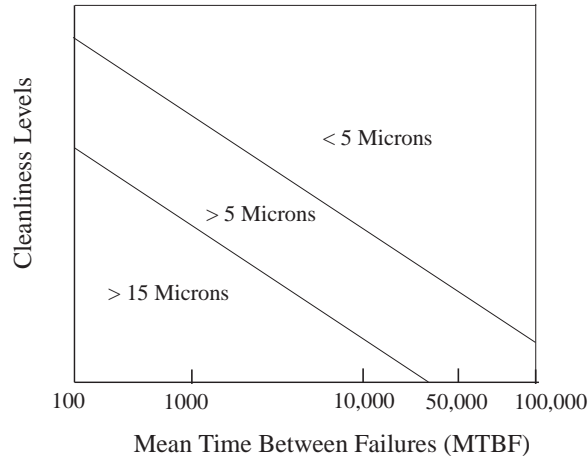


Fig. 14. MTBF vs. Cleanliness Levels

Solid particle ingestion into a closed lubrication/hydraulic system can come from a variety of sources that include new oil, service and manufacturing debris, improper seals, vents/breathers, filter breakdown, and internal wear generation. For the most part, ingress prevention is all about filtration. Introducing filtered clean new oil into a system will significantly retard the wear process and avoid clogging up breathers and in line filter systems.

Water Contamination .— Water Contamination is the other major lubricant contaminant that will significantly degrade the oil's life -Fig. 15. Lubrication fluid typically saturates at 0.04% or 400 ppm, whereas hydraulic fluid (excluding water glycol fluids) saturates at an even lower 0.03% or 300 ppm. Typical water sources are found in the fluid storage areas when lubricants are stored outdoors and subjected to the elements, or stored in continually changing temperatures causing condensation and rust that can be transferred into the equipment's lubrication system.

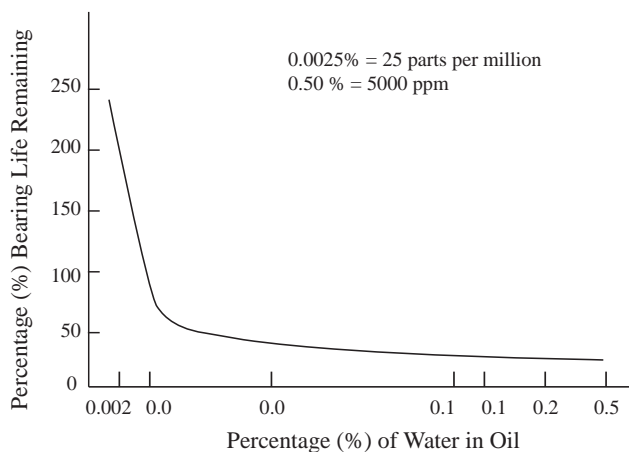


Fig. 15. Effect of Water in Oil on Bearing Life

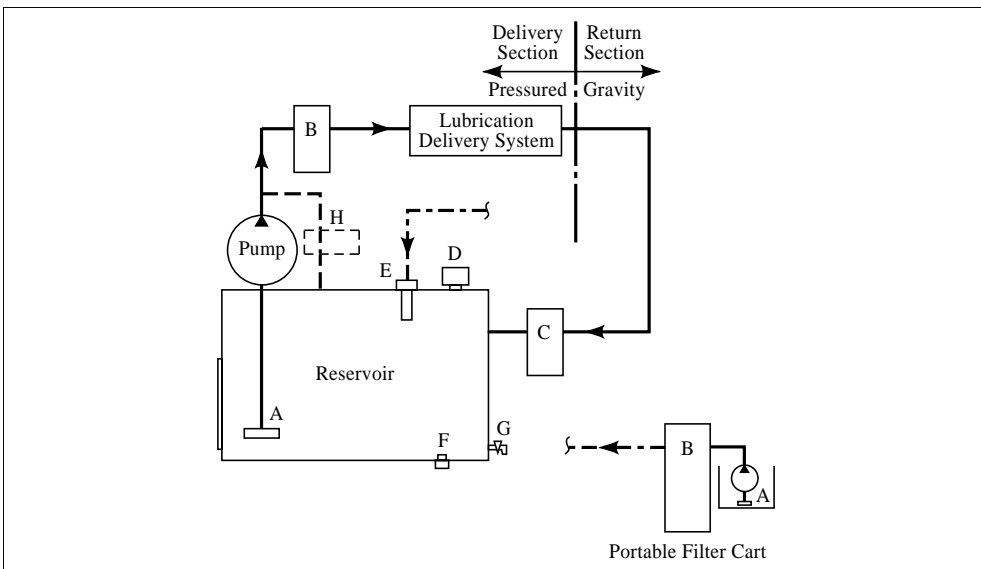
Filtration Systems.—Although contamination cannot be completely eliminated, with diligence and the use of effective filtration techniques and methods the effects of contamination can be seriously mitigated.

Working on the understanding that fluid cleanliness is the basis for contamination control, primary filtration commences on the virgin stock oils prior to the lubricant being placed in the working reservoir or lubrication / hydraulic system.

Once the lubricant is in a working system it will immediately begin to attract contaminants already in the system, from the air, outside sources, manufacturing materials, and wear materials that must be filtered out as the lubricant moves through the system. **Table 20** shows a typical pressure flow lubrication delivery, hydraulic system complete with a minimum filter media package. The function of these filters is to reduce operating costs and increase component life; therefore they must be properly sized for the system and be of the highest quality.

There are two basic types of filter design, surface filters and depth filters. Surface filters are the most common and use a screening material to trap debris. Depth filters are deep cleaning filtering devices that use multiple layers of dense materials to “polish” the lubricant. Depth filters are usually set up in parallel with the basic filter system and allow a small percentage of the lubricant flow to bypass the pump and be depth cleaned.

Table 20. Typical Minimum Filtration Requirements for a Closed Loop Lubrication Hydraulic System



	Location	Type	Degree	Material	Purpose
A	Pump Suction	Surface	Medium	Gauze, Paper	Pump Protection
B	Pump Delivery Header	Surface	Fine	Felt, Paper, Cellulose, Sintered metal	Primary System Protection
C	Return Line	Surface	Medium	Felt, Paper, Cellulose	Wear Products Protection
D	Reservoir Vent	Surface	Course / Medium	Wire, Wool, Paper, Oil Bath Desiccant	Remove Airborne Contaminant and Condensation
E	Reservoir Fill Port	Surface	Course	Gauze, Paper	Prevent Course Solids Ingress
F	Drain Plug	Surface	Fine	Magnet	Capture Ferrite Wear Metals And Debris
G	Drain Valve	n/a	n/a	n/a	Water Removal
H	Delivery Bypass Filter	Depth	Very Fine	Carbon, Cellulose, Diamataceous Earth, Felt	Lubricant Deep Cleaning And Polishing

A diagram and tabulation of the filtration requirements of a closed loop hydraulic system are shown in [Table 20](#). Fluid in the reservoir is sucked up by the pump through the suction filter (A) and pumped into the delivery header line under pressure. If a depth filter option is used, a small percentage, up to 15%, of the oil flow is diverted for deep cleaning through a depth filter (H) and sent back to the reservoir for recycling. The lubricant is then forced through the primary pressure filter and allowed to perform its work at the bearing point or hydraulic device before it eventually channels into the system return line under gravity to pass through a low pressure return line filter that takes out any wear materials gathered along the way. Once through the return filter the oil makes its way back into the reservoir. The reservoir is protected against airborne contaminants and condensation by the vent filter, and is protected against ingress of coarse solids by the fill neck screen filter. Because water is heavier than oil it will settle to the bottom of the tank where most of it can be drained off by opening the drain valve. Metallic debris also settle to the bottom and are captured by the magnetic drain plug at the bottom of the reservoir. As the lubricant oxidizes and breaks down, sludge will form on the bottom of the reservoir, which must be cleaned out periodically manually by removing the reservoir clean-out hatch.

Filter Efficiency: Most surface filters are sold in either one-time-use, or cleanable-reusable forms. Depth filters are all one-time-use filters. All filters are performance rated according to the media's particle removal efficiency, known as the filter's filtration ratio, or Beta ratio. Not all filters are made equal, and they are tested for dirt holding capacity, pressure differential capability, and filter efficiency, using an ISO 4572 Multipass Test Procedure in which fluid is circulated through a mock lube system in a controlled manner. Differential pressure across the test filter element is recorded as contamination is added into the lubricant upstream of the filter. Laser particle sensors determine contamination levels both upstream and downstream of the filter element and the beta ratio is determined using the following formula:

$$B_x = \frac{\# \text{ Upstream Particulate}}{\# \text{ Downstream Particulate}} \quad (6)$$

Where B = Filter Filtration Ratio

x = A specific particle size

Example: If 100,000 particles, 10 microns and larger are counted upstream of the test filter, and 1000 particles are counted after or downstream of the test filter element, the Beta ratio would equal:

$$B_{10} = \frac{100,000}{1000}$$

Efficiency is determined using the following equation:

$$\text{Efficiency}_x = \left(1 - \frac{1}{\text{Beta}}\right) \times 100 \quad (7)$$

$$\text{Efficiency}_{10} = \left(1 - \frac{1}{100}\right) \times 100 = 99\%$$

The higher the beta ratio, the better the capture efficiency of the filter, see [Table 21](#).

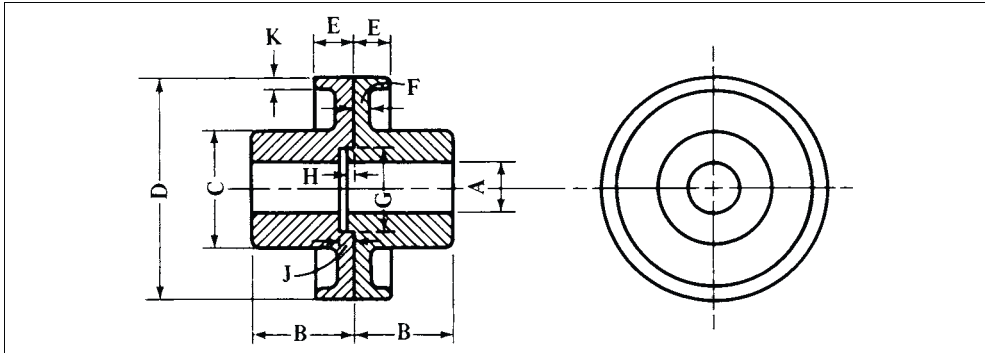
Table 21. Filter Efficiency

Beta Ratio at a Specific Particle Size.	Filter Efficiency at Same Specific Particle Size.	Beta Ratio at a Specific Particle Size.	Filter Efficiency at Same Specific Particle Size.	Beta Ratio at a Specific Particle Size.	Filter Efficiency at Same Specific Particle Size.
1.01	1%	5	80%	100	99%
1.1	9%	10	90%	200	99.5%
1.5	33%	20	95%	1000	99.9%
2	50%	75	98.7%

COUPLINGS, CLUTCHES, BRAKES

Connecting Shafts.—For couplings to transmit up to about 150 horsepower, simple flange-type couplings of appropriate size, as shown in the table, are commonly used. The design shown is known as a safety flange coupling because the bolt heads and nuts are shrouded by the flange, but such couplings today are normally shielded by a sheet metal or other cover.

Safety Flange Couplings



A	B	C	D	E	F	G	H	J	K	Bolts	
										No.	Dia.
1	1 3/4	2 1/4	4	1 1/16	5/16	1 1/2	1/4	9/32	1/4	5	3/8
1 1/4	2 3/16	2 3/4	5	1 3/16	3/8	1 7/8	1/4	9/32	1/4	5	7/16
1 1/2	2 5/8	3 3/8	6	1 5/16	7/16	2 1/4	1/4	9/32	1/4	5	1/2
1 3/4	3 1/16	4	7	1 1/16	1/2	2 5/8	1/4	9/32	1/4	5	9/16
2	3 1/2	4 1/2	8	1 3/16	9/16	3	1/4	9/32	5/16	5	5/8
2 1/4	3 15/16	5 5/8	9	1 5/16	5/8	3 3/8	1/4	9/32	5/16	5	1 1/16
2 1/2	4 3/8	5 5/8	10	1 7/16	1 1/16	3 3/4	1/4	9/32	5/16	5	3/4
2 3/4	4 13/16	6 1/4	11	1 9/16	3/4	4 1/8	1/4	9/32	5/16	5	13/16
3	5 1/4	6 3/4	12	1 11/16	13/16	4 1/2	1/4	9/32	3/8	5	7/8
3 1/4	5 11/16	7 3/8	13	1 13/16	7/8	4 7/8	1/4	9/32	3/8	5	15/16
3 1/2	6 1/8	8	14	1 15/16	15/16	5 1/4	1/4	9/32	3/8	5	1
3 3/4	6 9/16	8 1/2	15	2 1/16	1	5 5/8	1/4	9/32	3/8	5	1 1/16
4	7	9	16	2 1/4	1 1/8	6	1/4	9/32	7/16	5	1 1/8
4 1/2	7 7/8	10 1/4	18	2 1/2	1 1/4	6 3/4	1/4	9/32	7/16	5	1 1/4
5	8 3/4	11 1/4	20	2 3/4	1 3/8	7 1/2	1/4	9/32	7/16	5	1 3/8
5 1/2	8 3/4	11 1/4	20	2 3/4	1 3/8	7 1/2	1/4	9/32	7/16	5	1 3/8
6	10 1/2	12 3/8	22	2 15/16	1 1/2	8 1/4	5/16	1 1/32	1/2	5	1 7/16
6 1/2	11 3/8	13 1/2	24	3 1/8	1 5/8	9	5/16	1 1/32	1/2	5	1 1/2
7	12 1/4	14 5/8	26	3 1/4	1 3/4	9 3/4	5/16	1 1/32	9/16	6	1 1/2
7 1/2	13 3/8	15 3/4	28	3 7/16	1 7/8	10 1/2	5/16	1 1/32	9/16	6	1 9/16
8	14	16 7/8	28	3 1/2	2	10 7/8	5/16	1 1/32	5/8	7	1 1/2
8 1/2	14 7/8	18	30	3 11/16	2 1/8	11 1/4	5/16	1 1/32	5/8	7	1 9/16
9	15 3/4	19 1/8	31	3 3/4	2 1/4	11 3/8	5/16	1 1/32	1 1/16	8	1 1/2
9 1/2	16 3/8	20 1/4	32	3 15/16	2 3/8	12	5/16	1 1/32	1 1/16	8	1 9/16
10	17 1/2	21 3/8	34	4 1/8	2 1/2	12 3/4	5/16	1 1/32	3/4	8	1 5/8
10 1/2	18 3/8	22 1/2	35	4 1/4	2 5/8	13 1/8	5/16	1 1/32	3/4	10	1 5/8
11	19 1/4	23 3/8	36	4 7/16	2 3/4	13 1/2	5/16	1 1/32	7/8	10	1 11/16
11 1/2	20 3/8	24 3/4	37	4 3/8	2 7/8	13 3/8	5/16	1 1/32	7/8	10	1 3/4
12	21	25 7/8	38	4 13/16	3	14 1/4	5/16	1 1/32	1	10	1 13/16

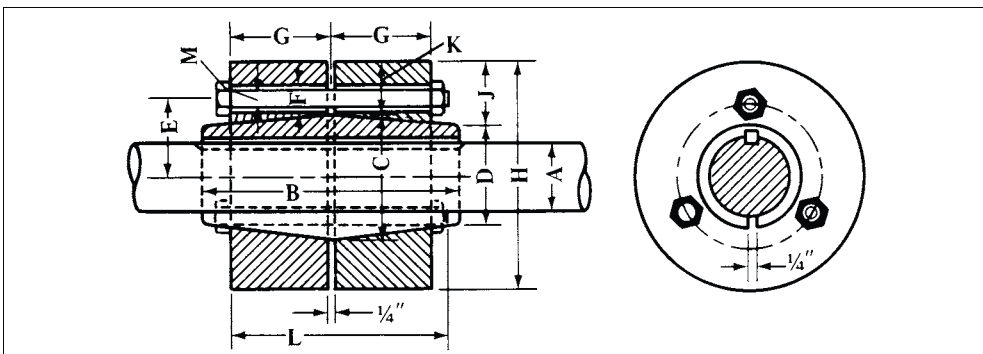
For small sizes and low power applications, a setscrew may provide the connection between the hub and the shaft, but higher power usually requires a key and perhaps two setscrews, one of them above the key. A flat on the shaft and some means of locking the set-screw(s) in position are advisable. In the AGMA Class I and II fits the shaft tolerances are -0.0005 inch from $\frac{1}{2}$ to $1\frac{1}{2}$ inches diameter and -0.001 inch on larger diameters up to 7 inches.

Class I coupling bore tolerances are $+0.001$ inch up to $1\frac{1}{2}$ inches diameter, then $+0.0015$ inch to 7 inches diameter. Class II coupling bore tolerances are $+0.002$ inch on sizes up to 3 inches diameter, $+0.003$ inch on sizes from $3\frac{1}{4}$ through $3\frac{3}{4}$ inches diameter, and $+0.004$ inch on larger diameters up to 7 inches.

Interference Fits.—Components of couplings transmitting over 150 horsepower often are made an interference fit on the shafts, which may reduce fretting corrosion. These couplings may or may not use keys, depending on the degree of interference. Keys may range in size from $\frac{1}{8}$ inch wide by $\frac{1}{16}$ inch high for $\frac{1}{2}$ -inch diameter shafts to $1\frac{3}{4}$ inches wide by $\frac{7}{8}$ inch high for 7-inch diameter shafts. Couplings transmitting high torque or operating at high speeds or both may use two keys. Keys must be a good fit in their keyways to ensure good transmission of torque and prevent failure. AGMA standards provide recommendations for square parallel, rectangular section, and plain tapered keys, for shafts of $\frac{5}{16}$ through 7 inches diameter, in three classes designated commercial, precision, and fitted. These standards also cover keyway offset, lead, parallelism, finish and radii, and face keys and splines. (See also ANSI and other Standards in *KEYS AND KEYSEATS* starting on page 2460 of this Handbook.)

Double-cone Clamping Couplings.—As shown in the table, double-cone clamping couplings are made in a range of sizes for shafts from $1\frac{7}{16}$ to 6 inches in diameter, and are easily assembled to shafts. These couplings provide an interference fit, but they usually cost more and have larger overall dimensions than regular flanged couplings.

Double-cone Clamping Couplings



A	B	C	D	E	F	G	H	J	K	L	M	No. of Bolts	No. of Keys
$1\frac{7}{16}$	$5\frac{1}{4}$	$2\frac{3}{4}$	$2\frac{1}{8}$	$1\frac{5}{8}$	$\frac{3}{8}$	$2\frac{1}{8}$	$4\frac{3}{4}$	$1\frac{1}{8}$	1	5	$\frac{1}{2}$	3	1
$1\frac{15}{16}$	7	$3\frac{1}{2}$	$2\frac{1}{8}$	$2\frac{1}{8}$	$\frac{5}{8}$	$2\frac{3}{4}$	$6\frac{1}{4}$	$1\frac{1}{8}$	$1\frac{3}{8}$	$6\frac{1}{4}$	$\frac{1}{2}$	3	1
$2\frac{1}{16}$	$8\frac{3}{4}$	$4\frac{5}{16}$	$3\frac{3}{8}$	3	$\frac{3}{4}$	$3\frac{1}{2}$	$7\frac{13}{16}$	$1\frac{3}{8}$	$1\frac{3}{4}$	$7\frac{7}{8}$	$\frac{5}{8}$	3	1
3	$10\frac{1}{2}$	$5\frac{1}{2}$	$4\frac{7}{32}$	$3\frac{1}{2}$	$\frac{3}{4}$	$4\frac{3}{16}$	9	$2\frac{1}{4}$	2	$9\frac{1}{2}$	$\frac{5}{8}$	3	1
$3\frac{1}{2}$	$12\frac{1}{4}$	7	$5\frac{3}{8}$	$4\frac{3}{8}$	$\frac{7}{8}$	$5\frac{5}{16}$	$11\frac{1}{4}$	$2\frac{3}{8}$	$2\frac{1}{8}$	$11\frac{1}{4}$	$\frac{3}{4}$	4	1
4	14	7	$5\frac{1}{2}$	$4\frac{3}{4}$	$\frac{7}{8}$	$5\frac{1}{2}$	12	$3\frac{3}{4}$	$2\frac{1}{2}$	12	$\frac{3}{4}$	4	1
$4\frac{1}{2}$	$15\frac{1}{2}$	8	$6\frac{1}{8}$	$5\frac{1}{4}$	$\frac{7}{8}$	$6\frac{3}{4}$	$13\frac{1}{2}$	$3\frac{3}{4}$	$2\frac{3}{4}$	$14\frac{1}{2}$	$\frac{3}{4}$	4	1
5	17	9	$7\frac{1}{4}$	$5\frac{3}{4}$	$\frac{7}{8}$	7	15	$3\frac{3}{4}$	3	$15\frac{1}{4}$	$\frac{3}{4}$	4	1
$5\frac{1}{2}$	$17\frac{1}{2}$	$9\frac{1}{2}$	$7\frac{3}{4}$	$6\frac{1}{4}$	1	7	$15\frac{1}{2}$	$3\frac{3}{4}$	3	$15\frac{1}{4}$	$\frac{7}{8}$	4	1
6	18	10	$8\frac{1}{4}$	$6\frac{3}{4}$	1	7	16	$3\frac{3}{4}$	3	$15\frac{3}{4}$	$\frac{7}{8}$	4	2

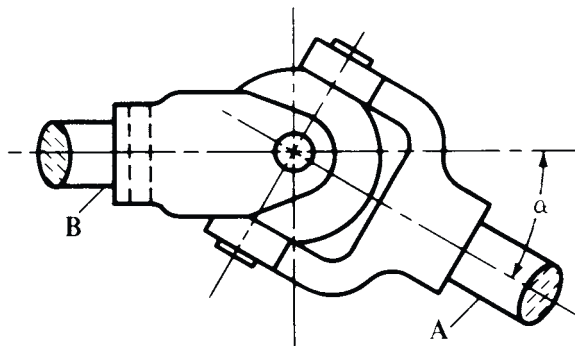
Flexible Couplings.—Shafts that are out of alignment laterally or angularly can be connected by any of several designs of flexible couplings. Such couplings also permit some degree of axial movement in one or both shafts. Some couplings use disks or diaphragms to transmit the torque. Another simple form of flexible coupling consists of two flanges connected by links or endless belts made of leather or other strong, pliable material. Alternatively, the flanges may have projections that engage spacers of molded rubber or other flexible materials that accommodate uneven motion between the shafts. More highly developed flexible couplings use toothed flanges engaged by correspondingly toothed elements, permitting relative movement. These couplings require lubrication unless one or more of the elements is made of a self-lubricating material. Other couplings use diaphragms or bellows that can flex to accommodate relative movement between the shafts.

The Universal Joint.—This form of coupling, originally known as a Cardan or Hooke's coupling, is used for connecting two shafts the axes of which are not in line with each other, but which merely intersect at a point. There are many different designs of universal joints or couplings, which are based on the principle embodied in the original design. One well-known type is shown by the accompanying diagram.

As a rule, a universal joint does not work well if the angle α (see illustration) is more than 45 degrees, and the angle should preferably be limited to about 20 degrees or 25 degrees, excepting when the speed of rotation is slow and little power is transmitted.

Variation in Angular Velocity of Driven Shaft: Owing to the angularity between two shafts connected by a universal joint, there is a variation in the angular velocity of one shaft during a single revolution, and because of this, the use of universal couplings is sometimes prohibited. Thus, the angular velocity of the driven shaft will not be the same at all points of the revolution as the angular velocity of the driving shaft. In other words, if the driving shaft moves with a uniform motion, then the driven shaft will have a variable motion and, therefore, the universal joint should not be used when absolute uniformity of motion is essential for the driven shaft.

Determining Maximum and Minimum Velocities: If shaft *A* (see diagram) runs at a constant speed, shaft *B* revolves at maximum speed when shaft *A* occupies the position shown in the illustration, and the minimum speed of shaft *B* occurs when the fork of the driving shaft *A* has turned 90 degrees from the position illustrated. The maximum speed of the driven shaft may be obtained by multiplying the speed of the driving shaft by the secant of angle α . The minimum speed of the driven shaft equals the speed of the driver multiplied by cosine α . Thus, if the driver rotates at a constant speed of 100 revolutions per minute and the shaft angle is 25 degrees, the maximum speed of the driven shaft is at a rate equal to $1.1034 \times 100 = 110.34$ rpm. The minimum speed rate equals $0.9063 \times 100 = 90.63$; hence, the extreme variation equals $110.34 - 90.63 = 19.71$ rpm.



Use of Intermediate Shaft between Two Universal Joints.—The lack of uniformity in the speed of the driven shaft resulting from the use of a universal coupling, as previously explained, is objectionable for some forms of mechanisms. This variation may be avoided if the two shafts are connected with an intermediate shaft and two universal joints, provided the latter are properly arranged or located. Two conditions are necessary to obtain a constant speed ratio between the driving and driven shafts. First, the shafts must make the same angle with the intermediate shaft; second, the universal joint forks (assuming that the fork design is employed) on the intermediate shaft must be placed relatively so that when the plane of the fork at the left end coincides with the center lines of the intermediate shaft and the shaft attached to the left-hand coupling, the plane of the right-hand fork must also coincide with the center lines of the intermediate shaft and the shaft attached to the right-hand coupling; therefore the driving and the driven shafts may be placed in a variety of positions. One of the most common arrangements is with the driving and driven shafts parallel. The forks on the intermediate shafts should then be placed in the same plane.

This intermediate connecting shaft is frequently made telescoping, and then the driving and driven shafts can be moved independently of each other within certain limits in longitudinal and lateral directions. The telescoping intermediate shaft consists of a rod which enters a sleeve and is provided with a suitable spline, to prevent rotation between the rod and sleeve and permit a sliding movement. This arrangement is applied to various machine tools.

Knuckle Joints.—Movement at the joint between two rods may be provided by knuckle joints, for which typical proportions are seen in the table *Proportions of Knuckle Joints* on page 2447.

Friction Clutches.—Clutches which transmit motion from the driving to the driven member by the friction between the engaging surfaces are built in many different designs, although practically all of them can be classified under four general types, namely, conical clutches; radially expanding clutches; contracting-band clutches; and friction disk clutches in single and multiple types. There are many modifications of these general classes, some of which combine the features of different types. The proportions of various sizes of cone clutches are given in the table “Cast-iron Friction Clutches.” The multicone friction clutch is a further development of the cone clutch. Instead of having a single cone-shaped surface, there is a series of concentric conical rings which engage annular grooves formed by corresponding rings on the opposite clutch member. The internal-expanding type is provided with shoes which are forced outward against an enclosing drum by the action of levers connecting with a collar free to slide along the shaft. The engaging shoes are commonly lined with wood or other material to increase the coefficient of friction. Disk clutches are based on the principle of multiple-plane friction, and use alternating plates or disks so arranged that one set engages with an outside cylindrical case and the other set with the shaft. When these plates are pressed together by spring pressure, or by other means, motion is transmitted from the driving to the driven members connected to the clutch. Some disk clutches have a few rather heavy or thick plates and others a relatively large number of thinner plates. Clutches of the latter type are common in automobile transmissions. One set of disks may be of soft steel and the other set of phosphor-bronze, or some other combination may be employed. For instance, disks are sometimes provided with cork inserts, or one set or series of disks may be faced with a special friction material such as asbestos-wire fabric, as in “dry plate” clutches, the disks of which are not lubricated like the disks of a clutch having, for example, the steel and phosphor-bronze combination. It is common practice to hold the driving and driven members of friction clutches in engagement by means of spring pressure, although pneumatic or hydraulic pressure may be employed.

Proportions of Knuckle Joints

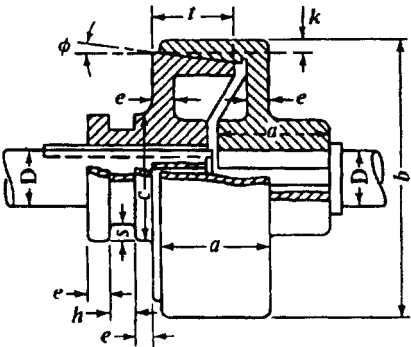
						For sizes not given below: $a = 1.2 D$ $h = 2 D$ $b = 1.1 D$ $i = 0.5 D$ $c = 1.2 D$ $j = 0.25 D$ $e = 0.75 D$ $k = 0.5 D$ $f = 0.6 D$ $l = 1.5 D$ $g = 1.5 D$					
						<i>D</i>	<i>a</i>	<i>b</i>	<i>c</i>	<i>e</i>	<i>f</i>
1/2	5/8	9/16	5/8	3/8	3/16	3/4	1	1/4	1/8	1/4	3/4
3/4	7/8	3/4	7/8	9/16	7/16	1 1/8	1 1/2	3/8	3/16	3/8	1 1/8
1	1 1/4	1 1/8	1 1/4	3/4	5/8	1 1/2	2	1/2	1/4	1/2	1 1/2
1 1/4	1 1/2	1 3/8	1 1/2	15/16	3/4	1 7/8	2 1/2	5/8	5/16	5/8	1 7/8
1 1/2	1 3/4	1 5/8	1 3/4	1 1/8	7/8	2 1/4	3	3/4	3/8	3/4	2 1/4
1 3/4	2 1/8	2	2 1/8	1 5/16	1 1/16	2 5/8	3 1/2	7/8	7/16	7/8	2 5/8
2	2 3/8	2 1/4	2 3/8	1 1/2	1 3/16	3	4	1	1/2	1	3
2 1/4	2 3/4	2 1/2	2 3/4	1 11/16	1 3/8	3 3/8	4 1/2	1 1/8	9/16	1 1/8	3 3/8
2 1/2	3	2 3/4	3	1 7/8	1 1/2	3 3/4	5	1 1/4	5/8	1 1/4	3 3/4
2 3/4	3 1/4	3	3 1/4	2 1/16	1 5/8	4 1/8	5 1/2	1 3/8	1 1/16	1 3/8	4 1/8
3	3 5/8	3 1/4	3 5/8	2 1/4	1 13/16	4 1/2	6	1 1/2	3/4	1 1/2	4 1/2
3 1/4	4	3 3/8	4	2 7/16	2	4 7/8	6 1/2	1 5/8	13/16	1 5/8	4 7/8
3 1/2	4 1/4	3 7/8	4 1/4	2 5/8	2 1/8	5 1/4	7	1 3/4	7/8	1 3/4	5 1/4
3 3/4	4 1/2	4 1/8	4 1/2	2 13/16	2 1/4	5 5/8	7 1/2	1 7/8	15/16	1 7/8	5 5/8
4	4 3/4	4 3/8	4 3/4	3	2 3/8	6	8	2	1	2	6
4 1/4	5 1/8	4 3/4	5 1/8	3 3/16	2 9/16	6 3/8	8 1/2	2 1/8	1 1/16	2 1/8	6 3/8
4 1/2	5 1/2	5	5 1/2	3 3/8	2 3/4	6 3/4	9	2 1/4	1 1/8	2 1/4	6 3/4
4 3/4	5 3/4	5 1/4	5 3/4	3 9/16	2 7/8	7 1/8	9 1/2	2 3/8	1 3/16	2 3/8	7 1/8
5	6	5 1/2	6	3 3/4	3	7 1/2	10	2 1/2	1 1/4	2 1/2	7 1/2

Power Transmitting Capacity of Friction Clutches.—When selecting a clutch for a given class of service, it is advisable to consider any overloads that may be encountered and base the power transmitting capacity of the clutch upon such overloads. When the load varies or is subject to frequent release or engagement, the clutch capacity should be greater than the actual amount of power transmitted. If the power is derived from a gas or gasoline engine, the horsepower rating of the clutch should be 75 or 100 per cent greater than that of the engine.

Power Transmitted by Disk Clutches.—The approximate amount of power that a disk clutch will transmit may be determined from the following formula, in which *H* = horsepower transmitted by the clutch; μ = coefficient of friction; *r* = mean radius of engaging surfaces; *F* = axial force in pounds (spring pressure) holding disks in contact; *N* = number of frictional surfaces; *S* = speed of shaft in revolutions per minute:

$$H = \frac{\mu r F N S}{63,000}$$

Cast-iron Friction Clutches

		For sizes not given below:						
		$a = 2D$	$b = 4 \text{ to } 8D$	$c = 2\frac{1}{4}D$	$t = 1\frac{1}{2}D$	$e = \frac{3}{8}D$	$h = \frac{1}{2}D$	$s = \frac{5}{16}D, \text{ nearly}$
<i>Note:</i> The angle ϕ of the cone may be from 4 to 10 degrees								
D	a	b	c	t	e	h	s	k
1	2	4 - 8	$2\frac{1}{4}$	$1\frac{1}{2}$	$\frac{3}{8}$	$\frac{1}{2}$	$\frac{5}{16}$	$\frac{1}{4}$
$1\frac{1}{4}$	$2\frac{1}{2}$	5-10	$2\frac{7}{8}$	$1\frac{7}{8}$	$\frac{1}{2}$	$\frac{5}{8}$	$\frac{3}{8}$	$\frac{5}{16}$
$1\frac{1}{2}$	3	6-12	$3\frac{3}{8}$	$2\frac{1}{4}$	$\frac{5}{8}$	$\frac{3}{4}$	$\frac{1}{2}$	$\frac{3}{8}$
$1\frac{3}{4}$	$3\frac{1}{2}$	7-14	4	$2\frac{5}{8}$	$\frac{5}{8}$	$\frac{7}{8}$	$\frac{5}{8}$	$\frac{7}{16}$
2	4	8-16	$4\frac{1}{2}$	3	$\frac{3}{4}$	1	$\frac{5}{8}$	$\frac{1}{2}$
$2\frac{1}{4}$	$4\frac{1}{2}$	9-18	5	$3\frac{3}{8}$	$\frac{7}{8}$	$1\frac{1}{8}$	$\frac{5}{8}$	$\frac{9}{16}$
$2\frac{1}{2}$	5	10-20	$5\frac{5}{8}$	$3\frac{3}{4}$	1	$1\frac{1}{4}$	$\frac{3}{4}$	$\frac{5}{8}$
$2\frac{3}{4}$	$5\frac{1}{2}$	11-22	$6\frac{1}{4}$	$4\frac{1}{8}$	1	$1\frac{3}{8}$	$\frac{7}{8}$	$1\frac{1}{16}$
3	6	12-24	$6\frac{3}{4}$	$4\frac{1}{2}$	$1\frac{1}{8}$	$1\frac{1}{2}$	$\frac{7}{8}$	$\frac{3}{4}$
$3\frac{1}{4}$	$6\frac{1}{2}$	13-26	$7\frac{3}{8}$	$4\frac{7}{8}$	$1\frac{1}{4}$	$1\frac{5}{8}$	1	$1\frac{3}{16}$
$3\frac{1}{2}$	7	14-28	$7\frac{7}{8}$	$5\frac{1}{4}$	$1\frac{3}{8}$	$1\frac{3}{4}$	1	$\frac{7}{8}$
$3\frac{3}{4}$	$7\frac{1}{2}$	15-30	$8\frac{1}{2}$	$5\frac{5}{8}$	$1\frac{3}{8}$	$1\frac{7}{8}$	$1\frac{1}{4}$	$1\frac{15}{16}$
4	8	16-32	9	6	$1\frac{1}{2}$	2	$1\frac{1}{4}$	1
$4\frac{1}{4}$	$8\frac{1}{2}$	17-34	$9\frac{1}{2}$	$6\frac{3}{8}$	$1\frac{5}{8}$	$2\frac{1}{8}$	$1\frac{3}{8}$	$1\frac{1}{16}$
$4\frac{1}{2}$	9	18-36	$10\frac{1}{4}$	$6\frac{3}{4}$	$1\frac{3}{4}$	$2\frac{1}{4}$	$1\frac{3}{8}$	$1\frac{1}{8}$
$4\frac{3}{4}$	$9\frac{1}{2}$	19-38	$10\frac{3}{4}$	$7\frac{1}{8}$	$1\frac{3}{4}$	$2\frac{3}{8}$	$1\frac{1}{2}$	$1\frac{13}{16}$
5	10	20-40	$11\frac{1}{4}$	$7\frac{1}{2}$	$1\frac{7}{8}$	$2\frac{1}{2}$	$1\frac{1}{2}$	$1\frac{1}{4}$
$5\frac{1}{4}$	$10\frac{1}{2}$	21-42	$11\frac{3}{4}$	$7\frac{7}{8}$	2	$2\frac{5}{8}$	$1\frac{5}{8}$	$1\frac{15}{16}$
$5\frac{1}{2}$	11	22-44	$12\frac{3}{8}$	$8\frac{1}{4}$	2	$2\frac{3}{4}$	$1\frac{3}{4}$	$1\frac{3}{8}$
$5\frac{3}{4}$	$11\frac{1}{2}$	23-46	13	$8\frac{5}{8}$	$2\frac{1}{4}$	$2\frac{7}{8}$	$1\frac{3}{4}$	$1\frac{7}{16}$
6	12	24-48	$13\frac{1}{2}$	9	$2\frac{1}{4}$	3	$1\frac{7}{8}$	$1\frac{1}{2}$

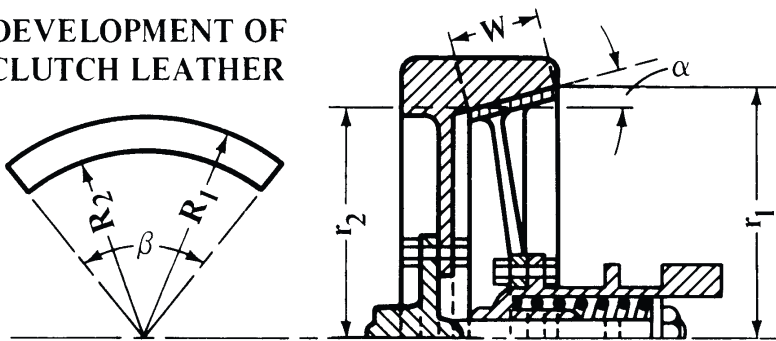
Frictional Coefficients for Clutch Calculations.—While the frictional coefficients used by designers of clutches differ somewhat and depend upon variable factors, the following values may be used in clutch calculations: For greasy leather on cast iron about 0.20 or 0.25, leather on metal that is quite oily 0.15; metal and cork on oily metal 0.32; the same on dry metal 0.35; metal on dry metal 0.15; disk clutches having lubricated surfaces 0.10.

Formulas for Cone Clutches.—In cone clutch design, different formulas have been developed for determining the horsepower transmitted. These formulas, at first sight, do not seem to agree, there being a variation due to the fact that in some of the formulas the friction clutch surfaces are assumed to engage without slip, whereas, in others, some allowance is made for slip. The following formulas include both of these conditions:

$H.P.$ = horsepower transmitted

- N = revolutions per minute
- r = mean radius of friction cone, in inches
- r_1 = large radius of friction cone, in inches
- r_2 = small radius of friction cone, in inches
- R_1 = outside radius of leather band, in inches
- R_2 = inside radius of leather band, in inches
- V = velocity of a point at distance r from the center, in feet per minute
- F = tangential force acting at radius r , in pounds
- P_n = total normal force between cone surfaces, in pounds
- P_s = spring force, in pounds
- α = angle of clutch surface with axis of shaft = 7 to 13 degrees
- β = included angle of clutch leather, when developed, in degrees
- f = coefficient of friction = 0.20 to 0.25 for greasy leather on iron
- p = allowable pressure per square inch of leather band = 7 to 8 pounds
- W = width of clutch leather, in inches

DEVELOPMENT OF CLUTCH LEATHER



$$R_1 = \frac{r_1}{\sin \alpha} \quad R_2 = \frac{r_2}{\sin \alpha}$$

$$\beta = \sin \alpha \times 360 \quad r = \frac{r_1 + r_2}{2}$$

$$V = \frac{2\pi r N}{12}$$

$$F = \frac{HP \times 33,000}{V} \quad W = \frac{P_n}{2\pi r p} \quad HP = \frac{P_n f r N}{63,025}$$

For engagement with some slip:

$$P_n = \frac{P_s}{\sin \alpha} \quad P_s = \frac{HP \times 63,025 \sin \alpha}{f r N}$$

For engagement without slip:

$$P_n = \frac{P_s}{\sin \alpha + f \cos \alpha} \quad P_s = \frac{HP \times 63,025 (\sin \alpha + f \cos \alpha)}{f r N}$$

Angle of Cone.—If the angle of the conical surface of the cone type of clutch is too small, it may be difficult to release the clutch on account of the wedging effect, whereas, if the angle is too large, excessive spring force will be required to prevent slipping. The minimum angle for a leather-faced cone is about 8 or 9 degrees and the maximum angle about 13 degrees. An angle of 12 1/2 degrees appears to be the most common and is generally con-

sidered good practice. These angles are given with relation to the clutch axis and are one-half the included angle.

Magnetic Clutches.—Many disk and other clutches are operated electromagnetically with the magnetic force used only to move the friction disk(s) and the clutch disk(s) into or out of engagement against spring or other pressure. On the other hand, in a magnetic particle clutch, transmission of power is accomplished by magnetizing a quantity of metal particles enclosed between the driving and the driven components, forming a bond between them. Such clutches can be controlled to provide either a rigid coupling or uniform slip, useful in wire drawing and manufacture of cables.

Another type of magnetic clutch uses eddy currents induced in the input member which interact with the field in the output rotor. Torque transmitted is proportional to the coil current, so precise control of torque is provided. A third type of magnetic clutch relies on the hysteresis loss between magnetic fields generated by a coil in an input drum and a close-fitting cup on the output shaft, to transmit torque. Torque transmitted with this type of clutch also is proportional to coil current, so close control is possible.

Permanent-magnet types of clutches also are available, in which the engagement force is exerted by permanent magnets when the electrical supply to the disengagement coils is cut off. These types of clutches have capacities up to five times the torque-to-weight ratio of spring-operated clutches. In addition, if the controls are so arranged as to permit the coil polarity to be reversed instead of being cut off, the combined permanent magnet and electromagnetic forces can transmit even greater torque.

Centrifugal and Free-wheeling Clutches.—Centrifugal clutches have driving members that expand outward to engage a surrounding drum when speed is sufficient to generate centrifugal force. Free-wheeling clutches are made in many different designs and use balls, cams or sprags, ratchets, and fluids to transmit motion from one member to the other. These types of clutches are designed to transmit torque in only one direction and to take up the drive with various degrees of gradualness up to instantaneously.

Slipping Clutch/Couplings.—Where high shock loads are likely to be experienced, a slipping clutch or coupling or both should be used. The most common design uses a clutch plate that is clamped between the driving and driven plates by spring pressure that can be adjusted. When excessive load causes the driven member to slow, the clutch plate surfaces slip, allowing reduction of the torque transmitted. When the overload is removed, the drive is taken up automatically. Switches can be provided to cut off current supply to the driving motor when the driven shaft slows to a preset limit or to signal a warning or both. The slip or overload torque is calculated by taking 150 per cent of the normal running torque.

Wrapped-spring Clutches.—For certain applications, a simple steel spring sized so that its internal diameter is a snug fit on both driving and driven shafts will transmit adequate torque in one direction. The tightness of grip of the spring on the shafts increases as the torque transmitted increases. Disengagement can be effected by slight rotation of the spring, through a projecting tang, using electrical or mechanical means, to wind up the spring to a larger internal diameter, allowing one of the shafts to run free within the spring.

Normal running torque T_r , in lb-ft = (required horsepower \times 5250) \div rpm. For heavy shock load applications, multiply by a 200 per cent or greater overload factor. (See Motors, factors governing selection.)

The clutch starting torque T_c , in lb-ft, required to accelerate a given inertia in a specific time is calculated from the formula:

$$T_c = \frac{WR^2 \times \Delta N}{308t}$$

where WR^2 = total inertia encountered by clutch in lb-ft² (W = weight and R = radius of gyration of rotating part)

ΔN = final rpm – initial rpm

308 = constant (see *Factors Governing Motor Selection* on page 2573)

t = time to required speed in seconds

Example 1: If the inertia is 80 lb-ft², and the speed of the driven shaft is to be increased from 0 to 1500 rpm in 3 seconds, find the clutch starting torque in lb-ft.

$$T_c = \frac{80 \times 1500}{308 \times 3} = 130 \text{ lb-ft}$$

The heat E , in BTU, generated in one engagement of a clutch can be calculated from the formula:

$$E = \frac{T_c \times WR^2 \times (N_1^2 - N_2^2)}{(T_c - T_1) \times 4.7 \times 10^6}$$

where: WR^2 = total inertia encountered by clutch in lb-ft.²

N_1 = final rpm N_2 = initial rpm

T_c = clutch torque in lb-ft T_1 = torque load in lb-ft

Example 2: Calculate the heat generated for each engagement under the conditions cited for **Example 1**.

$$E = \frac{130 \times 80 \times (1500)^2}{(130 - 10) \times 4.7 \times 10^6} = 41.5 \text{ BTU}$$

The preferred location for a clutch is on the high- rather than on the low-speed shaft because a smaller-capacity unit, of lower cost and with more rapid dissipation of heat, can be used. However, the heat generated may also be more because of the greater slippage at higher speeds, and the clutch may have a shorter life. For light-duty applications, such as to a machine tool, where cutting occurs after the spindle has reached operating speed, the calculated torque should be multiplied by a safety factor of 1.5 to arrive at the capacity of the clutch to be used. Heavy-duty applications such as frequent starting of a heavily loaded vibratory-finishing barrel require a safety factor of 3 or more.

Positive Clutches.—When the driving and driven members of a clutch are connected by the engagement of interlocking teeth or projecting lugs, the clutch is said to be “positive” to distinguish it from the type in which the power is transmitted by frictional contact. The positive clutch is employed when a sudden starting action is not objectionable and when the inertia of the driven parts is relatively small. The various forms of positive clutches differ merely in the angle or shape of the engaging surfaces. The least positive form is one having planes of engagement which incline backward, with respect to the direction of motion. The tendency of such a clutch is to disengage under load, in which case it must be held in position by axial pressure.

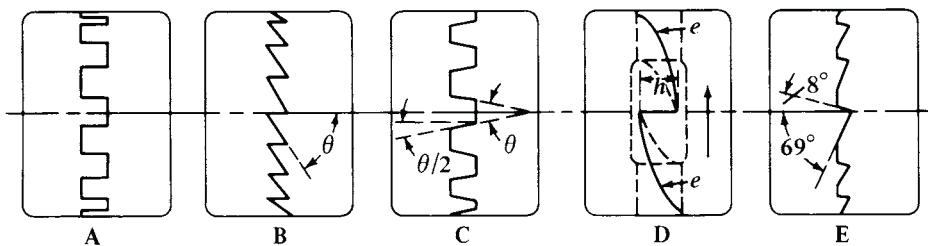


Fig. 1. Types of Clutch Teeth

This pressure may be regulated to perform normal duty, permitting the clutch to slip and disengage when over-loaded. Positive clutches, with the engaging planes parallel to the axis of rotation, are held together to obviate the tendency to jar out of engagement, but they provide no safety feature against over-load. So-called “under-cut” clutches engage more tightly the heavier the load, and are designed to be disengaged only when free from load.

The teeth of positive clutches are made in a variety of forms, a few of the more common styles being shown in Fig. 1. Clutch *A* is a straight-toothed type, and *B* has angular or saw-shaped teeth. The driving member of the former can be rotated in either direction: the latter is adapted to the transmission of motion in one direction only, but is more readily engaged. The angle θ of the cutter for a saw-tooth clutch *B* is ordinarily 60 degrees. Clutch *C* is similar to *A*, except that the sides of the teeth are inclined to facilitate engagement and disengagement. Teeth of this shape are sometimes used when a clutch is required to run in either direction without backlash. Angle θ is varied to suit requirements and should not exceed 16 or 18 degrees. The straight-tooth clutch *A* is also modified to make the teeth engage more readily, by rounding the corners of the teeth at the top and bottom. Clutch *D* (commonly called a "spiral-jaw" clutch) differs from *B* in that the surfaces *e* are helicoidal. The driving member of this clutch can transmit motion in only one direction.

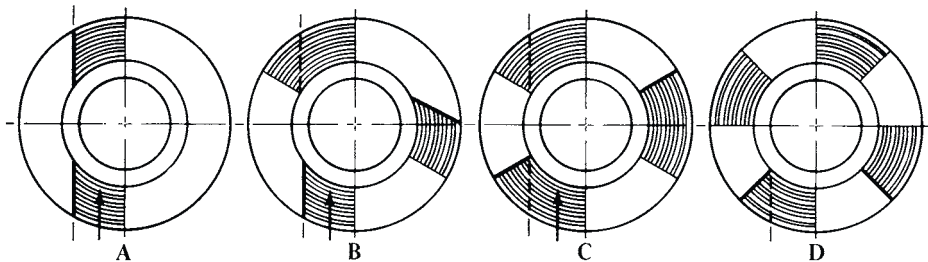


Fig. 2. Diagrammatic View Showing Method of Cutting Clutch Teeth

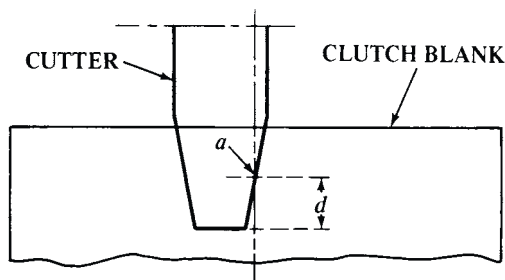


Fig. 3.

Clutches of this type are known as right- and left-hand, the former driving when turning to the right, as indicated by the arrow in the illustration. Clutch *E* is the form used on the back-shaft of the Brown & Sharpe automatic screw machines. The faces of the teeth are radial and incline at an angle of 8 degrees with the axis, so that the clutch can readily be disengaged. This type of clutch is easily operated, with little jar or noise. The 2-inch (50.8 mm) diameter size has 10 teeth. Height of working face, $\frac{1}{8}$ inch (3.175 mm).

Cutting Clutch Teeth.—A common method of cutting a straight-tooth clutch is indicated by the diagrams *A*, *B* and *C*, Fig. 2, which show the first, second and third cuts required for forming the three teeth. The work is held in the chuck of a dividing-head, the latter being set at right angles to the table. A plain milling cutter may be used (unless the corners of the teeth are rounded), the side of the cutter being set to exactly coincide with the center-line. When the number of teeth in the clutch is odd, the cut can be taken clear across the blank as shown, thus finishing the sides of two teeth with one passage of the cutter. When the number of teeth is even, as at *D*, it is necessary to mill all the teeth on one side and then set the cutter for finishing the opposite side. Therefore, clutches of this type commonly have an odd number of teeth. The maximum width of the cutter depends upon the width of the space at the narrow ends of the teeth. If the cutter must be quite narrow in order to pass the narrow ends, some stock may be left in the tooth spaces, which must be removed by a separate cut. If the tooth is of the modified form shown at *C*, Fig. 1, the cutter should be set as

indicated in Fig. 3; that is, so that a point *a* on the cutter at a radial distance *d* equal to one-half the depth of the clutch teeth lies in a radial plane. When it is important to eliminate all backlash, point *a* is sometimes located at a radial distance *d* equal to six-tenths of the depth of the tooth, in order to leave clearance spaces at the bottoms of the teeth; the two clutch members will then fit together tightly. Clutches of this type must be held in mesh.

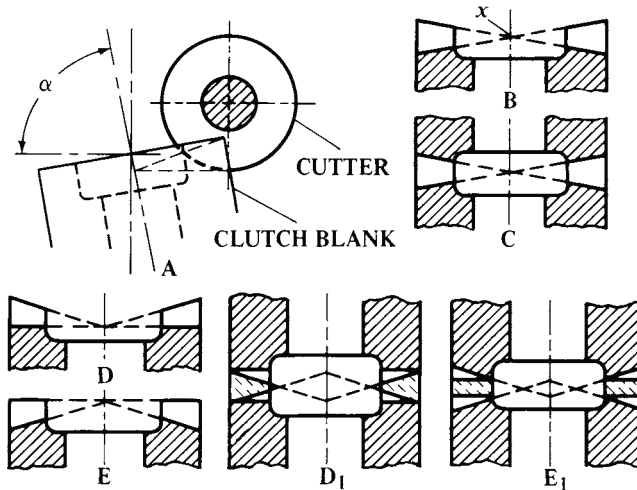


Fig. 4.

Angle of Dividing-head for Milling V-shaped Teeth with Single-angle Cutter

		$\cos \alpha = \frac{\tan(360^\circ / N) \times \cot \theta}{2}$											
		α is the angle shown in Fig. 4 and is the angle shown by the graduations on the dividing head. θ is the included angle of a single cutter, see Fig. 1.											
No. of Teeth, <i>N</i>	Angle of Single-angle Cutter, θ			No. of Teeth, <i>N</i>	Angle of Single-angle Cutter, θ								
	60°	70°	80°		60°	70°	80°						
		Dividing Head Angle, α					Dividing Head Angle, α						
5	27°	19.2'	55°	56.3'	74°	15.4'	18	83°	58.1'	86°	12.1'	88°	9.67'
6	60		71	37.6	81	13	19	84	18.8	86	25.1	88	15.9
7	68	46.7	76	48.5	83	39.2	20	84	37.1	86	36.6	88	21.5
8	73	13.3	79	30.9	84	56.5	21	84	53.5	86	46.9	88	26.5
9	75	58.9	81	13	85	45.4	22	85	8.26	86	56.2	88	31
10	77	53.6	82	24.1	86	19.6	23	85	21.6	87	4.63	88	35.1
11	79	18.5	83	17	86	45.1	24	85	33.8	87	12.3	88	38.8
12	80	24.4	83	58.1	87	4.94	25	85	45	87	19.3	88	42.2
13	81	17.1	84	31.1	87	20.9	26	85	55.2	87	25.7	88	45.3
14	82	.536	84	58.3	87	34	27	86	4.61	87	31.7	88	48.2
15	82	36.9	85	21.2	87	45	28	86	13.3	87	37.2	88	50.8
16	83	7.95	85	40.6	87	54.4	29	86	21.4	87	42.3	88	53.3
17	83	34.7	85	57.4	88	2.56	30	86	28.9	87	47	88	55.6

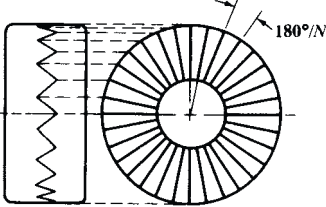
Cutting Saw-tooth Clutches: When milling clutches having angular teeth as shown at B, Fig. 1, the axis of the clutch blank should be inclined a certain angle α as shown at A in Fig. 4. If the teeth were milled with the blank vertical, the tops of the teeth would incline towards the center as at D, whereas, if the blank were set to such an angle that the tops of the teeth were square with the axis, the bottoms would incline upwards as at E. In either case,

the two clutch members would not mesh completely: the engagement of the teeth cut as shown at *D* and *E* would be as indicated at *D*₁ and *E*₁ respectively. As will be seen, when the outer points of the teeth at *D*₁ are at the bottom of the grooves in the opposite member, the inner ends are not together, the contact area being represented by the dotted lines. At *E*₁ the inner ends of the teeth strike first and spaces are left between the teeth around the outside of the clutch. To overcome this objectionable feature, the clutch teeth should be cut as indicated at *B*, or so that the bottoms and tops of the teeth have the same inclination, converging at a central point *x*. The teeth of both members will then engage across the entire width as shown at *C*. The angle α required for cutting a clutch as at *B* can be determined by the following formula in which α equals the required angle, *N* = number of teeth, θ = cutter angle, and $360^\circ/N$ = angle between teeth:

$$\cos \alpha = \frac{\tan(360^\circ/N) \times \cot \theta}{2}$$

The angles α for various numbers of teeth and for 60-, 70- or 80-degree single-angle cutters are given in the table on page 2453. The following table is for double-angle cutters used to cut V-shaped teeth.

Angle of Dividing-head for Milling V-shaped Teeth with Double-angle Cutter



$$\cos \alpha = \frac{\tan(180^\circ/N) \times \cot(\theta/2)}{2}$$

This is the angle (α , Fig. 4) shown by graduations on the dividing-head. θ is the included angle of a double-angle cutter, see Fig. 1.

No. of Teeth, <i>N</i>	Included Angle of Cutter, θ				No. of Teeth, <i>N</i>	Included Angle of Cutter, θ			
	60°		90°			60°		90°	
	Dividing Head Angle, α								
10	73°	39.4'	80°	39'	31	84°	56.9'	87°	5.13'
11	75	16.1	81	33.5	32	85	6.42	87	10.6
12	76	34.9	82	18	33	85	15.4	87	15.8
13	77	40.5	82	55.3	34	85	23.8	87	20.7
14	78	36	83	26.8	35	85	31.8	87	25.2
15	79	23.6	83	54	36	85	39.3	87	29.6
16	80	4.83	84	17.5	37	85	46.4	87	33.7
17	80	41	84	38.2	38	85	53.1	87	37.5
18	81	13	84	56.5	39	85	59.5	87	41.2
19	81	41.5	85	12.8	40	86	5.51	87	44.7
20	82	6.97	85	27.5	41	86	11.3	87	48
21	82	30	85	40.7	42	86	16.7	87	51.2
22	82	50.8	85	52.6	43	86	22	87	54.2
23	83	9.82	86	3.56	44	86	26.9	87	57
24	83	27.2	86	13.5	45	86	31.7	87	59.8
25	83	43.1	86	22.7	46	86	36.2	88	2.4
26	83	57.8	26	31.2	47	86	40.6	88	4.91
27	84	11.4	86	39	48	86	44.8	88	7.32
28	84	24	86	46.2	49	86	48.8	88	9.63
29	84	35.7	86	53	50	86	52.6	88	11.8
30	84	46.7	86	59.3	51	86	56.3	88	14

The angles given in the table above are applicable to the milling of V-shaped grooves in brackets, etc., which must have toothed surfaces to prevent the two members from turning relative to each other, except when unclamped for angular adjustment

Friction Brakes

Formulas for Band Brakes.—In any band brake, such as shown in Fig. 1, in the tabulation of formulas, where the brake wheel rotates in a clockwise direction, the tension in that

part of the band marked *x* equals $P \frac{1}{e^{\mu\theta} - 1}$

The tension in that part marked *y* equals $P \frac{e^{\mu\theta}}{e^{\mu\theta} - 1}$.

P = tangential force in pounds at rim of brake wheel

e = base of natural logarithms = 2.71828

μ = coefficient of friction between the brake band and the brake wheel

θ = angle of contact of the brake band with the brake wheel expressed in radians

$$\text{one radian} = \frac{180 \text{ deg.}}{\pi \text{ radians}} = 57.296 \frac{\text{deg.}}{\text{radian}}$$

See also *Conversion Tables of Angular Measure* starting on page 103.

For simplicity in the formulas presented, the tensions at *x* and *y* (Fig. 1) are denoted by *T*₁ and *T*₂ respectively, for clockwise rotation. When the direction of the rotation is reversed, the tension in *x* equals *T*₂, and the tension in *y* equals *T*₁, which is the reverse of the tension in the clockwise direction.

The value of the expression *e*^{*μθ*} in these formulas may be most easily found by using a hand-held calculator of the scientific type; that is, one capable of raising 2.71828 to the power *μθ*. The following example outlines the steps in the calculations.

Table of Values of *e*^{*μθ*}

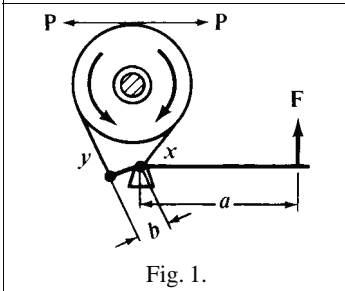
Proportion of Contact to Whole Circumference, $\frac{\theta}{2\pi}$	Steel Band on Cast Iron, $\mu = 0.18$	Leather Belt on			
		Wood	Cast Iron		
		Slightly Greasy; $\mu = 0.47$	Very Greasy; $\mu = 0.12$	Slightly Greasy; $\mu = 0.28$	Damp; $\mu = 0.38$
0.1	1.12	1.34	1.08	1.19	1.27
0.2	1.25	1.81	1.16	1.42	1.61
0.3	1.40	2.43	1.25	1.69	2.05
0.4	1.57	3.26	1.35	2.02	2.60
0.425	1.62	3.51	1.38	2.11	2.76
0.45	1.66	3.78	1.40	2.21	2.93
0.475	1.71	4.07	1.43	2.31	3.11
0.5	1.76	4.38	1.46	2.41	3.30
0.525	1.81	4.71	1.49	2.52	3.50
0.55	1.86	5.07	1.51	2.63	3.72
0.6	1.97	5.88	1.57	2.81	4.19
0.7	2.21	7.90	1.66	3.43	5.32
0.8	2.47	10.60	1.83	4.09	6.75
0.9	2.77	14.30	1.97	4.87	8.57
1.0	3.10	19.20	2.12	5.81	10.90

Formulas for Simple and Differential Band Brakes

F = force in pounds at end of brake handle; P = tangential force in pounds at rim of brake wheel; e = base of natural logarithms = 2.71828; μ = coefficient of friction between the brake band and the brake wheel; θ = angle of contact of the brake band with the brake wheel, expressed in radians (one radian = 57.296 degrees).

$$T_1 = P \frac{1}{e^{\mu\theta} - 1} \quad T_2 = P \frac{e^{\mu\theta}}{e^{\mu\theta} - 1}$$

Simple Band Brake

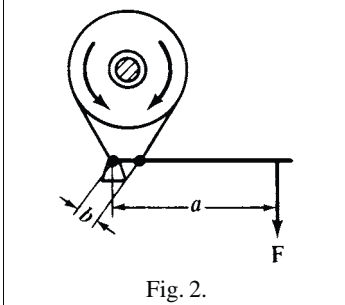


For clockwise rotation:

$$F = \frac{bT_2}{a} = \frac{Pb}{a} \left(\frac{e^{\mu\theta}}{e^{\mu\theta} - 1} \right)$$

For counter clockwise rotation:

$$F = \frac{bT_1}{a} = \frac{Pb}{a} \left(\frac{1}{e^{\mu\theta} - 1} \right)$$



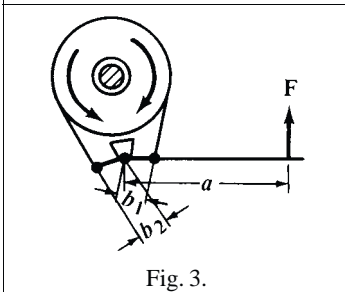
For clockwise rotation:

$$F = \frac{bT_1}{a} = \frac{Pb}{a} \left(\frac{1}{e^{\mu\theta} - 1} \right)$$

For counter clockwise rotation:

$$F = \frac{bT_2}{a} = \frac{Pb}{a} \left(\frac{e^{\mu\theta}}{e^{\mu\theta} - 1} \right)$$

Differential Band Brake



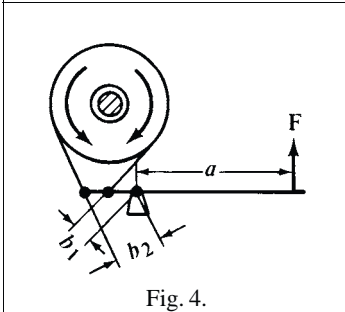
For clockwise rotation:

$$F = \frac{b_2T_2 - b_1T_1}{a} = \frac{P}{a} \left(\frac{b_2e^{\mu\theta} - b_1}{e^{\mu\theta} - 1} \right)$$

For counter clockwise rotation:

$$F = \frac{b_2T_1 - b_1T_2}{a} = \frac{P}{a} \left(\frac{b_2 - b_1e^{\mu\theta}}{e^{\mu\theta} - 1} \right)$$

In this case, if b_2 is equal to, or less than, $b_1e^{\mu\theta}$, the force F will be 0 or negative and the band brake works automatically.



For clockwise rotation:

$$F = \frac{b_2T_2 + b_1T_1}{a} = \frac{P}{a} \left(\frac{b_2e^{\mu\theta} + b_1}{e^{\mu\theta} - 1} \right)$$

For counter clockwise rotation:

$$F = \frac{b_1T_2 + b_2T_1}{a} = \frac{P}{a} \left(\frac{b_1e^{\mu\theta} + b_2}{e^{\mu\theta} - 1} \right)$$

If $b_2 = b_1$, both of the above formulas reduce to $F = \frac{Pb_1}{a} \left(\frac{e^{\mu\theta} + 1}{e^{\mu\theta} - 1} \right)$.

In this case, the same force F is required for rotation in either direction.

Example: In a band brake of the type in Fig. 1, dimension $a = 24$ inches, and $b = 4$ inches; force $P = 100$ pounds; coefficient $\mu = 0.2$, and angle of contact = 240 degrees, or

$$\theta = \frac{240}{180} \times \pi = 4.18$$

The rotation is clockwise. Find force F required.

$$\begin{aligned}
 F &= \frac{Pb}{a} \left(\frac{e^{\mu\theta}}{e^{\mu\theta} - 1} \right) \\
 &= \frac{100 \times 4}{24} \left(\frac{2.71828^{0.2 \times 4.18}}{2.71828^{0.2 \times 4.18} - 1} \right) \\
 &= \frac{400}{24} \times \frac{2.71828^{0.836}}{2.71828^{0.836} - 1} = 16.66 \times \frac{2.31}{2.31 - 1} = 29.4
 \end{aligned}$$

If a hand-held calculator is not used, determining the value of $e^{\mu\theta}$ is rather tedious, and the table on page 2455 will save calculations.

Coefficient of Friction in Brakes.—The coefficients of friction that may be assumed for friction brake calculations are as follows: Iron on iron, 0.25 to 0.3 leather on iron, 0.3; cork on iron, 0.35. Values somewhat lower than these should be assumed when the velocities exceed 400 feet per minute at the beginning of the braking operation.

For brakes where wooden brake blocks are used on iron drums, poplar has proved the best brake-block material. The best material for the brake drum is wrought iron. Poplar gives a high coefficient of friction, and is little affected by oil. The average coefficient of friction for poplar brake blocks and wrought-iron drums is 0.6; for poplar on cast iron, 0.35 for oak on wrought iron, 0.5; for oak on cast iron, 0.3; for beech on wrought iron, 0.5; for beech on cast iron, 0.3; for elm on wrought iron, 0.6; and for elm on cast iron, 0.35. The objection to elm is that the friction decreases rapidly if the friction surfaces are oily. The coefficient of friction for elm and wrought iron, if oily, is less than 0.4.

Calculating Horsepower from Dynamometer Tests.—When a dynamometer is arranged for measuring the horsepower transmitted by a shaft, as indicated by the diagrammatic view in Fig. 5, the horsepower may be obtained by the formula:

$$\text{HP} = \frac{2\pi LPN}{33000}$$

in which H.P. = horsepower transmitted; N = number of revolutions per minute; L = distance (as shown in illustration) from center of pulley to point of action of weight P , in feet; P = weight hung on brake arm or read on scale.

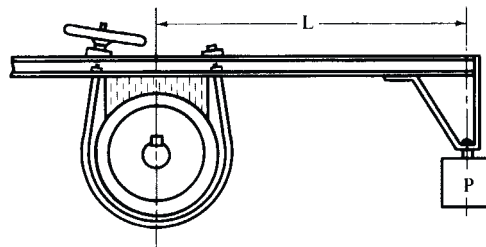


Fig. 5.

By adopting a length of brake arm equal to 5 feet 3 inches, the formula may be reduced to the simple form:

$$\text{HP} = \frac{NP}{1000}$$

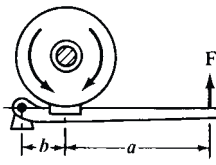
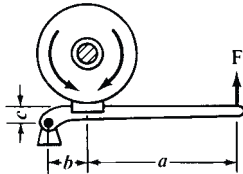
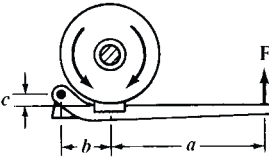
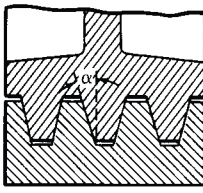
If a length of brake arm equal to 2 feet 7½ inches is adopted as a standard, the formula takes the form:

$$\text{HP} = \frac{NP}{2000}$$

The *transmission* type of dynamometer measures the power by transmitting it through the mechanism of the dynamometer from the apparatus in which it is generated, or to the

apparatus in which it is to be utilized. Dynamometers known as *indicators* operate by simultaneously measuring the pressure and volume of a confined fluid. This type may be used for the measurement of the power generated by steam or gas engines or absorbed by refrigerating machinery, air compressors, or pumps. An electrical dynamometer is for measuring the power of an electric current, based on the mutual action of currents flowing in two coils. It consists principally of one fixed and one movable coil, which, in the normal position, are at right angles to each other. Both coils are connected in series, and, when a current traverses the coils, the fields produced are at right angles; hence, the coils tend to take up a parallel position. The movable coil with an attached pointer will be deflected, the deflection measuring directly the electric current.

Formulas for Block Brakes

<p>F = force in pounds at end of brake handle; P = tangential force in pounds at rim of brake wheel; μ = coefficient of friction between the brake block and brake wheel.</p>	
 <p>Fig. 1.</p>	<p>Block brake. For rotation in either direction:</p> $F = P \frac{b}{a+b} \times \frac{1}{\mu} = \frac{Pb}{a+b} \left(\frac{1}{\mu} \right)$
 <p>Fig. 2.</p>	<p>Block brake. For clockwise rotation:</p> $F = \frac{\frac{Pb}{\mu} - Pc}{a+b} = \frac{Pb}{a+b} \left(\frac{1}{\mu} - \frac{c}{b} \right)$ <p>For counter clockwise rotation:</p> $F = \frac{\frac{Pb}{\mu} + Pc}{a+b} = \frac{Pb}{a+b} \left(\frac{1}{\mu} + \frac{c}{b} \right)$
 <p>Fig. 3.</p>	<p>Block brake. For clockwise rotation:</p> $F = \frac{\frac{Pb}{\mu} + Pc}{a+b} = \frac{Pb}{a+b} \left(\frac{1}{\mu} + \frac{c}{b} \right)$ <p>For counter clockwise rotation:</p> $F = \frac{\frac{Pb}{\mu} - Pc}{a+b} = \frac{Pb}{a+b} \left(\frac{1}{\mu} - \frac{c}{b} \right)$
 <p>Fig. 4.</p>	<p>The brake wheel and friction block of the block brake are often grooved as shown in Fig. 4. In this case, substitute for μ in the above equations the value $\frac{\mu}{\sin \alpha + \mu \cos \alpha}$ where α is one-half the angle included by the faces of the grooves.</p>

Friction Wheels for Power Transmission

When a rotating member is driven intermittently and the rate of driving does not need to be positive, friction wheels are frequently used, especially when the amount of power to be transmitted is comparatively small. The driven wheels in a pair of friction disks should always be made of a harder material than the driving wheels, so that if the driven wheel

should be held stationary by the load, while the driving wheel revolves under its own pressure, a flat spot may not be rapidly worn on the driven wheel. The driven wheels, therefore, are usually made of iron, while the driving wheels are made of or covered with, rubber, paper, leather, wood or fiber. The safe working force per inch of face width of contact for various materials are as follows: Straw fiber, 150; leather fiber, 240; tarred fiber, 240; leather, 150; wood, 100 to 150; paper, 150. Coefficients of friction for different combinations of materials are given in the following table. Smaller values should be used for exceptionally high speeds, or when the transmission must be started while under load.

Horsepower of Friction Wheels.—Let D = diameter of friction wheel in inches; N = Number of revolutions per minute; W = width of face in inches; f = coefficient of friction; P = force in pounds, per inch width of face. Then:

$$\text{H.P.} = \frac{3.1416 \times D \times N \times P \times W \times f}{33,000 \times 12}$$

Assume
$$\frac{3.1416 \times P \times f}{33,000 \times 12} = C$$

then,

for $P = 100$ and $f = 0.20$, $C = 0.00016$

for $P = 150$ and $f = 0.20$, $C = 0.00024$

for $P = 200$ and $f = 0.20$, $C = 0.00032$

Working Values of Coefficient of Friction

Materials	Coefficient of Friction	Materials	Coefficient of Friction
Straw fiber and cast iron	0.26	Tarred fiber and aluminum	0.18
Straw fiber and aluminum	0.27	Leather and cast iron	0.14
Leather fiber and cast iron	0.31	Leather and aluminum	0.22
Leather fiber and aluminum	0.30	Leather and typemetal	0.25
Tarred fiber and cast iron	0.15	Wood and metal	0.25
Paper and cast iron	0.20		

The horsepower transmitted is then:

$$\text{HP} = D \times N \times W \times C$$

Example: Find the horsepower transmitted by a pair of friction wheels; the diameter of the driving wheel is 10 inches, and it revolves at 200 revolutions per minute. The width of the wheel is 2 inches. The force per inch width of face is 150 pounds, and the coefficient of friction 0.20.

$$\text{HP} = 10 \times 200 \times 2 \times 0.00024 = 0.96 \text{ horsepower}$$

Horsepower Which May be Transmitted by Means of a Clean Paper Friction Wheel of One-inch Face when Run Under a Force of 150 Pounds (Rockwood Mfg. Co.)

Dia. of Friction Wheel	Revolutions per Minute										
	25	50	75	100	150	200	300	400	600	800	1000
4	0.023	0.047	0.071	0.095	0.142	0.190	0.285	0.380	0.571	0.76	0.95
6	0.035	0.071	0.107	0.142	0.214	0.285	0.428	0.571	0.856	1.14	1.42
8	0.047	0.095	0.142	0.190	0.285	0.380	0.571	0.761	1.142	1.52	1.90
10	0.059	0.119	0.178	0.238	0.357	0.476	0.714	0.952	1.428	1.90	2.38
14	0.083	0.166	0.249	0.333	0.499	0.666	0.999	1.332	1.999	2.66	3.33
16	0.095	0.190	0.285	0.380	0.571	0.761	1.142	1.523	2.284	3.04	3.80
18	0.107	0.214	0.321	0.428	0.642	0.856	1.285	1.713	2.570	3.42	4.28
24	0.142	0.285	0.428	0.571	0.856	1.142	1.713	2.284	3.427	4.56	5.71
30	0.178	0.357	0.535	0.714	1.071	1.428	2.142	2.856	4.284	5.71	7.14
36	0.214	0.428	0.642	0.856	1.285	1.713	2.570	3.427	5.140	6.85	8.56
42	0.249	0.499	0.749	0.999	1.499	1.999	2.998	3.998	5.997	7.99	9.99
48	0.285	0.571	0.856	1.142	1.713	2.284	3.427	4.569	6.854	9.13	11.42
50	0.297	0.595	0.892	1.190	1.785	2.380	3.570	4.760	7.140	9.52	11.90

KEYS AND KEYSEATS

Metric Square and Rectangular Keys and Keyways

The ASME B18.25.1M standard covers requirements for square and rectangular parallel keys and keyways intended for both alignment of shafts and hubs, and transmitting torque between shafts and hubs. Keys covered by this standard have a relatively tight width tolerance. The deviations are less than the basic size. Keys with greater width tolerance and with deviations greater than the basic size are covered by ASME B18.25.3M. All dimensions in this standard are in millimeters (mm).

Comparison with ISO R773-1969 and 2491-1974.—This standard is based on ISO Standards R773-1969, *Rectangular or Square Parallel Keys* and their corresponding keyways, and 2491-1974, *Thin Parallel Keys* and their corresponding keyways (dimensions in millimeters). Product manufactured to this standard will meet the ISO standards. Because of tighter width tolerances in this standard, products manufactured to the ISO standard may not meet the requirements of this standard.

This standard differs from ISO in that it: a) does not restrict the corners of a key to be chamfered but allows either a chamfer or a radius on the key; and b) specifies a key material hardness rather than a tensile property.

Tolerances.—Many of the tolerances shown in [Tables 1 and 2](#) are from ANSI B4.2 (ISO 286-1 and ISO 286-2). As a result, in addition to plus-minus tolerances which are common in the U.S., some are expressed as plus-plus or minus-minus deviations from the basic size. For further interpretation of these tolerances refer to ANSI B4.2 or ISO 286.

Designation.—Keys conforming to this standard shall be designated by the following data, preferably in the sequence as follows: a) ASME document number; b) product name; c) nominal size, width (b) \times height (h) \times length; d) form; and e) hardness (if other than non-hardened).

Examples: ASME B18.25.1M square key $3 \times 3 \times 15$ form B.

ASME B18.25.1 M rectangular key $10 \times 6 \times 20$ form C hardened

Preferred Lengths and Tolerances.—Preferred lengths and tolerances of square and rectangular keys are shown below. Tolerances are JS16. To minimize problems due to lack of straightness, key length should be less than 10 times the key width.

Length	\pm Tolerances	Length	\pm Tolerances
6	0.38	90, 100, 110	1.10
8, 10	0.45	125, 140, 150, 180	1.25
12, 14, 16, 18	0.56	200, 220, 250	1.45
20, 22, 25, 28	0.65	280	1.60
32, 36, 40, 45, 50	0.80	320, 360, 400	1.80
56, 63, 70, 80	0.95		

Material Requirements.—Standard steel keys shall have a hardness of 183 HV minimum. Hardened keys shall be alloy steel through hardened to a Vickers hardness of 390 to 510 HV. When other materials and properties are required, these shall be as agreed upon by the supplier and customer.

Dimensions and Tolerances.—Dimensions and tolerances for square and rectangular parallel keys are shown in [Table 1](#). Recommended dimensions and tolerances for keyways are shown in [Table 2](#).

Figures for Table 1 and Table 3

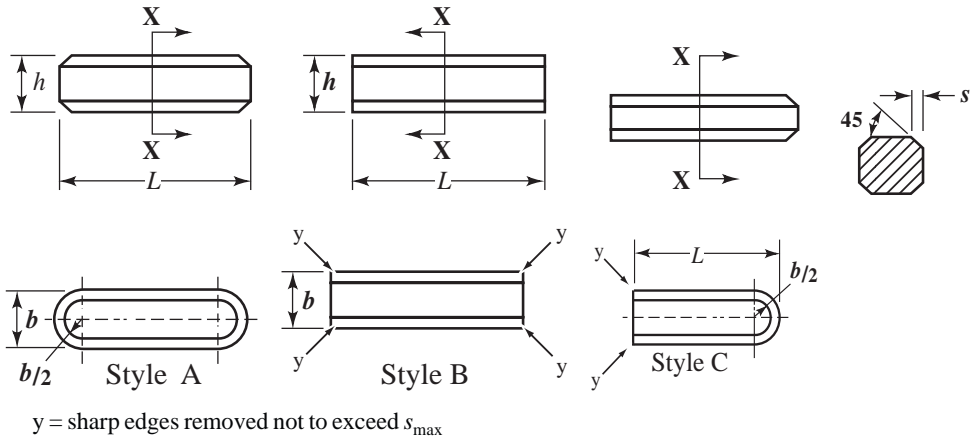


Table 1. Dimensions and Tolerances for Metric Square and Rectangular Parallel Keys ASME B18.25.1M

Width, b		Thickness, h		Chamfer or Radius, s		Range of Lengths	
Basic Size (mm)	Tolerance, $h8$	Basic Size	Tolerance, Square, $h8$ Rectangular, $h11$	Minimum	Maximum	From	To ^a
Square Keys							
2	0	2	0	0.16	0.25	6	20
3	-0.014	3	-0.014			6	36
4	0 -0.018	4	0	0.25	0.40	8	45
5		5	-0.018			10	56
6		6				14	70
Rectangular Keys							
5	0 -0.018	3	0 -0.060	0.25	0.40	10	56
6		4	0			14	70
8	0 -0.022	5	-0.075			0.60	0.60
10		7	0 -0.090	22	110		
12	0 -0.027	6	0 -0.075	0.40	0.60	28	110
		8	0 -0.090				
14	0 -0.027	6	0 -0.075	0.60	0.60	36	160
16		9	0 -0.090				
		7					
18	0 -0.027	10	0 -0.090	0.60	0.60	45	180
		7					
18	0 -0.110	11	0 -0.110	0.60	0.60	50	200

Table 1. (Continued) Dimensions and Tolerances for Metric Square and Rectangular Parallel Keys ASME B18.25.1M

Width, b		Thickness, h		Chamfer or Radius, s		Range of Lengths	
Basic Size (mm)	Tolerance, $h8$	Basic Size	Tolerance, Square, $h8$ Rectangular, $h11$	Minimum	Maximum	From	To ^a
Rectangular Keys							
20	0 -0.033	8	0 -0.090	0.60	0.80	56	220
		12	0 -0.110			63	260
22	0 -0.033	6	0 -0.075	0.60	0.80	70	280
		14	0 -0.110			80	320
25	0 -0.033	9	0 -0.090	0.60	0.80	90	360
		14	0 -0.110			100	400
28	0 -0.033	10	0 -0.090	0.60	0.80	100	400
		16	0 -0.110				
32	0 -0.039	11	0 -0.110	1.00	1.20	100	400
		18	0 -0.110				
36	0 -0.039	12	0 -0.110	1.00	1.20	100	400
		20	0 -0.110				
40	0 -0.046	22	0 -0.110	1.60	2.00	100	400
45		25	0 -0.160				
50	0 -0.054	28	0 -0.160	2.50	3.00	100	400
56		32	0 -0.160				
63	0 -0.046	32	0 -0.160	2.50	3.00	100	400
70		36	0 -0.160				
80	0 -0.054	40	0 -0.160	2.50	3.00	100	400
90		45	0 -0.160				
100	50	0 -0.160	2.50	3.00	100	400	

^a See *Preferred Lengths and Tolerances* starting on page 2460 for preferred maximum length of key. All dimensions in this standard are in millimeters (mm).

Figures for Table 2 and Table 4

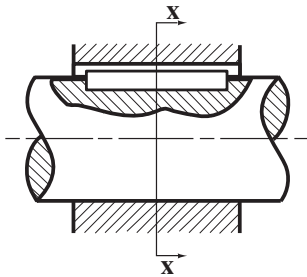


Fig. 1a.

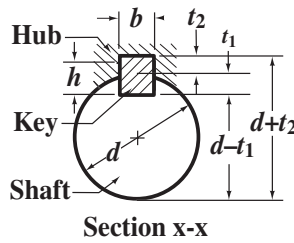


Fig. 1b.

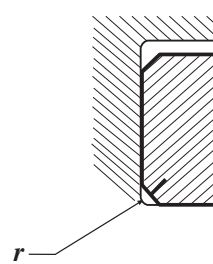


Fig. 1c.

Table 2. Keyway Dimensions and Tolerances for Metric Square and Rectangular Parallel Keys ASME B18.25.1M

Key size <i>b</i> × <i>h</i> (mm)	Keyway																
	Width.										Depth				Radius, <i>r</i>		
	Tolerance ^a and Resulting Fits ^b										Shaft, <i>t</i> ₁		Hub, <i>t</i> ₂				
	Basic Size	Normal Fit				Close Fit		Free Fit				Basic Size	Tolerance	Basic Size	Tolerance	Min.	Max.
		Shaft		Hub		Shaft and Hub		Shaft		Hub							
N9		Fit	JS9	Fit	P9	Fit	H9	Fit	D10	Fit							
2 × 2	2	-0.004	0.010L	+0.0125	0.0265L	-0.006	0.008L	+0.025	0.039L	+0.060	0.074L	1.2		1		0.08	0.16
3 × 3	3	-0.029	0.029T	-0.0125	0.0125T	-0.031	0.031T	0	0T	+0.020	0.020L	1.8		1.4			
4 × 4	4											2.5		1.8		0.16	0.25
5 × 3	5	0	0.018L	+0.0150	0.033L	-0.012	0.006L	+0.030	0.048L	+0.078	0.096L	1.8	+0.1	1.4	+0.1		
5 × 5	6	-0.030	0.030T	-0.0150	0.015T	-0.042	0.042T	0	0T	+0.030	0.030L	3	0	2.8	0		
6 × 4	6											2.5		1.8			
6 × 6	6											3.5		2.8			
8 × 5	8											3		2.8			
8 × 7	8											4	+0.2 0	3.3	+0.1 0	0.25	0.4
10 × 6	10	0	0.022L	+0.0180	0.040L	-0.015	0.007L	+0.036	0.058L	+0.098	0.120L	3.5	+0.1 0	2.8	+0.1 0		
10 × 8	10	-0.036	0.036T	-0.0180	0.018T	-0.051	0.051T	0	0T	+0.040	0.040L	5	+0.2 0	3.3	+0.2 0		
12 × 6	12											3.5	+0.1 0	2.8	+0.1 0		
12 × 8	12											5	+0.2 0	3.3	+0.2		
14 × 6	14	0	0.027L	+0.0215	0.0485L	-0.018	0.009L	+0.043	0.070L	+0.120	0.147L	3.5	+0.1 0	2.8	+0.1 0	0.25	0.4
14 × 9	14	-0.043	0.043T	-0.0215	0.0215T	-0.061	0.061T	0	0T	+0.050	0.050L	5.5		3.8			
16 × 7	16											4		3.3			
16 × 10	16											6	+0.2 0	4.3	+0.2 0		
18 × 7	18											4		3.3			
18 × 11	18											7		4.4			

Table 2. (Continued) Keyway Dimensions and Tolerances for Metric Square and Rectangular Parallel Keys ASME B18.25.1M

Key size <i>b</i> × <i>h</i> (mm)	Keyway																
	Basic Size	Width.										Depth				Radius, <i>r</i>	
		Tolerance ^a and Resulting Fits ^b										Shaft, <i>t</i> ₁		Hub, <i>t</i> ₂			
		Normal Fit				Close Fit		Free Fit				Basic Size	Toler- ance	Basic Size	Toler- ance	Min.	Max.
		Shaft		Hub		Shaft and Hub		Shaft		Hub							
N9	Fit	JS9	Fit	P9	Fit	H9	Fit	D10	Fit	Basic Size	Toler- ance	Basic Size	Toler- ance	Min.	Max.		
20 × 8	20											5		3.3			
20 × 12	20											7.5		4.9			
22 × 9	22											5.5		3.8			
22 × 14	22	0	0.033L	+0.026	0.059L	-0.022	0.011L	+0.052	0.085L	+0.149	0.182L	9		5.4			
25 × 9	25	-0.052	0.052T	-0.026	0.026T	-0.074	0.074T	0	0T	+0.065	0.065L	5.5	+0.2 0	3.8	+0.2 0	0.4	0.06
25 × 14	25											9		5.4			
28 × 10	28											6		4.3			
28 × 16	28											10		6.4			
32 × 11	32											7 ^c		4.4			
32 × 18	32											11 ^c		7.4			
36 × 12	36	0	0.039L	+0.031	0.070L	-0.026	0.013L	+0.062	0.101L	+0.180	0.219L	7.5 ^c		4.9			
36 × 20	36	-0.062	0.062T	-0.031	0.031T	-0.088	0.088T	0	0T	+0.080	0.080L	12		8.4		0.7	1.0
40 × 22	40											13	9.4				
45 × 25	45											15	10.4				
50 × 28	50											17	11.4				
56 × 32	56											20	+0.3 0	12.4	+0.3 0	1.2	1.6
63 × 32	63	0	0.046L	+0.037	0.083L	-0.032	0.014L	+0.074	0.120L	+0.220	0.266L	20		12.4			
70 × 36	70	-0.074	0.074T	0.037	0.037T	-0.106	0.106T	0	0T	+0.100	0.100L	22		14.4			
80 × 40	80											25		15.4			
90 × 45	90	0	0.054L	+0.0435	0.0975L	-0.037	0.017L	+0.087	0.139L	+0.260	0.314L	28		17.4		2.0	2.5
100 × 50	100	-0.087	0.87T	-0.0435	0.0435T	-0.1254	0.1254T	0	0T	+0.120	0.120L	31	19.5				

^aSome of the tolerances are expressed as plus-plus. See *Tolerances* on page 2460 for more information.

^bResulting fits: L indicates a clearance between the key and keyway; T indicates an interference between the key and keyway.

^cThis value differs from that given in *ASME B18.25.1M*, which is believed to be inaccurate.

**Metric Square And Rectangular Keys And Keyways:
Width Tolerances And Deviations Greater Than Basic Size**

This ASME B18.25.3M standard covers requirements for square and rectangular parallel keys and keyways intended for both alignment of shafts and hubs, and transmitting torque between shafts and hubs. Keys covered by this standard have a relatively loose width tolerance. All width tolerances are positive. Keys with minus width tolerances and a smaller tolerance range are covered by ASME B18.25.1M. Dimensions and tolerances for square and rectangular keys are shown in Table 3. Recommended dimensions and tolerances for keyways are shown in Table 4. All dimensions in this standard are in millimeters.

Table 3. Dimensions and Tolerances for Metric Square and Rectangular Parallel Keys ASME B18.25.3M-1998
Width Tolerances and Deviations Greater Than Basic Size

Width, <i>b</i>		Thickness, <i>h</i>		Chamfer or Radius, <i>s</i>		Range of Lengths		
Basic Size	Tolerance	Basic Size	Tolerance	Min.	Max.	From	To ^a	
Square Keys								
2	+0.040	2	+0.040	0.16	0.25	6	20	
3	-0.000	3	-0.000				36	
4	+0.045 -0.000	4	+0.045 -0.000	0.25	0.40	10	45	
5		5					56	
6		6					70	
Rectangular Keys								
5	+0.045 -0.000	3	+0.160 -0.000	0.25	0.40	10	56	
6		4	+0.175 -0.000				14	70
8	+0.050 -0.000	5	+0.190 -0.000			0.40	0.60	22
10		7	+0.175 -0.000	110				
		8	+0.19 -0.000					
12		6	+0.175 -0.000	0.40	0.60			
	8	+0.190 -0.000						
14	+0.075 -0.000	6	+0.175 -0.000	0.40	0.60	36	160	
16		9	+0.190 -0.000				45	180
		7						
		10						
18		7	+0.210 -0.000				50	200
	11							
20	+0.050 -0.033	8	+0.190 -0.000	0.60	0.80	56		
		12	+0.210 -0.000				63	

Table 3. (Continued) Dimensions and Tolerances for Metric Square and Rectangular Parallel Keys ASME B18.25.3M-1998
Width Tolerances and Deviations Greater Than Basic Size

Width, <i>b</i>		Thickness, <i>h</i>		Chamfer or Radius, <i>s</i>		Range of Lengths			
Basic Size	Tolerance	Basic Size	Tolerance	Min.	Max.	From	To ^a		
22	+0.050 -0.033	6	+0.175 -0.000	0.60	0.80	70	280		
		14	+0.210 -0.000			80	320		
9		+0.210 -0.000	90			360			
14		+0.190 -0.000	100			400			
28		10	+0.210 -0.000			1.00	1.20	1.60	2.00
		16	+0.280 -0.000						
32		11		+0.310 -0.000					
		18							
36		12			+0.310 -0.000				
		20							
40	22								
45	25								
50	28								
56	32								
63	+0.125 -0.000	32	1.60	2.00					
70		36							
80		40							
90	+0.135 -0.000	45	2.50	3.00					
100		50							

^a See *Preferred Lengths and Tolerances* on page 2466 for preferred maximum length of key except basic width of 2 mm.

Comparison With ISO R773-1969 and 2491-1974.—This standard has greater tolerances than ISO Standards R773-1969 and 2491-1974. Product manufactured to this standard is not interchangeable dimensionally with product manufactured to the ISO standards nor is product manufactured to the ISO standards dimensionally interchangeable with product manufactured to this standard. ISO standards do not include hardened keys.

Preferred Lengths and Tolerances.—Preferred lengths and tolerances of square and rectangular keys are shown below. Tolerances are JS 16 from ANSI B4.2. To minimize problems due to lack of straightness, key length should be less than 10 times the key width.

Length	±Tolerances	Length	±Tolerances
6	0.375	90,100,110	1.10
8, 10	0.45	125,140,160,180	1.25
12,14,16, 18	0.55	200,220,250	1.45
20,22,25,28	0.65	280	1.60
32,36,45,50	0.80	320,360,400	1.80
56,63,70,80	0.95		

Table 4. Keyway Dimensions and Tolerances for Metric Square and Rectangular Parallel Keys ASME B18.25.3M-1998
Width Tolerances and Deviations Greater Than Basic Size

Key Size, <i>b</i> × <i>h</i>	Keyway Width											Keyway Depth				Radius, <i>r</i> Max.		
	Nom- inal	Tolerance and Resulting Fit ^a										Shaft, <i>t</i> ₁		Hub, <i>t</i> ₂				
		Normal Fit				Close Fit		Free Fit				Nom- inal	Toler- ance	Nomi- nal	Toler- ance			
		Shaft		Hub		Shaft and Hub		Shaft		Hub								
Toler- ance	Fit	Toler- ance	Fit	Toler- ance	Fit	Toler- ance	Fit	Toler- ance	Fit	Toler- ance	Fit	Nom- inal	Toler- ance	Nomi- nal	Toler- ance			
2×2	2	+0.040	0.040L	+0.050	0.050L	+0.034	0.034L	+0.066	0.066L	+0.086	0.086L	1.2	+0.1 0	1	+0.1 0	0.16		
3×3	3	+0.010	0.030T	+0.025	0.015T	-0.008	0.032T	+0.040	0T	+0.060	0.020L	1.8		1.4				
4×4	4											2.5		1.8				
5×3	5											1.8		1.4				
5×5	5	+0.045	0.045L	+0.060	0.060L	+0.035	0.035L	+0.075	0.075L 0T	+0.105	0.105L	3		2.8				
6×4	6	+0.015	0.030T	+0.015	0.015T	-0.005	0.040T	+0.045		+0.075	0.030L	2.5		1.8				
6×6	6											3.5		2.8				
8×5	8											3		2.8				
8×7	8											4		+0.2 0			3.3	+0.2 0
10×6	10	+0.055 +0.015	0.055L 0.035T	+0.075 +0.035	0.075L 0.015T	+0.040 0.000	0.040L 0.050T	+0.090 +0.050	0.090L 0T	+0.130 +0.090	0.130L 0.040L	3.5		+0.1 0			2.8	+0.1 0
10×8	10											5	+0.2 0	3.3	+0.2 0			
12×6	12											3.5	+0.1 0	2.8	+0.1 0	0.6		
12×8	12	+0.080	0.080L	+0.095	0.095L	+0.055	0.055L	+0.135	0.135L	+0.185	0.185L	5	+0.2 0	3.3	+0.2 0			
14×6	14	-0.030	0.045T	+0.055	0.020T	-0.015	0.060T	+0.075	0T	+0.125	0.050L	3.5	+0.1 0	2.8	+0.1 0			
14×9	14											5.5	+0.2 0	3.8	+0.2 0			

Table 4. (Continued) Keyway Dimensions and Tolerances for Metric Square and Rectangular Parallel Keys ASME B18.25.3M-1998
Width Tolerances and Deviations Greater Than Basic Size

Key Size, <i>b</i> × <i>h</i>	Keyway Width											Keyway Depth				Radius, <i>r</i> Max.
	Nom- inal	Tolerance and Resulting Fit ^a										Shaft, <i>t</i> ₁		Hub, <i>t</i> ₂		
		Normal Fit				Close Fit		Free Fit				Nom- inal	Toler- ance	Nomi- nal	Toler- ance	
		Shaft		Hub		Shaft and Hub		Shaft		Hub						
Toler- ance	Fit	Toler- ance	Fit	Toler- ance	Fit	Toler- ance	Fit	Toler- ance	Fit	Toler- ance	Fit	Nom- inal	Toler- ance	Nomi- nal	Toler- ance	
16 × 7	16											4		3.3		0.6
16 × 10	16	+0.080	0.080L	+0.095	0.095L	+0.055	0.055L	+0.135	0.135L	+0.185	0.185L	6		4.3		
18 × 7	18	-0.030	0.045T	+0.055	0.020T	-0.015	0.060T	+0.075	0T	+0.125	0.050L	4		3.3		
18 × 11	18											7		4.4		
20 × 8	20											5		3.3		
20 × 12	10											7.5		4.9		
22 × 9	10											5.5		3.8		
22 × 14	22	+0.085	0.085L	+0.110	0.110L	+0.050	0.050L	+0.135	0.150L	+0.200	0.200L	9		5.4		
25 × 9	25	-0.035	0.050T	+0.060	0.025T	-0.010	0.075T	+0.085	0T	+0.110	0.065L	5.5		3.8		
25 × 14	25											9		5.4		
28 × 10	28											6	+0.2 0	4.3	+0.2 0	
28 × 16	28											10		6.4		
32 × 11	32											7 ^b		4.4		
32 × 18	32											11 ^b		7.4		
36 × 12	36											7.5 ^b		4.9		
56 × 32	56	+0.110	0.110L	+0.170	0.170L	+0.090	0.090L	+0.200	0.225L	+0.300	0.300L	20		12.4	1.6	
63 × 32	63	-0.050	0.075T	+0.090	0.035T	-0.020	0.105T	+0.125	0T	+0.225	0.100L			14.4		
70 × 36	70											22		15.4		
80 × 40	80											25		17.4		
90 × 45	90	+0.130	0.130L	+0.180	0.180L	+0.095	0.095L	+0.225	0.225L	+0.340	0.340L	28		19.5	2.5	
100 × 50	100	-0.050	0.085T	+0.090	0.045T	-0.015	0.120T	+0.135	0T	+0.255	0.120L	31				

^a In column labeled "Fit," an L indicates the maximum clearance between the key and keyway; the T indicates the maximum interference between the key and keyway.

^b This value differs from that given in ASME B18.25.3M, which is believed to be inaccurate.

Tolerances.—Many of the tolerances shown in [Table 3](#) and [4](#) are from ANSI B4.2 (ISO 286-1 and ISO 286-2). As a result, in addition to plus-minus tolerances which are common in the U.S., some are expressed as plus-plus deviations from the basic size.

Designation.—Keys conforming to this standard shall be designed by the following data, preferably in the sequence shown: a) ASME document number; b) product name; c) nominal size, width (b) \times height (h) \times length; d) style; and e) hardness (if other than non-hardened).

Optionally, a part identification number (PIN) per ASME B18.24.1 may be used.

Material Requirements.—Same as for ASME B18.25.1M. See page [2460](#).

Metric Keyway Sizes According to Shaft Diameter

Based on BS 4235:Part 1:1972 (1986)

Nominal Shaft Diameter, d		Key Size, $b \times h$	Nominal Keyway Width, b	Nominal Shaft Diameter, d		Key Size, $b \times h$	Nominal Keyway Width, b
Over	Up to and Incl.			Over	Up to and Incl.		
Keyways for Square Parallel Keys				<i>(Cont'd)</i> Keyways for Rectangular Parallel Keys			
6	8	2 \times 2	2	85	95	25 \times 14	25
8	10	3 \times 3	3	95	110	28 \times 16	28
10	12	4 \times 4	4	110	130	32 \times 18	32
12	17	5 \times 5	5	130	150	36 \times 20	36
17	22	6 \times 6	6	150	170	40 \times 22	40
Keyways for Rectangular Parallel Keys				170	200	45 \times 25	45
22	30	8 \times 7	8	200	230	50 \times 28	50
30	38	10 \times 8	10	230	260	56 \times 32	56
38	44	12 \times 8	12	260	290	63 \times 32	63
44	50	14 \times 9	14	290	330	70 \times 36	70
50	58	16 \times 10	16	330	380	80 \times 40	80
58	65	18 \times 11	18	380	440	90 \times 45	90
65	75	20 \times 12	20	440	500	100 \times 50	100
75	85	22 \times 14	22

Note: This table is NOT part of ASME B18.25.1M or ASME B18.25.3M, and is included for reference only. The selection of the proper size and type of key must rest with the design authority.

Metric Woodruff Keys and Keyways

This ASME B18.25.2M standard covers requirements for metric Woodruff keys and keyways intended for both alignment of shafts and hubs, and transmitting torque between shafts and hubs. All dimensions in this standard are in millimeters (mm). Dimensions and tolerances for Woodruff keys are shown in [Table 5](#). Recommended dimensions and tolerances for keyways are shown in [Table 6](#). For inch series Woodruff keys and keyseats, see *ANSI Standard Woodruff Keys and Keyseats* starting on page [2477](#).

Comparison With ISO 3912-1977.—This standard is based on ISO 3912-1977, *Woodruff Keys and Keyways*. However, to improve manufacturability, tolerances are decreased for the keyway width. The resulting fit is approximately the same. Keys manufactured to this standard are functionally interchangeable with keys manufactured to the ISO standard. Because of tighter width tolerances in this standard, products manufactured to the ISO standard may not meet the requirements of this standard.

ASME B18.25.2M also differs from ISO 3912 in that it: a) does not restrict the corners of a key to be chamfered but allows either a chamfer or a radius on the key; b) specifies a key material hardness rather than a tensile property; and c) specifies h12 rather than h11 for the tolerance of the height of the keys.

Tolerances.—Many of the tolerances shown in Tables 5 and 6 are from ANSI B4.2, Preferred Metric Limits and Fits (ISO 286-1 and ISO 286-2). As a result in addition to plus-minus tolerances which are common in the U.S. some are expressed as plus-plus deviations from the basic size.

Table 5. Dimensions for Metric Woodruff Keys ASME B18.25.2M-1996

Key Size $b \times h \times D$	Width		Height				Diameter, D	Chamfer or Radius, s		
	b	Tolerance	h_1	Tolerance h_{12}	h_2^a	Tolerance h_{12}	D	Tolerance h_{12}	Min.	Max.
1 × 1.4 × 4	1		1.4	0	1.1		4	0 -0.120		
1.5 × 2.6 × 7	1.5		2.6	-0.10	2.1	0	7			
2 × 2.6 × 7	2		2.6		2.1	-0.10	7	0		
2 × 3.7 × 10	2		3.7		3.0		10	-0.150	0.16	0.25
2.5 × 3.7 × 10	2.5		3.7	0 -0.12	3.0		10			
3 × 5 × 13	3		5.0		4.0		13			
3 × 6.5 × 16	3		6.5		5.2		16	0 -0.180		
4 × 6.5 × 16	4		6.5		5.2		16			
4 × 7.5 × 19	4	0 -0.025	7.5		6.0	0 -0.12	19	0 -0.210		
5 × 6.5 × 16	5		6.5	0 -0.15	5.2		16	0 -0.180		
5 × 7.5 × 19	5		7.5		6.0		19		0.25	0.40
5 × 9 × 22	5		9.0		7.2		22			
6 × 9 × 22	6		9.0		7.2	0	22	0 -0.210		
6 × 10 × 25	6		10.0		8.0	-0.15	25			
8 × 11 × 28	8		11.0		8.8		28			
10 × 13 × 32	10		13.0	0 -0.18	10.4	0 -0.18	32	0 -0.250	0.40	0.60

^aHeight h_2 is based on 0.80 times height h_1 .

Designation.—Keys conforming to this standard shall be designated by the following data, preferably in the sequence as follows: a) ASME document number; b) product name; c) nominal size, width (b) × height (h) × length; d) form; and e) hardness (if other than non-hardened).

Example: ASME B18.25.2M, Woodruff Key 6 × 10 × 25 normal hardened;

ASME B18.25.2M, Woodruff Key 3 × 5 × 13 Whitney.

Material Requirements.—Same as for ASME B18.25.1M. See page 2460.

Advantages of Woodruff Keys.—In the Woodruff key system, half-circular disks of steel are used as keys, the half-circular side of the key being inserted into the keyseat. Part of the key projects and enters into a keyway in the part to be keyed to the shaft in the ordinary way. The advantage of this type of key is that the keyway is easily milled by simply sinking a milling cutter, of the same diameter as the diameter of the stock from which the keys are made, into the shaft. The keys are also very cheaply made, as they are simply cut off from round bar stock and milled apart in the center. Examples of Woodruff keyseat cutters are shown on page 832.

Table 6. Keyway Dimensions for Metric Woodruff Keys ASME B18.25.2M-1996

Key Size ^a $b \times h_1 \times D$	Width						Depth				Radius, <i>R</i>	
	Basic Size	Tolerance ^b					Shaft, t_1		Hub, t_2			
		Normal Fit		Close Fit	Free Fit		Basic Size	Tolerance	Basic Size	Tolerance		
		Shaft N9	Hub S9	Shaft & Hub P9	Shaft H9	Hub D10						
Max.	Min.											
1 × 1.4 × 4	1							0.6				
1.5 × 2.6 × 7	1.5							0.8				
2 × 2.6 × 7	2						+0.1 0	1.0			0.16	0.08
2 × 3.7 × 10	2	-0.004 -0.029	+0.0125 -0.0125	-0.006 -0.031	+0.025 0	+0.60 +0.20	2.9	1.0				
2.5 × 3.7 × 10	2.5						2.7	1.2				
3 × 5 × 13	3						3.8	1.4				
3 × 6.5 × 16	3						5.3	1.4	+0.1 0			
4 × 6.5 × 16	4						5.0	1.8	+0.2 0			
4 × 7.5 × 19	4						6.0	1.8				
5 × 6.5 × 16	5						4.5	2.3				
5 × 7.5 × 19	5	-0.030 0	+0.015 -0.015	-0.012 -0.042	+0.030 0	+0.078 +0.030	5.5	2.3			0.25	0.16
5 × 9 × 22	5						7.0	2.3				
6 × 9 × 22	6						6.5	2.8				
6 × 10 × 25	6						7.5	2.8	+0.3 0			
8 × 11 × 28	8	0	+0.018	-0.015	+0.036	+0.098	8.0	3.3		+0.2 0		
10 × 13 × 32	10	-0.036	-0.018	-0.051	0	+0.040	10.0	3.3			0.4	0.25

^aThe nominal key diameter is the minimum keyway diameter.

^bSome of the tolerances are expressed as plus-plus or minus-minus. See *Tolerances* on page 2470 for more informations.

ANSI Standard Inch Series Keys and Keyseats.—American National Standard, B17.1 Keys and Keyseats, based on current industry practice, was approved in 1967, and reaffirmed in 2008. This standard establishes a uniform relationship between shaft sizes and key sizes for parallel and taper keys as shown in Table 1. Other data in this standard are given in Tables 2 and 3 through 7. The sizes and tolerances shown are for single key applications only.

The following definitions are given in the standard. *Note:* Inch dimensions converted to metric dimensions (enclosed in parenthesis) are not included in the standard.

Key: A demountable machinery part which, when assembled into keyseats, provides a positive means for transmitting torque between the shaft and hub.

Keyseat: An axially located rectangular groove in a shaft or hub.

This standard recognizes that there are two classes of stock for parallel keys used by industry. One is a close, plus toleranced key stock and the other is a broad, negative toleranced bar stock. Based on the use of two types of stock, two classes of fit are shown:

Class 1: A clearance or metal-to-metal side fit obtained by using bar stock keys and keyseat tolerances as given in Table 4. This is a relatively free fit and applies only to parallel keys.

Class 2: A side fit, with possible interference or clearance, obtained by using key stock and keyseat tolerances as given in Table 4. This is a relatively tight fit.

Class 3: This is an interference side fit and is not tabulated in Table 4 since the degree of interference has not been standardized. However, it is suggested that the top and bottom fit range given under Class 2 in Table 4, for parallel keys be used.

Table 1. Key Size Versus Shaft Diameter ANSI B17.1-1967 (R2008)

Nominal Shaft Diameter		Nominal Key Size			Normal Keyseat Depth	
Over	To (Incl.)	Width, W	Height, H		H/2	
			Square	Rectangular	Square	Rectangular
5/16	7/16	3/32	3/32	...	3/64	...
7/16	9/16	1/8	1/8	3/32	1/16	3/64
9/16	7/8	3/16	3/16	1/8	3/32	1/16
7/8	1 1/4	1/4	1/4	3/16	1/8	3/32
1 1/4	1 3/8	5/16	5/16	1/4	5/32	1/8
1 3/8	1 3/4	3/8	3/8	1/4	3/16	1/8
1 3/4	2 1/4	1/2	1/2	3/8	1/4	3/16
2 1/4	2 3/4	5/8	5/8	7/16	3/16	7/32
2 3/4	3 1/4	3/4	3/4	1/2	3/8	1/4
3 1/4	3 3/4	7/8	7/8	5/8	7/16	5/16
3 3/4	4 1/2	1	1	3/4	1/2	3/8
4 1/2	5 1/2	1 1/4	1 1/4	7/8	5/8	7/16
5 1/2	6 1/2	1 1/2	1 1/2	1	3/4	1/2
Square Keys preferred for shaft diameters above this line; rectangular keys, below						
6 1/2	7 1/2	1 3/4	1 3/4	1 1/2 ^a	7/8	3/4
7 1/2	9	2	2	1 1/2	1	3/4
9	11	2 1/2	2 1/2	1 3/4	1 1/4	7/8

^a Some key standards show 1 1/4 inches; preferred height is 1 1/2 inches.

All dimensions are given in inches. For larger shaft sizes, see *ANSI Standard Woodruff Keys and Keyseats*.

Key Size vs. Shaft Diameter: Shaft diameters are listed in Table 1 for identification of various key sizes and are not intended to establish shaft dimensions, tolerances or selections. For a stepped shaft, the size of a key is determined by the diameter of the shaft at the point of location of the key. Up through 6 1/2-inch (165.1 mm) diameter shafts square keys are preferred; rectangular keys are preferred for larger shafts.

If special considerations dictate the use of a keyseat in the hub shallower than the preferred nominal depth shown, it is recommended that the tabulated preferred nominal standard keyseat always be used in the shaft.

Keyseat Alignment Tolerances: A tolerance of 0.010 inch (0.254 mm), max is provided for offset (due to parallel displacement of keyseat centerline from centerline of shaft or bore) of keyseats in shaft and bore. The following tolerances for maximum lead (due to angular displacement of keyseat centerline from centerline of shaft or bore and measured at right angles to the shaft or bore centerline) of keyseats in shaft and bore are specified: 0.002 inch (0.0508 mm) for keyseat length up to and including 4 inches (101.6 mm); 0.0005 inch per inch of length (0.0127 mm per mm) for keyseat lengths above 4 inches to and including 10 inches (254 mm); and 0.005 inch (0.127 mm) for keyseat lengths above 10 inches. For the effect of keyways on shaft strength, see *Effect of Keyways on Shaft Strength* on page 301.

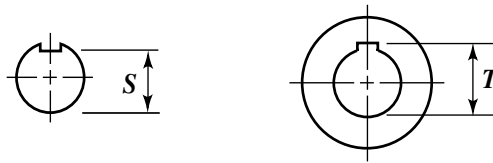


Table 2. Depth Control Values S and T for Shaft and Hub
ANSI B17.1-1967 (R2008)

Nominal Shaft Diameter	Shafts, Parallel and Taper		Hubs, Parallel		Hubs, Taper	
	Square	Rectangular	Square	Rectangular	Square	Rectangular
	S	S	T	T	T	T
1/2	0.430	0.445	0.560	0.544	0.535	0.519
9/16	0.493	0.509	0.623	0.607	0.598	0.582
5/8	0.517	0.548	0.709	0.678	0.684	0.653
11/16	0.581	0.612	0.773	0.742	0.748	0.717
3/4	0.644	0.676	0.837	0.806	0.812	0.781
13/16	0.708	0.739	0.900	0.869	0.875	0.844
7/8	0.771	0.802	0.964	0.932	0.939	0.907
15/16	0.796	0.827	1.051	1.019	1.026	0.994
1	0.859	0.890	1.114	1.083	1.089	1.058
1 1/16	0.923	0.954	1.178	1.146	1.153	1.121
1 1/8	0.986	1.017	1.241	1.210	1.216	1.185
1 3/16	1.049	1.080	1.304	1.273	1.279	1.248
1 1/4	1.112	1.144	1.367	1.336	1.342	1.311
1 3/8	1.137	1.169	1.455	1.424	1.430	1.399
1 3/8	1.201	1.232	1.518	1.487	1.493	1.462
1 7/16	1.225	1.288	1.605	1.543	1.580	1.518
1 1/2	1.289	1.351	1.669	1.606	1.644	1.581
1 9/16	1.352	1.415	1.732	1.670	1.707	1.645
1 5/8	1.416	1.478	1.796	1.733	1.771	1.708
1 11/16	1.479	1.541	1.859	1.796	1.834	1.771
1 3/4	1.542	1.605	1.922	1.860	1.897	1.835
1 13/16	1.527	1.590	2.032	1.970	2.007	1.945
1 7/8	1.591	1.654	2.096	2.034	2.071	2.009
1 15/16	1.655	1.717	2.160	2.097	2.135	2.072
2	1.718	1.781	2.223	2.161	2.198	2.136
2 1/16	1.782	1.844	2.287	2.224	2.262	2.199
2 1/8	1.845	1.908	2.350	2.288	2.325	2.263
2 3/16	1.909	1.971	2.414	2.351	2.389	2.326
2 1/4	1.972	2.034	2.477	2.414	2.452	2.389
2 3/8	1.957	2.051	2.587	2.493	2.562	2.468
2 3/8	2.021	2.114	2.651	2.557	2.626	2.532
2 7/16	2.084	2.178	2.714	2.621	2.689	2.596
2 1/2	2.148	2.242	2.778	2.684	2.753	2.659

**Table 2. (Continued) Depth Control Values *S* and *T* for Shaft and Hub
ANSI B17.1-1967 (R2008)**

Nominal Shaft Diameter	Shafts, Parallel and Taper		Hubs, Parallel		Hubs, Taper	
	Square	Rectangular	Square	Rectangular	Square	Rectangular
	<i>S</i>	<i>S</i>	<i>T</i>	<i>T</i>	<i>T</i>	<i>T</i>
2 ⁹ / ₁₆	2.211	2.305	2.841	2.748	2.816	2.723
2 ⁷ / ₈	2.275	2.369	2.905	2.811	2.880	2.786
2 ¹¹ / ₁₆	2.338	2.432	2.968	2.874	2.943	2.849
2 ³ / ₄	2.402	2.495	3.032	2.938	3.007	2.913
2 ¹³ / ₁₆	2.387	2.512	3.142	3.017	3.117	2.992
2 ⁷ / ₈	2.450	2.575	3.205	3.080	3.180	3.055
2 ¹⁵ / ₁₆	2.514	2.639	3.269	3.144	3.244	3.119
3	2.577	2.702	3.332	3.207	3.307	3.182
3 ¹ / ₁₆	2.641	2.766	3.396	3.271	3.371	3.246
3 ¹ / ₈	2.704	2.829	3.459	3.334	3.434	3.309
3 ³ / ₁₆	2.768	2.893	3.523	3.398	3.498	3.373
3 ¹ / ₄	2.831	2.956	3.586	3.461	3.561	3.436
3 ⁵ / ₁₆	2.816	2.941	3.696	3.571	3.671	3.546
3 ³ / ₈	2.880	3.005	3.760	3.635	3.735	3.610
3 ⁷ / ₁₆	2.943	3.068	3.823	3.698	3.798	3.673
3 ¹ / ₂	3.007	3.132	3.887	3.762	3.862	3.737
3 ⁹ / ₁₆	3.070	3.195	3.950	3.825	3.925	3.800
3 ⁵ / ₈	3.134	3.259	4.014	3.889	3.989	3.864
3 ¹¹ / ₁₆	3.197	3.322	4.077	3.952	4.052	3.927
3 ³ / ₄	3.261	3.386	4.141	4.016	4.116	3.991
3 ¹³ / ₁₆	3.246	3.371	4.251	4.126	4.226	4.101
3 ⁷ / ₈	3.309	3.434	4.314	4.189	4.289	4.164
3 ¹⁵ / ₁₆	3.373	3.498	4.378	4.253	4.353	4.228
4	3.436	3.561	4.441	4.316	4.416	4.291
4 ³ / ₁₆	3.627	3.752	4.632	4.507	4.607	4.482
4 ¹ / ₄	3.690	3.815	4.695	4.570	4.670	4.545
4 ³ / ₈	3.817	3.942	4.822	4.697	4.797	4.672
4 ⁷ / ₁₆	3.880	4.005	4.885	4.760	4.860	4.735
4 ¹ / ₂	3.944	4.069	4.949	4.824	4.924	4.799
4 ³ / ₄	4.041	4.229	5.296	5.109	5.271	5.084
4 ⁵ / ₈	4.169	4.356	5.424	5.236	5.399	5.211
4 ¹⁵ / ₁₆	4.232	4.422	5.487	5.300	5.462	5.275
5	4.296	4.483	5.551	5.363	5.526	5.338
5 ³ / ₁₆	4.486	4.674	5.741	5.554	5.716	5.529
5 ¹ / ₄	4.550	4.737	5.805	5.617	5.780	5.592
5 ⁷ / ₁₆	4.740	4.927	5.995	5.807	5.970	5.782
5 ¹ / ₂	4.803	4.991	6.058	5.871	6.033	5.846
5 ³ / ₄	4.900	5.150	6.405	6.155	6.380	6.130
5 ¹⁵ / ₁₆	5.091	5.341	6.596	6.346	6.571	6.321
6	5.155	5.405	6.660	6.410	6.635	6.385
6 ¹ / ₄	5.409	5.659	6.914	6.664	6.889	6.639
6 ¹ / ₂	5.662	5.912	7.167	6.917	7.142	6.892
6 ³ / ₄	5.760	^a 5.885	7.515	^a 7.390	7.490	^a 7.365
7	6.014	^a 6.139	7.769	^a 7.644	7.744	^a 7.619
7 ¹ / ₄	6.268	^a 6.393	8.023	^a 7.898	7.998	^a 7.873
7 ¹ / ₂	6.521	^a 6.646	8.276	^a 8.151	8.251	^a 8.126
7 ³ / ₄	6.619	6.869	8.624	8.374	8.599	8.349
8	6.873	7.123	8.878	8.628	8.853	8.603
9	7.887	8.137	9.892	9.642	9.867	9.617
10	8.591	8.966	11.096	10.721	11.071	10.696
11	9.606	9.981	12.111	11.736	12.086	11.711
12	10.309	10.809	13.314	12.814	13.289	12.789
13	11.325	11.825	14.330	13.830	14.305	13.805
14	12.028	12.528	15.533	15.033	15.508	15.008
15	13.043	13.543	16.548	16.048	16.523	16.023

^a 1³/₄ × 1¹/₂ inch key.

All dimensions are given in inches. See Table 4 for tolerances.

Table 3. ANSI Standard Plain and Gib Head Keys ANSI B17.1-1967 (R2008)

Key		Nominal Key Size		Tolerance				
		Width <i>W</i>		Width, <i>W</i>		Height, <i>H</i>		
		Over	To (Incl.)					
Parallel	Square	Keystock	...	1¼	+0.001	-0.000	+0.001	-0.000
			1¼	3	+0.002	-0.000	+0.002	-0.000
			3	3½	+0.003	-0.000	+0.003	-0.000
		Bar Stock	...	¾	+0.000	-0.002	+0.000	-0.002
			¾	1½	+0.000	-0.003	+0.000	-0.003
			1½	2½	+0.000	-0.004	+0.000	-0.004
	Rectangular	Keystock	...	1¼	+0.001	-0.000	+0.005	-0.005
			1¼	3	+0.002	-0.000	+0.005	-0.005
		Bar Stock	...	¾	+0.000	-0.003	+0.000	-0.003
			¾	1½	+0.000	-0.004	+0.000	-0.004
Taper	Plain or Gib Head Square or Rectangular	...	1¼	+0.001	-0.000	+0.005	-0.000	
		1¼	3	+0.002	-0.000	+0.005	-0.000	
		3	7	+0.003	-0.000	+0.005	-0.000	
		...	¾	+0.000	-0.003	+0.000	-0.003	
		¾	1½	+0.000	-0.004	+0.000	-0.004	
		1½	3	+0.000	-0.005	+0.000	-0.005	

Gib Head Nominal Dimensions													
Nominal Key Size Width, <i>W</i>	Square			Rectangular			Nominal Key Size Width, <i>W</i>	Square			Rectangular		
	<i>H</i>	<i>A</i>	<i>B</i>	<i>H</i>	<i>A</i>	<i>B</i>		<i>H</i>	<i>A</i>	<i>B</i>	<i>H</i>	<i>A</i>	<i>B</i>
1/8	1/8	1/4	1/4	3/32	3/16	1/8	1	1	1 5/8	1 1/8	3/4	1 1/4	7/8
3/16	3/16	5/16	5/16	1/8	1/4	1/4	1 1/4	1 1/4	2	1 7/16	7/8	1 3/8	1
1/4	1/4	7/16	3/8	3/16	5/16	5/16	1 1/2	1 1/2	2 3/8	1 3/4	1	1 5/8	1 1/8
5/16	5/16	1/2	7/16	1/4	7/16	3/8	1 3/4	1 3/4	2 3/4	2	1 1/2	2 3/8	1 3/4
3/8	3/8	5/8	1/2	1/4	7/16	3/8	2	2	3 1/2	2 1/4	1 1/2	2 3/8	1 3/4
1/2	1/2	7/8	5/8	3/8	5/8	1/2	2 1/2	2 1/2	4	3	1 3/4	2 3/4	2
5/8	5/8	1	3/4	7/16	3/4	9/16	3	3	5	3 1/2	2	3 1/2	2 1/4
3/4	3/4	1 1/4	7/8	1/2	7/8	5/8	3 1/2	3 1/2	6	4	2 1/2	4	3
7/8	7/8	1 3/8	1	5/8	1	3/4

All dimensions are given in inches.

*For locating position of dimension *H*. Tolerance does not apply.

For larger sizes the following relationships are suggested as guides for establishing *A* and *B*: $A = 1.8H$ and $B = 1.2H$.

Table 4. ANSI Standard Fits for Parallel and Taper Keys *ANSI B17.1-1967 (R2008)*

Type of Key	Key Width		Side Fit			Top and Bottom Fit			
	Over	To (Incl.)	Width Tolerance		Fit Range ^a	Depth Tolerance			Fit Range ^a
			Key	Key-Seat		Key	Shaft Key-Seat	Hub Key-Seat	
Class 1 Fit for Parallel Keys									
Square	...	1/2	+0.000 -0.002	+0.002 -0.000	0.004 CL 0.000	+0.000 -0.002	+0.000 -0.015	+0.010 -0.000	0.032 CL 0.005 CL
	1/2	3/4	+0.000 -0.002	+0.003 -0.000	0.005 CL 0.000	+0.000 -0.002	+0.000 -0.015	+0.010 -0.000	0.032 CL 0.005 CL
	3/4	1	+0.000 -0.003	+0.003 -0.000	0.006 CL 0.000	+0.000 -0.003	+0.000 -0.015	+0.010 -0.000	0.033 CL 0.005 CL
	1	1 1/2	+0.000 -0.003	+0.004 -0.000	0.007 CL 0.000	+0.000 -0.003	+0.000 -0.015	+0.010 -0.000	0.033 CL 0.005 CL
	1 1/2	2 1/2	+0.000 -0.004	+0.004 -0.000	0.008 CL 0.000	+0.000 -0.004	+0.000 -0.015	+0.010 -0.000	0.034 CL 0.005 CL
	2 1/2	3 1/2	+0.000 -0.006	+0.004 -0.000	0.010 CL 0.000	+0.000 -0.006	+0.000 -0.015	+0.010 -0.000	0.036 CL 0.005 CL
	Rectan- gular	...	1/2	+0.000 -0.003	+0.002 -0.000	0.005 CL 0.000	+0.000 -0.003	+0.000 -0.015	+0.010 -0.000
1/2		3/4	+0.000 -0.003	+0.003 -0.000	0.006 CL 0.000	+0.000 -0.003	+0.000 -0.015	+0.010 -0.000	0.033 CL 0.005 CL
3/4		1	+0.000 -0.004	+0.003 -0.000	0.007 CL 0.000	+0.000 -0.004	+0.000 -0.015	+0.010 -0.000	0.034 CL 0.005 CL
1		1 1/2	+0.000 -0.004	+0.004 -0.000	0.008 CL 0.000	+0.000 -0.004	+0.000 -0.015	+0.010 -0.000	0.034 CL 0.005 CL
1 1/2		3	+0.000 -0.005	+0.004 -0.000	0.009 CL 0.000	+0.000 -0.005	+0.000 -0.015	+0.010 -0.000	0.035 CL 0.005 CL
3		4	+0.000 -0.006	+0.004 -0.000	0.010 CL 0.000	+0.000 -0.006	+0.000 -0.015	+0.010 -0.000	0.036 CL 0.005 CL
4		6	+0.000 -0.008	+0.004 -0.000	0.012 CL 0.000	+0.000 -0.008	+0.000 -0.015	+0.010 -0.000	0.038 CL 0.005 CL
6		7	+0.000 -0.013	+0.004 -0.000	0.017 CL 0.000	+0.000 -0.013	+0.000 -0.015	+0.010 -0.000	0.043 CL 0.005 CL
Class 2 Fit for Parallel and Taper Keys									
Parallel Square	...	1 1/4	+0.001 -0.000	+0.002 -0.000	0.002 CL 0.001 INT	+0.001 -0.000	+0.000 -0.015	+0.010 -0.000	0.030 CL 0.004 CL
	1 1/4	3	+0.002 -0.000	+0.002 -0.000	0.002 CL 0.002 INT	+0.002 -0.000	+0.000 -0.015	+0.010 -0.000	0.030 CL 0.003 CL
	3	3 1/2	+0.003 -0.000	+0.002 -0.000	0.002 CL 0.003 INT	+0.003 -0.000	+0.000 -0.015	+0.010 -0.000	0.030 CL 0.002 CL
Parallel Rectan- gular	...	1 1/4	+0.001 -0.000	+0.002 -0.000	0.002 CL 0.001 INT	+0.005 -0.005	+0.000 -0.015	+0.010 -0.000	0.035 CL 0.000 CL
	1 1/4	3	+0.002 -0.000	+0.002 -0.000	0.002 CL 0.002 INT	+0.005 -0.005	+0.000 -0.015	+0.010 -0.000	0.035 CL 0.000 CL
	3	7	+0.003 -0.000	+0.002 -0.000	0.002 CL 0.003 INT	+0.005 -0.005	+0.000 -0.015	+0.010 -0.000	0.035 CL 0.000 CL
Taper	...	1 1/4	+0.001 -0.000	+0.002 -0.000	0.002 CL 0.001 INT	+0.005 -0.000	+0.000 -0.015	+0.010 -0.000	0.005 CL 0.025 INT
	1 1/4	3	+0.002 -0.000	+0.002 -0.000	0.002 CL 0.002 INT	+0.005 -0.000	+0.000 -0.015	+0.010 -0.000	0.005 CL 0.025 INT
	3	b	+0.003	+0.002	0.002 CL	+0.005	+0.000	+0.010	0.005 CL
			-0.000	-0.000	0.003 INT	-0.000	-0.015	-0.000	0.025 INT

^aLimits of variation. CL = Clearance; INT = Interference.

^bTo (Incl.) 3 1/2-inch Square and 7-inch Rectangular key widths.

All dimensions are given in inches. See also text on page 2460.

**Table 5. Suggested Keyseat Fillet Radius and Key Chamfer
ANSI B17.1-1967 (R2008)**

Keyseat Depth, <i>H</i> /2		Fillet Radius	45 deg. Chamfer	Keyseat Depth, <i>H</i> /2		Fillet Radius	45 deg. Chamfer
Over	To (Incl.)			Over	To (Incl.)		
1/8	1/4	1/32	3/64	7/8	1 1/4	3/16	7/32
1/4	1/2	1/16	5/64	1 1/4	1 3/4	1/4	9/32
1/2	7/8	1/8	5/32	1 3/4	2 1/2	3/8	13/32

All dimensions are given in inches.

Table 6. ANSI Standard Keyseat Tolerances for Electric Motor and Generator Shaft Extensions ANSI B17.1-1967 (R2008)

Keyseat Width		Width Tolerance	Depth Tolerance
Over	To (Incl.)		
...	1/4	+0.001 -0.001	+0.000 -0.015
1/4	3/4	+0.000 -0.002	+0.000 -0.015
3/4	1 1/4	+0.000 -0.003	+0.000 -0.015

All dimensions are given in inches.

Table 7. Set Screws for Use Over Keys ANSI B17.1-1967 (R2008)

Nom. Shaft Dia.		Nom. Key Width	Set Screw Dia.	Nom. Shaft Dia.		Nom. Key Width	Set Screw Dia.
Over	To (Incl.)			Over	To (Incl.)		
5/16	7/16	3/32	No. 10	2 1/4	2 3/4	5/8	1/2
7/16	9/16	1/8	No. 10	2 3/4	3 1/4	3/4	5/8
9/16	7/8	3/16	1/4	3 1/4	3 3/4	7/8	3/4
7/8	1 1/4	1/4	5/16	3 3/4	4 1/2	1	3/4
1 1/4	1 3/8	5/16	3/8	4 1/2	5 1/2	1 1/4	7/8
1 3/8	1 3/4	3/8	3/8	5 1/2	6 1/2	1 1/2	1
1 3/4	2 1/4	1/2	1/2

All dimensions are given in inches.

These set screw diameter selections are offered as a guide but their use should be dependent upon design considerations.

ANSI Standard Woodruff Keys and Keyseats.—American National Standard B17.2 was approved in 1967, and reaffirmed in 1990. Data from this standard are shown in **Tables 8, 9, and 10.**

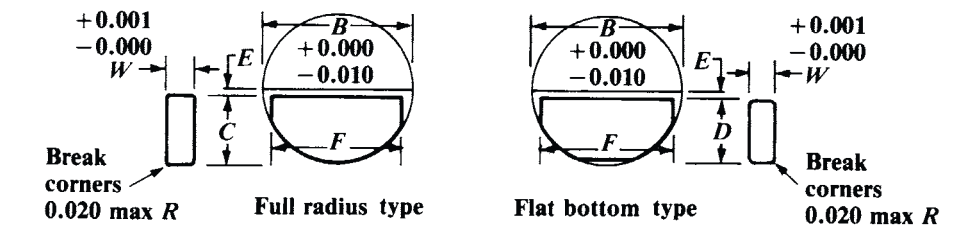
Table 8. ANSI Standard Woodruff Keys *ANSI B17.2-1967 (R2008)*

Key No.	Nominal Key Size $W \times B$	Actual Length F +0.000 -0.010	Height of Key				Distance Below Center E
			C		D		
			Max.	Min.	Max.	Min.	
202	$\frac{1}{16} \times \frac{1}{4}$	0.248	0.109	0.104	0.109	0.104	$\frac{1}{64}$
202.5	$\frac{1}{16} \times \frac{5}{16}$	0.311	0.140	0.135	0.140	0.135	$\frac{1}{64}$
302.5	$\frac{3}{32} \times \frac{5}{16}$	0.311	0.140	0.135	0.140	0.135	$\frac{1}{64}$
203	$\frac{1}{16} \times \frac{3}{8}$	0.374	0.172	0.167	0.172	0.167	$\frac{1}{64}$
303	$\frac{3}{32} \times \frac{3}{8}$	0.374	0.172	0.167	0.172	0.167	$\frac{1}{64}$
403	$\frac{1}{8} \times \frac{3}{8}$	0.374	0.172	0.167	0.172	0.167	$\frac{1}{64}$
204	$\frac{1}{16} \times \frac{1}{2}$	0.491	0.203	0.198	0.194	0.188	$\frac{3}{64}$
304	$\frac{3}{32} \times \frac{1}{2}$	0.491	0.203	0.198	0.194	0.188	$\frac{3}{64}$
404	$\frac{1}{8} \times \frac{1}{2}$	0.491	0.203	0.198	0.194	0.188	$\frac{3}{64}$
305	$\frac{3}{32} \times \frac{5}{8}$	0.612	0.250	0.245	0.240	0.234	$\frac{1}{16}$
405	$\frac{1}{8} \times \frac{5}{8}$	0.612	0.250	0.245	0.240	0.234	$\frac{1}{16}$
505	$\frac{5}{32} \times \frac{5}{8}$	0.612	0.250	0.245	0.240	0.234	$\frac{1}{16}$
605	$\frac{3}{16} \times \frac{5}{8}$	0.612	0.250	0.245	0.240	0.234	$\frac{1}{16}$
406	$\frac{1}{8} \times \frac{3}{4}$	0.740	0.313	0.308	0.303	0.297	$\frac{1}{16}$
506	$\frac{5}{32} \times \frac{3}{4}$	0.740	0.313	0.308	0.303	0.297	$\frac{1}{16}$
606	$\frac{3}{16} \times \frac{3}{4}$	0.740	0.313	0.308	0.303	0.297	$\frac{1}{16}$
806	$\frac{1}{4} \times \frac{3}{4}$	0.740	0.313	0.308	0.303	0.297	$\frac{1}{16}$
507	$\frac{5}{32} \times \frac{7}{8}$	0.866	0.375	0.370	0.365	0.359	$\frac{1}{16}$
607	$\frac{3}{16} \times \frac{7}{8}$	0.866	0.375	0.370	0.365	0.359	$\frac{1}{16}$
707	$\frac{7}{32} \times \frac{7}{8}$	0.866	0.375	0.370	0.365	0.359	$\frac{1}{16}$
807	$\frac{1}{4} \times \frac{7}{8}$	0.866	0.375	0.370	0.365	0.359	$\frac{1}{16}$
608	$\frac{3}{16} \times 1$	0.992	0.438	0.433	0.428	0.422	$\frac{1}{16}$
708	$\frac{7}{32} \times 1$	0.992	0.438	0.433	0.428	0.422	$\frac{1}{16}$
808	$\frac{1}{4} \times 1$	0.992	0.438	0.433	0.428	0.422	$\frac{1}{16}$
1008	$\frac{5}{16} \times 1$	0.992	0.438	0.433	0.428	0.422	$\frac{1}{16}$
1208	$\frac{3}{8} \times 1$	0.992	0.438	0.433	0.428	0.422	$\frac{1}{16}$
609	$\frac{3}{16} \times 1\frac{1}{8}$	1.114	0.484	0.479	0.475	0.469	$\frac{3}{64}$
709	$\frac{7}{32} \times 1\frac{1}{8}$	1.114	0.484	0.479	0.475	0.469	$\frac{3}{64}$
809	$\frac{1}{4} \times 1\frac{1}{8}$	1.114	0.484	0.479	0.475	0.469	$\frac{3}{64}$
1009	$\frac{5}{16} \times 1\frac{1}{8}$	1.114	0.484	0.479	0.475	0.469	$\frac{3}{64}$
610	$\frac{3}{16} \times 1\frac{1}{4}$	1.240	0.547	0.542	0.537	0.531	$\frac{5}{64}$
710	$\frac{7}{32} \times 1\frac{1}{4}$	1.240	0.547	0.542	0.537	0.531	$\frac{5}{64}$
810	$\frac{1}{4} \times 1\frac{1}{4}$	1.240	0.547	0.542	0.537	0.531	$\frac{5}{64}$
1010	$\frac{5}{16} \times 1\frac{1}{4}$	1.240	0.547	0.542	0.537	0.531	$\frac{5}{64}$
1210	$\frac{3}{8} \times 1\frac{1}{4}$	1.240	0.547	0.542	0.537	0.531	$\frac{5}{64}$
811	$\frac{1}{4} \times 1\frac{3}{8}$	1.362	0.594	0.589	0.584	0.578	$\frac{3}{32}$
1011	$\frac{5}{16} \times 1\frac{3}{8}$	1.362	0.594	0.589	0.584	0.578	$\frac{3}{32}$
1211	$\frac{3}{8} \times 1\frac{3}{8}$	1.362	0.594	0.589	0.584	0.578	$\frac{3}{32}$
812	$\frac{1}{4} \times 1\frac{1}{2}$	1.484	0.641	0.636	0.631	0.625	$\frac{7}{64}$
1012	$\frac{5}{16} \times 1\frac{1}{2}$	1.484	0.641	0.636	0.631	0.625	$\frac{7}{64}$
1212	$\frac{3}{8} \times 1\frac{1}{2}$	1.484	0.641	0.636	0.631	0.625	$\frac{7}{64}$

All dimensions are given in inches.

The Key numbers indicate normal key dimensions. The last two digits give the nominal diameter B in eighths of an inch and the digits preceding the last two give the nominal width W in thirty-seconds of an inch.

Table 9. ANSI Standard Woodruff Keys ANSI B17.2-1967 (R2008)



Key No.	Nominal Key Size $W \times B$	Actual Length F +0.000 -0.010	Height of Key				Distance Below Center E
			C		D		
			Max.	Min.	Max.	Min.	
617-1	$\frac{3}{16} \times 2\frac{1}{8}$	1.380	0.406	0.401	0.396	0.390	$\frac{21}{32}$
817-1	$\frac{1}{4} \times 2\frac{1}{8}$	1.380	0.406	0.401	0.396	0.390	$\frac{21}{32}$
1017-1	$\frac{5}{16} \times 2\frac{1}{8}$	1.380	0.406	0.401	0.396	0.390	$\frac{21}{32}$
1217-1	$\frac{3}{8} \times 2\frac{1}{8}$	1.380	0.406	0.401	0.396	0.390	$\frac{21}{32}$
617	$\frac{3}{16} \times 2\frac{1}{8}$	1.723	0.531	0.526	0.521	0.515	$\frac{17}{32}$
817	$\frac{1}{4} \times 2\frac{1}{8}$	1.723	0.531	0.526	0.521	0.515	$\frac{17}{32}$
1017	$\frac{5}{16} \times 2\frac{1}{8}$	1.723	0.531	0.526	0.521	0.515	$\frac{17}{32}$
1217	$\frac{3}{8} \times 2\frac{1}{8}$	1.723	0.531	0.526	0.521	0.515	$\frac{17}{32}$
822-1	$\frac{1}{4} \times 2\frac{3}{4}$	2.000	0.594	0.589	0.584	0.578	$\frac{25}{32}$
1022-1	$\frac{5}{16} \times 2\frac{3}{4}$	2.000	0.594	0.589	0.584	0.578	$\frac{25}{32}$
1222-1	$\frac{3}{8} \times 2\frac{3}{4}$	2.000	0.594	0.589	0.584	0.578	$\frac{25}{32}$
1422-1	$\frac{7}{16} \times 2\frac{3}{4}$	2.000	0.594	0.589	0.584	0.578	$\frac{25}{32}$
1622-1	$\frac{1}{2} \times 2\frac{3}{4}$	2.000	0.594	0.589	0.584	0.578	$\frac{25}{32}$
822	$\frac{1}{4} \times 2\frac{3}{4}$	2.317	0.750	0.745	0.740	0.734	$\frac{5}{8}$
1022	$\frac{5}{16} \times 2\frac{3}{4}$	2.317	0.750	0.745	0.740	0.734	$\frac{5}{8}$
1222	$\frac{3}{8} \times 2\frac{3}{4}$	2.317	0.750	0.745	0.740	0.734	$\frac{5}{8}$
1422	$\frac{7}{16} \times 2\frac{3}{4}$	2.317	0.750	0.745	0.740	0.734	$\frac{5}{8}$
1622	$\frac{1}{2} \times 2\frac{3}{4}$	2.317	0.750	0.745	0.740	0.734	$\frac{5}{8}$
1228	$\frac{3}{8} \times 3\frac{1}{2}$	2.880	0.938	0.933	0.928	0.922	$\frac{13}{16}$
1428	$\frac{7}{16} \times 3\frac{1}{2}$	2.880	0.938	0.933	0.928	0.922	$\frac{13}{16}$
1628	$\frac{1}{2} \times 3\frac{1}{2}$	2.880	0.938	0.933	0.928	0.922	$\frac{13}{16}$
1828	$\frac{9}{16} \times 3\frac{1}{2}$	2.880	0.938	0.933	0.928	0.922	$\frac{13}{16}$
2028	$\frac{5}{8} \times 3\frac{1}{2}$	2.880	0.938	0.933	0.928	0.922	$\frac{13}{16}$
2228	$\frac{11}{16} \times 3\frac{1}{2}$	2.880	0.938	0.933	0.928	0.922	$\frac{13}{16}$
2428	$\frac{3}{4} \times 3\frac{1}{2}$	2.880	0.938	0.933	0.928	0.922	$\frac{13}{16}$

All dimensions are given in inches.

The key numbers indicate nominal key dimensions. The last two digits give the nominal diameter B in eighths of an inch and the digits preceding the last two give the nominal width W in thirty-seconds of an inch.

The key numbers with the -1 designation, while representing the nominal key size have a shorter length F and due to a greater distance below center E are less in height than the keys of the same number without the -1 designation.

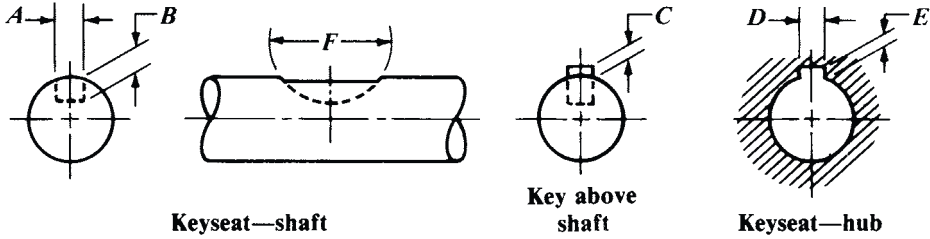


Table 10. ANSI Keyseat Dimensions for Woodruff Keys
ANSI B17.2-1967 (R2008)

Key No.	Nominal Size Key	Keyseat—Shaft					Key Above Shaft	Keyseat—Hub	
		Width A ^a		Depth B	Diameter F		Height C	Width D	Depth E
		Min.	Max.	+0.005 -0.000	Min.	Max.	+0.005 -0.005	+0.002 -0.000	+0.005 -0.000
202	1/16 × 1/4	0.0615	0.0630	0.0728	0.250	0.268	0.0312	0.0635	0.0372
202.5	1/16 × 5/16	0.0615	0.0630	0.1038	0.312	0.330	0.0312	0.0635	0.0372
302.5	3/32 × 5/16	0.0928	0.0943	0.0882	0.312	0.330	0.0469	0.0948	0.0529
203	1/16 × 3/8	0.0615	0.0630	0.1358	0.375	0.393	0.0312	0.0635	0.0372
303	3/32 × 3/8	0.0928	0.0943	0.1202	0.375	0.393	0.0469	0.0948	0.0529
403	1/8 × 3/8	0.1240	0.1255	0.1045	0.375	0.393	0.0625	0.1260	0.0685
204	1/16 × 1/2	0.0615	0.0630	0.1668	0.500	0.518	0.0312	0.0635	0.0372
304	3/32 × 1/2	0.0928	0.0943	0.1511	0.500	0.518	0.0469	0.0948	0.0529
404	1/8 × 1/2	0.1240	0.1255	0.1355	0.500	0.518	0.0625	0.1260	0.0685
305	3/32 × 5/8	0.0928	0.0943	0.1981	0.625	0.643	0.0469	0.0948	0.0529
405	1/8 × 5/8	0.1240	0.1255	0.1825	0.625	0.643	0.0625	0.1260	0.0685
505	5/32 × 5/8	0.1553	0.1568	0.1669	0.625	0.643	0.0781	0.1573	0.0841
605	3/16 × 5/8	0.1863	0.1880	0.1513	0.625	0.643	0.0937	0.1885	0.0997
406	1/8 × 3/4	0.1240	0.1255	0.2455	0.750	0.768	0.0625	0.1260	0.0685
506	5/32 × 3/4	0.1553	0.1568	0.2299	0.750	0.768	0.0781	0.1573	0.0841
606	3/16 × 3/4	0.1863	0.1880	0.2143	0.750	0.768	0.0937	0.1885	0.0997
806	1/4 × 3/4	0.2487	0.2505	0.1830	0.750	0.768	0.1250	0.2510	0.1310
507	5/32 × 7/8	0.1553	0.1568	0.2919	0.875	0.895	0.0781	0.1573	0.0841
607	3/16 × 7/8	0.1863	0.1880	0.2763	0.875	0.895	0.0937	0.1885	0.0997
707	7/32 × 7/8	0.2175	0.2193	0.2607	0.875	0.895	0.1093	0.2198	0.1153
807	1/4 × 7/8	0.2487	0.2505	0.2450	0.875	0.895	0.1250	0.2510	0.1310
608	3/16 × 1	0.1863	0.1880	0.3393	1.000	1.020	0.0937	0.1885	0.0997
708	7/32 × 1	0.2175	0.2193	0.3237	1.000	1.020	0.1093	0.2198	0.1153
808	1/4 × 1	0.2487	0.2505	0.3080	1.000	1.020	0.1250	0.2510	0.1310
1008	5/16 × 1	0.3111	0.3130	0.2768	1.000	1.020	0.1562	0.3135	0.1622
1208	3/8 × 1	0.3735	0.3755	0.2455	1.000	1.020	0.1875	0.3760	0.1935
609	3/16 × 1 1/8	0.1863	0.1880	0.3853	1.125	1.145	0.0937	0.1885	0.0997
709	7/32 × 1 1/8	0.2175	0.2193	0.3697	1.125	1.145	0.1093	0.2198	0.1153
809	1/4 × 1 1/8	0.2487	0.2505	0.3540	1.125	1.145	0.1250	0.2510	0.1310
1009	5/16 × 1 1/8	0.3111	0.3130	0.3228	1.125	1.145	0.1562	0.3135	0.1622
610	3/16 × 1 1/4	0.1863	0.1880	0.4483	1.250	1.273	0.0937	0.1885	0.0997
710	7/32 × 1 1/4	0.2175	0.2193	0.4327	1.250	1.273	0.1093	0.2198	0.1153
810	1/4 × 1 1/4	0.2487	0.2505	0.4170	1.250	1.273	0.1250	0.2510	0.1310
1010	5/16 × 1 1/4	0.3111	0.3130	0.3858	1.250	1.273	0.1562	0.3135	0.1622
1210	3/8 × 1 1/4	0.3735	0.3755	0.3545	1.250	1.273	0.1875	0.3760	0.1935
811	1/4 × 1 3/8	0.2487	0.2505	0.4640	1.375	1.398	0.1250	0.2510	0.1310
1011	5/16 × 1 3/8	0.3111	0.3130	0.4328	1.375	1.398	0.1562	0.3135	0.1622

Table 10. ANSI Keyseat Dimensions for Woodruff Keys
ANSI B17.2-1967 (R2008)

Key No.	Nominal Size Key	Keyseat—Shaft					Key Above Shaft	Keyseat—Hub	
		Width A ^a		Depth B	Diameter F		Height C	Width D	Depth E
		Min.	Max.	+0.005 −0.000	Min.	Max.	+0.005 −0.005	+0.002 −0.000	+0.005 −0.000
1211	$\frac{3}{8} \times 1\frac{3}{8}$	0.3735	0.3755	0.4015	1.375	1.398	0.1875	0.3760	0.1935
812	$\frac{1}{4} \times 1\frac{1}{2}$	0.2487	0.2505	0.5110	1.500	1.523	0.1250	0.2510	0.1310
1012	$\frac{5}{16} \times 1\frac{1}{2}$	0.3111	0.3130	0.4798	1.500	1.523	0.1562	0.3135	0.1622
1212	$\frac{3}{8} \times 1\frac{1}{2}$	0.3735	0.3755	0.4485	1.500	1.523	0.1875	0.3760	0.1935
617-1	$\frac{3}{16} \times 2\frac{1}{8}$	0.1863	0.1880	0.3073	2.125	2.160	0.0937	0.1885	0.0997
817-1	$\frac{1}{4} \times 2\frac{1}{8}$	0.2487	0.2505	0.2760	2.125	2.160	0.1250	0.2510	0.1310
1017-1	$\frac{5}{16} \times 2\frac{1}{8}$	0.3111	0.3130	0.2448	2.125	2.160	0.1562	0.3135	0.1622
1217-1	$\frac{3}{8} \times 2\frac{1}{8}$	0.3735	0.3755	0.2135	2.125	2.160	0.1875	0.3760	0.1935
617	$\frac{3}{16} \times 2\frac{1}{8}$	0.1863	0.1880	0.4323	2.125	2.160	0.0937	0.1885	0.0997
817	$\frac{1}{4} \times 2\frac{1}{8}$	0.2487	0.2505	0.4010	2.125	2.160	0.1250	0.2510	0.1310
1017	$\frac{5}{16} \times 2\frac{1}{8}$	0.3111	0.3130	0.3698	2.125	2.160	0.1562	0.3135	0.1622
1217	$\frac{3}{8} \times 2\frac{1}{8}$	0.3735	0.3755	0.3385	2.125	2.160	0.1875	0.3760	0.1935
822-1	$\frac{1}{4} \times 2\frac{3}{4}$	0.2487	0.2505	0.4640	2.750	2.785	0.1250	0.2510	0.1310
1022-1	$\frac{5}{16} \times 2\frac{3}{4}$	0.3111	0.3130	0.4328	2.750	2.785	0.1562	0.3135	0.1622
1222-1	$\frac{3}{8} \times 2\frac{3}{4}$	0.3735	0.3755	0.4015	2.750	2.785	0.1875	0.3760	0.1935
1422-1	$\frac{7}{16} \times 2\frac{3}{4}$	0.4360	0.4380	0.3703	2.750	2.785	0.2187	0.4385	0.2247
1622-1	$\frac{1}{2} \times 2\frac{3}{4}$	0.4985	0.5005	0.3390	2.750	2.785	0.2500	0.5010	0.2560
822	$\frac{1}{4} \times 2\frac{3}{4}$	0.2487	0.2505	0.6200	2.750	2.785	0.1250	0.2510	0.1310
1022	$\frac{5}{16} \times 2\frac{3}{4}$	0.3111	0.3130	0.5888	2.750	2.785	0.1562	0.3135	0.1622
1222	$\frac{3}{8} \times 2\frac{3}{4}$	0.3735	0.3755	0.5575	2.750	2.785	0.1875	0.3760	0.1935
1422	$\frac{7}{16} \times 2\frac{3}{4}$	0.4360	0.4380	0.5263	2.750	2.785	0.2187	0.4385	0.2247
1622	$\frac{1}{2} \times 2\frac{3}{4}$	0.4985	0.5005	0.4950	2.750	2.785	0.2500	0.5010	0.2560
1228	$\frac{3}{8} \times 3\frac{1}{2}$	0.3735	0.3755	0.7455	3.500	3.535	0.1875	0.3760	0.1935
1428	$\frac{7}{16} \times 3\frac{1}{2}$	0.4360	0.4380	0.7143	3.500	3.535	0.2187	0.4385	0.2247
1628	$\frac{1}{2} \times 3\frac{1}{2}$	0.4985	0.5005	0.6830	3.500	3.535	0.2500	0.5010	0.2560
1828	$\frac{9}{16} \times 3\frac{1}{2}$	0.5610	0.5630	0.6518	3.500	3.535	0.2812	0.5635	0.2872
2028	$\frac{5}{8} \times 3\frac{1}{2}$	0.6235	0.6255	0.6205	3.500	3.535	0.3125	0.6260	0.3185
2228	$\frac{11}{16} \times 3\frac{1}{2}$	0.6860	0.6880	0.5893	3.500	3.535	0.3437	0.6885	0.3497
2428	$\frac{3}{4} \times 3\frac{1}{2}$	0.7485	0.7505	0.5580	3.500	3.535	0.3750	0.7510	0.3810

^a These Width A values were set with the maximum keyseat (shaft) width as that figure which will receive a key with the greatest amount of looseness consistent with assuring the key's sticking in the keyseat (shaft). Minimum keyseat width is that figure permitting the largest shaft distortion acceptable when assembling maximum key in minimum keyseat. Dimensions A, B, C, D are taken at side intersection.

All dimensions are given in inches.

The following definitions are given in this standard:

Woodruff Key: A demountable machinery part which, when assembled into key-seats, provides a positive means for transmitting torque between the shaft and hub.

Woodruff Key Number: An identification number by which the size of key may be readily determined.

Woodruff Keyseat—Shaft: The circular pocket in which the key is retained.

Woodruff Keyseat—Hub: An axially located rectangular groove in a hub. (This has been referred to as a keyway.)

Woodruff Keyseat Milling Cutter: An arbor type or shank type milling cutter normally used for milling Woodruff keyseats in shafts (see page 832).

Chamfered Keys and Filleted Keyseats.—In general practice, chamfered keys and filleted keyseats are not used. However, it is recognized that fillets in keyseats decrease stress concentration at corners. When used, fillet radii should be as large as possible without causing excessive bearing stresses due to reduced contact area between the key and its mating parts. Keys must be chamfered or rounded to clear fillet radii. Values in [Table 5](#) assume general conditions and should be used only as a guide when critical stresses are encountered.

✦ **Depths for Milling Keyseats.**—[Table 11](#) on page 2483 has been compiled to facilitate the accurate milling of keyseats. This table gives the distance M (see illustration accompanying table) between the top of the shaft and a line passing through the upper corners or edges

of the keyseat. Dimension M is calculated by the formula: $M = \frac{1}{2}(S - \sqrt{S^2 - E^2})$ where S is diameter of shaft, and E is width of keyseat. A simple approximate formula that gives M to within 0.001 inch is $M = E^2 \div 4S$.

Keyseating Machines.—The machines which are designed especially for cutting keyseats or keyways in the hubs of pulleys, gears, etc., are generally known as keyseaters. Machines of this class usually have a base or frame which contains the mechanism for imparting a reciprocating motion to a cutter bar, which moves vertically for cutting a keyseat in the work. There are several types of machines which are used for internal keyseating operations in addition to the machines designed especially for this work. Broaching machines as well as slotters are commonly used, and keyseating is also done to some extent in shapers and planers.

Other Key Types.—The *sunk key* is the most common type and is of rectangular section that engages a groove or slot formed both in the shaft and hub of the gear or pulley. The width of an ordinary sunk key ordinarily is equal to about one-fourth of the shaft diameter and the thickness, when a flat key is preferred to the square form, is usually about one-sixth of the shaft diameter; these proportions are varied somewhat by different manufacturers.

The *flat key* is a rectangular shape which bears upon a flat surface formed on one side of the shaft. The *draw* or *gib key* is a sunk key which has a head by means of which it can be removed. The *round tapered key* is simply a taper pin which is driven into a hole that is partly in the shaft and partly in the hub; this form is used for light work. The name *feather* or *spline* is applied to a key which is fixed to either a shaft or hub, as when a gear must be driven by a shaft, but at the same time be free to slide in a lengthwise direction.

The taper of American Standard square and flat keys is 1.8 inch per foot.

The *saddle key* does not enter a slot in the shaft. It has parallel sides and is curved on its under side to fit the shaft. It is slightly tapered on top so that, when it is driven tightly in place, the shaft is held by frictional resistance. This key should be fitted so that it bears lightly on the sides and heavily between the shaft and hub throughout its entire length. As the drive with this type of key is not positive, it is only used where there is little power to transmit. It is an inexpensive method of keying, as the shaft does not need to be machined.

Effect of Keyways on Shaft Strength.—See *SHAFTS* starting on page 295 and *Effect of Keyways on Shaft Strength* starting on page 301.

British Standard Keys and Keyways.—See *Keys and Keyways* in the *ADDITIONAL* material on *Machinery's Handbook 29 CD*.

Cotters.—A cotter is a form of key that is used to connect rods, etc., that are subjected either to tension or compression or both, the cotter being subjected to shearing stresses at two transverse cross-sections. When taper cotters are used for drawing and holding parts together, if the cotter is held in place by the friction between the bearing surfaces, the taper should not be too great. Ordinarily a taper varying from $\frac{1}{4}$ to $\frac{1}{2}$ inch per foot is used for plain cotters. When a set-screw or other device is used to prevent the cotter from backing out of its slot, the taper may vary from 1 $\frac{1}{2}$ to 2 inches per foot.

Table 11. Finding Depth of Keyseat and Distance from Top of Key to Bottom of Shaft

For milling keyseats, the total depth to feed cutter in from outside of shaft to bottom of keyseat is $M + D$, where D is depth of keyseat.

For checking an assembled key and shaft, caliper measurement J between top of key and bottom of shaft is used.

$$J = S - (M + D) + C$$

where C is depth of key. For Woodruff keys, dimensions C and D can be found in Tables 8 through 10. Assuming shaft diameter S is normal size, the tolerance on dimension J for Woodruff keys in keyslots are $+0.000, -0.010$ inch.

Dia. of Shaft, S Inches	Width of Keyseat, E															
	1/16	3/32	1/8	5/32	3/16	7/32	1/4	5/16	3/8	7/16	1/2	9/16	5/8	11/16	3/4	
	Dimension M, Inch															
0.3125	.0032
0.3437	.0029	.0065
0.3750	.0026	.0060	.0107
0.4060	.0024	.0055	.0099
0.4375	.0022	.0051	.0091
0.4687	.0021	.0047	.0085	.0134
0.5000	.0020	.0044	.0079	.0125
0.56250039	.0070	.0111	.0161
0.62500035	.0063	.0099	.0144	.0198
0.68750032	.0057	.0090	.0130	.0179	.0235
0.75000029	.0052	.0082	.0119	.0163	.0214	.0341
0.81250027	.0048	.0076	.0110	.0150	.0197	.0312
0.87500025	.0045	.0070	.0102	.0139	.0182	.0288
0.93750042	.0066	.0095	.0129	.0170	.0263	.0391
1.00000039	.0061	.0089	.0121	.0159	.0250	.0365
1.06250037	.0058	.0083	.0114	.0149	.0235	.0342
1.12500035	.0055	.0079	.0107	.0141	.0221	.0322	.0443
1.18750033	.0052	.0074	.0102	.0133	.0209	.0304	.0418
1.25000031	.0049	.0071	.0097	.0126	.0198	.0288	.0395
1.37500045	.0064	.0088	.0115	.0180	.0261	.0357	.0471
1.50000041	.0059	.0080	.0105	.0165	.0238	.0326	.0429
1.62500038	.0054	.0074	.0097	.0152	.0219	.0300	.0394	.0502
1.75000050	.0069	.0090	.0141	.0203	.0278	.0365	.0464
1.87500047	.0064	.0084	.0131	.0189	.0259	.0340	.0432	.0536
2.00000044	.0060	.0078	.0123	.0177	.0242	.0318	.0404	.0501
2.12500056	.0074	.0116	.0167	.0228	.0298	.0379	.0470	.0572	.0684	...
2.25000070	.0109	.0157	.0215	.0281	.0357	.0443	.0538	.0643	...
2.37500103	.0149	.0203	.0266	.0338	.0419	.0509	.0608	...
2.50000141	.0193	.0253	.0321	.0397	.0482	.0576	...
2.62500135	.0184	.0240	.0305	.0377	.0457	.0547	...
2.75000175	.0229	.0291	.0360	.0437	.0521	...
2.87500168	.0219	.0278	.0344	.0417	.0498	...
3.00000210	.0266	.0329	.0399	.0476	...

FLEXIBLE BELTS AND SHEAVES

Flexible belt drives are used in industrial power transmission applications, especially when the speeds of the driver and driven shafts must be different or when shafts must be widely separated. The trend toward higher speed prime movers and the need to achieve a slower, useful driven speed are additional factors favoring the use of belts. Belts have numerous advantages over other means of power transmission; these advantages include overall economy, cleanliness, no need for lubrication, lower maintenance costs, easy installation, dampening of shock loads, and the abilities to be used for clutching and variable speed power transmission between widely spaced shafts.

Calculations for Belts and Pulleys

Belt speed plays an important role in the amount of load a friction drive system can transmit. Higher speeds will require higher preloads (increased belt tension) to compensate for the higher centrifugal force. In positive drive (toothed belt) systems, higher speeds generate dynamic forces caused by unavoidable tolerance errors that may result in increased tooth or pin stresses and shorter belt life.

Pulley Diameters and Drive Ratios.—Minimum pulley diameters determined by belt manufacturers are based on the minimum radius that a belt can wrap around a pulley without stressing the load-carrying members. For positive drive systems, minimum pulley diameters are also determined by the minimum number of teeth that must be engaged with the sprocket to guarantee the operating load.

Diameters of driving and driven pulleys determine the velocity ratio of the input relative to the output shaft and are derived from the following formulas: for all belt systems, velocity ratio $V = D_{pi}/D_{po}$, and for positive (toothed) drive systems, velocity ratio $V = N_i/N_o$, where D_{pi} is the pitch diameter of the driving pulley, D_{po} is the pitch diameter of the driven pulley, N_i is the number of teeth on the driving pulley, and N_o is the number of teeth on the driven pulley. For most drive systems, a velocity ratio of 8:1 is the largest that should be attempted with a single reduction drive, and 6:1 is a reasonable maximum.

Wrap Angles and Center-to-Center Distances.—The radial distance for which the belt is in contact with the pulley surface, or the number of teeth in engagement for positive drive belts, is called the wrap angle. Belt and sprocket combinations should be chosen to ensure a wrap angle of about 120° around the smaller pulley. The wrap angle should not be less than 90° , especially with positive drive belts, because if too few teeth are in engagement, the belt may jump a tooth or pin and timing or synchronization may be lost.

For flat belts, the minimum allowable center-to-center distance (CD) for any belt-and-sprocket combination should be chosen to ensure a minimum wrap angle around the smaller pulley. For high-velocity systems, a good rule of thumb is a minimum CD equal to the sum of the pitch diameter of the larger sprocket and one-half the pitch diameter of the smaller sprocket. This formula ensures a minimum wrap angle of approximately 120° , which is generally sufficient for friction drives and will ensure that positive drive belts do not jump teeth.

Pulley Center Distances and Belt Lengths.—Maximum center distances of pulleys should be about 15 to 20 times the pitch diameter of the smaller pulley. Greater spacing requires tight control of the belt tension because a small amount of stretch will cause a large drop in tension. Constant belt tension can be obtained by application of an adjustable tensioning pulley applied to the slack side of the belt. Friction drive systems using flat belts require much more tension than positive drive belt systems.

Belt length can be calculated from: $L = 2C + \pi(D_2 + D_1)/2 + (D_2 - D_1)^2/4C$ for friction drives, and length $L = 2C + \pi(D_2 + D_1)/2 + (D_2 + D_1)^2/4C$ for crossed belt friction belt drives, where C is the center distance, D_1 is the pitch diameter of the small pulley, and D_2 is

the pitch diameter of the large pulley. For serrated belt drives, the length determined by use of these equations should be divided by the serration pitch. The belt length must then be adjusted to provide a whole number of serrations.

Pulley Diameters and Speeds.—If D = diameter of driving pulley, d = diameter of driven pulley, S = speed of driving pulley, and s = speed of driven pulley:

$$D = \frac{d \times s}{S}, \quad d = \frac{D \times S}{s}, \quad S = \frac{d \times s}{D}, \quad \text{and} \quad s = \frac{D \times S}{d}$$

Example 1: If diameter of the driving pulley D is 24 inches, its speed is 100 rpm, and the driven pulley runs at 600 rpm, diameter of the driven pulley, $d = 24 \times 100/600 = 4$ inches.

Example 2: If the diameter of the driving pulley D is 60 cm, its speed is 100 rpm, and the driven pulley is to run at 600 rpm, the diameter of the driven pulley, $d = 60 \times 100/600 = 10$ cm.

Example 3: If the diameter of the driven pulley d is 36 inches, its required speed is to be 150 rpm, and the speed of the driving pulley is to be 600 rpm, the diameter of the driving pulley $D = 36 \times 150/600 = 9$ inches.

Example 4: If diameter of driven pulley d is 4 inches, its required speed is 800 rpm, and diameter of driving pulley D is 26 inches, speed of driving pulley $S = 4 \times 800/26 = 123$ rpm.

Example 5: If diameter of driven pulley d is 10 cm, its required speed is 800 rpm, and diameter of driving pulley D is 25 cm, speed of the driving pulley $S = 10 \times 800/25 = 320$ rpm.

Example 6: If the diameter of the driving pulley D is 15 inches and its speed is 180 rpm, and the diameter of the driven pulley d is 9 inches, then the speed of the driven pulley $s = 15 \times 180/9 = 300$ rpm.

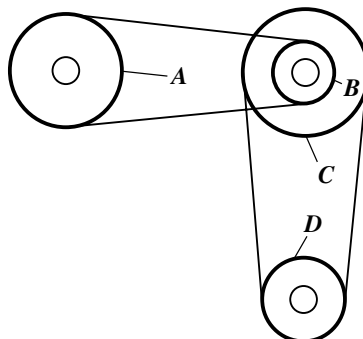
Pulley Diameters in Compound Drive.—If speeds of driving and driven pulleys, A , B , C , and D (see illustration) are known, the first step in finding their diameters is to form a fraction with the driving pulley speed as the numerator and the driven pulley speed as the denominator, and then reduce this fraction to its lowest terms. Resolve the numerator and the denominator into two pairs of factors (a pair being one factor in the numerator and one in the denominator) and, if necessary, multiply each pair by a trial number that will give pulleys of suitable diameters.

Example 7: If speed of pulley A is 260 rpm and the required speed of pulley D is 720 rpm, find the diameters of the four pulleys. Reduced to its lowest terms, the fraction $260/720 = 13/36$, which represents the required speed ratio. Resolve this ratio $13/36$ into two factors:

$$\frac{13}{36} = \frac{1 \times 13}{2 \times 18}$$

Multiply by trial numbers 12 and 1 to get:

$$\frac{(1 \times 12) \times (13 \times 1)}{(2 \times 12) \times (18 \times 1)} = \frac{12 \times 13}{24 \times 18}$$



Compound Drive with Four Pulleys.

The values 12 and 13 in the numerator represent the diameters of the *driven* pulleys, B and D , and the values 24 and 18 in the denominator represent the diameters of the *driving* pulleys, A and C , as shown in the illustration.

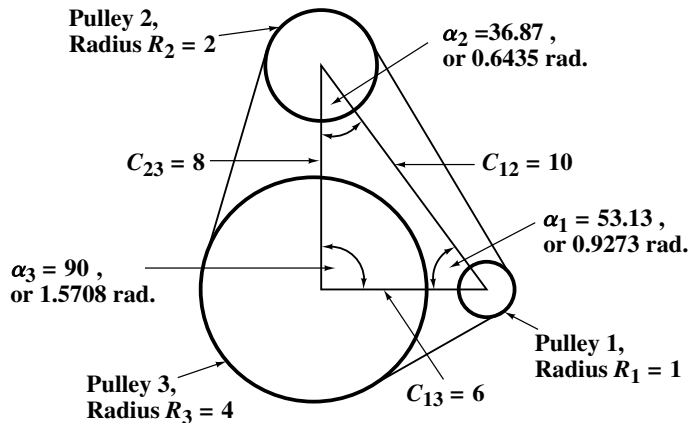
Speed of Driven Pulley in Compound Drive.—If diameters of pulleys A , B , C , and D (see illustration above), and speed of pulley A are known, the speed of the driven pulley D is found from:

$$\frac{\text{driving pulley diameter}}{\text{driven pulley diameter}} \times \frac{\text{driving pulley diameter}}{\text{driven pulley diameter}} \times \text{speed of first driving pulley}$$

✦ *Example 8:* If the diameters of driving pulleys A and C are 18 and 24 inches, diameters of driven pulleys B and D are 12 and 13 inches, and the speed of driving pulley A is 260 rpm, speed of driven pulley

$$D = \frac{18 \times 24}{12 \times 13} \times 260 = 720 \text{ rpm}$$

Length of Belt Traversing Three Pulleys.—The length L of a belt traversing three pulleys, as shown in the diagram below, and touching them on one side only, can be found by the following formula.



Flat Belt Traversing Three Pulleys.

Referring to the diagram, R_1 , R_2 , and R_3 are the radii of the three pulleys; C_{12} , C_{13} , and C_{23} are the center distances; and α_1 , α_2 , and α_3 are the angles, in radians, of the triangle formed by the center distances. Then:

$$L = C_{12} + C_{13} + C_{23} + \frac{1}{2} \left[\frac{(R_2 - R_1)^2}{C_{12}} + \frac{(R_3 - R_1)^2}{C_{13}} + \frac{(R_3 - R_2)^2}{C_{23}} \right] + \pi(R_1 + R_2 + R_3) - (\alpha_1 R_1 + \alpha_2 R_2 + \alpha_3 R_3)$$

✦ *Example 9:* Assume $R_1 = 1$, $R_2 = 2$, $R_3 = 4$, $C_{12} = 10$, $C_{13} = 6$, $C_{23} = 8$, $\alpha_1 = 53.13$ degrees or 0.9273 radian, $\alpha_2 = 36.87$ degrees or 0.6435 radian, and $\alpha_3 = 90$ degrees or 1.5708 radians. Then:

$$\begin{aligned} L &= 10 + 6 + 8 + \frac{1}{2} \left[\frac{(2-1)^2}{10} + \frac{(4-1)^2}{6} + \frac{(4-2)^2}{8} \right] \\ &\quad + \pi(1 + 2 + 4) + (0.9273 \times 1 + 0.6435 \times 2 + 1.5708 \times 4) \\ &= 24 + 1.05 + 21.9911 - 8.4975 = 38.5436 \end{aligned}$$

Power Transmitted by Belts.—With belt drives, the force that produces work acts on the rim of a pulley or sheave and causes it to rotate. Since a belt on a drive must be tight enough to prevent slip, there is a belt pull on both sides of a driven wheel. When a drive is stationary or operating with no power transmitted, the pulls on both sides of the driven wheel are equal. When the drive is transmitting power, however, the pulls are not the same. There is a tight side tension T_T and a slack side tension, T_S . The difference between these two pulls ($T_T - T_S$) is called *effective pull* or *net pull*. This effective pull is applied at the rim of the pulley and is the force that produces work.

Net pull equals horsepower (HP) \times 33,000 \div belt speed (fpm). Belt speed in fpm can be set by changing the pulley, sprocket, or sheave diameter. The shaft speeds remain the same. Belt speed is directly related to pulley diameter. Double the diameter and the total belt pull is cut in half, reducing the load on the shafts and bearings.

A belt experiences three types of tension as it rotates around a pulley: working tension (tight side – slack side), bending tension, and centrifugal tension.

The *tension ratio* (R) equals tight side divided by slack side tension (measured in pounds). The larger R is, the closer a V-belt is to slipping—the belt is too loose. (Synchronous belts do not slip, because they depend on the tooth grip principle.)

In addition to working tension (tight side – slack side), two other tensions are developed in a belt when it is operating on a drive. *Bending tension* T_B occurs when the belt bends around the pulley. One part of the belt is in tension and the other is in compression, so compressive stresses also occur. The amount of tension depends on the belt's construction and the pulley diameter. *Centrifugal tension* (T_C) occurs as the belt rotates around the drive and is calculated by $T_C = MV^2$, where T_C is centrifugal tension in pounds, M is a constant dependent on the belt's weight, and V is the belt velocity in feet per minute. Neither the bending nor centrifugal tensions are imposed on the pulley, shaft, or bearing—only on the belt.

Combining these three types of tension results in *peak tension* which is important in determining the degree of performance or belt life: $T_{\text{peak}} = T_T + T_B + T_C$.

Measuring the Effective Length.—The effective length of a V-belt is determined by placing the belt on a measuring device having two equal diameter sheaves with standard groove dimensions. The shaft of one of the sheaves is fixed. A specified measuring tension is applied to the housing for the shaft of the other sheave, moving it along a graduated scale. The belt is rotated around the sheaves at least two revolutions of the belt to seat it properly in the sheave grooves and to divide the total tension equally between the two strands of the belt.

The effective length of the belt is obtained by adding the effective (outside) circumference of one of the measuring sheaves to twice the center distance. Synchronous belts are measured in a similar manner.

The following sections cover common belts used in industrial applications for power transmission and specified in Rubber Manufacturers Association (RMA), Mechanical Power Transmission Association (MPTA), and The Rubber Association of Canada (RAC) standards. The information presented does not apply to automotive or agricultural drives, for which other standards exist. The belts covered in this section are Narrow, Classical, Double, and Light-Duty V-Belts, V-Ribbed Belts, Variable-Speed Belts, 60 deg V-Belts, and Synchronous (Timing) Belts.

Flat Belting

Flat belting was originally made from leather because it was the most durable material available and could easily be cut and joined to make a driving belt suitable for use with cylindrical or domed pulleys. This type of belting was popular because it could be used to

transmit high torques over long distances and it was employed in factories to drive many small machines from a large common power source such as a steam engine. As electric motors became smaller, more efficient, and more powerful, and new types of belts and chains were made possible by modern materials and manufacturing processes, flat belts fell out of favor. Flat belts are still used for some drive purposes, but leather has been replaced by other natural and synthetic materials such as urethanes, which can be reinforced by high-strength polyamide or steel fabrics to provide properties such as resistance to stretching. The high modulus of elasticity in these flat belts eliminates the need for periodic retensioning that is usually necessary with V-belts.

Driving belts can be given a coating of an elastomer with a high coefficient of friction, to enable belts to grip pulleys without the degree of tension common with earlier materials. Urethanes are commonly used for driving belts where high resistance to abrasion is required, and also resist attack by chemical solvents of most kinds. Flat belts having good resistance to high temperatures are also available. Typical properties of polyurethane belts include tensile strength up to 40,000 psi (276 MPa), depending on reinforcement type and Shore hardness of 85 to 95. Most polyurethane belts are installed under tension. The amount of tension varies with the belt cross-section, being greater for belts of small section. Belt tension can be measured by marking lines 10 inches, or 100 mm, apart on an installed belt, then applying tension until the separation increases by the desired percentage. For 2 per cent tension, lines on the tensioned belt would be 10.2 inches, or 102 mm, apart. Mechanical failure may result when belt tensioning is excessive, and 2 to 2.5 per cent elongation should be regarded as the limit.

Flat belts offer high load capacities and are capable of transmitting power over long distances, maintaining relative rotational direction, can operate without lubricants, and are generally inexpensive to maintain or replace when worn. Flat belt systems will operate with little maintenance and only periodic adjustment. Because they transmit motion by friction, flat belts have the ability to slip under excessive loads, providing a fail-safe action to guard against malfunctions. This advantage is offset by the problem that friction drives can both slip and creep so that they do not offer exact, consistent velocity ratios nor precision timing between input and output shafts. Flat belts can be made to any desired length, being joined by reliable chemical bonding processes.

Increasing centrifugal force has less effect on the load-carrying capacity of flat belts at high speeds than it has on V-belts, for instance. The low thickness of a flat belt, compared with a V-belt, places its center of gravity near the pulley surface. Flat belts therefore may be run at surface speeds of up to 16,000 or even 20,000 ft/min (81.28 to 101.6 m/s), although ideal speeds are in the range of 3,000 to 10,000 ft/min (15.25 to 50.8 m/s). Elastomeric drive surfaces on flat belts have eliminated the need for belt dressings that were often needed to keep leather belts in place. These surface coatings can also contain antistatic materials. Belt pulley wear and noise are low with flat belts shock and vibration are damped, and efficiency is generally greater than 98% compared with 96% for V-belts.

Driving belt load capacities can be calculated from torque $T = F(d/2)$ and horsepower $HP = T \times rpm/396,000$, where T is the torque in in-lb, F is the force transmitted in lb, and d is the pulley diameter in inches. Pulley width is usually about 10 per cent larger than the belt, and for good tracking, pulleys are often crowned by 0.012–0.10 inch (0.305–2.54 mm) for diameters in the range of 1.5–80 inches (3.8–203 cm).

Before a belt specification is written, the system should be checked for excessive startup and shut-down loads, which sometimes are more than 10 per cent above operating conditions. In overcoming such loads, the belt will transmit considerably more force than during normal operation. Large starting and stopping forces will also shorten belt life unless they are taken into account during the design stage.

Flat Belt Pulleys.— Flat belt pulleys are usually made of cast iron, fabricated steel, paper, fiber, or various kinds of wood. They may be solid or split and in either case the hub may be split for clamping to the shaft.

Pulley face widths are nominally the same as the widths of the belts they are to carry. The pulley face should be approximately one inch more than the belt width for belts under 12 inches (30.5 cm) wide, 2 inches (5.1 cm) more for belts from 12 to 24 inches (30.5–61 cm) wide, and 3 inches (7.6 cm) more for belts over 24 inches (61 cm) in width.

Belts may be made to center themselves by the use of crowned pulleys. The usual amount of crowning is $\frac{1}{8}$ inch per foot (10.4 mm per meter) of pulley width. Thus, the difference in maximum and minimum radii of a crowned 6-inch (152.4 mm) wide pulley would be $\frac{1}{16}$ inch (1.59 mm). Crowned pulleys have a rim section either with a convex curve or a flat V form. Flanges on the sides of flat belt pulleys are in general undesirable as the belt tends to crawl against them. Too much crown is undesirable because of the tendency to “break the belt’s back.” This is particularly true for riding idlers close to driving pulleys where the curvature of the belt changes rapidly from one pulley to the other. Here, the idler should under no circumstances be crowned and the adjacent pulley should have very little crown. Pulleys carrying shifting belts are not crowned.

Open belt drives connecting pulleys on short centers with one pulley considerably larger than the other may be unsatisfactory due to the small angle of wrap on the smaller pulley. This angle may be increased by the use of idler pulleys on one or both sides of the belt.

V-Belts

Narrow V-Belts ANSI/RMA IP-22.—Narrow V-belts serve the same applications as multiple, classical V-belts, but allow for a lighter, more compact drive. Three basic cross sections—3V and 3VX, 5V and 5VX, and 8V—are provided, as shown in Fig. 1. The 3VX and 5VX are molded, notched V-belts that have greater power capacity than conventional belts. Narrow V-belts are specified by cross section and effective length and have top widths ranging from $\frac{3}{8}$ to 1 inch (9.525–25.4 mm).

Narrow V-belts usually provide substantial weight and space savings over classical belts. Some narrow belts can transmit up to three times the horsepower of conventional belts in the same drive space, or the same horsepower in one-third to one-half the space. These belts are designed to operate in multiples and are also available in the joined configuration.

Belt Cross Sections: Nominal dimensions of the three cross sections are given in Fig. 1.

Belt Size Designation: Narrow V-belt sizes are identified by a standard belt number. The first figure of this number followed by the letter V denotes the belt cross section. An X following the V indicates a notched cross section. The remaining figures show the effective belt length in tenths of an inch. For example, the number 5VX1400 designates a notched V-belt with a 5V cross section and an effective length of 140.0 in. Standard effective lengths of narrow V-belts are shown in Table 1.

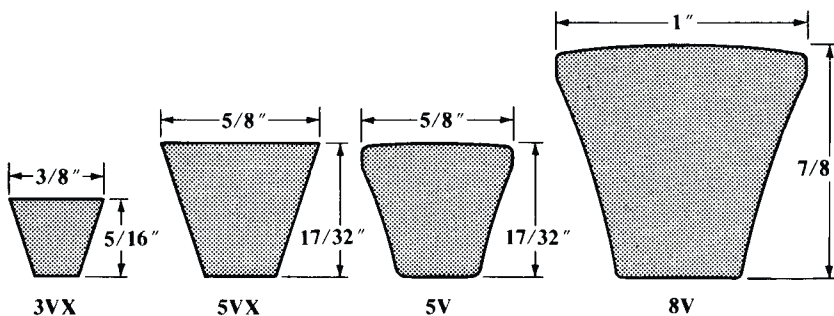


Fig. 1. Nominal Narrow V-Belt Dimensions

Sheave Dimensions: Groove angles and dimensions for sheaves and face widths of sheaves for multiple belt drives are given in Tables 2a and 2b, along with various tolerance values. Standard sheave outside diameters are given in Table 3.

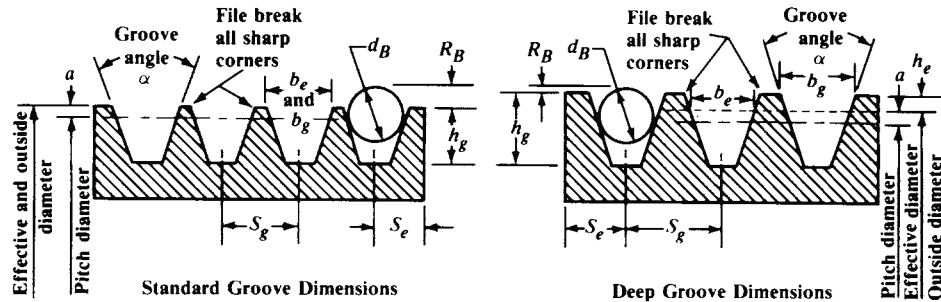
Table 1. Narrow V-Belt Standard Effective Lengths ANSI/RMA IP-22 (1983)

Standard Length Designation ^a	Standard Effective Outside Length			Permissible Deviation from Standard Length	Matching Limits for One Set	Standard Length Designation ^a	Standard Effective Outside Length			Permissible Deviation from Standard Length	Matching Limits for One Set
	Cross Section						Cross Section				
	3V	5V	8V				3V	5V	8V		
250	25.0	±0.3	0.15	1060	106.0	106.0	106.0	±0.6	0.30
265	26.5	±0.3	0.15	1120	112.0	112.0	112.0	±0.6	0.30
280	28.0	±0.3	0.15	1180	118.0	118.0	118.0	±0.6	0.30
300	30.0	±0.3	0.15	1250	125.0	125.0	125.0	±0.6	0.30
315	31.5	±0.3	0.15	1320	132.0	132.0	132.0	±0.6	0.30
335	33.5	±0.3	0.15	1400	140.0	140.0	140.0	±0.6	0.30
355	35.5	±0.3	0.15	1500	...	150.0	150.0	±0.8	0.30
375	37.5	±0.3	0.15	1600	...	160.0	160.0	±0.8	0.45
400	40.0	±0.3	0.15	1700	...	170.0	170.0	±0.8	0.45
425	42.5	±0.3	0.15	1800	...	180.0	180.0	±0.8	0.45
450	45.0	±0.3	0.15	1900	...	190.0	190.0	±0.8	0.45
475	47.5	±0.3	0.15	2000	...	200.0	200.0	±0.8	0.45
500	50.0	50.0	...	±0.3	0.15	2120	...	212.0	212.0	±0.8	0.45
530	53.0	53.0	...	±0.4	0.15	2240	...	224.0	224.0	±0.8	0.45
560	56.0	56.0	...	±0.4	0.15	2360	...	236.0	236.0	±0.8	0.45
600	60.0	60.0	...	±0.4	0.15	2500	...	250.0	250.0	±0.8	0.45
630	63.0	63.0	...	±0.4	0.15	2650	...	265.0	265.0	±0.8	0.60
670	67.0	67.0	...	±0.4	0.30	2800	...	280.0	280.0	±0.8	0.60
710	71.0	71.0	...	±0.4	0.30	3000	...	300.0	300.0	±0.8	0.60
750	75.0	75.0	...	±0.4	0.30	3150	...	315.0	315.0	±1.0	0.60
800	80.0	80.0	...	±0.4	0.30	3350	...	335.0	335.0	±1.0	0.60
850	85.0	85.0	...	±0.5	0.30	3550	...	355.0	355.0	±1.0	0.60
900	90.0	90.0	...	±0.5	0.30	3750	375.0	±1.0	0.60
950	95.0	95.0	...	±0.5	0.30	4000	400.0	±1.0	0.75
1000	100.0	100.0	100.0	±0.5	0.30	4250	425.0	±1.2	0.75

^aTo specify belt size, use the Standard Length Designation prefixed by the cross section, for example, 5 V850.

All dimensions in inches.

Table 2a. Narrow V-Belt Standard Sheave and Groove Dimensions ANSI/RMA IP-22 (1983)



Face Width of Standard and Deep Groove Sheaves = $s_g (N_g - 1) + 2s_e$, where N_g = number of grooves

Cross Section	Standard Groove Outside Diameter	Standard Groove Dimensions								Design Factors	
		Groove Angle, α , ± 0.25 deg	b_g ± 0.005	b_e (Ref)	h_g (Min)	R_B (Min)	d_B ± 0.0005	S_g^a ± 0.015	S_e	Min Recommended OD	$2a$
3V	Up through 3.49	36				0.181					
	Over 3.49 up to and including 6.00	38				0.183					
	Over 6.00 up to and including 12.00	40	0.350	0.350	0.340	0.186	0.3438	0.406	0.344 (+0.099, -0.031)	2.65	0.050
	Over 12.00	42				0.188					
5V	Up through 9.99	38				0.329					
	Over 9.99 up to and including 16.00	40	0.600	0.600	0.590	0.332	0.5938	0.688	0.500 (+0.125, -0.047)	7.10	0.100
	Over 16.00	42				0.336					
8V	Up through 15.99	38				0.575					
	Over 15.99 up to and including 22.40	40	1.000	1.000	0.990	0.580	1.0000	1.125	0.750 (+0.250, -0.062)	12.50	0.200
	Over 22.40	42				0.585					

^a See footnote ^b following Table 2b.

Table 2b. Narrow V-Belt Standard Sheave and Groove Dimensions ANSI/RMA IP-22 (1983)

Cross Section	Deep Groove Outside Diameter	Deep Groove Dimensions ^a								Design Factors		
		Groove Angle, α , ± 0.25 deg	b_g ± 0.005	b_e (Ref)	h_g (Min)	R_B (Min)	d_B ± 0.0005	S_g^b ± 0.015	S_e	Min Recommended OD	$2a$	$2h_e$
3V	Up through 3.71	36	0.421			0.070				2.87	0.050	0.218
	Over 3.71 up to and including 6.22	38	0.425	0.350	0.449	0.073	0.3438	0.500	0.375 (+0.094, -0.031)			
	Over 6.22 up to and including 12.22	40	0.429			0.076						
	Over 12.22	42	0.434			0.078						
5V	Up through 10.31	38	0.710			0.168				7.42	0.100	0.320
	Over 10.31 up to and including 16.32	40	0.716	0.600	0.750	0.172	0.5938	0.812	0.562 (+0.125, -0.047)			
	Over 16.32	42	0.723			0.175						
8V	Up through 16.51	38	1.180			0.312				13.02	0.200	0.524
	Over 16.51 up to and including 22.92	40	1.191	1.000	1.252	0.316	1.0000	1.312	0.844 (+0.250, -0.062)			
	Over 22.92	42	1.201			0.321						

^a Deep groove sheaves are intended for drives with belt offset such as quarter-turn or vertical shaft drives. They may also be necessary where oscillations in the center distance may occur. Joined belts will not operate in deep groove sheaves.

^b Summation of the deviations from S_g for all grooves in any one sheave should not exceed ± 0.031 in. The variations in pitch diameter between the grooves in any one sheave must be within the following limits: Up through 19.9 in. outside diameter and up through 6 grooves—0.010 in. (add 0.0005 in. for each additional groove). 20.0 in. and over on outside diameter and up through 10 grooves—0.015 in. (add 0.0005 in. for each additional groove). This variation can be obtained by measuring the distance across two measuring balls or rods placed in the grooves diametrically opposite each other. Comparing this “diameter over balls or rods” measurement between grooves will give the variation in pitch diameter.

Other Sheave Tolerances		
Outside Diameter	Radial Runout ^a	Axial Runout ^a
Up through 8.0 in. outside diameter ± 0.020 in. For each additional inch of outside diameter add ± 0.0025 in.	Up through 10.0 in. outside diameter 0.010 in. For each additional inch of outside diameter add 0.0005 in.	Up through 5.0 in. outside diameter 0.005 in. For each additional inch of outside diameter add 0.001 in.

^a Total indicator reading.
All dimensions in inches.

Table 3. Standard Sheave Outside Diameters ANSI/RMA IP-22, 1983

3V			5V			8V		
Nom	Min	Max	Nom	Min	Max	Nom	Min	Max
2.65	2.638	2.680	7.10	7.087	7.200	12.50	12.402	12.600
2.80	2.795	2.840	7.50	7.480	7.600	13.20	13.189	13.400
3.00	2.953	3.000	8.00	7.874	8.000	14.00	13.976	14.200
3.15	3.150	3.200	8.50	8.346	8.480	15.00	14.764	15.000
3.35	3.346	3.400	9.00	8.819	8.960	16.00	15.748	16.000
3.55	3.543	3.600	9.25	9.291	9.440	17.00	16.732	17.000
3.65	3.642	3.700	9.75	9.567	9.720	18.00	17.717	18.000
4.00	3.937	4.000	10.00	9.843	10.000	19.00	18.701	19.000
4.12	4.055	4.120	10.30	10.157	10.320	20.00	19.685	20.000
4.50	4.409	4.480	10.60	10.433	10.600	21.20	20.866	21.200
4.75	4.646	4.720	10.90	10.709	10.880	22.40	22.047	22.400
5.00	4.921	5.000	11.20	11.024	11.200	23.60	23.622	24.000
5.30	5.197	5.280	11.80	11.811	12.000	24.80	24.803	25.200
5.60	5.512	5.600	12.50	12.402	12.600	30.00	29.528	30.000
6.00	5.906	6.000	13.20	13.189	13.400	31.50	31.496	32.000
6.30	6.299	6.400	14.00	13.976	14.200	35.50	35.433	36.000
6.50	6.496	6.600	15.00	14.764	15.000	40.00	39.370	40.000
6.90	6.890	7.000	16.00	15.748	16.000	44.50	44.094	44.800
8.00	7.874	8.000	18.70	18.701	19.000	50.00	49.213	50.000
10.00	9.843	10.000	20.00	19.685	20.000	52.00	51.969	52.800
10.60	10.433	10.600	21.20	20.866	21.200	63.00	62.992	64.000
12.50	12.402	12.600	23.60	23.622	24.000	71.00	70.866	72.000
14.00	13.976	14.200	25.00	24.803	25.200	79.00	78.740	80.000
16.00	15.748	16.000	28.00	27.953	28.400	99.00	98.425	100.000
19.00	18.701	19.000	31.50	31.496	32.000
20.00	19.685	20.000	37.50	37.402	38.000
25.00	24.803	25.200	40.00	39.370	40.000
31.50	31.496	32.000	44.50	44.094	44.800
33.50	33.465	34.000	50.00	49.213	50.000
...	63.00	62.992	64.000
...	71.00	70.866	72.000

All dimensions in inches. The nominal diameters were selected from R40 and R80 preferred numbers (see page 672).

Minimum Sheave Size: The recommended minimum sheave size depends on the rpm of the faster shaft. Minimum sheave diameters for each belt cross-section are listed in Table 3.

Cross Section Selection: The chart (Fig. 2, on page 2494) is a guide to the V-belt cross section to use for any combination of design horsepower and speed of the faster shaft. When the intersection of the design horsepower and speed of the faster shaft falls near a line between two areas on the chart, it is advisable to investigate the possibilities in both areas. Special circumstances (such as space limitations) may lead to a choice of belt cross section different from that indicated in the chart.

Horsepower Ratings: The horsepower ratings of narrow V-belts can be calculated using the following formula:

$$HP = d_p r [K_1 - K_2/d_p - K_3(d_p r)^2 - K_4 \log(d_p r)] + K_{SR} r$$

where d_p = the pitch diameter of the small sheave, in.; r = rpm of the faster shaft divided by 1000; K_{SR} , speed ratio correction factor (Table 4), and K_1 , K_2 , K_3 , and K_4 , cross section parameters, are listed in the accompanying Table 5. This formula gives the basic horsepower rating, corrected for the speed ratio. To obtain the horsepower per belt for an arc of contact other than 180° and for belts shorter or longer than average length, multiply the horsepower obtained from this formula by the length correction factor (Table 7) and the arc of contact correction factor (Table 6).

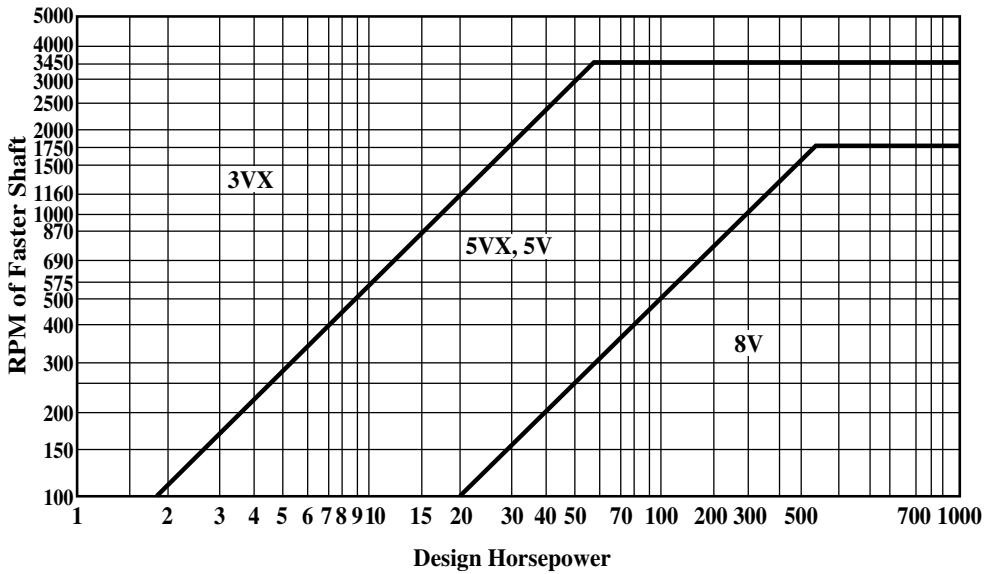


Fig. 2. Selection of Narrow V-Belt Cross Section

Table 4. Speed Ratio Correction Factors

Speed Ratio ^a Range	K_{SR}		Speed Ratio ^a Range	K_{SR}	
	Cross Section			Cross Section	
	3VX	5VX		5V	8V
1.00-1.01	0.0000	0.0000	1.00-1.01	0.0000	0.0000
1.02-1.03	0.0157	0.0801	1.02-1.05	0.0963	0.4690
1.04-1.06	0.0315	0.1600	1.06-1.11	0.2623	1.2780
1.07-1.09	0.0471	0.2398	1.12-1.18	0.4572	2.2276
1.10-1.13	0.0629	0.3201	1.19-1.26	0.6223	3.0321
1.14-1.18	0.0786	0.4001	1.27-1.38	0.7542	3.6747
1.19-1.25	0.0944	0.4804	1.39-1.57	0.8833	4.3038
1.26-1.35	0.1101	0.5603	1.58-1.94	0.9941	4.8438
1.36-1.57	0.1259	0.6405	1.95-3.38	1.0830	5.2767
Over 1.57	0.1416	0.7202	Over 3.38	1.1471	5.5892

^a D_p/d_p , where D_p (d_p) is the pitch diameter of the large (small) sheave.

Table 5. Cross Section Correction Factors

Cross Section	K_1	K_2	K_3	K_4
3VX	1.1691	1.5295	1.5229×10^{-4}	0.15960
5VX	3.3038	7.7810	3.6432×10^{-4}	0.43343
5V	3.3140	10.123	5.8758×10^{-4}	0.46527
8V	8.6628	49.323	1.5804×10^{-3}	1.1669

Arc of Contact: Arc of contact on the small sheave may be determined by the formulas.

Exact formula:
$$\text{Arc of Contact (deg)} = 2 \cos^{-1} \left(\frac{D_e - d_e}{2C} \right)$$

Approximate formula:
$$\text{Arc of Contact (deg)} = 180 - \frac{(D_e - d_e)60}{C}$$

where: D_e = Effective diameter of large sheave, inch or mm

d_e = Effective diameter of small sheave, inch or mm

C = Center distance, inch or mm

Table 6. Arc of Contact Correction Factors

$\frac{D_e - d_e}{C}$	Arc of Contact, θ , on Small Sheave (deg)	Correction Factor	$\frac{D_e - d_e}{C}$	Arc of Contact, θ , on Small Sheave (deg)	Correction Factor
0.00	180	1.00	0.80	133	0.87
0.10	174	0.99	0.90	127	0.85
0.20	169	0.97	1.00	120	0.82
0.30	163	0.96	1.10	113	0.80
0.40	157	0.94	1.20	106	0.77
0.50	151	0.93	1.30	99	0.73
0.60	145	0.91	1.40	91	0.70
0.70	139	0.89	1.50	83	0.65

Table 7. Length Correction Factors

Standard Length Designation	Cross Section			Standard Length Designation	Cross Section		
	3V	5V	8V		3V	5V	8V
250	0.83			1180	1.12	0.99	0.89
265	0.84			1250	1.13	1.00	0.90
280	0.85			1320	1.14	1.01	0.91
300	0.86			1400	1.15	1.02	0.92
315	0.87			1500		1.03	0.93
335	0.88			1600		1.04	0.94
355	0.89			1700		1.05	0.94
375	0.90			1800		1.06	0.95
400	0.92			1900		1.07	0.96
425	0.93			2000		1.08	0.97
450	0.94			2120		1.09	0.98
475	0.95			2240		1.09	0.98
500	0.96	0.85		2360		1.10	0.99
530	0.97	0.86		2500		1.11	1.00
560	0.98	0.87		2650		1.12	1.01
600	0.99	0.88		2800		1.13	1.02
630	1.00	0.89		3000		1.14	1.03
670	1.01	0.90		3150		1.15	1.03
710	1.02	0.91		3350		1.16	1.04
750	1.03	0.92		3550		1.17	1.05
800	1.04	0.93		3750			1.06
850	1.06	0.94		4000			1.07
900	1.07	0.95		4250			1.08
950	1.08	0.96		4500			1.09
1000	1.09	0.96	0.87	4750			1.09
1060	1.10	0.97	0.88	5000			1.10
1120	1.11	0.98	0.88

Number of Belts: The number of belts required for an application is obtained by dividing the design horsepower by the corrected horsepower rating for one belt.

Classical V-Belts ANSI/RMA IP-20.—Classical V-belts are most commonly used in heavy-duty applications and include these standard cross sections: A, AX, B, BX, C, CX, D, and DX (Fig. 3, page 2499). Top widths range from 1/2 to 1 1/4 in. and are specified by cross section and nominal length. Classical belts can be teamed in multiples of two or more. These multiple drives can transmit up to several hundred horsepower continuously and absorb reasonable shock loads.

Belt Cross Sections: Nominal dimensions of the four cross sections are given in Fig. 3.

Belt Size Designation: Classical V-belt sizes are identified by a standard belt number consisting of a letter-numeral combination. The letter identifies the cross section; the numeral identifies the length as shown in Table 8. For example, A60 indicates an A cross section and a standard length designation of 60. An X following the section letter designation indicates a molded notch cross section, for example, AX60.

Sheave Dimensions: Groove angles and dimensions for sheaves and the face widths of sheaves for multiple belt drives are given in **Table 9**, along with various tolerance values.

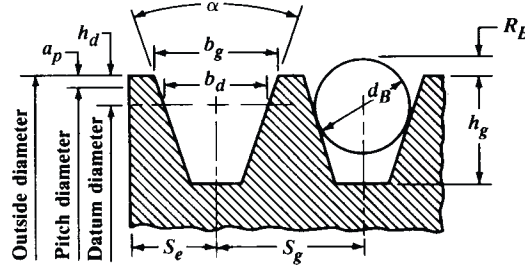
Table 8. Classical V-Belt Standard Datum Length ANSI/RMA IP-20, 1988

Standard Length Designation ^a	Standard Datum lengths				Permissible Deviations from Std. Datum Length	Matching Limits for One Set
	Cross Section					
	A, AX	B, BX	C, CX	D		
26	27.3	+0.6, -0.6	0.15
31	32.3	+0.6, -0.6	0.15
35	36.3	36.8	+0.6, -0.6	0.15
38	39.3	39.8	+0.7, -0.7	0.15
42	43.3	43.8	+0.7, -0.7	0.15
46	47.3	47.8	+0.7, -0.7	0.15
51	52.3	52.8	53.9	...	+0.7, -0.7	0.15
55	56.3	56.8	+0.7, -0.7	0.15
60	61.3	61.8	62.9	...	+0.7, -0.7	0.15
68	69.3	69.8	70.9	...	+0.7, -0.7	0.30
75	75.3	76.8	77.9	...	+0.7, -0.7	0.30
80	81.3	+0.7, -0.7	0.30
81	...	82.8	83.9	...	+0.7, -0.7	0.30
85	86.3	86.8	87.9	...	+0.7, -0.7	0.30
90	91.3	91.8	92.9	...	+0.8, -0.8	0.30
96	97.3	...	98.9	...	+0.8, -0.8	0.30
97	...	98.8	+0.8, -0.8	0.30
105	106.3	106.8	107.9	...	+0.8, -0.8	0.30
112	113.3	113.8	114.9	...	+0.8, -0.8	0.30
120	121.3	121.8	122.9	123.3	+0.8, -0.8	0.30
128	129.3	129.8	130.9	131.3	+0.8, -0.8	0.30
144	...	145.8	146.9	147.3	+0.8, -0.8	0.30
158	...	159.8	160.9	161.3	+1.0, -1.0	0.45
173	...	174.8	175.9	176.3	+1.0, -1.0	0.45
180	...	181.8	182.9	183.3	+1.0, -1.0	0.45
195	...	196.8	197.9	198.3	+1.1, -1.1	0.45
210	...	211.8	212.9	213.3	+1.1, -1.1	0.45
240	...	240.3	240.9	240.8	+1.3, -1.3	0.45
270	...	270.3	270.9	270.8	+1.6, -1.6	0.60
300	...	300.3	300.0	300.8	+1.6, -1.6	0.60
330	330.9	330.8	+2.0, -2.0	0.60
360	380.9	360.8	+2.0, -2.0	0.60
540	540.8	+3.3, -3.3	0.90
390	390.9	390.8	+2.0, -2.0	0.75
420	420.9	420.8	+3.3, -3.3	0.75
480	480.8	+3.3, -3.3	0.75
600	600.8	+3.3, -3.3	0.90
660	660.8	+3.3, -3.3	0.90

^aTo specify belt size use the Standard Length Designation prefixed by the letter indicating the cross section, e.g., B90.

All dimensions in inches.

Table 9. Classical V-Belt Sheave and Groove Dimensions ANSI/RMA IP-20, 1988



Face Width of Standard and Deep Groove Sheaves = $S_g(N_g - 1) + 2S_e$, where N_g = number of grooves

Standard Groove Dimensions											Design Factors	
Cross Section	Datum ^a Diameter Range	α Groove Angle ±0.33°	<i>b_d</i> Ref	<i>b_g</i>	<i>h_g</i> Min	2 <i>h_d</i>	<i>R_B</i> Min	<i>d_B</i> ±0.0005	<i>S_g^b</i> ±0.025	<i>S_e</i>	Min Recom. Datum Diameter	2 <i>a_p</i>
A, AX	Through 5.4 Over 5.4	34 38	0.418	0.494 ± 0.005 0.504	0.460	0.250	0.148 0.149	0.4375 (⁷ / ₁₆)	0.625	0.375 + 0.090 - 0.062	A 3.0 AX 2.2	0
B, BX	Through 7.0 Over 7.0	34 38	0.530	0.637 ± 0.006 0.650	0.550	0.350	0.189 0.190	0.5625 (⁹ / ₁₆)	0.750	0.500 + 0.120 - 0.065	B 5.4 BX 4.0	0
Combination	A, AX Belt	Through 7.4 ^c Over 7.4	0.508 ^d	0.612 ± 0.006 0.625	0.612	0.634 ^e 0.602 ^e	0.230 0.226	0.5625 (⁹ / ₁₆)	0.750	0.500 + 0.120 - 0.065	A 3.6 ^c AX 2.8	0.37
	B, BX Belt	Through 7.4 ^c Over 7.4		0.612 ± 0.006 0.625		0.333 ^e 0.334 ^e	0.230 0.226				B 5.7 ^c BX 4.3	
C, CX	Through 7.99	34	0.757	0.879	0.750	0.400	0.274	0.7812 (²⁵ / ₃₂)	1.000	0.688 + 0.160 - 0.070	C 9.0 CX 6.8	0
	Over 7.99 to and incl. 12.0	36		0.887 ± 0.007			0.276					
	Over 12.0	38		0.895			0.277					
D	Through 12.99 Over 12.99 to and incl. 17.0 Over 17.0	34 36 38	1.076	1.259 1.271 ± 0.008 1.283	1.020	0.600	0.410 0.410 0.411	1.1250 (1 ¹ / ₈)	1.438	0.875 + 0.220 - 0.080	13.0	0

Table 9. Classical V-Belt Sheave and Groove Dimensions ANSI/RMA IP-20, 1988

Deep Groove Dimensions ^f											Design Factors					
Cross Section	Datum ^a Dia. Range	α Groove Angle $\pm 0.33^\circ$	b_g Ref	b_g	h_g Min	$2h_d$ Ref	R_B Min	d_B ± 0.0005	S_g^b ± 0.025	S_e	Min Rec. Datum Diameter	$2a_p$				
B, BX	Through 7.0	34	0.530	0.747	0.730	0.710	0.007	0.5625	0.875	0.562	B 5.4 BX 4.0	0.36				
	Over 7.0	38		± 0.006										0.008	$(\frac{9}{16})$	+ 0.120 - 0.065
C, CX	Through 7.99	34	0.757	1.066	1.055	1.010	- 0.035	0.7812	1.250	0.812	C 9.0 CX 6.8	0.61				
	Over 7.99 to and incl. 12.0	36		± 0.007										- 0.032	$(\frac{25}{32})$	+ 0.160 - 0.070
	Over 12.0	38		1.105												
D	Through 12.99	34	1.076	1.513	1.435	1.430	- 0.010	1.1250	1.750	1.062	13.0	0.83				
	Over 12.99 to and incl. 17.0	36		± 0.008										- 0.009	$(1\frac{1}{8})$	+ 0.220 - 0.080
	Over 17.0	38		1.569												

^aThe A/AX, B/BX combination groove should be used when deep grooves are required for A or AX belts.

^bSummation of the deviations from S_g for all grooves in any one sheave should not exceed ± 0.050 in. The variation in datum diameter between the grooves in any one sheave must be within the following limits: Through 19.9 in. outside diameter and through 6 grooves: 0.010 in. (add 0.0005 in. for each additional groove). 20.0 in. and over on outside diameter and through 10 grooves: 0.015 in. (add 0.0005 in. for each additional groove). This variation can be obtained by measuring the distance across two measuring balls or rods placed diametrically opposite each other in a groove. Comparing this “diameter over balls or rods” measurement between grooves will give the variation in datum diameter.

^cDiameters shown for combination grooves are outside diameters. A specific datum diameter does not exist for either A or B belts in combination grooves.

^dThe b_d value shown for combination grooves is the “constant width” point, but does not represent a datum width for either A or B belts ($2h_d = 0.340$ ref).

^e $2h_d$ values for combination grooves are calculated based on b_d for A and B grooves.

^fDeep groove sheaves are intended for drives with belt offset such as quarter-turn or vertical shaft drives. Joined belts will not operate in deep groove sheaves. Also, A and AX joined belts will not operate in A/AX and B/BX combination grooves.

Other Sheave Tolerances		
Outside Diameter	Radial Runout ^a	Axial Runout ^a
Through 8.0 in. outside diameter ± 0.020 in. For each additional inch of outside diameter add ± 0.005 in.	Through 10.0 in. outside diameter 0.010 in. For each additional inch of outside diameter add 0.0005 in.	Through 5.0 in. outside diameter 0.005 in. For each additional inch of outside diameter add 0.001 in.

^aTotal indicator readings.

A, AX & B, BX Combin. All dimensions in inches.

Minimum Sheave Size: The recommended minimum sheave size depends on the rpm of the faster shaft. Minimum sheave diameters for each cross-section belt are listed in [Table 9](#).

Cross Section Selection: Use the chart ([Fig. 4](#)) as a guide to the Classical V-belt cross section for any combination of design horsepower and speed of the faster shaft. When the intersection of the design horsepower and speed of the faster shaft falls near a line between two areas on the chart, the possibilities in both areas should be investigated. Special circumstances (such as space limitations) may lead to a choice of belt cross section different from that indicated in the chart.

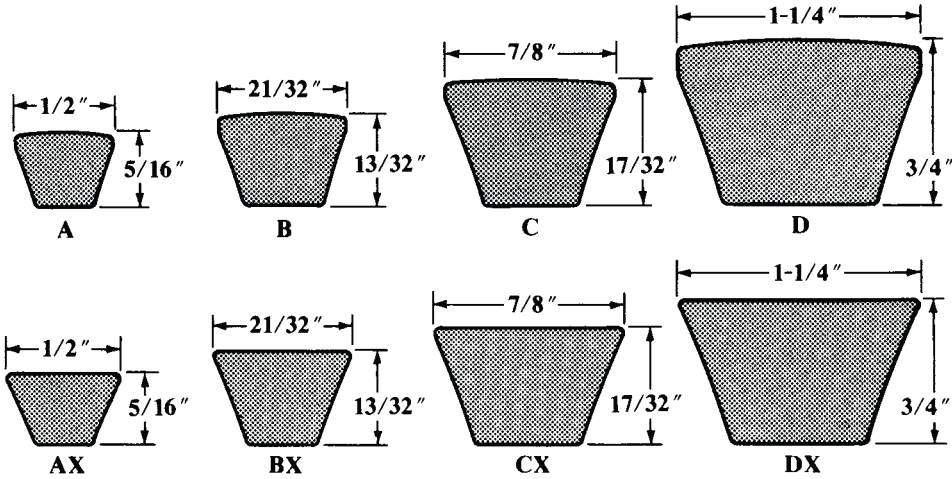


Fig. 3. Classical V-Belt Cross Sections

Horsepower Ratings: The horsepower rating formulas for classical V-belts are:

$$\begin{aligned} \mathbf{A:HP} = d_p r \left[1.004 - \frac{1.652}{d_p} - 1.547 \times 10^{-4} (d_p r)^2 - 0.2126 \log(d_p r) \right] \\ + 1.652 r \left(1 - \frac{1}{K_{SR}} \right) \end{aligned}$$

$$\begin{aligned} \mathbf{AX:HP} = d_p r \left[1.462 - \frac{2.239}{d_p} - 2.198 \times 10^{-4} (d_p r)^2 - 0.4238 \log(d_p r) \right] \\ + 2.239 r \left(1 - \frac{1}{K_{SR}} \right) \end{aligned}$$

$$\begin{aligned} \mathbf{B:HP} = d_p r \left[1.769 - \frac{4.372}{d_p} - 3.081 \times 10^{-4} (d_p r)^2 - 0.3658 \log(d_p r) \right] \\ + 4.372 r \left(1 - \frac{1}{K_{SR}} \right) \end{aligned}$$

$$\begin{aligned} \mathbf{B\!X:HP} = d_p r \left[2.051 - \frac{3.532}{d_p} - 3.097 \times 10^{-4} (d_p r)^2 - 0.5735 \log(d_p r) \right] \\ + 3.532 r \left(1 - \frac{1}{K_{SR}} \right) \end{aligned}$$

$$\begin{aligned} \mathbf{C:HP} = d_p r \left[3.325 - \frac{12.07}{d_p} - 5.828 \times 10^{-4} (d_p r)^2 - 0.6886 \log(d_p r) \right] \\ + 12.07 r \left(1 - \frac{1}{K_{SR}} \right) \end{aligned}$$

$$\begin{aligned} \mathbf{C\!X:HP} = d_p r \left[3.272 - \frac{6.655}{d_p} - 5.298 \times 10^{-4} (d_p r)^2 - 0.8637 \log(d_p r) \right] \\ + 6.655 r \left(1 - \frac{1}{K_{SR}} \right) \end{aligned}$$

$$\begin{aligned} \mathbf{D:HP} = d_p r \left[7.160 - \frac{43.21}{d_p} - 1.384 \times 10^{-3} (d_p r)^2 - 1.454 \log(d_p r) \right] \\ + 43.21 r \left(1 - \frac{1}{K_{SR}} \right) \end{aligned}$$

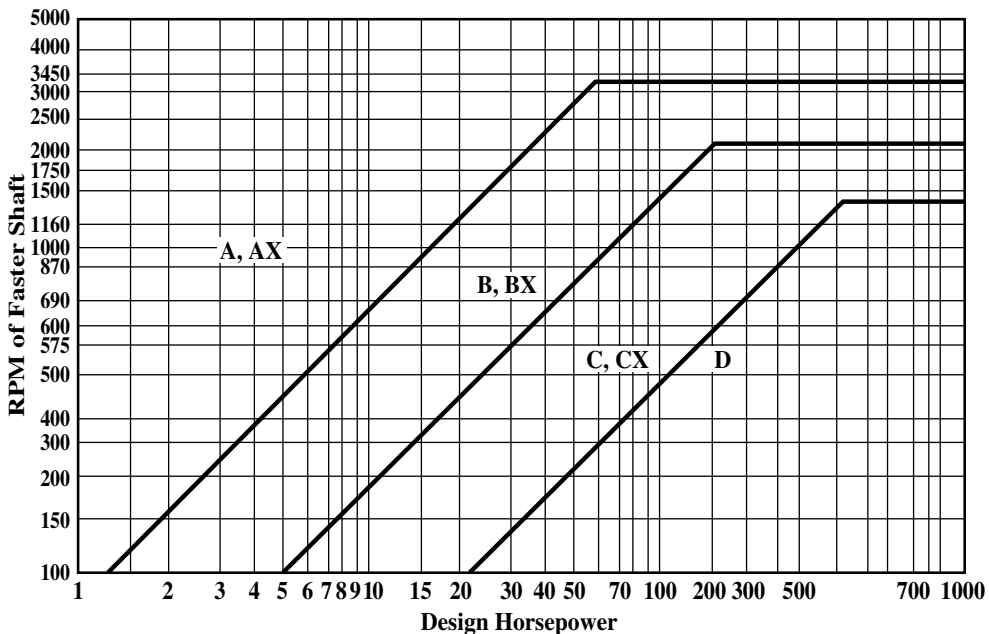


Fig. 4. Selection of Classic V-Belt Cross Sections

In these equations, d_p = pitch diameter of small sheave, in.; r = rpm of the faster shaft divided by 1000; K_{SR} = speed ratio factor given in the accompanying [Table 10](#). These formulas give the basic horsepower rating, corrected for the speed ratio. To obtain the horsepower per belt for an arc of contact other than 180 degrees and for belts shorter or longer than average length, multiply the horsepower obtained from these formulas by the length correction factor ([Table 11](#)) and the arc of contact correction factor ([Table 12](#)).

Table 10. Speed Ratio Correction Factors

Speed Ratio ^a Range	K_{SR}	Speed Ratio ^a Range	K_{SR}
1.00-1.01	1.0000	1.15-1.20	1.0586
1.02-1.04	1.0112	1.21-1.27	1.0711
1.05-1.07	1.0226	1.28-1.39	1.0840
1.08-1.10	1.0344	1.40-1.64	1.0972
1.11-1.14	1.0463	Over 1.64	1.1106

^a D_p/d_p , where D_p (d_p) is the pitch diameter of the large (small) sheave.

Table 11. Length Correction Factors

Std. Length Designation	Cross Section			
	A, AX	B, BX	C, CX	D
26	0.78
31	0.82
35	0.85	0.80
38	0.87	0.82
42	0.89	0.84
46	0.91	0.86
51	0.93	0.88	0.80	...
55	0.95	0.89
60	0.97	0.91	0.83	...
68	1.00	0.94	0.85	...
75	1.02	0.96	0.87	...
80	1.04
81	...	0.98	0.89	...
85	1.05	0.99	0.90	...
90	1.07	1.00	0.91	...
96	1.08	...	0.92	...
97	...	1.02
105	1.10	1.03	0.94	...
112	1.12	1.05	0.95	...
120	1.13	1.06	0.96	0.88
128	1.15	1.08	0.98	0.89
144	...	1.10	1.00	0.91
158	...	1.12	1.02	0.93
173	...	1.14	1.04	0.94
180	...	1.15	1.05	0.95
195	...	1.17	1.08	0.96
210	...	1.18	1.07	0.98
240	...	1.22	1.10	1.00
270	...	1.24	1.13	1.02
300	...	1.27	1.15	1.04
330	1.17	1.06
360	1.18	1.07
390	1.20	1.09
420	1.21	1.10
480	1.13
540	1.15
600	1.17
660	1.18

Number of Belts: The number of belts required for an application is obtained by dividing the design horsepower by the corrected horsepower rating for one belt.

Arc of Contact: Arc of contact on the small sheave may be determined by the formulas.

Exact formula: Arc of Contact (deg) = $2 \cos^{-1} \left(\frac{D_d - d_d}{2C} \right)$

Approximate formula: Arc of Contact (deg) = $180 - \left(\frac{(D_d - d_d)60}{C} \right)$

where D_d = Datum diameter of large sheave or flat pulley, inch or mm; d_d = Datum diameter of small sheave, inch or mm; and, C = Center distance, inch or mm.

Table 12. Arc of Contact Correction Factors

$\frac{D_d - d_d}{C}$	Arc of Contact, θ , Small Sheave (deg)	Correction Factor		$\frac{D_d - d_d}{C}$	Arc of Contact, θ Small Sheave (deg)	Correction Factor	
		V-V	V-Flat ^a			V-V	V-Flat ^a
0.00	180	1.00	0.75	0.80	133	0.87	0.85
0.10	174	0.99	0.76	0.90	127	0.85	0.85
0.20	169	0.97	0.78	1.00	120	0.82	0.82
0.30	163	0.96	0.79	1.10	113	0.80	0.80
0.40	157	0.94	0.80	1.20	106	0.77	0.77
0.50	151	0.93	0.81	1.30	99	0.73	0.73
0.60	145	0.91	0.83	1.40	91	0.70	0.70
0.70	139	0.89	0.84	1.50	83	0.65	0.65

^aA V-flat drive is one using a small sheave and a large diameter flat pulley.

Double V-Belts ANSI/RMA IP-21.—Double V-belts or hexagonal belts are used when power input or takeoff is required on both sides of the belt. Designed for use on “serpentine” drives, which consist of sheaves rotating in opposite directions, the belts are available in AA, BB, CC, and DD cross sections and operate in standard classical sheaves. They are specified by cross section and nominal length.

Belt Cross Sections: Nominal dimensions of the four cross sections are given in Fig. 5.

Belt Size Designation: Double V-belt sizes are identified by a standard belt number, consisting of a letter-numeral combination. The letters identify the cross section; the numbers identify length as shown in Column 1 of Table 13. For example, AA51 indicates an AA cross section and a standard length designation of 51.

Table 13. Double V-Belt Standard Effective Lengths ANSI/RMA IP-21, 1984

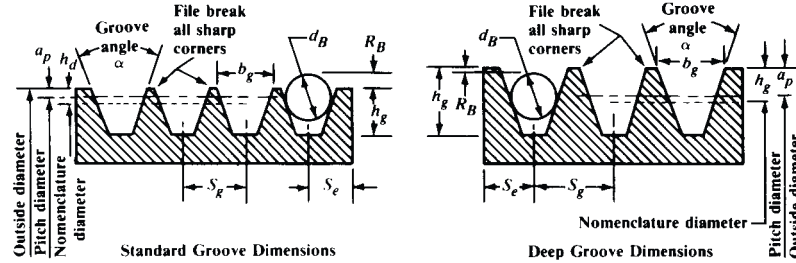
Standard Length Designation ^a	Standard Effective Length				Permissible Deviation from Standard Effective Length	Matching Limits for One Set
	AA	BB	CC	DD		
51	53.1	53.9	±0.7	0.15
55	...	57.9	±0.7	0.15
60	62.1	62.9	±0.7	0.15
68	70.1	70.9	±0.7	0.30
75	77.1	77.9	±0.7	0.30
80	82.1	±0.7	0.30
81	...	83.9	85.2	...	±0.7	0.30
85	87.1	87.9	89.2	...	±0.7	0.30
90	92.1	92.9	94.2	...	±0.8	0.30
96	98.1	...	100.2	...	±0.8	0.30
97	...	99.9	±0.8	0.30
105	107.1	107.9	109.2	...	±0.8	0.30
112	114.1	114.9	116.2	...	±0.8	0.30
120	122.1	122.9	124.2	125.2	±0.8	0.30
128	130.1	130.9	132.2	133.2	±0.8	0.30
144	...	146.9	148.2	149.2	±0.8	0.30
158	...	160.9	162.2	163.2	±1.0	0.45
173	...	175.9	177.2	178.2	±1.0	0.45
180	...	182.9	184.2	185.2	±1.0	0.45
195	...	197.9	199.2	200.2	±1.1	0.45
210	...	212.9	214.2	215.2	±1.1	0.45
240	...	241.4	242.2	242.7	±1.3	0.45
270	...	271.4	272.2	272.7	±1.6	0.60
300	...	301.4	302.2	302.7	±1.6	0.60
330	332.2	332.7	±2.0	0.60
360	362.2	362.7	±2.0	0.60

^aTo specify belt size use the Standard Length Designation prefixed by the letters indicating cross section; for example, BB90.

All dimensions in inches.

Sheave Dimensions: Groove angles and dimensions for sheaves and face widths of sheaves for multiple belt drives are given in Table 14, along with various tolerance values.

Table 14. Double V-Belt Sheave and Groove Dimensions ANSI/RMA IP-21, 1984



Face Width of Standard and Deep Groove Sheaves = $S_g(N_g - 1) + 2S_e$, where N_g = number of grooves

Standard Groove Dimensions											Drive Design Factors	
Cross Section	Outside Diameter Range	Groove Angle, α $\pm 0.33^\circ$	b_g	h_g (Min.)	$2h_d$	R_B (Min.)	d_B ± 0.0005	S_g^a ± 0.025	S_e		Min. Recomm. Outside Dia.	$2a_p^b$
AA	Up through 5.65	34	0.494	0.460	0.250	0.148	0.4375	0.625	0.375	+0.090	3.25	0.0
	Over 5.65	38	0.504						± 0.005	-0.062		
BB	Up through 7.35	34	0.637	0.550	0.350	0.189	0.5625	0.750	0.500	+0.120	5.75	0.0
	Over 7.35	38	0.650						± 0.006	-0.065		
AA-BB	Up through 7.35	34	0.612	0.612	A = 0.750	0.230	0.5625	0.750	0.500	+0.120	A = 3.620	A = 0.370
	Over 7.35	38	0.625						± 0.006	B = 0.350	0.226	$(\frac{9}{16})$
CC	Up through 8.39	34	0.879 0.887 0.895	0.750	0.400	0.274 0.276 0.277	0.7812 $(\frac{25}{32})$	1.000	0.688	+0.160 -0.070	9.4	0.0
	Over 8.39 up to and including 12.40	36										
	Over 12.40	38										
DD	Up through 13.59	34	1.259 1.271 1.283	1.020	0.600	0.410 0.410 0.411	1.1250 $(1\frac{1}{8})$	1.438	0.875	+0.220 -0.080	13.6	0.0
	Over 13.59 up to and including 17.60	36										
	Over 17.60	38										

Table 14. Double V-Belt Sheave and Groove Dimensions ANSI/RMA IP-21, 1984

Deep Groove Dimensions ^c											Drive Design Factors					
Cross Section	Outside Diameter Range	Groove Angle, α $\pm 0.33^\circ$	b_g	h_g (Min.)	$2h_d$	R_B (Min.)	d_B ± 0.0005	S_g^a ± 0.025	S_e		Minimum Recommended Outside Diameter	$2a_p$				
AA	Up through 5.96	34	0.589	0.615	0.560	-0.009	0.4375	0.750	0.438	+0.090	3.56	0.310				
	Over 5.96	38	0.611 ± 0.005										-0.008	($\frac{1}{16}$)	-0.062	
BB	Up through 7.71	34	0.747	0.730	0.710	+0.007	0.5625	0.875	0.562	+0.120	6.11	0.360				
	Over 7.71	38	0.774 ± 0.006										+0.008	($\frac{9}{16}$)	-0.065	
CC	Up through 9.00	34	1.066	1.055	1.010	-0.035	0.7812	1.250	0.812	+0.160	10.01	0.610				
	Over 9.00 up to and including 13.01	36	1.085										} ± 0.007	-0.032	(2 $\frac{5}{32}$)	-0.070
	Over 13.01	38	1.105													
DD	Up through 14.42	34	1.513	1.435	1.430	-0.010	1.1250	1.750	1.062	+0.220	14.43	0.830				
	Over 14.42 up to and including 18.43	36	1.541										} ± 0.008	-0.009	(1 $\frac{1}{8}$)	-0.080
	Over 18.43	38	1.569													

^a Summation of the deviations from S_g for all grooves in any one sheave shall not exceed ± 0.050 in. The variation in pitch diameter between the grooves in any one sheave must be within the following limits: Up through 19.9 in. outside diameter and up through 6 grooves: 0.010 in. (add 0.005 in. for each additional groove). 20.0 in. and over on outside diameter and up through 10 grooves: 0.015 in. (add 0.0005 in. for each additional groove). This variation can be obtained easily by measuring the distance across two measuring balls or rods placed diametrically opposite each other in a groove. Comparing this "diameter over balls or rods" measurement between grooves will give the variation in pitch diameter.

^b The a_p values shown for the A/B combination sheaves are the geometrically derived values. These values may be different from those shown in manufacturer's catalogs.

^c Deep groove sheaves are intended for drives with belt offset such as quarter-turn or vertical shaft drives.

Other Sheave Tolerances		
Outside Diameter	Radial Runout ^a	Axial Runout ^a
Up through 4.0 in. outside diameter ± 0.020 in. For each additional inch of outside diameter add ± 0.005 in.	Up through 10.0 in. outside diameter ± 0.010 in. For each additional inch of outside diameter add 0.0005 in.	Up through 5.0 in. outside diameter 0.005 in. For each additional inch of outside diameter add 0.001 in.

^a Total indicator reading.

All dimensions in inches.

Cross Section Selection: Use the chart (Fig. 6) as a guide to the double V-belt cross section for any combination of design horsepower and speed of the faster shaft. When the intersection of the design horsepower and speed of the faster shaft falls near a line between two areas on the chart, it is best to investigate the possibilities in both areas. Special circumstances (such as space limitations) may lead to a choice of belt cross section different from that indicated in the chart.

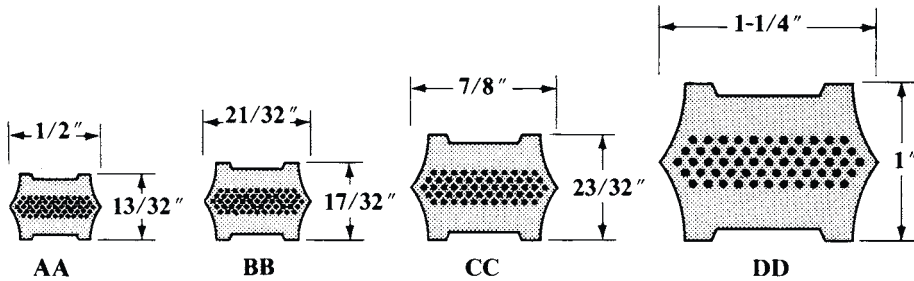


Fig. 5. Double-V Belt Cross Section

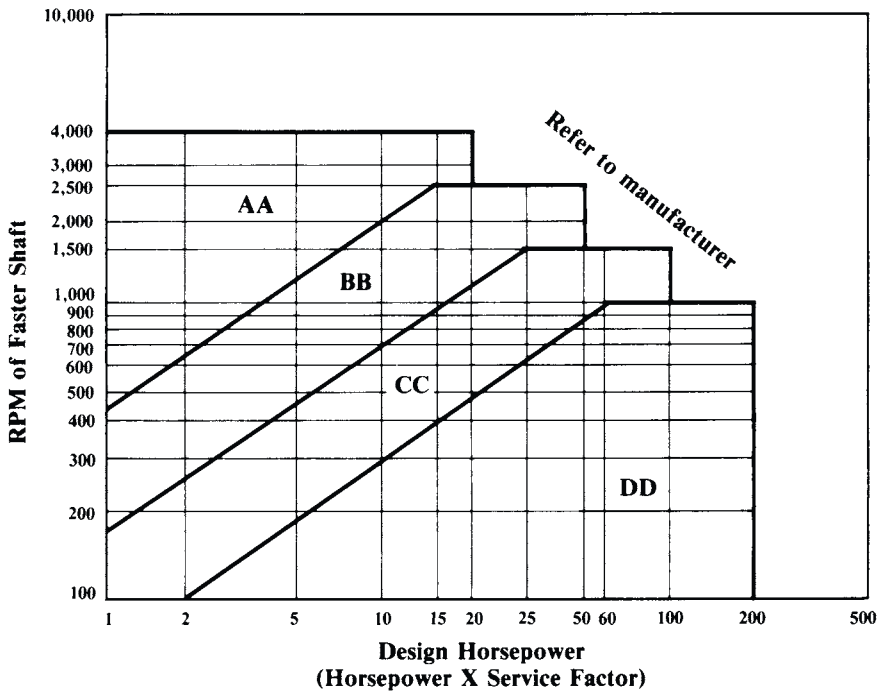


Fig. 6. Selection of Double V-Belt Cross Section

Effective Diameter Determination: Fig. 6 shows the relationship of effective diameter, outside diameter, and nomenclature diameter. Nomenclature diameter is used when ordering sheaves for double V-belt drives. The effective diameter is determined as follows:

$$\text{Effective diameter} = \text{Nomenclature diameter} + 2h_d - 2a_p$$

The values of $2h_d$ and $2a_p$ are given in Table 14.

Double V-belt Length Determination: The effective belt length of a specific drive may be determined by making a scaled layout of the drive. Draw the sheaves in terms of their effective diameters and in the position when a new belt is applied and first brought to driv-

ing tension. Next, measure the tangents and calculate the effective arc length (AL_e) of each sheave (see [Table 15](#) for a glossary of terms):

$$AL_e = \frac{d_e \theta}{115}$$

The effective length of the belt will then be the sum of the tangents and the connecting arc lengths. Manufacturers may be consulted for mathematical calculation of effective belt length for specific drive applications.

Table 15. Glossary of Terms for Double V-belt Calculations

AL_e = Length, arc, effective, in.	R = Ratio, tight side to slack side tension
$2a_p$ = Diameter, differential, pitch to outside, in.	$R/(R - 1)$ = Factor, tension ratio
d = Diameter, pitch, in. (same as effective diameter)	r = Angular velocity, faster shaft, rpm/1000
d_e = Diameter, effective, in.	S = Speed, belt, fpm/1000
$2h_d$ = Diameter differential, nomenclature to outside, in.	T_e = Tension, effective pull, lbf
K_f = Factor, length - flex correction	T_r = Tension, allowable tight side, lbf
L_e = Length, effective, in.	T_s = Tension, slack side, lbf
n = Sheaves, number on drive	T_T = Tension, tight side, lbf
P_d = Power, design, horsepower (transmitted horsepower \times service factor)	θ = Angle, arc of belt contact, deg

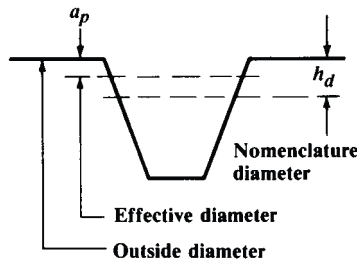


Fig. 7. Effective, Outside, and Nomenclature Sheave Diameters

Number of Belts Determination: The number of belts required may be determined on the basis of allowable tight side tension rating (T_r) at the most severe sheave. The allowable tight side tensions per belt are given in [Tables 16 through 19](#), and must be multiplied by the length-flex correction factors (K_f) listed in [Table 20](#). To select the allowable tight side tension from the tables for a given sheave, the belt speed and effective diameter of the sheave in question are required.

Double V-Belt Drive Design Method: The fourteen drive design steps are as follows:

- 1) Number the sheaves starting from the driver in the opposite direction to belt rotation; include the idlers.
- 2) Select the proper service factor for each loaded driven unit.
- 3) Multiply the horsepower requirement for each loaded driven sheave by the corresponding service factor. This is the design horsepower at each sheave.
- 4) Calculate driver design horsepower. This hp is equal to the sum of all the driven design horsepower.
- 5) Calculate belt speed (S) in thousands of feet per minute: $S = rd/3.820$.
- 6) Calculate effective tension (T_e) for each loaded sheave: $T_e = 33P_d/S$.
- 7) Determine minimum $R/(R - 1)$ for each loaded sheave from [Table 21](#) using the arc of contact determined from the drive layout.

8) In most drives, slippage will occur first at the driver sheave. Assume this to be true and calculate T_T and T_S for the driver: $T_T = T_e [R/(R - 1)]$ and $T_S = T_T - T_e$. Use $R/(R - 1)$ from Step 7 and T_e from Step 6 for the driver sheave.

9) Starting with the first driven sheave, determine T_T and T_S for each segment of the drive. The T_T for the driver becomes T_S for that sheave and is equal to $T_T - T_e$. Proceed around the drive in like manner.

10) Calculate actual $R/(R - 1)$ for each sheave using: $R/(R - 1) = T_T/T_e = T_T/(T_T - T_S)$. The T_T and T_S values are for those determined in Step 9. If these values are equal to or greater than those determined in Step 7, the assumption that slippage will first occur at the driver is correct and the next two steps are not necessary. If the value is less, the assumption was not correct, so proceed with Step 11.

11) Take the sheave where the actual value $R/(R - 1)$ (Step 10) is less than the minimum, as determined in Step 7, and calculate a new T_T and T_S for this sheave using the minimum $R/(R - 1)$ as determined in Step 7: $T_T = T_e [R/(R - 1)]$ and $T_S = T_T - T_e$.

12) Start with this sheave and recalculate the tension in each segment of the drive as in Step 9.

13) The length-flex factor (K_f) is taken from Table 20. Before using this table, calculate the value of L_e/n . Be sure to use the appropriate belt cross-section column when selecting the correction factor.

14) Beginning with the driver sheave, determine the number of belts (N_b) needed to satisfy the conditions at each loaded sheave using: $N_b = T_T/T_r K_f$. Note: T_T is tight side tension as determined in Step 9 or 11 and 12. T_r is allowable tight side tension as shown in Tables 18-21. K_f is the length-flex correction factor from Table 20. The sheave that requires the largest number of belts is the number of belts required for the drive. Any fraction of a belt should be treated as a whole belt.

Table 16. Allowable Tight Side Tension for an AA Section

Belt Speed (fpm)	Sheave Effective Diameter (in.)							
	3.0	3.5	4.0	4.5	5.0	5.5	6.0	6.5
200	30	46	57	66	73	79	83	88
400	23	38	49	58	65	71	76	80
600	18	33	44	53	60	66	71	75
800	14	30	41	50	57	63	67	72
1000	12	27	38	47	54	60	65	69
1200	9	24	36	45	52	57	62	66
1400	7	22	34	42	49	55	60	64
1600	5	20	32	40	47	53	58	62
1800	3	18	30	38	46	51	56	60
2000	1	16	28	37	44	50	54	58
2200	...	15	26	35	42	48	53	57
2400	...	13	24	33	40	46	51	55
2600	...	11	23	31	39	44	49	53
2800	...	9	21	30	37	43	47	51
3000	...	8	19	28	35	41	46	50
3200	...	6	17	26	33	39	44	48
3400	...	4	16	24	31	37	42	46
3600	...	2	14	23	30	35	40	44
3800	...	1	12	21	28	34	38	43
4000	10	19	26	32	37	41
4200	8	17	24	30	35	39
4400	6	15	22	28	33	37
4600	4	13	20	26	31	35
4800	2	11	18	24	29	33
5000	9	16	22	27	31
5200	7	14	20	24	28
5400	4	12	17	22	26
5600	2	9	15	20	24
5800	7	13	18	22

The allowable tight side tension must be evaluated for each sheave in the system (see Step 14). Values must be corrected by K_f from Table 20.

Table 17. Allowable Tight Side Tension for a BB Section

Belt Speed (fpm)	Sheave Effective Diameter (in.)								
	5.0	5.5	6.0	6.5	7.0	7.5	8.0	8.5	9.0
200	81	93	103	111	119	125	130	135	140
400	69	81	91	99	107	113	118	123	128
600	61	74	84	92	99	106	111	116	121
800	56	68	78	87	94	101	106	111	115
1000	52	64	74	83	90	96	102	107	111
1200	48	60	71	79	86	93	98	103	107
1400	45	57	67	76	83	89	95	100	104
1600	42	54	64	73	80	86	92	97	101
1800	39	51	61	70	77	84	89	94	98
2000	36	49	59	67	74	81	86	91	96
2200	34	46	56	64	72	78	84	89	93
2400	31	43	53	62	69	75	81	86	90
2600	29	41	51	59	67	73	78	83	88
2800	26	38	48	57	64	70	76	81	85
3000	23	35	45	54	61	68	73	78	82
3200	21	33	43	51	59	65	70	75	80
3400	18	30	40	49	56	62	68	73	77
3600	15	27	37	46	53	59	65	70	74
3800	12	24	35	43	50	57	62	67	71
4000	9	22	32	40	47	54	59	64	69
4200	7	19	29	37	45	51	56	61	66
4400	4	16	26	34	42	48	53	58	63
4600	1	13	23	31	39	45	50	55	60
4800	...	10	20	28	35	42	47	52	57
5000	...	6	16	25	32	39	44	49	53
5200	...	3	13	22	29	35	41	46	50
5400	10	18	26	32	38	42	47
5600	6	15	22	29	34	39	43
5800	3	11	19	25	31	36	40

The allowable tight side tension must be evaluated for each sheave in the system (see Step 14). Values must be corrected by K_f from Table 20.

Table 18. Allowable Tight Side Tension for a CC Section

Belt Speed (fpm)	Sheave Effective Diameter (in.)								
	7.0	8.0	9.0	10.0	11.0	12.0	13.0	14.0	15.0
200	121	158	186	207	228	244	257	268	278
400	99	135	164	187	206	221	234	246	256
600	85	122	151	173	192	208	221	232	242
800	75	112	141	164	182	198	211	222	232
1000	67	104	133	155	174	190	203	214	224
1200	60	97	126	149	167	183	196	207	217
1400	54	91	120	142	161	177	190	201	211
1600	48	85	114	137	155	171	184	196	205
1800	43	80	108	131	150	166	179	190	200
2000	38	75	103	126	145	160	174	185	195
2200	33	70	98	121	140	155	169	180	190
2400	28	65	93	116	135	150	164	175	185
2600	23	60	88	111	130	145	159	170	180
2800	18	55	83	106	125	140	154	165	175
3000	13	50	78	101	120	135	149	160	170
3200	8	45	73	96	115	130	144	155	165
3400	3	39	68	91	110	125	138	150	160
3600	...	34	63	86	104	120	133	145	154
3800	...	29	58	80	99	115	128	139	149
4000	...	24	52	75	94	109	123	134	144
4200	...	18	47	70	88	104	117	128	138
4400	...	12	41	64	83	98	112	123	133
4600	...	7	35	58	77	93	106	117	127
4800	...	1	29	52	71	87	100	111	121
5000	23	46	65	81	94	105	115
5200	17	40	59	75	88	99	109
5400	11	34	53	68	81	93	103
5600	5	27	46	62	75	86	96
5800	21	40	55	68	80	90

The allowable tight side tension must be evaluated for each sheave in the system (see Step 14). Values must be corrected by K_f from Table 20.

Table 19. Allowable Tight Side Tension for a DD Section

Belt Speed (fpm)	Sheave Effective Diameter (in.)								
	12.0	13.0	14.0	15.0	16.0	17.0	18.0	19.0	20.0
200	243	293	336	373	405	434	459	482	503
400	195	245	288	325	358	386	412	434	455
600	167	217	259	297	329	358	383	406	426
800	146	196	239	276	308	337	362	385	405
1000	129	179	222	259	291	320	345	368	389
1200	114	164	207	244	277	305	331	353	374
1400	101	151	194	231	263	292	318	340	361
1600	89	139	182	219	251	280	305	328	349
1800	78	128	170	207	240	269	294	317	337
2000	67	117	159	196	229	258	283	306	326
2200	56	106	149	186	218	247	272	295	316
2400	45	95	138	175	208	236	262	284	305
2600	35	85	128	165	197	226	251	274	294
2800	24	74	117	154	187	215	241	263	284
3000	14	64	106	144	176	205	230	253	273
3200	3	53	96	133	165	194	219	242	263
3400	...	42	85	122	155	183	209	231	252
3600	...	31	74	111	144	172	198	220	241
3800	...	20	63	100	132	161	186	209	230
4000	...	9	51	89	121	150	175	198	218
4200	40	77	109	138	163	186	207
4400	28	65	97	126	152	174	195
4600	16	53	85	114	139	162	183
4800	3	40	73	102	127	150	170
5000	28	60	89	114	137	158
5200	15	47	76	101	124	145
5400	1	34	62	88	111	131
5600	20	49	74	97	118
5800	6	35	60	83	104

The allowable tight side tension must be evaluated for each sheave in the system (see Step 14). Values must be corrected by K_f from Table 20.

Table 20. Length-Flex Correction Factors K_f

$\frac{L_e}{n}$	Belt Cross Section				$\frac{L_e}{n}$	Belt Cross Section			
	AA	BB	CC	DD		AA	BB	CC	DD
10	0.64	0.58	70	...	1.03	0.95	0.91
15	0.74	0.68	80	...	1.06	0.98	0.94
20	0.82	0.74	0.68	...	90	...	1.09	1.00	0.96
25	0.87	0.79	0.73	0.70	100	...	1.11	1.03	0.99
30	0.92	0.84	0.77	0.74	110	1.05	1.00
35	0.96	0.87	0.80	0.77	120	1.06	1.02
40	0.99	0.90	0.83	0.80	130	1.08	1.04
45	1.02	0.93	0.86	0.82	140	1.10	1.05
50	1.05	0.95	0.88	0.84	150	1.11	1.07
60	...	0.99	0.92	0.88

Tension Ratings: The tension rating formulas are:

$$AA \quad T_r = 118.5 - \frac{318.2}{d} - 0.8380S^2 - 25.76\log S$$

$$BB \quad T_r = 186.3 - \frac{665.1}{d} - 1.269S^2 - 39.02\log S$$

$$CC \quad T_r = 363.9 - \frac{2060}{d} - 2.400S^2 - 73.77 \log S$$

$$DD \quad T_r = 783.1 - \frac{7790}{d} - 5.078S^2 - 156.1 \log S$$

where T_r = The allowable tight side tension for a double-V belt drive, lbf (not corrected for tension ratio or length-flex correction factor)

d = Pitch diameter of small sheave, inch

S = Belt speed, fpm/1000

Table 21. Tension Ratio/Arc of Contact Factors

Arc of Contact, θ (deg.)	Design $\frac{R}{R-1}$	Arc of Contact, θ (deg.)	Design $\frac{R}{R-1}$
300	1.07	170	1.28
290	1.08	160	1.31
280	1.09	150	1.35
270	1.10	140	1.40
260	1.11	130	1.46
250	1.12	120	1.52
240	1.13	110	1.60
230	1.15	100	1.69
220	1.16	90	1.81
210	1.18	80	1.96
200	1.20	70	2.15
190	1.22	60	2.41
180	1.25	50	2.77

Minimum Sheave Size: The recommended minimum sheave size depends on the rpm of the faster shaft. Minimum groove diameters for each belt cross section are listed in [Table 14](#).

Light Duty V-Belts ANSI/RMA IP-23.—Light duty V-belts are typically used with fractional horsepower motors or small engines, and are designed primarily for fractional horsepower service. These belts are intended and specifically designed for use with small diameter sheaves and drives of loads and service requirements that are within the capacity of a single belt.

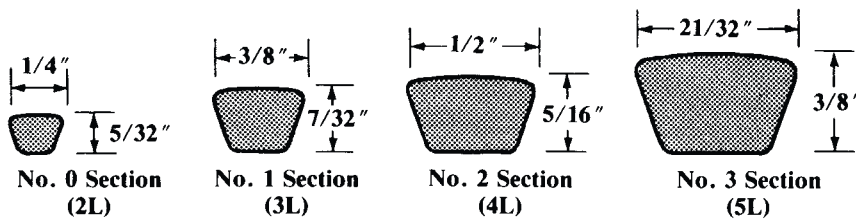


Fig. 8. Light Duty V-Belt Cross Sections

The four belt cross sections and sheave groove sizes are 2L, 3L, 4L, and 5L. The 2L is generally used only by OEMs and is not covered in the RMA standards.

Belt Cross Sections.—Nominal dimensions of the four cross sections are given in [Fig. 8](#).

Belt Size Designation.—V-belt sizes are identified by a standard belt number, consisting of a letter-numeral combination. The first number and letter identify the cross section; the remaining numbers identify length as shown in [Table 22](#). For example, a 3L520 belt has a 3L cross section and a length of 52.0 in.

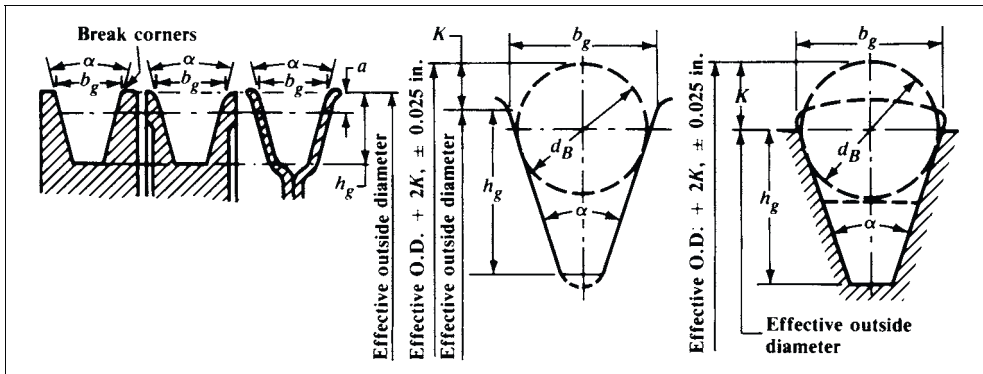
Table 22. Light Duty V-Belt Standard Dimensions ANSI/RMA IP-23, 1968

Standard Effective Outside Length (in.)				Permissible Deviation From Standard Effective Length (in.)	Standard Effective Outside Length (in.)				Permissible Deviation From Standard Effective Length (in.)
Cross Section					Cross Section				
2L	3L	4L	5L		2L	3L	4L	5L	
8	+0.12, -0.38	53	53	+0.25, -0.62
9	+0.12, -0.38	...	54	54	54	+0.25, -0.62
10	+0.12, -0.38	55	55	+0.25, -0.62
11	+0.12, -0.38	...	56	56	56	+0.25, -0.62
12	+0.12, -0.38	57	57	+0.25, -0.62
13	+0.12, -0.38	...	58	58	58	+0.25, -0.62
14	14	+0.12, -0.38	59	59	+0.25, -0.62
15	15	+0.12, -0.38	...	60	60	60	+0.25, -0.62
16	16	+0.12, -0.38	61	61	+0.31, -0.69
17	17	+0.12, -0.38	62	62	+0.31, -0.69
18	18	18	...	+0.12, -0.38	63	63	+0.31, -0.69
19	19	19	...	+0.12, -0.38	64	64	+0.31, -0.69
20	20	20	...	+0.12, -0.38	65	65	+0.31, -0.69
...	21	21	...	+0.25, -0.62	66	66	+0.31, -0.69
...	22	22	...	+0.25, -0.62	67	67	+0.31, -0.69
...	23	23	...	+0.25, -0.62	68	68	+0.31, -0.69
...	24	24	...	+0.25, -0.62	69	69	+0.31, -0.69
...	25	25	25	+0.25, -0.62	70	70	+0.31, -0.69
...	26	26	26	+0.25, -0.62	71	71	+0.31, -0.69
...	27	27	27	+0.25, -0.62	72	72	+0.31, -0.69
...	28	28	28	+0.25, -0.62	73	73	+0.31, -0.69
...	29	29	29	+0.25, -0.62	74	74	+0.31, -0.69
...	30	30	30	+0.25, -0.62	75	75	+0.31, -0.69
...	31	31	31	+0.25, -0.62	76	76	+0.31, -0.69
...	32	32	32	+0.25, -0.62	77	77	+0.31, -0.69
...	33	33	33	+0.25, -0.62	78	78	+0.31, -0.69
...	34	34	34	+0.25, -0.62	79	79	+0.31, -0.69
...	35	35	35	+0.25, -0.62	80	80	+0.62, -0.88
...	36	36	36	+0.25, -0.62	82	82	+0.62, -0.88
...	37	37	37	+0.25, -0.62	84	84	+0.62, -0.88
...	38	38	38	+0.25, -0.62	86	86	+0.62, -0.88
...	39	39	39	+0.25, -0.62	88	88	+0.62, -0.88
...	40	40	40	+0.25, -0.62	90	90	+0.62, -0.88
...	41	41	41	+0.25, -0.62	92	92	+0.62, -0.88
...	42	42	42	+0.25, -0.62	94	94	+0.62, -0.88
...	43	43	43	+0.25, -0.62	96	96	+0.62, -0.88
...	44	44	44	+0.25, -0.62	98	98	+0.62, -0.88
...	45	45	45	+0.25, -0.62	100	100	+0.62, -0.88
...	46	46	46	+0.25, -0.62
...	47	47	47	+0.25, -0.62
...	48	48	48	+0.25, -0.62
...	49	49	49	+0.25, -0.62
...	50	50	50	+0.25, -0.62
...	...	51	51	+0.25, -0.62
...	52	52	52	+0.25, -0.62

All dimensions in inches.

Sheave Dimensions: Groove angles and dimensions for sheaves and various sheave tolerances are given in **Table 23**.

Table 23. Light Duty V-Belt Sheave and Groove Dimensions
ANSI/RMA IP-23, 1968



Belt Section	Effective Outside Diameter		α Groove Angle $\pm 0^\circ 20'$ (deg)	d_B Ball Diameter ± 0.0005	$2K$	b_g (Ref)	h_g (min)	$2a^a$
	Min. Recomm.	Range						
2L	0.8	Less Than 1.50	32	0.2188	0.176	0.240	0.250	0.04
		1.50 to 1.99	34		0.182			
		2.00 to 2.50	36		0.188			
		Over 2.50	38		0.194			
3L	1.5	Less Than 2.20	32	0.3125	0.177	0.364	0.406	0.06
		2.20 to 3.19	34		0.191			
		3.20 to 4.20	36		0.203			
		Over 4.20	38		0.215			
4L	2.5	Less Than 2.65	30	0.4375	0.299	0.490	0.490	0.10
		2.65 to 3.24	32		0.316			
		3.25 to 5.65	34		0.331			
		Over 5.65	38		0.358			
5L	3.5	Less Than 3.95	30	0.5625	0.385	0.630	0.580	0.16
		3.95 to 4.94	32		0.406			
		4.95 to 7.35	34		0.426			
		Over 7.35	38		0.461			

^aThe diameter used in calculating speed ratio and belt speed is obtained by subtracting the $2a$ value from the Effective Outside Diameter of the sheave.

Other Sheave Tolerances					
Outside Diameters		Outside Diameter Eccentricity ^a		Groove Side Wobble & Runout ^a	
For outside diameters:		For outside diameters:		For outside diameters:	
under 6.0 in.	± 0.015 in.	10.0 in. and under	0.010 in.	20.0 in. and under	0.0015 in. per inch of outside diameter.
6.0 to 12.0 in.	± 0.020 in.	For each additional inch of outside diameter, add 0.0005 in.			
over 12.0 in.	± 0.040 in.			For each additional inch of outside diameter, add 0.0005 in.	

^aTotal indicator reading.

All dimensions in inches.

Horsepower Ratings: The horsepower ratings for light duty V-belts can be calculated from the following formulas:

$$3L \quad HP = r \left(\frac{0.2164d^{0.91}}{r^{0.09}} - 0.2324 - 0.0001396r^2d^3 \right)$$

$$4L \quad HP = r \left(\frac{0.4666d^{0.91}}{r^{0.09}} - 0.7231 - 0.0002286r^2d^3 \right)$$

$$5L \quad HP = r \left(\frac{0.7748d^{0.91}}{r^{0.09}} - 1.727 - 0.0003641r^2d^3 \right)$$

where $d = d_0 - 2a$; d_0 = effective outside diameter of small sheave, in.; r = rpm of the faster shaft divided by 1000. The corrected horsepower rating is obtained by dividing the horsepower rating by the combined correction factor (Table 24), which accounts for drive geometry and service factor requirements.

Table 24. Combined Correction Factors

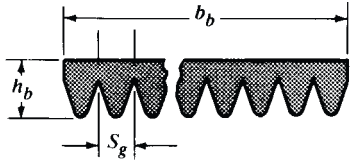
Type of Driven Unit	Speed Ratio	
	Less than 1.5	1.5 and Over
Fans and blowers	1.0	0.9
Domestic laundry machines	1.1	1.0
Centrifugal pumps	1.1	1.0
Generators	1.2	1.1
Rotary compressors	1.2	1.1
Machine tools	1.3	1.2
Reciprocating pumps	1.4	1.3
Reciprocating compressors	1.4	1.3
Wood working machines	1.4	1.3

V-Ribbed Belts ANSI/RMA IP-26.—V-ribbed belts are a cross between flat belts and V-belts. The belt is basically flat with V-shaped ribs projecting from the bottom, which guide the belt and provide greater stability than that found in a flat belt. The ribs operate in grooved sheaves.

V-ribbed belts do not have the wedging action of a V-belt and thus operate at higher tensions. This design provides excellent performance in high-speed and serpentine applications, and in drives that utilize small diameter sheaves. The V-ribbed belt comes in five cross sections: H, J, K, L, and M, specified by effective length, cross section and number of ribs.

Belt Cross Sections: Nominal dimensions of the five cross sections are given in Table 25.

**Table 25. Nominal Dimensions of V-Ribbed Belt Cross Sections
ANSI/RMA IP-26, 1977**



$b_b = N_r \times S_g$, where N_r = number of ribs and S_g is sheave groove spacing

Cross Section	h_b	S_g	Standard Number of Ribs
H	0.12	0.063	...
J	0.16	0.092	4, 6, 10, 16, 20
K	0.24	0.140	...
L	0.38	0.185	6, 8, 10, 12, 14, 16, 18, 20
M	0.66	0.370	6, 8, 10, 12, 14, 16, 18, 20

All dimensions in inches.

Table 26. V-Ribbed Belt Sheave and Groove Dimensions ANSI/RMA IP-26, 1977

Face width = $S_g (N_g - 1) + 2S_e$, where N_g is number of grooves

Cross Section	Minimum Recommended Outside Diameter	α Groove Angle ± 0.25 (deg)	S_g^a	r_t +0.005, -0.000	$2a$	r_b	h_g (min)	d_B ± 0.0005	S_e
H	0.50	40	0.063 ± 0.001	0.005	0.020	0.013 +0.000 -0.005	0.041	0.0469	0.080 +0.020 -0.010
J	0.80	40	0.092 ± 0.001	0.008	0.030	0.015 +0.000 -0.005	0.071	0.0625	0.125 +0.030 -0.015
K	1.50	40	0.140 ± 0.002	0.010	0.038	0.020 +0.000 -0.005	0.122	0.1093	0.125 +0.050 -0.000
L	3.00	40	0.185 ± 0.002	0.015	0.058	0.015 +0.000 -0.005	0.183	0.1406	0.375 +0.075 -0.030
M	7.00	40	0.370 ± 0.003	0.030	0.116	0.030 +0.000 -0.010	0.377	0.2812	0.500 +0.100 -0.040

^aSummation of the deviations from S_g for all grooves in any one sheave shall not exceed ± 0.010 in.

Other Sheave Tolerances ^a				
Outside Diameter		Radial Runout ^b		Axial Runout ^b
Outside Diameter:		Outside Diameter:		0.001 in. per inch of outside diameter
Up through 2.9 in.	± 0.010 in.	Up through 2.9 in.	0.005 in.	
Over 2.9 in. to and including 8.0 in.	± 0.020 in.	Over 2.9 in. to and including 10.0 in.	0.010 in.	
For each additional inch of outside diameter over 8.0 in., add ± 0.0025 in.		For each additional inch of outside diameter over 10.0 in., add 0.0005 in.		

^aVariations in pitch diameter between the grooves in any one sheave must be within the following limits: Up through 2.9 in. outside diameter and up through 6 grooves, 0.002 in. (add 0.001 in. for each additional groove); over 2.9 in. to and including 19.9 in. and up through 10 grooves, 0.005 in. (add 0.0002 in. for each additional groove); over 19.9 in. and up through 10 grooves, 0.010 in. (add 0.0005 in. for each additional groove). This variation can be obtained by measuring the distance across two measuring balls or rods placed in the grooves diametrically opposite each other. Comparing this “diameter-over-balls or -rods” measurement between grooves will give the variation in pitch diameter.

^bTotal indicator reading.

All dimensions in inches

Belt Size Designation: Belt sizes are identified by a standard belt number, which consists of belt effective length to the nearest tenth of an inch, a letter designating cross section, and the number of ribs. For example, 540L6 signifies a 54.0 in. effective length, L belt, six ribs wide.

Sheave Dimensions.: Groove angles and dimensions for sheaves and face widths of sheaves for multiple belt drives are given in Table 26, along with various tolerance values.

Cross Section Selection.: Use the chart (Fig. 9) as a guide to the V-ribbed belt cross section for any combination of design horsepower and speed of the faster shaft. When the intersection of the design horsepower and speed of the faster shaft falls near a line between two areas on the chart, the possibilities in both areas should be explored. Special circumstances (such as space limitations) may lead to a choice of belt cross section different from that indicated in the chart. H and K cross sections are not included because of their specialized use. Belt manufacturers should be contacted for specific data.

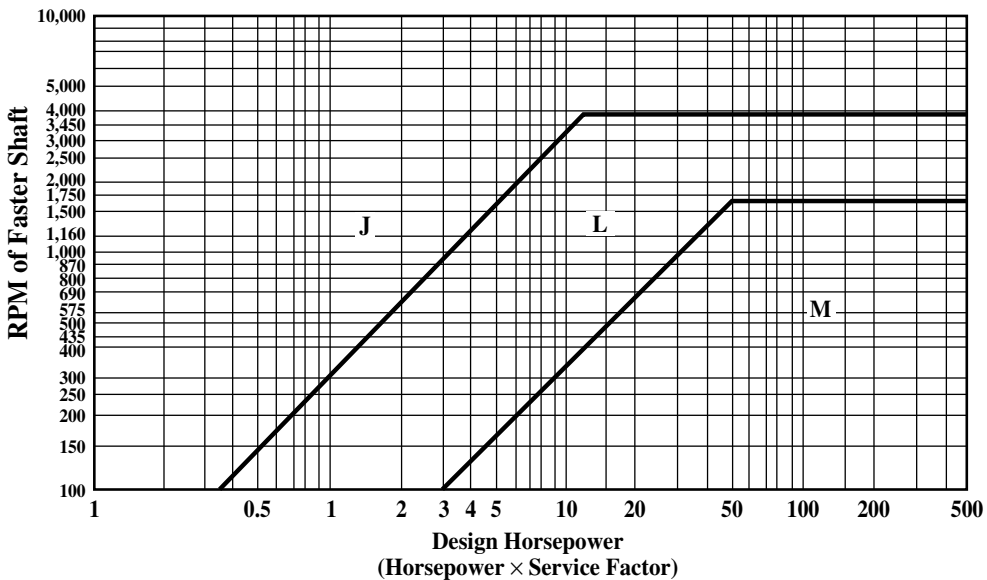


Fig. 9. Selection of V-Ribbed Belt Cross Section

Horsepower Ratings.: The horsepower rating formulas are:

$$\mathbf{J:HP} = d_p r \left[\frac{0.1240}{(d_p r)^{0.09}} - \frac{0.08663}{d_p} - 0.2318 \times 10^{-4} (d_p r)^2 \right] + 0.08663 r \left[1 - \frac{1}{K_{SR}} \right]$$

$$\mathbf{L:HP} = d_p r \left[\frac{0.5761}{(d_p r)^{0.09}} - \frac{0.8987}{d_p} - 1.018 \times 10^{-4} (d_p r)^2 \right] + 0.8987 r \left[1 - \frac{1}{K_{SR}} \right]$$

$$\mathbf{M:HP} = d_p r \left[\frac{1.975}{(d_p r)^{0.09}} - \frac{6.597}{d_p} - 3.922 \times 10^{-4} (d_p r)^2 \right] + 6.597 r \left[1 - \frac{1}{K_{SR}} \right]$$

In these equations, d_p = pitch diameter of the small sheave, in.; r = rpm of the faster shaft divided by 1000; K_{SR} = speed ratio factor given in the accompanying Table 30. These formulas give the maximum horsepower per rib recommended, corrected for the speed ratio. To obtain the horsepower per rib for an arc of contact other than 180 degrees, and for belts longer or shorter than the average length, multiply the horsepower obtained from these formulas by the length correction factor (Table 28) and the arc of contact correction factor (Table 29).

Table 27. V-Ribbed Belt Standard Effective Lengths ANSI/RMA IP-26, 1977

J Cross Section			L Cross Section			M Cross Section		
Standard Length Designation ^a	Standard Effective Length	Permissible Deviation From Standard Length	Standard Length Designation ^a	Standard Effective Length	Permissible Deviation From Standard Length	Standard Length Designation ^a	Standard Effective Length	Permissible Deviation From Standard Length
180	18.0	+0.2, -0.2	500	50.0	+0.2, -0.4	900	90.0	+0.4, -0.7
190	19.0	+0.2, -0.2	540	54.0	+0.2, -0.4	940	94.0	+0.4, -0.8
200	20.0	+0.2, -0.2	560	56.0	+0.2, -0.4	990	99.0	+0.4, -0.8
220	22.0	+0.2, -0.2	615	61.5	+0.2, -0.5	1060	106.0	+0.4, -0.8
240	24.0	+0.2, -0.2	635	63.5	+0.2, -0.5	1115	111.5	+0.4, -0.9
260	26.0	+0.2, -0.2	655	65.5	+0.2, -0.5	1150	115.0	+0.4, -0.9
280	28.0	+0.2, -0.2	675	67.5	+0.3, -0.6	1185	118.5	+0.4, -0.9
300	30.0	+0.2, -0.3	695	69.5	+0.3, -0.6	1230	123.0	+0.4, -1.0
320	32.0	+0.2, -0.3	725	72.5	+0.3, -0.6	1310	131.0	+0.5, -1.1
340	34.0	+0.2, -0.3	765	76.5	+0.3, -0.6	1390	139.0	+0.5, -1.1
360	36.0	+0.2, -0.3	780	78.0	+0.3, -0.6	1470	147.0	+0.6, -1.2
380	38.0	+0.2, -0.3	795	79.5	+0.3, -0.6	1610	161.0	+0.6, -1.2
400	40.0	+0.2, -0.4	815	81.5	+0.3, -0.7	1650	165.0	+0.6, -1.3
430	43.0	+0.2, -0.4	840	84.0	+0.3, -0.7	1760	176.0	+0.7, -1.4
460	46.0	+0.2, -0.4	865	86.5	+0.3, -0.7	1830	183.0	+0.7, -1.4
490	49.0	+0.2, -0.4	915	91.5	+0.4, -0.7	1980	198.0	+0.8, -1.6
520	52.0	+0.2, -0.4	975	97.5	+0.4, -0.8	2130	213.0	+0.8, -1.6
550	55.0	+0.2, -0.4	990	99.0	+0.4, -0.8	2410	241.0	+0.9, -1.6
580	58.0	+0.2, -0.5	1065	106.5	+0.4, -0.8	2560	256.0	+1.0, -1.8
610	61.0	+0.2, -0.5	1120	112.0	+0.4, -0.9	2710	271.0	+1.1, -2.2
650	65.0	+0.2, -0.5	1150	115.0	+0.4, -0.9	3010	301.0	+1.2, -2.4

^aTo specify belt size, use the standard length designation, followed by the letter indicating belt cross section and the number of ribs desired. For example: 865L10. All dimensions in inches.

Table 28. Length Correction Factors

Std. Length Designation	Cross Section			Std. Length Designation	Cross Section		
	J	L	M		J	L	M
180	0.83	1230	...	1.08	0.94
200	0.85	1310	...	1.10	0.96
240	0.89	1470	...	1.12	0.98
280	0.92	1610	...	1.14	1.00
320	0.95	1830	...	1.17	1.03
360	0.98	1980	...	1.19	1.05
400	1.00	2130	...	1.21	1.06
440	1.02	2410	...	1.24	1.09
500	1.05	0.89	...	2710	1.12
550	1.07	0.91	...	3010	1.14
610	1.09	0.93	...	3310	1.16
690	1.12	0.96	...	3610	1.18
780	1.16	0.98	...	3910	1.20
910	1.18	1.02	0.88	4210	1.22
940	1.19	1.02	0.89	4810	1.25
990	1.20	1.04	0.90	5410	1.28
1060	...	1.05	0.91	6000	1.30
1150	...	1.07	0.93

Table 29. Arc of Contact Correction Factors

$\frac{D_o - d_o}{C}$	Arc of Contact, θ , on Small Sheave, (deg)	Correction Factor
0.00	180	1.00
0.10	174	0.98
0.20	169	0.97
0.30	163	0.95
0.40	157	0.94
0.50	151	0.92
0.60	145	0.90
0.70	139	0.88
0.80	133	0.85
0.90	127	0.83
1.00	120	0.80
1.10	113	0.77
1.20	106	0.74
1.30	99	0.71
1.40	91	0.67
1.50	83	0.63

Number of Ribs: The number of ribs required for an application is obtained by dividing the design horsepower by the corrected horsepower rating for one rib.

Arc of contact on the small sheave may be determined by the following formulas:

Exact Formula: Arc of Contact (deg) = $2 \cos^{-1} \left(\frac{D_o - d_o}{2C} \right)$

Approximate Formula: Arc of Contact (deg) = $180 - \frac{(D_o - d_o)60}{C}$

D_o = Effective outside diameter of large sheave, in; d_o = Effective outside diameter of small sheave, in; and, C = Center distance, inch.

Table 30. Speed Ratio Correction Factors

Speed Ratio ^a	K_{SR}
1.00 to and incl. 1.10	1.0000
Over 1.01 to and incl. 1.04	1.0136
Over 1.04 to and incl. 1.08	1.0276
Over 1.08 to and incl. 1.12	1.0419
Over 1.12 to and incl. 1.18	1.0567
Over 1.18 to and incl. 1.24	1.0719
Over 1.24 to and incl. 1.34	1.0875
Over 1.34 to and incl. 1.51	1.1036
Over 1.51 to and incl. 1.99	1.1202
Over 1.99	1.1373

^a D_p/d_p , where D_p (d_p) is the pitch diameter of the large (small) sheave.

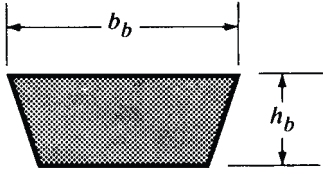
Variable Speed Belts ANSI/ RMA IP-25.—For drives that require more speed variation than can be obtained with conventional industrial V-belts, standard-line variable-speed drives are available. These drives use special wide, thin belts. Package units of standard-line variable-speed belts and sheaves, combined with the motor and output gearbox are available in ranges from approximately ½ through 100 horsepower.

The speed ranges of variable-speed drives can be much greater than those drives using classical V-belts. Speed ranges up to 10:1 can be obtained on lower horsepower units.

This section covers 12 variable speed belt cross sections and sheave groove sizes designed 1422V, 1922V, 2322V 1926V, 2926V, 3226V, 2530V, 3230V, 4430V, 4036V, 4436V, and 4836V. The industry supplies many other sizes that are not listed in this section.

Belt Cross Sections and Lengths: Nominal dimensions of the 12 cross sections are given in [Table 31](#), and lengths in [Table 32](#).

Table 31. Normal Variable-Speed Belt Dimensions ANSI/RMA IP-25, 1982

							
Cross Section	b_b	h_b	h_p/b_b	Cross Section	b_b	h_b	h_p/b_b
1422V	0.88	0.31	0.35	2530V	1.56	0.59	0.38
1922V	1.19	0.38	0.32	3230V	2.00	0.62	0.31
2322V	1.44	0.44	0.31	4430V	2.75	0.69	0.25
1926V	1.19	0.44	0.37	4036V	2.50	0.69	0.28
2926V	1.81	0.50	0.28	4436V	2.75	0.72	0.26
3226V	2.0	0.53	0.27	4836V	3.00	0.75	0.25

All dimensions in inches.

Table 32. Variable-Speed V-Belt Standard Belt Lengths ANSI/RMA IP-25, 1982

Standard Pitch Length Designation	Standard Effective Lengths												Permissible Deviations From Standard Length
	Cross Section												
	1422V	1922V	2322V	1926V	2926V	3226V	2530V	3230V	4430V	4036V	4436V	4836V	
315	32.1	±0.7
335	34.1	±0.7
355	36.1	36.2	...	36.3	±0.7
375	38.1	38.2	...	38.3	±0.7
400	40.6	40.7	40.8	40.8	±0.7
425	43.1	43.2	43.3	43.3	±0.8
450	45.6	45.7	45.8	45.8	±0.8
475	48.1	48.2	48.3	48.3	±0.8
500	50.6	50.7	50.8	50.8	50.9	±0.8
530	53.6	53.7	53.8	53.8	53.9	...	53.9	±0.8
560	56.6	56.7	56.8	56.8	56.9	56.9	56.9	57.1	57.3	57.3	57.3	57.4	±0.9
600	60.6	60.7	60.8	60.8	60.9	60.9	60.9	61.1	61.3	61.3	61.3	61.4	±0.9
630	63.6	63.7	63.8	63.8	63.9	63.9	63.9	64.1	64.3	64.3	64.3	64.4	±0.9
670	67.6	67.7	67.8	67.8	67.9	67.9	67.9	68.1	68.3	68.3	68.3	68.4	±0.9
710	71.6	71.7	71.8	71.8	71.9	71.9	71.9	72.1	72.3	72.3	72.3	72.4	±0.9
750	75.6	75.7	75.8	75.8	75.9	75.9	75.9	76.1	76.3	76.3	76.3	76.4	±1.0
800	...	80.7	80.8	80.8	80.9	80.9	80.9	81.1	81.3	81.3	81.3	81.4	±1.0
850	...	85.7	85.8	85.8	85.9	85.9	85.9	86.1	86.3	86.3	86.3	86.4	±1.1
900	...	90.7	90.8	90.8	90.9	90.9	90.9	91.1	91.3	91.3	91.3	91.4	±1.1
950	...	95.7	95.8	95.8	95.9	95.9	95.9	96.1	96.3	96.3	96.3	96.4	±1.1
1000	...	100.7	100.8	100.8	100.9	100.9	100.9	101.1	101.3	101.3	101.3	101.4	±1.2
1060	...	106.7	106.8	106.8	106.9	106.9	106.9	107.1	107.3	107.3	107.3	107.4	±1.2
1120	...	112.7	112.8	112.8	112.9	112.9	112.9	113.1	113.3	113.3	113.3	113.4	±1.2
1180	...	118.7	118.8	118.8	118.9	118.9	118.9	119.1	119.3	119.3	119.3	119.4	±1.3
1250	125.9	125.9	125.9	126.1	126.3	126.3	126.3	126.4	±1.3
1320	132.9	...	133.1	133.3	133.3	133.3	133.4	±1.3

All dimensions in inches.

The lengths given in this table are not necessarily available from all manufacturers. Availability should be investigated prior to design commitment.

VARIABLE SPEED BELTS

2519

Table 33. Variable-Speed Sheave and Groove Dimensions

Cross Section	Standard Groove Dimensions									Drive Design Factors			
	Variable					Companion							
	α Groove Angle ± 0.67 (deg)	b_g^a Closed +0.000 -0.030	b_{go} Open Max	h_{gv} Min	S_g ± 0.03	α Groove Angle ± 0.33 (deg)	b_g ± 0.010	h_g Min	S_g ± 0.03	Min. Recomm. Pitch Diameter	$2a$	$2av$ Max	CL Min
1422V	22	0.875	1.63	2.33	1.82	22	0.875	0.500	1.82	2.0	0.20	3.88	0.08
1922V	22	1.188	2.23	3.14	2.42	22	1.188	0.562	2.42	3.0	0.22	5.36	0.08
2322V	22	1.438	2.71	3.78	2.89	22	1.438	0.625	2.89	3.5	0.25	6.52	0.08
1926V	26	1.188	2.17	2.65	2.36	26	1.188	0.625	2.36	3.0	0.25	4.26	0.08
2926V	26	1.812	3.39	4.00	3.58	26	1.812	0.750	3.58	3.5	0.30	6.84	0.08
3226V	26	2.000	3.75	4.41	3.96	26	2.000	0.781	3.96	4.0	0.30	7.60	0.08
2530V	30	1.562	2.81	3.01	2.98	30	1.562	0.844	2.98	4.0	0.30	4.64	0.10
3230V	30	2.000	3.67	3.83	3.85	30	2.000	0.875	3.85	4.5	0.35	6.22	0.10
4430V	30	2.750	5.13	5.23	5.38	30	2.750	0.938	5.38	5.0	0.40	8.88	0.10
4036V	36	2.500	4.55	3.95	4.80	36	2.500	0.938	4.80	4.5	0.40	6.32	0.10
4436V	36	2.750	5.03	4.33	5.30	36	2.750	0.969	5.30	5.0	0.40	7.02	0.10
4836V	36	3.000	5.51	4.72	5.76	36	3.000	1.000	5.76	6.0	0.45	7.74	0.10

^aThe effective width (b_e), a reference dimension, is the same as the ideal top width of closed variable-speed sheave (b_g) and the ideal top width of the companion sheave (b_g).

Other Sheave Tolerances		
Outside Diameter	Radial Runout ^a	Axial Runout ^a
Up through 4.0 in. outside diameter For each additional inch of outside diameter add ± 0.005 in.	± 0.020 in. Up through 10.0 in. outside diameter For each additional inch of outside diameter add 0.0005 in.	0.010 in. Up through 5.0 in. outside diameter For each additional inch of outside diameter add 0.001 in.

^aTotal indicator reading.

Surface Finish			
Machined Surface Area	Max Surface Roughness Height, R_a (AA) (μ in.)	Machined Surface Area	Max Surface Roughness Height, R_a (AA) (μ in.)
V-Sheave groove sidewalls	125	Straight bores with 0.002 in. or less total tolerance	125
Rim edges and ID, Hub ends and OD	500	Taper and straight bores with total tolerance over 0.002 in.	250

All dimensions in inches, except where noted.

Belt Size Designation: Variable-speed belt sizes are identified by a standard belt number. The first two digits denote the belt top width in sixteenths of an inch; the third and fourth digits indicate the angle of the groove in which the belt is designed to operate. Letter V (for variable) follows the first four digits. The digits after the V indicate pitch length to the nearest 0.1 in. For example, 1422V450 is a belt of $\frac{7}{8}$ in. ($\frac{14}{16}$ in.) nominal top width designed to operate in a sheave of 22 degree groove angle and having a pitch length of 45.0 in.

Sheave Groove Data: A variable speed sheave is an assembly of movable parts, designed to permit one or both flanges of the sheave to be moved axially causing a radial movement of the variable speed belt in the sheave groove. This radial movement permits stepless speed variation within the physical limits of the sheave and the belt. A companion sheave may be a solid sheave having a constant diameter and groove profile or another variable sheave. Variable speed sheave designs should conform to the dimensions in Table 33 and Fig. 10. The included angle of the sheaves, top width, and clearance are boundary dimensions. Groove angles and dimensions of companion sheaves should conform to Table 33 and Fig. 11. Various tolerance values are also given in Table 33.

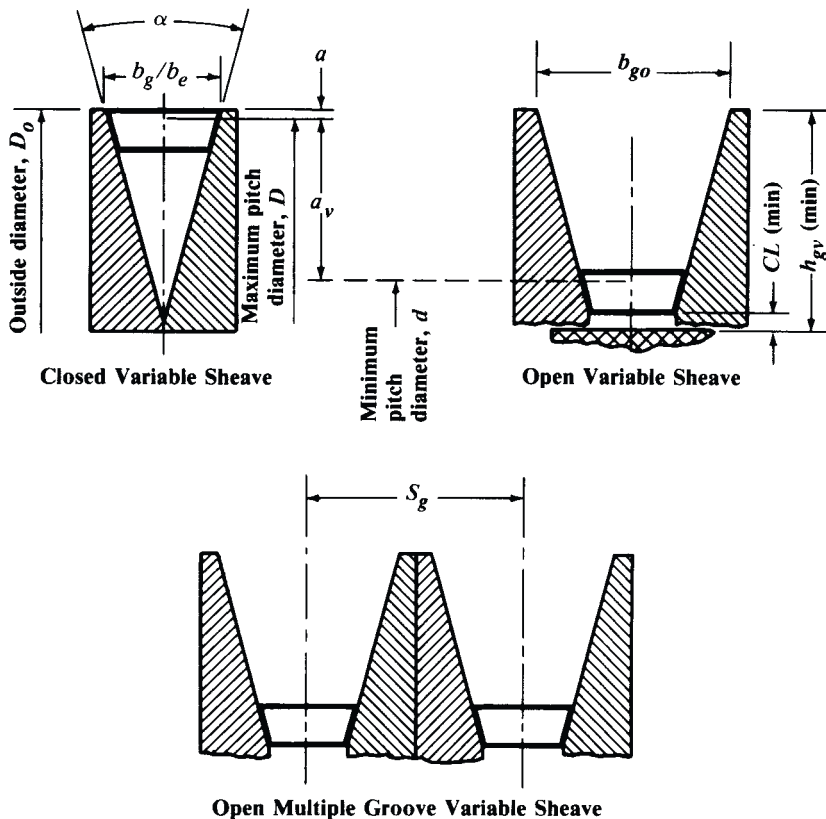


Fig. 10. Variable Sheaves

Variable-Speed Drive Design: Variable-speed belts are designed to operate in sheaves that are an assembly of movable parts. The sheave design permits one or both flanges of the sheave to be moved axially, causing a radial movement of the variable-speed belt in the sheave groove. The result is a stepless speed variation within the physical limits of the sheave and the variable-speed belt. Therefore, besides transmitting power, variable-speed belt drives provide speed variation.

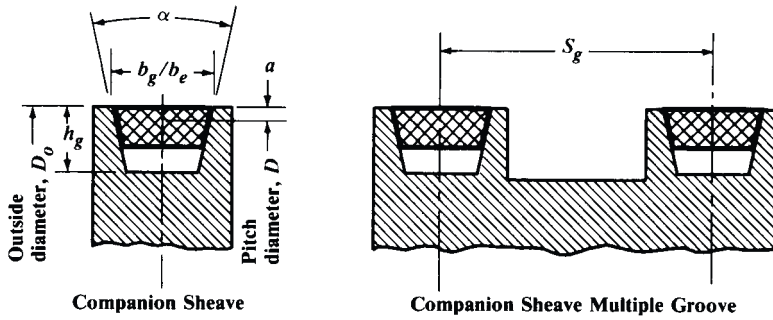


Fig. 11. Companion Sheaves

The factors that determine the amount of pitch diameter change on variable-speed sheaves are belt top width, belt thickness, and sheave angle. This pitch diameter change, combined with the selected operating pitch diameters for a sheave, determines the possible speed variation.

The range of output speeds from a variable-speed sheave drive is established by the companion sheave and is a function of the ratio of the pitch diameter of the companion sheave to the maximum and minimum pitch diameters of the variable sheave. Speed variation is usually obtained by varying the center distance between the two sheaves. This type of drive seldom exceeds a speed variation of 3:1.

For a single variable-speed sheave drive, the speed variation

$$\text{Speed variation} = \frac{\text{PD Max}}{\text{PD Min}} \text{ (of variable sheave)}$$

For a dual variable-speed sheave drive, which is frequently referred to as a compound drive because both sheaves are variable, the speed variation is

$$\text{Speed variation} = \frac{DR(DN)}{dr(dn)}$$

where $DR = \text{Max driver PD}$

$DN = \text{Max driven PD}$

$dr = \text{Min driver PD}$

$dn = \text{Min driven PD}$

With this design, the center distance is generally fixed and speed variation is usually accomplished by mechanically altering the pitch diameter of one sheave. In this type of drive, the other sheave is spring loaded to make an opposite change in the pitch diameter and to provide the correct belt tension. Speed variations of up to 10: 1 are common on this type of drive.

Speed Ratio Adjustment: All speed ratio changes must be made while the drives are running. Attempting to make adjustments while the unit is stopped creates unnecessary and possibly destructive forces on both the belt and sheaves. In stationary control drives, the belt tension should be released to allow the flanges to adjust without belt force interference.

Cross Section Selection: Selection of a variable speed belt cross section is based on the drive design horsepower and speed variation. Table 33 shows the maximum pitch diameter variation ($2av$) that each cross section can attain.

Horsepower Ratings: The general horsepower formulas for variable-speed belts are:

$$1422 \text{ V HP} = d_p r \left[0.4907(d_p r)^{-0.09} - \frac{0.8378}{d_p} - 0.000337(d_p r)^2 \right] + 0.8378r \left(1 - \frac{1}{K_{SR}} \right)$$

$$1922 \text{ VHP} = d_p r \left[0.8502(d_p r)^{-0.09} - \frac{1.453}{d_p} - 0.000538(d_p r)^2 \right] + 1.453 r \left(1 - \frac{1}{K_{SR}} \right)$$

$$2322 \text{ VHP} = d_p r \left[1.189(d_p r)^{-0.09} - \frac{2.356}{d_p} - 0.000777(d_p r)^2 \right] + 2.356 r \left(1 - \frac{1}{K_{SR}} \right)$$

$$1926 \text{ VHP} = d_p r \left[1.046(d_p r)^{-0.09} - \frac{1.833}{d_p} - 0.000589(d_p r)^2 \right] + 1.833 r \left(1 - \frac{1}{K_{SR}} \right)$$

$$2926 \text{ VHP} = d_p r \left[1.769(d_p r)^{-0.09} - \frac{4.189}{d_p} - 0.001059(d_p r)^2 \right] + 4.189 r \left(1 - \frac{1}{K_{SR}} \right)$$

$$3226 \text{ VHP} = d_p r \left[2.073(d_p r)^{-0.09} - \frac{5.236}{d_p} - 0.001217(d_p r)^2 \right] + 5.236 r \left(1 - \frac{1}{K_{SR}} \right)$$

$$2530 \text{ VHP} = d_p r \left[2.395(d_p r)^{-0.09} - \frac{6.912}{d_p} - 0.001148(d_p r)^2 \right] + 6.912 r \left(1 - \frac{1}{K_{SR}} \right)$$

$$3230 \text{ VHP} = d_p r \left[2.806(d_p r)^{-0.09} - \frac{7.854}{d_p} - 0.001520(d_p r)^2 \right] + 7.854 r \left(1 - \frac{1}{K_{SR}} \right)$$

$$4430 \text{ VHP} = d_p r \left[3.454(d_p r)^{-0.09} - \frac{7.854}{d_p} - 0.002196(d_p r)^2 \right] + 9.818 r \left(1 - \frac{1}{K_{SR}} \right)$$

$$4036 \text{ VHP} = d_p r \left[3.566(d_p r)^{-0.09} - \frac{9.687}{d_p} - 0.002060(d_p r)^2 \right] + 9.687 r \left(1 - \frac{1}{K_{SR}} \right)$$

$$4436 \text{ VHP} = d_p r \left[4.041(d_p r)^{-0.09} - \frac{11.519}{d_p} - 0.002297(d_p r)^2 \right] + 11.519 r \left(1 - \frac{1}{K_{SR}} \right)$$

$$4836 \text{ VHP} = d_p r \left[4.564(d_p r)^{-0.09} - \frac{13.614}{d_p} - 0.002634(d_p r)^2 \right] + 13.614 r \left(1 - \frac{1}{K_{SR}} \right)$$

In these equations, d_p = pitch diameter of small sheave, in.; r = rpm of faster shaft divided by 1000; K_{SR} = speed ratio factor given in the accompanying Table 34. These formulas give the basic horsepower rating, corrected for the speed ratio. To obtain the horsepower for arcs of contact other than 180 degrees and for belts longer or shorter than average length, multiply the horsepower obtained from these formulas by the arc of contact correction factor (Table 36) and the length correction factor (Table 35).

Table 34. Speed Ratio Correction Factors

Speed Ratio ^a	K_{SR}	Speed Ratio ^a	K_{SR}
1.00-1.01	1.0000	1.19-1.24	1.0719
1.02-1.04	1.0136	1.25-1.34	1.0875
1.05-1.08	1.0276	1.35-1.51	1.1036
1.09-1.12	1.0419	1.52-1.99	1.1202
1.13-1.18	1.0567	2.0 and over	1.1373

^a D_p/d_p , where D_p (d_p) is the pitch diameter of the large (small) sheave.

Table 35. Length Correction Factors

Standard Pitch Length Designation	Cross Section											
	1422V	1922V	2322V	1926V	2926V	3226V	2530V	3230V	4430V	4036V	4436V	4836V
315	0.93
335	0.94
355	0.95	0.90	...	0.90
375	0.96	0.91	...	0.91
400	0.97	0.92	0.90	0.92
425	0.98	0.93	0.91	0.93
450	0.99	0.94	0.92	0.94
475	1.00	0.95	0.93	0.95
500	1.01	0.95	0.94	0.95	0.90
530	1.02	0.96	0.95	0.96	0.92	...	0.92
560	1.03	0.97	0.96	0.97	0.93	0.92	0.93	0.91	0.90	0.91	0.91	0.92
600	1.04	0.98	0.97	0.98	0.94	0.93	0.94	0.93	0.92	0.93	0.92	0.93
630	1.05	0.99	0.98	0.99	0.95	0.94	0.95	0.94	0.93	0.94	0.93	0.94
670	1.06	1.00	0.99	1.00	0.97	0.95	0.96	0.95	0.94	0.95	0.95	0.95
710	1.07	1.01	1.00	1.01	0.98	0.96	0.98	0.96	0.96	0.96	0.96	0.96
750	1.08	1.02	1.01	1.02	0.99	0.98	0.99	0.97	0.97	0.97	0.97	0.98
800	...	1.03	1.02	1.03	1.00	0.99	1.00	0.99	0.99	0.99	0.99	0.99
850	...	1.04	1.03	1.04	1.01	1.00	1.01	1.00	1.00	1.00	1.00	1.00
900	...	1.05	1.04	1.05	1.02	1.01	1.02	1.01	1.01	1.01	1.01	1.01
950	...	1.06	1.05	1.06	1.03	1.02	1.04	1.02	1.03	1.02	1.02	1.02
1000	...	1.07	1.06	1.07	1.04	1.03	1.05	1.03	1.04	1.03	1.04	1.03
1060	...	1.08	1.07	1.07	1.06	1.04	1.06	1.05	1.06	1.05	1.05	1.04
1120	...	1.09	1.08	1.08	1.07	1.06	1.07	1.06	1.07	1.06	1.06	1.06
1180	...	1.09	1.09	1.09	1.08	1.07	1.08	1.07	1.08	1.07	1.07	1.07
1250	1.09	1.08	1.10	1.08	1.10	1.08	1.09	1.08
1320	1.09	...	1.09	1.11	1.09	1.10	1.09

Rim Speed: The material and design selected for sheaves must be capable of withstanding the high rim speeds that may occur in variable-speed drives. The rim speed is calculated as follows: Rim speed (fpm) = $(\pi/12)(D_o)$ (rpm).

Arc of Contact: Arc of contact on the small sheave may be determined by the formulas:

$$\text{Exact Formula: Arc of Contact (deg)} = 2 \cos^{-1} \left(\frac{D-d}{2C} \right)$$

$$\text{Approximate Formula: Arc of Contact (deg)} = 180 - \frac{(D-d)60}{C}$$

where D = Pitch diameter of large sheave or flat pulley, inch or mm

d = Pitch diameter of small sheave, inch or mm

C = Center distance, inch or mm

Table 36. Arc of Contact Correction Factors

$\frac{D-d}{C}$	Arc of Contact, θ , on Small Sheave, (deg)	Correction Factor	$\frac{D-d}{C}$	Arc of Contact, θ , on Small Sheave, (deg)	Correction Factor
0.00	180	1.00	0.80	0.80	0.87
0.10	174	0.99	0.90	0.90	0.85
0.20	169	0.97	1.00	1.00	0.82
0.30	163	0.96	1.10	1.10	0.80
0.40	157	0.94	1.20	1.20	0.77
0.50	151	0.93	1.30	1.30	0.73
0.60	145	0.91	1.40	1.40	0.70
0.70	139	0.89	1.50	1.50	0.65

60 Degree V-Belts.—60 degree V-belts are ideal for compact drives. Their 60 degree angle and ribbed top are specifically designed for long life on small diameter sheaves. These belts offer extremely smooth operation at high speeds (in excess of 10,000 rpm) and can be used on drives with high speed ratios. They are available in 3M, 5M, 7M, and 11M (3, 5, 7, 11 mm) cross sections (top widths) and are commonly found in the joined configuration, which provides extra stability and improved performance. They are specified by cross section and nominal length; for example, a 5M315 designation indicates a belt having a 5 mm cross section and an effective length of 315 mm.

Industry standards have not yet been published for 60 degree V-belts. Belt manufacturers should be contacted for specific applications, specifications, and additional information.

SAE Standard V-Belts.—The data for V-belts and pulleys shown in Table 37 cover nine sizes, three of which — 0.250, 0.315, and 0.440 — were added in 1977 to conform to existing practice. This standard was reaffirmed in 1987.

V-belts are produced in a variety of constructions in a basic trapezoidal shape and are to be dimensioned in such a way that they are functional in pulleys dimensioned as described in the standard. Standard belt lengths are in increments of $\frac{1}{2}$ inch (12.7 mm) up to and including 80 inches (203.2 cm). Standard lengths above 80 inches up to and including 100 inches (254 cm) are in increments of 1 inch (2.54 cm), without fractions. Standard belt length tolerances are based on the center distance and are as follows: For belt lengths of 50 inches (127 cm) or less, ± 0.12 inch; over 50 to 60 inches (127–152.4 cm), inclusive, ± 0.16 inch; over 60 to 80 inches (152.4–203.2 cm), inclusive, ± 0.19 inch; and over 80 to 100 inches (203.2–254 cm), inclusive, ± 0.22 inch.

Belt Storage and Handling.—To achieve maximum belt performance, proper belt storage procedures should always be practiced. If belts are not stored properly, their performance can be adversely affected. Four key rules are:

- 1) Do not store belts on floors unless they are protected by appropriate packaging.
- 2) Do not store belts near windows where the belts may be exposed to direct sunlight or moisture.

Table 37. SAE V-Belt and Pulley Dimensions

SAE Size	Recommended Min. Eff Dia ^a	A Groove Angle (deg) ±0.5	W Eff. Groove Width	D Groove Depth Min	d Ball or Rod Dia (±0.0005)	2K 2 × Ball Extension	2X ^b	S Groove ^c Spacing (±0.015)
0.250	2.25	36	0.248	0.276	0.2188	0.164	0.04	0.315
0.315	2.25	36	0.315	0.354	0.2812	0.222	0.05	0.413
0.380	2.40	36	0.380	0.433	0.3125	0.154	0.06	0.541
0.440	2.75	36	0.441	0.512	0.3750	0.231	0.07	0.591
0.500	3.00	36	0.500	0.551	0.4375	0.314	0.08	0.661
1 ¹ / ₁₆	3.00	34	0.597	0.551	0.500	0.258	0.00	0.778
	Over 4.00	36				0.280		
	Over 6.00	38				0.302		
3 ³ / ₄	3.00	34	0.660	0.630	0.5625	0.328	0.02	0.841
	Over 4.00	36				0.352		
	Over 6.00	38				0.374		
7 ⁷ / ₈	3.50	34	0.785	0.709	0.6875	0.472	0.04	0.966
	Over 4.50	36				0.496		
	Over 6.00	38				0.520		
1	4.00	34	0.910	0.827	0.8125	0.616	0.06	1.091
	Over 6.00	36				0.642		
	Over 8.00	38				0.666		

All dimensions in inches.

^a Pulley effective diameters below those recommended should be used with caution, because power transmission and belt life may be reduced.

^b The X dimension is radial; $2X$ is to be subtracted from the effective diameter to obtain “pitch diameter” for speed ratio calculations.

^c These values are intended for adjacent grooves of the same effective width (W). Choice of pulley manufacture or belt design parameter may justify variance from these values. The S dimension should be the same on all multiple groove pulleys in a drive using matched belts. © 1990, SAE, Inc.

3) Do not store belts near electrical devices that may generate ozone (transformers, electric motors, etc.).

4) Do not store belts in areas where solvents or chemicals are present in the atmosphere.

Belts should be stored in a cool, dry environment. When stacked on shelves, the stacks should be short enough to avoid excess weight on the bottom belts, which may cause distortion. When stored in containers, the container size and contents should be sufficiently limited to avoid distortion.

V-Belts: A common method is to hang the belts on pegs or pin racks. Very long belts stored this way should use sufficiently large pins or crescent shaped “saddles” to prevent their weight from causing distortion.

Joined V-belts, Synchronous Belts, V-Ribbed Belts: Like V-belts, these belts may be stored on pins or saddles with precautions taken to avoid distortion. However, belts of this

Table 38. Service Factors for V-Belts

Driving Unit	<i>AC Motors:</i> Normal Torque, Squirrel Cage, Synchronous and Split Phase. <i>DC Motors:</i> Shunt Wound. <i>Engines:</i> Multiple Cylinder Internal Combustion.			
	Types of Driven Machines	Intermittent Service (3-5 hours daily or seasonal)	Normal Service (8-10 hours daily)	Continuous Service (16-24 hours daily)
	Agitators for liquids; Blowers and exhausters; Centrifugal pumps & compressors; Fans up to 10 horsepower; Light duty conveyors	1.1	1.2	1.3
	Belt conveyors for sand, grain, etc.; Dough mixers; Fans over 10 horsepower; Generators; Line shafts; Laundry machinery; Machine tools; Punches, presses, shears; Printing machinery; Positive displacement rotary pumps; Revolving and vibrating screens	1.2	1.3	1.4
	Brick machinery; Bucket elevators; Exciters; Piston compressors; Conveyors (drag, pan, screw); Hammer mills; Paper mill beaters; Piston pumps; Positive displacement blowers; Pulverizers; Saw mill and woodworking machinery; Textile machinery	1.4	1.5	1.6
	Crushers (gyratory, jaw, roll); Mills (ball, rod, tube); Hoists; Rubber calendars, extruders, mills	1.5	1.6	1.8
Driving Unit	<i>AC Motors:</i> High Torque, High Slip, Repulsion-Induction, Single Phase, Series Wound, Slip Ring. <i>DC Motors:</i> Series Wound, Compound Wound. <i>Engines:</i> Single Cylinder Internal Combustion. <i>Line Shafts, Clutches</i>			
	Types of Driven Machines	Intermittent Service (3-5 hours daily or seasonal)	Normal Service (8-10 hours daily)	Continuous Service (16-24 hours daily)
	Agitators for liquids; Blowers and exhausters; Centrifugal pumps & compressors; Fans up to 10 horsepower; Light duty conveyors	1.1	1.2	1.3
	Belt conveyors for sand, grain, etc.; Dough mixers; Fans over 10 horsepower; Generators; Line shafts; Laundry machinery; Machine tools; Punches, presses, shears; Printing machinery; Positive displacement rotary pumps; Revolving and vibrating screens	1.2	1.3	1.4
	Brick machinery; Bucket elevators; Exciters; Piston compressors; Conveyors (drag, pan, screw); Hammer mills; Paper mill beaters; Piston pumps; Positive displacement blowers; Pulverizers; Saw mill and woodworking machinery; Textile machinery	1.4	1.5	1.6
	Crushers (gyratory, jaw, roll); Mills (ball, rod, tube); Hoists; Rubber calendars, extruders, mills	1.5	1.6	1.8

The machines listed above are representative samples only. Select the group listed above whose load characteristics most closely approximate those of the machine being considered.

type up to approximately 120 inch (3.05 m) are normally shipped in a “nested” configuration and should be stored in the same manner. Nests are formed by laying a belt on its side on a flat surface and placing as many belts inside the first belt as possible without undue force. When the nests are tight and are stacked with each rotated 180° from the one below, they may be stacked without damage.

Belts of this type over 120 in. may be “rolled up” and tied for shipment. These rolls may be stacked for easy storage. Care should be taken to avoid small bend radii which could damage the belts.

Variable Speed Belts: Variable speed belts are more sensitive to distortion than most other belts, and should not be hung from pins or racks but stored on shelves in the sleeves in which they are shipped.

Service Factors: Service factors for V-belts are listed in [Table 38](#).

Synchronous Belts

Synchronous Belts ANSI/RMA IP-24.—Synchronous belts are also known as timing or positive-drive belts. These belts have evenly spaced teeth on their surfaces, which mesh with teeth on pulleys or sprockets to produce a positive, no-slip transmission of power. Such designs should not be confused with molded notched V-belts, which transmit power by means of the wedging action of the V-shape. Synchronous belts are used where driven shaft speeds must be synchronized to the rotation of the driver shaft and to eliminate the noise and maintenance problems of chain drives.

Standard Timing Belts: Conventional trapezoidal, or rectangular tooth, timing belts come in six cross sections, which relate to the pitch of the belt. Pitch is the distance from center to center of the teeth. The six basic cross sections or pitches are MXL (mini extra light), XL (extra light), L (light), H (heavy), XH (extra heavy), and XXH (double extra heavy) (Fig. 12). Belts are specified by pitch length, cross section (pitch), and width.

Double-sided timing belts have identical teeth on both sides of the belt and are used where synchronization is required from each belt face. They are available in XL, L, and H cross sections.

Size Designations: Synchronous belt sizes are identified by a standard number. The first digits specify the belt length to 0.1 inch (2.54 mm) followed by the belt section (pitch) designation. The digits following the belt section designation represent the nominal belt width times 100. For example, an L section belt 30.000 inches pitch length and 0.75 inch in width would be specified as a 300L075 synchronous belt.

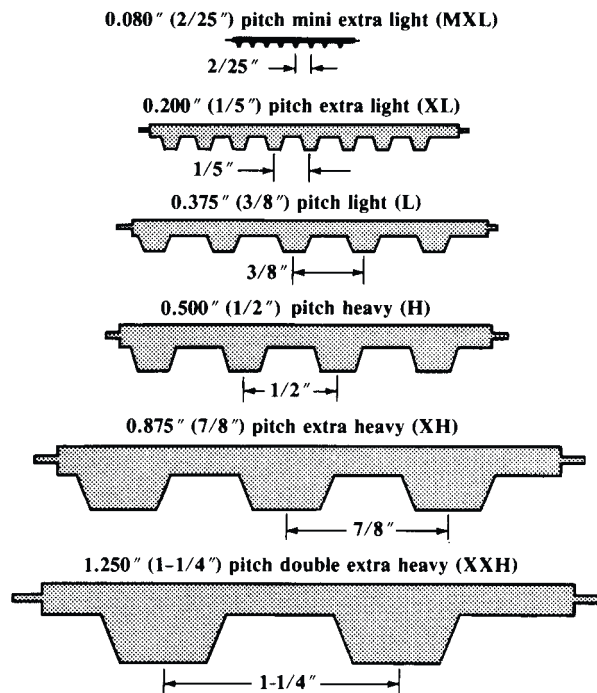


Fig. 12. Standard Synchronous Belt Sections

The RMA nomenclature for double-sided belts is the same as for single-sided belts with the addition of the prefix “D” in front of the belt section. However, some manufacturers use their own designation system for double-sided belts.

Standard Sections: Belt sections are specified in terms of pitch. Table 40 gives the Standard Belt Sections and their corresponding pitches.

Table 39. Service Factors for Synchronous Belt Drives

Driving Units	<i>AC Motors:</i> Normal Torque, Squirrel Cage, Synchronous and Split Phase. <i>DC Motors:</i> Shunt Wound. <i>Engines:</i> Multiple Cylinder Internal Combustion.		
Types of Driven Machines	Intermittent Service (3-5 hours daily or seasonal)	Normal Service (8-10 hours daily)	Continuous Service (16-24 hours daily)
Display, Dispensing, Projection, Medical equipment; Instrumentation; Measuring devices	1.0	1.2	1.4
Appliances, sweepers, sewing machines; Office equipment; Wood lathes, band saws	1.2	1.4	1.6
Conveyors: belt, light package, oven, screens, drums, conical	1.3	1.5	1.7
Agitators for liquids; Dough mixers; Drill presses, lathes; Screw machines, jointers; Circular saws, planes; Laundry, Paper, Printing machinery	1.4	1.6	1.8
Agitators for semiliquids; Brick machinery (except pug mills); Conveyor belt: ore, coal, sand; Line shafts; Machine tools: grinder, shaper, boring mill, milling machines; Pumps: centrifugal, gear, rotary	1.5	1.7	1.9
Conveyor: apron, pan, bucket, elevator; Extractors, washers; Fans, blowers; centrifugal, induced draft exhausters; Generators & exciters; Hoists, elevators; Rubber calenders, mills, extruders; Saw mill, Textile machinery inc. looms, spinning frames, twisters	1.6	1.8	2.0
Centrifuges; Conveyors: flight, screw; Hammer mills; Paper pulpers	1.7	1.9	2.1
Brick & clay pug mills; Fans, blowers, propeller mine fans, positive blowers	1.8	2.0	2.2
Driving Units	<i>AC Motors:</i> High Torque, High Slip, Repulsion-Induction, Single Phase Series Wound and Slip Ring. <i>DC Motors:</i> Series Wound and Compound Wound. <i>Engines:</i> Single Cylinder Internal Combustion. <i>Line Shafts. Clutches.</i>		
Types of Driven Machines	Intermittent Service (3-5 hours daily or seasonal)	Normal Service (8-10 hours daily)	Continuous Service (16-24 hours daily)
Display, Dispensing, Projection, Medical equipment; Instrumentation; Measuring devices	1.2	1.4	1.6
Appliances, sweepers, sewing machines; Office equipment; Wood lathes, band saws	1.4	1.6	1.8
Conveyors: belt, light package, oven, screens, drums, conical	1.5	1.7	1.9
Agitators for liquids; Dough mixers; Drill presses, lathes; Screw machines, jointers; Circular saws, planes; Laundry, Paper, Printing machinery	1.6	1.8	2.0
Agitators for semiliquids; Brick machinery (except pug mills); Conveyor belt: ore, coal, sand; Line shafts; Machine tools: grinder, shaper, boring mill, milling machines; Pumps: centrifugal, gear, rotary	1.7	1.9	2.1
Conveyor: apron, pan, bucket, elevator; Extractors, washers; Fans, blowers; centrifugal, induced draft exhausters; Generators & exciters; Hoists, elevators; Rubber calenders, mills, extruders; Saw mill, Textile machinery inc. looms, spinning frames, twisters	1.8	2.0	2.2
Centrifuges; Conveyors: flight, screw; Hammer mills; Paper pulpers	1.9	2.1	2.3
Brick & clay pug mills; Fans, blowers, propeller mine fans, positive blowers	2.0	2.2	2.4

Synchronous belts will not slip, and therefore must be belted for the highest loadings anticipated in the system. A minimum service factor of 2.0 is recommended for equipment subject to chocking.

Pitch Lengths: Standard belt pitch lengths, belt length designations, and numbers of teeth are shown in [Table 42](#). Belt length tolerances are also given in this table; these tolerances apply to all belt sections and represent the total manufacturing tolerance on belt length.

Nominal Tooth Dimensions: [Table 40](#) shows the nominal tooth dimensions for each of the standard belt sections. Tooth dimensions for single- and double-sided belts are identical.

**Table 40. Synchronous Belt Nominal Tooth and Section Dimensions
ANSI/RMA IP-24, 1983**

Single-Sided Belts

Double-Sided Belts

Belt Section (Pitch)	Tooth Angle	h_t	b_t	r_a	r_r	h_s	h_d	Belt Section (Pitch)	Tooth Angle	h_t	b_t	r_a	r_r	h_s	h_d
MXL (0.080)	40	0.020	0.045	0.005	0.005	0.045	...	XXH (1.250)	40	0.375	0.750	0.060	0.090	0.62	...
XL (0.200)	50	0.050	0.101	0.015	0.015	0.090	...	DXL (0.200)	50	0.050	0.101	0.015	0.015	...	0.120
L (0.375)	40	0.075	0.183	0.020	0.020	0.14	...	DL (0.375)	40	0.075	0.183	0.020	0.020	...	0.180
H (0.500)	40	0.090	0.241	0.040	0.040	0.16	...	DH (0.500)	40	0.090	0.241	0.040	0.040	...	0.234
XH (0.875)	40	0.250	0.495	0.047	0.062	0.44	...								

All dimensions in inches.

**Table 41. Synchronous Belt Standard Pulley and Flange Dimensions
ANSI/RMA IP-24, 1983**

Flanged Pulley

Unflanged Pulley

Flange Dimensions

Belt Section	Standard Nominal Pulley Width	Standard Pulley Width Designation	Minimum Pulley Width		Flange	
			Flanged b_f	Unflanged b'_f	Thickness (min)	Height ^a (min)
MXL	0.25	025	0.28	0.35	0.023	0.020
XL	0.38	037	0.41	0.48	0.029	0.040
L	0.50	050	0.55	0.67	0.050	0.065
	0.75	075	0.80	0.92		
H	1.00	100	1.05	1.17	0.050	0.080
	1.50	150	1.55	1.73		
	2.00	200	2.08	2.26		
	3.00	300	3.11	3.29		
XH	2.00	200	2.23	2.46	0.098	0.190
	3.00	300	3.30	3.50		
	4.00	400	4.36	4.59		
XXH	2.00	200	2.23	2.52	0.127	0.245
	3.00	300	3.30	3.59		
	4.00	400	4.36	4.65		
	5.00	500	5.42	5.72		

Table 42. Synchronous Belt Standard Pitch Lengths and Tolerances ANSI/RMA IP-24, 1983

Belt Length Designation	Pitch Length	Permissible Deviation From Standard Length	Number of Teeth for Standard Lengths						Belt Length Designation	Pitch Length	Permissible Deviation From Standard Length	Number of Teeth for Standard Lengths					
			MXL (0.080)	XL (0.200)	L (0.375)	H (0.500)	XH (0.875)	XXH (1.250)				MXL (0.080)	XL (0.200)	L (0.375)	H (0.500)	XH (0.875)	XXH (1.250)
36	3.600	±0.016	45						230	23.000	±0.024	...	115		
40	4.000	±0.016	50						240	24.000	±0.024	...	120	64	48		
44	4.400	±0.016	55						250	25.000	±0.024	...	125		
48	4.800	±0.016	60						255	25.500	±0.024	68	...		
56	5.600	±0.016	70						260	26.000	±0.024	...	130		
60	6.000	±0.016	75	30					270	27.000	±0.024	72	54		
64	6.400	±0.016	80	...					285	28.500	±0.024	76	...		
70	7.000	±0.016	...	35					300	30.000	±0.024	80	60		
72	7.200	±0.016	90	...					322	32.250	±0.026	86	...		
80	8.000	±0.016	100	40					330	33.000	±0.026	66		
88	8.800	±0.016	110	...					345	34.500	±0.026			92	...		
90	9.000	±0.016	...	45					360	36.000	±0.026			...	72		
100	10.000	±0.016	125	50					367	36.750	±0.026			98	...		
110	11.000	±0.018	...	55					390	39.000	±0.026			104	78		
112	11.200	±0.018	140	...					420	42.000	±0.030			112	84		
120	12.000	±0.018	...	60	...				450	45.000	±0.030			120	90	...	
124	12.375	±0.018	33				480	48.000	±0.030			128	96	...	
124	12.400	±0.018	155				507	50.750	±0.032			58	
130	13.000	±0.018	...	65	...				510	51.000	±0.032			136	102	...	
140	14.000	±0.018	175	70	...				540	54.000	±0.032			144	108	...	
150	15.000	±0.018	...	75	40				560	56.000	±0.032			64	
160	16.000	±0.020	200	80	...				570	57.000	±0.032			...	114	...	
170	17.000	±0.020	...	85	...				600	60.000	±0.032			160	120	...	
180	18.000	±0.020	225	90	...				630	63.000	±0.034			...	126	72	
187	18.750	±0.020	50				660	66.000	±0.034			...	132	...	
190	19.000	±0.020	...	95	...				700	70.000	±0.034			...	140	80	56
200	20.000	±0.020	250	100	...				750	75.000	±0.036			...	150
210	21.000	±0.024	...	105	56				770	77.000	±0.036			88	...
220	22.000	±0.024	...	110	...				800	80.000	±0.036			...	160	...	64
225	22.500	±0.024	60				840	84.000	±0.038			...	96

All dimensions in inches.

Table 43. Synchronous Belt Standard Widths and Tolerances
ANSI/RMA IP-24, 1983

Belt Section	Standard Belt Widths		Tolerances on Width for Belt Pitch Lengths		
	Designation	Dimensions	Up to and including 33 in.	Over 33 in. up to and including 66 in.	Over 66 in.
MXL (0.080)	012	0.12	+0.02
	019	0.19	-0.03		
	025	0.25			
XL (0.200)	025	0.25	+0.02
	037	0.38	-0.03		
L (0.375)	050	0.50	+0.03	+0.03	...
	075	0.75	-0.03	-0.05	
	100	1.00			
H (0.500)	075	0.75	+0.03	+0.03	+0.03
	100	1.00	-0.03	-0.05	-0.05
	150	1.50			
	200	2.00	+0.03	+0.05	+0.05
			-0.05	-0.05	-0.06
			+0.05	+0.06	+0.06
XH (0.875)	200	2.00			
	300	3.00	...	+0.19	+0.19
	400	4.00		-0.19	-0.19
XXH (1.250)	200	2.00			
	300	3.00			+0.19
	400	4.00	-0.19
	500	5.00			

Widths.: Standard belt widths, width designations, and width tolerances are shown in **Table 43**.

Length Determination.: The pitch length of a synchronous belt is determined by placing the belt on a measuring fixture having two pulleys of equal diameter, a method of applying force, and a means of measuring the center distance between the two pulleys. The position of one of the two pulleys is fixed and the other is movable along a graduated scale.

Synchronous Belt Pulley Diameters: **Table 44** lists the standard pulley diameters by belt section (pitch). **Fig. 13** defines the pitch, pitch diameter, outside diameter and pitch line differential.

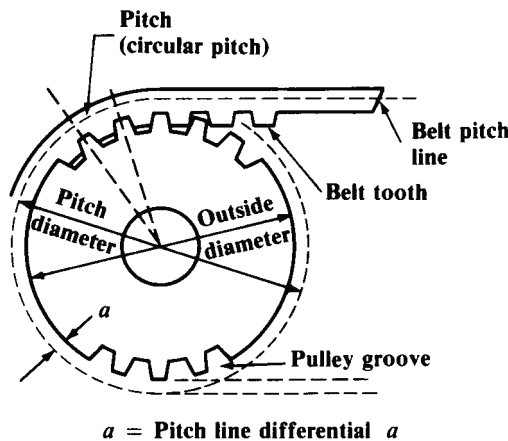


Fig. 13. Synchronous Belt Pulley Dimensions

Table 44. Synchronous Belt Standard Pulley Diameters ANSI/RMA IP-24, 1983

Number of Grooves	Belt Section											
	MXL (0.080)		XL (0.200)		L (0.375)		H (0.500)		XH (0.875)		XXH (1.250)	
	Diameters		Diameters		Diameters		Diameters		Diameters		Diameters	
	Pitch	Outside	Pitch	Outside	Pitch	Outside	Pitch	Outside	Pitch	Outside	Pitch	Outside
10	0.255	0.235	0.637	0.617	1.194 ^a	1.164
12	0.306	0.286	0.764	0.744	1.432 ^a	1.402
14	0.357	0.337	0.891	0.871	1.671	1.641	2.228 ^a	2.174
16	0.407	0.387	1.019	0.999	1.910	1.880	2.546	2.492
18	0.458	0.438	1.146	1.126	2.149	2.119	2.865	2.811	5.013	4.903	7.162	7.042
20	0.509	0.489	1.273	1.253	2.387	2.357	3.183	3.129	5.570	5.460	7.958	7.838
22	0.560	0.540	1.401	1.381	2.626	2.596	3.501	3.447	6.127	6.017	8.754	8.634
24	0.611	0.591	1.528	1.508	2.865	2.835	3.820	3.766	6.685	6.575	9.549	9.429
26	0.662	0.642	3.104	3.074	4.138	4.084	7.242	7.132	10.345	10.225
28	0.713	0.693	1.783	1.763	3.342	3.312	4.456	4.402	7.799	7.689
30	0.764	0.744	1.910	1.890	3.581	3.551	4.775	4.721	8.356	8.246	11.937	11.817
32	0.815	0.795	2.037	2.017	3.820	3.790	5.093	5.039	8.913	8.803
34	0.866	0.846	13.528	13.408
36	0.917	0.897	2.292	2.272	4.297	4.267	5.730	5.676
40	1.019	0.999	2.546	2.526	4.775	4.745	6.366	6.312	11.141	11.031	15.915	15.795
42	1.070	1.050	2.674	2.654
44	1.120	1.100	2.801	2.781	5.252	5.222	7.003	6.949
48	1.222	1.202	3.056	3.036	5.730	5.700	7.639	7.585	13.369	13.259	19.099	18.979
60	1.528	1.508	3.820	3.800	7.162	7.132	9.549	9.495	16.711	16.601	23.873	23.753
72	1.833	1.813	4.584	4.564	8.594	8.564	11.459	11.405	20.054	19.944	28.648	28.528
84	10.027	9.997	13.369	13.315	23.396	23.286
90	35.810	35.690
96	15.279	15.225	26.738	26.628
120	19.099	19.045	33.423	33.313

All dimensions in inches.

* Usually not available in all widths — consult supplier.

Widths: Standard pulley widths for each belt section are shown in **Table 41**. The nominal pulley width is specified in terms of the maximum standard belt width the pulley will accommodate. The minimum pulley width, whether flanged or unflanged, is also shown in **Table 41**, along with flange dimensions and various pulley tolerances.

Pulley Size Designation: Synchronous belt pulleys are designated by the number of grooves, the belt section, and a number representing 100 times the nominal width. For example, a 30 groove L section pulley with a nominal width of 0.75 in. would be designated by 30L075. Pulley tolerances are shown in **Table 45**.

Table 45. Pulley Tolerances (All Sections)

Outside Diameter Range	Outside Diameter Tolerance	Pitch to Pitch Tolerance	
		Adjacent Grooves	Accumulative Over 90 Degrees
Up thru 1.000	+0.002 -0.000	±0.001	±0.003
Over 1.000 to and including 2.000	+0.003 -0.000	±0.001	±0.004
Over 2.000 to and including 4.000	+0.004 -0.000	±0.001	±0.005
Over 4.000 to and including 7.000	+0.005 -0.000	±0.001	±0.005
Over 7.000 to and including 12.000	+0.006 -0.000	±0.001	±0.006
Over 12.000 to and including 20.000	+0.007 -0.000	±0.001	±0.007
Over 20.000	+0.008 -0.000	±0.001	±0.008

Radial Runout ^a	Axial Runout ^b
For outside diameters 8.0 in. and under 0.005 in. For each additional inch of outside diameter add 0.0005 in.	For outside diameters 1.0 in. and under 0.001 in. For each additional inch of outside diameter up through 10.0 in., add 0.001 in. For each additional inch of outside diameter over 10.0 in., add 0.0005 in.

^a Flange outside diameter equals pulley outside diameter plus twice flange height.

^b Total indicator reading.

All dimensions in inches.

Cross Section Selection: The chart (**Fig. 14**) may be used as a guide to the selection of a synchronous belt for any combination of design horsepower and speed of the faster shaft. When the intersection of the design horsepower and speed of the faster shaft falls near a line between two areas on the chart, the possibilities in both areas should be explored. Special circumstances (such as space limitations) may result in selection of a belt cross section different from that indicated in the chart. Belt manufacturers should be contacted for specific data.

Torque Ratings: It is customary to use torque load requirements rather than horsepower load when designing drives using the small pitch MXL section belts. These belts operate on small diameters resulting in relatively low belt speeds, so torque is essentially constant for all rpm. The torque rating formulas for MXL sections are:

$$Q_r = d[1.13 - 1.38 \times 10^{-3} d^2] \text{ for belt width} = 0.12 \text{ in.}$$

$$Q_r = d[1.88 - 2.30 \times 10^{-3} d^2] \text{ for belt width} = 0.19 \text{ in.}$$

$$Q_r = d[2.63 - 3.21 \times 10^{-3} d^2] \text{ for belt width} = 0.25 \text{ in.}$$

where Q_r = the maximum torque rating (lbf-in.) for a belt of specified width having six or more teeth in mesh and a pulley surface speed of 6500 fpm or less. Torque ratings for drives with less than six teeth in mesh must be corrected as shown in **Table 46**. d = pitch diameter of smaller pulley, inch.

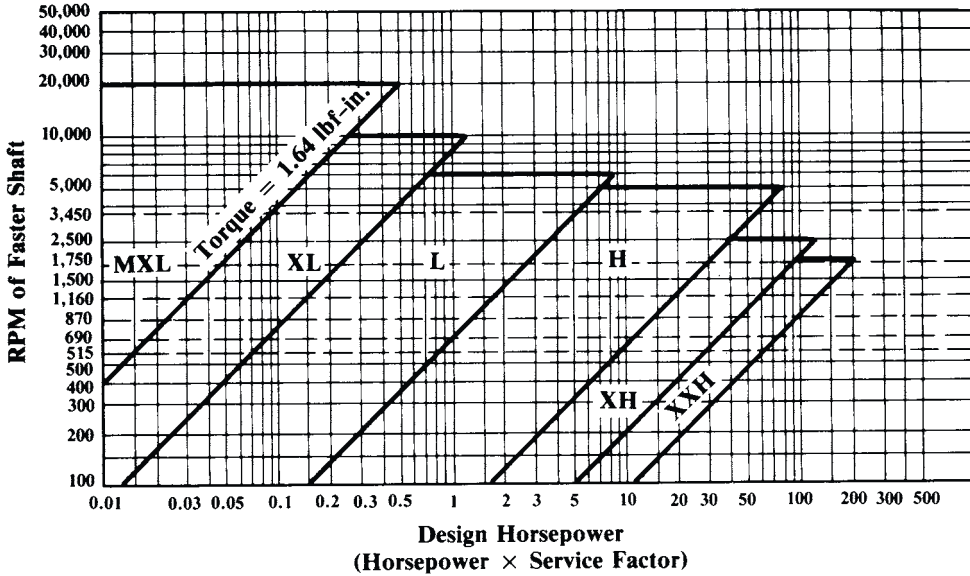


Fig. 14. Selection of Synchronous Belt Cross Section

Table 46. Teeth in Mesh Factor

Teeth in Mesh	Factor K_z	Teeth in Mesh	Factor K_z
6 or more	1.00	3	0.40
5	0.80	2	0.20
4	0.60		

Horsepower Rating Formulas: The horsepower rating formulas for synchronous belts, other than the MLX section, are determined from the following formulas, where the number in parentheses is the belt width in inches.

$$XL(0.38)HP = dr[0.0916 - 7.07 \times 10^{-5}(dr)^2]$$

$$L(1.00)HP = dr[0.436 - 3.01 \times 10^{-4}(dr)^2]$$

$$H(3.00)HP = dr[3.73 - 1.41 \times 10^{-3}(dr)^2]$$

$$XH(4.00)HP = dr[7.21 - 4.68 \times 10^{-3}(dr)^2]$$

$$XXH(5.00)HP = dr[11.4 - 7.81 \times 10^{-3}(dr)^2]$$

where HP = the maximum horsepower rating recommended for the specified standard belt width having six or more teeth in mesh and a pulley surface speed of 6500 fpm or less. Horsepower ratings for drives with less than six teeth in mesh must be corrected as shown in Table 46. d = pitch diameter of smaller pulley, in. r = rpm of faster shaft divided by 1000. Total horsepower ratings are the same for double-sided as for single-sided belts. Contact manufacturers for percentage of horsepower available for each side of the belt.

Finding the Required Belt Width: The belt width should not exceed the small pulley diameter or excessive side thrust will result.

Torque Rating Method (MXL Section): Divide the design torque by the teeth in mesh factor to obtain the corrected design torque. Compare the corrected design torque with the torque rating given in Table 47 for the pulley diameter being considered. Select the narrowest belt width that has a torque rating equal to or greater than the corrected design torque.

Table 47. Torque Rating for MXL Section (0.080 in. Pitch)

Belt Width, (in.)	Rated Torque (lbf-in.) for Small Pulley (Number of Grooves and Pitch Diameter, in.)									
	10MXL 0.255	12MXL 0.306	14MXL 0.357	16MXL 0.407	18MXL 0.458	20MXL 0.509	22MXL 0.560	24MXL 0.611	28MXL 0.713	30MXL 0.764
0.12	0.29	0.35	0.40	0.46	0.52	0.57	0.63	0.69	0.81	0.86
0.19	0.48	0.58	0.67	0.77	0.86	0.96	1.05	1.15	1.34	1.44
0.25	0.67	0.80	0.94	1.07	1.20	1.34	1.47	1.61	1.87	2.01

Horsepower Rating Method (XL, L, H, XH, and XXH Sections): Multiply the horsepower rating for the widest standard belt of the selected section by the teeth in mesh factor to obtain the corrected horsepower rating. Divide the design horsepower by the corrected horsepower rating to obtain the required belt width factor. Compare the required belt width factor with those shown in [Table 48](#). Select the narrowest belt width that has a width factor equal to or greater than the required belt width factor.

Table 48. Belt Width Factor

Belt Section	Belt Width (in.)											
	0.12	0.19	0.25	0.38	0.50	0.75	1.00	1.50	2.00	3.00	4.00	5.00
MXL (0.080)	0.43	0.73	1.00
XL (0.200)	0.62	1.00
L (0.375)	0.45	0.72	1.00
H (0.500)	0.21	0.29	0.45	0.63	1.00
XH (0.875)	0.45	0.72	1.00	...
XXH (1.250)	0.35	0.56	0.78	1.00

Drive Selection: Information on design and selection of synchronous belt drives is available in engineering manuals published by belt manufacturers. Manufacturers should be consulted on such matters as preferred stock sizes, desirable speeds, center distances, etc.

Minimum Pulley Size: The recommended minimum pulley size depends on the rpm of the faster shaft. Minimum sheave diameters for each cross-section belt are listed in [Table 44](#).

Selection of Flanged Pulleys: To determine when to use flanged pulleys, consider the following conditions:

- 1) On all two-pulley drives, the minimum flanging requirements are two flanges on one pulley, or one flange on each pulley on opposite sides.
- 2) On drives where the center distance is more than eight times the diameter of the small pulley, both pulleys should be flanged on both sides.
- 3) On vertical shaft drives, one pulley should be flanged on both sides and other pulleys in the system should be flanged on the bottom side only.
- 4) On drives with more than two pulleys, the minimum flanging requirements are two flanges on every other pulley, or one flange on every pulley, alternating sides around the system.

Service Factors: Service factors for synchronous belts in [Table 39](#).

TRANSMISSION CHAINS

Types of Chains

In addition to the standard roller and inverted tooth types, a wide variety of drive chains of different construction is available. Such chains are manufactured to various degrees of precision ranging from unfinished castings or forgings to chains having certain machined parts. Practically all of these chains as well as standard roller chains can be equipped with attachments to fit them for conveyor use. A few such types are briefly described in the following paragraphs. Detailed information about them can be obtained from the manufacturers.

Types of Chains.—*Detachable Chains:* The links of this type of chain, which are identical, are easily detachable. Each has a hook-shaped end in which the bar of the adjacent link articulates. These chains are available in malleable iron or pressed steel. The chief advantage is the ease with which any link can be removed.

Cast Roller Chains: Cast roller chains are constructed, wholly or partly, of cast metal parts and are available in various styles. In general the rollers and side bars are accurately made castings without machine finish. The links are usually connected by means of forged pins secured by nuts or cotters. Such chains are used for slow speeds and moderate loads, or where the precision of standard roller chains is not required.

Pintle Chains: Unlike the roller chain, the pintle chain is composed of hollow-cored cylinders cast or forged integrally with two offset side bars and each link identical. The links are joined by pins inserted in holes in the ends of the side bars and through the cored holes in the adjacent links. Lugs prevent turning of the pins in the side bars ensuring articulation of the chain between the pin and the cored cylinder.

Standard Roller Transmission Chains

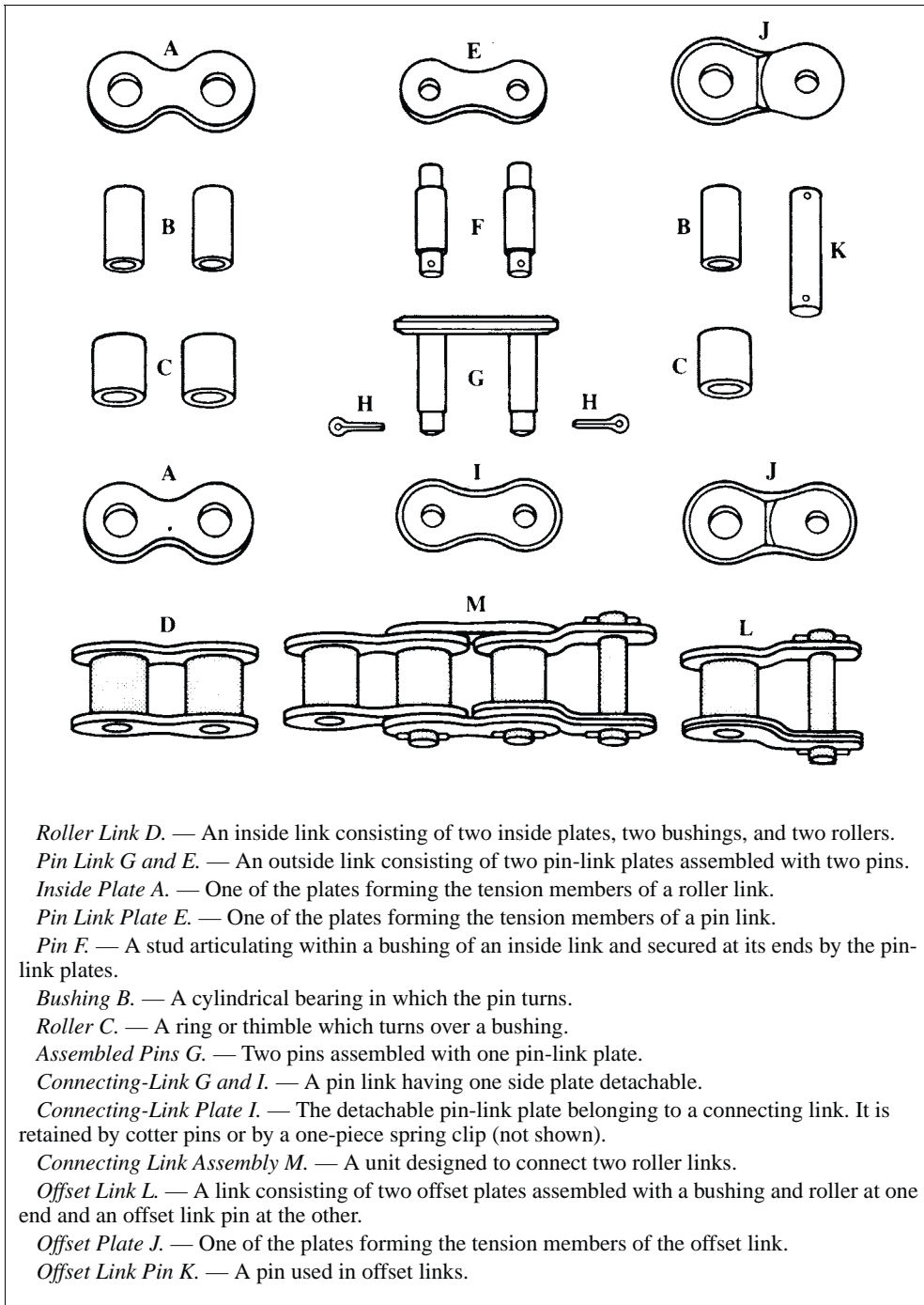
A roller chain is made up of two kinds of links: roller links and pin links alternately spaced throughout the length of the chain as shown in [Table 1](#).

Roller chains are manufactured in several types, each designed for the particular service required. All roller chains are so constructed that the rollers are evenly spaced throughout the chain. The outstanding advantage of this type of chain is the ability of the rollers to rotate when contacting the teeth of the sprocket. Two arrangements of roller chains are in common use: the single-strand type and the multiple-strand type. In the latter type, two or more chains are joined side by side by means of common pins which maintain the alignment of the rollers in the different strands.

Types of Roller Chains.—*Standard roller chains* are manufactured to the specifications in the American National Standard for precision power transmission roller chains, attachments, and sprockets ANSI/ASME B29.1M-1993 and, where indicated, the data in the subsequent tables have been taken from this standard. These roller chains and sprockets are commonly used for the transmission of power in industrial machinery, machine tools, motor trucks, motorcycles, tractors, and similar applications. In tabulating the dimensional information in ANSI/ASME B29.1M, customary inch-pound units were used. Metric (SI) units are given in separate tabulations in the Standard.

Nonstandard roller chains, developed individually by various manufacturers prior to the adoption of the ANSI standard, are similar in form and construction to standard roller chains but do not conform dimensionally to standard chains. Some sizes are still available from the originating manufacturers for replacement on existing equipment. They are not recommended for new installations, since their manufacture is being discontinued as rapidly as possible.

Table 1. ANSI Nomenclature for Roller Chain Parts
ANSI/ASME B29.1M-1993 (R1999)

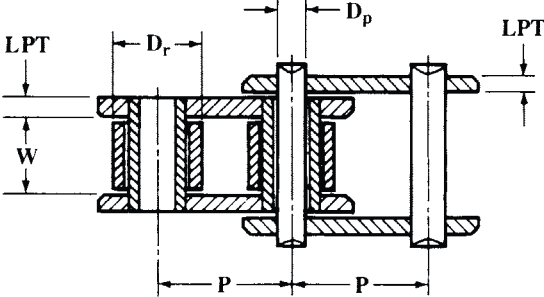


Standard double-pitch roller chains are like standard roller chains, except that their link plates have twice the pitch of the corresponding standard-pitch chain. Their design conforms to specifications in the ANSI Standard for double-pitch power transmission roller chains and sprockets ANSI/ASME B29.3M-1994. They are especially useful for low speeds, moderate loads, or long center distances.

Transmission Roller Chain

Standard Roller Chain Nomenclature, Dimensions and Loads.—Standard nomenclature for roller chain parts are given in Table 1. Dimensions for Standard Series roller chain are given in Table 2.

Table 2. ANSI Roller Chain Dimensions ASME/ANSI B29.1M-1986



Pitch <i>P</i>	Max. Roller Diameter <i>D_r</i>	Standard Series					Heavy Series
		Standard Chain No.	Width <i>W</i>	Pin Diameter <i>D_p</i>	Thickness of Link Plates <i>LPT</i>	Measuring Load, [†] Lb.	Thickness of Link Plates <i>LPT</i>
0.250	^a 0.130	25	0.125	0.0905	0.030	18	...
0.375	^a 0.200	35	0.188	0.141	0.050	18	...
0.500	0.306	41	0.250	0.141	0.050	18	...
0.500	0.312	40	0.312	0.156	0.060	31	...
0.625	0.400	50	0.375	0.200	0.080	49	...
0.750	0.469	60	0.500	0.234	0.094	70	0.125
1.000	0.625	80	0.625	0.312	0.125	125	0.156
1.250	0.750	100	0.750	0.375	0.156	195	0.187
1.500	0.875	120	1.000	0.437	0.187	281	0.219
1.750	1.000	140	1.000	0.500	0.219	383	0.250
2.000	1.125	160	1.250	0.562	0.250	500	0.281
2.250	1.406	180	1.406	0.687	0.281	633	0.312
2.500	1.562	200	1.500	0.781	0.312	781	0.375
3.000	1.875	240	1.875	0.937	0.375	1000	0.500

^a Bushing diameter. This size chain has no rollers.

All dimensions are in inches.

Roller Diameters *D_r* are approximately $\frac{5}{8}P$.

The width *W* is defined as the distance between the link plates. It is approximately $\frac{5}{8}$ of the chain pitch.

Pin Diameters *D_p* are approximately $\frac{5}{16}P$ or $\frac{1}{2}$ of the roller diameter.

Thickness *LPT* of Inside and Outside Link Plates for the standard series is approximately $\frac{1}{8}P$.

Thickness of Link Plates for the heavy series of any pitch is approximately that of the next larger pitch Standard Series chain.

Maximum Height of Roller Link Plates = 0.95 *P*.

Maximum Height of Pin Link Plates = 0.82 *P*.

Maximum Pin Diameter = nominal pin diameter + 0.0005 inch.

Minimum Hole in Bushing = nominal pin diameter + 0.0015 inch.

Maximum Width of Roller Link = nominal width of chain + (2.12 × nominal link plate thickness.)

Minimum Distance between Pin Link Plates = maximum width of roller link + 0.002 inch.

Chain Pitch: Distance in inches between centers of adjacent joint members. Other dimensions are proportional to the pitch.

Tolerances for Chain Length: New chains, under standard measuring load, must not be underlength. Overlength tolerance is $0.001/(\text{pitch in inches})^2 + 0.015$ inch per foot. Length measurements are to be taken over a length of at least 12 inches.

Measuring Load: The load in pounds under which a chain should be measured for length. It is equal to one per cent of the ultimate tensile strength, with a minimum of 18 pounds and a maximum of 1000 pounds for both single and multiple-strand chain.

Minimum Ultimate Tensile Strength: For single-strand chain, equal to or greater than $12,500 \times (\text{pitch in inches})^2$ pounds. The minimum tensile strength or breaking strength of a multiple-strand chain is equal to that of a single-strand chain multiplied by the number of strands. Minimum ultimate tensile strength is indicative only of the tensile strength quality of the chain, not the maximum load that can be applied.

Standard Roller Chain Numbers.—The right-hand figure in the chain number is zero for roller chains of the usual proportions, 1 for a lightweight chain, and 5 for a rollerless bushing chain. The numbers to the left of the right-hand figure denote the number of $\frac{1}{8}$ inches in the pitch. The letter *H* following the chain number denotes the heavy series; thus the number 80 *H* denotes a 1-inch pitch heavy chain. The hyphenated number 2 suffixed to the chain number denotes a double strand, 3 a triple strand, 4 a quadruple strand chain and so on.

Heavy Series: These chains, made in $\frac{3}{4}$ -inch and larger pitches, have thicker link plates than those of the regular standard. Their value is only in the acceptance of higher loads at lower speeds.

Light-weight Machinery Chain: This chain is designated as No. 41. It is $\frac{1}{2}$ inch pitch; $\frac{1}{4}$ inch wide; has 0.306-inch diameter rollers and a 0.141-inch pin diameter. The minimum ultimate tensile strength is 1500 pounds.

Multiple-strand Chain: This is essentially an assembly of two or more single-strand chains placed side by side with pins that extend through the entire width to maintain alignment of the different strands.

Types of Sprockets.—Four different designs or types of roller-chain sprockets are shown by the sectional views, Fig. 1. Type *A* is a plain plate; type *B* has a hub on one side only; type *C*, a hub on both sides; and type *D*, a detachable hub. Also used are shear pin and slip clutch sprockets designed to prevent damage to the drive or to other equipment caused by overloads or stalling.

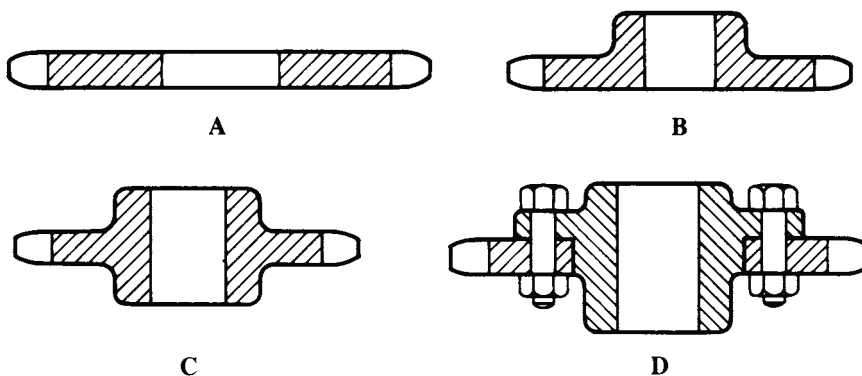
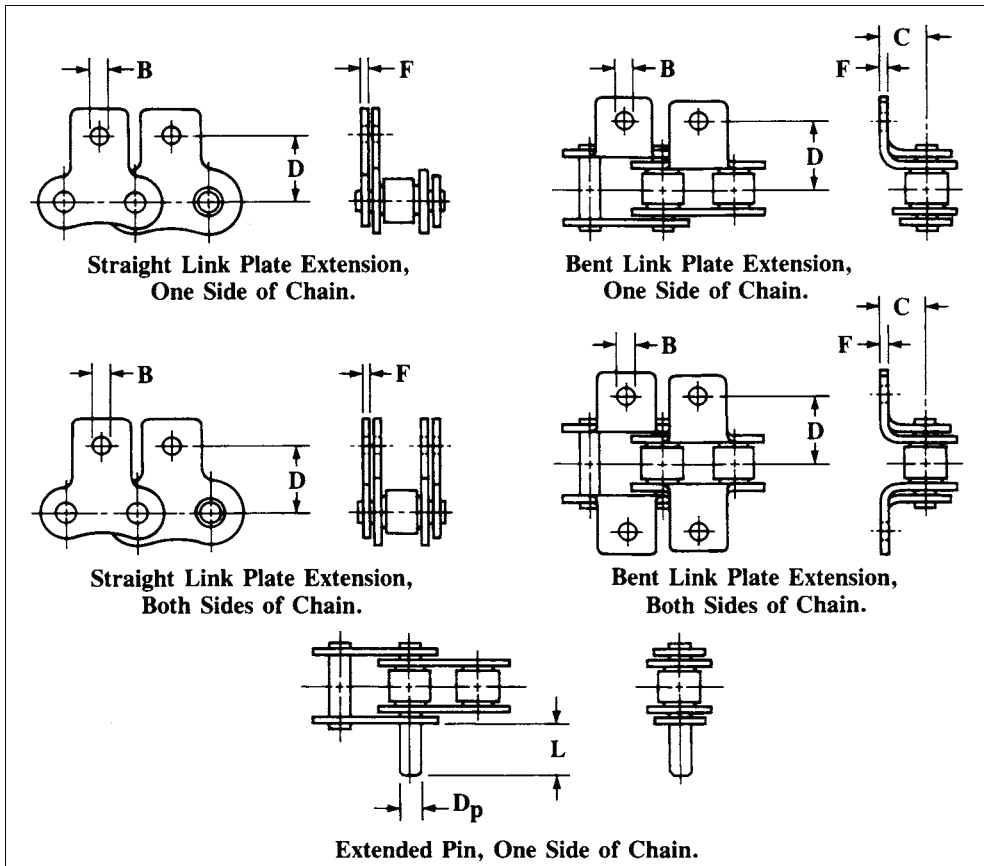


Fig. 1. Types of Sprockets

Attachments.—Modifications to standard chain components to adapt the chain for use in conveying, elevating, and timing operations are known as “attachments.” The components commonly modified are: 1) the link plates, which are provided with extended lugs which may be straight or bent; and 2) the chain pins, which are extended in length so as to project substantially beyond the outer surface of the pin link plates.

Hole diameters, thicknesses, hole locations and offset dimensions for straight link and bent link plate extensions and lengths and diameters of extended pins are given in Table 3.

Table 3. Straight and Bent Link Plate Extensions and Extended Pin Dimensions
ANSI/ASME B29.1M-1993 (R1999)



Chain No.	Straight Link Plate Extension			Bent Link Plate Extension				Extended Pin	
	<i>B</i> min.	<i>D</i>	<i>F</i>	<i>B</i> min.	<i>C</i>	<i>D</i>	<i>F</i>	<i>D_p</i> Nominal	<i>L</i>
35	0.102	0.375	0.050	0.102	0.250	0.375	0.050	0.141	0.375
40	0.131	0.500	0.060	0.131	0.312	0.500	0.060	0.156	0.375
50	0.200	0.625	0.080	0.200	0.406	0.625	0.080	0.200	0.469
60	0.200	0.719	0.094	0.200	0.469	0.750	0.094	0.234	0.562
80	0.261	0.969	0.125	0.261	0.625	1.000	0.125	0.312	0.750
100	0.323	1.250	0.156	0.323	0.781	1.250	0.156	0.375	0.938
120	0.386	1.438	0.188	0.386	0.906	1.500	0.188	0.437	1.125
140	0.448	1.750	0.219	0.448	1.125	1.750	0.219	0.500	1.312
160	0.516	2.000	0.250	0.516	1.250	2.000	0.250	0.562	1.500
200	0.641	2.500	0.312	0.641	1.688	2.500	0.312	0.781	1.875

All dimensions are in inches.

Sprocket Classes.—The American National Standard ANSI/ASME B29.1M-1993 provides for two classes of sprockets designated as Commercial and Precision. The selection of either is a matter of drive application judgment. The usual moderate to slow speed commercial drive is adequately served by Commercial sprockets. Where extreme high speed in combination with high load is involved, or where the drive involves fixed centers, critical timing, or register problems, or close clearance with outside interference, then the use of Precision sprockets may be more appropriate.

As a general guide, drives requiring Type A or Type B lubrication (see page 2559) would be served by Commercial sprockets. Drives requiring Type C lubrication may require Precision sprockets; the manufacturer should be consulted.

Keys, Keyways, and Set Screws.—To secure sprockets to the shaft, both keys and set screws should be used. The key is used to prevent rotation of the sprocket on the shaft. Keys should be fitted carefully in the shaft and sprocket keyways to eliminate all backlash, especially on the fluctuating loads. A set screw should be located over a flat key to secure it against longitudinal displacement.

Where a set screw is to be used with a parallel key, the following sizes are recommended by the American Chain Association. For a sprocket bore and shaft diameter in the range of

$\frac{1}{2}$ through $\frac{7}{8}$ inch, a $\frac{1}{4}$ -inch set screw

$\frac{15}{16}$ through $1\frac{3}{4}$ inches, a $\frac{3}{8}$ -inch set screw

$1\frac{13}{16}$ through $2\frac{1}{4}$ inches, a $\frac{1}{2}$ -inch set screw

$2\frac{5}{16}$ through $3\frac{1}{4}$ inches, a $\frac{5}{8}$ -inch set screw

$3\frac{3}{8}$ through $4\frac{1}{2}$ inches, a $\frac{3}{4}$ -inch set screw

$4\frac{3}{4}$ through $5\frac{1}{2}$ inches, a $\frac{7}{8}$ -inch set screw

$5\frac{3}{4}$ through $7\frac{3}{8}$ inches, a 1-inch set screw

$7\frac{1}{2}$ through $12\frac{1}{2}$ inches, a $1\frac{1}{4}$ -inch set screw

Sprocket Diameters.—The various diameters of roller chain sprockets are shown in Fig. 2. These are defined as follows.

Pitch Diameter: The pitch diameter is the diameter of the pitch circle that passes through the centers of the link pins as the chain is wrapped on the sprocket.

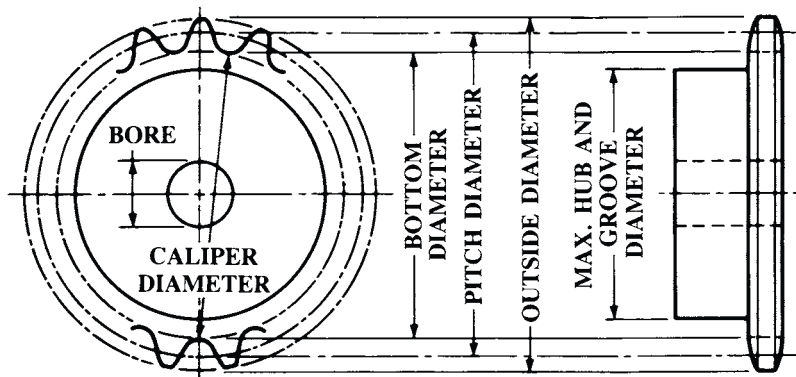


Fig. 2. Sprocket Diameters

Because the chain pitch is measured on a straight line between the centers of adjacent pins, the chain pitch lines form a series of chords of the sprocket pitch circle. Sprocket pitch diameters for one-inch pitch and for 9 to 108 teeth are given in Table 4. For lower (5 to 8) or higher (109 to 200) numbers of teeth use the following formula in which P = pitch, N = number of teeth: Pitch Diameter = $P \div \sin(180^\circ \div N)$.

Table 4. ANSI Roller Chain Sprocket Diameters ANSI/ASME B29.1M-1993 (R1999)

These diameters and caliper factors apply only to chain of 1-inch pitch. For any other pitch, multiply the values given below by the pitch.									
Caliper Dia. (even teeth) = Pitch Diameter – Roller Dia.									
Caliper Dia. (odd teeth) = Caliper factor × Pitch – Roller Dia.									
See Table 5 for tolerances on Caliper Diameters.									
No. Teeth ^a	Pitch Diameter	Outside Diameter		Caliper Factor	No. Teeth ^a	Pitch Diameter	Outside Diameter		Caliper Factor
		Turned	Topping Hob Cut				Turned	Topping Hob Cut	
9	2.9238	3.348	3.364	2.8794	59	18.7892	19.363	19.361	18.7825
10	3.2361	3.678	3.676		60	19.1073	19.681	19.680	
11	3.5495	4.006	3.990	3.5133	61	19.4255	20.000	19.998	19.4190
12	3.8637	4.332	4.352		62	19.7437	20.318	20.316	
13	4.1786	4.657	4.666	4.1481	63	20.0618	20.637	20.634	20.0556
14	4.4940	4.981	4.982		64	20.3800	20.956	20.952	
15	4.8097	5.304	5.298	4.7834	65	20.6982	21.274	21.270	20.6921
16	5.1258	5.627	5.614		66	21.0164	21.593	21.588	
17	5.4422	5.949	5.930	5.4190	67	21.3346	21.911	21.907	21.3287
18	5.7588	6.271	6.292		68	21.6528	22.230	22.225	
19	6.0755	6.593	6.609	6.0548	69	21.9710	22.548	22.543	21.9653
20	6.3924	6.914	6.926		70	22.2892	22.867	22.861	
21	6.7095	7.235	7.243	6.6907	71	22.6074	23.185	23.179	22.6018
22	7.0267	7.555	7.560		72	22.9256	23.504	23.498	
23	7.3439	7.876	7.877	7.3268	73	23.2438	23.822	23.816	23.2384
24	7.6613	8.196	8.195		74	23.5620	24.141	24.134	
25	7.9787	8.516	8.512	7.9630	75	23.8802	24.459	24.452	23.8750
26	8.2962	8.836	8.829		76	24.1984	24.778	24.770	
27	8.6138	9.156	9.147	8.5992	77	24.5166	25.096	25.089	24.5116
28	8.9314	9.475	9.465		78	24.8349	25.415	25.407	
29	9.2491	9.795	9.782	9.2355	79	25.1531	25.733	25.725	25.1481
30	9.5668	10.114	10.100		80	25.4713	26.052	26.043	
31	9.8845	10.434	10.418	9.8718	81	25.7896	26.370	26.362	25.7847
32	10.2023	10.753	10.736		82	26.1078	26.689	26.680	
33	10.5201	11.073	11.053	10.5082	83	26.4260	27.007	26.998	26.4213
34	10.8379	11.392	11.371		84	26.7443	27.326	27.316	
35	11.1558	11.711	11.728	11.1446	85	27.0625	27.644	27.635	27.0579
36	11.4737	12.030	12.046		86	27.3807	27.962	27.953	
37	11.7916	12.349	12.364	11.7810	87	27.6990	28.281	28.271	27.6945
38	12.1095	12.668	12.682		88	28.0172	28.599	28.589	
39	12.4275	12.987	13.000	12.4174	89	28.3354	28.918	28.907	28.3310
40	12.7455	13.306	13.318		90	28.6537	29.236	29.226	
41	13.0635	13.625	13.636	13.0539	91	28.9719	29.555	29.544	28.9676
42	13.3815	13.944	13.954		92	29.2902	29.873	29.862	
43	13.6995	14.263	14.272	13.6904	93	29.6084	30.192	30.180	29.6042
44	14.0175	14.582	14.590		94	29.9267	30.510	30.499	
45	14.3355	14.901	14.908	14.3269	95	30.2449	30.828	30.817	30.2408
46	14.6535	15.219	15.226		96	30.5632	31.147	31.135	
47	14.9717	15.538	15.544	14.9634	97	30.8815	31.465	31.454	30.8774
48	15.2898	15.857	15.862		98	31.1997	31.784	31.772	
49	15.6079	16.176	16.180	15.5999	99	31.5180	32.102	32.090	31.5140
50	15.9260	16.495	16.498		100	31.8362	32.421	32.408	
51	16.2441	16.813	16.816	16.2364	101	32.1545	32.739	32.727	32.1506
52	16.5622	17.132	17.134		102	32.4727	33.057	33.045	
53	16.8803	17.451	17.452	16.8729	103	32.7910	33.376	33.363	32.7872
54	17.1984	17.769	17.770		104	33.1093	33.694	33.681	
55	17.5165	18.088	18.089	17.5094	105	33.4275	34.013	34.000	33.4238
56	17.8347	18.407	18.407		106	33.7458	34.331	34.318	
57	18.1528	18.725	18.725	18.1459	107	34.0641	34.649	34.636	34.0604
58	18.4710	19.044	19.043		108	34.3823	34.968	34.954	

^aFor 5 - 8 and 109-200 teeth see text, pages 2542, 2544.

Bottom Diameter: The bottom diameter is the diameter of a circle tangent to the curve (called the seating curve) at the bottom of the tooth gap. It equals the pitch diameter minus the diameter of the roller.

Caliper Diameter: The caliper diameter is the same as the bottom diameter for a sprocket with an even number of teeth. For a sprocket with an odd number of teeth, it is defined as the distance from the bottom of one tooth gap to that of the nearest opposite tooth gap. The caliper diameter for an even tooth sprocket is equal to pitch diameter-roller diameter. The caliper diameter for an odd tooth sprocket is equal to caliper factor-roller diameter. Here, the caliper factor = $PD[\cos(90^\circ \div N)]$, where PD = pitch diameter and N = number of teeth. Caliper factors for 1-in. pitch and sprockets having 9-108 teeth are given in Table 4. For other tooth numbers use above formula. Caliper diameter tolerances are minus only and are equal to $0.002P\sqrt{N} + 0.006$ inch for the Commercial sprockets and $0.001P\sqrt{N} + 0.003$ inch for Precision sprockets. Tolerances are given in Table 5.

**Table 5. Minus Tolerances on the Caliper Diameters of Precision Sprockets
ANSI/ASME B29.1M-1993 (R1999)**

Pitch	Number of Teeth				
	Up to 15	16-24	25-35	36-48	49-63
0.250	0.004	0.004	0.004	0.005	0.005
0.375	0.004	0.004	0.004	0.005	0.005
0.500	0.004	0.005	0.0055	0.006	0.0065
0.625	0.005	0.0055	0.006	0.007	0.008
0.750	0.005	0.006	0.007	0.008	0.009
1.000	0.006	0.007	0.008	0.009	0.010
1.250	0.007	0.008	0.009	0.010	0.012
1.500	0.007	0.009	0.0105	0.012	0.013
1.750	0.008	0.010	0.012	0.013	0.015
2.000	0.009	0.011	0.013	0.015	0.017
2.250	0.010	0.012	0.014	0.016	0.018
2.500	0.010	0.013	0.015	0.018	0.020
3.000	0.012	0.015	0.018	0.021	0.024
Pitch	Number of Teeth				
	64-80	81-99	100-120	121-143	144 up
0.250	0.005	0.005	0.006	0.006	0.006
0.375	0.006	0.006	0.006	0.007	0.007
0.500	0.007	0.0075	0.008	0.0085	0.009
0.625	0.009	0.009	0.009	0.010	0.011
0.750	0.010	0.010	0.011	0.012	0.013
1.000	0.011	0.012	0.013	0.014	0.015
1.250	0.013	0.014	0.016	0.017	0.018
1.500	0.015	0.016	0.018	0.019	0.021
1.750	0.017	0.019	0.020	0.022	0.024
2.000	0.019	0.021	0.023	0.025	0.027
2.250	0.021	0.023	0.025	0.028	0.030
2.500	0.023	0.025	0.028	0.030	0.033
3.000	0.027	0.030	0.033	0.036	0.039

Minus tolerances for Commercial sprockets are twice those shown in this table.

Outside Diameter: OD is the diameter over the tips of teeth. Sprocket ODs for 1-in. pitch and 9-108 teeth are given in Table 4. For other tooth numbers the OD may be determined by the following formulas in which O = approximate OD; P = pitch of chain; N = number of sprocket teeth: $O = P [0.6 + \cot(180^\circ \div N)]$, for turned sprocket; $O =$ pitch diameter – roller diameter + $2 \times$ whole depth of topping hob cut, for topping hob cut sprocket.*

Table 6. American National Standard Roller Chain Sprocket Flange Thickness and Tooth Section Profile Dimension ANSI/ASME B29.1M-1993 (R1999)

Flange chamfer may be either as in Section "A" or Section "B" or anything in between.

Sprocket Flange Thickness										
Std. Chain No.	Width of Chain, W	Maximum Sprocket Flange Thickness, t			Minus Tolerance on t		Tolerance on M		Max. Variation of t on Each Flange	
		Single	Double & Triple	Quad. & Over	Commercial	Precision	Commercial Plus or Minus	Precision Minus Only	Commercial	Precision
25	0.125	0.110	0.106	0.096	0.021	0.007	0.007	0.007	0.021	0.004
35	0.188	0.169	0.163	0.150	0.027	0.008	0.008	0.008	0.027	0.004
41	0.250	0.226	0.032	0.009	0.032	0.004
40	0.312	0.284	0.275	0.256	0.035	0.009	0.009	0.009	0.035	0.004
50	0.375	0.343	0.332	0.310	0.036	0.010	0.010	0.010	0.036	0.005
60	0.500	0.459	0.444	0.418	0.036	0.011	0.011	0.011	0.036	0.006
80	0.625	0.575	0.556	0.526	0.040	0.012	0.012	0.012	0.040	0.006
100	0.750	0.692	0.669	0.633	0.046	0.014	0.014	0.014	0.046	0.007
120	1.000	0.924	0.894	0.848	0.057	0.016	0.016	0.016	0.057	0.008
140	1.000	0.924	0.894	0.848	0.057	0.016	0.016	0.016	0.057	0.008
160	1.250	1.156	1.119	1.063	0.062	0.018	0.018	0.018	0.062	0.009
180	1.406	1.302	1.259	1.198	0.068	0.020	0.020	0.020	0.068	0.010
200	1.500	1.389	1.344	1.278	0.072	0.021	0.021	0.021	0.072	0.010
240	1.875	1.738	1.682	1.602	0.087	0.025	0.025	0.025	0.087	0.012

Sprocket Tooth Section Profile Dimensions						
Std. Chain No.	Chain Pitch P	Depth of Chamfer h	Width of Chamfer g	Minimum Radius Rc	Transverse Pitch K	
					Standard Series	Heavy Series
25	0.250	0.125	0.031	0.265	0.252	...
35	0.375	0.188	0.047	0.398	0.399	...
41	0.500	0.250	0.062	0.531
40	0.500	0.250	0.062	0.531	0.566	...
50	0.625	0.312	0.078	0.664	0.713	...
60	0.750	0.375	0.094	0.796	0.897	1.028
80	1.000	0.500	0.125	1.062	1.153	1.283
100	1.250	0.625	0.156	1.327	1.408	1.539
120	1.500	0.750	0.188	1.593	1.789	1.924
140	1.750	0.875	0.219	1.858	1.924	2.055
160	2.000	1.000	0.250	2.124	2.305	2.437
180	2.250	1.125	0.281	2.392	2.592	2.723
200	2.500	1.250	0.312	2.654	2.817	3.083
240	3.000	1.500	0.375	3.187	3.458	3.985

All dimensions are in inches. $r_f \text{ max} = 0.04 P$ for max. hub diameter.

*This dimension was added in 1984 as a desirable goal for the future. It should in no way obsolete existing tools or sprockets. The whole depth WD is found from the formula: $WD = \frac{1}{2}D_r + P[0.3 - \frac{1}{2} \tan(90 \text{ deg} \div N_a)]$, where N_a is the intermediate number of teeth for the topping hob. For teeth range 5, $N_a = 5; 6, 6; 7-8, 7.47; 9-11, 9.9; 12-17, 14.07; 18-34, 23.54; 35$ and over, 56.

Proportions of Sprockets.—Typical proportions of single-strand and multiple-strand cast roller chain sprockets, as provided by the American Chain Association, are shown in Table 7. Typical proportions of roller chain bar-steel sprockets, also provided by this association, are shown in Table 8.

Table 7. Typical Proportions of Single-Strand and Multiple-Strand Cast Roller Chain Sprockets

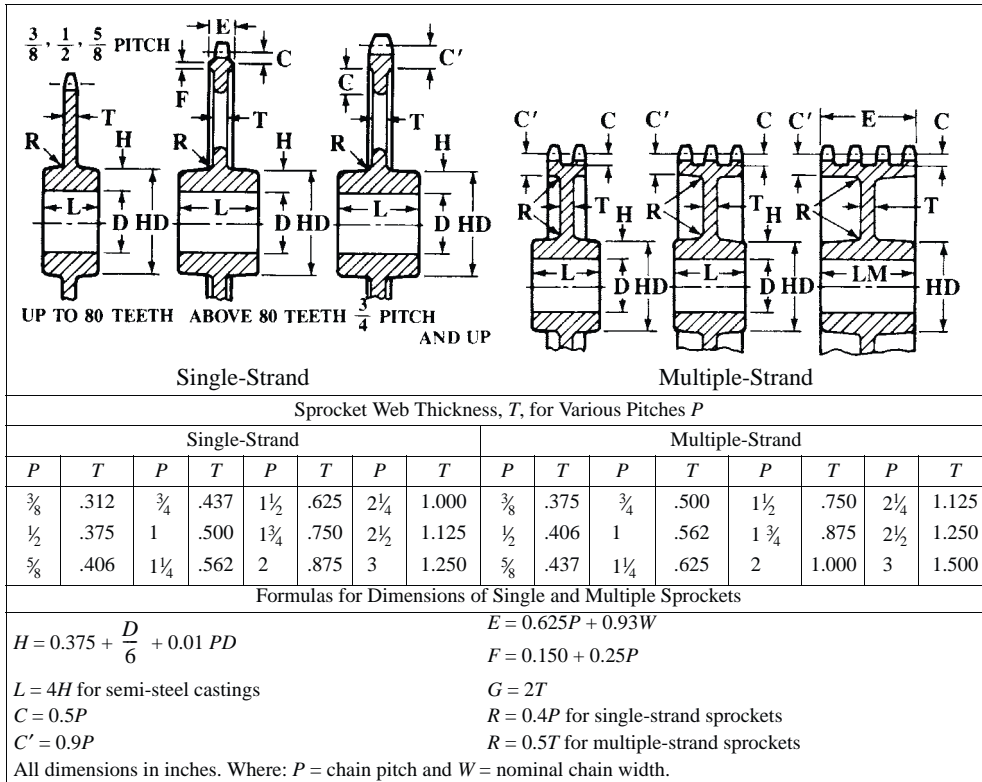
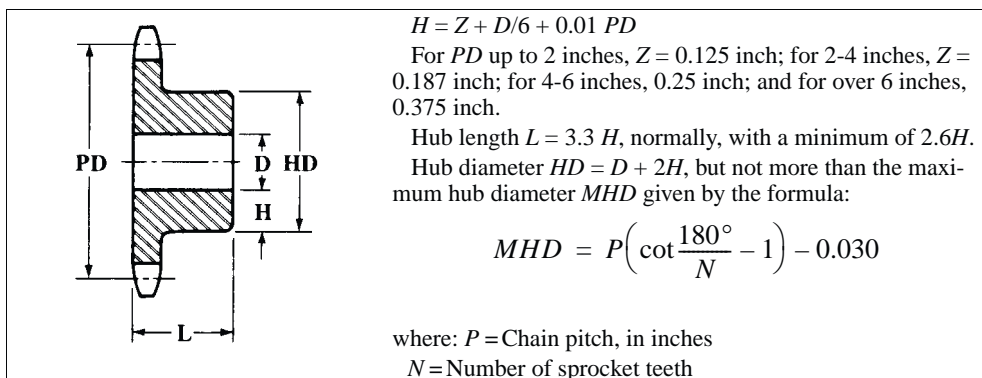


Table 8. Typical Proportions of Roller Chain Bar-steel Sprockets



When sprocket wheels are designed with spokes, the usual assumptions made in order to determine suitable proportions are as follows: 1) That the maximum torque load acting on a sprocket is the chain tensile strength times the sprocket pitch radius; 2) That the torque load is equally divided between the arms by the rim; and 3) That each arm acts as a cantilever beam.

The arms are generally elliptical in cross section, the major axis twice the minor axis.

Selection of Chain and Sprockets.—The smallest applicable pitch of roller chain is desirable for quiet operation and high speed. The horsepower capacity varies with the chain pitch as shown in Table 9. However, short pitch with high working load can often be obtained by the use of multiple-strand chain.

The small sprocket selected must be large enough to accommodate the shaft. Table 10 gives maximum bore and hub diameters consistent with commercial practice for sprockets with up to 25 teeth.

After selecting the small sprocket, the number of teeth in the larger sprocket is determined by the desired ratio of the shaft speed. Overemphasis on the exactness in the speed ratio may result in a cumbersome and expensive installation. In most cases, satisfactory operation can be obtained with a minor change in speed of one or both shafts.

Table 9. Horsepower Ratings for Roller Chain-1986

To properly use this table the following factors must be taken into consideration: 1) Service factors 2) Multiple Strand Factors 3) Lubrication <i>Service Factors:</i> See Table 15. <i>Multiple Strand Factors:</i> For two strands, the multiple strand factor is 1.7; for three strands, it is 2.5; and for four strands, it is 3.3. <i>Lubrication:</i> Required type of lubrication is indicated at the bottom of each roller chain size section of the table. For a description of each type of lubrication, see page 2559. Type A — Manual or Drip Lubrication Type B — Bath or Disc Lubrication Type C — Oil Stream Lubrication To find the required horsepower table rating, use the following formula: $\text{Required hp Table Rating} = \frac{\text{hp to be Transmitted} \times \text{Service Factor}}{\text{Multiple-Strand Factor}}$														
1/4-inch Pitch Standard Single-Strand Roller Chain — No. 25	No. of Teeth Small Spkt.	Revolutions per Minute — Small Sprocket ^a												
		50	100	300	500	700	900	1200	1500	1800	2100	2500	3000	3500
		Horsepower Rating												
	11	0.03	0.05	0.14	0.23	0.31	0.39	0.50	0.62	0.73	0.83	0.98	1.15	1.32
	12	0.03	0.06	0.16	0.25	0.34	0.43	0.55	0.68	0.80	0.92	1.07	1.26	1.45
	13	0.04	0.06	0.17	0.27	0.37	0.47	0.60	0.74	0.87	1.00	1.17	1.38	1.58
	14	0.04	0.07	0.19	0.30	0.40	0.50	0.65	0.80	0.94	1.08	1.27	1.49	1.71
	15	0.04	0.08	0.20	0.32	0.43	0.54	0.70	0.86	1.01	1.17	1.36	1.61	1.85
	16	0.04	0.08	0.22	0.34	0.47	0.58	0.76	0.92	1.09	1.25	1.46	1.72	1.98
	17	0.05	0.09	0.23	0.37	0.50	0.62	0.81	0.99	1.16	1.33	1.56	1.84	2.11
	18	0.05	0.09	0.25	0.39	0.53	0.66	0.86	1.05	1.24	1.42	1.66	1.96	2.25
	19	0.05	0.10	0.26	0.41	0.56	0.70	0.91	1.11	1.31	1.50	1.76	2.07	2.38
	20	0.06	0.10	0.28	0.44	0.59	0.74	0.96	1.17	1.38	1.59	1.86	2.19	2.52
	21	0.06	0.11	0.29	0.46	0.62	0.78	1.01	1.24	1.46	1.68	1.96	2.31	2.66
	22	0.06	0.11	0.31	0.48	0.66	0.82	1.07	1.30	1.53	1.76	2.06	2.43	2.79
	23	0.06	0.12	0.32	0.51	0.69	0.86	1.12	1.37	1.61	1.85	2.16	2.55	2.93
	24	0.07	0.13	0.34	0.53	0.72	0.90	1.17	1.43	1.69	1.94	2.27	2.67	3.07
	25	0.07	0.13	0.35	0.56	0.75	0.94	1.22	1.50	1.76	2.02	2.37	2.79	3.21
	26	0.07	0.14	0.37	0.58	0.79	0.98	1.28	1.56	1.84	2.11	2.47	2.91	3.34
	28	0.08	0.15	0.40	0.63	0.85	1.07	1.38	1.69	1.99	2.29	2.68	3.15	3.62
30	0.08	0.16	0.43	0.68	0.92	1.15	1.49	1.82	2.15	2.46	2.88	3.40	3.90	
32	0.09	0.17	0.46	0.73	0.98	1.23	1.60	1.95	2.30	2.64	3.09	3.64	4.18	
35	0.10	0.19	0.51	0.80	1.08	1.36	1.76	2.15	2.53	2.91	3.41	4.01	4.61	
40	0.12	0.22	0.58	0.92	1.25	1.57	2.03	2.48	2.93	3.36	3.93	4.64	5.32	
45	0.13	0.25	0.66	1.05	1.42	1.78	2.31	2.82	3.32	3.82	4.47	5.26	6.05	
		Type A						Type B						

Table 9. Horsepower Ratings for Roller Chain-1986

	No. of Teeth Small Spkt.	Revolutions per Minute — Small Sprocket ^a												
		50	100	300	500	700	900	1200	1500	1800	2100	2500	3000	3500
		Horsepower Rating												
3/8-inch Pitch Standard Single-Strand Roller Chain — No. 35	11	0.10	0.18	0.49	0.77	1.05	1.31	1.70	2.08	2.45	2.82	3.30	2.94	2.33
	12	0.11	0.20	0.54	0.85	1.15	1.44	1.87	2.29	2.70	3.10	3.62	3.35	2.66
	13	0.12	0.22	0.59	0.93	1.26	1.57	2.04	2.49	2.94	3.38	3.95	3.77	3.00
	14	0.13	0.24	0.63	1.01	1.36	1.71	2.21	2.70	3.18	3.66	4.28	4.22	3.35
	15	0.14	0.25	0.68	1.08	1.47	1.84	2.38	2.91	3.43	3.94	4.61	4.68	3.71
	16	0.15	0.27	0.73	1.16	1.57	1.97	2.55	3.12	3.68	4.22	4.94	5.15	4.09
	17	0.16	0.29	0.78	1.24	1.68	2.10	2.73	3.33	3.93	4.51	5.28	5.64	4.48
	18	0.17	0.31	0.83	1.32	1.78	2.24	2.90	3.54	4.18	4.80	5.61	6.15	4.88
	19	0.18	0.33	0.88	1.40	1.89	2.37	3.07	3.76	4.43	5.09	5.95	6.67	5.29
	20	0.19	0.35	0.93	1.48	2.00	2.51	3.25	3.97	4.68	5.38	6.29	7.20	5.72
	21	0.20	0.37	0.98	1.56	2.11	2.64	3.42	4.19	4.93	5.67	6.63	7.75	6.15
	22	0.21	0.38	1.03	1.64	2.22	2.78	3.60	4.40	5.19	5.96	6.97	8.21	6.59
	23	0.22	0.40	1.08	1.72	2.33	2.92	3.78	4.62	5.44	6.25	7.31	8.62	7.05
	24	0.23	0.42	1.14	1.80	2.44	3.05	3.96	4.84	5.70	6.55	7.66	9.02	7.51
	25	0.24	0.44	1.19	1.88	2.55	3.19	4.13	5.05	5.95	6.84	8.00	9.43	7.99
	26	0.25	0.46	1.24	1.96	2.66	3.33	4.31	5.27	6.21	7.14	8.35	9.84	8.47
	28	0.27	0.50	1.34	2.12	2.88	3.61	4.67	5.71	6.73	7.73	9.05	10.7	9.47
	30	0.29	0.54	1.45	2.29	3.10	3.89	5.03	6.15	7.25	8.33	9.74	11.5	10.5
32	0.31	0.58	1.55	2.45	3.32	4.17	5.40	6.60	7.77	8.93	10.4	12.3	11.6	
35	0.34	0.64	1.71	2.70	3.66	4.59	5.95	7.27	8.56	9.84	11.5	13.6	13.2	
40	0.39	0.73	1.97	3.12	4.23	5.30	6.87	8.40	9.89	11.4	13.3	15.7	16.2	
45	0.45	0.83	2.24	3.55	4.80	6.02	7.80	9.53	11.2	12.9	15.1	17.8	19.3	
		Type A			Type B						Type C			
1/2-inch Pitch Standard Single-Strand Roller Chain — No. 40		Revolutions per Minute — Small Sprocket ^a												
		50	100	200	300	400	500	700	900	1000	1200	1400	1600	1800
		Horsepower Rating												
	11	0.23	0.43	0.80	1.16	1.50	1.83	2.48	3.11	3.42	4.03	4.63	5.22	4.66
	12	0.25	0.47	0.88	1.27	1.65	2.01	2.73	3.42	3.76	4.43	5.09	5.74	5.31
	13	0.28	0.52	0.96	1.39	1.80	2.20	2.97	3.73	4.10	4.83	5.55	6.26	5.99
	14	0.30	0.56	1.04	1.50	1.95	2.38	3.22	4.04	4.44	5.23	6.01	6.78	6.70
	15	0.32	0.60	1.12	1.62	2.10	2.56	3.47	4.35	4.78	5.64	6.47	7.30	7.43
	16	0.35	0.65	1.20	1.74	2.25	2.75	3.72	4.66	5.13	6.04	6.94	7.83	8.18
	17	0.37	0.69	1.29	1.85	2.40	2.93	3.97	4.98	5.48	6.45	7.41	8.36	8.96
	18	0.39	0.73	1.37	1.97	2.55	3.12	4.22	5.30	5.82	6.86	7.88	8.89	9.76
	19	0.42	0.78	1.45	2.09	2.71	3.31	4.48	5.62	6.17	7.27	8.36	9.42	10.5
	20	0.44	0.82	1.53	2.21	2.86	3.50	4.73	5.94	6.53	7.69	8.83	9.96	11.1
	21	0.46	0.87	1.62	2.33	3.02	3.69	4.99	6.26	6.88	8.11	9.31	10.5	11.7
	22	0.49	0.91	1.70	2.45	3.17	3.88	5.25	6.58	7.23	8.52	9.79	11.0	12.3
	23	0.51	0.96	1.78	2.57	3.33	4.07	5.51	6.90	7.59	8.94	10.3	11.6	12.9
	24	0.54	1.00	1.87	2.69	3.48	4.26	5.76	7.23	7.95	9.36	10.8	12.1	13.5
	25	0.56	1.05	1.95	2.81	3.64	4.45	6.02	7.55	8.30	9.78	11.2	12.7	14.1
26	0.58	1.09	2.04	2.93	3.80	4.64	6.28	7.88	8.66	10.2	11.7	13.2	14.7	
28	0.63	1.18	2.20	3.18	4.11	5.03	6.81	8.54	9.39	11.1	12.7	14.3	15.9	
30	0.68	1.27	2.38	3.42	4.43	5.42	7.33	9.20	10.1	11.9	13.7	15.4	17.2	
32	0.73	1.36	2.55	3.67	4.75	5.81	7.86	9.86	10.8	12.8	14.7	16.5	18.4	
35	0.81	1.50	2.81	4.04	5.24	6.40	8.66	10.9	11.9	14.1	16.2	18.2	20.3	
40	0.93	1.74	3.24	4.67	6.05	7.39	10.0	12.5	13.8	16.3	18.7	21.1	23.4	
45	1.06	1.97	3.68	5.30	6.87	8.40	11.4	14.2	15.7	18.5	21.2	23.9	26.6	
		Type A			Type B						Type C			

Table 9. Horsepower Ratings for Roller Chain-1986

	No. of Teeth Small Spkt.	Revolutions per Minute — Small Sprocket ^a												
		10	25	50	100	200	300	400	500	700	900	1000	1200	1400
		Horsepower Rating												
1/2-inch Pitch Light Weight Machinery Roller Chain — No. 41	11	0.03	0.07	0.13	0.24	0.44	0.64	0.82	1.01	1.37	1.71	1.88	1.71	1.36
	12	0.03	0.07	0.14	0.26	0.49	0.70	0.91	1.11	1.50	1.88	2.07	1.95	1.55
	13	0.04	0.08	0.15	0.28	0.53	0.76	0.99	1.21	1.63	2.05	2.25	2.20	1.75
	14	0.04	0.09	0.16	0.31	0.57	0.83	1.07	1.31	1.77	2.22	2.44	2.46	1.95
	15	0.04	0.09	0.18	0.33	0.62	0.89	1.15	1.41	1.91	2.39	2.63	2.73	2.17
	16	0.04	0.10	0.19	0.36	0.66	0.95	1.24	1.51	2.05	2.57	2.82	3.01	2.39
	17	0.05	0.11	0.20	0.38	0.71	1.02	1.32	1.61	2.18	2.74	3.01	3.29	2.61
	18	0.05	0.12	0.22	0.40	0.75	1.08	1.40	1.72	2.32	2.91	3.20	3.59	2.85
	19	0.05	0.12	0.23	0.43	0.80	1.15	1.49	1.82	2.46	3.09	3.40	3.89	3.09
	20	0.06	0.13	0.24	0.45	0.84	1.21	1.57	1.92	2.60	3.26	3.59	4.20	3.33
	21	0.06	0.14	0.26	0.48	0.89	1.28	1.66	2.03	2.74	3.44	3.78	4.46	3.59
	22	0.06	0.14	0.27	0.50	0.93	1.35	1.74	2.13	2.89	3.62	3.98	4.69	3.85
	23	0.06	0.15	0.28	0.53	0.98	1.41	1.83	2.24	3.03	3.80	4.17	4.92	4.11
	24	0.07	0.16	0.29	0.55	1.03	1.48	1.92	2.34	3.17	3.97	4.37	5.15	4.38
	25	0.07	0.17	0.31	0.57	1.07	1.55	2.00	2.45	3.31	4.15	4.57	5.38	4.66
	26	0.07	0.17	0.32	0.60	1.12	1.61	2.09	2.55	3.46	4.33	4.76	5.61	4.94
	28	0.08	0.19	0.35	0.65	1.21	1.75	2.26	2.77	3.74	4.69	5.16	6.08	5.52
	30	0.08	0.20	0.38	0.70	1.31	1.88	2.44	2.98	4.03	5.06	5.56	6.55	6.13
	32	0.09	0.22	0.40	0.75	1.40	2.02	2.61	3.20	4.33	5.42	5.96	7.03	6.75
	35	0.10	0.24	0.44	0.83	1.54	2.22	2.88	3.52	4.76	5.97	6.57	7.74	7.72
40	0.12	0.27	0.51	0.96	1.78	2.57	3.33	4.07	5.50	6.90	7.59	8.94	9.43	
45	0.14	0.31	0.58	1.08	2.02	2.92	3.78	4.62	6.25	7.84	8.62	10.2	11.3	
		Type A				Type B					Type C			
	No. of Teeth Small Spkt.	Revolutions per Minute — Small Sprocket ^a												
		25	50	100	200	300	400	500	700	900	1000	1200	1400	1600
		Horsepower Rating												
5/8-inch Pitch Standard Single-Strand Roller Chain — No. 50	11	0.24	0.45	0.84	1.56	2.25	2.92	3.57	4.83	6.06	6.66	7.85	8.13	6.65
	12	0.26	0.49	0.92	1.72	2.47	3.21	3.92	5.31	6.65	7.31	8.62	9.26	7.58
	13	0.29	0.54	1.00	1.87	2.70	3.50	4.27	5.78	7.25	7.97	9.40	10.4	8.55
	14	0.31	0.58	1.09	2.03	2.92	3.79	4.63	6.27	7.86	8.64	10.2	11.7	9.55
	15	0.34	0.63	1.17	2.19	3.15	4.08	4.99	6.75	8.47	9.31	11.0	12.6	10.6
	16	0.36	0.67	1.26	2.34	3.38	4.37	5.35	7.24	9.08	9.98	11.8	13.5	11.7
	17	0.39	0.72	1.34	2.50	3.61	4.67	5.71	7.73	9.69	10.7	12.6	14.4	12.8
	18	0.41	0.76	1.43	2.66	3.83	4.97	6.07	8.22	10.3	11.3	13.4	15.3	13.9
	19	0.43	0.81	1.51	2.82	4.07	5.27	6.44	8.72	10.9	12.0	14.2	16.3	15.1
	20	0.46	0.86	1.60	2.98	4.30	5.57	6.80	9.21	11.5	12.7	15.0	17.2	16.3
	21	0.48	0.90	1.69	3.14	4.53	5.87	7.17	9.71	12.2	13.4	15.8	18.1	17.6
	22	0.51	0.95	1.77	3.31	4.76	6.17	7.54	10.2	12.8	14.1	16.6	19.1	18.8
	23	0.53	1.00	1.86	3.47	5.00	6.47	7.91	10.7	13.4	14.8	17.4	20.0	20.1
	24	0.56	1.04	1.95	3.63	5.23	6.78	8.29	11.2	14.1	15.5	18.2	20.9	21.4
	25	0.58	1.09	2.03	3.80	5.47	7.08	8.66	11.7	14.7	16.2	19.0	21.9	22.8
	26	0.61	1.14	2.12	3.96	5.70	7.39	9.03	12.2	15.3	16.9	19.9	22.8	24.2
	28	0.66	1.23	2.30	4.29	6.18	8.01	9.79	13.2	16.6	18.3	21.5	24.7	27.0
	30	0.71	1.33	2.48	4.62	6.66	8.63	10.5	14.3	17.9	19.7	23.2	26.6	30.0
	32	0.76	1.42	2.66	4.96	7.14	9.25	11.3	15.3	19.2	21.1	24.9	28.6	32.2
	35	0.84	1.57	2.93	5.46	7.86	10.2	12.5	16.9	21.1	23.2	27.4	31.5	35.5
40	0.97	1.81	3.38	6.31	9.08	11.8	14.4	19.5	24.4	26.8	31.6	36.3	41.0	
45	1.10	2.06	3.84	7.16	10.3	13.4	16.3	22.1	27.7	30.5	35.9	41.3	46.5	
		Type A			Type B					Type C				

Table 9. Horsepower Ratings for Roller Chain-1986

	No. of Teeth Small Spkt.	Revolutions per Minute — Small Sprocket ^a												
		25	50	100	150	200	300	400	500	600	700	800	900	1000
		Horsepower Rating												
3/4-inch Pitch Standard Single-Strand Roller Chain — No. 60	11	0.41	0.77	1.44	2.07	2.69	3.87	5.02	6.13	7.23	8.30	9.36	10.4	11.4
	12	0.45	0.85	1.58	2.28	2.95	4.25	5.51	6.74	7.94	9.12	10.3	11.4	12.6
	13	0.50	0.92	1.73	2.49	3.22	4.64	6.01	7.34	8.65	9.94	11.2	12.5	13.7
	14	0.54	1.00	1.87	2.69	3.49	5.02	6.51	7.96	9.37	10.8	12.1	13.5	14.8
	15	0.58	1.08	2.01	2.90	3.76	5.41	7.01	8.57	10.1	11.6	13.1	14.5	16.0
	16	0.62	1.16	2.16	3.11	4.03	5.80	7.52	9.19	10.8	12.4	14.0	15.6	17.1
	17	0.66	1.24	2.31	3.32	4.30	6.20	8.03	9.81	11.6	13.3	15.0	16.7	18.3
	18	0.70	1.31	2.45	3.53	4.58	6.59	8.54	10.4	12.3	14.1	15.9	17.7	19.5
	19	0.75	1.39	2.60	3.74	4.85	6.99	9.05	11.1	13.0	15.0	16.9	18.8	20.6
	20	0.79	1.47	2.75	3.96	5.13	7.38	9.57	11.7	13.8	15.8	17.9	19.8	21.8
	21	0.83	1.55	2.90	4.17	5.40	7.78	10.1	12.3	14.5	16.7	18.8	20.9	23.0
	22	0.87	1.63	3.05	4.39	5.68	8.19	10.6	13.0	15.3	17.5	19.8	22.0	24.2
	23	0.92	1.71	3.19	4.60	5.96	8.59	11.1	13.6	16.0	18.4	20.8	23.1	25.4
	24	0.96	1.79	3.35	4.82	6.24	8.99	11.6	14.2	16.8	19.3	21.7	24.2	26.6
	25	1.00	1.87	3.50	5.04	6.52	9.40	12.2	14.9	17.5	20.1	22.7	25.3	27.8
	26	1.05	1.95	3.65	5.25	6.81	9.80	12.7	15.5	18.3	21.0	23.7	26.4	29.0
	28	1.13	2.12	3.95	5.69	7.37	10.6	13.8	16.8	19.8	22.8	25.7	28.5	31.4
	30	1.22	2.28	4.26	6.13	7.94	11.4	14.8	18.1	21.4	24.5	27.7	30.8	33.8
32	1.31	2.45	4.56	6.57	8.52	12.3	15.9	19.4	22.9	26.3	29.7	33.0	36.3	
35	1.44	2.69	5.03	7.24	9.38	13.5	17.5	21.4	25.2	29.0	32.7	36.3	39.9	
40	1.67	3.11	5.81	8.37	10.8	15.6	20.2	24.7	29.1	33.5	37.7	42.0	46.1	
45	1.89	3.53	6.60	9.50	12.3	17.7	23.0	28.1	33.1	38.0	42.9	47.7	52.4	
		Type A			Type B					Type C				
1-inch Pitch Standard Single-Strand Roller Chain — No. 80		Revolutions per Minute — Small Sprocket ^a												
		25	50	100	150	200	300	400	500	600	700	800	900	1000
		Horsepower Ratings												
	11	0.97	1.80	3.36	4.84	6.28	9.04	11.7	14.3	16.9	19.4	21.9	23.0	19.6
	12	1.06	1.98	3.69	5.32	6.89	9.93	12.9	15.7	18.5	21.3	24.0	26.2	22.3
	13	1.16	2.16	4.03	5.80	7.52	10.8	14.0	17.1	20.2	23.2	26.2	29.1	25.2
	14	1.25	2.34	4.36	6.29	8.14	11.7	15.2	18.6	21.9	25.1	28.4	31.5	28.2
	15	1.35	2.52	4.70	6.77	8.77	12.6	16.4	20.0	23.6	27.1	30.6	34.0	31.2
	16	1.45	2.70	5.04	7.26	9.41	13.5	17.6	21.5	25.3	29.0	32.8	36.4	34.4
	17	1.55	2.88	5.38	7.75	10.0	14.5	18.7	22.9	27.0	31.0	35.0	38.9	37.7
	18	1.64	3.07	5.72	8.25	10.7	15.4	19.9	24.4	28.7	33.0	37.2	41.4	41.1
	19	1.74	3.25	6.07	8.74	11.3	16.3	21.1	25.8	30.4	35.0	39.4	43.8	44.5
	20	1.84	3.44	6.41	9.24	12.0	17.2	22.3	27.3	32.2	37.0	41.7	46.3	48.1
	21	1.94	3.62	6.76	9.74	12.6	18.2	23.5	28.8	33.9	39.0	43.9	48.9	51.7
	22	2.04	3.81	7.11	10.2	13.3	19.1	24.8	30.3	35.7	41.0	46.2	51.4	55.5
	23	2.14	4.00	7.46	10.7	13.9	20.1	26.0	31.8	37.4	43.0	48.5	53.9	59.3
	24	2.24	4.19	7.81	11.3	14.6	21.0	27.2	33.2	39.2	45.0	50.8	56.4	62.0
	25	2.34	4.37	8.16	11.8	15.2	21.9	28.4	34.7	40.9	47.0	53.0	59.0	64.8
26	2.45	4.56	8.52	12.3	15.9	22.9	29.7	36.2	42.7	49.1	55.3	61.5	67.6	
28	2.65	4.94	9.23	13.3	17.2	24.8	32.1	39.3	46.3	53.2	59.9	66.7	73.3	
30	2.85	5.33	9.94	14.3	18.5	26.7	34.6	42.3	49.9	57.3	64.6	71.8	78.9	
32	3.06	5.71	10.7	15.3	19.9	28.6	37.1	45.4	53.5	61.4	69.2	77.0	84.6	
35	3.37	6.29	11.7	16.9	21.9	31.6	40.9	50.0	58.9	67.6	76.3	84.8	93.3	
40	3.89	7.27	13.6	19.5	25.3	36.4	47.2	57.7	68.0	78.1	88.1	99.0	108	
45	4.42	8.25	15.4	22.2	28.7	41.4	53.6	65.6	77.2	88.7	100	111	122	
		Type A		Type B					Type C					

Table 9. Horsepower Ratings for Roller Chain-1986

	No. of Teeth Small Spkt.	Revolutions per Minute — Small Sprocket ^a													
		10	25	50	100	150	200	300	400	500	600	700	800	900	
		Horsepower Rating													
1 1/2-inch Pitch Standard Single-Strand Roller Chain — No. 100	11	0.81	1.85	3.45	6.44	9.28	12.0	17.3	22.4	27.4	32.3	37.1	32.8	27.5	
	12	0.89	2.03	3.79	7.08	10.2	13.2	19.0	24.6	30.1	35.5	40.8	37.3	31.3	
	13	0.97	2.22	4.13	7.72	11.1	14.4	20.7	26.9	32.8	38.7	44.5	42.1	35.3	
	14	1.05	2.40	4.48	8.36	12.0	15.6	22.5	29.1	35.6	41.9	48.2	47.0	39.4	
	15	1.13	2.59	4.83	9.01	13.0	16.8	24.2	31.4	38.3	45.2	51.9	52.2	43.7	
	16	1.22	2.77	5.17	9.66	13.9	18.0	26.0	33.6	41.1	48.4	55.6	57.5	48.2	
	17	1.30	2.96	5.52	10.3	14.8	19.2	27.7	35.9	43.9	51.7	59.4	63.0	52.8	
	18	1.38	3.15	5.88	11.0	15.8	20.5	29.5	38.2	46.7	55.0	63.2	68.6	57.5	
	19	1.46	3.34	6.23	11.6	16.7	21.7	31.2	40.5	49.5	58.3	67.0	74.4	62.3	
	20	1.55	3.53	6.58	12.3	17.7	22.9	33.0	42.8	52.3	61.6	70.8	79.8	67.3	
	21	1.63	3.72	6.94	13.0	18.7	24.2	34.8	45.1	55.1	65.0	74.6	84.2	72.4	
	22	1.71	3.91	7.30	13.6	19.6	25.4	36.6	47.4	58.0	68.3	78.5	88.5	77.7	
	23	1.80	4.10	7.66	14.3	20.6	26.7	38.4	49.8	60.8	71.7	82.3	92.8	83.0	
	24	1.88	4.30	8.02	15.0	21.5	27.9	40.2	52.1	63.7	75.0	86.2	97.2	88.5	
	25	1.97	4.49	8.38	15.6	22.5	29.2	42.0	54.4	66.6	78.4	90.1	102	94.1	
	26	2.05	4.68	8.74	16.3	23.5	30.4	43.8	56.8	69.4	81.8	94.0	106	99.8	
	28	2.22	5.07	9.47	17.7	25.5	33.0	47.5	61.5	75.2	88.6	102	115	112	
	30	2.40	5.47	10.2	19.0	27.4	35.5	51.2	66.3	81.0	95.5	110	124	124	
	32	2.57	5.86	10.9	20.4	29.4	38.1	54.9	71.1	86.9	102	118	133	136	
	35	2.83	6.46	12.0	22.5	32.4	42.0	60.4	78.3	95.7	113	130	146	156	
40	3.27	7.46	13.9	26.0	37.4	48.5	69.8	90.4	111	130	150	169	188		
45	3.71	8.47	15.8	29.5	42.5	55.0	79.3	103	126	148	170	192	213		
		Type A			Type B				Type C						
1 1/2-inch Pitch Standard Single-Strand Roller Chain — No. 120	11	1.37	3.12	5.83	10.9	15.7	20.3	29.2	37.9	46.3	54.6	46.3	37.9	31.8	
	12	1.50	3.43	6.40	11.9	17.2	22.3	32.1	41.6	50.9	59.9	52.8	43.2	36.2	
	13	1.64	3.74	6.98	13.0	18.8	24.3	35.0	45.4	55.5	65.3	59.5	48.7	40.8	
	14	1.78	4.05	7.56	14.1	20.3	26.3	37.9	49.1	60.1	70.8	66.5	54.4	45.6	
	15	1.91	4.37	8.15	15.2	21.9	28.4	40.9	53.0	64.7	76.3	73.8	60.4	50.6	
	16	2.05	4.68	8.74	16.3	23.5	30.4	43.8	56.8	69.4	81.8	81.3	66.5	55.7	
	17	2.19	5.00	9.33	17.4	25.1	32.5	46.8	60.6	74.1	87.3	89.0	72.8	61.0	
	18	2.33	5.32	9.92	18.5	26.7	34.6	49.8	64.5	78.8	92.9	97.0	79.4	66.5	
	19	2.47	5.64	10.5	19.6	28.3	36.6	52.8	68.4	83.6	98.5	105	86.1	72.1	
	20	2.61	5.96	11.1	20.7	29.9	38.7	55.8	72.2	88.3	104	114	92.9	77.9	
	21	2.75	6.28	11.7	21.9	31.5	40.8	58.8	76.2	93.1	110	122	100	83.8	
	22	2.90	6.60	12.3	23.0	33.1	42.9	61.8	80.1	97.9	115	131	107	89.9	
	23	3.04	6.93	12.9	24.1	34.8	45.0	64.9	84.0	103	121	139	115	96.1	
	24	3.18	7.25	13.5	25.3	36.4	47.1	67.9	88.0	108	127	146	122	102	
	25	3.32	7.58	14.1	26.4	38.0	49.3	71.0	91.9	112	132	152	130	109	
	26	3.47	7.91	14.8	27.5	39.7	51.4	74.0	95.9	117	138	159	138	115	
	28	3.76	8.57	16.0	29.8	43.0	55.7	80.2	104	127	150	172	154	129	
	30	4.05	9.23	17.2	32.1	46.3	60.0	86.4	112	137	161	185	171	143	
	32	4.34	9.90	18.5	34.5	49.6	64.3	92.6	120	147	173	199	188	158	
	35	4.78	10.9	20.3	38.0	54.7	70.9	102	132	162	190	219	215	180	
40	5.52	12.6	23.5	43.9	63.2	81.8	118	153	187	220	253		
45	6.27	14.3	26.7	49.8	71.7	92.9	134	173	212	250	287		
		Type A			Type B				Type C						

^a For lower or higher rpm, larger chain sizes, and rpm above 3500, see B29.1M-1993. For use of table see page 2547.

Table 10. Recommended Roller Chain Sprocket Maximum Bore and Hub Diameters

Roller Chain Pitch										
No. of Teeth	$\frac{3}{8}$		$\frac{1}{2}$		$\frac{5}{8}$		$\frac{3}{4}$		1	
	Max. Bore	Max. Hub Dia.	Max. Bore	Max. Hub Dia.	Max. Bore	Max. Hub Dia.	Max. Bore	Max. Hub Dia.	Max. Bore	Max. Hub Dia.
11	$\frac{19}{32}$	$\frac{55}{64}$	$\frac{25}{32}$	$\frac{11}{16}$	$\frac{3}{16}$	$\frac{15}{32}$	$\frac{1}{4}$	$\frac{19}{64}$	$\frac{1}{8}$	$\frac{23}{8}$
12	$\frac{5}{8}$	$\frac{63}{64}$	$\frac{7}{8}$	$\frac{12}{16}$	$\frac{5}{32}$	$\frac{143}{64}$	$\frac{19}{32}$	$\frac{2}{64}$	$\frac{125}{32}$	$\frac{245}{64}$
13	$\frac{3}{4}$	$\frac{17}{64}$	1	$\frac{1}{2}$	$\frac{19}{32}$	$\frac{17}{8}$	$\frac{1}{2}$	$\frac{2}{4}$	2	$\frac{3}{64}$
14	$\frac{27}{32}$	$\frac{15}{64}$	$\frac{5}{32}$	$\frac{21}{32}$	$\frac{5}{16}$	$\frac{25}{64}$	$\frac{1}{4}$	$\frac{2}{2}$	$\frac{29}{32}$	$\frac{311}{32}$
15	$\frac{7}{8}$	$\frac{123}{64}$	$\frac{1}{4}$	$\frac{13}{16}$	$\frac{17}{32}$	$\frac{29}{32}$	$\frac{125}{32}$	$\frac{23}{4}$	$\frac{213}{32}$	$\frac{343}{64}$
16	$\frac{31}{32}$	$\frac{115}{32}$	$\frac{19}{32}$	$\frac{63}{64}$	$\frac{11}{16}$	$\frac{231}{64}$	$\frac{131}{32}$	$\frac{263}{64}$	$\frac{223}{32}$	$\frac{363}{64}$
17	$\frac{13}{32}$	$\frac{199}{32}$	$\frac{3}{8}$	$\frac{29}{64}$	$\frac{125}{32}$	$\frac{211}{16}$	$\frac{27}{32}$	$\frac{37}{32}$	$\frac{213}{16}$	$\frac{45}{16}$
18	$\frac{17}{32}$	$\frac{123}{32}$	$\frac{17}{32}$	$\frac{219}{64}$	$\frac{17}{8}$	$\frac{257}{64}$	$\frac{29}{32}$	$\frac{315}{32}$	$\frac{3}{8}$	$\frac{41}{64}$
19	$\frac{1}{4}$	$\frac{127}{32}$	$\frac{11}{16}$	$\frac{229}{64}$	$\frac{27}{16}$	$\frac{35}{64}$	$\frac{27}{16}$	$\frac{35}{64}$	$\frac{35}{16}$	$\frac{461}{64}$
20	$\frac{19}{32}$	$\frac{61}{64}$	$\frac{125}{32}$	$\frac{25}{8}$	$\frac{27}{4}$	$\frac{39}{32}$	$\frac{211}{16}$	$\frac{39}{64}$	$\frac{3}{2}$	$\frac{5}{32}$
21	$\frac{5}{16}$	$\frac{25}{64}$	$\frac{125}{32}$	$\frac{225}{32}$	$\frac{29}{32}$	$\frac{331}{64}$	$\frac{213}{16}$	$\frac{43}{16}$	$\frac{33}{4}$	$\frac{519}{32}$
22	$\frac{17}{16}$	$\frac{213}{16}$	$\frac{15}{16}$	$\frac{215}{16}$	$\frac{27}{16}$	$\frac{311}{16}$	$\frac{215}{16}$	$\frac{47}{16}$	$\frac{37}{8}$	$\frac{559}{64}$
23	$\frac{9}{16}$	$\frac{25}{16}$	$\frac{23}{32}$	$\frac{33}{32}$	$\frac{25}{8}$	$\frac{357}{64}$	$\frac{3}{8}$	$\frac{43}{64}$	$\frac{43}{16}$	$\frac{615}{64}$
24	$\frac{11}{16}$	$\frac{27}{16}$	$\frac{27}{4}$	$\frac{317}{64}$	$\frac{213}{16}$	$\frac{43}{64}$	$\frac{3}{4}$	$\frac{429}{32}$	$\frac{47}{16}$	$\frac{67}{16}$
25	$\frac{13}{4}$	$\frac{29}{16}$	$\frac{29}{32}$	$\frac{327}{64}$	$\frac{227}{32}$	$\frac{49}{32}$	$\frac{33}{8}$	$\frac{53}{32}$	$\frac{411}{16}$	$\frac{67}{8}$
Roller Chain Pitch										
No. of Teeth	$\frac{1}{4}$		$\frac{1}{2}$		$\frac{3}{4}$		2		$2\frac{1}{2}$	
	Max. Bore	Max. Hub Dia.	Max. Bore	Max. Hub Dia.	Max. Bore	Max. Hub Dia.	Max. Bore	Max. Hub Dia.	Max. Bore	Max. Hub Dia.
11	$\frac{131}{32}$	$\frac{231}{32}$	$\frac{25}{16}$	$\frac{37}{64}$	$\frac{213}{16}$	$\frac{411}{64}$	$\frac{39}{32}$	$\frac{425}{32}$	$\frac{315}{16}$	$\frac{563}{64}$
12	$\frac{29}{32}$	$\frac{33}{8}$	$\frac{23}{4}$	$\frac{41}{16}$	$\frac{37}{4}$	$\frac{43}{4}$	$\frac{35}{8}$	$\frac{527}{64}$	$\frac{423}{32}$	$\frac{631}{64}$
13	$\frac{217}{32}$	$\frac{325}{32}$	$\frac{37}{16}$	$\frac{435}{64}$	$\frac{39}{16}$	$\frac{55}{16}$	$\frac{47}{16}$	$\frac{65}{64}$	$\frac{53}{32}$	$\frac{739}{64}$
14	$\frac{211}{16}$	$\frac{43}{16}$	$\frac{35}{16}$	$\frac{51}{32}$	$\frac{37}{8}$	$\frac{57}{8}$	$\frac{411}{16}$	$\frac{623}{32}$	$\frac{523}{32}$	$\frac{827}{64}$
15	$\frac{33}{32}$	$\frac{419}{32}$	$\frac{33}{4}$	$\frac{533}{64}$	$\frac{47}{16}$	$\frac{629}{64}$	$\frac{47}{8}$	$\frac{73}{8}$	$\frac{67}{4}$	$\frac{973}{32}$
16	$\frac{39}{32}$	5	4	6	$\frac{411}{16}$	$\frac{77}{64}$	$\frac{51}{2}$	$\frac{87}{64}$	7	$\frac{1013}{32}$
17	$\frac{321}{32}$	$\frac{513}{32}$	$\frac{415}{32}$	$\frac{631}{64}$	$\frac{57}{16}$	$\frac{737}{64}$	$\frac{511}{16}$	$\frac{823}{32}$	$\frac{77}{16}$	$\frac{1027}{32}$
18	$\frac{325}{32}$	$\frac{551}{64}$	$\frac{421}{32}$	$\frac{631}{32}$	$\frac{55}{8}$	$\frac{89}{64}$	$\frac{67}{4}$	$\frac{95}{16}$	$\frac{87}{8}$	$\frac{1141}{64}$
19	$\frac{43}{16}$	$\frac{613}{64}$	$\frac{415}{16}$	$\frac{729}{64}$	$\frac{517}{16}$	$\frac{845}{64}$	$\frac{67}{8}$	$\frac{99}{64}$	9	$\frac{1271}{16}$
20	$\frac{419}{32}$	$\frac{639}{64}$	$\frac{57}{16}$	$\frac{715}{16}$	$\frac{67}{4}$	$\frac{917}{64}$	7	$\frac{1019}{32}$	$\frac{93}{4}$	$\frac{1371}{4}$
21	$\frac{411}{16}$	7	$\frac{511}{16}$	$\frac{827}{64}$	$\frac{613}{16}$	$\frac{953}{64}$	$\frac{73}{4}$	$\frac{1115}{64}$	10	$\frac{1437}{64}$
22	$\frac{47}{8}$	$\frac{713}{32}$	$\frac{57}{8}$	$\frac{857}{64}$	$\frac{77}{4}$	$\frac{1025}{64}$	$\frac{83}{8}$	$\frac{117}{8}$	$\frac{107}{8}$	$\frac{1427}{32}$
23	$\frac{55}{16}$	$\frac{713}{16}$	$\frac{63}{8}$	$\frac{93}{8}$	$\frac{77}{16}$	$\frac{1015}{16}$	9	$\frac{1233}{64}$	$\frac{115}{8}$	$\frac{1527}{32}$
24	$\frac{511}{16}$	$\frac{813}{64}$	$\frac{613}{16}$	$\frac{955}{64}$	8	$\frac{111}{2}$	$\frac{95}{8}$	$\frac{133}{32}$	13	$\frac{1629}{64}$
25	$\frac{523}{32}$	$\frac{839}{64}$	$\frac{77}{4}$	$\frac{1011}{32}$	$\frac{89}{16}$	$\frac{121}{16}$	$\frac{107}{4}$	$\frac{1351}{64}$	$\frac{131}{2}$	$\frac{177}{4}$

All dimensions in inches.

For standard key dimensions see pages 2460 through 2473.

Source: American Chain Association.

Center Distance between Sprockets.—The center-to-center distance between sprockets, as a general rule, should not be less than $1\frac{1}{2}$ times the diameter of the larger sprocket and not less than thirty times the pitch nor more than about 50 times the pitch, although much depends upon the speed and other conditions. A center distance equivalent to 80 pitches may be considered an approved maximum. Very long center distances result in catenary tension in the chain. If roller-chain drives are designed correctly, the center-to-center distance for some transmissions may be so short that the sprocket teeth nearly touch each other, assuming that the load is not too great and the number of teeth is not too small. To

avoid interference of the sprocket teeth, the center distance must, of course, be somewhat greater than one-half the sum of the outside diameters of the sprockets. The chain should extend around at least 120 degrees of the pinion circumference, and this minimum amount of contact is obtained for all center distances provided the ratio is less than $3\frac{1}{2}$ to 1. Other things being equal, a fairly long chain is recommended in preference to the shortest one allowed by the sprocket diameters, because the rate of chain elongation due to natural wear is inversely proportional to the length, and also because the greater elasticity of the longer strand tends to absorb irregularities of motion and to decrease the effect of shocks.

If possible, the center distance should be adjustable in order to take care of slack due to elongation from wear and this range of adjustment should be at least one and one-half pitches. A little slack is desirable as it allows the chain links to take the best position on the sprocket teeth and reduces the wear on the bearings. Too much sag or an excessive distance between the sprockets may cause the chain to whip up and down — a condition detrimental to smooth running and very destructive to the chain. The sprockets should run in a vertical plane, the sprocket axes being approximately horizontal, unless an idler is used on the slack side to keep the chain in position. The most satisfactory results are obtained when the slack side of the chain is on the bottom.

Center Distance for a Given Chain Length.—When the distance between the driving and driven sprockets can be varied to suit the length of the chain, this center distance for a tight chain may be determined by the following formula, in which c = center-to-center distance in inches; L = chain length in pitches; P = pitch of chain; N = number of teeth in large sprocket; n = number of teeth in small sprocket.

$$c = \frac{P}{8}(2L - N - n + \sqrt{(2L - N - n)^2 - 0.810(N - n)^2})$$

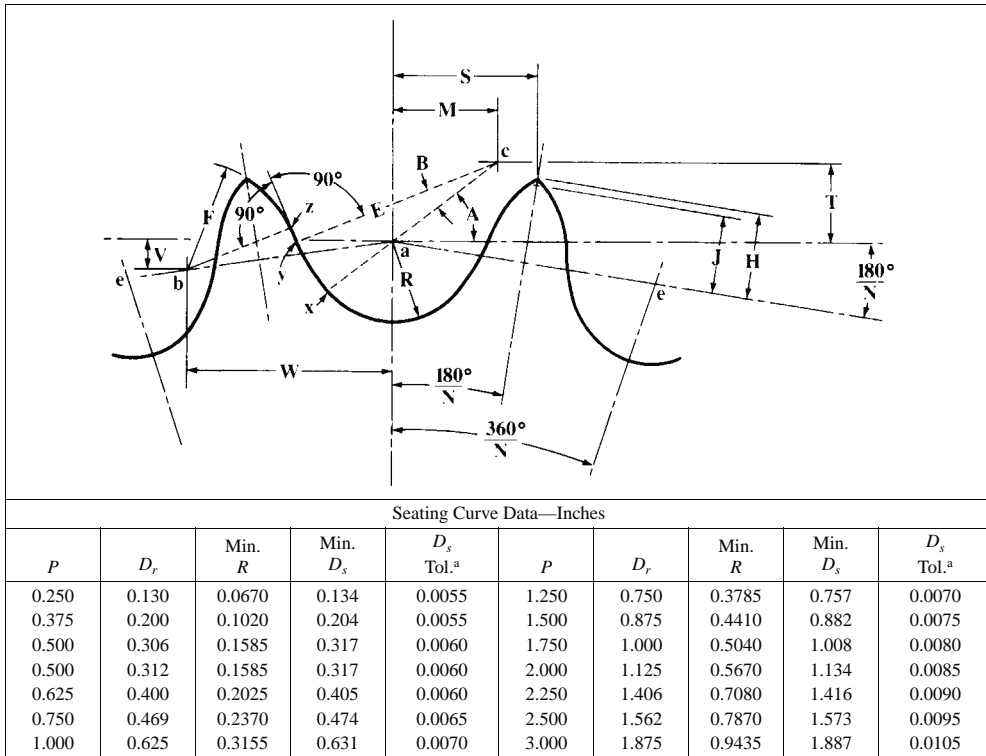
This formula is approximate, but the error is less than the variation in the length of the best chains. The length L in pitches should be an even number for a roller chain, so that the use of an offset connecting link will not be necessary.

Idler Sprockets.—When sprockets have a fixed center distance or are non-adjustable, it may be advisable to use an idler sprocket for taking up the slack. The idler should preferably be placed against the slack side between the two strands of the chain. When a sprocket is applied to the tight side of the chain to reduce vibration, it should be on the lower side and so located that the chain will run in a straight line between the two main sprockets. A sprocket will wear excessively if the number of teeth is too small and the speed too high, because there is impact between the teeth and rollers even though the idler carries practically no load.

Length of Driving Chain.—The total length of a block chain should be given in multiples of the pitch, whereas for a roller chain, the length should be in multiples of twice the pitch, because the ends must be connected with an outside and inside link. The length of a chain can be calculated accurately enough for ordinary practice by the use of the following formula, in which L = chain length in pitches; C = center distance in pitches; N = number of teeth in large sprocket; n = number of teeth in small sprocket:

$$L = 2C + \frac{N}{2} + \frac{n}{2} + \left(\frac{N-n}{2\pi}\right)^2 \times \frac{1}{C}$$

Table 11. ANSI Sprocket Tooth Form for Roller Chain ANSI/ASME B29.1M-1993



^a Plus tolerance only.

$P = \text{pitch } (ae)$

$N = \text{number of teeth } D_r = \text{nominal roller diameter}$

$D_s = \text{seating curve diameter} = 1.005 D_r + 0.003 \text{ (in inches)}$

$R = \frac{1}{2} D_s \text{ (} D_s \text{ has only plus tolerance)}$

$A = 35^\circ + (60^\circ \div N) \quad B = 18^\circ - (56^\circ \div N) \quad ac = 0.8 D_r$

$M = 0.8 D_r \cos (35^\circ + (60^\circ \div N))$

$T = 0.8 D_r \sin (35^\circ + (60^\circ \div N))$

$E = 1.3025 D_r + 0.0015 \text{ (in inches)}$

$\text{Chord } xy = (2.605 D_r + 0.003) \sin (9^\circ - (28^\circ \div N)) \text{ (in inches)}$

$yz = D_r [1.4 \sin (17^\circ - (64^\circ \div N)) - 0.8 \sin (18^\circ - (56^\circ \div N))]$

$\text{Length of a line between } a \text{ and } b = 1.4 D_r$

$W = 1.4 D_r \cos (180^\circ \div N); \quad V = 1.4 D_r \sin (180^\circ \div N)$

$F = D_r [0.8 \cos (18^\circ - (56^\circ \div N)) + 1.4 \cos (17^\circ - (64^\circ \div N)) - 1.3025] - 0.0015 \text{ inch}$

$H = \sqrt{F^2 - (1.4 D_r - 0.5 P)^2}$

$S = 0.5 P \cos (180^\circ \div N) + H \sin (180^\circ \div N)$

$\text{Approximate O.D. of sprocket when } J \text{ is } 0.3 P = P [0.6 + \cot (180^\circ \div N)]$

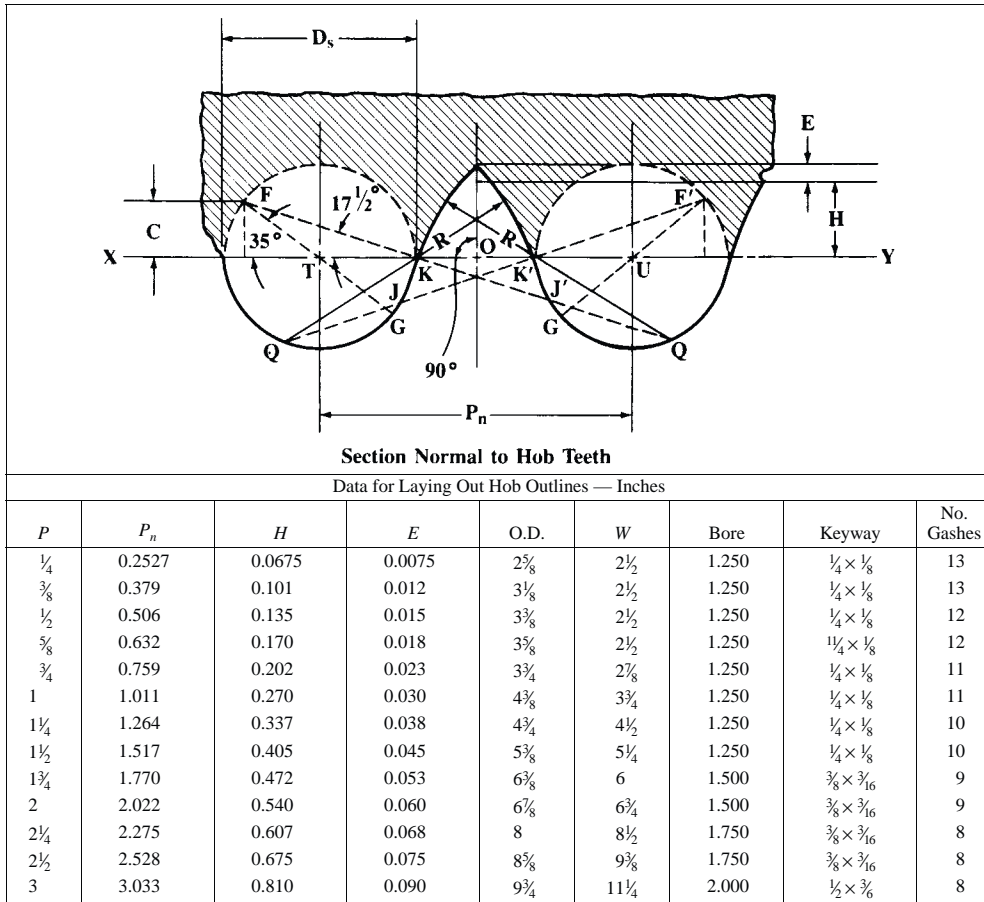
$\text{O.D. of sprocket when tooth is pointed} = P \cot (180^\circ \div N) + \cos (180^\circ \div N) (D_s - D_r) + 2H$

$\text{Pressure angle for new chain} = xab = 35^\circ - (120^\circ \div N)$

$\text{Minimum pressure angle} = xab - B = 17^\circ - (64^\circ \div N);$

$\text{Average pressure angle} = 26^\circ - (92^\circ \div N)$

Table 12. Standard Hob Design for Roller Chain Sprockets



Hobs designed for a given roller diameter (*D_r*) and chain pitch (*P*) will cut any number of teeth.

P = Pitch of Chain

P_n = Normal Pitch of Hob = 1.011 *P* inches

D_s = Minimum Diameter of Seating Curve = 1.005 *D_r* + 0.003 inches

F = Radius Center for Arc *GK*; *TO* = *OU* = *P_n* ÷ 2

H = 0.27 *P*; *E* = 0.03 *P* = Radius of Fillet Circle

Q is located on line passing through *F* and *J*. Point *J* is intersection of line *XY* with circle of diameter *D_s*. *R* is found by trial and the arc of this radius is tangent to arc *KG* at *K* and to fillet radius.

OD = Outside Diameter = 1.7 (Bore + *D_r* + 0.7 *P*) approx.

D_h = Pitch Diameter = *OD* - *D_s*; *M* = Helix Angle; sin *M* = *P_n* + π *D_h*

L = Lead = *P_n* ÷ cos *M*; *W* = Width = Not less than 2 × Bore, or 6 *D_r*, or 3.2 *P*

To the length obtained by this formula, add enough to make a whole number (and for a roller chain, an even number) of pitches. If a roller chain has an odd number of pitches, it will be necessary to use an offset connecting link.

Another formula for obtaining chain length in which *D* = distance between centers of shafts; *R* = pitch radius of large sprocket; *r* = pitch radius of small sprocket; *N* = number of teeth in large sprocket; *n* = number of teeth in small sprocket; *P* = pitch of chain and sprockets; and *l* = required chain length in inches, is:

$$l = \frac{180^\circ + 2\alpha}{360^\circ} NP + \frac{180^\circ - 2\alpha}{360^\circ} nP + 2D \cos \alpha \quad \text{where } \sin \alpha = \frac{R - r}{D}$$

Cutting Standard Sprocket Tooth Form.—The proportions and seating curve data for the standard sprocket tooth form for roller chain are given in Table 11. Either formed or generating types of sprocket cutters may be employed.

Hobs: Only one hob will be required to cut any number of teeth for a given pitch and roller diameter. All hobs should be marked with pitch and roller diameter to be cut. Formulas and data for standard hob design are given in Table 12.

Space Cutters: Five cutters of this type will be required to cut from 7 teeth up for any given roller diameter. The ranges are, respectively, 7-8, 9-11, 12-17, 18-34, and 35 teeth and over. If less than 7 teeth is necessary, special cutters conforming to the required number of teeth should be used.

The regular cutters are based upon an intermediate number of teeth N_a , equal to $2N_1N_2 \div (N_1 + N_2)$ in which N_1 = minimum number of teeth and N_2 = maximum number of teeth for which cutter is intended; but the topping curve radius F (see diagram in Table 13) is designed to produce adequate tooth height on a sprocket of N_2 teeth. The values of N_a for the several cutters are, respectively, 7.47, 9.9, 14.07, 23.54, and 56. Formulas and construction data for space cutter layout are given in Table 13 and recommended cutter sizes are given in Table 14.

Table 13. Standard Space Cutters for Roller-Chain Sprockets

Data for Laying Out Space Cutter				
Range of Teeth	M	T	W	V
7-8	$0.5848 D_r$	$0.5459 D_r$	$1.2790 D_r$	$0.5694 D_r$
9-11	$0.6032 D_r$	$0.5255 D_r$	$1.3302 D_r$	$0.4365 D_r$
12-17	$0.6194 D_r$	$0.5063 D_r$	$1.3694 D_r$	$0.2911 D_r$
18-34	$0.6343 D_r$	$0.4875 D_r$	$1.3947 D_r$	$0.1220 D_r$
35 up	$0.6466 D_r$	$0.4710 D_r$	$1.4000 D_r$	0
Range of Teeth	F	Chord xy	yz	Angle Yab
7-8	$0.8686 D_r - 0.0015$	$0.2384 D_r + 0.0003$	$0.0618 D_r$	24°
9-11	$0.8554 D_r - 0.0015$	$0.2800 D_r + 0.0003$	$0.0853 D_r$	$18^\circ 10'$
12-17	$0.8364 D_r - 0.0015$	$0.3181 D_r + 0.0004$	$0.1269 D_r$	12°
18-34	$0.8073 D_r - 0.0015$	$0.3540 D_r + 0.0004$	$0.1922 D_r$	5°
35 up	$0.7857 D_r - 0.0015$	$0.3850 D_r + 0.0004$	$0.2235 D_r$	0°

E (same for all ranges) = $1.3025 D_r + 0.0015$; G (same for all ranges) = $1.4 D_r$

See Table 14 for recommended cutter sizes.

Angle Yab is equal to $180^\circ \div N$ when the cutter is made for a specific number of teeth. For the design of cutters covering a range of teeth, angle Yab was determined by layout to ensure chain roller clearance and to avoid pointed teeth on the larger sprockets of each range. It has values as given below for cutters covering the range of teeth shown. The following formulas are for cutters covering the standard ranges of teeth where N_a equals intermediate values given on page 2556.

$$W = 1.4D_r \cos Yab \quad V = 1.4D_r \sin Yab$$

$$yz = D_r \left[1.4 \sin \left(17^\circ + \frac{116^\circ}{N_a} - Yab \right) - 0.8 \sin \left(18^\circ - \frac{56^\circ}{N_a} \right) \right]$$

$$F = D_r \left[0.8 \cos \left(18^\circ - \frac{56^\circ}{N_a} \right) + 1.4 \cos \left(17^\circ + \frac{116^\circ}{N_a} - Yab \right) - 1.3025 \right] - 0.0015 \text{ in.}$$

For other points, use the value of N_a for N in the standard formulas in Table 11.

Table 14. Recommended Space Cutter Sizes for Roller-Chain Sprockets

Pitch	Roller Dia.	Number of Teeth					
		6	7-8	9-11	12-17	18-34	35 up
		Cutter Diameter (Minimum)					
0.250	0.130	2.75	2.75	2.75	2.75	2.75	2.75
0.375	0.200	2.75	2.75	2.75	2.75	2.75	2.75
0.500	0.312	3.00	3.00	3.12	3.12	3.12	3.12
0.625	0.400	3.12	3.12	3.25	3.25	3.25	3.25
0.725	0.469	3.25	3.25	3.38	3.38	3.38	3.38
1.000	0.625	3.88	4.00	4.12	4.12	4.25	4.25
1.250	0.750	4.25	4.38	4.50	4.50	4.62	4.62
1.500	0.875	4.38	4.50	4.62	4.62	4.75	4.75
1.750	1.000	5.00	5.12	5.25	5.38	5.50	5.50
2.000	1.125	5.38	5.50	5.62	5.75	5.88	5.88
2.250	1.406	5.88	6.00	6.25	6.38	6.50	6.50
2.500	1.563	6.38	6.62	6.75	6.88	7.00	7.12
3.000	1.875	7.50	7.75	7.88	8.00	8.00	8.25
		Cutter Width (Minimum)					
0.250	0.130	0.31	0.31	0.31	0.31	0.28	0.28
0.375	0.200	0.47	0.47	0.47	0.44	0.44	0.41
0.500	0.312	0.75	0.75	0.75	0.75	0.72	0.69
0.625	0.400	0.75	0.75	0.75	0.75	0.72	0.69
0.750	0.469	0.91	0.91	0.91	0.88	0.84	0.81
1.000	0.625	1.50	1.50	1.47	1.47	1.41	1.34
1.250	0.750	1.81	1.81	1.78	1.75	1.69	1.62
1.500	0.875	1.81	1.81	1.78	1.75	1.69	1.62
1.750	1.000	2.09	2.09	2.06	2.03	1.97	1.88
2.000	1.125	2.41	2.41	2.38	2.31	2.25	2.16
2.250	1.406	2.69	2.69	2.66	2.59	2.47	2.41
2.500	1.563	3.00	3.00	2.94	2.91	2.75	2.69
3.000	1.875	3.59	3.59	3.53	3.47	3.34	3.22

Where the same roller diameter is commonly used with chains of two different pitches it is recommended that stock cutters be made wide enough to cut sprockets for both chains.

Marking of Cutters.— All cutters are to be marked, giving pitch, roller diameter and range of teeth to be cut.

Bores for Sprocket Cutters (recommended practice) are approximately as calculated from the formula:

$$\text{Bore} = 0.7 \sqrt{(\text{Width of Cutter} + \text{Roller Diameter} + 0.7 \text{ Pitch})}$$

and are equal to 1 inch for 1/4- through 3/4-inch pitches; 1 1/4 inches for 1- through 1 1/2-inch for 1 3/4- through 2 1/4-inch pitches; 1 3/4 inches for 2 1/2-inch pitch; and 2 inches for 3-inch pitch.

Minimum Outside Diameters of Space Cutters for 35 teeth and over (recommended practice) are approximately as calculated from the formula:

$$\text{Outside Diameter} = 1.2(\text{Bore} + \text{Roller Diameter} + 0.7 \text{ Pitch}) + 1 \text{ in.}$$

Shaper Cutters: Only one will be required to cut any number of teeth for a given pitch and roller diameter. The manufacturer should be referred to for information concerning the cutter form design to be used.

Sprocket Manufacture.—Cast sprockets have cut teeth, and the rim, hub face, and bore are machined. The smaller sprockets are generally cut from steel bar stock, and are finished all over. Sprockets are often made from forgings or forged bars. The extent of finishing depends on the particular specifications that are applicable. Many sprockets are made by welding a steel hub to a steel plate. This process produces a one-piece sprocket of desired proportions and one that can be heat-treated.

Sprocket Materials.—For large sprockets, cast iron is commonly used, especially in drives with large speed ratios, since the teeth of the larger sprocket are subjected to fewer chain engagements in a given time. For severe service, cast steel or steel plate is preferred.

The smaller sprockets of a drive are usually made of steel. With this material the body of the sprocket can be heat-treated to produce toughness for shock resistance, and the tooth surfaces can be hardened to resist wear.

Stainless steel or bronze may be used for corrosion resistance, and Formica, nylon or other suitable plastic materials for special applications.

Roller Chain Drive Ratings.—In 1961, under auspices of The American Sprocket Chain Manufacturers Association (now called American Chain Association), a joint research program was begun to study pin-bushing interaction at high speeds and to gain further data on the phenomenon of chain joint galling among other research areas. These studies have shown that a separating film of lubricant is formed in chain joints in a manner similar to that found in journal bearings. These developments appear in ANSI/ASME B29.1M-1993, and are contained in **Table 9**. The ratings shown in **Table 9** are below the galling range.

The horsepower ratings in **Table 9** apply to lubricated, single-pitch, single-strand roller chains, both ANSI Standard and Heavy series. To obtain ratings of multiple-strand chains, a multiple-strand factor is applied.

The ratings in **Table 9** are based upon: 1) A service factor of 1.; 2) A chain length of approximately 100 pitches.; 3) Use of recommended lubrication methods.; and 4) A drive arrangement where two aligned sprockets are mounted on parallel shafts in a horizontal plane.

Under these conditions, approximately 15,000 hours of service life at full load operation may be expected.

Table 15. Roller Chain Drive Service Factors

Type of Driven Load	Type of Input Power		
	Internal Combustion Engine with Hydraulic Drive	Electric Motor or Turbine	Internal Combustion Engine with Mechanical Drive
Smooth	1.0	1.0	1.2
Moderate Shock	1.2	1.3	1.4
Heavy Shock	1.4	1.5	1.7

Substantial increases in rated speed loads can be utilized, as when a service life of less than 15,000 hours is satisfactory, or when full load operation is encountered only during a portion of the required service life. Chain manufacturers should be consulted for assistance with any special application requirements.

The horsepower ratings shown in **Table 9** relate to the speed of the smaller sprocket and drive selections are made on this basis, whether the drive is speed reducing or speed increasing. Drives with more than two sprockets, idlers, composite duty cycles, or other unusual conditions often require special consideration. Where quietness or extra smooth operation are of special importance, small-pitch chain operating over large diameter sprockets will minimize noise and vibration.

When making drive selection, consideration is given to the loads imposed on the chain by the type of input power and the type of equipment to be driven. Service factors are used to compensate for these loads and the *required* horsepower rating of the chain is determined by the following formula:

$$\text{Required hp Table Rating} = \frac{\text{hp to be Transmitted} \times \text{Service Factor}}{\text{Multiple-Strand Factor}}$$

Service Factors: The service factors in **Table 15** are for normal chain loading. For unusual or extremely severe operating conditions not shown in this table, it is desirable to use larger service factors.

Multiple-Strand Factors: The horsepower ratings for multiple-strand chains equal single-strand ratings multiplied by these factors: for two strands, a factor of 1.7; for three strands, 2.5; and for four strands, 3.3.

Lubrication.—It has been shown that a separating wedge of fluid lubricant is formed in operating chain joints much like that formed in journal bearings. Therefore, fluid lubricant must be applied to ensure an oil supply to the joints and minimize metal-to-metal contact. If supplied in sufficient volume, lubrication also provides effective cooling and impact damping at higher speeds. For this reason, it is important that lubrication recommendations be followed. *The ratings in Table 9 apply only to drives lubricated in the manner specified in this table.*

Chain drives should be protected against dirt and moisture and the oil supply kept free of contamination. Periodic oil change is desirable. A good grade of non-detergent petroleum base oil is recommended. Heavy oils and greases are generally too stiff to enter and fill the chain joints. The following lubricant viscosities are recommended: For temperatures of 20° to 40°F, use SAE 20 lubricant; for 40° to 100°, use SAE 30; for 100° to 120°, use SAE 40; and for 120° to 140°, use SAE 50.

There are three basic types of lubrication for roller chain drives. The recommended type shown in Table 9 as Type A, Type B, or Type C is influenced by the chain speed and the amount of power transmitted. These are *minimum* lubrication requirements and the use of a better type (for example, Type C instead of Type B) is acceptable and may be beneficial. Chain life can vary appreciably depending upon the way the drive is lubricated. The better the chain lubrication, the longer the chain life. For this reason, it is important that the lubrication recommendations be followed when using the ratings given in Table 9. The types of lubrication are as follows:

Type A — Manual or Drip Lubrication: In manual lubrication, oil is applied copiously with a brush or spout can at least once every eight hours of operation. Volume and frequency should be sufficient to prevent overheating of the chain or discoloration of the chain joints. In drip lubrication, oil drops from a drip lubricator are directed between the link plate edges. The volume and frequency should be sufficient to prevent discoloration of the lubricant in the chain joints. Precautions must be taken against misdirection of the drops by windage.

Type B — Bath or Disc Lubrication: In bath lubrication, the lower strand of the chain runs through a sump of oil in the drive housing. The oil level should reach the pitch line of the chain at its lowest point while operating. In disc lubrication, the chain operates above the oil level. The disc picks up oil from the sump and deposits it onto the chain, usually by means of a trough. The diameter of the disc should be such as to produce rim speeds of between 600 and 8000 feet per minute.

Type C — Oil Stream Lubrication: The lubricant is usually supplied by a circulating pump capable of supplying each chain drive with a continuous stream of oil. The oil should be applied inside the chain loop evenly across the chain width, and directed at the slack strand.

The chain manufacturer should be consulted when it appears desirable to use a type of lubricant other than that recommended.

Installation and Alignment.—Sprockets should have the tooth form, thickness, profile, and diameters conforming to ASME/ANSI B29.1M. For maximum service life small sprockets operating at moderate to high speeds, or near the rated horsepower, should have hardened teeth. Normally, large sprockets should not exceed 120 teeth.

In general a center distance of 30 to 50 chain pitches is most desirable. The distance between sprocket centers should provide at least a 120 degree chain wrap on the smaller sprocket. Drives may be installed with either adjustable or fixed center distances. Adjustable centers simplify the control of chain slack. Sufficient housing clearance must always be provided for the chain slack to obtain full chain life.

Accurate alignment of shafts and sprocket tooth faces provides uniform distribution of the load across the entire chain width and contributes substantially to optimum drive life.

Shafting, bearings, and foundations should be suitable to maintain the initial alignment. Periodic maintenance should include an inspection of alignment.

Example of Roller Chain Drive Design Procedure.—The selection of a roller chain and sprockets for a specific design requirement is best accomplished by a systematic step-by-step procedure such as is used in the following example.

Example: Select a roller chain drive to transmit 10 horsepower from a countershaft to the main shaft of a wire drawing machine. The countershaft is $1\frac{5}{16}$ -inches diameter and operates at 1000 rpm. The main shaft is also $1\frac{5}{16}$ -inches diameter and must operate between 378 and 382 rpm. Shaft centers, once established, are fixed and by initial calculations must be approximately $22\frac{1}{2}$ inches. The load on the main shaft is uneven and presents “peaks,” which place it in the heavy shock load category. The input power is supplied by an electric motor. The driving head is fully enclosed and all parts are lubricated from a central system.

Step 1. Service Factor: From **Table 15** the service factor for heavy shock load and an electric motor drive is 1.5.

Step 2. Design Horsepower: The horsepower upon which the chain selection is based (design horsepower) is equal to the specified horsepower multiplied by the service factor, $10 \times 1.5 = 15$ hp.

Step 3. Chain Pitch and Small Sprocket Size for Single-Strand Drive: In **Table 9** under 1000 rpm, a $\frac{5}{8}$ -inch pitch chain with a 24-tooth sprocket or a $\frac{3}{4}$ -inch pitch chain with a 15-tooth sprocket are possible choices.

Step 4. Check of Chain Pitch and Sprocket Selection: From **Table 10** it is seen that only the 24-tooth sprocket in Step 3 can be bored to fit the $1\frac{5}{16}$ -inch diameter main shaft. In **Table 9** a $\frac{5}{8}$ -pitch chain at a small sprocket speed of 1000 rpm is rated at 15.5 hp for a 24-tooth sprocket.

Step 5. Selection of Large Sprocket: Since the driver is to operate at 1000 rpm and the driven at a minimum of 378 rpm, the speed ratio $1000/378 = 2.646$. Therefore the large sprocket should have $24 \times 2.646 = 63.5$ (use 63) teeth.

This combination of 24 and 63 teeth will produce a main drive shaft speed of 381 rpm which is within the limitation of 378 to 382 rpm established in the original specification.

Step 6. Computation of Chain Length: Since the 24- and 63-tooth sprockets are to be placed on $22\frac{1}{2}$ -inch centers, the chain length is determined from the formula:

$$L = 2C + \frac{N}{2} + \frac{n}{2} + \left(\frac{N-n}{2\pi}\right)^2 \times \frac{1}{C}$$

where L = chain length in pitches; C = shaft center distance in pitches; N = number of teeth in large sprocket; and n = number of teeth in small sprocket.

$$L = 2 \times 36 + \frac{63 + 24}{2} + \left(\frac{63 - 24}{6.28}\right)^2 \times \frac{1}{36} = 116.57 \text{ pitches}$$

Step 7. Correction of Center Distance: Since the chain is to couple at a whole number of pitches, 116 pitches will be used and the center distance recomputed based on this figure using the formula on page 2553 where c is the center distance in inches and P is the pitch.

$$c = \frac{P}{8}(2L - N - n + \sqrt{(2L - N - n)^2 - 0.810(N - n)^2})$$

$$c = \frac{5}{64}(2 \times 116 - 63 - 24 + \sqrt{(2 \times 116 - 63 - 24)^2 - 0.810(63 - 24)^2})$$

$$c = \frac{5}{64}(145 + 140.69) = 22.32 \text{ inches, say } 22\frac{3}{8} \text{ inches}$$

BALL AND ACME LEADSCREWS

Leadscrew Overview

Leadscrew assemblies convert rotary motion into linear travel and are well suited to precise control using electric motors. Acme leadscrews, much like machine screws, are threaded to allow a mating nut to be pushed or pulled along the axis of the screw as the shaft is rotated. Ball screws are threaded to allow ball bearings to support the attached nut. The nut has raceways that allow the ball bearings to recirculate as the nut travels down the axis of the shaft. Both provide efficient and accurate linear positioning for motion control applications. Each has strengths and weaknesses that makes each type of technology more suitable for different types of applications.

Ball Screws.—Ball screws generally require lower-torque motors than similarly sized Acme screws due to their higher efficiency in converting energy into linear movement. This efficiency is generally above 90 per cent compared to 40 per cent for Acme screws with plastic nuts and 25 per cent for acme screws with bronze-nuts. Ball screws can handle higher loading with high travel rates and lower backlash, though both technologies offer various anti-backlash nut assemblies. Ball screw life is more easily predicted using ball bearing load data. Compared to acme screws, ball screw assemblies exhibit a lower degradation in positional accuracy over time due to wear on the contact surfaces. Ball screws are more expensive and can be noisier than acme screws. Ball screws may back drive the shaft in vertical orientations.

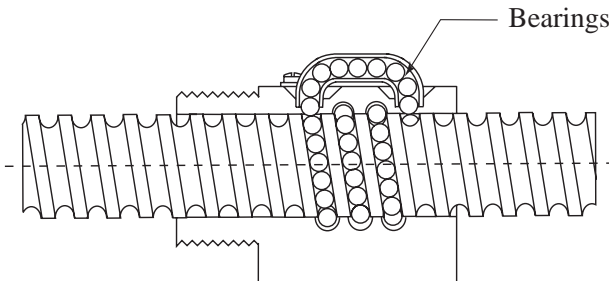


Fig. 1a. Ball Screw Cross Section

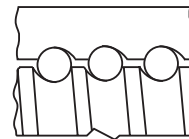


Fig. 1b. Ball Screw Detail

Acme Screws.—Acme screws with plastic nuts generally have an initial lower cost and lower noise levels compared to ball screws. Bronze-nut acme screws offer the lowest lead-screw cost as well as the lowest leadscrew performance characteristics. Due to their low efficiency, bronze-nut acme screws may not back drive in some applications where a ball screw would. Loading and travel rates are lower than ball screws. Also, compared to ball screws, lubrication requirements are higher and predicting travel life of acme screws is more difficult due to higher variations in friction and heat build up.

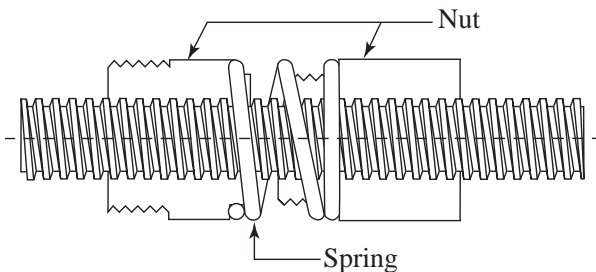


Fig. 2a. Acme Leadscrew with Anti-backlash Nut.

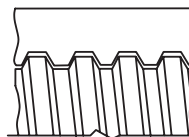


Fig. 2b. Acme Screw Detail

General Leadscrew Design Considerations.—The following design criteria should be considered when selecting leadscrews.

Load: The load is the weight “as seen by the screw.” For vertical applications such as lifting or jacking the load equals the weight of the load being moved. For horizontal applications the “load seen” equals the weight of the load times the coefficient of friction of the supporting media. Another way to determine the load in an actual application is to attach a scale to the load and pull it. Base the load on the moving force required, not on the higher starting (breakaway) force.

Tension and Compression Load: For reduced screw thread sizes, design for tension loads whenever possible. Compression load designs must factor in column strength to prevent buckling.

Back-drive: When a ball screw or acme nut is forced to move linearly along the shaft by an applied force, or gravity in vertical orientation, it forces or back-drives the shaft making it rotate. With their higher efficiency and lower initial start up (breakway) friction value, ball screw assemblies in vertical orientations may back-drive their shafts.

Driving Torque: The driving torque (T_d) is the amount of force required to rotate the screw and move a load.

$$T_d = \frac{P \times L}{2\pi e}$$

where T_d = driving torque (lbs-in.)

P = load (lbs.)

L = lead of screw (in./revolution)

e = ball bearing screw efficiency (Approximately 0.90 for ball screws, 0.40 for acme screws with plastic nuts, and 0.25 for acme screws with bronze nuts.)

Accuracy: Several factors affect accuracy. One factor is the lead deviation in inches per foot. Typical values can range from 0.005 in./ft to 0.001 in./ft. Backlash may also be a consideration in applications that require precise positioning in both directions and in CNC applications. A final consideration is accuracy versus time degradation due to screw wear and ball bearing fatigue. This is especially important in systems that require precise positioning but do not have closed-loop feedback controls. Ball screws have an advantage in long term accuracy since the useful life of ball screws is determined by metal fatigue rather than the ordinary wear characteristics of a conventional screw. Due to rolling contact, very little dimensional change occurs over the life of a ball bearing screw, thus eliminating the need for frequent compensating adjustments.

Lead: The distance the nut travels with one rotation of the screw.

Speed: When rapid travel is required, design for screws with a high lead to reduce shaft speed to avoid rotational and vibrational side effects.

Life: The recommended operating loads for ball screw assemblies are based on a predicted life of one million inches of travel, providing the assembly is lubricated. However, it is possible to operate at greater loads if a reduced life is acceptable. The load should not exceed the maximum static load shown in manufacturer design tables.

Backlash: Backlash, end play, positional inaccuracy, or lost motion between the nut and the screw can be eliminated by utilizing a preloaded nut assembly. Backlash can also be reduced, at increased cost, in ball screws by changing the conformity ratio (ball track radius/ball diameter) as well as using ogival (gothic) ball tracks. Fig. 3 illustrates the contact points between a preloaded ball screw assembly and the shaft.

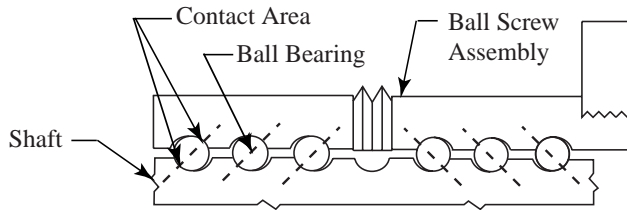


Fig. 3. Contact Points in a Preloaded Anti-Backlash Ball Screw Assembly

End Supports: End support type, free or fixed, and the number of end supports for a lead-screw shaft can have a significant impact on the speed and load capacity of the assembly.

Environment: Temperature extremes, dirty, dusty conditions, corrosive compounds, and metal chips can cause serious problems with lead screw assemblies. For applications in such conditions the use of wipers, boots, or both should be considered. Stainless steel or plated assemblies should be considered for corrosive applications. Corrosive environments can also attack lubricants and thus indirectly damage the assemblies.

Wipers: Brush type wipers maximize ball screw performance by helping to spread lubricant over the length of the screw and preventing internal ball nut contamination from foreign materials. Bellows and telescopic wipers are recommended for severely “dirty” environments.

Lubrication: Ball screws must be lubricated and kept clean. Failure to lubricate can substantially reduce bearing life. Oil and grease can be used but grease is not recommended for low temperature or high speed applications.

PV Value: Speed and load limits for acme leadscrew assemblies using plastic nuts are generally limited by heat build-up. The factor which affects heat generation in an application is the product of the pressure (lbs/in²) on the nut, and the surface velocity at the thread major diameter. This product is called the *PV* value.

CNC Considerations: CNC machine tools require the elimination of backlash and the minimization of elastic deflection to achieve high system stiffness, response, and repeatability of positioning.

Ball Screw Selection.—Many types and styles of ball screws and ball screw assemblies are offered by manufacturers. Consult the vendor’s specific data sheets for precise design criteria. The selection of the correct ball screw and nut for a particular application involves four factors, all of which are interrelated. These are: the equivalent load measured in pounds, the required life measured in linear inches of travel, travel speed measured in inches per minute, and the length between bearings measured in inches.

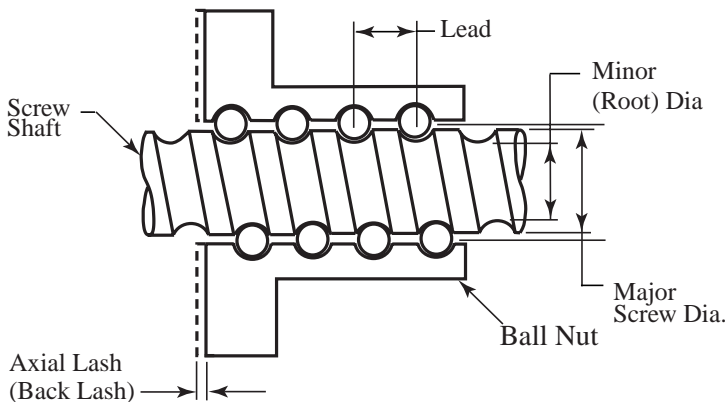


Fig. 4. Ball Screw Detail

Design Overview: To design a ball screw assembly many interrelated factors such as load, bearing length, life, and speed must be considered. Changing one parameter will influence others and generally an iterative approach to balancing these requirements is required. An example is the choice of a fine lead vs. coarse lead. A fine line lead provides better positioning sensitivity and lower drive torque, but also requires a higher rotary speed to achieve the same linear rate of speed. A coarse lead results in lower rotary speed, but requires a higher drive torque that may require a larger motor and related drive components. **Table 1** identifies some of these design interrelationships.

Table 1. Ball Screw Design Factor Interrelationships

Increase In	Affects	How	Increase In	Affects	How
Screw Length	Critical speed	Decreases	End Mounting Rigidity	Critical speed	Increases
	Compression load	Decreases		Compression load	Increases
Critical speed	Increases	System stiffness		Increases	
Screw Diameter	Inertia	Increases	Load	Life	Decreases
	Compression load	Increases	Preload	Positioning accuracy	Increases
	Stiffness	Increases		System stiffness	Increases
	Spring Rate	Increases		Drag torque	Increases
	Load capacity	Increases	Angular Velocity	Critical speed	Decreases
Lead	Drive torque	Increases	Nut length	Load capacity	Increases
	Angular velocity	Decreases		Stiffness	Increases
	Load capacity	Increases	Ball diameter	Life	Increases
	Positioning accuracy	Decreases		Stiffness	Increases
	Ball diameter	Increases		Load capacity	Increases

Screws, Power Transmission.—The square form of thread has a somewhat higher efficiency than threads with sloping sides, although when the angle of the thread form is comparatively small, as in the case of an Acme thread, there is little increase in frictional losses. The Acme thread has superseded the square form on many classes of equipment requiring lead-screws or other power transmitting screws, because the former has practical advantages in regard to cutting and also in compensating for wear between the screw and nut. Multiple thread screws are much more efficient than single-thread screws, as the efficiency is affected by the helix angle of the thread.

Force Required to Turn Screw: In determining the force which must be applied at the end of a given lever-arm in order to turn a screw (or nut surrounding it), there are two conditions to be considered:

- 1) When rotation is such that the load *resists* the movement of the screw, as in raising a load with a screw jack, $F = L \times \frac{l + 2r\pi\mu}{2r\pi - \mu l} \times \frac{r}{R}$.
- 2) When rotation is such that the load *assists* the movement of the screw, as in lowering a load, $F = L \times \frac{2r\pi\mu - l}{2r\pi + \mu l} \times \frac{r}{R}$.

In these formulas, F = force applied at end of lever-arm; L = load moved by screw; R = length of lever-arm; l = lead of screw thread; r = mean or pitch radius of screw; μ = coefficient of friction. If lead l is large in proportion to the diameter so that the helix angle is large, F will have a negative value, indicating that the screw will turn due to the load alone. The efficiency between a screw and nut increases quite rapidly for helix angles up to 10 or 15 degrees (measured from a plane perpendicular to the screw axis). The efficiency remains nearly constant for angles between about 25 and 65 degrees, and the angle of maximum efficiency is between 40 and 50 degrees. A screw will not be self-locking if the efficiency exceeds 50 per cent.

ELECTRIC MOTORS

Classes of NEMA Standards.—National Electrical Manufacturers Association Standards, available from the Association at 1300 North 17th Street, Rosslyn, VA 22209 are of two classes: 1) *NEMA Standard*, which relates to a product commercially standardized and subject to repetitive manufacture, which standard has been approved by at least 90 per cent of the members of the Subdivision eligible to vote thereon; and 2) *Suggested Standard for Future Design*, which may not have been regularly applied to a commercial product, but which suggests a sound engineering approach to future development and has been approved by at least two-thirds of the members of the Subdivision eligible to vote thereon.

Authorized Engineering Information consists of explanatory data and other engineering information of an informative character not falling within the classification of NEMA Standard or Suggested Standard for Future Design.

Mounting Dimensions and Frame Sizes for Electric Motors.—Dimensions for foot-mounted electric motors as standardized in the United States by the National Electrical Manufacturers Association (NEMA) include the spacing of bolt holes in the feet of the motor, the distance from the bottom of the feet to the center-line of the motor shaft, the size of the conduit, the length and diameter of shaft, and other dimensions likely to be required by designers or manufacturers of motor-driven equipment. The Standard provides dimensions for face-mounted and flange-mounted motors by means of standard motor frame numbers.

Standard dimensions also are given where the motor is to be mounted upon a belt-tightening base or upon rails.

The NEMA standards also prescribe lettering for dimension drawings, mounting and terminal housing locations and dimensions, symbols and terminal connections, and provision for grounding of field wiring. In addition, the standards give recommended knock-out and clearance hole dimensions; tolerances on shaft extension diameters and keyseats; methods of measuring shaft run-out and eccentricity, also face runout of mounting surfaces; and tolerances of face-mounted and flanged-mounted motors.

Design Letters of Polyphase Integral-horsepower Motors.—Designs A, B, C, and D motors are squirrel-cage motors designed to withstand full voltage starting and developing locked-rotor torque and breakdown torque, drawing locked-rotor current, and having a slip as specified below:

Design A: Locked-rotor torque as shown in [Table 2](#), breakdown torque as shown in [Table 3](#), locked-rotor current higher than the values shown in [Table 1](#), and a slip at rated load of less than 5 per cent. Motors with 10 or more poles may have a slightly greater slip.

Table 1. NEMA Standard Locked-rotor Current of 3-phase 60-hertz Integral-horsepower Squirrel-cage Induction Motors Rated at 230 Volts

Horse-power	Locked-rotor Current, Amps.	Design Letters	Horse-power	Locked-rotor Current, Amps.	Design Letters	Horse-power	Locked-rotor Current, Amps.	Design Letters
$\frac{1}{2}$	20	B, D	$7\frac{1}{2}$	127	B, C, D	50	725	B, C, D
$\frac{3}{4}$	25	B, D	10	162	B, C, D	60	870	B, C, D
1	30	B, D	15	232	B, C, D	75	1085	B, C, D
$1\frac{1}{2}$	40	B, D	20	290	B, C, D	100	1450	B, C, D
2	50	B, D	25	365	B, C, D	125	1815	B, C, D
3	64	B, C, D	30	435	B, C, D	150	2170	B, C, D
5	92	B, C, D	40	580	B, C, D	200	2900	B, C

Note: The locked-rotor current of a motor is the steady-state current taken from the line with the rotor locked and with rated voltage and frequency applied to the motor.

For motors designed for voltages other than 230 volts, the locked-rotor current is inversely proportional to the voltages. For motors larger than 200 hp, see NEMA Standard MG 1-12.34.

Table 2. NEMA Standard Locked-rotor Torque of Single-speed Polyphase 60- and 50-hertz Squirrel-cage Integral-horsepower Motors with Continuous Ratings

Hp	Designs A and B								Design C		
	Synchronous Speed, rpm								1800	1200	900
	60 hertz	3600	1800	1200	900	720	600	514			
50 hertz	3000	1500	1000	750	1500	1000	750	
Percent of Full-load Torque ^a											
½	140	140	115	110	
¾	175	135	135	115	110	
1	...	275	170	135	135	115	110	
1½	175	250	165	130	130	115	110	
2	170	235	160	130	125	115	110	
3	160	215	155	130	125	115	110	...	250	225	
5	150	185	150	130	125	115	110	250	250	225	
7½	140	175	150	125	120	115	110	250	225	200	
10	135	165	150	125	120	115	110	250	225	200	
15	130	160	140	125	120	115	110	225	200	200	
20	130	150	135	125	120	115	110	200 for all sizes above 15 hp.			
25	130	150	135	125	120	115	110				
30	130	150	135	125	120	115	110	For Design D motors, see footnote.			
40	125	140	135	125	120	115	110				
50	120	140	135	125	120	115	110				
60	120	140	135	125	120	115	110				
75	105	140	135	125	120	115	110				
100	105	125	125	125	120	115	110				
125	100	110	125	120	115	115	110				
150	100	110	120	120	115	115	...				
200	100	100	120	120	115				

^a These values represent the upper limit of application for these motors.

Note: The locked-rotor torque of a motor is the minimum torque which it will develop at rest for all angular positions of the rotor, with rated voltage applied at rated frequency.

The locked-rotor torque of Design D, 60- and 50-hertz 4-, 6-, and 8-pole single-speed, polyphase squirrel-cage motors rated 150 hp and smaller, with rated voltage and frequency applied is 275 per cent of full-load torque, which represents the upper limit of application for these motors.

For motors larger than 200 hp, see NEMA Standard MG 1-12.37.

Table 3. NEMA Standard Breakdown Torque of Single-speed Polyphase Squirrel-cage, Integral-horsepower Motors with Continuous Ratings

Horsepower	Synchronous Speed, rpm							
	60 hertz	3600	1800	1200	900	720	600	514
	50 hertz	3000	1500	1000	750
Per Cent of Full Load Torque								
Designs A and B ^a								
½	225	200	200	200	200
¾	275	220	200	200	200	200
1	...	300	265	215	200	200	200	200
1½	250	280	250	210	200	200	200	200
2	240	270	240	210	200	200	200	200
3	230	250	230	205	200	200	200	200
5	215	225	215	205	200	200	200	200
7½	200	215	205	200	200	200	200	200
10-125, incl.	200	200	200	200	200	200	200	200
150	200	200	200	200	200	200	200	...
200	200	200	200	200	200	200
Design C								
3	225	200
5	...	200	200	200
7½-200, incl.	...	190	190	190

^a Design A values are in excess of those shown.

These values represent the upper limit of the range of application for these motors. For above 200 hp, see NEMA Standard MG1-12.38.

Design B: Locked-rotor torque as shown in **Table 2**, breakdown torque as shown in **Table 3**, locked-rotor current not exceeding that in **Table 1**, and a slip at rated load of less than 5 per cent. Motors with 10 or more poles may have a slightly greater slip.

Design C: Locked-rotor torque for special high-torque applications up to values shown in **Table 2**, breakdown torque up to values shown in **Table 3**, locked-rotor current not exceeding values shown in **Table 1** and a slip at rated load of less than 5 per cent.

Design D: Locked-rotor torque as indicated in **Table 2**, locked-rotor current not greater than that shown in **Table 1** and a slip at rated load of 5 per cent or more.

Torque and Current Definitions.—The definitions which follow have been adopted as standard by the National Electrical Manufacturers Association.

Locked-Rotor or Static Torque: The locked-rotor torque of a motor is the minimum torque which it will develop at rest for all angular positions of the rotor, with rated voltage applied at rated frequency.

Breakdown Torque: The breakdown torque of a motor is the maximum torque which the motor will develop, with rated voltage applied at rated frequency, without an abrupt drop in speed (see **Table 4**).

Full-Load Torque: The full-load torque of a motor is the torque necessary to produce its rated horsepower at full load speed. In pounds at 1-foot radius, it is equal to the horsepower times 5252 divided by the full-load speed.

Pull-Out Torque: The pull-out torque of a synchronous motor is the maximum sustained torque which the motor will develop at synchronous speed with rated voltage applied at rated frequency and with normal excitation.

Pull-In Torque: The pull-in torque of a synchronous motor is the maximum constant torque under which the motor will pull its connected inertia load into synchronism at rated voltage and frequency, when its field excitation is applied.

Pull-Up Torque: The pull-up torque of an alternating current motor is the minimum torque developed by the motor during the period of acceleration from rest to the speed at which breakdown torque occurs. For motors which do not have a definite breakdown torque, the pull-up torque is the minimum torque developed up to rated speed.

Locked Rotor Current: The locked rotor current of a motor is the steady-state current taken from the line with the rotor locked and with rated voltage (and rated frequency in the case of alternating-current motors) applied to the motor.

Table 4. NEMA Standard Breakdown Torque of Polyphase Wound-rotor Motors with Continuous Ratings — 60- and 50-hertz

Horsepower	Speed, rpm			Horsepower	Speed, rpm		
	1800	1200	900		1800	1200	900
	Per cent of Full-load Torque				Per cent of Full-load Torque		
1	250	7½	275	250	225
1½	250	10	275	250	225
2	275	275	250	15	250	225	225
3	275	275	250	20-200, incl.	225	225	225
5	275	275	250

These values represent the upper limit of the range of application for these motors.

Standard Direction of Motor Rotation.—The standard direction of rotation for all non-reversing direct-current motors, all alternating-current single-phase motors, all synchronous motors, and all universal motors, is *counterclockwise* when facing that end of the motor opposite the drive.

This rule does not apply to two- and three-phase induction motors, as in most applications the phase sequence of the power lines is rarely known.

Motor Types According to Variability of Speed.—Five types of motors classified according to variability of speed are:

Constant-speed Motors: In this type of motor the normal operating speed is constant or practically constant; for example, a synchronous motor, an induction motor with small slip, or a direct-current shunt-wound motor.

Varying-speed Motor: In this type of motor, the speed varies with the load, ordinarily decreasing when the load increases; such as a series-wound or repulsion motor.

Adjustable-speed Motor: In this type of motor, the speed can be varied gradually over a considerable range, but when once adjusted remains practically unaffected by the load; such as a direct-current shunt-wound motor with field resistance control designed for a considerable range of speed adjustment.

The base speed of an adjustable-speed motor is the lowest rated speed obtained at rated load and rated voltage at the temperature rise specified in the rating.

Adjustable Varying-speed Motor: This type of motor is one in which the speed can be adjusted gradually, but when once adjusted for a given load will vary in considerable degree with the change in load; such as a direct-current compound-wound motor adjusted by field control or a wound-rotor induction motor with rheostatic speed control.

Multispeed Motor: This type of motor is one which can be operated at any one of two or more definite speeds, each being practically independent of the load; such as a direct-current motor with two armature windings or an induction motor with windings capable of various pole groupings. In the case of multispeed permanent-split capacitor and shaded pole motors, the speeds are dependent upon the load.

Pull-up Torque.—NEMA Standard pull up torques for single-speed, polyphase, squirrel-cage integral-horsepower motors, Designs A and B, with continuous ratings and with rated voltage and frequency applied are as follows: When the locked-rotor torque given in [Table 2](#) is 110 per cent or less, the pull-up torque is 90 per cent of the locked-rotor torque; when the locked-rotor torque is greater than 110 per cent but less than 145 per cent, the pull-up torque is 100 per cent of full-load torque; and when the locked-rotor torque is 145 per cent or more, the pull-up torque is 70 per cent of the locked-rotor torque.

For Design C motors, with rated voltage and frequency applied, the pull-up torque is not less than 70 per cent of the locked-rotor torque as given in [Table 2](#).

Types and Characteristics of Electric Motors

Types of Direct-Current Motors.—Direct-current motors may be grouped into three general classes: series-wound; shunt-wound; and compound-wound.

In the *series-wound motor* the field windings, which are fixed in the stator frame, and the armature windings, which are placed around the rotor, are connected in series so that all current passing through the armature also passes through the field. In the *shunt-wound motor*, both armature and field are connected across the main power supply so that the armature and field currents are separate. In the *compound-wound motor*, both series and shunt field windings are provided and these may be connected so that the currents in both are flowing in the same direction, called *cumulative compounding*, or so that the currents in each are flowing in opposite directions, called *differential compounding*.

Characteristics of Series-wound Direct-Current Motors.—In the series-wound motor, any increase in load results in more current passing through the armature and the field windings. As the field is strengthened by this increased current, the motor speed decreases. Conversely, as the load is decreased the field is weakened and the speed increases and at very light loads may become excessive. For this reason, series-wound direct-current motors are usually directly connected or geared to the load to prevent “run-away.” (A series-wound motor, designated as series-shunt wound, is sometimes provided with a light shunt field winding to prevent dangerously high speeds at light loads.) The increase in armature current with increasing load produces increased torque, so that the

series-wound motor is particularly suited to heavy starting duty and where severe overloads may be expected. Its speed may be adjusted by means of a variable resistance placed in series with the motor, but due to variation with load, the speed cannot be held at any constant value. This variation of speed with load becomes greater as the speed is reduced. Series-wound motors are used where the load is practically constant and can easily be controlled by hand. They are usually limited to traction and lifting service.

Shunt-wound Direct-Current Motors.—In the shunt-wound motor, the strength of the field is not affected appreciably by change in the load, so that a fairly constant speed (about 10 to 12 per cent drop from no load to full load speed) is obtainable. This type of motor may be used for the operation of machines requiring an approximately constant speed and imposing low starting torque and light overload on the motor.

The shunt-wound motor becomes an adjustable-speed motor by means of field control or by armature control. If a variable resistance is placed in the field circuit, the amount of current in the field windings and hence the speed of rotation can be controlled. As the speed increases, the torque decreases proportionately, resulting in nearly constant horsepower. A speed range of 6 to 1 is possible using field control, but 4 to 1 is more common. Speed regulation is somewhat greater than in the constant-speed shunt-wound motors, ranging from about 15 to 22 per cent. If a variable resistance is placed in the armature circuit, the voltage applied to the armature can be reduced and hence the speed of rotation can be reduced over a range of about 2 to 1. With armature control, speed regulation becomes poorer as speed is decreased, and is about 100 per cent for a 2 to 1 speed range. Since the current through the field remains unchanged, the torque remains constant.

Machine Tool Applications: The adjustable-speed shunt-wound motors are useful on larger machines of the boring mill, lathe, and planer type and are particularly adapted to spindle drives because constant horsepower characteristics permit heavy cuts at low speed and light or finishing cuts at high speed. They have long been used for planer drives because they can provide an adjustable low speed for the cutting stroke and a high speed for the return stroke. Their application has been limited, however, to plants in which direct-current power is available.

Adjustable-voltage Shunt-wound Motor Drive.—More extensive use of the shunt-wound motor has been made possible by a combination drive that includes a means of converting alternating current to direct current. This conversion may be effected by a self-contained unit consisting of a separately excited direct-current generator driven by a constant speed alternating-current motor connected to the regular alternating-current line, or by an electronic rectifier with suitable controls connected to the regular alternating-current supply lines. The latter has the advantage of causing no vibration when mounted directly on the machine tool, an important factor in certain types of grinders.

In this type of adjustable-speed, shunt-wound motor drive, speed control is effected by varying the voltage applied to the armature while supplying constant voltage to the field. In addition to providing for the adjustment of the voltage supplied by the conversion unit to the armature of the shunt-wound motor, the amount of current passing through the motor field may also be controlled. In fact, a single control may be provided to vary the motor speed from minimum to base speed (speed of the motor at full load with rated voltage on armature and field) by varying the voltage applied to the armature and from base speed to maximum speed by varying the current flowing through the field. When so controlled, the motor operates at constant torque up to base speed and at constant horsepower above base speed.

Speed Range: Speed ranges of at least 20 to 1 below base speed and 4 or 5 to 1 above base speed (a total range of 100 to 1, or more) are obtainable as compared with about 2 to 1 below normal speed and 3 or 4 to 1 above normal speed for the conventional type of control. Speed regulation may be as great as 25 per cent at high speeds. Special electronic controls, when used with this type shunt motor drive, make possible maintenance of motor

speeds with as little variation as $\frac{1}{2}$ to 1 per cent of full load speed from full load to no load over a line voltage variation of ± 10 per cent and over any normal variation in motor temperature and ambient temperature.

Applications: These direct-current, adjustable-voltage drives, as they are sometimes called, have been applied successfully to such machine tools as planers, milling machines, boring mills and lathes, as well as to other industrial machines where wide, stepless speed control, uniform speed under all operating conditions, constant torque acceleration and adaptability to automatic operation are required.

Compound-wound Motors.—In the compound-wound motor, the speed variation due to load changes is much less than in the series-wound motor, but greater than in the shunt-wound motor (ranging up to 25 per cent from full load to no load). It has a greater starting torque than the shunt-wound motor, is able to withstand heavier overloads, but has a narrower adjustable speed range. Standard motors of this type have a cumulative-compound winding, the differential-compound winding being limited to special applications. They are used where the starting load is very heavy or where the load changes suddenly and violently as with reciprocating pumps, printing presses and punch presses.

Types of Polyphase Alternating-Current Motors.—The most widely used polyphase motors are of the induction type. The “*squirrel cage*” *induction motor* consists of a wound stator which is connected to an external source of alternating-current power and a laminated steel core rotor with a number of heavy aluminum or copper conductors set into the core around its periphery and parallel to its axis. These conductors are connected together at each end of the rotor by a heavy ring, which provides closed paths for the currents induced in the rotor to circulate. The rotor bars form, in effect, a “squirrel cage” from which the motor takes its name.

Wound-rotor type of Induction motor: This type has in addition to a squirrel cage, a series of coils set into the rotor which are connected through slip-rings to external variable resistors. By varying the resistance of the wound-rotor circuits, the amount of current flowing in these circuits and hence the speed of the motor can be controlled. Since the rotor of an induction motor is not connected to the power supply, the motor is said to operate by transfer action and is analogous to a transformer with a short-circuited secondary that is free to rotate. Induction motors are built with a wide range of speed and torque characteristics which are discussed under “Operating Characteristics of Squirrel-cage Induction Motors.”

Synchronous Motor: The other type of polyphase alternating-current motor used industrially is the *synchronous motor*. In contrast to the induction motor, the rotor of the synchronous motor is connected to a direct-current supply which provides a field that rotates in step with the alternating-current field in the stator. After having been brought up to synchronous speed, which is governed by the frequency of the power supply and the number of poles in the rotor, the synchronous motor operates at this constant speed throughout its entire load range.

Operating Characteristics of Squirrel-cage Induction Motors.—In general, squirrel-cage induction motors are simple in design and construction and offer rugged service. They are essentially constant-speed motors, their speed changing very little with load and not being subject to adjustment. They are used for a wide range of industrial applications calling for integral horsepower ratings. According to the NEMA (National Electrical Manufacturers Association) Standards, there are four classes of squirrel-cage induction motors designated respectively as *A*, *B*, *C*, and *D*.

Design A motors are not commonly used since *Design B* has similar characteristics with the advantage of lower starting current.

Design B: motors may be designated as a general purpose type suitable for the majority of polyphase alternating-current applications such as blowers, compressors, drill presses, grinders, hammer mills, lathes, planers, polishers, saws, screw machines, shakers, stokers,

etc. The starting torque at 1800 R.P.M. is 250 to 275 per cent of full load torque for 3 H.P. (2.24 kW) and below; for 5-75 H.P. (3.73-56 kW) ratings the starting torque ranges from 185 to 150 per cent of full load torque. They have low starting current requirements, usually no more than 5 to 6 times full load current and can be started at full voltage. Their slip (difference between synchronous speed and actual speed at rated load) is relatively low.

Design C: motors have high starting torque (up to 250 per cent of full load torque) but low starting current. They can be started at full voltage. Slip at rated load is relatively low. They are used for compressors requiring a loaded start, heavy conveyors, reciprocating pumps and other applications requiring high starting torque.

Design D: motors have high slip at rated load, that is, the motor speed drops off appreciably as the load increases, permitting use of the stored energy of a flywheel. They provide heavy starting torque, up to 275 per cent of full load torque, are quiet in operation and have relatively low starting current. Applications are for impact, shock and other high peak loads or flywheel drives such as trains, elevators, hoists, punch and drawing presses, shears, etc.

Design F: motors are no longer standard. They had low starting torque, about 125 per cent of full-load torque, and low starting current. They were used to drive machines which required infrequent starting at no load or at very light load.

Multiple-Speed Induction Motors.—This type has a number of windings in the stator so arranged and connected that the number of effective poles and hence the speed can be changed. These motors are for the same types of starting conditions as the conventional squirrel-cage induction motors and are available in designs that provide constant horsepower at all rated speeds and in designs that provide constant torque at all rated speeds.

Typical speed combinations obtainable in these motors are 600, 900, 1200 and 1800 R.P.M.; 450, 600, 900 and 1200 R.P.M.; and 600, 720, 900 and 1200 R.P.M.

Where a gradual change in speed is called for, a wound rotor may be provided in addition to the multiple stator windings.

Wound-Rotor Induction Motors.—These motors are designed for applications where extremely low starting current with high starting torque are called for, such as in blowers, conveyors, compressors, fans and pumps. They may be employed for adjustable-varying speed service where the speed range does not extend below 50 per cent of synchronous speed, as for steel plate-forming rolls, printing presses, cranes, blowers, stokers, lathes and milling machines of certain types. The speed regulation of a wound rotor induction motor ranges from 5 to 10 per cent at maximum speed and from 18 to 30 per cent at low speed. They are also employed for reversing service as in cranes, gates, hoists and elevators.

High-Frequency Induction Motors.—This type is used in conjunction with frequency changers when very high speeds are desired, as on grinders, drills, routers, portable tools or woodworking machinery. These motors have an advantage over the series-wound or universal type of high speed motor in that they operate at a relatively constant speed over the entire load range. A motor-generator set, a two-unit frequency converter or a single unit inductor frequency converter may be used to supply three-phase power at the frequency required. The single unit frequency converter may be obtained for delivering any one of a number of frequencies ranging from 360 to 2160 cycles and it is self-driven and self-excited from the general polyphase power supply.

Synchronous Motors.—These are widely used in electric timing devices; to drive machines that must operate in synchronism; and also to operate compressors, rolling mills, crushers which are started without load, paper mill screens, shredders, vacuum pumps and motor-generator sets. Synchronous motors have an inherently high power factor and are often employed to make corrections for the low power factor of other types of motors on the same system.

Types of Single-Phase Alternating-Current Motors.—Most of the single-phase alternating-current motors are basically induction motors distinguished by different arrangements for starting. (A single-phase induction motor with only a squirrel-cage rotor has no starting torque.) In the *capacitor-start* single-phase motor, an auxiliary winding in the stator is connected in series with a capacitor and a centrifugal switch. During the starting and accelerating period the motor operates as a two-phase induction motor. At about two-thirds full-load speed, the auxiliary circuit is disconnected by the switch and the motor then runs as a single-phase induction motor. In the *capacitor-start, capacitor-run* motor, the auxiliary circuit is arranged to provide high effective capacity for high starting torque and to remain connected to the line but with reduced capacity during the running period. In the *single-value capacitor* or *capacitor split-phase* motor, a relatively small continuously-rated capacitor is permanently connected in one of the two stator windings and the motor both starts and runs like a two-phase motor.

In the *repulsion-start* single-phase motor, a drum-wound rotor circuit is connected to a commutator with a pair of short-circuited brushes set so that the magnetic axis of the rotor winding is inclined to the magnetic axis of the stator winding. The current flowing in this rotor circuit reacts with the field to produce starting and accelerating torques. At about two-thirds full load speed the brushes are lifted, the commutator is short circuited and the motor runs as a single-phase squirrel-cage motor. The *repulsion* motor employs a repulsion winding on the rotor for both starting and running. The *repulsion-induction* motor has an outer winding on the rotor acting as a repulsion winding and an inner squirrel-cage winding. As the motor comes up to speed, the induced rotor current partially shifts from the repulsion winding to the squirrel-cage winding and the motor runs partly as an induction motor.

In the *split-phase* motor, an auxiliary winding in the stator is used for starting with either a resistance connected in series with the auxiliary winding (*resistance-start*) or a reactor in series with the main winding (*reactor-start*).

The *series-wound* single-phase motor has a rotor winding in series with the stator winding as in the series-wound direct-current motor. Since this motor may also be operated on direct current, it is called a *universal* motor.

Characteristics of Single-Phase Alternating-Current Motors.—Single-phase motors are used in sizes up to about $7\frac{1}{2}$ horsepower (5.6 kW) for heavy starting duty chiefly in home and commercial appliances for which polyphase power is not available. The *capacitor-start* motor is available in normal starting torque designs for such applications as centrifugal pumps, fans, and blowers and in high-starting torque designs for reciprocating compressors, pumps, loaded conveyors, or belts. The *capacitor-start, capacitor-run* motor is exceptionally quiet in operation when loaded to at least 50 per cent of capacity. It is available in low-torque designs for fans and centrifugal pumps and in high-torque designs for applications similar to those of the capacitor-start motor.

The *capacitor split-phase* motor requires the least maintenance of all single-phase motors, but has very low starting torque. Its high maximum torque makes it potentially useful in floor sanders or in grinders where momentary overloads due to excessive cutting pressure are experienced. It is also used for slow-speed direct connected fans.

The *repulsion-start, induction-run* motor has higher starting torque than the capacitor motors, although for the same current, the capacitor motors have equivalent pull-up and maximum torque. Electrical and mechanical noise and the extra maintenance sometimes required are disadvantages. These motors are used for compressors, conveyors and stokers starting under full load. The *repulsion-induction* motor has relatively high starting torque and low starting current. It also has a smooth speed-torque curve with no break and a greater ability to withstand long accelerating periods than capacitor type motors. It is particularly suitable for severe starting and accelerating duty and for high inertia loads such as laundry extractors. Brush noise is, however, continuous.

The *repulsion* motor has no limiting synchronous speed and the speed changes with the load. At certain loads, slight changes in load cause wide changes in speed. A brush shifting arrangement may be provided to adjust the speed which may have a range of 4 to 1 if full rated constant torque is applied but a decreasing range as the torque falls below this value. This type of motor may be reversed by shifting the brushes beyond the neutral point. These motors are suitable for machines requiring constant-torque and adjustable speed.

The *split-phase* and *universal* motors are limited to about $\frac{1}{3}$ H.P. (0.25 kW) ratings and are used chiefly for small appliance and office machine applications.

Motors with Built-in Speed Reducers.—Electric motors having built-in speed-changing units are compact and the design of these motorized speed reducers tends to improve the appearance of the machines which they drive. There are several types of these speed reducers; they may be classified according to whether they are equipped with worm gearing, a regular gear train with parallel shafts, or planetary gearing.

The claims made for the worm gearing type of reduction unit are that the drive is quiet in operation and well adapted for use where the slow-speed shaft must be at right angles to the motor shaft and where a high speed ratio is essential.

For very low speeds, the double reduction worm gearing units are suitable. In these units two sets of worm gearing form the gear train, and both the slow-speed shaft and the armature shaft are parallel. The intermediate worm gear shaft can be built to extend from the housing, if required, so as to make two countershaft speeds available on the same unit.

In the parallel-shaft type of speed reducer, the slow-speed shaft is parallel with the armature shaft. The slow-speed shaft is rotated by a pinion on the armature shaft, this pinion meshing with a larger gear on the slow-speed shaft.

Geared motors having built-in speed-changing units are available with constant-mesh change gears for varying the speed ratio.

Planetary gearing permits a large speed reduction with few parts; hence, it is well adapted for geared-head motor units where economy and compactness are essential. The slow-speed shaft is in line with the armature shaft.

Factors Governing Motor Selection

Speed, Horsepower, Torque and Inertia Requirements.—Where more than one speed or a range of speeds are called for, one of the following types of motors may be selected, depending upon other requirements: For direct-current, the standard shunt-wound motor with field control has a 2 to 1 range in some designs; the adjustable speed motor may have a range of from 3 to 1 up to 6 to 1; the shunt motor with adjustable voltage supply has a range up to 20 to 1 or more below base speed and 4 or 5 to 1 above base speed, making a total range of up to 100 to 1 or more. For polyphase alternating current, multi-speed squirrel-cage induction motors have 2, 3 or 4 fixed speeds; the wound-rotor motor has a 2 to 1 range. The two-speed wound-rotor motor has a 4 to 1 range. The brush-shifting shunt motor has a 4 to 1 range. The brush-shifting series motor has a 3 to 1 range; and the squirrel-cage motor with a variable-frequency supply has a very wide range. For single-phase alternating current, the brush-shifting repulsion motor has a $2\frac{1}{2}$ to 1 range; the capacitor motor with tapped winding has a 2 to 1 range and the multi-speed capacitor motor has 2 or 3 fixed speeds. Speed regulation (variation in speed from no load to full load) is greatest with motors having series field windings and entirely absent with synchronous motors.

Horsepower: Where the load to be carried by the motor is not constant but follows a definite cycle, a horsepower-time curve enables the peak horsepower to be determined as well as the root-mean-square-average horsepower, which indicates the proper motor rating from a heating standpoint. Where the load is maintained at a constant value for a period of from 15 minutes to 2 hours depending on the size, the horsepower rating required will usually not be less than this constant value. When selecting the size of an induction motor, it should be kept in mind that this type of motor operates at maximum efficiency when it is

loaded to full capacity. Where operation is to be at several speeds, the horsepower requirement for each speed should be considered.

Torque: Starting torque requirements may vary from 10 per cent of full load to 250 per cent of full load torque depending upon the type of machine being driven. Starting torque may vary for a given machine because of frequency of start, temperature, type and amount of lubricant, etc., and such variables should be taken into account. The motor torque supplied to the machine must be well above that required by the driven machine at all points up to full speed. The greater the excess torque, the more rapid the acceleration. The approximate time required for acceleration from rest to full speed is given by the formula:

$$\text{Time} = \frac{N \times WR^2}{T_a \times 308} \text{ seconds}$$

where N = Full load speed in R.P.M.

T_a = Torque = average foot-pounds available for acceleration.

WR^2 = Inertia of rotating part in pounds feet squared (W = weight and R = radius of gyration of rotating part).

308 = Combined constant converting minutes into seconds, weight into mass and radius into circumference.

If the time required for acceleration is greater than 20 seconds, special motors or starters may be required to avoid overheating.

The running torque T_r is found by the formula:

$$T_r = \frac{5250 \times \text{HP}}{N} \text{ foot pounds}$$

where $H.P.$ = Horsepower being supplied to the driven machine

N = Running speed in R.P.M.

5250 = Combined constant converting horsepower to foot-pounds per minute and work per revolution into torque.

The peak horsepower determines the maximum torque required by the driven machine and the motor must have a maximum running torque in excess of this value.

Inertia: The inertia or flywheel effect of the rotating parts of a driven machine will, if large, appreciably affect the accelerating time and, hence, the amount of heating in the motor. If synchronous motors are used, the inertia (WR^2) of both the motor rotor and the rotating parts of the machine must be known since the pull-in torque (torque required to bring the driven machine up to synchronous speed) varies approximately as the square root of the total inertia of motor and load.

Space Limitations in Motor Selection.—If the motor is to become an integral part of the machine which it drives and space is at a premium, a partial motor may be called for. A complete motor is one made up of a stator, a rotor, a shaft, and two end shields with bearings. A *partial motor* is without one or more of these elements. One common type is furnished without drive-end end shield and bearing and is directly connected to the end or side of the machine which it drives, such as the headstock of a lathe. A so-called *shaftless type of motor* is supplied without shaft, end shields or bearings and is intended for built-in application in such units as multiple drilling machines, precision grinders, deep well pumps, compressors and hoists where the rotor is actually made a part of the driven machine. Where a partial motor is used, however, proper ventilation, mounting, alignment and bearings must be arranged for by the designer of the machine to which it is applied.

Sometimes it is possible to use a motor having a smaller frame size and wound with Class *B* insulation, permitting it to be subjected to a higher temperature rise than the larger-frame Class *A* insulated motor having the same horsepower rating.

Temperatures.—The applicability of a given motor is limited not only by its load starting and carrying ability, but also by the temperature which it reaches under load. Motors are given temperature ratings which are based upon the type of insulation (Class A or Class B are the most common) used in their construction and their type of frame (open, semien-closed, or enclosed).

Insulating Materials: Class A materials are: cotton, silk, paper, and similar organic materials when either impregnated or immersed in a liquid dielectric; molded and laminated materials with cellulose filler, phenolic resins, and other resins of similar properties; films and sheets of cellulose acetate and other cellulose derivatives of similar properties; and varnishes (enamel) as applied to conductors.

Class B insulating materials are: materials or combinations of materials such as mica, glass fiber, asbestos, etc., with suitable bonding substances. Other materials shown capable of operation at Class B temperatures may be included.

Ambient Temperature and Allowable Temperature Rise: Normal ambient temperature is taken to be 40°C (104°F). For open general-purpose motors with Class A insulation, the normal temperature rise on which the performance guarantees are based is 40°C (104°F).

Motors with Class A insulation having protected, semiprotected, drip-proof, or splash-proof, or drip-proof protected enclosures have a 50°C (122°F) rise rating.

Motors with Class A insulation and having totally enclosed, fan-cooled, explosion-proof, waterproof, dust-tight, submersible, or dust-explosion-proof enclosures have a 55°C (131°F) rise rating.

Motors with Class B insulation are permissible for total temperatures up to 110 degrees C (230°F) for open motors and 115°C (239°F) for enclosed motors.

Motors Exposed to Injurious Conditions.—Where motors are to be used in locations imposing unusual operating conditions, the manufacturer should be consulted, especially where any of the following conditions apply: exposure to chemical fumes; operation in damp places; operation at speeds in excess of specified overspeed; exposure to combustible or explosive dust; exposure to gritty or conducting dust; exposure to lint; exposure to steam; operation in poorly ventilated rooms; operation in pits, or where entirely enclosed in boxes; exposure to inflammable or explosive gases; exposure to temperatures below 10°C (50°F); exposure to oil vapor; exposure to salt air; exposure to abnormal shock or vibration from external sources; where the departure from rated voltage is excessive; and or where the alternating-current supply voltage is unbalanced.

Improved insulating materials and processes and greater mechanical protection against falling materials and liquids make it possible to use general-purpose motors in many locations where special-purpose motors were previously considered necessary. *Splash-proof motors* having well-protected ventilated openings and specially treated windings are used where they are to be subjected to falling and splashing water or are to be washed down as with a hose. Where climatic conditions are not severe, this type of motor is also successfully used in unprotected outdoor installations.

If the surrounding atmosphere carries abnormal quantities of metallic, abrasive, or non-explosive dust or acid or alkali fumes, a *totally enclosed fan-cooled motor* may be called for. In this type, the motor proper is completely enclosed but air is blown through an outer shell that completely or partially surrounds the inner case. If the dust in the atmosphere tends to pack or solidify and close the air passages of open splash-proof or totally enclosed fan-cooled motors, *totally enclosed (nonventilated) motors* are used. This type, which is limited to low horsepower ratings, is also used for outdoor service in mild or severe climates.

Table 1. Characteristics and Applications of D.C. Motors, 1-300 hp

Type	Starting Duty	Maximum Momentary Running Torque	Speed Regulation	Speed Control ^a	Applications
Shunt-wound, constant-speed	Medium starting torque. Varies with voltage supplied to armature, and is limited by starting resistor to 125 to 200% full-load torque	125 to 200%. Limited by commutation	8 to 12%	Basic speed to 200% basic speed by field control	Drives where starting requirements are not severe. Use constant-speed or adjustable-speed, depending on speed required. Centrifugal pumps, fans, blowers, conveyors, elevators, wood- and metalworking machines
Shunt-wound, adjustable speed			10 to 20%, increases with weak fields	Basic speed to 60% basic speed (lower for some ratings) by field control	
Shunt-wound, adjustable voltage control			Up to 25%. Less than 5% obtainable with special rotating regulator	Basic speed to 2% basic speed and basic speed to 200% basic speed	
Compound wound, constant-speed	Heavy starting torque, Limited by starting resistor to 130 to 260% of full-load torque	130 to 260%. Limited by commutation	Standard compounding 25%. Depends on amount of series winding	Basic speed to 125% basic speed by field control	Drives requiring high starting torque and fairly constant speed. Pulsating loads. Shears, bending rolls, pumps, conveyors, crushers, etc.
Series-wound, varying-speed	Very heavy starting torque. Limited to 300 to 350% full-load torque	300 to 350%. Limited by commutation	Very high. Infinite no-load speed	From zero to maximum speed, depending on control and load	Drives where very high starting torque is required and speed can be regulated. Cranes, hoists, gates, bridges, car dumpers, etc.

^aMinimum speed below basic speed by armature control limited by heating.

Table 2. Characteristics and Applications of Polyphase AC Motors

Polyphase Type	Ratings hp	Speed Regulation	Speed Control	Starting Torque	Breakdown Torque	Applications
General-purpose squirrel cage, normal stg current, normal stg torque. Design B	0.5 to 200	Less than 5%	None, except multi-speed types, designed for two to four fixed speeds	100 to 250% of full-load	200 to 300% of full-load	Constant-speed service where starting torque is not excessive. Fans, blowers, rotary compressors, centrifugal pumps, woodworking machines, machine tools, line shafts
Full-voltage starting, high stg torque, normal stg current, squirrel-cage, Design C	3 to 150	Less than 5%	None except multi-speed types, designed for two to four fixed speeds	200 to 250% of full-load	190 to 225% of full-load	Constant-speed service where fairly high starting torque is required at infrequent intervals with starting current of about 500% full-load. Reciprocating pumps and compressors, conveyors, crushers, pulverizers, agitators, etc.
Full-voltage starting, high stg-torque, high-slip squirrel cage, Design D	0.5 to 150	Drops about 7 to 12% from no load to full load	None, except multi-speed types, designed for two to four fixed speeds	275% of full-load depending on speed and rotor resistance	275% of full-load Will usually not stall until loaded to its maximum torque, which occurs at standstill	Constant-speed service and high-starting torque if starting not too frequent, and for taking high-peak loads with or without flywheels. Punch presses, die stamping, shears, bulldozers, bailers, hoists, cranes, elevators, etc.
Wound-rotor, external-resistance starting	0.5 to several thousand	With rotor rings short-circuited drops about 3% for large to 5% for small sizes	Speed can be reduced to 50% of normal by rotor resistance. Speed varies inversely as the load	Up to 300% depending on external resistance in rotor circuit and how distributed	200% when rotor slip rings are short circuited	Where high-starting torque with low-starting current or where limited speed control is required. Fans, centrifugal and plunger pumps, compressors, conveyors, hoists, cranes, ball mills, gate hoists, etc.
Synchronous	25 to several thousand	Constant	None, except special motors designed for two fixed speeds	40% for slow speed to 160% for medium speed 80% p-f designs. Special high-torque designs	Pull-out torque of unity-p-f motors 170%; 80%-p-f motors 225%. Special designs up to 300%	For constant-speed service, direct connection to slow-speed machines and where power-factor correction is required.

In addition to these special-purpose motors, there are two types of *explosion-proof motors* designed for hazardous locations. One type is for operation in hazardous dust locations (Class II, Group *G* of the National Electrical Code) and the other is for atmospheres containing explosive vapors and fumes classified as Class I, Group *D* (gasoline, naphtha, alcohols, acetone, lacquer-solvent vapors, natural gas).

Electric Motor Maintenance

Electric Motor Inspection Schedule.—Frequency and thoroughness of inspection depend upon such factors as 1) importance of the motor in the production scheme; 2) percentage of days the motor operates; 3) nature of service; and 4) winding conditions.

The following schedules, recommended by the General Electric Company, and covering both AC and DC motors are based on average conditions in so far as duty and dirt are concerned.

Weekly Inspection.—1) *Surroundings.* Check to see if the windings are exposed to any dripping water, acid or alcoholic fumes; also, check for any unusual amount of dust, chips, or lint on or about the motor. See if any boards, covers, canvas, etc., have been misplaced that might interfere with the motor ventilation or jam moving parts.

2) *Lubrication of sleeve-bearing motors.* In sleeve-bearing motors check oil level, if a gage is used, and fill to the specified line. If the journal diameter is less than 2 inches, the motor should be stopped before checking the oil level. For special lubricating systems, such as wool-packed, forced lubrication, flood and disk lubrication, follow instruction book. Oil should be added to bearing housing only when motor is at rest. A check should be made to see if oil is creeping along the shaft toward windings where it may harm the insulation.

3) *Mechanical condition.* Note any unusual noise that may be caused by metal-to-metal contact or any odor as from scorching insulation varnish.

4) *Ball or roller bearings.* Feel ball- or roller-bearing housings for evidence of vibration, and listen for any unusual noise. Inspect for creepage of grease on inside of motor.

5) *Commutators and brushes.* Check brushes and commutator for sparking. If the motor is on cyclic duty it should be observed through several cycles. Note color and surface condition of the commutator. A stable copper oxide-carbon film (as distinguished from a pure copper surface) on the commutator is an essential requirement for good commutation. Such a film may vary in color all the way from copper to straw, chocolate to black. It should be clean and smooth and have a high polish. All brushes should be checked for wear and pigtail connections for looseness. The commutator surface may be cleaned by using a piece of dry canvas or other hard, nonlinting material that is wound around and securely fastened to a wooden stick, and held against the rotating commutator.

6) *Rotors and armatures.* The air gap on sleeve-bearing motors should be checked, especially if they have been recently overhauled. After installing new bearings, make sure that the average reading is within 10 per cent, and reading should be less than 0.020 inch (0.51 mm). Check air passages through punchings and make sure they are free of foreign matter.

7) *Windings.* If necessary clean windings by suction or mild blowing. After making sure that the motor is dead, wipe off windings with dry cloth, note evidence of moisture, and see if any water has accumulated in the bottom of frame. Check if any oil or grease has worked its way up to the rotor or armature windings. Clean with carbon tetrachloride in a well-ventilated room.

8) *General.* This is a good time to check the belt, gears, flexible couplings, chain, and sprockets for excessive wear or improper location. The motor starting should be checked to make sure that it comes up to proper speed each time power is applied.

Monthly or Bimonthly Inspection.—1) *Windings.* Check shunt, series, and commutating field windings for tightness. Try to move field spools on the poles, as drying out may have caused some play. If this condition exists, a service shop should be consulted. Check motor cable connections for tightness.

2) *Brushes*. Check brushes in holders for fit and free play. Check the brush-spring pressure. Tighten brush studs in holders to take up slack from drying out of washers, making sure that studs are not displaced, particularly on DC motors. Replace brushes that are worn down almost to the brush rivet, examine brush faces for chipped toes or heels, and for heat cracks. Damaged brushes should be replaced immediately.

3) *Commutators*. Examine commutator surface for high bars and high mica, or evidence of scratches or roughness. See that the risers are clean and have not been damaged.

4) *Ball or roller bearings*. On hard-driven, 24-hour service ball- or roller-bearing motors, purge out old grease through drain hole and apply new grease. Check to make sure grease or oil is not leaking out of the bearing housing. If any leakage is present, correct the condition before continuing to operate.

5) *Sleeve bearings*. Check sleeve bearings for wear, including end-play bearing surfaces. Clean out oil wells if there is evidence of dirt or sludge. Flush with lighter oil before refilling.

6) *Enclosed gears*. For motors with enclosed gears, open drain plug and check oil flow for presence of metal scale, sand, or water. If condition of oil is bad, drain, flush, and refill as directed. Rock rotor to see if slack or backlash is increasing.

7) *Loads*. Check loads for changed conditions, bad adjustment, poor handling, or control.

8) *Couplings and other drive details*. Note if belt-tightening adjustment is all used up. Shorten belt if this condition exists. See if belt runs steadily and close to inside (motor edge) of pulley. Chain should be checked for evidence of wear and stretch. Clean inside of chain housing. Check chain-lubricating system. Note inclination of slanting base to make sure it does not cause oil rings to rub on housing.

Annual or Biannual Inspection.—1) *Windings*. Check insulation resistance by using either a megohmmeter or a voltmeter having a resistance of about 100 ohms per volt. Check insulation surfaces for dry cracks and other evidence of need for coatings of insulating material. Clean surfaces and ventilating passages thoroughly if inspection shows accumulation of dust. Check for mold or water standing in frame to determine if windings need to be dried out, varnished, and baked.

2) *Air gap and bearings*. Check air gap to make sure that average reading is within 10 per cent, provided reading should be less than 0.020 inch (0.51 mm). All bearings, ball, roller, and sleeve should be thoroughly checked and defective ones replaced. Waste-packed and wick-oiled bearings should have waste or wicks renewed, if they have become glazed or filled with metal or dirt, making sure that new waste bears well against shaft.

3) *Rotors (squirrel-cage)*. Check squirrel-cage rotors for broken or loose bars and evidence of local heating. If fan blades are not cast in place, check for loose blades. Look for marks on rotor surface indicating foreign matter in air gap or a worn bearing.

4) *Rotors (wound)*. Clean wound rotors thoroughly around collector rings, washers, and connections. Tighten connections if necessary. If rings are rough, spotted, or eccentric, refer to service shop for refinishing. See that all top sticks or wedges are tight. If any are loose, refer to service shop.

5) *Armatures*. Clean all armature air passages thoroughly if any are obstructed. Look for oil or grease creeping along shaft, checking back to bearing. Check commutator for surface condition, high bars, high mica, or eccentricity. If necessary, remachine the commutator to secure a smooth fresh surface.

6) *Loads*. Read load on motor with instruments at no load, full load, or through an entire cycle, as a check on the mechanical condition of the driven machine.

ADHESIVES AND SEALANTS

By strict definition, an adhesive is any substance that fastens or bonds materials to be joined (adherends) by means of surface attachment. The bond durability depends on the strength of the adhesive to the substrate (adhesion) and the strength within the adhesive (cohesion). Besides bonding a joint, an adhesive may serve as a seal against foreign matter. When an adhesive performs both bonding and sealing functions, it is usually referred to as an adhesive sealant. Joining materials with adhesives offers significant benefits compared with mechanical methods of uniting two materials.

Among these benefits are that an adhesive distributes a load over an area rather than concentrating it at a point, resulting in a more even distribution of stresses. The adhesive bonded joint is therefore more resistant to flexural and vibrational stresses than, for example, a bolted, riveted, or welded joint. Another benefit is that an adhesive forms a seal as well as a bond. This seal prevents the corrosion that may occur with dissimilar metals, such as aluminum and magnesium, or mechanically fastened joints, by providing a dielectric insulation between the substrates. An adhesive also joins irregularly shaped surfaces more easily than does a mechanical fastener. Other benefits include negligible weight addition and virtually no change to part dimensions or geometry.

Most adhesives are available in liquids, gels, pastes, and tape forms. The growing variety of adhesives available can make the selection of the proper adhesive or sealant a challenging experience. In addition to the technical requirements of the adhesive, time and costs are also important considerations. Proper choice of an adhesive is based on knowledge of the suitability of the adhesive or sealant for the particular substrates. Appropriate surface preparation, curing parameters, and matching the strength and durability characteristics of the adhesive to its intended use are essential. The performance of an adhesive-bonded joint depends on a wide range of these factors, many of them quite complex. Adhesive suppliers can usually offer essential expertise in the area of appropriate selection.

Adhesives can be classified as structural or nonstructural. In general, an adhesive can be considered structural when it is capable of supporting heavy loads; nonstructural when it cannot support such loads. Many adhesives and sealants, under various brand names, may be available for a particular bonding application. It is always advisable to check the adhesive manufacturers' information before making an adhesive sealant selection. Also, testing under end-use conditions is always suggested to help ensure bonded or sealed joints meet or exceed expected performance requirements.

Though not meant to be all-inclusive, the following information correlates the features of some successful adhesive compositions available in the marketplace.

Bonding Adhesives

Reactive-type bonding adhesives are applied as liquids and react (cure) to solids under appropriate conditions. The cured adhesive is either a thermosetting or thermoplastic polymer. These adhesives are supplied as two-component no-mix, two-component mix, and one-component no-mix types, which are discussed in the following paragraphs.

Two-Component No-Mix Adhesives

Types of Adhesives.—*Anaerobic (Urethane Methacrylate Ester) Structural Adhesives:* Anaerobic structural adhesives are mixtures of acrylic esters that remain liquid when exposed to air but harden when confined between metal substrates. These adhesives can be used for large numbers of industrial purposes where high reliability of bond joints is required. Benefits include: no mixing is required (no pot-life or waste problems), flexible/durable bonds are made that withstand thermal cycling, have excellent resistance to solvents and severe environments, and rapid cure at room temperatures (eliminating

expensive ovens). The adhesives are easily dispensed with automatic equipment. An activator is usually required to be present on one surface to initiate the cure for these adhesives. Applications for these adhesives include bonding of metals, magnets (ferrites), glass, thermosetting plastics, ceramics, and stone.

Acrylic Adhesives: Acrylic adhesives are composed of a polyurethane polymer backbone with acrylate end groups. They can be formulated to cure through heat or the use of an activator applied to the substrate surface, but many industrial acrylic adhesives are cured by light. Light-cured adhesives are used in applications where the bond geometry allows light to reach the adhesive and the production rate is high enough to justify the capital expense of a light source. Benefits include: no mixing is required (no pot-life or waste problems); formulations cure (solidify) with activator, heat, or light; the adhesive will bond to a variety of substrates, including metal and most thermoplastics; and tough and durable bonds are produced with a typical resistance to the effects of temperatures up to 180°C. Typical applications include automobile body parts (steel stiffeners), assemblies subjected to paint-baking cycles, speaker magnets to pole plates, and bonding of motor magnets, sheet steel, and many other structural applications. Other applications include bonding glass, sheet metal, magnets (ferrite), thermosetting and thermoplastic plastics, wood, ceramics, and stone.

Two-Component Mix Adhesives

Types of Adhesives.—*Epoxy Adhesives:* Two-component epoxy adhesives are well-established adhesives that offer many benefits in manufacturing. The reactive components of these adhesives are separated prior to use, so they usually have a good shelf life without refrigeration. Polymerization begins upon mixing, and a thermoset polymer is formed. Epoxy adhesives cure to form thermosetting polymers made up of a base side with the polymer resin and a second part containing the catalyst. The main benefit of these systems is that the depth of cure is unlimited. As a result, large volume can be filled for work such as potting, without the cure being limited by the need for access to an external influence such as moisture or light to activate the curing process.

For consistent adhesive performance, it is important that the mix ratio remain constant to eliminate variations in adhesive performance. Epoxies can be handled automatically, but the equipment involves initial and maintenance costs. Alternatively, adhesive components can be mixed by hand. However, this approach involves labor costs and the potential for human error. The major disadvantage of epoxies is that they tend to be very rigid and consequently have low peel strength. This lack of peel strength is less of a problem when bonding metal to metal than it is when bonding flexible substrates such as plastics.

Applications of epoxy adhesives include bonding, potting, and coating of metals, bonding of glass, rigid plastics, ceramics, wood, and stone.

Polyurethane Adhesives: Like epoxies, polyurethane adhesives are available as two-part systems or as one-component frozen premixes. They are also available as one-part moisture-cured systems. Polyurethane adhesives can provide a wide variety of physical properties. Their flexibility is greater than that of most epoxies. Coupled with the high cohesive strength, this flexibility provides a tough polymer able to achieve better peel strength and lower flexural modulus than most epoxy systems. This superior peel resistance allows use of polyurethanes in applications that require high flexibility. Polyurethanes bond very well to a variety of substrates, though a primer may be needed to prepare the substrate surface. These primers are moisture-reactive and require several hours to react sufficiently for the parts to be used. Such a time requirement may cause a production bottleneck if the bond-strength requirements are such that a primer is needed.

Applications for polyurethane adhesives include bonding of metals, glass, rubber, thermosetting and thermoplastic plastics, and wood.

One-Component No-Mix Adhesives

Types of Adhesives.—*Light-Curable Adhesives:* Light-curing systems use a unique curing mechanism. The adhesives contain photoinitiators that absorb light energy and dissociate to form radicals. These radicals then initiate the polymerization of the polymers, oligomers, and monomers in the adhesive. The photoinitiator acts as a chemical solar cell, converting the light energy into chemical energy for the curing process. Typically, these systems are formulated for use with ultraviolet light sources. However, newer products have been formulated for use with visible light sources.

One of the biggest benefits that light-curing adhesives offer to the manufacturer is the elimination of the work time to work-in-progress trade-off, which is embodied in most adhesive systems. With light-curing systems, the user can take as much time as needed to position the part without fear of the adhesive curing. Upon exposure to the appropriate light source, the adhesive then can be fully cured in less than 1 minute, minimizing the costs associated with work in progress. Adhesives that utilize light as the curing mechanism are often one-part systems with good shelf life, which makes them even more attractive for manufacturing use.

Applications for light-curable adhesives include bonding of glass, and glass to metal, tacking of wires, surface coating, thin-film encapsulation, clear substrate bonding, and potting of components,

Cyanoacrylate Adhesives (Instant Adhesives): Cyanoacrylates or instant adhesives are often called Superglue™. Cyanoacrylates are one-part adhesives that cure rapidly, as a result of the presence of surface moisture, to form high-strength bonds, when confined between two substrates. Cyanoacrylates have excellent adhesion to many substrates, including most plastics and they achieve fixture strength in seconds and full strength within 24 hours. These qualities make cyanoacrylates suitable for use in automated production environments. They are available in viscosities ranging from water-thin liquids to thixotropic gels.

Because cyanoacrylates are a relatively mature adhesive family, a wide variety of specialty formulations is now available to help the user address difficult assembly problems. One of the best examples is the availability of polyolefin primers, which allow users to obtain high bond strengths on difficult-to-bond plastics such as polyethylene and polypropylene. One common drawback of cyanoacrylates is that they form a very rigid polymer matrix, resulting in very low peel strengths. To address this problem, formulations have been developed that are rubber-toughened. Although the rubber toughening improves the peel strength of the system to some extent, peel strength remains a weak point for this system, and, therefore, cyanoacrylates are poor candidates for joint designs that require high peel resistance. In manufacturing environments with low relative humidity, the cure of the cyanoacrylate can be significantly retarded.

This problem can be addressed in one of two ways. One approach is to use accelerators that deposit active species on the surface to initiate the cure of the product. The other approach is to use specialty cyanoacrylate formulations that have been engineered to be surface-insensitive. These formulations can cure rapidly even on dry or slightly acidic surfaces.

Applications for cyanoacrylate adhesives include bonding of thermoplastic and thermosetting plastics, rubber, metals, wood, and leather, also strain relief of wires.

Hot-Melt Adhesives: Hot-melt adhesives are widely used in assembly applications. In general, hot-melt adhesives permit fixturing speeds that are much faster than can be achieved with water- or solvent-based adhesives. Usually supplied in solid form, hot-melt adhesives liquify when exposed to elevated temperatures. After application, they cool quickly, solidifying and forming a bond between two mating substrates. Hot-melt adhesives have been used successfully for a wide variety of adherends and can greatly reduce both the need for clamping and the length of time for curing. Some drawbacks with hot-

melt adhesives are their tendency to string during dispensing and relatively low-temperature resistance.

Applications for hot-melt adhesives are bonding of fabrics, wood, paper, plastics, and cardboard.

Rubber-Based Solvent Cements: Rubber-based solvent cements are adhesives made by combining one or more rubbers or elastomers in a solvent. These solutions are further modified with additives to improve the tack or stickiness, the degree of peel strength, flexibility, and the viscosity or body. Rubber-based adhesives are used in a wide variety of applications such as contact adhesive for plastics laminates like counter tops, cabinets, desks, and tables. Solvent-based rubber cements have also been the mainstay of the shoe and leather industry for many years.

Applications for rubber-based solvent cements include bonding of plastics laminates, wood, paper, carpeting, fabrics, and leather.

Moisture-Cured Polyurethane Adhesives: Like heat-curing systems, moisture-cured polyurethanes have the advantage of a very simple curing process. These adhesives start to cure when moisture from the atmosphere diffuses into the adhesive and initiates the polymerization process. In general, these systems will cure when the relative humidity is above 25 per cent, and the rate of cure will increase as the relative humidity increases.

The dependence of these systems on the permeation of moisture through the polymer is the source of their most significant process limitations. As a result of this dependence, depth of cure is limited to between 0.25 and 0.5 in. (6.35 and 12.7 mm). Typical cure times are in the range of 12 to 72 hours. The biggest use for these systems is for windshield bonding in automobile bodies.

Applications for moisture-cured polyurethane adhesives include bonding of metals, glass, rubber, thermosetting and thermoplastic plastics, and wood.

Retaining Compounds

The term *retaining compounds* is used to describe adhesives used in circumferential assemblies joined by inserting one part into the other. In general, retaining compounds are anaerobic adhesives composed of mixtures of acrylic esters that remain liquid when exposed to air but harden when confined between cylindrical machine components. A typical example is a bearing held in an electric motor housing with a retaining compound. The first retaining compounds were launched in 1963, and the reaction among users of bearings was very strong because these retaining compounds enabled buyers of new bearings to salvage worn housings and minimize their scrap rate.

The use of retaining compounds has many benefits, including elimination of bulk needed for high friction forces, ability to produce more accurate assemblies and to augment or replace press fits, increased strength in heavy press fits, and reduction of machining costs. Use of these compounds also helps in dissipating heat through assembly, and eliminating distortion when installing drill bushings, fretting corrosion and backlash in keys and splines, and bearing seizure during operation.

The major advantages of retaining compounds for structural assemblies are that they require less severe machining tolerances and no securing of parts. Components are assembled quickly and cleanly, and they transmit high forces and torques, including dynamic forces. Retaining compounds also seal, insulate, and prevent micromovements so that neither fretting corrosion nor stress corrosion occurs. The adhesive joint can be taken apart easily after heating above 450°F (230°C) for a specified time.

Applications for retaining compounds include mounting of bearings in housings or on shafts, avoiding distortion of precision tooling and machines, mounting of rotors on shafts, inserting drill jig bushings, retaining cylinder linings, holding oil filter tubes in castings, retaining engine-core plugs, restoring accuracy to worn machine tools, and eliminating keys and set screws.

Threadlocking

The term *threadlocker* is used to describe adhesives used in threaded assemblies for locking the threaded fasteners by filling the spaces between the nut and bolt threads with a hard, dense material that prevents loosening. In general, thread-lockers are anaerobic adhesives comprising mixtures of acrylic esters that remain liquid when exposed to air but harden when confined between threaded components. A typical example is a mounting bolt on a motor or a pump. Threadlocker strengths range from very low strength (removable) to high strength (permanent).

It is important that the total length of the thread is coated and that there is no restriction to the curing of the threadlocker material. (Certain oils or cleaning systems can impede or even completely prevent the adhesive from curing by anaerobic reaction.) The liquid threadlocker may be applied by hand or with special dispensing devices. Proper coating (wetting) of a thread is dependent on the size of the thread, the viscosity of the adhesive, and the geometry of the parts. With blind-hole threads, it is essential that the adhesive be applied all the way to the bottom of the threaded hole. The quantity must be such that after assembly, the displaced adhesive fills the whole length of the thread.

Some threadlocking products cured by anaerobic reaction have a positive influence on the coefficient of friction in the thread. The values are comparable with those of oiled bolts. Prestress and installation torque therefore can be defined exactly. This property allows threadlocking products cured by anaerobic reaction to be integrated into automated production lines using existing assembly equipment. The use of thread-lockers has many benefits including ability to lock and seal all popular bolt and nut sizes with all industrial finishes, and to replace mechanical locking devices. The adhesive can seal against most industrial fluids and will lubricate threads so that the proper clamp load is obtained. The materials also provide vibration-resistant joints that require handtool dismantling for servicing, prevent rusting of threads, and cure (solidify) without cracking or shrinking.

The range of applications includes such uses as locking and sealing nuts on hydraulic pistons, screws on vacuum cleaner bell housings, track bolts on bulldozers, hydraulic-line fittings, screws on typewriters, oil-pressure switch assembly, screws on carburetors, rocker nuts, machinery driving keys, and on construction equipment.

Sealants

The primary role of a sealant composition is the prevention of leakage from or access by dust, fluids, and other materials to assembly structures. Acceptable leak rates can range from a slight drip to bubbletight to molecular diffusion through the base materials. Equipment users in the industrial market want trouble-free operation, but it is not always practical to specify zero leak rates. Factors influencing acceptable leak rates are toxicity, product or environmental contamination, combustibility, economics, and personnel considerations. All types of fluid seals perform the same basic function: they seal the process fluid (gas, liquid, or vapor) and keep it where it belongs. A general term for these assembly approaches is gasketing. Many products are being manufactured that are capable of sealing a variety of substrates.

Types of Sealants.—*Anaerobic Formed-in-Place Gasketing Materials:* Mechanical assemblies that require the joining of metal-to-metal flange surfaces have long been designed with prefabricated, precut materials required to seal the imperfect surfaces of the assembly. Numerous gasket materials that have been used to seal these assemblies include paper, cork, asbestos, wood, metals, dressings, and even plastics. Fluid seals are divided into static and dynamic systems, depending on whether or not the parts move in relationship to each other. Flanges are classed as static systems, although they may be moved relative to each other by vibration, temperature, and/or pressure changes, shocks, and impacts.

The term *anaerobic formed-in-place gasketing* is used to describe sealants that are used in flanged assemblies to compensate for surface imperfections of metal-to-metal compo-

nents by filling the space between the substrates with a flexible, nonrunning material. In general, anaerobic formed-in-place gaskets are sealants made up of mixtures of acrylic esters that remain liquid when exposed to air but harden when confined between components. A typical example is sealing two halves of a split crankcase.

The use of anaerobic formed-in-place gaskets has many benefits, including the ability to seal all surface imperfections, allow true metal-to-metal contact, eliminate compression set and fastener loosening, and add structural strength to assemblies. These gaskets also help improve torque transmission between bolted flange joints, eliminate bolt retorquing needed with conventional gaskets, permit use of smaller fasteners and lighter flanges, and provide for easy disassembly and cleaning.

Applications in which formed-in-place gasketing can be used to produce leakproof joints include pipe flanges, split crankcases, pumps, compressors, power takeoff covers, and axle covers. These types of gaskets may also be used for repairing damaged conventional gaskets and for coating soft gaskets.

Silicone Rubber Formed-in-Place Gasketing: Another type of formed-in-place gasket uses room-temperature vulcanizing (RTV) silicone rubbers. These materials are one-component sealants that cure on exposure to atmospheric moisture. They have excellent properties for vehicle use such as flexibility, low volatility, good adhesion, and high resistance to most automotive fluids. The materials will also withstand temperatures up to 600°F (320°C) for intermittent operation.

RTV silicones are best suited for fairly thick section (gap) gasketing applications where flange flexing is greatest. In the form of a very thin film, for a rigid metal-to-metal seal, the cured elastomer may abrade and eventually fail under continual flange movement. The RTV silicone rubber does not unitize the assembly, and it requires relatively clean, oil-free surfaces for sufficient adhesion and leakproof seals.

Because of the silicone's basic polymeric structure, RTV silicone elastomers have several inherent characteristics that make them useful in a wide variety of applications. These properties include outstanding thermal stability at temperatures from 400 to 600°F (204 to 320°C), and good low-temperature flexibility at -85 to -165°F (-65 to -115°C). The material forms an instant seal, as is required of all liquid gaskets, and will fill large gaps up to 0.250 in. (6.35 mm) for stamped metal parts and flanges. The rubber also has good stability in ultraviolet light and excellent weathering resistance.

Applications for formed-in-place RTV silicones in the automotive field are valve, camshaft and rocker covers, manual transmission (gearbox) flanges, oil pans, sealing panels, rear axle housings, timing chain covers, and window plates. The materials are also used on oven doors and flues.

Tapered Pipe-thread Sealing

Thread sealants are used to prevent leakage of gases and liquids from pipe joints. All joints of this type are considered to be dynamic because of vibration, changing pressures, or changing temperatures.

Several types of sealants are used on pipe threads including noncuring pipe dopes, which are one of the oldest methods of sealing the spiral leak paths of threaded joints. In general, pipe dopes are pastes made from oils and various fillers. They lubricate joints and jam threads but provide no locking advantage. They also squeeze out under pressure, and have poor solvent resistance. Noncuring pipe dopes are not suitable for use on straight threads.

Another alternative is solvent-drying pipe dopes, which are an older method of sealing tapered threaded joints. These types of sealant offer the advantages of providing lubrication and orifice jamming and they also extrude less easily than noncuring pipe dopes. One disadvantage is that they shrink during cure as the solvents evaporate and fittings must be retorqued to minimize voids. These materials generally lock the threaded joint together by friction. A third type of sealer is the trapped elastomer supplied in the form of a thin tape

incorporating polytetrafluorethylene (PTFE). This tape gives a good initial seal and resists chemical attack, and is one of the only materials used for sealing systems that will seal against oxygen gas.

Some other advantages of PTFE are that it acts as a lubricant, allows for high torquing, and has a good resistance to various solvents. Some disadvantages are that it may not provide a true seal between the two threaded surfaces, and it lubricates in the off direction, so it may allow fittings to loosen. In dynamic joints, tape may allow creep, resulting in leakage over time. The lubrication effect may allow overtightening, which can add stress or lead to breakage. Tape also may be banned in some hydraulic systems due to shredding, which may cause clogging of key orifices.

Anaerobic Pipe Sealants.—The term *anaerobic pipe sealants* is used to describe anaerobic sealants used in tapered threaded assemblies for sealing and locking threaded joints. Sealing and locking are accomplished by filling the space between the threads with the sealant. In general, these pipe sealants are anaerobic adhesives consisting of mixtures of acrylic esters that remain liquid when exposed to air but harden when confined between threaded components to form an insoluble tough plastics. The strength of anaerobic pipe sealants is between that of elastomers and yielding metal.

Clamp loads need be only tight enough to prevent separation in use. Because they develop strength by curing after they are in place, these sealants are generally forgiving of tolerances, tool marks, and slight misalignment. These sealants are formulated for use on metal substrates. If the materials are used on plastics, an activator or primer should be used to prepare the surfaces.

Among the advantages of these anaerobic sealers are that they lubricate during assembly, they seal regardless of assembly torque, and they make seals that correspond with the burst rating of the pipe. They also provide controlled disassembly torque, do not cure outside the joint, and are easily dispensed on the production line. These sealants also have the lowest cost per sealed fitting. Among the disadvantages are that the materials are not suitable for oxygen service, for use with strong oxidizing agents, or for use at temperatures above 200°C (392°F). The sealants also are typically not suitable for diameters over M80 or 80 mm (approximately 3 inches).

The many influences faced by pipe joints during service should be known and understood at the design stage, when sealants are selected. Sealants must be chosen for reliability and long-term quality. Tapered pipe threads must remain leak-free under the severest vibration and chemical attack, also under heat and pressure surges.

Applications of aerobic sealants are found in industrial plant fluid power systems, the textile industry, chemical processing, utilities and power generation facilities, petroleum refining, and in marine, automotive, and industrial equipment. The materials are also used in the pulp and paper industries, in gas compression and distribution, and in waste-treatment facilities.

O-RINGS

An O-ring is a one-piece molded elastomeric seal with a circular cross-section that seals by distortion of its resilient elastic compound. Dimensions of O-rings are given in ANSI/SAE AS568A, Aerospace Size Standard for O-rings. The standard ring sizes have been assigned identifying dash numbers that, in conjunction with the compound (ring material), completely specifies the ring. Although the ring sizes are standardized, ANSI/SAE AS568A does not cover the compounds used in making the rings; thus, different manufacturers will use different designations to identify various ring compounds. For example, 230-8307 represents a standard O-ring of size 230 (2.484 in. ID by 0.139 in. width) made with compound 8307, a general-purpose nitrile compound. O-ring material properties are discussed at the end of this section.

When properly installed in a groove, an O-ring is normally slightly deformed so that the naturally round cross-section is squeezed diametrically out of round prior to the application of pressure. This compression ensures that under static conditions, the ring is in contact with the inner and outer walls enclosing it, with the resiliency of the rubber providing a zero-pressure seal. When pressure is applied, it tends to force the O-ring across the groove, causing the ring to further deform and flow up to the fluid passage and seal it against leakage, as in Fig. 1(a). As additional pressure is applied, the O-ring deforms into a D shape, as in Fig. 1(b). If the clearance gap between the sealing surface and the groove corners is too large or if the pressure exceeds the deformation limits of the O-ring material (compound), the O-ring will extrude into the clearance gap, reducing the effective life of the seal. For very low-pressure static applications, the effectiveness of the seal can be improved by using a softer durometer compound or by increasing the initial squeeze on the ring, but at higher pressures, the additional squeeze may reduce the ring's dynamic sealing ability, increase friction, and shorten ring life.

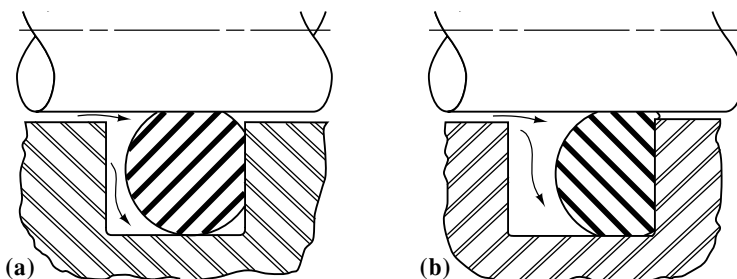


Fig. 1.

The initial diametral squeeze of the ring is very important in the success of an O-ring application. The squeeze is the difference between the ring width W and the gland depth F (Fig. 2) and has a great effect on the sealing ability and life of an O-ring application.

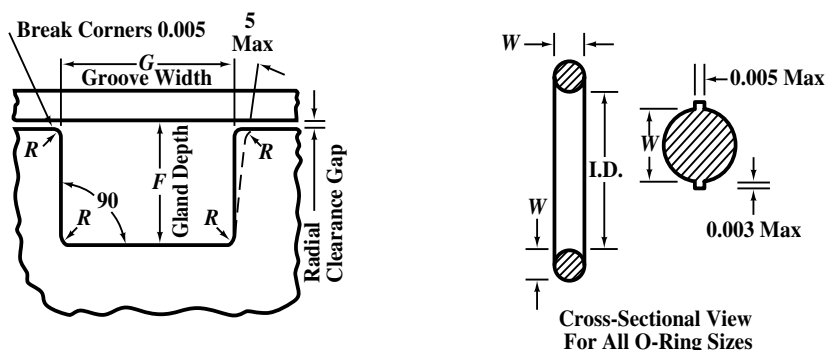


Fig. 2. Groove and Ring Details

The ideal squeeze varies according to the ring cross-section, with the average being about 20 per cent, i.e., the ring's cross-section W is about 20 per cent greater than the gland depth F (groove depth plus clearance gap). The groove width is normally about 1.5 times larger than the ring width W . When installed, an O-ring compresses slightly and distorts into the free space within the groove. Additional expansion or swelling may also occur due to contact of the ring with fluid or heat. The groove must be large enough to accommodate the maximum expansion of the ring or the ring may extrude into the clearance gap or rupture the assembly. In a dynamic application, the extruded ring material will quickly wear and fray, severely limiting seal life.

To prevent O-ring extrusion or to correct an O-ring application, reduce the clearance gap by modifying the dimensions of the system, reduce the system operating pressure, install antiextrusion backup rings in the groove with the O-ring, as in Fig. 3, or use a harder O-ring compound. A harder compound may result in higher friction and a greater tendency of the seal to leak at low pressures. Backup rings, frequently made of leather, Teflon, metal, phenolic, hard rubber, and other hard materials, prevent extrusion and nibbling where large clearance gaps and high pressure are necessary.

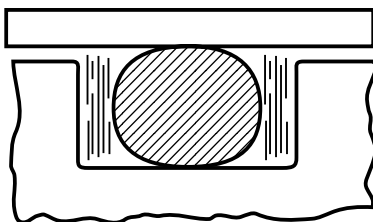


Fig. 3. Preferred Use of Backup Washers

The most effective and reliable sealing is generally provided by using the diametrical clearances given in manufacturers' literature. However, the information in Table 1 may be used to estimate the gland depth (groove depth plus radial clearance) required in O-ring applications. The radial clearance used (radial clearance equals one-half the diametral clearance) also depends on the system pressure, the ring compound and hardness, and specific details of the application.

Table 1. Gland Depth for O-Ring Applications

Standard O-Ring Cross-Sectional Diameter (in.)	Gland Depth (in.)	
	Reciprocating Seals	Static Seals
0.070	0.055 to 0.057	0.050 to 0.052
0.103	0.088 to 0.090	0.081 to 0.083
0.139	0.121 to 0.123	0.111 to 0.113
0.210	0.185 to 0.188	0.170 to 0.173
0.275	0.237 to 0.240	0.226 to 0.229

Source: Auburn Manufacturing Co. When possible, use manufacturer recommendations for clearance gaps and groove depth.

Fig. 4 indicates conditions where O-ring seals may be used, depending on the fluid pressure and the O-ring hardness. If the conditions of use fall to the right of the curve, extrusion of the O-ring into the surrounding clearance gap will occur, greatly reducing the life of the ring. If conditions fall to the left of the curve, no extrusion of the ring will occur, and the ring may be used under these conditions. For example, in an O-ring application with a 0.004-in. diametral clearance and 2500-psi pressure, extrusion will occur with a 70 durometer O-ring but not with an 80 durometer O-ring. As the graph indicates, high-pressure applications require lower clearances and harder O-rings for effective sealing.

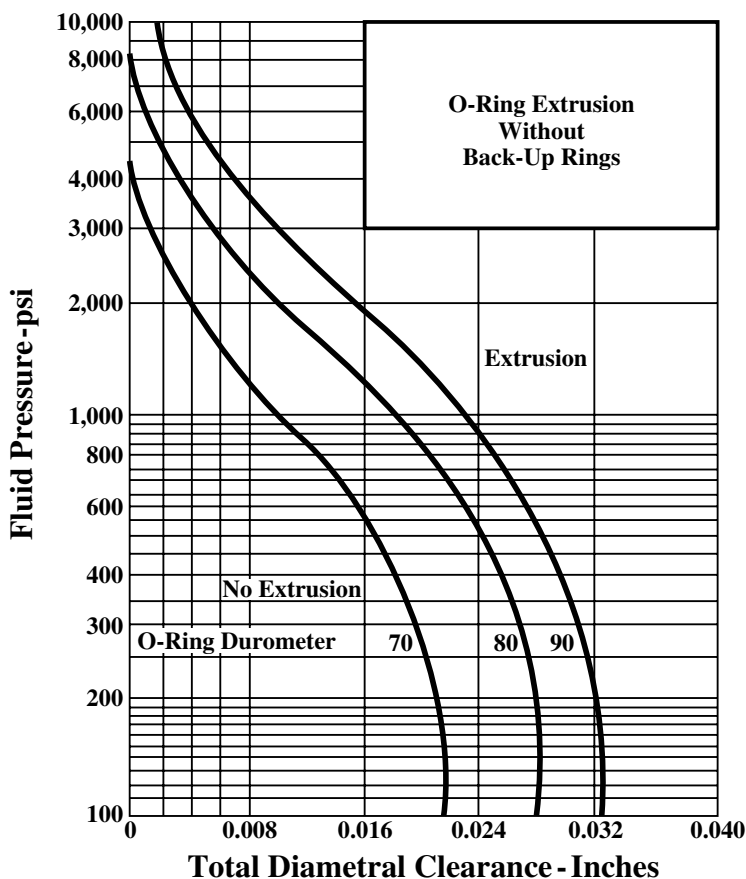


Fig. 4. Extrusion Potential of O-Rings as a Function of Hardness and Clearance

Recommended groove width, clearance dimensions, and bottom-of-groove radius for O-ring numbers up to 475 (25.940-in. ID by 0.275-in. width) can be found using [Table 2](#) in conjunction with [Fig. 5](#). In general, except for ring cross-sections smaller than $\frac{1}{16}$ in., the groove width is approximately $1.5W$, where W is the ring cross-sectional diameter. Straight-sided grooves are best for preventing extrusion of the ring or nibbling; however, for low-pressure applications (less than 1500 psi) sloped sides with an angle up to 5° can be used to simplify machining of the groove. The groove surfaces should be free of burrs, nicks, or scratches. For static seals (i.e., no contact between the O-ring and any moving parts), the groove surfaces should have a maximum roughness of 32 to 63 $\mu\text{in. rms}$ for liquid-sealing applications and 16 to 32 $\mu\text{in. rms}$ for gaseous-sealing applications. In dynamic seals, relative motion exists between the O-ring and one or more parts and the maximum groove surface roughness should be 8 to 16 $\mu\text{in. rms}$ for sliding contact applications (reciprocating seals, for example) and 16 to 32 $\mu\text{in. rms}$ for rotary contact applications (rotating and oscillating seals).

In dynamic seal applications, the roughness of surfaces in contact with O-rings (bores, pistons, and shafts, for example) should be 8 to 16 $\mu\text{in. rms}$, without longitudinal or circumferential scratches. Surface finishes of less than 5 $\mu\text{in. rms}$ are too smooth to give a good seal life because they wipe too clean, causing the ring to wear against the housing in the absence of a lubricating film. The best-quality surfaces are honed, burnished, or hard chromium plated. Soft and stringy metals such as aluminum, brass, bronze, Monel, or free machining stainless steel should not be used in contact with moving seals. In static applica-

tions, O-ring contacting surfaces should have a maximum surface roughness of 64 to 125 $\mu\text{in. rms}$.

Table 2. Diametral Clearance and Groove Sizes for O-Ring Applications

ANSI/SAE AS568 Number	Tolerances		Diametral Clearance, D		Groove Width, G			Bottom of Groove Radius, R
	A	B	Reciprocating & Static Seals	Rotary Seals	Backup Rigs			
					None	One	Two	
001	+0.001 -0.000	+0.000 -0.001	0.002 to 0.004	0.012 to 0.016	0.063	0.149	0.207	0.005 to 0.015
002					0.073			
003					0.083			
004 to 012					0.094			
013 to 050 102 to 129 130 to 178 201 to 284	+0.002 -0.000	+0.000 -0.002	0.002 to 0.005	0.016 to 0.020	0.141	0.183	0.245	0.010 to 0.025
0.002 to 0.006			0.188		0.235	0.304		
0.003 to 0.007			0.281		0.334	0.424		
309 to 395 425 to 475	+0.003 -0.000	+0.000 -0.003	0.004 to 0.010	0.020	0.375	0.475	0.579	0.020 to 0.035

Source: Auburn Manufacturing Co. All dimensions are in inches. Clearances listed are minimum and maximum values; standard groove widths may be reduced by about 10 per cent for use with ring compounds that free swell less than 15 per cent. Dimension A is the ID of any surface contacted by the outside circumference of the ring; B is the OD of any surface contacted by the inside circumference of the ring.

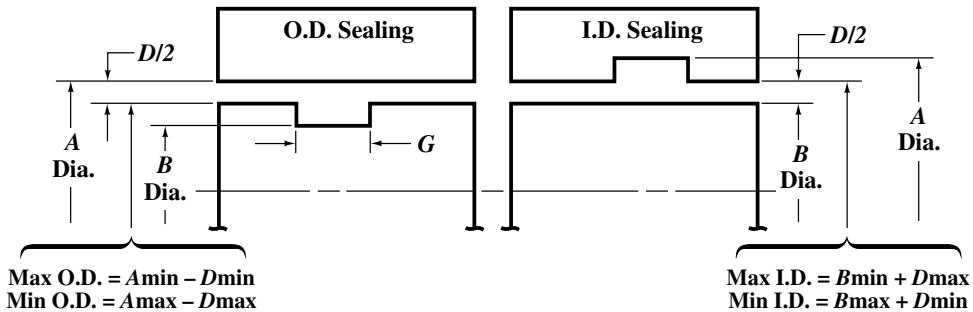


Fig. 5. Installation data for use with Table 2. Max and Min are maximum and minimum piston and bore diameters for O.D. and I.D., respectively.

The preferred bore materials are steel and cast iron, and pistons should be softer than the bore to avoid scratching them. The bore sections should be thick enough to resist expansion and contraction under pressure so that the radial clearance gap remains constant, reducing the chance of damage to the O-ring by extrusion and nibbling. Some compatibility problems may occur when O-rings are used with plastics parts because certain compounding ingredients may attack the plastics, causing crazing of the plastics surface.

O-rings are frequently used as driving belts in round bottom or V-grooves with light tension for low-power drive elements. Special compounds are available with high resistance to stress relaxation and fatigue for these applications. Best service is obtained in drive belt applications when the initial belt tension is between 80 and 200 psi and the initial installed stretch is between 8 and 25 per cent of the circumferential length. Most of the compounds used for drive belts operate best between 10 and 15 per cent stretch, although polyurethane has good service life when stretched as much as 20 to 25 per cent.

Table 3. Typical O-Ring Compounds

Nitrile	General-purpose compound for use with most petroleum oils, greases, gasoline, alcohols and glycols, LP gases, propane and butane fuels. Also for food service to resist vegetable and animal fats. Effective temperature range is about -40° to 250°F (-40 to 121°C). Excellent compression set, tear and abrasion resistance, but poor resistance to ozone, sunlight and weather. Higher-temperature nitrile compounds with similar properties are also available.
Hydrogenated Nitrile	Similar to general-purpose nitrile compounds with improved high-temperature performance, resistance to aging, and petroleum product compatibility.
Polychloroprene (Neoprene)	General-purpose compound with low compression set and good resistance to elevated temperatures. Good resistance to sunlight, ozone, and weathering, and fair oil resistance. Frequently used for refrigerator gases such as Freon. Effective temperature range is about -40° to 250°F (-40 to 121°C).
Ethylene Propylene	General-purpose compound with excellent resistance to polar fluids such as water, steam, ketones, and phosphate esters, and brake fluids, but not resistant to petroleum oils and solvents. Excellent resistance to ozone and flexing. Recommended for belt-drive applications. Continuous duty service in temperatures up to 250°F (121°C).
Silicone	Widest temperature range (-150° to 500°F or -101 to 260°C) and best low-temperature flexibility of all elastomeric compounds. Not recommended for dynamic applications, due to low strength, or for use with most petroleum oils. Shrinkage characteristics similar to organic rubber, allowing existing molds to be used.
Polyurethane	Toughest of the elastomers used for O-rings, characterized by high tensile strength, excellent abrasion resistance, and tear strength. Compression set and heat resistance are inferior to nitrile. Suitable for hydraulic applications that anticipate abrasive contaminants and shock loads. Temperature service range of -65° to 212°F (-54 to 100°C).
Fluorosilicone	Wide temperature range (-80° to 450°F or -62 to 232°C) for continuous duty and excellent resistance to petroleum oils and fuels. Recommended for static applications only, due to limited strength and low abrasion resistance.
Polyacrylate	Heat resistance better than nitrile compounds, but inferior low temperature, compression set, and water resistance. Often used in power steering and transmission applications due to excellent resistance to oil, automatic transmission fluids, oxidation, and flex cracking. Temperature service range of -20° to 300°F (-29 to 149°C).
Fluorocarbon (Viton)	General-purpose compound suitable for applications requiring resistance to aromatic or halogenated solvents or to high temperatures (-20° to 500°F or -29 to 260°C with limited service to 600°F or 316°C). Outstanding resistance to blended aromatic fuels, straight aromatics, and halogenated hydrocarbons and other petroleum products. Good resistance to strong acids (temperature range in acids -20° to 250°F or -29 to 121°C), but not effective for use with very hot water, steam, and brake fluids.

Ring Materials.—Thousands of O-ring compounds have been formulated for specific applications. Some of the most common types of compounds and their typical applications are given in [Table 3](#). The Shore A durometer is the standard instrument used for measuring the hardness of elastomeric compounds. The softest O-rings are 50 and 60 Shore A and stretch more easily, exhibit lower breakout friction, seal better on rough surfaces, and need less clamping pressure than harder rings. For a given squeeze, the higher the durometer hardness of a ring, the greater the associated friction because a greater compressive force is exerted by hard rings than soft rings.

The most widely used rings are medium-hard O-rings with 70 Shore A hardness, which have the best wear resistance and frictional properties for running seals. Applications that involve oscillating or rotary motion frequently use 80 Shore A materials. Rings with a hardness above 85 Shore A often leak more because of less effective wiping action. These harder rings have a greater resistance to extrusion, but for small sizes may break easily during installation. O-ring hardness varies inversely with temperature, but when used for continuous service at high temperatures, the hardness may eventually increase after an initial softening of the compound.

O-ring compounds have thermal coefficients of expansion in the range of 7 to 20 times that of metal components, so shrinkage or expansion with temperature change can pose problems of leakage past the seal at low temperatures and excessive pressures at high temperatures when a ring is installed in a tight-fitting groove. Likewise, when an O-ring is immersed in a fluid, the compound usually absorbs some of the fluid and consequently increases in volume. Manufacturer's data give volumetric increase data for compounds completely immersed in various fluids. For confined rings (those with only a portion of the ring exposed to fluid), the size increase may be considerably lower than for rings completely immersed in fluid. Certain fluids can also cause ring shrinkage during "idle" periods, i.e., when the seal has a chance to dry out. If this shrinkage is more than 3 to 4 per cent, the seal may leak.

Excessive swelling due to fluid contact and high temperatures softens all compounds approximately 20 to 30 Shore A points from room temperature values and designs should anticipate the expected operating conditions. At low temperatures, swelling may be beneficial because fluid absorption may make the seal more flexible. However, the combination of low temperature and low pressure makes a seal particularly difficult to maintain. A soft compound should be used to provide a resilient seal at low temperatures. Below -65°F , only compounds formulated with silicone are useful; other compounds are simply too stiff, especially for use with air and other gases.

Compression set is another material property and a very important sealing factor. It is a measure of the shape memory of the material, that is, the ability to regain shape after being deformed. Compression set is a ratio, expressed as a percentage, of the unrecovered to original thickness of an O-ring compressed for a specified period of time between two heated plates and then released. O-rings with excessive compressive set will fail to maintain a good seal because, over time, the ring will be unable to exert the necessary compressive force (squeeze) on the enclosing walls. Swelling of the ring due to fluid contact tends to increase the squeeze and may partially compensate for the loss due to compression set. Generally, compression set varies by compound and ring cross-sectional diameter, and increases with the operating temperature.

ROLLED STEEL, WIRE, SHEET-METAL, WIRE ROPE

Rolled Steel Sections

Lengths of Angles Bent to Circular Shape.—To calculate the length of an angle-iron used either inside or outside of a tank or smokestack, the following table of constants may be used: Assume, for example, that a stand-pipe, 20 feet inside diameter, is provided with a 3 by 3 by $\frac{3}{8}$ inch angle-iron on the inside at the top. The circumference of a circle 20 feet in diameter is 754 inches. From the table of constants, find the constant for a 3 by 3 by $\frac{3}{8}$ inch angle-iron, which is 4.319. The length of the angle then is $754 - 4.319 = 749.681$ inches. Should the angle be on the outside, add the constant instead of subtracting it; thus, $754 + 4.319 = 758.319$ inches.

Size of Angle	Const.	Size of Angle	Const.	Size of Angle	Const.
$\frac{1}{4} \times 2 \times 2$	2.879	$\frac{5}{16} \times 3 \times 3$	4.123	$\frac{1}{2} \times 5 \times 5$	6.804
$\frac{3}{16} \times 2 \times 2$	3.076	$\frac{3}{8} \times 3 \times 3$	4.319	$\frac{3}{8} \times 6 \times 6$	7.461
$\frac{3}{8} \times 2 \times 2$	3.272	$\frac{1}{2} \times 3 \times 3$	4.711	$\frac{1}{2} \times 6 \times 6$	7.854
$\frac{1}{4} \times 2\frac{1}{2} \times 2\frac{1}{2}$	3.403	$\frac{3}{8} \times 3\frac{1}{2} \times 3\frac{1}{2}$	4.843	$\frac{3}{4} \times 6 \times 6$	8.639
$\frac{5}{16} \times 2\frac{1}{2} \times 2\frac{1}{2}$	3.600	$\frac{1}{2} \times 3\frac{1}{2} \times 3\frac{1}{2}$	5.235	$\frac{1}{2} \times 8 \times 8$	9.949
$\frac{3}{8} \times 2\frac{1}{2} \times 2\frac{1}{2}$	3.796	$\frac{3}{8} \times 4 \times 4$	5.366	$\frac{3}{4} \times 8 \times 8$	10.734
$\frac{1}{2} \times 2\frac{1}{2} \times 2\frac{1}{2}$	4.188	$\frac{1}{2} \times 4 \times 4$	5.758	$1 \times 8 \times 8$	11.520
$\frac{1}{4} \times 3 \times 3$	3.926	$\frac{3}{8} \times 5 \times 5$	6.414

Standard Designations of Rolled Steel Shapes.—Through a joint effort, the American Iron and Steel Institute (AISI) and the American Institute of Steel Construction (AISC) have changed most of the designations for their hot-rolled structural steel shapes. The present designations, standard for steel producing and fabricating industries, should be used when designing, detailing, and ordering steel. The accompanying Table 1 compares the present designations with the previous descriptions.

Table 1. Hot-Rolled Structural Steel Shape Designations (AISI and AISC)

Present Designation	Type of Shape	Previous Designation
W 24 x 76	W shape	24 WF 76
W 14 x 26	W shape	14 B 26
S 24 x 100	S shape	24 I 100
M 8 x 18.5	M shape	8 M 18.5
M 10 x 9	M shape	10 JR 9.0
M 8 x 34.3	M shape	8 x 8 M 34.3
C 12 x 20.7	American Standard Channel	12 [20.7
MC 12 x 45	Miscellaneous Channel	12 x 4 [45.0
MC 12 x 10.6	Miscellaneous Channel	12 JR [10.6
HP 14 x 73	HP shape	14 BP 73
L 6 x 6 x $\frac{3}{4}$	Equal Leg Angle	$\angle 6 \times 6 \times \frac{3}{4}$
L 6 x 4 x $\frac{5}{8}$	Unequal Leg Angle	$\angle 6 \times 4 \times \frac{5}{8}$
WT 12 x 38	Structural Tee cut from W shape	ST 12 WF 38
WT 7 x 13	Structural Tee cut from W shape	ST 7 B 13
St 12 x 50	Structural Tee cut from S shape	ST 12 I 50
MT 4 x 9.25	Structural Tee cut from M shape	ST 4 M 9.25
MT 5 x 4.5	Structural Tee cut from M shape	ST 5 JR 4.5
MT 4 x 17.15	Structural Tee cut from M shape	ST 4 M 17.15
PL $\frac{1}{2} \times 18$	Plate	PL 18 x $\frac{1}{2}$
Bar 1	Square Bar	Bar 1
Bar 1 $\frac{1}{4} \varnothing$	Round Bar	Bar 1 $\frac{1}{4} \varnothing$
Bar 2 $\frac{1}{2}$ x $\frac{1}{2}$	Flat Bar	Bar 2 $\frac{1}{2}$ x $\frac{1}{2}$
Pipe 4 Std.	Pipe	Pipe 4 Std.
Pipe 4 X-Strong	Pipe	Pipe 4 X-Strong
Pipe 4 XX-Strong	Pipe	Pipe 4 XX-Strong
TS 4 x 4 x .375	Structural Tubing: Square	Tube 4 x 4 x .375
TS 5 x 3 x .375	Structural Tubing: Rectangular	Tube 5 x 3 x .375
TS 3 OD x .250	Structural Tubing: Circular	Tube 3 OD x .250

Data taken from the "Manual of Steel Construction," 8th Edition, 1980, with permission of the American Institute of Steel Construction.

Table 2a. Steel Wide-Flange Sections

Wide-flange sections are designated, in order, by a section letter, nominal depth of the member in inches, and the nominal weight in pounds per foot; thus:
W 18 × 64
 indicates a wide-flange section having a nominal depth of 18 inches, and a nominal weight per foot of 64 pounds. Actual geometry for each section can be obtained from the values below.

Designation	Area, A inch ²	Depth, d inch	Flange		Web Thickness, t _w inch	Axis X-X			Axis Y-Y		
			Width, b _f inch	Thick-ness, t _f inch		I inch ⁴	S inch ³	r inch	I inch ⁴	S inch ³	r inch
^a W 27 × 178	52.3	27.81	14.085	1.190	0.725	6990	502	11.6	555	78.8	3.26
× 161	47.4	27.59	14.020	1.080	0.660	6280	455	11.5	497	70.9	3.24
× 146	42.9	27.38	13.965	0.975	0.605	5630	411	11.4	443	63.5	3.21
× 114	33.5	27.29	10.070	0.930	0.570	4090	299	11.0	159	31.5	2.18
× 102	30.0	27.09	10.015	0.830	0.515	3620	267	11.0	139	27.8	2.15
× 94	27.7	26.92	9.990	0.745	0.490	3270	243	10.9	124	24.8	2.12
× 84	24.8	26.71	9.960	0.640	0.460	2850	213	10.7	106	21.2	2.07
W 24 × 162	47.7	25.00	12.955	1.220	0.705	5170	414	10.4	443	68.4	3.05
× 146	43.0	24.74	12.900	1.090	0.650	4580	371	10.3	391	60.5	3.01
× 131	38.5	24.48	12.855	0.960	0.605	4020	329	10.2	340	53.0	2.97
× 117	34.4	24.26	12.800	0.850	0.550	3540	291	10.1	297	46.5	2.94
× 104	30.6	24.06	12.750	0.750	0.500	3100	258	10.1	259	40.7	2.91
× 94	27.7	24.31	9.065	0.875	0.515	2700	222	9.87	109	24.0	1.98
× 84	24.7	24.10	9.020	0.770	0.470	2370	196	9.79	94.4	20.9	1.95
× 76	22.4	23.92	8.990	0.680	0.440	2100	176	9.69	82.5	18.4	1.92
× 68	20.1	23.73	8.965	0.585	0.415	1830	154	9.55	70.4	15.7	1.87
× 62	18.2	23.74	7.040	0.590	0.430	1550	131	9.23	34.5	9.80	1.38
× 55	16.2	23.57	7.005	0.505	0.395	1350	114	9.11	29.1	8.30	1.34
W 21 × 147	43.2	22.06	12.510	1.150	0.720	3630	329	9.17	376	60.1	2.95
× 132	38.8	21.83	12.440	1.035	0.650	3220	295	9.12	333	53.5	2.93
× 122	35.9	21.68	12.390	0.960	0.600	2960	273	9.09	305	49.2	2.92
× 111	32.7	21.51	12.340	0.875	0.550	2670	249	9.05	274	44.5	2.90
× 101	29.8	21.36	12.290	0.800	0.500	2420	227	9.02	248	40.3	2.89
× 93	27.3	21.62	8.420	0.930	0.580	2070	192	8.70	92.9	22.1	1.84
× 83	24.3	21.43	8.355	0.835	0.515	1830	171	8.67	81.4	19.5	1.83
× 73	21.5	21.24	8.295	0.740	0.455	1600	151	8.64	70.6	17.0	1.81
× 68	20.0	21.13	8.270	0.685	0.430	1480	140	8.60	64.7	15.7	1.80
× 62	18.3	20.99	8.240	0.615	0.400	1330	127	8.54	57.5	13.9	1.77
× 57	16.7	21.06	6.555	0.650	0.405	1170	111	8.36	30.6	9.35	1.35
× 50	14.7	20.83	6.530	0.535	0.380	984	94.5	8.18	24.9	7.64	1.30
× 44	13.0	20.66	6.500	0.450	0.350	843	81.6	8.06	20.7	6.36	1.26
W 18 × 119	35.1	18.97	11.265	1.060	0.655	2190	231	7.90	253	44.9	2.69
× 106	31.1	18.73	11.200	0.940	0.590	1910	204	7.84	220	39.4	2.66
× 97	28.5	18.59	11.145	0.870	0.535	1750	188	7.82	201	36.1	2.65
× 86	25.3	18.39	11.090	0.770	0.480	1530	166	7.77	175	31.6	2.63
× 76	22.3	18.21	11.035	0.680	0.425	1330	146	7.73	152	27.6	2.61
× 71	20.8	18.47	7.635	0.810	0.495	1170	127	7.50	60.3	15.8	1.70
× 65	19.1	18.35	7.590	0.750	0.450	1070	117	7.49	54.8	14.4	1.69
× 60	17.6	18.24	7.555	0.695	0.415	984	108	7.47	50.1	13.3	1.69
× 55	16.2	18.11	7.530	0.630	0.390	890	98.3	7.41	44.9	11.9	1.67
× 50	14.7	17.99	7.495	0.570	0.355	800	88.9	7.38	40.1	10.7	1.65
× 46	13.5	18.06	6.060	0.605	0.360	712	78.8	7.25	22.5	7.43	1.29
× 40	11.8	17.90	6.015	0.525	0.315	612	68.4	7.21	19.1	6.35	1.27
× 35	10.3	17.70	6.000	0.425	0.300	510	57.6	7.04	15.3	5.12	1.22

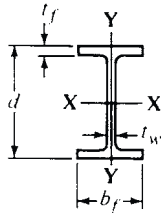
^a Consult the AISC Manual, noted above, for W steel shapes having nominal depths greater than 27 inches.

Symbols: I = moment of inertia; S = section modulus; r = radius of gyration.

Data taken from the “Manual of Steel Construction,” 8th Edition, 1980, with permission of the American Institute of Steel Construction.

Table 2b. Steel Wide-Flange Sections

Wide-flange sections are designated, in order, by a section letter, nominal depth of the member in inches, and the nominal weight in pounds per foot. Thus:
W 16 × 78
 indicates a wide-flange section having a nominal depth of 16 inches, and a nominal weight per foot of 78 pounds. Actual geometry for each section can be obtained from the values below.



Designation	Area, <i>A</i> inch ²	Depth, <i>d</i> inch	Flange		Web Thickness, <i>t_w</i> inch	Axis X-X			Axis Y-Y		
			Width, <i>b_f</i> inch	Thick-ness, <i>t_f</i> inch		<i>I</i> inch ⁴	<i>S</i> inch ³	<i>r</i> inch	<i>I</i> inch ⁴	<i>S</i> inch ³	<i>r</i> inch
W 16 × 100	29.4	16.97	10.425	0.985	0.585	1490	175	7.10	186	35.7	2.51
× 89	26.2	16.75	10.365	0.875	0.525	1300	155	7.05	163	31.4	2.49
× 77	22.6	16.52	10.295	0.760	0.455	1110	134	7.00	138	26.9	2.47
× 67	19.7	16.33	10.235	0.665	0.395	954	117	6.96	119	23.2	2.46
× 57	16.8	16.43	7.120	0.715	0.430	758	92.2	6.72	43.1	12.1	1.60
× 50	14.7	16.26	7.070	0.630	0.380	659	81.0	6.68	37.2	10.5	1.59
× 45	13.3	16.13	7.035	0.565	0.345	586	72.7	6.65	32.8	9.34	1.57
× 40	11.8	16.01	6.995	0.505	0.305	518	64.7	6.63	28.9	8.25	1.57
× 36	10.6	15.86	6.985	0.430	0.295	448	56.5	6.51	24.5	7.00	1.52
× 31	9.12	15.88	5.525	0.440	0.275	375	47.2	6.41	12.4	4.49	1.17
× 26	7.68	15.69	5.500	0.345	0.250	301	38.4	6.26	9.59	3.49	1.12
W 14 × 730	215.0	22.42	17.890	4.910	3.070	14300	1280	8.17	4720	527	4.69
× 665	196.0	21.64	17.650	4.520	2.830	12400	1150	7.98	4170	472	4.62
× 605	178.0	20.92	17.415	4.160	2.595	10800	1040	7.80	3680	423	4.55
× 550	162.0	20.24	17.200	3.820	2.380	9430	931	7.63	3250	378	4.49
× 500	147.0	19.60	17.010	3.500	2.190	8210	838	7.48	2880	339	4.43
× 455	134.0	19.02	16.835	3.210	2.015	7190	756	7.33	2560	304	4.38
× 426	125.0	18.67	16.695	3.035	1.875	6600	707	7.26	2360	283	4.34
× 398	117.0	18.29	16.590	2.845	1.770	6000	656	7.16	2170	262	4.31
× 370	109.0	17.92	16.475	2.660	1.655	5440	607	7.07	1990	241	4.27
× 342	101.0	17.54	16.360	2.470	1.540	4900	559	6.98	1810	221	4.24
× 311	91.4	17.12	16.230	2.260	1.410	4330	506	6.88	1610	199	4.20
× 283	83.3	16.74	16.110	2.070	1.290	3840	459	6.79	1440	179	4.17
× 257	75.6	16.38	15.995	1.890	1.175	3400	415	6.71	1290	161	4.13
× 233	68.5	16.04	15.890	1.720	1.070	3010	375	6.63	1150	145	4.10
× 211	62.0	15.72	15.800	1.560	0.980	2660	338	6.55	1030	130	4.07
× 193	56.8	15.48	15.710	1.440	0.890	2400	310	6.50	931	119	4.05
× 176	51.8	15.22	15.650	1.310	0.830	2140	281	6.43	838	107	4.02
× 159	46.7	14.98	15.565	1.190	0.745	1900	254	6.38	748	96.2	4.00
× 145	42.7	14.78	15.500	1.090	0.680	1710	232	6.33	677	87.3	3.98

Symbols: *I* = moment of inertia; *S* = section modulus; *r* = radius of gyration.

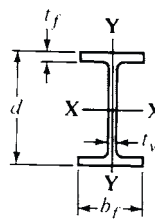
Data taken from the "Manual of Steel Construction," 8th Edition, 1980, with permission of the American Institute of Steel Construction.

Table 2c. Steel Wide-Flange Sections

Wide-flange sections are designated, in order, by a section letter, nominal depth of the member in inches, and the nominal weight in pounds per foot. Thus:

W 14 × 38

indicates a wide-flange section having a nominal depth of 14 inches, and a nominal weight per foot of 38 pounds. Actual geometry for each section can be obtained from the values below.



Designation	Area, A inch ²	Depth, d inch	Flange		Web Thickness, t _w inch	Axis X-X			Axis Y-Y		
			Width, b _f inch	Thick-ness, t _f inch		I inch ⁴	S inch ³	r inch	I inch ⁴	S inch ³	r inch
W 14 × 132	38.8	14.66	14.725	1.030	0.645	1530	209	6.28	548	74.5	3.76
× 120	35.3	14.48	14.670	0.940	0.590	1380	190	6.24	495	67.5	3.74
× 109	32.0	14.32	14.605	0.860	0.525	1240	173	6.22	447	61.2	3.73
× 99	29.1	14.16	14.565	0.780	0.485	1110	157	6.17	402	55.2	3.71
× 90	26.5	14.02	14.520	0.710	0.440	999	143	6.14	362	49.9	3.70
× 82	24.1	14.31	10.130	0.855	0.510	882	123	6.05	148	29.3	2.48
× 74	21.8	14.17	10.070	0.785	0.450	796	112	6.04	134	26.6	2.48
× 68	20.0	14.04	10.035	0.720	0.415	723	103	6.01	121	24.2	2.46
× 61	17.9	13.89	9.995	0.645	0.375	640	92.2	5.98	107	21.5	2.45
× 53	15.6	13.92	8.060	0.660	0.370	541	77.8	5.89	57.7	14.3	1.92
× 48	14.1	13.79	8.030	0.595	0.340	485	70.3	5.85	51.4	12.8	1.91
× 43	12.6	13.66	7.995	0.530	0.305	428	62.7	5.82	45.2	11.3	1.89
× 38	11.2	14.10	6.770	0.515	0.310	385	54.6	5.87	26.7	7.88	1.55
× 34	10.0	13.98	6.745	0.455	0.285	340	48.6	5.83	23.3	6.91	1.53
× 30	8.85	13.84	6.730	0.385	0.270	291	42.0	5.73	19.6	5.82	1.49
× 26	7.69	13.91	5.025	0.420	0.255	245	35.3	5.65	8.91	3.54	1.08
× 22	6.49	13.74	5.000	0.335	0.230	199	29.0	5.54	7.00	2.80	1.04
W 12 × 336	98.8	16.82	13.385	2.955	1.775	4060	483	6.41	1190	177	3.47
× 305	89.6	16.32	13.235	2.705	1.625	3550	435	6.29	1050	159	3.42
× 279	81.9	15.85	13.140	2.470	1.530	3110	393	6.16	937	143	3.38
× 252	74.1	15.41	13.005	2.250	1.395	2720	353	6.06	828	127	3.34
× 230	67.7	15.05	12.895	2.070	1.285	2420	321	5.97	742	115	3.31
× 210	61.8	14.71	12.790	1.900	1.180	2140	292	5.89	664	104	3.28
× 190	55.8	14.38	12.670	1.735	1.060	1890	263	5.82	589	93.0	3.25
× 170	50.0	14.03	12.570	1.560	0.960	1650	235	5.74	517	82.3	3.22
× 152	44.7	13.71	12.480	1.400	0.870	1430	209	5.66	454	72.8	3.19
× 136	39.9	13.41	12.400	1.250	0.790	1240	186	5.58	398	64.2	3.16
× 120	35.3	13.12	12.320	1.105	0.710	1070	163	5.51	345	56.0	3.13
× 106	31.2	12.89	12.220	0.990	0.610	933	145	5.47	301	49.3	3.11
× 96	28.2	12.71	12.160	0.900	0.550	833	131	5.44	270	44.4	3.09
× 87	25.6	12.53	12.125	0.810	0.515	740	118	5.38	241	39.7	3.07
× 79	23.2	12.38	12.080	0.735	0.470	662	107	5.34	216	35.8	3.05
× 72	21.1	12.25	12.040	0.670	0.430	597	97.4	5.31	195	32.4	3.04
× 65	19.1	12.12	12.000	0.605	0.390	533	87.9	5.28	174	29.1	3.02
× 58	17.0	12.19	10.010	0.640	0.360	475	78.0	5.28	107	21.4	2.51
× 53	15.6	12.06	9.995	0.575	0.345	425	70.6	5.23	95.8	19.2	2.48
× 50	14.7	12.19	8.080	0.640	0.370	394	64.7	5.18	56.3	13.9	1.96
× 45	13.2	12.06	8.045	0.575	0.335	350	58.1	5.15	50.0	12.4	1.94
× 40	11.8	11.94	8.005	0.515	0.295	310	51.9	5.13	44.1	11.0	1.93
× 35	10.3	12.50	6.560	0.520	0.300	285	45.6	5.25	24.5	7.47	1.54
× 30	8.79	12.34	6.520	0.440	0.260	238	38.6	5.21	20.3	6.24	1.52
× 26	7.65	12.22	6.490	0.380	0.230	204	33.4	5.17	17.3	5.34	1.51
× 22	6.48	12.31	4.030	0.425	0.260	156	25.4	4.91	4.66	2.31	0.847
× 19	5.57	12.16	4.005	0.350	0.235	130	21.3	4.82	3.76	1.88	0.822
× 16	4.71	11.99	3.990	0.265	0.220	103	17.1	4.67	2.82	1.41	0.773
× 14	4.16	11.91	3.970	0.225	0.200	88.6	14.9	4.62	2.36	1.19	0.753

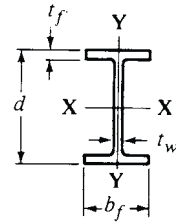
Data taken from the "Manual of Steel Construction," 8th Edition, 1980, with permission of the American Institute of Steel Construction.

Table 2d. Steel Wide-Flange Sections

Wide-flange sections are designated, in order, by a section letter, nominal depth of the member in inches, and the nominal weight in pounds per foot; thus:

W 8 × 67

indicates a wide-flange section having a nominal depth of 8 inches, and a nominal weight per foot of 67 pounds. Actual geometry for each section can be obtained from the values below.



Designation	Area, <i>A</i> inch ²	Depth, <i>d</i> inch	Flange		Web Thickness, <i>t_w</i> inch	Axis X-X			Axis Y-Y		
			Width, <i>b_f</i> inch	Thickness, <i>t_f</i> inch		<i>I</i> inch ⁴	<i>S</i> inch ³	<i>r</i> inch	<i>I</i> inch ⁴	<i>S</i> inch ³	<i>r</i> inch
W 10 × 112	32.9	11.36	10.415	1.250	0.755	716	126	4.66	236	45.3	2.68
× 100	29.4	11.10	10.340	1.120	0.680	623	112	4.60	207	40.0	2.65
× 88	25.9	10.84	10.265	0.990	0.605	534	98.5	4.54	179	34.8	2.63
× 77	22.6	10.60	10.190	0.870	0.530	455	85.9	4.49	154	30.1	2.60
× 68	20.0	10.40	10.130	0.770	0.470	394	75.7	4.44	134	26.4	2.59
× 60	17.6	10.22	10.080	0.680	0.420	341	66.7	4.39	116	23.0	2.57
× 54	15.8	10.09	10.030	0.615	0.370	303	60.0	4.37	103	20.6	2.56
× 49	14.4	9.98	10.000	0.560	0.340	272	54.6	4.35	93.4	18.7	2.54
× 45	13.3	10.10	8.020	0.620	0.350	248	49.1	4.32	53.4	13.3	2.01
× 39	11.5	9.92	7.985	0.530	0.315	209	42.1	4.27	45.0	11.3	1.98
× 33	9.71	9.73	7.960	0.435	0.290	170	35.0	4.19	36.6	9.20	1.94
× 30	8.84	10.47	5.810	0.510	0.300	170	32.4	4.38	16.7	5.75	1.37
× 26	7.61	10.33	5.770	0.440	0.260	144	27.9	4.35	14.1	4.89	1.36
× 22	6.49	10.17	5.750	0.360	0.240	118	23.2	4.27	11.4	3.97	1.33
× 19	5.62	10.24	4.020	0.395	0.250	96.3	18.8	4.14	4.29	2.14	0.874
× 17	4.99	10.11	4.010	0.330	0.240	81.9	16.2	4.05	3.56	1.78	0.844
× 15	4.41	9.99	4.000	0.270	0.230	68.9	13.8	3.95	2.89	1.45	0.810
× 12	3.54	9.87	3.960	0.210	0.190	53.8	10.9	3.90	2.18	1.10	0.785
W 8 × 67	19.7	9.00	8.280	0.935	0.570	272	60.4	3.72	88.6	21.4	2.12
× 58	17.1	8.75	8.220	0.810	0.510	228	52.0	3.65	75.1	18.3	2.10
× 48	14.1	8.50	8.110	0.685	0.400	184	43.3	3.61	60.9	15.0	2.08
× 40	11.7	8.25	8.070	0.560	0.360	146	35.5	3.53	49.1	12.2	2.04
× 35	10.3	8.12	8.020	0.495	0.310	127	31.2	3.51	42.6	10.6	2.03
× 31	9.13	8.00	7.995	0.435	0.285	110	27.5	3.47	37.1	9.27	2.02
× 28	8.25	8.06	6.535	0.465	0.285	98.0	24.3	3.45	21.7	6.63	1.62
× 24	7.08	7.93	6.495	0.400	0.245	82.8	20.9	3.42	18.3	5.63	1.61
× 21	6.16	8.28	5.270	0.400	0.250	75.3	18.2	3.49	9.77	3.71	1.26
× 18	5.26	8.14	5.250	0.330	0.230	61.9	15.2	3.43	7.97	3.04	1.23
× 15	4.44	8.11	4.015	0.315	0.245	48.0	11.8	3.29	3.41	1.70	0.876
× 13	3.84	7.99	4.000	0.255	0.230	39.6	9.91	3.21	2.73	1.37	0.843
× 10	2.96	7.89	3.940	0.205	0.170	30.8	7.81	3.22	2.09	1.06	0.841
W 6 × 25	7.34	6.38	6.080	0.455	0.320	53.4	16.7	2.70	17.1	5.61	1.52
× 20	5.87	6.20	6.020	0.365	0.260	41.4	13.4	2.66	13.3	4.41	1.50
× 16	4.74	6.28	4.030	0.405	0.260	32.1	10.2	2.60	4.43	2.20	0.966
× 15	4.43	5.99	5.990	0.260	0.230	29.1	9.72	2.56	9.32	3.11	1.46
× 12	3.55	6.03	4.000	0.280	0.230	22.1	7.31	2.49	2.99	1.50	0.918
× 9	2.68	5.90	3.940	0.215	0.170	16.4	5.56	2.47	2.19	1.11	0.905
W 5 × 19	5.54	5.15	5.030	0.430	0.270	26.2	10.2	2.17	9.13	3.63	1.28
× 16	4.68	5.01	5.000	0.360	0.240	21.3	8.51	2.13	7.51	3.00	1.27
W 4 × 13	3.83	4.16	4.060	0.345	0.280	11.3	5.46	1.72	3.86	1.90	1.00

Symbols: I = moment of inertia; *S* = section modulus; *r* = radius of gyration.

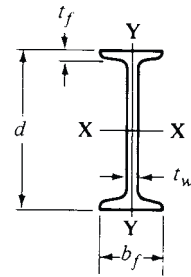
Data taken from the "Manual of Steel Construction," 8th Edition, 1980, with permission of the American Institute of Steel Construction.

Table 3. Steel S Sections

“S” is the section symbol for “I” Beams. S shapes are designated, in order, by their section letter, actual depth in inches, and nominal weight in pounds per foot. Thus:

S 5 × 14.75

indicates an S shape (or I beam) having a depth of 5 inches and a nominal weight of 14.75 pounds per foot.



Designation	Area <i>A</i> inch ²	Depth, <i>d</i> inch	Flange		Web Thick- ness, <i>t_w</i> inch	Axis-X-X			Axis Y-Y		
			Width, <i>b_f</i> inch	Thick- ness, <i>t_f</i> inch		<i>I</i> inch ⁴	<i>S</i> inch ³	<i>r</i> inch	<i>I</i> inch ⁴	<i>S</i> inch ³	<i>r</i> inch
S 24 × 121	35.6	24.50	8.050	1.090	0.800	3160	258	9.43	83.3	20.7	1.53
× 106	31.2	24.50	7.870	1.090	0.620	2940	240	9.71	77.1	19.6	1.57
× 100	29.3	24.00	7.245	0.870	0.745	2390	199	9.02	47.7	13.2	1.27
× 90	26.5	24.00	7.125	0.870	0.625	2250	187	9.21	44.9	12.6	1.30
× 80	23.5	24.00	7.000	0.870	0.500	2100	175	9.47	42.2	12.1	1.34
S 20 × 96	28.2	20.30	7.200	0.920	0.800	1670	165	7.71	50.2	13.9	1.33
× 86	25.3	20.30	7.060	0.920	0.660	1580	155	7.89	46.8	13.3	1.36
× 75	22.0	20.00	6.385	0.795	0.635	1280	128	7.62	29.8	9.32	1.16
× 66	19.4	20.00	6.255	0.795	0.505	1190	119	7.83	27.7	8.85	1.19
S 18 × 70	20.6	18.00	6.251	0.691	0.711	926	103	6.71	24.1	7.72	1.08
× 54.7	16.1	18.00	6.001	0.691	0.461	804	89.4	7.07	20.8	6.94	1.14
S 15 × 50	14.7	15.00	5.640	0.622	0.550	486	64.8	5.75	15.7	5.57	1.03
× 42.9	12.6	15.00	5.501	0.622	0.411	447	59.6	5.95	14.4	5.23	1.07
S 12 × 50	14.7	12.00	5.477	0.659	0.687	305	50.8	4.55	15.7	5.74	1.03
× 40.8	12.0	12.00	5.252	0.659	0.462	272	45.4	4.77	13.6	5.16	1.06
× 35	10.3	12.00	5.078	0.544	0.428	229	38.2	4.72	9.87	3.89	0.980
× 31.8	9.35	12.00	5.000	0.544	0.350	218	36.4	4.83	9.36	3.74	1.00
S 10 × 35	10.3	10.00	4.944	0.491	0.594	147	29.4	3.78	8.36	3.38	0.901
× 25.4	7.46	10.00	4.661	0.491	0.311	124	24.7	4.07	6.79	2.91	0.954
S 8 × 23	6.77	8.00	4.171	0.426	0.441	64.9	16.2	3.10	4.31	2.07	0.798
× 18.4	5.41	8.00	4.001	0.426	0.271	57.6	14.4	3.26	3.73	1.86	0.831
S 7 × 20	5.88	7.00	3.860	0.392	0.450	42.4	12.1	2.69	3.17	1.64	0.734
× 15.3	4.50	7.00	3.662	0.392	0.252	36.7	10.5	2.86	2.64	1.44	0.766
S 6 × 17.25	5.07	6.00	3.565	0.359	0.465	26.3	8.77	2.28	2.31	1.30	0.675
× 12.5	3.67	6.00	3.332	0.359	0.232	22.1	7.37	2.45	1.82	1.09	0.705
S 5 × 14.75	4.34	5.00	3.284	0.326	0.494	15.2	6.09	1.87	1.67	1.01	0.620
× 10	2.94	5.00	3.004	0.326	0.214	12.3	4.92	2.05	1.22	0.809	0.643
S 4 × 9.5	2.79	4.00	2.796	0.293	0.326	6.79	3.39	1.56	0.903	0.646	0.569
× 7.7	2.26	4.00	2.663	0.293	0.193	6.08	3.04	1.64	0.764	0.574	0.581
S 3 × 7.5	2.21	3.00	2.509	0.260	0.349	2.93	1.95	1.15	0.586	0.468	0.516
× 5.7	1.67	3.00	2.330	0.260	0.170	2.52	1.68	1.23	0.455	0.390	0.522

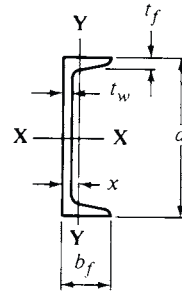
Data taken from the “Manual of Steel Construction,” 8th Edition, 1980, with permission of the American Institute of Steel Construction.

Table 4. American Standard Steel Channels

American Standard Channels are designated, in order, by a section letter, actual depth in inches, and nominal weight per foot in pounds. Thus:

C 7 × 14.75

indicates an American Standard Channel with a depth of 7 inches and a nominal weight of 14.75 pounds per foot.



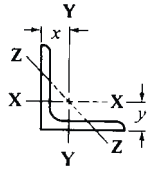
Designation	Area, <i>A</i> inch ²	Depth, <i>d</i> inch	Flange		Web Thick- ness, <i>t_w</i> inch	Axis X-X			Axis Y-Y			<i>x</i> inch
			Width, <i>b_f</i> inch	Thick- ness, <i>t_f</i> inch		<i>I</i> inch ⁴	<i>S</i> inch ³	<i>r</i> inch	<i>I</i> inch ⁴	<i>S</i> inch ³	<i>r</i> inch	
C 15 × 50	14.7	15.00	3.716	0.650	0.716	404	53.8	5.24	11.0	3.78	0.867	0.798
× 40	11.8	15.00	3.520	0.650	0.520	349	46.5	5.44	9.23	3.37	0.886	0.777
× 33.9	9.96	15.00	3.400	0.650	0.400	315	42.0	5.62	8.13	3.11	0.904	0.787
C 12 × 30	8.82	12.00	3.170	0.501	0.510	162	27.0	4.29	5.14	2.06	0.763	0.674
× 25	7.35	12.00	3.047	0.501	0.387	144	24.1	4.43	4.47	1.88	0.780	0.674
× 20.7	6.09	12.00	2.942	0.501	0.282	129	21.5	4.61	3.88	1.73	0.799	0.698
C 10 × 30	8.82	10.00	3.033	0.436	0.673	103	20.7	3.42	3.94	1.65	0.669	0.649
× 25	7.35	10.00	2.886	0.436	0.526	91.2	18.2	3.52	3.36	1.48	0.676	0.617
× 20	5.88	10.00	2.739	0.436	0.379	78.9	15.8	3.66	2.81	1.32	0.692	0.606
× 15.3	4.49	10.00	2.600	0.436	0.240	67.4	13.5	3.87	2.28	1.16	0.713	0.634
C 9 × 20	5.88	9.00	2.648	0.413	0.448	60.9	13.5	3.22	2.42	1.17	0.642	0.583
× 15	4.41	9.00	2.485	0.413	0.285	51.0	11.3	3.40	1.93	1.01	0.661	0.586
× 13.4	3.94	9.00	2.433	0.413	0.233	47.9	10.6	3.48	1.76	0.962	0.669	0.601
C 8 × 18.75	5.51	8.00	2.527	0.390	0.487	44.0	11.0	2.82	1.98	1.01	0.599	0.565
× 13.75	4.04	8.00	2.343	0.390	0.303	36.1	9.03	2.99	1.53	0.854	0.615	0.553
× 11.5	3.38	8.00	2.260	0.390	0.220	32.6	8.14	3.11	1.32	0.781	0.625	0.571
C 7 × 14.75	4.33	7.00	2.299	0.366	0.419	27.2	7.78	2.51	1.38	0.779	0.564	0.532
× 12.25	3.60	7.00	2.194	0.366	0.314	24.2	6.93	2.60	1.17	0.703	0.571	0.525
× 9.8	2.87	7.00	2.090	0.366	0.210	21.3	6.08	2.72	0.968	0.625	0.581	0.540
C 6 × 13	3.83	6.00	2.157	0.343	0.437	17.4	5.80	2.13	1.05	0.642	0.525	0.514
× 10.5	3.09	6.00	2.034	0.343	0.314	15.2	5.06	2.22	0.866	0.564	0.529	0.499
× 8.2	2.40	6.00	1.920	0.343	0.200	13.1	4.38	2.34	0.693	0.492	0.537	0.511
C 5 × 9	2.64	5.00	1.885	0.320	0.325	8.90	3.56	1.83	0.632	0.450	0.489	0.478
× 6.7	1.97	5.00	1.750	0.320	0.190	7.49	3.00	1.95	0.479	0.378	0.493	0.484
C 4 × 7.25	2.13	4.00	1.721	0.296	0.321	4.59	2.29	1.47	0.433	0.343	0.450	0.459
× 5.4	1.59	4.00	1.584	0.296	0.184	3.85	1.93	1.56	0.319	0.283	0.449	0.457
C 3 × 6	1.76	3.00	1.596	0.273	0.356	2.07	1.38	1.08	0.305	0.268	0.416	0.455
× 5	1.47	3.00	1.498	0.273	0.258	1.85	1.24	1.12	0.247	0.233	0.410	0.438
× 4.1	1.21	3.00	1.410	0.273	0.170	1.66	1.10	1.17	0.197	0.202	0.404	0.436

Symbols: *I* = moment of inertia; *S* = section modulus; *r* = radius of gyration; *x* = distance from center of gravity of section to outer face of structural shape.

Data taken from the "Manual of Steel Construction," 8th Edition, 1980, with permission of the American Institute of Steel Construction.

Table 5. Steel Angles with Equal Legs

These angles are commonly designated by section symbol, width of each leg, and thickness, thus:
 $L\ 3 \times 3 \times \frac{1}{4}$
 indicates a 3 × 3-inch angle of $\frac{1}{4}$ -inch thickness.



Size inch	Thickness inch	Weight per Foot lb.	Area inch ²	Axis X-X & Y-Y			Z-Z	
				<i>I</i> inch ⁴	<i>r</i> inch	<i>x</i> or <i>y</i> inch	<i>r</i> inch	
8 × 8	$\frac{1}{8}$	56.9	16.7	98.0	2.42	2.41	1.56	
	1	51.0	15.0	89.0	2.44	2.37	1.56	
	$\frac{7}{8}$	45.0	13.2	79.6	2.45	2.32	1.57	
	$\frac{3}{4}$	38.9	11.4	69.7	2.47	2.28	1.58	
	$\frac{5}{8}$	32.7	9.61	59.4	2.49	2.23	1.58	
	$\frac{9}{16}$	29.6	8.68	54.1	2.50	2.21	1.59	
	$\frac{1}{2}$	26.4	7.75	48.6	2.50	2.19	1.59	
	6 × 6	1	37.4	11.00	35.5	1.80	1.86	1.17
$\frac{7}{8}$		33.1	9.73	31.9	1.81	1.82	1.17	
$\frac{3}{4}$		28.7	8.44	28.2	1.83	1.78	1.17	
$\frac{5}{8}$		24.2	7.11	24.2	1.84	1.73	1.18	
$\frac{9}{16}$		21.9	6.43	22.1	1.85	1.71	1.18	
$\frac{1}{2}$		19.6	5.75	19.9	1.86	1.68	1.18	
$\frac{7}{16}$		17.2	5.06	17.7	1.87	1.66	1.19	
$\frac{3}{8}$		14.9	4.36	15.4	1.88	1.64	1.19	
5 × 5	$\frac{5}{16}$	12.4	3.65	13.0	1.89	1.62	1.20	
	$\frac{7}{8}$	27.2	7.98	17.8	1.49	1.57	.973	
	$\frac{3}{4}$	23.6	6.94	15.7	1.51	1.52	.975	
	$\frac{5}{8}$	20.0	5.86	13.6	1.52	1.48	.978	
	$\frac{1}{2}$	16.2	4.75	11.3	1.54	1.43	.983	
	$\frac{7}{16}$	14.3	4.18	10.0	1.55	1.41	.986	
	$\frac{3}{8}$	12.3	3.61	8.74	1.56	1.39	.990	
	$\frac{5}{16}$	10.3	3.03	7.42	1.57	1.37	.994	
4 × 4	$\frac{3}{4}$	18.5	5.44	7.67	1.19	1.27	.778	
	$\frac{5}{8}$	15.7	4.61	6.66	1.20	1.23	.779	
	$\frac{1}{2}$	12.8	3.75	5.56	1.22	1.18	.782	
	$\frac{7}{16}$	11.3	3.31	4.97	1.23	1.16	.785	
	$\frac{3}{8}$	9.8	2.86	4.36	1.23	1.14	.788	
	$\frac{5}{16}$	8.2	2.40	3.71	1.24	1.12	.791	
	$\frac{1}{4}$	6.6	1.94	3.04	1.25	1.09	.795	
	$3\frac{1}{2} \times 3\frac{1}{2}$	$\frac{1}{2}$	11.1	3.25	3.64	1.06	1.06	.683
$\frac{7}{16}$		9.8	2.87	3.26	1.07	1.04	.684	
$\frac{3}{8}$		8.5	2.48	2.87	1.07	1.01	.687	
$\frac{5}{16}$		7.2	2.09	2.45	1.08	.990	.690	
$\frac{1}{4}$		5.8	1.69	2.01	1.09	.968	.694	
3 × 3		$\frac{1}{2}$	9.4	2.75	2.22	.898	.932	.584
		$\frac{7}{16}$	8.3	2.43	1.99	.905	.910	.585
		$\frac{3}{8}$	7.2	2.11	1.76	.913	.888	.587
	$\frac{5}{16}$	6.1	1.78	1.51	.922	.865	.589	
	$\frac{1}{4}$	4.9	1.44	1.24	.930	.842	.592	
	$\frac{3}{16}$	3.71	1.09	.962	.939	.820	.596	
	$2\frac{1}{2} \times 2\frac{1}{2}$	$\frac{1}{2}$	7.7	2.25	1.23	.739	.806	.487
		$\frac{3}{8}$	5.9	1.73	.984	.753	.762	.487
$\frac{5}{16}$		5.0	1.46	.849	.761	.740	.489	
$\frac{1}{4}$		4.1	1.19	.703	.769	.717	.491	
2 × 2		$\frac{3}{16}$	3.07	.902	.547	.778	.694	.495
		$\frac{5}{8}$	4.7	1.36	.479	.594	.636	.389
		$\frac{3}{16}$	3.92	1.15	.416	.601	.614	.390
		$\frac{1}{4}$	3.19	.938	.348	.609	.592	.391
	$\frac{3}{16}$	2.44	.715	.272	.617	.569	.394	
	$\frac{1}{8}$	1.65	.484	.190	.626	.546	.398	

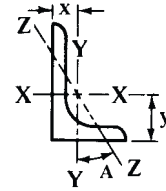
Data taken from the "Manual of Steel Construction," 8th Edition, 1980, with permission of the American Institute of Steel Construction.

Table 6. Steel Angles with Unequal Legs

These angles are commonly designated by section symbol, width of each leg, and thickness, thus:

$$L 7 \times 4 \times \frac{1}{2}$$

indicates a 7 × 4-inch angle of 1/2-inch thickness.



Size inch	Thick-ness inch	Weight per Ft. lb.	Area inch ²	Axis X-X				Axis Y-Y			Axis Z-Z		
				<i>I</i> inch ⁴	<i>S</i> inch ³	<i>r</i> inch	<i>y</i> inch	<i>I</i> inch ⁴	<i>S</i> inch ³	<i>r</i> inch	<i>x</i> inch	<i>r</i> inch	Tan A
9 × 4	5/8	26.3	7.73	64.9	11.5	2.90	3.36	8.32	2.65	1.04	.858	.847	.216
	3/16	23.8	7.00	59.1	10.4	2.91	3.33	7.63	2.41	1.04	.834	.850	.218
	1/2	21.3	6.25	53.2	9.34	2.92	3.31	6.92	2.17	1.05	.810	.854	.220
8 × 6	1	44.2	13.0	80.8	15.1	2.49	2.65	38.8	8.92	1.73	1.65	1.28	.543
	7/8	39.1	11.5	72.3	13.4	2.51	2.61	34.9	7.94	1.74	1.61	1.28	.547
	3/4	33.8	9.94	63.4	11.7	2.53	2.56	30.7	6.92	1.76	1.56	1.29	.551
	5/8	28.5	8.36	54.1	9.87	2.54	2.52	26.3	5.88	1.77	1.52	1.29	.554
	3/16	7	7.56	49.3	8.95	2.55	2.50	24.0	5.34	1.78	1.50	1.30	.556
	1/2	23.0	6.75	44.3	8.02	2.56	2.47	21.7	4.79	1.79	1.47	1.30	.558
8 × 4	7/16	20.2	5.93	39.2	7.07	2.57	2.45	19.3	4.23	1.80	1.45	1.31	.560
	1	37.4	11.0	69.6	14.1	2.52	3.05	11.6	3.94	1.03	1.05	.846	.247
	3/4	28.7	8.44	54.9	10.9	2.55	2.95	9.36	3.07	1.05	.953	.852	.258
	5/16	21.9	6.43	42.8	8.35	2.58	2.88	7.43	2.38	1.07	.882	.861	.265
	1/2	19.6	5.75	38.5	7.49	2.59	2.86	6.74	2.15	1.08	.859	.865	.267
7 × 4	3/4	26.2	7.69	37.8	8.42	2.22	2.51	9.05	3.03	1.09	1.01	.860	.324
	5/8	22.1	6.48	32.4	7.14	2.24	2.46	7.84	2.58	1.10	.963	.865	.329
	1/2	17.9	5.25	26.7	5.81	2.25	2.42	6.53	2.12	1.11	.917	.872	.335
6 × 4	3/8	13.6	3.98	20.6	4.44	2.27	2.37	5.10	1.63	1.13	.870	.880	.340
	7/8	27.2	7.98	27.7	7.15	1.86	2.12	9.75	3.39	1.11	1.12	.857	.421
	3/4	23.6	6.94	24.5	6.25	1.88	2.08	8.68	2.97	1.12	1.08	.860	.428
	5/8	20.0	5.86	21.1	5.31	1.90	2.03	7.52	2.54	1.13	1.03	.864	.435
	3/16	18.1	5.31	19.3	4.83	1.90	2.01	6.91	2.31	1.14	1.01	.866	.438
6 × 3 1/2	1/2	16.2	4.75	17.4	4.33	1.91	1.99	6.27	2.08	1.15	.987	.870	.440
	7/16	14.3	4.18	15.5	3.83	1.92	1.96	5.60	1.85	1.16	.964	.873	.443
	3/8	12.3	3.61	13.5	3.32	1.93	1.94	4.90	1.60	1.17	.941	.877	.446
	5/16	10.3	3.03	11.4	2.79	1.94	1.92	4.18	1.35	1.17	.918	.882	.448
	1/2	15.3	4.50	16.6	4.24	1.92	2.08	4.25	1.59	.972	.833	.759	.344
	3/8	11.7	3.42	12.9	3.24	1.94	2.04	3.34	1.23	.988	.787	.676	.350
	5/16	9.8	2.87	10.9	2.73	1.95	2.01	2.85	1.04	.996	.763	.772	.352
5 × 3 1/2	3/4	19.8	5.81	13.9	4.28	1.55	1.75	5.55	2.22	.977	.996	.748	.464
	5/8	16.8	4.92	12.0	3.65	1.56	1.70	4.83	1.90	.991	.951	.751	.472
	1/2	13.6	4.00	9.99	2.99	1.58	1.66	4.05	1.56	1.01	.906	.755	.479
	7/16	12.0	3.53	8.90	2.64	1.59	1.63	3.63	1.39	1.01	.883	.758	.482
	3/8	10.4	3.05	7.78	2.29	1.60	1.61	3.18	1.21	1.02	.861	.762	.486
5 × 3	3/16	8.7	2.56	6.60	1.94	1.61	1.59	2.72	1.02	1.03	.838	.766	.489
	1/4	7.0	2.06	5.39	1.57	1.62	1.56	2.23	.830	1.04	.814	.770	.492
	5/8	15.7	4.61	11.4	3.55	1.57	1.80	3.06	1.39	.815	.796	.644	.349
	1/2	12.8	3.75	9.45	2.91	1.59	1.75	2.58	1.15	.829	.750	.648	.357

Table 6. (Continued) Steel Angles with Unequal Legs

Size inch	Thick- ness inch	Weight per Ft. lb.	Area inch ²	Axis X-X				Axis Y-Y			Axis Z-Z		
				<i>I</i> inch ⁴	<i>S</i> inch ³	<i>r</i> inch	<i>y</i> inch	<i>I</i> inch ⁴	<i>S</i> inch ³	<i>r</i> inch	<i>x</i> inch	<i>r</i> inch	Tan <i>A</i>
5 × 3	7/16	11.3	3.31	8.43	2.58	1.60	1.73	2.32	1.02	.837	.727	.651	.361
	3/8	9.8	2.86	7.37	2.24	1.61	1.70	2.04	.888	.845	.704	.654	.364
	5/16	8.2	2.40	6.26	1.89	1.61	1.68	1.75	.753	.853	.681	.658	.368
	1/4	6.6	1.94	5.11	1.53	1.62	1.66	1.44	.614	.861	.657	.663	.371
4 × 3 1/2	5/8	14.7	4.30	6.37	2.35	1.22	1.29	4.52	1.84	1.03	1.04	.719	.745
	1/2	11.9	3.50	5.32	1.94	1.23	1.25	3.79	1.52	1.04	1.00	.722	.750
	7/16	10.6	3.09	4.76	1.72	1.24	1.23	3.40	1.35	1.05	.978	.724	.753
	3/8	9.1	2.67	4.18	1.49	1.25	1.21	2.95	1.17	1.06	.955	.727	.755
4 × 3	5/16	7.7	2.25	3.56	1.26	1.26	1.18	2.55	.994	1.07	.932	.730	.757
	1/4	6.2	1.81	2.91	1.03	1.27	1.16	2.09	.808	1.07	.909	.734	.759
	5/8	13.6	3.98	6.03	2.30	1.23	1.37	2.87	1.35	.849	.871	.637	.534
	1/2	11.1	3.25	5.05	1.89	1.25	1.33	2.42	1.12	.864	.827	.639	.543
3 1/2 × 3	7/16	9.8	2.87	4.52	1.68	1.25	1.30	2.18	.992	.871	.804	.641	.547
	3/8	8.5	2.48	3.96	1.46	1.26	1.28	1.92	.866	.879	.782	.644	.551
	5/16	7.2	2.09	3.38	1.23	1.27	1.26	1.65	.734	.887	.759	.647	.554
	1/4	5.8	1.69	2.77	1.00	1.28	1.24	1.36	.599	.896	.736	.651	.558
3 1/2 × 2 1/2	1/2	10.2	3.00	3.45	1.45	1.07	1.13	2.33	1.10	.881	.875	.621	.714
	7/16	9.1	2.65	3.10	1.29	1.08	1.10	2.09	.975	.889	.853	.622	.718
	3/8	7.9	2.30	2.72	1.13	1.09	1.08	1.85	.851	.897	.830	.625	.721
	5/16	6.6	1.93	2.33	.954	1.10	1.06	1.58	.722	.905	.808	.627	.724
3 × 2 1/2	1/4	5.4	1.56	1.91	.776	1.11	1.04	1.30	.589	.914	.785	.631	.727
	1/2	9.4	2.75	3.24	1.41	1.09	1.20	1.36	.760	.704	.705	.534	.486
	7/16	8.3	2.43	2.91	1.26	1.09	1.18	1.23	.677	.711	.682	.535	.491
	3/8	7.2	2.11	2.56	1.09	1.10	1.16	1.09	.592	.719	.660	.537	.496
3 × 2	5/16	6.1	1.78	2.19	.927	1.11	1.14	.939	.504	.727	.637	.540	.501
	1/4	4.9	1.44	1.80	.755	1.12	1.11	.777	.412	.735	.614	.544	.506
	1/2	8.5	2.50	2.08	1.04	.913	1.00	1.30	.744	.722	.750	.520	.667
	7/16	7.6	2.21	1.88	.928	.920	.978	1.18	.664	.729	.728	.521	.672
3 × 2	3/8	6.6	1.92	1.66	.810	.928	.956	1.04	.581	.736	.706	.522	.676
	5/16	5.6	1.62	1.42	.688	.937	.933	.898	.494	.744	.683	.525	.680
	1/4	4.5	1.31	1.17	.561	.945	.911	.743	.404	.753	.661	.528	.684
	3/16	3.39	.996	.907	.430	.954	.888	.577	.310	.761	.638	.533	.688
2 1/2 × 2	1/2	7.7	2.25	1.92	1.00	.924	1.08	.672	.474	.546	.583	.428	.414
	7/16	6.8	2.00	1.73	.894	.932	1.06	.609	.424	.553	.561	.429	.421
	3/8	5.9	1.73	1.53	.781	.940	1.04	.543	.371	.559	.539	.430	.428
	5/16	5.0	1.46	1.32	.664	.948	1.02	.740	.317	.567	.516	.432	.435
2 1/2 × 2	1/4	4.1	1.19	1.09	.542	.957	.993	.392	.260	.574	.493	.435	.440
	3/16	3.07	.902	.842	.415	.966	.970	.307	.200	.583	.470	.439	.446
	3/8	5.3	1.55	.912	.547	.768	.831	.514	.363	.577	.581	.420	.614
	5/16	4.5	1.31	.788	.466	.776	.809	.446	.310	.584	.559	.422	.620
2 1/2 × 2	1/4	3.62	1.06	.654	.381	.784	.787	.372	.254	.592	.537	.424	.626
	3/16	2.75	.809	.509	.293	.793	.764	.291	.196	.600	.514	.427	.631

Symbols: *I* = moment of inertia; *S* = section modulus; *r* = radius of gyration; *x* = distance from center of gravity of section to outer face of structural shape.

Data taken from the “Manual of Steel Construction,” 8th Edition, 1980, with permission of the American Institute of Steel Construction.

Table 7. Aluminum Association Standard Structural Shapes

Depth	Width	Weight per Foot	Area	Flange Thickness	Web Thickness	Fillet Radius	Axis X-X			Axis Y-Y			
							<i>I</i>	<i>S</i>	<i>r</i>	<i>I</i>	<i>S</i>	<i>r</i>	<i>x</i>
inch	inch	lb.	inch ²	inch	inch	inch	inch ⁴	inch ³	inch	inch ⁴	inch ³	inch	inch
I-BEAMS													
3.00	2.50	1.637	1.392	0.20	0.13	0.25	2.24	1.49	1.27	0.52	0.42	0.61	...
3.00	2.50	2.030	1.726	0.26	0.15	0.25	2.71	1.81	1.25	0.68	0.54	0.63	...
4.00	3.00	2.311	1.965	0.23	0.15	0.25	5.62	2.81	1.69	1.04	0.69	0.73	...
4.00	3.00	2.793	2.375	0.29	0.17	0.25	6.71	3.36	1.68	1.31	0.87	0.74	...
5.00	3.50	3.700	3.146	0.32	0.19	0.30	13.94	5.58	2.11	2.29	1.31	0.85	...
6.00	4.00	4.030	3.427	0.29	0.19	0.30	21.99	7.33	2.53	3.10	1.55	0.95	...
6.00	4.00	4.692	3.990	0.35	0.21	0.30	25.50	8.50	2.53	3.74	1.87	0.97	...
7.00	4.50	5.800	4.932	0.38	0.23	0.30	42.89	12.25	2.95	5.78	2.57	1.08	...
8.00	5.00	6.181	5.256	0.35	0.23	0.30	59.69	14.92	3.37	7.30	2.92	1.18	...
8.00	5.00	7.023	5.972	0.41	0.25	0.30	67.78	16.94	3.37	8.55	3.42	1.20	...
9.00	5.50	8.361	7.110	0.44	0.27	0.30	102.02	22.67	3.79	12.22	4.44	1.31	...
10.00	6.00	8.646	7.352	0.41	0.25	0.40	132.09	26.42	4.24	14.78	4.93	1.42	...
10.00	6.00	10.286	8.747	0.50	0.29	0.40	155.79	31.16	4.22	18.03	6.01	1.44	...
12.00	7.00	11.672	9.925	0.47	0.29	0.40	255.57	42.60	5.07	26.90	7.69	1.65	...
12.00	7.00	14.292	12.153	0.62	0.31	0.40	317.33	52.89	5.11	35.48	10.14	1.71	...
CHANNELS													
2.00	1.00	0.577	0.491	0.13	0.13	0.10	0.288	0.288	0.766	0.045	0.064	0.303	0.298
2.00	1.25	1.071	0.911	0.26	0.17	0.15	0.546	0.546	0.774	0.139	0.178	0.391	0.471
3.00	1.50	1.135	0.965	0.20	0.13	0.25	1.41	0.94	1.21	0.22	0.22	0.47	0.49
3.00	1.75	1.597	1.358	0.26	0.17	0.25	1.97	1.31	1.20	0.42	0.37	0.55	0.62
4.00	2.00	1.738	1.478	0.23	0.15	0.25	3.91	1.95	1.63	0.60	0.45	0.64	0.65
4.00	2.25	2.331	1.982	0.29	0.19	0.25	5.21	2.60	1.62	1.02	0.69	0.72	0.78
5.00	2.25	2.212	1.881	0.26	0.15	0.30	7.88	3.15	2.05	0.98	0.64	0.72	0.73
5.00	2.75	3.089	2.627	0.32	0.19	0.30	11.14	4.45	2.06	2.05	1.14	0.88	0.95
6.00	2.50	2.834	2.410	0.29	0.17	0.30	14.35	4.78	2.44	1.53	0.90	0.80	0.79
6.00	3.25	4.030	3.427	0.35	0.21	0.30	21.04	7.01	2.48	3.76	1.76	1.05	1.12
7.00	2.75	3.205	2.725	0.29	0.17	0.30	22.09	6.31	2.85	2.10	1.10	0.88	0.84
7.00	3.50	4.715	4.009	0.38	0.21	0.30	33.79	9.65	2.90	5.13	2.23	1.13	1.20
8.00	3.00	4.147	3.526	0.35	0.19	0.30	37.40	9.35	3.26	3.25	1.57	0.96	0.93
8.00	3.75	5.789	4.923	0.41	0.25	0.35	52.69	13.17	3.27	7.13	2.82	1.20	1.22
9.00	3.25	4.983	4.237	0.35	0.23	0.35	54.41	12.09	3.58	4.40	1.89	1.02	0.93
9.00	4.00	6.970	5.927	0.44	0.29	0.35	78.31	17.40	3.63	9.61	3.49	1.27	1.25
10.00	3.50	6.136	5.218	0.41	0.25	0.35	83.22	16.64	3.99	6.33	2.56	1.10	1.02
10.00	4.25	8.360	7.109	0.50	0.31	0.40	116.15	23.23	4.04	13.02	4.47	1.35	1.34
12.00	4.00	8.274	7.036	0.47	0.29	0.40	159.76	26.63	4.77	11.03	3.86	1.25	1.14
12.00	5.00	11.822	10.053	0.62	0.35	0.45	239.69	39.95	4.88	25.74	7.60	1.60	1.61

Structural sections are available in 6061-T6 aluminum alloy. Data supplied by The Aluminum Association.

Wire and Sheet-Metal Gages

The thicknesses of sheet metals and the diameters of wires conform to various gaging systems. These gage sizes are indicated by numbers, and the following tables give the decimal equivalents of the different gage numbers. Much confusion has resulted from the use of gage numbers, and in ordering materials it is preferable to give the exact dimensions in decimal fractions of an inch. While the dimensions thus specified should conform to the gage ordinarily used for a given class of material, any error in the specification due, for example, to the use of a table having "rounded off" or approximate equivalents, will be apparent to the manufacturer at the time the order is placed. Furthermore, the decimal method of indicating wire diameters and sheet metal thicknesses has the advantage of being self-explanatory, whereas arbitrary gage numbers are not. The decimal system of indicating gage sizes is now being used quite generally, and gage numbers are gradually being discarded. Unfortunately, there is considerable variation in the use of different gages. For example, a gage ordinarily used for copper, brass and other non-ferrous materials, may at times be used for steel, and vice versa. The gages specified in the following are the ones ordinarily employed for the materials mentioned, but there are some minor exceptions and variations in the different industries.

Wire Gages.—The wire gage system used by practically all of the steel producers in the United States is known by the name Steel Wire Gage or to distinguish it from the Standard Wire Gage (S.W.G.) used in Great Britain it is called the United States Steel Wire Gage. It is the same as the Washburn and Moen, American Steel and Wire Company, and Roebing Wire Gages. The name has the official sanction of the Bureau of Standards at Washington but is not legally effective. The only wire gage which has been recognized in Acts of Congress is the Birmingham Gage (also known as Stub's Iron Wire). The Birmingham Gage is, however, nearly obsolete in both the United States and Great Britain, where it originated. Copper and aluminum wires are specified in decimal fractions. They were formerly universally specified in the United States by the American or Brown & Sharpe Wire Gage. Music spring steel wire, one of the highest quality wires of several types used for mechanical springs, is specified by the piano or music wire gage.

In Great Britain one wire gage has been legalized. This is called the Standard Wire Gage (S.W.G.), formerly called Imperial Wire Gage.

Gages for Rods.—Steel wire rod sizes are designated by fractional or decimal parts of an inch and by the gage numbers of the United States Steel Wire Gage. Copper and aluminum rods are specified by decimal fractions and fractions. Drill rod may be specified in decimal fractions but in the carbon and alloy tool steel grades may also be specified in the Stub's Steel Wire Gage and in the high-speed steel drill rod grade may be specified by the Morse Twist Drill Gage (Manufacturers' Standard Gage for Twist Drills). For gage numbers with corresponding decimal equivalents see the tables of American Standard Straight Shank Twist Drills, for example, page 868, and Table 5a on page 2612.

Gages for Wall Thicknesses of Tubing.—At one time the Birmingham or Stub's Iron Wire Gage was used to specify the wall thickness of the following classes of tubing: seamless brass, seamless copper, seamless steel, and aluminum. The Brown & Sharpe Wire Gage was used for brazed brass and brazed copper tubing. Wall thicknesses are now specified by decimal parts of an inch but the wall thickness of steel pressure tubes and steel mechanical tubing may be specified by the Birmingham or Stub's Iron Wire Gage. In Great Britain the Standard Wire Gage (S.W.G.) is used to specify the wall thickness of some kinds of steel tubes.

Table 1. Wire Gages in Approximate Decimals of an Inch

No. of Wire Gage	American Wire or Brown & Sharpe Gage	Steel Wire Gage (U.S.) ^a	British Standard Wire Gage (Imperial Wire Gage)	Music or Piano Wire Gage	Birmingham or Stub's Iron Wire Gage	Stub's Steel Wire Gage	No. of Wire Gage	Stub's Steel Wire Gage
3/8	...	0.4900	0.5000	51	0.066
3/16	0.5800	0.4615	0.4640	0.004	52	0.063
5/16	0.5165	0.4305	0.4320	0.005	0.5000	...	53	0.058
1/4	0.4600	0.3938	0.4000	0.006	0.4540	...	54	0.055
5/16	0.4096	0.3625	0.3720	0.007	0.4250	...	55	0.050
3/8	0.3648	0.3310	0.3480	0.008	0.3800	...	56	0.045
1/2	0.3249	0.3065	0.3240	0.009	0.3400	...	57	0.042
1	0.2893	0.2830	0.3000	0.010	0.3000	0.227	58	0.041
2	0.2576	0.2625	0.2760	0.011	0.2840	0.219	59	0.040
3	0.2294	0.2437	0.2520	0.012	0.2590	0.212	60	0.039
4	0.2043	0.2253	0.2320	0.013	0.2380	0.207	61	0.038
5	0.1819	0.2070	0.2120	0.014	0.2200	0.204	62	0.037
6	0.1620	0.1920	0.1920	0.016	0.2030	0.201	63	0.036
7	0.1443	0.1770	0.1760	0.018	0.1800	0.199	64	0.035
8	0.1285	0.1620	0.1600	0.020	0.1650	0.197	65	0.033
9	0.1144	0.1483	0.1440	0.022	0.1480	0.194	66	0.032
10	0.1019	0.1350	0.1280	0.024	0.1340	0.191	67	0.031
11	0.0907	0.1205	0.1160	0.026	0.1200	0.188	68	0.030
12	0.0808	0.1055	0.1040	0.029	0.1090	0.185	69	0.029
13	0.0720	0.0915	0.0920	0.031	0.0950	0.182	70	0.027
14	0.0641	0.0800	0.0800	0.033	0.0830	0.180	71	0.026
15	0.0571	0.0720	0.0720	0.035	0.0720	0.178	72	0.024
16	0.0508	0.0625	0.0640	0.037	0.0650	0.175	73	0.023
17	0.0453	0.0540	0.0560	0.039	0.0580	0.172	74	0.022
18	0.0403	0.0475	0.0480	0.041	0.0490	0.168	75	0.020
19	0.0359	0.0410	0.0400	0.043	0.0420	0.164	76	0.018
20	0.0320	0.0348	0.0360	0.045	0.0350	0.161	77	0.016
21	0.0285	0.0318	0.0320	0.047	0.0320	0.157	78	0.015
22	0.0253	0.0286	0.0280	0.049	0.0280	0.155	79	0.014
23	0.0226	0.0258	0.0240	0.051	0.0250	0.153	80	0.013
24	0.0201	0.0230	0.0220	0.055	0.0220	0.151
25	0.0179	0.0204	0.0200	0.059	0.0200	0.148
26	0.0159	0.0181	0.0180	0.063	0.0180	0.146
27	0.0142	0.0173	0.0164	0.067	0.0160	0.143
28	0.0126	0.0162	0.0149	0.071	0.0140	0.139
29	0.0113	0.0150	0.0136	0.075	0.0130	0.134
30	0.0100	0.0140	0.0124	0.080	0.0120	0.127
31	0.00893	0.0132	0.0116	0.085	0.0100	0.120
32	0.00795	0.0128	0.0108	0.090	0.0090	0.115
33	0.00708	0.0118	0.0100	0.095	0.0080	0.112
34	0.00630	0.0104	0.0092	0.100	0.0070	0.110
35	0.00561	0.0095	0.0084	0.106	0.0050	0.108
36	0.00500	0.0090	0.0076	0.112	0.0040	0.106
37	0.00445	0.0085	0.0068	0.118	...	0.103
38	0.00396	0.0080	0.0060	0.124	...	0.101
39	0.00353	0.0075	0.0052	0.130	...	0.099
40	0.00314	0.0070	0.0048	0.138	...	0.097
41	0.00280	0.0066	0.0044	0.146	...	0.095
42	0.00249	0.0062	0.0040	0.154	...	0.092
43	0.00222	0.0060	0.0036	0.162	...	0.088
44	0.00198	0.0058	0.0032	0.170	...	0.085
45	0.00176	0.0055	0.0028	0.180	...	0.081
46	0.00157	0.0052	0.0024	0.079
47	0.00140	0.0050	0.0020	0.077
48	0.00124	0.0048	0.0016	0.075
49	0.00111	0.0046	0.0012	0.072
50	0.00099	0.0044	0.0010	0.069

^a Also known as Washburn and Moen, American Steel and Wire Co. and Roebing Wire Gages. A greater selection of sizes is available and is specified by what are known as split gage numbers. They can be recognized by 1/2 fractions which follow the gage number; i.e., 4 1/2. The decimal equivalents of split gage numbers are in the Steel Products Manual entitled: *Wire and Rods, Carbon Steel* published by the American Iron and Steel Institute, Washington, DC.

Wire Gauge^a, Diameter, and Area of Solid Copper Wire

Gauge	Diameter (in)	Area (in ²)	Gauge	Diameter (in)	Area (in ²)
0000	0.460000	0.1661901110	22	0.025350	0.0005047141
000	0.409600	0.1317678350	23	0.022570	0.0004000853
00	0.364800	0.1045199453	24	0.020100	0.0003173084
0	0.324900	0.0829065680	25	0.017900	0.0002516492
1	0.289300	0.0657334432	26	0.015940	0.0001995566
2	0.257600	0.0521172188	27	0.014200	0.0001583676
3	0.229400	0.0413310408	28	0.012640	0.0001254826
4	0.204300	0.0327813057	29	0.011260	0.0000995787
5	0.181900	0.0259869262	30	0.010030	0.0000790117
6	0.162000	0.0206119720	31	0.008928	0.0000626034
7	0.144300	0.0163559316	32	0.007950	0.0000496391
8	0.128500	0.0129686799	33	0.007080	0.0000393691
9	0.114400	0.0102787798	34	0.006305	0.0000312219
10	0.101900	0.0081552613	35	0.005615	0.0000247622
11	0.090740	0.0064667648	36	0.005000	0.0000196349
12	0.080810	0.0051288468	37	0.004453	0.0000155738
13	0.071960	0.0040669780	38	0.003965	0.0000123474
14	0.064080	0.0032250357	39	0.003531	0.0000097923
15	0.057070	0.0025580278	40	0.003145	0.0000077684
16	0.050820	0.0020284244	41	0.002800	0.0000061575
17	0.045260	0.0016088613	42	0.002490	0.0000048695
18	0.040300	0.0012755562	43	0.002220	0.0000038708
19	0.035890	0.0010116643	44	0.001970	0.0000030480
20	0.031960	0.0008022377	45	0.001760	0.0000024328
21	0.028460	0.0006361497	46	0.001570	0.0000019359

^aGauge is American Wire Gauge (AWG). For a given gauge, $d = 0.005 \times 92^{\frac{36 - \text{Gauge}}{39}}$.

Hypodermic Needle Dimensions

Gauge ^a	Needle Nominal Outside Diameter			Needle Nominal Inside Diameter		
	mm	inch	Tolerance (inch)	mm	inch	Tolerance (inch)
6	5.156	0.2030	±0.0010	4.394	0.1730	±0.0030
7	4.572	0.1800		3.810	0.1500	
8	4.191	0.1650		3.429	0.1350	
9	3.759	0.1480		2.997	0.1180	
10	3.404	0.1340		2.692	0.1060	
11	3.048	0.1200		2.388	0.0940	
12	2.769	0.1090		2.159	0.0850	
13	2.413	0.0950		1.803	0.0710	
14	2.108	0.0830		1.600	0.0630	
15	1.829	0.0720		1.372	0.0540	
16	1.651	0.0650	1.194	0.0470		
17	1.473	0.0580	1.067	0.0420		
18	1.270	0.0500	0.838	0.0330		
19	1.067	0.0420	0.686	0.0270		
20	0.902	0.0355	0.584	0.0230		
21	0.813	0.0320	0.495	0.0195		
22	0.711	0.0280	0.394	0.0155		
22s	0.711	0.0280	0.140	0.0055		
23	0.635	0.0250	0.318	0.0125		
24	0.559	0.0220	0.292	0.0115		
25	0.508	0.0200	0.241	0.0095		
25s	0.508	0.0200	0.140	0.0055		
26	0.457	0.0180	0.241	0.0095	+0.0015	
26s	0.467	0.0184	-0.0000	0.114	0.0045	-0.0000
27	0.406	0.0160	0.191	0.0075		
28	0.356	0.0140	0.165	0.0065		
29	0.330	0.0130	0.165	0.0065		
30	0.305	0.0120	0.140	0.0055		
31	0.254	0.0100	0.114	0.0045		
32	0.229	0.0090	0.089	0.0035		
33	0.203	0.0080	0.089	0.0035		

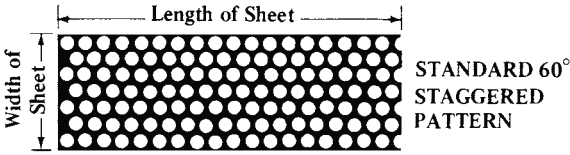
^aGauge is Birmingham Wire Gauge (same as Stub's Iron Wire Gauge)

Strength and Stiffness of Perforated Metals.—It is common practice to use perforated metals in equipment enclosures to provide cooling by the flow of air or fluids. If the perforated material is to serve also as a structural member, then calculations of stiffness and strength must be made that take into account the effect of the perforations on the strength of the panels.

The accompanying table provides equivalent or effective values of the yield strength S^* ; modulus of elasticity E^* ; and Poisson's ratio ν^* of perforated metals in terms of the values for solid material. The S^*/S and E^*/E ratios, given in the accompanying table for the standard round hole staggered pattern, can be used to determine the safety margins or deflections for perforated metal use as compared to the unperforated metal for any geometry or loading condition.

Perforated material has different strengths depending on the direction of loading; therefore, values of S^*/S in the table are given for the width (strongest) and length (weakest) directions. Also, the effective elastic constants are for plane stress conditions and apply to the in-plane loading of thin perforated sheets; the bending stiffness is greater. However, since most loading conditions involve a combination of bending and stretching, it is more convenient to use the same effective elastic constants for these combined loading conditions. The plane stress effective elastic constants given in the table can be conservatively used for all loading conditions.

Mechanical Properties of Materials Perforated with Round Holes in IPA Standard Staggered Hole Pattern



IPA No.	Perforation Diam. (in.)	Center Distance (in.)	Open Area (%)	S^*/S		E^*/E	ν^*
				Width (in.)	Length (in.)		
100	0.020	(625)	20	0.530	0.465	0.565	0.32
106	1/16	1/8	23	0.500	0.435	0.529	0.33
107	5/64	7/64	46	0.286	0.225	0.246	0.38
108	5/64	1/8	36	0.375	0.310	0.362	0.35
109	3/32	5/32	32	0.400	0.334	0.395	0.34
110	3/32	3/16	23	0.500	0.435	0.529	0.33
112	1/10	5/32	36	0.360	0.296	0.342	0.35
113	1/8	3/16	40	0.333	0.270	0.310	0.36
114	1/8	7/32	29	0.428	0.363	0.436	0.33
115	1/8	1/4	23	0.500	0.435	0.529	0.33
116	5/32	7/32	46	0.288	0.225	0.249	0.38
117	5/32	1/4	36	0.375	0.310	0.362	0.35
118	3/16	1/4	51	0.250	0.192	0.205	0.42
119	3/16	5/16	33	0.400	0.334	0.395	0.34
120	1/4	5/16	58	0.200	0.147	0.146	0.47
121	1/4	3/8	40	0.333	0.270	0.310	0.36
122	1/4	7/16	30	0.428	0.363	0.436	0.33
123	1/4	1/2	23	0.500	0.435	0.529	0.33
124	3/8	1/2	51	0.250	0.192	0.205	0.42
125	3/8	9/16	40	0.333	0.270	0.310	0.36
126	3/8	5/8	33	0.400	0.334	0.395	0.34
127	7/16	5/8	45	0.300	0.239	0.265	0.38
128	1/2	1 1/16	47	0.273	0.214	0.230	0.39
129	9/16	3/4	51	0.250	0.192	0.205	0.42

Value in parentheses specifies holes per square inch instead of center distance. S^*/S = ratio of yield strength of perforated to unperforated material; E^*/E = ratio of modulus of elasticity of perforated to unperforated material; ν^* = Poisson's ratio for given percentage of open area.

IPA is Industrial Perforators Association.

Sheet-Metal Gages.—Thicknesses of steel sheets given in **Table 2** are based upon a weight of 41.82 pounds per square foot per inch of thickness, which is known as the Manufacturers' Standard Gage for Sheet Steel. This gage differs from the older United States Standard Gage for iron and steel sheets and plates, established by Congress in 1893, based upon a weight of 40 pounds per square foot per inch of thickness which is the weight of wrought-iron plate.

Table 2. Sheet-Metal Gages in Approximate Decimals of an Inch

Gage No.	Steel Gage ^a	B.G. ^b	Galvanized Sheet	Zinc Gage	Gage No.	Steel Gage ^a	B.G. ^b	Galvanized Sheet	Zinc Gage
15/0	...	1.000	20	0.0359	0.0392	0.0396	0.070
14/0	...	0.9583	21	0.0329	0.0349	0.0366	0.080
13/0	...	0.9167	22	0.0299	0.03125	0.0336	0.090
12/0	...	0.8750	23	0.0269	0.02782	0.0306	0.100
11/0	...	0.8333	24	0.0239	0.02476	0.0276	0.125
10/0	...	0.7917	25	0.0209	0.02204	0.0247	...
9/0	...	0.7500	26	0.0179	0.01961	0.0217	...
8/0	...	0.7083	27	0.0164	0.01745	0.0202	...
7/0	...	0.6666	28	0.0149	0.01562	0.0187	...
6/0	...	0.6250	29	0.0135	0.01390	0.0172	...
5/0	...	0.5883	30	0.0120	0.01230	0.0157	...
4/0	...	0.5416	31	0.0105	0.01100	0.0142	...
3/0	...	0.5000	32	0.0097	0.00980	0.0134	...
2/0	...	0.4452	33	0.0090	0.00870
1/0	...	0.3964	34	0.0082	0.00770
1	...	0.3532	35	0.0075	0.00690
2	...	0.3147	36	0.0067	0.00610
3	0.2391	0.2804	...	0.006	37	0.0064	0.00540
4	0.2242	0.2500	...	0.008	38	0.0060	0.00480
5	0.2092	0.2225	...	0.010	39	...	0.00430
6	0.1943	0.1981	...	0.012	40	...	0.00386
7	0.1793	0.1764	...	0.014	41	...	0.00343
8	0.1644	0.1570	0.1681	0.016	42	...	0.00306
9	0.1495	0.1398	0.1532	0.018	43	...	0.00272
10	0.1345	0.1250	0.1382	0.020	44	...	0.00242
11	0.1196	0.1113	0.1233	0.024	45	...	0.00215
12	0.1046	0.0991	0.1084	0.028	46	...	0.00192
13	.0897	0.0882	0.0934	0.032	47	...	0.00170
14	0.0747	0.0785	0.0785	0.036	48	...	0.00152
15	0.0673	0.0699	0.0710	0.040	49	...	0.00135
16	0.0598	0.0625	0.0635	0.045	50	...	0.00120
17	0.0538	0.0556	0.0575	0.050	51	...	0.00107
18	.0478	0.0495	0.0516	0.055	52	...	0.00095
19	0.0418	0.0440	0.0456	0.060

^aManufacturers' Standard Gage for Sheet Steel

^bB.G. is the Birmingham Gage for sheets and hoops.

The United States Standard Gage (not shown above) for iron and steel sheets and plates was established by Congress in 1893 and was primarily a *weight* gage rather than a thickness gage. The equivalent thicknesses were derived from the weight of wrought iron. The weight per cubic foot was taken at 480 pounds, thus making the weight of a plate 12 inches square and 1 inch thick, 40 pounds. In converting weight to equivalent thickness, gage tables formerly published contained thicknesses equivalent to the basic weights just mentioned. For example, a No. 3 U.S. gage represents a wrought-iron plate having a weight of 10 pounds per square foot; hence, if the weight per square foot per inch thick is 40 pounds, the plate thickness for a No. 3 gage = $10 \div 40 = 0.25$ inch, which was the original thickness equivalent for this gage number. Because this and the other thickness equivalents were derived from the weight of wrought iron, they are not correct for steel.

Zinc sheets are usually ordered by specifying decimal thickness although a zinc gage exists and is shown in [Table 2](#).

Most sheet-metal products in Great Britain are specified by the British Standard Wire Gage (Imperial Wire Gage). Black iron and steel sheet and hooping, and galvanized flat and corrugated steel sheet, however, are specified by the Birmingham Gage (B.G.), which was legalized in 1914, and are also shown in [Table 2](#). This Birmingham Gage should not be confused with the Birmingham or Stub's Iron Wire Gage mentioned previously.

Thicknesses of aluminum, copper, and copper-base alloys were formerly designated by the American or Brown & Sharpe Wire Gage but now are specified in decimals or fractions of an inch. American National Standard B32.1-1952 (R1988) entitled Preferred Thicknesses for Uncoated Thin Flat Metals (see accompanying [Table 3](#)) gives thicknesses that are based on the 20- and 40-series of preferred numbers in American National Standard Preferred Numbers — ANSI Z17.1 (see Handbook page [672](#)) and are applicable to uncoated, thin, flat metals and alloys. Each number of the 20-series is approximately 12 percent greater than the next smaller one and each number of the 40-series is approximately 6 percent greater than the next smaller one.

**Table 3. Preferred Thicknesses for Uncoated Metals and Alloys—
Under 0.250 Inch in Thickness ANSI B32.1-1952 (R1994)**

Preferred Thickness, Inches							
Based on 20-Series	Based on 40-Series	Based on 20-Series	Based on 40-Series	Based on 20-Series	Based on 40-Series	Based on 20-Series	Based on 40-Series
...	0.236	0.100	0.100	...	0.042	0.018	0.018
0.224	0.224	...	0.095	0.040	0.040	...	0.017
...	0.212	0.090	0.090	...	0.038	0.016	0.016
0.200	0.200	...	0.085	0.036	0.036	...	0.015
...	0.190	0.080	0.080	...	0.034	0.014	0.014
0.180	0.180	...	0.075	0.032	0.032	...	0.013
...	0.170	0.071	0.071	...	0.030	0.012	0.012
0.160	0.160	...	0.067	0.028	0.028	0.011	0.011
...	0.150	0.063	0.063	...	0.026	0.010	0.010
0.140	0.140	...	0.060	0.025	0.025	0.009	0.009
...	0.132	0.056	0.056	...	0.024	0.008	0.008
0.125	0.125	...	0.053	0.022	0.022	0.007	0.007
...	0.118	0.050	0.050	...	0.021	0.006	0.006
0.112	0.112	...	0.048	0.020	0.020	0.005	0.005
...	0.106	0.045	0.045	...	0.019	0.004	0.004

The American National Standard ANSI B32.1-1952 (R1994) lists preferred thicknesses that are based on the 20- and 40-series of preferred numbers and states that those based on the 40-series should provide adequate coverage. However, where intermediate thicknesses are required, the Standard recommends that thicknesses be based on the 80-series of preferred numbers (see Handbook page [672](#)).

Thicknesses for copper and copper-base alloy flat products below $\frac{1}{4}$ inch thick are specified by the 20-series of American National Standard Preferred Numbers given in ANSI B32.1. Although the table in ANSI B32.1 gives only the 20- and 40-series of numbers, it states that when intermediate thicknesses are required they should be selected from thicknesses based on the 80-series of numbers (see Handbook page [672](#)).

Metric Sizes for Flat Metal Products.—American National Standard B32.100-2005, (R2010) establishes a preferred series of metric thicknesses, widths, and lengths for flat metal products of rectangular cross section; the thickness and width values are also applicable to base metals that may be coated in later operations. The standard also establishes a preferred series of metric sizes for round and hexagonal metal products.

The First Choice of sizes of this standard are derived from Renard's R5 series of preferred numbers (see *American National Standard for Preferred Numbers* on page 672, also ANSI B4.2 or ISO 497) in which each preferred number is approximately 60 per cent larger than the preceding number in the series. The Second Choice series are derived from the R10 series in which each number is approximately 25 per cent larger than the preceding, and Third Choice sizes are generally from the R20 series in which each number is approximately 12.5 per cent larger than the preceding number.

Table 4a gives preferred metric diameters from 1 to 500 millimeters for round metal products; Table lists the preferred thicknesses; Table 4c lists the preferred widths. Wherever possible, sizes should be selected from the First Choice series shown in the tables. Second and Third Choice series are also shown. For preferred metric diameters less than 1 millimeter, preferred across flat metric sizes of square and hexagon metal products, preferred across flat metric sizes of rectangular metal products, and preferred metric lengths of metal products, reference should be made to the B32.100-2005 Standard.

Table 4a. American National Standard Preferred Metric Diameters of Round Metal Product ANSI B32.100-2005 (R2009)

Basic Size, mm			Basic Size, mm		
First Choice	Second Choice	Third Choice	First Choice	Second Choice	Third Choice
1	25
...	...	1.1	26, 28
...	1.2	30	...
...	...	1.4	32, 35, 36, 38
1.6	40
...	...	1.8	42, 45, 48
...	2	50	...
...	...	2.2, 2.4	55, 56
2.5	60
...	...	2.6, 2.8	63, 65, 70, 75
...	3	80	...
...	...	3.2, 3.5, 3.8	85, 90, 95
4	100
...	...	4.5, 4.8	105, 110
...	5	120	...
...	...	5.5	125, 130, 140, 150
6	160
...	...	6.5, 7, 7.5	170, 180, 190
...	8	200	...
...	...	8.5, 9, 9.5	220, 240
10	250
...	...	11	260, 280
...	12	300	...
...	...	13, 14, 15	320, 340, 350, 360, 380
16	400
...	...	17, 18, 19	420, 440, 450, 480
...	20	500	...
...	...	21, 22, 23, 24

Table 4b. Preferred Metric Thicknesses (mm) for All Flat Metal Products ASME B32.100-2005 (R2010)

First Choice	Second Choice	Third Choice	First Choice	Second Choice	Third Choice	First Choice	Second Choice	Third Choice
...	0.050	...	1.6	25
0.060	1.7	28
...	0.080	1.8	...	30	...
0.10	2	32
...	...	0.11	2.2	35
...	0.12	2.3	38
...	...	0.14	2.5	40
0.16	2.6	45
...	...	0.18	2.8	...	50	...
...	0.20	3	55
...	...	0.22	3.2	60
0.25	3.5	70
...	...	0.28	3.8	...	80	...
...	0.30	...	4	90
...	...	0.35	4.5
0.40	5	...	100
...	...	0.45	5.5	110
...	0.50	...	6	120	...
...	...	0.55	7	130
0.60	8	140
...	...	0.65	9	150
...	...	0.70	10	160
...	...	0.75	11	180
...	0.80	12	200	...
...	...	0.90	14	250
1.0	15	...	300	...
...	...	1.1	16
...	1.2	18
...	...	1.4	...	20
...	...	1.5	22

Table 4c. Preferred Metric Widths (mm) for All Flat Metal Products ASME B32.100-2005 (R2010)

First Choice	Second Choice	Third Choice	First Choice	Second Choice	Third Choice	First Choice	Second Choice	Third Choice
...	2	...	60	400
2.5	70	...	500	...
...	3	80	...	600
4	90	700
...	5	...	100	800	...
6	110	900
...	8	120	...	1000
10	130	...	1200	...
...	12	140	1500
16	150	1600
...	20	...	160	2000	...
25	30	180	2500
...	...	35	...	200	3000	...
40	225	3500
...	...	45	250	4000
...	50	280	...	5000	...
...	...	55	...	300

All dimensions are in millimeters.

Table 5a. Decimal Equivalent of Numbered Drill Sizes

Drill Number	Decimal		Drill Number	Decimal		Drill Number	Decimal		Drill Number	Decimal	
	Inch	mm		Inch	mm		Inch	mm		Inch	mm
1	0.2280	5.791	26	0.1470	3.734	51	0.0670	1.702	76	0.0200	0.508
2	0.2210	5.613	27	0.1440	3.658	52	0.0635	1.613	77	0.0180	0.457
3	0.2130	5.410	28	0.1405	3.569	53	0.0595	1.511	78	0.0160	0.406
4	0.2090	5.309	29	0.1360	3.454	54	0.0550	1.397	79	0.0145	0.368
5	0.2055	5.220	30	0.1285	3.264	55	0.0520	1.321	80	0.0135	0.343
6	0.2040	5.182	31	0.1200	3.048	56	0.0465	1.181	81	0.0130	0.330
7	0.2010	5.105	32	0.1160	2.946	57	0.0430	1.092	82	0.0125	0.318
8	0.1990	5.054	33	0.1130	2.870	58	0.0420	1.067	83	0.0120	0.305
9	0.1960	4.978	34	0.1110	2.819	59	0.0410	1.041	84	0.0115	0.292
10	0.1935	4.915	35	0.1100	2.794	60	0.0400	1.016	85	0.0110	0.280
11	0.1910	4.851	36	0.1065	2.705	61	0.0390	0.991	86	0.0105	0.267
12	0.1890	4.800	37	0.1040	2.642	62	0.0380	0.965	87	0.0100	0.254
13	0.1850	4.700	38	0.1015	2.578	63	0.0370	0.940	88	0.0095	0.241
14	0.1820	4.623	39	0.0995	2.527	64	0.0360	0.914	89	0.0091	0.231
15	0.1800	4.572	40	0.0980	2.489	65	0.0350	0.889	90	0.0087	0.221
16	0.1770	4.496	41	0.0960	2.438	66	0.0330	0.838	91	0.0083	0.211
17	0.1730	4.394	42	0.0935	2.375	67	0.0320	0.813	92	0.0079	0.200
18	0.1695	4.305	43	0.0890	2.261	68	0.0310	0.787	93	0.0075	0.190
19	0.1660	4.216	44	0.0860	2.184	69	0.0292	0.742	94	0.0071	0.180
20	0.1610	4.089	45	0.0820	2.083	70	0.0280	0.711	95	0.0067	0.170
21	0.1590	4.039	46	0.0810	2.057	71	0.0260	0.660	96	0.0063	0.160
22	0.1570	3.988	47	0.0785	1.994	72	0.0250	0.635	97	0.0059	0.150
23	0.1540	3.912	48	0.0760	1.930	73	0.0240	0.610
24	0.1520	3.861	49	0.0730	1.854	74	0.0225	0.572
25	0.1495	3.797	50	0.0700	1.778	75	0.0210	0.533

Table 5b. Decimal Equivalent of Letter Drill Sizes

Drill Size	Decimal		Drill Size	Decimal		Drill Size	Decimal		Drill Size	Decimal		Drill Size	Decimal	
	Inch	mm		Inch	mm		Inch	mm		Inch	mm		Inch	mm
A	0.234	5.944	G	0.261	6.629	M	0.295	7.493	S	0.348	8.839	Y	0.404	10.262
B	0.238	6.045	H	0.266	6.756	N	0.302	7.671	T	0.358	9.093	Z	0.413	10.490
C	0.242	6.147	I	0.272	6.909	O	0.316	8.026	U	0.368	9.347
D	0.246	6.248	J	0.277	7.036	P	0.323	8.204	V	0.377	9.576
E	0.250	6.350	K	0.281	7.137	Q	0.332	8.433	W	0.386	9.804
F	0.257	6.528	L	0.290	7.366	R	0.339	8.611	X	0.397	10.084

Wire Drawing History.—Wire drawing is the process used for producing wire by drawing a wire or rod of larger diameter through a plate or die provided with a hole which reduces the size to the desired dimension. Previous to wire drawing, wire was made by hammering or beating metal into thin sheets or plates, which were cut into continuous strips. These strips were then afterwards rounded by hammering. There is evidence that wire was produced by a simple hammering process as early as 2000 B.C., and perhaps earlier. The history of the art does not clearly indicate when simple hammering was superseded by the method of drawing through a die, but records are available to show that wire drawing on a commercial scale was practiced in France in 1270, in Germany in 1350, and in England in 1466. The first wire-drawing mill in America was built in 1775, in Norwich, Conn., by Nathaniel Niles, who was granted a loan of \$1500 by the court for this purpose.

Shaped Wire.—Shaped wire is any wire not round in section; it may be square, rectangular, hexagonal, triangular, half-round, oval, etc. Some sections of shaped wire may be either rolled or drawn. Shaped wire is a specialty, subject to agreement between purchaser and manufacturer as to size, finish, temper, and weight of coils and packages.

Strength and Properties of Wire Rope

Wire Rope Construction.—Essentially, a wire rope is made up of a number of strands laid helically about a metallic or non-metallic core. Each strand consists of a number of wires also laid helically about a metallic or non-metallic center. Various types of wire rope have been developed to meet a wide range of uses and operating conditions. These types are distinguished by the kind of core; the number of strands; the number, sizes, and arrangement of the wires in each strand; and the way in which the wires and strands are wound or laid about each other. The following descriptive material is based largely on information supplied by the Bethlehem Steel Co.

Rope Wire Materials: Materials used in the manufacture of rope wire are, in order of increasing strength: iron, phosphor bronze, traction steel, plow steel, improved plow steel, and bridge rope steel. Iron wire rope is largely used for low-strength applications such as elevator ropes not used for hoisting, and for stationary guy ropes.

Phosphor bronze wire rope is used occasionally for elevator governor-cable rope and for certain marine applications as life lines, clearing lines, wheel ropes and rigging.

Traction steel wire rope is used primarily as hoist rope for passenger and freight elevators of the traction drive type, an application for which it was specifically designed.

Ropes made of galvanized wire or wire coated with zinc by the electro-deposition process are used in certain applications where additional protection against rusting is required. As will be noted from the tables of wire-rope sizes and strengths, the breaking strength of galvanized wire rope is 10 per cent less than that of ungalvanized (bright) wire rope. Beth-anized (zinc-coated) wire rope can be furnished to bright wire rope strength when so specified.

Galvanized carbon steel, tinned carbon steel, and stainless steel are used for small cords and strands ranging in diameter from $\frac{1}{64}$ to $\frac{3}{8}$ inch and larger.

Marline clad wire rope has each strand wrapped with a layer of tarred marline. The cladding provides hand protection for workers and wear protection for the rope.

Rope Cores: Wire-rope cores are made of fiber, cotton, asbestos, polyvinyl plastic, a small wire rope (independent wire-rope core), a multiple-wire strand (wire-strand core) or a cold-drawn wire-wound spring.

Fiber (manila or sisal) is the type of core most widely used when loads are not too great. It supports the strands in their relative positions and acts as a cushion to prevent nicking of the wires lying next to the core.

Cotton is used for small ropes such as sash cord and aircraft cord.

Asbestos cores can be furnished for certain special operations where the rope is used in oven operations.

Polyvinyl plastics cores are offered for use where exposure to moisture, acids, or caustics is excessive.

Wire-strand core often referred to as WSC, consists of a multiple-wire strand that may be the same as one of the strands of the rope. It is smoother and more solid than the independent wire rope core and provides a better support for the rope strands.

The *independent wire rope core*, often referred to as IWRC, is a small 6×7 wire rope with a wire-strand core and is used to provide greater resistance to crushing and distortion of the wire rope. For certain applications it has the advantage over a wire-strand core in that it stretches at a rate closer to that of the rope itself.

Wire ropes with wire-strand cores are, in general, less flexible than wire ropes with independent wire-rope or non-metallic cores.

Ropes with metallic cores are rated $7\frac{1}{2}$ per cent stronger than those with non-metallic cores.

Wire-Rope Lay: The lay of a wire rope is the direction of the helical path in which the strands are laid and, similarly, the lay of a strand is the direction of the helical path in which the wires are laid. If the wires in the strand or the strands in the rope form a helix similar to the threads of a right-hand screw, i.e., they wind around to the right, the lay is called right hand and, conversely, if they wind around to the left, the lay is called left hand. In the *regular lay*, the wires in the strands are laid in the opposite direction to the lay of the strands in the rope. In right-regular lay, the strands are laid to the right and the wires to the left. In left-regular lay, the strands are laid to the left, the wires to the right. In *Lang lay*, the wires and strands are laid in the same direction, i.e., in right Lang lay, both the wires and strands are laid to the right and in left Lang they are laid to the left.

Alternate lay ropes having alternate right and left laid strands are used to resist distortion and prevent clamp slippage, but because other advantages are missing, have limited use.

The regular lay wire rope is most widely used and right regular lay rope is customarily furnished. Regular lay rope has less tendency to spin or untwist when placed under load and is generally selected where long ropes are employed and the loads handled are frequently removed. Lang lay ropes have greater flexibility than regular lay ropes and are more resistant to abrasion and fatigue.

In preformed wire ropes the wires and strands are preshaped into a helical form so that when laid to form the rope they tend to remain in place. In a non-preformed rope, broken wires tend to "wicker out" or protrude from the rope and strands that are not seized tend to spring apart. Preforming also tends to remove locked-in stresses, lengthen service life, and make the rope easier to handle and to spool.

Strand Construction: Various arrangements of wire are used in the construction of wire rope strands. In the simplest arrangement six wires are grouped around a central wire thus making seven wires, all of the same size. Other types of construction known as "filler-wire," Warrington, Seale, etc. make use of wires of different sizes. Their respective patterns of arrangement are shown diagrammatically in the table of wire weights and strengths.

Specifying Wire Rope.—In specifying wire rope the following information will be required: length, diameter, number of strands, number of wires in each strand, type of rope construction, grade of steel used in rope, whether preformed or not preformed, type of center, and type of lay. The manufacturer should be consulted in selecting the best type of wire rope for a new application.

Properties of Wire Rope.—Important properties of wire rope are strength, wear resistance, flexibility, and resistance to crushing and distortion.

Strength: The strength of wire rope depends upon its size, kind of material of which the wires are made and their number, the type of core, and whether the wire is galvanized or not. Strengths of various types and sizes of wire ropes are given in the accompanying tables together with appropriate factors to apply for ropes with steel cores and for galvanized wire ropes.

Wear Resistance: When wire rope must pass back and forth over surfaces that subject it to unusual wear or abrasion, it must be specially constructed to give satisfactory service.

Such construction may make use of 1) relatively large outer wires; 2) Lang lay in which wires in each strand are laid in the same direction as the strand; and 3) flattened strands.

The object in each type is to provide a greater outside surface area to take the wear or abrasion. From the standpoint of material, improved plow steel has not only the highest tensile strength but also the greatest resistance to abrasion in regularly stocked wire rope.

Flexibility: Wire rope that undergoes repeated and severe bending, such as in passing around small sheaves and drums, must have a high degree of flexibility to prevent premature breakage and failure due to fatigue. Greater flexibility in wire rope is obtained by

1) using small wires in larger numbers; 2) using Lang lay; and 3) preforming, that is, the wires and strands of the rope are shaped during manufacture to fit the position they will assume in the finished rope.

Resistance to Crushing and Distortion: Where wire rope is to be subjected to transverse loads that may crush or distort it, care should be taken to select a type of construction that will stand up under such treatment.

Wire rope designed for such conditions may have 1) large outer wires to spread the load per wire over a greater area; and 2) an independent wire core or a high-carbon cold-drawn wound spring core.

Standard Classes of Wire Rope.—Wire rope is commonly designated by two figures, the first indicating the number of strands and the second, the number of wires per strand, as: 6×7 , a six-strand rope having seven wires per strand, or 8×19 , an eight-strand rope having 19 wires per strand. When such numbers are used as designations of standard wire rope classes, the second figure in the designation may be purely nominal in that the number of wires per strand for various ropes in the class may be slightly less or slightly more than the nominal as will be seen from the following brief descriptions. (For ropes with a wire strand core, a second group of two numbers may be used to indicate the construction of the wire core, as 1×21 , 1×43 , and so on.)

6 × 7 Class (Standard Coarse Laid Rope): Wire ropes in this class are for use where resistance to wear, as in dragging over the ground or across rollers, is an important requirement. Heavy hauling, rope transmissions, and well drilling are common applications. These wire ropes are furnished in right regular lay and occasionally in Lang lay. The cores may be of fiber, independent wire rope, or wire strand. Since this class is a relatively stiff type of construction, these ropes should be used with large sheaves and drums. Because of the small number of wires, a larger factor of safety may be called for.

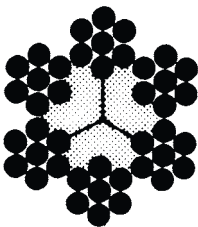


Fig. 1a.
 6×7 with fiber core

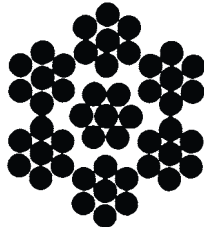


Fig. 1b.
 6×7 with 1×7 WSC

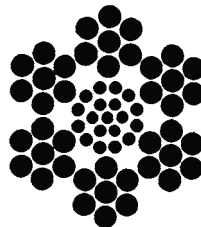


Fig. 1c.
 6×7 with 1×19 WSC

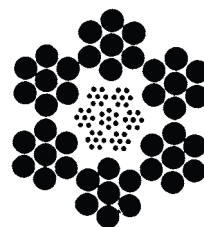


Fig. 1d.
 6×7 with IWRC

As shown in **Figs. 1a** through **Figs. 1d**, this class includes a 6×7 construction with fiber core; a 6×7 construction with 1×7 wire strand core (sometimes called 7×7); a 6×7 construction with 1×19 wire strand core; and a 6×7 construction with independent wire rope core. **Table 1** provides strength and weight data for this class.

Two special types of wire rope in this class are: aircraft cord, a 6×6 or 7×7 Bethanized wire rope of high tensile strength and sash cord, a 6×7 iron rope used for a variety of purposes where strength is not an important factor.

Table 1. Weights and Strengths of 6 × 7 (Standard Coarse Laid) Wire Ropes, Preformed and Not Preformed

Dia., Inches	Approx. Weight per Ft., Pounds	Breaking Strength, Tons of 2000 Lbs.			Dia., Inches	Approx. Weight per Ft., Pounds	Breaking Strength, Tons of 2000 Lbs.		
		Impr. Plow Steel	Plow Steel	Mild Plow Steel			Impr. Plow Steel	Plow Steel	Mild Plow Steel
¼	0.094	2.64	2.30	2.00	¾	0.84	22.7	19.8	17.2
⅕	0.15	4.10	3.56	3.10	⅞	1.15	30.7	26.7	23.2
⅜	0.21	5.86	5.10	4.43	1	1.50	39.7	34.5	30.0
⅙	0.29	7.93	6.90	6.00	1⅛	1.90	49.8	43.3	37.7
½	0.38	10.3	8.96	7.79	1¼	2.34	61.0	53.0	46.1
⅙	0.48	13.0	11.3	9.82	1⅜	2.84	73.1	63.6	55.3
⅝	0.59	15.9	13.9	12.0	1½	3.38	86.2	75.0	65.2

For ropes with steel cores, add 7½ per cent to above strengths.

For galvanized ropes, deduct 10 per cent from above strengths.

Source: Rope diagrams, Bethlehem Steel Co. All data, U.S. Simplified Practice Recommendation 198-50.

6 × 19 Class (Standard Hoisting Rope): This rope is the most popular and widely used class. Ropes in this class are furnished in regular or Lang lay and may be obtained preformed or not preformed. Cores may be of fiber, independent wire rope, or wire strand. As can be seen from Table 2 and Figs. 2a through 2h, there are four common types: 6 × 25 filler wire construction with fiber core (not illustrated), independent wire core, or wire strand core (1 × 25 or 1 × 43); 6 × 19 Warrington construction with fiber core; 6 × 21 filler wire construction with fiber core; and 6 × 19, 6 × 21, and 6 × 17 Seale construction with fiber core.

Table 2. Weights and Strengths of 6 × 19 (Standard Hoisting) Wire Ropes, Preformed and Not Preformed

Dia., Inches	Approx. Weight per Ft., Pounds	Breaking Strength, Tons of 2000 Lbs.			Dia., Inches	Approx. Weight per Ft., Pounds	Breaking Strength, Tons of 2000 Lbs.		
		Impr. Plow Steel	Plow Steel	Mild Plow Steel			Impr. Plow Steel	Plow Steel	Mild Plow Steel
¼	0.10	2.74	2.39	2.07	1¼	2.50	64.6	56.2	48.8
⅕	0.16	4.26	3.71	3.22	1⅝	3.03	77.7	67.5	58.8
⅜	0.23	6.10	5.31	4.62	1½	3.60	92.0	80.0	69.6
⅙	0.31	8.27	7.19	6.25	1⅞	4.23	107	93.4	81.2
½	0.40	10.7	9.35	8.13	1¾	4.90	124	108	93.6
⅙	0.51	13.5	11.8	10.2	1⅞	5.63	141	123	107
⅝	0.63	16.7	14.5	12.6	2	6.40	160	139	121
¾	0.90	23.8	20.7	18.0	2⅞	7.23	179	156	...
⅞	1.23	32.2	28.0	24.3	2¼	8.10	200	174	...
1	1.60	41.8	36.4	31.6	2½	10.00	244	212	...
1⅛	2.03	52.6	45.7	39.8	2¾	12.10	292	254	...

The 6 × 25 filler wire with fiber core not illustrated.

For ropes with steel cores, add 7½ per cent to above strengths.

For galvanized ropes, deduct 10 per cent from above strengths.

Source: Rope diagrams, Bethlehem Steel Co. All data, U.S. Simplified Practice Recommendation 198-50.

6 × 37 Class (Extra Flexible Hoisting Rope): For a given size of rope, the component wires are of smaller diameter than those in the two classes previously described and hence have less resistance to abrasion. Ropes in this class are furnished in regular and Lang lay with fiber core or independent wire rope core, preformed or not preformed.

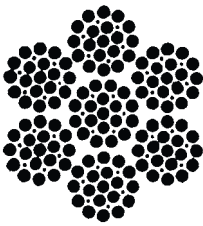


Fig. 2a.
6 × 25 filler wire
with WSC (1 × 25)

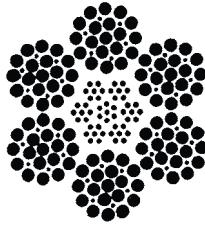


Fig. 2b.
6 × 25 filler wire
with IWRC

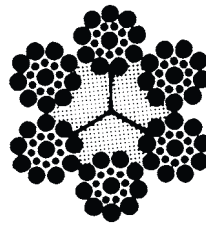


Fig. 2c.
6 × 19 Seale
with fiber core

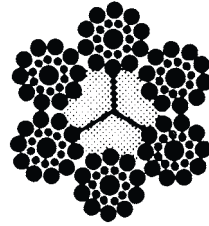


Fig. 2d.
6 × 21 Seale
with fiber core

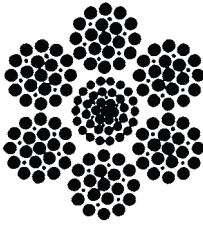


Fig. 2e.
6 × 25 filler wire
with WSC (1 × 43)

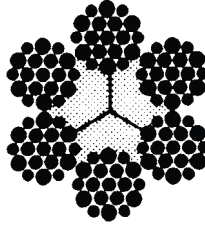


Fig. 2f.
6 × 19 Warrington
with fiber core

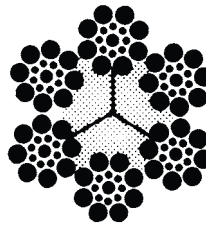


Fig. 2g.
6 × 17 Seale
with fiber core

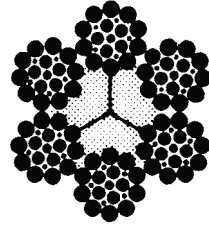


Fig. 2h.
6 × 21 filler wire
with fiber core

Table 3. Weights and Strengths of 6 × 37 (Extra Flexible Hoisting) Wire Ropes, Preformed and Not Preformed

Dia., Inches	Approx. Weight per Ft., Pounds	Breaking Strength, Tons of 2000 Lbs.		Dia., Inches	Approx. Weight per Ft., Pounds	Breaking Strength, Tons of 2000 Lbs.	
		Impr. Plow Steel	Plow Steel			Impr. Plow Steel	Plow Steel
¼	0.10	2.59	2.25	1½	3.49	87.9	76.4
⅕	0.16	4.03	3.50	1⅝	4.09	103	89.3
⅜	0.22	5.77	5.02	1¾	4.75	119	103
7/16	0.30	7.82	6.80	1⅞	5.45	136	118
½	0.39	10.2	8.85	2	6.20	154	134
9/16	0.49	12.9	11.2	2⅝	7.00	173	150
⅝	0.61	15.8	13.7	2¾	7.85	193	168
¾	0.87	22.6	19.6	2½	9.69	236	205
7/8	1.19	30.6	26.6	2¾	11.72	284	247
1	1.55	39.8	34.6	3	14.0	335	291
1⅝	1.96	50.1	43.5	3¼	16.4	390	339
1¼	2.42	61.5	53.5	3½	19.0	449	390
1⅜	2.93	74.1	64.5

For ropes with steel cores, add 7½ per cent to above strengths.

For galvanized ropes, deduct 10 per cent from above strengths.

Source: Rope diagrams, Bethlehem Steel Co. All data, U. S. Simplified Practice Recommendation 198-50.

As shown in Table 3 and Figs. 3a through 3h, there are four common types: 6 × 29 filler wire construction with fiber core and 6 × 36 filler wire construction with independent wire rope core, a special rope for construction equipment; 6 × 35 (two operations) construction with fiber core and 6 × 41 Warrington Seale construction with fiber core, a standard crane rope in this class of rope construction; 6 × 41 filler wire construction with fiber core or independent wire core, a special large shovel rope usually furnished in Lang lay; and 6 × 46

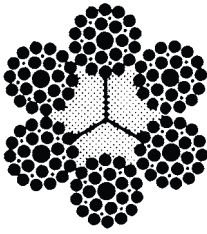


Fig. 3a.
6 × 29 filler wire
with fiber core

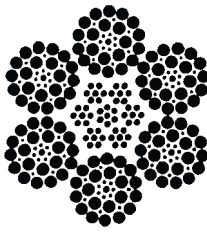


Fig. 3b.
6 × 36 filler wire
with IWRC

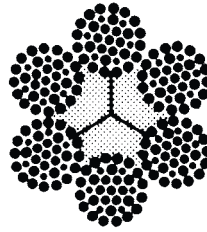


Fig. 3c.
6 × 35 with
fiber core

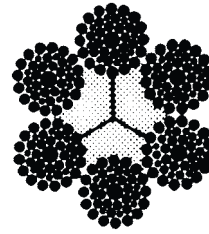


Fig. 3d.
6 × 41 Warrington-Seale
with fiber core

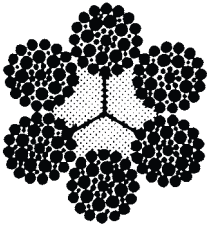


Fig. 3e.
6 × 41 filler wire
with fiber core

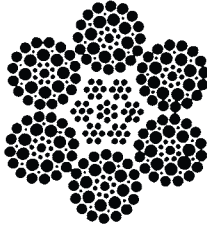


Fig. 3f.
6 × 41 filler wire
with IWRC

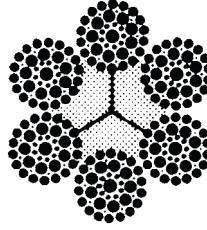


Fig. 3g.
6 × 46 filler wire
with fiber core

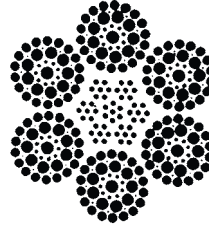


Fig. 3h.
6 × 46 filler wire
with IWRC

filler wire construction with fiber core or independent wire rope core, a special large shovel and dredge rope.

8 × 19 Class (Special Flexible Hoisting Rope): This rope is stable and smooth-running, and is especially suitable, because of its flexibility, for high speed operation with reverse bends. Ropes in this class are available in regular lay with fiber core.

As shown in [Table 4](#) and [Figs. 4a](#) through [4d](#), there are four common types: 8 × 25 filler wire construction, the most flexible but the least wear resistant rope of the four types; Warrington type in 8 × 19 construction, less flexible than the 8 × 25; 8 × 21 filler wire construction, less flexible than the Warrington; and Seale type in 8 × 19 construction, which has the greatest wear resistance of the four types but is also the least flexible.

Table 4. Weights and Strengths of 8 × 19 (Special Flexible Hoisting) Wire Ropes, Preformed and Not Preformed

Dia., Inches	Approx. Weight per Ft., Pounds	Breaking Strength, Tons of 2000 Lbs.		Dia., Inches	Approx. Weight per Ft., Pounds	Breaking Strength, Tons of 2000 Lbs.	
		Impr. Plow Steel	Plow Steel			Impr. Plow Steel	Plow Steel
¼	0.09	2.35	2.04	¾	0.82	20.5	17.8
⅜	0.14	3.65	3.18	⅞	1.11	27.7	24.1
½	0.20	5.24	4.55	1	1.45	36.0	31.3
⅝	0.28	7.09	6.17	1¼	1.84	45.3	39.4
¾	0.36	9.23	8.02	1½	2.27	55.7	48.4
⅞	0.46	11.6	10.1	1¾	2.74	67.1	58.3
1	0.57	14.3	12.4	1½	3.26	79.4	69.1

For ropes with steel cores, add 7½ per cent to above strengths.

For galvanized ropes, deduct 10 per cent from above strengths.

Source: Rope diagrams, Bethlehem Steel Co. All data, U. S. Simplified Practice Recommendation 198-50.

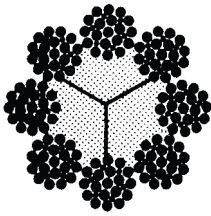


Fig. 4a.
8 x 25 filler wire
with fiber core

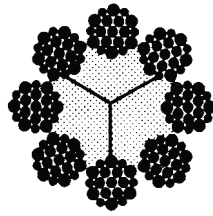


Fig. 4b.
8 x 19 Warrington
with fiber core

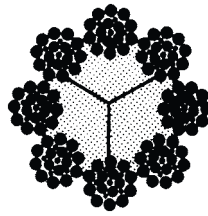


Fig. 4c.
8 x 21 filler wire
with fiber core

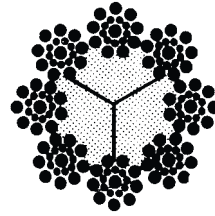
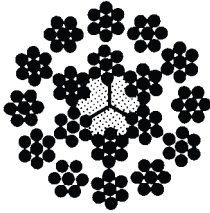


Fig. 4d.
8 x 19 Seale
with fiber core

Also in this class, but not shown in Table 4 are elevator ropes made of traction steel and iron.

18 x 7 Non-rotating Wire Rope: This rope is specially designed for use where a minimum of rotating or spinning is called for, especially in the lifting or lowering of free loads with a single-part line. It has an inner layer composed of 6 strands of 7 wires each laid in left Lang lay over a fiber core and an outer layer of 12 strands of 7 wires each laid in right regular lay. The combination of opposing lays tends to prevent rotation when the rope is stretched. However, to avoid any tendency to rotate or spin, loads should be kept to at least one-eighth and preferably one-tenth of the breaking strength of the rope. Weights and strengths are shown in Table 5.

Table 5. Weights and Strengths of Standard 18 x 7 Nonrotating Wire Rope, Preformed and Not Preformed

 <p>Fig. 5.</p>		Recommended Sheave and Drum Diameters					
		Single layer on drum		36 rope diameters			
		Multiple layers on drum		48 rope diameters			
		Mine service		60 rope diameters			
Dia., Inches	Approx. Weight per Ft., Pounds	Breaking Strength, Tons of 2000 Lbs.		Dia., Inches	Approx. Weight per Ft., Pounds	Breaking Strength, Tons of 2000 Lbs.	
		Impr. Plow Steel	Plow Steel			Impr. Plow Steel	Plow Steel
3/16	0.061	1.42	1.24	7/8	1.32	29.5	25.7
1/4	0.108	2.51	2.18	1	1.73	38.3	33.3
5/16	0.169	3.90	3.39	1 1/8	2.19	48.2	41.9
3/8	0.24	5.59	4.86	1 1/4	2.70	59.2	51.5
7/16	0.33	7.58	6.59	1 3/8	3.27	71.3	62.0
1/2	0.43	9.85	8.57	1 1/2	3.89	84.4	73.4
9/16	0.55	12.4	10.8	1 5/8	4.57	98.4	85.6
5/8	0.68	15.3	13.3	1 3/4	5.30	114	98.8
3/4	0.97	21.8	19.0

For galvanized ropes, deduct 10 per cent from above strengths.

Source: Rope diagrams, sheave and drum diameters, and data for 3/16, 1/4 and 5/16-inch sizes, Bethlehem Steel Co. All other data, U. S. Simplified Practice Recommendation 198-50.

Flattened Strand Wire Rope: The wires forming the strands of this type of rope are wound around triangular centers so that a flattened outer surface is provided with a greater area than in the regular round rope to withstand severe conditions of abrasion. The triangular shape of the strands also provides superior resistance to crushing. Flattened strand wire

rope is usually furnished in Lang lay and may be obtained with fiber core or independent wire rope core. The three types shown in Table 6 and Figs. 6a through 6c are flexible and are designed for hoisting work.

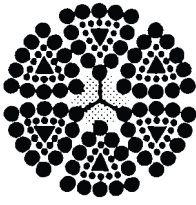


Fig. 6a.
6 × 25 with fiber core

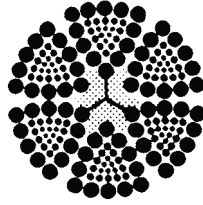


Fig. 6b.
6 × 30 with fiber core

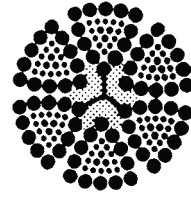


Fig. 6c.
6 × 27 with fiber core

Table 6. Weights and Strengths of Flattened Strand Wire Rope, Preformed and Not Preformed

Dia., Inches	Approx. Weight per Ft., Pounds	Breaking Strength, Tons of 2000 Lbs.		Dia., Inches	Approx. Weight per Ft., Pounds	Breaking Strength, Tons of 2000 Lbs.	
		Impr. Plow Steel	Mild Plow Steel			Impr. Plow Steel	Mild Plow Steel
$\frac{3}{8}$ ^a	0.25	6.71	...	$1\frac{3}{8}$	3.40	85.5	...
$\frac{1}{2}$ ^a	0.45	11.8	8.94	$1\frac{1}{2}$	4.05	101	...
$\frac{9}{16}$ ^a	0.57	14.9	11.2	$1\frac{5}{8}$	4.75	118	...
$\frac{5}{8}$	0.70	18.3	13.9	$1\frac{3}{4}$	5.51	136	...
$\frac{3}{4}$	1.01	26.2	19.8	2	7.20	176	...
$\frac{7}{8}$	1.39	35.4	26.8	$2\frac{1}{4}$	9.10	220	...
1	1.80	46.0	34.8	$2\frac{1}{2}$	11.2	269	...
$1\frac{1}{8}$	2.28	57.9	43.8	$2\frac{3}{4}$	13.6	321	...
$1\frac{1}{4}$	2.81	71.0	53.7

^a These sizes in Type B only.

Type H is not in U.S. Simplified Practice Recommendation.

Source: Rope diagrams, Bethlehem Steel Co. All other data, U.S. Simplified Practice Recommendation 198-50.

Flat Wire Rope: This type of wire rope is made up of a number of four-strand rope units placed side by side and stitched together with soft steel sewing wire. These four-strand units are alternately right and left lay to resist warping, curling, or rotating in service. Weights and strengths are shown in Table 7.

Simplified Practice Recommendations.—Because the total number of wire rope types is large, manufacturers and users have agreed upon and adopted a U.S. Simplified Practice Recommendation to provide a simplified listing of those kinds and sizes of wire rope which are most commonly used and stocked. These, then, are the types and sizes which are most generally available. Other types and sizes for special or limited uses also may be found in individual manufacturer's catalogs.


Sizes and Strengths of Wire Rope.—The data shown in Tables 1 through 7 have been taken from U.S. Simplified Practice Recommendation 198-50 but do not include those wire ropes shown in that Simplified Practice Recommendation which are intended primarily for marine use.

Wire Rope Diameter: The diameter of a wire rope is the diameter of the circle that will just enclose it, hence when measuring the diameter with calipers, care must be taken to obtain the largest outside dimension, taken across the opposite strands, rather than the smallest dimension across opposite "valleys" or "flats." It is standard practice for the nominal diameter to be the minimum with all tolerances taken on the plus side. Limits for diam-

eter as well as for minimum breaking strength and maximum pitch are given in Federal Specification for Wire Rope, RR-R—571a.

Wire Rope Strengths: The strength figures shown in the accompanying tables have been obtained by a mathematical derivation based on actual breakage tests of wire rope and represent from 80 to 95 per cent of the total strengths of the individual wires, depending upon the type of rope construction.

Table 7. Weights and Strengths of Standard Flat Wire Rope, Not Preformed

 Flat Wire Rope					This rope consists of a number of 4-strand rope units placed side by side and stitched together with soft steel sewing wire.				
Width and Thickness, Inches	No. of Ropes	Approx. Weight per Ft., Pounds	Breaking Strength, Tons of 2000 Lbs.		Width and Thickness, Inches	No. of Ropes	Approx. Weight per Ft., Pounds	Breaking Strength, Tons of 2000 Lbs.	
			Plow Steel	Mild Plow-Steel				Plow Steel	Mild Plow Steel
$\frac{1}{4} \times 1\frac{1}{2}$	7	0.69	16.8	14.6	$\frac{1}{2} \times 4$	9	3.16	81.8	71.2
$\frac{1}{4} \times 2$	9	0.88	21.7	18.8	$\frac{1}{2} \times 4\frac{1}{2}$	10	3.82	90.9	79.1
$\frac{1}{4} \times 2\frac{1}{2}$	11	1.15	26.5	23.0	$\frac{1}{2} \times 5$	12	4.16	109	94.9
$\frac{1}{4} \times 3$	13	1.34	31.3	27.2	$\frac{1}{2} \times 5\frac{1}{2}$	13	4.50	118	103
$\frac{5}{16} \times 1\frac{1}{2}$	5	0.77	18.5	16.0	$\frac{1}{2} \times 6$	14	4.85	127	111
$\frac{5}{16} \times 2$	7	1.05	25.8	22.4	$\frac{1}{2} \times 7$	16	5.85	145	126
$\frac{5}{16} \times 2\frac{1}{2}$	9	1.33	33.2	28.8	$\frac{5}{8} \times 3\frac{1}{2}$	6	3.40	85.8	74.6
$\frac{5}{16} \times 3$	11	1.61	40.5	35.3	$\frac{5}{8} \times 4$	7	3.95	100	87.1
$\frac{5}{16} \times 3\frac{1}{2}$	13	1.89	47.9	41.7	$\frac{5}{8} \times 4\frac{1}{2}$	8	4.50	114	99.5
$\frac{5}{16} \times 4$	15	2.17	55.3	48.1	$\frac{5}{8} \times 5$	9	5.04	129	112
$\frac{3}{8} \times 2$	6	1.25	31.4	27.3	$\frac{5}{8} \times 5\frac{1}{2}$	10	5.59	143	124
$\frac{3}{8} \times 2\frac{1}{2}$	8	1.64	41.8	36.4	$\frac{5}{8} \times 6$	11	6.14	157	137
$\frac{3}{8} \times 3$	9	1.84	47.1	40.9	$\frac{5}{8} \times 7$	13	7.23	186	162
$\frac{3}{8} \times 3\frac{1}{2}$	11	2.23	57.5	50.0	$\frac{5}{8} \times 8$	15	8.32	214	186
$\frac{3}{8} \times 4$	12	2.44	62.7	54.6	$\frac{3}{4} \times 5$	8	6.50	165	143
$\frac{3}{8} \times 4\frac{1}{2}$	14	2.83	73.2	63.7	$\frac{3}{4} \times 6$	9	7.31	185	161
$\frac{3}{8} \times 5$	15	3.03	78.4	68.2	$\frac{3}{4} \times 7$	10	8.13	206	179
$\frac{3}{8} \times 5\frac{1}{2}$	17	3.42	88.9	77.3	$\frac{3}{4} \times 8$	11	9.70	227	197
$\frac{3}{8} \times 6$	18	3.63	94.1	81.9	$\frac{7}{8} \times 5$	7	7.50	190	165
$\frac{1}{2} \times 2\frac{1}{2}$	6	2.13	54.5	47.4	$\frac{7}{8} \times 6$	8	8.56	217	188
$\frac{1}{2} \times 3$	7	2.47	63.6	55.4	$\frac{7}{8} \times 7$	9	9.63	244	212
$\frac{1}{2} \times 3\frac{1}{2}$	8	2.82	72.7	63.3	$\frac{7}{8} \times 8$	10	10.7	271	236

Source: Rope diagram, Bethlehem Steel Co.; all data, U.S. Simplified Practice Recommendation 198-50.

Safe Working Loads and Factors of Safety.—The maximum load for which a wire rope is to be used should take into account such associated factors as friction, load caused by bending around each sheave, acceleration and deceleration, and, if a long length of rope is to be used for hoisting, the weight of the rope at its maximum extension. The condition of the rope — whether new or old, worn or corroded — and type of attachments should also be considered.

Factors of safety for standing rope usually range from 3 to 4; for operating rope, from 5 to 12. Where there is the element of hazard to life or property, higher values are used.

SHAFT ALIGNMENT

Introduction

Shaft alignment is the positioning of the rotational centers of two or more shafts so that the shafts are co-linear when the machines are operating. The purpose of shaft alignment is to increase the operating life span of rotating machinery and to achieve high motor efficiency. It is not easy to detect misalignment when machines are running, but secondary effects of misalignment can be observed, such as excessive radial and axial vibration; high temperature in casings, bearings, or lubricant; loose, broken or missing coupling bolts or foundation bolts; cracks in shafts; and excessive amounts of lubricant leakage.

There are no universally accepted specifications for shaft alignment, however, there are defined limits for shaft-to-shaft alignment of coupled machines. The limits are defined in terms of two measures of misalignment, *angularity* and *offset*.

Angular Misalignment.—Angular misalignment is the difference in the slope of one shaft, as compared to slope of the other shaft. The units are expressed as rise/run. Rise is measured in mils (1 mil = 0.001 inch), and the run (distance along shaft) is measured in inches. The process of correcting this type of alignment problem is sometimes called gap or face alignment.



Fig. 1. Shafts in Angular Misaligned Position

Offset Misalignment.—Offset misalignment is the distance between the shaft centers of rotation measured at the plane of power transmission or coupling center. The units of measurement are mils.

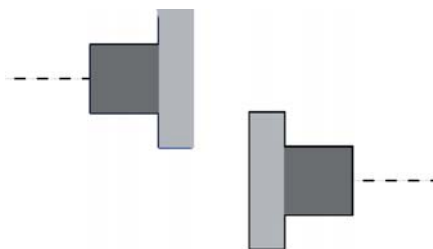


Fig. 2. Shafts in Offset Misaligned Position

There are four alignment parameters to be measured and corrected; vertical angularity, vertical offset, horizontal angularity, and horizontal offset. Values in [Table 1](#) may be used as a general guide for acceptable limits of misalignment. Proper shaft alignment is especially critical when shafts are running at high speeds, thus the allowable limits of misalignment decrease as shaft speeds increase.

Table 1. Misalignment Tolerance Guide

RPM	Offset Misalignment (Mils)		Angular Misalignment (mils/inch)	
	Excellent	Acceptable	Excellent	Acceptable
600	±2.00	±4.00	0.80	1.25
900	±1.50	±3.00	0.70	1.00
1200	±1.25	±2.00	0.50	0.80
1800	±1.0	±1.50	0.30	0.50
3600	±0.50	±0.75	0.20	0.30
≥4000	±0.50	±0.75	0.10	0.25

When the shafts of two machines require alignment, the process generally calls for one of the machines to be permanently mounted and the other one to be movable. The fixed unit is usually the driven machinery, such as the pump in a pump-motor pair. The second machine (usually the motor) is moved into approximate alignment (by eye and straight edge, for example) in preparation for measurements that will determine the magnitude and direction of moves required to put it in final alignment with the fixed machine. It is the movable machine whose shaft will be aligned with the shaft of the fixed machinery. The position of the movable machine is adjusted vertically by adding and/or removing shims from under its feet, and horizontally by making small lateral moves as required until satisfactory final alignment is obtained.

Shaft Alignment with Dial Indicators

The material that follows describes the process of shaft alignment when dial indicators are used to measure the alignment data.

Instruments and Methods.—Numbers of instruments are available for making shaft measurements and calculating moves, but the most important requirement for any shaft alignment system is repeatability of the readings. Dial indicators and lasers are two choice measuring systems.

Dial indicators provide accurate and reliable measurement of shaft alignment. They are the most useful because they can be used to measure bearing alignment, shaft runout, and soft foot directly. Measurement accuracy down to 0.001 inch (1 mil) or 0.025 mm may be achieved if care is taken in mounting and reading the indicators correctly, and controlling or accounting for such variables as indicator sag, axial endplay in the shaft, and vibration from outside sources. The data obtained from properly installed dial indicators is converted by equations described later in this section into the vertical and horizontal movements required to bring the movable unit into alignment with the fixed unit.

Laser measurement systems are another popular choice for shaft alignment work, although the cost of such systems is much greater than dial indicators. Accuracy of 0.0001 inch (0.0025 mm) or greater is possible, and setup and operation is generally faster and simpler than with dial indicators. Many laser systems can perform some or all of the calculations required to obtain the horizontal and vertical moves. Lasers may not be safe for use in explosive environments.

Runout Check.—A runout test of either or both couplings is important only if there is a runout problem. Seldom will the runout of a pump or motor coupling be enough to detect with the eye alone. Standard practice is to position a rim and face indicator setup on the uncoupled couplings (one at a time) and roll said couplings through several 360° turns while monitoring the indicators. The indicator bracket should be firmly attached to a static object close to the pump or motor coupling being checked. Usually a magnetic base designed to hold indicators is used for this purpose if the two couplings involved are more than five or six inches apart. For an ordinary pump and motor, however, it is frequently convenient to mount the indicator jig to the motor to check the runout on the pump and then vice-versa for the motor.

Fig. 3 shows a profile view on the left and a motor- or pump-eye view (right) of a typical runout check setup involving the use of indicators attached to a magnetic base. Assume the rim indicator to have been adjusted to zero, the coupling being checked is rotated several full turns. Repeated turns deliver repeated readings of a maximum minus of $-0.XXX$ inch at one extreme, and a maximum plus of $0.XXX$ inch at the other extreme. Assuming there is no paint or rust, etc. involved, at least three possibilities exist.

- 1) the coupling was bored off-center.
- 2) the shaft is bent.
- 3) a combination of the above two conditions.

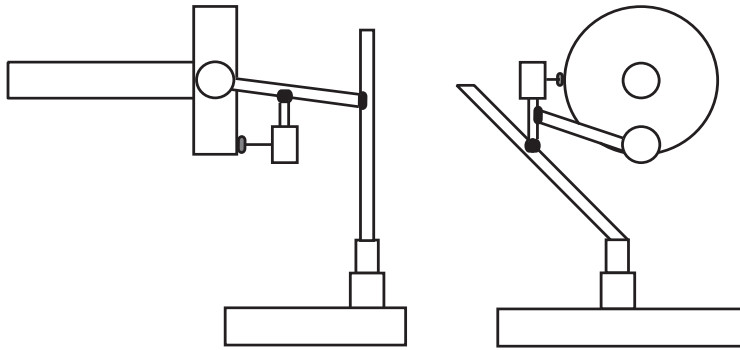


Fig. 3. Indicators set up for a runout check. In field applications, mount the face dial as near as possible to the rim indicator. The face indicator is drawn at the 6 o'clock position in both views for clarity.

Concerning **Item 3**) in the previous list, it is possible (however unlikely) for a coupling that was bored off center and would have shown up as coupling runout with a rim indicator test except that a slight bend in the shaft has canceled out what would normally have been evident due to the off-center bored coupling. This odd situation can cause vibration even when a standard test proves there is no misalignment. Coupling runout can also be caused by too large a coupling bore, with the slack being taken up by set screws.

Interpreting the Indicators: The actual amount of runout registered by the rim indicator is *half of the difference between the plus and minus reading extremes*.

Example: A rim indicator is mounted as shown in **Fig. 3** and set on zero. Then, several full turns of the shaft reveals a maximum minus of -0.006 inch and a maximum plus of $+0.012$ inch on the indicator. The total variation is 0.018 inch and half of 0.018 is 0.009 . Thus, the result of **Items 1**), **2**), or **3**) is 0.009 inch of eccentricity, or 0.018 inch TIR (total indicator reading) of coupling runout. *Note:* Much less coupling runout than is described above is usually expected.

If the face indicator shows zero at all points around a coupling while the rim indicator moves between $+0.XXX$ inch and $-0.XXX$ inch, it is probable that the coupling was bored off-center. If the rim indicator shows practically zero movement while the face indicator moves between $-0.XXX$ inch and $+0.XXX$ inch, the cause could be **Item 2**), or **3**) above, or the coupling was bored essentially centered, but at an angle other than perpendicular to the face of the coupling, as is shown in **Fig. 4**.

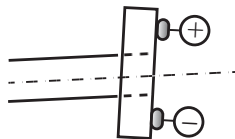


Fig. 4. Coupling Bore Centered but not Perpendicular to Coupling Face
Face Indicator Shown, Rim Indicator Not Shown

In **Fig. 4**, both the indicators shown will alternate from plus to minus and back again as the coupling being checked is rotated. Even if the shaft centerline goes through the center of the coupling, it will do so at an angle other than perpendicular to the face of the coupling. The result is serious coupling runout on the face indicator and less serious runout on the rim indicator.

Face runout can easily show up when there is none. If a machine has sleeve bearings and if the shaft is not axially restrained by a thrust bearing during the runout test, severe face runout will likely be indicated when little, if any, exists.

Note: Unacceptable runout of either or both couplings should be of little concern in the alignment process. The extended centerlines of the two shafts can be aligned even when

there is serious coupling runout. A runout check is mainly to have recorded information if excessive vibration occurs.

Soft Legs.—One of the most often overlooked precautions relevant to motor alignment is the firming up of the soft legs. For the motor in Fig. 5, one leg (D) is $\frac{1}{2}$ inch short. In alignment jargon, the short leg is said to be *soft*. It is also clear that if a $\frac{1}{2}$ inch shim were placed under the short leg, all four motor feet would firmly support the motor. On the other hand, if the motor were tightened down without the use of proper shims, its support would be very spongy and would produce non-repeatable indicator readings.

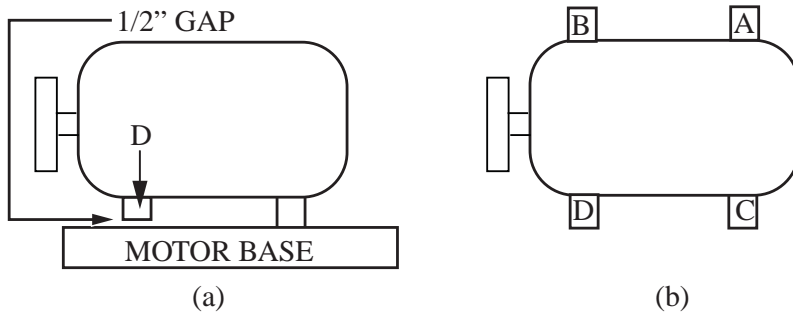


Fig. 5. Profile (a) and Overhead (b) Views of Motor with Soft Foot

On an ordinary electric motor any of the four motor feet may be either raised or lowered via the placement or removal of shims, as applicable, to render the motor equally supported by all four feet. Geometry may allow a certain freedom of choice, so it is practical to be very selective about which motor foot or feet will receive additional shims during the firming up of the motor.

When a soft leg involves only a few thousandths of an inch, it is much less obvious than in Fig. 5. By using what is known to some mechanics as the rock-a-bye method, it is possible to detect a slight amount of instability in the motor supports. With the bolts inserted, but only partly threaded in, alternately apply heel-of-the-hands pressure on or above two motor feet at a diagonal. If no rock-a-bye is evident when heel-of-the-hands pressure is alternately applied above feet A and D, switch to B and C. If rock-a-bye is found, remove applicable shims if possible or add shims under one or both of the unstable feet.

For the $\frac{1}{2}$ inch (12.7 mm) gap shown in Fig. 5, downward heel-of-the-hands pressure at points A and D would yield more movement than the indicators could handle. On more subtle soft feet, it takes an experienced feel to detect only a few mils of rock-a-bye at a motor foot. When feel becomes too little to be certain, it is time to apply indicators.

On units where 0.010 inch (0.254 mm) or more of movement is evident, a tapered wedge gauge can be inserted under the motor foot as the motor is gently rocked. When the motor will no longer rock, the approximate thickness of the wedge gauge under the motor foot will be the amount of shim material to insert under that foot. If a single foot requires more shim thickness than is desirable, put half the thickness under the soft foot and the other half under the opposite diagonal foot; then, a second slight amount of shim placed under one of the two feet should remove any unwanted slack. During the rock-a-bye test, trial and error shimming will eliminate any obvious soft feet in a few tries. The careful step-by-step elimination of unwanted slack in the support feet of a motor or other movable unit should result in a very stable movable unit.

On larger motors, leverage proportional to resistance should be used, involving anything from a small pry-bar to hydraulics. When the rock-a-bye method gets so involved, it is advisable to have dial indicators mounted at the applicable motor feet and/or at the motor coupling, with the indicator button on top of the pump coupling or comparable static object, to register any movement.

A heavy duty version of the rock-a-bye method is to have all the hold down bolts tight and then loosen them one at a time while monitoring the indicators.

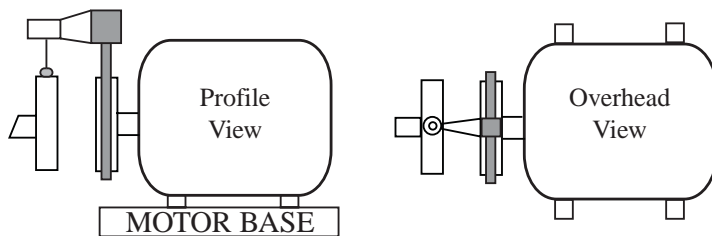


Fig. 6. Rim Indicator Mounted to Test for Soft Feet

Fig. 6 shows a profile view (left) and overhead view (right) of the motor previously shown. In this figure, the indicator illustrated is mounted exactly as the rim indicator will later be mounted for checking alignment, and any soft leg activity will register the same as in the line-up process. Once a motor gets a clean bill of health from this soft foot check, it is safe to proceed with the normal procedures of motor alignment. Mount the indicators in the most convenient manner that will apply to the problem at hand and select the proper formula as discussed in the material that follows. Be sure all the bolts are tight before making the first (vertical) indicator reading

Other Mounting Issues: Any combination of the mounting conditions illustrated in Fig. 7 will produce soft motor feet, even if the motor feet are machined properly. The motor, base, or shims will need alterations to circumvent the illustrated problems. Depending on the magnitude of the angle in a problem of this sort, wedge-shaped shims or machine work on the motor or the base may be required.

Sometimes on relatively unimportant equipment, it is permissible to simply fold shims in various thicknesses to take up the slack. This method should not be used as common practice; but as an emergency measure, it is very effective.

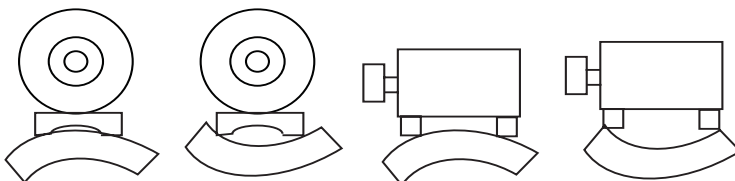


Fig. 7. Mounting Conditions That Produce Soft Motor Feet.

Mounting Dial Indicators, Perpendicular vs. Otherwise.—When indicators are mounted to get a rim reading on a coupling, the indicator stem should be set to aim straight through the center of the shaft, and at a perpendicular to the axis of the shaft. This center shot at a perpendicular does not have to be absolutely perfect, but it should be close enough so that a closer than casual visual inspection can find no flaw. This is close enough for practical purposes.

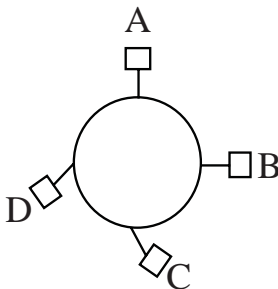


Fig. 8. Indicator Stem Orientation, Correct at A and B, Incorrect at C and D

In Fig. 8 observe the rim indicator settings at positions A, B, C, and D. Indicators at positions A and B are set correctly, indicators at C and D are not. A slight tilt in the mounting of the indicators will make too little difference to matter, but any tilt over a few degrees should be avoided.

Just as important, the face indicator should be set perpendicular to the coupling face with the centerline of the indicator stem parallel to the axis of the fixed unit coupling shaft.

Fig. 9a shows a setup with rim and face indicators set at odd angles that will cause incorrect readings. Note the difference between the arrangement of Fig. 9a, and the correct one shown in Fig. 9b.

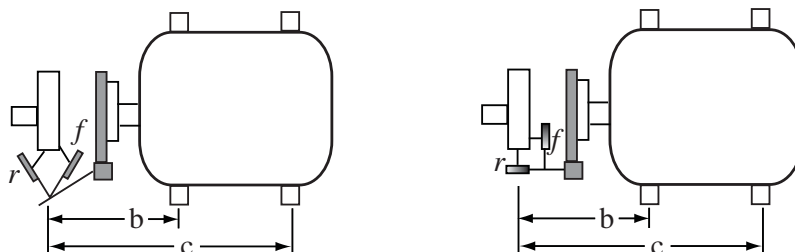


Fig. 9a. Incorrect Positioning of Dial Indicators Fig. 9b. Correct Positioning of Dial Indicators

Preparations.— Before starting an alignment process several important factors need to be considered, among them the following. Is temperature rise in the coupled machinery a consideration? What is the indicator sag of the dial indicators in use? Is coupling runout a consideration? Are there improperly supported or “soft feet” in the movable machine? Are the motor feet, jack bolts, and shims clean? Can the movable unit be moved laterally far enough to permit alignment, or is movement restricted by bolts (“bolt bound”) or nearby obstructions? Is the driving unit powered off and locked out?

Thermal Effects: Metals increase in length as temperature increases, and decrease in length as temperature decreases. Rotating equipment at rest slowly attains the temperature of the surrounding environment, the *ambient* or room temperature. In service, machinery such as electric motors and fuel-burning engines generate heat and increase in temperature during operation; other machinery such as pumps may warm or cool during operation.

If initial alignment adjustments are made when machines are at *ambient* or room temperature, thermal movement will occur in various parts of the machines as they reach operating temperature. The various dimensions will not increase or decrease uniformly. In a motor-pump combination, for example, the motor shaft height above the base may increase while the pump shaft height may decrease.

The amount of thermal expansion can be estimated by the formula $\Delta e = \alpha H \Delta T$:

where Δe = change in height of shaft

H = vertical height or distance between shaft centerline and shims

α = expansion coefficient of material in $\mu\text{in}/\text{in}\text{-}^\circ\text{F}$ (for stainless steel, 7.4, mild steel, 6.3, cast iron, 5.9, bronze=10, and aluminum, 12.6); *Note:* $1\mu\text{in}/\text{in}\text{-}^\circ\text{F}=1.8\mu\text{m}/\text{m}\text{-}^\circ\text{C}$

ΔT = the difference between operating temperature and ambient (initial measurement) temperature

Example 1(a): A pump is to be installed and aligned with a motor. The cast iron pump delivers fresh water at 34 °F and is at present at 75 °F. The pump shaft centerline is 12 inches above the baseline of the pump. The carbon steel motor is also at 75 °F and is expected to rise to 140 °F when in operation. The motor shaft centerline is 12 inches above the base of the motor. At operating temperature, compare the expected thermal growth of the pump and motor shaft centerlines.

For the pump, the change in shaft height:

$$\Delta e = \alpha H \Delta T = 0.0000059 \times 12 \times (34 - 75) = -0.002903 \text{ inch}$$

For the motor, the change in shaft height is:

$$\Delta e = \alpha H \Delta T = 0.0000063 \times 12 \times (140 - 75) = 0.004914 \text{ inch}$$

These calculations indicate that the pump and motor shafts, if they were in alignment at ambient temperature, would be misaligned at operating temperature by approximately 0.0078 inch difference in elevation.

Indicator Bracket Sag: Indicator sag, indicator bracket sag, or jig sag are all terms commonly used to describe the effect on indicator readings of the weight of the dial indicator(s) in combination with the length, weight, and orientation of the indicator bracket. Dial indicators are designed to be used in the vertical position and indicator bracket sag is especially significant in measurements that are made when the dial indicator is inverted in the vertical plane. Consider a rim indicator and bracket mounted on a shaft with the indicator zeroed at the 12 o'clock position; when the shaft and fixture are rotated to put the dial indicator in the 6 o'clock position, the reading will indicate a non-zero negative value, which is the indicator fixture sag factor.

Indicator bracket sag is dependent on the mounting arrangement of the indicators, and is difficult to measure accurately on equipment that is being aligned because the effect of shaft misalignment will combine with the indicator bracket sag to produce incorrect results.

To measure indicator fixture sag, set up the indicator and mounting components on the machinery to be aligned exactly as if doing alignment, and tighten everything down. Then, remove the bracket and indicator from the machine and remount in exactly the same manner on a rigid fixture, such as a piece of pipe supported by V-blocks. Zero the indicator at the 12 o'clock (reference) position, then without changing the setup carefully rotate the fixture and read the indicator at the 6 o'clock (reading) position. At the reading position, the indicator displays the total indicator reading (TIR) and this value is the *total sag factor*. The actual sag in the indicator bracket is equal to one half of the total indicator reading.

When the indicator bracket sag has been determined, it can be accounted for in measurements taken during the alignment procedure. One procedure is to add the indicator bracket sag factor to the indicator value when the indicator is "zeroed" at the reference position, so that the sag factor is accounted for throughout subsequent calculations. For example, if an indicator is zeroed at the 12 o'clock position and reads 0.006 inch at the 6 o'clock position, set the indicator to positive 0.006 at the 12 o'clock reference position to account for the sag factor in further measurements. If the reference position used for checking indicator sag is the 6 o'clock position (indicator zeroed at 6 o'clock position), the positive reading found at the 12 o'clock position is the sag factor that must be subtracted from indicator value when the indicator is zeroed at the 6 o'clock (reference) position.

Alignment Procedures for Machinery.— The *face and rim method* and the *reverse dial indicator method* are the techniques most commonly used for aligning machinery shafts. The usual shaft alignment procedure is to establish one machine as fixed, and the other as the movable machine. The driven machinery is usually the fixed unit. The shaft of the movable unit is positioned, as required, to align with the shaft of the fixed unit. Most aligning specialists recommend vertical alignment first, and then horizontal alignment. It is important to verify in advance that the movable unit has sufficient horizontal clearance and freedom of movement to obtain the required horizontal position before starting on the vertical alignment.

Vertical Moves: Vertical adjustments are accomplished by adding or removing shims from under the machine feet. Use as few shims as possible. Too many shims under a foot may cause it to act like a soft foot by creating a spring effect; usually a maximum of four shims are allowed. Shims should be measured by micrometer before placing. If possible, apply a single shim that is the total thickness required under the foot. Insert the shims all the way until the shim slot bottoms out on the bolt, then pull the shim back about a quarter inch before tightening the bolts. If alignment is not possible with four shims, then use fewer,

amounting to the required thickness. Tighten bolts to their prescribed torque each time after placing shims to avoid any movement when working on the other side of the machine.

Never loosen all hold down bolts at the same time. A maximum of two bolts are allowed to be loosened at a time. Loosening all hold down bolts will lose the entire alignment. Loosen the bolts from either the left or right side of the machine. Then, raise that side just enough to make the shim change. Raising the machine too high can bend the foot. Once the machine is lifted, remove all shims and add or subtract the number of shims required to make the necessary vertical move. Be very cautious at this point not to get confused among a lot of loose shims.

Horizontal Moves: It is preferable to utilize a base plate with jackbolts for horizontal moves. If jack bolts are not available, a small hydraulic jack, pipe clamps, or pony clamps can be used. The most accurate method for measuring the horizontal move is to place dial indicators around the machine at convenient locations, such as at machine feet. The indicators can be located anywhere convenient as long as the dimensions used in the alignment calculations reflect the actual position at which measurements are made. When the indicators are mounted, adjust the dials to zero, and move the unit the distance and direction indicated by the calculations. Once the horizontal move has been completed, a final set of readings should be taken to verify both vertical and horizontal alignment.

Safety: Shaft alignment should not be performed when machines are running. Before shaft alignment, all sources of power to the machine should be off and verified. Energy sources must be locked out by electrical controls; steam valves, gas main valve, and fuel oil valve must be shut down before shaft alignment.

Rim and Face Alignment Procedure.—Figs. 10 and 11 show dial indicator arrangements for rim and face alignment that are typical of those used in the remainder of this section. Fig. 10 illustrates a chain indicator jig, but it could be of any type. The arrangement in Fig. 11 represents an equivalent setup. In each figure, two dial indicators are shown, one for the rim reading and the other for the face reading. Darkened squares, triangles or circles are simply to indicate attachment points.

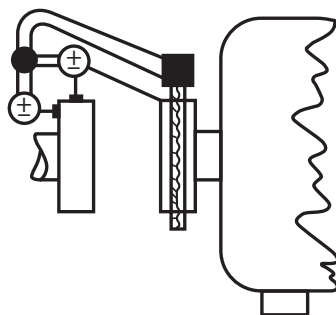


Fig. 10.

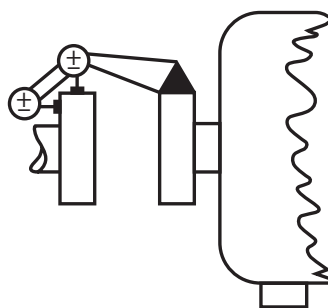


Fig. 11.

Starting on page 2633, a number of different indicator arrangements are illustrated in Figs. 1a through 16a. Each arrangement is associated with a specific equation and a chart that facilitates understanding the dial and face readings and the corresponding tasks of determining where shims need to be added or removed and what horizontal moves are required. To use this system, the mechanic needs to set up the rim and face indicators in the most convenient manner, then turn to the figure of the matching indicator arrangement and use the formulas provided.

Example Aligning a Motor with a Pump by the Rim and Face Method: A 10-horsepower (7.5 kW) electric motor needs to be precision aligned to a specific pump. Both the pump and motor are to be mounted on a base that when finished will look similar to Fig. 12. Not shown are the intake and discharge piping, electrical fixtures, and other incidentals including shims under the motor feet.

The shims are omitted to visually explain why the motor will usually have a little less distance from the motor shaft centerline to the base than the pump has. This set up is desirable because with the motor shaft a little lower than the pump shaft, the motor can be shimmed up until both shafts share a common elevation. If the motor shaft is higher than the pump shaft, it can be very difficult to alter the position of the pump because of the rigidly connected piping.

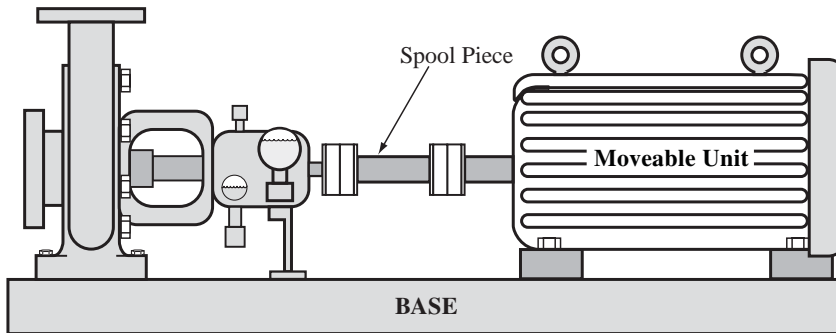


Fig. 12. Pump and Motor are to be Aligned

The motor in Fig. 12 is in its approximate finished position about 8 inches (203.2 mm) from the pump. The spool piece shown in Fig. 12 is to be bolted between the motor and pump couplings after alignment is complete. The spool piece (not shown in Fig. 13) is 8 inches long and there is an $8\frac{1}{8}$ inch (206.4 mm) space between pump and motor couplings.

Fig. 13 shows a viable mounting of dial indicators in the process of procuring readings from the zero setting at 12 o'clock (broken lines) to the 6 o'clock position (solid lines). Some calibrated eyeballing, a scale measure and some straight edging are used to align the motor initially to the pump.

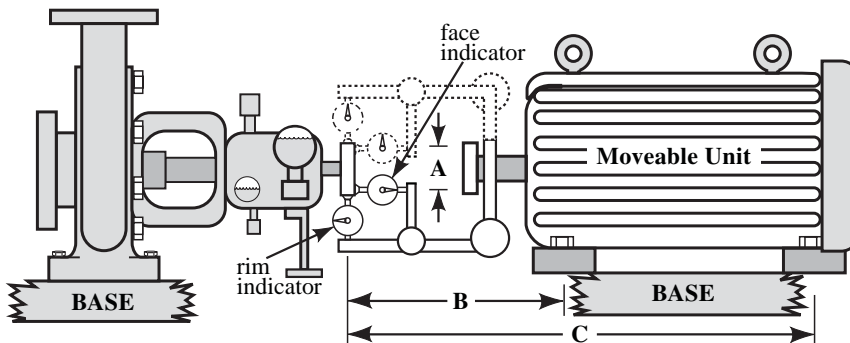


Fig. 13. Alignment Setup for Pump and Motor

There are many ways to mount and adjust dial indicators to measure the remaining misalignment between the two units. Several are correct and only a few are optimum. The mounting of the pair of dial indicators between the motor and pump shown in Fig. 13 is as good as any and commonly used. Many other arrangements are shown starting on page 2633.

Although there seem to be four dial indicators in Fig. 13, there are only two. The two indicators with broken lines are drawn at the initial 12 o'clock position where they are zeroed with about half the indicator stems exposed, (both indicator pointers are shown at 12 o'clock). Then the motor and pump shafts are both turned 180° to the 6 o'clock position (those indicators are drawn with solid lines, and the pointers are shown set to the 3 o'clock and 9 o'clock positions in Fig. 13). In real life alignments, the pointers might be aimed anywhere on the dial face, but the dial face will rotate 360° , so the zero can be manually adjusted to align with the pointer no matter which direction the needle points.

Solution for Vertical Alignment: Once a motor has been aligned with straight edges and such, it is probably close enough to use dial indicators. The dials most often used have a stem range of just over 0.200 inch (roughly $\frac{7}{32}$ inch). These dial indicators (usually two) are positioned with the buttons of the indicators against the rim and face of the pump coupling respectively, as shown in Fig. 13. The seasoned millwright/mechanic will adjust the indicator jig/bracket in such manner that the stem on each of the indicators has freedom to travel inward or outward about 0.100 inch. This adjustment is made at the 12 o'clock position, shown by broken lines in Fig. 13.

A good arrangement is for the rim indicator in Fig. 13 to register a minus r reading at the 6 o'clock position and the face indicator to register a plus f reading (see bottom right of Fig. 1b on page 2634). Readings on both indicators show that the motor needs to be raised, involving the simple task of determining how much shim material to add under each foot. For the indicator arrangement in Fig. 13, the required shim thickness can be determined by using the equations below.

$$F = \frac{\pm r}{-2} + \frac{\pm f \times B}{A} \quad \text{and} \quad R = \frac{\pm r}{-2} + \frac{\pm f \times C}{A}$$

where $F = \pm$ change in shim thickness needed under the front feet

$R = \pm$ change in shim thickness needed under the rear feet

$r =$ plus or minus rim indicator reading

$f =$ plus or minus face indicator reading

$A =$ diameter of face indicator path on coupling

$B =$ distance from rim indicator path to front feet

$C =$ distance from rim indicator path to rear feet

The equations use the gathered data to calculate the correct shim placement. With either equation, a positive solution indicates that shims equal to the calculated value are added, and a negative solution indicates that shims equal to the calculated value are removed.

The rim and face indicator setup depicted in Fig. 13 is one of the sixteen arrangements described in the material that follows. Each of these formats has its own similar but unique formula; just plug the variables into the formulas that matches the current indicator format and calculate the shims required.

Solution for Horizontal Alignment: Fig. 14 shows a top view of the motor in Fig. 13, with indicators in the reading positions for horizontal alignment. The rim and face indicators are zeroed at the position 180° opposed to that shown in Fig. 14.

The directions corresponding to horizontal movement of the motor in Fig. 14 are indicated by east and west arrows. Magnetic-mount dial indicators (not shown) may be set up to monitor the horizontal movements. The dimensions B and C represent the distances from the rim indicator path to the locations of the monitoring indicators or jackbolts.

If jackbolts (or monitor indicators) are positioned on the west side as indicated in Fig. 14, the B and C dimensions are used in the equations. If jackbolts (or monitor indicators) are positioned at a different location on the east side (for example, jackbolts shown by dashed lines in Fig. 14), the east-side set of dimensions, B' and C' , are used in the equations.

The equations are the same as previously used in the vertical alignment procedure. Per the indicator arrangement in Fig. 14, a positive solution demands a move eastward, and a negative solution requires a westward move.

$F = \pm$ east-west movement needed at the front monitoring location

$R = \pm$ east-west movement needed at the rear monitoring location

$r =$ plus or minus rim indicator reading

$f =$ plus or minus face indicator reading

$A =$ diameter of face indicator path

$B =$ distance from rim indicator path to front monitoring location

$C =$ distance from rim indicator path to rear monitoring location

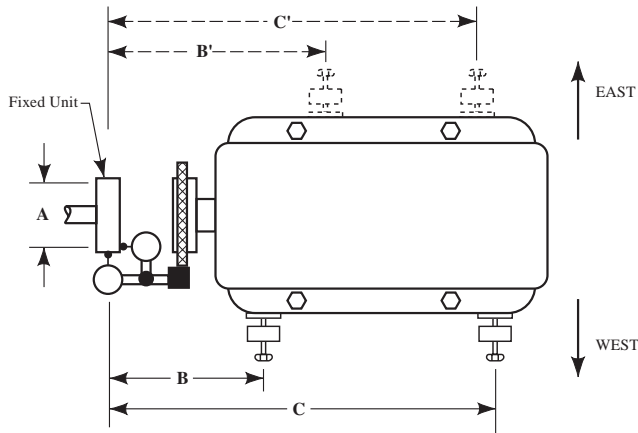


Fig. 14. Top View of Motor from Fig. 13

Side to Side Adjustment Using Jackbolts: Avoid using jackbolts that are longer than necessary. Make sure internal and external threads are clean and lubricated enough to be functional. Then, if heavy resistance is encountered when adjusting jackbolts, it indicates a mechanically-bound condition, not a rusty jackbolt thread. Before advancing jackbolts on one side of the movable unit, back off the jackbolts on the opposite side about $1\frac{1}{2}$ turns to provide enough space to make the movement without creating a mechanical bind.

Jackbolts should not be left in a “bind” against the movable unit to assist in keeping the movable unit in alignment. After alignment is complete, the jackbolts should be removed and stored for future use. This action will prevent jackbolt corrosion, and leave the jackbolt nuts vacant to receive a tap and lubrication, prior to being used again.

On movable units outfitted with jackbolts, one complete (360°) turn of a jackbolt will advance the thread an amount equal to the pitch of the screw thread. For inch-threaded screws, pitch equals one divided by the number of threads per inch ($1 \div \text{TPI}$). The axial travel per head flat is the pitch divided by the number of flats on the bolt head.

Example: A jackbolt has a $\frac{1}{2}$ -13 thread. Find the axial travel per revolution and per flat for square-head and hex-head bolts. The thread has 13 threads per inch.

$$\text{advance per revolution (full turn) of bolt} = \frac{1}{\text{TPI}} = \frac{1}{13} = 0.0769 \text{ inch}$$

$$\text{advance per flat (1/4 turn) of square-head bolt} = \frac{1}{\text{TPI} \times 4} = \frac{1}{(13 \times 4)} = 0.0192 \text{ inch}$$

$$\text{advance per flat (1/6 turn) of hex-head bolt} = \frac{1}{\text{TPI} \times 6} = \frac{1}{(13 \times 6)} = 0.0128 \text{ inch}$$

Example: A motor needs to be moved 0.064 inch east at the front jackbolt and 0.091 inch east at the rear. The square-head jackbolts are $\frac{5}{8}$ -11. How many turns of the front and rear jackbolts are needed to bring the unit into approximate alignment?

$$\text{one full turn of jackbolt} = \frac{1}{11} = 0.0909 \text{ inch}$$

$$\text{full turns at front jackbolt} = \frac{0.064}{0.0909} = 0.7040 \approx \frac{3}{4} \text{ turn or 3 flats}$$

$$\text{full turns at rear jackbolt} = \frac{0.091}{0.0909} = 1.0011 \text{ turn} \approx 1 \text{ turn or 4 flats}$$

Practical Rim and Face Dial Indicator Arrangements for Shaft Alignment

This phase of millwright/machinist work is usually referred to as motor-to-pump alignment. The true objective is to correctly align the axis of one shaft to the axis of another by any of a rather wide range of dial indicator mountings, depending on a myriad of varying situations. These motor to pump scenarios can be duplicated on almost any shaft that is axially in close proximity to another shaft that has to share a common axis. Addressed here is standard rim and face pump alignment.

There are sixteen indicator arrangements to select from in this rim and face section. Units are aligned as closely as possible with a straight edge before using the dial indicators. At the first indicator reading, a neat sketch of the scenario is made, along with a carefully measured dimensioning schedule such as that shown in Fig. 1a. Based on indicator readings, select the applicable block from the second illustration, Fig. 1b, that matches the current plus or minus (\pm) indicator reading. The dashed lines in Fig. 1b represent the centerline of the movable unit shaft. The two heavy round dots on the dashed lines (to the right of the couplings) represent points directly above or below the movable unit shim locations, and indicate that the movable unit must be raised or lowered at that location. The diagrams will help clarify the results of the shim calculations made using the appropriate formulas. Be certain to use minus signs any time they are called for in the formulas.

Note: In all the rim and face formats that follow, the axial location of the rim indicator always dictates the beginning point of the dimensions that are used in the various formulas. Also, the dial indicator arrangements in Figs. 1a through Figs. 16a are shown in the reading position, after having been zeroed at the position 180° opposite that shown and then rotated into the position shown.

1st Arrangement.—Fig. 1a illustrates the most universally accepted method of mounting dial indicators for shaft alignment, and it is also the same arrangement that was used in the preceding example, illustrated by Figs. 13 and 14.

When a reading of the rim and face indicators has been made, find the diagram in Fig. 1b that corresponds to the signs (positive or negative) of the readings obtained (positive rim value and negative face value, for example). The appropriate diagram will provide a visual clue to the meaning of the indicator readings, and indicate the direction that the motor feet must be moved to obtain alignment of the movable shaft with the fixed shaft.

Finally, use the equations adjacent to Fig. 1a to calculate the exact thickness of shims that need to be added or removed at each foot.

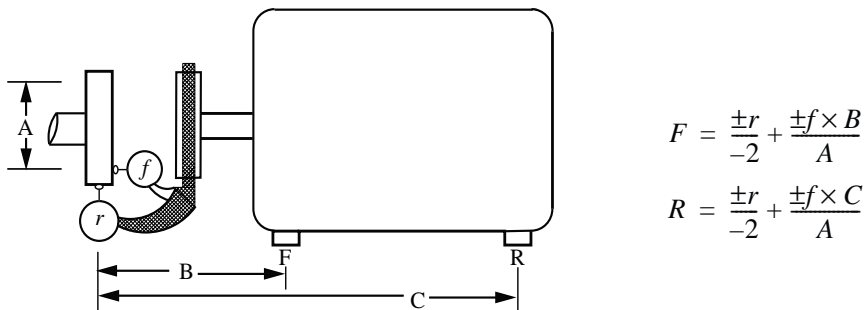


Fig. 1a. Dial Indicator Arrangement 1

In the rim and face format in Fig. 1a, r and f represent the values of the rim and face indicators in their reading positions. The F and R below the motor are the front and rear feet, corresponding to the F and R values in the formulas that represent the needed plus or minus (\pm) shim packs. The formulas adjacent to Fig. 1a, are used to calculate the necessary addition or subtraction of shims required on the front or rear feet.

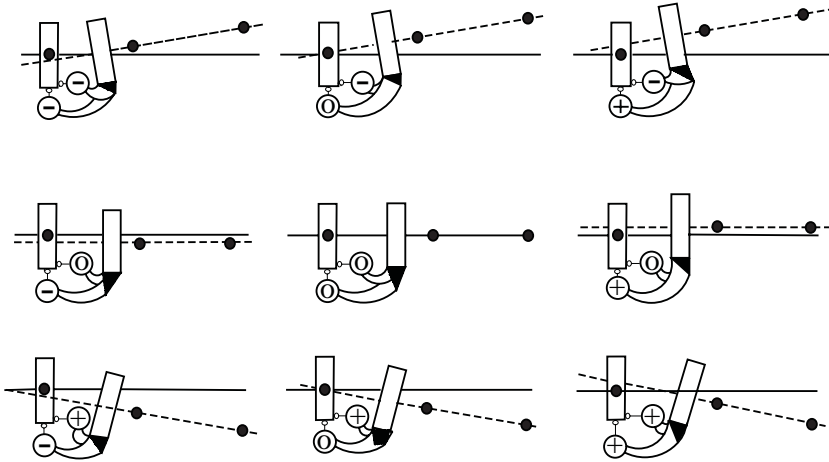


Fig. 1b. Interpreting Dial Indicator Readings for Indicator Arrangement 1

Indicators are shown in the reading position. Solid lines represent the desired location for the dashed lines (movable unit). The plus, minus, and zero readings on the indicators are represented by one of these nine scenarios. Depending on the magnitude of the variables, the generic graph gives a mental picture of what the formulas should yield.

Example 1(a), Vertical Alignment: Calculate the necessary shims for a pump and motor alignment where dimensions are $A = 4$ inches, $B = 6.5$ inches, and $C = 18$ inches. The two indicator dials read $r = \text{minus } (-) 0.014$ inch and $f = \text{plus } (+) 0.021$ inch respectively.

Solution: The lower left block in Fig. 1b corresponds to a negative rim reading and a positive face reading. The figure indicates that both the front and rear feet will require shims, and that the rear feet will require more shims than the front feet. Shims on front and rear feet will be as follows:

$$\begin{aligned}
 F &= \frac{\pm r}{-2} + \frac{\pm f \times B}{A} & R &= \frac{\pm r}{-2} + \frac{\pm f \times C}{A} \\
 &= \frac{-0.014}{-2} + \frac{0.021 \times 6.5}{4} & &= \frac{-0.014}{-2} + \frac{0.021 \times 18}{4} \\
 &= 0.007 + 0.034125 & &= 0.007 + 0.0945 \\
 &= 0.041 \text{ inch} & &= 0.102 \text{ inch}
 \end{aligned}$$

The calculations indicate that 0.041 inch of shims is required under both front feet, and 0.102 inch of shims is required under both rear feet.

Example 1(b), Horizontal Alignment: Fig. 1a shows the indicators in the reading position for horizontal alignment, if the figure is thought of as a view looking down at the motor from the top. Assuming the same data obtained in the previous example, the two indicator dials read $r = \text{minus } (-) 0.014$ inch and $f = \text{plus } (+) 0.021$ inch respectively. Calculate the necessary horizontal movement required to align the motor to the pump.

Solution: The equations adjacent to Fig. 1a apply, as in the previous example. The dimensions B and C in Fig. 1a are the respective distances from the rim indicator path on the coupling to the locations at the front and rear of the motor, not necessarily the feet, where the horizontal adjustments will be made. These locations could be the front and rear jackbolts, or they could be magnetic base monitoring indicators placed conveniently near the front and rear feet, as discussed previously with respect to Fig. 14.

The diagram in the lower left corner of Fig. 1b indicates the direction of the move when the figure is viewed as if looking at the motor from the top. If B and C are 6.5 and 18 inches, respectively, then the equations indicate that the front and rear of the motor must be moved in the same direction, +0.041 inch and +0.102 inch respectively, to attain alignment.

2nd Arrangement.—Rim and face indicators are placed as shown in Fig. 2a. This arrangement is commonly used when the space between couplings is limited.

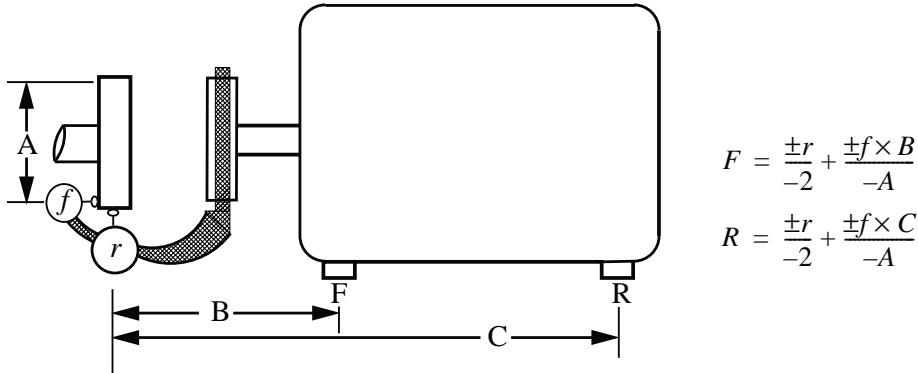


Fig. 2a. Dial Indicator Arrangement 2

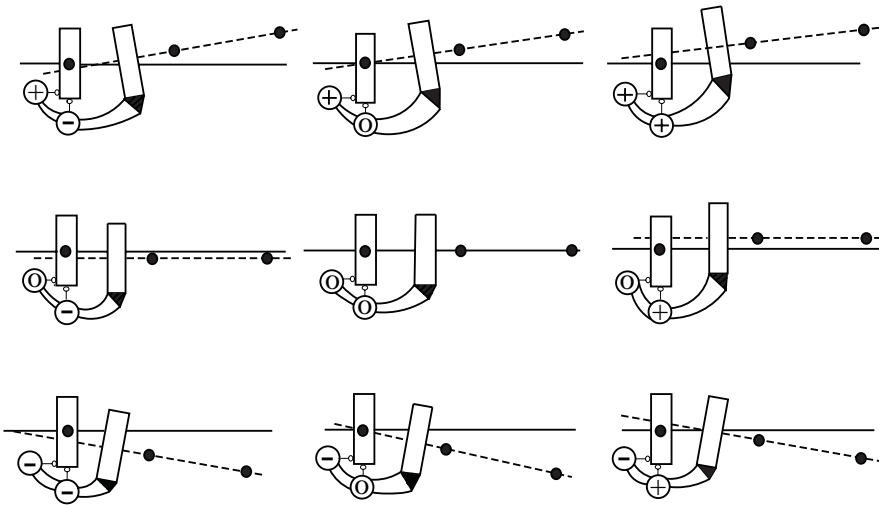


Fig. 2b. Interpreting Dial Indicator Readings for Indicator Arrangement 2

Indicators are shown in the reading position. Solid lines represent the desired location for the dashed lines (movable unit). The plus, minus, and zero readings on the indicators are represented by one of these nine scenarios. The generic graph gives a picture of what the formulas should yield.

Example: Calculate the shims necessary for a pump and motor alignment where dimensions are $A = 4.75$ inches, $B = 7.75$ inches, and $C = 17.25$ inches. The two indicator dials read $r = \text{plus (+)} 0.004$ inch and $f = \text{minus (-)} 0.022$ inch respectively.

Solution: The lower right block in Fig. 2b corresponds to a positive rim reading and a negative face. The diagram indicates that shims will be required under both the front and rear feet. Calculations confirm this, as follows:

$$\begin{aligned}
 F &= \frac{\pm r}{-2} + \frac{\pm f \times B}{-A} & R &= \frac{\pm r}{-2} + \frac{\pm f \times C}{-A} \\
 &= \frac{0.004}{-2} + \frac{-0.022 \times 7.75}{-4.75} & &= \frac{0.004}{-2} + \frac{-0.022 \times 17.25}{-4.75} \\
 &= -0.002 + 0.036 & &= -0.002 + 0.07989 \\
 &= 0.034 \text{ inch} & &= 0.078 \text{ inch}
 \end{aligned}$$

3rd Arrangement.—Place rim and face indicators as shown in Fig. 3a.

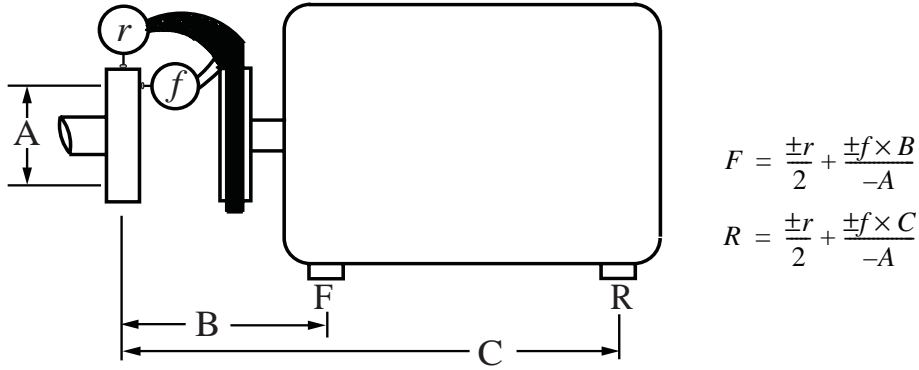


Fig. 3a. Dial Indicator Arrangement 3

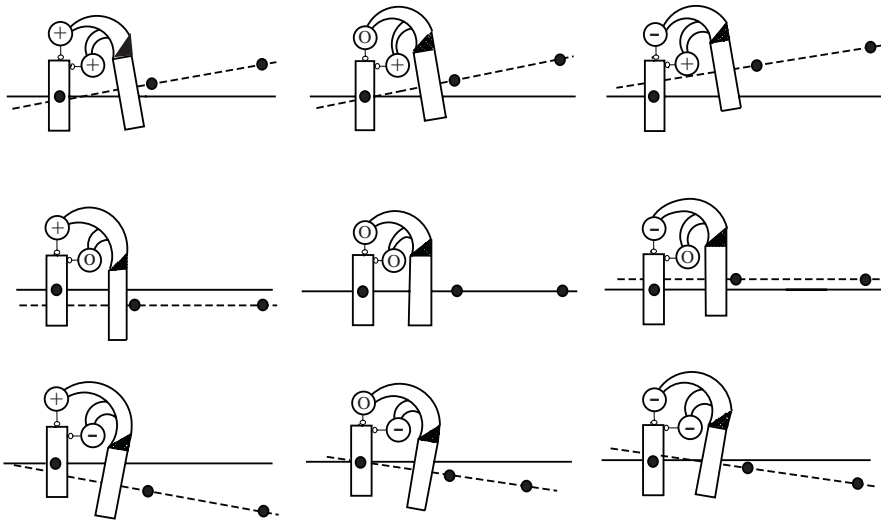


Fig. 3b. Interpreting Dial Indicator Readings for Indicator Arrangement 3

Solid lines represent the desired location for the dashed lines (movable unit). The plus, minus, and zero readings on the indicators are represented by one of these nine scenarios. Depending on the magnitude of the variables, the generic graph gives a mental picture of what the formulas should yield.

Example: Calculate the shims necessary for a pump and motor alignment where dimensions are $A = 4.25$ inches, $B = 8.875$ inches, and $C = 28.75$ inches. The two indicators read $r = \text{plus (+)}0.042$ inch and $f = \text{minus (-)} 0.036$ inch respectively.

Solution: Only the lower left block in Fig. 3b corresponds to a negative face reading and a positive rim reading. The diagram indicates that shims will be required under both front and rear feet. The required shim thickness for front and rear feet is calculated as follows:

$$\begin{aligned}
 F &= \frac{\pm r}{2} + \frac{\pm f \times B}{-A} & R &= \frac{\pm r}{2} + \frac{\pm f \times C}{-A} \\
 &= \frac{0.042}{2} + \frac{-0.036 \times 8.875}{-4.25} & &= \frac{0.042}{2} + \frac{-0.036 \times 28.75}{-4.25} \\
 &= 0.021 + 0.075 & &= 0.021 + 0.244 \\
 &= 0.096 \text{ inch} & &= 0.265 \text{ inch}
 \end{aligned}$$

4th Arrangement.—Place rim and face indicators as shown in Fig. 4a.

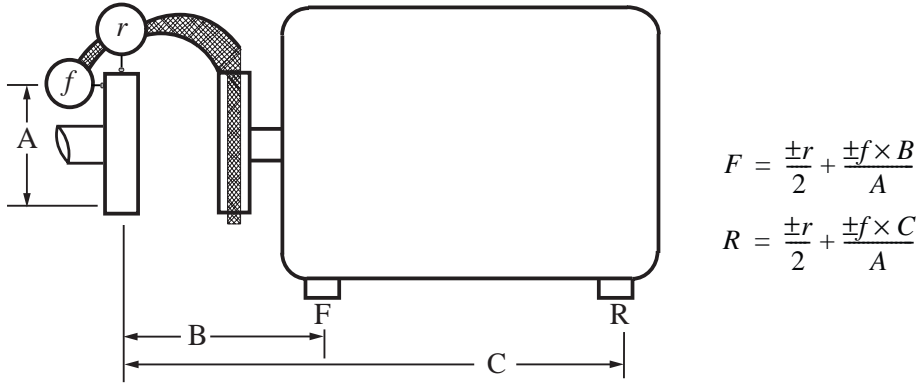


Fig. 4a. Dial Indicator Arrangement 4

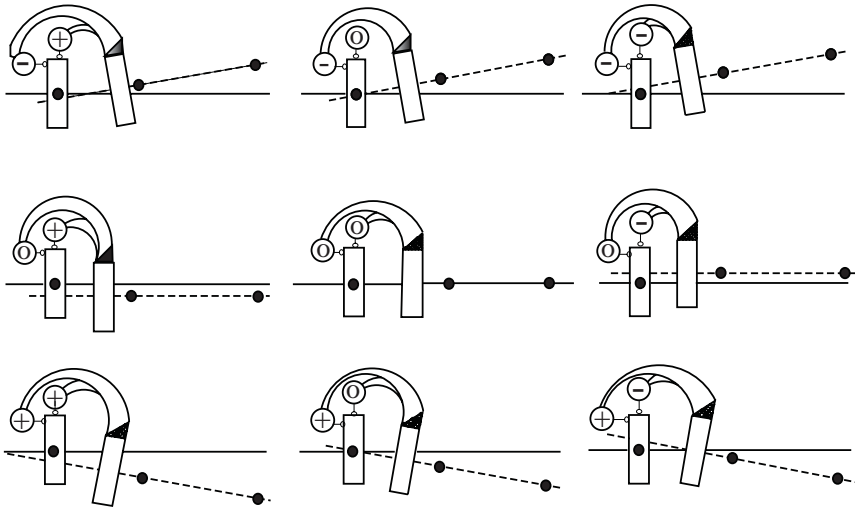


Fig. 4b. Interpreting Dial Indicator Readings for Indicator Arrangement 4

Solid lines represent the desired location for the dashed lines (movable unit). The plus, minus, and zero readings on the indicators are represented by one of these nine scenarios. Depending on the magnitude of the variables, the generic graph gives a mental picture of what the formulas should yield.

Example: Calculate the shims necessary for a pump and motor alignment where dimensions are $A = 3.5$ inches, $B = 8.25$ inches, and $C = 19.25$ inches. The two indicators read $r = \text{minus } (-) 0.011$ inch and $f = \text{minus } (-) 0.019$ inch respectively.

Solution: According to the top left block in Fig. 4b, the negative rim and negative face values indicate that the motor needs to have shims removed from beneath both the front and rear feet. The calculations that follow confirm that 0.05 inch needs to be removed from beneath the front feet, and 0.11 inch from below the rear feet. This adjusting may be difficult if the motor is sitting on its base without shims.

$$\begin{aligned}
 F &= \frac{\pm r}{2} + \frac{\pm f \times B}{A} & R &= \frac{\pm r}{2} + \frac{\pm f \times C}{A} \\
 &= \frac{-0.011}{2} + \frac{-0.019 \times 8.25}{3.5} & &= \frac{-0.011}{2} + \frac{-0.019 \times 19.25}{3.5} \\
 &= -0.0055 + (-0.04479) & &= -0.0055 + (-0.1045) \\
 &= -0.050 \text{ inch} & &= -0.110 \text{ inch}
 \end{aligned}$$

5th Arrangement.—Place rim and face indicators as shown in Fig. 5a. In the figure, notice that the origin of the dimensions B and C is the line of the rim indicator.

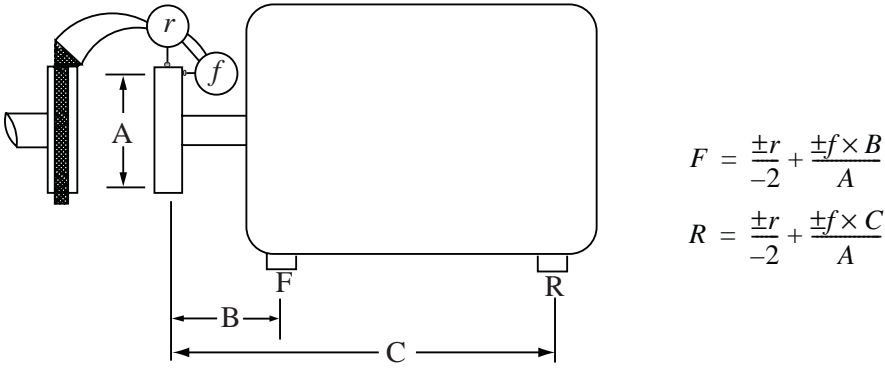


Fig. 5a. Dial Indicator Arrangement 5

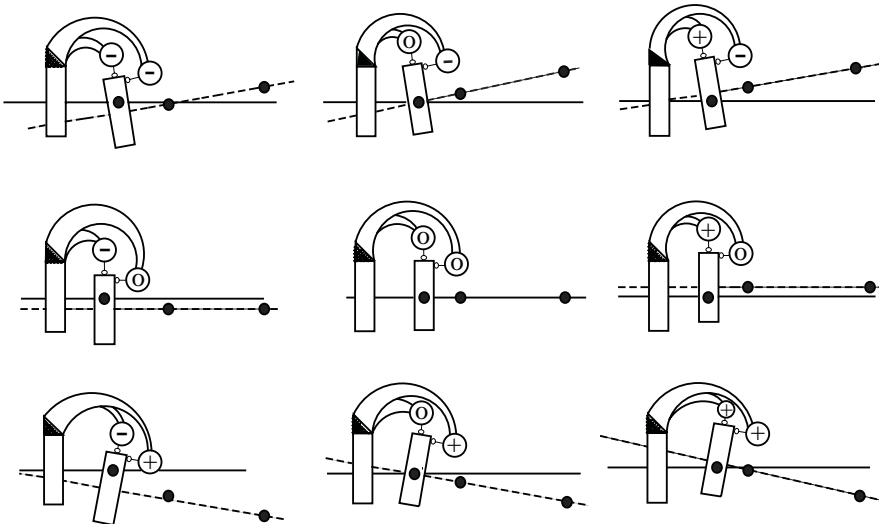


Fig. 5b. Interpreting Dial Indicator Readings for Indicator Arrangement 5

Solid lines represent the desired location for the dashed lines (movable unit). The plus, minus, and zero readings on the indicators are represented by one of these nine scenarios. Depending on the magnitude of the variables, the generic graph gives a mental picture of what the formulas should yield.

Example: Calculate the shims necessary for a pump and motor alignment where dimensions are $A = 4.0$ inches, $B = 5.50$ inches, and $C = 17$ inches. The two indicator dials read $r = \text{plus (+)} 0.042$ inch and $f = \text{minus (-)} 0.036$ inch respectively.

Solution: The top right block in Fig. 5b corresponds to the positive rim value and a negative face value of the indicators, and indicates that both ends of the motor need to be moved down. This requirement is confirmed by the negative shim numbers that provide the exact distance as follows:

$$\begin{aligned}
 F &= \frac{\pm r}{-2} + \frac{\pm f \times B}{A} & R &= \frac{\pm r}{-2} + \frac{\pm f \times C}{A} \\
 &= \frac{0.042}{-2} + \frac{-0.036 \times 5.50}{4.0} & &= \frac{0.042}{-2} + \frac{-0.036 \times 17.0}{4.0} \\
 &= -0.021 + (-0.0495) & &= -0.021 + (-0.153) \\
 &= -0.0705 \text{ inch} & &= -0.174 \text{ inch}
 \end{aligned}$$

6th Arrangement.—Place rim and face indicators as shown in Fig. 6a.

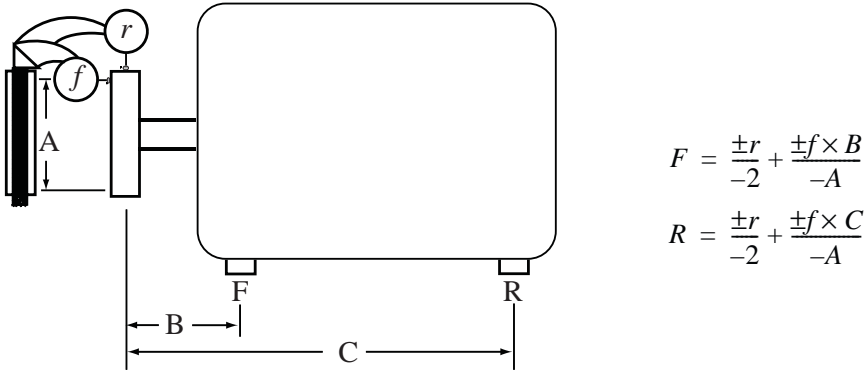


Fig. 6a. Dial Indicator Arrangement 6

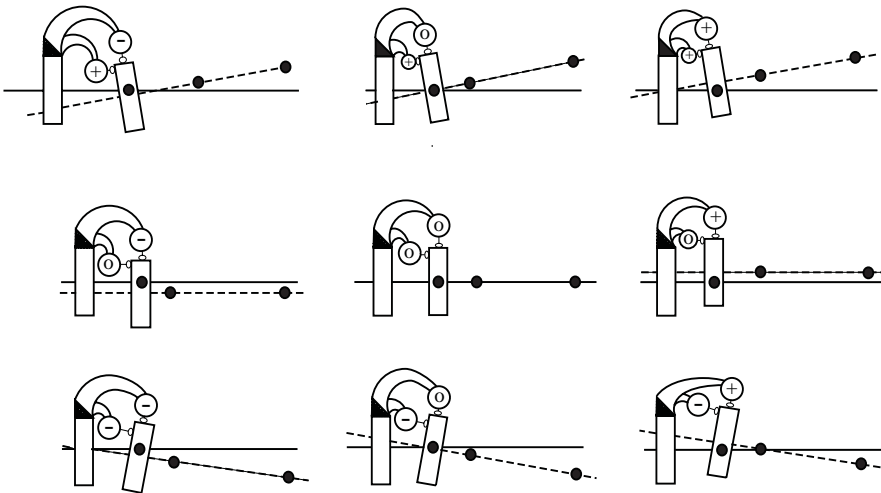


Fig. 6b. Interpreting Dial Indicator Readings for Indicator Arrangement 6

Solid lines represent the desired location for the dashed lines (movable unit). The plus, minus, and zero readings on the indicators are represented by one of these nine scenarios. Depending on the magnitude of the variables, the generic graph gives a mental picture of what the formulas should yield.

Example: Calculate the shims necessary for a pump and motor alignment where dimensions are $A = 4.75$ inches, $B = 6.25$ inches, and $C = 31.75$ inches. The two indicator dials: $r =$ minus ($-$) 0.024 inch and $f =$ plus ($+$) 0.005 inch respectively.

Solution: The top left block in Fig. 6b describes the situation of negative rim and positive face values. The generic graph suggests that both the front and rear feet need some shims to be removed, but the calculations below require that some positive movement of the front feet is required. If in doubt, follow the numbers; the graphs are not drawn to scale. The formulas call for 0.005 inch added under the front feet and the rear feet to be lowered by 0.021 inch:

$$\begin{aligned}
 F &= \frac{\pm r}{-2} + \frac{\pm f \times B}{-A} & R &= \frac{\pm r}{-2} + \frac{\pm f \times C}{-A} \\
 &= \frac{-0.024}{-2} + \frac{0.005 \times 6.25}{-4.75} & &= \frac{-0.024}{-2} + \frac{0.005 \times 31.75}{-4.75} \\
 &= 0.012 - 0.006578 & &= 0.012 + (-0.03342) \\
 &= 0.005 \text{ inch} & &= -0.021 \text{ inch}
 \end{aligned}$$

7th Arrangement.—Place rim and face indicators as shown in Fig. 7a.

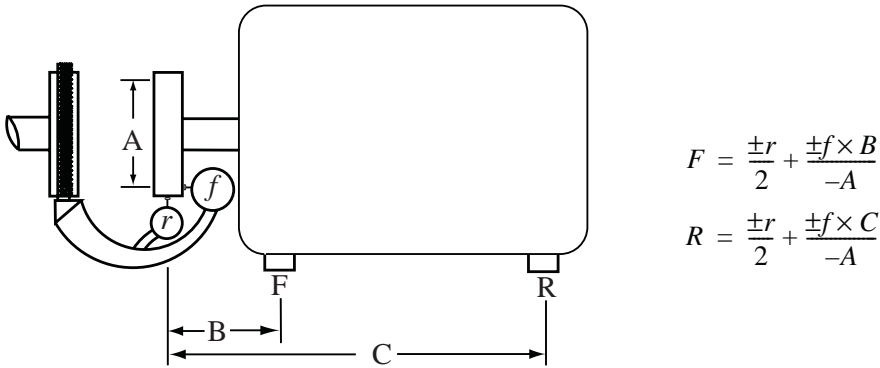


Fig. 7a. Dial Indicator Arrangement 7

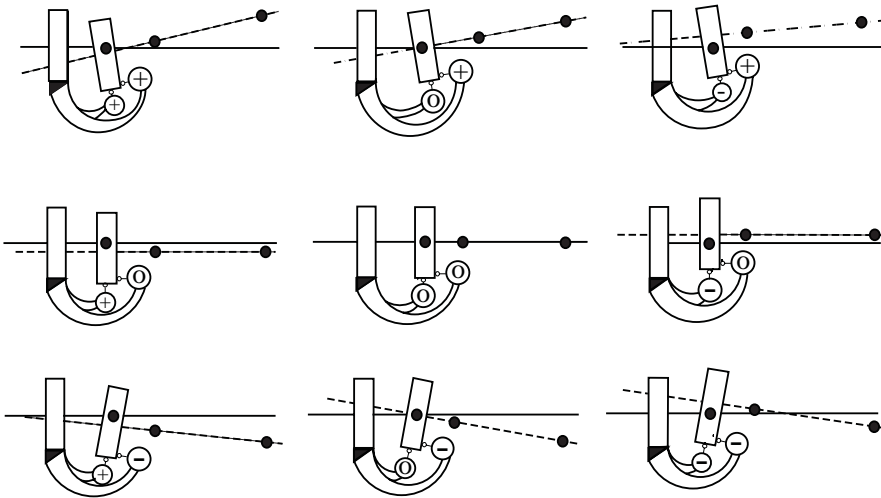


Fig. 7b. Interpreting Dial Indicator Readings for Indicator Arrangement 7

Solid lines represent the desired location for the dashed lines (movable unit). The plus, minus, and zero readings on the indicators are represented by one of these nine scenarios. Depending on the magnitude of the variables, the generic graph gives a mental picture of what the formulas should yield.

Example: Calculate the shims necessary for a pump and motor alignment where dimensions are $A = 12.375$ inches, $B = 14.875$ inches, and $C = 47.75$ inches. The two indicator dials: $r = \text{minus } (-) 0.002$ inch and $f = \text{plus } (+) 0.001$ inch respectively.

Solution: This motor is almost in alignment. The upper right block of Fig. 7b corresponds to the negative rim and positive face condition. The graph suggests both the front and rear motor feet be lowered, depending on the magnitude of the variables. The formula solution dictates exactly how much the movable unit needs to be lowered at both front and rear shim points. Shims on front and rear feet will be as follows:

$$\begin{aligned}
 F &= \frac{\pm r}{2} + \frac{\pm f \times B}{-A} & R &= \frac{\pm r}{2} + \frac{\pm f \times C}{-A} \\
 &= \frac{-0.002}{2} + \frac{0.001 \times 14.875}{-12.375} & &= \frac{-0.002}{2} + \frac{0.001 \times 47.75}{-12.375} \\
 &= -0.001 + (-0.001) & &= -0.001 + (-0.003858) \\
 &= -0.002 \text{ inch} & &= -0.005 \text{ inch}
 \end{aligned}$$

8th Arrangement.—Place rim and face indicators as shown in Fig. 8a.

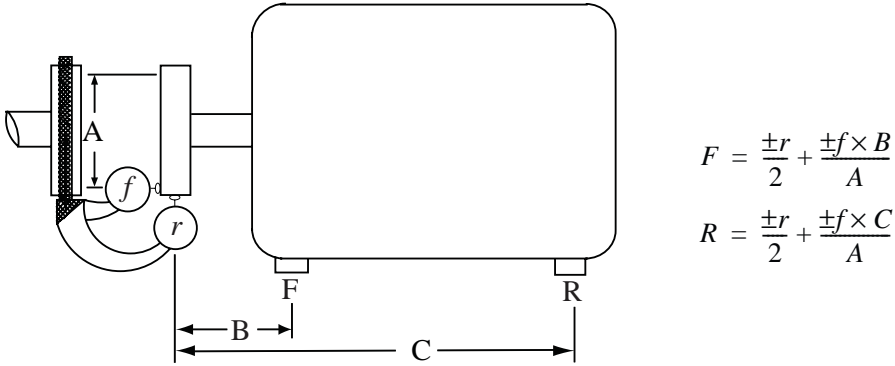


Fig. 8a. Dial Indicator Arrangement 8

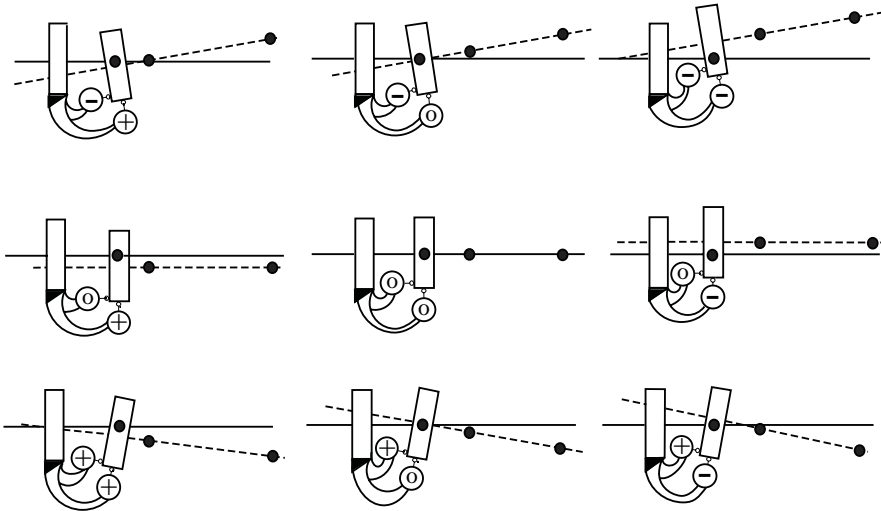


Fig. 8b. Interpreting Dial Indicator Readings for Indicator Arrangement 8

Solid lines represent the desired location for the dashed lines (movable unit). The plus, minus, and zero readings on the indicators are represented by one of these nine scenarios. Depending on the magnitude of the variables, the generic graph gives a mental picture of what the formulas should yield.

Example: Calculate the shims necessary for a pump and motor alignment where dimensions are $A = 12.375$ inches, $B = 14.875$ inches, and $C = 47.75$ inches. The two indicator dials: $r = \text{minus } (-) 0.042$ inch and $f = \text{minus } (-) 0.002$ inch respectively.

Solution: In Fig. 8b, the top right block conforms to negative rim and negative face values. The graph suggests both the front and rear motor feet be lowered. The formula dictates exactly how much the movable unit is to be lowered at both front and rear shim points. Shims removed on front and rear feet will be as follows:

$$\begin{aligned}
 F &= \frac{\pm r}{2} + \frac{\pm f \times B}{A} & R &= \frac{\pm r}{2} + \frac{\pm f \times C}{A} \\
 &= \frac{-0.042}{2} + \frac{-0.002 \times 14.875}{12.375} & &= \frac{-0.042}{2} + \frac{-0.002 \times 47.75}{12.375} \\
 &= -0.021 + (-0.002) & &= -0.021 + (-0.0077) \\
 &= -0.023 \text{ inch} & &= -0.029 \text{ inch}
 \end{aligned}$$

9th Arrangement.—Place rim and face indicators as shown in Fig. 9a. The driven unit here could be any of several devices including the “catch” drum for a centrifugal clutch.

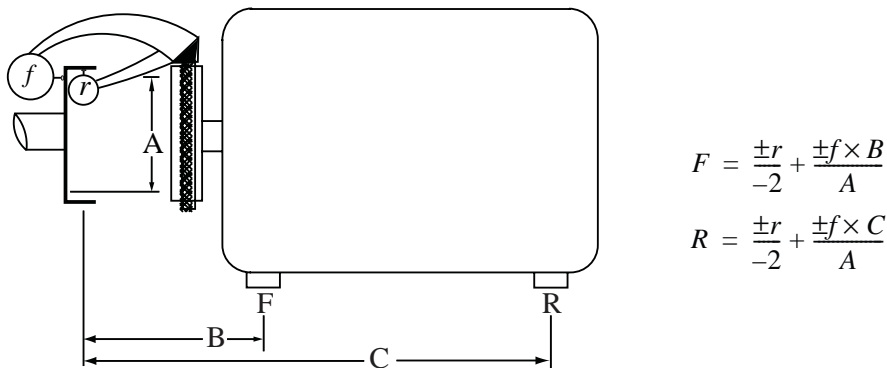


Fig. 9a. Dial Indicator Arrangement 9

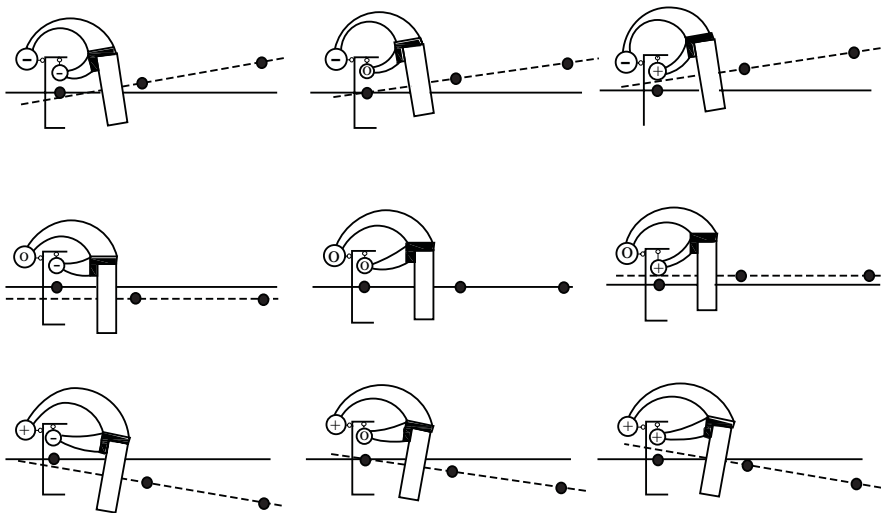


Fig. 9b. Interpreting Dial Indicator Readings for Indicator Arrangement 9

Solid lines represent the desired location for the dashed lines (movable unit). The plus, minus, and zero readings on the indicators are represented by one of these nine scenarios. Depending on the magnitude of the variables, the generic graph gives a mental picture of what the formulas should yield.

Example: Calculate the shims necessary for a pump and motor alignment where dimensions are $A = 10.375$ inches, $B = 22.0$ inches, and $C = 48.0$ inches. The two indicator dials read $r = 0.00$ inch and $f = \text{plus (+)} 0.017$ inch respectively.

Solution: In Fig. 9b, the center block of the bottom row represents zero rim and positive face values. The graph suggests both the front and rear motor feet be moved up by adding shims, depending on the magnitude of the variables. The formula solution below dictates that the front feet be moved up 0.036 inch and the rear feet be moved up 0.079 inch:

$$\begin{aligned}
 F &= \frac{\pm r}{-2} + \frac{\pm f \times B}{A} & R &= \frac{\pm r}{-2} + \frac{\pm f \times C}{A} \\
 &= \frac{0.00}{-2} + \frac{0.017 \times 22}{10.375} & &= \frac{0.00}{-2} + \frac{0.017 \times 48}{10.375} \\
 &= -0.00 + 0.036 & &= -0.00 + 0.079 \\
 &= 0.036 \text{ inch} & &= 0.079 \text{ inch}
 \end{aligned}$$

10th Arrangement.—Fig. 10a illustrates an arrangement used for taking two separate readings with one dial indicator.

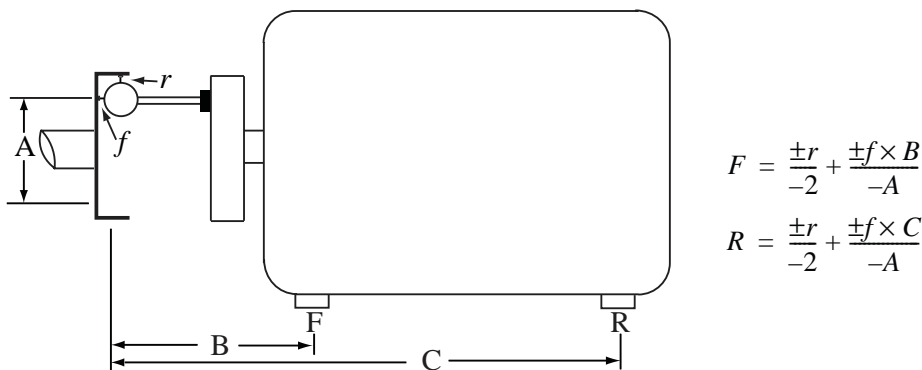


Fig. 10a. Dial Indicator Arrangement 10

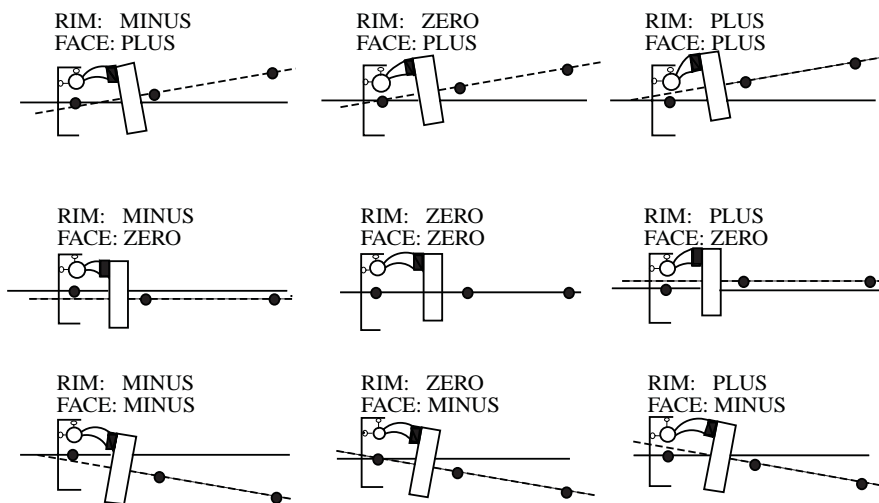


Fig. 10b. Interpreting Dial Indicator Readings for Indicator Arrangement 10

Solid lines represent the desired location for the dashed lines (movable unit). The plus, minus, and zero readings on the indicators are represented by one of these nine scenarios. Depending on the magnitude of the variables, the generic graph gives a mental picture of what the formulas should yield.

Example: Calculate the shims necessary for a pump and motor alignment where dimensions are $A = 5.50$ inches, $B = 14.0$ inches, and $C = 35.0$ inches. The indicator readings are $r = \text{plus (+)} 0.030$ inch and $f = \text{plus (+)} 0.022$ inch, respectively.

Solution: In Fig. 10b locate the block illustrating the positive rim and positive face condition. The graph suggests both the front and rear motor feet be lowered. The formula solution dictates exactly how much the movable unit is to be lowered at both front and rear shim points:

$$F = \frac{\pm r}{-2} + \frac{\pm f \times B}{-A}$$

$$R = \frac{\pm r}{-2} + \frac{\pm f \times C}{-A}$$

$$= \frac{0.030}{-2} + \frac{0.022 \times 14}{-5.5}$$

$$= \frac{0.030}{-2} + \frac{0.022 \times 35}{-5.5}$$

$$= -0.015 + (-0.056)$$

$$= -0.015 + (-0.140)$$

$$= -0.071 \text{ inch}$$

$$= -0.155 \text{ inch}$$

11th Arrangement.—Place rim and face indicators as shown in Fig. 11a.

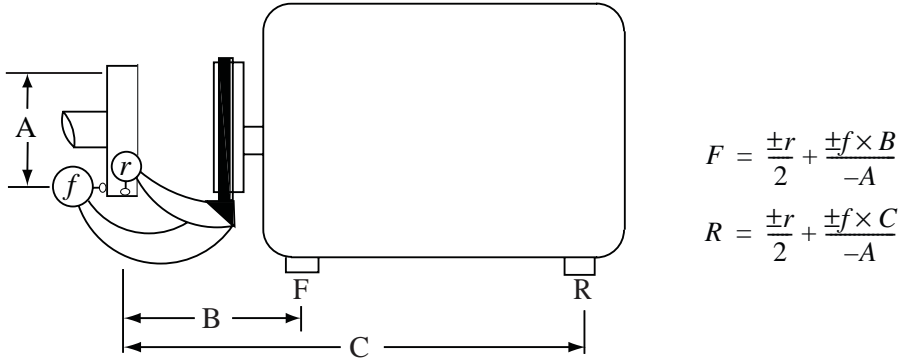


Fig. 11a. Dial Indicator Arrangement 11

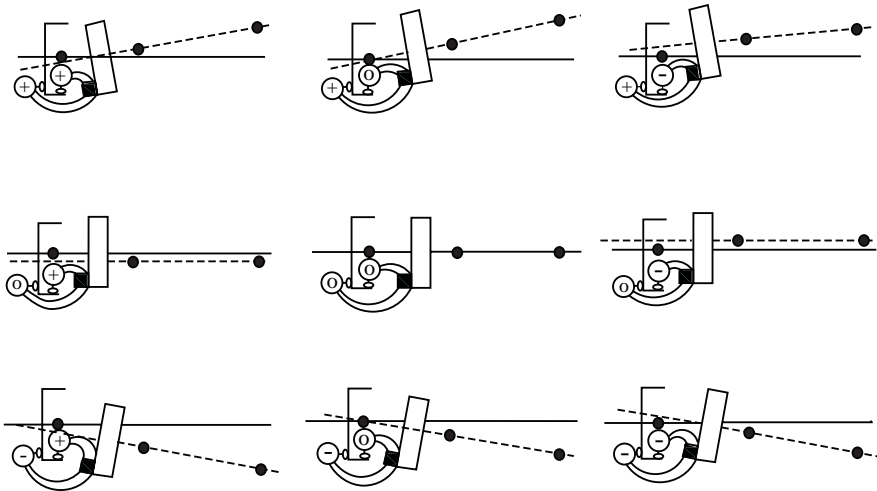


Fig. 11b. Interpreting Dial Indicator Readings for Indicator Arrangement 11

Solid lines represent the desired location for the dashed lines (movable unit). The plus, minus, and zero readings on the indicators are represented by one of these nine scenarios. Depending on the magnitude of the variables, the generic graph gives a mental picture of what the formulas should yield.

Example: Calculate the necessary shims for a pump and motor alignment where dimensions are $A = 6.50$ inches, $B = 16.625$ inches, and $C = 42.0$ inches. The two indicator dials read $r = 0.000$ inch and $f = \text{minus } (-) 0.026$ inch respectively.

Solution: The center block in the last row of Fig. 11b describes the zero rim and negative face value condition. The motor is too low because of angularity (face reading), but the elevation is correct at the axial position of the rim indicator reading. The graph suggests both the front and rear motor feet be moved up. The formula solution dictates exactly how much the movable unit is raised at both front and rear shim points:

$$\begin{aligned}
 F &= \frac{\pm r}{2} + \frac{\pm f \times B}{-A} & R &= \frac{\pm r}{2} + \frac{\pm f \times C}{-A} \\
 &= \frac{0.00}{2} + \frac{-0.026 \times 16.625}{-6.50} & &= \frac{0.00}{2} + \frac{-0.026 \times 42}{-6.50} \\
 &= 0.00 + 0.0665 & &= 0.00 + 0.168 \\
 &= 0.0665 \text{ inch} & &= 0.168 \text{ inch}
 \end{aligned}$$

12th Arrangement.—The set up in Fig. 12a could be one indicator with two stems, or one indicator taking separate face and rim readings at the same location.

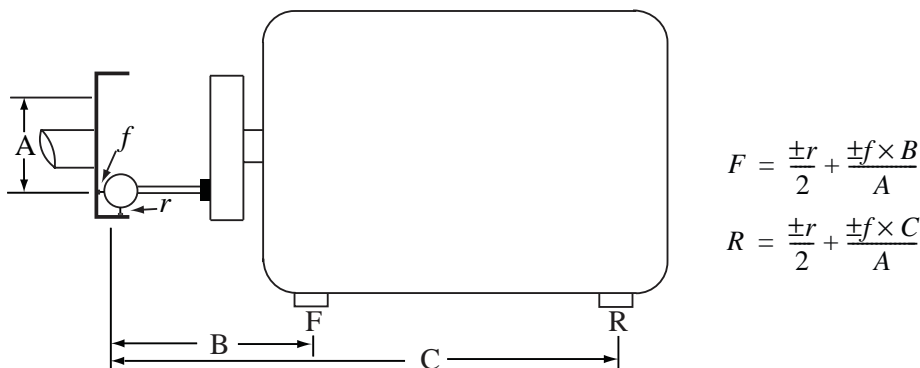


Fig. 12a. Dial Indicator Arrangement 12

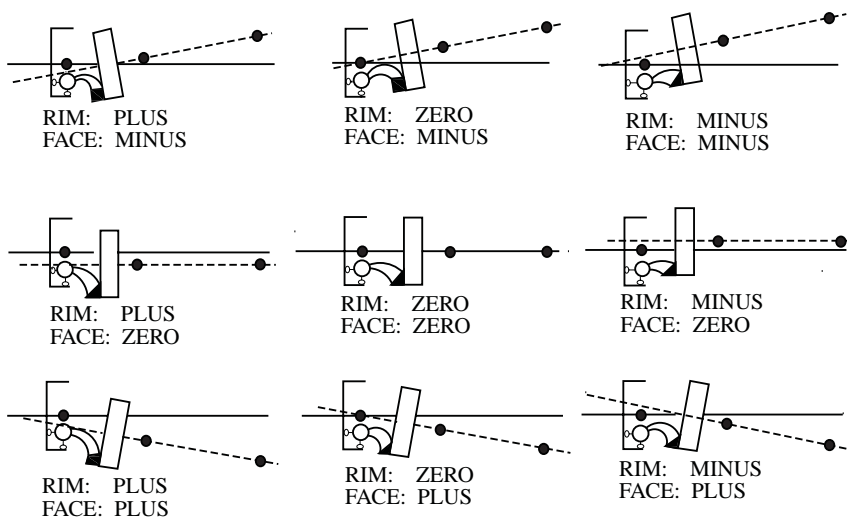


Fig. 12b. Interpreting Dial Indicator Readings for Indicator Arrangement 12

Solid lines represent the desired location for the dashed lines (movable unit). The plus, minus, and zero readings on the indicators are represented by one of these nine scenarios. Depending on the magnitude of the variables, the graph gives a mental picture of what the formulas should yield.

Example: Calculate the shims necessary for a pump and motor alignment where dimensions are $A = 23.0$ inches, $B = 41.0$ inches, and $C = 96.0$ inches. The two indicator readings are $r = 0.004$ inch and $f = \text{minus } (-) 0.003$ inch, respectively.

Solution: For practical purposes, this unit is already within tolerance by most standards. However, the block in the upper left corner of Fig. 12b illustrates the positive rim and negative face condition. The graph suggests both the front and rear motor feet be lowered. Removal of 0.003 inch of shim at the front and 0.011 inch at the rear feet will reduce misalignment to less than a mil on the next reading.

$$\begin{aligned}
 F &= \frac{\pm r}{2} + \frac{\pm f \times B}{A} & R &= \frac{\pm r}{2} + \frac{\pm f \times C}{A} \\
 &= \frac{0.004}{2} + \frac{-0.003 \times 41}{23.0} & &= \frac{0.004}{2} + \frac{-0.003 \times 96}{23.0} \\
 &= 0.002 + (-0.005) & &= 0.002 + (-0.013) \\
 &= -0.003 \text{ inch} & &= -0.011 \text{ inch}
 \end{aligned}$$

13th Arrangement.—In Fig. 13a, the indicator jig is mounted on the static unit and two separate readings are taken from surfaces of the inside of a centrifugal clutch drum on the movable unit.

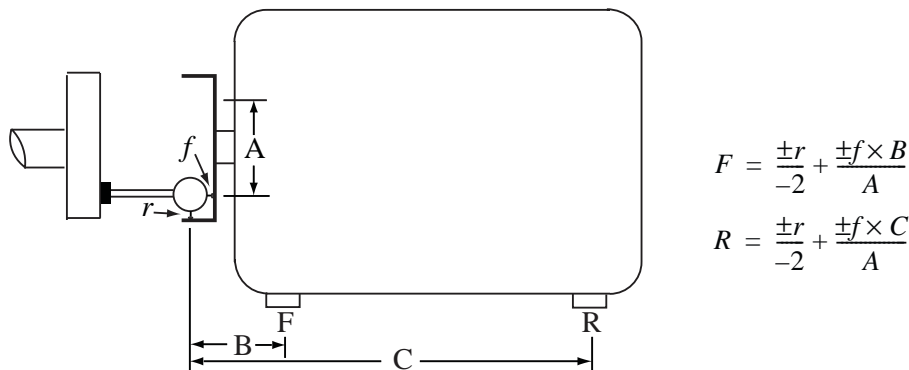


Fig. 13a. Dial Indicator Arrangement 13

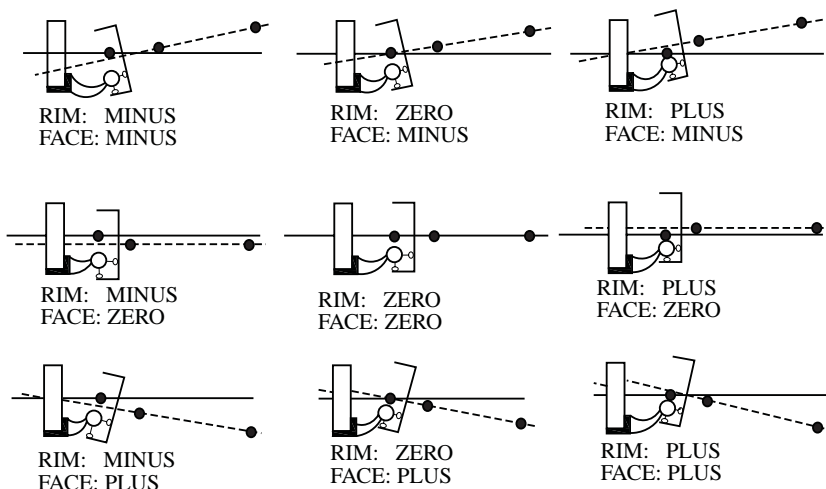


Fig. 13b. Interpreting Dial Indicator Readings for Indicator Arrangement 13

Solid lines represent the desired location for the dashed lines (movable unit). The plus, minus, and zero readings on the indicators are represented by one of these nine scenarios. Depending on the magnitude of the variables, the generic graph gives a mental picture of what the formulas should yield.

Example: Calculate the shims necessary for a pump and motor alignment where dimensions are $A = 23.0$ inches, $B = 20.0$ inches, and $C = 75.0$ inches. The indicator readings are $r = \text{plus } (+) 0.004$ inch and $f = \text{minus } (-) 0.003$ inch, respectively.

Solution: The positive rim and negative face condition is illustrated in the top right block of Fig. 13b. The graph suggests that both the front and rear motor feet need to be lowered. The formula solution dictates exactly how much the movable unit is to be lowered at both front and rear shim points:

$$\begin{aligned}
 F &= \frac{\pm r}{-2} + \frac{\pm f \times B}{A} & R &= \frac{\pm r}{-2} + \frac{\pm f \times C}{A} \\
 &= \frac{0.004}{-2} + \frac{-0.003 \times 20}{23.0} & &= \frac{0.004}{-2} + \frac{-0.003 \times 75}{23.0} \\
 &= -0.002 + (-0.0026) & &= -0.002 + (-0.00978) \\
 &= -0.005 \text{ inch} & &= -0.012 \text{ inch}
 \end{aligned}$$

14th Arrangement.—Place rim and face indicators as shown in Fig. 14a.

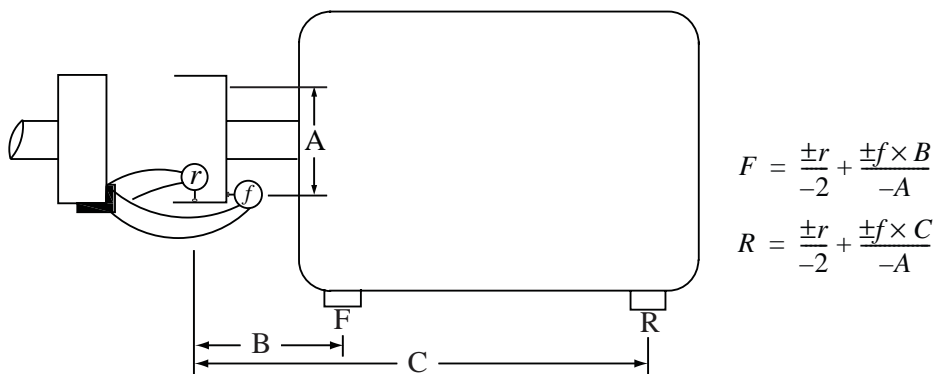


Fig. 14a. Dial Indicator Arrangement 14

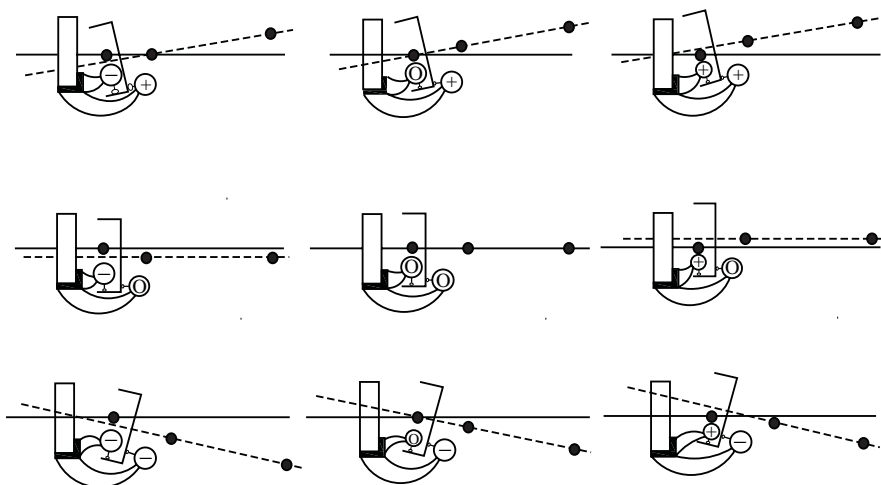


Fig. 14b. Interpreting Dial Indicator Readings for Indicator Arrangement 14

Solid lines represent the desired location for the dashed lines (movable unit). The plus, minus, and zero readings on the indicators are represented by one of these nine scenarios. Depending on the magnitude of the variables, the generic graph gives a mental picture of what the formulas should yield.

Example: Calculate the shims necessary for a pump and motor alignment where dimensions are $A = 4.625$ inches, $B = 10.75$ inches, and $C = 32.5$ inches. The two indicator dials read $r = \text{minus } (-) 0.014$ inch and $f = \text{plus } (+) 0.036$ inch respectively.

Solution: In Fig. 14b, the negative rim and positive face condition is shown in the top left block. The graph suggests that both the front and rear motor feet should be lowered, depending on the magnitude of the variables. The formula solution dictates exactly how much the movable unit is to be lowered at both front and rear shim points:

$$\begin{aligned} F &= \frac{\pm r}{-2} + \frac{\pm f \times B}{-A} & R &= \frac{\pm r}{-2} + \frac{\pm f \times C}{-A} \\ &= \frac{-0.014}{-2} + \frac{0.036 \times 10.75}{-4.625} & &= \frac{-0.014}{-2} + \frac{0.036 \times 32.5}{-4.625} \\ &= 0.007 + (-0.0837) & &= 0.007 + (-0.25297) \\ &= -0.077 \text{ inch} & &= -0.246 \text{ inch} \end{aligned}$$

15th Arrangement.—Place rim and face indicators as shown in Fig. 15a.

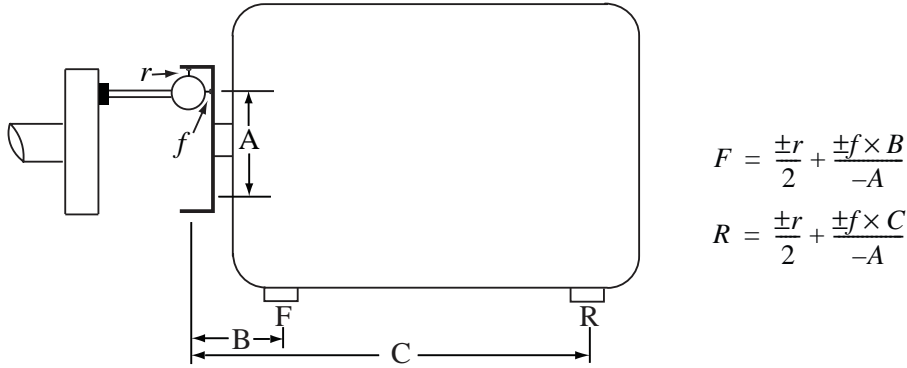


Fig. 15a. Dial Indicator Arrangement 15

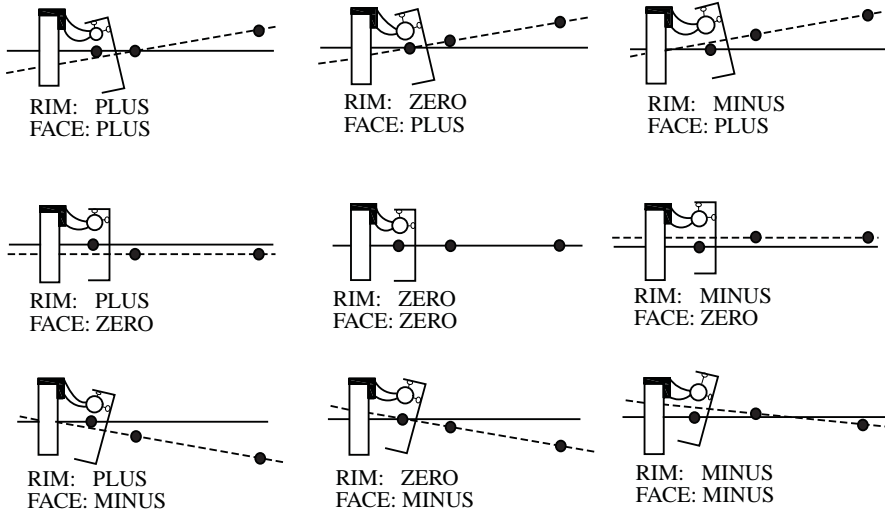


Fig. 15b. Interpreting Dial Indicator Readings for Indicator Arrangement 15

Solid lines represent the desired location for the dashed lines (movable unit). The plus, minus, and zero readings on the indicators are represented by one of these nine scenarios. Depending on the magnitude of the variables, the generic graph gives a mental picture of what the formulas should yield.

Example: Calculate the shims necessary for a pump and motor alignment where dimensions are $A = 6.0$ inches, $B = 38.0$ inches, and $C = 84.0$ inches. The two indicator dials reads $r = \text{minus } (-) 0.002$ inch and $f = \text{plus } (+) 0.003$ inch respectively.

Solution: The negative rim and positive face condition is found in the top right corner of Fig. 15b. The graph suggests that both the front and rear motor feet need to be lowered. The formula solution dictates exactly how much the movable unit is to be lowered at both front and rear shim points:

$$\begin{aligned}
 F &= \frac{\pm r}{2} + \frac{\pm f \times B}{-A} & R &= \frac{\pm r}{2} + \frac{\pm f \times C}{-A} \\
 &= \frac{-0.002}{2} + \frac{0.003 \times 38.0}{-6.0} & &= \frac{-0.002}{2} + \frac{0.003 \times 84.0}{-6.0} \\
 &= -0.001 + (-0.019) & &= -0.001 + (-0.042) \\
 &= -0.020 \text{ inch} & &= -0.043 \text{ inch}
 \end{aligned}$$

16th Arrangement.—Place rim and face indicators as shown in Fig. 16a.

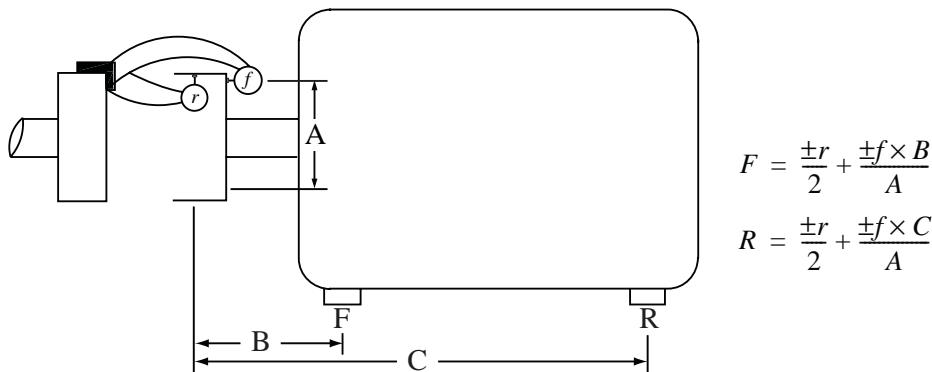


Fig. 16a. Dial Indicator Arrangement 16

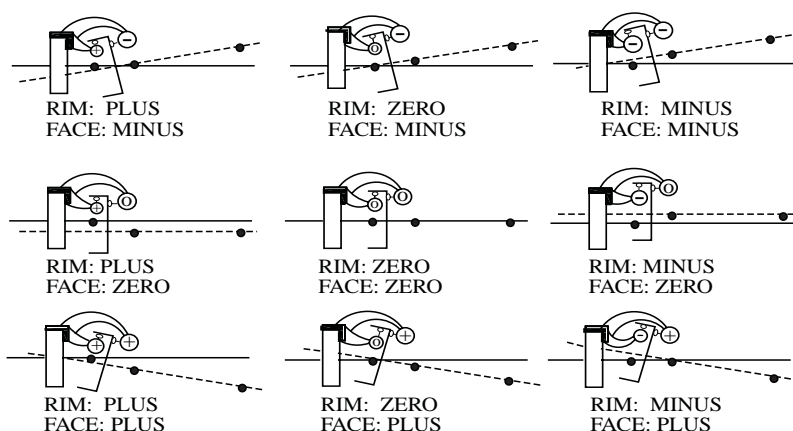


Fig. 16b. Interpreting Dial Indicator Readings for Indicator Arrangement 16

Solid lines represent the desired location for the dashed lines (movable unit). The plus, minus, and zero readings on the indicators are represented by one of these nine scenarios. Depending on the magnitude of the variables, the graph gives a mental picture of what the formulas should yield.

Example: Calculate the shims necessary for a pump and motor alignment where dimensions are $A = 16.0$ inches, $B = 26.0$ inches, and $C = 54.0$ inches. The two indicator dials read $r = \text{minus } (-) 0.002$ inch and $f = \text{minus } (-) 0.006$ inch respectively.

Solution: The rim and face numbers indicate that the whole movable machine is one mil high (from the rim indicator, $\frac{r}{2} = \frac{0.002}{2} = 0.001$), and the angularity from the face indicator say that for every 16 inches of axial length from the rim indicator there is an upward incline toward the rear of 0.006 inch. In Fig. 16b, locate the block with negative rim and negative face values. The graph suggests both the front and rear motor feet be lowered. The formula solution dictates that the movable unit is to be lowered at both front and rear shim points:

$$\begin{aligned}
 F &= \frac{\pm r}{2} + \frac{\pm f \times B}{A} & R &= \frac{\pm r}{2} + \frac{\pm f \times C}{A} \\
 &= \frac{-0.002}{2} + \frac{-0.006 \times 26}{16} & &= \frac{-0.002}{2} + \frac{-0.006 \times 54.0}{16} \\
 &= -0.001 + (-0.00975) & &= -0.001 + (-0.02025) \\
 &= -0.011 \text{ inch} & &= -0.021 \text{ inch}
 \end{aligned}$$

Rim and Face Method Extended to Motors with Extra Feet.—Fig. 17 illustrates an alignment problem that is complicated by the fact that the motor has ten feet. The indicator

arrangement used matches the arrangement illustrated in Fig. 14a. In this problem the solution is obtained by using the same equations as were used to obtain the solution of Fig. 14a, adapted slightly to deal with the additional feet.

Shim calculations for motor to pump alignment when the motor has more than four feet are performed in the same manner as the examples previously used. However, care must be used in determining the dimensions used in the equations. As in all the previous examples, the horizontal dimensions are measured from the location of the rim indicator. Distances to motor feet to the right of the rim indicator are assigned positive values, and distances measured to feet that are to the left of the rim indicator are assigned negative values in the formulas. The revised equations for this arrangement are shown beside Fig. 17. In the equations, S_F is the shim requirement at foot F, S_{F1} is the shim requirement at foot F1, etc.

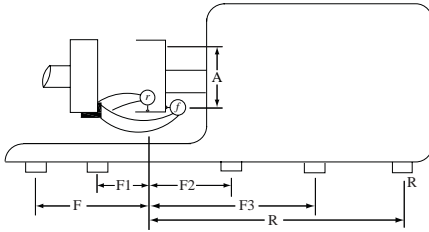


Fig. 17. Shaft Alignment When More than Four Feet are Involved

Dimensions are measured from the path of the rim indicator. Dimensions to locations left of the rim indicator enter the equations as minus (-) values, and dimension to the right of the rim indicator enter the equations as positive (+) quantities.

Example: Calculate the shims necessary for a pump and motor alignment where dimensions are $A = 4.5$ inches, $F = 22.0$ inches, $F1 = 10.0$ inches, $F2 = 8.0$ inches, $F3 = 24.0$ inches, and $R = 46.0$ inches. The two indicator dials read $r = \text{minus } (-) 0.054$ inch and $f = \text{plus } (+) 0.032$ inch respectively.

Solution, Vertical Alignment:

$$S_F = \frac{\pm r}{-2} + \frac{\pm f \times (-F)}{-A} = \frac{-0.054}{-2} + \frac{0.032 \times (-22)}{-4.5} = 0.027 + 0.156 = 0.183 \text{ inch}$$

$$S_{F1} = \frac{\pm r}{-2} + \frac{\pm f \times (-F1)}{-A} = \frac{-0.054}{-2} + \frac{0.032 \times (-10)}{-4.5} = 0.027 + 0.071 = 0.098 \text{ inch}$$

$$S_{F2} = \frac{\pm r}{-2} + \frac{\pm f \times F2}{-A} = \frac{-0.054}{-2} + \frac{0.032 \times 8}{-4.5} = 0.027 + (-0.156) = -0.030 \text{ inch}$$

$$S_{F3} = \frac{\pm r}{-2} + \frac{\pm f \times F3}{-A} = \frac{-0.054}{-2} + \frac{0.032 \times 24}{-4.5} = 0.027 + (-0.171) = -0.144 \text{ inch}$$

$$S_R = \frac{\pm r}{-2} + \frac{\pm f \times R}{-A} = \frac{-0.054}{-2} + \frac{0.032 \times 46}{-4.5} = 0.027 + (-0.327) = -0.300 \text{ inch}$$

The calculations show that more shims are required under the two pairs of front feet, F and F1, and need to be reduced for the other three pairs of rear feet. The top left figure in Fig. 14b (negative rim and positive face indicator readings) confirms that the numerical solution appears reasonable.

Solution, Horizontal Alignment: The horizontal alignment solution follows the same procedure as the vertical solution above, and will use the same equations if the indicator set up shown in Fig. 17 is used.

The dimensions F, F1, F2, F3, and R are the distances from the rim indicator path to the respective locations where the move occurs, whether it be the location of the hold-down bolts, or another location where a monitoring dial indicator is mounted. See *Solution for Horizontal Alignment* on page 2631 for additional information on this subject.

$$S_F = \frac{\pm r}{-2} + \frac{\pm f \times (-F)}{-A}$$

$$S_{F1} = \frac{\pm r}{-2} + \frac{\pm f \times (-F1)}{-A}$$

$$S_{F2} = \frac{\pm r}{-2} + \frac{\pm f \times F2}{-A}$$

$$S_{F3} = \frac{\pm r}{-2} + \frac{\pm f \times F3}{-A}$$

$$S_R = \frac{\pm r}{-2} + \frac{\pm f \times R}{-A}$$

TABLE OF CONTENTS

MEASURING UNITS

SYMBOLS AND ABBREVIATIONS

- 2652 Greek Alphabet
- 2652 Abbreviations
- 2652 Scientific and Engineering
- 2654 Mathematical Signs and
- 2655 Letter Symbols for Mechanics

MEASURING UNITS

- 2656 Metric Systems Of Measurement
- 2656 SI Unit System
- 2658 Prefixes for SI Units
- 2658 Binary Multiples
- 2658 SI Base Units
- 2660 Standard of Length
- 2660 U.S. Customary Unit System
- 2660 Fundamental Constants

U.S. SYSTEM AND METRIC SYSTEM CONVERSIONS

- 2661 Units of Length
- 2661 Linear Conversion Factors
- 2662 Angular Conversion Factors
- 2662 Feet and Inches to Inches
- 2662 Inch to Feet and Yards
- 2663 Inch Fractions to Decimal Feet
- 2664 Feet to Inches
- 2664 Inch \leftrightarrow Millimeter
- 2665 Feet to Millimeter
- 2666 Fractional Inch to Millimeters
- 2668 Decimal Inch to Millimeters
- 2670 Millimeters to Inches
- 2672 Microinches \leftrightarrow Micrometers
- 2674 Feet \leftrightarrow Meters
- 2674 Miles \leftrightarrow Kilometers
- 2675 Units of Area
- 2675 Conversion Factors
- 2676 Square Inch \leftrightarrow Square Centimeter
- 2676 Square Feet \leftrightarrow Square Meter
- 2677 Square Yard \leftrightarrow Square Meter
- 2677 Acre \leftrightarrow Hectare
- 2678 Units of Volume
- 2678 Conversion Factors
- 2679 Cubic Inch \leftrightarrow Cubic Centimeter
- 2680 Cubic Feet \leftrightarrow Cubic Meters
- 2680 Cubic Feet \leftrightarrow Liters
- 2681 U.K. Gallons \leftrightarrow Liters
- 2681 U.S. Gallons \leftrightarrow Liters
- 2682 U.S. Fluid Ounce \leftrightarrow Milliliters
- 2682 Units of Volumetric Flow Rate

U.S. SYSTEM AND METRIC SYSTEM CONVERSIONS

(Continued)

- 2682 Pitot Tube
- 2683 Units of Mass and Weight
- 2683 Conversion Factors
- 2683 Pound \leftrightarrow Kilogram
- 2684 Ounce \leftrightarrow Gram
- 2684 Density Conversion Factors
- 2685 Pound/Cu Inch \leftrightarrow Gram/Cu Cm
- 2685 Pound/Cu Inch \leftrightarrow Kg/Cu Meter
- 2686 Units of Pressure and Stress
- 2686 Conversion Factors
- 2686 Pound/Sq Inch \leftrightarrow Kg/Sq Cm
- 2687 Pound/Sq Foot \leftrightarrow Kg/Sq Meter
- 2687 Pound/Sq Inch \leftrightarrow Kilopascal
- 2688 Conversion Factors Table
- 2688 Units of Force
- 2688 Conversion Factors
- 2689 Pound \leftrightarrow Newton
- 2689 Units of Moment and Torque
- 2689 Conversion Factors
- 2689 Pound-Inch \leftrightarrow Newton-Meter
- 2690 Poundal
- 2690 Units of Energy, Power, and Heat
- 2690 Conversion Factor Tables
- 2691 Btu \leftrightarrow Foot-pound
- 2691 Btu \leftrightarrow Kilojoule
- 2692 Horsepower \leftrightarrow Kilowatt
- 2692 Foot-pound \leftrightarrow Joule
- 2693 Power Conversion Factors
- 2693 Energy and Work Conversion
- 2694 Thermal Conductance Conversion
- 2694 Conduction
- 2694 Fuel Oil, Coal and Gas Equiv.
- 2695 Units of Temperature
- 2695 Conversion Formulas
- 2695 Absolute Zero
- 2695 Thermal Energy Units
- 2696 Temperature Conversion Table
- 2698 Units of Velocity and Acceleration
- 2698 Velocity Conversion Factors
- 2698 Acceleration Conversion Factors
- 2698 Units of Viscosity
- 2699 Units of Inertia and Momentum
- 2699 Miscellaneous Measuring Units
- 2699 Ohm's Law
- 2700 Wind Chill Temperature
- 2700 Phonetic Alphabet
- 2700 Daylight Savings Time
- 2700 Bel

SYMBOLS AND ABBREVIATIONS

Greek Letters and Standard Abbreviations

The Greek letters are frequently used in mathematical expressions and formulas. The Greek alphabet is given below.

A	α	Alpha	H	η	Eta	N	ν	Nu	T	τ	Tau
B	β	Beta	Θ	$\vartheta\theta$	Theta	Ξ	ξ	Xi	Υ	υ	Upsilon
Γ	γ	Gamma	I	ι	Iota	O	o	Omicron	Φ	ϕ	Phi
Δ	δ	Delta	K	κ	Kappa	Π	π	Pi	X	χ	Chi
E	ε	Epsilon	Λ	λ	Lambda	R	ρ	Rho	Ψ	ψ	Psi
Z	ζ	Zeta	M	μ	Mu	Σ	$\sigma\varsigma$	Sigma	Ω	ω	Omega

ANSI Abbreviations for Scientific and Engineering Terms

ANSI Y1.1-1972 (R 1984)

Absolute	abs	Decibel	dB
Alternating current	ac	Degree	deg or °
Ampere	amp	Degree Centigrade	°C
Ampere-hour	amp hr	Degree Fahrenheit	°F
Angstrom unit	Å	Degree Kelvin	K
Antilogarithm	antilog	Diameter	dia
Arithmetical average	aa	Direct current	dc
Atmosphere	atm	Dozen	doz
Atomic weight	at wt	Dram	dr
Avoirdupois	avdp	Efficiency	eff
Barometer	baro	Electric	elec
Board feet (feet board measure)	fbm	Electromotive force	emf
Boiler pressure	bopress	Elevation	el
Boiling point	bp	Engine	eng
Brinell hardness number	Bhn	Engineer	engr
British thermal unit	Btu or B	Engineering	engrg
Bushel	bu	Equation	eq
Calorie	cal	External	ext
Candle	cd	Fluid	fl
Center to center	c to c	Foot	ft
Centimeter	cm	Foot-candle	fc
Centimeter-gram-second (system)	cgs	Foot-Lambert	fL or fl
Chemical	chem	Foot per minute	fpm
Chemically pure	cp	Foot per second	fps
Circular	circ	Foot-pound	ft lb
Circular mil	cmil	Foot-pound-second (system)	fps
Coefficient	coef	Free on board	fob
Cologarithm	colog	Freezing point	fp
Concentrate	conc	Frequency	freq
Conductivity	condct	Fusion point	fnpt
Constant	const	Gallon	gal
Cord	cd	Gallon per minute	gpm
Cosecant	csc	Gallon per second	gps
Cosine	cos	Grain	gr
Cost, insurance, and freight	cif	Gram	g
Cotangent	ctn	Greatest common divisor	gcd
Counter electromotive force	cemf	High pressure	hp
Cubic	cu	Horsepower	hp
Cubic centimeter	cm ³ or cc	Horsepower-hour	hp hr
Cubic foot	ft ³ or cu ft	Hour	h or hr
Cubic feet per second	ft ³ or cfs	Hyperbolic cosine	cosh
Cubic inch	in ³ or cu in	Hyperbolic sine	sinh
Cubic meter	m ³ or cu m	Hyperbolic tangent	tanh
Cubic millimeter	mm ³ or cumm	Inch	in
Cubic yard	yd ³ or cu yd	Inch per second	in/s or ips
Current density	cd	Inch-pound	in lb
Cylinder	cyl		

ANSI Abbreviations for Scientific and Engineering Terms (Continued)

ANSI Y1.1-1972 (R 1984)

Indicated horsepower-hour	iph	Pound-force foot	lb _f • ft or lb ft
Intermediate pressure	ip	Pound-force inch	lb _f • in or lb in
Internal	intl	pound-force per square foot	lb _f /ft ² or psf
Kilovolt-ampere/hour	KVA-h or kVah	pound-force per square inch	lb _f /in ² or psi
Kilowatt-hour meter	kwhm	pound per horsepower	lb/hp or php
Latitude	lat	Power factor	pf
Least common multiple	lcm	Quart	qt
Liquid	liq	Reactive volt-ampere meter	rva
Logarithm (common)	log	Revolution per minute	r/min or rpm
Logarithm (natural)	ln	Revolution per second	r/s or rps
Low pressure	lp	Root mean square	rms
Lumen per watt	lm/W or lpw	Round	rnd
Magnetomotive force	mmf	Secant	sec
Mathematics (ical)	math	Second	s or sec
Maximum	max	Sine	sin
Mean effective pressure	mep	Specific gravity	sp gr
Melting point	mp	Specific heat	sp ht
Meter	m	Square	sq
Meter-kilogram-second	mks	Square centimeter	cm ² or sq cm
Microfarad	μF	Square foot	ft ² or sq ft
Mile	mi	Square inch	in ² or sq in
Mile per hour	mi/h or mph	Square kilometer	km ² or sq km
Milliampere	m/A	Square root of mean square	rms
Minimum	min	Standard	std
Molecular weight	mol wt	Tangent	tan
Molecule	mo	Temperature	temp
National Electrical Code	NEC	Tensile strength	ts
Ounce	oz	Versed sine	vers
Ounce-inch	oz in	Volt	V
Pennyweight	dwt	Watt	W
Pint	pt	Wattour	Wh
Potential	pot	Week	wk
Potential difference	pd	Weight	wt
Pound	lb	Yard	yd

Alternative abbreviations conforming to the practice of the International Electrotechnical Commission.

Ampere	A	Kilovolt-ampere	kVA	Microfarad	μF		
Ampere-hour	Ah	Kilowatt	kW	Microwatt	μW	Volt	V
Coulomb	C			Milliampere	mA	Volt-ampere	VA
Farad	F	Kilowatthour	kWh	Millifarad	mF	Volt-coulomb	VC
Henry	H	Megawatt	MW	Millihenry	mH	Watt	W
Joule	J	Megohm	MΩ	Millivolt	mV	Wattour	Wh
Kilovolt	kV	Microampere	μA	Ohm	Ω		

Only the most commonly used terms have been included. These forms are recommended for those whose familiarity with the terms used makes possible a maximum of abbreviations. For others, less contracted combinations made up from this list may be used. For example, the list gives the abbreviation of the term "feet per second" as "fps." To some, however, ft per sec will be more easily understood.

Abbreviations should be used sparingly and only where their meaning will be clear. If there is any doubt, then spell out the term or unit of measurement.

The following points are good practice when preparing engineering documentation. Terms denoting units of measurement should be abbreviated in text only when preceded by the amounts indicated in numerals: "several inches," "one inch," "12 in." A sentence should not begin with a numeral followed by an abbreviation. The use of conventional signs for abbreviations in text should be avoided: use "lb," not "#" or "in," not ".

Symbols for the chemical elements are listed in the table on page 371.

Mathematical Signs and Commonly Used Abbreviations

+	Plus (sign of addition)	π	Pi (3.1416)
+	Positive	Σ	Sigma (sign of summation)
-	Minus (sign of subtraction)	ω	Omega (angles measured in radians)
-	Negative	g	Acceleration due to gravity (32.16 ft/s ² or 9.81 m/s ²)
\pm (\mp)	Plus or minus (minus or plus)	i (or j)	Imaginary quantity ($\sqrt{-1}$)
\times	Multiplied by (multiplication sign)	sin	Sine
\cdot	Multiplied by (multiplication sign)	cos	Cosine
\div	Divided by (division sign)	tan	Tangent
/	Divided by (division sign)	cot	Cotangent
:	Is to (in proportion)	sec	Secant
=	Equals	csc	Cosecant
\neq	Is not equal to	vers	Versed sine
\equiv	Is identical to	covers	Covered sine
\cong or \approx	Approximately equals	$\sin^{-1} a$	Arc the sine of which is a
>	Greater than	arcsin a or asin a	
<	Less than	$(\sin a)^{-1}$	Reciprocal of $\sin a$ ($1 \div \sin a$)
\geq	Greater than or equal to	$\sin^n x$	n th power of $\sin x$
\leq	Less than or equal to	sinh x	Hyperbolic sine of x
\rightarrow	Approaches as a limit	cosh x	Hyperbolic cosine of x
\propto	Varies directly as	Δ	Delta (increment of)
\therefore	Therefore	δ	Delta (variation of)
$::$	Equals (in proportion)	d	Differential (in calculus)
\sqrt{a}	Square root of a	∂	Partial differentiation (in calculus)
$\sqrt[3]{a}$	Cube root of a	\int	Integral (in calculus)
$\sqrt[4]{a}$	4th root of a	\int_a^b	Integral between the limits a and b
$\sqrt[n]{a}$	n th root of a	!	$5! = 1 \times 2 \times 3 \times 4 \times 5$ (Factorial)
a^2	a squared (2nd power of a)	\sphericalangle	Angle
a^3	a cubed (3rd power of a)	\perp	Right angle
a^4	4th power of a	\perp	Perpendicular to
a^n	n th power of a	\triangle	Triangle
a^{-n}	$1 \div a^n$	\bigcirc	Circle
$\frac{1}{n}$	Reciprocal value of n	\square	Parallelogram
log	Logarithm	$^\circ$	Degree (circular arc or temperature)
\log_e	Natural or Napierian logarithm	'	Minutes or feet
ln	Natural or Napierian logarithm	"	Seconds or inches
e	Base of natural logarithms (2.71828)	a'	a prime
lim	Limit value (of an expression)	a''	a double prime
∞	Infinity	a_1	a sub one
α	Alpha	a_2	a sub two
β	Beta	a_n	a sub n
γ	Gamma	()	Parentheses
θ	Theta	[]	Brackets
ϕ	Phi	{ }	Braces
μ	Mu (coefficient of friction)	$ K $	Absolute value of K , size of K irrespective of sign

commonly used to denote angles

Letter Symbols for Mechanics and Time-Related Phenomena
ANSI/ASME Y10.3M-1984

Acceleration, angular	α (alpha)	Height	h
Acceleration, due to gravity	g	Inertia, moment of	I or J
Acceleration, linear	a	Inertia, polar (area) moment of ^a	J
Amplitude ^a	A	Inertia, product (area) moment of ^a	I_{xy}
		Length	L or l
	α (alpha)	Load per unit distance ^a	q or w
	β (beta)	Load, total ^a	P or W
Angle	γ (gamma)	Mass	m
	θ (theta)	Moment of force, including bending moment	M
	ϕ (phi)	Neutral axis, distance to extreme fiber from ^a	c
	ψ (psi)	Period	T
Angle, solid	Ω (omega)	Poisson's ratio	μ (mu) or ν (nu)
Angular frequency	ω (omega)	Power	P
Angular momentum	L	Pressure, normal force per unit area	p
Angular velocity	ω (omega)	Radius	r
Arc length	s	Revolutions per unit of time	n
Area	A	Second moment of area (second axial moment of area)	I_a
Axes, through any point ^a	$X-X, Y-Y, \text{ or } Z-Z$	Second polar moment of area	I_p or J
Bulk modulus	K	Section modulus	Z
Breadth (width)	b	Shear force in beam section ^a	V
Coefficient of expansion, linear ^a	α (alpha)	Spring constant (load per unit deflection) ^a	k
Coefficient of friction	μ (mu)	Statical moment of any area about a given axis ^a	Q
Concentrated load (same as force)	F	Strain, normal	ϵ (epsilon)
Deflection of beam, max ^a	δ (delta)	Strain, shear	γ (gamma)
Density	ρ (rho)	Stress, concentration factor ^a	K
Depth	d, δ (delta), or t	Stress, normal	σ (sigma)
Diameter	D or d	Stress, shear	τ (tau)
Displacement ^a	u, v, w	Temperature, absolute ^b	$T, \text{ or } \theta$ (theta)
Distance, linear ^a	s	Temperature ^b	$t, \text{ or } \theta$ (theta)
Eccentricity of application of load ^a	e	Thickness	d, δ (delta), or t
Efficiency ^a	η (eta)	Time	t
Elasticity, modulus of	E	Torque	T
Elasticity, modulus of, in shear	G	Velocity, linear	v
Elongation, total ^a	δ (delta)	Volume	V
Energy, kinetic	E_k, K, T	Wavelength	λ (lambda)
Energy, potential	$E_p, V, \text{ or } \Phi$ (phi)	Weight	W
Factor of safety ^a	$N, \text{ or } n$	Weight per unit volume	γ (gamma)
Force or load, concentrated	F	Work	W
Frequency	f		
Gyration, radius of ^a	k		

^a Not specified in Standard

^b Specified in ANSI Y10.4-1982 (R1988)

MEASURING UNITS

Metric Systems Of Measurement

A metric system of measurement was first established in France in the years following the French Revolution, and various systems of metric units have been developed since that time. All metric unit systems are based, at least in part, on the International Metric Standards, which are the meter and kilogram, or decimal multiples or submultiples of these standards.

In 1795, a metric system called the centimeter-gram-second (cgs) system was proposed, and was adopted in France in 1799. In 1873, the British Association for the Advancement of Science recommended the use of the cgs system, and since then it has been widely used in all branches of science throughout the world. From the base units in the cgs system are derived the following:

Unit of velocity = 1 centimeter per second

Acceleration due to gravity (at Paris) = 981 centimeters per second per second

Unit of force = 1 dyne = $\frac{1}{981}$ gram

Unit of work = 1 erg = 1 dyne-centimeter

Unit of power = 1 watt = 10,000,000 ergs per second

Another metric system called the MKS (meter-kilogram-second) system of units was proposed by Professor G. Giorgi in 1902. In 1935, the International Electro-technical Commission (IEC) accepted his recommendation that this system of units of mechanics should be linked with the electromagnetic units by the adoption of a fourth base unit. In 1950, the IEC adopted the ampere, the unit of electric current, as the fourth unit, and the MKSA system thus came into being.

A gravitational system of metric units, known as the technical system, is based on the meter, the kilogram as a force, and the second. It has been widely used in engineering. Because the standard of force is defined as the weight of the mass of the standard kilogram, the fundamental unit of force varies due to the difference in gravitational pull at different locations around the earth. By international agreement, a standard value for acceleration due to gravity was chosen (9.81 meters per second squared) that for all practical measurements is approximately the same as the local value at the point of measurement.

The International System of Units (SI).—The Conference Generale des Poids et Mesures (CGPM), which is the body responsible for all international matters concerning the metric system, adopted in 1954, a rationalized and coherent system of units, based on the four MKSA units (see above), and including the *kelvin* as the unit of temperature and the *candela* as the unit of luminous intensity. In 1960, the CGPM formally named this system the *Système International d'Unites*, for which the abbreviation is SI in all languages. In 1971, the 14th CGPM adopted a seventh base unit, the *mole*, which is the unit of quantity (“amount of substance”).

In the period since the first metric system was established in France toward the end of the 18th century, most of the countries of the world have adopted a metric system. At the present time, most of the industrially advanced metric-using countries are changing from their traditional metric system to SI. Those countries that are currently changing or considering change from the English system of measurement to metric have the advantage that they can convert directly to the modernized system. The United Kingdom, which can be said to have led the now worldwide move to change from the English system, went straight to SI.

The use of SI units instead of the traditional metric units has little effect on everyday life or trade. The units of linear measurement, mass, volume, and time remain the same, viz. meter, kilogram, liter, and second.

The SI, like the traditional metric system, is based on decimal arithmetic. For each physical quantity, units of different sizes are formed by multiplying or dividing a single base value by powers of 10. Thus, changes can be made very simply by adding zeros or shifting decimal points. For example, the meter is the basic unit of length; the kilometer is a multiple (1000 meters); and the millimeter is a sub-multiple (one-thousandth of a meter).

In the older metric systems, the simplicity of a series of units linked by powers of ten is an advantage for plain quantities such as length, but this simplicity is lost as soon as more complex units are encountered. For example, in different branches of science and engineering, energy may appear as the erg, the calorie, the kilogram-meter, the liter-atmosphere, or the horsepower-hour. In contrast, the SI provides only one basic unit for each physical quantity, and universality is thus achieved.

As mentioned before, there are seven base units, which are for the basic quantities of length, mass, time, electric current, thermodynamic temperature, amount of substance, and luminous intensity, expressed as the meter (m), the kilogram (kg), the second (s), the ampere (A), the kelvin (K), the mole (mol), and the candela (cd). The units are defined in the accompanying [Table 1](#).

The SI is a coherent system. A system is said to be coherent if the product or quotient of any two unit quantities in the system is the unit of the resultant quantity. For example, in a coherent system in which the foot is the unit of length, the square foot is the unit of area, whereas the acre is not.

Other physical quantities are derived from the base units. For example, the unit of velocity is the meter per second (m/s), which is a combination of the base units of length and time. The unit of acceleration is the meter per second squared (m/s²). By applying Newton's second law of motion—force is proportional to mass multiplied by acceleration—the unit of force is obtained that is the kilogram-meter per second squared (kg-m/s²). This unit is known as the newton, or N. Work, or force times distance is the kilogram-meter squared per second squared (kg-m²/s²), which is the joule (1 joule = 1 newton-meter), and energy is also expressed in these terms. The abbreviation for joule is J. Power or work per unit time is the kilogram-meter squared per second cubed (kg-m²/s³), which is the watt (1 watt = 1 joule per second = 1 newton-meter per second). The abbreviation for watt is W. The term horsepower is not used in the SI and is replaced by the watt, which together with multiples and submultiples—kilowatt and milliwatt, for example—is the same unit as that used in electrical work.

The use of the newton as the unit of force is of particular interest to engineers. In practical work using the English or traditional metric systems of measurements, it is a common practice to apply weight units as force units. Thus, the unit of force in those systems is that force that when applied to unit mass produces an acceleration g rather than unit acceleration. The value of gravitational acceleration g varies around the earth, and thus the weight of a given mass also varies. In an effort to account for this minor error, the kilogram-force and pound-force were introduced, which are defined as the forces due to “standard gravity” acting on bodies of one kilogram or one pound mass, respectively. The standard gravitational acceleration is taken as 9.80665 meters per second squared or 32.174 feet per second squared. The newton is defined as “that force, which when applied to a body having a mass of one kilogram, gives it an acceleration of one meter per second squared.” It is independent of g . As a result, the factor g disappears from a wide range of formulas in dynamics. However, in some formulas in statics, where the weight of a body is important rather than its mass, g does appear where it was formerly absent (the weight of a mass of W kilograms is equal to a force of Wg newtons, where g = approximately 9.81 meters per second squared). Details concerning the use of SI units in mechanics calculations are given on [page 150](#) and throughout the Mechanics section in this Handbook. The use of SI units in strength of materials calculations is covered in the section on that subject.

Decimal multiples and sub-multiples of the SI units are formed by means of the prefixes given in the following table, which represent the numerical factors shown.

Factors and Prefixes for Forming Decimal Multiples of SI Units

Factor by which the unit is multiplied	Prefix	Symbol	Factor by which the unit is multiplied	Prefix	Symbol
10^{12}	tera	T	10^{-2}	centi	c
10^9	giga	G	10^{-3}	milli	m
10^6	mega	M	10^{-6}	micro	μ
10^3	kilo	k	10^{-9}	nano	n
10^2	hecto	h	10^{-12}	pico	p
10	deka	da	10^{-15}	femto	f
10^{-1}	deci	d	10^{-18}	atto	a

For more information on SI practice, the reader is referred to the following publications:

Metric Practice Guide, published by the American Society for Testing and Materials, 100 Barr Harbor Drive, West Conshohocken, PA 19428.

ISO International Standard 1000. This publication covers the rules for use of SI units, their multiples and sub-multiples. It can be obtained from the American National Standards Institute 25 West 43rd Street, New York, NY 10036.

The International System of Units, Special Publication 330 of the National Institute of Standards and Technology—Gaithersburg, MD 20899.

Binary Multiples.—The International Electrotechnical Commission has assigned the following prefixes to represent exponential binary multiples. This avoids confusion with standard SI decimal prefixes when representing powers of 2, as in bits and bytes.

Symbol	Name	Binary Power	Symbol	Name	Binary Power	Symbol	Name	Binary Power
Ki	kibi	2^{10}	Gi	gibi	2^{30}	Pi	pebi	2^{50}
Mi	mebi	2^{20}	Ti	tebi	2^{40}	Ei	exbi	2^{60}

Example 1: $2 \text{ Ki} = 2 \times 2^{10} = 2 \times 1,024 = 2,048$. This does *not* equal $2 \text{ K} = 2 \times 10^3 = 2,000$.

Example 2: 1 mebibyte = $1 \times 2^{20} = 1,048,576$ bytes. Again this does *not* equal 1 megabyte = $1 \times 10^6 = 1,000,000$ bytes, a value that is often confused with 1,048,576 bytes.

Table 1. International System (SI) Units

Physical Quantity	Name of Unit	Unit Symbol	Definition
Basic SI Units			
Length	meter	m	Distance traveled by light in vacuo during $1/299,792,458$ of a second.
Mass	kilogram	kg	Mass of the international prototype which is in the custody of the Bureau International des Poids et Mesures (BIPM) at Sèvres, near Paris.
Time	second	s	The duration of 9,192,631,770 periods of the radiation corresponding to the transition between the two hyperfine levels of the ground state of the cesium-133 atom.
Electric Current	ampere	A	The constant current which, if maintained in two parallel rectilinear conductors of infinite length, of negligible circular cross section, and placed at a distance of one meter apart in a vacuum, would produce between these conductors a force equal to 2×10^{-7} N/m length.
Thermodynamic Temperature	degree kelvin	K	The fraction $1/273.16$ of the thermodynamic temperature of the triple point of water.
Amount of Substance	mole	mol	The amount of substance of a system which contains as many elementary entities as there are atoms in 0.012 kilogram of carbon 12.
Luminous Intensity	candela	cd	Luminous intensity, in the perpendicular direction, of a surface of $1/600,000$ square meter of a black body at the temperature of freezing platinum under a pressure of 101,325 newtons per square meter.

Table 1. (Continued) International System (SI) Units

Physical Quantity	Name of Unit	Unit Symbol	Definition
SI Units Having Special Names			
Force	newton	$N = \text{kg}\cdot\text{m}/\text{s}^2$	That force which, when applied to a body having a mass of one kilogram, gives it an acceleration of one meter per second squared.
Work, Energy, Quantity of Heat	joule	$J = N\cdot\text{m}$	The work done when the point of application of a force of one newton is displaced through a distance of one meter in the direction of the force.
Electric Charge	coulomb	$C = A\cdot\text{s}$	The quantity of electricity transported in one second by a current of one ampere.
Electric Potential	volt	$V = W/A$	The difference of potential between two points of a conducting wire carrying a constant current of one ampere, when the power dissipated between these points is equal to one watt.
Electric Capacitance	farad	$F = C/V$	The capacitance of a capacitor between the plates of which there appears a difference of potential of one volt when it is charged by a quantity of electricity equal to one coulomb.
Electric Resistance	ohm	$\Omega = V/A$	The resistance between two points of a conductor when a constant difference of potential of one volt, applied between these two points, produces in this conductor a current of one ampere, this conductor not being the source of any electromotive force.
Magnetic Flux	weber	$\text{Wb} = V\cdot\text{s}$	The flux which, linking a circuit of one turn produces in it an electromotive force of one volt as it is reduced to zero at a uniform rate in one second.
Inductance	henry	$H = V\cdot\text{s}/A$	The inductance of a closed circuit in which an electromotive force of one volt is produced when the electric current in the circuit varies uniformly at the rate of one ampere per second.
Luminous Flux	lumen	$\text{lm} = \text{cd}\cdot\text{sr}$	The flux emitted within a unit solid angle of one steradian by a point source having a uniform intensity of one candela.
Illumination	lux	$\text{lx} = \text{lm}/\text{m}^2$	An illumination of one lumen per square meter.

Table 2. International System (SI) Units with Complex Names

Physical Quantity	SI Unit	Unit Symbol
SI Units Having Complex Names		
Area	square meter	m^2
Volume	cubic meter	m^3
Frequency	hertz ^a	Hz
Density (Mass Density)	kilogram per cubic meter	kg/m^3
Velocity	meter per second	m/s
Angular Velocity	radian per second	rad/s
Acceleration	meter per second squared	m/s^2
Angular Acceleration	radian per second squared	rad/s^2
Pressure	pascal ^b	Pa
Surface Tension	newton per meter	N/m
Dynamic Viscosity	newton second per meter squared	$\text{N s}/\text{m}^2$
Kinematic Viscosity	} meter squared per second	m^2/s
Diffusion Coefficient		
Thermal Conductivity	watt per meter degree Kelvin	$\text{W}/(\text{m } ^\circ\text{K})$
Electric Field Strength	volt per meter	V/m
Magnetic Flux Density	tesla ^c	T
Magnetic Field Strength	ampere per meter	A/m
Luminance	candela per square meter	cd/m^2

^a Hz = cycle/second^b Pa = newton/meter²^c T = weber/meter²

Standard of Length.—In 1866 the United States, by act of Congress, passed a law making legal the meter, the only measure of length that has been legalized by the United States Government. The United States yard is defined by the relation: 1 yard = $\frac{3600}{3937}$ meter. The legal equivalent of the meter for commercial purposes was fixed as 39.37 inches, by law, in July, 1866, and experience having shown that this value was exact within the error of observation, the United States Office of Standard Weights and Measures was, in 1893, authorized to derive the yard from the meter by the use of this relation. The United States prototype meters Nos. 27 and 21 were received from the International Bureau of Weights and Measures in 1889. Meter No. 27, sealed in its metal case, is preserved in a fireproof vault at the Bureau of Standards.

Comparisons made prior to 1893 indicated that the relation of the yard to the meter, fixed by the Act of 1866, was by chance the exact relation between the international meter and the British imperial yard, within the error of observation. A subsequent comparison made between the standards just mentioned indicates that the legal relation adopted by Congress is in error 0.0001 inch; but, in view of the fact that certain comparisons made by the English Standards Office between the imperial yard and its authentic copies show variations as great if not greater than this, it cannot be said with certainty that there is a difference between the imperial yard of Great Britain and the United States yard derived from the meter. The bronze yard No. 11, which was an exact copy of the British imperial yard both in form and material, had shown changes when compared with the imperial yard in 1876 and 1888, which could not reasonably be said to be entirely due to changes in Bronze No. 11. On the other hand, the new meters represented the most advanced ideas of standards, and it therefore seemed that greater stability as well as higher accuracy would be secured by accepting the international meter as a fundamental standard of length.

U.S. Customary Unit System

The USCS is originated from the foot-pound-second unit system or English unit system. The USCS system and English unit system are same for the measures of length and mass, but it varies for the measure of capacity. The U.S. gallon is defined as 231 cubic inches and bushel as 2,150.42 cubic inches where as the corresponding English units are 277.42 cubic inches and 2,219.36 cubic inches.

Fundamental Constants

Name	Symbol	USCS units	SI units
Avogadro's number	N_A		$6.022 \times 10^{23} \text{ mol}^{-1}$
Boltzman constant	k	$5.65 \times 10^{-24} \text{ ft} \cdot \text{lb}_f / ^\circ\text{R}$	$1.38065 \times 10^{-23} \text{ J} / ^\circ\text{K}$
Faraday Constant	F		96487 C/mol
Gravitational constant	g	$32.174 \text{ lb}_m \cdot \text{ft} / \text{lb}_f \cdot \text{sec}^2$	$9.80667 \text{ m} / \text{sec}^2$
Gravitational constant	G	$5.65 \times 10^{-24} \text{ ft} \cdot \text{lb}_f / ^\circ\text{R}$	$6.672 \times 10^{-11} \text{ N} \cdot \text{m}^2 / \text{kg}^2$
Specific gas constant	R	$53.3 \text{ ft} \cdot \text{lb}_f / \text{lb}_m \cdot ^\circ\text{R}$	$287 \text{ J} / \text{kg} \cdot ^\circ\text{K}$
Universal gas constant	R	$1545 \text{ ft} \cdot \text{lb}_f / \text{lbmol} \cdot ^\circ\text{R}$	$8314 \text{ J} / \text{kmol} \cdot ^\circ\text{K}$
Volume (molal ideal gas)	V	$359 \text{ ft}^3 / \text{lbmol}$	$22.41 \text{ m}^3 / \text{kmol}$
Pressure, atmospheric	P	$14.696 \text{ lb}_f / \text{in}^2$	$101330 \text{ Pa} (\text{n} / \text{m}^2)$
Temperature, standard	T	32°F	0°C
Density			
Air at 32°F (0°C)		$0.0805 \text{ lb}_m / \text{ft}^3$	$1.29 \text{ kg} / \text{m}^3$
Air at 70°F (20°C), 1 atm		$0.0749 \text{ lb}_m / \text{ft}^3$	$1.20 \text{ kg} / \text{m}^3$
Sea water		$64 \text{ lb}_m / \text{ft}^3$	$1025 \text{ kg} / \text{m}^3$
Fresh water		$62.4 \text{ lb}_m / \text{ft}^3$	$1000 \text{ kg} / \text{m}^3$
Mercury		$849 \text{ lb}_m / \text{ft}^3$	$13600 \text{ kg} / \text{m}^3$
Earth		$345 \text{ lb}_m / \text{ft}^3$	$5520 \text{ kg} / \text{m}^3$

U.S. SYSTEM AND METRIC SYSTEM CONVERSIONS

Units of Length

Table 1. Linear Measure Conversion Factors

Metric	US Customary
<i>1 kilometer (km) =</i> 1000 meters 100,000 centimeters 1,000,000 millimeters 0.539956 nautical mile 0.621371 mile 1093.61 yards 3280.83 feet 39,370.08 inches	<i>1 mile (mi) =</i> 0.868976 nautical mile 1760 yards 5280 feet 63,360 inches 1.609344 kilometers 1609.344 meters 160,934.4 centimeters 1,609,344 millimeters
<i>1 meter (m) =</i> 10 decimeters 100 centimeters 1000 millimeters 1.09361 yards 3.28084 feet 39.37008 inches	<i>1 yard (yd) =</i> 3 feet 36 inches 0.9144 meter 91.44 centimeter 914.4 millimeter
<i>1 decimeter (dm) = 10 centimeters</i>	<i>1 foot (international) (ft) =</i> 12 inches = $\frac{1}{3}$ yard 0.3048 meter 30.48 centimeter 304.8 millimeters
<i>1 centimeter (cm) =</i> 0.01 meter 10 millimeters 0.0328 foot 0.3937 inch	<i>1 survey foot =</i> 1.000002 international foot $\frac{12}{39.37} = 0.3048006096012$ meter
<i>1 millimeter (mm) =</i> 0.001 meter 0.1 centimeter 1000 micron 0.03937 inch	<i>1 inch (in) =</i> 1000 mils 1,000,000 micro-inch 2.54 centimeters 25.4 millimeters 25,400 microns
<i>1 micrometer or micron (μm) =</i> 0.000001 meter = one millionth meter 0.0001 centimeter 0.001 millimeter 0.00003937 inch 39.37 micro-inches	<i>1 mil =</i> 0.001 inch 1000 micro-inches 0.0254 millimeters
	<i>1 micro-inch (μin) =</i> 0.000001 inch = one millionth inch 0.0254 micrometer (micron)

Note: Figures in **Bold** indicate exact conversion values

Surveyors Measure	Nautical Measure
<i>1 mile = 8 furlongs = 80 chains</i>	<i>1 league = 3 nautical miles</i>
<i>1 furlong = 10 chains = 220 yards</i>	<i>1 nautical mile =</i> 1.1508 statute miles 6076.11549 feet 1.8516 kilometers
<i>1 chain =</i> 4 rods = 22 yards = 66 feet = 100 links	<i>1 fathom = 2 yards = 6 feet</i>
<i>1 rod =</i> 5.5 yards = 16.5 feet = 25 links 5.0292 meter	<i>1 knot = nautical unit of speed =</i> 1 nautical mile per hour 1.1508 statute miles per hour 1.8516 kilometers per hour
<i>1 link = 7.92 inches</i>	
<i>1 span = 9 inches</i>	
<i>1 hand = 4 inches</i>	

Table 1. (Continued) Linear Measure Conversion Factors

<i>One degree at the equator =</i> 60 nautical miles 69.047 statute miles 111.098 kilometers	<i>360 degrees at the equator =</i> circumference at equator 21,600 nautical miles 24,856.8 statute miles 39,995.4 kilometers
<i>One minute at the equator =</i> 1 nautical mile 1.1508 statute miles 1.8516 kilometers	

Table 2. Circular and Angular Measure Conversion Factors

<i>circumference of circle =</i> 360 degrees = 2π radian = 6.283185 radian	<i>1 degree (°) = 60 minutes = 3600 seconds =</i> $\pi/180$ radian = 0.017453 radian
<i>1 quadrant = 90 degrees = $\pi/2$ radian =</i> 1.570796 radian	<i>1 minute (′) = 60 seconds = 0.016667 degrees =</i> 0.000291 radian
<i>1 radian = 57.2957795 degrees</i>	$\pi = 3.141592654$

Table 3. Feet and Inches to Inches Conversion

Inches →	0	1	2	3	4	5	6	7	8	9	10	11
Feet ↓	Inches											
0	0	1	2	3	4	5	6	7	8	9	10	11
1	12	13	14	15	16	17	18	19	20	21	22	23
2	24	25	26	27	28	29	30	31	32	33	34	35
3	36	37	38	39	40	41	42	43	44	45	46	47
4	48	49	50	51	52	53	54	55	56	57	58	59
5	60	61	62	63	64	65	66	67	68	69	70	71
6	72	73	74	75	76	77	78	79	80	81	82	83
7	84	85	86	87	88	89	90	91	92	93	94	95
8	96	97	98	99	100	101	102	103	104	105	106	107
9	108	109	110	111	112	113	114	115	116	117	118	119
10	120	121	122	123	124	125	126	127	128	129	130	131
20	240	241	242	243	244	245	246	247	248	249	250	251
30	360	361	362	363	364	365	366	367	368	369	370	371
40	480	481	482	483	484	485	486	487	488	489	490	491
50	600	601	602	603	604	605	606	607	608	609	610	611
60	720	721	722	723	724	725	726	727	728	729	730	731
70	840	841	842	843	844	845	846	847	848	849	850	851
80	960	961	962	963	964	965	966	967	968	969	970	971
90	1080	1081	1082	1083	1084	1085	1086	1087	1088	1089	1090	1091
100	1200	1201	1202	1203	1204	1205	1206	1207	1208	1209	1210	1211

Example: A tape measure reads 17 feet 8 inches. How many inches is this? *Solution:* Read down the first column of **Table 3** to find 10 ft 0 inch = 120 inches. Next, find the intersection of the 7 ft row and the 8 inch column to get 92 inches. Add both results to get 120 inches + 92 inches = 212 inches.

Table 4. Inches to Feet and Yards Conversion

inch	feet	yard	inch	feet	yard	inch	feet	yard	inch	feet	yard	inch	feet	yard
100	8.3333	2.7778	10	0.8333	0.2778	1	0.0833	0.0278	0.1	0.0083	0.0028	0.01	0.0008	0.0003
200	16.6667	5.5556	20	1.6667	0.5556	2	0.1667	0.0556	0.2	0.0167	0.0056	0.02	0.0017	0.0006
300	25	8.3333	30	2.5	0.8333	3	0.25	0.0833	0.3	0.025	0.0083	0.03	0.0025	0.0008
400	33.3333	11.1111	40	3.3333	1.1111	4	0.3333	0.1111	0.4	0.0333	0.0111	0.04	0.0033	0.0011
500	41.6667	13.8889	50	4.1667	1.3889	5	0.4167	0.1389	0.5	0.0417	0.0139	0.05	0.0042	0.0014
600	50	16.6667	60	5	1.6667	6	0.5	0.1667	0.6	0.05	0.0167	0.06	0.005	0.0017
700	58.3333	19.4444	70	5.8333	1.9444	7	0.5833	0.1944	0.7	0.0583	0.0194	0.07	0.0058	0.0019
800	66.6667	22.2222	80	6.6667	2.2222	8	0.6667	0.2222	0.8	0.0667	0.0222	0.08	0.0067	0.0022
900	75	25.0000	90	7.5	2.5000	9	0.75	0.2500	0.9	0.075	0.0250	0.09	0.0075	0.0025
1000	83.3333	27.7778	100	8.3333	2.7778	10	0.8333	0.2778	1	0.0833	0.0278	0.1	0.0083	0.0028

Table 6. Feet to Inches Conversion

feet	inch	feet	inch	feet	inch	feet	inch	feet	inch	feet	inch	feet	inch
100	1200	10	120	1	12	0.1	1.2	0.01	0.12	0.001	0.012	0.0001	0.0012
200	2400	20	240	2	24	0.2	2.4	0.02	0.24	0.002	0.024	0.0002	0.0024
300	3600	30	360	3	36	0.3	3.6	0.03	0.36	0.003	0.036	0.0003	0.0036
400	4800	40	480	4	48	0.4	4.8	0.04	0.48	0.004	0.048	0.0004	0.0048
500	6000	50	600	5	60	0.5	6	0.05	0.6	0.005	0.06	0.0005	0.006
600	7200	60	720	6	72	0.6	7.2	0.06	0.72	0.006	0.072	0.0006	0.0072
700	8400	70	840	7	84	0.7	8.4	0.07	0.84	0.007	0.084	0.0007	0.0084
800	9600	80	960	8	96	0.8	9.6	0.08	0.96	0.008	0.096	0.0008	0.0096
900	10800	90	1080	9	108	0.9	10.8	0.09	1.08	0.009	0.108	0.0009	0.0108
1000	12000	100	1200	10	120	1	12	0.1	1.2	0.01	0.12	0.001	0.012

Table 7. Fractional Inch to Decimal Inch and Millimeter

Fractional Inch	Decimal Inch	Millimeters	Fractional Inch	Decimal Inch	Millimeters
1/64	0.015625	0.396875		0.511811024	13
1/32	0.03125	0.79375	33/64	0.515625	13.096875
	0.039370079	1	17/32	0.53125	13.49375
3/64	0.046875	1.190625	35/64	0.546875	13.890625
1/16	0.0625	1.5875		0.551181102	14
5/64	0.078125	1.984375	9/16	0.5625	14.2875
	0.078740157	2	37/64	0.578125	14.684375
3/32	0.09375	2.38125		0.590551181	15
7/64	0.109375	2.778125	19/32	0.59375	15.08125
	0.118110236	3	39/64	0.609375	15.478125
1/8	0.125	3.175	5/8	0.625	15.875
9/64	0.140625	3.571875		0.62992126	16
5/32	0.15625	3.96875	41/64	0.640625	16.271875
	0.157480315	4	21/32	0.65625	16.66875
11/64	0.171875	4.365625		0.669291339	17
3/16	0.1875	4.7625	43/64	0.671875	17.065625
	0.196850394	5	11/16	0.6875	17.4625
13/64	0.203125	5.159375	45/64	0.703125	17.859375
7/32	0.21875	5.55625		0.708661417	18
15/64	0.234375	5.953125	23/32	0.71875	18.25625
	0.236220472	6	47/64	0.734375	18.653125
1/4	0.25	6.35		0.748031496	19
17/64	0.265625	6.746875	3/4	0.75	19.05
	0.275590551	7	49/64	0.765625	19.446875
9/32	0.28125	7.14375	25/32	0.78125	19.84375
19/64	0.296875	7.540625		0.787401575	20
5/16	0.3125	7.9375	51/64	0.796875	20.240625
	0.31496063	8	13/16	0.8125	20.6375
21/64	0.328125	8.334375		0.826771654	21
11/32	0.34375	8.73125	53/64	0.828125	21.034375
	0.354330709	9	27/32	0.84375	21.43125
23/64	0.359375	9.128125	55/64	0.859375	21.828125
3/8	0.375	9.525		0.866141732	22
25/64	0.390625	9.921875	7/8	0.875	22.225
	0.393700787	10	57/64	0.890625	22.621875
13/32	0.40625	10.31875		0.905511811	23
27/64	0.421875	10.715625	29/32	0.90625	23.01875
	0.433070866	11	59/64	0.921875	23.415625
7/16	0.4375	11.1125	15/16	0.9375	23.8125
29/64	0.453125	11.509375		0.94488189	24
15/32	0.46875	11.90625	61/64	0.953125	24.209375
	0.472440945	12	31/32	0.96875	24.60625
31/64	0.484375	12.303125		0.984251969	25
1/2	0.5	12.7	63/64	0.984375	25.003125

Table 8a. Inch to Millimeters Conversion

inch	mm	inch	mm	inch	mm	inch	mm	inch	mm	inch	mm
10	254.00000	1	25.40000	0.1	2.54000	.01	0.25400	0.001	0.02540	0.0001	0.00254
20	508.00000	2	50.80000	0.2	5.08000	.02	0.50800	0.002	0.05080	0.0002	0.00508
30	762.00000	3	76.20000	0.3	7.62000	.03	0.76200	0.003	0.07620	0.0003	0.00762
40	1,016.00000	4	101.60000	0.4	10.16000	.04	1.01600	0.004	0.10160	0.0004	0.01016
50	1,270.00000	5	127.00000	0.5	12.70000	.05	1.27000	0.005	0.12700	0.0005	0.01270
60	1,524.00000	6	152.40000	0.6	15.24000	.06	1.52400	0.006	0.15240	0.0006	0.01524
70	1,778.00000	7	177.80000	0.7	17.78000	.07	1.77800	0.007	0.17780	0.0007	0.01778
80	2,032.00000	8	203.20000	0.8	20.32000	.08	2.03200	0.008	0.20320	0.0008	0.02032
90	2,286.00000	9	228.60000	0.9	22.86000	.09	2.28600	0.009	0.22860	0.0009	0.02286
100	2,540.00000	10	254.00000	1.0	25.40000	.10	2.54000	0.010	0.25400	0.0010	0.02540

All values in this table are exact. For inches to centimeters, shift decimal point in mm column one place to left and read centimeters, thus, for example, 40 in. = 1016 mm = 101.6 cm.

Table 8b. Millimeters to Inch Conversion

mm	inch	mm	inch	mm	inch	mm	inch	mm	inch	mm	inch
100	3.93701	10	0.39370	1	0.03937	0.1	0.00394	0.01	.000039	0.001	0.00004
200	7.87402	20	0.78740	2	0.07874	0.2	0.00787	0.02	.000079	0.002	0.00008
300	11.81102	30	1.18110	3	0.11811	0.3	0.01181	0.03	.00118	0.003	0.00012
400	15.74803	40	1.57480	4	0.15748	0.4	0.01575	0.04	.00157	0.004	0.00016
500	19.68504	50	1.96850	5	0.19685	0.5	0.01969	0.05	.00197	0.005	0.00020
600	23.62205	60	2.36220	6	0.23622	0.6	0.02362	0.06	.00236	0.006	0.00024
700	27.55906	70	2.75591	7	0.27559	0.7	0.02756	0.07	.00276	0.007	0.00028
800	31.49606	80	3.14961	8	0.31496	0.8	0.03150	0.08	.00315	0.008	0.00031
900	35.43307	90	3.54331	9	0.35433	0.9	0.03543	0.09	.00354	0.009	0.00035
1,000	39.37008	100	3.93701	10	0.39370	1.0	0.03937	0.10	.00394	0.010	0.00039

Based on 1 inch = 25.4 millimeters, exactly. For centimeters to inches, shift decimal point of centimeter value one place to right and enter mm column, thus, for example, 70 cm = 700 mm = 27.55906 inches.

Table 9. Feet to Millimeters Conversion

feet	mm	feet	mm	feet	mm	feet	mm	feet	mm
100	30,480	10	3,048	1	304.8	0.1	30.48	0.01	3.048
200	60,960	20	6,096	2	609.6	0.2	60.96	0.02	6.096
300	91,440	30	9,144	3	914.4	0.3	91.44	0.03	9.144
400	121,920	40	12,192	4	1,219.2	0.4	121.92	0.04	12.192
500	152,400	50	15,240	5	1,524.0	0.5	152.40	0.05	15.240
600	182,880	60	18,288	6	1,828.8	0.6	182.88	0.06	18.288
700	213,360	70	21,336	7	2,133.6	0.7	213.36	0.07	21.336
800	243,840	80	24,384	8	2,438.4	0.8	243.84	0.08	24.384
900	274,320	90	27,432	9	2,743.2	0.9	274.32	0.09	27.432
1,000	304,800	100	30,480	10	3,048.0	1.0	304.80	0.10	30.480

Based on 1 inch = 25.4 millimeters, exactly. All values in this table are exact.

Example 1: Convert 293 feet, $5\frac{47}{64}$ inches to mm.

200 ft	=	60,960.0	mm
90 ft	=	27,432.0	mm
3 ft	=	914.4	mm
5 inch	=	127.0	mm
$\frac{47}{64}$ inch	=	18.653	mm
293 ft $5\frac{47}{64}$ inch	=	89,452.053	mm

Example 2: Convert 71.86 feet to mm.

70.0	feet	=	21,336.0	mm
1.0	feet	=	304.8	mm
0.80	feet	=	243.84	mm
0.06	feet	=	18.288	mm
71.86	feet	=	21,902.928	mm

Table 10. Mixed Fractional Inches to Millimeters Conversion for 0 to 41 Inches in 1/64-Inch Increments

→ Inches↓	0	1	2	3	4	5	6	7	8	9	10	20	30	40
	Millimeters													
0	0	25.4	50.8	76.2	101.6	127.0	152.4	177.8	203.2	228.6	254.0	508.0	762.0	1016.0
1/64	0.396875	25.796875	51.196875	76.596875	101.996875	127.396875	152.796875	178.196875	203.596875	228.996875	254.396875	508.396875	762.396875	1016.396875
1/32	0.79375	26.19375	51.59375	76.99375	102.39375	127.79375	153.19375	178.59375	203.99375	229.39375	254.79375	508.79375	762.79375	1016.79375
3/64	1.190625	26.590625	51.990625	77.390625	102.790625	128.190625	153.590625	178.990625	204.390625	229.790625	255.190625	509.190625	763.190625	1017.190625
1/16	1.5875	26.9875	52.3875	77.7875	103.1875	128.5875	153.9875	179.3875	204.7875	230.1875	255.5875	509.5875	763.5875	1017.5875
5/64	1.984375	27.384375	52.784375	78.184375	103.584375	128.984375	154.384375	179.784375	205.184375	230.584375	255.984375	509.984375	763.984375	1017.984375
3/32	2.38125	27.78125	53.18125	78.58125	103.98125	129.38125	154.78125	180.18125	205.58125	230.98125	256.38125	510.38125	764.38125	1018.38125
7/64	2.778125	28.178125	53.578125	78.978125	104.378125	129.778125	155.178125	180.578125	205.978125	231.378125	256.778125	510.778125	764.778125	1018.778125
1/8	3.175	28.575	53.975	79.375	104.775	130.175	155.575	180.975	206.375	231.775	257.175	511.175	765.175	1019.175
9/64	3.571875	28.971875	54.371875	79.771875	105.171875	130.571875	155.971875	181.371875	206.771875	232.171875	257.571875	511.571875	765.571875	1019.571875
5/32	3.96875	29.36875	54.76875	80.16875	105.56875	130.96875	156.36875	181.76875	207.16875	232.56875	257.96875	511.96875	765.96875	1019.96875
11/64	4.365625	29.765625	55.165625	80.565625	105.965625	131.365625	156.765625	182.165625	207.565625	232.965625	258.365625	512.365625	766.365625	1020.365625
3/16	4.7625	30.1625	55.5625	80.9625	106.3625	131.7625	157.1625	182.5625	207.9625	233.3625	258.7625	512.7625	766.7625	1020.7625
13/64	5.159375	30.559375	55.959375	81.359375	106.759375	132.159375	157.559375	182.959375	208.359375	233.759375	259.159375	513.159375	767.159375	1021.159375
7/32	5.55625	30.95625	56.35625	81.75625	107.15625	132.55625	157.95625	183.35625	208.75625	234.15625	259.55625	513.55625	767.55625	1021.55625
15/64	5.953125	31.353125	56.753125	82.153125	107.553125	132.953125	158.353125	183.753125	209.153125	234.553125	259.953125	513.953125	767.953125	1021.953125
1/4	6.35	31.75	57.15	82.55	107.95	133.35	158.75	184.15	209.55	234.95	260.35	514.35	768.35	1022.35
17/64	6.746875	32.146875	57.546875	82.946875	108.346875	133.746875	159.146875	184.546875	209.946875	235.346875	260.746875	514.746875	768.746875	1022.746875
9/32	7.14375	32.54375	57.94375	83.34375	108.74375	134.14375	159.54375	184.94375	210.34375	235.74375	261.14375	515.14375	769.14375	1023.14375
19/64	7.540625	32.940625	58.340625	83.740625	109.140625	134.540625	159.940625	185.340625	210.740625	236.140625	261.540625	515.540625	769.540625	1023.540625
5/16	7.9375	33.3375	58.7375	84.1375	109.5375	134.9375	160.3375	185.7375	211.1375	236.5375	261.9375	515.9375	769.9375	1023.9375
21/64	8.334375	33.734375	59.134375	84.534375	109.934375	135.334375	160.734375	186.134375	211.534375	236.934375	262.334375	516.334375	770.334375	1024.334375
11/32	8.73125	34.13125	59.53125	84.93125	110.33125	135.73125	161.13125	186.53125	211.93125	237.33125	262.73125	516.73125	770.73125	1024.73125
23/64	9.128125	34.528125	59.928125	85.328125	110.728125	136.128125	161.528125	186.928125	212.328125	237.728125	263.128125	517.128125	771.128125	1025.128125
3/8	9.525	34.925	60.325	85.725	111.125	136.525	161.925	187.325	212.725	238.125	263.525	517.525	771.525	1025.525
25/64	9.921875	35.321875	60.721875	86.121875	111.521875	136.921875	162.321875	187.721875	213.121875	238.521875	263.921875	517.921875	771.921875	1025.921875
13/32	10.31875	35.71875	61.11875	86.51875	111.91875	137.31875	162.71875	188.11875	213.51875	238.91875	264.31875	518.31875	772.31875	1026.31875
27/64	10.715625	36.115625	61.515625	86.915625	112.315625	137.715625	163.115625	188.515625	213.915625	239.315625	264.715625	518.715625	772.715625	1026.715625
7/16	11.1125	36.5125	61.9125	87.3125	112.7125	138.1125	163.5125	188.9125	214.3125	239.7125	265.1125	519.1125	773.1125	1027.1125
29/64	11.509375	36.909375	62.309375	87.709375	113.109375	138.509375	163.909375	189.309375	214.709375	240.109375	265.509375	519.509375	773.509375	1027.509375
15/32	11.90625	37.30625	62.70625	88.10625	113.50625	138.90625	164.30625	189.70625	215.10625	240.50625	265.90625	519.90625	773.90625	1027.90625
31/64	12.303125	37.703125	63.103125	88.503125	113.903125	139.303125	164.703125	190.103125	215.503125	240.903125	266.303125	520.303125	774.303125	1028.303125
1/2	12.7	38.1	63.5	88.9	114.3	139.7	165.1	190.5	215.9	241.3	266.7	520.7	774.7	1028.7

Table 10. (Continued) Mixed Fractional Inches to Millimeters Conversion for 0 to 41 Inches in $\frac{1}{64}$ -Inch Increments

→ Inches↓	0	1	2	3	4	5	6	7	8	9	10	20	30	40
	Millimeters													
33/64	13.096875	38.496875	63.896875	89.296875	114.696875	140.096875	165.496875	190.896875	216.296875	241.696875	267.096875	521.096875	775.096875	1029.096875
17/32	13.49375	38.89375	64.29375	89.69375	115.09375	140.49375	165.89375	191.29375	216.69375	242.09375	267.49375	521.49375	775.49375	1029.49375
35/64	13.890625	39.290625	64.690625	90.090625	115.490625	140.890625	166.290625	191.690625	217.090625	242.490625	267.890625	521.890625	775.890625	1029.890625
9/16	14.2875	39.6875	65.0875	90.4875	115.8875	141.2875	166.6875	192.0875	217.4875	242.8875	268.2875	522.2875	776.2875	1030.2875
37/64	14.684375	40.084375	65.484375	90.884375	116.284375	141.684375	167.084375	192.484375	217.884375	243.284375	268.684375	522.684375	776.684375	1030.684375
19/32	15.08125	40.48125	65.88125	91.28125	116.68125	142.08125	167.48125	192.88125	218.28125	243.68125	269.08125	523.08125	777.08125	1031.08125
39/64	15.478125	40.878125	66.278125	91.678125	117.078125	142.478125	167.878125	193.278125	218.678125	244.078125	269.478125	523.478125	777.478125	1031.478125
5/8	15.875	41.275	66.675	92.075	117.475	142.875	168.275	193.675	219.075	244.475	269.875	523.875	777.875	1031.875
41/64	16.271875	41.671875	67.071875	92.471875	117.871875	143.271875	168.671875	194.071875	219.471875	244.871875	270.271875	524.271875	778.271875	1032.271875
21/32	16.66875	42.06875	67.46875	92.86875	118.26875	143.66875	169.06875	194.46875	219.86875	245.26875	270.66875	524.66875	778.66875	1032.66875
43/64	17.065625	42.465625	67.865625	93.265625	118.665625	144.065625	169.465625	194.865625	220.265625	245.665625	271.065625	525.065625	779.065625	1033.065625
11/16	17.4625	42.8625	68.2625	93.6625	119.0625	144.4625	169.8625	195.2625	220.6625	246.0625	271.4625	525.4625	779.4625	1033.4625
45/64	17.859375	43.259375	68.659375	94.059375	119.459375	144.859375	170.259375	195.659375	221.059375	246.459375	271.859375	525.859375	779.859375	1033.859375
23/32	18.25625	43.65625	69.05625	94.45625	119.85625	145.25625	170.65625	196.05625	221.45625	246.85625	272.25625	526.25625	780.25625	1034.25625
47/64	18.653125	44.053125	69.453125	94.853125	120.253125	145.653125	171.053125	196.453125	221.853125	247.253125	272.653125	526.653125	780.653125	1034.653125
3/4	19.05	44.45	69.85	95.25	120.65	146.05	171.45	196.85	222.25	247.65	273.05	527.05	781.05	1035.05
49/64	19.446875	44.846875	70.246875	95.646875	121.046875	146.446875	171.846875	197.246875	222.646875	248.046875	273.446875	527.446875	781.446875	1035.446875
25/32	19.84375	45.24375	70.64375	96.04375	121.44375	146.84375	172.24375	197.64375	223.04375	248.44375	273.84375	527.84375	781.84375	1035.84375
51/64	20.240625	45.640625	71.040625	96.440625	121.840625	147.240625	172.640625	198.040625	223.440625	248.840625	274.240625	528.240625	782.240625	1036.240625
13/16	20.6375	46.0375	71.4375	96.8375	122.2375	147.6375	173.0375	198.4375	223.8375	249.2375	274.6375	528.6375	782.6375	1036.6375
53/64	21.034375	46.434375	71.834375	97.234375	122.634375	148.034375	173.434375	198.834375	224.234375	249.634375	275.034375	529.034375	783.034375	1037.034375
27/32	21.43125	46.83125	72.23125	97.63125	123.03125	148.43125	173.83125	199.23125	224.63125	250.03125	275.43125	529.43125	783.43125	1037.43125
55/64	21.828125	47.228125	72.628125	98.028125	123.428125	148.828125	174.228125	199.628125	225.028125	250.428125	275.828125	529.828125	783.828125	1037.828125
7/8	22.225	47.625	73.025	98.425	123.825	149.225	174.625	200.025	225.425	250.825	276.225	530.225	784.225	1038.225
57/64	22.621875	48.021875	73.421875	98.821875	124.221875	149.621875	175.021875	200.421875	225.821875	251.221875	276.621875	530.621875	784.621875	1038.621875
29/32	23.01875	48.41875	73.81875	99.21875	124.61875	150.01875	175.41875	200.81875	226.21875	251.61875	277.01875	531.01875	785.01875	1039.01875
59/64	23.415625	48.815625	74.215625	99.615625	125.015625	150.415625	175.815625	201.215625	226.615625	252.015625	277.415625	531.415625	785.415625	1039.415625
15/16	23.8125	49.2125	74.6125	100.0125	125.4125	150.8125	176.2125	201.6125	227.0125	252.4125	277.8125	531.8125	785.8125	1039.8125
61/64	24.209375	49.609375	75.009375	100.409375	125.809375	151.209375	176.609375	202.009375	227.409375	252.809375	278.209375	532.209375	786.209375	1040.209375
31/32	24.60625	50.00625	75.40625	100.80625	126.20625	151.60625	177.00625	202.40625	227.80625	253.20625	278.60625	532.60625	786.60625	1040.60625
63/64	25.003125	50.403125	75.803125	101.203125	126.603125	152.003125	177.403125	202.803125	228.203125	253.603125	279.003125	533.003125	787.003125	1041.003125
1	25.4	50.8	76.2	101.6	127	152.4	177.8	203.2	228.6	254	279.4	533.4	787.4	1041.4

FRACTIONAL INCH TO MILLIMETER CONVERSION

Based on 1 inch = 25.4 millimeters, exactly. All values in this table are exact. *Example:* Convert $21\frac{23}{64}$ inches to millimeters. *Solution:* From the first page of this table, find 20 inches = 508.0 millimeters and add to that $1\frac{23}{64}$ inches = 34.528125 millimeters found at the intersection of the 1- inch column and the row containing $\frac{23}{64}$ inch. Thus, $21\frac{23}{64}$ inches = 508.0 + 34.528125 = 542.528125 mm, exactly.

Table 11. Decimals of an Inch to Millimeters Conversion

→ Inches ↓	0.000	0.001	0.002	0.003	0.004	0.005	0.006	0.007	0.008	0.009
	Millimeters									
0.000	...	0.0254	0.0508	0.0762	0.1016	0.1270	0.1524	0.1778	0.2032	0.2286
0.010	0.2540	0.2794	0.3048	0.3302	0.3556	0.3810	0.4064	0.4318	0.4572	0.4826
0.020	0.5080	0.5334	0.5588	0.5842	0.6096	0.6350	0.6604	0.6858	0.7112	0.7366
0.030	0.7620	0.7874	0.8128	0.8382	0.8636	0.8890	0.9144	0.9398	0.9652	0.9906
0.040	1.0160	1.0414	1.0668	1.0922	1.1176	1.1430	1.1684	1.1938	1.2192	1.2446
0.050	1.2700	1.2954	1.3208	1.3462	1.3716	1.3970	1.4224	1.4478	1.4732	1.4986
0.060	1.5240	1.5494	1.5748	1.6002	1.6256	1.6510	1.6764	1.7018	1.7272	1.7526
0.070	1.7780	1.8034	1.8288	1.8542	1.8796	1.9050	1.9304	1.9558	1.9812	2.0066
0.080	2.0320	2.0574	2.0828	2.1082	2.1336	2.1590	2.1844	2.2098	2.2352	2.2606
0.090	2.2860	2.3114	2.3368	2.3622	2.3876	2.4130	2.4384	2.4638	2.4892	2.5146
0.100	2.5400	2.5654	2.5908	2.6162	2.6416	2.6670	2.6924	2.7178	2.7432	2.7686
0.110	2.7940	2.8194	2.8448	2.8702	2.8956	2.9210	2.9464	2.9718	2.9972	3.0226
0.120	3.0480	3.0734	3.0988	3.1242	3.1496	3.1750	3.2004	3.2258	3.2512	3.2766
0.130	3.3020	3.3274	3.3528	3.3782	3.4036	3.4290	3.4544	3.4798	3.5052	3.5306
0.140	3.5560	3.5814	3.6068	3.6322	3.6576	3.6830	3.7084	3.7338	3.7592	3.7846
0.150	3.8100	3.8354	3.8608	3.8862	3.9116	3.9370	3.9624	3.9878	4.0132	4.0386
0.160	4.0640	4.0894	4.1148	4.1402	4.1656	4.1910	4.2164	4.2418	4.2672	4.2926
0.170	4.3180	4.3434	4.3688	4.3942	4.4196	4.4450	4.4704	4.4958	4.5212	4.5466
0.180	4.5720	4.5974	4.6228	4.6482	4.6736	4.6990	4.7244	4.7498	4.7752	4.8006
0.190	4.8260	4.8514	4.8768	4.9022	4.9276	4.9530	4.9784	5.0038	5.0292	5.0546
0.200	5.0800	5.1054	5.1308	5.1562	5.1816	5.2070	5.2324	5.2578	5.2832	5.3086
0.210	5.3340	5.3594	5.3848	5.4102	5.4356	5.4610	5.4864	5.5118	5.5372	5.5626
0.220	5.5880	5.6134	5.6388	5.6642	5.6896	5.7150	5.7404	5.7658	5.7912	5.8166
0.230	5.8420	5.8674	5.8928	5.9182	5.9436	5.9690	5.9944	6.0198	6.0452	6.0706
0.240	6.0960	6.1214	6.1468	6.1722	6.1976	6.2230	6.2484	6.2738	6.2992	6.3246
0.250	6.3500	6.3754	6.4008	6.4262	6.4516	6.4770	6.5024	6.5278	6.5532	6.5786
0.260	6.6040	6.6294	6.6548	6.6802	6.7056	6.7310	6.7564	6.7818	6.8072	6.8326
0.270	6.8580	6.8834	6.9088	6.9342	6.9596	6.9850	7.0104	7.0358	7.0612	7.0866
0.280	7.1120	7.1374	7.1628	7.1882	7.2136	7.2390	7.2644	7.2898	7.3152	7.3406
0.290	7.3660	7.3914	7.4168	7.4422	7.4676	7.4930	7.5184	7.5438	7.5692	7.5946
0.300	7.6200	7.6454	7.6708	7.6962	7.7216	7.7470	7.7724	7.7978	7.8232	7.8486
0.310	7.8740	7.8994	7.9248	7.9502	7.9756	8.0010	8.0264	8.0518	8.0772	8.1026
0.320	8.1280	8.1534	8.1788	8.2042	8.2296	8.2550	8.2804	8.3058	8.3312	8.3566
0.330	8.3820	8.4074	8.4328	8.4582	8.4836	8.5090	8.5344	8.5598	8.5852	8.6106
0.340	8.6360	8.6614	8.6868	8.7122	8.7376	8.7630	8.7884	8.8138	8.8392	8.8646
0.350	8.8900	8.9154	8.9408	8.9662	8.9916	9.0170	9.0424	9.0678	9.0932	9.1186
0.360	9.1440	9.1694	9.1948	9.2202	9.2456	9.2710	9.2964	9.3218	9.3472	9.3726
0.370	9.3980	9.4234	9.4488	9.4742	9.4996	9.5250	9.5504	9.5758	9.6012	9.6266
0.380	9.6520	9.6774	9.7028	9.7282	9.7536	9.7790	9.8044	9.8298	9.8552	9.8806
0.390	9.9060	9.9314	9.9568	9.9822	10.0076	10.0330	10.0584	10.0838	10.1092	10.1346
0.400	10.1600	10.1854	10.2108	10.2362	10.2616	10.2870	10.3124	10.3378	10.3632	10.3886
0.410	10.4140	10.4394	10.4648	10.4902	10.5156	10.5410	10.5664	10.5918	10.6172	10.6426
0.420	10.6680	10.6934	10.7188	10.7442	10.7696	10.7950	10.8204	10.8458	10.8712	10.8966
0.430	10.9220	10.9474	10.9728	10.9982	11.0236	11.0490	11.0744	11.0998	11.1252	11.1506
0.440	11.1760	11.2014	11.2268	11.2522	11.2776	11.3030	11.3284	11.3538	11.3792	11.4046
0.450	11.4300	11.4554	11.4808	11.5062	11.5316	11.5570	11.5824	11.6078	11.6332	11.6586
0.460	11.6840	11.7094	11.7348	11.7602	11.7856	11.8110	11.8364	11.8618	11.8872	11.9126
0.470	11.9380	11.9634	11.9888	12.0142	12.0396	12.0650	12.0904	12.1158	12.1412	12.1666
0.480	12.1920	12.2174	12.2428	12.2682	12.2936	12.3190	12.3444	12.3698	12.3952	12.4206
0.490	12.4460	12.4714	12.4968	12.5222	12.5476	12.5730	12.5984	12.6238	12.6492	12.6746
0.500	12.7000	12.7254	12.7508	12.7762	12.8016	12.8270	12.8524	12.8778	12.9032	12.9286

Table 11. (Continued) Decimals of an Inch to Millimeters Conversion

→ Inches ↓	0.000	0.001	0.002	0.003	0.004	0.005	0.006	0.007	0.008	0.009
	Millimeters									
0.510	12.9540	12.9794	13.0048	13.0302	13.0556	13.0810	13.1064	13.1318	13.1572	13.1826
0.520	13.2080	13.2334	13.2588	13.2842	13.3096	13.3350	13.3604	13.3858	13.4112	13.4366
0.530	13.4620	13.4874	13.5128	13.5382	13.5636	13.5890	13.6144	13.6398	13.6652	13.6906
0.540	13.7160	13.7414	13.7668	13.7922	13.8176	13.8430	13.8684	13.8938	13.9192	13.9446
0.550	13.9700	13.9954	14.0208	14.0462	14.0716	14.0970	14.1224	14.1478	14.1732	14.1986
0.560	14.2240	14.2494	14.2748	14.3002	14.3256	14.3510	14.3764	14.4018	14.4272	14.4526
0.570	14.4780	14.5034	14.5288	14.5542	14.5796	14.6050	14.6304	14.6558	14.6812	14.7066
0.580	14.7320	14.7574	14.7828	14.8082	14.8336	14.8590	14.8844	14.9098	14.9352	14.9606
0.590	14.9860	15.0114	15.0368	15.0622	15.0876	15.1130	15.1384	15.1638	15.1892	15.2146
0.600	15.2400	15.2654	15.2908	15.3162	15.3416	15.3670	15.3924	15.4178	15.4432	15.4686
0.610	15.4940	15.5194	15.5448	15.5702	15.5956	15.6210	15.6464	15.6718	15.6972	15.7226
0.620	15.7480	15.7734	15.7988	15.8242	15.8496	15.8750	15.9004	15.9258	15.9512	15.9766
0.630	16.0020	16.0274	16.0528	16.0782	16.1036	16.1290	16.1544	16.1798	16.2052	16.2306
0.640	16.2560	16.2814	16.3068	16.3322	16.3576	16.3830	16.4084	16.4338	16.4592	16.4846
0.650	16.5100	16.5354	16.5608	16.5862	16.6116	16.6370	16.6624	16.6878	16.7132	16.7386
0.660	16.7640	16.7894	16.8148	16.8402	16.8656	16.8910	16.9164	16.9418	16.9672	16.9926
0.670	17.0180	17.0434	17.0688	17.0942	17.1196	17.1450	17.1704	17.1958	17.2212	17.2466
0.680	17.2720	17.2974	17.3228	17.3482	17.3736	17.3990	17.4244	17.4498	17.4752	17.5006
0.690	17.5260	17.5514	17.5768	17.6022	17.6276	17.6530	17.6784	17.7038	17.7292	17.7546
0.700	17.7800	17.8054	17.8308	17.8562	17.8816	17.9070	17.9324	17.9578	17.9832	18.0086
0.710	18.0340	18.0594	18.0848	18.1102	18.1356	18.1610	18.1864	18.2118	18.2372	18.2626
0.720	18.2880	18.3134	18.3388	18.3642	18.3896	18.4150	18.4404	18.4658	18.4912	18.5166
0.730	18.5420	18.5674	18.5928	18.6182	18.6436	18.6690	18.6944	18.7198	18.7452	18.7706
0.740	18.7960	18.8214	18.8468	18.8722	18.8976	18.9230	18.9484	18.9738	18.9992	19.0246
0.750	19.0500	19.0754	19.1008	19.1262	19.1516	19.1770	19.2024	19.2278	19.2532	19.2786
0.760	19.3040	19.3294	19.3548	19.3802	19.4056	19.4310	19.4564	19.4818	19.5072	19.5326
0.770	19.5580	19.5834	19.6088	19.6342	19.6596	19.6850	19.7104	19.7358	19.7612	19.7866
0.780	19.8120	19.8374	19.8628	19.8882	19.9136	19.9390	19.9644	19.9898	20.0152	20.0406
0.790	20.0660	20.0914	20.1168	20.1422	20.1676	20.1930	20.2184	20.2438	20.2692	20.2946
0.800	20.3200	20.3454	20.3708	20.3962	20.4216	20.4470	20.4724	20.4978	20.5232	20.5486
0.810	20.5740	20.5994	20.6248	20.6502	20.6756	20.7010	20.7264	20.7518	20.7772	20.8026
0.820	20.8280	20.8534	20.8788	20.9042	20.9296	20.9550	20.9804	21.0058	21.0312	21.0566
0.830	21.0820	21.1074	21.1328	21.1582	21.1836	21.2090	21.2344	21.2598	21.2852	21.3106
0.840	21.3360	21.3614	21.3868	21.4122	21.4376	21.4630	21.4884	21.5138	21.5392	21.5646
0.850	21.5900	21.6154	21.6408	21.6662	21.6916	21.7170	21.7424	21.7678	21.7932	21.8186
0.860	21.8440	21.8694	21.8948	21.9202	21.9456	21.9710	21.9964	22.0218	22.0472	22.0726
0.870	22.0980	22.1234	22.1488	22.1742	22.1996	22.2250	22.2504	22.2758	22.3012	22.3266
0.880	22.3520	22.3774	22.4028	22.4282	22.4536	22.4790	22.5044	22.5298	22.5552	22.5806
0.890	22.6060	22.6314	22.6568	22.6822	22.7076	22.7330	22.7584	22.7838	22.8092	22.8346
0.900	22.8600	22.8854	22.9108	22.9362	22.9616	22.9870	23.0124	23.0378	23.0632	23.0886
0.910	23.1140	23.1394	23.1648	23.1902	23.2156	23.2410	23.2664	23.2918	23.3172	23.3426
0.920	23.3680	23.3934	23.4188	23.4442	23.4696	23.4950	23.5204	23.5458	23.5712	23.5966
0.930	23.6220	23.6474	23.6728	23.6982	23.7236	23.7490	23.7744	23.7998	23.8252	23.8506
0.940	23.8760	23.9014	23.9268	23.9522	23.9776	24.0030	24.0284	24.0538	24.0792	24.1046
0.950	24.1300	24.1554	24.1808	24.2062	24.2316	24.2570	24.2824	24.3078	24.3332	24.3586
0.960	24.3840	24.4094	24.4348	24.4602	24.4856	24.5110	24.5364	24.5618	24.5872	24.6126
0.970	24.6380	24.6634	24.6888	24.7142	24.7396	24.7650	24.7904	24.8158	24.8412	24.8666
0.980	24.8920	24.9174	24.9428	24.9682	24.9936	25.0190	25.0444	25.0698	25.0952	25.1206
0.990	25.1460	25.1714	25.1968	25.2222	25.2476	25.2730	25.2984	25.3238	25.3492	25.3746
1.000	25.4000

Based on 1 inch = 25.4 millimeters, exactly. All values in this table are exact. Use [Table 8a](#) to obtain whole inch and other decimal equivalents to add to decimal equivalents above. *Example:* Convert 10.9983 in. to mm. *Solution:* 10.9983 in. = 254.0 + 25.3492 + 0.00762 = 279.35682 mm.

Table 12. Millimeters to Inches Conversion

→ Millimeters ↓	0	1	2	3	4	5	6	7	8	9
	Inches									
0	...	0.03937	0.07874	0.11811	0.15748	0.19685	0.23622	0.27559	0.31496	0.35433
10	0.39370	0.43307	0.47244	0.51181	0.55118	0.59055	0.62992	0.66929	0.70866	0.74803
20	0.78740	0.82677	0.86614	0.90551	0.94488	0.98425	1.02362	1.06299	1.10236	1.14173
30	1.18110	1.22047	1.25984	1.29921	1.33858	1.37795	1.41732	1.45669	1.49606	1.53543
40	1.57480	1.61417	1.65354	1.69291	1.73228	1.77165	1.81102	1.85039	1.88976	1.92913
50	1.96850	2.00787	2.04724	2.08661	2.12598	2.16535	2.20472	2.24409	2.28346	2.32283
60	2.36220	2.40157	2.44094	2.48031	2.51969	2.55906	2.59843	2.63780	2.67717	2.71654
70	2.75591	2.79528	2.83465	2.87402	2.91339	2.95276	2.99213	3.03150	3.07087	3.11024
80	3.14961	3.18898	3.22835	3.26772	3.30709	3.34646	3.38583	3.42520	3.46457	3.50394
90	3.54331	3.58268	3.62205	3.66142	3.70079	3.74016	3.77953	3.81890	3.85827	3.89764
100	3.93701	3.97638	4.01575	4.05512	4.09449	4.13386	4.17323	4.21260	4.25197	4.29134
110	4.33071	4.37008	4.40945	4.44882	4.48819	4.52756	4.56693	4.60630	4.64567	4.68504
120	4.72441	4.76378	4.80315	4.84252	4.88189	4.92126	4.96063	5.00000	5.03937	5.07874
130	5.11811	5.15748	5.19685	5.23622	5.27559	5.31496	5.35433	5.39370	5.43307	5.47244
140	5.51181	5.55118	5.59055	5.62992	5.66929	5.70866	5.74803	5.78740	5.82677	5.86614
150	5.90551	5.94488	5.98425	6.02362	6.06299	6.10236	6.14173	6.18110	6.22047	6.25984
160	6.29921	6.33858	6.37795	6.41732	6.45669	6.49606	6.53543	6.57480	6.61417	6.65354
170	6.69291	6.73228	6.77165	6.81102	6.85039	6.88976	6.92913	6.96850	7.00787	7.04724
180	7.08661	7.12598	7.16535	7.20472	7.24409	7.28346	7.32283	7.36220	7.40157	7.44094
190	7.48031	7.51969	7.55906	7.59843	7.63780	7.67717	7.71654	7.75591	7.79528	7.83465
200	7.87402	7.91339	7.95276	7.99213	8.03150	8.07087	8.11024	8.14961	8.18898	8.22835
210	8.26772	8.30709	8.34646	8.38583	8.42520	8.46457	8.50394	8.54331	8.58268	8.62205
220	8.66142	8.70079	8.74016	8.77953	8.81890	8.85827	8.89764	8.93701	8.97638	9.01575
230	9.05512	9.09449	9.13386	9.17323	9.21260	9.25197	9.29134	9.33071	9.37008	9.40945
240	9.44882	9.48819	9.52756	9.56693	9.60630	9.64567	9.68504	9.72441	9.76378	9.80315
250	9.84252	9.88189	9.92126	9.96063	10.00000	10.0394	10.0787	10.1181	10.1575	10.1969
260	10.2362	10.2756	10.3150	10.3543	10.3937	10.4331	10.4724	10.5118	10.5512	10.5906
270	10.6299	10.6693	10.7087	10.7480	10.7874	10.8268	10.8661	10.9055	10.9449	10.9843
280	11.0236	11.0630	11.1024	11.1417	11.1811	11.2205	11.2598	11.2992	11.3386	11.3780
290	11.4173	11.4567	11.4961	11.5354	11.5748	11.6142	11.6535	11.6929	11.7323	11.7717
300	11.8110	11.8504	11.8898	11.9291	11.9685	12.0079	12.0472	12.0866	12.1260	12.1654
310	12.2047	12.2441	12.2835	12.3228	12.3622	12.4016	12.4409	12.4803	12.5197	12.5591
320	12.5984	12.6378	12.6772	12.7165	12.7559	12.7953	12.8346	12.8740	12.9134	12.9528
330	12.9921	13.0315	13.0709	13.1102	13.1496	13.1890	13.2283	13.2677	13.3071	13.3465
340	13.3858	13.4252	13.4646	13.5039	13.5433	13.5827	13.6220	13.6614	13.7008	13.7402
350	13.7795	13.8189	13.8583	13.8976	13.9370	13.9764	14.0157	14.0551	14.0945	14.1339
360	14.1732	14.2126	14.2520	14.2913	14.3307	14.3701	14.4094	14.4488	14.4882	14.5276
370	14.5669	14.6063	14.6457	14.6850	14.7244	14.7638	14.8031	14.8425	14.8819	14.9213
380	14.9606	15.0000	15.0394	15.0787	15.1181	15.1575	15.1969	15.2362	15.2756	15.3150
390	15.3543	15.3937	15.4331	15.4724	15.5118	15.5512	15.5906	15.6299	15.6693	15.7087
400	15.7480	15.7874	15.8268	15.8661	15.9055	15.9449	15.9843	16.0236	16.0630	16.1024
410	16.1417	16.1811	16.2205	16.2598	16.2992	16.3386	16.3780	16.4173	16.4567	16.4961
420	16.5354	16.5748	16.6142	16.6535	16.6929	16.7323	16.7717	16.8110	16.8504	16.8898
430	16.9291	16.9685	17.0079	17.0472	17.0866	17.1260	17.1654	17.2047	17.2441	17.2835
440	17.3228	17.3622	17.4016	17.4409	17.4803	17.5197	17.5591	17.5984	17.6378	17.6772
450	17.7165	17.7559	17.7953	17.8346	17.8740	17.9134	17.9528	17.9921	18.0315	18.0709
460	18.1102	18.1496	18.1890	18.2283	18.2677	18.3071	18.3465	18.3858	18.4252	18.4646
470	18.5039	18.5433	18.5827	18.6220	18.6614	18.7008	18.7402	18.7795	18.8189	18.8583
480	18.8976	18.9370	18.9764	19.0157	19.0551	19.0945	19.1339	19.1732	19.2126	19.2520
490	19.2913	19.3307	19.3701	19.4094	19.4488	19.4882	19.5276	19.5669	19.6063	19.6457

Table 12. (Continued) Millimeters to Inches Conversion

→ Millimeters ↓	0	1	2	3	4	5	6	7	8	9
	Inches									
500	19.6850	19.7244	19.7638	19.8031	19.8425	19.8819	19.9213	19.9606	20.0000	20.0394
510	20.0787	20.1181	20.1575	20.1969	20.2362	20.2756	20.3150	20.3543	20.3937	20.4331
520	20.4724	20.5118	20.5512	20.5906	20.6299	20.6693	20.7087	20.7480	20.7874	20.8268
530	20.8661	20.9055	20.9449	20.9843	21.0236	21.0630	21.1024	21.1417	21.1811	21.2205
540	21.2598	21.2992	21.3386	21.3780	21.4173	21.4567	21.4961	21.5354	21.5748	21.6142
550	21.6535	21.6929	21.7323	21.7717	21.8110	21.8504	21.8898	21.9291	21.9685	22.0079
560	22.0472	22.0866	22.1260	22.1654	22.2047	22.2441	22.2835	22.3228	22.3622	22.4016
570	22.4409	22.4803	22.5197	22.5591	22.5984	22.6378	22.6772	22.7165	22.7559	22.7953
580	22.8346	22.8740	22.9134	22.9528	22.9921	23.0315	23.0709	23.1102	23.1496	23.1890
590	23.2283	23.2677	23.3071	23.3465	23.3858	23.4252	23.4646	23.5039	23.5433	23.5827
600	23.6220	23.6614	23.7008	23.7402	23.7795	23.8189	23.8583	23.8976	23.9370	23.9764
610	24.0157	24.0551	24.0945	24.1339	24.1732	24.2126	24.2520	24.2913	24.3307	24.3701
620	24.4094	24.4488	24.4882	24.5276	24.5669	24.6063	24.6457	24.6850	24.7244	24.7638
630	24.8031	24.8425	24.8819	24.9213	24.9606	25.0000	25.0394	25.0787	25.1181	25.1575
640	25.1969	25.2362	25.2756	25.3150	25.3543	25.3937	25.4331	25.4724	25.5118	25.5512
650	25.5906	25.6299	25.6693	25.7087	25.7480	25.7874	25.8268	25.8661	25.9055	25.9449
660	25.9843	26.0236	26.0630	26.1024	26.1417	26.1811	26.2205	26.2598	26.2992	26.3386
670	26.3780	26.4173	26.4567	26.4961	26.5354	26.5748	26.6142	26.6535	26.6929	26.7323
680	26.7717	26.8110	26.8504	26.8898	26.9291	26.9685	27.0079	27.0472	27.0866	27.1260
690	27.1654	27.2047	27.2441	27.2835	27.3228	27.3622	27.4016	27.4409	27.4803	27.5197
700	27.5591	27.5984	27.6378	27.6772	27.7165	27.7559	27.7953	27.8346	27.8740	27.9134
710	27.9528	27.9921	28.0315	28.0709	28.1102	28.1496	28.1890	28.2283	28.2677	28.3071
720	28.3465	28.3858	28.4252	28.4646	28.5039	28.5433	28.5827	28.6220	28.6614	28.7008
730	28.7402	28.7795	28.8189	28.8583	28.8976	28.9370	28.9764	29.0157	29.0551	29.0945
740	29.1339	29.1732	29.2126	29.2520	29.2913	29.3307	29.3701	29.4094	29.4488	29.4882
750	29.5276	29.5669	29.6063	29.6457	29.6850	29.7244	29.7638	29.8031	29.8425	29.8819
760	29.9213	29.9606	30.0000	30.0394	30.0787	30.1181	30.1575	30.1969	30.2362	30.2756
770	30.3150	30.3543	30.3937	30.4331	30.4724	30.5118	30.5512	30.5906	30.6299	30.6693
780	30.7087	30.7480	30.7874	30.8268	30.8661	30.9055	30.949	30.9843	31.0236	31.0630
790	31.1024	31.1417	31.1811	31.2205	31.2598	31.2992	31.3386	31.3780	31.4173	31.4567
800	31.4961	31.5354	31.5748	31.6142	31.6535	31.6929	31.7323	31.7717	31.8110	31.8504
810	31.8898	31.9291	31.9685	32.0079	32.0472	32.0866	32.1260	32.1654	32.2047	32.2441
820	32.2835	32.3228	32.3622	32.4016	32.4409	32.4803	32.5197	32.5591	32.5984	32.6378
830	32.6772	32.7165	32.7559	32.7953	32.8346	32.8740	32.9134	32.9528	32.9921	33.0315
840	33.0709	33.1102	33.1496	33.1890	33.2283	33.2677	33.3071	33.3465	33.3858	33.4252
850	33.4646	33.5039	33.5433	33.5827	33.6220	33.6614	33.7008	33.7402	33.7795	33.8189
860	33.8583	33.8976	33.9370	33.9764	34.0157	34.0551	34.0945	34.1339	34.1732	34.2126
870	34.2520	34.2913	34.3307	34.3701	34.4094	34.4488	34.4882	34.5276	34.5669	34.6063
880	34.6457	34.6850	34.7244	34.7638	34.8031	34.8425	34.8819	34.9213	34.9606	35.0000
890	35.0394	35.0787	35.1181	35.1575	35.1969	35.2362	35.2756	35.3150	35.3543	35.3937
900	35.4331	35.4724	35.5118	35.5512	35.5906	35.6299	35.6693	35.7087	35.7480	35.7874
910	35.8268	35.8661	35.9055	35.9449	35.9843	36.0236	36.0630	36.1024	36.1417	36.1811
920	36.2205	36.2598	36.2992	36.3386	36.3780	36.4173	36.4567	36.4961	36.5354	36.5748
930	36.6142	36.6535	36.6929	36.7323	36.7717	36.8110	36.8504	36.8898	36.9291	36.9685
940	37.0079	37.0472	37.0866	37.1260	37.1654	37.2047	37.2441	37.2835	37.3228	37.3622
950	37.4016	37.409	37.4803	37.5197	37.5591	37.5984	37.6378	37.6772	37.7165	37.7559
960	37.7953	37.8346	37.8740	37.9134	37.9528	37.9921	38.0315	38.0709	38.1102	38.1496
970	38.1800	38.2283	38.2677	38.3071	38.3465	38.3858	38.4252	38.4646	38.5039	38.5433
980	38.5827	38.6220	38.6614	38.7008	38.7402	38.7795	38.8189	38.8583	38.8976	38.9370
990	38.9764	39.0157	39.0551	39.0945	39.1339	39.1732	39.2126	39.2520	39.2913	39.3307
1000	39.3701

Based on 1 inch = 25.4 millimeters, exactly.

Table 13a. Microinches to Micrometers (microns) Conversion

→ Microinches ↓	0	1	2	3	4	5	6	7	8	9
	Micrometers (microns)									
0	0	0.0254	0.0508	0.0762	0.1016	0.127	0.1524	0.1778	0.2032	0.2286
10	0.254	0.2794	0.3048	0.3302	0.3556	0.381	0.4064	0.4318	0.4572	0.4826
20	0.508	0.5334	0.5588	0.5842	0.6096	0.635	0.6604	0.6858	0.7112	0.7366
30	0.762	0.7874	0.8128	0.8382	0.8636	0.889	0.9144	0.9398	0.9652	0.9906
40	1.016	1.0414	1.0668	1.0922	1.1176	1.143	1.1684	1.1938	1.2192	1.2446
50	1.27	1.2954	1.3208	1.3462	1.3716	1.397	1.4224	1.4478	1.4732	1.4986
60	1.524	1.5494	1.5748	1.6002	1.6256	1.651	1.6764	1.7018	1.7272	1.7526
70	1.778	1.8034	1.8288	1.8542	1.8796	1.905	1.9304	1.9558	1.9812	2.0066
80	2.032	2.0574	2.0828	2.1082	2.1336	2.159	2.1844	2.2098	2.2352	2.2606
90	2.286	2.3114	2.3368	2.3622	2.3876	2.413	2.4384	2.4638	2.4892	2.5146
100	2.54	2.5654	2.5908	2.6162	2.6416	2.667	2.6924	2.7178	2.7432	2.7686
110	2.794	2.8194	2.8448	2.8702	2.8956	2.921	2.9464	2.9718	2.9972	3.0226
120	3.048	3.0734	3.0988	3.1242	3.1496	3.175	3.2004	3.2258	3.2512	3.2766
130	3.302	3.3274	3.3528	3.3782	3.4036	3.429	3.4544	3.4798	3.5052	3.5306
140	3.556	3.5814	3.6068	3.6322	3.6576	3.683	3.7084	3.7338	3.7592	3.7846
150	3.81	3.8354	3.8608	3.8862	3.9116	3.937	3.9624	3.9878	4.0132	4.0386
160	4.064	4.0894	4.1148	4.1402	4.1656	4.191	4.2164	4.2418	4.2672	4.2926
170	4.318	4.3434	4.3688	4.3942	4.4196	4.445	4.4704	4.4958	4.5212	4.5466
180	4.572	4.5974	4.6228	4.6482	4.6736	4.699	4.7244	4.7498	4.7752	4.8006
190	4.826	4.8514	4.8768	4.9022	4.9276	4.953	4.9784	5.0038	5.0292	5.0546
200	5.08	5.1054	5.1308	5.1562	5.1816	5.207	5.2324	5.2578	5.2832	5.3086
210	5.334	5.3594	5.3848	5.4102	5.4356	5.461	5.4864	5.5118	5.5372	5.5626
220	5.588	5.6134	5.6388	5.6642	5.6896	5.715	5.7404	5.7658	5.7912	5.8166
230	5.842	5.8674	5.8928	5.9182	5.9436	5.969	5.9944	6.0198	6.0452	6.0706
240	6.096	6.1214	6.1468	6.1722	6.1976	6.223	6.2484	6.2738	6.2992	6.3246
250	6.35	6.3754	6.4008	6.4262	6.4516	6.477	6.5024	6.5278	6.5532	6.5786
260	6.604	6.6294	6.6548	6.6802	6.7056	6.731	6.7564	6.7818	6.8072	6.8326
270	6.858	6.8834	6.9088	6.9342	6.9596	6.985	7.0104	7.0358	7.0612	7.0866
280	7.112	7.1374	7.1628	7.1882	7.2136	7.239	7.2644	7.2898	7.3152	7.3406
290	7.366	7.3914	7.4168	7.4422	7.4676	7.493	7.5184	7.5438	7.5692	7.5946
300	7.62	7.6454	7.6708	7.6962	7.7216	7.747	7.7724	7.7978	7.8232	7.8486
310	7.874	7.8994	7.9248	7.9502	7.9756	8.001	8.0264	8.0518	8.0772	8.1026
320	8.128	8.1534	8.1788	8.2042	8.2296	8.255	8.2804	8.3058	8.3312	8.3566
330	8.382	8.4074	8.4328	8.4582	8.4836	8.509	8.5344	8.5598	8.5852	8.6106
340	8.636	8.6614	8.6868	8.7122	8.7376	8.763	8.7884	8.8138	8.8392	8.8646
350	8.89	8.9154	8.9408	8.9662	8.9916	9.017	9.0424	9.0678	9.0932	9.1186
360	9.144	9.1694	9.1948	9.2202	9.2456	9.271	9.2964	9.3218	9.3472	9.3726
370	9.398	9.4234	9.4488	9.4742	9.4996	9.525	9.5504	9.5758	9.6012	9.6266
380	9.652	9.6774	9.7028	9.7282	9.7536	9.779	9.8044	9.8298	9.8552	9.8806
390	9.906	9.9314	9.9568	9.9822	10.0076	10.033	10.0584	10.0838	10.1092	10.1346
400	10.16	10.1854	10.2108	10.2362	10.2616	10.287	10.3124	10.3378	10.3632	10.3886
410	10.414	10.4394	10.4648	10.4902	10.5156	10.541	10.5664	10.5918	10.6172	10.6426
420	10.668	10.6934	10.7188	10.7442	10.7696	10.795	10.8204	10.8458	10.8712	10.8966
430	10.922	10.9474	10.9728	10.9982	11.0236	11.049	11.0744	11.0998	11.1252	11.1506
440	11.176	11.2014	11.2268	11.2522	11.2776	11.303	11.3284	11.3538	11.3792	11.4046
450	11.43	11.4554	11.4808	11.5062	11.5316	11.557	11.5824	11.6078	11.6332	11.6586
460	11.684	11.7094	11.7348	11.7602	11.7856	11.811	11.8364	11.8618	11.8872	11.9126
470	11.938	11.9634	11.9888	12.0142	12.0396	12.065	12.0904	12.1158	12.1412	12.1666
480	12.192	12.2174	12.2428	12.2682	12.2936	12.319	12.3444	12.3698	12.3952	12.4206
490	12.446	12.4714	12.4968	12.5222	12.5476	12.573	12.5984	12.6238	12.6492	12.6746
500	12.7	12.7254	12.7508	12.7762	12.8016	12.827	12.8524	12.8778	12.9032	12.9286

Use the small table below to convert microinches to micrometers for ranges higher than given in the main table above. Appropriate quantities chosen from both tables are simply added to obtain the higher converted value:

μin.	μm	μin.	μm	μin.	μm	μin.	μm	μin.	μm	μin.	μm
600	15.24	800	20.32	1000	25.4	1500	38.1	2100	53.34	2700	68.58
700	17.78	900	22.86	1200	30.48	1800	45.72	2400	60.96	3000	76.2

Both tables based on 1 microinch = 0.0254 micrometers, exactly. All values in both parts of this table are exact; figures to the right of the last place figures are all zeros.

Example: Convert 1375 μin. to μm:

$$\begin{array}{rcl}
 \text{From lower portion of Table 13a:} & 1200 \mu\text{in.} & = & 30.48 \mu\text{m} \\
 \text{From upper portion of Table 13a:} & 175 \mu\text{in.} & = & 4.445 \mu\text{m} \\
 \hline
 & 1375 \mu\text{in.} & = & 34.925 \mu\text{m}
 \end{array}$$

Table 13b. Micrometers (microns) to Microinches Conversion

→ Microns ↓	0	0.01	0.02	0.03	0.04	0.05	0.06	0.07	0.08	0.09
	Microinches									
0.00	0.0000	0.3937	0.7874	1.1811	1.5748	1.9685	2.3622	2.7559	3.1496	3.5433
0.10	3.9370	4.3307	4.7244	5.1181	5.5118	5.9055	6.2992	6.6929	7.0866	7.4803
0.20	7.8740	8.2677	8.6614	9.0551	9.4488	9.8425	10.2362	10.6299	11.0236	11.4173
0.30	11.8110	12.2047	12.5984	12.9921	13.3858	13.7795	14.1732	14.5669	14.9606	15.3543
0.40	15.7480	16.1417	16.5354	16.9291	17.3228	17.7165	18.1102	18.5039	18.8976	19.2913
0.50	19.6850	20.0787	20.4724	20.8661	21.2598	21.6535	22.0472	22.4409	22.8346	23.2283
0.60	23.6220	24.0157	24.4094	24.8031	25.1969	25.5906	25.9843	26.3780	26.7717	27.1654
0.70	27.5591	27.9528	28.3465	28.7402	29.1339	29.5276	29.9213	30.3150	30.7087	31.1024
0.80	31.4961	31.8898	32.2835	32.6772	33.0709	33.4646	33.8583	34.2520	34.6457	35.0394
0.90	35.4331	35.8268	36.2205	36.6142	37.0079	37.4016	37.7953	38.1890	38.5827	38.9764
1.00	39.3701	39.7638	40.1575	40.5512	40.9449	41.3386	41.7323	42.1260	42.5197	42.9134
1.10	43.3071	43.7008	44.0945	44.4882	44.8819	45.2756	45.6693	46.0630	46.4567	46.8504
1.20	47.2441	47.6378	48.0315	48.4252	48.8189	49.2126	49.6063	50.0000	50.3937	50.7874
1.30	51.1811	51.5748	51.9685	52.3622	52.7559	53.1496	53.5433	53.9370	54.3307	54.7244
1.40	55.1181	55.5118	55.9055	56.2992	56.6929	57.0866	57.4803	57.8740	58.2677	58.6614
1.50	59.0551	59.4488	59.8425	60.2362	60.6299	61.0236	61.4173	61.8110	62.2047	62.5984
1.60	62.9921	63.3858	63.7795	64.1732	64.5669	64.9606	65.3543	65.7480	66.1417	66.5354
1.70	66.9291	67.3228	67.7165	68.1102	68.5039	68.8976	69.2913	69.6850	70.0787	70.4724
1.80	70.8661	71.2598	71.6535	72.0472	72.4409	72.8346	73.2283	73.6220	74.0157	74.4094
1.90	74.8031	75.1969	75.5906	75.9843	76.3780	76.7717	77.1654	77.5591	77.9528	78.3465
2.00	78.7402	79.1339	79.5276	79.9213	80.3150	80.7087	81.1024	81.4961	81.8898	82.2835
2.10	82.6772	83.0709	83.4646	83.8583	84.2520	84.6457	85.0394	85.4331	85.8268	86.2205
2.20	86.6142	87.0079	87.4016	87.7953	88.1890	88.5827	88.9764	89.3701	89.7638	90.1575
2.30	90.5512	90.9449	91.3386	91.7323	92.1260	92.5197	92.9134	93.3071	93.7008	94.0945
2.40	94.4882	94.8819	95.2756	95.6693	96.0630	96.4567	96.8504	97.2441	97.6378	98.0315
2.50	98.4252	98.8189	99.2126	99.6063	100.0000	100.3937	100.7874	101.1811	101.5748	101.9685
2.60	102.3622	102.7559	103.1496	103.5433	103.9370	104.3307	104.7244	105.1181	105.5118	105.9055
2.70	106.2992	106.6929	107.0866	107.4803	107.8740	108.2677	108.6614	109.0551	109.4488	109.8425
2.80	110.2362	110.6299	111.0236	111.4173	111.8110	112.2047	112.5984	112.9921	113.3858	113.7795
2.90	114.1732	114.5669	114.9606	115.3543	115.7480	116.1417	116.5354	116.9291	117.3228	117.7165
3.00	118.1102	118.5039	118.8976	119.2913	119.6850	120.0787	120.4724	120.8661	121.2598	121.6535
3.10	122.0472	122.4409	122.8346	123.2283	123.6220	124.0157	124.4094	124.8031	125.1969	125.5906
3.20	125.9843	126.3780	126.7717	127.1654	127.5591	127.9528	128.3465	128.7402	129.1339	129.5276
3.30	129.9213	130.3150	130.7087	131.1024	131.4961	131.8898	132.2835	132.6772	133.0709	133.4646
3.40	133.8583	134.2520	134.6457	135.0394	135.4331	135.8268	136.2205	136.6142	137.0079	137.4016
3.50	137.7953	138.1890	138.5827	138.9764	139.3701	139.7638	140.1575	140.5512	140.9449	141.3386
3.60	141.7323	142.1260	142.5197	142.9134	143.3071	143.7008	144.0945	144.4882	144.8819	145.2756
3.70	145.6693	146.0630	146.4567	146.8504	147.2441	147.6378	148.0315	148.4252	148.8189	149.2126
3.80	149.6063	150.0000	150.3937	150.7874	151.1811	151.5748	151.9685	152.3622	152.7559	153.1496
3.90	153.5433	153.9370	154.3307	154.7244	155.1181	155.5118	155.9055	156.2992	156.6929	157.0866
4.00	157.4803	157.8740	158.2677	158.6614	159.0551	159.4488	159.8425	160.2362	160.6299	161.0236
4.10	161.4173	161.8110	162.2047	162.5984	162.9921	163.3858	163.7795	164.1732	164.5669	164.9606
4.20	165.3543	165.7480	166.1417	166.5354	166.9291	167.3228	167.7165	168.1102	168.5039	168.8976
4.30	169.2913	169.6850	170.0787	170.4724	170.8661	171.2598	171.6535	172.0472	172.4409	172.8346
4.40	173.2283	173.6220	174.0157	174.4094	174.8031	175.1969	175.5906	175.9843	176.3780	176.7717
4.50	177.1654	177.5591	177.9528	178.3465	178.7402	179.1339	179.5276	179.9213	180.3150	180.7087
4.60	181.1024	181.4961	181.8898	182.2835	182.6772	183.0709	183.4646	183.8583	184.2520	184.6457
4.70	185.0394	185.4331	185.8268	186.2205	186.6142	187.0079	187.4016	187.7953	188.1890	188.5827
4.80	188.9764	189.3701	189.7638	190.1575	190.5512	190.9449	191.3386	191.7323	192.1260	192.5197
4.90	192.9134	193.3071	193.7008	194.0945	194.4882	194.8819	195.2756	195.6693	196.0630	196.4567
5.00	196.8504	197.2441	197.6378	198.0315	198.4252	198.8189	199.2126	199.6063	200.0000	200.3937

The table given below can be used with the preceding main table to obtain higher converted values, simply by adding appropriate quantities chosen from each table:

µm	µin.	µm	µin.	µm	µin.	µm	µin.	µm	µin.
10	393.7008	20	787.4016	30	1,181.1024	40	1,574.8032	50	1,968.5039
15	590.5512	25	984.2520	35	1,378.9528	45	1,771.6535	55	2,165.3543

Both portions of **Table 13b** are based on 1 microinch = 0.0254 micrometers, exactly.

Example: Convert 23.55 µm to µin.:

$$\begin{aligned} \text{From above table: } 20.00 \mu\text{m} &= 787.4016 \mu\text{in} \\ \text{From main table: } 3.55 \mu\text{m} &= 139.7638 \mu\text{in} \\ \hline 23.55 \mu\text{m} &= 927.1654 \mu\text{in} \end{aligned}$$

Table 14a. Feet to Meters Conversion

feet	meters	feet	meters	feet	meters	feet	meters	feet	meters
100	30.48	10	3.048	1	0.3048	0.1	0.03048	0.01	0.003048
200	60.96	20	6.096	2	0.6096	0.2	0.06096	0.02	0.006096
300	91.44	30	9.144	3	0.9144	0.3	0.09144	0.03	0.009144
400	121.92	40	12.192	4	1.2192	0.4	0.12192	0.04	0.012192
500	152.4	50	15.24	5	1.524	0.5	0.1524	0.05	0.01524
600	182.88	60	18.288	6	1.8288	0.6	0.18288	0.06	0.018288
700	213.36	70	21.336	7	2.1336	0.7	0.21336	0.07	0.021336
800	243.84	80	24.384	8	2.4384	0.8	0.24384	0.08	0.024384
900	274.32	90	27.432	9	2.7432	0.9	0.27432	0.09	0.027432
1,000	304.8	100	30.48	10	3.048	1.0	0.3048	0.10	0.03048

1 ft = 0.3048 m, exactly

Table 14b. Meters to Feet Conversion

meters	feet	meters	feet	meters	feet	meters	feet	meters	feet
100	328.084	10	32.808	1	3.281	0.1	0.328	0.01	0.033
200	656.168	20	65.617	2	6.562	0.2	0.656	0.02	0.066
300	984.252	30	98.425	3	9.843	0.3	0.984	0.03	0.098
400	1,312.336	40	131.234	4	13.123	0.4	1.312	0.04	0.131
500	1,640.420	50	164.042	5	16.404	0.5	1.640	0.05	0.164
600	1,968.504	60	196.850	6	19.685	0.6	1.969	0.06	0.197
700	2,296.588	70	229.659	7	22.966	0.7	2.297	0.07	0.230
800	2,624.672	80	262.467	8	26.247	0.8	2.625	0.08	0.262
900	2,952.756	90	295.276	9	29.528	0.9	2.953	0.09	0.295
1,000	3,280.840	100	328.084	10	32.808	1.0	3.281	0.10	0.328

1 m = 3.280840 ft

Table 15a. Miles to Kilometers Conversion

miles	km	miles	km	miles	km	miles	km	miles	km
1,000	1,609.34	100	160.93	10	16.09	1	1.61	0.1	0.16
2,000	3,218.69	200	321.87	20	32.19	2	3.22	0.2	0.32
3,000	4,828.03	300	482.80	30	48.28	3	4.83	0.3	0.48
4,000	6,437.38	400	643.74	40	64.37	4	6.44	0.4	0.64
5,000	8,046.72	500	804.67	50	80.47	5	8.05	0.5	0.80
6,000	9,656.06	600	965.61	60	96.56	6	9.66	0.6	0.97
7,000	11,265.41	700	1,126.54	70	112.65	7	11.27	0.7	1.13
8,000	12,874.75	800	1,287.48	80	128.75	8	12.87	0.8	1.29
9,000	14,484.10	900	1,448.41	90	144.84	9	14.48	0.9	1.45
10,000	16,093.44	1,000	1,609.34	100	160.93	10	16.09	1.0	1.61

1 mile = 1.609344 km, exactly

Table 15b. Kilometers to Miles Conversion

km	miles	km	miles	km	miles	km	miles	km	miles
1,000	621.37	100	62.14	10	6.21	1	0.62	0.1	0.06
2,000	1,242.74	200	124.27	20	12.43	2	1.24	0.2	0.12
3,000	1,864.11	300	186.41	30	18.64	3	1.86	0.3	0.19
4,000	2,485.48	400	248.55	40	24.85	4	2.49	0.4	0.25
5,000	3,106.86	500	310.69	50	31.07	5	3.11	0.5	0.31
6,000	3,728.23	600	372.82	60	37.28	6	3.73	0.6	0.37
7,000	4,349.60	700	434.96	70	43.50	7	4.35	0.7	0.43
8,000	4,970.97	800	497.10	80	49.71	8	4.97	0.8	0.50
9,000	5,592.34	900	559.23	90	55.92	9	5.59	0.9	0.56
10,000	6,213.71	1,000	621.37	100	62.14	10	6.21	1.0	0.62

1 km = 0.6213712 mile

Units of Area

Table 16. Square Measure and Conversion Factors

Metric System	U.S. System
1 square kilometer (km ²) = 100 hectares 1,000,000 square meters 0.3861 square mile 247.1 acres	1 square mile (mi ²) = 640 acres 6400 square chains 2.5899 square kilometers
1 hectare (ha) = 0.01 square kilometer 100 ares 10,000 square meters 2.471 acres 107,639 square feet	1 acre = 10 square chains 4840 square yards 43,560 square feet a square, 208.71 feet on a side 0.4046856 hectare 40.47 ares 4046.856 square meters
1 are (a) = 0.0001 square kilometer 100 square meters 0.0247 acre 1076.4 square feet	1 square chain = 16 square rods 484 square yards 4356 square feet
1 square meter (m ²) = 0.000001 square kilometer 100 square decimeters 10000 square centimeters 1,000,000 square millimeters 10.764 square feet 1.196 square yards	1 square rod = 30.25 square yards 272.25 square feet 625 square links
1 square decimeter (dm ²) = 100 square centimeters	1 square yard (yd ²) = 9 square feet 1296 square inches 0.83612736 square meter 8361.2736 square centimeter 836,127.36 square millimeter
1 square centimeter (cm ²) = 0.0001 square meters 100 square millimeters 0.001076 square foot 0.155 square inch	1 square foot (ft ²) = 0.111111 square yard 144 square inches 0.09290304 square meter 929.0304 square centimeters 92,903.04 square millimeters
1 square millimeter (mm ²) = 0.01 square centimeters 1,000,000 square microns 0.00155 square inch	1 square inch (in ²) = 0.0007716 square yard 0.006944 square foot 0.00064516 square meter 6.4516 square centimeters 645.16 square millimeters
1 square micrometer (micron) (μm ²) = 1 × 10⁻¹² square meter 0.000001 square millimeters 1 × 10⁻⁹ square inch 1549.997 square micro-inch	1 square mil (mil ²) = 0.000001 square inch 0.00064516 square millimeter
	1 square micro-inch (μin ²) = 1 × 10⁻¹² square inch 0.00064516 square micrometer (micron)

Note: Figures in **Bold** indicate exact conversion values

Measure Used for Diameters and Areas of Electric Wires

1 circular inch = area of 1-inch diameter circle $\frac{7}{8}$ square inch 0.7854 square inch 5.067 square centimeter 1,000,000 circular mils	1 circular mil = area of 0.001-inch diameter circle $\frac{7}{8}$ square mill 1 square inch = 1.2732 circular inch 1,273,239 circular mils
--	---

Table 17a. Square Inches to Square Centimeters Conversion

inch ²	cm ²	inch ²	cm ²	inch ²	cm ²	inch ²	cm ²	inch ²	cm ²
100	645.16	10	64.516	1	6.4516	0.1	0.64516	0.01	0.064516
200	1,290.32	20	129.032	2	12.9032	0.2	1.29032	0.02	0.129032
300	1,935.48	30	193.548	3	19.3548	0.3	1.93548	0.03	0.135489
400	2,580.64	40	258.064	4	25.8064	0.4	2.58064	0.04	0.258064
500	3,225.80	50	322.58	5	32.258	0.5	3.2258	0.05	0.32258
600	30,870.96	60	387.096	6	38.7096	0.6	3.87096	0.06	0.387096
700	4,516.12	70	451.612	7	45.1612	0.7	4.51612	0.07	0.451612
800	5,161.28	80	516.128	8	51.6128	0.8	5.16128	0.08	0.516128
900	5,806.44	90	580.644	9	58.0644	0.9	5.80644	0.09	0.580644
1,000	6,451.60	100	645.16	10	64.516	1.0	6.4516	0.10	0.64516

Based on 1 inch = 2.54 centimeters, exactly, 1 inch² = 6.4516 cm², exactly.

Table 17b. Square Centimeters to Square Inches Conversion

cm ²	inch ²	cm ²	inch ²	cm ²	inch ²	cm ²	inch ²	cm ²	inch ²
100	15.500	10	1.550	1	0.155	0.1	0.016	0.01	0.002
200	31.000	20	3.100	2	0.310	0.2	0.031	0.02	0.003
300	46.500	30	4.650	3	0.465	0.3	0.047	0.03	0.005
400	62.000	40	6.200	4	0.620	0.4	0.062	0.04	0.006
500	77.500	50	7.750	5	0.75	0.5	0.078	0.05	0.008
600	93.000	60	9.300	6	0.930	0.6	0.093	0.06	0.009
700	108.500	70	10.850	7	1.085	0.7	0.109	0.07	0.011
800	124.000	80	12.400	8	1.240	0.8	0.124	0.08	0.012
900	139.500	90	13.950	9	1.395	0.9	0.140	0.09	0.014
1,000	155.000	100	15.500	10	1.550	1.0	0.155	0.10	0.016

Based on 1 inch = 2.54 centimeters, exactly, 1 cm² = 0.1550003 inch².

Table 18a. Square Feet to Square Meters Conversion

ft ²	m ²	ft ²	m ²	ft ²	m ²	ft ²	m ²	ft ²	m ²
1,000	92.903	100	9.290	10	0.929	1	0.093	0.1	0.009
2,000	185.806	200	18.581	20	1.858	2	0.186	0.2	0.019
3,000	278.709	300	27.871	30	2.787	3	0.279	0.3	0.028
4,000	371.612	400	37.161	40	3.716	4	0.372	0.4	0.037
5,000	464.515	500	46.452	50	4.645	5	0.465	0.5	0.046
6,000	557.418	600	55.742	60	5.574	6	0.557	0.6	0.056
7,000	650.321	700	65.032	70	6.503	7	0.650	0.7	0.065
8,000	743.224	800	74.322	80	7.432	8	0.743	0.8	0.074
9,000	836.127	900	83.613	90	8.361	9	0.836	0.9	0.084
10,000	929.030	1,000	92.903	100	9.290	10	0.929	1.0	0.093

Based on 1 inch = 2.54 centimeters, exactly, 1 ft² = 0.09290304 m², exactly.

Table 18b. Square Meters to Square Feet Conversion

m ²	ft ²	m ²	ft ²	m ²	ft ²	m ²	ft ²	m ²	ft ²
100	1,076.39	10	107.64	1	10.76	0.1	1.08	0.01	0.11
200	2,152.78	20	215.28	2	21.53	0.2	2.15	0.02	0.22
300	3,229.17	30	322.92	3	32.29	0.3	3.23	0.03	0.32
400	4,305.56	40	430.56	4	43.06	0.4	4.31	0.04	0.43
500	5,381.96	50	538.20	5	53.82	0.5	5.38	0.05	0.54
600	6,458.35	60	645.83	6	64.58	0.6	6.46	0.06	0.65
700	7,534.74	70	753.47	7	75.35	0.7	7.53	0.07	0.75
800	8,611.13	80	861.11	8	86.11	0.8	8.61	0.08	0.86
900	9,687.52	90	968.75	9	96.88	0.9	9.69	0.09	0.97
1,000	10,763.91	100	1,076.39	10	107.64	1.0	10.76	0.10	1.08

Based on 1 inch = 2.54 centimeters, exactly, 1 m² = 10.76391 ft².

Table 19a. Square Yard to Square Meter Conversion

yd ²	m ²	yd ²	m ²	yd ²	m ²	yd ²	m ²	yd ²	m ²
1000	836.12736	100	83.612736	10	8.3612736	1	0.83612736	0.1	0.083612736
2000	1672.25472	200	167.225472	20	16.7225472	2	1.67225472	0.2	0.167225472
3000	2508.38208	300	250.838208	30	25.0838208	3	2.50838208	0.3	0.250838208
4000	3344.50944	400	334.450944	40	33.4450944	4	3.34450944	0.4	0.334450944
5000	4180.6368	500	418.06368	50	41.806368	5	4.1806368	0.5	0.41806368
6000	5016.76416	600	501.676416	60	50.1676416	6	5.01676416	0.6	0.501676416
7000	5852.89152	700	585.289152	70	58.5289152	7	5.85289152	0.7	0.585289152
8000	6689.01888	800	668.901888	80	66.8901888	8	6.68901888	0.8	0.668901888
9000	7525.14624	900	752.514624	90	75.2514624	9	7.52514624	0.9	0.752514624
10000	8361.2736	1000	836.12736	100	83.612736	10	8.3612736	1	0.83612736

Based on 1 inch = 2.54 centimeters, exactly, 1 yd² = 0.83612736 m², exactly

Table 19b. Square Meter to Square Yard Conversion

m ²	yd ²	m ²	yd ²	m ²	yd ²	m ²	yd ²	m ²	yd ²
1000	1195.990046	100	119.5990046	10	11.95990046	1	1.195990046	0.1	0.119599005
2000	2391.980093	200	239.1980093	20	23.91980093	2	2.391980093	0.2	0.239198009
3000	3587.970139	300	358.7970139	30	35.87970139	3	3.587970139	0.3	0.358797014
4000	4783.960185	400	478.3960185	40	47.83960185	4	4.783960185	0.4	0.478396019
5000	5979.950232	500	597.9950232	50	59.79950232	5	5.979950232	0.5	0.597995023
6000	7175.940278	600	717.5940278	60	71.75940278	6	7.175940278	0.6	0.717594028
7000	8371.930324	700	837.1930324	70	83.71930324	7	8.371930324	0.7	0.837193032
8000	9567.92037	800	956.792037	80	95.6792037	8	9.56792037	0.8	0.956792037
9000	10763.91042	900	1076.391042	90	107.6391042	9	10.76391042	0.9	1.076391042
10000	11959.90046	1000	1195.990046	100	119.5990046	10	11.95990046	1	1.195990046

Based on 1 inch = 2.54 centimeters, exactly, 1 m² = 1.195990046 yd².

Table 20a. Acres to Hectares Conversion

→ acres ↓	0	10	20	30	40	50	60	70	80	90
	hectares									
0	...	4.047	8.094	12.141	16.187	20.234	24.281	28.328	32.375	36.422
100	40.469	44.515	48.562	52.609	56.656	60.703	64.750	68.797	72.843	76.890
200	80.937	84.984	89.031	93.078	97.125	101.171	105.218	109.265	113.312	117.359
300	121.406	125.453	129.499	133.546	137.593	141.640	145.687	149.734	153.781	157.827
400	161.874	165.921	169.968	174.015	178.062	182.109	186.155	190.202	194.249	198.296
500	202.343	206.390	240.437	214.483	218.530	222.577	226.624	230.671	234.718	238.765
600	242.811	246.858	250.905	254.952	258.999	263.046	267.092	271.139	275.186	279.233
700	283.280	287.327	291.374	295.420	299.467	303.514	307.561	311.608	315.655	319.702
800	323.748	327.795	331.842	335.889	339.936	343.983	348.030	352.076	356.123	360.170
900	364.217	368.264	372.311	376.358	380.404	384.451	388.498	392.545	396.592	400.639
1000	404.686

1 acre = 0.4046856 hectare

Table 20b. Hectares to Acres Conversion

→ hectares ↓	0	10	20	30	40	50	60	70	80	90
	acres									
0	...	24.71	49.42	74.13	98.84	123.55	148.26	172.97	197.68	222.39
100	247.11	271.82	296.53	321.24	345.95	370.66	395.37	420.08	444.79	469.50
200	494.21	518.92	543.63	568.34	593.05	617.76	642.47	667.18	691.90	716.61
300	741.32	766.03	790.74	815.45	840.16	864.87	889.58	914.29	939.00	963.71
400	988.42	1013.13	1037.84	1062.55	1087.26	1111.97	1136.68	1161.40	1186.11	1210.82
500	1235.53	1260.24	1284.95	1309.66	1334.37	1359.08	1383.79	1408.50	1433.21	1457.92
600	1482.63	1507.34	1532.05	1556.76	1581.47	1606.19	1630.90	1655.61	1680.32	1705.03
700	1729.74	1754.45	1779.16	1803.87	1828.58	1853.29	1878.00	1902.71	1927.42	1952.13
800	1976.84	2001.55	2026.26	2050.97	2075.69	2100.40	2125.11	2149.82	2174.53	2199.24
900	2223.95	2248.66	2273.37	2298.08	2322.79	2347.50	2372.21	2396.92	2421.63	2446.34
1000	2471.05

1 hectare = 2.471054 acres

Units of Volume

Table 21. Cubic Measure and Conversion Factors

Metric System	U.S. System
<i>1 cubic meter (m³) =</i>	<i>1 cubic yard (yd³) =</i>
1000 cubic decimeters (liters)	27 cubic feet
1,000,000 cubic centimeters	201.97403 U.S. gallons
1.30795 cubic yards	46,656 cubic inch
35.314667 cubic feet	0.7646 cubic meter
61,023.74 cubic inches	<i>1 cubic foot (ft³) =</i>
264.17205 U.S. gallons	1728 cubic inches
219.96925 British Imperial gallons	7.4805 U.S. gallons
<i>1 liter (l) or 1 cubic decimeter (dm³) =</i>	6.23 British Imperial gallons
1 liter = volume of 1 kg water at 39.2°F	0.02831685 cubic meter
0.001 cubic meter	28.31685 liters
1000 cubic centimeters	<i>1 cubic inch (in³) =</i>
10 deciliters	0.55411256 U.S. fluid ounces
0.03531466 cubic foot	16.387064 cubic centimeters
61.023744 cubic inches	
0.2642 U.S. gallon	
0.21997 British Imperial gallon	
1.0566882 U.S. quarts	
33.814 U.S. fluid ounces	
<i>1 cubic centimeter (cm³) =</i>	
0.001 liter	
1000 cubic millimeters	
0.061024 cubic inch	
<i>1 cubic millimeter = 0.001</i> cubic centimeters	
<i>1 hectoliter (hl) = 100</i> liters	
<i>1 deciliter (dl) = 10</i> centiliters	
<i>1 centiliter (cl) = 10</i> milliliters	
	Shipping Measure
	For measuring internal capacity of a vessel:
	<i>1 register ton = 100</i> cubic feet
	For measurement of cargo:
	<i>1 shipping ton =</i>
	Approximately 40 cubic feet of merchandise is considered a shipping ton, unless that bulk would weigh more than 2000 pounds, in which case the freight charge may be based upon weight
	<i>40 cubic feet =</i>
	32.143 U.S. bushels
	31.16 Imperial bushels
	U.S. Liquid Measure
British (Imperial) Liquid and Dry Measure	
<i>1 British Imperial gallon =</i>	<i>1 U.S. gallon =</i>
0.1605 cubic foot	0.13368 cubic foot
277.42 cubic inches	231 cubic inches
1.2009 U.S. gallon	128 U.S. fluid ounces
160 Imperial fluid ounces	4 U.S. quarts
4 Imperial quarts	8 U.S. pints
8 Imperial pints	0.8327 British Imperial gallon
4.54609 liters	3.785411784 liters
<i>1 quart =</i>	<i>1 quart =</i>
2 Imperial pints	2 U.S. pints
8 Imperial gills	8 U.S. gills
40 Imperial fluid ounces	32 U.S. fluid ounces
69.354 cubic inches	57.75 cubic inches
1.1365225 liters	0.9463529 liters
<i>1 pint =</i>	<i>1 pint =</i>
4 Imperial gills	4 U.S. gills
20 Imperial fluid ounces	16 U.S. fluid ounces
34.678 cubic inches	28.875 cubic inches
568.26125 milliliters	473.176 milliliters
<i>1 gill =</i>	<i>1 gill =</i>
5 Imperial fluid ounces	1/2 cup = 4 U.S. fluid ounces
8.669 cubic inches	7.21875 cubic inches
142.07 milliliters	118.29 milliliters

Note: Figures in **Bold** indicate exact conversion values

Table 21. (Continued) Cubic Measure and Conversion Factors

British (Imperial) Liquid and Dry Measure		Apothecaries' Fluid Measure	
<i>1 British Imperial fluid ounce =</i>	<i>1 U.S. fluid ounce =</i>	1.8046875 cubic inch	<i>1 U.S. fluid ounce =</i>
1.733871 cubic inch		$\frac{1}{128}$ U.S. gallon	
$\frac{1}{160}$ British Imperial gallon		8 drachms	
28.41306 milliliters		0.02957353 liter	
<i>1 British Imperial bushel =</i>		29.57353 milliliters	
8 Imperial gallons = 1.284 cubic feet		<i>1 fluid drachm = 60</i> minims	
2219.36 cubic inches			
U.S. Dry Measure		Old Liquid Measure	
<i>1 bushel (U.S. or Winchester struck bushel) =</i>	<i>1 barrel (bbl) =</i>	31½ gallons	
1.2445 cubic feet		<i>1 hogshead =</i>	2 barrels = 63 gallons
2150.42 cubic inches		<i>1 pipe or butt =</i>	2 hogsheads = 4 barrels = 126 gallons
a cylinder 18.5 inches dia., 8 inches deep		<i>1 tierce =</i>	42 gallons
a cylinder 47.0 cm dia., 20.3 cm deep		<i>1 puncheon =</i>	2 tierces = 84 gallons
<i>1 bushel =</i>	4 pecks = 32 quarts = 64 pints	<i>1 tun =</i>	2 pipes = 3 puncheons
<i>1 peck =</i>	8 quarts = 16 pints		
<i>1 dry quart =</i>	2 pints = 67.200625 cubic inches		
	1.101221 liters		
<i>1 heaped bushel =</i>	$1\frac{1}{4}$ struck bushel		
<i>1 cubic foot =</i>	0.8036 struck bushel		
		Other Cubic Measure	
		The following are used for wood and masonry:	
		<i>1 cord of wood =</i> 4 × 4 × 8 feet = 128 cubic feet	
		<i>1 perch of masonry =</i>	
		16½ × 1½ × 1 foot = 24¾ cubic feet	
		Barrel Measure	
<i>1 drum =</i>	55 U.S. gallon	<i>1 petroleum barrel (bo) =</i>	42 U.S. gallons
	7.3524 cubic feet		5.614583 cubic feet
	208.19765 liters		158.98729 liters

Note: Figures in **Bold** indicate exact conversion values

Table 22a. Cubic Inches to Cubic Centimeters Conversion

inch ³	cm ³	inch ³	cm ³	inch ³	cm ³	inch ³	cm ³	inch ³	cm ³
100	1,638.71	10	163.87	1	16.39	0.1	1.64	0.01	0.16
200	3,277.41	20	327.74	2	32.77	0.2	3.28	0.02	0.33
300	4,916.12	30	491.61	3	49.16	0.3	4.92	0.03	0.49
400	6,554.82	40	655.48	4	65.55	0.4	6.55	0.04	0.66
500	8,193.53	50	819.35	5	81.94	0.5	8.19	0.05	0.82
600	9,832.24	60	983.22	6	98.32	0.6	9.83	0.06	0.98
700	11,470.94	70	1,147.09	7	114.71	0.7	11.47	0.07	1.15
800	13,109.65	80	1,310.96	8	131.10	0.8	13.11	0.08	1.31
900	14,748.35	90	1,474.84	9	147.48	0.9	14.75	0.09	1.47
1,000	16,387.06	100	1,638.71	10	163.87	1.0	16.39	0.10	1.64

Based on 1 inch = 2.54 centimeters, exactly. 1 inch³ = 16.387064 cm³, exactly

Table 22b. Cubic Centimeters to Cubic Inches Conversion

cm ³	inch ³	cm ³	in ³	cm ³	inch ³	cm ³	in ³	cm ³	in ³
1,000	61.024	100	6.102	10	0.610	1	0.061	0.1	0.006
2,000	122.048	200	12.205	20	1.220	2	0.122	0.2	0.012
3,000	183.071	300	18.307	30	1.831	3	0.183	0.3	0.018
4,000	244.095	400	24.410	40	2.441	4	0.244	0.4	0.024
5,000	305.119	500	30.512	50	3.051	5	0.305	0.5	0.031
6,000	366.143	600	36.614	60	3.661	6	0.366	0.6	0.037
7,000	427.166	700	42.717	70	4.272	7	0.427	0.7	0.043
8,000	488.190	800	48.819	80	4.882	8	0.488	0.8	0.049
9,000	549.214	900	54.921	90	5.492	9	0.549	0.9	0.055
10,000	610.238	1,000	61.024	100	6.102	10	0.610	1.0	0.061

Based on 1 inch = 2.54 centimeters, exactly. 1 cm³ = 0.06102376 inch³

Table 23a. Cubic Feet to Cubic Meters Conversion

ft ³	m ³	ft ³	m ³	ft ³	m ³	ft ³	m ³	ft ³	m ³
1,000	28.317	100	2.832	10	0.283	1	0.028	0.1	0.003
2,000	56.634	200	5.663	20	0.566	2	0.057	0.2	0.006
3,000	84.951	300	8.495	30	0.850	3	0.085	0.3	0.008
4,000	113.267	400	11.327	40	1.133	4	0.113	0.4	0.011
5,000	141.584	500	14.158	50	1.416	5	0.142	0.5	0.014
6,000	169.901	600	16.990	60	1.699	6	0.170	0.6	0.017
7,000	198.218	700	19.822	70	1.982	7	0.198	0.7	0.020
8,000	226.535	800	22.653	80	2.265	8	0.227	0.8	0.023
9,000	254.852	900	25.485	90	2.549	9	0.255	0.9	0.025
10,000	283.168	1,000	28.317	100	2.832	10	0.283	1.0	0.028

Based on 1 inch = 2.54 centimeters, exactly. $1 \text{ ft}^3 = 0.02831685 \text{ m}^3$

Table 23b. Cubic Meters to Cubic Feet Conversion

m ³	ft ³	m ³	ft ³	m ³	ft ³	m ³	ft ³	m ³	ft ³
100	3,531.47	10	353.15	1	35.31	0.1	3.53	0.01	0.35
200	7,062.93	20	706.29	2	70.63	0.2	7.06	0.02	0.71
300	10,594.40	30	1,059.44	3	105.94	0.3	10.59	0.03	1.06
400	14,125.86	40	4,412.59	4	141.26	0.4	14.13	0.04	1.41
500	17,657.33	50	1,756.73	5	176.57	0.5	17.66	0.05	1.77
600	21,188.80	60	2,118.88	6	211.89	0.6	21.19	0.06	2.12
700	24,720.26	70	2,472.03	7	247.20	0.7	24.72	0.07	2.47
800	28,251.73	80	2,825.17	8	282.52	0.8	28.25	0.08	2.83
900	31,783.19	90	3,178.32	9	317.83	0.9	31.78	0.09	3.18
1,000	35,314.66	100	3,531.47	10	353.15	1.0	35.311	0.10	3.53

Based on 1 inch = 2.54 centimeters, exactly. $1 \text{ m}^3 = 35.31466 \text{ ft}^3$

Table 24a. Cubic Feet to Liters Conversion

ft ³	liters	ft ³	liters	ft ³	liters	ft ³	liters	ft ³	liters
100	2,831.68	10	283.17	1	28.32	0.1	2.83	0.01	0.28
200	5,663.37	20	566.34	2	56.63	0.2	5.66	0.02	0.57
300	8,495.06	30	849.51	3	84.95	0.3	8.50	0.03	0.85
400	11,326.74	40	1,132.67	4	113.27	0.4	11.33	0.04	1.13
500	14,158.42	50	1,415.84	5	141.58	0.5	14.16	0.05	1.42
600	16,990.11	60	1,699.01	6	169.90	0.6	16.99	0.06	1.70
700	19,821.80	70	1,982.18	7	198.22	0.7	19.82	0.07	1.98
800	22,653.48	80	2,263.35	8	226.53	0.8	22.65	0.08	2.27
900	25,485.16	90	2,548.52	9	254.85	0.9	25.49	0.09	2.55
1,000	28,316.85	100	2,831.68	10	283.17	1.0	28.32	0.10	2.83

$1 \text{ ft}^3 = 28.31685 \text{ liters}$

Table 24b. Liters to Cubic Feet Conversion

liters	ft ³	liters	ft ³	liters	ft ³	liters	ft ³	liters	ft ³
1,000	35.315	100	3.531	10	0.353	1	0.035	0.1	0.004
2,000	70.629	200	7.063	20	0.706	2	0.071	0.2	0.007
3,000	105.944	300	10.594	30	1.059	3	0.106	0.3	0.011
4,000	141.259	400	14.126	40	1.413	4	0.141	0.4	0.014
5,000	176.573	500	17.657	50	1.766	5	0.177	0.5	0.018
6,000	211.888	600	21.189	60	2.119	6	0.212	0.6	0.021
7,000	247.203	700	24.720	70	2.472	7	0.247	0.7	0.025
8,000	282.517	800	28.252	80	2.825	8	0.283	0.8	0.028
9,000	317.832	900	31.783	90	3.178	9	0.318	0.9	0.032
10,000	353.147	1,000	35.315	100	3.531	10	0.353	1.0	0.035

$1 \text{ liter} = 0.03531466 \text{ ft}^3$

Table 25a. U.K. (Imperial) Gallons to Liters Conversion

Imp. gals	0	1	2	3	4	5	6	7	8	9
	liters									
0	...	4.546	9.092	13.638	18.184	22.730	27.277	31.823	36.369	40.915
10	45.461	50.007	54.553	59.099	63.645	68.191	72.737	77.284	81.830	86.376
20	90.922	95.468	100.014	104.560	109.106	113.652	118.198	122.744	127.291	131.837
30	136.383	140.929	145.475	150.021	154.567	159.113	163.659	168.205	172.751	177.298
40	181.844	186.390	190.936	195.482	200.028	204.574	209.120	213.666	218.212	222.759
50	227.305	231.851	236.397	240.943	245.489	250.035	254.581	259.127	263.673	268.219
60	272.766	277.312	281.858	286.404	290.950	295.496	300.042	304.588	309.134	313.680
70	318.226	322.773	327.319	331.865	336.411	340.957	345.503	350.049	354.595	359.141
80	363.687	368.233	372.780	377.326	381.872	386.418	390.964	395.510	400.056	404.602
90	409.148	413.694	418.240	422.787	427.333	431.879	436.425	440.971	445.517	450.063
100	454.609	459.155	463.701	468.247	472.794	477.340	481.886	486.432	490.978	495.524

1 U.K. gallon = 4.546092 liters

Table 25b. Liters to U.K. (Imperial) Gallons Conversion

liters	0	1	2	3	4	5	6	7	8	9
	Imperial gallons									
0	...	0.220	0.440	0.660	0.880	1.100	1.320	1.540	1.760	1.980
10	2.200	2.420	2.640	2.860	3.080	3.300	3.520	3.739	3.959	4.179
20	4.399	4.619	4.839	5.059	5.279	5.499	5.719	5.939	6.159	6.379
30	6.599	6.819	7.039	7.259	7.479	7.699	7.919	8.139	8.359	8.579
40	8.799	9.019	9.239	9.459	9.679	9.899	10.119	10.339	10.559	10.778
50	10.998	11.218	11.438	11.658	11.878	12.098	12.318	12.538	12.758	12.978
60	13.198	13.418	13.638	13.858	14.078	14.298	14.518	14.738	14.958	15.178
70	15.398	15.618	15.838	16.058	16.278	16.498	16.718	16.938	17.158	17.378
80	17.598	17.818	18.037	18.257	18.477	18.697	18.917	19.137	19.357	19.577
90	19.797	20.017	20.237	20.457	20.677	20.897	21.117	21.337	21.557	21.777
100	21.997	22.217	22.437	22.657	22.877	23.097	23.317	23.537	23.757	23.977

1 liter = 0.2199692 U.K. gallons

Table 26a. U.S. Gallons to Liters Conversion

gals	liters	gals	liters	gals	liters	gals	liters	gals	liters
1,000	3,785.41	100	378.54	10	37.85	1	3.79	0.1	0.38
2,000	7,570.82	200	757.08	20	75.71	2	7.57	0.2	0.76
3,000	11,356.24	300	1,135.62	30	113.56	3	11.36	0.3	1.14
4,000	15,141.65	400	1,514.16	40	151.42	4	15.14	0.4	1.51
5,000	18,927.06	500	1,892.71	50	189.27	5	18.93	0.5	1.89
6,000	22,712.47	600	2,271.25	60	227.12	6	22.71	0.6	2.27
7,000	26,497.88	700	2,649.79	70	264.98	7	26.50	0.7	2.65
8,000	30,283.30	800	3,028.33	80	302.83	8	30.28	0.8	3.03
9,000	34,068.71	900	3,406.87	90	340.69	9	34.07	0.9	3.41
10,000	37,854.12	1,000	3,785.41	100	378.54	10	37.85	1.0	3.79

1 U.S. gallon = 3.785412 liters

Table 26b. Liters to U.S. Gallons Conversion

liters	gals	liters	gals	liters	gals	liters	gals	liters	gals
1,000	264.17	100	26.42	10	2.64	1	0.26	0.1	0.03
2,000	528.34	200	52.83	20	5.28	2	0.53	0.2	0.05
3,000	792.52	300	79.25	30	7.93	3	0.79	0.3	0.08
4,000	1,056.69	400	105.67	40	10.57	4	1.06	0.4	0.11
5,000	1,320.86	500	132.09	50	13.21	5	1.32	0.5	0.13
6,000	1,585.03	600	158.50	60	15.85	6	1.59	0.6	0.16
7,000	1,849.20	700	184.92	70	18.49	7	1.85	0.7	0.18
8,000	2,113.38	800	211.34	80	21.13	8	2.11	0.8	0.21
9,000	2,377.55	900	237.75	90	23.78	9	2.38	0.9	0.24
10,000	2,641.72	1,000	264.17	100	26.42	10	2.64	1.0	0.26

1 liter = 0.2641720 U.S. gallon

Table 27a. U.S. Fluid Ounces to Milliliters Conversion

oz	mL	oz	mL	oz	mL	oz	mL	oz	mL
100	2957.353	10	295.7353	1	29.57353	0.1	2.957353	0.01	0.2957353
200	5914.706	20	591.4706	2	59.14706	0.2	5.914706	0.02	0.5914706
300	8872.059	30	887.2059	3	88.72059	0.3	8.872059	0.03	0.8872059
400	11829.412	40	1182.9412	4	118.29412	0.4	11.829412	0.04	1.1829412
500	14786.765	50	1478.6765	5	147.86765	0.5	14.786765	0.05	1.4786765
600	17744.118	60	1774.4118	6	177.44118	0.6	17.744118	0.06	1.7744118
700	20701.471	70	2070.1471	7	207.01471	0.7	20.701471	0.07	2.0701471
800	23658.824	80	2365.8824	8	236.58824	0.8	23.658824	0.08	2.3658824
900	26616.177	90	2661.6177	9	266.16177	0.9	26.616177	0.09	2.6616177
1000	29573.53	100	2957.353	10	295.7353	1	29.57353	0.1	2.957353

1 U.S. fluid ounce = 29.57353 milliliters

Table 27b. Milliliters to U.S. Fluid Ounces Conversion

mL	oz	mL	oz	mL	oz	mL	oz	mL	oz
100	3.3814	10	0.33814	1	0.033814	0.1	0.0033814	0.01	0.00033814
200	6.7628	20	0.67628	2	0.067628	0.2	0.0067628	0.02	0.00067628
300	10.1442	30	1.01442	3	0.101442	0.3	0.0101442	0.03	0.00101442
400	13.5256	40	1.35256	4	0.135256	0.4	0.0135256	0.04	0.00135256
500	16.907	50	1.6907	5	0.16907	0.5	0.016907	0.05	0.0016907
600	20.2884	60	2.02884	6	0.202884	0.6	0.0202884	0.06	0.00202884
700	23.6698	70	2.36698	7	0.236698	0.7	0.0236698	0.07	0.00236698
800	27.0512	80	2.70512	8	0.270512	0.8	0.0270512	0.08	0.00270512
900	30.4326	90	3.04326	9	0.304326	0.9	0.0304326	0.09	0.00304326
1000	33.814	100	3.3814	10	0.33814	1	0.033814	0.1	0.0033814

1 milliliter = 0.003814 U.S. fluid ounce

Units of Volumetric Flow Rate

Table 28a. Volume Flow per Second Conversion

To Convert ↓	Multiply By Factor To Obtain ↓	Cm ³ /sec	Meter ³ /sec	Foot ³ /sec	Liter/sec	Gallon/sec (US)	Gallon/sec (UK)
Cm ³ /sec		1	1 × 10 ⁻⁶	3.531 × 10 ⁻⁵	0.001	2.642 × 10 ⁻⁴	2.19969 × 10 ⁻⁴
Meter ³ /sec		1 × 10 ⁶	1	35.31466	1,000	264.172	219.9692
Foot ³ /sec		28,316.846	0.028316	1	28.3168	7.480519	6.22883
Liter/sec		1000	0.001	0.0353146	1	0.264172	0.21996
Gallon/sec (US)		3,785.412	3.7854 × 10 ⁻³	0.133368	3.785412	1	0.8326739
Gallon/sec (UK)		4,546.092	4.546 × 10 ⁻³	0.1605432	4.546092	1.2009504	1

Table 28b. Volume Flow per Minute Conversion

To Convert ↓	Multiply By Factor To Obtain →	Foot ³ /min	Liter/min	Gallon/min (US)	Gallon/min (UK)
Foot ³ /min		1	28.316846	7.480519	6.2288327
Liter/min		0.035314	1	0.264172	0.2199692
Gallon/min (US)		0.133680	3.785412	1	0.832673
Gallon/min (UK)		0.1605437	4.546092	1.20095	1

Pitot Tube.— A pitot tube is a small, transparent, open tube bent at right angle. It is a hollow tube that is placed longitudinally in the direction of fluid flow, allowing the flow to enter one end at the fluids velocity of approach. When the fluids enter the pitot tube, it comes to a stop, all of the velocity head is converted to pressure head. The difference between the total and static energies is the kinetic energy of the fluid. The velocity of the fluid can be calculated by using the Bernoulli equation.

$$\frac{p_1}{\rho} + \frac{v_1^2}{2} = \frac{p_2}{\rho} \qquad v_1 = \sqrt{\frac{2(p_2 - p_1)}{\rho}} \text{ (SI)} \qquad v_1 = \sqrt{\frac{2(p_2 - p_1)g_c}{\rho}} \text{ (US)}$$

Units of Mass and Weight

Table 29. Mass and Weight Conversion Factors

Metric System	Avoirdupois or Commercial Weight
<i>1 metric ton (t) =</i> 1000 kilograms 2204.6223 pounds 0.9842 gross or long ton (of 2240 pounds) 0.9072 net or short ton (of 2000 pounds)	<i>1 gross or long ton =</i> 2240 pounds 1.016 metric ton 1016 kilograms
<i>1 kilogram (kg) =</i> 1000 grams = 10 hectograms 2.2046 pounds 35.274 ounces avoirdupois	<i>1 net or short ton = 2000</i> pounds <i>1 pound = 16</i> ounces 7000 grains 0.45359237 kilogram 453.6 grams
<i>1 hectogram (hg) = 10</i> dekagrams <i>1 dekagram (dag) = 10</i> grams	<i>1 ounce =</i> $\frac{1}{16}$ pound 16 drachms 437.5 grains 28.3495 grams 0.2780139 newton
<i>1 gram (g) =</i> 10 decigrams 0.0022046 pound 0.03215 ounce Troy 0.03527 ounce avoirdupois 15.432 grains	<i>1 grain Avoirdupois =</i> 1 grain apothecaries' weight = 1 grain Troy weight 0.064799 gram
<i>1 decigram (dg) = 10</i> centigrams <i>1 centigram (cg) = 10</i> milligrams	
Troy Weight	Apothecaries' Weight
Used for Weighing Gold and Silver	<i>1 pound = 12</i> ounces = 5760 grains
<i>1 pound Troy =</i> 12 ounces Troy = 5760 grains $\frac{144}{175}$ Avoirdupois pound	<i>1 ounce =</i> 8 drachms = 480 grains 31.103 grams
<i>1 ounce Troy =</i> 20 pennyweights = 480 grains 31.103 grams	<i>1 drachm = 3</i> scruples = 60 grains <i>1 scruple = 20</i> grains
<i>1 pennyweight = 24</i> grains	Old Weight Measures
<i>1 grain Troy =</i> 1 grain avoirdupois 1 grain apothecaries' weight 0.0648 gram	Measures for weight seldom used in the United States:
<i>1 carat (used in weighing diamonds) =</i> 3.086 grains 200 milligrams = $\frac{1}{5}$ gram	<i>1 gross or long ton = 20</i> hundred-weights <i>1 hundred-weight = 4</i> quarters = 112 pounds <i>1 quarter = 28</i> pounds <i>1 stone = 14</i> pounds <i>1 quintal = 100</i> pounds
<i>1 gold karat = $\frac{1}{24}$</i> proportion pure gold	

Note: Figures in **Bold** indicate exact conversion values

Table 30a. Pounds to Kilograms Conversion

lb	kg	lb	kg	lb	kg	lb	kg	lb	kg
1,000	453.59	100	45.36	10	4.54	1	0.45	0.1	0.05
2,000	907.18	200	90.72	20	9.07	2	0.91	0.2	0.09
3,000	1,360.78	300	136.08	30	13.61	3	1.36	0.3	0.14
4,000	1,814.37	400	181.44	40	18.14	4	1.81	0.4	0.18
5,000	2,267.96	500	226.80	50	22.68	5	2.27	0.5	0.23
6,000	2,721.55	600	272.16	60	27.22	6	2.72	0.6	0.27
7,000	3,175.15	700	317.51	70	31.75	7	3.18	0.7	0.32
8,000	3,628.74	800	362.87	80	36.29	8	3.63	0.8	0.36
9,000	4,082.33	900	408.23	90	40.82	9	4.08	0.9	0.41
10,000	4,535.92	1,000	453.59	100	45.36	10	4.54	1.0	0.45

1 pound = 0.4535924 kilogram

Table 30b. Kilograms to Pounds Conversion

kg	lb	kg	lb	kg	lb	kg	lb	kg	lb
1,000	2,204.62	100	220.46	10	22.05	1	2.20	0.1	0.22
2,000	4,409.24	200	440.92	20	44.09	2	4.41	0.2	0.44
3,000	6,613.87	300	661.39	30	66.14	3	6.61	0.3	0.66
4,000	8,818.49	400	881.85	40	88.18	4	8.82	0.4	0.88
5,000	11,023.11	500	1,102.31	50	110.23	5	11.02	0.5	1.10
6,000	13,227.73	600	1,322.77	60	132.28	6	13.23	0.6	1.32
7,000	15,432.35	700	1,543.24	70	154.32	7	15.43	0.7	1.54
8,000	17,636.98	800	1,763.70	80	176.37	8	17.64	0.8	1.76
9,000	19,841.60	900	1,984.16	90	198.42	9	19.84	0.9	1.98
10,000	22,046.22	1,000	2,204.62	100	220.46	10	22.05	1.0	2.20

1 kilogram = 2.204622 pounds

Table 31a. Ounces to Grams Conversion

oz	g	oz	g	oz	g	oz	g	oz	g
10	283.50	1	28.35	0.1	2.83	0.01	0.28	0.001	0.03
20	566.99	2	56.70	0.2	5.67	0.02	0.57	0.002	0.06
30	850.49	3	85.05	0.3	8.50	0.03	0.85	0.003	0.09
40	1,133.98	4	113.40	0.4	11.34	0.04	1.13	0.004	0.11
50	1,417.48	5	141.75	0.5	14.17	0.05	1.42	0.005	0.14
60	1,700.97	6	170.10	0.6	17.01	0.06	1.70	0.006	0.17
70	1,984.47	7	198.45	0.7	19.84	0.07	1.98	0.007	0.20
80	2,267.96	8	226.80	0.8	22.68	0.08	2.27	0.008	0.23
90	2,551.46	9	255.15	0.9	25.51	0.09	2.55	0.009	0.26
100	2,834.95	10	283.50	1.0	28.35	0.10	2.83	0.010	0.28

1 ounce = 28.34952 grams

Table 31b. Grams to Ounces Conversion

g	oz	g	oz	g	oz	g	oz	g	oz
100	3.527	10	0.353	1	0.035	0.1	0.004	0.01	0.000
200	7.055	20	0.705	2	0.071	0.2	0.007	0.02	0.001
300	10.582	30	1.058	3	0.106	0.3	0.011	0.03	0.001
400	14.110	40	1.411	4	0.141	0.4	0.014	0.04	0.001
500	17.637	50	1.764	5	0.176	0.5	0.018	0.05	0.002
600	21.164	60	2.116	6	0.212	0.6	0.021	0.06	0.002
700	24.692	70	2.469	7	0.247	0.7	0.025	0.07	0.002
800	28.219	80	2.822	8	0.282	0.8	0.028	0.08	0.003
900	31.747	90	3.175	9	0.317	0.9	0.032	0.09	0.003
1,000	35.274	100	3.527	10	0.353	1.0	0.035	0.10	0.004

1 gram = 0.03527397 ounce

Table 32. Density Conversion Factors

To Convert ↓	Multiply By This Factor, To Obtain ↓	Gram/mL	Gram/cm ³	Kg/m ³	Lb/inch ³	Lb/feet ³	Lb/gallon (US)	Ton/yard ³
Grams/mL		1	1	1000	0.036128	62.43	8.345	0.8428
Grams/cm ³		1	1	1000	0.036128	62.43	8.345	0.8428
Kilogram/m ³		0.001	0.001	1	3.6128×10^{-5}	0.06243	0.008345	8.428×10^{-4}
Lb/inch ³		27.67788	27.67788	27677.83	1	1728.0	230.9718	23.32687
Lb/feet ³		0.01602	0.01602	16.02	5.787×10^{-4}	1	0.1337	0.01349
Lb/gallon (US)		0.11983	0.11983	119.83	0.004329	7.481126	1	0.10099
Ton/yard ³		1.18652	1.18652	1186.52	0.042869	74.07451	9.9015	1

Table 33a. Pounds per Cubic Inch to Grams per Cubic Centimeter Conversion

lb/in ³	g/cm ³	lb/in ³	g/cm ³	lb/in ³	g/cm ³	lb/in ³	g/cm ³	lb/in ³	g/cm ³
100	2,767.99	10	276.80	1	27.68	0.1	2.77	0.01	0.28
200	5,535.98	20	553.60	2	55.36	0.2	5.54	0.02	0.55
300	8,303.97	30	830.40	3	83.04	0.3	8.30	0.03	0.83
400	11,071.96	40	1,107.20	4	110.72	0.4	11.07	0.04	1.11
500	13,839.95	50	1,384.00	5	138.40	0.5	13.84	0.05	1.38
600	16,607.94	60	1,660.79	6	166.08	0.6	16.61	0.06	1.66
700	19,375.93	70	1,937.59	7	193.76	0.7	19.38	0.07	1.94
800	22,143.92	80	2,214.39	8	221.44	0.8	22.14	0.08	2.21
900	24,911.91	90	2,491.19	9	249.12	0.9	24.91	0.09	2.49
1,000	27,679.90	100	2,767.99	10	276.80	1.0	27.68	0.10	2.77

1 lb/in³ = 27.67990 g/cm³

Table 33b. Grams per Cubic Centimeter to Pounds per Cubic Inch Conversion

g/cm ³	lb/in ³	g/cm ³	lb/in ³	g/cm ³	lb/in ³	g/cm ³	lb/in ³	g/cm ³	lb/in ³
1,000	36.127	100	3.613	10	0.361	1	0.036	0.1	0.004
2,000	72.255	200	7.225	20	0.723	2	0.072	0.2	0.007
3,000	108.382	300	10.838	30	1.084	3	0.108	0.3	0.011
4,000	144.509	400	14.451	40	1.445	4	0.145	0.4	0.014
5,000	180.636	500	18.064	50	1.806	5	0.181	0.5	0.018
6,000	216.764	600	21.676	60	2.168	6	0.217	0.6	0.022
7,000	252.891	700	25.289	70	2.529	7	0.253	0.7	0.025
8,000	289.018	800	28.902	80	2.890	8	0.289	0.8	0.029
9,000	325.146	900	32.515	90	3.251	9	0.325	0.9	0.033
10,000	361.273	1,000	36.127	100	3.613	10	0.361	1.0	0.036

1 g/cm³ = 0.03612730 lb/in³

Table 34a. Pounds per Cubic Foot to Kilograms per Cubic Meter Conversion

lb/ft ³	kg/m ³	lb/ft ³	kg/m ³	lb/ft ³	kg/m ³	lb/ft ³	kg/m ³	lb/ft ³	kg/m ³
100	1,601.85	10	160.18	1	16.02	0.1	1.60	0.01	0.16
200	3,203.69	20	320.37	2	32.04	0.2	3.20	0.02	0.32
300	4,805.54	30	480.55	3	48.06	0.3	4.81	0.03	0.48
400	6,407.38	40	640.74	4	64.07	0.4	6.41	0.04	0.64
500	8,009.23	50	800.92	5	80.09	0.5	8.01	0.05	0.80
600	9,611.08	60	961.11	6	96.11	0.6	9.61	0.06	0.96
700	11,212.92	70	1,121.29	7	112.13	0.7	11.21	0.07	1.12
800	12,814.77	80	1,281.48	8	128.15	0.8	12.81	0.08	1.28
900	14,416.61	90	1,441.66	9	144.17	0.9	14.42	0.09	1.44
1,000	16,018.46	100	1,601.85	10	160.18	1.0	16.02	0.10	1.60

1 lb/ft³ = 16.01846 kg/m³

Table 34b. Kilograms per Cubic Meter to Pounds per Cubic Foot Conversion

kg/m ³	lb/ft ³	kg/m ³	lb/ft ³	kg/m ³	lb/ft ³	kg/m ³	lb/ft ³	kg/m ³	lb/ft ³
1,000	62.428	100	6.243	10	0.624	1	0.062	0.1	0.006
2,000	124.856	200	12.486	20	1.249	2	0.125	0.2	0.012
3,000	187.284	300	18.728	30	1.873	3	0.187	0.3	0.019
4,000	249.712	400	24.971	40	2.497	4	0.250	0.4	0.025
5,000	312.140	500	31.214	50	3.121	5	0.312	0.5	0.031
6,000	374.568	600	37.457	60	3.746	6	0.375	0.6	0.037
7,000	436.996	700	43.700	70	4.370	7	0.437	0.7	0.044
8,000	499.424	800	49.942	80	4.994	8	0.499	0.8	0.050
9,000	561.852	900	56.185	90	5.619	9	0.562	0.9	0.056
10,000	624.280	1,000	62.428	100	6.243	10	0.624	1.0	0.062

1 kg/m³ = 0.06242797 lb/ft³

Units of Pressure and Stress

Table 35. Pressure and Stress Conversion Factors

<i>1 kilogram per sq. millimeter (kg_f/mm²) =</i> 1422.32 pounds per square inch	<i>1 pound per square inch =</i> 144 pounds per square foot 0.068 atmosphere 2.042 inches of mercury at 62°F 27.7 inches of water at 62°F 2.31 feet of water at 62°F 0.0703 kilogram per square centimeter 6.894757 kilopascals 6894.757 pascal
<i>1 kilogram per sq. centimeter (kg_f/cm²) =</i> 14.223 pounds per square inch	<i>1 atmosphere =</i> 30 inches of mercury at 62°F 14.7 pounds per square inch 2116.3 pounds per square foot 33.95 feet of water at 62°F
<i>1 bar =</i> 1,000,000 dynes per square centimeter 1000 millibars 100 kilopascals 750.06168 torr 1.0197162 kilogram force per sq. centimeter	<i>1 foot of water at 62°F =</i> 62.355 pounds per square foot 0.433 pound per square inch
<i>1 millibar =</i> 100,000 dynes per square centimeter 100 pascal	<i>1 inch of mercury at 62°F =</i> 1.132 foot of water 13.58 inches of water 0.491 pound per square inch
<i>1 torr =</i> 760 millimeters mercury $\frac{1}{760}$ atmosphere 133.224 pascal 1.333224 millibar	<i>1 inch of water =</i> 0.0735559 inch mercury at 0°C 1.8683205 torr 0.5780367 ounce force per square inch 0.0024583 atmosphere

Table 36a. Pounds per Square Inch to Kilograms per Square Centimeter Conversion

lb/in ²	kg/cm ²	lb/in ²	kg/cm ²	lb/in ²	kg/cm ²	lb/in ²	kg/cm ²	lb/in ²	kg/cm ²
1,000	70.307	100	7.031	10	0.703	1	0.070	0.1	0.007
2,000	140.614	200	14.061	20	1.406	2	0.141	0.2	0.014
3,000	210.921	300	21.092	30	2.109	3	0.211	0.3	0.021
4,000	281.228	400	28.123	40	2.812	4	0.281	0.4	0.028
5,000	351.535	500	35.153	50	3.515	5	0.352	0.5	0.035
6,000	421.842	600	42.184	60	4.218	6	0.422	0.6	0.042
7,000	492.149	700	49.215	70	4.921	7	0.492	0.7	0.049
8,000	562.456	800	56.246	80	5.625	8	0.562	0.8	0.056
9,000	632.763	900	63.276	90	6.328	9	0.633	0.9	0.063
10,000	703.070	1,000	70.307	100	7.031	10	0.703	1.0	0.070

1 lb/in² = 0.07030697 kg/cm²

Table 36b. Kilogram per Square Centimeter to Pounds per Square Inch Conversion

kg/cm ²	lb/in ²	kg/cm ²	lb/in ²	kg/cm ²	lb/in ²	kg/cm ²	lb/in ²	kg/cm ²	lb/in ²
100	1,422.33	10	142.23	1	14.22	0.1	1.42	0.01	0.14
200	2,844.67	20	284.47	2	28.45	0.2	2.84	0.02	0.28
300	4,267.00	30	426.70	3	42.67	0.3	4.27	0.03	0.43
400	5,689.34	40	568.93	4	56.89	0.4	5.69	0.04	0.57
500	7,111.67	50	711.17	5	71.12	0.5	7.11	0.05	0.71
600	8,534.00	60	853.40	6	85.34	0.6	8.53	0.06	0.85
700	9,956.34	70	995.63	7	99.56	0.7	9.96	0.07	1.00
800	11,378.67	80	1,137.87	8	113.79	0.8	11.38	0.08	1.14
900	12,801.01	90	1,280.10	9	128.01	0.9	12.80	0.09	1.28
1,000	14,223.34	100	1,422.33	10	142.23	1.0	14.22	0.10	1.42

1 kg/cm² = 14.22334 lb/in²

Table 37a. Pounds per Square Foot to Kilograms per Square Meter Conversion

lb/ft ²	kg/m ²	lb/ft ²	kg/m ²	lb/ft ²	kg/m ²	lb/ft ²	kg/m ²	lb/ft ²	kg/m ²
1,000	4,882.43	100	488.24	10	48.82	1	4.88	0.1	0.49
2,000	9,764.86	200	976.49	20	97.65	2	9.76	0.2	0.98
3,000	14,647.29	300	1,464.73	30	146.47	3	14.65	0.3	1.46
4,000	19,529.72	400	1,952.97	40	195.30	4	19.53	0.4	1.95
5,000	24,412.14	500	2,441.21	50	244.12	5	24.41	0.5	2.44
6,000	29,294.57	600	2,929.46	60	292.95	6	29.29	0.6	2.93
7,000	34,177.00	700	3,417.70	70	341.77	7	34.18	0.7	3.42
8,000	39,059.43	800	3,905.94	80	390.59	8	39.06	0.8	3.91
9,000	43,941.86	900	4,394.19	90	439.42	9	43.94	0.9	4.39
10,000	48,824.28	1,000	4,882.43	100	488.24	10	48.82	1.0	4.88

1 lb/ft² = 4.882429 kg/m²

Table 37b. Kilograms per Square Meter to Pounds per Square Foot Conversion

kg/m ²	lb/ft ²	kg/m ²	lb/ft ²	kg/m ²	lb/ft ²	kg/m ²	lb/ft ²	kg/m ²	lb/ft ²
1,000	204.82	100	20.48	10	2.05	1	0.20	0.1	0.02
2,000	409.63	200	40.96	20	4.10	2	0.41	0.2	0.04
3,000	614.45	300	61.44	30	6.14	3	0.61	0.3	0.06
4,000	819.26	400	81.93	40	8.19	4	0.82	0.4	0.08
5,000	1,024.08	500	102.41	50	10.24	5	1.02	0.5	0.10
6,000	1,228.90	600	122.89	60	12.29	6	1.23	0.6	0.12
7,000	1,433.71	700	143.37	70	14.34	7	1.43	0.7	0.14
8,000	1,638.53	800	163.85	80	16.39	8	1.64	0.8	0.16
9,000	1,843.34	900	184.33	90	18.43	9	1.84	0.9	0.18
10,000	2,048.16	1,000	204.82	100	20.48	10	2.05	1.0	0.20

1 kg/m² = 0.2048161 lb/ft²

Table 38a. Pounds Per Square Inch to Kilopascals Conversion

→ lb/in ² ↓	0	1	2	3	4	5	6	7	8	9
	kilopascals									
0	...	6.895	13.790	20.684	27.579	34.474	41.369	48.263	55.158	62.053
10	68.948	75.842	82.737	89.632	96.527	103.421	110.316	117.211	124.106	131.000
20	137.895	144.790	151.685	158.579	165.474	172.369	179.264	186.158	193.053	199.948
30	206.843	213.737	220.632	227.527	234.422	241.316	248.211	255.106	262.001	268.896
40	275.790	282.685	289.580	296.475	303.369	310.264	317.159	324.054	330.948	337.843
50	344.738	351.633	358.527	365.422	372.317	379.212	386.106	393.001	399.896	406.791
60	413.685	420.580	427.475	434.370	441.264	448.159	455.054	461.949	468.843	475.738
70	482.633	489.528	496.423	503.317	510.212	517.107	524.002	530.896	537.791	544.686
80	551.581	558.475	565.370	572.265	579.160	586.054	592.949	599.844	606.739	613.633
90	620.528	627.423	634.318	641.212	648.107	655.002	661.897	668.791	675.686	682.581
100	689.476	696.370	703.265	710.160	717.055	723.949	730.844	737.739	744.634	751.529

1 lb/in² = 6.894757 kPa. Note: 1 kilopascal = 1 kilonewton/meter².

Table 38b. Kilopascals to Pounds Per Square Inch Conversion

→ kPa ↓	0	1	2	3	4	5	6	7	8	9
	lb/in ²									
0	...	0.145	0.290	0.435	0.580	0.725	0.870	1.015	1.160	1.305
10	1.450	1.595	1.740	1.885	2.031	2.176	2.321	2.466	2.611	2.756
20	2.901	3.046	3.191	3.336	3.481	3.626	3.771	3.916	4.061	4.206
30	4.351	4.496	4.641	4.786	4.931	5.076	5.221	5.366	5.511	5.656
40	5.802	5.947	6.092	6.237	6.382	6.527	6.672	6.817	6.962	7.107
50	7.252	7.397	7.542	7.687	7.832	7.977	8.122	8.267	8.412	8.557
60	8.702	8.847	8.992	9.137	9.282	9.427	9.572	9.718	9.863	10.008
70	10.153	10.298	10.443	10.588	10.733	10.878	11.023	11.168	11.313	11.458
80	11.603	11.748	11.893	12.038	12.183	12.328	12.473	12.618	12.763	12.908
90	13.053	13.198	13.343	13.489	13.634	13.779	13.924	14.069	14.214	14.359
100	14.504	14.649	14.794	14.939	15.084	15.229	15.374	15.519	15.664	15.809

1 kPa = 0.1450377 lb/in². Note: 1 kilopascal = 1 kilonewton/meter².

Table 39. Pressure and Stress Conversion Factors

To Convert ↓	↓	Atmosphere	Pascal (N/m ²)	Dyne/cm ²	Bar	Kg/cm ²	Kg/m ²	Psi (lb/inch ²)	Pound/ft ²	Inch of Water	Inch of Mercury	Millimeter of Mercury	Ton/ft ² (Short)
Atmosphere	Multiply By This Factor, To Obtain ↓	1	101325	1.0133 × 10 ⁶	1.01325	1.03319076	10,331.9076	14.6959488	2,116.216	407.1893	29.9212	760	0.9597354
Pascal (N/m ²)		9.8692 × 10 ⁻⁶	1	10	1 × 10⁻⁵	1.01968 × 10 ⁻⁵	0.101968	0.00014504	0.02088	0.004019	0.0002953	0.0075	9.472 × 10 ⁻⁶
Dyne/cm ²		9.8692 × 10 ⁻⁷	0.1	1	1 × 10⁻⁶	1.01968 × 10 ⁻⁶	0.0101968	1.4504 × 10 ⁻⁵	0.002088	0.000402	2.95 × 10 ⁻⁵	0.00075	9.472 × 10 ⁻⁷
Bar		0.98692327	1 × 10⁵	1 × 10⁶	1	1.01968	10194.8	14.5037256	2088.5434	401.8646	29.5299	750.06168	0.9471852
Kilogram/cm ²		0.96784111	98,069.982	980,699.83	0.9807	1	10000	14.2232691	2048.6123	394.0945	28.9653	735.58536	0.9289043
Kilogram/meter ²		9.6787 × 10 ⁻⁵	9.80699	98.06998	9.807 × 10 ⁻⁵	0.0001	1	0.001422	0.204823	0.039409	0.002896	0.0735585	9.289 × 10 ⁻⁵
Psi (lb/inch ²)		0.06804596	6,894.7572	68,947.573	0.068947	0.07029148	703.0446	1	144	27.70768	2.03602	51.71493	0.0653061
Pound/ft ²		4.7254 × 10 ⁻⁴	47.88025	478.80258	0.000478	0.00048813	4.88225	0.006944	1	0.19241	0.014139	0.3591314	0.0004535
Inch of Water		0.00245586	248.8400	2488.4003	0.002488	0.00253690	25.3737	0.036091	5.19713	1	0.073482	1.866453	0.002356
Inch of Mercury		0.03342112	3386.3949	33,863.949	0.033863	0.03452401	345.3039	0.491153	70.72632	13.6087	1	25.4	0.0320754
Mm of Mercury		0.00131579	133.32236	1333.22368	0.001333	0.00135921	13.594615	0.019336	2.784495	0.53577	0.03937	1	0.0012628
Ton/ft ² (Short)		0.94508279	95760.514	957605.14	0.957605	0.9764854	9764.854	13.88888	2000	384.8277	28.27801	718.2616	1

Units of Force

Table 40. Force Conversion Factors

To Convert ↓	↓	Dyne	Gram-force	Joule/cm	Newton	Kg _f	Lb _f	Kip	Poundal	Ounce-force
Dyne	Multiply By This Factor, To Obtain ↓	1	0.00101968	0.001	0.00001	1.01968 × 10 ⁻⁶	2.24809 × 10 ⁻⁶	2.2481 × 10 ⁻⁹	7.233013 × 10 ⁻⁵	3.59694 × 10 ⁻⁵
Gram-force		980.7	1	0.9807	0.009807	0.001	0.0022047	2.2047 × 10 ⁻⁶	0.0709341	0.03527521
Joule/cm		1000	1.0196798	1	0.01	0.00101968	0.002248	2.2481 × 10 ⁻⁶	0.0723301	0.03596942
Newton		1 × 10⁵	101.96798	100	1	0.101967982	0.2248089	2.2481 × 10 ⁻⁴	7.23301	3.596942
Kg-force		9.807 × 10 ⁵	1000	980.7	9.807	1	2.2047	0.0022047	70.934129	35.2752102
Lb _f		4.4482 × 10 ⁵	453.57627	444.822	4.44822	0.45357626	1	0.001	32.174038	16
Kip		4.4482 × 10 ⁸	4.5357 × 10 ⁵	4.4482 × 10 ⁵	4448.2224	453.5762688	1000	1	32174.038	16000
Poundal		13825.50	14.097586	13.8255	0.1382555	0.014097586	0.0310809	3.1081 × 10 ⁻⁵	1	0.497296
Ounce-force		27801.39	28.348519	27.8013	0.278013	0.02834852	0.06250	6.25 × 10 ⁻⁵	2.010877	1

Figures in **bold face** indicate the conversion is exact

Table 41a. Pounds-Force to Newtons Conversion

lb _f → ↓	0	1	2	3	4	5	6	7	8	9
	newtons									
0	...	4.448	8.896	13.345	17.793	22.241	26.689	31.138	35.586	40.034
10	44.482	48.930	53.379	57.827	62.275	66.723	71.172	75.620	80.068	84.516
20	88.964	93.413	97.861	102.309	106.757	111.206	115.654	120.102	124.550	128.998
30	133.447	137.895	142.343	146.791	151.240	155.688	160.136	164.584	169.032	173.481
40	177.929	182.377	186.825	191.274	195.722	200.170	204.618	209.066	213.515	217.963
50	222.411	226.859	231.308	235.756	240.204	244.652	249.100	253.549	257.997	262.445
60	266.893	271.342	275.790	280.238	284.686	289.134	293.583	298.031	302.479	306.927
70	311.376	315.824	320.272	324.720	329.168	333.617	338.065	342.513	346.961	351.410
80	355.858	360.306	364.754	369.202	373.651	378.099	382.547	386.995	391.444	395.892
90	400.340	404.788	409.236	413.685	418.133	422.581	427.029	431.478	435.926	440.374
100	444.822	449.270	453.719	458.167	462.615	467.063	471.512	475.960	480.408	484.856

1 pound-force = 4.448222 newtons

Table 41b. Newtons to Pounds-Force Conversion

N→ ↓	0	1	2	3	4	5	6	7	8	9
	pounds-force									
0	...	0.22481	0.44962	0.67443	0.89924	1.12404	1.34885	1.57366	1.79847	2.02328
10	2.24809	2.47290	2.69771	2.92252	3.14732	3.37213	3.59694	3.82175	4.04656	4.27137
20	4.49618	4.72099	4.94580	5.17060	5.39541	5.62022	5.84503	6.06984	6.29465	6.51946
30	6.74427	6.96908	7.19388	7.41869	7.64350	7.86831	8.09312	8.31793	8.54274	8.76755
40	8.99236	9.21716	9.44197	9.66678	9.89159	10.1164	10.3412	10.5660	10.7908	11.0156
50	11.2404	11.4653	11.6901	11.9149	12.1397	12.3645	12.5893	12.8141	13.0389	13.2637
60	13.4885	13.7133	13.9382	14.1630	14.3878	14.6126	14.8374	15.0622	15.2870	15.5118
70	15.7366	15.9614	16.1862	16.4110	16.6359	16.8607	17.0855	17.3103	17.5351	17.7599
80	17.9847	18.2095	18.4343	18.6591	18.8839	19.1088	19.3336	19.5584	19.7832	20.0080
90	20.2328	20.4576	20.6824	20.9072	21.1320	21.3568	21.5817	21.8065	22.0313	22.2561
100	22.4809	22.7057	22.9305	23.1553	23.3801	23.6049	23.8297	24.0546	24.2794	24.5042

1 newton = 0.2248089 pound-force

Units of Moment and Torque

Table 42. Bending Moment or Torque Conversion Factors

To Convert ↓	→	Dyne-centimeter	Kilogram-meter	Newton-millimeter	Newton-meter	Ounce-inch	Pound-foot
Dyne-centimeter	Multiply By Factor.	1	1 × 10⁻⁷	0.0001	1 × 10⁻⁷	1.416 × 10 ⁻⁵	7.375 × 10 ⁻⁸
Kilogram-meter		9.80665 × 10 ⁷	1	9806.65	9.80665	1388.78818707	7.233271722
Newton-millimeter		10,000	0.000101968	1	0.001	0.14161193	0.000737562
Newton-meter		1 × 10⁷	0.101967982	1000	1	141.61192894	0.737562121
Ounce-inch		70615.52	0.000720052	7.061552	0.007061552	1	0.005208333
Pound-foot		13,558,180	0.138250025	1355.818	1.355818	192	1

Figures in **bold face** indicate the conversion is exact

Table 43a. Pound-Inches to Newton-Meters Conversion

lb _f -in	N•m	lb _f -in	N•m	lb _f -in	N•m	lb _f -in	N•m	lb _f -in	N•m
100	11.298	10	1.130	1	0.113	0.1	0.011	0.01	0.001
200	22.597	20	2.260	2	0.226	0.2	0.023	0.02	0.002
300	33.895	30	3.390	3	0.339	0.3	0.034	0.03	0.003
400	45.194	40	4.519	4	0.452	0.4	0.045	0.04	0.005
500	56.492	50	5.649	5	0.565	0.5	0.056	0.05	0.006
600	67.791	60	6.779	6	0.678	0.6	0.068	0.06	0.007
700	79.089	70	7.909	7	0.791	0.7	0.079	0.07	0.008
800	90.388	80	9.039	8	0.904	0.8	0.090	0.08	0.009
900	101.686	90	10.169	9	1.017	0.9	0.102	0.09	0.010
1000	112.985	100	11.298	10	1.130	1.0	0.113	0.10	0.011

1 pound-inch = 0.1129848 newton-meter

Table 43b. Newton-Meters to Pound-Inches Conversion

N•m	lb _f -in	N•m	lb _f -in	N•m	lb _f -in	N•m	lb _f -in	N•m	lb _f -in
100	885.07	10	88.51	1	8.85	0.1	0.89	0.01	0.09
200	1770.15	20	177.01	2	17.70	0.2	1.77	0.02	0.18
300	2655.22	30	265.52	3	26.55	0.3	2.66	0.03	0.27
400	3540.30	40	354.03	4	35.40	0.4	3.54	0.04	0.35
500	4425.37	50	442.54	5	44.25	0.5	4.43	0.05	0.44
600	5310.45	60	531.04	6	53.10	0.6	5.31	0.06	0.53
700	6195.52	40	619.55	7	61.96	0.7	6.20	0.07	0.62
800	7080.60	80	708.06	8	70.81	0.8	7.08	0.08	0.71
900	7965.67	90	796.57	9	79.66	0.9	7.97	0.09	0.80
1000	8850.75	100	885.07	10	88.51	1.0	8.85	0.10	0.89

1 newton meter = 8.850748 pound-inches

Poundal.—The expression “poundal” is sometimes used in connection with calculations in mechanics. Many mechanical handbooks, however, do not define it, because of its limited use. A poundal is a unit of force, and is defined as that force which, acting on a mass of one pound for one second, produces a velocity of one foot per second. A foot-poundal is a unit of energy equal to the energy resulting when a force of one poundal acts through a distance of one foot. In order to reduce foot-poundals to foot-pounds, multiply the number of foot-poundals by 0.03108. Dividing the number of foot-poundals by 32.16 (acceleration due to gravity) will also give foot-pounds.

Units of Energy, Power, and Heat

Table 44a. Energy Conversion Factors

<i>1 horsepower-hour</i> =	<i>1 kilowatt-hour</i> =
0.746 kilowatt-hour	1000 watt-hours
1,980,000 foot-pounds	1.34 horsepower-hour
2545 Btu (British thermal units)	2,655,200 foot-pounds
2.64 pounds of water evaporated at 212°F	3,600,000 joules
17 pounds of water raised from 62° to 212°F	3415 Btu
	3.54 pounds of water evaporated at 212°F
	22.8 pounds of water raised from 62° to 212°F

Table 44b. Power Conversion Factors

<i>1 horsepower</i> =	<i>1 kilowatt</i> =	<i>1 watt</i> =
746 watts	1000 watts	1 joule/second
0.746 kilowatt	1.34 horsepower	0.00134 horsepower
33,000 foot-pounds/minute	2,654,200 foot-pounds/hour	0.001 kilowatt
550 foot-pounds/second	44,200 foot-pounds/minute	3.42 Btu/hour
2545 Btu/hour	737 foot-pounds/second	44.22 foot-pounds/minute
42.4 Btu/minute	3415 Btu/hour	0.74 foot-pounds/second
0.71 Btu/second	57 Btu/minute	0.0035 pound of water evaporated per hour at 212°F
2.64 pounds of water evaporated per hour at 212°F	0.95 Btu/second	
	3.54 pounds of water evaporated per hour at 212°F	

Table 44c. Heat Conversion Factors

<i>1 Btu (British thermal unit)</i> =	<i>1 foot-pound</i> =	<i>1 joule</i> =
1052 watt-seconds	1.36 joules	1 watt-second
778 foot-pounds	0.00000377 kilowatt-hour	0.0000078 kilowatt-hour
0.252 kilogram-calorie	0.00129 Btu	0.00095 Btu
0.000292 kilowatt-hour	0.0000005 horsepower-hour	0.74 foot-pound
0.000393, horsepower-hour	<i>1 kilogram-meter</i> =	<i>1 therm</i> =
0.00104 pound of water evaporated at 212°F	7.233 foot-pounds	100,000 Btu (US)
<i>1 kilogram calorie</i> = 3.968 Btu		29.3 kilowatt-hour
		105.5 megajoule

1 joule = 0.0009478170 Btu

Table 47a. Horsepower to Kilowatts Conversion

hp	kW	hp	kW	hp	kW	hp	kW	hp	kW
1,000	745.7	100	74.6	10	7.5	1	0.7	0.1	0.07
2,000	1,491.4	200	149.1	20	14.9	2	1.5	0.2	0.15
3,000	2,237.1	300	223.7	30	22.4	3	2.2	0.3	0.22
4,000	2,982.8	400	298.3	40	29.8	4	3.0	0.4	0.30
5,000	3,728.5	500	372.8	50	37.3	5	3.7	0.5	0.37
6,000	4,474.2	600	447.4	60	44.7	6	4.5	0.6	0.45
7,000	5,219.9	700	522.0	70	52.2	7	5.2	0.7	0.52
8,000	5,965.6	800	596.6	80	59.7	8	6.0	0.8	0.60
9,000	6,711.3	900	671.1	90	67.1	9	6.7	0.9	0.67
10,000	7,457.0	1,000	745.7	100	74.6	10	7.5	1.0	0.75

1 hp = 0.7456999 kW, based on 1 horsepower = 550 foot-pounds per second.

Table 47b. Kilowatts to Horsepower Conversion

kW	hp	kW	hp	kW	hp	kW	hp	kW	hp
1,000	1,341.0	100	134.1	10	13.4	1	1.3	0.1	0.13
2,000	2,682.0	200	268.2	20	26.8	2	2.7	0.2	0.27
3,000	4,023.1	300	402.3	30	40.2	3	4.0	0.3	0.40
4,000	5,364.1	400	536.4	40	53.6	4	5.4	0.4	0.54
5,000	6,705.1	500	670.5	50	67.1	5	6.7	0.5	0.67
7,000	9,387.2	700	938.7	70	93.9	7	9.4	0.7	0.94
8,000	10,728.2	800	1,072.8	80	107.3	8	10.7	0.8	1.07
9,000	12,069.2	900	1,206.9	90	120.7	9	12.1	0.9	1.21
10,000	13,410.2	1,000	1,341.0	100	134.1	10	13.4	1.0	1.34

1 kW = 1.341022 hp, based on 1 horsepower = 550 foot-pounds per second.

Table 48a. Foot-Pounds to Joules Conversion

ft•lb→ ↓	0	1	2	3	4	5	6	7	8	9
	joules									
0	...	1.356	2.712	4.067	5.423	6.779	8.135	9.491	10.847	12.202
10	13.558	14.914	16.270	17.626	18.981	20.337	21.693	23.049	24.405	25.761
20	27.116	28.472	29.828	31.184	32.540	33.895	35.251	36.607	37.963	39.319
30	40.675	42.030	43.386	44.742	46.098	47.454	48.809	50.165	51.521	52.877
40	54.233	55.589	56.944	58.300	59.656	61.012	62.368	63.723	65.079	66.435
50	67.791	69.147	70.503	71.858	73.214	74.570	75.926	77.282	78.637	79.993
60	81.349	82.705	84.061	85.417	86.772	88.128	89.484	90.840	92.196	93.551
70	94.907	96.263	97.619	98.975	100.331	101.686	103.042	104.398	105.754	107.110
80	108.465	109.821	111.177	112.533	113.889	115.245	116.600	117.956	119.312	120.668
90	122.024	123.379	124.735	126.091	127.447	128.803	130.159	131.514	132.870	134.226
100	135.582	136.938	138.293	139.649	141.005	142.361	143.717	145.073	146.428	147.784

1 foot-pound = 1.355818 joules

Table 48b. Joules to Foot-Pounds Conversion

J→ ↓	0	1	2	3	4	5	6	7	8	9
	foot-pounds									
0	...	0.7376	1.4751	2.2127	2.9502	3.6878	4.4254	5.1629	5.9005	6.6381
10	7.3756	8.1132	8.8507	9.5883	10.3259	11.0634	11.8010	12.5386	13.2761	14.0137
20	14.7512	15.4888	16.2264	16.9639	17.7015	18.4391	19.1766	19.9142	20.6517	21.3893
30	22.1269	22.8644	23.6020	24.3395	25.0771	25.8147	26.5522	27.2898	28.0274	28.7649
40	29.5025	30.2400	30.9776	31.7152	32.4527	33.1903	33.9279	34.6654	35.4030	36.1405
50	36.8781	37.6157	38.3532	39.0908	39.8284	40.5659	41.3035	42.0410	42.7786	43.5162
60	44.2537	44.9913	45.7289	46.4664	47.2040	47.9415	48.6791	49.4167	50.1542	50.8918
70	51.6293	52.3669	53.1045	53.8420	54.5796	55.3172	56.0547	56.7923	57.5298	58.2674
80	59.0050	59.7425	60.4801	61.2177	61.9552	62.6928	63.4303	64.1679	64.9055	65.6430
90	66.3806	67.1182	67.8557	68.5933	69.3308	70.0684	70.8060	71.5435	72.2811	73.0186
100	73.7562	74.4938	75.2313	75.9689	76.7065	77.4440	78.1816	78.9191	79.6567	80.3943

1 joule = 0.7375621 foot-pound

Table 49. Power Conversion Factors

To Convert ↓	↓	Horsepower	Watts	Kilowatts	HP (metric)	Kg _f •m/s	Ft•Lb _f /s	Ft•Lb _f /min	Calories/sec	Btu/sec	Btu/hr
Horsepower	Multiply By This Factor, To Obtain	1	745.699	0.745699	1.0138681	76.04	550	33000	178.1	0.7068	2544.48
Watts		0.00134024	1	0.001	0.0013596	0.1019714	0.7375630	44.253727	0.2388363	0.0009478	3.4122
Kilowatts		1.34102365	1000	1	1.3596196	101.9713158	737.563011	44253.727270	238.836025	0.9478344	3412.20
HP (metric)		0.9863215	735.499	0.735499	1	75	542.476857	32548.61114	175.663869	0.6971321	2509.6754
Kg _f -m/s		0.01315097	9.8066	0.0098067	0.0133334	1	7.2330352	433.982114	2.3421883	0.0092951	33.4623
Ft•lb _f /s		0.00181818	1.35581	0.0013558	0.0018434	0.1382545	1	60	0.3238181	0.0012851	4.6263
Ft•lb _f /min		3.0303 × 10 ⁻⁵	0.02259	2.2596 × 10 ⁻⁵	3.07233 × 10 ⁻⁵	0.0023042	0.0166667	1	0.0053969	2.1418 × 10 ⁻⁵	0.077105
Calories/sec		0.00561482	4.18696	0.0041869	0.0056927	0.4269512	3.0881527	185.288916	1	0.0039686	14.2868
Btu/sec		1.41482739	1055.035	1.0550353	1.4344484	107.5834748	778.155065	46689.3039	252	1	3600
Btu/hr		0.0003930	0.29306	0.0002931	0.0003985	0.0298843	0.2161542	12.969251	0.069994	0.0002778	1

Figures in **bold face** indicate the conversion is exact

Table 50. Energy and Work Conversion Factors

To Convert ↓	↓	Joules	Ft•lb _f	Ft-Poundal	Btu	Kg-m	Calories	Watt-hour	Erg	Therm	HP-hours	HP-hours (m)
Joules	Multiply By This Factor, To Obtain	1	0.73756	23.7303	0.0009478	0.101972	0.2388458	0.00027778	1 × 10⁷	9.478 × 10 ⁻⁹	3.725 × 10 ⁻⁷	3.7764 × 10 ⁻⁷
Ft•lb _f		1.355818	1	32.1740	0.00128506	0.138255	0.3238316	0.00037661	1.356 × 10 ⁷	1.285 × 10 ⁻⁸	5.0505 × 10 ⁻⁷	5.1201 × 10 ⁻⁷
Ft-Poundal		0.04214	0.03108	1	3.994 × 10 ⁻⁵	0.0042971	0.010065	1.1705 × 10 ⁻⁵	4.214 × 10 ⁵	3.994 × 10 ⁻¹⁰	1.5697 × 10 ⁻⁸	1.5914 × 10 ⁻⁸
Btu		1055.055	778.1692	25036.8174	1	107.5875	252	0.29307071	1.055 × 10 ¹⁰	1 × 10 ⁻⁵	0.0003930	0.0003984
Kg-m		9.80665	7.233013	232.714987	0.00929524	1	2.342278	0.00272416	9.807 × 10 ⁷	9.294 × 10 ⁻⁸	3.653 × 10 ⁻⁶	3.703 × 10 ⁻⁶
Calories		4.1868	3.088025	99.35427	0.00396832	0.42691934	1	0.001163	4.187 × 10 ⁷	3.968 × 10 ⁻⁸	1.5596 × 10 ⁻⁶	1.5811 × 10 ⁻⁶
Watt-Hour		3600	2655.2237	85429.168	3.4121416	367.09783	859.845227	1	3.6 × 10 ¹⁰	3.412 × 10 ⁻⁵	0.001341	0.0013595
Erg		1 × 10⁻⁷	7.375 × 10 ⁻⁸	2.373 × 10 ⁻⁶	9.478 × 10 ⁻¹¹	1.0197 × 10 ⁻⁸	2.3884 × 10 ⁻⁸	2.778 × 10 ⁻¹¹	1	9.478 × 10 ⁻¹⁶	3.725 × 10 ⁻¹⁴	3.776 × 10 ⁻¹⁴
Therm		1.055 × 10 ⁸	7.781 × 10 ⁷	2.503 × 10 ⁷	1 × 10⁵	1.0758 × 10 ⁷	2.5196 × 10 ⁷	29307.222	1.055 × 10 ¹⁵	1	39.3020	39.843655
HP-hours		2.6845 × 10 ⁶	1.9799 × 10 ⁶	6.3704 × 10 ⁷	2544.4150	2.7374 × 10 ⁵	6.4118 × 10 ⁵	745.6944	2.685 × 10 ¹³	0.025444	1	1.0137839
HP-hours (m)		2.648 × 10 ⁶	1.953 × 10 ⁶	6.2837 × 10 ⁷	2509.8197	2.70 × 10 ⁵	6.3246 × 10 ⁵	735.555	2.648 × 10 ¹³	0.025098	0.9864034	1

Figures in **bold face** indicate the conversion is exact

Table 51. Thermal Conductance Conversion Factors

To Convert ↓	Multiply By This Factor, To Obtain ↓									
	Btu•ft/(h•ft ² •°F)	Btu•in/(h•ft ² •°F)	Btu•in/(sec•ft ² •°F)	Cal/(cm•s•°C)	Kcal/(cm•s•°C)	Kcal/(m•h•°C)	Erg/(cm•s•°C)	Joules/(m•h•°C)	Watt/(ft•°C)	Watt/(m•°K)
Btu•ft/(h•ft ² •°F)	1	12	0.00333333	0.00413385	4.13386 × 10 ⁻⁶	1.488188976	173076.378	6230.0055	0.5274738	1.73056
Btu•in/(h•ft ² •°F)	0.083333	1	0.000277778	0.00034448	3.44448 × 10 ⁻⁷	0.124015748	14423.0315	519.25573	0.04395615	0.14421
Btu•in/(sec•ft ² •°F)	300	3600	1	1.24001574	0.001240157	446.4566929	5.1925 × 10 ⁷	1.8693 × 10 ⁶	158.24214	519.167
Cal/(cm•s•°C)	241.9047	2902.8571	0.806349	1	0.001	360	4.1868 × 10 ⁷	1.507 × 10 ⁶	127.598424	418.63
Kcal/(cm•s•°C)	2.419 × 10 ⁵	2.902 × 10 ⁶	806.3492	1000	1	360000	4.1868 × 10 ¹⁰	1.507 × 10 ⁹	1.276 × 10 ⁵	4.1863 × 10 ⁵
Kcal/(m•h•°C)	0.671957	8.063349	0.00223985	0.00277778	2.77778 × 10 ⁻⁶	1	116300	4186.8	0.35444	1.16286
Erg/(cm•s•°C)	5.7778 × 10 ⁻⁶	6.933 × 10 ⁻⁵	1.92593 × 10 ⁻⁸	2.3884 × 10 ⁻⁸	2.3884 × 10 ⁻¹¹	8.5984 × 10 ⁻⁶	1	0.036	3.0476 × 10 ⁻⁶	1 × 10 ⁻⁵
Joules/(m•h•°C)	1.6051 × 10 ⁻⁴	0.00192616	5.35045 × 10 ⁻⁷	6.6354 × 10 ⁻⁷	6.6354 × 10 ⁻¹⁰	0.000238874	27.781095	1	8.4666 × 10 ⁻⁵	2.7777 × 10 ⁻⁴
Watt/(ft•°C)	1.895828	22.75	0.006319429	0.00783708	7.83709 × 10 ⁻⁶	2.821351461	328123.1749	11811.024	1	3.28
Watt/(m•°K)	0.5778486	6.934183	0.001926162	0.002388744	2.38874 × 10 ⁻⁶	0.859947925	1 × 10⁵	3600	0.304878	1

Figures in **bold face** indicate the conversion is exact

Conduction.—Whenever the molecules of a working substance, whether liquid, solid, or vapor, are restrained so that no appreciable relative translatory motion occurs among them, the kinetic energies of the various molecules will be largely due to vibration. If a temperature difference exists in the working substance, some adjacent molecules will necessarily be at different temperatures hence will possess different degrees of vibratory motion. In this case the molecule which is vibrating most rapidly will transfer some of its motion to the slower-moving molecule next to it, the one then undergoing a decrease in temperature and the other an increase. In this way, thermal energy will be transferred by the mechanism of conduction from the region of higher to the region of lower temperature. The process will continue spontaneously until the entire system has reached a uniform equilibrium temperature.

In contrast to radiation, conduction only occurs when a working substance is present and when the molecules of that working substance retain practically fixed positions with respect to one another. Thus, conductive heat flow would always occur through solids, but would take place in liquids and vapors only if special conditions prevented or greatly reduced the normal translatory motion of the molecules within these materials.

Fuel Oil, Coal and Gas Equivalents.—One gallon of fuel oil equals 13.1 pounds of coal, equals 160 cubic feet of natural gas. One barrel of fuel oil equals 0.278 ton of coal, equals 6806 cubic feet of natural gas. One pound of fuel oil equals 1.75 pounds of coal, equals 21.3 cubic feet of natural gas. One pound of coal equals 0.763 gallon of oil, equals 12.2 cubic feet of natural gas. One ton of coal equals 3.6 barrels of oil, equals 24,500 cubic feet of natural gas. The heating value of the average mid-continent fuel oil having a Baume gravity of 26.9 is 19,376 British thermal units per pound of oil, and 143,950 British thermal units per gallon of oil. The specific gravity and the heat value may be expressed approximately by means of a simple formula, as follows: BTU per pound = 18,650 + 40 × (Degrees Baume – 10).

Units of Temperature

There are two thermometer scales in general use: the Fahrenheit (F), which is used in the United States and in other countries still using the English system of units, and the Celsius (C) or Centigrade used throughout the rest of the world.

In the Fahrenheit thermometer, the freezing point of water is marked at 32 degrees on the scale and the boiling point, at atmospheric pressure, at 212 degrees. The distance between these two points is divided into 180 degrees. On the Celsius scale, the freezing point of water is at 0 degrees and the boiling point at 100 degrees. The following formulas may be used for converting temperatures given on any one of the scales to the other scale:

$$\text{Degrees Fahrenheit} = \frac{9 \times \text{degrees C}}{5} + 32$$

$$\text{Degrees Celsius} = \frac{5 \times (\text{degrees F} - 32)}{9}$$

Tables on the pages that follow can be used to convert degrees Celsius into degrees Fahrenheit or vice versa. In the event that the conversions are not covered in the tables, use those applicable portions of the formulas given above for converting.

Table 52. Temperature Conversion Formulas

To Convert	To	Use Formula	To Convert	To	Use Formula
Celsius, t_C	$^{\circ}\text{K}, t_K$	$t_K = t_C + 273.15$	Kelvin, t_K	$^{\circ}\text{C}, t_C$	$t_C = t_K - 273.15$
	$^{\circ}\text{F}, t_F$	$t_F = 1.8 t_C + 32$		$^{\circ}\text{F}, t_F$	$t_F = 1.8 t_K - 459.67$
	$^{\circ}\text{R}, t_R$	$t_R = 9(t_C + 273.15)/5$		$^{\circ}\text{R}, t_R$	$t_R = 9/5 \times t_K$
Fahrenheit, t_F	$^{\circ}\text{K}, t_K$	$t_K = (t_F + 459.67)/1.8$	Rankine, t_R	$^{\circ}\text{K}, t_K$	$t_K = 5/9 \times t_R$
	$^{\circ}\text{C}, t_C$	$t_C = (t_F - 32)/1.8$		$^{\circ}\text{C}, t_C$	$t_C = 5/9 \times t_R - 273.15$
	$^{\circ}\text{R}, t_R$	$t_R = t_F + 459.67$		$^{\circ}\text{F}, t_F$	$t_F = t_R - 459.67$

Absolute Temperature and Absolute Zero.—A point has been determined on the thermometer scale, by theoretical considerations, that is called the absolute zero and beyond which a further decrease in temperature is inconceivable. This point is located at -273.15 degrees Celsius or -459.67 degrees F. A temperature reckoned from this point, instead of from the zero on the ordinary thermometers, is called absolute temperature. Absolute temperature in degrees C is known as “degrees Kelvin” or the “Kelvin scale” (K) and absolute temperature in degrees F is known as “degrees Rankine” or the “Rankine scale” (R).

$$\text{Degrees Kelvin} = \text{degrees C} + 273.15$$

$$\text{Degrees Rankine} = \text{degrees F} + 459.67$$

Measures of the Quantity of Thermal Energy.—The unit of quantity of thermal energy used in the United States is the British thermal unit, which is the quantity of heat or thermal energy required to raise the temperature of one pound of pure water one degree F. (American National Standard abbreviation, Btu; conventional British symbol, B.Th.U.) The French thermal unit, or *kilogram calorie*, is the quantity of heat or thermal energy required to raise the temperature of one kilogram of pure water one degree C. One kilogram calorie = 3.968 British thermal units = 1000 gram calories. The number of foot-pounds of mechanical energy equivalent to one British thermal unit is called the *mechanical equivalent of heat*, and equals 778 foot-pounds.

In the modern metric or SI system of units, the unit for thermal energy is the *joule* (J); a commonly used multiple being the kilojoule (kJ), or 1000 joules. See page 2656 for an explanation of the SI System. One kilojoule = 0.9478 Btu. Also in the SI System, the *watt* (W), equal to joule per second (J/s), is used for power, where one watt = 3.412 Btu per hour.

Table 53. °C → °F and °R Temperature Conversion °F → °C and °K

°K	°C	°F	°R	°K	°C	°F	°R	°K	°C	°F	°R			
0.0	-273.2	-459.7	...	261.5	-11.7	11	51.8	511.5	293.7	20.6	69	156.2	615.9	
5.4	-267.8	-450	...	262.0	-11.1	12	53.6	513.3	294.3	21.1	70	158.0	617.7	
10.9	-262.2	-440	...	262.6	-10.6	13	55.4	515.1	294.8	21.7	71	159.8	619.5	
16.5	-256.7	-430	...	263.2	-10.0	14	57.2	516.9	295.4	22.2	72	161.6	621.3	
22.0	-251.1	-420	...	263.7	-9.4	15	59.0	518.7	295.9	22.8	73	163.4	623.1	
27.6	-245.6	-410	...	264.3	-8.9	16	60.8	520.5	296.5	23.3	74	165.2	624.9	
33.2	-240.0	-400	...	264.8	-8.3	17	62.6	522.3	297.0	23.9	75	167.0	626.7	
38.7	-234.4	-390	...	265.4	-7.8	18	64.4	524.1	297.6	24.4	76	168.8	628.5	
44.3	-228.9	-380	...	265.9	-7.2	19	66.2	525.9	298.2	25.0	77	170.6	630.3	
49.8	-223.3	-370	...	266.5	-6.7	20	68.0	527.7	298.7	25.6	78	172.4	632.1	
55.4	-217.8	-360	...	267.0	-6.1	21	69.8	529.5	299.3	26.1	79	174.2	633.9	
60.9	-212.2	-350	...	267.6	-5.6	22	71.6	531.3	299.8	26.7	80	176.0	635.7	
66.5	-206.7	-340	...	268.2	-5.0	23	73.4	533.1	300.4	27.2	81	177.8	637.5	
72.0	-201.1	-330	...	268.7	-4.4	24	75.2	534.9	300.9	27.8	82	179.6	639.3	
77.6	-195.6	-320	...	269.3	-3.9	25	77.0	536.7	301.5	28.3	83	181.4	641.1	
83.2	-190.0	-310	...	269.8	-3.3	26	78.8	538.5	302.0	28.9	84	183.2	642.9	
88.7	-184.4	-300	...	270.4	-2.8	27	80.6	540.3	302.6	29.4	85	185.0	644.7	
94.3	-178.9	-290	...	270.9	-2.2	28	82.4	542.1	303.2	30.0	86	186.8	646.5	
99.8	-173.3	-280	...	271.5	-1.7	29	84.2	543.9	303.7	30.6	87	188.6	648.3	
103.6	-169.5	-273.2	-459.7	0.0	272.0	-1.1	30	86.0	545.7	304.3	31.1	88	190.4	650.1
105.4	-167.8	-270	-454.0	5.7	272.6	-0.6	31	87.8	547.5	304.8	31.7	89	192.2	651.9
110.9	-162.2	-260	-436.0	23.7	273.2	0.0	32	89.6	549.3	305.4	32.2	90	194.0	653.7
116.5	-156.7	-250	-418.0	41.7	273.7	0.6	33	91.4	551.1	305.9	32.8	91	195.8	655.5
122.0	-151.1	-240	-400.0	59.7	274.3	1.1	34	93.2	552.9	306.5	33.3	92	197.6	657.3
127.6	-145.6	-230	-382.0	77.7	274.8	1.7	35	95.0	554.7	307.0	33.9	93	199.4	659.1
133.2	-140.0	-220	-364.0	95.7	275.4	2.2	36	96.8	556.5	307.6	34.4	94	201.2	660.9
138.7	-134.4	-210	-346.0	113.7	275.9	2.8	37	98.6	558.3	308.2	35.0	95	203.0	662.7
144.3	-128.9	-200	-328.0	131.7	276.5	3.3	38	100.4	560.1	308.7	35.6	96	204.8	664.5
149.8	-123.3	-190	-310.0	149.7	277.0	3.9	39	102.2	561.9	309.3	36.1	97	206.6	666.3
155.4	-117.8	-180	-292.0	167.7	277.6	4.4	40	104.0	563.7	309.8	36.7	98	208.4	668.1
160.9	-112.2	-170	-274.0	185.7	278.2	5.0	41	105.8	565.5	310.4	37.2	99	210.2	669.9
166.5	-106.7	-160	-256.0	203.7	278.7	5.6	42	107.6	567.3	310.9	37.8	100	212.0	671.7
172.0	-101.1	-150	-238.0	221.7	279.3	6.1	43	109.4	569.1	311.5	38.3	101	213.8	673.5
177.6	-95.6	-140	-220.0	239.7	279.8	6.7	44	111.2	570.9	312.0	38.9	102	215.6	675.3
183.2	-90.0	-130	-202.0	257.7	280.4	7.2	45	113.0	572.7	312.6	39.4	103	217.4	677.1
188.7	-84.4	-120	-184.0	275.7	280.9	7.8	46	114.8	574.5	313.2	40.0	104	219.2	678.9
194.3	-78.9	-110	-166.0	293.7	281.5	8.3	47	116.6	576.3	313.7	40.6	105	221.0	680.7
199.8	-73.3	-100	-148.0	311.7	282.0	8.9	48	118.4	578.1	314.3	41.1	106	222.8	682.5
205.4	-67.8	-90	-130.0	329.7	282.6	9.4	49	120.2	579.9	314.8	41.7	107	224.6	684.3
210.9	-62.2	-80	-112.0	347.7	283.2	10.0	50	122.0	581.7	315.4	42.2	108	226.4	686.1
216.5	-56.7	-70	-94.0	365.7	283.7	10.6	51	123.8	583.5	315.9	42.8	109	228.2	687.9
222.0	-51.1	-60	-76.0	383.7	284.3	11.1	52	125.6	585.3	316.5	43.3	110	230.0	689.7
227.6	-45.6	-50	-58.0	401.7	284.8	11.7	53	127.4	587.1	317.0	43.9	111	231.8	691.5
233.2	-40.0	-40	-40.0	419.7	285.4	12.2	54	129.2	588.9	317.6	44.4	112	233.6	693.3
238.7	-34.4	-30	-22.0	437.7	285.9	12.8	55	131.0	590.7	318.2	45.0	113	235.4	695.1
244.3	-28.9	-20	-4.0	455.7	286.5	13.3	56	132.8	592.5	318.7	45.6	114	237.2	696.9
249.8	-23.3	-10	14.0	473.7	287.0	13.9	57	134.6	594.3	319.3	46.1	115	239.0	698.7
255.4	-17.8	0	32.0	491.7	287.6	14.4	58	136.4	596.1	319.8	46.7	116	240.8	700.5
255.9	-17.2	1	33.8	493.5	288.2	15.0	59	138.2	597.9	320.4	47.2	117	242.6	702.3
256.5	-16.7	2	35.6	495.3	288.7	15.6	60	140.0	599.7	320.9	47.8	118	244.4	704.1
257.0	-16.1	3	37.4	497.1	289.3	16.1	61	141.8	601.5	321.5	48.3	119	246.2	705.9
257.6	-15.6	4	39.2	498.9	289.8	16.7	62	143.6	603.3	322.0	48.9	120	248.0	707.7
258.2	-15.0	5	41.0	500.7	290.4	17.2	63	145.4	605.1	322.6	49.4	121	249.8	709.5
258.7	-14.4	6	42.8	502.5	290.9	17.8	64	147.2	606.9	323.2	50.0	122	251.6	711.3
259.3	-13.9	7	44.6	504.3	291.5	18.3	65	149.0	608.7	323.7	50.6	123	253.4	713.1
259.8	-13.3	8	46.4	506.1	292.0	18.9	66	150.8	610.5	324.3	51.1	124	255.2	714.9
260.4	-12.8	9	48.2	507.9	292.6	19.4	67	152.6	612.3	324.8	51.7	125	257.0	716.7
260.9	-12.2	10	50.0	509.7	293.2	20.0	68	154.4	614.1	325.4	52.2	126	258.8	718.5

Table 53. (Continued) °C → °F and °R Temperature Conversion °F → °C and °K

°K	°C		°F	°R	°K	°C		°F	°R	°K	°C		°F	°R
325.9	52.8	127	260.6	720.3	357.6	84.4	184	363.2	822.9	741.5	468.3	875	1607.0	2066.7
326.5	53.3	128	262.4	722.1	358.2	85.0	185	365.0	824.7	755.4	482.2	900	1652.0	2111.7
327.0	53.9	129	264.2	723.9	358.7	85.6	186	366.8	826.5	769.3	496.1	925	1697.0	2156.7
327.6	54.4	130	266.0	725.7	359.3	86.1	187	368.6	828.3	783.2	510.0	950	1742.0	2201.7
328.2	55.0	131	267.8	727.5	359.8	86.7	188	370.4	830.1	797.0	523.9	975	1787.0	2246.7
328.7	55.6	132	269.6	729.3	360.4	87.2	189	372.2	831.9	810.9	537.8	1000	1832.0	2291.7
329.3	56.1	133	271.4	731.1	360.9	87.8	190	374.0	833.7	838.7	565.6	1050	1922.0	2381.7
329.8	56.7	134	273.2	732.9	361.5	88.3	191	375.8	835.5	866.5	593.3	1100	2012.0	2471.7
330.4	57.2	135	275.0	734.7	362.0	88.9	192	377.6	837.3	894.3	621.1	1150	2102.0	2561.7
330.9	57.8	136	276.8	736.5	362.6	89.4	193	379.4	839.1	922.0	648.9	1200	2192.0	2651.7
331.5	58.3	137	278.6	738.3	363.2	90.0	194	381.2	840.9	949.8	676.7	1250	2282.0	2741.7
332.0	58.9	138	280.4	740.1	363.7	90.6	195	383.0	842.7	977.6	704.4	1300	2372.0	2831.7
332.6	59.4	139	282.2	741.9	364.3	91.1	196	384.8	844.5	1005.4	732.2	1350	2462.0	2921.7
333.2	60.0	140	284.0	743.7	364.8	91.7	197	386.6	846.3	1033.2	760.0	1400	2552.0	3011.7
333.7	60.6	141	285.8	745.5	365.4	92.2	198	388.4	848.1	1060.9	787.8	1450	2642.0	3101.7
334.3	61.1	142	287.6	747.3	365.9	92.8	199	390.2	849.9	1088.7	815.6	1500	2732.0	3191.7
334.8	61.7	143	289.4	749.1	366.5	93.3	200	392.0	851.7	1116.5	843.3	1550	2822.0	3281.7
335.4	62.2	144	291.2	750.9	367.0	93.9	201	393.8	853.5	1144.3	871.1	1600	2912.0	3371.7
335.9	62.8	145	293.0	752.7	367.6	94.4	202	395.6	855.3	1172.0	898.9	1650	3002.0	3461.7
336.5	63.3	146	294.8	754.5	368.2	95.0	203	397.4	857.1	1199.8	926.7	1700	3092.0	3551.7
337.0	63.9	147	296.6	756.3	368.7	95.6	204	399.2	858.9	1227.6	954.4	1750	3182.0	3641.7
337.6	64.4	148	298.4	758.1	369.3	96.1	205	401.0	860.7	1255.4	982.2	1800	3272.0	3731.7
338.2	65.0	149	300.2	759.9	369.8	96.7	206	402.8	862.5	1283.2	1010.0	1850	3362.0	3821.7
338.7	65.6	150	302.0	761.7	370.4	97.2	207	404.6	864.3	1310.9	1037.8	1900	3452.0	3911.7
339.3	66.1	151	303.8	763.5	370.9	97.8	208	406.4	866.1	1338.7	1065.6	1950	3542.0	4001.7
339.8	66.7	152	305.6	765.3	371.5	98.3	209	408.2	867.9	1366.5	1093.3	2000	3632.0	4091.7
340.4	67.2	153	307.4	767.1	372.0	98.9	210	410.0	869.7	1394.3	1121.1	2050	3722.0	4181.7
340.9	67.8	154	309.2	768.9	372.6	99.4	211	411.8	871.5	1422.0	1148.9	2100	3812.0	4271.7
341.5	68.3	155	311.0	770.7	373.2	100.0	212	413.6	873.3	1449.8	1176.7	2150	3902.0	4361.7
342.0	68.9	156	312.8	772.5	373.7	104.4	220	428.0	887.7	1477.6	1204.4	2200	3992.0	4451.7
342.6	69.4	157	314.6	774.3	383.2	110.0	230	446.0	905.7	1505.4	1232.2	2250	4082.0	4541.7
343.2	70.0	158	316.4	776.1	388.7	115.6	240	464.0	923.7	1533.2	1260.0	2300	4172.0	4631.7
343.7	70.6	159	318.2	777.9	394.3	121.1	250	482.0	941.7	1560.9	1287.8	2350	4262.0	4721.7
344.3	71.1	160	320.0	779.7	408.2	135.0	275	527.0	986.7	1588.7	1315.6	2400	4352.0	4811.7
344.8	71.7	161	321.8	781.5	422.0	148.9	300	572.0	1031.7	1616.5	1343.3	2450	4442.0	4901.7
345.4	72.2	162	323.6	783.3	435.9	162.8	325	617.0	1076.7	1644.3	1371.1	2500	4532.0	4991.7
345.9	72.8	163	325.4	785.1	449.8	176.7	350	662.0	1121.7	1672.0	1398.9	2550	4622.0	5081.7
346.5	73.3	164	327.2	786.9	463.7	190.6	375	707.0	1166.7	1699.8	1426.7	2600	4712.0	5171.7
347.0	73.9	165	329.0	788.7	477.6	204.4	400	752.0	1211.7	1727.6	1454.4	2650	4802.0	5261.7
347.6	74.4	166	330.8	790.5	491.5	218.3	425	797.0	1256.7	1755.4	1482.2	2700	4892.0	5351.7
348.2	75.0	167	332.6	792.3	505.4	232.2	450	842.0	1301.7	1783.2	1510.0	2750	4982.0	5441.7
348.7	75.6	168	334.4	794.1	519.3	246.1	475	887.0	1346.7	1810.9	1537.8	2800	5072.0	5531.7
349.3	76.1	169	336.2	795.9	533.2	260.0	500	932.0	1391.7	1838.7	1565.6	2850	5162.0	5621.7
349.8	76.7	170	338.0	797.7	547.0	273.9	525	977.0	1436.7	1866.5	1593.3	2900	5252.0	5711.7
350.4	77.2	171	339.8	799.5	560.9	287.8	550	1022.0	1481.7	1894.3	1621.1	2950	5342.0	5801.7
350.9	77.8	172	341.6	801.3	574.8	301.7	575	1067.0	1526.7	1922.0	1648.9	3000	5432.0	5891.7
351.5	78.3	173	343.4	803.1	588.7	315.6	600	1112.0	1571.7	2033.2	1760.0	3200	5792.0	6251.7
352.0	78.9	174	345.2	804.9	602.6	329.4	625	1157.0	1616.7	2144.3	1871.1	3400	6152.0	6611.7
352.6	79.4	175	347.0	806.7	616.5	343.3	650	1202.0	1661.7	2255.4	1982.2	3600	6512.0	6971.7
353.2	80.0	176	348.8	808.5	630.4	357.2	675	1247.0	1706.7	2366.5	2093.3	3800	6872.0	7331.7
353.7	80.6	177	350.6	810.3	644.3	371.1	700	1292.0	1751.7	2477.6	2204.4	4000	7232.0	7691.7
354.3	81.1	178	352.4	812.1	658.2	385.0	725	1337.0	1796.7	2588.7	2315.6	4200	7592.0	8051.7
354.8	81.7	179	354.2	813.9	672.0	398.9	750	1382.0	1841.7	2699.8	2426.7	4400	7952.0	8411.7
355.4	82.2	180	356.0	815.7	685.9	412.8	775	1427.0	1886.7	2810.9	2537.8	4600	8312.0	8771.7
355.9	82.8	181	357.8	817.5	699.8	426.7	800	1472.0	1931.7	2922.0	2648.9	4800	8672.0	9131.7
356.5	83.3	182	359.6	819.3	713.7	440.6	825	1517.0	1976.7	3033.2	2760.0	5000	9032.0	9491.7
357.0	83.9	183	361.4	821.1	727.6	454.4	850	1562.0	2021.7

Table converts °C → °F and °R, or °F → °C and °K. Find “convert from” temperature in **bold** column and read result from °F and °R or °C and °K columns. *Example 1:* 183 °C = 361.4 °F and 821.1 °R. *Example 2:* 183 °F = 83.9 °C and 357.0 °K.

Units of Velocity and Acceleration

Table 54. Velocity Conversion Factors

To Convert ↓	Multiply By Factor, To Obtain ↓	cm/sec	m/sec	km/hr	ft/sec	ft/min	ft/hr	knot ^a	mile/hr
cm/sec	Multiply By Factor, To Obtain ↓	1	0.01	0.036	0.032808	1.9685	118.110236	0.01944	0.02237
m/sec		100	1	3.6	3.2808	196.8504	11811.0236	1.94384	2.236936
km/hr		27.77778	0.27778	1	0.911344	54.6806	3280.8399	0.53995	0.621371
ft/sec		30.48	0.3048	1.09728	1	60	3600	0.59248	0.681818
ft/min		0.5080	0.00508	0.018288	0.016667	1	60	9.8×10^{-3}	0.011364
ft/hr		0.008467	8.47×10^{-5}	3.05×10^{-4}	2.78×10^{-4}	0.01666	1	1.6×10^{-4}	1.89×10^{-4}
knot		51.444	0.51444	1.852	1.687808	101.2686	6076.11549	1	1.15167
mile/hr		44.704	0.447040	1.609344	1.466667	88	5280	0.8689	1

^a Knot means nautical miles per hour

Figures in **bold face** indicate the conversion is exact

Table 55. Acceleration Conversion Factors

To Convert ↓	Multiply By Factor, To Obtain ↓	cm/sec ²	m/sec ²	km/hr ²	feet/sec ²	ft/hr ²	Knot/sec	miles/hr ²
cm/sec ²	Multiply By Factor, To Obtain ↓	1	0.01	129.6	0.0328	4.252×10^5	0.0194384	80.529
m/sec ²		100	1	12960	3.280	4.252×10^7	1.943844	8052.970
km/hr ²		0.007716	7.72×10^{-5}	1	2.532×10^{-4}	3280.84	0.0001499	0.6213
ft/sec ²		30.48	0.3048	3950.20	1	1.296×10^7	0.592483	2454.545
ft/hr ²		2.35×10^{-6}	2.35×10^{-5}	3.048×10^{-4}	7.716×10^{-8}	1	4.571×10^{-8}	1.893×10^{-4}
Knot/sec		51.44444	0.514444	6667.2	1.687809	2.187×10^7	1	4142.8060
mile/hr ²		0.0124	0.000124	1.609	4.074×10^{-4}	5280	0.00024138	1

Figures in **bold face** indicate the conversion is exact.

Units of Viscosity

Table 56a. Oil Viscosity Conversion Factors

To Convert ↓	Multiply By This Factor, To Obtain ↓	Poise (P)	Centipoise (Z)	Reyn (μ)	Stoke (S)	Centistoke (v)
Poise (P)	Multiply By This Factor, To Obtain ↓	$\frac{\text{dyne-s}}{\text{cm}^2} = \frac{\text{gram mass}}{\text{cm-s}}$	1	100	1.45×10^{-5}	$\frac{1}{\rho}$
Centipoise (Z)		$\frac{\text{dyne-s}}{100 \text{ cm}^2} = \frac{\text{gram mass}}{100 \text{ cm-s}}$	0.01	1	1.45×10^{-7}	$\frac{0.01}{\rho}$
Reyn (μ)		$\frac{\text{lb force-s}}{\text{in}^2}$	6.9×10^4	6.9×10^6	1	$\frac{6.9 \times 10^4}{\rho}$
Stoke (S)		$\frac{\text{cm}^2}{\text{s}}$	ρ	100 ρ	$1.45 \times 10^{-5} \rho$	1
Centistoke (v)		$\frac{\text{cm}^2}{100 \text{ s}}$	0.01 ρ	ρ	$1.45 \times 10^{-7} \rho$	0.01

Table 56b. Additional Viscosity Conversion Factors

Multiply	By	To Obtain	Multiply	By	To Obtain
centipoise	0.001	pascal-second (Pa • s)	pascal-second	1000	centipoise
centistoke	0.000001	meter ² /second (m ² /s)	pascal-second	10	poise
stoke	0.0001	meter ² /second (m ² /s)	poise	0.1	pascal-second (Pa•s)

ρ = Specific gravity of the oil.

Figures in **bold face** indicate the conversion is exact

Units of Moment of Inertia and Momentum

Table 57. Moment of Inertia Conversion Factors

Multiply	By	To Obtain
Moment of Inertia and Section Modulus		
moment of inertia [kg • m ²]	23.73036	pound-foot ²
moment of inertia [kg • m ²]	3417.171	pound-inch ²
moment of inertia [lb • ft ²]	0.04214011	kilogram-meter ² (kg • m ²)
moment of inertia [lb • inch ²]	0.0002926397	kilogram-meter ² (kg • m ²)
moment of section [foot ⁴]	0.008630975	meter ⁴ (m ⁴)
moment of section [inch ⁴]	41.62314	centimeter ⁴
moment of section [meter ⁴]	115.8618	foot ⁴
moment of section [centimeter ⁴]	0.02402510	inch ⁴
section modulus [foot ³]	0.02831685	meter ³ (m ³)
section modulus [inch ³]	0.00001638706	meter ³ (m ³)
section modulus [meter ³]	35.31466	foot ³
section modulus [meter ³]	61,023.76	inch ³

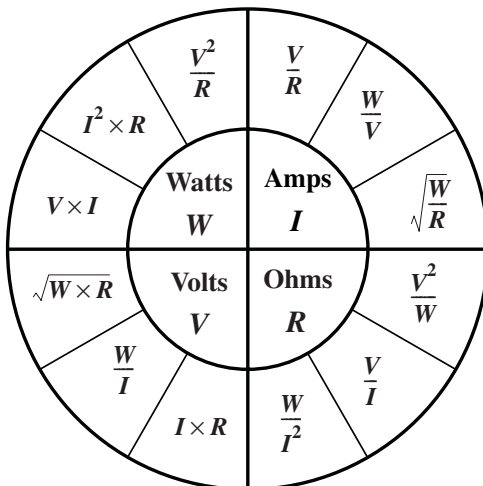
Table 58. Momentum Conversion Factors

Multiply	By	To Obtain
Momentum		
kilogram-meter/second	7.233011	pound-foot/second
kilogram-meter/second	86.79614	pound-inch/second
pound-foot/second	0.1382550	kilogram-meter/second (kg • m/s)
pound-inch/second	0.01152125	kilogram-meter/second (kg • m/s)

Miscellaneous Measuring Units

- | | |
|--|---|
| <p><i>1 great gross</i> = 12 gross = 144 dozen
 <i>1 gross</i> = 12 dozen = 144 units
 <i>1 dozen</i> = 12 units</p> | <p><i>1 quire</i> = 24 sheets
 <i>1 ream</i> = 20 quires = 480 sheets
 <i>1 ream printing paper</i> = 500 sheets
 <i>1 score</i> = 20 units</p> |
|--|---|

Ohm's Law.—The following figure represents basic electrical relationships. This chart has been formatted in such a way that each variable has been related to the other three variables. This figure is simply for reference.



Key to variables:
 V = Voltage (Volts)
 R = Resistance (Ohms)
 I = Current (Amps)
 W = Power (Watts)

Circular Model of Electrical Relations

Wind Chill Temperature.—Windchill temperature is a measure of the combined cooling effect of wind and temperature. The formula below is used for calculating wind chill by the National Weather Service (NWS) in the United States:

$$\text{Wind Chill Temperature } ^\circ\text{F} = 35.74 + 0.6215T - 35.75(V^{0.16}) + 0.4275T(V^{0.16})$$

where T = air temperature in $^\circ\text{F}$

V = wind speed in miles per hour (mph) measured at NWS standard height, 33 feet

The formula calculates the chilling effect of wind on the human body at 5 feet above the ground and assumes no influence caused by sunlight (that is, as if the temperature and wind speed measurements were made at night in clear sky conditions.) Windchill temperature is only defined for temperatures at or below 50 degrees F and wind speeds above 3 mph. Bright sunshine may increase the windchill temperature by 10 to 18 degrees F.

Wind Velocity to Pressure

V	P	V	P	V	P
5	0.1	35	4.9	65	16.9
10	0.4	40	6.4	70	19.6
15	0.9	45	8.1	75	22.5
20	1.6	50	10.0	80	25.6
25	2.5	55	12.1	100	40.0
30	3.6	60	14.4		

The formula is $P = 0.004V^2$ where V = wind velocity, mph; P = pressure, lbs/sq ft.

Phonetic Alphabet

A	Alfa	J	Juliett	S	Sierra	1	One
B	Bravo	K	Kilo	T	Tango	2	Two
C	Charlie	L	Lima	U	Uniform	3	Three
D	Delta	M	Mike	V	Victor	4	Four
E	Echo	N	November	W	Whiskey	5	Five
F	Foxtrot	O	Oscar	X	X-Ray	6	Six
G	Golf	P	Pappa	Y	Yankee	7	Seven
H	Hotel	Q	Quebec	Z	Zulu	8	Eight
I	India	R	Romeo	0	Zero	9	Nine

Daylight Savings Time.—The Congress of the United States of America extended Daylight Savings Time (DST) by about a month, effective from 2007. Before 2007, DST began at 2:00 AM on the first Sunday in April and ended at 2:00 AM on the last Sunday in October.

Beginning 2007, DST begins at 2:00 AM on the second Sunday in March and ends at 2:00 AM on the first Sunday in November.

Bel.—The *bel* is the fundamental division of a logarithmic scale for expressing the ratio of two amounts of power. The number of bels denoting such a ratio is the logarithm to the base 10 of this ratio. Thus, if P_1 and P_2 are two amounts of power, and N the number of bels

denoting their ratio, then $N = \log \frac{P_1}{P_2}$ bels .

The *decibel* is one-tenth of a bel and is commonly abbreviated as db. This unit is used extensively in the measurement of sound volume in telephone and radio transmission and reception, and in noise measurements of various kinds.

INDEX

Index Terms

Links

A

Abbreviations

accuracy	1324
mathematical signs and	2654
scientific and engineering terms	2652
symbols for mechanics	2655
welding	1479

Abrasive

belt

applications	1269			
cutting off difficulties	1272			
grinding	1269			
rotative speeds	1273			
selection	1269			
contact wheel selecting	1271			
cubic boron nitride (CBN)	794	1217	1234	1243
cutting	1269			
diamond	1216			
grains and materials	1216			
grinding	1216			
honing	1272			
lapping	1274			
polishing	1504			
stones for honing	1274			

Absolute

system of measurement	150
temperature	2695
viscosity	2425
zero	2695

Index Terms**Links**

Acceleration	150	175	
angular	177		
constant	175		
linear, of point on rotating body	177		
of gravity, g	150		
Accuracy			
effect of, on part tolerances	1323		
of NC machine tools	1321		
positioning	1319		
repeatability, and resolution, NC	1319		
significance of	1321		
Acme leadscrews	2561		
Acme threads			
abbreviations	1922		
angle of thread	1921		
ANSI Standard	1921		
centralizing	1928		
checking	2004		
diameter allowances	1921		
diameter tolerances	1921		
drill sizes for	944		
form	1921		
general purpose	1921		
length of engagement	1921		
multiple start	1922		
stub	1939		
alternative	1942		
60-degree	1942		
thread profile form	1921		
tolerances application	1933		
types of	1921	1930	1933
wire sizes for checking	2004		
Active face width	2125		
Acute-angle triangles solution	71	101	

Index Terms

Links

Addendum	2125
chordal	2144
modification	2173
involute spur and helical gears	2173
Addition	
decimal fractions	10
fractions and mixed numbers	9
matrix	122
Additives	
lubricant properties	2429
oil	2427
plastics	553
Adhesives	
acrylic	2581
bonding	2580
moisture cured polyurethane	2583
one-component	2582
retaining compounds	2583
rubber cements	2583
sealants	2584
threadlocking	2584
two-component	2580
types	2580
Adjoint of a matrix	124
Adjustable-bed press	1388
Adjusting gear blanks for milling	2188
Aerospace screws, bolts and nuts	1901
Aero-thread	1986
Aging of metal	461
Air	384
Air bending	1346
Air, weight	381
Airdry wood, weight per cubic foot	387
Airy points	720

Index Terms**Links****AISI-SAE**

alloy steels 404

carbon steels 402

Algebra and equations 30**Algebraic**

expressions and formulas 31

rearrangement and transposition of
terms 30**Alignment of shafts** 2622**Alligation** 384**Allowances and tolerances**

allowance defined 628 634

allowance for forced fits 630

application 629

bending sheet metal 1347 1351 1358

formulas 1347 1351

cylindrical fits, ANSI Standard for

fits 634

metric ISO, British Standard for

preferred series 635

tolerance defined 628 634

unilateral and bilateral tolerances 628

Alloy

low melting point used as filler 1386

Alloy cast iron 1404**Alloy steels** 397

AISI-SAE designations 400

basic numbering system 398 400

carburizing grades 413

casting 1407

compositions 404 1408 2242

directly hardenable grades 414

drilling and reaming 1060

effects of alloying elements 2243

Index Terms**Links****Alloy steels (*Cont.*)**

electrodes (welding)		
current to use with	1457	
elongation	1408	
forged and rolled	2241	
gears	2241	
hardness of heat-treated	424	
heat treatments	491	
mechanical properties	424	1408
milling	1044	
numbering system	398	400
strength of heat-treated	424	
tensile strength	1408	
turning	1026	

Alloys

aluminum	530	
antimony	544	
bearing	1417	2357
binary	399	
brazing	1426	
cast steels	1406	
copper	514	
copper-beryllium	528	
copper-silicon	528	
die casting	1415	
magnesium	545	547
nickel	548	
nonferrous	513	
numbering systems for	398	
quaternary	399	
soldering	1424	
ternary	399	
titanium	548	550

Alphabet, phonetic	2700	
--------------------	------	--

Index Terms

Links

Alternating current motors	2569	
Alternating stress	202	
Aluminum		
alloys	530	
anodizing	1507	
characteristics	543	
chemical composition	534	537
electrical conductivity	543	
elongation	534	
high corrosion resistance	543	
mechanical properties	543	
temper	534	
ultimate tensile strength	534	
workability	543	
yield strength	534	
Association	531	534
bearing material	2360	
bending	1351	
cast composition	534	
characteristics of	530	
clad alloys	542	
coefficient of expansion	376	
density	376	
designations	534	
die casting	1415	
elongation	391	
heat treatability of wrought	542	
machining	1192	
melting point	376	
soldering	1424	
specific heat	376	
structural shapes	2603	
temper designation	531	
tensile strength	391	

Index Terms

Links

Aluminum (*Cont.*)

thermal conductivity	376
welding	1460
wrought	542
yield strength	391

American

Boiler Makers Association	288			
Brass Company	528			
Foundrymen's Association	461			
Gear Manufacturers Association (AGMA)	2128	2131	2164	
Institute of Steel Construction column formulas	287 285			
Iron and Steel Institute (AISI)	398	400		
National Standards Institute (<i>see also</i> ANSI Standard)	ix	2175		
Society for Metals (ASM)	429			
Society for Testing and Materials (ASTM)	461	508	545	1404
copper alloys	513			
Society of Mechanical Engineers (ASME)	ix	2175		
(<i>see</i> Index of Standards)				
wire gage	2605			

AMO thread

design dimensions	1984			
design requirements	1983			
formulas	1984			
gage testing	1983			
lengths of engagement	1983			
limit of size	1985			
swiss screw thread	1985			
symbols	1984			
tolerances and allowances	1983	1985		

Index Terms

Links

Analysis, break-even	143	
Analytical geometry	40	
Angle		
between lines tangent to two circles	684	
between two lines	43	
compound	119	
cutting tool	758	
degrees into radians	103	105
functions of	95	
helix	2061	
indexing	2086	
involute functions of	110	
lead	2061	
length of arc of given radius	73	77
length of chord	73	77
measuring by disc method	682	
minutes, seconds into decimal degrees	104	
minutes, seconds into radian	103	
radian into degrees	103	
sine bar for measuring	678	
structural	2600	
bent to circular shape, lengths of	2593	
moment of inertia	2600	
radius of gyration	2600	
section modulus	2600	
weight per foot	2600	
taper per foot		
corresponding to	683	
thread, tolerances on gages	2013	
to find, given taper per foot	682	
tolerance, single point tool	775	
trigonometric functions of	106	
useful relationships among	106	

Index Terms

Links

Angular

acceleration	177
torque, relation to	180
backlash in gears	2169
indexing	2086
velocity	175
of rotating bodies	176

Annealing

constant temperature, transformation	483
temperatures	
carbon steel	483
stainless	494
tungsten	499

461

Annuities (calculation of)

136

Anode

1393

Anodizing

1508

hard

1512

ANSI Standard

abbreviations 2652

2655

Acme threads 1921

bolts, nuts, screws, washers

bolts, nuts, screws, washers

inch 1538

metric 1581

boring tools 899

903

carbide 899

buttress inch screw thread 1946

cap screws

inch hex 1542

inch slotted head 1680

inch socket head 1682

metric 1581

socket head 1594

chain, transmission 2537

Index Terms

Links

ANSI Standard (*Cont.*)

clearance fits	652	657
core drills	888	
cutting tools	764	
cylindrical fits	628	
diamond wheels	1240	
dowel pins, hardened and ground	1749	
drawing and drafting practices	609	
symbols		
accuracy	1324	
between	612	
comparison to ISO	612	
concentricity	1326	
controlled radius	612	
diameter	612	
parallelism	612	
part tolerance	612	650
perpendicularity	612	
position	612	1324
roundness	612	
runout	612	
section lining	611	
statical tolerance	612	
total runout	612	1327
welding	1476	
drill drivers	887	890
collet type	887	
drive screws	1716	
drive studs	1757	
electric socket and lamp base threads	1980	
engineering drawings	610	
fine-pitch		
helical gears	2204	
standard gear tooth parts	2136	

Index Terms

Links

ANSI Standard (*Cont.*)

worm gearing	2191		
fire hose connection threads	1970		
fits	635		
hole basis	653		
shaft basis	657		
flat metal products			
inch sizes	2608		
metric sizes	2610		
gagemakers tolerances	661		
gages	2006		
for self-holding tapers	956		
for Unified screw threads	2007		
usage, recommended	661		
gear tooth forms	2131		
geometric characteristic symbols	612		
geometric dimensioning and tolerancing	613		
grinding wheel safety	1246		
grinding wheels	1218	1234	1243
grooved pins	1756		
hexagon socket head shoulder screws	1686		
hexagon spline socket set screws	1689		
hose coupling screw threads	1969		
interference fits	652	655	1973
involute splines	2252	2256	
metric module	2272		
key drive	953		
keys and keyseats	2460		
keys and keyways	831		
knurls and knurling	991		
letter symbols for mechanics	2655		
limits and fits	634		
lock washers	1565		

Index Terms

Links

ANSI Standard (*Cont.*)

M profile thread		
design profile	1882	
designations	1899	
limits of size	1892	
tolerances of internal threads	1889	
machine screws	1643	
binding head	1651	
fillister head	1649	
flat, countersunk head	1644	
hexagon washer head	1646	
metric	1659	
oval head	1649	
pan head	1648	
round head	1652	
slotted hexagon	1647	
truss head	1647	
manufacturers' standard gage for sheet		
steel	2608	
metric		
cap screws	1581	
clearance fits	653	657
hex flange nuts	1601	
hex flange screws	1589	
interference fits	655	
nut thread series	1603	
nut tops	1601	
nuts	1599	1605
retaining rings	1763	
screw	1593	
screw threads, M profile	1878	
screw threads, MJ profile	1900	
screws, bolts, nuts, and washers	1581	
slotted hex nuts	1601	

Index Terms**Links**ANSI Standard (*Cont.*)

square neck bolts	1589			
transition fits	655	659		
microscope threads	1980			
milling cutters	809			
miniature threads	1858			
nuts	1538			
pins	1746			
pipe thread	1956			
plain washers	1562	1608		
preferred				
basic sizes	673			
fits	652			
metric limits and fits	639			
metric sizes	648	673		
thicknesses, thin, flat metals	2608			
reamers	851			
retaining rings	1763			
rivets	1734			
roundness symbols	1325			
runout symbols	1327			
screw thread symbols	1921	1933	1942	1974
metric	1880			
screw threads	1806	1813	1878	1946
	1977			
metric MJ profile	1900			
screws and bolts				
hex structural bolts	1591			
hexagon socket	1599			
metric	1581	1585		
metric hex bolts	1592			
metric neck bolts	1589			
square neck bolts	1590			
section lining symbols	611			

Index Terms

Links

ANSI Standard (*Cont.*)

self-tapping thread inserts	1716	
self-threading screws		
inch	1701	
metric head types	1718	
serrations, involute	2252	
set-screws		
heads and points	1687	
socket type	1688	1693
shoulder screws	1686	
slotted headless set screws	1687	
spindles and drives for portable tools	972	
spline socket set screws	1688	1693
splines, involute		
metric module	2272	
spring pin	1761	
spur gear tooth forms	2131	
square head set screws	1690	
straight pins	1752	
surface finish	747	
surface texture	733	
symbols	661	
accuracy symbols	1327	
concentricity	612	
diameter	1325	
for section lining	611	
tang drives	951	
tapers	948	
thread dimension	1975	
threads for electric sockets	1980	
thumb screws	1791	
T-nuts, T-bolts, T-slots	1726	
tolerances	635	
allowances for cylindrical fits	628	

Index Terms

Links

ANSI Standard (*Cont.*)

gagemakers	661	
symbols	612	
tooth proportions	2135	
transition fits	652	655
twist drills	866	
Unified threads	1806	1813
washers		
inch	1562	
metric	1604	1607
wing nuts and screws	1791	
wood screws	1801	
woodruff keys	2478	
worm gearing, fine pitch	2191	
wrench openings	1556	
Antifriction bearings	2365	
Apothecaries measure		
fluid	2679	
weight	2683	
Applications nickel alloys	548	
APT (automatically programmed tool)		
axis nomenclature	1315	
Arbors		
circular saw	972	
diameters for spring-winding	349	
dimensions of centers	851	
keys and keyways for	831	
milling cutters	827	
shell reamer	862	
standard milling machine	962	
Arc		
checking radius of	687	
cutting	1462	
electric, cutting of metals	1462	

Index Terms

Links

Arc (*Cont.*)

length of given angle and radius	73	77
plasma precision cutting	1462	
plasma welding	1458	
welding	1433	

Area

circle	46	73	
circular			
ring	74		
ring sector	46	74	
sector	73		
segments	46	73	78
cycloid	73		
donut	46		
ellipse	49	75	
elliptical section	49		
enclosed by cycloidal curve	68		
fillet	74		
finding by Simpson's rule	67		
geometrical figures	70		
hexagon	72		
hyperbola	75		
irregular outline	67		
octagon	72		
parabola	74		
segment of	75		
parallelogram	70		
plane figures	70		
plane surface of irregular outline	67		
polygon	72		
rectangle	70		
spandrel	74		
square	70		
surface of revolution	66		

Index Terms

Links

Area (*Cont.*)

trapezium	72		
trapezoid	71		
triangle	71		
units	2675		
units and conversion of	2675		
various sections	234		
volume	66		
Argon, welding gas	1437	1445	1458
Arithmetical			
operations, sequence of	5		
progressions	37		
ASA Code for transmission shafting	299		
ASME Standard surface finish	747		
Asperities	2420		
ASTM Plastics	554		
Atmospheric pressure	2686		
Atomic			
symbol	371		
weight	371		
Austempering	461	478	
Austenite	465	469	
Autocollimation	1322		
Automatic screw machines	1170		
knurling on	1170		
Avoirdupois or commercial weight	2683		
Azimuth reading displacements	1322		

B

B & S automatic screw machines	1170		
Babbitt metals	2357		
properties of	2359		
SAE general information	2357		

Index Terms

Links

Backlash	2126
allowance in checking gears by the pin	
method	2235
bevel gears	2165
calculation	2163
control of allowances in production	2166
control of in assemblies	2168
determining proper amount of	2163
excess depth of cut	2166
fine-pitch gears	2167
gearing	2163
hypoid gears	2165
recommended for gears	2165
Balancing	
calculations	191
counterbalancing masses	
located in single plane	192
located in two or more planes	194
dynamic	191
lathe fixtures	195
machines	191
rotating parts	191
running or dynamic	191
static	191
Ball bearing (<i>see</i> Bearings: ball)	
Ball screw assemblies	2561
Balls, standard	2419
package markings	2411
Band brakes	2455
coefficient of friction	2457
simple and differential	2456
Band saw	
blade selection	1177
blade types	1178

Index Terms

Links

Band saw (*Cont.*)

break-in	1181
speed and feed	1179
speed for cutting materials	1180
speeds and feeds, metal cutting	1179
tooth forms	1178

Barrel

effect	1394
liquid capacity	2679
volume	87

Base

circle	2126	2253
diameter	2253	
helix angle	2126	
oils for metal cutting	1185	
pitch	2126	
spur gear, diameter	2131	
tooth thickness	2126	

Basic

endurance limit	2173
gear dimensions	2137
rack profiles	2276
size	628
space width	2253

Baumé's hydrometer

conversion	381
------------	-----

Beams

	256	2593
channel	2599	2603
combined stresses in	211	
curved	275	
deflections	256	273
designing for	273	
fixed at one end	268	
I-beams	2593	2603

Index Terms

Links

Beams (*Cont.*)

rectangular solid	268	
stresses in	209	256
stresses produced by shocks	279	
supported at both ends	256	

Bearing capacity, soil and rocks 384

Bearings 2314

ball bearing	2365	2390
ABEC tolerances	2375	
alignment and squareness	2391	
allowance for axial displacement in	2382	
angular contact	2367	
cage materials	2373	
clamping and retaining methods	2393	
clearances, running	2400	
closures	2393	2398
deficiencies	2403	
design and installation	2382	
designation	2373	2385
double row bearing	2367	
equivalent thrust load	2409	
ball bearing		
failures	2403	
fatigue life	2403	
fits	2393	2398
flanged housing	2373	
friction losses	2398	
handling precautions	2402	
housing bore tolerances	2385	
housings, soft metal	2392	
life	2403	
adjustment factor application	2414	
adjustment factor for material	2414	
adjustment factors	2414	

Index Terms

Links

Bearings (*Cont.*)

criterion	2403	
limitations	2404	
load ratings	2403	
locknuts and shafts for	2395	
lockwashers for	2394	
lubrication method	2400	
materials for	2373	
mounting	2390	
precautions	2393	
types	2401	
pillow block	2373	
plastics	2372	
quiet or vibration-free mountings	2393	
radial and angular contact	2405	
radial and axial clearance	2401	
radial, deep groove and angular contact	2404	
rating life	2405	2412
reliability	2414	
seating fits	2393	
selection	2399	
shaft and housing fits for metric radial	2384	
bore limits	2385	
housing fits	2382	
tolerance classifications, metric	2383	
limits, metric	2384	
single row radial, filling slot	2366	
single row radial, non filling slot	2366	
soft metal and resilient housings	2392	
special or unconventional types of	2372	
squareness and alignment	2391	

Index Terms

Links

Bearings (*Cont.*)

starting torque	2399	
static		
equivalent load	2417	
load criterion	2404	
load ratings	2415	
symbols	2365	2367
thrust	2370	2408
thrust load	2409	
tolerances	2374	2380
types	2366	2404
grease packing guidelines	2436	
guide	2317	2356
hydrostatic	2317	
journal	2325	
allowable pressure	2330	
bearing pressure	2329	
journal		
capacity number	2332	
classes	2330	
clearance modulus	2330	
diameter of bearing	2329	
diametral clearance	2330	
eccentricity ratio	2331	
factor	2332	
film thickness	2335	
flow factor	2334	
flow of lubricant	2332	
friction horsepower	2332	
friction torque	2332	
hydrodynamic flow of lubricant	2334	
length of bearing	2329	
length to diameter ratio	2330	
lubrication analysis	2335	

Index Terms

Links

Bearings (*Cont.*)

operating temperature	2330		
pressure	2330		
pressure flow of lubricant	2334		
temperature of mineral oils	2332		
temperature rise	2335		
torque parameter	2332		
total flow of lubricant	2335		
viscosity of lubricant	2330		
keying	2319		
laminated phenolic	2361		
life adjustment factors	2414		
lubricants and lubrication			
grease	2323		
journal bearings	2326	2329	2335
plain bearings	2322		
materials, plain	2356		
aluminum	2357	2360	
babbitt metals	2357		
bronze	2359		
cadmium alloys	2359		
carbon-graphite	2360		
cast iron	2360		
compatibility	2356		
conformability	2356		
copper-lead	2357	2359	
corrosion resistance	2358		
embeddability	2356		
fatigue resistance	2356		
graphitic	2362		
laminated phenolics	2361		
load capacity	2358		
nylon	2361		
plastics laminates	2361		

Index Terms

Links

Bearings (Cont.)

porous	2361
properties	2356
rubber	2362
SAE compositions	2357
silver	2360
strength	2358
teflon (TFE)	2361
thermal conductivity	2358
tin-bronze	2357
white metal	2357
wood	2362
needle	2370
loose roller	2371
symbols	2370
types of	2370
needle roller	
designations of	2385
fitting and mounting practice	2387
roller and cage assemblies	2387
shaft and housing tolerances	2388
tolerances	2380
pillow block	2373
plain	2314
allowable pressures	2329
boundary lubrication	2318
circumferential-groove	2314
classes of	2314
clearances	2329
controlled clearance noncontact	
seals	2320
cylindrical-overshot	2316
cylindrical-undershot	2316
design	2317

Index Terms

Links

Bearings (Cont.)

design notation	2327	
die casting in place	1417	
displaced elliptical	2316	
elliptical-overshot	2316	
full film lubrication	2318	
full film operational mode	2318	
greases	2325	
grooving feeding	2326	
hardness and surface finish	2321	
heat radiating capacity	2325	
hydrostatic	2317	
journal	2326	
journal bearing oil grooving	2326	
journal bearing types	2327	
journal or sleeve	2314	
keying methods	2319	
length-to-diameter ratio	2329	
lubricants	2323	
lubrication analysis	2329	
lubrication methods	2322	
machining	2321	
materials	2356	
mixed-film lubrication mode	2318	
modes of operation	2317	2319
multiple-groove	2316	
nutcracker	2316	
oil bath lubrication	2323	
oil feeding	2326	
oil grooves	2325	2329
oil ring lubrication	2323	
operating temperatures	2330	
pivot-shoe	2316	
positive contact	2320	

Index Terms

Links

Bearings (*Cont.*)

press or shrink fit	2319
pressure	2316
pressure lubrication	2322
pressure profile	2327
retaining methods	2319
rubbing seals	2320
sealing methods	2319
plain	
sleeve	2326
solid lubricants	2325
splash lubrication	2322
static seals	2321
surface finish and hardness	2321
three-lobe	2316
types	2314
viscosity temperature chart	2324
waste pack lubrication	2323
porous	2361
retention	
dowel pin	2320
housing cap	2320
set screws	2319
woodruff key	2320
roller	2365
ABEC and RBEC tolerances	2385
alignment and squareness	2391
allowance for axial displacement	2382
barrel roller	2368
barrel type	2372
bearing closures	2398
cage materials	2373
clamping and retaining methods	2393
closures	2398

Index Terms**Links****Bearings (*Cont.*)**

cylindrical type	2368	2372
deficiencies	2403	
design and installation		
considerations	2382	
designation of	2373	2385
failures	2403	
fatigue life	2403	
fits	2393	2398
flanged housing	2373	
friction losses in	2398	
handling precautions	2402	
high speed effects	2409	
housing bore tolerances	2385	
housings, soft metal and resilient	2392	
internal clearance	2409	
life	2403	
adjustment factors	2414	
for application	2414	
for material	2414	
criterion	2403	
life adjustment factors	2414	
load ratings	2403	
location and seating	2390	
locknuts and shafts	2395	
lockwashers	2394	
lubrication	2400	2409
materials for	2373	2409
method of designation	2384	
mounting	2390	
precautions	2393	
type	2401	
needle type	2387	
pillow block	2373	

Index Terms

Links

Bearings (*Cont.*)

plastics	2372		
quiet or vibration-free mountings	2393		
roller			
radial	2411	2419	
radial and axial clearance	2401		
radial load	2411		
rating life	2410	2412	
reliability	2414		
seating fits for	2393		
selection	2399		
self-aligning	2370		
shaft and housing fits for	2393	2398	
metric radial	2382		
soft metal and resilient housings	2392		
special or unconventional types of	2372		
spherical roller	2368		
spherical type	2372		
squareness and alignment	2391		
static equivalent loads	2418		
static load criterion	2404		
stress concentrations	2409		
symbols	2365		
tapered	2369		
tapered roller thrust type	2369		
thrust	2369	2380	2412
tolerances for	2374		
torque, starting	2399		
types of	2368	2409	
roller thrust			
spherical roller	2370		
sleeve	2325		
spacing and			
shaft stiffness	2180		

Index Terms

Links

Bearings (*Cont.*)

tapered

land thrust bearing

2338

2347

2352

roller bearings

2369

roller thrust bearings

2369

thrust bearing

2338

2370

ball

2370

symbols

2368

design notation

2339

flat plate design

2338

2340

depth of chamber

2342

film flow

2341

flow per chamber

2341

friction power loss

2341

kinetic energy correction

2342

length of pad

2341

number of pad

2341

pitch line velocity

2341

radial pad width

2340

required oil flow

2341

flat plate type

2344

friction power loss

2342

leakage factor

2349

load

2339

parallel flat plate

2338

plain

2338

rated life

2408

roller

2369

2412

symbols

2369

static equivalent load

2418

step design

2338

2344

depth of step

2346

film thickness

2346

Index Terms

Links

Bearings (*Cont.*)

thrust bearing			
friction power loss	2346		
hydrodynamic oil flow	2346		
length of pad	2346		
number of pads	2346		
pad step length	2346		
pitch line circumference	2346		
pitch line velocity	2346		
radial pad width	2345		
temperature rise	2346		
tapered land design	2338	2347	2352
film thickness	2348		
friction power loss	2349		
length of pad	2348		
number of pads	2348		
oil film flow	2349		
oil flow factor	2349		
oil leakage factor	2348		
pitch line circumference	2348		
pitch line velocity	2348		
radial pad width	2348		
shape factor	2349		
taper values	2348		
tilting pad design	2338	2352	
bearing unit load	2353		
dimensionless film thickness	2355		
film thickness	2354		
friction coefficient	2354		
length of pad	2353		
number of pads	2353		
operating number	2353	2355	
pitch line velocity	2353		
radial pad width	2353		

Index Terms

Links

Bearings (*Cont.*)

temperature rise	2354
tolerances	2380
tolerances	2374
metric ball and roller	2375
needle roller	2374
thrust	2374

Bel 2700

Belleville disc springs or washers	344	350
(<i>see also</i> Springs: disc)		

Belts and pulleys 2484

flat belts	2487	
length formula	2484	
rules for diameters and speeds of		
pulleys	2484	
speed limitations	2487	
speed in compound drive	2486	
synchronous belts	2528	2532
cross section	2534	
designation	2528	2534
horsepower rating	2535	
length determination	2532	
pitch lengths	2531	
pulley		
and flange dimension	2530	
diameter	2532	
size	2533	2536
tolerances	2534	
section dimension	2530	
synchronous belts		
service factors	2528	
storage and handling	2525	
timing	2528	
tolerances	2531	

Index Terms

Links

Belts and pulleys (*Cont.*)

tooth dimensions	2529	
torque ratings	2534	
width factor	2536	
width, finding	2535	
widths and tolerances	2532	
variable speed belts	2518	
arc of contact	2525	
cross section selection	2522	
degree	2523	2525
designation	2521	
dimension	2518	
drive design	2521	
groove dimension	2520	
horsepower rating	2522	
length correction	2524	
lengths	2519	
sheave dimension	2520	
sheave groove data	2521	
speed ratio	2522	
V-belts	2489	
belt lengths and center distances	2494	
classical V-belts	2495	
arc of contact correction	2502	
cross section correction factors	2494	
datum length	2496	
groove dimension	2497	
horsepower ratings	2499	
length correction	2501	
sheave dimensions	2496	
speed ratio correction	2501	
double V-belts	2502	
arc of contact	2510	
design method	2506	

Index Terms

Links

Belts and pulleys (*Cont.*)

effective diameter	2505	
effective length	2502	
groove dimension	2503	
length determination	2505	
length-flex correction	2509	
number of belts	2506	
sheave dimension	2502	
tension	2510	
tension ratings	2509	
tight side tension	2507	
effective length	2487	
horsepower ratings	2484	
light duty V-belts	2510	
arc of contact	2510	
designation	2510	
dimensions	2511	
groove dimension	2512	
horsepower rating	2512	
sheave dimension	2512	
narrow V-belts	2489	2494
arc of contact correction	2495	
cross section selection	2493	
groove dimension	2491	
horsepower ratings	2493	
V-belts		
length correction factors	2495	
number of belts	2495	
sheave		
dimensions	2489	2491
outside diameter	2493	
size	2493	
speed ratio correction factors	2494	
ratio	2484	

Index Terms

Links

Belts and pulleys (*Cont.*)

SAE belts and belting	2525
belt dimensions	2526
pulley dimensions	2526
service factors	2527
sheaves	2484
sixty (60)-degree	2525
storage and handling	2526
V-ribbed belts	2513
arc of contact correction	2517
cross-sections	2513
designation	2515
dimensions	2513
effective length	2516
grooved dimension	2514
horsepower rating	2515
length correction	2517
sheave dimension	2514
speed ratio correction	2518
60 degree	2525
speed ratio correction	2523

Bending

formulas	
for beams	267
formulas for beams	256
formulas for shafts	295
pipe and tube	1382
press	1383
roll	1385
rotary draw	1384
use of filling material	1385
roll	1385
rotary draw	1384
sheet metal	1346

Index Terms

Links

Bending (Cont.)

allowances	1347	1351	1358
aluminum	1347		
angle other than 90°	1351		
brass	1347	1351	
bronze	1347	1351	
force	1352		
formulas	1347	1351	
radius	1346		
inside bend	1346		
maximum	1347		
minimum	1346		
steel	1347		
three-roll	1353		
stress in beams	256		
structural angles	2600		
Bending load, wood	385		
Bending moments units conversion	2689		
Beryllium and copper alloys	529		
Bevel gearing	2177		
ANSI/AGMA Standard	2181		
applications of	2179		
bearing spacing	2180		
blanks	2179		
bronze and brass gears	2243		
chordal addendum	2189		
chordal thickness	2188		
circular pitch	2184		
circular thickness	2189		
cutting angle	2184		
cutting teeth	2180		
design	2179		
dimensions	2183		
face angle	2184		

Index Terms

Links

Bevel gearing (*Cont.*)

factors for offset of cutter	2188		
formed cutters for	2185		
German standard tooth form	2217		
hypoid gears	2178		
materials for	2190		
milled	2181	2188	
milling cutters for	829		
milling setup	2188		
mountings	2180		
nomenclature	2181		
offset of cutter	2188		
pitch cone	2183		
pitch diameter	2183		
planetary	2211		
replacement gear dimensions	2250		
selecting formed cutters for	2187		
shaft stiffness	2180		
spiral	2178		
straight	2125	2177	2179
thickness of tooth	2184		
types of	2177		
typical steels used for	2190		
Zerol	2125	2178	
BHRA - British Hydromechanics			
Research Association	2439		
Bilateral and unilateral tolerances	628		
Binary multiples	2658		
Binding head miniature screw	1654		
Birmingham wire gage	2605		
Birnie's equation	291		
Blank diameters, drawing dies	1355	1357	
Blanking and punching	1339		
clearance	1340		

Index Terms

Links

Blanking and punching (*Cont.*)

stripper force

elastic stripper 1343

Blanks, sintered carbide 772

Blast cleaning of castings 1412

Block

brakes 2458

or multiple indexing 2117

Block and spacer torque test 1618

Blow molding 581

Blow, force of 183

Boilers, strength of flat stayed surfaces 288

Boiling temperature, various substances 372

Bolt hole circles

adapting equations for geometry 694

chordal distance 76

coordinates for 692

Type "A" 692 696 698

Type "B" 693 700 702

Bolts and nuts

angularity and eccentricity 1635

ANSI Standard 1540

ANSI, inch dimensions

cap or acorn nuts 1549

countersunk bolts 1554

flat jam nuts 1546

hex

flat nuts 1546

nuts 1545

slotted nuts 1546 1548

thick slotted nuts 1547

jam nuts 1545

ribbed neck bolts 1553

round head bolts 1551

Index Terms

Links

Bolts and nuts (*Cont.*)

round head fin neck bolts	1552			
slotted countersunk bolts	1555			
square				
neck bolts	1551	1554		
nuts	1538	1548		
step bolts	1554			
T-bolts	1727			
T-nuts	1728			
Unified	1538	1545	1548	
wing nuts	1791			
ANSI, metric dimensions				
diameters	1584			
heavy hex bolts	1591			
heavy hex flange screws	1588			
heavy hex nuts	1605			
hex jam nuts	1605			
hex nuts	1601			
prevailing torque hex				
flange nuts	1604			
nuts	1606			
reduced diameter bolts	1585			
slotted hex nuts	1601			
thread series	1603			
bolt designation	1539	1592	1604	1626
	1635	1644	1658	1680
	1691	1694	1702	1718
	1794	1797		
British Standard	1676			
fine thread	1700	1955		
hexagon bolts, screws, and nuts	1634			
hexagon slotted and castle nuts	1629			
metric hexagon	1630			
precision hexagon nuts	1628			

Index Terms**Links****Bolts and nuts (*Cont.*)**

slotted and castle nuts	1628			
Unified	1678			
Whitworth	1627	1672	1679	1700
chamfering	1635			
combination	1636			
counterbore sizes	899	1612		
countersinking	1635			
deflection	1521			
designation	1636			
diameter-length combinations	1594			
drill sizes	1612			
elongation and tightening tension	1530			
elongation measurements	1526			
finish	1634			
friction coefficient	1530			
friction coefficients	1524			
grade markings for steel	1534			
head markings				
inch	1534			
metric	1592	1601	1604	
heavy hex structural	1540			
heavy hex structural bolts	1591			
hex structural	1539			
hexagon bolts, screws, and nuts	1634			
hexagon sockets	1599			
identification symbols	1593			
length of thread	1635			
load allowable on bolts	1535			
loaded joints	1522			
marking	1636			
materials properties	1592			
metric hex bolts	1592			
metric hex cap screws	1595			

Index Terms

Links

Bolts and nuts (*Cont.*)

metric hex flange nuts	1601			
metric hex lag screws	1594			
metric round head bolts	1593			
metric screw	1593			
nominal lengths	1634			
preload	1521			
adjustments	1524			
application methods	1526			
applications	1523			
loaded joints	1522			
shear	1522			
proof strength	1521			
relaxation of preloads	1525			
round head neck bolts	1552			
socket head cap screws	1594	1599		
spacing for wrench clearances	1555			
spline sockets	1599			
square	1539			
steel nuts	1636			
strength grade designations	1534	1592	1601	1604
	1635			
tightening	1521			
torque	1521			
torque prevailing types	1603			
torque required to tighten	1521			
Unified square	1540			
Unified Standard	1540			
washer facing	1635			
working strength of bolts	1535			
wrench and socket clearances	1555			
wrench clearances for nuts	1556			
wrench openings	1556			
yield strength	1521			

Index Terms**Links**

Bonding plastics	593			
Bonding, adhesives	2580			
Boring				
carbide tools for	899			
cutting time for	1081			
insert holder	770			
wood	388			
Boring machine, origin	903			
Boring tools				
carbide carbide tipped round	901			
carbide sizes	899			
carbide style	899			
sintered carbide	899			
solid carbide	903			
Boring-bar, cutters, carbide	899			
Boron nitride				
cubic (CBN) abrasive	1012	1217	1234	1243
cutting tool materials	1012			
speeds and feeds for	1032	1038		
Bottom bending	1346			
Boundry film lubrication	2421			
Box wrench clearances	1561			
Box wrench clearances, US-Metric	1561			
Brakes				
band	2455			
block type	2458			
coefficient of friction	2455			
Brass and bronze				
alloys	514			
cast	515			
speeds and feeds				
drilling and reaming	1071			
wrought	519			
bending	1347	1351		

Index Terms

Links

Brass and bronze (*Cont.*)

speeds and feeds

turning 1036

strength data 513

Brass files 989

Brazing 1426

blowpipe 1431

dip 1431

filler metals for 1426

fluxes for 1426

furnace 1431

heating for 1431

induction 1431

methods 1431

resistance 1431

supplying heat blowpipe 1431

supplying heat torch 1431

symbols 1431

vacuum furnace 1431

work 1431

Breakaway torque 1623

Break-even analysis 143

Breaking load, bolts 1537

Breaking load, screws 1537

Bricks strength 394

Briggs (now ANSI) standard pipe

thread 1957 1986 1988

drills for 2037

Brinell hardness 505

aluminum alloys 534

heat-treated steels 424

Rockwell conversion tables 508

test 505

Index Terms

Links

British Association

basic dimensions	1982
instrument makers threads	1982
standard screw threads	1981
tolerance formulas	1982
tolerances and allowances	1982

British Standard

button head screws	1694		
buttress threads	1945		
cap screws	1695		
cheese head screw	1677		
clearance holes for metric bolts and screws	2034		
combined drills and countersinks	886		
core drills	892		
countersunk head screws	1672	1676	1679
deviations for holes	670		
deviations for shafts	668		
dowel pins, metric	1747		
drills and countersinks	890		
drills, metric	890	892	
fasteners, mechanical properties	1634	1694	
fine threads (BSF)			
basic dimensions	1955		
tolerance formulas	1953		
fits	666		
hexagon and thin nuts	1632		
hexagon bolts	1626		
hexagon bolts and screws	1631		
hexagon head screws	1676		
hexagon nuts	1629		
hexagon slotted and castle nuts	1628	1633	
hexagon socket countersunk	1694		

Index Terms

Links

British Standard (*Cont.*)

hexagon socket screws, metric	1694	1696	1699
button head	1698		
cap	1695		
set	1697	1699	
imperial wire gauge	2605		
interference fits	1637		
ISO metric			
grade markings	1634		
limits and fits	662		
tapping drill sizes for	2033		
threads	1901	1919	
ISO metric nuts	1632		
ISO profile dimensions	1910		
limits and fits	667		
limits of tolerance for shafts	665		
machine screw nuts	1667	1672	
machine screws	1666		
countersunk head	1670		
material	1667		
metric series	1669		
slotted countersunk head	1669		
machine screws and nuts	1676		
machine screws, cheese head	1674		
machine screws, metric series	1675		
metric			
and inch pipe threads	1966		
basic sizes, preferred	674		
bolts, clearance holes	2034		
metric			
bright metal washers	1641		
comparison of British, French, German			
and Swiss	1920		
dowel pins	1747		

Index Terms

Links

British Standard (*Cont.*)

drills	890			
gauge and letter sizes	891			
hexagon socket screws	1694	1699		
limits and fits	662			
machine screws and nuts	1666			
metal washers	1640			
series	1667			
series plain washers	1640			
series spring washers	1638			
spring washers	1639			
threads	1920			
morse taper	893			
mushroom head screw	1677			
nuts	1627	1632	1666	
pan head screw	1677			
pipe threads				
jointing threads	1966			
longscrew threads	1966			
non pressure tight joints	1965			
pressure tight joints	1966			
precision metric nuts	1633			
preferred metric basic sizes	674			
preferred numbers	674			
preferred sizes	674			
recessed head screws	1676			
rivets	1736	1745		
RMS thread	1982			
round head screw	1676			
screws	1626	1666	1679	1694
thread dimensions	1967	1982		
thread profiles	1863	1953		
slotted head screws	1676			
socket head	1695			

Index Terms

Links

British Standard (*Cont.*)

spark plug threads	1979		
spur and helical gears	2172		
straight splines	2278		
studs	1626	1637	
tolerance for holes and shafts	663	665	
twist drills	892		
Unified			
machine screws and nuts	1678		
screws and nuts	1678		
thread system			
UNJ profile threads	1863		
washers, plain, metric	1640		
Whitworth and fine machine screws	1667		
Whitworth threads (BSW)	1953		
basic dimensions	1954		
formulas	1954		
instrument threads	1982		
machine screws	1679		
measuring	1992	1995	1998
pipe threads	1965		
set-screws	1679	1700	
thread form	1953		
tolerance formulas	1953		
British thermal units, (BTU)	2695		
converted into foot-pounds	2691		
power and heat equivalents	2690		
Broaches			
chip breakers	983		
clearance angles for teeth	983		
depth of cut per tooth	982		
depth of teeth	983		
face angle or rake	983		
land width	983		

Index Terms**Links****Broaches (*Cont.*)**

pitch of teeth	980
radius of tooth fillet	983
shear angle	983
surface	981
total length of	983
types	979

Broaching

cutting oils for	1185
cutting speeds for	1073
difficulties	985
pressure	981
types of machines	983

Broken tap, removal of

2037

Bronze bearing material

2359

Bronze bending

1347

1351

Brown & Sharpe

automatic screw machines	1170		
forming tool formula	799		
indexing plates	2079	2107	
milling machine indexing	2079	2081	2107
taper	948	957	
taper reamers for sockets	864		
wire gage	2605		

Brush finishing, power

1500

Buckling, columns

282

Buffing and polishing

1501

Buffing wheels

1504

Bulk modulus of various material

394

Burs and files, rotary

989

Bushings gear

2245

Butt joint, riveted

1729

Button head screw

1694

Index Terms

Links

Buttress threads	1945	
allowances and tolerances	1951	
ANSI Standard inch type	1946	
basic dimensions	1945	
British Standard	1945	
designations	1952	
diameter equivalents	1948	
diameter-pitch combinations	1945	
dimensions	1951	
formula	1952	
height of thread engagement	1946	
lead and flank angles	1948	
pitch-diameter tolerances	1947	
symbols and formulas	1946	
thread form	1946	
tolerances	1947	1950
wire method of measuring	2006	
Byte	2658	
C		
Cables, wire, breaking strength	2616	
Cadmium		
bearing alloys	2359	
plating	1509	
vacuum coating	1515	
Cage materials, anti-friction bearings	2373	
Caliper		
gear tooth	2147	
measurement of gear teeth	2147	
vernier	675	
Calorie, kilogram	2690	2695
Cams and cam design	1174	2284
accelerating forces	2301	

Index Terms

Links

Cams and cam design (*Cont.*)

acceleration, velocity, and displacement		
formulas	2286	
classes of cams	2284	
constant velocity with parabolic		
matching	2291	
contact stresses	2306	
cylinder cams shape	2307	
displacement		
constant velocity	2286	
curves	2285	
cycloidal	2288	
diagrams	2285	
harmonic	2287	
parabolic	2286	
synthesis of	2288	
follower systems	2284	
forces	2301	
friction forces	2302	
harmonic motion	2300	
layout of a cylinder cams	2307	
materials	2301	2306
compressive stress	2306	
milling	2308	
offset translating follower	2294	
pressure angle	2293	2302
formula	2297	
harmonic motion	2298	
parabolic motion	2298	
uniform velocity motion	2298	
profile determination	2290	2292
radius of curvature	2299	
cycloidal motion	2300	
parabolic motion	2300	

Index Terms**Links****Cams and cam design** (*Cont.*)

rise for threading	1173	
size determination	2293	
stresses, contact	2301	2305
swinging roller follower	2292	2296
symbols	2285	
torque	2303	
translating roller follower	2292	
Cams and tool design	1174	
Cap screws	1542	1680
button head	1685	
drill and counterbore sizes for	1683	
finished, hexagonal	1542	
flat head	1684	
hexagon socket head	1694	
hexagon socket type	1682	
hexagonal	1542	
metric	1582	
round head	1681	
slotted fillister head	1681	
slotted flat head	1680	
slotted head	1680	
designation	1680	
length of thread	1680	
spline socket type	1682	
Capitalized cost	141	
Carat	2683	
Carbide blank		
designations	772	
sizes	772	
Carbide tools	779	785
application of cutting fluids to	1187	
boring	899	1074
coated	1010	

Index Terms

Links

Carbide tools (*Cont.*)

cutting	772	
grinding	1000	
insert holders	760	782
insert type	760	764
materials for	785	1009
nose angle	777	
nose radius	774	778
rectangular shank	775	
sharpening	1000	
side cutting edge angle	776	
single point	772	
sintered	772	
square shank	775	
standard blanks for	772	
style A	775	
style B	776	
style C	777	
style E	778	
style EL	778	
style ER	778	
tips for boring tools	899	
Carbides and carbonitrides	785	
Carbon steel	396	
AISI-SAE designations	400	
chemical compositions	402	2241
classification	410	
cold drawn	422	
electrodes	1457	
forged and rolled	2241	
free cutting	412	
gears	2241	
heat treatments	490	
mechanical properties	424	

Index Terms

Links

Carbon steel (<i>Cont.</i>)			
milling	1044		
numbering system	398	400	
structure of	465		
tool steel as a cutting tool material	1009		
turning	1026		
unified numbering system	398	400	
Carbonaceous mixtures	484		
Carbon-graphite bearings	2362		
Carbonitrides and carbides	785		
Carbonitriding	468		
Carburizing	461	467	484
gas	486		
liquid	486		
solid materials	484		
steels for	413		
temperatures			
alloy steel	491		
carbon steel	490		
vacuum	486		
Cartesian coordinate system	1279		
Cartesian coordinates	43		
Case hardening	461	484	
steel	484		
Cash flow conversion	136		
annuity to future value	138		
annuity to gradient value	138		
annuity to present value	138		
diagrams	137		
future value to annuity	138		
future value to gradient	138		
future value to present value	138		
present value to annuity	138		
present value to future value	138		

Index Terms**Links**

Cash flow conversion (<i>Cont.</i>)		
present value to gradient	138	
Casing thread	1986	
Cast copper alloys	514	
Cast iron		
bearings	2360	
coefficient of expansion	377	
cutting, flame	1463	
density	377	
ductile	1405	
malleable	1405	
melting points	377	
nodular	1405	
specific heat	377	
speeds and feeds for		
drilling, reaming, and threading	1067	
milling	1051	
turning	1032	
strength	432	
thermal conductivity	377	
Cast metals, power constant	1083	
Cast roller chains	2537	
Cast steel	1406	
austenitic manganese	1408	
chemical composition	1408	2242
corrosion resistant alloy	1408	
elongation	1408	
mechanical properties	1407	
strength	432	1407
tensile strength	1408	
yield point	1408	
Casting processes		
accuracy	1420	
aluminum alloys	1415	

Index Terms

Links

Casting processes (*Cont.*)

ductile iron	1405	
extrusion	1421	
gravity die casting	1410	
gray iron	1410	
green-sand molding	1409	
investment casting	1418	1420
investment removal	1420	
low pressure casting	1411	
permanent mold	1410	
shell-molding	1410	
squeeze casting	1411	
V-process	1410	
weights and sizes	1420	

Castings

alloy steel	1406	
blast cleaning	1412	
brass and bronze	513	
bronze and brass for gears	2243	
centrifugal	188	
cleaning	1412	
cleaning methods	1412	
die design	1415	
dimensions	1419	
ductile (nodular) iron	1405	
finishing operations	1411	
heat treatment	1411	
investment	1418	
malleable iron	432	1405
metal	1409	
milling cutters	1421	
nodular cast iron	1405	
removal of gates and risers	1411	
shrinkage of	1413	

Index Terms**Links****Castings (*Cont.*)**

steel, for gears	2190	2242	
surface texture of	744		
tolerances	1419		
weight	1412	1414	
Castle and slotted nuts	1539	1627	1629
Cathode	1394		
Cement, strength of	394		
Cementation	461		
Cemented carbide tools	785		
coated	790		
drilling with	1060		
grinding	1000		
materials for	1009		
milling with	1043		
turning with	1026		
Cementite	465		
Cements, pipe joints	2584		
Center			
distance, gear set	2137	2139	2207
drills reamers and machine			
countersinks	851		
of oscillation	231		
of percussion	231		
Center distance, gearing	2126		
Center of gravity	221	231	
any four-sided figure	222		
circle sector	223		
circular arc	222		
cone	225		
cone, frustum	225		
cylinder	224		
cylinder, portion of	224		
ellipse segment	223		

Index Terms

Links

Center of gravity (<i>Cont.</i>)		
ellipsoid, segment of	226	
fillet	223	
of two bodies	225	
parabola, area of	224	
paraboloid	226	
part of circle ring	223	
perimeter or area of parallelogram	221	
pyramid	225	
pyramid, frustum	225	
spandrel	223	
sphere, hollow	226	
spherical		
sector	226	
segment	226	
surface	223	
spheroid, segment of	226	
trapezoid	222	
triangle	221	
wedge	226	
Centering tools, length of point	889	
Centerless grinding	1259	
troubles	1260	
Centers, for arbors and reamers	851	
Centimeter-gram-second system of		
measurement	2656	
Centimeter-inch conversion tables	2665	
Centipoise (cP)	2425	
Centipoises	2698	
Centistokes	2698	
Centistokes (cSt)	2425	
Centralizing Acme threads	1928	1939
alternative series	1939	1942
basic dimensions	1930	

Index Terms

Links

Centralizing Acme threads (*Cont.*)

designation	1933	
diameter allowance	1932	
diameter tolerance	1933	
formulas for determining diameters	1930	1932
limiting dimensions	1930	
major and minor diameter allowances and tolerances	1932	
pitch diameter allowances	1932	
pitch diameter tolerance	1933	
single start screw thread	1932	
thread data	1931	
thread form	1930	

Centrifugal

casting	188	
clutches	2450	
force	187	
calculation	188	

Ceramic

coefficient of expansion	389	792
compressive properties	389	
compressive strength	389	792
cutting tool materials	790	1011
density	389	792
dielectric strength	389	
fracture toughness	792	
hardness	389	792
mechanical properties	389	
modulus of elasticity	792	
modulus of rigidity	792	
poission's ratio	792	
properties	792	
tensile strength	389	
thermal conductivity	389	792

Index Terms**Links**

Ceramic (<i>Cont.</i>)		
whisker reinforced	793	
Cermets	785	
Cgs system of measurement	2656	
Chain		
cast roller	2537	
detachable	2537	
pintle	2537	
saw files	989	
Chamfering insert holder	770	
Chamfers and corner clearance, gearing	2260	
Change gears		
compound	2042	2105
finding accurate ratios	2046	
finding ratios	2046	
helical gear hobbing	2208	
helical milling	2061	
idler gears	2105	
lathe	2042	
leads and angles for helical milling	2076	
odd inch pitch threads	2045	
output, quick change	2044	
relieving helical-fluted hobs	2046	
thread cutting, lathe	2042	
fractional ratios	2043	
fractional threads	2042	
metric pitches	2042	
modifying the gearbox output	2043	
threads per inch with given combination	2042	
trains, for fractional ratios	2043	
Channels		
aluminum	2603	
moment of inertia	2599	2603

Index Terms

Links

Channels (*Cont.*)

radius of gyration	2599	2603
section modulus	2599	2603
steel	2599	
structural	2599	2603
weight per foot	2599	2603

Checking

Acme threads by three-wire method	2002	
enlarged spur pinion	2239	
gear size	2221	
gears	2230	
measurements over pins or wires	2239	
radius of arc	687	
rake angles		
indicator drop method	841	
indicator drops on milling cutter face	842	
relief angles		
indicator drop method	841	
indicator drops on end teeth	841	
indicator drops on side teeth	841	
screw thread dimensions	1997	
shaft conditions	688	
spur gear by wires	2222	
spur gear size	2222	
Whitworth threads	1997	

Cheese head screws	1672	1677
---------------------------	------	------

Chemical composition	1617	
-----------------------------	------	--

Chemical compositions

alloy steels	404	1408
aluminum alloys	537	
carbon steels	402	1408
cast steels	2242	
copper	528	
copper alloys	515	

Index Terms**Links****Chemical compositions (*Cont.*)**

forged and rolled alloy steels	2242		
forged and rolled carbon steels	2241		
HSLA steels	421		
magnesium alloys	546		
molybdenum	499		
nickel alloys	548		
shock-resisting tool steels	455		
stainless steels	406		
tool steels	441		
treatment of metals	1505		
vapor deposition (CVD)	788		
Chemical elements	371		
atomic number	371		
atomic weight	371		
melting temperature	371		
symbol	371		
Chemical surface treatment of metals	1506		
Chilled cast iron	1404		
Chip flow angle	1139		
Chip thickness	1132	1197	
Chipbreakers	763		
angular shoulder type	763		
grinding	1002		
groove type	763		
light cuts	764		
parallel shoulder type	763		
Chord			
length for given number of divisions	695		
length given angle and radius	73	77	79
Chordal addendum	2126	2145	
milled bevel gear teeth	2189		
milled, full-depth gear teeth	2143		
Chordal distance of bolt circle	76	695	

Index Terms

Links

Chordal thickness	2126		
gear teeth	2142	2144	2188
milled bevel gear teeth	2189		
milled, full-depth gear teeth	2143		
Chrome	1509		
Chromium			
gearing material	2242		
plating	1467		
tool steels	449		
Chucking reamers	845		
expansion	854		
rose	846		
Chucks			
drill, tapers and threads for	961		
hexagonal, for portable tools	975		
spindle, for portable tool grinders	972		
Cincinnati milling machines, indexing			
movements	2113		
Circles	46		
center	46		
chords for dividing circumference of	695		
enclosed within a circle	88		
enclosed within a rectangle	93		
general equation	46		
geometry of	60		
lengths of chords for dividing	695		
moment of inertia	237		
packing			
in circles	88		
in circles and rectangles	88		
in rectangles	93		
radius	46		
radius of gyration	237		
section modulus	237		

Index Terms

Links

Circles (*Cont.*)

segments	73	77
squares of equivalent areas	80	

Circular

arc center of gravity	222	
disk, radius of gyration	229	
gear teeth	2135	
measure	2662	
mil gage for wires	2675	
pitch	2126	2253
given center distance and ratio	2141	
pitch gears, diameters of	2148	
pitch in gears	2148	
ring		
moment of inertia	238	
radius of gyration	238	
section modulus	238	
sector area	46	74
saws, arbors for	972	
sector segment	695	
sector, area	46	73
segment		
area	73	77
formulas	77	
table of dimensions	78	
thickness	2126	
milled bevel gear teeth	2189	
outside diameter		
has been enlarged	2142	
has been reduced	2142	
tools	806	

Circumference

chords for dividing	695	
---------------------	-----	--

Clad aluminum alloys	543	
----------------------	-----	--

Index Terms

Links

Cladding with lasers	1498			
Classical belts and pulleys				
V-belts	2495			
datum length	2496			
groove dimension	2497			
horsepower rating	2499			
length correction	2501			
sheave dimension	2496			
Classification of carbon steels	410			
Clavarino's equation	291			
Clearance	2126			
angles				
angles				
boring tools	899			
milling cutters	837			
reamers, tooth rest position	847			
box wrenches	1561			
drill sizes, machine screw	2030			
for wrench	1555			
holes	628	635	638	653
hex-head bolt and nut	899			
inch machine screws	2030			
metric				
bolts and screws	2034			
machine screws	1665			
socket head cap screws	1612			
square neck bolts	1611			
tapping screws	1721			
Clearance holes	1609			
inch fasteners	1609			
metric fasteners	1610			
substitute drills for	1610			
Cleveland forming tool formula	799			
Clevis pins	1747			

Index Terms

Links

Clutches	2446	
angle of cone	2449	
angle of dividing head for milling	2453	
centrifugal and free-wheeling	2450	
cone	2448	
cutting teeth	2452	
cutting with angular cutters	2452	2454
disk	2446	
double angle cutter	2454	
friction	2446	2448
friction coefficients	2448	
magnetic	2449	
positive	2451	
power capacity of	2447	
saw tooth	2453	
single angle cutter	2453	
slipping	2450	
wrapped spring	2450	
CNC	1279	
back boring	1298	
canned cycles	1295	
Cartesian coordinate system	1279	
computer based programming	1282	
contouring	1300	
coordinate geometry	1279	
depth of thread	1302	
features	1283	
fixed cycles	1295	
G address	1284	
G codes	1284	
holes	1294	
indexable threading insert	1302	
lathes	1288	1302
M codes	1287	

Index Terms

Links

CNC (Cont.)

manual data input (MDI)	1283
manual programming	1281
MDI, manual data input mode	1307
multiple repetitive cycles	1300
multi-start threads	1305
N Address	1284
O address	1284
offsets	1292
parametric programming	1306
peck depth	1296
program structure	1284
programming	
ABS	1312
absolute	1287
arc radius	1290
block number N	1284
branching	1313
circular interpolation	1290
comments and messages	1284
computer	1282
cutter radius compensation	1293
cutter radius offset	1293
defining a plane	1290
equidistant toolpath	1293
F-address	1288
feed rate override	1289
FIX	1311
fixed cycles	1295
FUP	1312
G00	1290
G01	1290
G02, G03	1290
G17, G18, G19	1290

Index Terms

Links

CNC (*Cont.*)

G20, G21	1287	
G32, G76 multi start threads	1305	
G32, G76 threading	1304	
G33, G34 threading	1304	
G41, G42	1289	1293
G43, G44	1293	
G50	1288	
G54 - G59	1292	
G65 prep command	1307	
G70, G76	1300	
G71, G73 rules	1302	
G73	1302	
G73 fixed cycle	1296	
G74 fixed cycle	1297	
G76		
one cycle	1304	
two cycle	1305	
G76 fixed cycle	1298	
G80 fixed cycle cancellation	1299	
G81 fixed cycle	1295	
G82 fixed cycle	1296	
G83 fixed cycle	1296	
G84 fixed cycle	1297	
G85 fixed cycle	1297	
G86 fixed cycle	1298	
G87 fixed cycle	1298	
G88 fixed cycle	1299	
G89 fixed cycle	1299	
G90, G91	1287	
G93	1289	
G94,G95	1288	
G96, G97	1288	
G96, G97, spindle speed	1302	

Index Terms

Links

CNC (*Cont.*)

programming		
helical interpolation	1292	
IJK vector	1290	
incremental	1287	
inverse time feed rate	1289	
lathes	1288	1302
linear interpolation	1290	
long hand threading	1304	
looping	1313	
machining holes	1294	
macros	1282	1305
# symbol	1307	
ABS	1312	
arithmetic functions	1310	
basic skill requirements	1307	
boolean functions	1312	
branching	1313	
common applications	1307	
common features	1307	
defined variables	1308	
determining if active	1307	
examples of	1313	
functions	1310	
functions and constants	1308	
G65 arguments	1308	
G65 prep command	1307	
G65, call command	1308	
logical functions	1308	1312
looping	1313	
MDI, manual data input mode	1307	
miscellaneous functions	1312	
rounding functions	1311	
SQRT	1312	

Index Terms

Links

CNC (*Cont.*)

trigonometric functions	1310
variables	1308
common	1309
declarations	1309
global	1309
local	1309
system	1309
manual	1281
milling offsets	1292
modal command	1290
modal, G-codes	1284
modal, M-codes	1287
M03, M04	1287
M98, call subprogram	1305
M99, end subprogram	1305
parametric	1306
preparatory commands, G	1284
preset method	1293
program number O	1284
radius	1290
rapid motion	1290
repetitive commands	1300
ROUND	1311
S-address	1287
shop floor	1282
spindle function	1287
spindle override	1288
spindle rotation	1287
programming	
SQRT	1312
subroutines	1305
T-address	1289
techniques	1305

Index Terms

Links

CNC (*Cont.*)

thread cutting	1302
threading commands	1304
tool function	1289
tool length offset	1293
tool nose radius compensation	1289
lathes	1293
touch-off method	1293
units of measurement	1287
work offset	1292
rectangular coordinate system	1279
Shop floor programming	1282
shop floor programming	1282
single point threading	1302
spindle speed	
cutting, peripheral, or surface	1288
subprograms	1305
subprograms, (subroutines)	1305
thread calculations	1302
thread cutting	1302
thread milling	1292
threading	
commands	1304
infeed	1303
angular method	1303
compound	1303
flank	1303
modified angular method	1303
plunge method	1303
radial	1303
operations	1304
threading commands	1304
turning and boring	1300

Index Terms

Links

Cobalt alloys	1011	
Cobaltchrom steel	496	
elongation	392	
hardness	392	
tensile strength	392	
yield strength	392	
Coefficient of expansion		
aluminum	376	
cast iron	377	
ceramics	389	
common materials	375	
copper alloys	376	
ductile iron	377	
plastics	390	
thermoplastics	375	
titanium alloys	377	
various substances	375	
friction	165	2459
rolling resistance	167	
steel on various materials	166	
various materials on metal	2448	
heat radiation	375	
heat transmission	375	
Cofactors of a matrix	124	
Coining	1346	
Cold-form tapping	2035	
Cold-work		
tool steels		
air hardening	453	
chemical composition	453	
heat treatment	453	
oil hardening	452	
Collets	969	

Index Terms**Links**

Colloidal suspension	1394	
Coloring metals	1506	
Columns	281	
American Institute of Steel		
Construction	285	287
American Railway Engineering		
Association formulas	281	
eccentrically loaded	282	
Euler formula	282	
J. B. Johnson formula	284	
Rankine or Gordon formulas	281	283
steel pipe, allowable concentric loads	286	
Combination	19	
drill and tap	2039	
involute spline types	2263	
shank, helix single end mills	819	
Combination die	1378	
Combined drills and countersinks	885	
Combined stress	211	
normal stresses at right angles	211	
Common fractions	8	
Compensation, insert radius, NC	782	
Complex conjugate	18	
Complex or imaginary numbers	18	
Composite, checking of gears	2169	
Compound		
angles	119	
indexing	2080	
Compound die	1378	
Compression		
in columns	281	
springs	304	
Compression bending	1385	

Index Terms

Links

Compressive properties

ceramics	389
definitions	201
strength	
ceramics	389
common non-metals	394
iron and steel	432
magnesium alloys	547
wood	386
strength, wood	386

Concave arbor-type

milling cutters	827
-----------------	-----

Concrete strength 394

Conductance, thermal 2694

Conductivity

electrical, of metals	1398
electrical, of plastics	572

Cone

center of gravity	225
clutches	2448
frustum	
center of gravity	225
of volume	84
polar moments of inertia	248
radius of gyration	230
polar moments of inertia	248
radius of gyration	230
volume	84

Coned springs 350

Conical pendulum 173

Conjugate fractions 12

Constants, fundamental 2660

Constructional steels 1227

Index Terms

Links

Contact

diameter	2126	2155
diameter, gearing	2155	
ratio	2126	2156
face	2126	
gearing	2156	
total	2126	
stress	2126	
stresses, cams	2306	

Contamination of lubricants 2438

Contents of tanks 68

Continued fractions 11

 use of as conjugates 13

Convergent 11

Conversion

acceleration	2698
acres to hectares	2675
bending moments	2689
Celsius to Fahrenheit temperatures	2695
centimeter to inch	2665
coordinate systems	43
cutting speed formulas	1015
density units	2684
energy units	2693
fahrenheit and celsius temperatures	2695
flow units	2682
force units	2688
fractional inch to millimeter	3
millimeter to fractional inch	3
moment and torque units	2689
moment of inertia units	2699
newton-meters into pound-inches	2689
numbers to powers-of-ten notation	15
pound-inches into newton-meters	2689

Index Terms

Links

Conversion (*Cont.*)

power units	2693	
pressure units	2688	
section modulus units	2699	
specific gravity	382	
tables		
angular measure	103	105
cutting speed and diameter to rpm	1016	1250
cutting speed formulas	2039	
decimal multiples of SI units	2658	
foot-pounds into Btu	2691	
fractional inch to millimeter	2664	
hardness	508	
horsepower into kilowatts	2691	
millimeter to fractional inch	2664	
tables		
pounds-force into newtons	2689	
power and heat	2690	
radians into degrees	103	105
thermal conductance	2694	
torque units	2689	
U.S.gallons into liters	2678	
UK gallons into liters	2678	
velocity units	2698	
viscosity	2698	
work units	2693	
Convex arbor-type milling cutters	827	
Coolants for		
lapping	1277	
machining		
aluminum	1192	
magnesium	1193	
tool sharpening	1002	
zinc alloys	1194	

Index Terms**Links**

Coolants for (<i>Cont.</i>)		
tapping	2039	
Coordinate system	43	
converting to another	44	
Copolymers	553	
Copper		
coloring	1506	
lead bearings	2357	
passivation	1506	
plating	1510	
wire	2606	
Copper and copper-base alloys		
classification	514	
coefficient of expansion	376	
composition	515	
copper-silicon alloys	528	
copper-zinc-tin alloys	528	
strength	394	
density	376	
die casting	1416	
elongation	391	515
hardness	391	
machinability	515	
melting points	376	
passivation	1506	1508
powdered metal alloys	393	
specific heat	376	
speeds, for drilling and reaming	1071	
for turning and milling	1036	
tensile strength	391	515
thermal conductivity	376	
UNS number	514	
yield strength	391	515
Copper- and iron-base sintered bearings	2363	

Index Terms**Links**

Copper-base powdered alloys				
density	393			
elongation	393			
hardness	393			
rupture strength	393			
ultimate strength	393			
yield strength	393			
Cordeaux thread	1987			
Core drills	888			
Corner-rounding milling cutters	812	827		
Corrosion-resisting alloys	415	418	513	529
Cosecant	95			
Cosine law of	96			
Cost				
cutting grinding	1154			
feeds and speeds	1157			
function	1147			
minimum	1146	1148	1200	
optimum	1148			
regrinding	1155			
tools with inserts	1155			
Cotangent	95			
Cotter pins, standard sizes	1746	1757	1760	
Cotters	2482			
Coulomb shear theory (plastics)	577			
Counterbores				
cutters and guides	898			
pilot	898			
solid	898			
three piece	898			
Counterboring	897			
Countersinks	851	903		
combined with drills	884			
machine	851			

Index Terms

Links

Countersunk head

cap screws	1680		
rivets	1734	1736	1742
British Standard	1742		
screw, British Standard	1676		
screws	1644	1649	1672
British Standard	1672		

Couples of forces

	156		
--	-----	--	--

Couplings

connecting shafts	2443		
double-cone	2444		
fire-hose	1970		
flexible	2445		
hose	1969		
interference fits	2444		
knuckle joint	2446		
safety flange	2443		
shaft	302		
single keys used as fixed	2265		
slipping	2450		
universal	2445		

Crane motors

	2576		
--	------	--	--

Crater-resistant carbide tools

	1010		
--	------	--	--

Creep	201	204	309
rupture	201	568	

Critical

slenderness ratio	282		
speeds	197		
formulas for	197		
of rotating bodies and shafts	197		
speeds of rotating shafts	302		
temperatures, heat treatment	461	470	
determining	473		

Index Terms

Links

Critical points of				
decalescance	472			
recalescance	472			
Croning shell mold process	1410			
Cross recesses				
for machine screws	1652			
for self-tapping screws	1704			
Cross section lining, ANSI Standard for				
drawings	611			
Crossed helical gears	2125			
Crowned involute splines	2269			
Crushing strength, wood	385			
Cryogenic treatment, steel	505			
cSt (centistokes)	2425			
Cube, volume	82			
Cubes of wire diameters	347			
Cubic				
boron nitride (CBN)	1012	1032	1034	1038
	1216	1234	1243	
grinding wheels	1234	1243		
conversions	2678			
equations	34			
measure	2678			
Cumulative fatigue damage	203			
Cupola malleable iron	1405			
Curve, normal distribution	1319			
Curved beams	275			
stress correction factor	275			
Curved tooth files	988			
Cutoff	1338			
Cutoff or roughness sampling length	743			
Cut-off tools, circular dimensions	807			
Cutter				
bevel gear, formed types	2185			

Index Terms

Links

Cutter (*Cont.*)

box-tool	1171
compensation, NC	782
helical gear, formed type	2204
internal gear	2170

Cutting

abrasive	976	
bevel gear teeth	2180	
blades	795	
clutch teeth	2452	
costs grinding	1154	
electric arc	1462	
fluids	1182	
application of to carbides	1187	
aqueous solutions	1183	
broaching	1185	
carbides	1187	
chlorinated oils	1183	
magnesium	1185	1187
mineral oil	1185	
selection	1183	
soluble oils and compounds	1183	
sulfurized oils	1183	1185
various alloys	1183	
gas torch cutting	1462	1464
metals oxidizing flame	1462	
roller chain sprocket teeth	2556	
time for turning, boring and facing	1081	
time per piece	1153	

Cutting fluids

for different materials	1184
for different operations	1184
for steel	1184

Cutting forces	1139
----------------	------

Index Terms

Links

Cutting plane irons	795	
Cutting speed		
economic	1149	
files and burs	990	
lives	1161	
optimum	1151	
Cutting speeds and feeds	1008	
automatic screw machine	1171	
bandsaw	1179	
broaching	1073	
chip thickness	1022	
cutting speed calculations	1035	
cutting tool materials	433	
CVD diamond tools	1012	
diamond tools	1011	
drilling and turning titanium and titanium alloys	1037	
drilling, reaming, and threading		
copper alloys	1071	
ferrous cast metals	1067	
glass	1064	
light metals	1069	
plain carbon and alloy steels	1060	
stainless steels	1066	
tool steels	1065	
equivalent		
chip thickness (ECT)	1022	
rpm for given cutting speed	1016	
rpm for given drill sizes and speed	1016	
formulas for	1015	1035
honing	1272	
metal cutting saws	1081	
milling	1039	
feeds for high-speed steel cutters	1053	

Index Terms

Links

Cutting speeds and feeds (*Cont.*)

ferrous cast metals	1051			
plain carbon and alloy steels	1044			
stainless steels	1049			
titanium and titanium alloys	1037			
planing	1081			
reamers	1070			
rpm for different speeds and diameters	1017			
shaping	1081			
tapping	1071	2089		
thread chasing	1071			
tool				
inserts	782			
life	1013			
adjusting	1034	1039	1042	1058
steels	1030	1048	1065	
turning				
copper alloys	1036			
ferrous cast metals	1032			
light metals	1037			
stainless steels	1031			
superalloys	1038			
titanium and titanium alloys	1037			
tool steels	1030			
unusual materials	1081			
twist drills	1070			
work materials	1008			
Cutting tool grade	1058			
Cutting tools	757			
angles	757	782		
angular				
milling	814	820	833	836
	846			

Index Terms**Links****Cutting tools (*Cont.*)**

application codes, ISO	791		
boring-bar	899		
carbide grade selection	785	1010	
carbon tool steels	1009		
carbonitrides (cermets)	785	1011	
cast nonferrous alloy	1011		
cemented carbides	785	1009	
ceramics	790	1011	
checking relief and rake angles	838	842	
chipbreaker	760		
chucking reamers	846		
clearance angles	838	843	
coated carbides	1010		
coatings	788	1010	
crater-resistant carbides	1010		
cubic boron nitride (CBN)	1012	1217	1234
	1243		
CVD diamond	1012		
diamond	793	1011	
polycrystalline	793	1011	
fluting, for reamers	845		
grades	1010		
grinding	835		
checking rake and relief angle	841		
high-speed steel	1009		
indexable insert holder	759		
indexable inserts	759	782	
machining data	794		
materials	779	785	1008
carbide ceramics	792		
metals			
compositions and properties	786		
hardness	786		

Index Terms

Links

Cutting tools (*Cont.*)

rupture strength	786		
structures	786		
tungsten carbide	786		
oxide ceramics	792		
silicon nitride base	793		
superhard	793		
milling	808		
hand of flute helix	811		
side	811		
staggered tooth	811		
point configuration	766		
radial relief, eccentric type	838		
rake angles	838		
rose chucking reamers	846		
sharpening	997		
single-point	757		
specifications, ISO	790		
spline	836		
titanium carbides	790	1010	
tool bit	759		
tooth rest positions	843		
trouble-shooting checklist	1014		
T-slot cutters	812		
tungsten carbide	779	785	1009
tungsten carbide			
combined with other elements	788		
wheels for sharpening milling cutters	835		
Woodruff keyseat cutters	832		
Cutting, surface, peripheral speed	1288		
Cyanide hardening (cyaniding)	462	468	485
Cycloid	2126		
area	73		
curves, area enclosed by	68		

Index Terms

Links

Cylinder

center of gravity	224
collapsing pressure	293
hollow	
polar moment of inertia	246
radius of gyration	230
volume	84
plates and shells	288
polar moment of inertia	246
portion of volume	83
portion of, center of gravity	224
radius of gyration	229
strength to resist internal pressure	290
volume	83
working pressure vs. radius ratio	291

Cylindrical

coordinates	45
tank, contents	68
to rectangular coordinates	45

Cylindrical grinding

	1251			
automation in	1254			
basic process data	1254			
high speed	1254			
machines	1251			
operating data	1253			
selection of grinding wheels	1219	1233	1243	1252
traverse and plunge grinding	1251			
troubles	1255			
workholding	1252			

Cylindrical roller bearings, symbols	2368
--------------------------------------	------

D

Damascus steel	399
----------------	-----

Dardelet thread	1987
-----------------	------

Index Terms

Links

Daylight savings time	2700	
Decalescence point in steel hardening	472	
Decibel	2700	
Decimal		
fractions	10	
inch into fraction inch	3	2664
multiples and submultiples of SI		
units	2658	
Dedendum	2126	
Definitions		
gear terms	2125	2173
spline terms	2253	2268
surface texture	735	
surfaces of solid materials	733	
Deflection		
beams	256	273
calculation	210	
flat plates	288	
shaft, linear	298	
shaft, torsional	297	
springs		
compression and extension	321	
torsion	339	
Degrees, expressed in radians	103	105
Density	380	
aluminum	376	
cast iron	377	
ceramics	389	
copper alloys	376	
copper-base powdered alloys	393	
ideal	2660	
iron-base powdered alloys	393	
nickel alloys	377	
plastics	390	

Index Terms

Links

Density (*Cont.*)

plastics materials	390
powdered metals	393
stainless steels	377
titanium alloys	377
tungsten-base powdered alloys	393
units conversion	2684
wood	387
Department of Commerce	293
Deposition rates (welding)	1439
Depreciation	139
double declining balance method	139
property class and factors	140
statutory depreciation system	139
straight line method	139
sum of the years digit method	139
Depth of cut	1013
Depth of engagement	2253
Derivatives of functions	35
Design rules	
for blanking and punching	1334
parts produced by bending	1335
parts produced by drawing	1336
Detachable chains	2537
Diameter factor	1202
Diameter of circle enclosing smaller	
circles	88
Diameters for finished shafting	299
Diametral pitch	
definition	2126
equivalent	
circular pitch and tooth	
proportions	2134
metric modules and circular pitch	2220

Index Terms

Links

Diametral pitch (*Cont.*)

knurls, (ANSI) Standard	991
system	2130

Diamond

built up edge	795	
concentration	1000	
cratering	795	
dust for lapping	1276	
grinding wheels	1229	
laps and lapping	1276	
tool materials	793	1011
truing	1235	
wheels	1000	1240
composition	1243	
designation symbols	1240	
diamond concentration	1000	
feeds and speeds	1246	
grades, grit sizes	1000	
modifications	1243	
operating guidelines for	1246	
operations and handling	1246	
selection of	1245	
shapes of standard	1240	
speeds and feeds	1246	
terminology	1240	
thread grinding	2053	
work speeds	1246	

Di-Basic Acid Esters	2430
-----------------------------	------

Die

classification of	1378
combination	1378
compound	1378
effect of clearance	1342
Multiple-station	1378

Index Terms

Links

Die (Cont.)

opening profile	1342	
progressive	1379	
sheet metal		
bending allowances	1358	
blank diameters for drawing	1355	
diameter reductions in drawing	1357	
stripper force	1343	
single-station	1378	
steel rule	1379	1381
cutting edges	1380	
dimensions	1380	
heat treatment	1382	
stamping	1379	
transfer	1379	

Die casting

alloys	1415	
bearing metals	1417	
design	1414	
dies machines	1417	
files	989	
injection molding	1417	
machining zinc alloy	1194	
porosity	1414	
skin effect	1415	

Dielectric strength

ceramics	389	
plastics	390	

Diemaker's reamers

834

Dies and taps

combination drill and tap	2039	
maximum pitches	2060	
tap drill size	944	2029
Acme threads	944	

Index Terms

Links

Dies and taps (*Cont.*)

formula	2030
metric	2033
pipe	2038
Unified	2021

Dies, threading, maximum pitches 2060

Differential

indexing	2104
pulley	171

Diffusion Bonding 1367

Diffusion bonding 1365 1367

Dimensioning and tolerancing, geometric 613

Dimensions and tolerancing 2463

Dip brazing 1431

Disc spring 350

contact surfaces	351	354
forces and stresses	354	
group classes	350	
materials	351	
nomenclature	350	
stacking	352	

Disk

circular, radius of gyration	229
clutches	2446
method of measuring tapers	682
springs	344

Displacement in ball and roller bearings,

allowance for axial	2382
---------------------	------

Distance across bolt circle 686

Distance between two points 40

Distribution curve, normal 1319

Dividing

fractions and mixed numbers	9
head, angular position	833

Index Terms

Links

Dividing (*Cont.*)

numbers written in powers-of-ten

notation 16

Dolly bars for riveting 1734

Double angle milling cutters 814

Double V-belts

(*see* Belts and pulleys: double V-belts)

Double-cone clamping couplings 2444

Dovetail slides, measuring 682

Dowel pins 1746

designation 1750

ductility 1750

hardened ground machine 1749

hardened ground production 1750

lengths and sizes 1750

metric 1746

shear strength 1750

unhardened ground 1751

Drafting practices, ANSI Standard 609

Draw-in bolt ends 965

Drawing

ANSI Standard

line conventions 609

surface texture symbols 741

welding 1486

applying surface texture symbols 742

bisect angle 62

circle around square 64

circle around triangle 63

circular arc 63

data for gear blanks 2160

data for gears 2163

data for involute splines 2263

data for spur and helical gear 2163

Index Terms

Links

Drawing (*Cont.*)

data, splines	2265	
dies		
blank diameters	1355	
blanks for rectangular shells	1359	
divide line into equal parts	61	
drafting practices	609	
ellipse	51	64
equilateral triangle	62	
helix	65	
hexagon around circle	64	
hyperbola	65	
involute	65	
ISO 1302	747	
metric dimensions on	744	
parabola	65	
parallel lines	62	
perpendicular lines	61	
scales of metric drawings	745	
sheet metal	1353	
cylinders	1355	
cylindrical cup with flange	1355	
cylindrical cup without flange	1354	
deep	1353	
drawability	1354	
mechanics of	1353	
wrinkling	1353	
diameters of shell blanks	1355	
force for first operation	1358	
force for subsequent operations	1359	
number of draws	1354	
rectangular flanged shells	1360	
rectangular parts	1359	
sheet sizes	609	

Index Terms

Links

Drawing (Cont.)

specifying spur and helical gear data	
on	2161
square around circle	64
symbols	
ANSI Standard section lining	611
geometric	612
ISO	612
lines	610
materials	611
tangent to circle	63
tempering, steel	479
triangle around circle	63
45-degree angle	62
60-degree angle	62

Dressing grinding wheels 1235

Drilling

accuracy of drilled holes	896
automatic screw machine feeds and	
speeds	1171
cutting speeds for	1170
ferrous cast metals	1067
light metals	1069
superalloys	1038
titanium and titanium alloys	1037
tool steels	1065
difficulties	1064
estimating thrust, torque, and power	1089
feed factors	1090
holes in glass	1064
holes, accuracy of	896
horsepower and thrust for	1089
machine, shaftless motor type	2574
spade	1074

Index Terms

Links

Drills

accuracy of drilled holes	896	
and countersink plain types	885	
and countersinks, bell types	885	
angle of cutting point	997	
ANSI Standards	866	
chucks, tapers	961	
cobalt high-speed steel	897	
combined drills and countersinks	884	
commercial microdrills	1125	
core, taper shank	886	
counterbores	866	
cutting speeds and equivalent rpm	1016	
definitions of terms	866	
diameter factors, thrust	1090	
diameter factors, torque	1090	
diameters of tap	2021	
driver, collet type	890	
driver, split sleeve	890	
drivers	890	
for taper pin reamers	1753	1756
grinding	997	
jobbers length	868	
length of point	889	
letter sizes and gauge	891	
metric, British Standard	886	
nomenclature	866	
screw machine drills	868	
sharpening	998	
sizes for tapping	2029	
for Acme threads	944	
sizes for tapping Acme threads	944	
spade	1074	
specifications	1754	

Index Terms

Links

Drills (*Cont.*)

steels for	896
straight shank	866
straight-shank drill sizes	
core drills	888
letter	872
metric	868
number	868
straight-shank, taper-length, drill sizes	
fractional	869
letter	872
metric	869
number	869
screw machine length	879
tangs for	878
tap and clearance hole sizes	2030
taper shank	866
taper-shank core drills	885
taper-shank drill sizes	
fractional inch	880
metric	880
terms	866
twist	866
twisted	
twisted	
jobber series	894
parallel series	895
types	866

Drives

nose key	953	
screws	1701	1716
square, for portable tools	973	
studs	1760	
taper	952	

Index Terms

Links

Drunken thread	1987	
Dry measure	2679	
Dryseal pipe threads	1962	
assembly limitations	1965	
designations	1964	
diameter pitch combinations	1965	
fine taper	1965	
limitation of assembly	1962	
limits on crest and root	1962	
pressure tight joints	1962	
taps for	940	
types	1962	
DST	2700	
Ductile		
cast iron	1405	
iron	432	1405
Ductility	1333	
Duranickel, machining	1194	
Durometer tests	509	
Dynamic		
balance	191	
stresses	279	
Dynamic factor	2174	
Dynamic stresses	279	
Dynamic viscosity	2425	
Dynamometers	2456	
Dyne	2425	2656
E		
Earth, composition of crust	384	
Eccentricity	2261	
Echols thread	1987	
Economic impact of lubrication	2423	
Economic tool-life	1149	

Index Terms

Links

ECT (equivalent chip thickness)	1022	
EDG (electrical discharge grinding)	1394	
EDM	1393	
capacitor	1394	
craters	1394	
dielectric		
filter	1394	
fluid	1394	
strength	1394	
discharge channel	1394	
dither	1394	
duty cycle	1394	1397
electrical controls	1398	
electrode		
growth	1394	
wear	1394	
electrode materials	1399	
electrode uses	1400	
electro-forming	1394	
electronic controls	1396	
Farad	1394	
flushing	1396	
gap current	1394	
gap voltage	1394	
heat-affected zone	1397	
ion	1394	
ionization	1394	
low-wear	1394	
machine settings	1397	
materials	1399	
characteristics	1399	
electrode	1399	
metal removal rates	1398	
negative electrode	1394	

Index Terms**Links****EDM (Cont.)**

no-wear	1394	
overcut	1395	
plasma	1395	
plunge (sinker) method		
electrode materials	1398	
machine settings	1396	
making electrodes	1401	
metal removal rates	1398	
positive electrode	1395	
power parameters	1395	
process	1395	
quench	1395	
recast layer	1395	1398
secondary discharge	1395	
spark frequency	1397	
spark in and out	1395	
square wave	1395	
stroke	1395	
UV axis	1395	
white layer	1395	
wire	1403	
drilling holes	1403	
EDM	1395	
guide	1395	
speed	1395	
wire electrode	1403	
wire method	1393	
workpiece materials	1398	
Effective		
dimensions, splines	2253	2261
length of bolt	1525	
Efficiency	2127	
influence of friction on	165	

Index Terms**Links****Efficiency (*Cont.*)**

machine tool	1085
of lubrication filters	2442
riveted joints	1730

Elastic

limit	200	
limit, plastics	562	
modulus	200	
in shear (torsion)	200	
spring materials	344	
various materials	200	
properties of material	394	
region	200	1529
tightening fasteners in	1523	

Electric

arc, cutting metals	1462
fixture threads	1981
motor keys and keyseats	2477
socket and lamp base threads	1980

Electrical fixture threads 1980

lamp base	1980
socket shell threads	1980

Electrical network 127**Electrical relationships** 2699**Electrode**

diameter, sheet metal	1451
making	1401
machining graphite	1401
material	1399
brass	1400
copper	1400
copper-tungsten	1400
graphite	1400
steel	1400

Index Terms**Links****Electrode (*Cont.*)**

zinc	1400
material selection	1401
uses on various materials	1400
wear	1401

Electrodes (welding)

characteristics of standard types	1452		
AWS E60XX	1449		
current to use with	1438	1457	
deposition rates	1435	1439	
diameter to use	1434	1443	1451
selecting GTAW tungsten type	1455		
wire, feed rates	1438		

Electrohydraulic forming 1371

Electromagnetic forming 1370

Electromagnetic metal forming 1370

Electron beam diffusion bonding 1368

Electropolishing 1512

Elements, table of chemical 371

Elevation reading displacements 1322

Ellipse 48 51

area	75	
drawing	51	64
eccentricity	48	
foci	48	
general equation	48	
major axis	48	
methods of drawing	64	
minor axis	48	
moment of inertia	238	
radius of gyration	238	
section modulus	238	
segment, center of gravity	223	

Index Terms**Links****Ellipsoid**

polar moment of inertia	247
radius of gyration	231
volume	85

Elliptic gears

Gears and gearing elliptic	2211
----------------------------	------

Elongation

alloy steel	1408	
aluminum	391	
aluminum alloys	534	
carbon and alloy steels	424	
carbon steel	1408	
carbon steel rounds, squares, and hexagons	422	
cobalt alloys	392	
copper alloys	391	515
copper-base powdered alloys	393	
copper-beryllium alloys	529	
copper-silicon alloys	528	
high-strength, low-alloy steels	421	
iron-base powdered alloys	393	
magnesium alloys	547	
measurement of bolts	1526	
nickel alloys	392	548
plastics	390	
powdered metals	393	
ranges	1334	
stainless steel	392	430
steels	391	1407
titanium alloys	550	
tungsten-base powdered alloys	393	

Emery

grades	1505
grain numbers for polishing	1505

Index Terms

Links

End mills

angles for milling teeth in	833		
ANSI Standard	816		
combination shanks for	818		
high speed steel	819		
plain and ball end	822		
terminology of	815		
with combination shank	819		
with straight shanks	820		
with taper shanks	821		
with weldon shanks	816	818	822
Endurance limit	201	2173	
for spring materials	314		
Energy	181	1394	
and momentum	179		
kinetic	181		
potential	182		
units conversion	2693		
Engagement, length of thread	1536		
Engine lathe, change gears	2042		
Engineering economics	134		
Enlarged pinions			
center-distance system for	2154		
in helical gearing	2204		
in spur gearing	2146	2154	
Epicyclic gearing	2211		
bevel gear type	2212		
ratios	2212		
Epicycloidal curves, areas	68		
Equations			
cubic	34		
line	41		
quadratic	32		
simultaneous	125		

Index Terms

Links

Equations (<i>Cont.</i>)		
solution of		
first degree with one unknown	32	
first degree with two unknowns	32	
numerical with one unknown	34	
quadratic with one unknown	32	
using Newton-Raphson method	34	
Equilateral triangle	95	
Equivalent chip thickness (ECT)	1022	
Equivalent pitch ratio	2127	
Equivalent uniform annual cost	142	
Erg	2656	
Etching and etching fluids	1505	
Euler's formulas for columns	282	
Evaluating alternatives	140	
benefit cost ratio	143	
capitalized cost	141	
equivalent uniform annual cost	142	
net present value	140	
payback period	143	
rate of return	143	
Evaluation length	736	
Evaporation, latent heat of	372	
Everdur copper-silicon alloy	528	
Exbi	2658	
Expansion		
chucking reamers	854	
fits	631	
hand reamers	856	
Explosive forming	1369	
Exponent	14	
External spline	2254	2263
External spur gear	2125	

Index Terms

Links

Extrusion

applications	1422
for tubes	1422
of metals	1421
process	1421
cold	1421
hot	1421

F

Fabric, bonding	2582	
Facing cutting time for	1081	
Facing insert holder	770	
Factorial	19	110
Factors		
of numbers	20	
prime number	20	
Factors of safety	204	
machine columns	284	
shafts	296	301
tubes subject to external pressure	294	
wire rope	2619	
F-address, CNC programming	1288	
Failure		
fatigue, modes of	203	
fatigue, springs	314	
of riveted joints	1730	
of springs	348	
Fasteners		
compressible washers		
designation	1579	
dimensional characteristics	1579	
dimensions	1579	
finish	1579	
lot number	1579	

Index Terms

Links

Fasteners (*Cont.*)

materials	1579
performance	1579
symbols	1579
workmanship	1579
hardened steel beveled washers	1577
designation	1577
dimensional characteristics	1578
dimensional conformance	1578
dimensions	1577
finish	1577
materials	1577
mechanical properties	1577
slope	1578
symbols	1578
taper	1578
workmanship	1577
hardened steel flat washers	
designation	1577
dimensional characteristics	1577
finish	1577
materials	1577
symbols	1577
tolerances	1576
workmanship	1577
hardened steel washers	1576
circular clipped washers	1576
flat washers	1576
heavy hex nuts	1573
corner fill	1574
countersink	1574
designation	1575
dimensional characteristics	1575
dimensional conformance	1575

Index Terms

Links

Fasteners (*Cont.*)

grade symbols	1575
materials	1575
nut thickness	1575
overtapping	1575
proof load	1574
source symbols	1575
thickness	1574
thread gaging	1575
threads	1575
tops and bearing surfaces of nuts	1574
true position of tapped hole	1574
width across flats	1573
workmanship	1575
heavy hex structural bolts	1570
plastics	597
structural bolts	
bearing surface	1572
body diameter	1570
bolt length	1572
designation	1570
dimensional characteristics	1573
finish	1570
structural bolts	
grade symbols	1570
head height	1571
head taper	1572
height	1570
identification symbols	1573
length	1570
material	1573
materials	1570
thread length	1571
threads	1570

Index Terms**Links****Fasteners (*Cont.*)**

true position of head	1572
width across corners	1571
workmanship	1570
structural steel	1570

Fasteners detecting counterfeit	1535
--	------

Fatigue

combined with creep	204	
contact	204	
corrosion	204	
cumulative damage	203	
failure, modes of	203	
influence of stress on	202	
life factor involute splines	2268	
low/high cycle	203	
properties	201	
S-N diagrams	201	203
springs	314	
surface	204	
thermal	203	

FCAW (flux-cored arc welding)	1442
--------------------------------------	------

Feed

rates	
centering tools	1171
for drilling	1171
for milling	1039
for turning	1026
hollow mills	1171
number of teeth	1167

Feeds and speeds	1008	1078	1170	1179
grinding	1197			
total costs	1157			

Feet

and inches into inches	2662
------------------------	------

Index Terms

Links

Feet (*Cont.*)

into meters	2674	
Feet per minute into rpm	1015	2039
Fellows stub tooth gears	2137	
Ferrite	465	
Ferrous		
cast metals, speeds		
for drilling, reaming, and		
threading	1067	
for milling	1051	
for turning	1032	
Fiber, vulcanized, strength of	394	
Fibers	553	
Files	1500	
chain saw	989	
characteristics	987	
classes	987	
American pattern	987	
classes		
curved tooth	987	
machinist's	987	
mill or saw	987	
rasp	987	
Swiss pattern	987	
coarseness of cut		
bastard	987	
coarse	987	
second	987	
smooth	987	
cross section	987	
curved tooth class	988	
cut		
double cut	987	
double cut finishing	987	

Index Terms

Links

Files (*Cont.*)

rasp	987
single cut	987
cutting speeds	990
definitions of terms	986
flat	988
machinist's class	988
flat	988
general purpose	988
half round	988
hand	988
knife	988
pillar	988
round	988
square	988
three square	988
warding	988
wood	988
mill or saw class	987
blunt hand saw	988
blunt mill	988
blunt triangular	988
cantsaw	987
crosscut	987
double ender	987
mill	987
taper saw	988
triangular saw	988
web saw	988
pillar	988
rasps	989
rifflers	989
rotary	989
round	988

Index Terms

Links

Files (*Cont.*)

shear tooth	989
special purpose	989
aluminum rasp	989
brass file	989
chain saw	989
die casting	989
foundry	989
lead float	989
long angle lathe	989
shear tooth	989
square	988
Swiss pattern class	989
Swiss pattern class	
blunt machine	989
die sinker	989
die sinker rifflers	989
needle	989
silversmiths rifflers	989
teeth, cut of	987
warding	988
wood	988
Filler metals for brazing	1426
Fillet	
area	74
center of gravity	223
radius	2127
Fillister head machine screws	1649
Fillister head miniature screw	1657
fillister head miniature screw	1653
Film	
lubricating transition	2421
thickness ratio	2420

Index Terms

Links

Filter

efficiency, lubrication	2442
filtration ratio, B	2442

Filtration

lubrication	2441
lubrication efficiency	2442

Fine blanking

tool dimensions	1345
V-projections in tools	1345

Finishing, power brush

1500

Fire hose connection

screw threads	1970
---------------	------

Fire hose connection screw threads

ANSI Standard	1970
thread designation	1970
thread form	1970

Fits

635

actual	635
and limits	

graphical representation	638
tolerances designation	649

basic shaft fits	639
------------------	-----

bilateral hole fits	639
---------------------	-----

British Standard

limits and fits	667
-----------------	-----

minimum and maximum clearances	666
--------------------------------	-----

tolerance limits

holes	665
-------	-----

shafts	665
--------	-----

clearance fits	653
----------------	-----

657

cylindrical

allowances and tolerances for	628
-------------------------------	-----

ANSI Standard	634
---------------	-----

British Standard	662
------------------	-----

Index Terms

Links

Fits (*Cont.*)

definitions	628	
expansion	631	
forced	629	646
metric ISO, British	662	
metric radial, ball and roller bearing shaft and housing	2382	
preferred series	635	
shrinkage	631	646
cylindrical		
transition	640	645
drive	639	
expansion	631	
force	638	646
allowance	630	
pressure in assembling	630	
hole basis		
British Standard	663	
figure	651	
hole system	635	
interference	635	652
locational	638	
clearance	638	643
interference	648	
interference	638	
transition	638	645
metric clearance fits	653	657
metric interference fits	655	
metric transition fits	655	
running	638	641
shaft basis		
British Standard	663	
figure	651	
shaft system	635	

Index Terms**Links****Fits (Cont.)**

shrinkage	631	638	646
allowance	631		
sliding	638	641	
transition	635	652	

Flame

cutting of metals	1462		
cutting torch	1463		
hardening	487		
spraying process	1516		

Flanged duct connections 1377

Flanged housing bearings 2373

Flank of tooth 2127

Flat

belts rivets	1736		
head cap screws	1680	1684	
head machine screws	1644	1676	
metal products, preferred thicknesses	2610		
plate			
circular	290		
square and rectangular	288		
strengths	288		
thin radius of gyration	228		
stayed surfaces in boiler work, strength	288		

Flat head miniature screw 1654

Flexible

belts	2484		
couplings	2445		

Flexural modulus, plastics 390

Floor and bench stand grinding 1268

Flow, units conversion 2682

Index Terms

Links

Fluid maintenance	1190	
biocide treatment	1190	
personal protective clothing	1190	
system service	1190	
Fluidized bed furnace	461	470
Fluting cutters, reamers	845	
Fluxes		
brazing	1426	
soldering	1424	
Foot-pound		
equivalents	2690	
into British thermal units	2691	
Force	149	199
acceleration resulting from	179	
addition and subtraction of	153	
algebraic composition and resolution of	156	
algebraic solution forces in same plane	157	
forces not in same plane	161	
and couples, work performed by	182	
centrifugal	187	
calculating	188	
colinear	156	
components of	153	156
composition	153	156
concurrent	156	
components of single force	157	
coplanar	156	
couples of	155	
differential pulley	171	
disc springs	354	
for moving body on horizontal plane	169	
friction	179	

Index Terms

Links

Force (*Cont.*)

graphical representation	153	
moment of	149	155
noncoplanar	156	
normal component	179	
of blow	183	
of gravity	179	
on inclined plane	168	
parallel	154	
parallelogram of	154	
polygon of	154	
pound	150	
relationship to time	199	
resolution of	153	156
into rectangular components	161	
resultant	153	156
any number of concurrent forces	161	
locating when components are		
known	164	
non-intersecting forces	159	
non-parallel, non-intersecting forces	163	
parallel forces	158	
parallel forces not in same plane	162	
single force and couple	158	
three or more concurrent forces	157	
two concurrent forces	157	
screw	171	
sheet metal work	1342	
systems	153	
toggle joint	172	
units conversion	2688	
work performed by	182	
Formed cutters for internal gears	2170	
Formica, machining	1195	

Index Terms

Links

Forming

electrohydraulic	1371
electromagnetic	1370
explosive	1369
radial	1371
rubber pad	1364
stretch	1361
stretch-draw	1361
stretch-wrap	1361
superplastic	1365

Forming tools

	796		
arrangement of	801		
circular	799		
constant for determining	801		
corrected diameter	801		
diameters of	801		
with top rake	801		
diameter	800		
dimensions	797		
feeds per revolution	801	807	1170
formula	799		
Acme machine	799		
Brown and Sharpe machine	799		
Cleveland machine	799		
screw machine dimensions	806		
speeds for	801	807	
straight	796		
with rake	796		

Formulas

algebraic	31
area	70
column	
American Railway Engineering	
Association	281

Index Terms**Links****Formulas (Cont.)**

Euler	282			
Johnson	282			
Rankine or Gordon	281			
straight-line	281			
contour milling	2121			
critical speeds	197			
cutting speed	1015			
derivative	35			
dimensions of milled bevel gears	2181		2183	
dimensions of SAE standard splines	2281			
dimensions of standard spur gears	2131			
distance across bolt circle	686			
for helical gears	2195	2197	2203	2206
for module system gears	2217	2219		
integral	35			
internal gears	2171			
linear motion, constant acceleration	175			
pendulum	173			
proportions of ANSI fine-pitch worms and wormgears	2191			
rearrangement of	30			
rotary motion, constant acceleration	177			
tooth parts, coarse pitch spur gear	2131			
torque capacity of involute splines	2266			
transposition	30			
triangle				
oblique	71	101		
triangle				
right	71	98	100	
trigonometric	96			
volume	82			
work and power	186			
Fractional inch to millimeter conversion	3	2664		

Index Terms

Links

Fractional threads	2042			
Fractions	10			
conjugate	12			
continued	11			
use of	13			
mixed numbers	9			
Free				
body diagram	179			
cutting steels	412			
wheeling clutches	2450			
Freezing mixtures	376			
French				
metric screw threads	1920			
thermal unit	2695			
thread	1987			
Fretting damage	2270			
Friction	165	179	2420	
brakes	2455			
clutches	2446	2448		
coefficient in gears	2174			
coefficients	166	1531	2448	2455
bolts	1524			
hexagon head bolt and nut	1530			
nuts	1524			
rolling resistance	167			
static steel on various materials	166			
torque	1530			
effect on efficiency	165			
fluid	2420			
in brakes	2457			
kinetic	2420			
laws of	165			
rolling	167			
solid	2420			

Index Terms

Links

Friction (*Cont.*)

static	2420		
wheels horsepower	2459		
wheels, power transmission	2457		
Friction loss in bearings	2398		
Fuels, equivalent	2694		
Full film lubrication	2421		
Functions			
derivatives	35		
integration	35		
involute	110		
of angles graphic illustration	105		
sevolute	110		
trigonometric	95	106	
tables of	106		
versed cosine	110		
versed sine	110		
Fundamental constants	2660		
Furnace brazing	1431		
Furnaces, steel heat-treating	461	469	501
Fusion, latent heat of	372		

G

G-address, CNC programming	1284		
Gage blocks	705		
calibration and verification of	706		
care of	705		
precision	707		
federal specifications for	707		
inch sizes	707		
metric sizes	708		
sets			
inch sizes	707		
metric sizes	708		

Index Terms**Links****Gage blocks (*Cont.*)**

wringing 706

Gage tolerances 2012

Gagemakers tolerances 661

Gages

ANSI Unified thread

classification 2007

constants for computing

dimensions 2012

form 2009 2012

formulas for limits 2014

tolerances for plain gages 2012

hypodermic needle 2606

rods 2604

sheet metal 2608

sheet zinc 2608

thickness and diameter sizes, galvanized

sheet 2608

thread form 2010

tolerances 2010

tubing 2604

usage, ANSI Standard recommended 661

wire 347 2604 2606

zinc 2608

Gaging methods and measuring

instruments 675

Gallons

cylindrical tanks 68

in tank at given level 68

into cubic inches 2678

U.S. into liters 2678 2681

Galvanized, (welding) 1434

Gap-frame press 1388

Index Terms

Links

Gas			
carburizing	486		
illuminating, specific gravity	381		
metal arc welding (GMAW)	1434		
specific gravity	381		
specific heat	373		
tungsten arc welding (GTAW)	1453		
Gear cutters, formed			
involute	2144	2170	2205
milling cutters for			
chain sprockets	829		
14.5 deg pressure angles	828		
number for bevel gears	2185		
Gear cutting			
block or multiple indexing	2117		
excess depth to obtain backlash	2166		
formed cutter selection	2148	2185	2204
internal gears	2170		
Gearing materials			
effect of alloying metals	2242		
chrome-molybdenum	2243		
chrome-nickel	2243		
chrome-vanadium	2243		
chromium	2242		
manganese	2243		
molybdenum	2243		
nickel	2242		
nickel-molybdenum	2243		
vanadium	2243		
forged and rolled			
alloy steels	2241		
carbon steels	2241		
non metallic	2245		
applications	2246		

Index Terms

Links

Gearing materials (*Cont.*)

bore sizes	2247	
diametral pitch for given power	2247	
diametral pitch for given torque	2248	
keyway stresses	2247	
mating gear	2246	
power transmitting capacity	2246	
preferred pitch	2247	
safe working stress	2246	
tooth form	2246	
sintered materials	2243	
steel castings	2242	
Gears and gearing	2195	
active face width	2125	
active spline length	2253	
actual safety factor	2174	
actual space width	2253	
actual tooth thickness	2253	
AGMA Standards	2164	2168
angular backlash	2163	
arc		
of action	2125	
of approach	2125	
of recession	2125	
thickness of internal gear tooth	2170	
thickness of pinion tooth	2170	
axial		
pitch	2125	
plane	2125	
thickness	2126	
backlash	2163	2235
angular	2169	
recommended	2165	
bearing spacing and shaft stiffness	2180	

Index Terms

Links

Gears and gearing (*Cont.*)

bevel gears	2177	
blanks		
design of	2161	
for fine pitch gears	2160	
bottom land	2126	
bronze and brass castings for	2243	
bulk temperature thermal flash factor	2175	
bushings for gears	2245	
calculated safety factors	2174	
calculating		
dimensions of milled bevel gears	2183	
replacement gear dimensions	2249	
spur gear proportions	2131	
case hardening steels for	2240	
change gears, for lathe	2042	
checking		
gear sizes	2221	
pressures	2169	
spur gear sizes	2231	
chordal measurement of teeth	2236	
circular pitch system	2130	
coefficient of		
friction	2174	
contact ratio factor	2156	2173
crossed helical	2125	
deburring tooth profile	1500	
design of bevel gear blanks	2179	
diametral pitch		
definition	2126	
preferred	2136	
system	2130	
differential indexing ratio	2104	
drawing		

Index Terms

Links

Gears and gearing (*Cont.*)

data for spur and helical gears	2163			
information to be given on	2172			
efficiency	2127			
elasticity factor	2173			
endurance limit	2174			
enlarged pinion				
fine-pitch	2150			
meshing without backlash	2154			
reduced dimensions to avoid				
interference	2146			
epicyclic	2211			
equivalent pitch radius	2127			
external spur gears	2125			
dimensions for checking over				
wires	2222			
face advance	2127			
Fellows stub tooth	2137			
fillet radius	2127			
fillet stress	2127			
finishing gear milling cutters	2150			
flank of tooth	2127			
forged and rolled				
alloy steels for gears	2241			
carbon steels for gears	2241			
formed cutters for bevel gears	2187			
formulas				
for helical gears	2195	2197	2203	2206
for module system gears	2217	2219		
for spur gears	2131	2135	2137	
given center distance and ratio	2137	2139		
to mesh with enlarged pinion	2154			
gear ratio, definition	2127			
geometrical factor	2174			

Index Terms

Links

Gears and gearing (*Cont.*)

given center distance and ratio	2139	
harder pinion	2241	
heat treatment to permit machining	2240	
helical	2125	2195
herringbone	2210	
highest point of single tooth contact (HPSTC)	2157	
hypoid bevel gears	2125	2178
increasing pinion diameter to avoid undercut or interference	2148	
inspection of gears	2169	
integral temperature criterion	2175	
interference	2127	
internal diameter	2127	
internal gears	2127	2170
spur	2125	2170
dimensions between wires	2226	
invention	2248	
involute curve	2130	
land	2127	
lead	2127	
length of action	2127	
life factor	2173	
line of action	2127	
load distribution	2174	
lowest point of single tooth contact (LPSTC)	2127	2155
lubricant influence	2174	
roughness, and speed	2173	
lubrication film factor	2174	
material quality	2173	
materials for	2240	
bevel gears	2190	

Index Terms

Links

Gears and gearing (*Cont.*)

maximum hob tip radius	2156	
measuring		
gear size over wires	2221	
teeth	2147	
methods of cutting internal gears	2170	
metric module gear cutters	2148	
module system	2217	
module, definition	2127	
mountings for bevel gears	2180	
nomenclature of gear teeth	2129	
non-metallic	604	2245
normal plane	2127	
number of teeth	2127	
to avoid undercutting	2154	
outside diameter	2127	
pin method of checking size	2221	
pinions flanges composition	2245	
pitch diameter	2130	
obtained with diametral pitch		
system	2130	
pitch point	2127	
plane of rotation	2127	
planetary	2211	
plastics gearing	604	
pressure angle	2128	2135
profile checker settings	2158	
rack	2128	
ratchet gearing	2215	
ratio, defined	2127	
relative sizes of internal gear and		
pinion	2170	
replacement gear dimensions	2249	
roll angle	2128	

Index Terms

Links

Gears and gearing (*Cont.*)

root diameter	2128	
selection of involute gear milling		
cutter	2148	
shapers, root diameters of gears cut		
on	2138	
size factor	2173	
size, checking	2221	
specifications	2163	
spur gear	2129	
external	2125	
internal	2125	2170
standard normal diametral pitches	2172	
steels for	2240	2242
straight bevel	2125	
surface condition factor	2174	
tangent plane	2128	
tangential force	2173	
teeth invention	2248	
terms used in gear specifications	2161	
through hardening steels for	2240	
tip relief	2128	
tooth caliper, vernier	2147	
tooth face	2128	
tooth profile		
deburring	1500	
producing a radius	1500	
tooth proportions		
comparative sizes and shape of	2129	
fine-pitch involute spur and helical		
gears	2135	
for enlarging fine-pitch pinions	2152	
tooth stiffness constants	2174	
tooth surface	2128	

Index Terms

Links

Gears and gearing (*Cont.*)

tooth thickness allowance for			
shaving	2141		
tooth-to-tooth composite error	2169		
total composite error	2169		
total face width	2128		
transverse load distribution factor	2174		
transverse plane	2128		
trochoid curve	2128		
true involute form diameter	2128	2157	
undercut	2128		
limit for hobbled involute gears	2157		
Van Keuren wire diameter	2229		
wear equalizing	2241		
welding factor	2175		
whole depth	2128		
wire diameter	2229		
work hardening factor	2173		
working depth	2128		
worm gears	2125	2191	
zerol bevel	2125		
zone factor	2173		
Gears, metric thread on inch lead screw	2044		
General purpose Acme threads	1921		
data	1923		
designation	1922		
form	1921	1923	1930
formulas for diameters	1923		
limiting dimensions	1922	1930	
pitch diameter allowances	1923		
thread form	1923	1930	
Generator shaft keys and keyseats	2477		
Geneva wheel	171		

Index Terms**Links**

Geometric dimensioning and tolerancing	613	
datum		
feature	615	
material removal required or		
prohibited	741	
mean line	735	
relation of surface roughness to		
tolerances	738	
Geometrical		
constructions	61	
dimensioning and tolerancing	613	
progression	37	
propositions	56	
symbols for drawings	612	
symbols, comparison of ANSI and		
ISO	612	
German standard		
gear tooth	2217	
screw threads, metric	1920	
Gib-head keys	2475	
Gibi	2658	
Gleason system,		
Zerol bevel gears	2178	
Glue, pattern	1412	
Glue, plastics	593	
GMAW		
(gas metal arc welding)	1434	
welding carbon steels	1437	
welding stainless steel	1437	
GO and NOT GO gages	2271	
Gold, plating	1512	
Goodman diagram	202	
Gordon formula for columns	281	283

Index Terms

Links

Grade markings on bolts and nuts

ASTM and SAE	1534
inch	1534
metric	1634

Grams

into ounces, avoirdupois	2683
per cubic centimeter into pounds per cubic inch	2685

Granite parallel, high precision

Granite rock-types and properties

Granite, strength

Graphical solution of force systems

Graphite materials for bearings

Graphitic materials for bearings

Gravitational system of measurement

Gravity

acceleration due to	150
center of, in various geometrical figures	221
die casting process	1410
force of	179
specific	380
gases	381
liquids	381
various substances	381

Gray cast iron

Grease

additives	2433
application	2435
classification	2433
consistency rating	2433
National Lubricating Grease Institute	2433
properties	2432

Greek symbols and alphabet

Index Terms

Links

Green sand molding	1409		
Green wood, weight per cubic feet	387		
Grind			
wheels			
safe operating speeds	1248		
Grindability data	1205	1228	
Grindability of tool steels	1228		
Grinders spindles for portable	974		
Grinding	1216		
abrasive belt grinding	1269		
abrasives	1216		
basic rules	1197		
carbide materials, diamond wheel	1212		
carbide tools	1000		
cast iron	1209		
centerless	1259		
centerless grinding troubles	1260		
ceramic materials, diamond wheel	1212		
chip breakers	1002		
cost	1215		
cutting forces	1203		
cutting time formula	1153		
cutting torque	1203		
cylindrical	1251		
cylindrical grinding troubles	1255		
data selection including wheel life	1204		
data, wheel life selection	1204		
diamond wheel	1000	1212	1240
ECT, grinding	1198		
equivalent diameter factor	1202		
feeds	1197		
finishing	1205		
floor and bench stand	1268		
fluids	1183		

Index Terms

Links

Grinding (*Cont.*)

grindability groups	1205
grinding rules and data selection	1197
heat resistant alloys	1211
inconel	1211
internal centerless	1259
milling cutters	835
minimum cost conditions	1200
mounted wheels and points	976
offhand grinding	1268
optimization planning	1215
optimum grinding data for roughing	1200
planing tools	764
plunge	1251
portable grinding	1268
power	1203
procedure to determine data	1207
ratio	1197
relative grindability	1206
rene	1211
rpm, various speeds and diameters	1250
screw threads	2053
side feed, roughing and finishing	1205
silicon carbide wheels	1000
spark-out time	1202
specific metal removal rates	1202
speeds	1202
spindles for portable tools	972
stainless steels	1208
surface	1261
surface finish, Ra	1201
surface grinding troubles	1266
swing-frame	1268
terms and definitions	1206

Index Terms

Links

Grinding (*Cont.*)

tool steels	1209		
tools			
carbide	1000		
twist drills	997		
traverse	1251		
unhardened steels	1208		
user calibration of recommendations	1213		
vertical and angle spindles	972		
wheel life			
cost	1215		
grinding data relationship	1199		
grinding ratio	1197		
life vs. cost	1215		
relationships and optimum grinding			
data	1199		
wheel safety	1246		
handling	1246		
inspection	1246		
machine conditions	1246		
mounting	1246		
portable grinders	1249		
safe operating speeds	1248		
speed conversion table	1250		
speeds, maximum	1249		
storage	1246		
wheels	1216	1246	
abrasive materials for	1216		
angles for eccentric type radial relief			
angles on milling cutters	840		
bond properties	1217	1266	
CBN	1217	1234	1243
cubic boron nitride	1216	1234	
cutting fluids	1204		

Index Terms

Links

Grinding (*Cont.*)

diamond	793	
truing of	1235	
dressing and truing of	1235	
eccentric type	840	
faces, shapes of	1227	
finishing	1205	
grades	1217	
handling	1247	
inspection	1247	
wheels		
markings, standard	1218	
mounted wheels and points		
metric	978	
mounting and safety	1246	
radial relief angle	840	
roughing	1205	
safe operating speeds	1204	
selection of	1204	1219
sequence of markings	1218	
shapes and sizes, standard	1219	
metric	1225	
side feed	1205	
silicate bonding process	1266	
single point truing diamonds	1239	
storage	1247	
structure	1217	
truing		
diamond feeds	1238	
diamond sizes	1238	
dressing of	1235	
vitrified	1266	
wheel markings	1218	
work speed		

Index Terms**Links****Grinding (*Cont.*)**

and depth of cut selection 1198

in rough and finish grinding 1202

Grooved drive studs

dimensions 1760

hole sizes 1760

Grooved pins 1756

designation 1757

hole sizes 1757

lengths and sizes 1756

materials 1757 1759

properties 1759

requirements 1757

standard sizes 1759

type 1758

Grooving and oil feeding of bearings 2325**Grooving insert holder 770****GTAW (gas tungsten arc welding) 1453****Guerin process 1364****Guide bearings 2317 2356****Guldinus or Pappus rules 66****Gutta percha, turning 1082****Gyration, radius of 228**

bar, small diameter 228

circular disk, thin 229

circular ring, thin flat 229

cone, frustum 230

cylinder, hollow 230

ellipsoid 231

flat plate, thin 228

hollow cylinder, thin 230

hollow sphere 231

paraboloid 231

parallelepiped 229

Index Terms

Links

Gyration, radius of (*Cont.*)

parallelogram	228
prism, rectangular	230
ring	228
sphere, hollow	231
spherical shell, thin	231
thin flat plate	228

H

Half circle

moment of inertia	237
radius of gyration	237
section modulus	237

Hand

expansion reamers	856
of flute helix	811
of milling cutter	809
reamers	844

Hard facing

austenitic high chromium irons	1465
austenitic manganese steels	1465
cobalt base alloys	1465
copper base alloys	1466
high speed steels	1464
materials	1464
nickel-chromium-boron alloys	1467

Hard rubber, machining

1195

Hardening

471

alloy steels	414
steel	461
flame	487
induction	487
temperatures	
stainless steel	494

470

473

Index Terms

Links

Hardening (*Cont.*)

tool steels	473
test methods	466
tool steels	435

Hardmetals

	785
carbonitride based	788
coated	790
ISO classifications	791
titanium carbide	787
tooling for wood and nonmetals	795
tungsten carbide	786

Hardness

	465
aluminum alloys	534
bearings	2321
ceramics	389
cobalt alloys	392
copper alloys	391
copper-base powdered alloys	393
heat-treated steels	422
iron-base powdered alloys	393
magnesium alloys	547
nickel alloys	392
number	
Brinell	510
Rockwell	510
steel	1407
O-ring	2587
plastics	390
powdered metal alloys	393
relation to tensile strength	509
scales	
comparison	507
scales	
Rockwell	506

Index Terms

Links

Hardness (*Cont.*)

unhardness scales	510			
stainless steel	392			
steel	391			
carbon and alloy	424			
tool steels	446	448	455	458
testing	505			
Brinell	505			
conversion errors, causes	509			
conversion tables	508			
durometer	509	2590		
Hultgren ball	505	509		
Keep's test	507			
Mohs hardness scale	509			
monotron	507			
Rockwell	506	508		
scleroscope	506	509		
Turner's sclerometer	509			
Vickers	506	509		
tungsten-base powdered alloys	393			
Hardness number conversion	1625			
Harmonic	174			
Harvey grip thread	1987			
HDL, Hydrodynamic Lubrication	2421			
Heat				
absolute temperature and zero	2695			
coefficients of radiation	375			
coefficients of transmission	375			
fahrenheit-celsius conversion	2695			
freezing mixtures	376			
ignition temperatures	376			
latent	372			
loss from uncovered steam pipes	373			
mechanical equivalent	2695			

Index Terms

Links

Heat (Cont.)

power equivalents	2690
quantity measurement	2695
radiating capacity of bearings	2325
radiation coefficient	375
scales	2695
specific	372
temperature scales	2695
thermal energy	2695

Heat treating furnace

fluidized bed furnace	471
oven or box	470
pit type	470
pot type	470
retort	470
vacuum furnace	470

Heat treatment

alloy steel	491
carburizing temperatures	491
normalizing temperatures	491
tempering temperatures	491
carbon steels	490
molybdenum high speed steels	500
stainless steel	494
quenching medium	494
tempering temperatures	494
stainless steel temperatures	494
steel	407
annealing	408
annealing temperatures	483
baths quenching	477
carburizing temperatures	484
case hardening	484
cleaning work after case hardening	486

461	473	1407
461	465	482
490		

Index Terms**Links****Heat treatment (*Cont.*)**

colors for tempering	480			
cooling period	504			
cooling subzero, to improve properties	504			
cyanide hardening	485			
decalescence point	461	470		
defects in hardening	475			
flame hardening	487			
furnaces	461	469		
hardening baths	475			
hardening temperatures	461	470	473	491
hardening, defects in	475			
induction hardening	487			
interrupted quenching	477			
lead bath temperatures	475			
liquid baths	474			
nitriding	501			
normalizing temperatures	408 490	482	484	
oil quenching	475			
pack-hardening	485			
pressure-spraying quenching	476			
protective coatings for molybdenum steels	500			
quenching temperatures	498 491			
quenching baths	475			
recalescence point	461	470		
scale formation	475			
spheroidizing	482	484		
stabilizing dimensions	503			
strength and hardness of AISI steels	424			
stress relieving	408			

Index Terms

Links

Heat treatment (*Cont.*)

subzero treatments	504	
surface hardening	489	
tanks for quenching baths	477	
tempering	464	479
temperatures	490	
tempering period	504	
time aging	503	
water quenching	476	

Hectares into acres 2675

Helical

end mills	821
gear, helix angle	2062
milling, change gears	2061
wire screw thread inserts	1716

Helical coil insert 1614

block and spacer torque test	1618
breakaway toque	1623
coatings	1614
configuration	1614
dimensions	1614
maximum locking torque	1623
properties	1614
self locking toque	1623
torque test	1618
torque test spacer	1624

Helical coil screw thread Inserts

chemical composition	1617
compatibility	1613
dimensions	1613
hardness	1625
helical coil insert	1614
insert length data	1617
inspection	1617

Index Terms

Links

Helical coil screw thread Inserts (*Cont.*)

length selection	1624			
material selection	1624			
tapped hole	1613			
taps	1625			
threaded hole data	1615			
tolerance classes	1613			
types	1613			
Helical coil screw thread inserts	1613			
Helical gearing	2125	2195		
addendum	2195			
modifications	2173			
backlash	2164			
British Standard	2172			
calculations	2195			
center distance	2195			
exact	2198			
for enlarged	2207			
change gears	2208			
checking gear size	2230	2235		
cutter for milling	2204			
data on drawings	2163			
direction of thrust	2195			
enlarged fine-pitch pinions	2204	2206		
feed rate change	2209			
fine pitch teeth	2206			
formulas	2195	2197	2203	2206
helical overlap	2127			
helix angles	2196	2201		
herringbone type	2210			
hobbing	2208	2210		
involute form milling cutter	2205			
lead accuracy	2209			
lead of tooth	2195			

Index Terms

Links

Helical gearing (*Cont.*)

machine		
with differential	2209	
without differential	2208	
measurements using wires or balls	2235	
milling the helical teeth	2205	
minimum center distance	2201	2203
normal tooth thickness	2135	
pitch diameter	2195	
pitch of cutter	2196	
replacement gear dimensions	2251	
shafts		
at right angles	2199	
parallel	2197	
shafts at right angle	2202	
specifications	2161	
spur gear replacement by helical		
gears	2249	2251
thrust	2195	
tooth proportions	2135	
tooth thickness measurement	2235	
troubleshooting	2210	
wire diameter	2230	

Helical milling

development of helix	2061	
helix angle	2062	
lead of ahelix	2061	

Helical overlap 2127

Helix	2061	
angle	2062	2127
angle factor	2174	
angles, screw threads	1844	
constructing	65	
end mills with welden shanks	817	

Index Terms

Links

Helix (*Cont.*)

lead and diameter	2077
lead and pitch radius	2078
lead angle	2062
lead for given angle	2073
measurement of angle	2061
number of tooth	2078

Herringbone gearing 2210

failures	2210
----------	------

Hertz stress 2127

Hertzian contact area 2421

Hexagon

area	72
distance across corners	81
moment of inertia	236
radius of gyration	236
section modulus	236

High-energy-rate metal forming 1369

Highest point of single tooth contact

(HPSTC)	2127	2157
---------	------	------

High-speed steels 446 1009

annealing rehardening	498
as cutting tool materials	1009
cobalt	896
cobaltcrom	496
cooling period	504
cutters	838
drawing	498
hardening molybdenum	499
heat treatment	496
annealing	499
cutting efficiency	497
equipment	501
hardening temperatures	497

Index Terms**Links****High-speed steels (*Cont.*)**

preheating tungsten	496			
quenching				
molybdenum	500			
tungsten	497			
subzero treatment	505			
tempering molybdenum	500			
time for through hardening	497			
molybdenum	446	451	499	
hardening	499			
quenching straightening	498			
tempering	498			
tool	448			
tungsten	448	451	496	499
tungsten annealing	499			
High-strength, low-alloy (HSLA) steels				
(<i>see HSLA steels</i>)				
Hob tip radius, maximum	2156			
Hobs				
change gears for relieving	2046			
roller chain sprocket	2555			
tip radius, maximum	2156			
worm gear	2191			
Hoisting chain and wire rope	2613			
Holders for NC, insert	766	782		
Hold-on or dolly bars for riveting	1734			
Hole circles				
adapting equations for geometry	694			
coordinates for	692			
Type "A"	692	696	698	
Type "B"	693	700	702	
Hole sizes, tapping	2031			
Holes				
accuracy of drilled	896			

Index Terms

Links

Holes (Cont.)

difficulties in reaming	852
for riveted joints	1729
for tapping	2021
in glass, drilling	1064
sizes for self-tapping screws	1709

Hollow

circle, moment of inertia	237
circle, radius of gyration	237
circle, section modulus	237
cylinder, radius of gyration	230
mills, feeds and speeds	1171
sphere, radius of gyration	231

Homopolymers 553

Honing process 1272

adjustments	1273
carbide tools	1002
rotative speeds in	1272
stock removal, rate of	1272
tolerances	1274

Hooke's law 561

plastics	555
----------	-----

Horsepower 149

calculating by dynamometer	2457
chain transmission	2547
converted into kilowatts	2690
disk clutches	2447
drilling different materials	1089
dynamometer test	2456
electric motor	2573
ratings	2566
equivalents	2690
formulas	186
friction wheels	2457

Index Terms

Links

Horsepower (*Cont.*)

gearing	2245	
hour equivalents	2690	
machining	1083	
nonmetallic gears	2245	
planing and shaping	1083	
roller chains	2547	
set-screw transmitting capacity	1699	
shafting	295	
spade drilling	1079	1089
torque equivalent	295	
V-belt drives	2487	
Hose connection screw threads	1968	
ANSI Standards	1968	
basic dimension	1971	
tolerances	1971	
Hot-working, tool steels for	449	
HSLA steels	400	
application	420	
chemical compositions	421	
composition	420	
elongation	421	
formability	421	
properties	420	
tensile strength	421	
toughness	421	
weldability	421	
yield strength	421	
Hunting tooth ratio	2194	
Hydrant screw thread	1970	
Hydraulic press	1389	
Hydrodynamic film lubrication	2421	
Hydroforming process	1364	

Index Terms

Links

Hydrometer, Baumé's, and specific gravity	381		
Hyperbola			
area	75		
area construction	65		
eccentricity	54		
foci	54		
general equation	54		
major and minor axis	54		
Hypocycloidal curves, areas	68		
Hypoid gears	2125	2176	2178
applications of	2179		
Hypotenuse	95		
Hysteresis	309		
I			
I-beam			
aluminum	2603		
standard structural steel	2598		
structural			
moment of inertia	2594		
section modulus	2594		
steel	2594		
weight per foot	2594		
Idler gears	2105		
Ignition temperature	376		
Impact force of	183		
Impact strength, Izod			
carbon and alloy steels	424		
plastics	390		
Impulse	184		
angular momentum	185		

Index Terms

Links

Inch

decimals of, into millimeters	2668		
into centimeter and millimeter	2665		
millimeters into decimals of	3	2664	2670

Inclinable-frame press	1388		
-------------------------------	------	--	--

Inclined plane	169	179	
force for moving body on	169		
forces on	168		
motion on	179		

Inconel metals	548		
-----------------------	-----	--	--

Index plates, one hole

moves of angular values	2087		
-------------------------	------	--	--

Indexable

carbide inserts	764		
insert holder			
boring	770		
chamfering	770		
end cutting edge angle	769		
facing	770		
grooving	770		
identification system	765	767	
insert shape	769		
lead angle	769		
NC	766	782	
planing	770		
plunge angle	770		
rake angle	769		
selection	769		
shank sizes	767		
shape	770		
tracing	770		
turning and backfacing	770		
turning and facing	770		

Index Terms

Links

Indexing

angular	2086		
block or multiple	2117		
Brown and Sharpe milling machine	2107		
compound	2080		
compound gearing ratio	2105		
differential	2104		
ratio of gearing	2104		
gear ratio finding	2105		
head angular position for			
milling end mills and angular			
cutters	833		
head worm wheel with 64 teeth	2119		
hole circles	2079		
milling machine	2079		
movements	2081	2105	2119
number of holes	2079		
ratio of gearing	2105		
reamer teeth for irregular spacing	845		
simple	2079	2107	
simple and differential	2107		
smaller angles	2103		
tables	2117		
Indicator drop method	841		
Induction			
annealing	489		
brazing	1431		
hardening	468	487	489
equipment	487		
gear teeth	489		
normalizing	489		
Inertia	149		
electric motor	2574		
moment of	233		

Index Terms**Links**

Inertia (<i>Cont.</i>)		
polar	244	
Injection mold design	585	
Injection molding	584	
plastics	592	
Injection molding, metal	1417	
Insert configuration	1617	
Insert length data	1617	
Insert length selection	1624	
Insert radius compensation	782	
Inserts		
hardmetal materials	785	
holders for NC	766	782
indexable	764	782
radius compensation, NC	782	
screw thread	1716	
self-tapping screw	1716	
throw away carbide	785	
Inspection methods	675	
Instrument maker's thread system	1980	
Integration of functions	35	
Interest	134	
compound	134	
finding unknown rate	136	
nominal vs. effective	135	
simple	134	
Interference	2127	
Interference fit threads	1973	
allowances	1977	
British Standard	1637	
change in diameter	1978	
coarse threads	1977	
design and application data	1974	
designation symbols	1974	

Index Terms

Links

Interference fit threads (*Cont.*)

dimensions	1975		
driving speed	1976		
driving torque and length			
of engagement relation	1977		
engagement lengths	1976		
interferences	1974	1976	
lead and angle variations	1978		
lubrication	1976		
materials for	1976		
profile	1973		
spur gearing	2146	2148	
surface roughness	1977		
thread dimensions	1975		
tolerances for pitch diameter	1977		
torques	1976		
variation in axial lead	1978		
Interferometer	714	732	1322
Internal diameter	2127		
Internal gears	2127		
spur	2125	2170	
International System (SI) units	2656		
Interpolation	121		
Interrupted quenching	476		
Inverse			
and direct proportions combined	7		
of a matrix	125		
ratio or reciprocal	5		
Investment			
casting	1418		
design	1420		
making procedure	1418		
milling cutters	1421		
materials	1419		

Index Terms

Links

Investment casting alloy			
elongation	391		
hardness	391		
tensile strength	391		
yield strength	391		
Involute	2127		
constructing	65		
curve properties	2131		
curve, properties	2130		
functions	110		
gear cutters, formed type	2148	2170	
serrations	2252		
true form diameter in gears	2128		
Involute splines	2127	2252	2255
American National Standard	2252		
application factor	2267		
basic dimension	2258		
basic rack profile	2277		
bursting stress	2269		
chamfers and fillets	2260	2277	
circular pitch	2253	2258	
classes of tolerances	2258		
combinations	2263		
combinations of types	2263		
compressive stress at side teeth	2269		
compressive stresses allowable	2268		
crowning for misalignment	2269		
diametral pitch	2254		
dimensions, effective and actual	2273	2275	
drawing data	2263	2265	
effect of spline variations	2261		
effective			
and actual dimensions	2261	2271	
clearance	2254		

Index Terms

Links

Involute splines (*Cont.*)

space width	2254		
tooth thickness	2254		
variation	2254	2276	
fatigue life factor	2268		
fillet	2254		
chamfers	2260	2277	
root splines	2254	2260	
fit classes	2258	2273	2277
flat root splines	2254	2260	
form circle	2255		
form clearance	2255		
form diameter	2255		
formulas	2277		
basic dimension	2257	2273	2275
2-pin measurement	2271		
fretting damage	2270		
inspection			
methods	2270		
types of gages	2271		
with gages	2271		
interchangeability	2263		
internal splines	2255	2263	
lead variations	2255	2261	
length of engagement	2255		
length of splines	2266		
load distribution factors	2267		
machining tolerance	2255	2277	
major circle	2255		
major diameter fit	2255	2258	
manufacturing	2283		
maximum			
actual space width	2262		
actual tooth thickness	2262		

Index Terms

Links

Involute splines (*Cont.*)

effective space width	2263		
effective tooth thickness	2262		
metric module	2272		
milling cutter	836		
minimum			
actual space width	2262		
actual tooth thickness	2262		
effective space width	2262		
effective tooth thickness	2263		
minor circle	2255		
minor diameter	2255		
misalignment	2267		
parallelism variation	2255		
pin measurement of	2271		
pitch	2255		
circle	2255		
diameter	2255		
point	2255		
pressure angle	2255		
rack profiles	2276		
reference dimensions	2263	2265	2277
shear stress			
allowable	2268		
at pitch diameter	2269		
at the pitch diameter of teeth	2269		
under roots of external teeth	2268		
side fit	2258		
sizes and lengths, estimating	2265		
space width and tooth thickness			
limits	2262	2273	
stub pitch	2255		
symbols	2255	2263	2273
tensile stresses allowable	2268		

Index Terms

Links

Involute splines (*Cont.*)

terms and definition	2253	2273	
tolerances	2258	2273	2276
tolerances and variations	2276		
tooth			
numbers	2255	2258	
proportions	2255		
thickness limits	2262	2276	
thickness modification	2276		
torque capacity formulas	2266		
total index variation	2255		
total tolerance	2255		
types and classes of fits	2258		
variations	2261	2276	
allowance	2255	2261	
eccentricity	2261		
effect of	2276		
effect of profile	2261		
lead	2261		
types of	2253	2276	
wear life factors, flexible splines	2268		
width and tooth thickness	2276		

Iron

and copper-base sintered bearings	2364
castings	1404
coloring	1507
copper-base sintered bearings	2363

Iron-base powdered alloys

density	393
elongation	393
hardness	393
rupture strength	393
ultimate strength	393
yield strength	393

Index Terms

Links

I-section

moment of inertia	238
radius of gyration	238
section modulus	238

ISO Standard

cleanliness code for lubrication	2439	
drawing symbols, compared with ANSI	612	
geometric dimensioning and tolerancing	613	
metric		
grade markings on bolts	1634	
hexagon bolts, screws and nuts	1630	
limits and fits, British Standard	662	
thread	1901	1919
thread system, miniature screw		
threads	1910	
surface finish	747	
profiles	750	
surface parameter symbols	748	
washers, compared with ANSI	1607	

ISO surface finish	747	
---------------------------	-----	--

ISO VG - viscosity	2425	
---------------------------	------	--

Isosceles triangle	95	
---------------------------	----	--

Isothermal

quenching	479	
-----------	-----	--

Izod impact strength

carbon and alloy steels	424	
plastics	390	

J

Jacobs tapers	961	
----------------------	-----	--

Jam nuts, standard	1539	1545
---------------------------	------	------

metric	1605	
--------	------	--

Index Terms**Links**

Jarno taper	948	959
Jig		
boring		
lengths of chords	704	
Jobbers reamers	857	
drills	868	
Johnson, J. B., column formula	284	
Joining plastics	593	
Joints		
riveted	1729	
toggle	172	
universal	2445	
Journal bearing (<i>see</i> Bearings: journal)		
 K		
 Karat	2683	
Keep's hardness test	507	
Kelvin, degrees	2695	
Key and spline sizes and lengths	2265	
Keying bearings	2319	
Keys and bits, hexagon and spline	1692	
Keys and keyseats	2460	
alignment tolerances	2473	
ANSI Standard	2460	
chamfered keys	2477	2482
cotters	2481	
depth control values	2473	
depth of keyseat	2482	
depths for milling keyseats	2482	
effect on shaft strength	301	
estimating key sizes	2265	
filleted keyseats	2477	2482
fitting	2476	
gib-head keys	2475	

Index Terms

Links

Keys and keyseats (*Cont.*)

keyseat milling cutters, Woodruff	832	
keyseats, depth of	2473	2482
milling cutters and arbors	831	
parallel and taper	2473	2476
plain	2475	
rectangular parallel keys	2469	
set screws for keys	2477	
shaft diameter	2472	
size vs. shaft diameter	2472	2482
strength considerations for shafts	301	
tolerances	2475	2477
transmission chain	2542	
woodruff keys and keyseats	2477	

Keys and keyways

designation	2460	2469
dimension of square and rectangular		
parallel keys	2461	
dimensions and tolerances	2467	
dimensions and tolerancing	2463	
keyways dimension	2463	
keyways tolerances	2463	
lengths and tolerances	2460	2466
material	2469	
material	2460	
parallel keys dimensions	2465	
parallel keys tolerances	2465	
square and parallel keys	2461	
square and rectangular type	2460	
tolerances	2460	2469
woodruff	2469	

Kibi 2658

Kilogram calorie 2695

Index Terms

Links

Kilograms	
into pounds	2683
per cubic meter into pounds per cubic foot	2685
per square centimeter into pounds per square inch	2687
per square meter into pounds per square foot	2687
per square meter into pounds per square inch	2687
Kilometers into miles	2674
Kilopascals into pounds per square inch	2687
Kilowatt	
hour equivalents	2690
into horsepower	2691
power required for machining	1083
Kinematic viscosity	2425
Kinematics and kinetics	149
Kinetic energy	181
Kingsbury thrust bearing	2338
Kirchoff current law	127
Kirchoff voltage law	127
K-Monel, machining	1194
Knee tools, speeds and feeds	1171
Knees (see Right angle plate)	723
Knoop hardness numbers	507
Knuckle joints	2446
proportions	2446
Knurls and knurling	991
automatic screw machines	1170
concave	995
diagonal teeth	991
diametral pitch knurls	991
dies marking	995

Index Terms

Links

Knurls and knurling (*Cont.*)

flat tools	993
formulas	993
lathe knurls	991
revolutions required for top knurling	1170
sizes, preferred	991
speeds and feeds	1171
straight teeth	991
tools	992
tracking correction	991
work diameter tolerances	994

L

Lag screws and threads	1543
metric	1586
Lame's formula for internal pressure	291
Land gear tooth drill	866
Laps and lapping	1274
abrasives	1277
carbide tools	1002
charging laps	1276
cutting properties	1277
cutting qualities	1277
flat surfaces	1275
grading abrasives for	1275
grading diamond dust for	1276
lubricants	1277
materials for	1274
pressures	1278
rotary diamond	1276
tests	1278
wear	1277
wet and dry	1278

Index Terms

Links

Lasers	1487	
beam focusing	1487	
beams	1487	
cladding	1498	
cutting metal with	1491	
cut edge roughness	1492	
cutting speeds	1495	
heat-affected zone	1493	
kerf widths	1492	
narrow kerf	1492	
cutting nonmetals	1493	
direct drilling	1497	
drilling	1497	
drilling rates	1498	
drilling theory	1497	
hardening rates	1498	
heat affected zones	1493	
heat treatment	1498	
industrial applications	1489	
industrial systems	1489	
light	1487	
marking	1499	
mask marking	1499	
materials	1490	1498
nonmetals cutting rates	1495	
safety	1490	
scanned beam marking	1499	
thermal properties	1491	
trepanning	1498	
types of industrial	1489	
welding		
conduction	1495	
deep penetration keyhole	1495	
joint design	1495	

Index Terms**Links****Lasers (*Cont.*)**

processing gas	1496
helium	1497
rates	1495
theory	1495

Latent heat	372
--------------------	-----

Lathe

change gears	2042
fixtures, balancing	195
screw constant	2042

Law of cosines	96
-----------------------	----

Law of sines	96
---------------------	----

Lay symbols	744
--------------------	-----

Lead

angle of cutting tools	757			
inserts	782			
angle of screw thread	2061			
tables for	1844	1923	1931	1942
	2004			

of helix

change gears and angles for	
milling	2076

of helix

find change gears for milling	2063	
for given angles	2073	2078

of milling machine	2060
--------------------	------

of screw thread	1989	2061
-----------------	------	------

side cutting edge	762
-------------------	-----

Lead and lead alloys

element	371
---------	-----

lead bath	475
-----------	-----

tempering in	481
--------------	-----

melting temperatures	371	481
----------------------	-----	-----

solder	1424
--------	------

Index Terms

Links

Lead-base alloys, die casting	1417
Leaded-bronze bearings	2357
Leadscrews	2561
Length	
differences due to temperature	378
engagement of screw thread	1536
of action	2127
of engagement	2031
of rivets for forming heads	1734
units and conversion of	2661
Lengths and tolerances	2460
Letter symbols for mechanics	2655
Levers	167
Light	
duty Belts and pulleys	
V-belts	2506
laser	1487
metals	
drilling, reaming, and threading	1069
milling	1043
turning	1037
wave interference bands, measuring surface	
variations with	731
Limestone	
cutting speed for	1082
strength	394
Limit	
D or DU on taps	911
elastic	200
endurance	201
H- and L-limits	906
proportional	199
Limits and fits	
actual size	634

Index Terms

Links

Limits and fits (*Cont.*)

allowance	634		
ANSI Standard preferred metric	639		
basic size	634	648	663
British Standard for holes and shafts	663		
cylindrical fits, ANSI Standard	634		
definitions	639		
design size	634		
deviations for holes	670		
deviations for shafts	668		
dimension	634		
gagemakers tolerance	661		
gages, plain	629	661	
gages, thread	2010		
graphical representation	639		
indicating on drawings	628		
maximum material condition	635		
metric screw threads	1882		
minimum material condition	635		
screw thread gages	2010		
size, nominal	634		
symbols	650		
tolerance	634	649	
bilateral	635		
unilateral	635		
tolerance limit	635		
tolerances	635	663	
woodruff keys	2478		

Line

angle between two	43		
conventions for drawings	609		
distance between point	40	43	
distance to external point	41		
equation of	41		

Index Terms**Links****Line (*Cont.*)**

geometry of	58
intermediate points on	40
of action	2127
parallel	42
perpendicular	42
slope of	41

Linear

coefficient of expansion	375	378
metals	375	
plastics	375	
deflection of shafting	298	

Linear motion 2561**Liquid**

baths, heating steel in	474
depth to volume conversion	68
specific gravity	380

Liters

into cubic feet	2680
into U.S. gallons	2678

Lloyd and lloyd thread 1988**Load**

rating, static, bearings	2415
ratings and fatigue life, bearings	2403

Lobing 690**Lock nut pipe thread** 1988**Lock nuts, ball and roller bearing** 2395**Lock wire procedure** 1537**Locking torque** 1623**Locknuts, ball and roller bearing** 2395

shafts for	2396
------------	------

Lockwashers

ANSI Standard	1566
ball and roller bearing	2394

Index Terms

Links

Lockwashers (*Cont.*)

British Standard, metric		
plain	1640	
spring	1638	
spring type	1566	
tooth lock	1568	
tooth type	1566	1568
Logarithms	17	
common	17	
mantissa	17	
natural	17	
using calculator to find	17	
Long angle lathe file	989	
Long hand threading, CNC	1304	
Low pressure casting	1411	
Löwenherz thread	1945	
L-section		
moment of inertia	242	
radius of gyration	242	
section modulus	242	
Lubricants	2423	
bearings	2323	
cutting	1182	
electric motors	2578	
grease	2323	2431
operating temperature	2325	
press work	1372	
blanking operations	1372	
drawing operations	1372	
effects on	1372	
removal from formed parts	1373	
properties of additives	2429	
temperature vs. viscosity	2324	

Index Terms

Links

Lubrication	2322	2420
absolute viscosity	2425	
additive properties	2429	
analysis	2335	
analysis, journal bearings	2329	
application	2433	
comparison of methods	2437	
bearings		
grease packing guidelines	2436	
blanking	1372	
boundry film	2421	
chain	2559	
cleanliness codes	2439	
contamination	2438	
contamination with water	2440	
delivery methods	2436	
drawing	1372	
economic impact	2423	
efficiency filtration	2442	
film thickness	2335	
film thickness ratio	2420	
film transition	2421	
films	2420	
filter efficiency	2442	
filter filtration ratio	2442	
filtration	2441	
grease	2431	
application	2435	
greases	2324	
hertzian contact area	2421	
hydrodynamic	2421	
hydrodynamic flow	2334	
ISO cleanliness	2439	
kinematic viscosity	2425	

Index Terms

Links

Lubrication (*Cont.*)

method	2400	
mixed film	2421	
motors	2578	
oil	2424	
oil bath	2323	
oil film thickness values	2423	
oxidation	2430	
plain bearings	2322	
press work		
mechanical and hydraulic presses	1391	
pressure flow	2334	
recirculative oil systems	2435	
replenishment rates	2435	
roller chain	2559	
selection	2433	
selection for bearings	2323	
surface degradation	2423	
systems	2436	
lost lubricant	1392	
re-circulating	1392	
temperature effects	2426	
terminating oil systems	2435	
theory	2420	
total flow	2335	
viscosity	2324	2425
viscosity index (V.I.)	2426	
viscosity selection	2433	
waste pack	2323	
wear		
corrosive	2424	
mechanical abrasion	2424	
mechanical adhesion	2424	
mechanical fatigue	2424	

Index Terms

Links

Lumber, sizes of sawn	388		
M			
M codes, CNC	1287		
M profile tap limits	930		
Machinability			
copper alloys	515		
of wood	387		
Machine			
accuracy, effect of on part tolerances	1323		
countersinks	851		
cutting time formula	1153		
elements, subjected to compressive			
loads	282		
nuts coating	1667		
screw coating	1667		
screw nuts	1676		
settings costs	1152		
settings economy	1152		
tool			
accuracy	1319		
efficiency	1087		
repeatability	1319		
resolution	1319		
Machine screw taps	904		
Machine screws			
ANSI Standard	1643		
binding head	1651		
body diameter	1644		
British Metric	1666	1679	
British Standard	1675		
British Unified	1676		
BSW and BSF	1666	1672	1679
cheese head	1674		

Index Terms**Links****Machine screws (*Cont.*)**

chesse head screw	1674	1677		
clearance holes, metric	1665			
countersunk head	1645	1660	1671	
countersunk head screw	1676			
cross recesses	1652			
designation	1644	1658		
diameter of body	1658			
diameter of unthreaded shank	1668			
end of screws	1671			
fillister head	1649			
flange head metric	1663			
flat head	1644	1660		
header points for metric	1649	1666		
header points for threading	1650			
hex and hex flange	1663			
hexagon head screw	1647	1677		
hexagon nuts	1643			
hexagon washer head	1646			
lengths of thread	1658	1667		
metric countersunk	1659	1661		
metric recessed countersunk head	1659			
metric thread lengths	1659			
metric, ANSI standard	1658			
mushroom head screw	1677			
nuts for	1643			
oval head	1649	1661		
pan head screw	1648	1662	1673	1677
radius under the head	1668			
recessed flat head	1660			
recessed pan head	1662			
round head screw	1652	1676		
slotted and crosses	1660	1662		
slotted countersunk head	1645	1670		

Index Terms**Links****Machine screws (*Cont.*)**

slotted pan head	1673		
slotted, recessed	1661		
square nuts	1643		
tap and clearance drills	2021	2030	2034
thread	1659	1667	
truss head	1647		
washerhead	1646		
washers for	1562	1640	

Machine tool

lathe, change gears for fractional ratios	2043		
motor types	2576		

Machinery foundations 384**Machining**

aluminum	1192		
bearings	2321		
copper alloys	1195		
economy			
chip thickness	1162	1164	
depth of cut	1162	1164	
high speed	1161		
high speed milling	1168		
formica	1195		
hard rubber	1195		
magnesium	1193		
micarta	1196		
monel and nickel alloys	1194		
nonferrous metals	1192		
plastics	598		
power constants	1083		
power factors			
chisel-edge	1090		
drill diameters	1090		

Index Terms**Links****Machining (*Cont.*)**

feeds	1084	1091	
machine tool efficiency	1087		
metal removal rates	1087		
tool wear	1084		
work materials	1089		
power, estimating	1083		
unit horsepower for	1079	1083	1088
processes, ANSI Standard tolerance grade			
relationships	635	637	662
speeds and feeds (<i>see</i> Speeds and feeds)			
tolerances and variations	2276		
ultrasonic	1196		
zinc alloy die castings	1194		
Machining holes, CNC	1294		
Macromilling	1108		
Magnesium alloys	545	1416	
applications	545		
bearing strength	547		
coloring	1508		
compositions	546		
compressive strength	547		
cutting fluids for	1187	1193	
designations	545		
die casting	1416		
elongation	547		
extruded bars	546		
machining	1193		
mechanical properties	547		
plate	546		
pressure die casting	546		
properties	547		
sand and permanent mold	546		
shear strength	547		

Index Terms**Links****Magnesium alloys (*Cont.*)**

sheet	546
soldering of	1426
tensile strength	547
yield strength	547

Magnesium, coating 1510

Magnetic clutches 2449

Malleable

iron castings	1405
Iron Research Institute	1413
strength	1405

Manganese

bronze castings	517
gearing material	2243
steel	404

Manganese-bronze castings 517

Mantissa, logarithm 17

Manufacturers' standard gage for sheet

steel	2608
-------	------

Marble turning 1082

Martempering 479

Martensite 469

Mass 149

units and conversion of	2683
-------------------------	------

Material 2460 2469

Material strength 1624

Materials

disc spring	351
mechanical properties of	199
spring, disc	351

Mathematical

constants, frequently used	16
signs and abbreviations	2654

Index Terms

Links

Matrix	122
addition	122
adjoint	124
cofactors	124
column	122
determination	123
diagonal	122
identity	122
inverse	125
minors	124
multiplication	122
rank	125
row	122
simultaneous equations	125
singular	125
square	122
subtraction	122
zero	122
Maximum	
bending load, wood	386
temperature, plastics	390
MBEC bearing tolerances	2359
MDI	1283
Mean positional deviation	1319
Measurement of backlash	2167
Measuring	
angles with sine-bar	678
buttress thread	2006
compound angles	119
dovetail slides	682
gear size	2221
instruments and gaging methods	675
over pins	
bolt circle	686

Index Terms

Links

Measuring (*Cont.*)

gear size	2221	
splines	2271	
over pins, bolt circle	686	
pitch diameter		
thread ring gages	2007	
three wire method	1996	
radius or arc, over rolls	686	
tapers	681	
center distance	685	
diameter	685	
threads		
American standard	1995	
buttress	2006	
taper screw	2005	
tapered	2005	
threads		
using micrometer	1989	
using screw thread gage	2006	
using three-wire method	1990	2006
Whitworth	1997	
V-shaped groove, over pins	686	
with light-wave interference bands	731	
with micrometer	677	1989
with vernier	675	

Measuring screw threads

Acme thread	1995	
Acme thread thickness	2001	
ball point micrometer	1990	
buckingham involute helicoid		
formula	1999	
buttress thread	1995	2006
contact pressure, measurement	1993	
formula for checking pitch diameter	1995	

Index Terms

Links

Measuring screw threads (*Cont.*)

formula to taper pipe threads	2005	
formula, three wire method	1994	
helical gear formula	1999	
lowenherz	1995	
pipe thread	1995	
pitch diameter equivalent	2005	
profiles	1991	
three wire method	1993	
Acme threads	2001	2003
buttress thread	2006	
checking thickness of Acme thread	2001	
stub Acme threads	2001	2003
testing angle of thread	2002	
wire diameters and constants	2003	
wire sizes	2002	
V thread	1995	
Whitworth	1995	1997
wire accuracy	1993	
wire diameter	2006	
wire sizes for checking pitch		
diameters	1992	
worm thread	1995	
Mebi	2658	
Mechanical equivalent of heat	2695	
Mechanical press	1386	
Mechanical properties		
aluminum alloys	542	
bolts, inch sizes	1534	
bolts, metric sizes	1581	
ceramics	389	
copper	528	
magnesium	545	
nickel	548	

Index Terms

Links

Mechanical properties (*Cont.*)

plastics	390	575
powdered metal alloys	393	
spring wire	395	
stainless steels	430	
steel	432	
titanium	548	550
tool steels	433	
various materials	199	
wood	385	
Mechanics of materials	149	
acceleration	177	179
acceleration		
due to gravity, g	150	
algebraic solution of force systems	153	156
angular		
impulse	185	
momentum	185	
velocity	175	177
center		
and radius of oscillation	231	
of gravity	221	231
of percussion	231	
centrifugal force	187	
calculating	188	
couples	155	
differential pulley	171	
dynamics	149	
energy	181	
force	153	156
force of a blow	183	
graphical solution of force systems	153	
impulse and momentum	184	
angular	185	

Index Terms

Links

Mechanics of materials (*Cont.*)

inclined plane	169	179
kinetic energy	181	
levers	167	
linear velocity	175	
metric SI units	149	
moment of inertia	232	
momentum	184	
Newton's laws	179	
pendulums	173	
potential energy	181	
pound force	150	
power	186	
pulleys	170	
radius of gyration	228	
radius of oscillation	231	
scalar and vector quantities	153	
screw	171	
SI metric units	149	
statics	149	
toggle joints	172	
torque	180	
units	150	
vectors	153	
velocity, angular	175	
velocity, linear	175	
wedge	169	
wheels	170	
work	182	186
and energy relation	182	
and power formulas	186	
performed by forces and couples	182	

Melting points

alloys of copper and zinc	1426
---------------------------	------

Index Terms

Links

Melting points (*Cont.*)

alloys of lead and tin	1424
aluminum	376
brazing alloys	1426
cast iron	377
chemical elements	371
copper alloys	376
solder	1424
stainless steels	377
titanium alloys	377

Metal

aluminum alloys	376	
balls, standard	2419	
bonded grinding wheels	1000	1217
casting	1409	
coatings		
conversion coatings	1506	
surface coatings	1508	
coloring	1506	
drawing	1353	
etching	1505	
foundry patterns	1413	
identification	399	509
injection molding	1417	
numbering systems for	398	
patterns	1413	
plasma welding	1458	
removal rate	1087	1202
slitting saws	813	
spraying process	1516	
temperature effect on strength	395	
working		
basic theory	1331	
fluids		

Index Terms

Links

Metal (*Cont.*)

application	1189
occupational exposure	1188
working fluids	1188

Metal washers

bright	1640
metric series	1640

Metallography

492

Metallurgy, powder

1423

Meters into feet

2674

Metric

basic sizes, British Standard preferred 674

bolts and screws, British Standard

clearance holes for 2034

box wrench 1561

conversion factors 2665

dimensions on drawings 744

dowel pins, British Standard 1747

drawings, scales 745

fasteners

ANSI hex nuts 1601

ANSI nut thread series 1603

bolts and screws

bolt designation 1593

bolt thread lengths 1593

cap screws 1595 1598

clearance holes 1611

countersink 1612

diameter-length combinations 1594 1596

drill and counterbore sizes 1612

drilled head dimensions 1599

hex flange screws 1595

hex screws 1595

fasteners

1612

1596

Index Terms

Links

Metric (*Cont.*)

hex structural bolts	1596	
identification symbols	1593	
neck bolts	1596	1611
socket head cap screws	1597	
socket head neck screws	1611	
thread length	1593	
hex structural bolts	1591	
nuts	1601	1603
ANSI Standard	1601	
bearing surfaces	1601	
materials	1601	
mechanical properties	1601	
heavy hex structural bolts	1591	
hex bolts	1592	
inch vernier, dual	676	
International System of Units (SI)	2656	
ISO limits and fits, British Standard	662	
micrometer, reading	677	
module, gear cutter	2148	
gear teeth	2217	
round head square neck bolts	1589	
screw		
shoulder		
socket head	1587	
shoulder socket head	1587	
screw threads		
aerospace screws, bolts and nuts	1901	
basic profile	1808	1883
crest diameter tolerance	1915	
design profiles	1913	
designation	1913	
diameter pitch combinations	1900	1919
dimensional effect of coating	1888	

Index Terms

Links

Metric (*Cont.*)

fits	1883		
fundamental deviation	1885	1914	
length of thread engagement	1885	1913	
lengths of engagement	1915		
limiting dimensions formula	1888		
limits and fits	1882		
limits and tolerance	1915		
M crest	1879		
M profile	1879		
external thread	1879		
internal thread	1879		
M profile designations	1885		
minor diameter tolerances	1885		
MJ profile			
designations	1903		
symbols	1903		
root form	1879		
tolerance system	1885		
tolerances of external threads	1890	1892	
tolerances of pitch -diameter	1890		
series British ISO			
hexagon bolts, nuts, and screws	1630		
machine screws and nuts	1666		
metal washers	1640		
series British ISO			
spring washers	1638		
SI units, factors and prefixes	2658		
sizes, preferred for flat metal			
products	2610		
systems of measurement	2656		
threads, British (ISO)	1901	1910	1919
threads, SI	1953		
twist drills, ANSI	866		

Index Terms**Links****Metric (Cont.)**

vernier, reading	676			
washers, plain, ANSI	1604	1607		
wrench, clearances	1561			

Metric system (SI)

base units	151			
in mechanics calculations	149			
in strength of materials calculations	199	209	214	217
	228	232	256	269
	273	276	279	282
	289	296	300	

Metrology

gage blocks	705			
parallel bars	716			
right angle plate	723			
surface plates	708			

Micarta, machining

1196

Microfabrication processes and

parameters	1122			
------------	------	--	--	--

Microinch

2661

into micrometers (microns)	2672			
----------------------------	------	--	--	--

Micromachining

1092

abrasive wear	1100	1102	1106	
attrition wear	1100	1127		
brittle materials	1109			
chip load	1094	1103	1108	1120
	1128			
chipping	1096	1100	1111	
coatings for microtools	1097			
commercial microdrills	1125			
commercial micromills	1122	1124		
compared with macromachining	1092	1098	1102	1104
	1106	1111	1128	
crater wear	1102	1121		

Index Terms**Links****Micromachining (Cont.)**

cumulative tool life	1106			
cutting fluid	1102	1110	1118	1121
	1125	1130		
cutting speed	1129			
CVD	1097			
depth of cut	1092	1094	1103	1106
	1110	1121	1128	
diamond machinable materials	1127			
ductile-regime machining	1108			
theory	1109			
elastic modulus	1110			
flood cooling	1111	1121		
goniometer	1113			
grain size	1092	1096	1103	1106
	1108	1128		
laser displacement sensor	1098			
lateral tool offset calculation	1098			
machine tool requirements	1092			
macrofacing	1121			
mechanical edge finder	1098			
microcutting tools	1093	1096		
microdrill	1092	1098	1112	1125
	1130			
microdrilling	1092	1096	1104	1111
	1122	1125	1128	
microdrilling/milling parameters	1129			
microdroplet	1113	1118		
microfabrication	1092	1122		
microfacing	1095			
microhardness	1110	1128		
micromill selection	1130			
micromilling	1092	1095		1104
	1108	1111	1120	1128

Index Terms**Links****Micromachining (Cont.)**

micromist	1112	1120	1125	1128
micromist lubrication				
contact angle	1113	1115		
contact angle measurement	1115	1118		
drop size measurement	1113			
sessile drop technique	1113	1115		
slide technique	1114			
droplet measurement techniques	1114			
dynamics of microdroplets	1118			
force balancing of microdroplets	1119			
wetting	1113	1116	1118	
microtool	1092			
microtool offset	1100			
microturning	1092	1096	1122	1127
microturning parameters	1128			
miniaturization	1092	1127		
minimum quantity lubrication				
(MQL)	1112			
mirror-finish	1110			
MQL (minimum quantity				
lubrication)	1112	1120		
negative rake	1110	1127		
normalized diameter	1116	1118		
pecking cycle	1125			
pendant drop technique	1113			
physical vapor deposition	1097			
plug gage	1093	1098		
propelling microdroplets	1118			
properties of selected lubricants	1115			
p-type silicon wafers	1110			
PVD	1097			
selection of cutting fluid	1113			
sensor requirement	1098			

Index Terms**Links****Micromachining (Cont.)**

single crystalline diamond tools	1094		1110	1127
speeds and feeds	1128	1130		
spindle runout	1092	1096	1125	1129
spindle speed, macro vs. micro machining	1093			
stiffness of microtools	1094			
surface finish	1094	1104	1108	1110
	1128			
surface microhardness	1110			
Taylor equation	1103	1106		
tool				
damage	1100	1105		
edge radius	1094	1102	1110	1128
flank wear	1102	1106	1121	
geometry	1096	1110	1122	
materials	1096			
offset	1097			
offset and positioning	1097			
offset calculation	1098	1100		
required included angle	1097			
sharpness	1094			
stiffness	1093			
tool life	1102	1111	1120	1123
	1128	1130		
torsional stiffness	1093			
turning parameter selection	1129			
vertical tool offset	1099			
vertical tool offset calculation	1100			
work hardening of titanium alloy	1128			
workpiece materials	1106			

Micrometer

into microinches	2672
reading	677

Index Terms**Links****Micrometer (*Cont.*)**

screw thread 1989

Micromist lubrication

benefits 1112

contact angle measurement 1115 1118

cutting fluids in micromachining 1111

drop size calculation 1115

drop size measurement 1113

sessile drop technique 1113 1115

slide technique 1114

dynamics of microdroplets 1118

force balancing microdroplets on tool 1119

in macrofacing 4140 Steel 1121

in micromilling 316L SS 1120

propelling microdroplets toward tool 1118

properties of selected lubricants 1115

safety 1112

selection of cutting fluid 1113

Microscope screw thread 1981

Mil 2661

Miles into kilometers 2674

Military plating specifications 1508

Mill or saw files 987

Miller index nomenclature 1109

Miller indices 1108

Millimeters

hundreds of, into inches 2665

into inches 3 2664 2670

thousandths of an inch, into 2668

Milling

angular 814 820

cam 2308

change gears for helical or spiral 2060

chip geometry 1162

Index Terms

Links

Milling (*Cont.*)

cost	1161	
cutters, hollow	1171	
depth of cut	1055	
economy	1168	
feeds for		
cemented carbide cutters	1043	
high-speed steel cutters	1053	
in inches per tooth for cemented carbide cutters	1043	
helical, change gears for different leads	2060	
horsepower for	1081	
lead angle	1055	1057
machine tool shanks	967	
short lead	2061	
speed adjustment factors	1055	
speeds and feeds		
aluminum alloys	1043	
automatic screw machine	1171	
copper alloys	1036	1054
ferrous cast metals	1051	
light metals	1043	
metal slitting (saws)	813	1042
plain carbon and alloy steels	1044	
stainless steels	1049	
titanium and titanium alloys	1037	
tool steels	1048	
thread	2058	
Milling cutters	808	
ANSI Standard	809	
arbor keys and keyways	831	
arbor type	827	
bevel gear	829	2185

Index Terms**Links****Milling cutters (*Cont.*)**

casting	1421	
clearance angles	808	837
commercial micromills	1122	1124
concave and convex	827	
corner rounding	812	827
double angle	814	
eccentric type radial relief	838	
end mills	816	
medium helix	825	
stub length	825	
terminology	815	
with weldon shanks	825	
gear	828	
grinding or sharpening	835	
hand of		
cut	809	
cutter	809	
flute helix	811	
rotation	810	
helical gear	2205	
high speed steel	819	
indicator drop methods of checking relief		
and rake angles	838	
keys and keyways	831	
keyseat	832	
metal slitting (saws)	813	
mounting method	809	
multiple flute	821	
number of teeth	808	
peripheral teeth	839	
pitch diameter	2205	
plain and ball end	822	
radial relief angle	839	

Index Terms

Links

Milling cutters (*Cont.*)

rake angles	808	838	
relief on cutting edges	809		
relieved corner rounding cutters	812		
roller chain sprocket	829		
selection of	808		
setting angles for milling teeth in	833		
sharpening wheels	836		
shell mills	815		
single angle	814	820	
sintered carbide	838		
speeds and feeds for sharpening	837		
spline shaft	836		
spur gear	828	2148	
taper and weldon shanks	812		
teeth, clearance angles	837		
terminology	813		
tool material	838		
T-slot	812		
weldon shanks	812	824	826
with taper shanks	821		
Woodruff keyseats	832		

Milling machine

Brown & Sharpe	2107		
centering plugs	965		
Cincinnati	2113		
cutters for 14.5-deg. pressure angle gears	828		
draw-in bolt ends	965		
indexing	2079		
lead of	2060		
spindle noses	962	966	
tapers for	962		
tool shanks	964		
V-flange, NC	967		

Index Terms**Links**

Miner's law of linear damage	203	
Mineral oil	2427	
Miniature end mills	820	
Miniature screw threads	1858	
basic thread form	1858	
design thread form	1858	
formulas	1858	
hole sizes	2032	
root flats	1862	
tapping	2032	
tolerances and size	1861	
Miniature screws	1653	
binding head	1653	
fillister head	1653	1657
flat head	1653	
pan head	1653	1657
Minors of a matrix	124	
Minutes into decimals of a degree	103	105
Miscellaneous threads, aero-thread	1986	
Mixed film lubrication	2421	
Mixed numbers	9	
Mixtures, rule of	384	
Modal, CNC G-codes	1284	
Module	2127	
splines, metric	2272	
system gearing	2217	
diametral pitch	2219	
formulas	2217	2219
rules	2219	
Modulus of		
elasticity, E (Young's modulus)	200	
for various materials	200	
iron and steel	432	
nickel-based alloy	308	

Index Terms**Links****Modulus of (Cont.)**

nonferrous metals	513		
of various materials	394		
perforated metal	2607		
plastics	390	557	561
spring materials	345		
elasticity, plastics	555		
polar section	209	244	
rupture			
powdered metal alloys	393		
wood	385		
secant	562		
shear, G (rigidity)	200		
for various materials	200	577	
in angular deflection formula	210		
nonferrous metals	513		
spring materials	346		
Mol	384		
Mold dispensable patterns	1419		
Molding			
green sand	1409		
shell	1410		
Molds, steels for permanent	455		
Molecular weight	384		
Molybdenum			
gearing material	2243		
high-speed steels			
chemical composition	499		
tool steels	446	448	451
steels, SAE	400		
Moment and torque			
in combined stresses	211		
in simple stresses	209		
unit conversion	2689		

Index Terms

Links

Moment of a force	149	155
Moments of inertia	232	
angles, steel	2600	
built-up sections	233	
channels, aluminum	2603	
channels, steel	2599	
circle	237	
circular ring	238	
cross-sections	234	
ellipse	238	
formulas for various sections	234	
half circle	237	
hollow circle	237	
I or S shapes, steel	2598	
I-beams, aluminum	2603	
I-beams, steel	2594	
I-section	238	
L-section	242	
octagon	237	
of complex areas	248	
pipe	2457	
plane areas	232	
polar	232	244
cone, frustum	248	
cylinder, hollow	246	
ellipsoid	247	
paraboloid	247	
prism	246	
pyramid	246	
solid ring	247	
sphere	246	
spherical sector and segment	247	
torus	247	
rectangles	235	249

Index Terms

Links

Moments of inertia (*Cont.*)

round shafts, table for	250	
structural channels	2599	2603
trapezoid	236	
triangle	236	
T-section	241	
units conversion	2699	
wide flange, steel	2594	
Z-section	243	
Momentum	184	
Monel metals, machining	1194	
properties	548	
Monotron for hardness testing	507	
Morse		
reamers for sockets	863	
stub taper shanks	948	
taper shank twist drill	893	
tapers	948	
Mortising wood	388	
Motion		
accelerated	177	179
constant acceleration	175	
constant velocity	175	
force and work	179	182
general formulas	175	177
constant acceleration	175	177
Newton		
first law	179	
second law	179	
third law	179	
on inclined plane	169	179
rotary, formulas	177	
uniformly accelerated	175	

Index Terms

Links

Motors, electric	2565
adjustable speed motors	2568
adjustable-voltage, shunt-wound	2569
alternating current	2569
armature rotors	2579
ball or roller bearings	2578
brushes	2578
characteristics	2568
classes of standards	2565
commutators	2578
compound-wound	2569
constant speed motors	2568
current definitions	2565
DC motors	2576
design letters	2565
direction of rotation	2567
frame sizes, standard	2565
high frequency induction	2571
horsepower requirements	2573
induction motor	2570
injurious operating conditions	2575
inspection schedule	2578
insulating materials	2575
locked rotor current and torque	
ratings	2566
lubrication, proper	2578
maintaining and repairing	2578
maintenance	2578
mechanical condition	2578
monthly inspection	2578
mounting dimensions, standard	2565
multiple speed induction	2571
multispeed motor	2568

Index Terms

Links

Motors, electric (*Cont.*)

NEMA	2565	
standards for	2565	
polyphase AC motor	2570	
polyphase wound-rotor	2566	
pull up torque	2566	2568
rotation, standard direction	2567	
rotors and armatures	2578	
selection	2573	
shunt-wound	2569	
single-phase motors characteristics	2572	
space limitations	2574	
speed reducer type	2573	
speed requirements	2573	
squirrel cage induction	2569	
squirrel cage rotors	2579	
synchronous motor	2570	
temperature effects	2575	
torque and inertia requirements	2573	
torque definitions	2567	
type, dc and ac	2568	
types and characteristics for different		
applications	2576	
variable speed	2567	
weekly inspection	2578	
windings	2578	
wound rotor induction	2571	
wound rotor type	2570	
Mounted wheels and points	976	
Mounting bearings	2390	
Multiple or block indexing	2117	
Multiplication of matrix	122	

Index Terms

Links

Multiplying

decimal fractions	10
fraction and mixed numbers	9
numbers written in powers-of-ten notation	15
Music wire	305
Music wire, gages	2604

N

N-address, CNC programming	1284
Nails and spikes, standard	1800
Napthenic oil	2427
National Tube Co.	294
Nautical measure	2661
Neat resins	552
Negative and positive numbers	4
Negative functions of angles	106
NEMA standards for electric motors	2565
Net present value	140
Neutral axis	
sheet metal	1347
Newton's laws of motion	179
Newton's laws of motion	151
Newton-Raphson method	34
Newtons into pounds force	2689
Nickel alloys	548
applications	548
chemical composition	548
chromium steels, SAE strength	432
coefficient of expansion	377
density	377
elongation	392
gearing material	2242
hardness	392

Index Terms**Links****Nickel alloys (*Cont.*)**

machining	1194	
melting points	377	
plating	1511	1513
specific heat	377	
tensile strength	392	548
thermal conductivity	377	
yield strength	392	
Nitinol, machining	1194	
Nitralloy steels	485	
Nitriding	467	485
high-speed steel tools	501	
ion nitriding	485	
Nitrogen, liquid temperature	631	
Nodular cast iron	1405	
Nomenclature		
bevel gears	2181	
gear teeth	2129	
spur gears	2130	
Nominal clearance	2255	
Nominal vs effective interest rates	135	
Nondestructive testing symbols	1485	
Nonferrous metals	513	
machining	1192	
modulus of elasticity	513	
modulus of shear	513	
shear strength	513	
strength	394	513
tensile strength	513	
yield strength	513	
Normal		
distribution curve	1319	
positional deviation	1319	

Index Terms

Links

Normalizing	408	
temperatures, alloy steel	490	
Norton Company	1219	1227
Nose radius	762	
carbide tools	774	
single point tool	774	
Number of nails and spikes in a pound	1800	
Number of teeth	2127	
Numbering systems		
for aluminum alloys	534	
for aluminum alloys, wrought	537	
for metals and alloys	398	400
for steel	398	
Numbers		
associative law	4	
commutative law	4	
distributive law	4	
identity law	4	
inverse law	4	
positive and negative	4	
powers-of-ten notation	14	16
preferred series	639	674
prime	20	
progressions	37	
Numerical control		
accuracy, repeatability, and resolution	1319	
axis nomenclature	1315	
cutter compensation	782	
insert holders for NC	782	
insert radius compensation	782	
part tolerance symbols		
ANSI	1324	
compared to ISO	612	

Index Terms**Links**Numerical control (*Cont.*)

repeatability, accuracy, and

resolution 1319

tapping 2038

tool

compensation 782

nose radius compensation 782

total indicator reading 1317

V-flange tool shanks 967

Nut taps 927

Nuts

acorn 1549

ANSI, inch dimensions

flat jam 1546

hex 1539

hex flat 1546

hex slotted 1546 1548

hex thick slotted 1547

jam 1545

machine screw 1643

square 1539 1548

T-type 1728

Unified 1545 1548

ANSI, metric dimensions

heavy hex 1605

hex jam 1605

hex, styles 2 and 3 1601

metric hex flange nuts 1601 1603

prevailing torque, hex 1604 1606

slotted hex 1601 1603

British Standard 1676

ISO metric 1630

metric 1666 1670

1672

1677

British Standard

Index Terms**Links****Nuts (*Cont.*)**

Unified	1678			
Whitworth	1627	1629	1679	1700
crown, low and high (SAE)	1549			
friction coefficients	1524			
high, SAE	1550			
slotted, high hex (SAE)	1550			
wing nuts	1791			
wrench clearances	1555			
wrench openings	1555			

Nylon

bearings	2361			
properties	390			

O

O-address, CNC programming	1284			
Obtuse-angle triangles solution	71	101		
Octagon				
area	72			
moment of inertia	237			
radius of gyration	237			
section modulus	237			
Offhand grinding	1268			
Offsets				
CNC milling	1292			
Ohm's law	2699			
Oil feeding and grooving of bearings	2325			
Oilless bearings	2363			
Oils	2420			
additive ingredients	2427			
additives	2427			
and compounds, machining	1182			
emulsifying or soluble	1183			
mineral	1185			

Index Terms

Links

Oils (*Cont.*)

sulfurized and chlorinated	1185	
application	2435	
coating	1512	
film thickness in machine parts	2423	
film thickness values	2423	
lubricating	2424	
mineral	2427	
synthetic	2429	
temperature effects	2430	
temperature oxidation effects	2430	
tempering	479	
Open end wrench clearances	1556	
Open-end press	1388	
Operations on complex numbers	18	
Orbit	1395	
Order of performing arithmetic	5	
O-ring	2587	
applications	2588	2590
compounds	2591	
diametral clearance	2590	
flurocarbon	2591	
gland depth	2588	
groove dimensions and clearances	2587	2590
hardness	2589	
nitrile	2591	
reciprocating seals	2588	
ring materials	2592	
silicon	2591	
squeeze	2587	
static seals	2588	
surface finish in contact with	2589	
tolerances	2590	
washers, backup	2588	

Index Terms

Links

Oscillation, center and radius of	231	
Ounces, avoirdupois, into grams	2683	
Out of roundness	690	
Oval head machine screws	1649	
Overhead		
machine-hour distribution	146	
man-hour distribution	146	
man-rate distribution	146	
Oxidation effects on oil	2430	
Oxygen gas in welding	1438	1463
P		
Pack hardening	485	
Packing		
in circles	88	
in circles and rectangles	88	
in rectangles	93	
PAG	2429	
Palladium, plating	1513	
Pan head machine screws	1648	
Pan head miniature screw	1654	1657
PAO	2429	
Paper, bonding	2582	
Pappus or Guldinus rules	66	
Parabola	54	
area	74	
center of gravity	224	
constructing	65	
directrix	54	
focus	54	
general equation	54	
latus rectum	54	
segment of area	75	
vertex	54	

Index Terms

Links

Paraboloid

center of gravity	226
polar moment of inertia	247
radius of gyration	231
segment volume	87
volume	86

Parallel bars 716

Airy points	720
calibration	
flatness (straightness)	720
height and width, matched sets	722
precision	720
Type I, solid	716
Type II, ribbed	717
Type III, box parallel	718
Type IV, adjustable parallel	719

Parallel lines 42

Parallelogram

area	70
center of gravity	221
geometry of	58
of forces	154
radius of gyration	228

Parison 581

Parraffinic oil 2427

Parting 1339

Passivation of copper 1506

Patterns for castings 1412

dispensable	1419
master mold	1419
materials	1412
metal	1413
shrinkage allowances	1413
varnish	1413

Index Terms**Links**

Patterns for castings (<i>Cont.</i>)		
weight of casting from	1414	
wood selection	1412	
Payback period	143	
Pearlite	465	469
Pearlitic malleable iron	1405	
Pebi	2658	
Pendulum	173	
calculations	173	
conical	173	
formulas for	173	
physical	173	
simple and compound	173	
torsional	173	
types of	173	
Penetration	1336	
Percentage	7	
Percussion, center of	231	
Perforated metals, strength and stiffness		
of	2607	
Peripheral speed, CNC spindle	1288	
Permanent mold, casting process	1410	
Permanickel, machining	1194	
Permutation	19	
Perpendicular lines	42	
Petroleum oils, application	2694	
Phenolic plastics	2361	
Philadelphia carriage bolt thread	1988	
Phonetic alphabet	2700	
Phosphor-bronze, worm gearing	2245	
Physical vapor deposition (PVD)	788	
Piano wire, working stresses	314	
at elevated temperatures	315	
Piles, weight of	382	

Index Terms

Links

Pillow block bearings	2373		
Pin method for checking			
gear sizes	2221		
allowance for backlash	2235		
for involute splines	2271		
wire diameters	2221	2230	
spur gear sizes	2231		
V-shaped grooves	686		
Pinion, spur gear			
enlarged to avoid undercut	2146		
Pins			
clevis	1747		
cotter	1746	1757	1760
dowel	1746		
grooved	1756	1760	
metric dowel	1746	1748	
spring	1761		
straight	1751		
strength of taper	220		
taper	1753		
Pintle chains	2537		
Pipe and pipe fittings			
British threads	1966		
columns	286		
dryseal	1962		
measuring by wire method	2005		
taper	1956		
threads	1962		
heat loss from uncovered steam	373		
internal thread in pipe couplings	1960		
loads, table of	286		
plastics			
threads	578		
reamers, taper	864		

Index Terms

Links

Pipe and pipe fittings (*Cont.*)

sealing joints	1730
taps, dimensions	
Briggs and Whitworth	2037
internal dryseal	1964
power for driving	2037
threads	
American National Standard	1956
British Standard	1965
designation and notation	1956
welding	1469
fill passes	1471
flux cored electrode	1472
fusion	1472
position	1470
flat	1470
horizontal	1470
overhead	1470
vertical up and down	1471
procedure	1473
carbon steel	1473
MIG	1473
root	1473
thick walled	1473
root passes	1470
thin wall	1472
Pipe and tube bending	1382
Pitch	2127
broach teeth	979
circle	2127
circular, of gears	2130
diameters, gears	
circular pitch	2148
helical	2195

Index Terms

Links

Pitch (Cont.)

pin method of checking	2221	
spur	2131	2148
worms	2191	
diameters, roller chain sprockets	2543	
diameters, thread		
diameters, thread		
checking	1989	
for tensile stress area	1528	
metric, M profile	1890	
unified	1813	
wire sizes for measuring	1991	
diameters, thread unified	1817	
gear	2131	
plane	2127	
rivets	1729	1733
screw threads, measuring	1989	
worm gearing	2191	
worms	2191	
Pitot tube	2682	
Plain bearing (<i>see</i> Bearings: plain)		
Plain milling cutters	810	
Plain washers		
inch	1562	
metric	1607	
types	1607	
Plane figures, areas and dimensions	70	
Plane of rotation	2127	
Planetary gearing	2211	
bevel gears	2211	
compound drive	2211	
direction of rotations	2211	
Planetary thread milling	2059	

Index Terms

Links

Planing

estimating cutting speeds	1081
power required	1083
speeds and feeds	1081
time	1081
tool grinding	764
wood	388

Planing insert holder	770
------------------------------	-----

Plastic deformation	1336
----------------------------	------

Plasticizers	553
---------------------	-----

Plastics	551
-----------------	-----

aging at elevated temperature	571
amorphous	552
anisotropy	556
application properties	554
assembly	597
assembly with fasteners	597
ASTM tests	554
beams	588
bearings	2372
anti-friction	2372
laminated, plain bearings	2361
sleeve	2361
bending stress	606
blow molding	581
bonding	593
brittleness	556
cellular	553
characteristics	551
chemical bonding	593
chemical resistance of	575
closed cell	553
coefficient of expansion	390
coefficient of friction	557

Index Terms**Links****Plastics (Cont.)**

compressive strength	566	
creep	558	569
crystalline	552	
density	390	554
design		
analysis	575	
for assembly	593	
for injection molding	579	
stress	577	
developing prototypes	602	
drilling speeds and feeds	601	
effects of temperature	570	
elasticity	555	562
electrical properties	572	
conductivity	572	
elongation	390	
environmental effects	574	
fasteners	597	
fibers	553	
fillets	591	
flexural modulus	390	
flow properties	592	
gearing	604	
accuracy	607	
backlash	606	
service factors	606	
tooth form factors	605	
hardness	390	556
haze	555	
heat dissipation factor	573	
heterogeneous	556	
homogeneous	556	
homopolymers	553	

Index Terms

Links

Plastics (*Cont.*)

Hooke's law	555	
impact resistance	592	
inhomogeneous	556	
injection mold design	585	
injection molding	584	
isotropy	556	
izod impact	390	
Izod test	556	
LCP	552	
Liquid-crystalline Polymers	552	
load-bearing	588	
machining	598	
cutting off	600	
drilling	600	
molded	602	
sawing thermoset cast	602	
tapping	601	
threading	601	
turning	600	
manufacturing	579	
material	551	
elastomers	552	
thermoplastic	552	
maximum temperature	390	
mechanical fasteners	593	
mechanical properties	575	
effect of temperature on	570	
milling	602	
mixtures copolymers	553	
modulus of elasticity	555	561
mold flow	592	
non newtonian	592	
normal strain	561	

Index Terms

Links

Plastics (*Cont.*)

notch sensitivity	556	
open cell	553	
parison	581	
physical properties	554	557
pipe threads	578	
plasticity	555	
polyurethanes	583	
press fits	577	
processing thermosets	581	
proportional limit	562	
PUR	583	
region	200	
reinforced	583	
relaxation	569	
resins	552	
sawing, speeds and numbers of teeth	602	
secant modulus	562	
shear modulus of G	565	
shear stress	563	
sheet thermoforming	581	
shrinkage	555	
snap-fit	593	
specific gravity	390	554
sprue	584	
stiffness	579	
stress	559	
normal	560	
stress relaxation	569	
stresses and deflections	588	
structural analysis	575	
safety factors	575	
structures	552	
temperature index	571	

Index Terms**Links****Plastics (Cont.)**

tensile impact	570	
tensile modulus	390	
thermal properties	570	
thermal stresses	578	
thermoplastic	551	
thermosetting	551	
toughness	556	
transparency	555	
ultimate strength	562	
undercuts	591	
viscoelastic	557	
wall thickness	587	
water absorption	555	
welding	595	
dielectric	597	
electromagnetic	597	
hot gas	596	
induction	597	
spin	596	
vibration	596	
yield point	555	562
Plates		
flat, strength and deflection of	288	
shells and cylinders, strength of	288	
Plating	1508	
chromium	1467	
magnesium anodic treatment	1510	
magnesium, coating	1510	
phosphate coating	1513	
surface coatings	1508	
zinc	1515	
Plow steel haulage rope, strength of	2616	
Plunge angle	770	

Index Terms**Links**

Poise	2425	2698	
Poisson's ratio	200		
flat plates	288		
for various materials	200	290	394
perforated metal	2607		
plastics	562		
Polar coordinates	43		
Polar moment of inertia	232	244	250
cone	248		
frustum	248		
cylinder, hollow	246		
ellipsoid	247		
formulas	246		
masses	232		
paraboloid	247		
plane areas	232		
prism	246		
pyramid	246		
solid ring	247		
spherical sector	247		
spherical segment	247		
torus	247		
Polar section modulus	244	250	
Polishers, spindles for portable	974		
Polishing and buffing	1501		
abrasives	1501	1504	
operations	1504		
speeds	1504		
wheels, material	1501		
Polyalkylene glycols	2429		
Poly-alpha-olefins	2429		
Polygon			
area	72	76	
forces	154		

Index Terms

Links

Polygon (*Cont.*)

formulas and table	76	
length of side	76	
radius of circumscribed circle	76	
radius of inscribed circle	72	76
Polygon shafts	2282	
connections	2282	
dimensions of	2282	
manufacturing	2283	
strength of connections	2283	
three- and four-sided designs	2282	
Polyol-Esters	2430	
Polyphase motors	2567	2570
Polyurethane plastics	2591	
Polyurethanes	583	
Porosity, pressure die castings	1414	
Porous bearings	2361	
Portable grinding	1268	
safety	1249	
Portable tools		
hexagonal chucks for	975	
spindles and drives for	972	
Positional deviation, mean	1319	
Positioning accuracy	1319	
Positive and negative numbers	4	
Positive clutches	2451	
Positive functions of angles	106	
Potential energy	181	
Poundal	2690	
Pounds		
force	150	
force into newtons	2689	
mass	151	
per cubic foot into kilograms per cubic meter	2685	

Index Terms

Links

Pounds (*Cont.*)

per cubic inch into grams per cubic
centimeter 2685

per square foot into kilograms per square
meter 2687

per square inch into kilograms per square
centimeter 2687

per square inch into kilopascals 2687

Powder metallurgy 1423

briquetting tools 1423

design 1423

limiting factors 1423

metal process 1423

Powdered metal alloys

copper base 393

density 393

elongation 393

hardness 393

iron base 393

tungsten base 393

Powdered metal bearings 2361

Power

calculating by dynamometer 2457

consumption spade drilling 1079

cutting tool 1085

feed factors 1084

for driving pipe taps 2038

general formulas 186

heat equivalents 2690

in mechanics 149

motor 1085

required for machining 1083

roots of numbers 14

Index Terms**Links****Power (Cont.)**

transmission

belting

2487

by friction wheels

2458

capacity

2246

2447

chain

2547

disc clutch

2447

friction wheels

2457

units conversion

2693

Power brush

brush finishing

1500

brush uses

1500

deburring

1500

deburring tooth profile of gears

1500

Power constant

alloy steels

1085

high temperature alloys

1084

nonferrous metals

1084

plain carbon steels

1085

stainless steel

1084

tool steels

1084

wrought steels

1085

Power of ten notation

14

16

expressing numbers in

15

Power transmission

roller chain

2537

Precipitation

hardening

462

heat-treatment

542

Precision

bolts and screws, British

1627

1634

gage blocks

707

investment casting

1418

Index Terms

Links

Preferred

basic sizes, ANSI Standard	673		
hole basis metric fits, ANSI Standard	652	656	
metric sizes			
ANSI Standard	648	673	2610
British Standard	674		
numbers, ANSI Standard	672		
numbers, British Standard	674		
roughness average values (Ra)	743		
roughness values and roughness			
grades	751		
series for tolerances and allowances	635		
series maximum waviness height			
values	744		
shaft basis metric fits, ANSI Standard	651	657	
thicknesses for			
flat metal products, metric	2610		
uncoated metals and alloys	2608		
Preload measurements	1525		
Preload relaxation	1525		
Preparatory command, CNC	1284		
Present value and discount	136		
Press			
adjustable-bed	1388		
bending	1383		
gap-frame	1388		
hydraulic	1389		
inclinable-frame	1388		
lubrication	1372		
mechanical	1386		
mechanical vs. hydraulic			
advantages, disadvantages	1390		
open-end	1388		
selection	1392		

Index Terms

Links

Press (*Cont.*)

sheet metal working	1386
solid-frame	1388
straight side	1389

Pressure

angle	2128
angle, cams	2293
composite checking of fine-pitch gears	2169
cylinders and tubes, collapsing pressure	293
definition and units for	152
effect on wood property	386
Lame's formula for internal spherical shells, strength to resist internal	291
tight joints	1960
tube, collapsing pressure	294
unit conversion	2686

Prime numbers and factors	20
----------------------------------	----

Principle reference planes	2128
-----------------------------------	------

Prism

polar moment of inertia	246
volume	82
volume formula	66

Prismoidal formula for volume	66
--------------------------------------	----

Processing thermosets	581
------------------------------	-----

Production rate	1147
------------------------	------

Profile checking, gearing	2158
----------------------------------	------

Progression

arithmetical	37
geometrical	37

Prony brake dynamometer	2457
--------------------------------	------

Index Terms

Links

Properties

mechanical	199	394	
compressive	201		
definitions	199		
fatigue	201		
modulus of elasticity values	200		
perforated metal	2607		
Poisson's ratio values	200		
shear	201		
strength	394	422	
thermal	372	395	
yield point values	200		
of materials			
aluminum alloys	530		
copper alloys	513		
copper-zinc-tin alloys	394		
magnesium alloys	545		
metals	394		
nickel alloys	548		
nonferrous alloys	513		
plastics	390		
powdered metal alloys	393		
specific gravity	381		
spring wire	395		
standard steels	396	418	422
titanium alloys	548	550	
tool steels	448	459	
wood	387		
strength effect of heat or temperature	570		

Proportion

compound	5		
inverse	6		
simple	6		

Index Terms

Links

Proportional limit	199	
plastics	562	
Protractor, reading vernier scale on	675	
Providing backlash	2166	
PTFE plastics	2361	2585
Pulley		
speeds, rpm into feet per minute	1015	
taps	927	
Pulleys and belts		
and belt drives	170	
and wheels in mechanics	170	
arc of contact correction factors	2495	
center distances, V-belt	2487	
center to center distance	2484	
cross section correction factors	2494	
diameter and speeds	2485	
diameter in compound drives	2485	
differential	171	
flat belt	2484	2487
length correction factors	2495	
length of belt traversing three pulleys	2486	
lengths of open and crossed belts	2484	
lengths of V-belt	2490	
rules for calculating diameters and speeds	2484	
sheave size	2493	
speed in compound drive	2486	
speed ratio correction factors	2494	
speeds, rpm into feet per minute	2039	
V-belt	2484	
wrap angles	2484	
Pull-up torque	2566	
Punching and blanking	1339	
deformation force	1342	

Index Terms

Links

Punching and blanking (*Cont.*)

deformation work 1342

force of press 1342

PUR 583

Pyramid

center of gravity 225

frustum center of gravity 225

polar moment of inertia 246

volume 82

volume of frustum 83

Q

Quadrant 106

Quadratic equations 32

Quenching 407

baths 477

tanks for 476

high speed steel 498

induction heating 489

interrupted 476

media 466

self 489

tungsten 498

air cooling 498

salt bath 498

R

Rack 2128

gear 2132

milling, indexing 2120

spline, metric 2277

Radial forming 1371

Radian per second conversion from rpm 177

Index Terms**Links**

Radians equivalent to degrees	103	105
Radius		
of arc, checking	686	
of curvature	2299	
of gyration	228	231
angles, steel	2600	
bar of small diameter	228	
bar, small diameter	228	
channels, aluminum	2603	
channels, steel	2599	
circle	237	
circular disk, thin	229	
circular ring	238	
circular ring, thin flat	229	
cone	230	
cone, frustum	230	
cylinder	229	
cylinder, hollow	230	
ellipse	238	
ellipsoid	231	
flat plate, thin	228	
half circle	237	
hexagon	236	
hollow circle	237	
hollow cylinder, thin	230	
hollow sphere	231	
I-beams	2594	
I-beams, aluminum	2603	
I-section	238	
L-section	242	
octagon	237	
paraboloid	231	
parallelepiped	229	
parallelogram	228	

Index Terms

Links

Radius (*Cont.*)

prism, rectangular	230	
rectangle	235	249
ring	228	
S- or W-shape, steel	2598	
sphere	231	
sphere, hollow	231	
spherical shell, thin	231	
structural angles	2600	
thin flat plate	228	
thin spherical shell	231	
trapezoid	236	
triangle	236	
T-section	241	
various cross-sections	234	
wide flange, steel	2594	
Z-section	243	
of oscillation	231	
Rails		
size to carry given load	277	
strength of	277	
Rake angles	761	
checking milling cutter	838	
single-point cutting tools		
single-point cutting tools		
lead angles	761	
turning tool	758	
Ram tube bending	1385	
Rank of a matrix	125	
Rankine's formulas for columns	281	283
Rankine, temperature	2695	
Rasps	989	
aluminum	989	

Index Terms

Links

Ratchet gearing	2215			
frictional	2216			
multiple pawl	2216			
pitch of wheel teeth	2216			
reversing	2216			
shape of wheel teeth	2216			
types	2215			
Rate of return (interest)	135	143		
Ratio	5			
and proportion	5			
compound	5			
contact, in gearing	2151			
epicyclic gearing	2211			
fractional, change gears for	2043			
gear for differential indexing	2104			
geometrical	37			
inverse or reciprocal	5			
mean proportional	6			
of volumes	87			
Poisson's	200			
slenderness, columns	281			
Ream, paper	2699			
Reamer				
bull center	863			
center	863			
Reamers	844			
ANSI Standard	844			
arbors for shell	862			
Brown & Sharpe taper socket	864			
center and countersink	851			
centers for	851			
chucking	846	849	853	858
straight flutes	858			
definition	847			

Index Terms

Links

Reamers (*Cont.*)

die-maker's	865	
drills for taper pin	1754	
driving slots and lugs	857	
expansion chucking	854	
expansion hand	856	
finishing	863	
fluting cutters	845	
dimension	846	
fluting to obtain negative rake	844	
formed	846	
hand	845	855
squared shank	856	
straight and helical flutes	855	
helical flutes	862	
jobbers	857	
letter sizes	859	
machine countersinks	852	
morse taper socket	863	
negative front rake	844	
pipe	864	
rose chucking	846	860
straight and helical flutes	860	
shell	857	861
straight and helical flutes	853	861
straight flutes	857	
straight shank	852	
stub screw machine	859	862
taper pin	865	
taper pin reamers, drills for	1753	1756
taper pipe	864	
taper shank	853	
taper, milling teeth	833	
terms applying to	847	

Index Terms

Links

drills for taper pin (*Cont.*)

threaded end	845
dimension	845
tooth-rest position for grinding	
clearance	847
wire gage sizes	858

Reaming

automatic screw machines	1171
cutting speeds for	
copper alloys	1071
ferrous cast metals	1067
light metals	1069
stainless steels	1066
tool steels	1065
difficulties	852
bellmouth holes	852
oversize holes	852
poor finish	853
taper pin	1755

Rearrangement of terms in formulas 30

Recalescence point in steel hardening 461 470

Recessing tools, speeds 1171

Reciprocals of numbers 5 8

Rectangle

area	70
moment of inertia	235 249
radius of gyration	235 249
section modulus	235 249
table of section moduli	250

Rectangular

coordinates	43
cylindrical coordinates	45
spherical coordinates, relationship	44

Rectangular keys 2460

Index Terms**Links**

Refrigeration of steel	504	
Reinforced plastics	583	
Relative density	380	
Relief and rake angles		
for single-point cutting tools	760	2040
indicator drop method of checking	838	
Relief angles		
for single-point cutting tools	760	
turning tool	758	
Repeatability, accuracy, and resolution	1319	
Replacement-gear dimensions	2249	
Resinoid bonded wheels	1000	1217
thread grinding	2053	
Resins	552	
Resistance brazing	1431	
Retaining rings	1763	
ANSI Standard	1763	
centrifugal capacity	1787	
compressed in bore	1769	
diameter tolerances	1781	
dimensions in inches	1780	1783
expanded over shaft	1767	
external dimensions	1784	1787
external series	1763	
external spiral	1774	1778
failure of	1781	1788
groove bottom radii	1764	
groove design and machining	1785	1789
groove diameter	1764	
groove diameter tolerances	1782	
groove failure	1788	
groove width	1764	
groove width tolerances	1782	
industrial	1786	

Index Terms**Links****Retaining rings (Cont.)**

internal	1787		
internal spiral	1772	1776	
load capacity	1779		
material	1779		
metric performance data	1767		
ring free diameter	1764		
rotation between parts	1788		
seated in groove	1767	1769	1771
selection	1763		
self locking dimensions	1786		
self locking external and internal	1787		
self locking inch series	1787		
self locking types	1786		
spiral	1774		
standards	1787		
tapered	1763		
thickness	1775	1779	
thickness tolerances	1775	1779	1781
thrust load capacities	1785		
thrust load safety factors	1784		
width capacity	1781		
Retarded motion	175		
Retention knobs,			
V-flange tool shanks	967		
Reyn	2425	2698	
Rhodium plating	1514		
Right angle plate	723		
calibration and maintenance	728		
flatness calibration	729		
parallelism calibration	729		
squareness calibration	730		
grades	723		

Index Terms

Links

Right angle plate (*Cont.*)

types	726
Type I	
Class 1, plain	726
Class 2, slotted	726
Class 3, measuring plane	726
Type II, inside right angle	726
Type III, universal	727
Type IV, machinist's adjustable	727
Type V, toolmaker's adjustable	728
Type VI, toolmaker's non-adjustable	728

Right-angle triangles solution	71	98
--------------------------------	----	----

Rigidity

modulus of (shear)	200
spring materials	344

Ring

area and volume	66
radius of gyration	228
solid	
polar moment of inertia	247
stresses in loaded	219

Rivet

allowable stresses	1731	
ANSI Standard	1734	
belt	1736	
British Standard	1742	1745
cold forged	1742	
hot forged	1742	
lengths	1742	
snap head	1742	
universal head	1742	
button head	1734	1736
cone head	1734	
cooper's	1736	

Index Terms

Links

Rivet (*Cont.*)

countersunk	1734	1742
diameters for given plate thicknesses	1729	
dimension countersunk head	1745	
dimension snap head	1745	
excess length to form head	1734	
flat head	1736	1742
hold-on or dolly bar sets	1734	
large rivets, standard	1734	
material	1730	
mushroom head	1742	
pan head	1734	1736
pitch	1729	1733
sets, dimensions of impressions in	1734	
shearing strength	1733	
small rivets, standard	1734	
spacing	1729	
steel	1730	
strength	1730	
tinner's	1736	
truss	1736	
types	1729	
Riveted joints	1729	
allowable stresses	1730	
double and triple	1733	
efficiency	1730	
failure	1730	
holes for	1729	
joint failure	1730	
joint strength	1730	
rivet length for forming heads	1734	
rivet materials	1730	
strength	1731	
types of riveted joints	1729	

Index Terms

Links

Riveted joints (*Cont.*)

working strength 1730

Rockwell hardness

conversion to Brinell hardness 508

number 510

scales 506

Rod gages 2604

Roebing wire gage 2604

Roll pipe and tube bending 1385

Rolled threads, electric socket and lamp

base 1980

Roller bearing (*see* Bearings: roller)

Roller chain, double pitch 2538

Rolling

contact bearings 2365

friction resistance 167

Rolling screw threads 2048

cylindrical die machines 2048

diameter of blank 2049

diameter of threading roll 2050

flat die machines 2048

in automatic screw machines 2050

shapes and kind of thread 2050

speeds, and feeds 2051

steels for 2049

Root diameter gearing 2128

Roots

and powers of numbers 14

finding square and cube 14

Rope

wire 2613

definitions of terms 2613

strength and properties 2616

Index Terms

Links

Rose chucking reamers	846	
fractional sizes	860	
Rotary draw bending	1384	
Rotary file or burs	989	
Rotary motion formulas	177	
Rotating parts, balancing	191	
Roughness		
control of	733	
cutoff	743	
height values	735	
parameters		
rules for determining	751	
rules for measurement of	751	
symbols indicating degree of	733	
values, grades, surface finish	751	
Round head machine screws	1652	
Royal Microscopical Society thread	1982	1985
Rpm		
conversion to radian per second	177	
for various cutting speeds and diameters,		
inch units	1017	
metric units	1019	
for various grinding speeds and		
diameters	1250	
Rubber		
bearings	2362	
bonded grinding wheels	1217	
bonding	2581	
turning	1081	
Rubber pad forming process	1364	
Running balance	191	
Rupture strength		
copper-base powdered alloys	393	
iron-base powdered alloys	393	

Index Terms**Links****Rupture strength (*Cont.*)**

tungsten-base powdered alloys 393

S**SAE Standards**

babbitt metals 2359

bearing metals 2359

crown or acorn nuts 1549

die casting alloys 1415

high nuts 1550

V-belts 2525

Woodruff keyseat cutters 832

SAE steels

basic numbering system 398

compositions 398 400 404

heat treatments for 490

Safe loads for wire rope 2616

Safety

factors of 204 2174

flange couplings 2443

for wire rope 2619

Salt baths for heat treating 474

Sand blast cleaning 1412

Sanders, spindles for portable 974

Sanding wood 388

Sandstone and limestone, strength 394

Saw tooth clutches 2453

Saws

band 1177

circular, arbors for 972

metal-cutting, speeds 1081

metal-slitting 813

sharpening files 987

slitting 813

Index Terms**Links**

Saybolt Universal Seconds (SUS)	2425	
Scalar and vector quantities	153	
Sceroscope	506	
Screw machines		
automatic	1170	
automatic box-tools	1171	
drilling speeds and feeds	1171	
drills	872	879
forming tools with rake	796	
knurling	1170	
reaming speeds and feeds	1171	
speeds and feeds	1171	
stock required for given production	1175	
threading cams	1170	
Screw thread insert taps	1625	
Screw thread Inserts		
chemical composition	1617	
compatibility	1613	
dimensions	1613	
hardness	1625	
helical coil	1613	
helical coil insert	1614	
insert length data	1617	
inspection	1617	
length selection	1624	
material strength	1624	
tapped hole	1613	
taps	1625	
threaded hole data	1615	
tolerance classes	1613	
types	1613	
Screws		
and bolts	1538	
angularity and eccentricity	1635	

Index Terms**Links****Screws (Cont.)**

ANSI head recesses	1704			
breaking load	1537			
British Standard				
BSF	1679			
inch	1626	1666	1694	
metric	1634	1666	1694	
Unified	1676	1678		
Whitworth	1626	1629	1679	1700
cap	1542	1680		
cap, metric	1582			
drive	1701	1716		
force for turning	171			
form	1635			
grade markings for steel	1534			
head recesses	1704			
heavy hex	1542			
hex cap	1539			
inserts	1716			
jig and fixture				
button head	1698			
heavy hex	1542			
hex	1539			
lag screw	1543			
metric	1586			
length of engagement	1536			
length of thread	1635			
mechanical principle of	171			
metric				
British Standard	1675			
cap	1582			
diameters	1584			
flange	1588			
formed	1583			

Index Terms**Links****Screws (Cont.)**

heavy hex	1584	
ISO	1631	
reduced body diameter	1585	
shoulder		
socket head	1587	
socket	1694	
miniature	1653	
self-threading	1701	
set	1687	
shoulder	1686	
shoulder, metric	1587	
sockets for	1689	
sockets metric series	1696	
strength of	1535	
stress areas	1528	1536
tap drills	2029	
tap marking symbols	908	
thumb	1795	1798
Unified Standard	1538	1678
wing	1795	
wood	1801	
worm threads	2191	
Sealants	2584	
anaerobic pipe	2586	
gasket materials	2585	
pipe joining	2584	
silicone rubber gasketing	2585	
tapered pipe threading	2585	
types	2584	
Sealing bearings	2319	
Seasoning steel, sub zero	505	
Secant95		
Secant modulus (plastics)	562	

Index Terms

Links

Section lining, standard for drawings	611		
Section modulus			
angles	2600		
circle	237		
circular ring	238		
ellipse	238		
for torsion	279		
formulas for various sections	234		
half circle	237		
hexagon	236		
hollow circle	237		
I-beams	2594		
I-section	238		
L-section	242		
octagon	237		
polar	244	250	
rectangle	235	249	
rectangles, table for	249		
round shafts, table for	250		
structural shapes			
angles, steel	2602		
channels, aluminum	2603		
I-beams or S-shapes			
aluminum	2603		
steel	2598		
wide flange, steel	2594		
steel	2599		
trapezoid	236		
triangle	236		
T-section	241		
units conversion	2699		
Z-section	243		
Segment, circular	73	77	
area	46	73	78

Index Terms

Links

Segment, circular (*Cont.*)

height for given angle and radius 73 77

Self alignment roller bearings

symbols 2368

Self locking torque 1623

Self-threading screws 1701

countersink heads 1701

cross recesses 1704

designations 1702

drill size 1712

drilled hole sizes 1710

drive type 1701

extruded hole sizes 1710

fillister head 1702

head cross recesses 1704

hex head 1702

hex washer head 1702

hole sizes 1709 1712

inch, metric 1716

metallic drive 1702

metals

brass sheet metal 1712

monel steel 1712

stainless steel 1712

steel 1712

metric 1716

clearance holes 1721

cutting tapping 1718

designations 1717

drilled hole sizes 1722 1724

extruded hole sizes 1721

head types 1716

heat treatment 1720

hole sizes for steel 1721

Index Terms

Links

Self-threading screws (*Cont.*)

hole sizes for tapping	1721		
material	1720		
punched hole size for steel	1722	1724	
recommended lengths	1719		
tapping	1721		
thread and point types	1717		
thread cutting types	1716		
tapping	1718		
thread forming	1718		
tapping	1722		
types	1716		
thread tapping			
in asbestos	1723		
in cast metals	1724		
in plastics	1723	1725	
in plywoods	1723		
in sheet metal	1724		
pan head	1702		
round head	1701		
self-tapping inserts	1716		
sheet metal hole sizes	1712		
slotted pan head	1702		
steel thread cutting	1713		
thread and point			
dimensions	1705		
types	1703		
thread cutting	1708		
sheet metals	1712		
tapping	1704		
types	1701	1704	1706
thread forming	1705	1709	
types	1703		
torsional strength requirements	1716		

Index Terms**Links****Self-threading screws (*Cont.*)**

truss head 1702

types of 1701

Sellers screw thread 1988**Sensitivity factor, gear material** 2174**Series, infinite** 35 110**Set-screws****British Standard**

metric 1694

Whitworth 1700

cone point 1687

cup point 1687

dog point 1687

flat point 1687

headless 1687

hexagon and spline 1688

hexagon socket 1694 1697 1699

hexagon socket type 1699

holding power 1699

oval point 1687

spline socket type 1693

square head type 1690 1700

Sevolute functions 110**Shaft alignment** 2622

dial indicators 2623

indicator formats 2633

procedure 2628

rim and face method 2623 2629 2633

soft legs 2625

tolerance guide 2622

Shaft conditions

checking 688

out of roundness 692

no. of lobes 692

Index Terms**Links****Shaft conditions (*Cont.*)**

V-block angles 692

out-of-roundness, lobing 690

Shafts 295

allowances and tolerances for fits 628

British Standard for fits 662

brittle materials, formulas for 301

checking for various conditions of 688

critical speeds of 302

deflection, linear 298

deflection, torsional 297

effect of keyways on strength 301

factor of safety 296 301

hollow 303

horsepower transmitted by 295

linear deflection 298

maximum allowable working stress 301

moment of inertia, polar 244 250

polygon type connections 2282

round, section moduli 250

steel, diameters of 299

strength 295

torsional

deflection 297

strength 295

hollow vs. solid 303

transmission, design of 299

Shanks taper 948**Shapes**

of grinding wheels 1219

of mounted wheels and points 976

Shaping wood 388**Shaping, speeds and feeds 1081****Sharp V-thread 1806**

Index Terms**Links****Sharpening**

carbide tools	1000	
circular saws	987	
diamond wheels for	1001	
drills	998	
milling cutters	832	836

Shaving

blanked workpiece	1346	
punched workpiece	1345	

Shear

formulas for	209	
modulus	200	
of G spring materials	344	
of various materials	200	394
properties	201	
spring design	346	
stress	199	210
combined with tension or		
compression	211	
in beams	211	

Shear spinning	1363	
----------------	------	--

Shear strength

cast iron	432	
magnesium alloys	547	
nonferrous metals	513	
rivets	1733	
steels	432	
wood	386	
wrought iron	432	

Shear tooth files	989	
-------------------	-----	--

Shearing

clearance	1338	
cutoff and parting	1338	
forces	1336	

Index Terms

Links

Shearing (*Cont.*)

fracture	1336
parting	1339
rotary cutters	1337
straight inclined blades	1337
straight parallel blades	1336
with rotary cutters	1337

Sheaves

for V-belt drives	2489	
for wire rope	349	2614

Sheet metal

	1331		
and wire gages	2608		
bending	1346		
allowances	1347	1352	1358
formula	1347	1351	
formulas	1347	1351	
radius	1346		
maximum	1347		
minimum	1347		
springback	1351		
blanking and punching	1339		
clearances	1335	1340	
cutoff	1338		
deep drawing	1353		
designing parts for production	1334		
die opening profile	1342		
drawing	1353		
edging process	1373		
fine blanking	1343		
forming	1371		
ironing force	1360		
ironing process	1360		
joining and edging	1373		
joining process	1373		

Index Terms

Links

Sheet metal (*Cont.*)

joint types

joint types

angle frame 1377

button punch snap lock 1375

clinch bar slip and angle 1377

clinch type flanged connections 1377

corner standing seam 1375

double flanges and cleats 1377

double seam 1375

flange 1375

flange and flange corner 1374

flanged duct connections 1377

flanged end and angle 1377

flat drive slip 1376

flat S slip 1376

flush lap 1374

formed flanges 1377

groove seam 1375

hem 1376

hemmed S slip 1376

pittsburg 1375

plain lap 1374

raw and flange corner 1374

slide corner 1375

standing drive slip 1376

standing seam 1374

joints 1374

neutral axis 1347

parting 1338

punching 1339

screws 1701

shaving 1345

shearing

Index Terms**Links****Sheet metal (*Cont.*)**

inclined blades	1337		
rotary cutters	1337		
springback	1351		
stock allowances	1348		
stress	1331		
stripper force	1343		
theory of metalworking	1331		
work and force	1342		
Sheet sizes for drawings	609		
Sheet steel			
bending	1347	1351	
Sheet thermoforming	581		
Shell			
blanks, diameters	1355		
mills	815		
molding	1410		
plates and cylinders, strength	288		
reamers	861		
Shielded metal arc welding (SMAW)	1449		
Shielding gases	1437		
Shipping measure	2678		
Shock-resisting			
tool steels	453		
chemical composition	455		
heat treatment	455		
Shocks, stresses in springs	279		
stresses produced by	279		
Shore's scleroscope	506	508	
Shoulder screws	1686		
Shrinkage allowance, patterns	1413		
Shrinkage fits	631	638	646
allowances	631		

Index Terms

Links

SI system units

binary prefixes	2658			
factors and prefixes	2658			
history	2656			
in strength of materials calculations	199	209	214	217
	228	232	256	269
	273	276	279	282
	289	296	300	
list of	2658			
metric	151			
use of in mechanics	149			
Side cutting edge	762			
Side milling cutters	811			
Sigma (standard deviation)	1320			
Significance of accuracy	1319			
Signs and abbreviations				
mathematical	2654			
scientific and engineering	2652			
Signs of trigonometric functions	96			
Silicon carbide grinding wheels	1000			
Silicone	2430			
Silver				
bearing material	2360			
brazing filler alloys	1426			
plating	1514			
Simple				
indexing	2107			
proportion	6			
stresses	209			
Simpson's rule	67			
Simultaneous equations	125			
Sine bar				
checking angle	679			
checking taper per foot	680			

Index Terms

Links

Sine bar (*Cont.*)

checking templets	680	
measuring angle of templet	679	
settling to a given angle	679	
settling 10- inch to an angle	680	
types of	678	
use of	678	
Sine, law of	96	
Single tooth contact	2127	
Single-angle milling cutters	814	820
Single-point cutting tools	757	899
angle tolerances	780	
carbide tips and inserts for	772	
chipbreakers	763	
definitions and terms	757	
end cutting edge angles	762	
indexable inserts	764	
insert toolholders	764	782
lead angles	762	
nose radius	762	779
numerical control		
tool compensation	782	
planing tools	764	
rake angles	761	
relief angles	760	
relief angles for thread cutting	2040	
side cutting edge angle	762	
tip overhang	773	
tool contour	757	
tool holders, indexable inserts	764	
Single-station dies	1378	
Singularity of a matrix	125	
Sinking funds	137	

Index Terms**Links****Sintered**

carbide tools		
ANSI Standard	772	
tool materials	1009	
gear materials	2243	
metal bearings	2361	
Sixty (60)-degree stub threads	1942	
Size factor cover	2174	
Sizes of sawn lumber	388	
Slate cutting speed for	1081	
Sleeve bearings	2325	
Sleeves, Morse taper	957	
Slenderness ratio, columns	281	
Slides, measuring	682	686
Slipping clutches, couplings	2450	
Slitting saws, metal	813	
Slope of a line	41	
Slots for T-bolts, ANSI Standard	1726	
Slug	150	
S-N diagrams	201	203
Socket		
ANSI hexagon and spline	1689	
head, screw type		
British Standard metric	1694	
cap	1682	1695
drill and counterbore sizes for	1683	
keys and bits for	1692	
set	1699	
shoulder	1686	
metric socket head	1587	
reamers, Morse taper	863	
taper shank	948	
threads for electric	1980	
wrench clearances	1557	1559

Index Terms**Links**

Solders and soldering	1424	1426
alloys for	1424	
aluminum	1424	
fluxes	1424	
forms	1424	
magnesium	1426	
methods	1424	
stainless steel	1426	
ultrasonic fluxless	1426	
Solid-frame press	1388	
Solidification temperature	631	
Solids, volumes and dimensions	82	
Soluble oils for		
machining operations	1183	
Solution heat treatment	462	
Sorbite	479	
Space cutters, roller chain sprockets	2556	
Spacing holes on jig borer	695	
Spade drills and drilling		
blades	1075	
drilling	1076	1078
feed rates for	1077	
geometry of	1074	
power consumption and thrust	1079	
Spandrel		
area	74	
center of gravity	223	
Spark out time	1202	
Spark plug		
threads	1979	
dimensions	1979	
hole in cylinder head	1979	
Spatter, (welding)	1458	

Index Terms

Links

Specific gravity	380			
conversion	382			
gases	381			
liquids	381			
of various metals	380			
plastics	390			
Specific heat	372			
aluminum	376			
copper alloys	376			
gasses	373			
Speed reducers, motors, built-in	2573			
Speeds				
calculating cutting speeds	1015			
critical, of rotating shafts	302			
pulleys, rules for calculating	2484			
rpm for different diameters and cutting				
speeds	1015			
Speeds and feeds, machining	1008			
abrasive belt grinding	1269			
bandsawing	1179			
CBN grinding wheels	1234			
cutting	602	1013	1015	1070
	1077	1170		
drilling	1171			
diameters and rpm	1016			
feeds for spade drills	1077			
end milling	1039			
face milling	1039			
form-turning	1171	1187		
general	1070	1170		
grinding wheels				
maximum peripheral speeds	1249			
truing and dressing	1237			
wheel and work speeds	2055			

Index Terms**Links****Speeds and feeds, machining (*Cont.*)**

grinding with diamond wheels	1246			
honing	1269			
milling	1021			
nonferrous metals	1192			
reaming	1070	1171		
reaming and threading	1021			
rotary files and burs	990			
sawing				
band	1179			
circular	1081			
shaping	1081			
slit and slot milling	1039	1042		
superalloys	1038			
surface grinding	1265			
tables, how to use	1021			
tapping and thread cutting	1060	1071	1171	2016
thread rolling	2051			
titanium and alloys	1037			
tool life	1013			
adjusting	1034	1039	1042	1058
tool steels				
drilling reaming, and threading	1065			
milling	1048			
turning	1030			
turning	1021	1025		
carbon and alloy steels	1026			
copper alloys	1036			
ferrous cast metals	1032			
hard-to-machine materials	1038			
light metals	1037			
speeds and feeds	1025	1171		
stainless steels	1031			
superalloys	1038			

Index Terms

Links

Speeds and feeds, machining (*Cont.*)

titanium	1037
tool steels	1030

Sphere

hollow	
center of gravity	226
radius of gyration	231
polar moment of inertia	246
radius of gyration	231
surface area	85
volume	85

Spherical

and rectangular coordinates,	
relationship	44
coordinates	44
sector	
center of gravity	226
polar moment of inertia	247
volume	85
segment	
center of gravity	226
polar moment of inertia	247
volume	85
shell, thin	231
shells, strength to resist internal	
pressure	291
surface center of gravity	223
wedge volume	86
zone volume	86

Spheroidal graphite iron 432 1405

Spheroidize, annealing 408

Spheroidizing 408 484

Spikes and nails, standard 1800

Index Terms

Links

Spindle		
for portable tools	972	
noses	962	
Spinning	1362	
conventional	1362	
shear	1363	
tube	1363	
Spiral bevel gears	2125	2178
tooth contact	2178	
Spline keys and bits	1692	
Splines	2255	
application factors	2267	
comparison of symbols	2273	
data and reference dimensions	2265	
dimensions, formula	2281	
fatigue-life factors for	2268	
fittings	2279	
fittings, torque capacity	2281	
for large misalignments	2269	
formulas for SAE standard	2281	
involute	2252	
(<i>see also</i> Involute splines)		
involute, socket keys and bits	1692	
machining tolerances and variations	2276	
milling cutter	836	
SAE standard splined fittings	2280	
terms, symbols, and drawing data	2263	
variations	2261	
Spray transfer (welding)	1436	
Spraying process, flame (metal)	1516	
Spring	304	
arbor diameters for	349	
Belleville	344	350
clock	344	

Index Terms

Links

Spring (*Cont.*)

compression, formulas for	317	
coned	350	
conical compression	344	
constant force	344	
copper-base spring alloys	307	
deflections for		
compression	321	
extension	321	
torsion	339	
design data	315	
disc	350	
contact surfaces	351	354
forces and stresses	354	
group classes	350	
materials	351	
nomenclature	350	
stacking	352	
stress	354	
elevated temperature stresses	314	
endurance limit for spring materials	314	
extension	320	
extension spring design	327	
failure in	348	
force, disc	354	
heat treatment of	344	
helical compression spring design	316	
helical, shock stresses produced in	279	
high-carbon spring steels	305	
index	315	
materials	305	
miscellaneous	344	
moduli of elasticity	344	
motor	344	

Index Terms

Links

Spring (*Cont.*)

music wire arbor diameters	349
nickel-base spring alloys	307
pins	1761
shock stresses produced in helical	279
spiral	344
stainless spring steels	306
steels for	305
stresses	315
produced by shocks	279
tolerances	
compression and extension	328
for torsion	337
torsion	
bars	343
design	331
modulus	344
volute	343
wire	
diameters for	305
maximum working temperature	308
tensile strength	395
Spring pins	
coiled type	1762
designation	1761
lengths and sizes	1761
materials	1761
slotted type	1761
Spring washers	
double coil	
rectangular section	1639
single coil square section	1640
Springback, sheet metal	1351

Index Terms

Links

Sprockets

chain transmission 2537

idler 2553

Spur gearing 2129

addendum modifications 2173

AGMA tolerances for fine pitch

gears 2168

American National Standard tooth

forms 2131 2135

angular backlash 2169

backlash 2163 2235

backlash range 2164

basic dimensions 2137

blanks for fine pitch gears 2160

British Standard 2172

bronze and brass gears 2243

caliper measurement of tooth 2147

center distance 2155

variable 2137 2139 2141

center distance for enlarged pinion 2154

checking gear size 2221

chordal

addendum 2144 2147

measurement 2238

thickness 2142 2144 2147

circular

pitch system 2130 2148

thickness 2142

given outside diameter 2141

composite error inspection 2169

contact

diameter 2155

lowest point of single tooth 2155

ratio 2155

Index Terms

Links

Spur gearing (*Cont.*)

data on drawings	2163	
diameters for hobbing, preshaving, and shaping	2138	
diametral pitch shown full size	2129	
diametral pitch system	2129	
dimensions and formulas	2131	
drawing data	2163	
enlarged pinions	2146	2204
external	2125	
Fellows stub tooth systems	2137	
fine-pitch	2135	2160
finishing gear milling cutters	2150	
formulas for basic dimensions	2257	
full-depth, teeth	2131	2142
gear milling cutters, series of metric module	2148	
gear tooth parts checking	2132 2221	
German standard tooth form	2217	
hob tip radius, maximum	2156	
interference, avoiding	2146	2148
internal	2125	2170
internal arc thickness	2170	
internal gear and pinion sizes	2170	
internal gears rule	2171	
involute curve properties	2130	
lowest point of single tooth contact	2156	
measurement of tooth with caliper	2147	
measurement over pins	2221	
measurement over wires	2231	
mesh with enlarged pinion	2154	
milling cutters metric module	2148 2148	

Index Terms

Links

Spur gearing (*Cont.*)

minimum number of teeth	2154	
module system	2217	
nonmetallic	604	2245
outside and root diameters	2138	2148
pinion arc thickness	2170	
pitch diameters, tabulated	2148	
profile checker settings	2158	
reduced gear	2146	
replacement gear dimensions	2249	
root and outside diameters	2138	2148
specifications	2161	
to avoid undercutting by hob	2154	
tooth		
contact of highest point	2157	
dimensions	2132	
forms	2131	
measurements over wires	2231	
proportions	2135	
thickness measurement	2141	
true involute form (TIF) diameter	2157	
undercut, limit for hobbled gears	2157	
Square		
area	70	
circles of area equal to	80	
distances across corners	81	
of wire diameters	347	
prism volume	82	
recesses, for machine screws		
recesses, for machine screws		
for self-tapping screws	1704	
roots of numbers	14	
Square and rectangular parallel keys	2461	
Square keys	2460	

Index Terms

Links

Square rectangular keys and keyways	2460		
Square thread	1944		
Squeeze casting	1410		
Squirrel cage induction motors	2566		
S-shapes, structural steel	2598		
moment of inertia	2598		
radius of gyration	2598		
section modulus	2598		
weight per foot	2598		
Stabilizing gages	503		
Stacking disc springs	352		
Stainless steels	397	415	418
application	418		
characteristics and applications	415		
chemical compositions	406		
coefficient of expansion	377		
compositions	406	418	
cutting, flame	1462		
density	377		
electrodes (welding) current to use			
with	1457		
elongation	392	430	
hardness	392		
heat treatments	494		
mechanical properties	430		
melting points	377		
properties	418		
soldering	1426		
ultrasonic	1426		
specific heat	377		
speeds			
for drilling, reaming, and threading	1066		
for milling	1049		
for turning	1031		

Index Terms

Links

Stainless steels (*Cont.*)

strength	432	
tensile strength	392	430
thermal conductivity	377	
yield strength	392	430

Stamping

blank diameters	1355
fine blanking	1343
steel rule dies	1379

Standard

deviation	1319
nomenclature	2175
organizations	2175
wire gage (SWG)	2605

Static

balancing	149
balancing	191
equivalent load, bearings	2415
load rating, bearings	2415

Statistics

absolute error of the sample mean	129
analysis	128
applications	130
coefficient of variation	129
confidence interval	129
degrees of freedom	129
distribution curves	128
example, manufacturing	132
normal distribution curves	128
normal distributions	1319
population mean	129
relative error of the sample mean	129
sample mean	128
sample standard deviation	128
standard deviation	1320

Index Terms**Links****Statistics (*Cont.*)**

Students distribution 131

t-distribution 131

Stayed surfaces, flat 288**Steel**

alloy

compositions of SAE 404

general properties 424

Bessemer 410 412

carbon steel structure 465

carburizing 411 413 484

case hardening 484

cast for gears 2242

castings 1406

brinell hardness number 1407

elongation 1407

mechanical properties 1407

tensile strength 1407

yield point 1407

chromium

compositions 418

nickel austenitic 415 418

classification 396 401

cobalt high-speed 896

cobaltcrom 496

color of heated 480

coloring 1507

columns, pipe 286

corrosion-resisting 415

Damascus 399

deep-drawing 410

elongation 391

free-cutting 412 414

stainless 415

Index Terms

Links

Steel (*Cont.*)

gearing, hardness	2243		
gearing, industrial	2243		
hardening	461	470	
hardness	391		
and tensile strength relationships	509		
of heat-treated	424		
heat treatment	407	461	496
of high speed steel	496		
high-speed	438		
hypereutectoid	468		
hypoeutectoid	468		
induction hardening	487		
killed	410		
molybdenum			
compositions	415	418	
high-speed	446		
molybdenum			
nickel chromium, SAE			
compositions	415	418	
nickel, SAE compositions	415		
SAE compositions	404		
nitriding	485		
numbering systems for	398		
pipe			
columns, allowable concentric			
loads	286		
rimmed	410		
rivets	1730		
rolled sections, shape designations	2593		
SAE specification numbers	398	400	
sheet, standard gage	2608		
silicon-manganese, SAE			
compositions	404		

Index Terms**Links****Steel (Cont.)**

stainless	406	415	418
strength	432		
and hardness data	424	432	
of heat-treated	432		
structural shapes	2593		
subzero treatment	502		
taps	2016		
tensile strength	391		
tool	433		
tungsten			
compositions	448		
high-speed	448		
twist drill	896		
yield strength	391		
Steel rule dies	1379	1381	
cutting edges	1380		
dimensions	1380		
heat treatment	1382		
Steel wool	990		
Steel-threading screws			
cast metals	1713	1715	
depth of penetration	1715		
drill sizes	1715		
hole sizes	1715		
plastics	1713	1715	
Stellite alloy	1011		
Step bearings	2338	2344	
STI tapped holes	1613		
STI threaded hole data	1615		
Stock, amount required for screw machine			
production	1175		
Stoke	2698		

Index Terms

Links

Straight

bevel gears	2125
line	40
line column formula	281
pins	1751
designation	1753
materails	1753

Straight pipe threads

free fitting mechanical joints	1960
hose couplings	1960
locknuts	1960
mechanical joints	1960

Straight splines, British Standard

2278

Strain

lateral	200
longitudinal	200
ratio of	200

Strain-hardening exponent

1333

Strength

hollow vs. solid shafts	303
of polygon connections	2283
of screws and bolts	1535
riveted joints	1730
struts or columns	281
tensile	200
ultimate	200
wire rope	2614
yield perforated metal	2607

Strength of materials

199

angles, lengths of bent	2593
beams	268
shock stresses in	279
channels, elements of	2599
columns	281

Index Terms

Links

Strength of materials (*Cont.*)

AISC formula	285	
AREA formula	281	
Euler formula for	282	
Gordon formula	281	283
Johnson formula for	282	
combined stresses	211	
compression	201	
critical speeds of shafts	302	
curved beams	275	
cylinders	290	
definitions	199	
deflection of beams	256	273
Euler formula	282	
factors of safety	204	
ferrous metals	432	
flat plates	288	
heat-treated steels	424	
influence of temperature	394	
Izod impact	390	424
J. B. Johnson column formula	282	
keyways in shafts	301	
linear deflection in shafts	298	
mechanical properties	199	
metals, properties of	394	
modulus of elasticity	200	
modulus of shear	200	
moment of inertia	234	
built-up sections	233	
perforated metals	2607	
pipe columns	286	
plates, shells, and cylinders	288	
polar		
moment of inertia	244	250

Index Terms

Links

Strength of materials (*Cont.*)

section modulus	244	250
rails	277	
Rankine, column formula	281	283
rings, stresses and deflections	219	
section moduli tables	234	
shafts	295	
American Standard design code	301	
brittle material formula for	301	
shafts		
critical speeds of	302	
effect of keyways on strength of	301	
horsepower transmitted by	295	
torsional strength of	295	
shear	199	201
shells, spherical	291	
shocks, stresses produced by	279	
simple stresses	209	
springs, shock stresses in	279	
steels	432	
straight-line column formula	281	
stress	152	199
areas of screw threads	1536	
concentration factors		
grooved shaft in torsion	208	
shaft with transverse hole in		
bending	208	
relieving	408	
working	204	
struts or columns	281	
taper pins, strength of	220	
temperature effects	395	
tensile stress	199	
torsional strength of shafting	295	

Index Terms

Links

Strength of materials (*Cont.*)

tubes	293	
working stresses	204	
Young's modulus	200	
Stress	152	
alternating	202	
area of thread	1528	1930
combined	211	
concentration factors	205	
grooved shaft in torsion	208	
shaft with transverse hole in bending	208	
contact, in cams	2305	
cyclic	201	
disc springs	354	
in beams	209	256
in bolts when tightening	1523	1531
in involute splines	2268	
in loaded ring	219	
in shafting	299	
in splines		
allowable contact stress	2174	
allowable shear	2268	
in springs	279	315
produced by shocks	279	
relieving	408	
shear	210	
in beams	211	
simple	209	
spline teeth compressive	2269	
strain curves	199	
superposition of	211	
three-dimensional, or triaxial	215	
true	1332	
units and conversion of	2686	

Index Terms

Links

Stress (<i>Cont.</i>)		
working, of various materials	204	
Stress-strain	1332	
curve	1333	
nominal	1332	
true	1332	
Stress-strain relationship	1332	
Stretch-draw forming	1361	
Stribeck curve	2421	
Structural shapes		
aluminum	2603	
steel	2593	
angles, properties of	2600	
channels, properties of	2599	
I- or S-shapes, properties of	2598	
standard designations	2593	
strength	432	
wide flange, properties of	2594	
Structure of carbon steel	468	
Stub Acme screw threads	1921	1932
alternative	1939	1942
ANSI Standard	1932	
basic dimensions	1922	
designations	1939	
formula for determining diameters	1939	
limiting dimensions	1923	
shear area	1923	
stress area	1923	
thread data	1942	
thread form	1921	1939
wire sizes for checking	2004	
29- and 60-degree	2059	2064
Stub screw machine reamers	859	

Index Terms**Links**

Stub tooth gearing	2132	2137		
Fellows	2137			
former American Standard	2132	2137		
outside and root diameters	2131	2138		
Stub's iron and steel wire gage	2605			
Studs				
British	1626	1637		
drive	1757			
Studs and pins				
designation	1757			
hole sizes	1757			
material	1757			
standard sizes	1757			
Subtracting				
decimal fractions	10			
fractions	9			
matrices	122			
Subzero treatment of steel	502			
carburized parts	504			
Superhard tool materials (CBN)	1012	1038	1217	1234
	1243			
Superplastic forming	1365			
Surface				
coatings for metals	1508			
finish and hardness of bearings	2321			
grinding	1261			
advantages	1261			
common faults and causes	1266			
principal systems	1262			
process data for	1265			
selection of grinding wheels for	1216	1261	1264	
wheel recommendations	1264			
of revolution, area	67			
roughness				

Index Terms

Links

Surface (*Cont.*)

measurements	740		
produced by common production			
methods	738		
produced by laser cutting	1493		
relationship to tolerances	738	740	
speeds, diameters and rpm			
CNC spindle	1288		
cutting speeds formula	1015	2039	
grinding wheels	1248	1250	
pulleys and sheaves	1015	1017	2039
Surface finish standards, list of ISO	748		
Surface finish text height	747		
Surface parameter symbols, ISO	748		
Surface plates	708		
calibration	711		
autocollimator	713		
interferometer	714		
repeat-o-meter	712		
granite properties	709		
materials and grades	708		
Surface texture	734		
applying symbols	741		
castings	744		
comparing measured values to specified			
limits	750		
control and production	733		
cutoff for roughness measurements	740		
definition of terms	733	735	
drawing practices for symbols	740		
error of form	733		
finish	1201		
differences between ISO and ANSI	747		
flaws	733		

Index Terms

Links

Surface texture (*Cont.*)

graphical centerline.	735	
instruments of measurements	739	
lay	733	744
symbols	744	
measurement	738	
area averaging methods	740	
instruments	739	
non-contact	739	
probe microscope	739	
skidded instruments	740	
skidless instruments	739	
profile	735	
measured	735	
modified	735	
nominal	735	
real	735	
total	735	
variation	2255	2261
root mean square	738	
roughness	733	
average (Ra)	737	743
evaluation length	737	
parameters	737	
production method	739	
profile	735	
sampling length	736	
roughness		
spacing	735	
topography	736	
roughness average (Ra)	737	
roughness sampling length	743	
sampling length	736	
spatial resolution	736	

Index Terms

Links

Surface texture (*Cont.*)

standard roughness sampling lengths	743		
symbols	613	740	744
lay	744		
material removal	741		
proportions of	741		
system height resolution	736		
topography	736		
measured	736		
modified	736		
traversing length	736		
use of symbols	741		
valley	736		
waviness	734	736	
evaluation length	736	738	
height	738	744	
long-wavelength cutoff	736		
parameters	738		
profile	736		
sampling length	736		
short-wavelength cutoff	736		
spacing	736		
topography	736		
Surveyor's measure	2661		
SUS (Saybolt Universal Seconds)	2425		
Swing frame grinding	1268		
Swiss pattern files	989		
Symbols			
abbreviations	2652	2654	
ANSI Y14.5M	611		
applying surface texture	741		
arc and gas welding	1476		
arrow	1476		
basic weld	1476		

Index Terms

Links

Symbols (*Cont.*)

bearing		
ball bearings	2365	2367
cylindrical roller bearings	2368	
needle bearings	2370	
roller bearings	2365	
self alignment roller bearings	2368	
tapered roller bearings	2369	
thrust ball bearings	2368	
thrust tapered roller bearings	2369	
between, ANSI	612	
brazing	1431	
buttness threads	1946	
cams and cam design	2285	
chemical elements	371	
concentricity, ANSI	612	1326
contour and finish	1477	
controlled radius, ANSI	612	
diameter, ANSI	612	1325
diamond wheel marking	1240	
dimensions	1477	
drawing practices for surface texture	740	
gagemakers tolerance	661	
geometric characteristic	612	
geometric controls		
forms	613	
locations	613	
orientation	613	
profiles	613	
runout	613	
straightness	613	
Greek	2652	
grinding wheel markings	1218	
hole basis	652	

Index Terms

Links

Symbols (*Cont.*)

involute splines	2255	2263
lines for drawings	610	
mechanics	2655	
metric module involute splines	2273	
nondestructive testing	1485	
parallelism, ANSI	612	1326
perpendicularity, ANSI	612	1327
reference line	1476	
roundness, ANSI	612	1325
runout, ANSI	612	1327
screw thread, for tap marking	908	
section lining		
aluminum	611	
bronze	611	
cast and malleable iron	611	
earth	611	
insulation	611	
magnesium	611	
materials	611	
rock	611	
sand	611	
steel	611	
white metal	611	
shaft basis	652	
standard geometric section lining	611	
statical tolerance, ANSI	612	
surface profile, ANSI	612	1325
surface texture	741	744
tolerances	650	
total runout, ANSI	612	1327
welding	1476	1486

Synchronous belts

(*see Belts and pulleys: synchronous belts*)

Index Terms**Links**

Synthetic oils	2429	
System of measurement		
absolute	150	
gravitational	150	
Système International d'Unites (SI)		
in mechanics calculations	149	
units of	2656	
T		
Tangent	95	
Tangential force	2174	
Tanks		
contents at given level	68	78
cylindrical, capacity in gallons	68	
quenching bath	476	
Tantung alloy	1011	
Tap drill selection		
(<i>See Tapping and tap drilling: tap drills</i>)		
Taper		
American (ANSI) Standard	948	
applications of standard	959	
British Standard	948	
Brown & Sharpe	948	957
collets	969	
for given angle	684	
gages for self-holding	956	
Jacobs	961	
Jarno	948	959
machine tool spindle	948	959
measurement methods	681	
measuring with		
V-block and sine bar	681	
method of dimensioning	681	

Index Terms

Links

Taper (*Cont.*)

milling machine spindles, arbors and		
spindle noses	962	
Morse	948	
stub taper shanks	948	
per foot and corresponding angles	683	
pin reamers	865	1755
pins	1753	1756
designation	1754	
diameter	1754	
drilling specifications	1754	
drills for	1753	1756
hole sizes	1753	
materials	1753	
small ends	1754	
strength	220	
reamers		
Brown & Sharpe	864	
Morse	863	
rules for figuring	684	
self-holding and self-releasing	948	
steep machine	955	960
Taper pipe threads	1956	
angle of thread	1959	
basic dimensions	1957	
external	1959	
form	1956	
internal	1959	
lead	1959	
pitch diameter formula	1956	
railing joint	1960	
taper	1956	
taps	940	
thread length	1956	

Index Terms**Links****Taper pipe threads (*Cont.*)**

tolerances on taper	1959		
Tapped holes	1613		
Taps	912		
blank number	926		
cut thread	936		
D or DU limits	911		
definitions	912		
dimensions			
dimensions			
cut thread	917	919	924
extension taps	924		
fine pitch taps	925		
fractional size	922		
ground thread	917	919	924
machine screw	922		
metric size taps	923		
neck and shortened thread length	921		
screw thread inserts	922		
straight pipe	927		
taper pipe	927		
tolerances	920		
fractional sizes	930	937	
ground thread	906	911	941
ground thread limits	930	933	
limits and tolerances	910		
locational tolerance	929		
M profile thread limits	930		
machine screw sizes	926	933	941
marking	906		
metric			
sizes	926	930	934
thread	911		
thread in inches	942		

Index Terms

Links

Taps (*Cont.*)

number of flutes	926			
oversize	907			
pulley	906			
runout tolerance	929			
screw thread insert	1625			
spiral point	926			
straight flutes	926			
straight pipe	939			
styles	904			
tap thread H- and L-limits	906			
taper pipe	940			
terms	912			
thread forms	904			
thread limits	909			
thread tolerances	909			
tolerances				
straight pipe	929			
taper pipe	929			
types of	904			
undersize	907			
UNS thread	906			
Taps and tapping	2015			
automatic screw machine	1171			
clearance holes				
ISO metric bolts and screws	2034			
CNC machine	2038			
cold form tapping	2035			
coolant	2039			
cutting oils	1186			
cutting speeds	1060	1071	1171	2017
hole size before tapping	2031			
Unified miniature thread	2021			
length of engagement and tolerances	2031			

Index Terms

Links

Taps and tapping (*Cont.*)

lubrication	1186	
methods of tapping	2015	
nitriding of	2016	
numerically controlled	2038	
pipe		
power for driving	2038	
tap drills for	2037	
pipe threads		
drill sizes	2037	
power required	2038	
pitch increased to compensate for		
shrinkage	2059	
rake angles for various materials	2017	
removing a broken tap	2037	
serial taps and close tolerances	2016	
speeds	2016	
spiral		
fluted	2016	
pointed	2015	
square threads	944	947
steel	2016	
surface treatment of	2016	
tap drills		
Acme threads	944	
American National threads	2029	
machine screws	2030	
diameter of tap drill	2020	
ISO metric threads	2033	
coarse pitch	2033	
cold form	2037	
pipe		
Briggs (NPT)	2037	
Whitworth	2037	

Index Terms

Links

Taps and tapping (*Cont.*)

Unified thread system				
cold form	2036			
miniature	2032			
tapping specific materials	2017			
alloy steel	2018			
aluminium	2019			
carbon steel	2017			
copper alloys	2020			
free cutting steel	2019			
gray cast iron	2019			
high temperature alloys	2019			
high tensile strength steels	2018			
malleable cast iron	2019			
nodular cast iron	2019			
stainless steel	2018			
titanium and titanium alloys	2019			
taps				
Acme	944			
drill hole size	944	947		
adjustable	944			
markings				
standard	908			
square thread	944			
thread series designations	908			
tolerances on minor diameter	2030			
Unified thread form	1806			
Taylor tool life equation	1022	1103	1106	1134
	1149	1156		
T-bolts and T-slots, ANSI Standard	1726			
Tebi	2658			
Teflon (TFE) bearings	2361			
Temper designations, aluminum alloy	531			

Index Terms

Links

Temperature

absolute	2695		
boiling points, various substances	372		
changes in length due to	378		
critical, heat treating of steel	462	465	469
effect on working stresses, of springs	314		
effects on drawing dimensions	613		
effects on oil	2426	2430	
fahrenheit and celsius	2695		
ignition	376		
influence on strength of metals	395		
judging by color, steel	480		
of carbon dioxide, solid	632		
of freezing mixtures	376		
of ignition, various materials	376		
of lead bath alloys	481		
of nitrogen, solid	632		
required to develop tightening stress in			
bolt	1526	1528	
Tempering	407	479	
double	482		
in oil	481		
in salt baths	481		
in sand	482		
lead bath temperatures	481		
steel	408	481	
temperature	480		
carbon steel tools	480		
Tensile			
modulus (<i>See</i> Modulus of: elasticity)			
strength	200	202	
aluminum alloys	391	534	
ceramics	389		
cobalt alloys	392		

Index Terms**Links****Tensile (Cont.)**

copper alloys	391	515
copper-beryllium alloys	529	
copper-silicon alloys	528	
copper-zinc-tin alloys	528	
Everdur	528	
magnesium alloys	547	
nickel alloys	392	548
nonferrous metals	513	
spring wire	395	
stainless steel	392	430
steel	391	422
heat-treated	424	
high-strength, low-alloy	421	
relation to hardness	509	
titanium alloys	550	
wood	386	
strength, alloy steel	1408	
strength, carbon steel	1408	
strength, steel	1407	
stress	199	202
test	203	
Test Instrument (TI)	729	
Therm	2690	2693
Thermal		
conductance	374	
conductance units conversion	2694	
conductivity	374	
aluminum	376	
cast iron	377	
ceramics	389	
copper alloys	376	
nickel alloys	377	
stainless steels	377	

Index Terms**Links****Thermal (Cont.)**

titanium alloys	377			
cracking of cutting tools	1187			
energy	2695			
expansion coefficients	375	378		
stresses	378			
plastics	578			
Thermometer scales	2695			
Thicknesses, preferred				
metal products	2610			
uncoated metals and alloys	2608			
Thin flat plate	228			
Thin spherical shell				
radius of gyration	231			
Thread cutting, CNC	1302			
Thread locking	2584			
Threading cam, screw machine	1170	1174		
cutting speeds, threading dies	1170			
Threads and threading	1806	1857	1878	1882
	1889	1892	1899	
Acme thread	1921			
pitch diameter allowance	1923	1928		
aerospace screws, bolts and nuts	1901			
Aero-thread	1986			
allowance and tolerance	1951			
American microscope objective (AMO)	1982			
American National form	1806			
angle, wire method of testing	2002			
ANSI Standard				
Acme thread	1921			
buttress thread	1946			
form or profile	1806			
M profile thread	1878			

Index Terms

Links

Threads and threading (*Cont.*)

allowances	1883	
basic profile	1808	1883
coarse pitch	1882	
coated threads	1886	1888
crest and root form	1879	
data	1881	
design profile, M series	1879	1882
designations	1899	
external thread design	1884	
external thread root	1884	
fine pitch	1884	
lengths of engagement	1885	
limiting dimensions	1893	1920
limits and fits	1882	
limits of size	1888	
major diameter tolerances	1890	
minor diameter tolerances	1889	1899
pitch diameter tolerances	1890	
profile data	1881	
profile series	1882	
ANSI Standard		
symbols	1880	
thread series	1880	1884
tolerance grades	1883	
MJ profile thread	1899	
Unified thread system	1813	
allowances	1817	
basic dimensions	1844	1853
coarse thread series	1816	
coated	1857	
definitions	1808	
design profile	1814	
designations	1856	

Index Terms

Links

Threads and threading (*Cont.*)

dimensions	1817	
external and internal thread		
forms	1806	1860
fine and extra fine series	1816	
hole sizes for tapping	1857	
internal and external profile	1814	
limits	1817	1854
miniature screw thread	1858	
miniature, design dimensions	1860	
pitch diameter tolerances	1856	
standard series, tables of	1817	
thread classes	1845	
thread form, data and formulas	1806	1813
thread series	1814	
uniform 4-6-8-12-16-20-28-, and 32-pitch series	1816	
Briggs pipe thread	1986	
British Standard		
buttress threads	1945	
ISO metric	1901	1919
ISO profile	1910	
pipe	1965	
RMS thread	1982	
UNJ profile	1863	
Whitworth	1953	
casing thread	1986	
change gears for lathe	2042	
for fractional output	2043	
modifying the quick change gearbox output	2043	
changing pitch slightly	2060	
chasing, cutting speeds for	1060	
checking by three-wire method,		

Index Terms

Links

Threads and threading (*Cont.*)

tables	1997	2002	
classes of tolerance	1845	1946	
CNC	1302		
cutting calculations	1302		
lathes, cutting threads	1302		
long hand threading	1304		
multi-start threads	1305		
thread milling	1292		
threading commands	1304		
threading operations	1304		
Cordeaux thread	1987		
crest diameter tolerance	1915		
cutting	2040		
square	944		
cutting, change gears	2042		
cutting, change gears			
fractional ratios	2043		
Dardelet thread	1987		
definitions	1808		
design and application data	1974		
design dimensions and tolerances	1860		
designation of Unified threads	1817		
designation symbols for	908		
on taps, marks and symbols for			
identifying	908		
deviation formulas	1914		
diameter pitch combinations	1816	1901	1919
diameters of wires for measuring	1991		
dies, maximum pitches	2060		
dimensional effect of coating	1888		
drunken thread	1987		
dryseal pipe	1962		
Echols thread	1987		

Index Terms

Links

Threads and threading (*Cont.*)

electric socket and lamp base	1980		
electrical fixture threads	1980		
external thread tolerances	1893		
formulas for three-wire			
measurement	1990		
French thread	1987		
fundamental deviation	1885		
gages for screw threads	2007		
classification	2007		
for unified screw threads	2007		
standard tolerances	2013		
grinding	2053		
centerless method	2057		
Harvey grip thread	1987		
helix angle	1810	1844	
hole size for tapping	1857		
hose coupling	1971		
indexable threading insert, CNC	1302		
instrument makers'	1980		
interference fit	1810	1973	
internal threads in pipe couplings	1960		
International Metric thread system	1807		
ISO metric	1808	1901	1919
design profile	1913		
designation	1913		
fundamental deviation formulas	1914		
lengths of thread engagements	1913		
lead angle	2062		
length of thread engagement	1810	1913	1915
limiting dimensions formula	1888		
limits			
Class 1A and 1B	1818		
Class 2A and 2B	1817		

Index Terms

Links

Threads and threading (*Cont.*)

Class 3A and 3B	1817			
limits and tolerance	1915			
Lloyd and Lloyd thread	1988			
lock nut pipe thread	1988			
Löwenherz	1945			
M profile limits of size	1892			
maximum material condition	1810			
measuring screw threads	1989			
measuring screw threads				
three wire method	1990			
contact pressure	1993			
formulas	1994	1997	1999	2005
accuracy	2000			
Whitworth				
best wire sizes	1992			
formulas	1995			
metric screw threads				
ANSI Standard				
M profile	1878			
allowance	1878			
comparison with inch threads	1878			
MJ profile	1899			
designations	1903			
diameter-pitch combinations	1900			
symbols	1903			
British Standard ISO metric	1910			
ISO metric	1808			
British Standard	1910			
miniature	1910			
trapezoidal	1903			
micrometers for measuring pitch				
diameters	1989			
microscope objective thread	1981			

Index Terms

Links

Threads and threading (*Cont.*)

milling	2058
changing pitch of thread slightly	2059
classes of work	2059
multiple cutter method	2058
planetary method	2059
single cutter method	2058
miniature	
ISO metric	1910
Unified	1858
minor diameter tolerances	1857
modified square thread, 10-degree	1944
molded in	593
multiple, designation	1857
multi-start threads, CNC	1305
National standard form or profile	1806
Philadelphia carriage bolt thread	1988
pipe	
ANSI Standard	1956
dryseal	1962
taper	1956
pitch	1811
pitch diameter	1811
pitch, changing slightly	2060
pitch, maximum when die cut	2059
pressure tight joints	1960
rolled lamp base threads	1980
SAE standard screw thread	1988
saw-tooth	1945
screw thread, definition	1812
self-forming screws	1701
self-tapping screws	1704
Sellers screw thread	1988
sharp V-type thread	1806

Index Terms

Links

Threads and threading (*Cont.*)

single point threading, CNC	1302			
spark plug threads	1979			
square thread	1944			
ten-degree modified	1944			
stress area	1528	1536	1812	1930
Acme thread	1923	1927		
Unified fine thread	1844			
stub Acme screw threads	1921	1932		
stub thread 60-degree	1942			
tap drill sizes	2021			
taper, measurement by wire method	2006			
thread calculations	1302			
thread cutting, CNC	1302			
thread forms	1806			
thread grinding				
accuracy obtainable	2053			
from the solid	2055			
multi-ribbed wheels	2054			
number of wheel passes	2054			
ribbed wheel for fine pitches	2055			
roughing and finishing wheels	2054			
single edge wheel	2053			
wheels	2053			
and work rotation	2055			
grain size	2057			
hardness of grade	2056			
speeds	2056			
truing	2056			
types for	2053			
work speeds	2056			
thread milling, CNC	1292			
thread rolling	2048			
advantages of process	2051			

Index Terms

Links

Threads and threading (*Cont.*)

automatic screw machines	2050		
blank diameter	2049		
dies, cylindrical	2048		
dies, flat	2048		
in automatic screw machines	2050		
machines used	2050		
precision thread rolling	2049		
production rates	2048		
speeds and feeds	2051		
steels	2049		
thread selection	1856		
tolerance system	1885	1911	
tolerances			
grade dimensions	1892		
of external threads	1890		
of pitch diameter	1890		
tools			
relief angles, single-point	2040		
tools for square threads	944		
trapezoidal metric thread	1903	1905	1909
formulas	1904		
US Standard	1806		
watch	1858		
Whitworth	1983		
truncated	1983	1985	
wire sizes for checking pitch			
diameters	1991		
Three-dimensional stress	215		
Three-wire measurement			
gears	2221		
screw threads	1990		
Thrust bearing (<i>see</i> Bearings: thrust)			

Index Terms

Links

Thumb screws			
dimensions	1798		
flat-head type	1795	1798	
lengths	1798		
materials	1795		
points	1799		
cone point	1799		
cup point	1799		
dog point	1799		
flat point	1799		
oval point	1799		
threads	1799		
types	1795		
TI (Test Instrument)	729		
Tin lead, plating	1510		
Tin plating	1515		
Tin-base alloys, die casting	1417		
Tin-lead alloys for soldering	1424		
Titanium and titanium alloys			
coefficient of expansion	377		
density	377		
melting points	377		
properties	548	550	
specific heat	377		
speeds and feeds	1037	1073	1181
thermal conductivity	377		
Titanium Metals Corp.	550		
Titanium carbides as cutting tool			
materials	1010		
T-nuts, ANSI Standard	1728		
Toggle joint	172		
Tolerances	784	1911	
ANSI Standard	635		
application of tolerances	629		

Index Terms**Links****Tolerances (*Cont.*)**

bilateral and unilateral	628	
symbols	612	650
ANSI symbols	1324	
ball and roller bearing	2374	
British Standard	663	
British Standard ISO threads	1911	
buttress threads	1946	1950
clearance fit	649	
compression spring	328	
core drill, metric	893	
cut thread	937	
cylindrical fits	628	
designation of limits and fits	649	
dimensions on drawings	628	
drilled holes	896	
extension spring	328	
fundamental deviations	663	
gagemakers	661	
gages, direction of tolerances on	629	
gear, composite tooth to tooth	2169	
gear, composite total	2169	
grades relative to machining		
processes	637	662
hole basis	649	
honing	1274	
interference fit	649	
involute splines, inch	2252	
involute splines, metric	2273	2276
ISO metric threads	1911	
crest diameter tolerance	1915	
finished uncoated threads	1915	1918
tolerance classes	1912	
tolerance grades	1912	

Index Terms**Links****Tolerances (*Cont.*)**

tolerance positions	1912		
tolerances classes	1912		
keys and keyways	2475		
knurling	995		
limits and fits	663		
machine screw taps	931		
nut threads	1911		
obtainable by various operations	635	637	662
preferred series of	635		
relationship to surface roughness	738	740	
screw thread inserts	941		
shaft basis	649		
symbols	612	1324	
tapped holes	2030		
taps	904	931	937
thread gage	2010		
torsion springs	337		
transition fits	649		
twist drill, metric	893		
Unified screw tap threads	932	937	
Unified thread gages	2013		
unilateral and bilateral	628		
Tolerancing and dimensions	2463		
Tolerancing and geometric dimensioning	613		
Ton			
long and short	2683		
metric	2683		
Tool			
change schedule	1153		
compensation, NC	782		
contour, cutting tools	757		
cost per batch	1154		
cost per edge	1155		

Index Terms

Links

Tool (*Cont.*)

cost, cutting	1154			
forming	796			
grade, cutting	1058			
grinding, angles	757			
holders	766			
letter symbols	768			
indexable inserts	764	782	791	
knurling	991			
life	1013	1133	1141	1153
adjusting	1034	1039	1042	1058
adjusting factors				
drilling	1058			
end milling	1058			
face milling	1058			
reaming	1058			
colding relation	1136			
cutting speed	1146			
drilling	1145			
economic	1149			
economy	1149			
envelope	1138			
factors for turning				
life				
carbides	1034			
CBN	1034			
ceramics	1034			
cermets	1034			
polycrystalline diamond	1034			
feed speed	1146			
global optimization	1150			
grinding	1145			
milling	1145			
optimization models	1149			

Index Terms

Links

Tool (*Cont.*)

optimum	1151		
surface finish	1143		
Taylor's equation	1134		
turning	1145		
materials	785	1008	
nose radius compensation, NC	782		
shanks, ANSI Standard for milling			
machines	964		
sharpening			
carbide tools	1000		
grinding wheels for	1000		
twist drills	997		
single-point	757	899	
steels	433		
air hardening	453		
alloying elements effects	437		
applications	443		
chemical compositions	441		
chromium types	449		
classification of	438		
cold work	452		
cutting speed for	1030	1048	1065
decarburization limits	459		
dimensional tolerances	459		
faults and failures, common	436		
grindability of	436	1228	
hardening	435		
hardness	436		
high-carbon, high-chromium	452		
high-speed	446		
hot work	449	451	
machinability	435		
machining allowances	459		

Index Terms

Links

Tool (*Cont.*)

mechanical properties	433	
mill production forms	458	
mold	453	455
molybdenum types	446	451
numbering system	398	400
oil hardening	453	
properties of	433	
shock resisting	453	455
special purpose	453	
speeds drilling, reaming, and threading	1065	
speeds, milling	1048	
speeds, turning	1030	
tolerances on dimensions	459	
toughness	436	441
tungsten types	448	
water hardening	457	
wear resistance	436	
trouble-shooting checklist	1014	
wear	996	1132
Tooling cost equivalent	1154	
Tooling cost time	1154	
Tooth rest position		
milling cutter grinding	843	
reamer grinding	847	
Torches, metal cutting	1462	
Torque	149	
calculating, for tightening bolts	171	
capacity		
formulas involute spline	2266	
spline fittings	2281	
clamping force	1529	
coefficient	1530	

Index Terms

Links

Tool (*Cont.*)

electric motor	2567	2574
pull-up	2566	
relationship to angular acceleration	180	
starting, small bearings	2399	
tension relation	1532	
tightening, for bolts	1521	
torsion springs	331	333
unit conversion	2689	

Torque test

1618

Torque test spacer

1624

Torsion

and bending of shafts, combined

formulas	209	215	299
deflection of shafts, formula	297		
formulas for shafts	295		
modulus	209	344	
springs, design	337		
strength of shafts	295		

Torus

polar moment of inertia	247
volume	87

Total indicator reading, NC

1317

Toughness

HSLA steels	421
tool steels	441

Transfer die

1379

Transmission chains

2537

cast roller chains	2537
detachable chains	2537
nonstandard	2537
pintle chains	2537
roller chain sprockets	2540
caliper diameter	2544

Index Terms

Links

Transmission chains (*Cont.*)

classes	2542	
diameters	2542	
flange thickness	2545	
manufacture	2557	
materials	2557	
proportions	2546	
roller chains	2537	2539
attachments	2541	
bar steel sprockets	2546	
bent link plate	2541	
bore and hub diameters	2552	
bottom diameter	2544	
center distances and chain links	2552	
roller chains		
cutters for sprockets	2557	
cutting sprocket tooth forms	2556	
design procedure	2560	
dimensions	2539	
drive ratings	2558	
hob design	2555	
horsepower ratings	2547	
idler sprockets	2553	
installation and alignment	2559	
keys, keyways and set-screws	2542	
length of driving chain	2553	
lubrication	2559	
multiple strand cast sprockets	2546	
nomenclature	2538	
nonstandard	2537	
numbering system	2540	
parts	2538	
pin dimensions	2541	
pitch	2540	

Index Terms

Links

Transmission chains (*Cont.*)

selection	2547		
single strand cast sprockets	2546		
straight link plate	2541		
tolerances	2540	2544	
tooth form	2554		
tooth section profile dimension	2545		
types	2537		
ultimate tensile strength	2540		
types	2537		
Transmission shafting design	299		
Transpose of a matrix	123		
Trap rock, strength	394		
Trapezium area	72		
Trapezoid			
area	71		
center of gravity	222		
moment of inertia	236		
radius of gyration	236		
section modulus	236		
Trapezoidal screw threads	1903		
data	1905		
formulas	1904		
Trepanning	1080	1498	
Tresca shear theory (plastics)	577		
Triangle			
acute	71	95	101
area	71		
center of gravity	221		
equilateral	95		
geometry of	56		
isosceles	95		
moment of inertia	236		
obtuse	71	95	101

Index Terms**Links****Triangle (Cont.)**

radius of gyration	236		
right-angle	71	95	98
section modulus	236		
solution	95		
oblique angle	101		
right angle	98		
Triaxial stress	215		
Tribology, see lubrication	2420		
Trigonometric			
formulas	96		
functions			
of angles	95		
signs of	96		
using calculator to find	110		
identities	96		
tables	106		
Trochoid curve	2128		
Troostite	479		
Trouble-shooting			
broaching	985		
drilling	1064		
machining difficulties	1014		
reaming	852		
tools	437		
Troy weight for gold and silver	2683		
True stress-strain	1332		
Truing and dressing grinding wheels	1235		
T-section			
moment of inertia	241		
radius of gyration	241		
section modulus	241		
T-slots and T-bolts, ANSI Standard	1726		
T-slot cutters, standard	812		

Index Terms

Links

Tube

collapsing pressure	293	
gages	2604	
maximum allowable pressures	294	
strength of	293	
subjected to external pressure		
factor of safety	294	
thickness and working pressure	293	
wall thickness gages	2593	2604

Tube spinning	1363	
---------------	------	--

Tungsten

carbide tools grinding	1000	
carbide tools materials	1009	
electrodes, welding	1453	
powdered alloys		
density	393	
elongation	393	
hardness	393	
rupture strength	393	
ultimate strength	393	
yield strength	393	
steels	448	
compositions	442	448
high-speed, heat-treatment of	496	
tool steels	448	

Turner's sclerometer	509	
----------------------	-----	--

Turning

and facing, insert holder	770	
cutting speeds for		
copper alloys	1036	
ferrous cast metals	1032	
hard-to-machine materials	1038	
light metals	1037	
plain carbon and alloy steels	1026	

Index Terms**Links****Turning (*Cont.*)**

stainless steels	1031	
cutting speeds for		
superalloys	1038	
titanium and titanium alloys	1037	
tool steels	1030	
unusual materials	1081	
cutting time for	1081	
insert holder	770	
speed adjustment factors		
depth of cut	1034	
feed	1034	
lead angle	1034	
speeds and feeds	1025	1171
Twist drill	866	870
equivalent of gage or letter size	868	
grinding (sharpening)	997	
length of point on	889	
parallel shank jobber	894	
parallel shank long series	895	
tolerances, metric	893	
types	866	
Type metal	544	

U**U.S.**

Board of Supervising Inspectors	288	
Dept. of Commerce, formula for pressure in		
tubes	293	
gallons into liters	2681	
standard screw threads	1806	
standard sheet metal gage	2608	
UK gallons to liters	2678	2681

Index Terms

Links

Ultimate strength

common materials	394
compressive	201
copper-base powdered alloys	393
iron and steel	432
iron-base powdered alloys	393
nonferrous metals	513
plastics	562
shear	201
tungsten-base powdered alloys	393

Ultrasonic fluxless soldering	1426
-------------------------------	------

Uncoated metals and alloys, preferred

thicknesses, metric	2608
---------------------	------

Undercut, in spur gearing	2146
---------------------------	------

Unified numbering system for metals

(See *UNS number*)

Unified thread system

cold form tap drill sizes	2036	
screw thread form	1806	1812
British UNJ	1863	
diameter-pitch combinations	1816	
hole sizes for tapping	1857	2021
miniature screw thread	1858	
standard series	1814	1817
coarse thread	1844	
constant pitch	1846	
extra-fine thread	1845	
fine thread	1844	
thread classes	1854	
screw thread form		
thread designation	1856	
thread formulas	1815	
threaded fasteners		

Index Terms**Links****Unified thread system (*Cont.*)**

bolts, screws, and nuts	1538	1626	1643	1666
	1676	1680	1684	1690
	1693	1701	1716	1794
	1799			
tensile stress area	1528	1536		
tensile stress due to tightening	1524			

Uniform motion

175

Unit systems

cgs	150	2656		
MKS	150	2656		
MKSA (m-kg-s-A)	2656			
SI metric	2656	2658		
US customary	2660			

Unit under test (UUT)

720

Units of measure and conversion factors

angular and circular	2662			
Apothecaries' fluid	2679			
area	2675			
barrel	2679			
dry	2679			
electric wires	2675			
energy	2693			
flow	2682			
fluid	2678			
force	2688			
heat	2690			
inertia and momentum	2699			
length	2661			
mass and weight	2683			
Apothecaries' weight	2683			
Avoirdupois or commercial	2683			
Troy weight	2683			
miscellaneous	2699			

Index Terms

Links

Units of measure and

conversion factors (*Cont.*)

nautical	2661		
power	2690	2693	
pressure and stress	2686		
shipping	2678		
surveyors	2661		
temperature	2695		
thermal conductance	2694		
velocity and acceleration	2698		
viscosity	2698		
volume	2678		
work	2693		
Universal joints	2445		
angular velocity of driven shaft	2445		
intermediate shaft	2446		
maximum and minimum velocities	2445		
UNS number	398		
copper alloys	515		
copper and copper alloys	514		
number	402		
plain carbon, alloy and tool steel	398	400	404
series of different metal	398		
stainless steel	398	406	
Upsetting, steel for cold	410		
UUT (Unit under test)	720		

V

V.I. (Viscosity Index)	2426		
Vacuum furnace brazing	1431		
Van Keuren gear measuring tables	2221		
Vanadium, gearing material	2243		
Variable speed belts (<i>see</i> Belts and pulleys:			
variable speed belts)			

Index Terms**Links**

Varnish, pattern	1413	
V-belts (<i>see</i> Belts and pulleys: V-belts)		
V-block	686	688
Vector and scalar quantities	153	
Vee-block	686	688
Velocity	149	175
angular	175	177
rpm to radian per second conversion	177	
converting to rpm	1015	
linear	175	
of points on rotating bodies	177	
unit conversion	2698	
Vernier scale		
dual metric-inch	676	
reading	675	
reading a metric	676	
reading on a protractor	675	
Versed sine and versed cosine	110	
V-flange tool shanks and retention knobs	967	
Vickers hardness	506	
Viscosity		
absolute	2425	
conversion table for lubricating oils	2698	
index (V.I.)	2426	
kinematic	2425	
lubrication	2425	
temperature chart for SAE oils	2324	
unit conversion	2698	
Vitrified bonded wheels	1000	1217
coolants for	1185	
thread grinding	2053	
Volume		
barrel	87	
cone	84	

Index Terms**Links****Volume (Cont.)**

cube	82	
cylinder	83	
hollow	84	
portion of	83	
ellipsoid	85	
frustum of cone	84	
geometrical figures	82	
measures	2678	
of solids	82	
paraboloid	86	
paraboloidal segment	87	
prism	82	
prismoidal formula	66	
pyramid	82	
frustum of	83	
solid of revolution	66	
specific gravity	380	
sphere	85	
sphere		
hollow	86	
spherical		
sector	85	
segment	85	
wedge	86	
zone	86	
square prism	82	
torus	87	
units and conversion of	2678	2682
wedge	83	
V -process, casting	1410	
V -shaped groove, checking by pins	686	
V -thread	1806	
Vulcanized fiber, strength	394	

Index Terms**Links**

W			
Wahl spring curvature correction factor	314		
Washburn & Moen wire gage	2605		
Washers			
ANSI, lock	1565		
ANSI, plain	1562	1604	1607
Belleville or disc spring	344	350	
British Standard metric	1640		
metric spring	1638		
designations	1641		
metric	1604	1607	
designations	1607		
materials	1607		
preferred sizes	1562		
spring lock type	1566		
tooth lock type	1566		
Watch screw threads	1858		
Water contamination of oil	2440		
Watt equivalent	2690		
Waviness	733		
height values	738		
Wax in oil	2427		
Wear life factor involute spline	2268		
Wear resistance cutting tool	996		
Wedge	169		
center of gravity	226		
mechanical principle of	169		
spherical, volume	86		
volume	83		
Weight	151		
air	381	384	
angles, structural steel	2600		
avoirdupois or commercial	2683		

Index Terms**Links****Weight (*Cont.*)**

castings, from pattern weight	1414	
channels, structural	2599	2603
earth	384	
earth or soil	384	
hollow shafts	303	
I-beams	2594	
metric measures	2683	
mol	384	
molecular	384	
nails and spikes	1800	
of natural piles	382	
per feet of wood	386	
specific gravity	380	
steel S-sections	2598	
troy, for gold and silver	2683	
water	380	
wide flange, steel	2594	
wood	386	
Weldability, HSLA steels	421	
Welding	1433	1495
aluminum	1460	
ANSI welding symbols	1476	
application of	1480	
nondestructive testing	1485	
arc cutting of metals	1463	
basic symbols	1476	
codes, rules, regulations,		
specifications	1478	
controls	1437	
current ranges diameter, sheet metal	1451	
current selection	1456	
cutting		
metals with electric arc	1463	

Index Terms

Links

Welding (*Cont.*)

metals with oxidizing flame	1462		
with lasers	1491		
definitions and symbols	1476		
designations	1479		
dies	1485		
dimensions	1477		
electrode	1433	1438	1456
AWS E60XX	1450		
AWS E70XX	1452		
carbon steels	1434		
characteristics	1451		
composition	1456		
current ranges	1456		
diameters	1451		
sizes	1434		
stainless steels	1434		
thoriated	1457		
zirconiated	1457		
electron beam welding	1468		
FCAW (flux-cored arc)	1442		
all position electrodes	1445		
alloy steels	1442		
carbon steels	1442	1444	
contact tip recess	1445		
deposition rates	1447		
electrodes	1442	1448	
diameter	1447		
gas shielded	1442	1444	
material condition	1443		
porosity and worm tracks	1445		
selection	1443		
settings	1443		
shielding gases	1449		

Index Terms

Links

Welding (*Cont.*)

stainless steels	1442	
weld requirements	1443	
fill passes	1471	1474
filler metals	1458	
fluxes	1433	
gas shielded, all position	1442	
GMAW (gas metal arc)		
electrode diameters	1434	
metal thickness	1439	
optimum settings	1441	
shielding gases	1435	1437
alloy steels	1435	
aluminum	1437	
carbon steels	1435	
stainless steels	1436	
spray transfer	1439	
welding sheet steel	1435	
GTAW (gas tungsten arc)	1453	
aluminum	1457	
current	1453	
EWP electrode	1457	
filler metals	1458	
selecting tungsten electrode	1456	
shielding gases	1458	
hard-facing	1464	
laser		
cutting	1491	
welding	1495	
letter designations for processes	1479	
materials used in welding	1476	
nondestructive testing	1485	
PAW (plasma arc)	1458	
applications	1459	

Index Terms

Links

Welding (*Cont.*)

cutting	1461	
equipment	1459	
fusion	1460	
gases for	1458	
of aluminum	1460	
surface coating	1461	
surfacing	1461	
pipe welding	1469	
plasma arc welding		
gases	1458	
shielding gases	1459	
argon	1459	
helium	1459	
hydrogen	1459	
plastics	595	
process letter designation	1479	
process names	1433	
shielding gas	1458	
SMAW (shielded metal arc)	1449	
characteristic of electrodes	1449	
specifications	1478	
supplementary symbols	1477	
symbol	1477	
arrow side	1482	
bead type back	1481	
bevel groove	1480	
built up surface	1481	
electron beam	1480	1484
fillet	1480	
intermittent fillet	1482	
letter designations	1478	
melt thru weld	1484	
plug groove	1480	

Index Terms**Links****Welding (Cont.)**

process	1478
symbol	
resistance-seam	1480
single pass back	1481
square groove	1480
U- groove	1483
V-groove	1482
tungsten electrode compositions	1456

Weldon shanks

dimensions of	816	
end mills	816	819

Wheel life in grinding

(See Grinding: wheel life)

Wheels

abrasive cutting	976	
and pulleys in mechanics	170	
buffing	1504	
diamond	1000	1240
dressing	1235	
Geneva	171	
grinding	1216	
diamond	1240	
mechanical principles of	170	
polishing	1501	1504
silicon carbide	1000	

White cast iron 1404**White metal bearing alloys** 2357**Whitworth**

bolts, screws, nuts, washers, and				
studs	1626	1666	1679	1700
screw thread form	1806	1953	1965	1981
	1987			
drills for pipe taps	2037			

Index Terms

Links

Whitworth (*Cont.*)

measuring	1992	1995	1998
truncated thread	1983		
wire size for measuring threads	1992		
Wide-flange shapes, steel	2594		
moment of inertia	2594		
radius of gyration	2594		
section modulus	2594		
weight per foot	2594		
Wind chill temperature	2700		
Wind velocity to pressure	2700		
Windlass	170		
Wing nuts and screws			
nuts			
dimensions	1791		
finish	1795		
materials	1795		
standard	1791		
types	1791		
screws	1791		
dimensions	1795		
lengths	1798		
materials	1795		
points	1799		
cone point	1799		
cup point	1799		
dog point	1799		
flat point	1799		
oval point	1799		
threads	1799		
screws			
types	1795		

Index Terms

Links

Wire

checking screw threads	1990	
Acme threads	1995	2004
buttress threads	2006	
contact pressure	1993	
formulas for large lead angles	1993	
taper screws	2005	
circular mill measurement	2675	
copper	2606	
diameters, raised to powers	347	
EDM	1393	1402
music	347	2604
nails and spikes	1800	
preferred thicknesses	2609	
rod gages	2604	
rope	2613	
sheet metal gages	2608	
size for checking gears	2221	
for external spur gears	2221	
for helical gears	2235	
for internal gears	2230	
for spur and helical gears	2230	
spring, tensile strength	395	
tubing, wall thickness gages	2604	
wire gages	2604	

Wire rope

breaking strengths	2614
classes	2614
construction	2613
definitions of terms	2613
factors of safety	2619
installation	2620
plow steel, strength of	2616
properties	2614

Index Terms

Links

Wire rope (*Cont.*)

safe loads for	2619
simplified practice recommendations	2618
sizes	2616
specification	2614
strength	2616
weight	2616

Wood

bearings	2362
bonding	2580
boring	388
compression perpendicular to grain	385
compression strength	386
crushing strength	385
density	387
dimensions of sawn lumber	387
hardmetal tooling for	795
ignition temperatures	376
machinability	387
maximum bending load	386
mechanical properties of	386
effect of pressure treatment	386
mechanical property	385
modulus of rupture	385
mortising	388
patterns	1412
planing	388
sanding	388
screws	1801
shaping	388
shear strength	386
shear strength parallel to grain	386
tensile strength	386
tooling for wood and nonmetals	795

Index Terms**Links**

Woodruff keys and keyseats			
ANSI	2477		
cutters	832		
key	2481		
dimensions	2478		
number	2481		
keyseat			
dimensions	2480		
hub	2481		
milling cutter	2481		
shaft	2481		
Woodruff keys and keyways	2469		
designation	2470		
materials	2470		
tolerances	2470		
Woodruff keys dimensions	2470		
Woodruff keyways dimensions	2471		
Woodworking cutters	795		
Work	149	182	
formulas	182		
formulas for work and power	186		
maximum load in bending wood	385		
relation to energy	182		
sheet metal forming	1342		
units conversion	2693		
Working stress	200	204	212
at elevated temperature	315		
factors of safety	204		
of bolts	1535		
shafts	301		
springs	301	315	
Worm gearing	2191		
addendum	2191		
ANSI Standard, fine-pitch	2191		

Index Terms**Links****Worm gearing (*Cont.*)**

effect on profile and pressure angle		
of cutting diameter	2193	
of production method	2193	
fine-pitch	2191	
formulas for dimensions	2191	
hobs for	2191	
lead angles	2191	
material	2193	2245
number of threads or “starts”	2194	
multi-thread worms	2194	
single-thread worms	2194	
outside diameter	2191	
pitch diameters, range	2192	
pitches, standard	2191	
pressure angles	2191	
proportions	2191	
ratio of teeth to thread starts	2194	
tooth form of worm and wormgear	2193	
Worm wheel, indexing movements	2119	
Wrapped spring clutches	2450	
Wrench		
clearances		
for box wrenches, metric	1561	
for hex wrenches	1557	1559
for open end wrenches	1556	
for spacing of bolts	1555	
openings, ANSI Standard	1556	
torque		
cap screws	1522	
steel bolts	1522	
studs	1522	
Wrinkling, sheet metal	1353	

Index Terms

Links

Wrought

copper alloys	519
copper-beryllium	529
iron	
strength	432
temperature effect on	394
thickness gage for sheet	2608

Y

Yield point	200	
for various materials	200	
heat-treated steels	424	
iron and steel	432	
plastics	562	
steel	1407	
Yield strength	200	
aluminum alloys	391	534
carbon steel	1408	
cobalt alloys	392	
compressive	201	
copper alloys	391	515
Cu-base powdered alloys	393	
Cu-beryllium alloys	529	
Cu-silicon alloys	528	
Everdur	528	
iron-base powdered alloys	393	
magnesium alloys	547	
nickel alloys	392	548
nonferrous metals	513	
perforated metal	2607	
plastics	562	
shear	201	
spring wire	395	
stainless steel	392	430

Index Terms**Links****Yield strength (*Cont.*)**

steel	391	422
high-strength, low-alloy	421	
titanium alloys	550	
tungsten-base powdered alloys	393	
Young's modulus (<i>see</i> Modulus of: elasticity)		

Z

Z ero, absolute	2695	
Z erol bevel gears	2125	2178
Z inc plating	1515	
Z inc-base alloys, die casting	1416	
Z NP curve	2421	
Z -section		
moment of inertia	243	
radius of gyration	243	
section modulus	243	

INDEX OF STANDARDS

Index Terms

Links

A

Aerospace Industries Association Standard

NAS 911	3158
NAS 912	3158
NAS 913	3158
NAS 914	3158
NAS 960	3158
NAS 963	3158
NAS 970	3158
NAS 971	3158
NAS 978	3158
NAS 990	3158
NAS 993	3158
NAS 994	3158
NAS 995	3158

Aerospace Standard

AS3215	1790
AS3216	1790
AS3217	1790
AS3218	1790
AS3219	1790

AGMA Standard

330.01	2181
370.01	2193
390.03	2165
112.05	2128
115.01	2128
116.01	2128
202.03	2181

Index Terms**Links****AGMA Standard (*Cont.*)**

208.03	2181
209.04	2181
390.03a	607

Alloys

babbitt, ASTM B23	2358
bearing and bushing	
SAE J459c	2357
SAE J460e	2357
sintered bronze	
ASTM B438-83a	2363
sintered iron	
ASTM B439-83	2363
white metal, ASTM B23	2358

Aluminum

alloys for electroplating		
ASTM B253	1511	
anodic coatings for		
MIL-A-8625F	1508	1512

American National Standard**AFBMA/AFBMA Standard**

Std 7	2383	2385
Std 9	2404	2414
Std 10	3360	3363
Std 11	2409	2414
Std 20	2375	
Std 8.2	2394	
Std 18.1	2381	2388
Std 18.2	2381	2387
Std 24.1	2380	
Std 24.2	2379	

ANSI Standard

ANSI B32.1	2609			
B1.1	972	1552	1554	1813

Index Terms

Links

American National Standard (*Cont.*)

B1.3	2009			
B1.5	1921	1939		
B1.7	1983			
B1.9	1946	1950	2007	
B1.11	1982			
B1.12	1973			
B4.1	634	636	640	648
	2385			
B4.2	648	650	653	662
	673	2610		
B5.18	962	964		
B6.9	2191			
B7.1	972	1247	1249	1259
	1271			
B47.1	2013			
B74.2	976	1219	1225	1227
B74.3	1240	1244		
B74.13	1218	1243		
B92.1	2256	2262	2264	2273
	2274			
B94.2	852	861		
B94.33	3127	3130		
B94.35	887	890		
B17.1	2472	2475		
B17.2	2478			
B18.3	1600			
B18.17	1791			
B27.6	1790			
B27.7	1763	1768	1770	
B1.20.3	1962	1964		
B1.20.4	1964			
B1.20.5	1964			
B18.1.2	1734	1736		

Index Terms

Links

American National Standard (*Cont.*)

B18.2.1	1538			
B18.2.2	1538	1556		
B18.6.1	1801			
B18.6.3	1643			

ANSI Standard

B18.6.4	1701	1703	1708	1716
B18.8.1	1747			
B18.22.1	1562	1565		
B18.2.3.1M	1581			
B18.2.3.2M	1581	1583	1585	
B18.2.3.3M	1581	1584		
B18.2.3.4M	1585			
B18.2.3.5M	1581	1585	1592	
B18.2.3.6M	1581	1585	1591	
B18.2.3.7M	1581	1590		
B18.2.3.8M	1581	1586	1594	
B18.2.3.9M	1585			
B18.2.4.1M	1581	1599	1602	
B18.2.4.2M	1581	1599	1602	
B18.2.4.3M	1581	1599		
B18.2.4.4M	1581	1599	1601	1603
B18.2.4.5M	1599	1605		
B18.2.4.6M	1581	1599	1605	
B1.20.6M	1964			
B18.3.1M	1583			
B18.6.7M	1643			
B18.16.1M	1603			
B18.16.3M	1581	1599	1604	
B1.3M	1899			
B1.13M	1885			
B1.13M	1603			
B1.18M	1878			
B4.4M	661			

Index Terms**Links**American National Standard (*Cont.*)

B32.4M	673			
B92.2M	2252	2272	2279	
B94.55M	1013			
B94.11M	866			
B18.22M	1581	1607		
B27.7M	1790			
B27.8M	1790			
B107.4	972			
B212.1	764	772	775	899
	903			
B212.3	782			
B212.4	765			
B212.5	767			
B212.12	765			
X3.37	3190			
Y10.4	2655			
Y14.2M	611	3213		
Y14.5M	968	1324		
Y14.36M	740			
Z17.1	672			
Z136.1	1490			
ANSI/AGMA 2005	2181			
ANSI/CAM-I 101	3157			
ANSI/EIA Standard				
408	3157			
431	3157			
441	3157			
449	3157			
484	3157			
494	3157			
ANSI/EIA Standard				
423-A	3157			
491-A	3157			

Index Terms

Links

American National Standard (*Cont.*)

227-A	3157			
358-B	3157			
267-B	3157			
232-D	3157			
RS 274-D	3157	3166	3169	3171
	3174	3190		

ANSI/RMA Standard

IP-20	2495			
IP-21	2502			
IP-22	2489			
IP-23	2510			
IP-24	2528	2530		
IP-25	2518			
IP-26	2513	2516		

ASME and ANSI/ASME Standard

ANSI/ASME B94.9	904			
ANSI/ASME B32.100	2611			
ANSI/ASME B32.3M	2610			
B1.1	1813	1843	1856	
B1.2	1969	1994	2007	2010
	2012	2014		
B1.5	944	1921	1924	1927
	1931	1933		
B1.8	1922	1928	1939	1943
B1.12	1973	1975		
B1.15	1900			
B5.50	967	3157		
B5.54	3157			
B5.10	887	951	960	
B5.15	2279			
B46.1	733	737		
B94.6	991	993		
B94.19	809	831		

Index Terms**Links**American National Standard (*Cont.*)

B18.3	1598	1682	1688	1692
B18.5	1551	1590		
B1.20.1	1957			
B1.20.7	1968	1970		
B46.3.1	733			
B18.1.1	1734	1739		
B18.2.1	1538	1626		
B18.2.2	1538	1545	1556	1626
B18.6.2	1680	1687	1690	
B18.8.2	1749	1756		
B18.21.1	1565			
B18.2.3.4M	1589			
B18.2.3.5M	1592			
B18.2.3.9M	1588			
B18.5.2.2M	1589	1593		
B89.1.12M	3157			
B18.1.3M	1736			
B18.3.1M	1594	1598	1600	
B18.6.5M	1704	1716		
B18.6.7M	1652	1658		
B18.16.3M	1606			

ASME and ANSI/ASME Standard

B18.21.2M	1565			
B1.3M	1813	1856	1978	
B1.7M	1807	1813		
B1.30M	1900			
B1.13M	1878	1880	1885	1889
	1899	1903		
B1.21M	1878	1900		
B5.1M	1726			
B36.10M	3397			
B92.2M	2279			

Index Terms

Links

American National Standard

ASME and ANSI/ASME Standard (*Cont.*)

B94.11M	868	876	878	885
	888			
B29.1M	2537	2541	2551	2554
	2558			
B29.3M	2538			
Y14.2M	610			
Y14.5M	612	741		
Y10.3M-1984	2655			

AWS Standard

ANSI/AWS 2.4	1431	1479	1485	
--------------	------	------	------	--

SAE Standard

ANSI/SAE				
AS568A	2587			
MA4030	1790			
MA4035	1790			
MA4036	1790			
MA4016	1790			
MA4017	1790			
MA4020	1790			
MA4021	1790			
MA4029	1790			

American Standards Association

ASA B1.1	1813			
ASA B1.6	1983			
ASA B1.10	1858	2032		
ASA B1.12	1634			
ASA B5.38	973			
ASA B17.1	299			
ASA B18.2	1538	1556		
ASA B18.2.1	1538			
ASA B17c	299			

ANSI	2655			
------	------	--	--	--

Index Terms

Links

ANSI Technical Report

ANSI B11 TR2	1189	1191
ANSI/ASME B18.15-1995, R2003	3455	

ASTM Standard

A31	1734	
A307	1534	1541
A325	1534	1592
A354	1534	1542
A449	1534	1542
A490	1534	1592
A502	1734	
A131	1734	
A152	1734	
A255	466	
A563M	1601	1603
A574M	1592	
ASTM A743	1409	
ASTM A220	1405	
ASTM A297	1408	
ASTM B32	1425	
ASTM B633	1515	
ASTM B253	1511	
B438	2363	
B439	2363	
B23-83	2358	
D1043	565	
E18	3363	
E140	509	3363
E1497	1189	
E1687	1189	
F568	1592	
F594	1540	
F467M	1603	
F837M	1593	

Index Terms

Links

B

Belts

synchronous

ANSI/RMA IP-24 2528 2530

V

drives using double-V

ANSI/RMA IP-21 2502

drives using multiple

ANSI/RMA IP-20 2495

drives using narrow multiple

ANSI/RMA IP-22 2489

drives using variable-speed 2518

light duty

ANSI/RMA IP-23 2510

ribbed

ANSI/RMA IP-26 2513

Bolts

British Association BS 57 1667

finished hexagon

ASA B18.2.1 1538

heavy hex

ANSI B18.2.3.6M 1581 1585 1591

heavy hex, structural

ANSI B18.2.3.7M 1581 1590

heavy hexagon, Unified, UNC and UNF

thread, black

BS 1769 1538 1626

hex

ANSI B18.2.3.5M 1581 1585 1592

ANSI/ASME B18.2.3.5M 1592

hexagon, ISO, black

BS 4190 1626 2034

Index Terms

Links

Bolts (*Cont.*)

machine

BSW and BSF thread

BS 450 1667 1676 1679

precision hexagon

BSW and BSF thread

BS 1083 1626 1628

ISO, **BS 3692** 1626 1630

precision hexagon

Unified, UNC and UNF thread

BS 1768 1538 1626

round head (inch)

ANSI/ASME B18.5 1551

ANSI/ASME B18.5.2.2M 1589 1593

square and hex (inch)

ANSI B18.2.1 1538

ANSI/ASME B18.2.1 1538 1626

ASA B18.2 1538 1556

Unified, UNC and UNF thread, black

BS 2708 1626

British Standard

BS 45 1979

BS 46 3386 3388

BS 57 1667

BS 84 1626 1955

BS 93 1626 1982

BS 21 1965

BS 308 2172

BS 3027 2172

BS 328 890

BS 3382 1634 1667

BS 3550 2279

BS 3643 1635 1667 1910 1915

1918 1919

Index Terms**Links****British Standard (Cont.)**

BS 3692	1626	1630	2034	
BS 3696	2172			
BS 4084	1863			
BS 4168	1694	2034		
BS 4183	1666	1669	1673	1675
	2034			
BS 4186	2034			
BS 4190	1626	2034		
BS 4235	3382			
BS 436	2172			
BS 4320	1640			
BS 4464	1638			
BS 450	1667	1676	1679	
BS 4620	1742			
BS 545	2172			
BS 6186	2279			
BS 641	1744			
BS 721	2172			
BS 821	2172			
BS 970	3382			
BS 978	2172			
BS 1083	1626	1628		
BS 1157	1955	2033		
BS 1387	1966			
BS 1449	1640			
BS 1580	1626			
BS 1657	1945			
BS 1768	1538	1626		
BS 1769	1538	1626		
BS 1981	1676	1678		
BS 1916	1748			
BS 2059	2278			
BS 235	2172			

Index Terms

Links

British Standard (*Cont.*)

BS 2519	2172		
BS 2693	1626	1634	1637
BS 275	1742	1745	
BS 2779	1965		
BS 2870	1640		
BS 2827	1667		
BS 4500	662	3383	
BS 6104	1694		
BS 6105	1694		
BS 1807	2172		
BS 2708	1626		
PD 3376	2172		
PD 6457	2173		
PD 6481	674		

C

Castings

corrosion resistant, ASTM A743 1409

Copper

rolled and alloys, sheet, strip, and foil

BS 2870 1640

D

Deutsches Institut für Normung

DIN 471	1790		
DIN 472	1790		
DIN 5417	1790		
DIN 6799	1790		
DIN 7993	1790		
DIN 867	2217		
DIN 984	1790		
DIN 103	1903	1909	

Index Terms

Links

Deutsches Institut für Normung (*Cont.*)

LN 471	1790
LN 472	1790
LN 6799	1790

Diamond and CBN

specification for shapes and sizes

ANSI B74.3	1240	1244
------------	------	------

Dimensioning and tolerancing

ANSI Y14.5M	968	1324
--------------------	-----	------

ANSI/ASME Y14.5M	612	741
-------------------------	-----	-----

Drawing

engineering practice BS 308	2172
-----------------------------	------

line conventions and lettering

ANSI Y14.2M	610	3213
--------------------	-----	------

method of indicating surface texture

ISO 1302	751
----------	-----

surface texture symbols

ANSI Y14.36M	740
---------------------	-----

symbols

welding, brazing, and nondestructive testing

ANSI/AWS A2.4	1431	1479	1485
---------------	------	------	------

E

Electronic Industries Association Standard

EIA AB3-D	3157
-----------	------

EIA Bulletin 12	3157
-----------------	------

F

Fasteners

clearance holes for bolts and screws

ISO 273	2034
----------------	------

Index Terms

Links

Fasteners (*Cont.*)

corrosion-resistant stainless steel

BS 6105 1694

externally threaded

mechanical and material requirements

SAE J429 1534 1542

SAE J995 1535

SAE J1199 1592

grade designation

SAE J429 1534

SAE J995 1535

SAE J1199 1592

hexagon, width across flats

ISO R272 1634

mechanical properties

BS 6104 1694

ISO 898 1899

O-rings, ANSI/SAE AS568A 2587

o-rings, ANSI/SAE AS568A 2587

threaded

general rules for tightening

JIS B 1083 1528

Federal Specification

GGG-G-15A 3118

GGG-G-15B 3118

GGG-G-15C 707 3118

RR-R-571a 3437 3440

Federal specification

gage blocks, inch

and metric sizes 707

Flat metal products

preferred sizes

ANSI/A 2610

Index Terms

Links

G

Gage blanks, ANSI B47.1	2013	
Gage blocks		
GGG-G-15A	3118	
GGG-G-15B	3118	
inch and metric		
GGG-G-15C	707	3118
Gears		
basic rack, ISO 53	2172	
bevel, machine cut, BS 545	2172	
classification and inspection		
AGMA 390.03	2165	
cylindrical, ISO 54	2172	
design		
bevel		
AGMA 330.01	2181	
AGMA 208.03	2181	
AGMA 209.04	2181	
ANSI/AGMA 2005	2181	
face gears, AGMA 202.03	2181	
fine pitch, AGMA 370.01	2193	
worm gear, fine pitch		
ANSI B6.9	2191	
double circular arc type		
PD 3376	2172	
fine pitch, BS 978	2172	
for traction, BS 235	2172	
for turbines and similar drives		
BS 1807	2172	
geometry		
AGMA 115.01		
Basic Gear Geometry	2128	
glossary of terms, BS 2519	2172	

Index Terms

Links

Gears (*Cont.*)

iron castings for BS 821	2172			
master, BS 3696	2172			
nomenclature, terms definitions, symbols and abbreviations				
AGMA 112.05	2128			
AGMA 116.01	2128			
spur and helical				
BS 436	2172			
guide to addendum modifications				
PD 6457	2173			
tooth proportions				
coarse-pitch involute spur				
USAS B6.1	2131	2135	2146	2149
fine-pitch involute spur and helical				
USAS B6.7	2135	2138	2150	2206
Involute, DIN 867	2217			
worm BS 721	2172			
worm dimensions, BS 3027	2172			

Grinding wheels

abrasive wheels, use, care, and protection				
ANSI B7.1	972	1247	1249	1259
	1271			
markings for identifying				
ANSI B74.13	1218			
shapes, sizes and identification				
ANSI B74.2	1219			

H

Hardness, metallic

conversion tables for ASTM E140	3363			
test methods, ASTM E18	3363			

Hexagon wrench keys

BS 4168	1694	2034		
----------------	------	------	--	--

Index Terms

Links

I

Iron

pearlitic malleable, ASTM A220	1405		
ISO 3098-2	747		
ISO metric screw threads			
BS 3643	1667		
ISO Standard			
ISO 53	2172		
ISO 54	2172		
ISO 68	1808	1878	1883
ISO 3592	3158		
ISO 4032	1599		
ISO 4033	1599		
ISO 4035	1599		
ISO 4156	2272		
ISO 4161	1599		
ISO 4336	3158		
ISO 4343	3158		
ISO 4762	1583		
ISO 841	3158		
ISO 887	1607		
ISO 898	1899		
ISO 965	1885	1889	1903
ISO 230	3158		
ISO 261	1900		
ISO 273	2034		
ISO 2972	3158		
ISO 6983/1	3174		
ISO 6983/2	3174		
ISO 6983/3	3174		
ISO 8038-1	1983		
ISO 1302	751		
ISO 230-2	1322		

Index Terms

Links

ISO Standard (*Cont.*)

ISO 2806	3158
ISO 2904	1903
ISO DR 911	1634
ISO DR 947	1634
ISO DR 950	1634
ISO DR 952	1634
ISO DR 987	1634
ISO R773	3382
ISO R774	3382
ISO R861	1583
ISO R272	1634
ISO R288	1634
ISO TC/600	2174
ISO TR 6132	3158
ISO/TC2/WG6/N47	1607

J

Japanese Industrial Standard

JIS B 6336	1322
JIS B 6338	1322
JIS B 1083	1528
JIS B 6201	1322

K

Keys and keyseats

ANSI B17.1	2472	2475
ASA B17.1	299	
metric, BS 4235	3382	
USAS B17.1	299	
Woodruff		
ANSI B17.2	2478	
BS 46	3386	3388

Index Terms

Links

L

Lasers, safe use of, ANSI Z136.1

1490

Letter symbols

heat and thermodynamics

ANSI Y10.4

2655

mechanics and time-related

ANSI/ASME Y10.3M-1984

2655

Limits and fits

for engineering, BS 1916

1748

ISO

BS 4500

662

Metric, **BS 3643**

1635

1667

metric, **BS 4500**

3383

preferred

cylindrical ANSI B4.1

634

636

640

648

2385

metric

ANSI B4.2

648

650

653

662

673

2610

M

Metalworking fluids

mist control consideration

ANSI B11 TR2

1189

1191

respiratory protection

NIOSH 1987a

1191

NIOSH 1987b

1191

virgin base oils

carcinogenic potential

ASTM E1687

1189

water miscible

standard practice for safe use

ASTM E1497

1189

Index Terms**Links**

Military Standard or
Specification

DOD-P-16232-F	1514			
MIL-A-8625F	1508	1512		
MIL-C-14550B	1510			
MIL-C-13924C	1509			
MIL-C-14538C	1508			
MIL-C-8837B	1515			
MIL-C-5541E	1509			
MIL-F-495E	1509			
MIL-G-45204C	1512			
MIL-L-46010D	1512			
MIL-M-45202C	1510			
MIL-M-3171C	1510			
MIL-P-81728AT	1510			
MIL-P-45209B	1513			
MIL-R-21248	1789			
MIL-R-27426	1772	1774	1776	1778
	1790			
MIL-R-46085B	1514			
MIL-R-21248B	1790			
MIL-T-10727C	1515			
MS 3215	1785			
MS 16624	1780			
MS 16632	1783			
MS 16633	1784			
QQ-C-320B	1509			
QQ-N-290A	1513			
QQ-P-416F	1509			
QQ-P-35C	1513			
QQ-S-365D	1514			
TT-C-490D	1513			

Index Terms

Links

N

National Electrical Manufacturers

Association Standard

NEMA 1A1 3158

National Fire Protection Association

NFPA 1963 1971

NFPA No. 194 1970

National Institute of Safety and Health

NIOSH 1987a 1191

NIOSH 1987b 1191

National Machine Tool Builders Association

Standard, NMTBA 3158

Numerical control

ASCII 3157

axis and motion nomenclature 3157

binary input format

ANSI/EIA 494 3157

computerized (CNC), specification for

NAS 995 3158

coordinate measuring machines

methods for performance evaluation

ANSI/ASME B89.1.12M 3157

coordinate system and motion

nomenclature, ISO 841 3158

data interface

asynchronous, ANSI/EIA 491-A 3157

parallel, ANSI/EIA 408 3157

serial

ANSI/EIA 449 3157

ANSI/EIA 232-D 3157

dimensional measuring interface standard

ANSI/CAM-I 101 3157

Index Terms

Links

Numerical control (*Cont.*)

direct numerical control system	
NAS 993	3158
electrical and mechanical interface for	
DNC and NC, ANSI/EIA 484	3157
electrical interface between machine tool	
and control, ANSI/EIA 431	3157
industrial automation systems	
output file structure and language	
format, ISO 3592	3158
post processor commands	
ISO 4343	3158
vocabulary, ISO 2806	3158
industrial cell controller, classification	
and selection	
NEMA 1A1	3158
interface signals between NC unit and	
electrical equipment	
ISO 4336	3158
machine tools	
test code, ISO 230	3158
tool holders, NAS 970	3158
machines	
composite filament tape laying	
NAS 990	3158
drilling, NAS 960	3158
glossary of terms	
EIA AB3-D	3157
horizontal boring, drilling, and milling	
NAS 914	3158
milling	
adaptive control system, NAS 994	3158
profiling and contouring, NAS 913	3158
spar, NAS 912	3158

Index Terms

Links

Numerical control (*Cont.*)

precision measuring/inspection

NAS 971 3158

vertical and horizontal jig boring

NAS 963 3158

machining centers

methods for performance evaluation

ANSI/ASME B5.54 3157

NAS 978 3158

milling machines

skin/profile, NAS 911 3158

one-inch perforated tape

ANSI/EIA 227-A 3157

operator interface function

ANSI/EIA 441 3157

programming

program format and definition of

address words

ISO TR 6132 3158

programming language

ANSI/EIA RS 274-D 3157

symbols ISO 2972 3158

Numerical control machines

program format and address words

ISO 6983/1 3174

ISO 6983/2 3174

ISO 6983/3 3174

programming language

ANSI/EIA RS 274-D 3166 3169 3171 3174

3190

APT, ANSI X3.37 3190

Nuts

British Association BS 57 1667

Index Terms

Links

Nuts (*Cont.*)

crown (blind, acorn)				
SAE J483a	1549			
heavy hex				
ANSI B18.2.4.6M	1581	1599	1605	
heavy hexagon				
Unified, UNC and UNF thread, black				
BS 1769	1538	1626		
hex				
flange				
ANSI B18.2.4.4M	1581	1599	1601	1603
jam				
ANSI B18.2.4.5M	1599	1605		
slotted				
ANSI B18.2.4.3M	1581	1599		
style 1				
ANSI B18.2.4.1M	1581	1599	1602	
style 2				
ANSI B18.2.4.2M	1581	1599	1602	
hexagon high SAE J482a	1550			
hexagon with flange				
ISO 4161	1599			
hexagon, ISO, black				
BS 4190	1626	2034		
hexagon, thin, ISO 4035	1599			
machine				
BS 4183	1666	1669	1673	2034
BS 1981	1676	1678		
BSW and BSF thread				
BS 450	1667	1676	1679	
machine screw				
ANSI B18.6.3	1643			
nonferrous specification for				
ASTM F467M	1603			

Index Terms

Links

Nuts (*Cont.*)

precision hexagon

BSW and BSF thread

BS 1083

1626

1628

ISO BS 3692

1626

1630

Unified, UNC and UNF thread

BS 1768

1538

1626

prevailing-torque, hex and hex flange

ANSI B18.16.1M

1603

ANSI B18.16.3M

1581

1599

1604

ANSI/ASME B18.16.3M

1606

slotted and castle **ISO R288**

1634

square and hex (inch)

ANSI B18.2.2

1538

1556

ANSI/ASME B18.2.2

1538

1545

1556

1626

ASA B18.2

1538

1556

Unified, UNC and UNF thread, black

BS 2708

1626

style 1 **ISO 4032**

1599

style 2 **ISO 4033**

1599

wing ANSI B18.17

1791

P

Pins

clevis and cotter

ANSI B18.8.1

1747

taper, BS 46

3386

3388

taper, dowel, straight, grooved and spring

(inch)

ANSI/ASME B18.8.2

1749

1756

Pipe

wrought steel, welded and seamless

ANSI/ASME B36.10M

3397

Index Terms

Links

Plating standard

black chrome, MIL-C-14538C	1508
black oxide, MIL-C-13924C	1509
cadmium, QQ-P-416F	1509
chemical films, MIL-C-5541E	1509
chemical finish, black	
MIL-F-495E	1509
chrome, QQ-C-320B	1509
copper, MIL-C-14550B	1510
gold, MIL-G-45204C	1512
lubricant, solid film	
MIL-L-46010D	1512
magnesium anodic	
MIL-M-45202C	1510
magnesium process	
MIL-M-3171C	1510
nickel, QQ-N-290A	1513
palladium, MIL-P-45209B	1513
passivate, QQ-P-35C	1513
phosphate, heavy	
DOD-P-16232-F	1514
phosphate, light, TT-C-490D	1513
rhodium, MIL-R-46085B	1514
silver, QQ-S-365D	1514
tin lead, MIL-P-81728AT	1510
tin, MIL-T-10727C	1515
vacuum deposited cadmium	
MIL-C-8837B	1515

Power transmission

roller chains and sprockets, double-pitch				
ANSI/ASME B29.3M	2538			
roller chains, attachments, and sprockets				
ANSI/ASME B29.1M	2537	2541	2551	2554
	2558			

Index Terms

Links

Preferred

limits and fits				
cylindrical, ANSI B4.1	634	636	640	648
	2385			
metric				
ANSI B4.2	648	650	653	662
	673	2610		
numbers				
ANSI Z17.1	672			
PD 6481	674			
sizes				
flat metal products				
ANSI/ASME B32.100	2611			
ANSI/ASME B32.3M	2610			
PD 6481	674			
round, square, rectangle, and hexagon metal products				
ANSI B32.4M	673			
thickness				
uncoated thin flat metals				
ANSI B32.1	2609			
Public Law 101-592	1538			

R

Retaining rings

aerospace				
internal, LN 472	1790			
shafts LN 471	1790			
ANSI B27.7	1763	1768	1770	
for bearings with ring groove				
DIN 5417	1790			
internal DIN 472	1790			
internal spring type DIN 984	1790			
reinforced external, MA4030	1790			

Index Terms

Links

Retaining rings (*Cont.*)

round wire, snap type

DIN 7993 1790

shafts DIN 471 1790

spiral

dimensional limits

AS3219 1790

external

AS3216 1790

AS3218 1790

MA4016 1790

internal

AS3215 1790

AS3217 1790

MA4017 1790

MIL-R-27426

1772

1774

1776

1778

1790

uniform section

ANSI B27.6 1790

MA4035 1790

tapered

external **MA4020** 1790

internal **MA4021** 1790

internal, beveled

MA4029 1790

tapered and reduced cross section

ANSI B27.7M 1790

ANSI B27.8M 1790

tapered and reduced section type

MIL-R-21248 1789

tapered width,

uniform thickness

MA4035 1790

Index Terms

Links

Retaining washers

aerospace lock, for shafts

LN 6799 1790

Rivets

dimensions

BS 275 1742 1745

general engineering

BS 4620 1742

large

ANSI B18.1.2 1734 1736

small dimensions BS 641

1744

small solid

ANSI/ASME B18.1.1 1734 1739

ANSI/ASME B18.1.3M 1736

steel, ASTM A31 1734

S

SAE Standard

SAE J406 466

SAE J429 1534 1542

SAE J501 3396

SAE J995 1535 1540

SAE J1199 1592

SAE J482a 1550

SAE J483a 1549

SAE J459c 2357

SAE J460e 2357

Screws

British Association BS 57 1667

heavy hex

ANSI B18.2.3.3M 1581 1584

heavy hex, flange

ANSI B18.2.3.9M 1585

ANSI/ASME B18.2.3.4M 1589

Index Terms

Links

Screws

heavy hex, flange (*Cont.*)

ANSI/ASME B18.2.3.9M 1588

heavy, Unified, UNC and UNF thread,

black

BS 1769 1538 1626

hex

cap

ANSI B18.2.3.1M 1581

flange

ANSI B18.2.3.4M 1585

ANSI/ASME B18.2.3.4M 1589

formed

ANSI B18.2.3.2M 1581 1583 1585

lag

ANSI B18.2.3.8M 1581 1586 1594

hex lag

ANSI/ASME B18.2.1 1544

hexagon head cap

ASA B18.2.1 1538

ISO, black, **BS 4190**

1626 2034

machine

ANSI B18.6.3 1643

machine

ANSI B18.6.7M 1643

ANSI/ASME B18.6.7M 1652 1658

BS 4183 1666 1669 1673 2034

BS 1981 1676 1678

BSW and BSF thread

BS 450 1667 1676 1679

pressed, British Association and

Whitworth thread

BS 2827 1667

Index Terms

Links

Screws (*Cont.*)

metallic drive

ANSI B18.6.4 1701 1703 1708 1716

metric

hex cap

ANSI B18.2.3.1M 1581

precision, BSW and BSF thread

BS 1083 1626 1628

precision, ISO

BS 3692 1626 1630

precision, Unified, UNC and UNF thread

BS 1768 1538 1626

set

ANSI B18.3 1600

ANSI B18.3.1M 1583

ANSI/ASME B18.3 1682 1688 1692

ANSI/ASME B18.3.1M 1594 1598 1600

slotted headles 1680 1687 1690

square head

ANSI/ASME B18.6.2 1680 1687 1690

shoulder

ANSI B18.3 1600

ANSI B18.3.1M 1583

ANSI/ASME B18.3 1598 1682 1688 1692

ANSI/ASME B18.3.1M 1594 1598 1600

slotted head cap

ANSI/ASME B18.6.2 1680 1687 1690

socket **BS 4168**

1694 2034

socket head cap

ANSI B18.3 1600

ANSI B18.3.1M 1583

ANSI/ASME B18.3 1598 1682 1688 1692

ANSI/ASME B18.3.1M 1594 1598 1600

Index Terms

Links

Screws (*Cont.*)

socket head cap, hex				
ISO 4762	1583			
square and hex (inch)				
ANSI B18.2.1	1538			
square and hex (inch)				
ANSI/ASME B18.2.1	1538	1626		
tapping				
ANSI B18.6.4	1701	1703	1708	1716
tapping, thread forming and thread				
tapping				
ANSI/ASME B18.6.5M	1704	1716		
thread forming and cutting				
ANSI B18.6.4	1701	1703	1708	1716
thumb and wing				
ANSI B18.17	1791			
Unified, UNC and UNF thread, black				
BS 2708	1626			
wing				
ANSI B18.17	1791			
wood, ANSI B18.6.1	1801			
Shaft ends, SAE J501	3396			
Solder, ASTM B32	1425			
Spark plugs, BS 45	1979			
Splines				
involute				
ANSI B92.1	2256	2262	2264	2273
BS 3550	2279			
metric module				
ANSI B92.2M	2252	2272	2279	
BS 6186	2279			
ISO 4156	2272			
straight sided and serrations				
BS 2059	2278			

Index Terms

Links

Stainless steel

corrosion-resistant for fasteners

BS 6105 1694

for nuts ASTM F594 1540

for socket head cap screws

ASTM F837M 1593

Steel

alloy

for nuts

ASTM A563M 1601 1603

for socket-head cap screws

ASTM A574M 1592

quenched and tempered

for bolts, studs and external threaded

fasteners

ASTM A354 1534 1542

carbon

for bolts and studs

ASTM A307 1534 1541

for nuts

ASTM A563M 1601 1603

castings

heat resistant, ASTM A297 1408

for rivets and pressure vessels

ASTM A31 1734

hardenability

method for determining

ASTM A255 466

SAE J406 466

heat treated

for structural bolts

ASTM A325 1534

ASTM A490 1534

ASTM A325M 1592

Index Terms

Links

Steel				
heat treated (<i>Cont.</i>)				
ASTM A490M	1592			
plate, sheet, and strip				
British Standard				
BS 1449B	1640			
quenched and tempered				
for bolts and studs				
ASTM A449	1534	1542		
structural, for ships				
ASTM A131	1734			
tube, BS 1387	1966			
wrought, BS 970	3382			
Studs, screwed				
BS 2693	1626	1634	1637	
Surface texture				
roughness, waviness and lay				
ANSI/ASME B46.1	733	737		
T				
Threads				
Acme				
ANSI B1.5	1921	1939		
ANSI/ASME B1.5	944	1921	1924	1927
	1931	1933	1938	
Acme, stub				
ANSI/ASME B1.8	1922	1928	1939	1943
British Association, BS 93	1626	1982		
buttress				
ANSI B1.9	1946	1950	2007	
BS 1657	1945			
calculating and rounding dimensions				
ANSI/ASME B1.30M	1900			

Index Terms

Links

Threads (*Cont.*)

class 5 interference-fit

ASA B1.12 1634

electroplated coating for

BS 3382 1634 1667

gaging and gaging systems

ANSI B1.3 2009

ANSI B1.3M 1899

ANSI/ASME B1.3M 1813 1856 1978

general purpose, basic profile

ISO 68 1808 1878 1883

Interference fit

ANSI B1.12 1973

ANSI/ASME B1.12 1973 1976

ISO metric

BS 3643 1635 1667 1910 1915
1918

metric

ANSI B1.13M 1603

general purpose tolerances

ISO 965 1885 1889 1903

general purpose, **ISO 261** 1900

M profile

ANSI B1.13M 1885

ANSI B1.18M 1878

ANSI/ASME B1.13M 1878 1880 1885 1889
1899 1903

ANSI/ASME B1.21M 1878 1900

M profile B1.18M 1878

trapezoidal

DIN 103 1903 1909

ISO 2904 1903

Index Terms

Links

Threads (*Cont.*)

microscope objective

ANSI B1.11 1982

ISO 8038-1 1983

nomenclature ANSI B1.7 1983

nomenclature, definitions, and letter

symbols for

ANSI/ASME B1.7M 1807 1813

pipe

dryseal

ANSI B1.20.3 1962 1964

ANSI B1.20.4 1964

gaging

ANSI B1.20.5 1964

ANSI B1.20.6M 1964

general purpose

ANSI/ASME B1.20.1 1957

not pressure tight

BS 2779 1965

pressure tight

BS 21 1965

UN and UNR

ANSI B1.1 972 1552 1554

Unified

ANSI B1.1 972 1552 1554 1813

ANSI/ASME B1.1 1813 1843 1856

ANSI/ASME B1.12 1975 1978

ASA B1.1 1813

BS 1580 1626

gaging

ANSI/ASME B1.2 1994 2007 2010 2012
2014

ANSI/ASME B1.20.1 1957

ANSI/ASME B1.20.7 1969

Index Terms

Links

Threads

Unified (*Cont.*)

miniature, ASA B1.10 1858 2032

UNJ

ANSI/ASME B1.15 1900

BS 4084 1863

Whitworth

BS 84 1626 1955

truncated, ASA B1.6 1983

Thumb screws

ANSI B18.17 1791

Tolerances

gagemaker **ANSI B4.4M** 661

Tools and tooling

cutting

indexable inserts

ANSI B212.4 765

drill sizes for tapping

BS 1157 1955 2033

drills

BS 328 890

driver, split-sleeve, collet type

ANSI B94.35 887 890

twist

ANSI/ASME B94.11M 866 868 876 878

885 888

driving and spindle ends

portable hand, air and air electric tools

ANSI B107.4 972

holders

indexable insert

ANSI B212.3 782

ANSI B212.5 767

Index Terms

Links

Tools and tooling

jig bushings (*Cont.*)

ANSI B94.33 3127 3130

knurling

ANSI/ASME B94.6 991 993

machine tapers

ANSI/ASME B5.10 887 951 960

machine tools

accuracy, work and position

VDI/DGQ 3441 1321

determination of accuracy and

repeatability

ISO 230-2 1322

running and rigidity tests

JIS B 6201 1322

machining center

test conditions, JIS B 6336 1322

V flange tool shanks

ANSI/ASME B5.50 967 3157

milling

cutters

ANSI/ASME B94.19 809 831

end mills

ANSI/ASME B94.19 809 831

machine spindle noses

ANSI B5.18 962 964

reamers

ANSI B94.2 852 861

BS 328 890

single-point

carbide blanks, brazed and solid

ANSI B212.1 772 775 899

ANSI B212.12 764

Index Terms

Links

Tools and tooling (*Cont.*)

spindles

portable tool, tapered and threaded

ASA B5.38 973

tool life testing, ANSI B94.55M 1013

turning tools ANSI B212.12 765

Transmission shafting design ASA B17c 299

T-slots, bolts, nuts and tongues

ANSI/ASME B5.1M 1726

U

USA Standard

USAS B6.1 2131 2135 2146 2149

USAS B6.7 2135 2138 2150 2206

USAS B17.1 299

V

Verein Deutscher Ingenieure

VDI/DGQ 3441 1321

W

Washers

general purpose, **BS 4320** 1640

lock

ANSI/ASME B18.21.1 1565

ANSI/ASME B18.21.2M 1565

plain

ANSI B18.22.1 1562 1565

ANSI B18.22M 1581 1607

ISO 887 1607

ISO/TC2/WG6/N47 1607

spring **BS 4464** 1638

Index Terms

Links

Wing nuts and screws

ANSI B18.17

1791

Z

Zinc

electrodeposited coatings on iron and steel

ASTM B633

1515

INDEX OF INTERACTIVE EQUATIONS

<u>Index Terms</u>	<u>Links</u>
A	
Air	
Compressed, Velocity of	
Escaping	3042
Density of	3032
Expansion and Compression	
Adiabatic	3036
Isothermal	3036
Horsepower Required to	
Compress	3037
Volume given Pressure and	
Temperature	3035
Volume Transmitted through	
Pipes	3041
Work Required to Compress	3036
Angle	
Conversion	
Decimal to Degree-Minute-	
Second	104
Degree-Minute-Second to	
Decimal	104
Degree-Minute-Second to	
Radian	103
Radian to Degree-Minute-	
Second	103
Area	
Acute-angle Triangle	71
Circle	73
Circular Ring	74

Index Terms

Links

Area (Cont.)

Circular Ring Sector	74
Cycloid	73
Ellipse	75
Hyperbola	75
Obtuse-angle Triangle	71
Parabola	74
Parallelogram	70
Rectangle	70
Regular Polygon	72
Right-angle Triangle	71
Spandrel or Fillet	74
Square	70
Trapezium	72
Trapezoid	71

B

Beam

Both Ends Overhanging Supports

Load at any Point Between	259
Single Overhanging Load	260
Symmetrical Overhanging Load	260
Symmetrical, Uniform Load	258
Unsymmetrical, Uniform Load	259

Combined Stresses

Direct Compression and Bending

Cantilever, Circular	212
Cantilever, Rectangular	212
Circular Beam or Shaft	213
Rectangular	213

Direct Compression and Torsion

Circular Beam or Shaft	213
Direct Compression, Offset Link	214

Direct Tension and Bending

Index Terms

Links

Beam (*Cont.*)

Cantilever, Circular	212	
Cantilever, Rectangular	213	
Circular Beam or Shaft	213	
Rectangular	213	
Direct Tension and Torsion		
Circular Shaft	214	
Direct Tension, Offset Link	214	
Continuous, Two Equal Spans		
Equal Loads at Center of Each	266	
Uniform Loads	266	
Continuous, Two Unequal Spans		
Unequal Loads at any Point	267	
Unequal Uniform Loads	265	
Design Example	217	
Fixed at Both Ends		
Load at any Point	264	
Load at Center	264	
Uniform Load	265	
Fixed at One End		
Free but Guided at the Other		
Load at Free End	263	
Uniform Load	263	
Intermediate Load	261	
Load at Other End	261	268
Supported at the Other		
Load at any Point	262	
Load at Center	262	
Uniform Load	263	
Uniform Load	261	268
Supported at Both Ends		
Load at Any Point	257	
Load at Center	257	
Single Load in Middle	268	

Index Terms

Links

Beam (Cont.)

Single Unsymmetrical Load	268	
Two Symmetrical Loads	258	268
Uniform Load	257	269
Uniform Load Part of Length		
Deflection	268	
Three Dimensional Stresses	216	

Bearings

Journal Bearing	2336	
Thrust		
Flat Plate Type	2342	
Step Type	2346	
Tapered Land Type	2349	
Tilting Pad Type	2354	

Broaching

Pitch of Teeth	982	
----------------	-----	--

C

Center of Gravity

Circle Sector	223	
Circular Arc	222	
Circular Segment	222	
Cone	225	
Cylinder	224	
Frustum of Cone	225	
Frustum of Pyramid	225	
Half of a Hollow Sphere	226	
Parabola	224	
Paraboloid	226	
Part of Circle Ring	223	
Pyramid	225	
Spandrel or Fillet	223	
Spherical Sector	226	
Spherical Segment	226	

Index Terms

Links

Center of Gravity (*Cont.*)

Trapezoid	222
Triangle	221
Two Bodies	225
Wedge	226

Circles and Squares with Equal Area	80
-------------------------------------	----

Circular Segment Formulas	73
---------------------------	----

Cold Form Tapping	2035
-------------------	------

Column

Eccentrically Loaded	283
Euler's Formulas	283
Rankine's Formulas	283

Combined Stresses

Direct Compression and Bending

Cantilever Beam

Circular	212
Rectangular	212

Direct Compression and Bending

Circular Beam or Shaft	213
Rectangular Beam	213

Direct Compression and Torsion

Circular Beam or Shaft	213
------------------------	-----

Direct Compression, Offset Link	214
---------------------------------	-----

Direct Tension and Bending

Cantilever Beam

Circular	212
Rectangular	213

Circular Beam or Shaft	213
------------------------	-----

Rectangular Beam	213
------------------	-----

Direct Tension and Torsion

Circular Shaft	214
----------------	-----

Direct Tension, Offset Link	214
-----------------------------	-----

Complex Numbers

Addition	18
----------	----

Index Terms

Links

Complex Numbers (*Cont.*)

Division 19

Multiplication 19

Contents of Cylindrical Tank 69

Conversion

Complex Number to Polar Form 18

Coordinates

Cylindrical to Rectangular 45

Polar to Rectangular 18 44

Rectangular to Polar 44

Rectangular to Spherical 45

Spherical to Rectangular 45

Cutting Speed to RPM 1015

Letter Drill Sizes 1016

Numbered Drill Sizes 1016

RPM to Cutting Speed 1015

Specific Gravity to Density 380

Temperature 2695

Critical Speed Formulas 198

Cubic Equation 34

Cutting Speed

Convert from RPM 1015

Convert to RPM 1015

Letter Drill Sizes 1016

Numbered Drill Sizes 1016

Cylinder Subject to Internal Pressure 291

D

Density of Wood 387

Diameter of Circle

Enclosing N Circles 91

Distance Across Squares and Hexagons 81

Distance Between Two Points 40

Index Terms

Links

Drilling

Tap Drill Size	2035
Metric	2030
Unified	2030
Thrust, Torque, and Power Required	
Inch	1090
Metric	1090
Thrust, Torque, and Power Required	
Spade Drills	1079

E

Economic Analysis

Annuity to Gradient	138
Depreciation	139
Future Value to Annuity	138
Future Value to Gradient	138
Net Present Value	140
Present Value to Annuity	138
Present Value to Future Value	138
Present Value to Gradient	138

F

Factorial of a Number	19	
Find Equation of Circle Given Point	46	
Finding Depth of Keyseat	2473	2482
Flat Belts and Pulleys		
Belt Lengths	2484	
Length of Belt Traversing Three		
Pulleys	2486	
Pulley Diameters and Speeds	2485	
Pulley Diameters in Compound		
Drive	2485	
Speed of Pulley in Compound Drive	2486	

Index Terms

Links

Force System Solution

Components of Single Force	157
Resolving Single Force into Rectangular Components	161
Resultant of Any Number of Concurrent Forces	161
Non-intersecting Forces	159
Non-parallel Forces Not Meeting at a Common Point	163
Parallel Forces Not in Same Plane	162
Three or More Forces	157
Two Concurrent Forces	157

G

Gears

Calculating Dimensions of Bevel Circular Thickness, Circular Addendum	2189
Examples	2187
Formulas for Milled Gears 14.5 and 20 Degree Full Depth	2183 2250
Calculating Dimensions of Helical Fellows 20 Degree Stub	2251
Fine Pitch Tooth Proportions 14.5 and 20 Degree Full Depth	2135 2251
20 Degree Stub	2251
Spur Fellows 20 Degree Stub	2249
Fine Pitch Tooth Proportions Outside and Root Diameters	2135 2138

Index Terms

Links

Gears (*Cont.*)

Standard Dimensions	2131
14.5 and 20 Degree Full Depth	2249
14.5 Degree Involute Full Depth	
Tooth Parts	2137
20 Degree Involute Full Depth	
Tooth Parts	2137
20 Degree Stub	2249
Helical Gearing	2195
Shafts at Right Angles	
Center Distance Approximate	2199
Center Distance Exact	2200
Shafts Parallel	
Center Distance Approximate	2197
Center Distance Exact	2198
Spur Gear Design	2158
Center Distance	2141
Center Distance for No	
Backlash	2155
Chordal Addendum	2145
Chordal Thickness	2145
Example	2140
Worm Gearing	2192

H

Hardness

Brinell, Calculate from Indentation	505
Tensile Strength Equivalent to	
Brinell	509

Hole Circle Coordinates

Type A	
Origin At Center	692
Origin At XY	693
Type B	

Index Terms

Links

Hole Circle Coordinates (*Cont.*)

Origin At Center 693

Origin At XY 694

Hydraulic Cylinder Force 3422

L

Length, Mm to Inch 2665

M

Machining

Cutting Speed to Utilize Max Power

Milling 1088

Turning 1088

Power Required

Turning 1087

Matrix

Addition 122

Determinant 123

Inverse 125

Multiplication 123

Solution of Simultaneous

Equations 126

Transpose 123

Measurement Over Pins

Checking Radius of Arc

Concave 688

Convex 688

Checking V-groove 686

Distance across Bolt Circle 686

Dovetail Slides 682

Measuring Screw Threads

Acme Thread 1999

2002

American National Standard Unified

Index Terms

Links

Measuring Screw Threads (*Cont.*)

Thread	1995
British Association Screw Thread	1995
British Standard and Whitworth Screw Thread	1995
Buckingham Exact Involute Helicoid	1999
Constants for Measuring American Standard and Whitworth Screw Threads	1996
International Standard Screw Thread	1995
Lowenherz Screw Thread	1995
Sharp V-Thread Screw Thread	1995
Whitworth Thread	1998
Wire Diameters	1996
Wire Diameters for Checking Pitch Diameter	1992

Moment of Inertia

Circle	237
Circular Ring	237
C-Section	240
Elliptical Section	238
Half Circular Section	237
Hexagon	236
Hollow Circular Section	238
Hollow Elliptical Section	238
Hollow Rectangle	235
Hollow Square	234
I-Section	238
L-Section	242
Polar Area Circle	245
Polar Area	

Index Terms

Links

Moment of Inertia (*Cont.*)

Circular Section with Hexagon	
Hole	245
Circular Section with Square	
Hole	245
Hexagon	245
Hollow Circular Section	245
Inverted Triangle	245
Rectangle	245
Square	245
Polar Mass	
Cone	248
Cylinder	246
Ellipsoid	247
Frustum of Cone	248
Hollow Cylinder	246
Paraboloid	247
Prism	246
Pyramid	246
Sphere	246
Spherical Sector	247
Spherical Segment	247
Torus	247
Rectangle	235
Square	234
Trapezium	236
Triangle	236
T-Section	241
X-Section	243
Z-Section	243

P

Packing of Circles in Circles	89
Packing of Circles in Rectangles	93

Index Terms

Links

Polygon Shafts

Four-sided 2282

Three-sided 2282

Prismoidal Formula for Volume 66

R

Radius of Gyration

Bar of Small Diameter 228

Bar of Small Diameter Bent

Circular 228

Cone 230

Cylinder 229

Ellipsoid and Paraboloid 231

Frustum of Cone 230

Hollow Cylinder 230

Hollow Sphere and Thin Spherical

Shell 231

Parallelepiped 229

Parallelogram 228

Rectangular Prism 230

Sphere 231

Thin Circular Section 229

Thin Hollow Cylinder 230

Thin, Flat Circular Ring 229

Ratio of Volumes 87

Rearrangement of Formulas 30

Replacement Icon 682

S

Screw Threads

Internal Metric Thread - M Profile

Limiting Dimensions 1893 1895

Pitch and Threads per Inch 1989

Index Terms

Links

Screw Threads (*Cont.*)

Unified Miniature Screw Threads	1861
Unified Screw Threads Dimension	1817

Shaft

Design of a Transmission Shaft	300
Design of Transmission Shafting	299
Diameter to Transmit Torque (FPS)	295
Diameter to Transmit Torque (MKS)	296
Torsional Deflection of	297

Sheet Metal

Allowance for Bends	1347	1351
---------------------	------	------

Simple Mechanism

Inclined Plane Wedge	169
----------------------	-----

Solution

Cubic Equation	34
First Degree Equation, Two Unknowns	32
Quadratic Equation	32

Specific Gravity

Conversion to Density	380
-----------------------	-----

Spline

Basic Dimensions	2257
Dimensions and Tolerances	2275

Spring

Closed and Ground End	318
Open or Plain End	
Ends Ground	318
Ends not Ground	318
Round Wire Spring Formula	318
Square Wire Spring Formula	318
Squared or Closed End, Ends not Ground	318

Index Terms

Links

T

Tap Drill

Cold Form Thread	2035
Metric Thread	2030
Unified Thread	2030

Taper

Angle given Diameter and Length	684
Angle given Taper	684
Center Distance given Diameter and Angle	685
Center Distance given Diameter and Taper	685
Center Distance given Taper Measured from One Side	685
Diameter of Disk in Contact with Another Disk	685
Measuring with V-block	681
Taper at Right Angle to One Side	685
Taper given Angle	684
Taper given Diameter and Length	684

Temperature

Adjusting Lengths for Changes of Length Change Due to Radius of Ring Change Due to	378 379 378
--	-------------------

Temperature Conversion 2695

Threads

Acme	
Shear Area	1923
Stress Area	1923
TPI-Pitch Conversion	1811

Triangle

Obtuse	
One Side, Two Angles	101

Index Terms

Links

Triangle (*Cont.*)

Three Sides Known	102
Two Sides and Angle Opposite One Side Known	102
Two Sides, Angle Between	101
Two Sides, Angle Opposite	102

Right

Hypotenuse and Angle Known	98
Side and Angle Known	98
Side and Hypotenuse Known	98
Two Sides Known	98

Trigonometric Functions

Involute and Sevolute Functions	110
Table Values	106
Versed Sine and Versed Cosine	110

V

Volume

Barrel	87
Cone	84
Cube	82
Cylinder	83
Ellipsoid	85
Frustrum of Cone	84
Frustrum of Pyramid	83
Hollow Cylinder	84
Hollow Sphere	86
Paraboloid	86
Paraboloidal Segment	87
Portion of Cylinder	83
Prism	82
Pyramid	82
Sphere	85
Spherical Sector	85

Index Terms**Links****Volume (*Cont.*)**

Spherical Segment	85
Spherical Wedge	86
Spherical Zone	86
Square Prism	82
Torus	87
Wedge	83

W**Water**

Velocity of, in Pipes	3028
-----------------------	------

Weight, Ounce to Pound	2683
-------------------------------	------

Whitworth Threads

Basic Dimensions	1954
------------------	------

Tolerances	1953
------------	------

Wind Chill Temperature	2700
-------------------------------	------

INDEX OF MATERIALS

Index Terms

Links

A

ABS				
chemical resistance to various				
materials	576			
coefficient of expansion	375			
density	390			
mechanical properties	390			
safe bending stress	606			
specific gravity	380	390		
speeds and feeds for drilling	601			
Absolute zero	3033			
Acetal	375	390	551	574
	576	587	601	606
chemical resistance to various				
materials	576			
coefficient of expansion	375			
density	390			
mechanical properties	390			
safe bending stress	606			
specific gravity	390			
speeds and feeds for drilling	601			
Acetic acid				
specific gravity	381			
specific heat	373			
Acetyl				
density	390			
mechanical properties	390			
specific gravity	390			

Index Terms

Links

Acetylene

specific gravity 381

Acrylic

375 380 390 551

574 587 601

coefficient of expansion 375

density 390

mechanical properties 390

polishing 604

specific gravity 380 390

speeds and feeds for drilling 601

Acrylite

polishing 604

Actinium

element properties 371

Air

atmospheric pressure 3032

composition 3032

density 3032

at various pressures and

temperatures 3034

density-temperature relationship 3032

expansion and compression 3035

pressure-temperature-volume

relationship 3035

specific gravity 381

specific heat 373

weight of 3033

Alcohol

boiling point 372

latent heat of evaporation 372

specific gravity 381

specific heat 373

wood

boiling point 372

Index Terms**Links****Alcohol vapor**

specific gravity 381

Alder

machinability of 388

weight of 387

Alloy steels

chemical composition 415

Alloys**aluminum**

casting, AA number

A356.0 535

A357.0 534 536

A444.0 534 536

B443.0 534

C355.0 534

201.0 534

204.0 534

208.0 534

222.0 534

242.0 534

295.0 534

296.0 536

308.0 534 536

319.0 534

328.0 534

332.0 534 536

333.0 534 536

336.0 534 536

354.0 535

355.0 534

356.0 534

357.0 534 536

359.0 536

443.0 534

Index Terms**Links**Alloys (*Cont.*)

512.0	534	
513.0	534	536
aluminum		
514.0	534	
520.0	534	
535.0	535	
705.0	534	
707.0	534	
710.0	534	
711.0	534	536
712.0	534	
713.0	535	
771.0	535	
850.0	534	
851.0	534	
852.0	535	
elastic properties	394	
investment casting alloys		
A354	391	
A356	391	
A357	391	
C355	391	
D712 (40E)	391	
KO-1	391	
Precedent	71	391
RR-350	391	
355	391	
356	391	
wrought, AA number		
Alclad	2014	539
Alclad	3003	540
Alclad	3004	540
Alclad	6061	541

Index Terms**Links**wrought, AA number (*Cont.*)

Alclad	7075	542		
1050	537			
1060	537	539		
1100	537	539		
1145	537			
1175	537			
1200	537			
1230	537			
1235	537			
1345	537			
1350	537	539	542	
2011	376	537	539	
2014	539			
2017	376	537	539	
2018	537	539		
2024	376	394	537	539
2025	537	539		
2036	537	539		
2117	537	539		
2124	537			
2218	537	539		
2219	537	539		
2319	537			
2618	537			
3003	376	538	540	
3004	538	540		
3005	538			
3105	540			
aluminum				
4032	538	540		
4043	538			
4045	538			
4047	538			

Index Terms

Links

aluminum (*Cont.*)

4145	538			
5005	538	540		
5050	538	540		
5052	376	538	540	
5056	538	540		
5083	538	540		
5086	376	538	541	
5154	541			
5183	538			
5252	538	541		
5254	538	541		
5356	538			
5454	541			
5456	538	541		
5457	538	541		
5554	538			
5556	538			
5652	538	541		
5654	538			
5657	541			
6003	538			
6005	538			
6053	538			
6061	376	394	538	541
6063	541			
6066	538	542		
6070	538	542		
6101	538	542		
6105	538			
6151	538			
6201	538			
6253	538			
6262	538	542		

Index Terms**Links**

aluminum (<i>Cont.</i>)			
6351	538	542	
6463	538	542	
7005	538		
7008	538		
7049	538	542	
7050	538	542	
7072	538		
7075	376	538	542
7108	538		
7178	538	542	
8017	538		
8030	538		
8176	542		
8177	538		
2011	376		
2017	376		
2024	376		
2024-T4			
elastic properties	394		
3003	376		
5052	376		
5086	376		
aluminum			
6061	376		
6061-T6			
elastic properties	394	7075	376
bearing strength			
magnesium alloys	547		
chemical composition			
alloy steels	415		
carbon steels	415		
copper alloys	515		
everdur	528		

Index Terms

Links

aluminum (<i>Cont.</i>)				
titanium alloys	550			
cobalt-base				
investment casting alloys				
cobalt 21	392			
cobalt 25	392			
cobalt 31	392			
cobalt 36	392			
F75	392			
N-155	392			
compressive strength				
magnesium alloys	547			
copper				
alloy name (UNS number)				
aluminum brass, arsenical (C68700)	526	1036	1071	
aluminum bronze, D (C61400)	525	1036	1071	
architectural bronze (C38500)	523	1036	1071	
beryllium Cu				
(C17000)	521	1036	1071	
(C17200)	376	521	1036	1071
(C17300)	376	521		
(C17500)	521	1036	1071	
(C17510)	521			
brass				
catridge 70% (C26000)	376			
extra-high-leaded (C35600)	376			
free machining (C36000)	376			
high-leaded (C35300)	376			
naval (C46400)	376			
red, 85% (C23000)	376			
yellow (C27000)	376			
bronze				
aluminum 11% A (C62400)	376			
aluminum 9% A (C62300)	376			

Index Terms**Links**aluminum (*Cont.*)

commercial, 90% (C22000)	376			
nickel aluminum (C63000)	376			
phosphor 5% A (C51000)	376			
phosphor, free cutting (C54400)	376			
cadmium Cu				
(C16200)	521			
(C16210)	521			
deoxidized (C14300)	520			
deoxidized (C14310)	520			
cartridge brass				
70% (C26000)	376	522	1036	1071
copper				
70% (C26100)	522			
70% (C26130)	522			
70% (C26200)	522			
chromium Cu				
(C18200)	376	521		
(C18400)	521			
(C18500)	521			
commercial bronze, 90%				
(C22000)	376	522	1036	1071
Cu nickel				
10% (C70600)	527	1036	1071	
20% (C71000)	527			
30% (C71500)	527	1036	1071	
5% (C70400)	526			
Cu- nickel- phosphorus- tellurium				
(C19100)	521			
Cu-nickel-phosphorus (C19000)	521			
forging brass (C37700)	523	1036	1071	
free machining Cu (C14500)	376			
free-cutting brass (C36000)	376	523	1036	1071
gilding, 95% (C21000)	522	1036	1071	

Index Terms**Links**aluminum (*Cont.*)

inhibited admiralty

(C44300) 524 1036 1071

(C44400) 524

(C44500) 524 1036 1071

jewelry bronze, 87.5% (C22600) 522 1036 1071

leaded brass

(C33500) 523 1036 1071

(C34000) 523 1036 1071

(C34200) 523 1036 1071

(C35000) 523

(C35300) 376 523 1036 1071

(C35600) 376 523 1036 1071

tube (C33000) 376 522

tube (C33200) 523 1036 1071

leaded commercial bronze

(C31400) 522 1036 1071

nickel-bearing (C31600) 522

leaded Cu

(C18700) 376 521

leaded naval brass (C48500) 1036 1071

low brass 80% 522 1036 1071

manganese brass (C66700) 526

manganese bronze, A (C67500) 526 1036 1071

Muntz metal

free-cutting (C37000) 523 1036 1071

leaded (C36500) 376 523 1036 1071

leaded (C36800) 523 1036 1071

60% (C28000) 376 522 1036 1071

naval brass

(C46400) 376 524

(C46700) 524

leaded (C48500) 524

Index Terms**Links**aluminum (*Cont.*)

copper

medium-leaded (C48200)	524		
nickel silver			
55-18 (C77000)	527	1036	1071
65-10 (C74500)	527	1036	1071
65-12 (C75700)	527	1036	1071
65-15 (C75400)	527	1036	1071
65-18 (C75200)	527	1036	1071

oxygen-free

(C10200)	519	1036	1071
electronic (C10100)	519		
extra-low phosphorus (C10300)	519		
low phosphorus (C10800)	519		
silver-bearing			
(C10400)	519		
(C10500)	519		
(C10700)	519		

phosphor bronze

1.25% E (C50500)	524		
10% D (C52400)	525	1036	1071
5% A (C51000)	376	524	1036
8% C (C52100)	525	1036	1071

phosphorus deoxidized Cu

arsenical (C14200)	520		
high residual phosphorus			
(C12200)	520	1036	1071
low residual phosphorus			
(C12000)	520		
(C12100)	520		

red brass, 85% (C23000) 376 522 1036 1071

silicon bronze

high, A (C65500)	526	1036	1071
low, B (C65100)	526	1036	1071

Index Terms**Links**

aluminum (<i>Cont.</i>)				
silicon red brass (C69400)	526			
sulfur bearing				
(C14700)	520			
(C14710)	520			
(C14720)	520			
tellurium bearing				
(C14500)	376	520		
(C14510)	520			
(C14520)	520			
tough pitch				
electrolytic (C11000)	376	519	1036	1071
fire refined, with silver				
(C12500)	520			
(C12700)	520			
(C12800)	520			
(C12900)	520			
(C13000)	520			
silver-bearing				
(C11300)	519			
(C11400)	519			
(C11500)	519			
(C11600)	519			
yellow brass				
copper				
(C26800)	522	1036	1071	
(C27000)	376	522		
zirconium Cu (C15000)	520			
beryllium copper				
elastic properties	394			
brass				
elastic properties				
cast	394			
70-30	394			

Index Terms

Links

aluminum (<i>Cont.</i>)	
low-leaded, tube (C33000)	376
bronze	
elastic properties	394
manganese	376
elastic properties	394
investment casting alloys	
beryllium Cu	
10C (820)	391
165C (824)	391
20C (825)	391
275C (828)	391
brass	
red	391
silicon	391
yellow leaded (854)	391
bronze	
aluminum, C (954)	391
aluminum, D (955)	391
manganese, A	391
manganese, C	391
silicon	391
tin	391
chrome copper	391
copper (pure)	391
manganese bronze	376
nickel silver	
elastic properties	394
nickel-silver	376
phosphor bronze	
elastic properties	394
tensile strength	395
powder metal alloys	
CNZ-1818	393

Index Terms**Links**aluminum (*Cont.*)

copper (pure)	393
CTG-1001	393
CTG-1004	393
CZP-3002	393

UNS number (alloy name)

C10100 (oxygen-free electronic)	519		
C10200 (oxygen-free Cu)	519	1036	1071
C10300 (oxygen-free, extra-low phosphorus)	519		
C10400 (oxygen-free, silver-bearing)	519		
C10500 (oxygen-free, silver-bearing)	519		
C10700 (oxygen-free, silver-bearing)	519		

copper

C10800 (oxygen-free, low phosphorus)	519			
C11000 (electrolytic tough pitch Cu)	376	519	1036	1071
C11000 (electrolytic tough pitch)	376			
C11300 (silver-bearing tough pitch Cu)	519			
C11400 (silver-bearing tough pitch Cu)	519			
C11500 (silver-bearing tough pitch Cu)	519			
C11600 (silver-bearing tough pitch Cu)	519			
C12000 (phosphorus deoxidized Cu, low residual phosphorus)	520			
C12100 (phosphorus deoxidized Cu, low residual phosphorus)	520			
C12200 (phosphorus deoxidized Cu, high residual phosphorus)	520	1036	1071	
C12500 (fire-refined tough pitch with silver)	520			
C12700 (fire-refined tough pitch with silver)	520			

Index Terms

Links

aluminum (*Cont.*)

C12800 (fire-refined tough pitch with silver)	520			
C12900 (fire-refined tough pitch with silver)	520			
C13000 (fire-refined tough pitch with silver)	520			
C14200 (phosphorus deoxidized Cu, arsenical)	520			
C14300 (cadmium Cu, deoxidized)	520			
C14310 (cadmium Cu, deoxidized)	520			
C14500 (free machining Cu)	376			
C14500 (tellurium bearing)	376	520		
C14510 (tellurium bearing)	520			
C14520 (tellurium bearing)	520			
C14700 (sulfur bearing)	520			
C14710 (sulfur bearing)	520			
C14720 (sulfur bearing)	520			
C15000 (zirconium Cu)	520			
C15500	520			
C15715	520			
C15720	520			
C15760	521			
C16200 (cadmium Cu)	521			
C16210 (cadmium Cu)	521			
C16500	521			
C17000 (beryllium Cu)	521	1036	1071	
C17200 (beryllium Cu)	376	521	1036	1071
C17300 (beryllium Cu)	376	521		
C17500 (beryllium Cu)	521	1036	1071	

copper

C17510 (beryllium Cu)	521			
-----------------------	-----	--	--	--

Index Terms**Links**aluminum (*Cont.*)

C18200 (chromium Cu)	376	521		
C18400 (chromium Cu)	521			
C18500 (chromium Cu)	521			
C18700 (leaded copper)	376	521		
C18700 (leaded Cu)	376			
C19000 (Cu-nickel-phosphorus)	521			
C19100 (Cu- nickel- phosphorus- tellurium)	521			
C19200	521			
C19400	522			
C19500	522			
C21000 (gilding, 95%)	522	1036	1071	
C22000 (commercial bronze, 90%)	376	522	1036	1071
C22600 (jewelry bronze, 87.5%)	522	1036	1071	
C23000 (red brass, 85%)	376	522	1036	1071
C24000 (low brass, 80%)	522	1036	1071	
C26000 (cartridge brass, 70%)	376	522	1036	1071
C26100 (cartridge brass, 70%)	522			
C26130 (cartridge brass, 70%)	522			
C26200 (cartridge brass, 70%)	522			
C26800 (yellow brass)	522	1036	1071	
C27000 (yellow brass)	376	522		
C28000 (Muntz metal, 60%)	376	522	1036	1071
C31400 (leaded commercial bronze)	522	1036	1071	
C31600 (leaded commercial bronze, nickel-bearing)	522			
C33000 (low-leaded brass tube)	376	522		
C33200 (high-leaded brass tube)	523	1036	1071	
C33500 (low-leaded brass)	523	1036	1071	
C34000 (medium-leaded brass)	523	1036	1071	
C34200 (high-leaded brass)	523	1036	1071	
C35000 (medium-leaded brass)	523			
C35300 (high-leaded brass)	376	523	1036	1071

Index Terms**Links**aluminum (*Cont.*)

C35600 (extra-high-leaded brass)	376	523	1036	1071
C36000 (free machining brass)	376			
C36000 (free-cutting brass)	376	523	1036	1071
C36500 (leaded Muntz metal)	376	523	1036	1071
C36800 (leaded Muntz metal)	523	1036	1071	

copper

C37000 (free-cutting Muntz metal)	523	1036	1071	
C37700 (forging brass)	523	1036	1071	
C38500 (architectural bronze)	523	1036	1071	
C40500	523			
C40800	523			
C41100	523			
C41300	523			
C41500	524			
C42200	524			
C42500	524			
C43000	524			
C43400	524			
C43500	524			
C44300 (inhibited admiralty)	524	1036	1071	
C44400 (inhibited admiralty)	524			
C44500 (inhibited admiralty)	524	1036	1071	
C46400 (naval brass)	376	524		
C46700 (naval brass)	524			
C48200 (naval brass, medium-leaded)	524			
C48500 (leaded naval brass)	1036	1071		
C48500 (naval brass, leaded)	524			
C50500 (phosphor bronze, 1.25% E)	524			
C51000 (phosphor bronze, 5% A)	376	524	1036	1071
C51100	524			
C52100 (phosphor bronze, 8% C)	525	1036	1071	
C52400 (phosphor bronze, 10% D)	525	1036	1071	

Index Terms**Links**aluminum (*Cont.*)

C54400	376	525	1036	1071
C54400 (free cutting phos. bronze)	376			
C60800	525			
C61000	525			
C61300	525			
C61400 (aluminum bronze, D)	525	1036	1071	
C61500	525			
C61800	525			
C61900	525			
C62300	376	525		
C62300 (aluminum bronze, 9%)	376			
C62400	376	525		
C62400 (aluminum bronze, 11%)	376			
C62500	525			
C63000	376	525		
C63000 (Ni-Al bronze)	376			
C63200	525			
C63600	526			
C63800	526			

copper

C64200	514	526		
C65100 (low-silicon bronze, B)	526	1036	1071	
C65500 (high-silicon bronze, A)	526	1036	1071	
C66700 (manganese brass)	526			
C67400	526			
C67500 (manganese bronze, A)	526	1036	1071	
C68700 (aluminum brass, arsenical)	526	1036	1071	
C68800	526			
C69000	526			
C69400 (silicon red brass)	526			
C70400 (Cu nickel, 5%)	526			
C70600 (Cu nickel, 10%)	527	1036	1071	

Index Terms**Links**aluminum (*Cont.*)

C71000 (Cu nickel, 20%)	527		
C71500 (Cu nickel, 30%)	527	1036	1071
C72200	527		
C72500	527		
C73500	527		
C74500 (nickel silver, 65-10)	527	1036	1071
C75200 (nickel silver, 65-18)	527	1036	1071
C75400 (nickel silver, 65-15)	527	1036	1071
C75700 (nickel silver, 65-12)	527	1036	1071
C76390	527		
C77000 (nickel silver, 55-18)	527	1036	1071
C78200	527		
C80100	515		
C80300	515		
C80500	515		
C80700	515		
C80900	515		
C81100	515		
C81300	515		
C81400	515		
C81500	515		
C81700	515		
C81800	515		
C82000	515		
C82100	515		
C82200	515		
C82400	515		
C82500	515		
C82600	515		
C82700	515		
C82800	515		
C83300	516		
C83400	516		

Index Terms**Links**aluminum (*Cont.*)

C83600	516
C83800	516
C84200	516

copper

C84400	516
C84500	516
C84800	516
C85200	516
C85400	516
C85500	516
C85700	516
C85800	516
C86100	516
C86200	516
C86300	516
C86400	516
C86500	516
C86700	516
C86800	516
C87200	516
C87400	516
C87500	517
C87600	517
C87800	517
C87900	517
C90200	517
C90300	517
C90500	517
C90700	517
C90900	517
C91000	517
C91100	517
C91300	517

Index Terms**Links**aluminum (*Cont.*)

C91600	517
C91700	517
C92200	517
C92300	517
C92500	517
C92600	517
C92700	517
C92800	517
C92900	517
C93200	517
C93400	517
C93500	517
C93700	517
C93800	517
C93900	517
C94300	517
C94400	517
C94500	517
C94700	518
C94800	518
C95200	518
C95300	518
C95400	518
C95500	518
C95600	518
C95700	518
C95800	518
C96200	518
C96300	518

copper

C96400	518
C96600	518
C97300	518

Index Terms

Links

aluminum (*Cont.*)

C97400	518
C97600	518
C97800	518
C99300	518
C99400	518
C99500	518
C99700	518
C99750	518

copper-beryllium

10	529
165	529
25	529
35	529
50	529

copper-silicon (Everdur)

637	528
651	528
655	528
6552	528
661	528

elongation

aluminum alloys	539
everdur	528
magnesium alloys	547
titanium alloys	550

endurance limit

aluminum alloys	539
-----------------	-----

hardness

magnesium alloys	547
------------------	-----

iron base

elastic properties

cast	394
ductile	394

Index Terms

Links

aluminum (*Cont.*)

grey cast	394
malleable	394
powder metal alloys	
FC-0208	393
FC-0508	393
FC-0800	393
FC-2008	393
FC-2015	393
FL-4605	393
FL-4608	393
FN-0005	393
FN-0200	393
FN-0205	393
FN-0208	393
FN-0405	393
FN-0408	393
FX-2008	393
F-0000	393
F-0008	393

magnesium

casting, pressure die cast

AM60A	546
AM60B	546
AS41A	546
AZ91A	546
AZ91B	546
AZ91D	546

casting, sand and permanent mold

AM100A	546
AZ63A	546
AZ81A	546
AZ91C	546
AZ91E	546

Index Terms

Links

aluminum (*Cont.*)

AZ92A	546
EZ33A	546
HK31A	546
HZ32A	546
K1A	546
QE22A	546
QH21A	546
WE54A	546
ZE41A	546
ZE63A	546
ZH62A	546
ZK51A	546
ZK61A	546

elastic properties 394

extrusion

AZ10A	546
AZ31B	546
AZ31C	546
AZ61A	546
AZ80A	546
HM31A	546
M1A	546
ZK40A	546
ZK60A	546

sheet and plate

AZ31B	546
AZ31C	546
HK31A	546
HM21A	546

nickel

Inconel

elastic properties 394

Monel metal

Index Terms

Links

aluminum (<i>Cont.</i>)		
elastic properties	394	
nickel-base		
alloy name (UNS number)		
commercially pure Ni (N02200)	549	
hastelloy		
hastelloy B (N10001)	549	
hastelloy C-22	377	
hastelloy C-276 (N10276)	377	549
hastelloy W (N10004)	549	
hastelloy X (N06002)	549	
IN 100 (N13100)	549	
incoloy		
incoloy 800 (N08800)	549	
incoloy 825 (N08825)	549	
incoloy 901 (N09901)	549	
nickel-base		
inconel		
inconel X-750 (N07750)	549	
inconel 600 (N06600)	549	
inconel 625 (N06625)	549	
inconel	718	377
Monel	377	
Monel K500 (N05500)	377	549
Monel R405	377	
Monel 400 (N04400)	377	549
nichrome (N06003)	549	
nickel 200 (N02200)	377	549
nickel 201 (N02201)	377	
nickel 205 (N02205)	377	
RA 333 (N06333)	549	
udimet (N07500)	549	
waspalloy (N07001)	549	
investment casting alloys		

Index Terms**Links**

aluminum (<i>Cont.</i>)				
Alloy B	392			
Alloy C	392			
Alloy X	392			
Inconel				
In	600	392		
In	625	392		
Invar (Fe-Ni alloy)	392			
Monel				
E	392			
M-35	392			
RH	392			
S	392			
410	392			
specific heat	377			
shearing strength				
aluminum alloys	539			
magnesium alloys	547			
stainless steel				
AFC-77	1031	1050		
AF-71	1031	1050		
AISI (SAE) Number				
... (51430F) 494				
201 (30201)	1031	1049	1066	
202 (30202)	1031	1049	1066	
203EZ ()	1031	1049	1066	
301 (30301)	1031	1049	1066	
302 (30302)	432	1031	1049	1066
303 (30303)	1031	1049	1066	
303MA ()	1031	1049	1066	
303Pb (30303)	1031	1049	1066	
304 (30304)	1031	1049	1066	
305 (30305)	1031	1049	1066	
310 (30310)	1031	1049	1066	

Index Terms**Links**aluminum (*Cont.*)

316 (30316)	1031	1049	1066	
317 (30317)	1031	1049		
321 (30321)	432	1031	1049	1066
347 (30347)	432	1031	1049	1066
410 (51410)	494	1031	1049	1066
414 (51414)	494	1031	1050	1066
416 (51416)	494	1031	1049	1066
420 (51420)	432	1031	1049	1066

stainless steel

430 (51430)	432	494	1031	1049
	1066			
431 (51431)	494	1031	1050	1066
440A (51440A)	1031	1050	1066	
440B (51440B)	1031	1050	1066	
440C (51440C)	1031	1050	1066	
442 (51442)	494	1031	1049	
446 (51446)	432	494	1031	1049
455 (51455)	1031	1050	1066	
501 (51501)	432	494	1031	1049
	1066			

AISI (SAE) number

... (51409)	419	495		
... (51416F)	419			
... (51420F)	419	495		
... (51430F)	419	495		
... (51434)	495			
... (51436)	495			
... (51440F)	419	495		
201 (30201)	406	415	418	430
	494			
202 (30202)	406	416	418	430
	494			

Index Terms**Links**aluminum (*Cont.*)

301 (30301)	406	415	418	430
	493			
302 (30302)	406	416	418	430
	494			
303 (30303)	406	416	430	494
303 (30330)	494			
304 (30304)	406	416	418	430
	494			
305 (30305)	406	416	430	494
310 (30310)	406	416	418	430
	494			
316 (30316)	406	416	419	430
	494			
317 (30317)	406	417	419	430
	494			
321 (30321)	406	417	419	430
	494			
325 (30325)	419	494		
347 (30347)	406	417	419	430
	493			
410 (51410)	407	417	419	430
	495			
414 (51414)	407	417	419	431
	495			
416 (51416)	407	417	430	495
420 (51420)	407	417	431	495
430 (51430)	406	417	431	495
431 (51431)	407	417	419	495
440A (51440A)	407	418	431	495
440B (51440B)	407	418	431	495
440C (51440C)	407	418	431	495
442 (51442)	406	418	495	
446 (51446)	406	418	431	495

Index Terms**Links**aluminum (*Cont.*)

501 (S1501)	407	418	431	495
-------------	-----	-----	-----	-----

AISI (UNS) Number

201 (S20100)	1031	1049	1066
--------------	------	------	------

202 (S20200)	1031	1049	1066
--------------	------	------	------

203EZ (S20300)	1031	1049	1066
----------------	------	------	------

301 (S30100)	1031	1049	1066
--------------	------	------	------

302 (S30200)	1031	1049	1066
--------------	------	------	------

302B (S30215)	1031	1049	1066
---------------	------	------	------

stainless steel

303 (S30300)	1031	1049	1066
--------------	------	------	------

303MA ()	1031	1049	1066
----------	------	------	------

303Pb (S30300)	1031	1049	1066
----------------	------	------	------

303Se (S30323)	1031	1049	1066
----------------	------	------	------

304 (S30400)	1031	1049	1066
--------------	------	------	------

304L (S30403)	1031	1049	1066
---------------	------	------	------

305 (S30500)	1031	1049	1066
--------------	------	------	------

308 (S30800)	1031	1049	1066
--------------	------	------	------

309 (S30309)	1031	1049	1066
--------------	------	------	------

309 (S30900)	1031	1049	1066
--------------	------	------	------

309S (S30908)	1031	1049	1066
---------------	------	------	------

310 (S31000)	1031	1049	1066
--------------	------	------	------

310S (S31008)	1031	1049	1066
---------------	------	------	------

314 (S31400)	1031	1049	1066
--------------	------	------	------

316 (S31600)	1031	1049	1066
--------------	------	------	------

316L (S31603)	1031	1049	
---------------	------	------	--

317 (S31700)	1031	1049	
--------------	------	------	--

321 (S32100)	1031	1049	1066
--------------	------	------	------

330 (N08330)	1031	1049	
--------------	------	------	--

347 (S34700)	1031	1049	1066
--------------	------	------	------

348 (S34800)	1031	1049	1066
--------------	------	------	------

403 (S40300)	1031	1049	1066
--------------	------	------	------

405 (S40500)	1031	1049	1066
--------------	------	------	------

409 (S40900)	1031	1049	1066
--------------	------	------	------

Index Terms**Links**aluminum (*Cont.*)

410 (S41000)	1031	1049	1066
414 (S41400)	1031	1050	1066
416 (S41600)	1031	1049	1066
416Se (S41623)	1031	1049	1066
420 (S42000)	1031	1049	1066
420F (S42020)	1031	1049	1066
420FSe ()	1031	1049	1066
429 (S42900)	1031	1049	1066
430 (S43000)	1031	1049	1066
430F (S43020)	1031	1049	1066
430FSe (S43023)	1031	1049	1066
431 (S43100)	1031	1050	1066
434 (S43400)	1031	1049	1066
436 (S43600)	1031	1049	
440A (S44002)	1031	1050	1066
440B (S44003)	1031	1050	1066
440C (S44004)	1031	1050	1066
440F (S44020)	1031	1049	1066
442 (S44200)	1031	1049	
446 (S44600)	1031	1049	
455 (S45500)	1031	1050	1066
501 (S50100)	1031	1049	1066
502 (S50200)	1031	1049	

AISI (UNS) number

201 (S20100)	406	415	430	494
201 (S20200)	406	416		
201 (S20500)	406	416		
202 (S20200)	406	416	430	494
205 (S20500)	406	416		
301 (S30100)	377	406	415	430
	494			
302 (S30200)	377	406	416	430
	494			

Index Terms**Links**aluminum (*Cont.*)

302B (S30215) 377 406 416 430

303 (S30300) 377 406 416 430

494

303Se (S30323) 377 406 416 430

stainless steel

304 (S30400) 377 406 416 430

494

304Cu (S30430) 377 406 416

304L (S30403) 406 416 430

304N (S30451) 406 416

305 (S30500) 377 406 416 430

494

308 (S30800) 377 406 416 430

309 (S30309) 406 416 418 430

494

309 (S30900) 377 406 416 430

494

309S (S30908) 377 406 416 430

310 (S31000) 377 406 416 430

494

310S (S31008) 377 406 416 430

314 (S31400) 406 416 430

316 (S31600) 377 406 416 430

494

316F (S31620) 406 416

316L (S31603) 406 416 430

316N (S31651) 406 416

317 (S31700) 377 406 417 430

494

317L (S31703) 377 406 417

321 (S32100) 377 406 417 430

494

329 (S32900) 406 417

Index Terms**Links**aluminum (*Cont.*)

330 (N08330)	406	417		
347 (S34700)	377	406	417	430
	494			
347 (S34800)	377			
348 (S34800)	406	417	430	
384 (S38400)	377	406	417	
403 (S40300)	377	407	417	430
405 (S40500)	377	406	417	431
409 (S40900)	406	417		
410 (S41000)	377	407	417	430
	495			
414 (S41400)	377	407	417	431
	495			
416 (S41600)	377	407	417	430
	495			
416Se (S41623)	377	407	417	430
420 (S42000)	377	407	417	431
	495			
420F (S42020)	377	407	417	431
422 (S42200)	377	407	417	
429 (S42900)	377	406	417	
430 (S43000)	377	406	417	431
	495			
430F (S43020)	377	406	417	431
430FSe (S43023)	377	406	417	431
431 (S43100)	407	417	495	
434 (S43400)	406	417		
436 (S43600)	377	406	418	
440A (S44002)	377	407	418	431
	495			
440B (S44003)	377	407	418	431
	495			

Index Terms**Links**aluminum (*Cont.*)

440C (S44004)	377	407	418	431
	495			
440F (S44020)	431			
442 (S44200)	406	418	495	
446 (S44600)	377	406	418	431
	495			
501 (S50100)	377	407	418	431
	495			
502 (S50200)	377	407	418	431

alloy, AISI-SAE (UNS) number

stainless steel

30615 ()	409			
30705 ()	410			
30805 ()	409			
30905 ()	409			
51210 ()	410			
51710 ()	410			
AM-350	1031	1050		
AM-355	1031	1050		
AM-362	1031	1050		
elastic properties 18-8	394			
HNM	1031	1050	1066	

investment casting alloys

austenitic

CF-16F	392			
CF-20	392			
CF-3	392			
CF-3M	392			
CF-8	392			
CF-8C	392			
CF-8M	392			
CH-20	392			
CK-20	392			

Index Terms**Links**aluminum (*Cont.*)

CN-7M 392

IC 316F 392

IC 321 392

hardenable

Am-355 392

CA-15 392

CA-40 392

CD-4M Cu 392

IC 15-5 392

IC 17-4 392

IC 416 392

IC 431 392

powder metal alloys

SS-303N1 393

SS-304N1 393

SS-316L 393

SS-410 393

Stainless W 1031 1050 1066

15-5PH 1031 1050

17-14CuMo 1031 1050

17-7PH 1031 1050

18-8

tensile strength 395

steel

alloy, AISI-SAE (UNS) number

E4340 (G43406) 400 404

E50100 (501) 415

E51100 (G51986) 400 405

E51100 (G52986) 415

E52100 (G52986) 400 405 409 415

432 493 1028 1046

1062 1085

10B46 (G10461) 403

Index Terms**Links**aluminum (*Cont.*)

1045 (G10450)	402	411	423	432
	1027	1045	1060	
10956 ()	410			

steel

1320 (G13200)	409	414	491	
1330 (G13300)	400	404	414	427
	432	493	1028	1046
	1053	1062	1085	
1335 (G13350)	400	404	415	493
	1028	1046	1062	1085
1340 (G13400)	400	404	415	425
	427	493	1028	1046
	1053	1062	1085	
1345 (G13450)	400	404	1028	1046
	1062			
2317 (G23170)	409	414	491	
2330 (G23300)	409	415	493	
2340 (G23400)	409	415	493	
2345 (G23450)	409	415	493	
2512 (G25120)	491			
2515 (G25150)	409	414		
2517 (G25170)	491			
30905 ()	409			
3115 (G31150)	409	414	491	
3120 (G31200)	409	414	491	
3130 (G31300)	409	415	493	
3135 (G31350)	409	414	493	
3140 (G31400)	409	415	425	432
3145 (G31450)	409	415	493	
3150 (G31500)	409	415	493	
3240 (G32400)	409			
3310 (G33100)	409	414	432	491
3316 (G33160)	491			

Index Terms**Links**aluminum (*Cont.*)

4012 (G40120)	1028	1046	1053	1061
4023 (G40230)	400	404	409	414
	432	1028	1046	1053
	1061	1085		
4024 (G40240)	400	404	414	1028
	1046	1061	1085	
4027 (G40270)	400	404	409	414
	1053	1085		
4028 (G40280)	400	404	414	1028
	1046	1061	1085	
4032 (G40320)	409	414	491	1028
	1046	1053	1062	1085
4037 (G40370)	400	404	415	427
	493	1028	1046	1053
	1062	1085		
4042 (G40420)	409	415	427	493
	1028	1046	1062	1085
4047 (G40470)	400	404	415	493
	1028	1046	1062	1085
4053 (G40530)	493			
4063 (G40630)	409	414	493	
4068 (G40680)	493			
41L30 (G41403)	1028	1046	1061	
41L40 (G41404)	405	1028	1046	1061
41L47()	1028	1046	1061	

steel

41L50 (G41405)	1028	1046	1061	
4118 (G41180)	400	404	1028	1046
	1053	1061		
4119 (G41190)	409	414	491	
4125 (G41250)	409	491		

Index Terms**Links**aluminum (*Cont.*)

4130 (G41300)	400	404	415	425
	427	432	493	1028
	1046	1053	1062	1085
4135 (G41350)	1028	1046	1062	
4137 (G41370)	400	404	414	493
	1028	1046	1062	1085
4140 (G41400)	400	404	409	414
	425	427	493	1027
	1045	1053	1061	1085
4142 (G41420)	400	404	1028	1046
	1062	1085		
4145 (G41450)	400	404	414	493
	1028	1046	1062	1085
4147 (G13300)	400			
4147 (G41470)	404	1028	1046	1062
	1085			
4150 (G41500)	400	404	415	425
	427	493	1027	1045
	1053	1061	1085	
4161 (G41610)	400	404	1028	1046
	1062			
43L47 ()	1028	1046	1061	
4317 (G43170)	492			
4320 (G43200)	400	404	409	414
	425	492	1028	1046
	1053	1061	1085	
4337 (G43370)	1028	1046	1062	
4340 (G43400)	400	404	409	415
	425	427	432	493
	1028	1046	1053	1062
	1085			
4419 (G44190)	1028	1046	1061	
4422 (G44220)	1028	1046	1053	1061

Index Terms**Links**aluminum (*Cont.*)

4427 (G44270)	1028	1046	1053	1061
4608 (G46080)	492			
4615 (G46150)	400	404	409	414
	1028	1046	1053	1061
	1085			
4620 (G46200)	400	404	409	414
	425	1028	1046	1053
	1061	1085		
4621 (G46210)	492	1028	1046	1061
4626 (G46260)	400	404	1028	1046
	1053	1061	1085	
4640 (G46400)	409	415	432	493
	1085			
4718 (G47180)	1028	1046	1053	1061
4720 (G47200)	400	404	1028	1046
	1061			
4812 (G48120)	492			

steel

4815 (G48150)	400	404	409	414
	1028	1046	1061	1085
4817 (G48170)	400	404	414	1028
	1046	1061	1085	
4820 (G48200)	400	404	409	414
	425	432	492	1028
	1046	1053	1061	1085
50B44 (G50441)	400	405	1028	1046
	1062			
50B46 (G50461)	400	405	428	1028
	1046	1062		
50B50 (G50501)	400	405	1028	1046
	1062			
50B60 (G50601)	400	405	428	1028
	1046	1053	1062	

Index Terms**Links**aluminum (*Cont.*)

50100 ()	493			
5045 (G50450)	493			
5046 (G50460)	428	493		
5050 (G51500)	404	409	414	425
	428	432	1028	1046
	1062	1085		
51B60 (G51601)	400	405	428	1028
	1046	1053	1062	
51L32 ()	1028	1046	1061	
51100 (G51986)	493			
5115 (G51150)	492			
5117 (G51170)	400	404	1028	1046
	1061			
5120 (G51200)	400	404	414	492
	1028	1046	1053	1061
	1085			
5130 (G51300)	400	404	415	428
	493	1028	1046	1053
	1062	1085		
5132 (G51320)	400	404	415	493
	1028	1046	1062	1085
51335 ()	409			
5135 (G51350)	400	404	415	493
	1085			
5140 (G51400)	400	404	409	415
	425	428	1028	1046
	1062	1085		
5145 (G51450)	493	1028	1046	1062
	1085			
5147 (G51470)	493	1028	1046	1062
5150 (G51500)	400			
5152 (G51520)	493			
5155 (G51550)	400	404		

Index Terms**Links**aluminum (*Cont.*)

5160 (G51600)	400	404	425	428
	1028	1046	1062	
51710 ()	409			
6118 (G51986)	405	1028	1046	1053
	1061	1085		
6118 (G61180)	400			
6150 (G52986)	405	409	415	425
	428	432	493	1028
	1046	1053	1062	1085
6150 (G61500)	400			
6421 ()	1029	1047	1062	
steel				
6422 ()	1029	1047	1062	
6424 ()	1029	1047	1062	
6427 ()	1029	1047	1062	
6428 ()	1029	1047	1062	
6430 ()	1029	1047	1062	
6432 ()	1029	1047	1062	
6434 ()	1029	1047	1062	
6436 ()	1029	1047	1062	
6442 ()	1029	1047	1062	
81B45 (G81451)	400	405	428	1028
	1046	1053	1062	
8115 (G81150)	1028	1046	1053	1061
86B45 (G86451)	429			
86L20 ()	1028	1046	1061	
86L40 ()	1028	1046	1061	
8615 (G86150)	400	405	414	492
	1028	1046	1061	1085
8617 (G86170)	400	405	414	1028
	1046	1061	1085	

Index Terms**Links**aluminum (*Cont.*)

8620 (G86200)	400	405	414	425
	1028	1046	1053	1061
	1085			
8622 (G86220)	400	405	414	1028
	1046	1061	1085	
8625 (G86250)	400	405	492	1028
	1046	1061	1085	
8627 (G86270)	400	405	493	1028
	1046	1053	1061	
8630 (G86300)	400	405	415	425
	429	1028	1046	1053
	1062	1085		
8632 (G86320)	493			
8635 (G86350)	493	1028	1046	1062
8637 (G86370)	400	405	415	1028
	1046	1062	1085	
8640 (G86400)	400	405	415	429
	1028	1046	1053	1062
	1085			
8641 (G86410)	493			
8642 (G86420)	400	405	415	493
	1028	1046	1062	1085
8645 (G86450)	400	405	415	1028
	1046	1062	1085	
8650 (G86500)	425	429		
8653 (G86530)	493			
8655 (G86550)	400	405	415	493
	1028	1046	1062	
8660 (G86600)	429	493	1028	1046
	1053	1062		
8720 (G87200)	400	405	414	492
	1028	1046	1053	1061
	1085			

Index Terms**Links**aluminum (*Cont.*)

8735 (G87350)	493			
8740 (G87400)	400	405	415	425
	429	432	493	1028
	1046	1053	1062	1085
8745 (G87450)	493			
8750 (G87500)	493			
8822 (G88220)	400	405	1028	1046
	1053	1061		

steel

9254 (G92540)	493	1028	1046	1062
9255 (G92550)	425	429	1028	1046
	1062			
9260 (G92600)	400	405	409	415
	429	1028	1046	1062
9262 (G92620)	493	1028	1046	1062
9310 (G93100)	425	492		
9317 (G93170)	492			
94B17 (G94171)	400	405	1028	1046
	1061			
94B30 (G94301)	400	405	429	1053
9437 (G94370)	493			
9440 (G94400)	493			
9442 (G94420)	493			
9747 (G97470)	493			
9840 (G98400)	493			
9845 (G98450)	493			
9850 (G98500)	415	493		
elastic properties	394			
cast	394			
cold-rolled	394			
elongation	424			
hardness bhn	424			
high speed				

Index Terms

Links

aluminum (*Cont.*)

cobalt

18-4-14 504

cobalt-molybdenum-tungsten, 6-6-2-8 442

cobalt-tungsten

14-4-2-5 442

18-4-1-5 442

18-4-2-12 442

18-4-2-8 442

molybdenum, 8-2-1 442

molybdenum-tungsten

6-6-2 442

6-6-3 442

6-6-4 442

tungsten

18-4-1 442 448 496 499
504

18-4-2 442

18-4-3 442

high-strength, low alloy, SAE number

942X 420

945A 420

945C 420

945X 420

950A 420

950B 420

950C 420

950D 420

950X 420

955X 420

960X 420

965X 420

970X 420

steel

Index Terms

Links

aluminum (*Cont.*)

980X 420

impact strength 424

investment casting alloys

IC 1010 391

IC 1020 391

IC 1030 391

IC 1035 391

IC 1045 391

IC 1050 391

IC 1060 391

IC 1090 391

IC 1722AS 392

IC 2345 391

IC 4130 391

IC 4140 391

IC 4150 391

IC 4330 391

IC 4340 391

IC 4620 391

IC 52100 392

IC 6150 391

IC 8620 391

IC 8630 391

IC 8640 391

IC 8665 392

IC 8730 392

IC 8740 391

plain carbon, AISI-SAE (UNS) number

10L45 (G10454) 403

1005 402

1005 (G10050) 400

1006 402

410 1026 1044
1053 1060

Index Terms**Links**aluminum (*Cont.*)

1006 (G10060)	400			
1008	402	409	1026	1044
	1060			
1008 (G10080)	400			
1009(G)	1026	1044	1060	1010
	402	409	1026	1044
	1060			
1010 (G10100)	400	490	1012	1026
	1044	1060		
1012 (G10120)	400	1015	402	409
	424	1026	1044	1060
1015 (G10150)	400	1016	402	411
	1026	1044	1060	
1016 (G10160)	400			
1017 (G10170)	400	402	411	1026
	1044	1060		
1018 (G10180)	400	402	411	422
	1026	1044	1060	
1019 (G10190)	400	402	411	1026
	1044	1060		
1020 (G10200)	400	402	409	424
	1026	1044	1060	
1021 (G10210)	400	402	411	1026
	1044	1060		
1022 (G10220)	400	402	409	411
	424	490	1026	1044
	1060			

steel

1023 (G10230)	400	402	411	1026
	1044	1060		
1024 (G10240)	409	411	490	1026
	1044	1060		

Index Terms**Links**aluminum (*Cont.*)

1025 (G10250)	400	402	411	422
	432	491	1026	1044
	1060			
1026 (G10260)	400	402	411	1026
	1044	1060		
1027 (G10270)	1027	1045	1060	
1029 (G10290)	400	402		
1030 (G10300)	400	402	409	424
	426	490	1027	1045
	1053	1060		
1033 (G10330)	411	491	1027	1045
	1053	1060		
1034 (G10340)	411			
1035 (G10350)	400	402	409	422
	491	1027	1045	1060
1036 (G10360)	409	411	491	1027
	1045	1060		
1037 (G10370)	400	402	1027	1045
	1060			
1038 (G10380)	400	402	411	491
	1027	1045	1060	
1039 (G10390)	400	402	411	1027
	1045	1060		
1040 (G10400)	400	402	409	422
	424	426	491	1027
	1045	1060		
1041 (G10410)	411	491	1027	1045
	1060			
1042 (G10420)	400	411	491	1027
	1045	1060		
1043 (G10430)	400	402	411	1027
	1045	1060		
1044 (G10440)	400	402		

Index Terms**Links**aluminum (*Cont.*)

1045 (G10450)	400	432	1027	1045
	1060			
1046 (G10460)	400	402	411	1027
	1045	1060		
1048 (G10480)	1027	1045	1060	
1049 (G10490)	400	1027	1045	1060
1050 (G10500)	400	402	411	423
	426	491	1027	1045
	1060			
1052 (G10520)	411	491	1027	1045
	1060			
1053 (G10530)	400	402		
1055 (G10550)	400	402	410	412
	491	1027	1045	1061
1059 (G10590)	400	402		
1060 (G10600)	400	402	409	412
	424	426	491	1027
	1045	1061		
1064 (G10640)	1027	1045	1061	
1065 (G10640)	1027	1045	1061	
1066 (G10660)	410	412		
steel				
1070 (G10700)	400	402	409	412
	1027	1045	1061	
1074 (G10740)	491	1027	1045	1061
1078 (G10780)	400	402	412	491
	1027	1045	1061	
1080 (G10800)	400	402	409	412
	424	426	491	1027
	1045	1061		
1084 (G10840)	400	402	1027	1045
	1061			
1085 (G10850)	409	412		

Index Terms**Links**aluminum (*Cont.*)

1086 (G10860)	400	402	412	1027
	1045	1061		
1090 (G10900)	400	402	410	412
	491	1027	1045	1061
1095 (G10950)	400	402	409	412
	424	426	432	491
	1027	1045	1053	1061
11L17 ()	1008	1026	1044	1060
11L18 ()	1026	1044	1060	
1108 (G11080)	1026	1044	1060	1085
1109 (G11090)	413	490	1026	1044
	1060	1085		
1110 (G11100)	400	403	1085	
1111 (G11110)	409	412	490	
1112 (G11120)	410	412	432	490
1113 (G11130)	409	412	490	
1114 (G11140)	413			
1115 (G11150)	410	413	1026	1044
	1060	1085		
1116 (G11160)	413	1085		
1117 (G11170)	400	413	1026	1044
	1060	1085		
1118 (G11180)	400	403	409	413
	422	424	1008	1026
	1044	1060	1085	
1119 (G11190)	413	1085		
1120 (G11200)	413	490	1026	1044
	1060	1085		
1126 (G11260)	413	490	1026	1044
	1060	1085		
1132 (G11320)	409	413	491	1026
	1044	1060	1085	

Index Terms**Links**aluminum (*Cont.*)

1137 (G11370)	400	403	409	413
	423	426	491	1026
	1044	1060	1085	
1138 (G11380)	491			
1139 (G11390)	400	403	1026	1044
	1060	1085		
1140 (G11400)	400	403	413	422
	491	1026	1044	1060
	1085			
1141 (G11410)	400	403	413	423
	427	491	1085	
1144 (G11440)	400	403	413	423
	427	491	1026	1044
	1060	1085		
1145 (G11450)	409	413	423	491
	1085			

steel

1146 (G11460)	400	403	413	423
	1026	1044	1060	1085
1151 (G11510)	400	403	413	423
	491	1026	1044	1060
	1085			
12L13 ()	1026	1044	1060	
12L14 (G12144)	400	403	1026	1044
	1060			
12L15 (G12154)	403			
1211 (G12110)	400	403	1026	1044
	1060			
1212 (G12120)	400	403	432	1026
	1044	1060		
1213 (G12130)	400	403	1026	1044
	1060			

Index Terms**Links**aluminum (*Cont.*)

1215 (G12150)	400	403	1026	1044
	1060			
1513 (G15130)	400	403	1026	1044
	1053	1060		
1522 (G15220)	400	403	1053	
1524 (G15240)	400	403	1027	1045
	1053	1060		
1526 (G15260)	400	403	1027	1045
	1060			
1527 (G15270)	400	403	1027	1045
	1060			
1541 (G15410)	400	403	1027	1045
	1060			
1548 (G15480)	400	403	1027	1045
	1061			
1551 (G15510)	400	403	1027	1045
	1061			
1552 (G15520)	400	403	1027	1045
	1061			
1561 (G15610)	400	403	1027	1045
	1061			
1566 (G15660)	400	403	1027	1045
	1053	1061		
tensile strength	422	424		
tool, AISI (UNS) number				
A10 (T30110)	400	454	1030	1048
	1065			
A2 (T30102)	400	443	445	453
	1030	1048	1065	
A3 (T30103)	400	454	1030	1048
	1065			
A4 (T30104)	400	454	1030	1048
	1065			

Index Terms**Links**aluminum (*Cont.*)

A5 (T30105)	400			
A6 (T30106)	400	445	453	1030
	1048	1065		
A7 (T30107)	400	454	1030	1048
	1065			
A8 (T30108)	400	454	1030	1048
	1065			
A9 (T30109)	400	454	1030	1048
	1065			
CA2 (T90102)	400			
CD2 (T90402)	400			

steel

CD5 (T90405)	400			
CH12 (T90812)	400			
CH13 (T90813)	400			
CO1 (T91501)	400			
CS5 (T91905)	400			
D2 (T30402)	400	436	443	452
	454	1030	1048	1065
D3 (T30403)	400	436	452	454
	1030	1048	1065	
D4 (T30404)	400	454	1030	1048
	1065			
D5 (T30405)	400	436	454	1030
	1048	1065		
D7 (T30407)	400	436	443	454
	1030	1048	1065	
F1 (T60601)	400	456		
F2 (T60602)	400	456		
H10 (T20810)	400	444	450	1030
	1048	1065		
H11 (T20811)	400	445	449	1030
	1048	1065		

Index Terms**Links**aluminum (*Cont.*)

H12 (T20812)	400	450	1030	1048
	1065			
H13 (T20813)	400	445	450	1030
	1048	1065		
H14 (T20814)	400	450	1030	1048
	1065			
H19 (T20819)	400	444	450	1030
	1048	1065		
H20 (T20820)	444	451		
H21 (T20821)	400	445	450	1030
	1048	1065		
H22 (T20822)	400	444	450	1030
	1048	1065		
H23 (T20823)	400	450	1030	1048
	1065			
H24 (T20824)	400	450	1030	1048
	1065			
H25 (T20825)	400	450	1030	1048
	1065			
H26 (T20826)	400	444	450	1030
	1048	1065		
H41 (T20841)	400	436	450	1030
	1048	1065		
H42 (T20842)	400	436	450	1030
	1048	1065		
H43 (T20843)	400	436	444	450
	452	1030	1048	1065
L2 (T61202)	400	456	1030	1048
	1065			
L3 (T61203)	400	456	1030	1048
	1065			
L6 (T61206)	400	445	456	1030
	1048	1065		

Index Terms**Links**aluminum (*Cont.*)

M1 (T11301)	400	436	445	1030
	1048	1065		
M10 (T11310)	400	436	446	1030
	1048	1065		
M15 (T11315)	436			

steel

M2 (T11302)	400	436	443	1030
	1048	1065		
M21 (T11321)	445			
M25 (T11325)	445			
M3 (...)	436	443	1030	1048
	1065			
M30 (T11330)	400	447	1030	1048
	1065			
M3-1 (T11313)	400	447	1030	1048
	1065			
M3-2 (T11323)	400	447	1030	1048
	1065			
M33 (T11333)	400	447	1030	1048
	1065			
M34 (T11334)	400	447	1030	1048
	1065			
M36 (T11336)	400	436	447	1030
	1048	1065		
M4 (T11304)	400	436	444	447
	1030	1048	1065	
M41 (T11341)	400	447	1030	1048
	1065			
M42 (T11342)	400	444	446	1030
	1048	1065		
M43 (T11343)	400	436	447	1030
	1048	1065		

Index Terms**Links**aluminum (*Cont.*)

M44 (T11344)	400 1048	444 1065	447	1030
M46 (T11346)	400 1065	447	1030	1048
M47 (T11347)	400 1065	447	1030	1048
M6 (T11306)	400 1065	447	1030	1048
M7 (T11307)	400 1048	436 1065	446	1030
M8 (T11308)	436			
O1 (T31501)	400 1048	445 1065	453	1030
O2 (T31502)	400 1065	453	1030	1048
O6 (T31506)	400 1065	453	1030	1048
O7 (T31507)	400 1065	454	1030	1048
P2 (T51602)	400 1048	445 1065	456	1030
P20 (T51620)	400 1065	445	456	1048
P21 (T51621)	400 1065	456	1030	1048
P3 (T51603)	400 1065	455	1030	1048
P4 (T51604)	400 1048	445 1065	455	1030
P5 (T51605)	400 1065	456	1030	1048

steel

Index Terms**Links**aluminum (*Cont.*)

P6 (T51606)	400	456	1030	1048
	1065			
S1 (T41901)	400	444	455	1030
	1048	1065		
S2 (T41902)	400	455	1030	1048
	1065			
S4 (T41904)	400			
S5 (T41905)	400	455	1030	1048
	1065			
S6 (T41906)	400	1030	1048	1065
S7 (T41907)	400	445	456	1030
	1048	1065		
T1 (T12001)	400	436	443	448
	451	1030	1048	1065
T15 (T12015)	400	436	443	448
	1009	1030	1048	1065
T2 (T12002)	400	436	448	1030
	1048	1065		
T3 (T12003)	436			
T4 (T12004)	400	448		
T5 (T12005)	400	436	444	448
	1030	1048	1065	
T6 (T12006)	400	436	448	1030
	1048	1065		
T8 (T12008)	400	448	1030	1048
	1065			
W1 (T72301)	400	445	458	1030
	1048	1065		
W2 (T72302)	400	445	458	1030
	1048	1065		
W5 (T72305)	400	458	1030	1048
	1065			
yield strength	422	424		

Index Terms

Links

aluminum (*Cont.*)

tensile strength

aluminum alloys	535	539
everdur	528	
magnesium alloys	547	
titanium alloys	550	

titanium

alpha alloys

5 Al, 2.5 Sn	377	550
--------------	-----	-----

alpha-beta alloys

10 V, 2 Fe, 3 Al	550	
------------------	-----	--

3 Al, 2.5 V	550	
-------------	-----	--

6 Al, 2 Sn, 4 Zr, 6 Mo	550	
------------------------	-----	--

6 Al, 4 V	550	
-----------	-----	--

6 Al, 4 V (low O2)	550	
--------------------	-----	--

6 Al, 6 V, 2 Sn	550	
-----------------	-----	--

7 Al, 4 Mo	550	
------------	-----	--

8 Mn	377	550
------	-----	-----

beta alloys

111.5 Mo, 6 Zr, 4.5 Sn	550	
------------------------	-----	--

13 V, 11 Cr, 3 Al	550	
-------------------	-----	--

8 Mo, 8 V, 2 Fe, 3 Al	550	
-----------------------	-----	--

commercially pure	377	
-------------------	-----	--

98.9 Ti	550	
---------	-----	--

99.0 Ti	394	550
---------	-----	-----

99.1 Ti	550	
---------	-----	--

99.2 Ti	550	
---------	-----	--

titanium

99.5 Ti	550	
---------	-----	--

elastic properties

Ti-8Al-1Mo-1V	394	
---------------	-----	--

99.0 Ti	394	
---------	-----	--

near alpha alloys

11 Sn, 1 Mo, 2.25 Al, 5.0 Zr, 1 Mo, 0.2 Si	550	
--	-----	--

Index Terms

Links

aluminum (*Cont.*)

5 Al, 5 Sn, 2 Zr, 2 Mo, 0.25 Si	550	
6 Al, 2 Nb, 1 Ta, 1 Mo	550	
6 Al, 2 Sn, 1.5 Zr, 1 Mo, 0.35 Bi, 0.1 Si	550	
6 Al, 2 Sn, 4 Zr, 2 Mo	550	
8 Al, 1 Mo, 1 V	394	550

tungsten

powder metal alloys

90W, 6Ni, 4Cu	393
90W, 7Ni, 3Cu	393
92.5W, Bal. Ni, Fe, and Mo	393
92.5W, 5.25Ni, 2.25Cu	393
93W, Bal. Ni, Fe, and Mo	393
95W, 3.5Ni, 1.5Cu	393
95W, 3.5Ni, 1.5Fe	393
97W, 2.1Ni, 0.9Fe	393

UNS numbering system

aluminum alloys	398
cast iron	398
cast steel	398
copper alloys	398
low-melting metals	398
miscellaneous nonferrous metals	398
miscellaneous steels and ferrous	398
nickel-base alloys	398
precious metals	398
rare- earth and earth-like metals, alloys	398
reactive and refractory metals, alloys	398
specified mechanical property	
steels	398
stainless steel alloys	398
tool steels, wrought and cast	398

Index Terms

Links

aluminum (*Cont.*)

welding filler metals 398

zinc-base alloys 398

yield strength

everdur 528

magnesium alloys 547

zinc

elastic properties

cast 394

wrought 394

Alumina silicate

density 389

mechanical properties 389

Aluminum

cast

specific gravity 380

chemical resistance to various

materials 576

coefficient of expansion 375

coefficient of heat transmission 375

density 376

element properties 371

melting point 376

specific heat 373 376

wrought

specific gravity 380

Aluminum alloys

casting, AA number

A356.0 535

A357.0 534 536

A444.0 534 536

B443.0 534

C355.0 534

201.0 534

Index Terms**Links**Aluminum alloys (*Cont.*)

204.0	534	
208.0	534	
222.0	534	
242.0	534	
295.0	534	
296.0	536	
308.0	534	536
319.0	534	
328.0	534	
332.0	534	536
333.0	534	536
336.0	534	536
354.0	535	
355.0	534	
356.0	534	
357.0	534	536
359.0	536	
443.0	534	
512.0	534	
513.0	534	536
514.0	534	
520.0	534	
535.0	535	
705.0	534	
707.0	534	
710.0	534	
711.0	534	536
712.0	534	
713.0	535	
771.0	535	
850.0	534	
851.0	534	
852.0	535	

Index Terms**Links****Aluminum alloys (Cont.)**

coefficient of expansion	376	
density	376	
elastic properties	394	
elongation	535	539
endurance limit	539	
investment casting alloys		
A354	391	
A356	391	
A357	391	
C355	391	
D712 (40E)	391	
investment casting alloys		
KO-1	391	
Precedent	71	391
RR-350	391	
355	391	
356	391	
melting point	376	
shearing strength	539	
tensile strength	534	539
thermal conductivity and		
conductance	376	
ultimate strength	535	539
UNS numbering system	398	
wrought, AA number		
Alclad	2014	539
Alclad	3003	540
Alclad	3004	540
Alclad	6061	541
Alclad	7075	542
1050	537	
1060	537	539
1100	537	539

Index Terms

Links

Aluminum alloys

wrought, AA number (*Cont.*)

1145	537			
1175	537			
1200	537			
1230	537			
1235	537			
1345	537			
1350	537	539	542	
2011	376	537	539	
2014	537	539		
2017	376	537	539	
2018	537	539		
2024	376	394	537	539
2025	537	539		
2036	537	539		
2117	537	539		
2124	537			
2218	537	539		
2219	537	539		
2319	537			
2618	537			
3003	376	538	540	
3004	538	540		
3005	538			
3105	540			
4032	538	540		
4043	538			
4045	538			
4047	538			
4145	538			
5005	538	540		
5050	538	540		
5052	376	538	540	

Index Terms**Links**

Aluminum alloys

wrought, AA number (*Cont.*)

5056	538	540		
5083	538	540		
5086	376	538	541	
5154	541			
5183	538			

wrought, AA number

5252	538	541		
5254	538	541		
5356	538			
5454	541			
5456	538	541		
5457	538	541		
5554	538			
5556	538			
5652	538	541		
5654	538			
5657	541			
6003	538			
6005	538			
6053	538			
6061	376	394	538	541
6063	541			
6066	538	542		
6070	538	542		
6101	538	542		
6105	538			
6151	538			
6201	538			
6253	538			
6262	538	542		
6351	538	542		
6463	538	542		

Index Terms**Links****Aluminum alloys**wrought, AA number (*Cont.*)

7005	538		
7008	538		
7049	538	542	
7050	538	542	
7072	538		
7075	376	538	542
7108	538		
7178	538	542	
8017	538		
8030	538		
8176	542		
8177	538		
yield strength	535	539	
2011	376		
2017	376		
2024	376		
3003	376		
5052	376		
5086	376		
6061	376		
6061-T6			
elastic properties	394	7075	376

Aluminum bronze

specific gravity 380

Aluminum oxide

for polishing plastics 604

Aluminum silicate

density 389

mechanical properties 389

Al₂O₃ (Alumina)

density 389

mechanical properties 389

Index Terms

Links

Americium	
element properties	371
Ammonia	
boiling point	372
latent heat of evaporation	372
specific gravity	381
specific heat	373
Ammonium nitrate (NH₄NO₃)	
in freezing mixtures	376
Amosite	
thermal conductivity and conductance	374
AMS 2404C	1511
AMS 2405B	1511
AMS 2433B	1511
Aniline	
boiling point	372
Antimony	
coefficient of heat transmission	375
element properties	371
specific heat	373
Argon	
element properties	371
Arsenic	
element properties	371
Asbestos	
specific gravity	380
Asbestos cement	
thermal conductivity and conductance	374
Asbestos paper	
thermal conductivity and conductance	374

Index Terms

Links

Ash	
machinability of	388
weight of	387
Aspen	
machinability of	388
weight of	387
Asphalt roll	
thermal conductivity and conductance	374
Asphaltum	
specific gravity	380
Astatine	
element properties	371
Atomic number and weight	371
Atomic symbol, elements	371
Azdel	
density	390
mechanical properties	390
specific gravity	390
B	
Barium	
element properties	371
Basswood	
machinability of	388
mechanical properties	386
weight of	387
Beech	
machinability of	388
weight of	387
weight per cord	386
Beeswax	
latent heat of fusion	372

Index Terms

Links

Bending stress

safe

various plastics

606

Benzine

boiling point

372

specific gravity

381

specific heat

373

Berkelium

element properties

371

Beryllium

element properties

371

Birch

machinability of

388

weight of

387

Bismuth

element properties

371

latent heat of fusion

372

Bisulfide of carbon

ignition temperature

376

Block

thermal conductivity and conductance

cinder

374

concrete

374

Board foot

weight of wood per

386

Boiling points

various substances

372

Borax

500

specific gravity

380

Boric acid

500

Boron

element properties

371

Brass

coefficient of expansion

375

Index Terms

Links

Brass (*Cont.*)

red	
coefficient of heat transmission	375
specific heat	373
yellow	
coefficient of heat transmission	375

Brick

coefficient of expansion	375
specific gravity	380
thermal conductivity and conductance	
common	374
face	374
ultimate strength	394

Brickwork

specific gravity	380
specific heat	373
ultimate strength	394

Brine

quenching	457	476	484
-----------	-----	-----	-----

quenching	477	491
-----------	-----	-----

Bromine

boiling point	372
element properties	371
specific gravity	381

Bronze

coefficient of expansion	375
commercial90%	376
strength, effect of temperature on	395

Bulk modulus

394

C

Cadmium

element properties	371
specific heat	373

Index Terms

Links

Calcium		
element properties	371	
Calcium chloride (CaCl₂)		
in freezing mixtures	376	
Californium		
element properties	371	
Carbide	602	
Carbolic acid		
specific gravity	381	
Carbon		
element properties	371	
Carbon bisulfide		
boiling point	372	
ignition temperature	376	
latent heat of evaporation	372	
Carbon dioxide		
specific gravity	381	
Carbon disulfide		
specific gravity	381	
Carbon monoxide		
specific gravity	381	
Carbon steels		
chemical composition	415	
Carbonic acid		
specific heat	373	
Carbonic oxide		
specific heat	373	
Cast iron		
ASTM A48	432	
coefficient of expansion	377	
cutting tools materials for	459	
density	377	
hardness	507	510
induction hardening	488	

Index Terms

Links

Cast iron (*Cont.*)

influence of temperature on strength	395
latent heat of fusion	372
malleablizing	463
melting point	377
specific gravity	380
strength data for	432
strength, effect of temperature on	395
thermal conductivity and conductance	377
UNS numbering system	398

Cast steel

coefficient of expansion	377
density	377
melting point	377
thermal conductivity and conductance	377

Cast steels

UNS numbering system	398
----------------------	-----

Cedar

mechanical properties	386
weight of	387
weight per board foot	386

Cellulose

thermal conductivity and conductance	374
---	-----

Cement

Portland	
coefficient of expansion	375
ultimate strength	394
specific gravity	380
thermal conductivity and conductance	374

Index Terms**Links****Ceramics**

coefficient of expansion	389
compressive strength	389
density	389
dielectric strength	389
flexural strength	389
Mohs's hardness	389
tensile strength	389
thermal conductivity	389

Cerium

element properties	371
--------------------	-----

Cesium

element properties	371
--------------------	-----

Chalk

specific gravity	380
specific heat	373

Charcoal

ignition temperature	376
specific heat	373

Chemical composition

copper alloys	519
nickel	549

Chemical compositions

aluminum alloys	534
magnesium alloys	546

Cherry

machinability of	388
weight of	387

Chestnut

machinability of	388
weight of	387
weight per board foot	386
weight per cord	386

Chlorinated PVC (CPVC)

380	390	551
-----	-----	-----

Index Terms

Links

Chlorine

element properties	371
specific gravity	381
specific heat	373

Chloroform

boiling point	372
specific heat	373

Chromium

element properties	371
--------------------	-----

Coal

specific gravity	380
specific heat	373

Cobalt

element properties	371
--------------------	-----

Cobalt-base alloys

investment casting alloys

cobalt 21	392
cobalt 25	392
cobalt 31	392
cobalt 36	392
F75	392
N-155	392

Coefficient of expansion

	375	389	551	578
ABS	375			
acetal	375			
acrylic	375			
aluminum	375			
aluminum alloys	376			
brass	375			
brick	375			
bronze	375			
cast iron	377			
cast steel	377			

Index Terms

Links

Coefficient of expansion (*Cont.*)

cement	
Portland	375
ceramics	389
concrete	375
copper	375
copper alloys	376
ductile iron	377
ebonite	375
epoxy	375
glass	375
hard	375
thermometer	375
granite	375
magnesium	375
malleable iron	377
marble	375
masonry	375
nickel-base alloys	377
nylon	375
pipe	3028
plaster	375
plastics	390
polycarbonate	375
polyethylene	375
polypropylene	375
porcelain	375
quartz	375
sandstone	375
slate	375
stainless steel alloys	377
steel	375
thermoplastic polyester	375
titanium alloys	377

Index Terms**Links****Coefficient of expansion (*Cont.*)**

wood

pine

375

zinc

375

Coefficient of friction

551

578

Coefficient of heat transmission

aluminum

375

antimony

375

brass

red

375

yellow

375

copper

375

german silver

375

iron

375

lead

375

mercury

375

silver

375

steel

hard

375

soft

375

tin

375

zinc

375

Coefficient of radiation

copper

375

glass

375

iron

375

cast

375

tinned and polished

375

oil

375

sand

fine

375

sawdust

375

silver

polished

375

Index Terms**Links****Coefficient of radiation (*Cont.*)**

tin	375
water	375

Coke

specific heat	373
---------------	-----

Compression modulus 566**Concrete**

coefficient of expansion	375
--------------------------	-----

Portland

ultimate strength	394
-------------------	-----

poured

thermal conductivity and conductance	374
---	-----

specific gravity	380
------------------	-----

Copper

coefficient of expansion	375
--------------------------	-----

coefficient of heat transmission	375
----------------------------------	-----

density	376
---------	-----

element properties	371
--------------------	-----

melting point	376
---------------	-----

polished

coefficient of radiation	375
--------------------------	-----

specific heat	373	376
---------------	-----	-----

strength, effect of temperature on	395
------------------------------------	-----

Copper alloys

alloy name (UNS number)

aluminum brass, arsenical

(C68700)	526	1036	1071
----------	-----	------	------

aluminum bronze, D (C61400)	525	1036	1071
-----------------------------	-----	------	------

architectural bronze (C38500)	523	1036	1071
-------------------------------	-----	------	------

beryllium Cu

(C17000)	521	1036	1071
----------	-----	------	------

(C17200)	376	521	1036	1071
----------	-----	-----	------	------

(C17300)	376	521		
----------	-----	-----	--	--

Index Terms**Links**Copper alloys (*Cont.*)

(C17500)	521	1036	1071
(C17510)	521		
C17200	376		
C17300	376		
brass			
cartridge 70% (C26000)	376		
extra-high-leaded (C35600)	376		
free machining (C36000)	376		
high-leaded (C35300)	376		
low-leaded, tube (C33000)	376		
naval (C46400)	376		
red, 85% (C23000)	376		
yellow (C27000)	376		
bronze			
aluminum 11% A (C62400)	376		
aluminum 9% A (C62300)	376		
commercial, 90% (C22000)	376		
nickel aluminum (C63000)	376		
phosphor 5% A (C51000)	376		
phosphor, free cutting (C54400)	376		
cadmium Cu			
(C16200)	521		
(C16210)	521		
deoxidized (C14300)	520		
deoxidized (C14310)	520		
cartridge brass			
70% (C26000)	376	522	1036 1071
70% (C26100)	522		
70% (C26130)	522		
70% (C26200)	522		
chromium Cu			
(C18200)	376	521	
(C18400)	521		

Index Terms**Links****Copper alloys (*Cont.*)**

(C18500)	521			
commercial bronze, 90%				
(C22000)	376	522	1036	1071
Cu nickel				
10% (C70600)	527	1036	1071	
20% (C71000)	527			
30% (C71500)	527	1036	1071	
5% (C70400)	526			
Cu- nickel- phosphorus- tellurium				
(C19100)	521			
alloy name (UNS number)				
Cu-nickel-phosphorus (C19000)	521			
forging brass (C37700)	523	1036	1071	
free machining Cu (C14500)	376			
free-cutting brass (C36000)	376	523	1036	1071
gilding, 95% (C21000)	522	1036	1071	
inhibited admiralty				
(C44300)	524	1036	1071	
(C44400)	524			
(C44500)	524	1036	1071	
jewelry bronze, 87.5% (C22600)	522	1036	1071	
leaded brass				
(C33500)	523	1036	1071	
(C34000)	523	1036	1071	
(C34200)	523	1036	1071	
(C35000)	523			
(C35300)	376	523	1036	1071
(C35600)	376	523	1036	1071
tube (C33000)	376	522		
tube (C33200)	523	1036	1071	
leaded commercial bronze				
(C31400)	522	1036	1071	
nickel-bearing (C31600)	522			

Index Terms**Links****Copper alloys (Cont.)**

lead Cu				
(C18700)	376	521		
low brass, 80%	522	1036	1071	
manganese brass (C66700)	526			
manganese bronze, A (C67500)	526	1036	1071	
Muntz metal				
free-cutting (C37000)	523	1036	1071	
lead (C36500)	376	523	1036	1071
lead (C36800)	523	1036	1071	
60% (C28000)	376	522	1036	1071
naval brass				
(C46400)	376	524		
(C46700)	524			
lead (C48500)	524	1036	1071	
medium-lead (C48200)	524			
nickel silver				
55-18 (C77000)	527	1036	1071	
65-10 (C74500)	527	1036	1071	
65-12 (C75700)	527	1036	1071	
65-15 (C75400)	527	1036	1071	
65-18 (C75200)	527	1036	1071	
oxygen-free				
(C10200)	519	1036	1071	
electronic (C10100)	519			
extra-low phosphorus (C10300)	519			
low phosphorus (C10800)	519			
silver-bearing				
(C10400)	519			
(C10500)	519			
(C10700)	519			
phosphor bronze				
alloy name (UNS number)				
1.25% E (C50500)	524			

Index Terms**Links****Copper alloys (*Cont.*)**

10% D (C52400)	525	1036	1071	
5% A (C51000)	376	524	1036	1071
8% C (C52100)	525	1036	1071	
phosphorus deoxidized Cu arsenical (C14200)	520			
high residual phosphorus (C12200)	520	1036	1071	
low residual phosphorus (C12000)	520			
(C12100)	520			
red brass, 85% (C23000)	376	522	1036	1071
silicon bronze				
high, A (C65500)	526	1036	1071	
low, B (C65100)	526	1036	1071	
silicon red brass (C69400)	526			
sulfur bearing				
(C14700)	520			
(C14710)	520			
(C14720)	520			
tellurium bearing				
(C14500)	376	520		
(C14510)	520			
(C14520)	520			
tough pitch				
electrolytic (C11000)	376	519	1036	1071
fire refined, with silver				
(C12500)	520			
(C12700)	520			
(C12800)	520			
(C12900)	520			
(C13000)	520			
silver-bearing				
(C11300)	519			

Index Terms**Links**Copper alloys (*Cont.*)

(C11400)	519		
(C11500)	519		
(C11600)	519		
yellow brass			
(C26800)	522	1036	1071
(C27000)	376	522	
zirconium Cu (C15000)	520		
beryllium copper			
elastic properties	394		
brass			
elastic properties			
cast	394		
70-30	394		
bronze			
elastic properties	394		
manganese	376		
chemical compositions	519		
coefficient of expansion	376		
density	376		
elastic properties	394		
elongation	515	519	
investment casting alloys			
beryllium Cu			
10C (820)	391		
165C (824)	391		
20C (825)	391		
275C (828)	391		
brass			
red	391		
silicon	391		
yellow leaded (854)	391		
bronze			
aluminum, C (954)	391		

Index Terms**Links****Copper alloys (*Cont.*)**

aluminum, D (955)	391		
manganese, A	391		
manganese, C	391		
silicon	391		
tin	391		
chrome copper	391		
copper (pure)	391		
machinability	515	519	
manganese bronze	376		
melting point	376		
nickel silver			
elastic properties	394		
nickel-silver	376		
phosphor bronze			
elastic properties	394		
wire			
tensile strength	395		
powder metal alloys			
CNZ-1818	393		
copper (pure)	393		
CTG-1001	393		
CTG-1004	393		
CZP-3002	393		
tensile strength	515	519	
thermal conductivity and conductance	376		
UNS number (alloy name)			
C10100 (oxygen-free electronic)	519		
C10200 (oxygen-free Cu)	519	1036	1071
C10300 (oxygen-free, extra-low phosphorus)	519		
C10400 (oxygen-free, silver- bearing)	519		

Index Terms**Links**Copper alloys (*Cont.*)

C10500 (oxygen-free, silver-bearing)	519			
C10700 (oxygen-free, silver-bearing)	519			
C10800 (oxygen-free, low phosphorus)	519			
C11000 (electrolytic tough pitch)	376	519	1036	1071
C11300 (silver-bearing tough pitch)	519			
C11400 (silver-bearing tough pitch)	519			
UNS number (alloy name)				
C11500 (silver-bearing tough pitch)	519			
C11600 (silver-bearing tough pitch)	519			
C12000 (phosphorus deoxidized Cu, low residual phosphorus)	520			
C12100 (phosphorus deoxidized Cu, low residual phosphorus)	520			
C12200 (phosphorus deoxidized Cu, high residual phosphorus)	520	1036	1071	
C12500 (fire-refined tough pitch with silver)	520			
C12700 (fire-refined tough pitch with silver)	520			
C12800 (fire-refined tough pitch with silver)	520			
C12900 (fire-refined tough pitch with silver)	520			
C13000 (fire-refined tough pitch with silver)	520			

Index Terms

Links

Copper alloys (*Cont.*)

C14200 (phosphorus deoxidized Cu, arsenical)	520			
C14300 (cadmium Cu, deoxidized)	520			
C14310 (cadmium Cu, deoxidized)	520			
C14500 (free machining Cu)	376			
C14500 (tellurium bearing)	376	520		
C14510 (tellurium bearing)	520			
C14520 (tellurium bearing)	520			
C14700 (sulfur bearing)	520			
C14710 (sulfur bearing)	520			
C14720 (sulfur bearing)	520			
C15000 (zirconium Cu)	520			
C15500	520			
C15715	520			
C15720	520			
C15760	521			
C16200 (cadmium Cu)	521			
C16210 (cadmium Cu)	521			
C16500	521			
C17000 (beryllium Cu)	521	1036	1071	
C17200 (beryllium Cu)	376	521	1036	1071
C17300 (beryllium Cu)	376	521		
C17500 (beryllium Cu)	521	1036	1071	
C17510 (beryllium Cu)	521			
C18200 (chromium Cu)	376	521		
C18400 (chromium Cu)	521			
C18500 (chromium Cu)	521			
C18700 (leaded copper)	376	521		
C18700 (leaded Cu)	376			
C19000 (Cu-nickel-phosphorus)	521			
C19100 (Cu- nickel- phosphorus- tellurium alloy)	521			
C19200	521			

Index Terms**Links**Copper alloys (*Cont.*)

C19400	522			
UNS number (alloy name)				
C19500	522			
C21000 (gilding, 95%)	522	1036	1071	
C22000 (commercial bronze, 90%)	376	522	1036	1071
C22600 (jewelry bronze, 87.5%)	522	1036	1071	
C23000 (red brass, 85%)	376	522	1036	1071
C24000 (low brass, 80%)	522	1036	1071	
C26000 (cartridge brass 70%)	376	522	1036	1071
C26100 (cartridge brass, 70%)	522			
C26130 (cartridge brass, 70%)	522			
C26200 (cartridge brass, 70%)	522			
C26800 (yellow brass)	522	1036	1071	
C27000 (yellow brass)	376	522		
C28000 (Muntz metal 60%)	376	522	1036	1071
C31400 (lead commercial bronze)	522	1036	1071	
C31600 (lead commercial bronze, nickel-bearing)	522			
C33000 (low-lead brass tube)	376	522		
C33200 (high-lead brass tube)	523	1036	1071	
C33500 (low-lead brass)	523	1036	1071	
C34000 (medium-lead brass)	523	1036	1071	
C34200 (high-lead brass)	523	1036	1071	
C35000 (medium-lead brass)	523			
C35300 (high-lead brass)	376	523	1036	1071
C35600 (extra-high-lead brass)	376	523	1036	1071
C36000 (free machining brass)	376			
C36000 (free-cutting brass)	376	523	1036	1071
C36500 (lead Muntz metal)	376	523	1036	1071
C36800 (lead Muntz metal)	523	1036	1071	
C37000 (free-cutting Muntz metal)	523	1036	1071	

Index Terms**Links**Copper alloys (*Cont.*)

C37700 (forging brass)	523	1036	1071
C38500 (architectural bronze)	523	1036	1071
C40500	523		
C40800	523		
C41100	523		
C41300	523		
C41500	524		
C42200	524		
C42500	524		
C43000	524		

UNS number (alloy name)

C43400	524			
C43500	524			
C44300 (inhibited admiralty)	524	1036	1071	
C44400 (inhibited admiralty)	524			
C44500 (inhibited admiralty)	524	1036	1071	
C46400 (naval brass)	376	524		
C46700 (naval brass)	524			
C48200 (naval brass, medium-leaded)	524			
C48500 (leaded naval brass)	524	1036	1071	
C50500 (phosphor bronze, 1.25% E)	524			
C51000 (phosphor bronze, 5% A)	376	524	1036	1071
C51100	524			
C52100 (phosphor bronze, 8% C)	525	1036	1071	
C52400 (phosphor bronze, 10% D)	525	1036	1071	
C54400	376	525	1036	1071
C54400 (free cutting phos. bronze)	376			
C60800	525			
C61000	525			
C61300	525			
C61400 (aluminum bronze, D)	525	1036	1071	
C61500	525			
C61800	525			

Index Terms**Links**Copper alloys (*Cont.*)

C61900	525		
C62300	376	525	
C62300 (aluminum bronze, 9%)	376		
C62400	376	525	
C62400 (aluminum bronze, 11%)	376		
C62500	525		
C63000	376	525	
C63000 (Ni-Al bronze)	376		
C63200	525		
C63600	526		
C63800	526		
C64200	514	526	
C65100 (low-silicon bronze, B)	526	1036	1071
C65500 (high-silicon bronze, A)	526	1036	1071
C66700 (manganese brass)	526		
C67400	526		
C67500 (manganese bronze, A)	526	1036	1071
C68700 (aluminum brass, arsenical)	526	1036	1071
C68800	526		
C69000	526		
C69400 (silicon red brass)	526		
C70400 (Cu nickel, 5%)	526		
UNS number (alloy name)			
C70600 (Cu nickel, 10%)	527	1036	1071
C71000 (Cu nickel, 20%)	527		
C71500 (Cu nickel, 30%)	527	1036	1071
C72200	527		
C72500	527		
C73500	527		
C74500 (nickel silver, 65-10)	527	1036	1071
C75200 (nickel silver, 65-18)	527	1036	1071
C75400 (nickel silver, 65-15)	527	1036	1071

Index Terms**Links**Copper alloys (*Cont.*)

C75700 (nickel silver, 65-12)	527	1036	1071
C76390	527		
C77000 (nickel silver, 55-18)	527	1036	1071
C78200	527		
C80100	515		
C80300	515		
C80500	515		
C80700	515		
C80900	515		
C81100	515		
C81300	515		
C81400	515		
C81500	515		
C81700	515		
C81800	515		
C82000	515		
C82100	515		
C82200	515		
C82400	515		
C82500	515		
C82600	515		
C82700	515		
C82800	515		
C83300	516		
C83400	516		
C83600	516		
C83800	516		
C84200	516		
C84400	516		
C84500	516		
C84800	516		
C85200	516		
C85400	516		

Index Terms**Links**Copper alloys (*Cont.*)

C85500	516
C85700	516
C85800	516
C86100	516
C86200	516
C86300	516
C86400	516
C86500	516
C86700	516
C86800	516

UNS number (alloy name)

C87200	516
C87400	516
C87500	517
C87600	517
C87800	517
C87900	517
C90200	517
C90300	517
C90500	517
C90700	517
C90900	517
C91000	517
C91100	517
C91300	517
C91600	517
C91700	517
C92200	517
C92300	517
C92500	517
C92600	517
C92700	517
C92800	517

Index Terms

Links

Copper alloys (*Cont.*)

C92900	517
C93200	517
C93400	517
C93500	517
C93700	517
C93800	517
C93900	517
C94300	517
C94400	517
C94500	517
C94700	518
C94800	518
C95200	518
C95300	518
C95400	518
C95500	518
C95600	518
C95700	518
C95800	518
C96200	518
C96300	518
C96400	518
C96600	518
C97300	518
C97400	518
C97600	518
C97800	518
C99300	518
C99400	518
C99500	518
C99700	518
C99750	518
UNS numbering system	398

Index Terms**Links****Copper alloys (*Cont.*)**

yield strength 515 519

Copper-beryllium alloys

tensile strength 529

yield strength 529

10 529

165 529

25 529

35 529

50 529

Copper-silicon alloys (Everdur)

637 528

651 528

655 528

6552 528

661 528

Copper-zinc-tin alloys

tensile strength 528

Cord

weight per wood in 386

Cordierite (2MgO·2Al₂O₃·5SiO₂)

density 389

mechanical properties 389

Corrosion resistance

salt water

stainless steel 419

Corundum

specific heat 373

Cotton-seed oil

specific gravity 381

Cottonwood

machinability of 388

weight of 387

Index Terms

Links

CPVC

density	390		
mechanical properties	390		
specific gravity	380	390	
CPVC (chlorinated PVC)	380	390	551

Curium

element properties	371
--------------------	-----

Cypress

weight of	387
weight per board foot	386

C18900	521
--------	-----

D

Density

air	3032
at various pressures and temperatures	3034
aluminum alloys	376
cast iron	377
cast steel	377
ceramics	389
copper alloys	376
ductile iron	377
iron	
cast	377
ductile	377
malleable	377
malleable iron	377
nickel-base alloys	377
plastics	390
stainless steel alloys	377

Steel

cast	377
titanium alloys	377
various metals	376

Index Terms

Links

Density (*Cont.*)

water 3026 3028

Dielectric constant

nylon 6/6 574

Dielectric strength

ceramics 389

plastics 390

Douglas Fir

mechanical properties 386

Douglas fir

weight of 387

Ductile iron

A536 377

coefficient of expansion 377

density 377

investment casting alloys

ferritic 392

pearlitic 392

Melting point 377

thermal conductivity and

conductance 377

Dysprosium

element properties 371

E

Earth

specific gravity 380

Ebonite

coefficient of expansion 375

Einsteinium

element properties 371

Element

atomic number and weight 371

melting point 371

Index Terms**Links****Element (*Cont.*)**

symbol 371

Elm

machinability of 388

weight of 387

weight per cord 386

Elongation

investment casting alloys 391

Emery

specific gravity 380

Epoxy

coefficient of expansion 375

Erbium

element properties 371

Ether

boiling point 372

latent heat of evaporation 372

specific heat 373

vapor

specific gravity 381

Ether, sulfuric

specific gravity 381

Ethylene

specific gravity 381

specific heat 373

Europium

element properties 371

Everdur

chemical composition 528

elongation 528

tensile strength 528

yield strength 528

Everdur (copper-silicon) alloys

637 528

Index Terms**Links****Everdur (copper-silicon) alloys (*Cont.*)**

651	528
655	528
6552	528
661	528

F**Felt**

thermal conductivity and conductance	374
---	-----

Fermium

element properties	371
--------------------	-----

Fe ₃ O ₄	3018
--------------------------------	------

Fiber glass sheet

density	390
mechanical properties	390
specific gravity	390

Fiberglass	551
------------	-----

Fir

mechanical properties	386
weight of	387
weight per board foot	386

Flexural modulus	574	587
------------------	-----	-----

plastics	390
----------	-----

Flexural strength

ceramics	389
----------	-----

Fluoric acid

specific gravity	381
------------------	-----

Fluorine

element properties	371
--------------------	-----

Forsterite (2MgO·SiO₂)

density	389
mechanical properties	389

Index Terms

Links

Francium

element properties 371

Freezing mixtures 376

ammonium nitrate (NH_4NO_3) 376

calcium chloride (CaCl_2)

potassium hydrate (KOH) 376 376

sal ammoniac (NH_4Cl)

salt, common 376

Friction, coefficient of 551 578

Fusel oil

specific heat 373

G

Gadolinium

element properties 371

Gallium

element properties 371

Gas

specific heat 373

Gasoline

specific gravity 381

German silver

coefficient of heat transmission 375

Germanium

element properties 371

Glass

coefficient of expansion 375

coefficient of radiation 375

elastic properties 394

hard

coefficient of expansion 375

specific gravity 380

specific heat 373

thermal conductivity and

Index Terms

Links

Glass (*Cont.*)

conductance 374

thermometer

coefficient of expansion 375

Glass ceramic (machinable)

elastic properties 394

Glass ceramic, machinable

density 389

mechanical properties 389

Glass mica

density 389

mechanical properties 389

Gold

element properties 371

specific gravity 380

specific heat 373

Granite

coefficient of expansion 375

specific gravity 380

ultimate strength 394

Graphite

specific heat 373

Gravel

specific gravity 380

Gum

weight of 387

Gun cotton

ignition temperature 376

Gypsum

specific gravity 380

H

Hackberry

machinability of 388

Index Terms

Links

Hafnium

element properties 371

Hardness

plastics 390

Helium

element properties 371

Hemlock

mechanical properties 386

weight of 387

weight per board foot 386

Hickory

machinability of 388

weight of 387

Holmium

element properties 371

Honeylocust

weight of 387

Hydrochloric acid

specific gravity 381

Hydrofluoric acid

specific gravity 381

Hydrogen

element properties 371

specific gravity 381

specific heat 373

I

Ice

latent heat of fusion 372

specific gravity 380

specific heat 373

Ignition temperature

bisulfide of carbon 376

charcoal 376

Index Terms

Links

Ignition temperature (*Cont.*)

dry wood	
oak	376
pine	376
gun cotton	376
nitro-glycerine	376
phosphorus	
amorphous	376
transparent	376
rifle powder	376

Illuminating gas

specific gravity	381
------------------	-----

Indium

element properties	371
--------------------	-----

Iodine

element properties	371
--------------------	-----

Iridium

element properties	371
--------------------	-----

Iron

cast	
coefficient of radiation	375
density	377
latent heat of fusion	372
melting point	377
specific gravity	380
specific heat	373
strength, effect of temperature on	395
UNS numbering system	398
coefficient of heat transmission	375
coefficient of radiation	375
ductile	
density	377
investment casting alloys	
ferritic	392

Index Terms

Links

Iron (*Cont.*)

pearlitic	392
melting point	377
specific heat	377
elastic properties	
cast	394
ductile	394
grey cast	394
malleable	394
element properties	371
investment casting alloys 1.2% Si	392
malleable	
density	377
melting point	377
specific heat	377
powder metal alloys	
FC-0208	393
FC-0508	393
FC-0800	393
FC-2008	393
FC-2015	393
FL-4605	393
FL-4608	393
FN-0005	393
FN-0200	393
FN-0205	393
FN-0208	393
FN-0405	393
FN-0408	393
FX-2008	393
F-0000	393
F-0008	393
sheet, polished	
coefficient of radiation	375

Index Terms

Links

Iron (*Cont.*)

specific gravity	380
specific heat	373
wrought	
specific heat	373
strength, effect of temperature on	395

Iron slag

specific gravity	380
------------------	-----

Izod impact

plastics	390
----------	-----

K

Kerosene

specific gravity	381
specific heat	373

Krypton

element properties	371
--------------------	-----

L

Lanthanum

element properties	371
--------------------	-----

Larch

weight of	387
-----------	-----

Latent heat

of evaporation	372
of fusion	372

Lava

density	389
mechanical properties	389

Lawrencium

element properties	371
--------------------	-----

Lead

coefficient of heat transmission	375
----------------------------------	-----

Index Terms

Links

Lead (*Cont.*)

elastic properties	394
element properties	371
latent heat of fusion	372
specific gravity	380
specific heat	373

Lime

thermal conductivity and conductance	374
---	-----

Limestone

specific gravity	380
specific heat	373
ultimate strength	394

Linseed oil

boiling point	372
specific gravity	381

Liquid crystal polymer

chemical resistance to various materials	576
---	-----

Lithium

element properties	371
--------------------	-----

Locust

weight of	387
-----------	-----

Lodestone

3018

Lutetium

element properties	371
--------------------	-----

M

Magnesia

specific heat	373
thermal conductivity and conductance	374

Magnesium

coefficient of expansion	375
--------------------------	-----

Index Terms

Links

Magnesium (*Cont.*)

elastic properties 394

element properties 371

Magnesium alloys

bearing strength 547

casting, pressure die cast

AM60A 546

AM60B 546

AS41A 546

AZ91A 546

AZ91B 546

AZ91D 546

casting, sand and permanent mold

AM100A 546

AZ63A 546

AZ81A 546

AZ91C 546

AZ91E 546

AZ92A 546

EZ33A 546

HK31A 546

HZ32A 546

K1A 546

QE22A 546

QH21A 546

WE54A 546

ZE41A 546

ZE63A 546

ZH62A 546

ZK51A 546

ZK61A 546

compressive strength 547

elastic properties 394

elongation 547

Index Terms

Links

Magnesium (*Cont.*)

extrusion	
AZ10A	546
AZ31B	546
AZ31C	546
AZ61A	546
AZ80A	546
HM31A	546
M1A	546
ZK40A	546
ZK60A	546
hardness	547
shear strength	547
sheet and plate	
AZ31B	546
AZ31C	546
HK31A	546
HM21A	546
tensile strength	547
yield strength	547
Magnetite	3018
Magnolia	
machinability of	388
Malleable iron	
A220	377
coefficient of expansion	377
density	377
melting point	377
thermal conductivity and conductance	377
Manganese	
element properties	371
Maple	
machinability of	388

Index Terms**Links****Maple (Cont.)**

weight of	387
weight per cord	386

Marble

coefficient of expansion	375
specific gravity	380
specific heat	373

Marsh gas

specific gravity	381
------------------	-----

Masonry

brick	
coefficient of expansion	375
specific heat	373
specific gravity	380

Maximum operating temperature

plastics	390
----------	-----

MB

wire	
tensile strength	
hard-drawn	395
oil tempered	395

Mechanical properties

elongation		
alloy steel	424	
aluminum alloys	535	
copper alloys	515	519
investment casting alloys	391	
nickel	549	
hardness no.		
alloy steel	424	
impact strength		
alloy steel	424	
machinability		
copper alloys	515	

Index Terms

Links

Mechanical properties (*Cont.*)

machinability

copper alloys 519

tensile strength

alloy steel 424

cold drawn steel 422

copper alloys 515 519

investment casting alloys 391

nickel 549

ultimate strength

aluminum alloys 535 539

Wood

compressive strength 386

shearing strength 386

tensile strength 386

wood

compressive strength 385

density 387

machinability 387

wood

maximum crushing strength 385

maximum load in bending 385

modulus of rupture 385

shearing strength 386

tensile strength 386

work to max load 386

yield strength

alloy steel 424

aluminum alloys 535 539

cold drawn steel 422

copper alloys 515 519

copper-beryllium alloys 529

investment casting alloys 391

nickel 549

Index Terms

Links

Melting point

aluminum alloys	376
cast iron	377
cast steel	377
copper alloys	376
ductile iron	377
elements	371
iron	
cast	377
ductile	377
malleable	377
malleable iron	377
nickel-base alloys	377
stainless steel alloys	377
steel	
cast	377
titanium alloys	377

Mendelevium

element properties	371
--------------------	-----

Mechanical properties

tensile strength	
copper-beryllium alloys	529

Mercury

boiling point	372
coefficient of heat transmission	375
element properties	371
specific gravity	380
specific heat	373

Mercury vapor

specific gravity	381
------------------	-----

MgO·SiO₂ (Steatite)

density	389
mechanical properties	389

Index Terms**Links****Mica**

specific gravity 380

Mineral fiber

thermal conductivity and conductance 374

Mineral fiber cement

thermal conductivity and conductance 374

Mineral oil

quenching baths 475

specific gravity 381

tempering in 481

Modulus of elasticity

394 432 513 558

561 565 575 578

600

Modulus of rigidity, G

432

Modulus of rupture

wood 385

Moh's hardness

ceramics 389

Molybdenum

elastic properties 394

element properties 371

Mortar

specific gravity 380

thermal conductivity and
conductance 374

Muriatic acid

specific gravity 381

Music wire

tensile strength 395

N**Naphtha**

specific gravity 381

specific heat 373

Index Terms

Links

Napthaline		
boiling point	372	
Neodymium		
element properties	371	
Neon		
element properties	371	
Neptunium		
element properties	371	
Nickel		
element properties	371	
specific gravity	380	
specific heat	373	
Nickel alloys		
chemical composition	549	
elongation	549	
Inconel		
elastic properties	394	
Monel metal		
elastic properties	394	
tensile strength	549	
yield strength	549	
Nickel steel		
elastic properties	394	
Nickel-base alloys		
alloy name (UNS number)		
hastelloy		
hastelloy C-22	377	
hastelloy C-276	377	
inconel		
inconel	718	377
Monel	377	
alloy name (UNS number)		
Monel K500 (N05500)	377	
Monel R405	377	

Index Terms

Links

Nickel-base alloys (*Cont.*)

Monel 400 (N05500)	377
nickel 200 (N02200)	377
nickel 201 (N02201)	377
nickel 205 (N02205)	377
coefficient of expansion	377
density	377
investment casting alloys	
Alloy B	392
Alloy C	392
Alloy X	392
Inconel	
In 600	392
In 625	392
Invar (Fe-Ni alloy)	392
Monel	
E	392
M-35	392
RH	392
S	392
410	392
melting point	377
nickel alloys	377
specific heat	377
thermal conductivity and conductance	377
UNS numbering system	398
Niobium	
element properties	371
Nitric acid	
boiling point	372
specific gravity	381
Nitric oxide	
specific gravity	381

Index Terms

Links

Nitrogen

element properties	371
specific gravity	381
specific heat	373

Nitro-glycerine

ignition temperature	376
----------------------	-----

Nitrous oxide

specific gravity	381
------------------	-----

Nobelium

element properties	371
--------------------	-----

Nylon

	375	380	390	551
	574	576	587	601
	606			
coefficient of expansion	375			
density	390			
family characteristics	551			
glass reinforced				
coefficient of expansion	375			
milling	602			
mechanical properties	390			
nylon6/6				
chemical resistance to various materials	576			
dielectric constant	574			
nylon 6/6				
flow characteristics	588			
speeds and feeds for drilling	601			
safe bending stress	606			
specific gravity	380	390		
wall thickness for molding	587			

O

Oak

machinability of	388
weight of	387

Index Terms

Links

Oak (*Cont.*)

weight per board foot	386
weight per cord	386

Oil

coefficient of radiation	375
--------------------------	-----

linseed

boiling point	372
specific gravity	381

machine

specific heat	373
---------------	-----

mineral

quenching baths	475
specific gravity	381
tempering in	481

olive

specific gravity	381
specific heat	373

petroleum

specific gravity	381
------------------	-----

quenching

476	484	489	493
501			

quenching baths

mineral	475
---------	-----

rape

specific gravity	381
------------------	-----

saponifiable

481

tempering

481

turpentine

boiling point	372
specific gravity	381

whale

specific gravity	381
------------------	-----

Olive oil

specific gravity	381
------------------	-----

Index Terms

Links

Osmium

element properties 371

Oxygen

element properties 371

specific gravity 381

specific heat 373

P

Palladium

element properties 371

Palm oil

specific gravity 381

Paraffine

latent heat of fusion 372

PBT

chemical resistance to various
materials 576

Pecan

machinability of 388

PEEK(polyetherether-ketone) 551

Percent elongation

plastics 390

Perlite

thermal conductivity and
conductance 374

PET

chemical resistance to various
materials 576

density 390

mechanical properties 390

specific gravity 390

PET (polyethylene-terephthalate) 390 551 576

Petroleum oil

specific gravity 381

Index Terms**Links**

Phenolic	551	602
Phenolics		
density	390	
mechanical properties	390	
specific gravity	390	
Phosphoric acid		
specific gravity	381	
Phosphorus		
element properties	371	
ignition temperature		
amorphous	376	
transparent	376	
latent heat of fusion	372	
specific gravity	380	
specific heat	373	
Pine		
mechanical properties	386	
weight of	387	
weight per board foot	386	
weight per cord	386	
Pipe		
gallons of water per foot	3029	
thermal expansion of	3029	
Plaster		
coefficient of expansion	375	
thermal conductivity and conductance	374	
Plaster of Paris		
specific gravity	380	
Plastics		
coefficient of expansion	390	
density	390	
dielectric strength	390	
flexural modulus	390	

Index Terms**Links****Plastics (Cont.)**

hardness	390
Izod impact	390
maximum operating temperature	390
percent elongation	390
sawing, speeds and numbers of teeth	602
specific gravity	390
speeds and feeds for drilling	601
tensile modulus	390

Platinum

element properties	371
specific gravity	380
specific heat	373

Plexiglass

polishing	604
-----------	-----

Plutonium

element properties	371
--------------------	-----

Plywood

thermal conductivity and conductance	374
---	-----

Poisson's ratio

394	558	562
-----	-----	-----

Polonium

element properties	371
--------------------	-----

Polyarylate

chemical resistance to various materials	576
---	-----

Polycarbonate

375	380	390	551
574	576	587	601

606

chemical resistance to various materials	576
---	-----

coefficient of expansion	375
--------------------------	-----

density	390
---------	-----

mechanical properties	390
-----------------------	-----

Index Terms**Links****Polycarbonate (*Cont.*)**

safe bending stress	606	
specific gravity	380	390
speeds and feeds for drilling	601	

Polyester

safe bending stress	606	
speeds and feeds for drilling	601	

Polyester elastomer

chemical resistance to various materials	576	
--	-----	--

Polyetherimide

density	390	
mechanical properties	390	
specific gravity	390	

Polyethylene

coefficient of expansion	375	
density	390	
mechanical properties	390	
specific gravity	380	390
speeds and feeds for drilling	601	

Polyethylene-terephthalate (PET)

390	551	576
-----	-----	-----

Polyimide

milling	602	
---------	-----	--

Polymer

liquid, for prototypes	603	
------------------------	-----	--

Polymethylpentene

density	390	
mechanical properties	390	
specific gravity	390	

Polymid

density	390	
mechanical properties	390	
specific gravity	390	

Index Terms**Links****Polyphenylene oxide**

chemical resistance to various materials 576

Polyphenylene sulfide

chemical resistance to various materials 576

density 390

mechanical properties 390

specific gravity 390

Polypropylene 375 380 390 551

574 576 587 601

chemical resistance to various materials 576

coefficient of expansion 375

density 390

mechanical properties 390

specific gravity 380 390

speeds and feeds for drilling 601

Polystyrene

speeds and feeds for drilling 601

thermal conductivity and conductance

beaded 374

rigid 374

Polysulfone 390 551 574 576

587

chemical resistance to various materials 576

density 390

mechanical properties 390

specific gravity 390

Polytetrafluoroethylene

speeds and feeds for drilling 601

Polytetrafluoro-ethylene (PTFE) 380 390 551

Index Terms**Links**

Polyurethane	380	390	551	587
	606			
density	390			
mechanical properties	390			
safe bending stress	606			
specific gravity	380	390		
Polyvinyl chloride				
speeds and feeds for drilling	601			
Polyvinyl chloride (PVC)	390	551	587	601
	3029			
Polyvinylidene-fluoride (PVDF)	390	551		3029
Poplar				
machinability of	388			
weight of	387			
weight per cord	386			
Porcelain				
coefficient of expansion	375			
Potassium				
element properties	371			
Potassium hydrate (KOH)				
in freezing mixtures	376			
Praseodymium				
element properties	371			
Pressure				
barometric	3032			
Promethium				
element properties	371			
Protactinium				
element properties	371			
PTFE				
density	390			
mechanical properties	390			
specific gravity	380	390		
PTFE (polytetrafluoro-ethylene)	380	390	551	

Index Terms

Links

PVC				
density	390			
mechanical properties	390			
specific gravity	390			
PVC (polyvinyl chloride)	390	551	587	601
	3029			
PVDF				
density	390			
mechanical properties	390			
specific gravity	390			
PVDF (polyvinylidene-fluoride)	390	551	3029	
Q				
Quartz				
coefficient of expansion	375			
specific gravity	380			
specific heat	373			
Quenching				
brine	457	476	484	491
caustic solution	493			
oil	476	484	489	493
	501			
salt	476	478		
tanks for	477			
water	407	411	413	429
	437	439	455	466
	468	476	484	489
	491	493	543	
water-polymer	466			
R				
Radium				
element properties	371			

Index Terms

Links

Radon

element properties 371

Rape oil

specific gravity 381

Redwood

mechanical properties 386

weight of 387

Rhenium

element properties 371

Rhodium

element properties 371

Rifle powder

ignition temperature 376

Roofing

thermal conductivity and
conductance 374

Rouge

for polishing plastics 604

Rubber, rigid foam

thermal conductivity and
conductance 374

Rubidium

element properties 371

Ruthenium

element properties 371

S

Sal ammoniac (NH₄Cl)

in freezing mixtures 376

Salt

freezing mixtures 376

quenching 476

specific gravity 380

Index Terms**Links****Samarium**

element properties 371

Sand

fine

coefficient of radiation 375

specific gravity 380

specific heat 373

thermal conductivity and
conductance

374

Sandstone

coefficient of expansion 375

specific gravity 380

ultimate strength 394

Saturated brine

boiling point 372

Sawdust

coefficient of radiation 375

Scandium

element properties 371

Selenium

element properties 371

Shear modulus

394

432

564

Shingle

asbestos cement

thermal conductivity and
conductance

374

asphalt

thermal conductivity and
conductance

374

wood

thermal conductivity and
conductance

374

Siding

metal

Index Terms

Links

Siding (*Cont.*)

thermal conductivity and
conductance 374

Silica

for polishing plastics 604
specific heat 373

Silica aerogel

thermal conductivity and
conductance 374

Silica foam

density 389
mechanical properties 389

Silicon

element properties 371

Silicon carbide

for polishing plastics 604

Silicone

milling 602

Silver

coefficient of heat transmission 375
element properties 371
latent heat of fusion 372
polished
 coefficient of radiation 375
specific gravity 380
specific heat 373

Slate

coefficient of expansion 375
specific gravity 380
ultimate strength 394

Soapstone

specific gravity 380

Soda

specific heat 373

Index Terms

Links

Sodium

element properties 371

Specific gravity 380

Baumé's hydrometer conversion 382

gasses 381

plastics 390

various liquids 381

various substances 380

water 380

Specific heat 372

cast steel 377

copper alloys 376

iron

cast 377

ductile 377

malleable 377

of gasses 373

stainless steel alloys 377

titanium alloys 377

various metals 376

various substances 373

various woods 373

Speeds and feeds

plastics

drilling 600

milling 602

sawing 602

tapping and threading 601

plastics

turning and cutting off 600

Spruce

mechanical properties 386

weight of 387

weight per board foot 386

Index Terms

Links

Stainless steel

alloy, AISI-SAE (UNS) number

30615 () 409

30705 () 410

30805 () 409

30905 () 409

51210 () 410

51710 () 410

UNS numbering system 398 316

chemical resistance to various
materials 576

Stainless steel alloys

AISI (SAE) Number

... (51430F) 494

201 (30201) 1031 1049 1066

202 (30202) 1031 1049 1066

203EZ () 1031 1049 1066

301 (30301) 1031 1049 1066

302 (30302) 432 1031 1049 1066

303 (30303) 1031 1049 1066

303MA () 1031 1049 1066

303Pb () 1031 1049 1066

304 (30304) 1031 1049 1066

305 (30305) 1031 1049 1066

310 (30310) 1031 1049 1066

316 (30316) 1031 1049 1066

317 (30317) 1031 1049

321 (30321) 432 1031 1049 1066

347 (30347) 432 1031 1049 1066

410 (51410) 494 1031 1049 1066

414 (51414) 494 1031 1050 1066

416 (51416) 494 1031 1049 1066

420 (51420) 432 1031 1049 1066

Index Terms**Links****Stainless steel alloys (Cont.)**

430 (51430)	432	494	1031	1049
	1066			
431 (51431)	494	1031	1050	1066
440A (51440A)	1031	1050	1066	
440B (51440B)	1031	1050	1066	
440C (51440C)	1031	1050	1066	
442 (51442)	494	1031	1049	
446 (51446)	432	494	1031	1049
455 ()	1031	1050	1066	
501 (51501)	432	494	1031	1049
	1066			

AISI (SAE) number

... (51409)	419	495		
... (51416F)	419			
... (51420F)	419	495		
... (51430F)	419	495		
... (51434)	495			
... (51436)	495			
... (51440F)	419	495		

AISI (SAE) number

201 (30201)	406	415	418	430
	494			
202 (30202)	406	416	418	430
	494			
301 (30301)	406	415	418	430
	493			
302 (30302)	406	416	418	430
	494			
303 (30303)	406	416	430	494
303(30330)	494			
304 (30304)	406	416	418	430
	494			
305 (30305)	406	416	430	494

Index Terms**Links****Stainless steel alloys (Cont.)**

310 (30310)	406 494	416	418	430
316 (30316)	406 494	416	419	430
317 (30317)	406 494	417	419	430
321 (30321)	406 494	417	419	430
325 (30325)	419	494		
347 (30347)	406 493	417	419	430
410 (51410)	407 495	417	419	430
414 (51414)	407 495	417	419	431
416 (51416)	407	417	430	495
420 (51420)	407	417	431	495
430 (51430)	406	417	431	495
431 (51431)	407	417	419	495
440A (51440A)	407	418	431	495
440B (51440B)	407	418	431	495
440C (51440C)	407	418	431	495
442 (51442)	406	418	495	
446 (51446)	406	418	431	495
501 (51501)	407	418	431	495
AISI (UNS) Number				
201 (S20100)	1031	1049	1066	
202 (S20200)	1031	1049	1066	
203EZ ()	1031	1049	1066	
301 (S30100)	1031	1049	1066	
302 (S30200)	1031	1049	1066	
302B (S30215)	1031	1049	1066	
303 (S30300)	1031	1049	1066	

Index Terms**Links****Stainless steel alloys (Cont.)**

303MA ()	1031	1049	1066
303Pb ()	1031	1049	1066
303Se (S30323)	1031	1049	1066
304 (S30400)	1031	1049	1066
304L (S30403)	1031	1049	1066
305 (S30500)	1031	1049	1066
308 (S30800)	1031	1049	1066
309 (S30309)	1031	1049	1066
309 (S30900)	1031	1049	1066
309S (S30908)	1031	1049	1066
310 (S31000)	1031	1049	1066
310S (S31008)	1031	1049	1066
314 (S31400)	1031	1049	1066
316 (S31600)	1031	1049	1066
316L (S31603)	1031	1049	
317 (S31700)	1031	1049	
321 (S32100)	1031	1049	1066
330 (N08330)	1031	1049	
347 (S34700)	1031	1049	1066
348 (S34800)	1031	1049	1066
403 (S40300)	1031	1049	1066
AISI (UNS) Number			
405 (S40500)	1031	1049	1066
409 (S40900)	1031	1049	1066
410 (S41000)	1031	1049	1066
414 (S41400)	1031	1050	1066
416 (S41600)	1031	1049	1066
416Se (S41623)	1031	1049	1066
420 (S42000)	1031	1049	1066
420F (S42020)	1031	1049	1066
420FSe ()	1031	1049	1066
429 (S42900)	1031	1049	1066
430 (S43000)	1031	1049	1066

Index Terms**Links****Stainless steel alloys (Cont.)**

430F (S43020)	1031	1049		
430FSe (S43023)	1031	1049	1066	
431 (S43100)	1031	1050	1066	
434 (S43400)	1031	1049	1066	
436 (S43600)	1031	1049		
440A (S44002)	1031	1050	1066	
440B (S44003)	1031	1050	1066	
440C (S44004)	1031	1050	1066	
440FSe ()	1031	1049	1066	
442 (S44200)	1031	1049		
446 (S44600)	1031	1049		
455 (S45500)	1031	1050	1066	
501 (S50100)	1031	1049	1066	
502 (S50200)	1031	1049		

AISI (UNS) number

201 (S20100)	406	415	430	494
201 (S20200)	406	416		
201 (S20500)	406	416		
202 (S20200)	406	416	430	494
205 (S20500)	406	416		
301 (S30100)	377	406	415	430
	494			
302 (S30200)	377	406	416	430
	494			
302B (S30215)	377	406	416	430
303 (S30300)	377	406	416	430
	494			
303Se (S30323)	377	406	416	430
304 (S30400)	377	406	416	430
	494			
304Cu (S30430)	377	406	416	
304L (S30403)	406	416	430	
304N (S30451)	406	416		

Index Terms**Links****Stainless steel alloys (Cont.)**

305 (S30500)	377	406	416	430
	494			
308 (S30800)	377	406	416	430
309 (S30309)	406	416	418	430
	494			
309 (S30900)	377	406	416	430
	494			
309S (S30908)	377	406	416	430
310 (S31000)	377	406	416	430
	494			
310S (S31008)	377	406	416	430
314 (S31400)	406	416	430	
316 (S31600)	377	406	416	430
	494			
316F (S31620)	406	416		
316L (S31603)	406	416	430	
316N (S31651)	406	416		
317 (S31700)	377	406	417	430
	494			
317 (S31703)	377			
317L (S31703)	406	417		
AISI (UNS) number				
321 (S32100)	377	406	417	430
	494			
329 (S32900)	406	417		
330 (N08330)	406	417		
347 (S34700)	377	406	417	430
	494			
348 (S34800)	377	406	417	430
384 (S38400)	377	406	417	
403 (S40300)	377	407	417	430
405 (S40500)	377	406	417	431
409 (S40900)	406	417		

Index Terms**Links****Stainless steel alloys (Cont.)**

410 (S41000)	377	407	417	430
	495			
414 (S41400)	377	407	417	431
	495			
416 (S41600)	377	407	417	430
	495			
416Se (S41623)	377	407	417	430
420 (S42000)	377	407	417	431
	495			
420F (S42020)	377	407	417	431
422 (S42200)	377	407	417	
429 (S42900)	377	406	417	
430 (S43000)	377	406	417	431
	495			
430F (S43020)	377	406	417	431
430FSe (S43023)	406	417	431	
430Se (S43023)	377			
431 (S43100)	407	417	495	
434 (S43400)	406	417		
436 (S43600)	377	406	418	
440A (S44002)	377	407	418	431
	495			
440B (S44003)	377	407	418	431
	495			
440C (S44004)	377	407	418	431
	495			
440F (S44020)	431			
442 (S44200)	406	418	495	
446 (S44600)	377	406	418	431
	495			
501 (S50100)	377	407	418	431
	495			
502 (S50200)	377	407	418	431

Index Terms

Links

Stainless steel alloys (*Cont.*)

coefficient of expansion	377
density	377
elastic properties	
18-8	394
investment casting alloys	
austenitic	
CF-16F	392
CF-20	392
CF-3	392
CF-3M	392
CF-8	392
CF-8C	392
CF-8M	392
CH-20	392
CK-20	392
CN-7M	392
IC 316F	392
IC 321	392
hardenable	
Am-355	392
CA-15	392
CA-40	392
CD-4M Cu	392
IC 15-5	392
IC 17-4	392
investment casting alloys	
IC 416	392
IC 431	392
melting point	377
powder metal alloys	
SS-303N1	393
SS-304N1	393
SS-316L	393

Index Terms**Links****Stainless steel alloys (Cont.)**

SS-410	393	
specific heat	377	
thermal conductivity and conductance	377	
15-5PH	1031	1050
17-4PH	1031	1050
17-7PH	1031	1050
18-8		
wire		
tensile strength	395	

Steam

specific heat	373	
---------------	-----	--

Steel

alloy, AISI-SAE (UNS) number

E4340 (G43406)	400	404		
E50100 (501)	415			
E51100 (G51986)	400	405		
E51100 (G52986)	415			
E52100 (G52986)	400	405	409	415
	432	493	1028	1046
	1062	1085		
10B46 (G10461)	403			
1045 (G10450)	402	411	423	432
	1027	1045	1060	
10956 ()	410			
1108 (G11080)	1026	1044	1060	1085
1320 (G13200)	409	414	491	
1330 (G13300)	400	404	414	427
	432	493	1028	1046
	1053	1062	1085	
1335 (G13350)	400	404	415	493
	1028	1046	1062	1085

Index Terms**Links****Steel (Cont.)**

1340 (G13400)	400	404	415	425
	427	493	1028	1046
	1053	1062	1085	
1345 (G13450)	400	404	1028	1046
	1062			
2317 (G23170)	409	414	491	
2330 (G23300)	409	415	493	
2340 (G23400)	409	415	493	
2512 (G25120)	491			
2515 (G25150)	409	414		
2517 (G25170)	491			
30905 ()	409			
3115 (G31150)	409	414	491	
3120 (G31200)	409	414	491	
3130 (G31300)	409	415	493	
3135 (G31350)	409	414	493	
3140 (G31400)	409	415	425	432
3141 (G31410)	409	415	493	
3145 (G31450)	409	415	493	
alloy, AISI-SAE (UNS) number				
3150 (G31500)	409	415	493	
3240 (G32400)	409			
3310 (G33100)	409	414	432	491
3316 (G33160)	491			
4012 (G40120)	1028	1046	1053	1061
4017 (G40170)	491			
4023 (G40230)	400	404	409	414
	432	1028	1046	1053
	1061	1085		
4024 (G40240)	400	404	414	1028
	1046	1061	1085	
4027 (G40270)	400	404	409	414
	1053	1085		

Index Terms**Links****Steel (Cont.)**

4028 (G40280)	400	404	414	1028
	1046	1061	1085	
4032 (G40320)	409	414	491	1028
	1046	1053	1062	1085
4037 (G40370)	400	404	415	427
	493	1028	1046	1053
	1062	1085		
4042 (G40420)	409	415	427	493
	1028	1046	1062	1085
4047 (G40470)	400	404	415	493
	1028	1046	1062	1085
4053 (G40530)	493			
4063 (G40630)	409	414	493	
4068 (G40680)	493			
41L30 (G41403)	1028	1046	1061	
41L40 (G41404)	405	1028	1046	1061
41L47 ()	1028	1046	1061	
41L50 (G41405)	1028	1046	1061	
4118 (G41180)	400	404	1028	1046
	1053	1061		
4119 (G41190)	409	414	491	
4125 (G41250)	409	491		
4130 (G41300)	400	404	415	425
	427	432	493	1028
	1046	1053	1062	1085
4135 (G41350)	1028	1046	1062	
4137 (G41370)	400	404	414	493
	1028	1046	1062	1085
4140 (G41400)	400	404	409	414
	425	427	493	1027
	1045	1053	1061	1085
4142 (G41420)	400	404	1028	1046
	1062	1085		

Index Terms**Links****Steel (Cont.)**

4145 (G41450)	400	404	414	493
	1028	1046	1062	1085
4147 (G13300)	400			
4147 (G41470)	404	1028	1046	1062
	1085			
4150 (G41500)	400	404	415	425
	427	493	1027	1045
	1053	1061	1085	
4161 (G41610)	400	404	1028	1046
	1062			
43L47 ()	1028	1046	1061	
4317 (G43170)	492			
alloy, AISI-SAE (UNS) number				
4320 (G43200)	400	404	409	414
	425	492	1028	1046
	1053	1061	1085	
4337 (G43370)	1028	1046	1062	
4340 (G43400)	400	404	409	415
	425	427	432	493
	1028	1046	1053	1062
	1085			
4419 (G44190)	1028	1046	1061	
4422 (G44220)	1028	1046	1053	1061
4427 (G44270)	1028	1046	1053	1061
4608 (G46080)	492			
4615 (G46150)	400	404	409	414
	1028	1046	1053	1061
	1085			
4620 (G46200)	400	404	409	414
	425	1028	1046	1053
	1061	1085		
4621 (G46210)	492	1028	1046	1061

Index Terms**Links****Steel (Cont.)**

4626 (G46260)	400	404	1028	1046
	1053	1061	1085	
4640 (G46400)	409	415	432	493
	1085			
4718 (G47180)	1028	1046	1061	
4720 (G47200)	400	404	1028	1046
	1053	1061		
4812 (G48120)	492			
4815 (G48150)	400	404	409	414
	1028	1046	1061	1085
4817 (G48170)	400	404	414	1028
	1046	1061	1085	
4820 (G48200)	400	404	409	414
	425	432	492	1028
	1046	1053	1061	1085
50B44 (G50441)	400	405	1028	1046
	1062			
50B46 (G50461)	400	405	428	1028
	1046	1062		
50B50 (G50501)	400	405	1028	1046
	1062			
50B60 (G50601)	400	405	428	1028
	1046	1053	1062	
50100 ()	493			
5045 (G50450)	493			
5046 (G50460)	428	493		
5050 (G51500)	404	409	414	425
	428	432	1028	1046
	1062	1085		
51B60 (G51601)	400	405	428	1028
	1046	1053	1062	
51100 (G51986)	493			
5115 (G51150)	492			

Index Terms**Links****Steel (Cont.)**

5117 (G51170)	400	404	1028	1046
	1061			
5120 (G51200)	400	404	414	492
	1028	1046	1053	1061
	1085			
5130 (G51300)	400	404	415	428
	493	1028	1046	1053
	1062	1085		
5132 (G51320)	400	404	415	493
	1028	1046	1062	1085
alloy, AISI-SAE (UNS) number				
51335 ()	409			
5135 (G51350)	400	404	415	493
	1085			
5140 (G51400)	400	404	409	415
	425	428	1028	1046
	1062	1085		
5145 (G51450)	493	1028	1046	1062
	1085			
5147 (G51470)	493	1028	1046	1062
5150 (G51500)	400			
5152 (G51520)	493			
5155 (G51550)	400	404		
5160 (G51600)	400	404	425	428
	1028	1046	1062	
51710 ()	409			
6118 (G51986)	405	1028	1046	1053
	1061	1085		
6118 (G61180)	400			
6150 (G52986)	405	409	415	425
	428	432	493	1028
	1046	1053	1062	1085
6150 (G61500)	400			

Index Terms**Links****Steel (Cont.)**

6421 ()	1029	1047	1062	
6422 ()	1029	1047	1062	
6424 ()	1029	1047	1062	
6427 ()	1029	1047	1062	
6428 ()	1029	1047	1062	
6430 ()	1029	1047	1062	
6432 ()	1029	1047	1062	
6434 ()	1029	1047	1062	
6436 ()	1029	1047	1062	
6442 ()	1029	1047	1062	
81B45 (G81451)	400	405	428	1028
	1046	1053	1062	
8115 (G81150)	1028	1046	1053	1061
86B45 (G86451)	429			
86L20 ()	1028	1046	1061	
86L40 ()	1028	1046	1061	
8615 (G86150)	400	405	414	492
	1028	1046	1061	1085
8617 (G86170)	400	405	414	1028
	1046	1061	1085	
8620 (G86200)	400	405	414	425
	1028	1046	1053	1061
	1085			
8622 (G86220)	400	405	414	1028
	1046	1061	1085	
8625 (G86250)	400	405	492	1028
	1046	1061	1085	
8627 (G86270)	400	405	493	1028
	1046	1053	1061	
8630 (G86300)	400	405	415	425
	429	1028	1046	1053
	1062	1085		
8632 (G86320)	493			

Index Terms**Links****Steel (Cont.)**

8635 (G86350)	493	1028	1046	1062
8637 (G86370)	400	405	415	1028
	1046	1062	1085	
8640 (G86400)	400	405	415	429
	1028	1046	1053	1062
	1085			
8641 (G86410)	415	493		
alloy, AISI-SAE (UNS) number				
8642 (G86420)	400	405	415	493
	1028	1046	1062	1085
8645 (G86450)	400	405	415	1028
	1046	1062	1085	
8650 (G86500)	425	429		
8653 (G86530)	493			
8655 (G86550)	400	405	415	493
	1028	1046	1062	
8660 (G86600)	429	493	1028	1046
	1053	1062		
8720 (G87200)	400	405	414	492
	1028	1046	1053	1061
	1085			
8735 (G87350)	493			
8740 (G87400)	400	405	415	425
	429	432	493	1028
	1046	1053	1062	1085
8745 (G87450)	493			
8750 (G87500)	493			
8822 (G88220)	400	405	1028	1046
	1053	1061		
9254 (G92540)	493	1028	1046	1062
9255 (G92550)	425	429	1028	1046
	1062			

Index Terms

Links

Steel (*Cont.*)

9260 (G92600)	400	405	409	415
	429	1028	1046	1062
9262 (G92620)	493	1028	1046	1062
9310 (G93100)	425	492		
9317 (G93170)	492			
94B17 (G94171)	400	405	1028	1046
	1061			
94B30 (G94301)	400	405	429	1053
9437 (G94370)	493			
9440 (G94400)	493			
9442 (G94420)	493			
9747 (G97470)	493			
9840 (G98400)	493			
9845 (G98450)	493			
9850 (G98500)	415	493		
carbon				
chemical resistance to various materials	576			
cast				
density	377			
melting point	377			
specific heat	377			
UNS numbering system	398			
castings				
strength, effect of temperature on	395			
coefficient of expansion	375			
hard				
coefficient of heat transmission	375			
high speed				
cobalt				
18-4-14	504			
cobalt-molybdenum-tungsten, 6-6-2-8	442			
cobalt-tungsten				

Index Terms**Links****Steel (Cont.)**

14-4-2-5	442			
high speed				
18-4-1-5	442			
18-4-2-12	442			
18-4-2-8	442			
molybdenum, 8-2-1	442			
molybdenum-tungsten				
6-6-2	442			
6-6-3	442			
6-6-4	442			
tungsten				
18-4-1	442	448	496	499
	504			
18-4-2	442			
18-4-3	442			
high-strength, low alloy, SAE number				
942X	420			
945A	420			
945C	420			
945X	420			
950A	420			
950B	420			
950C	420			
950D	420			
950X	420			
955X	420			
960X	420			
965X	420			
970X	420			
980X	420			
investment casting alloys				
IC 1010	391			
IC 1020	391			

Index Terms**Links****Steel (Cont.)**

IC 1030	391			
IC 1035	391			
IC 1045	391			
IC 1050	391			
IC 1060	391			
IC 1090	391			
IC 1722AS	392			
IC 2345	391			
IC 4130	391			
IC 4140	391			
IC 4150	391			
IC 4330	391			
IC 4340	391			
IC 4620	391			
IC 52100	392			
IC 6150	391			
IC 8620	391			
IC 8630	391			
IC 8640	391			
IC 8665	392			
IC 8730	392			
IC 8740	391			
plain carbon, AISI-SAE (UNS) number				
10L45 (G10454)	403			
1005 (G10050)	400	402		
1006 (G)	402	410	1026	1044
	1053	1060		
1006 (G10060)	400			
plain carbon, AISI-SAE (UNS) number				
1008 (G)	402	409	1026	1044
	1060			
1008 (G10080)	400			
1009 (G)	1026	1044	1060	

Index Terms**Links****Steel (Cont.)**

1010 (G)	402	409	1026	1044
	1060			
1010 (G10100)	400	490		
1012 (G)	1026	1044	1060	
1012 (G10120)	400			
1015 (G)	402	409	424	1026
	1044	1060		
1015 (G10150)	400			
1016 (G)	402	411	1026	1044
	1060			
1016 (G10160)	400			
1017 (G10170)	400	402	411	1026
	1044	1060		
1018 (G10180)	400	402	411	422
	1026	1044	1060	
1019 (G10190)	400	402	411	1026
	1044	1060		
1020 (G10200)	400	402	409	424
	1026	1044	1060	
1021 (G10210)	400	402	411	1026
	1044	1060		
1022 (G10220)	400	402	409	411
	424	490	1026	1044
	1060			
1023 (G10230)	400	402	411	1026
	1044	1060		
1024 (G10240)	409	411	490	1026
	1044	1060		
1025 (G10250)	400	402	411	422
	432	491	1026	1044
	1060			
1026 (G10260)	400	402	411	1026
	1044	1060		

Index Terms**Links****Steel (Cont.)**

1027(G10270)	1027	1045	1060	
1029 (G10290)	400	402		
1030 (G10300)	400	402	409	424
	426	490	1027	1045
	1053	1060		
1033 (G10330)	411	491	1027	1045
	1053	1060		
1034 (G10340)	411			
1035 (G10350)	400	402	409	422
	491	1027	1045	1060
1036 (G10360)	409	411	491	1027
	1045	1060		
1037 (G10370)	400	402	1027	1045
	1060			
1038 (G10380)	400	402	411	491
	1027	1045	1060	
1039 (G10390)	400	402	411	1027
	1045	1060		
1040 (G10400)	400	402	409	422
	424	426	491	1027
	1045	1060		
1041 (G10410)	411	491	1027	1045
	1060			
plain carbon, AISI-SAE (UNS) number				
1042 (G10420)	400	491	1027	1045
	1060			
1043 (G10430)	400	402	411	1027
	1045	1060		
1044 (G10440)	400	402		
1045 (G10450)	400	432	1027	1045
	1060			
1046 (G10460)	400	402	411	1027
	1045	1060		

Index Terms**Links****Steel (Cont.)**

1048 (G10480)	1027	1045	1060	
1049 (G10490)	400	1027	1045	1060
1050 (G10500)	400	402	411	423
	426	491	1027	1045
	1060			
1052 (G10520)	411	491	1027	1045
	1060			
1053 (G10530)	400	402		
1055 (G10550)	400	402	410	412
	491	1027	1045	1061
1059 (G10590)	400	402		
1060 (G10600)	400	402	409	412
	424	426	491	1027
	1045	1061		
1064 (G10640)	1027	1045	1061	
1065 (G10640)	1027	1045	1061	
1066 (G10660)	410	412		
1070 (G10700)	400	402	409	412
	1027	1045	1061	
1074 (G10740)	491	1027	1045	1061
1078 (G10780)	400	402	412	491
	1027	1045	1061	
1080 (G10800)	400	402	409	412
	424	426	491	1027
	1045	1061		
1084 (G10840)	400	402	1027	1045
	1061			
1085 (G10850)	409	412		
1086 (G10860)	400	402	412	1027
	1045	1061		
1090 (G10900)	400	402	410	412
	491	1027	1045	1061

Index Terms**Links****Steel (Cont.)**

1095 (G10950)	400	402	409	412
	424	426	432	491
	1027	1045	1053	1061
11L17 ()	1008	1026	1044	1060
11L18 ()	1026	1044	1060	
1109 (G11090)	413	1026	1044	1060
	1085			
1110 (G11100)	400	403	1085	
1111 (G11110)	409	412	490	
1112 (G11120)	410	412	432	490
1113 (G11130)	409	412	490	
1114 (G11140)	413			
1115 (G11150)	410	413	1026	1044
	1060	1085		
1116 (G11160)	413	1085		
1117 (G11170)	400	413	1026	1044
	1060	1085		
1118 (G11180)	400	403	409	413
	422	424	1008	1026
	1044	1060	1085	
1119 (G11190)	413	1085		
plain carbon, AISI-SAE (UNS) number				
1120 (G11200)	413	490	1026	1044
	1060	1085		
1126 (G11260)	413	490	1026	1044
	1060	1085		
1132 (G11320)	409	413	491	1026
	1044	1060	1085	
1137 (G11370)	400	403	409	413
	423	426	491	1026
	1044	1060	1085	
1138 (G11380)	491			

Index Terms**Links****Steel (Cont.)**

1139 (G11390)	400	403	1026	1044
	1060	1085		
1140 (G11400)	400	403	413	422
	491	1026	1044	1060
	1085			
1141 (G11410)	400	403	413	423
	427	491	1085	
1144 (G11440)	400	403	413	423
	427	491	1026	1044
	1060	1085		
1145 (G11450)	409	413	423	491
	1085			
1146 (G11460)	400	403	413	423
	1026	1044	1060	1085
1151 (G11510)	400	403	413	423
	491	1026	1044	1060
	1085			
12L13 ()	1026	1044	1060	
12L14 (G12144)	400	403	1026	1044
	1060			
12L15 (G12154)	403			
1211 (G12110)	400	403	1026	1044
	1060			
1212 (G12120)	400	403	432	1026
	1044	1060		
1213 (G12130)	400	403	1026	1044
	1060			
1215 (G12150)	400	403	1026	1044
	1060			
1513 (G15130)	400	403		
1514 (G15140)	1026	1044	1060	
1522 (G15220)	400	403	1053	

Index Terms**Links****Steel (Cont.)**

1524 (G15240)	400	403	1027	1045
	1053	1060		
1526 (G15260)	400	403	1027	1045
	1060			
1527 (G15270)	400	403	1027	1045
	1060			
1541 (G15410)	400	403	1027	1045
	1060			
1548 (G15480)	400	403	1027	1045
	1061			
1551 (G15510)	400	403	1027	1045
	1061			
1552 (G15520)	400	403	1027	1045
	1061			
1561 (G15610)	400	403	1027	1045
	1061			
1566 (G15660)	400	403	1027	1045
	1053	1061		
soft				
coefficient of heat transmission	375			
specific gravity	380			
specific heat				
high carbon	373			
mild	373			
structural				
strength, effect of temperature on	395			
tool, AISI (UNS) number				
A10 (T30110)	400	454	1030	1048
	1065			
A2 (T30102)	400	443	445	453
	1030	1048	1065	
A3 (T30103)	400	454	1030	1048
	1065			

Index Terms**Links****Steel (Cont.)**

A4 (T30104)	400	454	1030	1048
	1065			
A5 (T30105)	400			
A6 (T30106)	400	445	453	1030
	1048	1065		
A7 (T30107)	400	432	454	1030
	1048	1065		
A8 (T30108)	400	454	1030	1048
	1065			
A9 (T30109)	400	454	1030	1048
	1065			
CA2 (T90102)	400			
CD2 (T90402)	400			
CD5 (T90405)	400			
CH12 (T90812)	400			
CH13 (T90813)	400			
CO1 (T91501)	400			
CS5 (T91905)	400			
D2 (T30402)	400	436	443	452
	454	1030	1048	1065
D3 (T30403)	400	436	452	454
	1030	1048	1065	
D4 (T30404)	400	454	1030	1048
	1065			
D5 (T30405)	400	436	454	1030
	1048	1065		
D7 (T30407)	400	436	443	454
	1030	1048	1065	
F1 (T60601)	400	456		
F2 (T60602)	400	456		
H10 (T20810)	400	444	450	1030
	1048	1065		

Index Terms**Links****Steel (Cont.)**

H11 (T20811)	400	445	449	1030
	1048	1065		
H12 (T20812)	400	450	1030	1048
	1065			
H13 (T20813)	400	445	450	1030
	1048	1065		
H14 (T20814)	400	450	1030	1048
	1065			
H19 (T20819)	400	444	450	1030
1048	1065			
H20 (T20820)	444	451		
H21 (T20821)	400	445	450	1030
	1048	1065		
tool, AISI (UNS) number				
H22 (T20822)	400	444	450	1030
	1048	1065		
H23 (T20823)	400	450	1030	1048
	1065			
H24 (T20824)	400	450	1030	1048
	1065			
H25 (T20825)	400	450	1030	1048
	1065			
H26 (T20826)	400	444	450	1030
	1048	1065		
H41 (T20841)	400	436	450	1030
	1048	1065		
H42 (T20842)	400	436	450	1030
	1048	1065		
H43 (T20843)	400	436	444	450
	452	1030	1048	1065
L2 (T61202)	400	456	1030	1048
	1065			

Index Terms**Links****Steel (Cont.)**

L3 (T61203)	400	456	1030	1048
	1065			
L6 (T61206)	400	445	456	1030
	1048	1065		
M1 (T11301)	400	436	445	1030
	1048	1065		
M10 (T11310)	400	436	446	1030
	1048	1065		
M15 (T11315)	436			
M2 (T11302)	400	436	443	1030
	1048	1065		
M21 (T11321)	445			
M25 (T11325)	445			
M3 (...)	436	443	1030	1048
	1065			
M30 (T11330)	400	447	1030	1048
	1065			
M3-1 (T11313)	400	447	1030	1048
	1065			
M3-2 (T11323)	400	447	1030	1048
	1065			
M33 (T11333)	400	447	1030	1048
	1065			
M34 (T11334)	400	447	1030	1048
	1065			
M36 (T11336)	400	436	447	1030
	1048	1065		
M4 (T11304)	400	436	444	447
	1030	1048	1065	
M41 (T11341)	400	447	1030	1048
	1065			
M42 (T11342)	400	444	446	1030
	1048	1065		

Index Terms**Links****Steel (Cont.)**

M43 (T11343)	400	436	447	1030
	1048	1065		
M44 (T11344)	400	444	447	1030
	1048	1065		
M46 (T11346)	400	447	1030	1048
	1065			
tool, AISI (UNS) number				
M47 (T11347)	400	447	1030	1048
	1065			
M6 (T11306)	400	447	1030	1048
	1065			
M7 (T11307)	400	436	446	1030
	1048	1065		
M8 (T11308)	436			
O1 (T31501)	400	445	453	1030
	1048	1065		
O2 (T31502)	400	453	1030	1048
	1065			
O6 (T31506)	400	453	1030	1048
	1065			
O7 (T31507)	400	454	1030	1048
	1065			
P2 (T51602)	400	445	456	1030
	1048	1065		
P20 (T51620)	400	445	456	1048
	1065			
P21 (T51621)	400	456	1030	1048
	1065			
P3 (T51603)	400	455	1030	1048
	1065			
P4 (T51604)	400	445	455	1030
	1048	1065		

Index Terms**Links****Steel (Cont.)**

P5 (T51605)	400	456	1030	1048
	1065			
P6 (T51606)	400	456	1030	1048
	1065			
S1 (T41901)	400	444	455	1030
	1048	1065		
S2 (T41902)	400	455	1030	1048
	1065			
S4 (T41904)	400			
S5 (T41905)	400	455	1030	1048
	1065			
S6 (T41906)	400	1030	1048	1065
S7 (T41907)	400	445	456	1030
	1048	1065		
T1 (T12001)	400	436	443	448
	451	1030	1048	1065
T15 (T12015)	400	436	443	448
	1009	1030	1048	1065
T2 (T12002)	400	436	448	1030
	1048	1065		
T3 (T12003)	436			
T4 (T12004)	400	448		
T5 (T12005)	400	436	444	448
	1030	1048	1065	
T6 (T12006)	400	436	448	1030
	1048	1065		
T8 (T12008)	400	448	1030	1048
	1065			
W1 (T72301)	400	445	458	1030
	1048	1065		
W2 (T72302)	400	445	458	1030
	1048	1065		

Index Terms**Links****Steel (*Cont.*)**

W5 (T72305) 400 458 1030 1048
1065

Steel alloys

elastic properties 394

cast 394

cold-rolled 394

Steel castings

strength, effect of temperature on 395

Stone

specific heat 373

Strontium

element properties 371

Structural steel

strength, effect of temperature on 395

Stucco

thermal conductivity and
conductance 374

Sulfur

boiling point 372

element properties 371

latent heat of fusion 372

specific gravity 380

specific heat 373

Sulfur dioxide

latent heat of evaporation 372

specific gravity 381

Sulfuric acid

boiling point 372

specific gravity 381

specific heat 373

Sweetgum

machinability of 388

Index Terms**Links****Sycamore**

machinability of	388
weight of	387

T**Tamarack**

weight of	387
-----------	-----

Tanoak

machinability of	388
------------------	-----

Tantalum

element properties	371
--------------------	-----

Tar

specific gravity	380
------------------	-----

Technetium

element properties	371
--------------------	-----

Tellurium

element properties	371
--------------------	-----

Temperature

absolute	3033
Rankine	3032

Tempering oil

specific gravity	481
------------------	-----

Tensile modulus

394	432	513	558
561	565	575	578
600			

plastics	390
----------	-----

Tensile strength

ceramics	389
copper-zinc-tin alloys	528
investment casting alloys	391
wire	395

Terbium

element properties	371
--------------------	-----

Index Terms

Links

Textile

thermal conductivity and
conductance 374

Thallium

element properties 371

Thermal conductivity

ceramics 389

various metals 376

Thermal conductivity and conductance

aluminum alloys 376

amosite 374

asbestos cement 374

asbestos paper 374

asphalt roll 374

block

cinder 374

concrete 374

brick

common 374

face 374

cast iron 377

cast steel 377

cellulose 374

cement 374

concrete (poured) 374

copper alloys 376

ductile iron 377

felt 374

glass 374

lime or sand 374

magnesia 374

malleable iron 377

mineral fiber 374

mineral fiber cement 374

Index Terms

Links

Thermal conductivity and conductance (*Cont.*)

mortar	374			
nickel-base alloys	377			
perlite	374			
plaster	374			
plywood	374			
polystyrene				
beaded	374			
rigid	374			
roofing	374			
rubber, rigid foam	374			
shingle				
asbestos cement	374			
asphalt	374			
wood	374			
siding				
metal	374			
wood, medium density	374			
silica aerogel	374			
stainless steel alloys	377			
stucco	374			
textile	374			
tile	374			
titanium alloys	377			
vermiculite	374			
wall tile	374			
wood felt	374			
wood subfloor	374			
Thermal expansion, coefficient of	375	389	551	578
Thermoplastic polyester				
coefficient of expansion	375			
Thermoplastic Polyester (PBT)				
chemical resistance to various materials	576			

Index Terms

Links

Thermoplastic polyester (PET)

chemical resistance to various materials 576

Thorium

element properties 371

Thulium

element properties 371

Tile

specific gravity 380

thermal conductivity and conductance 374

Tin

coefficient of heat transmission 375

element properties 371

latent heat of fusion 372

polished

coefficient of radiation 375

specific heat 373

TiO₂ (Titania)

density 389

mechanical properties 389

Titanium

element properties 371

Titanium alloys

alpha alloys

5 Al, 2.5 Sn 377 550

alpha-beta alloys

10 V, 2 Fe, 3 Al 550

3 Al, 2.5 V 550

6 Al, 2 Sn, 2 Zr, 2 Mo, 2 Cr, 0.25 Si 550

6 Al, 2 Sn, 4 Zr, 6 Mo 550

6 Al, 4 V 550

6 Al, 4 V (low O₂) 550

6 Al, 6 V, 2 Sn 550

Index Terms

Links

Titanium alloys (*Cont.*)

7 Al, 4 Mo	550	
8 Mn	377	550
beta alloys		
11.5 Mo, 6 Zr, 4.5 Sn	550	
13 V, 11 Cr, 3 Al	550	
3 Al, 8 V, 6 Cr, 4 Mo, 4 Zr	550	
8 Mo, 8 V, 2 Fe, 3 Al	550	
chemical composition	550	
coefficient of expansion	377	
commercially pure	377	
98.9 Ti	550	
commercially pure		
99.0 Ti	394	550
99.1 Ti	550	
99.2 Ti	550	
99.5 Ti	550	
density	377	
elastic properties		
Ti-8Al-1Mo-1V	394	
99.0 Ti	394	
elongation	550	
melting point	377	
near alpha alloys		
11 Sn, 1 Mo, 2.25 Al, 5.0 Zr, 1 Mo, 0.2 Si	550	
5 Al, 5 Sn, 2 Zr, 2 Mo, 0.25 Si	550	
6 Al, 2 Nb, 1 Ta, 1 Mo	550	
6 Al, 2 Sn, 1.5 Zr, 1 Mo, 0.35 Bi, 0.1 Si	550	
6 Al, 2 Sn, 4 Zr, 2 Mo	550	
8 Al, 1 Mo, 1 V	394	550
specific heat	377	
thermal conductivity and		
conductance	377	
titanium alloys	377	

Index Terms

Links

Titanium alloys tensile strength	550
Tool steels	
C2	
for milling plastics	602
for milling plastics	602
molybdenum high-speed steel	
for tapping and threading plastics	601
M1	
for tapping and threading plastics	601
M10	
for tapping and threading plastics	601
M2	
for milling plastics	602
M3	
for milling plastics	602
M33	
for drilling plastics	600
M41	
for drilling plastics	600
M47	
for drilling plastics	600
M7	
for milling plastics	602
for tapping and threading plastics	601
T15	
for drilling plastics	600
for milling plastics	602
UNS numbering system	
wrought and cast	398
water hardening	437
Trap rock	
specific gravity	380
ultimate strength	394

Index Terms

Links

Tripoli	
for polishing plastics	604
Tungsten	
element properties	371
Tungsten alloys	
powder metal alloys	
90W, 6Ni, 4Cu	393
90W, 7Ni, 3Cu	393
92.5W, Bal. Ni, Fe, and Mo	393
92.5W, 5.25Ni, 2.25Cu	393
93W, Bal. Ni, Fe, and Mo	393
95W, 3.5Ni, 1.5Cu	393
95W, 3.5Ni, 1.5Fe	393
97W, 2.1Ni, 0.9Fe	393
Tupelo	
machinability of	388
Turpentine	
latent heat of evaporation	372
oil of	
boiling point	372
specific gravity	381
specific heat	373
U	
Ultimate strength	
brick	394
brickwork	394
cement	
Portland	394
concrete	
Portland	394
granite	394
limestone	394
sandstone	394

Index Terms**Links****Ultimate strength (*Cont.*)**

slate	394
trap rock	394
vulcanized fiber	394

Unnilhexium

element properties	371
--------------------	-----

Unnilnonium

element properties	371
--------------------	-----

Unniloctium

element properties	371
--------------------	-----

Unnilpentium

element properties	371
--------------------	-----

Unnilquadium

element properties	371
--------------------	-----

Unnilseptium

element properties	371
--------------------	-----

Uranium

element properties	371
--------------------	-----

V**Vanadium**

element properties	371
--------------------	-----

Vermiculite

thermal conductivity and conductance	374
--------------------------------------	-----

Vinegar

specific gravity	381
------------------	-----

Vulcanized fiber

ultimate strength	394
-------------------	-----

W**Wall tile**

thermal conductivity and conductance	374
---	-----

Index Terms

Links

Walnut

machinability of	388
weight of	387

Water

boiling point	372	3026	3028	
coefficient of radiation	375			
compressibility	3026	3028		
density	3026	3028		
latent heat of evaporation	372			
pressure-head relationship	3026	3028		
quenching	407	411	413	429
	437	439	455	466
	468	476	484	489
	491	493	543	
salt	419			
specific gravity	380			
specific heat	373			
vapor				
specific gravity	381			
volume at various temperatures	3027			

Water, sea

boiling point	372
specific gravity	381

Whale oil

specific gravity	381
------------------	-----

White metal

specific gravity	380
------------------	-----

Willow

machinability of	388
------------------	-----

Wire

tensile strength	
chrome silicon	395
Cr-V alloy	395
MB	

Index Terms

Links

Wire (*Cont.*)

hard-drawn	395
oil tempered	395
music wire	395
phosphor bronze	395
stainless steel	
18-8	395

Wood

fir

specific heat	373
---------------	-----

machinability of	388
------------------	-----

mechanical properties	386
-----------------------	-----

medium density

thermal conductivity and conductance	374
---	-----

oak

ignition temperature	376
----------------------	-----

specific heat	373
---------------	-----

pine

coefficient of expansion	375
--------------------------	-----

ignition temperature	376
----------------------	-----

specific heat	373
---------------	-----

subfloor

thermal conductivity and conductance	374
---	-----

thermal conductivity and conductance

plywood	374
---------	-----

weight of	386
-----------	-----

weight per board foot	386
-----------------------	-----

weight per cord	386
-----------------	-----

Wood felt

thermal conductivity and conductance	374
---	-----

Index Terms**Links****Wrought iron**

strength, effect of temperature on 395

X**Xenon**

element properties 371

Y

Yield 549

Yield strength

investment casting alloys 391

Young's modulus 394 432 513 558

561 565 575 578

600

Ytterbium

element properties 371

Yttrium

element properties 371

Z**Zinc**

coefficient of expansion 375

coefficient of heat transmission 375

element properties 371

latent heat of fusion 372

specific gravity 380

specific heat 373

Zinc alloys

elastic properties

cast 394

wrought 394

Zinc-base alloys

UNS numbering system 398

Index Terms

Links

Zirconium

element properties 371

Zirconium phosphate

density 389

mechanical properties 389

Z-nickel

elastic properties 394

ZrO₂

density 389

mechanical properties 389

ZrO₂-SiO₂ (Zircon)

density 389

mechanical properties 389

INDEX OF ADDITIONAL CONTENT ON THE CD

<u>Index Terms</u>	<u>Links</u>
A	
ABS plastics	3399
Absolute	
programming, NC	3160
Adaptive control, NC	3158
Addresses, letter, NC	3164
Adhesives, sealants, lutes, cements	3367
Adiabatic expansion and compression	3030
AGMA Standard	
AGMA 370.01	3325
Air	
absolute pressure	3033
adiabatic expansion and	
compression	3031
compression and flow	3027
density	3029
expansion and compression	
adiabatic	3030
compression	3030
expansion	3030
horsepower to compress	3032
isothermal	3031
work to compress	3031
flow in pipes	3036
gage pressure	3033
power or work to compress	3031
pressure, temperature, and volume	3035
relationships	3030
properties of	3027

Index Terms**Links****Air** (*Cont.*)

velocity of escaping	3037
volume and weight at different temperatures	3027
volume transmitted through pipes	3036
work to compress	3031

Allowance	3045
------------------	------

Aluminum

wrought sheet alloys	3017
----------------------	------

American

Bureau of Shipping	3444
Iron and Steel Institute (AISI)	3434
Standard Code for Information Interchange (ASCII)	3210

ANSI B6.9	3322
------------------	------

ANSI Standard

B6.9	3321
fine-pitch worm gearing	3321
fine-pitch worm gearing	

ANSI Standard

fine-pitch worm gearing ANSI B6.9	3321
jig bushings	3121
numerical control	3151
pipe and pipe fittings	3392
welded and seamless wrought steel pipe	3393
worm gearing, fine pitch	3321

Anvil

blacksmiths'	3230
setting	3230

APT (automatically programmed tool)	3184
--	------

circles	3186
---------	------

Index Terms

Links

APT (automatically programmed (*Cont.*))

computational statements	3186
for turning	3199
geometry statements	3186
geometry, 3-D	3195
motion statements	3191
planes	3194
points	3187
postprocessor statements	3196
program	3198
programming	3184
tabulated cylinder	3195
Archimedean screw	2997
ASCII, American Standard Code for Information Interchange	3210
Atmospheric pressure	3027
Auger speeds in wood	3143

B

Balance wheels	3000
Balls, standard	
grades	3357
hardness corrections for curvatures	3360
hardness ranges	3358
materials	3357
number per kilogram	3362
number per pound	3361
ordering specifications	3355
preferred gages	3355
preferred sizes	3356 3359
tolerances	3357
Barometer reading and equivalent pressure	3030
Basic dimension	3045

Index Terms

Links

Bearings

ball

lubrication 3352

Bearings

knife-edge 3354

oilless 3353

percentage of radial and thrust loads 3352

roller 3352

Billet 3222

Blacksmiths'

anvil 3230

hammer 3216

steel for tools 3218

tap 3141

tongs

flat jaw 3231

goose neck 3232

Block

NC 3162 3164 3166

Bolt hole circles

coordinates for 3097

Bolts and nuts

eye bolts and nuts 3448

Bort 3149

Brazing and soldering 3256

British Standard

keys and keyways 3377 3387

metric

keys and keyways 3377 3387

Buoyancy 3027

Burnishing 3269

Burs 3138

Bushel, Winchester 3481

Index Terms

Links

Bushings

jig, materials for 3121
standard, for jigs 3121

Byte, PLC 3154

C

Cables, wire, breaking strength 3426

CAD/CAM 3201

drawing exchange standards 3209

projections 3204

rapid prototyping 3210

standard lettering sizes 3208

tips 3205

Calipers, transfer 3044

Canned (fixed) cycles, NC 3179

Carat 3149

Carbide tools 3219

tungsten carbide 3219

tungsten-titanium carbide 3219

Carbon 3013

Cast iron

alloy 3217

nickel chromium 3217

drawing dies 3218

seasoning 3017

Cast steel

crankshafts 3218

Catenary curve 2999

Cell, flexible manufacturing, NC 3160

Cement 3363

Chain

close-link 3444

crane and hoisting 3440

safe working load 3441

Index Terms

Links

Chain (<i>Cont.</i>)		
strength	3440	
wrought iron	3440	
Charcoal	3013	
Chip breaker	3142	
Chipless machining	3142	
Chord		
length for given number of divisions	3097	
Circle, circumference and area	2977	
Circles		
chords for dividing circumference of	3097	
dividing, on jig boring machine	3101	
lengths of chords for dividing	3097	
programming in APT (NC)	3188	
Circular		
interpolation, NC	3175	
sector segment	3097	
Circumference		
chords for dividing	3097	
of a circle, spacing	3099	
CL data, NC	3163	
Clearance	3045	3225
angles		
for dies	3225	
punch and die	3224	
die	3225	
effects on working pressure	3225	
punch and die	3224	3227
Climb-cut milling	3142	
Closed-loop system	3158	3409
CNC	3149	
programming	3160	

Index Terms**Links**

Cold extrusion	3221	
Cold swaging	3233	
Coloring metal	3262	
Compound		
thread cutting, NC	3184	
Compressive properties		
of air	3030	3037
Computer numerical control, CNC	3149	
programming	3160	
Computer-aided (or-assisted)		
design (CAD)	3201	
manufacturing (CAM)	3201	
Concrete	3365	
Conditional expressions, NC	3179	
Continuity equation	3032	
Control, adaptive, NC	3158	
Conversational part programming,		
NC	3161	
Coordinates, for jig boring	3132	
Copper-clad steel	3014	
CPVC plastics	3399	
Crane		
chain		
hoisting	3440	
safe loads	3441	3444
slings	3441	
strength	3440	
hooks, eyes, shackles	3440	
capacity of	3447	
dimensions	3447	
Crosby Group	3446	
Cubes		
mixed numbers	2926	

Index Terms

Links

Cutter	
compensation, NC	3172
location data (CL data)	3163
Cutting	
wire rope	3434
D	
Data input, manual, NC	3161
Decimal	
point programming, NC	3166
Density	
air	3029
of air at different temperature	3027
water	3022
Dies	
bulldozer	3234
Dies, sheet metal	
clearance between punch and die	3224
lubricants	3226
rectangular drawing	3226
Direct (or distributed) NC	3211
Distributed numerical control (DNC)	3211
Dividing	
circles	3101
Drawing dies	
annealing drawn shells	3226
brass	3226
depth drawn in one operation	3227
diameter reduction in one operation	3227
rectangular	3226
Drop forging dies	3239
amount of flash	3240
break-down	3240
cooling	3240

Index Terms

Links

Drop forging dies (*Cont.*)

draft allowance	3239	
for bronze and copper	3241	
hardening	3240	
heating	3240	
locating impression	3239	
obtaining weight of forging	3239	
shrinkage allowance	3239	
steel for	3239	
tempering	3241	
tolerances	3242	3244
trimming	3241	
Drums, chain		
and wire rope	3432	3445
Duronze	3017	
Dynamometer	2998	

E

Electric cord

minimum		
gage rating	3482	

Energy

of flywheels	3000	3002
--------------	------	------

Etching and

etching fluids	3267	
----------------	------	--

Expansion

air	3030	
pipe	3023	

Extrusion, cold

Eye bolts and nuts

engineering capacity	3450	
rigger's capacity	3450	
specifying capacity	3450	

Index Terms

Links

F

Factors of safety

wire rope 3430

Fastener

bolt

expansion 3275

North 3275

nut

width across flats

standard 3275

rivet

cold formed 3274

explosive 3275

flattening test 3274

screw

wood 3276

stove bolt 3274

wood screw

holding power 3277

Fasteners

distinguishing bolts from screws 3272

Federal specification

gage blocks, inch and metric sizes 3113

Feed

function, NC 3170

rate override, NC 3172

Feed rate

drilling 3143

gear hobb 3143

grinding machines 3143

milling 3143

planing 3143

turning 3143

Index Terms

Links

File	3135	
history	3135	
rotary	3138	
teeth	3136	
cutting	3136	
File		
teeth		
resharpening	3137	
testing	3138	
types	3135	
Firebrick	3012	
Fits	3045	
Fittings		
pipe	3392	
pipe,friction loss in	3024	
Fixed (canned) cycles, NC	3179	
Fixtures and jigs	3121	
Flexible		
manufacturing		
cell	3160	
module	3160	
systems, (FMS)	3159	
Floors,machinery and forge	3237	
Flow of air in pipes	3036	3233
Flow of water through nozzles	3025	
in pipes	3022	3397
Flywheels	3000	
bursting speed tests	3009	
calculations	3001	
centrifugal stresses in	3005	
classification	3000	
design, general procedure	3001	
energy of	3000	3002

Index Terms

Links

Flywheels (*Cont.*)

for presses, punches, shears	3001
dimensions of	3003
rim velocity	3003
simplified calculations	3004
weight of rim	3004
pulley	3000
spokes or arms of	3011
stream engine	3010
stresses	3010
centrifugal in rim	3005
combined bending and centrifugal	3006
in rotating disks	3010
types of	3000

Forge

air pressure and pipe size	3233
shop equipment	3230
welding	3244
fluxes	3245
fuel	3245
resistance	3245
weld types	3246

Forging

brass, advantages	3018
-------------------	------

Forging press 3232

Format

classification	3164
detail, NC	3164
word address, NC	3164

Formica machining 3144

Formulas

proportions of ANSI fine-pitch worms	
and wormgears	3322

Fractions

Index Terms

Links

Fractions (*Cont.*)

decimal equivalent	2933
multiplication table	2919
pi	2932
squares and cubes, mixed numbers	2926
squares, cubes, roots, logs of	2933

Friction loss

elbow	
45 degree	3024
90 degree	3024
standard tee	
flow thru branch	3024
flow thru run	3024

Fuel oil heating value	3012
------------------------	------

G

Gage block sets

inch sizes	3114
metric sizes	3115

Gage blocks, precision

federal specifications for	3113
inch sizes	3114
metric sizes	3115

G-code programming, NC

Gearing

materials for		
worm	3321	3325
worm gearing	3321	

Gears and gearing

criteria for gear tooth capacity	3303	3320
gear shaving	3347	
geometry factors		
for gear teeth	3285	

Index Terms

Links

Gears and gearing (*Cont.*)

hobs	3345
helical fluted	3345
worm gearing	3345
Maag gearing	3351
motion control	3414
power transmitting capacity, gear teeth	3301
speeds and feeds	3347
worm gearing	3321
hobs	3345
Geneva stop	2997
Govenors	3453
engine	3453
fly-ball	3454
sensitivity and stability	3454
shaft	3455
Grinding	
cutter	
tooth-rest	3148
steadyrest	3148
Grinding wheel	
bort	3149
silicate bonding process	3148
vitrified	3149
G-word, NC	3166
Gyroscope	2998

H

Hammer

drop	3230
power	
efficiency	3234
helve	3234
vertical	3234

Index Terms**Links****Hammer (Cont.)**

steam 3230

Haynes stellite 3218 2400 3219

Heat transfer

conduction 3012

Helical interpolation, NC 3176

Helix angle 3279

Hobs, worm gear 3321

Hoisting chain

and wire rope 3423 3440

Holes

coordinate dimension factors for jig

boring 3101

spacing of, on a jig borer 3101

Hooks, dimensions of crane 3447

Horsepower

air compression 3035

to compress air 3032

water at a given head 3022

Hydraulic press 3223

calculations 3223

capacity 3223

I**IGES (initial graphics exchange**

specification) 3209

Ignition temperatures 3012

Inch

Miner's 3481

Inconel 3014

X 3014

Incremental

programming, NC 3169

Index Terms

Links

Initial graphics exchange	
specification	
(IGES), NC	3209
Interpolation	2990
circular, NC	3175
helical and parabolic, NC	3176
linear, NC	3174
Iron	
wrought	3214
chain	3440
strength	3227
Iron and steel manufacture	3212
Bessemer process	3215
classes of steel	3214
electric furnace process	3213
Iron and steel manufacture	
iron ore	3212
making of iron	3212
making of steel	3212
open hearth process	3212
malleable-iron castings	3215
melting and degassing process	3213
oxygen process	3213
pig iron	3214
puddling process	3214
Isothermal	
expansion, compression of air	3031
J	
Jig	
boring	3132
hole coordinate dimension factors	
for	3101
lengths of chords	3098

Index Terms

Links

Jig

boring (<i>Cont.</i>)		
transfer of tolerances	3133	
bushings	3121	
definitions	3121	
designation system for	3131	
fixed type wearing bushings	3127	
head type liner bushings	3125	3129
headless type liner bushings	3125	3128
headless type press fit	3123	
locking mechanisms for	3130	
materials	3121	
plate thickness	3131	
press fit wearing bushings	3122	3125
slip type	3126	
fixture	3121	
fixture definition	3131	

J-Metal

3219

Joints

plastics pipe	3398	
---------------	------	--

K

Kerosene Lubrication

3354

Keys and keyseats

British Standards	3377	3387
keyways and keybars	3383	
rectangular parallel keys	3383	
woodruff keys and keyways	3388	
dimensions and tolerances	3382	
flat key	3390	
gib-head keys	3381	3385
Kennedy key	3390	
metric	3377	
metric keys length	3378	3381

Index Terms

Links

Keys and keyseats (*Cont.*)

Nordberg key	3390
parallel and taper	3382
parallel keys	3378
plain	3385
preferred length	3381

Keys and keyseats

rectangular parallel keys	3378
rectangular taper keys	3380
saddle key	3390
square parallel keys	3378
square taper keys	3380
taper key tolerances	3382
taper keys	3381
woodruff keys and keyseats	3388

Knife-edge bearings 3354

L

Letter

addresses, NC	3164
---------------	------

Linear

coefficient of expansion	
pipe material	
copper	3024
FRP	3024
PP & PVDF	3024
PVC	3024
steel	3024
interpolation, NC	3174

Lines, points,

circles (APT) NC	3186
------------------	------

Locomotive development 3480

Lodestone 3013

Index Terms

Links

Logarithms	2989		
common	2989	2993	
extracting roots by	2992		
mantissa	2989		
natural	2989	2991	2995
obtaining powers by	2991		
tables	2993		
common	2993		
natural	2995		
using calculator to find	2991		
Lubricants			
kerosene	3354		
presswork	3226		
Lumber	3018		
 M			
Machinability and hardness	3143		
Machine tools			
boring machine origin	3120		
feed rate	3143		
graduating	3120		
history	3119		
milling machine			
Lincoln type	3119		
origin	3119		
nut forging			
tools and dies for	3234		
saddle	3119		
transfer machine	3120		
Machinery and forge			
shop floors	3237		
Machinery and forge shop floors			
concrete and wood	3237		
to prevent dust on concrete	3238		

Index Terms**Links**

Machinery and hammer		
foundations	3236	
concrete	3236	
drop hammer	3237	
steam hammer	3237	
Machining		
formica	3144	
noise	3455	
Macro, NC	3178	
Magnet	3013	
Malleable iron		
castings	3215	
physical properties	3215	
Manganese steel castings	3216	
Manila rope, strength	3441	3445
Mannesmann process	3229	
Mantissa, logarithm	2989	
Manual data input, NC	3161	
Manufacturing cell,		
flexible, NC	3160	
module	3160	
system	3160	
Materials for worm gearing	3331	
M-codes (M-words), NC	3170	
Mechanics of materials		
flywheels	3000	3011
Mechanisms	2997	
Meehanite		
castings	3216	
physical properties	3216	
Metal		
balls, standard	3355	
coloring	3262	

Index Terms

Links

Metal balls	
ordering specification	3355
preferred gages	3356
tolerances	3356
Metallography	3044
Metric	
keys and keyways, British	
Standard	3377
Micarta	3013
Microprocessor	3154
Milling	
climb-cut	3142
Miner's inch	3481
Miscellaneous functions, NC	3170
Module	
flexible manufacturing, NC	3160
Monel	3014
H	3015
K	3015
KR	3015
R	3015
S	3015
Motion control	3408
analog transducers	3416
closed loop system	3409
control function	3411
Motion control	
control function	
features of controllers	3411
damping system response	3411
driving power	3411
electric motors	3413
electromechanical system	3412
electronic control	3421

Index Terms

Links

Motion control (*Cont.*)

feedback transducers	3415	
gearing	3414	
hydraulic fluids	3417	
hydraulic pumps	3417	
hydraulic systems	3418	
control systems	3417	
electronic controls	3421	
proportional control	3420	
pumps and fluids	3416	
mechanical stiffness and vibration	3412	
motor types	3409	
open loop systems	3408	
pneumatic systems	3417	3421
proportional system	3420	
synchros and resolvers	3416	
system application factors	3408	
torsional vibration	3412	
Motors, electric	3413	
control	3409	3413
hydraulic, NC	3416	
stepper, NC	3414	
type, dc and ac	3413	
types and characteristics for different applications	3413	
M-words, NC	3170	
N		
NC programming	3160	
Nichrome	3016	
Nickel		
acid resistant	3016	
Noise, machinery	3455	
Nozzles, flow of water through	3025	

Index Terms

Links

Numbers

powers, roots, reciprocals 2934

Numerical control 3149

absolute programming 3169

adaptive control 3158

addresses, letter 3164

APT programming 3184

circles 3190 3193

computational statements 3186

example program 3198

for turning 3199

geometry statements 3186

lines 3188

motion statements 3191

planes 3194

points 3187

postprocessor statements 3196

Numerical control

APT programming

tabulated cylinder 3195

automatically programmed tool

(APT) 3184

bit 3154

block 3164

byte 3154

CAD/CAM 3211

central processing unit 3154

circular interpolation 3175

closed-loop system 3158

computer-aided part programming 3162

control, adaptive 3158

cutter compensation 3172

cutter location data 3163

decimal point programming 3164

Index Terms

Links

Numerical control (*Cont.*)

direct (or distributed) NC	3211	
feed rate override	3172	
fixed (canned) cycles	3179	
flexible manufacturing		
cell	3160	
module	3160	
system	3159	
format detail	3164	
F-word	3171	
G-code addresses	3166	
helical interpolation	3176	
incremental programming	3169	
initial graphics exchange specification (IGES)	3209	
interpolation		
circular	3175	
helical and parabolic	3176	
linear	3174	
letter addresses	3164	
macro	3178	
manual data input	3161	
microprocessor	3154	
miscellaneous functions	3170	
parabolic interpolation	3176	
parametric		
expressions and macros	3178	
programming, NC	3178	
subroutine	3178	
part programming	3160	
points, lines, circles (APT)	3187	
postprocessor	3163	3186
preload registers (G92)	3170	
preparatory word	3166	

Index Terms

Links

Numerical control (*Cont.*)

programmable controllers	3154
programming	
absolute	3169
incremental	3169
NC	3160
sequence number	3166
standards	3151
stepper motors	3414
subroutine	3177
S-word	3172
thread cutting	3183

Numerical control

tool	
data table	3172
length offset	3174
nose radius compensation	3174
offset	3173
turning cycles	3183
T-word	3172
word address format	3164
zero suppression	3166

Nuts

eye nuts	3449
forging machines	3234
speeds for tapping	3148

Nylon

rope, strength of	3443
-------------------	------

O

Open-loop system	3158	3408
-------------------------	------	------

Index Terms

Links

P

Parabolic interpolation, NC	3176	
Parametric subroutine, NC	3178	
Pi, fractions of	2932	
Pipe and pipe fittings	3392	
ANSI Standard wrought steel	3395	
bending pipe and tubes	3401	
cross-sectional area of metal	3395	
cubic contents for given length	3024	3395
definitions	3392	3398
definitions of pipe fittings	3402	
flow in	3397	
gallons per foot	3024	3395
grades of	3393	
length per cubic foot	3395	
metric weights and mass	3392	
moment of inertia	3395	
plastics	3398	
joining	3398	
pressure ratings	3400	
properties and use of	3399	
temperature correction factors	3400	
weights and dimensions	3398	
radius of gyration	3395	
schedule numbers	3393	
seamless drawn	3229	
section modulus	3395	
steel, welded and seamless	3393	
wall thickness	3392	
weight per foot	3393	
wrought steel	3392	
Pitch		
worms	3321	

Index Terms

Links

Plastics

pipe and fittings 3398

PLC (programmable logic control) 3154

Plow steel

wire rope 3017

Plow steel haulage

rope, strength of 3426 3441

Points, lines, circles, (APT) NC 3186

Polypropylene plastics 3399

Postprocessor, NC 3163 3186

Precision

gage blocks 3113

Preload registers, (G-114 word) NC 3170

Preparatory word, (G-word) NC 3166

Press

forging 3232

Pressure

and flow of water 3021

head in foot to psia relation 3021

radial on sheave or drum 3433

unit conversion 3030

wind 3028

Programmable

logic controller, NC 3154

Programming

absolute, NC 3169

APT 3184

G-code 3164

incremental, NC 3169

numerical control 3160

Prony brake 2998

Properties

of materials

air 3027

Index Terms

Links

Properties (Cont.)

water 3021

Pulleys and belts

flywheel pulley 3000

Pump

head and horsepower relation 3022

horsepower at different head 3022

Punch presses speeds and pressures 3226

Punches and dies

pressures required 3227

PVC plastics 3399

Pyrometers 3116

R

Radius

of gyration

pipe 3395

Reamers 3141

bridge 3141

teeth spacing 3141

Rope

manila, safe loads and strength 3441 3445

nylon, safe loads and strength 3443

safe loads for 3441

slings, strength 3441 3443

weight per 100 feet 3445

Rope

wire 3423

definitions of terms 3423

strength and properties 3426

winding drum, grooves for 3432

Rope splicing 3451

Index Terms

Links

S	
SAE Standards	
taper shaft ends	3391
Safe loads for wire rope	3426
Safety	
for wire rope	3430
Screw threads and thread systems	
worm threads	3321 3325
Seamless drawn pipe	3229
Section modulus	
pipe	3395
Seizing and cutting wire rope	3434
Semi-steel castings	3216
Sequence number, NC	3166
Shackle and end-link chain	3446
Shafts	
taper ends, SAE Standard	3391
Sheaves	
for wire rope	3424
Shut height, power press	3227
Sine-bar constants	3048
inch	3048
mm	3076
Slings	
and fittings for wire rope	3435
strength of rope and chain	3441
Soldering and brazing	3256
Sound level	
specifications	3455
Spacing holes on jig borer	3097
Speeds and feeds	
gear cutting	3347
milling	3145

Index Terms

Links

Speeds and feeds (*Cont.*)

planing 3144

Sphere, area and volume 2974

Spindle

function, NC 3172

noses 3172

Splicing rope 3451

Squares

mixed numbers 2924

numbers 2922

Stamping

die clearances 3224

lubricants for 3226

pressures required 3227

Standard

NC 3151

Steam hammer

power 3230

rating 3230

Steel

Steel

castings 3215

copper-clad 3014

for punches, dies, on hot work 3220

graphitic

for punches and dies 3219

life 3220

hot work 3220

manganese

castings 3216

pipe

ANSI standard 3393

seasoning 3017

Index Terms

Links

Steel (*Cont.*)

semi	
castings	3216
temper	3216
vanadium	3018
wrought pipe	3392

Stellite	3218
-----------------	------

Stepper motors	3414
-----------------------	------

Strength

wire rope	3424
-----------	------

Stress

bending in flywheels	3006
centrifugal in	
flywheels	3005
hoop in flywheels	3005
in flywheels	3010
in rotating disks	3010

Subprogram, NC	3177
-----------------------	------

Subroutine, NC	3177
-----------------------	------

Swaging, cold	3233
----------------------	------

S-word, NC	3172
-------------------	------

Symbols

air conditioning	3038
air conditioning piping	3042
fittings	3043
heating and ventilation	3040
heating piping	3042
piping	3042
plumbing piping	3042
pneumatic tubes	3042
sprinklers	3042
valves, pipe fitting	3041

Index Terms

Links

T

Taper

- keys 3381
- shaft ends, SAE Standard 3391

Taps 3141 3282

- blacksmiths' 3141
- stub machine screw 3141
- tap drill diameter 3284
- tapping lubricants 3283
- wash-out 3141

Tempering

- color method 3241

Thermit welding 3246

Thermoil-Granodine 3354

Threads and threading

- Briggs pipe thread (NPT) history 3278
- cutting
 - numerically controlled 3183
- hand chaser 3281
- lock-nut pipe thread 3279
- milling
 - on numerically controlled machines 3183
- National pipe thread (Briggs)
 - history 3278
- taper thread cutting 3282
- thread cutting methods 3281
- thread grinding 3280
- Whitworth thread origin 3279

Tolerances 3045

Tongs

- flat jaw 3231
- goose necked 3232

Index Terms

Links

T

data table	3172
function, NC	3172
length offset, NC	3174
nose radius compensation, NC	3174
offset, NC	3173
steel	3218
open-hearth	3218
Trigonometry tables	2874
Truflex	3014
Tube	3392
flattening test	3274
Turning cycles, NC	3183
T-word, NC	3172
Type metal	3017

V

Vanadium steel	3018
----------------	------

V

air at different temperatures	3027		
flow in pipes and tubes	3022	3024	3397
nozzles	3025		
water at different temperature	3022		

W

Washed metal	3017
--------------	------

W

boiling point	3021	
brake	2999	
density	3022	
flow in pipes	3022	3397
flow through nozzles	3025	
pressure	3021	

Index Terms

Links

Water (*Cont.*)

pressure, head		
or depth known	3021	
velocity due to head	3026	
volume of flow in pipes and tubes	3024	3397
wheel	3027	

Wax impression 3481

Weight

air	3027	
pipe, per foot	3393	
water	3021	

Welding

fluxes	3245	
forge	3244	
fuel	3245	
weld types	3246	
gas or autogenous	3249	
hardfacing	3255	
resistance forge	3245	
thermit	3246	

Wheatstone bridge 3480

Wheels

flywheel		
balance wheels	3000	
flywheel pulley	3000	

Whitworth motion 2997

Winchester bushel 3481

Wind pressure 3028

Winding drums, wire rope and chain 3432 3445

Wire

electric, minimum gage	3482	
------------------------	------	--

Wire rope 3423

bending stresses	3434	
breaking strengths	3424	

Index Terms

Links

Wire rope (*Cont.*)

classes	3425
construction	3423
cutting and seizing	3434
definitions of terms	3423
drum or reel capacity	3432
drum score for winding	3445
factors of safety	3430
installation	3430
life	3435
lubrication	3435
maintenance	3435
plow steel	3017
plow steel, strength of	3426
properties	3424
rated capacities of	3436
replacement	3435
rope loads due	
to bending	3434
safe loads for	3430
sheave and drum dimensions	3432
simplified practice	
recommendations	3428
sizes	3426
slings and fittings	3435
specification	3424
strength	3426
weight	3426
Wood	3018
auger speeds	3143
balsa	3020
cork	3020
life	3020
lumber	3018

Index Terms

Links

Wood

preservative	
creosoting process	3020
Kyanizing	3020
seasoning	3019
water content	3019

Wood's Metal	3017
---------------------	------

Woodruff keys and keyseats

British Standard	3388
------------------	------

Word address format, NC	3164
--------------------------------	------

Word, NC	3164
-----------------	------

Working stress, flywheels	3006
----------------------------------	------

Worm gearing	3321	3325
---------------------	------	------

addendum	3322
----------	------

ANSI Standard, fine-pitch	3321
---------------------------	------

center distance	3322
-----------------	------

effect of cutting method on profile	3323
-------------------------------------	------

effect of production method	
on profile and pressure angle	3325

fine-pitch	3321
------------	------

formulas for dimensions	3322
-------------------------	------

hobs for	3321
----------	------

lead angles	3321
-------------	------

material for	3331
--------------	------

materials for	3325
---------------	------

multithread	3325
-------------	------

multi-thread worms	3332
--------------------	------

number of threads or "starts"	3332
-------------------------------	------

outside diameter	3322
------------------	------

pitch diameter	3322
----------------	------

range	3323
-------	------

pitch diameter range	3323
----------------------	------

pitches	3321
---------	------

pitches, standard	3321
-------------------	------

Index Terms

Links

Worm gearing (*Cont.*)

pressure angle	3321	3323
pressure angles	3321	
proportions	3322	
ratios	3325	
single-thread	3325	
single-thread worms	3331	
tooth form	3323	
tooth form of worm and wormgear	3323	

Wrought

aluminum	3017	
iron	3214	
anvil	3230	
strength	3227	
iron chain	3440	
steel pipe	3392	

Z

Zero suppression, NC	3166	
----------------------	------	--

TABLE OF CONTENTS
ADDITIONAL ONLY ON THE CD

MATHEMATICS	MECHANICS AND STRENGTH OF MATERIALS
<p>2874 Trig and Involute Functions</p> <p>2874 0 Degrees</p> <p>2879 5 Degrees</p> <p>2884 10 Degrees</p> <p>2889 15 Degrees</p> <p>2894 20 Degrees</p> <p>2899 25 Degrees</p> <p>2904 30 Degrees</p> <p>2909 35 Degrees</p> <p>2914 40 Degrees</p> <p>2918 45 Degrees</p> <p>2919 Multiplication of Fractions</p> <p>2919 Fractions & Whole Numbers</p> <p>2920 Common Fractions</p> <p>2922 Squares of Numbers</p> <p>2922 Numbers from 1 to 999</p> <p>2924 Mixed Numbers from 1/64 to 12</p> <p>2926 Fractions, Squares and Cubes</p> <p>2932 Fractions of Pi (π)</p> <p>2933 Fractions: Decimals, Squares, Cubes, Roots, Logarithms</p> <p>2934 Powers, Roots, and Reciprocals</p> <p>2934 From 1 to 200</p> <p>2938 From 201 to 400</p> <p>2942 From 401 to 600</p> <p>2946 From 601 to 800</p> <p>2950 From 801 to 1000</p> <p>2954 From 1001 to 1500</p> <p>2964 From 1501 to 2000</p> <p>2974 Area and Volume of Spheres</p> <p>2977 Circumference and Area of Circles</p> <p>2989 Logarithms</p> <p>2989 Common Logarithms</p> <p>2990 Inverse Logarithm</p> <p>2991 Natural Logarithms</p> <p>2991 Powers of Number by Logarithms</p> <p>2992 Roots of Number by Logarithms</p> <p>2993 Tables of Logarithms</p>	<p><i>(Continued)</i></p> <p>2999 Water Brakes</p> <p>2999 Catenary Curve</p> <p>3000 Flywheels</p> <p>3000 Classification</p> <p>3000 Energy Due to Velocity</p> <p>3001 General Design Procedures</p> <p>3001 Presses, Punches and Shears</p> <p>3003 Dimensions of Flywheels</p> <p>3004 Simplified Flywheel Calculations</p> <p>3005 Centrifugal Stresses in Flywheels</p> <p>3006 Combined Stresses in Flywheels</p> <p>3006 Thickness of Flywheel Rims</p> <p>3007 Safety Factors</p> <p>3007 Safe Rim Speeds</p> <p>3008 Safe Rotation Speeds</p> <p>3009 Bursting Speeds</p> <p>3010 Stresses in Rotating Disks</p> <p>3010 Steam Engine Flywheels</p> <p>3011 Spokes or Arms of Flywheels</p>
<p style="text-align: center;">MECHANICS AND STRENGTH OF MATERIALS</p> <p>2997 Mechanisms</p> <p>2997 Archimedean Screw</p> <p>2997 Geneva Stop</p> <p>2997 Whitworth Motion</p> <p>2998 Gyroscope</p> <p>2998 Dynamometers</p> <p>2998 Prony Brake</p>	<p style="text-align: center;">PROPERTIES, TREATMENT, TESTING OF MATERIALS</p> <p>3012 Heat and Heat Transfer, Conduction</p> <p>3012 Fuel Oil Heating Values</p> <p>3012 Ignition Temperatures</p> <p>3012 Firebrick Properties</p> <p>3013 Non-metallic Materials</p> <p>3013 Carbon</p> <p>3013 Charcoal</p> <p>3013 Lodestone</p> <p>3013 Micarta</p> <p>3014 Metals and Alloys</p> <p>3014 Copper-Clad Steel</p> <p>3014 Truflex</p> <p>3014 Inconel</p> <p>3014 Inconel "X"</p> <p>3014 Monel</p> <p>3015 "R" Monel</p> <p>3015 "K" Monel</p> <p>3015 "KR" Monel</p> <p>3015 "S" Monel</p> <p>3015 "H" Monel</p> <p>3016 Nichrome</p> <p>3016 Nickel Alloy for Resisting Acids</p> <p>3017 Wood's Metal</p> <p>3017 Washed Metal</p>

TABLE OF CONTENTS
ADDITIONAL ONLY ON THE CD

PROPERTIES, TREATMENT, TESTING OF MATERIALS	DIMENSIONING, GAGING, MEASURING, INSPECTION
<i>(Continued)</i>	<i>(Continued)</i>
3017 Seasoning Steel and Cast Iron	3045 Basic Dimension
3017 Duronze	3045 Clearance
3017 Aluminum Wrought Sheet Alloys	3045 Allowance
3017 Plow-steel Wire Rope	3045 Tolerances
3017 Type Metal	3047 Tables of Sine-bar Constants
3018 Vanadium Steel	3047 Sine-bar
3018 Brass Forging, Advantages of	3048 Constants for Sine-Bars
3018 Wood	3048 2.5-inch Sine-Bar
3018 Lumber	3055 3-inch Sine-Bar
3019 Lumber, Manufactured	3062 5-inch Sine-Bar
3019 Lumber Water Content	3069 10-inch Sine-Bar
3019 Wood Seasoning Processes	3076 75-mm Sine-Bar
3020 Wood Life	3083 100-mm Sine-Bar
3020 Balsa	3090 125-mm Sine-Bar
3020 Cork	3097 Determining Hole Coordinates
3021 Pressure and Flow of Water	3097 Coordinate Dimension Factors
3021 Water Pressure	3099 Spacing Off Circumferences
3022 Flow of Water in Pipes	3101 Hole Coordinate Tables
3024 Friction Loss	3113 Gage Blocks
3025 Flow through Nozzle	3113 Precision Gage Blocks
3027 Buoyancy	3114 Gage Block Sets, Inch
3027 Water-Wheel	3115 Gage Block Sets, Metric
3027 Properties of Air	3116 Pyrometers
3028 Volumes and Weights	3116 Radiation Pyrometer
3028 Wind Pressures	3116 Optical Pyrometers
3029 Density of Air	3116 Judging Temperatures by Color
3030 Expansion and Compression	3116 Seger Temperature Cones
3032 Horsepower Required to Compress Air	3117 Calibration of Pyrometers
3032 Continuity Equation	3117 Calibrating by the Melting Point of Copper
3036 Flow of Air in Pipes	3118 Calibrating by the Freezing Point of Melted Salts
3036 Flow of Compressed Air in Pipes	
3037 Velocity of Escaping Compressed Air	
DIMENSIONING, GAGING, MEASURING, INSPECTION	TOOLING AND TOOL MAKING
3038 Symbols For Drafting	3119 Machine Tools
3038 Air Conditioning Symbols	3119 Machine Tool History
3040 Heating and Ventilation Symbols	3119 Milling Machine Origin
3041 Valve Symbols	3119 Milling Machines, Lincoln Type
3042 Piping Symbols	3119 Saddle
3043 Pipe Fittings Symbols	3120 Transfer Machines
3044 Inspection	3120 Boring Machines, Origin
3044 Transfer Calipers	3120 Graduating
3044 Metallography	
3045 Fits	

TABLE OF CONTENTS
ADDITIONAL ONLY ON THE CD

TOOLING AND TOOL MAKING	MACHINING OPERATIONS
<i>(Continued)</i> 3121 Jig Bushings 3121 Materials Press Fit Wearing Bushings 3122 Head Type 3123 Headless Type 3125 Specifications Renewable Wearing Bushings 3125 Slip Type 3127 Fixed Type 3128 Headless Type Liner Bushings 3130 Locking Mechanisms 3131 Jig Bushing Definitions 3131 Jig Plate Thickness 3131 Jig Bushing Designation System 3131 Jig Boring Definition of Jig and Fixture 3131 Jig Borers 3132 Jig-Boring Practice 3133 Transfer of Tolerances 3135 Files 3135 File History 3135 Files, Types 3136 File Teeth 3136 File Teeth, Cutting 3137 File Teeth, Resharpener 3138 File Terms 3138 File Testing 3138 Rotary Files and Burs 3139 Scraping Machine Parts 3139 Scrapers 3140 Spotter 3141 Taps 3141 Blacksmiths' Taps 3141 Stub Machine Screw Taps 3141 Wash-Out Taps 3141 Reamers 3141 Reamer Teeth Spacing 3141 Bridge Reamers	<i>(Continued)</i> 3144 Planing Speeds and Feeds 3144 Planing Speeds 3144 Feeds for Planing 3145 Speeds and Feeds for Milling 3148 Speeds for Tapping Nuts 3148 Grinding Tooth-rest for Cutter Grinding 3148 Steadyrests for Grinding 3148 Silicate Bonding Process 3149 Vitrified Grinding Wheels 3149 Bort 3149 Numerical Control Introduction 3150 CNC Technology 3150 Numerical Control vs. Manual Operations 3151 Numerical Control Standards 3154 Programmable Controller 3158 Closed-Loop System 3158 Open-Loop System 3158 Adaptive Control 3159 Flexible Manufacturing Systems 3160 Flexible Manufacturing Cell 3160 Flexible Manufacturing Module 3160 Programming 3163 Postprocessors 3164 G-Code Programming 3164 Format Classification 3165 Letter Addresses 3166 Sequence Number (N-Word) 3166 Preparatory Word (G-Word) 3170 Miscellaneous Functions 3171 Feed Function (F-Word) 3172 Spindle Function (S-Word) 3172 Tool Function (T-Word) 3174 Linear Interpolation 3175 Circular Interpolation 3176 Helical and Parabolic Interpolation 3177 Subroutine 3179 Conditional Expressions 3179 Fixed (Canned) Cycles 3183 Turning Cycles 3183 Thread Cutting 3184 APT Programming 3186 APT Computational Statements 3186 APT Geometry Statements 3187 Points, Lines and Circles 3191 APT Motion Statements
MACHINING OPERATIONS	
3142 Machining Topics 3142 Climb-Cut Milling 3142 Chip Breaker 3142 Chipless Machining 3143 Machinability and Hardness 3143 Feed Rate on Machine Tools 3143 Auger Speeds in Wood 3144 Formica Machining	

TABLE OF CONTENTS
ADDITIONAL ONLY ON THE CD

MACHINING OPERATIONS	MANUFACTURING PROCESS
<i>(Continued)</i> 3192 Contouring Cutter Movements 3193 Circles and Planes 3195 3-D Geometry 3196 APT Postprocessor Statements 3198 APT Example Program 3199 APT for Turning 3201 CAD/CAM 3204 Drawing Projections 3205 Drawing Tips and Traps 3209 Drawing Exchange Standards 3210 Rapid Automated Prototyping 3211 DNC	<i>(Continued)</i> 3221 Cold Extrusion 3222 Billet 3223 Hydraulic Press 3223 Rules and Formulas 3224 Punches and Dies 3224 Clearance 3226 Lubricants for Press Work 3226 Annealing Drawn Shells 3226 Drawing Rectangular Shapes 3226 Speeds and Pressures for Presses 3227 Pressure Required for Punching 3227 Punch and Die Clearance, Amount of Clearance 3227 Shut Height of Press 3227 Depth and Diameter Reductions 3229 Seamless Tube 3229 Mannesmann Process 3230 Forge Shop Equipment 3230 Blacksmiths' Anvils 3230 Setting the Anvil 3230 Steam Hammer Rating 3230 Capacity of Steam Hammers 3230 Power for Operating Steam Hammers 3230 Board Drop-hammers 3232 Forging Presses 3233 Air Pressures and Pipe Sizes for Forges 3233 The Cold Swaging Process 3234 Forging Machines 3234 Hot-pressed Center-feed Nut Machines 3234 Bulldozer Dies 3234 Helve Hammers 3234 Vertical Power Hammers 3234 Efficiency of Forging Hammers 3236 Machinery and Hammer Foundations 3236 Concrete Foundations 3237 Drop Hammer Foundations 3237 Foundation for Steam Hammer 3237 Machine and Forge Shop Floor Materials 3237 Concrete and Wooden Floors 3238 Prevent Dust on Concrete Floors 3238 Floors for Forge Shops 3239 Drop-Forging Dies 3239 Steel for Drop-forging Dies 3239 Allowance for Shrinkage
MANUFACTURING PROCESS	
3212 Principles of Iron and Steel Manufacture 3212 Iron Ores 3212 The Making of Iron 3212 The Making of Steel 3213 Vacuum Melting and Degassing Processes 3213 Iron Ore 3214 Pig Iron 3214 Classes of Steel 3214 Puddling Process 3215 Bessemer Process 3215 Malleable-iron Castings 3215 Physical Properties of Malleable Iron 3215 Steel Castings 3216 Manganese Steel Castings 3216 Semi-steel Castings 3216 The Temper of Steel 3216 Meehanite Castings 3217 Alloy Cast Iron 3217 Nickel-Chromium Cast Iron 3218 Drawing Dies Cast from Iron Alloys 3218 Steel for Cast Crankshafts 3218 Tool Steel 3218 Open-hearth Tool Steel 3218 Haynes Stellite 3219 Carbide Tools 3219 Graphitic Steel for Punches and Dies 3220 Life of Graphitic Steel Dies 3220 Steels for Dies, Punches and Shears Used on Hot Work	

TABLE OF CONTENTS
ADDITIONAL ONLY ON THE CD

MANUFACTURING PROCESS	MANUFACTURING PROCESS
<i>(Continued)</i>	<i>(Continued)</i>
3239 Draft Allowance	3253 Aluminum Welding
3239 Locating Impression in the Die	3254 Aluminum Welding Fluxes
3239 Obtaining Weight of Forging from Lead Proof	3254 Welding Brass
3240 Amount of Flash for Drop-forging Dies	3254 Welding Copper
3240 Break-down of Drop-forging Dies	3255 Welding High-speed Steel to Machine Steel
3240 Hardening Drop-forging Dies	3255 Welding Cast Iron to Steel
3240 Heating the Die	3255 Welding Steel Castings
3240 Cooling the Heated Die	3255 Welding Malleable Iron
3241 Tempering Dies	3255 Welding Tool Steel
3241 Tempering by the Color Method	3255 Welding Alloy Steels
3241 Dies for Bronze and Copper Forgings	3255 Hard-Facing
3241 Trimming Dies for Drop-forgings	3256 Hard-Facing Materials
3242 Standard Tolerances for Forgings	3256 Soldering and Brazing
3244 Welding Methods	3256 Solders
3244 Classes of Welds	3256 Soft Solders
3244 Welding Heat	3257 Hard Soldering and Brazing
3245 Fire for Welding	3258 Fluxes for Soldering
3245 Fluxes for Welding	3259 Alloys for Brazing Solders
3245 Welding, Resistance Forge	3259 Silver Solders
3245 Fuels for Forge	3259 Dip Brazing
3246 Machine Welding	3259 Brazing Band-saws
3246 Welding with Thermit	3260 Cleaning Surfaces to be Brazed
3246 Thermit Process	3260 Aluminum Solder
3247 Preparation of Part to be Welded	3260 Sweating
3247 Mold for Thermit Welding	3260 Brazing High-speed Steel Tips to Carbon Steel Shanks
3248 Thermit Required for Welding	3260 Brazing Carbide Tips to Steel Shanks
3248 Thermit Additions	3261 Braze Hardening
3248 Pre-heating — Making a Weld	3262 Coloring Metals
3248 Filling Shrinkage Holes and Surface Flaws	3262 General Requirements in the Coloring of Metal Surfaces
3249 Composition of Thermit Steel	3262 Cleaning Metals for Coloring
3249 High- and Low-pressure Torches	3262 Pickling Solutions or Dips for Coloring
3249 Autogenous or Gas Welding	3262 Coloring Brass
3249 Welding Torch	3262 To Produce a Rich Gold Color
3250 Adjusting the Torch	3263 White Colors or Coatings
3251 Temperatures	3263 Silvering
3251 Size of Torch Tip to Use	3263 To Give Brass a Green Tint
3251 Preparing Joint for Welding	3263 Blackening Brass
3252 Provision for Expansion and Contraction	3263 Preservation of Color
3252 Welding Rods or Adding Materials	3263 Niter Process of Bluing Steel
3252 General Procedure when Welding	3264 Bluing Steel by Heat-treatment
3252 Pre-heating Castings	3264 Blue-black Finish
3252 Welding Cast Iron	3264 Black Finish
3253 Welding Steel	3264 Gun Metal Finish
	3265 Browning Iron and Steel

TABLE OF CONTENTS
ADDITIONAL ONLY ON THE CD

MANUFACTURING PROCESS	THREADS AND THREADING
<i>(Continued)</i>	
3265 To Produce a Bronze Color	3278 Threads and Threading
3265 To Produce a Gray Color	3278 History of Briggs Pipe Thread (NPT)
3265 Mottled Coloring	3279 Lock-Nut Pipe Thread
3265 Coppering Solution	3279 Whitworth Thread Origin
3265 White Coatings for Laying Out Lines	3279 Helix Angle
3265 To Produce Gray Colors	3280 Thread Grinding
3265 Blue and Violet Shades	3281 Hand Chaser
3266 To Give Brass a Green Tint	3281 Thread-Cutting Methods
3266 Chromium Plating	3282 Taper Thread Cutting
3267 Bronzing	3282 Taps
3267 Etching And Etching Fluids	3283 Tapping Lubricants
3267 Etching Fluids for Different Metals	3284 Tap Drill Diameters
3268 Etching Brass Nameplates	
3268 Producing a Black Background	GEARS, SPLINES, AND CAMS
3268 Etching Ornamental Designs in Metal	3285 Geometry Factors For Gear Teeth
3269 Etching Resists	3285 Contact and Bending Stresses
3269 Burnishing	3285 Geometry Factors for Pitting Resistance and Bending Strength
3270 Burnishing Broach	3285 Exceptions to the Information Sheet Data and Procedures
3271 Burnishing by Ball Process	3286 Basic Gear Geometry of Spur and Helical Gears
3271 Burnishing Dies	3287 Contact Ratios
3271 Burnishing Lathes	3288 Minimum Lengths of Lines of Contact
3271 Burnishing Roller	3288 Load Sharing Ratio, mN
FASTENERS	3288 Calculating the Pitting Resistance Geometry Factor, I
3272 Distinguishing Bolts From Screws	3289 Bending Strength Geometry Factor, J
3272 Specification	3290 Pressure Angle at Load Application Point
3272 Explanatory Data	3291 Generating-Rack Shift Coefficient
3272 Procedure	3292 Geometry Factors, I and J
3272 Primary Criteria	3301 Power-Transmitting Capacity of Spur Gears
3273 Supplementary Criteria	3301 Modes of Failure
3274 Fasteners	3301 Strength Calculations for Spur and Helical Gears
3274 Stove Bolt	3302 Rating Formulas
3274 Flattening Test	3302 Exceptions
3274 Rivets, Cold Formed	3302 Additional Considerations
3275 Explosive Rivets	3303 Criteria for Gear Tooth Capacity
3275 Expansion Bolt	3303 Relationship of Pitting Resistance and Bending Strength Ratings
3275 North Bolt	3304 Fundamental Rating Formulas
3275 Washers	3304 Pitting Resistance
3275 Nut Standardization	
3276 Wood Screws	
3277 Wood-Screw Holding Power	

TABLE OF CONTENTS
ADDITIONAL ONLY ON THE CD

GEARS, SPLINES, AND CAMS	GEARS, SPLINES, AND CAMS
3305 Symbols Used in Gear Rating Equations	3336 Designing Worm Gearing Relative to Center Distance and Ratio
3307 Pitting Resistance Power Rating	3337 Efficiency of Worm Gearing
3307 Contact Load Factor, K	3339 Self-locking or Irreversible Worm Gearing
3308 Bending Strength	3339 Worm Gearing Operating Temperatures
3308 Allowable Bending Stress Number	3339 Thermal Rating
3309 Bending Strength Power Rating	3339 Water and Forced-Air Cooling
3309 Values in Fundamental Equations	3340 Double-enveloping Worm Gearing
3309 Rim Thickness Factor KB	3344 Worm Thread Cutting
3309 Geometry Factors I and J	3345 Hobs for Gearing
3309 Transmitted Tangential Load, Wt	3345 Wormgear Hobs
3310 Dynamic Factors, Cv and Kd	3345 Helical Fluted Hobs
3312 Application Factors, Ca and Ka	3347 Gear Shaving
3312 Service Factors, CSF and KSF	3347 Speeds and Feeds for Gear Cutting
3313 Elastic Coefficient, Cp	3349 Feeds for Hobbing
3313 Surface Condition Factor, Cf	3349 Feeds for Given Pitch and Material
3313 Size Factors, Cs and Ks	3350 Other Gear Topics
3313 Load Distribution Factors, Cm and Km	3350 Hunting Tooth Gear Ratios
3315 Allowable Stress Numbers, Sac and Sat	3351 Maag Gearing
3316 Case Depth of Surface-Hardened Gears	
3317 Momentary Overloads	MACHINE ELEMENTS
3317 Yield Strength	3352 Bearings
3317 Hardness Ratio Factor CH	3352 Percentages of Radial and Thrust Loads
3318 Life Factors CL and KL	3352 Roller Bearing
3319 Localized Yielding	3352 Ball Bearing Lubrication
3319 Reliability Factors, CR and KR	3353 Oilless Bearings
3319 Temperature Factors CT and KT	3354 Thermoil-Granodine
3321 Worm Gearing	3354 Knife-Edge Bearings
3321 Worm-Gear Applications	3354 Kerosene Lubrication
3321 Standard Design for Fine-pitch	3355 Standard Metal Balls
3322 Formulas for Proportions of Wormgears	3355 Definitions and Symbols
3323 Proportions of Fine-pitch Worms and Wormgears	3356 Preferred Ball Gages
3329 Calculating Worm Deviations and Pressure Angle Changes	3359 Preferred Ball Sizes
3331 Materials for Worm Gearing	3361 Number of Metal Balls per Pound
3331 Single-thread Worms	3362 Number of Metal Balls per Kg
3332 Multi-thread Worms	3363 Cement
3332 Ratio for Obtaining "Hunting Tooth" Action	3363 Cement Pastes
3335 Pitch Diameter of Worm	3364 Use of Portland Cement
3335 Addendum and Dedendum	3364 Natural Cement
3335 Outside Diameter of Wormgear	3365 Pozzuolanic or Slag Cement
3336 Pressure Angles	3365 Concrete
	3365 Concrete
	3365 Concrete Mixtures

TABLE OF CONTENTS
ADDITIONAL ONLY ON THE CD

MACHINE ELEMENTS	MACHINE ELEMENTS
<i>(Continued)</i>	<i>(Continued)</i>
3365 Sand, Gravel, and Stone for Concrete	3407 Positive Clutch
3365 Amount of Water for Mixing Concrete	3407 Clutches that Automatically Disengage
3366 Reinforced Concrete	3408 Motion Control Systems
3366 Strength of Concrete	3409 Control Motor Types
3366 Durability of Concrete in Sea Water	3411 Controllers
3366 Waterproofing Concrete	3411 Control Function
3366 Resistance to Acids and Oils	3412 Electromechanical Control Systems
3367 Lutes and Cements	3412 Mechanical Stiffness
3367 Water-proof Compositions	3412 Torsional Vibration
3367 Oil-proof Cements	3413 Electric Motors
3367 Acid-proof Cements	3414 Stepper Motors
3368 Gasket Compositions	3414 Gearing
3368 Machinists Cements	3415 Feedback Transducers
3368 Leather Cements	3416 Analog Transducers
3368 Iron and Stone Cements	3416 Synchros and Resolvers
3368 Cement Proof to Hydrocarbon Gases	3416 Hydraulic and Pneumatic Systems
3368 Cements Proof to Chlorine	3417 Hydraulic Pumps
3368 Elastic Cements	3417 Hydraulic Fluids
3369 General Purposes	3420 Proportional Control Systems
3369 Acid-proof Lining	3421 Electronic Controls
3369 Cements for Pipe Joints	3421 Pneumatic Systems
3369 Adhesives and Sealants	3423 Wire Rope
3369 Adhesives Bonding	3423 Wire Rope Construction
3373 Sealants	3424 Properties of Wire Rope
3374 Waterproof Compositions	3425 Classes of Wire Rope
3374 Marine Glue	3430 Sizes and Strengths
3374 Glues for Wood	3431 Safe Loads, Factors of Safety
3375 Rust Prevention	3432 Installing Wire Rope
3377 Keys and Keyways	3434 Pressures for Drums and Sheaves
3377 British Metric Keys and Keyways	3434 Groove Dimensions
3381 British Inch Keys and Keyways	3435 Cutting and Seizing
3390 Key	3435 Maintenance
3390 Sunk Key	3435 Lubrication of Wire Rope
3390 Saddle Key	3436 Wire Rope Slings and Fittings
3390 Flat Key	3436 Slings
3390 Nordberg Key	3436 Wire Rope Fittings
3390 Kennedy Key	3436 Applying Clips and Sockets
3392 Pipe and Pipe Fittings	3438 Load Capacities
3392 Wrought Steel Pipe	3440 Crane Chain and Hooks
3398 Plastics Pipe	3440 Material for Crane Chains
3401 Pipe and Tube Bending	3440 Strength of Chains
3401 Threading Pipe	3440 Hoisting and Crane Chains
3402 Definitions of Pipe Fittings	3440 Maximum Wear on a Link
3405 Clutches	3441 Safe Loads for Ropes and Chains
3405 Friction Clutches	3441 Manila Rope and Chains
	3442 Protection from Sharp Corners
	3442 Heat-Treated Alloy Steel Chain
	3442 Strength of Manila Rope

TABLE OF CONTENTS
ADDITIONAL ONLY ON THE CD

MACHINE ELEMENTS	MACHINE ELEMENTS
<i>(Continued)</i>	<i>(Continued)</i>
3443 Nylon Rope	3476 Double-Flexure Silent Chain
3444 Loads Lifted by Crane Chains	3476 Horsepower Ratings Per Inch of Chain Width for Silent Chain Drives — 1982
3445 Dimensions of Hooks, Eyes, and Drums	
3445 Winding Drum Scores for Chain	ADDITIONAL
3445 Sprocket Wheels for Link Chains	
3447 Crane Hooks	3480 Miscellaneous Topics
3448 Eye-bolts	3480 Locomotive Development
3449 Eye Nuts and Lift Eyes	3480 Wheatstone Bridge
3450 Specifying Eyebolt Capacities	3481 Wax Impressions
3450 Rigger's Capacity	3481 Winchester Bushel
3450 Engineering Capacity	3481 Miner's Inch
3451 Rope Splicing	3481 Locating Holes by the Disk Method
3451 Short Splice	3482 Electrical Cord Gage Rating
3451 Long Splice	3483 The Slide-rule
3452 Eye-Splice	3483 Reading the Slide-rule Graduations
3453 Governors	3485 Multiplication of Whole Numbers
3453 Engine Governors	3485 Multiplication of Decimals
3454 Loaded or Weighted Fly-ball Governors	3487 Continued Multiplication
3454 Sensitiveness and Stability of Governors	3487 Division of Whole Numbers
3455 Shaft Governors	3487 When Divisor is Greater than Dividend
3455 Machinery Noise	3489 Division of Decimals
3455 Sound Level Specifications	3489 Squares of Numbers
3455 Measuring Machinery Noise	3489 Square Root
3457 Silent or Inverted Tooth Chain	3490 Cubes of Numbers
3457 Characteristics of Silent Chain Drives	3490 Cube Root
3457 Standard Silent Chain Designation	3492 Diameters and Circumferences of Circles
3457 Silent Chain Links	
3458 Silent Chain Sprocket Diameters	
3458 Silent Chain Sprocket Profiles and Chain Widths	
3468 Sprocket Hub Dimensions	
3472 Sprocket Design and Tooth Form	
3472 Cutting Silent Chain Sprocket Teeth	
3474 Design of Silent Chain Drives	
3474 Pitch of Silent Chain	
3474 Maximum Ratios for Silent Chain Drives	
3475 Center Distance for Silent Chain Drives	
3475 Silent Tooth Chain Horsepower Capacity	
3475 Installation of Silent Chain Drives	

MATHEMATICS

↓ 0° or 180° **Trigonometric and Involute Functions** 179° or 359° ↓

Minutes	Sine	Cosine	Tangent	Cotangent	Secant	Cosecant	Involute 0°-1°	Read Up	Minutes
0	0.000000	1.000000	0.000000	Infinite	1.000000	Infinite	0.0000000	Infinite	60
1	0.000291	1.000000	0.000291	3437.75	1.000000	3437.75	0.0000000	3436.176	59
2	0.000582	1.000000	0.000582	1718.87	1.000000	1718.87	0.0000000	1717.303	58
3	0.000873	1.000000	0.000873	1145.92	1.000000	1145.92	0.0000000	1144.345	57
4	0.001164	0.999999	0.001164	859.436	1.000001	859.437	0.0000000	857.8667	56
5	0.001454	0.999999	0.001454	687.549	1.000001	687.550	0.0000000	685.9795	55
6	0.001745	0.999998	0.001745	572.957	1.000002	572.958	0.0000000	571.3882	54
7	0.002036	0.999998	0.002036	491.106	1.000002	491.107	0.0000000	489.5372	53
8	0.002327	0.999997	0.002327	429.718	1.000003	429.719	0.0000000	428.1491	52
9	0.002618	0.999997	0.002618	381.971	1.000003	381.972	0.0000000	380.4028	51
10	0.002909	0.999996	0.002909	343.774	1.000004	343.775	0.0000000	342.2058	50
11	0.003200	0.999995	0.003200	312.521	1.000005	312.523	0.0000000	310.9538	49
12	0.003491	0.999994	0.003491	286.478	1.000006	286.479	0.0000000	284.9104	48
13	0.003782	0.999993	0.003782	264.441	1.000007	264.443	0.0000000	262.8738	47
14	0.004072	0.999992	0.004072	245.552	1.000008	245.554	0.0000000	243.9853	46
15	0.004363	0.999990	0.004363	229.182	1.000010	229.184	0.0000000	227.6152	45
16	0.004654	0.999989	0.004654	214.858	1.000011	214.860	0.0000000	213.2915	44
17	0.004945	0.999988	0.004945	202.219	1.000012	202.221	0.0000000	200.6529	43
18	0.005236	0.999986	0.005236	190.984	1.000014	190.987	0.0000000	189.4186	42
19	0.005527	0.999985	0.005527	180.932	1.000015	180.935	0.0000001	179.3669	41
20	0.005818	0.999983	0.005818	171.885	1.000017	171.888	0.0000001	170.3204	40
21	0.006109	0.999981	0.006109	163.700	1.000019	163.703	0.0000001	162.1355	39
22	0.006399	0.999980	0.006399	156.259	1.000020	156.262	0.0000001	154.6947	38
23	0.006690	0.999978	0.006691	149.465	1.000022	149.468	0.0000001	147.9009	37
24	0.006981	0.999976	0.006981	143.237	1.000024	143.241	0.0000001	141.6733	36
25	0.007272	0.999974	0.007272	137.507	1.000026	137.511	0.0000001	135.9439	35
26	0.007563	0.999971	0.007563	132.219	1.000029	132.222	0.0000001	130.6553	34
27	0.007854	0.999969	0.007854	127.321	1.000031	127.325	0.0000002	125.7584	33
28	0.008145	0.999967	0.008145	122.774	1.000033	122.778	0.0000002	121.2113	32
29	0.008436	0.999964	0.008436	118.540	1.000036	118.544	0.0000002	116.9778	31
30	0.008727	0.999962	0.008727	114.589	1.000038	114.593	0.0000002	113.0266	30
31	0.009017	0.999959	0.009018	110.892	1.000041	110.897	0.0000002	109.3303	29
32	0.009308	0.999957	0.009309	107.426	1.000043	107.431	0.0000003	105.8650	28
33	0.009599	0.999954	0.009600	104.171	1.000046	104.176	0.0000003	102.6097	27
34	0.009890	0.999951	0.009891	101.107	1.000049	101.112	0.0000003	99.54600	26
35	0.010181	0.999948	0.010181	98.2179	1.000052	98.2230	0.0000004	96.65733	25
36	0.010472	0.999945	0.010472	95.4895	1.000055	95.4947	0.0000004	93.92915	24
37	0.010763	0.999942	0.010763	92.9085	1.000058	92.9139	0.0000004	91.34845	23
38	0.011054	0.999939	0.011054	90.4633	1.000061	90.4689	0.0000005	88.90359	22
39	0.011344	0.999936	0.011345	88.1436	1.000064	88.1492	0.0000005	86.58412	21
40	0.011635	0.999932	0.011636	85.9398	1.000068	85.9456	0.0000005	84.38063	20
41	0.011926	0.999929	0.011927	83.8435	1.000071	83.8495	0.0000006	82.28464	19
42	0.012217	0.999925	0.012218	81.8470	1.000075	81.8531	0.0000006	80.28846	18
43	0.012508	0.999922	0.012509	79.9434	1.000078	79.9497	0.0000007	78.38514	17
44	0.012799	0.999918	0.012800	78.1263	1.000082	78.1327	0.0000007	76.56834	16
45	0.013090	0.999914	0.013091	76.3900	1.000086	76.3966	0.0000007	74.83230	15
46	0.013380	0.999910	0.013382	74.7292	1.000090	74.7359	0.0000008	73.17175	14
47	0.013671	0.999907	0.013673	73.1390	1.000093	73.1458	0.0000009	71.58187	13
48	0.013962	0.999903	0.013964	71.6151	1.000097	71.6221	0.0000009	70.05824	12
49	0.014253	0.999898	0.014254	70.1533	1.000102	70.1605	0.0000010	68.59680	11
50	0.014544	0.999894	0.014545	68.7501	1.000106	68.7574	0.0000010	67.19384	10
51	0.014835	0.999890	0.014836	67.4019	1.000110	67.4093	0.0000011	65.84589	9
52	0.015126	0.999886	0.015127	66.1055	1.000114	66.1130	0.0000012	64.54980	8
53	0.015416	0.999881	0.015418	64.8580	1.000119	64.8657	0.0000012	63.30263	7
54	0.015707	0.999877	0.015709	63.6567	1.000123	63.6646	0.0000013	62.10165	6
55	0.015998	0.999872	0.016000	62.4992	1.000128	62.5072	0.0000014	60.94436	5
56	0.016289	0.999867	0.016291	61.3829	1.000133	61.3911	0.0000014	59.82840	4
57	0.016580	0.999863	0.016582	60.3058	1.000137	60.3141	0.0000015	58.75160	3
58	0.016871	0.999858	0.016873	59.2659	1.000142	59.2743	0.0000016	57.71195	2
59	0.017162	0.999853	0.017164	58.2612	1.000147	58.2698	0.0000017	56.70754	1
60	0.017452	0.999848	0.017455	57.2900	1.000152	57.2987	0.0000018	55.73662	0
Minutes	Cosine	Sine	Cotangent	Tangent	Cosecant	Secant	Read Down	89°-90° Involute	Minutes

↑ 90° or 270°

89° or 269° ↑

↓ 1° or 181° **Trigonometric and Involute Functions** 178° or 358° ↓

Min-utes	Sine	Cosine	Tangent	Cotangent	Secant	Cosecant	Involute 1°-2°	Read Up	Min-utes
0	0.017452	0.999848	0.017455	57.2900	1.000152	57.2987	0.0000018	55.73662	60
1	0.017743	0.999843	0.017746	56.3506	1.000157	56.3595	0.0000019	54.79754	59
2	0.018034	0.999837	0.018037	55.4415	1.000163	55.4505	0.0000020	53.88876	58
3	0.018325	0.999832	0.018328	54.5613	1.000168	54.5705	0.0000021	53.00883	57
4	0.018616	0.999827	0.018619	53.7086	1.000173	53.7179	0.0000022	52.15641	56
5	0.018907	0.999821	0.018910	52.8821	1.000179	52.8916	0.0000023	51.33022	55
6	0.019197	0.999816	0.019201	52.0807	1.000184	52.0903	0.0000024	50.52907	54
7	0.019488	0.999810	0.019492	51.3032	1.000190	51.3129	0.0000025	49.75185	53
8	0.019779	0.999804	0.019783	50.5485	1.000196	50.5584	0.0000026	48.99749	52
9	0.020070	0.999799	0.020074	49.8157	1.000201	49.8258	0.0000027	48.26500	51
10	0.020361	0.999793	0.020365	49.1039	1.000207	49.1141	0.0000028	47.55345	50
11	0.020652	0.999787	0.020656	48.4121	1.000213	48.4224	0.0000029	46.86194	49
12	0.020942	0.999781	0.020947	47.7395	1.000219	47.7500	0.0000031	46.18965	48
13	0.021233	0.999775	0.021238	47.0853	1.000226	47.0960	0.0000032	45.53578	47
14	0.021524	0.999768	0.021529	46.4489	1.000232	46.4596	0.0000033	44.89959	46
15	0.021815	0.999762	0.021820	45.8294	1.000238	45.8403	0.0000035	44.28037	45
16	0.022106	0.999756	0.022111	45.2261	1.000244	45.2372	0.0000036	43.67745	44
17	0.022397	0.999749	0.022402	44.6386	1.000251	44.6498	0.0000037	43.09020	43
18	0.022687	0.999743	0.022693	44.0661	1.000257	44.0775	0.0000039	42.51801	42
19	0.022978	0.999736	0.022984	43.5081	1.000264	43.5196	0.0000040	41.96031	41
20	0.023269	0.999729	0.023275	42.9641	1.000271	42.9757	0.0000042	41.41655	40
21	0.023560	0.999722	0.023566	42.4335	1.000278	42.4452	0.0000044	40.88623	39
22	0.023851	0.999716	0.023857	41.9158	1.000285	41.9277	0.0000045	40.36885	38
23	0.024141	0.999709	0.024148	41.4106	1.000292	41.4227	0.0000047	39.86393	37
24	0.024432	0.999701	0.024439	40.9174	1.000299	40.9296	0.0000049	39.37105	36
25	0.024723	0.999694	0.024731	40.4358	1.000306	40.4482	0.0000050	38.88977	35
26	0.025014	0.999687	0.025022	39.9655	1.000313	39.9780	0.0000052	38.41968	34
27	0.025305	0.999680	0.025313	39.5059	1.000320	39.5185	0.0000054	37.96041	33
28	0.025595	0.999672	0.025604	39.0568	1.000328	39.0696	0.0000056	37.51157	32
29	0.025886	0.999665	0.025895	38.6177	1.000335	38.6307	0.0000058	37.07283	31
30	0.026177	0.999657	0.026186	38.1885	1.000343	38.2016	0.0000060	36.64384	30
31	0.026468	0.999650	0.026477	37.7686	1.000350	37.7818	0.0000062	36.22429	29
32	0.026759	0.999642	0.026768	37.3579	1.000358	37.3713	0.0000064	35.81386	28
33	0.027049	0.999634	0.027059	36.9560	1.000366	36.9695	0.0000066	35.41226	27
34	0.027340	0.999626	0.027350	36.5627	1.000374	36.5763	0.0000068	35.01921	26
35	0.027631	0.999618	0.027641	36.1776	1.000382	36.1914	0.0000070	34.63443	25
36	0.027922	0.999610	0.027933	35.8006	1.000390	35.8145	0.0000073	34.25768	24
37	0.028212	0.999602	0.028224	35.4313	1.000398	35.4454	0.0000075	33.88870	23
38	0.028503	0.999594	0.028515	35.0695	1.000406	35.0838	0.0000077	33.52726	22
39	0.028794	0.999585	0.028806	34.7151	1.000415	34.7295	0.0000080	33.17312	21
40	0.029085	0.999577	0.029097	34.3678	1.000423	34.3823	0.0000082	32.82606	20
41	0.029375	0.999568	0.029388	34.0273	1.000432	34.0420	0.0000085	32.48589	19
42	0.029666	0.999560	0.029679	33.6935	1.000440	33.7083	0.0000087	32.15238	18
43	0.029957	0.999551	0.029970	33.3662	1.000449	33.3812	0.0000090	31.82536	17
44	0.030248	0.999542	0.030262	33.0452	1.000458	33.0603	0.0000092	31.50463	16
45	0.030539	0.999534	0.030553	32.7303	1.000467	32.7455	0.0000095	31.19001	15
46	0.030829	0.999525	0.030844	32.4213	1.000476	32.4367	0.0000098	30.88133	14
47	0.031120	0.999516	0.031135	32.1181	1.000485	32.1337	0.0000101	30.57843	13
48	0.031411	0.999507	0.031426	31.8205	1.000494	31.8362	0.0000103	30.28114	12
49	0.031702	0.999497	0.031717	31.5284	1.000503	31.5442	0.0000106	29.98930	11
50	0.031992	0.999488	0.032009	31.2416	1.000512	31.2576	0.0000109	29.70278	10
51	0.032283	0.999479	0.032300	30.9599	1.000522	30.9761	0.0000112	29.42142	9
52	0.032574	0.999469	0.032591	30.6833	1.000531	30.6996	0.0000115	29.14509	8
53	0.032864	0.999460	0.032882	30.4116	1.000540	30.4280	0.0000118	28.87365	7
54	0.033155	0.999450	0.033173	30.1446	1.000550	30.1612	0.0000122	28.60698	6
55	0.033446	0.999441	0.033465	29.8823	1.000560	29.8990	0.0000125	28.34495	5
56	0.033737	0.999431	0.033756	29.6245	1.000570	29.6414	0.0000128	28.08745	4
57	0.034027	0.999421	0.034047	29.3711	1.000579	29.3881	0.0000131	27.83434	3
58	0.034318	0.999411	0.034338	29.1220	1.000589	29.1392	0.0000135	27.58553	2
59	0.034609	0.999401	0.034630	28.8771	1.000599	28.8944	0.0000138	27.34091	1
60	0.034899	0.999391	0.034921	28.6363	1.000610	28.6537	0.0000142	27.10036	0
Min-utes	Cosine	Sine	Cotangent	Tangent	Cosecant	Secant	Read Down	88°-89° Involute	Min-utes

↑ 91° or 271°

88° or 268° ↑

↓ 2° or 182° **Trigonometric and Involute Functions** 177° or 357° ↓

Min-utes	Sine	Cosine	Tangent	Cotangent	Secant	Cosecant	Involute 2°-3°	Read Up	Min-utes
0	0.034899	0.999391	0.034921	28.6363	1.000610	28.6537	0.0000142	27.10036	60
1	0.035190	0.999381	0.035212	28.3994	1.000620	28.4170	0.0000145	26.86380	59
2	0.035481	0.999370	0.035503	28.1664	1.000630	28.1842	0.0000149	26.63111	58
3	0.035772	0.999360	0.035795	27.9372	1.000640	27.9551	0.0000153	26.40222	57
4	0.036062	0.999350	0.036086	27.7117	1.000651	27.7298	0.0000157	26.17701	56
5	0.036353	0.999339	0.036377	27.4899	1.000661	27.5080	0.0000160	25.95542	55
6	0.036644	0.999328	0.036668	27.2715	1.000672	27.2898	0.0000164	25.73734	54
7	0.036934	0.999318	0.036960	27.0566	1.000683	27.0750	0.0000168	25.52270	53
8	0.037225	0.999307	0.037251	26.8450	1.000694	26.8636	0.0000172	25.31142	52
9	0.037516	0.999296	0.037542	26.6367	1.000704	26.6555	0.0000176	25.10342	51
10	0.037806	0.999285	0.037834	26.4316	1.000715	26.4505	0.0000180	24.89862	50
11	0.038097	0.999274	0.038125	26.2296	1.000726	26.2487	0.0000185	24.69695	49
12	0.038388	0.999263	0.038416	26.0307	1.000738	26.0499	0.0000189	24.49834	48
13	0.038678	0.999252	0.038707	25.8348	1.000749	25.8542	0.0000193	24.30271	47
14	0.038969	0.999240	0.038999	25.6418	1.000760	25.6613	0.0000198	24.11002	46
15	0.039260	0.999229	0.039290	25.4517	1.000772	25.4713	0.0000202	23.92017	45
16	0.039550	0.999218	0.039581	25.2644	1.000783	25.2841	0.0000207	23.73313	44
17	0.039841	0.999206	0.039873	25.0798	1.000795	25.0997	0.0000211	23.54881	43
18	0.040132	0.999194	0.040164	24.8978	1.000806	24.9179	0.0000216	23.36717	42
19	0.040422	0.999183	0.040456	24.7185	1.000818	24.7387	0.0000220	23.18815	41
20	0.040713	0.999171	0.040747	24.5418	1.000830	24.5621	0.0000225	23.01169	40
21	0.041004	0.999159	0.041038	24.3675	1.000842	24.3880	0.0000230	22.83773	39
22	0.041294	0.999147	0.041330	24.1957	1.000854	24.2164	0.0000235	22.66622	38
23	0.041585	0.999135	0.041621	24.0263	1.000866	24.0471	0.0000240	22.49712	37
24	0.041876	0.999123	0.041912	23.8593	1.000878	23.8802	0.0000245	22.33037	36
25	0.042166	0.999111	0.042204	23.6945	1.000890	23.7156	0.0000250	22.16592	35
26	0.042457	0.999098	0.042495	23.5321	1.000903	23.5533	0.0000256	22.00373	34
27	0.042748	0.999086	0.042787	23.3718	1.000915	23.3932	0.0000261	21.84374	33
28	0.043038	0.999073	0.043078	23.2137	1.000927	23.2352	0.0000266	21.68592	32
29	0.043329	0.999061	0.043370	23.0577	1.000940	23.0794	0.0000272	21.53022	31
30	0.043619	0.999048	0.043661	22.9038	1.000953	22.9256	0.0000277	21.37660	30
31	0.043910	0.999035	0.043952	22.7519	1.000965	22.7739	0.0000283	21.22502	29
32	0.044201	0.999023	0.044244	22.6020	1.000978	22.6241	0.0000288	21.07543	28
33	0.044491	0.999010	0.044535	22.4541	1.000991	22.4764	0.0000294	20.92781	27
34	0.044782	0.998997	0.044827	22.3081	1.001004	22.3305	0.0000300	20.78210	26
35	0.045072	0.998984	0.045118	22.1640	1.001017	22.1865	0.0000306	20.63827	25
36	0.045363	0.998971	0.045410	22.0217	1.001030	22.0444	0.0000312	20.49629	24
37	0.045654	0.998957	0.045701	21.8813	1.001044	21.9041	0.0000318	20.35612	23
38	0.045944	0.998944	0.045993	21.7426	1.001057	21.7656	0.0000324	20.21773	22
39	0.046235	0.998931	0.046284	21.6056	1.001071	21.6288	0.0000330	20.08108	21
40	0.046525	0.998917	0.046576	21.4704	1.001084	21.4937	0.0000336	19.94615	20
41	0.046816	0.998904	0.046867	21.3369	1.001098	21.3603	0.0000343	19.81289	19
42	0.047106	0.998890	0.047159	21.2049	1.001111	21.2285	0.0000349	19.68128	18
43	0.047397	0.998876	0.047450	21.0747	1.001125	21.0984	0.0000356	19.55128	17
44	0.047688	0.998862	0.047742	20.9460	1.001139	20.9698	0.0000362	19.42288	16
45	0.047978	0.998848	0.048033	20.8188	1.001153	20.8428	0.0000369	19.29603	15
46	0.048269	0.998834	0.048325	20.6932	1.001167	20.7174	0.0000376	19.17071	14
47	0.048559	0.998820	0.048617	20.5691	1.001181	20.5934	0.0000382	19.04690	13
48	0.048850	0.998806	0.048908	20.4465	1.001195	20.4709	0.0000389	18.92456	12
49	0.049140	0.998792	0.049200	20.3253	1.001210	20.3499	0.0000396	18.80367	11
50	0.049431	0.998778	0.049491	20.2056	1.001224	20.2303	0.0000403	18.68421	10
51	0.049721	0.998763	0.049783	20.0872	1.001238	20.1121	0.0000411	18.56614	9
52	0.050012	0.998749	0.050075	19.9702	1.001253	19.9952	0.0000418	18.44946	8
53	0.050302	0.998734	0.050366	19.8546	1.001268	19.8798	0.0000425	18.33412	7
54	0.050593	0.998719	0.050658	19.7403	1.001282	19.7656	0.0000433	18.22011	6
55	0.050883	0.998705	0.050949	19.6273	1.001297	19.6528	0.0000440	18.10740	5
56	0.051174	0.998690	0.051241	19.5156	1.001312	19.5412	0.0000448	17.99598	4
57	0.051464	0.998675	0.051533	19.4051	1.001327	19.4309	0.0000455	17.88582	3
58	0.051755	0.998660	0.051824	19.2959	1.001342	19.3218	0.0000463	17.77690	2
59	0.052045	0.998645	0.052116	19.1879	1.001357	19.2140	0.0000471	17.66920	1
60	0.052336	0.998630	0.052408	19.0811	1.001372	19.1073	0.0000479	17.56270	0
Min-utes	Cosine	Sine	Cotangent	Tangent	Cosecant	Secant	Read Down	87°-88° Involute	Min-utes

↑ 92° or 272°

87° or 267° ↑

↓ 3° or 183° **Trigonometric and Involute Functions** 176° or 356° ↓

Min-utes	Sine	Cosine	Tangent	Cotangent	Secant	Cosecant	Involute 3°-4°	Read Up	Min-utes
0	0.052336	0.998630	0.052408	19.0811	1.001372	19.1073	0.0000479	17.56270	60
1	0.052626	0.998614	0.052699	18.9755	1.001388	19.0019	0.0000487	17.45738	59
2	0.052917	0.998599	0.052991	18.8711	1.001403	18.8975	0.0000495	17.35321	58
3	0.053207	0.998583	0.053283	18.7678	1.001419	18.7944	0.0000503	17.25019	57
4	0.053498	0.998568	0.053575	18.6656	1.001434	18.6923	0.0000512	17.14829	56
5	0.053788	0.998552	0.053866	18.5645	1.001450	18.5914	0.0000520	17.04749	55
6	0.054079	0.998537	0.054158	18.4645	1.001465	18.4915	0.0000529	16.94778	54
7	0.054369	0.998521	0.054450	18.3655	1.001481	18.3927	0.0000537	16.84914	53
8	0.054660	0.998505	0.054742	18.2677	1.001497	18.2950	0.0000546	16.75155	52
9	0.054950	0.998489	0.055033	18.1708	1.001513	18.1983	0.0000555	16.65499	51
10	0.055241	0.998473	0.055325	18.0750	1.001529	18.1026	0.0000563	16.55945	50
11	0.055531	0.998457	0.055617	17.9802	1.001545	18.0079	0.0000572	16.46491	49
12	0.055822	0.998441	0.055909	17.8863	1.001562	17.9142	0.0000581	16.37136	48
13	0.056112	0.998424	0.056200	17.7934	1.001578	17.8215	0.0000591	16.27879	47
14	0.056402	0.998408	0.056492	17.7015	1.001594	17.7298	0.0000600	16.18717	46
15	0.056693	0.998392	0.056784	17.6106	1.001611	17.6389	0.0000609	16.09649	45
16	0.056983	0.998375	0.057076	17.5205	1.001628	17.5490	0.0000619	16.00673	44
17	0.057274	0.998359	0.057368	17.4314	1.001644	17.4600	0.0000628	15.91789	43
18	0.057564	0.998342	0.057660	17.3432	1.001661	17.3720	0.0000638	15.82995	42
19	0.057854	0.998325	0.057951	17.2558	1.001678	17.2848	0.0000647	15.74290	41
20	0.058145	0.998308	0.058243	17.1693	1.001695	17.1984	0.0000657	15.65672	40
21	0.058435	0.998291	0.058535	17.0837	1.001712	17.1130	0.0000667	15.57140	39
22	0.058726	0.998274	0.058827	16.9990	1.001729	17.0283	0.0000677	15.48692	38
23	0.059016	0.998257	0.059119	16.9150	1.001746	16.9446	0.0000687	15.40328	37
24	0.059306	0.998240	0.059411	16.8319	1.001763	16.8616	0.0000698	15.32046	36
25	0.059597	0.998223	0.059703	16.7496	1.001781	16.7794	0.0000708	15.23845	35
26	0.059887	0.998205	0.059995	16.6681	1.001798	16.6981	0.0000718	15.15724	34
27	0.060177	0.998188	0.060287	16.5874	1.001816	16.6175	0.0000729	15.07681	33
28	0.060468	0.998170	0.060579	16.5075	1.001833	16.5377	0.0000739	14.99716	32
29	0.060758	0.998153	0.060871	16.4283	1.001851	16.4587	0.0000750	14.91828	31
30	0.061049	0.998135	0.061163	16.3499	1.001869	16.3804	0.0000761	14.84015	30
31	0.061339	0.998117	0.061455	16.2722	1.001887	16.3029	0.0000772	14.76276	29
32	0.061629	0.998099	0.061747	16.1952	1.001905	16.2261	0.0000783	14.68610	28
33	0.061920	0.998081	0.062039	16.1190	1.001923	16.1500	0.0000794	14.61016	27
34	0.062210	0.998063	0.062331	16.0435	1.001941	16.0746	0.0000805	14.53494	26
35	0.062500	0.998045	0.062623	15.9687	1.001959	15.9999	0.0000817	14.46041	25
36	0.062791	0.998027	0.062915	15.8945	1.001977	15.9260	0.0000828	14.38658	24
37	0.063081	0.998008	0.063207	15.8211	1.001996	15.8527	0.0000840	14.31343	23
38	0.063371	0.997990	0.063499	15.7483	1.002014	15.7801	0.0000851	14.24095	22
39	0.063661	0.997972	0.063791	15.6762	1.002033	15.7081	0.0000863	14.16914	21
40	0.063952	0.997953	0.064083	15.6048	1.002051	15.6368	0.0000875	14.09798	20
41	0.064242	0.997934	0.064375	15.5340	1.002070	15.5661	0.0000887	14.02747	19
42	0.064532	0.997916	0.064667	15.4638	1.002089	15.4961	0.0000899	13.95759	18
43	0.064823	0.997897	0.064959	15.3943	1.002108	15.4267	0.0000911	13.88835	17
44	0.065113	0.997878	0.065251	15.3254	1.002127	15.3579	0.0000924	13.81972	16
45	0.065403	0.997859	0.065543	15.2571	1.002146	15.2898	0.0000936	13.75171	15
46	0.065693	0.997840	0.065836	15.1893	1.002165	15.2222	0.0000949	13.68429	14
47	0.065984	0.997821	0.066128	15.1222	1.002184	15.1553	0.0000961	13.61748	13
48	0.066274	0.997801	0.066420	15.0557	1.002203	15.0889	0.0000974	13.55125	12
49	0.066564	0.997782	0.066712	14.9898	1.002222	15.0231	0.0000987	13.48560	11
50	0.066854	0.997763	0.067004	14.9244	1.002242	14.9579	0.0001000	13.42052	10
51	0.067145	0.997743	0.067296	14.8596	1.002262	14.8932	0.0001013	13.35601	9
52	0.067435	0.997724	0.067589	14.7954	1.002282	14.8291	0.0001026	13.29206	8
53	0.067725	0.997704	0.067881	14.7317	1.002301	14.7656	0.0001040	13.22866	7
54	0.068015	0.997684	0.068173	14.6685	1.002321	14.7026	0.0001053	13.16580	6
55	0.068306	0.997664	0.068465	14.6059	1.002341	14.6401	0.0001067	13.10348	5
56	0.068596	0.997645	0.068758	14.5438	1.002361	14.5782	0.0001080	13.04169	4
57	0.068886	0.997625	0.069050	14.4823	1.002381	14.5168	0.0001094	12.98042	3
58	0.069176	0.997604	0.069342	14.4212	1.002401	14.4559	0.0001108	12.91966	2
59	0.069466	0.997584	0.069635	14.3607	1.002422	14.3955	0.0001122	12.85942	1
60	0.069756	0.997564	0.069927	14.3007	1.002442	14.3356	0.0001136	12.79968	0
Min-utes	Cosine	Sine	Cotangent	Tangent	Cosecant	Secant	Read Down	86°-87° Involute	Min-utes

↑ 93° or 273°

86° or 266° ↑

↓ 4° or 184° **Trigonometric and Involute Functions** 175° or 355° ↓

Min-utes	Sine	Cosine	Tangent	Cotangent	Secant	Cosecant	Involute 4°-5°	Read Up	Min-utes
0	0.069756	0.997564	0.069927	14.3007	1.002442	14.3356	0.0001136	12.79968	60
1	0.070047	0.997544	0.070219	14.2411	1.002462	14.2762	0.0001151	12.74044	59
2	0.070337	0.997523	0.070511	14.1821	1.002483	14.2173	0.0001165	12.68169	58
3	0.070627	0.997503	0.070804	14.1235	1.002503	14.1589	0.0001180	12.62343	57
4	0.070917	0.997482	0.071096	14.0655	1.002524	14.1010	0.0001194	12.56564	56
5	0.071207	0.997462	0.071389	14.0079	1.002545	14.0435	0.0001209	12.50833	55
6	0.071497	0.997441	0.071681	13.9507	1.002566	13.9865	0.0001224	12.45148	54
7	0.071788	0.997420	0.071973	13.8940	1.002587	13.9300	0.0001239	12.39510	53
8	0.072078	0.997399	0.072266	13.8378	1.002608	13.8739	0.0001254	12.33917	52
9	0.072368	0.997378	0.072558	13.7821	1.002629	13.8183	0.0001269	12.28369	51
10	0.072658	0.997357	0.072851	13.7267	1.002650	13.7631	0.0001285	12.22866	50
11	0.072948	0.997336	0.073143	13.6719	1.002671	13.7084	0.0001300	12.17407	49
12	0.073238	0.997314	0.073435	13.6174	1.002693	13.6541	0.0001316	12.11992	48
13	0.073528	0.997293	0.073728	13.5634	1.002714	13.6002	0.0001332	12.06619	47
14	0.073818	0.997272	0.074020	13.5098	1.002736	13.5468	0.0001347	12.01289	46
15	0.074108	0.997250	0.074313	13.4566	1.002757	13.4937	0.0001363	11.96001	45
16	0.074399	0.997229	0.074605	13.4039	1.002779	13.4411	0.0001380	11.90754	44
17	0.074689	0.997207	0.074898	13.3515	1.002801	13.3889	0.0001396	11.85548	43
18	0.074979	0.997185	0.075190	13.2996	1.002823	13.3371	0.0001412	11.80383	42
19	0.075269	0.997163	0.075483	13.2480	1.002845	13.2857	0.0001429	11.75257	41
20	0.075559	0.997141	0.075775	13.1969	1.002867	13.2347	0.0001445	11.70172	40
21	0.075849	0.997119	0.076068	13.1461	1.002889	13.1841	0.0001462	11.65125	39
22	0.076139	0.997097	0.076361	13.0958	1.002911	13.1339	0.0001479	11.60117	38
23	0.076429	0.997075	0.076653	13.0458	1.002934	13.0840	0.0001496	11.55148	37
24	0.076719	0.997053	0.076946	12.9962	1.002956	13.0346	0.0001513	11.50216	36
25	0.077009	0.997030	0.077238	12.9469	1.002978	12.9855	0.0001530	11.45321	35
26	0.077299	0.997008	0.077531	12.8981	1.003001	12.9368	0.0001548	11.40464	34
27	0.077589	0.996985	0.077824	12.8496	1.003024	12.8884	0.0001565	11.35643	33
28	0.077879	0.996963	0.078116	12.8014	1.003046	12.8404	0.0001583	11.30858	32
29	0.078169	0.996940	0.078409	12.7536	1.003069	12.7928	0.0001601	11.26109	31
30	0.078459	0.996917	0.078702	12.7062	1.003092	12.7455	0.0001619	11.21395	30
31	0.078749	0.996894	0.078994	12.6591	1.003115	12.6986	0.0001637	11.16716	29
32	0.079039	0.996872	0.079287	12.6124	1.003138	12.6520	0.0001655	11.12072	28
33	0.079329	0.996848	0.079580	12.5660	1.003161	12.6057	0.0001674	11.07461	27
34	0.079619	0.996825	0.079873	12.5199	1.003185	12.5598	0.0001692	11.02885	26
35	0.079909	0.996802	0.080165	12.4742	1.003208	12.5142	0.0001711	10.98342	25
36	0.080199	0.996779	0.080458	12.4288	1.003232	12.4690	0.0001729	10.93832	24
37	0.080489	0.996756	0.080751	12.3838	1.003255	12.4241	0.0001748	10.89355	23
38	0.080779	0.996732	0.081044	12.3390	1.003279	12.3795	0.0001767	10.84910	22
39	0.081069	0.996709	0.081336	12.2946	1.003302	12.3352	0.0001787	10.80497	21
40	0.081359	0.996685	0.081629	12.2505	1.003326	12.2913	0.0001806	10.76116	20
41	0.081649	0.996661	0.081922	12.2067	1.003350	12.2476	0.0001825	10.71766	19
42	0.081939	0.996637	0.082215	12.1632	1.003374	12.2043	0.0001845	10.67447	18
43	0.082228	0.996614	0.082508	12.1201	1.003398	12.1612	0.0001865	10.63159	17
44	0.082518	0.996590	0.082801	12.0772	1.003422	12.1185	0.0001885	10.58901	16
45	0.082808	0.996566	0.083094	12.0346	1.003446	12.0761	0.0001905	10.54673	15
46	0.083098	0.996541	0.083386	11.9923	1.003471	12.0340	0.0001925	10.50475	14
47	0.083388	0.996517	0.083679	11.9504	1.003495	11.9921	0.0001945	10.46306	13
48	0.083678	0.996493	0.083972	11.9087	1.003519	11.9506	0.0001965	10.42166	12
49	0.083968	0.996468	0.084265	11.8673	1.003544	11.9093	0.0001986	10.38055	11
50	0.084258	0.996444	0.084558	11.8262	1.003569	11.8684	0.0002007	10.33973	10
51	0.084547	0.996419	0.084851	11.7853	1.003593	11.8277	0.0002028	10.29919	9
52	0.084837	0.996395	0.085144	11.7448	1.003618	11.7873	0.0002049	10.25892	8
53	0.085127	0.996370	0.085437	11.7045	1.003643	11.7471	0.0002070	10.21893	7
54	0.085417	0.996345	0.085730	11.6645	1.003668	11.7073	0.0002091	10.17922	6
55	0.085707	0.996320	0.086023	11.6248	1.003693	11.6677	0.0002113	10.13978	5
56	0.085997	0.996295	0.086316	11.5853	1.003718	11.6284	0.0002134	10.10060	4
57	0.086286	0.996270	0.086609	11.5461	1.003744	11.5893	0.0002156	10.06169	3
58	0.086576	0.996245	0.086902	11.5072	1.003769	11.5505	0.0002178	10.02304	2
59	0.086866	0.996220	0.087196	11.4685	1.003794	11.5120	0.0002200	9.9846536	1
60	0.087156	0.996195	0.087489	11.4301	1.003820	11.4737	0.0002222	9.9465224	0
Min-utes	Cosine	Sine	Cotangent	Tangent	Cosecant	Secant	Read Down	85°-86° Involute	Min-utes

↑ 94° or 274°

85° or 265° ↑

↓ 5° or 185° **Trigonometric and Involute Functions** 174° or 354° ↓

Min-utes	Sine	Cosine	Tangent	Cotangent	Secant	Cosecant	Involute 5°-6°	Read Up	Min-utes
0	0.087156	0.996195	0.087489	11.4301	1.003820	11.4737	0.0002222	9.9465224	60
1	0.087446	0.996169	0.087782	11.3919	1.003845	11.4357	0.0002244	9.9086459	59
2	0.087735	0.996144	0.088075	11.3540	1.003871	11.3979	0.0002267	9.8710215	58
3	0.088025	0.996118	0.088368	11.3163	1.003897	11.3604	0.0002289	9.8336468	57
4	0.088315	0.996093	0.088661	11.2789	1.003923	11.3231	0.0002312	9.7965192	56
5	0.088605	0.996067	0.088954	11.2417	1.003949	11.2861	0.0002335	9.7596363	55
6	0.088894	0.996041	0.089248	11.2048	1.003975	11.2493	0.0002358	9.7229958	54
7	0.089184	0.996015	0.089541	11.1681	1.004001	11.2128	0.0002382	9.6865952	53
8	0.089474	0.995989	0.089834	11.1316	1.004027	11.1765	0.0002405	9.6504322	52
9	0.089763	0.995963	0.090127	11.0954	1.004053	11.1404	0.0002429	9.6145046	51
10	0.090053	0.995937	0.090421	11.0594	1.004080	11.1045	0.0002452	9.5788100	50
11	0.090343	0.995911	0.090714	11.0237	1.004106	11.0689	0.0002476	9.5433462	49
12	0.090633	0.995884	0.091007	10.9882	1.004133	11.0336	0.0002500	9.5081109	48
13	0.090922	0.995858	0.091300	10.9529	1.004159	10.9984	0.0002524	9.4731021	47
14	0.091212	0.995832	0.091594	10.9178	1.004186	10.9635	0.0002549	9.4383174	46
15	0.091502	0.995805	0.091887	10.8829	1.004213	10.9288	0.0002573	9.4037549	45
16	0.091791	0.995778	0.092180	10.8483	1.004240	10.8943	0.0002598	9.3694123	44
17	0.092081	0.995752	0.092474	10.8139	1.004267	10.8600	0.0002622	9.3352876	43
18	0.092371	0.995725	0.092767	10.7797	1.004294	10.8260	0.0002647	9.3013788	42
19	0.092660	0.995698	0.093061	10.7457	1.004321	10.7921	0.0002673	9.2676838	41
20	0.092950	0.995671	0.093354	10.7119	1.004348	10.7585	0.0002698	9.2342005	40
21	0.093239	0.995644	0.093647	10.6783	1.004375	10.7251	0.0002723	9.2009271	39
22	0.093529	0.995617	0.093941	10.6450	1.004403	10.6919	0.0002749	9.1678616	38
23	0.093819	0.995589	0.094234	10.6118	1.004430	10.6589	0.0002775	9.1350020	37
24	0.094108	0.995562	0.094528	10.5789	1.004458	10.6261	0.0002801	9.1023464	36
25	0.094398	0.995535	0.094821	10.5462	1.004485	10.5935	0.0002827	9.0698930	35
26	0.094687	0.995507	0.095115	10.5136	1.004513	10.5611	0.0002853	9.0376399	34
27	0.094977	0.995479	0.095408	10.4813	1.004541	10.5289	0.0002879	9.0055852	33
28	0.095267	0.995452	0.095702	10.4491	1.004569	10.4969	0.0002906	8.9737272	32
29	0.095556	0.995424	0.095995	10.4172	1.004597	10.4650	0.0002933	8.9420640	31
30	0.095846	0.995396	0.096289	10.3854	1.004625	10.4334	0.0002959	8.9105939	30
31	0.096135	0.995368	0.096583	10.3538	1.004653	10.4020	0.0002986	8.8793151	29
32	0.096425	0.995340	0.096876	10.3224	1.004682	10.3708	0.0003014	8.8482258	28
33	0.096714	0.995312	0.097170	10.2913	1.004710	10.3397	0.0003041	8.8173245	27
34	0.097004	0.995284	0.097464	10.2602	1.004738	10.3089	0.0003069	8.7866094	26
35	0.097293	0.995256	0.097757	10.2294	1.004767	10.2782	0.0003096	8.7560788	25
36	0.097583	0.995227	0.098051	10.1988	1.004795	10.2477	0.0003124	8.7257311	24
37	0.097872	0.995199	0.098345	10.1683	1.004824	10.2174	0.0003152	8.6955646	23
38	0.098162	0.995170	0.098638	10.1381	1.004853	10.1873	0.0003180	8.6655778	22
39	0.098451	0.995142	0.098932	10.1080	1.004882	10.1573	0.0003209	8.6357690	21
40	0.098741	0.995113	0.099226	10.0780	1.004911	10.1275	0.0003237	8.6061367	20
41	0.099030	0.995084	0.099519	10.0483	1.004940	10.0979	0.0003266	8.5766794	19
42	0.099320	0.995056	0.099813	10.0187	1.004969	10.0685	0.0003295	8.5473954	18
43	0.099609	0.995027	0.100107	9.989305	1.004998	10.0392	0.0003324	8.5182834	17
44	0.099899	0.994998	0.100401	9.960072	1.005028	10.0101	0.0003353	8.4893417	16
45	0.100188	0.994969	0.100695	9.931009	1.005057	9.981229	0.0003383	8.4605689	15
46	0.100477	0.994939	0.100989	9.902113	1.005086	9.952479	0.0003412	8.4319635	14
47	0.100767	0.994910	0.101282	9.873382	1.005116	9.923894	0.0003442	8.4035241	13
48	0.101056	0.994881	0.101576	9.844817	1.005146	9.895474	0.0003472	8.3752493	12
49	0.101346	0.994851	0.101870	9.816414	1.005175	9.867218	0.0003502	8.3471377	11
50	0.101635	0.994822	0.102164	9.788173	1.005205	9.839123	0.0003532	8.3191877	10
51	0.101924	0.994792	0.102458	9.760093	1.005235	9.811188	0.0003563	8.2913982	9
52	0.102214	0.994763	0.102752	9.732171	1.005265	9.783412	0.0003593	8.2637676	8
53	0.102503	0.994733	0.103046	9.704407	1.005295	9.755794	0.0003624	8.2362947	7
54	0.102793	0.994703	0.103340	9.676800	1.005325	9.728333	0.0003655	8.2089781	6
55	0.103082	0.994673	0.103634	9.649347	1.005356	9.701026	0.0003686	8.1818164	5
56	0.103371	0.994643	0.103928	9.622049	1.005386	9.673873	0.0003718	8.1548085	4
57	0.103661	0.994613	0.104222	9.594902	1.005416	9.646872	0.0003749	8.1279529	3
58	0.103950	0.994583	0.104516	9.567907	1.005447	9.620023	0.0003781	8.1012485	2
59	0.104239	0.994552	0.104810	9.541061	1.005478	9.593323	0.0003813	8.0746939	1
60	0.104528	0.994522	0.105104	9.514364	1.005508	9.566772	0.0003845	8.0482879	0
Min-utes	Cosine	Sine	Cotangent	Tangent	Cosecant	Secant	Read Down	84°-85° Involute	Min-utes

↑ 95° or 275°

84° or 264° ↑

↓ 6° or 186° **Trigonometric and Involute Functions** 173° or 353° ↓

Min-utes	Sine	Cosine	Tangent	Cotangent	Secant	Cosecant	Involute 6°-7°	Read Up	Min-utes
0	0.104528	0.994522	0.105104	9.514364	1.005508	9.566772	0.0003845	8.0482879	60
1	0.104818	0.994491	0.105398	9.487815	1.005539	9.540369	0.0003877	8.0220292	59
2	0.105107	0.994461	0.105692	9.461412	1.005570	9.514111	0.0003909	7.9959168	58
3	0.105396	0.994430	0.105987	9.435153	1.005601	9.487998	0.0003942	7.9699492	57
4	0.105686	0.994400	0.106281	9.409038	1.005632	9.462030	0.0003975	7.9441254	56
5	0.105975	0.994369	0.106575	9.383066	1.005663	9.436203	0.0004008	7.9184441	55
6	0.106264	0.994338	0.106869	9.357236	1.005694	9.410518	0.0004041	7.8929043	54
7	0.106553	0.994307	0.107163	9.331545	1.005726	9.384974	0.0004074	7.8675047	53
8	0.106843	0.994276	0.107458	9.305994	1.005757	9.359568	0.0004108	7.8422441	52
9	0.107132	0.994245	0.107752	9.280580	1.005788	9.334301	0.0004141	7.8171216	51
10	0.107421	0.994214	0.108046	9.255304	1.005820	9.309170	0.0004175	7.7921359	50
11	0.107710	0.994182	0.108340	9.230163	1.005852	9.284175	0.0004209	7.7672859	49
12	0.107999	0.994151	0.108635	9.205156	1.005883	9.259314	0.0004244	7.7425705	48
13	0.108289	0.994120	0.108929	9.180284	1.005915	9.234588	0.0004278	7.7179887	47
14	0.108578	0.994088	0.109223	9.155544	1.005947	9.209993	0.0004313	7.6935394	46
15	0.108867	0.994056	0.109518	9.130935	1.005979	9.185531	0.0004347	7.6692216	45
16	0.109156	0.994025	0.109812	9.106456	1.006011	9.161198	0.0004382	7.6450341	44
17	0.109445	0.993993	0.110107	9.082107	1.006043	9.136995	0.0004417	7.6209759	43
18	0.109734	0.993961	0.110401	9.057887	1.006076	9.112920	0.0004453	7.5970461	42
19	0.110023	0.993929	0.110695	9.033793	1.006108	9.088972	0.0004488	7.5732436	41
20	0.110313	0.993897	0.110990	9.009826	1.006141	9.065151	0.0004524	7.5495673	40
21	0.110602	0.993865	0.111284	8.985984	1.006173	9.041455	0.0004560	7.5260164	39
22	0.110891	0.993833	0.111579	8.962267	1.006206	9.017884	0.0004596	7.5025898	38
23	0.111180	0.993800	0.111873	8.938673	1.006238	8.994435	0.0004632	7.4792865	37
24	0.111469	0.993768	0.112168	8.915201	1.006271	8.971110	0.0004669	7.4561056	36
25	0.111758	0.993735	0.112463	8.891850	1.006304	8.947905	0.0004706	7.4330461	35
26	0.112047	0.993703	0.112757	8.868621	1.006337	8.924821	0.0004743	7.4101071	34
27	0.112336	0.993670	0.113052	8.845510	1.006370	8.901857	0.0004780	7.3872877	33
28	0.112625	0.993638	0.113346	8.822519	1.006403	8.879011	0.0004817	7.3645869	32
29	0.112914	0.993605	0.113641	8.799645	1.006436	8.856283	0.0004854	7.3420037	31
30	0.113203	0.993572	0.113936	8.776887	1.006470	8.833671	0.0004892	7.3195374	30
31	0.113492	0.993539	0.114230	8.754246	1.006503	8.811176	0.0004930	7.2971870	29
32	0.113781	0.993506	0.114525	8.731720	1.006537	8.788796	0.0004968	7.2749516	28
33	0.114070	0.993473	0.114820	8.709308	1.006570	8.766530	0.0005006	7.2528304	27
34	0.114359	0.993439	0.115114	8.687009	1.006604	8.744377	0.0005045	7.2308224	26
35	0.114648	0.993406	0.115409	8.664822	1.006638	8.722336	0.0005083	7.2089269	25
36	0.114937	0.993373	0.115704	8.642747	1.006671	8.700407	0.0005122	7.1871429	24
37	0.115226	0.993339	0.115999	8.620783	1.006705	8.678589	0.0005161	7.1654696	23
38	0.115515	0.993306	0.116294	8.598929	1.006739	8.656881	0.0005200	7.1439062	22
39	0.115804	0.993272	0.116588	8.577184	1.006773	8.635281	0.0005240	7.1224518	21
40	0.116093	0.993238	0.116883	8.555547	1.006808	8.613790	0.0005280	7.1011057	20
41	0.116382	0.993205	0.117178	8.534017	1.006842	8.592407	0.0005319	7.0798671	19
42	0.116671	0.993171	0.117473	8.512594	1.006876	8.571130	0.0005359	7.0587350	18
43	0.116960	0.993137	0.117768	8.491277	1.006911	8.549958	0.0005400	7.0377088	17
44	0.117249	0.993103	0.118063	8.470065	1.006945	8.528892	0.0005440	7.0167876	16
45	0.117537	0.993068	0.118358	8.448957	1.006980	8.507930	0.0005481	6.9959707	15
46	0.117826	0.993034	0.118653	8.427953	1.007015	8.487072	0.0005522	6.9752573	14
47	0.118115	0.993000	0.118948	8.407052	1.007049	8.466316	0.0005563	6.9546467	13
48	0.118404	0.992966	0.119243	8.386252	1.007084	8.445663	0.0005604	6.9341380	12
49	0.118693	0.992931	0.119538	8.365554	1.007119	8.425111	0.0005645	6.9137305	11
50	0.118982	0.992896	0.119833	8.344956	1.007154	8.404659	0.0005687	6.8934236	10
51	0.119270	0.992862	0.120128	8.324458	1.007190	8.384306	0.0005729	6.8732164	9
52	0.119559	0.992827	0.120423	8.304059	1.007225	8.364053	0.0005771	6.8531082	8
53	0.119848	0.992792	0.120718	8.283758	1.007260	8.343899	0.0005813	6.8330984	7
54	0.120137	0.992757	0.121013	8.263555	1.007295	8.323841	0.0005856	6.8131861	6
55	0.120426	0.992722	0.121308	8.243448	1.007331	8.303881	0.0005898	6.7933708	5
56	0.120714	0.992687	0.121604	8.223438	1.007367	8.284017	0.0005941	6.7736516	4
57	0.121003	0.992652	0.121899	8.203524	1.007402	8.264249	0.0005985	6.7540279	3
58	0.121292	0.992617	0.122194	8.183704	1.007438	8.244575	0.0006028	6.7344991	2
59	0.121581	0.992582	0.122489	8.163979	1.007474	8.224995	0.0006071	6.7150644	1
60	0.121869	0.992546	0.122785	8.144346	1.007510	8.205509	0.0006115	6.6957231	0
Min-utes	Cosine	Sine	Cotangent	Tangent	Cosecant	Secant	Read Down	83°-84° Involute	Min-utes

↑ 96° or 276°

83° or 263° ↑

↓ 7° or 187° **Trigonometric and Involute Functions** 172° or 352° ↓

Min-utes	Sine	Cosine	Tangent	Cotangent	Secant	Cosecant	Involute 7°-8°	Read Up	Min-utes
0	0.121869	0.992546	0.122785	8.144346	1.007510	8.205509	0.0006115	6.6957231	60
1	0.122158	0.992511	0.123080	8.124807	1.007546	8.186116	0.0006159	6.6764747	59
2	0.122447	0.992475	0.123375	8.105360	1.007582	8.166815	0.0006203	6.6573184	58
3	0.122735	0.992439	0.123670	8.086004	1.007618	8.147605	0.0006248	6.6382536	57
4	0.123024	0.992404	0.123966	8.066739	1.007654	8.128486	0.0006292	6.6192796	56
5	0.123313	0.992368	0.124261	8.047565	1.007691	8.109457	0.0006337	6.6003959	55
6	0.123601	0.992332	0.124557	8.028480	1.007727	8.090518	0.0006382	6.5816017	54
7	0.123890	0.992296	0.124852	8.009483	1.007764	8.071668	0.0006427	6.5628964	53
8	0.124179	0.992260	0.125147	7.990576	1.007801	8.052906	0.0006473	6.5442795	52
9	0.124467	0.992224	0.125443	7.971755	1.007837	8.034232	0.0006518	6.5257502	51
10	0.124756	0.992187	0.125738	7.953022	1.007874	8.015645	0.0006564	6.5073080	50
11	0.125045	0.992151	0.126034	7.934376	1.007911	7.997144	0.0006610	6.4889523	49
12	0.125333	0.992115	0.126329	7.915815	1.007948	7.978730	0.0006657	6.4706825	48
13	0.125622	0.992078	0.126625	7.897340	1.007985	7.960400	0.0006703	6.4524979	47
14	0.125910	0.992042	0.126920	7.878949	1.008022	7.942156	0.0006750	6.4343981	46
15	0.126199	0.992005	0.127216	7.860642	1.008059	7.923995	0.0006797	6.4163823	45
16	0.126488	0.991968	0.127512	7.842419	1.008097	7.905918	0.0006844	6.3984501	44
17	0.126776	0.991931	0.127807	7.824279	1.008134	7.887924	0.0006892	6.3806008	43
18	0.127065	0.991894	0.128103	7.806221	1.008172	7.870012	0.0006939	6.3628339	42
19	0.127353	0.991857	0.128399	7.788245	1.008209	7.852182	0.0006987	6.3451489	41
20	0.127642	0.991820	0.128694	7.770351	1.008247	7.834433	0.0007035	6.3275451	40
21	0.127930	0.991783	0.128990	7.752537	1.008285	7.816766	0.0007083	6.3100220	39
22	0.128219	0.991746	0.129286	7.734803	1.008323	7.799178	0.0007132	6.2925791	38
23	0.128507	0.991709	0.129582	7.717149	1.008361	7.781670	0.0007181	6.2752158	37
24	0.128796	0.991671	0.129877	7.699574	1.008399	7.764241	0.0007230	6.2579315	36
25	0.129084	0.991634	0.130173	7.682077	1.008437	7.746890	0.0007279	6.2407259	35
26	0.129373	0.991596	0.130469	7.664658	1.008475	7.729618	0.0007328	6.2235982	34
27	0.129661	0.991558	0.130765	7.647317	1.008513	7.712423	0.0007378	6.2065481	33
28	0.129949	0.991521	0.131061	7.630053	1.008552	7.695305	0.0007428	6.1895749	32
29	0.130238	0.991483	0.131357	7.612866	1.008590	7.678263	0.0007478	6.1726782	31
30	0.130526	0.991445	0.131652	7.595754	1.008629	7.661298	0.0007528	6.1558575	30
31	0.130815	0.991407	0.131948	7.578718	1.008668	7.644407	0.0007579	6.1391122	29
32	0.131103	0.991369	0.132244	7.561757	1.008706	7.627592	0.0007629	6.1224418	28
33	0.131391	0.991331	0.132540	7.544870	1.008745	7.610852	0.0007680	6.1058460	27
34	0.131680	0.991292	0.132836	7.528057	1.008784	7.594185	0.0007732	6.0893240	26
35	0.131968	0.991254	0.133132	7.511318	1.008823	7.577592	0.0007783	6.0728756	25
36	0.132256	0.991216	0.133428	7.494651	1.008862	7.561071	0.0007835	6.0565001	24
37	0.132545	0.991177	0.133725	7.478058	1.008902	7.544624	0.0007887	6.0401971	23
38	0.132833	0.991138	0.134021	7.461536	1.008941	7.528248	0.0007939	6.0239662	22
39	0.133121	0.991100	0.134317	7.445086	1.008980	7.511944	0.0007991	6.0078069	21
40	0.133410	0.991061	0.134613	7.428706	1.009020	7.495711	0.0008044	5.9917186	20
41	0.133698	0.991022	0.134909	7.412398	1.009059	7.479548	0.0008096	5.9757010	19
42	0.133986	0.990983	0.135205	7.396160	1.009099	7.463456	0.0008150	5.9597535	18
43	0.134274	0.990944	0.135502	7.379991	1.009139	7.447433	0.0008203	5.9438758	17
44	0.134563	0.990905	0.135798	7.363892	1.009178	7.431480	0.0008256	5.9280674	16
45	0.134851	0.990866	0.136094	7.347861	1.009218	7.415596	0.0008310	5.9123277	15
46	0.135139	0.990827	0.136390	7.331899	1.009258	7.399780	0.0008364	5.8966565	14
47	0.135427	0.990787	0.136687	7.316005	1.009298	7.384032	0.0008418	5.8810532	13
48	0.135716	0.990748	0.136983	7.300178	1.009339	7.368351	0.0008473	5.8655174	12
49	0.136004	0.990708	0.137279	7.284418	1.009379	7.352738	0.0008527	5.8500487	11
50	0.136292	0.990669	0.137576	7.268725	1.009419	7.337191	0.0008582	5.8346466	10
51	0.136580	0.990629	0.137872	7.253099	1.009460	7.321710	0.0008638	5.8193107	9
52	0.136868	0.990589	0.138169	7.237538	1.009500	7.306295	0.0008693	5.8040407	8
53	0.137156	0.990549	0.138465	7.222042	1.009541	7.290946	0.0008749	5.7888360	7
54	0.137445	0.990509	0.138761	7.206612	1.009581	7.275662	0.0008805	5.7736963	6
55	0.137733	0.990469	0.139058	7.191246	1.009622	7.260442	0.0008861	5.7586212	5
56	0.138021	0.990429	0.139354	7.175944	1.009663	7.245286	0.0008917	5.7436102	4
57	0.138309	0.990389	0.139651	7.160706	1.009704	7.230194	0.0008974	5.7286629	3
58	0.138597	0.990349	0.139948	7.145531	1.009745	7.215165	0.0009031	5.7137791	2
59	0.138885	0.990309	0.140244	7.130419	1.009786	7.200200	0.0009088	5.6989581	1
60	0.139173	0.990268	0.140541	7.115370	1.009828	7.185297	0.0009145	5.6841997	0
Min-utes	Cosine	Sine	Cotangent	Tangent	Cosecant	Secant	Read Down	82°-83° Involute	Min-utes

↑ 97° or 277°

82° or 262° ↑

↓ 8° or 188° Trigonometric and Involute Functions 171° or 351° ↓

Min-utes	Sine	Cosine	Tangent	Cotangent	Secant	Cosecant	Involute 8°-9°	Read Up	Min-utes
0	0.139173	0.990268	0.140541	7.115370	1.009828	7.185297	0.0009145	5.6841997	60
1	0.139461	0.990228	0.140837	7.100383	1.009869	7.170456	0.0009203	5.6695035	59
2	0.139749	0.990187	0.141134	7.085457	1.009910	7.155676	0.0009260	5.6548691	58
3	0.140037	0.990146	0.141431	7.070593	1.009952	7.140959	0.0009318	5.6402961	57
4	0.140325	0.990105	0.141728	7.055790	1.009993	7.126302	0.0009377	5.6257841	56
5	0.140613	0.990065	0.142024	7.041048	1.010035	7.111706	0.0009435	5.6113327	55
6	0.140901	0.990024	0.142321	7.026366	1.010077	7.097170	0.0009494	5.5969416	54
7	0.141189	0.989983	0.142618	7.011744	1.010119	7.082694	0.0009553	5.5826104	53
8	0.141477	0.989942	0.142915	6.997182	1.010161	7.068278	0.0009612	5.5683387	52
9	0.141765	0.989900	0.143212	6.982678	1.010203	7.053920	0.0009672	5.5541261	51
10	0.142053	0.989859	0.143508	6.968234	1.010245	7.039622	0.0009732	5.5399724	50
11	0.142341	0.989818	0.143805	6.953847	1.010287	7.025382	0.0009792	5.5258771	49
12	0.142629	0.989776	0.144102	6.939519	1.010329	7.011200	0.0009852	5.5118399	48
13	0.142917	0.989735	0.144399	6.925249	1.010372	6.997076	0.0009913	5.4978604	47
14	0.143205	0.989693	0.144696	6.911036	1.010414	6.983009	0.0009973	5.4839383	46
15	0.143493	0.989651	0.144993	6.896880	1.010457	6.968999	0.0010034	5.4700733	45
16	0.143780	0.989610	0.145290	6.882781	1.010499	6.955046	0.0010096	5.4562649	44
17	0.144068	0.989568	0.145587	6.868738	1.010542	6.941150	0.0010157	5.4425129	43
18	0.144356	0.989526	0.145884	6.854751	1.010585	6.927309	0.0010219	5.4288168	42
19	0.144644	0.989484	0.146181	6.840820	1.010628	6.913524	0.0010281	5.4151765	41
20	0.144932	0.989442	0.146478	6.826944	1.010671	6.899794	0.0010343	5.4015914	40
21	0.145220	0.989399	0.146776	6.813123	1.010714	6.886119	0.0010406	5.3880614	39
22	0.145507	0.989357	0.147073	6.799357	1.010757	6.872499	0.0010469	5.3745861	38
23	0.145795	0.989315	0.147370	6.785645	1.010801	6.858934	0.0010532	5.3611651	37
24	0.146083	0.989272	0.147667	6.771987	1.010844	6.845422	0.0010595	5.3477981	36
25	0.146371	0.989230	0.147964	6.758383	1.010887	6.831964	0.0010659	5.3344848	35
26	0.146659	0.989187	0.148262	6.744832	1.010931	6.818560	0.0010722	5.3212249	34
27	0.146946	0.989144	0.148559	6.731334	1.010975	6.805208	0.0010786	5.3080181	33
28	0.147234	0.989102	0.148856	6.717889	1.011018	6.791909	0.0010851	5.2948640	32
29	0.147522	0.989059	0.149154	6.704497	1.011062	6.778663	0.0010915	5.2817624	31
30	0.147809	0.989016	0.149451	6.691156	1.011106	6.765469	0.0010980	5.2687129	30
31	0.148097	0.988973	0.149748	6.677868	1.011150	6.752327	0.0011045	5.2557152	29
32	0.148385	0.988930	0.150046	6.664631	1.011194	6.739236	0.0011111	5.2427691	28
33	0.148672	0.988886	0.150343	6.651445	1.011238	6.726196	0.0011176	5.2298742	27
34	0.148960	0.988843	0.150641	6.638310	1.011283	6.713208	0.0011242	5.2170302	26
35	0.149248	0.988800	0.150938	6.625226	1.011327	6.700270	0.0011308	5.2042369	25
36	0.149535	0.988756	0.151236	6.612192	1.011371	6.687382	0.0011375	5.1914939	24
37	0.149823	0.988713	0.151533	6.599208	1.011416	6.674545	0.0011441	5.1788009	23
38	0.150111	0.988669	0.151831	6.586274	1.011461	6.661757	0.0011508	5.1661577	22
39	0.150398	0.988626	0.152129	6.573389	1.011505	6.649018	0.0011575	5.1535639	21
40	0.150686	0.988582	0.152426	6.560554	1.011550	6.636329	0.0011643	5.1410193	20
41	0.150973	0.988538	0.152724	6.547767	1.011595	6.623689	0.0011711	5.1285236	19
42	0.151261	0.988494	0.153022	6.535029	1.011640	6.611097	0.0011779	5.1160766	18
43	0.151548	0.988450	0.153319	6.522340	1.011685	6.598554	0.0011847	5.1036779	17
44	0.151836	0.988406	0.153617	6.509698	1.011730	6.586059	0.0011915	5.0913272	16
45	0.152123	0.988362	0.153915	6.497105	1.011776	6.573611	0.0011984	5.0790243	15
46	0.152411	0.988317	0.154213	6.484558	1.011821	6.561211	0.0012053	5.0667689	14
47	0.152698	0.988273	0.154510	6.472059	1.011866	6.548859	0.0012122	5.0545608	13
48	0.152986	0.988228	0.154808	6.459607	1.011912	6.536553	0.0012192	5.0423997	12
49	0.153273	0.988184	0.155106	6.447202	1.011957	6.524294	0.0012262	5.0302852	11
50	0.153561	0.988139	0.155404	6.434843	1.012003	6.512081	0.0012332	5.0182172	10
51	0.153848	0.988094	0.155702	6.422530	1.012049	6.499915	0.0012402	5.0061954	9
52	0.154136	0.988050	0.156000	6.410263	1.012095	6.487794	0.0012473	4.9942195	8
53	0.154423	0.988005	0.156298	6.398042	1.012141	6.475720	0.0012544	4.9822893	7
54	0.154710	0.987960	0.156596	6.385866	1.012187	6.463690	0.0012615	4.9704044	6
55	0.154998	0.987915	0.156894	6.373736	1.012233	6.451706	0.0012687	4.9585647	5
56	0.155285	0.987870	0.157192	6.361650	1.012279	6.439767	0.0012758	4.9467700	4
57	0.155572	0.987824	0.157490	6.349609	1.012326	6.427872	0.0012830	4.9350198	3
58	0.155860	0.987779	0.157788	6.337613	1.012372	6.416022	0.0012903	4.9233141	2
59	0.156147	0.987734	0.158086	6.325660	1.012419	6.404215	0.0012975	4.9116525	1
60	0.156434	0.987688	0.158384	6.313752	1.012465	6.392453	0.0013048	4.9000348	0
Min-utes	Cosine	Sine	Cotangent	Tangent	Cosecant	Secant	Read Down	81°-82° Involute	Min-utes

↑ 98° or 278°

81° or 261° ↑

↓ 9° or 189° **Trigonometric and Involute Functions** 170° or 350° ↓

Min-utes	Sine	Cosine	Tangent	Cotangent	Secant	Cosecant	Involute 9°-10°	Read Up	Min-utes
0	0.156434	0.987688	0.158384	6.313752	1.012465	6.392453	0.0013048	4.9000348	60
1	0.156722	0.987643	0.158683	6.301887	1.012512	6.380735	0.0013121	4.8884608	59
2	0.157009	0.987597	0.158981	6.290065	1.012559	6.369060	0.0013195	4.8769302	58
3	0.157296	0.987551	0.159279	6.278287	1.012605	6.357428	0.0013268	4.8654428	57
4	0.157584	0.987506	0.159577	6.266551	1.012652	6.345839	0.0013342	4.8539983	56
5	0.157871	0.987460	0.159876	6.254859	1.012699	6.334292	0.0013416	4.8425965	55
6	0.158158	0.987414	0.160174	6.243209	1.012747	6.322788	0.0013491	4.8312372	54
7	0.158445	0.987368	0.160472	6.231601	1.012794	6.311327	0.0013566	4.8199202	53
8	0.158732	0.987322	0.160771	6.220035	1.012841	6.299907	0.0013641	4.8086451	52
9	0.159020	0.987275	0.161069	6.208511	1.012889	6.288530	0.0013716	4.7974119	51
10	0.159307	0.987229	0.161368	6.197028	1.012936	6.277193	0.0013792	4.7862201	50
11	0.159594	0.987183	0.161666	6.185587	1.012984	6.265898	0.0013868	4.7750697	49
12	0.159881	0.987136	0.161965	6.174186	1.013031	6.254645	0.0013944	4.7639604	48
13	0.160168	0.987090	0.162263	6.162827	1.013079	6.243432	0.0014020	4.7528920	47
14	0.160455	0.987043	0.162562	6.151508	1.013127	6.232259	0.0014097	4.7418642	46
15	0.160743	0.986996	0.162860	6.140230	1.013175	6.221128	0.0014174	4.7308769	45
16	0.161030	0.986950	0.163159	6.128992	1.013223	6.210036	0.0014251	4.7199298	44
17	0.161317	0.986903	0.163458	6.117794	1.013271	6.198984	0.0014329	4.7090227	43
18	0.161604	0.986856	0.163756	6.106636	1.013319	6.187972	0.0014407	4.6981553	42
19	0.161891	0.986809	0.164055	6.095517	1.013368	6.177000	0.0014485	4.6873276	41
20	0.162178	0.986762	0.164354	6.084438	1.013416	6.166067	0.0014563	4.6765392	40
21	0.162465	0.986714	0.164652	6.073398	1.013465	6.155174	0.0014642	4.6657899	39
22	0.162752	0.986667	0.164951	6.062397	1.013513	6.144319	0.0014721	4.6550796	38
23	0.163039	0.986620	0.165250	6.051434	1.013562	6.133503	0.0014800	4.6444080	37
24	0.163326	0.986572	0.165549	6.040510	1.013611	6.122725	0.0014880	4.6337750	36
25	0.163613	0.986525	0.165848	6.029625	1.013659	6.111986	0.0014960	4.6231802	35
26	0.163900	0.986477	0.166147	6.018777	1.013708	6.101285	0.0015040	4.6126236	34
27	0.164187	0.986429	0.166446	6.007968	1.013757	6.090622	0.0015120	4.6021049	33
28	0.164474	0.986381	0.166745	5.997196	1.013807	6.079996	0.0015201	4.5916239	32
29	0.164761	0.986334	0.167044	5.986461	1.013856	6.069409	0.0015282	4.5811805	31
30	0.165048	0.986286	0.167343	5.975754	1.013905	6.058858	0.0015363	4.5707743	30
31	0.165334	0.986238	0.167642	5.965104	1.013954	6.048345	0.0015445	4.5604053	29
32	0.165621	0.986189	0.167941	5.954481	1.014004	6.037868	0.0015527	4.5500732	28
33	0.165908	0.986141	0.168240	5.943895	1.014054	6.027428	0.0015609	4.5397779	27
34	0.166195	0.986093	0.168539	5.933346	1.014103	6.017025	0.0015691	4.5295190	26
35	0.166482	0.986045	0.168838	5.922832	1.014153	6.006658	0.0015774	4.5192966	25
36	0.166769	0.985996	0.169137	5.912355	1.014203	5.996327	0.0015857	4.5091103	24
37	0.167056	0.985947	0.169437	5.901914	1.014253	5.986033	0.0015941	4.4989600	23
38	0.167342	0.985899	0.169736	5.891508	1.014303	5.975774	0.0016024	4.4888455	22
39	0.167629	0.985850	0.170035	5.881139	1.014353	5.965550	0.0016108	4.4787665	21
40	0.167916	0.985801	0.170334	5.870804	1.014403	5.955362	0.0016193	4.4687230	20
41	0.168203	0.985752	0.170634	5.860505	1.014453	5.945210	0.0016277	4.4587148	19
42	0.168489	0.985703	0.170933	5.850241	1.014504	5.935092	0.0016362	4.4487416	18
43	0.168776	0.985654	0.171233	5.840012	1.014554	5.925009	0.0016447	4.4388032	17
44	0.169063	0.985605	0.171532	5.829817	1.014605	5.914961	0.0016533	4.4288996	16
45	0.169350	0.985556	0.171831	5.819657	1.014656	5.904948	0.0016618	4.4190305	15
46	0.169636	0.985507	0.172131	5.809532	1.014706	5.894969	0.0016704	4.4091957	14
47	0.169923	0.985457	0.172430	5.799440	1.014757	5.885024	0.0016791	4.3993951	13
48	0.170209	0.985408	0.172730	5.789383	1.014808	5.875113	0.0016877	4.3896285	12
49	0.170496	0.985358	0.173030	5.779359	1.014859	5.865236	0.0016964	4.3798957	11
50	0.170783	0.985309	0.173329	5.769369	1.014910	5.855392	0.0017051	4.3701965	10
51	0.171069	0.985259	0.173629	5.759412	1.014962	5.845582	0.0017139	4.3605308	9
52	0.171356	0.985209	0.173929	5.749489	1.015013	5.835805	0.0017227	4.3508984	8
53	0.171643	0.985159	0.174228	5.739599	1.015064	5.826062	0.0017315	4.3412992	7
54	0.171929	0.985109	0.174528	5.729742	1.015116	5.816351	0.0017403	4.3317329	6
55	0.172216	0.985059	0.174828	5.719917	1.015167	5.806673	0.0017492	4.3221994	5
56	0.172502	0.985009	0.175127	5.710126	1.015219	5.797028	0.0017581	4.3126986	4
57	0.172789	0.984959	0.175427	5.700366	1.015271	5.787415	0.0017671	4.3032303	3
58	0.173075	0.984909	0.175727	5.690639	1.015323	5.777835	0.0017760	4.2937942	2
59	0.173362	0.984858	0.176027	5.680945	1.015375	5.768287	0.0017850	4.2843903	1
60	0.173648	0.984808	0.176327	5.671282	1.015427	5.758770	0.0017941	4.2750184	0
Min-utes	Cosine	Sine	Cotangent	Tangent	Cosecant	Secant	Read Down	80°-81° Involute	Min-utes

↑ 99° or 279°

80° or 260° ↑

↓ 10° or 190° **Trigonometric and Involute Functions** 169° or 349° ↓

Min-utes	Sine	Cosine	Tangent	Cotangent	Secant	Cosecant	Involute 10°–11°	Read Up	Min-utes
0	0.173648	0.984808	0.176327	5.671282	1.015427	5.758770	0.0017941	4.2750184	60
1	0.173935	0.984757	0.176627	5.661651	1.015479	5.749286	0.0018031	4.2656783	59
2	0.174221	0.984707	0.176927	5.652052	1.015531	5.739833	0.0018122	4.2563699	58
3	0.174508	0.984656	0.177227	5.642484	1.015583	5.730412	0.0018213	4.2470930	57
4	0.174794	0.984605	0.177527	5.632947	1.015636	5.721022	0.0018305	4.2378475	56
5	0.175080	0.984554	0.177827	5.623442	1.015688	5.711664	0.0018397	4.2286332	55
6	0.175367	0.984503	0.178127	5.613968	1.015741	5.702336	0.0018489	4.2194499	54
7	0.175653	0.984452	0.178427	5.604525	1.015793	5.693039	0.0018581	4.2102975	53
8	0.175939	0.984401	0.178727	5.595112	1.015846	5.683773	0.0018674	4.2011758	52
9	0.176226	0.984350	0.179028	5.585730	1.015899	5.674538	0.0018767	4.1920848	51
10	0.176512	0.984298	0.179328	5.576379	1.015952	5.665333	0.0018860	4.1830241	50
11	0.176798	0.984247	0.179628	5.567057	1.016005	5.656158	0.0018954	4.1739938	49
12	0.177085	0.984196	0.179928	5.557766	1.016058	5.647014	0.0019048	4.1649936	48
13	0.177371	0.984144	0.180229	5.548505	1.016111	5.637899	0.0019142	4.1560234	47
14	0.177657	0.984092	0.180529	5.539274	1.016165	5.628815	0.0019237	4.1470830	46
15	0.177944	0.984041	0.180829	5.530072	1.016218	5.619760	0.0019332	4.1381724	45
16	0.178230	0.983989	0.181130	5.520900	1.016272	5.610735	0.0019427	4.1292913	44
17	0.178516	0.983937	0.181430	5.511758	1.016325	5.601739	0.0019523	4.1204396	43
18	0.178802	0.983885	0.181731	5.502645	1.016379	5.592772	0.0019619	4.1116172	42
19	0.179088	0.983833	0.182031	5.493560	1.016433	5.583834	0.0019715	4.1028239	41
20	0.179375	0.983781	0.182332	5.484505	1.016487	5.574926	0.0019812	4.0940596	40
21	0.179661	0.983729	0.182632	5.475479	1.016541	5.566046	0.0019909	4.0853241	39
22	0.179947	0.983676	0.182933	5.466481	1.016595	5.557195	0.0020006	4.0766173	38
23	0.180233	0.983624	0.183234	5.457512	1.016649	5.548373	0.0020103	4.0679392	37
24	0.180519	0.983571	0.183534	5.448572	1.016703	5.539579	0.0020201	4.0592894	36
25	0.180805	0.983519	0.183835	5.439659	1.016757	5.530813	0.0020299	4.0506680	35
26	0.181091	0.983466	0.184136	5.430775	1.016812	5.522075	0.0020398	4.0420747	34
27	0.181377	0.983414	0.184437	5.421919	1.016866	5.513366	0.0020496	4.0335094	33
28	0.181663	0.983361	0.184737	5.413091	1.016921	5.504684	0.0020596	4.0249720	32
29	0.181950	0.983308	0.185038	5.404290	1.016975	5.496030	0.0020695	4.0164624	31
30	0.182236	0.983255	0.185339	5.395517	1.017030	5.487404	0.0020795	4.0079804	30
31	0.182522	0.983202	0.185640	5.386772	1.017085	5.478806	0.0020895	3.9995259	29
32	0.182808	0.983149	0.185941	5.378054	1.017140	5.470234	0.0020995	3.9910988	28
33	0.183094	0.983096	0.186242	5.369363	1.017195	5.461690	0.0021096	3.9826989	27
34	0.183379	0.983043	0.186543	5.360699	1.017250	5.453173	0.0021197	3.9743261	26
35	0.183665	0.982989	0.186844	5.352063	1.017306	5.444683	0.0021298	3.9659803	25
36	0.183951	0.982935	0.187145	5.343453	1.017361	5.436220	0.0021400	3.9576613	24
37	0.184237	0.982882	0.187446	5.334870	1.017416	5.427784	0.0021502	3.9493691	23
38	0.184523	0.982828	0.187747	5.326313	1.017472	5.419374	0.0021605	3.9411034	22
39	0.184809	0.982774	0.188048	5.317783	1.017527	5.410990	0.0021707	3.9328643	21
40	0.185095	0.982721	0.188349	5.309279	1.017583	5.402633	0.0021810	3.9246514	20
41	0.185381	0.982667	0.188651	5.300802	1.017639	5.394303	0.0021914	3.9164648	19
42	0.185667	0.982613	0.188952	5.292350	1.017695	5.385998	0.0022017	3.9083044	18
43	0.185952	0.982559	0.189253	5.283925	1.017751	5.377719	0.0022121	3.9001698	17
44	0.186238	0.982505	0.189555	5.275526	1.017807	5.369466	0.0022226	3.8920612	16
45	0.186524	0.982450	0.189856	5.267152	1.017863	5.361239	0.0022330	3.8839783	15
46	0.186810	0.982396	0.190157	5.258804	1.017919	5.353038	0.0022435	3.8759210	14
47	0.187096	0.982342	0.190459	5.250481	1.017976	5.344862	0.0022541	3.8678892	13
48	0.187381	0.982287	0.190760	5.242184	1.018032	5.336711	0.0022646	3.8598828	12
49	0.187667	0.982233	0.191062	5.233912	1.018089	5.328586	0.0022752	3.8519017	11
50	0.187953	0.982178	0.191363	5.225665	1.018145	5.320486	0.0022859	3.8439457	10
51	0.188238	0.982123	0.191665	5.217443	1.018202	5.312411	0.0022965	3.8360147	9
52	0.188524	0.982069	0.191966	5.209246	1.018259	5.304361	0.0023073	3.8281087	8
53	0.188810	0.982014	0.192268	5.201074	1.018316	5.296335	0.0023180	3.8202275	7
54	0.189095	0.981959	0.192570	5.192926	1.018373	5.288335	0.0023288	3.8123709	6
55	0.189381	0.981904	0.192871	5.184804	1.018430	5.280359	0.0023396	3.8045390	5
56	0.189667	0.981849	0.193173	5.176705	1.018487	5.272407	0.0023504	3.7967315	4
57	0.189952	0.981793	0.193475	5.168631	1.018544	5.264480	0.0023613	3.7889483	3
58	0.190238	0.981738	0.193777	5.160581	1.018602	5.256577	0.0023722	3.7811894	2
59	0.190523	0.981683	0.194078	5.152556	1.018659	5.248698	0.0023831	3.7734547	1
60	0.190809	0.981627	0.194380	5.144554	1.018717	5.240843	0.0023941	3.7657439	0
Min-utes	Cosine	Sine	Cotangent	Tangent	Cosecant	Secant	Read Down	79°–80° Involute	Min-utes

↑ 100° or 280°

79° or 259° ↑

↓ 11° or 191° **Trigonometric and Involute Functions** 168° or 348° ↓

Min-utes	Sine	Cosine	Tangent	Cotangent	Secant	Cosecant	Involute 11°-12°	Read Up	Min-utes
0	0.190809	0.981627	0.194380	5.144554	1.018717	5.240843	0.0023941	3.7657439	60
1	0.191095	0.981572	0.194682	5.136576	1.018774	5.233012	0.0024051	3.7580571	59
2	0.191380	0.981516	0.194984	5.128622	1.018832	5.225205	0.0024161	3.7503940	58
3	0.191666	0.981460	0.195286	5.120692	1.018890	5.217422	0.0024272	3.7427547	57
4	0.191951	0.981405	0.195588	5.112786	1.018948	5.209662	0.0024383	3.7351390	56
5	0.192237	0.981349	0.195890	5.104902	1.019006	5.201925	0.0024495	3.7275467	55
6	0.192522	0.981293	0.196192	5.097043	1.019064	5.194212	0.0024607	3.7199778	54
7	0.192807	0.981237	0.196494	5.089206	1.019122	5.186523	0.0024719	3.7124322	53
8	0.193093	0.981180	0.196796	5.081393	1.019180	5.178856	0.0024831	3.7049098	52
9	0.193378	0.981124	0.197099	5.073602	1.019239	5.171213	0.0024944	3.6974104	51
10	0.193664	0.981068	0.197401	5.065835	1.019297	5.163592	0.0025057	3.6899340	50
11	0.193949	0.981012	0.197703	5.058091	1.019356	5.155995	0.0025171	3.6824804	49
12	0.194234	0.980955	0.198005	5.050369	1.019415	5.148420	0.0025285	3.6750496	48
13	0.194520	0.980899	0.198308	5.042670	1.019473	5.140868	0.0025399	3.6676414	47
14	0.194805	0.980842	0.198610	5.034994	1.019532	5.133338	0.0025513	3.6602558	46
15	0.195090	0.980785	0.198912	5.027339	1.019591	5.125831	0.0025628	3.6528927	45
16	0.195376	0.980728	0.199215	5.019708	1.019650	5.118346	0.0025744	3.6455519	44
17	0.195661	0.980672	0.199517	5.012098	1.019709	5.110884	0.0025859	3.6382334	43
18	0.195946	0.980615	0.199820	5.004511	1.019769	5.103443	0.0025975	3.6309370	42
19	0.196231	0.980558	0.200122	4.996946	1.019828	5.096025	0.0026091	3.6236627	41
20	0.196517	0.980500	0.200425	4.989403	1.019887	5.088628	0.0026208	3.6164103	40
21	0.196802	0.980443	0.200727	4.981881	1.019947	5.081254	0.0026325	3.6091798	39
22	0.197087	0.980386	0.201030	4.974382	1.020006	5.073901	0.0026443	3.6019711	38
23	0.197372	0.980329	0.201333	4.966904	1.020066	5.066570	0.0026560	3.5947840	37
24	0.197657	0.980271	0.201635	4.959447	1.020126	5.059261	0.0026678	3.5876186	36
25	0.197942	0.980214	0.201938	4.952012	1.020186	5.051973	0.0026797	3.5804746	35
26	0.198228	0.980156	0.202241	4.944599	1.020246	5.044706	0.0026916	3.5733520	34
27	0.198513	0.980098	0.202544	4.937207	1.020306	5.037461	0.0027035	3.5662507	33
28	0.198798	0.980041	0.202847	4.929836	1.020366	5.030237	0.0027154	3.5591705	32
29	0.199083	0.979983	0.203149	4.922486	1.020426	5.023034	0.0027274	3.5521115	31
30	0.199368	0.979925	0.203452	4.915157	1.020487	5.015852	0.0027394	3.5450736	30
31	0.199653	0.979867	0.203755	4.907849	1.020547	5.008691	0.0027515	3.5380565	29
32	0.199938	0.979809	0.204058	4.900562	1.020608	5.001551	0.0027636	3.5310603	28
33	0.200223	0.979750	0.204361	4.893296	1.020668	4.994431	0.0027757	3.5240848	27
34	0.200508	0.979692	0.204664	4.886050	1.020729	4.987332	0.0027879	3.5171300	26
35	0.200793	0.979634	0.204967	4.878825	1.020790	4.980254	0.0028001	3.5101958	25
36	0.201078	0.979575	0.205271	4.871620	1.020851	4.973196	0.0028123	3.5032820	24
37	0.201363	0.979517	0.205574	4.864436	1.020912	4.966159	0.0028246	3.4963886	23
38	0.201648	0.979458	0.205877	4.857272	1.020973	4.959142	0.0028369	3.4895156	22
39	0.201933	0.979399	0.206180	4.850128	1.021034	4.952145	0.0028493	3.4826627	21
40	0.202218	0.979341	0.206483	4.843005	1.021095	4.945169	0.0028616	3.4758300	20
41	0.202502	0.979282	0.206787	4.835901	1.021157	4.938212	0.0028741	3.4690173	19
42	0.202787	0.979223	0.207090	4.828817	1.021218	4.931275	0.0028865	3.4622245	18
43	0.203072	0.979164	0.207393	4.821754	1.021280	4.924359	0.0028990	3.4554517	17
44	0.203357	0.979105	0.207697	4.814710	1.021341	4.917462	0.0029115	3.4486986	16
45	0.203642	0.979045	0.208000	4.807685	1.021403	4.910584	0.0029241	3.4419653	15
46	0.203927	0.978986	0.208304	4.800681	1.021465	4.903727	0.0029367	3.4352515	14
47	0.204211	0.978927	0.208607	4.793696	1.021527	4.896889	0.0029494	3.4285573	13
48	0.204496	0.978867	0.208911	4.786730	1.021589	4.890070	0.0029620	3.4218825	12
49	0.204781	0.978808	0.209214	4.779784	1.021651	4.883271	0.0029747	3.4152272	11
50	0.205065	0.978748	0.209518	4.772857	1.021713	4.876491	0.0029875	3.4085911	10
51	0.205350	0.978689	0.209822	4.765949	1.021776	4.869730	0.0030003	3.4019742	9
52	0.205635	0.978629	0.210126	4.759060	1.021838	4.862988	0.0030131	3.3953764	8
53	0.205920	0.978569	0.210429	4.752191	1.021900	4.856266	0.0030260	3.3887977	7
54	0.206204	0.978509	0.210733	4.745340	1.021963	4.849562	0.0030389	3.3822379	6
55	0.206489	0.978449	0.211037	4.738508	1.022026	4.842877	0.0030518	3.3756971	5
56	0.206773	0.978389	0.211341	4.731695	1.022089	4.836211	0.0030648	3.3691750	4
57	0.207058	0.978329	0.211645	4.724901	1.022151	4.829564	0.0030778	3.3626717	3
58	0.207343	0.978268	0.211949	4.718126	1.022214	4.822936	0.0030908	3.3561870	2
59	0.207627	0.978208	0.212253	4.711369	1.022277	4.816326	0.0031039	3.3497209	1
60	0.207912	0.978148	0.212557	4.704630	1.022341	4.809734	0.0031171	3.3432733	0
Min-utes	Cosine	Sine	Cotangent	Tangent	Cosecant	Secant	Read Down	78°-79° Involute	Min-utes

↑ 101° or 281°

78° or 258° ↑

↓ 12° or 192° **Trigonometric and Involute Functions** 167° or 347° ↓

Min-utes	Sine	Cosine	Tangent	Cotangent	Secant	Cosecant	Involute 12°–13°	Read Up	Min-utes
0	0.207912	0.978148	0.212557	4.704630	1.022341	4.809734	0.0031171	3.3432733	60
1	0.208196	0.978087	0.212861	4.697910	1.022404	4.803161	0.0031302	3.3368441	59
2	0.208481	0.978026	0.213165	4.691208	1.022467	4.796607	0.0031434	3.3304333	58
3	0.208765	0.977966	0.213469	4.684525	1.022531	4.790070	0.0031566	3.3240407	57
4	0.209050	0.977905	0.213773	4.677860	1.022594	4.783552	0.0031699	3.3176663	56
5	0.209334	0.977844	0.214077	4.671212	1.022658	4.777052	0.0031832	3.3113100	55
6	0.209619	0.977783	0.214381	4.664583	1.022722	4.770570	0.0031966	3.3049718	54
7	0.209903	0.977722	0.214686	4.657972	1.022785	4.764106	0.0032100	3.2986515	53
8	0.210187	0.977661	0.214990	4.651379	1.022849	4.757660	0.0032234	3.2923491	52
9	0.210472	0.977600	0.215294	4.644803	1.022913	4.751231	0.0032369	3.2860645	51
10	0.210756	0.977539	0.215599	4.638246	1.022977	4.744821	0.0032504	3.2797977	50
11	0.211040	0.977477	0.215903	4.631706	1.023040	4.738428	0.0032639	3.2735486	49
12	0.211325	0.977416	0.216208	4.625183	1.023106	4.732052	0.0032775	3.2673170	48
13	0.211609	0.977354	0.216512	4.618678	1.023170	4.725695	0.0032911	3.2611030	47
14	0.211893	0.977293	0.216817	4.612191	1.023235	4.719354	0.0033048	3.2549064	46
15	0.212178	0.977231	0.217121	4.605721	1.023299	4.713031	0.0033185	3.2487273	45
16	0.212462	0.977169	0.217426	4.599268	1.023364	4.706726	0.0033322	3.2425654	44
17	0.212746	0.977108	0.217731	4.592832	1.023429	4.700437	0.0033460	3.2364208	43
18	0.213030	0.977046	0.218035	4.586414	1.023494	4.694166	0.0033598	3.2302933	42
19	0.213315	0.976984	0.218340	4.580013	1.023559	4.687912	0.0033736	3.2241830	41
20	0.213599	0.976921	0.218645	4.573629	1.023624	4.681675	0.0033875	3.2180896	40
21	0.213883	0.976859	0.218950	4.567261	1.023689	4.675455	0.0034014	3.2120133	39
22	0.214167	0.976797	0.219254	4.560911	1.023754	4.669252	0.0034154	3.2059538	38
23	0.214451	0.976735	0.219559	4.554578	1.023819	4.663065	0.0034294	3.1999112	37
24	0.214735	0.976672	0.219864	4.548261	1.023885	4.656896	0.0034434	3.1938853	36
25	0.215019	0.976610	0.220169	4.541961	1.023950	4.650743	0.0034575	3.1878762	35
26	0.215303	0.976547	0.220474	4.535677	1.024016	4.644606	0.0034716	3.1818836	34
27	0.215588	0.976485	0.220779	4.529410	1.024082	4.638487	0.0034858	3.1759076	33
28	0.215872	0.976422	0.221084	4.523160	1.024148	4.632384	0.0035000	3.1699481	32
29	0.216156	0.976359	0.221389	4.516926	1.024214	4.626297	0.0035142	3.1640050	31
30	0.216440	0.976296	0.221695	4.510709	1.024280	4.620226	0.0035285	3.1580783	30
31	0.216724	0.976233	0.222000	4.504507	1.024346	4.614172	0.0035428	3.1521679	29
32	0.217008	0.976170	0.222305	4.498322	1.024412	4.608134	0.0035572	3.1462737	28
33	0.217292	0.976107	0.222610	4.492153	1.024478	4.602113	0.0035716	3.1403957	27
34	0.217575	0.976044	0.222916	4.486000	1.024544	4.596107	0.0035860	3.1345338	26
35	0.217859	0.975980	0.223221	4.479864	1.024611	4.590117	0.0036005	3.1286879	25
36	0.218143	0.975917	0.223526	4.473743	1.024678	4.584144	0.0036150	3.1228580	24
37	0.218427	0.975853	0.223832	4.467638	1.024744	4.578186	0.0036296	3.1170440	23
38	0.218711	0.975790	0.224137	4.461549	1.024811	4.572244	0.0036441	3.1112458	22
39	0.218995	0.975726	0.224443	4.455476	1.024878	4.566318	0.0036588	3.1054635	21
40	0.219279	0.975662	0.224748	4.449418	1.024945	4.560408	0.0036735	3.0996968	20
41	0.219562	0.975598	0.225054	4.443376	1.025012	4.554513	0.0036882	3.0939458	19
42	0.219846	0.975535	0.225360	4.437350	1.025079	4.548634	0.0037029	3.0882104	18
43	0.220130	0.975471	0.225665	4.431339	1.025146	4.542771	0.0037177	3.0824906	17
44	0.220414	0.975406	0.225971	4.425344	1.025214	4.536923	0.0037325	3.0767862	16
45	0.220697	0.975342	0.226277	4.419364	1.025281	4.531090	0.0037474	3.0710972	15
46	0.220981	0.975278	0.226583	4.413400	1.025349	4.525273	0.0037623	3.0654236	14
47	0.221265	0.975214	0.226889	4.407450	1.025416	4.519471	0.0037773	3.0597653	13
48	0.221548	0.975149	0.227194	4.401516	1.025484	4.513684	0.0037923	3.0541223	12
49	0.221832	0.975085	0.227500	4.395598	1.025552	4.507913	0.0038073	3.0484944	11
50	0.222116	0.975020	0.227806	4.389694	1.025620	4.502157	0.0038224	3.0428816	10
51	0.222399	0.974956	0.228112	4.383805	1.025688	4.496415	0.0038375	3.0372838	9
52	0.222683	0.974891	0.228418	4.377932	1.025756	4.490689	0.0038527	3.0317011	8
53	0.222967	0.974826	0.228724	4.372073	1.025824	4.484977	0.0038679	3.0261333	7
54	0.223250	0.974761	0.229031	4.366229	1.025892	4.479281	0.0038831	3.0205804	6
55	0.223534	0.974696	0.229337	4.360400	1.025961	4.473599	0.0038984	3.0150424	5
56	0.223817	0.974631	0.229643	4.354586	1.026029	4.467932	0.0039137	3.0095190	4
57	0.224101	0.974566	0.229949	4.348787	1.026098	4.462280	0.0039291	3.0040104	3
58	0.224384	0.974501	0.230255	4.343002	1.026166	4.456643	0.0039445	2.9985165	2
59	0.224668	0.974435	0.230562	4.337232	1.026235	4.451020	0.0039599	2.9930372	1
60	0.224951	0.974370	0.230868	4.331476	1.026304	4.445411	0.0039754	2.9875724	0
Min-utes	Cosine	Sine	Cotangent	Tangent	Cosecant	Secant	77°–78° Read Down	77°–78° Involute	Min-utes

↑ 102° or 282°

77° or 257° ↑

↓ 13° or 193° **Trigonometric and Involute Functions** 166° or 346° ↓

Min-utes	Sine	Cosine	Tangent	Cotangent	Secant	Cosecant	Involute 13°-14°	Read Up	Min-utes
0	0.224951	0.974370	0.230868	4.331476	1.026304	4.445411	0.0039754	2.9875724	60
1	0.225234	0.974305	0.231175	4.325735	1.026373	4.439818	0.0039909	2.9821220	59
2	0.225518	0.974239	0.231481	4.320008	1.026442	4.434238	0.0040065	2.9766861	58
3	0.225801	0.974173	0.231788	4.314295	1.026511	4.428673	0.0040221	2.9712646	57
4	0.226085	0.974108	0.232094	4.308597	1.026581	4.423122	0.0040377	2.9658574	56
5	0.226368	0.974042	0.232401	4.302914	1.026650	4.417586	0.0040534	2.9604645	55
6	0.226651	0.973976	0.232707	4.297244	1.026719	4.412064	0.0040692	2.9550858	54
7	0.226935	0.973910	0.233014	4.291589	1.026789	4.406556	0.0040849	2.9497212	53
8	0.227218	0.973844	0.233321	4.285947	1.026859	4.401062	0.0041007	2.9443708	52
9	0.227501	0.973778	0.233627	4.280320	1.026928	4.395582	0.0041166	2.9390344	51
10	0.227784	0.973712	0.233934	4.274707	1.026998	4.390116	0.0041325	2.9337119	50
11	0.228068	0.973645	0.234241	4.269107	1.027068	4.384664	0.0041484	2.9284035	49
12	0.228351	0.973579	0.234548	4.263522	1.027138	4.379226	0.0041644	2.9231089	48
13	0.228634	0.973512	0.234855	4.257950	1.027208	4.373801	0.0041804	2.9178281	47
14	0.228917	0.973446	0.235162	4.252392	1.027278	4.368391	0.0041965	2.9125612	46
15	0.229200	0.973379	0.235469	4.246848	1.027349	4.362994	0.0042126	2.9073080	45
16	0.229484	0.973313	0.235776	4.241318	1.027419	4.357611	0.0042288	2.9020684	44
17	0.229767	0.973246	0.236083	4.235801	1.027490	4.352242	0.0042450	2.8968425	43
18	0.230050	0.973179	0.236390	4.230298	1.027560	4.346886	0.0042612	2.8916302	42
19	0.230333	0.973112	0.236697	4.224808	1.027631	4.341544	0.0042775	2.8864313	41
20	0.230616	0.973045	0.237004	4.219332	1.027702	4.336215	0.0042938	2.8812460	40
21	0.230899	0.972978	0.237312	4.213869	1.027773	4.330900	0.0043101	2.8760741	39
22	0.231182	0.972911	0.237619	4.208420	1.027844	4.325598	0.0043266	2.8709156	38
23	0.231465	0.972843	0.237926	4.202983	1.027915	4.320309	0.0043430	2.8657704	37
24	0.231748	0.972776	0.238234	4.197561	1.027986	4.315034	0.0043595	2.8606384	36
25	0.232031	0.972708	0.238541	4.192151	1.028057	4.309772	0.0043760	2.8555197	35
26	0.232314	0.972641	0.238848	4.186755	1.028129	4.304523	0.0043926	2.8504142	34
27	0.232597	0.972573	0.239156	4.181371	1.028200	4.299287	0.0044092	2.8453218	33
28	0.232880	0.972506	0.239464	4.176001	1.028272	4.294064	0.0044259	2.8402425	32
29	0.233163	0.972438	0.239771	4.170644	1.028343	4.288854	0.0044426	2.8351762	31
30	0.233445	0.972370	0.240079	4.165300	1.028415	4.283658	0.0044593	2.8301229	30
31	0.233728	0.972302	0.240386	4.159969	1.028487	4.278474	0.0044761	2.8250825	29
32	0.234011	0.972234	0.240694	4.154650	1.028559	4.273303	0.0044929	2.8200550	28
33	0.234294	0.972166	0.241002	4.149345	1.028631	4.268145	0.0045098	2.8150404	27
34	0.234577	0.972098	0.241310	4.144052	1.028703	4.263000	0.0045267	2.8100385	26
35	0.234859	0.972029	0.241618	4.138772	1.028776	4.257867	0.0045437	2.8050494	25
36	0.235142	0.971961	0.241925	4.133505	1.028848	4.252747	0.0045607	2.8000730	24
37	0.235425	0.971893	0.242233	4.128250	1.028920	4.247640	0.0045777	2.7951093	23
38	0.235708	0.971824	0.242541	4.123008	1.028993	4.242546	0.0045948	2.7901581	22
39	0.235990	0.971755	0.242849	4.117778	1.029066	4.237464	0.0046120	2.7852195	21
40	0.236273	0.971687	0.243157	4.112561	1.029138	4.232394	0.0046291	2.7802934	20
41	0.236556	0.971618	0.243466	4.107357	1.029211	4.227337	0.0046464	2.7753798	19
42	0.236838	0.971549	0.243774	4.102165	1.029284	4.222293	0.0046636	2.7704786	18
43	0.237121	0.971480	0.244082	4.096985	1.029357	4.217261	0.0046809	2.7655898	17
44	0.237403	0.971411	0.244390	4.091818	1.029430	4.212241	0.0046983	2.7607133	16
45	0.237686	0.971342	0.244698	4.086663	1.029503	4.207233	0.0047157	2.7558491	15
46	0.237968	0.971273	0.245007	4.081520	1.029577	4.202238	0.0047331	2.7509972	14
47	0.238251	0.971204	0.245315	4.076389	1.029650	4.197255	0.0047506	2.7461574	13
48	0.238533	0.971134	0.245624	4.071271	1.029724	4.192284	0.0047681	2.7413298	12
49	0.238816	0.971065	0.245932	4.066164	1.029797	4.187325	0.0047857	2.7365143	11
50	0.239098	0.970995	0.246241	4.061070	1.029871	4.182378	0.0048033	2.7317109	10
51	0.239381	0.970926	0.246549	4.055988	1.029945	4.177444	0.0048210	2.7269195	9
52	0.239663	0.970856	0.246858	4.050917	1.030019	4.172521	0.0048387	2.7221401	8
53	0.239946	0.970786	0.247166	4.045859	1.030093	4.167610	0.0048564	2.7173726	7
54	0.240228	0.970716	0.247475	4.040813	1.030167	4.162711	0.0048742	2.7126170	6
55	0.240510	0.970647	0.247784	4.035778	1.030241	4.157824	0.0048921	2.7078732	5
56	0.240793	0.970577	0.248092	4.030755	1.030315	4.152949	0.0049099	2.7031413	4
57	0.241075	0.970506	0.248401	4.025744	1.030390	4.148086	0.0049279	2.6984211	3
58	0.241357	0.970436	0.248710	4.020745	1.030464	4.143234	0.0049458	2.6937126	2
59	0.241640	0.970366	0.249019	4.015757	1.030539	4.138394	0.0049638	2.6890158	1
60	0.241922	0.970296	0.249328	4.010781	1.030614	4.133565	0.0049819	2.6843307	0
Min-utes	Cosine	Sine	Cotangent	Tangent	Cosecant	Secant	Read Down	76°-77° Involute	Min-utes

↑ 103° or 283°

76° or 256° ↑

↓ 14° or 194° **Trigonometric and Involute Functions** 165° or 345° ↓

Min-utes	Sine	Cosine	Tangent	Cotangent	Secant	Cosecant	Involute 14°–15°	Read Up	Min-utes
0	0.241922	0.970296	0.249328	4.010781	1.030614	4.133565	0.0049819	2.6843307	60
1	0.242204	0.970225	0.249637	4.005817	1.030688	4.128749	0.0050000	2.6796572	59
2	0.242486	0.970155	0.249946	4.000864	1.030763	4.123943	0.0050182	2.6749952	58
3	0.242769	0.970084	0.250255	3.995922	1.030838	4.119150	0.0050364	2.6703447	57
4	0.243051	0.970014	0.250564	3.990992	1.030913	4.114368	0.0050546	2.6657057	56
5	0.243333	0.969943	0.250873	3.986074	1.030989	4.109597	0.0050729	2.6610781	55
6	0.243615	0.969872	0.251183	3.981167	1.031064	4.104837	0.0050912	2.6564620	54
7	0.243897	0.969801	0.251492	3.976271	1.031139	4.100089	0.0051096	2.6518572	53
8	0.244179	0.969730	0.251801	3.971387	1.031215	4.095353	0.0051280	2.6472636	52
9	0.244461	0.969659	0.252111	3.966514	1.031290	4.090627	0.0051465	2.6426814	51
10	0.244743	0.969588	0.252420	3.961652	1.031366	4.085913	0.0051650	2.6381104	50
11	0.245025	0.969517	0.252729	3.956801	1.031442	4.081210	0.0051835	2.6335506	49
12	0.245307	0.969445	0.253039	3.951962	1.031518	4.076518	0.0052021	2.6290019	48
13	0.245589	0.969374	0.253348	3.947133	1.031594	4.071837	0.0052208	2.6244644	47
14	0.245871	0.969302	0.253658	3.942316	1.031670	4.067168	0.0052395	2.6199379	46
15	0.246153	0.969231	0.253968	3.937509	1.031746	4.062509	0.0052582	2.6154225	45
16	0.246435	0.969159	0.254277	3.932714	1.031822	4.057862	0.0052770	2.6109181	44
17	0.246717	0.969088	0.254587	3.927930	1.031899	4.053225	0.0052958	2.6064246	43
18	0.246999	0.969016	0.254897	3.923156	1.031975	4.048599	0.0053147	2.6019421	42
19	0.247281	0.968944	0.255207	3.918394	1.032052	4.043984	0.0053336	2.5974704	41
20	0.247563	0.968872	0.255516	3.913642	1.032128	4.039380	0.0053526	2.5930096	40
21	0.247845	0.968800	0.255826	3.908901	1.032205	4.034787	0.0053716	2.5885595	39
22	0.248126	0.968728	0.256136	3.904171	1.032282	4.030205	0.0053907	2.5841203	38
23	0.248408	0.968655	0.256446	3.899452	1.032359	4.025633	0.0054098	2.5796918	37
24	0.248690	0.968583	0.256756	3.894743	1.032436	4.021072	0.0054289	2.5752739	36
25	0.248972	0.968511	0.257066	3.890045	1.032513	4.016522	0.0054481	2.5708668	35
26	0.249253	0.968438	0.257377	3.885357	1.032590	4.011982	0.0054674	2.5664702	34
27	0.249535	0.968366	0.257687	3.880681	1.032668	4.007453	0.0054867	2.5620843	33
28	0.249817	0.968293	0.257997	3.876014	1.032745	4.002935	0.0055060	2.5577088	32
29	0.250098	0.968220	0.258307	3.871358	1.032823	3.998427	0.0055254	2.5533439	31
30	0.250380	0.968148	0.258618	3.866713	1.032900	3.993929	0.0055448	2.5489895	30
31	0.250662	0.968075	0.258928	3.862078	1.032978	3.989442	0.0055643	2.5446455	29
32	0.250943	0.968002	0.259238	3.857454	1.033056	3.984965	0.0055838	2.5403119	28
33	0.251225	0.967929	0.259549	3.852840	1.033134	3.980499	0.0056034	2.5359887	27
34	0.251506	0.967856	0.259859	3.848236	1.033212	3.976043	0.0056230	2.5316758	26
35	0.251788	0.967782	0.260170	3.843642	1.033290	3.971597	0.0056427	2.5273732	25
36	0.252069	0.967709	0.260480	3.839059	1.033368	3.967162	0.0056624	2.5230809	24
37	0.252351	0.967636	0.260791	3.834486	1.033447	3.962737	0.0056822	2.5187988	23
38	0.252632	0.967562	0.261102	3.829923	1.033525	3.958322	0.0057020	2.5145268	22
39	0.252914	0.967489	0.261413	3.825371	1.033604	3.953917	0.0057218	2.5102651	21
40	0.253195	0.967415	0.261723	3.820828	1.033682	3.949522	0.0057417	2.5060134	20
41	0.253477	0.967342	0.262034	3.816296	1.033761	3.945138	0.0057617	2.5017719	19
42	0.253758	0.967268	0.262345	3.811773	1.033840	3.940763	0.0057817	2.4975404	18
43	0.254039	0.967194	0.262656	3.807261	1.033919	3.936399	0.0058017	2.4933189	17
44	0.254321	0.967120	0.262967	3.802759	1.033998	3.932044	0.0058218	2.4891074	16
45	0.254602	0.967046	0.263278	3.798266	1.034077	3.927700	0.0058420	2.4849058	15
46	0.254883	0.966972	0.263589	3.793784	1.034156	3.923365	0.0058622	2.4807142	14
47	0.255165	0.966898	0.263900	3.789311	1.034236	3.919040	0.0058824	2.4765324	13
48	0.255446	0.966823	0.264211	3.784848	1.034315	3.914725	0.0059027	2.4723605	12
49	0.255727	0.966749	0.264521	3.780395	1.034395	3.910420	0.0059230	2.4681984	11
50	0.256008	0.966675	0.264834	3.775952	1.034474	3.906125	0.0059434	2.4640461	10
51	0.256289	0.966600	0.265145	3.771518	1.034554	3.901840	0.0059638	2.4599035	9
52	0.256571	0.966526	0.265457	3.767095	1.034634	3.897564	0.0059843	2.4557707	8
53	0.256852	0.966451	0.265768	3.762681	1.034714	3.893298	0.0060048	2.4516475	7
54	0.257133	0.966376	0.266079	3.758276	1.034794	3.889041	0.0060254	2.4475340	6
55	0.257414	0.966301	0.266391	3.753882	1.034874	3.884794	0.0060460	2.4434301	5
56	0.257695	0.966226	0.266702	3.749496	1.034954	3.880557	0.0060667	2.4393358	4
57	0.257976	0.966151	0.267014	3.745121	1.035035	3.876329	0.0060874	2.4352511	3
58	0.258257	0.966076	0.267326	3.740755	1.035115	3.872111	0.0061081	2.4311759	2
59	0.258538	0.966001	0.267637	3.736398	1.035196	3.867903	0.0061289	2.4271101	1
60	0.258819	0.965926	0.267949	3.732051	1.035276	3.863703	0.0061498	2.4230539	0
Min-utes	Cosine	Sine	Cotangent	Tangent	Cosecant	Secant	Read Down	75°–76° Involute	Min-utes

↑ 104° or 284°

75° or 255° ↑

↓ 15° or 195° **Trigonometric and Involute Functions** 164° or 344° ↓

Min-utes	Sine	Cosine	Tangent	Cotangent	Secant	Cosecant	Involute 15°-16°	Read Up	Min-utes
0	0.258819	0.965926	0.267949	3.732051	1.035276	3.863703	0.0061498	2.4230539	60
1	0.259100	0.965850	0.268261	3.727713	1.035357	3.859514	0.0061707	2.4190070	59
2	0.259381	0.965775	0.268573	3.723385	1.035438	3.855333	0.0061917	2.4149696	58
3	0.259662	0.965700	0.268885	3.719066	1.035519	3.851162	0.0062127	2.4109415	57
4	0.259943	0.965624	0.269197	3.714756	1.035600	3.847001	0.0062337	2.4069228	56
5	0.260224	0.965548	0.269509	3.710456	1.035681	3.842848	0.0062548	2.4029133	55
6	0.260505	0.965473	0.269821	3.706165	1.035762	3.838705	0.0062760	2.3989132	54
7	0.260785	0.965397	0.270133	3.701883	1.035843	3.834571	0.0062972	2.3949222	53
8	0.261066	0.965321	0.270445	3.697610	1.035925	3.830447	0.0063184	2.3909405	52
9	0.261347	0.965245	0.270757	3.693347	1.036006	3.826331	0.0063397	2.3869680	51
10	0.261628	0.965169	0.271069	3.689093	1.036088	3.822225	0.0063611	2.3830046	50
11	0.261908	0.965093	0.271382	3.684848	1.036170	3.818128	0.0063825	2.3790503	49
12	0.262189	0.965016	0.271694	3.680611	1.036252	3.814000	0.0064039	2.3751052	48
13	0.262470	0.964940	0.272006	3.676384	1.036334	3.809961	0.0064254	2.3711691	47
14	0.262751	0.964864	0.272319	3.672166	1.036416	3.805891	0.0064470	2.3672420	46
15	0.263031	0.964787	0.272631	3.667958	1.036498	3.801830	0.0064686	2.3633239	45
16	0.263312	0.964711	0.272944	3.663758	1.036580	3.797778	0.0064902	2.3594148	44
17	0.263592	0.964634	0.273256	3.659566	1.036662	3.793735	0.0065119	2.3555147	43
18	0.263873	0.964557	0.273569	3.655384	1.036745	3.789701	0.0065337	2.3516234	42
19	0.264154	0.964481	0.273882	3.651211	1.036827	3.785676	0.0065555	2.3477410	41
20	0.264434	0.964404	0.274194	3.647047	1.036910	3.781660	0.0065773	2.3438675	40
21	0.264715	0.964327	0.274507	3.642891	1.036993	3.777652	0.0065992	2.3400029	39
22	0.264995	0.964250	0.274820	3.638744	1.037076	3.773653	0.0066211	2.3361470	38
23	0.265276	0.964173	0.275133	3.634606	1.037159	3.769664	0.0066431	2.3322999	37
24	0.265556	0.964095	0.275446	3.630477	1.037242	3.765682	0.0066652	2.3284615	36
25	0.265837	0.964018	0.275759	3.626357	1.037325	3.761710	0.0066873	2.3246318	35
26	0.266117	0.963941	0.276072	3.622245	1.037408	3.757746	0.0067094	2.3208108	34
27	0.266397	0.963863	0.276385	3.618141	1.037492	3.753791	0.0067316	2.3169985	33
28	0.266678	0.963786	0.276698	3.614047	1.037575	3.749845	0.0067539	2.3131948	32
29	0.266958	0.963708	0.277011	3.609961	1.037659	3.745907	0.0067762	2.3093997	31
30	0.267238	0.963630	0.277325	3.605884	1.037742	3.741978	0.0067985	2.3056132	30
31	0.267519	0.963553	0.277638	3.601815	1.037826	3.738057	0.0068209	2.3018352	29
32	0.267799	0.963475	0.277951	3.597754	1.037910	3.734145	0.0068434	2.2980658	28
33	0.268079	0.963397	0.278265	3.593702	1.037994	3.730241	0.0068659	2.2943048	27
34	0.268359	0.963319	0.278578	3.589659	1.038078	3.726346	0.0068884	2.2905523	26
35	0.268640	0.963241	0.278891	3.585624	1.038162	3.722459	0.0069110	2.2868082	25
36	0.268920	0.963163	0.279205	3.581598	1.038246	3.718580	0.0069337	2.2830726	24
37	0.269200	0.963084	0.279519	3.577579	1.038331	3.714711	0.0069564	2.2793453	23
38	0.269480	0.963006	0.279832	3.573570	1.038415	3.710849	0.0069791	2.2756264	22
39	0.269760	0.962928	0.280146	3.569568	1.038500	3.706996	0.0070019	2.2719158	21
40	0.270040	0.962849	0.280460	3.565575	1.038584	3.703151	0.0070248	2.2682135	20
41	0.270320	0.962770	0.280773	3.561590	1.038669	3.699314	0.0070477	2.2645194	19
42	0.270600	0.962692	0.281087	3.557613	1.038754	3.695485	0.0070706	2.2608337	18
43	0.270880	0.962613	0.281401	3.553645	1.038839	3.691665	0.0070936	2.2571561	17
44	0.271160	0.962534	0.281715	3.549685	1.038924	3.687853	0.0071167	2.2534868	16
45	0.271440	0.962455	0.282029	3.545733	1.039009	3.684049	0.0071398	2.2498256	15
46	0.271720	0.962376	0.282343	3.541789	1.039095	3.680254	0.0071630	2.2461725	14
47	0.272000	0.962297	0.282657	3.537853	1.039180	3.676466	0.0071862	2.2425276	13
48	0.272280	0.962218	0.282971	3.533925	1.039266	3.672687	0.0072095	2.2388908	12
49	0.272560	0.962139	0.283286	3.530005	1.039351	3.668915	0.0072328	2.2352620	11
50	0.272840	0.962059	0.283600	3.526094	1.039437	3.665152	0.0072561	2.2316413	10
51	0.273120	0.961980	0.283914	3.522190	1.039523	3.661396	0.0072796	2.2280286	9
52	0.273400	0.961901	0.284229	3.518295	1.039609	3.657649	0.0073030	2.2244239	8
53	0.273679	0.961821	0.284543	3.514407	1.039695	3.653910	0.0073266	2.2208271	7
54	0.273959	0.961741	0.284857	3.510527	1.039781	3.650178	0.0073501	2.2172383	6
55	0.274239	0.961662	0.285172	3.506655	1.039867	3.646455	0.0073738	2.2136574	5
56	0.274519	0.961582	0.285487	3.502792	1.039953	3.642739	0.0073975	2.2100844	4
57	0.274798	0.961502	0.285801	3.498936	1.040040	3.639031	0.0074212	2.2065193	3
58	0.275078	0.961422	0.286116	3.495087	1.040126	3.635332	0.0074450	2.2029620	2
59	0.275358	0.961342	0.286431	3.491247	1.040213	3.631640	0.0074688	2.1994125	1
60	0.275637	0.961262	0.286745	3.487414	1.040299	3.627955	0.0074927	2.1958708	0
Min-utes	Cosine	Sine	Cotangent	Tangent	Cosecant	Secant	Read Down	74°-75° Involute	Min-utes

↑ 105° or 285°

74° or 254° ↑

↓ 16° or 196° **Trigonometric and Involute Functions** 163° or 343° ↓

Min-utes	Sine	Cosine	Tangent	Cotangent	Secant	Cosecant	Involute 16°-17°	Read Up	Min-utes
0	0.275637	0.961262	0.286745	3.487414	1.040299	3.627955	0.0074927	2.1958708	60
1	0.275917	0.961181	0.287060	3.483590	1.040386	3.624279	0.0075166	2.1923369	59
2	0.276197	0.961101	0.287375	3.479773	1.040473	3.620610	0.0075406	2.1888107	58
3	0.276476	0.961021	0.287690	3.475963	1.040560	3.616949	0.0075647	2.1852922	57
4	0.276756	0.960940	0.288005	3.472162	1.040647	3.613296	0.0075888	2.1817815	56
5	0.277035	0.960860	0.288320	3.468368	1.040735	3.609650	0.0076130	2.1782784	55
6	0.277315	0.960779	0.288635	3.464581	1.040822	3.606012	0.0076372	2.1747830	54
7	0.277594	0.960698	0.288950	3.460803	1.040909	3.602382	0.0076614	2.1712951	53
8	0.277874	0.960618	0.289266	3.457031	1.040997	3.598759	0.0076857	2.1678149	52
9	0.278153	0.960537	0.289581	3.453268	1.041085	3.595144	0.0077101	2.1643423	51
10	0.278432	0.960456	0.289896	3.449512	1.041172	3.591536	0.0077345	2.1608772	50
11	0.278712	0.960375	0.290211	3.445764	1.041260	3.587936	0.0077590	2.1574196	49
12	0.278991	0.960294	0.290527	3.442023	1.041348	3.584344	0.0077835	2.1539696	48
13	0.279270	0.960212	0.290842	3.438289	1.041436	3.580759	0.0078081	2.1505270	47
14	0.279550	0.960131	0.291158	3.434563	1.041524	3.577181	0.0078327	2.1470919	46
15	0.279829	0.960050	0.291473	3.430845	1.041613	3.573611	0.0078574	2.1436643	45
16	0.280108	0.959968	0.291789	3.427133	1.041701	3.570048	0.0078822	2.1402440	44
17	0.280388	0.959887	0.292105	3.423430	1.041789	3.566493	0.0079069	2.1368311	43
18	0.280667	0.959805	0.292420	3.419733	1.041878	3.562945	0.0079318	2.1334256	42
19	0.280946	0.959724	0.292736	3.416044	1.041967	3.559404	0.0079567	2.1300275	41
20	0.281225	0.959642	0.293052	3.412363	1.042055	3.555871	0.0079817	2.1266367	40
21	0.281504	0.959560	0.293368	3.408688	1.042144	3.552345	0.0080067	2.1232532	39
22	0.281783	0.959478	0.293684	3.405021	1.042233	3.548826	0.0080317	2.1198769	38
23	0.282062	0.959396	0.294000	3.401361	1.042322	3.545315	0.0080568	2.1165079	37
24	0.282341	0.959314	0.294316	3.397709	1.042412	3.541811	0.0080820	2.1131462	36
25	0.282620	0.959232	0.294632	3.394063	1.042501	3.538314	0.0081072	2.1097917	35
26	0.282900	0.959150	0.294948	3.390425	1.042590	3.534824	0.0081325	2.1064443	34
27	0.283179	0.959067	0.295265	3.386794	1.042680	3.531341	0.0081578	2.1031041	33
28	0.283457	0.958985	0.295581	3.383170	1.042769	3.527866	0.0081832	2.0997711	32
29	0.283736	0.958902	0.295897	3.379553	1.042859	3.524398	0.0082087	2.0964452	31
30	0.284015	0.958820	0.296213	3.375943	1.042949	3.520937	0.0082342	2.0931264	30
31	0.284294	0.958737	0.296530	3.372341	1.043039	3.517482	0.0082597	2.0898147	29
32	0.284573	0.958654	0.296846	3.368745	1.043129	3.514035	0.0082853	2.0865101	28
33	0.284852	0.958572	0.297163	3.365157	1.043219	3.510595	0.0083110	2.0832124	27
34	0.285131	0.958489	0.297480	3.361575	1.043309	3.507162	0.0083367	2.0799219	26
35	0.285410	0.958406	0.297796	3.358001	1.043400	3.503737	0.0083625	2.0766383	25
36	0.285688	0.958323	0.298113	3.354433	1.043490	3.500318	0.0083883	2.0733616	24
37	0.285967	0.958239	0.298430	3.350873	1.043581	3.496906	0.0084142	2.0700920	23
38	0.286246	0.958156	0.298747	3.347319	1.043671	3.493500	0.0084401	2.0668292	22
39	0.286525	0.958073	0.299063	3.343772	1.043762	3.490102	0.0084661	2.0635734	21
40	0.286803	0.957990	0.299380	3.340233	1.043853	3.486711	0.0084921	2.0603245	20
41	0.287082	0.957906	0.299697	3.336700	1.043944	3.483327	0.0085182	2.0570824	19
42	0.287361	0.957822	0.300014	3.333174	1.044035	3.479949	0.0085444	2.0538472	18
43	0.287639	0.957739	0.300331	3.329654	1.044126	3.476578	0.0085706	2.0506189	17
44	0.287918	0.957655	0.300649	3.326142	1.044217	3.473215	0.0085969	2.0473973	16
45	0.288196	0.957571	0.300966	3.322636	1.044309	3.469858	0.0086232	2.0441825	15
46	0.288475	0.957487	0.301283	3.319137	1.044400	3.466507	0.0086496	2.0409746	14
47	0.288753	0.957404	0.301600	3.315645	1.044492	3.463164	0.0086760	2.0377733	13
48	0.289032	0.957319	0.301918	3.312160	1.044583	3.459827	0.0087025	2.0345788	12
49	0.289310	0.957235	0.302235	3.308681	1.044675	3.456497	0.0087290	2.0313910	11
50	0.289589	0.957151	0.302553	3.305209	1.044767	3.453173	0.0087556	2.0282099	10
51	0.289867	0.957067	0.302870	3.301744	1.044859	3.449857	0.0087823	2.0250354	9
52	0.290145	0.956983	0.303188	3.298285	1.044951	3.446547	0.0088090	2.0218676	8
53	0.290424	0.956898	0.303506	3.294833	1.045043	3.443243	0.0088358	2.0187064	7
54	0.290702	0.956814	0.303823	3.291388	1.045136	3.439947	0.0088626	2.0155519	6
55	0.290981	0.956729	0.304141	3.287949	1.045228	3.436656	0.0088895	2.0124039	5
56	0.291259	0.956644	0.304459	3.284516	1.045321	3.433373	0.0089164	2.0092625	4
57	0.291537	0.956560	0.304777	3.281091	1.045413	3.430096	0.0089434	2.0061277	3
58	0.291815	0.956475	0.305095	3.277671	1.045506	3.426825	0.0089704	2.0029994	2
59	0.292094	0.956390	0.305413	3.274259	1.045599	3.423561	0.0089975	1.9998776	1
60	0.292372	0.956305	0.305731	3.270853	1.045692	3.420304	0.0090247	1.9967623	0
Min-utes	Cosine	Sine	Cotangent	Tangent	Cosecant	Secant	Read Down	73°-74° Involute	Min-utes

↑ 106° or 286°

73° or 253° ↑

↓ 17° or 197° **Trigonometric and Involute Functions** 162° or 342° ↓

Min-utes	Sine	Cosine	Tangent	Cotangent	Secant	Cosecant	Involute 17°-18°	Read Up	Min-utes
0	0.292372	0.956305	0.305731	3.270853	1.045692	3.420304	0.0090247	1.9967623	60
1	0.292650	0.956220	0.306049	3.267453	1.045785	3.417053	0.0090519	1.9936534	59
2	0.292928	0.956134	0.306367	3.264060	1.045878	3.413808	0.0090792	1.9905511	58
3	0.293206	0.956049	0.306685	3.260673	1.045971	3.410570	0.0091065	1.9874551	57
4	0.293484	0.955964	0.307003	3.257292	1.046065	3.407338	0.0091339	1.9843656	56
5	0.293762	0.955879	0.307322	3.253918	1.046158	3.404113	0.0091614	1.9812825	55
6	0.294040	0.955793	0.307640	3.250551	1.046252	3.400894	0.0091889	1.9782058	54
7	0.294318	0.955707	0.307959	3.247190	1.046345	3.397682	0.0092164	1.9751354	53
8	0.294596	0.955622	0.308277	3.243835	1.046439	3.394475	0.0092440	1.9720714	52
9	0.294874	0.955536	0.308596	3.240486	1.046533	3.391276	0.0092717	1.9690137	51
10	0.295152	0.955450	0.308914	3.237144	1.046627	3.388082	0.0092994	1.9659623	50
11	0.295430	0.955364	0.309233	3.233808	1.046721	3.384895	0.0093272	1.9629172	49
12	0.295708	0.955278	0.309552	3.230478	1.046815	3.381714	0.0093551	1.9598783	48
13	0.295986	0.955192	0.309870	3.227155	1.046910	3.378539	0.0093830	1.9568458	47
14	0.296264	0.955106	0.310189	3.223837	1.047004	3.375371	0.0094109	1.9538194	46
15	0.296542	0.955020	0.310508	3.220526	1.047099	3.372208	0.0094390	1.9507993	45
16	0.296819	0.954934	0.310827	3.217221	1.047193	3.369052	0.0094670	1.9477853	44
17	0.297097	0.954847	0.311146	3.213923	1.047288	3.365903	0.0094952	1.9447776	43
18	0.297375	0.954761	0.311465	3.210630	1.047383	3.362759	0.0095234	1.9417760	42
19	0.297653	0.954674	0.311784	3.207344	1.047478	3.359621	0.0095516	1.9387805	41
20	0.297930	0.954588	0.312104	3.204064	1.047573	3.356490	0.0095799	1.9357912	40
21	0.298208	0.954501	0.312423	3.200790	1.047668	3.353365	0.0096083	1.9328080	39
22	0.298486	0.954414	0.312742	3.197522	1.047763	3.350246	0.0096367	1.9298309	38
23	0.298763	0.954327	0.313062	3.194260	1.047859	3.347132	0.0096652	1.9268598	37
24	0.299041	0.954240	0.313381	3.191004	1.047954	3.344025	0.0096937	1.9238948	36
25	0.299318	0.954153	0.313700	3.187754	1.048050	3.340924	0.0097223	1.9209359	35
26	0.299596	0.954066	0.314020	3.184510	1.048145	3.337829	0.0097510	1.9179830	34
27	0.299873	0.953979	0.314340	3.181272	1.048241	3.334740	0.0097797	1.9150360	33
28	0.300151	0.953892	0.314659	3.178041	1.048337	3.331658	0.0098085	1.9120951	32
29	0.300428	0.953804	0.314979	3.174815	1.048433	3.328581	0.0098373	1.9091601	31
30	0.300706	0.953717	0.315299	3.171595	1.048529	3.325510	0.0098662	1.9062311	30
31	0.300983	0.953629	0.315619	3.168381	1.048625	3.322444	0.0098951	1.9033080	29
32	0.301261	0.953542	0.315939	3.165173	1.048722	3.319385	0.0099241	1.9003908	28
33	0.301538	0.953454	0.316258	3.161971	1.048818	3.316332	0.0099532	1.8974796	27
34	0.301815	0.953366	0.316578	3.158774	1.048915	3.313285	0.0099823	1.8945742	26
35	0.302093	0.953279	0.316899	3.155584	1.049011	3.310243	0.0100115	1.8916747	25
36	0.302370	0.953191	0.317219	3.152399	1.049108	3.307208	0.0100407	1.8887810	24
37	0.302647	0.953103	0.317539	3.149221	1.049205	3.304178	0.0100700	1.8858932	23
38	0.302924	0.953015	0.317859	3.146048	1.049302	3.301154	0.0100994	1.8830112	22
39	0.303202	0.952926	0.318179	3.142881	1.049399	3.298136	0.0101288	1.8801350	21
40	0.303479	0.952838	0.318500	3.139719	1.049496	3.295123	0.0101583	1.8772646	20
41	0.303756	0.952750	0.318820	3.136564	1.049593	3.292117	0.0101878	1.8743999	19
42	0.304033	0.952661	0.319141	3.133414	1.049691	3.289116	0.0102174	1.8715411	18
43	0.304310	0.952573	0.319461	3.130270	1.049788	3.286121	0.0102471	1.8686879	17
44	0.304587	0.952484	0.319782	3.127132	1.049886	3.283132	0.0102768	1.8658405	16
45	0.304864	0.952396	0.320103	3.123999	1.049984	3.280148	0.0103066	1.8629987	15
46	0.305141	0.952307	0.320423	3.120872	1.050081	3.277170	0.0103364	1.8601627	14
47	0.305418	0.952218	0.320744	3.117751	1.050179	3.274198	0.0103663	1.8573323	13
48	0.305695	0.952129	0.321065	3.114635	1.050277	3.271231	0.0103963	1.8545076	12
49	0.305972	0.952040	0.321386	3.111525	1.050376	3.268270	0.0104263	1.8516885	11
50	0.306249	0.951951	0.321707	3.108421	1.050474	3.265315	0.0104564	1.8488751	10
51	0.306526	0.951862	0.322028	3.105322	1.050572	3.262365	0.0104865	1.8460672	9
52	0.306803	0.951773	0.322349	3.102229	1.050671	3.259421	0.0105167	1.8432650	8
53	0.307080	0.951684	0.322670	3.099142	1.050769	3.256483	0.0105469	1.8404683	7
54	0.307357	0.951594	0.322991	3.096060	1.050868	3.253550	0.0105773	1.8376772	6
55	0.307633	0.951505	0.323312	3.092983	1.050967	3.250622	0.0106076	1.8348916	5
56	0.307910	0.951415	0.323634	3.089912	1.051066	3.247700	0.0106381	1.8321116	4
57	0.308187	0.951326	0.323955	3.086847	1.051165	3.244784	0.0106686	1.8293371	3
58	0.308464	0.951236	0.324277	3.083787	1.051264	3.241873	0.0106991	1.8265681	2
59	0.308740	0.951146	0.324598	3.080732	1.051363	3.238968	0.0107298	1.8238045	1
60	0.309017	0.951057	0.324920	3.077684	1.051462	3.236068	0.0107604	1.8210465	0
Min-utes	Cosine	Sine	Cotangent	Tangent	Cosecant	Secant	Read Down	72°-73° Involute	Min-utes

↑ 107° or 287°

72° or 252° ↑

↓ 18° or 198° **Trigonometric and Involute Functions** 161° or 341° ↓

Min-utes	Sine	Cosine	Tangent	Cotangent	Secant	Cosecant	Involute 18°-19°	Read Up	Min-utes
0	0.309017	0.951057	0.324920	3.077684	1.051462	3.236068	0.0107604	1.8210465	60
1	0.309294	0.950967	0.325241	3.074640	1.051562	3.233174	0.0107912	1.8182939	59
2	0.309570	0.950877	0.325563	3.071602	1.051661	3.230285	0.0108220	1.8155467	58
3	0.309847	0.950786	0.325885	3.068569	1.051761	3.227401	0.0108528	1.8128050	57
4	0.310123	0.950696	0.326207	3.065542	1.051861	3.224523	0.0108838	1.8100686	56
5	0.310400	0.950606	0.326528	3.062520	1.051960	3.221650	0.0109147	1.8073377	55
6	0.310676	0.950516	0.326850	3.059504	1.052060	3.218783	0.0109458	1.8046121	54
7	0.310953	0.950425	0.327172	3.056493	1.052161	3.215921	0.0109769	1.8018919	53
8	0.311229	0.950335	0.327494	3.053487	1.052261	3.213064	0.0110081	1.7991771	52
9	0.311506	0.950244	0.327817	3.050487	1.052361	3.210213	0.0110393	1.7964676	51
10	0.311782	0.950154	0.328139	3.047492	1.052461	3.207367	0.0110706	1.7937634	50
11	0.312059	0.950063	0.328461	3.044502	1.052562	3.204527	0.0111019	1.7910645	49
12	0.312335	0.949972	0.328783	3.041517	1.052663	3.201691	0.0111333	1.7883709	48
13	0.312611	0.949881	0.329106	3.038538	1.052763	3.198861	0.0111648	1.7856826	47
14	0.312888	0.949790	0.329428	3.035564	1.052864	3.196037	0.0111964	1.7829995	46
15	0.313164	0.949699	0.329751	3.032595	1.052965	3.193217	0.0112280	1.7803217	45
16	0.313440	0.949608	0.330073	3.029632	1.053066	3.190403	0.0112596	1.7776491	44
17	0.313716	0.949517	0.330396	3.026674	1.053167	3.187594	0.0112913	1.7749817	43
18	0.313992	0.949425	0.330718	3.023721	1.053269	3.184790	0.0113231	1.7723196	42
19	0.314269	0.949334	0.331041	3.020773	1.053370	3.181991	0.0113550	1.7696626	41
20	0.314545	0.949243	0.331364	3.017830	1.053471	3.179198	0.0113869	1.7670108	40
21	0.314821	0.949151	0.331687	3.014893	1.053573	3.176410	0.0114189	1.7643642	39
22	0.315097	0.949059	0.332010	3.011960	1.053675	3.173626	0.0114509	1.7617227	38
23	0.315373	0.948968	0.332333	3.009033	1.053777	3.170848	0.0114830	1.7590864	37
24	0.315649	0.948876	0.332656	3.006111	1.053878	3.168076	0.0115151	1.7564552	36
25	0.315925	0.948784	0.332979	3.003194	1.053981	3.165308	0.0115474	1.7538290	35
26	0.316201	0.948692	0.333302	3.000282	1.054083	3.162545	0.0115796	1.7512080	34
27	0.316477	0.948600	0.333625	2.997375	1.054185	3.159788	0.0116120	1.7485921	33
28	0.316753	0.948508	0.333949	2.994473	1.054287	3.157035	0.0116444	1.7459812	32
29	0.317029	0.948416	0.334272	2.991577	1.054390	3.154288	0.0116769	1.7433753	31
30	0.317305	0.948324	0.334595	2.988685	1.054492	3.151545	0.0117094	1.7407745	30
31	0.317580	0.948231	0.334919	2.985798	1.054595	3.148808	0.0117420	1.7381788	29
32	0.317856	0.948139	0.335242	2.982917	1.054698	3.146076	0.0117747	1.7355880	28
33	0.318132	0.948046	0.335566	2.980040	1.054801	3.143348	0.0118074	1.7330022	27
34	0.318408	0.947954	0.335890	2.977168	1.054904	3.140626	0.0118402	1.7304215	26
35	0.318684	0.947861	0.336213	2.974302	1.055007	3.137909	0.0118730	1.7278456	25
36	0.318959	0.947768	0.336537	2.971440	1.055110	3.135196	0.0119059	1.7252748	24
37	0.319235	0.947676	0.336861	2.968583	1.055213	3.132489	0.0119389	1.7227089	23
38	0.319511	0.947583	0.337185	2.965731	1.055317	3.129786	0.0119720	1.7201479	22
39	0.319786	0.947490	0.337509	2.962884	1.055420	3.127089	0.0120051	1.7175918	21
40	0.320062	0.947397	0.337833	2.960042	1.055524	3.124396	0.0120382	1.7150407	20
41	0.320337	0.947304	0.338157	2.957205	1.055628	3.121708	0.0120715	1.7124944	19
42	0.320613	0.947210	0.338481	2.954373	1.055732	3.119025	0.0121048	1.7099530	18
43	0.320889	0.947117	0.338806	2.951545	1.055836	3.116347	0.0121381	1.7074164	17
44	0.321164	0.947024	0.339130	2.948723	1.055940	3.113674	0.0121715	1.7048848	16
45	0.321439	0.946930	0.339454	2.945905	1.056044	3.111006	0.0122050	1.7023579	15
46	0.321715	0.946837	0.339779	2.943092	1.056148	3.108342	0.0122386	1.6998359	14
47	0.321990	0.946743	0.340103	2.940284	1.056253	3.105683	0.0122722	1.6973187	13
48	0.322266	0.946649	0.340428	2.937481	1.056357	3.103030	0.0123059	1.6948063	12
49	0.322541	0.946555	0.340752	2.934682	1.056462	3.100381	0.0123396	1.6922986	11
50	0.322816	0.946462	0.341077	2.931888	1.056567	3.097736	0.0123734	1.6897958	10
51	0.323092	0.946368	0.341402	2.929099	1.056672	3.095097	0.0124073	1.6872977	9
52	0.323367	0.946274	0.341727	2.926315	1.056777	3.092462	0.0124412	1.6848044	8
53	0.323642	0.946180	0.342052	2.923536	1.056882	3.089832	0.0124752	1.6823158	7
54	0.323917	0.946085	0.342377	2.920761	1.056987	3.087207	0.0125093	1.6798319	6
55	0.324193	0.945991	0.342702	2.917991	1.057092	3.084586	0.0125434	1.6773527	5
56	0.324468	0.945897	0.343027	2.915226	1.057198	3.081970	0.0125776	1.6748783	4
57	0.324743	0.945802	0.343352	2.912465	1.057303	3.079359	0.0126119	1.6724085	3
58	0.325018	0.945708	0.343677	2.909709	1.057409	3.076752	0.0126462	1.6699434	2
59	0.325293	0.945613	0.344002	2.906958	1.057515	3.074151	0.0126806	1.6674829	1
60	0.325568	0.945519	0.344328	2.904211	1.057621	3.071553	0.0127151	1.6650271	0
Min-utes	Cosine	Sine	Cotangent	Tangent	Cosecant	Secant	Read Down	71°-72° Involute	Min-utes

↑ 108° or 288°

71° or 251° ↑

↓ 19° or 199° **Trigonometric and Involute Functions** 160° or 340° ↓

Min-utes	Sine	Cosine	Tangent	Cotangent	Secant	Cosecant	Involute 19°-20°	Read Up	Min-utes
0	0.325568	0.945519	0.344328	2.904211	1.057621	3.071553	0.0127151	1.6650271	60
1	0.325843	0.945424	0.344653	2.901469	1.057727	3.068961	0.0127496	1.6625759	59
2	0.326118	0.945329	0.344978	2.898731	1.057833	3.066373	0.0127842	1.6601294	58
3	0.326393	0.945234	0.345304	2.895999	1.057939	3.063790	0.0128188	1.6576875	57
4	0.326668	0.945139	0.345630	2.893270	1.058045	3.061211	0.0128535	1.6552502	56
5	0.326943	0.945044	0.345955	2.890547	1.058152	3.058637	0.0128883	1.6528174	55
6	0.327218	0.944949	0.346281	2.887828	1.058258	3.056068	0.0129232	1.6503893	54
7	0.327493	0.944854	0.346607	2.885113	1.058365	3.053503	0.0129581	1.6479657	53
8	0.327768	0.944758	0.346933	2.882403	1.058472	3.050942	0.0129931	1.6455466	52
9	0.328042	0.944663	0.347259	2.879698	1.058579	3.048386	0.0130281	1.6431321	51
10	0.328317	0.944568	0.347585	2.876997	1.058686	3.045835	0.0130632	1.6407221	50
11	0.328592	0.944472	0.347911	2.874301	1.058793	3.043288	0.0130984	1.6383167	49
12	0.328867	0.944376	0.348237	2.871609	1.058900	3.040746	0.0131336	1.6359157	48
13	0.329141	0.944281	0.348563	2.868921	1.059007	3.038208	0.0131689	1.6335193	47
14	0.329416	0.944185	0.348889	2.866239	1.059115	3.035675	0.0132043	1.6311273	46
15	0.329691	0.944089	0.349216	2.863560	1.059222	3.033146	0.0132398	1.6287398	45
16	0.329965	0.943993	0.349542	2.860886	1.059330	3.030622	0.0132753	1.6263567	44
17	0.330240	0.943897	0.349868	2.858217	1.059438	3.028102	0.0133108	1.6239781	43
18	0.330514	0.943801	0.350195	2.855552	1.059545	3.025587	0.0133465	1.6216040	42
19	0.330789	0.943705	0.350522	2.852891	1.059653	3.023076	0.0133822	1.6192342	41
20	0.331063	0.943609	0.350848	2.850235	1.059762	3.020569	0.0134180	1.6168689	40
21	0.331338	0.943512	0.351175	2.847583	1.059870	3.018067	0.0134538	1.6145080	39
22	0.331612	0.943416	0.351502	2.844936	1.059978	3.015569	0.0134897	1.6121514	38
23	0.331887	0.943319	0.351829	2.842293	1.060087	3.013076	0.0135257	1.6097993	37
24	0.332161	0.943223	0.352156	2.839654	1.060195	3.010587	0.0135617	1.6074515	36
25	0.332435	0.943126	0.352483	2.837020	1.060304	3.008102	0.0135978	1.6051080	35
26	0.332710	0.943029	0.352810	2.834390	1.060412	3.005622	0.0136340	1.6027689	34
27	0.332984	0.942932	0.353137	2.831764	1.060521	3.003146	0.0136702	1.6004342	33
28	0.333258	0.942836	0.353464	2.829143	1.060630	3.000675	0.0137065	1.5981037	32
29	0.333533	0.942739	0.353791	2.826526	1.060739	2.998207	0.0137429	1.5957776	31
30	0.333807	0.942641	0.354119	2.823913	1.060848	2.995744	0.0137794	1.5934558	30
31	0.334081	0.942544	0.354446	2.821304	1.060958	2.993286	0.0138159	1.5911382	29
32	0.334355	0.942447	0.354773	2.818700	1.061067	2.990831	0.0138525	1.5888250	28
33	0.334629	0.942350	0.355101	2.816100	1.061177	2.988381	0.0138891	1.5865160	27
34	0.334903	0.942252	0.355429	2.813505	1.061287	2.985935	0.0139258	1.5842112	26
35	0.335178	0.942155	0.355756	2.810913	1.061396	2.983494	0.0139626	1.5819107	25
36	0.335452	0.942057	0.356084	2.808326	1.061506	2.981056	0.0139994	1.5796145	24
37	0.335726	0.941960	0.356412	2.805743	1.061616	2.978623	0.0140364	1.5773224	23
38	0.336000	0.941862	0.356740	2.803165	1.061727	2.976194	0.0140734	1.5750346	22
39	0.336274	0.941764	0.357068	2.800590	1.061837	2.973769	0.0141104	1.5727510	21
40	0.336547	0.941666	0.357396	2.798020	1.061947	2.971349	0.0141475	1.5704716	20
41	0.336821	0.941569	0.357724	2.795454	1.062058	2.968933	0.0141847	1.5681963	19
42	0.337095	0.941471	0.358052	2.792892	1.062168	2.966521	0.0142220	1.5659252	18
43	0.337369	0.941372	0.358380	2.790334	1.062279	2.964113	0.0142593	1.5636583	17
44	0.337643	0.941274	0.358708	2.787780	1.062390	2.961709	0.0142967	1.5613955	16
45	0.337917	0.941176	0.359037	2.785231	1.062501	2.959309	0.0143342	1.5591369	15
46	0.338190	0.941078	0.359365	2.782685	1.062612	2.956914	0.0143717	1.5568824	14
47	0.338464	0.940979	0.359694	2.780144	1.062723	2.954522	0.0144093	1.5546320	13
48	0.338738	0.940881	0.360022	2.777607	1.062834	2.952135	0.0144470	1.5523857	12
49	0.339012	0.940782	0.360351	2.775074	1.062945	2.949752	0.0144847	1.5501435	11
50	0.339285	0.940684	0.360679	2.772545	1.063057	2.947372	0.0145225	1.5479054	10
51	0.339559	0.940585	0.361008	2.770020	1.063168	2.944997	0.0145604	1.5456714	9
52	0.339832	0.940487	0.361337	2.767499	1.063280	2.942627	0.0145983	1.5434415	8
53	0.340106	0.940388	0.361666	2.764982	1.063392	2.940260	0.0146363	1.5412156	7
54	0.340380	0.940288	0.361995	2.762470	1.063504	2.937897	0.0146744	1.5389937	6
55	0.340653	0.940189	0.362324	2.759961	1.063616	2.935538	0.0147126	1.5367759	5
56	0.340927	0.940090	0.362653	2.757456	1.063728	2.933183	0.0147508	1.5345621	4
57	0.341200	0.939991	0.362982	2.754955	1.063840	2.930833	0.0147891	1.5323523	3
58	0.341473	0.939891	0.363312	2.752459	1.063953	2.928486	0.0148275	1.5301465	2
59	0.341747	0.939792	0.363641	2.749966	1.064065	2.926143	0.0148659	1.5279447	1
60	0.342020	0.939693	0.363970	2.747477	1.064178	2.923804	0.0149044	1.5257469	0
Min-utes	Cosine	Sine	Cotangent	Tangent	Cosecant	Secant	Read Down	70°-71° Involute	Min-utes

↑ 109° or 289°

70° or 250° ↑

↓ 20° or 200° **Trigonometric and Involute Functions** 159° or 339° ↓

Min-utes	Sine	Cosine	Tangent	Cotangent	Secant	Cosecant	Involute 20°-21°	Read Up	Min-utes
0	0.342020	0.939693	0.363970	2.747477	1.064178	2.923804	0.0149044	1.5257469	60
1	0.342293	0.939593	0.364300	2.744993	1.064290	2.921470	0.0149430	1.5235531	59
2	0.342567	0.939493	0.364629	2.742512	1.064403	2.919139	0.0149816	1.5213633	58
3	0.342840	0.939394	0.364959	2.740035	1.064516	2.916812	0.0150203	1.5191774	57
4	0.343113	0.939294	0.365288	2.737562	1.064629	2.914489	0.0150591	1.5169954	56
5	0.343387	0.939194	0.365618	2.735093	1.064743	2.912170	0.0150979	1.5148174	55
6	0.343660	0.939094	0.365948	2.732628	1.064856	2.909855	0.0151369	1.5126433	54
7	0.343933	0.938994	0.366278	2.730167	1.064969	2.907544	0.0151758	1.5104731	53
8	0.344206	0.938894	0.366608	2.727710	1.065083	2.905237	0.0152149	1.5083068	52
9	0.344479	0.938794	0.366938	2.725257	1.065196	2.902934	0.0152540	1.5061444	51
10	0.344752	0.938694	0.367268	2.722808	1.065310	2.900635	0.0152932	1.5039860	50
11	0.345025	0.938593	0.367598	2.720362	1.065424	2.898339	0.0153325	1.5018313	49
12	0.345298	0.938493	0.367928	2.717920	1.065538	2.896048	0.0153719	1.4996806	48
13	0.345571	0.938393	0.368259	2.715483	1.065652	2.893760	0.0154113	1.4975337	47
14	0.345844	0.938292	0.368589	2.713049	1.065766	2.891476	0.0154507	1.4953907	46
15	0.346117	0.938191	0.368919	2.710619	1.065881	2.889196	0.0154903	1.4932515	45
16	0.346390	0.938091	0.369250	2.708192	1.065995	2.886920	0.0155299	1.4911161	44
17	0.346663	0.937990	0.369581	2.705770	1.066110	2.884647	0.0155696	1.4889845	43
18	0.346936	0.937889	0.369911	2.703351	1.066224	2.882379	0.0156094	1.4868568	42
19	0.347208	0.937788	0.370242	2.700936	1.066339	2.880114	0.0156492	1.4847328	41
20	0.347481	0.937687	0.370573	2.698525	1.066454	2.877853	0.0156891	1.4826127	40
21	0.347754	0.937586	0.370904	2.696118	1.066569	2.875596	0.0157291	1.4804963	39
22	0.348027	0.937485	0.371235	2.693715	1.066684	2.873343	0.0157692	1.4783837	38
23	0.348299	0.937383	0.371566	2.691315	1.066799	2.871093	0.0158093	1.4762749	37
24	0.348572	0.937282	0.371897	2.688919	1.066915	2.868847	0.0158495	1.4741698	36
25	0.348845	0.937181	0.372228	2.686527	1.067030	2.866605	0.0158898	1.4720685	35
26	0.349117	0.937079	0.372559	2.684138	1.067146	2.864367	0.0159301	1.4699709	34
27	0.349390	0.936977	0.372890	2.681754	1.067262	2.862132	0.0159705	1.4678770	33
28	0.349662	0.936876	0.373222	2.679372	1.067377	2.859902	0.0160110	1.4657869	32
29	0.349935	0.936774	0.373553	2.676995	1.067493	2.857674	0.0160516	1.4637004	31
30	0.350207	0.936672	0.373885	2.674621	1.067609	2.855451	0.0160922	1.4616177	30
31	0.350480	0.936570	0.374216	2.672252	1.067726	2.853231	0.0161329	1.4595386	29
32	0.350752	0.936468	0.374548	2.669885	1.067842	2.851015	0.0161737	1.4574632	28
33	0.351025	0.936366	0.374880	2.667523	1.067958	2.848803	0.0162145	1.4553915	27
34	0.351297	0.936264	0.375211	2.665164	1.068075	2.846594	0.0162554	1.4533235	26
35	0.351569	0.936162	0.375543	2.662809	1.068191	2.844389	0.0162964	1.4512591	25
36	0.351842	0.936060	0.375875	2.660457	1.068308	2.842188	0.0163375	1.4491984	24
37	0.352114	0.935957	0.376207	2.658109	1.068425	2.839990	0.0163786	1.4471413	23
38	0.352386	0.935855	0.376539	2.655765	1.068542	2.837796	0.0164198	1.4450878	22
39	0.352658	0.935752	0.376872	2.653424	1.068659	2.835605	0.0164611	1.4430380	21
40	0.352931	0.935650	0.377204	2.651087	1.068776	2.833419	0.0165024	1.4409917	20
41	0.353203	0.935547	0.377536	2.648753	1.068894	2.831235	0.0165439	1.4389491	19
42	0.353475	0.935444	0.377869	2.646423	1.069011	2.829056	0.0165854	1.4369100	18
43	0.353747	0.935341	0.378201	2.644097	1.069129	2.826880	0.0166269	1.4348746	17
44	0.354019	0.935238	0.378534	2.641774	1.069246	2.824707	0.0166686	1.4328427	16
45	0.354291	0.935135	0.378866	2.639455	1.069364	2.822538	0.0167103	1.4308144	15
46	0.354563	0.935032	0.379199	2.637139	1.069482	2.820373	0.0167521	1.4287896	14
47	0.354835	0.934929	0.379532	2.634827	1.069600	2.818211	0.0167939	1.4267684	13
48	0.355107	0.934826	0.379864	2.632519	1.069718	2.816053	0.0168359	1.4247507	12
49	0.355379	0.934722	0.380197	2.630214	1.069836	2.813898	0.0168779	1.4227366	11
50	0.355651	0.934619	0.380530	2.627912	1.069955	2.811747	0.0169200	1.4207260	10
51	0.355923	0.934515	0.380863	2.625614	1.070073	2.809599	0.0169621	1.4187189	9
52	0.356194	0.934412	0.381196	2.623320	1.070192	2.807455	0.0170044	1.4167153	8
53	0.356466	0.934308	0.381530	2.621029	1.070311	2.805315	0.0170467	1.4147152	7
54	0.356738	0.934204	0.381863	2.618741	1.070429	2.803178	0.0170891	1.4127186	6
55	0.357010	0.934101	0.382196	2.616457	1.070548	2.801044	0.0171315	1.4107255	5
56	0.357281	0.933997	0.382530	2.614177	1.070668	2.798914	0.0171740	1.4087359	4
57	0.357553	0.933893	0.382863	2.611900	1.070787	2.796787	0.0172166	1.4067497	3
58	0.357825	0.933789	0.383197	2.609626	1.070906	2.794664	0.0172593	1.4047670	2
59	0.358096	0.933685	0.383530	2.607356	1.071025	2.792544	0.0173021	1.4027877	1
60	0.358368	0.933580	0.383864	2.605089	1.071145	2.790428	0.0173449	1.4008119	0
Min-utes	Cosine	Sine	Cotangent	Tangent	Cosecant	Secant	Read Down	69°-70° Involute	Min-utes

↑ 110° or 290°

69° or 249° ↑

↓ 21° or 201° Trigonometric and Involute Functions 158° or 338° ↓

Min-utes	Sine	Cosine	Tangent	Cotangent	Secant	Cosecant	Involute 21°-22°	Read Up	Min-utes
0	0.358368	0.933580	0.383864	2.605089	1.071145	2.790428	0.0173449	1.4008119	60
1	0.358640	0.933476	0.384198	2.602826	1.071265	2.788315	0.0173878	1.3988395	59
2	0.358911	0.933372	0.384532	2.600566	1.071384	2.786206	0.0174308	1.3968705	58
3	0.359183	0.933267	0.384866	2.598309	1.071504	2.784100	0.0174738	1.3949050	57
4	0.359454	0.933163	0.385200	2.596056	1.071624	2.781997	0.0175169	1.3929428	56
5	0.359725	0.933058	0.385534	2.593807	1.071744	2.779898	0.0175601	1.3909841	55
6	0.359997	0.932954	0.385868	2.591561	1.071865	2.777802	0.0176034	1.3890287	54
7	0.360268	0.932849	0.386202	2.589318	1.071985	2.775710	0.0176468	1.3870768	53
8	0.360540	0.932744	0.386536	2.587078	1.072106	2.773621	0.0176902	1.3851282	52
9	0.360811	0.932639	0.386871	2.584842	1.072226	2.771535	0.0177337	1.3831829	51
10	0.361082	0.932534	0.387205	2.582609	1.072347	2.769453	0.0177773	1.3812411	50
11	0.361353	0.932429	0.387540	2.580380	1.072468	2.767374	0.0178209	1.3793026	49
12	0.361625	0.932324	0.387874	2.578154	1.072589	2.765299	0.0178646	1.3773674	48
13	0.361896	0.932219	0.388209	2.575931	1.072710	2.763227	0.0179084	1.3754356	47
14	0.362167	0.932113	0.388544	2.573712	1.072831	2.761158	0.0179523	1.3735071	46
15	0.362438	0.932008	0.388879	2.571496	1.072952	2.759092	0.0179963	1.3715819	45
16	0.362709	0.931902	0.389214	2.569283	1.073074	2.757030	0.0180403	1.3696600	44
17	0.362980	0.931797	0.389549	2.567074	1.073195	2.754971	0.0180844	1.3677414	43
18	0.363251	0.931691	0.389884	2.564867	1.073317	2.752916	0.0181286	1.3658262	42
19	0.363522	0.931586	0.390219	2.562665	1.073439	2.750863	0.0181728	1.3639142	41
20	0.363793	0.931480	0.390554	2.560465	1.073561	2.748814	0.0182172	1.3620055	40
21	0.364064	0.931374	0.390889	2.558269	1.073683	2.746769	0.0182616	1.3601001	39
22	0.364335	0.931268	0.391225	2.556076	1.073805	2.744726	0.0183061	1.3581979	38
23	0.364606	0.931162	0.391560	2.553886	1.073927	2.742687	0.0183506	1.3562990	37
24	0.364877	0.931056	0.391896	2.551699	1.074049	2.740651	0.0183953	1.3544034	36
25	0.365148	0.930950	0.392231	2.549516	1.074172	2.738619	0.0184400	1.3525110	35
26	0.365418	0.930843	0.392567	2.547336	1.074295	2.736589	0.0184848	1.3506218	34
27	0.365689	0.930737	0.392903	2.545159	1.074417	2.734563	0.0185296	1.3487359	33
28	0.365960	0.930631	0.393239	2.542985	1.074540	2.732540	0.0185746	1.3468532	32
29	0.366231	0.930524	0.393574	2.540815	1.074663	2.730520	0.0186196	1.3449737	31
30	0.366502	0.930418	0.393910	2.538648	1.074786	2.728504	0.0186647	1.3430974	30
31	0.366772	0.930311	0.394247	2.536484	1.074909	2.726491	0.0187099	1.3412243	29
32	0.367042	0.930204	0.394583	2.534323	1.075033	2.724480	0.0187551	1.3393544	28
33	0.367313	0.930097	0.394919	2.532165	1.075156	2.722474	0.0188004	1.3374876	27
34	0.367584	0.929990	0.395255	2.530011	1.075280	2.720470	0.0188458	1.3356241	26
35	0.367854	0.929884	0.395592	2.527860	1.075403	2.718469	0.0188913	1.3337637	25
36	0.368125	0.929776	0.395928	2.525712	1.075527	2.716472	0.0189369	1.3319065	24
37	0.368395	0.929669	0.396265	2.523567	1.075651	2.714478	0.0189825	1.3300524	23
38	0.368665	0.929562	0.396601	2.521425	1.075775	2.712487	0.0190282	1.3282015	22
39	0.368936	0.929455	0.396938	2.519286	1.075899	2.710499	0.0190740	1.3263537	21
40	0.369206	0.929348	0.397275	2.517151	1.076024	2.708514	0.0191199	1.3245091	20
41	0.369476	0.929240	0.397611	2.515018	1.076148	2.706532	0.0191659	1.3226676	19
42	0.369747	0.929133	0.397948	2.512889	1.076273	2.704554	0.0192119	1.3208292	18
43	0.370017	0.929025	0.398285	2.510763	1.076397	2.702578	0.0192580	1.3189939	17
44	0.370287	0.928917	0.398622	2.508640	1.076522	2.700606	0.0193042	1.3171617	16
45	0.370557	0.928810	0.398960	2.506520	1.076647	2.698637	0.0193504	1.3153326	15
46	0.370828	0.928702	0.399297	2.504403	1.076772	2.696671	0.0193968	1.3135066	14
47	0.371098	0.928594	0.399634	2.502289	1.076897	2.694708	0.0194432	1.3116837	13
48	0.371368	0.928486	0.399971	2.500178	1.077022	2.692748	0.0194897	1.3098638	12
49	0.371638	0.928378	0.400309	2.498071	1.077148	2.690791	0.0195363	1.3080470	11
50	0.371908	0.928270	0.400646	2.495966	1.077273	2.688837	0.0195829	1.3062333	10
51	0.372178	0.928161	0.400984	2.493865	1.077399	2.686887	0.0196296	1.3044227	9
52	0.372448	0.928053	0.401322	2.491766	1.077525	2.684939	0.0196765	1.3026150	8
53	0.372718	0.927945	0.401660	2.489671	1.077650	2.682995	0.0197233	1.3008105	7
54	0.372988	0.927836	0.401997	2.487578	1.077776	2.681053	0.0197703	1.2990089	6
55	0.373258	0.927728	0.402335	2.485489	1.077902	2.679114	0.0198174	1.2972104	5
56	0.373528	0.927619	0.402673	2.483402	1.078029	2.677179	0.0198645	1.2954149	4
57	0.373797	0.927510	0.403011	2.481319	1.078155	2.675247	0.0199117	1.2936224	3
58	0.374067	0.927402	0.403350	2.479239	1.078281	2.673317	0.0199590	1.2918329	2
59	0.374337	0.927293	0.403688	2.477161	1.078408	2.671391	0.0200063	1.2900465	1
60	0.374607	0.927184	0.404026	2.475087	1.078535	2.669467	0.0200538	1.2882630	0
Min-utes	Cosine	Sine	Cotangent	Tangent	Cosecant	Secant	Read Down	68°-69° Involute	Min-utes

↑ 111° or 291°

68° or 248° ↑

↓ 22° or 202° **Trigonometric and Involute Functions** 157° or 337° ↓

Min-utes	Sine	Cosine	Tangent	Cotangent	Secant	Cosecant	Involute 22°-23°	Read Up	Min-utes
0	0.374607	0.927184	0.404026	2.475087	1.078535	2.669467	0.0200538	1.2882630	60
1	0.374876	0.927075	0.404365	2.473015	1.078662	2.667547	0.0201013	1.2864825	59
2	0.375146	0.926966	0.404703	2.470947	1.078788	2.665629	0.0201489	1.2847049	58
3	0.375416	0.926857	0.405042	2.468882	1.078916	2.663715	0.0201966	1.2829304	57
4	0.375685	0.926747	0.405380	2.466819	1.079043	2.661803	0.0202444	1.2811588	56
5	0.375955	0.926638	0.405719	2.464760	1.079170	2.659895	0.0202922	1.2793901	55
6	0.376224	0.926529	0.406058	2.462703	1.079297	2.657989	0.0203401	1.2776245	54
7	0.376494	0.926419	0.406397	2.460649	1.079425	2.656086	0.0203881	1.2758617	53
8	0.376763	0.926310	0.406736	2.458599	1.079553	2.654187	0.0204362	1.2741019	52
9	0.377033	0.926200	0.407075	2.456551	1.079680	2.652290	0.0204844	1.2723451	51
10	0.377302	0.926090	0.407414	2.454506	1.079808	2.650396	0.0205326	1.2705911	50
11	0.377571	0.925980	0.407753	2.452464	1.079936	2.648505	0.0205809	1.2688401	49
12	0.377841	0.925871	0.408092	2.450425	1.080065	2.646617	0.0206293	1.2670920	48
13	0.378110	0.925761	0.408432	2.448389	1.080193	2.644732	0.0206778	1.2653468	47
14	0.378379	0.925651	0.408771	2.446356	1.080321	2.642850	0.0207264	1.2636044	46
15	0.378649	0.925541	0.409111	2.444328	1.080450	2.640971	0.0207750	1.2618650	45
16	0.378918	0.925430	0.409450	2.442298	1.080578	2.639095	0.0208238	1.2601285	44
17	0.379187	0.925320	0.409790	2.440274	1.080707	2.637221	0.0208726	1.2583948	43
18	0.379456	0.925210	0.410130	2.438252	1.080836	2.635351	0.0209215	1.2566640	42
19	0.379725	0.925099	0.410470	2.436233	1.080965	2.633483	0.0209704	1.2549361	41
20	0.379994	0.924989	0.410810	2.434217	1.081094	2.631618	0.0210195	1.2532111	40
21	0.380263	0.924878	0.411150	2.432204	1.081223	2.629756	0.0210686	1.2514889	39
22	0.380532	0.924768	0.411490	2.430194	1.081353	2.627897	0.0211178	1.2497695	38
23	0.380801	0.924657	0.411830	2.428186	1.081482	2.626041	0.0211671	1.2480530	37
24	0.381070	0.924546	0.412170	2.426182	1.081612	2.624187	0.0212165	1.2463393	36
25	0.381339	0.924435	0.412511	2.424180	1.081742	2.622337	0.0212660	1.2446284	35
26	0.381608	0.924324	0.412851	2.422181	1.081872	2.620489	0.0213155	1.2429204	34
27	0.381877	0.924213	0.413192	2.420185	1.082002	2.618644	0.0213651	1.2412152	33
28	0.382146	0.924102	0.413532	2.418192	1.082132	2.616802	0.0214148	1.2395127	32
29	0.382415	0.923991	0.413873	2.416201	1.082262	2.614962	0.0214646	1.2378131	31
30	0.382683	0.923880	0.414214	2.414214	1.082392	2.613126	0.0215145	1.2361163	30
31	0.382952	0.923768	0.414554	2.412229	1.082523	2.611292	0.0215644	1.2344223	29
32	0.383221	0.923657	0.414895	2.410247	1.082653	2.609461	0.0216145	1.2327310	28
33	0.383490	0.923545	0.415236	2.408267	1.082784	2.607633	0.0216646	1.2310426	27
34	0.383758	0.923434	0.415577	2.406291	1.082915	2.605808	0.0217148	1.2293569	26
35	0.384027	0.923322	0.415919	2.404317	1.083046	2.603985	0.0217651	1.2276740	25
36	0.384295	0.923210	0.416260	2.402346	1.083177	2.602165	0.0218154	1.2259938	24
37	0.384564	0.923098	0.416601	2.400372	1.083308	2.600348	0.0218659	1.2243164	23
38	0.384832	0.922986	0.416943	2.398411	1.083439	2.598534	0.0219164	1.2226417	22
39	0.385101	0.922875	0.417284	2.396449	1.083571	2.596723	0.0219670	1.2209698	21
40	0.385369	0.922762	0.417626	2.394489	1.083703	2.594914	0.0220177	1.2193006	20
41	0.385638	0.922650	0.417967	2.392532	1.083834	2.593108	0.0220685	1.2176341	19
42	0.385906	0.922538	0.418309	2.390577	1.083966	2.591304	0.0221193	1.2159704	18
43	0.386174	0.922426	0.418651	2.388625	1.084098	2.589504	0.0221703	1.2143093	17
44	0.386443	0.922313	0.418993	2.386676	1.084230	2.587706	0.0222213	1.2126510	16
45	0.386711	0.922201	0.419335	2.384729	1.084362	2.585911	0.0222724	1.2109954	15
46	0.386979	0.922088	0.419677	2.382786	1.084495	2.584118	0.0223236	1.2093425	14
47	0.387247	0.921976	0.420019	2.380844	1.084627	2.582328	0.0223749	1.2076923	13
48	0.387516	0.921863	0.420361	2.378906	1.084760	2.580541	0.0224262	1.2060447	12
49	0.387784	0.921750	0.420704	2.376970	1.084892	2.578757	0.0224777	1.2043999	11
50	0.388052	0.921638	0.421046	2.375037	1.085025	2.576975	0.0225292	1.2027577	10
51	0.388320	0.921525	0.421389	2.373107	1.085158	2.575196	0.0225808	1.2011182	9
52	0.388588	0.921412	0.421731	2.371179	1.085291	2.573420	0.0226325	1.1994814	8
53	0.388856	0.921299	0.422074	2.369254	1.085424	2.571646	0.0226843	1.1978472	7
54	0.389124	0.921185	0.422417	2.367332	1.085558	2.569875	0.0227361	1.1962156	6
55	0.389392	0.921072	0.422759	2.365412	1.085691	2.568107	0.0227881	1.1945867	5
56	0.389660	0.920959	0.423102	2.363495	1.085825	2.566341	0.0228401	1.1929605	4
57	0.389928	0.920845	0.423445	2.361580	1.085959	2.564578	0.0228922	1.1913369	3
58	0.390196	0.920732	0.423788	2.359668	1.086092	2.562818	0.0229444	1.1897159	2
59	0.390463	0.920618	0.424132	2.357759	1.086226	2.561060	0.0229967	1.1880975	1
60	0.390731	0.920505	0.424475	2.355852	1.086360	2.559305	0.0230491	1.1864818	0
Min-utes	Cosine	Sine	Cotangent	Tangent	Cosecant	Secant	Read Down	67°-68° Involute	Min-utes

↑ 112° or 292°

67° or 247° ↑

↓ 23° or 203° **Trigonometric and Involute Functions** 156° or 336° ↓

Min-utes	Sine	Cosine	Tangent	Cotangent	Secant	Cosecant	Involute 23°-24°	Read Up	Min-utes
0	0.390731	0.920505	0.424475	2.355852	1.086360	2.559305	0.0230491	1.1864818	60
1	0.390999	0.920391	0.424818	2.353948	1.086495	2.557552	0.0231015	1.1848686	59
2	0.391267	0.920277	0.425162	2.352047	1.086629	2.555802	0.0231541	1.1832581	58
3	0.391534	0.920164	0.425505	2.350148	1.086763	2.554055	0.0232067	1.1816502	57
4	0.391802	0.920050	0.425849	2.348252	1.086898	2.552310	0.0232594	1.1800448	56
5	0.392070	0.919936	0.426192	2.346358	1.087033	2.550568	0.0233122	1.1784421	55
6	0.392337	0.919821	0.426536	2.344467	1.087167	2.548828	0.0233651	1.1768419	54
7	0.392605	0.919707	0.426880	2.342579	1.087302	2.547091	0.0234181	1.1752443	53
8	0.392872	0.919593	0.427224	2.340693	1.087437	2.545357	0.0234711	1.1736493	52
9	0.393140	0.919479	0.427568	2.338809	1.087573	2.543625	0.0235242	1.1720569	51
10	0.393407	0.919364	0.427912	2.336929	1.087708	2.541896	0.0235775	1.1704670	50
11	0.393675	0.919250	0.428256	2.335050	1.087843	2.540169	0.0236308	1.1688797	49
12	0.393942	0.919135	0.428601	2.333175	1.087979	2.538445	0.0236842	1.1672949	48
13	0.394209	0.919021	0.428945	2.331302	1.088115	2.536724	0.0237376	1.1657126	47
14	0.394477	0.918906	0.429289	2.329431	1.088251	2.535005	0.0237912	1.1641329	46
15	0.394744	0.918791	0.429634	2.327563	1.088387	2.533288	0.0238449	1.1625558	45
16	0.395011	0.918676	0.429979	2.325698	1.088523	2.531574	0.0238986	1.1609811	44
17	0.395278	0.918561	0.430323	2.323835	1.088659	2.529863	0.0239524	1.1594090	43
18	0.395546	0.918446	0.430668	2.321974	1.088795	2.528154	0.0240063	1.1578394	42
19	0.395813	0.918331	0.431013	2.320116	1.088932	2.526448	0.0240603	1.1562723	41
20	0.396080	0.918216	0.431358	2.318261	1.089068	2.524744	0.0241144	1.1547077	40
21	0.396347	0.918101	0.431703	2.316408	1.089205	2.523043	0.0241686	1.1531457	39
22	0.396614	0.917986	0.432048	2.314557	1.089342	2.521344	0.0242228	1.1515861	38
23	0.396881	0.917870	0.432393	2.312709	1.089479	2.519648	0.0242772	1.1500290	37
24	0.397148	0.917755	0.432739	2.310864	1.089616	2.517954	0.0243316	1.1484744	36
25	0.397415	0.917639	0.433084	2.309021	1.089753	2.516262	0.0243861	1.1469222	35
26	0.397682	0.917523	0.433430	2.307180	1.089890	2.514574	0.0244407	1.1453726	34
27	0.397949	0.917408	0.433775	2.305342	1.090028	2.512887	0.0244954	1.1438254	33
28	0.398215	0.917292	0.434121	2.303506	1.090166	2.511203	0.0245502	1.1422807	32
29	0.398482	0.917176	0.434467	2.301673	1.090303	2.509522	0.0246050	1.1407384	31
30	0.398749	0.917060	0.434812	2.299843	1.090441	2.507843	0.0246600	1.1391986	30
31	0.399016	0.916944	0.435158	2.298014	1.090579	2.506166	0.0247150	1.1376612	29
32	0.399283	0.916828	0.435504	2.296188	1.090717	2.504492	0.0247702	1.1361263	28
33	0.399549	0.916712	0.435850	2.294365	1.090855	2.502821	0.0248254	1.1345938	27
34	0.399816	0.916595	0.436197	2.292542	1.090994	2.501151	0.0248807	1.1330638	26
35	0.400082	0.916479	0.436543	2.290726	1.091132	2.499485	0.0249361	1.1315361	25
36	0.400349	0.916363	0.436889	2.288910	1.091271	2.497820	0.0249916	1.1300109	24
37	0.400616	0.916246	0.437236	2.287096	1.091410	2.496159	0.0250471	1.1284882	23
38	0.400882	0.916130	0.437582	2.285285	1.091549	2.494499	0.0251028	1.1269678	22
39	0.401149	0.916013	0.437929	2.283476	1.091688	2.492842	0.0251585	1.1254498	21
40	0.401415	0.915896	0.438276	2.281669	1.091827	2.491187	0.0252143	1.1239342	20
41	0.401681	0.915779	0.438622	2.279865	1.091966	2.489535	0.0252703	1.1224211	19
42	0.401948	0.915663	0.438969	2.278064	1.092105	2.487885	0.0253263	1.1209103	18
43	0.402214	0.915546	0.439316	2.276264	1.092245	2.486238	0.0253824	1.1194019	17
44	0.402480	0.915429	0.439663	2.274467	1.092384	2.484593	0.0254386	1.1178959	16
45	0.402747	0.915311	0.440011	2.272673	1.092524	2.482950	0.0254948	1.1163922	15
46	0.403013	0.915194	0.440358	2.270881	1.092664	2.481310	0.0255512	1.1148910	14
47	0.403279	0.915077	0.440705	2.269091	1.092804	2.479672	0.0256076	1.1133921	13
48	0.403545	0.914960	0.441053	2.267304	1.092944	2.478037	0.0256642	1.1118955	12
49	0.403811	0.914842	0.441400	2.265518	1.093085	2.476403	0.0257208	1.1104014	11
50	0.404078	0.914725	0.441748	2.263736	1.093225	2.474773	0.0257775	1.1089095	10
51	0.404344	0.914607	0.442095	2.261955	1.093366	2.473144	0.0258343	1.1074201	9
52	0.404610	0.914490	0.442443	2.260177	1.093506	2.471518	0.0258912	1.1059329	8
53	0.404876	0.914372	0.442791	2.258402	1.093647	2.469894	0.0259482	1.1044481	7
54	0.405142	0.914254	0.443139	2.256628	1.093788	2.468273	0.0260053	1.1029656	6
55	0.405408	0.914136	0.443487	2.254857	1.093929	2.466654	0.0260625	1.1014855	5
56	0.405673	0.914018	0.443835	2.253089	1.094070	2.465037	0.0261197	1.1000077	4
57	0.405939	0.913900	0.444183	2.251322	1.094212	2.463423	0.0261771	1.0985321	3
58	0.406205	0.913782	0.444532	2.249558	1.094353	2.461811	0.0262345	1.0970589	2
59	0.406471	0.913664	0.444880	2.247796	1.094495	2.460201	0.0262920	1.0955881	1
60	0.406737	0.913545	0.445229	2.246037	1.094636	2.458593	0.0263497	1.0941195	0
Min-utes	Cosine	Sine	Cotangent	Tangent	Cosecant	Secant	Read Down	66°-67° Involute	Min-utes

↑ 113° or 293°

66° or 246° ↑

↓ 24° or 204° **Trigonometric and Involute Functions** 155° or 335° ↓

Min-utes	Sine	Cosine	Tangent	Cotangent	Secant	Cosecant	Involute 24°–25°	Read Up	Min-utes
0	0.406737	0.913545	0.445229	2.246037	1.094636	2.458593	0.0263497	1.0941195	60
1	0.407002	0.913427	0.445577	2.244280	1.094778	2.456988	0.0264074	1.0926532	59
2	0.407268	0.913309	0.445926	2.242525	1.094920	2.455385	0.0264652	1.0911892	58
3	0.407534	0.913190	0.446275	2.240772	1.095062	2.453785	0.0265231	1.0897275	57
4	0.407799	0.913072	0.446624	2.239022	1.095204	2.452186	0.0265810	1.0882680	56
5	0.408065	0.912953	0.446973	2.237274	1.095347	2.450591	0.0266391	1.0868109	55
6	0.408330	0.912834	0.447322	2.235528	1.095489	2.448997	0.0266973	1.0853560	54
7	0.408596	0.912715	0.447671	2.233785	1.095632	2.447405	0.0267555	1.0839034	53
8	0.408861	0.912596	0.448020	2.232043	1.095775	2.445816	0.0268139	1.0824531	52
9	0.409127	0.912477	0.448369	2.230304	1.095917	2.444229	0.0268723	1.0810050	51
10	0.409392	0.912358	0.448719	2.228568	1.096060	2.442645	0.0269308	1.0795592	50
11	0.409658	0.912239	0.449068	2.226833	1.096204	2.441062	0.0269894	1.0781156	49
12	0.409923	0.912120	0.449418	2.225101	1.096347	2.439482	0.0270481	1.0766743	48
13	0.410188	0.912001	0.449768	2.223371	1.096490	2.437904	0.0271069	1.0752352	47
14	0.410454	0.911881	0.450117	2.221643	1.096634	2.436329	0.0271658	1.0737983	46
15	0.410719	0.911762	0.450467	2.219918	1.096777	2.434756	0.0272248	1.0723637	45
16	0.410984	0.911643	0.450817	2.218194	1.096921	2.433184	0.0272839	1.0709313	44
17	0.411249	0.911523	0.451167	2.216473	1.097065	2.431616	0.0273430	1.0695011	43
18	0.411514	0.911403	0.451517	2.214754	1.097209	2.430049	0.0274023	1.0680732	42
19	0.411779	0.911284	0.451868	2.213038	1.097353	2.428484	0.0274617	1.0666474	41
20	0.412045	0.911164	0.452218	2.211323	1.097498	2.426922	0.0275211	1.0652239	40
21	0.412310	0.911044	0.452568	2.209611	1.097642	2.425362	0.0275806	1.0638026	39
22	0.412575	0.910924	0.452919	2.207901	1.097787	2.423804	0.0276403	1.0623835	38
23	0.412840	0.910804	0.453269	2.206193	1.097931	2.422249	0.0277000	1.0609665	37
24	0.413104	0.910684	0.453620	2.204488	1.098076	2.420695	0.0277598	1.0595518	36
25	0.413369	0.910563	0.453971	2.202784	1.098221	2.419144	0.0278197	1.0581392	35
26	0.413634	0.910443	0.454322	2.201083	1.098366	2.417595	0.0278797	1.0567288	34
27	0.413899	0.910323	0.454673	2.199384	1.098511	2.416048	0.0279398	1.0553206	33
28	0.414164	0.910202	0.455024	2.197687	1.098657	2.414504	0.0279999	1.0539146	32
29	0.414429	0.910082	0.455375	2.195992	1.098802	2.412961	0.0280602	1.0525108	31
30	0.414693	0.909961	0.455726	2.194300	1.098948	2.411421	0.0281206	1.0511091	30
31	0.414958	0.909841	0.456078	2.192609	1.099094	2.409883	0.0281810	1.0497095	29
32	0.415223	0.909720	0.456429	2.190921	1.099239	2.408347	0.0282416	1.0483122	28
33	0.415487	0.909599	0.456781	2.189235	1.099386	2.406813	0.0283023	1.0469169	27
34	0.415752	0.909478	0.457132	2.187551	1.099532	2.405282	0.0283630	1.0455238	26
35	0.416016	0.909357	0.457484	2.185869	1.099678	2.403752	0.0284238	1.0441329	25
36	0.416281	0.909236	0.457836	2.184189	1.099824	2.402225	0.0284847	1.0427441	24
37	0.416545	0.909115	0.458188	2.182512	1.099971	2.400700	0.0285458	1.0413574	23
38	0.416810	0.908994	0.458540	2.180836	1.100118	2.399176	0.0286069	1.0399729	22
39	0.417074	0.908872	0.458892	2.179163	1.100264	2.397656	0.0286681	1.0385905	21
40	0.417338	0.908751	0.459244	2.177492	1.100411	2.396137	0.0287294	1.0372102	20
41	0.417603	0.908630	0.459596	2.175823	1.100558	2.394620	0.0287908	1.0358320	19
42	0.417867	0.908508	0.459949	2.174156	1.100706	2.393106	0.0288523	1.0344559	18
43	0.418131	0.908387	0.460301	2.172491	1.100853	2.391593	0.0289139	1.0330820	17
44	0.418396	0.908265	0.460654	2.170828	1.101000	2.390083	0.0289756	1.0317101	16
45	0.418660	0.908143	0.461006	2.169168	1.101148	2.388575	0.0290373	1.0303403	15
46	0.418924	0.908021	0.461359	2.167509	1.101296	2.387068	0.0290992	1.0289727	14
47	0.419188	0.907899	0.461712	2.165853	1.101444	2.385564	0.0291612	1.0276071	13
48	0.419452	0.907777	0.462065	2.164198	1.101592	2.384063	0.0292232	1.0262436	12
49	0.419716	0.907655	0.462418	2.162546	1.101740	2.382563	0.0292854	1.0248822	11
50	0.419980	0.907533	0.462771	2.160896	1.101888	2.381065	0.0293476	1.0235229	10
51	0.420244	0.907411	0.463124	2.159248	1.102036	2.379569	0.0294100	1.0221656	9
52	0.420508	0.907289	0.463478	2.157602	1.102185	2.378076	0.0294724	1.0208104	8
53	0.420772	0.907166	0.463831	2.155958	1.102334	2.376584	0.0295349	1.0194573	7
54	0.421036	0.907044	0.464185	2.154316	1.102482	2.375095	0.0295976	1.0181062	6
55	0.421300	0.906922	0.464538	2.152676	1.102631	2.373608	0.0296603	1.0167572	5
56	0.421563	0.906799	0.464892	2.151038	1.102780	2.372122	0.0297231	1.0154103	4
57	0.421827	0.906676	0.465246	2.149402	1.102930	2.370639	0.0297860	1.0140654	3
58	0.422091	0.906554	0.465600	2.147768	1.103079	2.369158	0.0298490	1.0127225	2
59	0.422355	0.906431	0.465954	2.146137	1.103228	2.367679	0.0299121	1.0113817	1
60	0.422618	0.906308	0.466308	2.144507	1.103378	2.366202	0.0299753	1.0100429	0
Min-utes	Cosine	Sine	Cotangent	Tangent	Cosecant	Secant	Read Down	65°–66° Involute	Min-utes

↑ 114° or 294°

65° or 245° ↑

↓ 25° or 205° **Trigonometric and Involute Functions** 154° or 334° ↓

Min-utes	Sine	Cosine	Tangent	Cotangent	Secant	Cosecant	Involute 25°–26°	Read Up	Min-utes
0	0.422618	0.906308	0.466308	2.144507	1.103378	2.366202	0.0299753	1.0100429	60
1	0.422882	0.906185	0.466662	2.142879	1.103528	2.364727	0.0300386	1.0087062	59
2	0.423145	0.906062	0.467016	2.141254	1.103678	2.363254	0.0301020	1.0073714	58
3	0.423409	0.905939	0.467371	2.139630	1.103828	2.361783	0.0301655	1.0060387	57
4	0.423673	0.905815	0.467725	2.138009	1.103978	2.360314	0.0302291	1.0047080	56
5	0.423936	0.905692	0.468080	2.136389	1.104128	2.358847	0.0302928	1.0033794	55
6	0.424199	0.905569	0.468434	2.134771	1.104278	2.357382	0.0303566	1.0020527	54
7	0.424463	0.905445	0.468789	2.133156	1.104429	2.355919	0.0304205	1.0007281	53
8	0.424726	0.905322	0.469144	2.131542	1.104580	2.354458	0.0304844	0.9994054	52
9	0.424990	0.905198	0.469499	2.129931	1.104730	2.352999	0.0305485	0.9980848	51
10	0.425253	0.905075	0.469854	2.128321	1.104881	2.351542	0.0306127	0.9967661	50
11	0.425516	0.904951	0.470209	2.126714	1.105032	2.350088	0.0306769	0.9954495	49
12	0.425779	0.904827	0.470564	2.125108	1.105184	2.348635	0.0307413	0.9941348	48
13	0.426042	0.904703	0.470920	2.123505	1.105335	2.347184	0.0308058	0.9928221	47
14	0.426306	0.904579	0.471275	2.121903	1.105486	2.345735	0.0308703	0.9915114	46
15	0.426569	0.904455	0.471631	2.120303	1.105638	2.344288	0.0309350	0.9902027	45
16	0.426832	0.904331	0.471986	2.118706	1.105790	2.342843	0.0309997	0.9888959	44
17	0.427095	0.904207	0.472342	2.117110	1.105942	2.341400	0.0310646	0.9875912	43
18	0.427358	0.904083	0.472698	2.115516	1.106094	2.339959	0.0311295	0.9862883	42
19	0.427621	0.903958	0.473054	2.113925	1.106246	2.338520	0.0311946	0.9849875	41
20	0.427884	0.903834	0.473410	2.112335	1.106398	2.337083	0.0312597	0.9836886	40
21	0.428147	0.903709	0.473766	2.110747	1.106551	2.335648	0.0313250	0.9823916	39
22	0.428410	0.903585	0.474122	2.109161	1.106703	2.334215	0.0313903	0.9810966	38
23	0.428672	0.903460	0.474478	2.107577	1.106856	2.332784	0.0314557	0.9798035	37
24	0.428935	0.903335	0.474835	2.105995	1.107009	2.331355	0.0315213	0.9785124	36
25	0.429198	0.903210	0.475191	2.104415	1.107162	2.329928	0.0315869	0.9772232	35
26	0.429461	0.903086	0.475548	2.102837	1.107315	2.328502	0.0316527	0.9759360	34
27	0.429723	0.902961	0.475905	2.101261	1.107468	2.327079	0.0317185	0.9746507	33
28	0.429986	0.902836	0.476262	2.099686	1.107621	2.325658	0.0317844	0.9733673	32
29	0.430249	0.902710	0.476619	2.098114	1.107775	2.324238	0.0318504	0.9720858	31
30	0.430511	0.902585	0.476976	2.096544	1.107929	2.322820	0.0319166	0.9708062	30
31	0.430774	0.902460	0.477333	2.094975	1.108082	2.321405	0.0319828	0.9695286	29
32	0.431036	0.902335	0.477690	2.093408	1.108236	2.319991	0.0320491	0.9682529	28
33	0.431299	0.902209	0.478047	2.091844	1.108390	2.318579	0.0321156	0.9669790	27
34	0.431561	0.902084	0.478405	2.090281	1.108545	2.317169	0.0321821	0.9657071	26
35	0.431823	0.901958	0.478762	2.088720	1.108699	2.315761	0.0322487	0.9644371	25
36	0.432086	0.901833	0.479120	2.087161	1.108853	2.314355	0.0323154	0.9631690	24
37	0.432348	0.901707	0.479477	2.085604	1.109008	2.312951	0.0323823	0.9619027	23
38	0.432610	0.901581	0.479835	2.084049	1.109163	2.311549	0.0324492	0.9606384	22
39	0.432873	0.901455	0.480193	2.082495	1.109318	2.310149	0.0325162	0.9593759	21
40	0.433135	0.901329	0.480551	2.080944	1.109473	2.308750	0.0325833	0.9581153	20
41	0.433397	0.901203	0.480909	2.079394	1.109628	2.307354	0.0326506	0.9568566	19
42	0.433659	0.901077	0.481267	2.077847	1.109783	2.305959	0.0327179	0.9555998	18
43	0.433921	0.900951	0.481626	2.076301	1.109938	2.304566	0.0327853	0.9543449	17
44	0.434183	0.900825	0.481984	2.074757	1.110094	2.303175	0.0328528	0.9530918	16
45	0.434445	0.900698	0.482343	2.073215	1.110250	2.301786	0.0329205	0.9518405	15
46	0.434707	0.900572	0.482701	2.071674	1.110406	2.300399	0.0329882	0.9505912	14
47	0.434969	0.900445	0.483060	2.070136	1.110562	2.299013	0.0330560	0.9493436	13
48	0.435231	0.900319	0.483419	2.068599	1.110718	2.297630	0.0331239	0.9480980	12
49	0.435493	0.900192	0.483778	2.067065	1.110874	2.296248	0.0331920	0.9468542	11
50	0.435755	0.900065	0.484137	2.065532	1.111030	2.294869	0.0332601	0.9456122	10
51	0.436017	0.899939	0.484496	2.064001	1.111187	2.293491	0.0333283	0.9443721	9
52	0.436278	0.899812	0.484855	2.062472	1.111344	2.292115	0.0333967	0.9431338	8
53	0.436540	0.899685	0.485214	2.060944	1.111500	2.290740	0.0334651	0.9418973	7
54	0.436802	0.899558	0.485574	2.059419	1.111657	2.289368	0.0335336	0.9406627	6
55	0.437063	0.899431	0.485933	2.057895	1.111814	2.287997	0.0336023	0.9394299	5
56	0.437325	0.899304	0.486293	2.056373	1.111972	2.286629	0.0336710	0.9381989	4
57	0.437587	0.899176	0.486653	2.054853	1.112129	2.285262	0.0337399	0.9369697	3
58	0.437848	0.899049	0.487013	2.053335	1.112287	2.283897	0.0338088	0.9357424	2
59	0.438110	0.898922	0.487373	2.051818	1.112444	2.282533	0.0338778	0.9345168	1
60	0.438371	0.898794	0.487733	2.050304	1.112602	2.281172	0.0339470	0.9332931	0
Min-utes	Cosine	Sine	Cotangent	Tangent	Cosecant	Secant	Read Down	64°–65° Involute	Min-utes

↑ 115° or 295°

64° or 244° ↑

↓ 26° or 206° **Trigonometric and Involute Functions** 153° or 333° ↓

Min-utes	Sine	Cosine	Tangent	Cotangent	Secant	Cosecant	Involute 26°-27°	Read Up	Min-utes
0	0.438371	0.898794	0.487733	2.050304	1.112602	2.281172	0.0339470	0.9332931	60
1	0.438633	0.898666	0.488093	2.048791	1.112760	2.279812	0.0340162	0.9320712	59
2	0.438894	0.898539	0.488453	2.047280	1.112918	2.278455	0.0340856	0.9308511	58
3	0.439155	0.898411	0.488813	2.045771	1.113076	2.277099	0.0341550	0.9296328	57
4	0.439417	0.898283	0.489174	2.044263	1.113234	2.275744	0.0342246	0.9284162	56
5	0.439678	0.898156	0.489534	2.042758	1.113393	2.274392	0.0342942	0.9272015	55
6	0.439939	0.898028	0.489895	2.041254	1.113552	2.273042	0.0343640	0.9259886	54
7	0.440200	0.897900	0.490256	2.039752	1.113710	2.271693	0.0344339	0.9247774	53
8	0.440462	0.897771	0.490617	2.038252	1.113869	2.270346	0.0345038	0.9235680	52
9	0.440723	0.897643	0.490978	2.036753	1.114028	2.269001	0.0345739	0.9223604	51
10	0.440984	0.897515	0.491339	2.035256	1.114187	2.267657	0.0346441	0.9211546	50
11	0.441245	0.897387	0.491700	2.033762	1.114347	2.266315	0.0347144	0.9199506	49
12	0.441506	0.897258	0.492061	2.032268	1.114506	2.264976	0.0347847	0.9187483	48
13	0.441767	0.897130	0.492422	2.030777	1.114666	2.263638	0.0348552	0.9175478	47
14	0.442028	0.897001	0.492784	2.029287	1.114826	2.262301	0.0349258	0.9163490	46
15	0.442289	0.896873	0.493145	2.027799	1.114985	2.260967	0.0349965	0.9151520	45
16	0.442550	0.896744	0.493507	2.026313	1.115145	2.259634	0.0350673	0.9139568	44
17	0.442810	0.896615	0.493869	2.024829	1.115306	2.258303	0.0351382	0.9127633	43
18	0.443071	0.896486	0.494231	2.023346	1.115466	2.256974	0.0352092	0.9115715	42
19	0.443332	0.896358	0.494593	2.021865	1.115626	2.255646	0.0352803	0.9103815	41
20	0.443593	0.896229	0.494955	2.020386	1.115787	2.254320	0.0353515	0.9091932	40
21	0.443853	0.896099	0.495317	2.018909	1.115948	2.252996	0.0354228	0.9080067	39
22	0.444114	0.895970	0.495679	2.017433	1.116108	2.251674	0.0354942	0.9068219	38
23	0.444375	0.895841	0.496042	2.015959	1.116269	2.250354	0.0355658	0.9056389	37
24	0.444635	0.895712	0.496404	2.014487	1.116431	2.249035	0.0356374	0.9044575	36
25	0.444896	0.895582	0.496767	2.013016	1.116592	2.247718	0.0357091	0.9032779	35
26	0.445156	0.895453	0.497130	2.011548	1.116753	2.246402	0.0357810	0.9021000	34
27	0.445417	0.895323	0.497492	2.010081	1.116915	2.245089	0.0358529	0.9009239	33
28	0.445677	0.895194	0.497855	2.008615	1.117077	2.243777	0.0359249	0.8997494	32
29	0.445937	0.895064	0.498218	2.007152	1.117238	2.242467	0.0359971	0.8985767	31
30	0.446198	0.894934	0.498582	2.005690	1.117400	2.241158	0.0360694	0.8974056	30
31	0.446458	0.894805	0.498945	2.004229	1.117563	2.239852	0.0361417	0.8962363	29
32	0.446718	0.894675	0.499308	2.002771	1.117725	2.238547	0.0362142	0.8950687	28
33	0.446979	0.894545	0.499672	2.001314	1.117887	2.237243	0.0362868	0.8939027	27
34	0.447239	0.894415	0.500035	1.999859	1.118050	2.235942	0.0363594	0.8927385	26
35	0.447499	0.894284	0.500399	1.998406	1.118212	2.234642	0.0364322	0.8915760	25
36	0.447759	0.894154	0.500763	1.996954	1.118375	2.233344	0.0365051	0.8904151	24
37	0.448019	0.894024	0.501127	1.995505	1.118538	2.232047	0.0365781	0.8892559	23
38	0.448279	0.893894	0.501491	1.994055	1.118701	2.230753	0.0366512	0.8880985	22
39	0.448539	0.893763	0.501855	1.992609	1.118865	2.229459	0.0367244	0.8869426	21
40	0.448799	0.893633	0.502219	1.991164	1.119028	2.228168	0.0367977	0.8857885	20
41	0.449059	0.893502	0.502583	1.989720	1.119192	2.226878	0.0368712	0.8846361	19
42	0.449319	0.893371	0.502948	1.988279	1.119355	2.225590	0.0369447	0.8834853	18
43	0.449579	0.893241	0.503312	1.986839	1.119519	2.224304	0.0370183	0.8823361	17
44	0.449839	0.893110	0.503677	1.985400	1.119683	2.223019	0.0370921	0.8811887	16
45	0.450098	0.892979	0.504041	1.983964	1.119847	2.221736	0.0371659	0.8800429	15
46	0.450358	0.892848	0.504406	1.982529	1.120011	2.220455	0.0372399	0.8788988	14
47	0.450618	0.892717	0.504771	1.981095	1.120176	2.219175	0.0373139	0.8777563	13
48	0.450878	0.892586	0.505136	1.979664	1.120340	2.217897	0.0373881	0.8766154	12
49	0.451137	0.892455	0.505502	1.978233	1.120505	2.216621	0.0374624	0.8754762	11
50	0.451397	0.892323	0.505867	1.976805	1.120670	2.215346	0.0375368	0.8743387	10
51	0.451656	0.892192	0.506232	1.975378	1.120835	2.214073	0.0376113	0.8732028	9
52	0.451916	0.892061	0.506598	1.973953	1.121000	2.212802	0.0376859	0.8720685	8
53	0.452175	0.891929	0.506963	1.972530	1.121165	2.211532	0.0377606	0.8709359	7
54	0.452435	0.891798	0.507329	1.971108	1.121331	2.210264	0.0378354	0.8698049	6
55	0.452694	0.891666	0.507695	1.969687	1.121496	2.208997	0.0379103	0.8686756	5
56	0.452953	0.891534	0.508061	1.968269	1.121662	2.207732	0.0379853	0.8675478	4
57	0.453213	0.891402	0.508427	1.966852	1.121828	2.206469	0.0380605	0.8664217	3
58	0.453472	0.891270	0.508793	1.965436	1.121994	2.205208	0.0381357	0.8652972	2
59	0.453731	0.891139	0.509159	1.964023	1.122160	2.203948	0.0382111	0.8641743	1
60	0.453990	0.891007	0.509525	1.962611	1.122326	2.202689	0.0382866	0.8630531	0
Min-utes	Cosine	Sine	Cotangent	Tangent	Cosecant	Secant	Read Down	63°-64° Involute	Min-utes

↑ 116° or 296°

63° or 243° ↑

↓ 27° or 207° **Trigonometric and Involute Functions** 152° or 332° ↓

Min-utes	Sine	Cosine	Tangent	Cotangent	Secant	Cosecant	Involute 27°-28°	Read Up	Min-utes
0	0.453990	0.891007	0.509525	1.962611	1.122326	2.202689	0.0382866	0.8630531	60
1	0.454250	0.890874	0.509892	1.961200	1.122493	2.201433	0.0383621	0.8619334	59
2	0.454509	0.890742	0.510258	1.959791	1.122659	2.200177	0.0384378	0.8608154	58
3	0.454768	0.890610	0.510625	1.958384	1.122826	2.198924	0.0385136	0.8596990	57
4	0.455027	0.890478	0.510992	1.956978	1.122993	2.197672	0.0385895	0.8585841	56
5	0.455286	0.890345	0.511359	1.955574	1.123160	2.196422	0.0386655	0.8574709	55
6	0.455545	0.890213	0.511726	1.954171	1.123327	2.195173	0.0387416	0.8563592	54
7	0.455804	0.890080	0.512093	1.952770	1.123494	2.193926	0.0388179	0.8552492	53
8	0.456063	0.889948	0.512460	1.951371	1.123662	2.192681	0.0388942	0.8541408	52
9	0.456322	0.889815	0.512828	1.949973	1.123829	2.191437	0.0389706	0.8530339	51
10	0.456580	0.889682	0.513195	1.948577	1.123997	2.190195	0.0390472	0.8519286	50
11	0.456839	0.889549	0.513563	1.947183	1.124165	2.188954	0.0391239	0.8508249	49
12	0.457098	0.889416	0.513930	1.945790	1.124333	2.187715	0.0392006	0.8497228	48
13	0.457357	0.889283	0.514298	1.944398	1.124501	2.186478	0.0392775	0.8486222	47
14	0.457615	0.889150	0.514666	1.943008	1.124669	2.185242	0.0393545	0.8475233	46
15	0.457874	0.889017	0.515034	1.941620	1.124838	2.184007	0.0394316	0.8464259	45
16	0.458133	0.888884	0.515402	1.940233	1.125006	2.182775	0.0395088	0.8453300	44
17	0.458391	0.888751	0.515770	1.938848	1.125175	2.181543	0.0395862	0.8442358	43
18	0.458650	0.888617	0.516138	1.937465	1.125344	2.180314	0.0396636	0.8431431	42
19	0.458908	0.888484	0.516507	1.936082	1.125513	2.179086	0.0397411	0.8420519	41
20	0.459166	0.888350	0.516875	1.934702	1.125682	2.177859	0.0398188	0.8409623	40
21	0.459425	0.888217	0.517244	1.933323	1.125851	2.176635	0.0398966	0.8398743	39
22	0.459683	0.888083	0.517613	1.931946	1.126021	2.175411	0.0399745	0.8387878	38
23	0.459942	0.887949	0.517982	1.930570	1.126191	2.174189	0.0400524	0.8377029	37
24	0.460200	0.887815	0.518351	1.929196	1.126360	2.172969	0.0401306	0.8366195	36
25	0.460458	0.887681	0.518720	1.927823	1.126530	2.171751	0.0402088	0.8355376	35
26	0.460716	0.887548	0.519089	1.926452	1.126700	2.170534	0.0402871	0.8344573	34
27	0.460974	0.887413	0.519458	1.925082	1.126870	2.169318	0.0403655	0.8333785	33
28	0.461232	0.887279	0.519828	1.923714	1.127041	2.168104	0.0404441	0.8323013	32
29	0.461491	0.887145	0.520197	1.922347	1.127211	2.166892	0.0405227	0.8312255	31
30	0.461749	0.887011	0.520567	1.920982	1.127382	2.165681	0.0406015	0.8301513	30
31	0.462007	0.886876	0.520937	1.919619	1.127553	2.164471	0.0406804	0.8290787	29
32	0.462265	0.886742	0.521307	1.918257	1.127724	2.163263	0.0407594	0.8280075	28
33	0.462523	0.886608	0.521677	1.916896	1.127895	2.162057	0.0408385	0.8269379	27
34	0.462780	0.886473	0.522047	1.915537	1.128066	2.160852	0.0409177	0.8258698	26
35	0.463038	0.886338	0.522417	1.914180	1.128237	2.159649	0.0409970	0.8248032	25
36	0.463296	0.886204	0.522787	1.912824	1.128409	2.158447	0.0410765	0.8237381	24
37	0.463554	0.886069	0.523158	1.911469	1.128581	2.157247	0.0411561	0.8226745	23
38	0.463812	0.885934	0.523528	1.910116	1.128752	2.156048	0.0412357	0.8216125	22
39	0.464069	0.885799	0.523899	1.908765	1.128924	2.154851	0.0413155	0.8205519	21
40	0.464327	0.885664	0.524270	1.907415	1.129096	2.153655	0.0413954	0.8194928	20
41	0.464584	0.885529	0.524641	1.906066	1.129269	2.152461	0.0414754	0.8184353	19
42	0.464842	0.885394	0.525012	1.904719	1.129441	2.151268	0.0415555	0.8173792	18
43	0.465100	0.885258	0.525383	1.903374	1.129614	2.150077	0.0416358	0.8163246	17
44	0.465357	0.885123	0.525754	1.902030	1.129786	2.148888	0.0417161	0.8152715	16
45	0.465615	0.884988	0.526125	1.900687	1.129959	2.147699	0.0417966	0.8142199	15
46	0.465872	0.884852	0.526497	1.899346	1.130132	2.146513	0.0418772	0.8131698	14
47	0.466129	0.884717	0.526868	1.898007	1.130305	2.145327	0.0419579	0.8121211	13
48	0.466387	0.884581	0.527240	1.896669	1.130479	2.144144	0.0420387	0.8110740	12
49	0.466644	0.884445	0.527612	1.895332	1.130652	2.142962	0.0421196	0.8100283	11
50	0.466901	0.884309	0.527984	1.893997	1.130826	2.141781	0.0422006	0.8089841	10
51	0.467158	0.884174	0.528356	1.892663	1.131000	2.140602	0.0422818	0.8079413	9
52	0.467416	0.884038	0.528728	1.891331	1.131173	2.139424	0.0423630	0.8069000	8
53	0.467673	0.883902	0.529100	1.890001	1.131348	2.138247	0.0424444	0.8058602	7
54	0.467930	0.883766	0.529473	1.888671	1.131522	2.137073	0.0425259	0.8048219	6
55	0.468187	0.883629	0.529845	1.887344	1.131696	2.135899	0.0426075	0.8037850	5
56	0.468444	0.883493	0.530218	1.886017	1.131871	2.134727	0.0426892	0.8027495	4
57	0.468701	0.883357	0.530591	1.884692	1.132045	2.133557	0.0427710	0.8017156	3
58	0.468958	0.883221	0.530963	1.883369	1.132220	2.132388	0.0428530	0.8006830	2
59	0.469215	0.883084	0.531336	1.882047	1.132395	2.131221	0.0429351	0.7996520	1
60	0.469472	0.882948	0.531709	1.880726	1.132570	2.130054	0.0430172	0.7986223	0
Min-utes	Cosine	Sine	Cotangent	Tangent	Cosecant	Secant	Read Down	62°-63° Involute	Min-utes

↑ 117° or 297°

62° or 242° ↑

↓ 28° or 208° **Trigonometric and Involute Functions** 151° or 331° ↓

Min-utes	Sine	Cosine	Tangent	Cotangent	Secant	Cosecant	Involute 28°-29°	Read Up	Min-utes
0	0.469472	0.882948	0.531709	1.880726	1.132570	2.130054	0.0430172	0.7986223	60
1	0.469728	0.882811	0.532083	1.879407	1.132745	2.128890	0.0430995	0.7975941	59
2	0.469985	0.882674	0.532456	1.878090	1.132921	2.127727	0.0431819	0.7965674	58
3	0.470242	0.882538	0.532829	1.876774	1.133096	2.126565	0.0432645	0.7955421	57
4	0.470499	0.882401	0.533203	1.875459	1.133272	2.125405	0.0433471	0.7945182	56
5	0.470755	0.882264	0.533577	1.874145	1.133448	2.124246	0.0434299	0.7934958	55
6	0.471012	0.882127	0.533950	1.872834	1.133624	2.123089	0.0435128	0.7924748	54
7	0.471268	0.881990	0.534324	1.871523	1.133800	2.121933	0.0435957	0.7914552	53
8	0.471525	0.881853	0.534698	1.870214	1.133976	2.120778	0.0436789	0.7904370	52
9	0.471782	0.881715	0.535072	1.868906	1.134153	2.119625	0.0437621	0.7894203	51
10	0.472038	0.881578	0.535446	1.867600	1.134329	2.118474	0.0438454	0.7884050	50
11	0.472294	0.881441	0.535821	1.866295	1.134506	2.117324	0.0439289	0.7873911	49
12	0.472551	0.881303	0.536195	1.864992	1.134683	2.116175	0.0440124	0.7863786	48
13	0.472807	0.881166	0.536570	1.863690	1.134860	2.115027	0.0440961	0.7853676	47
14	0.473063	0.881028	0.536945	1.862390	1.135037	2.113882	0.0441799	0.7843579	46
15	0.473320	0.880891	0.537319	1.861091	1.135215	2.112737	0.0442639	0.7833497	45
16	0.473576	0.880753	0.537694	1.859793	1.135392	2.111594	0.0443479	0.7823429	44
17	0.473832	0.880615	0.538069	1.858496	1.135570	2.110452	0.0444321	0.7813374	43
18	0.474088	0.880477	0.538445	1.857202	1.135748	2.109312	0.0445163	0.7803334	42
19	0.474344	0.880339	0.538820	1.855908	1.135926	2.108173	0.0446007	0.7793308	41
20	0.474600	0.880201	0.539195	1.854616	1.136104	2.107036	0.0446853	0.7783295	40
21	0.474856	0.880063	0.539571	1.853325	1.136282	2.105900	0.0447699	0.7773297	39
22	0.475112	0.879925	0.539946	1.852036	1.136460	2.104765	0.0448546	0.7763312	38
23	0.475368	0.879787	0.540322	1.850748	1.136639	2.103632	0.0449395	0.7753342	37
24	0.475624	0.879649	0.540698	1.849461	1.136818	2.102500	0.0450245	0.7743385	36
25	0.475880	0.879510	0.541074	1.848176	1.136997	2.101370	0.0451096	0.7733442	35
26	0.476136	0.879372	0.541450	1.846892	1.137176	2.100241	0.0451948	0.7723513	34
27	0.476392	0.879233	0.541826	1.845610	1.137355	2.099113	0.0452801	0.7713598	33
28	0.476647	0.879095	0.542203	1.844329	1.137534	2.097987	0.0453656	0.7703696	32
29	0.476903	0.878956	0.542579	1.843049	1.137714	2.096862	0.0454512	0.7693808	31
30	0.477159	0.878817	0.542956	1.841771	1.137893	2.095739	0.0455369	0.7683934	30
31	0.477414	0.878678	0.543332	1.840494	1.138073	2.094616	0.0456227	0.7674074	29
32	0.477670	0.878539	0.543709	1.839218	1.138253	2.093496	0.0457086	0.7664227	28
33	0.477925	0.878400	0.544086	1.837944	1.138433	2.092376	0.0457947	0.7654394	27
34	0.478181	0.878261	0.544463	1.836671	1.138613	2.091258	0.0458808	0.7644574	26
35	0.478436	0.878122	0.544840	1.835400	1.138794	2.090142	0.0459671	0.7634768	25
36	0.478692	0.877983	0.545218	1.834130	1.138974	2.089027	0.0460535	0.7624976	24
37	0.478947	0.877844	0.545595	1.832861	1.139155	2.087913	0.0461401	0.7615197	23
38	0.479203	0.877704	0.545973	1.831594	1.139336	2.086800	0.0462267	0.7605432	22
39	0.479458	0.877565	0.546350	1.830327	1.139517	2.085689	0.0463135	0.7595680	21
40	0.479713	0.877425	0.546728	1.829063	1.139698	2.084579	0.0464004	0.7585942	20
41	0.479968	0.877286	0.547106	1.827799	1.139879	2.083471	0.0464874	0.7576217	19
42	0.480223	0.877146	0.547484	1.826537	1.140061	2.082364	0.0465745	0.7566505	18
43	0.480479	0.877006	0.547862	1.825277	1.140242	2.081258	0.0466618	0.7556807	17
44	0.480734	0.876867	0.548240	1.824017	1.140424	2.080154	0.0467491	0.7547123	16
45	0.480989	0.876727	0.548619	1.822759	1.140606	2.079051	0.0468366	0.7537451	15
46	0.481244	0.876587	0.548997	1.821503	1.140788	2.077949	0.0469242	0.7527793	14
47	0.481499	0.876447	0.549376	1.820247	1.140971	2.076849	0.0470120	0.7518149	13
48	0.481754	0.876307	0.549755	1.818993	1.141153	2.075750	0.0470998	0.7508517	12
49	0.482009	0.876167	0.550134	1.817741	1.141336	2.074652	0.0471878	0.7498899	11
50	0.482263	0.876026	0.550513	1.816489	1.141518	2.073556	0.0472759	0.7489294	10
51	0.482518	0.875886	0.550892	1.815239	1.141701	2.072461	0.0473641	0.7479703	9
52	0.482773	0.875746	0.551271	1.813990	1.141884	2.071367	0.0474525	0.7470124	8
53	0.483028	0.875605	0.551650	1.812743	1.142067	2.070275	0.0475409	0.7460559	7
54	0.483282	0.875465	0.552030	1.811497	1.142251	2.069184	0.0476295	0.7451007	6
55	0.483537	0.875324	0.552409	1.810252	1.142434	2.068094	0.0477182	0.7441468	5
56	0.483792	0.875183	0.552789	1.809009	1.142618	2.067006	0.0478070	0.7431942	4
57	0.484046	0.875042	0.553169	1.807766	1.142802	2.065919	0.0478960	0.7422429	3
58	0.484301	0.874902	0.553549	1.806526	1.142986	2.064833	0.0479851	0.7412930	2
59	0.484555	0.874761	0.553929	1.805286	1.143170	2.063748	0.0480743	0.7403443	1
60	0.484810	0.874620	0.554309	1.804048	1.143354	2.062665	0.0481636	0.7393969	0
Min-utes	Cosine	Sine	Cotangent	Tangent	Cosecant	Secant	Read Down	61°-62° Involute	Min-utes

↑ 118° or 298°

61° or 241° ↑

↓ 29° or 209° Trigonometric and Involute Functions 150° or 330° ↓

Min-utes	Sine	Cosine	Tangent	Cotangent	Secant	Cosecant	Involute 29°-30°	Read Up	Min-utes
0	0.484810	0.874620	0.554309	1.804048	1.143354	2.062665	0.0481636	0.7393969	60
1	0.485064	0.874479	0.554689	1.802811	1.143539	2.061584	0.0482530	0.7384508	59
2	0.485318	0.874338	0.555070	1.801575	1.143723	2.060503	0.0483426	0.7375061	58
3	0.485573	0.874196	0.555450	1.800341	1.143908	2.059424	0.0484323	0.7365626	57
4	0.485827	0.874055	0.555831	1.799108	1.144093	2.058346	0.0485221	0.7356204	56
5	0.486081	0.873914	0.556212	1.797876	1.144278	2.057269	0.0486120	0.7346795	55
6	0.486335	0.873772	0.556593	1.796645	1.144463	2.056194	0.0487020	0.7337399	54
7	0.486590	0.873631	0.556974	1.795416	1.144648	2.055120	0.0487922	0.7328016	53
8	0.486844	0.873489	0.557355	1.794188	1.144834	2.054048	0.0488825	0.7318645	52
9	0.487098	0.873347	0.557736	1.792962	1.145020	2.052976	0.0489730	0.7309288	51
10	0.487352	0.873206	0.558118	1.791736	1.145205	2.051906	0.0490635	0.7299943	50
11	0.487606	0.873064	0.558499	1.790512	1.145391	2.050837	0.0491542	0.7290611	49
12	0.487860	0.872922	0.558881	1.789289	1.145578	2.049770	0.0492450	0.7281291	48
13	0.488114	0.872780	0.559263	1.788068	1.145764	2.048704	0.0493359	0.7271985	47
14	0.488367	0.872638	0.559645	1.786847	1.145950	2.047639	0.0494269	0.7262691	46
15	0.488621	0.872496	0.560027	1.785628	1.146137	2.046575	0.0495181	0.7253410	45
16	0.488875	0.872354	0.560409	1.784411	1.146324	2.045513	0.0496094	0.7244141	44
17	0.489129	0.872212	0.560791	1.783194	1.146511	2.044451	0.0497008	0.7234885	43
18	0.489382	0.872070	0.561174	1.781979	1.146698	2.043392	0.0497924	0.7225642	42
19	0.489636	0.871927	0.561556	1.780765	1.146885	2.042333	0.0498840	0.7216411	41
20	0.489890	0.871784	0.561939	1.779552	1.147073	2.041276	0.0499758	0.7207193	40
21	0.490143	0.871642	0.562322	1.778341	1.147260	2.040220	0.0500677	0.7197987	39
22	0.490397	0.871499	0.562705	1.777131	1.147448	2.039165	0.0501598	0.7188794	38
23	0.490650	0.871357	0.563088	1.775922	1.147636	2.038111	0.0502519	0.7179614	37
24	0.490904	0.871214	0.563471	1.774714	1.147824	2.037059	0.0503442	0.7170446	36
25	0.491157	0.871071	0.563854	1.773508	1.148012	2.036008	0.0504367	0.7161290	35
26	0.491411	0.870928	0.564238	1.772302	1.148200	2.034958	0.0505292	0.7152147	34
27	0.491664	0.870785	0.564621	1.771098	1.148389	2.033910	0.0506219	0.7143016	33
28	0.491917	0.870642	0.565005	1.769896	1.148578	2.032863	0.0507147	0.7133898	32
29	0.492170	0.870499	0.565389	1.768694	1.148767	2.031817	0.0508076	0.7124792	31
30	0.492424	0.870356	0.565773	1.767494	1.148956	2.030772	0.0509006	0.7115698	30
31	0.492677	0.870212	0.566157	1.766295	1.149145	2.029729	0.0509938	0.7106617	29
32	0.492930	0.870069	0.566541	1.765097	1.149334	2.028686	0.0510871	0.7097548	28
33	0.493183	0.869926	0.566925	1.763901	1.149524	2.027645	0.0511806	0.7088491	27
34	0.493436	0.869782	0.567310	1.762705	1.149713	2.026606	0.0512741	0.7079447	26
35	0.493689	0.869639	0.567694	1.761511	1.149903	2.025567	0.0513678	0.7070415	25
36	0.493942	0.869495	0.568079	1.760318	1.150093	2.024530	0.0514616	0.7061395	24
37	0.494195	0.869351	0.568464	1.759127	1.150283	2.023494	0.0515555	0.7052387	23
38	0.494448	0.869207	0.568849	1.757936	1.150473	2.022459	0.0516496	0.7043392	22
39	0.494700	0.869064	0.569234	1.756747	1.150664	2.021425	0.0517438	0.7034408	21
40	0.494953	0.868920	0.569619	1.755559	1.150854	2.020393	0.0518381	0.7025437	20
41	0.495206	0.868776	0.570004	1.754372	1.151045	2.019362	0.0519326	0.7016478	19
42	0.495459	0.868632	0.570390	1.753187	1.151236	2.018332	0.0520271	0.7007531	18
43	0.495711	0.868487	0.570776	1.752002	1.151427	2.017303	0.0521218	0.6998596	17
44	0.495964	0.868343	0.571161	1.750819	1.151618	2.016276	0.0522167	0.6989673	16
45	0.496217	0.868199	0.571547	1.749637	1.151810	2.015249	0.0523116	0.6980762	15
46	0.496469	0.868054	0.571933	1.748456	1.152001	2.014224	0.0524067	0.6971864	14
47	0.496722	0.867910	0.572319	1.747277	1.152193	2.013200	0.0525019	0.6962977	13
48	0.496974	0.867765	0.572705	1.746098	1.152385	2.012178	0.0525973	0.6954102	12
49	0.497226	0.867621	0.573092	1.744921	1.152577	2.011156	0.0526928	0.6945239	11
50	0.497479	0.867476	0.573478	1.743745	1.152769	2.010136	0.0527884	0.6936389	10
51	0.497731	0.867331	0.573865	1.742571	1.152962	2.009117	0.0528841	0.6927550	9
52	0.497983	0.867187	0.574252	1.741397	1.153154	2.008099	0.0529799	0.6918723	8
53	0.498236	0.867042	0.574638	1.740225	1.153347	2.007083	0.0530759	0.6909907	7
54	0.498488	0.866897	0.575026	1.739053	1.153540	2.006067	0.0531721	0.6901104	6
55	0.498740	0.866752	0.575413	1.737883	1.153733	2.005053	0.0532683	0.6892313	5
56	0.498992	0.866607	0.575800	1.736714	1.153926	2.004040	0.0533647	0.6883533	4
57	0.499244	0.866461	0.576187	1.735547	1.154119	2.003028	0.0534612	0.6874765	3
58	0.499496	0.866316	0.576575	1.734380	1.154313	2.002018	0.0535578	0.6866009	2
59	0.499748	0.866171	0.576962	1.733215	1.154507	2.001008	0.0536546	0.6857265	1
60	0.500000	0.866025	0.577350	1.732051	1.154701	2.000000	0.0537515	0.6848533	0
Min-utes	Cosine	Sine	Cotangent	Tangent	Cosecant	Secant	Read Down	60°-61° Involute	Min-utes

↑ 119° or 299°

60° or 240° ↑

↓ 30° or 210° **Trigonometric and Involute Functions** 149° or 329° ↓

Min-utes	Sine	Cosine	Tangent	Cotangent	Secant	Cosecant	Involute 30°-31°	Read Up	Min-utes
0	0.500000	0.866025	0.577350	1.732051	1.154701	2.000000	0.0537515	0.6848533	60
1	0.500252	0.865880	0.577738	1.730888	1.154895	1.998993	0.0538485	0.6839812	59
2	0.500504	0.865734	0.578126	1.729726	1.155089	1.997987	0.0539457	0.6831103	58
3	0.500756	0.865589	0.578514	1.728565	1.155283	1.996982	0.0540430	0.6822405	57
4	0.501007	0.865443	0.578903	1.727406	1.155478	1.995979	0.0541404	0.6813720	56
5	0.501259	0.865297	0.579291	1.726248	1.155672	1.994976	0.0542379	0.6805045	55
6	0.501511	0.865151	0.579680	1.725091	1.155867	1.993975	0.0543356	0.6796383	54
7	0.501762	0.865006	0.580068	1.723935	1.156062	1.992975	0.0544334	0.6787732	53
8	0.502014	0.864860	0.580457	1.722780	1.156257	1.991976	0.0545314	0.6779093	52
9	0.502266	0.864713	0.580846	1.721626	1.156452	1.990979	0.0546295	0.6770465	51
10	0.502517	0.864567	0.581235	1.720474	1.156648	1.989982	0.0547277	0.6761849	50
11	0.502769	0.864421	0.581625	1.719322	1.156844	1.988987	0.0548260	0.6753244	49
12	0.503020	0.864275	0.582014	1.718172	1.157039	1.987993	0.0549245	0.6744651	48
13	0.503271	0.864128	0.582403	1.717023	1.157235	1.987000	0.0550231	0.6736070	47
14	0.503523	0.863982	0.582793	1.715875	1.157432	1.986008	0.0551218	0.6727500	46
15	0.503774	0.863836	0.583183	1.714728	1.157628	1.985017	0.0552207	0.6718941	45
16	0.504025	0.863689	0.583573	1.713583	1.157824	1.984028	0.0553197	0.6710394	44
17	0.504276	0.863542	0.583963	1.712438	1.158021	1.983039	0.0554188	0.6701858	43
18	0.504528	0.863396	0.584353	1.711295	1.158218	1.982052	0.0555181	0.6693333	42
19	0.504779	0.863249	0.584743	1.710153	1.158415	1.981066	0.0556175	0.6684820	41
20	0.505030	0.863102	0.585134	1.709012	1.158612	1.980081	0.0557170	0.6676319	40
21	0.505281	0.862955	0.585524	1.707872	1.158809	1.979097	0.0558166	0.6667828	39
22	0.505532	0.862808	0.585915	1.706733	1.159007	1.978115	0.0559164	0.6659349	38
23	0.505783	0.862661	0.586306	1.705595	1.159204	1.977133	0.0560164	0.6650881	37
24	0.506034	0.862514	0.586697	1.704459	1.159402	1.976153	0.0561164	0.6642425	36
25	0.506285	0.862366	0.587088	1.703323	1.159600	1.975174	0.0562166	0.6633980	35
26	0.506535	0.862219	0.587479	1.702189	1.159798	1.974195	0.0563169	0.6625546	34
27	0.506786	0.862072	0.587870	1.701056	1.159996	1.973218	0.0564174	0.6617123	33
28	0.507037	0.861924	0.588262	1.699924	1.160195	1.972243	0.0565180	0.6608712	32
29	0.507288	0.861777	0.588653	1.698793	1.160393	1.971268	0.0566187	0.6600311	31
30	0.507538	0.861629	0.589045	1.697663	1.160592	1.970294	0.0567196	0.6591922	30
31	0.507789	0.861481	0.589437	1.696534	1.160791	1.969322	0.0568206	0.6583544	29
32	0.508040	0.861334	0.589829	1.695407	1.160990	1.968351	0.0569217	0.6575177	28
33	0.508290	0.861186	0.590221	1.694280	1.161189	1.967381	0.0570230	0.6566822	27
34	0.508541	0.861038	0.590613	1.693155	1.161389	1.966411	0.0571244	0.6558477	26
35	0.508791	0.860890	0.591006	1.692031	1.161589	1.965444	0.0572259	0.6550143	25
36	0.509041	0.860742	0.591398	1.690908	1.161788	1.964477	0.0573276	0.6541821	24
37	0.509292	0.860594	0.591791	1.689786	1.161988	1.963511	0.0574294	0.6533509	23
38	0.509542	0.860446	0.592184	1.688665	1.162188	1.962546	0.0575313	0.6525209	22
39	0.509792	0.860297	0.592577	1.687545	1.162389	1.961583	0.0576334	0.6516919	21
40	0.510043	0.860149	0.592970	1.686426	1.162589	1.960621	0.0577356	0.6508641	20
41	0.510293	0.860001	0.593363	1.685308	1.162790	1.959659	0.0578380	0.6500374	19
42	0.510543	0.859852	0.593757	1.684192	1.162990	1.958699	0.0579405	0.6492117	18
43	0.510793	0.859704	0.594150	1.683077	1.163191	1.957740	0.0580431	0.6483871	17
44	0.511043	0.859555	0.594544	1.681962	1.163393	1.956782	0.0581458	0.6475637	16
45	0.511293	0.859406	0.594937	1.680849	1.163594	1.955825	0.0582487	0.6467413	15
46	0.511543	0.859258	0.595331	1.679737	1.163795	1.954870	0.0583518	0.6459200	14
47	0.511793	0.859109	0.595725	1.678626	1.163997	1.953915	0.0584549	0.6450998	13
48	0.512043	0.858960	0.596120	1.677516	1.164199	1.952961	0.0585582	0.6442807	12
49	0.512293	0.858811	0.596514	1.676407	1.164401	1.952009	0.0586617	0.6434627	11
50	0.512543	0.858662	0.596908	1.675299	1.164603	1.951058	0.0587652	0.6426457	10
51	0.512792	0.858513	0.597303	1.674192	1.164805	1.950107	0.0588690	0.6418298	9
52	0.513042	0.858364	0.597698	1.673086	1.165008	1.949158	0.0589728	0.6410150	8
53	0.513292	0.858214	0.598093	1.671982	1.165210	1.948210	0.0590768	0.6402013	7
54	0.513541	0.858065	0.598488	1.670878	1.165413	1.947263	0.0591809	0.6393887	6
55	0.513791	0.857915	0.598883	1.669776	1.165616	1.946317	0.0592852	0.6385771	5
56	0.514040	0.857766	0.599278	1.668674	1.165819	1.945373	0.0593896	0.6377666	4
57	0.514290	0.857616	0.599674	1.667574	1.166022	1.944429	0.0594941	0.6369571	3
58	0.514539	0.857467	0.600069	1.666475	1.166226	1.943486	0.0595988	0.6361488	2
59	0.514789	0.857317	0.600465	1.665377	1.166430	1.942545	0.0597036	0.6353415	1
60	0.515038	0.857167	0.600861	1.664279	1.166633	1.941604	0.0598086	0.6345352	0
Min-utes	Cosine	Sine	Cotangent	Tangent	Cosecant	Secant	Read Down	59°-60° Involute	Min-utes

↑ 120° or 300°

59° or 239° ↑

↓ 31° or 211° **Trigonometric and Involute Functions** 148° or 328° ↓

Min-utes	Sine	Cosine	Tangent	Cotangent	Secant	Cosecant	Involute 31°-32°	Read Up	Min-utes
0	0.515038	0.857167	0.600861	1.664279	1.166633	1.941604	0.0598086	0.6345352	60
1	0.515287	0.857017	0.601257	1.663183	1.166837	1.940665	0.0599136	0.6337300	59
2	0.515537	0.856868	0.601653	1.662088	1.167042	1.939726	0.0600189	0.6329259	58
3	0.515786	0.856718	0.602049	1.660994	1.167246	1.938789	0.0601242	0.6321229	57
4	0.516035	0.856567	0.602445	1.659902	1.167450	1.937853	0.0602297	0.6313209	56
5	0.516284	0.856417	0.602842	1.658810	1.167655	1.936918	0.0603354	0.6305199	55
6	0.516533	0.856267	0.603239	1.657719	1.167860	1.935983	0.0604412	0.6297200	54
7	0.516782	0.856117	0.603635	1.656629	1.168065	1.935050	0.0605471	0.6289212	53
8	0.517031	0.855966	0.604032	1.655541	1.168270	1.934119	0.0606532	0.6281234	52
9	0.517280	0.855816	0.604429	1.654453	1.168475	1.933188	0.0607594	0.6273266	51
10	0.517529	0.855665	0.604827	1.653366	1.168681	1.932258	0.0608657	0.6265309	50
11	0.517778	0.855515	0.605224	1.652281	1.168887	1.931329	0.0609722	0.6257363	49
12	0.518027	0.855364	0.605622	1.651196	1.169093	1.930401	0.0610788	0.6249427	48
13	0.518276	0.855214	0.606019	1.650113	1.169299	1.929475	0.0611856	0.6241501	47
14	0.518525	0.855063	0.606417	1.649030	1.169505	1.928549	0.0612925	0.6233586	46
15	0.518773	0.854912	0.606815	1.647949	1.169711	1.927624	0.0613995	0.6225681	45
16	0.519022	0.854761	0.607213	1.646869	1.169918	1.926701	0.0615067	0.6217786	44
17	0.519271	0.854610	0.607611	1.645789	1.170124	1.925778	0.0616140	0.6209902	43
18	0.519519	0.854459	0.608010	1.644711	1.170331	1.924857	0.0617215	0.6202028	42
19	0.519768	0.854308	0.608408	1.643634	1.170538	1.923937	0.0618291	0.6194164	41
20	0.520016	0.854156	0.608807	1.642558	1.170746	1.923017	0.0619368	0.6186311	40
21	0.520265	0.854005	0.609205	1.641482	1.170953	1.922099	0.0620447	0.6178468	39
22	0.520513	0.853854	0.609604	1.640408	1.171161	1.921182	0.0621527	0.6170635	38
23	0.520761	0.853702	0.610003	1.639335	1.171368	1.920265	0.0622609	0.6162813	37
24	0.521010	0.853551	0.610403	1.638263	1.171576	1.919350	0.0623692	0.6155000	36
25	0.521258	0.853399	0.610802	1.637192	1.171785	1.918436	0.0624777	0.6147198	35
26	0.521506	0.853248	0.611201	1.636122	1.171993	1.917523	0.0625863	0.6139407	34
27	0.521754	0.853096	0.611601	1.635053	1.172201	1.916611	0.0626950	0.6131625	33
28	0.522002	0.852944	0.612001	1.633985	1.172410	1.915700	0.0628039	0.6123853	32
29	0.522251	0.852792	0.612401	1.632918	1.172619	1.914790	0.0629129	0.6116092	31
30	0.522499	0.852640	0.612801	1.631852	1.172828	1.913881	0.0630221	0.6108341	30
31	0.522747	0.852488	0.613201	1.630787	1.173037	1.912973	0.0631314	0.6100600	29
32	0.522995	0.852336	0.613601	1.629723	1.173246	1.912066	0.0632408	0.6092869	28
33	0.523244	0.852184	0.614002	1.628660	1.173456	1.911160	0.0633504	0.6085148	27
34	0.523492	0.852032	0.614402	1.627598	1.173665	1.910255	0.0634602	0.6077437	26
35	0.523740	0.851880	0.614803	1.626537	1.173875	1.909351	0.0635700	0.6069736	25
36	0.523988	0.851727	0.615204	1.625477	1.174085	1.908448	0.0636801	0.6062045	24
37	0.524236	0.851574	0.615605	1.624418	1.174295	1.907546	0.0637902	0.6054364	23
38	0.524484	0.851422	0.616006	1.623360	1.174506	1.906646	0.0639005	0.6046694	22
39	0.524732	0.851269	0.616408	1.622303	1.174716	1.905746	0.0640110	0.6039033	21
40	0.524979	0.851117	0.616809	1.621247	1.174927	1.904847	0.0641216	0.6031382	20
41	0.525227	0.850964	0.617211	1.620192	1.175138	1.903949	0.0642323	0.6023741	19
42	0.525475	0.850811	0.617613	1.619138	1.175349	1.903052	0.0643432	0.6016110	18
43	0.525723	0.850658	0.618015	1.618085	1.175560	1.902156	0.0644542	0.6008489	17
44	0.525971	0.850505	0.618417	1.617033	1.175772	1.901262	0.0645654	0.6000878	16
45	0.526219	0.850352	0.618819	1.615982	1.175983	1.900368	0.0646767	0.5993277	15
46	0.526467	0.850199	0.619221	1.614932	1.176195	1.899475	0.0647882	0.5985686	14
47	0.526715	0.850046	0.619624	1.613883	1.176407	1.898583	0.0648998	0.5978104	13
48	0.526963	0.849893	0.620026	1.612835	1.176619	1.897692	0.0650116	0.5970533	12
49	0.527211	0.849739	0.620429	1.611788	1.176831	1.896803	0.0651235	0.5962971	11
50	0.527459	0.849586	0.620832	1.610742	1.177044	1.895914	0.0652355	0.5955419	10
51	0.527707	0.849433	0.621235	1.609697	1.177257	1.895026	0.0653477	0.5947877	9
52	0.527955	0.849279	0.621638	1.608653	1.177469	1.894139	0.0654600	0.5940344	8
53	0.528203	0.849125	0.622042	1.607609	1.177682	1.893253	0.0655725	0.5932822	7
54	0.528451	0.848972	0.622445	1.606567	1.177896	1.892368	0.0656851	0.5925309	6
55	0.528699	0.848818	0.622849	1.605526	1.178109	1.891485	0.0657979	0.5917806	5
56	0.528947	0.848664	0.623253	1.604486	1.178322	1.890602	0.0659108	0.5910312	4
57	0.529195	0.848510	0.623657	1.603446	1.178536	1.889720	0.0660239	0.5902829	3
58	0.529443	0.848356	0.624061	1.602408	1.178750	1.888839	0.0661371	0.5895355	2
59	0.529691	0.848202	0.624465	1.601371	1.178964	1.887959	0.0662505	0.5887890	1
60	0.529939	0.848048	0.624869	1.600335	1.179178	1.887080	0.0663640	0.5880436	0
Min-utes	Cosine	Sine	Cotangent	Tangent	Cosecant	Secant	Read Down	58°-59° Involute	Min-utes

↑ 121° or 301°

58° or 238° ↑

↓ 32° or 212° Trigonometric and Involute Functions 147° or 327° ↓

Min-utes	Sine	Cosine	Tangent	Cotangent	Secant	Cosecant	Involute 32°-33°	Read Up	Min-utes
0	0.529919	0.848048	0.624869	1.600335	1.179178	1.887080	0.0663640	0.5880436	60
1	0.530166	0.847894	0.625274	1.599299	1.179393	1.886202	0.0664776	0.5872991	59
2	0.530413	0.847740	0.625679	1.598265	1.179607	1.885325	0.0665914	0.5865555	58
3	0.530659	0.847585	0.626083	1.597231	1.179822	1.884449	0.0667054	0.5858129	57
4	0.530906	0.847431	0.626488	1.596199	1.180037	1.883574	0.0668195	0.5850713	56
5	0.531152	0.847276	0.626894	1.595167	1.180252	1.882700	0.0669337	0.5843307	55
6	0.531399	0.847122	0.627299	1.594137	1.180468	1.881827	0.0670481	0.5835910	54
7	0.531645	0.846967	0.627704	1.593107	1.180683	1.880954	0.0671627	0.5828522	53
8	0.531891	0.846813	0.628110	1.592078	1.180899	1.880083	0.0672774	0.5821144	52
9	0.532138	0.846658	0.628516	1.591051	1.181115	1.879213	0.0673922	0.5813776	51
10	0.532384	0.846503	0.628921	1.590024	1.181331	1.878344	0.0675072	0.5806417	50
11	0.532630	0.846348	0.629327	1.588998	1.181547	1.877476	0.0676223	0.5799067	49
12	0.532876	0.846193	0.629734	1.587973	1.181763	1.876608	0.0677376	0.5791727	48
13	0.533122	0.846038	0.630140	1.586949	1.181980	1.875742	0.0678530	0.5784397	47
14	0.533368	0.845883	0.630546	1.585926	1.182197	1.874876	0.0679684	0.5777076	46
15	0.533615	0.845728	0.630953	1.584904	1.182414	1.874012	0.0680843	0.5769764	45
16	0.533861	0.845573	0.631360	1.583883	1.182631	1.873148	0.0682002	0.5762462	44
17	0.534106	0.845417	0.631767	1.582863	1.182848	1.872286	0.0683162	0.5755169	43
18	0.534352	0.845262	0.632174	1.581844	1.183065	1.871424	0.0684324	0.5747886	42
19	0.534598	0.845106	0.632581	1.580825	1.183283	1.870564	0.0685487	0.5740612	41
20	0.534844	0.844951	0.632988	1.579808	1.183501	1.869704	0.0686652	0.5733347	40
21	0.535090	0.844795	0.633396	1.578792	1.183719	1.868845	0.0687818	0.5726092	39
22	0.535335	0.844640	0.633804	1.577776	1.183937	1.867987	0.0688986	0.5718846	38
23	0.535581	0.844484	0.634211	1.576761	1.184155	1.867131	0.0690155	0.5711609	37
24	0.535827	0.844328	0.634619	1.575748	1.184374	1.866275	0.0691326	0.5704382	36
25	0.536072	0.844172	0.635027	1.574735	1.184593	1.865420	0.0692498	0.5697164	35
26	0.536318	0.844016	0.635436	1.573723	1.184812	1.864566	0.0693672	0.5689955	34
27	0.536563	0.843860	0.635844	1.572713	1.185031	1.863713	0.0694848	0.5682756	33
28	0.536809	0.843704	0.636253	1.571703	1.185250	1.862860	0.0696024	0.5675565	32
29	0.537054	0.843548	0.636661	1.570694	1.185469	1.862009	0.0697203	0.5668384	31
30	0.537300	0.843391	0.637070	1.569686	1.185689	1.861159	0.0698383	0.5661213	30
31	0.537545	0.843235	0.637479	1.568678	1.185909	1.860310	0.0699564	0.5654050	29
32	0.537790	0.843079	0.637888	1.567672	1.186129	1.859461	0.0700747	0.5646896	28
33	0.538035	0.842922	0.638298	1.566667	1.186349	1.858614	0.0701931	0.5639752	27
34	0.538281	0.842766	0.638707	1.565662	1.186569	1.857767	0.0703117	0.5632617	26
35	0.538526	0.842609	0.639117	1.564659	1.186790	1.856922	0.0704304	0.5625491	25
36	0.538771	0.842452	0.639527	1.563656	1.187011	1.856077	0.0705493	0.5618374	24
37	0.539016	0.842296	0.639937	1.562655	1.187232	1.855233	0.0706684	0.5611267	23
38	0.539261	0.842139	0.640347	1.561654	1.187453	1.854390	0.0707876	0.5604168	22
39	0.539506	0.841982	0.640757	1.560654	1.187674	1.853548	0.0709069	0.5597078	21
40	0.539751	0.841825	0.641167	1.559655	1.187895	1.852707	0.0710265	0.5589998	20
41	0.539996	0.841668	0.641578	1.558657	1.188117	1.851867	0.0711461	0.5582927	19
42	0.540240	0.841511	0.641989	1.557660	1.188339	1.851028	0.0712659	0.5575864	18
43	0.540485	0.841354	0.642399	1.556664	1.188561	1.850190	0.0713859	0.5568811	17
44	0.540730	0.841196	0.642810	1.555669	1.188783	1.849352	0.0715060	0.5561767	16
45	0.540974	0.841039	0.643222	1.554674	1.189005	1.848516	0.0716263	0.5554731	15
46	0.541219	0.840882	0.643633	1.553681	1.189228	1.847681	0.0717467	0.5547705	14
47	0.541464	0.840724	0.644044	1.552688	1.189451	1.846846	0.0718673	0.5540688	13
48	0.541708	0.840567	0.644456	1.551696	1.189674	1.846012	0.0719880	0.5533679	12
49	0.541953	0.840409	0.644868	1.550705	1.189897	1.845179	0.0721089	0.5526680	11
50	0.542197	0.840251	0.645280	1.549715	1.190120	1.844348	0.0722300	0.5519689	10
51	0.542442	0.840094	0.645692	1.548726	1.190344	1.843517	0.0723512	0.5512708	9
52	0.542686	0.839936	0.646104	1.547738	1.190567	1.842687	0.0724725	0.5505735	8
53	0.542930	0.839778	0.646516	1.546751	1.190791	1.841857	0.0725940	0.5498771	7
54	0.543174	0.839620	0.646929	1.545765	1.191015	1.841029	0.0727157	0.5491816	6
55	0.543419	0.839462	0.647342	1.544779	1.191239	1.840202	0.0728375	0.5484870	5
56	0.543663	0.839304	0.647755	1.543795	1.191464	1.839375	0.0729595	0.5477933	4
57	0.543907	0.839146	0.648168	1.542811	1.191688	1.838550	0.0730816	0.5471005	3
58	0.544151	0.838987	0.648581	1.541828	1.191913	1.837725	0.0732039	0.5464085	2
59	0.544395	0.838829	0.648994	1.540846	1.192138	1.836901	0.0733263	0.5457175	1
60	0.544639	0.838671	0.649408	1.539865	1.192363	1.836078	0.0734489	0.5450273	0

↑ 122° or 302°

57° or 237° ↑

↓ 33° or 213° **Trigonometric and Involute Functions** 146° or 326° ↓

Min-utes	Sine	Cosine	Tangent	Cotangent	Secant	Cosecant	Involute 33°-34°	Read Up	Min-utes
0	0.544639	0.838671	0.649408	1.539865	1.192363	1.836078	0.0734489	0.5450273	60
1	0.544883	0.838512	0.649821	1.538885	1.192589	1.835256	0.0735717	0.5443380	59
2	0.545127	0.838354	0.650235	1.537905	1.192814	1.834435	0.0736946	0.5436495	58
3	0.545371	0.838195	0.650649	1.536927	1.193040	1.833615	0.0738177	0.5429620	57
4	0.545615	0.838036	0.651063	1.535949	1.193266	1.832796	0.0739409	0.5422753	56
5	0.545858	0.837878	0.651477	1.534973	1.193492	1.831977	0.0740643	0.5415895	55
6	0.546102	0.837719	0.651892	1.533997	1.193718	1.831160	0.0741878	0.5409046	54
7	0.546346	0.837560	0.652306	1.533022	1.193945	1.830343	0.0743115	0.5402205	53
8	0.546589	0.837401	0.652721	1.532048	1.194171	1.829527	0.0744354	0.5395373	52
9	0.546833	0.837242	0.653136	1.531075	1.194398	1.828713	0.0745594	0.5388550	51
10	0.547076	0.837083	0.653551	1.530102	1.194625	1.827899	0.0746835	0.5381735	50
11	0.547320	0.836924	0.653966	1.529131	1.194852	1.827085	0.0748079	0.5374929	49
12	0.547563	0.836764	0.654382	1.528160	1.195080	1.826273	0.0749324	0.5368132	48
13	0.547807	0.836605	0.654797	1.527190	1.195307	1.825462	0.0750570	0.5361343	47
14	0.548050	0.836446	0.655213	1.526222	1.195535	1.824651	0.0751818	0.5354563	46
15	0.548293	0.836286	0.655629	1.525253	1.195763	1.823842	0.0753068	0.5347791	45
16	0.548536	0.836127	0.656045	1.524286	1.195991	1.823033	0.0754319	0.5341028	44
17	0.548780	0.835967	0.656461	1.523320	1.196219	1.822225	0.0755571	0.5334274	43
18	0.549023	0.835807	0.656877	1.522355	1.196448	1.821418	0.0756826	0.5327528	42
19	0.549266	0.835648	0.657294	1.521390	1.196677	1.820612	0.0758082	0.5320791	41
20	0.549509	0.835488	0.657710	1.520426	1.196906	1.819806	0.0759339	0.5314062	40
21	0.549752	0.835328	0.658127	1.519463	1.197135	1.819002	0.0760598	0.5307342	39
22	0.549995	0.835168	0.658544	1.518501	1.197364	1.818199	0.0761859	0.5300630	38
23	0.550238	0.835008	0.658961	1.517540	1.197593	1.817396	0.0763121	0.5293927	37
24	0.550481	0.834848	0.659379	1.516580	1.197823	1.816594	0.0764385	0.5287232	36
25	0.550724	0.834688	0.659796	1.515620	1.198053	1.815793	0.0765651	0.5280546	35
26	0.550966	0.834527	0.660214	1.514661	1.198283	1.814993	0.0766918	0.5273868	34
27	0.551209	0.834367	0.660631	1.513704	1.198513	1.814194	0.0768187	0.5267199	33
28	0.551452	0.834207	0.661049	1.512747	1.198744	1.813395	0.0769457	0.5260538	32
29	0.551694	0.834046	0.661467	1.511790	1.198974	1.812598	0.0770729	0.5253886	31
30	0.551937	0.833886	0.661886	1.510833	1.199205	1.811801	0.0772003	0.5247242	30
31	0.552180	0.833725	0.662304	1.509881	1.199436	1.811005	0.0773278	0.5240606	29
32	0.552422	0.833565	0.662723	1.508927	1.199667	1.810210	0.0774555	0.5233979	28
33	0.552664	0.833404	0.663141	1.507974	1.199898	1.809416	0.0775833	0.5227360	27
34	0.552907	0.833243	0.663560	1.507022	1.200130	1.808623	0.0777113	0.5220749	26
35	0.553149	0.833082	0.663979	1.506071	1.200362	1.807830	0.0778395	0.5214147	25
36	0.553392	0.832921	0.664398	1.505121	1.200594	1.807039	0.0779678	0.5207553	24
37	0.553634	0.832760	0.664818	1.504172	1.200826	1.806248	0.0780963	0.5200967	23
38	0.553876	0.832599	0.665237	1.503223	1.201058	1.805458	0.0782249	0.5194390	22
39	0.554118	0.832438	0.665657	1.502275	1.201291	1.804669	0.0783537	0.5187821	21
40	0.554360	0.832277	0.666077	1.501328	1.201523	1.803881	0.0784827	0.5181260	20
41	0.554602	0.832115	0.666497	1.500382	1.201756	1.803094	0.0786118	0.5174708	19
42	0.554844	0.831954	0.666917	1.499437	1.201989	1.802307	0.0787411	0.5168164	18
43	0.555086	0.831793	0.667337	1.498492	1.202223	1.801521	0.0788706	0.5161628	17
44	0.555328	0.831631	0.667758	1.497549	1.202456	1.800736	0.0790002	0.5155100	16
45	0.555570	0.831470	0.668179	1.496606	1.202690	1.799952	0.0791300	0.5148581	15
46	0.555812	0.831308	0.668599	1.495664	1.202924	1.799169	0.0792600	0.5142069	14
47	0.556054	0.831146	0.669020	1.494723	1.203158	1.798387	0.0793901	0.5135566	13
48	0.556296	0.830984	0.669442	1.493782	1.203392	1.797605	0.0795204	0.5129071	12
49	0.556537	0.830823	0.669863	1.492843	1.203626	1.796825	0.0796508	0.5122585	11
50	0.556779	0.830661	0.670284	1.491904	1.203861	1.796045	0.0797814	0.5116106	10
51	0.557021	0.830499	0.670706	1.490966	1.204096	1.795266	0.0799122	0.5109635	9
52	0.557262	0.830337	0.671128	1.490029	1.204331	1.794488	0.0800431	0.5103173	8
53	0.557504	0.830174	0.671550	1.489092	1.204566	1.793710	0.0801742	0.5096719	7
54	0.557745	0.830012	0.671972	1.488157	1.204801	1.792934	0.0803055	0.5090273	6
55	0.557987	0.829850	0.672394	1.487222	1.205037	1.792158	0.0804369	0.5083835	5
56	0.558228	0.829688	0.672817	1.486288	1.205273	1.791383	0.0805685	0.5077405	4
57	0.558469	0.829525	0.673240	1.485355	1.205509	1.790609	0.0807003	0.5070983	3
58	0.558710	0.829363	0.673662	1.484423	1.205745	1.789836	0.0808322	0.5064569	2
59	0.558952	0.829200	0.674085	1.483492	1.205981	1.789063	0.0809643	0.5058164	1
60	0.559193	0.829038	0.674509	1.482561	1.206218	1.788292	0.0810966	0.5051766	0
Min-utes	Cosine	Sine	Cotangent	Tangent	Cosecant	Secant	Read Down	56°-57° Involute	Min-utes

↑ 123° or 303°

56° or 236° ↑

↓ 34° or 214° **Trigonometric and Involute Functions** 145° or 325° ↓

Min-utes	Sine	Cosine	Tangent	Cotangent	Secant	Cosecant	Involute 34°–35°	Read Up	Min-utes
0	0.559193	0.829038	0.674509	1.482561	1.206218	1.788292	0.0810966	0.5051766	60
1	0.559434	0.828875	0.674932	1.481631	1.206455	1.787521	0.0812290	0.5045376	59
2	0.559675	0.828712	0.675355	1.480702	1.206692	1.786751	0.0813616	0.5038995	58
3	0.559916	0.828549	0.675779	1.479774	1.206929	1.785982	0.0814943	0.5032621	57
4	0.560157	0.828386	0.676203	1.478846	1.207166	1.785213	0.0816273	0.5026255	56
5	0.560398	0.828223	0.676627	1.477920	1.207404	1.784446	0.0817604	0.5019897	55
6	0.560639	0.828060	0.677051	1.476994	1.207641	1.783679	0.0818936	0.5013548	54
7	0.560880	0.827897	0.677475	1.476069	1.207879	1.782913	0.0820271	0.5007206	53
8	0.561121	0.827734	0.677900	1.475144	1.208118	1.782148	0.0821606	0.5000872	52
9	0.561361	0.827571	0.678324	1.474221	1.208356	1.781384	0.0822944	0.4994546	51
10	0.561602	0.827407	0.678749	1.473298	1.208594	1.780620	0.0824283	0.4988228	50
11	0.561843	0.827244	0.679174	1.472376	1.208833	1.779857	0.0825624	0.4981918	49
12	0.562083	0.827081	0.679599	1.471455	1.209072	1.779095	0.0826967	0.4975616	48
13	0.562324	0.826917	0.680025	1.470535	1.209311	1.778334	0.0828311	0.4969322	47
14	0.562564	0.826753	0.680450	1.469615	1.209550	1.777574	0.0829657	0.4963035	46
15	0.562805	0.826590	0.680876	1.468697	1.209790	1.776815	0.0831005	0.4956757	45
16	0.563045	0.826426	0.681302	1.467779	1.210030	1.776056	0.0832354	0.4950486	44
17	0.563286	0.826262	0.681728	1.466862	1.210270	1.775298	0.0833705	0.4944223	43
18	0.563526	0.826098	0.682154	1.465945	1.210510	1.774541	0.0835058	0.4937968	42
19	0.563766	0.825934	0.682580	1.465030	1.210750	1.773785	0.0836413	0.4931721	41
20	0.564007	0.825770	0.683007	1.464115	1.210991	1.773029	0.0837769	0.4925481	40
21	0.564247	0.825606	0.683433	1.463201	1.211231	1.772274	0.0839127	0.4919249	39
22	0.564487	0.825442	0.683860	1.462287	1.211472	1.771520	0.0840486	0.4913026	38
23	0.564727	0.825278	0.684287	1.461375	1.211713	1.770767	0.0841847	0.4906809	37
24	0.564967	0.825113	0.684714	1.460463	1.211954	1.770015	0.0843210	0.4900601	36
25	0.565207	0.824949	0.685142	1.459552	1.212196	1.769263	0.0844575	0.4894400	35
26	0.565447	0.824785	0.685569	1.458642	1.212438	1.768513	0.0845941	0.4888207	34
27	0.565687	0.824620	0.685997	1.457733	1.212680	1.767763	0.0847309	0.4882022	33
28	0.565927	0.824456	0.686425	1.456824	1.212922	1.767013	0.0848679	0.4875845	32
29	0.566166	0.824291	0.686853	1.455916	1.213164	1.766265	0.0850050	0.4869675	31
30	0.566406	0.824126	0.687281	1.455009	1.213406	1.765517	0.0851424	0.4863513	30
31	0.566646	0.823961	0.687709	1.454103	1.213649	1.764770	0.0852799	0.4857359	29
32	0.566886	0.823797	0.688138	1.453197	1.213892	1.764024	0.0854175	0.4851212	28
33	0.567125	0.823632	0.688567	1.452292	1.214135	1.763279	0.0855553	0.4845073	27
34	0.567365	0.823467	0.688995	1.451388	1.214378	1.762535	0.0856933	0.4838941	26
35	0.567604	0.823302	0.689425	1.450485	1.214622	1.761791	0.0858315	0.4832817	25
36	0.567844	0.823136	0.689854	1.449583	1.214866	1.761048	0.0859699	0.4826701	24
37	0.568083	0.822971	0.690283	1.448681	1.215109	1.760306	0.0861084	0.4820593	23
38	0.568323	0.822806	0.690713	1.447780	1.215354	1.759564	0.0862471	0.4814492	22
39	0.568562	0.822641	0.691143	1.446880	1.215598	1.758824	0.0863859	0.4808398	21
40	0.568801	0.822475	0.691572	1.445980	1.215842	1.758084	0.0865250	0.4802312	20
41	0.569040	0.822310	0.692003	1.445081	1.216087	1.757345	0.0866642	0.4796234	19
42	0.569280	0.822144	0.692433	1.444183	1.216332	1.756606	0.0868036	0.4790163	18
43	0.569519	0.821978	0.692863	1.443286	1.216577	1.755869	0.0869431	0.4784100	17
44	0.569758	0.821813	0.693294	1.442390	1.216822	1.755132	0.0870829	0.4778044	16
45	0.569997	0.821647	0.693725	1.441494	1.217068	1.754396	0.0872228	0.4771996	15
46	0.570236	0.821481	0.694156	1.440599	1.217313	1.753661	0.0873628	0.4765956	14
47	0.570475	0.821315	0.694587	1.439705	1.217559	1.752926	0.0875031	0.4759923	13
48	0.570714	0.821149	0.695018	1.438811	1.217805	1.752192	0.0876435	0.4753897	12
49	0.570952	0.820983	0.695450	1.437919	1.218052	1.751459	0.0877841	0.4747879	11
50	0.571191	0.820817	0.695881	1.437027	1.218298	1.750727	0.0879249	0.4741868	10
51	0.571430	0.820651	0.696313	1.436136	1.218545	1.749996	0.0880659	0.4735865	9
52	0.571669	0.820485	0.696745	1.435245	1.218792	1.749265	0.0882070	0.4729869	8
53	0.571907	0.820318	0.697177	1.434355	1.219039	1.748535	0.0883483	0.4723881	7
54	0.572146	0.820152	0.697610	1.433466	1.219286	1.747806	0.0884898	0.4717900	6
55	0.572384	0.819985	0.698042	1.432578	1.219534	1.747078	0.0886314	0.4711926	5
56	0.572623	0.819819	0.698475	1.431691	1.219782	1.746350	0.0887732	0.4705960	4
57	0.572861	0.819652	0.698908	1.430804	1.220030	1.745623	0.0889152	0.4700001	3
58	0.573100	0.819486	0.699341	1.429918	1.220278	1.744897	0.0890574	0.4694050	2
59	0.573338	0.819319	0.699774	1.429033	1.220526	1.744171	0.0891998	0.4688106	1
60	0.573576	0.819152	0.700208	1.428148	1.220775	1.743447	0.0893423	0.4682169	0

↑ 124° or 304°

55° or 235° ↑

Min-utes	Cosine	Sine	Cotangent	Tangent	Cosecant	Secant	Read Down	55°–56° Involute	Min-utes
----------	--------	------	-----------	---------	----------	--------	-----------	------------------	----------

↓ 35° or 215° Trigonometric and Involute Functions 144° or 324° ↓

Min-utes	Sine	Cosine	Tangent	Cotangent	Secant	Cosecant	Involute 35°–36°	Read Up	Min-utes
0	0.573576	0.819152	0.700208	1.428148	1.220775	1.743447	0.0893423	0.4682169	60
1	0.573815	0.818985	0.700641	1.427264	1.221023	1.742723	0.0894850	0.4676240	59
2	0.574053	0.818818	0.701075	1.426381	1.221272	1.742000	0.0896279	0.4670318	58
3	0.574291	0.818651	0.701509	1.425499	1.221521	1.741277	0.0897710	0.4664403	57
4	0.574529	0.818484	0.701943	1.424617	1.221771	1.740556	0.0899142	0.4658496	56
5	0.574767	0.818317	0.702377	1.423736	1.222020	1.739835	0.0900576	0.4652596	55
6	0.575005	0.818150	0.702812	1.422856	1.222270	1.739115	0.0902012	0.4646703	54
7	0.575243	0.817982	0.703246	1.421977	1.222520	1.738395	0.0903450	0.4640818	53
8	0.575481	0.817815	0.703681	1.421098	1.222770	1.737676	0.0904889	0.4634940	52
9	0.575719	0.817648	0.704116	1.420220	1.223021	1.736958	0.0906331	0.4629069	51
10	0.575957	0.817480	0.704551	1.419343	1.223271	1.736241	0.0907774	0.4623205	50
11	0.576195	0.817313	0.704987	1.418466	1.223522	1.735525	0.0909218	0.4617349	49
12	0.576432	0.817145	0.705422	1.417590	1.223773	1.734809	0.0910665	0.4611499	48
13	0.576670	0.816977	0.705858	1.416715	1.224024	1.734094	0.0912113	0.4605657	47
14	0.576908	0.816809	0.706294	1.415841	1.224276	1.733380	0.0913564	0.4599823	46
15	0.577145	0.816642	0.706730	1.414967	1.224527	1.732666	0.0915016	0.4593995	45
16	0.577383	0.816474	0.707166	1.414094	1.224779	1.731953	0.0916469	0.4588175	44
17	0.577620	0.816306	0.707603	1.413222	1.225031	1.731241	0.0917925	0.4582361	43
18	0.577858	0.816138	0.708039	1.412351	1.225284	1.730530	0.0919382	0.4576555	42
19	0.578095	0.815969	0.708476	1.411480	1.225536	1.729819	0.0920842	0.4570757	41
20	0.578332	0.815801	0.708913	1.410610	1.225789	1.729110	0.0922303	0.4564965	40
21	0.578570	0.815633	0.709350	1.409740	1.226042	1.728400	0.0923765	0.4559180	39
22	0.578807	0.815465	0.709788	1.408872	1.226295	1.727692	0.0925230	0.4553403	38
23	0.579044	0.815296	0.710225	1.408004	1.226548	1.726984	0.0926696	0.4547632	37
24	0.579281	0.815128	0.710663	1.407137	1.226801	1.726277	0.0928165	0.4541869	36
25	0.579518	0.814959	0.711101	1.406270	1.227055	1.725571	0.0929635	0.4536113	35
26	0.579755	0.814791	0.711539	1.405404	1.227309	1.724866	0.0931106	0.4530364	34
27	0.579992	0.814622	0.711977	1.404539	1.227563	1.724161	0.0932580	0.4524622	33
28	0.580229	0.814453	0.712416	1.403675	1.227818	1.723457	0.0934055	0.4518887	32
29	0.580466	0.814284	0.712854	1.402811	1.228072	1.722753	0.0935533	0.4513159	31
30	0.580703	0.814116	0.713293	1.401948	1.228327	1.722051	0.0937012	0.4507439	30
31	0.580940	0.813947	0.713732	1.401086	1.228582	1.721349	0.0938493	0.4501725	29
32	0.581176	0.813778	0.714171	1.400224	1.228837	1.720648	0.0939975	0.4496018	28
33	0.581413	0.813608	0.714611	1.399364	1.229092	1.719947	0.0941460	0.4490318	27
34	0.581650	0.813439	0.715050	1.398503	1.229348	1.719247	0.0942946	0.4484626	26
35	0.581886	0.813270	0.715490	1.397644	1.229604	1.718548	0.0944435	0.4478940	25
36	0.582123	0.813101	0.715930	1.396785	1.229860	1.717850	0.0945925	0.4473261	24
37	0.582359	0.812931	0.716370	1.395927	1.230116	1.717152	0.0947417	0.4467589	23
38	0.582596	0.812762	0.716810	1.395070	1.230373	1.716456	0.0948910	0.4461924	22
39	0.582832	0.812592	0.717250	1.394213	1.230629	1.715759	0.0950406	0.4456267	21
40	0.583069	0.812423	0.717691	1.393357	1.230886	1.715064	0.0951903	0.4450616	20
41	0.583305	0.812253	0.718132	1.392502	1.231143	1.714369	0.0953402	0.4444972	19
42	0.583541	0.812084	0.718573	1.391647	1.231400	1.713675	0.0954904	0.4439335	18
43	0.583777	0.811914	0.719014	1.390793	1.231658	1.712982	0.0956406	0.4433705	17
44	0.584014	0.811744	0.719455	1.389940	1.231916	1.712289	0.0957911	0.4428081	16
45	0.584250	0.811574	0.719897	1.389088	1.232174	1.711597	0.0959418	0.4422465	15
46	0.584486	0.811404	0.720339	1.388236	1.232432	1.710906	0.0960926	0.4416856	14
47	0.584722	0.811234	0.720781	1.387385	1.232690	1.710215	0.0962437	0.4411253	13
48	0.584958	0.811064	0.721223	1.386534	1.232949	1.709525	0.0963949	0.4405657	12
49	0.585194	0.810894	0.721665	1.385684	1.233207	1.708836	0.0965463	0.4400069	11
50	0.585429	0.810723	0.722108	1.384835	1.233466	1.708148	0.0966979	0.4394487	10
51	0.585665	0.810553	0.722550	1.383987	1.233726	1.707460	0.0968496	0.4388911	9
52	0.585901	0.810383	0.722993	1.383139	1.233985	1.706773	0.0970016	0.4383343	8
53	0.586137	0.810212	0.723436	1.382292	1.234245	1.706087	0.0971537	0.4377782	7
54	0.586372	0.810042	0.723879	1.381446	1.234504	1.705401	0.0973061	0.4372227	6
55	0.586608	0.809871	0.724323	1.380600	1.234764	1.704716	0.0974586	0.4366679	5
56	0.586844	0.809700	0.724766	1.379755	1.235025	1.704032	0.0976113	0.4361138	4
57	0.587079	0.809530	0.725210	1.378911	1.235285	1.703348	0.0977642	0.4355604	3
58	0.587314	0.809359	0.725654	1.378067	1.235546	1.702665	0.0979173	0.4350076	2
59	0.587550	0.809188	0.726098	1.377224	1.235807	1.701983	0.0980705	0.4344555	1
60	0.587785	0.809017	0.726543	1.376382	1.236068	1.701302	0.0982240	0.4339041	0
Min-utes	Cosine	Sine	Cotangent	Tangent	Cosecant	Secant	Read Down	54°–55° Involute	Min-utes

↑ 125° or 305°

54° or 234° ↑

↓ 36° or 216° **Trigonometric and Involute Functions** 143° or 323° ↓

Min-utes	Sine	Cosine	Tangent	Cotangent	Secant	Cosecant	Involute 36°-37°	Read Up	Min-utes
0	0.587785	0.809017	0.726543	1.376382	1.236068	1.701302	0.0982240	0.4339041	60
1	0.588021	0.808846	0.726987	1.375540	1.236329	1.700621	0.0983776	0.4333534	59
2	0.588256	0.808675	0.727432	1.374699	1.236591	1.699941	0.0985315	0.4328033	58
3	0.588491	0.808504	0.727877	1.373859	1.236853	1.699261	0.0986855	0.4322540	57
4	0.588726	0.808333	0.728322	1.373019	1.237115	1.698582	0.0988397	0.4317052	56
5	0.588961	0.808161	0.728767	1.372181	1.237377	1.697904	0.0989941	0.4311572	55
6	0.589196	0.807990	0.729213	1.371342	1.237639	1.697227	0.0991487	0.4306098	54
7	0.589431	0.807818	0.729658	1.370505	1.237902	1.696550	0.0993035	0.4300631	53
8	0.589666	0.807647	0.730104	1.369668	1.238165	1.695874	0.0994584	0.4295171	52
9	0.589901	0.807475	0.730550	1.368832	1.238428	1.695199	0.0996136	0.4289717	51
10	0.590136	0.807304	0.730996	1.367996	1.238691	1.694524	0.0997689	0.4284270	50
11	0.590371	0.807132	0.731443	1.367161	1.238955	1.693850	0.0999244	0.4278830	49
12	0.590606	0.806960	0.731889	1.366327	1.239218	1.693177	0.1000802	0.4273396	48
13	0.590840	0.806788	0.732336	1.365493	1.239482	1.692505	0.1002361	0.4267969	47
14	0.591075	0.806617	0.732783	1.364660	1.239746	1.691833	0.1003922	0.4262548	46
15	0.591310	0.806445	0.733230	1.363828	1.240011	1.691161	0.1005485	0.4257134	45
16	0.591544	0.806273	0.733678	1.362996	1.240275	1.690491	0.1007050	0.4251727	44
17	0.591779	0.806100	0.734125	1.362165	1.240540	1.689821	0.1008616	0.4246326	43
18	0.592013	0.805928	0.734573	1.361335	1.240805	1.689152	0.1010185	0.4240932	42
19	0.592248	0.805756	0.735021	1.360505	1.241070	1.688483	0.1011756	0.4235545	41
20	0.592482	0.805584	0.735469	1.359676	1.241336	1.687815	0.1013328	0.4230164	40
21	0.592716	0.805411	0.735917	1.358848	1.241602	1.687148	0.1014903	0.4224789	39
22	0.592951	0.805239	0.736366	1.358020	1.241867	1.686481	0.1016479	0.4219421	38
23	0.593185	0.805066	0.736815	1.357193	1.242134	1.685815	0.1018057	0.4214060	37
24	0.593419	0.804894	0.737264	1.356367	1.242400	1.685150	0.1019637	0.4208705	36
25	0.593653	0.804721	0.737713	1.355541	1.242666	1.684486	0.1021219	0.4203357	35
26	0.593887	0.804548	0.738162	1.354716	1.242933	1.683822	0.1022804	0.4198015	34
27	0.594121	0.804376	0.738611	1.353892	1.243200	1.683159	0.1024389	0.4192680	33
28	0.594355	0.804203	0.739061	1.353068	1.243467	1.682496	0.1025977	0.4187351	32
29	0.594589	0.804030	0.739511	1.352245	1.243735	1.681834	0.1027567	0.4182029	31
30	0.594823	0.803857	0.739961	1.351422	1.244003	1.681173	0.1029159	0.4176713	30
31	0.595057	0.803684	0.740411	1.350600	1.244270	1.680512	0.1030753	0.4171403	29
32	0.595290	0.803511	0.740862	1.349779	1.244539	1.679853	0.1032348	0.4166101	28
33	0.595524	0.803337	0.741312	1.348959	1.244807	1.679193	0.1033946	0.4160804	27
34	0.595758	0.803164	0.741763	1.348139	1.245075	1.678535	0.1035545	0.4155514	26
35	0.595991	0.802991	0.742214	1.347320	1.245344	1.677877	0.1037147	0.4150230	25
36	0.596225	0.802817	0.742666	1.346501	1.245613	1.677220	0.1038750	0.4144953	24
37	0.596458	0.802644	0.743117	1.345683	1.245882	1.676563	0.1040356	0.4139682	23
38	0.596692	0.802470	0.743569	1.344866	1.246152	1.675907	0.1041963	0.4134418	22
39	0.596925	0.802297	0.744020	1.344049	1.246421	1.675252	0.1043572	0.4129160	21
40	0.597159	0.802123	0.744472	1.343233	1.246691	1.674597	0.1045184	0.4123908	20
41	0.597392	0.801949	0.744925	1.342418	1.246961	1.673943	0.1046797	0.4118663	19
42	0.597625	0.801776	0.745377	1.341603	1.247232	1.673290	0.1048412	0.4113424	18
43	0.597858	0.801602	0.745830	1.340789	1.247502	1.672637	0.1050029	0.4108192	17
44	0.598091	0.801428	0.746282	1.339975	1.247773	1.671985	0.1051648	0.4102966	16
45	0.598325	0.801254	0.746735	1.339162	1.248044	1.671334	0.1053269	0.4097746	15
46	0.598558	0.801080	0.747189	1.338350	1.248315	1.670683	0.1054892	0.4092532	14
47	0.598791	0.800906	0.747642	1.337539	1.248587	1.670033	0.1056517	0.4087325	13
48	0.599024	0.800731	0.748096	1.336728	1.248858	1.669383	0.1058144	0.4082124	12
49	0.599256	0.800557	0.748549	1.335917	1.249130	1.668735	0.1059773	0.4076930	11
50	0.599489	0.800383	0.749003	1.335108	1.249402	1.668086	0.1061404	0.4071741	10
51	0.599722	0.800208	0.749458	1.334298	1.249675	1.667439	0.1063037	0.4066559	9
52	0.599955	0.800034	0.749912	1.333490	1.249947	1.666792	0.1064672	0.4061384	8
53	0.600188	0.799859	0.750366	1.332682	1.250220	1.666146	0.1066309	0.4056214	7
54	0.600420	0.799685	0.750821	1.331875	1.250493	1.665500	0.1067947	0.4051051	6
55	0.600653	0.799510	0.751276	1.331068	1.250766	1.664855	0.1069588	0.4045894	5
56	0.600885	0.799335	0.751731	1.330262	1.251040	1.664211	0.1071231	0.4040744	4
57	0.601118	0.799160	0.752187	1.329457	1.251313	1.663567	0.1072876	0.4035599	3
58	0.601350	0.798985	0.752642	1.328652	1.251587	1.662924	0.1074523	0.4030461	2
59	0.601583	0.798811	0.753098	1.327848	1.251861	1.662282	0.1076171	0.4025329	1
60	0.601815	0.798636	0.753554	1.327045	1.252136	1.661640	0.1077822	0.4020203	0
Min-utes	Cosine	Sine	Cotangent	Tangent	Cosecant	Secant	Read Down	53°-54° Involute	Min-utes

↑ 126° or 306°

53° or 233° ↑

↓ 37° or 217° **Trigonometric and Involute Functions** 142° or 322° ↓

Min-utes	Sine	Cosine	Tangent	Cotangent	Secant	Cosecant	Involute 37°-38°	Read Up	Min-utes
0	0.601815	0.798636	0.753554	1.327045	1.252136	1.661640	0.1077822	0.4020203	60
1	0.602047	0.798460	0.754010	1.326242	1.252410	1.660999	0.1079475	0.4015084	59
2	0.602280	0.798285	0.754467	1.325440	1.252685	1.660359	0.1081130	0.4009970	58
3	0.602512	0.798110	0.754923	1.324638	1.252960	1.659719	0.1082787	0.4004863	57
4	0.602744	0.797935	0.755380	1.323837	1.253235	1.659080	0.1084445	0.3999762	56
5	0.602976	0.797759	0.755837	1.323037	1.253511	1.658441	0.1086106	0.3994667	55
6	0.603208	0.797584	0.756294	1.322237	1.253787	1.657803	0.1087769	0.3989578	54
7	0.603440	0.797408	0.756751	1.321438	1.254062	1.657166	0.1089434	0.3984496	53
8	0.603672	0.797233	0.757209	1.320639	1.254339	1.656529	0.1091101	0.3979419	52
9	0.603904	0.797057	0.757667	1.319841	1.254615	1.655893	0.1092770	0.3974349	51
10	0.604136	0.796882	0.758125	1.319044	1.254892	1.655258	0.1094440	0.3969285	50
11	0.604367	0.796706	0.758583	1.318247	1.255169	1.654623	0.1096113	0.3964227	49
12	0.604599	0.796530	0.759041	1.317451	1.255446	1.653989	0.1097788	0.3959175	48
13	0.604831	0.796354	0.759500	1.316656	1.255723	1.653355	0.1099465	0.3954129	47
14	0.605062	0.796178	0.759959	1.315861	1.256000	1.652722	0.1101144	0.3949089	46
15	0.605294	0.796002	0.760418	1.315067	1.256278	1.652090	0.1102825	0.3944056	45
16	0.605526	0.795826	0.760877	1.314273	1.256556	1.651458	0.1104508	0.3939028	44
17	0.605757	0.795650	0.761336	1.313480	1.256834	1.650827	0.1106193	0.3934007	43
18	0.605988	0.795473	0.761796	1.312688	1.257113	1.650197	0.1107880	0.3928991	42
19	0.606220	0.795297	0.762256	1.311896	1.257392	1.649567	0.1109570	0.3923982	41
20	0.606451	0.795121	0.762716	1.311105	1.257671	1.648938	0.1111261	0.3918978	40
21	0.606682	0.794944	0.763176	1.310314	1.257950	1.648309	0.1112954	0.3913981	39
22	0.606914	0.794768	0.763636	1.309524	1.258229	1.647681	0.1114649	0.3908990	38
23	0.607145	0.794591	0.764097	1.308735	1.258509	1.647054	0.1116347	0.3904004	37
24	0.607376	0.794415	0.764558	1.307946	1.258789	1.646427	0.1118046	0.3899025	36
25	0.607607	0.794238	0.765019	1.307157	1.259069	1.645801	0.1119747	0.3894052	35
26	0.607838	0.794061	0.765480	1.306370	1.259349	1.645175	0.1121451	0.3889085	34
27	0.608069	0.793884	0.765941	1.305583	1.259629	1.644551	0.1123156	0.3884123	33
28	0.608300	0.793707	0.766403	1.304796	1.259910	1.643926	0.1124864	0.3879168	32
29	0.608531	0.793530	0.766865	1.304011	1.260191	1.643303	0.1126573	0.3874219	31
30	0.608761	0.793353	0.767327	1.303225	1.260472	1.642680	0.1128285	0.3869275	30
31	0.608992	0.793176	0.767789	1.302441	1.260754	1.642057	0.1129999	0.3864338	29
32	0.609223	0.792999	0.768252	1.301657	1.261036	1.641435	0.1131715	0.3859406	28
33	0.609454	0.792822	0.768714	1.300873	1.261317	1.640814	0.1133433	0.3854481	27
34	0.609684	0.792646	0.769177	1.300090	1.261600	1.640194	0.1135153	0.3849561	26
35	0.609915	0.792467	0.769640	1.299308	1.261882	1.639574	0.1136875	0.3844647	25
36	0.610145	0.792290	0.770104	1.298526	1.262165	1.638954	0.1138599	0.3839739	24
37	0.610376	0.792112	0.770567	1.297745	1.262448	1.638335	0.1140325	0.3834837	23
38	0.610606	0.791935	0.771031	1.296965	1.262731	1.637717	0.1142053	0.3829941	22
39	0.610836	0.791757	0.771495	1.296185	1.263014	1.637100	0.1143784	0.3825051	21
40	0.611067	0.791579	0.771959	1.295406	1.263298	1.636483	0.1145516	0.3820167	20
41	0.611297	0.791401	0.772423	1.294627	1.263581	1.635866	0.1147250	0.3815289	19
42	0.611527	0.791224	0.772888	1.293849	1.263865	1.635251	0.1148987	0.3810416	18
43	0.611757	0.791046	0.773353	1.293071	1.264150	1.634636	0.1150726	0.3805549	17
44	0.611987	0.790868	0.773818	1.292294	1.264434	1.634021	0.1152466	0.3800689	16
45	0.612217	0.790690	0.774283	1.291518	1.264719	1.633407	0.1154209	0.3795834	15
46	0.612447	0.790511	0.774748	1.290742	1.265004	1.632794	0.1155954	0.3790984	14
47	0.612677	0.790333	0.775214	1.289967	1.265289	1.632181	0.1157701	0.3786141	13
48	0.612907	0.790155	0.775680	1.289192	1.265574	1.631569	0.1159451	0.3781304	12
49	0.613137	0.789977	0.776146	1.288418	1.265860	1.630957	0.1161202	0.3776472	11
50	0.613367	0.789798	0.776612	1.287645	1.266146	1.630346	0.1162955	0.3771646	10
51	0.613596	0.789620	0.777078	1.286872	1.266432	1.629736	0.1164711	0.3766826	9
52	0.613826	0.789441	0.777545	1.286099	1.266719	1.629126	0.1166468	0.3762012	8
53	0.614056	0.789263	0.778012	1.285328	1.267005	1.628517	0.1168228	0.3757203	7
54	0.614285	0.789084	0.778479	1.284557	1.267292	1.627908	0.1169990	0.3752400	6
55	0.614515	0.788905	0.778946	1.283786	1.267579	1.627300	0.1171754	0.3747603	5
56	0.614744	0.788727	0.779414	1.283016	1.267866	1.626693	0.1173520	0.3742812	4
57	0.614974	0.788548	0.779881	1.282247	1.268154	1.626086	0.1175288	0.3738026	3
58	0.615203	0.788369	0.780349	1.281478	1.268442	1.625480	0.1177058	0.3733247	2
59	0.615432	0.788190	0.780817	1.280709	1.268730	1.624874	0.1178831	0.3728473	1
60	0.615661	0.788011	0.781286	1.279942	1.269018	1.624269	0.1180605	0.3723704	0
Min-utes	Cosine	Sine	Cotangent	Tangent	Cosecant	Secant	Read Down	52°-53° Involute	Min-utes

↑ 127° or 307°

52° or 232° ↑

↓ 38° or 218° **Trigonometric and Involute Functions** 141° or 321° ↓

Min-utes	Sine	Cosine	Tangent	Cotangent	Secant	Cosecant	Involute 38°-39°	Read Up	Min-utes
0	0.615661	0.788011	0.781286	1.279942	1.269018	1.624269	0.1180605	0.3723704	60
1	0.615891	0.787832	0.781754	1.279174	1.269307	1.623665	0.1182382	0.3718942	59
2	0.616120	0.787652	0.782223	1.278408	1.269596	1.623061	0.1184161	0.3714185	58
3	0.616349	0.787473	0.782692	1.277642	1.269885	1.622458	0.1185942	0.3709433	57
4	0.616578	0.787294	0.783161	1.276876	1.270174	1.621855	0.1187725	0.3704688	56
5	0.616807	0.787114	0.783631	1.276112	1.270463	1.621253	0.1189510	0.3699948	55
6	0.617036	0.786935	0.784100	1.275347	1.270753	1.620651	0.1191297	0.3695214	54
7	0.617265	0.786756	0.784570	1.274584	1.271043	1.620050	0.1193087	0.3690485	53
8	0.617494	0.786576	0.785040	1.273820	1.271333	1.619450	0.1194878	0.3685763	52
9	0.617722	0.786396	0.785510	1.273058	1.271624	1.618850	0.1196672	0.3681045	51
10	0.617951	0.786217	0.785981	1.272296	1.271914	1.618251	0.1198468	0.3676334	50
11	0.618180	0.786037	0.786451	1.271534	1.272205	1.617652	0.1200266	0.3671628	49
12	0.618408	0.785857	0.786922	1.270773	1.272496	1.617054	0.1202066	0.3666928	48
13	0.618637	0.785677	0.787394	1.270013	1.272788	1.616457	0.1203869	0.3662233	47
14	0.618865	0.785497	0.787865	1.269253	1.273079	1.615860	0.1205673	0.3657544	46
15	0.619094	0.785317	0.788336	1.268494	1.273371	1.615264	0.1207480	0.3652861	45
16	0.619322	0.785137	0.788808	1.267735	1.273663	1.614668	0.1209289	0.3648183	44
17	0.619551	0.784957	0.789280	1.266977	1.273956	1.614073	0.1211100	0.3643511	43
18	0.619779	0.784776	0.789752	1.266220	1.274248	1.613478	0.1212913	0.3638844	42
19	0.620007	0.784596	0.790225	1.265463	1.274541	1.612884	0.1214728	0.3634183	41
20	0.620235	0.784416	0.790697	1.264706	1.274834	1.612291	0.1216546	0.3629527	40
21	0.620464	0.784235	0.791170	1.263950	1.275128	1.611698	0.1218366	0.3624878	39
22	0.620692	0.784055	0.791643	1.263195	1.275421	1.611106	0.1220188	0.3620233	38
23	0.620920	0.783874	0.792117	1.262440	1.275715	1.610514	0.1222012	0.3615594	37
24	0.621148	0.783693	0.792590	1.261686	1.276009	1.609923	0.1223838	0.3610961	36
25	0.621376	0.783513	0.793064	1.260932	1.276303	1.609332	0.1225666	0.3606333	35
26	0.621604	0.783332	0.793538	1.260179	1.276598	1.608742	0.1227497	0.3601711	34
27	0.621831	0.783151	0.794012	1.259427	1.276893	1.608153	0.1229330	0.3597094	33
28	0.622059	0.782970	0.794486	1.258675	1.277188	1.607564	0.1231165	0.3592483	32
29	0.622287	0.782789	0.794961	1.257923	1.277483	1.606976	0.1233002	0.3587878	31
30	0.622515	0.782608	0.795436	1.257172	1.277779	1.606388	0.1234842	0.3583277	30
31	0.622742	0.782427	0.795911	1.256422	1.278074	1.605801	0.1236683	0.3578683	29
32	0.622970	0.782246	0.796386	1.255672	1.278370	1.605214	0.1238527	0.3574093	28
33	0.623197	0.782065	0.796862	1.254923	1.278667	1.604628	0.1240373	0.3569510	27
34	0.623425	0.781883	0.797337	1.254174	1.278963	1.604043	0.1242221	0.3564931	26
35	0.623652	0.781702	0.797813	1.253426	1.279260	1.603458	0.1244072	0.3560359	25
36	0.623880	0.781520	0.798290	1.252678	1.279557	1.602873	0.1245924	0.3555791	24
37	0.624107	0.781339	0.798766	1.251931	1.279854	1.602290	0.1247779	0.3551229	23
38	0.624334	0.781157	0.799242	1.251185	1.280152	1.601706	0.1249636	0.3546673	22
39	0.624561	0.780976	0.799719	1.250439	1.280450	1.601124	0.1251495	0.3542122	21
40	0.624789	0.780794	0.800196	1.249693	1.280748	1.600542	0.1253357	0.3537576	20
41	0.625016	0.780612	0.800674	1.248948	1.281046	1.599960	0.1255221	0.3533036	19
42	0.625243	0.780430	0.801151	1.248204	1.281344	1.599379	0.1257087	0.3528501	18
43	0.625470	0.780248	0.801629	1.247460	1.281643	1.598799	0.1258955	0.3523972	17
44	0.625697	0.780067	0.802107	1.246717	1.281942	1.598219	0.1260825	0.3519448	16
45	0.625923	0.779884	0.802585	1.245974	1.282241	1.597639	0.1262698	0.3514929	15
46	0.626150	0.779702	0.803063	1.245232	1.282541	1.597061	0.1264573	0.3510416	14
47	0.626377	0.779520	0.803542	1.244490	1.282840	1.596482	0.1266450	0.3505908	13
48	0.626604	0.779338	0.804021	1.243749	1.283140	1.595905	0.1268329	0.3501406	12
49	0.626830	0.779156	0.804500	1.243009	1.283441	1.595328	0.1270210	0.3496909	11
50	0.627057	0.778973	0.804979	1.242268	1.283741	1.594751	0.1272094	0.3492417	10
51	0.627284	0.778791	0.805458	1.241529	1.284042	1.594175	0.1273980	0.3487931	9
52	0.627510	0.778608	0.805938	1.240790	1.284343	1.593600	0.1275869	0.3483450	8
53	0.627737	0.778426	0.806418	1.240052	1.284644	1.593025	0.1277759	0.3478974	7
54	0.627963	0.778243	0.806898	1.239314	1.284945	1.592450	0.1279652	0.3474503	6
55	0.628189	0.778060	0.807379	1.238576	1.285247	1.591877	0.1281547	0.3470038	5
56	0.628416	0.777878	0.807859	1.237839	1.285549	1.591303	0.1283444	0.3465579	4
57	0.628642	0.777695	0.808340	1.237103	1.285851	1.590731	0.1285344	0.3461124	3
58	0.628868	0.777512	0.808821	1.236367	1.286154	1.590158	0.1287246	0.3456675	2
59	0.629094	0.777329	0.809303	1.235632	1.286457	1.589587	0.1289150	0.3452231	1
60	0.629320	0.777146	0.809784	1.234897	1.286760	1.589016	0.1291056	0.3447792	0
Min-utes	Cosine	Sine	Cotangent	Tangent	Cosecant	Secant	Read Down	51°-52° Involute	Min-utes

↑ 128° or 308°

51° or 231° ↑

↓ 39° or 219° **Trigonometric and Involute Functions** 140° or 320° ↓

Min-utes	Sine	Cosine	Tangent	Cotangent	Secant	Cosecant	Involute 39°-40°	Read Up	Min-utes
0	0.629320	0.777146	0.809784	1.234897	1.286760	1.589016	0.1291056	0.3447792	60
1	0.629546	0.776963	0.810266	1.234163	1.287063	1.588445	0.1292965	0.3443359	59
2	0.629772	0.776780	0.810748	1.233429	1.287366	1.587875	0.1294876	0.3438931	58
3	0.629998	0.776596	0.811230	1.232696	1.287670	1.587306	0.1296789	0.3434508	57
4	0.630224	0.776413	0.811712	1.231963	1.287974	1.586737	0.1298704	0.3430091	56
5	0.630450	0.776230	0.812195	1.231231	1.288278	1.586169	0.1300622	0.3425678	55
6	0.630676	0.776046	0.812678	1.230500	1.288583	1.585601	0.1302542	0.3421271	54
7	0.630902	0.775863	0.813161	1.229769	1.288887	1.585033	0.1304464	0.3416870	53
8	0.631127	0.775679	0.813644	1.229038	1.289192	1.584467	0.1306389	0.3412473	52
9	0.631353	0.775496	0.814128	1.228308	1.289498	1.583900	0.1308316	0.3408082	51
10	0.631578	0.775312	0.814612	1.227579	1.289803	1.583335	0.1310245	0.3403695	50
11	0.631804	0.775128	0.815096	1.226850	1.290109	1.582770	0.1312177	0.3399315	49
12	0.632029	0.774944	0.815580	1.226121	1.290415	1.582205	0.1314110	0.3394939	48
13	0.632255	0.774761	0.816065	1.225393	1.290721	1.581641	0.1316046	0.3390568	47
14	0.632480	0.774577	0.816549	1.224666	1.291028	1.581078	0.1317985	0.3386203	46
15	0.632705	0.774393	0.817034	1.223939	1.291335	1.580515	0.1319925	0.3381843	45
16	0.632931	0.774209	0.817519	1.223212	1.291642	1.579952	0.1321868	0.3377488	44
17	0.633156	0.774024	0.818005	1.222487	1.291949	1.579390	0.1323814	0.3373138	43
18	0.633381	0.773840	0.818491	1.221761	1.292256	1.578829	0.1325761	0.3368793	42
19	0.633606	0.773656	0.818976	1.221036	1.292564	1.578268	0.1327711	0.3364454	41
20	0.633831	0.773472	0.819463	1.220312	1.292872	1.577708	0.1329663	0.3360119	40
21	0.634056	0.773287	0.819949	1.219588	1.293181	1.577148	0.1331618	0.3355790	39
22	0.634281	0.773103	0.820435	1.218865	1.293489	1.576589	0.1333575	0.3351466	38
23	0.634506	0.772918	0.820922	1.218142	1.293798	1.576030	0.1335534	0.3347147	37
24	0.634731	0.772734	0.821409	1.217420	1.294107	1.575472	0.1337495	0.3342833	36
25	0.634955	0.772549	0.821897	1.216698	1.294416	1.574914	0.1339459	0.3338524	35
26	0.635180	0.772364	0.822384	1.215977	1.294726	1.574357	0.1341425	0.3334221	34
27	0.635405	0.772179	0.822872	1.215256	1.295036	1.573800	0.1343394	0.3329922	33
28	0.635629	0.771995	0.823360	1.214536	1.295346	1.573244	0.1345365	0.3325629	32
29	0.635854	0.771810	0.823848	1.213816	1.295656	1.572689	0.1347338	0.3321341	31
30	0.636078	0.771625	0.824336	1.213097	1.295967	1.572134	0.1349313	0.3317057	30
31	0.636303	0.771440	0.824825	1.212378	1.296278	1.571579	0.1351291	0.3312779	29
32	0.636527	0.771254	0.825314	1.211660	1.296589	1.571025	0.1353271	0.3308506	28
33	0.636751	0.771069	0.825803	1.210942	1.296900	1.570472	0.1355254	0.3304238	27
34	0.636976	0.770884	0.826292	1.210225	1.297212	1.569919	0.1357239	0.3299975	26
35	0.637200	0.770699	0.826782	1.209509	1.297524	1.569366	0.1359226	0.3295717	25
36	0.637424	0.770513	0.827272	1.208792	1.297836	1.568815	0.1361216	0.3291464	24
37	0.637648	0.770328	0.827762	1.208077	1.298149	1.568263	0.1363208	0.3287216	23
38	0.637872	0.770142	0.828252	1.207362	1.298461	1.567712	0.1365202	0.3282973	22
39	0.638096	0.769957	0.828743	1.206647	1.298774	1.567162	0.1367199	0.3278736	21
40	0.638320	0.769771	0.829234	1.205933	1.299088	1.566612	0.1369198	0.3274503	20
41	0.638544	0.769585	0.829725	1.205219	1.299401	1.566063	0.1371199	0.3270275	19
42	0.638768	0.769400	0.830216	1.204506	1.299715	1.565514	0.1373203	0.3266052	18
43	0.638992	0.769214	0.830707	1.203793	1.300029	1.564966	0.1375209	0.3261834	17
44	0.639215	0.769028	0.831199	1.203081	1.300343	1.564418	0.1377218	0.3257621	16
45	0.639439	0.768842	0.831691	1.202369	1.300658	1.563871	0.1379228	0.3253414	15
46	0.639663	0.768656	0.832183	1.201658	1.300972	1.563324	0.1381242	0.3249211	14
47	0.639886	0.768470	0.832676	1.200947	1.301287	1.562778	0.1383257	0.3245013	13
48	0.640110	0.768284	0.833169	1.200237	1.301603	1.562232	0.1385275	0.3240820	12
49	0.640333	0.768097	0.833662	1.199528	1.301918	1.561687	0.1387296	0.3236632	11
50	0.640557	0.767911	0.834155	1.198818	1.302234	1.561142	0.1389319	0.3232449	10
51	0.640780	0.767725	0.834648	1.198110	1.302550	1.560598	0.1391344	0.3228271	9
52	0.641003	0.767538	0.835142	1.197402	1.302867	1.560055	0.1393372	0.3224098	8
53	0.641226	0.767352	0.835636	1.196694	1.303183	1.559511	0.1395402	0.3219930	7
54	0.641450	0.767165	0.836130	1.195987	1.303500	1.558969	0.1397434	0.3215766	6
55	0.641673	0.766979	0.836624	1.195280	1.303817	1.558427	0.1399469	0.3211608	5
56	0.641896	0.766792	0.837119	1.194574	1.304135	1.557885	0.1401506	0.3207454	4
57	0.642119	0.766605	0.837614	1.193868	1.304453	1.557344	0.1403546	0.3203306	3
58	0.642342	0.766418	0.838109	1.193163	1.304771	1.556803	0.1405588	0.3199162	2
59	0.642565	0.766231	0.838604	1.192458	1.305089	1.556263	0.1407632	0.3195024	1
60	0.642788	0.766044	0.839100	1.191754	1.305407	1.555724	0.1409679	0.3190890	0
Min-utes	Cosine	Sine	Cotangent	Tangent	Cosecant	Secant	Read Down	50°-51° Involute	Min-utes

↑ 129° or 309°

50° or 230° ↑

↓ 40° or 220° **Trigonometric and Involute Functions** 139° or 319° ↓

Min-utes	Sine	Cosine	Tangent	Cotangent	Secant	Cosecant	Involute 40°-41°	Read Up	Min-utes
0	0.642788	0.766044	0.839100	1.191754	1.305407	1.555724	0.1409679	0.3190890	60
1	0.643010	0.765857	0.839595	1.191050	1.305726	1.555185	0.1411729	0.3186761	59
2	0.643233	0.765670	0.840092	1.190347	1.306045	1.554646	0.1413780	0.3182637	58
3	0.643456	0.765483	0.840588	1.189644	1.306364	1.554108	0.1415835	0.3178517	57
4	0.643679	0.765296	0.841084	1.188941	1.306684	1.553571	0.1417891	0.3174403	56
5	0.643901	0.765109	0.841581	1.188240	1.307004	1.553034	0.1419950	0.3170293	55
6	0.644124	0.764921	0.842078	1.187538	1.307324	1.552497	0.1422012	0.3166189	54
7	0.644346	0.764734	0.842575	1.186837	1.307644	1.551961	0.1424076	0.3162089	53
8	0.644569	0.764547	0.843073	1.186137	1.307965	1.551425	0.1426142	0.3157994	52
9	0.644791	0.764359	0.843571	1.185437	1.308286	1.550890	0.1428211	0.3153904	51
10	0.645013	0.764171	0.844069	1.184738	1.308607	1.550356	0.1430282	0.3149819	50
11	0.645235	0.763984	0.844567	1.184039	1.308928	1.549822	0.1432355	0.3145738	49
12	0.645458	0.763796	0.845066	1.183340	1.309250	1.549288	0.1434432	0.3141662	48
13	0.645680	0.763608	0.845564	1.182642	1.309572	1.548755	0.1436510	0.3137591	47
14	0.645902	0.763420	0.846063	1.181945	1.309894	1.548223	0.1438591	0.3133525	46
15	0.646124	0.763232	0.846562	1.181248	1.310217	1.547691	0.1440675	0.3129464	45
16	0.646346	0.763044	0.847062	1.180551	1.310540	1.547159	0.1442761	0.3125408	44
17	0.646568	0.762856	0.847562	1.179855	1.310863	1.546628	0.1444849	0.3121356	43
18	0.646790	0.762668	0.848062	1.179160	1.311186	1.546097	0.1446940	0.3117309	42
19	0.647012	0.762480	0.848562	1.178464	1.311510	1.545567	0.1449033	0.3113267	41
20	0.647233	0.762292	0.849062	1.177770	1.311833	1.545038	0.1451129	0.3109229	40
21	0.647455	0.762104	0.849563	1.177076	1.312158	1.544509	0.1453227	0.3105197	39
22	0.647677	0.761915	0.850064	1.176382	1.312482	1.543980	0.1455328	0.3101169	38
23	0.647898	0.761727	0.850565	1.175689	1.312807	1.543452	0.1457431	0.3097146	37
24	0.648120	0.761538	0.851067	1.174996	1.313132	1.542924	0.1459537	0.3093127	36
25	0.648341	0.761350	0.851568	1.174304	1.313457	1.542397	0.1461645	0.3089113	35
26	0.648563	0.761161	0.852070	1.173612	1.313782	1.541871	0.1463756	0.3085105	34
27	0.648784	0.760972	0.852573	1.172921	1.314108	1.541345	0.1465869	0.3081100	33
28	0.649006	0.760784	0.853075	1.172230	1.314434	1.540819	0.1467985	0.3077101	32
29	0.649227	0.760595	0.853578	1.171539	1.314760	1.540294	0.1470103	0.3073106	31
30	0.649448	0.760406	0.854081	1.170850	1.315087	1.539769	0.1472223	0.3069116	30
31	0.649669	0.760217	0.854584	1.170160	1.315414	1.539245	0.1474347	0.3065130	29
32	0.649890	0.760028	0.855087	1.169471	1.315741	1.538721	0.1476472	0.3061150	28
33	0.650111	0.759839	0.855591	1.168783	1.316068	1.538198	0.1478600	0.3057174	27
34	0.650332	0.759650	0.856095	1.168095	1.316396	1.537675	0.1480731	0.3053202	26
35	0.650553	0.759461	0.856599	1.167407	1.316724	1.537153	0.1482864	0.3049236	25
36	0.650774	0.759271	0.857104	1.166720	1.317052	1.536631	0.1485000	0.3045274	24
37	0.650995	0.759082	0.857608	1.166033	1.317381	1.536110	0.1487138	0.3041316	23
38	0.651216	0.758893	0.858113	1.165347	1.317710	1.535589	0.1489279	0.3037364	22
39	0.651437	0.758703	0.858619	1.164662	1.318039	1.535069	0.1491422	0.3033416	21
40	0.651657	0.758514	0.859124	1.163976	1.318368	1.534549	0.1493568	0.3029472	20
41	0.651878	0.758324	0.859630	1.163292	1.318698	1.534030	0.1495716	0.3025533	19
42	0.652098	0.758134	0.860136	1.162607	1.319027	1.533511	0.1497867	0.3021599	18
43	0.652319	0.757945	0.860642	1.161923	1.319358	1.532993	0.1500020	0.3017670	17
44	0.652539	0.757755	0.861148	1.161240	1.319688	1.532475	0.1502176	0.3013745	16
45	0.652760	0.757565	0.861655	1.160557	1.320019	1.531957	0.1504335	0.3009825	15
46	0.652980	0.757375	0.862162	1.159875	1.320350	1.531440	0.1506496	0.3005909	14
47	0.653200	0.757185	0.862669	1.159193	1.320681	1.530924	0.1508659	0.3001998	13
48	0.653421	0.756995	0.863177	1.158511	1.321013	1.530408	0.1510825	0.2998092	12
49	0.653641	0.756805	0.863685	1.157830	1.321344	1.529892	0.1512994	0.2994190	11
50	0.653861	0.756615	0.864193	1.157149	1.321677	1.529377	0.1515165	0.2990292	10
51	0.654081	0.756425	0.864701	1.156469	1.322009	1.528863	0.1517339	0.2986400	9
52	0.654301	0.756234	0.865209	1.155790	1.322342	1.528349	0.1519515	0.2982512	8
53	0.654521	0.756044	0.865718	1.155110	1.322675	1.527835	0.1521694	0.2978628	7
54	0.654741	0.755853	0.866227	1.154432	1.323008	1.527322	0.1523875	0.2974749	6
55	0.654961	0.755663	0.866736	1.153753	1.323341	1.526809	0.1526059	0.2970875	5
56	0.655180	0.755472	0.867246	1.153075	1.323675	1.526297	0.1528246	0.2967005	4
57	0.655400	0.755282	0.867756	1.152398	1.324009	1.525785	0.1530435	0.2963140	3
58	0.655620	0.755091	0.868266	1.151721	1.324343	1.525274	0.1532626	0.2959279	2
59	0.655839	0.754900	0.868776	1.151044	1.324678	1.524763	0.1534821	0.2955422	1
60	0.656059	0.754710	0.869287	1.150368	1.325013	1.524253	0.1537017	0.2951571	0
Min-utes	Cosine	Sine	Cotangent	Tangent	Cosecant	Secant	Read Down	49°-50° Involute	Min-utes

↑ 130° or 310°

49° or 229° ↑

↓ 41° or 221° **Trigonometric and Involute Functions** 138° or 318° ↓

Min-utes	Sine	Cosine	Tangent	Cotangent	Secant	Cosecant	Involute 41°–42°	Read Up	Min-utes
0	0.656059	0.754710	0.869287	1.150368	1.325013	1.524253	0.1537017	0.2951571	60
1	0.656279	0.754519	0.869798	1.149693	1.325348	1.523743	0.1539217	0.2947724	59
2	0.656498	0.754328	0.870309	1.149018	1.325684	1.523234	0.1541419	0.2943881	58
3	0.656717	0.754137	0.870820	1.148343	1.326019	1.522725	0.1543623	0.2940043	57
4	0.656937	0.753946	0.871332	1.147669	1.326355	1.522217	0.1545831	0.2936209	56
5	0.657156	0.753755	0.871843	1.146995	1.326692	1.521709	0.1548040	0.2932380	55
6	0.657375	0.753563	0.872356	1.146322	1.327028	1.521201	0.1550253	0.2928555	54
7	0.657594	0.753372	0.872868	1.145649	1.327365	1.520694	0.1552468	0.2924735	53
8	0.657814	0.753181	0.873381	1.144976	1.327702	1.520188	0.1554685	0.2920919	52
9	0.658033	0.752989	0.873894	1.144304	1.328040	1.519682	0.1556906	0.2917108	51
10	0.658252	0.752798	0.874407	1.143633	1.328378	1.519176	0.1559128	0.2913301	50
11	0.658471	0.752606	0.874920	1.142961	1.328716	1.518671	0.1561354	0.2909499	49
12	0.658689	0.752415	0.875434	1.142291	1.329054	1.518166	0.1563582	0.2905701	48
13	0.658908	0.752223	0.875948	1.141621	1.329393	1.517662	0.1565812	0.2901908	47
14	0.659127	0.752032	0.876462	1.140951	1.329731	1.517158	0.1568046	0.2898119	46
15	0.659346	0.751840	0.876976	1.140281	1.330071	1.516655	0.1570281	0.2894334	45
16	0.659564	0.751648	0.877491	1.139613	1.330410	1.516152	0.1572520	0.2890554	44
17	0.659783	0.751456	0.878006	1.138944	1.330750	1.515650	0.1574761	0.2886779	43
18	0.660002	0.751264	0.878521	1.138276	1.331090	1.515148	0.1577005	0.2883008	42
19	0.660220	0.751072	0.879037	1.137609	1.331430	1.514646	0.1579251	0.2879241	41
20	0.660439	0.750880	0.879553	1.136941	1.331771	1.514145	0.1581500	0.2875479	40
21	0.660657	0.750688	0.880069	1.136275	1.332112	1.513645	0.1583752	0.2871721	39
22	0.660875	0.750496	0.880585	1.135609	1.332453	1.513145	0.1586006	0.2867967	38
23	0.661094	0.750303	0.881102	1.134943	1.332794	1.512645	0.1588263	0.2864218	37
24	0.661312	0.750111	0.881619	1.134277	1.333136	1.512146	0.1590523	0.2860473	36
25	0.661530	0.749919	0.882136	1.133612	1.333478	1.511647	0.1592785	0.2856733	35
26	0.661748	0.749726	0.882653	1.132948	1.333820	1.511149	0.1595050	0.2852997	34
27	0.661966	0.749534	0.883171	1.132284	1.334163	1.510651	0.1597318	0.2849265	33
28	0.662184	0.749341	0.883689	1.131620	1.334506	1.510154	0.1599588	0.2845538	32
29	0.662402	0.749148	0.884207	1.130957	1.334849	1.509657	0.1601861	0.2841815	31
30	0.662620	0.748956	0.884725	1.130294	1.335192	1.509160	0.1604136	0.2838097	30
31	0.662838	0.748763	0.885244	1.129632	1.335536	1.508665	0.1606414	0.2834383	29
32	0.663056	0.748570	0.885763	1.128970	1.335880	1.508169	0.1608695	0.2830673	28
33	0.663273	0.748377	0.886282	1.128309	1.336225	1.507674	0.1610979	0.2826968	27
34	0.663491	0.748184	0.886802	1.127648	1.336569	1.507179	0.1613265	0.2823267	26
35	0.663709	0.747991	0.887321	1.126987	1.336914	1.506685	0.1615554	0.2819570	25
36	0.663926	0.747798	0.887842	1.126327	1.337259	1.506191	0.1617846	0.2815877	24
37	0.664144	0.747605	0.888362	1.125667	1.337605	1.505698	0.1620140	0.2812189	23
38	0.664361	0.747412	0.888882	1.125008	1.337951	1.505205	0.1622437	0.2808506	22
39	0.664579	0.747218	0.889403	1.124349	1.338297	1.504713	0.1624737	0.2804826	21
40	0.664796	0.747025	0.889924	1.123691	1.338643	1.504221	0.1627039	0.2801151	20
41	0.665013	0.746832	0.890446	1.123033	1.338990	1.503730	0.1629344	0.2797480	19
42	0.665230	0.746638	0.890967	1.122375	1.339337	1.503239	0.1631652	0.2793814	18
43	0.665448	0.746445	0.891489	1.121718	1.339684	1.502748	0.1633963	0.2790151	17
44	0.665665	0.746251	0.892012	1.121062	1.340032	1.502258	0.1636276	0.2786493	16
45	0.665882	0.746057	0.892534	1.120405	1.340379	1.501768	0.1638592	0.2782840	15
46	0.666099	0.745864	0.893057	1.119750	1.340728	1.501279	0.1640910	0.2779190	14
47	0.666316	0.745670	0.893580	1.119094	1.341076	1.500790	0.1643232	0.2775545	13
48	0.666532	0.745476	0.894103	1.118439	1.341425	1.500302	0.1645556	0.2771904	12
49	0.666749	0.745282	0.894627	1.117785	1.341774	1.499814	0.1647882	0.2768268	11
50	0.666966	0.745088	0.895151	1.117130	1.342123	1.499327	0.1650212	0.2764635	10
51	0.667183	0.744894	0.895675	1.116477	1.342473	1.498840	0.1652544	0.2761007	9
52	0.667399	0.744700	0.896199	1.115823	1.342823	1.498353	0.1654879	0.2757383	8
53	0.667616	0.744506	0.896724	1.115171	1.343173	1.497867	0.1657217	0.2753764	7
54	0.667833	0.744312	0.897249	1.114518	1.343523	1.497381	0.1659557	0.2750148	6
55	0.668049	0.744117	0.897774	1.113866	1.343874	1.496896	0.1661900	0.2746537	5
56	0.668265	0.743923	0.898299	1.113215	1.344225	1.496411	0.1664246	0.2742930	4
57	0.668482	0.743728	0.898825	1.112563	1.344577	1.495927	0.1666595	0.2739328	3
58	0.668698	0.743534	0.899351	1.111913	1.344928	1.495443	0.1668946	0.2735729	2
59	0.668914	0.743339	0.899877	1.111262	1.345280	1.494960	0.1671301	0.2732135	1
60	0.669131	0.743145	0.900404	1.110613	1.345633	1.494477	0.1673658	0.2728545	0
Min-utes	Cosine	Sine	Cotangent	Tangent	Cosecant	Secant	Read Down	48°–49° Involute	Min-utes

↑ 131° or 311°

48° or 228° ↑

↓ 42° or 222° **Trigonometric and Involute Functions** 137° or 317° ↓

Min-utes	Sine	Cosine	Tangent	Cotangent	Secant	Cosecant	Involute 42°-43°	Read Up	Min-utes
0	0.669131	0.743145	0.900404	1.110613	1.345633	1.494477	0.1673658	0.2728545	60
1	0.669347	0.742950	0.900931	1.109963	1.345985	1.493994	0.1676017	0.2724959	59
2	0.669563	0.742755	0.901458	1.109314	1.346338	1.493512	0.1678380	0.2721377	58
3	0.669779	0.742561	0.901985	1.108665	1.346691	1.493030	0.1680745	0.2717800	57
4	0.669995	0.742366	0.902513	1.108017	1.347045	1.492549	0.1683113	0.2714226	56
5	0.670211	0.742171	0.903041	1.107369	1.347399	1.492068	0.1685484	0.2710657	55
6	0.670427	0.741976	0.903569	1.106722	1.347753	1.491588	0.1687857	0.2707092	54
7	0.670642	0.741781	0.904098	1.106075	1.348107	1.491108	0.1690234	0.2703531	53
8	0.670858	0.741586	0.904627	1.105428	1.348462	1.490628	0.1692613	0.2699975	52
9	0.671074	0.741391	0.905156	1.104782	1.348817	1.490149	0.1694994	0.2696422	51
10	0.671289	0.741195	0.905685	1.104137	1.349172	1.489670	0.1697379	0.2692874	50
11	0.671505	0.741000	0.906215	1.103491	1.349528	1.489192	0.1699767	0.2689330	49
12	0.671721	0.740805	0.906745	1.102846	1.349884	1.488714	0.1702157	0.2685790	48
13	0.671936	0.740609	0.907275	1.102202	1.350240	1.488237	0.1704550	0.2682254	47
14	0.672151	0.740414	0.907805	1.101558	1.350596	1.487760	0.1706946	0.2678722	46
15	0.672367	0.740218	0.908336	1.100914	1.350953	1.487283	0.1709344	0.2675194	45
16	0.672582	0.740023	0.908867	1.100271	1.351310	1.486807	0.1711746	0.2671671	44
17	0.672797	0.739827	0.909398	1.099628	1.351668	1.486332	0.1714150	0.2668151	43
18	0.673013	0.739631	0.909930	1.098986	1.352025	1.485856	0.1716557	0.2664636	42
19	0.673228	0.739435	0.910462	1.098344	1.352383	1.485382	0.1718967	0.2661125	41
20	0.673443	0.739239	0.910994	1.097702	1.352742	1.484907	0.1721380	0.2657618	40
21	0.673658	0.739043	0.911526	1.097061	1.353100	1.484433	0.1723795	0.2654115	39
22	0.673873	0.738848	0.912059	1.096420	1.353459	1.483960	0.1726214	0.2650616	38
23	0.674088	0.738651	0.912592	1.095780	1.353818	1.483487	0.1728635	0.2647121	37
24	0.674302	0.738455	0.913125	1.095140	1.354178	1.483014	0.1731059	0.2643630	36
25	0.674517	0.738259	0.913659	1.094500	1.354538	1.482542	0.1733486	0.2640143	35
26	0.674732	0.738063	0.914193	1.093861	1.354898	1.482070	0.1735915	0.2636661	34
27	0.674947	0.737867	0.914727	1.093222	1.355258	1.481599	0.1738348	0.2633182	33
28	0.675161	0.737670	0.915261	1.092584	1.355619	1.481128	0.1740783	0.2629708	32
29	0.675376	0.737474	0.915796	1.091946	1.355980	1.480657	0.1743221	0.2626237	31
30	0.675590	0.737277	0.916331	1.091309	1.356342	1.480187	0.1745662	0.2622771	30
31	0.675805	0.737081	0.916866	1.090671	1.356703	1.479718	0.1748106	0.2619309	29
32	0.676019	0.736884	0.917402	1.090035	1.357065	1.479248	0.1750553	0.2615850	28
33	0.676233	0.736687	0.917938	1.089398	1.357428	1.478779	0.1753003	0.2612396	27
34	0.676448	0.736491	0.918474	1.088762	1.357790	1.478311	0.1755455	0.2608946	26
35	0.676662	0.736294	0.919010	1.088127	1.358153	1.477843	0.1757911	0.2605500	25
36	0.676876	0.736097	0.919547	1.087492	1.358516	1.477376	0.1760369	0.2602058	24
37	0.677090	0.735900	0.920084	1.086857	1.358880	1.476908	0.1762830	0.2598619	23
38	0.677304	0.735703	0.920621	1.086223	1.359244	1.476442	0.1765294	0.2595185	22
39	0.677518	0.735506	0.921159	1.085589	1.359608	1.475975	0.1767761	0.2591755	21
40	0.677732	0.735309	0.921697	1.084955	1.359972	1.475509	0.1770230	0.2588329	20
41	0.677946	0.735112	0.922235	1.084322	1.360337	1.475044	0.1772703	0.2584907	19
42	0.678160	0.734915	0.922773	1.083690	1.360702	1.474579	0.1775179	0.2581489	18
43	0.678373	0.734717	0.923312	1.083057	1.361068	1.474114	0.1777657	0.2578075	17
44	0.678587	0.734520	0.923851	1.082425	1.361433	1.473650	0.1780138	0.2574665	16
45	0.678801	0.734323	0.924390	1.081794	1.361799	1.473186	0.1782622	0.2571258	15
46	0.679014	0.734125	0.924930	1.081163	1.362166	1.472723	0.1785109	0.2567856	14
47	0.679228	0.733927	0.925470	1.080532	1.362532	1.472260	0.1787599	0.2564458	13
48	0.679441	0.733730	0.926010	1.079902	1.362899	1.471797	0.1790092	0.2561064	12
49	0.679655	0.733532	0.926551	1.079272	1.363267	1.471335	0.1792588	0.2557673	11
50	0.679868	0.733334	0.927091	1.078642	1.363634	1.470874	0.1795087	0.2554287	10
51	0.680081	0.733137	0.927632	1.078013	1.364002	1.470412	0.1797589	0.2550904	9
52	0.680295	0.732939	0.928174	1.077384	1.364370	1.469951	0.1800093	0.2547526	8
53	0.680508	0.732741	0.928715	1.076756	1.364739	1.469491	0.1802601	0.2544151	7
54	0.680721	0.732543	0.929257	1.076128	1.365108	1.469031	0.1805111	0.2540781	6
55	0.680934	0.732345	0.929800	1.075501	1.365477	1.468571	0.1807624	0.2537414	5
56	0.681147	0.732147	0.930342	1.074873	1.365846	1.468112	0.1810141	0.2534051	4
57	0.681360	0.731949	0.930885	1.074247	1.366216	1.467653	0.1812660	0.2530693	3
58	0.681573	0.731750	0.931428	1.073620	1.366586	1.467195	0.1815182	0.2527338	2
59	0.681786	0.731552	0.931971	1.072994	1.366957	1.466737	0.1817707	0.2523987	1
60	0.681998	0.731354	0.932515	1.072369	1.367327	1.466279	0.1820235	0.2520640	0
Min-utes	Cosine	Sine	Cotangent	Tangent	Cosecant	Secant	Read Down	47°-48° Involute	Min-utes

↑ 132° or 312°

47° or 227° ↑

↓ 43° or 223° **Trigonometric and Involute Functions** 136° or 316° ↓

Min-utes	Sine	Cosine	Tangent	Cotangent	Secant	Cosecant	Involute 43°-44°	Read Up	Min-utes
0	0.681998	0.731354	0.932515	1.072369	1.367327	1.466279	0.1820235	0.2520640	60
1	0.682211	0.731155	0.933059	1.071744	1.367699	1.465822	0.1822766	0.2517296	59
2	0.682424	0.730957	0.933603	1.071119	1.368070	1.465365	0.1825300	0.2513957	58
3	0.682636	0.730758	0.934148	1.070494	1.368442	1.464909	0.1827837	0.2510622	57
4	0.682849	0.730560	0.934693	1.069870	1.368814	1.464453	0.1830377	0.2507290	56
5	0.683061	0.730361	0.935238	1.069247	1.369186	1.463997	0.1832920	0.2503963	55
6	0.683274	0.730162	0.935783	1.068623	1.369559	1.463542	0.1835465	0.2500639	54
7	0.683486	0.729963	0.936329	1.068000	1.369932	1.463087	0.1838014	0.2497319	53
8	0.683698	0.729765	0.936875	1.067378	1.370305	1.462633	0.1840566	0.2494003	52
9	0.683911	0.729566	0.937422	1.066756	1.370678	1.462179	0.1843121	0.2490691	51
10	0.684123	0.729367	0.937968	1.066134	1.371052	1.461726	0.1845678	0.2487383	50
11	0.684335	0.729168	0.938515	1.065513	1.371427	1.461273	0.1848239	0.2484078	49
12	0.684547	0.728969	0.939063	1.064892	1.371801	1.460820	0.1850803	0.2480778	48
13	0.684759	0.728769	0.939610	1.064271	1.372176	1.460368	0.1853369	0.2477481	47
14	0.684971	0.728570	0.940158	1.063651	1.372551	1.459916	0.1855939	0.2474188	46
15	0.685183	0.728371	0.940706	1.063031	1.372927	1.459464	0.1858512	0.2470899	45
16	0.685395	0.728172	0.941255	1.062412	1.373303	1.459013	0.1861087	0.2467614	44
17	0.685607	0.727972	0.941803	1.061793	1.373679	1.458562	0.1863666	0.2464332	43
18	0.685818	0.727773	0.942352	1.061174	1.374055	1.458112	0.1866248	0.2461055	42
19	0.686030	0.727573	0.942902	1.060556	1.374432	1.457662	0.1868832	0.2457781	41
20	0.686242	0.727374	0.943451	1.059938	1.374809	1.457213	0.1871420	0.2454511	40
21	0.686453	0.727174	0.944001	1.059321	1.375187	1.456764	0.1874011	0.2451245	39
22	0.686665	0.726974	0.944552	1.058703	1.375564	1.456315	0.1876604	0.2447982	38
23	0.686876	0.726775	0.945102	1.058087	1.375943	1.455867	0.1879201	0.2444724	37
24	0.687088	0.726575	0.945653	1.057470	1.376321	1.455419	0.1881801	0.2441469	36
25	0.687299	0.726375	0.946204	1.056854	1.376700	1.454971	0.1884404	0.2438218	35
26	0.687510	0.726175	0.946756	1.056239	1.377079	1.454524	0.1887010	0.2434971	34
27	0.687721	0.725975	0.947307	1.055624	1.377458	1.454077	0.1889619	0.2431728	33
28	0.687932	0.725775	0.947859	1.055009	1.377838	1.453631	0.1892230	0.2428488	32
29	0.688144	0.725575	0.948412	1.054394	1.378218	1.453185	0.1894845	0.2425252	31
30	0.688355	0.725374	0.948965	1.053780	1.378598	1.452740	0.1897463	0.2422020	30
31	0.688566	0.725174	0.949518	1.053166	1.378979	1.452295	0.1900084	0.2418792	29
32	0.688776	0.724974	0.950071	1.052553	1.379360	1.451850	0.1902709	0.2415567	28
33	0.688987	0.724773	0.950624	1.051940	1.379742	1.451406	0.1905336	0.2412347	27
34	0.689198	0.724573	0.951178	1.051328	1.380123	1.450962	0.1907966	0.2409130	26
35	0.689409	0.724372	0.951733	1.050715	1.380505	1.450518	0.1910599	0.2405916	25
36	0.689620	0.724172	0.952287	1.050103	1.380888	1.450075	0.1913236	0.2402707	24
37	0.689830	0.723971	0.952842	1.049492	1.381270	1.449632	0.1915875	0.2399501	23
38	0.690041	0.723771	0.953397	1.048881	1.381653	1.449190	0.1918518	0.2396299	22
39	0.690251	0.723570	0.953953	1.048270	1.382037	1.448748	0.1921163	0.2393101	21
40	0.690462	0.723369	0.954508	1.047660	1.382420	1.448306	0.1923812	0.2389906	20
41	0.690672	0.723168	0.955064	1.047050	1.382804	1.447865	0.1926464	0.2386715	19
42	0.690882	0.722967	0.955621	1.046440	1.383189	1.447424	0.1929119	0.2383528	18
43	0.691093	0.722766	0.956177	1.045831	1.383573	1.446984	0.1931777	0.2380344	17
44	0.691303	0.722565	0.956734	1.045222	1.383958	1.446544	0.1934438	0.2377165	16
45	0.691513	0.722364	0.957292	1.044614	1.384344	1.446104	0.1937102	0.2373988	15
46	0.691723	0.722163	0.957849	1.044006	1.384729	1.445665	0.1939769	0.2370816	14
47	0.691933	0.721962	0.958407	1.043398	1.385115	1.445226	0.1942440	0.2367647	13
48	0.692143	0.721760	0.958966	1.042790	1.385502	1.444788	0.1945113	0.2364482	12
49	0.692353	0.721559	0.959524	1.042183	1.385888	1.444350	0.1947790	0.2361321	11
50	0.692563	0.721357	0.960083	1.041577	1.386275	1.443912	0.1950469	0.2358163	10
51	0.692773	0.721156	0.960642	1.040970	1.386663	1.443475	0.1953152	0.2355010	9
52	0.692983	0.720954	0.961202	1.040364	1.387050	1.443038	0.1955838	0.2351859	8
53	0.693192	0.720753	0.961761	1.039759	1.387438	1.442601	0.1958527	0.2348713	7
54	0.693402	0.720551	0.962322	1.039154	1.387827	1.442165	0.1961220	0.2345570	6
55	0.693611	0.720349	0.962882	1.038549	1.388215	1.441729	0.1963915	0.2342430	5
56	0.693821	0.720148	0.963443	1.037944	1.388604	1.441294	0.1966613	0.2339295	4
57	0.694030	0.719946	0.964004	1.037340	1.388994	1.440859	0.1969315	0.2336163	3
58	0.694240	0.719744	0.964565	1.036737	1.389383	1.440425	0.1972020	0.2333034	2
59	0.694449	0.719542	0.965127	1.036133	1.389773	1.439990	0.1974728	0.2329910	1
60	0.694658	0.719340	0.965689	1.035530	1.390164	1.439557	0.1977439	0.2326789	0
Min-utes	Cosine	Sine	Cotangent	Tangent	Cosecant	Secant	Read Down	46°-47° Involute	Min-utes

↑ 133° or 313°

46° or 226° ↑

↓ 44° or 224° **Trigonometric and Involute Functions** 135° or 315° ↓

Min-utes	Sine	Cosine	Tangent	Cotangent	Secant	Cosecant	Involute 44°-45°	Read Up	Min-utes
0	0.694658	0.719340	0.965689	1.035530	1.390164	1.439557	0.1977439	0.2326789	60
1	0.694868	0.719138	0.966251	1.034928	1.390554	1.439123	0.1980153	0.2323671	59
2	0.695077	0.718936	0.966814	1.034325	1.390945	1.438690	0.1982871	0.2320557	58
3	0.695286	0.718733	0.967377	1.033724	1.391337	1.438257	0.1985591	0.2317447	57
4	0.695495	0.718531	0.967940	1.033122	1.391728	1.437825	0.1988315	0.2314341	56
5	0.695704	0.718329	0.968504	1.032521	1.392120	1.437393	0.1991042	0.2311238	55
6	0.695913	0.718126	0.969067	1.031920	1.392513	1.436962	0.1993772	0.2308138	54
7	0.696122	0.717924	0.969632	1.031319	1.392905	1.436531	0.1996505	0.2305042	53
8	0.696330	0.717721	0.970196	1.030719	1.393298	1.436100	0.1999242	0.2301950	52
9	0.696539	0.717519	0.970761	1.030120	1.393692	1.435669	0.2001982	0.2298862	51
10	0.696748	0.717316	0.971326	1.029520	1.394086	1.435239	0.2004724	0.2295777	50
11	0.696957	0.717113	0.971892	1.028921	1.394480	1.434810	0.2007471	0.2292695	49
12	0.697165	0.716911	0.972458	1.028323	1.394874	1.434380	0.2010220	0.2289618	48
13	0.697374	0.716708	0.973024	1.027724	1.395269	1.433952	0.2012972	0.2286543	47
14	0.697582	0.716505	0.973590	1.027126	1.395664	1.433523	0.2015728	0.2283473	46
15	0.697790	0.716302	0.974157	1.026529	1.396059	1.433095	0.2018487	0.2280406	45
16	0.697999	0.716099	0.974724	1.025931	1.396455	1.432667	0.2021249	0.2277342	44
17	0.698207	0.715896	0.975291	1.025335	1.396851	1.432240	0.2024014	0.2274282	43
18	0.698415	0.715693	0.975859	1.024738	1.397248	1.431813	0.2026783	0.2271226	42
19	0.698623	0.715490	0.976427	1.024142	1.397644	1.431386	0.2029554	0.2268173	41
20	0.698832	0.715286	0.976996	1.023546	1.398042	1.430960	0.2032329	0.2265124	40
21	0.699040	0.715083	0.977564	1.022951	1.398439	1.430534	0.2035108	0.2262078	39
22	0.699248	0.714880	0.978133	1.022356	1.398837	1.430109	0.2037889	0.2259036	38
23	0.699455	0.714676	0.978703	1.021761	1.399235	1.429684	0.2040674	0.2255997	37
24	0.699663	0.714473	0.979272	1.021166	1.399634	1.429259	0.2043462	0.2252962	36
25	0.699871	0.714269	0.979842	1.020572	1.400033	1.428834	0.2046253	0.2249931	35
26	0.700079	0.714066	0.980413	1.019979	1.400432	1.428410	0.2049047	0.2246903	34
27	0.700287	0.713862	0.980983	1.019385	1.400831	1.427987	0.2051845	0.2243878	33
28	0.700494	0.713658	0.981554	1.018792	1.401231	1.427564	0.2054646	0.2240857	32
29	0.700702	0.713454	0.982126	1.018200	1.401631	1.427141	0.2057450	0.2237840	31
30	0.700909	0.713250	0.982697	1.017607	1.402032	1.426718	0.2060257	0.2234826	30
31	0.701117	0.713047	0.983269	1.017015	1.402433	1.426296	0.2063068	0.2231815	29
32	0.701324	0.712843	0.983842	1.016424	1.402834	1.425874	0.2065882	0.2228808	28
33	0.701531	0.712639	0.984414	1.015833	1.403236	1.425453	0.2068699	0.2225805	27
34	0.701739	0.712434	0.984987	1.015242	1.403638	1.425032	0.2071520	0.2222805	26
35	0.701946	0.712230	0.985560	1.014651	1.404040	1.424611	0.2074344	0.2219808	25
36	0.702153	0.712026	0.986134	1.014061	1.404443	1.424191	0.2077171	0.2216815	24
37	0.702360	0.711822	0.986708	1.013471	1.404846	1.423771	0.2080001	0.2213826	23
38	0.702567	0.711617	0.987282	1.012882	1.405249	1.423351	0.2082835	0.2210840	22
39	0.702774	0.711413	0.987857	1.012293	1.405653	1.422932	0.2085672	0.2207857	21
40	0.702981	0.711209	0.988432	1.011704	1.406057	1.422513	0.2088512	0.2204878	20
41	0.703188	0.711004	0.989007	1.011115	1.406462	1.422095	0.2091356	0.2201903	19
42	0.703395	0.710799	0.989582	1.010527	1.406867	1.421677	0.2094203	0.2198930	18
43	0.703601	0.710595	0.990158	1.009939	1.407272	1.421259	0.2097053	0.2195962	17
44	0.703808	0.710390	0.990735	1.009352	1.407677	1.420842	0.2099907	0.2192996	16
45	0.704015	0.710185	0.991311	1.008765	1.408083	1.420425	0.2102764	0.2190035	15
46	0.704221	0.709981	0.991888	1.008178	1.408489	1.420008	0.2105624	0.2187076	14
47	0.704428	0.709776	0.992465	1.007592	1.408896	1.419592	0.2108487	0.2184121	13
48	0.704634	0.709571	0.993043	1.007006	1.409303	1.419176	0.2111354	0.2181170	12
49	0.704841	0.709366	0.993621	1.006420	1.409710	1.418761	0.2114225	0.2178222	11
50	0.705047	0.709161	0.994199	1.005835	1.410118	1.418345	0.2117098	0.2175277	10
51	0.705253	0.708956	0.994778	1.005250	1.410526	1.417931	0.2119975	0.2172336	9
52	0.705459	0.708750	0.995357	1.004665	1.410934	1.417516	0.2122855	0.2169398	8
53	0.705665	0.708545	0.995936	1.004081	1.411343	1.417102	0.2125739	0.2166464	7
54	0.705872	0.708340	0.996515	1.003497	1.411752	1.416688	0.2128626	0.2163533	6
55	0.706078	0.708134	0.997095	1.002913	1.412161	1.416275	0.2131516	0.2160605	5
56	0.706284	0.707929	0.997676	1.002330	1.412571	1.415862	0.2134410	0.2157681	4
57	0.706489	0.707724	0.998256	1.001747	1.412981	1.415449	0.2137307	0.2154760	3
58	0.706695	0.707518	0.998837	1.001164	1.413392	1.415037	0.2140207	0.2151843	2
59	0.706901	0.707312	0.999418	1.000582	1.413802	1.414625	0.2143111	0.2148929	1
60	0.707107	0.707107	1.000000	1.000000	1.414214	1.414214	0.2146018	0.2146018	0
Min-utes	Cosine	Sine	Cotangent	Tangent	Cosecant	Secant	Read Down	45°-46° Involute	Min-utes

↑ 134° or 314°

45° or 225° ↑

Multiplication of Fractions

Multiplication Table for Common Fractions and Whole Numbers From 1 to 9

	1	2	3	4	5	6	7	8	9
$\frac{1}{64}$	0.0156	0.0313	0.0469	0.0625	0.0781	0.0938	0.1094	0.1250	0.1406
$\frac{1}{32}$	0.0313	0.0625	0.0938	0.1250	0.1563	0.1875	0.2188	0.2500	0.2813
$\frac{3}{64}$	0.0469	0.0938	0.1406	0.1875	0.2344	0.2813	0.3281	0.3750	0.4219
$\frac{1}{16}$	0.0625	0.1250	0.1875	0.2500	0.3125	0.3750	0.4375	0.5000	0.5625
$\frac{5}{64}$	0.0781	0.1563	0.2344	0.3125	0.3906	0.4688	0.5469	0.6250	0.7031
$\frac{3}{32}$	0.0938	0.1875	0.2813	0.3750	0.4688	0.5625	0.6563	0.7500	0.8438
$\frac{7}{64}$	0.1094	0.2188	0.3281	0.4375	0.5469	0.6563	0.7656	0.8750	0.9844
$\frac{1}{8}$	0.1250	0.2500	0.3750	0.5000	0.6250	0.7500	0.8750	1.0000	1.1250
$\frac{9}{64}$	0.1406	0.2813	0.4219	0.5625	0.7031	0.8438	0.9844	1.1250	1.2656
$\frac{5}{32}$	0.1563	0.3125	0.4688	0.6250	0.7813	0.9375	1.0938	1.2500	1.4063
$\frac{11}{64}$	0.1719	0.3438	0.5156	0.6875	0.8594	1.0313	1.2031	1.3750	1.5469
$\frac{3}{16}$	0.1875	0.3750	0.5625	0.7500	0.9375	1.1250	1.3125	1.5000	1.6875
$\frac{13}{64}$	0.2031	0.4063	0.6094	0.8125	1.0156	1.2188	1.4219	1.6250	1.8281
$\frac{7}{32}$	0.2188	0.4375	0.6563	0.8750	1.0938	1.3125	1.5313	1.7500	1.9688
$\frac{15}{64}$	0.2344	0.4688	0.7031	0.9375	1.1719	1.4063	1.6406	1.8750	2.1094
$\frac{1}{4}$	0.2500	0.5000	0.7500	1.0000	1.2500	1.5000	1.7500	2.0000	2.2500
$\frac{17}{64}$	0.2656	0.5313	0.7969	1.0625	1.3281	1.5938	1.8594	2.1250	2.3906
$\frac{9}{32}$	0.2813	0.5625	0.8438	1.1250	1.4063	1.6875	1.9688	2.2500	2.5313
$\frac{19}{64}$	0.2969	0.5938	0.8906	1.1875	1.4844	1.7813	2.0781	2.3750	2.6719
$\frac{5}{16}$	0.3125	0.6250	0.9375	1.2500	1.5625	1.8750	2.1875	2.5000	2.8125
$\frac{21}{64}$	0.3281	0.6563	0.9844	1.3125	1.6406	1.9688	2.2969	2.6250	2.9531
$\frac{11}{32}$	0.3438	0.6875	1.0313	1.3750	1.7188	2.0625	2.4063	2.7500	3.0938
$\frac{23}{64}$	0.3594	0.7188	1.0781	1.4375	1.7969	2.1563	2.5156	2.8750	3.2344
$\frac{3}{8}$	0.3750	0.7500	1.1250	1.5000	1.8750	2.2500	2.6250	3.0000	3.3750
$\frac{25}{64}$	0.3906	0.7813	1.1719	1.5625	1.9531	2.3438	2.7344	3.1250	3.5156
$\frac{13}{32}$	0.4063	0.8125	1.2188	1.6250	2.0313	2.4375	2.8438	3.2500	3.6563
$\frac{27}{64}$	0.4219	0.8438	1.2656	1.6875	2.1094	2.5313	2.9531	3.3750	3.7969
$\frac{7}{16}$	0.4375	0.8750	1.3125	1.7500	2.1875	2.6250	3.0625	3.5000	3.9375
$\frac{29}{64}$	0.4531	0.9063	1.3594	1.8125	2.2656	2.7188	3.1719	3.6250	4.0781
$\frac{15}{32}$	0.4688	0.9375	1.4063	1.8750	2.3438	2.8125	3.2813	3.7500	4.2188
$\frac{31}{64}$	0.4844	0.9688	1.4531	1.9375	2.4219	2.9063	3.3906	3.8750	4.3594
$\frac{1}{2}$	0.5000	1.0000	1.5000	2.0000	2.5000	3.0000	3.5000	4.0000	4.5000
$\frac{33}{64}$	0.5156	1.0313	1.5469	2.0625	2.5781	3.0938	3.6094	4.1250	4.6406
$\frac{17}{32}$	0.5313	1.0625	1.5938	2.1250	2.6563	3.1875	3.7188	4.2500	4.7813
$\frac{35}{64}$	0.5469	1.0938	1.6406	2.1875	2.7344	3.2813	3.8281	4.3750	4.9219
$\frac{9}{16}$	0.5625	1.1250	1.6875	2.2500	2.8125	3.3750	3.9375	4.5000	5.0625
$\frac{37}{64}$	0.5781	1.1563	1.7344	2.3125	2.8906	3.4688	4.0469	4.6250	5.2031
$\frac{19}{32}$	0.5938	1.1875	1.7813	2.3750	2.9688	3.5625	4.1563	4.7500	5.3438
$\frac{39}{64}$	0.6094	1.2188	1.8281	2.4375	3.0469	3.6563	4.2656	4.8750	5.4844
$\frac{5}{8}$	0.6250	1.2500	1.8750	2.5000	3.1250	3.7500	4.3750	5.0000	5.6250
$\frac{41}{64}$	0.6406	1.2813	1.9219	2.5625	3.2031	3.8438	4.4844	5.1250	5.7656
$\frac{21}{32}$	0.6563	1.3125	1.9688	2.6250	3.2813	3.9375	4.5938	5.2500	5.9063
$\frac{43}{64}$	0.6719	1.3438	2.0156	2.6875	3.3594	4.0313	4.7031	5.3750	6.0469
$\frac{11}{16}$	0.6875	1.3750	2.0625	2.7500	3.4375	4.1250	4.8125	5.5000	6.1875
$\frac{45}{64}$	0.7031	1.4063	2.1094	2.8125	3.5156	4.2188	4.9219	5.6250	6.3281
$\frac{23}{32}$	0.7188	1.4375	2.1563	2.8750	3.5938	4.3125	5.0313	5.7500	6.4688
$\frac{47}{64}$	0.7344	1.4688	2.2031	2.9375	3.6719	4.4063	5.1406	5.8750	6.6094
$\frac{3}{4}$	0.7500	1.5000	2.2500	3.0000	3.7500	4.5000	5.2500	6.0000	6.7500
$\frac{49}{64}$	0.7656	1.5313	2.2969	3.0625	3.8281	4.5938	5.3594	6.1250	6.8906
$\frac{25}{32}$	0.7813	1.5625	2.3438	3.1250	3.9063	4.6875	5.4688	6.2500	7.0313
$\frac{51}{64}$	0.7969	1.5938	2.3906	3.1875	3.9844	4.7813	5.5781	6.3750	7.1719
$\frac{13}{16}$	0.8125	1.6250	2.4375	3.2500	4.0625	4.8750	5.6875	6.5000	7.3125
$\frac{53}{64}$	0.8281	1.6563	2.4844	3.3125	4.1406	4.9688	5.7969	6.6250	7.4531
$\frac{27}{32}$	0.8438	1.6875	2.5313	3.3750	4.2188	5.0625	5.9063	6.7500	7.5938
$\frac{55}{64}$	0.8594	1.7188	2.5781	3.4375	4.2969	5.1563	6.0156	6.8750	7.7344
$\frac{7}{8}$	0.8750	1.7500	2.6250	3.5000	4.3750	5.2500	6.1250	7.0000	7.8750
$\frac{57}{64}$	0.8906	1.7813	2.6719	3.5625	4.4531	5.3438	6.2344	7.1250	8.0156
$\frac{29}{32}$	0.9063	1.8125	2.7188	3.6250	4.5313	5.4375	6.3438	7.2500	8.1563
$\frac{59}{64}$	0.9219	1.8438	2.7656	3.6875	4.6094	5.5313	6.4531	7.3750	8.2969
$\frac{15}{16}$	0.9375	1.8750	2.8125	3.7500	4.6875	5.6250	6.5625	7.5000	8.4375
$\frac{61}{64}$	0.9531	1.9063	2.8594	3.8125	4.7656	5.7188	6.6719	7.6250	8.5781
$\frac{31}{32}$	0.9688	1.9375	2.9063	3.8750	4.8438	5.8125	6.7813	7.7500	8.7188
$\frac{63}{64}$	0.9844	1.9688	2.9531	3.9375	4.9219	5.9063	6.8906	7.8750	8.8594

Multiplication Table for Common Fractions From $\frac{1}{32}$ to $\frac{1}{2}$

	$\frac{1}{32}$	$\frac{1}{16}$	$\frac{3}{32}$	$\frac{1}{8}$	$\frac{5}{32}$	$\frac{3}{16}$	$\frac{7}{32}$	$\frac{1}{4}$	$\frac{9}{32}$	$\frac{5}{16}$	$\frac{11}{32}$	$\frac{3}{8}$	$\frac{13}{32}$	$\frac{7}{16}$	$\frac{15}{32}$	$\frac{1}{2}$
$\frac{1}{32}$	0.00098	0.00195	0.00293	0.00391	0.00488	0.00586	0.00684	0.00781	0.00879	0.00977	0.01074	0.01172	0.01270	0.01367	0.01465	0.01563
$\frac{1}{16}$	0.00195	0.00391	0.00586	0.00781	0.00977	0.01172	0.01367	0.01563	0.01758	0.01953	0.02148	0.02344	0.02539	0.02734	0.02930	0.03125
$\frac{3}{32}$	0.00293	0.00586	0.00879	0.01172	0.01465	0.01758	0.02051	0.02344	0.02637	0.02930	0.03223	0.03516	0.03809	0.04102	0.04395	0.04688
$\frac{1}{8}$	0.00391	0.00781	0.01172	0.01563	0.01953	0.02344	0.02734	0.03125	0.03516	0.03906	0.04297	0.04688	0.05078	0.05469	0.05859	0.06250
$\frac{5}{32}$	0.00488	0.00977	0.01465	0.01953	0.02441	0.02930	0.03418	0.03906	0.04395	0.04883	0.05371	0.05859	0.06348	0.06836	0.07324	0.07813
$\frac{3}{16}$	0.00586	0.01172	0.01758	0.02344	0.02930	0.03516	0.04102	0.04688	0.05273	0.05859	0.06445	0.07031	0.07617	0.08203	0.08789	0.09375
$\frac{7}{32}$	0.00684	0.01367	0.02051	0.02734	0.03418	0.04102	0.04785	0.05469	0.06152	0.06836	0.07520	0.08203	0.08887	0.09570	0.10254	0.10938
$\frac{1}{4}$	0.00781	0.01563	0.02344	0.03125	0.03906	0.04688	0.05469	0.06250	0.07031	0.07813	0.08594	0.09375	0.10156	0.10938	0.11719	0.12500
$\frac{9}{32}$	0.00879	0.01758	0.02637	0.03516	0.04395	0.05273	0.06152	0.07031	0.07910	0.08789	0.09668	0.10547	0.11426	0.12305	0.13184	0.14063
$\frac{5}{16}$	0.00977	0.01953	0.02930	0.03906	0.04883	0.05859	0.06836	0.07813	0.08789	0.09766	0.10742	0.11719	0.12695	0.13672	0.14648	0.15625
$\frac{11}{32}$	0.01074	0.02148	0.03223	0.04297	0.05371	0.06445	0.07520	0.08594	0.09668	0.10742	0.11816	0.12891	0.13965	0.15039	0.16113	0.17188
$\frac{3}{8}$	0.01172	0.02344	0.03516	0.04688	0.05859	0.07031	0.08203	0.09375	0.10547	0.11719	0.12891	0.14063	0.15234	0.16406	0.17578	0.18750
$\frac{13}{32}$	0.01270	0.02539	0.03809	0.05078	0.06348	0.07617	0.08887	0.10156	0.11426	0.12695	0.13965	0.15234	0.16504	0.17773	0.19043	0.20313
$\frac{7}{16}$	0.01367	0.02734	0.04102	0.05469	0.06836	0.08203	0.09570	0.10938	0.12305	0.13672	0.15039	0.16406	0.17773	0.19141	0.20508	0.21875
$\frac{15}{32}$	0.01465	0.02930	0.04395	0.05859	0.07324	0.08789	0.10254	0.11719	0.13184	0.14648	0.16113	0.17578	0.19043	0.20508	0.21973	0.23438
$\frac{1}{2}$	0.01563	0.03125	0.04688	0.06250	0.07813	0.09375	0.10938	0.12500	0.14063	0.15625	0.17188	0.18750	0.20313	0.21875	0.23438	0.25000
$\frac{17}{32}$	0.01660	0.03320	0.04980	0.06641	0.08301	0.09961	0.11621	0.13281	0.14941	0.16602	0.18262	0.19922	0.21582	0.23242	0.24902	0.26563
$\frac{9}{16}$	0.01758	0.03516	0.05273	0.07031	0.08789	0.10547	0.12305	0.14063	0.15820	0.17578	0.19336	0.21094	0.22852	0.24609	0.26367	0.28125
$\frac{19}{32}$	0.01855	0.03711	0.05566	0.07422	0.09277	0.11133	0.12988	0.14844	0.16699	0.18555	0.20410	0.22266	0.24121	0.25977	0.27832	0.29688
$\frac{5}{8}$	0.01953	0.03906	0.05859	0.07813	0.09766	0.11719	0.13672	0.15625	0.17578	0.19531	0.21484	0.23438	0.25391	0.27344	0.29297	0.31250
$\frac{21}{32}$	0.02051	0.04102	0.06152	0.08203	0.10254	0.12305	0.14355	0.16406	0.18457	0.20508	0.22559	0.24609	0.26660	0.28711	0.30762	0.32813
$\frac{11}{16}$	0.02148	0.04297	0.06445	0.08594	0.10742	0.12891	0.15039	0.17188	0.19336	0.21484	0.23633	0.25781	0.27930	0.30078	0.32227	0.34375
$\frac{23}{32}$	0.02246	0.04492	0.06738	0.08984	0.11230	0.13477	0.15723	0.17969	0.20215	0.22461	0.24707	0.26953	0.29199	0.31445	0.33691	0.35938
$\frac{3}{4}$	0.02344	0.04688	0.07031	0.09375	0.11719	0.14063	0.16406	0.18750	0.21094	0.23438	0.25781	0.28125	0.30469	0.32813	0.35156	0.37500
$\frac{25}{32}$	0.02441	0.04883	0.07324	0.09766	0.12207	0.14648	0.17090	0.19531	0.21973	0.24414	0.26855	0.29297	0.31738	0.34180	0.36621	0.39063
$\frac{13}{16}$	0.02539	0.05078	0.07617	0.10156	0.12695	0.15234	0.17773	0.20313	0.22852	0.25391	0.27930	0.30469	0.33008	0.35547	0.38086	0.40625
$\frac{27}{32}$	0.02637	0.05273	0.07910	0.10547	0.13184	0.15820	0.18457	0.21094	0.23730	0.26367	0.29004	0.31641	0.34277	0.36914	0.39551	0.42188
$\frac{7}{8}$	0.02734	0.05469	0.08203	0.10938	0.13672	0.16406	0.19141	0.21875	0.24609	0.27344	0.30078	0.32813	0.35547	0.38281	0.41016	0.43750
$\frac{29}{32}$	0.02832	0.05664	0.08496	0.11328	0.14160	0.16992	0.19824	0.22656	0.25488	0.28320	0.31152	0.33984	0.36816	0.39648	0.42480	0.45313
$\frac{15}{16}$	0.02930	0.05859	0.08789	0.11719	0.14648	0.17578	0.20508	0.23438	0.26367	0.29297	0.32227	0.35156	0.38086	0.41016	0.43945	0.46875
$\frac{31}{32}$	0.03027	0.06055	0.09082	0.12109	0.15137	0.18164	0.21191	0.24219	0.27246	0.30273	0.33301	0.36328	0.39355	0.42383	0.45410	0.48438
1	0.03125	0.06250	0.09375	0.12500	0.15625	0.18750	0.21875	0.25000	0.28125	0.31250	0.34375	0.37500	0.40625	0.43750	0.46875	0.50000

Multiplication Table for Common Fractions From $\frac{17}{32}$ to 1

	$\frac{17}{32}$	$\frac{9}{16}$	$\frac{19}{32}$	$\frac{5}{8}$	$\frac{21}{32}$	$\frac{11}{16}$	$\frac{23}{32}$	$\frac{3}{4}$	$\frac{25}{32}$	$\frac{13}{16}$	$\frac{27}{32}$	$\frac{7}{8}$	$\frac{29}{32}$	$\frac{15}{16}$	$\frac{31}{32}$	1
$\frac{1}{32}$	0.01660	0.01758	0.01855	0.01953	0.02051	0.02148	0.02246	0.02344	0.02441	0.02539	0.02637	0.02734	0.02832	0.02930	0.03027	0.03125
$\frac{1}{16}$	0.03320	0.03516	0.03711	0.03906	0.04102	0.04297	0.04492	0.04688	0.04883	0.05078	0.05273	0.05469	0.05664	0.05859	0.06055	0.06250
$\frac{3}{32}$	0.04980	0.05273	0.05566	0.05859	0.06152	0.06445	0.06738	0.07031	0.07324	0.07617	0.07910	0.08203	0.08496	0.08789	0.09082	0.09375
$\frac{1}{8}$	0.06641	0.07031	0.07422	0.07813	0.08203	0.08594	0.08984	0.09375	0.09766	0.10156	0.10547	0.10938	0.11328	0.11719	0.12109	0.12500
$\frac{5}{32}$	0.08301	0.08789	0.09277	0.09766	0.10254	0.10742	0.11230	0.11719	0.12207	0.12695	0.13184	0.13672	0.14160	0.14648	0.15137	0.15625
$\frac{3}{16}$	0.09961	0.10547	0.11133	0.11719	0.12305	0.12891	0.13477	0.14063	0.14648	0.15234	0.15820	0.16406	0.16992	0.17578	0.18164	0.18750
$\frac{7}{32}$	0.11621	0.12305	0.12988	0.13672	0.14355	0.15039	0.15723	0.16406	0.17090	0.17773	0.18457	0.19141	0.19824	0.20508	0.21191	0.21875
$\frac{1}{4}$	0.13281	0.14063	0.14844	0.15625	0.16406	0.17188	0.17969	0.18750	0.19531	0.20313	0.21094	0.21875	0.22656	0.23438	0.24219	0.25000
$\frac{9}{32}$	0.14941	0.15820	0.16699	0.17578	0.18457	0.19336	0.20215	0.21094	0.21973	0.22852	0.23730	0.24609	0.25488	0.26367	0.27246	0.28125
$\frac{5}{16}$	0.16602	0.17578	0.18555	0.19531	0.20508	0.21484	0.22461	0.23438	0.24414	0.25391	0.26367	0.27344	0.28320	0.29297	0.30273	0.31250
$\frac{11}{32}$	0.18262	0.19336	0.20410	0.21484	0.22559	0.23633	0.24707	0.25781	0.26855	0.27930	0.29004	0.30078	0.31152	0.32227	0.33301	0.34375
$\frac{3}{8}$	0.19922	0.21094	0.22266	0.23438	0.24609	0.25781	0.26953	0.28125	0.29297	0.30469	0.31641	0.32813	0.33984	0.35156	0.36328	0.37500
$\frac{13}{32}$	0.21582	0.22852	0.24121	0.25391	0.26660	0.27930	0.29199	0.30469	0.31738	0.33008	0.34277	0.35547	0.36816	0.38086	0.39355	0.40625
$\frac{7}{16}$	0.23242	0.24609	0.25977	0.27344	0.28711	0.30078	0.31445	0.32813	0.34180	0.35547	0.36914	0.38281	0.39648	0.41016	0.42383	0.43750
$\frac{15}{32}$	0.24902	0.26367	0.27832	0.29297	0.30762	0.32227	0.33691	0.35156	0.36621	0.38086	0.39551	0.41016	0.42480	0.43945	0.45410	0.46875
$\frac{1}{2}$	0.26563	0.28125	0.29688	0.31250	0.32813	0.34375	0.35938	0.37500	0.39063	0.40625	0.42188	0.43750	0.45313	0.46875	0.48438	0.50000
$\frac{17}{32}$	0.28223	0.29883	0.31543	0.33203	0.34863	0.36523	0.38184	0.39844	0.41504	0.43164	0.44824	0.46484	0.48145	0.49805	0.51465	0.53125
$\frac{9}{16}$	0.29883	0.31641	0.33398	0.35156	0.36914	0.38672	0.40430	0.42188	0.43945	0.45703	0.47461	0.49219	0.50977	0.52734	0.54492	0.56250
$\frac{19}{32}$	0.31543	0.33398	0.35254	0.37109	0.38965	0.40820	0.42676	0.44531	0.46387	0.48242	0.50098	0.51953	0.53809	0.55664	0.57520	0.59375
$\frac{5}{8}$	0.33203	0.35156	0.37109	0.39063	0.41016	0.42969	0.44922	0.46875	0.48828	0.50781	0.52734	0.54688	0.56641	0.58594	0.60547	0.62500
$\frac{21}{32}$	0.34863	0.36914	0.38965	0.41016	0.43066	0.45117	0.47168	0.49219	0.51270	0.53320	0.55371	0.57422	0.59473	0.61523	0.63574	0.65625
$\frac{11}{16}$	0.36523	0.38672	0.40820	0.42969	0.45117	0.47266	0.49414	0.51563	0.53711	0.55859	0.58008	0.60156	0.62305	0.64453	0.66602	0.68750
$\frac{23}{32}$	0.38184	0.40430	0.42676	0.44922	0.47168	0.49414	0.51660	0.53906	0.56152	0.58398	0.60645	0.62891	0.65137	0.67383	0.69629	0.71875
$\frac{3}{4}$	0.39844	0.42188	0.44531	0.46875	0.49219	0.51563	0.53906	0.56250	0.58594	0.60938	0.63281	0.65625	0.67969	0.70313	0.72656	0.75000
$\frac{25}{32}$	0.41504	0.43945	0.46387	0.48828	0.51270	0.53711	0.56152	0.58594	0.61035	0.63477	0.65918	0.68359	0.70801	0.73242	0.75684	0.78125
$\frac{13}{16}$	0.43164	0.45703	0.48242	0.50781	0.53320	0.55859	0.58398	0.60938	0.63477	0.66016	0.68555	0.71094	0.73633	0.76172	0.78711	0.81250
$\frac{27}{32}$	0.44824	0.47461	0.50098	0.52734	0.55371	0.58008	0.60645	0.63281	0.65918	0.68555	0.71191	0.73828	0.76465	0.79102	0.81738	0.84375
$\frac{7}{8}$	0.46484	0.49219	0.51953	0.54688	0.57422	0.60156	0.62891	0.65625	0.68359	0.71094	0.73828	0.76563	0.79297	0.82031	0.84766	0.87500
$\frac{29}{32}$	0.48145	0.50977	0.53809	0.56641	0.59473	0.62305	0.65137	0.67969	0.70801	0.73633	0.76465	0.79297	0.82129	0.84961	0.87793	0.90625
$\frac{15}{16}$	0.49805	0.52734	0.55664	0.58594	0.61523	0.64453	0.67383	0.70313	0.73242	0.76172	0.79102	0.82031	0.84961	0.87891	0.90820	0.93750
$\frac{31}{32}$	0.51465	0.54492	0.57520	0.60547	0.63574	0.66602	0.69629	0.72656	0.75684	0.78711	0.81738	0.84766	0.87793	0.90820	0.93848	0.96875
1	0.53125	0.56250	0.59375	0.62500	0.65625	0.68750	0.71875	0.75000	0.78125	0.81250	0.84375	0.87500	0.90625	0.93750	0.96875	1.00000

Squares of Numbers

Squares of Numbers from 1 to 999

	0	1	2	3	4	5	6	7	8	9
0	0	1	4	9	16	25	36	49	64	81
1	100	121	144	169	196	225	256	289	324	361
2	400	441	484	529	576	625	676	729	784	841
3	900	961	1024	1089	1156	1225	1296	1369	1444	1521
4	1600	1681	1764	1849	1936	2025	2116	2209	2304	2401
5	2500	2601	2704	2809	2916	3025	3136	3249	3364	3481
6	3600	3721	3844	3969	4096	4225	4356	4489	4624	4761
7	4900	5041	5184	5329	5476	5625	5776	5929	6084	6241
8	6400	6561	6724	6889	7056	7225	7396	7569	7744	7921
9	8100	8281	8464	8649	8836	9025	9216	9409	9604	9801
10	10000	10201	10404	10609	10816	11025	11236	11449	11664	11881
11	12100	12321	12544	12769	12996	13225	13456	13689	13924	14161
12	14400	14641	14884	15129	15376	15625	15876	16129	16384	16641
13	16900	17161	17424	17689	17956	18225	18496	18769	19044	19321
14	19600	19881	20164	20449	20736	21025	21316	21609	21904	22201
15	22500	22801	23104	23409	23716	24025	24336	24649	24964	25281
16	25600	25921	26244	26569	26896	27225	27556	27889	28224	28561
17	28900	29241	29584	29929	30276	30625	30976	31329	31684	32041
18	32400	32761	33124	33489	33856	34225	34596	34969	35344	35721
19	36100	36481	36864	37249	37636	38025	38416	38809	39204	39601
20	40000	40401	40804	41209	41616	42025	42436	42849	43264	43681
21	44100	44521	44944	45369	45796	46225	46656	47089	47524	47961
22	48400	48841	49284	49729	50176	50625	51076	51529	51984	52441
23	52900	53361	53824	54289	54756	55225	55696	56169	56644	57121
24	57600	58081	58564	59049	59536	60025	60516	61009	61504	62001
25	62500	63001	63504	64009	64516	65025	65536	66049	66564	67081
26	67600	68121	68644	69169	69696	70225	70756	71289	71824	72361
27	72900	73441	73984	74529	75076	75625	76176	76729	77284	77841
28	78400	78961	79524	80089	80656	81225	81796	82369	82944	83521
29	84100	84681	85264	85849	86436	87025	87616	88209	88804	89401
30	90000	90601	91204	91809	92416	93025	93636	94249	94864	95481
31	96100	96721	97344	97969	98596	99225	99856	100489	101124	101761
32	102400	103041	103684	104329	104976	105625	106276	106929	107584	108241
33	108900	109561	110224	110889	111556	112225	112896	113569	114244	114921
34	115600	116281	116964	117649	118336	119025	119716	120409	121104	121801
35	122500	123201	123904	124609	125316	126025	126736	127449	128164	128881
36	129600	130321	131044	131769	132496	133225	133956	134689	135424	136161
37	136900	137641	138384	139129	139876	140625	141376	142129	142884	143641
38	144400	145161	145924	146689	147456	148225	148996	149769	150544	151321
39	152100	152881	153664	154449	155236	156025	156816	157609	158404	159201
40	160000	160801	161604	162409	163216	164025	164836	165649	166464	167281
41	168100	168921	169744	170569	171396	172225	173056	173889	174724	175561
42	176400	177241	178084	178929	179776	180625	181476	182329	183184	184041
43	184900	185761	186624	187489	188356	189225	190096	190969	191844	192721
44	193600	194481	195364	196249	197136	198025	198916	199809	200704	201601
45	202500	203401	204304	205209	206116	207025	207936	208849	209764	210681
46	211600	212521	213444	214369	215296	216225	217156	218089	219024	219961
47	220900	221841	222784	223729	224676	225625	226576	227529	228484	229441
48	230400	231361	232324	233289	234256	235225	236196	237169	238144	239121
49	240100	241081	242064	243049	244036	245025	246016	247009	248004	249001
50	250000	251001	252004	253009	254016	255025	256036	257049	258064	259081

Squares of Numbers from 1 to 999

	0	1	2	3	4	5	6	7	8	9
51	260100	261121	262144	263169	264196	265225	266256	267289	268324	269361
52	270400	271441	272484	273529	274576	275625	276676	277729	278784	279841
53	280900	281961	283024	284089	285156	286225	287296	288369	289444	290521
54	291600	292681	293764	294849	295936	297025	298116	299209	300304	301401
55	302500	303601	304704	305809	306916	308025	309136	310249	311364	312481
56	313600	314721	315844	316969	318096	319225	320356	321489	322624	323761
57	324900	326041	327184	328329	329476	330625	331776	332929	334084	335241
58	336400	337561	338724	339889	341056	342225	343396	344569	345744	346921
59	348100	349281	350464	351649	352836	354025	355216	356409	357604	358801
60	360000	361201	362404	363609	364816	366025	367236	368449	369664	370881
61	372100	373321	374544	375769	376996	378225	379456	380689	381924	383161
62	384400	385641	386884	388129	389376	390625	391876	393129	394384	395641
63	396900	398161	399424	400689	401956	403225	404496	405769	407044	408321
64	409600	410881	412164	413449	414736	416025	417316	418609	419904	421201
65	422500	423801	425104	426409	427716	429025	430336	431649	432964	434281
66	435600	436921	438244	439569	440896	442225	443556	444889	446224	447561
67	448900	450241	451584	452929	454276	455625	456976	458329	459684	461041
68	462400	463761	465124	466489	467856	469225	470596	471969	473344	474721
69	476100	477481	478864	480249	481636	483025	484416	485809	487204	488601
70	490000	491401	492804	494209	495616	497025	498436	499849	501264	502681
71	504100	505521	506944	508369	509796	511225	512656	514089	515524	516961
72	518400	519841	521284	522729	524176	525625	527076	528529	529984	531441
73	532900	534361	535824	537289	538756	540225	541696	543169	544644	546121
74	547600	549081	550564	552049	553536	555025	556516	558009	559504	561001
75	562500	564001	565504	567009	568516	570025	571536	573049	574564	576081
76	577600	579121	580644	582169	583696	585225	586756	588289	589824	591361
77	592900	594441	595984	597529	599076	600625	602176	603729	605284	606841
78	608400	609961	611524	613089	614656	616225	617796	619369	620944	622521
79	624100	625681	627264	628849	630436	632025	633616	635209	636804	638401
80	640000	641601	643204	644809	646416	648025	649636	651249	652864	654481
81	656100	657721	659344	660969	662596	664225	665856	667489	669124	670761
82	672400	674041	675684	677329	678976	680625	682276	683929	685584	687241
83	688900	690561	692224	693889	695556	697225	698896	700569	702244	703921
84	705600	707281	708964	710649	712336	714025	715716	717409	719104	720801
85	722500	724201	725904	727609	729316	731025	732736	734449	736164	737881
86	739600	741321	743044	744769	746496	748225	749956	751689	753424	755161
87	756900	758641	760384	762129	763876	765625	767376	769129	770884	772641
88	774400	776161	777924	779689	781456	783225	784996	786769	788544	790321
89	792100	793881	795664	797449	799236	801025	802816	804609	806404	808201
90	810000	811801	813604	815409	817216	819025	820836	822649	824464	826281
91	828100	829921	831744	833569	835396	837225	839056	840889	842724	844561
92	846400	848241	850084	851929	853776	855625	857476	859329	861184	863041
93	864900	866761	868624	870489	872356	874225	876096	877969	879844	881721
94	883600	885481	887364	889249	891136	893025	894916	896809	898704	900601
95	902500	904401	906304	908209	910116	912025	913936	915849	917764	919681
96	921600	923521	925444	927369	929296	931225	933156	935089	937024	938961
97	940900	942841	944784	946729	948676	950625	952576	954529	956484	958441
98	960400	962361	964324	966289	968256	970225	972196	974169	976144	978121
99	980100	982081	984064	986049	988036	990025	992016	994009	996004	998001

To find the square of a given whole number, divide the number by 10 and find the row in the first column that contains the whole number portion of the result. The selected row contains the square of given number under the column corresponding to the last digit in the number.

Example: The square of 673, found in row labeled 67, under column labeled 3, is given as 452,929.

Squares of Mixed Numbers from $\frac{1}{64}$ to 6, by 64ths

No.	0	1	2	3	4	5
$\frac{1}{64}$	0.00024	1.03149	4.06274	9.09399	16.12524	25.15649
$\frac{2}{64}$	0.00098	1.06348	4.12598	9.18848	16.25098	25.31348
$\frac{3}{64}$	0.00220	1.09595	4.18970	9.28345	16.37720	25.47095
$\frac{4}{64}$	0.00391	1.12891	4.25391	9.37891	16.50391	25.62891
$\frac{5}{64}$	0.00610	1.16235	4.31860	9.47485	16.63110	25.78735
$\frac{6}{64}$	0.00879	1.19629	4.38379	9.57129	16.75879	25.94629
$\frac{7}{64}$	0.01196	1.23071	4.44946	9.66821	16.88696	26.10571
$\frac{8}{64}$	0.01563	1.26563	4.51563	9.76563	17.01563	26.26563
$\frac{9}{64}$	0.01978	1.30103	4.58228	9.86353	17.14478	26.42603
$\frac{10}{64}$	0.02441	1.33691	4.64941	9.96191	17.27441	26.58691
$\frac{11}{64}$	0.02954	1.37329	4.71704	10.06079	17.40454	26.74829
$\frac{12}{64}$	0.03516	1.41016	4.78516	10.16016	17.53516	26.91016
$\frac{13}{64}$	0.04126	1.44751	4.85376	10.26001	17.66626	27.07251
$\frac{14}{64}$	0.04785	1.48535	4.92285	10.36035	17.79785	27.23535
$\frac{15}{64}$	0.05493	1.52368	4.99243	10.46118	17.92993	27.39868
$\frac{16}{64}$	0.06250	1.56250	5.06250	10.56250	18.06250	27.56250
$\frac{17}{64}$	0.07056	1.60181	5.13306	10.66431	18.19556	27.72681
$\frac{18}{64}$	0.07910	1.64160	5.20410	10.76660	18.32910	27.89160
$\frac{19}{64}$	0.08813	1.68188	5.27563	10.86938	18.46313	28.05688
$\frac{20}{64}$	0.09766	1.72266	5.34766	10.97266	18.59766	28.22266
$\frac{21}{64}$	0.10767	1.76392	5.42017	11.07642	18.73267	28.38892
$\frac{22}{64}$	0.11816	1.80566	5.49316	11.18066	18.86816	28.55566
$\frac{23}{64}$	0.12915	1.84790	5.56665	11.28540	19.00415	28.72290
$\frac{24}{64}$	0.14063	1.89063	5.64063	11.39063	19.14063	28.89063
$\frac{25}{64}$	0.15259	1.93384	5.71509	11.49634	19.27759	29.05884
$\frac{26}{64}$	0.16504	1.97754	5.79004	11.60254	19.41504	29.22754
$\frac{27}{64}$	0.17798	2.02173	5.86548	11.70923	19.55298	29.39673
$\frac{28}{64}$	0.19141	2.06641	5.94141	11.81641	19.69141	29.56641
$\frac{29}{64}$	0.20532	2.11157	6.01782	11.92407	19.83032	29.73657
$\frac{30}{64}$	0.21973	2.15723	6.09473	12.03223	19.96973	29.90723
$\frac{31}{64}$	0.23462	2.20337	6.17212	12.14087	20.10962	30.07837
$\frac{32}{64}$	0.25000	2.25000	6.25000	12.25000	20.25000	30.25000
$\frac{33}{64}$	0.26587	2.29712	6.32837	12.35962	20.39087	30.42212
$\frac{34}{64}$	0.28223	2.34473	6.40723	12.46973	20.53223	30.59473
$\frac{35}{64}$	0.29907	2.39282	6.48657	12.58032	20.67407	30.76782
$\frac{36}{64}$	0.31641	2.44141	6.56641	12.69141	20.81641	30.94141
$\frac{37}{64}$	0.33423	2.49048	6.64673	12.80298	20.95923	31.11548
$\frac{38}{64}$	0.35254	2.54004	6.72754	12.91504	21.10254	31.29004
$\frac{39}{64}$	0.37134	2.59009	6.80884	13.02759	21.24634	31.46509
$\frac{40}{64}$	0.39063	2.64063	6.89063	13.14063	21.39063	31.64063
$\frac{41}{64}$	0.41040	2.69165	6.97290	13.25415	21.53540	31.81665
$\frac{42}{64}$	0.43066	2.74316	7.05566	13.36816	21.68066	31.99316
$\frac{43}{64}$	0.45142	2.79517	7.13892	13.48267	21.82642	32.17017
$\frac{44}{64}$	0.47266	2.84766	7.22266	13.59766	21.97266	32.34766
$\frac{45}{64}$	0.49438	2.90063	7.30688	13.71313	22.11938	32.52563
$\frac{46}{64}$	0.51660	2.95410	7.39160	13.82910	22.26660	32.70410
$\frac{47}{64}$	0.53931	3.00806	7.47681	13.94556	22.41431	32.88306
$\frac{48}{64}$	0.56250	3.06250	7.56250	14.06250	22.56250	33.06250
$\frac{49}{64}$	0.58618	3.11743	7.64868	14.17993	22.71118	33.24243
$\frac{50}{64}$	0.61035	3.17285	7.73535	14.29785	22.86035	33.42285
$\frac{51}{64}$	0.63501	3.22876	7.82251	14.41626	23.01001	33.60376
$\frac{52}{64}$	0.66016	3.28516	7.91016	14.53516	23.16016	33.78516
$\frac{53}{64}$	0.68579	3.34204	7.99829	14.65454	23.31079	33.96704
$\frac{54}{64}$	0.71191	3.39941	8.08691	14.77441	23.46191	34.14941
$\frac{55}{64}$	0.73853	3.45728	8.17603	14.89478	23.61353	34.33228
$\frac{56}{64}$	0.76563	3.51563	8.26563	15.01563	23.76563	34.51563
$\frac{57}{64}$	0.79321	3.57446	8.35571	15.13696	23.91821	34.69946
$\frac{58}{64}$	0.82129	3.63379	8.44629	15.25879	24.07129	34.88379
$\frac{59}{64}$	0.84985	3.69360	8.53735	15.38110	24.22485	35.06860
$\frac{60}{64}$	0.87891	3.75391	8.62891	15.50391	24.37891	35.25391
$\frac{61}{64}$	0.90845	3.81470	8.72095	15.62720	24.53345	35.43970
$\frac{62}{64}$	0.93848	3.87598	8.81348	15.75098	24.68848	35.62598
$\frac{63}{64}$	0.96899	3.93774	8.90649	15.87524	24.84399	35.81274
1	1.00000	4.00000	9.00000	16.00000	25.00000	36.00000

Squares of Mixed Numbers from $6\frac{1}{64}$ to 12, by 64ths

No.	6	7	8	9	10	11
$\frac{1}{64}$	36.18774	49.21899	64.25024	81.28149	100.31274	121.34399
$\frac{2}{64}$	36.37598	49.43848	64.50098	81.56348	100.62598	121.68848
$\frac{3}{64}$	36.56470	49.65845	64.75220	81.84595	100.93970	122.03345
$\frac{4}{64}$	36.75391	49.87891	65.00391	82.12891	101.25391	122.37891
$\frac{5}{64}$	36.94360	50.09985	65.25610	82.41235	101.56860	122.72485
$\frac{6}{64}$	37.13379	50.32129	65.50879	82.69629	101.88379	123.07129
$\frac{7}{64}$	37.32446	50.54321	65.76196	82.98071	102.19946	123.41821
$\frac{8}{64}$	37.51563	50.76563	66.01563	83.26563	102.51563	123.76563
$\frac{9}{64}$	37.70728	50.98853	66.26978	83.55103	102.83228	124.11353
$\frac{10}{64}$	37.89941	51.21191	66.52441	83.83691	103.14941	124.46191
$\frac{11}{64}$	38.09204	51.43579	66.77954	84.12329	103.46704	124.81079
$\frac{12}{64}$	38.28516	51.66016	67.03516	84.41016	103.78516	125.16016
$\frac{13}{64}$	38.47876	51.88501	67.29126	84.69751	104.10376	125.51001
$\frac{14}{64}$	38.67285	52.11035	67.54785	84.98535	104.42285	125.86035
$\frac{15}{64}$	38.86743	52.33618	67.80493	85.27368	104.74243	126.21118
$\frac{16}{64}$	39.06250	52.56250	68.06250	85.56250	105.06250	126.56250
$\frac{17}{64}$	39.25806	52.78931	68.32056	85.85181	105.38306	126.91431
$\frac{18}{64}$	39.45410	53.01660	68.57910	86.14160	105.70410	127.26660
$\frac{19}{64}$	39.65063	53.24438	68.83813	86.43188	106.02563	127.61938
$\frac{20}{64}$	39.84766	53.47266	69.09766	86.72266	106.34766	127.97266
$\frac{21}{64}$	40.04517	53.70142	69.35767	87.01392	106.67017	128.32642
$\frac{22}{64}$	40.24316	53.93066	69.61816	87.30566	106.99316	128.68066
$\frac{23}{64}$	40.44165	54.16040	69.87915	87.59790	107.31665	129.03540
$\frac{24}{64}$	40.64063	54.39063	70.14063	87.89063	107.64063	129.39063
$\frac{25}{64}$	40.84009	54.62134	70.40259	88.18384	107.96509	129.74634
$\frac{26}{64}$	41.04004	54.85254	70.66504	88.47754	108.29004	130.10254
$\frac{27}{64}$	41.24048	55.08423	70.92798	88.77173	108.61548	130.45923
$\frac{28}{64}$	41.44141	55.31641	71.19141	89.06641	108.94141	130.81641
$\frac{29}{64}$	41.64282	55.54907	71.45532	89.36157	109.26782	131.17407
$\frac{30}{64}$	41.84473	55.78223	71.71973	89.65723	109.59473	131.53223
$\frac{31}{64}$	42.04712	56.01587	71.98462	89.95337	109.92212	131.89087
$\frac{32}{64}$	42.25000	56.25000	72.25000	90.25000	110.25000	132.25000
$\frac{33}{64}$	42.45337	56.48462	72.51587	90.54712	110.57837	132.60962
$\frac{34}{64}$	42.65723	56.71973	72.78223	90.84473	110.90723	132.96973
$\frac{35}{64}$	42.86157	56.95532	73.04907	91.14282	111.23657	133.33032
$\frac{36}{64}$	43.06641	57.19141	73.31641	91.44141	111.56641	133.69141
$\frac{37}{64}$	43.27173	57.42798	73.58423	91.74048	111.89673	134.05298
$\frac{38}{64}$	43.47754	57.66504	73.85254	92.04004	112.22754	134.41504
$\frac{39}{64}$	43.68384	57.90259	74.12134	92.34009	112.55884	134.77759
$\frac{40}{64}$	43.89063	58.14063	74.39063	92.64063	112.89063	135.14063
$\frac{41}{64}$	44.09790	58.37915	74.66040	92.94165	113.22290	135.50415
$\frac{42}{64}$	44.30566	58.61816	74.93066	93.24316	113.55566	135.86816
$\frac{43}{64}$	44.51392	58.85767	75.20142	93.54517	113.88892	136.23267
$\frac{44}{64}$	44.72266	59.09766	75.47266	93.84766	114.22266	136.59766
$\frac{45}{64}$	44.93188	59.33813	75.74438	94.15063	114.55688	136.96313
$\frac{46}{64}$	45.14160	59.57910	76.01660	94.45410	114.89160	137.32910
$\frac{47}{64}$	45.35181	59.82056	76.28931	94.75806	115.22681	137.69556
$\frac{48}{64}$	45.56250	60.06250	76.56250	95.06250	115.56250	138.06250
$\frac{49}{64}$	45.77368	60.30493	76.83618	95.36743	115.89868	138.42993
$\frac{50}{64}$	45.98535	60.54785	77.11035	95.67285	116.23535	138.79785
$\frac{51}{64}$	46.19751	60.79126	77.38501	95.97876	116.57251	139.16626
$\frac{52}{64}$	46.41016	61.03516	77.66016	96.28516	116.91016	139.53516
$\frac{53}{64}$	46.62329	61.27954	77.93579	96.59204	117.24829	139.90454
$\frac{54}{64}$	46.83691	61.52441	78.21191	96.89941	117.58691	140.27441
$\frac{55}{64}$	47.05103	61.76978	78.48853	97.20728	117.92603	140.64478
$\frac{56}{64}$	47.26563	62.01563	78.76563	97.51563	118.26563	141.01563
$\frac{57}{64}$	47.48071	62.26196	79.04321	97.82446	118.60571	141.38696
$\frac{58}{64}$	47.69629	62.50879	79.32129	98.13379	118.94629	141.75879
$\frac{59}{64}$	47.91235	62.75610	79.59985	98.44360	119.28735	142.13110
$\frac{60}{64}$	48.12891	63.00391	79.87891	98.75391	119.62891	142.50391
$\frac{61}{64}$	48.34595	63.25220	80.15845	99.06470	119.97095	142.87720
$\frac{62}{64}$	48.56348	63.50098	80.43848	99.37598	120.31348	143.25098
$\frac{63}{64}$	48.78149	63.75024	80.71899	99.68774	120.65649	143.62524
1	49.00000	64.00000	81.00000	100.00000	121.00000	144.00000

Squares and Cubes of Fractions

Squares and Cubes of Numbers from $\frac{1}{32}$ to $6\frac{15}{16}$

No.	Square	Cube	No.	Square	Cube	No.	Square	Cube
$\frac{1}{32}$	0.00098	0.00003	$1\frac{17}{32}$	2.34473	3.59036	4	16.00000	64.00000
$\frac{1}{16}$	0.00391	0.00024	$1\frac{9}{16}$	2.44141	3.81470	$4\frac{1}{16}$	16.50391	67.04712
$\frac{3}{32}$	0.00879	0.00082	$1\frac{19}{32}$	2.54004	4.04819	$4\frac{1}{8}$	17.01563	70.18945
$\frac{1}{8}$	0.01563	0.00195	$1\frac{5}{8}$	2.64063	4.29102	$4\frac{3}{16}$	17.53516	73.42847
$\frac{5}{32}$	0.02441	0.00381	$1\frac{21}{32}$	2.74316	4.54337	$4\frac{1}{4}$	18.06250	76.76563
$\frac{3}{16}$	0.03516	0.00659	$1\frac{11}{16}$	2.84766	4.80542	$4\frac{5}{16}$	18.59766	80.20239
$\frac{7}{32}$	0.04785	0.01047	$1\frac{23}{32}$	2.95410	5.07736	$4\frac{3}{8}$	19.14063	83.74023
$\frac{1}{4}$	0.06250	0.01563	$1\frac{3}{4}$	3.06250	5.35938	$4\frac{7}{16}$	19.69141	87.38062
$\frac{9}{32}$	0.07910	0.02225	$1\frac{25}{32}$	3.17285	5.65164	$4\frac{1}{2}$	20.25000	91.12500
$\frac{5}{16}$	0.09766	0.03052	$1\frac{13}{16}$	3.28516	5.95435	$4\frac{9}{16}$	20.81641	94.97485
$1\frac{1}{32}$	0.11816	0.04062	$1\frac{27}{32}$	3.39941	6.26767	$4\frac{5}{8}$	21.39063	98.93164
$\frac{3}{8}$	0.14063	0.05273	$1\frac{7}{8}$	3.51563	6.59180	$4\frac{11}{16}$	21.97266	102.99683
$1\frac{3}{32}$	0.16504	0.06705	$1\frac{29}{32}$	3.63379	6.92691	$4\frac{3}{4}$	22.56250	107.17188
$\frac{7}{16}$	0.19141	0.08374	$1\frac{15}{16}$	3.75391	7.27319	$4\frac{13}{16}$	23.16016	111.45825
$1\frac{5}{32}$	0.21973	0.10300	$1\frac{31}{32}$	3.87598	7.63083	$4\frac{7}{8}$	23.76563	115.85742
$\frac{1}{2}$	0.25000	0.12500	2	4.00000	8.00000	$4\frac{15}{16}$	24.37891	120.37085
$1\frac{17}{32}$	0.28223	0.14993	$2\frac{1}{32}$	4.12598	8.38089	5	25.00000	125.00000
$\frac{9}{16}$	0.31641	0.17798	$2\frac{1}{16}$	4.25391	8.77368	$5\frac{1}{16}$	25.62891	129.74634
$1\frac{19}{32}$	0.35254	0.20932	$2\frac{1}{8}$	4.51563	9.59570	$5\frac{1}{8}$	26.26563	134.61133
$\frac{5}{8}$	0.39063	0.24414	$2\frac{3}{16}$	4.78516	10.46753	$5\frac{3}{16}$	26.91016	139.59644
$2\frac{1}{32}$	0.43066	0.28262	$2\frac{1}{4}$	5.06250	11.39063	$5\frac{1}{4}$	27.56250	144.70313
$1\frac{1}{16}$	0.47266	0.32495	$2\frac{5}{16}$	5.34766	12.36646	$5\frac{5}{16}$	28.22266	149.93286
$2\frac{3}{32}$	0.51660	0.37131	$2\frac{3}{8}$	5.64063	13.39648	$5\frac{3}{8}$	28.89063	155.28711
$\frac{3}{4}$	0.56250	0.42188	$2\frac{7}{16}$	5.94141	14.48218	$5\frac{7}{16}$	29.56641	160.76733
$2\frac{5}{32}$	0.61035	0.47684	$2\frac{1}{2}$	6.25000	15.62500	$5\frac{1}{2}$	30.25000	166.37500
$1\frac{13}{16}$	0.66016	0.53638	$2\frac{9}{16}$	6.56641	16.82642	$5\frac{9}{16}$	30.94141	172.11157
$2\frac{7}{32}$	0.71191	0.60068	$2\frac{5}{8}$	6.89063	18.08789	$5\frac{5}{8}$	31.64063	177.97852
$\frac{7}{8}$	0.76563	0.66992	$2\frac{11}{16}$	7.22266	19.41089	$5\frac{11}{16}$	32.34766	183.97729
$2\frac{9}{32}$	0.82129	0.74429	$2\frac{3}{4}$	7.56250	20.79688	$5\frac{3}{4}$	33.06250	190.10938
$1\frac{15}{16}$	0.87891	0.82397	$2\frac{13}{16}$	7.91016	22.24731	$5\frac{13}{16}$	33.78516	196.37622
$3\frac{1}{32}$	0.93848	0.90915	$2\frac{7}{8}$	8.26563	23.76367	$5\frac{7}{8}$	34.51563	202.77930
1	1.00000	1.00000	$2\frac{15}{16}$	8.62891	25.34741	$5\frac{15}{16}$	35.25391	209.32007
$1\frac{1}{32}$	1.06348	1.09671	3	9.00000	27.00000	6	36.00000	216.00000
$1\frac{1}{16}$	1.12891	1.19946	$3\frac{1}{16}$	9.37891	28.72290	$6\frac{1}{16}$	36.75391	222.82056
$1\frac{3}{32}$	1.19629	1.30844	$3\frac{1}{8}$	9.76563	30.51758	$6\frac{1}{8}$	37.51563	229.78320
$1\frac{1}{8}$	1.26563	1.42383	$3\frac{3}{16}$	10.16016	32.38550	$6\frac{3}{16}$	38.28516	236.88940
$1\frac{5}{32}$	1.33691	1.54581	$3\frac{1}{4}$	10.56250	34.32813	$6\frac{1}{4}$	39.06250	244.14063
$1\frac{3}{16}$	1.41016	1.67456	$3\frac{5}{16}$	10.97266	36.34692	$6\frac{5}{16}$	39.84766	251.53833
$1\frac{7}{32}$	1.48535	1.81027	$3\frac{3}{8}$	11.39063	38.44336	$6\frac{3}{8}$	40.64063	259.08398
$1\frac{1}{4}$	1.56250	1.95313	$3\frac{7}{16}$	11.81641	40.61890	$6\frac{7}{16}$	41.44141	266.77905
$1\frac{9}{32}$	1.64160	2.10330	$3\frac{1}{2}$	12.25000	42.87500	$6\frac{1}{2}$	42.25000	274.62500
$1\frac{5}{16}$	1.72266	2.26099	$3\frac{9}{16}$	12.69141	45.21313	$6\frac{9}{16}$	43.06641	282.62329
$1\frac{11}{32}$	1.80566	2.42636	$3\frac{5}{8}$	13.14063	47.63477	$6\frac{5}{8}$	43.89063	290.77539
$1\frac{3}{8}$	1.89063	2.59961	$3\frac{11}{16}$	13.59766	50.14136	$6\frac{11}{16}$	44.72266	299.08276
$1\frac{13}{32}$	1.97754	2.78091	$3\frac{3}{4}$	14.06250	52.73438	$6\frac{3}{4}$	45.56250	307.54688
$1\frac{7}{16}$	2.06641	2.97046	$3\frac{13}{16}$	14.53516	55.41528	$6\frac{13}{16}$	46.41016	316.16919
$1\frac{15}{32}$	2.15723	3.16843	$3\frac{7}{8}$	15.01563	58.18555	$6\frac{7}{8}$	47.26563	324.95117
$1\frac{1}{2}$	2.25000	3.37500	$3\frac{15}{16}$	15.50391	61.04663	$6\frac{15}{16}$	48.12891	333.89429

Squares and Cubes of Numbers from 7 to $21\frac{7}{8}$

No.	Square	Cube	No.	Square	Cube	No.	Square	Cube
7	49.00000	343.00000	10	100.00000	1000.00000	16	256.00000	4096.00000
$\frac{1}{16}$	49.87891	352.26978	$\frac{1}{8}$	102.51563	1037.97070	$\frac{1}{8}$	260.01563	4192.75195
$\frac{1}{8}$	50.76563	361.70508	$\frac{1}{4}$	105.06250	1076.89063	$\frac{1}{4}$	264.06250	4291.01563
$\frac{3}{16}$	51.66016	371.30737	$\frac{3}{8}$	107.64063	1116.77148	$\frac{3}{8}$	268.14063	4390.80273
$\frac{1}{4}$	52.56250	381.07813	$\frac{1}{2}$	110.25000	1157.62500	$\frac{1}{2}$	272.25000	4492.12500
$\frac{5}{16}$	53.47266	391.01880	$\frac{5}{8}$	112.89063	1199.46289	$\frac{5}{8}$	276.39063	4594.99414
$\frac{3}{8}$	54.39063	401.13086	$\frac{3}{4}$	115.56250	1242.29688	$\frac{3}{4}$	280.56250	4699.42188
$\frac{7}{16}$	55.31641	411.41577	$\frac{7}{8}$	118.26563	1286.13867	$\frac{7}{8}$	284.76563	4805.41992
$\frac{1}{2}$	56.25000	421.87500	11	121.00000	1331.00000	17	289.00000	4913.00000
$\frac{9}{16}$	57.19141	432.51001	$\frac{1}{8}$	123.76563	1376.89258	$\frac{1}{8}$	293.26563	5022.17383
$\frac{5}{8}$	58.14063	443.32227	$\frac{1}{4}$	126.56250	1423.82813	$\frac{1}{4}$	297.56250	5132.95313
$\frac{11}{16}$	59.09766	454.31323	$\frac{3}{8}$	129.39063	1471.81836	$\frac{3}{8}$	301.89063	5245.34961
$\frac{3}{4}$	60.06250	465.48438	$\frac{1}{2}$	132.25000	1520.87500	$\frac{1}{2}$	306.25000	5359.37500
$\frac{13}{16}$	61.03516	476.83716	$\frac{5}{8}$	135.14063	1571.00977	$\frac{5}{8}$	310.64063	5475.04102
$\frac{7}{8}$	62.01563	488.37305	$\frac{3}{4}$	138.06250	1622.23438	$\frac{3}{4}$	315.06250	5592.35938
$\frac{15}{16}$	63.00391	500.09351	$\frac{7}{8}$	141.01563	1674.56055	$\frac{7}{8}$	319.51563	5711.34180
8	64.00000	512.00000	12	144.00000	1728.00000	18	324.00000	5832.00000
$\frac{1}{16}$	65.00391	524.09399	$\frac{1}{8}$	147.01563	1782.56445	$\frac{1}{8}$	328.51563	5954.34570
$\frac{1}{8}$	66.01563	536.37695	$\frac{1}{4}$	150.06250	1838.26563	$\frac{1}{4}$	333.06250	6078.39063
$\frac{3}{16}$	67.03516	548.85034	$\frac{3}{8}$	153.14063	1895.11523	$\frac{3}{8}$	337.64063	6204.14648
$\frac{1}{4}$	68.06250	561.51563	$\frac{1}{2}$	156.25000	1953.12500	$\frac{1}{2}$	342.25000	6331.62500
$\frac{5}{16}$	69.09766	574.37427	$\frac{5}{8}$	159.39063	2012.30664	$\frac{5}{8}$	346.89063	6460.83789
$\frac{3}{8}$	70.14063	587.42773	$\frac{3}{4}$	162.56250	2072.67188	$\frac{3}{4}$	351.56250	6591.79688
$\frac{7}{16}$	71.19141	600.67749	$\frac{7}{8}$	165.76563	2134.23242	$\frac{7}{8}$	356.26563	6724.51367
$\frac{1}{2}$	72.25000	614.12500	13	169.00000	2197.00000	19	361.00000	6859.00000
$\frac{9}{16}$	73.31641	627.77173	$\frac{1}{8}$	172.26563	2260.98633	$\frac{1}{8}$	365.76563	6995.26758
$\frac{5}{8}$	74.39063	641.61914	$\frac{1}{4}$	175.56250	2326.20313	$\frac{1}{4}$	370.56250	7133.32813
$\frac{11}{16}$	75.47266	655.66870	$\frac{3}{8}$	178.89063	2392.66211	$\frac{3}{8}$	375.39063	7273.19336
$\frac{3}{4}$	76.56250	669.92188	$\frac{1}{2}$	182.25000	2460.37500	$\frac{1}{2}$	380.25000	7414.87500
$\frac{13}{16}$	77.66016	684.38013	$\frac{5}{8}$	185.64063	2529.35352	$\frac{5}{8}$	385.14063	7558.38477
$\frac{7}{8}$	78.76563	699.04492	$\frac{3}{4}$	189.06250	2599.60938	$\frac{3}{4}$	390.06250	7703.73438
$\frac{15}{16}$	79.87891	713.91772	$\frac{7}{8}$	192.51563	2671.15430	$\frac{7}{8}$	395.01563	7850.93555
9	81.00000	729.00000	14	196.00000	2744.00000	20	400.00000	8000.00000
$\frac{1}{16}$	82.12891	744.29321	$\frac{1}{8}$	199.51563	2818.15820	$\frac{1}{8}$	405.01563	8150.93945
$\frac{1}{8}$	83.26563	759.79883	$\frac{1}{4}$	203.06250	2893.64063	$\frac{1}{4}$	410.06250	8303.76563
$\frac{3}{16}$	84.41016	775.51831	$\frac{3}{8}$	206.64063	2970.45898	$\frac{3}{8}$	415.14063	8458.49023
$\frac{1}{4}$	85.56250	791.45313	$\frac{1}{2}$	210.25000	3048.62500	$\frac{1}{2}$	420.25000	8615.12500
$\frac{5}{16}$	86.72266	807.60474	$\frac{5}{8}$	213.89063	3128.15039	$\frac{5}{8}$	425.39063	8773.68164
$\frac{3}{8}$	87.89063	823.97461	$\frac{3}{4}$	217.56250	3209.04688	$\frac{3}{4}$	430.56250	8934.17188
$\frac{7}{16}$	89.06641	840.56421	$\frac{7}{8}$	221.26563	3291.32617	$\frac{7}{8}$	435.76563	9096.60742
$\frac{1}{2}$	90.25000	857.37500	15	225.00000	3375.00000	21	441.00000	9261.00000
$\frac{9}{16}$	91.44141	874.40845	$\frac{1}{8}$	228.76563	3460.08008	$\frac{1}{8}$	446.26563	9427.36133
$\frac{5}{8}$	92.64063	891.66602	$\frac{1}{4}$	232.56250	3546.57813	$\frac{1}{4}$	451.56250	9595.70313
$\frac{11}{16}$	93.84766	909.14917	$\frac{3}{8}$	236.39063	3634.50586	$\frac{3}{8}$	456.89063	9766.03711
$\frac{3}{4}$	95.06250	926.85938	$\frac{1}{2}$	240.25000	3723.87500	$\frac{1}{2}$	462.25000	9938.37500
$\frac{13}{16}$	96.28516	944.79810	$\frac{5}{8}$	244.14063	3814.69727	$\frac{5}{8}$	467.64063	10112.72852
$\frac{7}{8}$	97.51563	962.96680	$\frac{3}{4}$	248.06250	3906.98438	$\frac{3}{4}$	473.06250	10289.10938
$\frac{15}{16}$	98.75391	981.36694	$\frac{7}{8}$	252.01563	4000.74805	$\frac{7}{8}$	478.51563	10467.52930

Squares and Cubes of Numbers from 22 to 39 $\frac{7}{8}$

No.	Square	Cube	No.	Square	Cube	No.	Square	Cube
22	484.00000	10648.00000	28	784.00000	21952.00000	34	1156.00000	39304.00000
$\frac{1}{8}$	489.51563	10830.53320	$\frac{1}{8}$	791.01563	22247.31445	$\frac{1}{8}$	1164.51563	39739.09570
$\frac{1}{4}$	495.06250	11015.14063	$\frac{1}{4}$	798.06250	22545.26563	$\frac{1}{4}$	1173.06250	40177.39063
$\frac{3}{8}$	500.64063	11201.83398	$\frac{3}{8}$	805.14063	22845.86523	$\frac{3}{8}$	1181.64063	40618.89648
$\frac{1}{2}$	506.25000	11390.62500	$\frac{1}{2}$	812.25000	23149.12500	$\frac{1}{2}$	1190.25000	41063.62500
$\frac{5}{8}$	511.89063	11581.52539	$\frac{5}{8}$	819.39063	23455.05664	$\frac{5}{8}$	1198.89063	41511.58789
$\frac{3}{4}$	517.56250	11774.54688	$\frac{3}{4}$	826.56250	23763.67188	$\frac{3}{4}$	1207.56250	41962.79688
$\frac{7}{8}$	523.26563	11969.70117	$\frac{7}{8}$	833.76563	24074.98242	$\frac{7}{8}$	1216.26563	42417.26367
23	529.00000	12167.00000	29	841.00000	24389.00000	35	1225.00000	42875.00000
$\frac{1}{8}$	534.76563	12366.45508	$\frac{1}{8}$	848.26563	24705.73633	$\frac{1}{8}$	1233.76563	43336.01758
$\frac{1}{4}$	540.56250	12568.07813	$\frac{1}{4}$	855.56250	25025.20313	$\frac{1}{4}$	1242.56250	43800.32813
$\frac{3}{8}$	546.39063	12771.88086	$\frac{3}{8}$	862.89063	25347.41211	$\frac{3}{8}$	1251.39063	44267.94336
$\frac{1}{2}$	552.25000	12977.87500	$\frac{1}{2}$	870.25000	25672.37500	$\frac{1}{2}$	1260.25000	44738.87500
$\frac{5}{8}$	558.14063	13186.07227	$\frac{5}{8}$	877.64063	26000.10352	$\frac{5}{8}$	1269.14063	45213.13477
$\frac{3}{4}$	564.06250	13396.48438	$\frac{3}{4}$	885.06250	26330.60938	$\frac{3}{4}$	1278.06250	45690.73438
$\frac{7}{8}$	570.01563	13609.12305	$\frac{7}{8}$	892.51563	26663.90430	$\frac{7}{8}$	1287.01563	46171.68555
24	576.00000	13824.00000	30	900.00000	27000.00000	36	1296.00000	46656.00000
$\frac{1}{8}$	582.01563	14041.12695	$\frac{1}{8}$	907.51563	27338.90820	$\frac{1}{8}$	1305.01563	47143.68945
$\frac{1}{4}$	588.06250	14260.51563	$\frac{1}{4}$	915.06250	27680.64063	$\frac{1}{4}$	1314.06250	47634.76563
$\frac{3}{8}$	594.14063	14482.17773	$\frac{3}{8}$	922.64063	28025.20898	$\frac{3}{8}$	1323.14063	48129.24023
$\frac{1}{2}$	600.25000	14706.12500	$\frac{1}{2}$	930.25000	28372.62500	$\frac{1}{2}$	1332.25000	48627.12500
$\frac{5}{8}$	606.39063	14932.36914	$\frac{5}{8}$	937.89063	28722.90039	$\frac{5}{8}$	1341.39063	49128.43164
$\frac{3}{4}$	612.56250	15160.92188	$\frac{3}{4}$	945.56250	29076.04688	$\frac{3}{4}$	1350.56250	49633.17188
$\frac{7}{8}$	618.76563	15391.79492	$\frac{7}{8}$	953.26563	29432.07617	$\frac{7}{8}$	1359.76563	50141.35742
25	625.00000	15625.00000	31	961.00000	29791.00000	37	1369.00000	50653.00000
$\frac{1}{8}$	631.26563	15860.54883	$\frac{1}{8}$	968.76563	30152.83008	$\frac{1}{8}$	1378.26563	51168.11133
$\frac{1}{4}$	637.56250	16098.45313	$\frac{1}{4}$	976.56250	30517.57813	$\frac{1}{4}$	1387.56250	51686.70313
$\frac{3}{8}$	643.89063	16338.72461	$\frac{3}{8}$	984.39063	30885.25586	$\frac{3}{8}$	1396.89063	52208.78711
$\frac{1}{2}$	650.25000	16581.37500	$\frac{1}{2}$	992.25000	31255.87500	$\frac{1}{2}$	1406.25000	52734.37500
$\frac{5}{8}$	656.64063	16826.41602	$\frac{5}{8}$	1000.14063	31629.44727	$\frac{5}{8}$	1415.64063	53263.47852
$\frac{3}{4}$	663.06250	17073.85938	$\frac{3}{4}$	1008.06250	32005.98438	$\frac{3}{4}$	1425.06250	53796.10938
$\frac{7}{8}$	669.51563	17323.71680	$\frac{7}{8}$	1016.01563	32385.49805	$\frac{7}{8}$	1434.51563	54332.27930
26	676.00000	17576.00000	32	1024.00000	32768.00000	38	1444.00000	54872.00000
$\frac{1}{8}$	682.51563	17830.72070	$\frac{1}{8}$	1032.01563	33153.50195	$\frac{1}{8}$	1453.51563	55415.28320
$\frac{1}{4}$	689.06250	18087.89063	$\frac{1}{4}$	1040.06250	33542.01563	$\frac{1}{4}$	1463.06250	55962.14063
$\frac{3}{8}$	695.64063	18347.52148	$\frac{3}{8}$	1048.14063	33933.55273	$\frac{3}{8}$	1472.64063	56512.58398
$\frac{1}{2}$	702.25000	18609.62500	$\frac{1}{2}$	1056.25000	34328.12500	$\frac{1}{2}$	1482.25000	57066.62500
$\frac{5}{8}$	708.89063	18874.21289	$\frac{5}{8}$	1064.39063	34725.74414	$\frac{5}{8}$	1491.89063	57624.27539
$\frac{3}{4}$	715.56250	19141.29688	$\frac{3}{4}$	1072.56250	35126.42188	$\frac{3}{4}$	1501.56250	58185.54688
$\frac{7}{8}$	722.26563	19410.88867	$\frac{7}{8}$	1080.76563	35530.16992	$\frac{7}{8}$	1511.26563	58750.45117
27	729.00000	19683.00000	33	1089.00000	35937.00000	39	1521.00000	59319.00000
$\frac{1}{8}$	735.76563	19957.64258	$\frac{1}{8}$	1097.26563	36346.92383	$\frac{1}{8}$	1530.76563	59891.20508
$\frac{1}{4}$	742.56250	20234.82813	$\frac{1}{4}$	1105.56250	36759.95313	$\frac{1}{4}$	1540.56250	60467.07813
$\frac{3}{8}$	749.39063	20514.56836	$\frac{3}{8}$	1113.89063	37176.09961	$\frac{3}{8}$	1550.39063	61046.63086
$\frac{1}{2}$	756.25000	20796.87500	$\frac{1}{2}$	1122.25000	37595.37500	$\frac{1}{2}$	1560.25000	61629.87500
$\frac{5}{8}$	763.14063	21081.75977	$\frac{5}{8}$	1130.64063	38017.79102	$\frac{5}{8}$	1570.14063	62216.82227
$\frac{3}{4}$	770.06250	21369.23438	$\frac{3}{4}$	1139.06250	38443.35938	$\frac{3}{4}$	1580.06250	62807.48438
$\frac{7}{8}$	777.01563	21659.31055	$\frac{7}{8}$	1147.51563	38872.09180	$\frac{7}{8}$	1590.01563	63401.87305

Squares and Cubes of Numbers from 40 to $57\frac{7}{8}$

No.	Square	Cube	No.	Square	Cube	No.	Square	Cube
40	1600.00000	64000.00000	46	2116.00000	97336.00000	52	2704.00000	140608.00000
$\frac{1}{8}$	1610.01563	64601.87695	$\frac{1}{8}$	2127.51563	98131.65820	$\frac{1}{8}$	2717.01563	141624.43945
$\frac{1}{4}$	1620.06250	65207.51563	$\frac{1}{4}$	2139.06250	98931.64063	$\frac{1}{4}$	2730.06250	142645.76563
$\frac{3}{8}$	1630.14063	65816.92773	$\frac{3}{8}$	2150.64063	99735.95898	$\frac{3}{8}$	2743.14063	143671.99023
$\frac{1}{2}$	1640.25000	66430.12500	$\frac{1}{2}$	2162.25000	100544.62500	$\frac{1}{2}$	2756.25000	144703.12500
$\frac{5}{8}$	1650.39063	67047.11914	$\frac{5}{8}$	2173.89063	101357.65039	$\frac{5}{8}$	2769.39063	145739.18164
$\frac{3}{4}$	1660.56250	67667.92188	$\frac{3}{4}$	2185.56250	102175.04688	$\frac{3}{4}$	2782.56250	146780.17188
$\frac{7}{8}$	1670.76563	68292.54492	$\frac{7}{8}$	2197.26563	102996.82617	$\frac{7}{8}$	2795.76563	147826.10742
41	1681.00000	68921.00000	47	2209.00000	103823.00000	53	2809.00000	148877.00000
$\frac{1}{8}$	1691.26563	69553.29883	$\frac{1}{8}$	2220.76563	104653.58008	$\frac{1}{8}$	2822.26563	149932.86133
$\frac{1}{4}$	1701.56250	70189.45313	$\frac{1}{4}$	2232.56250	105488.57813	$\frac{1}{4}$	2835.56250	150993.70313
$\frac{3}{8}$	1711.89063	70829.47461	$\frac{3}{8}$	2244.39063	106328.00586	$\frac{3}{8}$	2848.89063	152059.53711
$\frac{1}{2}$	1722.25000	71473.37500	$\frac{1}{2}$	2256.25000	107171.87500	$\frac{1}{2}$	2862.25000	153130.37500
$\frac{5}{8}$	1732.64063	72121.16602	$\frac{5}{8}$	2268.14063	108020.19727	$\frac{5}{8}$	2875.64063	154206.22852
$\frac{3}{4}$	1743.06250	72772.85938	$\frac{3}{4}$	2280.06250	108872.98438	$\frac{3}{4}$	2889.06250	155287.10938
$\frac{7}{8}$	1753.51563	73428.46680	$\frac{7}{8}$	2292.01563	109730.24805	$\frac{7}{8}$	2902.51563	156373.02930
42	1764.00000	74088.00000	48	2304.00000	110592.00000	54	2916.00000	157464.00000
$\frac{1}{8}$	1774.51563	74751.47070	$\frac{1}{8}$	2316.01563	111458.25195	$\frac{1}{8}$	2929.51563	158560.03320
$\frac{1}{4}$	1785.06250	75418.89063	$\frac{1}{4}$	2328.06250	112329.01563	$\frac{1}{4}$	2943.06250	159661.14063
$\frac{3}{8}$	1795.64063	76090.27148	$\frac{3}{8}$	2340.14063	113204.30273	$\frac{3}{8}$	2956.64063	160767.33398
$\frac{1}{2}$	1806.25000	76765.62500	$\frac{1}{2}$	2352.25000	114084.12500	$\frac{1}{2}$	2970.25000	161878.62500
$\frac{5}{8}$	1816.89063	77444.96289	$\frac{5}{8}$	2364.39063	114968.49414	$\frac{5}{8}$	2983.89063	162995.02539
$\frac{3}{4}$	1827.56250	78128.29688	$\frac{3}{4}$	2376.56250	115857.42188	$\frac{3}{4}$	2997.56250	164116.54688
$\frac{7}{8}$	1838.26563	78815.63867	$\frac{7}{8}$	2388.76563	116750.91992	$\frac{7}{8}$	3011.26563	165243.20117
43	1849.00000	79507.00000	49	2401.00000	117649.00000	55	3025.00000	166375.00000
$\frac{1}{8}$	1859.76563	80202.39258	$\frac{1}{8}$	2413.26563	118551.67383	$\frac{1}{8}$	3038.76563	167511.95508
$\frac{1}{4}$	1870.56250	80901.82813	$\frac{1}{4}$	2425.56250	119458.95313	$\frac{1}{4}$	3052.56250	168654.07813
$\frac{3}{8}$	1881.39063	81605.31836	$\frac{3}{8}$	2437.89063	120370.84961	$\frac{3}{8}$	3066.39063	169801.38086
$\frac{1}{2}$	1892.25000	82312.87500	$\frac{1}{2}$	2450.25000	121287.37500	$\frac{1}{2}$	3080.25000	170953.87500
$\frac{5}{8}$	1903.14063	83024.50977	$\frac{5}{8}$	2462.64063	122208.54102	$\frac{5}{8}$	3094.14063	172111.57227
$\frac{3}{4}$	1914.06250	83740.23438	$\frac{3}{4}$	2475.06250	123134.35938	$\frac{3}{4}$	3108.06250	173274.48438
$\frac{7}{8}$	1925.01563	84460.06055	$\frac{7}{8}$	2487.51563	124064.84180	$\frac{7}{8}$	3122.01563	174442.62305
44	1936.00000	85184.00000	50	2500.00000	125000.00000	56	3136.00000	175616.00000
$\frac{1}{8}$	1947.01563	85912.06445	$\frac{1}{8}$	2512.51563	125939.84570	$\frac{1}{8}$	3150.01563	176794.62695
$\frac{1}{4}$	1958.06250	86644.26563	$\frac{1}{4}$	2525.06250	126884.39063	$\frac{1}{4}$	3164.06250	177978.51563
$\frac{3}{8}$	1969.14063	87380.61523	$\frac{3}{8}$	2537.64063	127833.64648	$\frac{3}{8}$	3178.14063	179167.67773
$\frac{1}{2}$	1980.25000	88121.12500	$\frac{1}{2}$	2550.25000	128787.62500	$\frac{1}{2}$	3192.25000	180362.12500
$\frac{5}{8}$	1991.39063	88865.80664	$\frac{5}{8}$	2562.89063	129746.33789	$\frac{5}{8}$	3206.39063	181561.86914
$\frac{3}{4}$	2002.56250	89614.67188	$\frac{3}{4}$	2575.56250	130709.79688	$\frac{3}{4}$	3220.56250	182766.92188
$\frac{7}{8}$	2013.76563	90367.73242	$\frac{7}{8}$	2588.26563	131678.01367	$\frac{7}{8}$	3234.76563	183977.29492
45	2025.00000	91125.00000	51	2601.00000	132651.00000	57	3249.00000	185193.00000
$\frac{1}{8}$	2036.26563	91886.48633	$\frac{1}{8}$	2613.76563	133628.76758	$\frac{1}{8}$	3263.26563	186414.04883
$\frac{1}{4}$	2047.56250	92652.20313	$\frac{1}{4}$	2626.56250	134611.32813	$\frac{1}{4}$	3277.56250	187640.45313
$\frac{3}{8}$	2058.89063	93422.16211	$\frac{3}{8}$	2639.39063	135598.69336	$\frac{3}{8}$	3291.89063	188872.22461
$\frac{1}{2}$	2070.25000	94196.37500	$\frac{1}{2}$	2652.25000	136590.87500	$\frac{1}{2}$	3306.25000	190109.37500
$\frac{5}{8}$	2081.64063	94974.85352	$\frac{5}{8}$	2665.14063	137587.88477	$\frac{5}{8}$	3320.64063	191351.91602
$\frac{3}{4}$	2093.06250	95757.60938	$\frac{3}{4}$	2678.06250	138589.73438	$\frac{3}{4}$	3335.06250	192599.85938
$\frac{7}{8}$	2104.51563	96544.65430	$\frac{7}{8}$	2691.01563	139596.43555	$\frac{7}{8}$	3349.51563	193853.21680

Squares and Cubes of Numbers from 58 to 75 $\frac{7}{8}$

No.	Square	Cube	No.	Square	Cube	No.	Square	Cube
58	3364.00000	195112.00000	64	4096.00000	262144.00000	70	4900.00000	343000.00000
$\frac{1}{8}$	3378.51563	196376.22070	$\frac{1}{8}$	4112.01563	263683.00195	$\frac{1}{8}$	4917.51563	344840.78320
$\frac{1}{4}$	3393.06250	197645.89063	$\frac{1}{4}$	4128.06250	265228.01563	$\frac{1}{4}$	4935.06250	346688.14063
$\frac{3}{8}$	3407.64063	198921.02148	$\frac{3}{8}$	4144.14063	266779.05273	$\frac{3}{8}$	4952.64063	348542.08398
$\frac{1}{2}$	3422.25000	200201.62500	$\frac{1}{2}$	4160.25000	268336.12500	$\frac{1}{2}$	4970.25000	350402.62500
$\frac{5}{8}$	3436.89063	201487.71289	$\frac{5}{8}$	4176.39063	269899.24414	$\frac{5}{8}$	4987.89063	352269.77539
$\frac{3}{4}$	3451.56250	202779.29688	$\frac{3}{4}$	4192.56250	271468.42188	$\frac{3}{4}$	5005.56250	354143.54688
$\frac{7}{8}$	3466.26563	204076.38867	$\frac{7}{8}$	4208.76563	273043.66992	$\frac{7}{8}$	5023.26563	356023.95117
59	3481.00000	205379.00000	65	4225.00000	274625.00000	71	5041.00000	357911.00000
$\frac{1}{8}$	3495.76563	206687.14258	$\frac{1}{8}$	4241.26563	276212.42383	$\frac{1}{8}$	5058.76563	359804.70508
$\frac{1}{4}$	3510.56250	208000.82813	$\frac{1}{4}$	4257.56250	277805.95313	$\frac{1}{4}$	5076.56250	361705.07813
$\frac{3}{8}$	3525.39063	209320.06836	$\frac{3}{8}$	4273.89063	279405.59961	$\frac{3}{8}$	5094.39063	363612.13086
$\frac{1}{2}$	3540.25000	210644.87500	$\frac{1}{2}$	4290.25000	281011.37500	$\frac{1}{2}$	5112.25000	365525.87500
$\frac{5}{8}$	3555.14063	211975.25977	$\frac{5}{8}$	4306.64063	282623.29102	$\frac{5}{8}$	5130.14063	367446.32227
$\frac{3}{4}$	3570.06250	213311.23438	$\frac{3}{4}$	4323.06250	284241.35938	$\frac{3}{4}$	5148.06250	369373.48438
$\frac{7}{8}$	3585.01563	214652.81055	$\frac{7}{8}$	4339.51563	285865.59180	$\frac{7}{8}$	5166.01563	371307.37305
60	3600.00000	216000.00000	66	4356.00000	287496.00000	72	5184.00000	373248.00000
$\frac{1}{8}$	3615.01563	217352.81445	$\frac{1}{8}$	4372.51563	289132.59570	$\frac{1}{8}$	5202.01563	375195.37695
$\frac{1}{4}$	3630.06250	218711.26563	$\frac{1}{4}$	4389.06250	290775.39063	$\frac{1}{4}$	5220.06250	377149.51563
$\frac{3}{8}$	3645.14063	220075.36523	$\frac{3}{8}$	4405.64063	292424.39648	$\frac{3}{8}$	5238.14063	379110.42773
$\frac{1}{2}$	3660.25000	221445.12500	$\frac{1}{2}$	4422.25000	294079.62500	$\frac{1}{2}$	5256.25000	381078.12500
$\frac{5}{8}$	3675.39063	222820.55664	$\frac{5}{8}$	4438.89063	295741.08789	$\frac{5}{8}$	5274.39063	383052.61914
$\frac{3}{4}$	3690.56250	224201.67188	$\frac{3}{4}$	4455.56250	297408.79688	$\frac{3}{4}$	5292.56250	385033.92188
$\frac{7}{8}$	3705.76563	225588.48242	$\frac{7}{8}$	4472.26563	299082.76367	$\frac{7}{8}$	5310.76563	387022.04492
61	3721.00000	226981.00000	67	4489.00000	300763.00000	73	5329.00000	389017.00000
$\frac{1}{8}$	3736.26563	228379.23633	$\frac{1}{8}$	4505.76563	302449.51758	$\frac{1}{8}$	5347.26563	391018.79883
$\frac{1}{4}$	3751.56250	229783.20313	$\frac{1}{4}$	4522.56250	304142.32813	$\frac{1}{4}$	5365.56250	393027.45313
$\frac{3}{8}$	3766.89063	231192.91211	$\frac{3}{8}$	4539.39063	305841.44336	$\frac{3}{8}$	5383.89063	395042.97461
$\frac{1}{2}$	3782.25000	232608.37500	$\frac{1}{2}$	4556.25000	307546.87500	$\frac{1}{2}$	5402.25000	397065.37500
$\frac{5}{8}$	3797.64063	234029.60352	$\frac{5}{8}$	4573.14063	309258.63477	$\frac{5}{8}$	5420.64063	399094.66602
$\frac{3}{4}$	3813.06250	235456.60938	$\frac{3}{4}$	4590.06250	310976.73438	$\frac{3}{4}$	5439.06250	401130.85938
$\frac{7}{8}$	3828.51563	236889.40430	$\frac{7}{8}$	4607.01563	312701.18555	$\frac{7}{8}$	5457.51563	403173.96680
62	3844.00000	238328.00000	68	4624.00000	314432.00000	74	5476.00000	405224.00000
$\frac{1}{8}$	3859.51563	239772.40820	$\frac{1}{8}$	4641.01563	316169.18945	$\frac{1}{8}$	5494.51563	407280.97070
$\frac{1}{4}$	3875.06250	241222.64063	$\frac{1}{4}$	4658.06250	317912.76563	$\frac{1}{4}$	5513.06250	409344.89063
$\frac{3}{8}$	3890.64063	242678.70898	$\frac{3}{8}$	4675.14063	319662.74023	$\frac{3}{8}$	5531.64063	411415.77148
$\frac{1}{2}$	3906.25000	244140.62500	$\frac{1}{2}$	4692.25000	321419.12500	$\frac{1}{2}$	5550.25000	413493.62500
$\frac{5}{8}$	3921.89063	245608.40039	$\frac{5}{8}$	4709.39063	323181.93164	$\frac{5}{8}$	5568.89063	415578.46289
$\frac{3}{4}$	3937.56250	247082.04688	$\frac{3}{4}$	4726.56250	324951.17188	$\frac{3}{4}$	5587.56250	417670.29688
$\frac{7}{8}$	3953.26563	248561.57617	$\frac{7}{8}$	4743.76563	326726.85742	$\frac{7}{8}$	5606.26563	419769.13867
63	3969.00000	250047.00000	69	4761.00000	328509.00000	75	5625.00000	421875.00000
$\frac{1}{8}$	3984.76563	251538.33008	$\frac{1}{8}$	4778.26563	330297.61133	$\frac{1}{8}$	5643.76563	423987.89258
$\frac{1}{4}$	4000.56250	253035.57813	$\frac{1}{4}$	4795.56250	332092.70313	$\frac{1}{4}$	5662.56250	426107.82813
$\frac{3}{8}$	4016.39063	254538.75586	$\frac{3}{8}$	4812.89063	333894.28711	$\frac{3}{8}$	5681.39063	428234.81836
$\frac{1}{2}$	4032.25000	256047.87500	$\frac{1}{2}$	4830.25000	335702.37500	$\frac{1}{2}$	5700.25000	430368.87500
$\frac{5}{8}$	4048.14063	257562.94727	$\frac{5}{8}$	4847.64063	337516.97852	$\frac{5}{8}$	5719.14063	432510.00977
$\frac{3}{4}$	4064.06250	259083.98438	$\frac{3}{4}$	4865.06250	339338.10938	$\frac{3}{4}$	5738.06250	434658.23438
$\frac{7}{8}$	4080.01563	260610.99805	$\frac{7}{8}$	4882.51563	341165.77930	$\frac{7}{8}$	5757.01563	436813.56055

Squares and Cubes of Numbers from 76 to 93 $\frac{7}{8}$

No.	Square	Cube	No.	Square	Cube	No.	Square	Cube
76	5776.00000	438976.00000	82	6724.00000	551368.00000	88	7744.00000	681472.00000
$\frac{1}{8}$	5795.01563	441145.56445	$\frac{1}{8}$	6744.51563	553893.34570	$\frac{1}{8}$	7766.01563	684380.12695
$\frac{1}{4}$	5814.06250	443322.26563	$\frac{1}{4}$	6765.06250	556426.39063	$\frac{1}{4}$	7788.06250	687296.51563
$\frac{3}{8}$	5833.14063	445506.11523	$\frac{3}{8}$	6785.64063	558967.14648	$\frac{3}{8}$	7810.14063	690221.17773
$\frac{1}{2}$	5852.25000	447697.12500	$\frac{1}{2}$	6806.25000	561515.62500	$\frac{1}{2}$	7832.25000	693154.12500
$\frac{5}{8}$	5871.39063	449895.30664	$\frac{5}{8}$	6826.89063	564071.83789	$\frac{5}{8}$	7854.39063	696095.36914
$\frac{3}{4}$	5890.56250	452100.67188	$\frac{3}{4}$	6847.56250	566635.79688	$\frac{3}{4}$	7876.56250	699044.92188
$\frac{7}{8}$	5909.76563	454313.23242	$\frac{7}{8}$	6868.26563	569207.51367	$\frac{7}{8}$	7898.76563	702002.79492
77	5929.00000	456533.00000	83	6889.00000	571787.00000	89	7921.00000	704969.00000
$\frac{1}{8}$	5948.26563	458759.98633	$\frac{1}{8}$	6909.76563	574374.26758	$\frac{1}{8}$	7943.26563	707943.54883
$\frac{1}{4}$	5967.56250	460994.20313	$\frac{1}{4}$	6930.56250	576969.32813	$\frac{1}{4}$	7965.56250	710926.45313
$\frac{3}{8}$	5986.89063	463235.66211	$\frac{3}{8}$	6951.39063	579572.19336	$\frac{3}{8}$	7987.89063	713917.72461
$\frac{1}{2}$	6006.25000	465484.37500	$\frac{1}{2}$	6972.25000	582182.87500	$\frac{1}{2}$	8010.25000	716917.37500
$\frac{5}{8}$	6025.64063	467740.35352	$\frac{5}{8}$	6993.14063	584801.38477	$\frac{5}{8}$	8032.64063	719925.41602
$\frac{3}{4}$	6045.06250	470003.60938	$\frac{3}{4}$	7014.06250	587427.73438	$\frac{3}{4}$	8055.06250	722941.85938
$\frac{7}{8}$	6064.51563	472274.15430	$\frac{7}{8}$	7035.01563	590061.93555	$\frac{7}{8}$	8077.51563	725966.71680
78	6084.00000	474552.00000	84	7056.00000	592704.00000	90	8100.00000	729000.00000
$\frac{1}{8}$	6103.51563	476837.15820	$\frac{1}{8}$	7077.01563	595353.93945	$\frac{1}{8}$	8122.51563	732041.72070
$\frac{1}{4}$	6123.06250	479129.64063	$\frac{1}{4}$	7098.06250	598011.76563	$\frac{1}{4}$	8145.06250	735091.89063
$\frac{3}{8}$	6142.64063	481429.45898	$\frac{3}{8}$	7119.14063	600677.49023	$\frac{3}{8}$	8167.64063	738150.52148
$\frac{1}{2}$	6162.25000	483736.62500	$\frac{1}{2}$	7140.25000	603351.12500	$\frac{1}{2}$	8190.25000	741217.62500
$\frac{5}{8}$	6181.89063	486051.15039	$\frac{5}{8}$	7161.39063	606032.68164	$\frac{5}{8}$	8212.89063	744293.21289
$\frac{3}{4}$	6201.56250	488373.04688	$\frac{3}{4}$	7182.56250	608722.17188	$\frac{3}{4}$	8235.56250	747377.29688
$\frac{7}{8}$	6221.26563	490702.32617	$\frac{7}{8}$	7203.76563	611419.60742	$\frac{7}{8}$	8258.26563	750469.88867
79	6241.00000	493039.00000	85	7225.00000	614125.00000	91	8281.00000	753571.00000
$\frac{1}{8}$	6260.76563	495383.08008	$\frac{1}{8}$	7246.26563	616838.36133	$\frac{1}{8}$	8303.76563	756680.64258
$\frac{1}{4}$	6280.56250	497734.57813	$\frac{1}{4}$	7267.56250	619559.70313	$\frac{1}{4}$	8326.56250	759798.82813
$\frac{3}{8}$	6300.39063	500093.50586	$\frac{3}{8}$	7288.89063	622289.03711	$\frac{3}{8}$	8349.39063	762925.56836
$\frac{1}{2}$	6320.25000	502459.87500	$\frac{1}{2}$	7310.25000	625026.37500	$\frac{1}{2}$	8372.25000	766060.87500
$\frac{5}{8}$	6340.14063	504833.69727	$\frac{5}{8}$	7331.64063	627771.72852	$\frac{5}{8}$	8395.14063	769204.75977
$\frac{3}{4}$	6360.06250	507214.98438	$\frac{3}{4}$	7353.06250	630525.10938	$\frac{3}{4}$	8418.06250	772357.23438
$\frac{7}{8}$	6380.01563	509603.74805	$\frac{7}{8}$	7374.51563	633286.52930	$\frac{7}{8}$	8441.01563	775518.31055
80	6400.00000	512000.00000	86	7396.00000	636056.00000	92	8464.00000	778688.00000
$\frac{1}{8}$	6420.01563	514403.75195	$\frac{1}{8}$	7417.51563	638833.53320	$\frac{1}{8}$	8487.01563	781866.31445
$\frac{1}{4}$	6440.06250	516815.01563	$\frac{1}{4}$	7439.06250	641619.14063	$\frac{1}{4}$	8510.06250	785053.26563
$\frac{3}{8}$	6460.14063	519233.80273	$\frac{3}{8}$	7460.64063	644412.83398	$\frac{3}{8}$	8533.14063	788248.86523
$\frac{1}{2}$	6480.25000	521660.12500	$\frac{1}{2}$	7482.25000	647214.62500	$\frac{1}{2}$	8556.25000	791453.12500
$\frac{5}{8}$	6500.39063	524093.99414	$\frac{5}{8}$	7503.89063	650024.52539	$\frac{5}{8}$	8579.39063	794666.05664
$\frac{3}{4}$	6520.56250	526535.42188	$\frac{3}{4}$	7525.56250	652842.54688	$\frac{3}{4}$	8602.56250	797887.67188
$\frac{7}{8}$	6540.76563	528984.41992	$\frac{7}{8}$	7547.26563	655668.70117	$\frac{7}{8}$	8625.76563	801117.98242
81	6561.00000	531441.00000	87	7569.00000	658503.00000	93	8649.00000	804357.00000
$\frac{1}{8}$	6581.26563	533905.17383	$\frac{1}{8}$	7590.76563	661345.45508	$\frac{1}{8}$	8672.26563	807604.73633
$\frac{1}{4}$	6601.56250	536376.95313	$\frac{1}{4}$	7612.56250	664196.07813	$\frac{1}{4}$	8695.56250	810861.20313
$\frac{3}{8}$	6621.89063	538856.34961	$\frac{3}{8}$	7634.39063	667054.88086	$\frac{3}{8}$	8718.89063	814126.41211
$\frac{1}{2}$	6642.25000	541343.37500	$\frac{1}{2}$	7656.25000	669921.87500	$\frac{1}{2}$	8742.25000	817400.37500
$\frac{5}{8}$	6662.64063	543838.04102	$\frac{5}{8}$	7678.14063	672797.07227	$\frac{5}{8}$	8765.64063	820683.10352
$\frac{3}{4}$	6683.06250	546340.35938	$\frac{3}{4}$	7700.06250	675680.48438	$\frac{3}{4}$	8789.06250	823974.60938
$\frac{7}{8}$	6703.51563	548850.34180	$\frac{7}{8}$	7722.01563	678572.12305	$\frac{7}{8}$	8812.51563	827274.90430

Squares and Cubes of Numbers from 94 to 100

No.	Square	Cube	No.	Square	Cube	No.	Square	Cube
94	8836.00000	830584.00000	96	9216.00000	884736.00000	98	9604.00000	941192.00000
$\frac{1}{8}$	8859.51563	833901.90820	$\frac{1}{8}$	9240.01563	888196.50195	$\frac{1}{8}$	9628.51563	944798.09570
$\frac{1}{4}$	8883.06250	837228.64063	$\frac{1}{4}$	9264.06250	891666.01563	$\frac{1}{4}$	9653.06250	948413.39063
$\frac{3}{8}$	8906.64063	840564.20898	$\frac{3}{8}$	9288.14063	895144.55273	$\frac{3}{8}$	9677.64063	952037.89648
$\frac{1}{2}$	8930.25000	843908.62500	$\frac{1}{2}$	9312.25000	898632.12500	$\frac{1}{2}$	9702.25000	955671.62500
$\frac{5}{8}$	8953.89063	847261.90039	$\frac{5}{8}$	9336.39063	902128.74414	$\frac{5}{8}$	9726.89063	959314.58789
$\frac{3}{4}$	8977.56250	850624.04688	$\frac{3}{4}$	9360.56250	905634.42188	$\frac{3}{4}$	9751.56250	962966.79688
$\frac{7}{8}$	9001.26563	853995.07617	$\frac{7}{8}$	9384.76563	909149.16992	$\frac{7}{8}$	9776.26563	966628.26367
95	9025.00000	857375.00000	97	9409.00000	912673.00000	99	9801.00000	970299.00000
$\frac{1}{8}$	9048.76563	860763.83008	$\frac{1}{8}$	9433.26563	916205.92383	$\frac{1}{8}$	9825.76563	973979.01758
$\frac{1}{4}$	9072.56250	864161.57813	$\frac{1}{4}$	9457.56250	919747.95313	$\frac{1}{4}$	9850.56250	977668.32813
$\frac{3}{8}$	9096.39063	867568.25586	$\frac{3}{8}$	9481.89063	923299.09961	$\frac{3}{8}$	9875.39063	981366.94336
$\frac{1}{2}$	9120.25000	870983.87500	$\frac{1}{2}$	9506.25000	926859.37500	$\frac{1}{2}$	9900.25000	985074.87500
$\frac{5}{8}$	9144.14063	874408.44727	$\frac{5}{8}$	9530.64063	930428.79102	$\frac{5}{8}$	9925.14063	988792.13477
$\frac{3}{4}$	9168.06250	877841.98438	$\frac{3}{4}$	9555.06250	934007.35938	$\frac{3}{4}$	9950.06250	992518.73438
$\frac{7}{8}$	9192.01563	881284.49805	$\frac{7}{8}$	9579.51563	937595.09180	$\frac{7}{8}$	9975.01563	996254.68555
						100	10,000.00	1,000,000

Fractions of Pi (π)

Table of Fractions of $\pi = 3.14159265$

a	π/a	a	π/a	a	π/a	a	π/a	a	π/a
1	3.14159	21	0.14960	41	0.07662	61	0.05150	81	0.03879
2	1.57080	22	0.14280	42	0.07480	62	0.05067	82	0.03831
3	1.04720	23	0.13659	43	0.07306	63	0.04987	83	0.03785
4	0.78540	24	0.13090	44	0.07140	64	0.04909	84	0.03740
5	0.62832	25	0.12566	45	0.06981	65	0.04833	85	0.03696
6	0.52360	26	0.12083	46	0.06830	66	0.04760	86	0.03653
7	0.44880	27	0.11636	47	0.06684	67	0.04689	87	0.03611
8	0.39270	28	0.11220	48	0.06545	68	0.04620	88	0.03570
9	0.34907	29	0.10833	49	0.06411	69	0.04553	89	0.03530
10	0.31416	30	0.10472	50	0.06283	70	0.04488	90	0.03491
11	0.28560	31	0.10134	51	0.06160	71	0.04425	91	0.03452
12	0.26180	32	0.09817	52	0.06042	72	0.04363	92	0.03415
13	0.24166	33	0.09520	53	0.05928	73	0.04304	93	0.03378
14	0.22440	34	0.09240	54	0.05818	74	0.04245	94	0.03342
15	0.20944	35	0.08976	55	0.05712	75	0.04189	95	0.03307
16	0.19635	36	0.08727	56	0.05610	76	0.04134	96	0.03272
17	0.18480	37	0.08491	57	0.05512	77	0.04080	97	0.03239
18	0.17453	38	0.08267	58	0.05417	78	0.04028	98	0.03206
19	0.16535	39	0.08055	59	0.05325	79	0.03977	99	0.03173
20	0.15708	40	0.07854	60	0.05236	80	0.03927	100	0.03142

Decimal Equivalents, Squares, Cubes, Square Roots, Cube Roots, and Logarithms of Fractions from $\frac{1}{64}$ to 1, by 64ths

Fraction	Decimal	Log	Square	Log	Cube	Log	Sq. Root	Log	Cube Root	Log
$\frac{1}{64}$	0.015625	-1.80618	0.00024	-3.61236	0.00000	-5.41854	0.12500	-0.90309	0.25000	-0.60206
$\frac{1}{32}$	0.031250	-1.50515	0.00098	-3.01030	0.00003	-4.51545	0.17678	-0.75257	0.31498	-0.50172
$\frac{3}{64}$	0.046875	-1.32906	0.00220	-2.65812	0.00010	-3.98718	0.21651	-0.66453	0.36056	-0.44302
$\frac{1}{16}$	0.062500	-1.20412	0.00391	-2.40824	0.00024	-3.61236	0.25000	-0.60206	0.39685	-0.40137
$\frac{5}{64}$	0.078125	-1.10721	0.00610	-2.21442	0.00048	-3.32163	0.27951	-0.55361	0.42749	-0.36907
$\frac{3}{32}$	0.093750	-1.02803	0.00879	-2.05606	0.00082	-3.08409	0.30619	-0.51402	0.45428	-0.34268
$\frac{7}{64}$	0.109375	-0.96108	0.01196	-1.92216	0.00131	-2.88325	0.33072	-0.48054	0.47823	-0.32036
$\frac{1}{8}$	0.125000	-0.90309	0.01563	-1.80618	0.00195	-2.70927	0.35355	-0.45155	0.50000	-0.30103
$\frac{9}{64}$	0.140625	-0.85194	0.01978	-1.70388	0.00278	-2.55581	0.37500	-0.42597	0.52002	-0.28398
$\frac{5}{32}$	0.156250	-0.80618	0.02441	-1.61236	0.00381	-2.41854	0.39529	-0.40309	0.53861	-0.26873
$\frac{11}{64}$	0.171875	-0.76479	0.02954	-1.52958	0.00508	-2.29436	0.41458	-0.38239	0.55600	-0.25493
$\frac{3}{16}$	0.187500	-0.72700	0.03516	-1.45400	0.00659	-2.18100	0.43301	-0.36350	0.57236	-0.24233
$\frac{13}{64}$	0.203125	-0.69224	0.04126	-1.38447	0.00838	-2.07671	0.45069	-0.34612	0.58783	-0.23075
$\frac{7}{32}$	0.218750	-0.66005	0.04785	-1.32010	0.01047	-1.98016	0.46771	-0.33003	0.60254	-0.22002
$\frac{15}{64}$	0.234375	-0.63009	0.05493	-1.26018	0.01287	-1.89027	0.48412	-0.31504	0.61655	-0.21003
$\frac{1}{4}$	0.250000	-0.60206	0.06250	-1.20412	0.01563	-1.80618	0.50000	-0.30103	0.62996	-0.20069
$\frac{17}{64}$	0.265625	-0.57573	0.07056	-1.15146	0.01874	-1.72719	0.51539	-0.28787	0.64282	-0.19191
$\frac{9}{32}$	0.281250	-0.55091	0.07910	-1.10182	0.02225	-1.65272	0.53033	-0.27545	0.65519	-0.18364
$\frac{19}{64}$	0.296875	-0.52743	0.08813	-1.05485	0.02617	-1.58228	0.54486	-0.26371	0.66710	-0.17581
$\frac{5}{16}$	0.312500	-0.50515	0.09766	-1.01030	0.03052	-1.51545	0.55902	-0.25258	0.67860	-0.16838
$\frac{21}{64}$	0.328125	-0.48396	0.10767	-0.96792	0.03533	-1.45188	0.57282	-0.24198	0.68973	-0.16132
$\frac{11}{32}$	0.343750	-0.46376	0.11816	-0.92752	0.04062	-1.39127	0.58630	-0.23188	0.70051	-0.15459
$\frac{23}{64}$	0.359375	-0.44445	0.12915	-0.88890	0.04641	-1.33336	0.59948	-0.22223	0.71097	-0.14815
$\frac{3}{8}$	0.375000	-0.42597	0.14063	-0.85194	0.05273	-1.27791	0.61237	-0.21299	0.72113	-0.14199
$\frac{25}{64}$	0.390625	-0.40824	0.15259	-0.81648	0.05960	-1.22472	0.62500	-0.20412	0.73100	-0.13608
$\frac{13}{32}$	0.406250	-0.39121	0.16504	-0.78241	0.06705	-1.17362	0.63738	-0.19560	0.74062	-0.13040
$\frac{27}{64}$	0.421875	-0.37482	0.17798	-0.74963	0.07508	-1.12445	0.64952	-0.18741	0.75000	-0.12494
$\frac{7}{16}$	0.437500	-0.35902	0.19141	-0.71804	0.08374	-1.07707	0.66144	-0.17951	0.75915	-0.11967
$\frac{29}{64}$	0.453125	-0.34378	0.20532	-0.68756	0.09304	-1.03135	0.67315	-0.17189	0.76808	-0.11459
$\frac{15}{32}$	0.468750	-0.32906	0.21973	-0.65812	0.10300	-0.98718	0.68465	-0.16453	0.77681	-0.10969
$\frac{31}{64}$	0.484375	-0.31482	0.23462	-0.62964	0.11364	-0.94446	0.69597	-0.15741	0.78535	-0.10494
$\frac{1}{2}$	0.500000	-0.30103	0.25000	-0.60206	0.12500	-0.90309	0.70711	-0.15052	0.79370	-0.10034
$\frac{33}{64}$	0.515625	-0.28767	0.26587	-0.57533	0.13709	-0.86300	0.71807	-0.14383	0.80188	-0.09589
$\frac{17}{32}$	0.531250	-0.27470	0.28223	-0.54940	0.14993	-0.82410	0.72887	-0.13735	0.80990	-0.09157
$\frac{35}{64}$	0.546875	-0.26211	0.29907	-0.52422	0.16356	-0.78634	0.73951	-0.13106	0.81777	-0.08737
$\frac{9}{16}$	0.562500	-0.24988	0.31641	-0.49976	0.17798	-0.74963	0.75000	-0.12494	0.82548	-0.08329
$\frac{37}{64}$	0.578125	-0.23798	0.33423	-0.47596	0.19323	-0.71394	0.76035	-0.11899	0.83306	-0.07933
$\frac{19}{32}$	0.593750	-0.22640	0.35254	-0.45279	0.20932	-0.67919	0.77055	-0.11320	0.84049	-0.07547
$\frac{39}{64}$	0.609375	-0.21512	0.37134	-0.43023	0.22628	-0.64535	0.78063	-0.10756	0.84780	-0.07171
$\frac{5}{8}$	0.625000	-0.20412	0.39063	-0.40824	0.24414	-0.61236	0.79057	-0.10206	0.85499	-0.06804
$\frac{41}{64}$	0.640625	-0.19340	0.41040	-0.38679	0.26291	-0.58019	0.80039	-0.09670	0.86205	-0.06447
$\frac{21}{32}$	0.656250	-0.18293	0.43066	-0.36586	0.28262	-0.54879	0.81009	-0.09147	0.86901	-0.06098
$\frac{43}{64}$	0.671875	-0.17271	0.45142	-0.34542	0.30330	-0.51814	0.81968	-0.08636	0.87585	-0.05757
$\frac{11}{16}$	0.687500	-0.16273	0.47266	-0.32546	0.32495	-0.48818	0.82916	-0.08136	0.88259	-0.05424
$\frac{45}{64}$	0.703125	-0.15297	0.49438	-0.30594	0.34761	-0.45890	0.83853	-0.07648	0.88922	-0.05099
$\frac{23}{32}$	0.718750	-0.14342	0.51660	-0.28684	0.37131	-0.43027	0.84779	-0.07171	0.89576	-0.04781
$\frac{47}{64}$	0.734375	-0.13408	0.53931	-0.26816	0.39605	-0.40225	0.85696	-0.06704	0.90221	-0.04469
$\frac{3}{4}$	0.750000	-0.12494	0.56250	-0.24988	0.42188	-0.37482	0.86603	-0.06247	0.90856	-0.04165
$\frac{49}{64}$	0.765625	-0.11598	0.58618	-0.23197	0.44880	-0.34795	0.87500	-0.05799	0.91483	-0.03866
$\frac{25}{32}$	0.781250	-0.10721	0.61035	-0.21442	0.47684	-0.32163	0.88388	-0.05361	0.92101	-0.03574
$\frac{51}{64}$	0.796875	-0.09861	0.63501	-0.19722	0.50602	-0.29583	0.89268	-0.04931	0.92711	-0.03287
$\frac{13}{16}$	0.812500	-0.09018	0.66016	-0.18035	0.53638	-0.27053	0.90139	-0.04509	0.93313	-0.03006
$\frac{53}{64}$	0.828125	-0.08190	0.68579	-0.16381	0.56792	-0.24571	0.91001	-0.04095	0.93907	-0.02730
$\frac{27}{32}$	0.843750	-0.07379	0.71191	-0.14757	0.60068	-0.22136	0.91856	-0.03689	0.94494	-0.02460
$\frac{55}{64}$	0.859375	-0.06582	0.73853	-0.13164	0.63467	-0.19745	0.92703	-0.03291	0.95074	-0.02194
$\frac{7}{8}$	0.875000	-0.05799	0.76563	-0.11598	0.66992	-0.17398	0.93541	-0.02900	0.95647	-0.01933
$\frac{57}{64}$	0.890625	-0.05031	0.79321	-0.10061	0.70646	-0.15092	0.94373	-0.02515	0.96213	-0.01677
$\frac{29}{32}$	0.906250	-0.04275	0.82129	-0.08550	0.74429	-0.12826	0.95197	-0.02138	0.96772	-0.01425
$\frac{59}{64}$	0.921875	-0.03533	0.84985	-0.07066	0.78346	-0.10598	0.96014	-0.01766	0.97325	-0.01178
$\frac{15}{16}$	0.937500	-0.02803	0.87891	-0.05606	0.82397	-0.08409	0.96825	-0.01401	0.97872	-0.00934
$\frac{61}{64}$	0.953125	-0.02085	0.90845	-0.04170	0.86586	-0.06255	0.97628	-0.01043	0.98412	-0.00695
$\frac{31}{32}$	0.968750	-0.01379	0.93848	-0.02758	0.90915	-0.04137	0.98425	-0.00689	0.98947	-0.00460
$\frac{63}{64}$	0.984375	-0.00684	0.96899	-0.01368	0.95385	-0.02052	0.99216	-0.00342	0.99476	-0.00228
1	1.000000	0.00000	1.00000	0.00000	1.00000	0.00000	1.00000	0.00000	1.00000	0.00000

Powers, Roots, and Reciprocals**Powers, Roots, and Reciprocals From 1 to 50**

No.	Square	Cube	Sq. Root	Cube Root	Reciprocal	No.
1	1	1	1.00000	1.00000	1.0000000	1
2	4	8	1.41421	1.25992	0.5000000	2
3	9	27	1.73205	1.44225	0.3333333	3
4	16	64	2.00000	1.58740	0.2500000	4
5	25	125	2.23607	1.70998	0.2000000	5
6	36	216	2.44949	1.81712	0.1666667	6
7	49	343	2.64575	1.91293	0.1428571	7
8	64	512	2.82843	2.00000	0.1250000	8
9	81	729	3.00000	2.08008	0.1111111	9
10	100	1000	3.16228	2.15443	0.1000000	10
11	121	1331	3.31662	2.22398	0.0909091	11
12	144	1728	3.46410	2.28943	0.0833333	12
13	169	2197	3.60555	2.35133	0.0769231	13
14	196	2744	3.74166	2.41014	0.0714286	14
15	225	3375	3.87298	2.46621	0.0666667	15
16	256	4096	4.00000	2.51984	0.0625000	16
17	289	4913	4.12311	2.57128	0.0588235	17
18	324	5832	4.24264	2.62074	0.0555556	18
19	361	6859	4.35890	2.66840	0.0526316	19
20	400	8000	4.47214	2.71442	0.0500000	20
21	441	9261	4.58258	2.75892	0.0476190	21
22	484	10648	4.69042	2.80204	0.0454545	22
23	529	12167	4.79583	2.84387	0.0434783	23
24	576	13824	4.89898	2.88450	0.0416667	24
25	625	15625	5.00000	2.92402	0.0400000	25
26	676	17576	5.09902	2.96250	0.0384615	26
27	729	19683	5.19615	3.00000	0.0370370	27
28	784	21952	5.29150	3.03659	0.0357143	28
29	841	24389	5.38516	3.07232	0.0344828	29
30	900	27000	5.47723	3.10723	0.0333333	30
31	961	29791	5.56776	3.14138	0.0322581	31
32	1024	32768	5.65685	3.17480	0.0312500	32
33	1089	35937	5.74456	3.20753	0.0303030	33
34	1156	39304	5.83095	3.23961	0.0294118	34
35	1225	42875	5.91608	3.27107	0.0285714	35
36	1296	46656	6.00000	3.30193	0.0277778	36
37	1369	50653	6.08276	3.33222	0.0270270	37
38	1444	54872	6.16441	3.36198	0.0263158	38
39	1521	59319	6.24500	3.39121	0.0256410	39
40	1600	64000	6.32456	3.41995	0.0250000	40
41	1681	68921	6.40312	3.44822	0.0243902	41
42	1764	74088	6.48074	3.47603	0.0238095	42
43	1849	79507	6.55744	3.50340	0.0232558	43
44	1936	85184	6.63325	3.53035	0.0227273	44
45	2025	91125	6.70820	3.55689	0.0222222	45
46	2116	97336	6.78233	3.58305	0.0217391	46
47	2209	103823	6.85565	3.60883	0.0212766	47
48	2304	110592	6.92820	3.63424	0.0208333	48
49	2401	117649	7.00000	3.65931	0.0204082	49
50	2500	125000	7.07107	3.68403	0.0200000	50

Powers, Roots, and Reciprocals From 51 to 100

No.	Square	Cube	Sq. Root	Cube Root	Reciprocal	No.
51	2601	132651	7.14143	3.70843	0.0196078	51
52	2704	140608	7.21110	3.73251	0.0192308	52
53	2809	148877	7.28011	3.75629	0.0188679	53
54	2916	157464	7.34847	3.77976	0.0185185	54
55	3025	166375	7.41620	3.80295	0.0181818	55
56	3136	175616	7.48331	3.82586	0.0178571	56
57	3249	185193	7.54983	3.84850	0.0175439	57
58	3364	195112	7.61577	3.87088	0.0172414	58
59	3481	205379	7.68115	3.89300	0.0169492	59
60	3600	216000	7.74597	3.91487	0.0166667	60
61	3721	226981	7.81025	3.93650	0.0163934	61
62	3844	238328	7.87401	3.95789	0.0161290	62
63	3969	250047	7.93725	3.97906	0.0158730	63
64	4096	262144	8.00000	4.00000	0.0156250	64
65	4225	274625	8.06226	4.02073	0.0153846	65
66	4356	287496	8.12404	4.04124	0.0151515	66
67	4489	300763	8.18535	4.06155	0.0149254	67
68	4624	314432	8.24621	4.08166	0.0147059	68
69	4761	328509	8.30662	4.10157	0.0144928	69
70	4900	343000	8.36660	4.12129	0.0142857	70
71	5041	357911	8.42615	4.14082	0.0140845	71
72	5184	373248	8.48528	4.16017	0.0138889	72
73	5329	389017	8.54400	4.17934	0.0136986	73
74	5476	405224	8.60233	4.19834	0.0135135	74
75	5625	421875	8.66025	4.21716	0.0133333	75
76	5776	438976	8.71780	4.23582	0.0131579	76
77	5929	456533	8.77496	4.25432	0.0129870	77
78	6084	474552	8.83176	4.27266	0.0128205	78
79	6241	493039	8.88819	4.29084	0.0126582	79
80	6400	512000	8.94427	4.30887	0.0125000	80
81	6561	531441	9.00000	4.32675	0.0123457	81
82	6724	551368	9.05539	4.34448	0.0121951	82
83	6889	571787	9.11043	4.36207	0.0120482	83
84	7056	592704	9.16515	4.37952	0.0119048	84
85	7225	614125	9.21954	4.39683	0.0117647	85
86	7396	636056	9.27362	4.41400	0.0116279	86
87	7569	658503	9.32738	4.43105	0.0114943	87
88	7744	681472	9.38083	4.44796	0.0113636	88
89	7921	704969	9.43398	4.46475	0.0112360	89
90	8100	729000	9.48683	4.48140	0.0111111	90
91	8281	753571	9.53939	4.49794	0.0109890	91
92	8464	778688	9.59166	4.51436	0.0108696	92
93	8649	804357	9.64365	4.53065	0.0107527	93
94	8836	830584	9.69536	4.54684	0.0106383	94
95	9025	857375	9.74679	4.56290	0.0105263	95
96	9216	884736	9.79796	4.57886	0.0104167	96
97	9409	912673	9.84886	4.59470	0.0103093	97
98	9604	941192	9.89949	4.61044	0.0102041	98
99	9801	970299	9.94987	4.62607	0.0101010	99
100	10000	1000000	10.00000	4.64159	0.0100000	100

Powers, Roots, and Reciprocals From 101 to 150

No.	Square	Cube	Sq. Root	Cube Root	Reciprocal	No.
101	10201	1030301	10.04988	4.65701	0.0099010	101
102	10404	1061208	10.09950	4.67233	0.0098039	102
103	10609	1092727	10.14889	4.68755	0.0097087	103
104	10816	1124864	10.19804	4.70267	0.0096154	104
105	11025	1157625	10.24695	4.71769	0.0095238	105
106	11236	1191016	10.29563	4.73262	0.0094340	106
107	11449	1225043	10.34408	4.74746	0.0093458	107
108	11664	1259712	10.39230	4.76220	0.0092593	108
109	11881	1295029	10.44031	4.77686	0.0091743	109
110	12100	1331000	10.48809	4.79142	0.0090909	110
111	12321	1367631	10.53565	4.80590	0.0090090	111
112	12544	1404928	10.58301	4.82028	0.0089286	112
113	12769	1442897	10.63015	4.83459	0.0088496	113
114	12996	1481544	10.67708	4.84881	0.0087719	114
115	13225	1520875	10.72381	4.86294	0.0086957	115
116	13456	1560896	10.77033	4.87700	0.0086207	116
117	13689	1601613	10.81665	4.89097	0.0085470	117
118	13924	1643032	10.86278	4.90487	0.0084746	118
119	14161	1685159	10.90871	4.91868	0.0084034	119
120	14400	1728000	10.95445	4.93242	0.0083333	120
121	14641	1771561	11.00000	4.94609	0.0082645	121
122	14884	1815848	11.04536	4.95968	0.0081967	122
123	15129	1860867	11.09054	4.97319	0.0081301	123
124	15376	1906624	11.13553	4.98663	0.0080645	124
125	15625	1953125	11.18034	5.00000	0.0080000	125
126	15876	2000376	11.22497	5.01330	0.0079365	126
127	16129	2048383	11.26943	5.02653	0.0078740	127
128	16384	2097152	11.31371	5.03968	0.0078125	128
129	16641	2146689	11.35782	5.05277	0.0077519	129
130	16900	2197000	11.40175	5.06580	0.0076923	130
131	17161	2248091	11.44552	5.07875	0.0076336	131
132	17424	2299968	11.48913	5.09164	0.0075758	132
133	17689	2352637	11.53256	5.10447	0.0075188	133
134	17956	2406104	11.57584	5.11723	0.0074627	134
135	18225	2460375	11.61895	5.12993	0.0074074	135
136	18496	2515456	11.66190	5.14256	0.0073529	136
137	18769	2571353	11.70470	5.15514	0.0072993	137
138	19044	2628072	11.74734	5.16765	0.0072464	138
139	19321	2685619	11.78983	5.18010	0.0071942	139
140	19600	2744000	11.83216	5.19249	0.0071429	140
141	19881	2803221	11.87434	5.20483	0.0070922	141
142	20164	2863288	11.91638	5.21710	0.0070423	142
143	20449	2924207	11.95826	5.22932	0.0069930	143
144	20736	2985984	12.00000	5.24148	0.0069444	144
145	21025	3048625	12.04159	5.25359	0.0068966	145
146	21316	3112136	12.08305	5.26564	0.0068493	146
147	21609	3176523	12.12436	5.27763	0.0068027	147
148	21904	3241792	12.16553	5.28957	0.0067568	148
149	22201	3307949	12.20656	5.30146	0.0067114	149
150	22500	3375000	12.24745	5.31329	0.0066667	150

Powers, Roots, and Reciprocals From 151 to 200

No.	Square	Cube	Sq. Root	Cube Root	Reciprocal	No.
151	22801	3442951	12.28821	5.32507	0.0066225	151
152	23104	3511808	12.32883	5.33680	0.0065789	152
153	23409	3581577	12.36932	5.34848	0.0065359	153
154	23716	3652264	12.40967	5.36011	0.0064935	154
155	24025	3723875	12.44990	5.37169	0.0064516	155
156	24336	3796416	12.49000	5.38321	0.0064103	156
157	24649	3869893	12.52996	5.39469	0.0063694	157
158	24964	3944312	12.56981	5.40612	0.0063291	158
159	25281	4019679	12.60952	5.41750	0.0062893	159
160	25600	4096000	12.64911	5.42884	0.0062500	160
161	25921	4173281	12.68858	5.44012	0.0062112	161
162	26244	4251528	12.72792	5.45136	0.0061728	162
163	26569	4330747	12.76715	5.46256	0.0061350	163
164	26896	4410944	12.80625	5.47370	0.0060976	164
165	27225	4492125	12.84523	5.48481	0.0060606	165
166	27556	4574296	12.88410	5.49586	0.0060241	166
167	27889	4657463	12.92285	5.50688	0.0059880	167
168	28224	4741632	12.96148	5.51785	0.0059524	168
169	28561	4826809	13.00000	5.52877	0.0059172	169
170	28900	4913000	13.03840	5.53966	0.0058824	170
171	29241	5000211	13.07670	5.55050	0.0058480	171
172	29584	5088448	13.11488	5.56130	0.0058140	172
173	29929	5177717	13.15295	5.57205	0.0057803	173
174	30276	5268024	13.19091	5.58277	0.0057471	174
175	30625	5359375	13.22876	5.59344	0.0057143	175
176	30976	5451776	13.26650	5.60408	0.0056818	176
177	31329	5545233	13.30413	5.61467	0.0056497	177
178	31684	5639752	13.34166	5.62523	0.0056180	178
179	32041	5735339	13.37909	5.63574	0.0055866	179
180	32400	5832000	13.41641	5.64622	0.0055556	180
181	32761	5929741	13.45362	5.65665	0.0055249	181
182	33124	6028568	13.49074	5.66705	0.0054945	182
183	33489	6128487	13.52775	5.67741	0.0054645	183
184	33856	6229504	13.56466	5.68773	0.0054348	184
185	34225	6331625	13.60147	5.69802	0.0054054	185
186	34596	6434856	13.63818	5.70827	0.0053763	186
187	34969	6539203	13.67479	5.71848	0.0053476	187
188	35344	6644672	13.71131	5.72865	0.0053191	188
189	35721	6751269	13.74773	5.73879	0.0052910	189
190	36100	6859000	13.78405	5.74890	0.0052632	190
191	36481	6967871	13.82027	5.75897	0.0052356	191
192	36864	7077888	13.85641	5.76900	0.0052083	192
193	37249	7189057	13.89244	5.77900	0.0051813	193
194	37636	7301384	13.92839	5.78896	0.0051546	194
195	38025	7414875	13.96424	5.79889	0.0051282	195
196	38416	7529536	14.00000	5.80879	0.0051020	196
197	38809	7645373	14.03567	5.81865	0.0050761	197
198	39204	7762392	14.07125	5.82848	0.0050505	198
199	39601	7880599	14.10674	5.83827	0.0050251	199
200	40000	8000000	14.14214	5.84804	0.0050000	200

Powers, Roots, and Reciprocals From 201 to 250

No.	Square	Cube	Sq. Root	Cube Root	Reciprocal	No.
201	40401	8120601	14.17745	5.85777	0.0049751	201
202	40804	8242408	14.21267	5.86746	0.0049505	202
203	41209	8365427	14.24781	5.87713	0.0049261	203
204	41616	8489664	14.28286	5.88677	0.0049020	204
205	42025	8615125	14.31782	5.89637	0.0048780	205
206	42436	8741816	14.35270	5.90594	0.0048544	206
207	42849	8869743	14.38749	5.91548	0.0048309	207
208	43264	8998912	14.42221	5.92499	0.0048077	208
209	43681	9129329	14.45683	5.93447	0.0047847	209
210	44100	9261000	14.49138	5.94392	0.0047619	210
211	44521	9393931	14.52584	5.95334	0.0047393	211
212	44944	9528128	14.56022	5.96273	0.0047170	212
213	45369	9663597	14.59452	5.97209	0.0046948	213
214	45796	9800344	14.62874	5.98142	0.0046729	214
215	46225	9938375	14.66288	5.99073	0.0046512	215
216	46656	10077696	14.69694	6.00000	0.0046296	216
217	47089	10218313	14.73092	6.00925	0.0046083	217
218	47524	10360232	14.76482	6.01846	0.0045872	218
219	47961	10503459	14.79865	6.02765	0.0045662	219
220	48400	10648000	14.83240	6.03681	0.0045455	220
221	48841	10793861	14.86607	6.04594	0.0045249	221
222	49284	10941048	14.89966	6.05505	0.0045045	222
223	49729	11089567	14.93318	6.06413	0.0044843	223
224	50176	11239424	14.96663	6.07318	0.0044643	224
225	50625	11390625	15.00000	6.08220	0.0044444	225
226	51076	11543176	15.03330	6.09120	0.0044248	226
227	51529	11697083	15.06652	6.10017	0.0044053	227
228	51984	11852352	15.09967	6.10911	0.0043860	228
229	52441	12008989	15.13275	6.11803	0.0043668	229
230	52900	12167000	15.16575	6.12693	0.0043478	230
231	53361	12326391	15.19868	6.13579	0.0043290	231
232	53824	12487168	15.23155	6.14463	0.0043103	232
233	54289	12649337	15.26434	6.15345	0.0042918	233
234	54756	12812904	15.29706	6.16224	0.0042735	234
235	55225	12977875	15.32971	6.17101	0.0042553	235
236	55696	13144256	15.36229	6.17975	0.0042373	236
237	56169	13312053	15.39480	6.18846	0.0042194	237
238	56644	13481272	15.42725	6.19715	0.0042017	238
239	57121	13651919	15.45962	6.20582	0.0041841	239
240	57600	13824000	15.49193	6.21447	0.0041667	240
241	58081	13997521	15.52417	6.22308	0.0041494	241
242	58564	14172488	15.55635	6.23168	0.0041322	242
243	59049	14348907	15.58846	6.24025	0.0041152	243
244	59536	14526784	15.62050	6.24880	0.0040984	244
245	60025	14706125	15.65248	6.25732	0.0040816	245
246	60516	14886936	15.68439	6.26583	0.0040650	246
247	61009	15069223	15.71623	6.27431	0.0040486	247
248	61504	15252992	15.74802	6.28276	0.0040323	248
249	62001	15438249	15.77973	6.29119	0.0040161	249
250	62500	15625000	15.81139	6.29961	0.0040000	250

Powers, Roots, and Reciprocals From 251 to 300

No.	Square	Cube	Sq. Root	Cube Root	Reciprocal	No.
251	63001	15813251	15.84298	6.30799	0.0039841	251
252	63504	16003008	15.87451	6.31636	0.0039683	252
253	64009	16194277	15.90597	6.32470	0.0039526	253
254	64516	16387064	15.93738	6.33303	0.0039370	254
255	65025	16581375	15.96872	6.34133	0.0039216	255
256	65536	16777216	16.00000	6.34960	0.0039063	256
257	66049	16974593	16.03122	6.35786	0.0038911	257
258	66564	17173512	16.06238	6.36610	0.0038760	258
259	67081	17373979	16.09348	6.37431	0.0038610	259
260	67600	17576000	16.12452	6.38250	0.0038462	260
261	68121	17779581	16.15549	6.39068	0.0038314	261
262	68644	17984728	16.18641	6.39883	0.0038168	262
263	69169	18191447	16.21727	6.40696	0.0038023	263
264	69696	18399744	16.24808	6.41507	0.0037879	264
265	70225	18609625	16.27882	6.42316	0.0037736	265
266	70756	18821096	16.30951	6.43123	0.0037594	266
267	71289	19034163	16.34013	6.43928	0.0037453	267
268	71824	19248832	16.37071	6.44731	0.0037313	268
269	72361	19465109	16.40122	6.45531	0.0037175	269
270	72900	19683000	16.43168	6.46330	0.0037037	270
271	73441	19902511	16.46208	6.47127	0.0036900	271
272	73984	20123648	16.49242	6.47922	0.0036765	272
273	74529	20346417	16.52271	6.48715	0.0036630	273
274	75076	20570824	16.55295	6.49507	0.0036496	274
275	75625	20796875	16.58312	6.50296	0.0036364	275
276	76176	21024576	16.61325	6.51083	0.0036232	276
277	76729	21253933	16.64332	6.51868	0.0036101	277
278	77284	21484952	16.67333	6.52652	0.0035971	278
279	77841	21717639	16.70329	6.53434	0.0035842	279
280	78400	21952000	16.73320	6.54213	0.0035714	280
281	78961	22188041	16.76305	6.54991	0.0035587	281
282	79524	22425768	16.79286	6.55767	0.0035461	282
283	80089	22665187	16.82260	6.56541	0.0035336	283
284	80656	22906304	16.85230	6.57314	0.0035211	284
285	81225	23149125	16.88194	6.58084	0.0035088	285
286	81796	23393656	16.91153	6.58853	0.0034965	286
287	82369	23639903	16.94107	6.59620	0.0034843	287
288	82944	23887872	16.97056	6.60385	0.0034722	288
289	83521	24137569	17.00000	6.61149	0.0034602	289
290	84100	24389000	17.02939	6.61911	0.0034483	290
291	84681	24642171	17.05872	6.62671	0.0034364	291
292	85264	24897088	17.08801	6.63429	0.0034247	292
293	85849	25153757	17.11724	6.64185	0.0034130	293
294	86436	25412184	17.14643	6.64940	0.0034014	294
295	87025	25672375	17.17556	6.65693	0.0033898	295
296	87616	25934336	17.20465	6.66444	0.0033784	296
297	88209	26198073	17.23369	6.67194	0.0033670	297
298	88804	26463592	17.26268	6.67942	0.0033557	298
299	89401	26730899	17.29162	6.68688	0.0033445	299
300	90000	27000000	17.32051	6.69433	0.0033333	300

Powers, Roots, and Reciprocals From 301 to 350

No.	Square	Cube	Sq. Root	Cube Root	Reciprocal	No.
301	90601	27270901	17.34935	6.70176	0.0033223	301
302	91204	27543608	17.37815	6.70917	0.0033113	302
303	91809	27818127	17.40690	6.71657	0.0033003	303
304	92416	28094464	17.43560	6.72395	0.0032895	304
305	93025	28372625	17.46425	6.73132	0.0032787	305
306	93636	28652616	17.49286	6.73866	0.0032680	306
307	94249	28934443	17.52142	6.74600	0.0032573	307
308	94864	29218112	17.54993	6.75331	0.0032468	308
309	95481	29503629	17.57840	6.76061	0.0032362	309
310	96100	29791000	17.60682	6.76790	0.0032258	310
311	96721	30080231	17.63519	6.77517	0.0032154	311
312	97344	30371328	17.66352	6.78242	0.0032051	312
313	97969	30664297	17.69181	6.78966	0.0031949	313
314	98596	30959144	17.72005	6.79688	0.0031847	314
315	99225	31255875	17.74824	6.80409	0.0031746	315
316	99856	31554496	17.77639	6.81128	0.0031646	316
317	100489	31855013	17.80449	6.81846	0.0031546	317
318	101124	32157432	17.83255	6.82562	0.0031447	318
319	101761	32461759	17.86057	6.83277	0.0031348	319
320	102400	32768000	17.88854	6.83990	0.0031250	320
321	103041	33076161	17.91647	6.84702	0.0031153	321
322	103684	33386248	17.94436	6.85412	0.0031056	322
323	104329	33698267	17.97220	6.86121	0.0030960	323
324	104976	34012224	18.00000	6.86829	0.0030864	324
325	105625	34328125	18.02776	6.87534	0.0030769	325
326	106276	34645976	18.05547	6.88239	0.0030675	326
327	106929	34965783	18.08314	6.88942	0.0030581	327
328	107584	35287552	18.11077	6.89643	0.0030488	328
329	108241	35611289	18.13836	6.90344	0.0030395	329
330	108900	35937000	18.16590	6.91042	0.0030303	330
331	109561	36264691	18.19341	6.91740	0.0030211	331
332	110224	36594368	18.22087	6.92436	0.0030120	332
333	110889	36926037	18.24829	6.93130	0.0030030	333
334	111556	37259704	18.27567	6.93823	0.0029940	334
335	112225	37595375	18.30301	6.94515	0.0029851	335
336	112896	37933056	18.33030	6.95205	0.0029762	336
337	113569	38272753	18.35756	6.95894	0.0029674	337
338	114244	38614472	18.38478	6.96582	0.0029586	338
339	114921	38958219	18.41195	6.97268	0.0029499	339
340	115600	39304000	18.43909	6.97953	0.0029412	340
341	116281	39651821	18.46619	6.98637	0.0029326	341
342	116964	40001688	18.49324	6.99319	0.0029240	342
343	117649	40353607	18.52026	7.00000	0.0029155	343
344	118336	40707584	18.54724	7.00680	0.0029070	344
345	119025	41063625	18.57418	7.01358	0.0028986	345
346	119716	41421736	18.60108	7.02035	0.0028902	346
347	120409	41781923	18.62794	7.02711	0.0028818	347
348	121104	42144192	18.65476	7.03385	0.0028736	348
349	121801	42508549	18.68154	7.04058	0.0028653	349
350	122500	42875000	18.70829	7.04730	0.0028571	350

Powers, Roots, and Reciprocals From 351 to 400

No.	Square	Cube	Sq. Root	Cube Root	Reciprocal	No.
351	123201	43243551	18.73499	7.05400	0.0028490	351
352	123904	43614208	18.76166	7.06070	0.0028409	352
353	124609	43986977	18.78829	7.06738	0.0028329	353
354	125316	44361864	18.81489	7.07404	0.0028249	354
355	126025	44738875	18.84144	7.08070	0.0028169	355
356	126736	45118016	18.86796	7.08734	0.0028090	356
357	127449	45499293	18.89444	7.09397	0.0028011	357
358	128164	45882712	18.92089	7.10059	0.0027933	358
359	128881	46268279	18.94730	7.10719	0.0027855	359
360	129600	46656000	18.97367	7.11379	0.0027778	360
361	130321	47045881	19.00000	7.12037	0.0027701	361
362	131044	47437928	19.02630	7.12694	0.0027624	362
363	131769	47832147	19.05256	7.13349	0.0027548	363
364	132496	48228544	19.07878	7.14004	0.0027473	364
365	133225	48627125	19.10497	7.14657	0.0027397	365
366	133956	49027896	19.13113	7.15309	0.0027322	366
367	134689	49430863	19.15724	7.15960	0.0027248	367
368	135424	49836032	19.18333	7.16610	0.0027174	368
369	136161	50243409	19.20937	7.17258	0.0027100	369
370	136900	50653000	19.23538	7.17905	0.0027027	370
371	137641	51064811	19.26136	7.18552	0.0026954	371
372	138384	51478848	19.28730	7.19197	0.0026882	372
373	139129	51895117	19.31321	7.19840	0.0026810	373
374	139876	52313624	19.33908	7.20483	0.0026738	374
375	140625	52734375	19.36492	7.21125	0.0026667	375
376	141376	53157376	19.39072	7.21765	0.0026596	376
377	142129	53582633	19.41649	7.22405	0.0026525	377
378	142884	54010152	19.44222	7.23043	0.0026455	378
379	143641	54439939	19.46792	7.23680	0.0026385	379
380	144400	54872000	19.49359	7.24316	0.0026316	380
381	145161	55306341	19.51922	7.24950	0.0026247	381
382	145924	55742968	19.54482	7.25584	0.0026178	382
383	146689	56181887	19.57039	7.26217	0.0026110	383
384	147456	56623104	19.59592	7.26848	0.0026042	384
385	148225	57066625	19.62142	7.27479	0.0025974	385
386	148996	57512456	19.64688	7.28108	0.0025907	386
387	149769	57960603	19.67232	7.28736	0.0025840	387
388	150544	58411072	19.69772	7.29363	0.0025773	388
389	151321	58863869	19.72308	7.29989	0.0025707	389
390	152100	59319000	19.74842	7.30614	0.0025641	390
391	152881	59776471	19.77372	7.31238	0.0025575	391
392	153664	60236288	19.79899	7.31861	0.0025510	392
393	154449	60698457	19.82423	7.32483	0.0025445	393
394	155236	61162984	19.84943	7.33104	0.0025381	394
395	156025	61629875	19.87461	7.33723	0.0025316	395
396	156816	62099136	19.89975	7.34342	0.0025253	396
397	157609	62570773	19.92486	7.34960	0.0025189	397
398	158404	63044792	19.94994	7.35576	0.0025126	398
399	159201	63521199	19.97498	7.36192	0.0025063	399
400	160000	64000000	20.00000	7.36806	0.0025000	400

Powers, Roots, and Reciprocals From 401 to 450

No.	Square	Cube	Sq. Root	Cube Root	Reciprocal	No.
401	160801	64481201	20.02498	7.37420	0.0024938	401
402	161604	64964808	20.04994	7.38032	0.0024876	402
403	162409	65450827	20.07486	7.38644	0.0024814	403
404	163216	65939264	20.09975	7.39254	0.0024752	404
405	164025	66430125	20.12461	7.39864	0.0024691	405
406	164836	66923416	20.14944	7.40472	0.0024631	406
407	165649	67419143	20.17424	7.41080	0.0024570	407
408	166464	67917312	20.19901	7.41686	0.0024510	408
409	167281	68417929	20.22375	7.42291	0.0024450	409
410	168100	68921000	20.24846	7.42896	0.0024390	410
411	168921	69426531	20.27313	7.43499	0.0024331	411
412	169744	69934528	20.29778	7.44102	0.0024272	412
413	170569	70444997	20.32240	7.44703	0.0024213	413
414	171396	70957944	20.34699	7.45304	0.0024155	414
415	172225	71473375	20.37155	7.45904	0.0024096	415
416	173056	71991296	20.39608	7.46502	0.0024038	416
417	173889	72511713	20.42058	7.47100	0.0023981	417
418	174724	73034632	20.44505	7.47697	0.0023923	418
419	175561	73560059	20.46949	7.48292	0.0023866	419
420	176400	74088000	20.49390	7.48887	0.0023810	420
421	177241	74618461	20.51828	7.49481	0.0023753	421
422	178084	75151448	20.54264	7.50074	0.0023697	422
423	178929	75686967	20.56696	7.50666	0.0023641	423
424	179776	76225024	20.59126	7.51257	0.0023585	424
425	180625	76765625	20.61553	7.51847	0.0023529	425
426	181476	77308776	20.63977	7.52437	0.0023474	426
427	182329	77854483	20.66398	7.53025	0.0023419	427
428	183184	78402752	20.68816	7.53612	0.0023364	428
429	184041	78953589	20.71232	7.54199	0.0023310	429
430	184900	79507000	20.73644	7.54784	0.0023256	430
431	185761	80062991	20.76054	7.55369	0.0023202	431
432	186624	80621568	20.78461	7.55953	0.0023148	432
433	187489	81182737	20.80865	7.56535	0.0023095	433
434	188356	81746504	20.83267	7.57117	0.0023041	434
435	189225	82312875	20.85665	7.57698	0.0022989	435
436	190096	82881856	20.88061	7.58279	0.0022936	436
437	190969	83453453	20.90454	7.58858	0.0022883	437
438	191844	84027672	20.92845	7.59436	0.0022831	438
439	192721	84604519	20.95233	7.60014	0.0022779	439
440	193600	85184000	20.97618	7.60590	0.0022727	440
441	194481	85766121	21.00000	7.61166	0.0022676	441
442	195364	86350888	21.02380	7.61741	0.0022624	442
443	196249	86938307	21.04757	7.62315	0.0022573	443
444	197136	87528384	21.07131	7.62888	0.0022523	444
445	198025	88121125	21.09502	7.63461	0.0022472	445
446	198916	88716536	21.11871	7.64032	0.0022422	446
447	199809	89314623	21.14237	7.64603	0.0022371	447
448	200704	89915392	21.16601	7.65172	0.0022321	448
449	201601	90518849	21.18962	7.65741	0.0022272	449
450	202500	91125000	21.21320	7.66309	0.0022222	450

Powers, Roots, and Reciprocals From 451 to 500

No.	Square	Cube	Sq. Root	Cube Root	Reciprocal	No.
451	203401	91733851	21.23676	7.66877	0.0022173	451
452	204304	92345408	21.26029	7.67443	0.0022124	452
453	205209	92959677	21.28380	7.68009	0.0022075	453
454	206116	93576664	21.30728	7.68573	0.0022026	454
455	207025	94196375	21.33073	7.69137	0.0021978	455
456	207936	94818816	21.35416	7.69700	0.0021930	456
457	208849	95443993	21.37756	7.70262	0.0021882	457
458	209764	96071912	21.40093	7.70824	0.0021834	458
459	210681	96702579	21.42429	7.71384	0.0021786	459
460	211600	97336000	21.44761	7.71944	0.0021739	460
461	212521	97972181	21.47091	7.72503	0.0021692	461
462	213444	98611128	21.49419	7.73061	0.0021645	462
463	214369	99252847	21.51743	7.73619	0.0021598	463
464	215296	99897344	21.54066	7.74175	0.0021552	464
465	216225	100544625	21.56386	7.74731	0.0021505	465
466	217156	101194696	21.58703	7.75286	0.0021459	466
467	218089	101847563	21.61018	7.75840	0.0021413	467
468	219024	102503232	21.63331	7.76394	0.0021368	468
469	219961	103161709	21.65641	7.76946	0.0021322	469
470	220900	103823000	21.67948	7.77498	0.0021277	470
471	221841	104487111	21.70253	7.78049	0.0021231	471
472	222784	105154048	21.72556	7.78599	0.0021186	472
473	223729	105823817	21.74856	7.79149	0.0021142	473
474	224676	106496424	21.77154	7.79697	0.0021097	474
475	225625	107171875	21.79449	7.80245	0.0021053	475
476	226576	107850176	21.81742	7.80793	0.0021008	476
477	227529	108531333	21.84033	7.81339	0.0020964	477
478	228484	109215352	21.86321	7.81885	0.0020921	478
479	229441	109902239	21.88607	7.82429	0.0020877	479
480	230400	110592000	21.90890	7.82974	0.0020833	480
481	231361	111284641	21.93171	7.83517	0.0020790	481
482	232324	111980168	21.95450	7.84059	0.0020747	482
483	233289	112678587	21.97726	7.84601	0.0020704	483
484	234256	113379904	22.00000	7.85142	0.0020661	484
485	235225	114084125	22.02272	7.85683	0.0020619	485
486	236196	114791256	22.04541	7.86222	0.0020576	486
487	237169	115501303	22.06808	7.86761	0.0020534	487
488	238144	116214272	22.09072	7.87299	0.0020492	488
489	239121	116930169	22.11334	7.87837	0.0020450	489
490	240100	117649000	22.13594	7.88374	0.0020408	490
491	241081	118370771	22.15852	7.88909	0.0020367	491
492	242064	119095488	22.18107	7.89445	0.0020325	492
493	243049	119823157	22.20360	7.89979	0.0020284	493
494	244036	120553784	22.22611	7.90513	0.0020243	494
495	245025	121287375	22.24860	7.91046	0.0020202	495
496	246016	122023936	22.27106	7.91578	0.0020161	496
497	247009	122763473	22.29350	7.92110	0.0020121	497
498	248004	123505992	22.31591	7.92641	0.0020080	498
499	249001	124251499	22.33831	7.93171	0.0020040	499
500	250000	125000000	22.36068	7.93701	0.0020000	500

Powers, Roots, and Reciprocals From 501 to 550

No.	Square	Cube	Sq. Root	Cube Root	Reciprocal	No.
501	251001	125751501	22.38303	7.94229	0.0019960	501
502	252004	126506008	22.40536	7.94757	0.0019920	502
503	253009	127263527	22.42766	7.95285	0.0019881	503
504	254016	128024064	22.44994	7.95811	0.0019841	504
505	255025	128787625	22.47221	7.96337	0.0019802	505
506	256036	129554216	22.49444	7.96863	0.0019763	506
507	257049	130323843	22.51666	7.97387	0.0019724	507
508	258064	131096512	22.53886	7.97911	0.0019685	508
509	259081	131872229	22.56103	7.98434	0.0019646	509
510	260100	132651000	22.58318	7.98957	0.0019608	510
511	261121	133432831	22.60531	7.99479	0.0019569	511
512	262144	134217728	22.62742	8.00000	0.0019531	512
513	263169	135005697	22.64950	8.00520	0.0019493	513
514	264196	135796744	22.67157	8.01040	0.0019455	514
515	265225	136590875	22.69361	8.01559	0.0019417	515
516	266256	137388096	22.71563	8.02078	0.0019380	516
517	267289	138188413	22.73763	8.02596	0.0019342	517
518	268324	138991832	22.75961	8.03113	0.0019305	518
519	269361	139798359	22.78157	8.03629	0.0019268	519
520	270400	140608000	22.80351	8.04145	0.0019231	520
521	271441	141420761	22.82542	8.04660	0.0019194	521
522	272484	142236648	22.84732	8.05175	0.0019157	522
523	273529	143055667	22.86919	8.05689	0.0019120	523
524	274576	143877824	22.89105	8.06202	0.0019084	524
525	275625	144703125	22.91288	8.06714	0.0019048	525
526	276676	145531576	22.93469	8.07226	0.0019011	526
527	277729	146363183	22.95648	8.07737	0.0018975	527
528	278784	147197952	22.97825	8.08248	0.0018939	528
529	279841	148035889	23.00000	8.08758	0.0018904	529
530	280900	148877000	23.02173	8.09267	0.0018868	530
531	281961	149721291	23.04344	8.09776	0.0018832	531
532	283024	150568768	23.06513	8.10284	0.0018797	532
533	284089	151419437	23.08679	8.10791	0.0018762	533
534	285156	152273304	23.10844	8.11298	0.0018727	534
535	286225	153130375	23.13007	8.11804	0.0018692	535
536	287296	153990656	23.15167	8.12310	0.0018657	536
537	288369	154854153	23.17326	8.12814	0.0018622	537
538	289444	155720872	23.19483	8.13319	0.0018587	538
539	290521	156590819	23.21637	8.13822	0.0018553	539
540	291600	157464000	23.23790	8.14325	0.0018519	540
541	292681	158340421	23.25941	8.14828	0.0018484	541
542	293764	159220088	23.28089	8.15329	0.0018450	542
543	294849	160103007	23.30236	8.15831	0.0018416	543
544	295936	160989184	23.32381	8.16331	0.0018382	544
545	297025	161878625	23.34524	8.16831	0.0018349	545
546	298116	162771336	23.36664	8.17330	0.0018315	546
547	299209	163667323	23.38803	8.17829	0.0018282	547
548	300304	164566592	23.40940	8.18327	0.0018248	548
549	301401	165469149	23.43075	8.18824	0.0018215	549
550	302500	166375000	23.45208	8.19321	0.0018182	550

Powers, Roots, and Reciprocals From 551 to 600

No.	Square	Cube	Sq. Root	Cube Root	Reciprocal	No.
551	303601	167284151	23.47339	8.19818	0.0018149	551
552	304704	168196608	23.49468	8.20313	0.0018116	552
553	305809	169112377	23.51595	8.20808	0.0018083	553
554	306916	170031464	23.53720	8.21303	0.0018051	554
555	308025	170953875	23.55844	8.21797	0.0018018	555
556	309136	171879616	23.57965	8.22290	0.0017986	556
557	310249	172808693	23.60085	8.22783	0.0017953	557
558	311364	173741112	23.62202	8.23275	0.0017921	558
559	312481	174676879	23.64318	8.23766	0.0017889	559
560	313600	175616000	23.66432	8.24257	0.0017857	560
561	314721	176558481	23.68544	8.24747	0.0017825	561
562	315844	177504328	23.70654	8.25237	0.0017794	562
563	316969	178453547	23.72762	8.25726	0.0017762	563
564	318096	179406144	23.74868	8.26215	0.0017730	564
565	319225	180362125	23.76973	8.26703	0.0017699	565
566	320356	181321496	23.79075	8.27190	0.0017668	566
567	321489	182284263	23.81176	8.27677	0.0017637	567
568	322624	183250432	23.83275	8.28164	0.0017606	568
569	323761	184220009	23.85372	8.28649	0.0017575	569
570	324900	185193000	23.87467	8.29134	0.0017544	570
571	326041	186169411	23.89561	8.29619	0.0017513	571
572	327184	187149248	23.91652	8.30103	0.0017483	572
573	328329	188132517	23.93742	8.30587	0.0017452	573
574	329476	189119224	23.95830	8.31069	0.0017422	574
575	330625	190109375	23.97916	8.31552	0.0017391	575
576	331776	191102976	24.00000	8.32034	0.0017361	576
577	332929	192100033	24.02082	8.32515	0.0017331	577
578	334084	193100552	24.04163	8.32995	0.0017301	578
579	335241	194104539	24.06242	8.33476	0.0017271	579
580	336400	195112000	24.08319	8.33955	0.0017241	580
581	337561	196122941	24.10394	8.34434	0.0017212	581
582	338724	197137368	24.12468	8.34913	0.0017182	582
583	339889	198155287	24.14539	8.35390	0.0017153	583
584	341056	199176704	24.16609	8.35868	0.0017123	584
585	342225	200201625	24.18677	8.36345	0.0017094	585
586	343396	201230056	24.20744	8.36821	0.0017065	586
587	344569	202262003	24.22808	8.37297	0.0017036	587
588	345744	203297472	24.24871	8.37772	0.0017007	588
589	346921	204336469	24.26932	8.38247	0.0016978	589
590	348100	205379000	24.28992	8.38721	0.0016949	590
591	349281	206425071	24.31049	8.39194	0.0016920	591
592	350464	207474688	24.33105	8.39667	0.0016892	592
593	351649	208527857	24.35159	8.40140	0.0016863	593
594	352836	209584584	24.37212	8.40612	0.0016835	594
595	354025	210644875	24.39262	8.41083	0.0016807	595
596	355216	211708736	24.41311	8.41554	0.0016779	596
597	356409	212776173	24.43358	8.42025	0.0016750	597
598	357604	213847192	24.45404	8.42494	0.0016722	598
599	358801	214921799	24.47448	8.42964	0.0016694	599
600	360000	216000000	24.49490	8.43433	0.0016667	600

Powers, Roots, and Reciprocals From 601 to 650

No.	Square	Cube	Sq. Root	Cube Root	Reciprocal	No.
601	361201	217081801	24.51530	8.43901	0.0016639	601
602	362404	218167208	24.53569	8.44369	0.0016611	602
603	363609	219256227	24.55606	8.44836	0.0016584	603
604	364816	220348864	24.57641	8.45303	0.0016556	604
605	366025	221445125	24.59675	8.45769	0.0016529	605
606	367236	222545016	24.61707	8.46235	0.0016502	606
607	368449	223648543	24.63737	8.46700	0.0016474	607
608	369664	224755712	24.65766	8.47165	0.0016447	608
609	370881	225866529	24.67793	8.47629	0.0016420	609
610	372100	226981000	24.69818	8.48093	0.0016393	610
611	373321	228099131	24.71841	8.48556	0.0016367	611
612	374544	229220928	24.73863	8.49018	0.0016340	612
613	375769	230346397	24.75884	8.49481	0.0016313	613
614	376996	231475544	24.77902	8.49942	0.0016287	614
615	378225	232608375	24.79919	8.50403	0.0016260	615
616	379456	233744896	24.81935	8.50864	0.0016234	616
617	380689	234885113	24.83948	8.51324	0.0016207	617
618	381924	236029032	24.85961	8.51784	0.0016181	618
619	383161	237176659	24.87971	8.52243	0.0016155	619
620	384400	238328000	24.89980	8.52702	0.0016129	620
621	385641	239483061	24.91987	8.53160	0.0016103	621
622	386884	240641848	24.93993	8.53618	0.0016077	622
623	388129	241804367	24.95997	8.54075	0.0016051	623
624	389376	242970624	24.97999	8.54532	0.0016026	624
625	390625	244140625	25.00000	8.54988	0.0016000	625
626	391876	245314376	25.01999	8.55444	0.0015974	626
627	393129	246491883	25.03997	8.55899	0.0015949	627
628	394384	247673152	25.05993	8.56354	0.0015924	628
629	395641	248858189	25.07987	8.56808	0.0015898	629
630	396900	250047000	25.09980	8.57262	0.0015873	630
631	398161	251239591	25.11971	8.57715	0.0015848	631
632	399424	252435968	25.13961	8.58168	0.0015823	632
633	400689	253636137	25.15949	8.58620	0.0015798	633
634	401956	254840104	25.17936	8.59072	0.0015773	634
635	403225	256047875	25.19921	8.59524	0.0015748	635
636	404496	257259456	25.21904	8.59975	0.0015723	636
637	405769	258474853	25.23886	8.60425	0.0015699	637
638	407044	259694072	25.25866	8.60875	0.0015674	638
639	408321	260917119	25.27845	8.61325	0.0015649	639
640	409600	262144000	25.29822	8.61774	0.0015625	640
641	410881	263374721	25.31798	8.62222	0.0015601	641
642	412164	264609288	25.33772	8.62671	0.0015576	642
643	413449	265847707	25.35744	8.63118	0.0015552	643
644	414736	267089984	25.37716	8.63566	0.0015528	644
645	416025	268336125	25.39685	8.64012	0.0015504	645
646	417316	269586136	25.41653	8.64459	0.0015480	646
647	418609	270840023	25.43619	8.64904	0.0015456	647
648	419904	272097792	25.45584	8.65350	0.0015432	648
649	421201	273359449	25.47548	8.65795	0.0015408	649
650	422500	274625000	25.49510	8.66239	0.0015385	650

Powers, Roots, and Reciprocals From 651 to 700

No.	Square	Cube	Sq. Root	Cube Root	Reciprocal	No.
651	423801	275894451	25.51470	8.66683	0.0015361	651
652	425104	277167808	25.53429	8.67127	0.0015337	652
653	426409	278445077	25.55386	8.67570	0.0015314	653
654	427716	279726264	25.57342	8.68012	0.0015291	654
655	429025	281011375	25.59297	8.68455	0.0015267	655
656	430336	282300416	25.61250	8.68896	0.0015244	656
657	431649	283593393	25.63201	8.69338	0.0015221	657
658	432964	284890312	25.65151	8.69778	0.0015198	658
659	434281	286191179	25.67100	8.70219	0.0015175	659
660	435600	287496000	25.69047	8.70659	0.0015152	660
661	436921	288804781	25.70992	8.71098	0.0015129	661
662	438244	290117528	25.72936	8.71537	0.0015106	662
663	439569	291434247	25.74879	8.71976	0.0015083	663
664	440896	292754944	25.76820	8.72414	0.0015060	664
665	442225	294079625	25.78759	8.72852	0.0015038	665
666	443556	295408296	25.80698	8.73289	0.0015015	666
667	444889	296740963	25.82634	8.73726	0.0014993	667
668	446224	298077632	25.84570	8.74162	0.0014970	668
669	447561	299418309	25.86503	8.74598	0.0014948	669
670	448900	300763000	25.88436	8.75034	0.0014925	670
671	450241	302111711	25.90367	8.75469	0.0014903	671
672	451584	303464448	25.92296	8.75904	0.0014881	672
673	452929	304821217	25.94224	8.76338	0.0014859	673
674	454276	306182024	25.96151	8.76772	0.0014837	674
675	455625	307546875	25.98076	8.77205	0.0014815	675
676	456976	308915776	26.00000	8.77638	0.0014793	676
677	458329	310288733	26.01922	8.78071	0.0014771	677
678	459684	311665752	26.03843	8.78503	0.0014749	678
679	461041	313046839	26.05763	8.78935	0.0014728	679
680	462400	314432000	26.07681	8.79366	0.0014706	680
681	463761	315821241	26.09598	8.79797	0.0014684	681
682	465124	317214568	26.11513	8.80227	0.0014663	682
683	466489	318611987	26.13427	8.80657	0.0014641	683
684	467856	320013504	26.15339	8.81087	0.0014620	684
685	469225	321419125	26.17250	8.81516	0.0014599	685
686	470596	322828856	26.19160	8.81945	0.0014577	686
687	471969	324242703	26.21068	8.82373	0.0014556	687
688	473344	325660672	26.22975	8.82801	0.0014535	688
689	474721	327082769	26.24881	8.83228	0.0014514	689
690	476100	328509000	26.26785	8.83656	0.0014493	690
691	477481	329939371	26.28688	8.84082	0.0014472	691
692	478864	331373888	26.30589	8.84509	0.0014451	692
693	480249	332812557	26.32489	8.84934	0.0014430	693
694	481636	334255384	26.34388	8.85360	0.0014409	694
695	483025	335702375	26.36285	8.85785	0.0014388	695
696	484416	337153536	26.38181	8.86210	0.0014368	696
697	485809	338608873	26.40076	8.86634	0.0014347	697
698	487204	340068392	26.41969	8.87058	0.0014327	698
699	488601	341532099	26.43861	8.87481	0.0014306	699
700	490000	343000000	26.45751	8.87904	0.0014286	700

Powers, Roots, and Reciprocals From 701 to 750

No.	Square	Cube	Sq. Root	Cube Root	Reciprocal	No.
701	491401	344472101	26.47640	8.88327	0.0014265	701
702	492804	345948408	26.49528	8.88749	0.0014245	702
703	494209	347428927	26.51415	8.89171	0.0014225	703
704	495616	348913664	26.53300	8.89592	0.0014205	704
705	497025	350402625	26.55184	8.90013	0.0014184	705
706	498436	351895816	26.57066	8.90434	0.0014164	706
707	499849	353393243	26.58947	8.90854	0.0014144	707
708	501264	354894912	26.60827	8.91274	0.0014124	708
709	502681	356400829	26.62705	8.91693	0.0014104	709
710	504100	357911000	26.64583	8.92112	0.0014085	710
711	505521	359425431	26.66458	8.92531	0.0014065	711
712	506944	360944128	26.68333	8.92949	0.0014045	712
713	508369	362467097	26.70206	8.93367	0.0014025	713
714	509796	363994344	26.72078	8.93784	0.0014006	714
715	511225	365525875	26.73948	8.94201	0.0013986	715
716	512656	367061696	26.75818	8.94618	0.0013966	716
717	514089	368601813	26.77686	8.95034	0.0013947	717
718	515524	370146232	26.79552	8.95450	0.0013928	718
719	516961	371694959	26.81418	8.95866	0.0013908	719
720	518400	373248000	26.83282	8.96281	0.0013889	720
721	519841	374805361	26.85144	8.96696	0.0013870	721
722	521284	376367048	26.87006	8.97110	0.0013850	722
723	522729	377933067	26.88866	8.97524	0.0013831	723
724	524176	379503424	26.90725	8.97938	0.0013812	724
725	525625	381078125	26.92582	8.98351	0.0013793	725
726	527076	382657176	26.94439	8.98764	0.0013774	726
727	528529	384240583	26.96294	8.99176	0.0013755	727
728	529984	385828352	26.98148	8.99588	0.0013736	728
729	531441	387420489	27.00000	9.00000	0.0013717	729
730	532900	389017000	27.01851	9.00411	0.0013699	730
731	534361	390617891	27.03701	9.00822	0.0013680	731
732	535824	392223168	27.05550	9.01233	0.0013661	732
733	537289	393832837	27.07397	9.01643	0.0013643	733
734	538756	395446904	27.09243	9.02053	0.0013624	734
735	540225	397065375	27.11088	9.02462	0.0013605	735
736	541696	398688256	27.12932	9.02871	0.0013587	736
737	543169	400315553	27.14774	9.03280	0.0013569	737
738	544644	401947272	27.16616	9.03689	0.0013550	738
739	546121	403583419	27.18455	9.04097	0.0013532	739
740	547600	405224000	27.20294	9.04504	0.0013514	740
741	549081	406869021	27.22132	9.04911	0.0013495	741
742	550564	408518488	27.23968	9.05318	0.0013477	742
743	552049	410172407	27.25803	9.05725	0.0013459	743
744	553536	411830784	27.27636	9.06131	0.0013441	744
745	555025	413493625	27.29469	9.06537	0.0013423	745
746	556516	415160936	27.31300	9.06942	0.0013405	746
747	558009	416832723	27.33130	9.07347	0.0013387	747
748	559504	418508992	27.34959	9.07752	0.0013369	748
749	561001	420189749	27.36786	9.08156	0.0013351	749
750	562500	421875000	27.38613	9.08560	0.0013333	750

Powers, Roots, and Reciprocals From 751 to 800

No.	Square	Cube	Sq. Root	Cube Root	Reciprocal	No.
751	564001	423564751	27.40438	9.08964	0.0013316	751
752	565504	425259008	27.42262	9.09367	0.0013298	752
753	567009	426957777	27.44085	9.09770	0.0013280	753
754	568516	428661064	27.45906	9.10173	0.0013263	754
755	570025	430368875	27.47726	9.10575	0.0013245	755
756	571536	432081216	27.49545	9.10977	0.0013228	756
757	573049	433798093	27.51363	9.11378	0.0013210	757
758	574564	435519512	27.53180	9.11779	0.0013193	758
759	576081	437245479	27.54995	9.12180	0.0013175	759
760	577600	438976000	27.56810	9.12581	0.0013158	760
761	579121	440711081	27.58623	9.12981	0.0013141	761
762	580644	442450728	27.60435	9.13380	0.0013123	762
763	582169	444194947	27.62245	9.13780	0.0013106	763
764	583696	445943744	27.64055	9.14179	0.0013089	764
765	585225	447697125	27.65863	9.14577	0.0013072	765
766	586756	449455096	27.67671	9.14976	0.0013055	766
767	588289	451217663	27.69476	9.15374	0.0013038	767
768	589824	452984832	27.71281	9.15771	0.0013021	768
769	591361	454756609	27.73085	9.16169	0.0013004	769
770	592900	456533000	27.74887	9.16566	0.0012987	770
771	594441	458314011	27.76689	9.16962	0.0012970	771
772	595984	460099648	27.78489	9.17359	0.0012953	772
773	597529	461889917	27.80288	9.17754	0.0012937	773
774	599076	463684824	27.82086	9.18150	0.0012920	774
775	600625	465484375	27.83882	9.18545	0.0012903	775
776	602176	467288576	27.85678	9.18940	0.0012887	776
777	603729	469097433	27.87472	9.19335	0.0012870	777
778	605284	470910952	27.89265	9.19729	0.0012853	778
779	606841	472729139	27.91057	9.20123	0.0012837	779
780	608400	474552000	27.92848	9.20516	0.0012821	780
781	609961	476379541	27.94638	9.20910	0.0012804	781
782	611524	478211768	27.96426	9.21303	0.0012788	782
783	613089	480048687	27.98214	9.21695	0.0012771	783
784	614656	481890304	28.00000	9.22087	0.0012755	784
785	616225	483736625	28.01785	9.22479	0.0012739	785
786	617796	485587656	28.03569	9.22871	0.0012723	786
787	619369	487443403	28.05352	9.23262	0.0012706	787
788	620944	489303872	28.07134	9.23653	0.0012690	788
789	622521	491169069	28.08914	9.24043	0.0012674	789
790	624100	493039000	28.10694	9.24434	0.0012658	790
791	625681	494913671	28.12472	9.24823	0.0012642	791
792	627264	496793088	28.14249	9.25213	0.0012626	792
793	628849	498677257	28.16026	9.25602	0.0012610	793
794	630436	500566184	28.17801	9.25991	0.0012594	794
795	632025	502459875	28.19574	9.26380	0.0012579	795
796	633616	504358336	28.21347	9.26768	0.0012563	796
797	635209	506261573	28.23119	9.27156	0.0012547	797
798	636804	508169592	28.24889	9.27544	0.0012531	798
799	638401	510082399	28.26659	9.27931	0.0012516	799
800	640000	512000000	28.28427	9.28318	0.0012500	800

Powers, Roots, and Reciprocals From 801 to 850

No.	Square	Cube	Sq. Root	Cube Root	Reciprocal	No.
801	641601	513922401	28.30194	9.28704	0.0012484	801
802	643204	515849608	28.31960	9.29091	0.0012469	802
803	644809	517781627	28.33725	9.29477	0.0012453	803
804	646416	519718464	28.35489	9.29862	0.0012438	804
805	648025	521660125	28.37252	9.30248	0.0012422	805
806	649636	523606616	28.39014	9.30633	0.0012407	806
807	651249	525557943	28.40775	9.31018	0.0012392	807
808	652864	527514112	28.42534	9.31402	0.0012376	808
809	654481	529475129	28.44293	9.31786	0.0012361	809
810	656100	531441000	28.46050	9.32170	0.0012346	810
811	657721	533411731	28.47806	9.32553	0.0012330	811
812	659344	535387328	28.49561	9.32936	0.0012315	812
813	660969	537367797	28.51315	9.33319	0.0012300	813
814	662596	539353144	28.53069	9.33702	0.0012285	814
815	664225	541343375	28.54820	9.34084	0.0012270	815
816	665856	543338496	28.56571	9.34466	0.0012255	816
817	667489	545338513	28.58321	9.34847	0.0012240	817
818	669124	547343432	28.60070	9.35229	0.0012225	818
819	670761	549353259	28.61818	9.35610	0.0012210	819
820	672400	551368000	28.63564	9.35990	0.0012195	820
821	674041	553387661	28.65310	9.36370	0.0012180	821
822	675684	555412248	28.67054	9.36751	0.0012165	822
823	677329	557441767	28.68798	9.37130	0.0012151	823
824	678976	559476224	28.70540	9.37510	0.0012136	824
825	680625	561515625	28.72281	9.37889	0.0012121	825
826	682276	563559976	28.74022	9.38268	0.0012107	826
827	683929	565609283	28.75761	9.38646	0.0012092	827
828	685584	567663552	28.77499	9.39024	0.0012077	828
829	687241	569722789	28.79236	9.39402	0.0012063	829
830	688900	571787000	28.80972	9.39780	0.0012048	830
831	690561	573856191	28.82707	9.40157	0.0012034	831
832	692224	575930368	28.84441	9.40534	0.0012019	832
833	693889	578009537	28.86174	9.40911	0.0012005	833
834	695556	580093704	28.87906	9.41287	0.0011990	834
835	697225	582182875	28.89637	9.41663	0.0011976	835
836	698896	584277056	28.91366	9.42039	0.0011962	836
837	700569	586376253	28.93095	9.42414	0.0011947	837
838	702244	588480472	28.94823	9.42789	0.0011933	838
839	703921	590589719	28.96550	9.43164	0.0011919	839
840	705600	592704000	28.98275	9.43539	0.0011905	840
841	707281	594823321	29.00000	9.43913	0.0011891	841
842	708964	596947688	29.01724	9.44287	0.0011876	842
843	710649	599077107	29.03446	9.44661	0.0011862	843
844	712336	601211584	29.05168	9.45034	0.0011848	844
845	714025	603351125	29.06888	9.45407	0.0011834	845
846	715716	605495736	29.08608	9.45780	0.0011820	846
847	717409	607645423	29.10326	9.46152	0.0011806	847
848	719104	609800192	29.12044	9.46525	0.0011792	848
849	720801	611960049	29.13760	9.46897	0.0011779	849
850	722500	614125000	29.15476	9.47268	0.0011765	850

Powers, Roots, and Reciprocals From 851 to 900

No.	Square	Cube	Sq. Root	Cube Root	Reciprocal	No.
851	724201	616295051	29.17190	9.47640	0.0011751	851
852	725904	618470208	29.18904	9.48011	0.0011737	852
853	727609	620650477	29.20616	9.48381	0.0011723	853
854	729316	622835864	29.22328	9.48752	0.0011710	854
855	731025	625026375	29.24038	9.49122	0.0011696	855
856	732736	627222016	29.25748	9.49492	0.0011682	856
857	734449	629422793	29.27456	9.49861	0.0011669	857
858	736164	631628712	29.29164	9.50231	0.0011655	858
859	737881	633839779	29.30870	9.50600	0.0011641	859
860	739600	636056000	29.32576	9.50969	0.0011628	860
861	741321	638277381	29.34280	9.51337	0.0011614	861
862	743044	640503928	29.35984	9.51705	0.0011601	862
863	744769	642735647	29.37686	9.52073	0.0011587	863
864	746496	644972544	29.39388	9.52441	0.0011574	864
865	748225	647214625	29.41088	9.52808	0.0011561	865
866	749956	649461896	29.42788	9.53175	0.0011547	866
867	751689	651714363	29.44486	9.53542	0.0011534	867
868	753424	653972032	29.46184	9.53908	0.0011521	868
869	755161	656234909	29.47881	9.54274	0.0011507	869
870	756900	658503000	29.49576	9.54640	0.0011494	870
871	758641	660776311	29.51271	9.55006	0.0011481	871
872	760384	663054848	29.52965	9.55371	0.0011468	872
873	762129	665338617	29.54657	9.55736	0.0011455	873
874	763876	667627624	29.56349	9.56101	0.0011442	874
875	765625	669921875	29.58040	9.56466	0.0011429	875
876	767376	672221376	29.59730	9.56830	0.0011416	876
877	769129	674526133	29.61419	9.57194	0.0011403	877
878	770884	676836152	29.63106	9.57557	0.0011390	878
879	772641	679151439	29.64793	9.57921	0.0011377	879
880	774400	681472000	29.66479	9.58284	0.0011364	880
881	776161	683797841	29.68164	9.58647	0.0011351	881
882	777924	686128968	29.69848	9.59009	0.0011338	882
883	779689	688465387	29.71532	9.59372	0.0011325	883
884	781456	690807104	29.73214	9.59734	0.0011312	884
885	783225	693154125	29.74895	9.60095	0.0011299	885
886	784996	695506456	29.76575	9.60457	0.0011287	886
887	786769	697864103	29.78255	9.60818	0.0011274	887
888	788544	700227072	29.79933	9.61179	0.0011261	888
889	790321	702595369	29.81610	9.61540	0.0011249	889
890	792100	704969000	29.83287	9.61900	0.0011236	890
891	793881	707347971	29.84962	9.62260	0.0011223	891
892	795664	709732288	29.86637	9.62620	0.0011211	892
893	797449	712121957	29.88311	9.62980	0.0011198	893
894	799236	714516984	29.89983	9.63339	0.0011186	894
895	801025	716917375	29.91655	9.63698	0.0011173	895
896	802816	719323136	29.93326	9.64057	0.0011161	896
897	804609	721734273	29.94996	9.64415	0.0011148	897
898	806404	724150792	29.96665	9.64774	0.0011136	898
899	808201	726572699	29.98333	9.65132	0.0011123	899
900	810000	729000000	30.00000	9.65489	0.0011111	900

Powers, Roots, and Reciprocals From 901 to 950

No.	Square	Cube	Sq. Root	Cube Root	Reciprocal	No.
901	811801	731432701	30.01666	9.65847	0.0011099	901
902	813604	733870808	30.03331	9.66204	0.0011086	902
903	815409	736314327	30.04996	9.66561	0.0011074	903
904	817216	738763264	30.06659	9.66918	0.0011062	904
905	819025	741217625	30.08322	9.67274	0.0011050	905
906	820836	743677416	30.09983	9.67630	0.0011038	906
907	822649	746142643	30.11644	9.67986	0.0011025	907
908	824464	748613312	30.13304	9.68342	0.0011013	908
909	826281	751089429	30.14963	9.68697	0.0011001	909
910	828100	753571000	30.16621	9.69052	0.0010989	910
911	829921	756058031	30.18278	9.69407	0.0010977	911
912	831744	758550528	30.19934	9.69762	0.0010965	912
913	833569	761048497	30.21589	9.70116	0.0010953	913
914	835396	763551944	30.23243	9.70470	0.0010941	914
915	837225	766060875	30.24897	9.70824	0.0010929	915
916	839056	768575296	30.26549	9.71177	0.0010917	916
917	840889	771095213	30.28201	9.71531	0.0010905	917
918	842724	773620632	30.29851	9.71884	0.0010893	918
919	844561	776151559	30.31501	9.72236	0.0010881	919
920	846400	778688000	30.33150	9.72589	0.0010870	920
921	848241	781229961	30.34798	9.72941	0.0010858	921
922	850084	783777448	30.36445	9.73293	0.0010846	922
923	851929	786330467	30.38092	9.73645	0.0010834	923
924	853776	788889024	30.39737	9.73996	0.0010823	924
925	855625	791453125	30.41381	9.74348	0.0010811	925
926	857476	794022776	30.43025	9.74699	0.0010799	926
927	859329	796597983	30.44667	9.75049	0.0010787	927
928	861184	799178752	30.46309	9.75400	0.0010776	928
929	863041	801765089	30.47950	9.75750	0.0010764	929
930	864900	804357000	30.49590	9.76100	0.0010753	930
931	866761	806954491	30.51229	9.76450	0.0010741	931
932	868624	809557568	30.52868	9.76799	0.0010730	932
933	870489	812166237	30.54505	9.77148	0.0010718	933
934	872356	814780504	30.56141	9.77497	0.0010707	934
935	874225	817400375	30.57777	9.77846	0.0010695	935
936	876096	820025856	30.59412	9.78195	0.0010684	936
937	877969	822656953	30.61046	9.78543	0.0010672	937
938	879844	825293672	30.62679	9.78891	0.0010661	938
939	881721	827936019	30.64311	9.79239	0.0010650	939
940	883600	830584000	30.65942	9.79586	0.0010638	940
941	885481	833237621	30.67572	9.79933	0.0010627	941
942	887364	835896888	30.69202	9.80280	0.0010616	942
943	889249	838561807	30.70831	9.80627	0.0010604	943
944	891136	841232384	30.72458	9.80974	0.0010593	944
945	893025	843908625	30.74085	9.81320	0.0010582	945
946	894916	846590536	30.75711	9.81666	0.0010571	946
947	896809	849278123	30.77337	9.82012	0.0010560	947
948	898704	851971392	30.78961	9.82357	0.0010549	948
949	900601	854670349	30.80584	9.82703	0.0010537	949
950	902500	857375000	30.82207	9.83048	0.0010526	950

Powers, Roots, and Reciprocals From 951 to 1000

No.	Square	Cube	Sq. Root	Cube Root	Reciprocal	No.
951	904401	860085351	30.83829	9.83392	0.0010515	951
952	906304	862801408	30.85450	9.83737	0.0010504	952
953	908209	865523177	30.87070	9.84081	0.0010493	953
954	910116	868250664	30.88689	9.84425	0.0010482	954
955	912025	870983875	30.90307	9.84769	0.0010471	955
956	913936	873722816	30.91925	9.85113	0.0010460	956
957	915849	876467493	30.93542	9.85456	0.0010449	957
958	917764	879217912	30.95158	9.85799	0.0010438	958
959	919681	881974079	30.96773	9.86142	0.0010428	959
960	921600	884736000	30.98387	9.86485	0.0010417	960
961	923521	887503681	31.00000	9.86827	0.0010406	961
962	925444	890277128	31.01612	9.87169	0.0010395	962
963	927369	893056347	31.03224	9.87511	0.0010384	963
964	929296	895841344	31.04835	9.87853	0.0010373	964
965	931225	898632125	31.06445	9.88195	0.0010363	965
966	933156	901428696	31.08054	9.88536	0.0010352	966
967	935089	904231063	31.09662	9.88877	0.0010341	967
968	937024	907039232	31.11270	9.89217	0.0010331	968
969	938961	909853209	31.12876	9.89558	0.0010320	969
970	940900	912673000	31.14482	9.89898	0.0010309	970
971	942841	915498611	31.16087	9.90238	0.0010299	971
972	944784	918330048	31.17691	9.90578	0.0010288	972
973	946729	921167317	31.19295	9.90918	0.0010277	973
974	948676	924010424	31.20897	9.91257	0.0010267	974
975	950625	926859375	31.22499	9.91596	0.0010256	975
976	952576	929714176	31.24100	9.91935	0.0010246	976
977	954529	932574833	31.25700	9.92274	0.0010235	977
978	956484	935441352	31.27299	9.92612	0.0010225	978
979	958441	938313739	31.28898	9.92950	0.0010215	979
980	960400	941192000	31.30495	9.93288	0.0010204	980
981	962361	944076141	31.32092	9.93626	0.0010194	981
982	964324	946966168	31.33688	9.93964	0.0010183	982
983	966289	949862087	31.35283	9.94301	0.0010173	983
984	968256	952763904	31.36877	9.94638	0.0010163	984
985	970225	955671625	31.38471	9.94975	0.0010152	985
986	972196	958585256	31.40064	9.95311	0.0010142	986
987	974169	961504803	31.41656	9.95648	0.0010132	987
988	976144	964430272	31.43247	9.95984	0.0010121	988
989	978121	967361669	31.44837	9.96320	0.0010111	989
990	980100	970299000	31.46427	9.96655	0.0010101	990
991	982081	973242271	31.48015	9.96991	0.0010091	991
992	984064	976191488	31.49603	9.97326	0.0010081	992
993	986049	979146657	31.51190	9.97661	0.0010070	993
994	988036	982107784	31.52777	9.97996	0.0010060	994
995	990025	985074875	31.54362	9.98331	0.0010050	995
996	992016	988047936	31.55947	9.98665	0.0010040	996
997	994009	991026973	31.57531	9.98999	0.0010030	997
998	996004	994011992	31.59114	9.99333	0.0010020	998
999	998001	997002999	31.60696	9.99667	0.0010010	999
1000	1000000	1000000000	31.62278	10.00000	0.0010000	1000

Powers, Roots, and Reciprocals From 1001 to 1050

No.	Square	Cube	Sq. Root	Cube Root	Reciprocal	No.
1001	1002001	1003003001	31.63858	10.00333	0.0009990	1001
1002	1004004	1006012008	31.65438	10.00666	0.0009980	1002
1003	1006009	1009027027	31.67018	10.00999	0.0009970	1003
1004	1008016	1012048064	31.68596	10.01332	0.0009960	1004
1005	1010025	1015075125	31.70173	10.01664	0.0009950	1005
1006	1012036	1018108216	31.71750	10.01996	0.0009940	1006
1007	1014049	1021147343	31.73326	10.02328	0.0009930	1007
1008	1016064	1024192512	31.74902	10.02660	0.0009921	1008
1009	1018081	1027243729	31.76476	10.02991	0.0009911	1009
1010	1020100	1030301000	31.78050	10.03322	0.0009901	1010
1011	1022121	1033364331	31.79623	10.03653	0.0009891	1011
1012	1024144	1036433728	31.81195	10.03984	0.0009881	1012
1013	1026169	1039509197	31.82766	10.04315	0.0009872	1013
1014	1028196	1042590744	31.84337	10.04645	0.0009862	1014
1015	1030225	1045678375	31.85906	10.04975	0.0009852	1015
1016	1032256	1048772096	31.87475	10.05305	0.0009843	1016
1017	1034289	1051871913	31.89044	10.05635	0.0009833	1017
1018	1036324	1054977832	31.90611	10.05964	0.0009823	1018
1019	1038361	1058089859	31.92178	10.06294	0.0009814	1019
1020	1040400	1061208000	31.93744	10.06623	0.0009804	1020
1021	1042441	1064332261	31.95309	10.06952	0.0009794	1021
1022	1044484	1067462648	31.96873	10.07280	0.0009785	1022
1023	1046529	1070599167	31.98437	10.07609	0.0009775	1023
1024	1048576	1073741824	32.00000	10.07937	0.0009766	1024
1025	1050625	1076890625	32.01562	10.08265	0.0009756	1025
1026	1052676	1080045576	32.03123	10.08593	0.0009747	1026
1027	1054729	1083206683	32.04684	10.08920	0.0009737	1027
1028	1056784	1086373952	32.06244	10.09248	0.0009728	1028
1029	1058841	1089547389	32.07803	10.09575	0.0009718	1029
1030	1060900	1092727000	32.09361	10.09902	0.0009709	1030
1031	1062961	1095912791	32.10919	10.10228	0.0009699	1031
1032	1065024	1099104768	32.12476	10.10555	0.0009690	1032
1033	1067089	1102302937	32.14032	10.10881	0.0009681	1033
1034	1069156	1105507304	32.15587	10.11207	0.0009671	1034
1035	1071225	1108717875	32.17142	10.11533	0.0009662	1035
1036	1073296	1111934656	32.18695	10.11859	0.0009653	1036
1037	1075369	1115157653	32.20248	10.12184	0.0009643	1037
1038	1077444	1118386872	32.21801	10.12510	0.0009634	1038
1039	1079521	1121622319	32.23352	10.12835	0.0009625	1039
1040	1081600	1124864000	32.24903	10.13159	0.0009615	1040
1041	1083681	1128111921	32.26453	10.13484	0.0009606	1041
1042	1085764	1131366088	32.28002	10.13808	0.0009597	1042
1043	1087849	1134626507	32.29551	10.14133	0.0009588	1043
1044	1089936	1137893184	32.31099	10.14457	0.0009579	1044
1045	1092025	1141166125	32.32646	10.14780	0.0009569	1045
1046	1094116	1144445336	32.34192	10.15104	0.0009560	1046
1047	1096209	1147730823	32.35738	10.15427	0.0009551	1047
1048	1098304	1151022592	32.37283	10.15751	0.0009542	1048
1049	1100401	1154320649	32.38827	10.16074	0.0009533	1049
1050	1102500	1157625000	32.40370	10.16396	0.0009524	1050

Powers, Roots, and Reciprocals From 1051 to 1100

No.	Square	Cube	Sq. Root	Cube Root	Reciprocal	No.
1051	1104601	1160935651	32.41913	10.16719	0.0009515	1051
1052	1106704	1164252608	32.43455	10.17041	0.0009506	1052
1053	1108809	1167575877	32.44996	10.17363	0.0009497	1053
1054	1110916	1170905464	32.46537	10.17685	0.0009488	1054
1055	1113025	1174241375	32.48076	10.18007	0.0009479	1055
1056	1115136	1177583616	32.49615	10.18329	0.0009470	1056
1057	1117249	1180932193	32.51154	10.18650	0.0009461	1057
1058	1119364	1184287112	32.52691	10.18971	0.0009452	1058
1059	1121481	1187648379	32.54228	10.19292	0.0009443	1059
1060	1123600	1191016000	32.55764	10.19613	0.0009434	1060
1061	1125721	1194389981	32.57299	10.19933	0.0009425	1061
1062	1127844	1197770328	32.58834	10.20254	0.0009416	1062
1063	1129969	1201157047	32.60368	10.20574	0.0009407	1063
1064	1132096	1204550144	32.61901	10.20894	0.0009398	1064
1065	1134225	1207949625	32.63434	10.21213	0.0009390	1065
1066	1136356	1211355496	32.64966	10.21533	0.0009381	1066
1067	1138489	1214767763	32.66497	10.21852	0.0009372	1067
1068	1140624	1218186432	32.68027	10.22171	0.0009363	1068
1069	1142761	1221611509	32.69557	10.22490	0.0009355	1069
1070	1144900	1225043000	32.71085	10.22809	0.0009346	1070
1071	1147041	1228480911	32.72614	10.23128	0.0009337	1071
1072	1149184	1231925248	32.74141	10.23446	0.0009328	1072
1073	1151329	1235376017	32.75668	10.23764	0.0009320	1073
1074	1153476	1238833224	32.77194	10.24082	0.0009311	1074
1075	1155625	1242296875	32.78719	10.24400	0.0009302	1075
1076	1157776	1245766976	32.80244	10.24717	0.0009294	1076
1077	1159929	1249243533	32.81768	10.25035	0.0009285	1077
1078	1162084	1252726552	32.83291	10.25352	0.0009276	1078
1079	1164241	1256216039	32.84814	10.25669	0.0009268	1079
1080	1166400	1259712000	32.86335	10.25986	0.0009259	1080
1081	1168561	1263214441	32.87856	10.26302	0.0009251	1081
1082	1170724	1266723368	32.89377	10.26619	0.0009242	1082
1083	1172889	1270238787	32.90897	10.26935	0.0009234	1083
1084	1175056	1273760704	32.92416	10.27251	0.0009225	1084
1085	1177225	1277289125	32.93934	10.27566	0.0009217	1085
1086	1179396	1280824056	32.95451	10.27882	0.0009208	1086
1087	1181569	1284365503	32.96968	10.28197	0.0009200	1087
1088	1183744	1287913472	32.98485	10.28513	0.0009191	1088
1089	1185921	1291467969	33.00000	10.28828	0.0009183	1089
1090	1188100	1295029000	33.01515	10.29142	0.0009174	1090
1091	1190281	1298596571	33.03029	10.29457	0.0009166	1091
1092	1192464	1302170688	33.04542	10.29772	0.0009158	1092
1093	1194649	1305751357	33.06055	10.30086	0.0009149	1093
1094	1196836	1309338584	33.07567	10.30400	0.0009141	1094
1095	1199025	1312932375	33.09078	10.30714	0.0009132	1095
1096	1201216	1316532736	33.10589	10.31027	0.0009124	1096
1097	1203409	1320139673	33.12099	10.31341	0.0009116	1097
1098	1205604	1323753192	33.13608	10.31654	0.0009107	1098
1099	1207801	1327373299	33.15117	10.31967	0.0009099	1099
1100	1210000	1331000000	33.16625	10.32280	0.0009091	1100

Powers, Roots, and Reciprocals From 1101 to 1150

No.	Square	Cube	Sq. Root	Cube Root	Reciprocal	No.
1101	1212201	1334633301	33.18132	10.32593	0.0009083	1101
1102	1214404	1338273208	33.19639	10.32905	0.0009074	1102
1103	1216609	1341919727	33.21144	10.33218	0.0009066	1103
1104	1218816	1345572864	33.22650	10.33530	0.0009058	1104
1105	1221025	1349232625	33.24154	10.33842	0.0009050	1105
1106	1223236	1352899016	33.25658	10.34154	0.0009042	1106
1107	1225449	1356572043	33.27161	10.34465	0.0009033	1107
1108	1227664	1360251712	33.28663	10.34777	0.0009025	1108
1109	1229881	1363938029	33.30165	10.35088	0.0009017	1109
1110	1232100	1367631000	33.31666	10.35399	0.0009009	1110
1111	1234321	1371330631	33.33167	10.35710	0.0009001	1111
1112	1236544	1375036928	33.34666	10.36020	0.0008993	1112
1113	1238769	1378749897	33.36165	10.36331	0.0008985	1113
1114	1240996	1382469544	33.37664	10.36641	0.0008977	1114
1115	1243225	1386195875	33.39162	10.36951	0.0008969	1115
1116	1245456	1389928896	33.40659	10.37261	0.0008961	1116
1117	1247689	1393668613	33.42155	10.37571	0.0008953	1117
1118	1249924	1397415032	33.43651	10.37880	0.0008945	1118
1119	1252161	1401168159	33.45146	10.38190	0.0008937	1119
1120	1254400	1404928000	33.46640	10.38499	0.0008929	1120
1121	1256641	1408694561	33.48134	10.38808	0.0008921	1121
1122	1258884	1412467848	33.49627	10.39117	0.0008913	1122
1123	1261129	1416247867	33.51119	10.39425	0.0008905	1123
1124	1263376	1420034624	33.52611	10.39734	0.0008897	1124
1125	1265625	1423828125	33.54102	10.40042	0.0008889	1125
1126	1267876	1427628376	33.55592	10.40350	0.0008881	1126
1127	1270129	1431435383	33.57082	10.40658	0.0008873	1127
1128	1272384	1435249152	33.58571	10.40966	0.0008865	1128
1129	1274641	1439069689	33.60060	10.41273	0.0008857	1129
1130	1276900	1442897000	33.61547	10.41580	0.0008850	1130
1131	1279161	1446731091	33.63034	10.41888	0.0008842	1131
1132	1281424	1450571968	33.64521	10.42195	0.0008834	1132
1133	1283689	1454419637	33.66007	10.42501	0.0008826	1133
1134	1285956	1458274104	33.67492	10.42808	0.0008818	1134
1135	1288225	1462135375	33.68976	10.43114	0.0008811	1135
1136	1290496	1466003456	33.70460	10.43421	0.0008803	1136
1137	1292769	1469878353	33.71943	10.43727	0.0008795	1137
1138	1295044	1473760072	33.73426	10.44033	0.0008787	1138
1139	1297321	1477648619	33.74907	10.44338	0.0008780	1139
1140	1299600	1481544000	33.76389	10.44644	0.0008772	1140
1141	1301881	1485446221	33.77869	10.44949	0.0008764	1141
1142	1304164	1489355288	33.79349	10.45254	0.0008757	1142
1143	1306449	1493271207	33.80828	10.45559	0.0008749	1143
1144	1308736	1497193984	33.82307	10.45864	0.0008741	1144
1145	1311025	1501123625	33.83785	10.46169	0.0008734	1145
1146	1313316	1505060136	33.85262	10.46473	0.0008726	1146
1147	1315609	1509003523	33.86739	10.46778	0.0008718	1147
1148	1317904	1512953792	33.88215	10.47082	0.0008711	1148
1149	1320201	1516910949	33.89690	10.47386	0.0008703	1149
1150	1322500	1520875000	33.91165	10.47690	0.0008696	1150

Powers, Roots, and Reciprocals From 1151 to 1200

No.	Square	Cube	Sq. Root	Cube Root	Reciprocal	No.
1151	1324801	1524845951	33.92639	10.47993	0.0008688	1151
1152	1327104	1528823808	33.94113	10.48297	0.0008681	1152
1153	1329409	1532808577	33.95585	10.48600	0.0008673	1153
1154	1331716	1536800264	33.97058	10.48903	0.0008666	1154
1155	1334025	1540798875	33.98529	10.49206	0.0008658	1155
1156	1336336	1544804416	34.00000	10.49508	0.0008651	1156
1157	1338649	1548816893	34.01470	10.49811	0.0008643	1157
1158	1340964	1552836312	34.02940	10.50113	0.0008636	1158
1159	1343281	1556862679	34.04409	10.50416	0.0008628	1159
1160	1345600	1560896000	34.05877	10.50718	0.0008621	1160
1161	1347921	1564936281	34.07345	10.51019	0.0008613	1161
1162	1350244	1568983528	34.08812	10.51321	0.0008606	1162
1163	1352569	1573037747	34.10279	10.51623	0.0008598	1163
1164	1354896	1577098944	34.11744	10.51924	0.0008591	1164
1165	1357225	1581167125	34.13210	10.52225	0.0008584	1165
1166	1359556	1585242296	34.14674	10.52526	0.0008576	1166
1167	1361889	1589324463	34.16138	10.52827	0.0008569	1167
1168	1364224	1593413632	34.17601	10.53127	0.0008562	1168
1169	1366561	1597509809	34.19064	10.53428	0.0008554	1169
1170	1368900	1601613000	34.20526	10.53728	0.0008547	1170
1171	1371241	1605723211	34.21988	10.54028	0.0008540	1171
1172	1373584	1609840448	34.23449	10.54328	0.0008532	1172
1173	1375929	1613964717	34.24909	10.54628	0.0008525	1173
1174	1378276	1618096024	34.26368	10.54928	0.0008518	1174
1175	1380625	1622234375	34.27827	10.55227	0.0008511	1175
1176	1382976	1626379776	34.29286	10.55526	0.0008503	1176
1177	1385329	1630532233	34.30743	10.55826	0.0008496	1177
1178	1387684	1634691752	34.32200	10.56124	0.0008489	1178
1179	1390041	1638858339	34.33657	10.56423	0.0008482	1179
1180	1392400	1643032000	34.35113	10.56722	0.0008475	1180
1181	1394761	1647212741	34.36568	10.57020	0.0008467	1181
1182	1397124	1651400568	34.38023	10.57318	0.0008460	1182
1183	1399489	1655595487	34.39477	10.57617	0.0008453	1183
1184	1401856	1659797504	34.40930	10.57914	0.0008446	1184
1185	1404225	1664006625	34.42383	10.58212	0.0008439	1185
1186	1406596	1668222856	34.43835	10.58510	0.0008432	1186
1187	1408969	1672446203	34.45287	10.58807	0.0008425	1187
1188	1411344	1676676672	34.46738	10.59105	0.0008418	1188
1189	1413721	1680914269	34.48188	10.59402	0.0008410	1189
1190	1416100	1685159000	34.49638	10.59699	0.0008403	1190
1191	1418481	1689410871	34.51087	10.59995	0.0008396	1191
1192	1420864	1693669888	34.52535	10.60292	0.0008389	1192
1193	1423249	1697936057	34.53983	10.60588	0.0008382	1193
1194	1425636	1702209384	34.55431	10.60885	0.0008375	1194
1195	1428025	1706489875	34.56877	10.61181	0.0008368	1195
1196	1430416	1710777536	34.58323	10.61477	0.0008361	1196
1197	1432809	1715072373	34.59769	10.61772	0.0008354	1197
1198	1435204	1719374392	34.61214	10.62068	0.0008347	1198
1199	1437601	1723683599	34.62658	10.62363	0.0008340	1199
1200	1440000	1728000000	34.64102	10.62659	0.0008333	1200

Powers, Roots, and Reciprocals From 1201 to 1250

No.	Square	Cube	Sq. Root	Cube Root	Reciprocal	No.
1201	1442401	1732323601	34.65545	10.62954	0.0008326	1201
1202	1444804	1736654408	34.66987	10.63249	0.0008319	1202
1203	1447209	1740992427	34.68429	10.63543	0.0008313	1203
1204	1449616	1745337664	34.69870	10.63838	0.0008306	1204
1205	1452025	1749690125	34.71311	10.64132	0.0008299	1205
1206	1454436	1754049816	34.72751	10.64427	0.0008292	1206
1207	1456849	1758416743	34.74191	10.64721	0.0008285	1207
1208	1459264	1762790912	34.75629	10.65015	0.0008278	1208
1209	1461681	1767172329	34.77068	10.65309	0.0008271	1209
1210	1464100	1771561000	34.78505	10.65602	0.0008264	1210
1211	1466521	1775956931	34.79943	10.65896	0.0008258	1211
1212	1468944	1780360128	34.81379	10.66189	0.0008251	1212
1213	1471369	1784770597	34.82815	10.66482	0.0008244	1213
1214	1473796	1789188344	34.84250	10.66775	0.0008237	1214
1215	1476225	1793613375	34.85685	10.67068	0.0008230	1215
1216	1478656	1798045696	34.87119	10.67361	0.0008224	1216
1217	1481089	1802485313	34.88553	10.67653	0.0008217	1217
1218	1483524	1806932232	34.89986	10.67946	0.0008210	1218
1219	1485961	1811386459	34.91418	10.68238	0.0008203	1219
1220	1488400	1815848000	34.92850	10.68530	0.0008197	1220
1221	1490841	1820316861	34.94281	10.68822	0.0008190	1221
1222	1493284	1824793048	34.95712	10.69113	0.0008183	1222
1223	1495729	1829276567	34.97142	10.69405	0.0008177	1223
1224	1498176	1833767424	34.98571	10.69696	0.0008170	1224
1225	1500625	1838265625	35.00000	10.69987	0.0008163	1225
1226	1503076	1842771176	35.01428	10.70279	0.0008157	1226
1227	1505529	1847284083	35.02856	10.70569	0.0008150	1227
1228	1507984	1851804352	35.04283	10.70860	0.0008143	1228
1229	1510441	1856331989	35.05710	10.71151	0.0008137	1229
1230	1512900	1860867000	35.07136	10.71441	0.0008130	1230
1231	1515361	1865409391	35.08561	10.71732	0.0008123	1231
1232	1517824	1869959168	35.09986	10.72022	0.0008117	1232
1233	1520289	1874516337	35.11410	10.72312	0.0008110	1233
1234	1522756	1879080904	35.12834	10.72601	0.0008104	1234
1235	1525225	1883652875	35.14257	10.72891	0.0008097	1235
1236	1527696	1888232256	35.15679	10.73181	0.0008091	1236
1237	1530169	1892819053	35.17101	10.73470	0.0008084	1237
1238	1532644	1897413272	35.18522	10.73759	0.0008078	1238
1239	1535121	1902014919	35.19943	10.74048	0.0008071	1239
1240	1537600	1906624000	35.21363	10.74337	0.0008065	1240
1241	1540081	1911240521	35.22783	10.74626	0.0008058	1241
1242	1542564	1915864488	35.24202	10.74914	0.0008052	1242
1243	1545049	1920495907	35.25621	10.75203	0.0008045	1243
1244	1547536	1925134784	35.27038	10.75491	0.0008039	1244
1245	1550025	1929781125	35.28456	10.75779	0.0008032	1245
1246	1552516	1934434936	35.29873	10.76067	0.0008026	1246
1247	1555009	1939096223	35.31289	10.76355	0.0008019	1247
1248	1557504	1943764992	35.32704	10.76643	0.0008013	1248
1249	1560001	1948441249	35.34119	10.76930	0.0008006	1249
1250	1562500	1953125000	35.35534	10.77217	0.0008000	1250

Powers, Roots, and Reciprocals From 1251 to 1300

No.	Square	Cube	Sq. Root	Cube Root	Reciprocal	No.
1251	1565001	1957816251	35.36948	10.77505	0.0007994	1251
1252	1567504	1962515008	35.38361	10.77792	0.0007987	1252
1253	1570009	1967221277	35.39774	10.78078	0.0007981	1253
1254	1572516	1971935064	35.41186	10.78365	0.0007974	1254
1255	1575025	1976656375	35.42598	10.78652	0.0007968	1255
1256	1577536	1981385216	35.44009	10.78938	0.0007962	1256
1257	1580049	1986121593	35.45420	10.79224	0.0007955	1257
1258	1582564	1990865512	35.46830	10.79511	0.0007949	1258
1259	1585081	1995616979	35.48239	10.79796	0.0007943	1259
1260	1587600	2000376000	35.49648	10.80082	0.0007937	1260
1261	1590121	2005142581	35.51056	10.80368	0.0007930	1261
1262	1592644	2009916728	35.52464	10.80653	0.0007924	1262
1263	1595169	2014698447	35.53871	10.80939	0.0007918	1263
1264	1597696	2019487744	35.55278	10.81224	0.0007911	1264
1265	1600225	2024284625	35.56684	10.81509	0.0007905	1265
1266	1602756	2029089096	35.58089	10.81794	0.0007899	1266
1267	1605289	2033901163	35.59494	10.82079	0.0007893	1267
1268	1607824	2038720832	35.60899	10.82363	0.0007886	1268
1269	1610361	2043548109	35.62303	10.82648	0.0007880	1269
1270	1612900	2048383000	35.63706	10.82932	0.0007874	1270
1271	1615441	2053225511	35.65109	10.83216	0.0007868	1271
1272	1617984	2058075648	35.66511	10.83500	0.0007862	1272
1273	1620529	2062933417	35.67913	10.83784	0.0007855	1273
1274	1623076	2067798824	35.69314	10.84068	0.0007849	1274
1275	1625625	2072671875	35.70714	10.84351	0.0007843	1275
1276	1628176	2077552576	35.72114	10.84635	0.0007837	1276
1277	1630729	2082440933	35.73514	10.84918	0.0007831	1277
1278	1633284	2087336952	35.74913	10.85201	0.0007825	1278
1279	1635841	2092240639	35.76311	10.85484	0.0007819	1279
1280	1638400	2097152000	35.77709	10.85767	0.0007813	1280
1281	1640961	2102071041	35.79106	10.86050	0.0007806	1281
1282	1643524	2106997768	35.80503	10.86332	0.0007800	1282
1283	1646089	2111932187	35.81899	10.86615	0.0007794	1283
1284	1648656	2116874304	35.83295	10.86897	0.0007788	1284
1285	1651225	2121824125	35.84690	10.87179	0.0007782	1285
1286	1653796	2126781656	35.86084	10.87461	0.0007776	1286
1287	1656369	2131746903	35.87478	10.87743	0.0007770	1287
1288	1658944	2136719872	35.88872	10.88024	0.0007764	1288
1289	1661521	2141700569	35.90265	10.88306	0.0007758	1289
1290	1664100	2146689000	35.91657	10.88587	0.0007752	1290
1291	1666681	2151685171	35.93049	10.88868	0.0007746	1291
1292	1669264	2156689088	35.94440	10.89150	0.0007740	1292
1293	1671849	2161700757	35.95831	10.89430	0.0007734	1293
1294	1674436	2166720184	35.97221	10.89711	0.0007728	1294
1295	1677025	2171747375	35.98611	10.89992	0.0007722	1295
1296	1679616	2176782336	36.00000	10.90272	0.0007716	1296
1297	1682209	2181825073	36.01389	10.90553	0.0007710	1297
1298	1684804	2186875592	36.02777	10.90833	0.0007704	1298
1299	1687401	2191933899	36.04164	10.91113	0.0007698	1299
1300	1690000	2197000000	36.05551	10.91393	0.0007692	1300

Powers, Roots, and Reciprocals From 1301 to 1350

No.	Square	Cube	Sq. Root	Cube Root	Reciprocal	No.
1301	1692601	2202073901	36.06938	10.91673	0.0007686	1301
1302	1695204	2207155608	36.08324	10.91952	0.0007680	1302
1303	1697809	2212245127	36.09709	10.92232	0.0007675	1303
1304	1700416	2217342464	36.11094	10.92511	0.0007669	1304
1305	1703025	2222447625	36.12478	10.92790	0.0007663	1305
1306	1705636	2227560616	36.13862	10.93069	0.0007657	1306
1307	1708249	2232681443	36.15245	10.93348	0.0007651	1307
1308	1710864	2237810112	36.16628	10.93627	0.0007645	1308
1309	1713481	2242946629	36.18011	10.93906	0.0007639	1309
1310	1716100	2248091000	36.19392	10.94184	0.0007634	1310
1311	1718721	2253243231	36.20773	10.94463	0.0007628	1311
1312	1721344	2258403328	36.22154	10.94741	0.0007622	1312
1313	1723969	2263571297	36.23534	10.95019	0.0007616	1313
1314	1726596	2268747144	36.24914	10.95297	0.0007610	1314
1315	1729225	2273930875	36.26293	10.95575	0.0007605	1315
1316	1731856	2279122496	36.27671	10.95852	0.0007599	1316
1317	1734489	2284322013	36.29049	10.96130	0.0007593	1317
1318	1737124	2289529432	36.30427	10.96407	0.0007587	1318
1319	1739761	2294744759	36.31804	10.96684	0.0007582	1319
1320	1742400	2299968000	36.33180	10.96961	0.0007576	1320
1321	1745041	2305199161	36.34556	10.97238	0.0007570	1321
1322	1747684	2310438248	36.35932	10.97515	0.0007564	1322
1323	1750329	2315685267	36.37307	10.97792	0.0007559	1323
1324	1752976	2320940224	36.38681	10.98068	0.0007553	1324
1325	1755625	2326203125	36.40055	10.98345	0.0007547	1325
1326	1758276	2331473976	36.41428	10.98621	0.0007541	1326
1327	1760929	2336752783	36.42801	10.98897	0.0007536	1327
1328	1763584	2342039552	36.44173	10.99173	0.0007530	1328
1329	1766241	2347334289	36.45545	10.99449	0.0007524	1329
1330	1768900	2352637000	36.46917	10.99724	0.0007519	1330
1331	1771561	2357947691	36.48287	11.00000	0.0007513	1331
1332	1774224	2363266368	36.49658	11.00275	0.0007508	1332
1333	1776889	2368593037	36.51027	11.00551	0.0007502	1333
1334	1779556	2373927704	36.52396	11.00826	0.0007496	1334
1335	1782225	2379270375	36.53765	11.01101	0.0007491	1335
1336	1784896	2384621056	36.55133	11.01376	0.0007485	1336
1337	1787569	2389979753	36.56501	11.01650	0.0007479	1337
1338	1790244	2395346472	36.57868	11.01925	0.0007474	1338
1339	1792921	2400721219	36.59235	11.02199	0.0007468	1339
1340	1795600	2406104000	36.60601	11.02474	0.0007463	1340
1341	1798281	2411494821	36.61967	11.02748	0.0007457	1341
1342	1800964	2416893688	36.63332	11.03022	0.0007452	1342
1343	1803649	2422300607	36.64696	11.03296	0.0007446	1343
1344	1806336	2427715584	36.66061	11.03570	0.0007440	1344
1345	1809025	2433138625	36.67424	11.03843	0.0007435	1345
1346	1811716	2438569736	36.68787	11.04117	0.0007429	1346
1347	1814409	2444008923	36.70150	11.04390	0.0007424	1347
1348	1817104	2449456192	36.71512	11.04663	0.0007418	1348
1349	1819801	2454911549	36.72874	11.04936	0.0007413	1349
1350	1822500	2460375000	36.74235	11.05209	0.0007407	1350

Powers, Roots, and Reciprocals From 1351 to 1400

No.	Square	Cube	Sq. Root	Cube Root	Reciprocal	No.
1351	1825201	2465846551	36.75595	11.05482	0.0007402	1351
1352	1827904	2471326208	36.76955	11.05755	0.0007396	1352
1353	1830609	2476813977	36.78315	11.06028	0.0007391	1353
1354	1833316	2482309864	36.79674	11.06300	0.0007386	1354
1355	1836025	2487813875	36.81032	11.06572	0.0007380	1355
1356	1838736	2493326016	36.82391	11.06844	0.0007375	1356
1357	1841449	2498846293	36.83748	11.07116	0.0007369	1357
1358	1844164	2504374712	36.85105	11.07388	0.0007364	1358
1359	1846881	2509911279	36.86462	11.07660	0.0007358	1359
1360	1849600	2515456000	36.87818	11.07932	0.0007353	1360
1361	1852321	2521008881	36.89173	11.08203	0.0007348	1361
1362	1855044	2526569928	36.90528	11.08474	0.0007342	1362
1363	1857769	2532139147	36.91883	11.08746	0.0007337	1363
1364	1860496	2537716544	36.93237	11.09017	0.0007331	1364
1365	1863225	2543302125	36.94591	11.09288	0.0007326	1365
1366	1865956	2548895896	36.95944	11.09559	0.0007321	1366
1367	1868689	2554497863	36.97296	11.09829	0.0007315	1367
1368	1871424	2560108032	36.98648	11.10100	0.0007310	1368
1369	1874161	2565726409	37.00000	11.10370	0.0007305	1369
1370	1876900	2571353000	37.01351	11.10641	0.0007299	1370
1371	1879641	2576987811	37.02702	11.10911	0.0007294	1371
1372	1882384	2582630848	37.04052	11.11181	0.0007289	1372
1373	1885129	2588282117	37.05401	11.11451	0.0007283	1373
1374	1887876	2593941624	37.06751	11.11720	0.0007278	1374
1375	1890625	2599609375	37.08099	11.11990	0.0007273	1375
1376	1893376	2605285376	37.09447	11.12260	0.0007267	1376
1377	1896129	2610969633	37.10795	11.12529	0.0007262	1377
1378	1898884	2616662152	37.12142	11.12798	0.0007257	1378
1379	1901641	2622362939	37.13489	11.13067	0.0007252	1379
1380	1904400	2628072000	37.14835	11.13336	0.0007246	1380
1381	1907161	2633789341	37.16181	11.13605	0.0007241	1381
1382	1909924	2639514968	37.17526	11.13874	0.0007236	1382
1383	1912689	2645248887	37.18871	11.14142	0.0007231	1383
1384	1915456	2650991104	37.20215	11.14411	0.0007225	1384
1385	1918225	2656741625	37.21559	11.14679	0.0007220	1385
1386	1920996	2662500456	37.22902	11.14947	0.0007215	1386
1387	1923769	2668267603	37.24245	11.15216	0.0007210	1387
1388	1926544	2674043072	37.25587	11.15484	0.0007205	1388
1389	1929321	2679826869	37.26929	11.15751	0.0007199	1389
1390	1932100	2685619000	37.28270	11.16019	0.0007194	1390
1391	1934881	2691419471	37.29611	11.16287	0.0007189	1391
1392	1937664	2697228288	37.30952	11.16554	0.0007184	1392
1393	1940449	2703045457	37.32292	11.16821	0.0007179	1393
1394	1943236	2708870984	37.33631	11.17089	0.0007174	1394
1395	1946025	2714704875	37.34970	11.17356	0.0007168	1395
1396	1948816	2720547136	37.36308	11.17623	0.0007163	1396
1397	1951609	2726397773	37.37646	11.17889	0.0007158	1397
1398	1954404	2732256792	37.38984	11.18156	0.0007153	1398
1399	1957201	2738124199	37.40321	11.18423	0.0007148	1399
1400	1960000	2744000000	37.41657	11.18689	0.0007143	1400

Powers, Roots, and Reciprocals From 1401 to 1450

No.	Square	Cube	Sq. Root	Cube Root	Reciprocal	No.
1401	1962801	2749884201	37.42993	11.18955	0.0007138	1401
1402	1965604	2755776808	37.44329	11.19221	0.0007133	1402
1403	1968409	2761677827	37.45664	11.19487	0.0007128	1403
1404	1971216	2767587264	37.46999	11.19753	0.0007123	1404
1405	1974025	2773505125	37.48333	11.20019	0.0007117	1405
1406	1976836	2779431416	37.49667	11.20285	0.0007112	1406
1407	1979649	2785366143	37.51000	11.20550	0.0007107	1407
1408	1982464	2791309312	37.52333	11.20816	0.0007102	1408
1409	1985281	2797260929	37.53665	11.21081	0.0007097	1409
1410	1988100	2803221000	37.54997	11.21346	0.0007092	1410
1411	1990921	2809189531	37.56328	11.21611	0.0007087	1411
1412	1993744	2815166528	37.57659	11.21876	0.0007082	1412
1413	1996569	2821151997	37.58989	11.22141	0.0007077	1413
1414	1999396	2827145944	37.60319	11.22406	0.0007072	1414
1415	2002225	2833148375	37.61649	11.22670	0.0007067	1415
1416	2005056	2839159296	37.62978	11.22934	0.0007062	1416
1417	2007889	2845178713	37.64306	11.23199	0.0007057	1417
1418	2010724	2851206632	37.65634	11.23463	0.0007052	1418
1419	2013561	2857243059	37.66962	11.23727	0.0007047	1419
1420	2016400	2863288000	37.68289	11.23991	0.0007042	1420
1421	2019241	2869341461	37.69615	11.24255	0.0007037	1421
1422	2022084	2875403448	37.70942	11.24518	0.0007032	1422
1423	2024929	2881473967	37.72267	11.24782	0.0007027	1423
1424	2027776	2887553024	37.73592	11.25045	0.0007022	1424
1425	2030625	2893640625	37.74917	11.25309	0.0007018	1425
1426	2033476	2899736776	37.76242	11.25572	0.0007013	1426
1427	2036329	2905841483	37.77565	11.25835	0.0007008	1427
1428	2039184	2911954752	37.78889	11.26098	0.0007003	1428
1429	2042041	2918076589	37.80212	11.26360	0.0006998	1429
1430	2044900	2924207000	37.81534	11.26623	0.0006993	1430
1431	2047761	2930345991	37.82856	11.26886	0.0006988	1431
1432	2050624	2936493568	37.84178	11.27148	0.0006983	1432
1433	2053489	2942649737	37.85499	11.27410	0.0006978	1433
1434	2056356	2948814504	37.86819	11.27673	0.0006974	1434
1435	2059225	2954987875	37.88139	11.27935	0.0006969	1435
1436	2062096	2961169856	37.89459	11.28197	0.0006964	1436
1437	2064969	2967360453	37.90778	11.28458	0.0006959	1437
1438	2067844	2973559672	37.92097	11.28720	0.0006954	1438
1439	2070721	2979767519	37.93415	11.28982	0.0006949	1439
1440	2073600	2985984000	37.94733	11.29243	0.0006944	1440
1441	2076481	2992209121	37.96051	11.29505	0.0006940	1441
1442	2079364	2998442888	37.97368	11.29766	0.0006935	1442
1443	2082249	3004685307	37.98684	11.30027	0.0006930	1443
1444	2085136	3010936384	38.00000	11.30288	0.0006925	1444
1445	2088025	3017196125	38.01316	11.30549	0.0006920	1445
1446	2090916	3023464536	38.02631	11.30809	0.0006916	1446
1447	2093809	3029741623	38.03945	11.31070	0.0006911	1447
1448	2096704	3036027392	38.05260	11.31331	0.0006906	1448
1449	2099601	3042321849	38.06573	11.31591	0.0006901	1449
1450	2102500	3048625000	38.07887	11.31851	0.0006897	1450

Powers, Roots, and Reciprocals From 1451 to 1500

No.	Square	Cube	Sq. Root	Cube Root	Reciprocal	No.
1451	2105401	3054936851	38.09199	11.32111	0.0006892	1451
1452	2108304	3061257408	38.10512	11.32371	0.0006887	1452
1453	2111209	3067586677	38.11824	11.32631	0.0006882	1453
1454	2114116	3073924664	38.13135	11.32891	0.0006878	1454
1455	2117025	3080271375	38.14446	11.33151	0.0006873	1455
1456	2119936	3086626816	38.15757	11.33410	0.0006868	1456
1457	2122849	3092990993	38.17067	11.33670	0.0006863	1457
1458	2125764	3099363912	38.18377	11.33929	0.0006859	1458
1459	2128681	3105745579	38.19686	11.34188	0.0006854	1459
1460	2131600	3112136000	38.20995	11.34447	0.0006849	1460
1461	2134521	3118535181	38.22303	11.34706	0.0006845	1461
1462	2137444	3124943128	38.23611	11.34965	0.0006840	1462
1463	2140369	3131359847	38.24918	11.35224	0.0006835	1463
1464	2143296	3137785344	38.26225	11.35482	0.0006831	1464
1465	2146225	3144219625	38.27532	11.35741	0.0006826	1465
1466	2149156	3150662696	38.28838	11.35999	0.0006821	1466
1467	2152089	3157114563	38.30144	11.36257	0.0006817	1467
1468	2155024	3163575232	38.31449	11.36515	0.0006812	1468
1469	2157961	3170044709	38.32754	11.36773	0.0006807	1469
1470	2160900	3176523000	38.34058	11.37031	0.0006803	1470
1471	2163841	3183010111	38.35362	11.37289	0.0006798	1471
1472	2166784	3189506048	38.36665	11.37547	0.0006793	1472
1473	2169729	3196010817	38.37968	11.37804	0.0006789	1473
1474	2172676	3202524424	38.39271	11.38062	0.0006784	1474
1475	2175625	3209046875	38.40573	11.38319	0.0006780	1475
1476	2178576	3215578176	38.41875	11.38576	0.0006775	1476
1477	2181529	3222118333	38.43176	11.38833	0.0006770	1477
1478	2184484	3228667352	38.44477	11.39090	0.0006766	1478
1479	2187441	3235225239	38.45777	11.39347	0.0006761	1479
1480	2190400	3241792000	38.47077	11.39604	0.0006757	1480
1481	2193361	3248367641	38.48376	11.39860	0.0006752	1481
1482	2196324	3254952168	38.49675	11.40117	0.0006748	1482
1483	2199289	3261545587	38.50974	11.40373	0.0006743	1483
1484	2202256	3268147904	38.52272	11.40630	0.0006739	1484
1485	2205225	3274759125	38.53570	11.40886	0.0006734	1485
1486	2208196	3281379256	38.54867	11.41142	0.0006729	1486
1487	2211169	3288008303	38.56164	11.41398	0.0006725	1487
1488	2214144	3294646272	38.57460	11.41653	0.0006720	1488
1489	2217121	3301293169	38.58756	11.41909	0.0006716	1489
1490	2220100	3307949000	38.60052	11.42165	0.0006711	1490
1491	2223081	3314613771	38.61347	11.42420	0.0006707	1491
1492	2226064	3321287488	38.62642	11.42676	0.0006702	1492
1493	2229049	3327970157	38.63936	11.42931	0.0006698	1493
1494	2232036	3334661784	38.65230	11.43186	0.0006693	1494
1495	2235025	3341362375	38.66523	11.43441	0.0006689	1495
1496	2238016	3348071936	38.67816	11.43696	0.0006684	1496
1497	2241009	3354790473	38.69108	11.43951	0.0006680	1497
1498	2244004	3361517992	38.70400	11.44205	0.0006676	1498
1499	2247001	3368254499	38.71692	11.44460	0.0006671	1499
1500	2250000	3375000000	38.72983	11.44714	0.0006667	1500

Powers, Roots, and Reciprocals From 1501 to 1550

No.	Square	Cube	Sq. Root	Cube Root	Reciprocal	No.
1501	2253001	3381754501	38.74274	11.44969	0.0006662	1501
1502	2256004	3388518008	38.75564	11.45223	0.0006658	1502
1503	2259009	3395290527	38.76854	11.45477	0.0006653	1503
1504	2262016	3402072064	38.78144	11.45731	0.0006649	1504
1505	2265025	3408862625	38.79433	11.45985	0.0006645	1505
1506	2268036	3415662216	38.80722	11.46238	0.0006640	1506
1507	2271049	3422470843	38.82010	11.46492	0.0006636	1507
1508	2274064	3429288512	38.83298	11.46746	0.0006631	1508
1509	2277081	3436115229	38.84585	11.46999	0.0006627	1509
1510	2280100	3442951000	38.85872	11.47252	0.0006623	1510
1511	2283121	3449795831	38.87158	11.47506	0.0006618	1511
1512	2286144	3456649728	38.88444	11.47759	0.0006614	1512
1513	2289169	3463512697	38.89730	11.48012	0.0006609	1513
1514	2292196	3470384744	38.91015	11.48265	0.0006605	1514
1515	2295225	3477265875	38.92300	11.48517	0.0006601	1515
1516	2298256	3484156096	38.93584	11.48770	0.0006596	1516
1517	2301289	3491055413	38.94868	11.49022	0.0006592	1517
1518	2304324	3497963832	38.96152	11.49275	0.0006588	1518
1519	2307361	3504881359	38.97435	11.49527	0.0006583	1519
1520	2310400	3511808000	38.98718	11.49779	0.0006579	1520
1521	2313441	3518743761	39.00000	11.50032	0.0006575	1521
1522	2316484	3525688648	39.01282	11.50283	0.0006570	1522
1523	2319529	3532642667	39.02563	11.50535	0.0006566	1523
1524	2322576	3539605824	39.03844	11.50787	0.0006562	1524
1525	2325625	3546578125	39.05125	11.51039	0.0006557	1525
1526	2328676	3553559576	39.06405	11.51290	0.0006553	1526
1527	2331729	3560550183	39.07685	11.51542	0.0006549	1527
1528	2334784	3567549952	39.08964	11.51793	0.0006545	1528
1529	2337841	3574558889	39.10243	11.52044	0.0006540	1529
1530	2340900	3581577000	39.11521	11.52295	0.0006536	1530
1531	2343961	3588604291	39.12800	11.52546	0.0006532	1531
1532	2347024	3595640768	39.14077	11.52797	0.0006527	1532
1533	2350089	3602686437	39.15354	11.53048	0.0006523	1533
1534	2353156	3609741304	39.16631	11.53299	0.0006519	1534
1535	2356225	3616805375	39.17908	11.53549	0.0006515	1535
1536	2359296	3623878656	39.19184	11.53800	0.0006510	1536
1537	2362369	3630961153	39.20459	11.54050	0.0006506	1537
1538	2365444	3638052872	39.21734	11.54300	0.0006502	1538
1539	2368521	3645153819	39.23009	11.54550	0.0006498	1539
1540	2371600	3652264000	39.24283	11.54800	0.0006494	1540
1541	2374681	3659383421	39.25557	11.55050	0.0006489	1541
1542	2377764	3666512088	39.26831	11.55300	0.0006485	1542
1543	2380849	3673650007	39.28104	11.55550	0.0006481	1543
1544	2383936	3680797184	39.29377	11.55799	0.0006477	1544
1545	2387025	3687953625	39.30649	11.56049	0.0006472	1545
1546	2390116	3695119336	39.31921	11.56298	0.0006468	1546
1547	2393209	3702294323	39.33192	11.56547	0.0006464	1547
1548	2396304	3709478592	39.34463	11.56797	0.0006460	1548
1549	2399401	3716672149	39.35734	11.57046	0.0006456	1549
1550	2402500	3723875000	39.37004	11.57295	0.0006452	1550

Powers, Roots, and Reciprocals From 1551 to 1600

No.	Square	Cube	Sq. Root	Cube Root	Reciprocal	No.
1551	2405601	3731087151	39.38274	11.57543	0.0006447	1551
1552	2408704	3738308608	39.39543	11.57792	0.0006443	1552
1553	2411809	3745539377	39.40812	11.58041	0.0006439	1553
1554	2414916	3752779464	39.42081	11.58289	0.0006435	1554
1555	2418025	3760028875	39.43349	11.58538	0.0006431	1555
1556	2421136	3767287616	39.44617	11.58786	0.0006427	1556
1557	2424249	3774555693	39.45884	11.59034	0.0006423	1557
1558	2427364	3781833112	39.47151	11.59282	0.0006418	1558
1559	2430481	3789119879	39.48417	11.59530	0.0006414	1559
1560	2433600	3796416000	39.49684	11.59778	0.0006410	1560
1561	2436721	3803721481	39.50949	11.60026	0.0006406	1561
1562	2439844	3811036328	39.52215	11.60273	0.0006402	1562
1563	2442969	3818360547	39.53479	11.60521	0.0006398	1563
1564	2446096	3825694144	39.54744	11.60768	0.0006394	1564
1565	2449225	3833037125	39.56008	11.61016	0.0006390	1565
1566	2452356	3840389496	39.57272	11.61263	0.0006386	1566
1567	2455489	3847751263	39.58535	11.61510	0.0006382	1567
1568	2458624	3855122432	39.59798	11.61757	0.0006378	1568
1569	2461761	3862503009	39.61060	11.62004	0.0006373	1569
1570	2464900	3869893000	39.62323	11.62251	0.0006369	1570
1571	2468041	3877292411	39.63584	11.62498	0.0006365	1571
1572	2471184	3884701248	39.64846	11.62744	0.0006361	1572
1573	2474329	3892119517	39.66106	11.62991	0.0006357	1573
1574	2477476	3899547224	39.67367	11.63237	0.0006353	1574
1575	2480625	3906984375	39.68627	11.63483	0.0006349	1575
1576	2483776	3914430976	39.69887	11.63730	0.0006345	1576
1577	2486929	3921887033	39.71146	11.63976	0.0006341	1577
1578	2490084	3929352552	39.72405	11.64222	0.0006337	1578
1579	2493241	3936827539	39.73663	11.64468	0.0006333	1579
1580	2496400	3944312000	39.74921	11.64713	0.0006329	1580
1581	2499561	3951805941	39.76179	11.64959	0.0006325	1581
1582	2502724	3959309368	39.77436	11.65205	0.0006321	1582
1583	2505889	3966822287	39.78693	11.65450	0.0006317	1583
1584	2509056	3974344704	39.79950	11.65695	0.0006313	1584
1585	2512225	3981876625	39.81206	11.65941	0.0006309	1585
1586	2515396	3989418056	39.82462	11.66186	0.0006305	1586
1587	2518569	3996969003	39.83717	11.66431	0.0006301	1587
1588	2521744	4004529472	39.84972	11.66676	0.0006297	1588
1589	2524921	4012099469	39.86226	11.66921	0.0006293	1589
1590	2528100	4019679000	39.87480	11.67165	0.0006289	1590
1591	2531281	4027268071	39.88734	11.67410	0.0006285	1591
1592	2534464	4034866688	39.89987	11.67654	0.0006281	1592
1593	2537649	4042474857	39.91240	11.67899	0.0006277	1593
1594	2540836	4050092584	39.92493	11.68143	0.0006274	1594
1595	2544025	4057719875	39.93745	11.68387	0.0006270	1595
1596	2547216	4065356736	39.94997	11.68632	0.0006266	1596
1597	2550409	4073003173	39.96248	11.68876	0.0006262	1597
1598	2553604	4080659192	39.97499	11.69120	0.0006258	1598
1599	2556801	4088324799	39.98750	11.69363	0.0006254	1599
1600	2560000	4096000000	40.00000	11.69607	0.0006250	1600

Powers, Roots, and Reciprocals From 1601 to 1650

No.	Square	Cube	Sq. Root	Cube Root	Reciprocal	No.
1601	2563201	4103684801	40.01250	11.69851	0.0006246	1601
1602	2566404	4111379208	40.02499	11.70094	0.0006242	1602
1603	2569609	4119083227	40.03748	11.70338	0.0006238	1603
1604	2572816	4126796864	40.04997	11.70581	0.0006234	1604
1605	2576025	4134520125	40.06245	11.70824	0.0006231	1605
1606	2579236	4142253016	40.07493	11.71067	0.0006227	1606
1607	2582449	4149995543	40.08740	11.71310	0.0006223	1607
1608	2585664	4157747712	40.09988	11.71553	0.0006219	1608
1609	2588881	4165509529	40.11234	11.71796	0.0006215	1609
1610	2592100	4173281000	40.12481	11.72039	0.0006211	1610
1611	2595321	4181062131	40.13726	11.72281	0.0006207	1611
1612	2598544	4188852928	40.14972	11.72524	0.0006203	1612
1613	2601769	4196653397	40.16217	11.72766	0.0006200	1613
1614	2604996	4204463544	40.17462	11.73009	0.0006196	1614
1615	2608225	4212283375	40.18706	11.73251	0.0006192	1615
1616	2611456	4220112896	40.19950	11.73493	0.0006188	1616
1617	2614689	4227952113	40.21194	11.73735	0.0006184	1617
1618	2617924	4235801032	40.22437	11.73977	0.0006180	1618
1619	2621161	4243659659	40.23680	11.74219	0.0006177	1619
1620	2624400	4251528000	40.24922	11.74460	0.0006173	1620
1621	2627641	4259406061	40.26164	11.74702	0.0006169	1621
1622	2630884	4267293848	40.27406	11.74943	0.0006165	1622
1623	2634129	4275191367	40.28647	11.75185	0.0006161	1623
1624	2637376	4283098624	40.29888	11.75426	0.0006158	1624
1625	2640625	4291015625	40.31129	11.75667	0.0006154	1625
1626	2643876	4298942376	40.32369	11.75908	0.0006150	1626
1627	2647129	4306878883	40.33609	11.76149	0.0006146	1627
1628	2650384	4314825152	40.34848	11.76390	0.0006143	1628
1629	2653641	4322781189	40.36087	11.76631	0.0006139	1629
1630	2656900	4330747000	40.37326	11.76872	0.0006135	1630
1631	2660161	4338722591	40.38564	11.77113	0.0006131	1631
1632	2663424	4346707968	40.39802	11.77353	0.0006127	1632
1633	2666689	4354703137	40.41039	11.77593	0.0006124	1633
1634	2669956	4362708104	40.42277	11.77834	0.0006120	1634
1635	2673225	4370722875	40.43513	11.78074	0.0006116	1635
1636	2676496	4378747456	40.44750	11.78314	0.0006112	1636
1637	2679769	4386781853	40.45986	11.78554	0.0006109	1637
1638	2683044	4394826072	40.47221	11.78794	0.0006105	1638
1639	2686321	4402880119	40.48456	11.79034	0.0006101	1639
1640	2689600	4410944000	40.49691	11.79274	0.0006098	1640
1641	2692881	4419017721	40.50926	11.79513	0.0006094	1641
1642	2696164	4427101288	40.52160	11.79753	0.0006090	1642
1643	2699449	4435194707	40.53394	11.79992	0.0006086	1643
1644	2702736	4443297984	40.54627	11.80232	0.0006083	1644
1645	2706025	4451411125	40.55860	11.80471	0.0006079	1645
1646	2709316	4459534136	40.57093	11.80710	0.0006075	1646
1647	2712609	4467667023	40.58325	11.80949	0.0006072	1647
1648	2715904	4475809792	40.59557	11.81188	0.0006068	1648
1649	2719201	4483962449	40.60788	11.81427	0.0006064	1649
1650	2722500	4492125000	40.62019	11.81666	0.0006061	1650

Powers, Roots, and Reciprocals From 1651 to 1700

No.	Square	Cube	Sq. Root	Cube Root	Reciprocal	No.
1651	2725801	4500297451	40.63250	11.81904	0.0006057	1651
1652	2729104	4508479808	40.64480	11.82143	0.0006053	1652
1653	2732409	4516672077	40.65710	11.82381	0.0006050	1653
1654	2735716	4524874264	40.66940	11.82620	0.0006046	1654
1655	2739025	4533086375	40.68169	11.82858	0.0006042	1655
1656	2742336	4541308416	40.69398	11.83096	0.0006039	1656
1657	2745649	4549540393	40.70626	11.83334	0.0006035	1657
1658	2748964	4557782312	40.71855	11.83572	0.0006031	1658
1659	2752281	4566034179	40.73082	11.83810	0.0006028	1659
1660	2755600	4574296000	40.74310	11.84048	0.0006024	1660
1661	2758921	4582567781	40.75537	11.84286	0.0006020	1661
1662	2762244	4590849528	40.76763	11.84523	0.0006017	1662
1663	2765569	4599141247	40.77990	11.84761	0.0006013	1663
1664	2768896	4607442944	40.79216	11.84998	0.0006010	1664
1665	2772225	4615754625	40.80441	11.85236	0.0006006	1665
1666	2775556	4624076296	40.81666	11.85473	0.0006002	1666
1667	2778889	4632407963	40.82891	11.85710	0.0005999	1667
1668	2782224	4640749632	40.84116	11.85947	0.0005995	1668
1669	2785561	4649101309	40.85340	11.86184	0.0005992	1669
1670	2788900	4657463000	40.86563	11.86421	0.0005988	1670
1671	2792241	4665834711	40.87787	11.86658	0.0005984	1671
1672	2795584	4674216448	40.89010	11.86894	0.0005981	1672
1673	2798929	4682608217	40.90232	11.87131	0.0005977	1673
1674	2802276	4691010024	40.91455	11.87367	0.0005974	1674
1675	2805625	4699421875	40.92676	11.87604	0.0005970	1675
1676	2808976	4707843776	40.93898	11.87840	0.0005967	1676
1677	2812329	4716275733	40.95119	11.88076	0.0005963	1677
1678	2815684	4724717752	40.96340	11.88312	0.0005959	1678
1679	2819041	4733169839	40.97560	11.88548	0.0005956	1679
1680	2822400	4741632000	40.98780	11.88784	0.0005952	1680
1681	2825761	4750104241	41.00000	11.89020	0.0005949	1681
1682	2829124	4758586568	41.01219	11.89256	0.0005945	1682
1683	2832489	4767078987	41.02438	11.89492	0.0005942	1683
1684	2835856	4775581504	41.03657	11.89727	0.0005938	1684
1685	2839225	4784094125	41.04875	11.89963	0.0005935	1685
1686	2842596	4792616856	41.06093	11.90198	0.0005931	1686
1687	2845969	4801149703	41.07311	11.90433	0.0005928	1687
1688	2849344	4809692672	41.08528	11.90668	0.0005924	1688
1689	2852721	4818245769	41.09745	11.90903	0.0005921	1689
1690	2856100	4826809000	41.10961	11.91138	0.0005917	1690
1691	2859481	4835382371	41.12177	11.91373	0.0005914	1691
1692	2862864	4843965888	41.13393	11.91608	0.0005910	1692
1693	2866249	4852559557	41.14608	11.91843	0.0005907	1693
1694	2869636	4861163384	41.15823	11.92077	0.0005903	1694
1695	2873025	4869777375	41.17038	11.92312	0.0005900	1695
1696	2876416	4878401536	41.18252	11.92546	0.0005896	1696
1697	2879809	4887035873	41.19466	11.92781	0.0005893	1697
1698	2883204	4895680392	41.20680	11.93015	0.0005889	1698
1699	2886601	4904335099	41.21893	11.93249	0.0005886	1699
1700	2890000	4913000000	41.23106	11.93483	0.0005882	1700

Powers, Roots, and Reciprocals From 1701 to 1750

No.	Square	Cube	Sq. Root	Cube Root	Reciprocal	No.
1701	2893401	4921675101	41.24318	11.93717	0.0005879	1701
1702	2896804	4930360408	41.25530	11.93951	0.0005875	1702
1703	2900209	4939055927	41.26742	11.94185	0.0005872	1703
1704	2903616	4947761664	41.27953	11.94419	0.0005869	1704
1705	2907025	4956477625	41.29165	11.94652	0.0005865	1705
1706	2910436	4965203816	41.30375	11.94886	0.0005862	1706
1707	2913849	4973940243	41.31586	11.95119	0.0005858	1707
1708	2917264	4982686912	41.32796	11.95352	0.0005855	1708
1709	2920681	4991443829	41.34005	11.95586	0.0005851	1709
1710	2924100	5000211000	41.35215	11.95819	0.0005848	1710
1711	2927521	5008988431	41.36424	11.96052	0.0005845	1711
1712	2930944	5017776128	41.37632	11.96285	0.0005841	1712
1713	2934369	5026574097	41.38840	11.96518	0.0005838	1713
1714	2937796	5035382344	41.40048	11.96750	0.0005834	1714
1715	2941225	5044200875	41.41256	11.96983	0.0005831	1715
1716	2944656	5053029696	41.42463	11.97216	0.0005828	1716
1717	2948089	5061868813	41.43670	11.97448	0.0005824	1717
1718	2951524	5070718232	41.44876	11.97681	0.0005821	1718
1719	2954961	5079577959	41.46082	11.97913	0.0005817	1719
1720	2958400	5088448000	41.47288	11.98145	0.0005814	1720
1721	2961841	5097328361	41.48494	11.98377	0.0005811	1721
1722	2965284	5106219048	41.49699	11.98610	0.0005807	1722
1723	2968729	5115120067	41.50904	11.98841	0.0005804	1723
1724	2972176	5124031424	41.52108	11.99073	0.0005800	1724
1725	2975625	5132953125	41.53312	11.99305	0.0005797	1725
1726	2979076	5141885176	41.54516	11.99537	0.0005794	1726
1727	2982529	5150827583	41.55719	11.99768	0.0005790	1727
1728	2985984	5159780352	41.56922	12.00000	0.0005787	1728
1729	2989441	5168743489	41.58125	12.00231	0.0005784	1729
1730	2992900	5177717000	41.59327	12.00463	0.0005780	1730
1731	2996361	5186700891	41.60529	12.00694	0.0005777	1731
1732	2999824	5195695168	41.61730	12.00925	0.0005774	1732
1733	3003289	5204699837	41.62932	12.01156	0.0005770	1733
1734	3006756	5213714904	41.64133	12.01387	0.0005767	1734
1735	3010225	5222740375	41.65333	12.01618	0.0005764	1735
1736	3013696	5231776256	41.66533	12.01849	0.0005760	1736
1737	3017169	5240822553	41.67733	12.02080	0.0005757	1737
1738	3020644	5249879272	41.68933	12.02310	0.0005754	1738
1739	3024121	5258946419	41.70132	12.02541	0.0005750	1739
1740	3027600	5268024000	41.71331	12.02771	0.0005747	1740
1741	3031081	5277112021	41.72529	12.03002	0.0005744	1741
1742	3034564	5286210488	41.73727	12.03232	0.0005741	1742
1743	3038049	5295319407	41.74925	12.03462	0.0005737	1743
1744	3041536	5304438784	41.76123	12.03692	0.0005734	1744
1745	3045025	5313568625	41.77320	12.03922	0.0005731	1745
1746	3048516	5322708936	41.78516	12.04152	0.0005727	1746
1747	3052009	5331859723	41.79713	12.04382	0.0005724	1747
1748	3055504	5341020992	41.80909	12.04612	0.0005721	1748
1749	3059001	5350192749	41.82105	12.04842	0.0005718	1749
1750	3062500	5359375000	41.83300	12.05071	0.0005714	1750

Powers, Roots, and Reciprocals From 1751 to 1800

No.	Square	Cube	Sq. Root	Cube Root	Reciprocal	No.
1751	3066001	5368567751	41.84495	12.05301	0.0005711	1751
1752	3069504	5377771008	41.85690	12.05530	0.0005708	1752
1753	3073009	5386984777	41.86884	12.05759	0.0005705	1753
1754	3076516	5396209064	41.88078	12.05989	0.0005701	1754
1755	3080025	5405443875	41.89272	12.06218	0.0005698	1755
1756	3083536	5414689216	41.90465	12.06447	0.0005695	1756
1757	3087049	5423945093	41.91658	12.06676	0.0005692	1757
1758	3090564	5433211512	41.92851	12.06905	0.0005688	1758
1759	3094081	5442488479	41.94043	12.07133	0.0005685	1759
1760	3097600	5451776000	41.95235	12.07362	0.0005682	1760
1761	3101121	5461074081	41.96427	12.07591	0.0005679	1761
1762	3104644	5470382728	41.97618	12.07819	0.0005675	1762
1763	3108169	5479701947	41.98809	12.08048	0.0005672	1763
1764	3111696	5489031744	42.00000	12.08276	0.0005669	1764
1765	3115225	5498372125	42.01190	12.08504	0.0005666	1765
1766	3118756	5507723096	42.02380	12.08733	0.0005663	1766
1767	3122289	5517084663	42.03570	12.08961	0.0005659	1767
1768	3125824	5526456832	42.04759	12.09189	0.0005656	1768
1769	3129361	5535839609	42.05948	12.09417	0.0005653	1769
1770	3132900	5545233000	42.07137	12.09645	0.0005650	1770
1771	3136441	5554637011	42.08325	12.09872	0.0005647	1771
1772	3139984	5564051648	42.09513	12.10100	0.0005643	1772
1773	3143529	5573476917	42.10701	12.10328	0.0005640	1773
1774	3147076	5582912824	42.11888	12.10555	0.0005637	1774
1775	3150625	5592359375	42.13075	12.10782	0.0005634	1775
1776	3154176	5601816576	42.14262	12.11010	0.0005631	1776
1777	3157729	5611284433	42.15448	12.11237	0.0005627	1777
1778	3161284	5620762952	42.16634	12.11464	0.0005624	1778
1779	3164841	5630252139	42.17819	12.11691	0.0005621	1779
1780	3168400	5639752000	42.19005	12.11918	0.0005618	1780
1781	3171961	5649262541	42.20190	12.12145	0.0005615	1781
1782	3175524	5658783768	42.21374	12.12372	0.0005612	1782
1783	3179089	5668315687	42.22558	12.12599	0.0005609	1783
1784	3182656	5677858304	42.23742	12.12825	0.0005605	1784
1785	3186225	5687411625	42.24926	12.13052	0.0005602	1785
1786	3189796	5696975656	42.26109	12.13278	0.0005599	1786
1787	3193369	5706550403	42.27292	12.13505	0.0005596	1787
1788	3196944	5716135872	42.28475	12.13731	0.0005593	1788
1789	3200521	5725732069	42.29657	12.13957	0.0005590	1789
1790	3204100	5735339000	42.30839	12.14184	0.0005587	1790
1791	3207681	5744956671	42.32021	12.14410	0.0005583	1791
1792	3211264	5754585088	42.33202	12.14636	0.0005580	1792
1793	3214849	5764224257	42.34383	12.14861	0.0005577	1793
1794	3218436	5773874184	42.35564	12.15087	0.0005574	1794
1795	3222025	5783534875	42.36744	12.15313	0.0005571	1795
1796	3225616	5793206336	42.37924	12.15539	0.0005568	1796
1797	3229209	5802888573	42.39104	12.15764	0.0005565	1797
1798	3232804	5812581592	42.40283	12.15990	0.0005562	1798
1799	3236401	5822285399	42.41462	12.16215	0.0005559	1799
1800	3240000	5832000000	42.42641	12.16440	0.0005556	1800

Powers, Roots, and Reciprocals From 1801 to 1850

No.	Square	Cube	Sq. Root	Cube Root	Reciprocal	No.
1801	3243601	5841725401	42.43819	12.16666	0.0005552	1801
1802	3247204	5851461608	42.44997	12.16891	0.0005549	1802
1803	3250809	5861208627	42.46175	12.17116	0.0005546	1803
1804	3254416	5870966464	42.47352	12.17341	0.0005543	1804
1805	3258025	5880735125	42.48529	12.17566	0.0005540	1805
1806	3261636	5890514616	42.49706	12.17791	0.0005537	1806
1807	3265249	5900304943	42.50882	12.18015	0.0005534	1807
1808	3268864	5910106112	42.52058	12.18240	0.0005531	1808
1809	3272481	5919918129	42.53234	12.18464	0.0005528	1809
1810	3276100	5929741000	42.54409	12.18689	0.0005525	1810
1811	3279721	5939574731	42.55585	12.18913	0.0005522	1811
1812	3283344	5949419328	42.56759	12.19138	0.0005519	1812
1813	3286969	5959274797	42.57934	12.19362	0.0005516	1813
1814	3290596	5969141144	42.59108	12.19586	0.0005513	1814
1815	3294225	5979018375	42.60282	12.19810	0.0005510	1815
1816	3297856	5988906496	42.61455	12.20034	0.0005507	1816
1817	3301489	5998805513	42.62628	12.20258	0.0005504	1817
1818	3305124	6008715432	42.63801	12.20482	0.0005501	1818
1819	3308761	6018636259	42.64974	12.20705	0.0005498	1819
1820	3312400	6028568000	42.66146	12.20929	0.0005495	1820
1821	3316041	6038510661	42.67318	12.21153	0.0005491	1821
1822	3319684	6048464248	42.68489	12.21376	0.0005488	1822
1823	3323329	6058428767	42.69660	12.21600	0.0005485	1823
1824	3326976	6068404224	42.70831	12.21823	0.0005482	1824
1825	3330625	6078390625	42.72002	12.22046	0.0005479	1825
1826	3334276	6088387976	42.73172	12.22269	0.0005476	1826
1827	3337929	6098396283	42.74342	12.22492	0.0005473	1827
1828	3341584	6108415552	42.75512	12.22715	0.0005470	1828
1829	3345241	6118445789	42.76681	12.22938	0.0005467	1829
1830	3348900	6128487000	42.77850	12.23161	0.0005464	1830
1831	3352561	6138539191	42.79019	12.23384	0.0005461	1831
1832	3356224	6148602368	42.80187	12.23607	0.0005459	1832
1833	3359889	6158676537	42.81355	12.23829	0.0005456	1833
1834	3363556	6168761704	42.82523	12.24052	0.0005453	1834
1835	3367225	6178857875	42.83690	12.24274	0.0005450	1835
1836	3370896	6188965056	42.84857	12.24497	0.0005447	1836
1837	3374569	6199083253	42.86024	12.24719	0.0005444	1837
1838	3378244	6209212472	42.87190	12.24941	0.0005441	1838
1839	3381921	6219352719	42.88356	12.25163	0.0005438	1839
1840	3385600	6229504000	42.89522	12.25385	0.0005435	1840
1841	3389281	6239666321	42.90688	12.25607	0.0005432	1841
1842	3392964	6249839688	42.91853	12.25829	0.0005429	1842
1843	3396649	6260024107	42.93018	12.26051	0.0005426	1843
1844	3400336	6270219584	42.94182	12.26272	0.0005423	1844
1845	3404025	6280426125	42.95346	12.26494	0.0005420	1845
1846	3407716	6290643736	42.96510	12.26716	0.0005417	1846
1847	3411409	6300872423	42.97674	12.26937	0.0005414	1847
1848	3415104	6311112192	42.98837	12.27158	0.0005411	1848
1849	3418801	6321363049	43.00000	12.27380	0.0005408	1849
1850	3422500	6331625000	43.01163	12.27601	0.0005405	1850

Powers, Roots, and Reciprocals From 1851 to 1900

No.	Square	Cube	Sq. Root	Cube Root	Reciprocal	No.
1851	3426201	6341898051	43.02325	12.27822	0.0005402	1851
1852	3429904	6352182208	43.03487	12.28043	0.0005400	1852
1853	3433609	6362477477	43.04649	12.28264	0.0005397	1853
1854	3437316	6372783864	43.05810	12.28485	0.0005394	1854
1855	3441025	6383101375	43.06971	12.28706	0.0005391	1855
1856	3444736	6393430016	43.08132	12.28927	0.0005388	1856
1857	3448449	6403769793	43.09292	12.29147	0.0005385	1857
1858	3452164	6414120712	43.10452	12.29368	0.0005382	1858
1859	3455881	6424482779	43.11612	12.29589	0.0005379	1859
1860	3459600	6434856000	43.12772	12.29809	0.0005376	1860
1861	3463321	6445240381	43.13931	12.30029	0.0005373	1861
1862	3467044	6455635928	43.15090	12.30250	0.0005371	1862
1863	3470769	6466042647	43.16248	12.30470	0.0005368	1863
1864	3474496	6476460544	43.17407	12.30690	0.0005365	1864
1865	3478225	6486889625	43.18565	12.30910	0.0005362	1865
1866	3481956	6497329896	43.19722	12.31130	0.0005359	1866
1867	3485689	6507781363	43.20880	12.31350	0.0005356	1867
1868	3489424	6518244032	43.22037	12.31570	0.0005353	1868
1869	3493161	6528717909	43.23193	12.31789	0.0005350	1869
1870	3496900	6539203000	43.24350	12.32009	0.0005348	1870
1871	3500641	6549699311	43.25506	12.32229	0.0005345	1871
1872	3504384	6560206848	43.26662	12.32448	0.0005342	1872
1873	3508129	6570725617	43.27817	12.32667	0.0005339	1873
1874	3511876	6581255624	43.28972	12.32887	0.0005336	1874
1875	3515625	6591796875	43.30127	12.33106	0.0005333	1875
1876	3519376	6602349376	43.31282	12.33325	0.0005330	1876
1877	3523129	6612913133	43.32436	12.33544	0.0005328	1877
1878	3526884	6623488152	43.33590	12.33763	0.0005325	1878
1879	3530641	6634074439	43.34743	12.33982	0.0005322	1879
1880	3534400	6644672000	43.35897	12.34201	0.0005319	1880
1881	3538161	6655280841	43.37050	12.34420	0.0005316	1881
1882	3541924	6665900968	43.38202	12.34639	0.0005313	1882
1883	3545689	6676532387	43.39355	12.34857	0.0005311	1883
1884	3549456	6687175104	43.40507	12.35076	0.0005308	1884
1885	3553225	6697829125	43.41659	12.35294	0.0005305	1885
1886	3556996	6708494456	43.42810	12.35513	0.0005302	1886
1887	3560769	6719171103	43.43961	12.35731	0.0005299	1887
1888	3564544	6729859072	43.45112	12.35949	0.0005297	1888
1889	3568321	6740558369	43.46263	12.36167	0.0005294	1889
1890	3572100	6751269000	43.47413	12.36386	0.0005291	1890
1891	3575881	6761990971	43.48563	12.36604	0.0005288	1891
1892	3579664	6772724288	43.49713	12.36822	0.0005285	1892
1893	3583449	6783468957	43.50862	12.37039	0.0005283	1893
1894	3587236	6794224984	43.52011	12.37257	0.0005280	1894
1895	3591025	6804992375	43.53160	12.37475	0.0005277	1895
1896	3594816	6815771136	43.54308	12.37693	0.0005274	1896
1897	3598609	6826561273	43.55456	12.37910	0.0005271	1897
1898	3602404	6837362792	43.56604	12.38128	0.0005269	1898
1899	3606201	6848175699	43.57752	12.38345	0.0005266	1899
1900	3610000	6859000000	43.58899	12.38562	0.0005263	1900

Powers, Roots, and Reciprocals From 1901 to 1950

No.	Square	Cube	Sq. Root	Cube Root	Reciprocal	No.
1901	3613801	6869835701	43.60046	12.38780	0.0005260	1901
1902	3617604	6880682808	43.61192	12.38997	0.0005258	1902
1903	3621409	6891541327	43.62339	12.39214	0.0005255	1903
1904	3625216	6902411264	43.63485	12.39431	0.0005252	1904
1905	3629025	6913292625	43.64631	12.39648	0.0005249	1905
1906	3632836	6924185416	43.65776	12.39865	0.0005247	1906
1907	3636649	6935089643	43.66921	12.40082	0.0005244	1907
1908	3640464	6946005312	43.68066	12.40298	0.0005241	1908
1909	3644281	6956932429	43.69210	12.40515	0.0005238	1909
1910	3648100	6967871000	43.70355	12.40731	0.0005236	1910
1911	3651921	6978821031	43.71499	12.40948	0.0005233	1911
1912	3655744	6989782528	43.72642	12.41164	0.0005230	1912
1913	3659569	7000755497	43.73786	12.41381	0.0005227	1913
1914	3663396	7011739944	43.74929	12.41597	0.0005225	1914
1915	3667225	7022735875	43.76071	12.41813	0.0005222	1915
1916	3671056	7033743296	43.77214	12.42029	0.0005219	1916
1917	3674889	7044762213	43.78356	12.42245	0.0005216	1917
1918	3678724	7055792632	43.79498	12.42461	0.0005214	1918
1919	3682561	7066834559	43.80639	12.42677	0.0005211	1919
1920	3686400	7077888000	43.81780	12.42893	0.0005208	1920
1921	3690241	7088952961	43.82921	12.43109	0.0005206	1921
1922	3694084	7100029448	43.84062	12.43324	0.0005203	1922
1923	3697929	7111117467	43.85202	12.43540	0.0005200	1923
1924	3701776	7122217024	43.86342	12.43756	0.0005198	1924
1925	3705625	7133328125	43.87482	12.43971	0.0005195	1925
1926	3709476	7144450776	43.88622	12.44186	0.0005192	1926
1927	3713329	7155584983	43.89761	12.44402	0.0005189	1927
1928	3717184	7166730752	43.90900	12.44617	0.0005187	1928
1929	3721041	7177888089	43.92038	12.44832	0.0005184	1929
1930	3724900	7189057000	43.93177	12.45047	0.0005181	1930
1931	3728761	7200237491	43.94315	12.45262	0.0005179	1931
1932	3732624	7211429568	43.95452	12.45477	0.0005176	1932
1933	3736489	7222633237	43.96590	12.45692	0.0005173	1933
1934	3740356	7233848504	43.97727	12.45907	0.0005171	1934
1935	3744225	7245075375	43.98863	12.46121	0.0005168	1935
1936	3748096	7256313856	44.00000	12.46336	0.0005165	1936
1937	3751969	7267563953	44.01136	12.46550	0.0005163	1937
1938	3755844	7278825672	44.02272	12.46765	0.0005160	1938
1939	3759721	7290099019	44.03408	12.46979	0.0005157	1939
1940	3763600	7301384000	44.04543	12.47194	0.0005155	1940
1941	3767481	7312680621	44.05678	12.47408	0.0005152	1941
1942	3771364	7323988888	44.06813	12.47622	0.0005149	1942
1943	3775249	7335308807	44.07947	12.47836	0.0005147	1943
1944	3779136	7346640384	44.09082	12.48050	0.0005144	1944
1945	3783025	7357983625	44.10215	12.48264	0.0005141	1945
1946	3786916	7369338536	44.11349	12.48478	0.0005139	1946
1947	3790809	7380705123	44.12482	12.48692	0.0005136	1947
1948	3794704	7392083392	44.13615	12.48906	0.0005133	1948
1949	3798601	7403473349	44.14748	12.49119	0.0005131	1949
1950	3802500	7414875000	44.15880	12.49333	0.0005128	1950

Powers, Roots, and Reciprocals From 1951 to 2000

No.	Square	Cube	Sq. Root	Cube Root	Reciprocal	No.
1951	3806401	7426288351	44.17013	12.49547	0.0005126	1951
1952	3810304	7437713408	44.18144	12.49760	0.0005123	1952
1953	3814209	7449150177	44.19276	12.49973	0.0005120	1953
1954	3818116	7460598664	44.20407	12.50187	0.0005118	1954
1955	3822025	7472058875	44.21538	12.50400	0.0005115	1955
1956	3825936	7483530816	44.22669	12.50613	0.0005112	1956
1957	3829849	7495014493	44.23799	12.50826	0.0005110	1957
1958	3833764	7506509912	44.24929	12.51039	0.0005107	1958
1959	3837681	7518017079	44.26059	12.51252	0.0005105	1959
1960	3841600	7529536000	44.27189	12.51465	0.0005102	1960
1961	3845521	7541066681	44.28318	12.51678	0.0005099	1961
1962	3849444	7552609128	44.29447	12.51890	0.0005097	1962
1963	3853369	7564163347	44.30576	12.52103	0.0005094	1963
1964	3857296	7575729344	44.31704	12.52316	0.0005092	1964
1965	3861225	7587307125	44.32832	12.52528	0.0005089	1965
1966	3865156	7598896696	44.33960	12.52741	0.0005086	1966
1967	3869089	7610498063	44.35087	12.52953	0.0005084	1967
1968	3873024	7622111232	44.36215	12.53165	0.0005081	1968
1969	3876961	7633736209	44.37342	12.53378	0.0005079	1969
1970	3880900	7645373000	44.38468	12.53590	0.0005076	1970
1971	3884841	7657021611	44.39595	12.53802	0.0005074	1971
1972	3888784	7668682048	44.40721	12.54014	0.0005071	1972
1973	3892729	7680354317	44.41846	12.54226	0.0005068	1973
1974	3896676	7692038424	44.42972	12.54438	0.0005066	1974
1975	3900625	7703734375	44.44097	12.54649	0.0005063	1975
1976	3904576	7715442176	44.45222	12.54861	0.0005061	1976
1977	3908529	7727161833	44.46347	12.55073	0.0005058	1977
1978	3912484	7738893352	44.47471	12.55284	0.0005056	1978
1979	3916441	7750636739	44.48595	12.55496	0.0005053	1979
1980	3920400	7762392000	44.49719	12.55707	0.0005051	1980
1981	3924361	7774159141	44.50843	12.55919	0.0005048	1981
1982	3928324	7785938168	44.51966	12.56130	0.0005045	1982
1983	3932289	7797729087	44.53089	12.56341	0.0005043	1983
1984	3936256	7809531904	44.54211	12.56552	0.0005040	1984
1985	3940225	7821346625	44.55334	12.56763	0.0005038	1985
1986	3944196	7833173256	44.56456	12.56974	0.0005035	1986
1987	3948169	7845011803	44.57578	12.57185	0.0005033	1987
1988	3952144	7856862272	44.58699	12.57396	0.0005030	1988
1989	3956121	7868724669	44.59821	12.57607	0.0005028	1989
1990	3960100	7880599000	44.60942	12.57818	0.0005025	1990
1991	3964081	7892485271	44.62062	12.58028	0.0005023	1991
1992	3968064	7904383488	44.63183	12.58239	0.0005020	1992
1993	3972049	7916293657	44.64303	12.58449	0.0005018	1993
1994	3976036	7928215784	44.65423	12.58660	0.0005015	1994
1995	3980025	7940149875	44.66542	12.58870	0.0005013	1995
1996	3984016	7952095936	44.67662	12.59081	0.0005010	1996
1997	3988009	7964053973	44.68781	12.59291	0.0005008	1997
1998	3992004	7976023992	44.69899	12.59501	0.0005005	1998
1999	3996001	7988005999	44.71018	12.59711	0.0005003	1999
2000	4000000	8000000000	44.72136	12.59921	0.0005000	2000

Area and Volume of Spheres*

Surface Area and Volume of Spheres From $\frac{1}{64}$ to $14\frac{3}{4}$

$d = \text{diameter}$			Surface = πd^2			Volume = $\pi d^3 \div 6$		
Dia.	Surface	Volume	Dia.	Surface	Volume	Dia.	Surface	Volume
$\frac{1}{64}$	0.00077	0.000002	2	12.566	4.1888	$6\frac{1}{2}$	132.73	143.79
$\frac{1}{32}$	0.00307	0.00002	$2\frac{1}{16}$	13.364	4.5939	$6\frac{3}{8}$	137.89	152.25
$\frac{1}{16}$	0.01227	0.00013	$2\frac{1}{8}$	14.186	5.0243	$6\frac{3}{4}$	143.14	161.03
$\frac{3}{32}$	0.02761	0.00043	$2\frac{3}{16}$	15.033	5.4808	$6\frac{7}{8}$	148.49	170.14
$\frac{1}{8}$	0.04909	0.00102	$2\frac{1}{4}$	15.904	5.9641	7	153.94	179.59
$\frac{5}{32}$	0.07670	0.00200	$2\frac{5}{16}$	16.800	6.4751	$7\frac{1}{8}$	159.48	189.39
$\frac{3}{16}$	0.11045	0.00345	$2\frac{3}{8}$	17.721	7.0144	$7\frac{1}{4}$	165.13	199.53
$\frac{7}{32}$	0.15033	0.00548	$2\frac{7}{16}$	18.665	7.5829	$7\frac{3}{8}$	170.87	210.03
$\frac{1}{4}$	0.19635	0.00818	$2\frac{1}{2}$	19.635	8.1812	$7\frac{1}{2}$	176.71	220.89
$\frac{9}{32}$	0.24850	0.01165	$2\frac{9}{16}$	20.629	8.8103	$7\frac{5}{8}$	182.65	232.12
$\frac{5}{16}$	0.30680	0.01598	$2\frac{5}{8}$	21.648	9.4708	$7\frac{3}{4}$	188.69	243.73
$\frac{11}{32}$	0.37122	0.02127	$2\frac{11}{16}$	22.691	10.164	$7\frac{7}{8}$	194.83	255.71
$\frac{3}{8}$	0.44179	0.02761	$2\frac{3}{4}$	23.758	10.889	8	201.06	268.08
$\frac{13}{32}$	0.51849	0.03511	$2\frac{13}{16}$	24.850	11.649	$8\frac{1}{8}$	207.39	280.85
$\frac{7}{16}$	0.60132	0.04385	$2\frac{7}{8}$	25.967	12.443	$8\frac{1}{4}$	213.82	294.01
$\frac{15}{32}$	0.69029	0.05393	$2\frac{15}{16}$	27.109	13.272	$8\frac{3}{8}$	220.35	307.58
$\frac{1}{2}$	0.78540	0.06545	3	28.274	14.137	$8\frac{1}{2}$	226.98	321.56
$\frac{17}{32}$	0.88664	0.07850	$3\frac{1}{16}$	29.465	15.039	$8\frac{5}{8}$	233.71	335.95
$\frac{9}{16}$	0.99402	0.09319	$3\frac{1}{8}$	30.680	15.979	$8\frac{3}{4}$	240.53	350.77
$\frac{19}{32}$	1.1075	0.10960	$3\frac{3}{16}$	31.919	16.957	$8\frac{7}{8}$	247.45	366.02
$\frac{5}{8}$	1.2272	0.12783	$3\frac{1}{4}$	33.183	17.974	9	254.47	381.70
$\frac{21}{32}$	1.3530	0.14798	$3\frac{5}{16}$	34.472	19.031	$9\frac{1}{8}$	261.59	397.83
$\frac{11}{16}$	1.4849	0.17014	$3\frac{3}{8}$	35.785	20.129	$9\frac{1}{4}$	268.80	414.40
$\frac{23}{32}$	1.6230	0.19442	$3\frac{7}{16}$	37.122	21.268	$9\frac{3}{8}$	276.12	431.43
$\frac{3}{4}$	1.7671	0.22089	$3\frac{1}{2}$	38.485	22.449	$9\frac{1}{2}$	283.53	448.92
$\frac{25}{32}$	1.9175	0.24967	$3\frac{5}{8}$	41.282	24.942	$9\frac{5}{8}$	291.04	466.88
$\frac{13}{16}$	2.0739	0.28085	$3\frac{3}{4}$	44.179	27.612	$9\frac{3}{4}$	298.65	485.30
$\frac{27}{32}$	2.2365	0.31451	$3\frac{7}{8}$	47.173	30.466	$9\frac{7}{8}$	306.35	504.21
$\frac{7}{8}$	2.4053	0.35077	4	50.265	33.510	10	314.16	523.60
$\frac{29}{32}$	2.5802	0.38971	$4\frac{1}{8}$	53.456	36.751	$10\frac{1}{4}$	330.06	563.86
$\frac{15}{16}$	2.7612	0.43143	$4\frac{1}{4}$	56.745	40.194	$10\frac{1}{2}$	346.36	606.13
$\frac{31}{32}$	2.9483	0.47603	$4\frac{3}{8}$	60.132	43.846	$10\frac{3}{4}$	363.05	650.47
1	3.1416	0.52360	$4\frac{1}{2}$	63.617	47.713	11	380.13	696.91
$1\frac{1}{16}$	3.5466	0.62804	$4\frac{5}{8}$	67.201	51.800	$11\frac{1}{4}$	397.61	745.51
$1\frac{1}{8}$	3.9761	0.74551	$4\frac{3}{4}$	70.882	56.115	$11\frac{1}{2}$	415.48	796.33
$1\frac{3}{16}$	4.4301	0.87680	$4\frac{7}{8}$	74.662	60.663	$11\frac{3}{4}$	433.74	849.40
$1\frac{1}{4}$	4.9087	1.0227	5	78.540	65.450	12	452.39	904.78
$1\frac{5}{16}$	5.4119	1.1838	$5\frac{1}{8}$	82.516	70.482	$12\frac{1}{4}$	471.44	962.51
$1\frac{3}{8}$	5.9396	1.3612	$5\frac{1}{4}$	86.590	75.766	$12\frac{1}{2}$	490.87	1022.7
$1\frac{7}{16}$	6.4918	1.5553	$5\frac{3}{8}$	90.763	81.308	$12\frac{3}{4}$	510.71	1085.2
$1\frac{1}{2}$	7.0686	1.7671	$5\frac{1}{2}$	95.033	87.114	13	530.93	1150.3
$1\frac{9}{16}$	7.6699	1.9974	$5\frac{5}{8}$	99.402	93.189	$13\frac{1}{4}$	551.55	1218.0
$1\frac{5}{8}$	8.2958	2.2468	$5\frac{3}{4}$	103.87	99.541	$13\frac{1}{2}$	572.56	1288.2
$1\frac{11}{16}$	8.9462	2.5161	$5\frac{7}{8}$	108.43	106.17	$13\frac{3}{4}$	593.96	1361.2
$1\frac{3}{4}$	9.6211	2.8062	6	113.10	113.10	14	615.75	1436.8
$1\frac{13}{16}$	10.321	3.1177	$6\frac{1}{8}$	117.86	120.31	$14\frac{1}{4}$	637.94	1515.1
$1\frac{7}{8}$	11.045	3.4515	$6\frac{1}{4}$	122.72	127.83	$14\frac{1}{2}$	660.52	1596.3
$1\frac{15}{16}$	11.793	3.8082	$6\frac{3}{8}$	127.68	135.66	$14\frac{3}{4}$	683.49	1680.3

*The figures given in the table can be used for English and Metric (SI) units.

Surface Area and Volume of Spheres From 15 to 75½

Dia.	Surface	Volume	Dia.	Surface	Volume	Dia.	Surface	Volume
15	706.86	1767.1	27½	2375.8	10,889	51	8171.3	69,456
15¼	730.62	1857.0	27¾	2419.2	11,189	51½	8332.3	71,519
15½	754.77	1949.8	28	2463.0	11,494	52	8494.9	73,622
15¾	779.31	2045.7	28¼	2507.2	11,805	52½	8659.0	75,766
16	804.25	2144.7	28½	2551.8	12,121	53	8824.7	77,952
16¼	829.58	2246.8	28¾	2596.7	12,443	53½	8992.0	80,179
16½	855.30	2352.1	29	2642.1	12,770	54	9160.9	82,448
16¾	881.41	2460.6	29½	2734.0	13,442	54½	9331.3	84,759
17	907.92	2572.4	30	2827.4	14,137	55	9503.3	87,114
17¼	934.82	2687.6	30½	2922.5	14,856	55½	9676.9	89,511
17½	962.11	2806.2	31	3019.1	15,599	56	9852.0	91,952
17¾	989.80	2928.2	31½	3117.2	16,366	56½	10,029	94,437
18	1017.9	3053.6	32	3217.0	17,157	57	10,207	96,967
18¼	1046.3	3182.6	32½	3318.3	17,974	57½	10,387	99,541
18½	1075.2	3315.2	33	3421.2	18,817	58	10,568	102,160
18¾	1104.5	3451.5	33½	3525.7	19,685	58½	10,751	104,825
19	1134.1	3591.4	34	3631.7	20,580	59	10,936	107,536
19¼	1164.2	3735.0	34½	3739.3	21,501	59½	11,122	110,293
19½	1194.6	3882.4	35	3848.5	22,449	60	11,310	113,097
19¾	1225.4	4033.7	35½	3959.2	23,425	60½	11,499	115,948
20	1256.6	4188.8	36	4071.5	24,429	61	11,690	118,847
20¼	1288.2	4347.8	36½	4185.4	25,461	61½	11,882	121,793
20½	1320.3	4510.9	37	4300.8	26,522	62	12,076	124,788
20¾	1352.7	4677.9	37½	4417.9	27,612	62½	12,272	127,832
21	1385.4	4849.0	38	4536.5	28,731	63	12,469	130,924
21¼	1418.6	5024.3	38½	4656.6	29,880	63½	12,668	134,066
21½	1452.2	5203.7	39	4778.4	31,059	64	12,868	137,258
21¾	1486.2	5387.4	39½	4901.7	32,269	64½	13,070	140,500
22	1520.5	5575.3	40	5026.5	33,510	65	13,273	143,793
22¼	1555.3	5767.5	40½	5153.0	34,783	65½	13,478	147,137
22½	1590.4	5964.1	41	5281.0	36,087	66	13,685	150,533
22¾	1626.0	6165.1	41½	5410.6	37,423	66½	13,893	153,980
23	1661.9	6370.6	42	5541.8	38,792	67	14,103	157,479
23¼	1698.2	6580.6	42½	5674.5	40,194	67½	14,314	161,031
23½	1734.9	6795.2	43	5808.8	41,630	68	14,527	164,636
23¾	1772.1	7014.4	43½	5944.7	43,099	68½	14,741	168,295
24	1809.6	7238.2	44	6082.1	44,602	69	14,957	172,007
24¼	1847.5	7466.8	44½	6221.1	46,140	69½	15,175	175,773
24½	1885.7	7700.1	45	6361.7	47,713	70	15,394	179,594
24¾	1924.4	7938.2	45½	6503.9	49,321	70½	15,615	183,470
25	1963.5	8181.2	46	6647.6	50,965	71	15,837	187,402
25¼	2003.0	8429.1	46½	6792.9	52,645	71½	16,061	191,389
25½	2042.8	8682.0	47	6939.8	54,362	72	16,286	195,432
25¾	2083.1	8939.9	47½	7088.2	56,115	72½	16,513	199,532
26	2123.7	9202.8	48	7238.2	57,906	73	16,742	203,689
26¼	2164.8	9470.8	48½	7389.8	59,734	73½	16,972	207,903
26½	2206.2	9744.0	49	7543.0	61,601	74	17,203	212,175
26¾	2248.0	10,022	49½	7697.7	63,506	74½	17,437	216,505
27	2290.2	10,306	50	7854.0	65,450	75	17,671	220,893
27¼	2332.8	10,595	50½	8011.8	67,433	75½	17,908	225,341

Surface Area and Volume of Spheres From 76 to 200

Dia.	Surface	Volume	Dia.	Surface	Volume	Dia.	Surface	Volume
76	18,146	229,847	101	32,047	539,464	151	71,631	1,802,725
76½	18,385	234,414	102	32,685	555,647	152	72,583	1,838,778
77	18,627	239,040	103	33,329	572,151	153	73,542	1,875,309
77½	18,869	243,727	104	33,979	588,977	154	74,506	1,912,321
78	19,113	248,475	105	34,636	606,131	155	75,477	1,949,816
78½	19,359	253,284	106	35,299	623,615	156	76,454	1,987,799
79	19,607	258,155	107	35,968	641,431	157	77,437	2,026,271
79½	19,856	263,087	108	36,644	659,584	158	78,427	2,065,237
80	20,106	268,083	109	37,325	678,076	159	79,423	2,104,699
80½	20,358	273,141	110	38,013	696,910	160	80,425	2,144,661
81	20,612	278,262	111	38,708	716,090	161	81,433	2,185,125
81½	20,867	283,447	112	39,408	735,619	162	82,448	2,226,095
82	21,124	288,696	113	40,115	755,499	163	83,469	2,267,574
82½	21,382	294,009	114	40,828	775,735	164	84,496	2,309,565
83	21,642	299,387	115	41,548	796,328	165	85,530	2,352,071
83½	21,904	304,830	116	42,273	817,283	166	86,570	2,395,096
84	22,167	310,339	117	43,005	838,603	167	87,616	2,438,642
84½	22,432	315,914	118	43,744	860,290	168	88,668	2,482,713
85	22,698	321,555	119	44,488	882,347	169	89,727	2,527,311
85½	22,966	327,263	120	45,239	904,779	170	90,792	2,572,441
86	23,235	333,038	121	45,996	927,587	171	91,863	2,618,104
86½	23,506	338,881	122	46,759	950,776	172	92,941	2,664,305
87	23,779	344,791	123	47,529	974,348	173	94,025	2,711,046
87½	24,053	350,770	124	48,305	998,306	174	95,115	2,758,331
88	24,328	356,818	125	49,087	1,022,654	175	96,211	2,806,162
88½	24,606	362,935	126	49,876	1,047,394	176	97,314	2,854,543
89	24,885	369,121	127	50,671	1,072,531	177	98,423	2,903,477
89½	25,165	375,377	128	51,472	1,098,066	178	99,538	2,952,967
90	25,447	381,704	129	52,279	1,124,004	179	100,660	3,003,016
90½	25,730	388,101	130	53,093	1,150,347	180	101,788	3,053,628
91	26,016	394,569	131	53,913	1,177,098	181	102,922	3,104,805
91½	26,302	401,109	132	54,739	1,204,260	182	104,062	3,156,551
92	26,590	407,720	133	55,572	1,231,838	183	105,209	3,208,868
92½	26,880	414,404	134	56,410	1,259,833	184	106,362	3,261,761
93	27,172	421,160	135	57,256	1,288,249	185	107,521	3,315,231
93½	27,465	427,990	136	58,107	1,317,090	186	108,687	3,369,283
94	27,759	434,893	137	58,965	1,346,357	187	109,858	3,423,919
94½	28,055	441,870	138	59,828	1,376,055	188	111,036	3,479,142
95	28,353	448,921	139	60,699	1,406,187	189	112,221	3,534,956
95½	28,652	456,046	140	61,575	1,436,755	190	113,411	3,591,364
96	28,953	463,247	141	62,458	1,467,763	191	114,608	3,648,369
96½	29,255	470,523	142	63,347	1,499,214	192	115,812	3,705,973
97	29,559	477,874	143	64,242	1,531,111	193	117,021	3,764,181
97½	29,865	485,302	144	65,144	1,563,458	194	118,237	3,822,996
98	30,172	492,807	145	66,052	1,596,256	195	119,459	3,882,419
98½	30,481	500,388	146	66,966	1,629,511	196	120,687	3,942,456
99	30,791	508,047	147	67,887	1,663,224	197	121,922	4,003,108
99½	31,103	515,784	148	68,813	1,697,398	198	123,163	4,064,379
100	31,416	523,599	149	69,746	1,732,038	199	124,410	4,126,272
100½	31,731	531,492	150	70,686	1,767,146	200	125,664	4,188,790

Circumference and Area of Circles

Circumferences and Areas of Circles From $\frac{1}{64}$ to $9\frac{7}{8}$

Diameter	Circumference	Area	Diameter	Circumference	Area	Diameter	Circumference	Area
$\frac{1}{64}$	0.0491	0.0002	2	6.2832	3.1416	5	15.7080	19.635
$\frac{1}{32}$	0.0982	0.0008	$2\frac{1}{16}$	6.4795	3.3410	$5\frac{1}{16}$	15.9043	20.129
$\frac{1}{16}$	0.1963	0.0031	$2\frac{1}{8}$	6.6759	3.5466	$5\frac{1}{8}$	16.1007	20.629
$\frac{3}{32}$	0.2945	0.0069	$2\frac{3}{16}$	6.8722	3.7583	$5\frac{3}{16}$	16.2970	21.135
$\frac{1}{8}$	0.3927	0.0123	$2\frac{1}{4}$	7.0686	3.9761	$5\frac{1}{4}$	16.4934	21.648
$\frac{5}{32}$	0.4909	0.0192	$2\frac{5}{16}$	7.2649	4.2000	$5\frac{5}{16}$	16.6897	22.166
$\frac{3}{16}$	0.5890	0.0276	$2\frac{3}{8}$	7.4613	4.4301	$5\frac{3}{8}$	16.8861	22.691
$\frac{7}{32}$	0.6872	0.0376	$2\frac{7}{16}$	7.6576	4.6664	$5\frac{7}{16}$	17.0824	23.221
$\frac{1}{4}$	0.7854	0.0491	$2\frac{1}{2}$	7.8540	4.9087	$5\frac{1}{2}$	17.2788	23.758
$\frac{9}{32}$	0.8836	0.0621	$2\frac{9}{16}$	8.0503	5.1572	$5\frac{9}{16}$	17.4751	24.301
$\frac{5}{16}$	0.9817	0.0767	$2\frac{5}{8}$	8.2467	5.4119	$5\frac{5}{8}$	17.6715	24.850
$1\frac{1}{32}$	1.0799	0.0928	$2\frac{11}{16}$	8.4430	5.6727	$5\frac{11}{16}$	17.8678	25.406
$\frac{3}{8}$	1.1781	0.1104	$2\frac{3}{4}$	8.6394	5.9396	$5\frac{3}{4}$	18.0642	25.967
$1\frac{1}{32}$	1.2763	0.1296	$2\frac{13}{16}$	8.8357	6.2126	$5\frac{13}{16}$	18.2605	26.535
$\frac{7}{16}$	1.3744	0.1503	$2\frac{7}{8}$	9.0321	6.4918	$5\frac{7}{8}$	18.4569	27.109
$1\frac{5}{32}$	1.4726	0.1726	$2\frac{15}{16}$	9.2284	6.7771	$5\frac{15}{16}$	18.6532	27.688
$\frac{1}{2}$	1.5708	0.1963	3	9.4248	7.0686	6	18.8496	28.274
$1\frac{7}{32}$	1.6690	0.2217	$3\frac{1}{16}$	9.6211	7.3662	$6\frac{1}{8}$	19.2423	29.465
$\frac{9}{16}$	1.7671	0.2485	$3\frac{1}{8}$	9.8175	7.6699	$6\frac{1}{4}$	19.6350	30.680
$1\frac{9}{32}$	1.8653	0.2769	$3\frac{3}{16}$	10.0138	7.9798	$6\frac{3}{8}$	20.0277	31.919
$\frac{5}{8}$	1.9635	0.3068	$3\frac{1}{4}$	10.2102	8.2958	$6\frac{1}{2}$	20.4204	33.183
$2\frac{1}{32}$	2.0617	0.3382	$3\frac{5}{16}$	10.4065	8.6179	$6\frac{5}{8}$	20.8131	34.472
$1\frac{1}{16}$	2.1598	0.3712	$3\frac{3}{8}$	10.6029	8.9462	$6\frac{3}{4}$	21.2058	35.785
$2\frac{3}{32}$	2.2580	0.4057	$3\frac{7}{16}$	10.7992	9.2806	$6\frac{7}{8}$	21.5984	37.122
$\frac{3}{4}$	2.3562	0.4418	$3\frac{1}{2}$	10.9956	9.6211	7	21.9911	38.485
$2\frac{5}{32}$	2.4544	0.4794	$3\frac{9}{16}$	11.1919	9.9678	$7\frac{1}{8}$	22.3838	39.871
$1\frac{1}{16}$	2.5525	0.5185	$3\frac{5}{8}$	11.388	10.3206	$7\frac{1}{4}$	22.7765	41.282
$2\frac{7}{32}$	2.6507	0.5591	$3\frac{11}{16}$	11.585	10.6796	$7\frac{3}{8}$	23.1692	42.718
$\frac{7}{8}$	2.7489	0.6013	$3\frac{3}{4}$	11.781	11.0447	$7\frac{1}{2}$	23.5619	44.179
$2\frac{9}{32}$	2.8471	0.6450	$3\frac{13}{16}$	11.977	11.4159	$7\frac{5}{8}$	23.9546	45.664
$1\frac{5}{16}$	2.9452	0.6903	$3\frac{7}{8}$	12.174	11.7932	$7\frac{3}{4}$	24.3473	47.173
$3\frac{1}{32}$	3.0434	0.7371	$3\frac{15}{16}$	12.370	12.1767	$7\frac{7}{8}$	24.7400	48.707
1	3.1416	0.7854	4	12.566	12.5664	8	25.1327	50.265
$1\frac{1}{16}$	3.3379	0.8866	$4\frac{1}{16}$	12.763	12.9621	$8\frac{1}{8}$	25.5254	51.849
$1\frac{1}{8}$	3.5343	0.9940	$4\frac{1}{8}$	12.959	13.3640	$8\frac{1}{4}$	25.9181	53.456
$1\frac{3}{16}$	3.7306	1.1075	$4\frac{3}{16}$	13.155	13.7721	$8\frac{3}{8}$	26.3108	55.088
$1\frac{1}{4}$	3.9270	1.2272	$4\frac{1}{4}$	13.352	14.1863	$8\frac{1}{2}$	26.7035	56.745
$1\frac{5}{16}$	4.1233	1.3530	$4\frac{5}{16}$	13.548	14.6066	$8\frac{5}{8}$	27.0962	58.426
$1\frac{3}{8}$	4.3197	1.4849	$4\frac{3}{8}$	13.744	15.0330	$8\frac{3}{4}$	27.4889	60.132
$1\frac{7}{16}$	4.5160	1.6230	$4\frac{7}{16}$	13.941	15.4656	$8\frac{7}{8}$	27.8816	61.862
$1\frac{1}{2}$	4.7124	1.7671	$4\frac{1}{2}$	14.137	15.9043	9	28.2743	63.617
$1\frac{9}{16}$	4.9087	1.9175	$4\frac{9}{16}$	14.334	16.3492	$9\frac{1}{8}$	28.6670	65.397
$1\frac{5}{8}$	5.1051	2.0739	$4\frac{5}{8}$	14.530	16.8002	$9\frac{1}{4}$	29.0597	67.201
$1\frac{11}{16}$	5.3014	2.2365	$4\frac{11}{16}$	14.726	17.2573	$9\frac{3}{8}$	29.4524	69.029
$1\frac{3}{4}$	5.4978	2.4053	$4\frac{3}{4}$	14.923	17.7205	$9\frac{1}{2}$	29.8451	70.882
$1\frac{13}{16}$	5.6941	2.5802	$4\frac{13}{16}$	15.119	18.1899	$9\frac{5}{8}$	30.2378	72.760
$1\frac{7}{8}$	5.8905	2.7612	$4\frac{7}{8}$	15.315	18.6655	$9\frac{3}{4}$	30.6305	74.662
$1\frac{15}{16}$	6.0868	2.9483	$4\frac{15}{16}$	15.512	19.1471	$9\frac{7}{8}$	31.0232	76.589

Circumferences and Areas of Circles From 10 to $27\frac{7}{8}$

Diameter	Circumference	Area	Diameter	Circumference	Area	Diameter	Circumference	Area
10	31.41593	78.53983	16	50.26549	201.06195	22	69.11505	380.13275
$\frac{1}{8}$	31.80863	80.51559	$\frac{1}{8}$	50.65819	204.21582	$\frac{1}{8}$	69.50775	384.46472
$\frac{1}{4}$	32.20133	82.51590	$\frac{1}{4}$	51.05089	207.39423	$\frac{1}{4}$	69.90044	388.82122
$\frac{3}{8}$	32.59403	84.54076	$\frac{3}{8}$	51.44359	210.59718	$\frac{3}{8}$	70.29314	393.20227
$\frac{1}{2}$	32.98673	86.59016	$\frac{1}{2}$	51.83628	213.82467	$\frac{1}{2}$	70.68584	397.60786
$\frac{5}{8}$	33.37943	88.66410	$\frac{5}{8}$	52.22898	217.07671	$\frac{5}{8}$	71.07854	402.03800
$\frac{3}{4}$	33.77212	90.76259	$\frac{3}{4}$	52.62168	220.35330	$\frac{3}{4}$	71.47124	406.49268
$\frac{7}{8}$	34.16482	92.88561	$\frac{7}{8}$	53.01438	223.65442	$\frac{7}{8}$	71.86394	410.97191
11	34.55752	95.03319	17	53.40708	226.98009	23	72.25664	415.47567
$\frac{1}{8}$	34.95022	97.20531	$\frac{1}{8}$	53.79978	230.33031	$\frac{1}{8}$	72.64934	420.00399
$\frac{1}{4}$	35.34292	99.40197	$\frac{1}{4}$	54.19248	233.70507	$\frac{1}{4}$	73.04204	424.55684
$\frac{3}{8}$	35.73562	101.62317	$\frac{3}{8}$	54.58518	237.10437	$\frac{3}{8}$	73.43474	429.13424
$\frac{1}{2}$	36.12832	103.86892	$\frac{1}{2}$	54.97788	240.52821	$\frac{1}{2}$	73.82744	433.73618
$\frac{5}{8}$	36.52102	106.13921	$\frac{5}{8}$	55.37058	243.97660	$\frac{5}{8}$	74.22013	438.36267
$\frac{3}{4}$	36.91372	108.43405	$\frac{3}{4}$	55.76328	247.44954	$\frac{3}{4}$	74.61283	443.01370
$\frac{7}{8}$	37.30642	110.75343	$\frac{7}{8}$	56.15597	250.94701	$\frac{7}{8}$	75.00553	447.68927
12	37.69912	113.09735	18	56.54867	254.46903	24	75.39823	452.38939
$\frac{1}{8}$	38.09182	115.46581	$\frac{1}{8}$	56.94137	258.01560	$\frac{1}{8}$	75.79093	457.11405
$\frac{1}{4}$	38.48451	117.85882	$\frac{1}{4}$	57.33407	261.58670	$\frac{1}{4}$	76.18363	461.86326
$\frac{3}{8}$	38.87721	120.27638	$\frac{3}{8}$	57.72677	265.18236	$\frac{3}{8}$	76.57633	466.63701
$\frac{1}{2}$	39.26991	122.71848	$\frac{1}{2}$	58.11947	268.80255	$\frac{1}{2}$	76.96903	471.43530
$\frac{5}{8}$	39.66261	125.18512	$\frac{5}{8}$	58.51217	272.44729	$\frac{5}{8}$	77.36173	476.25814
$\frac{3}{4}$	40.05531	127.67630	$\frac{3}{4}$	58.90487	276.11657	$\frac{3}{4}$	77.75443	481.10552
$\frac{7}{8}$	40.44801	130.19203	$\frac{7}{8}$	59.29757	279.81040	$\frac{7}{8}$	78.14713	485.97744
13	40.84071	132.73230	19	59.69027	283.52877	25	78.53983	490.87391
$\frac{1}{8}$	41.23341	135.29712	$\frac{1}{8}$	60.08297	287.27168	$\frac{1}{8}$	78.93252	495.79492
$\frac{1}{4}$	41.62611	137.88648	$\frac{1}{4}$	60.47567	291.03914	$\frac{1}{4}$	79.32522	500.74047
$\frac{3}{8}$	42.01881	140.50038	$\frac{3}{8}$	60.86836	294.83114	$\frac{3}{8}$	79.71792	505.71057
$\frac{1}{2}$	42.41151	143.13883	$\frac{1}{2}$	61.26106	298.64768	$\frac{1}{2}$	80.11062	510.70521
$\frac{5}{8}$	42.80420	145.80182	$\frac{5}{8}$	61.65376	302.48877	$\frac{5}{8}$	80.50332	515.72440
$\frac{3}{4}$	43.19690	148.48936	$\frac{3}{4}$	62.04646	306.35440	$\frac{3}{4}$	80.89602	520.76813
$\frac{7}{8}$	43.58960	151.20143	$\frac{7}{8}$	62.43916	310.24458	$\frac{7}{8}$	81.28872	525.83640
14	43.98230	153.93806	20	62.83186	314.15930	26	81.68142	530.92922
$\frac{1}{8}$	44.37500	156.69922	$\frac{1}{8}$	63.22456	318.09856	$\frac{1}{8}$	82.07412	536.04658
$\frac{1}{4}$	44.76770	159.48493	$\frac{1}{4}$	63.61726	322.06237	$\frac{1}{4}$	82.46682	541.18848
$\frac{3}{8}$	45.16040	162.29519	$\frac{3}{8}$	64.00996	326.05072	$\frac{3}{8}$	82.85952	546.35493
$\frac{1}{2}$	45.55310	165.12998	$\frac{1}{2}$	64.40266	330.06361	$\frac{1}{2}$	83.25221	551.54592
$\frac{5}{8}$	45.94580	167.98932	$\frac{5}{8}$	64.79536	334.10105	$\frac{5}{8}$	83.64491	556.76146
$\frac{3}{4}$	46.33850	170.87321	$\frac{3}{4}$	65.18805	338.16303	$\frac{3}{4}$	84.03761	562.00154
$\frac{7}{8}$	46.73120	173.78163	$\frac{7}{8}$	65.58075	342.24956	$\frac{7}{8}$	84.43031	567.26616
15	47.12390	176.71461	21	65.97345	346.36063	27	84.82301	572.55532
$\frac{1}{8}$	47.51659	179.67212	$\frac{1}{8}$	66.36615	350.49624	$\frac{1}{8}$	85.21571	577.86903
$\frac{1}{4}$	47.90929	182.65418	$\frac{1}{4}$	66.75885	354.65640	$\frac{1}{4}$	85.60841	583.20729
$\frac{3}{8}$	48.30199	185.66078	$\frac{3}{8}$	67.15155	358.84110	$\frac{3}{8}$	86.00111	588.57009
$\frac{1}{2}$	48.69469	188.69193	$\frac{1}{2}$	67.54425	363.05034	$\frac{1}{2}$	86.39381	593.95743
$\frac{5}{8}$	49.08739	191.74762	$\frac{5}{8}$	67.93695	367.28413	$\frac{5}{8}$	86.78651	599.36931
$\frac{3}{4}$	49.48009	194.82785	$\frac{3}{4}$	68.32965	371.54246	$\frac{3}{4}$	87.17921	604.80574
$\frac{7}{8}$	49.87279	197.93263	$\frac{7}{8}$	68.72235	375.82533	$\frac{7}{8}$	87.57190	610.26671
16	50.26549	201.06195	22	69.11505	380.13275	28	87.96460	615.75223

Circumferences and Areas of Circles From 28 to 45 $\frac{7}{8}$

Diameter	Circumference	Area	Diameter	Circumference	Area	Diameter	Circumference	Area
28	87.96460	615.75223	34	106.81416	907.92038	40	125.66372	1256.63720
$\frac{1}{8}$	88.35730	621.26229	$\frac{1}{8}$	107.20686	914.60853	$\frac{1}{8}$	126.05642	1264.50345
$\frac{1}{4}$	88.75000	626.79689	$\frac{1}{4}$	107.59956	921.32123	$\frac{1}{4}$	126.44912	1272.39425
$\frac{3}{8}$	89.14270	632.35604	$\frac{3}{8}$	107.99226	928.05848	$\frac{3}{8}$	126.84182	1280.30959
$\frac{1}{2}$	89.53540	637.93973	$\frac{1}{2}$	108.38496	934.82027	$\frac{1}{2}$	127.23452	1288.24948
$\frac{5}{8}$	89.92810	643.54796	$\frac{5}{8}$	108.77766	941.60660	$\frac{5}{8}$	127.62722	1296.21391
$\frac{3}{4}$	90.32080	649.18074	$\frac{3}{4}$	109.17036	948.41747	$\frac{3}{4}$	128.01991	1304.20288
$\frac{7}{8}$	90.71350	654.83806	$\frac{7}{8}$	109.56306	955.25289	$\frac{7}{8}$	128.41261	1312.21640
29	91.10620	660.51993	35	109.95576	962.11286	41	128.80531	1320.25446
$\frac{1}{8}$	91.49890	666.22634	$\frac{1}{8}$	110.34845	968.99736	$\frac{1}{8}$	129.19801	1328.31706
$\frac{1}{4}$	91.89160	671.95729	$\frac{1}{4}$	110.74115	975.90641	$\frac{1}{4}$	129.59071	1336.40421
$\frac{3}{8}$	92.28429	677.71279	$\frac{3}{8}$	111.13385	982.84001	$\frac{3}{8}$	129.98341	1344.51590
$\frac{1}{2}$	92.67699	683.49283	$\frac{1}{2}$	111.52655	989.79814	$\frac{1}{2}$	130.37611	1352.65214
$\frac{5}{8}$	93.06969	689.29741	$\frac{5}{8}$	111.91925	996.78083	$\frac{5}{8}$	130.76881	1360.81291
$\frac{3}{4}$	93.46239	695.12654	$\frac{3}{4}$	112.31195	1003.78805	$\frac{3}{4}$	131.16151	1368.99824
$\frac{7}{8}$	93.85509	700.98021	$\frac{7}{8}$	112.70465	1010.81982	$\frac{7}{8}$	131.55421	1377.20810
30	94.24779	706.85843	36	113.09735	1017.87613	42	131.94691	1385.44251
$\frac{1}{8}$	94.64049	712.76118	$\frac{1}{8}$	113.49005	1024.95699	$\frac{1}{8}$	132.33961	1393.70147
$\frac{1}{4}$	95.03319	718.68849	$\frac{1}{4}$	113.88275	1032.06239	$\frac{1}{4}$	132.73230	1401.98496
$\frac{3}{8}$	95.42589	724.64033	$\frac{3}{8}$	114.27545	1039.19233	$\frac{3}{8}$	133.12500	1410.29300
$\frac{1}{2}$	95.81859	730.61672	$\frac{1}{2}$	114.66814	1046.34682	$\frac{1}{2}$	133.51770	1418.62559
$\frac{5}{8}$	96.21129	736.61766	$\frac{5}{8}$	115.06084	1053.52585	$\frac{5}{8}$	133.91040	1426.98272
$\frac{3}{4}$	96.60398	742.64313	$\frac{3}{4}$	115.45354	1060.72942	$\frac{3}{4}$	134.30310	1435.36439
$\frac{7}{8}$	96.99668	748.69315	$\frac{7}{8}$	115.84624	1067.95754	$\frac{7}{8}$	134.69580	1443.77060
31	97.38938	754.76772	37	116.23894	1075.21020	43	135.08850	1452.20136
$\frac{1}{8}$	97.78208	760.86683	$\frac{1}{8}$	116.63164	1082.48741	$\frac{1}{8}$	135.48120	1460.65667
$\frac{1}{4}$	98.17478	766.99048	$\frac{1}{4}$	117.02434	1089.78916	$\frac{1}{4}$	135.87390	1469.13651
$\frac{3}{8}$	98.56748	773.13867	$\frac{3}{8}$	117.41704	1097.11545	$\frac{3}{8}$	136.26660	1477.64090
$\frac{1}{2}$	98.96018	779.31141	$\frac{1}{2}$	117.80974	1104.46629	$\frac{1}{2}$	136.65930	1486.16984
$\frac{5}{8}$	99.35288	785.50870	$\frac{5}{8}$	118.20244	1111.84167	$\frac{5}{8}$	137.05199	1494.72332
$\frac{3}{4}$	99.74558	791.73052	$\frac{3}{4}$	118.59514	1119.24159	$\frac{3}{4}$	137.44469	1503.30134
$\frac{7}{8}$	100.13828	797.97689	$\frac{7}{8}$	118.98783	1126.66606	$\frac{7}{8}$	137.83739	1511.90390
32	100.53098	804.24781	38	119.38053	1134.11507	44	138.23009	1520.53101
$\frac{1}{8}$	100.92368	810.54327	$\frac{1}{8}$	119.77323	1141.58863	$\frac{1}{8}$	138.62279	1529.18266
$\frac{1}{4}$	101.31637	816.86327	$\frac{1}{4}$	120.16593	1149.08673	$\frac{1}{4}$	139.01549	1537.85886
$\frac{3}{8}$	101.70907	823.20781	$\frac{3}{8}$	120.55863	1156.60937	$\frac{3}{8}$	139.40819	1546.55960
$\frac{1}{2}$	102.10177	829.57690	$\frac{1}{2}$	120.95133	1164.15656	$\frac{1}{2}$	139.80089	1555.28488
$\frac{5}{8}$	102.49447	835.97053	$\frac{5}{8}$	121.34403	1171.72829	$\frac{5}{8}$	140.19359	1564.03471
$\frac{3}{4}$	102.88717	842.38871	$\frac{3}{4}$	121.73673	1179.32456	$\frac{3}{4}$	140.58629	1572.80908
$\frac{7}{8}$	103.27987	848.83143	$\frac{7}{8}$	122.12943	1186.94538	$\frac{7}{8}$	140.97899	1581.60800
33	103.67257	855.29869	39	122.52213	1194.59074	45	141.37169	1590.43146
$\frac{1}{8}$	104.06527	861.79050	$\frac{1}{8}$	122.91483	1202.26064	$\frac{1}{8}$	141.76438	1599.27946
$\frac{1}{4}$	104.45797	868.30685	$\frac{1}{4}$	123.30753	1209.95509	$\frac{1}{4}$	142.15708	1608.15200
$\frac{3}{8}$	104.85067	874.84775	$\frac{3}{8}$	123.70022	1217.67408	$\frac{3}{8}$	142.54978	1617.04909
$\frac{1}{2}$	105.24337	881.41319	$\frac{1}{2}$	124.09292	1225.41762	$\frac{1}{2}$	142.94248	1625.97073
$\frac{5}{8}$	105.63606	888.00317	$\frac{5}{8}$	124.48562	1233.18570	$\frac{5}{8}$	143.33518	1634.91690
$\frac{3}{4}$	106.02876	894.61769	$\frac{3}{4}$	124.87832	1240.97832	$\frac{3}{4}$	143.72788	1643.88762
$\frac{7}{8}$	106.42146	901.25676	$\frac{7}{8}$	125.27102	1248.79549	$\frac{7}{8}$	144.12058	1652.88289
34	106.81416	907.92038	40	125.66372	1256.63720	46	144.51328	1661.90270

Circumferences and Areas of Circles From 46 to 63 $\frac{7}{8}$

Diameter	Circumference	Area	Diameter	Circumference	Area	Diameter	Circumference	Area
46	144.51328	1661.90270	52	163.36284	2123.71687	58	182.21239	2642.07971
$\frac{1}{8}$	144.90598	1670.94705	$\frac{1}{8}$	163.75554	2133.93932	$\frac{1}{8}$	182.60509	2653.48026
$\frac{1}{4}$	145.29868	1680.01594	$\frac{1}{4}$	164.14823	2144.18631	$\frac{1}{4}$	182.99779	2664.90535
$\frac{3}{8}$	145.69138	1689.10938	$\frac{3}{8}$	164.54093	2154.45785	$\frac{3}{8}$	183.39049	2676.35498
$\frac{1}{2}$	146.08407	1698.22737	$\frac{1}{2}$	164.93363	2164.75393	$\frac{1}{2}$	183.78319	2687.82916
$\frac{5}{8}$	146.47677	1707.36989	$\frac{5}{8}$	165.32633	2175.07455	$\frac{5}{8}$	184.17589	2699.32788
$\frac{3}{4}$	146.86947	1716.53696	$\frac{3}{4}$	165.71903	2185.41972	$\frac{3}{4}$	184.56859	2710.85115
$\frac{7}{8}$	147.26217	1725.72858	$\frac{7}{8}$	166.11173	2195.78943	$\frac{7}{8}$	184.96129	2722.39896
47	147.65487	1734.94473	53	166.50443	2206.18368	59	185.35399	2733.97131
$\frac{1}{8}$	148.04757	1744.18544	$\frac{1}{8}$	166.89713	2216.60248	$\frac{1}{8}$	185.74669	2745.56820
$\frac{1}{4}$	148.44027	1753.45068	$\frac{1}{4}$	167.28983	2227.04583	$\frac{1}{4}$	186.13939	2757.18964
$\frac{3}{8}$	148.83297	1762.74047	$\frac{3}{8}$	167.68253	2237.51371	$\frac{3}{8}$	186.53208	2768.83563
$\frac{1}{2}$	149.22567	1772.05480	$\frac{1}{2}$	168.07523	2248.00614	$\frac{1}{2}$	186.92478	2780.50615
$\frac{5}{8}$	149.61837	1781.39368	$\frac{5}{8}$	168.46792	2258.52311	$\frac{5}{8}$	187.31748	2792.20123
$\frac{3}{4}$	150.01107	1790.75710	$\frac{3}{4}$	168.86062	2269.06463	$\frac{3}{4}$	187.71018	2803.92084
$\frac{7}{8}$	150.40376	1800.14506	$\frac{7}{8}$	169.25332	2279.63069	$\frac{7}{8}$	188.10288	2815.66500
48	150.79646	1809.55757	54	169.64602	2290.22130	60	188.49558	2827.43370
$\frac{1}{8}$	151.18916	1818.99462	$\frac{1}{8}$	170.03872	2300.83645	$\frac{1}{8}$	188.88828	2839.22695
$\frac{1}{4}$	151.58186	1828.45621	$\frac{1}{4}$	170.43142	2311.47614	$\frac{1}{4}$	189.28098	2851.04473
$\frac{3}{8}$	151.97456	1837.94235	$\frac{3}{8}$	170.82412	2322.14037	$\frac{3}{8}$	189.67368	2862.88707
$\frac{1}{2}$	152.36726	1847.45303	$\frac{1}{2}$	171.21682	2332.82915	$\frac{1}{2}$	190.06638	2874.75394
$\frac{5}{8}$	152.75996	1856.98826	$\frac{5}{8}$	171.60952	2343.54248	$\frac{5}{8}$	190.45908	2886.64536
$\frac{3}{4}$	153.15266	1866.54803	$\frac{3}{4}$	172.00222	2354.28034	$\frac{3}{4}$	190.85177	2898.56133
$\frac{7}{8}$	153.54536	1876.13234	$\frac{7}{8}$	172.39492	2365.04275	$\frac{7}{8}$	191.24447	2910.50184
49	153.93806	1885.74120	55	172.78762	2375.82971	61	191.63717	2922.46689
$\frac{1}{8}$	154.33076	1895.37460	$\frac{1}{8}$	173.18031	2386.64120	$\frac{1}{8}$	192.02987	2934.45648
$\frac{1}{4}$	154.72346	1905.03254	$\frac{1}{4}$	173.57301	2397.47725	$\frac{1}{4}$	192.42257	2946.47062
$\frac{3}{8}$	155.11615	1914.71503	$\frac{3}{8}$	173.96571	2408.33783	$\frac{3}{8}$	192.81527	2958.50930
$\frac{1}{2}$	155.50885	1924.42206	$\frac{1}{2}$	174.35841	2419.22296	$\frac{1}{2}$	193.20797	2970.57253
$\frac{5}{8}$	155.90155	1934.15364	$\frac{5}{8}$	174.75111	2430.13263	$\frac{5}{8}$	193.60067	2982.66030
$\frac{3}{4}$	156.29425	1943.90976	$\frac{3}{4}$	175.14381	2441.06685	$\frac{3}{4}$	193.99337	2994.77261
$\frac{7}{8}$	156.68695	1953.69042	$\frac{7}{8}$	175.53651	2452.02561	$\frac{7}{8}$	194.38607	3006.90947
50	157.07965	1963.49563	56	175.92921	2463.00891	62	194.77877	3019.07087
$\frac{1}{8}$	157.47235	1973.32537	$\frac{1}{8}$	176.32191	2474.01676	$\frac{1}{8}$	195.17147	3031.25682
$\frac{1}{4}$	157.86505	1983.17967	$\frac{1}{4}$	176.71461	2485.04915	$\frac{1}{4}$	195.56416	3043.46731
$\frac{3}{8}$	158.25775	1993.05851	$\frac{3}{8}$	177.10731	2496.10609	$\frac{3}{8}$	195.95686	3055.70234
$\frac{1}{2}$	158.65045	2002.96189	$\frac{1}{2}$	177.50000	2507.18756	$\frac{1}{2}$	196.34956	3067.96191
$\frac{5}{8}$	159.04315	2012.88981	$\frac{5}{8}$	177.89270	2518.29359	$\frac{5}{8}$	196.74226	3080.24603
$\frac{3}{4}$	159.43584	2022.84228	$\frac{3}{4}$	178.28540	2529.42415	$\frac{3}{4}$	197.13496	3092.55470
$\frac{7}{8}$	159.82854	2032.81929	$\frac{7}{8}$	178.67810	2540.57926	$\frac{7}{8}$	197.52766	3104.88790
51	160.22124	2042.82085	57	179.07080	2551.75891	63	197.92036	3117.24565
$\frac{1}{8}$	160.61394	2052.84695	$\frac{1}{8}$	179.46350	2562.96311	$\frac{1}{8}$	198.31306	3129.62795
$\frac{1}{4}$	161.00664	2062.89759	$\frac{1}{4}$	179.85620	2574.19185	$\frac{1}{4}$	198.70576	3142.03479
$\frac{3}{8}$	161.39934	2072.97278	$\frac{3}{8}$	180.24890	2585.44514	$\frac{3}{8}$	199.09846	3154.46617
$\frac{1}{2}$	161.79204	2083.07251	$\frac{1}{2}$	180.64160	2596.72296	$\frac{1}{2}$	199.49116	3166.92209
$\frac{5}{8}$	162.18474	2093.19678	$\frac{5}{8}$	181.03430	2608.02534	$\frac{5}{8}$	199.88385	3179.40256
$\frac{3}{4}$	162.57744	2103.34560	$\frac{3}{4}$	181.42700	2619.35225	$\frac{3}{4}$	200.27655	3191.90758
$\frac{7}{8}$	162.97014	2113.51896	$\frac{7}{8}$	181.81969	2630.70371	$\frac{7}{8}$	200.66925	3204.43713
52	163.36284	2123.71687	58	182.21239	2642.07971	64	201.06195	3216.99123

Circumferences and Areas of Circles From 64 to 81 $\frac{7}{8}$

Diameter	Circumference	Area	Diameter	Circumference	Area	Diameter	Circumference	Area
64	201.06195	3216.99123	70	219.91151	3848.45143	76	238.76107	4536.46029
$\frac{1}{8}$	201.45465	3229.56988	$\frac{1}{8}$	220.30421	3862.20817	$\frac{1}{8}$	239.15377	4551.39513
$\frac{1}{4}$	201.84735	3242.17306	$\frac{1}{4}$	220.69691	3875.98945	$\frac{1}{4}$	239.54647	4566.35451
$\frac{3}{8}$	202.24005	3254.80079	$\frac{3}{8}$	221.08961	3889.79528	$\frac{3}{8}$	239.93917	4581.33844
$\frac{1}{2}$	202.63275	3267.45307	$\frac{1}{2}$	221.48231	3903.62565	$\frac{1}{2}$	240.33186	4596.34691
$\frac{5}{8}$	203.02545	3280.12989	$\frac{5}{8}$	221.87501	3917.48057	$\frac{5}{8}$	240.72456	4611.37992
$\frac{3}{4}$	203.41815	3292.83125	$\frac{3}{4}$	222.26770	3931.36003	$\frac{3}{4}$	241.11726	4626.43748
$\frac{7}{8}$	203.81085	3305.55716	$\frac{7}{8}$	222.66040	3945.26403	$\frac{7}{8}$	241.50996	4641.51958
65	204.20355	3318.30761	71	223.05310	3959.19258	77	241.90266	4656.62622
$\frac{1}{8}$	204.59624	3331.08260	$\frac{1}{8}$	223.44580	3973.14567	$\frac{1}{8}$	242.29536	4671.75741
$\frac{1}{4}$	204.98894	3343.88214	$\frac{1}{4}$	223.83850	3987.12330	$\frac{1}{4}$	242.68806	4686.91314
$\frac{3}{8}$	205.38164	3356.70622	$\frac{3}{8}$	224.23120	4001.12548	$\frac{3}{8}$	243.08076	4702.09342
$\frac{1}{2}$	205.77434	3369.55484	$\frac{1}{2}$	224.62390	4015.15220	$\frac{1}{2}$	243.47346	4717.29824
$\frac{5}{8}$	206.16704	3382.42801	$\frac{5}{8}$	225.01660	4029.20347	$\frac{5}{8}$	243.86616	4732.52760
$\frac{3}{4}$	206.55974	3395.32572	$\frac{3}{4}$	225.40930	4043.27928	$\frac{3}{4}$	244.25886	4747.78151
$\frac{7}{8}$	206.95244	3408.24798	$\frac{7}{8}$	225.80200	4057.37963	$\frac{7}{8}$	244.65155	4763.05996
66	207.34514	3421.19478	72	226.19470	4071.50453	78	245.04425	4778.36295
$\frac{1}{8}$	207.73784	3434.16612	$\frac{1}{8}$	226.58740	4085.65397	$\frac{1}{8}$	245.43695	4793.69049
$\frac{1}{4}$	208.13054	3447.16201	$\frac{1}{4}$	226.98009	4099.82795	$\frac{1}{4}$	245.82965	4809.04257
$\frac{3}{8}$	208.52324	3460.18244	$\frac{3}{8}$	227.37279	4114.02648	$\frac{3}{8}$	246.22235	4824.41920
$\frac{1}{2}$	208.91593	3473.22741	$\frac{1}{2}$	227.76549	4128.24955	$\frac{1}{2}$	246.61505	4839.82037
$\frac{5}{8}$	209.30863	3486.29693	$\frac{5}{8}$	228.15819	4142.49717	$\frac{5}{8}$	247.00775	4855.24608
$\frac{3}{4}$	209.70133	3499.39099	$\frac{3}{4}$	228.55089	4156.76933	$\frac{3}{4}$	247.40045	4870.69633
$\frac{7}{8}$	210.09403	3512.50960	$\frac{7}{8}$	228.94359	4171.06603	$\frac{7}{8}$	247.79315	4886.17113
67	210.48673	3525.65274	73	229.33629	4185.38727	79	248.18585	4901.67048
$\frac{1}{8}$	210.87943	3538.82044	$\frac{1}{8}$	229.72899	4199.73306	$\frac{1}{8}$	248.57855	4917.19437
$\frac{1}{4}$	211.27213	3552.01267	$\frac{1}{4}$	230.12169	4214.10340	$\frac{1}{4}$	248.97125	4932.74280
$\frac{3}{8}$	211.66483	3565.22945	$\frac{3}{8}$	230.51439	4228.49828	$\frac{3}{8}$	249.36394	4948.31577
$\frac{1}{2}$	212.05753	3578.47078	$\frac{1}{2}$	230.90709	4242.91770	$\frac{1}{2}$	249.75664	4963.91329
$\frac{5}{8}$	212.45023	3591.73664	$\frac{5}{8}$	231.29978	4257.36166	$\frac{5}{8}$	250.14934	4979.53535
$\frac{3}{4}$	212.84293	3605.02705	$\frac{3}{4}$	231.69248	4271.83017	$\frac{3}{4}$	250.54204	4995.18196
$\frac{7}{8}$	213.23562	3618.34201	$\frac{7}{8}$	232.08518	4286.32322	$\frac{7}{8}$	250.93474	5010.85311
68	213.62832	3631.68151	74	232.47788	4300.84082	80	251.32744	5026.54880
$\frac{1}{8}$	214.02102	3645.04555	$\frac{1}{8}$	232.87058	4315.38296	$\frac{1}{8}$	251.72014	5042.26904
$\frac{1}{4}$	214.41372	3658.43414	$\frac{1}{4}$	233.26328	4329.94964	$\frac{1}{4}$	252.11284	5058.01382
$\frac{3}{8}$	214.80642	3671.84727	$\frac{3}{8}$	233.65598	4344.54087	$\frac{3}{8}$	252.50554	5073.78314
$\frac{1}{2}$	215.19912	3685.28494	$\frac{1}{2}$	234.04868	4359.15664	$\frac{1}{2}$	252.89824	5089.57701
$\frac{5}{8}$	215.59182	3698.74716	$\frac{5}{8}$	234.44138	4373.79695	$\frac{5}{8}$	253.29094	5105.39542
$\frac{3}{4}$	215.98452	3712.23392	$\frac{3}{4}$	234.83408	4388.46181	$\frac{3}{4}$	253.68363	5121.23838
$\frac{7}{8}$	216.37722	3725.74522	$\frac{7}{8}$	235.22678	4403.15121	$\frac{7}{8}$	254.07633	5137.10588
69	216.76992	3739.28107	75	235.61948	4417.86516	81	254.46903	5152.99792
$\frac{1}{8}$	217.16262	3752.84146	$\frac{1}{8}$	236.01217	4432.60365	$\frac{1}{8}$	254.86173	5168.91450
$\frac{1}{4}$	217.55532	3766.42640	$\frac{1}{4}$	236.40487	4447.36668	$\frac{1}{4}$	255.25443	5184.85563
$\frac{3}{8}$	217.94801	3780.03587	$\frac{3}{8}$	236.79757	4462.15425	$\frac{3}{8}$	255.64713	5200.82131
$\frac{1}{2}$	218.34071	3793.66990	$\frac{1}{2}$	237.19027	4476.96637	$\frac{1}{2}$	256.03983	5216.81153
$\frac{5}{8}$	218.73341	3807.32846	$\frac{5}{8}$	237.58297	4491.80304	$\frac{5}{8}$	256.43253	5232.82629
$\frac{3}{4}$	219.12611	3821.01157	$\frac{3}{4}$	237.97567	4506.66425	$\frac{3}{4}$	256.82523	5248.86559
$\frac{7}{8}$	219.51881	3834.71923	$\frac{7}{8}$	238.36837	4521.55000	$\frac{7}{8}$	257.21793	5264.92944
70	219.91151	3848.45143	76	238.76107	4536.46029	82	257.61063	5281.01783

Circumferences and Areas of Circles From 82 to 99%

Diameter	Circumference	Area	Diameter	Circumference	Area	Diameter	Circumference	Area
82	257.61063	5281.01783	88	276.46018	6082.12405	94	295.30974	6939.77894
$\frac{1}{8}$	258.00333	5297.13077	$\frac{1}{8}$	276.85288	6099.41508	$\frac{1}{8}$	295.70244	6958.24807
$\frac{1}{4}$	258.39602	5313.26825	$\frac{1}{4}$	277.24558	6116.73066	$\frac{1}{4}$	296.09514	6976.74174
$\frac{3}{8}$	258.78872	5329.43027	$\frac{3}{8}$	277.63828	6134.07078	$\frac{3}{8}$	296.48784	6995.25996
$\frac{1}{2}$	259.18142	5345.61684	$\frac{1}{2}$	278.03098	6151.43544	$\frac{1}{2}$	296.88054	7013.80272
$\frac{5}{8}$	259.57412	5361.82795	$\frac{5}{8}$	278.42368	6168.82465	$\frac{5}{8}$	297.27324	7032.37003
$\frac{3}{4}$	259.96682	5378.06360	$\frac{3}{4}$	278.81638	6186.23840	$\frac{3}{4}$	297.66594	7050.96188
$\frac{7}{8}$	260.35952	5394.32380	$\frac{7}{8}$	279.20908	6203.67670	$\frac{7}{8}$	298.05864	7069.57827
83	260.75222	5410.60854	89	279.60178	6221.13954	95	298.45134	7088.21921
$\frac{1}{8}$	261.14492	5426.91783	$\frac{1}{8}$	279.99448	6238.62692	$\frac{1}{8}$	298.84403	7106.88469
$\frac{1}{4}$	261.53762	5443.25166	$\frac{1}{4}$	280.38718	6256.13885	$\frac{1}{4}$	299.23673	7125.57471
$\frac{3}{8}$	261.93032	5459.61003	$\frac{3}{8}$	280.77987	6273.67532	$\frac{3}{8}$	299.62943	7144.28928
$\frac{1}{2}$	262.32302	5475.99295	$\frac{1}{2}$	281.17257	6291.23633	$\frac{1}{2}$	300.02213	7163.02839
$\frac{5}{8}$	262.71571	5492.40041	$\frac{5}{8}$	281.56527	6308.82189	$\frac{5}{8}$	300.41483	7181.79204
$\frac{3}{4}$	263.10841	5508.83241	$\frac{3}{4}$	281.95797	6326.43199	$\frac{3}{4}$	300.80753	7200.58024
$\frac{7}{8}$	263.50111	5525.28896	$\frac{7}{8}$	282.35067	6344.06664	$\frac{7}{8}$	301.20023	7219.39299
84	263.89381	5541.77005	90	282.74337	6361.72583	96	301.59293	7238.23027
$\frac{1}{8}$	264.28651	5558.27569	$\frac{1}{8}$	283.13607	6379.40956	$\frac{1}{8}$	301.98563	7257.09210
$\frac{1}{4}$	264.67921	5574.80587	$\frac{1}{4}$	283.52877	6397.11783	$\frac{1}{4}$	302.37833	7275.97848
$\frac{3}{8}$	265.07191	5591.36059	$\frac{3}{8}$	283.92147	6414.85065	$\frac{3}{8}$	302.77103	7294.88939
$\frac{1}{2}$	265.46461	5607.93985	$\frac{1}{2}$	284.31417	6432.60802	$\frac{1}{2}$	303.16372	7313.82485
$\frac{5}{8}$	265.85731	5624.54366	$\frac{5}{8}$	284.70687	6450.38992	$\frac{5}{8}$	303.55642	7332.78486
$\frac{3}{4}$	266.25001	5641.17202	$\frac{3}{4}$	285.09956	6468.19638	$\frac{3}{4}$	303.94912	7351.76941
$\frac{7}{8}$	266.64271	5657.82492	$\frac{7}{8}$	285.49226	6486.02737	$\frac{7}{8}$	304.34182	7370.77850
85	267.03541	5674.50236	91	285.88496	6503.88291	97	304.73452	7389.81213
$\frac{1}{8}$	267.42810	5691.20434	$\frac{1}{8}$	286.27766	6521.76299	$\frac{1}{8}$	305.12722	7408.87031
$\frac{1}{4}$	267.82080	5707.93087	$\frac{1}{4}$	286.67036	6539.66762	$\frac{1}{4}$	305.51992	7427.95304
$\frac{3}{8}$	268.21350	5724.68194	$\frac{3}{8}$	287.06306	6557.59679	$\frac{3}{8}$	305.91262	7447.06030
$\frac{1}{2}$	268.60620	5741.45756	$\frac{1}{2}$	287.45576	6575.55050	$\frac{1}{2}$	306.30532	7466.19211
$\frac{5}{8}$	268.99890	5758.25772	$\frac{5}{8}$	287.84846	6593.52876	$\frac{5}{8}$	306.69802	7485.34847
$\frac{3}{4}$	269.39160	5775.08242	$\frac{3}{4}$	288.24116	6611.53156	$\frac{3}{4}$	307.09072	7504.52937
$\frac{7}{8}$	269.78430	5791.93167	$\frac{7}{8}$	288.63386	6629.55890	$\frac{7}{8}$	307.48341	7523.73481
86	270.17700	5808.80546	92	289.02656	6647.61079	98	307.87611	7542.96479
$\frac{1}{8}$	270.56970	5825.70379	$\frac{1}{8}$	289.41926	6665.68722	$\frac{1}{8}$	308.26881	7562.21932
$\frac{1}{4}$	270.96240	5842.62667	$\frac{1}{4}$	289.81195	6683.78819	$\frac{1}{4}$	308.66151	7581.49839
$\frac{3}{8}$	271.35510	5859.57409	$\frac{3}{8}$	290.20465	6701.91371	$\frac{3}{8}$	309.05421	7600.80201
$\frac{1}{2}$	271.74779	5876.54606	$\frac{1}{2}$	290.59735	6720.06378	$\frac{1}{2}$	309.44691	7620.13017
$\frac{5}{8}$	272.14049	5893.54257	$\frac{5}{8}$	290.99005	6738.23838	$\frac{5}{8}$	309.83961	7639.48287
$\frac{3}{4}$	272.53319	5910.56362	$\frac{3}{4}$	291.38275	6756.43753	$\frac{3}{4}$	310.23231	7658.86012
$\frac{7}{8}$	272.92589	5927.60921	$\frac{7}{8}$	291.77545	6774.66123	$\frac{7}{8}$	310.62501	7678.26191
87	273.31859	5944.67935	93	292.16815	6792.90946	99	311.01771	7697.68825
$\frac{1}{8}$	273.71129	5961.77404	$\frac{1}{8}$	292.56085	6811.18225	$\frac{1}{8}$	311.41041	7717.13913
$\frac{1}{4}$	274.10399	5978.89327	$\frac{1}{4}$	292.95355	6829.47957	$\frac{1}{4}$	311.80311	7736.61455
$\frac{3}{8}$	274.49669	5996.03704	$\frac{3}{8}$	293.34625	6847.80144	$\frac{3}{8}$	312.19580	7756.11451
$\frac{1}{2}$	274.88939	6013.20535	$\frac{1}{2}$	293.73895	6866.14785	$\frac{1}{2}$	312.58850	7775.63902
$\frac{5}{8}$	275.28209	6030.39821	$\frac{5}{8}$	294.13164	6884.51881	$\frac{5}{8}$	312.98120	7795.18808
$\frac{3}{4}$	275.67479	6047.61561	$\frac{3}{4}$	294.52434	6902.91431	$\frac{3}{4}$	313.37390	7814.76167
$\frac{7}{8}$	276.06748	6064.85756	$\frac{7}{8}$	294.91704	6921.33435	$\frac{7}{8}$	313.76660	7834.35982
88	276.46018	6082.12405	94	295.30974	6939.77894	100	314.15930	7853.98250

Circumferences and Areas of Circles From 100 to 249

Diameter	Circumference	Area	Diameter	Circumference	Area	Diameter	Circumference	Area
100	314.15930	7853.98250	150	471.23895	17671.46063	200	628.31860	31415.93000
101	317.30089	8011.84755	151	474.38054	17907.86550	201	631.46019	31730.87470
102	320.44249	8171.28339	152	477.52214	18145.84117	202	634.60179	32047.39019
103	323.58408	8332.29003	153	480.66373	18385.38763	203	637.74338	32365.47648
104	326.72567	8494.86747	154	483.80532	18626.50490	204	640.88497	32685.13357
105	329.86727	8659.01571	155	486.94692	18869.19296	205	644.02657	33006.36146
106	333.00886	8824.73474	156	490.08851	19113.45181	206	647.16816	33329.16014
107	336.15045	8992.02456	157	493.23010	19359.28146	207	650.30975	33653.52961
108	339.29204	9160.88519	158	496.37169	19606.68191	208	653.45134	33979.46989
109	342.43364	9331.31661	159	499.51329	19855.65316	209	656.59294	34306.98096
110	345.57523	9503.31883	160	502.65488	20106.19520	210	659.73453	34636.06283
111	348.71682	9676.89184	161	505.79647	20358.30804	211	662.87612	34966.71549
112	351.85842	9852.03565	162	508.93807	20611.99167	212	666.01772	35298.93895
113	355.00001	10028.75025	163	512.07966	20867.24610	213	669.15931	35632.73320
114	358.14160	10207.03566	164	515.22125	21124.07133	214	672.30090	35968.09826
115	361.28320	10386.89186	165	518.36285	21382.46736	215	675.44250	36305.03411
116	364.42479	10568.31885	166	521.50444	21642.43418	216	678.58409	36643.54075
117	367.56638	10751.31664	167	524.64603	21903.97179	217	681.72568	36983.61819
118	370.70797	10935.88523	168	527.78762	22167.08021	218	684.86727	37325.26643
119	373.84957	11122.02462	169	530.92922	22431.75942	219	688.00887	37668.48547
120	376.99116	11309.73480	170	534.07081	22698.00943	220	691.15046	38013.27530
121	380.13275	11499.01578	171	537.21240	22965.83023	221	694.29205	38359.63593
122	383.27435	11689.86755	172	540.35400	23235.22183	222	697.43365	38707.56735
123	386.41594	11882.29012	173	543.49559	23506.18422	223	700.57524	39057.06957
124	389.55753	12076.28349	174	546.63718	23778.71742	224	703.71683	39408.14259
125	392.69913	12271.84766	175	549.77878	24052.82141	225	706.85843	39760.78641
126	395.84072	12468.98262	176	552.92037	24328.49619	226	710.00002	40115.00102
127	398.98231	12667.68837	177	556.06196	24605.74177	227	713.14161	40470.78642
128	402.12390	12867.96493	178	559.20355	24884.55815	228	716.28320	40828.14263
129	405.26550	13069.81228	179	562.34515	25164.94533	229	719.42480	41187.06963
130	408.40709	13273.23043	180	565.48674	25446.90330	230	722.56639	41547.56743
131	411.54868	13478.21937	181	568.62833	25730.43207	231	725.70798	41909.63602
132	414.69028	13684.77911	182	571.76993	26015.53163	232	728.84958	42273.27541
133	417.83187	13892.90964	183	574.91152	26302.20199	233	731.99117	42638.48559
134	420.97346	14102.61098	184	578.05311	26590.44315	234	735.13276	43005.26658
135	424.11506	14313.88311	185	581.19471	26880.25511	235	738.27436	43373.61836
136	427.25665	14526.72603	186	584.33630	27171.63786	236	741.41595	43743.54093
137	430.39824	14741.13975	187	587.47789	27464.59140	237	744.55754	44115.03430
138	433.53983	14957.12427	188	590.61948	27759.11575	238	747.69913	44488.09847
139	436.68143	15174.67959	189	593.76108	28055.21089	239	750.84073	44862.73344
140	439.82302	15393.80570	190	596.90267	28352.87683	240	753.98232	45238.93920
141	442.96461	15614.50261	191	600.04426	28652.11356	241	757.12391	45616.71576
142	446.10621	15836.77031	192	603.18586	28952.92109	242	760.26551	45996.06311
143	449.24780	16060.60881	193	606.32745	29255.29941	243	763.40710	46376.98126
144	452.38939	16286.01811	194	609.46904	29559.24854	244	766.54869	46759.47021
145	455.53099	16512.99821	195	612.61064	29864.76846	245	769.69029	47143.52996
146	458.67258	16741.54910	196	615.75223	30171.85917	246	772.83188	47529.16050
147	461.81417	16971.67078	197	618.89382	30480.52068	247	775.97347	47916.36183
148	464.95576	17203.36327	198	622.03541	30790.75299	248	779.11506	48305.13397
149	468.09736	17436.62655	199	625.17701	31102.55610	249	782.25666	48695.47690

Circumferences and Areas of Circles From 250 to 399

Diameter	Circumference	Area	Diameter	Circumference	Area	Diameter	Circumference	Area
250	785.39825	49087.39063	300	942.47790	70685.84250	350	1099.55755	96211.28563
251	788.53984	49480.87515	301	945.61949	71157.86685	351	1102.69914	96761.84980
252	791.68144	49875.93047	302	948.76109	71631.46199	352	1105.84074	97313.98477
253	794.82303	50272.55658	303	951.90268	72106.62793	353	1108.98233	97867.69053
254	797.96462	50670.75350	304	955.04427	72583.36467	354	1112.12392	98422.96710
255	801.10622	51070.52121	305	958.18587	73061.67221	355	1115.26552	98979.81446
256	804.24781	51471.85971	306	961.32746	73541.55054	356	1118.40711	99538.23261
257	807.38940	51874.76901	307	964.46905	74022.99966	357	1121.54870	100098.22156
258	810.53099	52279.24911	308	967.61064	74506.01959	358	1124.69029	100659.78131
259	813.67259	52685.30001	309	970.75224	74990.61031	359	1127.83189	101222.91186
260	816.81418	53092.92170	310	973.89383	75476.77183	360	1130.97348	101787.61320
261	819.95577	53502.11419	311	977.03542	75964.50414	361	1134.11507	102353.88534
262	823.09737	53912.87747	312	980.17702	76453.80725	362	1137.25667	102921.72827
263	826.23896	54325.21155	313	983.31861	76944.68115	363	1140.39826	103491.14200
264	829.38055	54739.11643	314	986.46020	77437.12586	364	1143.53985	104062.12653
265	832.52215	55154.59211	315	989.60180	77931.14136	365	1146.68145	104634.68186
266	835.66374	55571.63858	316	992.74339	78426.72765	366	1149.82304	105208.80798
267	838.80533	55990.25584	317	995.88498	78923.88474	367	1152.96463	105784.50489
268	841.94692	56410.44391	318	999.02657	79422.61263	368	1156.10622	106361.77261
269	845.08852	56832.20277	319	1002.16817	79922.91132	369	1159.24782	106940.61112
270	848.23011	57255.53243	320	1005.30976	80424.78080	370	1162.38941	107521.02043
271	851.37170	57680.43288	321	1008.45135	80928.22108	371	1165.53100	108103.00053
272	854.51330	58106.90413	322	1011.59295	81433.23215	372	1168.67260	108686.55143
273	857.65489	58534.94617	323	1014.73454	81939.81402	373	1171.81419	109271.67312
274	860.79648	58964.55902	324	1017.87613	82447.96669	374	1174.95578	109858.36562
275	863.93808	59395.74266	325	1021.01773	82957.69016	375	1178.09738	110446.62891
276	867.07967	59828.49709	326	1024.15932	83468.98442	376	1181.23897	111036.46299
277	870.22126	60262.82232	327	1027.30091	83981.84947	377	1184.38056	111627.86787
278	873.36285	60698.71835	328	1030.44250	84496.28533	378	1187.52215	112220.84355
279	876.50445	61136.18518	329	1033.58410	85012.29198	379	1190.66375	112815.39003
280	879.64604	61575.22280	330	1036.72569	85529.86943	380	1193.80534	113411.50730
281	882.78763	62015.83122	331	1039.86728	86049.01767	381	1196.94693	114009.19537
282	885.92923	62458.01043	332	1043.00888	86569.73671	382	1200.08853	114608.45423
283	889.07082	62901.76044	333	1046.15047	87092.02654	383	1203.23012	115209.28389
284	892.21241	63347.08125	334	1049.29206	87615.88718	384	1206.37171	115811.68435
285	895.35401	63793.97286	335	1052.43366	88141.31861	385	1209.51331	116415.65561
286	898.49560	64242.43526	336	1055.57525	88668.32083	386	1212.65490	117021.19766
287	901.63719	64692.46845	337	1058.71684	89196.89385	387	1215.79649	117628.31050
288	904.77878	65144.07245	338	1061.85843	89727.03767	388	1218.93808	118236.99415
289	907.92038	65597.24724	339	1065.00003	90258.75229	389	1222.07968	118847.24859
290	911.06197	66051.99283	340	1068.14162	90792.03770	390	1225.22127	119459.07383
291	914.20356	66508.30921	341	1071.28321	91326.89391	391	1228.36286	120072.46986
292	917.34516	66966.19639	342	1074.42481	91863.32091	392	1231.50446	120687.43669
293	920.48675	67425.65436	343	1077.56640	92401.31871	393	1234.64605	121303.97431
294	923.62834	67886.68314	344	1080.70799	92940.88731	394	1237.78764	121922.08274
295	926.76994	68349.28271	345	1083.84959	93482.02671	395	1240.92924	122541.76196
296	929.91153	68813.45307	346	1086.99118	94024.73690	396	1244.07083	123163.01197
297	933.05312	69279.19423	347	1090.13277	94569.01788	397	1247.21242	123785.83278
298	936.19471	69746.50619	348	1093.27436	95114.86967	398	1250.35401	124410.22439
299	939.33631	70215.38895	349	1096.41596	95662.29225	399	1253.49561	125036.18680

Circumferences and Areas of Circles From 400 to 549

Dia- meter	Circum- ference	Area	Dia- meter	Circum- ference	Area	Dia- meter	Circum- ference	Area
400	1256.63720	125663.72000	450	1413.71685	159043.14563	500	1570.79650	196349.56250
401	1259.77879	126292.82400	451	1416.85844	159750.78945	501	1573.93809	197135.74615
402	1262.92039	126923.49879	452	1420.00004	160460.00407	502	1577.07969	197923.50059
403	1266.06198	127555.74438	453	1423.14163	161170.78948	503	1580.22128	198712.82583
404	1269.20357	128189.56077	454	1426.28322	161883.14570	504	1583.36287	199503.72187
405	1272.34517	128824.94796	455	1429.42482	162597.07271	505	1586.50447	200296.18871
406	1275.48676	129461.90594	456	1432.56641	163312.57051	506	1589.64606	201090.22634
407	1278.62835	130100.43471	457	1435.70800	164029.63911	507	1592.78765	201885.83476
408	1281.76994	130740.53429	458	1438.84959	164748.27851	508	1595.92924	202683.01399
409	1284.91154	131382.20466	459	1441.99119	165468.48871	509	1599.07084	203481.76401
410	1288.05313	132025.44583	460	1445.13278	166190.26970	510	1602.21243	204282.08483
411	1291.19472	132670.25779	461	1448.27437	166913.62149	511	1605.35402	205083.97644
412	1294.33632	133316.64055	462	1451.41597	167638.54407	512	1608.49562	205887.43885
413	1297.47791	133964.59410	463	1454.55756	168365.03745	513	1611.63721	206692.47205
414	1300.61950	134614.11846	464	1457.69915	169093.10163	514	1614.77880	207499.07606
415	1303.76110	135265.21361	465	1460.84075	169822.73661	515	1617.92040	208307.25086
416	1306.90269	135917.87955	466	1463.98234	170553.94238	516	1621.06199	209116.99645
417	1310.04428	136572.11629	467	1467.12393	171286.71894	517	1624.20358	209928.31284
418	1313.18587	137227.92383	468	1470.26552	172021.06631	518	1627.34517	210741.20003
419	1316.32747	137885.30217	469	1473.40712	172756.98447	519	1630.48677	211555.65802
420	1319.46906	138544.25130	470	1476.54871	173494.47343	520	1633.62836	212371.68680
421	1322.61065	139204.77123	471	1479.69030	174233.53318	521	1636.76995	213189.28638
422	1325.75225	139866.86195	472	1482.83190	174974.16373	522	1639.91155	214008.45675
423	1328.89384	140530.52347	473	1485.97349	175716.36507	523	1643.05314	214829.19792
424	1332.03543	141195.75579	474	1489.11508	176460.13722	524	1646.19473	215651.50989
425	1335.17703	141862.55891	475	1492.25668	177205.48016	525	1649.33633	216475.39266
426	1338.31862	142530.93282	476	1495.39827	177952.39389	526	1652.47792	217300.84622
427	1341.46021	143200.87752	477	1498.53986	178700.87842	527	1655.61951	218127.87057
428	1344.60180	143872.39303	478	1501.68145	179450.93375	528	1658.76110	218956.46573
429	1347.74340	144545.47933	479	1504.82305	180202.55988	529	1661.90270	219786.63168
430	1350.88499	145220.13643	480	1507.96464	180955.75680	530	1665.04429	220618.36843
431	1354.02658	145896.36432	481	1511.10623	181710.52452	531	1668.18588	221451.67597
432	1357.16818	146574.16301	482	1514.24783	182466.86303	532	1671.32748	222286.55431
433	1360.30977	147253.53249	483	1517.38942	183224.77234	533	1674.46907	223123.00344
434	1363.45136	147934.47278	484	1520.53101	183984.25245	534	1677.61066	223961.02338
435	1366.59296	148616.98386	485	1523.67261	184745.30336	535	1680.75226	224800.61411
436	1369.73455	149301.06573	486	1526.81420	185507.92506	536	1683.89385	225641.77563
437	1372.87614	149986.71840	487	1529.95579	186272.11755	537	1687.03544	226484.50795
438	1376.01773	150673.94187	488	1533.09738	187037.88085	538	1690.17703	227328.81107
439	1379.15933	151362.73614	489	1536.23898	187805.21494	539	1693.31863	228174.68499
440	1382.30092	152053.10120	490	1539.38057	188574.11983	540	1696.46022	229022.12970
441	1385.44251	152745.03706	491	1542.52216	189344.59551	541	1699.60181	229871.14521
442	1388.58411	153438.54371	492	1545.66376	190116.64199	542	1702.74341	230721.73151
443	1391.72570	154133.62116	493	1548.80535	190890.25926	543	1705.88500	231573.88861
444	1394.86729	154830.26941	494	1551.94694	191665.44734	544	1709.02659	232427.61651
445	1398.00889	155528.48846	495	1555.08854	192442.20621	545	1712.16819	233282.91521
446	1401.15048	156228.27830	496	1558.23013	193220.53587	546	1715.30978	234139.78470
447	1404.29207	156929.63893	497	1561.37172	194000.43633	547	1718.45137	234998.22498
448	1407.43366	157632.57037	498	1564.51331	194781.90759	548	1721.59296	235858.23607
449	1410.57526	158337.07260	499	1567.65491	195564.94965	549	1724.73456	236719.81795

Circumferences and Areas of Circles From 550 to 699

Dia- meter	Circum- ference	Area	Dia- meter	Circum- ference	Area	Dia- meter	Circum- ference	Area
550	1727.87615	237582.97063	600	1884.95580	282743.37000	650	2042.03545	331830.76063
551	1731.01774	238447.69410	601	1888.09739	283686.63330	651	2045.17704	332852.56375
552	1734.15934	239313.98837	602	1891.23899	284631.46739	652	2048.31864	333875.93767
553	1737.30093	240181.85343	603	1894.38058	285577.87228	653	2051.46023	334900.88238
554	1740.44252	241051.28930	604	1897.52217	286525.84797	654	2054.60182	335927.39790
555	1743.58412	241922.29596	605	1900.66377	287475.39446	655	2057.74342	336955.48421
556	1746.72571	242794.87341	606	1903.80536	288426.51174	656	2060.88501	337985.14131
557	1749.86730	243669.02166	607	1906.94695	289379.19981	657	2064.02660	339016.36921
558	1753.00889	244544.74071	608	1910.08854	290333.45869	658	2067.16819	340049.16791
559	1756.15049	245422.03056	609	1913.23014	291289.28836	659	2070.30979	341083.53741
560	1759.29208	246300.89120	610	1916.37173	292246.68883	660	2073.45138	342119.47770
561	1762.43367	247181.32264	611	1919.51332	293205.66009	661	2076.59297	343156.98879
562	1765.57527	248063.32487	612	1922.65492	294166.20215	662	2079.73457	344196.07067
563	1768.71686	248946.89790	613	1925.79651	295128.31500	663	2082.87616	345236.72335
564	1771.85845	249832.04173	614	1928.93810	296091.99866	664	2086.01775	346278.94683
565	1775.00005	250718.75636	615	1932.07970	297057.25311	665	2089.15935	347322.74111
566	1778.14164	251607.04178	616	1935.22129	298024.07835	666	2092.30094	348368.10618
567	1781.28323	252496.89799	617	1938.36288	298992.47439	667	2095.44253	349415.04204
568	1784.42482	253388.32501	618	1941.50447	299962.44123	668	2098.58412	350463.54871
569	1787.56642	254281.32282	619	1944.64607	300933.97887	669	2101.72572	351513.62617
570	1790.70801	255175.89143	620	1947.78766	301907.08730	670	2104.86731	352565.27443
571	1793.84960	256072.03083	621	1950.92925	302881.76653	671	2108.00890	353618.49348
572	1796.99120	256969.74103	622	1954.07085	303858.01655	672	2111.15050	354673.28333
573	1800.13279	257869.02202	623	1957.21244	304835.83737	673	2114.29209	355729.64397
574	1803.27438	258769.87382	624	1960.35403	305815.22899	674	2117.43368	356787.57542
575	1806.41598	259672.29641	625	1963.49563	306796.19141	675	2120.57528	357847.07766
576	1809.55757	260576.28979	626	1966.63722	307778.72462	676	2123.71687	358908.15069
577	1812.69916	261481.85397	627	1969.77881	308762.82862	677	2126.85846	359970.79452
578	1815.84075	262388.98895	628	1972.92040	309748.50343	678	2130.00005	361035.00915
579	1818.98235	263297.69473	629	1976.06200	310735.74903	679	2133.14165	362100.79458
580	1822.12394	264207.97130	630	1979.20359	311724.56543	680	2136.28324	363168.15080
581	1825.26553	265119.81867	631	1982.34518	312714.95262	681	2139.42483	364237.07782
582	1828.40713	266033.23683	632	1985.48678	313706.91061	682	2142.56643	365307.57563
583	1831.54872	266948.22579	633	1988.62837	314700.43939	683	2145.70802	366379.64424
584	1834.69031	267864.78555	634	1991.76996	315695.53898	684	2148.84961	367453.28365
585	1837.83191	268782.91611	635	1994.91156	316692.20936	685	2151.99121	368528.49386
586	1840.97350	269702.61746	636	1998.05315	317690.45053	686	2155.13280	369605.27486
587	1844.11509	270623.88960	637	2001.19474	318690.26250	687	2158.27439	370683.62665
588	1847.25668	271546.73255	638	2004.33633	319691.64527	688	2161.41598	371763.54925
589	1850.39828	272471.14629	639	2007.47793	320694.59884	689	2164.55758	372845.04264
590	1853.53987	273397.13083	640	2010.61952	321699.12320	690	2167.69917	373928.10683
591	1856.68146	274324.68616	641	2013.76111	322705.21836	691	2170.84076	375012.74181
592	1859.82306	275253.81229	642	2016.90271	323712.88431	692	2173.98236	376098.94759
593	1862.96465	276184.50921	643	2020.04430	324722.12106	693	2177.12395	377186.72416
594	1866.10624	277116.77694	644	2023.18589	325732.92861	694	2180.26554	378276.07154
595	1869.24784	278050.61546	645	2026.32749	326745.30696	695	2183.40714	379366.98971
596	1872.38943	278986.02477	646	2029.46908	327759.25610	696	2186.54873	380459.47867
597	1875.53102	279923.00488	647	2032.61067	328774.77603	697	2189.69032	381553.53843
598	1878.67261	280861.55579	648	2035.75226	329791.86677	698	2192.83191	382649.16899
599	1881.81421	281801.67750	649	2038.89386	330810.52830	699	2195.97351	383746.37035

Circumferences and Areas of Circles From 700 to 849

Dia- meter	Circum- ference	Area	Dia- meter	Circum- ference	Area	Dia- meter	Circum- ference	Area
700	2199.11510	384845.14250	750	2356.19475	441786.51563	800	2513.27440	502654.88000
701	2202.25669	385945.48545	751	2359.33634	442965.39840	801	2516.41599	503912.30260
702	2205.39829	387047.39919	752	2362.47794	444145.85197	802	2519.55759	505171.29599
703	2208.53988	388150.88373	753	2365.61953	445327.87633	803	2522.69918	506431.86018
704	2211.68147	389255.93907	754	2368.76112	446511.47150	804	2525.84077	507693.99517
705	2214.82307	390362.56521	755	2371.90272	447696.63746	805	2528.98237	508957.70096
706	2217.96466	391470.76214	756	2375.04431	448883.37421	806	2532.12396	510222.97754
707	2221.10625	392580.52986	757	2378.18590	450071.68176	807	2535.26555	511489.82491
708	2224.24784	393691.86839	758	2381.32749	451261.56011	808	2538.40714	512758.24309
709	2227.38944	394804.77771	759	2384.46909	452453.00926	809	2541.54874	514028.23206
710	2230.53103	395919.25783	760	2387.61068	453646.02920	810	2544.69033	515299.79183
711	2233.67262	397035.30874	761	2390.75227	454840.61994	811	2547.83192	516572.92239
712	2236.81422	398152.93045	762	2393.89387	456036.78147	812	2550.97352	517847.62375
713	2239.95581	399272.12295	763	2397.03546	457234.51380	813	2554.11511	519123.89590
714	2243.09740	400392.88626	764	2400.17705	458433.81693	814	2557.25670	520401.73886
715	2246.23900	401515.22036	765	2403.31865	459634.69086	815	2560.39830	521681.15261
716	2249.38059	402639.12525	766	2406.46024	460837.13558	816	2563.53989	522962.13715
717	2252.52218	403764.60094	767	2409.60183	462041.15109	817	2566.68148	524244.69249
718	2255.66377	404891.64743	768	2412.74342	463246.73741	818	2569.82307	525528.81863
719	2258.80537	406020.26472	769	2415.88502	464453.89452	819	2572.96467	526814.51557
720	2261.94696	407150.45280	770	2419.02661	465662.62243	820	2576.10626	528101.78330
721	2265.08855	408282.21168	771	2422.16820	466872.92113	821	2579.24785	529390.62183
722	2268.23015	409415.54135	772	2425.30980	468084.79063	822	2582.38945	530681.03115
723	2271.37174	410550.44182	773	2428.45139	469298.23092	823	2585.53104	531973.01127
724	2274.51333	411686.91309	774	2431.59298	470513.24202	824	2588.67263	533266.56219
725	2277.65493	412824.95516	775	2434.73458	471729.82391	825	2591.81423	534561.68391
726	2280.79652	413964.56802	776	2437.87617	472947.97659	826	2594.95582	535858.37642
727	2283.93811	415105.75167	777	2441.01776	474167.70007	827	2598.09741	537156.63972
728	2287.07970	416248.50613	778	2444.15935	475388.99435	828	2601.23900	538456.47383
729	2290.22130	417392.83138	779	2447.30095	476611.85943	829	2604.38060	539757.87873
730	2293.36289	418538.72743	780	2450.44254	477836.29530	830	2607.52219	541060.85443
731	2296.50448	419686.19427	781	2453.58413	479062.30197	831	2610.66378	542365.40092
732	2299.64608	420835.23191	782	2456.72573	480289.87943	832	2613.80538	543671.51821
733	2302.78767	421985.84034	783	2459.86732	481519.02769	833	2616.94697	544979.20629
734	2305.92926	423138.01958	784	2463.00891	482749.74675	834	2620.08856	546288.46518
735	2309.07086	424291.76961	785	2466.15051	483982.03661	835	2623.23016	547599.29486
736	2312.21245	425447.09043	786	2469.29210	485215.89726	836	2626.37175	548911.69533
737	2315.35404	426603.98205	787	2472.43369	486451.32870	837	2629.51334	550225.66660
738	2318.49563	427762.44447	788	2475.57528	487688.33095	838	2632.65493	551541.20867
739	2321.63723	428922.47769	789	2478.71688	488926.90399	839	2635.79653	552858.32154
740	2324.77882	430084.08170	790	2481.85847	490167.04783	840	2638.93812	554177.00520
741	2327.92041	431247.25651	791	2485.00006	491408.76246	841	2642.07971	555497.25966
742	2331.06201	432412.00211	792	2488.14166	492652.04789	842	2645.22131	556819.08491
743	2334.20360	433578.31851	793	2491.28325	493896.90411	843	2648.36290	558142.48096
744	2337.34519	434746.20571	794	2494.42484	495143.33114	844	2651.50449	559467.44781
745	2340.48679	435915.66371	795	2497.56644	496391.32896	845	2654.64609	560793.98546
746	2343.62838	437086.69250	796	2500.70803	497640.89757	846	2657.78768	562122.09390
747	2346.76997	438259.29208	797	2503.84962	498892.03698	847	2660.92927	563451.77313
748	2349.91156	439433.46247	798	2506.99121	500144.74719	848	2664.07086	564783.02317
749	2353.05316	440609.20365	799	2510.13281	501399.02820	849	2667.21246	566115.84400

Circumferences and Areas of Circles From 850-999

Dia- meter	Circum- ference	Area	Dia- meter	Circum- ference	Area	Dia- meter	Circum- ference	Area
850	2670.35405	567450.23563	900	2827.43370	636172.58250	950	2984.51335	708821.92063
851	2673.49564	568786.19805	901	2830.57529	637587.08475	951	2987.65494	710314.96270
852	2676.63724	570123.73127	902	2833.71689	639003.15779	952	2990.79654	711809.57557
853	2679.77883	571462.83528	903	2836.85848	640420.80163	953	2993.93813	713305.75923
854	2682.92042	572803.51010	904	2840.00007	641840.01627	954	2997.07972	714803.51370
855	2686.06202	574145.75571	905	2843.14167	643260.80171	955	3000.22132	716302.83896
856	2689.20361	575489.57211	906	2846.28326	644683.15794	956	3003.36291	717803.73501
857	2692.34520	576834.95931	907	2849.42485	646107.08496	957	3006.50450	719306.20186
858	2695.48679	578181.91731	908	2852.56644	647532.58279	958	3009.64609	720810.23951
859	2698.62839	579530.44611	909	2855.70804	648959.65141	959	3012.78769	722315.84796
860	2701.76998	580880.54570	910	2858.84963	650388.29083	960	3015.92928	723823.02720
861	2704.91157	582232.21609	911	2861.99122	651818.50104	961	3019.07087	725331.77724
862	2708.05317	583585.45727	912	2865.13282	653250.28205	962	3022.21247	726842.09807
863	2711.19476	584940.26925	913	2868.27441	654683.63385	963	3025.35406	728353.98970
864	2714.33635	586296.65203	914	2871.41600	656118.55646	964	3028.49565	729867.45213
865	2717.47795	587654.60561	915	2874.55760	657555.04986	965	3031.63725	731382.48536
866	2720.61954	589014.12998	916	2877.69919	658993.11405	966	3034.77884	732899.08938
867	2723.76113	590375.22514	917	2880.84078	660432.74904	967	3037.92043	734417.26419
868	2726.90272	591737.89111	918	2883.98237	661873.95483	968	3041.06202	735937.00981
869	2730.04432	593102.12787	919	2887.12397	663316.73142	969	3044.20362	737458.32622
870	2733.18591	594467.93543	920	2890.26556	664761.07880	970	3047.34521	738981.21343
871	2736.32750	595835.31378	921	2893.40715	666206.99698	971	3050.48680	740505.67143
872	2739.46910	597204.26293	922	2896.54875	667654.48595	972	3053.62840	742031.70023
873	2742.61069	598574.78287	923	2899.69034	669103.54572	973	3056.76999	743559.29982
874	2745.75228	599946.87362	924	2902.83193	670554.17629	974	3059.91158	745088.47022
875	2748.89388	601320.53516	925	2905.97353	672006.37766	975	3063.05318	746619.21141
876	2752.03547	602695.76749	926	2909.11512	673460.14982	976	3066.19477	748151.52339
877	2755.17706	604072.57062	927	2912.25671	674915.49277	977	3069.33636	749685.40617
878	2758.31865	605450.94455	928	2915.39830	676372.40653	978	3072.47795	751220.85975
879	2761.46025	606830.88928	929	2918.53990	677830.89108	979	3075.61955	752757.88413
880	2764.60184	608212.40480	930	2921.68149	679290.94643	980	3078.76114	754296.47930
881	2767.74343	609595.49112	931	2924.82308	680752.57257	981	3081.90273	755836.64527
882	2770.88503	610980.14823	932	2927.96468	682215.76951	982	3085.04433	757378.38203
883	2774.02662	612366.37614	933	2931.10627	683680.53724	983	3088.18592	758921.68959
884	2777.16821	613754.17485	934	2934.24786	685146.87578	984	3091.32751	760466.56795
885	2780.30981	615143.54436	935	2937.38946	686614.78511	985	3094.46911	762013.01711
886	2783.45140	616534.48466	936	2940.53105	688084.26523	986	3097.61070	763561.03706
887	2786.59299	617926.99575	937	2943.67264	689555.31615	987	3100.75229	765110.62780
888	2789.73458	619321.07765	938	2946.81423	691027.93787	988	3103.89388	766661.78935
889	2792.87618	620716.73034	939	2949.95583	692502.13039	989	3107.03548	768214.52169
890	2796.01777	622113.95383	940	2953.09742	693977.89370	990	3110.17707	769768.82483
891	2799.15936	623512.74811	941	2956.23901	695455.22781	991	3113.31866	771324.69876
892	2802.30096	624913.11319	942	2959.38061	696934.13271	992	3116.46026	772882.14349
893	2805.44255	626315.04906	943	2962.52220	698414.60841	993	3119.60185	774441.15901
894	2808.58414	627718.55574	944	2965.66379	699896.65491	994	3122.74344	776001.74534
895	2811.72574	629123.63321	945	2968.80539	701380.27221	995	3125.88504	777563.90246
896	2814.86733	630530.28147	946	2971.94698	702865.46030	996	3129.02663	779127.63037
897	2818.00892	631938.50053	947	2975.08857	704352.21918	997	3132.16822	780692.92908
898	2821.15051	633348.29039	948	2978.23016	705840.54887	998	3135.30981	782259.79859
899	2824.29211	634759.65105	949	2981.37176	707330.44935	999	3138.45141	783828.23890

Logarithms

Logarithms have long been used to facilitate and shorten calculations involving multiplication, division, the extraction of roots, and obtaining powers of numbers; however, since the advent of hand-held calculators logarithms are rarely used for multiplication and division problems. Logarithms still come up in other problems, and the following properties of logarithms are useful:

$$\begin{aligned} \log_c c &= 1 & \log_c c^p &= p & \log_c 1 &= 0 \\ \log_c(a \times b) &= \log_c a + \log_c b & \log_c(a \div b) &= \log_c a - \log_c b \\ \log_c(a^p) &= p \log_c a & \log_c(\sqrt[p]{a}) &= 1/p \log_c a \end{aligned}$$

The logarithm of a number is defined as the exponent of a base number raised to a power. For example, $\log_{10} 3.162277 = 0.500$ means the logarithm of 3.162277 is equal to 0.500. Another way of expressing the same relationship is $10^{0.500} = 3.162277$, where 10 is the base number and the exponent 0.500 is the logarithm of 3.162277. A common example of a logarithmic expression $10^2 = 100$ means that the base 10 logarithm of 100 is 2, that is, $\log_{10} 100 = 2.00$. There are two standard systems of logarithms in use: the “common” system (base 10) and the so-called “natural” system (base $e = 2.71828\dots$). Logarithms to base e are frequently written using “ln” instead of “ \log_e ” such as $\ln 6.1 = 1.808289$. Logarithms of a number can be converted between the natural- and common-based systems as follows: $\ln_e A = 2.3026 \times \log_{10} A$ and $\log_{10} A = 0.43430 \times \ln_e A$. Additional information on the use of “natural logarithms” is given at the end of this section.

A logarithm consists of two parts, a whole number and a decimal. The whole number, which may be positive, negative, or zero, is called the characteristic; the decimal is called the mantissa. As a rule, only the decimal or mantissa is given in tables of common logarithms; tables of natural logarithms give both the characteristic and mantissa. The tables given in this section are abbreviated, but very accurate results can be obtained by using the method of interpolation described in *Interpolation from the Tables* on page 2990. These tables are especially useful for finding logarithms and calculating powers and roots of numbers on calculators without these functions built in.

Evaluating Logarithms

Common Logarithms.—For common logarithms, the characteristic is prefixed to the mantissa according to the following rules: For numbers greater than or equal to 1, the characteristic is one less than the number of places to the left of the decimal point. For example, the characteristic of the logarithm of 237 is 2, and of 2536.5 is 3. For numbers smaller than 1 and greater than 0, the characteristic is negative and its numerical value is one more than the number of zeros immediately to the right of the decimal point. For example, the characteristic of the logarithm of 0.036 is -2 , and the characteristic of the logarithm of 0.0006 is -4 . The minus sign is usually written over the figure, as in $\bar{2}$ to indicate that the minus sign refers only to the characteristic and not to the mantissa, which is never negative. The logarithm of 0 does not exist.

The table of common logarithms in this section gives the mantissas of the logarithms of numbers from 1 to 10 and from 1.00 to 1.01. When finding the mantissa, the decimal point in a number is disregarded. The mantissa of the logarithms of 2716, 271.6, 27.16, 2.716, or 0.02716, for example, is the same. The tables give directly the mantissas of logarithms of numbers with three figures or less; the logarithms for numbers with four or more figures can be found by interpolation, as described in *Interpolation from the Tables* on page 2990 and illustrated in the examples. All the mantissas in the common logarithmic tables are decimals and the decimal point has been omitted in the table. However, a decimal point should always be put before the mantissa as soon as it is taken from the table. Logarithmic

tables are sufficient for many purposes, but electronic calculators and computers are faster, simpler, and more accurate than tables.

To find the common logarithm of a number from the tables, find the left-hand column of the table and follow down to locate the first two figures of the number. Then look at the top row of the table, on the same page, and follow across it to find the third figure of the number. Follow down the column containing this last figure until opposite the row on which the first two figures were found. The number at the intersection of the row and column is the mantissa of the logarithm. If the logarithm of a number with less than three figures is being obtained, add extra zeros to the right of the number so as to obtain three figures. For example, if the mantissa of the logarithm of 6 is required, find the mantissa of 600.

Interpolation from the Tables.—If the logarithm of a number with more than three figures is needed, linear interpolation is a method of using two values from the table to estimate the value of the logarithm desired. To find the logarithm of a number not listed in the tables, find the mantissa corresponding to the first three digits of the given number (disregarding the decimal point and leading zeros) and find the mantissa of the first three digits of the given number plus one. For example, to find the logarithm of 601.2, 60.12, or 0.006012, find the mantissa of 601 and find the mantissa of 602 from the tables. Then subtract the mantissa of the smaller number from the mantissa of the larger number and multiply the result by a decimal number made from the remaining (additional greater than 3) figures of the original number. Add the result to the mantissa of the smaller number. Find the characteristic as described previously.

Example 1: Find the logarithm of 4032. The characteristic portion of the logarithm found in the manner described before is 3. Find the mantissa by locating 40 in the left-hand column of the logarithmic tables and then follow across the top row of the table to the column headed 3. Follow down the 3 column to the intersection with the 40 row and read the mantissa. The mantissa of the logarithm of 4030 is 0.605305. Because 4032 is between 4030 and 4040, the logarithm of 4032 is the logarithm of 4030 plus two tenths of the difference in the logarithms of 4030 and 4040. Find the mantissa of 4040 and then subtract from it the mantissa of 4030. Multiply the difference obtained by 0.2 and add the result to the mantissa of the logarithm of 4030. Finally, add the characteristic portion of the logarithm. The result is $\log_{10} 4032 = 3 + 0.605305 + 0.2 \times (0.606381 - 0.605305) = 3.60552$.

Finding a Number Whose Logarithm Is Given.—When a logarithm is given and it is required to find the corresponding number, find the number in the body of the table equal to the value of the mantissa. This value may appear in any column 0 to 9. Follow the row on which the mantissa is found across to the left to read the first two digits of the number sought. Read the third digit of the number from the top row of the table by following up the column on which the mantissa is found to the top. If the characteristic of the logarithm is positive, the number of figures to the left of the decimal in the number is one greater than the value of the characteristic. For example, if the figures corresponding to a given mantissa are 376 and the characteristic is 5, then the number sought has six figures to the left of the decimal point and is 376,000. If the characteristic had been $\bar{3}$, then the number sought would have been 0.00376. If the mantissa is not exactly obtainable in the tables, find the mantissa in the table that is nearest to the one given and determine the corresponding number. This procedure usually gives sufficiently accurate results. If more accuracy is required, find the two mantissas in the tables nearest to the mantissa given, one smaller and the other larger. For each of the two mantissas, read the three corresponding digits from the left column and top row to obtain the first three figures of the number as described before. The exact number sought lies between the two numbers found in this manner.

Next: 1) subtract the smaller mantissa from the given mantissa and; and 2) subtract the smaller mantissa from the larger mantissa.

Divide the result of (1) by the result of (2) and add the quotient to the number corresponding to the smaller mantissa.

Example 2: Find the number whose logarithm is 2.70053. First, find the number closest to the mantissa 70053 in the body of the tables. The closest mantissa listed in the tables is 700704, so read across the table to the left to find the first two digits of the number sought (50) and up the column to find the third digit of the number (2). The characteristic of the logarithm given is 2, so the number sought has three digits to the left of the decimal point. Therefore, the number sought is slightly less than 502 and greater than 501. If greater accuracy is required, find the two mantissas in the table closest to the given mantissa (699838 and 700704). Subtract the smaller mantissa from the mantissa of the given logarithm and divide the result by the smaller mantissa subtracted from the larger mantissa. Add the result to the number corresponding to the smaller mantissa. The resulting answer is $501 + (700530 - 699838) \div (700704 - 699838) = 501 + 0.79 = 501.79$.

Natural Logarithms.—In certain formulas and in some branches of mathematical analysis, use is made of logarithms (formerly also called Napierian or hyperbolic logarithms). As previously mentioned, the base of this system, $e = 2.7182818284\dots$, is the limit of certain mathematical series. The logarithm of a number A to the base e is usually written $\log_e A$ or $\ln A$. Tables of natural logarithms for numbers ranging from 1 to 10 and 1.00 to 1.01 are given in this Handbook after the table of common logarithms. To obtain natural logs of numbers less than 1 or greater than 10, proceed as in the following examples: $\log_e 0.239 = \log_e 2.39 - \log_e 10$; $\log_e 0.0239 = \log_e 2.39 - 2 \log_e 10$; $\log_e 239 = \log_e 2.39 + 2 \log_e 10$; $\log_e 2390 = \log_e 2.39 + 3 \log_e 10$, etc.

Using Calculators to Find Logarithms.—A scientific calculator is usually the quickest and most accurate method of finding logarithms and numbers corresponding to given logarithms. On most scientific calculators, the key labeled **log** is used to find common logarithms (base 10) and the key labeled **ln** is used for finding natural logarithms (base e). The keystrokes to find a logarithm will vary slightly from one calculator to another, so specific instructions are not given. To find the number corresponding to a given logarithm: use the key labeled **10^x** if a common logarithm is given or use the key labeled **e^x** if a natural logarithm is given; calculators without the **10^x** or **e^x** keys may have a key labeled **x^y** that can be used by substituting 10 or e (2.718281...), as required, for x and substituting the logarithm whose corresponding number is sought for y . On some other calculators, the **log** and **ln** keys are used to find common and natural logarithms, and the same keys in combination with the **INV**, or inverse, key are used to find the number corresponding to a given logarithm.

Obtaining the Powers of Numbers.—A number may be raised to any power by simply multiplying the logarithm of the number by the exponent of the number. The product gives the logarithm of the value of the power.

Example 3: Find the value of 6.51^3

$$\log 6.51 = 0.81358$$

$$3 \times 0.81358 = 2.44074$$

The logarithm 2.44074 is the logarithm of 6.51^3 . Hence, 6.51^3 equals the number corresponding to this logarithm, as found from the tables, or $6.51^3 = 275.9$.

Example 4: Find the value of $12^{1.29}$

$$\log 12 = 1.07918$$

$$1.29 \times 1.07918 = 1.39214$$

Hence, $12^{1.29} = 24.67$.

Raising a decimal to a decimal power presents a somewhat more difficult problem because of the negative characteristic of the logarithm and the fact that the logarithm must be multiplied by a decimal exponent. The method for avoiding the use of negative charac-

teristics, that is adding a number to and subtracting it from the characteristic, as shown below, is helpful here.

Example 5: Find the value of $0.0813^{0.46}$

$$\begin{aligned}\log 0.0813 &= \bar{2}.91009 = 8.91009 - 10 \\ \log 0.0813^{0.46} &= 0.46 \times (8.91009 - 10) = 4.09864 - 4.6\end{aligned}$$

Subtract and add 0.6 to make the characteristic a whole number:

$$\begin{array}{r} 4.09864 - 4.6 \\ -0.6 \quad + 0.6 \\ \hline \log 0.0813^{0.46} = 3.49864 - 4 = \bar{1}.49864\end{array}$$

Hence, $0.0813^{0.46} = 0.3152$.

Extracting Roots by Logarithms.—Roots of numbers, for example, $\sqrt[5]{37}$, can be extracted easily by means of logarithms. The small ($\overset{\circ}{5}$) in the radical ($\sqrt{\quad}$) of the root sign is called the index of the root. Any root of a number may be found by dividing its logarithm by the index of the root; the quotient is the logarithm of the root.

Example 6: Find $\sqrt[3]{276}$

$$\begin{aligned}\log 276 &= 2.44091 \\ 2.44091 \div 3 &= 0.81364\end{aligned}$$

Hence, $\log \sqrt[3]{276} = 0.81364$ and $\sqrt[3]{276} = 6.511$

Example 7: Find $\sqrt[3]{0.67}$

$$\log 0.67 = \bar{1}.82607$$

Here it is not possible to divide directly, because there is a negative characteristic and a positive mantissa, another instance where the method of avoiding the use of negative characteristics, previously outlined, is helpful. The preferred procedure is to add and subtract some number to the characteristic that is evenly divisible by the index of the root. The root index is 3, so 9 can be added to and subtracted from the characteristic, and the resulting logarithm divided by 3.

$$\begin{aligned}\log 0.67 &= \bar{1}.82607 = 8.82607 - 9 \\ \log \sqrt[3]{0.67} &= \frac{8.82607 - 9}{3} = 2.94202 - 3 \\ \log \sqrt[3]{0.67} &= 2.94202 - 3 = \bar{1}.94202\end{aligned}$$

Hence, $\sqrt[3]{0.67} = 0.875$

Example 8: Find $\sqrt[1.7]{0.2}$

$$\begin{aligned}\log 0.2 &= \bar{1}.30103 = 16.30103 - 17 \\ \log \sqrt[1.7]{0.2} &= \frac{16.30103 - 17}{1.7} = 9.58884 - 10 = \bar{1}.58884\end{aligned}$$

Hence,

$$\sqrt[1.7]{0.2} = 0.388$$

Table of Logarithms

Table of Common Logarithms

	0	1	2	3	4	5	6	7	8	9
10	000000	004321	008600	012837	017033	021189	025306	029384	033424	037426
11	041393	045323	049218	053078	056905	060698	064458	068186	071882	075547
12	079181	082785	086360	089905	093422	096910	100371	103804	107210	110590
13	113943	117271	120574	123852	127105	130334	133539	136721	139879	143015
14	146128	149219	152288	155336	158362	161368	164353	167317	170262	173186
15	176091	178977	181844	184691	187521	190332	193125	195900	198657	201397
16	204120	206826	209515	212188	214844	217484	220108	222716	225309	227887
17	230449	232996	235528	238046	240549	243038	245513	247973	250420	252853
18	255273	257679	260071	262451	264818	267172	269513	271842	274158	276462
19	278754	281033	283301	285557	287802	290035	292256	294466	296665	298853
20	301030	303196	305351	307496	309630	311754	313867	315970	318063	320146
21	322219	324282	326336	328380	330414	332438	334454	336460	338456	340444
22	342423	344392	346353	348305	350248	352183	354108	356026	357935	359835
23	361728	363612	365488	367356	369216	371068	372912	374748	376577	378398
24	380211	382017	383815	385606	387390	389166	390935	392697	394452	396199
25	397940	399674	401401	403121	404834	406540	408240	409933	411620	413300
26	414973	416641	418301	419956	421604	423246	424882	426511	428135	429752
27	431364	432969	434569	436163	437751	439333	440909	442480	444045	445604
28	447158	448706	450249	451786	453318	454845	456366	457882	459392	460898
29	462398	463893	465383	466868	468347	469822	471292	472756	474216	475671
30	477121	478566	480007	481443	482874	484300	485721	487138	488551	489958
31	491362	492760	494155	495544	496930	498311	499687	501059	502427	503791
32	505150	506505	507856	509203	510545	511883	513218	514548	515874	517196
33	518514	519828	521138	522444	523746	525045	526339	527630	528917	530200
34	531479	532754	534026	535294	536558	537819	539076	540329	541579	542825
35	544068	545307	546543	547775	549003	550228	551450	552668	553883	555094
36	556303	557507	558709	559907	561101	562293	563481	564666	565848	567026
37	568202	569374	570543	571709	572872	574031	575188	576341	577492	578639
38	579784	580925	582063	583199	584331	585461	586587	587711	588832	589950
39	591065	592177	593286	594393	595496	596597	597695	598791	599883	600973
40	602060	603144	604226	605305	606381	607455	608526	609594	610660	611723
41	612784	613842	614897	615950	617000	618048	619093	620136	621176	622214
42	623249	624282	625312	626340	627366	628389	629410	630428	631444	632457
43	633468	634477	635484	636488	637490	638489	639486	640481	641474	642465
44	643453	644439	645422	646404	647383	648360	649335	650308	651278	652246
45	653213	654177	655138	656098	657056	658011	658965	659916	660865	661813
46	662758	663701	664642	665581	666518	667453	668386	669317	670246	671173
47	672098	673021	673942	674861	675778	676694	677607	678518	679428	680336
48	681241	682145	683047	683947	684845	685742	686636	687529	688420	689309
49	690196	691081	691965	692847	693727	694605	695482	696356	697229	698101
50	698970	699838	700704	701568	702431	703291	704151	705008	705864	706718
51	707570	708421	709270	710117	710963	711807	712650	713491	714330	715167
52	716003	716838	717671	718502	719331	720159	720986	721811	722634	723456
53	724276	725095	725912	726727	727541	728354	729165	729974	730782	731589
54	732394	733197	733999	734800	735599	736397	737193	737987	738781	739572
55	740363	741152	741939	742725	743510	744293	745075	745855	746634	747412
56	748188	748963	749736	750508	751279	752048	752816	753583	754348	755112
57	755875	756636	757396	758155	758912	759668	760422	761176	761928	762679
58	763428	764176	764923	765669	766413	767156	767898	768638	769377	770115
59	770852	771587	772322	773055	773786	774517	775246	775974	776701	777427

Table of Common Logarithms

	0	1	2	3	4	5	6	7	8	9
60	778151	778874	779596	780317	781037	781755	782473	783189	783904	784617
61	785330	786041	786751	787460	788168	788875	789581	790285	790988	791691
62	792392	793092	793790	794488	795185	795880	796574	797268	797960	798651
63	799341	800029	800717	801404	802089	802774	803457	804139	804821	805501
64	806180	806858	807535	808211	808886	809560	810233	810904	811575	812245
65	812913	813581	814248	814913	815578	816241	816904	817565	818226	818885
66	819544	820201	820858	821514	822168	822822	823474	824126	824776	825426
67	826075	826723	827369	828015	828660	829304	829947	830589	831230	831870
68	832509	833147	833784	834421	835056	835691	836324	836957	837588	838219
69	838849	839478	840106	840733	841359	841985	842609	843233	843855	844477
70	845098	845718	846337	846955	847573	848189	848805	849419	850033	850646
71	851258	851870	852480	853090	853698	854306	854913	855519	856124	856729
72	857332	857935	858537	859138	859739	860338	860937	861534	862131	862728
73	863323	863917	864511	865104	865696	866287	866878	867467	868056	868644
74	869232	869818	870404	870989	871573	872156	872739	873321	873902	874482
75	875061	875640	876218	876795	877371	877947	878522	879096	879669	880242
76	880814	881385	881955	882525	883093	883661	884229	884795	885361	885926
77	886491	887054	887617	888179	888741	889302	889862	890421	890980	891537
78	892095	892651	893207	893762	894316	894870	895423	895975	896526	897077
79	897627	898176	898725	899273	899821	900367	900913	901458	902003	902547
80	903090	903633	904174	904716	905256	905796	906335	906874	907411	907949
81	908485	909021	909556	910091	910624	911158	911690	912222	912753	913284
82	913814	914343	914872	915400	915927	916454	916980	917506	918030	918555
83	919078	919601	920123	920645	921166	921686	922206	922725	923244	923762
84	924279	924796	925312	925828	926342	926857	927370	927883	928396	928908
85	929419	929930	930440	930949	931458	931966	932474	932981	933487	933993
86	934498	935003	935507	936011	936514	937016	937518	938019	938520	939020
87	939519	940018	940516	941014	941511	942008	942504	943000	943495	943989
88	944483	944976	945469	945961	946452	946943	947434	947924	948413	948902
89	949390	949878	950365	950851	951338	951823	952308	952792	953276	953760
90	954243	954725	955207	955688	956168	956649	957128	957607	958086	958564
91	959041	959518	959995	960471	960946	961421	961895	962369	962843	963316
92	963788	964260	964731	965202	965672	966142	966611	967080	967548	968016
93	968483	968950	969416	969882	970347	970812	971276	971740	972203	972666
94	973128	973590	974051	974512	974972	975432	975891	976350	976808	977266
95	977724	978181	978637	979093	979548	980003	980458	980912	981366	981819
96	982271	982723	983175	983626	984077	984527	984977	985426	985875	986324
97	986772	987219	987666	988113	988559	989005	989450	989895	990339	990783
98	991226	991669	992111	992554	992995	993436	993877	994317	994757	995196
99	995635	996074	996512	996949	997386	997823	998259	998695	999131	999565
100	000000	000434	000868	001301	001734	002166	002598	003029	003461	003891
101	004321	004751	005181	005609	006038	006466	006894	007321	007748	008174
102	008600	009026	009451	009876	010300	010724	011147	011570	011993	012415
103	012837	013259	013680	014100	014521	014940	015360	015779	016197	016616
104	017033	017451	017868	018284	018700	019116	019532	019947	020361	020775
105	021189	021603	022016	022428	022841	023252	023664	024075	024486	024896
106	025306	025715	026125	026533	026942	027350	027757	028164	028571	028978
107	029384	029789	030195	030600	031004	031408	031812	032216	032619	033021
108	033424	033826	034227	034628	035029	035430	035830	036230	036629	037028
109	037426	037825	038223	038620	039017	039414	039811	040207	040602	040998

Table of Natural Logarithms

	0	1	2	3	4	5	6	7	8	9
1.0	0.00000	0.009950	0.019803	0.029559	0.039221	0.048790	0.058269	0.067659	0.076961	0.086178
1.1	0.09531	0.104360	0.113329	0.122218	0.131028	0.139762	0.148420	0.157004	0.165514	0.173953
1.2	0.18232	0.190620	0.198851	0.207014	0.215111	0.223144	0.231112	0.239017	0.246860	0.254642
1.3	0.26236	0.270027	0.277632	0.285179	0.292670	0.300105	0.307485	0.314811	0.322083	0.329304
1.4	0.33647	0.343590	0.350657	0.357674	0.364643	0.371564	0.378436	0.385262	0.392042	0.398776
1.5	0.40546	0.412110	0.418710	0.425268	0.431782	0.438255	0.444686	0.451076	0.457425	0.463734
1.6	0.47000	0.476234	0.482426	0.488580	0.494696	0.500775	0.506818	0.512824	0.518794	0.524729
1.7	0.53062	0.536493	0.542324	0.548121	0.553885	0.559616	0.565314	0.570980	0.576613	0.582216
1.8	0.58778	0.593327	0.598837	0.604316	0.609766	0.615186	0.620576	0.625938	0.631272	0.636577
1.9	0.64185	0.647103	0.652325	0.657520	0.662688	0.667829	0.672944	0.678034	0.683097	0.688135
2.0	0.69314	0.698135	0.703098	0.708036	0.712950	0.717840	0.722706	0.727549	0.732368	0.737164
2.1	0.74193	0.746688	0.751416	0.756122	0.760806	0.765468	0.770108	0.774727	0.779325	0.783902
2.2	0.78845	0.792993	0.797507	0.802002	0.806476	0.810930	0.815365	0.819780	0.824175	0.828552
2.3	0.83290	0.837248	0.841567	0.845868	0.850151	0.854415	0.858662	0.862890	0.867100	0.871293
2.4	0.87546	0.879627	0.883768	0.887891	0.891998	0.896088	0.900161	0.904218	0.908259	0.912283
2.5	0.91629	0.920283	0.924259	0.928219	0.932164	0.936093	0.940007	0.943906	0.947789	0.951658
2.6	0.95551	0.959350	0.963174	0.966984	0.970779	0.974560	0.978326	0.982078	0.985817	0.989541
2.7	0.99325	0.996949	1.000632	1.004302	1.007958	1.011601	1.015231	1.018847	1.022451	1.026042
2.8	1.02961	1.033184	1.036737	1.040277	1.043804	1.047319	1.050822	1.054312	1.057790	1.061257
2.9	1.06471	1.068153	1.071584	1.075002	1.078410	1.081805	1.085189	1.088562	1.091923	1.095273
3.0	1.09861	1.101940	1.105257	1.108563	1.111858	1.115142	1.118415	1.121678	1.124930	1.128171
3.1	1.13140	1.134623	1.137833	1.141033	1.144223	1.147402	1.150572	1.153732	1.156881	1.160021
3.2	1.16315	1.166271	1.169381	1.172482	1.175573	1.178655	1.181727	1.184790	1.187843	1.190888
3.3	1.19392	1.196948	1.199965	1.202972	1.205971	1.208960	1.211941	1.214913	1.217876	1.220830
3.4	1.22377	1.226712	1.229641	1.232560	1.235471	1.238374	1.241269	1.244155	1.247032	1.249902
3.5	1.25276	1.255616	1.258461	1.261298	1.264127	1.266948	1.269761	1.272566	1.275363	1.278152
3.6	1.28093	1.283708	1.286474	1.289233	1.291984	1.294727	1.297463	1.300192	1.302913	1.305626
3.7	1.30833	1.311032	1.313724	1.316408	1.319086	1.321756	1.324419	1.327075	1.329724	1.332366
3.8	1.33500	1.337629	1.340250	1.342865	1.345472	1.348073	1.350667	1.353255	1.355835	1.358409
3.9	1.36097	1.363537	1.366092	1.368639	1.371181	1.373716	1.376244	1.378766	1.381282	1.383791
4.0	1.38629	1.388791	1.391282	1.393766	1.396245	1.398717	1.401183	1.403643	1.406097	1.408545
4.1	1.41098	1.413423	1.415853	1.418277	1.420696	1.423108	1.425515	1.427916	1.430311	1.432701
4.2	1.43508	1.437463	1.439835	1.442202	1.444563	1.446919	1.449269	1.451614	1.453953	1.456287
4.3	1.45861	1.460938	1.463255	1.465568	1.467874	1.470176	1.472472	1.474763	1.477049	1.479329
4.4	1.48160	1.483875	1.486140	1.488400	1.490654	1.492904	1.495149	1.497388	1.499623	1.501853
4.5	1.50407	1.506297	1.508512	1.510722	1.512927	1.515127	1.517323	1.519513	1.521699	1.523880
4.6	1.52605	1.528228	1.530395	1.532557	1.534714	1.536867	1.539015	1.541159	1.543298	1.545433
4.7	1.54756	1.549688	1.551809	1.553925	1.556037	1.558145	1.560248	1.562346	1.564441	1.566530
4.8	1.56861	1.570697	1.572774	1.574846	1.576915	1.578979	1.581038	1.583094	1.585145	1.587192
4.9	1.58923	1.591274	1.593309	1.595339	1.597365	1.599388	1.601406	1.603420	1.605430	1.607436
5.0	1.60943	1.611436	1.613430	1.615420	1.617406	1.619388	1.621366	1.623341	1.625311	1.627278
5.1	1.62924	1.631199	1.633154	1.635106	1.637053	1.638997	1.640937	1.642873	1.644805	1.646734
5.2	1.64865	1.650580	1.652497	1.654411	1.656321	1.658228	1.660131	1.662030	1.663926	1.665818
5.3	1.66770	1.669592	1.671473	1.673351	1.675226	1.677097	1.678964	1.680828	1.682688	1.684545
5.4	1.68639	1.688249	1.690096	1.691939	1.693779	1.695616	1.697449	1.699279	1.701105	1.702928
5.5	1.70474	1.706565	1.708378	1.710188	1.711995	1.713798	1.715598	1.717395	1.719189	1.720979
5.6	1.722767	1.724551	1.726332	1.728109	1.729884	1.731656	1.733424	1.735189	1.736951	1.738710
5.7	1.74046	1.742219	1.743969	1.745716	1.747459	1.749200	1.750937	1.752672	1.754404	1.756132
5.8	1.75785	1.759581	1.761300	1.763017	1.764731	1.766442	1.768150	1.769855	1.771557	1.773256
5.9	1.77495	1.776646	1.778336	1.780024	1.781709	1.783391	1.785070	1.786747	1.788421	1.790091

Table of Natural Logarithms

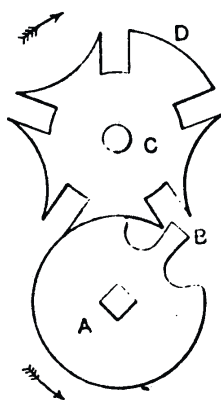
	0	1	2	3	4	5	6	7	8	9
6.0	1.791759	1.793425	1.795087	1.796747	1.798404	1.800058	1.801710	1.803359	1.805005	1.806648
6.1	1.808289	1.809927	1.811562	1.813195	1.814825	1.816452	1.818077	1.819699	1.821318	1.822935
6.2	1.824549	1.826161	1.827770	1.829376	1.830980	1.832581	1.834180	1.835776	1.837370	1.838961
6.3	1.840550	1.842136	1.843719	1.845300	1.846879	1.848455	1.850028	1.851599	1.853168	1.854734
6.4	1.856298	1.857859	1.859418	1.860975	1.862529	1.864080	1.865629	1.867176	1.868721	1.870263
6.5	1.871802	1.873339	1.874874	1.876407	1.877937	1.879465	1.880991	1.882514	1.884035	1.885553
6.6	1.887070	1.888584	1.890095	1.891605	1.893112	1.894617	1.896119	1.897620	1.899118	1.900614
6.7	1.902108	1.903599	1.905088	1.906575	1.908060	1.909543	1.911023	1.912501	1.913977	1.915451
6.8	1.916923	1.918392	1.919859	1.921325	1.922788	1.924249	1.925707	1.927164	1.928619	1.930071
6.9	1.931521	1.932970	1.934416	1.935860	1.937302	1.938742	1.940179	1.941615	1.943049	1.944481
7.0	1.945910	1.947338	1.948763	1.950187	1.951608	1.953028	1.954445	1.955860	1.957274	1.958685
7.1	1.960095	1.961502	1.962908	1.964311	1.965713	1.967112	1.968510	1.969906	1.971299	1.972691
7.2	1.974081	1.975469	1.976855	1.978239	1.979621	1.981001	1.982380	1.983756	1.985131	1.986504
7.3	1.987874	1.989243	1.990610	1.991976	1.993339	1.994700	1.996060	1.997418	1.998774	2.000128
7.4	2.001480	2.002830	2.004179	2.005526	2.006871	2.008214	2.009555	2.010895	2.012233	2.013569
7.5	2.014903	2.016235	2.017566	2.018895	2.020222	2.021548	2.022871	2.024193	2.025513	2.026832
7.6	2.028148	2.029463	2.030776	2.032088	2.033398	2.034706	2.036012	2.037317	2.038620	2.039921
7.7	2.041220	2.042518	2.043814	2.045109	2.046402	2.047693	2.048982	2.050270	2.051556	2.052841
7.8	2.054124	2.055405	2.056685	2.057963	2.059239	2.060514	2.061787	2.063058	2.064328	2.065596
7.9	2.066863	2.068128	2.069391	2.070653	2.071913	2.073172	2.074429	2.075684	2.076938	2.078191
8.0	2.079442	2.080691	2.081938	2.083185	2.084429	2.085672	2.086914	2.088153	2.089392	2.090629
8.1	2.091864	2.093098	2.094330	2.095561	2.096790	2.098018	2.099244	2.100469	2.101692	2.102914
8.2	2.104134	2.105353	2.106570	2.107786	2.109000	2.110213	2.111425	2.112635	2.113843	2.115050
8.3	2.116256	2.117460	2.118662	2.119863	2.121063	2.122262	2.123458	2.124654	2.125848	2.127041
8.4	2.128232	2.129421	2.130610	2.131797	2.132982	2.134166	2.135349	2.136531	2.137710	2.138889
8.5	2.140066	2.141242	2.142416	2.143589	2.144761	2.145931	2.147100	2.148268	2.149434	2.150599
8.6	2.151762	2.152924	2.154085	2.155245	2.156403	2.157559	2.158715	2.159869	2.161022	2.162173
8.7	2.163323	2.164472	2.165619	2.166765	2.167910	2.169054	2.170196	2.171337	2.172476	2.173615
8.8	2.174752	2.175887	2.177022	2.178155	2.179287	2.180417	2.181547	2.182675	2.183802	2.184927
8.9	2.186051	2.187174	2.188296	2.189416	2.190536	2.191654	2.192770	2.193886	2.195000	2.196113
9.0	2.197225	2.198335	2.199444	2.200552	2.201659	2.202765	2.203869	2.204972	2.206074	2.207175
9.1	2.208274	2.209373	2.210470	2.211566	2.212660	2.213754	2.214846	2.215937	2.217027	2.218116
9.2	2.219203	2.220290	2.221375	2.222459	2.223542	2.224624	2.225704	2.226783	2.227862	2.228939
9.3	2.230014	2.231089	2.232163	2.233235	2.234306	2.235376	2.236445	2.237513	2.238580	2.239645
9.4	2.240710	2.241773	2.242835	2.243896	2.244956	2.246015	2.247072	2.248129	2.249184	2.250239
9.5	2.251292	2.252344	2.253395	2.254445	2.255493	2.256541	2.257588	2.258633	2.259678	2.260721
9.6	2.261763	2.262804	2.263844	2.264883	2.265921	2.266958	2.267994	2.269028	2.270062	2.271094
9.7	2.272126	2.273156	2.274186	2.275214	2.276241	2.277267	2.278292	2.279316	2.280339	2.281361
9.8	2.282382	2.283402	2.284421	2.285439	2.286456	2.287471	2.288486	2.289500	2.290513	2.291524
9.9	2.292535	2.293544	2.294553	2.295560	2.296567	2.297573	2.298577	2.299581	2.300583	2.301585
1.00	0.000000	0.001000	0.001998	0.002996	0.003992	0.004988	0.005982	0.006976	0.007968	0.008960
1.01	0.009950	0.010940	0.011929	0.012916	0.013903	0.014889	0.015873	0.016857	0.017840	0.018822
1.02	0.019803	0.020783	0.021761	0.022739	0.023717	0.024693	0.025668	0.026642	0.027615	0.028587
1.03	0.029559	0.030529	0.031499	0.032467	0.033435	0.034401	0.035367	0.036332	0.037296	0.038259
1.04	0.039221	0.040182	0.041142	0.042101	0.043059	0.044017	0.044973	0.045929	0.046884	0.047837
1.05	0.048790	0.049742	0.050693	0.051643	0.052592	0.053541	0.054488	0.055435	0.056380	0.057325
1.06	0.058269	0.059212	0.060154	0.061095	0.062035	0.062975	0.063913	0.064851	0.065788	0.066724
1.07	0.067659	0.068593	0.069526	0.070458	0.071390	0.072321	0.073250	0.074179	0.075107	0.076035
1.08	0.076961	0.077887	0.078811	0.079735	0.080658	0.081580	0.082501	0.083422	0.084341	0.085260
1.09	0.086178	0.087095	0.088011	0.088926	0.089841	0.090754	0.091667	0.092579	0.093490	0.094401

MECHANICS AND STRENGTH OF MATERIALS

Mechanisms

Archimedean Screw.—A device, said to have been invented by Archimedes for raising water, consists principally of a cylinder within which is a shaft with a deep helical thread or groove. The cylinder is placed in an inclined position with its lower end and the screw immersed in water. As the tops of the thread of the screw fit the cylinder closely, water will move upward through the helical chambers formed by the groove or thread when the screw is revolved. The modern screw conveyer, used for raising other materials, is a form of Archimedean screw.

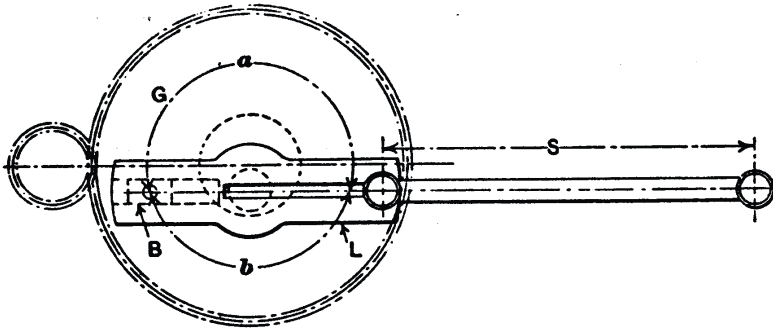
Geneva Stop.—The Geneva stop is a simple form of mechanism applied to watches, etc., to prevent winding the main spring too tightly. The principle of the mechanism is illustrated by the diagram. A disk *A* has one projecting tooth *B*, and is fixed upon the spindle of the barrel or casing containing the main spring.



Geneva Stop

Another disk *C* provided with notches that are engaged by tooth *B* is rotated through part of a revolution each time tooth *B* makes one complete turn and engages one of the notches or tooth spaces. As that part of disk *C* between the notches is curved to the same radius as disk *A*, disk *C* is locked and prevented from rotating during the time that the tooth *B* is out of engagement. When disk *A* is turned, the intermittent motion of disk *C* continues until the convex portion *D* comes around into engagement with disk *A*, thus preventing any further rotation. With this arrangement, the number of revolutions for disk *A* can be positively regulated so that over-winding of the spring is avoided. When the winding action has ceased, the disks will return to their original positions as the mechanism of the watch is driven by the spring and runs down. The principle of the Geneva stop has been applied to various classes of machinery in order to obtain the intermittent motion resulting from this form of mechanism.

Whitworth Motion.—A quick-return method that has been widely used in slotter construction, and on certain classes of shapers and other tools is illustrated by the diagram. This mechanism is known as the “Whitworth motion.” The gear *G* drives a slotted link *L*, which is pivoted at the same point within the path of the crankpin or Block *B*, thus permitting the link to rotate through a complete revolution. As the center about which link *L* rotates is offset with relation to the center of the driving gear *G*, the driving pin *B* moves through an arc *a* during the cutting stroke, and through a shorter arc *b* for the return stroke, which, therefore, requires less time, in proportion to the respective lengths of arc *a* and *b*. This mechanism, when incorporated in the driving mechanism of a machine like a slotter, serves to return the ram and tool quickly after the cutting stroke, thus reducing the time for the idle or non-cutting period.

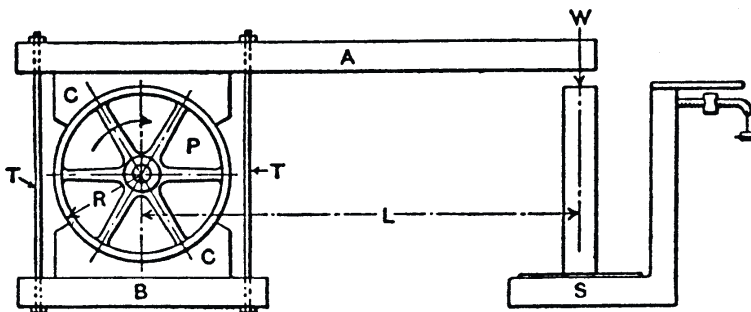


Principle of Whitworth Quick-return Motion

Gyroscope.—The gyroscope may be defined, in general, as a mechanism in which a rotating wheel or disk is mounted in gimbals so that the principal axis of rotation always passes through a fixed point. The gyroscope possesses the peculiar quality of resisting any angular displacement of its axis after it has once been set in motion; hence, it is used for securing equilibrium in a great number of devices. Gyroscopes are applied as stabilizers. The gyroscope is also used in a special type of gyroscopic compass which has been highly successful.

Dynamometers.—A dynamometer is an apparatus for measuring the power developed, absorbed, or transmitted by any piece of machinery. *Absorption dynamometers* absorb the power generated or transmitted by any mechanism, measuring it during the process of absorption. Dynamometers of another type measure the power by transmitting it through the mechanism of the dynamometer from the apparatus in which it is generated, or to the apparatus in which it is to be utilized. Dynamometers of this class are known as *transmission dynamometers*. Dynamometers known as indicators operate by simultaneously measuring the pressure and volume of a confined fluid. *Indicators* are very seldom used, however, except for the measurement of the power generated by steam or gas engines or absorbed by refrigerating machinery, air compressors, or pumps.

Prony Brake.—The simplest form of absorption dynamometer is the Prony brake (see diagram). This consists of a wooden beam *A* and a shorter beam *B*, connected by the two tie-rods *T*; fastened to the beams are the two wooden pieces *C*. These pieces are sawed so that they fit the surface of the pulley *P*. By tightening the nuts on the tie-rods, the friction between the blocks and the pulley surface is increased. A knife-edge fastened to the beam *A* rests upon a support that transmits the pressure to the platform scale *S*. As the pulley revolves in the direction indicated by the arrow, its motion is opposed by the friction of the blocks. The brake absorbs the power generated or transmitted by the machine to which the pulley is attached.



The Prony Brake

The horizontal distance *L* between a vertical line through the axis of the pulley, and a vertical line through the knife-edge which supports the brake, is known as the *arm* of the

brake. The weight indicated by the scale when the brake is absorbing power is known as the *tare* of the brake. The weight which would be indicated by the scale, if the pulley were absolutely frictionless, is known as the *zero reading* of the brake. The difference between the tare and the zero reading is known as the *brake reading*. In order to determine the zero reading, the nuts are loosened so as to reduce the friction as much as possible, and the pulley is then revolved slowly forward and the scale reading taken. The pulley is then revolved slowly backward and the scale reading again taken. The average of these two readings is the zero reading. If, for any reason, it is not convenient or possible to make these two readings, the nuts on the tie-rods may be loosened until a section of round iron or steel of small diameter can be placed between the rim of the pulley and the friction surface of the upper block, parallel to and vertically over the axis of the pulley. The weight registered by the scale in this case is the zero reading of the brake. The power absorbed by the brake may be determined by the formula:

$$\text{H.P.} = \frac{2\pi LNW}{33,000}$$

in which H.P. horsepower absorbed by the brake;

L = length of the brake arm in feet;

N = Number of revolutions of the pulley per minute;

W = brake reading in pounds;

Water Brakes.—All the power absorbed by a Prony brake is transformed into heat. When the amount of power to be absorbed is considerable, the Prony brake becomes unsatisfactory for the reason that it is impossible to conduct away such enormous quantities of heat, and avoid temperatures which will be destructive both to the pulley and to the brake. In such cases, some form of water brake is generally used. A water brake usually consists of a casing in which disks or paddles revolve and churn or agitate a quantity of water contained in the casing. The disks or paddles are fixed to a shaft which delivers the power to be absorbed. The casing is free to turn about the shaft, and an arm extending from it rests upon some form of weighing apparatus. Vanes or ribs fixed to the casing prevent the water from turning with the rotating member. The same formulas are employed in computing the power absorbed as are used in the case of a Prony brake. In order to carry off the heat generated, the water which is agitated is allowed to flow away and is continuously replenished by fresh cold water. The power absorbed by a brake of this type depends upon the speed and upon the quantity of water which is agitated. Other things being equal, the power absorbed is approximately proportional to the cube of the number of revolutions per minute.

Catenary Curve.—The catenary is the curve assumed by a string or chain of uniform weight hanging freely between two supports. The cables of a suspension bridge, if uniformly loaded, assume the form of the catenary curve. It has, therefore, considerable importance in structural engineering.

The curve formed by a cable or chain of uniform weight can be described by the following formula when $a = 1$:

$$y = a \cosh\left(\frac{x}{a}\right) = \frac{a}{2} \left(e^{\frac{x}{a}} + e^{-\frac{x}{a}} \right)$$

where x, y = any point on the curve

a = the y -intercept of the function, i.e., the value of the function at $x = 0$

cosh = the hyperbolic cosine function

e = the mathematical constant, 2.71828

Flywheels

Classification.—Flywheels may be classified as *balance wheels* or as *flywheel pulleys*. The object of all flywheels is to equalize the energy exerted and the work done and thereby prevent excessive or sudden changes of speed. The permissible speed variation is an important factor in all flywheel designs. The allowable speed change varies considerably for different classes of machinery; for instance, it is about 1 or 2 per cent in steam engines, while in punching and shearing machinery a speed variation of 20 per cent may be allowed.

The function of a balance wheel is to absorb and equalize energy in case the resistance to motion, or driving power, varies throughout the cycle. Therefore, the rim section is generally quite heavy and is designed with reference to the energy that must be stored in it to prevent excessive speed variations and, with reference to the strength necessary to withstand safely the stresses resulting from the required speed. The rims of most balance wheels are either square or nearly square in section, but flywheel pulleys are commonly made wide to accommodate a belt and relatively thin in a radial direction, although this is not an invariable rule.

Flywheels, in general, may either be formed of a solid or one-piece section, or they may be of sectional construction. Flywheels in diameters up to about eight feet are usually cast solid, the hubs sometimes being divided to relieve cooling stresses. Flywheels ranging from, say, eight feet to fifteen feet in diameter, are commonly cast in half sections, and the larger sizes in several sections, the number of which may equal the number of arms in the wheel. Sectional flywheels may be divided into two general classes. One class includes cast wheels which are formed of sections principally because a solid casting would be too large to transport readily. The second class includes wheels of sectional construction which, by reason of the materials used and the special arrangement of the sections, enables much higher peripheral speeds to be obtained safely than would be possible with ordinary sectional wheels of the type not designed especially for high speeds. Various designs have been built to withstand the extreme stresses encountered in some classes of service. The rims in some designs are laminated, being partly or entirely formed of numerous segment-shaped steel plates. Another type of flywheel, which is superior to an ordinary sectional wheel, has a solid cast-iron rim connected to the hub by disk-shaped steel plates instead of cast spokes.

Steel wheels may be divided into three distinct types, including 1) those having the center and rim built up entirely of steel plates; 2) those having a cast-iron center and steel rim; and 3) those having a cast-steel center and rim formed of steel plates.

Wheels having wire-wound rims have been used to a limited extent when extremely high speeds have been necessary.

When the rim is formed of sections held together by joints it is very important to design these joints properly. The ordinary bolted and flanged rim joints located between the arms average about 20 per cent of the strength of a solid rim and about 25 per cent is the maximum strength obtainable for a joint of this kind. However, by placing the joints at the ends of the arms instead of between them, an efficiency of 50 per cent of the strength of the rim may be obtained, because the joint is not subjected to the outward bending stresses between the arms but is directly supported by the arm, the end of which is secured to the rim just beneath the joint. When the rim sections of heavy balance wheels are held together by steel links shrunk into place, an efficiency of 60 per cent may be obtained; and by using a rim of box or I-section, a link type of joint connection may have an efficiency of 100 per cent.

Energy Due to Changes of Velocity.—When a flywheel absorbs energy from a variable driving force, as in a steam engine, the velocity increases; and when this stored energy is given out, the velocity diminishes. When the driven member of a machine encounters a variable resistance in performing its work, as when the punch of a punching machine is passing through a steel plate, the flywheel gives up energy while the punch is at work, and,

consequently, the speed of the flywheel is reduced. The total energy that a flywheel would give out if brought to a standstill is given by the formula:

$$E = \frac{Wv^2}{2g} = \frac{Wv^2}{64.32}$$

in which E = total energy of flywheel, in foot-pounds

W = weight of flywheel rim, in pounds

v = velocity at mean radius of flywheel rim, in feet per second

g = acceleration due to gravity = 32.16 ft/s²

If the velocity of a flywheel changes, the energy it will absorb or give up is proportional to the difference between the squares of its initial and final speeds, and is equal to the difference between the energy that it would give out if brought to a full stop and the energy that is still stored in it at the reduced velocity. Hence:

$$E_1 = \frac{Wv_1^2}{2g} - \frac{Wv_2^2}{2g} = \frac{W(v_1^2 - v_2^2)}{64.32}$$

in which E_1 = energy in foot-pounds that a flywheel will give out while the speed is reduced from v_1 to v_2

W = weight of flywheel rim, in pounds

v_1 = velocity at mean radius of flywheel rim before any energy has been given out, in feet per second

v_2 = velocity of flywheel rim at end of period during which the energy has been given out, in feet per second

Ordinarily, the effects of the arms and hub do not enter into flywheel calculations, and only the weight of the rim is considered. In computing the velocity, the mean radius of the rim is commonly used.

Using metric SI units, the formulas are $E = \frac{1}{2}Mv^2$, and $E_1 = \frac{1}{2}M(v_1^2 - v_2^2)$, where E and E_1 are in joules; M = the mass of the rim in kilograms; and v , v_1 , and v_2 = velocities in meters per second. Note: In the SI, the unit of mass is the kilogram. If the weight of the flywheel rim is given in kilograms, the value referred to is the mass, M . Should the weight be given in newtons, N , then

$$M = \frac{W(\text{newtons})}{g}$$

where g is approximately 9.81 meters per second squared.

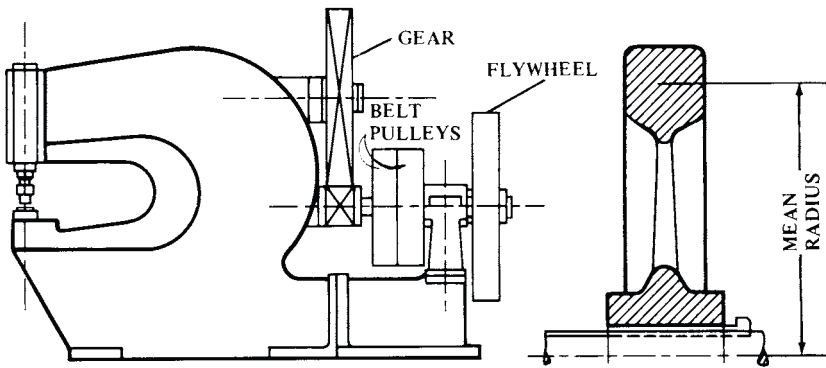
Flywheel Calculations

General Procedure in Flywheel Design.—The general method of designing a flywheel is to determine first the value of E_1 or the energy the flywheel must either supply or absorb for a given change in velocity, which, in turn, varies for different classes of service. The mean diameter of the flywheel may be assumed, or it may be fixed within certain limits by the general design of the machine. Ordinarily the speed of the flywheel shaft is known, at least approximately; the values of v_1 and v_2 can then be determined, the latter depending upon the allowable percentage of speed variation. When these values are known, the weight of the rim and the cross-sectional area required to obtain this weight may be computed. The general procedure will be illustrated more in detail by considering the design of flywheels for punching and shearing machinery.

Flywheels for Presses, Punches, Shears, Etc.—In these classes of machinery, the work that the machine performs is of an intermittent nature and is done during a small part of the time required for the driving shaft of the machine to make a complete revolution. To distribute the work of the machine over the entire period of revolution of the driving shaft, a

heavy-rimmed flywheel is placed on the shaft, giving the belt an opportunity to perform an almost uniform amount of work during the whole revolution. During the greater part of the revolution of the driving shaft, the belt power is used to accelerate the speed of the flywheel. During the part of the revolution when the work is done, the energy thus stored up in the flywheel is given out at the expense of its velocity. The problem is to determine the weight and cross-sectional area of the rim when the conditions affecting the design of the flywheel are known.

Example: A flywheel is required for a punching machine capable of punching $\frac{3}{4}$ -inch holes through structural steel plates $\frac{3}{4}$ inch thick. This machine (see accompanying diagram) is of the general type having a belt-driven shaft at the rear which carries a flywheel and a pinion that meshes with a large gear on the main shaft at the top of the machine. It is assumed that the relative speeds of the pinion and large gear are 7 to 1, respectively, and that the slide is to make 30 working strokes per minute. The preliminary layout shows that the flywheel should have a mean diameter (see enlarged detail) of about 30 inches. Find the weight of the flywheel and the remaining rim dimensions.



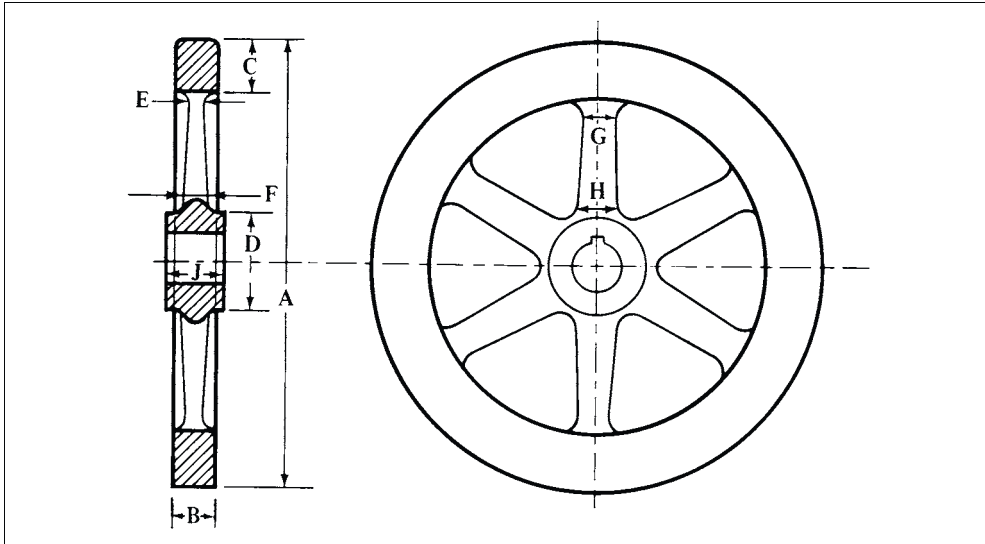
Punch Press and Flywheel Detail

Energy Supplied by Flywheel: The energy that the flywheel must give up for a given change in velocity, and the weight of rim necessary to supply that energy, must be determined. The maximum force for shearing a $\frac{3}{4}$ -inch hole through $\frac{3}{4}$ -inch structural steel equals approximately the circumference of the hole multiplied by the thickness of the stock multiplied by the tensile strength, which is nearly the same as the shearing resistance of the steel. Thus, in this case, $3.1416 \times \frac{3}{4} \times \frac{3}{4} \times 60,000 = 106,000$ pounds. The average force will be much less than the maximum. Some designers assume that the average force is about one-half the maximum, although experiments show that the material is practically sheared off when the punch has entered the sheet a distance equal to about one-third the sheet thickness. On this latter basis, the average energy E_a is 2200 foot-pounds for the example given. Thus:

$$E_a = \frac{106,000 \times \frac{1}{3} \times \frac{3}{4}}{12} = \frac{106,000}{4 \times 12} = 2200 \text{ foot-pounds.}$$

If the efficiency of the machine is taken as 85 per cent, the energy required will equal $2200/0.85 = 2600$ foot-pounds nearly. Assume that the energy supplied by the belt while the punch is at work is determined by calculation to equal 175 foot-pounds. Then the flywheel must supply $2600 - 175 = 2425$ foot-pounds = E_1 .

Dimensions of Flywheels for Punches and Shears



A	B	C	D	E	F	G	H	J	Max. R.P.M.
24	3	3½	6	1¼	1⅜	2¾	3¼	3½	955
30	3½	4	7	1⅜	1½	3	3¾	4	796
36	4	4½	8	1½	1¾	3¼	4¼	4½	637
42	4¼	4¾	9	1¾	2	3½	4½	5	557
48	4½	5	10	1¾	2	3¾	4¾	5½	478
54	4¾	5½	11	2	2¼	4	5	6	430
60	5	6	12	2¼	2½	4½	5½	6½	382
72	5½	7	13	2½	2¾	5	6½	7	318
84	6	8	14	3	3½	5½	7½	8	273
96	7	9	15	3½	4	6	9	9	239
108	8	10	16½	3¾	4½	6½	10½	10	212
120	9	11	18	4	5	7½	12	12	191

The maximum number of revolutions per minute given in this table should never be exceeded for cast-iron flywheels.

Rim Velocity at Mean Radius: When the mean radius of the flywheel is known, the velocity of the rim at the mean radius, in feet per second, is:

$$v = \frac{2 \times 3.1416 \times R \times n}{60}$$

in which v = velocity at mean radius of flywheel, in feet per second

R = mean radius of flywheel rim, in feet

n = number of revolutions per minute

According to the preliminary layout the mean diameter in this example should be about 30 inches and the driving shaft is to make 210 rpm, hence,

$$v = \frac{2 \times 3.1416 \times 1.25 \times 210}{60} = 27.5 \text{ feet per second}$$

Weight of Flywheel Rim: Assuming that the allowable variation in velocity when punching is about 15 per cent, and values of v_1 and v_2 are respectively 27.5 and 23.4 feet per second ($27.5 \times 0.85 = 23.4$), the weight of a flywheel rim necessary to supply a given amount of energy in foot-pounds while the speed is reduced from v_1 to v_2 would be:

$$W = \frac{E_1 \times 64.32}{v_1^2 - v_2^2} = \frac{2425 \times 64.32}{27.5^2 - 23.4^2} = 750 \text{ pounds}$$

Size of Rim for Given Weight: Since 1 cubic inch of cast iron weighs 0.26 pound, a flywheel rim weighing 750 pounds contains $750/0.26 = 2884$ cubic inches. The cross-sectional area of the rim in square inches equals the total number of cubic inches divided by the mean circumference, or $2884/94.25 = 31$ square inches nearly, which is approximately the area of a rim $5\frac{1}{2}$ inches wide and 6 inches deep.

Simplified Flywheel Calculations.—Calculations for designing the flywheels of punches and shears are simplified by the following formulas and the accompanying table of constants applying to different percentages of speed reduction. In these formulas let:

HP = horsepower required

N = number of strokes per minute

E = total energy required per stroke, in foot-pounds

E_1 = energy given up by flywheel, in foot-pounds

T = time in seconds per stroke

T_1 = time in seconds of actual cut

W = weight of flywheel rim, in pounds

D = mean diameter of flywheel rim, in feet

R = maximum allowable speed of flywheel in revolutions per minute

C and C_1 = speed reduction values as given in table

a = width of flywheel rim

b = depth of flywheel rim

y = ratio of depth to width of rim

$$HP = \frac{EN}{33,000} = \frac{E}{T \times 550} \quad E_1 = E \left(1 - \frac{T_1}{T} \right)$$

$$W = \frac{E_1}{CD^2R^2} \quad a = \sqrt{\frac{1.22W}{12Dy}} \quad b = ay$$

For cast-iron flywheels, with a maximum stress of 1000 pounds per square inch:

$$W = C_1 E_1 \quad R = 1940 \div D$$

Values of C and C_1 in the Previous Formulas

Per Cent Reduction	C	C_1	Per Cent Reduction	C	C_1
$2\frac{1}{2}$	0.00000213	0.1250	10	0.00000810	0.0328
5	0.00000426	0.0625	15	0.00001180	0.0225
$7\frac{1}{2}$	0.00000617	0.0432	20	0.00001535	0.0173

Example 1: A hot slab shear is required to cut a slab 4×15 inches which, at a shearing stress of 6000 pounds per square inch, gives a force between the knives of 360,000 pounds. The total energy required for the cut will then be $360,000 \times \frac{1}{12} = 120,000$ foot-pounds. The shear is to make 20 strokes per minute; the actual cutting time is 0.75 second, and the balance of the stroke is 2.25 seconds.

The flywheel is to have a mean diameter of 6 feet 6 inches and is to run at a speed of 200 rpm; the reduction in speed to be 10 per cent per stroke when cutting.

$$HP = \frac{120,000 \times 20}{33,000} = 72.7 \text{ horsepower}$$

$$E_1 = 120,000 \times \left(1 - \frac{0.75}{3}\right) = 90,000 \text{ foot-pounds}$$

$$W = \frac{90,000}{0.0000081 \times 6.5^2 \times 200^2} = 6570 \text{ pounds}$$

Assuming a ratio of 1.22 between depth and width of rim,

$$a = \sqrt{\frac{6570}{12 \times 6.5}} = 9.18 \text{ inches}$$

$$b = 1.22 \times 9.18 = 11.2 \text{ inches}$$

or size of rim, say, $9 \times 11\frac{1}{2}$ inches.

Example 2: Suppose that the flywheel in **Example 1** is to be made with a stress due to centrifugal force of 1000 pounds per square inch of rim section.

$$C_1 \text{ for 10 per cent} = 0.0328$$

$$W = 0.0328 \times 90,000 = 2950 \text{ pounds}$$

$$R = \frac{1940}{D} \quad \text{If } D = 6 \text{ feet,} \quad R = \frac{1940}{6} = 323 \text{ rpm}$$

Assuming a ratio of 1.22 between depth and width of rim, as before:

$$a = \sqrt{\frac{2950}{12 \times 6}} = 6.4 \text{ inches}$$

$$b = 1.22 \times 6.4 = 7.8 \text{ inches}$$

or size of rim, say, $6\frac{1}{4} \times 8$ inches.

Centrifugal Stresses in Flywheel Rims.—In general, high speed is desirable for flywheels in order to avoid using wheels that are unnecessarily large and heavy. The centrifugal tension or hoop tension stress, that tends to rupture a flywheel rim of given area, depends solely upon the rim velocity and is independent of the rim radius. The bursting velocity of a flywheel, based on hoop stress alone (not considering bending stresses), is related to the tensile stress in the flywheel rim by the following formula which is based on the centrifugal force formula from mechanics.

$$V = \sqrt{10 \times s} \quad \text{or,} \quad s = V^2 \div 10$$

where V = velocity of outside circumference of rim in feet per second, and s is the tensile strength of the rim material in pounds per square inch.

For cast iron having a tensile strength of 19,000 pounds per square inch the bursting speed would be:

$$V = \sqrt{10 \times 19,000} = 436 \text{ feet per second}$$

Built-up Flywheels: Flywheels built up of solid disks of rolled steel plate stacked and bolted together on a through shaft have greater speed capacity than other types. The maximum hoop stress is at the bore and is given by the formula,

$$s = 0.0194V^2[4.333 + (d/D)^2]$$

In this formula, s and V are the stress and velocity as previously defined and d and D are the bore and outside diameters, respectively.

Assuming the plates to be of steel having a tensile strength of 60,000 pounds per square inch and a safe working stress of 24,000 pounds per square inch (using a factor of safety of 2.5 on stress or $\sqrt{2.5}$ on speed) and taking the worst condition (when d approaches D), the safe rim speed for this type of flywheel is 500 feet per second or 30,000 feet per minute.

Combined Stresses in Flywheels.—The bending stresses in the rim of a flywheel may exceed the centrifugal (hoop tension) stress predicted by the simple formula $s = V^2/10$ by a considerable amount. By taking into account certain characteristics of flywheels, relatively simple formulas have been developed to determine the stress due to the combined effect of hoop tension and bending stress. Some of the factors that influence the magnitude of the maximum combined stress acting at the rim of a flywheel are:

1) *The number of spokes.* Increasing the number of spokes decreases the rim span between spokes and hence decreases the bending moment. Thus an eight-spoke wheel can be driven to a considerably higher speed before bursting than a six-spoke wheel having the same rim.

2) *The relative thickness of the spokes.* If the spokes were extremely thin, like wires, they could offer little constraint to the rim in expanding to its natural diameter under centrifugal force, and hence would cause little bending stress. Conversely, if the spokes were extremely heavy in proportion to the rim, they would restrain the rim thereby setting up heavy bending stresses at the junctions of the rim and spokes.

3) *The relative thickness of the rim to the diameter.* If the rim is quite thick (i.e., has a large section modulus in proportion to span), its resistance to bending will be great and bending stress small. Conversely, thin rims with a section modulus small in comparison with diameter or span have little resistance to bending, thus are subject to high bending stresses.

4) *Residual stresses.* These include shrinkage stresses, impact stresses, and stresses caused by operating torques and imperfections in the material. Residual stresses are taken into account by the use of a suitable factor of safety. (See *Factors of Safety for Flywheels.*)

The formulas that follow give the maximum combined stress at the rim of flywheels having 6, 8, and 10 spokes. These formulas are for flywheels with *rectangular rim sections* and take into account the first three of the four factors listed as influencing the magnitude of the combined stress in flywheels.

$$\text{For 6 spokes:} \quad s = \frac{V^2}{10} \left[1 + \left(\frac{0.56B - 1.81}{3Q + 3.14} \right) Q \right]$$

$$\text{For 8 spokes:} \quad s = \frac{V^2}{10} \left[1 + \left(\frac{0.42B - 2.53}{4Q + 3.14} \right) Q \right]$$

$$\text{For 10 spokes:} \quad s = \frac{V^2}{10} \left[1 + \left(\frac{0.33B - 3.22}{5Q + 3.14} \right) Q \right]$$

In these formulas, s = maximum combined stress in pounds per square inch; Q = ratio of mean spoke cross-section area to rim cross-section area; B = ratio of outside diameter of rim to rim thickness; and V = velocity of flywheel rim in feet per second.

Thickness of Cast Iron Flywheel Rims.—The mathematical analysis of the stresses in flywheel rims is not conclusive owing to the uncertainty of shrinkage stresses in castings or the strength of the joint in sectional wheels. When a flywheel of ordinary design is revolving at high speed, the tendency of the rim is to bend or bow outward between the arms, and the bending stresses may be serious, especially if the rim is wide and thin and the spokes are rather widely spaced. When the rims are thick, this tendency does not need to be considered, but in a thin rim running at high speed, the stress in the middle might become suf-

ficiently great to cause the wheel to fail. The proper thickness of a cast-iron rim to resist this tendency is given for solid rims by **Formula (1)** and for a jointed rim by **Formula (2)**.

$$t = \frac{0.475d}{n^2 \left(\frac{6000}{v^2} - \frac{1}{10} \right)} \quad (1)$$

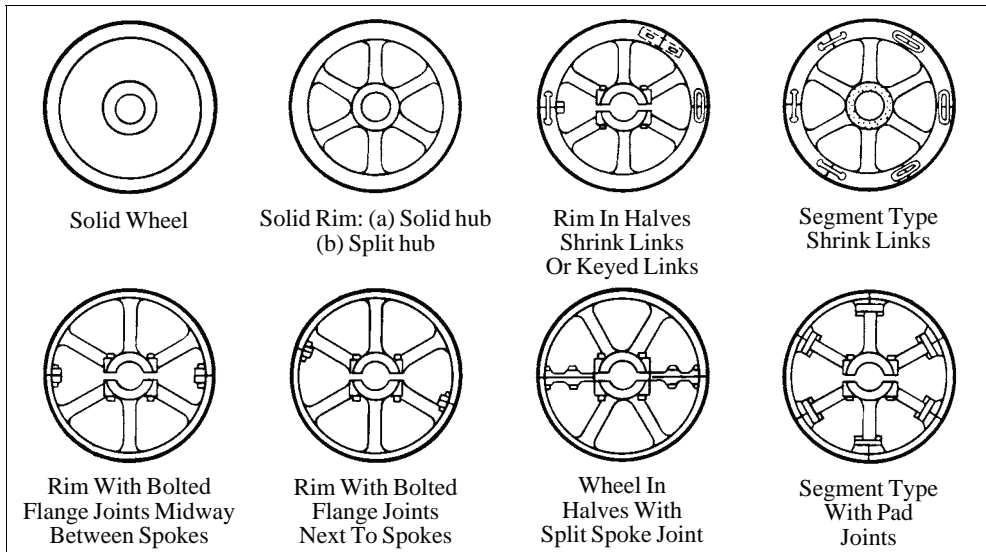
$$t = \frac{0.95d}{n^2 \left(\frac{6000}{v^2} - \frac{1}{10} \right)} \quad (2)$$

In these formulas, t = thickness of rim, in inches; d = diameter of flywheel, in inches; n = number of arms; v = peripheral speed, in feet per second.

Factors of Safety for Flywheels.—Cast-iron flywheels are commonly designed with a factor of safety of 10 to 13. A factor of safety of 10 applied to the tensile strength of a flywheel material is equivalent to a factor of safety of $\sqrt{10}$ or 3.16 on the speed of the flywheel because the stress on the rim of a flywheel increases as the square of the speed. Thus, a flywheel operating at a speed twice that for which it was designed would undergo rim stresses four times as great as at the design speed.

Tables of Safe Speeds for Flywheels.—The accompanying **Table 1**, prepared by T. C. Rathbone of The Fidelity and Casualty Company of New York, gives general recommendations for safe rim speeds for flywheels of various constructions. **Table 2** shows the number of revolutions per minute corresponding to the rim speeds in **Table 1**.

Table 1. Safe Rim Speeds for Flywheels



Type of Wheel	Safe Rim Speed	
	Feet per Sec.	Feet per Min.
Solid cast iron (balance wheels—heavy rims)	110	6,600
Solid cast iron (pulley wheels—thin rims)	85	5,100
Wheels with shrink link joints	77.5	4,650
Wheels with pad type joints	70.7	4,240
Wheels with bolted flange joints	50	3,000
Solid cast steel wheels	200	12,000
Wheels built up of stacked steel plates	500	30,000

To find the safe speed in revolutions per minute, divide the safe rim speed in feet per minute by 3.14 times the outside diameter of the flywheel rim in feet. For flywheels up to 15 feet in diameter, see **Table 2**.

Table 2. Safe Speeds of Rotation for Flywheels

Outside Diameter of Rim (feet)	Safe Rim Speed in Feet per Minute (from Table 1)						
	6,600	5,100	4,650	4,240	3,000	12,000	30,000
	Safe Speed of Rotation in Revolutions per Minute						
1	2100	1623	1480	1350	955	3820	9549
2	1050	812	740	676	478	1910	4775
3	700	541	493	450	318	1273	3183
4	525	406	370	338	239	955	2387
5	420	325	296	270	191	764	1910
6	350	271	247	225	159	637	1592
7	300	232	211	193	136	546	1364
8	263	203	185	169	119	478	1194
9	233	180	164	150	106	424	1061
10	210	162	148	135	96	382	955
11	191	148	135	123	87	347	868
12	175	135	123	113	80	318	796
13	162	125	114	104	73	294	735
14	150	116	106	97	68	273	682
15	140	108	99	90	64	255	637

Safe speeds of rotation are based on safe rim speeds shown in Table 1.

Safe Speed Formulas for Flywheels and Pulleys.—No simple formula can accommodate all the various types and proportions of flywheels and pulleys and at the same time provide a uniform factor of safety for each. Because of considerations of safety, such a formula would penalize the better constructions to accommodate the weaker designs.

One formula that has been used to check the maximum rated operating speed of flywheels and pulleys and which takes into account material properties, construction, rim thickness, and joint efficiencies is the following:

$$N = \frac{CAMEK}{D}$$

In this formula,

N = maximum rated operating speed in revolutions per minute

C = 1.0 for wheels driven by a constant speed electric motor (i.e., a-c squirrel-cage induction motor or a-c synchronous motor, etc.)

0.90 for wheels driven by variable speed motors, engines or turbines where overspeed is not over 10 per cent of rated operating speed

A = 0.90 for 4 arms or spokes

1.00 for 6 arms or spokes

1.08 for 8 arms or spokes

1.50 for disc type

M = 1.00 for cast iron of 20,000 psi tensile strength, or unknown

1.12 for cast iron of 25,000 psi tensile strength

1.22 for cast iron of 30,000 psi tensile strength

1.32 for cast iron of 35,000 psi tensile strength

2.20 for nodular iron of 60,000 psi tensile strength

2.45 for cast steel of 60,000 psi tensile strength

2.75 for plate or forged steel of 60,000 psi tensile strength

E = joint efficiency

1.0 for solid rim

0.85 for link or prison joints

0.75 for split rim — bolted joint at arms

0.70 for split rim — bolted joint between arms

$K = 1355$ for rim thickness equal to 1 per cent of outside diameter
 1650 for rim thickness equal to 2 per cent of outside diameter
 1840 for rim thickness equal to 3 per cent of outside diameter
 1960 for rim thickness equal to 4 per cent of outside diameter
 2040 for rim thickness equal to 5 per cent of outside diameter
 2140 for rim thickness equal to 7 per cent of outside diameter
 2225 for rim thickness equal to 10 per cent of outside diameter
 2310 for rim thickness equal to 15 per cent of outside diameter
 2340 for rim thickness equal to 20 per cent of outside diameter

$D =$ outside diameter of rim in feet

Example: A six-spoke solid cast iron balance wheel 8 feet in diameter has a rectangular rim 10 inches thick. What is the safe speed, in revolutions per minute, if driven by a constant speed motor?

In this instance, $C = 1$; $A = 1$; $M = 1$, since tensile strength is unknown; $E = 1$; $K = 2225$ since the rim thickness is approximately 10 per cent of the wheel diameter; and $D = 8$ feet. Thus,

$$N = \frac{1 \times 1 \times 1 \times 2225}{8} = 278 \text{ rpm}$$

(*Note:* This safe speed is slightly greater than the value of 263 rpm obtainable directly from [Tables 1](#) and [2](#).)

Tests to Determine Flywheel Bursting Speeds.—Tests made by Prof. C. H. Benjamin, to determine the bursting speeds of flywheels, showed the following results:

Cast-iron Wheels with Solid Rims: Cast-iron wheels having solid rims burst at a rim speed of 395 feet per second, corresponding to a centrifugal tension of about 15,600 pounds per square inch.

Wheels with Jointed Rims: Four wheels were tested with joints and bolts inside the rim, using the familiar design ordinarily employed for band wheels, but with the joints located at points one-fourth of the distance from one arm to the next. These locations represent the points of least bending moment, and, consequently, the points at which the deflection due to centrifugal force would be expected to have the least effect. The tests, however, did not bear out this conclusion. The wheels burst at a rim speed of 194 feet per second, corresponding to a centrifugal tension of about 3750 pounds per square inch. These wheels, therefore, were only about one-quarter as strong as the wheels with solid rims, and burst at practically the same speed as wheels in a previous series of tests in which the rim joints were midway between the arms.

Bursting Speed for Link Joints: Another type of wheel with deep rim, fastened together at the joints midway between the arms by links shrunk into recesses, after the manner of flywheels for massive engines, gave much superior results. This wheel burst at a speed of 256 feet per second, indicating a centrifugal tension of about 6600 pounds per square inch.

Wheel having Tie-rods: Tests were made on a band wheel having joints inside the rim, midway between the arms, and in all respects like others of this design previously tested, except that tie-rods were used to connect the joints with the hub. This wheel burst at a speed of 225 feet per second, showing an increase of strength of from 30 to 40 per cent over similar wheels without the tie-rods.

Wheel Rim of I-section: Several wheels of special design, not in common use, were also tested, the one giving the greatest strength being an English wheel, with solid rim of I-section, made of high-grade cast iron and with the rim tied to the hub by steel wire spokes. These spokes were adjusted to have a uniform tension. The wheel gave way at a rim speed of 424 feet per second, which is slightly higher than the speed of rupture of the solid rim wheels with ordinary style of spokes.

Tests on Flywheel of Special Construction: A test was made on a flywheel 49 inches in diameter and weighing about 900 pounds. The rim was $6\frac{3}{4}$ inches wide and $1\frac{1}{8}$ inches thick, and was built of ten segments, the material being cast steel. Each joint was secured by three "prisoners" of an I-section on the outside face, by link prisoners on each edge, and by a dovetailed bronze clamp on the inside, fitting over lugs on the rim. The arms were of phosphor-bronze, twenty in number, ten on each side, and were cross-shaped in section. These arms came midway between the rim joints and were bolted to plane faces on the polygonal hub. The rim was further reinforced by a system of diagonal bracing, each section of the rim being supported at five points on each side, in such a way as to relieve it almost entirely from bending. The braces, like the arms, were of phosphor-bronze, and all bolts and connecting links were of steel. This wheel was designed as a model of a proposed 30-foot flywheel. On account of the excessive air resistance the wheel was enclosed at the sides between sheet-metal disks. This wheel burst at 1775 revolutions per minute or at a linear speed of 372 feet per second. The hub and main spokes of the wheel remained nearly in place, but parts of the rim were found 200 feet away. This sudden failure of the rim casting was unexpected, as it was thought the flange bolts would be the parts to give way first. The tensile strength of the casting at the point of fracture was about four times the strength of the wheel rim at a solid section.

Stresses in Rotating Disks.—When a disk of uniform width is rotated, the maximum stress S_t is tangential and at the bore of the hub, and the tangential stress is always greater than the radial stress at the same point on the disk. If S_t = maximum tangential stress in pounds per sq. in.; w = weight of material, lb. per cu. in.; N = rev. per min.; m = Poisson's ratio = 0.3 for steel; R = outer radius of disk, inches; r = inner radius of disk or radius of bore, inches.

$$S_t = 0.0000071wN^2[(3 + m)R^2 + (1 - m)r^2]$$

Steam Engine Flywheels.—The variable amount of energy during each stroke and the allowable percentage of speed variation are of special importance in designing steam engine flywheels. The earlier the point of cut-off, the greater the variation in energy and the larger the flywheel that will be required. The weight of the reciprocating parts and the length of the connecting-rod also affect the variation. The following formula is used for computing the weight of the flywheel rim:

Let W = weight of rim in pounds
 D = mean diameter of rim in feet
 N = number of revolutions per minute
 $\frac{1}{n}$ = allowable variation in speed (from $\frac{1}{50}$ to $\frac{1}{100}$)
 E = excess and deficiency of energy in foot-pounds
 c = factor of energy excess, from the accompanying table
 HP = indicated horsepower

Then, if the indicated horsepower is given:

$$W = \frac{387,587,500 \times cn \times HP}{D^2 N^3} \quad (1)$$

If the work in foot-pounds is given, then:

$$W = \frac{11,745nE}{D^2 N^2} \quad (2)$$

In the second formula, E equals the average work in foot-pounds done by the engine in one revolution, multiplied by the decimal given in the accompanying table, "*Factors for Engine Flywheel Calculations*," which covers both condensing and non-condensing engines:

Factors for Engine Flywheel Calculations

Condensing Engines						
Fraction of stroke at which steam is cut off	1/3	1/4	1/5	1/6	1/7	1/8
Factor of energy excess	0.163	0.173	0.178	0.184	0.189	0.191
Non-condensing Engines						
Steam cut off at	1/2		1/3	1/4	1/5	
Factor of energy excess	0.160		0.186	0.209	0.232	

Example 1: A non-condensing engine of 150 indicated horsepower is to make 200 revolutions per minute, with a speed variation of 2 per cent. The average cut-off is to be at one-quarter stroke, and the flywheel is to have a mean diameter of 6 feet. Find the necessary weight of the rim in pounds.

From the table $c = 0.209$, and from the data given $HP = 150; N = 200; 1/n = 1/50$ or $n = 50$; and, $D = 6$.

Substituting these values in **Equation (1)**:

$$W = \frac{387,587,500 \times 0.209 \times 50 \times 150}{6^2 \times 200^3} = 2110 \text{ pounds, nearly}$$

Example 2: A condensing engine, 24×42 inches, cuts off at one-third stroke and has a mean effective pressure of 50 pounds per square inch. The flywheel is to be 18 feet in mean diameter and make 75 revolutions per minute with a variation of 1 per cent. Find the required weight of the rim.

The work done on the piston in one revolution is equal to the pressure on the piston multiplied by the distance traveled or twice the stroke in feet. The area of the piston is 452.4 square inches, and twice the stroke is 7 feet. The work done on the piston in one revolution is, therefore, $452.4 \times 50 \times 7 = 158,340$ foot-pounds. From the table $c = 0.163$, and therefore:

$$E = 158,340 \times 0.163 = 25,810 \text{ foot-pounds}$$

From the data given: $n = 100; D = 18; N = 75$. Substituting these values in **Equation (2)**:

$$W = \frac{11,745 \times 100 \times 25,810}{18^2 \times 75^2} = 16,650 \text{ pounds, nearly}$$

Spokes or Arms of Flywheels.—Flywheel arms are usually of elliptical cross-section. The major axis of the ellipse is in the plane of rotation to give the arms greater resistance to bending stresses and reduce the air resistance which may be considerable at high velocity. The stresses in the arms may be severe, due to the inertia of a heavy rim when sudden load changes occur. The strength of the arms should equal three-fourths the strength of the shaft in torsion.

If W equals the width of the arm at the hub (length of major axis) and D equals the shaft diameter, then W equals $1.3 D$ for a wheel having 6 arms; and for an 8-arm wheel W equals $1.2 D$. The thickness of the arm at the hub (length of minor axis) equals one-half the width. The arms usually taper toward the rim. The cross-sectional area at the rim should not be less than two-thirds the area at the hub.

PROPERTIES, TREATMENT, TESTING OF MATERIALS

Thermal Properties

Heat and Heat Transfer, Conduction.—Whenever the molecules of a working substance, whether liquid, solid, or vapor, are restrained so that no appreciable relative translatory motion occurs among them, the kinetic energies of the various molecules will be largely due to vibration. If a temperature difference exists in the working substance, some adjacent molecules will necessarily be at different temperatures hence will possess different degrees of vibratory motion. In this case the molecule which is vibrating most rapidly will transfer some of its motion to the slower-moving molecule next to it, the one then undergoing a decrease in temperature and the other an increase. In this way, thermal energy will be transferred by the mechanism of conduction from the region of higher to the region of lower temperature. The process will continue spontaneously until the entire system has reached a uniform equilibrium temperature. If external conditions prevent attainment of a uniform temperature, as, for example, when one end of a copper rod is placed in a fire and the other end in an icebox, heat will continue to flow by conduction from the region of higher to the region of lower temperature. In contrast to radiation, conduction only occurs when a working substance is present and when the molecules of that working substance retain practically fixed positions with respect to one another. Thus, conductive heat flow would always occur through solids, but would take place in liquids and vapors only if special conditions prevented or greatly reduced the normal translatory motion of the molecules within these materials.

Fuel Oil Heating Values.—In order to determine the calorific values in British thermal units per pound of fuel oils, sixty-four samples of petroleum oils ranging from heavy crude oil to gasoline, representing the products of the principal oil fields in the United States, have been examined for calorific power. It was found that the oils varied in fuel value from about 18,500 to 21,100 BTU per pound. In general, the decrease in calorific power with an increase in specific gravity is regular, so that the relation between the specific gravity and the heat value may be expressed approximately by means of a simple formula, as follows: $\text{BTU per pound} = 18,650 + 40 \times (\text{Number of Degrees Baume} - 10)$.

Ignition Temperatures.—The temperature of ignition is the degree of temperature at which a substance will combine with oxygen at a rate sufficiently rapid to produce a flame. The temperature of ignition has often been regarded as the temperature at which chemical combination begins, but this is not correct, because chemical combination has begun before a flame appears. The following temperatures are required to ignite the different substances specified: Phosphorus, transparent, 120 degrees F.; bisulphide of carbon, 300 degrees F.; guncotton, 430 degrees F.; nitroglycerin, 490 degrees F.; phosphorus, amorphous, 500 degrees F.; rifle powder, 550 degrees F.; charcoal, 660 degrees F.; dry pine wood, 300 degrees F.; dry oak wood, 900 degrees F.; illuminating gas, 1110 degrees F.; benzine, 780 degrees F.; petroleum, 715 degrees F.; gas oil, 660 degrees F.; machine oil, 715 degrees F.; coal tars, 930 degrees F.; and benzol, 970 degrees F.

Firebrick Properties.—Brick intended for use in furnaces, flues, and cupolas, where the brickwork is subjected to very high temperatures, is generally known as "firebrick." There are several classes of firebrick, such as fireclay brick, silica brick, bauxite brick, chrome brick, and magnesia brick.

Ordinary firebricks are made from fireclay; that is, clays which will stand a high temperature without fusion, excessive shrinkage, or warping. There is no fixed standard of refractoriness for fireclay, but, as a general rule, no clay is classed as a fireclay that fuses below 2900 degrees F.

Fireclays vary in composition, but they all contain high percentages of alumina and silica, and only small percentages of such constituents as oxide of iron, magnesia, lime, soda, and potash. A great number of different kinds of firebrick are manufactured to meet the

various conditions to which firebricks are subjected. Different classes of bricks are required to withstand different temperatures, as well as the corrosive action of gases, the chemical action of furnace charges, etc.

The most common firebrick will melt at a temperature ranging from 2830 to 3140 degrees F.; bauxite brick, from 2950 to 3245 degrees F.; silica brick, from 3090 to 3100 degrees F.; chromite brick, at 3720 degrees F.; and magnesia brick, at 4950 degrees F.

Non-metallic Materials

Carbon.—In nature, carbon is found free in two forms, as the diamond and as graphite; in combination with other elements carbon enters as a constituent of practically all animal and vegetable compounds, and of coal and petroleum. The specific gravity of carbon in the form of diamond is 3.5. When found as graphite, the specific gravity is about 2. Charcoal is also a porous form of nearly pure carbon. The properties of carbon vary according to the form in which it is found; thus, for example, the specific heat of diamond at 10 degrees C. (50 degrees F.) is about 0.11; of graphite at the same temperature it is about 0.16; and of wood-charcoal, 0.17. Besides the industrial uses of carbon in the form of graphite and charcoal, it is the chief constituent of all combustible materials, and is one of the most important of the chemical elements in its combination with other elements. The carbon content of steel, for example, determines to a very large extent its characteristics. In fact, the distinction between wrought iron, mild steel, tool steel, and cast iron is due mainly to the different percentages of carbon contained in the metal.

Charcoal.—Charcoal is the residue consisting of impure carbon which is obtained by expelling the volatile matter from animal or vegetable substances. The most abundant source of charcoal is wood. Under average conditions, 100 parts of wood yield about 60 parts, by volume, or 25 parts, by weight, of charcoal. The modern methods of producing charcoal from wood consist in using a cast-iron retort in which the wood is heated in order to remove the volatile constituents. Valuable by-products are also obtained in this manner (wood alcohol, wood tar, etc.). The uses of charcoal in the industries are many. It is an important fuel, especially in many metallurgical processes; it is also important as a constituent of gun powder; it is used as a filtering medium; and it has the power of removing coloring matters from solutions, and is, therefore, used to some extent in laboratory practice. The specific gravity of wood charcoal is 0.4. Its density is 25 pounds per cubic foot.

Lodestone.—The most highly magnetic substances are iron and steel. Nickel and cobalt are also magnetic, but in a less degree. The name "magnet" has been derived from that of Magnesia, a town in Asia Minor, where an iron ore was found in early days which had the power of attracting iron.

This ore is known as magnetite and consists of about 72 per cent, by weight, of iron and 28 per cent of oxygen, the chemical formula being Fe_3O_4 . The ore possessing this magnetic property is also known as lodestone. If a bar of hardened steel is rubbed with a piece of lodestone, it will acquire magnetic properties similar to those of the lodestone itself.

Micarta.—Micarta is a non-metallic laminated product of specially treated woven fabric. By means of the various processes through which it is passed, it becomes a homogenous structure with physical properties which make it especially adapted for use as gears and pinions. Micarta can be supplied either in plate form or cut into blanks. It may also be molded into rings or on metal hubs for applications such as timing gears, where quantity production is attained. Micarta may be machined in the ordinary manner with standard tools and equipment.

Micarta gears do not require shrouds or end plates except where it is desired to provide additional strength for keyway support or to protect the keyway and bore against rough usage in mounting drive fits and the like. When end plates for hub support are employed they should extend only to the root of the tooth or slightly less.

Properties: The physical and mechanical properties of Micarta are as follows: weight per cubic inch, 0.05 pound; specific gravity, 1.4; oil absorption, practically none; shrinkage, swelling or warping, practically none up to 100 degrees C.; coefficient of expansion per inch per degree Centigrade, 0.00002 inch in the direction parallel to the laminations (edgewise), 0.00009 inch in the direction perpendicular to the laminations (flat wise); tensile strength, edgewise, 10,000 pounds per square inch; compressive strength, flat wise, 40,000 pounds per square inch; compressive strength, edgewise, 20,000 pounds per square inch; bending strength, flatwise, 22,000 pounds per square inch; bending strength, edgewise, 20,000 pounds per square inch.

Metals and Alloys

Copper-Clad Steel.—A material generally used in the form of wire, in which a steel wire is covered with a coating of copper. It is produced either by alloying the copper with the surface of the metal or by welding it onto the surface. When the copper is alloyed with the surface, it is brought to a molten state before being applied, while, when welded to the surface, it is merely in a plastic state.

Truflex.—Thermostatic bimetal made in different types for automatically controlling temperature ranges of from —50 degrees F. to 1000 degrees F. Used for automatically controlling the operation of devices either heated or cooled by electricity, oil, or gas, as, for example: electric refrigerators, irons, toasters, gas ranges, water heaters, and domestic oil burners. Available in helical and spiral coils, rings, flat pieces, U-shapes, and in sheets up to 8 inches wide.

Inconel.—This heat resistant alloy retains its strength at high heats, resists oxidation and corrosion, has a high creep strength and is non-magnetic. It is used for high temperature applications (up to 2000 degrees F.) such as engine exhaust manifolds and furnace and heat treating equipment. Springs operating at temperatures up to 700 degrees F. are also made from it.

Approximate Composition: Nickel, 76; copper, 0.20; iron, 7.5; chromium, 15.5; silicon, 0.25; manganese, 0.25; carbon, 0.08; and sulphur, 0.007.

Physical Properties: Wrought Inconel in the annealed, hot-rolled, cold-drawn, and hard temper cold-rolled conditions exhibits yield strengths (0.2 per cent offset) of 35,000, 60,000, 90,000, and 110,000 pounds per square inch, respectively; tensile strengths of 85,000, 100,000, 115,000, and 135,000 pounds per square inch, respectively; elongations in 2 inches of 45, 35, 20, and 5 per cent, respectively; and Brinell hardnesses of 150, 180, 200, and 260, respectively.

Inconel "X".—This alloy has a low creep rate, is age-hardenable and non-magnetic, resists oxidation and exhibits a high strength at elevated temperatures. Uses include the making of bolts and turbine rotors used at temperatures up to 1500 degrees F., aviation brake drum springs and relief valve and turbine springs with low load loss or relaxation for temperatures up to 1000 degrees F.

Approximate Composition: Nickel, 73; copper, 0.2 maximum; iron, 7; chromium, 15; aluminum, 0.7; silicon, 0.4; manganese, 0.5; carbon, 0.04; sulphur, 0.007; columbium, 1; and titanium, 2.5.

Average Physical Properties: Wrought Inconel "X" in the annealed and age-hardened hot-rolled conditions exhibits yield strengths (0.2 per cent offset) of 50,000 and 120,000 pounds per square inch, respectively; tensile strengths of 115,000 and 180,000 pounds per square inch, respectively; elongations in 2 inches of 50 and 25 per cent, respectively; and Brinell hardnesses of 200 and 360, respectively.

Monel.—This general purpose alloy is corrosion-resistant, strong, tough and has a silvery-white color. It is used for making abrasion- and heat-resistant valves and pump parts, propeller shafts, laundry machines, chemical processing equipment, etc.

Approximate Composition: Nickel, 67; copper, 30; iron, 1.4; silicon, 0.1; manganese, 1; carbon, 0.15; and sulphur 0.01.

Average Physical Properties: Wrought Monel in the annealed, hot-rolled, cold-drawn, and hard temper cold-rolled conditions exhibits yield strengths (0.2 per cent offset) of 35,000, 50,000, 80,000, and 100,000 pounds per square inch, respectively; tensile strengths of 75,000, 90,000, 100,000, and 110,000 pounds per square inch, respectively; elongations in 2 inches of 40, 35, 25, and 5 per cent, respectively; and Brinell hardnesses of 125, 150, 190, and 240, respectively.

“R” Monel.—This free-cutting, corrosion resistant alloy is used for automatic screw machine products such as bolts, screws and precision parts.

Approximate Composition: Nickel, 67; copper, 30; iron, 1.4; silicon, 0.05; manganese, 1; carbon, 0.15; and sulphur, 0.035.

Average Physical Properties: In the hot-rolled and cold-drawn conditions this alloy exhibits yield strengths (0.2 per cent offset) of 45,000 and 75,000 pounds per square inch, respectively; tensile strengths of 85,000 and 90,000 pounds per square inch, respectively; elongations in 2 inches of 35, and 25 per cent, respectively; and Brinell hardnesses of 145 and 180, respectively.

“K” Monel.—This strong and hard alloy, comparable to heat-treated alloy steel, is age-hardenable, non-magnetic and has low-sparking properties. It is used for corrosive applications where the material is to be machined or formed, then age hardened. Pump and valve parts, scrapers, and instrument parts are made from this alloy.

Approximate Composition: Nickel, 66; copper, 29; iron, 0.9; aluminum, 2.75; silicon, 0.5; manganese, 0.75; carbon, 0.15; and sulphur, 0.005.

Average Physical Properties: In the hot-rolled, hot-rolled and age-hardened, cold-drawn, and cold-drawn and age-hardened conditions the alloy exhibits yield strengths (0.2 per cent offset) of 45,000, 110,000, 85,000, and 115,000 pounds per square inch, respectively; tensile strengths of 100,000, 150,000, 115,000, and 155,000 pounds per square inch, respectively; elongations in 2 inches of 40, 25, 25, and 20 per cent, respectively; and Brinell hardnesses of 160, 280, 210, and 290, respectively.

“KR” Monel.—This strong, hard, age-hardenable and non-magnetic alloy is more readily machinable than “K” Monel. It is used for making valve stems, small parts for pumps, and screw machine products requiring an age-hardening material that is corrosion-resistant.

Approximate Composition: Nickel, 66; copper, 29; iron, 0.9; aluminum, 2.75; silicon, 0.5; manganese, 0.75; carbon, 0.28; and sulphur, 0.005.

Average Physical Properties: Essentially the same as “K” Monel.

“S” Monel.—This extra hard casting alloy is non-galling, corrosion-resisting, non-magnetic, age-hardenable and has low-sparking properties. It is used for gall-resistant pump and valve parts which have to withstand high temperatures, corrosive chemicals and severe abrasion.

Approximate Composition: Nickel, 63; copper, 30; iron, 2; silicon, 4; manganese, 0.75; carbon, 0.1; and sulphur, 0.015.

Average Physical Properties: In the annealed sand-cast, as-cast sand-cast, and age-hardened sand-cast conditions it exhibits yield strengths (0.2 per cent offset) of 70,000, 100,000, and 100,000 pounds per square inch, respectively; tensile strengths of 90,000, 130,000, and 130,000 pounds per square inch, respectively; elongations in 2 inches of and 3, 2, and 2 per cent, respectively; and Brinell hardnesses of 275, 320, and 350, respectively.

“H” Monel.—An extra hard casting alloy with good ductility, intermediate strength and hardness that is used for pumps, impellers and steam nozzles.

Approximate Composition: Nickel, 63; copper, 31; iron, 2; silicon, 3; manganese, 0.75; carbon, 0.1; and sulphur, 0.015.

Average Physical Properties: In the as-cast sand-cast condition this alloy exhibits a yield strength (0.2 per cent offset) of 60,000 pounds per square inch, a tensile strength of 100,000 pounds per square inch, an elongation in 2 inches of 15 per cent and a Brinell hardness of 210.

Nichrome.—“Nichrome” is the trade name of an alloy composed of nickel and chromium, which is practically non-corrosive and far superior to nickel in its ability to withstand high temperatures. Its melting point is about 1550 degrees C. (about 2800 degrees F.). Nichrome shows a remarkable resistance to sulphuric and lactic acids. In general, nichrome is adapted for annealing and carburizing boxes, heating retorts of various kinds, conveyor chains subjected to high temperatures, valves and valve seats of internal combustion engines, molds, plungers and conveyors for use in the working of glass, wire baskets or receptacles of other form that must resist the action of acids, etc. Nichrome may be used as a substitute for other materials, especially where there is difficulty from oxidation, pitting of surfaces, corrosion, change of form, or lack of strength at high temperatures. It can be used in electrically-heated appliances and resistance elements. Large plates of this alloy are used by some manufacturers for containers and furnace parts, and when perforated, as screens for use in chemical sifting and ore roasting apparatus, for services where temperatures between 1700 degrees F. and 2200 degrees F. are encountered.

Strength of Nichrome: The strength of a nichrome casting, when cold, varies from 45,000 to 50,000 pounds per square inch. The ultimate strength at 200 degrees F. is 94,000 pounds per square inch; at 400 degrees F., 91,000 pounds per square inch; at 600 degrees F., 59,000 pounds per square inch; and at 800 degrees F., 32,000 pounds per square inch. At a temperature of 1800 degrees F., nichrome has a tensile strength of about 30,000 pounds per square inch, and it is tough and will bend considerably before breaking, even when heated red or white hot.

Nichrome in Cast Iron: Because of the irregularity of the castings, the numerous cores required, and the necessity for sound castings, gray iron with a high silicon content has been the best cast iron available to the automotive industry. Attempts have been made to alloy this metal in such a way that the strength and hardness would be increased, but considerable difficulty has been experienced in obtaining uniform results. Nickel has been added to the cupola with success, but in the case of automotive castings, where a large quantity of silicon is present, the nickel has combined with the silicon in forming large flakes of graphite, which, of course, softens the product. To offset this, chromium has also been added, but it has been uncertain just what the chromium content of the poured mixture should be, as a considerable amount of the chromium oxidizes.

Nichrome (Grade B) may be added to the ladle to obtain chromium and nickel in definite controllable amounts. The analysis of this nichrome is, approximately: Nickel, 60 per cent; chromium, 12 per cent; and iron, 24 per cent. It is claimed that the process produces castings of closer grain, greater hardness, greater resistance to abrasion, increased durability, improved machinability, and decreased brittleness. Nichrome-processed iron is suitable for casting internal-combustion engine cylinders; electrical equipment, where a control of the magnetic properties is desired; cast-iron cams; iron castings of thin sections where machinability and durability are factors; electrical resistance grids; pistons; piston-rings; and water, steam, gas, and other valves.

Nickel Alloy for Resisting Acids.—The resistance of nickel to acids is considerably increased by an addition of tantalum. Ordinarily from 5 to 10 per cent may be added, but the resistance increases with an increasing percentage of tantalum. An alloy of nickel with 30 per cent tantalum, for example, can be boiled in aquaregia or any other acid without being affected. The alloy is claimed to be tough, easily rolled, capable of being hammered or drawn into wire. The nickel loses its magnetic quality when alloyed with tantalum. The alloy can be heated in the open air at a high temperature without oxidizing. The method of producing the alloy consists in mixing the two metals in a powdered form, compressing

them at high pressure, and bringing them to a high heat in a crucible or quartz tube in a vacuum. For general purposes, the alloy is too expensive.

Wood's Metal.—The composition of Wood's metal, which is a so-called "fusible metal," is as follows: 50 parts of bismuth, 25 parts of lead, 12.5 parts of tin and 12.5 parts of cadmium. The melting point of this alloy is from 66 to 71 degrees centigrade (151 to 160 degrees F. approximately).

Washed Metal.—Washed metal is a name used for cast iron from which most of the silicon and phosphorus have been removed, by the so-called "Bell-Krupp process," without removing much of the carbon contents, so that the metal still contains enough carbon (over 2.2 per cent) to be classified as cast iron.

Seasoning Steel and Cast Iron.—It is a well-known fact that hardened pieces of steel will undergo minute but measurable changes in form during a long period of time after the hardening has taken place. These changes are due to the internal stresses produced by the hardening process, which are slowly and gradually relieved. In order to eliminate slight inaccuracies which might result from these changes, steel used for gages and other tools requiring a high degree of accuracy is allowed to season before is finally ground and lapped to the finished dimensions. The time allowed for this seasoning varies considerably among different toolmakers and also depends upon the form of the work and the degree of accuracy which is necessary in the finished product. Some toolmakers rough-grind the hardened part quite close to the finished size and then allow it to season or "age" for three or four months, and, in some cases, a year or more. Castings will often change their shape slightly after being planed, especially if the planed surface represents a large proportion of the total surface. To prevent errors from such changes, castings are sometimes allowed to season for several weeks or months, after taking the roughing cuts and before finishing. A common method of avoiding the long seasoning period is to anneal the castings. Artificial seasoning is also applied to steel parts by subjecting them repeatedly to alternate heating and cooling.

Duronze.—An alloy of high resistance to wear and corrosion, composed of aluminum, copper, and silicon, with a tensile strength of 90,000 pounds per square inch. Developed for the manufacture of valve bushings for valves that must operate satisfactorily at high pressures and high temperatures without lubrication.

Aluminum Alloys, Wrought, Sheet.—*Physical Properties:* In the form of sheets, the tensile strength varies from 35,000 for soft temper to 62,000 pounds per square inch for heat-treated sheets, and the elongation in 2 inches from 12 to 18 per cent. The yield strength of a heat-treated sheet is about 40,000 pounds per square inch minimum.

Plow-steel Wire Rope.—The name "plow" steel originated in England and was applied to a strong grade of steel wire used in the construction of very strong ropes employed in the mechanical operation of plows. The name "plow" steel, however, has become a commercial trade name, and, applied to wire, simply means a high-grade open-hearth steel of a tensile strength in wire of from 200,000 to 260,000 pounds per square inch of sectional area. A strength of 200,000 pounds per square inch is obtained in wire about 0.200 inch in diameter. Plow steel when used for wire ropes has the advantage of combining lightness and great strength. It is a tough material, but not as pliable as crucible steel. The very highest grade of steel wire used for wire rope is made from special steels ranging in tensile strength in wire from 220,000 to 280,000 pounds per square inch of sectional area. This steel is especially useful when great strength, lightness, and abrasive resisting qualities are required.

Type Metal.—Antimony gives to metals the property of expansion on solidification, and hence, is used in type metal for casting type for the printing trades to insure completely filling the molds. Type metals are generally made with from 5 to 25 per cent of antimony, and with lead, tin and sometimes a small percentage of copper as the other alloying metals.

The compositions of a number of type metal alloys are as follows (figures given are percentages): lead 77.5, tin 6.5, antimony 16; lead 70, tin, 10, antimony 18, copper, 2; lead 63.2, tin 12, antimony 24, copper 0.8; lead 60.5, tin 14.5, antimony 24-25, copper 0.75; lead 60, tin 35, antimony 5; and lead 55.5, tin 40, antimony 4.5.

A high grade of type metal is composed of the following percentages: lead 50; tin 25; and antimony 25.

Vanadium Steel.— The two most marked characteristics of vanadium steel are its high tensile strength and its high elastic limit. Another equally important characteristic is its great resistance to shocks; vanadium steel is essentially a non-fatigue metal, and, therefore, does not become crystallized and break under repeated shocks like other steels. Tests of the various spring steels show that, when subjected to successive shocks for a considerable length of time, a crucible carbon-steel spring was broken by 125,000 alternations of the testing machine, while a chrome-vanadium steel spring withstood 5,000,000 alternations, remaining unbroken. Another characteristic of vanadium steel is its great ductility. Highly-tempered vanadium-steel springs may be bent sharply, in the cold state, to an angle of 90 degrees or more, and even straightened again, cold, without a sign of fracture; vanadium-steel shafts and axles may be twisted around several complete turns, in the cold state, without fracture. This property, combined with its great tensile strength, makes vanadium steel highly desirable for this class of work, as well as for gears which are subjected to heavy strains or shocks upon the teeth. Chromium gives to steel a brittle hardness which makes it very difficult to forge, machine, or work, but vanadium, when added to chrome-steel, reduces this brittle hardness to such an extent that it can be machined as readily as an 0.40-per-cent carbon steel, and it is much more easily. Vanadium steels ordinarily contain from 0.16 to 0.25 per cent of vanadium. Steels of this composition are especially adapted for springs, car axles, gears subjected to severe service, and for all parts which must withstand constant vibration and varying stresses. Vanadium steels containing chromium are used for many automobile parts, particularly springs, axles, driving-shafts, and gears.

Brass Forging, Advantages of.— Brass forgings average 50,000 pounds per square inch tensile strength, as compared with 20,000 to 30,000 pounds per square inch for brass castings. Forgings are made of virgin metal. It is impossible to make a porous forging; while with castings it is difficult to know whether they will leak or not. Forgings are never scrapped or tested for leaks. Forgings contain no sand to dull and wear out tools, and consequently, the life of tools used on forgings is many times longer than that of tools used on sand castings. Forgings are clean, and alike as to strength, shape or size. When chucked, they run true, and for this reason, less allowance for finish is required on a forging. Considerable saving can be shown on screw machine parts, where 30 per cent or more of the stock is turned into chips. If a part has a flange on it, or a hub on each side, it will be economical to forge it. Take the case of piano caster rollers made of bar stock; the bar stock costs \$150 for a thousand parts; if forged, the material costs approximately \$70 per thousand parts.

Wood

Lumber.—Lumber is the product of the saw and planing mill not further manufactured than by sawing, resawing, and passing lengthwise through a standard planing machine, cross-cutting to length and working. When not in excess of one-quarter inch thickness and intended for use as veneering it is classified as veneer. According to the Simplified Practice Recommendations promulgated by the National Bureau of Standards, lumber is classified by its principal use as: yard lumber, factory and shop lumber, and structural lumber.

Yard lumber is defined as lumber of all sizes and patterns which is intended for general building purposes. Its grading is based on intended use and is applied to each piece without reference to size and length when graded and without consideration to further manufacture. As classified by size it includes: strips, which are yard lumber less than 2 inches thick and less than 8 inches wide; boards, which are yard lumber less than 2 inches thick but 8

inches or more wide; dimension, which includes all yard lumber except strips, boards and timbers; and timbers, which are yard lumber of 5 or more inches in the least dimension.

Factory and shop lumber is defined as lumber intended to be cut up for use in further manufacture. It is graded on the basis of the percentage of the area which will produce a limited number of cuttings of a specified, or of a given minimum, size and quality.

Structural lumber is defined as lumber that is 2 or more inches thick and 4 or more inches wide, intended for use where working stresses are required. The grading of structural lumber is based on the strength of the piece and the use of the entire piece. As classified by size and use it includes *joists* and *planks*—lumber from 2 inches to but not including 5 inches thick, and 4 or more inches wide, of rectangular cross section and graded with respect to its strength in bending, when loaded either on the narrow face as joist or on the wide face as plank; *beams* and *stringers*—lumber of rectangular cross section 5 or more inches thick and 8 or more inches wide and graded with respect to its strength in bending when loaded on the narrow face; and *posts* and *timbers*—pieces of square or approximately square cross section 5 by 5 inches and larger and graded primarily for use as posts or columns carrying longitudinal load, but adapted to miscellaneous uses in which strength in bending is not especially important.

Lumber, Manufactured.—According to the Simplified Practice Recommendations promulgated by the National Bureau of Standards, lumber may be classified according to the extent which it is manufactured as:

Rough lumber which is lumber that is undressed as it comes from the saw.

Surfaced lumber which is lumber that is dressed by running it through a planer and may be surfaced on one or more sizes and edges.

Worked lumber which is lumber that has been run through a matching machine, sticker or molder and includes: *matched lumber* which has been worked to provide a close tongue-and-groove joint at the edges or, in the case of end-matched lumber, at the ends also; *ship-lapped lumber* which has been worked to provide a close rabbetted or lapped joint at the edges; and *patterned lumber* which has been shaped to a patterned or molded form.

Lumber Water Content.—The origin of lumber has a noticeable effect on its water content. Lumber or veneer (thin lumber produced usually by rotary cutting or flat slicing, sometimes by sawing), when produced from the log, contains a large proportion of water, ranging from 25 to 75 per cent of the total weight. One square foot (board measure, one inch thick) of gum lumber, weighing approximately five pounds when sawed, will be reduced to about three pounds when its water content of approximately one quart has been evaporated. Oak grown on a hillside may contain only a pint (approximately 1 lb.) and swamp gum may have from 2 to 4 pints of water per square foot, board measure. This water content of wood exists in two forms—free moisture and cell moisture. The former is readily evaporable in ordinary air drying, but the latter requires extensive air drying (several years) or artificial treatment in kilns. It is possible to use artificial means to remove the free moisture, but a simple air exposure is usually more economical.

Wood Seasoning Processes.—There have been differences of opinion as to whether kiln-dried wood is as strong as wood that has been air-dried. In order to determine the relative properties, the Forest Products Laboratory of the United States Forest Service at Madison, Wis., made some 150,000 comparative strength tests on specimens from twenty-eight different common species of wood. The results of these experiments showed conclusively that good kiln-drying and good air-drying have the same effect upon the strength of wood. The belief that kiln-drying produces stronger wood than air-drying is usually the result of failure to consider differences in moisture content. The moisture content of wood, on leaving the kiln, is usually from 2 to 6 per cent lower than that of thoroughly air-dried stock. Since wood increases in strength with loss of moisture, higher strength values may be obtained from kiln-dried than from air-dried wood; but this difference in strength has no

practical significance, since eventually a piece of wood will come to approximately the same moisture condition, whether it is kiln-dried or air-dried.

Wood Life.—The life of wooden poles for transmission lines varies according to the kind of wood, rapidity of growth, amount of sap at time of cutting, and seasoning after cutting. The following figures, based on a large number of observations, indicate the average life of untreated poles: Cedar, 13 to 14 years; chestnut, 11 to 12 years; cypress, 9 to 10 years; juniper, 8 to 9 years; pine, 6 to 7 years. Poles cut during the winter months when the sap is low always have a longer life than those cut in summer when the sap is up. The proper seasoning of poles also has a great influence on their life. They should be trimmed and peeled immediately after being cut, and should be supported on skids in separate layers for a period of from six months to a year, so that they will be thoroughly air-dried. It is now almost universal practice to give the butts of the poles and sometimes the cross-arms and tops a preservative treatment. Often the entire pole is treated. There are a number of different preservative materials that may be used. The principal of these is dead oil of coal tar or so-called “coal-tar creosote.” This is a distillate obtained from coal tar at temperatures ranging from 400 to 750 degrees F. Coal tar itself is a distillate by-product obtained in the manufacture of coal gas and coke at temperatures of from 1500 to 3000 degrees F. Coal tar is of little use as a wood preservative, but the creosotes are of great value.

Creosoting Processes: Different methods are used for applying creosotes or other preservatives to wood poles. In the closed-tank method, the poles are placed in a large tank and steamed for from five to eight hours; a partial vacuum is then applied, after which the creosote is run in at a temperature of from 140 to 175 degrees F. under sufficient pressure to obtain the amount of absorption desired. In the open-tank creosoting process, usually applied to the butts of poles only, the poles are placed in an inclined or vertical position with the butts immersed in the creosote, which is kept at a temperature of about 220 degrees F., for about six hours. The bath is then allowed to cool, and after it has fallen to 110 degrees F., the poles may be removed; or the poles may be changed to a cold bath (110 to 150 degrees F.) and allowed to remain for several hours. During the period of the warm bath, the air and moisture in the cells of the wood are driven out, and during the period of cooling off, the creosote enters the cells and remains there. By the open-tank method it is not possible to impregnate the wood to the same depth as with the closed-tank or pressure method. The treatment is, however, worth while, and the United States Forest Service estimates the useful life to be approximately twenty years for chestnut and western cedar, twenty-two years for northern white cedar, and twenty years for pine in the dry climate of western United States. In this connection, it should be mentioned that in poles with treated butts, it is the upper part of the poles that will decay first and govern the life of the pole. In the so-called “brush treatment,” the preservative is applied with a brush. This practice is sometimes modified by pouring or spraying the preservative on the poles.

Kyanizing: Kyanizing is a treatment applied to wood to render it proof against decay, by saturating it with a solution of corrosive sublimate (mercuric chloride, HgCl_2). The saturating is done either in open tanks or under pressure in closed tanks.

Balsa.—Balsa, one of the commonest trees in the forests of Costa Rica, is said to be the lightest of all known woods, weighing but 7.3 pounds per cubic foot. Ordinary cork is three times as heavy as Balsa wood. This wood is very soft, and can be readily indented with the finger nail. It absorbs water readily, but it may be treated with paraffin, and then used in making floats for life preservers and in the construction of life rafts. It is also used for buoys and floating attachments to light signals.

Cork.—Cork is obtained from the outer layer of the bark of an evergreen species of oak, growing in the south of Europe and on the north coast of Africa. Water and many liquids have no deteriorating effect upon cork, and it may be compressed many thousand times without changing its molecular structure. An important application of cork is for cork inserts in friction clutches, owing to the fact that cork has a high coefficient of friction,

probably double that of wood or leather on iron. As a rule, the cork, which has previously been boiled and softened, is forced into holes formed in one of the metallic friction surfaces so that it slightly protrudes above the surface. When the clutch is engaged, the cork will engage the opposing friction surface first, but if sufficient pressure is applied to the clutch, the cork is pressed down flush with the metal surface and acts with it in carrying the load. The coefficient of friction with cork-insert surfaces has been found to average about 0.34, while the average coefficient of friction of cast iron on cast iron is about 0.16, and of bronze on cast iron, about 0.14.

Pressure and Flow of Water

Water Pressure.—Water is composed of two elements, hydrogen and oxygen, in the ratio of two volumes of hydrogen to one of oxygen. In the common system of measure, water boils under atmospheric pressure at 212 degrees F and freezes at 32 degrees F. Water’s greatest density is 62.425 pounds per cubic foot, at 39.1 degrees F. In metric (SI) measure, water boils under atmospheric pressure at 100°C (Celsius) and freezes at 0°C. Its density is equal to 1 kilogram per liter, where 1 liter is 1 cubic decimeter. Also in metric SI, pressure is given in pascals (Pa) or the equivalent newtons per square meter. See page 2656 for additional information on the metric (SI) system of units.

For higher temperatures, the pressure slightly decreases in the proportion indicated by the table *Density of Water at Different Temperatures*. The pressure per square inch is equal in all directions, downwards, upwards, and sideways. Water can be compressed only to a very slight degree, the compressibility being so slight that even at the depth of a mile, a cubic foot of water weighs only about one-half pound more than at the surface.

Pressure in Pounds per Square Inch for Different Heads of Water

Head, ft	0	1	2	3	4	5	6	7	8	9
0	...	0.43	0.87	1.30	1.73	2.16	2.60	3.03	3.46	3.90
10	4.33	4.76	5.20	5.63	6.06	6.49	6.93	7.36	7.79	8.23
20	8.66	9.09	9.53	9.96	10.39	10.82	11.26	11.69	12.12	12.56
30	12.99	13.42	13.86	14.29	14.72	15.15	15.59	16.02	16.45	16.89
40	17.32	17.75	18.19	18.62	19.05	19.48	19.92	20.35	20.78	21.22
50	21.65	22.08	22.52	22.95	23.38	23.81	24.25	24.68	25.11	25.55
60	25.98	26.41	26.85	27.28	27.71	28.14	28.58	29.01	29.44	29.88
70	30.31	30.74	31.18	31.61	32.04	32.47	32.91	33.34	33.77	34.21
80	34.64	35.07	35.51	35.94	36.37	36.80	37.24	37.67	38.10	38.54
90	38.97	39.40	39.84	40.27	40.70	41.13	41.57	42.00	42.43	42.87

Heads of Water in Feet Corresponding to Certain Pressures in Pounds per Square Inch

Pressure, lb/in ²	0	1	2	3	4	5	6	7	8	9
0	...	2.3	4.6	6.9	9.2	11.5	13.9	16.2	18.5	20.8
10	23.1	25.4	27.7	30.0	32.3	34.6	36.9	39.3	41.6	43.9
20	46.2	48.5	50.8	53.1	55.4	57.7	60.0	62.4	64.7	67.0
30	69.3	71.6	73.9	76.2	78.5	80.8	83.1	85.4	87.8	90.1
40	92.4	94.7	97.0	99.3	101.6	103.9	106.2	108.5	110.8	113.2
50	115.5	117.8	120.1	122.4	124.7	127.0	129.3	131.6	133.9	136.3
60	138.6	140.9	143.2	145.5	147.8	150.1	152.4	154.7	157.0	159.3
70	161.7	164.0	166.3	168.6	170.9	173.2	175.5	177.8	180.1	182.4
80	184.8	187.1	189.4	191.7	194.0	196.3	198.6	200.9	203.2	205.5
90	207.9	210.2	212.5	214.8	217.1	219.4	221.7	224.0	226.3	228.6

Volumes of Water at Different Temperatures

Degrees F	Volume	Degrees F	Volume	Degrees F	Volume	Degrees F	Volume
39.1	1.00000	86	1.00425	131	1.01423	176	1.02872
50	1.00025	95	1.00586	140	1.01678	185	1.03213
59	1.00083	104	1.00767	149	1.01951	194	1.03570
68	1.00171	113	1.00967	158	1.02241	203	1.03943
77	1.00286	122	1.01186	167	1.02548	212	1.04332

Density of Water at Different Temperatures

Temp. (°F)	Wt. per Cu Ft (lb/ft ³)	Temp. (°F)	Wt. per Cu Ft (lb/ft ³)	Temp. (°F)	Wt. per Cu Ft (lb/ft ³)	Temp. (°F)	Wt. per Cu Ft (lb/ft ³)	Temp. (°F)	Wt. per Cu Ft (lb/ft ³)	Temp. (°F)	Wt. per Cu Ft (lb/ft ³)
32	62.42	130	61.56	220	59.63	320	56.66	420	52.6	520	47.6
40	62.42	140	61.37	230	59.37	330	56.30	430	52.2	530	47.0
50	62.41	150	61.18	240	59.11	340	55.94	440	51.7	540	46.3
60	62.37	160	60.98	250	58.83	350	55.57	450	51.2	550	45.6
70	62.31	170	60.77	260	58.55	360	55.18	460	50.7	560	44.9
80	62.23	180	60.55	270	58.26	370	54.78	470	50.2	570	44.1
90	62.13	190	60.32	280	57.96	380	54.36	480	49.7	580	43.3
100	62.02	200	60.12	290	57.65	390	53.94	490	49.2	590	42.6
110	61.89	210	59.88	300	57.33	400	53.50	500	48.7	600	41.8
120	61.74	212	59.83	310	57.00	410	53.00	510	48.1

Table of Horsepower due to Certain Head of Water

Head in Feet	Horse-power	Head in Feet	Horse-power	Head in Feet	Horse-power	Head in Feet	Horse-power	Head in Feet	Horse-power
1	0.0016	170	0.274	340	0.547	520	0.837	1250	2.012
10	0.0161	180	0.290	350	0.563	540	0.869	1300	2.093
20	0.0322	190	0.306	360	0.580	560	0.901	1350	2.173
30	0.0483	200	0.322	370	0.596	580	0.934	1400	2.254
40	0.0644	210	0.338	380	0.612	600	0.966	1450	2.334
50	0.0805	220	0.354	390	0.628	650	1.046	1500	2.415
60	0.0966	230	0.370	400	0.644	700	1.127	1550	2.495
70	0.1127	240	0.386	410	0.660	750	1.207	1600	2.576
80	0.1288	250	0.402	420	0.676	800	1.288	1650	2.656
90	0.1449	260	0.418	430	0.692	850	1.368	1700	2.737
100	0.1610	270	0.435	440	0.708	900	1.449	1750	2.818
110	0.1771	280	0.451	450	0.724	950	1.529	1800	2.898
120	0.1932	290	0.467	460	0.740	1000	1.610	1850	2.978
130	0.2093	300	0.483	470	0.757	1050	1.690	1900	3.059
140	0.2254	310	0.499	480	0.773	1100	1.771	1950	3.139
150	0.2415	320	0.515	490	0.789	1150	1.851	2000	3.220
160	0.2576	330	0.531	500	0.805	1200	1.932	2100	3.381

The table gives the horsepower of 1 cubic foot of water per minute, and is based on an efficiency of 85 per cent.

Flow of Water in Pipes.—The quantity of water that will flow through a pipe depends primarily on the head but also on the diameter of the pipe, the character of the interior surface, and the number and shape of the bends. The head may be either the distance between the levels of the surface of water in a reservoir and the point of discharge, or it may be caused by mechanically applied pressure, as by pumping, when the head is calculated as the vertical distance corresponding to the pressure.

One pound per square inch is equal to 2.309 feet head, and a 1-foot head is equal to a pressure of 0.433 pound per square inch.

All formulas for finding the amount of water that will flow through a pipe in a given time are approximate. The formula that follows will give results within 5 or 10 per cent of actual flows, if applied to pipe lines carefully laid and in fair condition.

$$V = C \sqrt{\frac{hD}{L + 54D}}$$

where V = approximate mean velocity in feet per second; C = coefficient from the accompanying table; D = diameter of pipe in feet; h = total head in feet; and, L = total length of pipe line in feet.

Values of Coefficient C

Dia. of Pipe		C	Dia. of Pipe		C	Dia. of Pipe		C
Feet	Inches		Feet	Inches		Feet	Inches	
0.1	1.2	23	0.8	9.6	46	3.5	42	64
0.2	2.4	30	0.9	10.8	47	4.0	48	66
0.3	3.6	34	1.0	12.0	48	5.0	60	68
0.4	4.8	37	1.5	18.0	53	6.0	72	70
0.5	6.0	39	2.0	24.0	57	7.0	84	72
0.6	7.2	42	2.5	30.0	60	8.0	96	74
0.7	8.4	44	3.0	36.0	62	10.0	120	77

Example: A pipe line, 1 mile long, 12 inches in diameter, discharges water under a head of 100 feet. Find the velocity and quantity of discharge.

From the table, the coefficient C is found to be 48 for a pipe 1 foot in diameter, hence:

$$V = 48 \sqrt{\frac{100 \times 1}{5280 + 54 \times 1}} = 6.57 \text{ feet per second}$$

To find the discharge in cubic feet per second, multiply the velocity found by the area of cross-section of the pipe in square feet:

$$6.57 \times 0.7854 = 5.16 \text{ cubic feet per second}$$

The loss of head due to a bend in the pipe is most frequently given as the equivalent length of straight pipe, which would cause the same loss in head as the bend. Experiments show that a right-angle bend should have a radius of about three times the diameter of the pipe. Assuming this curvature, then, if d is the diameter of the pipe in inches and L is the length of straight pipe in feet that causes the same loss of head as the bend in the pipe, the following formula gives the equivalent length of straight pipe that should be added to simulate a right-angle bend:

$$L = 4d \div 3$$

Thus, the loss of head due to a right-angle bend in a 6-inch pipe would be equal to that in 8 feet of straight pipe. Experiments undertaken to determine the losses due to valves in pipe lines indicate that a fully open gate valve in a pipe causes a loss of head corresponding to the loss in a length of pipe equal to six diameters.

Pipe Expansion Due to Temperature Changes.—The expansion for any length of pipe caused by a given temperature change can be determined from the following table. Find the expansion factor corresponding to the expected difference in the minimum and maximum pipe temperatures and divide by 100 to obtain the increase in length per foot of pipe. Multiply the increase per foot result by the length of the pipe run to get the total change in pipe length.

Linear Expansion and Contraction Factors per 100 Feet of Pipe

Temperature Change, °F	Pipe Material				
	Steel	Copper	PVC	FRP	PP & PVDF
0	0	0	0	0	0
20	0.15	0.25	0.62	0.26	2.00
40	0.30	0.45	1.30	0.52	4.00
60	0.46	0.65	2.20	0.78	6.00
80	0.61	0.87	2.80	1.05	8.00
100	0.77	1.10	3.50	1.31	10.00
120	0.92	1.35	4.25	1.57	12.00
140	1.08	1.57	4.80	1.83	14.00
160	1.24	1.77	5.50	2.09	16.00
180	1.40	2.00	6.30	2.35	18.00
200	1.57	2.25	7.12	2.62	20.00

Multiply the length of pipe by the table factor and divide by 100 for the increase or decrease in length.

Gallons of Water per Foot of Pipe

Nominal Pipe Size (in.)	Iron or Steel		Copper		
	Sched. 40	Sched. 80	Type K	Type L	Type M
1/8	0.0030	0.0019	0.0014	0.0016	0.0016
1/4	0.0054	0.0037	0.0039	0.0040	0.0043
3/8	0.0099	0.0073	0.0066	0.0075	0.0083
1/2	0.0158	0.0122	0.0113	0.0121	0.0132
5/8	0.0173	0.0181	0.0194
3/4	0.0277	0.0225	0.0226	0.0251	0.0268
1	0.0449	0.0374	0.0404	0.0429	0.0454

Multiply the length of pipe in feet by the factor from the table to find the volume contained in gallons.

Friction Loss in Fittings—Equivalent Length of Pipe in Feet

Nominal Pipe Size (in.)	Elbows					Standard Tee		
	90° Std.	45° Std.	90° Long Radius	90° Street	45° Street	Square Corner	Flow thru Run	Flow thru Branch
1/4	0.9	0.5	0.6	1.5	0.8	1.7	0.6	1.8
1/2	1.6	0.8	1.0	2.6	1.3	3.0	1.0	4.0
3/4	2.1	1.1	1.4	3.4	1.8	3.9	1.4	5.1
1	2.6	1.4	1.7	4.4	2.3	5.0	1.7	6.0
1 1/4	3.5	1.8	2.3	5.8	3.0	6.5	2.3	6.9
1 1/2	4.0	2.1	2.7	6.7	3.5	7.6	2.7	8.1
2	5.5	2.8	4.3	8.6	4.5	9.8	4.3	12.0
2 1/2	6.2	3.3	5.1	10.3	5.4	11.7	5.1	14.3
3	7.7	4.1	6.3	12.8	6.6	14.6	6.3	16.3
4	10.1	5.4	8.3	16.8	8.7	19.1	8.3	22.1
6	15.2	8.1	12.5	25.3	13.1	28.8	12.5	32.2
8	20.0	10.6	16.5	33.3	17.3	37.9	16.5	39.9
10	25.1	13.4	20.7	41.8	21.7	47.6	20.7	50.1
12	29.8	15.9	24.7	49.7	25.9	56.7	24.7	59.7

Flow of Water Through Nozzles in Cubic Feet per Second

Head in Feet, at Nozzle	Pressure, lb/in ²	Theoretical Velocity, ft/s	Diameter of Nozzle, Inches							
			1	1.5	2	2.5	3	3.5	4	4.5
5	2.17	17.93	0.10	0.22	0.39	0.61	0.88	1.20	1.56	1.98
10	4.33	25.36	0.14	0.31	0.55	0.86	1.24	1.69	2.21	2.80
20	8.66	35.87	0.20	0.44	0.78	1.22	1.76	2.40	3.13	3.96
30	12.99	43.93	0.24	0.54	0.96	1.50	2.16	2.93	3.83	4.85
40	17.32	50.72	0.28	0.62	1.11	1.73	2.49	3.39	4.43	5.60
50	21.65	56.71	0.31	0.70	1.24	1.93	2.78	3.79	4.95	6.26
60	25.99	62.12	0.34	0.76	1.36	2.12	3.05	4.15	5.42	6.86
70	30.32	67.10	0.37	0.82	1.46	2.29	3.29	4.48	5.86	7.41
80	34.65	71.73	0.39	0.88	1.56	2.45	3.52	4.79	6.26	7.92
90	38.98	76.08	0.41	0.93	1.66	2.59	3.73	5.08	6.64	8.40
100	43.31	80.20	0.44	0.98	1.75	2.73	3.94	5.36	7.00	8.86
120	51.97	87.85	0.48	1.08	1.92	2.99	4.31	5.87	7.67	9.70
140	60.63	94.89	0.52	1.16	2.07	3.23	4.66	6.34	8.28	10.48
160	69.29	101.45	0.55	1.24	2.21	3.46	4.98	6.78	8.85	11.20
180	77.96	107.60	0.59	1.32	2.35	3.67	5.28	7.19	9.39	11.88
200	86.62	113.42	0.62	1.39	2.47	3.87	5.57	7.58	9.90	12.53
250	108.27	126.81	0.69	1.56	2.77	4.32	6.22	8.47	11.07	14.01
300	129.93	138.91	0.76	1.70	3.03	4.74	6.82	9.28	12.12	15.34
350	151.58	150.04	0.82	1.84	3.27	5.11	7.37	10.02	13.09	16.57
400	173.24	160.40	0.87	1.97	3.50	5.47	7.87	10.72	14.00	17.72
450	194.89	170.13	0.93	2.09	3.71	5.80	8.35	11.37	14.85	18.79
500	216.54	179.33	0.98	2.20	3.91	6.11	8.80	11.98	15.65	19.81
Head in Feet, at Nozzle	Pressure, lb/in ²	Theoretical Velocity, ft/s	Diameter of Nozzle, Inches							
			5	6	7	8	9	10	11	12
5	2.17	17.93	2.45	3.52	4.79	6.3	7.9	9.8	11.8	14.1
10	4.33	25.36	3.46	4.98	6.78	8.9	11.2	13.8	16.7	19.9
20	8.66	35.87	4.89	7.04	9.59	12.5	15.8	19.6	23.7	28.2
30	12.99	43.93	5.99	8.63	11.74	15.3	19.4	24.0	29.0	34.5
40	17.32	50.72	6.92	9.96	13.56	17.7	22.4	27.7	33.5	39.8
50	21.65	56.71	7.73	11.13	15.16	19.8	25.1	30.9	37.4	44.5
60	25.99	62.12	8.47	12.20	16.60	21.7	27.4	33.9	41.0	48.8
70	30.32	67.10	9.15	13.18	17.93	23.4	29.6	36.6	44.3	52.7
80	34.65	71.73	9.78	14.08	19.17	25.0	31.7	39.1	47.3	56.3
90	38.98	76.08	10.37	14.94	20.33	26.6	33.6	41.5	50.2	59.8
100	43.31	80.20	10.94	15.75	21.43	28.0	35.4	43.7	52.9	63.0
120	51.97	87.85	11.98	17.25	23.48	30.7	38.8	47.9	58.0	69.0
140	60.63	94.89	12.94	18.63	25.36	33.1	41.9	51.8	62.6	74.5
160	69.29	101.45	13.83	19.92	27.11	35.4	44.8	55.3	66.9	79.7
180	77.96	107.60	14.67	21.13	28.76	37.6	47.5	58.7	71.0	84.5
200	86.62	113.42	15.47	22.27	30.31	39.6	50.1	61.9	74.9	89.1
250	108.27	126.81	17.29	24.90	33.89	44.3	56.0	69.2	83.7	99.6
300	129.93	138.91	18.94	27.27	37.12	48.5	61.4	75.8	91.7	109.1
350	151.58	150.04	20.46	29.46	40.10	52.4	66.3	81.8	99.0	117.8
400	173.24	160.40	21.87	31.49	42.87	56.0	70.9	87.5	105.9	126.0
450	194.89	170.13	23.20	33.40	45.47	59.4	75.2	92.8	112.3	133.6
500	216.54	179.33	24.45	35.21	47.93	62.6	79.2	97.8	118.4	140.8

Theoretical Velocity of Water Due to Head in Feet

Head in Feet	Theoretical Velocity		Head in Feet	Theoretical Velocity		Head in Feet	Theoretical Velocity	
	ft/s	ft/min		ft/s	ft/min		ft/s	ft/min
1	8.01	481	48	55.56	3334	95	78.16	4690
2	11.34	681	49	56.13	3368	96	78.57	4715
3	13.89	833	50	56.70	3403	97	78.98	4739
4	16.04	962	51	57.27	3436	98	79.39	4764
5	17.93	1076	52	57.83	3470	99	79.79	4788
6	19.64	1179	53	58.38	3503	100	80.19	4812
7	21.21	1273	54	58.93	3536	105	82.18	4931
8	22.68	1361	55	59.47	3569	110	84.11	5047
9	24.05	1444	56	60.01	3601	115	86.00	5160
10	25.36	1522	57	60.54	3633	120	87.85	5271
11	26.59	1596	58	61.07	3665	125	89.66	5380
12	27.78	1667	59	61.60	3696	130	91.44	5487
13	28.91	1735	60	62.12	3727	135	93.18	5591
14	30.00	1800	61	62.63	3758	140	94.89	5694
15	31.06	1864	62	63.14	3789	145	96.57	5794
16	32.07	1925	63	63.65	3819	150	98.22	5893
17	33.06	1984	64	64.15	3850	155	99.84	5991
18	34.02	2042	65	64.65	3880	160	101.44	6087
19	34.95	2097	66	65.15	3909	165	103.01	6181
20	35.86	2152	67	65.64	3939	170	104.56	6274
21	36.75	2205	68	66.13	3968	175	106.09	6366
22	37.61	2257	69	66.61	3997	180	107.59	6456
23	38.46	2308	70	67.09	4026	185	109.08	6545
24	39.28	2357	71	67.57	4055	190	110.54	6633
25	40.09	2406	72	68.05	4083	195	111.99	6720
26	40.89	2454	73	68.52	4111	200	113.42	6805
27	41.67	2500	74	68.99	4139	205	114.82	6890
28	42.43	2546	75	69.45	4167	210	116.22	6973
29	43.18	2591	76	69.91	4195	215	117.59	7056
30	43.92	2636	77	70.37	4222	220	118.95	7137
31	44.65	2679	78	70.83	4250	225	120.30	7218
32	45.36	2722	79	71.28	4277	230	121.62	7298
33	46.07	2764	80	71.73	4304	235	122.94	7377
34	46.76	2806	81	72.17	4331	240	124.24	7455
35	47.44	2847	82	72.62	4357	245	125.53	7532
36	48.11	2887	83	73.06	4384	250	126.80	7608
37	48.78	2927	84	73.50	4410	255	128.06	7684
38	49.43	2966	85	73.94	4436	260	129.31	7759
39	50.08	3005	86	74.37	4462	270	131.78	7907
40	50.72	3043	87	74.80	4488	280	134.20	8052
41	51.35	3081	88	75.23	4514	290	136.57	8195
42	51.97	3119	89	75.66	4540	300	138.91	8335
43	52.59	3155	90	76.08	4565	310	141.20	8472
44	53.19	3192	91	76.50	4590	320	143.46	8608
45	53.79	3228	92	76.92	4615	330	145.69	8741
46	54.39	3264	93	77.34	4641	340	147.88	8873
47	54.98	3299	94	77.75	4665	350	150.04	9002

Buoyancy.—A body submerged in water or other fluid will lose in weight an amount equal to the weight of the fluid displaced by the body. This is known as the principle of Archimedes.

Example, Weight of a Submerged Body: To illustrate, suppose the upper surface of a 10-inch cube is 20 inches below the surface of the water. The total downward pressure on the upper side of this cube will equal the area of the top surface of the cube, in square inches, multiplied by the product of the depth, in inches, to which the surface is submerged and the weight of 1 cubic inch of water.

Thus, the

weight of 1 cubic inch of water: 0.03617 pounds

downward pressure: $10 \times 10 \times 20 \times 0.03617 = 72.34$ pounds

upward pressure on the under side: $10 \times 10 \times 30 \times 0.03617 = 108.51$ pounds

weight of the water displaced by the body: $10 \times 10 \times 10 \times 0.03617 = 36.17$ pounds

upward pressure – downward pressure: $108.51 - 72.34 = 36.17$ pounds

This excess of upward pressure explains why it is comparatively easy to lift a submerged stone or other body.

Water-Wheel.—A water-wheel or water turbine may be defined as a prime mover in which the potential energy of a body of water is transformed into mechanical work. The water-wheel, also commonly called a hydraulic motor, is in its various forms one of the simplest devices for the development of power.

Hydraulic motors may be divided into three general classes:

1) Current and gravity wheels, which utilize either the impact of the current or the weight of the water.

2) Impulse wheels and turbines, which utilize the kinetic energy of a jet at high velocity. These are commonly employed in connection with a limited volume of water under a high head, which, in practice, may vary from 300 to 3000 feet.

3) Reaction turbines, which utilize both the kinetic energy and the pressure of the water. These are employed for conditions the reverse of those under (2), that is, with a large volume of water under a low or medium head. In practice, reaction turbines are used under heads ranging from 5 to 500 feet.

The available power in any given case depends upon the fall or head, and the volume of water. In case the water is utilized for the development of power by passing through a water motor, the efficiency of the latter must be taken into consideration. For approximate work, it is customary to assume an efficiency of 80 per cent, in which case the delivered or brake horsepower may be determined as follows: Multiply the cubic feet of water passing through the motor per minute, by the head, in feet; then divide the product by 661.

Properties, Compression, and Flow of Air

Properties of Air.—Air is a mechanical mixture composed of 78 per cent of nitrogen, 21 per cent of oxygen, and 1 per cent of argon, by volume. The density of dry air at 32 degrees F and atmospheric pressure (29.92 inches of mercury or 14.70 pounds per square inch) is 0.08073 pound per cubic foot. The density of air at any other temperature or pressure is

$$\rho = \frac{1.325 \times B}{T}$$

in which ρ = density in pounds per cubic foot; B = height of barometric pressure in inches of mercury; T = absolute temperature in degrees Rankine. (When using pounds as a unit, here and elsewhere, care must be exercised to differentiate between pounds mass and pounds force. See *Acceleration of Gravity g Used in Mechanics Formulas* on page 150 and *The Use of the Metric SI System in Mechanics Calculations* on page 150.)

Volumes and Weights of Air at Different Temperatures, at Atmospheric Pressure

Temperature, °F	Volume of 1 lb of Air in Cubic Feet	Density, Pounds per Cubic Foot	Temperature, °F	Volume of 1 lb of Air in Cubic Feet	Density, Pounds per Cubic Foot	Temperature, °F	Volume of 1 lb of Air in Cubic Feet	Density, Pounds per Cubic Foot
0	11.57	0.0864	172	15.92	0.0628	800	31.75	0.0315
12	11.88	0.0842	182	16.18	0.0618	900	34.25	0.0292
22	12.14	0.0824	192	16.42	0.0609	1000	37.31	0.0268
32	12.39	0.0807	202	16.67	0.0600	1100	39.37	0.0254
42	12.64	0.0791	212	16.92	0.0591	1200	41.84	0.0239
52	12.89	0.0776	230	17.39	0.0575	1300	44.44	0.0225
62	13.14	0.0761	250	17.89	0.0559	1400	46.95	0.0213
72	13.39	0.0747	275	18.52	0.0540	1500	49.51	0.0202
82	13.64	0.0733	300	19.16	0.0522	1600	52.08	0.0192
92	13.89	0.0720	325	19.76	0.0506	1700	54.64	0.0183
102	14.14	0.0707	350	20.41	0.0490	1800	57.14	0.0175
112	14.41	0.0694	375	20.96	0.0477	2000	62.11	0.0161
122	14.66	0.0682	400	21.69	0.0461	2200	67.11	0.0149
132	14.90	0.0671	450	22.94	0.0436	2400	72.46	0.0138
142	15.17	0.0659	500	24.21	0.0413	2600	76.92	0.0130
152	15.41	0.0649	600	26.60	0.0376	2800	82.64	0.0121
162	15.67	0.0638	700	29.59	0.0338	3000	87.72	0.0114

The absolute zero from which all temperatures must be counted when dealing with the weight and volume of gases is assumed to be -459.7 degrees F. Hence, to obtain the absolute temperature T used in preceding formula, add the value 459.7 to the temperature observed on a regular Fahrenheit thermometer.

In obtaining the value of B , 1 inch of mercury at 32 degrees F may be taken as equal to a pressure of 0.491 pound per square inch.

Example 1: What would be the weight of a cubic foot of air at atmospheric pressure (29.92 inches of mercury) at 100 degrees F? The weight, W , is given by $W = \rho V$.

$$W = \rho V = \frac{1.325 \times 29.92}{100 + 459.7} \times 1 = 0.0708 \text{ pound}$$

Wind Pressures.—Wind pressures per square foot for different wind velocities in miles per hour are as follows: Fresh breeze of 10 miles per hour, pressure 0.4 pound; stiff breeze of 20 miles per hour, pressure 1.6 pounds; strong wind of 30 miles per hour, pressure 3.6 pounds; high wind of 40 miles per hour, pressure 6.4 pounds; storm with velocity of 50 miles per hour, pressure 10 pounds; violent storm with velocity of 60 miles per hour, pressure 14.4 pounds; hurricane with velocity of 80 miles per hour, pressure 25.6 pounds; violent hurricane with velocity of 100 miles per hour, pressure 40 pounds per square foot. The foregoing figures are based on data obtained by the U. S. Signal Service at Mt. Washington, N. H.

Density of Air at Different Pressures and Temperatures

Temp. of Air, °F	Gage Pressure, Pounds														
	0	5	10	20	30	40	50	60	80	100	120	150	200	250	300
	Density in Pounds per Cubic Foot														
-20	0.0900	0.1205	0.1515	0.2125	0.274	0.336	0.397	0.458	0.580	0.702	0.825	1.010	1.318	1.625	1.930
-10	0.0882	0.1184	0.1485	0.2090	0.268	0.328	0.388	0.448	0.567	0.687	0.807	0.989	1.288	1.588	1.890
0	0.0864	0.1160	0.1455	0.2040	0.263	0.321	0.380	0.438	0.555	0.672	0.790	0.968	1.260	1.553	1.850
10	0.0846	0.1136	0.1425	0.1995	0.257	0.314	0.372	0.429	0.543	0.658	0.774	0.947	1.233	1.520	1.810
20	0.0828	0.1112	0.1395	0.1955	0.252	0.307	0.364	0.420	0.533	0.645	0.757	0.927	1.208	1.489	1.770
30	0.0811	0.1088	0.1366	0.1916	0.246	0.301	0.357	0.412	0.522	0.632	0.742	0.908	1.184	1.460	1.735
40	0.0795	0.1067	0.1338	0.1876	0.241	0.295	0.350	0.404	0.511	0.619	0.727	0.890	1.161	1.431	1.701
50	0.0780	0.1045	0.1310	0.1839	0.237	0.290	0.343	0.396	0.501	0.607	0.713	0.873	1.139	1.403	1.668
60	0.0764	0.1025	0.1283	0.1803	0.232	0.284	0.336	0.388	0.493	0.596	0.700	0.856	1.116	1.376	1.636
80	0.0736	0.0988	0.1239	0.1738	0.224	0.274	0.324	0.374	0.473	0.572	0.673	0.824	1.074	1.325	1.573
100	0.0710	0.0954	0.1197	0.1676	0.215	0.264	0.312	0.360	0.455	0.551	0.648	0.794	1.035	1.276	1.517
120	0.0680	0.0921	0.1155	0.1618	0.208	0.255	0.302	0.348	0.440	0.533	0.626	0.767	1.001	1.234	1.465
140	0.0663	0.0889	0.1115	0.1565	0.201	0.246	0.291	0.336	0.426	0.516	0.606	0.742	0.968	1.194	1.416
150	0.0652	0.0874	0.1096	0.1541	0.198	0.242	0.286	0.331	0.419	0.508	0.596	0.730	0.953	1.175	1.392
175	0.0626	0.0840	0.1054	0.1482	0.191	0.233	0.275	0.318	0.403	0.488	0.573	0.701	0.914	1.128	1.337
200	0.0603	0.0809	0.1014	0.1427	0.184	0.225	0.265	0.305	0.388	0.470	0.552	0.674	0.879	1.084	1.287
225	0.0581	0.0779	0.0976	0.1373	0.177	0.216	0.255	0.295	0.374	0.452	0.531	0.649	0.846	1.043	1.240
250	0.0560	0.0751	0.0941	0.1323	0.170	0.208	0.247	0.284	0.360	0.436	0.513	0.627	0.817	1.007	1.197
275	0.0541	0.0726	0.0910	0.1278	0.164	0.201	0.238	0.274	0.348	0.421	0.494	0.605	0.789	0.972	1.155
300	0.0523	0.0707	0.0881	0.1237	0.159	0.194	0.230	0.265	0.336	0.407	0.478	0.585	0.762	0.940	1.118
350	0.0491	0.0658	0.0825	0.1160	0.149	0.183	0.216	0.249	0.316	0.382	0.449	0.549	0.715	0.883	1.048
400	0.0463	0.0621	0.0779	0.1090	0.140	0.172	0.203	0.235	0.297	0.360	0.423	0.517	0.674	0.831	0.987
450	0.0437	0.0586	0.0735	0.1033	0.133	0.163	0.192	0.222	0.281	0.340	0.399	0.488	0.637	0.786	0.934
500	0.0414	0.0555	0.0696	0.978	0.126	0.154	0.182	0.210	0.266	0.322	0.379	0.463	0.604	0.746	0.885
550	0.0394	0.0528	0.0661	0.930	0.120	0.146	0.173	0.200	0.253	0.306	0.359	0.440	0.573	0.749	0.841
600	0.0376	0.0504	0.0631	0.885	0.114	0.139	0.165	0.190	0.241	0.292	0.343	0.419	0.547	0.675	0.801

WIND PRESSURES

3029

Relation Between Pressure, Temperature, and Volume of Air.—This relationship is expressed by the following formulas:

$$\begin{aligned}
 PV &= 53.3mT && \text{For fps units} \\
 PV &= 1545.3nT && \text{For fps units} \\
 PV &= 8314nT && \text{For SI units}
 \end{aligned}$$

in which P = absolute pressure in pounds per square foot or Pa (N/m^2); V = volume in cubic feet or cubic meter; T = absolute temperature in degrees R or degrees K; m = the mass of substance; and n = number of pound moles or kg moles. A mole is the mass of substance, in appropriate units, divided by its molecular weight. The first equation above is for air only; the second and third are general forms that apply to any gas that behaves the ideal gas law.

✧ *Example 2:* What is the volume of one pound of air at a pressure of 24.7 pounds per square inch and at a temperature of 210 degrees F?

$$\begin{aligned}
 PV &= 53.3mT & V &= \frac{53.3mT}{P} & V &= \frac{53.3 \times 1 \times (210 + 459.6)}{24.7 \times 144} \\
 & & & & & = 10.04 \text{ cubic ft}
 \end{aligned}$$

Relation Between Barometric Pressure, and Pressures in Pounds per Square Inch and Square Foot

Baro- meter, Inches	Pressure in Psi ^a	Pressure in Psf ^a	Baro- meter, Inches	Pressure in Psi ^a	Pressure in Psf ^a	Baro- meter, Inches	Pressure in Psi ^a	Pressure in Psf ^a
28.00	13.75	1980	29.25	14.36	2068	30.50	14.98	2156
28.25	13.87	1997	29.50	14.48	2086	30.75	15.10	2174
28.50	13.99	2015	29.75	14.61	2103	31.00	15.22	2192
28.75	14.12	2033	30.00	14.73	2121	31.25	15.34	2210
29.00	14.24	2050	30.25	14.85	2139

^a Psi is pounds per square inch; Psf is pounds per square foot

Expansion and Compression of Air.—The formula for the relationship between pressure, temperature, and volume of air just given indicates that when the pressure remains constant the volume is directly proportional to the absolute temperature. If the temperature remains constant, the volume is inversely proportional to the absolute pressure. Theoretically, air (as well as other gases) can be expanded or compressed according to different laws.

Adiabatic Expansion or Compression takes place when the air is expanded or compressed without transmission of heat to or from it, as, for example, if the air could be expanded or compressed in a cylinder of an absolutely nonconducting material.

- Let: P_1 = initial absolute pressure in pounds per square foot
 V_1 = initial volume in cubic feet
 T_1 = initial absolute temperature in degrees R
 P_2 = absolute pressure in pounds per square foot, after compression
 V_2 = volume in cubic feet, after compression
 T_2 = absolute temperature in degrees R, after compression

Then:

$$\begin{aligned}
 \frac{V_2}{V_1} &= \left(\frac{P_1}{P_2}\right)^{0.71} & \frac{P_2}{P_1} &= \left(\frac{V_1}{V_2}\right)^{1.41} & \frac{T_2}{T_1} &= \left(\frac{V_1}{V_2}\right)^{0.41} \\
 \frac{V_2}{V_1} &= \left(\frac{T_1}{T_2}\right)^{2.46} & \frac{P_2}{P_1} &= \left(\frac{T_2}{T_1}\right)^{3.46} & \frac{T_2}{T_1} &= \left(\frac{P_2}{P_1}\right)^{0.29}
 \end{aligned}$$

These formulas are also applicable if all pressures are in pounds per square inch; if all volumes are in cubic inches; or if any other consistent set of units is used for pressure or volume.

Example 3: A volume of 165 cubic feet of air, at a pressure of 15 pounds per square inch, is compressed adiabatically to a pressure of 80 pounds per square inch. What will be the volume at this pressure? †

$$V_2 = V_1 \left(\frac{P_1}{P_2} \right)^{0.71} = 165 \left(\frac{15}{80} \right)^{0.71} = 50 \text{ cubic feet, approx.}$$

Isothermal Expansion or Compression takes place when a gas is expanded or compressed with an addition or transmission of sufficient heat to maintain a constant temperature.

Let: P_1 = initial absolute pressure in pounds per square foot

V_1 = initial volume in cubic feet

P_2 = absolute pressure in pounds per square foot, after compression

V_2 = volume in cubic feet, after compression

$R = 53.3$

T = temperature in degrees Rankine maintained during isothermal expansion or contraction

Then:

$$P_1 \times V_1 = P_2 \times V_2 = RT$$

Example 4: The same volume of air as in **Example 3** is compressed isothermally from 15 to 80 pounds per square inch. What will be the volume after compression? †

$$V_2 = \frac{P_1 \times V_1}{P_2} = \frac{15 \times 165}{80} = 31 \text{ cubic feet}$$

**Foot-pounds of Work Required in Compression of Air
Initial Pressure = 1 atmosphere = 14.7 pounds per square inch**

Gage Pressure in Pounds per Square Inch	Isothermal Compression	Adiabatic Compression	Actual Compression	Gage Pressure in Pounds per Square Inch	Isothermal Compression	Adiabatic Compression	Actual Compression
	Foot-pounds Required per Cubic Foot of Air at Initial Pressure				Foot-pounds Required per Cubic Foot of Air at Initial Pressure		
5	619.6	649.5	637.5	55	3393.7	4188.9	3870.8
10	1098.2	1192.0	1154.6	60	3440.4	4422.8	4029.8
15	1488.3	1661.2	1592.0	65	3577.6	4645.4	4218.2
20	1817.7	2074.0	1971.4	70	3706.3	4859.6	4398.1
25	2102.6	2451.6	2312.0	75	3828.0	5063.9	4569.5
30	2353.6	2794.0	2617.8	80	3942.9	5259.7	4732.9
35	2578.0	3111.0	2897.8	85	4051.5	5450.0	4890.1
40	2780.8	3405.5	3155.6	90	4155.7	5633.1	5042.1
45	2966.0	3681.7	3395.4	95	4254.3	5819.3	5187.3
50	3136.2	3942.3	3619.8	100	4348.1	5981.2	5327.9

Work Required in Compression of Air.—The total work required for compression and expulsion of air, adiabatically compressed, is: †

$$\text{Total work in foot-pounds} = 2.44P_1V_1 \left[\left(\frac{P_2}{P_1} \right)^{0.29} - 1 \right]$$

P_1 = initial absolute pressure in pounds per square foot; P_2 = absolute pressure in pounds per square foot, after compression; and, V_1 = initial volume in cubic feet.

The total work required for isothermal compression is:

$$\text{Total work in foot-pounds} = P_1 V_1 \log_e \frac{V_1}{V_2}$$

in which P_1 , P_2 , and V_1 denote the same quantities as in the previous equation, and V_2 = volume of air in cubic feet, after compression.

The work required to compress air isothermally, that is, when the heat of compression is removed as rapidly as produced, is considerably less than the work required for compressing air adiabatically, or when all the heat is retained. In practice, neither of these two theoretical extremes is obtainable, but the power required for air compression is about the median between the powers that would be required for each. The accompanying table gives the average number of foot-pounds of work required to compress air.

Horsepower Required to Compress Air.—In the accompanying tables is given the horsepower required to compress one cubic foot of free air per minute (isothermally and adiabatically) from atmospheric pressure (14.7 pounds per square inch) to various gage pressures, for one-, two-, and three-stage compression. The formula for calculating the horsepower required to compress, adiabatically, a given volume of free air to a given pressure is:

$$\text{HP} = \frac{144NPVn}{33,000(n-1)} \left[\left(\frac{P_2}{P} \right)^{\frac{n-1}{Nn}} - 1 \right]$$

where N = number of stages in which compression is accomplished

P = atmospheric pressure in pounds per square inch

P_2 = absolute terminal pressure in pounds per square inch

V = volume of air, in cubic feet, compressed per minute, at atmospheric pressure

n = exponent of the compression curve = 1.41 for adiabatic compression

For different methods of compression and for one cubic foot of air per minute, this formula may be simplified as follows:

For one-stage compression: $\text{HP} = 0.015P(R^{0.29} - 1)$

For two-stage compression: $\text{HP} = 0.030P(R^{0.145} - 1)$

For three-stage compression: $\text{HP} = 0.045P(R^{0.0975} - 1)$

For four-stage compression: $\text{HP} = 0.060P(R^{0.0725} - 1)$

In these latter formulas $R = \frac{P_2}{P}$ = number of atmospheres to be compressed

The formula for calculating the horsepower required to compress isothermally a given volume of free air to a given pressure is:

$$\text{HP} = \frac{144PV}{33000} \left(\log_e \frac{P_2}{P} \right)$$

Natural logarithms are obtained by multiplying common logarithms by 2.30259 or by using a handheld calculator.

Continuity Equation.—The net rate of mass inflow to the control volume is equal to the rate of increase of mass within the control volume.

For steady flow, $\rho_1 A_1 V_1 = \rho_2 A_2 V_2 = M$ where ρ = density, A = area, V = velocity, and M = mass flow rate.

If the flow is steady and incompressible, then $A_1 V_1 = A_2 V_2 = Q$ where Q is flow.

Horsepower Required to Compress Air, Single-Stage Compression

Horsepower required to compress one cubic foot of free air per minute (isothermally and adiabatically) from atmospheric pressure (14.7 pounds per square inch) to various gage pressures.
 Single-Stage Compression, initial temperature of air, 60°F, jacket cooling not considered.

Gage Pressure, Pounds	Absolute Pressure, Pounds	Number of Atmospheres	Isothermal Compression		Adiabatic Compression			
			Mean Effective Pressure ^a	Horsepower	Mean Effective Pressure, ^a Theoretical	Mean Eff. Pressure plus 15% Friction	Horsepower, Theoretical	Horsepower plus 15% Friction
5	19.7	1.34	4.13	0.018	4.46	5.12	0.019	0.022
10	24.7	1.68	7.57	0.033	8.21	9.44	0.036	0.041
15	29.7	2.02	11.02	0.048	11.46	13.17	0.050	0.057
20	34.7	2.36	12.62	0.055	14.30	16.44	0.062	0.071
25	39.7	2.70	14.68	0.064	16.94	19.47	0.074	0.085
30	44.7	3.04	16.30	0.071	19.32	22.21	0.084	0.096
35	49.7	3.38	17.90	0.078	21.50	24.72	0.094	0.108
40	54.7	3.72	19.28	0.084	25.53	27.05	0.103	0.118
45	59.7	4.06	20.65	0.090	25.40	29.21	0.111	0.127
50	64.7	4.40	21.80	0.095	27.23	31.31	0.119	0.136
55	69.7	4.74	22.95	0.100	28.90	33.23	0.126	0.145
60	74.7	5.08	23.90	0.104	30.53	35.10	0.133	0.153
65	79.7	5.42	24.80	0.108	32.10	36.91	0.140	0.161
70	84.7	5.76	25.70	0.112	33.57	38.59	0.146	0.168
75	89.7	6.10	26.62	0.116	35.00	40.25	0.153	0.175
80	94.7	6.44	27.52	0.120	36.36	41.80	0.159	0.182
85	99.7	6.78	28.21	0.123	37.63	43.27	0.164	0.189
90	104.7	7.12	28.93	0.126	38.89	44.71	0.169	0.195
95	109.7	7.46	29.60	0.129	40.11	46.12	0.175	0.201
100	114.7	7.80	30.30	0.132	41.28	47.46	0.180	0.207
110	124.7	8.48	31.42	0.137	43.56	50.09	0.190	0.218
120	134.7	9.16	32.60	0.142	45.69	52.53	0.199	0.229
130	144.7	9.84	33.75	0.147	47.72	54.87	0.208	0.239
140	154.7	10.52	34.67	0.151	49.64	57.08	0.216	0.249
150	164.7	11.20	35.59	0.155	51.47	59.18	0.224	0.258
160	174.7	11.88	36.30	0.158	53.70	61.80	0.234	0.269
170	184.7	12.56	37.20	0.162	55.60	64.00	0.242	0.278
180	194.7	13.24	38.10	0.166	57.20	65.80	0.249	0.286
190	204.7	13.92	38.80	0.169	58.80	67.70	0.256	0.294
200	214.7	14.60	39.50	0.172	60.40	69.50	0.263	0.303

^a Mean Effective Pressure (MEP) is defined as that single pressure rise, above atmospheric, which would require the same horsepower as the actual varying pressures during compression.

Horsepower Required to Compress Air, Two-Stage Compression

Horsepower required to compress one cubic foot of free air per minute (isothermally and adiabatically) from atmospheric pressure (14.7 pounds per square inch) to various gage pressures.

Two-Stage Compression, initial temperature of air, 60°F, jacket cooling not considered.

Gage Pressure, Pounds	Absolute Pressure, Pounds	Number of Atmospheres	Correct Ratio of Cylinder Volumes	Intercooler Gage Pressure	Isothermal Compression		Adiabatic Compression				Percentage of Saving over One-stage Compression
					Mean Effective Pressure ^a	Horsepower	Mean Eff. Pressure, ^a Theoretical	Mean Eff. Pressure plus 15 per cent Friction	Horsepower, Theoretical	HP plus 15 per cent Friction	
50	64.7	4.40	2.10	16.2	21.80	0.095	24.30	27.90	0.106	0.123	10.9
60	74.7	5.08	2.25	18.4	23.90	0.104	27.20	31.30	0.118	0.136	11.3
70	84.7	5.76	2.40	20.6	25.70	0.112	29.31	33.71	0.128	0.147	12.3
80	94.7	6.44	2.54	22.7	27.52	0.120	31.44	36.15	0.137	0.158	13.8
90	104.7	7.12	2.67	24.5	28.93	0.126	33.37	38.36	0.145	0.167	14.2
100	114.7	7.80	2.79	26.3	30.30	0.132	35.20	40.48	0.153	0.176	15.0
110	124.7	8.48	2.91	28.1	31.42	0.137	36.82	42.34	0.161	0.185	15.2
120	134.7	9.16	3.03	29.8	32.60	0.142	38.44	44.20	0.168	0.193	15.6
130	144.7	9.84	3.14	31.5	33.75	0.147	39.86	45.83	0.174	0.200	16.3
140	154.7	10.52	3.24	32.9	34.67	0.151	41.28	47.47	0.180	0.207	16.7
150	164.7	11.20	3.35	34.5	35.59	0.155	42.60	48.99	0.186	0.214	16.9
160	174.7	11.88	3.45	36.1	36.30	0.158	43.82	50.39	0.191	0.219	18.4
170	184.7	12.56	3.54	37.3	37.20	0.162	44.93	51.66	0.196	0.225	19.0
180	194.7	13.24	3.64	38.8	38.10	0.166	46.05	52.95	0.201	0.231	19.3
190	204.7	13.92	3.73	40.1	38.80	0.169	47.16	54.22	0.206	0.236	19.5
200	214.7	14.60	3.82	41.4	39.50	0.172	48.18	55.39	0.210	0.241	20.1
210	224.7	15.28	3.91	42.8	40.10	0.174	49.35	56.70	0.216	0.247	...
220	234.7	15.96	3.99	44.0	40.70	0.177	50.30	57.70	0.220	0.252	...
230	244.7	16.64	4.08	45.3	41.30	0.180	51.30	59.10	0.224	0.257	...
240	254.7	17.32	4.17	46.6	41.90	0.183	52.25	60.10	0.228	0.262	...
250	264.7	18.00	4.24	47.6	42.70	0.186	52.84	60.76	0.230	0.264	...
260	274.7	18.68	4.32	48.8	43.00	0.188	53.85	62.05	0.235	0.270	...
270	284.7	19.36	4.40	50.0	43.50	0.190	54.60	62.90	0.238	0.274	...
280	294.7	20.04	4.48	51.1	44.00	0.192	55.50	63.85	0.242	0.278	...
290	304.7	20.72	4.55	52.2	44.50	0.194	56.20	64.75	0.246	0.282	...
300	314.7	21.40	4.63	53.4	45.80	0.197	56.70	65.20	0.247	0.283	...
350	364.7	24.80	4.98	58.5	47.30	0.206	60.15	69.16	0.262	0.301	...
400	414.7	28.20	5.31	63.3	49.20	0.214	63.19	72.65	0.276	0.317	...
450	464.7	31.60	5.61	67.8	51.20	0.223	65.93	75.81	0.287	0.329	...
500	514.7	35.01	5.91	72.1	52.70	0.229	68.46	78.72	0.298	0.342	...

^a Mean Effective Pressure (MEP) is defined as that single pressure rise, above atmospheric, which would require the same horsepower as the actual varying pressures during compression.

Horsepower Required to Compress Air, Three-stage Compression

Horsepower required for compressing one cubic foot of free air per minute (isothermally and adiabatically) from atmospheric pressure (14.7 pounds per square inch) to various gage pressures.
 Three-stage Compression, initial temperature of air, 60°F, jacket-cooling not considered.

Gage Pressure, Pounds	Absolute Pressure, Pounds	Number of Atmospheres	Correct Ratio of Cylinder Volumes	Intercooler Gage Pressure, First and Second Stages	Isothermal Compression		Adiabatic Compression				Percentage of Saving over Two-stage Compression
					Mean Effective Pressure ^a	Horsepower	Mean Eff. Pressure, ^a Theoretical	Mean Eff. Pressure plus 15 per cent Friction	Horsepower Theoretical	HP plus 15 per cent Friction	
100	114.7	7.8	1.98	14.4-42.9	30.30	0.132	33.30	38.30	0.145	0.167	5.23
150	164.7	11.2	2.24	18.2-59.0	35.59	0.155	40.30	46.50	0.175	0.202	5.92
200	214.7	14.6	2.44	21.2-73.0	39.50	0.172	45.20	52.00	0.196	0.226	6.67
250	264.7	18.0	2.62	23.8-86.1	42.70	0.186	49.20	56.60	0.214	0.246	6.96
300	314.7	21.4	2.78	26.1-98.7	45.30	0.197	52.70	60.70	0.229	0.264	7.28
350	364.7	24.8	2.92	28.2-110.5	47.30	0.206	55.45	63.80	0.242	0.277	7.64
400	414.7	28.2	3.04	30.0-121.0	49.20	0.214	58.25	66.90	0.253	0.292	8.33
450	464.7	31.6	3.16	31.8-132.3	51.20	0.223	60.40	69.40	0.263	0.302	8.36
500	514.7	35.0	3.27	33.4-142.4	52.70	0.229	62.30	71.70	0.273	0.314	8.38
550	564.7	38.4	3.38	35.0-153.1	53.75	0.234	65.00	74.75	0.283	0.326	8.80
600	614.7	41.8	3.47	36.3-162.3	54.85	0.239	66.85	76.90	0.291	0.334	8.86
650	664.7	45.2	3.56	37.6-171.5	56.00	0.244	67.90	78.15	0.296	0.340	9.02
700	714.7	48.6	3.65	38.9-180.8	57.15	0.249	69.40	79.85	0.303	0.348	9.18
750	764.7	52.0	3.73	40.1-189.8	58.10	0.253	70.75	81.40	0.309	0.355	...
800	814.7	55.4	3.82	41.4-199.5	59.00	0.257	72.45	83.25	0.315	0.362	...
850	864.7	58.8	3.89	42.5-207.8	60.20	0.262	73.75	84.90	0.321	0.369	...
900	914.7	62.2	3.95	43.4-214.6	60.80	0.265	74.80	86.00	0.326	0.375	...
950	964.7	65.6	4.03	44.6-224.5	61.72	0.269	76.10	87.50	0.331	0.381	...
1000	1014.7	69.0	4.11	45.7-233.3	62.40	0.272	77.20	88.80	0.336	0.383	...
1050	1064.7	72.4	4.15	46.3-238.3	63.10	0.275	78.10	90.10	0.340	0.391	...
1100	1114.7	75.8	4.23	47.5-248.3	63.80	0.278	79.10	91.10	0.344	0.396	...
1150	1164.7	79.2	4.30	48.5-256.8	64.40	0.281	80.15	92.20	0.349	0.401	...
1200	1214.7	82.6	4.33	49.0-261.3	65.00	0.283	81.00	93.15	0.353	0.405	...
1250	1264.7	86.0	4.42	50.3-272.3	65.60	0.286	82.00	94.30	0.357	0.411	...
1300	1314.7	89.4	4.48	51.3-280.8	66.30	0.289	82.90	95.30	0.362	0.416	...
1350	1364.7	92.8	4.53	52.0-287.3	66.70	0.291	84.00	96.60	0.366	0.421	...
1400	1414.7	96.2	4.58	52.6-293.5	67.00	0.292	84.60	97.30	0.368	0.423	...
1450	1464.7	99.6	4.64	53.5-301.5	67.70	0.295	85.30	98.20	0.371	0.426	...
1500	1514.7	103.0	4.69	54.3-309.3	68.30	0.298	85.80	98.80	0.374	0.430	...
1550	1564.7	106.4	4.74	55.0-317.3	68.80	0.300	86.80	99.85	0.378	0.434	...
1600	1614.7	109.8	4.79	55.8-323.3	69.10	0.302	87.60	100.80	0.382	0.438	...

^a Mean Effective Pressure (MEP) is defined as that single pressure rise, above atmospheric, which would require the same horsepower as the actual varying pressures during compression.

Flow of Air in Pipes.—The following formulas are used:

$$v = \sqrt{\frac{25,000 dp}{L}} \quad p = \frac{Lv^2}{25,000 d}$$

where v = velocity of air in feet per second

p = loss of pressure due to flow through the pipes in ounces per square inch

d = inside diameter of pipe in inches

L = length of pipe in feet

The quantity of air discharged in cubic feet per second is the product of the velocity as obtained from the preceding formula and the area of the pipe in square feet. The horsepower required to drive air through a pipe equals the volume of air in cubic feet per second multiplied by the pressure in pounds per square foot, and this product divided by 550.

Volume of Air Transmitted Through Pipes, in Cubic Feet per Minute

Velocity of Air in Feet per Second	Actual Inside Diameter of Pipe, Inches									
	1	2	3	4	6	8	10	12	16	24
1	0.33	1.31	2.95	5.2	11.8	20.9	32.7	47.1	83.8	188
2	0.65	2.62	5.89	10.5	23.6	41.9	65.4	94.2	167.5	377
3	0.98	3.93	8.84	15.7	35.3	62.8	98.2	141.4	251.3	565
4	1.31	5.24	11.78	20.9	47.1	83.8	131.0	188.0	335.0	754
5	1.64	6.55	14.7	26.2	59.0	104.0	163.0	235.0	419.0	942
6	1.96	7.85	17.7	31.4	70.7	125.0	196.0	283.0	502.0	1131
7	2.29	9.16	20.6	36.6	82.4	146.0	229.0	330.0	586.0	1319
8	2.62	10.50	23.5	41.9	94.0	167.0	262.0	377.0	670.0	1508
9	2.95	11.78	26.5	47.0	106.0	188.0	294.0	424.0	754.0	1696
10	3.27	13.1	29.4	52.0	118.0	209.0	327.0	471.0	838.0	1885
12	3.93	15.7	35.3	63.0	141.0	251.0	393.0	565.0	1005.0	2262
15	4.91	19.6	44.2	78.0	177.0	314.0	491.0	707.0	1256.0	2827
18	5.89	23.5	53.0	94.0	212.0	377.0	589.0	848.0	1508.0	3393
20	6.55	26.2	59.0	105.0	235.0	419.0	654.0	942.0	1675.0	3770
24	7.86	31.4	71.0	125.0	283.0	502.0	785.0	1131.0	2010.0	4524
25	8.18	32.7	73.0	131.0	294.0	523.0	818.0	1178.0	2094.0	4712
28	9.16	36.6	82.0	146.0	330.0	586.0	916.0	1319.0	2346.0	5278
30	9.80	39.3	88.0	157.0	353.0	628.0	982.0	1414.0	2513.0	5655

Flow of Compressed Air in Pipes.—When there is a comparatively small difference of pressure at the two ends of the pipe, the volume of flow in cubic feet per minute is found by the formula:

$$V = 58 \sqrt{\frac{pd^5}{WL}}$$

where V = volume of air in cubic feet per minute

p = difference in pressure at the two ends of the pipe in pounds per square inch

d = inside diameter of pipe in inches

W = weight in pounds of one cubic foot of entering air

L = length of pipe in feet

Velocity of Escaping Compressed Air.—If air, or gas, flows from one chamber to another, as from a chamber or tank through an orifice or nozzle into the open air, large changes in velocity may take place owing to the difference in pressures. Since the change takes place almost instantly, little heat can escape from the fluid and the flow may be assumed to be adiabatic.

For a large container with a small orifice or hole from which the air escapes, the velocity of escape (theoretical) may be calculated from the formula:

$$v_2 = \sqrt{2g \cdot \frac{k}{k-1} \cdot 53.3(459.7 + F) \left[1 - \left(\frac{p_2}{p_1} \right)^{\frac{k-1}{k}} \right]}$$

In this formula, v_2 = velocity of escaping air in feet per second; g = acceleration due to gravity, 32.16 feet per second squared; $k = 1.41$ for adiabatic expansion or compression of air; F = temperature, degrees F; p_2 = atmospheric pressure = 14.7 pounds per square inch; and p_1 = pressure of air in container, pounds per square inch. In applying the preceding formula, when the ratio p_2/p_1 approximately equals 0.53, under normal temperature conditions at sea level, the escape velocity v_2 will be equal to the velocity of sound. Increasing the pressure p_1 will not increase the velocity of escaping air beyond this limiting velocity unless a special converging diverging nozzle design is used rather than an orifice.

The accompanying table provides velocity of escaping air for various values of p_1 . These values were calculated from the preceding formula simplified by substituting the appropriate constants:

$$v_2 = 108.58 \sqrt{(459.7 + F) \left[1 - \left(\frac{14.7}{p_1} \right)^{0.29} \right]}$$

Velocity of Escaping Air at 70-Degrees F

Pressure Above Atmospheric Pressure			Theoretical Velocity, Feet per Second	Pressure Above Atmospheric Pressure			Theoretical Velocity, Feet per Second
In Atmospheres	In Inches Mercury	In lbs per sq. in.		In Atmospheres	In Inches Mercury	In lbs per sq. in.	
0.010	0.30	0.147	134	0.408	12.24	6.00	769
0.068	2.04	1.00	344	0.500	15.00	7.35	833
0.100	3.00	1.47	413	0.544	16.33	8.00	861
0.136	4.08	2.00	477	0.612	18.37	9.00	900
0.204	6.12	3.00	573	0.680	20.41	10.0	935
0.272	8.16	4.00	650	0.816	24.49	12.0	997
0.340	10.20	5.00	714	0.884	26.53	13.0	1025

The theoretical velocities in the preceding table must be reduced by multiplying by a "coefficient of discharge," which varies with the orifice and the pressure. The following coefficients are used for orifices in thin plates and short tubes.

Type of Orifice	Pressures in Atmospheres Above Atmospheric Pressure			
	0.01	0.1	0.5	1
Orifice in thin plate	0.65	0.64	0.57	0.54
Orifice in short tube	0.83	0.82	0.71	0.67

DIMENSIONING, GAGING, MEASURING, INSPECTION

Symbols For Drafting

Table 1. Standard Graphical Symbols for Air Conditioning


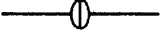









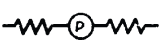














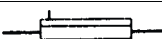

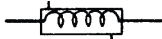

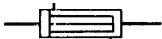








Capillary tube		Filter line	
Compressor		Filter and strainer, line	
Compressor, rotary (Enclosed crankcase, belted)		Float, high side	
Compressor, reciprocating (open crankcase, belted)		Float, low side	
Compressor, reciprocating (open crankcase, direct- drive)		Gage	
Motor compressor, recipro- cating (direct connected, enclosed crankcase)		Pressurestat	
Motor compressor, rotary (direct connected, enclosed crankcase)		Pressure switch	
Motor compressor, recipro- cating (sealed crankcase)		Pressure switch (with high pressure cut-out)	
Motor compressor, rotary (sealed crankcase)		Receiver, horizontal	
Condensing Unit (air cooled)		Receiver, vertical	
Condensing Unit (water-cooled)		Scale trap	
Condenser air cooled (finned, forced air)		Spray pond	
Condenser air cooled (finned, static)		Thermal bulb	
Condenser water cooled (concentric tube in a tube)		Thermostat (remote bulb)	
Condenser water cooled (shell and coil)		Valve, expansion, automatic	
Condenser water cooled (shell and tube)		Valve, expansion, hand	
Condenser evaporative		Valve, expansion, thermostatic	
		Valve, compressor suction pressure limiting (throt- tling type, compressor side)	
Cooling unit, finned (natural convection)		Valve, constant pressure, suction	
Cooling unit (forced convection)		Valve, evaporator pressure regulating (snap action)	

Table 1. (Continued) Standard Graphical Symbols for Air Conditioning











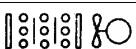





Cooling unit, immersion		Valve, evaporator pressure regulating (thermostatic throttling type)	
Cooling tower		Valve, evaporator pressure regulating (throttling type, evaporator side)	
Dryer		Valve, magnetic stop	
Evaporator, circular (Ceiling type, finned)		Valve, snap action	
Evaporator, manifolded (Bare tube, gravity air)		Valve, suction vapor regulating	
Evaporator, manifolded (finned, forced air)		Valve suction	
Evaporator, manifolded (finned, gravity air)		Valve water	
Evaporator, plate coils (headered or manifolded)		Vibration absorber, line	

Table 2. Standard Graphical Symbols for Heating and Ventilation

Air eliminator		Access door	
Anchor		Adjustable blank off	
Expansion joint		Adjustable plaque	
Hanger or support			
Heat exchanger		Automatic damper	
Heat transfer surface (plan, indicate type, such as convector)			
Pump (Indicate type, such as vacuum)		Canvas connection	
Strainer		Deflecting damper	
Tank (designate type)		Direction of flow	
Thermometer		Duct (first figure is side shown)	
Thermostat		Duct section (exhaust or return)	
Trap, boiler return		Duct section (supply)	
Trap, blast thermostatic		Exhaust inlet, ceiling (indicate type)	
Trap, float		Exhaust inlet, wall (indicate type)	
Trap, float and thermostatic		Fan and motor (with belt guard)	
Trap, thermostatic			
Unit heater (centrifugal fan type- plan)		Inclined drop (with respect to air flow)	
Unit heater (propeller fan type- plan)		Inclined rise (with respect to air flow)	
Unit ventilator, plan		Intake louvers	
Valve, check		Louber opening	
Valve, diaphragm		Supply outlet, ceiling (Indicate type)	
Valve, gate		Supply outlet, wall (Indicate type)	
Valve, glove		Vanes	
Valve, lock and shield			
Valve, motor operated		Volume damper	
Valve, pressure reducing			
Valve relief (either pressure or vacuum)			
Vent point			

Table 3. Standard Graphical Symbols for Valves

Name of Valve	Flanged	Screwed	Bell & Spigot	Welded	Soldered
Angle valve, check					
Angle valve, gate (elevation)					
Angle valve, gate (plan)					
Angle valve, globe (elevation)					
Angle valve, globe (plan)					
Automatic by-pass valve					
Automatic governor operated valve					
Automatic reducing valve					
Check valve, straight way					
Cock					
Diaphragm valve					
Float valve					
Gate valve also used as Stop valve					
Gate valve motor operated					
Globe valve					
Globe valve motor operated					
Hose valve, angle					
Hose valve, gate					
Hose valve, glove					
Lockshield valve					
Quick opening valve					
Safety valve					

Table 4. Standard Graphical Symbols for Piping

Air Conditioning			
Brine return	- - - BR - - -	Brine supply	— B —
Chilled or hot water flow (circulating)	— CH —	Chilled or hot water return (circulating)	- - - CHR - - -
Condenser water flow	— C —	Condenser water return	- - - CR - - -
Drain	— D —	Humidification line	- · - H - · -
Make-up water	- · - · -	Refrigerant discharge	— RD —
Refrigerant liquid	— RL —	Refrigerant liquid	- - - RS - - -
Heating			
Air relief line	- - - - -	Boiler blow-off	— — —
Compressed air	— A —	Condensate discharge	- O - - O - - O -
Feed water pump discharge	- O O - - O O - - O O -	Fuel -oil flow	— FOF —
Fuel-oil return	- - - FOR - - -	Fuel-oil tank vent	- - - FOV - - -
High pressure return	# — # —	High pressure steam	# — # —
Hot water heating return	- - - - -	Hot water heating supply	— — —
Low pressure return	- - - - -	Low pressure steam	— — —
Make-up water	- - - - -	Medium pressure return	# — # —
Medium pressure steam	# — # —		
Plumbing			
Acid waste	— ACID —	Cold water	- - - - -
Compressed air	— A —	Drinking water flow	- · - · - · -
Drinking water return	- - - - -	Fire line	— F — F —
Gas	— G — G —		
Hot water	- - - - -	Hot water return	- · - · - · -
Soil, waste, or leader (above grade)	— — —	Soil, waste, or leader (below grade)	- - - - -
Vacuum cleaning	— V — V —	Vent	- - - - -
Pneumatic Tubes			
Tube runs	- - - - -		
Sprinklers			
Branch and head	— O — O —	Drain	- - - S - - -
Main supplies	— S —		

Table 5. Standard Graphical Symbols for Pipe Fittings

Name of Fitting	Flanged	Screwed	Bell & Spigot	Welded	Soldered
Bushing					
Cap					
Cross, reducing					
Cross, straight size					
Cross					
Elbow, 45-degree					
Elbow, 90-degree					
Elbow, turned down					
Elbow, turned up					
Elbow, base					
Elbow, double branch					
Elbow, long branch					
Elbow, reducing					
Elbow, side outlet (outlet down)					
Elbow, side outlet (outlet up)					
Elbow, street					
Joint, connecting pipe					
Joint, expansion					

Inspection

Transfer Calipers.—Calipers provided with an auxiliary arm which can be located so that the calipers may be opened or closed to the original setting, if required. Calipers of this type are generally used for inside measurements, and are employed for measuring recesses where it is necessary to move the caliper points in order to remove the calipers from the place where the measurement is taken.

Metallography.—The science or study of the microstructure of metal is known by most metallurgists as “metallography.” The name “crystallography” is also used to some extent. The examination of metals and metal alloys by the aid of the microscope has become one of the most effective methods of studying their properties, and it is also a valuable means of controlling the quality of manufactured metallic articles and of testing the finished product. In preparing the specimen to be examined, a flat surface is first formed by filing or grinding, and this surface is then given a high polish, which is later subjected to the action of a suitable acid or etching reagent, in order to reveal clearly the internal structure of the metal when the specimen is examined under the microscope. This process shows clearly to an experienced observer the effect of variation in composition, heat-treatment, etc., and in many cases it has proved a correct means of determining certain properties of industrial products that a chemical analysis has failed to reveal.

Preparing Hardened Steel for Microscopic Study: To cause the constituents of the specimen to contrast with one another as seen through the microscope is the desired end, and a reagent is used which acts differently towards these elements; generally this reagent acts on one element more than on another so that the one least affected reflects the light from the faces of its crystals while the etched part absorbs the light, and, therefore, appears dark when photographed.

In etching specimens to develop the constituents of hardened anti tempered steels, very good results are obtained with sulphurous acid that is composed of 4 parts of sulphur dioxide to 96 parts of distilled water. The specimens are immersed in this, face upward, and removed as soon as the polished surface is frosted. This takes from 7 seconds to 1 minute. They are then rinsed with water and dried with alcohol. Very thin layers of iron sulphide are deposited on the different constituents in different thicknesses, and this gives them different colors. Austenite remains a pale brown; martensite is given a pale blue and deep blue and brown color; troostite is made very dark; sorbite is uncolored; cementite exhibits a brilliant white; and ferrite is made dark brown. When the etching has proceeded to the desired extent, the specimen is at once washed thoroughly in order to remove all trace of the etching reagent. Usually it is simply rinsed with water, but frequently the washing is done with absolute alcohol, while ether and chloroform are also sometimes used.

The apparatus used for examining the etched surfaces of metals is composed of a microscope and camera combined with an arc lamp or other means of illumination.

Microscopic Study of Steel: Steel, in particular, shows many changes of structure due to the mechanical and thermal treatment, so that the microscope has become a very valuable instrument with which to inspect steel. To one who understands what the different formations of crystalline structure denote, the magnified surface reveals the temperature at which the steel was hardened, or at which it was drawn, and the depth to which the hardness penetrated. It also shows whether the steel was annealed or casehardened, as well as the depth to which the carbon penetrated. The carbon content can be closely judged, when the steel is annealed, and also how much of it is in the graphitic state in the high carbon steels. The quantity of special elements that is added to steel, such as nickel, chromium, tungsten, etc., can also be estimated, when the alloy to be examined has been put through its prescribed heat-treatment. Likewise, the impurities that may be present are clearly seen, regardless of whether they are of solid or gaseous origin.

Fits

Basic Dimension.—The basic size of a screw thread or machine part is the theoretical or nominal standard size from which variations are made, as in the case of fitted parts which must have an allowance for providing a certain class of fit. The use of the hole diameter as the basic diameter has practical advantages in obtaining different classes of fits, especially when it is economical to finish holes by means of standard tools. For example, assume that holes are to be finished by reaming, and that shafts or plugs are to be fitted into them, this being a common condition in connection with various machine-building operations. If the diameter of the hole is basic, its size, within a small tolerance, may be maintained readily by the use of proper reaming equipment, and the diameter of a shaft or plug may be varied much more readily than that of the hole, in order to obtain the allowance for whatever class of fit is desired; therefore, different kinds of fits in holes finished by the same reamer may be obtained merely by grinding the shaft or plug to a diameter which gives the proper fit allowance. In the case of threaded holes, the tap is usually solid or non-adjustable, whereas dies ordinarily may be adjusted readily to obtain different classes of fits. As both the hole and shaft or plug would ordinarily be given a certain tolerance, the basic dimension of a hole (except for forced fits) should be the minimum limit or diameter, there being a plus tolerance, and the nominal dimension of a shaft or plug should represent the maximum limit or diameter, there being a minus tolerance. The advantage of this method is that the minimum clearance between hole and shaft, or the “danger zone,” is indicated by a direct comparison of the basic hole diameter and the nominal shaft diameter; the direction of the tolerances is such as to increase this clearance. For a forced fit, the basic hole size is the maximum diameter, the tolerance being minus, and the nominal shaft size is the minimum diameter the tolerance being plus; consequently, the minimum fit allowance or interference between hole and shaft (or the “danger zone” for a forced fit) is indicated by a comparison of the basic hole diameter and the nominal shaft diameter. In this case the direction of the tolerances increases the interference or forced fit allowance. When it is economical to use cold-drawn or other commercial stock without machining then the maximum shaft size should be basic.

Clearance.—“Clearance” is a term signifying the allowance between working parts to admit of motion and lubrication. In other words, the clearance is the space between adjacent parts, whether this space is allowed merely to avoid interference, or in order to obtain definite classes of free fits. The clearance allowed between different parts is governed by the conditions under which the parts are to work.

Allowance.—The term “allowance,” as applied to the fitting of machine parts, means a difference in dimensions prescribed in order to secure classes of fits; in other words, allowance is the amount required either above or below a nominal size, so that a certain class of fit is obtained, as, for example, a running fit, a forced or pressed fit, etc. For instance, if the hole in a crank disk is 3 inches in diameter and the shaft is made 3.005 inches in diameter in order to secure a forced fit, the 0.005 inch would represent the allowance for that part. The terms “allowance” and “tolerance” are often-but incorrectly-used interchangeably; according to common usage “tolerance” is a difference in dimensions prescribed in order to allow unavoidable imperfections of workmanship.

Tolerances.—Tolerance is the amount of variation permitted on dimensions or surfaces of machine parts. The tolerance is equal to the difference between the maximum and minimum limits of any specified dimension. For example, if the maximum limit for the diameter of a shaft is 2.000 inches and its minimum limit 1.990 inches, the tolerance for this diameter is 0.010 inch. By determining the maximum and minimum clearances required on operating surfaces, the extent of these tolerances is established. As applied to the fitting of machine parts, the word tolerance means the amount that duplicate parts are allowed to vary in size in connection with manufacturing operations, owing to unavoidable imperfections of workmanship. Tolerance may also be defined as the amount that duplicate parts are

permitted to vary in size in order to secure sufficient accuracy without unnecessary refinement. The terms “tolerance” and “allowance” are often used interchangeably, but, according to common usage, allowance is a difference in dimensions prescribed in order to secure various classes of fits between different parts.

Unilateral and Bilateral Tolerances: The term “unilateral tolerance” means that the total tolerance, as related to a basic dimension, is in one direction only. For example, if the basic dimension were 1 inch and the tolerance were expressed as $1.00 - 0.002$, or as $1.00 + 0.002$, these would be unilateral tolerances, since the total tolerance in each case is in one direction. On the contrary, if the tolerance were divided, so as to be partly plus and partly minus, it would be classed as “bilateral.” Thus,

$$1.00 \begin{matrix} +0.001 \\ -0.001 \end{matrix} \quad \text{or} \quad 1.00 \pm 0.001$$

is an example of bilateral tolerance, because the total tolerance of 0.002 is given in two directions, plus and minus. Unilateral tolerances generally are recommended.

When unilateral tolerances are used, one of the three following methods should be used to express them:

1) Specify limiting dimensions only as

Diameter of hole: 2.250, 2.252

Diameter of shaft: 2.249, 2.247

2) One limiting size may be specified with its tolerances as

Diameter of hole: $2.250 + 0.002, -0.000$

Diameter of shaft: $2.249 + 0.000, -0.002$

3) The nominal size may be specified for both parts, with a notation showing both allowance and tolerance, as

Diameter of hole: $2\frac{1}{4} + 0.002, -0.000$

Diameter of shaft: $2\frac{1}{4} - 0.001, -0.003$

Bilateral tolerances should be specified as such, usually with plus and minus tolerances of equal amount. Example of the expression of bilateral tolerances follow:

$$2.00 \pm 0.001 \quad \text{or} \quad 2.00 \begin{matrix} +0.001 \\ -0.001 \end{matrix}$$

How to Apply Tolerances: According to practice approved by the Society of Automotive Engineers, tolerances should show the permissible amount of variation in the direction that is less dangerous. When a variation in either direction is equally dangerous, a bilateral tolerance should be given. When a variation in one direction is more dangerous than a variation in another, a unilateral tolerance should be given in the less dangerous direction. One exception to the use of unilateral tolerances on mating surfaces occurs when tapers are involved. In such cases either bilateral or unilateral tolerances may prove advisable, depending upon conditions.

Where tolerances are required on the distances between holes, usually they should be bilateral, as variation in either direction is usually equally dangerous. The variation in the distance between shafts carrying gears, however, should always be unilateral and plus; otherwise the gears might run too tight. A slight increase in the backlash between gears is seldom of much importance.

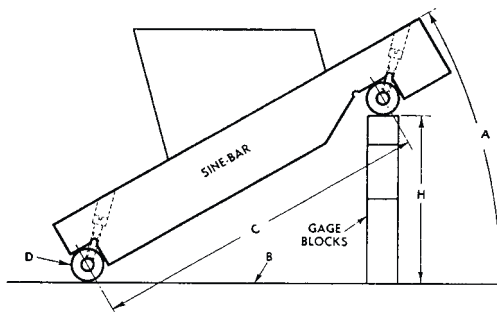
Basic Dimensions: The minimum hole should be of basic size in all cases where the use of standard tools represents the greatest economy. The maximum shaft should be of basic size in all cases where the use of standard purchased material, without further machining, represents the greatest economy, even though special tools are required to machine the mating part.

Standardization in Different Countries: National standard fits have been established in the United States, Austria, Germany, Great Britain, Holland, Sweden, and Switzerland.

All national standards, except the British, are based exclusively on the unilateral system of tolerances. The British Standard gives both the unilateral and the bilateral systems, recommending the former. The national standards, with the exception of the American, the British, and the Dutch, give both the basic hole and the basic shaft systems. The United States and Great Britain have adopted the basic hole system, Holland the basic shaft system exclusively. The Dutch system is at one extreme, in affording the maximum freedom of choice in the combination of hole and shaft. It specifies limits only, and does not give allowances or tolerances. The other extreme is formed by the type of system adopted by the Austrians, Germans, Swedes, and Swiss, which gives a number of fits completely defined by their allowances and tolerances. The American system lies between these two extremes. The standard reference temperature for gages is 20 degrees C., or 68 degrees F., in all the countries mentioned, except Great Britain, where it is 62 degrees F., or $16\frac{2}{3}$ degrees C.

Tables of Sine-bar Constants

Sine-bar.—The sine-bar, or *sine-protractor*, as it is sometimes called, is used either for measuring angles accurately or for locating work to a given angle in connection with such work as surface grinding operations on templets, gages and other angular work requiring great accuracy. Sine-bars are commonly used by toolmakers and gage-makers because they provide a very precise method of measuring or checking angles. A common form of sine-bar is illustrated by the diagram. This particular form is notched at the ends for receiving cylindrical plugs *D*. These plugs must be lapped to the same diameter and the distance *C* between their centers usually is either 5 or 10 inches to simplify the use of the sine-bar. This center distance should be as accurate as possible and the upper and lower edges of the bar should be parallel with a plane intersecting the axes of the plugs. The sine-bar is always used in conjunction with some true surface *H* from which measurements can be taken.



Method of setting Sine-bar to Given Angle A

The angle *A* to which the sine-bar is set depends upon the height *H* of one plug above the surface *B* upon which the other plug rests. The sine-bar frequently is set to the required height *H* by using gage-blocks to obtain great accuracy. If the sine-bar is to be set to a given angle, height *H* for this angle is determined by using the sine of the angle; hence, the name "sine-bar."

Rule: To set a sine-bar to a given angle, find the sine of the angle in a *trig table* containing the sines of angles, and then multiply this sine by the center distance *C* to obtain height *H*. Or, find the angle in a *sine-bar table* corresponding to length *C*, and obtain height *H* directly from the table.

Constants for 2.5-inch Sine-Bar, page 3048

Constants for 3-inch Sine-Bar, page 3055

Constants for 5-inch Sine-Bar, page 3062

Constants for 10-inch Sine-Bar, page 3069

Constants for 75-mm Sine-Bar, page 3076

Constants for 100-millimeter Sine-bar, page 3083

Constants for 125-mm Sine-Bar, page 3090

Constants for 2.5-inch Sine-Bar

Constants for Setting a 2.5-inch Sine-Bar for 0° to 7°

Min.	0°	1°	2°	3°	4°	5°	6°	7°
0	0.000000	0.043631	0.087249	0.130840	0.174391	0.217889	0.261321	0.304673
1	0.000727	0.044358	0.087976	0.131566	0.175117	0.218614	0.262044	0.305395
2	0.001454	0.045085	0.088702	0.132292	0.175842	0.219338	0.262768	0.306117
3	0.002182	0.045812	0.089429	0.133019	0.176567	0.220063	0.263491	0.306839
4	0.002909	0.046539	0.090156	0.133745	0.177293	0.220787	0.264214	0.307560
5	0.003636	0.047267	0.090883	0.134471	0.178018	0.221511	0.264937	0.308282
6	0.004363	0.047994	0.091609	0.135197	0.178744	0.222236	0.265660	0.309004
7	0.005091	0.048721	0.092336	0.135923	0.179469	0.222960	0.266383	0.309725
8	0.005818	0.049448	0.093063	0.136649	0.180194	0.223684	0.267106	0.310447
9	0.006545	0.050175	0.093789	0.137375	0.180920	0.224409	0.267829	0.311169
10	0.007272	0.050902	0.094516	0.138102	0.181645	0.225133	0.268552	0.311890
11	0.007999	0.051629	0.095243	0.138828	0.182370	0.225857	0.269275	0.312612
12	0.008727	0.052356	0.095970	0.139554	0.183095	0.226581	0.269998	0.313333
13	0.009454	0.053083	0.096696	0.140280	0.183821	0.227306	0.270721	0.314055
14	0.010181	0.053810	0.097423	0.141006	0.184546	0.228030	0.271444	0.314777
15	0.010908	0.054537	0.098150	0.141732	0.185271	0.228754	0.272167	0.315499
16	0.011635	0.055264	0.098876	0.142458	0.185996	0.229478	0.272890	0.316221
17	0.012363	0.055991	0.099603	0.143184	0.186722	0.230202	0.273613	0.316940
18	0.013090	0.056718	0.100329	0.143910	0.187447	0.230926	0.274336	0.317662
19	0.013817	0.057445	0.101056	0.144636	0.188172	0.231651	0.275059	0.318383
20	0.014544	0.058172	0.101783	0.145362	0.188897	0.232375	0.275781	0.319104
21	0.015272	0.058899	0.102509	0.146088	0.189622	0.233099	0.276504	0.319825
22	0.015999	0.059626	0.103236	0.146814	0.190347	0.233823	0.277227	0.320547
23	0.016726	0.060353	0.103963	0.147540	0.191072	0.234547	0.277950	0.321268
24	0.017453	0.061080	0.104689	0.148266	0.191798	0.235271	0.278672	0.321989
25	0.018180	0.061807	0.105416	0.148992	0.192523	0.235995	0.279395	0.322710
26	0.018908	0.062534	0.106142	0.149718	0.193248	0.236719	0.280118	0.323431
27	0.019635	0.063261	0.106869	0.150444	0.193973	0.237443	0.280840	0.324152
28	0.020362	0.063988	0.107595	0.151170	0.194698	0.238167	0.281563	0.324873
29	0.021089	0.064715	0.108322	0.151895	0.195423	0.238890	0.282285	0.325594
30	0.021816	0.065442	0.109048	0.152621	0.196148	0.239614	0.283008	0.326315
31	0.022544	0.066169	0.109775	0.153347	0.196873	0.240338	0.283731	0.327036
32	0.023271	0.066896	0.110502	0.154073	0.197598	0.241062	0.284453	0.327757
33	0.023998	0.067623	0.111228	0.154799	0.198323	0.241786	0.285176	0.328478
34	0.024725	0.068350	0.111955	0.155525	0.199048	0.242510	0.285898	0.329199
35	0.025452	0.069077	0.112681	0.156251	0.199772	0.243234	0.286620	0.329920
36	0.026179	0.069804	0.113407	0.156976	0.200497	0.243957	0.287343	0.330641
37	0.026907	0.070531	0.114134	0.157702	0.201222	0.244681	0.288065	0.331362
38	0.027634	0.071258	0.114860	0.158428	0.201947	0.245405	0.288788	0.332083
39	0.028361	0.071985	0.115587	0.159154	0.202672	0.246128	0.289510	0.332803
40	0.029088	0.072712	0.116313	0.159879	0.203397	0.246852	0.290232	0.333524
41	0.029815	0.073439	0.117040	0.160605	0.204122	0.247576	0.290955	0.334245
42	0.030543	0.074166	0.117766	0.161331	0.204846	0.248299	0.291677	0.334965
43	0.031270	0.074893	0.118493	0.162056	0.205571	0.249023	0.292399	0.335686
44	0.031997	0.075619	0.119219	0.162782	0.206296	0.249747	0.293121	0.336407
45	0.032724	0.076346	0.119945	0.163508	0.207021	0.250470	0.293844	0.337127
46	0.033451	0.077073	0.120672	0.164233	0.207745	0.251194	0.294566	0.337848
47	0.034178	0.077800	0.121398	0.164959	0.208470	0.251917	0.295288	0.338568
48	0.034905	0.078527	0.122124	0.165685	0.209195	0.252641	0.296010	0.339289
49	0.035633	0.079254	0.122851	0.166410	0.209919	0.253364	0.296732	0.340009
50	0.036360	0.079981	0.123577	0.167136	0.210644	0.254088	0.297454	0.340730
51	0.037087	0.080707	0.124303	0.167862	0.211369	0.254811	0.298176	0.341450
52	0.037814	0.081434	0.125030	0.168587	0.212093	0.255535	0.298898	0.342171
53	0.038541	0.082161	0.125756	0.169313	0.212818	0.256258	0.299620	0.342891
54	0.039268	0.082888	0.126482	0.170038	0.213542	0.256981	0.300342	0.343611
55	0.039995	0.083615	0.127209	0.170764	0.214267	0.257705	0.301064	0.344332
56	0.040723	0.084342	0.127935	0.171489	0.214991	0.258428	0.301786	0.345052
57	0.041450	0.085068	0.128661	0.172215	0.215716	0.259151	0.302508	0.345772
58	0.042177	0.085795	0.129387	0.172940	0.216440	0.259875	0.303230	0.346492
59	0.042904	0.086522	0.130114	0.173666	0.217165	0.260598	0.303952	0.347213
60	0.043631	0.087249	0.130840	0.174391	0.217889	0.261321	0.304673	0.347933

Constants for Setting a 2.5-inch Sine-Bar for 8° to 15°

Min.	8°	9°	10°	11°	12°	13°	14°	15°
0	0.347933	0.391086	0.434120	0.477022	0.519779	0.562378	0.604805	0.6477048
1	0.348653	0.391804	0.434837	0.477736	0.520491	0.563086	0.605510	0.6477750
2	0.349373	0.392523	0.435553	0.478450	0.521202	0.563795	0.606216	0.648452
3	0.350093	0.393241	0.436269	0.479164	0.521913	0.564503	0.606921	0.649155
4	0.350813	0.393959	0.436985	0.479878	0.522624	0.565212	0.607627	0.649857
5	0.351533	0.394677	0.437701	0.480591	0.523335	0.565920	0.608332	0.650559
6	0.352253	0.395395	0.438417	0.481305	0.524046	0.566628	0.609038	0.651261
7	0.352973	0.396113	0.439133	0.482019	0.524757	0.567337	0.609743	0.651963
8	0.353693	0.396831	0.439849	0.482732	0.525468	0.568045	0.610448	0.652665
9	0.354413	0.397549	0.440564	0.483446	0.526179	0.568753	0.611153	0.653367
10	0.355133	0.398267	0.441280	0.484159	0.526890	0.569461	0.611858	0.654069
11	0.355853	0.398985	0.441996	0.484872	0.527601	0.570169	0.612563	0.654771
12	0.356572	0.399703	0.442712	0.485586	0.528312	0.570877	0.613268	0.655473
13	0.357292	0.400421	0.443428	0.486299	0.529023	0.571585	0.613973	0.656175
14	0.358012	0.401139	0.444143	0.487013	0.529734	0.572293	0.614678	0.656876
15	0.358732	0.401856	0.444859	0.487726	0.530444	0.573001	0.615383	0.657578
16	0.359451	0.402574	0.445574	0.488439	0.531155	0.573709	0.616088	0.658280
17	0.360171	0.403292	0.446290	0.489152	0.531865	0.574417	0.616793	0.658981
18	0.360891	0.404010	0.447006	0.489865	0.532576	0.575124	0.617498	0.659683
19	0.361610	0.404727	0.447721	0.490578	0.533287	0.575832	0.618202	0.660384
20	0.362330	0.405445	0.448436	0.491292	0.533997	0.576540	0.618907	0.661085
21	0.363049	0.406162	0.449152	0.492005	0.534707	0.577247	0.619611	0.661787
22	0.363769	0.406880	0.449867	0.492718	0.535418	0.577955	0.620316	0.662488
23	0.364488	0.407597	0.450583	0.493430	0.536128	0.578662	0.621020	0.663189
24	0.365208	0.408315	0.451298	0.494143	0.536838	0.579370	0.621725	0.663890
25	0.365927	0.409032	0.452013	0.494856	0.537549	0.580077	0.622429	0.664591
26	0.366646	0.409750	0.452728	0.495569	0.538259	0.580784	0.623133	0.665292
27	0.367366	0.410467	0.453444	0.496282	0.538969	0.581492	0.623838	0.665993
28	0.368085	0.411184	0.454159	0.496994	0.539679	0.582199	0.624542	0.666694
29	0.368804	0.411902	0.454874	0.497707	0.540389	0.582906	0.625246	0.667395
30	0.369524	0.412619	0.455589	0.498420	0.541099	0.583613	0.625950	0.668096
31	0.370243	0.413336	0.456304	0.499132	0.541809	0.584321	0.626654	0.668797
32	0.370962	0.414053	0.457019	0.499845	0.542519	0.585028	0.627358	0.669497
33	0.371681	0.414771	0.457734	0.500558	0.543229	0.585735	0.628062	0.670198
34	0.372400	0.415488	0.458449	0.501270	0.543939	0.586442	0.628766	0.670899
35	0.373119	0.416205	0.459164	0.501982	0.544648	0.587148	0.629470	0.671599
36	0.373838	0.416922	0.459878	0.502695	0.545358	0.587855	0.630173	0.672300
37	0.374557	0.417639	0.460593	0.503407	0.546068	0.588562	0.630877	0.673000
38	0.375276	0.418356	0.461308	0.504119	0.546777	0.589269	0.631581	0.673700
39	0.375995	0.419073	0.462023	0.504832	0.547487	0.589976	0.632284	0.674401
40	0.376714	0.419790	0.462737	0.505544	0.548197	0.590682	0.632988	0.675101
41	0.377433	0.420507	0.463452	0.506256	0.548906	0.591389	0.633691	0.675801
42	0.378152	0.421223	0.464167	0.506968	0.549616	0.592095	0.634395	0.676501
43	0.378871	0.421940	0.464881	0.507680	0.550325	0.592802	0.635098	0.677201
44	0.379590	0.422657	0.465596	0.508392	0.551034	0.593508	0.635802	0.677901
45	0.380308	0.423374	0.466310	0.509104	0.551744	0.594215	0.636505	0.678601
46	0.381027	0.424090	0.467025	0.509816	0.552453	0.594921	0.637208	0.679301
47	0.381746	0.424807	0.467739	0.510528	0.553162	0.595627	0.637911	0.680001
48	0.382465	0.425524	0.468453	0.511240	0.553871	0.596334	0.638614	0.680701
49	0.383183	0.426240	0.469168	0.511952	0.554580	0.597040	0.639317	0.681400
50	0.383902	0.426957	0.469882	0.512664	0.555289	0.597746	0.640020	0.682100
51	0.384620	0.427673	0.470596	0.513376	0.555999	0.598452	0.640723	0.682800
52	0.385339	0.428390	0.471310	0.514087	0.556708	0.599158	0.641426	0.683499
53	0.386057	0.429106	0.472025	0.514799	0.557416	0.599864	0.642129	0.684199
54	0.386776	0.429823	0.472739	0.515510	0.558125	0.600570	0.642832	0.684898
55	0.387494	0.430539	0.473453	0.516222	0.558834	0.601276	0.643535	0.685597
56	0.388213	0.431255	0.474167	0.516934	0.559543	0.601982	0.644237	0.686297
57	0.388931	0.431972	0.474881	0.517645	0.560252	0.602688	0.644940	0.686996
58	0.389650	0.432688	0.475595	0.518357	0.560960	0.603393	0.645643	0.687695
59	0.390368	0.433404	0.476309	0.519068	0.561669	0.604099	0.646345	0.688394
60	0.391086	0.434120	0.477022	0.519779	0.562378	0.604805	0.647048	0.689093

Constants for Setting a 2.5-inch Sine-Bar for 16° to 23°

Min.	16°	17°	18°	19°	20°	21°	22°	23°
0	0.689093	0.730929	0.772543	0.813920	0.855050	0.895920	0.936517	0.976828
1	0.689792	0.731625	0.773234	0.814608	0.855734	0.896599	0.937191	0.977497
2	0.690491	0.732320	0.773926	0.815295	0.856417	0.897278	0.937865	0.978166
3	0.691190	0.733015	0.774617	0.815983	0.857100	0.897956	0.938539	0.978836
4	0.691889	0.733711	0.775309	0.816670	0.857783	0.898635	0.939213	0.979505
5	0.692588	0.734406	0.776000	0.817358	0.858466	0.899314	0.939887	0.980174
6	0.693287	0.735101	0.776691	0.818045	0.859149	0.899992	0.940561	0.980843
7	0.693985	0.735796	0.777382	0.818732	0.859832	0.900670	0.941234	0.981512
8	0.694684	0.736491	0.778073	0.819419	0.860515	0.901349	0.941908	0.982180
9	0.695382	0.737186	0.778764	0.820106	0.861198	0.902027	0.942582	0.982849
10	0.696081	0.737881	0.779455	0.820793	0.861880	0.902705	0.943255	0.983518
11	0.696779	0.738575	0.780146	0.821480	0.862563	0.903383	0.943929	0.984186
12	0.697478	0.739270	0.780837	0.822167	0.863246	0.904061	0.944602	0.984855
13	0.698176	0.739965	0.781528	0.822853	0.863928	0.904739	0.945275	0.985523
14	0.698874	0.740659	0.782219	0.823540	0.864610	0.905417	0.945948	0.986191
15	0.699573	0.741354	0.782910	0.824227	0.865293	0.906095	0.946622	0.986860
16	0.700271	0.742048	0.783600	0.824913	0.865975	0.906773	0.947295	0.987528
17	0.700969	0.742743	0.784291	0.825600	0.866657	0.907450	0.947968	0.988196
18	0.701667	0.743437	0.784981	0.826286	0.867339	0.908128	0.948640	0.988864
19	0.702365	0.744132	0.785672	0.826972	0.868021	0.908806	0.949313	0.989532
20	0.703063	0.744826	0.786362	0.827659	0.868703	0.909483	0.949986	0.990199
21	0.703761	0.745520	0.787052	0.828345	0.869385	0.910160	0.950659	0.990867
22	0.704458	0.746214	0.787742	0.829031	0.870067	0.910838	0.951331	0.991535
23	0.705156	0.746908	0.788433	0.829717	0.870748	0.911515	0.952004	0.992202
24	0.705854	0.747602	0.789123	0.830403	0.871430	0.912192	0.952676	0.992870
25	0.706551	0.748296	0.789813	0.831089	0.872112	0.912869	0.953348	0.993537
26	0.707249	0.748990	0.790503	0.831775	0.872793	0.913546	0.954020	0.994204
27	0.707946	0.749684	0.791192	0.832460	0.873475	0.914223	0.954693	0.994872
28	0.708644	0.750377	0.791882	0.833146	0.874156	0.914900	0.955365	0.995539
29	0.709341	0.751071	0.792572	0.833832	0.874837	0.915576	0.956037	0.996206
30	0.710038	0.751765	0.793262	0.834517	0.875519	0.916253	0.956709	0.996873
31	0.710736	0.752458	0.793951	0.835203	0.876200	0.916930	0.957380	0.997540
32	0.711433	0.753151	0.794641	0.835888	0.876881	0.917606	0.958052	0.998206
33	0.712130	0.753845	0.795330	0.836573	0.877562	0.918283	0.958724	0.998873
34	0.712827	0.754538	0.796020	0.837259	0.878243	0.918959	0.959395	0.999540
35	0.713524	0.755232	0.796709	0.837944	0.878923	0.919635	0.960067	1.000206
36	0.714221	0.755925	0.797398	0.838629	0.879604	0.920311	0.960738	1.000873
37	0.714918	0.756618	0.798087	0.839314	0.880285	0.920988	0.961410	1.001539
38	0.715615	0.757311	0.798777	0.839999	0.880965	0.921664	0.962081	1.002205
39	0.716311	0.758004	0.799466	0.840684	0.881646	0.922339	0.962752	1.002871
40	0.717008	0.758697	0.800155	0.841369	0.882326	0.923015	0.963423	1.003538
41	0.717705	0.759390	0.800844	0.842053	0.883007	0.923691	0.964094	1.004204
42	0.718401	0.760083	0.801533	0.842738	0.883687	0.924367	0.964765	1.004869
43	0.719098	0.760775	0.802221	0.843423	0.884367	0.925043	0.965436	1.005535
44	0.719794	0.761468	0.802910	0.844107	0.885048	0.925718	0.966107	1.006201
45	0.720491	0.762161	0.803599	0.844792	0.885728	0.926394	0.966777	1.006867
46	0.721187	0.762853	0.804287	0.845476	0.886408	0.927069	0.967448	1.007532
47	0.721883	0.763546	0.804976	0.846161	0.887088	0.927744	0.968119	1.008198
48	0.722579	0.764238	0.805664	0.846845	0.887767	0.928420	0.968789	1.008863
49	0.723276	0.764931	0.806353	0.847529	0.888447	0.929095	0.969459	1.009529
50	0.723972	0.765623	0.807041	0.848213	0.889127	0.929770	0.970130	1.010194
51	0.724668	0.766315	0.807729	0.848897	0.889807	0.930445	0.970800	1.010859
52	0.725364	0.767007	0.808417	0.849581	0.890486	0.931120	0.971470	1.011524
53	0.726060	0.767699	0.809106	0.850265	0.891166	0.931795	0.972140	1.012189
54	0.726755	0.768392	0.809794	0.850949	0.891845	0.932469	0.972810	1.012854
55	0.727451	0.769083	0.810482	0.851633	0.892524	0.933144	0.973480	1.013519
56	0.728147	0.769775	0.811169	0.852316	0.893204	0.933819	0.974150	1.014184
57	0.728843	0.770467	0.811857	0.853000	0.893883	0.934493	0.974819	1.014848
58	0.729538	0.771159	0.812545	0.853684	0.894562	0.935168	0.975489	1.015513
59	0.730234	0.771851	0.813233	0.854367	0.895241	0.935842	0.976158	1.016177
60	0.730929	0.772543	0.813920	0.855050	0.895920	0.936517	0.976828	1.016842

Constants for Setting a 2.5-inch Sine-Bar for 24° to 31°

Min.	24°	25°	26°	27°	28°	29°	30°	31°
0	1.016842	1.056546	1.095928	1.134976	1.173679	1.212024	1.250000	1.287595
1	1.017506	1.057205	1.096581	1.135624	1.174321	1.212660	1.250630	1.288218
2	1.018170	1.057864	1.097235	1.136272	1.174963	1.213296	1.251259	1.288842
3	1.018834	1.058522	1.097888	1.136920	1.175605	1.213932	1.251889	1.289465
4	1.019498	1.059181	1.098542	1.137567	1.176247	1.214567	1.252518	1.290088
5	1.020162	1.059840	1.099195	1.138215	1.176888	1.215203	1.253148	1.290711
6	1.020826	1.060499	1.099848	1.138862	1.177530	1.215839	1.253777	1.291333
7	1.021490	1.061157	1.100501	1.139510	1.178171	1.216474	1.254406	1.291956
8	1.022154	1.061816	1.101154	1.140157	1.178813	1.217109	1.255035	1.292579
9	1.022817	1.062474	1.101807	1.140804	1.179454	1.217744	1.255664	1.293201
10	1.023481	1.063132	1.102459	1.141451	1.180095	1.218379	1.256293	1.293823
11	1.024144	1.063790	1.103112	1.142098	1.180736	1.219014	1.256921	1.294445
12	1.024808	1.064448	1.103765	1.142745	1.181377	1.219649	1.257550	1.295068
13	1.025471	1.065106	1.104417	1.143392	1.182018	1.220284	1.258178	1.295690
14	1.026134	1.065764	1.105070	1.144038	1.182659	1.220919	1.258807	1.296311
15	1.026797	1.066422	1.105722	1.144685	1.183299	1.221553	1.259435	1.296933
16	1.027460	1.067080	1.106374	1.145331	1.183940	1.222188	1.260063	1.297555
17	1.028123	1.067737	1.107026	1.145978	1.184580	1.222822	1.260691	1.298176
18	1.028786	1.068395	1.107678	1.146624	1.185220	1.223456	1.261319	1.298798
19	1.029449	1.069052	1.108330	1.147270	1.185861	1.224090	1.261947	1.299419
20	1.030111	1.069709	1.108982	1.147916	1.186501	1.224724	1.262575	1.300040
21	1.030774	1.070367	1.109633	1.148562	1.187141	1.225358	1.263202	1.300661
22	1.031436	1.071024	1.110285	1.149208	1.187781	1.225992	1.263830	1.301282
23	1.032099	1.071681	1.110937	1.149854	1.188421	1.226626	1.264457	1.301903
24	1.032761	1.072338	1.111588	1.150499	1.189061	1.227259	1.265084	1.302524
25	1.033423	1.072995	1.112239	1.151145	1.189700	1.227893	1.265712	1.303145
26	1.034085	1.073652	1.112890	1.151790	1.190340	1.228526	1.266339	1.303765
27	1.034748	1.074308	1.113542	1.152436	1.190979	1.229160	1.266966	1.304386
28	1.035409	1.074965	1.114193	1.153081	1.191619	1.229793	1.267593	1.305006
29	1.036071	1.075621	1.114844	1.153726	1.192258	1.230426	1.268219	1.305626
30	1.036733	1.076278	1.115495	1.154372	1.192897	1.231059	1.268846	1.306246
31	1.037395	1.076934	1.116145	1.155017	1.193536	1.231692	1.269472	1.306866
32	1.038056	1.077590	1.116796	1.155661	1.194175	1.232325	1.270099	1.307486
33	1.038718	1.078246	1.117447	1.156306	1.194814	1.232957	1.270725	1.308106
34	1.039379	1.078903	1.118097	1.156951	1.195453	1.233590	1.271351	1.308726
35	1.040041	1.079558	1.118747	1.157596	1.196091	1.234222	1.271978	1.309345
36	1.040702	1.080214	1.119398	1.158240	1.196730	1.234855	1.272604	1.309965
37	1.041363	1.080870	1.120048	1.158885	1.197368	1.235487	1.273229	1.310584
38	1.042024	1.081526	1.120698	1.159529	1.198006	1.236119	1.273855	1.311203
39	1.042685	1.082181	1.121348	1.160173	1.198645	1.236751	1.274481	1.311822
40	1.043346	1.082837	1.121998	1.160817	1.199283	1.237383	1.275106	1.312441
41	1.044007	1.083492	1.122648	1.161461	1.199921	1.238015	1.275732	1.313060
42	1.044668	1.084148	1.123298	1.162105	1.200559	1.238647	1.276357	1.313679
43	1.045328	1.084803	1.123947	1.162749	1.201197	1.239278	1.276983	1.314298
44	1.045989	1.085458	1.124597	1.163393	1.201834	1.239910	1.277608	1.314916
45	1.046649	1.086113	1.125246	1.164036	1.202472	1.240541	1.278233	1.315535
46	1.047310	1.086768	1.125896	1.164680	1.203110	1.241173	1.278858	1.316153
47	1.047970	1.087423	1.126545	1.165323	1.203747	1.241804	1.279482	1.316771
48	1.048630	1.088078	1.127194	1.165967	1.204384	1.242435	1.280107	1.317389
49	1.049290	1.088732	1.127843	1.166610	1.205022	1.243066	1.280732	1.318008
50	1.049950	1.089387	1.128492	1.167253	1.205659	1.243697	1.281356	1.318625
51	1.050610	1.090042	1.129141	1.167896	1.206296	1.244328	1.281981	1.319243
52	1.051270	1.090696	1.129790	1.168539	1.206932	1.244958	1.282605	1.319861
53	1.051930	1.091350	1.130438	1.169182	1.207569	1.245589	1.283229	1.320478
54	1.052590	1.092005	1.131087	1.169825	1.208206	1.246219	1.283853	1.321096
55	1.053249	1.092659	1.131735	1.170467	1.208843	1.246850	1.284477	1.321713
56	1.053909	1.093313	1.132384	1.171110	1.209479	1.247480	1.285101	1.322330
57	1.054568	1.093967	1.133032	1.171752	1.210116	1.248110	1.285725	1.322948
58	1.055227	1.094620	1.133680	1.172395	1.210752	1.248740	1.286348	1.323565
59	1.055887	1.095274	1.134328	1.173037	1.211388	1.249370	1.286972	1.324181
60	1.056546	1.095928	1.134976	1.173679	1.212024	1.250000	1.287595	1.324798

Constants for Setting a 2.5-inch Sine-Bar for 32° to 39°

Min.	32°	33°	34°	35°	36°	37°	38°	39°
0	1.324798	1.361598	1.397982	1.433941	1.469463	1.504538	1.539154	1.573301
1	1.325415	1.362207	1.398585	1.434537	1.470051	1.505118	1.539727	1.573866
2	1.326031	1.362817	1.399188	1.435132	1.470640	1.505699	1.540300	1.574431
3	1.326648	1.363427	1.399790	1.435728	1.471228	1.506279	1.540872	1.574996
4	1.327264	1.364036	1.400393	1.436323	1.471815	1.506860	1.541445	1.575561
5	1.327880	1.364646	1.400995	1.436918	1.472403	1.507440	1.542017	1.576125
6	1.328496	1.365255	1.401597	1.437513	1.472991	1.508020	1.542590	1.576689
7	1.329112	1.365864	1.402200	1.438108	1.473578	1.508600	1.543162	1.577254
8	1.329728	1.366473	1.402802	1.438703	1.474166	1.509180	1.543734	1.577818
9	1.330344	1.367082	1.403404	1.439298	1.474753	1.509760	1.544306	1.578382
10	1.330960	1.367691	1.404005	1.439892	1.475340	1.510339	1.544878	1.578946
11	1.331575	1.368300	1.404607	1.440487	1.475927	1.510918	1.545449	1.579510
12	1.332191	1.368908	1.405208	1.441081	1.476514	1.511498	1.546021	1.580073
13	1.332806	1.369517	1.405810	1.441675	1.477101	1.512077	1.546592	1.580637
14	1.333421	1.370125	1.406411	1.442269	1.477688	1.512656	1.547164	1.581200
15	1.334036	1.370733	1.407012	1.442863	1.478274	1.513235	1.547735	1.581763
16	1.334651	1.371341	1.407613	1.443457	1.478860	1.513814	1.548306	1.582326
17	1.335266	1.371949	1.408214	1.444051	1.479447	1.514392	1.548877	1.582889
18	1.335881	1.372557	1.408815	1.444644	1.480033	1.514971	1.549448	1.583452
19	1.336496	1.373165	1.409416	1.445238	1.480619	1.515549	1.550018	1.584015
20	1.337110	1.373772	1.410016	1.445831	1.481205	1.516128	1.550589	1.584577
21	1.337724	1.374380	1.410617	1.446424	1.481791	1.516706	1.551159	1.585140
22	1.338339	1.374987	1.411217	1.447017	1.482376	1.517284	1.551729	1.585702
23	1.338953	1.375595	1.411818	1.447610	1.482962	1.517862	1.552300	1.586264
24	1.339567	1.376202	1.412418	1.448203	1.483547	1.518440	1.552870	1.586826
25	1.340181	1.376809	1.413018	1.448796	1.484133	1.519017	1.553439	1.587388
26	1.340795	1.377416	1.413617	1.449388	1.484718	1.519595	1.554009	1.587950
27	1.341409	1.378023	1.414217	1.449981	1.485303	1.520172	1.554579	1.588512
28	1.342022	1.378629	1.414817	1.450573	1.485888	1.520749	1.555148	1.589073
29	1.342636	1.379236	1.415416	1.451165	1.486472	1.521327	1.555717	1.589634
30	1.343249	1.379843	1.416016	1.451757	1.487057	1.521904	1.556287	1.590196
31	1.343862	1.380449	1.416615	1.452349	1.487641	1.522480	1.556856	1.590757
32	1.344476	1.381055	1.417214	1.452941	1.488226	1.523057	1.557425	1.591318
33	1.345088	1.381661	1.417813	1.453533	1.488810	1.523634	1.557993	1.591878
34	1.345701	1.382267	1.418412	1.454125	1.489394	1.524210	1.558562	1.592439
35	1.346314	1.382873	1.419011	1.454716	1.489978	1.524787	1.559131	1.593000
36	1.346927	1.383479	1.419609	1.455307	1.490562	1.525363	1.559699	1.593560
37	1.347540	1.384084	1.420208	1.455899	1.491146	1.525939	1.560267	1.594120
38	1.348152	1.384690	1.420806	1.456490	1.491730	1.526515	1.560835	1.594680
39	1.348765	1.385296	1.421405	1.457081	1.492313	1.527091	1.561404	1.595240
40	1.349377	1.385901	1.422003	1.457672	1.492897	1.527667	1.561971	1.595800
41	1.349989	1.386506	1.422601	1.458262	1.493480	1.528242	1.562539	1.596360
42	1.350601	1.387111	1.423199	1.458853	1.494063	1.528818	1.563107	1.596920
43	1.351213	1.387716	1.423797	1.459444	1.494646	1.529393	1.563674	1.597479
44	1.351825	1.388321	1.424394	1.460034	1.495229	1.529968	1.564242	1.598038
45	1.352436	1.388926	1.424992	1.460624	1.495812	1.530543	1.564809	1.598598
46	1.353048	1.389530	1.425589	1.461214	1.496394	1.531118	1.565376	1.599157
47	1.353659	1.390135	1.426187	1.461804	1.496977	1.531693	1.565943	1.599715
48	1.354271	1.390739	1.426784	1.462394	1.497559	1.532268	1.566509	1.600274
49	1.354882	1.391343	1.427381	1.462984	1.498141	1.532842	1.567076	1.600833
50	1.355493	1.391947	1.427978	1.463574	1.498723	1.533417	1.567643	1.601391
51	1.356104	1.392551	1.428575	1.464163	1.499305	1.533991	1.568209	1.601950
52	1.356715	1.393155	1.429172	1.464752	1.499887	1.534565	1.568775	1.602508
53	1.357326	1.393759	1.429768	1.465342	1.500469	1.535139	1.569342	1.603066
54	1.357936	1.394363	1.430365	1.465931	1.501051	1.535713	1.569908	1.603624
55	1.358547	1.394966	1.430961	1.466520	1.501632	1.536287	1.570474	1.604182
56	1.359157	1.395570	1.431557	1.467109	1.502213	1.536860	1.571039	1.604740
57	1.359767	1.396173	1.432153	1.467698	1.502795	1.537434	1.571605	1.605297
58	1.360378	1.396776	1.432750	1.468286	1.503376	1.538007	1.572170	1.605855
59	1.360988	1.397379	1.433345	1.468875	1.503957	1.538581	1.572736	1.606412
60	1.361598	1.397982	1.433941	1.469463	1.504538	1.539154	1.573301	1.606969

Constants for Setting a 2.5-inch Sine-Bar for 40° to 47°

Min.	40°	41°	42°	43°	44°	45°	46°	47°
0	1.606969	1.640148	1.672827	1.704996	1.736646	1.767767	1.798349	1.828384
1	1.607526	1.640696	1.673367	1.705528	1.737169	1.768281	1.798855	1.828880
2	1.608083	1.641245	1.673907	1.706059	1.737692	1.768795	1.799360	1.829376
3	1.608640	1.641793	1.674447	1.706591	1.738215	1.769309	1.799864	1.829871
4	1.609196	1.642342	1.674987	1.707122	1.738737	1.769823	1.800369	1.830367
5	1.609753	1.642890	1.675527	1.707653	1.739260	1.770336	1.800873	1.830862
6	1.610309	1.643438	1.676067	1.708184	1.739782	1.770850	1.801378	1.831357
7	1.610865	1.643986	1.676606	1.708715	1.740304	1.771363	1.801882	1.831852
8	1.611421	1.644534	1.677145	1.709246	1.740826	1.771876	1.802386	1.832347
9	1.611977	1.645082	1.677685	1.709777	1.741348	1.772389	1.802890	1.832842
10	1.612533	1.645629	1.678224	1.710307	1.741870	1.772902	1.803394	1.833336
11	1.613089	1.646176	1.678763	1.710838	1.742391	1.773414	1.803897	1.833831
12	1.613644	1.646724	1.679302	1.711368	1.742913	1.773927	1.804401	1.834325
13	1.614200	1.647271	1.679840	1.711898	1.743434	1.774439	1.804904	1.834819
14	1.614755	1.647818	1.680379	1.712428	1.743955	1.774951	1.805407	1.835313
15	1.615310	1.648365	1.680917	1.712958	1.744476	1.775463	1.805910	1.835806
16	1.615865	1.648911	1.681455	1.713487	1.744997	1.775975	1.806413	1.836300
17	1.616420	1.649458	1.681993	1.714017	1.745518	1.776487	1.806915	1.836793
18	1.616974	1.650004	1.682531	1.714546	1.746038	1.776999	1.807418	1.837286
19	1.617529	1.650550	1.683069	1.715075	1.746559	1.777510	1.807920	1.837780
20	1.618083	1.651097	1.683607	1.715604	1.747079	1.778021	1.808422	1.838273
21	1.618638	1.651643	1.684144	1.716133	1.747599	1.778533	1.808924	1.838765
22	1.619192	1.652188	1.684682	1.716662	1.748119	1.779044	1.809426	1.839258
23	1.619746	1.652734	1.685219	1.717190	1.748639	1.779554	1.809928	1.839751
24	1.620300	1.653280	1.685756	1.717719	1.749158	1.780065	1.810430	1.840243
25	1.620854	1.653825	1.686293	1.718247	1.749678	1.780576	1.810931	1.840735
26	1.621407	1.654370	1.686830	1.718775	1.750197	1.781086	1.811432	1.841227
27	1.621961	1.654916	1.687366	1.719303	1.750716	1.781596	1.811934	1.841719
28	1.622514	1.655461	1.687903	1.719831	1.751235	1.782106	1.812435	1.842211
29	1.623067	1.656005	1.688439	1.720359	1.751754	1.782616	1.812935	1.842702
30	1.623620	1.656550	1.688976	1.720886	1.752273	1.783126	1.813436	1.843193
31	1.624173	1.657095	1.689512	1.721414	1.752792	1.783636	1.813936	1.843685
32	1.624726	1.657639	1.690048	1.721941	1.753310	1.784145	1.814437	1.844176
33	1.625278	1.658183	1.690583	1.722468	1.753829	1.784655	1.814937	1.844667
34	1.625831	1.658728	1.691119	1.722995	1.754347	1.785164	1.815437	1.845157
35	1.626383	1.659272	1.691655	1.723522	1.754865	1.785673	1.815937	1.845648
36	1.626935	1.659816	1.692190	1.724049	1.755383	1.786182	1.816437	1.846138
37	1.627488	1.660359	1.692725	1.724575	1.755900	1.786690	1.816936	1.846629
38	1.628040	1.660903	1.693260	1.725102	1.756418	1.787199	1.817436	1.847119
39	1.628592	1.661446	1.693795	1.725628	1.756935	1.787708	1.817935	1.847609
40	1.629143	1.661990	1.694330	1.726154	1.757453	1.788216	1.818434	1.848099
41	1.629695	1.662533	1.694865	1.726680	1.757970	1.788724	1.818933	1.848588
42	1.630246	1.663076	1.695399	1.727206	1.758487	1.789232	1.819432	1.849078
43	1.630797	1.663619	1.695934	1.727732	1.759004	1.789740	1.819931	1.849567
44	1.631348	1.664162	1.696468	1.728257	1.759520	1.790247	1.820429	1.850056
45	1.631899	1.664704	1.697002	1.728783	1.760037	1.790755	1.820928	1.850545
46	1.632450	1.665247	1.697536	1.729308	1.760553	1.791262	1.821426	1.851034
47	1.633001	1.665789	1.698070	1.729833	1.761069	1.791770	1.821924	1.851523
48	1.633551	1.666331	1.698603	1.730358	1.761586	1.792277	1.822422	1.852012
49	1.634102	1.666873	1.699137	1.730883	1.762102	1.792783	1.822919	1.852500
50	1.634652	1.667415	1.699670	1.731407	1.762617	1.793290	1.823417	1.852988
51	1.635202	1.667957	1.700203	1.731932	1.763133	1.793797	1.823914	1.853476
52	1.635752	1.668499	1.700736	1.732456	1.763648	1.794303	1.824412	1.853964
53	1.636302	1.669040	1.701270	1.732981	1.764164	1.794810	1.824909	1.854452
54	1.636852	1.669582	1.701802	1.733505	1.764679	1.795316	1.825406	1.854940
55	1.637402	1.670123	1.702335	1.734029	1.765194	1.795822	1.825903	1.855427
56	1.637951	1.670664	1.702867	1.734552	1.765709	1.796328	1.826399	1.855914
57	1.638500	1.671205	1.703400	1.735076	1.766224	1.796833	1.826896	1.856402
58	1.639050	1.671745	1.703932	1.735599	1.766738	1.797339	1.827392	1.856889
59	1.639599	1.672286	1.704464	1.736123	1.767253	1.797844	1.827888	1.857375
60	1.640148	1.672827	1.704996	1.736646	1.767767	1.798349	1.828384	1.857862

Constants for Setting a 2.5-inch Sine-Bar for 48° to 55°

Min.	48°	49°	50°	51°	52°	53°	54°	55°
0	1.857862	1.886774	1.915111	1.942865	1.970027	1.996589	2.022542	2.047880
1	1.858349	1.887251	1.915578	1.943323	1.970475	1.997026	2.022970	2.048297
2	1.858835	1.887728	1.916046	1.943780	1.970922	1.997464	2.023397	2.048714
3	1.859321	1.888205	1.916513	1.944237	1.971369	1.997901	2.023824	2.049131
4	1.859807	1.888681	1.916980	1.944694	1.971816	1.998338	2.024251	2.049547
5	1.860293	1.889157	1.917446	1.945151	1.972263	1.998775	2.024678	2.049963
6	1.860779	1.889634	1.917913	1.945608	1.972710	1.999212	2.025104	2.050380
7	1.861264	1.890110	1.918379	1.946064	1.973157	1.999648	2.025530	2.050796
8	1.861750	1.890586	1.918846	1.946521	1.973603	2.000085	2.025957	2.051212
9	1.862235	1.891061	1.919312	1.946977	1.974050	2.000521	2.026383	2.051627
10	1.862720	1.891537	1.919778	1.947433	1.974496	2.000957	2.026809	2.052043
11	1.863205	1.892012	1.920243	1.947889	1.974942	2.001393	2.027234	2.052458
12	1.863690	1.892488	1.920709	1.948345	1.975388	2.001828	2.027660	2.052873
13	1.864175	1.892963	1.921174	1.948801	1.975833	2.002264	2.028085	2.053288
14	1.864659	1.893438	1.921640	1.949256	1.976279	2.002699	2.028510	2.053703
15	1.865143	1.893913	1.922105	1.949711	1.976724	2.003134	2.028935	2.054117
16	1.865628	1.894387	1.922570	1.950166	1.977169	2.003570	2.029360	2.054532
17	1.866112	1.894862	1.923034	1.950621	1.977614	2.004004	2.029784	2.054946
18	1.866596	1.895336	1.923499	1.951076	1.978059	2.004439	2.030209	2.055360
19	1.867079	1.895810	1.923963	1.951531	1.978503	2.004874	2.030633	2.055774
20	1.867563	1.896284	1.924428	1.951985	1.978948	2.005308	2.031057	2.056188
21	1.868046	1.896758	1.924892	1.952439	1.979392	2.005742	2.031481	2.056601
22	1.868529	1.897231	1.925356	1.952893	1.979836	2.006176	2.031905	2.057015
23	1.869012	1.897705	1.925820	1.953347	1.980280	2.006610	2.032329	2.057428
24	1.869495	1.898178	1.926283	1.953801	1.980724	2.007044	2.032752	2.057841
25	1.869978	1.898651	1.926747	1.954255	1.981168	2.007477	2.033175	2.058254
26	1.870461	1.899125	1.927210	1.954708	1.981611	2.007910	2.033598	2.058666
27	1.870943	1.899597	1.927673	1.955162	1.982055	2.008344	2.034021	2.059079
28	1.871425	1.900070	1.928136	1.955615	1.982498	2.008777	2.034444	2.059491
29	1.871907	1.900543	1.928599	1.956068	1.982941	2.009210	2.034867	2.059904
30	1.872389	1.901015	1.929062	1.956520	1.983383	2.009642	2.035289	2.060316
31	1.872871	1.901487	1.929524	1.956973	1.983826	2.010075	2.035711	2.060727
32	1.873353	1.901959	1.929986	1.957425	1.984268	2.010507	2.036133	2.061139
33	1.873834	1.902431	1.930448	1.957878	1.984711	2.010939	2.036555	2.061550
34	1.874316	1.902903	1.930910	1.958330	1.985153	2.011371	2.036977	2.061962
35	1.874797	1.903374	1.931372	1.958782	1.985595	2.011803	2.037398	2.062373
36	1.875278	1.903846	1.931834	1.959234	1.986037	2.012234	2.037819	2.062784
37	1.875759	1.904317	1.932295	1.959685	1.986478	2.012666	2.038241	2.063195
38	1.876239	1.904788	1.932757	1.960137	1.986920	2.013097	2.038662	2.063605
39	1.876720	1.905259	1.933218	1.960588	1.987361	2.013528	2.039083	2.064016
40	1.877200	1.905730	1.933679	1.961039	1.987802	2.013959	2.039503	2.064426
41	1.877680	1.906200	1.934140	1.961490	1.988243	2.014390	2.039924	2.064836
42	1.878160	1.906671	1.934601	1.961941	1.988684	2.014821	2.040344	2.065246
43	1.878640	1.907141	1.935061	1.962392	1.989124	2.015251	2.040764	2.065655
44	1.879120	1.907611	1.935521	1.962842	1.989565	2.015682	2.041184	2.066065
45	1.879600	1.908081	1.935982	1.963292	1.990005	2.016112	2.041604	2.066474
46	1.880079	1.908551	1.936442	1.963742	1.990445	2.016541	2.042024	2.066884
47	1.880558	1.909021	1.936902	1.964193	1.990885	2.016971	2.042443	2.067293
48	1.881037	1.909490	1.937361	1.964642	1.991325	2.017401	2.042862	2.067701
49	1.881516	1.909959	1.937821	1.965092	1.991764	2.017830	2.043281	2.068110
50	1.881995	1.910429	1.938280	1.965541	1.992204	2.018260	2.043700	2.068519
51	1.882474	1.910897	1.938739	1.965991	1.992643	2.018688	2.044119	2.068927
52	1.882952	1.911366	1.939198	1.966440	1.993082	2.019117	2.044538	2.069335
53	1.883430	1.911835	1.939657	1.966889	1.993521	2.019546	2.044956	2.069743
54	1.883909	1.912304	1.940116	1.967338	1.993960	2.019975	2.045374	2.070151
55	1.884387	1.912772	1.940575	1.967786	1.994398	2.020403	2.045792	2.070559
56	1.884864	1.913240	1.941033	1.968235	1.994837	2.020831	2.046210	2.070966
57	1.885342	1.913708	1.941491	1.968683	1.995275	2.021259	2.046628	2.071373
58	1.885819	1.914176	1.941949	1.969131	1.995713	2.021687	2.047045	2.071780
59	1.886297	1.914644	1.942407	1.969579	1.996151	2.022115	2.047463	2.072187
60	1.886774	1.915111	1.942865	1.970027	1.996589	2.022542	2.047880	2.072594

Constants for 3-inch Sine-Bar

Constants for Setting a 3-inch Sine-Bar for 0° to 7°

Min.	0°	1°	2°	3°	4°	5°	6°	7°
0	0.000000	0.052357	0.104698	0.157008	0.209269	0.261467	0.313585	0.365608
1	0.000873	0.053230	0.105571	0.157879	0.210140	0.262337	0.314453	0.366474
2	0.001745	0.054102	0.106443	0.158751	0.211010	0.263206	0.315321	0.367340
3	0.002618	0.054975	0.107315	0.159622	0.211881	0.264075	0.316189	0.368206
4	0.003491	0.055847	0.108187	0.160494	0.212751	0.264944	0.317057	0.369072
5	0.004363	0.056720	0.109059	0.161365	0.213622	0.265814	0.317924	0.369938
6	0.005236	0.057592	0.109931	0.162236	0.214492	0.266683	0.318792	0.370804
7	0.006109	0.058465	0.110803	0.163108	0.215363	0.267552	0.319660	0.371670
8	0.006981	0.059337	0.111675	0.163979	0.216233	0.268421	0.320528	0.372536
9	0.007854	0.060210	0.112547	0.164851	0.217104	0.269290	0.321395	0.373402
10	0.008727	0.061082	0.113419	0.165722	0.217974	0.270160	0.322263	0.374268
11	0.009599	0.061955	0.114291	0.166593	0.218844	0.271029	0.323131	0.375134
12	0.010472	0.062827	0.115163	0.167465	0.219715	0.271898	0.323998	0.376000
13	0.011345	0.063700	0.116035	0.168336	0.220585	0.272767	0.324866	0.376865
14	0.012217	0.064572	0.116907	0.169207	0.221455	0.273636	0.325733	0.377731
15	0.013090	0.065445	0.117779	0.170078	0.222325	0.274505	0.326601	0.378597
16	0.013963	0.066317	0.118651	0.170950	0.223196	0.275374	0.327468	0.379463
17	0.014835	0.067190	0.119523	0.171821	0.224066	0.276243	0.328336	0.380328
18	0.015708	0.068062	0.120395	0.172692	0.224936	0.277112	0.329203	0.381194
19	0.016581	0.068934	0.121267	0.173563	0.225806	0.277981	0.330070	0.382059
20	0.017453	0.069807	0.122139	0.174434	0.226677	0.278850	0.330938	0.382925
21	0.018326	0.070679	0.123011	0.175306	0.227547	0.279718	0.331805	0.383790
22	0.019198	0.071552	0.123883	0.176177	0.228417	0.280587	0.332672	0.384656
23	0.020071	0.072424	0.124755	0.177048	0.229287	0.281456	0.333540	0.385521
24	0.020944	0.073297	0.125627	0.177919	0.230157	0.282325	0.334407	0.386387
25	0.021816	0.074169	0.126499	0.178790	0.231027	0.283194	0.335274	0.387252
26	0.022689	0.075041	0.127371	0.179661	0.231897	0.284062	0.336141	0.388118
27	0.023562	0.075914	0.128243	0.180532	0.232767	0.284931	0.337008	0.388983
28	0.024434	0.076786	0.129114	0.181404	0.233637	0.285800	0.337875	0.389848
29	0.025307	0.077658	0.129986	0.182275	0.234507	0.286669	0.338743	0.390713
30	0.026180	0.078531	0.130858	0.183146	0.235377	0.287537	0.339610	0.391579
31	0.027052	0.079403	0.131730	0.184017	0.236247	0.288406	0.340477	0.392444
32	0.027925	0.080276	0.132602	0.184888	0.237117	0.289275	0.341344	0.393309
33	0.028797	0.081148	0.133474	0.185759	0.237987	0.290143	0.342211	0.394174
34	0.029670	0.082020	0.134345	0.186630	0.238857	0.291012	0.343078	0.395039
35	0.030543	0.082893	0.135217	0.187501	0.239727	0.291880	0.343945	0.395904
36	0.031415	0.083765	0.136089	0.188372	0.240597	0.292749	0.344811	0.396769
37	0.032288	0.084637	0.136961	0.189242	0.241467	0.293617	0.345678	0.397634
38	0.033161	0.085510	0.137832	0.190113	0.242336	0.294486	0.346545	0.398499
39	0.034033	0.086382	0.138704	0.190984	0.243206	0.295354	0.347412	0.399364
40	0.034906	0.087254	0.139576	0.191855	0.244076	0.296223	0.348279	0.400229
41	0.035778	0.088126	0.140448	0.192726	0.244946	0.297091	0.349146	0.401094
42	0.036651	0.088999	0.141319	0.193597	0.245816	0.297959	0.350012	0.401959
43	0.037524	0.089871	0.142191	0.194468	0.246685	0.298828	0.350879	0.402823
44	0.038396	0.090743	0.143063	0.195339	0.247555	0.299696	0.351746	0.403688
45	0.039269	0.091616	0.143934	0.196209	0.248425	0.300564	0.352612	0.404553
46	0.040141	0.092488	0.144806	0.197080	0.249294	0.301432	0.353479	0.405418
47	0.041014	0.093360	0.145678	0.197951	0.250164	0.302301	0.354345	0.406282
48	0.041887	0.094232	0.146549	0.198822	0.251034	0.303169	0.355212	0.407147
49	0.042759	0.095105	0.147421	0.199692	0.251903	0.304037	0.356078	0.408011
50	0.043632	0.095977	0.148293	0.200563	0.252773	0.304905	0.356945	0.408876
51	0.044504	0.096849	0.149164	0.201434	0.253642	0.305773	0.357811	0.409740
52	0.045377	0.097721	0.150036	0.202305	0.254512	0.306641	0.358678	0.410605
53	0.046249	0.098593	0.150907	0.203175	0.255381	0.307510	0.359544	0.411469
54	0.047122	0.099466	0.151779	0.204046	0.256251	0.308378	0.360411	0.412334
55	0.047995	0.100338	0.152650	0.204917	0.257120	0.309246	0.361277	0.413198
56	0.048867	0.101210	0.153522	0.205787	0.257990	0.310114	0.362143	0.414062
57	0.049740	0.102082	0.154393	0.206658	0.258859	0.310982	0.363009	0.414927
58	0.050612	0.102954	0.155265	0.207528	0.259728	0.311850	0.363876	0.415791
59	0.051485	0.103826	0.156136	0.208399	0.260598	0.312717	0.364742	0.416655
60	0.052357	0.104698	0.157008	0.209269	0.261467	0.313585	0.365608	0.417519

Constants for Setting a 3-inch Sine-Bar for 8° to 15°

Min.	8°	9°	10°	11°	12°	13°	14°	15°
0	0.417519	0.469303	0.520945	0.572427	0.623735	0.674853	0.725766	0.776457
1	0.418383	0.470165	0.521804	0.573284	0.624589	0.675703	0.726612	0.777300
2	0.419248	0.471027	0.522663	0.574140	0.625442	0.676554	0.727459	0.778143
3	0.420112	0.471889	0.523523	0.574997	0.626296	0.677404	0.728306	0.778986
4	0.420976	0.472751	0.524382	0.575853	0.627149	0.678254	0.729152	0.779828
5	0.421840	0.473612	0.525241	0.576710	0.628002	0.679104	0.729999	0.780671
6	0.422704	0.474474	0.526100	0.577566	0.628856	0.679954	0.730845	0.781514
7	0.423568	0.475336	0.526959	0.578422	0.629709	0.680804	0.731691	0.782356
8	0.424432	0.476197	0.527818	0.579278	0.630562	0.681654	0.732538	0.783198
9	0.425295	0.477059	0.528677	0.580135	0.631415	0.682504	0.733384	0.784041
10	0.426159	0.477921	0.529536	0.580991	0.632268	0.683353	0.734230	0.784883
11	0.427023	0.478782	0.530395	0.581847	0.633121	0.684203	0.735076	0.785725
12	0.427887	0.479644	0.531254	0.582703	0.633974	0.685053	0.735922	0.786568
13	0.428751	0.480505	0.532113	0.583559	0.634827	0.685902	0.736768	0.787410
14	0.429614	0.481366	0.532972	0.584415	0.635680	0.686752	0.737614	0.788252
15	0.430478	0.482228	0.533831	0.585271	0.636533	0.687601	0.738460	0.789094
16	0.431341	0.483089	0.534689	0.586127	0.637386	0.688451	0.739306	0.789936
17	0.432205	0.483950	0.535548	0.586983	0.638239	0.689300	0.740151	0.790777
18	0.433069	0.484811	0.536407	0.587838	0.639091	0.690149	0.740997	0.791619
19	0.433932	0.485673	0.537265	0.588694	0.639944	0.690998	0.741843	0.792461
20	0.434796	0.486534	0.538124	0.589550	0.640796	0.691848	0.742688	0.793302
21	0.435659	0.487395	0.538982	0.590405	0.641649	0.692697	0.743534	0.794144
22	0.436522	0.488256	0.539841	0.591261	0.642501	0.693546	0.744379	0.794986
23	0.437386	0.489117	0.540699	0.592117	0.643354	0.694395	0.745224	0.795827
24	0.438249	0.489978	0.541557	0.592972	0.644206	0.695244	0.746070	0.796668
25	0.439112	0.490839	0.542416	0.593827	0.645058	0.696093	0.746915	0.797510
26	0.439976	0.491700	0.543274	0.594683	0.645911	0.696941	0.747760	0.798351
27	0.440839	0.492561	0.544132	0.595538	0.646763	0.697790	0.748605	0.799192
28	0.441702	0.493421	0.544990	0.596393	0.647615	0.698639	0.749450	0.800033
29	0.442565	0.494282	0.545849	0.597249	0.648467	0.699488	0.750295	0.800874
30	0.443428	0.495143	0.546707	0.598104	0.649319	0.700336	0.751140	0.801715
31	0.444291	0.496004	0.547565	0.598959	0.650171	0.701185	0.751985	0.802556
32	0.445154	0.496864	0.548423	0.599814	0.651023	0.702033	0.752830	0.803397
33	0.446017	0.497725	0.549281	0.600669	0.651875	0.702882	0.753674	0.804238
34	0.446880	0.498585	0.550138	0.601524	0.652726	0.703730	0.754519	0.805078
35	0.447743	0.499446	0.550996	0.602379	0.653578	0.704578	0.755364	0.805919
36	0.448606	0.500306	0.551854	0.603234	0.654430	0.705426	0.756208	0.806759
37	0.449469	0.501167	0.552712	0.604089	0.655281	0.706275	0.757053	0.807600
38	0.450332	0.502027	0.553569	0.604943	0.656133	0.707123	0.757897	0.808441
39	0.451194	0.502887	0.554427	0.605798	0.656984	0.707971	0.758741	0.809282
40	0.452057	0.503748	0.555285	0.606653	0.657836	0.708819	0.759586	0.810121
41	0.452920	0.504608	0.556142	0.607507	0.658687	0.709667	0.760430	0.810961
42	0.453782	0.505468	0.557000	0.608362	0.659539	0.710514	0.761274	0.811801
43	0.454645	0.506328	0.557857	0.609216	0.660390	0.711362	0.762118	0.812641
44	0.455508	0.507188	0.558715	0.610071	0.661241	0.712210	0.762962	0.813481
45	0.456370	0.508049	0.559572	0.610925	0.662092	0.713058	0.763806	0.814321
46	0.457233	0.508909	0.560429	0.611780	0.662943	0.713905	0.764650	0.815161
47	0.458095	0.509769	0.561287	0.612634	0.663795	0.714753	0.765494	0.816001
48	0.458958	0.510629	0.562144	0.613488	0.664645	0.715600	0.766337	0.816841
49	0.459820	0.511488	0.563001	0.614342	0.665496	0.716448	0.767181	0.817680
50	0.460682	0.512348	0.563858	0.615197	0.666347	0.717295	0.768025	0.818520
51	0.461545	0.513208	0.564715	0.616051	0.667198	0.718143	0.768868	0.819360
52	0.462407	0.514068	0.565572	0.616905	0.668049	0.718990	0.769712	0.820199
53	0.463269	0.514928	0.566429	0.617759	0.668900	0.719837	0.770555	0.821038
54	0.464131	0.515787	0.567286	0.618613	0.669750	0.720684	0.771398	0.821878
55	0.464993	0.516647	0.568143	0.619466	0.670601	0.721531	0.772242	0.822717
56	0.465855	0.517507	0.569000	0.620320	0.671452	0.722378	0.773085	0.823556
57	0.466717	0.518366	0.569857	0.621174	0.672302	0.723225	0.773928	0.824395
58	0.467579	0.519226	0.570714	0.622028	0.673152	0.724072	0.774771	0.825234
59	0.468441	0.520085	0.571570	0.622881	0.674003	0.724919	0.775614	0.826073
60	0.469303	0.520945	0.572427	0.623735	0.674853	0.725766	0.776457	0.826912

Constants for Setting a 3-inch Sine-Bar for 16° to 23°

Min.	16°	17°	18°	19°	20°	21°	22°	23°
0	0.826912	0.877115	0.927051	0.976704	1.026060	1.075104	1.123820	1.172193
1	0.827751	0.877950	0.927881	0.977530	1.026880	1.075919	1.124629	1.172997
2	0.828590	0.878784	0.928711	0.978355	1.027700	1.076733	1.125438	1.173800
3	0.829428	0.879618	0.929540	0.979179	1.028520	1.077548	1.126247	1.174603
4	0.830267	0.880453	0.930370	0.980004	1.029340	1.078362	1.127056	1.175406
5	0.831106	0.881287	0.931200	0.980829	1.030160	1.079176	1.127864	1.176209
6	0.831944	0.882121	0.932029	0.981654	1.030979	1.079991	1.128673	1.177011
7	0.832782	0.882955	0.932859	0.982478	1.031799	1.080805	1.129481	1.177814
8	0.833621	0.883789	0.933688	0.983303	1.032618	1.081619	1.130290	1.178617
9	0.834459	0.884623	0.934517	0.984127	1.033437	1.082433	1.131098	1.179419
10	0.835297	0.885457	0.935347	0.984951	1.034256	1.083246	1.131906	1.180221
11	0.836135	0.886290	0.936176	0.985776	1.035076	1.084060	1.132714	1.181024
12	0.836973	0.887124	0.937005	0.986600	1.035895	1.084874	1.133522	1.181826
13	0.837811	0.887958	0.937834	0.987424	1.036714	1.085687	1.134330	1.182628
14	0.838649	0.888791	0.938663	0.988248	1.037532	1.086501	1.135138	1.183430
15	0.839487	0.889625	0.939491	0.989072	1.038351	1.087314	1.135946	1.184232
16	0.840325	0.890458	0.940320	0.989896	1.039170	1.088127	1.136754	1.185033
17	0.841163	0.891291	0.941149	0.990719	1.039988	1.088941	1.137561	1.185835
18	0.842000	0.892125	0.941977	0.991543	1.040807	1.089754	1.138368	1.186636
19	0.842838	0.892958	0.942806	0.992367	1.041625	1.090567	1.139176	1.187438
20	0.843675	0.893791	0.943634	0.993190	1.042444	1.091380	1.139983	1.188239
21	0.844513	0.894624	0.944463	0.994014	1.043262	1.092193	1.140790	1.189041
22	0.845350	0.895457	0.945291	0.994837	1.044080	1.093005	1.141597	1.189842
23	0.846187	0.896290	0.946119	0.995660	1.044898	1.093818	1.142404	1.190643
24	0.847024	0.897122	0.946947	0.996483	1.045716	1.094630	1.143211	1.191444
25	0.847861	0.897955	0.947775	0.997306	1.046534	1.095443	1.144018	1.192245
26	0.848698	0.898788	0.948603	0.998129	1.047352	1.096255	1.144825	1.193045
27	0.849536	0.899620	0.949431	0.998952	1.048170	1.097067	1.145631	1.193846
28	0.850372	0.900453	0.950259	0.999775	1.048987	1.097880	1.146438	1.194646
29	0.851209	0.901285	0.951086	1.000598	1.049805	1.098692	1.147244	1.195447
30	0.852046	0.902117	0.951914	1.001421	1.050622	1.099504	1.148050	1.196247
31	0.852883	0.902950	0.952742	1.002243	1.051440	1.100316	1.148857	1.197047
32	0.853719	0.903782	0.953569	1.003066	1.052257	1.101127	1.149663	1.197848
33	0.854556	0.904614	0.954396	1.003888	1.053074	1.101939	1.150469	1.198648
34	0.855392	0.905446	0.955224	1.004710	1.053891	1.102751	1.151275	1.199448
35	0.856229	0.906278	0.956051	1.005533	1.054708	1.103562	1.152080	1.200247
36	0.857065	0.907110	0.956878	1.006355	1.055525	1.104374	1.152886	1.201047
37	0.857901	0.907941	0.957705	1.007177	1.056342	1.105185	1.153692	1.201847
38	0.858738	0.908773	0.958532	1.007999	1.057158	1.105996	1.154497	1.202646
39	0.859574	0.909605	0.959359	1.008821	1.057975	1.106807	1.155303	1.203446
40	0.860410	0.910436	0.960186	1.009642	1.058792	1.107618	1.156108	1.204245
41	0.861246	0.911268	0.961012	1.010464	1.059608	1.108429	1.156913	1.205044
42	0.862082	0.912099	0.961839	1.011286	1.060425	1.109240	1.157718	1.205843
43	0.862917	0.912931	0.962666	1.012107	1.061241	1.110051	1.158523	1.206642
44	0.863753	0.913762	0.963492	1.012929	1.062057	1.110862	1.159328	1.207441
45	0.864589	0.914593	0.964318	1.013750	1.062873	1.111672	1.160133	1.208240
46	0.865424	0.915424	0.965145	1.014571	1.063689	1.112483	1.160938	1.209039
47	0.866260	0.916255	0.965971	1.015393	1.064505	1.113293	1.161742	1.209837
48	0.867095	0.917086	0.966797	1.016214	1.065321	1.114104	1.162547	1.210636
49	0.867931	0.917917	0.967623	1.017035	1.066137	1.114914	1.163351	1.211434
50	0.868766	0.918748	0.968449	1.017856	1.066952	1.115724	1.164156	1.212233
51	0.869601	0.919578	0.969275	1.018677	1.067768	1.116534	1.164960	1.213031
52	0.870436	0.920409	0.970101	1.019497	1.068583	1.117344	1.165764	1.213829
53	0.871272	0.921239	0.970927	1.020318	1.069399	1.118154	1.166568	1.214627
54	0.872107	0.922070	0.971752	1.021139	1.070214	1.118963	1.167372	1.215425
55	0.872941	0.922900	0.972578	1.021959	1.071029	1.119773	1.168176	1.216223
56	0.873776	0.923731	0.973403	1.022780	1.071844	1.120583	1.168979	1.217020
57	0.874611	0.924561	0.974229	1.023600	1.072659	1.121392	1.169783	1.217818
58	0.875446	0.925391	0.975054	1.024420	1.073474	1.122201	1.170587	1.218615
59	0.876281	0.926221	0.975879	1.025240	1.074289	1.123011	1.171390	1.219413
60	0.877115	0.927051	0.976704	1.026060	1.075104	1.123820	1.172193	1.220210

Constants for Setting a 3-inch Sine-Bar for 24° to 31°

Min.	24°	25°	26°	27°	28°	29°	30°	31°
0	1.220210	1.267855	1.315113	1.361971	1.408415	1.454429	1.500000	1.545114
1	1.221007	1.268646	1.315898	1.362749	1.409185	1.455192	1.500756	1.545862
2	1.221804	1.269436	1.316682	1.363526	1.409956	1.455955	1.501511	1.546610
3	1.222601	1.270227	1.317466	1.364304	1.410726	1.456718	1.502267	1.547358
4	1.223398	1.271018	1.318250	1.365081	1.411496	1.457481	1.503022	1.548105
5	1.224195	1.271808	1.319034	1.365858	1.412266	1.458244	1.503777	1.548853
6	1.224991	1.272598	1.319818	1.366635	1.413036	1.459006	1.504532	1.549600
7	1.225788	1.273389	1.320601	1.367412	1.413805	1.459769	1.505287	1.550347
8	1.226584	1.274179	1.321385	1.368188	1.414575	1.460531	1.506042	1.551094
9	1.227381	1.274969	1.322168	1.368965	1.415344	1.461293	1.506797	1.551841
10	1.228177	1.275758	1.322951	1.369741	1.416114	1.462055	1.507551	1.552588
11	1.228973	1.276548	1.323735	1.370518	1.416883	1.462817	1.508306	1.553334
12	1.229769	1.277338	1.324518	1.371294	1.417652	1.463579	1.509060	1.554081
13	1.230565	1.278127	1.325301	1.372070	1.418421	1.464341	1.509814	1.554827
14	1.231361	1.278917	1.326083	1.372846	1.419190	1.465102	1.510568	1.555574
15	1.232157	1.279706	1.326866	1.373622	1.419959	1.465864	1.511322	1.556320
16	1.232952	1.280496	1.327649	1.374398	1.420728	1.466625	1.512076	1.557066
17	1.233748	1.281285	1.328431	1.375173	1.421496	1.467386	1.512829	1.557812
18	1.234543	1.282074	1.329214	1.375949	1.422265	1.468147	1.513583	1.558557
19	1.235338	1.282863	1.329996	1.376724	1.423033	1.468908	1.514336	1.559303
20	1.236134	1.283651	1.330778	1.377499	1.423801	1.469669	1.515090	1.560048
21	1.236929	1.284440	1.331560	1.378275	1.424569	1.470430	1.515843	1.560794
22	1.237724	1.285229	1.332342	1.379050	1.425337	1.471190	1.516596	1.561539
23	1.238519	1.286017	1.333124	1.379825	1.426105	1.471951	1.517349	1.562284
24	1.239313	1.286805	1.333906	1.380599	1.426873	1.472711	1.518101	1.563029
25	1.240108	1.287594	1.334687	1.381374	1.427640	1.473472	1.518854	1.563774
26	1.240903	1.288382	1.335469	1.382149	1.428408	1.474232	1.519606	1.564518
27	1.241697	1.289170	1.336250	1.382923	1.429175	1.474992	1.520359	1.565263
28	1.242491	1.289958	1.337031	1.383698	1.429942	1.475751	1.521111	1.566007
29	1.243286	1.290746	1.337812	1.384472	1.430709	1.476511	1.521863	1.566752
30	1.244080	1.291533	1.338593	1.385246	1.431476	1.477271	1.522615	1.567496
31	1.244874	1.292321	1.339374	1.386020	1.432243	1.478030	1.523367	1.568240
32	1.245668	1.293108	1.340155	1.386794	1.433010	1.478789	1.524119	1.568984
33	1.246462	1.293896	1.340936	1.387568	1.433776	1.479549	1.524870	1.569727
34	1.247255	1.294683	1.341717	1.388341	1.434543	1.480308	1.525622	1.570471
35	1.248049	1.295470	1.342497	1.389115	1.435309	1.481067	1.526373	1.571214
36	1.248842	1.296257	1.343277	1.389888	1.436076	1.481826	1.527124	1.571958
37	1.249636	1.297044	1.344058	1.390661	1.436842	1.482584	1.527875	1.572701
38	1.250429	1.297831	1.344838	1.391435	1.437608	1.483343	1.528626	1.573444
39	1.251222	1.298618	1.345618	1.392208	1.438374	1.484101	1.529377	1.574187
40	1.252015	1.299404	1.346398	1.392981	1.439139	1.484860	1.530128	1.574930
41	1.252808	1.300191	1.347177	1.393753	1.439905	1.485618	1.530878	1.575672
42	1.253601	1.300977	1.347957	1.394526	1.440671	1.486376	1.531629	1.576415
43	1.254394	1.301764	1.348737	1.395299	1.441436	1.487134	1.532379	1.577157
44	1.255187	1.302550	1.349516	1.396071	1.442201	1.487892	1.533129	1.577900
45	1.255979	1.303336	1.350295	1.396844	1.442966	1.488650	1.533879	1.578642
46	1.256772	1.304122	1.351075	1.397616	1.443731	1.489407	1.534629	1.579384
47	1.257564	1.304908	1.351854	1.398388	1.444496	1.490165	1.535379	1.580126
48	1.258356	1.305693	1.352633	1.399160	1.445261	1.490922	1.536129	1.580867
49	1.259148	1.306479	1.353412	1.399932	1.446026	1.491679	1.536878	1.581609
50	1.259941	1.307264	1.354190	1.400704	1.446790	1.492436	1.537628	1.582350
51	1.260732	1.308050	1.354969	1.401475	1.447555	1.493193	1.538377	1.583092
52	1.261524	1.308835	1.355747	1.402247	1.448319	1.493950	1.539126	1.583833
53	1.262316	1.309620	1.356526	1.403018	1.449083	1.494707	1.539875	1.584574
54	1.263107	1.310405	1.357304	1.403790	1.449847	1.495463	1.540624	1.585315
55	1.263899	1.311190	1.358082	1.404561	1.450611	1.496220	1.541373	1.586056
56	1.264690	1.311975	1.358860	1.405332	1.451375	1.496976	1.542121	1.586797
57	1.265482	1.312760	1.359638	1.406103	1.452139	1.497732	1.542870	1.587537
58	1.266273	1.313545	1.360416	1.406873	1.452902	1.498488	1.543618	1.588277
59	1.267064	1.314329	1.361194	1.407644	1.453666	1.499244	1.544366	1.589018
60	1.267855	1.315113	1.361971	1.408415	1.454429	1.500000	1.545114	1.589758

Constants for Setting a 3-inch Sine-Bar for 32° to 39°

Min.	32°	33°	34°	35°	36°	37°	38°	39°
0	1.589758	1.633917	1.677579	1.720729	1.763356	1.805445	1.846985	1.887961
1	1.590498	1.634649	1.678302	1.721444	1.764062	1.806142	1.847672	1.888639
2	1.591238	1.635381	1.679025	1.722159	1.764768	1.806839	1.848359	1.889317
3	1.591977	1.636112	1.679749	1.722873	1.765473	1.807535	1.849047	1.889995
4	1.592717	1.636844	1.680471	1.723588	1.766179	1.808232	1.849734	1.890673
5	1.593456	1.637575	1.681194	1.724302	1.766884	1.808928	1.850421	1.891350
6	1.594196	1.638306	1.681917	1.725016	1.767589	1.809624	1.851108	1.892027
7	1.594935	1.639037	1.682639	1.725730	1.768294	1.810320	1.851794	1.892704
8	1.595674	1.639768	1.683362	1.726444	1.768999	1.811016	1.852481	1.893382
9	1.596413	1.640499	1.684084	1.727157	1.769704	1.811711	1.853167	1.894058
10	1.597152	1.641229	1.684806	1.727871	1.770408	1.812407	1.853853	1.894735
11	1.597890	1.641959	1.685528	1.728584	1.771113	1.813102	1.854539	1.895412
12	1.598629	1.642690	1.686250	1.729297	1.771817	1.813797	1.855225	1.896088
13	1.599367	1.643420	1.686972	1.730010	1.772521	1.814492	1.855911	1.896764
14	1.600106	1.644150	1.687693	1.730723	1.773225	1.815187	1.856596	1.897440
15	1.600844	1.644880	1.688415	1.731436	1.773929	1.815882	1.857282	1.898116
16	1.601582	1.645609	1.689136	1.732148	1.774633	1.816577	1.857967	1.898792
17	1.602319	1.646339	1.689857	1.732861	1.775336	1.817271	1.858652	1.899467
18	1.603057	1.647069	1.690578	1.733573	1.776040	1.817965	1.859337	1.900143
19	1.603795	1.647798	1.691299	1.734285	1.776743	1.818659	1.860022	1.900818
20	1.604532	1.648527	1.692020	1.734997	1.777446	1.819353	1.860706	1.901493
21	1.605269	1.649256	1.692740	1.735709	1.778149	1.820047	1.861391	1.902168
22	1.606007	1.649985	1.693461	1.736421	1.778852	1.820741	1.862075	1.902843
23	1.606744	1.650714	1.694181	1.737132	1.779554	1.821434	1.862759	1.903517
24	1.607481	1.651442	1.694901	1.737844	1.780257	1.822128	1.863443	1.904192
25	1.608217	1.652171	1.695621	1.738555	1.780959	1.822821	1.864127	1.904866
26	1.608954	1.652899	1.696341	1.739266	1.781661	1.823514	1.864811	1.905540
27	1.609690	1.653627	1.697061	1.739977	1.782363	1.824207	1.865494	1.906214
28	1.610427	1.654355	1.697780	1.740688	1.783065	1.824899	1.866178	1.906888
29	1.611163	1.655083	1.698500	1.741398	1.783767	1.825592	1.866861	1.907561
30	1.611899	1.655811	1.699219	1.742109	1.784468	1.826284	1.867544	1.908235
31	1.612635	1.656539	1.699938	1.742819	1.785170	1.826977	1.868227	1.908908
32	1.613371	1.657266	1.700657	1.743529	1.785871	1.827669	1.868909	1.909581
33	1.614106	1.657993	1.701376	1.744240	1.786572	1.828361	1.869592	1.910254
34	1.614842	1.658721	1.702094	1.744949	1.787273	1.829052	1.870274	1.910927
35	1.615577	1.659448	1.702813	1.745659	1.787974	1.829744	1.870957	1.911600
36	1.616312	1.660175	1.703531	1.746369	1.788675	1.830436	1.871639	1.912272
37	1.617047	1.660901	1.704250	1.747078	1.789375	1.831127	1.872321	1.912944
38	1.617783	1.661628	1.704968	1.747788	1.790076	1.831818	1.873003	1.913617
39	1.618517	1.662355	1.705686	1.748497	1.790776	1.832509	1.873684	1.914289
40	1.619252	1.663081	1.706403	1.749206	1.791476	1.833200	1.874366	1.914960
41	1.619987	1.663807	1.707121	1.749915	1.792176	1.833891	1.875047	1.915632
42	1.620721	1.664533	1.707839	1.750624	1.792876	1.834581	1.875728	1.916304
43	1.621455	1.665259	1.708556	1.751332	1.793575	1.835272	1.876409	1.916975
44	1.622189	1.665985	1.709273	1.752041	1.794275	1.835962	1.877090	1.917646
45	1.622923	1.666711	1.709990	1.752749	1.794974	1.836652	1.877770	1.918317
46	1.623657	1.667436	1.710707	1.753457	1.795673	1.837342	1.878451	1.918988
47	1.624391	1.668162	1.711424	1.754165	1.796372	1.838032	1.879131	1.919659
48	1.625125	1.668887	1.712141	1.754873	1.797071	1.838721	1.879811	1.920329
49	1.625858	1.669612	1.712857	1.755581	1.797770	1.839411	1.880491	1.921000
50	1.626591	1.670337	1.713574	1.756288	1.798468	1.840100	1.881171	1.921670
51	1.627325	1.671062	1.714290	1.756996	1.799166	1.840789	1.881851	1.922340
52	1.628058	1.671786	1.715006	1.757703	1.799865	1.841478	1.882531	1.923010
53	1.628791	1.672511	1.715722	1.758410	1.800563	1.842167	1.883210	1.923679
54	1.629524	1.673235	1.716438	1.759117	1.801261	1.842856	1.883889	1.924349
55	1.630256	1.673960	1.717153	1.759824	1.801959	1.843544	1.884568	1.925018
56	1.630989	1.674684	1.717869	1.760531	1.802656	1.844233	1.885247	1.925688
57	1.631721	1.675408	1.718584	1.761237	1.803354	1.844921	1.885926	1.926357
58	1.632453	1.676131	1.719299	1.761944	1.804051	1.845609	1.886605	1.927026
59	1.633185	1.676855	1.720014	1.762650	1.804748	1.846297	1.887283	1.927694
60	1.633917	1.677579	1.720729	1.763356	1.805445	1.846985	1.887961	1.928363

Constants for Setting a 3-inch Sine-Bar for 40° to 47°

Min.	40°	41°	42°	43°	44°	45°	46°	47°
0	1.928363	1.968177	2.007392	2.045995	2.083975	2.121320	2.158020	2.194061
1	1.929031	1.968836	2.008040	2.046633	2.084603	2.121937	2.158626	2.194656
2	1.929700	1.969494	2.008688	2.047271	2.085230	2.122554	2.159231	2.195251
3	1.930368	1.970152	2.009337	2.047909	2.085858	2.123171	2.159837	2.195846
4	1.931036	1.970810	2.009984	2.048547	2.086485	2.123787	2.160443	2.196440
5	1.931703	1.971468	2.010632	2.049184	2.087112	2.124403	2.161048	2.197035
6	1.932371	1.972126	2.011280	2.049821	2.087738	2.125020	2.161653	2.197629
7	1.933038	1.972783	2.011927	2.050458	2.088365	2.125635	2.162258	2.198223
8	1.933706	1.973441	2.012575	2.051095	2.088991	2.126251	2.162863	2.198817
9	1.934373	1.974098	2.013222	2.051732	2.089618	2.126867	2.163468	2.199410
10	1.935040	1.974755	2.013869	2.052369	2.090244	2.127482	2.164072	2.200003
11	1.935706	1.975412	2.014515	2.053005	2.090870	2.128097	2.164677	2.200597
12	1.936373	1.976068	2.015162	2.053641	2.091495	2.128712	2.165281	2.201190
13	1.937040	1.976725	2.015808	2.054277	2.092121	2.129327	2.165885	2.201782
14	1.937706	1.977381	2.016454	2.054913	2.092746	2.129942	2.166488	2.202375
15	1.938372	1.978037	2.017101	2.055549	2.093371	2.130556	2.167092	2.202968
16	1.939038	1.978693	2.017746	2.056185	2.093997	2.131171	2.167695	2.203560
17	1.939704	1.979349	2.018392	2.056820	2.094621	2.131784	2.168298	2.204152
18	1.940369	1.980005	2.019037	2.057455	2.095246	2.132398	2.168901	2.204744
19	1.941035	1.980661	2.019683	2.058090	2.095870	2.133012	2.169504	2.205336
20	1.941700	1.981316	2.020328	2.058725	2.096495	2.133626	2.170107	2.205927
21	1.942365	1.981971	2.020973	2.059360	2.097119	2.134239	2.170709	2.206518
22	1.943030	1.982626	2.021618	2.059994	2.097743	2.134852	2.171312	2.207109
23	1.943695	1.983281	2.022263	2.060628	2.098366	2.135465	2.171914	2.207700
24	1.944360	1.983936	2.022907	2.061263	2.098990	2.136078	2.172516	2.208291
25	1.945024	1.984590	2.023552	2.061897	2.099613	2.136691	2.173117	2.208882
26	1.945689	1.985245	2.024196	2.062530	2.100237	2.137303	2.173719	2.209472
27	1.946353	1.985899	2.024840	2.063164	2.100860	2.137916	2.174320	2.210063
28	1.947017	1.986553	2.025484	2.063797	2.101483	2.138528	2.174922	2.210653
29	1.947681	1.987207	2.026127	2.064431	2.102105	2.139140	2.175522	2.211242
30	1.948344	1.987860	2.026771	2.065064	2.102728	2.139751	2.176123	2.211832
31	1.949008	1.988514	2.027414	2.065697	2.103350	2.140363	2.176724	2.212421
32	1.949671	1.989167	2.028057	2.066329	2.103972	2.140974	2.177324	2.213011
33	1.950334	1.989820	2.028700	2.066962	2.104594	2.141586	2.177924	2.213600
34	1.950997	1.990473	2.029343	2.067594	2.105216	2.142197	2.178524	2.214189
35	1.951660	1.991126	2.029985	2.068227	2.105838	2.142807	2.179124	2.214777
36	1.952323	1.991779	2.030628	2.068859	2.106459	2.143418	2.179724	2.215366
37	1.952985	1.992431	2.031270	2.069490	2.107080	2.144028	2.180324	2.215954
38	1.953648	1.993084	2.031912	2.070122	2.107702	2.144639	2.180923	2.216543
39	1.954310	1.993736	2.032554	2.070754	2.108323	2.145249	2.181522	2.217131
40	1.954972	1.994388	2.033196	2.071385	2.108943	2.145859	2.182121	2.217718
41	1.955634	1.995039	2.033838	2.072016	2.109564	2.146469	2.182720	2.218306
42	1.956295	1.995691	2.034479	2.072647	2.110184	2.147078	2.183318	2.218893
43	1.956957	1.996343	2.035120	2.073278	2.110804	2.147688	2.183917	2.219481
44	1.957618	1.996994	2.035761	2.073909	2.111424	2.148297	2.184515	2.220068
45	1.958279	1.997645	2.036402	2.074539	2.112044	2.148906	2.185113	2.220654
46	1.958940	1.998296	2.037043	2.075170	2.112664	2.149515	2.185711	2.221241
47	1.959601	1.998947	2.037683	2.075800	2.113283	2.150123	2.186308	2.221828
48	1.960262	1.999597	2.038324	2.076430	2.113903	2.150732	2.186906	2.222414
49	1.960922	2.000248	2.038964	2.077059	2.114522	2.151340	2.187503	2.223000
50	1.961583	2.000898	2.039604	2.077689	2.115141	2.151948	2.188100	2.223586
51	1.962243	2.001548	2.040244	2.078318	2.115759	2.152556	2.188697	2.224171
52	1.962903	2.002198	2.040884	2.078948	2.116378	2.153164	2.189294	2.224757
53	1.963563	2.002848	2.041523	2.079577	2.116997	2.153772	2.189891	2.225343
54	1.964223	2.003498	2.042163	2.080206	2.117615	2.154379	2.190487	2.225928
55	1.964882	2.004147	2.042802	2.080834	2.118233	2.154986	2.191083	2.226513
56	1.965541	2.004797	2.043441	2.081463	2.118851	2.155593	2.191679	2.227097
57	1.966201	2.005445	2.044080	2.082091	2.119468	2.156200	2.192275	2.227682
58	1.966860	2.006094	2.044718	2.082719	2.120086	2.156807	2.192870	2.228266
59	1.967518	2.006743	2.045357	2.083347	2.120703	2.157413	2.193466	2.228851
60	1.968177	2.007392	2.045995	2.083975	2.121320	2.158020	2.194061	2.229434

Constants for Setting a 3-inch Sine-Bar for 48° to 55°

Min.	48°	49°	50°	51°	52°	53°	54°	55°
0	2.229434	2.264129	2.298133	2.331438	2.364032	2.395907	2.427051	2.457456
1	2.230018	2.264701	2.298694	2.331987	2.364569	2.396432	2.427564	2.457957
2	2.230602	2.265273	2.299255	2.332536	2.365106	2.396956	2.428077	2.458457
3	2.231185	2.265846	2.299815	2.333085	2.365643	2.397481	2.428589	2.458957
4	2.231769	2.266417	2.300375	2.333633	2.366180	2.398006	2.429101	2.459457
5	2.232352	2.266989	2.300936	2.334181	2.366716	2.398530	2.429613	2.459956
6	2.232935	2.267560	2.301496	2.334729	2.367252	2.399054	2.430125	2.460456
7	2.233517	2.268132	2.302055	2.335277	2.367788	2.399578	2.430636	2.460955
8	2.234100	2.268703	2.302615	2.335825	2.368324	2.400102	2.431148	2.461454
9	2.234682	2.269274	2.303174	2.336373	2.368860	2.400625	2.431659	2.461953
10	2.235264	2.269845	2.303733	2.336920	2.369395	2.401148	2.432170	2.462451
11	2.235846	2.270415	2.304292	2.337467	2.369930	2.401671	2.432681	2.462950
12	2.236428	2.270985	2.304851	2.338014	2.370465	2.402194	2.433192	2.463448
13	2.237010	2.271555	2.305409	2.338561	2.371000	2.402717	2.433702	2.463946
14	2.237591	2.272125	2.305967	2.339107	2.371534	2.403239	2.434212	2.464443
15	2.238172	2.272695	2.306525	2.339653	2.372069	2.403761	2.434722	2.464941
16	2.238753	2.273265	2.307083	2.340200	2.372603	2.404284	2.435232	2.465438
17	2.239334	2.273834	2.307641	2.340745	2.373137	2.404805	2.435741	2.465935
18	2.239915	2.274403	2.308199	2.341291	2.373671	2.405327	2.436251	2.466432
19	2.240495	2.274972	2.308756	2.341837	2.374204	2.405848	2.436760	2.466929
20	2.241075	2.275541	2.309313	2.342382	2.374738	2.406370	2.437269	2.467425
21	2.241655	2.276109	2.309870	2.342927	2.375271	2.406891	2.437777	2.467921
22	2.242235	2.276678	2.310427	2.343472	2.375804	2.407411	2.438286	2.468418
23	2.242815	2.277246	2.310983	2.344017	2.376337	2.407932	2.438794	2.468914
24	2.243394	2.277814	2.311540	2.344562	2.376869	2.408453	2.439302	2.469409
25	2.243974	2.278382	2.312096	2.345106	2.377401	2.408973	2.439810	2.469905
26	2.244553	2.278949	2.312652	2.345650	2.377934	2.409493	2.440318	2.470400
27	2.245132	2.279517	2.313208	2.346194	2.378465	2.410012	2.440825	2.470895
28	2.245710	2.280084	2.313763	2.346738	2.378997	2.410532	2.441333	2.471390
29	2.246289	2.280651	2.314319	2.347281	2.379529	2.411052	2.441840	2.471884
30	2.246867	2.281218	2.314874	2.347825	2.380060	2.411571	2.442347	2.472379
31	2.247445	2.281785	2.315429	2.348368	2.380591	2.412090	2.442853	2.472873
32	2.248023	2.282351	2.315984	2.348911	2.381122	2.412608	2.443360	2.473367
33	2.248601	2.282917	2.316538	2.349453	2.381653	2.413127	2.443866	2.473861
34	2.249179	2.283483	2.317092	2.349996	2.382183	2.413645	2.444372	2.474354
35	2.249756	2.284049	2.317647	2.350538	2.382714	2.414163	2.444878	2.474847
36	2.250333	2.284615	2.318201	2.351080	2.383244	2.414681	2.445383	2.475341
37	2.250910	2.285180	2.318754	2.351622	2.383774	2.415199	2.445889	2.475833
38	2.251487	2.285746	2.319308	2.352164	2.384304	2.415717	2.446394	2.476326
39	2.252064	2.286311	2.319862	2.352706	2.384833	2.416234	2.446899	2.476819
40	2.252640	2.286876	2.320415	2.353247	2.385362	2.416751	2.447404	2.477311
41	2.253217	2.287441	2.320968	2.353788	2.385892	2.417268	2.447908	2.477803
42	2.253793	2.288005	2.321521	2.354329	2.386420	2.417785	2.448413	2.478295
43	2.254368	2.288569	2.322073	2.354870	2.386949	2.418301	2.448917	2.478787
44	2.254944	2.289134	2.322626	2.355411	2.387478	2.418818	2.449421	2.479278
45	2.255519	2.289697	2.323178	2.355951	2.388006	2.419334	2.449925	2.479769
46	2.256095	2.290261	2.323730	2.356491	2.388534	2.419850	2.450428	2.480260
47	2.256670	2.290825	2.324282	2.357031	2.389062	2.420366	2.450932	2.480751
48	2.257245	2.291388	2.324833	2.357571	2.389590	2.420881	2.451435	2.481242
49	2.257819	2.291951	2.325385	2.358110	2.390117	2.421396	2.451938	2.481732
50	2.258394	2.292514	2.325936	2.358650	2.390645	2.421911	2.452440	2.482222
51	2.258968	2.293077	2.326487	2.359189	2.391172	2.422426	2.452943	2.482712
52	2.259542	2.293640	2.327038	2.359728	2.391699	2.422941	2.453445	2.483202
53	2.260117	2.294202	2.327589	2.360267	2.392226	2.423455	2.453947	2.483692
54	2.260690	2.294764	2.328139	2.360805	2.392752	2.423970	2.454449	2.484181
55	2.261264	2.295326	2.328690	2.361344	2.393278	2.424484	2.454951	2.484670
56	2.261837	2.295888	2.329240	2.361882	2.393804	2.424998	2.455452	2.485159
57	2.262410	2.296450	2.329789	2.362420	2.394330	2.425511	2.455954	2.485648
58	2.262983	2.297011	2.330339	2.362957	2.394856	2.426025	2.456455	2.486136
59	2.263556	2.297572	2.330889	2.363495	2.395381	2.426538	2.456955	2.486625
60	2.264129	2.298133	2.331438	2.364032	2.395907	2.427051	2.457456	2.487113

Constants for 5-inch Sine-Bar

Constants for Setting a 5-inch Sine-Bar for 1° to 7°

Min.	0°	1°	2°	3°	4°	5°	6°	7°
0	0.00000	0.08726	0.17450	0.26168	0.34878	0.43578	0.52264	0.60935
1	0.00145	0.08872	0.17595	0.26313	0.35023	0.43723	0.52409	0.61079
2	0.00291	0.09017	0.17740	0.26458	0.35168	0.43868	0.52554	0.61223
3	0.00436	0.09162	0.17886	0.26604	0.35313	0.44013	0.52698	0.61368
4	0.00582	0.09308	0.18031	0.26749	0.35459	0.44157	0.52843	0.61512
5	0.00727	0.09453	0.18177	0.26894	0.35604	0.44302	0.52987	0.61656
6	0.00873	0.09599	0.18322	0.27039	0.35749	0.44447	0.53132	0.61801
7	0.01018	0.09744	0.18467	0.27185	0.35894	0.44592	0.53277	0.61945
8	0.01164	0.09890	0.18613	0.27330	0.36039	0.44737	0.53421	0.62089
9	0.01309	0.10035	0.18758	0.27475	0.36184	0.44882	0.53566	0.62234
10	0.01454	0.10180	0.18903	0.27620	0.36329	0.45027	0.53710	0.62378
11	0.01600	0.10326	0.19049	0.27766	0.36474	0.45171	0.53855	0.62522
12	0.01745	0.10471	0.19194	0.27911	0.36619	0.45316	0.54000	0.62667
13	0.01891	0.10617	0.19339	0.28056	0.36764	0.45461	0.54144	0.62811
14	0.02036	0.10762	0.19485	0.28201	0.36909	0.45606	0.54289	0.62955
15	0.02182	0.10907	0.19630	0.28346	0.37054	0.45751	0.54433	0.63099
16	0.02327	0.11053	0.19775	0.28492	0.37199	0.45896	0.54578	0.63244
17	0.02473	0.11198	0.19921	0.28637	0.37344	0.46040	0.54723	0.63388
18	0.02618	0.11344	0.20066	0.28782	0.37489	0.46185	0.54867	0.63532
19	0.02763	0.11489	0.20211	0.28927	0.37634	0.46330	0.55012	0.63677
20	0.02909	0.11634	0.20357	0.29072	0.37779	0.46475	0.55156	0.63821
21	0.03054	0.11780	0.20502	0.29218	0.37924	0.46620	0.55301	0.63965
22	0.03200	0.11925	0.20647	0.29363	0.38069	0.46765	0.55445	0.64109
23	0.03345	0.12071	0.20793	0.29508	0.38214	0.46909	0.55590	0.64254
24	0.03491	0.12216	0.20938	0.29653	0.38360	0.47054	0.55734	0.64398
25	0.03636	0.12361	0.21083	0.29798	0.38505	0.47199	0.55879	0.64542
26	0.03782	0.12507	0.21228	0.29944	0.38650	0.47344	0.56024	0.64686
27	0.03927	0.12652	0.21374	0.30089	0.38795	0.47489	0.56168	0.64830
28	0.04072	0.12798	0.21519	0.30234	0.38940	0.47633	0.56313	0.64975
29	0.04218	0.12943	0.21664	0.30379	0.39085	0.47778	0.56457	0.65119
30	0.04363	0.13088	0.21810	0.30524	0.39230	0.47923	0.56602	0.65263
31	0.04509	0.13234	0.21955	0.30669	0.39375	0.48068	0.56746	0.65407
32	0.04654	0.13379	0.22100	0.30815	0.39520	0.48212	0.56891	0.65551
33	0.04800	0.13525	0.22246	0.30960	0.39665	0.48357	0.57035	0.65696
34	0.04945	0.13670	0.22391	0.31105	0.39810	0.48502	0.57180	0.65840
35	0.05090	0.13815	0.22536	0.31250	0.39954	0.48647	0.57324	0.65984
36	0.05236	0.13961	0.22681	0.31395	0.40099	0.48791	0.57469	0.66128
37	0.05381	0.14106	0.22827	0.31540	0.40244	0.48936	0.57613	0.66272
38	0.05527	0.14252	0.22972	0.31686	0.40389	0.49081	0.57758	0.66417
39	0.05672	0.14397	0.23117	0.31831	0.40534	0.49226	0.57902	0.66561
40	0.05818	0.14542	0.23263	0.31976	0.40679	0.49370	0.58046	0.66705
41	0.05963	0.14688	0.23408	0.32121	0.40824	0.49515	0.58191	0.66849
42	0.06109	0.14833	0.23553	0.32266	0.40969	0.49660	0.58335	0.66993
43	0.06254	0.14979	0.23699	0.32411	0.41114	0.49805	0.58480	0.67137
44	0.06399	0.15124	0.23844	0.32556	0.41259	0.49949	0.58624	0.67281
45	0.06545	0.15269	0.23989	0.32702	0.41404	0.50094	0.58769	0.67425
46	0.06690	0.15415	0.24134	0.32847	0.41549	0.50239	0.58913	0.67570
47	0.06836	0.15560	0.24280	0.32992	0.41694	0.50383	0.59058	0.67714
48	0.06981	0.15705	0.24425	0.33137	0.41839	0.50528	0.59202	0.67858
49	0.07127	0.15851	0.24570	0.33282	0.41984	0.50673	0.59346	0.68002
50	0.07272	0.15996	0.24715	0.33427	0.42129	0.50818	0.59491	0.68146
51	0.07417	0.16141	0.24861	0.33572	0.42274	0.50962	0.59635	0.68290
52	0.07563	0.16287	0.25006	0.33717	0.42419	0.51107	0.59780	0.68434
53	0.07708	0.16432	0.25151	0.33863	0.42564	0.51252	0.59924	0.68578
54	0.07854	0.16578	0.25296	0.34008	0.42708	0.51396	0.60068	0.68722
55	0.07999	0.16723	0.25442	0.34153	0.42853	0.51541	0.60213	0.68866
56	0.08145	0.16868	0.25587	0.34298	0.42998	0.51686	0.60357	0.69010
57	0.08290	0.17014	0.25732	0.34443	0.43143	0.51830	0.60502	0.69154
58	0.08435	0.17159	0.25877	0.34588	0.43288	0.51975	0.60646	0.69298
59	0.08581	0.17304	0.26023	0.34733	0.43433	0.52120	0.60790	0.69443
60	0.08726	0.17450	0.26168	0.34878	0.43578	0.52264	0.60935	0.69587

Constants for Setting a 5-inch Sine-Bar for 8° to 15°

Min.	8°	9°	10°	11°	12°	13°	14°	15°
0	0.69587	0.78217	0.86824	0.95404	1.03956	1.12476	1.20961	1.29410
1	0.69731	0.78361	0.86967	0.95547	1.04098	1.12617	1.21102	1.29550
2	0.69875	0.78505	0.87111	0.95690	1.04240	1.12759	1.21243	1.29690
3	0.70019	0.78648	0.87254	0.95833	1.04383	1.12901	1.21384	1.29831
4	0.70163	0.78792	0.87397	0.95976	1.04525	1.13042	1.21525	1.29971
5	0.70307	0.78935	0.87540	0.96118	1.04667	1.13184	1.21666	1.30112
6	0.70451	0.79079	0.87683	0.96261	1.04809	1.13326	1.21808	1.30252
7	0.70595	0.79223	0.87827	0.96404	1.04951	1.13467	1.21949	1.30393
8	0.70739	0.79366	0.87970	0.96546	1.05094	1.13609	1.22090	1.30533
9	0.70883	0.79510	0.88113	0.96689	1.05236	1.13751	1.22231	1.30673
10	0.71027	0.79653	0.88256	0.96832	1.05378	1.13892	1.22372	1.30814
11	0.71171	0.79797	0.88399	0.96974	1.05520	1.14034	1.22513	1.30954
12	0.71314	0.79941	0.88542	0.97117	1.05662	1.14175	1.22654	1.31095
13	0.71458	0.80084	0.88686	0.97260	1.05805	1.14317	1.22795	1.31235
14	0.71602	0.80228	0.88829	0.97403	1.05947	1.14459	1.22936	1.31375
15	0.71746	0.80371	0.88972	0.97545	1.06089	1.14600	1.23077	1.31516
16	0.71890	0.80515	0.89115	0.97688	1.06231	1.14742	1.23218	1.31656
17	0.72034	0.80658	0.89258	0.97830	1.06373	1.14883	1.23359	1.31796
18	0.72178	0.80802	0.89401	0.97973	1.06515	1.15025	1.23500	1.31937
19	0.72322	0.80945	0.89544	0.98116	1.06657	1.15166	1.23640	1.32077
20	0.72466	0.81089	0.89687	0.98258	1.06799	1.15308	1.23781	1.32217
21	0.72610	0.81232	0.89830	0.98401	1.06941	1.15449	1.23922	1.32357
22	0.72754	0.81376	0.89973	0.98544	1.07084	1.15591	1.24063	1.32498
23	0.72898	0.81519	0.90117	0.98686	1.07226	1.15732	1.24204	1.32638
24	0.73042	0.81663	0.90260	0.98829	1.07368	1.15874	1.24345	1.32778
25	0.73185	0.81806	0.90403	0.98971	1.07510	1.16015	1.24486	1.32918
26	0.73329	0.81950	0.90546	0.99114	1.07652	1.16157	1.24627	1.33058
27	0.73473	0.82093	0.90689	0.99256	1.07794	1.16298	1.24768	1.33199
28	0.73617	0.82237	0.90832	0.99399	1.07936	1.16440	1.24908	1.33339
29	0.73761	0.82380	0.90975	0.99541	1.08078	1.16581	1.25049	1.33479
30	0.73905	0.82524	0.91118	0.99684	1.08220	1.16723	1.25190	1.33619
31	0.74049	0.82667	0.91261	0.99826	1.08362	1.16864	1.25331	1.33759
32	0.74192	0.82811	0.91404	0.99969	1.08504	1.17006	1.25472	1.33899
33	0.74336	0.82954	0.91547	1.00112	1.08646	1.17147	1.25612	1.34040
34	0.74480	0.83098	0.91690	1.00254	1.08788	1.17288	1.25753	1.34180
35	0.74624	0.83241	0.91833	1.00396	1.08930	1.17430	1.25894	1.34320
36	0.74768	0.83384	0.91976	1.00539	1.09072	1.17571	1.26035	1.34460
37	0.74911	0.83528	0.92119	1.00681	1.09214	1.17712	1.26175	1.34600
38	0.75055	0.83671	0.92262	1.00824	1.09355	1.17854	1.26316	1.34740
39	0.75199	0.83815	0.92405	1.00966	1.09497	1.17995	1.26457	1.34880
40	0.75343	0.83958	0.92547	1.01109	1.09639	1.18136	1.26598	1.35020
41	0.75487	0.84101	0.92690	1.01251	1.09781	1.18278	1.26738	1.35160
42	0.75630	0.84245	0.92833	1.01394	1.09923	1.18419	1.26879	1.35300
43	0.75774	0.84388	0.92976	1.01536	1.10065	1.18560	1.27020	1.35440
44	0.75918	0.84531	0.93119	1.01678	1.10207	1.18702	1.27160	1.35580
45	0.76062	0.84675	0.93262	1.01821	1.10349	1.18843	1.27301	1.35720
46	0.76205	0.84818	0.93405	1.01963	1.10491	1.18984	1.27442	1.35860
47	0.76349	0.84961	0.93548	1.02106	1.10632	1.19125	1.27582	1.36000
48	0.76493	0.85105	0.93691	1.02248	1.10774	1.19267	1.27723	1.36140
49	0.76637	0.85248	0.93834	1.02390	1.10916	1.19408	1.27863	1.36280
50	0.76780	0.85391	0.93976	1.02533	1.11058	1.19549	1.28004	1.36420
51	0.76924	0.85535	0.94119	1.02675	1.11200	1.19690	1.28145	1.36560
52	0.77068	0.85678	0.94262	1.02817	1.11342	1.19832	1.28285	1.36700
53	0.77211	0.85821	0.94405	1.02960	1.11483	1.19973	1.28426	1.36840
54	0.77355	0.85965	0.94548	1.03102	1.11625	1.20114	1.28566	1.36980
55	0.77499	0.86108	0.94691	1.03244	1.11767	1.20255	1.28707	1.37119
56	0.77643	0.86251	0.94833	1.03387	1.11909	1.20396	1.28847	1.37259
57	0.77786	0.86394	0.94976	1.03529	1.12050	1.20538	1.28988	1.37399
58	0.77930	0.86538	0.95119	1.03671	1.12192	1.20679	1.29129	1.37539
59	0.78074	0.86681	0.95262	1.03814	1.12334	1.20820	1.29269	1.37679
60	0.78217	0.86824	0.95404	1.03956	1.12476	1.20961	1.29410	1.37819

Constants for Setting a 5-inch Sine-Bar for 16° to 23°

Min.	16°	17°	18°	19°	20°	21°	22°	23°
0	1.37819	1.46186	1.54509	1.62784	1.71010	1.79184	1.87303	1.95366
1	1.37958	1.46325	1.54647	1.62922	1.71147	1.79320	1.87438	1.95499
2	1.38098	1.46464	1.54785	1.63059	1.71283	1.79456	1.87573	1.95633
3	1.38238	1.46603	1.54923	1.63197	1.71420	1.79591	1.87708	1.95767
4	1.38378	1.46742	1.55062	1.63334	1.71557	1.79727	1.87843	1.95901
5	1.38518	1.46881	1.55200	1.63472	1.71693	1.79863	1.87977	1.96035
6	1.38657	1.47020	1.55338	1.63609	1.71830	1.79998	1.88112	1.96169
7	1.38797	1.47159	1.55476	1.63746	1.71966	1.80134	1.88247	1.96302
8	1.38937	1.47298	1.55615	1.63884	1.72103	1.80270	1.88382	1.96436
9	1.39076	1.47437	1.55753	1.64021	1.72240	1.80405	1.88516	1.96570
10	1.39216	1.47576	1.55891	1.64159	1.72376	1.80541	1.88651	1.96704
11	1.39356	1.47715	1.56029	1.64296	1.72513	1.80677	1.88786	1.96837
12	1.39496	1.47854	1.56167	1.64433	1.72649	1.80812	1.88920	1.96971
13	1.39635	1.47993	1.56306	1.64571	1.72786	1.80948	1.89055	1.97105
14	1.39775	1.48132	1.56444	1.64708	1.72922	1.81083	1.89190	1.97238
15	1.39915	1.48271	1.56582	1.64845	1.73059	1.81219	1.89324	1.97372
16	1.40054	1.48410	1.56720	1.64983	1.73195	1.81355	1.89459	1.97506
17	1.40194	1.48549	1.56858	1.65120	1.73331	1.81490	1.89594	1.97639
18	1.40333	1.48687	1.56996	1.65257	1.73468	1.81626	1.89728	1.97773
19	1.40473	1.48826	1.57134	1.65394	1.73604	1.81761	1.89863	1.97906
20	1.40613	1.48965	1.57272	1.65532	1.73741	1.81897	1.89997	1.98040
21	1.40752	1.49104	1.57410	1.65669	1.73877	1.82032	1.90132	1.98173
22	1.40892	1.49243	1.57548	1.65806	1.74013	1.82168	1.90266	1.98307
23	1.41031	1.49382	1.57687	1.65943	1.74150	1.82303	1.90401	1.98440
24	1.41171	1.49520	1.57825	1.66081	1.74286	1.82438	1.90535	1.98574
25	1.41310	1.49659	1.57963	1.66218	1.74422	1.82574	1.90670	1.98707
26	1.41450	1.49798	1.58101	1.66355	1.74559	1.82709	1.90804	1.98841
27	1.41589	1.49937	1.58238	1.66492	1.74695	1.82845	1.90939	1.98974
28	1.41729	1.50075	1.58376	1.66629	1.74831	1.82980	1.91073	1.99108
29	1.41868	1.50214	1.58514	1.66766	1.74967	1.83115	1.91207	1.99241
30	1.42008	1.50353	1.58652	1.66903	1.75104	1.83251	1.91342	1.99375
31	1.42147	1.50492	1.58790	1.67041	1.75240	1.83386	1.91476	1.99508
32	1.42287	1.50630	1.58928	1.67178	1.75376	1.83521	1.91610	1.99641
33	1.42426	1.50769	1.59066	1.67315	1.75512	1.83657	1.91745	1.99775
34	1.42565	1.50908	1.59204	1.67452	1.75649	1.83792	1.91879	1.99908
35	1.42705	1.51046	1.59342	1.67589	1.75785	1.83927	1.92013	2.00041
36	1.42844	1.51185	1.59480	1.67726	1.75921	1.84062	1.92148	2.00175
37	1.42984	1.51324	1.59617	1.67863	1.76057	1.84198	1.92282	2.00308
38	1.43123	1.51462	1.59755	1.68000	1.76193	1.84333	1.92416	2.00441
39	1.43262	1.51601	1.59893	1.68137	1.76329	1.84468	1.92550	2.00574
40	1.43402	1.51739	1.60031	1.68274	1.76465	1.84603	1.92685	2.00708
41	1.43541	1.51878	1.60169	1.68411	1.76601	1.84738	1.92819	2.00841
42	1.43680	1.52017	1.60307	1.68548	1.76737	1.84873	1.92953	2.00974
43	1.43820	1.52155	1.60444	1.68685	1.76873	1.85009	1.93087	2.01107
44	1.43959	1.52294	1.60582	1.68821	1.77010	1.85144	1.93221	2.01240
45	1.44098	1.52432	1.60720	1.68958	1.77146	1.85279	1.93355	2.01373
46	1.44237	1.52571	1.60857	1.69095	1.77282	1.85414	1.93490	2.01506
47	1.44377	1.52709	1.60995	1.69232	1.77418	1.85549	1.93624	2.01640
48	1.44516	1.52848	1.61133	1.69369	1.77553	1.85684	1.93758	2.01773
49	1.44655	1.52986	1.61271	1.69506	1.77689	1.85819	1.93892	2.01906
50	1.44794	1.53125	1.61408	1.69643	1.77825	1.85954	1.94026	2.02039
51	1.44934	1.53263	1.61546	1.69779	1.77961	1.86089	1.94160	2.02172
52	1.45073	1.53401	1.61683	1.69916	1.78097	1.86224	1.94294	2.02305
53	1.45212	1.53540	1.61821	1.70053	1.78233	1.86359	1.94428	2.02438
54	1.45351	1.53678	1.61959	1.70190	1.78369	1.86494	1.94562	2.02571
55	1.45490	1.53817	1.62096	1.70327	1.78505	1.86629	1.94696	2.02704
56	1.45629	1.53955	1.62234	1.70463	1.78641	1.86764	1.94830	2.02837
57	1.45769	1.54093	1.62371	1.70600	1.78777	1.86899	1.94964	2.02970
58	1.45908	1.54232	1.62509	1.70737	1.78912	1.87034	1.95098	2.03103
59	1.46047	1.54370	1.62647	1.70873	1.79048	1.87168	1.95232	2.03235
60	1.46186	1.54509	1.62784	1.71010	1.79184	1.87303	1.95366	2.03368

Constants for Setting a 5-inch Sine-Bar for 24° to 31°

Min.	24°	25°	26°	27°	28°	29°	30°	31°
0	2.03368	2.11309	2.19186	2.26995	2.34736	2.42405	2.50000	2.57519
1	2.03501	2.11441	2.19316	2.27125	2.34864	2.42532	2.50126	2.57644
2	2.03634	2.11573	2.19447	2.27254	2.34993	2.42659	2.50252	2.57768
3	2.03767	2.11704	2.19578	2.27384	2.35121	2.42786	2.50378	2.57893
4	2.03900	2.11836	2.19708	2.27513	2.35249	2.42913	2.50504	2.58018
5	2.04032	2.11968	2.19839	2.27643	2.35378	2.43041	2.50630	2.58142
6	2.04165	2.12100	2.19970	2.27772	2.35506	2.43168	2.50755	2.58267
7	2.04298	2.12231	2.20100	2.27902	2.35634	2.43295	2.50881	2.58391
8	2.04431	2.12363	2.20231	2.28031	2.35763	2.43422	2.51007	2.58516
9	2.04563	2.12495	2.20361	2.28161	2.35891	2.43549	2.51133	2.58640
10	2.04696	2.12626	2.20492	2.28290	2.36019	2.43676	2.51259	2.58765
11	2.04829	2.12758	2.20622	2.28420	2.36147	2.43803	2.51384	2.58889
12	2.04962	2.12890	2.20753	2.28549	2.36275	2.43930	2.51510	2.59014
13	2.05094	2.13021	2.20883	2.28678	2.36404	2.44057	2.51636	2.59138
14	2.05227	2.13153	2.21014	2.28808	2.36532	2.44184	2.51761	2.59262
15	2.05359	2.13284	2.21144	2.28937	2.36660	2.44311	2.51887	2.59387
16	2.05492	2.13416	2.21275	2.29066	2.36788	2.44438	2.52013	2.59511
17	2.05625	2.13547	2.21405	2.29196	2.36916	2.44564	2.52138	2.59635
18	2.05757	2.13679	2.21536	2.29325	2.37044	2.44691	2.52264	2.59760
19	2.05890	2.13810	2.21666	2.29454	2.37172	2.44818	2.52389	2.59884
20	2.06022	2.13942	2.21796	2.29583	2.37300	2.44945	2.52515	2.60008
21	2.06155	2.14073	2.21927	2.29712	2.37428	2.45072	2.52640	2.60132
22	2.06287	2.14205	2.22057	2.29842	2.37556	2.45198	2.52766	2.60256
23	2.06420	2.14336	2.22187	2.29971	2.37684	2.45325	2.52891	2.60381
24	2.06552	2.14468	2.22318	2.30100	2.37812	2.45452	2.53017	2.60505
25	2.06685	2.14599	2.22448	2.30229	2.37940	2.45579	2.53142	2.60629
26	2.06817	2.14730	2.22578	2.30358	2.38068	2.45705	2.53268	2.60753
27	2.06950	2.14862	2.22708	2.30487	2.38196	2.45832	2.53393	2.60877
28	2.07082	2.14993	2.22839	2.30616	2.38324	2.45959	2.53519	2.61001
29	2.07214	2.15124	2.22969	2.30745	2.38452	2.46085	2.53644	2.61125
30	2.07347	2.15256	2.23099	2.30874	2.38579	2.46212	2.53769	2.61249
31	2.07479	2.15387	2.23229	2.31003	2.38707	2.46338	2.53894	2.61373
32	2.07611	2.15518	2.23359	2.31132	2.38835	2.46465	2.54020	2.61497
33	2.07744	2.15649	2.23489	2.31261	2.38963	2.46591	2.54145	2.61621
34	2.07876	2.15781	2.23619	2.31390	2.39091	2.46718	2.54270	2.61745
35	2.08008	2.15912	2.23749	2.31519	2.39218	2.46844	2.54396	2.61869
36	2.08140	2.16043	2.23880	2.31648	2.39346	2.46971	2.54521	2.61993
37	2.08273	2.16174	2.24010	2.31777	2.39474	2.47097	2.54646	2.62117
38	2.08405	2.16305	2.24140	2.31906	2.39601	2.47224	2.54771	2.62241
39	2.08537	2.16436	2.24270	2.32035	2.39729	2.47350	2.54896	2.62364
40	2.08669	2.16567	2.24400	2.32163	2.39857	2.47477	2.55021	2.62488
41	2.08801	2.16698	2.24530	2.32292	2.39984	2.47603	2.55146	2.62612
42	2.08934	2.16830	2.24660	2.32421	2.40112	2.47729	2.55271	2.62736
43	2.09066	2.16961	2.24789	2.32550	2.40239	2.47856	2.55397	2.62860
44	2.09198	2.17092	2.24919	2.32679	2.40367	2.47982	2.55522	2.62983
45	2.09330	2.17223	2.25049	2.32807	2.40494	2.48108	2.55647	2.63107
46	2.09462	2.17354	2.25179	2.32936	2.40622	2.48235	2.55772	2.63231
47	2.09594	2.17485	2.25309	2.33065	2.40749	2.48361	2.55896	2.63354
48	2.09726	2.17616	2.25439	2.33193	2.40877	2.48487	2.56021	2.63478
49	2.09858	2.17746	2.25569	2.33322	2.41004	2.48613	2.56146	2.63602
50	2.09990	2.17877	2.25698	2.33451	2.41132	2.48739	2.56271	2.63725
51	2.10122	2.18008	2.25828	2.33579	2.41259	2.48866	2.56396	2.63849
52	2.10254	2.18139	2.25958	2.33708	2.41386	2.48992	2.56521	2.63972
53	2.10386	2.18270	2.26088	2.33836	2.41514	2.49118	2.56646	2.64096
54	2.10518	2.18401	2.26217	2.33965	2.41641	2.49244	2.56771	2.64219
55	2.10650	2.18532	2.26347	2.34093	2.41769	2.49370	2.56895	2.64343
56	2.10782	2.18663	2.26477	2.34222	2.41896	2.49496	2.57020	2.64466
57	2.10914	2.18793	2.26606	2.34350	2.42023	2.49622	2.57145	2.64590
58	2.11045	2.18924	2.26736	2.34479	2.42150	2.49748	2.57270	2.64713
59	2.11177	2.19055	2.26866	2.34607	2.42278	2.49874	2.57394	2.64836
60	2.11309	2.19186	2.26995	2.34736	2.42405	2.50000	2.57519	2.64960

Constants for Setting a 5-inch Sine-Bar for 32° to 39°

Min.	32°	33°	34°	35°	36°	37°	38°	39°
0	2.64960	2.72320	2.79596	2.86788	2.93893	3.00908	3.07831	3.14660
1	2.65083	2.72441	2.79717	2.86907	2.94010	3.01024	3.07945	3.14773
2	2.65206	2.72563	2.79838	2.87026	2.94128	3.01140	3.08060	3.14886
3	2.65330	2.72685	2.79958	2.87146	2.94246	3.01256	3.08174	3.14999
4	2.65453	2.72807	2.80079	2.87265	2.94363	3.01372	3.08289	3.15112
5	2.65576	2.72929	2.80199	2.87384	2.94481	3.01488	3.08403	3.15225
6	2.65699	2.73051	2.80319	2.87503	2.94598	3.01604	3.08518	3.15338
7	2.65822	2.73173	2.80440	2.87622	2.94716	3.01720	3.08632	3.15451
8	2.65946	2.73295	2.80560	2.87741	2.94833	3.01836	3.08747	3.15564
9	2.66069	2.73416	2.80681	2.87860	2.94951	3.01952	3.08861	3.15676
10	2.66192	2.73538	2.80801	2.87978	2.95068	3.02068	3.08976	3.15789
11	2.66315	2.73660	2.80921	2.88097	2.95185	3.02184	3.09090	3.15902
12	2.66438	2.73782	2.81042	2.88216	2.95303	3.02300	3.09204	3.16015
13	2.66561	2.73903	2.81162	2.88335	2.95420	3.02415	3.09318	3.16127
14	2.66684	2.74025	2.81282	2.88454	2.95538	3.02531	3.09433	3.16240
15	2.66807	2.74147	2.81402	2.88573	2.95655	3.02647	3.09547	3.16353
16	2.66930	2.74268	2.81523	2.88691	2.95772	3.02763	3.09661	3.16465
17	2.67053	2.74390	2.81643	2.88810	2.95889	3.02878	3.09775	3.16578
18	2.67176	2.74511	2.81763	2.88929	2.96007	3.02994	3.09890	3.16690
19	2.67299	2.74633	2.81883	2.89048	2.96124	3.03110	3.10004	3.16803
20	2.67422	2.74754	2.82003	2.89166	2.96241	3.03226	3.10118	3.16915
21	2.67545	2.74876	2.82123	2.89285	2.96358	3.03341	3.10232	3.17028
22	2.67668	2.74997	2.82243	2.89403	2.96475	3.03457	3.10346	3.17140
23	2.67791	2.75119	2.82364	2.89522	2.96592	3.03572	3.10460	3.17253
24	2.67913	2.75240	2.82484	2.89641	2.96709	3.03688	3.10574	3.17365
25	2.68036	2.75362	2.82604	2.89759	2.96827	3.03803	3.10688	3.17478
26	2.68159	2.75483	2.82723	2.89878	2.96944	3.03919	3.10802	3.17590
27	2.68282	2.75605	2.82843	2.89996	2.97061	3.04034	3.10916	3.17702
28	2.68404	2.75726	2.82963	2.90115	2.97178	3.04150	3.11030	3.17815
29	2.68527	2.75847	2.83083	2.90233	2.97294	3.04265	3.11143	3.17927
30	2.68650	2.75969	2.83203	2.90351	2.97411	3.04381	3.11257	3.18039
31	2.68772	2.76090	2.83323	2.90470	2.97528	3.04496	3.11371	3.18151
32	2.68895	2.76211	2.83443	2.90588	2.97645	3.04611	3.11485	3.18264
33	2.69018	2.76332	2.83563	2.90707	2.97762	3.04727	3.11599	3.18376
34	2.69140	2.76453	2.83682	2.90825	2.97879	3.04842	3.11712	3.18488
35	2.69263	2.76575	2.83802	2.90943	2.97996	3.04957	3.11826	3.18600
36	2.69385	2.76696	2.83922	2.91061	2.98112	3.05073	3.11940	3.18712
37	2.69508	2.76817	2.84042	2.91180	2.98229	3.05188	3.12053	3.18824
38	2.69630	2.76938	2.84161	2.91298	2.98346	3.05303	3.12167	3.18936
39	2.69753	2.77059	2.84281	2.91416	2.98463	3.05418	3.12281	3.19048
40	2.69875	2.77180	2.84401	2.91534	2.98579	3.05533	3.12394	3.19160
41	2.69998	2.77301	2.84520	2.91652	2.98696	3.05648	3.12508	3.19272
42	2.70120	2.77422	2.84640	2.91771	2.98813	3.05764	3.12621	3.19384
43	2.70243	2.77543	2.84759	2.91889	2.98929	3.05879	3.12735	3.19496
44	2.70365	2.77664	2.84879	2.92007	2.99046	3.05994	3.12848	3.19608
45	2.70487	2.77785	2.84998	2.92125	2.99162	3.06109	3.12962	3.19720
46	2.70610	2.77906	2.85118	2.92243	2.99279	3.06224	3.13075	3.19831
47	2.70732	2.78027	2.85237	2.92361	2.99395	3.06339	3.13189	3.19943
48	2.70854	2.78148	2.85357	2.92479	2.99512	3.06454	3.13302	3.20055
49	2.70976	2.78269	2.85476	2.92597	2.99628	3.06568	3.13415	3.20167
50	2.71099	2.78389	2.85596	2.92715	2.99745	3.06683	3.13529	3.20278
51	2.71221	2.78510	2.85715	2.92833	2.99861	3.06798	3.13642	3.20390
52	2.71343	2.78631	2.85834	2.92950	2.99977	3.06913	3.13755	3.20502
53	2.71465	2.78752	2.85954	2.93068	3.00094	3.07028	3.13868	3.20613
54	2.71587	2.78873	2.86073	2.93186	3.00210	3.07143	3.13982	3.20725
55	2.71709	2.78993	2.86192	2.93304	3.00326	3.07257	3.14095	3.20836
56	2.71831	2.79114	2.86311	2.93422	3.00443	3.07372	3.14208	3.20948
57	2.71953	2.79235	2.86431	2.93540	3.00559	3.07487	3.14321	3.21059
58	2.72076	2.79355	2.86550	2.93657	3.00675	3.07601	3.14434	3.21171
59	2.72198	2.79476	2.86669	2.93775	3.00791	3.07716	3.14547	3.21282
60	2.72320	2.79596	2.86788	2.93893	3.00908	3.07831	3.14660	3.21394

Constants for Setting a 5-inch Sine-Bar for 40° to 47°

Min.	40°	41°	42°	43°	44°	45°	46°	47°
0	3.21394	3.28030	3.34565	3.40999	3.47329	3.53553	3.59670	3.65677
1	3.21505	3.28139	3.34673	3.41106	3.47434	3.53656	3.59771	3.65776
2	3.21617	3.28249	3.34781	3.41212	3.47538	3.53759	3.59872	3.65875
3	3.21728	3.28359	3.34889	3.41318	3.47643	3.53862	3.59973	3.65974
4	3.21839	3.28468	3.34997	3.41424	3.47747	3.53965	3.60074	3.66073
5	3.21951	3.28578	3.35105	3.41531	3.47852	3.54067	3.60175	3.66172
6	3.22062	3.28688	3.35213	3.41637	3.47956	3.54170	3.60276	3.66271
7	3.22173	3.28797	3.35321	3.41743	3.48061	3.54273	3.60376	3.66370
8	3.22284	3.28907	3.35429	3.41849	3.48165	3.54375	3.60477	3.66469
9	3.22395	3.29016	3.35537	3.41955	3.48270	3.54478	3.60578	3.66568
10	3.22507	3.29126	3.35645	3.42061	3.48374	3.54580	3.60679	3.66667
11	3.22618	3.29235	3.35753	3.42168	3.48478	3.54683	3.60779	3.66766
12	3.22729	3.29345	3.35860	3.42274	3.48583	3.54785	3.60880	3.66865
13	3.22840	3.29454	3.35968	3.42380	3.48687	3.54888	3.60981	3.66964
14	3.22951	3.29564	3.36076	3.42486	3.48791	3.54990	3.61081	3.67063
15	3.23062	3.29673	3.36183	3.42592	3.48895	3.55093	3.61182	3.67161
16	3.23173	3.29782	3.36291	3.42697	3.48999	3.55195	3.61283	3.67260
17	3.23284	3.29892	3.36399	3.42803	3.49104	3.55297	3.61383	3.67359
18	3.23395	3.30001	3.36506	3.42909	3.49208	3.55400	3.61484	3.67457
19	3.23506	3.30110	3.36614	3.43015	3.49312	3.55502	3.61584	3.67556
20	3.23617	3.30219	3.36721	3.43121	3.49416	3.55604	3.61684	3.67655
21	3.23728	3.30329	3.36829	3.43227	3.49520	3.55707	3.61785	3.67753
22	3.23838	3.30438	3.36936	3.43332	3.49624	3.55809	3.61885	3.67852
23	3.23949	3.30547	3.37044	3.43438	3.49728	3.55911	3.61986	3.67950
24	3.24060	3.30656	3.37151	3.43544	3.49832	3.56013	3.62086	3.68049
25	3.24171	3.30765	3.37259	3.43649	3.49936	3.56115	3.62186	3.68147
26	3.24281	3.30874	3.37366	3.43755	3.50039	3.56217	3.62286	3.68245
27	3.24392	3.30983	3.37473	3.43861	3.50143	3.56319	3.62387	3.68344
28	3.24503	3.31092	3.37581	3.43966	3.50247	3.56421	3.62487	3.68442
29	3.24613	3.31201	3.37688	3.44072	3.50351	3.56523	3.62587	3.68540
30	3.24724	3.31310	3.37795	3.44177	3.50455	3.56625	3.62687	3.68639
31	3.24835	3.31419	3.37902	3.44283	3.50558	3.56727	3.62787	3.68737
32	3.24945	3.31528	3.38010	3.44388	3.50662	3.56829	3.62887	3.68835
33	3.25056	3.31637	3.38117	3.44494	3.50766	3.56931	3.62987	3.68933
34	3.25166	3.31746	3.38224	3.44599	3.50869	3.57033	3.63087	3.69031
35	3.25277	3.31854	3.38331	3.44704	3.50973	3.57135	3.63187	3.69130
36	3.25387	3.31963	3.38438	3.44810	3.51077	3.57236	3.63287	3.69228
37	3.25498	3.32072	3.38545	3.44915	3.51180	3.57338	3.63387	3.69326
38	3.25608	3.32181	3.38652	3.45020	3.51284	3.57440	3.63487	3.69424
39	3.25718	3.32289	3.38759	3.45126	3.51387	3.57542	3.63587	3.69522
40	3.25829	3.32398	3.38866	3.45231	3.51491	3.57643	3.63687	3.69620
41	3.25939	3.32507	3.38973	3.45336	3.51594	3.57745	3.63787	3.69718
42	3.26049	3.32615	3.39080	3.45441	3.51697	3.57846	3.63886	3.69816
43	3.26159	3.32724	3.39187	3.45546	3.51801	3.57948	3.63986	3.69913
44	3.26270	3.32832	3.39294	3.45651	3.51904	3.58049	3.64086	3.70011
45	3.26380	3.32941	3.39400	3.45757	3.52007	3.58151	3.64186	3.70109
46	3.26490	3.33049	3.39507	3.45862	3.52111	3.58252	3.64285	3.70207
47	3.26600	3.33158	3.39614	3.45967	3.52214	3.58354	3.64385	3.70305
48	3.26710	3.33266	3.39721	3.46072	3.52317	3.58455	3.64484	3.70402
49	3.26820	3.33375	3.39827	3.46177	3.52420	3.58557	3.64584	3.70500
50	3.26930	3.33483	3.39934	3.46281	3.52523	3.58658	3.64683	3.70598
51	3.27040	3.33591	3.40041	3.46386	3.52627	3.58759	3.64783	3.70695
52	3.27150	3.33700	3.40147	3.46491	3.52730	3.58861	3.64882	3.70793
53	3.27260	3.33808	3.40254	3.46596	3.52833	3.58962	3.64982	3.70890
54	3.27370	3.33916	3.40360	3.46701	3.52936	3.59063	3.65081	3.70988
55	3.27480	3.34025	3.40467	3.46806	3.53039	3.59164	3.65181	3.71085
56	3.27590	3.34133	3.40573	3.46910	3.53142	3.59266	3.65280	3.71183
57	3.27700	3.34241	3.40680	3.47015	3.53245	3.59367	3.65379	3.71280
58	3.27810	3.34349	3.40786	3.47120	3.53348	3.59468	3.65478	3.71378
59	3.27920	3.34457	3.40893	3.47225	3.53451	3.59569	3.65578	3.71475
60	3.28030	3.34565	3.40999	3.47329	3.53553	3.59670	3.65677	3.71572

Constants for Setting a 5-inch Sine-Bar for 48° to 55°

Min.	48°	49°	50°	51°	52°	53°	54°	55°
0	3.71572	3.77355	3.83022	3.88573	3.94005	3.99318	4.04508	4.09576
1	3.71670	3.77450	3.83116	3.88665	3.94095	3.99405	4.04594	4.09659
2	3.71767	3.77546	3.83209	3.88756	3.94184	3.99493	4.04679	4.09743
3	3.71864	3.77641	3.83303	3.88847	3.94274	3.99580	4.04765	4.09826
4	3.71961	3.77736	3.83396	3.88939	3.94363	3.99668	4.04850	4.09909
5	3.72059	3.77831	3.83489	3.89030	3.94453	3.99755	4.04936	4.09993
6	3.72156	3.77927	3.83583	3.89122	3.94542	3.99842	4.05021	4.10076
7	3.72253	3.78022	3.83676	3.89213	3.94631	3.99930	4.05106	4.10159
8	3.72350	3.78117	3.83769	3.89304	3.94721	4.00017	4.05191	4.10242
9	3.72447	3.78212	3.83862	3.89395	3.94810	4.00104	4.05277	4.10325
10	3.72544	3.78307	3.83956	3.89487	3.94899	4.00191	4.05362	4.10409
11	3.72641	3.78402	3.84049	3.89578	3.94988	4.00279	4.05447	4.10492
12	3.72738	3.78498	3.84142	3.89669	3.95078	4.00366	4.05532	4.10575
13	3.72835	3.78593	3.84235	3.89760	3.95167	4.00453	4.05617	4.10658
14	3.72932	3.78688	3.84328	3.89851	3.95256	4.00540	4.05702	4.10741
15	3.73029	3.78783	3.84421	3.89942	3.95345	4.00627	4.05787	4.10823
16	3.73126	3.78877	3.84514	3.90033	3.95434	4.00714	4.05872	4.10906
17	3.73222	3.78972	3.84607	3.90124	3.95523	4.00801	4.05957	4.10989
18	3.73319	3.79067	3.84700	3.90215	3.95612	4.00888	4.06042	4.11072
19	3.73416	3.79162	3.84793	3.90306	3.95701	4.00975	4.06127	4.11155
20	3.73513	3.79257	3.84886	3.90397	3.95790	4.01062	4.06211	4.11238
21	3.73609	3.79352	3.84978	3.90488	3.95878	4.01148	4.06296	4.11320
22	3.73706	3.79446	3.85071	3.90579	3.95967	4.01235	4.06381	4.11403
23	3.73802	3.79541	3.85164	3.90669	3.96056	4.01322	4.06466	4.11486
24	3.73899	3.79636	3.85257	3.90760	3.96145	4.01409	4.06550	4.11568
25	3.73996	3.79730	3.85349	3.90851	3.96234	4.01495	4.06635	4.11651
26	3.74092	3.79825	3.85442	3.90942	3.96322	4.01582	4.06720	4.11733
27	3.74189	3.79919	3.85535	3.91032	3.96411	4.01669	4.06804	4.11816
28	3.74285	3.80014	3.85627	3.91123	3.96500	4.01755	4.06889	4.11898
29	3.74381	3.80109	3.85720	3.91214	3.96588	4.01842	4.06973	4.11981
30	3.74478	3.80203	3.85812	3.91304	3.96677	4.01928	4.07058	4.12063
31	3.74574	3.80297	3.85905	3.91395	3.96765	4.02015	4.07142	4.12145
32	3.74671	3.80392	3.85997	3.91485	3.96854	4.02101	4.07227	4.12228
33	3.74767	3.80486	3.86090	3.91576	3.96942	4.02188	4.07311	4.12310
34	3.74863	3.80581	3.86182	3.91666	3.97031	4.02274	4.07395	4.12392
35	3.74959	3.80675	3.86274	3.91756	3.97119	4.02361	4.07480	4.12475
36	3.75056	3.80769	3.86367	3.91847	3.97207	4.02447	4.07564	4.12557
37	3.75152	3.80863	3.86459	3.91937	3.97296	4.02533	4.07648	4.12639
38	3.75248	3.80958	3.86551	3.92027	3.97384	4.02619	4.07732	4.12721
39	3.75344	3.81052	3.86644	3.92118	3.97472	4.02706	4.07817	4.12803
40	3.75440	3.81146	3.86736	3.92208	3.97560	4.02792	4.07901	4.12885
41	3.75536	3.81240	3.86828	3.92298	3.97649	4.02878	4.07985	4.12967
42	3.75632	3.81334	3.86920	3.92388	3.97737	4.02964	4.08069	4.13049
43	3.75728	3.81428	3.87012	3.92478	3.97825	4.03050	4.08153	4.13131
44	3.75824	3.81522	3.87104	3.92568	3.97913	4.03136	4.08237	4.13213
45	3.75920	3.81616	3.87196	3.92658	3.98001	4.03222	4.08321	4.13295
46	3.76016	3.81710	3.87288	3.92748	3.98089	4.03308	4.08405	4.13377
47	3.76112	3.81804	3.87380	3.92839	3.98177	4.03394	4.08489	4.13459
48	3.76207	3.81898	3.87472	3.92928	3.98265	4.03480	4.08572	4.13540
49	3.76303	3.81992	3.87564	3.93018	3.98353	4.03566	4.08656	4.13622
50	3.76399	3.82086	3.87656	3.93108	3.98441	4.03652	4.08740	4.13704
51	3.76495	3.82179	3.87748	3.93198	3.98529	4.03738	4.08824	4.13785
52	3.76590	3.82273	3.87840	3.93288	3.98616	4.03823	4.08908	4.13867
53	3.76686	3.82367	3.87931	3.93378	3.98704	4.03909	4.08991	4.13949
54	3.76782	3.82461	3.88023	3.93468	3.98792	4.03995	4.09075	4.14030
55	3.76877	3.82554	3.88115	3.93557	3.98880	4.04081	4.09158	4.14112
56	3.76973	3.82648	3.88207	3.93647	3.98967	4.04166	4.09242	4.14193
57	3.77068	3.82742	3.88298	3.93737	3.99055	4.04252	4.09326	4.14275
58	3.77164	3.82835	3.88390	3.93826	3.99143	4.04337	4.09409	4.14356
59	3.77259	3.82929	3.88481	3.93916	3.99230	4.04423	4.09493	4.14437
60	3.77355	3.83022	3.88573	3.94005	3.99318	4.04508	4.09576	4.14519

Constants for 10-inch Sine-Bar

Constants for Setting a 10-inch Sine-Bar for 0° to 7°

Min.	0°	1°	2°	3°	4°	5°	6°	7°
0	0.000000	0.17452	0.34899	0.52336	0.69756	0.87156	1.04528	1.218693
1	0.002909	0.17743	0.35190	0.52626	0.70047	0.87446	1.04818	1.221581
2	0.005818	0.18034	0.35481	0.52917	0.70337	0.87735	1.05107	1.224468
3	0.008727	0.18325	0.35772	0.53207	0.70627	0.88025	1.05396	1.227355
4	0.011636	0.18616	0.36062	0.53498	0.70917	0.88315	1.05686	1.230241
5	0.014544	0.18907	0.36353	0.53788	0.71207	0.88605	1.05975	1.233128
6	0.017453	0.19197	0.36644	0.54079	0.71497	0.88894	1.06264	1.236015
7	0.020362	0.19488	0.36934	0.54369	0.71788	0.89184	1.06553	1.238901
8	0.023271	0.19779	0.37225	0.54660	0.72078	0.89474	1.06843	1.241788
9	0.026180	0.20070	0.37516	0.54950	0.72368	0.89763	1.07132	1.244674
10	0.029089	0.20361	0.37806	0.55241	0.72658	0.90053	1.07421	1.247560
11	0.031998	0.20652	0.38097	0.55531	0.72948	0.90343	1.07710	1.250446
12	0.034907	0.20942	0.38388	0.55822	0.73238	0.90633	1.07999	1.253332
13	0.037815	0.21233	0.38678	0.56112	0.73528	0.90922	1.08289	1.256218
14	0.040724	0.21524	0.38969	0.56402	0.73818	0.91212	1.08578	1.259104
15	0.043633	0.21815	0.39260	0.56693	0.74108	0.91502	1.08867	1.261990
16	0.046542	0.22106	0.39550	0.56983	0.74399	0.91791	1.09156	1.264875
17	0.049451	0.22397	0.39841	0.57274	0.74689	0.92081	1.09445	1.267761
18	0.052360	0.22687	0.40132	0.57564	0.74979	0.92371	1.09734	1.270646
19	0.055268	0.22978	0.40422	0.57854	0.75269	0.92660	1.10023	1.273531
20	0.058177	0.23269	0.40713	0.58145	0.75559	0.92950	1.10313	1.276417
21	0.061086	0.23560	0.41004	0.58435	0.75849	0.93239	1.10602	1.279302
22	0.063995	0.23851	0.41294	0.58726	0.76139	0.93529	1.10891	1.282187
23	0.066904	0.24141	0.41585	0.59016	0.76429	0.93819	1.11180	1.285071
24	0.069813	0.24432	0.41876	0.59306	0.76719	0.94108	1.11469	1.287956
25	0.072722	0.24723	0.42166	0.59597	0.77009	0.94398	1.11758	1.290841
26	0.075630	0.25014	0.42457	0.59887	0.77299	0.94687	1.12047	1.293725
27	0.078539	0.25305	0.42748	0.60177	0.77589	0.94977	1.12336	1.296609
28	0.081448	0.25595	0.43038	0.60468	0.77879	0.95267	1.12625	1.299494
29	0.084357	0.25886	0.43329	0.60758	0.78169	0.95556	1.12914	1.302378
30	0.087265	0.26177	0.43619	0.61049	0.78459	0.95846	1.13203	1.305262
31	0.090174	0.26468	0.43910	0.61339	0.78749	0.96135	1.13492	1.308146
32	0.093083	0.26759	0.44201	0.61629	0.79039	0.96425	1.13781	1.311030
33	0.095992	0.27049	0.44491	0.61920	0.79329	0.96714	1.14070	1.313913
34	0.098900	0.27340	0.44782	0.62210	0.79619	0.97004	1.14359	1.316797
35	0.101809	0.27631	0.45072	0.62500	0.79909	0.97293	1.14648	1.319681
36	0.104718	0.27922	0.45363	0.62791	0.80199	0.97583	1.14937	1.322564
37	0.107627	0.28212	0.45654	0.63081	0.80489	0.97872	1.15226	1.325447
38	0.110535	0.28503	0.45944	0.63371	0.80779	0.98162	1.15515	1.328330
39	0.113444	0.28794	0.46235	0.63661	0.81069	0.98451	1.15804	1.331213
40	0.116353	0.29085	0.46525	0.63952	0.81359	0.98741	1.16093	1.334096
41	0.119261	0.29375	0.46816	0.64242	0.81649	0.99030	1.16382	1.336979
42	0.122170	0.29666	0.47106	0.64532	0.81939	0.99320	1.16671	1.339862
43	0.125079	0.29957	0.47397	0.64823	0.82228	0.99609	1.16960	1.342744
44	0.127987	0.30248	0.47688	0.65113	0.82518	0.99899	1.17249	1.345627
45	0.130896	0.30539	0.47978	0.65403	0.82808	1.00188	1.17537	1.348509
46	0.133805	0.30829	0.48269	0.65693	0.83098	1.00477	1.17826	1.351392
47	0.136713	0.31120	0.48559	0.65984	0.83388	1.00767	1.18115	1.354274
48	0.139622	0.31411	0.48850	0.66274	0.83678	1.01056	1.18404	1.357156
49	0.142530	0.31702	0.49140	0.66564	0.83968	1.01346	1.18693	1.360038
50	0.145439	0.31992	0.49431	0.66854	0.84258	1.01635	1.18982	1.362919
51	0.148348	0.32283	0.49721	0.67145	0.84547	1.01924	1.19270	1.365801
52	0.151256	0.32574	0.50012	0.67435	0.84837	1.02214	1.19559	1.368683
53	0.154165	0.32864	0.50302	0.67725	0.85127	1.02503	1.19848	1.371564
54	0.157073	0.33155	0.50593	0.68015	0.85417	1.02793	1.20137	1.374446
55	0.159982	0.33446	0.50883	0.68306	0.85707	1.03082	1.20426	1.377327
56	0.162890	0.33737	0.51174	0.68596	0.85997	1.03371	1.20714	1.380208
57	0.165799	0.34027	0.51464	0.68886	0.86286	1.03661	1.21003	1.383089
58	0.168707	0.34318	0.51755	0.69176	0.86576	1.03950	1.21292	1.385970
59	0.171616	0.34609	0.52045	0.69466	0.86866	1.04239	1.21581	1.388850
60	0.174524	0.34899	0.52336	0.69756	0.87156	1.04528	1.21869	1.391731

Constants for Setting a 10-inch Sine-Bar for 8° to 15°

Min.	8°	9°	10°	11°	12°	13°	14°	15°
0	1.391731	1.56434	1.73648	1.90809	2.07912	2.24951	2.41922	2.588191
1	1.394611	1.56722	1.73935	1.91095	2.08196	2.25234	2.42204	2.591000
2	1.397492	1.57009	1.74221	1.91380	2.08481	2.25518	2.42486	2.593810
3	1.400372	1.57296	1.74508	1.91666	2.08765	2.25801	2.42769	2.596619
4	1.403252	1.57584	1.74794	1.91951	2.09050	2.26085	2.43051	2.599428
5	1.406132	1.57871	1.75080	1.92237	2.09334	2.26368	2.43333	2.602237
6	1.409012	1.58158	1.75367	1.92522	2.09619	2.26651	2.43615	2.605045
7	1.411892	1.58445	1.75653	1.92807	2.09903	2.26935	2.43897	2.607853
8	1.414772	1.58732	1.75939	1.93093	2.10187	2.27218	2.44179	2.610662
9	1.417651	1.59020	1.76226	1.93378	2.10472	2.27501	2.44461	2.613469
10	1.420531	1.59307	1.76512	1.93664	2.10756	2.27784	2.44743	2.616277
11	1.423410	1.59594	1.76798	1.93949	2.11040	2.28068	2.45025	2.619085
12	1.426289	1.59881	1.77085	1.94234	2.11325	2.28351	2.45307	2.621892
13	1.429168	1.60168	1.77371	1.94520	2.11609	2.28634	2.45589	2.624699
14	1.432047	1.60455	1.77657	1.94805	2.11893	2.28917	2.45871	2.627506
15	1.434926	1.60743	1.77944	1.95090	2.12178	2.29200	2.46153	2.630312
16	1.437805	1.61030	1.78230	1.95376	2.12462	2.29484	2.46435	2.633119
17	1.440684	1.61317	1.78516	1.95661	2.12746	2.29767	2.46717	2.635925
18	1.443562	1.61604	1.78802	1.95946	2.13030	2.30050	2.46999	2.638731
19	1.446440	1.61891	1.79088	1.96231	2.13315	2.30333	2.47281	2.641536
20	1.449319	1.62178	1.79375	1.96517	2.13599	2.30616	2.47563	2.644342
21	1.452197	1.62465	1.79661	1.96802	2.13883	2.30899	2.47845	2.647147
22	1.455075	1.62752	1.79947	1.97087	2.14167	2.31182	2.48126	2.649952
23	1.457953	1.63039	1.80233	1.97372	2.14451	2.31465	2.48408	2.652757
24	1.460830	1.63326	1.80519	1.97657	2.14735	2.31748	2.48690	2.655561
25	1.463708	1.63613	1.80805	1.97942	2.15019	2.32031	2.48972	2.658366
26	1.466585	1.63900	1.81091	1.98228	2.15303	2.32314	2.49253	2.661170
27	1.469463	1.64187	1.81377	1.98513	2.15588	2.32597	2.49535	2.663974
28	1.472340	1.64474	1.81663	1.98798	2.15872	2.32880	2.49817	2.666777
29	1.475217	1.64761	1.81950	1.99083	2.16156	2.33163	2.50098	2.669581
30	1.478094	1.65048	1.82236	1.99368	2.16440	2.33445	2.50380	2.672384
31	1.480971	1.65334	1.82522	1.99653	2.16724	2.33728	2.50662	2.675187
32	1.483848	1.65621	1.82808	1.99938	2.17008	2.34011	2.50943	2.677990
33	1.486724	1.65908	1.83094	2.00223	2.17292	2.34294	2.51225	2.680792
34	1.489601	1.66195	1.83379	2.00508	2.17575	2.34577	2.51506	2.683594
35	1.492477	1.66482	1.83665	2.00793	2.17859	2.34859	2.51788	2.686396
36	1.495354	1.66769	1.83951	2.01078	2.18143	2.35142	2.52069	2.689198
37	1.498230	1.67056	1.84237	2.01363	2.18427	2.35425	2.52351	2.692000
38	1.501106	1.67342	1.84523	2.01648	2.18711	2.35708	2.52632	2.694801
39	1.503981	1.67629	1.84809	2.01933	2.18995	2.35990	2.52914	2.697602
40	1.506857	1.67916	1.85095	2.02218	2.19279	2.36273	2.53195	2.700403
41	1.509733	1.68203	1.85381	2.02502	2.19562	2.36556	2.53477	2.703204
42	1.512608	1.68489	1.85667	2.02787	2.19846	2.36838	2.53758	2.706005
43	1.515483	1.68776	1.85952	2.03072	2.20130	2.37121	2.54039	2.708805
44	1.518359	1.69063	1.86238	2.03357	2.20414	2.37403	2.54321	2.711605
45	1.521234	1.69350	1.86524	2.03642	2.20697	2.37686	2.54602	2.714405
46	1.524109	1.69636	1.86810	2.03927	2.20981	2.37968	2.54883	2.717204
47	1.526984	1.69923	1.87096	2.04211	2.21265	2.38251	2.55165	2.720003
48	1.529858	1.70210	1.87381	2.04496	2.21549	2.38533	2.55446	2.722804
49	1.532733	1.70496	1.87667	2.04781	2.21832	2.38816	2.55727	2.725601
50	1.535607	1.70783	1.87953	2.05065	2.22116	2.39098	2.56008	2.728400
51	1.538482	1.71069	1.88238	2.05350	2.22399	2.39381	2.56289	2.731199
52	1.541356	1.71356	1.88524	2.05635	2.22683	2.39663	2.56571	2.733997
53	1.544230	1.71643	1.88810	2.05920	2.22967	2.39946	2.56852	2.736794
54	1.547104	1.71929	1.89095	2.06204	2.23250	2.40228	2.57133	2.739592
55	1.549978	1.72216	1.89381	2.06489	2.23534	2.40510	2.57414	2.742390
56	1.552851	1.72502	1.89667	2.06773	2.23817	2.40793	2.57695	2.745187
57	1.555725	1.72789	1.89952	2.07058	2.24101	2.41075	2.57976	2.747984
58	1.558598	1.73075	1.90238	2.07343	2.24384	2.41357	2.58257	2.750781
59	1.561472	1.73362	1.90523	2.07627	2.24668	2.41640	2.58538	2.753577
60	1.564345	1.73648	1.90809	2.07912	2.24951	2.41922	2.58819	2.756374

Constants for Setting a 10-inch Sine-Bar for 16° to 23°

Min.	16°	17°	18°	19°	20°	21°	22°	23°
0	2.756374	2.92372	3.09017	3.25568	3.42020	3.58368	3.74607	3.907311
1	2.759170	2.92650	3.09294	3.25843	3.42293	3.58640	3.74876	3.909989
2	2.761966	2.92928	3.09570	3.26118	3.42567	3.58911	3.75146	3.912666
3	2.764761	2.93206	3.09847	3.26393	3.42840	3.59183	3.75416	3.915343
4	2.767557	2.93484	3.10123	3.26668	3.43113	3.59454	3.75685	3.918020
5	2.770352	2.93762	3.10400	3.26943	3.43387	3.59725	3.75955	3.920696
6	2.773147	2.94040	3.10676	3.27218	3.43660	3.59997	3.76224	3.923371
7	2.775941	2.94318	3.10953	3.27493	3.43933	3.60268	3.76494	3.926047
8	2.778736	2.94596	3.11229	3.27768	3.44206	3.60540	3.76763	3.928722
9	2.781530	2.94874	3.11506	3.28042	3.44479	3.60811	3.77033	3.931397
10	2.784324	2.95152	3.11782	3.28317	3.44752	3.61082	3.77302	3.934071
11	2.787117	2.95430	3.12059	3.28592	3.45025	3.61353	3.77571	3.936745
12	2.789911	2.95708	3.12335	3.28867	3.45298	3.61625	3.77841	3.939419
13	2.792705	2.95986	3.12611	3.29141	3.45571	3.61896	3.78110	3.942093
14	2.795497	2.96264	3.12888	3.29416	3.45844	3.62167	3.78379	3.944766
15	2.798290	2.96542	3.13164	3.29691	3.46117	3.62438	3.78649	3.947439
16	2.801083	2.96819	3.13440	3.29965	3.46390	3.62709	3.78918	3.950111
17	2.803875	2.97097	3.13716	3.30240	3.46663	3.62980	3.79187	3.952783
18	2.806667	2.97375	3.13992	3.30514	3.46936	3.63251	3.79456	3.955455
19	2.809459	2.97653	3.14269	3.30789	3.47208	3.63522	3.79725	3.958127
20	2.812251	2.97930	3.14545	3.31063	3.47481	3.63793	3.79994	3.960798
21	2.815042	2.98208	3.14821	3.31338	3.47754	3.64064	3.80263	3.963469
22	2.817833	2.98486	3.15097	3.31612	3.48027	3.64335	3.80532	3.966139
23	2.820624	2.98763	3.15373	3.31887	3.48299	3.64606	3.80801	3.968809
24	2.823415	2.99041	3.15649	3.32161	3.48572	3.64877	3.81070	3.971479
25	2.826205	2.99318	3.15925	3.32435	3.48845	3.65148	3.81339	3.974148
26	2.828995	2.99596	3.16201	3.32710	3.49117	3.65418	3.81608	3.976817
27	2.831785	2.99873	3.16477	3.32984	3.49390	3.65689	3.81877	3.979486
28	2.834575	3.00151	3.16753	3.33258	3.49662	3.65960	3.82146	3.982155
29	2.837364	3.00428	3.17029	3.33533	3.49935	3.66231	3.82415	3.984823
30	2.840153	3.00706	3.17305	3.33807	3.50207	3.66501	3.82683	3.987491
31	2.842942	3.00983	3.17581	3.34081	3.50480	3.66772	3.82952	3.990158
32	2.845731	3.01261	3.17856	3.34355	3.50752	3.67042	3.83221	3.992825
33	2.848520	3.01538	3.18132	3.34629	3.51025	3.67313	3.83490	3.995492
34	2.851308	3.01815	3.18408	3.34903	3.51297	3.67584	3.83758	3.998159
35	2.854096	3.02093	3.18684	3.35178	3.51569	3.67854	3.84027	4.000825
36	2.856884	3.02370	3.18959	3.35452	3.51842	3.68125	3.84295	4.003490
37	2.859671	3.02647	3.19235	3.35726	3.52114	3.68395	3.84564	4.006156
38	2.862458	3.02924	3.19511	3.36000	3.52386	3.68665	3.84832	4.008821
39	2.865246	3.03202	3.19786	3.36274	3.52658	3.68936	3.85101	4.011486
40	2.868032	3.03479	3.20062	3.36547	3.52931	3.69206	3.85369	4.014150
41	2.870819	3.03756	3.20337	3.36821	3.53203	3.69476	3.85638	4.016814
42	2.873605	3.04033	3.20613	3.37095	3.53475	3.69747	3.85906	4.019478
43	2.876391	3.04310	3.20889	3.37369	3.53747	3.70017	3.86174	4.022141
44	2.879177	3.04587	3.21164	3.37643	3.54019	3.70287	3.86443	4.024804
45	2.881963	3.04864	3.21439	3.37917	3.54291	3.70557	3.86711	4.027467
46	2.884748	3.05141	3.21715	3.38190	3.54563	3.70828	3.86979	4.030129
47	2.887533	3.05418	3.21990	3.38464	3.54835	3.71098	3.87247	4.032791
48	2.890318	3.05695	3.22266	3.38738	3.55107	3.71368	3.87516	4.035453
49	2.893103	3.05972	3.22541	3.39012	3.55379	3.71638	3.87784	4.038115
50	2.895887	3.06249	3.22816	3.39285	3.55651	3.71908	3.88052	4.040775
51	2.898671	3.06526	3.23092	3.39559	3.55923	3.72178	3.88320	4.043436
52	2.901455	3.06803	3.23367	3.39832	3.56194	3.72448	3.88588	4.046096
53	2.904239	3.07080	3.23642	3.40106	3.56466	3.72718	3.88856	4.048756
54	2.907022	3.07357	3.23917	3.40380	3.56738	3.72988	3.89124	4.051416
55	2.909805	3.07633	3.24193	3.40653	3.57010	3.73258	3.89392	4.054075
56	2.912588	3.07910	3.24468	3.40927	3.57281	3.73528	3.89660	4.056734
57	2.915371	3.08187	3.24743	3.41200	3.57553	3.73797	3.89928	4.059393
58	2.918153	3.08464	3.25018	3.41473	3.57825	3.74067	3.90196	4.062051
59	2.920935	3.08740	3.25293	3.41747	3.58096	3.74337	3.90463	4.064709
60	2.923717	3.09017	3.25568	3.42020	3.58368	3.74607	3.90731	4.067367

Constants for Setting a 10-inch Sine-Bar for 24° to 31°

Min.	24°	25°	26°	27°	28°	29°	30°	31°
0	4.067367	4.22618	4.38371	4.53991	4.69472	4.84810	5.00000	5.150381
1	4.070024	4.22882	4.38633	4.54250	4.69728	4.85064	5.00252	5.152874
2	4.072680	4.23145	4.38894	4.54509	4.69985	4.85318	5.00504	5.155367
3	4.075337	4.23409	4.39155	4.54768	4.70242	4.85573	5.00756	5.157859
4	4.077993	4.23673	4.39417	4.55027	4.70499	4.85827	5.01007	5.160351
5	4.080649	4.23936	4.39678	4.55286	4.70755	4.86081	5.01259	5.162843
6	4.083305	4.24199	4.39939	4.55545	4.71012	4.86335	5.01511	5.165333
7	4.085960	4.24463	4.40200	4.55804	4.71268	4.86590	5.01762	5.167824
8	4.088614	4.24726	4.40462	4.56063	4.71525	4.86844	5.02014	5.170314
9	4.091269	4.24990	4.40723	4.56322	4.71781	4.87098	5.02266	5.172804
10	4.093923	4.25253	4.40984	4.56580	4.72038	4.87352	5.02517	5.175293
11	4.096577	4.25516	4.41245	4.56839	4.72294	4.87606	5.02769	5.177782
12	4.099231	4.25779	4.41506	4.57098	4.72551	4.87860	5.03020	5.180270
13	4.101883	4.26043	4.41767	4.57357	4.72807	4.88114	5.03271	5.182758
14	4.104536	4.26306	4.42028	4.57615	4.73063	4.88367	5.03523	5.185246
15	4.107189	4.26569	4.42289	4.57874	4.73320	4.88621	5.03774	5.187733
16	4.109840	4.26832	4.42550	4.58133	4.73576	4.88875	5.04025	5.190219
17	4.112492	4.27095	4.42810	4.58391	4.73832	4.89129	5.04276	5.192706
18	4.115144	4.27358	4.43071	4.58650	4.74088	4.89382	5.04528	5.195191
19	4.117795	4.27621	4.43332	4.58908	4.74344	4.89636	5.04779	5.197677
20	4.120445	4.27884	4.43593	4.59166	4.74600	4.89890	5.05030	5.200161
21	4.123096	4.28147	4.43853	4.59425	4.74856	4.90143	5.05281	5.202646
22	4.125746	4.28410	4.44114	4.59683	4.75112	4.90397	5.05532	5.205130
23	4.128395	4.28672	4.44375	4.59942	4.75368	4.90650	5.05783	5.207613
24	4.131044	4.28935	4.44635	4.60200	4.75624	4.90904	5.06034	5.210096
25	4.133693	4.29198	4.44896	4.60458	4.75880	4.91157	5.06285	5.212579
26	4.136342	4.29461	4.45156	4.60716	4.76136	4.91411	5.06535	5.215061
27	4.138990	4.29723	4.45417	4.60974	4.76392	4.91664	5.06786	5.217543
28	4.141638	4.29986	4.45677	4.61233	4.76647	4.91917	5.07037	5.220025
29	4.144285	4.30249	4.45937	4.61491	4.76903	4.92170	5.07288	5.222506
30	4.146933	4.30511	4.46198	4.61749	4.77159	4.92424	5.07538	5.224986
31	4.149580	4.30774	4.46458	4.62007	4.77414	4.92677	5.07789	5.227466
32	4.152225	4.31036	4.46718	4.62265	4.77670	4.92930	5.08040	5.229945
33	4.154872	4.31299	4.46979	4.62523	4.77925	4.93183	5.08290	5.232424
34	4.157518	4.31561	4.47239	4.62780	4.78181	4.93436	5.08541	5.234903
35	4.160163	4.31823	4.47499	4.63038	4.78436	4.93689	5.08791	5.237381
36	4.162808	4.32086	4.47759	4.63296	4.78692	4.93942	5.09041	5.239859
37	4.165453	4.32348	4.48019	4.63554	4.78947	4.94195	5.09292	5.242337
38	4.168097	4.32610	4.48279	4.63812	4.79203	4.94448	5.09542	5.244813
39	4.170741	4.32873	4.48539	4.64069	4.79458	4.94700	5.09792	5.247290
40	4.173385	4.33135	4.48799	4.64327	4.79713	4.94953	5.10043	5.249766
41	4.176028	4.33397	4.49059	4.64584	4.79968	4.95206	5.10293	5.252242
42	4.178671	4.33659	4.49319	4.64842	4.80224	4.95459	5.10543	5.254717
43	4.181314	4.33921	4.49579	4.65100	4.80479	4.95711	5.10793	5.257191
44	4.183956	4.34183	4.49839	4.65357	4.80734	4.95964	5.11043	5.259665
45	4.186597	4.34445	4.50098	4.65615	4.80989	4.96217	5.11293	5.262139
46	4.189239	4.34707	4.50358	4.65872	4.81244	4.96469	5.11543	5.264613
47	4.191880	4.34969	4.50618	4.66129	4.81499	4.96722	5.11793	5.267086
48	4.194521	4.35231	4.50878	4.66387	4.81754	4.96974	5.12043	5.269558
49	4.197162	4.35493	4.51137	4.66644	4.82009	4.97226	5.12293	5.272030
50	4.199801	4.35755	4.51397	4.66901	4.82263	4.97479	5.12543	5.274502
51	4.202441	4.36017	4.51656	4.67158	4.82518	4.97731	5.12792	5.276973
52	4.205081	4.36278	4.51916	4.67416	4.82773	4.97983	5.13042	5.279443
53	4.207719	4.36540	4.52175	4.67673	4.83028	4.98236	5.13292	5.281914
54	4.210358	4.36802	4.52435	4.67930	4.83282	4.98488	5.13541	5.284383
55	4.212996	4.37063	4.52694	4.68187	4.83537	4.98740	5.13791	5.286853
56	4.215634	4.37325	4.52953	4.68444	4.83792	4.98992	5.14040	5.289321
57	4.218272	4.37587	4.53213	4.68701	4.84046	4.99244	5.14290	5.291790
58	4.220910	4.37848	4.53472	4.68958	4.84301	4.99496	5.14539	5.294258
59	4.223546	4.38110	4.53731	4.69215	4.84555	4.99748	5.14789	5.296726
60	4.226183	4.38371	4.53991	4.69472	4.84810	5.00000	5.15038	5.299193

Constants for Setting a 10-inch Sine-Bar for 32° to 39°

Min.	32°	33°	34°	35°	36°	37°	38°	39°
0	5.299193	5.44639	5.59193	5.73576	5.87785	6.01815	6.15661	6.293204
1	5.301660	5.44883	5.59434	5.73815	5.88021	6.02047	6.15891	6.295465
2	5.304125	5.45127	5.59675	5.74053	5.88256	6.02280	6.16120	6.297724
3	5.306591	5.45371	5.59916	5.74291	5.88491	6.02512	6.16349	6.299984
4	5.309057	5.45614	5.60157	5.74529	5.88726	6.02744	6.16578	6.302242
5	5.311522	5.45858	5.60398	5.74767	5.88961	6.02976	6.16807	6.304501
6	5.313986	5.46102	5.60639	5.75005	5.89196	6.03208	6.17036	6.306758
7	5.316450	5.46346	5.60880	5.75243	5.89431	6.03440	6.17265	6.309015
8	5.318913	5.46589	5.61121	5.75481	5.89666	6.03672	6.17494	6.311272
9	5.321377	5.46833	5.61361	5.75719	5.89901	6.03904	6.17722	6.313529
10	5.323839	5.47076	5.61602	5.75957	5.90136	6.04136	6.17951	6.315784
11	5.326302	5.47320	5.61843	5.76195	5.90371	6.04367	6.18180	6.318039
12	5.328763	5.47563	5.62083	5.76432	5.90606	6.04599	6.18408	6.320293
13	5.331224	5.47807	5.62324	5.76670	5.90840	6.04831	6.18637	6.322547
14	5.333685	5.48050	5.62564	5.76908	5.91075	6.05062	6.18865	6.324800
15	5.336145	5.48293	5.62805	5.77145	5.91310	6.05294	6.19094	6.327054
16	5.338605	5.48536	5.63045	5.77383	5.91544	6.05526	6.19322	6.329306
17	5.341064	5.48780	5.63286	5.77620	5.91779	6.05757	6.19551	6.331558
18	5.343524	5.49023	5.63526	5.77858	5.92013	6.05988	6.19779	6.333809
19	5.345982	5.49266	5.63766	5.78095	5.92248	6.06220	6.20007	6.336060
20	5.348440	5.49509	5.64007	5.78332	5.92482	6.06451	6.20235	6.338310
21	5.350898	5.49752	5.64247	5.78570	5.92716	6.06682	6.20464	6.340559
22	5.353355	5.49995	5.64487	5.78807	5.92950	6.06914	6.20692	6.342808
23	5.355812	5.50238	5.64727	5.79044	5.93185	6.07145	6.20920	6.345057
24	5.358268	5.50481	5.64967	5.79281	5.93419	6.07376	6.21148	6.347305
25	5.360724	5.50724	5.65207	5.79518	5.93653	6.07607	6.21376	6.349553
26	5.363179	5.50966	5.65447	5.79755	5.93887	6.07838	6.21604	6.351800
27	5.365634	5.51209	5.65687	5.79992	5.94121	6.08069	6.21831	6.354046
28	5.368089	5.51452	5.65927	5.80229	5.94355	6.08300	6.22059	6.356292
29	5.370543	5.51694	5.66166	5.80466	5.94589	6.08531	6.22287	6.358538
30	5.372996	5.51937	5.66406	5.80703	5.94823	6.08761	6.22515	6.360782
31	5.375449	5.52180	5.66646	5.80940	5.95057	6.08992	6.22742	6.363027
32	5.377902	5.52422	5.66886	5.81177	5.95290	6.09223	6.22970	6.365270
33	5.380354	5.52664	5.67125	5.81413	5.95524	6.09454	6.23197	6.367514
34	5.382806	5.52907	5.67365	5.81650	5.95758	6.09684	6.23425	6.369756
35	5.385257	5.53149	5.67604	5.81886	5.95991	6.09915	6.23652	6.371998
36	5.387708	5.53392	5.67844	5.82123	5.96225	6.10145	6.23880	6.374240
37	5.390158	5.53634	5.68083	5.82359	5.96458	6.10376	6.24107	6.376481
38	5.392609	5.53876	5.68323	5.82596	5.96692	6.10606	6.24334	6.378722
39	5.395058	5.54118	5.68562	5.82832	5.96925	6.10836	6.24561	6.380962
40	5.397507	5.54360	5.68801	5.83069	5.97159	6.11067	6.24789	6.383201
41	5.399955	5.54602	5.69040	5.83305	5.97392	6.11297	6.25016	6.385440
42	5.402403	5.54844	5.69280	5.83541	5.97625	6.11527	6.25243	6.387679
43	5.404851	5.55086	5.69519	5.83777	5.97858	6.11757	6.25470	6.389916
44	5.407298	5.55328	5.69758	5.84014	5.98092	6.11987	6.25697	6.392153
45	5.409745	5.55570	5.69997	5.84250	5.98325	6.12217	6.25923	6.394390
46	5.412191	5.55812	5.70236	5.84486	5.98558	6.12447	6.26150	6.396626
47	5.414637	5.56054	5.70475	5.84722	5.98791	6.12677	6.26377	6.398862
48	5.417082	5.56296	5.70714	5.84958	5.99024	6.12907	6.26604	6.401097
49	5.419527	5.56537	5.70952	5.85194	5.99257	6.13137	6.26830	6.403332
50	5.421971	5.56779	5.71191	5.85429	5.99489	6.13367	6.27057	6.405566
51	5.424415	5.57021	5.71430	5.85665	5.99722	6.13596	6.27284	6.407799
52	5.426859	5.57262	5.71669	5.85901	5.99955	6.13826	6.27510	6.410032
53	5.429302	5.57504	5.71907	5.86137	6.00188	6.14056	6.27737	6.412265
54	5.431745	5.57745	5.72146	5.86372	6.00420	6.14285	6.27963	6.414497
55	5.434187	5.57987	5.72384	5.86608	6.00653	6.14515	6.28189	6.416728
56	5.436628	5.58228	5.72623	5.86844	6.00885	6.14744	6.28416	6.418959
57	5.439070	5.58469	5.72861	5.87079	6.01118	6.14974	6.28642	6.421189
58	5.441511	5.58711	5.73100	5.87315	6.01350	6.15203	6.28868	6.423419
59	5.443951	5.58952	5.73338	5.87550	6.01583	6.15432	6.29094	6.425648
60	5.446391	5.59193	5.73576	5.87785	6.01815	6.15661	6.29320	6.427876

Constants for Setting a 10-inch Sine-Bar for 40° to 47°

Min.	40°	41°	42°	43°	44°	45°	46°	47°
0	6.427876	6.56059	6.69131	6.81998	6.94658	7.07107	7.19340	7.313537
1	6.430104	6.56279	6.69347	6.82211	6.94868	7.07312	7.19542	7.315521
2	6.432332	6.56498	6.69563	6.82424	6.95077	7.07518	7.19744	7.317503
3	6.434559	6.56717	6.69779	6.82636	6.95286	7.07724	7.19946	7.319486
4	6.436785	6.56937	6.69995	6.82849	6.95495	7.07929	7.20148	7.321467
5	6.439011	6.57156	6.70211	6.83061	6.95704	7.08134	7.20349	7.323449
6	6.441236	6.57375	6.70427	6.83274	6.95913	7.08340	7.20551	7.325429
7	6.443461	6.57594	6.70642	6.83486	6.96122	7.08545	7.20753	7.327409
8	6.445686	6.57814	6.70858	6.83698	6.96330	7.08750	7.20954	7.329389
9	6.447909	6.58033	6.71074	6.83911	6.96539	7.08956	7.21156	7.331367
10	6.450132	6.58252	6.71290	6.84123	6.96748	7.09161	7.21357	7.333345
11	6.452355	6.58471	6.71505	6.84335	6.96957	7.09366	7.21559	7.335322
12	6.454577	6.58689	6.71721	6.84547	6.97165	7.09571	7.21760	7.337299
13	6.456799	6.58908	6.71936	6.84759	6.97374	7.09776	7.21962	7.339275
14	6.459020	6.59127	6.72151	6.84971	6.97582	7.09981	7.22163	7.341250
15	6.461240	6.59346	6.72367	6.85183	6.97790	7.10185	7.22364	7.343225
16	6.463460	6.59564	6.72582	6.85395	6.97999	7.10390	7.22565	7.345200
17	6.465679	6.59783	6.72797	6.85607	6.98207	7.10595	7.22766	7.347173
18	6.467898	6.60002	6.73012	6.85818	6.98415	7.10800	7.22967	7.349146
19	6.470116	6.60220	6.73228	6.86030	6.98623	7.11004	7.23168	7.351119
20	6.472334	6.60439	6.73443	6.86242	6.98832	7.11209	7.23369	7.353090
21	6.474551	6.60657	6.73658	6.86453	6.99040	7.11413	7.23570	7.355061
22	6.476768	6.60875	6.73873	6.86665	6.99248	7.11617	7.23771	7.357032
23	6.478984	6.61094	6.74088	6.86876	6.99455	7.11822	7.23971	7.359002
24	6.481199	6.61312	6.74302	6.87088	6.99663	7.12026	7.24172	7.360971
25	6.483414	6.61530	6.74517	6.87299	6.99871	7.12230	7.24372	7.362940
26	6.485629	6.61748	6.74732	6.87510	7.00079	7.12434	7.24573	7.364908
27	6.487843	6.61966	6.74947	6.87721	7.00287	7.12639	7.24773	7.366875
28	6.490056	6.62184	6.75161	6.87932	7.00494	7.12843	7.24974	7.368842
29	6.492269	6.62402	6.75376	6.88144	7.00702	7.13047	7.25174	7.370808
30	6.494481	6.62620	6.75590	6.88355	7.00909	7.13250	7.25374	7.372774
31	6.496692	6.62838	6.75805	6.88566	7.01117	7.13454	7.25575	7.374738
32	6.498903	6.63056	6.76019	6.88776	7.01324	7.13658	7.25775	7.376703
33	6.501114	6.63273	6.76233	6.88987	7.01531	7.13862	7.25975	7.378666
34	6.503324	6.63491	6.76448	6.89198	7.01739	7.14066	7.26175	7.380629
35	6.505533	6.63709	6.76662	6.89409	7.01946	7.14269	7.26375	7.382592
36	6.507742	6.63926	6.76876	6.89620	7.02153	7.14473	7.26575	7.384553
37	6.509951	6.64144	6.77090	6.89830	7.02360	7.14676	7.26775	7.386515
38	6.512159	6.64361	6.77304	6.90041	7.02567	7.14880	7.26974	7.388475
39	6.514366	6.64579	6.77518	6.90251	7.02774	7.15083	7.27174	7.390435
40	6.516572	6.64796	6.77732	6.90462	7.02981	7.15286	7.27374	7.392395
41	6.518779	6.65013	6.77946	6.90672	7.03188	7.15490	7.27573	7.394353
42	6.520984	6.65230	6.78160	6.90882	7.03395	7.15693	7.27773	7.396311
43	6.523189	6.65448	6.78373	6.91093	7.03601	7.15896	7.27972	7.398269
44	6.525394	6.65665	6.78587	6.91303	7.03808	7.16099	7.28172	7.400225
45	6.527598	6.65882	6.78801	6.91513	7.04015	7.16302	7.28371	7.402182
46	6.529801	6.66099	6.79014	6.91723	7.04221	7.16505	7.28570	7.404137
47	6.532004	6.66316	6.79228	6.91933	7.04428	7.16708	7.28769	7.406092
48	6.534206	6.66532	6.79441	6.92143	7.04634	7.16911	7.28969	7.408046
49	6.536408	6.66749	6.79655	6.92353	7.04841	7.17113	7.29168	7.410000
50	6.538609	6.66966	6.79868	6.92563	7.05047	7.17316	7.29367	7.411952
51	6.540810	6.67183	6.80081	6.92773	7.05253	7.17519	7.29566	7.413905
52	6.543010	6.67399	6.80295	6.92982	7.05459	7.17721	7.29765	7.415857
53	6.545209	6.67616	6.80508	6.93192	7.05666	7.17924	7.29964	7.417808
54	6.547409	6.67833	6.80721	6.93402	7.05872	7.18126	7.30162	7.419759
55	6.549607	6.68049	6.80934	6.93611	7.06078	7.18329	7.30361	7.421709
56	6.551805	6.68265	6.81147	6.93821	7.06284	7.18531	7.30560	7.423658
57	6.554002	6.68482	6.81360	6.94030	7.06489	7.18733	7.30758	7.425606
58	6.556199	6.68698	6.81573	6.94240	7.06695	7.18936	7.30957	7.427554
59	6.558395	6.68914	6.81786	6.94449	7.06901	7.19138	7.31155	7.429502
60	6.560590	6.69131	6.81998	6.94658	7.07107	7.19340	7.31354	7.431448

Constants for Setting a 10-inch Sine-Bar for 48° to 55°

Min.	48°	49°	50°	51°	52°	53°	54°	55°
0	7.431448	7.54710	7.66044	7.77146	7.88011	7.98636	8.09017	8.191521
1	7.433394	7.54900	7.66231	7.77329	7.88190	7.98811	8.09188	8.193189
2	7.435340	7.55091	7.66418	7.77512	7.88369	7.98986	8.09359	8.194856
3	7.437285	7.55282	7.66605	7.77695	7.88548	7.99160	8.09530	8.196523
4	7.439229	7.55472	7.66792	7.77878	7.88727	7.99335	8.09700	8.198189
5	7.441173	7.55663	7.66979	7.78060	7.88905	7.99510	8.09871	8.199854
6	7.443115	7.55853	7.67165	7.78243	7.89084	7.99685	8.10042	8.201519
7	7.445058	7.56044	7.67352	7.78426	7.89263	7.99859	8.10212	8.203182
8	7.447000	7.56234	7.67538	7.78608	7.89441	8.00034	8.10383	8.204846
9	7.448941	7.56425	7.67725	7.78791	7.89620	8.00208	8.10553	8.206509
10	7.450881	7.56615	7.67911	7.78973	7.89798	8.00383	8.10723	8.208171
11	7.452821	7.56805	7.68097	7.79156	7.89977	8.00557	8.10894	8.209832
12	7.454760	7.56995	7.68284	7.79338	7.90155	8.00731	8.11064	8.211493
13	7.456699	7.57185	7.68470	7.79520	7.90333	8.00906	8.11234	8.213152
14	7.458637	7.57375	7.68656	7.79702	7.90511	8.01080	8.11404	8.214811
15	7.460574	7.57565	7.68842	7.79884	7.90690	8.01254	8.11574	8.216470
16	7.462511	7.57755	7.69028	7.80067	7.90868	8.01428	8.11744	8.218127
17	7.464447	7.57945	7.69214	7.80248	7.91046	8.01602	8.11914	8.219784
18	7.466382	7.58134	7.69400	7.80430	7.91224	8.01776	8.12084	8.221440
19	7.468317	7.58324	7.69585	7.80612	7.91401	8.01950	8.12253	8.223096
20	7.470251	7.58514	7.69771	7.80794	7.91579	8.02123	8.12423	8.224751
21	7.472184	7.58703	7.69957	7.80976	7.91757	8.02297	8.12592	8.226405
22	7.474117	7.58893	7.70142	7.81157	7.91935	8.02470	8.12762	8.228059
23	7.476050	7.59082	7.70328	7.81339	7.92112	8.02644	8.12931	8.229712
24	7.477981	7.59271	7.70513	7.81521	7.92290	8.02818	8.13101	8.231364
25	7.479912	7.59461	7.70699	7.81702	7.92467	8.02991	8.13270	8.233015
26	7.481843	7.59650	7.70884	7.81883	7.92645	8.03164	8.13439	8.234666
27	7.483772	7.59839	7.71069	7.82065	7.92822	8.03337	8.13608	8.236316
28	7.485701	7.60028	7.71254	7.82246	7.92999	8.03511	8.13778	8.237966
29	7.487629	7.60217	7.71440	7.82427	7.93176	8.03684	8.13947	8.239614
30	7.489557	7.60406	7.71625	7.82608	7.93353	8.03857	8.14116	8.241262
31	7.491485	7.60595	7.71810	7.82789	7.93530	8.04030	8.14284	8.242909
32	7.493411	7.60784	7.71994	7.82970	7.93707	8.04203	8.14453	8.244555
33	7.495337	7.60972	7.72179	7.83151	7.93884	8.04376	8.14622	8.246202
34	7.497262	7.61161	7.72364	7.83332	7.94061	8.04548	8.14791	8.247847
35	7.499187	7.61350	7.72549	7.83513	7.94238	8.04721	8.14959	8.249492
36	7.501111	7.61538	7.72734	7.83693	7.94415	8.04894	8.15128	8.251135
37	7.503034	7.61727	7.72918	7.83874	7.94591	8.05066	8.15296	8.252778
38	7.504957	7.61915	7.73103	7.84055	7.94768	8.05239	8.15465	8.254421
39	7.506879	7.62104	7.73287	7.84235	7.94944	8.05411	8.15633	8.256063
40	7.508801	7.62292	7.73472	7.84416	7.95121	8.05584	8.15801	8.257704
41	7.510721	7.62480	7.73656	7.84596	7.95297	8.05756	8.15969	8.259343
42	7.512641	7.62668	7.73840	7.84776	7.95474	8.05928	8.16138	8.260983
43	7.514561	7.62856	7.74024	7.84957	7.95650	8.06100	8.16306	8.262622
44	7.516480	7.63045	7.74209	7.85137	7.95826	8.06273	8.16474	8.264260
45	7.518398	7.63232	7.74393	7.85317	7.96002	8.06445	8.16642	8.265898
46	7.520316	7.63420	7.74577	7.85497	7.96178	8.06617	8.16809	8.267534
47	7.522233	7.63608	7.74761	7.85677	7.96354	8.06788	8.16977	8.269171
48	7.524149	7.63796	7.74944	7.85857	7.96530	8.06960	8.17145	8.270805
49	7.526065	7.63984	7.75128	7.86037	7.96706	8.07132	8.17313	8.272441
50	7.527980	7.64171	7.75312	7.86217	7.96882	8.07304	8.17480	8.274075
51	7.529894	7.64359	7.75496	7.86396	7.97057	8.07475	8.17648	8.275707
52	7.531808	7.64547	7.75679	7.86576	7.97233	8.07647	8.17815	8.277340
53	7.533722	7.64734	7.75863	7.86756	7.97408	8.07819	8.17982	8.278973
54	7.535634	7.64921	7.76046	7.86935	7.97584	8.07990	8.18150	8.280603
55	7.537546	7.65109	7.76230	7.87115	7.97759	8.08161	8.18317	8.282234
56	7.539457	7.65296	7.76413	7.87294	7.97935	8.08333	8.18484	8.283864
57	7.541368	7.65483	7.76596	7.87473	7.98110	8.08504	8.18651	8.285493
58	7.543278	7.65670	7.76780	7.87652	7.98285	8.08675	8.18818	8.287121
59	7.545187	7.65857	7.76963	7.87832	7.98460	8.08846	8.18985	8.288749
60	7.547096	7.66044	7.77146	7.88011	7.98636	8.09017	8.19152	8.290376

Constants for 75-mm Sine-Bar

Constants for Setting a 75-mm Sine-Bar for 0° to 7°

Min.	0°	1°	2°	3°	4°	5°	6°	7°
0	0.000000	1.308931	2.617462	3.925197	5.231736	6.536681	7.839635	9.140201
1	0.021817	1.330744	2.639266	3.946983	5.253499	6.558414	7.861332	9.161855
2	0.043633	1.352557	2.661068	3.968770	5.275262	6.580147	7.883028	9.183507
3	0.065450	1.374370	2.682871	3.990556	5.297024	6.601880	7.904724	9.205160
4	0.087266	1.396183	2.704674	4.012341	5.318786	6.623611	7.926418	9.226810
5	0.109083	1.417996	2.726476	4.034126	5.340548	6.645342	7.948112	9.248462
6	0.130900	1.439808	2.748278	4.055911	5.362309	6.667072	7.969805	9.270111
7	0.152716	1.461621	2.770080	4.077695	5.384069	6.688803	7.991498	9.291760
8	0.174533	1.483433	2.791882	4.099480	5.405829	6.710532	8.013190	9.313408
9	0.196349	1.505245	2.813683	4.121264	5.427589	6.732261	8.034882	9.335055
10	0.218166	1.527058	2.835484	4.143047	5.449348	6.753989	8.056572	9.356702
11	0.239982	1.548870	2.857285	4.164830	5.471107	6.775717	8.078262	9.378348
12	0.261799	1.570682	2.879086	4.186613	5.492865	6.797443	8.099952	9.399993
13	0.283615	1.592493	2.900886	4.208395	5.514623	6.819170	8.121640	9.421637
14	0.305432	1.614305	2.922686	4.230177	5.536380	6.840896	8.143329	9.443280
15	0.327248	1.636116	2.944486	4.251959	5.558137	6.862622	8.165016	9.464923
16	0.349065	1.657928	2.966286	4.273740	5.579894	6.884346	8.186703	9.486565
17	0.370881	1.679739	2.988085	4.295521	5.601649	6.906071	8.208388	9.508205
18	0.392697	1.701550	3.009884	4.317302	5.623405	6.927794	8.230074	9.529846
19	0.414514	1.723361	3.031683	4.339082	5.645160	6.949517	8.251758	9.551485
20	0.436330	1.745172	3.053482	4.360862	5.666914	6.971240	8.273442	9.573124
21	0.458146	1.766982	3.075280	4.382642	5.688668	6.992961	8.295125	9.594762
22	0.479962	1.788793	3.097079	4.404421	5.710422	7.014683	8.316808	9.616399
23	0.501778	1.810603	3.118877	4.426200	5.732174	7.036404	8.338489	9.638035
24	0.523595	1.832413	3.140674	4.447978	5.753927	7.058124	8.360170	9.659670
25	0.545411	1.854223	3.162472	4.469756	5.775679	7.079843	8.381850	9.681304
26	0.567227	1.876033	3.184269	4.491534	5.797431	7.101562	8.403530	9.702938
27	0.589043	1.897843	3.206065	4.513311	5.819182	7.123280	8.425209	9.724571
28	0.610859	1.919653	3.227862	4.535088	5.840933	7.144998	8.446887	9.746203
29	0.632674	1.941462	3.249658	4.556864	5.862682	7.166715	8.468564	9.767834
30	0.654490	1.963271	3.271454	4.578640	5.884432	7.188432	8.490241	9.789465
31	0.676306	1.985080	3.293250	4.600416	5.906182	7.210148	8.511917	9.811094
32	0.698122	2.006889	3.315045	4.622191	5.927930	7.231863	8.533592	9.832723
33	0.719937	2.028698	3.336840	4.643967	5.949678	7.253578	8.555267	9.854351
34	0.741753	2.050506	3.358635	4.665741	5.971426	7.275291	8.576941	9.875978
35	0.763568	2.072315	3.380430	4.687515	5.993173	7.297005	8.598615	9.897604
36	0.785384	2.094123	3.402224	4.709289	6.014919	7.318717	8.620286	9.919230
37	0.807199	2.115931	3.424018	4.731062	6.036666	7.340430	8.641958	9.940854
38	0.829015	2.137739	3.445812	4.752836	6.058411	7.362141	8.663629	9.962478
39	0.850830	2.159546	3.467606	4.774608	6.080156	7.383852	8.685300	9.984100
40	0.872645	2.181354	3.489399	4.796380	6.101901	7.405562	8.706968	10.005722
41	0.894460	2.203161	3.511191	4.818152	6.123645	7.427272	8.728638	10.027344
42	0.916275	2.224968	3.532984	4.839923	6.145388	7.448981	8.750305	10.048964
43	0.938090	2.246775	3.554776	4.861694	6.167131	7.470690	8.771973	10.070583
44	0.959905	2.268582	3.576568	4.883465	6.188873	7.492397	8.793639	10.092202
45	0.981720	2.290389	3.598360	4.905235	6.210616	7.514105	8.815305	10.113820
46	1.003534	2.312195	3.620151	4.927004	6.232358	7.535811	8.836970	10.135437
47	1.025349	2.334001	3.641942	4.948774	6.254098	7.557517	8.858634	10.157053
48	1.047164	2.355807	3.663733	4.970542	6.275839	7.579223	8.880298	10.178668
49	1.068978	2.377613	3.685523	4.992311	6.297578	7.600927	8.901960	10.200282
50	1.090792	2.399418	3.707313	5.014079	6.319318	7.622631	8.923623	10.221896
51	1.112607	2.421224	3.729103	5.035847	6.341056	7.644334	8.945284	10.243508
52	1.134421	2.443029	3.750892	5.057614	6.362795	7.666037	8.966945	10.265121
53	1.156235	2.464834	3.772682	5.079381	6.384532	7.687739	8.988604	10.286731
54	1.178049	2.486638	3.794471	5.101147	6.406270	7.709441	9.010263	10.308341
55	1.199863	2.508443	3.816259	5.122913	6.428006	7.731141	9.031921	10.329950
56	1.221676	2.530247	3.838048	5.144678	6.449742	7.752841	9.053579	10.351559
57	1.243490	2.552051	3.859835	5.166443	6.471478	7.774540	9.075235	10.373166
58	1.265304	2.573855	3.881623	5.188208	6.493213	7.796239	9.096891	10.394773
59	1.287117	2.595659	3.903410	5.209972	6.514947	7.817937	9.118546	10.416378
60	1.308931	2.617462	3.925197	5.231736	6.536681	7.839635	9.140201	10.437983

Constants for Setting a 75-mm Sine-Bar for 8° to 15°

Min.	8°	9°	10°	11°	12°	13°	14°	15°
0	10.437983	11.732585	13.023614	14.310675	15.593377	16.871330	18.144142	19.411428
1	10.459586	11.754132	13.045098	14.332089	15.614717	16.892586	18.165310	19.432501
2	10.481191	11.775680	13.066583	14.353505	15.636055	16.913841	18.186478	19.453573
3	10.502792	11.797225	13.088064	14.374917	15.657392	16.935095	18.207642	19.474642
4	10.524393	11.818769	13.109546	14.396328	15.678726	16.956348	18.228804	19.495708
5	10.545993	11.840312	13.131025	14.417738	15.700060	16.977598	18.249966	19.516773
6	10.567594	11.861856	13.152505	14.439148	15.721394	16.998850	18.271128	19.537840
7	10.589191	11.883397	13.173983	14.460556	15.742724	17.020098	18.292286	19.558901
8	10.610788	11.904937	13.195459	14.481962	15.764053	17.041344	18.313442	19.579962
9	10.632385	11.926476	13.216935	14.503367	15.785382	17.062588	18.334597	19.601021
10	10.653982	11.948016	13.238410	14.524773	15.806710	17.083834	18.355751	19.622080
11	10.675576	11.969553	13.259884	14.546175	15.828035	17.105076	18.376904	19.643135
12	10.697170	11.991089	13.281356	14.567576	15.849360	17.126316	18.398054	19.664188
13	10.718762	12.012625	13.302827	14.588977	15.870683	17.147554	18.419203	19.685242
14	10.740356	12.034160	13.324298	14.610377	15.892006	17.168793	18.440351	19.706293
15	10.761947	12.055693	13.345766	14.631775	15.913326	17.190029	18.461498	19.727341
16	10.783537	12.077225	13.367234	14.653171	15.934645	17.211264	18.482641	19.748388
17	10.805127	12.098757	13.388701	14.674567	15.955963	17.232500	18.503786	19.769436
18	10.826715	12.120287	13.410167	14.695961	15.977280	17.253731	18.524927	19.790480
19	10.848303	12.141816	13.431631	14.717354	15.998594	17.274961	18.546066	19.811522
20	10.869889	12.163344	13.453094	14.738746	16.019909	17.296190	18.567204	19.832561
21	10.891476	12.184873	13.474557	14.760138	16.041222	17.317419	18.588343	19.853601
22	10.913060	12.206398	13.496017	14.781527	16.062532	17.338646	18.609476	19.874640
23	10.934645	12.227923	13.517477	14.802914	16.083841	17.359869	18.630610	19.895676
24	10.956227	12.249447	13.538936	14.824301	16.105150	17.381092	18.651741	19.916708
25	10.977810	12.270971	13.560394	14.845687	16.126457	17.402315	18.672873	19.937742
26	10.999391	12.292493	13.581850	14.867071	16.147762	17.423536	18.694002	19.958773
27	11.020970	12.314013	13.603306	14.888453	16.169067	17.444754	18.715128	19.979801
28	11.042550	12.335533	13.624760	14.909835	16.190369	17.465971	18.736254	20.000828
29	11.064129	12.357053	13.646214	14.931216	16.211672	17.487188	18.757380	20.021854
30	11.085706	12.378571	13.667665	14.952596	16.232971	17.508402	18.778502	20.042879
31	11.107283	12.400087	13.689116	14.973973	16.254271	17.529615	18.799622	20.063900
32	11.128859	12.421604	13.710566	14.995351	16.275568	17.550829	18.820742	20.084923
33	11.150434	12.443118	13.732014	15.016726	16.296864	17.572039	18.841860	20.105940
34	11.172007	12.464632	13.753461	15.038100	16.318159	17.593246	18.862974	20.126957
35	11.193579	12.486144	13.774906	15.059472	16.339451	17.614452	18.884089	20.147972
36	11.215152	12.507657	13.796352	15.080845	16.360744	17.635660	18.905203	20.168987
37	11.236722	12.529167	13.817796	15.102215	16.382034	17.656864	18.926313	20.189999
38	11.258291	12.550676	13.839238	15.123584	16.403322	17.678066	18.947424	20.211010
39	11.279860	12.572185	13.860679	15.144951	16.424610	17.699266	18.968531	20.232018
40	11.301429	12.593693	13.882120	15.166319	16.445898	17.720467	18.989639	20.253025
41	11.322996	12.615199	13.903559	15.187684	16.467182	17.741665	19.010742	20.274031
42	11.344562	12.636703	13.924996	15.209047	16.488466	17.762861	19.031847	20.295034
43	11.366126	12.658208	13.946433	15.230410	16.509747	17.784056	19.052948	20.316034
44	11.387691	12.679711	13.967869	15.251772	16.531029	17.805250	19.074049	20.337036
45	11.409254	12.701213	13.989303	15.273131	16.552307	17.826443	19.095146	20.358034
46	11.430816	12.722713	14.010736	15.294490	16.573586	17.847633	19.116243	20.379030
47	11.452378	12.744215	14.032168	15.315848	16.594864	17.868822	19.137339	20.400026
48	11.473938	12.765713	14.053599	15.337205	16.616138	17.890011	19.158432	20.421019
49	11.495498	12.787210	14.075028	15.358560	16.637411	17.911196	19.179523	20.442011
50	11.517056	12.808706	14.096457	15.379912	16.658684	17.932381	19.200615	20.462999
51	11.538613	12.830203	14.117885	15.401266	16.679955	17.953564	19.221704	20.483990
52	11.560169	12.851697	14.139310	15.422616	16.701225	17.974745	19.242790	20.504974
53	11.581725	12.873191	14.160735	15.443966	16.722492	17.995926	19.263876	20.525959
54	11.603279	12.894682	14.182158	15.465314	16.743759	18.017103	19.284960	20.546942
55	11.624833	12.916175	14.203582	15.486662	16.765024	18.038280	19.306042	20.567923
56	11.646385	12.937664	14.225002	15.508007	16.786289	18.059456	19.327124	20.588902
57	11.667936	12.959153	14.246422	15.529351	16.807550	18.080629	19.348202	20.609880
58	11.689487	12.980640	14.267840	15.550694	16.828812	18.101803	19.369278	20.630856
59	11.711037	13.002129	14.289259	15.572037	16.850071	18.122974	19.390356	20.651831
60	11.732585	13.023614	14.310675	15.593377	16.871330	18.144142	19.411428	20.672802

Constants for Setting a 75-mm Sine-Bar for 16° to 23°

Min.	16°	17°	18°	19°	20°	21°	22°	23°
0	20.672802	21.927879	23.176275	24.417612	25.651512	26.877598	28.095495	29.304836
1	20.693773	21.948740	23.197023	24.438238	25.672010	26.897963	28.115723	29.324917
2	20.714741	21.969601	23.217768	24.458864	25.692509	26.918327	28.135946	29.344994
3	20.735708	21.990459	23.238512	24.479486	25.713003	26.938688	28.156168	29.365070
4	20.756676	22.011318	23.259256	24.500109	25.733500	26.959049	28.176390	29.385145
5	20.777639	22.032173	23.279995	24.520727	25.753990	26.979406	28.196606	29.405216
6	20.798599	22.053026	23.300734	24.541344	25.774479	26.999762	28.216822	29.425285
7	20.819559	22.073877	23.321468	24.561958	25.794964	27.020115	28.237034	29.445351
8	20.840517	22.094725	23.342203	24.582569	25.815449	27.040464	28.257242	29.465414
9	20.861473	22.115572	23.362934	24.603180	25.835932	27.060812	28.277451	29.485476
10	20.882429	22.136417	23.383665	24.623789	25.856411	27.081158	28.297655	29.505533
11	20.903381	22.157261	23.404392	24.644394	25.876888	27.101501	28.317858	29.525589
12	20.924334	22.178104	23.425121	24.665001	25.897367	27.121845	28.338060	29.545645
13	20.945284	22.198944	23.445845	24.685602	25.917839	27.142183	28.358259	29.565697
14	20.966230	22.219782	23.466566	24.706202	25.938311	27.162519	28.378454	29.585745
15	20.987177	22.240620	23.487286	24.726799	25.958780	27.182854	28.398647	29.605789
16	21.008120	22.261454	23.508003	24.747395	25.979246	27.203186	28.418839	29.625834
17	21.029062	22.282286	23.528721	24.767988	25.999712	27.223515	28.439026	29.645874
18	21.050003	22.303116	23.549435	24.788580	26.020174	27.243841	28.459211	29.665913
19	21.070944	22.323946	23.570148	24.809170	26.040636	27.264170	28.479397	29.685951
20	21.091881	22.344772	23.590858	24.829758	26.061094	27.284492	28.499578	29.705984
21	21.112816	22.365597	23.611567	24.850344	26.081551	27.304811	28.519756	29.726015
22	21.133749	22.386419	23.632273	24.870926	26.102003	27.325130	28.539934	29.746042
23	21.154680	22.407240	23.652975	24.891506	26.122456	27.345446	28.560106	29.766069
24	21.175610	22.428059	23.673677	24.912085	26.142904	27.365759	28.580278	29.786093
25	21.196537	22.448877	23.694378	24.932661	26.163351	27.386070	28.600447	29.806112
26	21.217463	22.469692	23.715076	24.953236	26.183796	27.406380	28.620613	29.826132
27	21.238390	22.490507	23.735775	24.973810	26.204241	27.426687	28.640779	29.846149
28	21.259312	22.511318	23.756468	24.994381	26.224680	27.446991	28.660942	29.866161
29	21.280233	22.532127	23.777161	25.014950	26.245119	27.467293	28.681101	29.886173
30	21.301151	22.552935	23.797850	25.035515	26.265554	27.487593	28.701258	29.906181
31	21.322069	22.573742	23.818539	25.056080	26.285988	27.507891	28.721413	29.926186
32	21.342983	22.594545	23.839224	25.076641	26.306419	27.528185	28.741564	29.946190
33	21.363897	22.615347	23.859907	25.097200	26.326849	27.548477	28.761715	29.966190
34	21.384811	22.636148	23.880592	25.117760	26.347279	27.568769	28.781864	29.986191
35	21.405720	22.656946	23.901272	25.138315	26.367702	27.589058	28.802008	30.006186
36	21.426628	22.677742	23.921949	25.158869	26.388124	27.609343	28.822151	30.026178
37	21.447535	22.698538	23.942625	25.179420	26.408545	27.629625	28.842291	30.046169
38	21.468439	22.719330	23.963299	25.199968	26.428963	27.649906	28.862427	30.066156
39	21.489342	22.740120	23.983971	25.220516	26.449379	27.670185	28.882563	30.086142
40	21.510242	22.760908	24.004641	25.241060	26.469791	27.690460	28.902695	30.106125
41	21.531141	22.781694	24.025309	25.261602	26.490204	27.710735	28.922825	30.126104
42	21.552040	22.802481	24.045977	25.282146	26.510614	27.731009	28.942955	30.146086
43	21.572935	22.823263	24.066639	25.302685	26.531021	27.751278	28.963079	30.166059
44	21.593828	22.844044	24.087301	25.323221	26.551426	27.771544	28.983202	30.186033
45	21.614721	22.864822	24.107960	25.343754	26.571829	27.791809	29.003323	30.206003
46	21.635611	22.885599	24.128618	25.364286	26.592228	27.812071	29.023441	30.225969
47	21.656498	22.906374	24.149273	25.384815	26.612627	27.832331	29.043556	30.245935
48	21.677385	22.927147	24.169928	25.405344	26.633022	27.852587	29.063669	30.265898
49	21.698271	22.947922	24.190580	25.425871	26.653418	27.872845	29.083782	30.285860
50	21.719154	22.968689	24.211229	25.446394	26.673809	27.893097	29.103889	30.305817
51	21.740034	22.989456	24.231876	25.466915	26.694197	27.913347	29.123995	30.325771
52	21.760912	23.010221	24.252522	25.487434	26.714584	27.933596	29.144098	30.345722
53	21.781790	23.030985	24.273165	25.507952	26.734968	27.953840	29.164198	30.365673
54	21.802664	23.051746	24.293806	25.528467	26.755350	27.974085	29.184296	30.385620
55	21.823538	23.072506	24.314445	25.548979	26.775730	27.994326	29.204391	30.405563
56	21.844410	23.093264	24.335083	25.569489	26.796108	28.014563	29.224485	30.425505
57	21.865280	23.114021	24.355721	25.590000	26.816484	28.034801	29.244577	30.445446
58	21.886148	23.134775	24.376352	25.610506	26.836859	28.055035	29.264666	30.465384
59	21.907015	23.155525	24.396984	25.631010	26.857229	28.075266	29.284752	30.485317
60	21.927879	23.176275	24.417612	25.651512	26.877598	28.095495	29.304836	30.505249

Constants for Setting a 75-mm Sine-Bar for 24° to 31°

Min.	24°	25°	26°	27°	28°	29°	30°	31°
0	30.505249	31.696371	32.877838	34.049290	35.210369	36.360722	37.500000	38.627857
1	30.525177	31.716141	32.897446	34.068726	35.229630	36.379803	37.518894	38.646557
2	30.545105	31.735910	32.917049	34.088158	35.248886	36.398880	37.537781	38.665249
3	30.565027	31.755674	32.936649	34.107590	35.268143	36.417950	37.556667	38.683941
4	30.584951	31.775440	32.956249	34.127022	35.287395	36.437023	37.575550	38.702633
5	30.604870	31.795200	32.975845	34.146446	35.306644	36.456089	37.594429	38.721317
6	30.624786	31.814959	32.995438	34.165871	35.325893	36.475155	37.613308	38.740002
7	30.644699	31.834713	33.015030	34.185287	35.345135	36.494217	37.632179	38.758678
8	30.664610	31.854465	33.034618	34.204704	35.364376	36.513275	37.651051	38.777355
9	30.684519	31.874214	33.054203	34.224121	35.383614	36.532330	37.669914	38.796028
10	30.704424	31.893961	33.073784	34.243530	35.402847	36.551380	37.688778	38.814697
11	30.724327	31.913706	33.093361	34.262939	35.422077	36.570427	37.707638	38.833363
12	30.744228	31.933449	33.112942	34.282345	35.441311	36.589478	37.726498	38.852028
13	30.764128	31.953188	33.132515	34.301750	35.460533	36.608521	37.745350	38.870686
14	30.784021	31.972923	33.152084	34.321148	35.479755	36.627560	37.764202	38.889343
15	30.803915	31.992657	33.171654	34.340546	35.498978	36.646595	37.783051	38.907997
16	30.823805	32.012386	33.191219	34.359940	35.518192	36.665627	37.801895	38.926643
17	30.843693	32.032116	33.210781	34.379330	35.537407	36.684658	37.820736	38.945290
18	30.863577	32.051838	33.230339	34.398716	35.556614	36.703686	37.839573	38.963932
19	30.883461	32.071564	33.249897	34.418102	35.575825	36.722710	37.858410	38.982574
20	30.903341	32.091286	33.269451	34.437485	35.595028	36.741730	37.877239	39.001213
21	30.923218	32.111000	33.289001	34.456863	35.614231	36.760750	37.896069	39.019844
22	30.943092	32.130714	33.308552	34.476242	35.633430	36.779762	37.914894	39.038475
23	30.962963	32.150425	33.328094	34.495613	35.652622	36.798775	37.933716	39.057098
24	30.982832	32.170135	33.347637	34.514984	35.671818	36.817783	37.952534	39.075722
25	31.002699	32.189842	33.367180	34.534351	35.691006	36.836788	37.971348	39.094341
26	31.022562	32.209545	33.386715	34.553715	35.710190	36.855789	37.990162	39.112961
27	31.042427	32.229248	33.406250	34.573078	35.729378	36.874790	38.008972	39.131573
28	31.062284	32.248947	33.425781	34.592438	35.748558	36.893787	38.027775	39.150185
29	31.082140	32.268642	33.445313	34.611794	35.767735	36.912777	38.046577	39.168789
30	31.101994	32.288334	33.464836	34.631145	35.786907	36.931767	38.065376	39.187393
31	31.121845	32.308022	33.484360	34.650497	35.806080	36.950756	38.084175	39.205994
32	31.141693	32.327709	33.503880	34.669842	35.825249	36.969738	38.102966	39.224590
33	31.161537	32.347393	33.523396	34.689186	35.844414	36.988716	38.121758	39.243183
34	31.181383	32.367077	33.542912	34.708530	35.863575	37.007698	38.140545	39.261776
35	31.201223	32.386757	33.562424	34.727867	35.882736	37.026672	38.159328	39.280361
36	31.221060	32.406433	33.581932	34.747204	35.901890	37.045643	38.178108	39.298943
37	31.240896	32.426105	33.601440	34.766537	35.921043	37.064610	38.196884	39.317524
38	31.260727	32.445778	33.620941	34.785866	35.940193	37.083572	38.215656	39.336102
39	31.280558	32.465443	33.640442	34.805191	35.959339	37.102535	38.234428	39.354675
40	31.300385	32.485107	33.659939	34.824516	35.978485	37.121494	38.253193	39.373245
41	31.320208	32.504772	33.679432	34.843834	35.997623	37.140450	38.271957	39.391811
42	31.340033	32.524433	33.698925	34.863155	36.016766	37.159401	38.290722	39.410378
43	31.359852	32.544090	33.718414	34.882469	36.035900	37.178352	38.309479	39.428936
44	31.379667	32.563744	33.737900	34.901783	36.055031	37.197296	38.328232	39.447491
45	31.399481	32.583397	33.757385	34.921089	36.074158	37.216240	38.346981	39.466045
46	31.419292	32.603043	33.776863	34.940395	36.093285	37.235180	38.365730	39.484596
47	31.439100	32.622688	33.796341	34.959698	36.112408	37.254116	38.384476	39.503143
48	31.458906	32.642334	33.815815	34.978996	36.131527	37.273048	38.403214	39.521687
49	31.478712	32.661976	33.835289	34.998299	36.150642	37.291981	38.421955	39.540226
50	31.498512	32.681614	33.854759	35.017590	36.169758	37.310905	38.440689	39.558762
51	31.518309	32.701248	33.874222	35.036880	36.188866	37.329830	38.459419	39.577297
52	31.538105	32.720879	33.893688	35.056171	36.207973	37.348751	38.478149	39.595825
53	31.557898	32.740509	33.913147	35.075455	36.227077	37.367668	38.496872	39.614353
54	31.577686	32.760136	33.932602	35.094738	36.246178	37.386581	38.515594	39.632877
55	31.597473	32.779758	33.952057	35.114014	36.265278	37.405491	38.534313	39.651394
56	31.617258	32.799377	33.971508	35.133293	36.284370	37.424400	38.553028	39.669910
57	31.637041	32.819000	33.990959	35.152565	36.303467	37.443306	38.571743	39.688427
58	31.656820	32.838615	34.010406	35.171837	36.322556	37.462208	38.590450	39.706936
59	31.676598	32.858227	34.029850	35.191105	36.341640	37.481106	38.609154	39.725441
60	31.696371	32.877838	34.049290	35.210369	36.360722	37.500000	38.627857	39.743946

Constants for Setting a 75-mm Sine-Bar for 32° to 39°

Min.	32°	33°	34°	35°	36°	37°	38°	39°
0	39.743946	40.847927	41.939468	43.018234	44.083897	45.136127	46.174610	47.199032
1	39.762444	40.866222	41.957554	43.036102	44.101543	45.153549	46.191803	47.215984
2	39.780941	40.884514	41.975636	43.053967	44.119186	45.170967	46.208988	47.232933
3	39.799435	40.902802	41.993713	43.071831	44.136826	45.188381	46.226170	47.249874
4	39.817924	40.921089	42.011787	43.089687	44.154465	45.205791	46.243347	47.266815
5	39.836411	40.939369	42.029858	43.107544	44.172096	45.223198	46.260521	47.283752
6	39.854893	40.957645	42.047924	43.125393	44.189728	45.240597	46.277691	47.300686
7	39.873371	40.975922	42.065987	43.143242	44.207352	45.257996	46.294857	47.317612
8	39.891853	40.994194	42.084053	43.161087	44.224976	45.275394	46.312023	47.334541
9	39.910324	41.012463	42.102108	43.178928	44.242596	45.292786	46.329182	47.351463
10	39.928795	41.030727	42.120159	43.196766	44.260208	45.310173	46.346336	47.368378
11	39.947262	41.048988	42.138210	43.214596	44.277821	45.327557	46.363483	47.385292
12	39.965721	41.067245	42.156254	43.232426	44.295425	45.344936	46.380630	47.402199
13	39.984180	41.085499	42.174297	43.250252	44.313030	45.362312	46.397774	47.419106
14	40.002636	41.103748	42.192337	43.268074	44.330627	45.379681	46.414913	47.436005
15	40.021091	41.121994	42.210369	43.285889	44.348225	45.397049	46.432049	47.452900
16	40.039539	41.140236	42.228401	43.303703	44.365818	45.414413	46.449177	47.469791
17	40.057983	41.158474	42.246429	43.321514	44.383404	45.431774	46.466305	47.486683
18	40.076427	41.176712	42.264454	43.339321	44.400990	45.449131	46.483429	47.503567
19	40.094864	41.194942	42.282475	43.357124	44.418568	45.466484	46.500546	47.520447
20	40.113300	41.213173	42.300491	43.374924	44.436146	45.483829	46.517662	47.537323
21	40.131733	41.231400	42.318504	43.392719	44.453720	45.501175	46.534771	47.554195
22	40.150162	41.249622	42.336514	43.410515	44.471287	45.518517	46.551880	47.571064
23	40.168591	41.267841	42.354527	43.428307	44.488857	45.535858	46.568989	47.587933
24	40.187012	41.286057	42.372528	43.446091	44.506420	45.553192	46.586086	47.604790
25	40.205429	41.304268	42.390526	43.463871	44.523975	45.570518	46.603180	47.621647
26	40.223846	41.322479	42.408524	43.481647	44.541531	45.587845	46.620274	47.638500
27	40.242256	41.340683	42.426514	43.499424	44.559082	45.605167	46.637360	47.655346
28	40.260666	41.358883	42.444504	43.517193	44.576630	45.622486	46.654446	47.672192
29	40.279072	41.377079	42.462486	43.534962	44.594170	45.639797	46.671524	47.689034
30	40.297470	41.395275	42.480469	43.552723	44.611710	45.657108	46.688599	47.705868
31	40.315868	41.413464	42.498447	43.570480	44.629246	45.674416	46.705669	47.722698
32	40.334263	41.431652	42.516418	43.588238	44.646778	45.691715	46.722736	47.739529
33	40.352654	41.449837	42.534389	43.605988	44.664303	45.709015	46.739803	47.756351
34	40.371044	41.468018	42.552357	43.623737	44.681828	45.726311	46.756863	47.773170
35	40.389427	41.486191	42.570320	43.641483	44.699348	45.743599	46.773918	47.789986
36	40.407806	41.504364	42.588280	43.659222	44.716866	45.760887	46.790970	47.806797
37	40.426186	41.522533	42.606236	43.676960	44.734379	45.778172	46.808018	47.823608
38	40.444565	41.540707	42.624191	43.694698	44.751892	45.795452	46.825066	47.840412
39	40.462936	41.558868	42.642143	43.712425	44.769394	45.812729	46.842106	47.857212
40	40.481300	41.577026	42.660088	43.730152	44.786896	45.829998	46.859142	47.874008
41	40.499664	41.595181	42.678028	43.747875	44.804394	45.847267	46.876175	47.890800
42	40.518024	41.613335	42.695965	43.765594	44.821888	45.864529	46.893200	47.907589
43	40.536385	41.631481	42.713902	43.783306	44.839378	45.881790	46.910225	47.924370
44	40.554737	41.649628	42.731831	43.801018	44.856865	45.899044	46.927246	47.941151
45	40.573086	41.667770	42.749760	43.818726	44.874348	45.916298	46.944260	47.957928
46	40.591434	41.685905	42.767681	43.836430	44.891823	45.933544	46.961273	47.974697
47	40.609776	41.704041	42.785603	43.854130	44.909298	45.950790	46.978283	47.991467
48	40.628117	41.722172	42.803516	43.871826	44.926769	45.968029	46.995285	48.008228
49	40.646454	41.740299	42.821430	43.889519	44.944237	45.985264	47.012287	48.024986
50	40.664783	41.758423	42.839340	43.907207	44.961700	46.002499	47.029282	48.041740
51	40.683113	41.776543	42.857246	43.924892	44.979160	46.019726	47.046276	48.058495
52	40.701439	41.794659	42.875145	43.942574	44.996616	46.036953	47.063263	48.075241
53	40.719769	41.812775	42.893047	43.960255	45.014072	46.054176	47.080250	48.091988
54	40.738087	41.830887	42.910942	43.977928	45.031521	46.071392	47.097233	48.108727
55	40.756401	41.848991	42.928833	43.995598	45.048965	46.088604	47.114208	48.125462
56	40.774715	41.867096	42.946720	44.013268	45.066402	46.105816	47.131180	48.142189
57	40.793022	41.885193	42.964603	44.030930	45.083839	46.123020	47.148148	48.158916
58	40.811329	41.903290	42.982483	44.048588	45.101273	46.140221	47.165115	48.175640
59	40.829632	41.921379	43.000362	44.066242	45.118702	46.157417	47.182076	48.192356
60	40.847927	41.939468	43.018234	44.083897	45.136127	46.174610	47.199032	48.209072

Constants for Setting a 75-mm Sine-Bar for 40° to 47°

Min.	40°	41°	42°	43°	44°	45°	46°	47°
0	48.209072	49.204430	50.184795	51.149879	52.099380	53.033009	53.950485	54.851528
1	48.225780	49.220890	50.201008	51.165833	52.115070	53.048435	53.965637	54.866405
2	48.242489	49.237350	50.217213	51.181782	52.130756	53.063854	53.980785	54.881275
3	48.259190	49.253803	50.233414	51.197723	52.146439	53.079269	53.995930	54.896145
4	48.275887	49.270256	50.249615	51.213665	52.162117	53.094681	54.011070	54.911007
5	48.292583	49.286701	50.265808	51.229603	52.177792	53.110085	54.026203	54.925865
6	48.309273	49.303143	50.281998	51.245533	52.193459	53.125488	54.041332	54.940716
7	48.325958	49.319580	50.298180	51.261459	52.209126	53.140884	54.056458	54.955566
8	48.342644	49.336018	50.314365	51.277386	52.224789	53.156281	54.071583	54.970413
9	48.359322	49.352448	50.330544	51.293304	52.240444	53.171669	54.086697	54.985252
10	48.375996	49.368874	50.346714	51.309219	52.256096	53.187054	54.101810	55.000088
11	48.392662	49.385296	50.362881	51.325130	52.271744	53.202431	54.116917	55.014915
12	48.409328	49.401711	50.379047	51.341034	52.287384	53.217808	54.132019	55.029743
13	48.425991	49.418125	50.395206	51.356937	52.303024	53.233177	54.147118	55.044563
14	48.442646	49.434532	50.411362	51.372833	52.318657	53.248543	54.162209	55.059380
15	48.459301	49.450935	50.427513	51.388725	52.334286	53.263905	54.177299	55.074188
16	48.475948	49.467339	50.443657	51.404613	52.349911	53.279263	54.192383	55.088997
17	48.492592	49.483734	50.459801	51.420498	52.365532	53.294613	54.207462	55.103798
18	48.509235	49.500126	50.475941	51.436378	52.381145	53.309959	54.222538	55.118595
19	48.525871	49.516514	50.492073	51.452251	52.396759	53.325306	54.237606	55.133389
20	48.542503	49.532898	50.508202	51.468124	52.412365	53.340641	54.252674	55.148174
21	48.559132	49.549274	50.524326	51.483990	52.427967	53.355976	54.267735	55.162960
22	48.575756	49.565651	50.540447	51.499851	52.443565	53.371307	54.282791	55.177738
23	48.592381	49.582027	50.556568	51.515713	52.459164	53.386635	54.297844	55.192516
24	48.608994	49.598392	50.572681	51.531567	52.474754	53.401955	54.312893	55.207283
25	48.625607	49.614754	50.588791	51.547417	52.490337	53.417271	54.327934	55.222050
26	48.642216	49.631115	50.604893	51.563259	52.505920	53.432583	54.342972	55.236809
27	48.658817	49.647469	50.620995	51.579102	52.521496	53.447891	54.358006	55.251564
28	48.675419	49.663818	50.637089	51.594936	52.537067	53.463192	54.373035	55.266315
29	48.692013	49.680164	50.653179	51.610767	52.552631	53.478493	54.388058	55.281059
30	48.708603	49.696507	50.669266	51.626595	52.568195	53.493786	54.403080	55.295803
31	48.725193	49.712841	50.685349	51.642418	52.583755	53.509075	54.418095	55.310539
32	48.741776	49.729176	50.701427	51.658234	52.599308	53.524357	54.433105	55.325272
33	48.758354	49.745502	50.717503	51.674049	52.614857	53.539639	54.448109	55.339996
34	48.774929	49.761829	50.733570	51.689857	52.630402	53.554913	54.463112	55.354721
35	48.791500	49.778149	50.749638	51.705666	52.645943	53.570183	54.478107	55.369438
36	48.808067	49.794464	50.765697	51.721466	52.661480	53.585449	54.493099	55.384151
37	48.824627	49.810776	50.781754	51.737263	52.677010	53.600712	54.508087	55.398857
38	48.841190	49.827087	50.797810	51.753059	52.692539	53.615974	54.523075	55.413567
39	48.857746	49.843391	50.813858	51.768845	52.708065	53.631226	54.538052	55.428265
40	48.874294	49.859692	50.829903	51.784630	52.723583	53.646473	54.553024	55.442959
41	48.890839	49.875988	50.845943	51.800407	52.739094	53.661716	54.567993	55.457649
42	48.907383	49.892277	50.861977	51.816181	52.754604	53.676956	54.582958	55.472336
43	48.923920	49.908566	50.878010	51.831951	52.770111	53.692192	54.597919	55.487015
44	48.940453	49.924847	50.894035	51.847717	52.785610	53.707420	54.612873	55.501690
45	48.956982	49.941128	50.910057	51.863480	52.801105	53.722649	54.627823	55.516361
46	48.973507	49.957401	50.926075	51.879238	52.816597	53.737869	54.642769	55.531029
47	48.990028	49.973671	50.942089	51.894989	52.832085	53.753086	54.657711	55.545689
48	49.006546	49.989937	50.958099	51.910740	52.847565	53.768295	54.672649	55.560345
49	49.023060	50.006199	50.974102	51.926483	52.863045	53.783504	54.687580	55.574997
50	49.039566	50.022453	50.990105	51.942223	52.878517	53.798706	54.702507	55.589645
51	49.056072	50.038708	51.006100	51.957958	52.893986	53.813904	54.717430	55.604286
52	49.072571	50.054955	51.022091	51.973686	52.909451	53.829098	54.732349	55.618927
53	49.089073	50.071205	51.038086	51.989418	52.924915	53.844292	54.747265	55.633560
54	49.105564	50.087444	51.054070	52.005138	52.940369	53.859474	54.762173	55.648190
55	49.122051	50.103680	51.070045	52.020859	52.955822	53.874657	54.777077	55.662815
56	49.138535	50.119911	51.086021	52.036572	52.971268	53.889832	54.791977	55.677433
57	49.155014	50.136139	51.101994	52.052280	52.986710	53.905003	54.806873	55.692047
58	49.171490	50.152363	51.117958	52.067982	53.002148	53.920166	54.821762	55.706657
59	49.187962	50.168583	51.133919	52.083683	53.017582	53.935329	54.836647	55.721264
60	49.204430	50.184795	51.149879	52.099380	53.033009	53.950485	54.851528	55.735863

Constants for Setting a 75-mm Sine-Bar for 48° to 55°

Min.	48°	49°	50°	51°	52°	53°	54°	55°
0	55.735863	56.603218	57.453335	58.285950	59.100807	59.897663	60.676277	61.436405
1	55.750458	56.617531	57.467354	58.299675	59.114235	59.910789	60.689098	61.448914
2	55.765044	56.631836	57.481373	58.313396	59.127659	59.923912	60.701912	61.461422
3	55.779636	56.646137	57.495380	58.327114	59.141079	59.937031	60.714722	61.473923
4	55.794216	56.660431	57.509388	58.340828	59.154495	59.950142	60.727528	61.486416
5	55.808792	56.674725	57.523388	58.354534	59.167904	59.963249	60.740330	61.498905
6	55.823364	56.689011	57.537388	58.368237	59.181305	59.976349	60.753124	61.511391
7	55.837933	56.703293	57.551376	58.381935	59.194706	59.989445	60.765911	61.523869
8	55.852497	56.717571	57.565369	58.395630	59.208103	60.002541	60.778702	61.536346
9	55.867058	56.731842	57.579350	58.409317	59.221493	60.015625	60.791481	61.548817
10	55.881611	56.746113	57.593327	58.423000	59.234875	60.028706	60.804256	61.561279
11	55.896156	56.760372	57.607300	58.436676	59.248253	60.041782	60.817024	61.573738
12	55.910702	56.774632	57.621265	58.450348	59.261627	60.054855	60.829788	61.586193
13	55.925240	56.788883	57.635227	58.464016	59.274998	60.067921	60.842548	61.598640
14	55.939774	56.803131	57.649185	58.477680	59.288361	60.080982	60.855301	61.611084
15	55.954304	56.817375	57.663139	58.491337	59.301720	60.094036	60.868050	61.623520
16	55.968830	56.831612	57.677086	58.504990	59.315071	60.107086	60.880795	61.635956
17	55.983349	56.845848	57.691029	58.518639	59.328423	60.120132	60.893532	61.648380
18	55.997864	56.860077	57.704967	58.532280	59.341766	60.133175	60.906265	61.660805
19	56.012375	56.874298	57.718899	58.545918	59.355103	60.146210	60.918995	61.673222
20	56.026882	56.888519	57.732830	58.559551	59.368439	60.159241	60.931717	61.685631
21	56.041382	56.902733	57.746754	58.573181	59.381767	60.172264	60.944435	61.698040
22	56.055878	56.916943	57.760670	58.586803	59.395092	60.185284	60.957146	61.710442
23	56.070374	56.931152	57.774586	58.600426	59.408413	60.198303	60.969856	61.722839
24	56.084858	56.945351	57.788494	58.614037	59.421726	60.211311	60.982559	61.735229
25	56.099342	56.959545	57.802399	58.627647	59.435036	60.224319	60.995258	61.747616
26	56.113819	56.973736	57.816299	58.641251	59.448338	60.237316	61.007950	61.759995
27	56.128292	56.987923	57.830193	58.654846	59.461636	60.250313	61.020634	61.772369
28	56.142757	57.002102	57.844082	58.668442	59.474930	60.263302	61.033318	61.784740
29	56.157223	57.016277	57.857967	58.682030	59.488216	60.276287	61.045994	61.797108
30	56.171680	57.030449	57.871845	58.695614	59.501503	60.289265	61.058666	61.809464
31	56.186134	57.044613	57.885719	58.709190	59.514782	60.302238	61.071331	61.821819
32	56.200584	57.058777	57.899590	58.722763	59.528053	60.315208	61.083992	61.834167
33	56.215027	57.072933	57.913452	58.736332	59.541321	60.328175	61.096649	61.846512
34	56.229465	57.087086	57.927315	58.749897	59.554585	60.341133	61.109299	61.858852
35	56.243900	57.101231	57.941170	58.763454	59.567844	60.354088	61.121944	61.871185
36	56.258331	57.115372	57.955017	58.777008	59.581097	60.367035	61.134586	61.883511
37	56.272755	57.129509	57.968864	58.790558	59.594345	60.379978	61.147221	61.895836
38	56.287178	57.143646	57.982708	58.804104	59.607590	60.392921	61.159851	61.908157
39	56.301594	57.157772	57.996540	58.817642	59.620831	60.405853	61.172478	61.920467
40	56.316006	57.171894	58.010372	58.831177	59.634064	60.418781	61.185097	61.932774
41	56.330410	57.186012	58.024197	58.844707	59.647289	60.431705	61.197712	61.945076
42	56.344810	57.200127	58.038017	58.858231	59.660511	60.444622	61.210320	61.957375
43	56.359207	57.214233	58.051834	58.871750	59.673729	60.457535	61.222923	61.969666
44	56.373600	57.228336	58.065643	58.885262	59.686943	60.470444	61.235523	61.981953
45	56.387985	57.242435	58.079449	58.898769	59.700150	60.483345	61.248119	61.994232
46	56.402370	57.256531	58.093250	58.912273	59.713352	60.496243	61.260708	62.006508
47	56.416744	57.270618	58.107048	58.925774	59.726551	60.509136	61.273289	62.018780
48	56.431118	57.284702	58.120838	58.939266	59.739746	60.522022	61.285870	62.031044
49	56.445488	57.298782	58.134624	58.952755	59.752934	60.534904	61.298443	62.043304
50	56.459850	57.312855	58.148403	58.966240	59.766113	60.547783	61.311008	62.055557
51	56.474209	57.326927	58.162182	58.979721	59.779293	60.560654	61.323570	62.067806
52	56.488560	57.340988	58.175953	58.993195	59.792465	60.573521	61.336128	62.080051
53	56.502914	57.355053	58.189720	59.006664	59.805634	60.586388	61.348682	62.092293
54	56.517258	57.369106	58.203484	59.020130	59.818798	60.599243	61.361233	62.104527
55	56.531597	57.383156	58.217239	59.033588	59.831955	60.612095	61.373772	62.116756
56	56.545929	57.397202	58.230991	59.047043	59.845108	60.624943	61.386311	62.128979
57	56.560261	57.411243	58.244740	59.060490	59.858253	60.637783	61.398842	62.141197
58	56.574585	57.425278	58.258480	59.073936	59.871395	60.650620	61.411369	62.153408
59	56.588905	57.439308	58.272217	59.087376	59.884533	60.663448	61.423889	62.165615
60	56.603218	57.453335	58.285950	59.100807	59.897663	60.676277	61.436405	62.177818

Constants for 100-millimeter Sine-bar

Constants for Setting a 100-mm Sine-bar for 0° to 7°

Min.	0°	1°	2°	3°	4°	5°	6°	7°
0	0.000000	1.745241	3.489950	5.233596	6.975647	8.715574	10.452847	12.186934
1	0.029089	1.774325	3.519021	5.262644	7.004666	8.744553	10.481776	12.215807
2	0.058178	1.803409	3.548091	5.291693	7.033682	8.773529	10.510704	12.244677
3	0.087266	1.832493	3.577162	5.320741	7.062699	8.802505	10.539631	12.273546
4	0.116355	1.861577	3.606232	5.349788	7.091714	8.831481	10.568558	12.302414
5	0.145444	1.890661	3.635301	5.378835	7.120730	8.860456	10.597483	12.331282
6	0.174533	1.919744	3.664371	5.407881	7.149745	8.889430	10.626408	12.360147
7	0.203622	1.948828	3.693440	5.436927	7.178759	8.918404	10.655332	12.389013
8	0.232710	1.977911	3.722509	5.465973	7.207772	8.947375	10.684254	12.417877
9	0.261799	2.006994	3.751578	5.495018	7.236785	8.976348	10.713176	12.446741
10	0.290888	2.036077	3.780646	5.524063	7.265797	9.005319	10.742096	12.475602
11	0.319977	2.065159	3.809714	5.553107	7.294809	9.034289	10.771017	12.504464
12	0.349065	2.094242	3.838781	5.582151	7.323820	9.063258	10.799935	12.533323
13	0.378154	2.123324	3.867848	5.611194	7.352830	9.092227	10.828855	12.562182
14	0.407242	2.152407	3.896915	5.640237	7.381840	9.121195	10.857771	12.591040
15	0.436331	2.181489	3.925982	5.669279	7.410849	9.150162	10.886688	12.619897
16	0.465420	2.210570	3.955048	5.698321	7.439858	9.179129	10.915604	12.648753
17	0.494508	2.239652	3.984114	5.727362	7.468865	9.208094	10.944518	12.677608
18	0.523596	2.268733	4.013179	5.756403	7.497873	9.237060	10.973432	12.706462
19	0.552685	2.297815	4.042244	5.785443	7.526879	9.266023	11.002344	12.735313
20	0.581773	2.326896	4.071309	5.814483	7.555886	9.294987	11.031256	12.764166
21	0.610861	2.355977	4.100374	5.843522	7.584891	9.323949	11.060166	12.793015
22	0.639950	2.385057	4.129438	5.872561	7.613896	9.352911	11.089077	12.821865
23	0.669038	2.414138	4.158502	5.901600	7.642900	9.381871	11.117986	12.850713
24	0.698126	2.443218	4.187566	5.930638	7.671903	9.410831	11.146894	12.879560
25	0.727214	2.472298	4.216629	5.959675	7.700905	9.439791	11.175800	12.908405
26	0.756302	2.501378	4.245691	5.988712	7.729908	9.468750	11.204707	12.937251
27	0.785390	2.530457	4.274754	6.017748	7.758909	9.497706	11.233611	12.966094
28	0.814478	2.559537	4.303816	6.046784	7.787910	9.526664	11.262516	12.994938
29	0.843566	2.588616	4.332878	6.075819	7.816910	9.555620	11.291419	13.023779
30	0.872654	2.617695	4.361939	6.104854	7.845910	9.584576	11.320322	13.052620
31	0.901741	2.646774	4.391000	6.133888	7.874909	9.613530	11.349223	13.081459
32	0.930829	2.675852	4.420060	6.162922	7.903907	9.642484	11.378123	13.110297
33	0.959916	2.704930	4.449121	6.191956	7.932905	9.671437	11.407023	13.139134
34	0.989004	2.734009	4.478180	6.220988	7.961901	9.700389	11.435922	13.167971
35	1.018091	2.763086	4.507240	6.250021	7.990898	9.729341	11.464819	13.196806
36	1.047179	2.792164	4.536299	6.279052	8.019893	9.758290	11.493715	13.225639
37	1.076266	2.821241	4.565357	6.308083	8.048887	9.787240	11.522612	13.254473
38	1.105353	2.850318	4.594416	6.337114	8.077881	9.816189	11.551505	13.283303
39	1.134440	2.879395	4.623474	6.366144	8.106875	9.845137	11.580400	13.312135
40	1.163527	2.908472	4.652532	6.395174	8.135867	9.874084	11.609291	13.340963
41	1.192613	2.937548	4.681589	6.424202	8.164860	9.903030	11.638184	13.369792
42	1.221700	2.966624	4.710645	6.453231	8.193851	9.931975	11.667073	13.398619
43	1.250787	2.995700	4.739702	6.482259	8.222842	9.960920	11.695964	13.427444
44	1.279873	3.024776	4.768757	6.511286	8.251831	9.989863	11.724852	13.456269
45	1.308960	3.053851	4.797813	6.540313	8.280821	10.018806	11.753740	13.485093
46	1.338046	3.082927	4.826868	6.569339	8.309810	10.047749	11.782627	13.513916
47	1.367132	3.112001	4.855923	6.598365	8.338798	10.076690	11.811512	13.542737
48	1.396218	3.141076	4.884977	6.627390	8.367785	10.105630	11.840398	13.571558
49	1.425304	3.170151	4.914031	6.656415	8.396770	10.134569	11.869281	13.600377
50	1.454390	3.199224	4.943084	6.685439	8.425757	10.163508	11.898164	13.629195
51	1.483476	3.228298	4.972137	6.714462	8.454741	10.192446	11.927045	13.658011
52	1.512561	3.257372	5.001190	6.743485	8.483727	10.221383	11.955926	13.686828
53	1.541646	3.286445	5.030242	6.772508	8.512710	10.250319	11.984805	13.715641
54	1.570732	3.315518	5.059294	6.801529	8.541693	10.279254	12.013684	13.744455
55	1.599817	3.344591	5.088346	6.830551	8.570675	10.308188	12.042562	13.773267
56	1.628902	3.373663	5.117396	6.859571	8.599656	10.337122	12.071439	13.802078
57	1.657987	3.402735	5.146447	6.888591	8.628636	10.366054	12.100314	13.830888
58	1.687072	3.431807	5.175497	6.917611	8.657617	10.394986	12.129189	13.859696
59	1.716156	3.460879	5.204546	6.946630	8.686596	10.423916	12.158062	13.888504
60	1.745241	3.489950	5.233596	6.975647	8.715574	10.452847	12.186934	13.917311

Constants for Setting a 100-mm Sine-bar for 8° to 15°

Min.	8°	9°	10°	11°	12°	13°	14°	15°
0	13.917311	15.643447	17.364819	19.080900	20.791170	22.495106	24.192190	25.881905
1	13.946115	15.672176	17.393463	19.109453	20.819622	22.523447	24.220413	25.910002
2	13.974920	15.700907	17.422110	19.138006	20.848074	22.551790	24.248636	25.938097
3	14.003723	15.729633	17.450752	19.166555	20.876522	22.580128	24.276855	25.966188
4	14.032524	15.758359	17.479393	19.195105	20.904968	22.608463	24.305073	25.994278
5	14.061324	15.787084	17.508034	19.223652	20.933413	22.636799	24.333288	26.022366
6	14.090124	15.815807	17.536674	19.252197	20.961857	22.665133	24.361502	26.050451
7	14.118922	15.844529	17.565311	19.280741	20.990299	22.693462	24.389713	26.078535
8	14.147718	15.873250	17.593946	19.309282	21.018738	22.721790	24.417923	26.106615
9	14.176514	15.901969	17.622580	19.337824	21.047176	22.750118	24.446129	26.134695
10	14.205309	15.930688	17.651215	19.366364	21.075613	22.778444	24.474335	26.162773
11	14.234102	15.959404	17.679844	19.394899	21.104048	22.806767	24.502539	26.190845
12	14.262894	15.988119	17.708475	19.423435	21.132481	22.835087	24.530739	26.218918
13	14.291684	16.016832	17.737103	19.451969	21.160910	22.863405	24.558937	26.246988
14	14.320475	16.045546	17.765730	19.480503	21.189341	22.891726	24.587135	26.275057
15	14.349262	16.074257	17.794355	19.509033	21.217768	22.920040	24.615330	26.303122
16	14.378049	16.102966	17.822979	19.537561	21.246193	22.948353	24.643522	26.331184
17	14.406837	16.131676	17.851603	19.566090	21.274618	22.976665	24.671715	26.359247
18	14.435621	16.160383	17.880222	19.594616	21.303040	23.004974	24.699902	26.387306
19	14.464404	16.189089	17.908842	19.623138	21.331459	23.033281	24.728088	26.415361
20	14.493186	16.217793	17.937458	19.651661	21.359877	23.061586	24.756271	26.443417
21	14.521968	16.246496	17.966076	19.680183	21.388294	23.089891	24.784456	26.471470
22	14.550748	16.275198	17.994690	19.708702	21.416710	23.118193	24.812635	26.499519
23	14.579526	16.303898	18.023304	19.737219	21.445122	23.146492	24.840813	26.527567
24	14.608303	16.332596	18.051914	19.765734	21.473532	23.174789	24.868988	26.555613
25	14.637080	16.361296	18.080526	19.794249	21.501944	23.203087	24.897163	26.583656
26	14.665854	16.389990	18.109135	19.822762	21.530350	23.231380	24.925335	26.611696
27	14.694628	16.418684	18.137741	19.851271	21.558756	23.259672	24.953505	26.639736
28	14.723400	16.447378	18.166346	19.879780	21.587158	23.287962	24.981672	26.667770
29	14.752172	16.476070	18.194950	19.908289	21.615562	23.316252	25.009838	26.695807
30	14.780942	16.504761	18.223553	19.936794	21.643963	23.344538	25.038002	26.723839
31	14.809710	16.533449	18.252153	19.965298	21.672359	23.372820	25.066162	26.751867
32	14.838478	16.562140	18.280754	19.993801	21.700758	23.401104	25.094322	26.779896
33	14.867244	16.590824	18.309351	20.022301	21.729153	23.429384	25.122478	26.807920
34	14.896008	16.619509	18.337948	20.050800	21.757544	23.457661	25.150633	26.835943
35	14.924772	16.648193	18.366541	20.079296	21.785934	23.485937	25.178785	26.863964
36	14.953535	16.676876	18.395136	20.107794	21.814325	23.514212	25.206938	26.891983
37	14.982296	16.705557	18.423727	20.136286	21.842712	23.542484	25.235085	26.920000
38	15.011056	16.734236	18.452316	20.164778	21.871098	23.570755	25.263231	26.948013
39	15.039814	16.762913	18.480906	20.193268	21.899481	23.599022	25.291374	26.976025
40	15.068572	16.791590	18.509493	20.221758	21.927864	23.627289	25.319517	27.004034
41	15.097328	16.820265	18.538078	20.250244	21.956244	23.655554	25.347658	27.032042
42	15.126082	16.848938	18.566662	20.278730	21.984621	23.683815	25.375795	27.060045
43	15.154835	16.877609	18.595243	20.307213	22.012997	23.712074	25.403931	27.088047
44	15.183589	16.906282	18.623825	20.335695	22.041372	23.740334	25.432064	27.116049
45	15.212339	16.934952	18.652405	20.364176	22.069744	23.768589	25.460196	27.144045
46	15.241088	16.963619	18.680981	20.392654	22.098114	23.796844	25.488325	27.172041
47	15.269837	16.992287	18.709558	20.421131	22.126484	23.825096	25.516453	27.200035
48	15.298584	17.020950	18.738132	20.449606	22.154850	23.853346	25.544577	27.228025
49	15.327330	17.049614	18.766705	20.478079	22.183216	23.881594	25.572699	27.256014
50	15.356073	17.078276	18.795275	20.506550	22.211578	23.909840	25.600819	27.284000
51	15.384818	17.106937	18.823847	20.535021	22.239941	23.938086	25.628939	27.311985
52	15.413560	17.135597	18.852413	20.563488	22.268299	23.966328	25.657055	27.339966
53	15.442300	17.164253	18.880980	20.591955	22.296656	23.994566	25.685167	27.367945
54	15.471039	17.192909	18.909544	20.620419	22.325012	24.022804	25.713280	27.395922
55	15.499778	17.221565	18.938108	20.648882	22.353367	24.051041	25.741390	27.423899
56	15.528514	17.250219	18.966669	20.677343	22.381718	24.079275	25.769497	27.451870
57	15.557248	17.278872	18.995230	20.705801	22.410067	24.107506	25.797602	27.479839
58	15.585982	17.307520	19.023787	20.734259	22.438416	24.135736	25.825705	27.507807
59	15.614716	17.336170	19.052345	20.762716	22.466763	24.163965	25.853807	27.535774
60	15.643447	17.364819	19.080900	20.791170	22.495106	24.192190	25.881905	27.563736

Constants for Setting a 100-mm Sine-bar for 16° to 23°

Min.	16°	17°	18°	19°	20°	21°	22°	23°
0	27.563736	29.237171	30.901701	32.556816	34.202015	35.836796	37.460659	39.073112
1	27.591696	29.264988	30.929363	32.584320	34.229347	35.863953	37.487629	39.099888
2	27.619656	29.292801	30.957024	32.611816	34.256680	35.891102	37.514595	39.126659
3	27.647610	29.320612	30.984682	32.639317	34.284004	35.918251	37.541557	39.153427
4	27.675568	29.348425	31.012341	32.666813	34.311333	35.945400	37.568520	39.180195
5	27.703518	29.376230	31.039993	32.694302	34.338654	35.972542	37.595474	39.206955
6	27.731466	29.404034	31.067644	32.721790	34.365971	35.999683	37.622429	39.233715
7	27.759413	29.431835	31.095291	32.749275	34.393288	36.026817	37.649376	39.260468
8	27.787357	29.459635	31.122936	32.776760	34.420597	36.053951	37.676323	39.287220
9	27.815298	29.487431	31.150579	32.804241	34.447906	36.081081	37.703266	39.313965
10	27.843239	29.515224	31.178219	32.831718	34.475216	36.108212	37.730206	39.340710
11	27.871176	29.543015	31.205856	32.859192	34.502518	36.135334	37.757145	39.367451
12	27.899113	29.570807	31.233494	32.886665	34.529823	36.162460	37.784081	39.394192
13	27.927044	29.598593	31.261126	32.914135	34.557121	36.189579	37.811012	39.420929
14	27.954975	29.626377	31.288755	32.941601	34.584415	36.216694	37.837940	39.447659
15	27.982903	29.654158	31.316381	32.969067	34.611706	36.243805	37.864864	39.474388
16	28.010828	29.681936	31.344006	32.996525	34.638996	36.270912	37.891785	39.501110
17	28.038750	29.709713	31.371626	33.023983	34.666283	36.298019	37.918701	39.527832
18	28.066669	29.737488	31.399244	33.051437	34.693565	36.325123	37.945614	39.554550
19	28.094591	29.765261	31.426865	33.078896	34.720848	36.352226	37.972530	39.581268
20	28.122507	29.793030	31.454477	33.106342	34.748127	36.379322	37.999439	39.607979
21	28.150421	29.820797	31.482088	33.133789	34.775398	36.406418	38.026344	39.634686
22	28.178331	29.848560	31.509697	33.161236	34.802670	36.433506	38.053246	39.661392
23	28.206240	29.876320	31.537302	33.188675	34.829941	36.460594	38.080143	39.688091
24	28.234146	29.904079	31.564903	33.216114	34.857204	36.487679	38.107037	39.714790
25	28.262049	29.931835	31.592505	33.243549	34.884468	36.514759	38.133930	39.741486
26	28.289951	29.959589	31.620102	33.270981	34.911728	36.541840	38.160820	39.768173
27	28.317852	29.987343	31.647699	33.298416	34.938988	36.568916	38.187706	39.794865
28	28.345749	30.015091	31.675291	33.325840	34.966240	36.595989	38.214588	39.821548
29	28.373644	30.042837	31.702881	33.353264	34.993492	36.623058	38.241470	39.848232
30	28.401535	30.070581	31.730467	33.380688	35.020741	36.650124	38.268345	39.874908
31	28.429424	30.098322	31.758051	33.408104	35.047985	36.677185	38.295216	39.901581
32	28.457312	30.126060	31.785631	33.435520	35.075226	36.704247	38.322086	39.928253
33	28.485195	30.153795	31.813210	33.462933	35.102463	36.731304	38.348953	39.954922
34	28.513081	30.181532	31.840790	33.490349	35.129704	36.758358	38.375816	39.981586
35	28.540960	30.209263	31.868362	33.517754	35.156937	36.785408	38.402679	40.008247
36	28.568838	30.236990	31.895933	33.545158	35.184166	36.812458	38.429535	40.034904
37	28.596712	30.264715	31.923500	33.572559	35.211395	36.839500	38.456387	40.061558
38	28.624586	30.292439	31.951065	33.599960	35.238617	36.866543	38.483238	40.088207
39	28.652456	30.320160	31.978628	33.627354	35.265839	36.893581	38.510082	40.114857
40	28.680323	30.347878	32.006187	33.654747	35.293056	36.920616	38.536926	40.141499
41	28.708189	30.375593	32.033745	33.682137	35.320271	36.947647	38.563766	40.168140
42	28.736053	30.403309	32.061302	33.709530	35.347488	36.974678	38.590607	40.194778
43	28.763914	30.431019	32.088852	33.736912	35.374695	37.001705	38.617439	40.221413
44	28.791773	30.458725	32.116402	33.764294	35.401901	37.028725	38.644272	40.248043
45	28.819628	30.486431	32.143948	33.791672	35.429104	37.055744	38.671097	40.274670
46	28.847481	30.514133	32.171490	33.819050	35.456306	37.082760	38.697922	40.301292
47	28.875332	30.541832	32.199032	33.846420	35.483501	37.109772	38.724743	40.327911
48	28.903179	30.569530	32.226570	33.873791	35.510696	37.136784	38.751560	40.354530
49	28.931028	30.597227	32.254108	33.901161	35.537891	37.163792	38.778374	40.381145
50	28.958872	30.624920	32.281639	33.928528	35.565079	37.190796	38.805187	40.407757
51	28.986712	30.652609	32.309170	33.955887	35.592262	37.217796	38.831993	40.434361
52	29.014551	30.680296	32.336697	33.983246	35.619446	37.244793	38.858799	40.460964
53	29.042387	30.707981	32.364220	34.010601	35.646626	37.271790	38.885597	40.487564
54	29.070219	30.735662	32.391743	34.037956	35.673801	37.298779	38.912395	40.514160
55	29.098051	30.763342	32.419262	34.065304	35.700974	37.325768	38.939190	40.540752
56	29.125879	30.791018	32.446777	34.092651	35.728142	37.352753	38.965981	40.567341
57	29.153708	30.818695	32.474293	34.119999	35.755314	37.379734	38.992771	40.593929
58	29.181532	30.846365	32.501804	34.147343	35.782478	37.406712	39.019554	40.620510
59	29.209352	30.874035	32.529312	34.174679	35.809639	37.433689	39.046337	40.647091
60	29.237171	30.901701	32.556816	34.202015	35.836796	37.460659	39.073112	40.673664

Constants for Setting a 100-mm Sine-bar for 24° to 31°

Min.	24°	25°	26°	27°	28°	29°	30°	31°
0	40.673664	42.261826	43.837116	45.399052	46.947159	48.480965	50.000000	51.503807
1	40.700237	42.288189	43.863258	45.424969	46.972839	48.506401	50.025192	51.528740
2	40.726807	42.314545	43.889397	45.450878	46.998516	48.531837	50.050377	51.553669
3	40.753372	42.340900	43.915531	45.476788	47.024189	48.557270	50.075558	51.578590
4	40.779934	42.367252	43.941666	45.502697	47.049862	48.582699	50.100735	51.603512
5	40.806492	42.393600	43.967796	45.528595	47.075527	48.608120	50.125908	51.628426
6	40.833046	42.419945	43.993919	45.554493	47.101189	48.633541	50.151077	51.653336
7	40.859600	42.446285	44.020039	45.580387	47.126846	48.658955	50.176239	51.678242
8	40.886147	42.472618	44.046154	45.606274	47.152500	48.684364	50.201397	51.703140
9	40.912689	42.498951	44.072269	45.632160	47.178150	48.709770	50.226555	51.728039
10	40.939232	42.525280	44.098377	45.658043	47.203796	48.735172	50.251705	51.752930
11	40.965767	42.551605	44.124481	45.683918	47.229439	48.760571	50.276852	51.777817
12	40.992306	42.577930	44.150589	45.709797	47.255077	48.785969	50.301998	51.802704
13	41.018837	42.604248	44.176685	45.735664	47.280712	48.811359	50.327137	51.827583
14	41.045364	42.630566	44.202778	45.761532	47.306343	48.836742	50.352268	51.852455
15	41.071888	42.656876	44.228870	45.787392	47.331966	48.862125	50.377399	51.877327
16	41.098408	42.683182	44.254955	45.813251	47.357590	48.887505	50.402523	51.902191
17	41.124924	42.709488	44.281040	45.839104	47.383205	48.912876	50.427647	51.927055
18	41.151436	42.735786	44.307117	45.864956	47.408821	48.938244	50.452763	51.951912
19	41.177948	42.762085	44.333199	45.890804	47.434433	48.963612	50.477879	51.976768
20	41.204453	42.788380	44.359268	45.916649	47.460041	48.988976	50.502987	52.001614
21	41.230957	42.814667	44.385338	45.942486	47.485641	49.014332	50.528091	52.026459
22	41.257458	42.840954	44.411400	45.968323	47.511238	49.039684	50.553192	52.051300
23	41.283951	42.867237	44.437462	45.994152	47.536831	49.065033	50.578285	52.076134
24	41.310444	42.893513	44.463520	46.019978	47.562420	49.090378	50.603378	52.100964
25	41.336933	42.919788	44.489571	46.045803	47.588009	49.115715	50.628464	52.125790
26	41.363419	42.946060	44.515621	46.071621	47.613590	49.141052	50.653545	52.150612
27	41.389900	42.972332	44.541668	46.097439	47.639168	49.166386	50.678627	52.175430
28	41.416378	42.998592	44.567711	46.123253	47.664742	49.191715	50.703701	52.200245
29	41.442856	43.024853	44.593750	46.149059	47.690311	49.217037	50.728771	52.225052
30	41.469326	43.051109	44.619781	46.174862	47.715878	49.242359	50.753838	52.249859
31	41.495792	43.077362	44.645813	46.200661	47.741440	49.267673	50.778900	52.274658
32	41.522259	43.103615	44.671841	46.226460	47.766994	49.292984	50.803955	52.299454
33	41.548717	43.129860	44.697861	46.252251	47.792549	49.318291	50.829010	52.324245
34	41.575176	43.156105	44.723885	46.278042	47.818100	49.343597	50.854061	52.349033
35	41.601631	43.182343	44.749901	46.303825	47.843647	49.368893	50.879105	52.373814
36	41.628082	43.208576	44.775909	46.329605	47.869186	49.394188	50.904144	52.398594
37	41.654526	43.234806	44.801918	46.355381	47.894726	49.419479	50.929180	52.423367
38	41.680969	43.261036	44.827923	46.381153	47.920258	49.444763	50.954208	52.448135
39	41.707409	43.287258	44.853924	46.406921	47.945786	49.470047	50.979237	52.472900
40	41.733845	43.313480	44.879917	46.432686	47.971313	49.495323	51.004261	52.497658
41	41.760277	43.339695	44.905910	46.458447	47.996834	49.520596	51.029278	52.522415
42	41.786709	43.365910	44.931904	46.484207	48.022350	49.545868	51.054295	52.547169
43	41.813133	43.392120	44.957886	46.509960	48.047863	49.571133	51.079304	52.571915
44	41.839558	43.418324	44.983868	46.535709	48.073372	49.596394	51.104309	52.596657
45	41.865974	43.444527	45.009846	46.561455	48.098877	49.621651	51.129311	52.621395
46	41.892391	43.470726	45.035820	46.587193	48.124378	49.646904	51.154308	52.646126
47	41.918800	43.496918	45.061787	46.612930	48.149876	49.672153	51.179298	52.670856
48	41.945210	43.523109	45.087753	46.638664	48.175369	49.697395	51.204288	52.695580
49	41.971615	43.549301	45.113720	46.664394	48.200859	49.722637	51.229275	52.720303
50	41.998016	43.575481	45.139679	46.690121	48.226341	49.747875	51.254253	52.745018
51	42.024414	43.601662	45.165630	46.715843	48.251823	49.773106	51.279228	52.769730
52	42.050804	43.627838	45.191582	46.741558	48.277298	49.798332	51.304199	52.794434
53	42.077194	43.654011	45.217529	46.767273	48.302773	49.823555	51.329163	52.819138
54	42.103580	43.680180	45.243473	46.792980	48.328239	49.848774	51.354126	52.843834
55	42.129963	43.706345	45.269409	46.818687	48.353703	49.873989	51.379082	52.868526
56	42.156345	43.732506	45.295345	46.844387	48.379162	49.899200	51.404037	52.893215
57	42.182724	43.758667	45.321281	46.870090	48.404621	49.924408	51.428989	52.917904
58	42.209095	43.784821	45.347206	46.895782	48.430073	49.949612	51.453934	52.942581
59	42.235462	43.810970	45.373131	46.921471	48.455521	49.974808	51.478874	52.967258
60	42.261826	43.837116	45.399052	46.947159	48.480965	50.000000	51.503807	52.991928

Constants for Setting a 100-mm Sine-bar for 32° to 39°

Min.	32°	33°	34°	35°	36°	37°	38°	39°
0	52.991928	54.463905	55.919292	57.357643	58.778526	60.181503	61.566151	62.932041
1	53.016594	54.488297	55.943405	57.381470	58.802055	60.204731	61.589069	62.954643
2	53.041256	54.512688	55.967514	57.405293	58.825584	60.227955	61.611984	62.977242
3	53.065914	54.537071	55.991615	57.429108	58.849102	60.251175	61.634892	62.999836
4	53.090565	54.561451	56.015717	57.452919	58.872620	60.274387	61.657795	63.022423
5	53.115211	54.585827	56.039810	57.476723	58.896130	60.297596	61.680695	63.045002
6	53.139858	54.610195	56.063900	57.500523	58.919636	60.320797	61.703587	63.067581
7	53.164497	54.634560	56.087982	57.524323	58.943134	60.343994	61.726475	63.090153
8	53.189137	54.658928	56.112068	57.548119	58.966637	60.367195	61.749363	63.112724
9	53.213768	54.683285	56.136143	57.571903	58.990128	60.390381	61.772240	63.135284
10	53.238392	54.707634	56.160213	57.595684	59.013615	60.413563	61.795113	63.157837
11	53.263012	54.731983	56.184280	57.619461	59.037094	60.436741	61.817982	63.180389
12	53.287628	54.756325	56.208340	57.643234	59.060570	60.459915	61.840843	63.202934
13	53.312241	54.780663	56.232395	57.667000	59.084042	60.483082	61.863697	63.225471
14	53.336849	54.804996	56.256447	57.690762	59.107506	60.506245	61.886551	63.248005
15	53.361454	54.829323	56.280495	57.714520	59.130966	60.529400	61.909397	63.270535
16	53.386051	54.853649	56.304535	57.738274	59.154423	60.552551	61.932236	63.293056
17	53.410645	54.877968	56.328571	57.762020	59.177872	60.575699	61.955074	63.315575
18	53.435234	54.902283	56.352604	57.785763	59.201317	60.598839	61.977905	63.338089
19	53.459820	54.926594	56.376633	57.809502	59.224758	60.621979	62.000729	63.360596
20	53.484402	54.950897	56.400654	57.833233	59.248196	60.645107	62.023548	63.383095
21	53.508976	54.975197	56.424675	57.856960	59.271626	60.668236	62.046364	63.405594
22	53.533546	54.999493	56.448685	57.880684	59.295052	60.691357	62.069172	63.428085
23	53.558121	55.023792	56.472702	57.904408	59.318478	60.714478	62.091984	63.450573
24	53.582684	55.048077	56.496704	57.928120	59.341892	60.737587	62.114780	63.473053
25	53.607243	55.072361	56.520702	57.951828	59.365303	60.760693	62.137577	63.495529
26	53.631794	55.096638	56.544697	57.975533	59.388710	60.783794	62.160362	63.517998
27	53.656342	55.120911	56.568687	57.999229	59.412109	60.806889	62.183147	63.540462
28	53.680889	55.145176	56.592670	58.022926	59.435505	60.829979	62.205925	63.562923
29	53.705425	55.169441	56.616650	58.046612	59.458893	60.853065	62.228699	63.585377
30	53.729961	55.193699	56.640625	58.070297	59.482281	60.876144	62.251465	63.607822
31	53.754494	55.217953	56.664597	58.093975	59.505661	60.899220	62.274227	63.630264
32	53.779018	55.242203	56.688560	58.117649	59.529037	60.922287	62.296986	63.652702
33	53.803539	55.266449	56.712521	58.141319	59.552406	60.945354	62.319736	63.675137
34	53.828056	55.290688	56.736477	58.164982	59.575771	60.968414	62.342484	63.697563
35	53.852570	55.314922	56.760429	58.188641	59.599133	60.991467	62.365223	63.719982
36	53.877079	55.339153	56.784374	58.212296	59.622486	61.014515	62.387959	63.742397
37	53.901581	55.363380	56.808315	58.235947	59.645836	61.037560	62.410690	63.764809
38	53.926086	55.387608	56.832256	58.259594	59.669186	61.060604	62.433418	63.787220
39	53.950581	55.411823	56.856190	58.283234	59.692528	61.083637	62.456139	63.809620
40	53.975067	55.436035	56.880116	58.306870	59.715862	61.106667	62.478855	63.832012
41	53.999554	55.460243	56.904037	58.330498	59.739193	61.129688	62.501564	63.854401
42	54.024036	55.484444	56.927956	58.354122	59.762516	61.152706	62.524269	63.876785
43	54.048512	55.508644	56.951866	58.377743	59.785835	61.175720	62.546967	63.899162
44	54.072983	55.532837	56.975777	58.401360	59.809151	61.198727	62.569660	63.921535
45	54.097450	55.557026	56.999676	58.424969	59.832462	61.221729	62.592350	63.943901
46	54.121910	55.581207	57.023575	58.448574	59.855766	61.244728	62.615032	63.966263
47	54.146370	55.605389	57.047470	58.472172	59.879066	61.267719	62.637711	63.988621
48	54.170822	55.629562	57.071358	58.495770	59.902359	61.290707	62.660381	64.010971
49	54.195271	55.653732	57.095242	58.519360	59.925652	61.313686	62.683048	64.033318
50	54.219715	55.677895	57.119118	58.542942	59.948933	61.336662	62.705711	64.055656
51	54.244152	55.702057	57.142994	58.566525	59.972214	61.359634	62.728367	64.077988
52	54.268589	55.726212	57.166862	58.590099	59.995487	61.382603	62.751019	64.100319
53	54.293022	55.750370	57.190731	58.613674	60.018761	61.405567	62.773670	64.122650
54	54.317448	55.774513	57.214592	58.637238	60.042027	61.428524	62.796310	64.144966
55	54.341869	55.798656	57.238445	58.660801	60.065285	61.451473	62.818943	64.167282
56	54.366287	55.822792	57.262295	58.684357	60.088539	61.474419	62.841576	64.189590
57	54.390697	55.846924	57.286140	58.707905	60.111790	61.497360	62.864201	64.211891
58	54.415104	55.871052	57.309978	58.731449	60.135033	61.520294	62.886818	64.234184
59	54.439507	55.895172	57.333817	58.754990	60.158272	61.543224	62.909431	64.256477
60	54.463905	55.919292	57.357643	58.778526	60.181503	61.566151	62.932041	64.278763

Constants for Setting a 100-mm Sine-bar for 40° to 47°

Min.	40°	41°	42°	43°	44°	45°	46°	47°
0	64.278763	65.605904	66.913063	68.199837	69.465836	70.710678	71.933983	73.135368
1	64.301041	65.627853	66.934677	68.221107	69.486763	70.731247	71.954185	73.155205
2	64.323318	65.649803	66.956284	68.242371	69.507675	70.751808	71.974380	73.175034
3	64.345589	65.671738	66.977890	68.263634	69.528587	70.772362	71.994576	73.194855
4	64.367851	65.693672	66.999481	68.284889	69.549492	70.792908	72.014755	73.214676
5	64.390106	65.715599	67.021072	68.306137	69.570389	70.813446	72.034935	73.234482
6	64.412361	65.737526	67.042664	68.327377	69.591278	70.833984	72.055107	73.254288
7	64.434608	65.759438	67.064240	68.348610	69.612167	70.854515	72.075279	73.274086
8	64.456856	65.781357	67.085823	68.369850	69.633049	70.875038	72.095444	73.293884
9	64.479095	65.803261	67.107391	68.391075	69.653923	70.895561	72.115601	73.313667
10	64.501328	65.825165	67.128952	68.412292	69.674797	70.916069	72.135750	73.333450
11	64.523552	65.847061	67.150513	68.433502	69.695656	70.936577	72.155891	73.353226
12	64.545769	65.868950	67.172058	68.454712	69.716515	70.957077	72.176025	73.372986
13	64.567986	65.890831	67.193611	68.475914	69.737366	70.977570	72.196159	73.392746
14	64.590195	65.912712	67.215149	68.497108	69.758209	70.998055	72.216278	73.412506
15	64.612396	65.934586	67.236679	68.518303	69.779045	71.018539	72.236397	73.432251
16	64.634598	65.956451	67.258209	68.539482	69.799881	71.039017	72.256508	73.451996
17	64.656792	65.978310	67.279732	68.560661	69.820709	71.059486	72.276619	73.471733
18	64.678978	66.000168	67.301254	68.581833	69.841530	71.079948	72.296715	73.491463
19	64.701164	66.022018	67.322762	68.603004	69.862343	71.100403	72.316811	73.511185
20	64.723335	66.043861	67.344269	68.624161	69.883156	71.120857	72.336899	73.530899
21	64.745506	66.065704	67.365768	68.645317	69.903961	71.141304	72.356979	73.550613
22	64.767677	66.087532	67.387268	68.666466	69.924759	71.161743	72.377052	73.570320
23	64.789841	66.109367	67.408760	68.687614	69.945549	71.182182	72.397125	73.590019
24	64.811996	66.131187	67.430244	68.708755	69.966339	71.202606	72.417191	73.609711
25	64.834145	66.153008	67.451721	68.729889	69.987114	71.223030	72.437248	73.629395
26	64.856285	66.174820	67.473190	68.751015	70.007889	71.243446	72.457298	73.649078
27	64.878426	66.196625	67.494659	68.772133	70.028656	71.263855	72.477341	73.668755
28	64.900558	66.218422	67.516121	68.793251	70.049423	71.284256	72.497383	73.688416
29	64.922684	66.240219	67.537575	68.814354	70.070175	71.304657	72.517410	73.708084
30	64.944809	66.262009	67.559021	68.835457	70.090927	71.325043	72.537437	73.727737
31	64.966919	66.283791	67.580467	68.856560	70.111671	71.345428	72.557457	73.747383
32	64.989037	66.305565	67.601906	68.877647	70.132408	71.365814	72.577469	73.767029
33	65.011139	66.327339	67.623337	68.898735	70.153145	71.386185	72.597481	73.786659
34	65.033241	66.349106	67.644760	68.919815	70.173866	71.406555	72.617485	73.806290
35	65.055336	66.370865	67.666183	68.940887	70.194588	71.426910	72.637474	73.825920
36	65.077423	66.392624	67.687599	68.961952	70.215302	71.447266	72.657463	73.845535
37	65.099503	66.414368	67.709007	68.983017	70.236015	71.467613	72.677452	73.865143
38	65.121590	66.436119	67.730415	69.004074	70.256721	71.487961	72.697433	73.884758
39	65.143661	66.457855	67.751808	69.025131	70.277420	71.508301	72.717400	73.904350
40	65.165726	66.479591	67.773201	69.046173	70.298111	71.528633	72.737366	73.923943
41	65.187790	66.501320	67.794586	69.067207	70.318794	71.548958	72.757324	73.943535
42	65.209846	66.523041	67.815971	69.088242	70.339470	71.569275	72.777275	73.963112
43	65.231895	66.544754	67.837341	69.109268	70.360146	71.589592	72.797226	73.982689
44	65.253937	66.566467	67.858711	69.130295	70.380814	71.609894	72.817162	74.002251
45	65.275978	66.588165	67.880074	69.151306	70.401474	71.630196	72.837097	74.021812
46	65.298012	66.609863	67.901436	69.172318	70.422127	71.650490	72.857025	74.041367
47	65.320038	66.631561	67.922783	69.193321	70.442780	71.670776	72.876945	74.060921
48	65.342064	66.653244	67.944130	69.214317	70.463425	71.691063	72.896866	74.080460
49	65.364075	66.674927	67.965469	69.235313	70.484062	71.711334	72.916771	74.099998
50	65.386093	66.696602	67.986809	69.256294	70.504692	71.731606	72.936676	74.119530
51	65.408096	66.718277	68.008133	69.277275	70.525314	71.751869	72.956573	74.139053
52	65.430099	66.739944	68.029457	69.298248	70.545937	71.772133	72.976463	74.158569
53	65.452095	66.761604	68.050781	69.319221	70.566551	71.792389	72.996353	74.178085
54	65.474083	66.783257	68.072090	69.340187	70.587158	71.812630	73.016228	74.197586
55	65.496071	66.804909	68.093399	69.361145	70.607765	71.832870	73.036102	74.217087
56	65.518044	66.826546	68.114693	69.382095	70.628357	71.853104	73.055969	74.236580
57	65.540016	66.848183	68.135986	69.403038	70.648949	71.873337	73.075829	74.256065
58	65.561989	66.869820	68.157280	69.423981	70.669533	71.893555	73.095680	74.275543
59	65.583946	66.891441	68.178558	69.444908	70.690109	71.913773	73.115532	74.295013
60	65.605904	66.913063	68.199837	69.465836	70.710678	71.933983	73.135368	74.314484

Constants for Setting a 100-mm Sine-bar for 48° to 55°

Min.	48°	49°	50°	51°	52°	53°	54°	55°
0	74.314484	75.470963	76.604446	77.714600	78.801079	79.863556	80.901703	81.915207
1	74.333946	75.490044	76.623138	77.732903	78.818985	79.881058	80.918793	81.931885
2	74.353400	75.509117	76.641830	77.751198	78.836884	79.898552	80.935883	81.948563
3	74.372849	75.528183	76.660507	77.769485	78.854774	79.916039	80.952965	81.965225
4	74.392288	75.547241	76.679184	77.787766	78.872658	79.933525	80.970039	81.981888
5	74.411728	75.566299	76.697853	77.806046	78.890533	79.950996	80.987106	81.998543
6	74.431152	75.585350	76.716515	77.824318	78.908409	79.968468	81.004166	82.015190
7	74.450577	75.604385	76.735168	77.842575	78.926277	79.985931	81.021217	82.031830
8	74.470001	75.623428	76.753822	77.860840	78.944138	80.003387	81.038269	82.048462
9	74.489410	75.642456	76.772469	77.879089	78.961990	80.020836	81.055305	82.065086
10	74.508812	75.661484	76.791100	77.897331	78.979836	80.038277	81.072342	82.081711
11	74.528214	75.680496	76.809731	77.915565	78.997673	80.055710	81.089363	82.098320
12	74.547600	75.699509	76.828354	77.933800	79.015503	80.073143	81.106384	82.114922
13	74.566986	75.718513	76.846970	77.952019	79.033325	80.090561	81.123398	82.131523
14	74.586365	75.737511	76.865578	77.970238	79.051147	80.107979	81.140404	82.148109
15	74.605736	75.756500	76.884186	77.988449	79.068962	80.125381	81.157402	82.164696
16	74.625107	75.775482	76.902779	78.006653	79.086761	80.142784	81.174393	82.181274
17	74.644463	75.794464	76.921371	78.024849	79.104561	80.160179	81.191376	82.197845
18	74.663818	75.813431	76.939957	78.043045	79.122353	80.177567	81.208351	82.214401
19	74.683167	75.832397	76.958534	78.061226	79.140137	80.194946	81.225327	82.230957
20	74.702507	75.851357	76.977104	78.079399	79.157921	80.212318	81.242287	82.247513
21	74.721840	75.870308	76.995667	78.097572	79.175690	80.229683	81.259247	82.264053
22	74.741173	75.889259	77.014229	78.115738	79.193451	80.247047	81.276199	82.280586
23	74.760498	75.908203	77.032784	78.133896	79.211220	80.264404	81.293144	82.297119
24	74.779816	75.927132	77.051331	78.152054	79.228966	80.281754	81.310081	82.313637
25	74.799118	75.946060	77.069862	78.170197	79.246712	80.299088	81.327011	82.330154
26	74.818428	75.964981	77.088394	78.188332	79.264450	80.316422	81.343933	82.346664
27	74.837723	75.983894	77.106926	78.206467	79.282181	80.333748	81.360847	82.363159
28	74.857010	76.002800	77.125443	78.224586	79.299904	80.351067	81.377754	82.379654
29	74.876297	76.021706	77.143951	78.242706	79.317627	80.368385	81.394661	82.396141
30	74.895576	76.040596	77.162460	78.260818	79.335335	80.385689	81.411552	82.412621
31	74.914848	76.059486	77.180962	78.278923	79.353043	80.402985	81.428444	82.429092
32	74.934113	76.078369	77.199455	78.297020	79.370735	80.420280	81.445320	82.445557
33	74.953369	76.097244	77.217941	78.315109	79.388428	80.437561	81.462196	82.462013
34	74.972618	76.116112	77.236420	78.333199	79.406113	80.454842	81.479065	82.478470
35	74.991867	76.134972	77.254890	78.351273	79.423790	80.472115	81.495926	82.494911
36	75.011108	76.153831	77.273354	78.369347	79.441460	80.489380	81.512779	82.511353
37	75.030342	76.172684	77.291817	78.387413	79.459129	80.506638	81.529625	82.527779
38	75.049568	76.191528	77.310272	78.405472	79.476791	80.523895	81.546471	82.544205
39	75.068794	76.210365	77.328720	78.423523	79.494438	80.541138	81.563301	82.560623
40	75.088005	76.229195	77.347160	78.441566	79.512085	80.558372	81.580132	82.577034
41	75.107216	76.248016	77.365593	78.459610	79.529716	80.575607	81.596947	82.593437
42	75.126419	76.266838	77.384026	78.477638	79.547348	80.592827	81.613762	82.609833
43	75.145615	76.285645	77.402443	78.495667	79.564972	80.610046	81.630569	82.626221
44	75.164803	76.304451	77.420860	78.513680	79.582588	80.627258	81.647362	82.642601
45	75.183983	76.323250	77.439262	78.531693	79.600204	80.644463	81.664154	82.658974
46	75.203156	76.342041	77.457664	78.549698	79.617805	80.661659	81.680939	82.675346
47	75.222328	76.360825	77.476059	78.567696	79.635399	80.678848	81.697723	82.691704
48	75.241493	76.379601	77.494446	78.585693	79.652992	80.696030	81.714493	82.708061
49	75.260651	76.398376	77.512833	78.603676	79.670578	80.713211	81.731255	82.724403
50	75.279800	76.417145	77.531204	78.621651	79.688156	80.730377	81.748009	82.740746
51	75.298943	76.435898	77.549576	78.639626	79.705719	80.747543	81.764763	82.757080
52	75.318085	76.454651	77.567932	78.657593	79.723289	80.764694	81.781502	82.773399
53	75.337219	76.473404	77.586296	78.675552	79.740845	80.781853	81.798248	82.789726
54	75.356346	76.492142	77.604645	78.693504	79.758392	80.798988	81.814972	82.806038
55	75.375458	76.510880	77.622986	78.711449	79.775940	80.816124	81.831696	82.822342
56	75.394577	76.529602	77.641319	78.729393	79.793472	80.833252	81.848412	82.838638
57	75.413681	76.548325	77.659653	78.747322	79.811005	80.850380	81.865120	82.854927
58	75.432777	76.567039	77.677971	78.765244	79.828529	80.867493	81.881821	82.871216
59	75.451874	76.585747	77.696289	78.783165	79.846046	80.884598	81.898521	82.887489
60	75.470963	76.604446	77.714600	78.801079	79.863556	80.901703	81.915207	82.903755

Constants for 125-mm Sine-Bar

Constants for Setting a 125-mm Sine-Bar for 0° to 7°

Min.	0°	1°	2°	3°	4°	5°	6°	7°
0	0.000000	2.181551	4.362437	6.541995	8.719560	10.894468	13.066058	15.233668
1	0.036361	2.217906	4.398776	6.578306	8.755832	10.930691	13.102220	15.269758
2	0.072722	2.254261	4.435114	6.614616	8.792103	10.969911	13.138380	15.305845
3	0.109083	2.290616	4.471452	6.650926	8.828374	11.003133	13.174540	15.341933
4	0.145444	2.326972	4.507790	6.687235	8.864643	11.039351	13.210696	15.378017
5	0.181805	2.363326	4.544127	6.723544	8.900913	11.075570	13.246854	15.414103
6	0.218166	2.399680	4.580463	6.759851	8.937181	11.111787	13.283010	15.450185
7	0.254527	2.436035	4.616800	6.796159	8.973449	11.148005	13.319164	15.486267
8	0.290888	2.472389	4.653136	6.832467	9.009715	11.184219	13.355317	15.522346
9	0.327249	2.508742	4.689472	6.868773	9.045981	11.220434	13.391470	15.558426
10	0.363610	2.545096	4.725807	6.905079	9.082246	11.256648	13.427621	15.594503
11	0.399971	2.581449	4.762142	6.941384	9.118511	11.292861	13.463771	15.630580
12	0.436331	2.617803	4.798476	6.977688	9.154775	11.329072	13.499920	15.666655
13	0.472692	2.654155	4.834810	7.013992	9.191038	11.365284	13.536068	15.702728
14	0.509053	2.690508	4.871144	7.050296	9.227300	11.401493	13.572214	15.738800
15	0.545414	2.726861	4.907477	7.086599	9.263561	11.437702	13.608359	15.774872
16	0.581774	2.763213	4.943810	7.122901	9.299823	11.473911	13.644505	15.810942
17	0.618135	2.799565	4.980142	7.159203	9.336082	11.510118	13.680647	15.847010
18	0.654496	2.835917	5.016474	7.195503	9.372341	11.546324	13.716789	15.883077
19	0.690856	2.872268	5.052805	7.231804	9.408599	11.582529	13.752930	15.919142
20	0.727216	2.908620	5.089137	7.268104	9.444858	11.618733	13.789070	15.955207
21	0.763577	2.944971	5.125467	7.304403	9.481113	11.654936	13.825208	15.991269
22	0.799937	2.981322	5.161798	7.340702	9.517369	11.691138	13.861346	16.027330
23	0.836297	3.017672	5.198128	7.377000	9.553624	11.727339	13.897482	16.063391
24	0.872658	3.054022	5.234457	7.413297	9.589879	11.763539	13.933618	16.099451
25	0.909018	3.090372	5.270786	7.449594	9.626132	11.799738	13.969750	16.135508
26	0.945378	3.126722	5.307115	7.485890	9.662385	11.835937	14.005883	16.171564
27	0.981738	3.163072	5.343442	7.522185	9.698636	11.872133	14.042014	16.207619
28	1.018098	3.199421	5.379770	7.558480	9.734888	11.908330	14.078145	16.243671
29	1.054457	3.235770	5.416097	7.594774	9.771137	11.944525	14.114274	16.279724
30	1.090817	3.272119	5.452424	7.631068	9.807387	11.980720	14.150402	16.315775
31	1.127177	3.308467	5.488750	7.667360	9.843637	12.016913	14.186529	16.351824
32	1.163536	3.344815	5.525075	7.703653	9.879884	12.053104	14.222654	16.387871
33	1.199896	3.381163	5.561400	7.739944	9.916131	12.089296	14.258779	16.423918
34	1.236255	3.417511	5.597725	7.776235	9.952376	12.125485	14.294902	16.459963
35	1.272614	3.453858	5.634050	7.812525	9.988622	12.161675	14.331024	16.496008
36	1.308973	3.490205	5.670373	7.848815	10.024865	12.197863	14.367144	16.532049
37	1.345332	3.526552	5.706697	7.885104	10.061110	12.234050	14.403264	16.568090
38	1.381691	3.562898	5.743020	7.921392	10.097352	12.270235	14.439382	16.604130
39	1.418050	3.599244	5.779343	7.957680	10.133594	12.306421	14.475499	16.640167
40	1.454408	3.635590	5.815664	7.993967	10.169834	12.342604	14.511615	16.676205
41	1.490767	3.671935	5.851986	8.030253	10.206075	12.378787	14.547729	16.712240
42	1.527125	3.708281	5.888307	8.066539	10.242313	12.414968	14.583842	16.748274
43	1.563483	3.744626	5.924627	8.102823	10.278552	12.451150	14.619955	16.784306
44	1.599842	3.780970	5.960947	8.139108	10.314789	12.487329	14.656065	16.820337
45	1.636199	3.817314	5.997266	8.175391	10.351027	12.523508	14.692175	16.856367
46	1.672557	3.853658	6.033585	8.211674	10.387262	12.559686	14.728284	16.892395
47	1.708915	3.890002	6.069903	8.247956	10.423496	12.595862	14.764391	16.928421
48	1.745273	3.926345	6.106221	8.284238	10.459731	12.632038	14.800497	16.964447
49	1.781630	3.962688	6.142539	8.320518	10.495964	12.668212	14.836601	17.000471
50	1.817987	3.999031	6.178855	8.356798	10.532196	12.704386	14.872705	17.036493
51	1.854344	4.035373	6.215172	8.393078	10.568427	12.740557	14.908807	17.072514
52	1.890701	4.071715	6.251487	8.429357	10.604658	12.776729	14.944907	17.108534
53	1.927058	4.108056	6.287803	8.465634	10.640887	12.812899	14.981007	17.144552
54	1.963415	4.144397	6.324118	8.501912	10.677115	12.849068	15.017105	17.180569
55	1.999771	4.180738	6.360432	8.538188	10.713343	12.885235	15.053202	17.216583
56	2.036128	4.217079	6.396746	8.574464	10.749570	12.921402	15.089298	17.252598
57	2.072484	4.253419	6.433059	8.610739	10.785795	12.957567	15.125392	17.288610
58	2.108840	4.289759	6.469371	8.647013	10.822021	12.993732	15.161486	17.324621
59	2.145195	4.326098	6.505683	8.683287	10.858245	13.029896	15.197577	17.360630
60	2.181551	4.362437	6.541995	8.719560	10.894468	13.066058	15.233668	17.396639

Constants for Setting a 125-mm Sine-Bar for 8° to 15°

Min.	8°	9°	10°	11°	12°	13°	14°	15°
0	17.396639	19.554308	21.706022	23.851126	25.988962	28.118883	30.240238	32.352383
1	17.432644	19.590221	21.741831	23.886816	26.024527	28.154310	30.275517	32.387501
2	17.468651	19.626133	21.777637	23.922508	26.060091	28.189737	30.310795	32.422623
3	17.504654	19.662043	21.813440	23.958195	26.095652	28.225159	30.346069	32.457737
4	17.540655	19.697948	21.849243	23.993881	26.131210	28.260580	30.381340	32.492847
5	17.576654	19.733854	21.885042	24.029564	26.166765	28.295998	30.416611	32.527958
6	17.612656	19.769760	21.920843	24.065247	26.202322	28.331415	30.451878	32.563065
7	17.648653	19.805662	21.956638	24.100927	26.237873	28.366829	30.487143	32.598167
8	17.684649	19.841562	21.992432	24.136604	26.273422	28.402239	30.522404	32.633270
9	17.720642	19.877460	22.028225	24.172279	26.308969	28.437647	30.557661	32.668369
10	17.756636	19.913361	22.064018	24.207954	26.344517	28.473055	30.592920	32.703465
11	17.792627	19.949255	22.099806	24.243626	26.380060	28.508459	30.628174	32.738560
12	17.828617	19.985149	22.135593	24.279295	26.415600	28.543859	30.663424	32.773647
13	17.864605	20.021040	22.171377	24.314960	26.451138	28.579258	30.698671	32.808735
14	17.900593	20.056932	22.207163	24.350628	26.486675	28.614656	30.733919	32.843822
15	17.936579	20.092821	22.242945	24.386292	26.522209	28.650049	30.769163	32.878902
16	17.972561	20.128708	22.278723	24.421951	26.557741	28.685440	30.804403	32.913982
17	18.008545	20.164595	22.314503	24.457613	26.593273	28.720833	30.839643	32.949059
18	18.044525	20.200480	22.350279	24.493269	26.628799	28.756218	30.874878	32.984131
19	18.080505	20.236361	22.386051	24.528923	26.664324	28.791603	30.910110	33.019203
20	18.116482	20.272240	22.421824	24.564577	26.699846	28.826984	30.945341	33.054272
21	18.152460	20.308121	22.457596	24.600229	26.735369	28.862366	30.980570	33.089336
22	18.188435	20.343998	22.493362	24.635878	26.770887	28.897741	31.015795	33.124401
23	18.224407	20.379871	22.529129	24.671524	26.806402	28.933117	31.051016	33.159458
24	18.260378	20.415745	22.564894	24.707167	26.841915	28.968489	31.086235	33.194515
25	18.296350	20.451618	22.600657	24.742811	26.877428	29.003859	31.121454	33.229568
26	18.332317	20.487488	22.636417	24.778452	26.912937	29.039227	31.156670	33.264622
27	18.368284	20.523355	22.672176	24.814089	26.948444	29.074591	31.191881	33.299667
28	18.404249	20.559221	22.707932	24.849726	26.983950	29.109953	31.227089	33.334713
29	18.440214	20.595089	22.743689	24.885361	27.019453	29.145313	31.262299	33.369759
30	18.476177	20.630951	22.779442	24.920992	27.054953	29.180672	31.297501	33.404797
31	18.512136	20.666813	22.815191	24.956621	27.090450	29.216026	31.332703	33.439835
32	18.548098	20.702673	22.850943	24.992250	27.125948	29.251381	31.367903	33.474869
33	18.584055	20.738531	22.886690	25.027876	27.161440	29.286730	31.403099	33.509903
34	18.620010	20.774387	22.922434	25.063499	27.196930	29.322077	31.438292	33.544930
35	18.655964	20.810240	22.958178	25.099121	27.232418	29.357422	31.473482	33.579956
36	18.691919	20.846094	22.993919	25.134741	27.267906	29.392765	31.508671	33.614979
37	18.727871	20.881945	23.029659	25.170359	27.303391	29.428106	31.543856	33.649998
38	18.763819	20.917793	23.065397	25.205973	27.338871	29.463442	31.579039	33.685017
39	18.799767	20.953640	23.101131	25.241585	27.374352	29.498777	31.614218	33.720028
40	18.835714	20.989489	23.136868	25.277199	27.409830	29.534111	31.649397	33.755043
41	18.871660	21.025331	23.172598	25.312807	27.445303	29.569441	31.684572	33.790051
42	18.907602	21.061172	23.208326	25.348412	27.480776	29.604769	31.719744	33.825058
43	18.943544	21.097012	23.244055	25.384016	27.516245	29.640093	31.754913	33.860058
44	18.979486	21.132853	23.279781	25.419621	27.551716	29.675417	31.790081	33.895061
45	19.015425	21.168688	23.315506	25.455219	27.587179	29.710737	31.825245	33.930058
46	19.051361	21.204523	23.351227	25.490816	27.622643	29.746054	31.860405	33.965050
47	19.087297	21.240358	23.386948	25.526415	27.658106	29.781372	31.895565	34.000046
48	19.123230	21.276188	23.422665	25.562008	27.693563	29.816683	31.930721	34.035030
49	19.159163	21.312017	23.458382	25.597599	27.729019	29.851994	31.965874	34.070019
50	19.195091	21.347845	23.494095	25.633188	27.764473	29.887300	32.001022	34.105000
51	19.231022	21.383673	23.529808	25.668776	27.799925	29.922607	32.036175	34.139980
52	19.266949	21.419497	23.565517	25.704361	27.835375	29.957909	32.071320	34.174957
53	19.302874	21.455317	23.601225	25.739943	27.870821	29.993208	32.106461	34.209930
54	19.338799	21.491137	23.636930	25.775522	27.906265	30.028505	32.141598	34.244904
55	19.374722	21.526957	23.672636	25.811104	27.941708	30.063803	32.176739	34.279873
56	19.410643	21.562775	23.708338	25.846680	27.977148	30.099094	32.211872	34.314838
57	19.446560	21.598589	23.744038	25.882252	28.012585	30.134382	32.247002	34.349800
58	19.482477	21.634401	23.779734	25.917824	28.048019	30.169670	32.282131	34.384758
59	19.518394	21.670214	23.815432	25.953396	28.083452	30.204956	32.317257	34.419716
60	19.554308	21.706022	23.851126	25.988962	28.118883	30.240238	32.352383	34.454670

Constants for Setting a 125-mm Sine-Bar for 16° to 23°

Min.	16°	17°	18°	19°	20°	21°	22°	23°
0	34.454670	36.546463	38.627125	40.696022	42.752518	44.795994	46.825825	48.841393
1	34.489620	36.581234	38.661705	40.730396	42.786686	44.829937	46.859535	48.874859
2	34.524567	36.616001	38.696281	40.764774	42.820847	44.863876	46.893242	48.908325
3	34.559513	36.650764	38.730854	40.799145	42.855007	44.897816	46.926945	48.941784
4	34.594460	36.685532	38.765427	40.833515	42.889164	44.931751	46.960648	48.975243
5	34.629398	36.720287	38.799992	40.867878	42.923317	44.965679	46.994343	49.008694
6	34.664333	36.755043	38.834557	40.902241	42.957462	44.999603	47.028034	49.042141
7	34.699265	36.789795	38.869114	40.936596	42.991608	45.033524	47.061722	49.075584
8	34.734196	36.824543	38.903671	40.970951	43.025749	45.067440	47.095406	49.109024
9	34.769123	36.859287	38.938225	41.005299	43.059887	45.101353	47.129086	49.142460
10	34.804047	36.894032	38.972775	41.039646	43.094017	45.135262	47.162758	49.175888
11	34.838970	36.928768	39.007320	41.073990	43.128147	45.169170	47.196430	49.209316
12	34.873890	36.963509	39.041866	41.108334	43.162277	45.203075	47.230103	49.242741
13	34.908806	36.998241	39.076408	41.142670	43.196400	45.236973	47.263763	49.276161
14	34.943718	37.032970	39.110943	41.177002	43.230518	45.270866	47.297424	49.309574
15	34.978626	37.067699	39.145477	41.211330	43.264633	45.304756	47.331078	49.342983
16	35.013535	37.102421	39.180008	41.245659	43.298744	45.338642	47.364731	49.376389
17	35.048439	37.137142	39.214535	41.279980	43.332851	45.372524	47.398376	49.409790
18	35.083340	37.171860	39.249058	41.314297	43.366955	45.406403	47.432018	49.443188
19	35.118240	37.206577	39.283581	41.348618	43.401062	45.440281	47.465664	49.476585
20	35.153133	37.241287	39.318096	41.382931	43.435158	45.474152	47.499298	49.509972
21	35.188026	37.275993	39.352612	41.417236	43.469250	45.508018	47.532928	49.543358
22	35.222916	37.310699	39.387119	41.451542	43.503338	45.541885	47.566555	49.576740
23	35.257801	37.345402	39.421627	41.485844	43.537426	45.575745	47.600178	49.610115
24	35.292683	37.380100	39.456131	41.520142	43.571507	45.609600	47.633797	49.643486
25	35.327560	37.414795	39.490631	41.554436	43.605583	45.643452	47.667412	49.676853
26	35.362438	37.449486	39.525127	41.588726	43.639660	45.677299	47.701023	49.710220
27	35.397316	37.484180	39.559624	41.623016	43.673733	45.711147	47.734634	49.743580
28	35.432186	37.518864	39.594112	41.657303	43.707802	45.744987	47.768238	49.776936
29	35.467056	37.553547	39.628601	41.691582	43.741863	45.778824	47.801834	49.810287
30	35.501919	37.588226	39.663082	41.725857	43.775925	45.812656	47.835430	49.843636
31	35.536781	37.622902	39.697563	41.760132	43.809978	45.846481	47.869022	49.876976
32	35.571640	37.657574	39.732040	41.794403	43.844032	45.880306	47.902607	49.910316
33	35.606495	37.692245	39.766514	41.828667	43.878082	45.914127	47.936192	49.943649
34	35.641350	37.726913	39.800987	41.862934	43.912128	45.947948	47.969772	49.976982
35	35.676201	37.761578	39.835453	41.897194	43.946171	45.981762	48.003345	50.010311
36	35.711048	37.796238	39.869915	41.931450	43.980209	46.015572	48.036919	50.043633
37	35.745892	37.830894	39.904377	41.965698	44.014240	46.049377	48.070484	50.076950
38	35.780731	37.865547	39.938831	41.999947	44.048271	46.083176	48.104046	50.110260
39	35.815571	37.900200	39.973286	42.034195	44.082298	46.116974	48.137604	50.143570
40	35.850403	37.934845	40.007732	42.068436	44.116322	46.150768	48.171158	50.176876
41	35.885235	37.969490	40.042179	42.102673	44.150341	46.184559	48.204708	50.210175
42	35.920067	38.004133	40.076626	42.136909	44.184357	46.218346	48.238258	50.243473
43	35.954891	38.038773	40.111065	42.171139	44.218369	46.252129	48.271801	50.276768
44	35.989716	38.073406	40.145500	42.205368	44.252377	46.285908	48.305336	50.310055
45	36.024536	38.108040	40.179935	42.239590	44.286381	46.319679	48.338871	50.343338
46	36.059349	38.142666	40.214363	42.273811	44.320381	46.353451	48.372402	50.376617
47	36.094162	38.177292	40.248791	42.308025	44.354378	46.387218	48.405926	50.409893
48	36.128975	38.211914	40.283211	42.342239	44.388371	46.420979	48.439449	50.443161
49	36.163784	38.246536	40.317635	42.376453	44.422363	46.454742	48.472969	50.476433
50	36.198589	38.281151	40.352051	42.410660	44.456348	46.488495	48.506481	50.509693
51	36.233391	38.315762	40.386463	42.444859	44.490330	46.522247	48.539993	50.542950
52	36.268188	38.350368	40.420872	42.479057	44.524307	46.555992	48.573498	50.576206
53	36.302982	38.384975	40.455276	42.513252	44.558281	46.589733	48.606998	50.609455
54	36.337776	38.419579	40.489677	42.547443	44.592251	46.623474	48.640495	50.642700
55	36.372562	38.454178	40.524075	42.581631	44.626217	46.657207	48.673988	50.675938
56	36.407349	38.488773	40.558472	42.615814	44.660179	46.690937	48.707474	50.709175
57	36.442135	38.523369	40.592865	42.650002	44.694141	46.724670	48.740963	50.742413
58	36.476913	38.557957	40.627254	42.684177	44.728096	46.758392	48.774445	50.775639
59	36.511692	38.592545	40.661640	42.718349	44.762047	46.792110	48.807919	50.808861
60	36.546463	38.627125	40.696022	42.752518	44.795994	46.825825	48.841393	50.842083

Constants for Setting a 125-mm Sine-Bar for 24° to 31°

Min.	24°	25°	26°	27°	28°	29°	30°	31°
0	50.842083	52.827286	54.796394	56.748814	58.683949	60.601204	62.500000	64.379761
1	50.875298	52.860237	54.829075	56.781208	58.716049	60.633003	62.531487	64.410927
2	50.908508	52.893181	54.861748	56.813599	58.748146	60.664799	62.562969	64.442085
3	50.941711	52.926125	54.894417	56.845985	58.780239	60.696587	62.594444	64.473236
4	50.974918	52.959068	54.927082	56.878368	58.812328	60.728374	62.625919	64.504387
5	51.008118	52.992001	54.959743	56.910744	58.844410	60.760151	62.657383	64.535530
6	51.041309	53.024929	54.992397	56.943115	58.876488	60.791924	62.688843	64.566666
7	51.074497	53.057854	55.025047	56.975483	58.908558	60.823692	62.720299	64.597801
8	51.107681	53.090775	55.057693	57.007843	58.940628	60.855457	62.751747	64.628929
9	51.140865	53.123692	55.090336	57.040199	58.972687	60.887215	62.783192	64.660049
10	51.174038	53.156601	55.122971	57.072552	59.004745	60.918968	62.814632	64.691162
11	51.207211	53.189507	55.155605	57.104897	59.036797	60.950714	62.846066	64.722275
12	51.240383	53.222416	55.188236	57.137245	59.068848	60.982460	62.877495	64.753380
13	51.273544	53.255314	55.220856	57.169582	59.100891	61.014198	62.908920	64.784477
14	51.306705	53.288204	55.253475	57.201912	59.132927	61.045929	62.940338	64.815575
15	51.339859	53.321095	55.286087	57.234241	59.164959	61.077656	62.971748	64.846657
16	51.373009	53.353977	55.318695	57.266563	59.196987	61.109379	63.003155	64.877739
17	51.406155	53.386856	55.351299	57.298882	59.229008	61.141094	63.034557	64.908821
18	51.439293	53.419731	55.383900	57.331196	59.261024	61.172806	63.065952	64.939888
19	51.472435	53.452606	55.416496	57.363506	59.293041	61.204517	63.097347	64.970955
20	51.505569	53.485474	55.449085	57.395809	59.325050	61.236217	63.128735	65.002022
21	51.538696	53.518333	55.481670	57.428108	59.357052	61.267914	63.160114	65.033073
22	51.571819	53.551193	55.514252	57.460400	59.389050	61.299603	63.191486	65.064125
23	51.604939	53.584045	55.546825	57.492691	59.421040	61.331291	63.222858	65.095169
24	51.638054	53.616894	55.579399	57.524975	59.453026	61.362968	63.254223	65.126205
25	51.671165	53.649734	55.611965	57.557251	59.485008	61.394646	63.285580	65.157234
26	51.704273	53.682575	55.644527	57.589527	59.516987	61.426315	63.316933	65.188263
27	51.737377	53.715412	55.677086	57.621799	59.548962	61.457985	63.348286	65.219292
28	51.770473	53.748241	55.709637	57.654064	59.580929	61.489643	63.379627	65.250305
29	51.803566	53.781067	55.742184	57.686325	59.612888	61.521297	63.410965	65.281319
30	51.836658	53.813889	55.774727	57.718578	59.644848	61.552948	63.442295	65.312325
31	51.869740	53.846706	55.807266	57.750828	59.676800	61.584591	63.473625	65.343323
32	51.902821	53.879517	55.839798	57.783073	59.708744	61.616230	63.504944	65.374313
33	51.935898	53.912323	55.872326	57.815311	59.740688	61.647861	63.536259	65.405304
34	51.968971	53.945129	55.904854	57.847549	59.772625	61.679493	63.567574	65.436295
35	52.002037	53.977928	55.937374	57.879780	59.804558	61.711117	63.598881	65.467270
36	52.035103	54.010719	55.969887	57.912006	59.836483	61.742737	63.630180	65.498238
37	52.068161	54.043510	56.002399	57.944225	59.868404	61.774349	63.661472	65.529205
38	52.101212	54.076294	56.034901	57.976444	59.900322	61.805954	63.692764	65.560165
39	52.134262	54.109074	56.067402	58.008652	59.932232	61.837559	63.724045	65.591125
40	52.167309	54.141850	56.099899	58.040859	59.964138	61.869156	63.755325	65.622070
41	52.200348	54.174618	56.132389	58.073059	59.996040	61.900745	63.786598	65.653015
42	52.233387	54.207390	56.164879	58.105259	60.027939	61.932335	63.817867	65.683960
43	52.266418	54.240150	56.197357	58.137451	60.059830	61.963917	63.849129	65.714890
44	52.299446	54.272907	56.229836	58.169636	60.091717	61.995495	63.880386	65.745819
45	52.332470	54.305660	56.262306	58.201817	60.123596	62.027065	63.911636	65.776741
46	52.365486	54.338406	56.294773	58.233994	60.155472	62.058632	63.942883	65.807655
47	52.398502	54.371147	56.327236	58.266163	60.187344	62.090191	63.974125	65.838570
48	52.431511	54.403889	56.359692	58.298328	60.219208	62.121746	64.005356	65.869476
49	52.464520	54.436626	56.392147	58.330494	60.251072	62.153297	64.036591	65.900375
50	52.497520	54.469353	56.424595	58.362652	60.282928	62.184845	64.067818	65.931274
51	52.530514	54.502079	56.457039	58.394802	60.314777	62.216381	64.099037	65.962158
52	52.563507	54.534798	56.489479	58.426949	60.346622	62.247917	64.130249	65.993042
53	52.596493	54.567513	56.521912	58.459091	60.378464	62.279446	64.161453	66.023918
54	52.629478	54.600224	56.554340	58.491226	60.410297	62.310966	64.192657	66.054794
55	52.662457	54.632931	56.586761	58.523357	60.442127	62.342487	64.223854	66.085655
56	52.695431	54.665630	56.619183	58.555485	60.473953	62.374001	64.255043	66.116516
57	52.728404	54.698334	56.651600	58.587612	60.505775	62.405510	64.286232	66.147377
58	52.761368	54.731026	56.684010	58.619728	60.537590	62.437012	64.317413	66.178230
59	52.794327	54.763710	56.716415	58.651840	60.569401	62.468510	64.348595	66.209068
60	52.827286	54.796394	56.748814	58.683949	60.601204	62.500000	64.379761	66.239906

Constants for Setting a 125-mm Sine-Bar for 32° to 39°

Min.	32°	33°	34°	35°	36°	37°	38°	39°
0	66.239906	68.079880	69.899117	71.697060	73.473160	75.226883	76.957687	78.665054
1	66.270744	68.110374	69.929253	71.726837	73.502571	75.255913	76.986336	78.693306
2	66.301567	68.140862	69.959389	71.756615	73.531975	75.284943	77.014977	78.721550
3	66.332390	68.171341	69.989517	71.786385	73.561378	75.313965	77.043617	78.749794
4	66.363205	68.201813	70.019646	71.816147	73.590775	75.342987	77.072243	78.778030
5	66.394020	68.232285	70.049759	71.845901	73.620163	75.371994	77.100868	78.806252
6	66.424820	68.262741	70.079872	71.875656	73.649544	75.401001	77.129486	78.834473
7	66.455620	68.293198	70.109978	71.905403	73.678917	75.429993	77.158096	78.862686
8	66.486420	68.323662	70.140083	71.935150	73.708298	75.458992	77.186707	78.890900
9	66.517212	68.354103	70.170181	71.964882	73.737656	75.487976	77.215302	78.919106
10	66.547989	68.384544	70.200264	71.994606	73.767014	75.516953	77.243889	78.947296
11	66.578766	68.414978	70.230347	72.024330	73.796364	75.545929	77.272476	78.975487
12	66.609535	68.445404	70.260422	72.054039	73.825714	75.574890	77.301056	79.003670
13	66.640305	68.475830	70.290497	72.083748	73.855049	75.603851	77.329620	79.031837
14	66.671059	68.506248	70.320557	72.113457	73.884384	75.632805	77.358185	79.060005
15	66.701813	68.536652	70.350616	72.143150	73.913712	75.661751	77.386749	79.088165
16	66.732567	68.567062	70.380669	72.172844	73.943024	75.690689	77.415298	79.116325
17	66.763306	68.597458	70.410713	72.202522	73.972343	75.719620	77.443840	79.144470
18	66.794044	68.627853	70.440758	72.232201	74.001648	75.748550	77.472382	79.172607
19	66.824776	68.658241	70.470787	72.261879	74.030945	75.777473	77.500908	79.200745
20	66.855499	68.688622	70.500816	72.291542	74.060242	75.806389	77.529434	79.228874
21	66.886223	68.718994	70.530838	72.321205	74.089531	75.835297	77.557953	79.256989
22	66.916939	68.749367	70.560860	72.350853	74.118813	75.864197	77.586464	79.285103
23	66.947647	68.779739	70.590874	72.380508	74.148094	75.893097	77.614975	79.313217
24	66.978355	68.810097	70.620880	72.410149	74.177368	75.921982	77.643478	79.341316
25	67.009048	68.840446	70.650879	72.439789	74.206627	75.950867	77.671967	79.369415
26	67.039742	68.870796	70.680870	72.469414	74.235886	75.979744	77.700455	79.397499
27	67.070427	68.901138	70.710861	72.499039	74.265137	76.008614	77.728935	79.425583
28	67.101112	68.931473	70.740837	72.528656	74.294380	76.037476	77.757408	79.453651
29	67.131783	68.961800	70.770813	72.558266	74.323616	76.066330	77.785873	79.481720
30	67.162453	68.992126	70.800781	72.587868	74.352852	76.095177	77.814331	79.509781
31	67.193115	69.022446	70.830742	72.617470	74.382072	76.124023	77.842781	79.537834
32	67.223770	69.052757	70.860703	72.647064	74.411293	76.152863	77.871231	79.565880
33	67.254425	69.083061	70.890648	72.676651	74.440506	76.181694	77.899673	79.593918
34	67.285072	69.113358	70.920593	72.706230	74.469711	76.210518	77.928101	79.621956
35	67.315712	69.143654	70.950531	72.735802	74.498917	76.239334	77.956528	79.649979
36	67.346344	69.173943	70.980469	72.765373	74.528107	76.268143	77.984947	79.678001
37	67.376976	69.204224	71.010391	72.794930	74.557297	76.296951	78.013359	79.706009
38	67.407608	69.234512	71.040321	72.824493	74.586487	76.325752	78.041779	79.734024
39	67.438225	69.264778	71.070236	72.854042	74.615662	76.354546	78.070175	79.762024
40	67.468834	69.295044	71.100143	72.883583	74.644829	76.383331	78.098572	79.790016
41	67.499443	69.325302	71.130051	72.913124	74.673988	76.412109	78.126953	79.818001
42	67.530045	69.355560	71.159943	72.942657	74.703148	76.440880	78.155334	79.845978
43	67.560638	69.385803	71.189835	72.972176	74.732300	76.469650	78.183708	79.873955
44	67.591225	69.416046	71.219719	73.001701	74.761436	76.498405	78.212074	79.901917
45	67.621811	69.446281	71.249596	73.031212	74.790573	76.527161	78.240433	79.929878
46	67.652390	69.476509	71.279472	73.060715	74.819710	76.555908	78.268791	79.957832
47	67.682961	69.506737	71.309334	73.090218	74.848831	76.584648	78.297134	79.985771
48	67.713524	69.536949	71.339195	73.119713	74.877953	76.613380	78.325478	80.013710
49	67.744087	69.567162	71.369049	73.149200	74.907059	76.642113	78.353813	80.041641
50	67.774643	69.597374	71.398895	73.178680	74.936165	76.670830	78.382141	80.069572
51	67.805191	69.627571	71.428741	73.208153	74.965263	76.699547	78.410461	80.097488
52	67.835732	69.657768	71.458580	73.237625	74.994362	76.728249	78.438774	80.125397
53	67.866280	69.687958	71.488411	73.267090	75.023453	76.756958	78.467087	80.153313
54	67.896812	69.718140	71.518242	73.296547	75.052536	76.785652	78.495384	80.181206
55	67.927338	69.748322	71.548058	73.325996	75.081604	76.814346	78.523682	80.209099
56	67.957855	69.778488	71.577866	73.355446	75.110672	76.843025	78.551971	80.236984
57	67.988373	69.808655	71.607674	73.384880	75.139732	76.871696	78.580246	80.264862
58	68.018883	69.838814	71.637474	73.414314	75.168793	76.900368	78.608521	80.292732
59	68.049385	69.868965	71.667267	73.443741	75.197838	76.929031	78.636787	80.320595
60	68.079880	69.899117	71.697060	73.473160	75.226883	76.957687	78.665054	80.348450

Constants for Setting a 125-mm Sine-Bar for 40° to 47°

Min.	40°	41°	42°	43°	44°	45°	46°	47°
0	80.348450	82.007378	83.641327	85.249794	86.832298	88.388351	89.917480	91.419212
1	80.376305	82.034821	83.668343	85.276382	86.858452	88.414055	89.942734	91.444008
2	80.404144	82.062248	83.695358	85.302971	86.884598	88.439758	89.967979	91.468796
3	80.431984	82.089676	83.722359	85.329544	86.910728	88.465446	89.993217	91.493576
4	80.459816	82.117088	83.749359	85.356110	86.936859	88.491135	90.018448	91.518341
5	80.487640	82.144501	83.776344	85.382668	86.962982	88.516808	90.043671	91.543106
6	80.515450	82.171906	83.803329	85.409218	86.989098	88.542480	90.068886	91.567863
7	80.543266	82.199303	83.830299	85.435768	87.015205	88.568138	90.094101	91.592613
8	80.571068	82.226700	83.857277	85.462311	87.041313	88.593803	90.119301	91.617355
9	80.598869	82.254082	83.884239	85.488838	87.067406	88.619446	90.144501	91.642090
10	80.626656	82.281456	83.911194	85.515366	87.093491	88.645088	90.169685	91.666809
11	80.654442	82.308823	83.938141	85.541885	87.119568	88.670723	90.194862	91.691528
12	80.682213	82.336189	83.965080	85.568390	87.145638	88.696342	90.220032	91.716240
13	80.709984	82.363541	83.992012	85.594894	87.171707	88.721962	90.245193	91.740936
14	80.737747	82.390884	84.018936	85.621391	87.197762	88.747574	90.270348	91.765633
15	80.765503	82.418228	84.045853	85.647873	87.223808	88.773170	90.295494	91.790314
16	80.793251	82.445564	84.072762	85.674355	87.249847	88.798767	90.320641	91.814995
17	80.820992	82.472893	84.099670	85.700829	87.275887	88.824356	90.345772	91.839661
18	80.848724	82.500206	84.126564	85.727295	87.301910	88.849937	90.370895	91.864326
19	80.876450	82.527519	84.153458	85.753754	87.327934	88.875504	90.396011	91.888977
20	80.904175	82.554825	84.180336	85.780205	87.353943	88.901070	90.421120	91.913628
21	80.931885	82.582130	84.207214	85.806648	87.379944	88.926628	90.446220	91.938263
22	80.959595	82.609421	84.234077	85.833084	87.405945	88.952179	90.471313	91.962898
23	80.987297	82.636711	84.260948	85.859520	87.431938	88.977722	90.496407	91.987526
24	81.014992	82.663986	84.287804	85.885941	87.457924	89.003258	90.521484	92.012138
25	81.042679	82.691261	84.314651	85.912361	87.483894	89.028786	90.546555	92.036751
26	81.070358	82.718521	84.341492	85.938766	87.509865	89.054306	90.571625	92.061348
27	81.098030	82.745781	84.368324	85.965164	87.535828	89.079819	90.596680	92.085938
28	81.125694	82.773026	84.395149	85.991562	87.561775	89.105324	90.621727	92.110527
29	81.153358	82.800270	84.421967	86.017944	87.587723	89.130821	90.646767	92.135101
30	81.181007	82.827507	84.448776	86.044327	87.613663	89.156311	90.671799	92.159668
31	81.208656	82.854736	84.475578	86.070694	87.639587	89.181793	90.696823	92.184227
32	81.236290	82.881958	84.502380	86.097061	87.665512	89.207260	90.721840	92.208786
33	81.263924	82.909172	84.529167	86.123413	87.691429	89.232727	90.746849	92.233330
34	81.291550	82.936378	84.555954	86.149765	87.717339	89.258186	90.771851	92.257866
35	81.319168	82.963585	84.582726	86.176109	87.743240	89.283638	90.796844	92.282394
36	81.346779	82.990776	84.609497	86.202446	87.769135	89.309082	90.821831	92.306915
37	81.374382	83.017960	84.636253	86.228767	87.795013	89.334518	90.846809	92.331429
38	81.401985	83.045151	84.663017	86.255096	87.820900	89.359955	90.871788	92.355942
39	81.429573	83.072319	84.689766	86.281410	87.846771	89.385376	90.896751	92.380440
40	81.457161	83.099487	84.716507	86.307716	87.872635	89.410789	90.921707	92.404930
41	81.484734	83.126648	84.743233	86.334015	87.898491	89.436195	90.946655	92.429413
42	81.512306	83.153801	84.769958	86.360306	87.924339	89.461594	90.971596	92.453888
43	81.539864	83.180939	84.796677	86.386589	87.950180	89.486984	90.996529	92.478355
44	81.567421	83.208076	84.823395	86.412865	87.976013	89.512367	91.021454	92.502815
45	81.594971	83.235207	84.850098	86.439133	88.001839	89.537743	91.046371	92.527267
46	81.622513	83.262337	84.876793	86.465393	88.027664	89.563110	91.071281	92.551712
47	81.650047	83.289452	84.903481	86.491653	88.053474	89.588470	91.096184	92.576149
48	81.677574	83.316559	84.930161	86.517899	88.079277	89.613823	91.121078	92.600578
49	81.705101	83.343658	84.956841	86.544136	88.105072	89.639175	91.145966	92.624992
50	81.732613	83.370758	84.983505	86.570374	88.130859	89.664513	91.170845	92.649406
51	81.760117	83.397842	85.010170	86.596596	88.156647	89.689842	91.195717	92.673813
52	81.787621	83.424927	85.036819	86.622810	88.182419	89.715164	91.220581	92.698212
53	81.815117	83.452003	85.063477	86.649033	88.208191	89.740486	91.245438	92.722603
54	81.842606	83.479073	85.090111	86.675232	88.233948	89.765793	91.270287	92.746986
55	81.870087	83.506134	85.116745	86.701431	88.259705	89.791092	91.295128	92.771355
56	81.897560	83.533188	85.143372	86.727615	88.285446	89.816383	91.319962	92.795723
57	81.925026	83.560234	85.169991	86.753799	88.311180	89.841667	91.344788	92.820084
58	81.952484	83.587273	85.196594	86.779976	88.336914	89.866943	91.369606	92.844429
59	81.979935	83.614304	85.223198	86.806137	88.362633	89.892212	91.394417	92.868774
60	82.007378	83.641327	85.249794	86.832298	88.388351	89.917480	91.419212	92.893105

Constants for Setting a 125-mm Sine-Bar for 48° to 55°

Min.	48°	49°	50°	51°	52°	53°	54°	55°
0	92.893105	94.338699	95.755554	97.143250	98.501343	99.829437	101.127129	102.394005
1	92.917435	94.362549	95.778923	97.166122	98.523727	99.851318	101.148491	102.414856
2	92.941750	94.386391	95.802284	97.188995	98.546104	99.873192	101.169853	102.435699
3	92.966057	94.410225	95.825638	97.211861	98.568466	99.895050	101.191208	102.456535
4	92.990364	94.434052	95.848984	97.234711	98.590820	99.916901	101.212547	102.477364
5	93.014656	94.457870	95.872314	97.257553	98.613174	99.938744	101.233879	102.498177
6	93.038940	94.481682	95.895645	97.280396	98.635513	99.960579	101.255203	102.518982
7	93.063225	94.505486	95.918961	97.303223	98.657845	99.982407	101.276520	102.539787
8	93.087502	94.529289	95.942276	97.326050	98.680168	100.004234	101.297836	102.560577
9	93.111763	94.553070	95.965584	97.348862	98.702484	100.026047	101.319130	102.581360
10	93.136017	94.576851	95.988876	97.371666	98.724792	100.047844	101.340424	102.602135
11	93.160263	94.600624	96.012161	97.394463	98.747093	100.069641	101.361710	102.622902
12	93.184502	94.624382	96.035446	97.417252	98.769379	100.091423	101.382980	102.643654
13	93.208733	94.648140	96.058716	97.440025	98.791664	100.113197	101.404243	102.664398
14	93.232956	94.671883	96.081978	97.462799	98.813934	100.134972	101.425499	102.685143
15	93.257172	94.695625	96.105232	97.485565	98.836197	100.156731	101.446747	102.705872
16	93.281380	94.719353	96.128479	97.508316	98.858452	100.178482	101.467987	102.726593
17	93.305580	94.743080	96.151718	97.531067	98.880699	100.200226	101.489220	102.747299
18	93.329773	94.766792	96.174942	97.553802	98.902939	100.221954	101.510445	102.768005
19	93.353958	94.790497	96.198166	97.576530	98.925171	100.243683	101.531654	102.788704
20	93.378136	94.814201	96.221382	97.599251	98.947395	100.265396	101.552864	102.809387
21	93.402306	94.837891	96.244583	97.621964	98.969612	100.287109	101.574059	102.830063
22	93.426460	94.861572	96.267784	97.644669	98.991814	100.308807	101.595245	102.850731
23	93.450623	94.885254	96.290977	97.667374	99.014023	100.330505	101.616432	102.871399
24	93.474762	94.908920	96.314163	97.690063	99.036209	100.352188	101.637596	102.892052
25	93.498901	94.932579	96.337334	97.712746	99.058388	100.373863	101.658760	102.912689
26	93.523033	94.956230	96.360497	97.735413	99.080566	100.395531	101.679916	102.933327
27	93.547150	94.979866	96.383652	97.758080	99.102730	100.417191	101.701057	102.953949
28	93.571266	95.003502	96.406799	97.780739	99.124886	100.438835	101.722198	102.974571
29	93.595367	95.027130	96.429939	97.803383	99.147034	100.460480	101.743324	102.995178
30	93.619469	95.050751	96.453072	97.826019	99.169167	100.482109	101.764442	103.015778
31	93.643555	95.074356	96.476196	97.848656	99.191299	100.503731	101.785553	103.036369
32	93.667641	95.097961	96.499313	97.871277	99.213425	100.525345	101.806656	103.056946
33	93.691711	95.121552	96.522423	97.893890	99.235535	100.546959	101.827744	103.077522
34	93.715775	95.145142	96.545525	97.916496	99.257645	100.568550	101.848831	103.098083
35	93.739838	95.168716	96.568611	97.939095	99.279739	100.590141	101.869904	103.118637
36	93.763885	95.192291	96.591698	97.961685	99.301826	100.611725	101.890976	103.139191
37	93.787926	95.215851	96.614769	97.984261	99.323906	100.633301	101.912033	103.159729
38	93.811966	95.239410	96.637840	98.006844	99.345985	100.654869	101.933090	103.180260
39	93.835991	95.262955	96.660904	98.029404	99.368050	100.676422	101.954132	103.200783
40	93.860008	95.286491	96.683952	98.051964	99.390106	100.697968	101.975159	103.221291
41	93.884018	95.310020	96.706993	98.074509	99.412148	100.719505	101.996185	103.241798
42	93.908020	95.333542	96.730026	98.097046	99.434189	100.741035	102.017204	103.262291
43	93.932014	95.357056	96.753052	98.119583	99.456215	100.762558	102.038208	103.282776
44	93.956001	95.380562	96.776070	98.142105	99.478241	100.784073	102.059204	103.303253
45	93.979980	95.404060	96.799080	98.164619	99.500252	100.805580	102.080193	103.323723
46	94.003944	95.427551	96.822083	98.187126	99.522255	100.827072	102.101181	103.344177
47	94.027908	95.451035	96.845078	98.209625	99.544250	100.848564	102.122147	103.364632
48	94.051865	95.474503	96.868065	98.232109	99.566238	100.870041	102.143112	103.385071
49	94.075813	95.497971	96.891037	98.254593	99.588219	100.891510	102.164070	103.405502
50	94.099747	95.521423	96.914009	98.277069	99.610191	100.912971	102.185013	103.425934
51	94.123680	95.544876	96.936966	98.299530	99.632156	100.934425	102.205956	103.446342
52	94.147598	95.568314	96.959923	98.321991	99.654106	100.955872	102.226883	103.466751
53	94.171524	95.591751	96.982872	98.344444	99.676056	100.977310	102.247810	103.487160
54	94.195427	95.615181	97.005806	98.366882	99.697998	100.998741	102.268715	103.507545
55	94.219330	95.638596	97.028732	98.389313	99.719925	101.020157	102.289619	103.527924
56	94.243217	95.662003	97.051651	98.411736	99.741844	101.041573	102.310516	103.548302
57	94.267097	95.685402	97.074562	98.434151	99.763756	101.062973	102.331406	103.568665
58	94.290977	95.708794	97.097466	98.456558	99.785660	101.084366	102.352280	103.589012
59	94.314842	95.732178	97.120361	98.478958	99.807556	101.105751	102.373146	103.609360
60	94.338699	95.755554	97.143250	98.501343	99.829437	101.127129	102.394005	103.629700

Determining Hole Coordinates

On the following pages are given tables of the lengths of chords for spacing off the circumferences of circles. The object of these tables is to make possible the division of the periphery into a number of equal parts without trials with the dividers. The first table, **Table 6**, is calculated for circles having a diameter equal to 1. For circles of other diameters, the length of chord given in the table should be multiplied by the diameter of the circle. **Table 6** may be used by toolmakers when setting “buttons” in circular formation. Assume that it is required to divide the periphery of a circle of 20 inches diameter into thirty-two equal parts. From the table the length of the chord is found to be 0.098017 inch, if the diameter of the circle were 1 inch. With a diameter of 20 inches the length of the chord for one division would be $20 \times 0.098017 = 1.9603$ inches. Another example in metric units: For a 100 millimeter diameter requiring 5 equal divisions, the length of the chord for one division would be $100 \times 0.587785 = 58.7785$ millimeters.

Tables 7a and **7b** starting on page 3099 are additional tables for the spacing off of circles; the tables, in this case, being worked out for diameters from $\frac{1}{16}$ inch to 14 inches. As an example, assume that it is required to divide a circle having a diameter of $6\frac{1}{2}$ inches into seven equal parts. Find first, in the column headed “6” and in line with 7 divisions, the length of the chord for a 6-inch circle, which is 2.603 inches. Then find the length of the chord for a $\frac{1}{2}$ -inch diameter circle, 7 divisions, which is 0.217. The sum of these two values, $2.603 + 0.217 = 2.820$ inches, is the length of the chord required for spacing off the circumference of a $6\frac{1}{2}$ -inch circle into seven equal divisions.

As another example, assume that it is required to divide a circle having a diameter of $9\frac{23}{32}$ inches into 15 equal divisions. First find the length of the chord for a 9-inch circle, which is 1.871 inch. The length of the chord for a $\frac{23}{32}$ -inch circle can easily be estimated from the table by taking the value that is exactly between those given for $\frac{1}{16}$ and $\frac{3}{4}$ inch. The value for $\frac{1}{16}$ inch is 0.143, and for $\frac{3}{4}$ inch, 0.156. For $\frac{23}{32}$ the value would be 0.150. Then, $1.871 + 0.150 = 2.021$ inches.

Hole Coordinate Dimension Factors for Jig Boring.—Tables of hole coordinate dimension factors for use in jig boring are given in **Tables 8** through **11** starting on page 3101. The coordinate axes shown in the figure accompanying each table are used to reference the tool path; the values listed in each table are for the end points of the tool path. In this machine coordinate system, a positive *Y* value indicates that the effective motion of the tool with reference to the work is toward the front of the jig borer (the actual motion of the jig borer table is toward the column). Similarly, a positive *X* value indicates that the effective motion of the tool with respect to the work is toward the right (the actual motion of the jig borer table is toward the left). When entering data into most computer-controlled jig borers, current practice is to use the more familiar Cartesian coordinate axis system in which the positive *Y* direction is “up” (i.e., pointing toward the column of the jig borer). The computer will automatically change the signs of the entered *Y* values to the signs that they would have in the machine coordinate system. Therefore, before applying the coordinate dimension factors given in the tables, it is important to determine the coordinate system to be used. If a Cartesian coordinate system is to be used for the tool path, then the sign of the *Y* values in the tables must be changed, from positive to negative and from negative to positive. For example, when programming for a three-hole type *A* circle using Cartesian coordinates, the *Y* values from **Table 10** would be $y_1 = +0.50000$, $y_2 = -0.25000$, and $y_3 = -0.25000$.

Table 6. Lengths of Chords for Spacing Off the Circumferences of Circles with a Diameter Equal to 1 (English or Metric units)

No. of Spaces	Length of Chord	No. of Spaces	Length of Chord	No. of Spaces	Length of Chord	No. of Spaces	Length of Chord
3	0.866025	41	0.076549	79	0.039757	117	0.026848
4	0.707107	42	0.074730	80	0.039260	118	0.026621
5	0.587785	43	0.072995	81	0.038775	119	0.026397
6	0.500000	44	0.071339	82	0.038303	120	0.026177
7	0.433884	45	0.069756	83	0.037841	121	0.025961
8	0.382683	46	0.068242	84	0.037391	122	0.025748
9	0.342020	47	0.066793	85	0.036951	123	0.025539
10	0.309017	48	0.065403	86	0.036522	124	0.025333
11	0.281733	49	0.064070	87	0.036102	125	0.025130
12	0.258819	50	0.062791	88	0.035692	126	0.024931
13	0.239316	51	0.061561	89	0.035291	127	0.024734
14	0.222521	52	0.060378	90	0.034899	128	0.024541
15	0.207912	53	0.059241	91	0.034516	129	0.024351
16	0.195090	54	0.058145	92	0.034141	130	0.024164
17	0.183750	55	0.057089	93	0.033774	131	0.023979
18	0.173648	56	0.056070	94	0.033415	132	0.023798
19	0.164595	57	0.055088	95	0.033063	133	0.023619
20	0.156434	58	0.054139	96	0.032719	134	0.023443
21	0.149042	59	0.053222	97	0.032382	135	0.023269
22	0.142315	60	0.052336	98	0.032052	136	0.023098
23	0.136167	61	0.051479	99	0.031728	137	0.022929
24	0.130526	62	0.050649	100	0.031411	138	0.022763
25	0.125333	63	0.049846	101	0.031100	139	0.022599
26	0.120537	64	0.049068	102	0.030795	140	0.022438
27	0.116093	65	0.048313	103	0.030496	141	0.022279
28	0.111964	66	0.047582	104	0.030203	142	0.022122
29	0.108119	67	0.046872	105	0.029915	143	0.021967
30	0.104528	68	0.046183	106	0.029633	144	0.021815
31	0.101168	69	0.045515	107	0.029356	145	0.021664
32	0.098017	70	0.044865	108	0.029085	146	0.021516
33	0.095056	71	0.044233	109	0.028818	147	0.021370
34	0.092268	72	0.043619	110	0.028556	148	0.021225
35	0.089639	73	0.043022	111	0.028299	149	0.021083
36	0.087156	74	0.042441	112	0.028046	150	0.020942
37	0.084806	75	0.041876	113	0.027798	151	0.020804
38	0.082579	76	0.041325	114	0.027554	152	0.020667
39	0.080467	77	0.040789	115	0.027315	153	0.020532
40	0.078459	78	0.040266	116	0.027079	154	0.020399

For circles of other diameters, multiply length given in table by diameter of circle.

Example: In a drill jig, 8 holes, each $\frac{1}{2}$ inch diameter, were spaced evenly on a 6-inch diameter circle. To test the accuracy of the jig, plugs were placed in adjacent holes, and the distance over the plugs was measured with a micrometer. What should be the micrometer reading?

Solution: The micrometer reading equals the diameter of one plug plus 6 times the chordal distance between adjacent hole centers given in the table above. Thus, the reading should be $\frac{1}{2} + (6 \times 0.382683) = 2.796098$ inches.

Table 7a. Table for Spacing Off the Circumferences of Circles

No. of Divisions	Degrees in Arc	Diameter of Circle to be Spaced Off														
		$\frac{1}{16}$	$\frac{1}{8}$	$\frac{3}{16}$	$\frac{1}{4}$	$\frac{5}{16}$	$\frac{3}{8}$	$\frac{7}{16}$	$\frac{1}{2}$	$\frac{9}{16}$	$\frac{5}{8}$	$\frac{11}{16}$	$\frac{3}{4}$	$\frac{13}{16}$	$\frac{7}{8}$	$\frac{15}{16}$
		Length of Chord														
3	120	0.054	0.108	0.162	0.217	0.271	0.325	0.379	0.433	0.487	0.541	0.595	0.650	0.704	0.758	0.812
4	90	0.044	0.088	0.133	0.177	0.221	0.265	0.309	0.354	0.398	0.442	0.486	0.530	0.575	0.619	0.663
5	72	0.037	0.073	0.110	0.147	0.184	0.220	0.257	0.294	0.331	0.367	0.404	0.441	0.478	0.514	0.551
6	60	0.031	0.063	0.094	0.125	0.156	0.188	0.219	0.250	0.281	0.313	0.344	0.375	0.406	0.438	0.469
7	51 $\frac{3}{7}$	0.027	0.054	0.081	0.108	0.136	0.163	0.190	0.217	0.244	0.271	0.298	0.325	0.353	0.380	0.407
8	45	0.024	0.048	0.072	0.096	0.120	0.144	0.167	0.191	0.215	0.239	0.263	0.287	0.311	0.335	0.359
9	40	0.021	0.043	0.064	0.086	0.107	0.128	0.150	0.171	0.192	0.214	0.235	0.257	0.278	0.299	0.321
10	36	0.019	0.039	0.058	0.077	0.097	0.116	0.135	0.155	0.174	0.193	0.212	0.232	0.251	0.270	0.290
11	32 $\frac{8}{11}$	0.018	0.035	0.053	0.070	0.088	0.106	0.123	0.141	0.158	0.176	0.194	0.211	0.229	0.247	0.264
12	30	0.016	0.032	0.049	0.065	0.081	0.097	0.113	0.129	0.146	0.162	0.178	0.194	0.210	0.226	0.243
13	27 $\frac{9}{13}$	0.015	0.030	0.045	0.060	0.075	0.090	0.105	0.120	0.135	0.150	0.165	0.179	0.194	0.209	0.224
14	25 $\frac{5}{7}$	0.014	0.028	0.042	0.056	0.069	0.083	0.097	0.111	0.125	0.139	0.153	0.167	0.181	0.195	0.209
15	24	0.013	0.026	0.039	0.052	0.065	0.078	0.091	0.104	0.117	0.130	0.143	0.156	0.169	0.182	0.195
16	22 $\frac{1}{2}$	0.012	0.024	0.037	0.049	0.061	0.073	0.085	0.098	0.110	0.122	0.134	0.146	0.159	0.171	0.183
17	21 $\frac{3}{17}$	0.011	0.023	0.034	0.046	0.057	0.069	0.080	0.092	0.103	0.115	0.126	0.138	0.149	0.161	0.172
18	20	0.011	0.022	0.033	0.043	0.054	0.065	0.076	0.087	0.098	0.109	0.119	0.130	0.141	0.152	0.163
19	18 $\frac{18}{19}$	0.010	0.021	0.031	0.041	0.051	0.062	0.072	0.082	0.093	0.103	0.113	0.123	0.134	0.144	0.154
20	18	0.010	0.020	0.029	0.039	0.049	0.059	0.068	0.078	0.088	0.098	0.108	0.117	0.127	0.137	0.147
21	17 $\frac{1}{7}$	0.009	0.019	0.028	0.037	0.047	0.056	0.065	0.075	0.084	0.093	0.102	0.112	0.121	0.130	0.140
22	16 $\frac{4}{11}$	0.009	0.018	0.027	0.036	0.044	0.053	0.062	0.071	0.080	0.089	0.098	0.107	0.116	0.125	0.133
23	15 $\frac{15}{23}$	0.009	0.017	0.026	0.034	0.043	0.051	0.060	0.068	0.077	0.085	0.094	0.102	0.111	0.119	0.128
24	15	0.008	0.016	0.024	0.033	0.041	0.049	0.057	0.065	0.073	0.082	0.090	0.098	0.106	0.114	0.122
25	14 $\frac{2}{5}$	0.008	0.016	0.023	0.031	0.039	0.047	0.055	0.063	0.070	0.078	0.086	0.094	0.102	0.110	0.117
26	13 $\frac{11}{13}$	0.008	0.015	0.023	0.030	0.038	0.045	0.053	0.060	0.068	0.075	0.083	0.090	0.098	0.105	0.113
28	12 $\frac{6}{7}$	0.007	0.014	0.021	0.028	0.035	0.042	0.049	0.056	0.063	0.070	0.077	0.084	0.091	0.098	0.105
30	12	0.007	0.013	0.020	0.026	0.033	0.039	0.046	0.052	0.059	0.065	0.072	0.078	0.085	0.091	0.098
32	11 $\frac{1}{4}$	0.006	0.012	0.018	0.025	0.031	0.037	0.043	0.049	0.055	0.061	0.067	0.074	0.080	0.086	0.092

HOLE COORDINATES

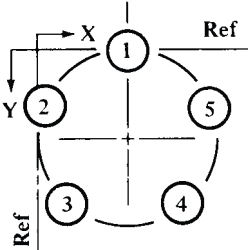
Table 7b. Table for Spacing Off the Circumferences of Circles

No. of Divisions	Degrees in Arc	Diameter of Circle to be Spaced Off													
		1	2	3	4	5	6	7	8	9	10	11	12	13	14
		Length of Chord													
3	120	0.866	1.732	2.598	3.464	4.330	5.196	6.062	6.928	7.794	8.660	9.526	10.392	11.258	12.124
4	90	0.707	1.414	2.121	2.828	3.536	4.243	4.950	5.657	6.364	7.071	7.778	8.485	9.192	9.899
5	72	0.588	1.176	1.763	2.351	2.939	3.527	4.114	4.702	5.290	5.878	6.466	7.053	7.641	8.229
6	60	0.500	1.000	1.500	2.000	2.500	3.000	3.500	4.000	4.500	5.000	5.500	6.000	6.500	7.000
7	51 $\frac{3}{7}$	0.434	0.868	1.302	1.736	2.169	2.603	3.037	3.471	3.905	4.339	4.773	5.207	5.640	6.074
8	45	0.383	0.765	1.148	1.531	1.913	2.296	2.679	3.061	3.444	3.827	4.210	4.592	4.975	5.358
9	40	0.342	0.684	1.026	1.368	1.710	2.052	2.394	2.736	3.078	3.420	3.762	4.104	4.446	4.788
10	36	0.309	0.618	0.927	1.236	1.545	1.854	2.163	2.472	2.781	3.090	3.399	3.708	4.017	4.326
11	32 $\frac{2}{11}$	0.282	0.563	0.845	1.127	1.409	1.690	1.972	2.254	2.536	2.817	3.099	3.381	3.663	3.944
12	30	0.259	0.518	0.776	1.035	1.294	1.553	1.812	2.071	2.329	2.588	2.847	3.106	3.365	3.623
13	27 $\frac{1}{13}$	0.239	0.479	0.718	0.957	1.197	1.436	1.675	1.915	2.154	2.393	2.632	2.872	3.111	3.350
14	25 $\frac{5}{7}$	0.223	0.445	0.668	0.890	1.113	1.335	1.558	1.780	2.003	2.225	2.448	2.670	2.893	3.115
15	24	0.208	0.416	0.624	0.832	1.040	1.247	1.455	1.663	1.871	2.079	2.287	2.495	2.703	2.911
16	22 $\frac{1}{2}$	0.195	0.390	0.585	0.780	0.975	1.171	1.366	1.561	1.756	1.951	2.146	2.341	2.536	2.731
17	21 $\frac{3}{17}$	0.184	0.367	0.551	0.735	0.919	1.102	1.286	1.470	1.654	1.837	2.021	2.205	2.389	2.572
18	20	0.174	0.347	0.521	0.695	0.868	1.042	1.216	1.389	1.563	1.736	1.910	2.084	2.257	2.431
19	18 $\frac{8}{19}$	0.165	0.329	0.494	0.658	0.823	0.988	1.152	1.317	1.481	1.646	1.811	1.975	2.140	2.304
20	18	0.156	0.313	0.469	0.626	0.782	0.939	1.095	1.251	1.408	1.564	1.721	1.877	2.034	2.190
21	17 $\frac{1}{2}$	0.149	0.298	0.447	0.596	0.745	0.894	1.043	1.192	1.341	1.490	1.639	1.789	1.938	2.087
22	16 $\frac{4}{11}$	0.142	0.285	0.427	0.569	0.712	0.854	0.996	1.139	1.281	1.423	1.565	1.708	1.850	1.992
23	15 $\frac{15}{23}$	0.136	0.272	0.408	0.545	0.681	0.817	0.953	1.089	1.225	1.362	1.498	1.634	1.770	1.906
24	15	0.131	0.261	0.392	0.522	0.653	0.783	0.914	1.044	1.175	1.305	1.436	1.566	1.697	1.827
25	14 $\frac{2}{5}$	0.125	0.251	0.376	0.501	0.627	0.752	0.877	1.003	1.128	1.253	1.379	1.504	1.629	1.755
26	13 $\frac{11}{13}$	0.121	0.241	0.362	0.482	0.603	0.723	0.844	0.964	1.085	1.205	1.326	1.446	1.567	1.688
28	12 $\frac{6}{7}$	0.112	0.224	0.336	0.448	0.560	0.672	0.784	0.896	1.008	1.120	1.232	1.344	1.456	1.568
30	12	0.105	0.209	0.314	0.418	0.523	0.627	0.732	0.836	0.941	1.045	1.150	1.254	1.359	1.463
32	11 $\frac{1}{4}$	0.098	0.196	0.294	0.392	0.490	0.588	0.686	0.784	0.882	0.980	1.078	1.176	1.274	1.372

See *Determining Hole Coordinates* on page 3097 for explanatory matter.

Table 8. Hole Coordinate Dimension Factors for Jig Boring — Type “A” Hole Circles (English or Metric Units)

3 Holes		4 Holes		5 Holes		6 Holes		7 Holes		8 Holes		9 Holes	
x1	0.50000	x1	0.50000	x1	0.50000	x1	0.50000	x1	0.50000	x1	0.50000	x1	0.50000
y1	0.00000	y1	0.00000	y1	0.00000	y1	0.00000	y1	0.00000	y1	0.00000	y1	0.00000
x2	0.06699	x2	0.00000	x2	0.02447	x2	0.06699	x2	0.10908	x2	0.14645	x2	0.17861
y2	0.75000	y2	0.50000	y2	0.34549	y2	0.25000	y2	0.18826	y2	0.14645	y2	0.11698
x3	0.93301	x3	0.50000	x3	0.20611	x3	0.06699	x3	0.01254	x3	0.00000	x3	0.00760
y3	0.75000	y3	1.00000	y3	0.90451	y3	0.75000	y3	0.61126	y3	0.50000	y3	0.41318
		x4	1.00000	x4	0.79389	x4	0.50000	x4	0.28306	x4	0.14645	x4	0.06699
		y4	0.50000	y4	0.90451	y4	1.00000	y4	0.95048	y4	0.85355	y4	0.75000
				x5	0.97553	x5	0.93301	x5	0.71694	x5	0.50000	x5	0.32899
				y5	0.34549	y5	0.75000	y5	0.95048	y5	1.00000	y5	0.96985
						x6	0.93301	x6	0.98746	x6	0.85355	x6	0.67101
						y6	0.25000	y6	0.61126	y6	0.85355	y6	0.96985
								x7	0.89092	x7	1.00000	x7	0.93301
								y7	0.18826	y7	0.50000	y7	0.75000
										x8	0.85355	x8	0.99240
										y8	0.14645	y8	0.41318
												x9	0.82139
												y9	0.11698
10 Holes		11 Holes		12 Holes		13 Holes		14 Holes		15 Holes		16 Holes	
x1	0.50000	x1	0.50000	x1	0.50000	x1	0.50000	x1	0.50000	x1	0.50000	x1	0.50000
y1	0.00000	y1	0.00000	y1	0.00000	y1	0.00000	y1	0.00000	y1	0.00000	y1	0.00000
x2	0.20611	x2	0.22968	x2	0.25000	x2	0.26764	x2	0.28306	x2	0.29663	x2	0.30866
y2	0.09549	y2	0.07937	y2	0.06699	y2	0.05727	y2	0.04952	y2	0.04323	y2	0.03806
x3	0.02447	x3	0.04518	x3	0.06699	x3	0.08851	x3	0.10908	x3	0.12843	x3	0.14645
y3	0.34549	y3	0.29229	y3	0.25000	y3	0.21597	y3	0.18826	y3	0.16543	y3	0.14645
x4	0.02447	x4	0.00509	x4	0.00000	x4	0.00365	x4	0.01254	x4	0.02447	x4	0.03806
y4	0.65451	y4	0.57116	y4	0.50000	y4	0.43973	y4	0.38874	y4	0.34549	y4	0.30866
x5	0.20611	x5	0.12213	x5	0.06699	x5	0.03249	x5	0.01254	x5	0.00274	x5	0.00000
y5	0.90451	y5	0.82743	y5	0.75000	y5	0.67730	y5	0.61126	y5	0.55226	y5	0.50000
x6	0.50000	x6	0.35913	x6	0.25000	x6	0.16844	x6	0.10908	x6	0.06699	x6	0.03806
y6	1.00000	y6	0.97975	y6	0.93301	y6	0.87426	y6	0.81174	y6	0.75000	y6	0.69134
x7	0.79389	x7	0.64087	x7	0.50000	x7	0.38034	x7	0.28306	x7	0.20611	x7	0.14645
y7	0.90451	y7	0.97975	y7	1.00000	y7	0.98547	y7	0.95048	y7	0.90451	y7	0.85355
x8	0.97553	x8	0.87787	x8	0.75000	x8	0.61966	x8	0.50000	x8	0.39604	x8	0.30866
y8	0.65451	y8	0.82743	y8	0.93301	y8	0.98547	y8	1.00000	y8	0.98907	y8	0.96194
x9	0.97553	x9	0.99491	x9	0.93301	x9	0.83156	x9	0.71694	x9	0.60396	x9	0.50000
y9	0.34549	y9	0.57116	y9	0.75000	y9	0.87426	y9	0.95048	y9	0.98907	y9	1.00000
x10	0.79389	x10	0.95482	x10	1.00000	x10	0.96751	x10	0.89092	x10	0.79389	x10	0.69134
y10	0.09549	y10	0.29229	y10	0.50000	y10	0.67730	y10	0.81174	y10	0.90451	y10	0.96194
		x11	0.77032	x11	0.93801	x11	0.99635	x11	0.98746	x11	0.93301	x11	0.85355
		y11	0.07937	y11	0.25000	y11	0.43973	y11	0.61126	y11	0.75000	y11	0.85355
				x12	0.75000	x12	0.91149	x12	0.98746	x12	0.99726	x12	0.96194
				y12	0.06699	y12	0.21597	y12	0.38874	y12	0.55226	y12	0.69134
						x13	0.73236	x13	0.89092	x13	0.97553	x13	1.00000
						y13	0.05727	y13	0.18826	y13	0.34549	y13	0.50000
								x14	0.71694	x14	0.87157	x14	0.96194
								y14	0.04952	y14	0.16543	y14	0.30866
										x15	0.70337	x15	0.85355
										y15	0.04323	y15	0.14645
												x16	0.69134
												y16	0.03806



The diagram shows a type “A” circle for a 5-hole circle. Coordinates x , y are given in the table for hole circles of from 3 to 28 holes. Dimensions are for holes numbered in a counterclockwise direction (as shown). Dimensions given are based upon a hole circle of unit diameter. For a hole circle of, say, 3-inch or 3-centimeter diameter, multiply table values by 3.

Table 8. (Continued) Hole Coordinate Dimension Factors for Jig Boring — Type “A” Hole Circles (English or Metric Units)

17 Holes		18 Holes		19 Holes		20 Holes		21 Holes		22 Holes		23 Holes	
x1	0.50000	x1	0.50000	x1	0.50000	x1	0.50000	x1	0.50000	x1	0.50000	x1	0.50000
y1	0.00000	y1	0.00000	y1	0.00000	y1	0.00000	y1	0.00000	y1	0.00000	y1	0.00000
x2	0.31938	x2	0.32899	x2	0.33765	x2	0.34549	x2	0.35262	x2	0.35913	x2	0.36510
y2	0.03376	y2	0.03015	y2	0.02709	y2	0.02447	y2	0.02221	y2	0.02025	y2	0.01854
x3	0.16315	x3	0.17861	x3	0.19289	x3	0.20611	x3	0.21834	x3	0.22968	x3	0.24021
y3	0.13050	y3	0.11698	y3	0.10543	y3	0.09549	y3	0.08688	y3	0.07937	y3	0.07279
x4	0.05242	x4	0.06699	x4	0.08142	x4	0.09549	x4	0.10908	x4	0.12213	x4	0.13458
y4	0.27713	y4	0.25000	y4	0.22653	y4	0.20611	y4	0.18826	y4	0.17257	y4	0.15872
x5	0.00213	x5	0.00760	x5	0.01530	x5	0.02447	x5	0.03456	x5	0.04518	x5	0.05606
y5	0.45387	y5	0.41318	y5	0.37726	y5	0.34549	y5	0.31733	y5	0.29229	y5	0.26997
x6	0.01909	x6	0.00760	x6	0.00171	x6	0.00000	x6	0.00140	x6	0.00509	x6	0.01046
y6	0.63683	y6	0.58682	y6	0.54129	y6	0.50000	y6	0.46263	y6	0.42884	y6	0.39827
x7	0.10099	x7	0.06699	x7	0.04211	x7	0.02447	x7	0.01254	x7	0.00509	x7	0.00117
y7	0.80132	y7	0.75000	y7	0.70085	y7	0.65451	y7	0.61126	y7	0.57116	y7	0.53412
x8	0.23678	x8	0.17861	x8	0.13214	x8	0.09549	x8	0.06699	x8	0.04518	x8	0.02887
y8	0.92511	y8	0.88302	y8	0.83864	y8	0.79389	y8	0.75000	y8	0.70771	y8	0.66744
x9	0.40813	x9	0.32899	x9	0.26203	x9	0.20611	x9	0.15991	x9	0.12213	x9	0.09152
y9	0.99149	y9	0.96985	y9	0.93974	y9	0.90451	y9	0.86653	y9	0.82743	y9	0.78834
x10	0.59187	x10	0.50000	x10	0.41770	x10	0.34549	x10	0.28306	x10	0.22968	x10	0.18446
y10	0.99149	y10	1.00000	y10	0.99318	y10	0.97553	y10	0.95048	y10	0.92063	y10	0.88786
x11	0.76322	x11	0.67101	x11	0.58230	x11	0.50000	x11	0.42548	x11	0.35913	x11	0.30080
y11	0.92511	y11	0.96985	y11	0.99318	y11	1.00000	y11	0.99442	y11	0.97975	y11	0.95861
x12	0.89901	x12	0.82139	x12	0.73797	x12	0.65451	x12	0.57452	x12	0.50000	x12	0.43192
y12	0.80132	y12	0.88302	y12	0.93974	y12	0.97553	y12	0.99442	y12	1.00000	y12	0.99534
x13	0.98091	x13	0.93301	x13	0.86786	x13	0.79389	x13	0.71694	x13	0.64087	x13	0.56808
y13	0.63683	y13	0.75000	y13	0.83864	y13	0.90451	y13	0.95048	y13	0.97975	y13	0.99534
x14	0.99787	x14	0.99240	x14	0.95789	x14	0.90451	x14	0.84009	x14	0.77032	x14	0.69920
y14	0.45387	y14	0.58682	y14	0.70085	y14	0.79389	y14	0.86653	y14	0.92063	y14	0.95861
x15	0.94758	x15	0.99240	x15	0.99829	x15	0.97553	x15	0.93301	x15	0.87787	x15	0.81554
y15	0.27713	y15	0.41318	y15	0.54129	y15	0.65451	y15	0.75000	y15	0.82743	y15	0.88786
x16	0.83685	x16	0.93301	x16	0.98470	x16	1.00000	x16	0.98746	x16	0.95482	x16	0.90848
y16	0.13050	y16	0.25000	y16	0.37726	y16	0.50000	y16	0.61126	y16	0.70771	y16	0.78834
x17	0.68062	x17	0.82139	x17	0.91858	x17	0.97553	x17	0.99860	x17	0.99491	x17	0.97113
y17	0.03376	y17	0.11698	y17	0.22658	y17	0.34549	y17	0.46263	y17	0.57116	y17	0.66744
		x18	0.67101	x18	0.80711	x18	0.90451	x18	0.96544	x18	0.99491	x18	0.99883
		x18	0.03015	x18	0.10543	x18	0.20611	x18	0.31733	x18	0.42884	x18	0.53412
				x19	0.66235	x19	0.79389	x19	0.89092	x19	0.95482	x19	0.98954
				x19	0.02709	x19	0.09549	x19	0.18826	x19	0.29229	x19	0.39827
						x20	0.65451	x20	0.78166	x20	0.87787	x20	0.94394
						y20	0.02447	y20	0.08688	y20	0.17257	y20	0.26997
								x21	0.64738	x21	0.77032	x21	0.86542
								y21	0.02221	y21	0.07937	y21	0.15872
										x22	0.64087	x22	0.75979
										y22	0.02025	y22	0.07279
												x23	0.63490
												y23	0.01854
24Holes		25 Holes		26 Holes		27 Holes		28 Holes					
x1	0.50000	x1	0.50000	x1	0.50000	x1	0.50000	x1	0.50000				
y1	0.00000	y1	0.00000	y1	0.00000	y1	0.00000	y1	0.00000				
x2	0.37059	x2	0.37566	x2	0.38034	x2	0.38469	x2	0.38874				
y2	0.01704	y2	0.01571	y2	0.01453	y2	0.01348	y2	0.01254				
x3	0.25000	x3	0.25912	x3	0.26764	x3	0.27560	x3	0.28306				

The diagram shows a type “A” circle for a 5-hole circle. Coordinates x, y are given in the table for hole circles of from 3 to 28 holes. Dimensions are for holes numbered in a counterclockwise direction (as shown). Dimensions given are based upon a hole circle of unit diameter. For a hole circle of, say, 3-inch or 3-centimeter diameter, multiply table values by 3.

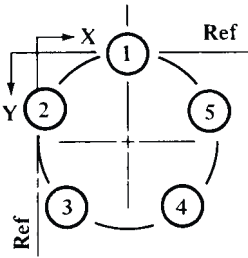
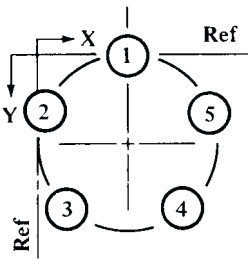


Table 8. (Continued) Hole Coordinate Dimension Factors for Jig Boring — Type “A” Hole Circles (English or Metric Units)

24Holes		25 Holes		26 Holes		27 Holes		28 Holes	
y3	0.06699	y3	0.06185	y3	0.05727	y3	0.05318	y3	0.04952
x4	0.14645	x4	0.15773	x4	0.16844	x4	0.17861	x4	0.18826
y4	0.14645	y4	0.13552	y4	0.12574	y4	0.11698	y4	0.10908
x5	0.06699	x5	0.07784	x5	0.08851	x5	0.09894	x5	0.10908
y5	0.25000	y5	0.23209	y5	0.21597	y5	0.20142	y5	0.18826
x6	0.01704	x6	0.02447	x6	0.03249	x6	0.04089	x6	0.04952
y6	0.37059	y6	0.34549	y6	0.32270	y6	0.30196	y6	0.28306
x7	0.00000	x7	0.00099	x7	0.00365	x7	0.00760	x7	0.01254
y7	0.50000	y7	0.46860	y7	0.43973	y7	0.41318	y7	0.38874
x8	0.01704	x8	0.00886	x8	0.00365	x8	0.00085	x8	0.00000
y8	0.62941	y8	0.59369	y8	0.56027	y8	0.52907	y8	0.50000
x9	0.06699	x9	0.04759	x9	0.03249	x9	0.02101	x9	0.01254
y9	0.75000	y9	0.71289	y9	0.67730	y9	0.64340	y9	0.61126
x10	0.14645	x10	0.11474	x10	0.08851	x10	0.06699	x10	0.04952
y10	0.85355	y10	0.81871	y10	0.78403	y10	0.75000	y10	0.71694
x11	0.25000	x11	0.20611	x11	0.16844	x11	0.13631	x11	0.10908
y11	0.93301	y11	0.90451	y11	0.87426	y11	0.84312	y11	0.81174
x12	0.37059	x12	0.31594	x12	0.26764	x12	0.22525	x12	0.18826
y12	0.98296	y12	0.96489	y12	0.94273	y12	0.91774	y12	0.89092
x13	0.50000	x13	0.43733	x13	0.38034	x13	0.32899	x13	0.28306
y13	1.00000	y13	0.99606	y13	0.98547	y13	0.96985	y13	0.95048
x14	0.62941	x14	0.56267	x14	0.50000	x14	0.44195	x14	0.38874
y14	0.98296	y14	0.99606	y14	1.00000	y14	0.99662	y14	0.98746
x15	0.75000	x15	0.68406	x15	0.61966	x15	0.55805	x15	0.50000
y15	0.93301	y15	0.96489	y15	0.98547	y15	0.99662	y15	1.00000
x16	0.85355	x16	0.79389	x16	0.73236	x16	0.67101	x16	0.61126
y16	0.85355	y16	0.90451	y16	0.94273	y16	0.96985	y16	0.98746
x17	0.93301	x17	0.88526	x17	0.83156	x17	0.77475	x17	0.71694
y17	0.75000	y17	0.81871	y17	0.87426	y17	0.91774	y17	0.95048
x18	0.98296	x18	0.95241	x18	0.91149	x18	0.86369	x18	0.81174
y18	0.62941	y18	0.71289	y18	0.78403	y18	0.84312	y18	0.89092
x19	1.00000	x19	0.99114	x19	0.96751	x19	0.93301	x19	0.89092
y19	0.50000	y19	0.59369	y19	0.67730	y19	0.75000	y19	0.81174
x20	0.98296	x20	0.99901	x20	0.99635	x20	0.97899	x20	0.95048
y20	0.37059	y20	0.46860	y20	0.56027	y20	0.64340	y20	0.71694
x21	0.93301	x21	0.97553	x21	0.99635	x21	0.99915	x21	0.98746
y21	0.25000	y21	0.34549	y21	0.43973	y21	0.52907	y21	0.61126
x22	0.85355	x22	0.92216	x22	0.96751	x22	0.99240	x22	1.00000
y22	0.14645	y22	0.23209	y22	0.32270	y22	0.41318	y22	0.50000
x23	0.75000	x23	0.84227	x23	0.91149	x23	0.95911	x23	0.98746
y23	0.66999	y23	0.13552	y23	0.21597	y23	0.30196	y23	0.38874
x24	0.62941	x24	0.74088	x24	0.83156	x24	0.90106	x24	0.95048
y24	0.01704	y24	0.06185	y24	0.12574	y24	0.20142	y24	0.28306
		x25	0.62434	x25	0.73236	x25	0.82139	x25	0.89092
		y25	0.01571	y25	0.05727	y25	0.11698	y25	0.18826
				x26	0.61966	x26	0.72440	x26	0.81174
				y26	0.01453	y26	0.05318	y26	0.10908
						x27	0.61531	x27	0.71694
						y27	0.01348	y27	0.04952
								x28	0.61126
								y28	0.01254



The diagram shows a type “A” circle for a 5-hole circle. Coordinates x, y are given in the table for hole circles of from 3 to 28 holes. Dimensions are for holes numbered in a counterclockwise direction (as shown). Dimensions given are based upon a hole circle of unit diameter. For a hole circle of, say, 3-inch or 3-centimeter diameter, multiply table values by 3.

Table 9. Hole Coordinate Dimension Factors for Jig Boring — Type “B” Hole Circles (English or Metric Units)

3 Holes		4 Holes		5 Holes		6 Holes		7 Holes		8 Holes		9 Holes	
x1	0.06699	x1	0.14645	x1	0.20611	x1	0.25000	x1	0.28306	x1	0.30866	x1	0.32899
y1	0.25000	y1	0.14645	y1	0.09549	y1	0.06699	y1	0.04952	y1	0.03806	y1	0.03015
x2	0.50000	x2	0.14645	x2	0.02447	x2	0.00000	x2	0.01254	x2	0.03806	x2	0.06699
y2	1.00000	y2	0.85355	y2	0.65451	y2	0.50000	y2	0.38874	y2	0.30866	y2	0.25000
x3	0.93301	x3	0.85355	x3	0.50000	x3	0.25000	x3	0.10908	x3	0.03806	x3	0.00760
y3	0.25000	y3	0.85355	y3	1.00000	y3	0.93301	y3	0.81174	y3	0.69134	y3	0.58682
		x4	0.85355	x4	0.97553	x4	0.75000	x4	0.50000	x4	0.30866	x4	0.17861
		y4	0.14645	y4	0.65451	y4	0.93301	y4	1.00000	y4	0.96194	y4	0.88302
				x5	0.79389	x5	1.00000	x5	0.89092	x5	0.69134	x5	0.50000
				y5	0.09549	y5	0.50000	y5	0.81174	y5	0.96194	y5	1.00000
						x6	0.75000	x6	0.98746	x6	0.96194	x6	0.82139
						y6	0.06699	y6	0.38874	y6	0.69134	y6	0.88302
								x7	0.71694	x7	0.96194	x7	0.99240
								y7	0.04952	y7	0.30866	y7	0.58682
										x8	0.69134	x8	0.93301
										y8	0.03806	y8	0.25000
												x9	0.67101
												y9	0.03015
10 Holes		11 Holes		12 Holes		13 Holes		14 Holes		15 Holes		16 Holes	
x1	0.34549	x1	0.35913	x1	0.37059	x1	0.38034	x1	0.38874	x1	0.39604	x1	0.40245
y1	0.02447	y1	0.02025	y1	0.01704	y1	0.01453	y1	0.01254	y1	0.01093	y1	0.00961
x2	0.09549	x2	0.12213	x2	0.14645	x2	0.16844	x2	0.18826	x2	0.20611	x2	0.22221
y2	0.20611	y2	0.17257	y2	0.14645	y2	0.12574	y2	0.10908	y2	0.09549	y2	0.08427
x3	0.00000	x3	0.00509	x3	0.01704	x3	0.03249	x3	0.04952	x3	0.06699	x3	0.08427
y3	0.50000	y3	0.42884	y3	0.37059	y3	0.32270	y3	0.28306	y3	0.25000	y3	0.22221
x4	0.09549	x4	0.04518	x4	0.01704	x4	0.00365	x4	0.00000	x4	0.00274	x4	0.00961
y4	0.79389	y4	0.70771	y4	0.62941	y4	0.56027	y4	0.50000	y4	0.44774	y4	0.40245
x5	0.34549	x5	0.22968	x5	0.14645	x5	0.08851	x5	0.04952	x5	0.02447	x5	0.00961
y5	0.97553	y5	0.92063	y5	0.85355	y5	0.78403	y5	0.71694	y5	0.65451	y5	0.59755
x6	0.65451	x6	0.50000	x6	0.37059	x6	0.26764	x6	0.18826	x6	0.12843	x6	0.08427
y6	0.97553	y6	1.00000	y6	0.98296	y6	0.94273	y6	0.89092	y6	0.83457	y6	0.77779
x7	0.90451	x7	0.77032	x7	0.62941	x7	0.50000	x7	0.38874	x7	0.29663	x7	0.22221
y7	0.79389	y7	0.92063	y7	0.98296	y7	1.00000	y7	0.98746	y7	0.95677	y7	0.91573
x8	1.00000	x8	0.95482	x8	0.85355	x8	0.73236	x8	0.61126	x8	0.50000	x8	0.40245
y8	0.50000	y8	0.70771	y8	0.85355	y8	0.94273	y8	0.98746	y8	1.00000	y8	0.99039
x9	0.90451	x9	0.99491	x9	0.98296	x9	0.91149	x9	0.81174	x9	0.70337	x9	0.59755
y9	0.20611	y9	0.42884	y9	0.62941	y9	0.78403	y9	0.89092	y9	0.95677	y9	0.99039
x10	0.65451	x10	0.87787	x10	0.98296	x10	0.99635	x10	0.95048	x10	0.87157	x10	0.77779
y10	0.02447	y10	0.17257	y10	0.37059	y10	0.56027	y10	0.71694	y10	0.83457	y10	0.91573
		x11	0.64087	x11	0.85355	x11	0.96751	x11	1.00000	x11	0.97553	x11	0.91573
		y11	0.02025	y11	0.14645	y11	0.32270	y11	0.50000	y11	0.65451	y11	0.77779
				x12	0.62941	x12	0.83156	x12	0.95048	x12	0.99726	x12	0.99039
				y12	0.01704	y12	0.12574	y12	0.28306	y12	0.44774	y12	0.59755
						x13	0.61966	x13	0.81174	x13	0.93301	x13	0.99039
						y13	0.01453	y13	0.10908	y13	0.25000	y13	0.40245
								x14	0.61126	x14	0.79389	x14	0.91573
								y14	0.01254	y14	0.09549	y14	0.22221
										x15	0.60396	x15	0.77779
										y15	0.01093	y15	0.08427
												x16	0.59755
												y16	0.00961

The diagram shows a type “B” circle for a 5-hole circle. Coordinates x , y are given in the table for hole circles of from 3 to 28 holes. Dimensions are for holes numbered in a counterclockwise direction (as shown). Dimensions given are based upon a hole circle of unit diameter. For a hole circle of, say, 3-inch or 3-centimeter diameter, multiply table values by 3.

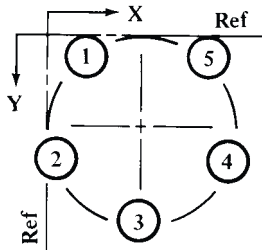
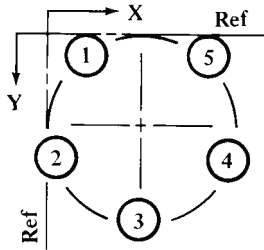


Table 9. (Continued) Hole Coordinate Dimension Factors for Jig Boring — Type “B” Hole Circles (English or Metric Units)

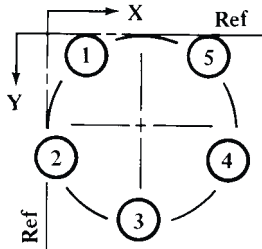
17 Holes		18 Holes		19 Holes		20 Holes		21 Holes		22 Holes		23 Holes	
x1	0.40813	x1	0.41318	x1	0.41770	x1	0.42178	x1	0.42548	x1	0.42884	x1	0.43192
y1	0.00851	y1	0.00760	y1	0.00682	y1	0.00616	y1	0.00558	y1	0.00509	y1	0.00466
x2	0.23678	x2	0.25000	x2	0.26203	x2	0.27300	x2	0.28306	x2	0.29229	x2	0.30080
y2	0.07489	y2	0.06699	y2	0.06026	y2	0.05450	y2	0.04952	y2	0.04518	y2	0.04139
x3	0.10099	x3	0.11698	x3	0.13214	x3	0.14645	x3	0.15991	x3	0.17257	x3	0.18446
y3	0.19868	y3	0.17861	y3	0.16136	y3	0.14645	y3	0.13347	y3	0.12213	y3	0.11214
x4	0.01909	x4	0.03015	x4	0.04211	x4	0.05450	x4	0.06699	x4	0.07937	x4	0.09152
y4	0.36317	y4	0.32899	y4	0.29915	y4	0.27300	y4	0.25000	y4	0.22968	y4	0.21166
x5	0.00213	x5	0.00000	x5	0.00171	x5	0.00616	x5	0.01254	x5	0.02025	x5	0.02887
y5	0.54613	y5	0.50000	y5	0.45871	y5	0.42178	y5	0.38874	y5	0.35913	y5	0.33256
x6	0.05242	x6	0.03015	x6	0.01530	x6	0.00616	x6	0.00140	x6	0.00000	x6	0.00117
y6	0.72287	y6	0.67101	y6	0.62274	y6	0.57822	y6	0.53737	y6	0.50000	y6	0.46588
x7	0.16315	x7	0.11698	x7	0.08142	x7	0.05450	x7	0.03456	x7	0.02025	x7	0.01046
y7	0.86950	y7	0.82139	y7	0.77347	y7	0.72700	y7	0.68267	y7	0.64087	y7	0.60173
x8	0.31938	x8	0.25000	x8	0.19289	x8	0.14645	x8	0.10908	x8	0.07937	x8	0.05606
y8	0.96624	y8	0.93301	y8	0.89457	y8	0.85355	y8	0.81174	y8	0.77032	y8	0.73003
x9	0.50000	x9	0.41318	x9	0.33765	x9	0.27300	x9	0.21834	x9	0.17257	x9	0.13458
y9	1.00000	y9	0.99240	y9	0.97291	y9	0.94550	y9	0.91312	y9	0.87787	y9	0.84128
x10	0.68062	x10	0.58682	x10	0.50000	x10	0.42178	x10	0.35262	x10	0.29229	x10	0.24021
y10	0.96624	y10	0.99240	y10	1.00000	y10	0.99384	y10	0.97779	y10	0.95482	y10	0.92721
x11	0.83685	x11	0.75000	x11	0.66235	x11	0.57822	x11	0.50000	x11	0.42884	x11	0.36510
y11	0.86950	y11	0.93301	y11	0.97291	y11	0.99384	y11	1.00000	y11	0.99491	y11	0.98146
x12	0.94758	x12	0.88302	x12	0.80711	x12	0.72700	x12	0.64738	x12	0.57116	x12	0.50000
y12	0.72287	y12	0.82139	y12	0.89457	y12	0.94550	y12	0.97779	y12	0.99491	y12	1.00000
x13	0.99787	x13	0.96985	x13	0.91858	x13	0.85355	x13	0.78166	x13	0.70771	x13	0.63490
y13	0.54613	y13	0.67101	y13	0.77347	y13	0.85355	y13	0.91312	y13	0.95482	y13	0.98146
x14	0.98091	x14	1.00000	x14	0.98470	x14	0.94550	x14	0.89092	x14	0.82743	x14	0.75979
y14	0.36317	y14	0.50000	y14	0.62274	y14	0.72700	y14	0.81174	y14	0.87787	y14	0.92721
x15	0.89901	x15	0.96985	x15	0.99829	x15	0.99384	x15	0.96544	x15	0.92063	x15	0.86542
y15	0.19868	y15	0.32899	y15	0.45871	y15	0.57822	y15	0.68267	y15	0.77032	y15	0.84128
x16	0.76322	x16	0.88302	x16	0.95789	x16	0.99384	x16	0.99860	x16	0.97975	x16	0.94394
y16	0.07489	y16	0.17861	y16	0.29915	y16	0.42178	y16	0.53737	y16	0.64087	y16	0.73003
x17	0.59187	x17	0.75000	x17	0.86786	x17	0.94550	x17	0.98746	x17	1.00000	x17	0.98954
y17	0.00851	y17	0.06699	y17	0.16136	y17	0.27300	y17	0.38874	y17	0.50000	y17	0.60173
		x18	0.58682	x18	0.73797	x18	0.85355	x18	0.93301	x18	0.97975	x18	0.99883
		y18	0.00760	y18	0.06026	y18	0.14645	y18	0.25000	y18	0.35913	y18	0.46588
				x19	0.58230	x19	0.72700	x19	0.84009	x19	0.92063	x19	0.97113
				y19	0.00682	y19	0.05450	y19	0.13347	y19	0.22968	y19	0.33256
						x20	0.57822	x20	0.71694	x20	0.82743	x20	0.90848
						y20	0.00616	y20	0.04952	y20	0.12213	y20	0.21166
								x21	0.57452	x21	0.70771	x21	0.81554
								y21	0.00558	y21	0.04518	y21	0.11214
										x22	0.57116	x22	0.69920
										y22	0.00509	y22	0.04139
												x23	0.56808
												y23	0.00466
24 Holes		25 Holes		26 Holes		27 Holes		28 Holes					
x1	0.43474	x1	0.43733	x1	0.43973	x1	0.44195	x1	0.44402				
y1	0.00428	y1	0.00394	y1	0.00365	y1	0.00338	y1	0.00314				
x2	0.30866	x2	0.31594	x2	0.32270	x2	0.32899	x2	0.33486				
y2	0.03806	y2	0.03511	y2	0.03249	y2	0.03015	y2	0.02806				
x3	0.19562	x3	0.20611	x3	0.21597	x3	0.22525	x3	0.23398				
y3	0.10332	y3	0.09549	y3	0.08851	y3	0.08226	y3	0.07664				



The diagram shows a type “B” circle for a 5-hole circle. Coordinates *x*, *y* are given in the table for hole circles of from 3 to 28 holes. Dimensions are for holes numbered in a counterclockwise direction (as shown). Dimensions given are based upon a hole circle of unit diameter. For a hole circle of, say, 3-inch or 3-centimeter diameter, multiply table values by 3.

Table 9. (Continued) Hole Coordinate Dimension Factors for Jig Boring — Type “B” Hole Circles (English or Metric Units)

24 Holes		25 Holes		26 Holes		27 Holes		28 Holes	
x4	0.10332	x4	0.11474	x4	0.12574	x4	0.13631	x4	0.14645
y4	0.19562	y4	0.18129	y4	0.16844	y4	0.15688	y4	0.14645
x5	0.03806	x5	0.04759	x5	0.05727	x5	0.06699	x5	0.07664
y5	0.30866	y5	0.28711	y5	0.26764	y5	0.25000	y5	0.23398
x6	0.00428	x6	0.00886	x6	0.01453	x6	0.02101	x6	0.02806
y6	0.43474	y6	0.40631	y6	0.38034	y6	0.35660	y6	0.33486
x7	0.00428	x7	0.00099	x7	0.00000	x7	0.00085	x7	0.00314
y7	0.56526	y7	0.53140	y7	0.50000	y7	0.47093	y7	0.44402
x8	0.03806	x8	0.02447	x8	0.01453	x8	0.00760	x8	0.00314
y8	0.69134	y8	0.65451	y8	0.61966	y8	0.58682	y8	0.55598
x9	0.10332	x9	0.07784	x9	0.05727	x9	0.04089	x9	0.02806
y9	0.80438	y9	0.76791	y9	0.73236	y9	0.69804	y9	0.66514
x10	0.19562	x10	0.15773	x10	0.12574	x10	0.09894	x10	0.07664
y10	0.89668	y10	0.86448	y10	0.83156	y10	0.79858	y10	0.76602
x11	0.30866	x11	0.25912	x11	0.21597	x11	0.17861	x11	0.14645
y11	0.96194	y11	0.93815	y11	0.91149	y11	0.88302	y11	0.85355
x12	0.43474	x12	0.37566	x12	0.32270	x12	0.27560	x12	0.23398
y12	0.99572	y12	0.98429	y12	0.96751	y12	0.94682	y12	0.92336
x13	0.56526	x13	0.50000	x13	0.43973	x13	0.38469	x13	0.33486
y13	0.99572	y13	1.00000	y13	0.99635	y13	0.98652	y13	0.97194
x14	0.69134	x14	0.62434	x14	0.56027	x14	0.50000	x14	0.44402
y14	0.96194	y14	0.98429	y14	0.99635	y14	1.00000	y14	0.99686
x15	0.80438	x15	0.74088	x15	0.67730	x15	0.61531	x15	0.55598
y15	0.89668	y15	0.93815	y15	0.96751	y15	0.98652	y15	0.99686
x16	0.89668	x16	0.84227	x16	0.78403	x16	0.72440	x16	0.66514
y16	0.80438	y16	0.86448	y16	0.91149	y16	0.94682	y16	0.97194
x17	0.96194	x17	0.92216	x17	0.87426	x17	0.82139	x17	0.76602
y17	0.69134	y17	0.76791	y17	0.83156	y17	0.88302	y17	0.92336
x18	0.99572	x18	0.97553	x18	0.94273	x18	0.90106	x18	0.85355
y18	0.56526	y18	0.65451	y18	0.73236	y18	0.79858	y18	0.85355
x19	0.99572	x19	0.99901	x19	0.98547	x19	0.95911	x19	0.92336
y19	0.43474	y19	0.53140	y19	0.61966	y19	0.69804	y19	0.76602
x20	0.96194	x20	0.99114	x20	1.00000	x20	0.99240	x20	0.97194
y20	0.30866	y20	0.40631	y20	0.50000	y20	0.58682	y20	0.66514
x21	0.89668	x21	0.95241	x21	0.98547	x21	0.99915	x21	0.99686
y21	0.19562	y21	0.28711	y21	0.38034	y21	0.47093	y21	0.55598
x22	0.80438	x22	0.88526	x22	0.94273	x22	0.97899	x22	0.99686
y22	0.10332	y22	0.18129	y22	0.26764	y22	0.35660	y22	0.44402
x23	0.69134	x23	0.79389	x23	0.87426	x23	0.93301	x23	0.97194
y23	0.03806	y23	0.09549	y23	0.16844	y23	0.25000	y23	0.33486
x24	0.56526	x24	0.68406	x24	0.78403	x24	0.86369	x24	0.92336
y24	0.00428	y24	0.03511	y24	0.08851	y24	0.15688	y24	0.23398
		x25	0.56267	x25	0.67730	x25	0.77475	x25	0.85355
		y25	0.00394	y25	0.03249	y25	0.08226	y25	0.14645
				x26	0.56027	x26	0.67101	x26	0.76602
				y26	0.00365	y26	0.03015	y26	0.07664
						x27	0.55805	x27	0.66514
						y27	0.00338	y27	0.02806
								x28	0.55598
								y28	0.00314



The diagram shows a type “B” circle for a 5-hole circle. Coordinates x , y are given in the table for hole circles of from 3 to 28 holes. Dimensions are for holes numbered in a counterclockwise direction (as shown). Dimensions given are based upon a hole circle of unit diameter. For a hole circle of, say, 3-inch or 3-centimeter diameter, multiply table values by 3.

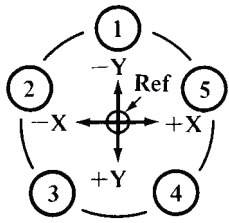
Table 10. Hole Coordinate Dimension Factors for Jig Boring — Type “A” Hole Circles, Central Coordinates (English or Metric Units)

The diagram shows a type “A” circle for a 5-hole circle. Coordinates x , y are given in the table for hole circles of from 3 to 28 holes. Dimensions are for holes numbered in a counterclockwise direction (as shown). Dimensions given are based upon a hole circle of unit diameter. For a hole circle of, say, 3-inch or 3-centimeter diameter, multiply table values by 3.

3 Holes		4 Holes		5 Holes		6 Holes		7 Holes		8 Holes		9 Holes	
x_1	0.00000	x_1	0.00000	x_1	0.00000	x_1	0.00000	x_1	0.00000	x_1	0.00000	x_1	0.00000
y_1	-0.50000	y_1	-0.50000	y_1	-0.50000	y_1	-0.50000	y_1	-0.50000	y_1	-0.50000	y_1	-0.50000
x_2	-0.43301	x_2	-0.50000	x_2	-0.47553	x_2	-0.43301	x_2	-0.39092	x_2	-0.35355	x_2	-0.32139
y_2	+0.25000	y_2	0.00000	y_2	-0.15451	y_2	-0.25000	y_2	-0.31174	y_2	-0.35355	y_2	-0.38302
x_3	+0.43301	x_3	0.00000	x_3	-0.29389	x_3	-0.43301	x_3	-0.48746	x_3	-0.50000	x_3	-0.49240
y_3	+0.25000	y_3	+0.50000	y_3	+0.40451	y_3	+0.25000	y_3	+0.11126	y_3	0.00000	y_3	-0.08682
		x_4	+0.50000	x_4	+0.29389	x_4	0.00000	x_4	-0.21694	x_4	-0.35355	x_4	-0.43301
		y_4	0.00000	y_4	+0.40451	y_4	+0.50000	y_4	+0.45048	y_4	+0.35355	y_4	+0.25000
				x_5	+0.47553	x_5	+0.43301	x_5	+0.21694	x_5	0.00000	x_5	-0.17101
				y_5	-0.15451	y_5	+0.25000	y_5	+0.45048	y_5	+0.50000	y_5	+0.46985
						x_6	+0.43301	x_6	+0.48746	x_6	+0.35355	x_6	+0.17101
						y_6	-0.25000	y_6	+0.11126	y_6	+0.35355	y_6	+0.46985
								x_7	+0.39092	x_7	+0.50000	x_7	+0.43301
								y_7	-0.31174	y_7	0.00000	y_7	+0.25000
										x_8	+0.35355	x_8	+0.49240
										y_8	-0.35355	y_8	-0.08682
												x_9	+0.32139
												y_9	-0.38302
10 Holes		11 Holes		12 Holes		13 Holes		14 Holes		15 Holes		16 Holes	
x_1	0.00000	x_1	0.00000	x_1	0.00000	x_1	0.00000	x_1	0.00000	x_1	0.00000	x_1	0.00000
y_1	-0.50000	y_1	-0.50000	y_1	-0.50000	y_1	-0.50000	y_1	-0.50000	y_1	-0.50000	y_1	-0.50000
x_2	-0.29389	x_2	-0.27032	x_2	-0.25000	x_2	-0.23236	x_2	-0.21694	x_2	-0.20337	x_2	-0.19134
y_2	-0.40451	y_2	-0.42063	y_2	-0.43301	y_2	-0.44273	y_2	-0.45048	y_2	-0.45677	y_2	-0.46194
x_3	-0.47553	x_3	-0.45482	x_3	-0.43301	x_3	-0.41149	x_3	-0.39092	x_3	-0.37157	x_3	-0.35355
y_3	-0.15451	y_3	-0.20771	y_3	-0.25000	y_3	-0.28403	y_3	-0.31174	y_3	-0.33457	y_3	-0.35355
x_4	-0.47553	x_4	-0.49491	x_4	-0.50000	x_4	-0.49635	x_4	-0.48746	x_4	-0.47553	x_4	-0.46194
y_4	+0.15451	y_4	+0.07116	y_4	0.00000	y_4	-0.06027	y_4	-0.11126	y_4	-0.15451	y_4	-0.19134
x_5	-0.29389	x_5	-0.37787	x_5	-0.43301	x_5	-0.46751	x_5	-0.48746	x_5	-0.49726	x_5	-0.50000
y_5	+0.40451	y_5	+0.32743	y_5	+0.25000	y_5	+0.17730	y_5	+0.11126	y_5	+0.05226	y_5	0.00000
x_6	0.00000	x_6	-0.14087	x_6	-0.25000	x_6	-0.33156	x_6	-0.39092	x_6	-0.43301	x_6	-0.46194
y_6	+0.50000	y_6	+0.47975	y_6	+0.43301	y_6	+0.37426	y_6	+0.31174	y_6	+0.25000	y_6	+0.19134
x_7	+0.29389	x_7	+0.14087	x_7	0.00000	x_7	-0.11966	x_7	-0.21694	x_7	-0.29389	x_7	-0.35355
y_7	+0.40451	y_7	+0.47975	y_7	+0.50000	y_7	+0.48547	y_7	+0.45048	y_7	+0.40451	y_7	+0.35355
x_8	+0.47553	x_8	+0.37787	x_8	+0.25000	x_8	+0.11966	x_8	0.00000	x_8	-0.10396	x_8	-0.19134
y_8	+0.15451	y_8	+0.32743	y_8	+0.43301	y_8	+0.48547	y_8	+0.50000	y_8	+0.48907	y_8	+0.46194
x_9	+0.47553	x_9	+0.49491	x_9	+0.43301	x_9	+0.33156	x_9	+0.21694	x_9	+0.10396	x_9	0.00000
y_9	-0.15451	y_9	+0.07116	y_9	+0.25000	y_9	+0.37426	y_9	+0.45048	y_9	+0.48907	y_9	+0.50000
x_{10}	+0.29389	x_{10}	+0.45482	x_{10}	+0.50000	x_{10}	+0.46751	x_{10}	+0.39092	x_{10}	+0.29389	x_{10}	+0.19134
y_{10}	-0.40451	y_{10}	-0.20771	y_{10}	0.00000	y_{10}	+0.17730	y_{10}	+0.31174	y_{10}	+0.40451	y_{10}	+0.46194
		x_{11}	+0.27032	x_{11}	+0.43301	x_{11}	+0.49635	x_{11}	+0.48746	x_{11}	+0.43301	x_{11}	+0.35355
		y_{11}	-0.42063	y_{11}	-0.25000	y_{11}	-0.06027	y_{11}	+0.11126	y_{11}	+0.25000	y_{11}	+0.35355
				x_{12}	+0.41149	x_{12}	+0.41149	x_{12}	+0.48746	x_{12}	+0.49726	x_{12}	+0.46194
				y_{12}	-0.43301	y_{12}	-0.28403	y_{12}	-0.11126	y_{12}	+0.05226	y_{12}	+0.19134
						x_{13}	+0.23236	x_{13}	+0.39092	x_{13}	+0.47553	x_{13}	+0.50000
						y_{13}	-0.44273	y_{13}	-0.31174	y_{13}	-0.15451	y_{13}	0.00000
								x_{14}	+0.21694	x_{14}	+0.37157	x_{14}	+0.46194
								y_{14}	-0.45048	y_{14}	-0.33457	y_{14}	-0.19134
										x_{15}	+0.20337	x_{15}	+0.35355
										y_{15}	-0.45677	y_{15}	-0.35355
												x_{16}	+0.19134
												y_{16}	-0.46194

Table 10. (Continued) Hole Coordinate Dimension Factors for Jig Boring — Type “A” Hole Circles, Central Coordinates (English or Metric Units)

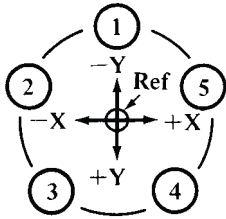
17 Holes		18 Holes		19 Holes		20 Holes		21 Holes		22 Holes		23 Holes	
x1	0.00000	x1	0.00000	x1	0.00000	x1	0.000000	x1	0.000000	x1	0.000000	x1	0.000000
y1	-0.50000	y1	-0.50000	y1	-0.50000	y1	-0.500000	y1	-0.500000	y1	-0.500000	y1	-0.500000
x2	-0.18062	x2	-0.17101	x2	-0.16235	x2	-0.15451	x2	-0.14738	x2	-0.14087	x2	-0.13490
y2	-0.46624	y2	-0.46985	y2	-0.47291	y2	-0.47553	y2	-0.47779	y2	-0.47975	y2	-0.48146
x3	-0.33685	x3	+0.32139	x3	-0.30711	x3	-0.29389	x3	-0.28166	x3	-0.27032	x3	-0.25979
y3	-0.36950	y3	-0.38302	y3	-0.39457	y3	-0.40451	y3	-0.41312	y3	-0.42063	y3	-0.42721
x4	-0.44758	x4	-0.43301	x4	-0.41858	x4	-0.40451	x4	-0.39092	x4	-0.37787	x4	-0.36542
y4	-0.22287	y4	-0.25000	y4	-0.27347	y4	-0.29389	y4	-0.31174	y4	-0.32743	y4	-0.34128
x5	-0.49787	x5	-0.49240	x5	-0.48470	x5	-0.47553	x5	-0.46544	x5	-0.45482	x5	-0.44394
y5	-0.04613	y5	-0.08682	y5	-0.12274	y5	-0.15451	y5	-0.18267	y5	-0.20771	y5	-0.23003
x6	-0.48091	x6	-0.49420	x6	-0.49829	x6	-0.50000	x6	-0.49860	x6	-0.49491	x6	-0.48954
y6	+0.13683	y6	+0.08682	y6	+0.04129	y6	0.00000	y6	-0.03737	y6	-0.07116	y6	-0.10173
x7	-0.39901	x7	-0.43301	x7	-0.45789	x7	-0.47553	x7	-0.48746	x7	-0.49491	x7	-0.49883
y7	+0.30132	y7	+0.25000	y7	+0.20085	y7	+0.15451	y7	+0.11126	y7	+0.07116	y7	+0.03412
x8	-0.26322	x8	-0.32139	x8	-0.36786	x8	-0.40451	x8	-0.43301	x8	-0.45482	x8	-0.47113
y8	+0.42511	y8	+0.38302	y8	+0.33864	y8	+0.29389	y8	+0.25000	y8	+0.20771	y8	+0.16744
x9	-0.09187	x9	-0.17101	x9	-0.23797	x9	-0.29389	x9	-0.34009	x9	-0.37787	x9	-0.40848
y9	+0.49149	y9	+0.46985	y9	+0.43974	y9	+0.40451	y9	+0.36653	y9	+0.32743	y9	+0.28834
x10	+0.09187	x10	0.00000	x10	-0.08230	x10	-0.15451	x10	-0.21694	x10	-0.27032	x10	-0.31554
y10	+0.49149	y10	+0.50000	y10	+0.49318	y10	+0.47553	y10	+0.45048	y10	+0.42063	y10	+0.38786
x11	+0.26322	x11	+0.17101	x11	+0.08230	x11	0.00000	x11	-0.07452	x11	-0.14087	x11	-0.19920
y11	+0.42511	y11	+0.46985	y11	+0.49318	y11	+0.50000	y11	+0.49442	y11	+0.47975	y11	+0.45861
x12	+0.39901	x12	+0.32139	x12	+0.23797	x12	+0.15451	x12	+0.07452	x12	0.00000	x12	-0.06808
y12	+0.30132	y12	+0.38302	y12	+0.43974	y12	+0.47553	y12	+0.49442	y12	+0.50000	y12	+0.49534
x13	+0.48091	x13	+0.43301	x13	+0.36786	x13	+0.29389	x13	+0.21694	x13	+0.14087	x13	+0.06808
y13	+0.13683	y13	+0.25000	y13	+0.33864	y13	+0.40451	y13	+0.45048	y13	+0.47975	y13	+0.49534
x14	-0.49787	x14	-0.49240	x14	+0.45789	x14	+0.40451	x14	+0.34009	x14	+0.27032	x14	+0.19920
y14	-0.04613	y14	+0.08682	y14	+0.20085	y14	+0.29389	y14	+0.36653	y14	+0.42063	y14	+0.45861
x15	+0.44758	x15	+0.49240	x15	+0.49829	x15	+0.47553	x15	+0.43301	x15	+0.37787	x15	+0.31554
y15	-0.22287	y15	-0.08682	y15	+0.04129	y15	+0.15451	y15	+0.25000	y15	+0.32743	y15	+0.38786
x16	+0.33685	x16	-0.43301	x16	+0.48470	x16	+0.50000	x16	+0.48746	x16	+0.45482	x16	+0.40848
y16	-0.36950	y16	-0.25000	y16	-0.12274	y16	0.00000	y16	+0.11126	y16	+0.20771	y16	+0.28834
x17	+0.18062	x17	+0.32139	x17	+0.41858	x17	+0.47553	x17	+0.49860	x17	+0.49491	x17	+0.47113
y17	-0.46624	y17	-0.38302	y17	-0.27347	y17	-0.15451	y17	-0.03737	y17	+0.07116	y17	+0.16744
		y18	+0.17101	x18	+0.30711	x18	+0.40451	x18	+0.46544	x18	+0.49491	x18	+0.49883
		y18	-0.46985	y18	-0.39457	y18	-0.29389	y18	-0.18267	y18	-0.07116	y18	+0.03412
				x19	+0.16235	x19	+0.29389	x19	+0.39092	x19	+0.45482	x19	+0.48954
				y19	-0.47291	y19	-0.40451	y19	-0.31174	y19	-0.20771	y19	-0.10173
						x20	+0.15451	x20	+0.28166	x20	+0.37787	x20	+0.44394
						y20	-0.47553	y20	-0.41312	y20	-0.32743	y20	-0.23003
								x21	+0.14738	x21	+0.27032	x21	+0.36542
								y21	-0.47779	y21	-0.42063	y21	-0.34128
										x22	+0.14087	x22	+0.25979
										y22	-0.47975	y22	-0.42721
												x23	+0.13490
												y23	-0.48146
24 Holes		25 Holes		26 Holes		27 Holes		28 Holes					
x1	0.00000	x1	0.00000	x1	0.00000	x1	0.00000	x1	0.00000				
y1	-0.50000	y1	-0.50000	y1	-0.50000	y1	-0.50000	y1	-0.50000				
x2	-0.12941	x2	-0.12434	x2	-0.11966	x2	-0.11531	x2	-0.11126				
y2	-0.48296	y2	-0.48429	y2	-0.48547	y2	-0.48652	y2	-0.48746				
x3	-0.25000	x3	-0.24088	x3	-0.23236	x3	-0.22440	x3	-0.21694				
y3	-0.43301	y3	-0.43815	y3	-0.44273	y3	-0.44682	y3	-0.45048				



The diagram shows a type “A” circle for a 5-hole circle. Coordinates x, y are given in the table for hole circles of from 3 to 28 holes. Dimensions are for holes numbered in a counterclockwise direction (as shown). Dimensions given are based upon a hole circle of unit diameter. For a hole circle of, say, 3-inch or 3-centimeter diameter, multiply table values by 3.

Table 10. (Continued) Hole Coordinate Dimension Factors for Jig Boring — Type “A” Hole Circles, Central Coordinates (English or Metric Units)

24 Holes		25 Holes		26 Holes		27 Holes		28 Holes	
x4	-0.35355	x4	-0.34227	x4	-0.33156	x4	-0.32139	x4	-0.31174
y4	-0.35355	y4	-0.36448	y4	-0.37426	y4	-0.38302	y4	-0.39092
x5	-0.43301	x5	-0.42216	x5	-0.41149	x5	-0.40106	x5	-0.39092
y5	-0.25000	y5	-0.26791	y5	-0.28403	y5	-0.29858	y5	-0.31174
x6	-0.48296	x6	-0.47553	x6	-0.46751	x6	-0.45911	x6	-0.45048
y6	-0.12941	y6	-0.15451	y6	-0.17730	y6	-0.19804	y6	-0.21694
x7	-0.50000	x7	-0.49901	x7	-0.49635	x7	-0.49240	x7	-0.48746
y7	0.00000	y7	-0.03140	y7	-0.06027	y7	-0.08682	y7	-0.11126
x8	-0.48296	x8	-0.49114	x8	-0.49635	x8	-0.49915	x8	-0.50000
y8	+0.12941	y8	+0.09369	y8	+0.06027	y8	+0.02907	y8	0.00000
x9	-0.43301	x9	-0.45241	x9	-0.46751	x9	-0.47899	x9	-0.48746
y9	+0.25000	y9	+0.21289	y9	+0.17730	y9	+0.14340	y9	+0.11126
x10	-0.35355	x10	-0.38526	x10	-0.41149	x10	-0.43301	x10	-0.45048
y10	+0.35355	y10	+0.31871	y10	+0.28403	y10	+0.25000	y10	+0.21694
x11	-0.25000	x11	-0.29389	x11	-0.33156	x11	-0.36369	x11	-0.39092
y11	+0.43301	y11	+0.40451	y11	+0.37426	y11	+0.34312	y11	+0.31174
x12	-0.12941	x12	-0.18406	x12	-0.23236	x12	-0.27475	x12	-0.31174
y12	+0.48296	y12	+0.46489	y12	+0.44273	y12	+0.41774	y12	+0.39092
x13	0.00000	x13	-0.06267	x13	-0.11966	x13	-0.17101	x13	-0.21694
y13	+0.50000	y13	+0.49606	y13	+0.48547	y13	+0.46985	y13	+0.45048
x14	+0.12941	x14	+0.06267	x14	0.00000	x14	-0.05805	x14	-0.11126
y14	+0.48296	y14	+0.49606	y14	+0.50000	y14	+0.49662	y14	+0.48746
x15	+0.25000	x15	+0.18406	x15	+0.11966	x15	+0.05805	x15	0.00000
y15	+0.43301	y15	+0.46489	y15	+0.48547	y15	+0.49662	y15	+0.50000
x16	+0.35355	x16	+0.29389	x16	+0.23236	x16	+0.17101	x16	+0.11126
y16	+0.35355	y16	+0.40451	y16	+0.44273	y16	+0.46985	y16	+0.48746
x17	+0.43301	x17	+0.38526	x17	+0.33156	x17	+0.27475	x17	+0.21694
y17	+0.25000	y17	+0.31871	y17	+0.37426	y17	+0.41774	y17	+0.45048
x18	+0.48296	x18	+0.45241	x18	+0.41149	x18	+0.36369	x18	+0.31174
y18	+0.12941	y18	+0.21289	y18	+0.28403	y18	+0.34312	y18	+0.39092
x19	+0.50000	x19	+0.49114	x19	+0.46751	x19	+0.43301	x19	+0.39092
y19	0.00000	y19	+0.09369	y19	+0.17730	y19	+0.25000	y19	+0.31174
x20	+0.48296	x20	+0.49901	x20	+0.49635	x20	+0.47899	x20	+0.45048
y20	-0.12941	y20	-0.03140	y20	+0.06027	y20	+0.14340	y20	+0.21694
x21	+0.43301	x21	+0.47553	x21	+0.49635	x21	+0.49915	x21	+0.48746
y21	-0.25000	y21	-0.15451	y21	-0.06027	y21	+0.02907	y21	+0.11126
x22	+0.35355	x22	+0.42216	x22	+0.46751	x22	+0.49240	x22	+0.50000
y22	-0.35355	y22	-0.26791	y22	-0.17730	y22	-0.08682	y22	0.00000
x23	+0.25000	x23	+0.34227	x23	+0.41149	x23	+0.45911	x23	+0.48746
y23	-0.43301	y23	-0.36448	y23	-0.28403	y23	-0.19804	y23	-0.11126
x24	+0.12941	x24	+0.24088	x24	+0.33156	x24	+0.40106	x24	+0.45048
y24	-0.48296	y24	-0.43815	y24	-0.37426	y24	-0.29858	y24	-0.21694
		x25	+0.12434	x25	+0.23236	x25	+0.32139	x25	+0.39092
		y25	-0.48429	y25	-0.44273	y25	-0.38302	y25	-0.31174
				x26	+0.11966	x26	+0.22440	x26	+0.31174
				y26	-0.48547	y26	-0.44682	y26	-0.39092
						x27	+0.11531	x27	+0.21694
						y27	-0.48652	y27	-0.45048
								x28	+0.11126
								y28	-0.48746



The diagram shows a type “A” circle for a 5-hole circle. Coordinates x , y are given in the table for hole circles of from 3 to 28 holes. Dimensions are for holes numbered in a counterclockwise direction (as shown). Dimensions given are based upon a hole circle of unit diameter. For a hole circle of, say, 3-inch or 3-centimeter diameter, multiply table values by 3.

Table 11. Hole Coordinate Dimension Factors for Jig Boring — Type “B” Hole Circles Central Coordinates (English or Metric units)

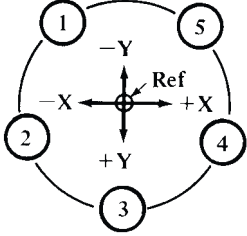
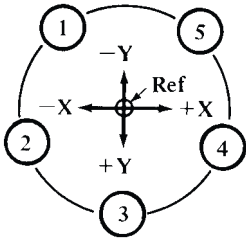
						
<p>The diagram shows a type “B” circle for a 5-hole circle. Coordinates x, y are given in the table for hole circles of from 3 to 28 holes. Dimensions are for holes numbered in a counterclockwise direction (as shown). Dimensions given are based upon a hole circle of unit diameter. For a hole circle of, say, 3-inch or 3-centimeter diameter, multiply table values by 3.</p>						
3 Holes	4 Holes	5 Holes	6 Holes	7 Holes	8 Holes	9 Holes
x_1 -0.43301	x_1 -0.35355	x_1 -0.29389	x_1 -0.25000	x_1 -0.21694	x_1 -0.19134	x_1 -0.17101
y_1 -0.25000	y_1 -0.35355	y_1 -0.40451	y_1 -0.43301	y_1 -0.45048	y_1 -0.46194	y_1 -0.46985
x_2 0.00000	x_2 -0.35355	x_2 -0.47553	x_2 -0.50000	x_2 -0.48746	x_2 -0.46194	x_2 -0.43301
y_2 +0.50000	y_2 +0.35355	y_2 +0.15451	y_2 0.00000	y_2 -0.11126	y_2 -0.19134	y_2 -0.25000
x_3 +0.43301	x_3 +0.35355	x_3 0.00000	x_3 -0.25000	x_3 -0.39092	x_3 -0.46194	x_3 -0.49240
y_3 -0.25000	y_3 +0.35355	y_3 +0.50000	y_3 +0.43301	y_3 +0.31174	y_3 +0.19134	y_3 +0.08682
	x_4 +0.35355	x_4 +0.47553	x_4 +0.25000	x_4 0.00000	x_4 -0.19134	x_4 -0.32139
	y_4 -0.35355	y_4 +0.15451	y_4 +0.43301	y_4 +0.50000	y_4 +0.46194	y_4 +0.38302
		x_5 +0.29389	x_5 +0.50000	x_5 +0.39092	x_5 +0.19134	x_5 0.00000
		y_5 -0.40451	y_5 0.00000	y_5 +0.31174	y_5 +0.46194	y_5 +0.50000
			x_6 +0.25000	x_6 +0.48746	x_6 +0.46194	x_6 +0.32139
			y_6 -0.43301	y_6 -0.11126	y_6 +0.19134	y_6 +0.38302
				x_7 +0.21694	x_7 +0.46194	x_7 +0.49240
				y_7 -0.45048	y_7 -0.19134	y_7 +0.08682
					x_8 +0.19134	x_8 +0.43301
					y_8 -0.46194	y_8 -0.25000
						x_9 +0.17101
						y_9 -0.46985
10 Holes	11 Holes	12 Holes	13 Holes	14 Holes	15 Holes	16 Holes
x_1 -0.15451	x_1 -0.14087	x_1 -0.12941	x_1 -0.11966	x_1 -0.11126	x_1 -0.10396	x_1 -0.09755
y_1 -0.47553	y_1 -0.47975	y_1 -0.48296	y_1 -0.48547	y_1 -0.48746	y_1 -0.48907	y_1 -0.49039
x_2 -0.40451	x_2 -0.37787	x_2 -0.35355	x_2 -0.33156	x_2 -0.31174	x_2 -0.29389	x_2 -0.27779
y_2 -0.29389	y_2 -0.32743	y_2 -0.35355	y_2 -0.37426	y_2 -0.39092	y_2 -0.40451	y_2 -0.41573
x_3 -0.50000	x_3 -0.49491	x_3 -0.48296	x_3 -0.46751	x_3 -0.45048	x_3 -0.43301	x_3 -0.41573
y_3 0.00000	y_3 -0.07116	y_3 -0.12941	y_3 -0.17730	y_3 -0.21694	y_3 -0.25000	y_3 -0.27779
x_4 -0.40451	x_4 -0.45482	x_4 -0.48296	x_4 -0.49635	x_4 -0.50000	x_4 -0.49726	x_4 -0.49039
y_4 +0.29389	y_4 +0.20771	y_4 +0.12941	y_4 +0.06027	y_4 0.00000	y_4 -0.05226	y_4 -0.09755
x_5 -0.15451	x_5 -0.27032	x_5 -0.35355	x_5 -0.41149	x_5 -0.45048	x_5 -0.47553	x_5 -0.49039
y_5 +0.47553	y_5 +0.42063	y_5 +0.35355	y_5 +0.28403	y_5 +0.21694	y_5 +0.15451	y_5 +0.09755
x_6 +0.15451	x_6 0.00000	x_6 -0.12941	x_6 -0.23236	x_6 -0.31174	x_6 -0.37157	x_6 -0.41573
y_6 +0.47553	y_6 +0.50000	y_6 +0.48296	y_6 +0.44273	y_6 +0.39092	y_6 +0.33457	y_6 +0.27779
x_7 +0.40451	x_7 +0.27032	x_7 +0.12941	x_7 0.00000	x_7 -0.11126	x_7 -0.20337	x_7 -0.27779
y_7 +0.29389	y_7 +0.42063	y_7 +0.48296	y_7 +0.50000	y_7 +0.48746	y_7 +0.45677	y_7 +0.41573
x_8 +0.50000	x_8 +0.45482	x_8 +0.35355	x_8 +0.23236	x_8 +0.11126	x_8 0.00000	x_8 -0.09755
y_8 0.00000	y_8 +0.20771	y_8 +0.35355	y_8 +0.44273	y_8 +0.48746	y_8 +0.50000	y_8 +0.49039
x_9 +0.40451	x_9 +0.49491	x_9 +0.48296	x_9 +0.41149	x_9 +0.31174	x_9 +0.20337	x_9 +0.09755
y_9 -0.29389	y_9 -0.07116	y_9 +0.12941	y_9 +0.28403	y_9 +0.39092	y_9 +0.45677	y_9 +0.49039
x_{10} +0.15451	x_{10} +0.37787	x_{10} +0.48296	x_{10} +0.49635	x_{10} +0.45048	x_{10} +0.37157	x_{10} +0.27779
y_{10} -0.47553	y_{10} -0.32743	y_{10} -0.12941	y_{10} +0.06027	y_{10} +0.21694	y_{10} +0.33457	y_{10} +0.41573
	x_{11} +0.14087	x_{11} +0.35355	x_{11} +0.46751	x_{11} +0.50000	x_{11} +0.47553	x_{11} +0.41573
	y_{11} -0.47975	y_{11} -0.35355	y_{11} -0.17730	y_{11} 0.00000	y_{11} +0.15451	y_{11} +0.27779
		x_{12} +0.12941	x_{12} +0.33156	x_{12} +0.45048	x_{12} +0.49726	x_{12} +0.49039
		y_{12} -0.48296	y_{12} -0.37426	y_{12} -0.21694	y_{12} -0.05226	y_{12} +0.09755
			x_{13} +0.11966	x_{13} +0.31174	x_{13} +0.43301	x_{13} +0.49039
			y_{13} -0.48547	y_{13} -0.39092	y_{13} -0.25000	y_{13} -0.09755
				x_{14} +0.11126	x_{14} +0.29389	x_{14} +0.41573
				y_{14} -0.48746	y_{14} -0.40451	y_{14} -0.27779
					x_{15} +0.10396	x_{15} +0.27779
					y_{15} -0.48907	y_{15} -0.41573
						x_{16} +0.09755
						y_{16} -0.49039

Table 11. (Continued) Hole Coordinate Dimension Factors for Jig Boring — Type “B” Hole Circles Central Coordinates (English or Metric units)

24 Holes		25 Holes		26 Holes		27 Holes		28 Holes	
x4 -0.39668	x4 -0.30438	x4 -0.38526	y4 -0.31871	x4 -0.37426	y4 -0.33156	x4 -0.36369	y4 -0.34312	x4 -0.35355	y4 -0.35355
x5 -0.46194	x5 -0.49572	x5 -0.45241	y5 -0.21289	x5 -0.44273	y5 -0.23236	x5 -0.43301	y5 -0.25000	x5 -0.42336	y5 -0.26602
y5 -0.19134	y6 -0.06526	y6 -0.09369	x6 -0.49114	x6 -0.48547	y6 -0.11966	x6 -0.47899	y6 -0.14340	x6 -0.47194	y6 -0.16514
x6 -0.49572	x7 -0.49572	x7 -0.49901	x6 -0.49114	x7 -0.50000	x7 -0.50000	x7 -0.49915	x7 -0.49915	x7 -0.49686	x7 -0.49686
y6 -0.06526	y7 +0.06526	y7 +0.03140	x7 -0.49901	y7 0.00000	y7 0.00000	y7 -0.02907	y7 -0.02907	y7 -0.05598	y7 -0.05598
x7 -0.49572	x8 -0.46194	x8 -0.47553	y7 +0.03140	x8 -0.48547	x8 -0.48547	x8 -0.49240	x8 -0.49240	x8 -0.49686	x8 -0.49686
y7 +0.06526	y8 +0.19134	y8 +0.15451	x8 -0.47553	x9 +0.11966	x9 +0.11966	x9 +0.08682	x9 +0.08682	y8 +0.05598	y8 +0.05598
x8 -0.46194	x9 -0.39668	x9 -0.42216	y8 +0.15451	x9 -0.44273	x9 -0.44273	x9 -0.45911	x9 -0.45911	x9 -0.47194	x9 -0.47194
y8 +0.19134	y9 +0.30438	y9 +0.26791	x9 -0.42216	y9 +0.23236	y9 +0.23236	y9 +0.19804	y9 +0.19804	y9 +0.16514	y9 +0.16514
x9 -0.39668	x10 -0.30438	x10 -0.34227	y9 +0.26791	x10 -0.37426	x10 -0.37426	x10 -0.40106	x10 -0.40106	x10 -0.42336	x10 -0.42336
x10 -0.30438	x11 -0.19134	x11 -0.24088	x10 -0.34227	x11 -0.28403	x11 -0.28403	x11 -0.32139	x11 -0.32139	x11 -0.35355	x11 -0.35355
y10 +0.39668	y11 +0.46194	y11 +0.43815	x11 -0.24088	x12 -0.17730	x12 -0.17730	x12 -0.22440	x12 -0.22440	x12 -0.26602	x12 -0.26602
x11 -0.19134	x12 -0.06526	x12 +0.48429	x12 -0.17730	x13 -0.06027	x13 -0.06027	x13 -0.11531	x13 -0.11531	x13 -0.16514	x13 -0.16514
y11 +0.46194	y12 +0.49572	y12 +0.48429	x12 -0.06526	x14 +0.06027	x14 +0.06027	x14 +0.48652	x14 +0.48652	x14 +0.47194	x14 +0.47194
x12 -0.06526	x13 +0.06526	x13 0.00000	y12 +0.49572	x15 +0.17730	x15 +0.17730	x15 +0.11531	x15 +0.11531	x15 +0.05598	x15 +0.05598
y12 +0.49572	y13 +0.49572	y13 +0.50000	x13 +0.06526	x16 +0.46751	x16 +0.46751	x16 +0.48652	x16 +0.48652	x16 +0.49686	x16 +0.49686
x13 +0.06526	x14 +0.19134	x14 +0.12434	y13 +0.49572	x17 +0.37426	x17 +0.37426	x17 +0.32139	x17 +0.32139	x17 +0.26602	x17 +0.26602
y13 +0.49572	x15 +0.46194	x15 +0.48429	x14 +0.19134	x18 +0.33156	x18 +0.33156	x18 +0.38302	x18 +0.38302	x18 +0.42336	x18 +0.42336
x14 +0.19134	x16 +0.39668	x16 +0.34227	x15 +0.46194	x19 +0.48547	x19 +0.48547	x19 +0.45911	x19 +0.45911	x19 +0.42336	x19 +0.42336
y14 +0.46194	y15 +0.39668	y15 +0.43815	x16 +0.39668	x20 +0.50000	x20 +0.50000	x20 +0.49240	x20 +0.49240	x20 +0.47194	x20 +0.47194
x15 +0.30438	x16 +0.30438	x17 +0.42216	y15 +0.39668	x21 +0.48547	x21 +0.48547	x21 +0.49915	x21 +0.49915	x21 +0.49686	x21 +0.49686
y15 +0.39668	y16 +0.30438	y17 +0.42216	x16 +0.30438	x22 +0.44273	x22 +0.44273	x22 +0.47899	x22 +0.47899	x22 +0.49686	x22 +0.49686
x16 +0.30438	x17 +0.46194	x18 +0.47553	y16 +0.30438	x23 +0.23236	x23 +0.23236	x23 -0.14340	x23 -0.14340	x23 -0.05598	x23 -0.05598
y16 +0.30438	y17 +0.46194	y18 +0.47553	x17 +0.46194	x24 +0.28403	x24 +0.28403	x24 +0.36369	x24 +0.36369	x24 +0.42336	x24 +0.42336
x17 +0.46194	x18 +0.19134	x19 +0.49572	y17 +0.46194	x25 +0.17730	x25 +0.17730	x25 +0.27475	x25 +0.27475	x25 +0.35355	x25 +0.35355
y17 +0.46194	x19 +0.49572	x20 +0.49114	x18 +0.19134	x26 +0.06027	x26 +0.06027	x26 +0.17101	x26 +0.17101	x26 +0.26602	x26 +0.26602
x18 +0.49572	x20 +0.49572	x21 +0.49901	x19 +0.49572	x27 +0.05805	x27 +0.05805	x27 +0.05805	x27 +0.05805	x27 +0.16514	x27 +0.16514
y18 +0.06526	y19 -0.06526	y20 +0.03140	x20 +0.49572	x28 -0.49662	x28 -0.49662	x28 -0.49662	x28 -0.49662	x28 +0.05598	x28 +0.05598
x20 +0.46194	x21 +0.39668	x22 +0.45241	y19 -0.06526	y25 -0.49606	y25 -0.49606	y25 -0.49606	y25 -0.49606	x28 +0.05598	x28 +0.05598
x21 +0.39668	x22 -0.30438	x23 -0.40451	x21 +0.39668					y28 -0.49686	y28 -0.49686
y21 -0.30438	x23 +0.30438	x24 +0.18406	x22 -0.30438						
x22 +0.30438	y22 -0.39668	y24 -0.46489	x23 +0.30438						
y22 -0.39668	x24 -0.49572	x25 +0.06267	y22 -0.39668						
x23 +0.19134		y25 -0.49606	x24 -0.49572						
y23 -0.46194									
x24 +0.06526									
y24 -0.49572									



The diagram shows a type “B” circle for a 5-hole circle. Coordinates x , y are given in the table for hole circles of from 3 to 28 holes. Dimensions are for holes numbered in a counterclockwise direction (as shown). Dimensions given are based upon a hole circle of unit diameter. For a hole circle of, say, 3-inch or 3-centimeter diameter, multiply table values by 3.

Gage Blocks

Precision Gage Blocks.—Precision gage blocks are usually purchased in sets comprising a specific number of blocks of different sizes. The nominal gage lengths of individual blocks in a set are determined mathematically so that particular desired lengths can be obtained by combining selected blocks. They are made to several different tolerance grades which categorize them as master blocks, calibration blocks, inspection blocks, and workshop blocks. *Master blocks* are employed as basic reference standards; *calibration blocks* are used for high precision gaging work and calibrating inspection blocks; *inspection blocks* are used as toolroom standards and for checking and setting limit and comparator gages, for example. The *workshop blocks* are working gages used as shop standards for a variety of direct precision measurements and gaging applications, including sine-bar settings.

Federal Specification GGG-G-15C, Gage Blocks (see below), lists typical sets, and gives details of materials, design, and manufacturing requirements, and tolerance grades. When there is in a set no single block of the exact size that is wanted, two or more blocks are combined by “wringing” them together. Wringing is achieved by first placing one block crosswise on the other and applying some pressure. Then a swiveling motion is used to twist the blocks to a parallel position, causing them to adhere firmly to one another.

When combining blocks for a given dimension, the object is to use as few blocks as possible to obtain the dimension. The procedure for selecting blocks is based on successively eliminating the right-hand figure of the desired dimension.

Example: Referring to gage block set number 1 in [Table 1](#), determine the blocks required to obtain 3.6742 inches. *Step 1:* Eliminate 0.0002 by selecting a 0.1002 block. Subtract 0.1002 from 3.6743 = 3.5740. *Step 2:* Eliminate 0.004 by selecting a 0.124 block. Subtract 0.124 from 3.5740 = 3.450. *Step 3:* Eliminate 0.450 with a block this size. Subtract 0.450 from 3.450 = 3.000. *Step 4:* Select a 3.000 inch block. The combined blocks are $0.1002 + 0.124 + 0.450 + 3.000 = 3.6742$ inches.

Federal Specification for Gage Blocks, Inch and Metric Sizes.—This Specification, GGG-G-15C, March 20, 1975, which supersedes GGG-G-15B, November 6, 1970, covers design, manufacturing, and purchasing details for precision gage blocks in inch and metric sizes up to and including 20 inches and 500 millimeters gage lengths. The shapes of blocks are designated Style 1, which is rectangular; Style 2, which is square with a center accessory hole, and Style 3, which defines other shapes as may be specified by the purchaser. Blocks may be made from steel, chromium-plated steel, chromium carbide, or tungsten carbide. There are four tolerance grades, which are designated Grade 0.5 (formerly Grade AAA in the GGG-G-15A issue of the Specification); Grade 1 (formerly Grade AA); Grade 2 (formerly Grade A+); and Grade 3 (a compromise between former Grades A and B). Grade 0.5 blocks are special reference gages used for extremely high precision gaging work, and are not recommended for general use. Grade 1 blocks are laboratory reference standards used for calibrating inspection gage blocks and high precision gaging work. Grade 2 blocks are used as inspection and toolroom standards, and Grade 3 blocks are used as shop standards.

Inch and metric sizes of blocks in specific sets are given in [Tables 1](#) and [2](#), which is not a complete list of available sizes. It should be noted that some gage blocks must be ordered as specials, some may not be available in all materials, and some may not be available from all manufacturers. Gage block set number 4 (88 blocks), listed in the Specification, is not given in [Table 1](#). It is the same as set number 1 (81 blocks) but contains seven additional blocks measuring 0.0625, 0.078125, 0.093750, 0.100025, 0.100050, 0.100075, and 0.109375 inch. In [Table 2](#), gage block set number 3M (112 blocks) is not given. It is similar to set number 2M (88 blocks), and the chief difference is the inclusion of a larger number of blocks in the 0.5 millimeter increment series up to 24.5 mm. Set numbers 5M (88 blocks), 6M (112 blocks), and 7M (17 blocks) also are not listed.

Table 1. Gage Block Sets—Inch Sizes *Federal Specification GGG-G-15C*

Set Number 1 (81 Blocks)									
First Series: 0.0001 Inch Increments (9 Blocks)									
.1001	.1002	.1003	.1004	.1005	.1006	.1007	.1008	.1009	
Second Series: 0.001 Inch Increments (49 Blocks)									
.101	.102	.103	.104	.105	.106	.107	.108	.109	.110
.111	.112	.113	.114	.115	.116	.117	.118	.119	.120
.121	.122	.123	.124	.125	.126	.127	.128	.129	.130
.131	.132	.133	.134	.135	.136	.137	.138	.139	.140
.141	.142	.143	.144	.145	.146	.147	.148	.149	
Third Series: 0.050 Inch Increments (19 Blocks)									
.050	.100	.150	.200	.250	.300	.350	.400	.450	.500
.550	.600	.650	.700	.750	.800	.850	.900	.950	
Fourth Series: 1.000 Inch Increments (4 Blocks)									
	1.000		2.000		3.000		4.000		
Set Number 5 (21 Blocks)									
First Series: 0.0001 Inch Increments (9 Blocks)									
.0101	.0102	.0103	.0104	.0105	.0106	.0107	.0108	.0109	
Second Series: 0.001 Inch Increments (11 Blocks)									
.010	.011	.012	.013	.014	.015	.016	.017	.018	.019
.020									.020
One Block 0.01005 Inch									
Set Number 6 (28 Blocks)									
First Series: 0.0001 Inch Increments (9 Blocks)									
.0201	.0202	.0203	.0204	.0205	.0206	.0207	.0208	.0209	
Second Series: 0.001 Inch Increments (9 Blocks)									
.021	.022	.023	.024	.025	.026	.027	.028	.029	
Third Series: 0.010 Inch Increments (9 Blocks)									
.010	.020	.030	.040	.050	.060	.070	.080	.090	
One Block 0.02005 Inch									
Long Gage Block Set Number 7 (8 Blocks)									
Whole Inch Series (8 Blocks)									
	5	6	7	8	10	12	16	20	
Set Number 8 (36 Blocks)									
First Series: 0.0001 Inch Increments (9 Blocks)									
.1001	.1002	.1003	.1004	.1005	.1006	.1007	.1008	.1009	
Second Series: 0.001 Inch Increments (11 Blocks)									
.100	.101	.102	.103	.104	.105	.106	.107	.108	.109
.110									.110
Third Series: 0.010 Inch Increments (8 Blocks)									
.120	.130	.140	.150	.160	.170	.180	.190		
Fourth Series: 0.100 Inch Increments (4 Blocks)									
	.200		.300		.400		.500		
Whole Inch Series (3 Blocks)									
	1		2		3		4		
One Block 0.050 Inch									
Set Number 9 (20 Blocks)									
First Series: 0.0001 Inch Increments (9 Blocks)									
.0501	.0502	.0503	.0504	.0505	.0506	.0507	.0508	.0509	
Second Series: 0.001 Inch Increments (10 Blocks)									
.050	.051	.052	.053	.054	.055	.056	.057	.058	.059
One Block 0.05005 Inch									

Set number 4 is not shown, and the Specification does not list a set 2 or 3. Arranged here in incremental series for convenience of use.

Table 2. Gage Block Sets—Metric Sizes *Federal Specification GGG-G-15C*

Set Number 1M (45 Blocks)									
First Series: 0.001 Millimeter Increments (9 Blocks)									
1.001	1.002	1.003	1.004	1.005	1.006	1.007	1.008	1.009	
Second Series: 0.01 Millimeter Increments (9 Blocks)									
1.01	1.02	1.03	1.04	1.05	1.06	1.07	1.08	1.09	
Third Series: 0.10 Millimeter Increments (9 Blocks)									
1.10	1.20	1.30	1.40	1.50	1.60	1.70	1.80	1.90	
Fourth Series: 1.0 Millimeter Increments (9 Blocks)									
1.0	2.0	3.0	4.0	5.0	6.0	7.0	8.0	9.0	
Fifth Series: 10 Millimeter Increments (9 Blocks)									
10	20	30	40	50	60	70	80	90	
Set Number 2M (88 Blocks)									
First Series: 0.001 Millimeter Increments (9 Blocks)									
1.001	1.002	1.003	1.004	1.005	1.006	1.007	1.008	1.009	
Second Series: 0.01 Millimeter Increments (49 Blocks)									
1.01	1.02	1.03	1.04	1.05	1.06	1.07	1.08	1.09	1.10
1.11	1.12	1.13	1.14	1.15	1.16	1.17	1.18	1.19	1.20
1.21	1.22	1.23	1.24	1.25	1.26	1.27	1.28	1.29	1.30
1.31	1.32	1.33	1.34	1.35	1.36	1.37	1.38	1.39	1.40
1.41	1.42	1.43	1.44	1.45	1.46	1.47	1.48	1.49	
Third Series: 0.50 Millimeter Increments (19 Blocks)									
0.5	1.0	1.5	2.0	2.5	3.0	3.5	4.0	4.5	5.0
5.5	6.0	6.5	7.0	7.5	8.0	8.5	9.0	9.5	
Fourth Series: 10 Millimeter Increments (10 Blocks)									
10	20	30	40	50	60	70	80	90	100
One Block 1.0005 mm									
Set Number 4M (45 Blocks)									
First Series: 0.001 Millimeter Increments (9 Blocks)									
2.001	2.002	2.003	2.004	2.005	2.006	2.007	2.008	2.009	
Second Series: 0.01 Millimeter Increments (9 Blocks)									
2.01	2.02	2.03	2.04	2.05	2.06	2.07	2.08	2.09	
Third Series: 0.10 Millimeter Increments (9 Blocks)									
2.1	2.2	2.3	2.4	2.5	2.6	2.7	2.8	2.9	
Fourth Series: 1 Millimeter Increments (9 Blocks)									
1.0	2.0	3.0	4.0	5.0	6.0	7.0	8.0	9.0	
Fifth Series: 10 Millimeter Increments (9 Blocks)									
10	20	30	40	50	60	70	80	90	
Long Gage Block Set Number 8M (8 Blocks)									
Whole Millimeter Series (8 Blocks)									
125	150	175	200	250	300	400	500		

Set numbers 3M, 5M, 6M, and 7M are not listed.

Arranged here in incremental series for convenience of use.

Note: Gage blocks measuring 1.09 millimeters and under in set number 1M, blocks measuring 1.5 millimeters and under in set number 2M, and block measuring 1.0 millimeter in set number 4M are not available in tolerance grade 0.5.

Pyrometers

Radiation Pyrometer.—This type measures radiated heat and is adapted for very high temperatures. The Féry radiation pyrometer is practically a reflecting telescope having a concave mirror which focuses the radiant heat of the object upon the “hot” junction of a small thermo-couple. There is a diaphragm for reducing the aperture when the instrument is pointed at a very hot object, in order to prevent over-heating the thermo-couple. With the Brown radiation pyrometer, the rays of heat from the furnace or molten metal which enter the pyrometer tube are reflected from a concave mirror onto a sensitive thermo-couple, and the temperature is indicated on a milli-voltmeter, graduated in temperature degrees, the same as a thermo-electric pyrometer. No part of the instrument is inserted in the high heat to be measured. If the temperature of a furnace is being measured, the tube is either held on a tripod or in the hand, and is pointed toward the door of the furnace. The temperature can then be read off on the indicator.

Optical Pyrometers.—There are several classes of optical pyrometers. The *Morse thermo-gage* indicates the temperature by heating the filament of an electric lamp to the same color as that of the incandescent body, the temperature of which is required. The small low-voltage lamp is placed inside a tube through which the heated object is observed. To determine the temperature, the current for the lamp is so regulated (by means of a rheostat) that the color of the lamp filament corresponds to that of the heated object which is observed through the instrument. The current then being consumed is indicated by a milli-ammeter, and the corresponding temperature is determined. This instrument is accurate to within 2 or 3 degrees C. When absorbent glasses are used to reduce the brilliancy of the heated part, the highest temperatures required for industrial work can be gaged. The *Measure and Novel optical pyrometer* is a very simple type, which, by means of prisms and reflectors, enables temperatures to be determined by utilizing the colored field produced by the polarization and refraction of light from the heated part. The accuracy of a reading depends upon the observer's judgment of relative colors and may vary 50 degrees C. (90 degrees F.) or more, at temperatures above 1000 degrees C. (1832 degrees F.). This type is adapted to the taking of frequent readings. With the *photometric type* (including the Wanner and Le Chatelier optical and Féry absorption pyrometers) there is an illuminated field, one-half of which receives light from the heated object, and the other half, from a standard source of light forming part of the instrument. With the Le Chatelier instrument, the amount of light admitted from the heated part is regulated by an adjustable diaphragm. When both halves are of the same intensity or brightness, the temperature is indicated by a scale on the diaphragm.

Judging Temperatures by Color.—The U. S. Bureau of Standards states that skilled observers may vary as much as 100 degrees F. in their estimation of relatively low temperatures by color; beyond 2200 degrees F. it is practically impossible to make estimations with any certainty.

Seeger Temperature Cones.—The “sentinel” pyrometer or Seeger temperature cones are in the form of triangular pyramids (about 3 inches high), composed of metallic and mineral substances which fuse at certain temperatures. They are made in series, each successive cone having a fusing temperature that differs slightly from the one above or below in the scale; that is, if the series were placed in a furnace and the temperature gradually raised, one cone after another would melt as its melting point was reached. These cones are sometimes used in pairs to determine the minimum and maximum temperatures for a given process, one cone being selected for the lowest and another for the highest temperature required. Tests have shown that this method for determining temperatures is very trustworthy within 35 degrees F.

Melting Temperatures of Seger Cones

No. of Cone	Melting Temp., Deg. F.	No. of Cone	Melting Temp., Deg. F.	No. of Cone	Melting Temp., Deg. F.	No. of Cone	Melting Temp., Deg. F.	No. of Cone	Melting Temp., Deg. F.
010	1743	01	2066	9	2390	18	2714	27	3038
09	1778	1	2102	10	2426	19	2750	28	3074
08	1814	2	2138	11	2462	20	2786	29	3110
07	1850	3	2174	12	2498	21	2822	30	3146
06	1886	4	2210	13	2534	22	2858	31	3182
05	1922	5	2246	14	2570	23	2894	32	3218
04	1958	6	2282	15	2606	24	2930	33	3254
03	1994	7	2318	16	2642	25	2966
02	2030	8	2354	17	2678	26	3002

Calibration of Pyrometers.—Pyrometers should occasionally be compared with a standard pyrometer or be calibrated in some other way. The following general instructions are given by the Hoskins Mfg. Co. The accuracy of both meter and thermo-couple should be checked. When checking the meter see that all connections are tight and that the protection tubes are sound. Set the zero of the check meter and the service meter to the same temperature and then take readings of both meters when they are alternately connected to any couple. If the instruments are both calibrated for the same external resistance, then only one set of leads is necessary, this set being connected first to one and then the other meter. If the meters are calibrated for different external resistances, then the individual leads of proper resistance must be used with each. In this method of checking, the check meter and the one being tested must be of the same kind; that is, both must be high or low resistance. When checking the thermo-couple, if only one thermo-couple is being used with the meter, see that the zero setting of the meter corresponds to the temperature of the “cold end” of the couple. If several couples are used with one meter, the zero setting should be in agreement with the average temperature of the cold ends of the several couples. Set the zero of the check meter in agreement with the cold-end temperature of the check couple; place check couple and service couple in same protection tube and compare the readings of the two meters.

If the meter operates with only one couple, then the *indicated* error is the *actual* error of the thermo-couple, assuming that the zero settings of both the check and the service meter are correct. If the service meter proved to be accurate, and it is serving more than one couple, then the difference between the readings of the two meters in this test is the combined error of the thermo-couple and the error due to the cold-end setting of the meter. To determine the portion of this due to the thermo-couple, note the *difference* in temperature between the zero setting of the service meter and the actual cold-end temperature of the particular couple being tested. Subtract this difference from the *indicated* error, as shown by the meter readings and the result is the error in the thermo-couple.

Calibrating by the Melting Point of Copper.—For calibrating pyrometers for temperatures above a red heat, the welded or “hot end” of the thermo-couple should be covered with a tight winding of No. 14 or 16 B. & S. gage, standard melting-point wire. The couple should then be inserted in a tube furnace with the welded end approximately in the center. The furnace should be of the required heat before inserting the couple, and should be kept at a temperature approximately 100 degrees F. higher than the melting point of the calibrating wire. The pointer of the meter will then move up the scale with a gradually decreasing speed until the calibrating wire begins to melt, when the pointer will come to rest. After the wire has melted, the pointer will again move upward. Pure copper wire, under oxidizing conditions, melts at 1083 degrees C. (1981 degrees F.), and pure zinc wire, at 419 degrees C. (786 degrees F.). In order to have a strictly oxidizing atmosphere, an open-end electric furnace should be used for calibrating. With this method of calibrating, care should be taken not to have the furnace temperature too far above the melting point of the calibrating wire, because the pointer will move so rapidly and the melting will be of such short duration that the temporary pause of the pointer may not be observed.

Calibrating by the Freezing Point of Melted Salts.—A very satisfactory way of calibrating pyrometers is by using the “freezing points” of melted salts. Pure common salt (NaCl) is melted in a pure graphite crucible. When the salt has been raised to a temperature of 100 to 200 degrees F. above its melting point, the bare welded end of the thermo-couple is inserted to a depth of 2 or 3 inches. The crucible is then removed from the furnace and allowed to cool. The pointer on the meter will drop gradually until the salt begins to freeze or solidify; then the pointer will stop until the salt is frozen. The freezing point of pure salt is taken at 800 degrees C. (1472 deg. F.). After calibrating and before being further used, the couple end should be washed in hot water to remove all traces of the salt, as otherwise the couple will deteriorate rapidly, especially when heated considerably above the melting point of salt in an open furnace. When calibrating pyrometers, care should be taken that the zero setting of the meter agrees with the cold end of the couple, which is always kept away from the heat and generally at the temperature of the outside air. The following table gives the latest available data by the Bureau of Standards on certain substances which may be used for calibrating pyrometers.

Water boils at	100 °C	(212 °F)
Tin freezes at	231.9 °C	(449.4 °F)
Zinc freezes at	419.4 °C	(786.9 °F)
Common salt freezes at	800 °C	(1472 °F)
Copper freezes at	1083 °C	(1981.4 °F)

TOOLING AND TOOL MAKING

Machine Tools

Machine Tool History.—The development of simple tools into more complex designs to replace manual labor is comparatively recent, and may generally be considered as having begun near the end of the eighteenth century. The history of civilization since that time has been so profoundly affected by the work of the engineer and the mechanic that the past and the present century may well be called the "age of machinery." The facilities for cutting metal in 1780 were little better than those of the middle ages. The mechanics or millwrights of that day worked almost wholly with the hammer, chisel, and file. Without doubt, the best mechanics during the eighteenth century were the French, and their work contained suggestions of a number of the modern machine tools; but their tendency was toward refined handicraft and ingenious novelties, and they showed little inclination toward commercial production on a large scale. The real development of the modern machine tool has taken place almost wholly in England and in the United States. The general machine tools, such as the lathe, planer, shaper, drill press, and steam hammer, and the small tools, such as taps and dies, were developed in England from about 1800 to 1850. In America, partially overlapping this period, but in the main in the latter part of the nineteenth century, were developed the automatic lathe, the universal milling machine, drop-hammers, special machine tools of various kinds, and the interchangeable system of manufacture, the last involving the use of jigs, fixtures, and limit-gages.

Milling Machine Origin.—The first practical machine for plain milling operations is said to have been built by Eli Whitney, well-known inventor of the cotton gin, about 1818. This machine, now in the possession of Yale University, is a small bench type. A solid wooden block forms the base of the Whitney milling machine and the supporting legs are made of wrought iron. The main spindle is driven directly by a belt pulley, and between the two main spindle bearings there is a double-grooved wooden pulley connecting with a smaller pulley on a worm-gear shaft of the feed mechanism. The worm of this shaft engages a worm wheel mounted upon the table feed-screw. This worm is held in engagement by a spring latch which permits disengagement for hand feeding. The worm shaft is pivoted at one end so that the worm could readily drop out of engagement.

Milling Machines, Lincoln Type.—The well-known Lincoln type of milling machine is named after George S. Lincoln of the firm then known as George S. Lincoln & Co., Hartford, Conn. Mr. Lincoln, however, did not originate this type but he introduced an improved design. Milling machines constructed along the same general lines had previously been built by the Phoenix Iron Works of Hartford, Conn., and also by Robbins & Lawrence Co., of Windsor, Vt. Milling machines of this class are intended especially for manufacturing and are not adapted to a great variety of milling operations, but are designed for machining large numbers of duplicate parts. Some milling machines which are designed along the same lines as the Lincoln type are referred to as the *manufacturing type*. The distinguishing features of the Lincoln type are as follows: The work table, instead of being carried by an adjustable knee, is mounted on the solid bed of the machine and the outer arbor support is also attached directly to the bed. This construction gives a very rigid support both for the work and the cutter. The work is usually held in a fixture or vise attached to the table, and the milling is done as the table feeds longitudinally. The table is not adjustable vertically but the spindle head and spindles can be raised or lowered as may be required.

Saddle.—A machine tool saddle is a slide which is mounted upon the ways of a bed, cross-rail, arm, or other guiding surfaces, and the saddle metal-cutting tools or a work-holding table. On holding either metal-cutting tools or a work-holding table. On a knee-type milling machine the saddle is that part which slides upon the knee and which supports the work-holding table. The saddle of a planer or boring mill is mounted upon the cross-rail

and supports the tool-holding slide. The saddle of a lathe is that part of a carriage which slides. The saddle of a lathe is that part of a carriage which slides directly upon the lathe bed and supports the cross-slide.

Transfer Machines.—These specialized machine tools are used to perform various machining operations on parts or parts in fixtures as the parts are moved along on an automatic conveyor which is part of the machine tool set-up. In a set-up, the parts can move in a straight line from their entry point to their exit point, or the setup may be constructed in a U-shape so that the parts are expelled near where they start.

Boring Machines, Origin.—The first boring machine was built by John Wilkinson, in 1775. Smeaton had built one in 1769 which had a large rotary head, with inserted cutters, carried on the end of a light, overhanging shaft. The cylinder to be bored was fed forward against the cutter on a rude carriage, running on a track laid in the floor. The cutter head followed the inaccuracies of the bore, doing little more than to smooth out local roughness of the surface. Watt's first steam cylinders were bored on this machine and he complained that one, 18 inches in diameter, was $\frac{3}{8}$ inch out of true. Wilkinson thought of the expedient, which had escaped both Smeaton and Watt, of extending the boring-bar completely through the cylinder and giving it an out-board bearing, at the same time making it much larger and stiffer. With this machine cylinders 57 inches in diameter were bored which were within $\frac{1}{16}$ inch of true. Its importance can hardly be overestimated as it insured the commercial success of Watt's steam engine which, up to that time, had not passed the experimental stage.

Gratuating.—The dividing of circular and straight scales into a given number of equal spaces or divisions is known as graduating. The type of machine or tool used for graduating and the method of producing the graduation marks or lines varies with different classes of work, depending upon the degree of accuracy necessary and the form of the parts to be graduated. The work of graduating may be divided into two branches, which include, first, the method of spacing, and second, the means for making suitable marks or lines upon the parts to be graduated.

The machines used in laboratories and by tool and instrument manufacturers, for graduating various kinds of straight scales, may be classified as the precision screw type and the pantograph type. The former is equipped with a very accurate lead-screw, which, by means of a suitable indexing or spacing mechanism, is rotated an amount depending upon the spacing required, and as this screw actuates the work-holding table, a tool that is given a cross-movement makes graduation lines either in a "resist" or directly upon the work. The pantograph machines have a pantograph mechanism which serves to reproduce, on a smaller scale, the graduation lines or figures which have been previously cut in a pattern or master scale.

The marks or lines which represent divisions or spaces on graduated scales, etc., may be formed by the etching process, by the direct-cutting action of a tool, or, for some grades of work, by the stamping or impression process. With the etching process, the part to be graduated is first covered with some acid-resisting material or "resist," as it is called, and then the lines or figures are cut into this resist by a mechanically-guided graduating tool, thus exposing the metal wherever these lines or figures are made. An etching acid is then applied, and, wherever the metal is exposed, the acid eats into the surface and forms the division lines. When very fine graduation lines are needed the general practice is to employ the direct-cutting method, since the marks obtained by a very sharp-pointed tool are finer and more accurate than is possible to obtain by the etching process. See *Etching Resists*.

Jig Bushings

Material for Jig Bushings.—Bushings are generally made of a good grade of tool steel to ensure hardening at a fairly low temperature and to lessen the danger of fire cracking. They can also be made from machine steel, which will answer all practical purposes, provided the bushings are properly casehardened to a depth of about $\frac{1}{16}$ inch. Sometimes, bushings for guiding tools may be made of cast iron, but only when the cutting tool is of such a design that no cutting edges come within the bushing itself. For example, bushings used simply to support the smooth surface of a boring-bar or the shank of a reamer might, in some instances, be made of cast iron, but hardened steel bushings should always be used for guiding drills, reamers, taps, etc., when the cutting edges come in direct contact with the guiding surfaces. If the outside diameter of the bushing is very large, as compared with the diameter of the cutting tool, the cost of the bushing can sometimes be reduced by using an outer cast-iron body and inserting a hardened tool steel bushing.

When tool steel bushings are made and hardened, it is recommended that A-2 steel be used. The furnace should be set to 1750°F and the bushing placed in the furnace and held there approximately 20 minutes after the furnace reaches temperature. Remove the bushing and cool in still air. After the part cools to 100-150°F, immediately place in a tempering furnace that has been heated to 300°F. Remove the bushing after one hour and cool in still air. If an atmospherically controlled furnace is unavailable, the part should be wrapped in stainless foil to prevent scaling and oxidation at the 1750°F temperature.

American National Standard Jig Bushings.—Specifications for the following types of jig bushings are given in American National Standard B94.33-1974 (R1986). Head Type Press Fit Wearing Bushings, Type H (Fig. 1 and Tables 1 and 3); Headless Type Press Fit Wearing Bushings, Type P (Fig. 2 and Tables 1 and 3); Slip Type Renewable Wearing Bushings, Type S (Fig. 3 and Tables 4 and 5); Fixed Type Renewable Wearing Bushings, Type F (Fig. 4 and Tables 5 and 6); Headless Type Liner Bushings, Type L (Fig. 5 and Table 7); and Head Type Liner Bushings, Type HL (Fig. 6 and Table 8). Specifications for locking mechanisms are also given in Table 9.

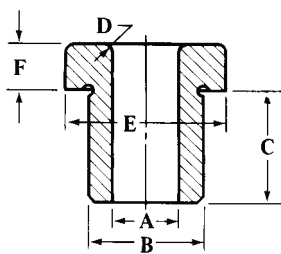


Fig. 1. Head Type Press Fit Wearing Bushings — Type H

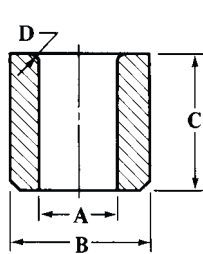


Fig. 2. Headless Type Press Fit Wearing Bushings — Type P

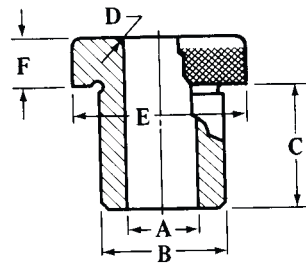


Fig. 3. Slip Type Renewable Wearing Bushings — Type S

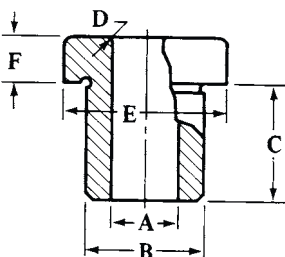


Fig. 4. Fixed Type Renewable Wearing Bushings — Type F

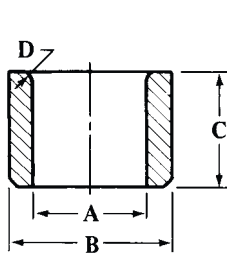


Fig. 5. Headless Type Liner Bushings — Type L

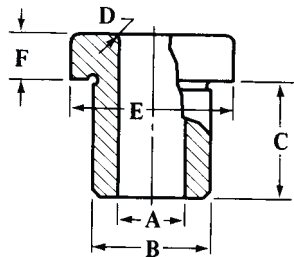


Fig. 6. Head Type Liner Bushings — Type HL

Table 1. American National Standard Head Type Press Fit Wearing Bushings — Type H ANSI B94.33-1974 (R1986)

Range of Hole Sizes A	Body Diameter B					Body Length C	Radius D	Head Diam. E Max	Head Thickness F Max	Number
	Nom	Unfinished		Finished						
		Max	Min	Max	Min					
0.0135 up to and including 0.0625	0.156	0.166	0.161	0.1578	0.1575	0.250	0.016	0.250	0.094	H-10-4
						0.312				H-10-5
						0.375				H-10-6
						0.500				H-10-8
0.0630 to 0.0995	0.203	0.213	0.208	0.2046	0.2043	0.250	0.016	0.312	0.094	H-13-4
						0.312				H-13-5
						0.375				H-13-6
						0.500				H-13-8
						0.750				H-13-12
0.1015 to 0.1405	0.250	0.260	0.255	0.2516	0.2513	0.250	0.016	0.375	0.094	H-16-4
						0.312				H-16-5
						0.375				H-16-6
						0.500				H-16-8
0.1406 to 0.1875	0.312	0.327	0.322	0.3141	0.3138	0.750	0.031	0.438	0.125	H-16-12
						1.000				H-20-4
						0.250				H-20-5
						0.312				H-20-6
						0.375				H-20-8
0.189 to 0.2500	0.406	0.421	0.416	0.4078	0.4075	0.500	0.031	0.531	0.156	H-20-12
						0.750				H-20-16
						1.000				H-20-22
						1.375				H-26-4
						1.750				H-26-5
						0.250				H-26-6
						0.312				H-26-8
						0.375				H-26-12
0.2570 to 0.3125	0.500	0.520	0.515	0.5017	0.5014	0.500	0.047	0.625	0.219	H-26-16
						0.750				H-26-22
						1.000				H-32-5
						1.375				H-32-6
						1.750				H-32-8
						0.312				H-32-12
						0.375				H-32-16
						0.500				H-32-22
0.3160 to 0.4219	0.625	0.645	0.640	0.6267	0.6264	0.750	0.047	0.812	0.219	H-32-28
						1.000				H-40-5
						1.375				H-40-6
						1.750				H-40-8
						2.125				H-40-12
						0.500				H-40-16
						0.750				H-40-22
						1.000				H-40-28
						1.375				H-40-34
0.4375 to 0.5000	0.750	0.770	0.765	0.7518	0.7515	1.750	0.062	0.938	0.219	H-48-8
						2.125				H-48-12
						0.500				H-48-16
						0.750				H-48-22
						1.000				H-48-28
						1.375				H-48-34
0.5156 to 0.6250	0.875	0.895	0.890	0.8768	0.8765	1.750	0.062	0.125	0.250	H-29-28
						2.125				H-56-8
						2.500				H-56-12
						0.500				H-56-16
						0.750				H-56-22
						1.000				H-56-28
						1.375				H-56-34
1.750	H-56-40									

Table 1. (Continued) American National Standard Head Type Press Fit Wearing Bushings — Type H ANSI B94.33-1974 (R1986)

Range of Hole Sizes A	Body Diameter B					Body Length C	Radius D	Head Diam. E Max	Head Thickness F Max	Number
	Nom	Unfinished		Finished						
		Max	Min	Max	Min					
0.6406 to 0.7500	1.000	1.020	1.015	1.0018	1.0015	0.500	0.094	1.250	0.312	H-64-8
						0.750				H-64-12
						1.000				H-64-16
						1.375				H-64-22
						1.750				H-64-28
						2.125				H-64-34
2.500	H-64-40									
0.7656 to 1.0000	1.375	1.395	1.390	1.3772	1.3768	0.750	0.094	1.625	0.375	H-88-12
						1.000				H-88-16
						1.375				H-88-22
						1.750				H-88-28
						2.125				H-88-34
						2.500				H-88-40
1.0156 to 1.3750	1.750	1.770	1.765	1.7523	1.7519	1.000	0.094	2.000	0.375	H-112-16
						1.375				H-112-22
						1.750				H-112-28
						2.125				H-112-34
						2.500				H-112-40
						3.000				H-112-48
1.3906 to 1.7500	2.250	2.270	2.265	2.2525	2.2521	1.000	0.094	2.500	0.375	H-144-16
						1.375				H-144-22
						1.750				H-144-28
						2.125				H-144-34
						2.500				H-144-40
						3.000				H-144-48

All dimensions are in inches.
See also Table 3 for additional specifications.

Table 2. American National Standard Headless Type Press Fit Wearing Bushings — Type P ANSI B94.33-1974 (R1986)

Range of Hole Sizes A	Body Diameter B					Body Length C	Radius D	Number
	Nom	Unfinished		Finished				
		Max	Min	Max	Min			
0.0135 up to and including 0.0625	0.156	0.166	0.161	0.1578	0.1575	0.250	0.016	P-10-4
						0.312		P-10-5
						0.375		P-10-6
						0.500		P-10-8
0.0630 to 0.0995	0.203	0.213	0.208	0.2046	0.2043	0.250	0.016	P-13-4
						0.312		P-13-5
						0.375		P-13-6
						0.500		P-13-8
						0.750		P-13-12
0.1015 to 0.1405	0.250	0.260	0.255	0.2516	0.2513	0.250	0.016	P-16-4
						0.312		P-16-5
						0.375		P-16-6
						0.500		P-16-8
0.750	P-16-12							
0.1406 to 0.1875	0.312	0.327	0.322	0.3141	0.3138	0.250	0.031	P-20-4
						0.312		P-20-5
						0.375		P-20-6
						0.500		P-20-8
						0.750		P-20-12
1.000	P-20-16							

Table 2. (Continued) American National Standard Headless Type Press Fit Wearing Bushings — Type P ANSI B94.33-1974 (R1986)

Range of Hole Sizes A	Body Diameter B					Body Length C	Radius D	Number
	Nom	Unfinished		Finished				
		Max	Min	Max	Min			
0.1890 to 0.2500	0.406	0.421	0.416	0.4078	0.4075	0.250	0.031	P-26-4
						0.312		P-26-5
						0.375		P-26-6
						0.500		P-26-8
						0.750		P-26-12
						1.000		P-26-16
						1.375		P-26-22
1.750	P-26-28							
0.2570 to 0.3125	0.500	0.520	0.515	0.5017	0.5014	0.312	0.047	P-32-5
						0.375		P-32-6
						0.500		P-32-8
						0.750		P-32-12
						1.000		P-32-16
						1.375		P-32-22
1.750	P-32-28							
0.3160 to 0.4219	0.625	0.645	0.640	0.6267	0.6264	0.312	0.047	P-40-5
						0.375		P-40-6
						0.500		P-40-8
						0.750		P-40-12
						1.000		P-40-16
						1.375		P-40-22
						1.750		P-40-28
2.125	P-40-34							
0.4375 to 0.5000	0.750	0.770	0.765	0.7518	0.7515	0.500	0.062	P-48-8
						0.750		P-48-12
						1.000		P-48-16
						1.375		P-48-22
						1.750		P-48-28
						2.125		P-48-34
0.5156 to 0.6250	0.875	0.895	0.890	0.8768	0.8765	0.500	0.062	P-56-8
						0.750		P-56-12
						1.000		P-56-16
						1.375		P-56-22
						1.750		P-56-28
						2.125		P-56-34
						2.500		P-56-40
0.6406 to 0.7500	1.000	1.020	1.015	1.0018	1.0015	0.500	0.062	P-64-8
						0.750		P-64-12
						1.000		P-64-16
						1.375		P-64-22
						1.750		P-64-28
						2.125		P-64-34
						2.500		P-64-40
0.7656 to 1.0000	1.375	1.395	1.390	1.3772	1.3768	0.750	0.094	P-88-12
						1.000		P-88-16
						1.375		P-88-22
						1.750		P-88-28
						2.125		P-88-34
						2.500		P-88-40
1.0156 to 1.3750	1.750	1.770	1.765	1.7523	1.7519	1.000	0.094	P-112-16
						1.375		P-112-22
						1.750		P-112-28
						2.125		P-112-34
						2.500		P-112-40
						3.000		P-112-48
1.3906 to 1.7500	2.250	2.270	2.265	2.2525	2.2521	1.000	0.094	P-144-16
						1.375		P-144-22
						1.750		P-144-28
						2.125		P-144-34
						2.500		P-144-40
3.000	P-144-48							

All dimensions are in inches. See [Table 3](#) for additional specifications.

Table 3. Specifications for Head Type H and Headless Type P Press Fit Wearing Bushings ANSI B94.33-1974 (R1986)

<p>All dimensions given in inches. Tolerance on dimensions where not otherwise specified shall be ± 0.010 inch. Size and type of chamfer on lead end to be manufacturer's option. The length, <i>C</i>, is the overall length for the headless type and length underhead for the head type. The head design shall be in accordance with the manufacturer's practice. Diameter <i>A</i> must be concentric to diameter <i>B</i> within 0.0005 T.I.V. on finish ground bushings. The body diameter, <i>B</i>, for unfinished bushings is larger than the nominal diameter in order to provide grinding stock for fitting to jig plate holes. The grinding allowance is: 0.005 to 0.010 in. for sizes 0.156, 0.203 and 0.250 in. 0.010 to 0.015 in. for sizes 0.312 and 0.406 in. 0.015 to 0.020 in. for sizes 0.500 in. and up. Hole sizes are in accordance with American National Standard Twist Drill Sizes. The maximum and minimum values of the hole size, <i>A</i>, shall be as follows:</p>													
Nominal Size of Hole				Maximum				Minimum					
Above 0.0135 to 0.2500 in., incl.				Nominal + 0.0004 in.				Nominal + 0.0001 in.					
Above 0.2500 to 0.7500 in., incl.				Nominal + 0.0005 in.				Nominal + 0.0001 in.					
Above 0.7500 to 1.5000 in., incl.				Nominal + 0.0006 in.				Nominal + 0.0002 in.					
Above 1.5000 in.				Nominal + 0.0007 in.				Nominal + 0.0003 in.					
<p>Bushings in the size range from 0.0135 through 0.3125 will be counterbored to provide for lubrication and chip clearance. Bushings without counterbore are optional and will be furnished upon request. The size of the counterbore shall be inside diameter of the bushing + 0.031 inch. The included angle at the bottom of the counterbore shall be 118 deg. \pm 2 deg. The depth of the counterbore shall be in accordance with the table below to provide adequate drill bearing.</p>													
Body Length	Drill Bushing Hole Size												
	0.0135 to 0.0625		0.0630 to 0.0995		0.1015 to 0.1405		0.1406 to 0.1875		0.1890 to 0.2500		0.2570 to 0.3125		
	P	H	P	H	P	H	P	H	P	H	P	H	
	Minimum Drill Bearing Length—Inch												
0.250	X	0.250	X	X	X	X	X	X	X	X	X	X	X
0.312	X	0.250	X	X	X	X	X	X	X	X	X	X	X
0.375	0.250	0.250	X	X	X	X	X	X	X	X	X	X	X
0.500	0.250	0.250	X	0.312	X	0.312	X	0.375	X	X	X	X	X
0.750	+	+	0.375	0.375	0.375	0.375	X	0.375	X	X	X	X	X
1.000	+	+	+	+	+	+	0.625	0.625	0.625	0.625	0.625	0.625	0.625
1.375	+	+	+	+	+	+	+	+	0.625	0.625	0.625	0.625	0.625
1.750	+	+	+	+	+	+	+	+	0.625	0.625	0.625	0.625	0.625

All dimensions are in inches.

X indicates no counterbore.

+ indicates not American National Standard

Table 4. American National Standard Slip Type Renewable Wearing Bushings — Type S ANSI B94.33-1974 (R1986)

Range of Hole Sizes <i>A</i>	Body Diameter <i>B</i>			Length UnderHead <i>C</i>	Radius <i>D</i>	Head Diam. <i>E</i> Max	Head Thickness <i>F</i> Max	Number
	Nom	Max	Min					
0.0135 up to and including 0.0469	0.188	0.1875	0.1873	0.250	0.031	0.312	0.188	S-12-4
				0.312				S-12-5
				0.375				S-12-6
				0.500				S-12-8
0.0492 to 0.1562	0.312	0.3125	0.3123	0.312	0.047	0.562	0.375	S-20-5
				0.500				S-20-8
				0.750				S-20-12
				1.000				S-20-16
0.1570 to 0.3125	0.500	0.5000	0.4998	0.312	0.047	0.812	0.438	S-32-5
				0.500				S-32-8
				0.750				S-32-12
				1.000				S-32-16
				1.375				S-32-22
1.750	S-32-28							
0.3160 to 0.5000	0.750	0.7500	0.7498	0.500	0.094	1.062	0.438	S-48-8
				0.750				S-48-12
				1.000				S-48-16
				1.375				S-48-22
				1.750				S-48-28
2.125	S-48-34							

Table 4. (Continued) American National Standard Slip Type Renewable Wearing Bushings — Type S ANSI B94.33-1974 (R1986)

Range of Hole Sizes A	Body Diameter B			Length Under Head C	Radius D	Head Diam. E Max	Head Thickness F Max	Number
	Nom	Max	Min					
0.5156 to 0.7500	1.000	1.0000	0.9998	0.500	0.094	1.438	0.438	S-64-8
				0.750				S-64-12
				1.000				S-64-16
				1.375				S-64-22
				1.750				S-64-28
				2.125				S-64-34
				2.500				S-64-40
0.7656 to 1.0000	1.375	1.3750	1.3747	0.750	0.094	1.812	0.438	S-88-12
				1.000				S-88-16
				1.375				S-88-22
				1.750				S-88-28
				2.125				S-88-34
				2.500				S-88-40
1.0156 to 1.3750	1.750	1.7500	1.7497	1.000	0.125	2.312	0.625	S-112-16
				1.375				S-112-22
				1.750				S-112-28
				2.125				S-112-34
				2.500				S-112-40
				3.000				S-112-48
1.3906 to 1.7500	2.250	2.2500	2.2496	1.000	0.125	2.812	0.625	S-144-16
				1.375				S-144-22
				1.750				S-144-28
				2.125				S-144-34
				2.500				S-144-40
				3.000				S-144-48

All dimensions are in inches. See also Table 5 for additional specifications.

Table 5. Specifications for Slip Type S and Fixed Type F Renewable Wearing Bushings ANSI B94.33-1974 (R1986)

Tolerance on dimensions where not otherwise specified shall be plus or minus 0.010 inch.												
Hole sizes are in accordance with the American Standard Twist Drill Sizes.												
The maximum and minimum values of hole size, A, shall be as follows:												
Nominal Size of Hole			Maximum				Minimum					
Above 0.0135 to 0.2500 in. incl.			Nominal + 0.0004 in.				Nominal + 0.0001 in.					
Above 0.2500 to 0.7500 in. incl.			Nominal + 0.0005 in.				Nominal + 0.0001 in.					
Above 0.7500 to 1.5000 in. incl.			Nominal + 0.0006 in.				Nominal + 0.0002 in.					
Above 1.5000			Nominal + 0.0007 in.				Nominal + 0.0003 in.					
The head design shall be in accordance with the manufacturer's practice.												
Head of slip type is usually knurled.												
When renewable wearing bushings are used with liner bushings of the head type, the length under the head will still be equal to the thickness of the jig plate, because the head of the liner bushing will be countersunk into the jig plate.												
Diameter A must be concentric to diameter B within 0.0005 T.I.R. on finish ground bushings.												
Size and type of chamfer on lead end to be manufacturer's option.												
Bushings in the size range from 0.0135 through 0.3125 will be counterbored to provide for lubrication and chip clearance.												
Bushings without counterbore are optional and will be furnished upon request.												
The size of the counterbore shall be inside diameter of the bushings plus 0.031 inch.												
The included angle at the bottom of the counterbore shall be 118 deg., plus or minus 2 deg.												
The depth of the counterbore shall be in accordance with the table below to provide adequate drill bearing.												
Body Length	Drill Bearing Hole Size											
	0.0135 to 0.0625		0.0630 to 0.0995		0.1015 to 0.1405		0.1406 to 0.1875		0.1890 to 0.2500		0.2500 to 0.3125	
	S	F	S	F	S	F	S	F	S	F	S	F
	Minimum Drill Bearing Length											
0.250	0.250	0.250	0.375	0.375	X	X	X	X	X	X	X	X
0.312	0.250	0.250	0.375	0.375	0.375	0.375	0.375	0.375	0.375	0.375	X	X
0.375	0.250	0.250	0.375	0.375	0.375	0.375	0.375	0.375	0.375	0.375	X	X
0.500	0.250	0.250	0.375	0.375	0.375	0.375	0.375	0.375	0.375	0.375	X	X
0.750	0.250	0.250	0.375	0.375	0.375	0.375	0.375	0.375	0.625	0.625	0.625	0.625
1.000	0.312	0.312	0.375	0.375	0.375	0.375	0.625	0.625	0.625	0.625	0.625	0.625
1.375	+	+	+	+	+	+	0.625	0.625	0.625	0.625	0.625	0.625
1.750	+	+	+	+	+	+	0.625	0.625	0.625	0.625	0.625	0.625

All dimensions are in inches.

X indicates no counterbore, + indicates not American National Standard length.

Table 6. American National Standard Fixed Type Renewable Wearing Bushings — Type F ANSI B94.33-1974 (R1986)

Range of Hole Sizes A	Body Diameter B			Length Under Head C	Radius D	Head Diam. E Max	Head Thickness F Max	Number
	Nom	Max	Min					
0.0135 up to and including 0.0469	0.188	0.1875	0.1873	0.250	0.031	0.312	0.188	F-12-4
				0.312				F-12-5
				0.375				F-12-6
				0.500				F-12-8
0.0492 to 0.1562	0.312	0.3125	0.3123	0.312	0.047	0.562	0.250	F-20-5
				0.500				F-20-8
				0.750				F-20-12
				1.000				F-20-16
0.1570 to 0.3125	0.500	0.5000	0.4998	0.312	0.047	0.812	0.250	F-32-5
				0.500				F-32-8
				0.750				F-32-12
				1.000				F-32-16
				1.375				F-32-22
0.3160 to 0.5000	0.750	0.7500	0.7498	1.750	0.094	1.062	0.250	F-32-28
				0.500				F-48-8
				0.750				F-48-12
				1.000				F-48-16
				1.375				F-48-22
0.5156 to 0.7500	1.000	1.0000	0.9998	1.750	0.094	1.438	0.375	F-48-28
				2.125				F-48-34
				2.500				F-64-8
				0.500				F-64-12
				0.750				F-64-16
				1.000				F-64-22
0.7656 to 1.0000	1.375	1.3750	1.3747	1.375	0.094	1.812	0.375	F-64-28
				1.750				F-64-34
				2.125				F-64-40
				2.500				F-88-12
				0.750				F-88-16
				1.000				F-88-22
1.0156 to 1.3750	1.750	1.7500	1.7497	1.375	0.125	2.312	0.375	F-88-28
				1.750				F-88-34
				2.125				F-88-40
				2.500				F-112-16
				3.000				F-112-22
				1.000				F-112-28
1.3906 to 1.7500	2.250	2.2500	2.2496	1.750	0.125	2.812	0.375	F-112-34
				2.125				F-112-40
				2.500				F-112-48
				3.000				F-144-16
				1.000				F-144-22
				1.375				F-144-28
1.3906 to 1.7500	2.250	2.2500	2.2496	1.750	0.125	2.812	0.375	F-144-34
				2.125				F-144-40
				2.500				F-144-48
				3.000				

All dimensions are in inches. See also Table 5 for additional specifications.

**Table 7. American National Standard Headless Type Liner Bushings —
Type L ANSI B94.33-1974 (R1986)**

Range of Hole Sizes in Renewable Bushings	Inside Diameter <i>A</i>			Body Diameter <i>B</i>					Over-all Length <i>C</i>	Radius <i>D</i>	Number
				Unfinished			Finished				
	Nom	Max	Min	Nom	Max	Min	Max	Min			
0.0135 up to and including 0.0469	0.188	0.1879	0.1876	0.312	0.3341	0.3288	0.3141	0.3138	0.250	0.031	L-20-4
									0.312		L-20-5
									0.375		L-20-6
									0.500		L-20-8
0.0492 to 0.1562	0.312	0.3129	0.3126	0.500	0.520	0.515	0.5017	0.5014	0.312	0.047	L-32-5
									0.500		L-32-8
									0.750		L-32-12
									1.000		L-32-16
0.1570 to 0.3125	0.500	0.5005	0.5002	0.750	0.770	0.765	0.7518	0.7515	0.312	0.062	L-48-5
									0.500		L-48-8
									0.750		L-48-12
									1.000		L-48-16
									1.375		L-48-22
1.750	L-48-28										
0.3160 to 0.5000	0.750	0.7506	0.7503	1.000	1.020	1.015	1.0018	1.0015	0.500	0.062	L-64-8
									0.750		L-64-12
									1.000		L-64-16
									1.375		L-64-22
									1.750		L-64-28
2.125	L-64-34										
0.5156 to 0.7500	1.000	1.0007	1.0004	1.375	1.395	1.390	1.3772	1.3768	0.500	0.094	L-88-8
									1.750		L-88-12
									1.000		L-88-16
									1.375		L-88-22
									1.750		L-88-28
									2.125		L-88-34
2.500	L-88-40										
0.7656 to 1.0000	1.375	1.3760	1.3756	1.750	1.770	1.765	1.7523	1.7519	0.750	0.094	L-112-12
									1.000		L-112-16
									1.375		L-112-22
									1.750		L-112-28
									2.125		L-112-34
2.500	L-112-40										
1.0156 to 1.3750	1.750	1.7512	1.7508	2.250	2.270	2.265	2.2525	2.2521	1.000	0.094	L-144-16
									1.375		L-144-22
									1.750		L-144-28
									2.125		L-144-34
									2.500		L-144-40
3.000	L-144-48										
1.3906 to 1.7500	2.250	2.2515	2.2510	2.750	2.770	2.765	2.7526	2.7522	1.000	0.125	L-176-16
									1.375		L-176-22
									1.750		L-176-28
									2.125		L-176-34
									2.500		L-176-40
3.000	L-176-48										

All dimensions are in inches.

Tolerances on dimensions where otherwise not specified are ± 0.010 in.

The body diameter, *B*, for unfinished bushings is 0.015 to 0.020 in. larger than the nominal diameter in order to provide grinding stock for fitting to jig plate holes.

Diameter *A* must be concentric to diameter *B* within 0.0005 T.I.R. on finish ground bushings.

**Table 8. American National Standard Head Type Liner Bushing —
Type HL ANSI B94.33-1974 (R1986)**

Range of Hole Sizes in Renewable Bushings	Inside Diameter A			Body Diameter B					Overall Length C	Radius D	Head Dia. E	Head Thickness F Max	Number
				Unfinished			Finished						
	Nom	Max	Min	Nom	Max	Min	Max	Min					
0.0135 to 0.1562	0.312	0.3129	0.3126	0.500	0.520	0.515	0.5017	0.5014	0.312	0.047	0.625	0.094	HL-32-5
									0.500				HL-32-8
									0.750				HL-32-12
									1.000				HL-32-16
0.1570 to 0.3125	0.500	0.5005	0.5002	0.750	0.770	0.765	0.7518	0.7515	0.312	0.062	0.875	0.094	HL-48-5
									0.500				HL-48-8
									0.750				HL-48-12
									1.000				HL-48-16
									1.375				HL-48-22
1.750	HL-48-28												
0.3160 to 0.5000	0.750	0.7506	0.7503	1.000	1.020	1.015	1.0018	1.0015	0.500	0.062	1.125	0.125	HL-64-8
									0.750				HL-64-12
									1.000				HL-64-16
									1.375				HL-64-22
									1.750				HL-64-28
									2.125				HL-64-34
0.5156 to 0.7500	1.000	1.0007	1.0004	1.375	1.395	1.390	1.3772	1.3768	0.500	0.094	1.500	0.125	HL-88-8
									0.750				HL-88-12
									1.000				HL-88-16
									1.375				HL-88-22
									1.750				HL-88-28
									2.125				HL-88-34
									2.500				HL-88-40
0.7656 to 1.0000	1.375	1.3760	1.3756	1.750	1.770	1.765	1.7523	1.7519	0.750	0.094	1.875	0.188	HL-112-12
									1.000				HL-112-16
									1.375				HL-112-22
									1.750				HL-112-28
									2.125				HL-112-34
									2.500				HL-112-40
1.0156 to 1.3750	1.750	1.7512	1.7508	2.250	2.27	2.265	2.2525	2.2521	1.000	0.094	2.375	0.188	HL-144-16
									1.375				HL-144-22
									1.750				HL-144-28
									2.125				HL-144-34
									2.500				HL-144-40
									3.000				HL-144-48
1.3906 to 1.7500	2.250	2.2515	2.2510	2.750	2.770	2.765	2.7526	2.7522	1.000	0.125	2.875	0.188	HL-176-16
									1.375				HL-176-22
									1.750				HL-176-28
									2.125				HL-176-34
									2.500				HL-176-40
									3.000				HL-176-48

All dimensions are in inches.

See also footnotes to [Table 7](#).

**Table 9. American National Standard Locking Mechanisms for Jig Bushings
ANSI B94.33-1974 (R1986)**

Lock Screw for Use with Slip or Fixed Renewable Bushings											
No.	A	B	C	D	E	F	UNC Thread				
LS-0	0.438	0.188	0.312	Per Manufacturer's Standard	0.188	0.105-0.100	8-32				
LS-1	0.625	0.375	0.625		0.250	0.138-0.132	5/16-18				
LS-2	0.875	0.375	0.625		0.375	0.200-0.194	5/16-18				
LS-3	1.000	0.438	0.750		0.375	0.200-0.194	3/8-16				
Round Clamp Optional Only for Use with Fixed Renewable Bushing											
Number	A	B	C	D	E	F	G	H	Use With Socket Head Screw		
RC-1	0.625	0.312	0.484	0.150	0.203	0.125	0.531	0.328	5/16-18		
RC-2	0.625	0.438	0.484	0.219	0.187	0.188	0.906	0.328	5/16-18		
RC-3	0.750	0.500	0.578	0.281	0.219	0.188	1.406	0.391	3/8-16		
Locking Mechanism Dimensions of Slip and Fixed Renewable Bushings											
Body OD	Max Diam. F When Used With Locking Device	G Head Thickness		H ± 0.005	J	L Max	R	Locking Dim. of Lock Screw (Slip or Fixed)	Locking Dim. of Clamp (Fixed Only)	Max Head Diam. of Mating Liner Used to Clear Locking Device	Clamp or Screw LS or RC
		Slip	Fixed								
0.188	0.312	0.188	0.188	0.094	0.094	55°	0.266	0.105-0.100	0
0.312	0.562	0.375	0.250	0.125	0.172	65°	0.500	0.138-0.132	0.125-0.115	0.625	1
0.500	0.812	0.438	0.250	0.125	0.297	65°	0.625	0.138-0.132	0.125-0.115	0.875	1
0.750	1.062	0.438	0.250	0.125	0.422	50°	0.750	0.138-0.132	0.125-0.115	1.125	1
1.000	1.438	0.438	0.375	0.188	0.594	35°	0.922	0.200-0.194	0.187-0.177	1.500	2
1.375	1.812	0.438	0.375	0.188	0.781	30°	1.109	0.200-0.194	0.187-0.177	1.875	2
1.750	2.312	0.625	0.375	0.188	1.000	30°	1.391	0.200-0.194	0.187-0.177	2.375	3
2.250	2.812	0.625	0.375	0.188	1.250	25°	1.641	0.200-0.194	0.187-0.177	2.875	3

All dimensions are in inches.

Jig Bushing Definitions.— *Renewable Bushings:* Renewable wearing bushings to guide the tool are for use in liners which in turn are installed in the jig. They are used where the bushing will wear out or become obsolete before the jig or where several bushings are to be interchangeable in one hole. Renewable wearing bushings are divided into two classes, “Fixed” and “Slip.” Fixed renewable bushings are installed in the liner with the intention of leaving them in place until worn out. Slip renewable bushings are interchangeable in a given size of liner and, to facilitate removal, they are usually made with a knurled head. They are most frequently used where two or more operations requiring different inside diameters are performed in a single jig, such as where drilling is followed by reaming, tapping, spot facing, counterboring, or some other secondary operation.

Press Fit Bushings: Press fit wearing bushings to guide the tool are for installation directly in the jig without the use of a liner and are employed principally where the bushings are used for short production runs and will not require replacement. They are intended also for short center distances.

Liner Bushings: Liner bushings are provided with and without heads and are permanently installed in a jig to receive the renewable wearing bushings. They are sometimes called master bushings.

Jig Plate Thickness.—The standard length of the press fit portion of jig bushings as established are based on standardized uniform jig plate thicknesses of $\frac{5}{16}$, $\frac{3}{8}$, $\frac{1}{2}$, $\frac{3}{4}$, 1, $1\frac{3}{8}$, $1\frac{3}{4}$, $2\frac{1}{8}$, $2\frac{1}{2}$, and 3 inches.

Jig Bushing Designation System.—*Inside Diameter:* The inside diameter of the hole is specified by a decimal dimension.

Type Bushing: The type of bushing is specified by a letter: S for Slip Renewable, F for Fixed Renewable, L for Headless Liner, HL for Head Liner, P for Headless Press Fit, and H for Head Press Fit.

Body Diameter: The body diameter is specified in multiples of 0.0156 inch. For example, a 0.500-inch body diameter = $0.500/0.0156 = 32$.

Body Length: The effective or body length is specified in multiples of 0.0625 inch. For example, a 0.500-inch length = $0.500/0.0625 = 8$.

Unfinished Bushings: All bushings with grinding stock on the body diameter are designated by the letter U following the number.

Example: A slip renewable bushing having a hole diameter of 0.5000 inch, a body diameter of 0.750 inch, and a body length of 1.000 inch would be designated as .5000-S-48-16.

Jig Boring

Definition of Jig and Fixture.—The distinction between a jig and fixture is not easy to define, but, as a general rule, it is as follows: A jig either holds or is held on the work, and, at the same time, contains guides for the various cutting tools, whereas a fixture holds the work while the cutting tools are in operation, but does not contain any special arrangements for guiding the tools. A fixture, therefore, must be securely held or fixed to the machine on which the operation is performed—hence the name. A fixture is sometimes provided with a number of gages and stops, but not with bushings or other devices for guiding and supporting the cutting tools.

Jig Borers.—Jig borers are used for precision hole-location work. For this reason, the coordinate measuring systems on these machines are designed to provide longitudinal and transverse movements that are accurate to 0.0001 in. One widely used method of obtaining this accuracy utilizes ultraprecision lead screws. Another measuring system employs precision end measuring rods and a micrometer head that are placed in a trough which is parallel to the table movement. However, the purpose of all coordinate measuring systems used is the same: to provide a method of aligning the spindle at the precise location where a hole is to be produced. Since the work table of a jig borer moves in two directions, the

coordinate system of dimensioning is used, where dimensions are given from two perpendicular reference axes, usually the sides of the workpiece, frequently its upper left-hand corner. See Fig. 1C.

Jig-Boring Practice.—The four basic steps to follow to locate and machine a hole on a jig borer are:

Align and Clamp the Workpiece: The first consideration in placing the workpiece on the jig-borer table should be the relation of the coordinate measuring system of the jig borer to the coordinate dimensions on the drawing. Therefore, the coordinate measuring system is designed so that the readings of the coordinate measurements are direct when the table is moved toward the left and when it is moved toward the column of the jig borer. The result would be the same if the spindle were moved toward the right and away from the column, with the workpiece situated in such a position that one reference axis is located at the left and the other axis at the back, toward the column.

If the holes to be bored are to pass through the bottom of the workpiece, then the workpiece must be placed on precision parallel bars. In order to prevent the force exerted by the clamps from bending the workpiece the parallel bars are placed directly under the clamps, which hold the workpiece on the table. The reference axes of the workpiece must also be aligned with respect to the transverse and longitudinal table movements before it is firmly clamped. This alignment can be done with a dial-test indicator held in the spindle of the jig borer and bearing against the longitudinal reference edge. As the table is traversed in the longitudinal direction, the workpiece is adjusted until the dial-test indicator readings are the same for all positions.

Locate the Two Reference Axes of the Workpiece with Respect to the Spindle: The jig-borer table is now moved to position the workpiece in a precise and known location from where it can be moved again to the location of the holes to be machined. Since all the holes are dimensioned from the two reference axes, the most convenient position to start from is where the axis of the jig-borer spindle and the intersection of the two workpiece reference axes are aligned. This is called the starting position, which is similar to a zero reference position. When so positioned, the longitudinal and transverse measuring systems of the jig borer are set to read zero. Occasionally, the reference axes are located outside the body of the workpiece: a convenient edge or hole on the workpiece is picked up as the starting position, and the dimensions from this point to the reference axes are set on the positioning measuring system.

Locate the Hole: Precise coordinate table movements are used to position the workpiece so that the spindle axis is located exactly where the hole is to be machined. When the measuring system has been set to zero at the starting position, the coordinate readings at the hole location will be the same as the coordinate dimensions of the hole center.

The movements to each hole must be made in one direction for both the transverse and longitudinal directions, to eliminate the effect of any backlash in the lead screw. The usual table movements are toward the left and toward the column.

The most convenient sequence on machines using micrometer dials as position indicators (machines with lead screws) is to machine the hole closest to the starting position first and then the next closest, and so on. On jig borers using end measuring rods, the opposite sequence is followed: The farthest hole is machined first and then the next farthest, and so on, since it is easier to remove end rods and replace them with shorter rods.

Drill and Bore Hole to Size: The sequence of operations used to produce a hole on a jig borer is as follows: 1) a short, stiff drill, such as a center drill, that will not deflect when cutting should be used to spot a hole when the work and the axis of the machine tool spindle are located at the exact position where the hole is wanted; 2) the initial hole is made by a twist drill; and 3) a single-point boring tool that is set to rotate about the axis of the machine tool spindle is then used to generate a cut surface that is concentric to the axis of rotation.

Heat will be generated by the drilling operation, so it is good practice to drill all the holes first, and then allow the workpiece to cool before the holes are bored to size.

Transfer of Tolerances.—All of the dimensions that must be accurately held on precision machines and engine parts are usually given a tolerance. And when such dimensions are changed from the conventional to the coordinate system of dimensioning, the tolerances must also be included. Because of their importance, the transfer of the tolerances must be done with great care, keeping in mind that the sum of the tolerances of any pair of dimensions in the coordinate system must not be larger than the tolerance of the dimension that they replaced in the conventional system. An example is given in Fig. 1.

The first step in the procedure is to change the tolerances given in Fig. 1A to equal, bilateral tolerances given in Fig. 1B. For example, the dimension $2.125^{+0.003}_{-0.001}$ has a total tolerance of 0.004. The equal, bilateral tolerance would be plus or minus one-half of this value, or ± 0.002 . Then to keep the limiting dimensions the same, the basic dimension must be changed to 2.126, in order to give the required values of 2.128 and 2.124. When changing to equal, bilateral tolerances, if the upper tolerance is decreased (as in this example), the basic dimension must be increased by a like amount. The upper tolerance was decreased by $0.003 - 0.002 = 0.001$; therefore, the basic dimension was increased by 0.001 to 2.126. Conversely, if the upper tolerance is increased, the basic dimension is decreased.

The next step is to transfer the revised basic dimension to the coordinate dimensioning system. To transfer the 2.126 dimension, the distance of the applicable holes from the left reference axis must be determined. The first holes to the right are 0.8750 from the reference axis. The second hole is 2.126 to the right of the first holes. Therefore, the second hole is $0.8750 + 2.126 = 3.0010$ to the right of the reference axis. This value is then the coordinate dimension for the second hole, while the 0.8750 value is the coordinate dimension of the first two, vertically aligned holes. This procedure is followed for all the holes to find their distances from the two reference axes. These values are given in Fig. 1C.

The final step is to transfer the tolerances. The 2.126 value in Fig. 1B has been replaced by the 0.8750 and 3.0010 values in Fig. 1C. The 2.126 value has an available tolerance of ± 0.002 . Dividing this amount equally between the two replacement values gives 0.8750 ± 0.001 and 3.0010 ± 0.001 . The sum of these tolerances is .002, and as required, does not exceed the tolerance that was replaced. Next transfer the tolerance of the 0.502 dimension. Divide the available tolerance, ± 0.002 , equally between the two replacement values to yield 3.0010 ± 0.001 and 3.5030 ± 0.001 . The sum of these two tolerances equals the replaced tolerance, as required. However, the 1.125 value of the last hole to the right (coordinate dimension 4.6280 in.) has a tolerance of only ± 0.001 . Therefore, the sum of the tolerances on the 3.5030 and 4.6280 values cannot be larger than 0.001. Dividing this tolerance equally would give $3.5030 \pm .0005$ and 4.6280 ± 0.0005 . This new, smaller tolerance replaces the ± 0.001 tolerance on the 3.5030 value in order to satisfy all tolerance sum requirements. This example shows how the tolerance of a coordinate value is affected by more than one other dimensional requirement.

The following discussion will summarize the various tolerances listed in Fig. 1C. For the 0.8750 ± 0.0010 dimension, the ± 0.0010 tolerance together with the ± 0.0010 tolerance on the 3.0010 dimension is required to maintain the ± 0.002 tolerance of the 2.126 dimension. The $\pm .0005$ tolerances on the 3.5030 and 4.2680 dimensions are required to maintain the ± 0.001 tolerance of the 1.125 dimension, at the same time as the sum of the $\pm .0005$ tolerance on the 3.5030 dimension and the ± 0.001 tolerance on the 3.0010 dimension does not exceed the ± 0.002 tolerance on the replaced 0.503 dimension. The ± 0.0005 tolerances on the 1.0000 and 2.0000 values maintain the ± 0.001 tolerance on the 1.0000 value given at the right in Fig. 1A. The ± 0.0045 tolerance on the 3.0000 dimension together with the ± 0.0005 tolerance on the 1.0000 value maintains the $\pm .005$ tolerance on the 2.0000 dimension of Fig. 1A. It should be noted that the $2.000 \pm .005$ dimension in Fig. 1A was replaced by the 1.0000 and 3.0000 dimensions in Fig. 1C. Each of these values could have had a tol-

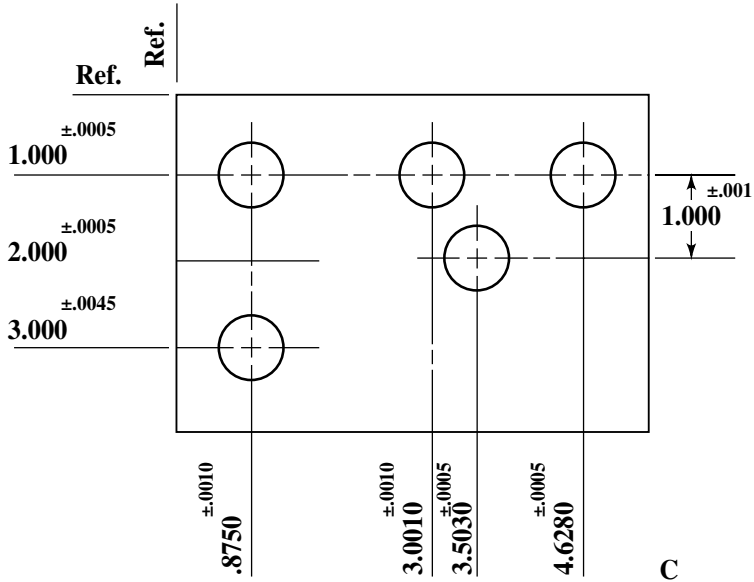
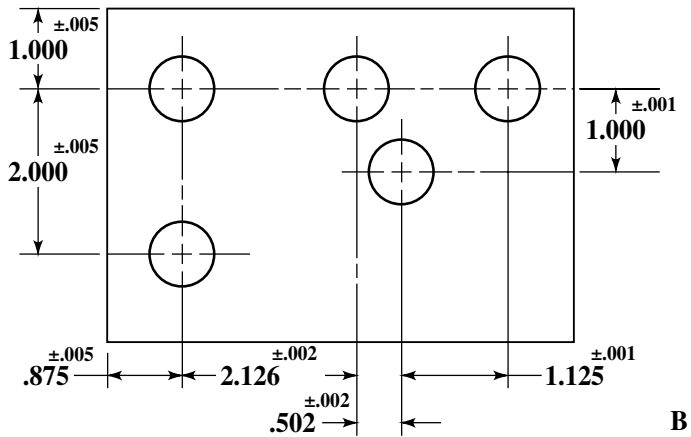
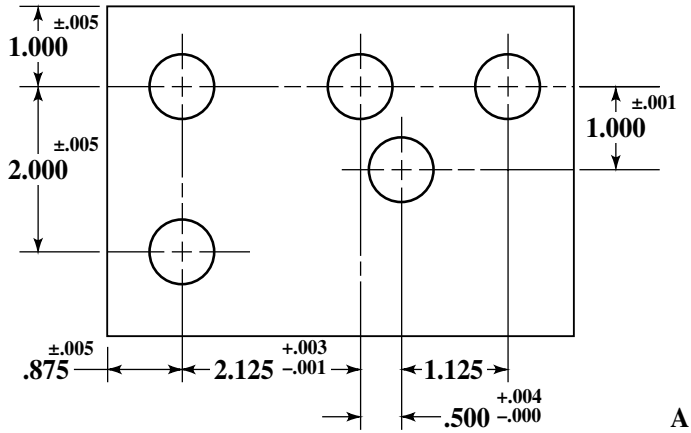


Fig. 1. (A) Conventional Dimensions, Mixed Tolerances; (B) Conventional Dimensions, All Equal, Bilateral Tolerances; and (C) Coordinate Dimensions

erance of ± 0.0025 , except that the tolerance on the 1.0000 dimension on the left in Fig. 1A is also bound by the ± 0.001 tolerance on the 1.0000 dimension on the right, thus the ± 0.0005 tolerance value is used. This procedure requires the tolerance on the 3.0000 value to be increased to ± 0.0045 .

Files

File History.—One of the earliest implements for filing, to which reference can be found, appears to have been made from the skins of certain fish, and even today in Great Britain old-fashioned wood carvers use the skins of the dog fish to smooth their work. *Bronze files* were in use when this metal was the general material for tools and implements, and there is evidence in the Bible that different shapes of files were in use about three thousand years ago. Several specimens of ancient bronze files are still in existence. One of these, believed to be about 3500 years old, was dug up in Crete. This file has a rounded back, as well as a fiat surface, bearing an astonishing resemblance to the half-round file of today. It is about $3\frac{5}{8}$ inches long, $\frac{5}{8}$ inch wide, and $\frac{1}{4}$ inch thick.

One of the earliest examples of *iron files* was found on the site of the Swiss lake dwellings, and dates from the time when Europe was the home of a race far more ancient than any of which we have any permanent records. This file has coarse teeth running across the blade at right angles to the sides and has a well developed tang, much like that of modern files. Another ancient iron file forms part of the collection of tools left at Thebes in Egypt by Assyrian invaders. This file is believed to date from about the seventh century B. C. Files have been found on the sites of the old Roman camps in England.

Specific references to files were made by Daimachus, a Greek writer in the time of Alexander the Great, about 300 years B. C. This writer enumerates four kinds of steel, describing their uses. From one kind were made files, augers, chisels, and implements for cutting stone. *Steel files* have been used for several centuries, and in an eighteenth century French encyclopedia there are a number of illustrations of files which differ in few respects from the modern tool. Formerly all files were cut by hand, but now practically all files are machine-cut. Although the machine-cutting of files is a comparatively recent development, the idea of machine-cutting is by no means new. Raoul, a Frenchman, cut files by machinery in the eighteenth century, and in 1836 a file-cutting machine patented by Captain John Ericsson was used in England. Machine-cut files are made with as many as 180 teeth to the inch, the cuts being scarcely discernible to the eye.

Files, Types.—The following types conform to the simplified practice recommendation of the National Bureau of Standards.

Band-saw, Blunt: Equilaterally triangular in section. Parallel throughout. Corners rounded. For sharpening saws with rounded gullets.

Band-saw, Taper: Same as band-saw, blunt, but tapered on all sides.

Cabinet: Flat on one side, convex on the other. Width tapered. Edges slightly blunted and cut.

Cant-saw: Section is an isosceles triangle, with an obtuse angle between the equal sides. For filing cross-cut saws having M-shaped teeth.

Cross-cut (Great American): Knife-shaped section; that is, thicker at one edge than at the other. Width uniform. Thick edge rounded. Used to file two-man saws having Great American style teeth.

Double-ender: Has no tang. Reversible. Tapered from center to each end.

Flat: Width and thickness uniform from heel to middle of cut, and tapered from middle of cut to point.

Half-round: One side flat, the other convex. Width and thickness tapered.

Hand: Width uniform, thickness tapered.

Hand-finishing: Section of regular hand files, up-cut at a short angle, and over-cut at a very long angle to produce a very smooth finish.

Hand-saw, Blunt: Equilaterally triangular in section. Edges parallel throughout.

Knife: Of knife-shaped section; that is, thicker at one edge than at the other. Width tapered.

Lead-float: Open single-cut type having teeth at proper angle for use on lead.

Mill: Width and thickness tapered.

Mill Blunt: Sides and faces parallel.

Pillar: Width uniform, thickness tapered. In general, the thickness is greater, relative to the width, than in other types.

Planer-knife: Parallel in width and thickness. One half of each side single cut, the other half double cut.

Round: Round in section and tapered.

Special Cross-cut: Sides and face parallel, same as mill blunt.

Square: Square in section! Tapered on all sides.

Taper: Equilaterally triangular in section. Tapered on all sides.

Three-square: Equilaterally triangular in section. Tapered on all sides.

Warding: Width greatly tapered, thickness very slightly tapered.

Wood: Open double-cut type having teeth at proper angle for use on wood.

File Teeth.—A single-cut file or “float,” as the coarser cuts are sometimes called, has single rows of parallel teeth extending across the face at an angle of from 65 to 85 degrees with the axis of the file. This angle depends upon the form of the file and the nature of the work it is intended for. A double-cut file has two rows of teeth crossing each other. The angle of the first row is, for general work, from 40 to 45 degrees, and the second row, from 70 to 80 degrees. Rasp teeth are round on top and disconnected, being formed by raising, with a punch, small portions of stock from the surface of the blank.

Single- and double-cut files are further classified according to the spacing of the teeth. The names commonly used to designate the different grades of cut are “rough,” “coarse,” “bastard,” “second-cut,” “smooth,” “dead - smooth,” or “super - smooth.” “Rough” files are usually single-cut, and the “dead-smooth,” double-cut. The other grades are made in both double- and single-cuts. Degrees of coarseness are only comparable when files of the same length are considered, the number of teeth per inch of length decreasing as the length or size of the file increases. Some makers use a series of numbers to designate the cut or coarseness instead of names.

File Teeth, Cutting.—There are three general methods of cutting the teeth of files: 1. By hand (using a hammer and chisel). 2. By means of special file-cutting machines of the mechanically-operated chisel type. 3. By etching with a mechanically guided tool. While the hand method is comparatively slow and expensive, skillful workmen are able to produce excellent files, although practically all files now used are cut by machines. These machines have been developed so that they not only enable the work to be done efficiently but produce files which are more accurate and effective than those cut by hand.

The hand method to be described has been practiced by the hand file-cutters in Sheffield and Lancashire for a century. The large file blanks are ground, and the smaller ones filed to shape, and slightly greased before cutting. The cutter sits before a square stake on which the blank is laid with the tang toward him and the two ends held down by two leather loops which are pressed down by the right foot. Cutting is begun at the point and is done by a very short chisel, the edge of which is slightly blunted to indent rather than cut the steel. To cut opposite faces of a file the face first cut is laid upon a plate of pewter; triangular and round files are laid in corresponding grooves in blocks of lead.

A file-cutting machine is designed to strike a series of rapid blows with a suitably formed chisel, for producing tooth grooves of any desired depth in a file blank which is fed automatically past the chisel at such a rate as to give the desired spacing of the teeth. The chisel head or hammer of a file-cutting machine weighs, complete, from 8 to 12 pounds, and ordinarily makes from 2000 to 8000 strokes per minutes, although the number of strokes may vary from 500 to 3500 per minute, the speed of cutting depending upon the weight of the

file being cut. The first known record of a file-cutting machine is a design made by Leonardo da Vinci, the well-known Italian genius, about 1500.

Large quantities of files are not cut by means of a mechanically-operated chisel but by a grooving process that is known as etching. This process is entirely different from that of cutting by means of a chisel and produces a higher grade of file. When forming the teeth by etching, the file is laid in a holder where it is steadied and guided by the workman's left hand. With his right hand he operates the etching tool, which is attached to a swinging framework. The etching tool is simply swept back and forth across the work at the proper angle and with the proper degree of pressure, the latter being controlled by the foot of the operator which bears down upon a stirrup which hangs from the handle of the etching tool. This pressure must be varied to suit conditions, such as hard spots in the blanks or the necessity of cutting deeper at one point than at another. The shape of the file is what determines whether a blank should be etched or cut with a chisel. A fiat surface should not be etched nor is there any need for it. On round surfaces, however, particularly where it is necessary to preserve accurately the outline of the blank, etching is preferable to cutting. A satisfactory machine has been developed for etching the first teeth of a double-cut file.

File Teeth, Resharpener.—There are several processes for resharpener files by the use of acid solutions. The acid must not be permitted to attack the files unduly. To prevent this, it is advisable to make a few tests or trials to determine the length of time the files should be immersed in order to obtain the desired results, before proceeding with the work on a quantity basis.

Cleaning Solution: First clean the files by immersing them in a solution of caustic soda and boiling water for a period of from ten to fifteen minutes. This solution is made by dissolving 100 grains of caustic soda in one gallon of water. The same proportions should be used if a larger quantity of the solution is required. Two gallons will ordinarily be sufficient for cleaning 100 files of the sizes generally employed in the shop.

Use of Nitric and Sulphuric Acids: After the cleansing treatment, the files are placed in an acid bath. This bath is made by adding twelve parts of water (by volume) to a solution consisting of one part nitric acid, one part fuming (Nordhausen) sulphuric acid, and one-third part concentrated sulphuric acid. These parts are measured by volume and not by weight. The files, when placed in the acid solution, should not overlap and should be arranged so that the solution will reach all surfaces. It is preferable first to suspend the files in the tank and then add the acid solution. The files should be allowed to remain in the solution from five to ten minutes, the exact time being determined by experiment.

Sulphuric-acid Process: Experience in sharpening between 2000 and 3000 files in acid solutions indicates that the following method gives good results. The first step is to remove all grease and dirt from the files. This may be done by soaking the files a few hours in gasoline and then brushing them with a wire brush, or by boiling them a few minutes in a 10 or 15 per cent water solution of caustic soda, and then drying and brushing them. It is essential that the files be thoroughly cleaned, as the acid cannot reach the steel through grease or oil. The clean files are placed in an enamel basin, a lead-lined box, or a "Pyrex" glass baking dish. Short pieces of wire or nails are placed between the files to separate them sufficiently to permit the acid to reach all the surfaces that are to be sharpened.

After covering the files with water, sulphuric acid is slowly poured into the tank until a solution that is about 25 per cent acid is obtained. As the acid combines with the water, a considerable amount of heat is generated which causes the acid to act more rapidly. Files having fine teeth may be sharpened in from three to five minutes, while files with coarse teeth generally require from five to twenty minutes. A second batch of files can be treated in the same solution by adding a little sulphuric acid. After two or three batches of files have been treated, however, it is usually necessary either to heat the solution or make a new one.

Nitric and Hydrochloric Acids: Another process consists of immersing the files in a warm aqueous solution of nitric acid and hydrochloric acid, consisting preferably of about

equal parts of the acids and of water. This solution should be kept at a constant temperature. After the files have been treated with the acid solution, they should be washed in lime water or some other alkaline solution, and then wiped with oil.

Adding Acid to Water: Caution must be exercised in mixing sulphuric acid and water. Always pour the acid into the water slowly; never pour water on the acid, as an explosion may result, the same as when babbitt is poured into a wet box or mold. In both cases the explosion is caused by the sudden generation of steam. Commercial hydrochloric acid diluted with about 10 per cent water and heated to near the boiling point can be used instead of sulphuric-acid solution. The diluted hydrochloric acid has the advantage of being safer to handle.

As soon as the files are removed from the acid solution, they are washed in running water and dried rapidly by heating. After drying, they may be dipped in gasoline containing about 5 per cent paraffin or engine oil. The gasoline evaporates, leaving a thin coat of oil on the files.

File Terms.—The length of a file means the distance from the point to the heel and does not include the tang. The heel is that end of the file body adjacent to the handle. A blunt file is one having the same sectional shape from the point to the tang. The coarse grades of single-cut files are sometimes called floats. Safe-edge means that the edge or side is smooth and without teeth, and may be presented to a surface that does not require filing. Over-cut is a term used to describe the first series of teeth on a double-cut file. Up-cut means the series of teeth superimposed on the over-cut series of a double-cut file. Re-cut means the working over of old worn-out files by annealing, grinding out the old teeth, re-cutting, hardening, etc. Re-cutting is seldom practiced at the present time. The term superfine (or super) cut is used by Lancashire file-makers to designate the grade of cut known in the United States as “dead-smooth.” Taper is used to distinguish a file having tapering sides from one that is blunt or straight. A file is tapered when it is thinner at the point than at the middle, and is full-tapered when thinner at the point and the heel than at the middle. Custom has also established the use of the term “taper” as a short name for “three-square” or triangular handsaw files.

File Testing.—The quality of files can be tested by a special machine which records the endurance and capacity for removing metal, by producing a curve or diagram on sectioned paper wound about a cylindrical drum connected with the file reciprocating mechanism, so as to make one revolution to 120,000 strokes of the file. On these diagrams, the horizontal distances represent the number of strokes made by the file being tested and the vertical distances, the number of cubic inches of metal removed. Tests show a remarkable difference in the quality of files, some being worn out after removing less than one cubic inch of iron, and cutting at the rate of only one cubic inch per 10,000 strokes; whereas, files of good quality remove 12½ cubic inches and cut at the rate of 5 cubic inches per 10,000 strokes.

It has been estimated that the useful life of a file is, on an average, 25,000 strokes, which is equivalent to two full working days of ten hours each.

Rotary Files and Burs.—Rotary files and burs are used with power-operated tools, such as flexible- or stationary-shaft machines, drilling machines, lathes, and portable electric or pneumatic tools, for abrading or smoothing metals and other materials. Corners can be broken and chamfered, burs and fins removed, holes and slots enlarged or elongated, and scale removed in die-sinking, metal patternmaking, mold finishing, toolmaking and casting operations.

The difference between rotary files and rotary burs, as defined by most companies, is that the former have teeth cut by hand with hammer and chisel, whereas the latter have teeth or flutes ground from the solid blank after hardening, or milled from the solid blank before hardening. (At least one company, however prefers to differentiate the two by use and size: The larger-sized general purpose tools with ¼-inch shanks, whether hand cut or ground, are referred to as rotary files; the smaller shanked - ⅛-inch - and correspondingly smaller-

headed tools used by diesinkers and jewelers are referred to as burs.) Rotary files are made from high-speed steel and rotary burs from high-speed steel or cemented carbide in various cuts such as double extra coarse, extra coarse or rough, coarse or standard, medium, fine, and smooth. Standard shanks are $\frac{1}{4}$ inch in diameter.

There is very little difference in the efficiency of rotary files or burs when used in electric tools and when used in air tools, provided speeds have been reasonably well selected. Flexible-shaft and other machines used as a power source for these tools have a limited number of speeds which govern the revolutions per minute at which the tools can be operated.

The carbide bur may be used on hard or soft materials with equally good results. The principal difference in construction of the carbide bur is that its teeth or flutes are provided with negative rather than a radial rake. Carbide burs are relatively brittle and must be treated more carefully than ordinary burs. They should be kept cutting freely, in order to prevent too much pressure, which might result in crumbling of the cutting edges.

At the same speeds, both high-speed steel and carbide burs remove approximately the same amount of metal. However, when carbide burs are used at their most efficient speeds, the rate of stock removal may be as much as four times that of ordinary burs. It has been demonstrated that a carbide bur will last up to 100 times as long as a high-speed steel bur of corresponding size and shape.

Scraping Machine Parts

In metal working, slight errors in plane or curved surfaces are often corrected by the use of hand scrapers; scraping is also employed to produce ornamental effects on exposed surfaces. For correcting errors, the part to be scraped is ordinarily applied to whatever surface it is being fitted; the bearing marks or "high spots" are then noted and removed by scraping. By repeatedly obtaining these bearing marks and then removing them, a more evenly distributed bearing is secured. In this way, bearing boxes are often fitted to their shafts after having been bored. Small flat surfaces are scraped to make them more accurate, the method being to first apply the work to a standard surface plate, note the bearing marks and, if there is unevenness, correct the error by scraping. In fitting two fiat parts together, it is common practice to first scrape one member to secure as true a surface as possible, and then use it as a standard while fitting the other part. In order to make the bearing marks show clearly, some kind of red or black marking material is generally used. A thin coating is applied to the bearing shaft, surface plate, or whatever surface the work is to be scraped to fit. The work is then rubbed over this surface and the marking material shows just where the high spots are. It is important to keep the marking material in a covered box in order to exclude all grit or chips. The scraper should be made "glass hard" and be given a fine edge by the use of an oilstone. The materials commonly used to show the bearing marks are oil mixed with lampblack, Prussian blue, or red lead.

Scrapers.—The different forms of scrapers commonly used in fitting machine parts, etc., are shown by the accompanying illustrations.

The *flat scraper* Fig. 1a is almost invariably used for plane surfaces. For ordinary purposes, the scraper blade is about $\frac{3}{16}$ inch thick, from 1 to $1\frac{1}{4}$ inches wide, and is drawn out at the point to a thickness of about $\frac{1}{16}$ inch. The cutting end is as hard as possible and is rounded slightly, in grinding, so that the outer corners will not score the surface being scraped. The grinding should be done, preferably, on a wet grindstone, the edge being finished with an oilstone.

The *hook scraper* Fig. 1b is also used on flat surfaces. It is preferred by some workmen for obtaining a fine, smooth surface and can be used, occasionally, in narrow spaces where there would not be room enough for a straight, flat scraper.

Straight and curved scrapers of the "half round" type are shown at Fig. 1c and Fig. 1d. These are used for scraping bearings, etc., the sides forming the cutting edges. The curved

type **Fig. 1d** is more convenient to use on large half-bearings, as it is held at an angle and the scraping is done by the curved edge.

The *three-cornered* or *three-square scraper* shown at **Fig. 1e** is also used to some extent on curved surfaces. When the end is beveled, as shown in the detail view to the left, this form of scraper is convenient for producing sharp corners or for “relieving” them slightly.

The *two-handled scraper* shown at **Fig. 1f** is an excellent form for scraping bearing boxes and all curved surfaces which are so located that this type can be used. This style of scraper is much superior to the form shown at **Fig. 1c** and **Fig. 1d**, especially for large work. The straight or curved half-round type works very well on soft bearing metals such as babbitt metal, but on brass or bronze, it cuts slowly and, as soon as the edge is slightly dulled, considerable downward pressure is necessary.

The type **Fig. 1f** requires very much less effort on the part of the workman, and it will cut rapidly. As there are two handles instead of a single handle at one end, the blade can be pressed against the work with little exertion. This form of scraper is largely used for the heavy scraping required in fitting large connecting-rod brasses, etc. The sides are sometimes ground slightly concave (to give the cutting edges “rake”) by holding them against the face of the grinding wheel.

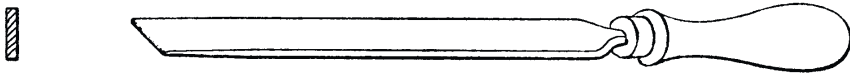


Fig. 1a. Flat Scraper

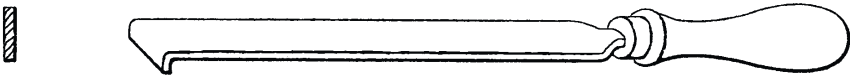


Fig. 1b. Hook Scraper

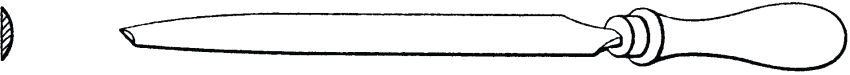


Fig. 1c. Half-round Scrapers

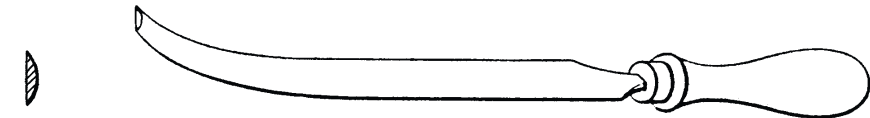


Fig. 1d. Half-round Scrapers



Fig. 1e. Three-corner or Three-square Scraper



Fig. 1f. Two-handled Scrapers

Spotter.—Flat finished surfaces on the ways of machine tools, etc., are often finished by spotting, frosting or flaking, partly to obtain an ornamental appearance and also because the spotted surface holds lubricant more effectively. One type of spotter placed on the market is so arranged that the scraper, as it is pushed across a guide placed upon the work, receives a rocking motion so that the blade produces a uniform half-moon effect without

skill or experience on the part of the workman. By adjusting a small thumb screw, different shaped spots may be obtained.

Taps

Blacksmiths' Taps.—A class of taps known as “blacksmiths' taps” has a long taper thread and a very short shank, the shank being only long enough for a square and a collar to prevent the tap wrench from slipping from the square down upon the body of the tap. The taper of the thread is $\frac{3}{4}$ inch per foot; the size by which the tap is known is measured $\frac{5}{8}$ inch from the large end of the thread. These taps are generally made with the standard number of V-threads per inch corresponding to their nominal diameter.

Stub Machine Screw Taps.—A machine screw tap having three flutes for all sizes and with a thread considerably shorter than a regular (standard) machine screw tap. For use in tapping thin metal, and to overcome breakage.

Wash-Out Taps.—Mud and wash-out taps are used in boiler work, the same as taper boiler taps and patch-bolt taps. These taps are sometimes referred to as *arch pipe taps*, but the former name is the more common. They taper $1\frac{1}{4}$ inch per foot, and have 12 threads per inch. The thread form may be either the American Standard or the sharp V-thread.

Reamers

Reamer Teeth Spacing.—There are three methods of spacing reamer teeth. First, they may be spaced evenly around the entire surface; second, the spacing may be irregular but with one half of the circumference corresponding to the other half, so that the cutting edges are diametrically opposite; and third, the spacing may be irregular around the entire circumference. The object of uneven spacing is to eliminate chatter and produce smoother holes than are obtained with uniformly spaced teeth. Some contend that a reamer spaced according to the second method is liable to chatter and that no two cutting edges should be diametrically opposite.

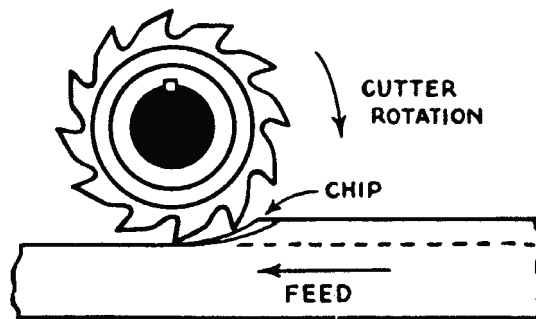
It is undoubtedly true that an odd number of teeth in a reamer favors smoother work than an even number of equally spaced teeth. The reason for this is as follows: In a reamer having an even number of teeth, any ridge or hard spot in the work tends to push the tooth away at that point and the action is transmitted diametrically across the reamer to the opposite side of the hole. If the reamer has an odd number of teeth, the effect is transmitted across the hole to two teeth instead of one and is, therefore, less than if concentrated on one tooth. In other words, the irregularities are not see-sawed back and forth across the hole by the action of the teeth as much with an uneven number of teeth as with an even number. The average manufacturer, however, prefers reamers with an even number of teeth because of the difficulty of measuring those with an odd number of teeth. Reamers that have an even number of teeth, but with the spacing broken up so that it is irregular, can be made to ream a hole as true as an odd-toothed reamer.

Bridge Reamers.—Taper reamers used in bridge and structural iron work are generally known as bridge reamers or taper bridge reamers; they are employed for reaming the rivet holes in structural work, and are made either with a Morse taper or straight squared shank. The fluted part is tapered for part of its length and the remaining part is straight. The taper is 1 inch per foot for the $\frac{1}{2}$ inch size, and increases to $1\frac{1}{2}$ inch per foot for the $1\frac{1}{4}$ inch size.

MACHINING OPERATIONS

Machining Topics

Climb-Cut Milling.—In milling, the feeding movement and cutting movement are in *opposite* directions, as a general rule. This is sometimes known as the “normal” or “conventional” method of milling to distinguish it from the climb-cut method. The term *climb-cut* or *climb* milling means that the feeding movement of the work and the cutting movement are in the same direction. Several advantages are claimed for climb-cut milling, assuming that conditions are favorable to its application. One important advantage cited is that the cutter life is increased and at the same time higher speeds and feeds may be employed. When the cutter rotation is against the feeding movement (as in the conventional method) the cutting edge of each tooth rubs against the work or rides upon it momentarily before beginning to cut, which results in greater dulling of the cutter than when each cutting edge enters the metal at the top of the cut or at the point of greatest chip thickness. The advantage of the climb-cut method is said to be even greater for the harder materials, although there may be an exception when castings have a hard sandy scale.



Climb-cut milling has another important advantage in that it enables pieces that are difficult to clamp securely in a fixture or on the machine table to be milled efficiently. The downward action of the cutter teeth in climb milling such pieces tends to seat them firmly in the holding devices. Cutters used in the conventional manner would tend to lift the pieces from their seats and might make the operation impractical. It is evident that a machine used for climb-cut milling must be in good condition and be so constructed that the machine table will resist the cutting forces in either direction. Any play or lost motion which would permit the cutter to climb into the work faster than intended would, of course, be objectionable.

Chip Breaker.—The term “chip breaker” indicates a method of grinding turning tools, that will break up the chips into short pieces, thus preventing the formation of long or continuous chips which would occupy considerable space and be difficult to handle. The chip-breaking form of cutting end is especially useful in turning with carbide-tipped steel turning tools because the cutting speeds are high and the chip formation rapid. The chip breaker consists of a shoulder back of the cutting edge. As the chip encounters this shoulder it is bent and broken repeatedly into small pieces. Some tools have attached or “mechanical” chip breakers which serve the same purpose as the shoulder.

Chipless Machining.—Chipless machining is the term being increasingly applied to the newer methods of cold forming metals to the required finished part shape (or nearly finished shape) without the production of chips (or with a minimum of subsequent machining required). Cold forming of steel is not new—having long been performed in such operations as wire-, bar-, and tube-drawing; cold-heading; coining; and conventional stamping and drawing. However, newer methods of plastic deformation with greatly increased degrees of metal displacement have been developed. Among these processes are: the rolling of serrations, splines, and gears; power spinning; internal swaging; radial forging; the cold forming of multiple-diameter shafts; cold extrusion; and high-energy-rate forming, which

includes explosive forming. Also, the not-so-new processes of cold heading, thread rolling and rotary swaging are also considered chipless machining processes.

Machinability and Hardness.— In cutting steels, the allowable cutting speed for a given tool life between grindings is, as a general rule, inversely proportional to the hardness of a given steel. To illustrate, tests in turning an alloy steel with a high-speed steel tool showed a cutting speed of 70 feet per minute when the hardness of the steel was 180 Brinell; the cutting speed had to be reduced to about 35 feet per minute when the hardness was increased to 360 Brinell, the life between tool grindings for these tests being 20 minutes in each case. The machinability of other steels of the same hardness might vary. For example, the tests just referred to showed more or less variation in the cutting speeds for steels of the same hardness, but having different compositions or properties. Thus, while there is a constant relationship between the hardness of a steel and its tensile strength, there is not the same constant relationship between steel hardness and machinability as applied to different steels.

Feed Rate on Machine Tools.— The rate of feed as applied to machine tools in general, usually indicates (1) the movement of a tool per work revolution, (2) the movement of a tool per tool revolution, (3) or the movement of the work per tool revolution.

Rate of Feed in Turning: The term "feed" as applied to a lathe indicates the distance that the tool moves during each revolution of the work. There are two ways of expressing the rate of feed. One is to give the actual tool movement per work revolution in thousandths of an inch. For example, the range of feeds may be given as 0.002 to 0.125 inch. This is the usual method. Another way of indicating a feed range is to give the number of cuts per inch or the number of ridges that would be left by a pointed tool after turning a length of one inch. For example, the feed range might be given as 8 to 400. In connection with turning and other lathe operations, the feed is regulated to suit the kind of material, depth of cut, and in some cases the finish desired.

Rate of Feed in Milling: The feed rate of milling indicates the movement of the work per cutter revolution.

Rate of Feed in Drilling: The rate of feed on drilling machines ordinarily indicates the feeding movement of the drill per drill revolution.

Rate of Feed in Planing: On planers, the rate of feed represents the tool movement per cutting stroke. On shapers, which are also machines of the planing type, the rate of feed represents the work movement per cutting stroke.

Rate of Feed on Gear Hobb: The feed rate of a gear hobbing machine represents the feeding movement of the hob per revolution of the gear being hobbled.

Feed on Grinding Machines: The traversing movement in grinding is equivalent to the feeding movement on other types of machine tools and represents either the axial movement of the work per work revolution or the traversing movement of the wheel per work revolution, depending upon the design of the machine.

Auger Speeds in Wood.— Auger speeds depend largely upon the condition of the wood in regard to seasoning. For example, with the same wood, say pine, speeds could vary by as much as one-third for samples that were very resinous or not properly seasoned. A hard wood, say mahogany, can be satisfactorily cut at a heavier feed and quicker speed than a soft wood badly seasoned or spongy. With spongy woods, there is often difficulty in clearing the chip or core, and this limits the speed. Again, many woodworking machines have an insufficient range of speeds, and small augers have to be underspeeded to avoid overspeeding the large ones. The following speeds for average woods may be taken as a guide for use with a good quality machine and auger: $\frac{1}{2}$ -inch augers, 200 revolutions per minute; $\frac{3}{4}$ -inch augers, 1600; 1-inch augers, 1300; $1\frac{1}{4}$ -inch augers, 1200; $1\frac{1}{2}$ -inch, 1100; and 2-inch, 1000.

Formica Machining.—Blanks can be cut from sheets of "Formica" either by a band saw or by trepanning tools in a boring mill or a drill press. To saw blanks, first describe a circle as a guide line, then use a 21-gage 31/2-point saw running at a speed of 5000 feet per minute. The saw should be sharp, with a 1/64-inch set on both sides. In drilling, use an ordinary high-speed drill whose point is ground to an included angle of 55 to 60 degrees. Another method is to grind the drill point slightly off center. The feed must be rapid and caution used to prevent the drill from lagging in its work, and the speed must be 1200 revolutions per minute. For all machine operations on "Formica" gear material, provision must be made in grinding for the tools to clear themselves. For reaming, the entry of the reamer and the reaming process must be rapid. There must be no lag between the end of the reaming operation and the withdrawal of the reamer. In turning the outside diameter and sides of blanks, the tools must be sharp and have 3 to 5 degrees more rake than is common practice for metal. A cutting speed of 750 feet per minute, which is equal to 720 revolutions per minute on a 4-inch diameter blank, is recommended. The depth of the cut can be 1/16 to 1/8 inch, but the feed should be 0.010 inch, regardless of the depth of the cut. Teeth may be cut on a hobbing machine, shaper, or milling machine. The speed of the cutter should be 150 feet per minute, and the feed from 0.023 to 0.040 inch per revolution. It is advisable to back up the blank to prevent fraying or breaking out of the material as the cutter comes through. The backing plates can be economically made from hard wood.

Planing Speeds and Feeds

Planing Speeds.—The speeds for planing usually vary from 30 to 50 feet per minute on the cutting stroke, with a return speed three to four times as great. A general idea of planer speeds may be obtained from the following figures, given by the Cincinnati Planer Co., and representing the practice in some of the best machine shops: Cast iron, roughing, 40 to 50 feet per minute; cast iron, finishing, 20 to 25 feet per minute; steel castings, roughing, 30 to 35 feet per minute; wrought iron, roughing, 30 to 45 feet per minute; steel castings, finishing, 20 feet per minute; wrought iron, finishing, 20 feet per minute; bronze and brass, 50 to 60 feet per minute; machinery steel, 30 to 35 feet per minute. When high-speed steel tools are used, a speed of 35 feet per minute is given as about the maximum that can ordinarily be used to advantage. The net or actual cutting speeds for various combinations of forward and return speeds are given in the table, "Actual Cutting Speeds of Planers." The upper half of this table shows how many feet per minute the planer actually cuts, and the lower half gives the same data in feet per hour. A slight increase in the forward speed has a much greater effect on the net cutting speed and rate of production than a comparatively high increase of the return speed. To illustrate, when the cutting speed is 30 feet per minute and the return speed, 90 feet per minute, a planer tool actually cuts 22.5 feet per minute. If the return speed is increased to 150 feet per minute, the net cutting speed is increased to 25 feet — a gain of 2.5 feet for a return-speed increase of approximately 66 per cent. If the cutting speed is increased to 35 feet (the return speed remaining at 90), the net cutting speed is increased to approximately 25 feet per minute, as before, but with a cutting speed increase of only about 16 per cent. Hence, it is important to have the cutting speed as high as conditions will permit.

Feeds for Planing.—The feed of a planing tool varies widely for different kinds of material and classes of work; it is also governed by the depth of cut, the nature of the cut (whether roughing or finishing), and by the rigidity of the work when damped in position for planing. Feeds, ordinarily vary from 1/10 to 1/2 inch for rough-planing steel, and from 1/8 to 3/4 inch for roughing cast iron. When taking light finishing cuts in cast iron, a broad tool having a flat edge is commonly used and the feed ordinarily varies from 1/4 to 1/2 inch per stroke. When planing large rigid castings, a feed as coarse as 3/4 or 1 inch per stroke is often employed.

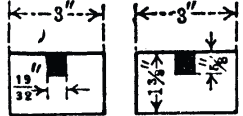
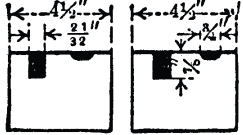
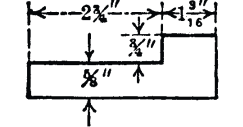
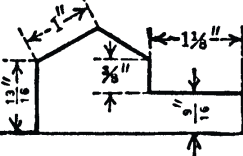
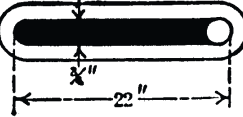
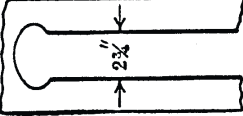
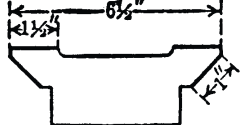
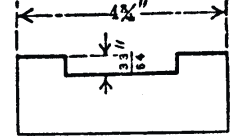
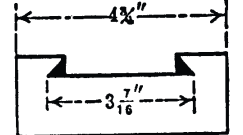
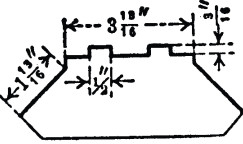
Actual Cutting Speeds of Planers

Cutting Speed, Feet per Minute	Return Speed, Feet per Minute							
	50	60	70	80	90	100	120	150
	Actual Number of Feet Traversed on Cutting Strokes per Minute							
20	14.3	15.0	15.5	16.0	16.4	16.7	17.1	17.6
25	16.7	17.0	18.4	19.0	19.6	20.0	20.7	21.4
30	18.7	20.0	21.0	21.8	22.5	23.1	24.0	25.0
35	20.6	22.0	23.3	24.3	25.2	25.9	27.1	28.4
40	22.2	24.0	25.4	26.7	27.7	28.6	30.0	31.6
45	23.7	25.7	27.4	28.8	30.0	31.0	32.7	34.6
50	25.0	27.3	29.2	30.8	32.1	33.3	35.3	37.5
	Actual Number of Feet Traversed on Cutting Strokes per Hour							
20	857	900	933	960	981	1000	1028	1058
25	1000	1058	1105	1142	1173	1200	1241	1285
30	1125	1200	1260	1309	1350	1384	1440	1500
35	1235	1321	1400	1460	1512	1555	1625	1702
40	1333	1440	1527	1600	1661	1714	1800	1894
45	1421	1542	1643	1728	1800	1862	1964	2076
50	1500	1636	1750	1846	1928	2000	2117	2250

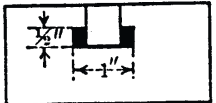
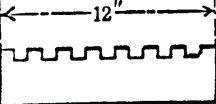
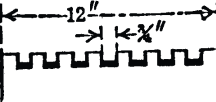

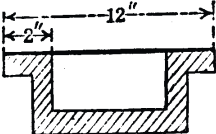
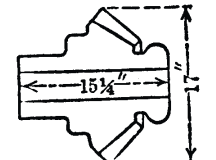
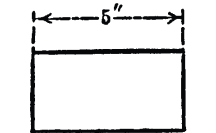
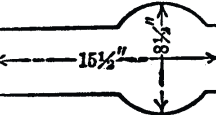
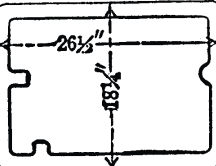
Speeds and Feeds for Milling

Milled Surface Indicated by Heavy Line	Material Milled, Width and Depth of Cut, Feed of Table and Speed of Cutters
	Material, cast iron. Total width of cut, 15 inches. Maximum depth, $\frac{3}{16}$ inch. Feed, $4\frac{3}{4}$ inches per minute. Largest cutter of gang, 6 inches diameter, $9\frac{3}{8}$ -inch face. Speed, 32 revolutions per minute.
	Material, cast iron. Total width of milled surface, $16\frac{3}{8}$ inches. Depth of cut, $\frac{3}{16}$ inch. Feed, 6.3 inches per minute. Diameter of side mills for finishing sides of casting, $10\frac{1}{2}$ inches. Speed of cutter, 21 revolutions per minute.
	Material, cast iron. Total width of milled surface, 2.3 inches. Depth of cut, $\frac{1}{2}$ inch. Feed of table, $4\frac{3}{4}$ inches per minute. Diameter of side mills, $13\frac{1}{2}$ inches. Diameter of intermediate cutters for top surfaces, 3 inches. Speed, 14 revolutions per minute.
	Material, cast iron. Total width of cut, $7\frac{5}{8}$ inches. Size of milled groove, $\frac{19}{32}$ inch wide, $\frac{1}{8}$ inch deep. Feed of table, 9.9 inches per minute. Depth of cut, $\frac{1}{8}$ inch.
	Material, cast iron. Total width of cut, $13\frac{5}{8}$ inches. Size of slot milled from solid, $\frac{15}{16}$ by $\frac{19}{32}$ inch. Depth of cut on top and sides, $8,46$ inch. Feed, 4 inches per minute. Cutter diameters, 8, $3\frac{1}{2}$ and $\frac{3}{16}$ inches. Speed, 36 revolutions per minute.

(Continued) Speeds and Feeds for Milling

Milled Surface Indicated by Heavy Line	Material Milled, Width and Depth of Cut, Feed of Table and Speed of Cutters
	<p>Material, close-grained cast iron. Operation, roughing two castings simultaneously, removing $\frac{3}{16}$ inch stock and milling from solid, two $\frac{3}{16}$-inch slots. Feed, 4 inches per minute. Speed of gang cutter, 36 revolutions per minute.</p>
	<p>Material, 50-point carbon steel bars. Operation, milling two bars simultaneously. Travel of table, $1 \frac{1}{16}$ inch per minute. Depth of cut, $\frac{1}{4}$ inch. Highspeed steel cutters, 4 inches and $5 \frac{3}{4}$ inches in diameter. Peripheral speed of large cutter, 30 feet per minute.</p>
	<p>Material, cast iron. Total width of finished surface, $4 \frac{3}{4}$ inches. Depth of cut, $\frac{1}{8}$ inch. Feed per minute, $1 \frac{7}{8}$ inch. Cutter diameters, $4 \frac{1}{2}$ and 3 inches, respectively. Limit of accuracy, 0.001 inch.</p>
	<p>Material, cast iron. Total width of surface finished, 5 inches. Depth of cut, $\frac{3}{32}$ inch. Feed of table, 2.9 inches per minute. Largest cutters in gang, $5 \frac{1}{2}$ inches; smallest, 2 inches. Speed, 53 revolutions per minute.</p>
	<p>Operation, milling slots in cast-iron bars 1 inch thick, with a single cut, using a $\frac{3}{4}$-inch, 3-fluted, high-speed steel end mill. Feed of table, $3 \frac{5}{8}$ inches per minute. Speed of cutter, 365 revolutions per minute, giving a surface speed of 72 feet.</p>
	<p>Material, close-grained cast iron. Operation, milling both sides of a slot. Diameter of cutter, $2 \frac{3}{4}$ inches. Width of cut, $2 \frac{3}{4}$ inches. Depth of cut at top and bottom, $\frac{1}{16}$ inch. Feed, 3 inches per minute.</p>
	<p>Material, close-grained cast iron. Operation, roughing dovetail bearings. Depth of cut, $\frac{3}{16}$ inch. Feed, $7 \frac{3}{4}$ inches per minute. Width of surfacemilled by side mill, $1 \frac{1}{2}$ inch; by angular cutter, $1 \frac{1}{4}$ inch. Speed, 36 revolutions per minute. Machine, vertical type.</p>
	<p>Material, steel castings. First operation, roughing out channel and top surface. Depth of cut, $\frac{1}{8}$ inch; $\frac{1}{4}$ inch on the sides of channel. Feed, $7 \frac{3}{4}$ inches per minute. Cutters, high-speed steel. (Succeeding operation follows.)</p>
	<p>Second operation, in vertical machine. Cutters, 6-inch side mill, 3-inch angular mill, mounted as a gang, but used independently. First cut, truing top surface. Feed, $2 \frac{1}{4}$ inches per minute. Dovetailed sides finished in two cuts. Feed, $1 \frac{1}{16}$ inch per minute, feed being slow to insure accuracy.</p>
	<p>Material, gray iron. Total width of cut, 9.4 inches. Average depth, $\frac{3}{16}$ inch. Feed, $6 \frac{7}{8}$ inches per minute. Diameter of angular cutters for sloping sides, $7 \frac{1}{2}$ inches. Diameter of cutters for top surfaces, $3 \frac{1}{2}$ and $3 \frac{1}{8}$ inches. Speed, 33 revolutions per minute.</p>

(Continued) Speeds and Feeds for Milling

Milled Surface Indicated by Heavy Line	Material Milled, Width and Depth of Cut, Feed of Table and Speed of Cutters
	<p>Operation, undercutting T-slots in cast iron. Cutter, high-speed steel, 1 inch in diameter, 1/2 inch wide. Speed, 286 revolutions per minute. Feed of table, 15 3/4 inches per minute.</p>
	<p>Material, cast-iron plates. First operation, milling full width of plate. Depth of cut, 1/8 inch. Feed of table, inches per minute. Cutter, inches in diameter. Speed, 66 revolutions per minute. (Succeeding operation follows.)</p>
	<p>Second operation, finishing slots and sides. Width of slots, 3/4 inch. Feed of table, 1 3/4 inch per minute. Cutter diameters, 4 and 8 inches, respectively. Speed, 66 revolutions per minute. Limit of accuracy, 0.001 inch.</p>
	<p>Material, steel. Operation, finishing simultaneously the four sides of two connecting-rod straps. -Width of each milled surface, 2 1/4 inches. Depth of cut, 1/2 to 3/16 inch. Feed of table, 1 inch per minute. Cutters, high-speed steel, 8 1/2 inches in diameter. Cutting speed, 50 feet per minute.</p>
	<p>Material, gray iron. Diameter of face mill, 12 5/8 inches. Surface is rough milled by one passage of cutter, then feed is reversed and a finishing cut 0.010 inch deep is taken. Rate of feed, 20 inches per minute. Machine, vertical type.</p>
	<p>Material, steel castings. Operation, facing flat surface with a 9 1/2-inch face mill. Depth of roughing cut, 3/16 inch. Feed, 3 11/16 inches per minute. Speed, 21 revolutions per minute. Depth of finishing cut, 0.010 inch. Machine, vertical type.</p>
	<p>Material, machine steel bars. Operation, milling flat surface inches wide, with 12 2-inch inserted-tooth cutter. Depth of cut, 1/8 inch. Feed, 16 inches per minute. Speed, 17 revolutions per minute. Machine, vertical type.</p>
	<p>Material, cast iron. Maximum width of cut, 8 inches. First operation, roughing cut 3/16 inch deep; feed, 7 3/4 inches per minute. Second operation, finishing cut; feed, 20 inches per minute. Machine, vertical type.</p>
	<p>Material, cast iron. Roughing cut, 3/16 inch deep; feed, 20 inches per minute. Cutter, 10-inch face mill. Rectangular surface is covered by using longitudinal and cross feeds. Machine; vertical type.</p>

Speeds for Tapping Nuts

Peripheral Speed, 10 Feet per Minute				Peripheral Speed, 10 Feet per Minute				Peripheral Speed, 10 Feet per Minute				
Tap Diam.	Rev. per Min.	Tap Diam.	Rev. per Min.	Tap Diam.	Rev. per Min.	Tap Diam.	Rev. per Min.	Tap Diam.	Rev. per Min.	Tap Diam.	Rev. per Min.	
$\frac{1}{8}$	Faster than 10 ft. per minute	$1\frac{1}{2}$	25	$\frac{1}{8}$	460	$1\frac{1}{2}$	38	$\frac{1}{8}$	612	$1\frac{1}{2}$	Slower than 20 ft. per minute	
$\frac{1}{4}$		$1\frac{3}{8}$	23	$\frac{1}{4}$	230	$1\frac{5}{8}$	35	$\frac{1}{4}$	306	$1\frac{3}{8}$		
$\frac{5}{16}$		$1\frac{1}{4}$	22	$\frac{5}{16}$	188	$1\frac{3}{4}$	32	$\frac{5}{16}$	244	$1\frac{3}{4}$		
$\frac{3}{8}$		$1\frac{1}{8}$	20	$\frac{3}{8}$	153	$1\frac{7}{8}$	30	$\frac{3}{8}$	204	$1\frac{7}{8}$		
$\frac{7}{16}$		2	19	$\frac{7}{16}$	131	2	28	$\frac{7}{16}$	176	2		
$\frac{1}{2}$		$2\frac{1}{4}$	17	$\frac{1}{2}$	115	$2\frac{1}{4}$	25	$\frac{1}{2}$	153	$2\frac{1}{4}$		
$\frac{9}{16}$		$2\frac{1}{2}$	15	$\frac{9}{16}$	102	$2\frac{1}{2}$	22	$\frac{9}{16}$	136	$2\frac{1}{2}$		
$\frac{5}{8}$		$2\frac{3}{4}$	14	$\frac{5}{8}$	93	$2\frac{3}{4}$	20	$\frac{5}{8}$	122	$2\frac{3}{4}$		
$\frac{3}{4}$		3	12	$\frac{3}{4}$	75	3	18	$\frac{3}{4}$	102	3		
$\frac{7}{8}$		$3\frac{1}{4}$	11	$\frac{7}{8}$	65	$\frac{7}{8}$	88	$3\frac{1}{4}$		
1		38	$3\frac{1}{2}$	10	1	55	1	76		$3\frac{1}{2}$
$1\frac{1}{8}$		34	$3\frac{3}{4}$	9	$1\frac{1}{8}$	50	$1\frac{1}{8}$...		$3\frac{3}{4}$
$1\frac{1}{4}$		30	4	8	$1\frac{1}{4}$	45	$1\frac{1}{4}$...		4
$1\frac{3}{8}$		28	$1\frac{3}{8}$	40	$1\frac{3}{8}$

Grinding

Tooth-rest for Cutter Grinding.—A tooth-rest is used to support a cutter while grinding the teeth. For grinding a cylindrical cutter having helical or "spiral" teeth, the tooth-rest must remain in a fixed position relative to the grinding wheel. The tooth being ground will then slide over the tooth-rest, thus causing the cutter to turn as it moves longitudinally, so that the edge of the helical tooth is ground to a uniform distance from the center, throughout its length. For grinding a straight-fluted cutter, it is also preferable to have the tooth-rest in a fixed position relative to the wheel, unless the cutter is quite narrow, because any warping of the cutter in hardening will result in inaccurate grinding, if the tooth rest moves with the work. The tooth-rest should be placed as close to the cutting edge of the cutter as is practicable, and bear against the face of the tooth being ground.

Steadyrests for Grinding.—Practically all parts that are ground on centers should be supported by suitable steadyrests or back-rests, as their use will not only obviate chattering, when properly applied, but permit taking deeper cuts with coarser feeds and also increase the "sizing power" of the wheel. In grinding long and slender parts, such supports are indispensable, and, even for work which is short and rigid, steadyrests are desirable to prevent vibration, which increases wheel wear and affects the quality of the ground surface. These supports are fastened to the table of the machine and are equipped with shoes of hardwood or metal which bear against the piece being ground. The number of steadyrests used depends upon the form and diameter of the work. According to a commonly accepted rule, the distance between the steadyrests should be from six to ten times the diameter of the part being ground. Some recommend the use of as many rests as can conveniently be fixed in position.

Silicate Bonding Process.—Silicate grinding wheels derive their name from the fact that silicate of soda or water glass is the principal ingredient used in the bond. These wheels are also sometimes referred to as semi-vitrified wheels. Ordinarily, they cut smoothly and with comparatively little heat, and for grinding operations requiring the lowest wheel wear, compatible with cool cutting, silicate wheels are often used. Their grade is also dependable and much larger wheels can be made by this bonding process than by the vitrified process. Some of the grinding operations for which silicate wheels have been found to be especially adapted are as follows: For grinding high-speed steel machine shop tools,

such as reamers, milling cutters, etc.; for hand-grinding lathe and planer tools; for surface grinding with machines of the vertical ring-wheel type; and for operations requiring dish-shaped wheels and cool cutting. These wheels are unequaled for wet grinding on hardened steel and for wet tool grinding. They are easily recognized by their light gray color.

Vitrified Grinding Wheels.—: The term "vitrified" denotes the type of bond used in these grinding wheels. The bond in a grinding wheel is the material which holds the abrasive grains together and supports them while they cut. With a given type of bond, it is the amount of bond that determines the "hardness" or softness" of wheels. The abrasive itself is extremely hard in all wheels, and the terms "hard" and "soft" refer to the strength of bonding; the greater the percentage of bond with respect to the abrasive, the heavier the coating of bond around the abrasive grains and the stronger the bond posts, the "harder" the wheel. Most wheels are made with a vitrified bond composed of clays and feldspar selected for their fusibility. During the "burning" process in grinding wheel manufacture, the clays are fused into a molten glass condition. Upon cooling, a span or post of this glass connects each abrasive grain to its neighbors to make a rigid, strong, grinding wheel. These wheels are porous, free cutting and unaffected by water, acids, oils, heat, or cold. Vitrified wheels are extensively used for cylindrical grinding, surface grinding, internal grinding and cutter grinding.

Bort.—Bort is an inferior variety of diamond which is used in the industries for truing soft grinding wheels and for making diamond dies for wire drawing and similar purposes. It is not as hard as the variety of diamond known as the carbon or black diamond, and is considerably lower in price; but it is not as economical to use as the black diamond for truing hard grinding wheels. While the bort is a semi-transparent stone known as an "imperfect brilliant," and, therefore, useless as a precious stone, it is very useful as an abrasive agent. It generally occurs in small spherical masses of grayish color. In its commercial usage, the term "bort" is often extended to all small and impure diamonds and crystalline fragments of diamonds which cannot be used as gems. A large proportion of these stones come from South Africa. All classes of diamonds are invariably weighed in carats and in the subdivision 1/2, 1/4, 1/8, 1/16, 1/32 and 1/64 of a carat. 1 carat (International system) = 3.086 grains = 0.200 gram; 1 ounce troy = 155.5 carats.

Numerical Control

Introduction.—The Electronic Industries Association (EIA) defines numerical control as "a system in which actions are controlled by the direct insertion of numerical data at some point." More specifically, numerical control, or NC as it will be called here, involves machines controlled by electronic systems designed to accept numerical data and other instructions, usually in a coded form. These instructions may come directly from some source such as a punched tape, a floppy disk, directly from a computer, or from an operator.

The key to the success of numerical control lies in its flexibility. To machine a different part, it is only necessary to "play" a different tape. NC machines are more productive than conventional equipment and consequently produce parts at less cost even when the higher investment is considered. NC machines also are more accurate and produce far less scrap than their conventional counterparts. By 1985, over 110,000 NC machine tools were operating in the United States. Over 80 per cent of the dollars being spent on the most common types of machine tools, namely, drilling, milling, boring, and turning machines, are going into NC equipment.

NC is a generic term for the whole field of numerical control and encompasses a complete field of endeavor. Sometimes CNC, which stands for Computer Numerical Control and applies only to the control system, is used erroneously as a replacement term for NC. Albeit a monumental development, use of the term CNC should be confined to installations where the older hardware control systems have been replaced.

Metal cutting is the most popular application, but NC is being applied successfully to other equipment, including punch presses, EDM wire cutting machines, inspection

machines, laser and other cutting and torching machines, tube bending machines, and sheet metal cutting and forming machines.

State of the CNC Technology Today.—Early numerical control machines were ordinary machines retrofitted with controls and motors to drive tools and tables. The operations performed were the same as the operations were on the machines replaced. Over the years, NC machines began to combine additional operations such as automatically changing tools and workpieces. The structure of the machines has been strengthened to provide more rigid platforms. These changes have resulted in a class of machine that can outperform its predecessors in both speed and accuracy. Typical capabilities of a modern machining center are accuracy better than ± 0.00035 inch; spindle speeds in the range up to 25,000 rpm or more, and increasing; feed rates up to 400 inches per minute and increasing; tool change times hovering between 2 and 4 seconds and decreasing. Specialized machines have been built that can achieve accuracy better than one millionth (0.000001) of an inch.

Computer numerical control of machines has undergone a great deal of change in the last decade, largely as a result of rapid increases in computer capability. Development of new and improved materials for tooling and bearings, improvements in tool geometry, and the added structural stiffness of the new machines have made it possible to perform cutting operations at speeds and feeds that were formerly impossible to attain.

Numerical Control vs. Manual Operations.—The initial cost of a CNC machine is generally much higher than a manual machine of the same nominal capacity, and the higher initial cost leads to a higher overall cost of the machine per hour of its useful life. However, the additional cost of a CNC machine has to be considered against potential savings that the machine may make possible. Some of the individual factors that make NC and CNC machining attractive are considered below.

Labor is usually one of the highest costs in the production of a part, but the labor rate paid to a CNC machine operator may be lower than the rate paid to the operator of conventional machines. This statement is particularly true when there is a shortage of operators with specialized skills necessary for setting up and operating a manual machine. However, it should not be assumed that skilled CNC machine operators are not needed because most CNCs have manual overrides that allow the operator to adjust feeds and speeds and to manually edit or enter programs as necessary. Also, skilled setup personnel and operators are likely to promote better production rates and higher efficiency in the shop. In addition, the labor rate for setting up and operating a CNC machine can sometimes be divided between two or more machines, further reducing the labor costs and cost per part produced.

The quantity and quality requirements for an order of parts often determines what manufacturing process will be used to produce them. CNC machines are probably most effective when the jobs call for a small to medium number of components that require a wide range of operations to be performed. For example, if a large number of parts are to be machined and the allowable tolerances are large, then manual or automatic fixed-cycle machines may be the most viable process. But, if a large quantity of high quality parts with strict tolerances are required, then a CNC machine will probably be able to produce the parts for the lowest cost per piece because of the speed and accuracy of CNC machines. Moreover, if the production run requires designing and making a lot of specialized form tools, cams, fixtures, or jigs, then the economics of CNC machining improves even more because much of the preproduction work is not required by the nature of the CNC process.

CNC machines can be effective for producing one-of-a-kind jobs if the part is complicated and requires a lot of different operations that, if done manually, would require specialized setups, jigs, fixtures, etc. On the other hand, a single component requiring only one or two setups might be more practical to produce on a manual machine, depending on the tolerances required. When a job calls for a small to medium number of components that require a wide range of operations, CNC is usually preferable. CNC machines are also especially well suited for batch jobs where small numbers of components are produced from an existing part program, as inventory is needed. Once the part program has been tested, a batch of the parts can be run whenever necessary. Design changes can be incorpo-

rated by changing the part program as required. The ability to process batches also has an additional benefit of eliminating large inventories of finished components.

CNC machining can help reduce machine idle time. Surveys have indicated that when machining on manual machines, the average time spent on material removal is only about 40 per cent of the time required to complete a part. On particularly complicated pieces, this ratio can drop to as low as 10 per cent or even less. The balance of the time is spent on positioning the tool or work, changing tools, and similar activities. On numerically controlled machines, the metal removal time frequently has been found to be in excess of 70 per cent of the total time spent on the part. CNC nonmachining time is lower because CNC machines perform quicker tool changes and tool or work positioning than manual machines. CNC part programs require a skilled programmer and cost additional preproduction time, but specialized jigs and fixtures that are frequently required with manual machines are not usually required with CNC machines, thereby reducing setup time and cost considerably.

Additional advantages of CNC machining are reduced lead time; improved cutting efficiency and longer tool life, as a result of better control over the feeds and speeds; improved quality and consistently accurate parts, reduced scrap, and less rework; lower inspection costs after the first part is produced and proven correct; reduced handling of parts because more operations can be performed per setup; and faster response to design changes because most part changes can be made by editing the CNC program.

Numerical Control Standards.—Standards for NC hardware and software have been developed by many organizations, and copies of the latest standards may be obtained from the following: Electronic Industries Association (EIA), 2001 Pennsylvania Avenue NW, Washington, DC 20006 (EIA and ANSI/EIA); American Society of Mechanical Engineers (ASME), 345 East 47th Street, New York, NY 10017 (ANSI/ASME); American National Standards Institute (ANSI), 25 West 43rd Street, New York, NY 10036 (ANSI, ANSI/EIA, ANSI/ASME, and ISO); National Standards Association, Inc. (NSA), 1200 Quince Orchard Boulevard, Gaithersburg, MD 20878; NMTBA The Association for Manufacturing Technology, 7901 Westpark Drive, McLean, VA 22102. Some of the standards and their contents are listed briefly in the accompanying table.

Numerical Control Standards

Standard Title	Description
ANSI/CAM-I 101-1990	Dimensional Measuring Interface Specification
ANSI/ASME B5.50	V-Flange Tool Shanks for Machining Centers with Automatic Tool Changers
ANSI/ASME B5.54-1992	Methods for Performance Evaluation of Computer Numerically Controlled Machining Centers
ANSI/ASME B89.1.12M	Methods for Performance Evaluation of Coordinate Measuring Machines
ANSI/EIA 227-A	1-inch Perforated Tape
ANSI/EIA 232-D	Interface Between Data Terminal Equipment and Data Circuit-Terminating Equipment Employing Serial Binary Data Interchange
ANSI/EIA 267-B	Axis and Motion Nomenclature for Numerically Controlled Machines
ANSI/EIA 274-D	Interchangeable Variable Block Data Format for Positioning, Contouring and Contouring/Positioning Numerically Controlled Machines
ANSI/EIA 358-B	Subset of American National Standard Code for Information Interchange for Numerical Machine Control Perforated Tape
ANSI/EIA 408	Interface Between NC Equipment and Data Terminal Equipment Employing Parallel Binary Data Interchange
ANSI/EIA 423-A	Electrical Characteristics of Unbalanced Voltage Digital Interface Circuits
ANSI/EIA 431	Electrical Interface Between Numerical Control and Machine Tools
ANSI/EIA 441	Operator Interface Function of Numerical Controls
ANSI/EIA 449	General Purpose 37-position and 9-position Interface for Data Terminal Equipment and Data Circuit-Terminating Equipment Employing Serial Binary Data Interchange
ANSI/EIA 484	Electrical and Mechanical Interface Characteristics and Line Control Protocol Using Communication Control Characters for Serial Data Link between a Direct Numerical Control System and Numerical Control Equipment Employing Asynchronous Full Duplex Transmission
ANSI/EIA 491-A -1990	Interface between a Numerical Control Unit and Peripheral Equipment Employing Asynchronous Binary Data Interchange over Circuits having EIA-423-A Electrical Characteristics
ANSI/EIA 494	32-bit Binary CL Interchange (BCL) Input Format for Numerically Controlled Machines
EIA AB3-D	Glossary of Terms for Numerically Controlled Machines
EIA Bulletin 12	Application Notes on Interconnection between Interface Circuits Using RS-449 and RS-232-C
ANSI X 3.94	Programming Aid for Numerically Controlled Manufacturing
ANSI X 3.37	Programming Language APT
ANSI X 3.20	1-inch Perforated Tape Take-up Reels for Information Interchange
ANSI X 3.82	One-sided Single Density Unformatted 5.25 inch Flexible Disc Cartridges

Numerical Control Standards

Standard Title	Description
ISO 841	Numerical Control of Machines—Axis and Motion Nomenclature
ISO 2806	Numerical Control of Machines—Bilingual Vocabulary
ISO 2972	Numerical Control of Machines—Symbols
ISO 3592	Numerical Control of Machines—Numerical Control Processor Output, Logical Structure and Major Words
ISO 4336	Numerical Control of Machines—Specification of Interface Signals between the Numerical Control Unit and the Electrical Equipment of a Numerically Controlled Machine
ISO 4343	Numerical Control of Machines—NC Processor Output— Minor Elements of 2000-type Records (Post Processor Commands)
ISO TR 6132	Numerical Control of Machines—Program Format and Definition of Address Words—Part 1: Data Format for Positioning, Line Motion and Contouring Control Systems
ISO 230-1	Geometric Accuracy of Machines Operating Under No-Load or Finishing Conditions
ISO 230-2	Determination of Accuracy and Repeatability of Positioning of Numerically Controlled Machine Tools
NAS 911	Numerically Controlled Skin/Profile Milling Machines
NAS 912	Numerically Controlled Spar Milling Machines
NAS 913	Numerically Controlled Profiling and Contouring Milling Machines
NAS 914	Numerically Controlled Horizontal Boring, Drilling and Milling Machines
NAS 960	Numerically Controlled Drilling Machines
NAS 963	Computer Numerically Controlled Vertical and Horizontal Jig Boring Machines
NAS 970	Basic Tool Holders for Numerically Controlled Machine Tools
NAS 971	Precision Numerically Controlled Measuring/Inspection Machines
NAS 978	Numerically Controlled Machining Centers
NAS 990	Numerically Controlled Composite Filament Tape Laying Machines
NAS 993	Direct Numerical Control System
NAS 994	Adaptive Control System for Numerically Controlled Milling Machines
NAS 995	Specification for Computerized Numerical Control (CNC)
NMTBA	Common Words as They Relate to Numerical Control Software
NMTBA	Definition and Evaluation of Accuracy and Repeatability of Numerically Controlled Machine Tools
NMTBA	Numerical Control Character Code Cross Reference Chart
NMTBA	Selecting an Appropriate Numerical Control Programming Method
NEMA 1A1	Industrial Cell Controller Classification Concepts and Selection Guide

Programmable Controller.—Frequently referred to as a PC or PLC (the latter term meaning Programmable Logic Controller), a programmable controller is an electronic unit or small computer. PLCs are used to control machinery, equipment, and complete processes, and to assist CNC systems in the control of complex NC machine tools and flexible manufacturing modules and cells. In effect, PLCs are the technological replacements for electrical relay systems.

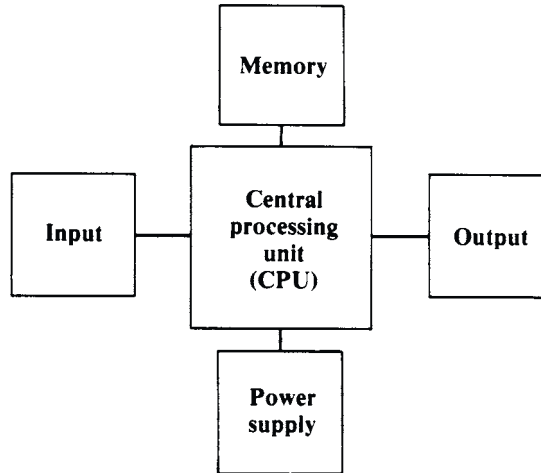


Fig. 1. Programmable Controllers' Four Basic Elements

As shown in Fig. 1, a PLC is composed of four basic elements: the equipment for handling input and output (I/O) signals, the central processing unit (CPU), the power supply, and the memory. Generally, the CPU is a microprocessor and the brain of the PLC. Early PLCs used hardwired special-purpose electronic logic circuits, but most PLCs now being offered are based on microprocessors and have far more logic and control capabilities than was possible with hardwired systems. The CPU scans the status of the input devices continuously, correlates these inputs with the control logic in the memory, and produces the appropriate output responses needed to control the machine or equipment.

Input to a PLC is either discrete or continuous. Discrete inputs may come from push buttons, micro switches, limit switches, photocells, proximity switches or pressure switches, for instance. Continuous inputs may come from sources such as thermocouples, potentiometers, or voltmeters. Outputs from a PLC normally are directed to actuating hardware such as solenoids, solenoid valves, and motor starters. The function of a PLC is to examine the status of an input or set of inputs and, based on this status, actuate or regulate an output or set of outputs.

Digital control logic and sensor input signals are stored in the memory as a series of binary numbers (zeros and ones). Each memory location holds only one "bit" (either 0 or 1) of binary information; however, most of the data in a PLC are used in groups of 8 bits, or bytes. A word is a group of bytes that is operated on at one time by the PLC. The word size in modern PLCs ranges from 8 to 32 bits (1 to 4 bytes), depending on the design of the PLC. In general, the larger the word size that a system is able to operate on (that is, to work on at one time), the faster the system is going to perform. New systems are now beginning to appear that can operate on 64 bits of information at a time.

There are two basic categories of memory: volatile and nonvolatile. Volatile memory loses the stored information when the power is turned off, but nonvolatile memory retains its logic even when power is cut off. A backup battery must be used if the information stored in volatile memory is to be retained. There are six commonly used types of memory. Of these six, random-access memory (RAM) is the most common type because it is the easiest to program and edit. RAM is also the only one of the six common types that is vola-

tile memory. The five nonvolatile memory types are: core memory, read-only memory (ROM), programmable read-only memory (PROM), electronically alterable programmable read-only memory (EAPROM), and electronically erasable programmable read-only memory (EEPROM). EEPROMs are becoming more popular due to their relative ease of programming and their nonvolatile characteristic. ROM is often used as a generic term to refer to the general class of read-only memory types and to indicate that this type of memory is not usually reprogrammed.

More than 90 per cent of the microprocessor PLCs now in the field use RAM memory. RAM is primarily used to store data, which are collected or generated by a process, and to store programs that are likely to change frequently. For example, a part program for machining a workpiece on a CNC machining center is loaded into and stored in RAM. When a different part is to be made, a different program can be loaded in its place. The non-volatile memory types are usually used to store programs and data that are not expected to be changed. Programs that directly control a specific piece of equipment and contain specific instructions that allow other programs (such as a part program stored in RAM) to access and operate the hardware are usually stored in nonvolatile memory or ROM. The benefit of ROM is that stored programs and data do not have to be reloaded into the memory after the power has been turned off.

PLCs are used primarily with handling systems such as conveyors, automatic retrieval and storage systems, robots, and automatic guided vehicles (AGV), such as are used in flexible manufacturing cells, modules, and systems (see *Flexible Manufacturing Systems (FMS)*, *Flexible Manufacturing Cell*, and *Flexible Manufacturing Module*). PLCs are also to be found in applications as diverse as combustion chamber control, chemical process control, and printed-circuit-board manufacturing.

Types of Programmable Controllers

Type	No. of I/Os	General Applications	Math Capability
Mini	32	Replaces relays, timers, and counters.	Yes
Micro	32–64	Replaces relays, timers, and counters.	Yes
Small	64–128	Replaces relays, timers, and counters. Used for materials handling, and some process control.	Yes
Medium	128–512	Replaces relays, timers, and counters. Used for materials handling, process control, and data collection.	Yes
Large	512+	Replaces relays, timers, and counters. Master control for other PLCs and cells and for generation of reports. High-level network capability	Yes

Types of PLCs may be divided into five groups consisting of micro, mini, small, medium, and large according to the number of I/Os, functional capabilities, and memory capacity. The smaller the number of I/Os and memory capacity, and the fewer the functions, the simpler the PLC. Micro and mini PLCs are usually little more than replacements for relay systems, but larger units may have the functional capabilities of a small computer and be able to handle mathematical functions, generate reports, and maintain high-level communications.

The preceding guidelines have some gray areas because mini, micro, and small PLCs are now available with large memory sizes and functional capacities normally reserved for medium and large PLCs. The accompanying table compares the various types of PLCs and their applications.

Instructions that are input to a PLC are called programs. Four major programming languages are used with PLCs, comprising ladder diagrams, Boolean mnemonics, functional blocks, and English statements. Some PLC systems even support high-level programming languages such as BASIC and PASCAL. Ladder diagrams and Boolean mnemonics are the basic control-level languages. Functional blocks and English statements are considered high-level languages. Ladder diagrams were used with electrical relay systems before these systems were replaced by PLCs and are still the most popular programming method, so they will be discussed further.

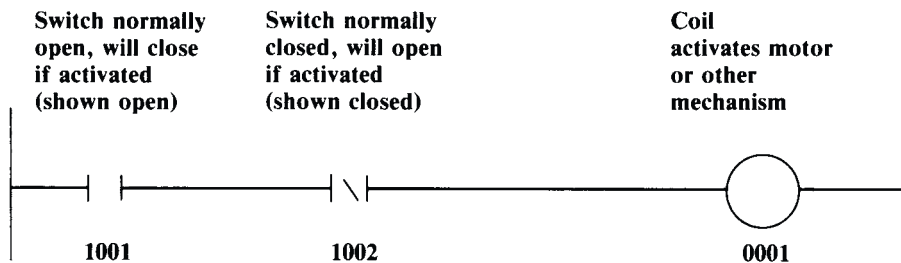


Fig. 2. One Rung on a Ladder Diagram

A ladder diagram consists of symbols, or ladder logic elements, that represent relay contacts or switches and other elements in the control system. One of the more basic symbols represents a normally open switch and is described by the symbol $\text{—}| \text{—}|$. Another symbol is the normally closed switch, described by the symbol $\text{—}| \text{—}| \text{—}/ \text{—}|$. When the normally open switch is activated, it will close, and when the normally closed switch is activated, it will open. Fig. 2 shows one rung (line) on a ladder diagram. Switch 1001 is normally open and switch 1002 is closed. A symbol for a coil (0001) is shown at the right. If switch 1001 is actuated, it will close. If switch 1002 is not activated, it will stay closed. With the two switches closed, current will flow through the line and energize coil 0001. The coil will activate some mechanism such as an electric motor, a robot, or an NC machine tool, for instance.

As an example, Fig. 3 shows a flexible manufacturing module (FMM), consisting of a turning center (NC lathe), an infeed conveyor, an outfeed conveyor, a robot that moves workpieces between the infeed conveyor, the turning center, and the outfeed conveyor, and a PLC. The arrowed lines show the signals going to and coming from the PLC.

Fig. 4 shows a ladder diagram for a PLC that would control the operations of the FMM by:

- 1) Activating the infeed conveyor to move the workpiece to a position where the robot can pick it up
- 2) Activating the robot to pick up the workpiece and load it into the chuck on the NC lathe
- 3) Activating the robot to remove the finished workpiece and place it on the outfeed conveyor
- 4) Activating the outfeed conveyor to move the workpiece to the next operation

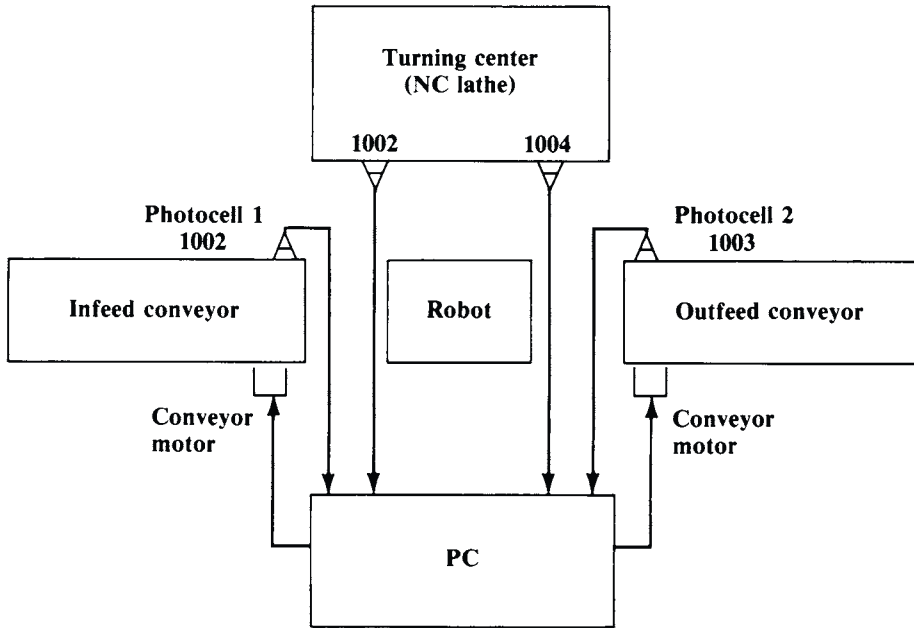


Fig. 3. Layout of a Flexible Manufacturing Module

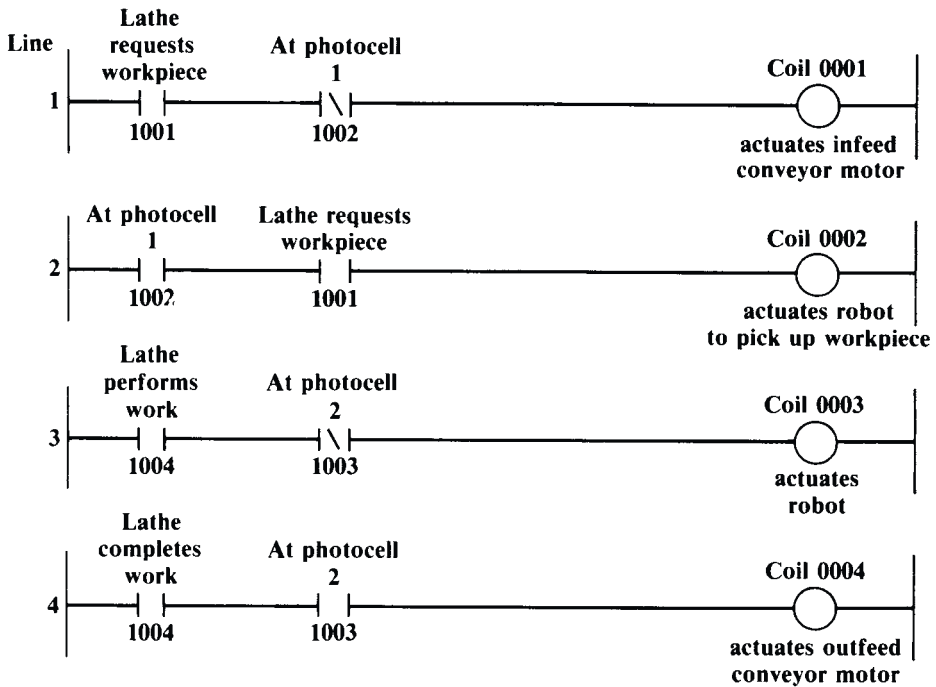


Fig. 4. Portion of a Typical Ladder Diagram for Control of a Flexible Manufacturing Module Including a Turning Center, Conveyors, a Robot, and a Programmable Controller

In Rung 1 of Fig. 4, a request signal for a workpiece from the NC lathe closes the normally open switch 1001. Switch 1002 will remain closed if photocell 1 is not activated, i.e., if it does not detect a workpiece. The signal therefore closes the circuit, energizes the coil, and starts the conveyor motor to bring the next workpiece into position for the robot to grasp.

In Rung 2, switch 1002 (which has been changed in the program of the PLC from a normally closed to a normally open switch) closes when it is activated as photocell 1 detects the workpiece. The signal thus produced, together with the closing of the now normally open switch 1001, energizes the coil, causing the robot to pick up the workpiece from the infeed conveyor.

In Rung 3, switch 1004 on the lathe closes when processing of the part is completed and it is ready to be removed by the robot. Photocell 2 checks to see if there is a space on the conveyor to accept the completed part. If no part is seen by photocell 2, switch 1003 will remain closed, and with switch 1004 closed, the coil will be energized, activating the robot to transfer the completed part to the outfeed conveyor.

Rung 4 shows activation of the output conveyor when a part is to be transferred. Normally open switch 1004 was closed when processing of the part was completed. Switch 1003 (which also was changed from a normally closed to a normally open switch by the program) closes if photocell 2 detects a workpiece. The circuit is then closed and the coil is energized, starting the conveyor motor to move the workpiece clear to make way for the succeeding workpiece.

Closed-Loop System.—Also referred to as a servo or feedback system, a closed-loop system is a control system that issues commands to the drive motors of an NC machine. The system then compares the results of these commands as measured by the movement or location of the machine component, such as the table or spindlehead. The feedback devices normally used for measuring movement or location of the component are called resolvers, encoders, Inductosyns, or optical scales. The resolver, which is a rotary analog mechanism, is the least expensive, and has been the most popular since the first NC machines were developed. Resolvers are normally connected to the lead-screws of NC machines. Linear measurement is derived from monitoring the angle of rotation of the leadscrew and is quite accurate.

Encoders also are normally connected to the leadscrew of the NC machine, and measurements are in digital form. Pulses, or a binary code in digital form, are generated by rotation of the encoder, and represent turns or partial turns of the leadscrew. These pulses are well suited to the digital NC system, and encoders have therefore become very popular with such systems. Encoders generally are somewhat more expensive than resolvers.

The Inductosyn (a trade name of Farrand Controls, Inc.) also produces analog signals, but is attached to the slide or fixed part of a machine to measure the position of the table, spindlehead, or other component. The Inductosyn provides almost twice the measurement accuracy of the resolver, but is considerably more expensive, depending on the length of travel to be measured.

Optical scales generally produce information in digital form and, like the Inductosyn, are attached to the slide or fixed part of the machine. Optical scale measurements are more accurate than either resolvers or encoders and, because of their digital nature, are well suited to the digital computer in a CNC system. Like the Inductosyn, optical scales are more costly than either resolvers or encoders.

Open-Loop System.—A control system that issues commands to the drive motors of an NC machine and has no means of assessing the results of these commands is known as an open-loop system. In such a system, no provision is made for feedback of information concerning movement of the slide(s), or rotation of the leadscrew(s). Stepping motors are popular as drives for open-loop systems.

Adaptive Control.—Measuring performance of a process and then adjusting the process to obtain optimum performance is called adaptive control. In the machine tool field, adaptive control is a means of adjusting the feed and/or speed of the cutting tool, based on sensor feedback information, to maintain optimum cutting conditions. A typical arrangement is seen in Fig. 5. Adaptive control is used primarily for cutting higher-strength materials

such as titanium, although the concept is applicable to the cutting of any material. The costs of the sensors and software have restricted wider use of the feature.

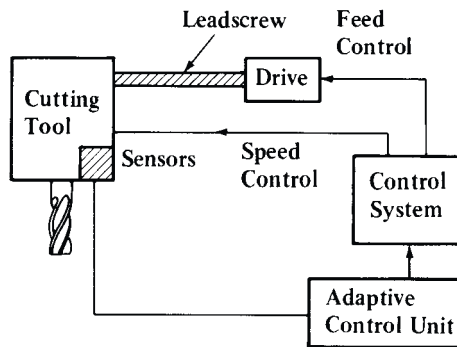


Fig. 5.

The sensors used for adaptive control are generally mounted on the machine drive shafts, tools, or even built into the drive motor. Typically, sensors are used to provide information such as the temperature at the tip of the cutting tool and the cutting force exerted by the tool. The information measured by the sensors is used by the control system computer to analyze the cutting process and adjust the feeds and speeds of the machine to maximize the material removal rate or to optimize another process variable such as surface finish. For the computer to effectively evaluate the process in real time (i.e., while cutting is in progress), details such as maximum allowable tool temperature, maximum allowable cutting force, and information about the drive system need to be integrated into the computer program monitoring the cutting process.

Adaptive control can be used to detect worn, broken, or dull tooling. Ordinarily, the adaptive control system monitors the cutting process to keep the process variables (cutting speed and feed rate, for example) within the proper range. Because the force required to machine a workpiece is lowest when the tool is new or recently resharpened, a steady increase in cutting force during a machining operation, assuming that the feed remains the same, is an indication that the tool is becoming dull (temperature may increase as well). Upon detecting cutting forces that are greater than a predetermined maximum allowable force, the control system causes the feed rate, the cutting speed, or both to be adjusted to maintain the cutting force within allowable limits. If the cutting force cannot be maintained without causing the speed and/or feed rate to be adjusted outside its allowable limits, the machine will be stopped, indicating that the tool is too dull and must be resharpened or replaced.

On some systems, the process monitoring equipment can interface directly with the machine control system, as discussed above. On other systems, the adaptive control is implemented by a separate monitoring system that is independent of the machine control system. These systems include instrumentation to monitor the operations of the machine tool, but do not have the capability to directly change operating parameters, such as feeds and speeds. In addition, this type of control does not require any modification of the existing part programs for control of the machine.

Flexible Manufacturing Systems (FMS).—A flexible manufacturing system (FMS) is a computer-controlled machining arrangement that can perform a variety of continuous metal-cutting operations on a range of components without manual intervention. The objective of such a system is to produce components at the lowest possible cost, especially components of which only small quantities are required. Flexibility, or the ability to switch from manufacture of one type of component to another, or from one type of machining to another, without interrupting production, is the prime requirement of such a system. In general, FMS are used for production of numbers of similar parts between 200 and 2000,

although larger quantities are not uncommon. An FMS involves almost all the departments in a company, including engineering, methods, tooling and part programming, planning and scheduling, purchasing, sales and customer service, accounting, maintenance, and quality control. Initial costs of an FMS are estimated as being borne (percentages in parentheses) by machine tools (46.2), materials handling systems (7.7), tooling and fixtures (5.9), pallets (1.9), computer hardware (3.7), computer software (2.2), wash stations (2.8), automatic storage and retrieval systems (6.8), coolant and chip systems (2.4), spares (2), and others (18.4).

FMS are claimed to bring reductions in direct labor (80–90), production planning and control (65), and inspection (70). Materials handling and shop supervision are reduced, and individual productivity is raised. In the materials field, savings are made in tooling (35), scrap and rework (65), and floor space (50). Inventory is reduced and many other costs are avoided. Intangible savings claimed to result from FMS include reduced tooling changeover time, ability to produce complex parts, to incorporate engineering changes more quickly and efficiently than with other approaches, and to make special designs, so that a company can adapt quickly to changing market conditions. Requirements for spare parts with good fit are easily met, and the lower costs combine with higher quality to improve market share. FMS also are claimed to improve morale among workers, leading to higher productivity, with less paper work and more orderly shop operations. Better control of costs and improved cost data help to produce more accurate forecasts of sales and manpower requirements. Response to surges in demand and more economical materials ordering are other advantages claimed with FMS.

Completion of an FMS project is said to average 57 months, including 20 months from the time of starting investigations to the placing of the purchase order. A further 13 months are needed for delivery and a similar period for installation. Debugging and building of production takes about another 11 months before production is running smoothly. FMS are expensive, requiring large capital outlays and investments in management time, software, engineering, and shop support. Efficient operation of FMS also require constant workflow because gaps in the production cycle are very costly.

Flexible Manufacturing Cell.—A flexible manufacturing cell usually consists of two or three NC machines with some form of pallet-changing equipment or an industrial robot. Prismatic-type parts, such as would be processed on a machining center, are usually handled on pallets. Cylindrical parts, such as would be machined on an NC lathe, usually are handled with an overhead type of robot. The cell may be controlled by a computer, but is often run by programmable controllers. The systems can be operated without attendants, but the mixture of parts usually must be less than with a flexible manufacturing system (FMS).

Flexible Manufacturing Module.—A flexible manufacturing module is defined as a single machining center (or turning center) with some type of automatic materials handling equipment such as multiple pallets for machining centers, or robots for manipulating cylindrical parts and chucks for turning centers. The entire module is usually controlled by one or more programmable logic controllers.

Numerical Control Programming

Programming.—A numerical control (NC) program is a list of instructions (commands) that completely describes, in sequence, every operation to be carried out by a machine. When a program is run, each instruction is interpreted by the machine controller, which causes an action such as starting or stopping of a spindle or coolant, changing of spindle speed or rotation, or moving a table or slide a specified direction, distance, or speed. The form that program instructions can take, and how programs are stored and/or loaded into the machine, depends on the individual machine/control system. However, program instructions must be in a form (language) that the machine controller can understand.

A programming language is a system of symbols, codes, and rules that describes the manner in which program instructions can be written. One of the earliest and most widely recognized numerical control programming languages is based on the Standard ANSI/EIA RS-274-D-1980. The standard defines a recommended data format and codes for sending instructions to machine controllers. Although adherence to the standard is not mandatory, most controller manufacturers support it and most NC machine controllers (especially controllers on older NC machines using tape input) can accept data in a format that conforms, at least in part, with the recommended codes described in the RS-274-D standard. Most newer controllers also accept instructions written in proprietary formats offered (specified) by the controller's manufacturer.

One of the primary benefits of a standardized programming format is easy transfer of programs from one machine to another, but even standardized code formats such as RS-274-D are implemented differently on different machines. Consequently, a program written for one machine may not operate correctly on another machine without some modification of the program. On the other hand, proprietary formats are attractive because of features that are not available using the standardized code formats. For example, a proprietary format may make available certain codes that allow a programmer, with only a few lines of code, to program complex motions that would be difficult or even impossible to do in the standard language. The disadvantage of proprietary formats is that transferring programs to another machine may require a great deal of program modification or even complete rewriting. Generally, with programs written in a standardized format, the modifications required to get a program written for one machine to work on another machine are not extensive.

In programming, before describing the movement of any machine part, it is necessary to establish a coordinate system(s) as a reference frame for identifying the type and direction of the motion. A description of accepted terminology used worldwide to indicate the types of motion and the orientation of machine axes is contained in a separate section (Axis Nomenclature). Part geometry is programmed with reference to the same axes as are used to describe motion.

Manual data input (MDI) permits the machine operator to insert machining instructions directly into the NC machine control system via push buttons, pressure pads, knobs, or other arrangements. MDI has been available since the earliest NC machines were designed, but the method was less efficient than tape for machining operations and was used primarily for setting up the NC machine. Computer numerical control (CNC) systems, with their canned cycles and other computing capabilities, have now made the MDI concept more feasible and for some work MDI may be more practical than preparing a program. The choice depends very much on the complexity of the machining work to be done and, to a lesser degree, on the skill of the person who prepares the program.

Conversational part programming is a form of MDI that requires the operator or programmer to answer a series of questions displayed on the control panel of the CNC. The operator replies to questions that describe the part, material, tool and machine settings, and machining operations by entering numbers that identify the material, blank size and thickness or diameter, tool definitions, and other required data. Depending on capability, some controls can select the required spindle speed and feed rate automatically by using a materials look-up table; other systems request the appropriate feed and speed data. Tool motions needed to machine a part are described by selecting a linear or circular motion programming mode and entering endpoint and intersection coordinates of lines and radius, diameter, tangent points, and directions of arcs and circles (with some controllers, intersection and tangent points are calculated automatically). Machined elements such as holes, slots, and bolt circles are entered by selecting the appropriate tool and describing its action, or with "canned routines" built into the CNC to perform specific machining operations. On some systems, if a feature is once described, it can be copied and/or moved by: translation (copy and/or move), rotation about a point, mirror image (copy and rotate about an axis),

and scaling (copy and change size). On many systems, as each command is entered, a graphic image of the part or operation gives a visual check that the program is producing the intended results. When all the necessary data have been entered, the program is constructed and can be run immediately or saved on tape, floppy disk, or other storage media for later use.

Conversational programming gives complete control of machine operations to the shop personnel, taking advantage of the experience and practical skills of the machine operator/programmer. Control systems that provide conversational programming usually include many built-in routines (fixed or canned cycles) for commonly used machining operations and may also have routines for specialized operations. Built-in routines speed programming because one command may replace many lines of program code that would take considerable time to write. Some built-in cycles allow complex machining operations to be programmed simply by specifying the final component profile and the starting stock size, handling such details as developing tool paths, depth of cut, number of roughing passes, and cutter speed automatically. On turning machines, built-in cycles for reducing diameters, chamfer and radius turning, and cutting threads automatically are common. Although many CNC machines have a conversational programming mode, the programming methods used and the features available are not standardized. Some control systems cannot be programmed from the control panel while another program is running (i.e., while a part is being machined), but those systems that can be thus programmed are more productive because programming does not require the machine to be idle. Conversational programming is especially beneficial in reducing programming time in shops that do most of their part programming from the control panel of the machine.

Manual part programming describes the preparation of a part program by manually writing the part program in word addressed format. In the past, this method implied programming without using a computer to determine tool paths, speeds and feeds, or any of the calculations normally required to describe the geometry of a part. Today, however, computers are frequently used for writing and storing the program on disk, as well as for calculations required to program the part. Manual part programming consists of writing codes, in a format appropriate to the machine controller, that instruct the controller to perform a specific action. The most widely accepted form of coding the instructions for numerically controlled machines uses the codes and formats suggested in the ANSI/EIA RS-274-D-1980, standard. This type of programming is sometimes called G-code programming, referring to a commonly used word address used in the RS-274-D standard. Basic details of programming in this format, using the various codes available, are discussed in the next section (G-Code Programming).

Computer-assisted part programming (CAPP) uses a computer to help in the preparation of the detailed instructions for operating an NC machine. In the past, defining a curve or complicated surface profile required a series of complex calculations to describe the features in intimate detail. However, with the introduction of the microprocessor as an integral part of the CNC machine, the process of defining many complex shapes has been reduced to the simple task of calling up a canned cycle to calculate the path of the cutter. Most new CNC systems have some graphic programming capability, and many use graphic images of the part "drawn" on a computer screen. The part programmer moves a cutter about the part to generate the part program or the detailed block format instructions required by the control system. Machining instructions, such as the speed and feed rate, are entered via the keyboard. Using the computer as an assistant is faster and far more accurate than the manual part programming method.

Computer-assisted part programming methods generally can be characterized as either language-based or graphics-based, the distinction between the two methods being primarily in the manner by which the tool paths are developed. Some modern-language-based programming systems, such as Compact II, use interactive alphanumeric input so that programming errors are detected as soon as they are entered. Many of these programming sys-

tems are completely integrated with computer graphics and display an image of the part or operation as soon as an instruction is entered. The language-based programming systems are usually based on, or are a variation of, the APT programming language, which is discussed separately within this section (APT Programming).

The choice between computer-assisted part programming and manual part programming depends on the complexity of the part (particularly its geometry) and how many parts need to be programmed. The more complicated the part, the more benefit to be gained by CAPP, and if many parts are to be programmed, even if they are simple ones, the benefits of a computer-aided system are substantial. If the parts are not difficult to program but involve much repetition, computer-assisted part programming may also be preferred. If parts are to be programmed for several different control systems, a high-level part programming language such as APT will make writing the part programs easier. Because almost all machines have some deviations from standard practices, and few control systems use exactly the same programming format, a higher-level language allows the programmer to concentrate primarily on part geometry and machining considerations. The postprocessors (see *Postprocessors* below) for the individual control systems accommodate most of the variations in the programming required. The programmer only needs to write the program; the postprocessor deals with the machine specifics.

Graphical programming involves building a two- or three-dimensional model of a part on a computer screen by graphically defining the geometric shapes and surfaces of the part using the facilities of a CAD program. In many cases, depending on features of the CAD software package, the same computer drawing used in the design and drafting stage of a project can also be used to generate the program to produce the part. The graphical entities, such as holes, slots, and surfaces, are linked with additional information required for the specific machining operations needed. Most of the cutter movements (path of the cutter), such as those needed for the generation of pockets and lathe roughing cuts, are handled automatically by the computer. The program may then sort the various machining operations into an efficient sequence so that all operations that can be performed with a particular tool are done together, if possible. The output of graphical part programming is generally an alphanumeric part programming language output file, in a format such as an APT or Compact II file.

The part programming language file can be manually checked, and modified, as necessary before being run, and to help detect errors, many graphics programming systems also include some form of part verification software that simulates machining the part on the computer screen. Nongraphic data, such as feed rates, spindle speeds and coolant on/off, must be typed in by the part programmer or entered from a computer data base at the appropriate points in the program, although some programs prompt for this information when needed. When the part program language file is run or compiled, the result is a center line data (CL data) file describing the part. With most computer-aided part programming output files, the CL data file needs to be processed through a postprocessor (see *Postprocessors* below) to tailor the final code produced to the actual machine being used. Postprocessor output is in a form that can be sent directly to the control system, or can be saved on tape or magnetic media and transferred to the machine tool when necessary. The graphic image of the part and the alphanumeric output files are saved in separate files so that either can be edited in the future if changes in the part become necessary. Revised files must be run and processed again for the part modifications to be included in the part program. Software for producing part programs is discussed further in the CAD/CAM section.

Postprocessors.—A postprocessor is computer software that contains a set of computer instructions designed to tailor the cutter center line location data (CL data), developed by a computerized part programming language, to meet the requirements of a particular machine tool/system combination. Generally, when a machine tool is programmed in a graphical programming environment or any high-level language such as APT, a file is cre-

ated that describes all movements required of a cutting tool to make the part. The file thus created is run, or compiled, and the result is a list of coordinates (CL data) that describes the successive positions of the cutter relative to the origin of the machine's coordinate system. The output of the program must be customized to fit the input requirements of the machine controller that will receive the instructions. Cutter location data must be converted into a format recognized by the control system, such as G codes and M codes, or into another language or proprietary format recognized by the controller. Generally, some instructions are also added or changed by the programmer at this point.

The lack of standardization among machine tool control systems means that almost all computerized part programming languages require a postprocessor to translate the computer-generated language instructions into a form that the machine controller recognizes. Postprocessors are software and are generally prepared for a fee by the machine tool builder, the control system builder, a third party vendor, or by the user.

G-Code Programming

Programs written to operate numerical control (NC) machines with control systems that comply with the ANSI/EIA RS-274-D-1980, Standard consist of a series of data blocks, each of which is treated as a unit by the controller and contains enough information for a complete command to be carried out by the machine. Each block is made up of one or more words that indicate to the control system how its corresponding action is to be performed. A word is an ordered set of characters, consisting of a letter plus some numerical digits, that triggers a specific action of a machine tool. The first letter of the word is called the letter address of the word, and is used to identify the word to the control system. For example, X is the letter address of a dimension word that requires a move in the direction of the X-axis, Y is the letter address of another dimension word; and F is the letter address of the feed rate. The assigned letter addresses and their meanings, as listed in ANSI/EIA RS-274-D, are shown in [Table 1](#).

Format Classification.—The *format classification sheet* completely describes the format requirements of a control system and gives other important information required to program a particular control including: the type of machine, the format classification shorthand and format detail, a listing of specific letter address codes recognized by the system (for example, G-codes: G01, G02, G17, etc.) and the range of values the available codes may take (S range: 10 to 1800 rpm, for example), an explanation of any codes not specifically assigned by the Standard, and any other unique features of the system.

The *format classification shorthand* is a nine- or ten-digit code that gives the type of system, the number of motion and other words available, the type and format of dimensional data required by the system, the number of motion control channels, and the number of numerically controlled axes of the system. The *format detail* very succinctly summarizes details of the machine and control system. This NC shorthand gives the letter address words and word lengths that can be used to make up a block. The format detail defines the basic features of the control system and the type of machine tool to which it refers. For example, the format detail

N4G2X + 24Y + 24Z + 24B24I24J24F31T4M2

specifies that the NC machine is a machining center (has X-, Y-, and Z-axes) and a tool changer with a four-digit tool selection code (T4); the three linear axes are programmed with two digits before the decimal point and four after the decimal point (X + 24Y + 24Z + 24) and can be positive or negative; probably has a horizontal spindle and rotary table (B24 = rotary motion about the Y-axis); has circular interpolation (I24J24); has a feed rate range in which there are three digits before and one after the decimal point (F31); and can handle a four-digit sequence number (N4), two-digit G-words (G2), and two-digit miscellaneous words (M2). The sequence of letter addresses in the format detail is also the sequence in which words with those addresses should appear when used in a block.

Table 1. Letter Addresses Used in Numerical Control

Letter Address	Description	Refers to
A	Angular dimension about the <i>X</i> -axis. Measured in decimal parts of a degree	Axis nomenclature
B	Angular dimension about the <i>Y</i> -axis. Measured in decimal parts of a degree	Axis nomenclature
C	Angular dimension about the <i>Z</i> -axis. Measured in decimal parts of a degree	Axis nomenclature
D	Angular dimension about a special axis, or third feed function, or tool function for selection of tool compensation	Axis nomenclature
E	Angular dimension about a special axis or second feed function	Axis nomenclature
F	Feed word (code)	Feed words
G	Preparatory word (code)	Preparatory words
H	Unassigned	
I	Interpolation parameter or thread lead parallel to the <i>X</i> -axis	Circular interpolation and threading
J	Interpolation parameter or thread lead parallel to the <i>Y</i> -axis	Circular interpolation and threading
K	Interpolation parameter or thread lead parallel to the <i>Z</i> -axis	Circular interpolation and threading
L	Unassigned	
M	Miscellaneous or auxilliary function	Miscellaneous functions
N	Sequence number	Sequence number
O	Sequence number for secondary head only	Sequence number
P	Third rapid-traverse dimension or tertiary-motion dimension parallel to <i>X</i>	Axis nomenclature
Q	Second rapid-traverse dimension or tertiary-motion dimension parallel to <i>Y</i>	Axis nomenclature
R	First rapid-traverse dimension or tertiary-motion dimension parallel to <i>Z</i> or radius for constant surface-speed calculation	Axis nomenclature
S	Spindle-speed function	Spindle speed
T	Tool function	Tool function
U	Secondary-motion dimension parallel to <i>X</i>	Axis nomenclature
V	Secondary-motion dimension parallel to <i>Y</i>	Axis nomenclature
W	Secondary-motion dimension parallel to <i>Z</i>	Axis nomenclature
X	Primary <i>X</i> -motion dimension	Axis nomenclature
Y	Primary <i>Y</i> -motion dimension	Axis nomenclature
Z	Primary <i>Z</i> -motion dimension	Axis nomenclature

The information given in the format shorthand and format detail is especially useful when programs written for one machine are to be used on different machines. Programs that use the variable block data format described in RS-274-D can be used interchangeably on systems that have the same format classification, but for complete program compatibility between machines, other features of the machine and control system must also be compatible, such as the relationships of the axes and the availability of features and control functions.

Control systems differ in the way that the numbers may be written. Most newer CNC machines accept numbers written in a decimal-point format, however, some systems require numbers to be in a fixed-length format that does not use an explicit decimal point. In the latter case, the control system evaluates a number based on the number of digits it has, including zeros. *Zero suppression* in a control system is an arrangement that allows zeros before the first significant figure to be dropped (leading zero suppression) or allows zeros after the last significant figure to be dropped (trailing zero suppression). An X-axis movement of 05.3400, for example, could be expressed as 053400 if represented in the full field format, 53400 (leading zero suppression), or 0534 (trailing zero suppression). With decimal-point programming, the above number is expressed simply as 5.34. To ensure program compatibility between machines, all leading and trailing zeros should be included in numbers unless decimal-point programming is used.

Sequence Number (N-Word).—A block normally starts with a sequence number that identifies the block within the part program. Most control systems use a four-digit sequence number allowing step numbers up to N9999. The numbers are usually advanced by fives or tens in order to leave spaces for additional blocks to be inserted later if required. For example, the first block in a program would be N0000, the next block N0005; the next N0010; and so on. The slash character, /, placed in a block, before the sequence number, is called an *optional stop* and causes the block to be skipped over when actuated by the operator. The block that is being worked on by the machine is often displayed on a digital read-out so that the operator may know the precise operation being performed.

Preparatory Word (G-Word).—A preparatory word (also referred to as a preparatory function or G-code) consists of the letter address G and usually two digits. The preparatory word is placed at the beginning of a block, normally following the sequence number. Most newer CNC machines allow more than one G-code to be used in a single block, although many of the older systems do not. To ensure compatibility with older machines and with the RS-274-D Standard, only one G-code per block should be used.

The G-word indicates to the control system how to interpret the remainder of the block. For example, G01 refers to linear interpolation and indicates that the words following in the block will move the cutter in a straight line. The G02 code indicates that the words following in the block will move the cutter in a clockwise circular path. A G-word can completely change the normal meaning of other words in a block. For example, X is normally a dimension word that describes a distance or position in the X-direction. However, if a block contains the G04 word, which is the code for a dwell, the X word represents the time, in seconds, that the machine is to dwell.

The majority of G-codes are designated as modal, which means that once used, the code remains in effect for succeeding blocks unless it is specifically changed or canceled. Therefore, it is not necessary to include modal G-codes in succeeding blocks except to change or cancel them. Unless a G-code is modal, it is only effective within its designated block for the operation it defines. **Table 2**, G-Code Addresses, lists standardized G-code addresses and modality.

Table 2. G-Code Addresses

Code	Description	Code	Description
G00	ab* Rapid traverse, point to point (M,L)	G34	ab* Thread cutting, increasing lead (L)
G01	abc Linear interpolation (M,L)	G35	abc Thread cutting, decreasing lead (L)
G02	abc Circular interpolation—clockwise movement (M,L)	G36-G39	ab Permanently unassigned
G03	abc Circular interpolation—counterclockwise movement (M,L)	G36	c Used for automatic acceleration and deceleration when the blocks are short (M,L)
G04	ab Dwell—a programmed time delay (M,L)	G37, G37.1, G37.2, G37.3, G37.4	Used for tool gaging (M,L)
G05	ab Unassigned		
G06	abc Parabolic interpolation (M,L)	G38	Used for probing to measure the diameter and center of a hole (M)
G07	c Used for programming with cylindrical diameter values (L)	G38.1	Used with a probe to measure the parallelness of a part with respect to an axis (M)
G08	ab Programmed acceleration (M,L). ^d Also for lathe programming with cylindrical diameter values	G39, G39.1	Generates a nonprogrammed block to improve cycle time and corner cutting quality when used with cutter compensation (M)
G09	ab Programmed deceleration (M,L). ^d Used to stop the axis movement at a precise location (M,L)	G39	Tool tip radius compensation used with linear generated block (L)
G10-G12	ab Unassigned. ^d Sometimes used for machine lock and unlock devices	G39.1	Tool tip radius compensation used with circular generated block (L)
G13-G16	ac Axis selection (M,L)	G40	abc Cancel cutter compensation/offset (M)
G13-G16	b Unassigned	G41	abc Cutter compensation, left (M)
G13	Used for computing lines and circle intersections (M,L)	G42	abc Cutter compensation, right (M)
G14, G14.1	c Used for scaling (M,L)	G43	abc Cutter offset, inside corner (M,L)
G15-G16	c Polar coordinate programming (M)	G44	abc Cutter offset, outside corner (M,L)
G15, G16.1	c Cylindrical interpolation—C axis (L)	G45-G49	ab Unassigned
G16.2	c End face milling—C axis (L)	G50-G59	a Reserved for adaptive control (M,L)
G17-G19	abc X-Y, X-Z, Y-Z plane selection, respectively (M,L)	G50	bb Unassigned
G20	Unassigned	G50.1	c Cancel mirror image (M,L)
G22-G32	ab Unassigned	G51.1	c Program mirror image (M,L)
G22-G23	c Defines safety zones in which the machine axis may not enter (M,L)	G52	b Unassigned
G22.1, G233.1	c Defines safety zones in which the cutting tool may not exit (M,L)	G52	Used to offset the axes with respect to the coordinate zero point (see G92) (M,L)
G24	c Single-pass rough-facing cycle (L)	G53	bc Datum shift cancel
G27-G29	Used for automatically moving to and returning from home position (M,L)	G53	c Call for motion in the machine coordinate system (M,L)
G30	Return to an alternate home position (M,L)	G54-G59	bc Datum shifts (M,L)
G31, G31.1, G31.2, G31.3, G31.4	External skip function, moves an axis on a linear path until an external signal aborts the move (M,L)	G54-G59.3	c Allows for presetting of work coordinate systems (M,L)
G33	abc Thread cutting, constant lead (L)	G60-G62	abc Unassigned

Table 2. (Continued) G-Code Addresses

Code	Description	Code	Description
G61	c Modal equivalent of G09 except that rapid moves are not taken to a complete stop before the next motion block is executed (M,L)	G80	abc Cancel fixed cycles
G62	c Automatic corner override, reduces the feed rate on an inside corner cut (M,L)	G81	abc Drill cycle, no dwell and rapid out (M,L)
G63	a Unassigned	G82	abc Drill cycle, dwell and rapid out (M,L)
G63	bc Tapping mode (M,L)	G83	abc Deep hole peck drilling cycle (M,L)
G64-G69	abc Unassigned	G84	abc Right-hand tapping cycle (M,L)
G64	c Cutting mode, usually set by the system installer (M,L)	G84.1	c Left-hand tapping cycle (M,L)
G65	c Calls for a parametric macro (M,L)	G85	abc Boring cycle, no dwell, feed out (M,L)
G66	c Calls for a parametric macro. Applies to motion blocks only (M,L)	G86	abc Boring cycle, spindle stop, rapid out (M,L)
G66.1	c Same as G66 but applies to all blocks (M,L)	G87	abc Boring cycle, manual retraction (M,L)
G67	c Stop the modal parametric macro (see G65, G66, G66.1) (M,L)	G88	abc Boring cycle, spindle stop, manual retraction (M,L)
G68	c Rotates the coordinate system (i.e., the axes) (M)	G88.1	Pocket milling (rectangular and circular), roughing cycle (M)
G69	c Cancel axes rotation (M)	G88.2	Pocket milling (rectangular and circular), finish cycle (M)
G70	abc Inch programming (M,L)	G88.3	Post milling, roughs out material around a specified area (M)
G71	abc Metric programming (M,L)	G88.4	Post milling, finish cuts material around a post (M)
G72	ac Circular interpolation CW (three-dimensional) (M)	G88.5	Hemisphere milling, roughing cycle (M)
G72	b Unassigned	G88.6	Hemisphere milling, finishing cycle (M)
G72	c Used to perform the finish cut on a turned part along the Z-axis after the roughing cuts initiated under G73, G74, or G75 codes (L)	G89	abc Boring cycle, dwell and feed out (M,L)
G73	b Unassigned	G89.1	Irregular pocket milling, roughing cycle (M)
G73	c Deep hole peck drilling cycle (M); OD and ID roughing cycle, running parallel to the Z-axis (L)	G89.2	Irregular pocket milling, finishing cycle (M)
G74	ac Cancel multiquadrant circular interpolation (M,L)	G90	abc Absolute dimension input (M,L)
G74	bc Move to home position (M,L)	G91	abc Incremental dimension input (M,L)
G74	c Left-hand tapping cycle (M)	G92	abc Preload registers, used to shift the coordinate axes relative to the current tool position (M,L)
G74	Rough facing cycle (L)	G93	abc Inverse time feed rate (velocity/distance) (M,L)
G75	ac Multiquadrant circular interpolation (M,L)	G94	c Feed rate in inches or millimeters per minute (ipm or mpm) (M,L)
G75	b Unassigned	G95	abc Feed rate given directly in inches or millimeters per revolution (ipr or mpr) (M,L)
G75	Roughing routine for castings or forgings (L)	G96	abc Maintains a constant surface speed, feet (meters) per minute (L)
G76-G79	ab Unassigned	G97	abc Spindle speed programmed in rpm (M,L)
		G98-99	ab Unassigned

^a Adheres to ANSI/EIA RS-274-D;

^b Adheres to ISO 6983/1,2,3 Standards; where both symbols appear together, the ANSI/EIA and ISO standard codes are comparable;

^c This code is modal. All codes that are not identified as modal are nonmodal, when used according to the corresponding definition.

^d Indicates a use of the code that does not conform with the Standard.

Symbols following a description: (M) indicates that the code applies to a mill or machining center; (L) indicates that the code applies to turning machines; (M,L) indicates that the code applies to both milling and turning machines.

Codes that appear more than once in the table are codes that are in common use, but are not defined by the Standard or are used in a manner that is different than that designated by the Standard (e.g., see G61).

Most systems that support the RS-274-D Standard codes do not use all the codes available in the Standard. Unassigned G-words in the Standard are often used by builders of machine tool control systems for a variety of special purposes, sometimes leading to confusion as to the meanings of unassigned codes. Even more confusing, some builders of systems and machine tools use the less popular standardized codes for other than the meaning listed in the Standard. For these reasons, machine code written specifically for one machine/controller will not necessarily work correctly on another machine controller without modification.

Dimension words contain numerical data that indicate either a distance or a position. The dimension units are selected by using G70 (inch programming) or G71 (metric programming) code. G71 is canceled by a G70 command, by miscellaneous functions M02 (end of program), or by M30 (end of data). The dimension words immediately follow the G-word in a block and on multiaxis machines should be placed in the following order: X, Y, Z, U, V, W, P, Q, R, A, B, C, D, and E.

Absolute programming (G90) is a method of defining the coordinate locations of points to which the cutter (or workpiece) is to move based on the fixed machine zero point. In Fig. 1, the X – Y coordinates of P1 are X = 1.0, Y = 0.5 and the coordinates of P2 are X = 2.0, Y = 1.1. To indicate the movement of the cutter from one point to another when using the absolute coordinate system, only the coordinates of the destination point P2 are needed.

Incremental programming (G91) is a method of identifying the coordinates of a particular location in terms of the distance of the new location from the current location. In the example shown in Fig. 2, a move from P1 to P2 is written as X + 1.0, Y + 0.6. If there is no movement along the Z-axis, Z is zero and normally is not noted. An X – Y incremental move from P2 to P3 in Fig. 2 is written as X + 1.0, Y – 0.7.

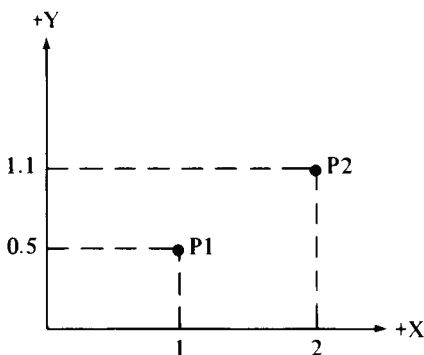


Fig. 1.

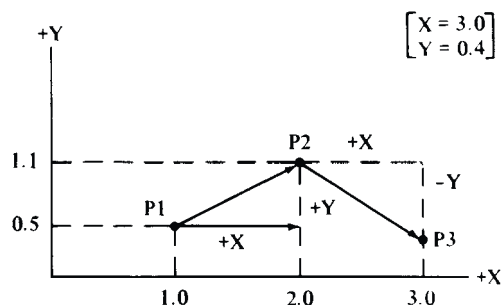


Fig. 2.

Most CNC systems offer both absolute and incremental part programming. The choice is handled by G-code G90 for absolute programming and G91 for incremental programming. G90 and G91 are both modal, so they remain in effect until canceled.

The G92 word is used to preload the registers in the control system with desired values. A common example is the loading of the axis-position registers in the control system for a lathe. Fig. 3 shows a typical home position of the tool tip with respect to the zero point on the machine. The tool tip here is registered as being 15.0000 inches in the Z-direction and 4.5000 inches in the X-direction from machine zero. No movement of the tool is required. Although it will vary with different control system manufacturers, the block to accomplish the registration shown in Fig. 3 will be approximately:

N0050 G92 X4.5 Z15.0

Miscellaneous Functions (M-Words).—Miscellaneous functions, or M-codes, also referred to as auxiliary functions, constitute on-off type commands. M functions are used to control actions such as starting and stopping of motors, turning coolant on and off, changing tools, and clamping and unclamping parts. M functions are made up of the letter M followed by a two-digit code. Table 3 lists the standardized M-codes, however, the functions available will vary from one control system to another. Most systems provide fewer M functions than the complete list and may use some of the unassigned codes to provide additional functions that are not covered by the Standard. If an M-code is used in a block, it follows the T-word and is normally the last word in the block.

Table 3. Miscellaneous Function Words from ANSI/EIA RS-274-D

Code	Description
M00	Automatically <i>stops</i> the machine. The operator must push a button to continue with the remainder of the program.
M01	An <i>optional stop</i> acted upon only when the operator has previously signaled for this command by pushing a button. The machine will automatically stop when the control system senses the M01 code.
M02	This <i>end-of-program</i> code stops the machine when all commands in the block are completed. May include rewinding of tape.
M03	Start <i>spindle rotation</i> in a <i>clockwise</i> direction—looking out from the spindle face.
M04	Start <i>spindle rotation</i> in a <i>counterclockwise</i> direction—looking out from the spindle face.
M05	<i>Stop</i> the spindle in a normal and efficient manner.
M06	Command to <i>change a tool</i> (or tools) manually or automatically. Does not cover tool selection, as is possible with the T-words.
M07 to M08	M07 (coolant 2) and M08 (coolant 1) are codes to <i>turn on coolant</i> . M07 may control <i>flood</i> coolant and M08 <i>mist</i> coolant.
M09	Shuts off the coolant.
M10 to M11	M10 applies to automatic <i>clamping</i> of the machine slides, workpiece, fixture spindle, etc. M11 is an unclamping code.
M12	An inhibiting code used to synchronize multiple sets of axes, such as a four-axis lathe having two independently operated heads (turrets).
M13	Starts <i>CW spindle</i> motion and <i>coolant on</i> in the same command.
M14	Starts <i>CCW spindle</i> motion and <i>coolant on</i> in the same command.
M15 to M16	Rapid traverse of feed motion in either the +(M15) or -(M16) direction.
M17 to M18	Unassigned.
M19	Oriented spindle stop. Causes the spindle to stop at a predetermined angular position.
M20 to M29	Permanently unassigned.
M30	An <i>end-of-tape</i> code similar to M02, but M30 will also rewind the tape; also may switch automatically to a second tape reader.
M31	A command known as <i>interlock bypass</i> for temporarily circumventing a normally provided interlock.

Table 3. (Continued) **Miscellaneous Function Words from ANSI/EIA RS-274-D**

Code	Description
M32 to M35	Unassigned.
M36 to M39	Permanently unassigned.
M40 to M46	Used to signal gear changes if required at the machine; otherwise, unassigned.
M47	Continues program execution from the start of the program unless inhibited by an interlock signal.
M48 to M49	M49 deactivates a manual spindle or feed override and returns the parameter to the programmed value; M48 cancels M49.
M50 to M57	Unassigned.
M58 to M59	Holds the rpm constant at the value in use when M59 is initiated; M58 cancels M59.
M60 to M89	Unassigned.
M90 to M99	Reserved for use by the machine user.

Feed Function (F-Word).—F-word stands for feed-rate word or feed rate. The meaning of the feed word depends on the system of units in use and the feed mode. For example, F15 could indicate a feed rate of 0.15 inch (or millimeter) per revolution or 15 inches (or millimeters) per minute, depending on whether G70 or G71 is used to indicate inch or metric programming and whether G94 or G95 is used to specify feed rate expressed as inches (or mm) per minute or revolution. The G94 word is used to indicate inches/minute (ipm) or millimeters/minute (mmpm) and G95 is used for inches/revolution (ipr) or millimeters/revolution (mmpr). The default system of units is selected by G70 (inch programming) or G71 (metric programming) prior to using the feed function. The feed function is modal, so it stays in effect until it is changed by setting a new feed rate. In a block, the feed function is placed immediately following the dimension word of the axis to which it applies or immediately following the last dimension word to which it applies if it is used for more than one axis.

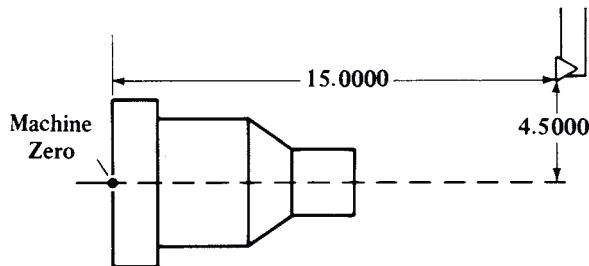


Fig. 3.

In turning operations, when G95 is used to set a constant feed rate per revolution, the spindle speed is varied to compensate for the changing diameter of the work — the spindle speed increases as the working diameter decreases. To prevent the spindle speed from increasing beyond a maximum value, the S-word, see *Spindle Function (S-Word)*, is used to specify the maximum allowable spindle speed before issuing the G95 command. If the spindle speed is changed after the G95 is used, the feed rate is also changed accordingly. If G94 is used to set a constant feed per unit of time (inches or millimeters per minute), changes in the spindle speed do not affect the feed rate.

Feed rates expressed in inches or millimeters per revolution can be converted to feed rates in inches or millimeters per minute by multiplying the feed rate by the spindle speed in revolutions per minute: $\text{feed/minute} = \text{feed/revolution} \times \text{spindle speed in rpm}$. Feed rates for milling cutters are sometimes given in inches or millimeters per tooth. To convert feed

per tooth to feed per revolution, multiply the feed rate per tooth by the number of cutter teeth: $\text{feed/revolution} = \text{feed/tooth} \times \text{number of teeth}$.

For certain types of cuts, some systems require an inverse-time *feed command* that is the reciprocal of the time in minutes required to complete the block of instructions. The feed command is indicated by a G93 code followed by an F-word value found by dividing the feed rate, in inches (millimeters) or degrees per minute, by the distance moved in the block: $\text{feed command} = \text{feed rate/distance} = (\text{distance/time})/\text{distance} = 1/\text{time}$.

Feed-rate override refers to a control, usually a rotary dial on the control system panel, that allows the programmer or operator to override the programmed feed rate. Feed-rate override does not change the program; permanent changes can only be made by modifying the program. The range of override typically extends from 0 to 150 per cent of the programmed feed rate on CNC machines; older hardwired systems are more restrictive and most cannot be set to exceed 100 per cent of the preset rate.

Spindle Function (S-Word).—An S-word specifies the speed of rotation of the spindle. The spindle function is programmed by the address S followed by the number of digits specified in the format detail (usually a four-digit number). Two G-codes control the selection of spindle speed input: G96 selects a constant cutting speed in surface feet per minute (sfm) or meters per minute (mpm) and G97 selects a constant spindle speed in revolutions per minute (rpm).

In turning, a constant spindle speed (G97) is applied for threading cycles and for machining parts in which the diameter remains constant. Feed rate can be programmed with either G94 (inches or millimeters per minute) or G95 (inches or millimeters per revolution) because each will result in a constant cutting speed to feed relationship.

G96 is used to select a constant cutting speed (i.e., a constant surface speed) for facing and other cutting operations in which the diameter of the workpiece changes. The spindle speed is set to an initial value specified by the S-word and then automatically adjusted as the diameter changes so that a constant surface speed is maintained. The control system adjusts spindle speed automatically, as the working diameter of the cutting tool changes, decreasing spindle speed as the working diameter increases or increasing spindle speed as the working diameter decreases. When G96 is used for a constant cutting speed, G95 in a succeeding block maintains a constant feed rate per revolution.

Speeds given in surface feet or meters per minute can be converted to speeds in revolutions per minute (rpm) by the formulas:

$$\text{rpm} = \frac{\text{sfm} \times 12}{\pi \times d} \qquad \text{rpm} = \frac{\text{mpm} \times 1000}{\pi \times d}$$

where d is the diameter, in inches or millimeters, of the part on a lathe or of the cutter on a milling machine; and π is equal to 3.14159.

Tool Function (T-Word).—The T-word calls out the tool that is to be selected on a machining center or lathe having an automatic tool changer or indexing turret. On machines without a tool changer, this word causes the machine to stop and request a tool change. This word also specifies the proper turret face on a lathe. The word usually is accompanied by several numbers, as in T0101, where the first pair of numbers refers to the tool number (and carrier or turret if more than one) and the second pair of numbers refers to the tool offset number. Therefore, T0101 refers to tool 1, offset 1.

Information about the tools and the tool setups is input to the CNC system in the form of a *tool data table*. Details of specific tools are transferred from the table to the part program via the T-word. The tool nose radius of a lathe tool, for example, is recorded in the tool data table so that the necessary tool path calculations can be made by the CNC system. The miscellaneous code M06 can also be used to signal a tool change, either manually or automatically.

Compensation for variations in the tool nose radius, particularly on turning machines, allows the programmer to program the part geometry from the drawing and have the tool follow the correct path in spite of variations in the tool nose shape. Typical of the data required, as shown in Fig. 4, are the nose radius of the cutter, the X and Z distances from the gage point to some fixed reference point on the turret, and the orientation of the cutter (tool tip orientation code), as shown in Fig. 5. Details of nose radius compensation for numerical control is given in a separate section (Indexable Insert Holders for NC).

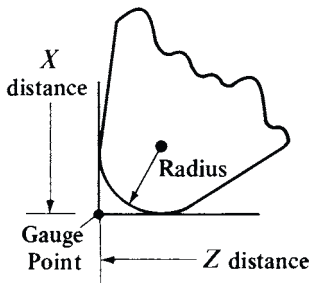
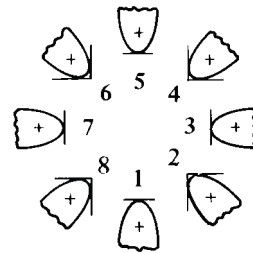


Fig. 4.



Tool tip orientation codes

Fig. 5.

Tool offset, also called cutter offset, is the amount of cutter adjustment in a direction parallel to the axis of a tool. Tool offset allows the programmer to accommodate the varying dimensions of different tooling by assuming (for the sake of the programming) that all the tools are identical. The actual size of the tool is totally ignored by the programmer who programs the movement of the tools to exactly follow the profile of the workpiece shape. Once tool geometry is loaded into the tool data table and the cutter compensation controls of the machine activated, the machine automatically compensates for the size of the tools in the programmed movements of the slide. In gage length programming, the tool length and tool radius or diameter are included in the program calculations. Compensation is then used only to account for minor variations in the setup dimensions and tool size.

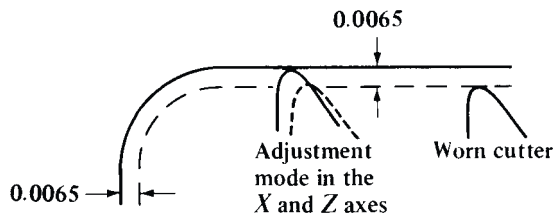


Fig. 6.

Customarily, the tool offset is used in the beginning of a program to initialize each individual tool. Tool offset also allows the machinist to correct for conditions, such as tool wear, that would cause the location of the cutting edge to be different from the programmed location. For example, owing to wear, the tool tip in Fig. 6 is positioned a distance of 0.0065 inch from the location required for the work to be done. To compensate for this wear, the operator (or part programmer), by means of the CNC control panel, adjusts the tool tip with reference to the X- and Z-axes, moving the tool closer to the work by

0.0065 inch throughout its traverse. The tool offset number causes the position of the cutter to be displaced by the value assigned to that offset number.

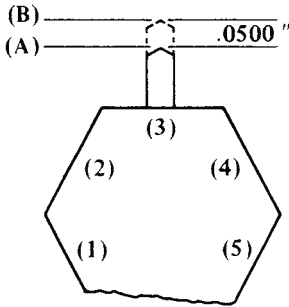


Fig. 7.

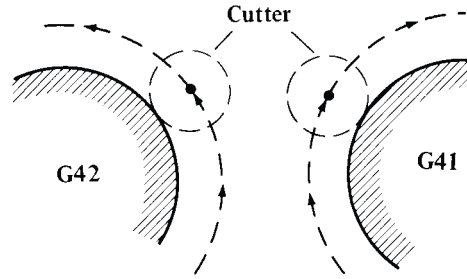


Fig. 8.

Changes to the programmed positions of cutting tool tip(s) can be made by *tool length offset* programs included in the control system. A dial or other means is generally provided on milling, drilling, and boring machines, and machining centers, allowing the operator or part programmer to override the programmed axial, or Z-axis, position. This feature is particularly helpful when setting the lengths of tools in their holders or setting a tool in a turret, as shown in Fig. 7, because an exact setting is not necessary. The tool can be set to an approximate length and the discrepancy eliminated by the control system.

The amount of offset may be determined by noting the amount by which the cutter is moved manually to a fixed point on the fixture or on the part, from the programmed Z-axis location. For example, in Fig. 7, the programmed Z-axis motion results in the cutter being moved to position A, whereas the required location for the tool is at B. Rather than resetting the tool or changing the part program, the tool length offset amount of 0.0500 inch is keyed into the control system. The 0.0500-inch amount is measured by moving the cutter tip manually to position B and reading the distance moved on the readout panel. Thereafter, every time that cutter is brought into the machining position, the programmed Z-axis location will be overridden by 0.0500 inch.

Manual adjustment of the cutter center path to correct for any variance between nominal and actual cutter radius is called *cutter compensation*. The net effect is to move the path of the center of the cutter closer to, or away from, the edge of the workpiece, as shown in Fig. 8. The compensation may also be handled via a tool data table. When cutter compensation is used, it is necessary to include in the program a G41 code if the cutter is to be to the left of the part and a G42 code if to the right of the part, as shown in Fig. 8. A G40 code cancels cutter compensation. Cutter compensation with earlier hardwire systems was expensive, very limited, and usually held to ± 0.0999 inch. The range for cutter compensation with CNC control systems can go as high as ± 999.9999 inches, although adjustments of this magnitude are unlikely to be required.

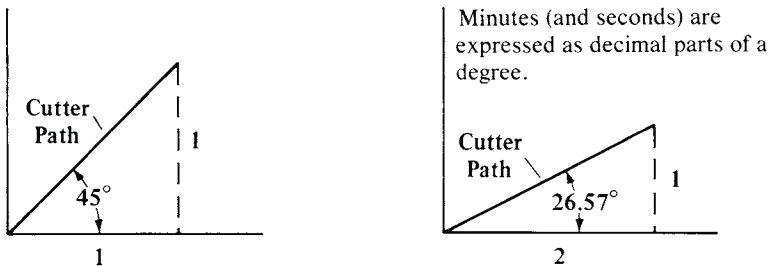


Fig. 9.

Linear Interpolation.—The ability of the control system to guide the workpiece along a straight-line path at an angle to the slide movements is called linear interpolation. Move-

ments of the slides are controlled through simultaneous monitoring of pulses by the control system. For example, if monitoring of the pulses for the X-axis of a milling machine is at the same rate as for the Y-axis, the cutting tool will move at a 45-degree angle relative to the X-axis. However, if the pulses are monitored at twice the rate for the X-axis as for the Y-axis, the angle that the line of travel will make with the X-axis will be 26.57 degrees (tangent of 26.57 degrees = $\frac{1}{2}$), as shown in Fig. 9. The data required are the distances traveled in the X- and Y-directions, and from these data, the control system will generate the straight line automatically. This monitoring concept also holds for linear motions along three axes. The required G-code for linear interpolation blocks is G01. The code is modal, which means that it will hold for succeeding blocks until it is changed.

Circular Interpolation.—A simplified means of programming circular arcs in one plane, using one block of data, is called circular interpolation. This procedure eliminates the need to break the arc into straight-line segments. Circular interpolation is usually handled in one plane, or two dimensions, although three-dimensional circular interpolation is described in the Standards. The plane to be used is selected by a G or preparatory code. In Fig. 10, G17 is used if the circle is to be formed in the X–Y plane,

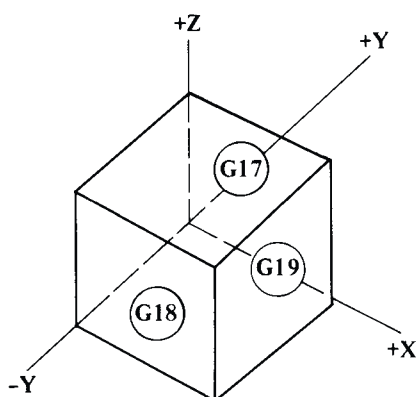


Fig. 10.

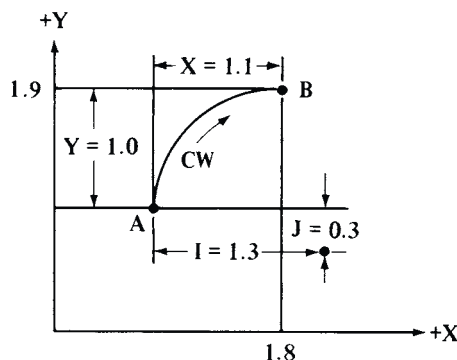


Fig. 11.

G18 if in the X–Z plane, and G19 if in the Y–Z plane. Often the control system is preset for the circular interpolation feature to operate in only one plane (e.g., the X–Y plane for milling machines or machining centers or the X–Z plane for lathes), and for these machines, the G-codes are not necessary.

A circular arc may be described in several ways. Originally, the RS-274 Standard specified that, with incremental programming, the block should contain:

1) A G-code describing the direction of the arc, G02 for clockwise (CW), and G03 for counterclockwise (CCW).

2) Directions for the component movements around the arc parallel to the axes. In the example shown in Fig. 11, the directions are X = +1.1 inches and Y = +1.0 inch. The signs are determined by the direction in which the arc is being generated. Here, both X and Y are positive.

3) The I dimension, which is parallel to the X-axis with a value of 1.3 inches, and the J dimension, which is parallel to the Y-axis with a value of 0.3 inch. These values, which locate point A with reference to the center of the arc, are called offset dimensions. The block for this work would appear as follows:

```
N0025 G02 X011000 Y010000 I013000 J003000
(The sequence number, N0025, is arbitrary.)
```

The block would also contain the plane selection (i.e., G17, G18, or G19), if this selection is not preset in the system. Most of the newer control systems allow duplicate words in the

same block, but most of the older systems do not. In these older systems, it is necessary to insert the plane selection code in a separate and prior block, for example, N0020 G17.

Another stipulation in the Standard is that the arc is limited to one quadrant. Therefore, four blocks would be required to complete a circle. Four blocks would also be required to complete the arc shown in Fig. 12, which extends into all four quadrants.

When utilizing absolute programming, the coordinates of the end point are described. Again from Fig. 11, the block, expressed in absolute coordinates, appears as:

```
N0055 G02 X01800 Y019000 I013000 J003000
```

where the arc is continued from a previous block; the starting point for the arc in this block would be the end point of the previous block.

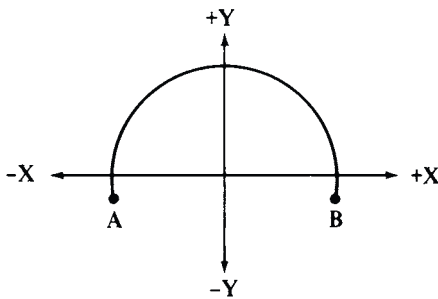


Fig. 12.

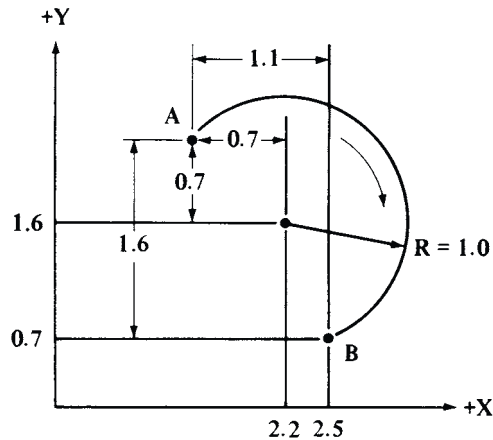


Fig. 13.

The Standard still contains the format discussed, but simpler alternatives have been developed. The latest version of the Standard (RS-274-D) allows *multiple quadrant programming* in one block, by inclusion of a G75 word. In the absolute-dimension mode (G90), the coordinates of the arc center are specified. In the incremental-dimension mode (G91), the signed (plus or minus) incremental distances from the beginning point of the arc to the arc center are given. Most system builders have introduced some variations on this format. One system builder utilizes the center and the end point of the arc when in an absolute mode, and might describe the block for going from A to B in Fig. 13 as:

```
N0065 G75 G02 X2.5 Y0.7 I2.2 J1.6
```

The I and the J words are used to describe the coordinates of the arc center. Decimal-point programming is also used here. A block for the same motion when programmed incrementally might appear as:

```
N0075 G75 G02 X1.1 Y - 1.6 I0.7 J0.7
```

This approach is more in conformance with the RS-274-D Standard in that the X and Y values describe the displacement between the starting and ending points (points A and B), and the I and J indicate the offsets of the starting point from the center. Another and even more convenient way of formulating a circular motion block is to note the coordinates of the ending point and the radius of the arc. Using absolute programming, the block for the motion in Fig. 13 might appear as:

```
N0085 G75 G02 X2.5 Y0.7 R10.0
```

The starting point is derived from the previous motion block. Multi-quadrant circular interpolation is canceled by a G74 code.

Helical and Parabolic Interpolation.—Helical interpolation is used primarily for milling large threads and lubrication grooves, as shown in Fig. 14. Generally, helical interpolation involves motion in all three axes (X, Y, Z) and is accomplished by using circular

interpolation (G02 or G03) while changing the third dimension. Parabolic interpolation (G06) is simultaneous and coordinated control of motion—such that the resulting cutter path describes part of a parabola. The RS-274-D Standard provides further details.

Subroutine.—A subroutine is a set of instructions or blocks that can be inserted into a program and repeated whenever required. Parametric subroutines permit letters or symbols to be inserted into the program in place of numerical values (see *Parametric Expressions and Macros*). Parametric subroutines can be called during part programming and values assigned to the letters or symbols. This facility is particularly helpful when dealing with families of parts.

A subprogram is similar to a subroutine except that a subprogram is not wholly contained within another program, as is a subroutine. Subprograms are used when it is necessary to perform the same task frequently, in different programs. The advantage of subprograms over subroutines is that subprograms may be called by any other program, whereas the subroutine can only be called by the program that contains the subroutine.

There is no standard subroutine format; however, the example below is typical of a program that might be used for milling the three pockets shown in Fig. 15. In the example, the beginning and end of the subroutine are indicated by the codes M92 and M93, respectively, and M94 is the code that is used to call the subroutine. The codes M92, M93, and M94 are not standardized (M-codes M90 through M99 are reserved for the user) and may be different from control system to control system. The subroutine functions may use different codes or may not be available at all on other systems.

N0010 G00 X.6 Y.85	Cutter is moved at a rapid traverse rate to a position over the corner of the first pocket to be cut.
N0020 M92	Tells the system that the subroutine is to start in the next block.
N0030 G01 Z-.25 F2.0	Cutter is moved axially into the workpiece 0.25 inch at 2.0 ipm.
N0040 X.8	Cutter is moved to the right 0.8 inch.
N0050 Y.2	Cutter is moved laterally up 0.2 inch.
N0060 X-.8	Cutter is moved to the left 0.8 inch.
N0070 Y.2	Cutter is moved laterally up 0.2 inch.

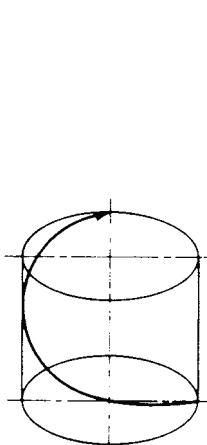


Fig. 14.

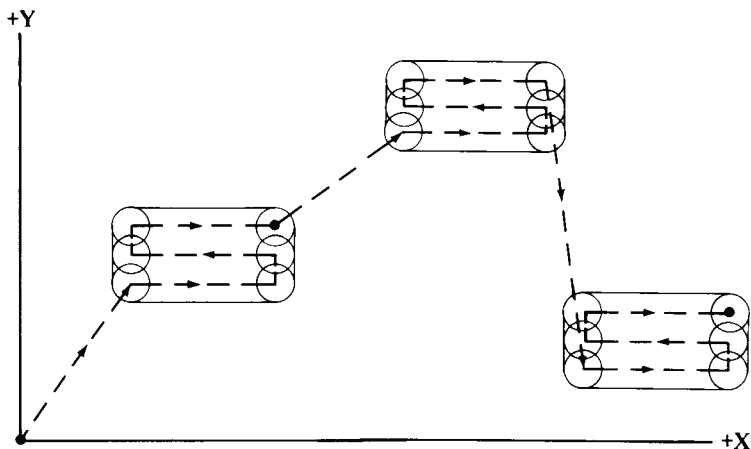


Fig. 15.

N0080 X.8	Cutter is moved to the right 0.8 inch.
N0090 G00 Z.25 M93	Cutter is moved axially out of pocket at rapid traverse rate. Last block of subroutine is signaled by word M93.
N0100 X.75 Y.5	Cutter is moved to bottom left-hand corner of second pocket at rapid traverse rate.
N0110 M94 N0030	Word M94 calls for repetition of the subroutine that starts at sequence number N0030 and ends at sequence number N0090.
N0120 G00 X.2 Y-I.3	After the second pocket is cut by repetition of sequence numbers N0030 through N0090, the cutter is moved to start the third pocket.
N0130 M94 N0030	Repetition of subroutine is called for by word M94 and the third pocket is cut.

Parametric Expressions and Macros.—Parametric programming is a method whereby a variable or replaceable parameter representing a value is placed in the machining code instead of using the actual value. In this manner, a section of code can be used several or many times with different numerical values, thereby simplifying the programming and reducing the size of the program. For example, if the values of X and Y in lines N0040 to N0080 of the previous example are replaced as follows:

N0040 X#1

N0050 Y#2

N0060 X#3

N0070 Y#4

then the subroutine starting at line N0030 is a parametric subroutine. That is, the numbers following the # signs are the variables or parameters that will be replaced with actual values when the program is run. In this example, the effect of the program changes is to allow the same group of code to be used for milling pockets of different sizes. If on the other hand, lines N0010, N0100, and N0120 of the original example were changed in a similar manner, the effect would be to move the starting location of each of the slots to the location specified by the replaceable parameters.

Before the program is run, the values that are to be assigned to each of the parameters or variables are entered as a list at the start of the part program in this manner:

#1 = .8

#2 = .2

#3 = .8

#4 = .2

All that is required to repeat the same milling process again, but this time creating a different size pocket, is to change the values assigned to each of the parameters #1, #2, #3, and #4 as necessary. Techniques for using parametric programming are not standardized and are not recognized by all control systems. For this reason, consult the programming manual of the particular system for specific details.

As with a parametric subroutine, macro describes a type of program that can be recalled to allow insertion of finite values for letter variables. The difference between a macro and a parametric subroutine is minor. The term macro normally applies to a source program that is used with computer-assisted part programming; the parametric subroutine is a feature of the CNC system and can be input directly into that system.

Conditional Expressions.—It is often useful for a program to make a choice between two or more options, depending on whether or not a certain condition exists. A program can contain one or more blocks of code that are not needed every time the program is run, but are needed some of the time. For example, refer to the previous program for milling three slots. An occasion arises that requires that the first and third slots be milled, but not the second one. If the program contained the following block of code, the machine could be easily instructed to skip the milling of the second slot:

```
N0095 IF [#5 EQ 0] GO TO N0120
```

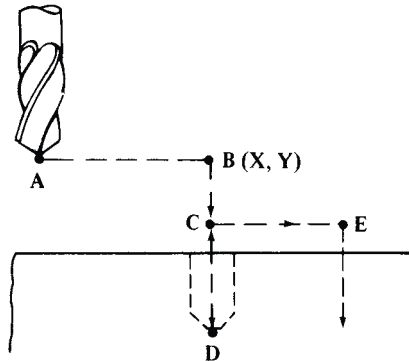
In this block, #5 is the name of a variable; EQ is a conditional expression meaning *equals*; and GO TO is a branch statement meaning resume execution of the program at the following line number. The block causes steps N0100 and N0110 of the program to be skipped if the value of #5 (a dummy variable) is set equal to zero. If the value assigned to #5 is any number other than zero, the expression (#5 EQ 0) is not true and the remaining instructions in block N0095 are not executed. Program execution continues with the next step, N0100, and the second pocket is milled. For the second pocket to be milled, parameter #5 is initialized at the beginning of the program with a statement such as #5 = 1 or #5 = 2. Initializing #5 = 0 guarantees that the pocket is not machined. On control systems that automatically initialize all variables to zero whenever the system is reset or a program is loaded, the second slot will not be machined unless the #5 is assigned a nonzero value each time the program is run.

Other conditional expressions are: NE = not equal to; GT = greater than; LT = less than; GE = greater than or equal to; and LE = less than or equal to. As with parametric expressions, conditional expressions may not be featured on all machines and techniques and implementation will vary. Therefore, consult the control system programming manual for the specific command syntax.

Fixed (Canned) Cycles.—Fixed (canned) cycles comprise sets of instructions providing for a preset sequence of events initiated by a single command or a block of data. Fixed cycles generally are offered by the builder of the control system or machine tool as part of the software package that accompanies the CNC system. Limited numbers of canned cycles began to appear on hardwire control systems shortly before their demise. The canned cycles offered generally consist of the standard G-codes covering drilling, boring, and tapping operations, plus options that have been developed by the system builder such as thread cutting and turning cycles. (See *Thread Cutting* and *Turning Cycles*.) Some standard canned cycles included in RS-274-D are shown herewith. A block of data that might be used to generate the cycle functions is also shown above each illustration. Although the G-codes for the functions are standardized, the other words in the block and the block format are not, and different control system builders have different arrangements. The blocks shown are reasonable examples of fixed cycles and do not represent those of any particular system builder.

The G81 block for a simple drilling cycle is:

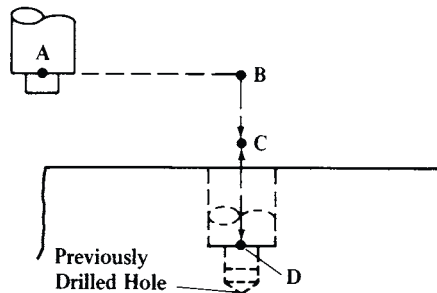
```
N___ G81 X___ Y___ C___ D___ F___ EOB
N___ X___ Y___ EOB
```



This G81 drilling cycle will move the drill point from position A to position B and then down to C at a rapid traverse rate; the drill point will next be fed from C to D at the programmed feed rate, then returned to C at the rapid traverse rate. If the cycle is to be repeated at a subsequent point, such as point E in the illustration, it is necessary Only to give the required X and Y coordinates. This repetition capability is typical of canned cycles.

The G82 block for a spotfacing or drilling cycle with a dwell:

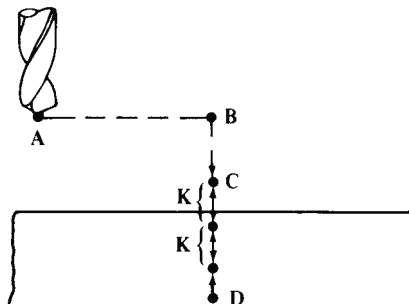
```
N___ G82 X___ Y___ C___ D___ T___ F___ EOB
```



This G82 code produces a cycle that is very similar to the cycle of the G81 code except for the dwell period at point D. The dwell period allows the tool to smooth out the bottom of the counterbore or spotface. The time for the dwell, in seconds, is noted as a T-word.

The G83 block for a peck-drilling cycle is:

```
N___ G83 X___ Y___ C___ D___ K___ F___ EOB
```

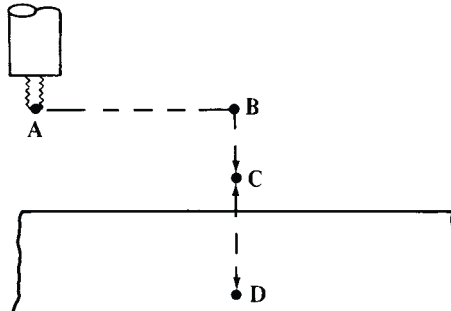


In the G83 peck-drilling cycle, the drill is moved from point A to point B and then to point C at the rapid traverse rate; the drill is then fed the incremental distance K, followed by

rapid return to C. Down feed again at the rapid traverse rate through the distance K is next, after which the drill is fed another distance K. The drill is then rapid traversed back to C, followed by rapid traverse for a distance of $K + K$; down feed to D follows before the drill is rapid traversed back to C, to end the cycle.

The G84 block for a tapping cycle is:

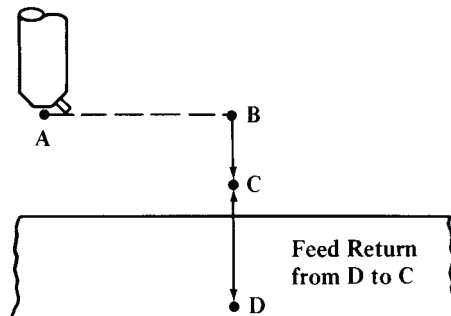
N___G84 X___Y___C___D___F___EOB



The G84 canned tapping cycle starts with the end of the tap being moved from point A to point B and then to point C at the rapid traverse rate. The tap is then fed to point D, reversed, and moved back to point C.

The G85 block for a boring cycle with tool retraction at the feed rate is:

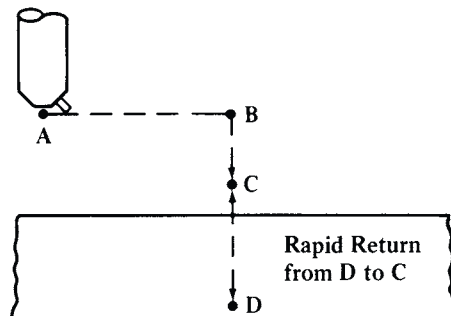
N___G85 X___Y___C___D___F___EOB



In the G85 boring cycle, the tool is moved from point A to point B and then to point C at the rapid traverse rate. The tool is next fed to point D and then, while still rotating, is moved back to point C at the same feed rate.

The G86 block for a boring cycle with rapid traverse retraction is:

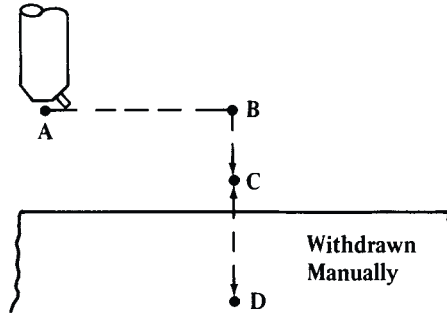
N___G86 X___Y___C___D___F___EOB



The G86 boring cycle is similar to the G85 cycle except that the tool is withdrawn at the rapid traverse rate.

The G87 block for a boring cycle with manual withdrawal of the tool is:

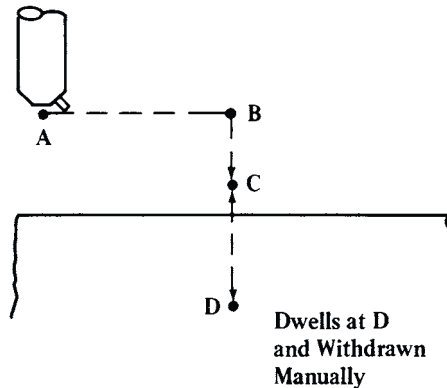
N___G87 X___Y___C___D___F___EOB



In the G87 canned boring cycle, the cutting tool is moved from A to B and then to C at the rapid traverse rate. The tool is then fed to D. The cycle is identical to the other boring cycles except that the tool is withdrawn manually.

The G88 block for a boring cycle with dwell and manual withdrawal is:

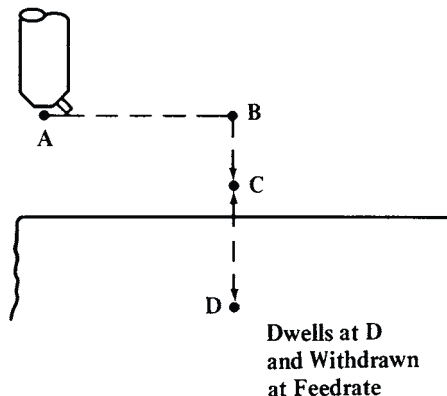
N___G88 X___Y___C___D___T___F___EOB



In the G88 dwell cycle, the tool is moved from A to B to C at the rapid traverse rate and then fed at the prescribed feed rate to D. The tool dwells at D, then stops rotating and is withdrawn manually.

The G89 block for a boring cycle with dwell and withdrawal at the feed rate is:

N___G89 X___Y___C___D___T___F___EOB



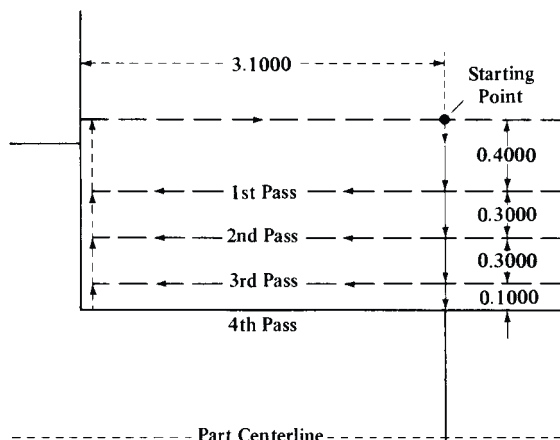


Fig. 16.

Turning Cycles.—Canned turning cycles are available from most system builders and are designed to allow the programmer to describe a complete turning operation in one or a few blocks. There is no standard for this type of operation, so a wide variety of programs have developed. Fig. 16 shows a hypothetical sequence in which the cutter is moved from the start point to depth for the first pass. If incremental programming is in effect, this distance is specified as D1. The depths of the other cuts will also be programmed as D2, D3, and so on. The length of the cut will be set by the W-word, and will remain the same with each pass. The preparatory word that calls for the roughing cycle is G77. The roughing feed rate is 0.03 ipr (inch per revolution), and the finishing feed rate (last pass) is 0.005 ipr. The block appears as follows:

```
N0054 G77 W=3.1 D1=.4 D2=.3 D3=.3 D4=.1 F1=.03 F2=.005
```

Thread Cutting.—Most NC lathes can produce a variety of thread types including constant-lead threads, variable-lead threads (increasing), variable-lead threads (decreasing), multiple threads, taper threads, threads running parallel to the spindle axis, threads (spiral groove) perpendicular to the spindle axis, and threads containing a combination of the preceding. Instead of the feed rate, the lead is specified in the threading instruction block, so that the feed rate is made consistent with, and dependent upon, the selected speed (rpm) of the spindle.

The thread lead is generally noted by either an I- or a K-word. The I-word is used if the thread is parallel to the X-axis and the K-word if the thread is parallel to the Z-axis, the latter being by far the most common. The G-word for a constant-lead thread is G33, for an increasing variable-lead thread is G34, and for a decreasing variable-lead thread is G35. Taper threads are obtained by noting the X- and Z-coordinates of the beginning and end points of the thread if the G90 code is in effect (absolute programming), or the incremental movement from the beginning point to the end point of the thread if the G91 code (incremental programming) is in effect.

N0001 G91	(Incremental programming)
N0002 G00 X-.1000	(Rapid traverse to depth)
N0003 G33 Z-1.0000 K.0625	(Produce a thread with a constant lead of 0.625 inch)
N0004 G00 X.1000	(Withdraw at rapid traverse)
N0005 Z1.0000	(Move back to start point)

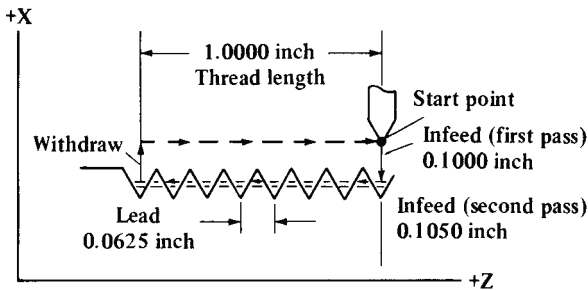


Fig. 17.

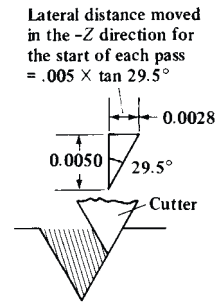


Fig. 18.

Multiple threads are specified by a code in the block that spaces the start of the threads equally around the cylinder being threaded. For example, if a triple thread is to be cut, the threads will start 120 degrees apart. Typical single-block thread cutting utilizing a plunge cut is illustrated in Fig. 17 and shows two passes. The passes are identical except for the distance of the plunge cut. Builders of control systems and machine tools use different code-words for threading, but those shown below can be considered typical. For clarity, both zeros and decimal points are shown.

The only changes in the second pass are the depth of the plunge cut and the withdrawal. The blocks will appear as follows:

```
N0006 X - .1050
N0007 G33 Z - 1.0000 K.0625
N0008 G00 X.1050
N0009 Z1.000
```

Compound thread cutting, rather than straight plunge thread cutting, is possible also, and is usually used on harder materials. As illustrated in Fig. 18, the starting point for the thread is moved laterally in the -Z direction by an amount equal to the depth of the cut times the tangent of an angle that is slightly less than 30 degrees. The program for the second pass of the example shown in Fig. 18 is as follows:

```
N0006 X - .1050 Z - .0028
N0007 G33 Z - 1.0000 K.0625
N0008 G00 X.1050
N0009 Z1.0000
```

Fixed (canned), one-block cycles also have been developed for CNC systems to produce the passes needed to complete a thread. These cycles may be offered by the builder of the control system or machine tool as standard or optional features. Subroutines also can generally be prepared by the user to accomplish the same purpose (see Subroutine). A one-block fixed threading cycle might look something like:

```
N0048 G98 X - .2000 Z - 1.0000 D.0050 F.0010
```

where G98 = preparatory code for the threading cycle

X - .2000 = total distance from the starting point to the bottom of the thread

Z - 1.0000 = length of the thread

D.0050 = depths of successive cuts

F.0010 = depth(s) of the finish cut(s)

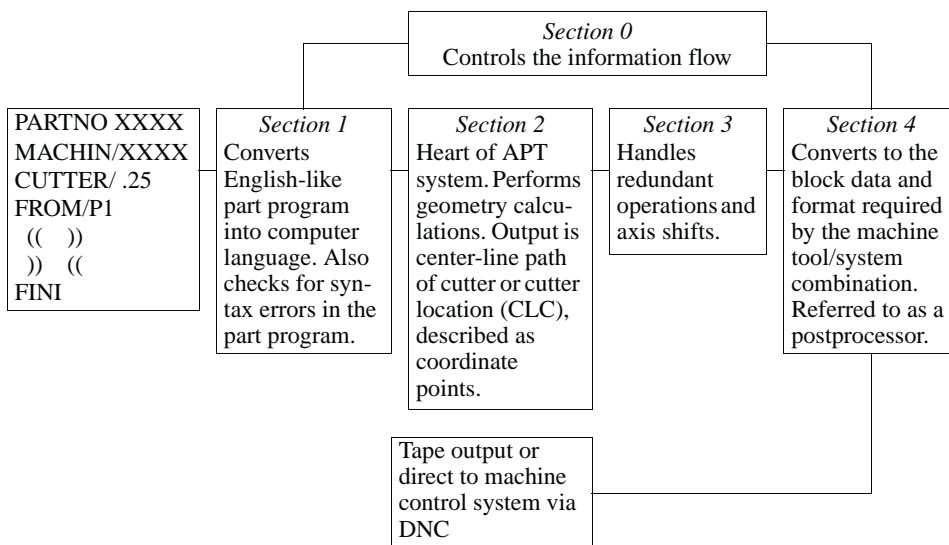
APT Programming

APT.—APT stands for Automatically Programmed Tool and is one of many computer languages designed for use with NC machine tools. The selection of a computer-assisted part-programming language depends on the type and complexity of the parts being machined more than on any other factor. Although some of the other languages may be easier to use, APT has been chosen to be covered in this book because it is a nonproprietary

language in the public domain, has the broadest range of capability, and is one of the most advanced and universally accepted NC programming languages available. APT (or a variation thereof) is also one of the languages that is output by many computer programs that produce CNC part programs directly from drawings produced with CAD systems.

APT is suitable for use in programming part geometry from simple to exceptionally complex shapes. APT was originally designed and used on mainframe computers, however, it is now available, in many forms, on mini- and microcomputers as well. APT has also been adopted as ANSI Standard X3.37 and by the International Organization for Standardization (ISO) as a standardized language for NC programming. APT is a very dynamic program and is continually being updated. APT is being used as a processor for part-programming graphic systems, some of which have the capability of producing an APT program from a graphic screen display or CAD drawing and of producing a graphic display on the CAD system from an APT program.

APT is a high-level programming language. One difference between APT and the ANSI/EIA RS-274-D (G-codes) programming format discussed in the last section is that APT uses English like words and expressions to describe the motion of the tool or work-piece. APT has the capability of programming the machining of parts in up to five axes, and also allows computations and variables to be included in the programming statements so that a whole family of similar parts can be programmed easily. This section describes the general capabilities of the APT language and includes a ready reference guide to the basic geometry and motion statements of APT, which is suitable for use in programming the machining of the majority of cubic type parts involving two-dimensional movements. Some of the three-dimensional geometry capability of APT and a description of its five-dimensional capability are also included.



As shown above, the APT system can be thought of comprising the input program, the five sections 0 through IV, and the output program. The input program shown on the left progresses through the first four sections and all four are controlled by the fifth, section 0. Section IV, the postprocessor, is the software package that is added to sections II and III to customize the output and produce the necessary program format (including the G-words, M-words, etc.) so that the coded instructions will be recognizable by the control system. The postprocessor is software that is separate from the main body of the APT program, but for purposes of discussion, it may be easier to consider it as a unit within the APT program.

APT Computational Statements.—Algebraic and trigonometric functions and computations can be performed with the APT system as follows:

Arithmetic Form	APT Form	Arithmetic Form	APT Form	Arithmetic Form	APT Form
25×25	25*25	25^2	25**2	$\cos \theta$	COSF(θ)
$25 \div 25$	25/25	25^n	25**n	$\tan \theta$	TANF(θ)
$25 + 25$	25 + 25	$\sqrt{25}$	SQRTF (25)	$\arctan .5000$	ATANF(.5)
$25 - 25$	25 - 25	$\sin \theta$	SINF(θ)		

Computations may be used in the APT system in two ways. One way is to let a factor equal the computation and then substitute the factor in a statement; the other is to put the computation directly into the statement. The following is a series of APT statements illustrating the first approach.

P1 = POINT/0,0,1

T = (25*2/3 + (3**2 - 1))

P2 = POINT/T,0,0

The second way would be as follows;

P1 = POINT/0,0,1

P2 = POINT/(25*2/3 + (3**2 - 1)),0,0

Note: The parentheses have been used as they would be in an algebraic formula so that the calculations will be carried out in proper sequence. The operations within the inner parentheses would be carried out first. It is important for the total number of left-hand parentheses to equal the total number of right-hand parentheses; otherwise, the program will fail.

APT Geometry Statements.—Before movements around the geometry of a part can be described, the geometry must be defined. For example, in the statement GOTO/P1, the computer must know where P1 is located before the statement can be effective. P1 therefore must be described in a geometry statement, prior to its use in the motion statement GOTO/P1. The simplest and most direct geometry statement for a point is

P1 = POINT/X ordinate, Y ordinate, Z ordinate

If the Z ordinate is zero and the point lies on the X–Y plane, the Z location need not be noted. There are other ways of defining the position of a point, such as at the intersection of two lines or where a line is tangent to a circular arc. These alternatives are described below, together with ways to define lines and circles. Referring to the preceding statement, P1 is known as a symbol. Any combination of letters and numbers may be used as a symbol providing the total does not exceed six characters and at least one of them is a letter. MOUSE2 would be an acceptable symbol, as would CAT3 or FRISBE. However, it is sensible to use symbols that help define the geometry. For example, C1 or CIR3 would be good symbols for a circle. A good symbol for a vertical line would be VL5.

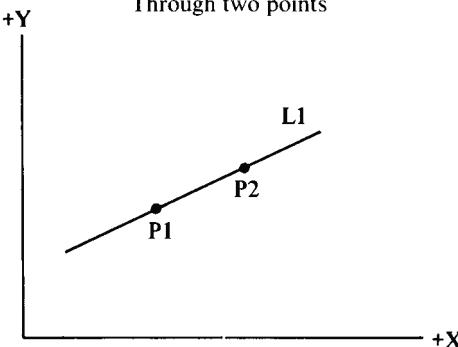
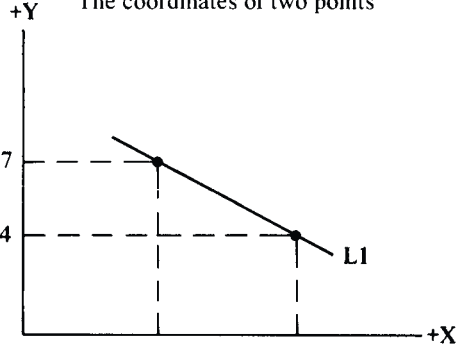
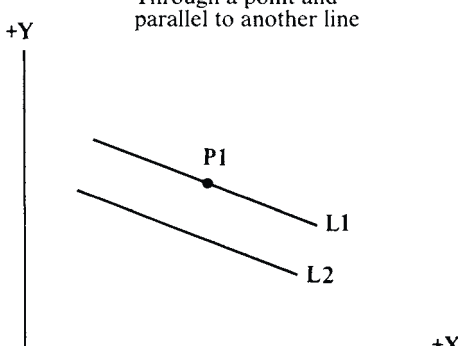
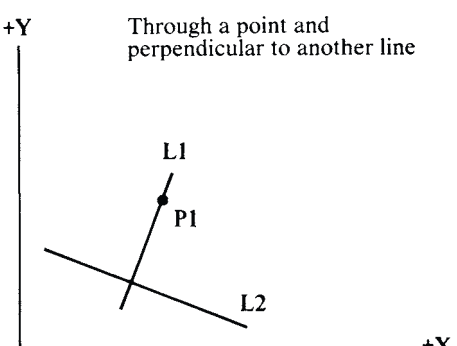
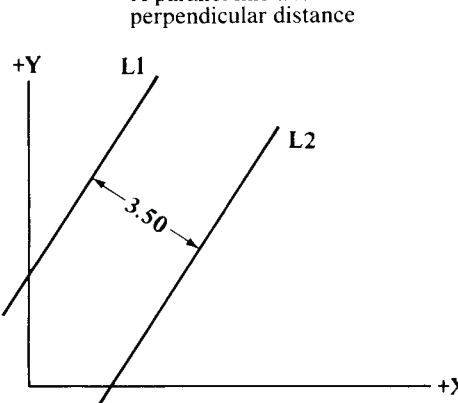
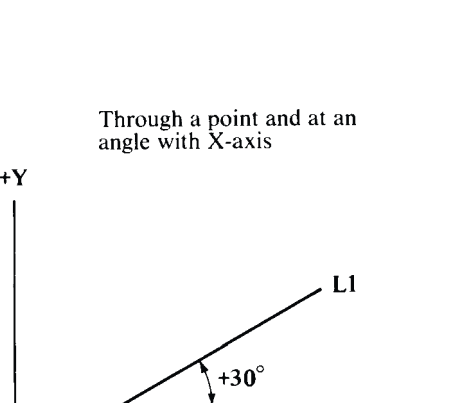
Next, and after the equal sign, the particular geometry is noted. Here, it is a POINT. This word is a vocabulary word and must be spelled exactly as prescribed. Throughout, the designers of APT have tried to use words that are as close to English as possible. A slash follows the vocabulary word and is followed by a specific description of the particular geometry, such as the coordinates of the point P1. A usable statement for P1 might appear as P1 = POINT/1,5,4. The 1 would be the X ordinate; the 5, the Y ordinate; and the 4, the Z ordinate.

Lines as calculated by the computer are infinitely long, and circles consist of 360 degrees. As the cutter is moved about the geometry under control of the motion statements, the lengths of the lines and the amounts of the arcs are “cut” to their proper size. (Some of the geometry statements shown in the accompanying illustrations for defining POINTS, LINES, CIRCLES, TABULATED CYLINDERS, CYLINDERS, CONES, and SPHERES, in the APT language, may not be included in some two-dimensional [ADAPT] systems.)

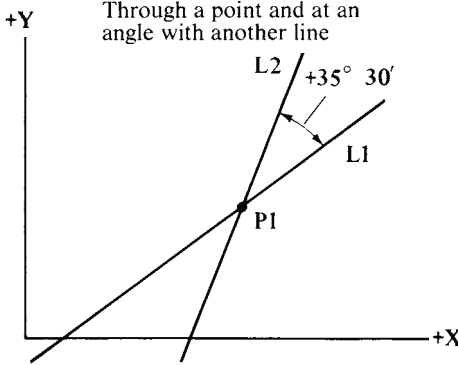
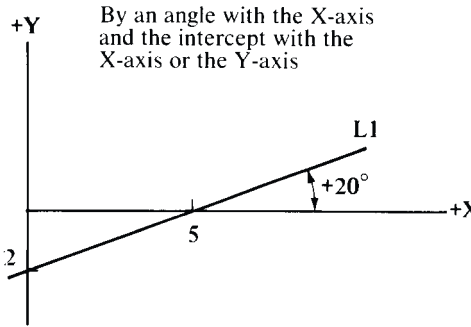
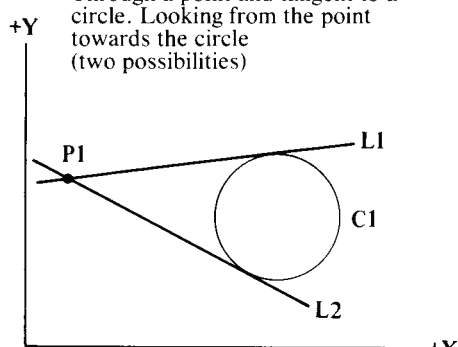
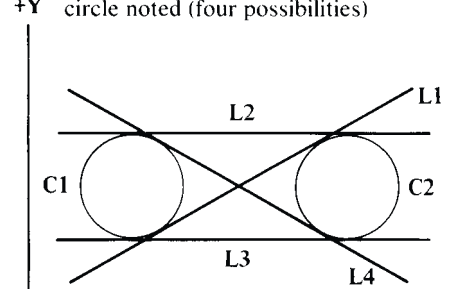
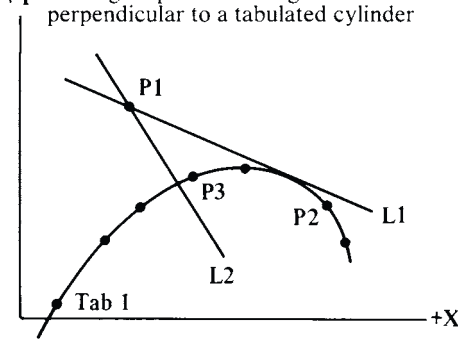
Points

<p>Point in space</p> <p>$P1 = \text{POINT}/4, 5, 2$ $P2 = \text{POINT}/2, 2$</p>	<p>Intersection of two lines</p> <p>$P3 = \text{POINT}/\text{INTOF}, L1, L2$</p>
<p>Intersection of line and circle (two possibilities)</p> <p>$P1 = \text{POINT}/\text{XLARGE}, \text{INTOF}, L1, C1$ or $P1 = \text{POINT}/\text{YLARGE}, \text{INTOF}, L1, C1$ $P2 = \text{POINT}/\text{XSMALL}, \text{INTOF}, L1, C1$ or $P2 = \text{POINT}/\text{YSMALL}, \text{INTOF}, L1, C1$ The X and Y ordinates of P1 are larger than the X and Y ordinates of P2</p>	<p>Intersection of two circles (two possibilities)</p> <p>$P1 = \text{POINT}/\text{XSMALL}, \text{INTOF}, C1, C2$ or $P1 = \text{POINT}/\text{YLARGE}, \text{INTOF}, C1, C2$ $P2 = \text{POINT}/\text{XLARGE}, \text{INTOF}, C1, C2$ or $P2 = \text{POINT}/\text{YSMALL}, \text{INTOF}, C1, C2$</p>
<p>Intersection of a radial line and a circle</p> <p>$P1 = \text{POINT}/C1, \text{ATANGL}, 20$</p>	<p>Center of a circle</p> <p>$P1 = \text{POINT}/\text{CENTER}, C1$</p>

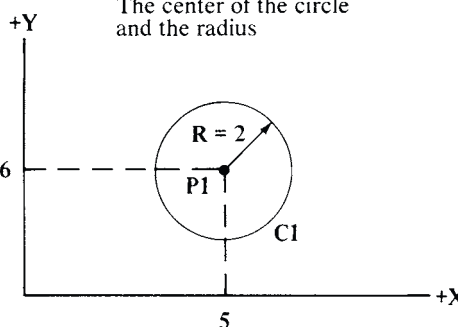
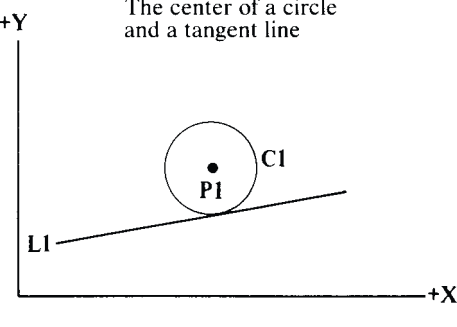
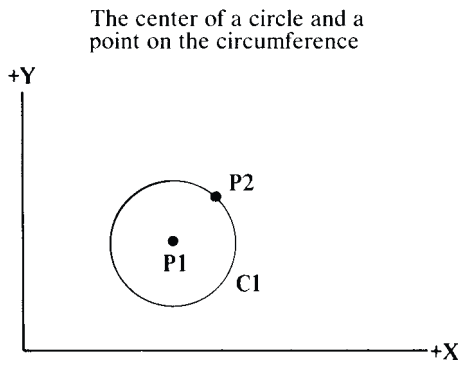
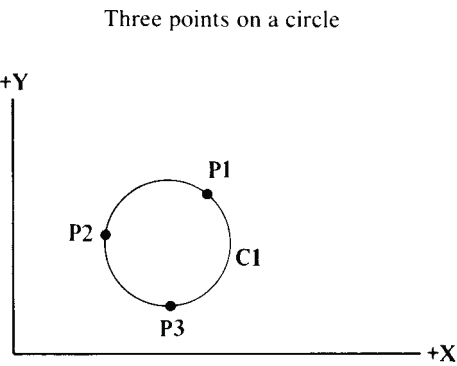
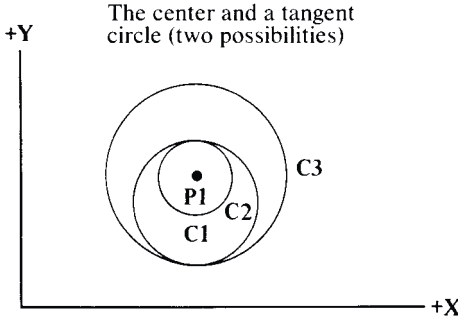
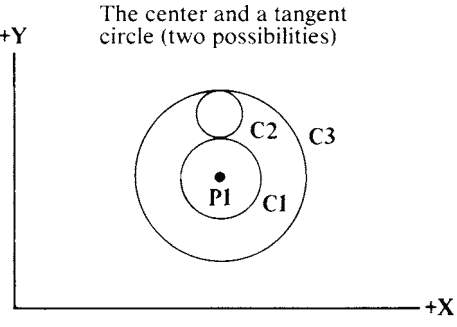
Lines

<p style="text-align: center;">Through two points</p>  <p style="text-align: center;">$L1 = \text{LINE}/P1, P2$</p>	<p style="text-align: center;">The coordinates of two points</p>  <p style="text-align: center;">$L1 = \text{LINE}/5, 7, 10, 4$</p>
<p style="text-align: center;">Through a point and parallel to another line</p>  <p style="text-align: center;">$L1 = \text{LINE}/P1, \text{PARLEL}, L2$</p>	<p style="text-align: center;">Through a point and perpendicular to another line</p>  <p style="text-align: center;">$L1 = \text{LINE}/P1, \text{PERPTO}, L2$</p>
<p style="text-align: center;">A parallel line and a perpendicular distance</p>  <p> $L1 = \text{LINE}/\text{PARLEL}, L2, \text{XSMALL}, 3.50$ or $L1 = \text{LINE}/\text{PARLEL}, L2, \text{YLARGE}, 3.50$ $L2 = \text{LINE}/\text{PARLEL}, L1, \text{XLARGE}, 3.50$ or $L2 = \text{LINE}/\text{PARLEL}, L1, \text{YSMALL}, 3.50$ </p>	<p style="text-align: center;">Through a point and at an angle with X-axis</p>  <p style="text-align: center;">$L1 = \text{LINE}/P1, \text{ATANGL}, 30$</p>

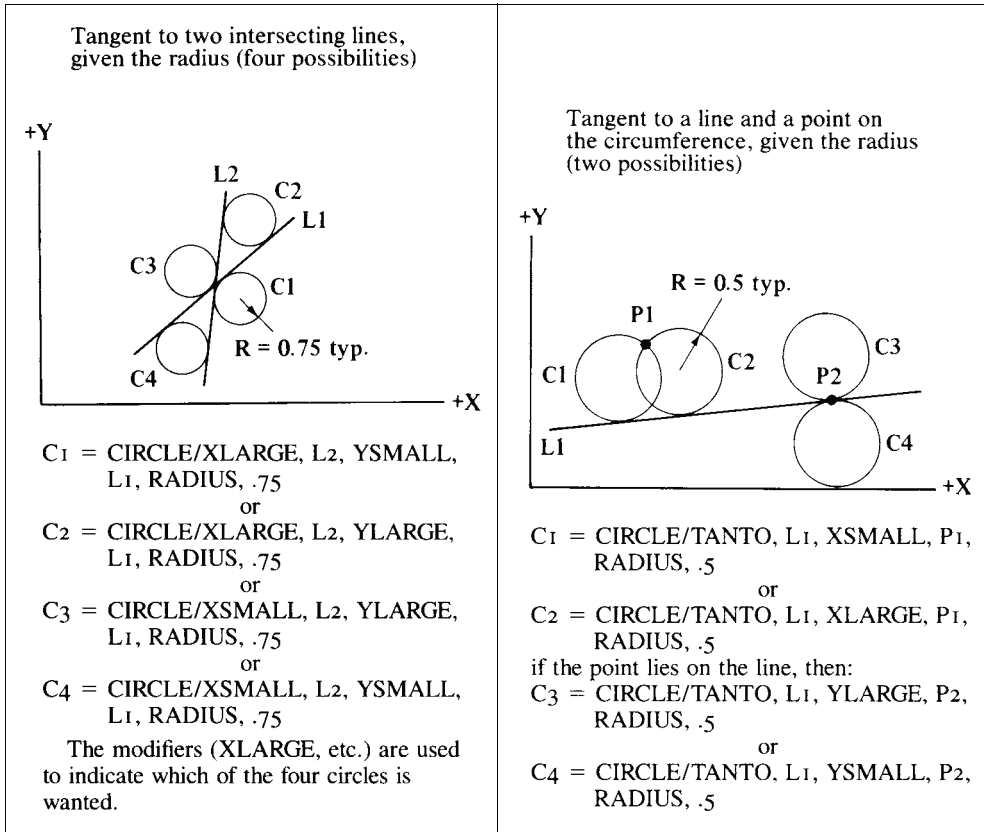
Lines

<p>Through a point and at an angle with another line</p>  <p>L2 = LINE/P1, ATANGL, 35.5, L1</p>	<p>By an angle with the X-axis and the intercept with the X-axis or the Y-axis</p>  <p>L1 = LINE/ATANGL, 20, INTERC, XAXIS, 5 L1 = LINE/ATANGL, 20, INTERC, YAXIS, 2</p>
<p>Through a point and tangent to a circle. Looking from the point towards the circle (two possibilities)</p>  <p>L1 = LINE/P1, LEFT, TANTO, C1 L2 = LINE/P1, RIGHT, TANTO, C1</p>	<p>Tangent to two circles. Looking from the first circle noted in the statement towards the second circle (four possibilities)</p>  <p>L1 = LINE/RIGHT, TANTO, C2, LEFT, TANTO, C1 or L1 = LINE/RIGHT, TANTO, C1, LEFT, TANTO, C2 L2 = LINE/LEFT, TANTO, C1, LEFT, TANTO, C2 or L2 = LINE/RIGHT, TANTO, C2, RIGHT, TANTO, C1 L3 = LINE/RIGHT, TANTO, C1, RIGHT, TANTO, C2 or L3 = LINE/LEFT, TANTO, C2, LEFT, TANTO, C1 L4 = LINE/LEFT, TANTO, C2, RIGHT, TANTO, C1 or L4 = LINE/LEFT, TANTO, C1, RIGHT, TANTO, C2</p>
<p>Through a point and tangent or perpendicular to a tabulated cylinder</p>  <p>L1 = LINE/P1, TANTO, TAB1, P2 L1 = LINE/P1, PERPTO, TAB1, P3 P2 and P3 are points close to the tangent points of L1 and the intersection point of L2, therefore cannot be end points of the tabulated cylinder</p>	

Circles

<p>The center of the circle and the radius</p>  <p>$C1 = \text{CIRCLE}/5, 6, 2$ or $C1 = \text{CIRCLE}/5, 6, 0, 2$ <small>(where 0 = Z ordinate)</small> or $C1 = \text{CIRCLE}/\text{CENTER}, P1, \text{RADIUS}, 2$</p>	<p>The center of a circle and a tangent line</p>  <p>$C1 = \text{CIRCLE}/\text{CENTER}, P1, \text{TANTO}, L1$</p>
<p>The center of a circle and a point on the circumference</p>  <p>$C1 = \text{CIRCLE}/\text{CENTER}, P1, P2$</p>	<p>Three points on a circle</p>  <p>$C1 = \text{CIRCLE}/P1, P2, P3$</p>
<p>The center and a tangent circle (two possibilities)</p>  <p>$C1 = \text{CIRCLE}/\text{CENTER}, P1, \text{SMALL}, \text{TANTO}, C2$ or $C3 = \text{CIRCLE}/\text{CENTER}, P1, \text{LARGE}, \text{TANTO}, C2$</p>	<p>The center and a tangent circle (two possibilities)</p>  <p>$C1 = \text{CIRCLE}/\text{CENTER}, P1, \text{SMALL}, \text{TANTO}, C2$ or $C3 = \text{CIRCLE}/\text{CENTER}, \text{LARGE}, \text{TANTO}, C2$</p>

Circles



APT Motion Statements.—APT is based on the concept that a milling cutter is guided by two surfaces when in a contouring mode. Examples of these surfaces are shown in Fig. 1, and they are called the “part” and the “drive” surfaces. Usually, the part surface guides the bottom of the cutter and the drive surface guides the side of the cutter. These surfaces may or may not be actual surfaces on the part, and although they may be imaginary to the part programmer, they are very real to the computer. The cutter is either stopped or redirected by a third surface called a check surface. If one were to look directly down on these surfaces, they would appear as lines, as shown in Figs. 2a through 2c.

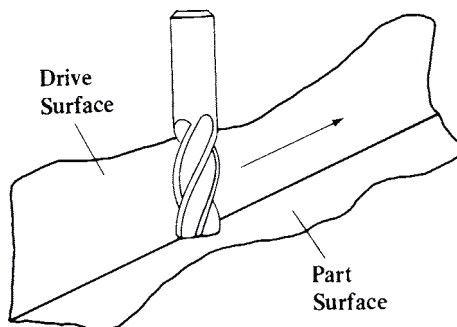


Fig. 1. Contouring Mode Surfaces

When the cutter is moving toward the check surface, it may move to it, onto it, or past it, as illustrated in Fig. 2a. When the cutter meets the check surface, it may go right, denoted by the APT command GORGT, or go left, denoted by the command GOLFT, in Fig. 2b.

Alternatively, the cutter may go forward, instructed by the command GOFWD, as in Fig. 2c. The command GOFWD is used when the cutter is moving either onto or off a tangent circular arc. These code instructions are part of what are called motion commands. Fig. 3 shows a cutter moving along a drive surface, L1, toward a check surface, L2. When it arrives at L2, the cutter will make a right turn and move along L2 and past the new check surface L3. Note that L2 changes from a check surface to a drive surface the moment the cutter begins to move along it. The APT motion statement for this move is:

GORGT/L2,PAST,L3

Contouring Cutter Movements

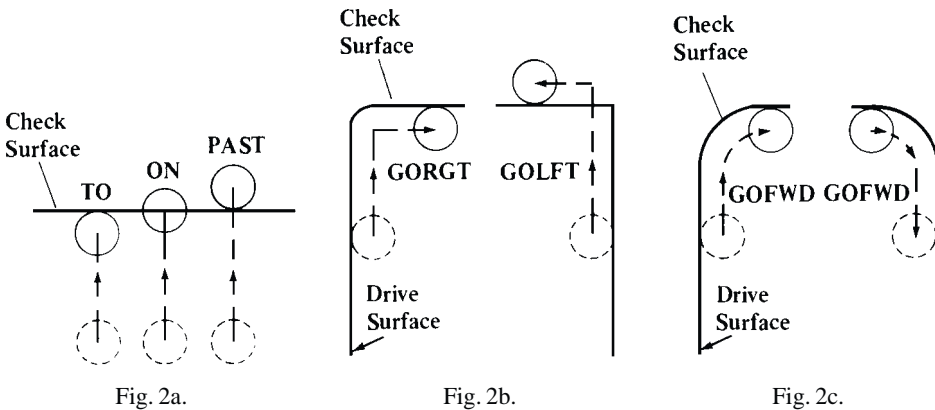


Fig. 2a.

Fig. 2b.

Fig. 2c.

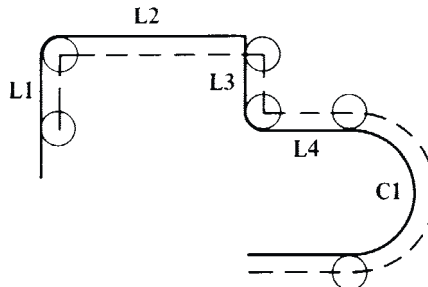


Fig. 3. Motion Statements for Movements Around a Workpiece

Still referring to Fig. 3, the cutter moves along L3 until it comes to L4. L3 now becomes the drive surface and L4 the check surface. The APT statement is:

GORGT/L3,TO,L4

The next statement is:

GOLFT/L4,TANTO,C1

Even though the cutter is moving to the right, it makes a left turn if one is looking in the direction of travel of the cutter. In writing the motion statements, the part programmers must imagine they are steering the cutter. The drive surface now becomes L4 and the check surface, C1. The next statement will therefore be:

GOFWD/C1,TANTO,L5

This movement could continue indefinitely, with the cutter being guided by the drive, part, and check surfaces.

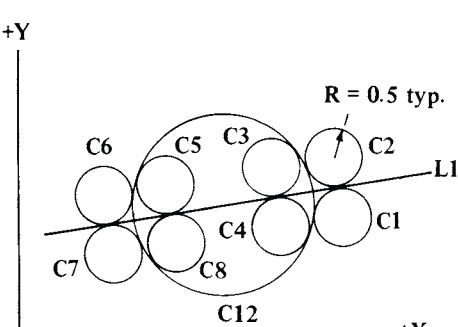
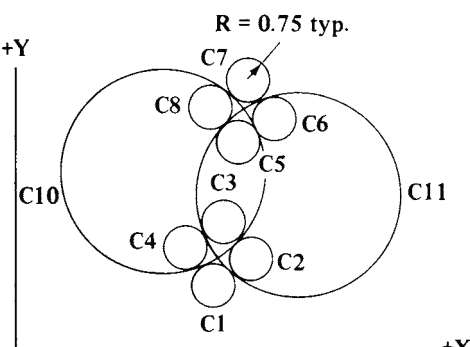
Start-Up Statements: For the cutter to move along them, it must first be brought into contact with the three guiding surfaces by means of a start-up statement. There are three different start-up statements, depending on how many surfaces are involved.

A three-surface start-up statement is one in which the cutter is moved to the drive, part, and check surfaces, as seen in Fig. 4a. A two-surface start-up is one in which the cutter is

moved to the drive and part surfaces, as in Fig. 4b. A one-surface start-up is one in which the cutter is moved to the drive surface and the X-Y plane, where $Z = 0$, as in Fig. 4c. With the two- and one-surface start-up statements, the cutter moves in the most direct path, or perpendicular to the surfaces. Referring to Fig. 4a (three-surface start-up), the move is initiated from a point P1. The two statements that will move the cutter from P1 to the three surfaces are:

FROM/P1
GO/TO,DS,TO,PS,TO,CS

Circles

<p style="text-align: center;">Tangent to a line and a circle, given the radius (eight possibilities)</p>  <p style="text-align: center;">+Y</p> <p style="text-align: center;">+X</p> <p>C1 = CIRCLE/YSMALL, L1, XLARGE, OUT, C12, RADIUS, .5 C2 = CIRCLE/YLARGE, L1, XLARGE, OUT, C12, RADIUS, .5 C3 = CIRCLE/YLARGE, L1, XLARGE, IN, C12, RADIUS, .5 C4 = CIRCLE/YSMALL, L1, XLARGE, IN, C12, RADIUS, .5 C5 = CIRCLE/YLARGE, L1, XSMALL, OUT, C12, RADIUS, .5 C6 = CIRCLE/XLARGE, L1, XSMALL, OUT, C12, RADIUS, .5 C7 = CIRCLE/YSMALL, L1, XSMALL, OUT, C12, RADIUS, .5 C8 = CIRCLE/YSMALL, L1, XSMALL, IN, C12, RADIUS, .5</p> <p>Recommendations:</p> <ol style="list-style-type: none"> 1. Note which side of line circle is on (e.g., YSMALL, L1). 2. Note whether the circle being defined is inside (IN), or outside (OUT), the known circle. 3. Of the two remaining circles, note whether the circle to be defined is XLARGE, XSMALL, or YLARGE or YSMALL, to arrive at the second modifier in the statement. 	<p style="text-align: center;">Tangent to two circles, given the radius (eight possibilities)</p>  <p style="text-align: center;">+Y</p> <p style="text-align: center;">+X</p> <p>C1 = CIRCLE/YSMALL, OUT, C10, OUT, C11, RADIUS, .75 C2 = CIRCLE/YSMALL, OUT, C10, IN, C11, RADIUS, .75 C3 = CIRCLE/YSMALL, IN, C10, IN, C11, RADIUS, .75 C4 = CIRCLE/YSMALL, IN, C10, OUT, C11, RADIUS, .75 C5 = CIRCLE/YLARGE, IN, C10, IN, C11, RADIUS, .75 C6 = CIRCLE/YLARGE, OUT, C10, IN, C11, RADIUS, .75 C7 = CIRCLE/YLARGE, OUT, C10, OUT, C11, RADIUS, .75 C8 = CIRCLE/YLARGE, IN, C10, OUT, C11, RADIUS, .75</p> <p>Recommendations</p> <ol style="list-style-type: none"> 1. Apply IN, OUT modifiers. 2. Apply XLARGE, etc., modifiers.
--	---

DS is used as the symbol for the Drive Surface; PS as the symbol for the Part Surface; and CS as the symbol for the Check Surface. The surfaces must be denoted in this sequence. The drive surface is the surface that the cutter will move along after coming in contact with the three surfaces. The two statements applicable to the two-surface start-up (Fig. 4b) are:

```
FROM/P1
GO/TO,DS,TO,PS
```

The one-surface start-up (Fig. 4c) is:

```
FROM/P1
GO/TO,DS
```

Planes

Planes are often used as the part surface, and are defined by three points not lying in a straight line
 $PL1 = PLANE/P1, P2, P3$

A plane that is horizontal, or parallel to the X-Y plane, may be defined as:
 $PL1 = PLANE/0, 0, 1, 5$ (0, 0, 1 does not change)

Alternatively, PL2 may be defined as a plane parallel to PL1
 $PL2 = PLANE/PARLEL, PL1, ZLARGE, 10$

Cutter Movement Surfaces

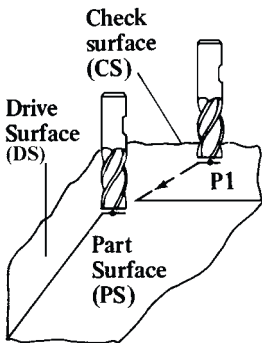


Fig. 4a.

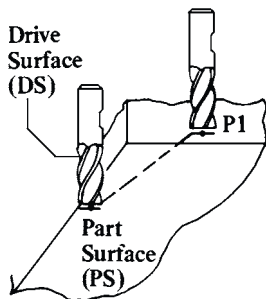


Fig. 4b.

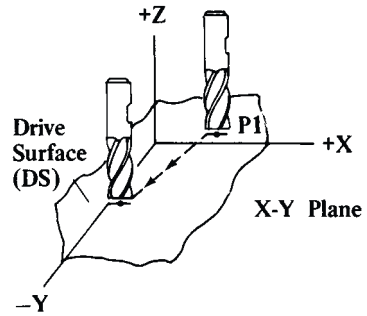


Fig. 4c.

Tabulated Cylinder

A tabulated cylinder is the line that is formed when an irregular cylinder intersects a plane. The plane intersected in the figure at the left is the X - Y plane.

A section of the line can be defined by a series of points on the line, as seen at the right. This line is called a TABCYL. The line must pass through all the points, therefore, it is best not to use too many. The statement to the computer would read:

TAB1 = TABCYL/NOZ, SPLINE, P1, P2, P3, P4, P5, P6

or

TAB1 = TABCYL/NOZ, SPLINE, X., Y., X2, Y2, X3, Y3, X4, Y4, X5, Y5, X6, Y6
(where X and Y are the coordinates of the points)

3-D Geometry

Cylinder

Length of vector = 1

A cylinder is defined by a vector, a point on the centerline, and the radius

CL1 = CYLNDR/P1, V2, 1.5

where V2 is a unit vector in line with the cylinder centerline, and is described by the X , Y , and Z components. The cylinder centerline lies on the X - Y plane and is parallel to the Y -axis. The statement for the vector is therefore:

V2 = VECTOR/ X component, Y component, Z component

V2 = VECTOR/0, 1, 0

Cone

A cone is defined by its vertex, its axis as a unit vector, and the half angle (refer to cylinder for an example of a vector statement)

CON1 = CONE/P1, V1, 45

Sphere

A sphere is defined by the center and the radius

SP1 = SPHERE/P1, RADIUS, 2.5

or

SP1 = SPHERE/5, 5, 3, 2.5 (where 5, 5, and 3 are the X , Y , and Z coordinates of P1, and 2.5 is the radius)

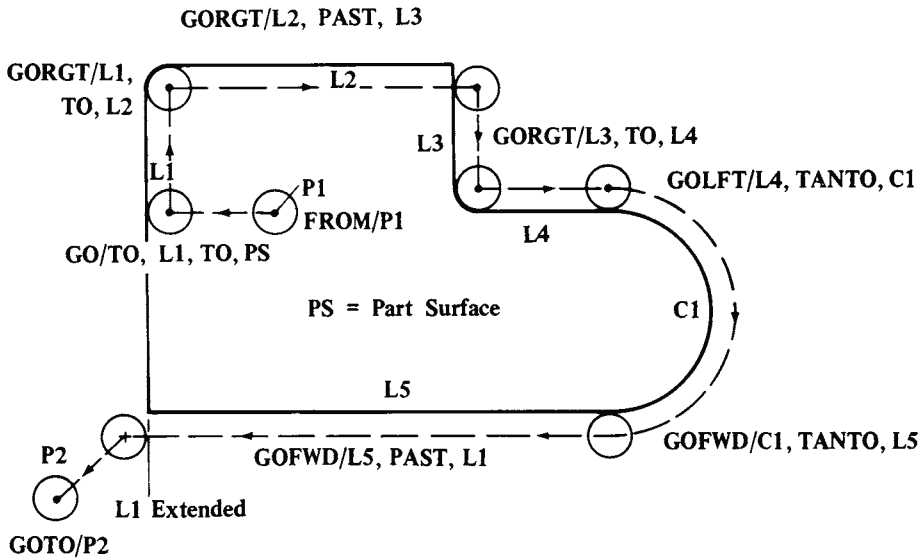


Fig. 5. A Completed Two-Surface Start-Up

Note that, in all three motion statements, the slash mark (/) lies between the GO and the TO. When the cutter is moving to a point rather than to surfaces, such as in a start-up, the statement is GOTO/ rather than GO/TO. A two-surface start-up, Fig. 3, when completed, might appear as shown in Fig. 5, which includes the motion statements needed. The motion statements, as they would appear in a part program, are shown at the left, below:

FROM/P1	FROM/P1
GO/TO,L1,TO,PS	GOTO/P2
GORGT/L1,TO,L2	GOTO/P3
GORGT/L2,PAST,L3	GOTO/P4
GORGT/L3,TO,L4	GOTO/P5
GOLFT/L4,TANTO,C1	GOTO/P6
GOFWD/C1,TANTO,L5	GOTO/P7
GOFWD/L5,PAST,L1	
GOTO/P2	

GOTO statements can move the cutter throughout the range of the machine, as shown in Fig. 6. APT statements for such movements are shown at the right in the preceding example. The cutter may also be moved incrementally, as shown in Fig. 7. Here, the cutter is to move 2 inches in the + X direction, 1 inch in the + Y direction, and 1.5 inches in the + Z direction. The incremental move statement (indicated by DLTA) is:

GODLTA/2,1,1.5

The first position after the slash is the X movement; the second the Y movement, and the third, the Z movement.

Five-Axis Machining: Machining on five axes is achieved by causing the APT program to generate automatically a unit vector that is normal to the surface being machined, as shown in Fig. 8. The vector would be described by its X, Y, and Z components. These components, along with the X, Y, and Z coordinate positions of the tool tip, are fed into the post-processor, which determines the locations and angles for the machine tool head and/or table.

APT Postprocessor Statements.—Statements that refer to the operation of the machine rather than to the geometry of the part or the motion of the cutter about the part are called postprocessor statements. APT postprocessor statements have been standardized internationally. Some common statements and an explanation of their meaning follow:

MACHIN/ Specifies the postprocessor that is to be used. Every postprocessor has an identity code, and this code must follow the slash mark (/). For example: *MACHIN/LATH,82*

FEDRATE/ Denotes the feed rate. If in inches per minute (ipm), only the number

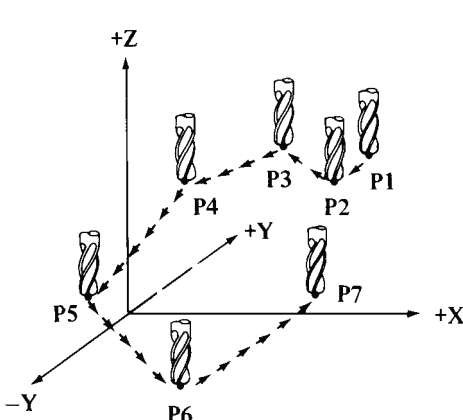


Fig. 6. A Series of GOTO Statements

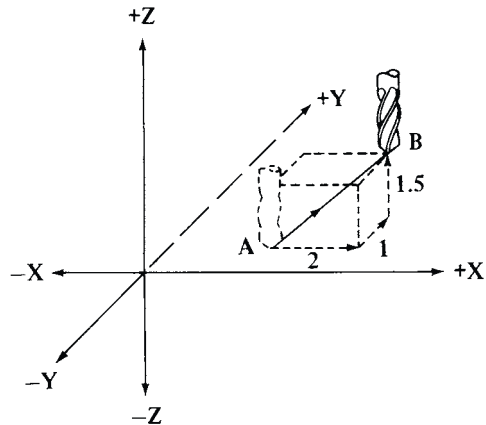


Fig. 7. Incremental Cutter Movements

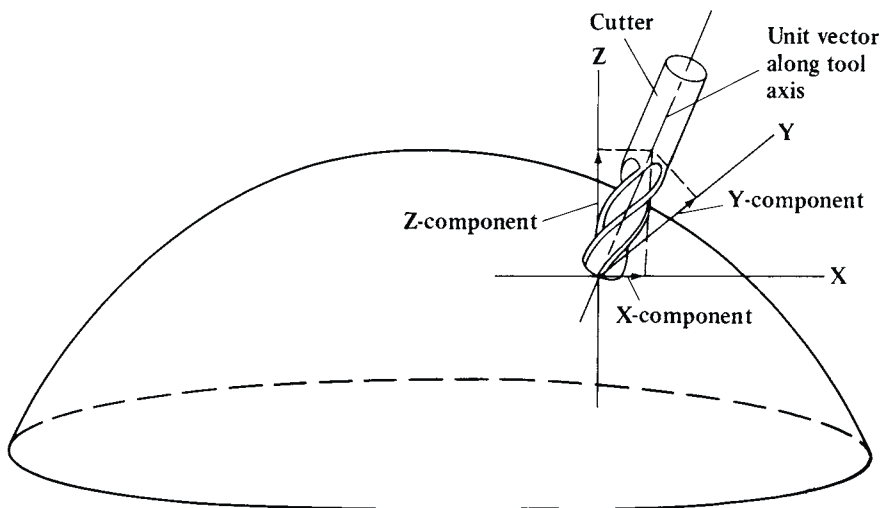


Fig. 8. Five-Axis Machining

need be shown. If in inches per revolution (ipr), IPR must be shown, for example: *FED-RAT/.005,IPR*

RAPID Means rapid traverse and applies only to the statement that immediately follows it
SPINDL/ Refers to spindle speed. If in revolutions per minute (rpm), only the number need be shown. If in surface feet per minute (sfm), the letters SFM need to be shown, for example: *SPINDL/ 100SFM*

COOLNT/ Means cutting fluid and can be subdivided into: *COOLNT/ON*, *COOLNT/MIST*, *COOLNT/FLOOD*, *COOLNT/OFF*

TURRET/ Used to call for a selected tool or turret position

CYCLE/ Specifies a cycle operation such as a drilling or boring cycle. An example of a drilling cycle is: *CYCLE/DRILL,RAPTO,.45,FEDTO,0,IPR,.004*. The next statement might be *GOTO/PI* and the drill will then move to P1 and perform the cycle operation. The cycle will repeat until the *CYCLE/OFF* statement is read

END Stops the machine but does not turn off the control system

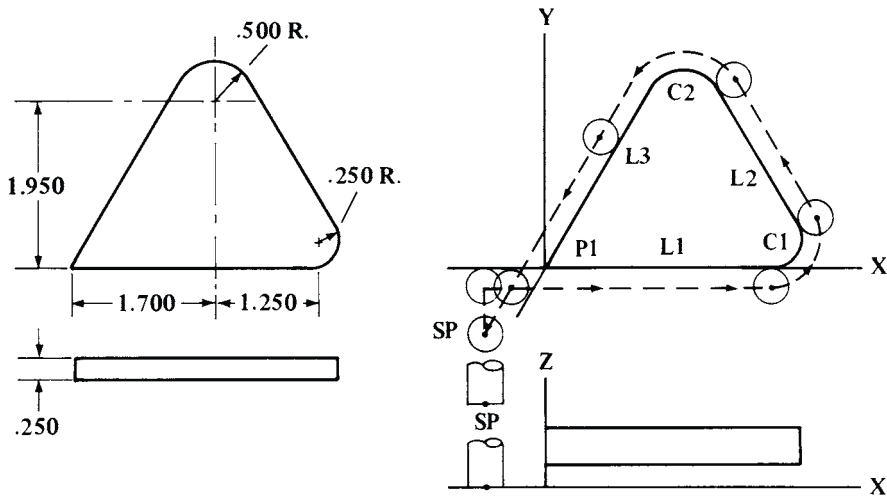


Fig. 9. Symbols for Geometrical Elements

APT Example Program.—A dimensioned drawing of a part and a drawing with the symbols for the geometry elements are shown in Fig. 9. A complete APT program for this part, starting with the statement PARTNO 47F36542 and ending with FINI, is shown at the left below.

The numbers at the left of the statements are for reference purposes only, and are not part of the program. The cutter is set initially at a point represented by the symbol SP, having coordinates $X = -0.5$, $Y = -0.5$, $Z = 0.75$, and moves to L1 (extended) with a one-surface start-up so that the bottom of the cutter rests on the X - Y plane. The cutter then moves counterclockwise around the part, past L1 (extended), and returns to SP. The coordinates of P1 are $X = 0$, $Y = 0$, and $Z = 1$.

(1) PARTNO	(1) PARTNO
(2) CUTTER/.25	(2) CUTTER/.25
(3) FEDRAT/5	(3) FEDRAT/5
(4) SP = POINT/-.5, -.5, .75	(4) SP = POINT/-.5, -.5, .75
(5) P1 = POINT/0, 0, 1	(5) P1 = POINT/0, 0, 1
(6) L1 = LINE/P1, ATANGL, 0	(6) L1 = LINE/P1, ATANGL, 0
(7) C1 = CIRCLE/(1.700 + 1.250), .250, .250	(7) C1 = CIRCLE/(1.700 + 1.250), .250, .250
(8) C2 = CIRCLE/1.700, 1.950, .5	(8) C2 = CIRCLE/1.700, 1.950, .5
(9) L2 = LINE/RIGHT, TANTO, C1, RIGHT, TANTO, C2	(9) L2 = LINE/RIGHT, TANTO, C1, RIGHT, TANTO, C2
(10) L3 = LINE/P1, LEFT, TANTO, C2	(10) L3 = LINE/P1, LEFT, TANTO, C2
(11) FROM/SP	(11) FROM/SP
(12) GO/TO, L1	(12) FRO -.500 -.5000 .7500 M
(13) GORGT/L1, TANTO, C1	(13) GO/TO/, L1
(14) GOFWD/C1, TANTO, L2	(14) GT -.5000 -.1250 .0000
(15) GOFWD/L2, TANTO, C2	(15) GORGT/L1, TANTO, C1
(16) GOFWD/C2, TANTO, L3	(16) GT 2.9500 -.1250 .0000
(17) GOFWD/L3, PAST, L1	(17) GOFWD/C1, TANTO, L2
(18) GOTO/SP	(18) CIR 2.9500 .2500 .3750 CCLW

	CNC		3199
(19) FINI	(19)	3.2763 .4348	.0000
	(20)	GOFWD/L2, TANTO, C2	
	(21)	GT 2.2439 2.2580	.0000
	(22)	GOFWD/C2, TANTO, L3	
	(23)	CIR 1.700 1.9500 .6250	CCLW
	(24)	1.1584 2.2619	.0000
	(25)	GOFWD/L3, PAST, L1	
	(26)	GT -.2162 -.1250	.0000
	(27)	GOTO/SP	
	(28)	GT -.5000 -.5000	.7500
	(29)	FINI	

Referring to the numbers at the left of the program:

(1) PARTNO must begin every program. Any identification can follow.

(2) The diameter of the cutter is specified. Here it is 0.25 inch.

(3) The feed rate is given as 5 inches per minute, which is contained in a postprocessor statement.

(4)-(10) Geometry statements.

(11)-(18) Motion statements.

(19) All APT programs end with FINI.

A computer printout from section II of the APT program is shown at the right, above. This program was run on a desktop personal computer. Lines (1) through (10) repeat the geometry statements from the original program. The motion statements are also repeated, and below each motion statement are shown the *X*, *Y*, and *Z* coordinates of the end points of the center-line (CL) movements for the cutter. Two lines of data follow those for the circular movements. For example, Line (18), which follows Line (17), GOFWD/C1,TANTO,L2, describes the *X* coordinate of the center of the arc, 2.9500, the *Y* coordinate of the center of the arc, 0.2500, and the radius of the arc required to be traversed by the cutter.

This radius is that of the arc shown on the part print, plus the radius of the cutter ($0.2500 + 0.1250 = 0.3750$). Line (18) also shows that the cutter is traveling in a counterclockwise (CCLW) motion. A circular motion is described in Lines (22), (23), and (24). Finally, the cutter is directed to return to the starting point, SP, and this command is noted in Line (27). The *X*, *Y*, and *Z* coordinates of SP are shown in Line (28).

APT for Turning.—In its basic form, APT is not a good program for turning. Although APT is probably the most suitable program for three-, four-, and five-axis machining, it is awkward for the simple two-axis geometry required for lathe operations. To overcome this problem, preprocessors have been developed especially for lathe part programming. The statements in the lathe program are automatically converted to basic APT statements in the computer and processed by the regular APT processor. An example of a lathe program, based on the APT processor and made available by the McDonnell Douglas Automation Co., is shown below. The numbers in parentheses are not part of the program, but are used only for reference. Fig. 10 shows the general set-up for the part, and Fig. 11 shows an enlarged view of the part profile with dimensions expressed along what would be the *X*- and *Y*-axes on the part print.

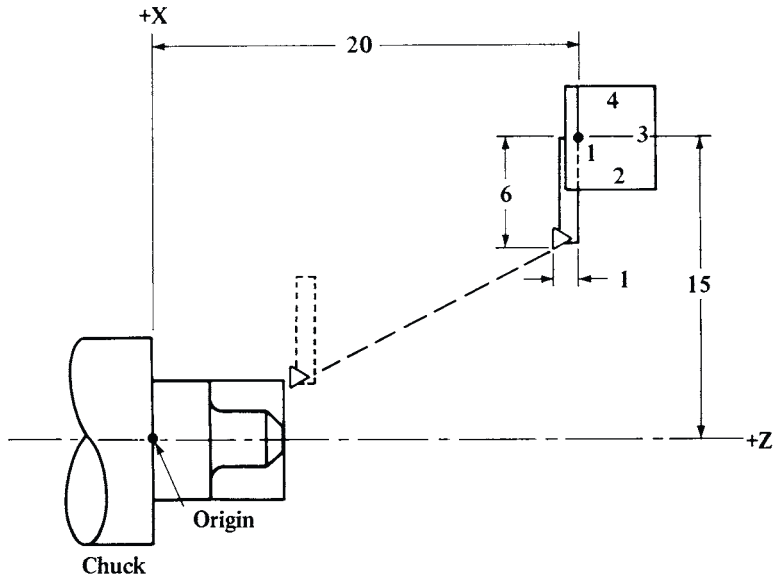


Fig. 10. Setup for APT Turning

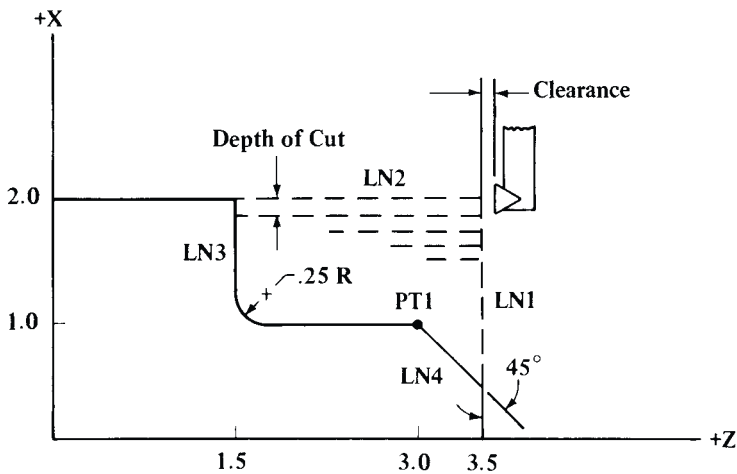


Fig. 11.

- (1) PARTNO LATHE EXAMPLE
- (2) MACHIN/MODEL LATHE
- (3) T1 = TOOL/FACE, 1, XOFF, -1, YOFF, -6, RADIUS, .031
- (4) BLANK1 = SHAPE/FACE, 3.5, TURN, 2
- (5) PART1 = SHAPE/FACE, 3.5, TAPER, 3.5, .5, ATANGL, -45, TURN, 1,\$
FILLET, .25 FACE, 1.5 TURN, 2
- (6) FROM/(20-1), (15-6)
- (7) LATHE/ROUGH, BLANK1, PART1, STEP, .1, STOCK, .05,\$
SFM, 300, IPR, .01, T1
- (8) LATHE/FINISH, PART1, SFM, 400, IPR, .005, T1
- (9) END
- (10) FINI

Line (3) describes the tool. Here, the tool is located on face 1 of the turret and its tip is -1 inch “off” (offset) in the X direction and -6 inches “off” in the Y direction, when considering X – Y rather than X – Z axes. The cutting tool tip radius is also noted in this statement. Line (4) describes the dimensions of the rough material, or blank. Lines parallel to the X -axis are noted as FACE lines, and lines parallel to the Z -axis are noted as TURN lines. The FACE line (LN1) is located 3.5 inches along the Z -axis and parallel to the X -axis. The TURN line (LN2) is located 2 inches above the Z -axis and parallel to it. Note that in Figs. 10 and 11, the X -axis is shown in a vertical position and the Z -axis in a horizontal position. Line (5) describes the shape of the finished part. The term FILLET is used in this statement to describe a circle that is tangent to the line described by TURN, 1 and the line that is described by FACE, 1.5. The \$ sign means that the statement is continued on the next line. These geometry elements must be contiguous and must be described in sequence. Line (6) specifies the position of the tool tip at the start of the operation, relative to the point of origin. Line (7) describes the roughing operation and notes that the material to be roughed out lies between BLANK1 and PART1; that the STEP, or depth of roughing cuts, is to be 0.1 inch; that 0.05 inch is to be left for the finish cut; that the speed is to be 300 sfm and the feed rate is to be 0.01 ipr; and that the tool to be used is identified by the symbol T1. Line (8) describes the finish cut, which is to be along the contour described by PART1.

CAD/CAM

CAD/CAM.—CAD in engineering means computer-aided design using a computer graphics system to develop mechanical, electrical/electronic, and architectural designs. A second D (CADD) is sometimes added (computer-aided drafting and design) and simply indicates a mechanical drafting or drawing program. CAD technology is the foundation for a wide variety of engineering, design, drafting, analysis, and manufacturing activities. Often a set of drawings initially developed in the design phase of a project is also used for analyzing and optimizing the design, creating mechanical drawings of parts and assemblies and for generating NC/CNC part programs that control machining operations. Formerly, after a component had been designed with CAD, the design was passed to a part programmer who developed a program for machining the components, either manually or directly on the computer (graphic) screen, but the process often required redefining and reentering part geometry. This procedure is often regarded as the CAM part of CAD/CAM, although CAM (for computer-aided manufacturing) has a much broader meaning and involves the computer in many other manufacturing activities such as factory simulation and planning analyses. Improvements in the speed and capability of computers, operating systems, and programs (including, but not limited to CAD) have simplified the process of integrating the manufacturing process and passing drawings (revised, modified, and translated, as necessary) through the design, analysis, simulation, and manufacturing stages.

A CAD drawing is a graphic representation of part geometry data stored in a drawing database file. The drawing database generally contains the complete list of entity (line, arc, etc.) and coordinate information required to build the CAD drawing, and additional information that may be required to define solid surfaces and other model characteristics. The format of data in a drawing file depends on the CAD program used to create the file. Generally, drawings are not directly interchangeable between drawing programs, however, drawings created in one system can usually be translated into an intermediate format or file type, such as DXF, that allows some of the drawing information to be exchanged between different programs. Translation frequently results in some loss of detail or loss of other drawing information because the various drawing programs do not all have the same features. The section Drawing Exchange Standards covers some of the available methods of transferring drawing data between different CAD programs.

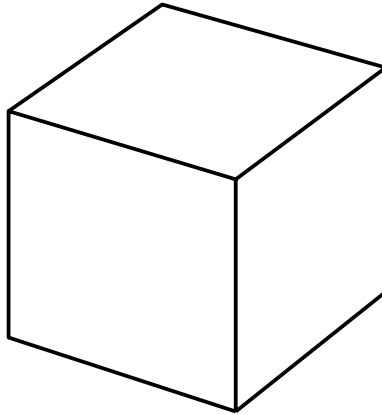


Fig. 1. Simple Wireframe Cube with Hidden Lines Automatically Removed

The simplest CAD drawings are two-dimensional and conform to normal engineering drafting practice showing orthographic (front, top, and side views, for example), exploded, isometric, or other views of a component. Depending on the complexity of the part and machining requirements, two-dimensional drawings are often sufficient for use in developing NC/CNC part programs. If a part can be programmed within a two-dimensional CAD framework, a significant cost saving may be realized because 3-D drawings require considerably more time, drawing skill, and experience to produce than 2-D drawings.

Wireframes are the simplest two- and three-dimensional forms of drawing images and are created by defining all edges of a part and, where required, lines defining surfaces. Wireframe drawing elements consist primarily of lines and arcs that can be used in practically any combination. A wireframe drawing of a cube, as in Fig. 1, consists of 12 lines of equal length (some are hidden and thus not shown), each perpendicular to the others. Information about the interior of the cube and the character of the surfaces is not included in the drawing. With such a system, if a 1-inch cube is drawn and a 0.5-inch cylinder is required to intersect the cube's surface at the center of one of its faces, the intersection points cannot be determined because nothing is known about the area between the edges. A wireframe model of this type is ambiguous if the edges overlap or do not meet where they should. Hidden-line removal can be used to indicate the relative elevations of the drawing elements, but normally a drawing cannot be edited when hidden lines have been removed. Hidden lines can be shown dashed or can be omitted from the view.

Two-dimensional drawing elements, such as lines, arcs, and circles, are constructed by directly or indirectly specifying point coordinates, usually x and y , that identify the location, size, and orientation of the entities. Three-dimensional drawings are also made up of a collection of lines, arcs, circles, and other drawing elements and are stored in a similar manner. A third point coordinate, z , indicates the elevation of a point in 3-D drawings. On the drawing screen, working in the x - y plane, the elevation is commonly thought of as the distance of a point or object into the screen (away from the observer) or out of the viewing screen (toward the observer). Coordinate axes are oriented according to the right-hand rule: If the fingers of the right hand point in the direction from the positive x -axis to the positive y -axis, the thumb of the right hand points in the direction of the positive z -axis.

Assigning a thickness (or extruding) to objects drawn in two dimensions quickly gives some 3-D characteristics to an object and can be used to create simple prismatic 3-D shapes, such as cubes and cylinders. Usually, the greatest difficulty in creating 3-D drawings is in picking and visualizing the three-dimensional points in a two-dimensional workspace (the computer display screen). To assist in the selection of 3-D points, many CAD programs use a split or windowed screen drawing area that can simultaneously show different views of a drawing. Changes made in the current or active window are reflected in each of the other windows. A typical window setup might show three orthogonal (mutually

perpendicular) views of the drawing and a perspective or 3-D view. Usually, the views shown can be changed as required to suit the needs of the operator.

If carefully constructed, wireframe images may contain enough information to completely define the external geometry of simple plane figures. Wireframe images are especially useful for visualization of 3-D objects and are effectively used during the design process to check fits, clearances, and dimensional accuracy. Parts designed to be used together can be checked for accuracy of fit by bringing them together in a drawing, superimposing the images, and graphically measuring clearances. If the parts have been designed or drawn incorrectly, the errors will frequently be obvious and appropriate corrections can be made.

A more complicated level of 3-D drawing involves solids, with sections of the part being depicted on the screen as solid geometrical structures called primitives, such as cylinders, spheres, and cubes. Primitives can be assembled on a drawing to show more complex parts. Three distinct forms of image may be generated by 3-D systems, although not all systems make use of all three.

Surface Images: A surface image defines not only the edges of the part, but also the “skin” of each face or surface. For the example mentioned previously, the intersection for the 0.5-inch cylinder would be calculated and drawn in position. Surface models are necessary for designing free-form objects such as automotive body panels and plastics injection moldings used in consumer goods. For a surface model, the computer must be provided with much more information about the part in addition to the x , y , z coordinates defining each point, as in a wireframe. This information may include tangent vectors, surface normals, and weighting that determines how much influence one point has on another, twists, and other mathematical data that define abstract curves, for instance. Fig. 2 shows a typical 3-D surface patch.

Shaded images may be constructed using simulated light sources, reflections, colors, and textures to make renderings more lifelike. Surface images are sometimes ambiguous, with surfaces that overlap or miss each other entirely. Information about the interior of the part, such as the center of gravity or the volume, also may not be available, depending on the CAD package.

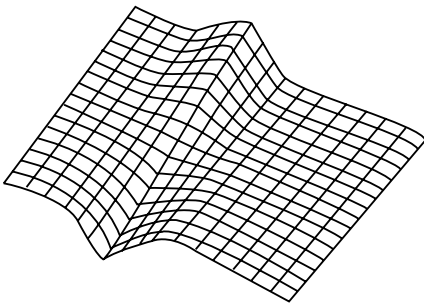


Fig. 2. A 3-D Surface Patch

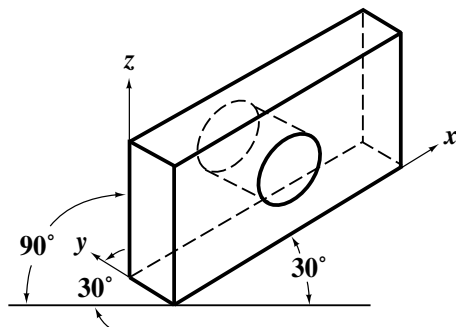


Fig. 3. Isometric Drawing Showing Orientation of Principle Drawing Axes

Solid Images: A solid image is the ultimate electronic representation of a part, containing all the necessary information about edges, surfaces, and the interior. Most solid-imaging programs can calculate volume, center of mass, centroid, and moment of inertia. Several methods are available for building a solid model. One method is to perform Boolean operations on simple shapes such as cylinders, cones, cubes, and blocks. Boolean operations are used to union (join), difference (subtract one from another), and intersect (find the common volume between two objects). Thus, making a hole in a part requires subtracting a cylinder from a rectangular block. This type of program is called constructive solid geometry (CSG).

The boundary representation type of imaging program uses profiles of 2-D shapes that it extrudes, rotates, and otherwise translates in 3-D space to create the required solid. Sometimes combinations of the above two programs are used to attain a blend of flexibility, accuracy, and performance. For more precision, greatly increased time is needed for calculations, so compromises sometimes are needed to maintain reasonable productivity. Solid images may be sliced or sectioned on the screen to provide a view of the interior. This type of image is also useful for checking fit and assembly of one part with another.

Solid images provide complete, unambiguous representation of a part, but the programs require large amounts of computer memory. Each time a Boolean operation is performed, the list of calculations that must be done to define the model becomes longer, so that computation time increases.

Drawing Projections.—Several different techniques are used to display objects on paper or a computer screen to give an accurate three-dimensional appearance. Several of these methods are commonly used in CAD drawings.

Isometric drawings, as in Fig. 3, can be used to good effect for visualizing a part because they give the impression of a 3-D view and are often much faster to create. Isometric drawings are created in 2-D space, with the x - and y -axes being inclined at 30 degrees to the horizontal, as shown in Fig. 3, and the z -axis as vertical. Holes and cylinders in isometric drawings become elliptical. Because of the orientation of the x -, y -, and z -axes, the true length of lines may not be accurately represented in isometric drawings and dimensions should not be taken directly from a print. Some CAD programs have a special set of pre-defined drawing axes to facilitate creating isometric drawings.

In *parallel projections*, lines that are parallel in an object, assembly, or part being portrayed remain parallel in the drawing. Parallel projections show 3-D objects in a dimensionally correct manner, so that relative and scaled dimensions may be taken directly from a drawing. However, drawings may not appear as realistic as isometric or perspective drawings.

A characteristic of *perspective drawings* is that parallel lines converge (see Fig. 4) so that objects that are farther away from the observer appear smaller. Perspective drawing techniques are used in some three-dimensional drawings to convey the true look of an object, or group of objects. Because objects in perspective drawings are not drawn to scale, dimensional information cannot be extracted from the drawings of a part. Some 3-D drawing packages have a true perspective drawing capability, and others use a simulation technique to portray a 3-D perspective.

An *axonometric projection* is a 3-D perpendicular projection of an object onto a surface, such that the object is tilted relative to its normal orientation. An axonometric projection of a cube, as in Fig. 1, shows three faces of the cube. CAD systems are adept at using this type of view, making it easy to see an object from any angle.

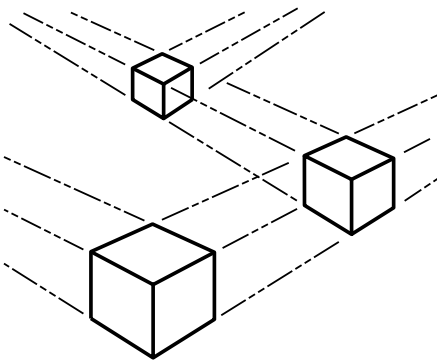


Fig. 4. Perspective Drawing of Three Equal-Size Cubes and Construction Lines

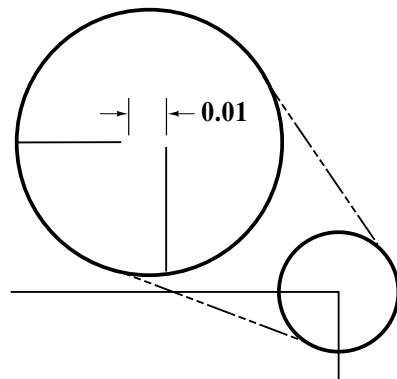


Fig. 5. A Common Positioning Error

Drawing Tips and Traps.—Images sometimes appear correct on the screen but contain errors that show up when the drawing is printed or used to produce NC/CNC part programs. In Fig. 5, the two lines within the smaller circle appear to intersect at a corner, but when the view of the intersection is magnified, as in the larger circle, it is clear that the lines actually do not touch. Although an error of this type may not be easily visible, other parts placed in the drawing relative to this part will be out of position.

A common problem that shows up in plotting, but is difficult to detect on the screen, comes from placing lines in the same spot. When two or more lines occupy exactly the same location on the screen, there is usually no noticeable effect on the display. However, when the drawing is plotted, each line is plotted separately, causing the single line visible to become thicker and darker. Likewise, if a line that appears continuous on the screen is actually made up of several segments, plotting the line will frequently result in a broken, marred, or blotted appearance to the line because the individual segments are plotted separately, and at different times. To avoid these problems and to get cleaner looking plots, replace segmented lines with single lines and avoid constructions that place one line directly on top of another.

Exact decimal values should be used when entering point coordinates from the keyboard, if possible; fractional sizes should be entered as fractions, not truncated decimals. For example, $\frac{5}{16}$ should be entered as 0.3125 or $\frac{5}{16}$, not 0.313. Accumulated rounding errors and surprises later on when parts do not fit are thus reduced. Drawing dimensions, on the other hand, should not have more significant digits or be more precise than necessary. Unnecessary precision in dimensioning leads to increased difficulty in the production stage because the part has to be made according to the accuracy indicated on the drawing.

Snap and *object snap* commands make selecting lines, arcs, circles, or other drawing entities faster, easier, and more accurate when picking and placing objects on the screen. Snap permits only points that are even multiples of the snap increment to be selected by the pointer. A $\frac{1}{8}$ -inch snap setting, for example, will allow points to be picked at exactly $\frac{1}{8}$ -inch intervals. Set the *snap increment* to the smallest distance increment (1 in., $\frac{1}{4}$ in., 1 ft., etc.) being used in the area of the drawing under construction and reset the snap increment frequently, if necessary. The snap feature can be turned off during a command to override the setting or to select points at a smaller interval than the snap increment allows. Some systems permit setting a different snap value for each coordinate axis.

The *object snap* selection mode is designed to select points on a drawing entity according to predefined characteristics of the entity. For example, if end-point snap is in effect, picking a point anywhere along a line will select the end point of the line nearest the point picked. Object snap modes include point, intersection, midpoint, center and quadrants of circles, tangency point (allows picking a point on an arc or circle that creates a tangent to a line), and perpendicular point (picks a point that makes a perpendicular from the base point to the object selected). When two or more object snap modes are used together, the nearest point that meets the selection criteria will be chosen. Using object snap will greatly reduce the frequency of the type of problem shown in Fig. 5.

Copy: Once drawn, avoid redrawing the same object. It is almost always faster to copy and modify a drawing than to draw it again. The basic copy commands are: copy, array, offset, and mirror. Use these, along with move and rotate and the basic editing commands, to modify existing objects. Copy and move should be the most frequently used commands. If possible, create just one instance of a drawing object and then copy and move it to create others.

To create multiple copies of an object, use the *copy, multiple* feature to copy selected objects as many times as required simply by indicating the destination points. The *array* command makes multiple copies of an object according to a regular pattern. The rectangular array produces rows and columns, and the polar array puts the objects into a circular pattern, such as in a bolt circle. *Offset* copies an entity and places the new entity a specified

distance from the original and is particularly effective at placing parallel lines and curves, and for creating concentric copies of closed shapes. *Mirror* creates a mirror image copy of an object, and is useful for making right- and left-hand variations of an object as well as for copying objects from one side of an assembly to the other. In some CAD programs, a system variable controls whether text is mirrored along with other objects.

Many manufacturers distribute drawings of their product lines in libraries of CAD drawings, usually as DXF files, that can be incorporated into existing drawings. The suitability of such drawings depends on the CAD program and drawing format being used, the skill of the technician who created the drawings, and the accuracy of the drawings. A typical example, Fig. 6, shows a magnetically coupled actuator drawing distributed by Tol-O-Matic, Inc. Libraries of frequently used drawing symbols and blocks are also available from commercial sources.

Create Blocks of Frequently Used Objects: Once created, complete drawings or parts of drawings can be saved and later recalled, as needed, into another drawing. Such objects can be scaled, copied, stretched, mirrored, rotated, or otherwise modified without changing the original. When shapes are initially drawn in unit size (i.e., fitting within a 1×1 square) and saved, they can be inserted into any drawing and scaled very easily. One or more individual drawing elements can be saved as a group element, or *block*, that can be manipulated in a drawing as a single element. Block properties vary, depending on the drawing program, but are among the most powerful features of CAD. Typically, blocks are uniquely named and, as with simple objects, may be saved in a file on the disk. Blocks are ideal for creating libraries of frequently used drawing symbols. Blocks can be copied, moved, scaled very easily, rotated, arrayed, and inserted as many times as is required in a drawing and manipulated as one object. When scaled, each object within the block is also scaled to the same degree.

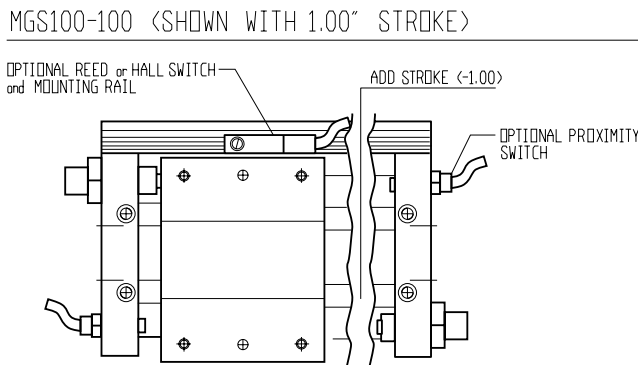


Fig. 6. Manufacturer's Drawing of a Magnetically Coupled Actuator (Courtesy of Tol-O-Matic, Inc.)

When a family of parts is to be drawn, create and block a single drawing of the part that fits within a unit cube of convenient size, such as $1 \times 1 \times 1$. When the block is inserted in a drawing, it is scaled appropriately in the x -, y -, and z -directions. For example, $\frac{3}{8}$ -inch bolts can be drawn 1 inch long in the x -direction and $\frac{3}{8}$ -inch in diameter in the y - z plane. If a 5-inch bolt is needed, insert the "bolt" block with a scale of 5 in the x -direction and a scale of 1 in the y - and z -directions.

Once blocked, the individual components of a block (lines, arcs, circles, surfaces, and text, for example) cannot be individually changed or edited. To edit a block, a copy (instance) of the block must be *exploded* (unblocked) to divide it into its original components. Once exploded, all the individual elements of the block (except other blocks) can be edited. When the required changes have been made, the block must be redefined (redeclared as a block by giving it a name and identifying its components). If the block is redefined using the same name, any previous references to the block in the drawing will be

updated to match the redefined block. For example, an assembly drawing is needed that shows a mechanical frame with 24 similar control panels attached to it. Once one of the panels is drawn and defined as a block (using the name *PANEL*, for instance), the block can be inserted (or copied) into the drawing 24 times. Later, if changes need to be made to the panel design, one instance of the block *PANEL* can be exploded, modified, and redefined with the name *PANEL*. When *PANEL* is redefined, every other copy of the *PANEL* block in the drawing is also redefined, so every copy of *PANEL* in the drawing is updated. On the other hand, if the block was redefined with a different name, say, *PANEL1*, existing copies of *PANEL* remain unchanged. When redefining a block that already exists in the drawing, be sure to use the same insertion point that was used for the original definition of the block; otherwise, the positions of existing blocks with the same name will be changed.

Use of Text Attributes to Request Drawing Information Automatically: Text attributes are a useful method for attaching textual information to a particular part or feature of a drawing. An attribute is basically a text variable that has a name and can be assigned a value. Attributes are created by defining attribute characteristics such as a name, location in the drawing, text size and style, and default value. The attribute value is assigned when the attribute is inserted into a drawing as part of a block.

Fig. 7 shows two views of a title block for size A to C drawing sheets. The upper figure includes the title block dimensions (included only for reference) and the names and locations of the attributes (COMPANY, TITLE1, TITLE2, etc.). When a block containing text attributes is inserted in a drawing, the operator is asked to enter the value of each attribute. To create this title block, first draw the frame of the title block and define the attributes (name, location and default value for: company name and address, drawing titles [2 lines], drawing size, drawing number, revision number, scale, and sheet number). Finally, create and name a block containing the title frame and all the attribute definitions (do not include the dimensions).

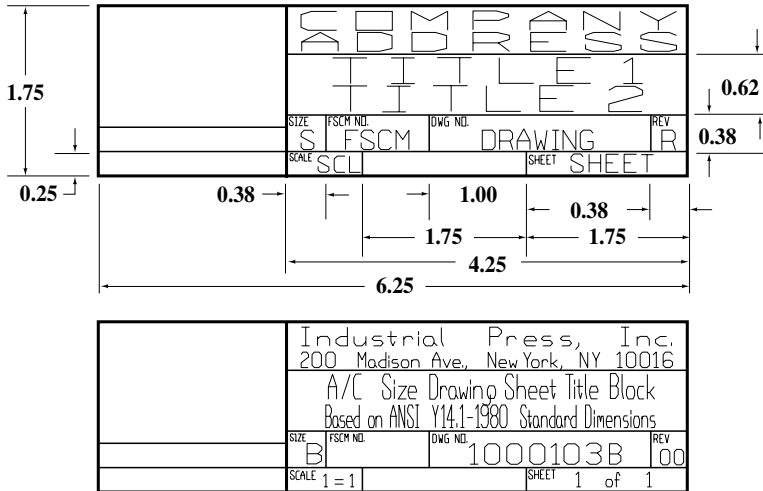


Fig. 7. Title Block for A to C Size Drawing Sheets Showing the Placement of Text Attributes. The Lower Figure Shows the Completed Block

When the block is inserted into a drawing, the operator is asked to enter the attribute values (such as company name, drawing title, etc.), which are placed into the title block at the predetermined location. The lower part of Fig. 7 shows a completed title block as it might appear inserted in a drawing. A complete drawing sheet could include several additional blocks, such as a sheet frame, a revision block, a parts list block, and any other supplementary blocks needed. Some of these blocks, such as the sheet frame, title, and parts list blocks, might be combined into a single block that could be inserted into a drawing at one time.

Define a Default Drawing Configuration: Drawing features that are commonly used in a particular type of drawing can be set up in a template file so that frequently used settings, such as text and dimension styles, text size, drawing limits, initial view, and other default settings, are automatically set up when a new drawing is started. Different configurations can be defined for each frequently used drawing type, such as assembly, parts, or printed circuit drawings. When creating a new drawing, use one of the template files as a pattern or open a template file and use it to create the new drawing, saving it with a new name.

Scaling Drawings: Normally, for fast and accurate drawing, it is easiest to draw most objects full scale, or with a 1:1 scale. This procedure greatly simplifies creation of the initial drawing, and ensures accuracy, because scale factors do not need to be calculated. If it becomes necessary to fit a large drawing onto a small drawing sheet (for example, to fit a 15 × 30 inch assembly onto a 11 × 17 inch, B-sized, drawing sheet), the drawing sheet can be scaled larger to fit the assembly size. Likewise, large drawing sheets can be scaled down to fit small drawings. The technique takes some practice, but it permits the drawing assembly to be treated full scale. If editing is required at a later date (to move something or add a hole in a particular location, for example), changes can be made without rescaling and dimensions can be taken directly from the unscaled drawing on the computer.

Scaling Text on Drawing Sheets: It is usually desirable that text, dimensions, and a few other features on drawings stay a consistent size on each sheet, even when the drawing size is very different. The following procedure ensures that text and dimensions (other features as well, if desired) will be the same size, from drawing to drawing without resorting to scaling the drawing to fit onto the drawing sheet.

Create a drawing sheet having the exact dimensions of the actual sheet to be output (A, B, C, D, or E size, for example). Use text attributes, such as the title block illustrated in Fig. 7, to include any text that needs to be entered each time the drawing sheet is used. Create a block of the drawing sheet, including the text attributes, and save the block to disk. Repeat for each size drawing sheet required.

Establish the nominal text and dimension size requirements for the drawing sheet when it is plotted full size (1:1 scale). This is the size text that will appear on a completed drawing. Use Table 1 as a guide to recommended text sizes of various drawing features.

Table 1. Standard Sizes of Mechanical Drawing Lettering ANSI Y14.2M-1992

Use For	Inch		Metric	
	Min. Letter Heights, (in)	Drawing Size	Min. Letter Heights, (mm)	Drawing Size
Drawing title, drawing size, CAGE Code, drawing number, and revision letter ^a	0.24	D, E, F, H, J, K	6	A0, A1
	0.12	A, B, C, G	3	A2, A3, A4
Section and view letters	0.24	All	6	All
Zone letters and numerals in borders	0.24	All	6	All
Drawing block headings	0.10	All	2.5	All
All other characters	0.12	All	3	All

^aWhen used within the title block.

Test the sheet by setting the text size and dimension scale variables to their nominal values (established above) and place some text and dimensions onto the drawing sheet. Plot a copy of the drawing sheet and check that text and dimensions are the expected size.

To use the drawing sheet, open a drawing to be placed on the sheet and insert the sheet block into the drawing. Scale and move the sheet block to locate the sheet relative to the drawing contents. When scaling the sheet, try to use whole-number scale factors (3:1, 4:1, etc.), if possible; this will make setting text size and dimension scale easier later on. Set the text-size variable equal to the nominal text size multiplied by the drawing sheet insertion scale (for example, for 0.24 text height on a drawing sheet scaled 3:1, the text-size variable will be set to $3 \times 0.24 = 0.72$). Likewise, set the dimension-scale variable equal to the nominal dimension size multiplied by the drawing sheet insertion scale.

Once the text size and dimensions scale variables have been set, enter all the text and dimensions into the drawing. If text of another size is needed, multiply the *new* nominal text size by the sheet scale to get the actual size of the text to use in the drawing.

Use Appropriate Detail: Excessive detail may reduce the effectiveness of the drawing, increase the drawing time on individual commands and the overall time spent on a drawing, and reduce performance and speed of the CAD program. Whenever possible, symbolic drawing elements should be used to represent more complicated parts of a drawing unless the appearance of that particular component is essential to the drawing.

Drawing everything to scale often serves no purpose but to complicate a drawing and increase drawing time. The importance of detail depends on the purpose of a drawing, but detail in one drawing is unnecessary in another. For example, the slot size of a screw head (length and width) varies with almost every size of screw. If the purpose of a drawing is to show the type and location of the hardware, a symbolic representation of a screw is usually all that is required. The same is generally true of other screw heads, bolt threads, bolt head diameters and width across the flats, wire diameters, and many other hardware features.

Drawing Exchange Standards.—The ability to transfer working data between different CAD, CAD/CAM, design analysis, and NC/CNC programs is one of the most important requirements of engineering drawing programs. Once an engineer, designer, draftsman, or machinist enters relevant product data into his or her machine (computer or machine tool), the information defining the characteristics of the product should be available to the others involved in the project without recreating or reentering it. In view of manufacturing goals of reducing lead time and increasing productivity, concurrent engineering, and improved product performance, interchangeable data are a critical component in a CAD/CAM program. Depending on the requirements of a project, it may be entirely possible to transfer most if not all of the necessary product drawings from one drawing system to another.

IGES stands for Initial Graphics Exchange Specification and is a means of exchanging or converting drawings and CAD files for use in a different computer graphics system. The concept is shown diagrammatically in Fig. 8. Normally, a drawing prepared on the computer graphics system supplied by company A would have to be redrawn before it would operate on the computer graphics system supplied by company B. However, with IGES, the drawing can be passed through a software package called a preprocessor that converts it into a standardized IGES format that can be stored on a magnetic disk. A postprocessor at company B is then used to convert the standard IGES format to that required for their graphics system. Both firms would be responsible for purchasing or developing their own preprocessors and postprocessors, to suit their own machines and control systems. Almost all the major graphics systems manufacturing companies today either have or are developing IGES preprocessor and postprocessor programs to convert software from one system to another.

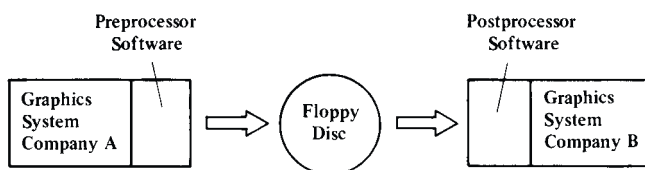


Fig. 8.

DXF stands for Drawing Exchange Format and is a pseudo-standard file format used for exchanging drawings and associated information between different CAD and design analysis programs. Nearly all two- and three-dimensional CAD programs support some sort of drawing exchange through the use of DXF files, and most can read and export DXF files. There are, however, differences in the drawing features supported and the manner in which the DXF files are handled by each program. For example, if a 3-D drawing is exported in the DXF format and imported into a 2-D CAD program, some loss of information results

because all the 3-D features are not supported by the 2-D program, so that most attempts to make a transfer between such programs fail completely. Most common drawing entities (lines, arcs, etc.) will transfer successfully, although other problems may occur. For example, drawing entities that are treated as a single object in an original drawing (such as blocks, hatch patterns, and symbols) may be divided into hundreds of individual components when converted into a DXF file. Consequently, such a drawing may become much more difficult to edit after it is transferred to another drawing program.

ASCII stands for American Standard Code for Information Interchange. ASCII is a code system that describes the manner in which character-based information is stored in a computer system. Files stored in the ASCII format can be transferred easily between computers, even those using different operating systems. Although ASCII is not a drawing file format, many CAD drawing formats (DXF and IGES, for example) are ASCII files. In these files, the drawing information is stored according to a specific format using ASCII characters. ASCII files are often referred to as pure text files because they can be read and edited by simple text editors.

HPGL, for Hewlett-Packard Graphics Language, is a format that was first developed for sending vector- (line-) based drawing information to pen plotters. The format is commonly used for sending drawing files to printers and plotters for printing. Because HPGL is a character-based format (ASCII), it can be transferred between computers easily. Normally, devices that recognize the HPGL format can print the files without using the program on which the file (a drawing, for example) was created.

STL is a CAD drawing format that is primarily used to send CAD drawings to *rapid automated prototyping* machines. STL is a mnemonic abbreviation for stereo-lithography, the technique that is used to create three-dimensional solid models directly from computer-generated drawings and for which the drawing format was originally developed. Most prototyping machines use 3-D CAD drawing files in STL format to create a solid model of the part represented by a drawing.

STEP stands for Standard for Exchange of Product Model Data and is a series of existing and proposed ISO standards written to allow access to all the data that surround a product. It extends the IGES idea of providing a geometric data transfer to include all the other data that would need to be communicated about a product over its lifetime, and facilitates the use and accessibility of the product data. Although STEP is a new standard, software tools have been developed for converting data from the IGES to STEP format and from STEP to IGES.

Rapid Automated Prototyping.—Rapid automated prototyping is a method of quickly creating an accurate three-dimensional physical model directly from a computerized conception of the part. The process is accomplished without machining or the removal of any material, but rather is a method of building up the model in three-dimensional space. The process makes it possible to easily and automatically create shapes that would be difficult or impossible to produce by any other method. Currently, production methods are able to produce models with an accuracy tolerance of ± 0.005 inch. Models are typically constructed of photoreactive polymer resins, nylon, polycarbonate or other thermoplastics, and investment casting wax. The model size is limited by the capability of the modeling machines to about 1 cubic foot at the present, however, large models can be built in sections and glued or otherwise fastened together.

Much of the work and a large part of the cost associated with creating a physical model by rapid prototyping are in the initial creation of the CAD model. The model needs to be a 3-D design model, built using wireframe, surface, or solid CAD modeling techniques. Many full-featured CAD systems support translation of drawing files into the STL format, which is the preferred file format for downloading CAD models to rapid prototyping machines. CAD programs without STL file format capability can use the IGES or DXF file format. This process can be time-consuming and expensive because additional steps may have to

be taken by the service bureau to recreate features lost in converting the IGES or DXF file into STL format. If the design file has to be edited by a service bureau to recreate surfaces lost in the translation, unwanted changes to the model may occur, unnoticed. The safest route is to create a CAD model and export it directly into the STL format, leaving little chance for unexpected errors. Reverse STL generators are also available that will display a file saved in STL format or convert it into a form that can be imported into a CAD program.

DNC.—DNC stands for Direct Numerical Control and refers to a method of controlling numerical control machines from a remote location by means of a link to a computer or computer network. In its simplest form, DNC consists of one NC or CNC machine linked by its serial port to a computer. The computer may be used to develop and store CNC part programs and to transfer part programs to the machine as required. DNC links are normally two-directional, meaning that the NC/CNC can be operated from a computer terminal and the computer can be operated or ordered to supply data to the NC/CNC from the machine's control panel.

The number of machines that can be connected to a DNC network depends on the network's capability; in theory, any number of machines can be attached, and controlled. The type of network depends on the individual DNC system, but most industry standard network protocols are supported, so DNC nodes can be connected to existing networks very easily. Individual NC/CNC machines on a network can be controlled locally, from a network terminal in another building, or even from a remote location miles away through phone or leased lines.

MANUFACTURING PROCESS

Principles of Iron and Steel Manufacture

Steel is the most useful of known metals. Its major constituent is iron which is combined with carbon, and often also with various alloying elements. Metallic iron in its pure form is not available in the crust of the earth; it is found only in iron-bearing materials, designated as iron ores.

Iron Ores.—About five per cent of the earth's crust is composed of iron, which is almost always found in chemical combination with oxygen, sulphur, silicon and other chemical elements. In order to be commercially usable the iron ore must contain a sufficient proportion of iron. In the past, only iron ores with a relatively high, about 50 to 70 per cent, iron content were used, but the gradual exhaustion of known deposits of richer ores has made the use of ores with lower iron content, in the order of 20 to 40 per cent, necessary. Ores with poorer iron content must first be treated to eliminate the excess rock material, using processes known as *beneficiation*. These consist of crushing the ores, reducing them to a fine powder from which the non-iron-bearing constituents can be removed. The remaining rich iron-bearing mineral powder is then mixed with powdered coal to form pellets which can be baked (sintered) for obtaining the increased strength needed for handling.

The Making of Iron.—Blast furnaces are used for extracting the iron from the ores. These are high, cylindrical structures which are loaded with alternate layers of coke, iron and lime. The burning of the coke is supported by a continuous blast of heated air blown into the furnace in large quantities. The high heat causes the iron content of the ore to melt, while the carbon monoxide gas generated by the combustion of the coke reduces the oxides of iron. The limestone functions as a flux, converting into an easily removable slag many of those elements of the ore which would constitute undesirable impurities in the iron. The blast furnace is kept in continuous operation, new charges of coke, iron ore and flux being introduced periodically, while at intervals, the formed slag and the molten, greatly deoxidized iron are removed.

Most of the iron produced in blast furnaces is used in the molten state in steel making furnaces. In this country, only about five per cent of the output is used in solid form, known as pigs, hence the blast furnace product is called pig iron, a general designation regardless of its state.

The Making of Steel.—The pig iron produced by the blast furnace process contains a high amount of carbon, a part of which must be removed for obtaining steel with a closely controlled carbon content, usually in the order of less than one per cent. There are several methods for achieving that goal, but most of the steel produced presently originates from one of the following three general processes.

1) *The Basic Open Hearth Process:* The name originates from the general shape of the furnaces, which are installed in rows of several units, operated concurrently but with staggered charging periods, all being serviced from a common charging floor. The furnaces operate by combining two systems, the *reverberatory*, in which part of the heating effect is accomplished by radiation from the heated roof, and the *regenerative*, utilizing the hot gases from the combustion of the fuel for heating either of two brick lined chambers, which are then used alternately for preheating the cold incoming air before conducting it into the furnace.

The charge used in open hearth furnaces may consist of a) steel scrap and liquid pig iron; b) steel scrap and solid pig iron; and c) all steel scrap, depending on the availability and the relative cost of the different charge materials.

After the meltdown and the different phases of the working period, a cycle requiring usually about ten hours unless accelerated by the use of oxygen, the hot steel is tapped into ladles, the content of which is poured into ingot molds. This is called teeming.

2) *The Basic Oxygen Process*: The furnaces are tiltable converted vessels of large size holding about 300 tons of charge material which consists mainly of liquid pig iron. Often scrap is also added, the maximum proportion (about 30 per cent) of which, however, is less than that admissible for open hearth furnaces. After the charge has been loaded, a tube with a special nozzle, called a lance, is introduced, through which a jet of high purity oxygen is blown at supersonic speed onto the charge. This causes a vehement reaction of the charge, converting it within a short time (about 30 minutes) into steel of the desired carbon content. When the process is finished, the oxygen flow is shut off, the lance retracted and the converter tilted into a position where the molten metal can be poured into the ladle. Alloying elements may be added to the content of the ladle prior to emptying the metal into ingot molds in a teeming process similar to that used in the open hearth method. The basic oxygen process, a relatively recent development, is much faster than the open hearth process and is preferred when sufficient amount of liquid pig iron is available. Currently about one-half of the steel manufactured in the United States is produced by the basic oxygen process.

3) *Air Melt Electric Furnace Processes*: Two different systems are used, based on the following types of equipment:

- a) The basic electric-arc furnace, in which heat is produced through arcing action from electrodes to metal, the electrodes being lowered when the level of the metal sinks as its melting progresses. Since no oxygen is necessary to support combustion, the purity of the metal can be better controlled than in the previously discussed types of furnaces. Electric arc furnaces can accept charges consisting almost entirely of solid scrap.
- b) The induction furnace, which is essentially a transformer, is surrounded by a coil in which high frequency current is circulating, with the metal acting as the core. Induction furnaces are mostly used for remelting processes, in the refinement and alloying of steel.

Vacuum Melting and Degassing Processes.—The purpose of degassing is to remove hydrogen, oxygen and nitrogen from the steel, because the presence of these elements affects the purity, and thereby the desirable mechanical properties of the metal. These processes are based on the principle that the solubility of a gas in the liquid steel decreases with a decreasing pressure of the surrounding atmosphere. Steel refinement by these processes is rapidly growing in acceptance as a means of producing purer steels of more consistently dependable quality.

Three basic systems are generally applied, each serving primarily a specific area of use:

1) *Vacuum degassing of large sections* such as ingots and heavy forgings, can be carried out by:

- a) stream degassing, immediately preceding the pouring of the metal into the ingot mold, leading the metal through an intermediate ladle kept under vacuum;
- b) ladle degassing, in which the ladle is placed in a steel tank, which then is evacuated;
- c) vacuum lifter degassing, using a vacuum chamber suspended above a ladle and connected with it by a nozzle, utilizing atmospheric pressure to transfer the steel.

2) *Vacuum induction melting*, a process in use over 30 years, in which an ordinary induction furnace is placed inside a vacuum chamber, thereby producing the steel under close heat control and free from air contamination.

3) *Consumable electrode vacuum arc remelting*, using electrodes of predetermined composition, remelting them by electric arc in vacuum, into a water cooled copper crucible. It is a refining process for producing steel of very high purity.

Iron Ore.—Iron ore is an oxide of iron containing, ordinarily, from 35 to 65 per cent of iron, and, in addition, oxygen, phosphorus, sulphur, silica (sand) and other impurities. If the ore contains less than 40 per cent iron, it must first be concentrated, and if less than 25 per cent iron, it is not considered a commercial product, owing to the excessive cost of smelting. At the present time, the ores mined in this country average slightly over 50 per cent iron, although the "Lake" ores sometimes contain over 60 per cent.

Pig Iron.—When iron ore is charged in a blast furnace, mixed with limestone as a flux, and melted down with either charcoal, coke or anthracite coal as fuel, the resulting metal is what is commercially known as pig iron. It contains about 93 per cent of pure iron, from 3 to 5 per cent of carbon, and some silicon, phosphorus, sulphur, etc. Pig iron is used in foundries for the manufacture of iron castings by simply re-melting it in a cupola and without materially changing its chemical composition.

Pig iron is classified: 1) according to the method of manufacture; 2) its intended use; and 3) its composition.

The methods of manufacture produce: 1) coke pig iron, which is smelted with coke and always with a hot blast; 2) charcoal pig, which is smelted with charcoal and either a hot or cold blast; and 3) anthracite pig, smelted with anthracite coal mixed with coke, using a hot blast.

Classifications according to intended use are: 1) Bessemer pig, used for the Bessemer and acid open-hearth processes of making steel; 2) basic pig, used for the basic process; 3) malleable pig, used for malleable cast-iron castings; 4) foundry pig, used for foundry work; and 5) forge pig, an inferior grade used for puddling and some classes of foundry work.

The grading according to composition was formerly done by breaking the pig and examining the fracture; the modern method is by chemical analysis. In this country pig iron is usually sold in tons of 2240 pounds.

Classes of Steel.—The word steel is applied to many mixtures which differ greatly from each other in their chemical as well as physical qualities. The ingredient that exerts the most influence on steel is carbon. High-grade razor steel contains about 1.25 per cent of carbon, spring steel 1 per cent, steel rails from 0.50 to 0.75 per cent, and soft steel boiler plate may have as little as 0.062 per cent of carbon. Steel which is very low in carbon can easily be welded, but it cannot be hardened; when the carbon is above 0.33 per cent, welding is more difficult and can be done only by the use of borax or some other flux, or by the electric or thermit processes. Steel with carbon above 0.75 per cent can readily be hardened. In tool steel, other ingredients than carbon are sometimes used to influence its hardness, such as nickel, manganese, chromium, tungsten, etc., the last named playing an important part in so-called “high-speed steels,” that is, tool steels that will cut metal at a high speed without losing their temper or hardness. Pig iron and cast iron contain about 4 per cent of carbon, and wrought iron only a trace of it, while steel is between these two extremes; hence, in the manufacture of steel it is important to get the right proportion of carbon. One method is to burn the carbon out of pig iron, as in the Bessemer and open-hearth processes, and the other method is to add carbon to wrought iron, as in the crucible process.

Puddling Process.—In the manufacture of wrought iron, pig iron is melted in a puddling furnace where most of the silicon, carbon, phosphorus, and other impurities are separated from the iron, forming the puddle cinder. Pig iron melts at about 2100 degrees F., steel at about 2500 degrees, and wrought iron at about 2800 degrees. The temperature in the puddling furnace is high enough to melt pig iron, but not high enough to keep wrought iron in a liquid state; therefore, as soon as the small particles of iron become purified, they partly congeal (“come to nature”) forming a spongy mass in which small globules of iron are in a semi-plastic state. This mass is divided by the puddler into “puddle balls” or lumps of about 200 pounds each. These lumps are formed into elongated blooms in a rotary squeezer and, while still hot, are rolled out into “muck bars.” These bars are cut into pieces of from 2 to 4 feet long and are stacked up in piles varying in weight from 100 to 2000 pounds. These piles are heated in a re-heating furnace, and when white hot, are taken to the rolls to be rolled out and welded together into iron bars, sheets, plates, or structural shapes. This material, after re-rolling, is known as refined iron, and if subjected to a second piling, heating and re-rolling, is called double-refined iron. Instead of starting the process with pig

iron, as described, scrap iron can also be employed. "Common iron" is wrought iron made from coke pig, whereas finer grades or "charcoal iron" are made from charcoal pig.

Bessemer Process.—In the Bessemer process of making steel, the molten pig iron is put into a large pear-shaped vessel, called the "converter," and the impurities are oxidized and removed by blowing air up through the molten mass. The molten iron (from 10 to 15 tons at a time) is poured into the converter while the latter is in a horizontal position; then the compressed air is turned into the blast box at the furnaces. Electric furnaces permit of very close control of the composition of steel, and alloy additions may be made in the furnace itself rather than in the ladle. It is practicable to use relatively cheap raw materials in the electric furnace. This furnace may be employed for recovering alloy scrap.

Malleable-iron Castings.—Malleable iron is produced by the annealing or graphitization of "white iron" castings. Malleable castings are used for many industrial applications where strength, ductility, machinability, and resistance to shock are important factors. In manufacturing these castings, the usual procedure is to produce first a hard brittle white iron from a charge of pig iron and scrap. These hard white-iron castings are then placed in annealing pots and the graphitization (malleablizing) of the castings is accomplished by means of a suitable heat treatment. During this annealing period the temperature is slowly increased to 1550 or 1600 degrees F., and this temperature is maintained from 48 to 60 hours, after which it is slowly reduced. This malleablizing process is applicable to sections at least 4 inches thick, graphitization occurring throughout the entire section.

Physical Properties of Malleable Iron.—The average values of the tensile strength, yield point, and elongation of malleable iron, based upon approximately twenty thousand tests made by seventeen investigators, are as follows: Tensile strength (pounds per square inch) 54,000; yield point, 36,000; elongation in 2 inches, 18 per cent. The average ultimate shearing strength is about 48,000; the modulus of elasticity in tension, 25,000,000; and, in shear, 12,500,000 pounds per square inch. The average chemical composition is as follows: Carbon, 1.00 to 2.00; silicon, 0.60 to 1.10; manganese, under 0.30; phosphorus, under 0.20; sulphur, 0.06 to 0.15 per cent.

Steel Castings.—Steel castings are especially adapted for machine parts that must withstand shocks or heavy loads. They are stronger than either wrought iron, cast iron, or malleable iron and are very tough. The steel used for making steel castings may be produced either by the Bessemer, open-hearth, electric, or crucible processes. The raw materials used are steel scrap, pig iron, and iron ore, the materials and their proportions varying according to the process and the type of furnace used. Steel for comparatively small castings may be made by the Bessemer or crucible furnaces, whereas for large castings, the open-hearth furnace is preferable. The electric furnace is now used considerably, some of the larger sizes being employed in conjunction with open-hearth furnaces and Bessemer converters which partially refine the charge. Steel castings are used for such parts as cylinder covers, cross-heads, cross-head guides, bearing caps, bedplates, stern-posts for ships, rudder frames, gun mounts, locomotive side frames, etc. They are of special importance in ship construction and for various classes of railway equipment.

There are two very general classes of steel castings — namely, the carbon steel and the alloy steel. The carbon steel castings may have a carbon content ranging from 0.05 to 1.70; manganese, from 0.50 to 1.00; silicon, from 0.20 to 0.75; phosphorus, 0.05 maximum; and sulphur, 0.06 maximum. Low-carbon steels (containing less than 0.20 per cent carbon) may have a tensile strength ranging from 40,000 to 70,000 pounds per square inch. High-carbon steels containing more than 0.40 per cent carbon may have a tensile strength ranging from 70,000 to 120,000 pounds per square inch. The medium-carbon cast steels with a carbon content varying from 0.20 to 0.40 may have a tensile strength varying from 60,000 to 80,000 pounds per square inch. Alloy cast steels contain special elements, such as chromium, nickel, molybdenum, tungsten, etc. These various alloys, in conjunction with suit-

able heat-treatments, make it possible to secure steel castings having a wide range of physical properties.

Manganese Steel Castings.—The metal for manganese steel castings is refined in a Bessemer converter from which it is poured into a ladle in which the proper quantity of ferromanganese has been previously placed. Manganese steel castings are generally allowed to cool in the mold, and are then annealed for from 3 to 26 hours at temperatures ranging from 1800 to 2000 degrees F. Unannealed manganese steel castings are exceptionally brittle and almost glass hard. After the heat-treatment, they are tough and ductile with a tensile strength of about 90,000 pounds and an elastic limit of about 60,000 pounds per square inch.

Semi-steel Castings.—What is commonly known as “semi-steel” and less frequently as “toughened cast iron” is produced by adding soft steel or wrought-iron scrap to the charge in a cupola. The semi-steel castings obtained from this mixture are cast in the same manner as ordinary castings. The mixture or charge for making semi-steel castings usually contains about 20 per cent of steel scrap, although any amount up to about 70 per cent may be used. Semi-steel castings have less total carbon than ordinary cast iron, there seldom being more than 3 per cent. The fine grain of semi-steel is due to the low percentage and fineness of the graphitic carbon. Semi-steel is commonly used for large gears, for the tables, saddles, slides, etc., of machine tools, and for parts requiring a good appearance.

The Temper of Steel.—The term “temper” or “carbon-temper” is used by steel makers to designate the proportion of carbon in the steel. The temper marks or numbers are arbitrarily selected; their relation to the percentage of carbon varying with different makers. The following list of tempers and the purpose for which the various steels are adapted is given by Joseph T. Ryerson & Son:

Temper Number	Per Cent Carbon	Tools for which Steel is Adapted
7	0.65 to 0.75	{ Blacksmiths' hammers, table knives, dies for drop hammers, large hot forgings, flatters, fullers, track chisels and tools.
8	0.75 to 0.85	{ Large shear knives, punches, chisels, hammers, boilers, boiler makers' tools, lathe centers, etc.
9	0.85 to 0.95	{ Punches and dies, hand chisels, mining tools, shear blades, etc.
10	0.95 to 1.05	{ Drills, large milling cutters, axes, taps, reamers, bolt header dies and similar tools.
11	1.05 to 1.15	{ Granite chisels, milling cutters, taps, reamers, mill picks, threading dies, cups, cones, etc.
12	1.15 to 1.25	{ Milling cutters, small taps, threading dies, twist drills, forming and boring tools, mandrels, razors.
13	1.25 to 1.35	{ Inserted milling cutter teeth, lathe, planer and slotter tools, and tools requiring great hardness.
14	1.35 to 1.45	{ Cutting disks, granite lathe tools, paper knives, engravers' tools, roll corrugating and chilled roll turning tools.
15	1.45 to 1.55	{ Steel for turning chilled rolls, etc., requiring great hardness.

Meehanite Castings.—Castings produced by the Meehanite controlled process may have various combinations of physical properties to meet different requirements. In addition to a number of general engineering types, there are heat-resisting, wear-resisting and corrosion-resisting Meehanite castings. These castings may be produced in a cupola, open hearth or electric furnace, but the cupola is the most widely used. The patented “Equiblast” system is especially adapted to the production of Meehanite casting.

Physical Properties: The general engineering types have minimum tensile strengths ranging from 30,000 to 55,000 pounds per square inch, and compressive strengths from

120,000 to 200,000 pounds per square inch. Some types of Meehanite are adapted to heat-treatment, thus increasing the tensile strength to 75,000 pounds per square inch or higher. The tensile strengths of heat-resisting types vary from 27,000 to 40,000 pounds per square inch, and the compressive strengths from 130,000 to 162,000 pounds per square inch. The general engineering types withstand elevated temperatures so as to meet service requirements for the installation involved for the use of superheated steam in contact with important engine, turbine and similar parts. The corrosion-resisting types of Meehanite castings have a minimum tensile strength of 42,000 pounds per square inch and a compressive strength of 160,000 pounds per square inch.

Applications: Meehanite castings have a wide range of applications. Because of their uniform solidity and density, they are applicable not only for complex sections but for various classes of pressure castings used with water, oil, steam, gas, and other substances. These castings are also used for cylinders and rams of hydraulic presses; for locomotive parts subject to wear such as pistons, cylinder liners, packing rings, cross-head shoes, air compressor parts, grate bars, etc.; truck and trailer brake-drums; gears, retorts, rolls, conveyor chains, part requiring resistance to corrosion growth, etc. The resistance to growth of Meehanite under either continuous high temperatures or alternating high and low temperatures has established it as an essential material in many industrial furnace and high-temperature applications.

In pumping machinery in gravel, cement, mining, crude oil, and chemical plants, the resistance of this metal to abrasion and corrosion is one of its most valuable characteristics. The wear resisting property of Meehanite has given it an important place in the making of dies for forming, pressing, drawing, and stamping metal. By virtue of its hard, tough, and dense structure, the metal does not crush at its edges nor deform or gall, but, on the contrary, work-hardens on the surface, acquiring a glazed skin which greatly increases the life of the die.

Welding: Meehanite castings may be welded by means of the electric arc, using a steel or alloy rod or special cast-iron rod. They may also be welded by gas, using a cast-iron Meehanite or bronze rod.

Alloy Cast Iron.—Alloy cast irons are used for various applications requiring strength and resistance to wear. Numerous compositions provide varying properties suitable for different classes of service. There are eight S.A.E. compositions used for such parts as cylinders, cylinder liners, brake-drums, sprockets, clutch plates, and pistons. These eight compositions contain from 2.80 to 3.40 total carbon; from 0.40 to 0.83 combined carbon; from 0.50 to 0.75 manganese; from 2 to 2.35 silicon. In addition, one or more of the alloying elements chromium, copper, molybdenum and nickel are used, but the kinds and amounts of these alloying elements are not specified because of specific service requirements, variations in foundry practice, possible variations in combinations of the alloying constituents. The tensile strength of alloy cast irons range for some applications from 35,000 to 45,000 pounds per square inch, and from 55,000 to 65,000 for classes of service requiring greater strength.

Nickel Cast Iron: A few compositions of nickel cast irons taken from actual practice are as follows. Crankshafts: Total carbon, 2.75 to 3; silicon, 1.90 to 2.30; manganese, 0.55 to 0.75; nickel, 1 to 1.50; molybdenum, 0.50 to 0.75. Diesel Engine Heads: Total carbon, 3.15; silicon, 1.90; manganese, 0.90; nickel, 1.60; chromium, 0.35; molybdenum, 0.35. Coin Press Parts: Total carbon, 2.75; silicon, 1.75; manganese, 0.80; nickel, 2.50; chromium, 0.40; molybdenum, 0.25.

Nickel-Chromium Cast Iron.—A corrosion- and heat-resistant cast iron having the same coefficient of expansion as plain cast iron at elevated temperatures consists of 28 to 32 per cent nickel, 4 to 5 per cent chromium, and the remainder cast iron. It is very tough, is machineable, and maintains its properties without deterioration at high temperatures. The hardness is from 140 to 240 Brinell, and the tensile strength is approximately 30,000

pounds per square inch. This metal is intended for use in contact with plain cast iron or steel — for example, as a liner or insert — where it will attain a higher temperature than its surroundings, and must pass through the heating and cooling cycles without becoming separated from the base metal that surrounds it. Examples of its application are bushings and liners for pumps and compressors that handle hot liquids or vapors and automobile-engine valve-seat inserts.

Drawing Dies Cast from Iron Alloys.—Dies cast from nickel-chromium alloys and heat-treated have proved unusually successful in a number of sheet-metal stamping and drawing operations. The alloy compositions for this service have a nickel content of from 2 to 4 per cent and a chromium content of from 0.75 to 1 per cent. These nickel-chromium alloys can be easily heat-treated, possess a fine grain structure, take a high polish, and eliminate streaking of the metal being formed. Before heat-treatment, the Brinell hardness is between 250 and 300, and the tensile strength ranges from 40,000 to 50,000 pounds per square inch. After heat-treatment, the hardness is from 450 to 550 Brinell, and the tensile strength is between 30,000 and 40,000 pounds per square inch.

In most instances, it is possible to cast dies to such close dimensions that the male and female units will fit within small fractions of an inch even before being filed.

Steel for Cast Crankshafts.—Crankshafts cast from a steel alloy of the following composition have proved successful as applied to the engines of a well-known automobile. Chromium, 0.40 to 0.50 per cent; silicon, 0.85 to 1.10 per cent; manganese, 0.60 to 0.80 per cent; carbon, 1.35 to 1.60 per cent; copper, 1.50 to 2.00 per cent; phosphorus, 0.10 per cent maximum; and sulphur, 0.06 per cent maximum.

Torsion tests conducted on these cast crankshafts show an elastic limit ranging from 88,000 to 96,500 pounds per square inch and an ultimate tensile strength ranging from 128,000 to 130,000 pounds per square inch. The Brinell hardness number varies between 255 and 321.

The alloy for these crankshafts is melted in electric furnaces. The time required to bring the furnace from a cool charge to the pouring time is about $3\frac{1}{2}$ hours. The pouring range is between 2670 and 2700 degrees F. After the cast crankshafts reach normal atmospheric temperature, they are heated in a furnace to 1650 degrees F. within one hour and held at that temperature for twenty minutes. They are then permitted to cool to 1000 degrees F. in air, after which they are reheated to 1400 degrees F. within an hour and held at that temperature for one hour. The crankshafts are discharged from this furnace at a temperature of 1000 degrees F. and placed on a cooling conveyor for delivery to the cleaning room.

Tool Steel.—Tool steel, as the term is used in the machine-building industry, may be defined in a general way as any steel that is suitable for making cutting or certain other classes of tools. Tool steel contains a sufficient amount of carbon so that it will harden if heated above a certain temperature and rapidly cooled. The crucible process formerly was used for making all the high-grade tool steel used for metal-cutting tools and, consequently, the terms “tool steel” and “crucible steel” are often used interchangeably, but at the present time the electric furnace is used extensively for producing tool steel.

Open-hearth Tool Steel.—Open-hearth tool steel is used for a large variety of tools and implements which ordinarily are made from steels containing about 0.65 to 0.85 per cent carbon. These tools include hammers, sledges, pliers, woodworking tools, stone cutters' tools, picks, bars, axes, cheap knives, blacksmith tools, forging dies, agricultural implements, and numerous other products. The extensive use of open-hearth steel in the agricultural field accounts for the name “agricultural tool steel.”

Haynes Stellite.—Haynes Stellite is an alloy of cobalt, chromium and tungsten and is non-ferrous or without iron in its composition. The hardness of this alloy is not materially affected by heat up to 1500 degrees F. and it is actually tougher at red heat than when cold. This important characteristic explains its wide application as a cutting tool material.

Haynes Stellite works best when operated at high speed and with a comparatively light feed.

J-Metal: The cutting tool material known as J-Metal is an improved grade of Haynes Stellite. The use of J-Metal results either in higher cutting speeds or in greater production between tool grindings. J-Metal is adapted to various classes of machining operations on practically all kinds of machinable materials, excepting chilled cast iron and manganese steel. The hardness of J-Metal at room temperature is 600 Brinell or Rockwell C, 60–62. It is important to note that the hardness of J-Metal is practically unaffected at red heat and this red hardness is considerably greater than that of high-speed steel.

Haynes Stellite—2400: This is another cobalt-chromium-tungsten alloy. Cutting tools made of this material have greater edge strength and longer economic tool life at even higher speeds than tools made of J-Metal, without reduction of feed or depth of cut. In fact, the speeds and feeds recommended are from 10 to 50 per cent greater than those for J-Metal. This alloy may be used for roughing or finishing cast and forged steels, cast and malleable irons, nitrided, stainless and other alloy steels.

Carbide Tools.—Cemented or sintered carbides are used in the machine building and various other industries, chiefly for cutting tools but also for certain other tools or parts subject to considerable abrasion or wear. Carbide cutting tools, when properly selected to obtain the right combination of strength and hardness, are very effective in machining all classes of iron and steel, non-ferrous alloys, non-metallic materials, hard rubber, synthetic resins, slate, marble, and other materials which would quickly dull steel tools either because of hardness or abrasive action. Carbide cutting tools are not only durable, but capable of exceptionally high cutting speeds. There are different classes of sintered carbides, and various grades in each general class with different combinations of hardness and strength. They are applied to various types of tools for turning, milling, drilling, reaming, etc. Information about the particular grade or type of carbide tool for a given purpose should be obtained directly from the manufacturers. Data from practice on the allowable speeds and feeds will be found in that section of the handbook dealing with this subject:

Tungsten carbide is used extensively in cutting cast iron, non-ferrous metals which form short chips in cutting; plastics and various other non-metallic materials. A grade having a hardness of 87.5 Rockwell A might be used where a strong grade is required, as for roughing cuts, whereas for light high-speed finishing or other cuts, a hardness of about 92 might be preferable. When tungsten carbide is applied to steel, craters or chip cavities are formed back of the cutting edge; hence other carbides have been developed which offer greater resistance to abrasion.

Tungsten-titanium carbide (often called “titanium carbide”) is adapted to cutting either heat-treated or unheat-treated steels, cast steel, or any tough material which might form chip cavities. It is also applicable to bronzes, monel metal, aluminum alloys, etc. *Tungsten-tantalum carbide* or “tantalum carbide” cutting tools are also applicable to steels, bronzes or other tough materials. A hardness of 86.8 Rockwell A is recommended by one manufacturer for roughing steel, whereas a grade for finishing might have a hardness ranging from 88.8 to 91.5 Rockwell A.

Graphitic Steel for Punches and Dies.—Graphitic steel contains approximately 1.50 per cent total carbon and around 1.00 per cent silicon, and in one form carries approximately 0.25 per cent molybdenum. It can readily be forged to shape from the “as rolled” condition, but before machining to shape it must always be normalized and annealed; this precipitates part of the total carbon in the form of free graphite, uniformly distributed throughout the steel, and develops the spheroidized pearlitic structure so well suited to good machining. Quenching develops a martensitic structure, the steel reacting in much the same manner as eutectoid tool steel. The resulting dies and punches show remarkable hardness and toughness, and are highly resistant to wear. For water-hardening uses, no molybdenum is added, this type of graphitic steel being known as “Graph-sil.” When spe-

cial toughness is required or freedom from distortion is essential, the oil-hardening "Graph-mo" is used.

Life of Graphitic Steel Dies.—Graphitic steel has now practically replaced all other types of steel used for dies and punches in the plant of the Timken Roller Bearing Co., Canton, Ohio. Every die or punch made from graphitic steel has shown from two to four times the life of the same part made from the steels formerly used. In many instances, as, for example, in a sizing die, from ten to thirty times the life has been secured. In one case, one of the dies formerly used, when examined after it had sized 10,000 pieces, was not found to be in anywhere nearly as good condition as a graphitic-steel die that had sized 309,000 pieces. Increased die and punch life alone was enough to justify the change, but combined with that, was the lower cost of the steel and the decrease in machining time. Graphitic steel can be machined practically as easily as gray cast iron, which means approximately a 30 to 50 per cent saving in machining time, as compared with the steel formerly used. A reduction of 80 per cent in die-dressing time is also effected.

Even greater is the saving that results from avoiding press shut-downs. The decrease in the number of dies and punches that must be kept in stock to assure continuous operation is also an important item. To all of these saving must be added the saving in production time gained by the capacity of the graphitic-steel dies and punches to stand up under high-speed heavy-duty service without requiring polishing or regrinding during a normal production run; and finally, the greater accuracy and improved appearance of the finished parts must be taken into consideration.

Steels for Dies, Punches and Shears Used on Hot Work.—In the selection of die steels for use in modern forging equipment, special consideration must be given to the resistance of the steel to heat, abrasion, and pressure. It is not possible to select a hot-work steel that will possess maximum ability to meet all of these service conditions. In one case, it will be necessary to select a steel having maximum resistance to heat and to abrasion. In another case, the capacity to withstand pressure, shock, and fatigue will be the governing factor.

Hot-work steels may be classified broadly as the tungsten (or molybdenum) type and the chromium type. The accepted usage of the term "hot-work steels," covers all steels used in manufacturing dies, shears, punches, etc., for use in forging machines, presses, hot trimmers, etc.

Tungsten steels may offer the best resistance to heat and abrasion. Molybdenum possesses heat-resisting properties similar to tungsten, and is sometimes used in analyses in place of tungsten in quantities equal to about one-half the tungsten content. Tungsten is an expensive element, but on jobs where dies operate at high temperatures, tungsten steels prove the most economical. Chromium is next to tungsten and molybdenum in heat-resisting qualities. Chromium steels are used largely in automatic hot-working machines where resistance to repeated impact and to heat are important.

The accompanying table gives the analyses for tungsten and chromium steels with broad limits. The compositions suggested are modified by steel makers to meet specific applications. No simple rule can be laid down for selecting a steel that will best meet the problems of a particular job. A thorough analysis of the job is the only sound basis for an intelligent solution of the problem. In the selection of hot-work steels for forging jobs, designers should not hesitate to draw upon the experience of the steel manufacturer.

Hot-Work Steels for Dies, Punches and Shears

Analyses of Tungsten Steels Suitable for Hot-Work Dies					
Carbon	Tungsten	Chromium	Vanadium	Silicon	
0.40–0.60	17.00–19.00	3.00–4.25	0.00–1.20	...	
0.25–0.50	12.00–16.00	2.00–3.00	0.30–0.50	...	
0.35–0.45	10.00–12.00	1.00–2.00	0.00–0.20	...	
0.25–0.45	8.00–10.00	2.50–3.50	0.20–0.40	0.80–1.20	
0.30–0.45	4.00–6.00	5.00–6.00	0.20–0.40	...	
0.50–0.60	2.00–3.00	1.00–2.00	0.15–0.25	...	

Analyses of Chromium Steels that Meet Certain Requirements of Hot-Work Dies					
Carbon	Chromium	Vanadium	Molybdenum	Silicon	Nickel
0.75–1.00	3.00–4.50
0.50–0.70	3.50–4.00	0.75–1.00	0.35–0.50
0.35–0.45	4.50–5.50	0.30–0.50	1.00–1.50	0.90–1.20	...
0.35–0.45	2.00–2.50	2.25–3.00

Dies can be maintained at a fairly even temperature by providing a large flow of liquid coolant, usually water. The application of a small stream of water may cause localized cooling and heat checking. Long slender punches have a tendency to warp when inadequate coolant is used. An air blast is a safer, although more expensive, method of removing scale and reducing heat.

The effect of abrasion on die life approaches that of heat. In high-speed presses and forging machines, abrasion surpasses heat in its effect on die life, since the dies of these fast machines do not operate at the high temperatures encountered with the slower machines. Abrasion is practically the limiting factor on die life when producing forgings to close tolerances. Tungsten steels, in addition to offering resistance to high temperatures, resist abrasion to a high degree. Lubricants, such as heavy oil or oil mixed with graphite, are often used to reduce abrasive action.

Cold Extrusion.—In simplest terms, cold extrusion can be defined as the forcing of unheated metal to flow through a shape-forming die. It is a method of shaping metal by plastically deforming it under compression at room temperature while the metal is within a die cavity formed by the tools. The metal issues from the die in at least one direction with the desired cross-sectional contour, as permitted by the orifice created by the tools.

Cold extrusion is always performed at a temperature well below the recrystallization temperature of the metal (about 1100 to 1300 degrees F. for steel) so that work-hardening always occurs. In hot extrusion, recrystallization eliminates the effects of work-hardening, unless rapid cooling of the extrusion prevents recrystallization from being completed.

Extrusion differs from other processes, such as drawing, in that the metal is always being pushed under compression and never pulled in tension. As a result, the material suffers much less from cracking. While coining is closely related to extrusion, it differs in that metal is completely confined in the die cavity instead of being forced through openings in the die. Some forging operations combine both coining and extrusion.

The pressure of the punch against the metal in an open die, and the resultant shaped part obtained by displacing the metal along paths of least resistance through an orifice formed between the punch and die, permits considerably higher deformation rates without tearing and large changes in the shape. Extrusion is characterized by a thorough kneading of the material. The cross-sectional shape of the part will not change due to expansion or contraction as it leaves the tool orifice. The term "cold extrusion" is not too descriptive and is not universally accepted. Other names for the same process include impact extrusion, extrusion-forging, cold forging, extrusion pressing, and heavy cold forming. Impact extrusion, however, is more frequently used to describe the production of non-ferrous parts, such as collapsible tubes and other components, while cold extrusion seems to be preferred by manufacturers of steel parts. In Germany, the practice is called *Kaltspritzen*—a literal translation of which is "cold-squirting."

One probable reason for not using impact extrusion in referring to the cold extrusion of steel is that the term implies plastic deformation by striking the metal an impact blow. Actually, the metal must be pushed through the die orifice, with pressure required over a definite period of time. One disadvantage of the terminology "cold extrusion" is the possible confusion with the older, more conventional direct extrusion process in which billets of hot metal are placed in a cylinder and pushed by a ram through a die (usually in a large, horizontal hydraulic press) to form rods, bars, tubes, or irregular shapes of considerable length.

Another possible disadvantage is the connotation of the word "cold". While the process is started with blanks, slugs, tubular sections, or pre-formed cups at room temperature, the internal, frictional resistance of the metal to plastic flow raises the surface temperature of the part to 400 degrees F. or more, and the internal temperature even higher (depending on the severity of the operation). These are still below the recrystallization temperature and the extrusions retain the advantages of improved physical properties resulting from the cold working.

Billet.—A "billet," as the term is applied in rolling mill practice, is square or round in section and from 1½ inches in diameter or square to almost 6 inches in diameter or square. Rolling mills used to prepare the ingot for the forming mills are termed "blooming mills," "billet mills," etc.

Hydraulic Press

Rules and Formulas for Hydraulic Press Calculations.—To find the total pressure of a hydraulic press when the diameter of the ram in inches and the water pressure (gage pressure) in pounds per square inch are given, multiply the area of the cross-section of the ram by the pressure per square inch, and divide by 2000. The result is the capacity of the hydraulic press in tons. The same result may be obtained as follows: Multiply the square of the diameter of the ram by the pressure per square inch, and multiply this product by 0.00039. The result is the total pressure of the press in tons.

The pressure per square inch on the material under pressure in the press can be determined when the total pressure of the press and the area of the material under pressure are known. Multiply the total pressure of the press in tons by 2000, and divide the product by the area of the material to be pressed. The quotient is the pressure in pounds per square inch on the surface of the material.

Table 1a. Capacity of Hydraulic Presses

Diam. of Ram, Inches	Area of Ram, Sq. Ins.	Pressure in Pounds per Square Inch on End of Ram										
		2000	2100	2200	2300	2400	2500	2600	2700	2800	2900	3000
		Capacity of Hydraulic Press in Tons										
1	0.785	0.8	0.8	0.9	0.9	0.9	1.0	1.0	1.1	1.1	1.1	1.2
2	3.142	3.1	3.3	3.5	3.6	3.8	3.9	4.1	4.2	4.4	4.5	4.7
3	7.069	7.0	7.4	7.8	8.1	8.5	8.8	9.2	9.5	9.9	10.2	10.6
4	12.566	12.5	13	14.0	14.5	15.0	15.5	16.0	17.0	17.5	18.0	19
5	19.635	20	21	21.5	22.5	23.5	24.5	25.5	26.5	27.5	28.5	29
6	28.274	28	30	31	33	34	35	37	38	40	41	42
7	38.484	38	40	42	44	46	48	50	52	54	56	58
8	50.265	50	53	55	58	60	63	65	68	70	73	75
9	63.617	63	67	70	73	76	80	83	86	89	92	95
10	78.540	78	82	86	90	94	98	102	106	110	114	118
11	95.033	95	100	105	109	114	119	124	128	133	138	143
12	113.097	113	119	124	130	136	141	147	153	158	164	170
13	132.732	132	139	146	153	159	166	172	179	186	193	199
14	153.938	154	162	169	177	185	192	200	208	216	223	231
15	176.715	177	185	194	203	212	221	230	239	247	256	265
16	201.062	201	211	221	231	241	251	261	271	281	292	302
17	226.980	227	238	250	261	272	284	295	306	318	329	340
18	254.469	254	267	280	293	305	318	331	344	356	369	382
19	283.529	284	298	312	326	340	354	369	383	397	411	425
20	314.160	314	330	346	361	377	393	408	424	440	456	471
21	346.361	346	364	381	398	416	433	450	468	485	502	520
22	380.133	380	399	418	437	456	475	494	513	532	551	570
23	415.476	415	436	457	478	499	519	540	561	582	602	623
24	452.390	452	475	498	520	543	565	588	611	633	656	679
25	490.875	491	515	540	565	589	614	638	663	687	712	736
26	530.930	531	557	584	612	637	664	690	717	743	770	796
27	572.556	573	601	630	658	687	716	744	773	802	830	859
28	615.753	616	647	677	708	739	770	800	831	862	893	924
29	660.521	661	694	727	760	793	826	859	892	925	958	991
30	706.860	707	742	778	813	848	884	919	954	990	1025	1060

Table 1b. Capacity of Hydraulic Presses

Diam. of Ram, Inches	Area of Ram, Sq. Ins.	Pressure in Pounds per Square Inch on End of Ram									
		3100	3200	3300	3400	3500	3600	3700	3800	3900	4000
		Capacity of Hydraulic Press in Tons									
1	0.785	1.2	1.3	1.3	1.3	1.4	1.4	1.4	1.5	1.5	1.6
2	3.142	4.9	5.0	5.2	5.3	5.5	5.7	5.8	6.0	6.1	6.3
3	7.069	10.9	11.3	11.7	12.0	12.4	12.7	13.1	13.4	13.8	14.1
4	12.566	19.5	20	20.5	21	22	22.5	23	24	24.5	25
5	19.635	30	31	32	33	34	35	36	37	38	39
6	28.274	44	45	47	48	49	51	52	54	55	56
7	38.484	60	62	64	66	67	69	71	73	75	77
8	50.265	78	80	83	85	88	90	93	95	98	100
9	63.617	99	102	105	108	111	115	118	121	124	127
10	78.540	122	126	130	134	137	141	145	149	153	157
11	95.033	147	152	157	162	166	171	176	181	185	190
12	113.097	175	181	187	192	198	204	209	215	221	226
13	132.732	206	212	219	226	232	238	245	252	259	265
14	153.938	239	246	254	262	269	277	285	293	300	308
15	176.715	274	283	292	300	309	318	327	336	345	353
16	201.062	312	322	332	342	352	362	372	382	392	402
17	226.980	352	363	375	386	397	409	420	431	443	454
18	254.469	394	407	420	433	445	458	471	483	496	509
19	283.529	439	454	468	482	496	510	525	539	553	567
20	314.160	487	503	518	534	550	566	581	597	613	628
21	346.361	537	554	571	589	606	623	641	658	675	693
22	380.133	589	608	627	646	665	684	703	722	741	760
23	415.476	644	665	686	706	727	748	769	789	810	831
24	452.390	701	724	746	769	792	814	837	860	882	905
25	490.875	761	785	810	834	859	884	908	933	957	982
26	530.930	823	850	876	903	929	956	982	1009	1035	1062
27	572.556	887	916	945	973	1002	1031	1059	1088	1116	1145
28	615.753	954	985	1016	1047	1078	1108	1139	1170	1201	1232
29	660.521	1024	1057	1090	1123	1156	1189	1222	1255	1288	1321
30	706.860	1096	1131	1166	1202	1237	1272	1308	1343	1378	1414

When a certain pressure per square inch on the material under pressure is required, the gage pressure of the press necessary to obtain this pressure may be calculated as follows: Multiply the area of the surface under pressure by the pressure per square inch desired on the material. Divide this product by 0.7854 times the square of the diameter of the ram. The quotient will be the desired gage pressure.

Expressing these rules as formulas, let D = diameter of ram in inches; P = water pressure in pounds per square inch (gage pressure); C = total pressure or capacity of press in tons; A = area of material to be pressed, in square inches; P_a = pressure in pounds per square inch on material under pressure; then:

$$C = 0.00039D^2 \times P \quad P_a = \frac{2000C}{A} \quad P = \frac{A \times P_a}{0.7854D^2}$$

Punches, Dies, and Press Work

Clearance between Punches and Dies.—The amount of clearance between a punch and die for blanking and perforating is governed by the thickness and kind of stock to be operated upon. For thin material, the punch should be a close sliding fit to prevent ragged edges, but for heavier stock, there should be some clearance. The clearance between the punch

and die in cutting heavy material reduces the pressure required for the punching operation and the danger of breaking the punch.

Meaning of the Term "Clearance".—There is a difference of opinion among diemakers as to the method of designating clearance. The prevailing practice of fifteen firms specializing in die work is as follows: Ten of these firms define clearance as the space between the punch and die on *one side*, or one-half the difference between the punch and die sizes. The remaining five firms consider clearance as the total difference between the punch and die sizes; for example, if the die is round, clearance equals die diameter minus punch diameter. The advantage of designating clearance as the space on each side is particularly evident with dies of irregular form or of angular shape. Although the practice of designating clearance as the difference between the punch and die diameters may be satisfactory for round dies, it leads to confusion when the dies are of unsymmetrical forms. The term "clearance" should not be used in specifications without indicating clearly just what it means. According to one die manufacturer, the term "cutting clearance" is used to indicate the space between the punch and die on each side, and the term "die clearance" refers to the angular clearance provided below the cutting edge so that the parts will fall easily through the die. The term "clearance" as here used means the space on one side only; hence, for round dies, clearance equals die radius minus punch radius.

Clearances Generally Allowed.—For brass and soft steel, most dies are given a clearance on one side equal to the stock thickness multiplied by 0.05 or 0.06; but one-half of this clearance is preferred for some classes of work, and a clearance equal to the stock thickness multiplied by 0.10 may give the cleanest fracture for certain other operations such as punching holes in ductile steel boiler plate.

Where Clearance Is Applied.—Whether clearance is deducted from the diameter of the punch or added to the diameter of the die depends upon the nature of the work. If a blank of given size is required, the die is made to that size and the punch is made smaller. Inversely, when holes of a given size are required, the punch is made to the diameter wanted and the die is made larger. Therefore, for blanking to a given size, the clearance is deducted from the size of the punch, and for perforating, the clearance is added to the size of the die.

Effect of Clearance on Working Pressure.—Clearance affects not only the smoothness of the fracture, but also the pressure required for punching or blanking. This pressure is greatest when the punch diameter is small compared to the thickness of the stock. In one test, for example, a punching pressure of about 32,000 pounds was required to punch $\frac{3}{4}$ inch holes into $\frac{5}{16}$ -inch mild steel plate when the clearance was about 10 per cent. With a clearance of about 4.5 per cent, the pressure increased to 33,000 pounds and a clearance of 2.75 per cent resulted in a pressure of 34,500 pounds.

Soft ductile metal requires more clearance than hard metal, although it has been common practice to increase the clearance for harder metals. In punching holes in fairly hard steel, a clean fracture was obtained with a clearance of only 0.03 times stock thickness.

Angular Clearance for Dies.—The angular clearance ordinarily used in a blanking die varies from 1 to 2 degrees, although dies intended for producing a comparatively small number of blanks are sometimes given a clearance angle of 4 or 5 degrees to facilitate making the die quickly. When large numbers of blanks are required, a clearance of about 1 degree is used.

There are two methods of giving clearance to dies: In one method, the clearance extends to the top face of the die; and in the other, there is a space about $\frac{1}{8}$ inch below the cutting edge that is left practically straight, or having a very small amount of clearance.

For very soft metal, such as soft, thin brass, the first method is employed, but for harder material, such as hard brass, steel, etc., it is better to have a very small clearance for a short distance below the cutting edge. When a die is made in this way, thousands of blanks can

be cut with little variation in their size, as grinding the die face will not enlarge the hole to any appreciable extent.

Lubricants for Press Work.—Blanking dies used for carbon and low-alloy steels are often run with only residual mill lubricant, but will last longer if lightly oiled. Higher alloy and stainless steels require thicker lubricants. Kerosene is usually used with aluminum. Lubricant thickness needs to be about 0.0001 in. and can be obtained with about 1 pint of fluid to cover 500 sq. ft of material. During successive strokes, metal debris adheres to the punch and may accelerate wear, but damage may be reduced by application of the lubricant to the sheet or strip by means of rollers or spray. High-speed blanking may require heavier applications or a continuous airless spraying of oil. For sheet thicker than $\frac{1}{8}$ in. and for stainless steel, high-pressure lubricants containing sulfurs and chlorines are often used.

Shallow drawing and forming of steel can be done with low-viscosity oils and soap solutions, but deeper draws require light- to medium-viscosity oils containing fats and such active elements as sulfur or phosphorus, and mineral fillers such as chalk or mica. Deep drawing often involves ironing or thinning of the walls by up to 35 per cent, and thick oils containing high proportions of chemically active compounds are used. Additives used in drawing compounds are selected for their ability to maintain a physical barrier between the tool surfaces and the metal being shaped. Dry soaps and polymer films are frequently used for these purposes. Aluminum can be shallow drawn with oils of low to medium viscosity, and for deep drawing, tallow may be added, also wax or soap suspensions for very large reductions.

Annealing Drawn Shells.—When drawing steel, iron, brass, or copper, annealing is necessary after two or three draws have been made, because the metal is hardened by the drawing process. For steel and brass, anneal between alternate reductions, at least. Tin plate or stock that cannot be annealed without spoiling the finish must ordinarily be drawn to size in one or two operations. Aluminum can be drawn deeper and with less annealing than the other commercial metals, provided the proper grade is used. If it is necessary to anneal aluminum, it should be heated in a muffle furnace, care being taken to see that the temperature does not exceed 700 degrees F.

Drawing Brass.—When drawing brass shells or cup-shaped articles, it is usually possible to make the depth of the first draw equal to the diameter of the shell. By heating brass to a temperature just below what would show a dull red in a dark room, it is possible to draw difficult shapes, otherwise almost impossible, and to produce shapes with square corners.

Drawing Rectangular Shapes.—When square or rectangular shapes are to be drawn, the radius of the corners should be as large as possible, because defects usually occur in the corners when drawing. Moreover, the smaller the radius, the less the depth that can be obtained in the first draw.

The maximum depths that can be drawn with corners of a given radii are approximately as follows: With a radius of $\frac{3}{32}$ to $\frac{3}{16}$ inch, depth of draw, 1 inch; radius $\frac{3}{16}$ to $\frac{3}{8}$ inch, depth 1 $\frac{1}{2}$ inches; radius $\frac{3}{8}$ to $\frac{1}{2}$ inch, depth 2 inches; and radius $\frac{1}{2}$ to $\frac{3}{4}$ inch, depth 3 inches.

These figures are taken from actual practice and can doubtless be exceeded slightly when using metal prepared for the process. If the box needs to be quite deep and the radius is quite small, two or more drawing operations will be necessary.

Speeds and Pressures for Presses.—The speeds for presses equipped with cutting dies depend largely upon the kind of material being worked, and its thickness. For punching and shearing ordinary metals not over $\frac{1}{4}$ inch thick, the speeds usually range between 50 and 200 strokes per minute, 100 strokes per minute being a fair average. For punching metal over $\frac{1}{4}$ inch thick, geared presses with speeds ranging from 25 to 75 strokes per minute are commonly employed.

The cutting pressures required depend upon the shearing strength of the material, and the actual area of the surface being severed. For round holes, the pressure required equals the circumference of the hole \times the thickness of the stock \times the shearing strength.

To allow for some excess pressure, the tensile strength may be substituted for the shearing strength; the tensile strength for these calculations may be roughly assumed as follows: Mild steel, 60,000; wrought iron, 50,000; bronze, 40,000; copper, 30,000; aluminum, 20,000; zinc, 10,000; and tin and lead, 5,000 pounds per square inch.

Pressure Required for Punching.—The formula for the force in tons required to punch a circular hole in sheet steel is $\pi DST/2000$, where S = the shearing strength of the material in lb/in.², T = thickness of the steel in inches, and 2000 is the number of lb in 1 ton. An approximate formula is $DT \times 80$, where D and T are the diameter of the hole and the thickness of the steel, respectively, both in inches, and 80 is a factor for steel. The result is the force in tons.

Example: Find the pressure required to punch a hole, 2 inches in diameter, through $\frac{1}{4}$ -in. thick steel. By applying the approximate formula, $2 \times \frac{1}{4} \times 80 = 40$ tons.

If the hole is not circular, replace the hole diameter with the value of one-third of the perimeter of the hole to be punched.

Example: Find the pressure required to punch a 1-inch square hole in $\frac{1}{4}$ -in. thick steel. The total length of the hole perimeter is 4 in. and one-third of 4 in. is $1\frac{1}{3}$ in., so the force is $1\frac{1}{3} \times \frac{1}{4} \times 80 = 26\frac{2}{3}$ tons.

The corresponding factor for punching holes in brass is 65 instead of 80. So, to punch a hole measuring 1 by 2 inches in $\frac{1}{4}$ -in. thick brass sheet, the factor for hole size is the perimeter length $6 \div 3 = 2$, and the formula is $2 \times \frac{1}{4} \times 65 = 32\frac{1}{2}$ tons.

Punch and Die Clearance, Amount of Clearance.—The amount of clearance between a punch and die for blanking and perforating is governed by the thickness and kind of stock to be operated upon. For thin material such as tin, for example, the punch should be a close sliding fit, as, otherwise, the punching will have ragged edges, but for heavier stock there should be some clearance. The clearance between the punch and die in cutting heavy material, lessens the danger of breaking the punch and reduces the pressure required for the punching operation. For brass and soft steel, most dies are given a clearance on one side equal to the stock thickness multiplied by 0.05 or 0.06; but one-half of this clearance is preferred for some classes of work, and a clearance equal to the stock thickness multiplied by 0.10 may give the cleanest fracture for certain other operations such, for example, as punching holes in ductile steel boiler plate.

Shut Height of Press.—The term “shut height,” as applied to power presses, indicates the die space when the slide is at the bottom of its stroke and the slide connection has been adjusted upward as far as possible. The “shut height” is the distance from the lower face of the slide, either to the top of the bed or to the top of the bolster plate, there being two methods of determining it; hence, this term should always be accompanied by a definition explaining its meaning. According to one press manufacturer, the safest plan is to define “shut height” as the distance from the top of the bolster to the bottom of the slide, with the stroke down and the adjustment up, because most dies are mounted on bolster plates of standard thickness, and a misunderstanding that results in providing too much die space is less serious than having insufficient die space. It is believed that the expression “shut height” was applied first to dies rather than to presses, the shut height of a die being the distance from the bottom of the lower section to the top of the upper section or punch, excluding the shank, and measured when the punch is in the lowest working position.

Depth and Diameter Reductions of Drawn Cylindrical Shells.—The depth to which metal can be drawn in one operation depends upon the quality and kind of material, its thickness, the slant or angle of the dies, and the amount that the stock is thinned or “ironed”

in drawing. A general rule for determining the depth to which cylindrical shells can be drawn in one operation is as follows: The depth or length of the first draw should never be greater than the diameter of the shell. If the shell is to have a flange at the top, it may not be practicable to draw as deeply as is indicated by this rule, unless the metal is extra good, because the stock is subjected to a higher tensile stress, owing to the larger blank needed to form the flange. According to another rule, the depth given the shell on the first draw should equal one-third the diameter of the blank. Ordinarily, it is possible to draw sheet steel of any thickness up to $\frac{1}{4}$ inch, so that the diameter of the first shell equals about six-tenths of the blank diameter. When drawing plain shells, the amount that the diameter is reduced for each draw must be governed by the quality of the metal and its susceptibility to drawing. The reduction for various thicknesses of metal is about as follows:

Approximate thickness of sheet steel	$\frac{1}{16}$	$\frac{1}{8}$	$\frac{3}{16}$	$\frac{1}{4}$	$\frac{5}{16}$
Possible reduction in diameter for each succeeding step, per cent	20	15	12	10	8

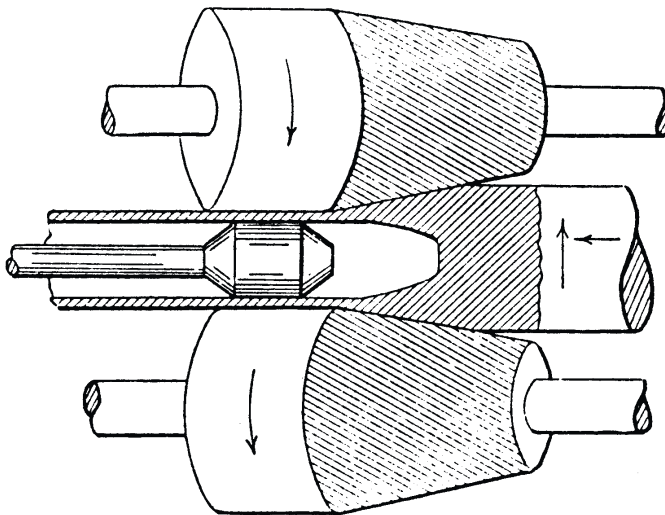
For example, if a shell made of $\frac{1}{16}$ -inch stock is 3 inches in diameter after the first draw, it can be reduced 20 per cent on the next draw, and so on until the required diameter is obtained. These figures are based upon the assumption that the shell is annealed after the first drawing operation, and at least between every two of the following operations. Necking operations—that is, the drawing out of a short portion of the lower part of the cup into a long neck—may be done without such frequent annealings. In double-action presses, where the inside of the cup is supported by a bushing during drawing, the reductions possible may be increased to 30, 24, 18, 15, and 12 per cent, respectively. (The latter figures may also be used for brass in single-action presses.)

When a hole is to be pierced at the bottom of a cup and the remaining metal is to be drawn after the hole has been pierced or punched, always pierce from the opposite direction to that in which the stock is to be drawn after piercing. It may be necessary to machine the metal around the pierced hole to prevent the starting of cracks or flaws in the subsequent drawing operations.

The foregoing figures represent conservative practice and it is often possible to make greater reductions than are indicated by these figures, especially when using a good drawing metal. Taper shells require smaller reductions than cylindrical shells, because the metal tends to wrinkle if the shell to be drawn is much larger than the punch. The amount that the stock is “ironed” or thinned out while being drawn must also be considered, because a reduction in gage or thickness means greater force will be exerted by the punch against the bottom of the shell; hence the amount that the shell diameter is reduced for each drawing operation must be smaller when much ironing is necessary. The extent to which a shell can be ironed in one drawing operation ranges between 0.002 and 0.004 inch per side, and should not exceed 0.001 inch on the final draw, if a good finish is required.

Seamless Tube

Mannesmann Process.— The piercing process used in the production of seamless tubes, commonly called the "Mannesmann process," is based upon the fact that the cross-rolling of a heated round bar of steel produces a rupturing of the material along its center line, and a tendency to form a hole along its longitudinal axis. The diagram illustrates the principle of the Mannesmann piercing process. A round solid billet is passed between two rolls the axes of which are at an angle, as the illustration indicates. These rolls impart to the billet a high rotative speed and a slow advancing movement, forcing the billet over a pointed mandrel and thus increasing its length and changing it from the solid to the tubular form. The forward motion of the billet is caused by the inclination of the axes of the conical rolls relative to each other. A satisfactory explanation for the remarkable results obtained by this method is difficult to give. It seems that the material, instead of flowing in a longitudinal direction, as in ordinary rolling, has a tendency to flow outward toward the circumference, owing to the rotary motion, and a distinct displacement of the fiber takes place. This method of piercing billets can be applied in a number of ways.



Mannesmann Process of Making Seamless Tubes

Seamless Drawn Brass and Copper Pipe

Made to correspond with iron pipe and to fit iron pipe fittings (American Tube Works).									
Diameter			Approximate Weight per Foot, Pounds		Diameter			Approximate Weight per Foot, Pounds	
Iron Pipe Size	Approx. Outside Diam.	Exact Outside Diam.	Brass	Copper	Iron Pipe Size	Approx. Outside Diam.	Exact Outside Diam.	Brass	Copper
1 $\frac{3}{8}$	3 $\frac{3}{8}$	0.405	0.25	0.26	2 $\frac{1}{2}$	2 $\frac{7}{8}$	2.875	5.75	6.05
1 $\frac{3}{4}$	9 $\frac{1}{8}$	0.540	0.43	0.45	3	3 $\frac{1}{2}$	3.500	8.30	8.74
3 $\frac{3}{8}$	11 $\frac{1}{8}$	0.675	0.62	0.65	3 $\frac{1}{2}$	4	4.000	10.90	11.47
1 $\frac{1}{2}$	13 $\frac{1}{8}$	0.840	0.90	0.95	4	4 $\frac{1}{2}$	4.500	12.70	13.37
3 $\frac{1}{4}$	1 $\frac{1}{16}$	1.050	1.25	1.32	4 $\frac{1}{2}$	5	5.000	13.90	14.63
1	1 $\frac{5}{16}$	1.315	1.70	1.79	5	5 $\frac{1}{16}$	5.563	15.75	16.58
1 $\frac{1}{4}$	1 $\frac{3}{8}$	1.660	2.50	2.63	6	6 $\frac{7}{8}$	6.625	18.31	19.27
1 $\frac{1}{2}$	1 $\frac{7}{8}$	1.900	3.00	3.16	7	7 $\frac{5}{8}$	7.625	23.73	24.98
2	2 $\frac{3}{8}$	2.375	4.00	4.21

Forge Shop Equipment

Blacksmiths' Anvils.—The quality of an anvil can generally be judged by its ring, a good anvil giving out a clear, sharp sound when struck with a hammer. If soft or defective, the sound will be dull. A good anvil so mounted that it gives out a full volume of sound is easier to work upon than one having a dead ring. Anvils ordinarily vary in weight from 150 to 300 pounds. A mistake is often made in selecting anvils that are too light for the service required. A 300-pound anvil is suitable for almost any kind of machine blacksmithing, and, if of this weight or heavier, it will not move around while in use or need to be strapped to its block. The square hole in the face of an anvil for receiving the cutting and forming tools is called the "hardie hole," and the small round hole near it is called the "pritchel hole." Anvils are usually made with a wrought-iron body to which is welded a hardened steel face.

Setting the Anvil.—The height of an anvil should be such that when standing beside it the knuckles of the hands will just reach the top surface or face. A solid oak block set endwise in the ground is often used as a foundation, but a cast-iron mounting block is preferable as it can easily be moved. The casting should have a fairly broad base, and a pocket at the top for receiving the anvil; a flat block of wood is provided to act as a cushion. An anvil should not be strapped rigidly to its foundation, as this checks the vibration which tends to keep the face free from scales, and renders a high-grade wrought-iron anvil little better than one made of cast iron. When a wooden block is used under the anvil, it is necessary to drive in a few spikes to keep the anvil in place, but these should be so placed that they do not bear directly upon or bind against the corners.

Steam Hammer Rating.—The capacity of a steam hammer or its rating is the weight of the ram and its attached parts, such as the piston and rod. The steam pressure behind the piston is not considered as far as the rating is concerned. For example, a 1000-pound hammer has reciprocating parts of that weight. The steam pressures for operating hammers usually vary from 75 to 100 pounds per square inch.

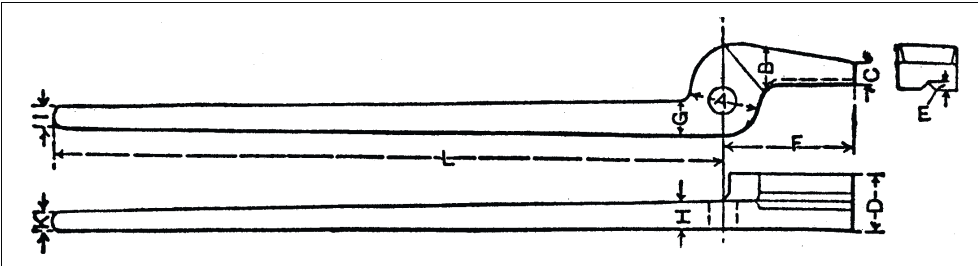
Capacity of Steam Hammers.—Capacity of a steam hammer or the proper size to use for working iron and steel of a given cross-sectional area can be determined approximately by the following rule: Multiply the area of the largest cross-section to be worked by 80, if of steel, or 60, if of iron, and the product will be the required rating of the hammer in pounds. For example, the capacity of a hammer for working steel billets 5 inches square would be determined as follows: $5 \times 5 = 25$; and $25 \times 80 = 2000$, which is the rating of the hammer in pounds. A hammer rated according to this rule is an economical size to use, although it can, of course, be employed for heavier work.

Power for Operating Steam Hammers.—The boiler horsepower for operating a steam hammer depends upon the service required and the number of hammers in use. Ordinarily, the boiler capacity can be less where there are a number of hammers, because all of the hammers are rarely, if ever, used at the same time; consequently, there is a reserve power; but with a single hammer, especially when in constant service, the boiler capacity should be proportionately greater. For average conditions, the boiler horsepower can be determined approximately by the following rule: Divide the rated capacity of the hammer in pounds by 100, and the quotient will be the boiler horsepower required for continuous operation. For example, if the hammer is rated at 2000 pounds, the boiler horsepower would equal $2000 \div 100 = 20$ H.P. This rule is also applicable in cases where the hammer is not used continually, by estimating the amount of idle time and making suitable allowance, but the boiler capacity must not be reduced to such an extent that there is a decided diminution in the pressure during the working period. For foundations for steam hammers, see section on "Machinery and Hammer Foundations."

Board Drop-hammers.—This type of hammer is generally considered superior to the steam hammer for producing drop-forgings of small and medium size. When the work is heavy and requires a great deal of "breaking down" or drawing, or even when the forgings

are light, but have thin sections that cool quickly, thus requiring sharp, rapid blows, the steam hammer will usually give better results than aboard drop. The capacity of most of the board drop-hammers in use varies from 800 to 1500 pounds; the steam hammers found in drop forging plants usually range from 2000 to 5000 pounds capacity, for handling average work. It does not seem practicable to build board drops larger than 3000 pounds falling weight, and where the forgings are heavy enough to require a capacity over 1500 or 2000 pounds, steam hammers are usually preferred. The latter type is also preferred in some forge shops for all classes of work. It is generally conceded that the cost of operation and repairs is greater for steam hammers, but the latter has a greater output for a given capacity. The power required for operating board drop-hammers varies considerably with the nature of the work. Very little power is required at the point of "pick up," if the work is practically "die to die;" but when the work is soft and there is no rebound, a great deal more power is required, as the rolls have to pick up a "dead load" from rest and there is tattle kinetic energy in the driving pulleys. When there is a good rebound, with the knock-off properly timed, the board will be moving upward with considerable velocity when engaged by the rolls, and much less power is required. Seasoned maple boards have proved superior to any other kind for board drop-hammers. Paper fiber has been tried with fair results, but at present the cost of this material is too high. For foundations for drop-hammers, see the section *Machinery and Hammer Foundations* starting on page 3236.

Table 1. Dimensions of Flat-jawed Tongs



Capacity, Inches	A	B	C	D	E	F	G	H	I	K	L	Rivet
0 - 1/8	5/8	3/8	1/4	5/8	1/16	2 1/8	1/2	5/16	5/16	1/4	14	1/4
3/16 - 5/16	3/4	7/16	5/16	5/8	1/16	2 1/4	9/16	5/16	5/16	1/4	15	1/4
3/8 - 7/16	7/8	1/2	5/16	3/4	1/16	2 1/2	5/8	3/8	3/8	5/16	16	5/16
1/2 - 5/8	1	9/16	3/8	7/8	3/32	2 3/4	11/16	7/16	3/8	5/16	18	3/8
3/4 - 7/8	1 1/8	5/8	3/8	1	5/32	3	3/4	1/2	7/16	3/8	20	7/16
1 - 1 1/8	1 1/4	11/16	7/16	1 1/8	3/16	3 1/4	13/16	9/16	1/2	7/16	22	1/2
1 1/4 - 1 3/8	1 3/8	3/4	1/2	1 1/8	1/4	3 1/2	7/8	9/16	1/2	7/16	24	9/16
1 1/2 - 1 5/8	1 1/2	3/4	1/2	1 1/4	3/8	3 3/4	1	5/8	5/8	1/2	26	5/8
1 3/4 - 1 7/8	1 5/8	13/16	9/16	1 3/8	7/16	4	1 1/16	11/16	5/8	1/2	28	5/8
2	1 3/4	7/8	5/8	1 1/2	7/16	4 1/4	1 1/8	1 1/8	11/16	1/2	30	1 1/16

Table 2. Dimensions of Goose-neck Tong

Capacity, Inches	A	B	C	D	E	F	G	H	I	L	Rivet
$\frac{1}{4}$ - $\frac{5}{16}$	$\frac{5}{8}$	$\frac{1}{2}$	$\frac{7}{16}$	$\frac{5}{16}$	$\frac{1}{8}$	1	$\frac{1}{2}$	$\frac{5}{16}$	$\frac{1}{4}$	14	$\frac{1}{4}$
$\frac{3}{8}$ - $\frac{7}{16}$	$\frac{3}{4}$	$\frac{9}{16}$	$\frac{1}{2}$	$\frac{5}{16}$	$\frac{3}{16}$	$1\frac{1}{8}$	$\frac{9}{16}$	$\frac{5}{16}$	$\frac{1}{4}$	16	$\frac{5}{16}$
$\frac{1}{2}$ - $\frac{5}{8}$	$\frac{7}{8}$	$\frac{5}{8}$	$\frac{9}{16}$	$\frac{3}{8}$	$\frac{1}{4}$	$1\frac{1}{4}$	$\frac{5}{8}$	$\frac{3}{8}$	$\frac{5}{16}$	18	$\frac{3}{8}$
$\frac{3}{4}$ - $\frac{7}{8}$	1	$\frac{3}{4}$	$\frac{5}{8}$	$\frac{7}{16}$	$\frac{3}{8}$	$1\frac{1}{2}$	$\frac{3}{4}$	$\frac{3}{8}$	$\frac{5}{16}$	20	$\frac{7}{16}$
1 - $1\frac{1}{8}$	$1\frac{1}{8}$	$\frac{7}{8}$	$1\frac{1}{16}$	$\frac{1}{2}$	$\frac{1}{2}$	$1\frac{3}{4}$	$\frac{7}{8}$	$\frac{3}{8}$	$\frac{5}{16}$	20	$\frac{1}{2}$
$1\frac{1}{4}$ - $1\frac{3}{8}$	$1\frac{1}{4}$	1	$\frac{3}{4}$	$\frac{9}{16}$	$\frac{5}{8}$	2	1	$\frac{7}{16}$	$\frac{3}{8}$	22	$\frac{1}{2}$
$1\frac{1}{2}$ - $1\frac{3}{4}$	$1\frac{3}{8}$	$\frac{3}{4}$	$\frac{1}{2}$	$1\frac{1}{8}$	$\frac{3}{4}$	$2\frac{1}{8}$	$1\frac{1}{8}$	$\frac{1}{2}$	$\frac{3}{8}$	24	$\frac{9}{16}$
$1\frac{7}{8}$ - $2\frac{1}{8}$	$1\frac{3}{8}$	$1\frac{3}{16}$	$\frac{15}{16}$	$1\frac{1}{16}$	1	$2\frac{1}{4}$	$1\frac{1}{4}$	$\frac{1}{2}$	$\frac{3}{8}$	26	$\frac{5}{8}$
$2\frac{1}{4}$ - $2\frac{1}{2}$	$1\frac{1}{2}$	$1\frac{1}{4}$	1	$\frac{3}{4}$	$1\frac{1}{8}$	$2\frac{1}{2}$	$1\frac{1}{2}$	$\frac{9}{16}$	$\frac{7}{16}$	28	$\frac{5}{8}$
$2\frac{5}{8}$ - $2\frac{7}{8}$	$1\frac{1}{2}$	$1\frac{5}{16}$	$1\frac{1}{16}$	$\frac{3}{4}$	$1\frac{1}{4}$	$2\frac{3}{4}$	$1\frac{3}{4}$	$\frac{9}{16}$	$\frac{7}{16}$	30	$\frac{3}{4}$
3 - $3\frac{1}{4}$	$1\frac{5}{8}$	$1\frac{3}{8}$	$1\frac{1}{8}$	$\frac{3}{4}$	$1\frac{1}{2}$	3	2	$\frac{5}{8}$	$\frac{1}{2}$	32	$\frac{3}{4}$
$3\frac{1}{2}$ - $3\frac{3}{4}$	$1\frac{3}{4}$	$1\frac{1}{2}$	$1\frac{1}{4}$	$\frac{3}{4}$	$1\frac{3}{4}$	$3\frac{1}{4}$	$2\frac{1}{4}$	$\frac{5}{8}$	$\frac{1}{2}$	34	$\frac{3}{4}$
4 - $4\frac{1}{4}$	2	$1\frac{5}{8}$	$1\frac{5}{16}$	$1\frac{3}{16}$	2	$3\frac{1}{4}$	$2\frac{1}{2}$	$1\frac{1}{16}$	$\frac{9}{16}$	36	$\frac{3}{4}$
$4\frac{1}{2}$ - $4\frac{3}{4}$	$2\frac{1}{8}$	$1\frac{5}{8}$	$1\frac{5}{16}$	$1\frac{3}{16}$	$2\frac{1}{8}$	$3\frac{1}{4}$	$2\frac{3}{4}$	$1\frac{1}{16}$	$\frac{9}{16}$	38	$\frac{3}{4}$
5	$2\frac{1}{4}$	$1\frac{3}{4}$	$1\frac{3}{8}$	$\frac{7}{8}$	$2\frac{1}{4}$	$3\frac{1}{2}$	$3\frac{1}{4}$	$\frac{3}{4}$	$\frac{5}{8}$	40	$\frac{7}{8}$

Forging Presses.—The power of forging presses for the average line of work is approximately as follows: For mild steel at a fair heat, a pressure of from 3 to 5 tons per square inch on the faces of the tools is generally sufficient, but when swages or dies are used, it may be necessary to double these pressures. For the very hardest steels, the pressure required may be as high as 10 or even 15 tons per square inch, but this is an exceptional case. For small forgings, including such parts as can be made from 8-inch square blooms or 12- by 6-inch flats, a press of 300 tons is sufficient, and for larger forgings, such as those used for heavy marine shafts and cranks, a 3000-ton press is generally considered sufficient and can readily handle a 60-inch ingot. The table above indicates, in a general way, the capacity of presses for handling ingots of various diameters.

Table 3. Capacity of Forging Presses

Capacity of Press, Tons	Maximum Diam. of Ingot, Inches	Capacity of Press, Tons	Maximum Diam. of Ingot, Inches
300	10	1500	36
500	14	2000	48
800	20	3000	60
1200	27	4000	72

A press of comparatively small capacity may, with suitable appliances, handle work that is really too heavy for it, but at some sacrifice of speed; for economical operation, there should be ample power. As is generally known, the forging press is superior to the steam hammer for comparatively large forgings, because the hammer tends to spread the surface metal without acting upon the center of the ingot to the required degree. With a press, the forging action goes right to the center of the ingot, as evidenced by the bulging that takes place at the sides, and if there is a cavity in the ingot, forging under the press closes it, whereas a hammer, by spreading the surface metal, may tend to enlarge it. As forgings diminish in size, the difference in favor of the press is less marked. Owing to the recent increase in the operating speed of forging presses, however, they now compete with power hammers in the forging of comparatively light work, and the range of presses has been greatly extended.

Air Pressures and Pipe Sizes for Forges.—Blacksmiths' forges require air pressures varying from 1½ to 6 ounces per square inch. Small forges with the blower close to them are adequately supplied with 1½ ounce pressure. If the blower is some distance away and a long discharge pipe with many bends leads to the forge, even though the latter be small, it may be necessary to carry 3 ounces pressure or more, to overcome the friction in the air ducts. Large forges usually require from 3 to 6 ounces pressure. The table, *Air Pressures and Pipe Sizes for Forges*, gives the diameters of discharge mains for various tuyere sizes and numbers of forges.

Table 4. Air Pressures and Pipe Sizes for Forges

Diam. Forge Tuy- ere, Inches	Number of Forges Supplied by Blower									
	1	2	3	4	5	6	7	8	9	10
	Diameter Discharge Main at Blower, Inches									
¾	1½	1½	2	2	2½	2½	3	3	3	3
1	1½	2	2½	3	3	3½	3½	4	4	4
1¼	2	2½	3	3½	4	4	4½	5	5	5
1½	2	3	3½	4	4½	5	6	6	6	6
1¾	2½	3½	4	4½	5	6	6	7	7	7
2	3	4	4½	5	6	7	7	8	8	8
2¼	3	4	5	6	7	7	8	9	9	9
2½	3½	5	6	7	8	8	9	9	10	10
2¾	4	5	6	7	8	9	10	10	11	11
3	4	6	7	8	9	10	11	11	12	12
3½	4½	7	8	9	10	11	12	13	14	14
4	6	8	9	11	12	13	14	15	16	17

American Blower Co.

The Cold Swaging Process.—Cold swaging is a method of reducing or forming steel or other material while cold, by drawing to a point or reducing the diameter, as may be required. This is performed by a machine that causes the work to be struck a large number of successive blows by a pair of dies shaped to give the required form. This process is principally applied to the reduction of wires, rods and tubes, and is the only method by which rolled or plated stock can be reduced without destroying the plating or coating. For this reason, it is largely employed for jewelers' work. It is also extensively used for pointing rods or tubes which are to be drawn. The process is used in the manufacture of needles, bicycle spokes, button hooks, crochet needles, etc.

Forging Machines.—Some forging machines are intended especially for bolt and rivet heading, and others for more general work. The form or shape into which a part is forged is governed by dies of the required shape and also by a heading tool or plunger which bends or upsets the heated bar of metal and forces it into the die impression. The die may have a single impression, or two or three impressions may be required in order to forge the part by successive operations.

Dies for Bolt and Rivet Forging Machines.—Bolt and rivet dies used in forging machines are, as a rule, made from steel containing from 0.60 to 0.80 per cent carbon and are hardened and drawn. The heading tool, which must be tougher than the dies, is generally made from steel containing from 0.40 to 0.50 per cent carbon, and is drawn considerably more than the forming dies.

Dies and Tools Used in Hot-pressed Center-feed Nut Machines.—The dies used in hot-pressed center-feed nut machines are usually made from chilled iron castings, the dies being ground to size. It is claimed that dies made from this material will last fully eight times as long as those made from ordinary carbon steel, but as it is somewhat difficult to obtain the proper amount of chill, many manufacturers use a good grade of open-hearth crucible steel instead. A crucible steel which is found to give good results contains from 0.90 to 1.10 per cent carbon. In many cases, vanadium alloy steel is used for dies for nut forging machines. The composition of vanadium steel for dies varies. Two grades of vanadium tool steel are recommended for forging machine dies by the American Vanadium Co., of Pittsburgh, Pa. One is composed of carbon, 0.50 per cent; chromium, from 0.80 to 1.10 per cent; manganese, from 0.40 to 0.60 per cent; vanadium, not less than 0.16 per cent; silicon, not more than 0.20 per cent. The heat-treatment recommended for this steel is as follows: Heat to 1550 degrees F. and quench in oil; then reheat to from 1425 to 1450 degrees F., and quench in water, submerging the face of the die only.

The second kind of vanadium tool steel recommended has the following analysis: Carbon, from 0.65 to 0.75 per cent; manganese, from 0.40 to 0.60 per cent; vanadium, not less than 0.16 per cent; silicon, not more than 0.20 per cent. The heat-treatment for this steel should be as follows: Heat to 1525 degrees F. and quench in water, with only the face of the die submerged. Ordinary carbon tool steel dies should be drawn to a light straw color.

Bulldozer Dies.—Many of the tools or dies used on bulldozers are made of cast iron, in order to reduce the cost, and those parts of the dies which are subjected to wear are faced with hardened steel plates which may readily be replaced, if necessary. Whenever hot punching or cutting is done, high-speed self-hardening steel should be used for the working members of the tool.

Helve Hammers.—Power hammers of the helve type are adapted especially for relatively light forging operations, particularly when a rapid succession of blows is required. Ordinary helve hammers are usually built in sizes ranging from 15 to 200 pounds, this rating being based upon the weight of the hammer head. Some "upright helve" hammers are made in sizes up to 500 pounds.

Vertical Power Hammers.—Vertical power hammers of the crank- and pneumatically-operated types are used for general forging operations, especially on the lighter classes of work. Power hammers of the vertical type usually range in size from 25 pounds up to 500 pounds.

Efficiency of Forging Hammers.—The Heim method for determining the efficiency of forging hammers is based on the results of numerous tests conducted by allowing an ordinary drop-hammer to fall a predetermined distance upon a pure lead cylinder, the height of which is 1.5 times its diameter. The diameters of the cylinders which have been adopted for use in testing various sizes of hammers (with regard to their falling weight) are given in [Table 5](#). The following formula gives the number of foot-pounds of work done by one blow of the hammer:

$$\text{Work} = 36.75D^3 [8.85A + 13.12(A^2 + A^4)] \text{ foot-pounds}$$

Where D = Diameter of the lead cylinder;

$$A = (H - H_1) \div H$$

H = Original height of the cylinder

H₁ = height of the cylinder after being struck by the hammer.

If the expression inside the brackets in the formula is designated by B, the formula may be expressed in the following form:

$$\text{Work} = 36.75D^3 B$$

After the lead cylinder has been struck by the hammer, the value of A is calculated and the number of foot-pounds of work developed by the hammer is then obtained by taking the value of B from Table 6 and substituting in the formula.

Example: Suppose a 100-kilogram (220-pound) hammer striking 180 blows per minute is allowed to strike a lead cylinder, the original dimensions of which are 50 millimeters (1.97 inch) in diameter by 75 millimeters (2.95 inches) high. After the blow has been struck, the resulting height of the cylinder is 48 millimeters (1.90 inch). From the preceding formula:

$$A = \frac{2.95 - 1.90}{2.95} = 0.35$$

B = 4.9, from Table 6

Substituting the values of D and B in the formula for the work done by one blow of the hammer:

$$36.75 \times 1.97^3 \times 4.9 = 1376 \text{ foot-pounds} = \text{work done by one blow.}$$

$$\frac{1376 \times 180}{60} = 4128 \text{ foot-pounds} = \text{work done by one blow.}$$

The maximum power required to drive the hammer is 10.3 horsepower. As one horsepower is equivalent to 550 foot-pounds of work per second, the amount of power consumed by the hammer per second is: 10.3 × 550 = 5665 foot-pounds. The efficiency of the is found to be:

$$\text{Efficiency} = \frac{\text{useful work}}{\text{power supplied}} = \frac{4128}{5665} = 72 \text{ percent.}$$

The Heim formula and method of testing may be applied to all types of hammers, but, when used on steam hammers, the test must made while the hammer is running continuously and not when set to deliver a single blow.

Table 5. Dimensions of Lead Plugs Used for Testing Various Sizes of Hammers

Falling Weight of Hammer		Diameter of Lead Cylinder ^a		Falling Weight of Hammer		Diameter of Lead Cylinder	
Pounds	Kilograms	Inches	Millimeters	Pounds	Kilograms	Inches	Millimeters
66	30	1.18	30	330	150	2.36	60
110	50	1.38	35	506	230	2.76	70
165	75	1.57	40	770	350	3.15	80
220	100	1.97	50	1100	500	3.54	90

^a Height equals 1.5 × diameter.

Table 6. Values of Factors Used in Calculating Power of Hammers

A	0.10	0.15	0.20	0.25	0.30	0.35	0.40	0.45	0.50	0.55	0.60
B	1.01	1.63	2.31	3.08	3.94	4.90	5.97	7.17	8.52	10.03	11.73

Machinery and Hammer Foundations

The materials commonly used are concrete, stone, brick, and wood in conjunction with concrete for machines subjected to considerable vertical shock. The principal characteristics of these materials are briefly as follows: Concrete is an ideal foundation material, as it becomes practically one solid piece and is much cheaper than a masonry foundation. Stone, in addition to being strong and durable, has great vibrations absorbing power, but is quite costly. Brick is not so durable as stone, but is cheaper and available everywhere. In building a foundation, provision should be made for the foundation bolts, when these are necessary. Sometimes the bolts are set permanently in the foundation, or they may be placed in pipes and have pockets at the lower ends, thus permitting adjustment or removal, if necessary. The bolts are usually located in the proper position by making a wooden templet in which holes are bored to coincide with the holes in the machine base. The inclination of the sides of a foundation should vary from $1\frac{1}{2}$ to 3 inches per foot from the vertical. The foundation pit should be excavated below the frost line of the locality.

Concrete Foundations.—The timber used for making the forms in which concrete foundations are molded should be about 1 inch thick, dressed on the inner side to give a smooth surface. The form should be braced externally about every $2\frac{1}{2}$ feet, and internally about every foot in height. As the form is being filled, the inside braces can be removed. If pocket molds are used for the lower ends of the bolts, they should be soaked in water two or three hours before using, to prevent their swelling and sticking in the concrete. Do not use concrete that has been mixed over twenty minutes. Ram with hammers weighing about 1 pound per square inch of face area, the ramming being continued until water just shows at the surface.

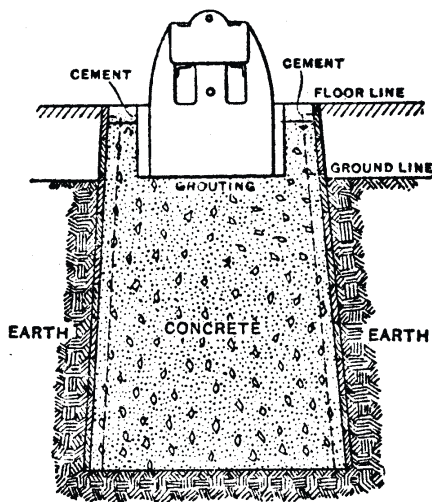


Fig. 1.

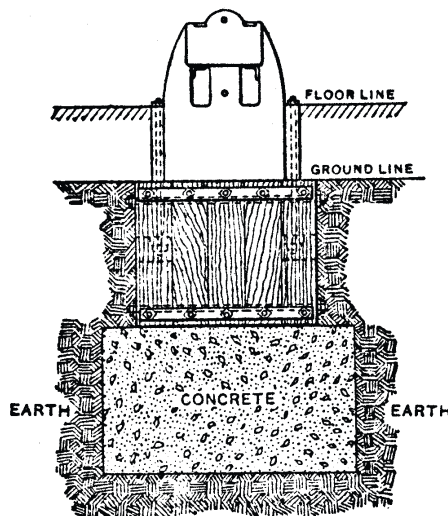


Fig. 2.

Put down the concrete in layers about 6 inches thick and work it onto the form with a shovel, to obtain a smooth, even surface. The foundation may be partly filled with stones about the size of a man's head, placed approximately one foot apart and not less than one foot from the foundation surfaces. These stones should be wet before laying. If the work is stopped at night before completion, make grooves in the surface and when starting the next day, sprinkle and dust over with dry cement. As soon as the concrete has set, remove the

form, as it is much easier to patch when the cement is somewhat "green." Foundations are sometimes "slushed" instead of being rammed. In this case, the concrete is mixed just wet enough so that it cannot be piled up. It is then dumped into the molds and worked in them to prevent air bubbles. The first method gives a more homogeneous structure as there is no chance for the broken stones to settle. When the machine is in position, the space around the foundation bolts may be filled with liquid cement, lead or melted sulphur.

Drop Hammer Foundations.—The following drop-hammer foundations are recommended by the E. W. Bliss Company:

Concrete Foundation: : Excavate a hole from 10 to 14 feet deep and from 8 to 12 feet square; build up a block of concrete with tapering sides, as shown in Fig. 1, having a top about 6 to 12 inches wider, all around, than the base of the anvil. Place the anvil in position and wedge it level; then run a thin mixture of concrete the anvil and allow it to set. Next move the wedges and build up a wall of concrete from 4 to 6 inches thick around the anvil. (See Fig. 1 and Fig. 2) This will make the use of bolts unnecessary and the anvil will set solid and will not be likely to shift. Solid concrete makes an excellent foundation that does not deteriorate, as is the case with timber when subjected to dampness from the earth or atmospheric moisture. Another advantage is that it is almost impervious to sparks or hot pieces of metal.

Timber Concrete Foundations: Excavate a hole somewhat larger than the anvil or base of the hammer. At the bottom lay a bed of concrete from 1 to 2 feet thick, as shown in Fig. 2. On this concrete bed place, endwise, Georgia pine timbers 12 by 12 inches by 6 to 8 feet long. These should be securely strapped together by steel bands on the outside fastened with through bolts. The timber base should preferably be a little larger than the anvil. To preserve the timbers coat them with oil of tar or creosote. The tops of the timbers should be dazed off evenly to obtain a level surface for the anvil. Another method of making a foundation of this kind, for small and medium sized hammers, is to put the timbers upon a foot or more of gravel rammed down on a hard-pan bottom. When the timbers, which are also placed endwise and bolted, are in position, the space around the sides is filled with gravel tightly rammed.

Foundation for Steam Hammer.—To secure the greatest efficiency from steam power hammers, the foundations on which they are mounted must be solid concrete resting upon hard-pan has given better results than the combination of heavy wooden beams and concrete often used. When making solid concrete foundations, there should be several inches of cement placed over the concrete, and a cushion of wood, at least 3 inches tuck, between the cement and base of the anvil, to give the necessary resiliency and prevent the concrete from being pulverized by the impact of the blows. In the front and rear of the hammer there should be openings down to the level of the anvil base, so that it can be leveled or adjusted by wedging and grouting with cement, in case it should sag or get out of alignment with the upper parts of the hammer. These openings can be covered with hatches set level with the floor.

Machine and Forge Shop Floor Materials

Machine shop floors are commonly made of wood or concrete. Probably there is no floor for the machine shop as good as one made of selected hard maple, properly laid and supported, as it wears smoothly and evenly. Concrete, however, has its advantages, the most important of which is its fire-resisting qualities. There are few objections to a wooden floor, and from the standpoint of health it is generally considered superior to concrete. Where there is much heat, or large quantities of moisture or chemicals in bulk, wooden doors should not be used. In certain classes of store-rooms, or where there is a likelihood of considerable moisture, as in wash rooms, concrete floors are considered superior to wood.

Concrete and Wooden Floors.—The following information on shop floors and their materials is abstracted from a paper by Mr. L. C. Wason read before the American Society

of Mechanical Engineers. While the factor of cost is to be considered first, very often the maintenance and adaptability for the particular Service required is of first importance. The initial cost of a granolithic floor surface is at no disadvantage compared with a wooden floor, as the cost of such a surface laid in the best manner is about equal to the cost of seven-eighths maple flooring. In addition, the granolithic surface is fire-proof and will not decay or disintegrate as the result of moisture, which is one of the weak points of the wooden floor. On the other hand, a wooden floor is more easily repaired than a granolithic surface. In making a comparison between wooden and granolithic floors, it is also necessary to consider the workmanship. With a maple top floor, the wearing quality depends comparatively little on the skill of the one who lays the floor, but with a granolithic finish, the work must be done care fully and intelligently. Among the objections to the granolithic surface, one of the most prominent is the bad effect of a concrete floor upon the health and comfort of the workmen. This is not due to the hardness of the floor, but rather to its heat conductivity. When a workman stands for hours on a concrete floor, the heat of the body is conducted to the floor quite rapidly, which tends to disarrange the circulation and cause physical ailments, such as rheumatism, etc. For men working steadily at machines, and usually in one position, this objectionable feature can be overcome by the use of insulating foot-boards or wooden gratings upon which to stand.

The dust produced by the wear of some granolithic surfaces has proved harmful to delicate machinery, whereas a wooden floor does not of itself produce a dust capable of any appreciable abrasive action. It is possible, however, by gluing battleship linoleum to concrete floors, to obtain many of the advantages of a wooden surface. Linoleum is also an effective insulation against the loss of bodily heat. High resistance to wear and practically complete dustlessness can be secured in a granolithic surface if properly made. To secure a durable and practically dustless floor, proceed as follows: Do not use sand, as sand grains are quickly broken by abrasion and form dust. The granolithic finish should contain the highest possible proportion of tough stone aggregate. Use stone suitable for macadam road, and of a size that will pass through a half-inch round mesh screen, but use nothing smaller than that passed by a 20-mesh screen. Mix the concrete dry, and of a consistency for making blocks, so that considerable tamping will be required to bring enough water to the surface for troweling. Finally, do the troweling before the mortar sets. Prolonged troweling of a wet mixture brings to the top the "laitance" of the concrete, which is the part incapable of a true set. A top layer of laitance is therefore porous and wears down quickly. Even the fine particles of good cement should not be brought to the surface, as they form a layer which is weakly bonded to the rest of the concrete and wears away rapidly, appearing in the air as dust.

Prevent Dust on Concrete Floors.—The Aberthaw Construction Co. of Boston, contracting engineers specializing in concrete, recommends the following method of curing a dusty concrete floor: Have the surface entirely dry; then paint it with a mixture of boiled linseed oil thinned with gasoline. Apply several coats, until the oil shows glossy on the top. The theory of this is that the linseed oil, having been boiled, has lost most of its volatile components and is practically permanent. The gasoline thins this down enough so that it will strike into the pores. A little experimenting will show the proper proportions. The thinner it is, the more coats will be required and the deeper it will strike in. A floor that is causing serious trouble from dust can often be cured with very little trouble and expense in this way.

Floors for Forge Shops.—There is considerable difference in opinion as to the best material for blacksmith shop flooring. Wood is too inflammable, bricks crack and break from the heat, cement or concrete has the same objectionable features, and asphalt is out of the question. Perhaps nothing is superior to or cheaper than dirt mixed with ashes. If kept moist by sprinkling at least once a day, it is more comfortable to stand upon than the other materials mentioned. It is easily repaired and leveled in case holes are worn in it, and is not affected by dropping heavy or hot pieces upon it. The space between the walls and forges,

however, may be covered with concrete to facilitate the handle of such appliances as portable surface-plates and vises.

Drop-Forging Dies

Steel for Drop-forging Dies.—Practically all drop-forging dies are made of high-grade open-hearth steel. A 60-point carbon steel is mostly used, although steel as low as 40-point and as high as 85-point carbon is employed in some cases. A special hardening treatment is required for the low-carbon steel, which more than offsets the saving in price, and, except in special cases, there is no advantage in using high-carbon steels, owing to the expense. The average 60-point carbon steel die, if properly hardened, should last for from 15,000 to 40,000 forgings, and sometimes as many as 70,000 forgings can be made from one set of dies. When making dies for large forgings, it is often thought advisable to use 80-point carbon steel, and not harden the dies. This obviates the danger from “checking” or cracking in hardening, and the un-hardened steel is hard enough to resist the tendency to stretch. A steel that is quite high in carbon should always be used for dies that are intended for making forgings from tool steel or any other hard steel.

Allowance for Shrinkage.—When making dies for small cold-trimmed steel forgings, the proper allowance for shrinkage is $\frac{3}{16}$ inch to the foot, or 0.015 inch to the inch. Such forgings are finished at a bright red heat and the rate of shrinkage is considerable. When making dies for hot-trimmed steel forgings of medium and large sizes, the shrinkage allowance is $\frac{1}{8}$ inch to the foot, or 0.010 inch to the inch. Hot-trimmed forgings receive the finishing blow while comparatively cold, and shrink a smaller amount than the cold-trimmed forgings. The foregoing allowances are used for all dimensions of the die impression, such as depth, width or length. The shrinkage allowance for dies to be used in forging bronze or copper is practically the same as that for steel.

Draft Allowance.—The amount of draft in a drop-forging die varies from 3 to 10 degrees. If the die is for a thin forging of uniform section, 3 degrees is ample, but if the forging is deep and has narrow ribs which are apt to stick, at least 7 degrees is necessary. If a die is used for forging a piece that is ring-shaped or has an annular part, the central plug that forms the interior of the ring should have a draft of 10 degrees, because, as the forging cools while being worked, it tends to shrink around the plug and if the draft is insufficient, it will stick in the die. With the foregoing exception, most drop-forging dies have a 7-degree draft. For convenience in laying out, it is well to remember that a 7-degree taper is approximately equal to a $\frac{1}{8}$ -inch taper to the inch, and a 10-degree taper, $\frac{3}{16}$ inch to the inch.

Locating Impression in the Die.—When laying out a drop-forging die, the impression should be located so that the heaviest end of the forging will be at the front of the die-block. This makes the forging easier to handle and also permits the use of a fairly large sprue. There should be at least $1\frac{1}{2}$ inch left all around between the impression and the outside edge of the block. This also holds true for any part of the die, such as the edger, anvil or forming impression. If the forging has a hub or other projection that extends some distance from the main part on one side, the upper or top die should contain this deeper impression.

Obtaining Weight of Forging from Lead Proof.—After the upper and lower dies have been completed, shrinkage allowances and the general finish of the impressions are ordinarily tested by taking a “lead proof,” and by weighing the lead, an approximate idea of the weight of the finished forging can be obtained. Roughly speaking, the finished forging will weigh two-thirds as much as the lead proof. The shrinkage of lead is practically the same as that of steel, so that the finished forging will also measure about the same as the one made of lead. In case of dies for eye-bolts and similar work, this rule must be disregarded, because the plugs that form the central opening will prevent the lead from shrinking naturally. When taking the lead proof, the die impressions are dusted with powdered chalk, and after the dies are clamped together, the molten lead is poured.

Amount of Flash for Drop-forging Dies.—Theoretically, there should be just enough forging metal in a die to fill the impression, and no more, but this is, of course, not practicable, as there is always some stock that must be disposed of after the impression is filled. To take care of this excess metal, dies are relieved all around the impression by milling a flat shallow recess about $\frac{1}{64}$ inch deep and $\frac{5}{8}$ inch wide. These dimensions are for dies of average size; in comparatively large dies this recess or “flash” would be a little deeper and wider. Both the upper and lower dies are flashed in this way. In addition, the upper die is “back-flashed,” which means that there is a deeper recess, sometimes called the “gutter,” milled around the impression at a distance of $\frac{1}{4}$ inch from the impression at every point. This back-flash is $\frac{3}{64}$ inch deep and acts as a relief for the excess metal after it has been squeezed from the flash proper. Only the finishing impression is provided with a flash and back-flash.

The Break-down of Drop-forging Dies.—The width of section used as a break-down (also known as the edger or side cut) should be enough wider than the forging to give plenty of room for the work of forging. A forging 1 inch thick should have a break-down $1\frac{1}{2}$ inch wide, and about the same proportions should be followed for forgings of other widths. The break-down should have a section corresponding with the gate and sprue of the die impression, but it should be made slightly longer, so that the forging will not be stretched when struck in the impression.

Hardening Drop-forging Dies.—Dies to be carburized should always be packed for hardening in cast-iron or sheet-iron boxes containing a mixture of fresh bone and charcoal. The ordinary mixture is half bone and half charcoal. More bone gives greater hardness and more charcoal, less hardness, for a given heat; hence, the proportions should be varied according to requirements. The die should be packed face down on a one- or two-inch layer of this mixture and be settled so that the impression is filled. Sometimes the face is coated, before packing, with a thick paste of linseed oil and powdered bone-black, to protect the delicate edges from oxidation when in contact with the air. Fill the space between the sides of the die and the box with the bone and charcoal mixture, and cover over with a thick layer of wet clay paste to prevent the charcoal from burning out. Dies made of steel having less than 60-point carbon content should always be carburized. Open-hearth steel dies containing 60-point carbon or over can be hardened without carburizing.

Heating the Die.—An oil or gas furnace is recommended for heating, although a coal or coke-fired muffle furnace, capable of maintaining a temperature of at least 1600 degrees F., may be used, provided the temperature can be held constant. A temperature indicating device is necessary. The die should be put into the furnace as soon as the latter is lighted. If the correct quenching temperature for the steel is, say, 1500 degrees F., the furnace should be checked when the pyrometer indicates 1400 degrees, the die being allowed to “soak” at that heat for three or four hours. Then the heat should be slowly raised to 1500 degrees and held at that point one or two hours longer, according to the size of the die. Five hours is the minimum total time for heating, and seven or eight hours is much safer. A 60-point carbon die should be quenched between 1425 and 1450 degrees F.

Cooling the Heated Die.—When cooling, the face of the die should receive a sufficient flow of cold water to cause it to harden to the greatest possible depth. The back of the die should, at the same time, be cooled to make the shrinkage of the face and back equal, and to prevent warping. A good form of cooling tank is one having a large supply pipe extending up through the bottom for cooling the die face, and a smaller pipe above the tank to cool the back. Unless a jet of water under pressure is applied to the face of the die, the sunken parts of the impression will not harden equally with the face. Dies should not be cooled in a tank of still water, because steam forms in the die cavity which prevents the water from entering, thus causing the formation of soft spots. To overcome this, the water must be forced into the impression by pressure sufficient to overcome the resistance of the steam thus formed. Oil should not be used for hardening hammer dies, as its cooling action is not great

enough to produce a sufficient depth of hardening. Hammer dies which are simply surface hardened will not withstand the heavy blows received in service. To secure a greater hardening effect, brine of about 40 per cent solution is used by some die-makers.

Tempering Dies.—Dies should be tempered and drawn as soon as they are cool enough to remove from the tank. The dies should be heated in an oil bath, and quenched in water or cool oil. Any high-grade cylinder oil of high flash-point is suitable. Low-grade oils smoke unpleasantly and will not stand high temperatures. The drawing temperature of die steels is about 450 degrees F., for average conditions. The corners of the die and the cut-off should be drawn to a purple color with the aid of a blow torch.

Tempering by the Color Method.—Hardened steel can be tempered or made softer and less brittle by re-heating it to a certain temperature (depending upon the nature of the steel and its intended use), and then cooling. When steel is tempered by the color method, the temper is gaged by the colors formed on the surface as the heat increases, but the color method of gaging temperatures is not dependable, as the color is affected, to some extent, by the composition of the metal. The modern method of tempering, especially in quantity, is to heat the hardened parts to the required temperature in a bath of molten lead, heated oil or other liquids; the parts are then removed from the bath and quenched. The bath method makes it possible to heat the work uniformly, and to a given temperature within close limits.

High Temperatures Judged by Color, and Colors for Tempering

Degrees Centi-grade	Degrees Fahrenheit	High Temperatures Judged by Color	Degrees Centi-grade	Degrees Fahrenheit	Colors for Tempering
400	752	Red heat, visible in the dark	221	430	Very pale yellow
474	885	Red heat, visible in the twilight	227	440	Light yellow
525	975	Red heat, visible in the daylight	232	450	Pale straw-yellow
581	1077	Red heat, visible in the sunlight	238	460	Straw-yellow
700	1292	Dark red	243	470	Deep straw-yellow
800	1472	Dull cherry-red	249	480	Dark yellow
900	1652	Cherry-red	254	490	Yellow-brown
1000	1832	Bright cherry-red	260	500	Brown-yellow
1100	2012	Orange-red	266	510	Spotted red-brown
1200	2192	Orange-yellow	271	520	Brown-purple
1300	2372	Yellow-white	277	530	Light purple
1400	2552	White welding heat	282	540	Full purple
1500	2732	Brilliant white	288	550	Dark purple
1600	2912	Dazzling white (bluish-white)	293	560	Full blue
			299	570	Dark blue

Dies for Bronze and Copper Forgings.—Dies for producing drop-forgings from bronze or copper differ from those used for steel or iron forgings principally in the matter of finish. Owing to the softness of copper and bronze, the metal is driven into very minute impressions in the surface of the dies; hence, these surfaces must be perfectly free from scratches, in order to insure a smooth finish on the work. Even though these metals are soft, the hammering necessary when forging is very hard on the dies, and to prevent them from dishing or spreading, tool steel is ordinarily used, unless the forgings are extra large and heavy. The shrinkage, draft and finish allowances on this class of drop-forging dies are practically the same as on dies for steel and iron.

Trimming Dies for Drop-forgings.—Hot-trimming dies are made of a special grade of steel known as hot-trimming die-stock. The objection to use ordinary tool steel for hot-trimming dies is that the edges of a hardened die check badly after the die has been used for a short time, and this checking is followed by a breaking away of the steel around the edges, thus rendering the die unfit for use. This special steel requires no hardening, and after the die is in use, the edges toughen and give better service than the best hardened tool steel. The usual form of punch for hot-trimming dies merely supports the forging while it is being pushed through. If the forging has a broad, flat top face, the punch need only be a little more

than a flat piece that covers the forging and acts as a pusher. Such punches are commonly made of cast iron. Cold-trimming dies are made from good tool steel of from 1.00 to 1.25 per cent carbon, and hardened and drawn to a dark straw color. The punches for cold trimmers are also made of tool steel and are hardened and drawn to a very dark straw color. These punches are hardened to prevent them from upsetting at the edges. As with hot-trimming punches, the punch should fit the die loosely, but it should support the forging at every point while it is being pushed through the die. There are two instances in which trimming punches should fit the dies as closely as the average punching die for sheet metal work; first, when trimming forgings on which the fin comes at the corner of the forging; second, forgings that are formed all in one die, the other die being flat. In these two cases, unless the dies fit very well, there will be burrs at the trimmed edges.

Standard Tolerances for Forgings.—The tolerances adopted by the Drop Forging Association in 1937 (see accompanying [Tables 1a](#) through [1e](#)) apply to forgings under 100 pounds each. Forging tolerances may either be “special” or “regular.” *Special tolerances* are those which are particularly noted in the specifications and may state any or all tolerances in any way as required. Special tolerances apply only to the particular dimensions noted. In all cases where special tolerances are not specified, regular tolerances apply.

**Table 1a. Standard Tolerances for Forgings Adopted, 1937,
by Drop Forging Association for Forgings under 100 Pounds Each**

Thickness Tolerances, Inch ^a									
Net Weights, Pounds, up to –	Commercial		Close		Net Weights, Pounds, up to –	Commercial		Close	
	–	+	–	+		–	+	–	+
.2	.008	.024	.004	.012	20	.026	.078	.013	.039
.4	.009	.027	.005	.015	30	.030	.090	.015	.045
.6	.010	.030	.005	.015	40	.034	.102	.017	.051
.8	.011	.033	.006	.018	50	.038	.114	.019	.057
1	.012	.036	.006	.018	60	.042	.126	.021	.063
2	.015	.045	.008	.024	70	.046	.138	.023	.069
3	.017	.051	.009	.027	80	.050	.150	.025	.075
4	.018	.054	.009	.027	90	.054	.162	.027	.081
5	.019	.057	.010	.030	100	.058	.174	.029	.087
10	.022	.066	.011	.033					

^a Thickness tolerances apply to the over-all thickness. For drop-hammer forgings, they apply to the thickness in a direction perpendicular to the main or fundamental parting plane of the die. For upset forgings, they apply to the thickness in the direction parallel to the travel of the ram, but only to such dimensions as are enclosed by the actually formed by the die.

**Table 1b. Standard Tolerances for Forgings Adopted, 1937,
by Drop Forging Association for Forgings under 100 Pounds Each**

Shrinkage		Plus		Die Wear		Mismatching		
Lengths or widths up to - in.	Commercial + or -	Close + or -	Net wt. up to - lbs.	Commercial + or -	Close + or -	Net Weights, Pounds, up to -	Commercial	Close
1	.003	.002	1	.032	.016	1	.015	.010
2	.006	.003	3	.035	.018	7	.018	.012
3	.009	.005	5	.038	.019	13	.021	.014
4	.012	.006	7	.041	.021	19	.024	.016
5	.015	.008	9	.044	.022	25	.027	.018
6	.018	.009	11	.047	.024	31	.030	.020

For each additional inch under shrinkage, add 0.003 to the commercial tolerance and 0.0015 to the close tolerance. For example, if length or width is 12 inches, the commercial tolerance is plus or minus 0.036 and the close tolerance plus or minus 0.018.

For each additional 2 pounds under die wear, add 0.003 to the commercial tolerance and 0.0015 to the close tolerance. Thus, if the net weight is 21 pounds, the die wear commercial tolerance is 0.062 plus or minus, and the close tolerance 0.031 plus or minus.

For each additional 6 pounds under mismatching, add 0.003 to the commercial tolerance and 0.002 to the close tolerance. Thus, if the net weight is 37 pounds, the mismatching commercial tolerance is 0.033 and the close tolerance 0.022.

**Table 1c. Standard Tolerances for Forgings Adopted, 1937,
by Drop Forging Association for Forgings under 100 Pounds Each**

Draft angle tolerances — the permissible variations from the standard or nominal draft angle							
Drop-Hammer Forgings				Upset Forgings			
Location of Surface	Nominal Angle Degrees	Commercial Limits	Close Limits	Location of Surface	Nominal Angle Degrees	Commercial Limits	Close Limits
Outside	7	0-10	0-8	Outside	3	0-5	0-4
Holes and Depressions }	10	0-13	...	Holes and Depressions }	5	0-8	0-7
	7	...	0-8				

**Table 1d. Standard Tolerances for Forgings Adopted, 1937,
by Drop Forging Association for Forgings under 100 Pounds Each**

Quantity Tolerances					
Number of Pieces on Order	Permissible Variation		Number of Pieces on Order	Permissible Variation	
	Over-run, Pieces	Under-run, Pieces		Over-run, Per cent	Under-run, Per cent
1 - 2	1	0	100 - 199	10	5.0
3 - 5	2	1	200 - 299	9	4.5
6 - 19	3	1	300 - 599	8	4.0
20 - 29	4	2	600 - 1,249	7	3.5
30 - 39	5	2	1,259 - 2,999	6	3.0
40 - 49	6	3	3,000 - 9,999	5	2.5
50 - 59	7	3	10,000 - 39,999	4	2.0
60 - 69	8	4	40,000 - 299,999	3	1.5
70 - 79	9	4	300,000 up	2	1.0
80 - 99	10	5			

These quantity tolerances represent the permissible over-run or under-run allowed for each release or part shipment of an order. Any shipping quantity within the limits of over-run or under-run shall be considered as completing the order.

**Table 1e. Standard Tolerances for Forgings Adopted, 1937,
by Drop Forging Association for Forgings under 100 Pounds Each**

Maximum Radii of Fillets and Corners, Inch					
Net Weights, Pounds, up to —	Commercial	Close	Net Weights, Pounds, up to —	Commercial	Close
.3	$\frac{3}{32}$	$\frac{3}{64}$	10	$\frac{3}{16}$	$\frac{3}{32}$
1	$\frac{1}{8}$	$\frac{1}{16}$	30	$\frac{7}{32}$	$\frac{7}{64}$
3	$\frac{5}{32}$	$\frac{5}{64}$	100	$\frac{1}{4}$	$\frac{1}{8}$

Regular tolerances: are divided into two divisions — “Commercial Standard” and “Close Standard.” “Commercial Standard” tolerances are for general forging practice, but when extra close work is desired involving additional expense and care in the production of forgings, “Close Standard” may be specified. When no standard is specified, “Commercial Standard” shall apply.

Regular tolerances are applicable to 1) thickness; 2) width, including shrinkage and die wear, mismatching, and trimmed size; 3) draft angle; 4) quantity in shipment; and 5) fillets and corners.

Thickness Tolerances: Thickness tolerances shall apply to the overall thickness of a forging. (See [Table 1a.](#))

Width and Length Tolerances: Width and length tolerances shall be alike and shall apply to the width or length of a forging. When applied to drop hammer forgings, they shall apply to the width or length in a direction parallel to the main or fundamental parting plane of the die, but only to such dimensions as are enclosed by and actually formed by the die. When applied to upset forgings, they shall apply to the width or length in a direction perpendicular to the direction of travel of the ramp.

Width and length tolerances consist of the three subdivisions following: a) Shrinkage and die wear tolerance; b) mismatching tolerance; and c) trimmed size tolerance.

Welding Methods

Classes of Welds.—Welds are classified according to the way the ends are formed prior to making the weld. The different welds ordinarily made in hand forging practice are the scarf weld, butt weld, lap weld, cleft or split weld and jump weld. These welds are shown by the accompanying illustration. It will be seen that the surfaces, in most instances, are rounded or crowned. This is done so that when the heated ends are brought together they will unite first in the center. Any slag or dirt which may have adhered to the heated surfaces will then be forced out as the welding proceeds from the center outward. When making a lap weld, the hammering should begin at the center in order to work all the slag out, as the faces in this case are not rounded.

Welding Heat.—When two pieces of wrought iron or mild steel are heated until they become soft and plastic and will stick together when one is pressed or hammered against the other, they have reached what is commonly known as a welding heat. The quality of the weld depends largely upon the welding heat. If the ends to be heated are not hot enough, they will not stick together; inversely, if the work remains in the fire too long, it becomes overheated and burned, which greatly injures the metal. Iron which has been overheated has a rough, spongy appearance and is brittle. The danger of burning is increased when the air blast is too strong and the fire is oxidizing. It is important to heat the work slowly to secure a uniform temperature throughout the ends to be heated. With rapid heating, the out-

side may be raised to the welding temperature, while the interior is much below it; consequently, the weld will be defective.

Fire for Welding.—When heated iron comes into contact with the air it absorbs oxygen, thus forming a scale or oxide of iron on the surface, which prevents the formation of a good weld. A fire for heating parts to be welded should have a fairly thick bed between the tuyere and the work, so that the oxygen in the air blast will be consumed before it reaches the parts being heated. When there is only a thin bed of fuel beneath the work, or if too strong a blast is used, the excess of oxygen will pass through and oxidize the iron. The hotter the iron, the greater the formation of scale. The surface being heated can be given an additional protection by covering it with some substance that will exclude the air. (See *Fluxes for Welding*.) Ordinarily, the air blast for a forge fire should have a pressure varying from 3 to 6 ounces per square inch. (See *Air Pressures and Pipe Sizes for Forges* on page 3233.)

Fluxes for Welding.—When iron is being heated preparatory to welding, the heated surfaces are oxidized to some extent or covered with oxide of iron, which forms a black scale when the hot iron comes into contact with the air. If this scale is not removed, it will cause a defective weld. Wrought iron can be heated to a high enough temperature to melt this oxide so that the latter is forced out from between the surfaces by the hammer blows; but when welding machine steel, and especially tool steel, a temperature high enough to melt the oxide would burn the steel, and it is necessary to use what is called a flux. This is a substance, such as sand or borax, having a melting temperature below the welding temperature of the work, and it is sprinkled upon the heated ends when they have reached about a yellow heat. The flux serves two purposes: It melts and covers the heated surfaces, thus protecting them from oxidation, and, when molten, aids in dissolving any oxide that may have formed, the oxide melting at a lower temperature when combined with the flux. Wrought iron can be welded in a clean, well-kept fire without using a flux of any kind, except when the material is very thin. The fluxes commonly used are fine clean sand and borax. When borax is used, it will give better results if burned. This can be done by heating it in a crucible until reduced to the liquid state. It should then be poured onto a flat surface to form a sheet; when cold, it can easily be broken up and pulverized. The borax powder can be used plain or it can be mixed with an equal quantity of fine clean sand and about 25 per cent iron (not steel) filings. For tool steel, a flux made of one part sal-ammoniac and twelve parts borax is recommended. When pieces are put together previous to welding, as in split welds, or when taking a second heat (usually termed a "wash"), a flux that will flow easily should be used. There are many welding compounds on the market, some of which are suited for one class of welding and some for another.

Steel which is very low in carbon can easily be welded, but it cannot be hardened; when the carbon is above 0.33 per cent, welding is more difficult and can be done only by the use of borax or some other flux, or by the electric or thermit processes.

Welding, Resistance Forge.—Resistance forge-welding is a process of heavy-duty electric resistance welding which enables the spot-welding of structural steel and iron sections formerly considered impossible to weld with conventional equipment. The method consists of first applying pressure to the work, then interrupted current, and finally superimposing a hammering action on the electrode. Under high pressure and with sufficient heat, the surfaces of the work are brought into intimate contact, so that when additional impact pressure and intermittent heat are applied, a forged weld of superior quality is obtained.

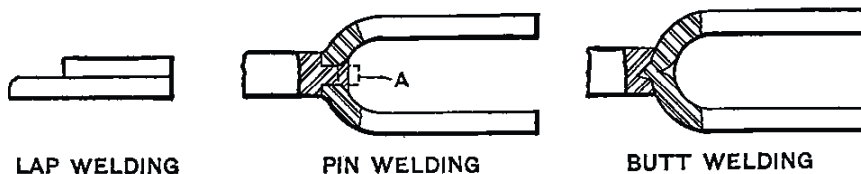
Fuels for Forge.—Coke, coal, charcoal, oil and gas are used as fuels for heating iron and steel preparatory to forging or welding. For general work, a coke fire is the best, although bituminous coal is extensively used. With anthracite coal, it is difficult to get a hot enough fire, especially on a small forge. Coke or bituminous coal should be low in sulphur, because sulphur makes the iron "hot short" or brittle while hot. Sulphur, lead, bronze or brass must not be in the fuel or fire to be used for heating iron or steel. A weld may be spoiled by throwing brass filings into a fire before heating the work.

Machine Welding.—There are three common types of welds that can be made satisfactorily in a forging machine, simple examples of which are shown in the accompanying illustration.

Lap-welding: This is one of the most successful methods that can be used in joining pieces together in a forging machine, whenever requirements will permit. There are several applications of this type of welding: Two pieces can be joined together (as shown in the illustration) or several pieces can be welded together in one block. Machine lap-welding is also employed for enlarging the diameter of a bar, this being accomplished by welding a U-shaped piece of rectangular stock to the end, and then upsetting the mass into the shape desired. An end plunger is used to upset the bar after the latter is securely held between the opposing faces of the gripping dies.

Pin-welding: In order to make a pin weld, the end of the bar is reduced and inserted in a hole in the part to which it is to be joined (see illustration). The reduced end is usually made from one-quarter to one-half the diameter of the original bar. The U-shaped piece, or other part which is to be joined to it, is generally made thicker where the weld is made, in order to strengthen the weld. The welding operation is effected by a plunger in the ram of the machine, which upsets the "pin" and at the same time forms the joint.

Butt-welding: This method of machine welding is not as common as the other two methods referred to, but is satisfactory when properly applied. To make a butt weld, it is not necessary to prepare the stock beforehand, although the pieces should have practically the desired shape. The weld is effected by a plunger having a pointed end which is forced through the forward member to be joined, thus closely pressing together the material and insuring a solid weld (see illustration).



This method of welding is not considered as practicable as pin-welding, but when properly handled, it is satisfactory for many classes of work. Wrought iron is welded in a forging machine without using any flux but the parts to be joined must be clean and free from scale. As a rule, compressed air is used to remove the scale formed by oxidization. A small jet of air is directed against the work just before the machine is operated. For welding steel having a comparatively high carbon content, it is necessary to use a flux to make a satisfactory weld. (See *Fluxes for Welding*.)

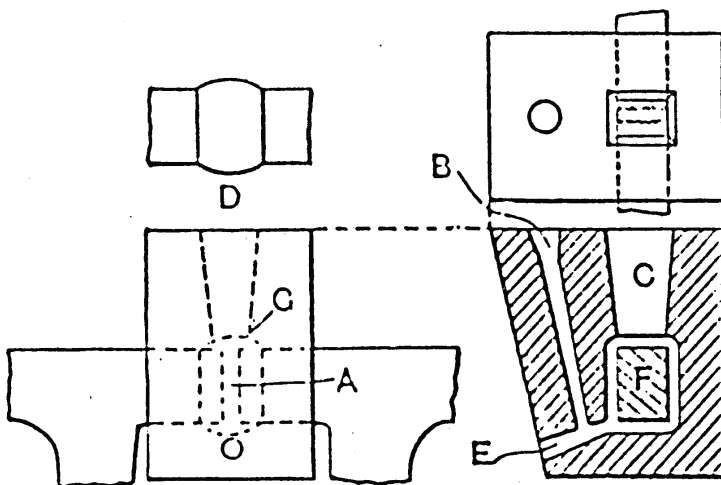
Welding with Thermit

Thermit Process.—This process of welding metals is effected by pouring superheated thermit steel around the parts to be united. Thermit is a mixture of finely divided aluminum and iron oxide. This mixture is placed in a crucible and the steel is produced by igniting the thermit in one spot by means of a special powder, which generates the intense heat necessary to start the chemical reaction. When the reaction is once started it continues throughout the entire mass, the oxygen of the iron being taken up by the aluminum (which has a strong affinity for it), producing aluminum oxide (or slag) and superheated thermit steel. ordinarily, the reaction requires from 35 seconds to one minute, depending upon the amount of thermit used. As soon as it ceases, the steel sinks to the bottom of the crucible and is tapped into a mold surrounding the parts to be welded. As the temperature of the steel is about 5400 degrees F., it fuses and amalgamates with the broken sections, thus forming a homogeneous weld.

It is necessary to pre-heat the sections to be welded before pouring, to prevent chilling the steel. The principal steps of the welding operation are, to clean the sections to be welded, remove enough metal at the fracture to provide for a free flow of thermit steel, align the broken members and surround them with a mold to retain the steel, pre-heat by means of a gasoline torch to prevent chilling the steel, ignite the thermit and tap the molten steel into the mold. This process is especially applicable to the welding of large sections. It has been extensively used for welding locomotive frames, broken motor casings, rudder- and stern-posts of ships, crankshafts, spokes of driving wheels, connecting rods, and heavy repair work in general. One of the great advantages of the thermit process is that broken parts can usually be welded in place. For example, locomotive frames are welded by simply removing parts that would interfere with the application of a suitable mold. Thermit is also used for pipe welding, rail welding, and in foundry practice, to prevent the "piping" of ingots.

Preparation of Part to be Welded.—The first step in the operation of thermit welding is to clean the fractured parts and cut away enough metal to insure an unobstructed flow of the molten thermit. The oxy-acetylene or oxy-hydrogen cutting torch is very efficient for this operation. The amount that should be cut away depends upon the size of the work. Assuming that a locomotive frame is to be welded, the space should be about $\frac{3}{4}$ inch wide for a small frame, and 1 inch wide for a large frame. The frame sections are then jacked apart about $\frac{1}{4}$ inch to allow for contraction of the weld when cooling; trammel marks are scribed on each side of the fracture to show the normal length. If the weld is to be made on one member of a double-bar frame, the other parallel member should be heated with a torch to equalize the expansion in both sections and prevent unequal strains.

Mold for Thermit Welding.—The mold surrounding the fractured part should be so arranged that the molten thermit will run through a gate to the lowest part of the mold and rise through and around the parts to be welded into a large riser. The accompanying illustration shows a mold applied to a locomotive frame that is broken between the pedestals at *A*. The thermit steel is poured through gate *B*, and rises into space *C* after passing around and between the ends of frame *F*. The mold must allow for a reinforcing band or collar of thermit steel to be cast around the ends to be welded. Space *G*, for forming this collar, and the opening between the frame ends, must be filled before ramming up the mold. Yellow wax is ordinarily used for this purpose. The shape of this band or collar should be as indicated by the view of the completed weld at *D*. The thickest part is directly over the fracture and the band overlaps the edges of the fracture at least one inch.



For a frame of average size, the collars are made about 4 inches wide and 1 inch thick at the center, the thickness being increased for comparatively large sections. An opening is also made at *E* for pre-heating the ends to be welded.

Patterns for the riser, pouring and heating gates can be made of wood. The riser *C* should be quite large because the steel that first enters the mold is chilled somewhat by coming into contact with the metal, even when pre-heated. This chilling effect is overcome by using enough thermit steel to force the chilled portion up into the riser and replacing it by metal which has practically the full temperature received during reaction. The mold must be made of a refractory material, owing to the intense heat. The best material is made of one part fire sand, one part fire-clay and one part ground firebrick, thoroughly mixed while dry and moistened just enough to pack well. If these ingredients cannot be obtained, one part fire-clay and one part clean, dry sand may be used. When the mold and box are filled and tamped, the wooden runner and riser patterns are withdrawn. The mold is then ready for the pre-heating and drying operation which causes the wax matrix to melt and run out.

Thermit Required for Welding.—The quantity of thermit required for making a weld can be determined from the cubic contents of the weld. Calculate the cubic contents of the weld and its reinforcement in cubic inches; double this amount to allow for filling the gate and riser, and multiply by 0.56 to get the number of pounds of thermit required. When wax is used for filling, the weight of the thermit can be determined as follows: Weigh the wax supply before and after filling the fracture. The difference in weight in pounds, or the quantity used, multiplied by 32 will give the weight of thermit in pounds.

Thermit Additions.—When a quantity of more than 10 pounds of thermit is to be used, add 10 per cent of steel punchings (not over $\frac{1}{2}$ inch in diameter) or steel scrap, free from grease, into the thermit powder. If the thermit exceeds 50 pounds, 15 per cent of small mild steel rivets may be mixed with it. One per cent (by weight) of pure manganese and 1 per cent of nickel - thermit should be added to increase the strength of the thermit steel.

Pre-heating — Making a Weld.—The ends to be welded should be red hot at the moment the thermit steel is tapped into the mold. This pre-heating is done, preferably, by a gasoline, compressed-air torch, and, as previously mentioned, it melts the wax matrix used for filling the fracture to form the pattern for the reinforcing band. When the ends have been heated red, quickly remove the torch and plug the pre-heating hole *E* with a dry sand core, backing it up with a few shovelfuls of sand, well packed. The end of the cone-shaped crucible should be directly over the pouring gate and not more than 4 inches above it. To start the reaction, place one-half teaspoonful of ignition powder on top of the thermit and ignite with a storm match. It is important that sufficient time be allowed for the completion of the thermit reaction and for fusion of the steel punchings which have been mixed within the thermit. Within charges containing from 30 to 50 pounds of thermit, the crucible should not be tapped in less than 35 seconds; with charges containing from 50 to 75 pounds, 40 seconds; 75 to 100 pounds, 50 seconds to one minute.

When welding a frame broken as shown in the illustration previously referred to, the screw jack used for forcing the pedestals apart should be turned back somewhat to release the pressure gradually as the weld cools. After pouring, the mold should remain in place as long as possible (preferably 10 or 12 hours) to anneal the steel in the weld, and, in any case, it should not be disturbed for at least two hours after pouring.

When welding a broken spoke in a driving wheel, or a similar part, it is necessary to pre-heat the adjacent spokes in order to prevent undue strains due to expansion and contraction. If a section of a spoke is broken out, it can be cast in, but if the space is over 6 inches long, it is better to insert a piece of steel and make a weld at each end. Owing to the high temperature (5400 degrees F.) and the violent ebullition of thermit during reaction, the crucible must be lined with a very refractory material. The crucibles used for this purpose have a sheet-iron shell and are lined with magnesia.

Filling Shrinkage Holes and Surface Flaws.—The filling of surface flaws in castings and forgings usually requires from 2 to 10 pounds of thermit. To make a weld of this kind, place an open mold around the part to be filled, large enough to overlap it about $\frac{1}{2}$ inch. Clean the hole thoroughly and heat to a red heat by means of a strong blow-torch. Use eigh-

teen ounces of thermit for each cubic inch of space to be filled, but do not use less than two pounds for any one weld. Place a small amount of thermit in the crucible which, in this case, is of a small size for hand use. Ignite the thermit with ignition powder and as soon as it begins to burn, add the remainder, feeding it fast enough to keep the combustion going. When the reaction is completed, quickly pour the slag (which is about three-fourths of the total liquid) into dry sand; then pour the steel into the open mold and sprinkle loose thermit on top to prolong the reaction, as the casting, even when pre-heated, will have a chilling effect on the steel.

Composition of Thermit Steel.—An average analysis of thermit steel is as follows: carbon, 0.05 to 0.10 per cent; manganese, 0.08 to 0.10 per cent; silicon, 0.09 to 0.20 per cent; sulphur, 0.03 to 0.04 per cent; phosphorus, 0.04 to 0.05 per cent; aluminum, 0.07 to 0.18 per cent. The tensile strength is about 65,000 pounds per square inch.

High- and Low-pressure Torches.—The difference between high- and low-pressure welding and cutting torches, according to the generally accepted meaning of the term, is in the pressure of the acetylene. The first oxy-acetylene torches developed by Fouche were of the high-pressure type, using acetylene dissolved in acetone. Later, he developed a low-pressure torch, working on the injector principle, acetylene being drawn into the carburetor chamber where it mixed with the oxygen. The high pressures originally employed in the first torches could not be safely employed with the acetylene produced in generators, because the safe pressure of acetylene in volume should never exceed from 15 to 20 pounds per square inch, and the pressure is limited to 25 pounds per square inch by the Underwriters' Association in the United States: hence, the medium pressure which is in general use was developed. The proportion of oxygen to acetylene varies somewhat in the different torches. Usually from 1.04 to 1.12 times more oxygen is consumed than acetylene.

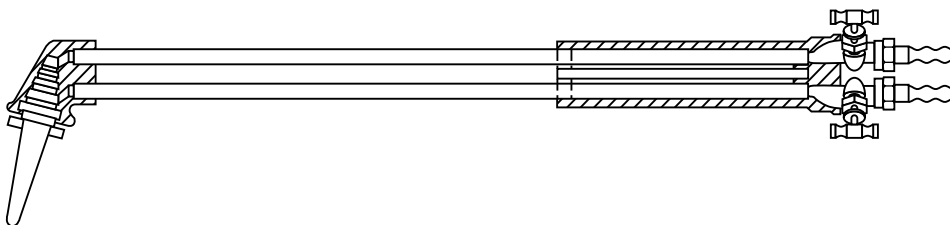
Welders and cutters should be provided with goggles or spectacles fitted with approved colored lenses that protect the eye from destructive light rays, flying sparks and globules of molten metal.

Autogenous or Gas Welding

Autogenous welding is usually defined as a process of uniting metals by fusing them together without compression or hammering and also without using a flux or adding new material to form the joint. When using a high-temperature gas flame, such as is obtained with an oxy-acetylene torch, additional material (in the form of a rod or wire) is ordinarily fused between the parts to be welded and a flux may also be used; hence, the term "autogenous welding" which has been commonly used to designate this method, is not strictly accurate and for this reason the expression "gas welding" is also used to indicate the welding of metals by means of a high-temperature gas flame.

Many different metals can be welded with an oxy-acetylene torch, although in the practical application of this method it is essential to distinguish between classes of work that can be welded on a commercial basis and work which should be done only to meet an emergency and which, under ordinary conditions, might be done more cheaply by other methods.

Welding Torch.—The intense local heat required for welding metal by the gas process is obtained by the combustion of a mixture of gases such as oxygen and acetylene or oxygen and hydrogen.



The arrangement of a Davis-Bournonville oxy-acetylene torch, suitable for medium and heavy welding, is shown by the accompanying illustration. This torch is a simple device, consisting of a handle, two needle valves, a tube for the oxygen and another tube for the acetylene, a head and a tip. The upper tube is connected with the oxygen supply and the lower one with the acetylene supply. The acetylene is admitted under lower pressure than the oxygen, and regulators on the storage tanks serve to control the working pressure of both gases. The mixing of the acetylene and oxygen gases takes place in the head of the torch, where the oxygen, flowing longitudinally, meets the cross currents of the acetylene gas flowing in through the holes in the sides. The diameter of the holes in the tip and the pressures of the respective gases determine the quality of the mixture. The diameters of the holes are graded and the tips are numbered to correspond. Those tips are interchangeable, different sizes being required for various classes of work.

Adjusting the Torch.—Before using the welding torch, it is essential to regulate the acetylene and oxygen gas pressures with reference to the thickness of metal to be welded. The accompanying table (compiled by Davis-Bournonville Co.) gives the tip number, the range of metal thicknesses for which it is suited, the acetylene and oxygen pressures and the approximate gas consumption in cubic feet per hour. When using gases from acetylene and oxygen cylinders, it is customary to increase the working pressures slightly above those given in the table, when starting to weld, in order to compensate for the loss of pressure as the gases are used from the cylinders.

The following general instructions for regulating the pressures and adjusting the flame are given by the Davis-Bournonville Co.: First, identify the oxygen and acetylene hose and their respective valves and regulators. Next, open the oxygen needle valve in the torch handle; then, open the oxygen cylinder valve very slowly. Adjust the oxygen gas regulator to obtain a working pressure suitable for the thickness of metal (see table). Close the oxygen needle valve and open the acetylene needle valve. Then, open the acetylene cylinder valve slowly. Adjust the gas regulator to obtain the required working pressure, and light the gas quickly with a “spark lighter.”

Obtaining a Neutral Flame: The oxygen and acetylene must now be adjusted to obtain a *neutral flame*, which will neither oxidize (burn) the metal nor carbonize it. When a white cone appears at the tip and beyond the cone there is a white envelope of flame with a long blue streamer flame, the combustion is unbalanced. There is insufficient oxygen and an excess of carbon in the flame. Now, if the oxygen needle valve is opened full, the white-hot cone at the tip will be very short and surrounded by a blue-white envelope. Combustion is now unbalanced because of the excess of oxygen, which combines with all of the acetylene gas available while the remainder tends to attack the metal. Combustion is accompanied by a roaring sound, and the flame is oxidizing. If the oxygen valve is closed slightly until combustion in the flame is balanced, two distinct cones will become visible. The one next to the tip is white hot and beyond is a long blue cone, which is also very hot. The sound differs from that of the carbonizing and oxidizing flames. This is the neutral flame which should be used.

Acetylene and Oxygen Pressures for Welding

Tip No.	Thickness of Metal, Inches	Acetylene Pressure, Pounds	Oxygen Pressure, Pounds	Acetylene ^a Consumption Per Hour, Cu. Ft.	Oxygen ^a Consumption Per Hour, Cu. Ft.	Tip No.	Thickness of Metal, Inches	Acetylene Pressure, Pounds	Oxygen Pressure, Pounds	Acetylene ^a Consumption Per Hour, Cu. Ft.	Oxygen ^a Consumption Per Hour, Cu. Ft.
∞	Very Light }	1	1	0.6	0.8	6	5/16-3/8	6	12	25.0	28.5
0		1	2	1.0	1.3	7	7/16-1/2	6	14	33.2	37.9
1	1/32-1/16	1	2	3.2	3.7	8	1/2-5/8	6	16	42.0	47.9
2		2	4	4.8	5.5	9	5/8-3/4	6	18	58.0	65.9
3	3/32-1/8	3	6	8.1	9.3	10	3/4-up	6	20	82.5	94.0
4		4	8	12.5	14.3	11	Extra Heavy }	8	22	89.0	101.2
5	1/4-5/16	5	10	17.8	21.3	12		8	24	114.5	130.5

^a Gas consumption per hour is the maximum with torch burning continuously.

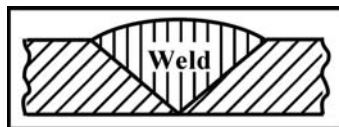
Davis-Bourmonville Style C welding torches with Style 99 and 100 tips.

Operators frequently adjust the pressure regulators from one to two pounds above the figures given in the table to allow for gage variations and drop for pressure when the gases are supplied in cylinders.

Temperatures.—The temperature of the oxy-hydrogen flame is estimated to be about 4000 degrees F., and the temperature of the oxy-acetylene flame is estimated to be about 5400 degrees F. by some authorities and as high as 6300 degrees F. by others. The exact temperatures are not known. With the oxy-acetylene flame the number of British thermal units per cubic foot is approximately five times greater than is obtained with the oxy-hydrogen flame.

Size of Torch Tip to Use.—The proper size of tip to use for welding depends upon the thickness of metal and the rate at which the heat is dissipated. Sometimes the rate of conduction and radiation is affected by the location of the parts to be welded. The tip sizes given in the accompanying table represent conservative practice, and welders are advised to use as large a tip as possible without overheating the metal, in order to weld faster and use less gas. If the flame is too small for the thickness of the metal to be welded, the heat will be radiated too rapidly.

Preparing Joint for Welding.—When material is only about 1/16 to 1/8 inch thick, it can be welded successfully when the edges are square, but when thicker plates are to be welded, it is necessary to bevel the edges to obtain the best results, as otherwise the heat of the flame suitable for welding will not penetrate and cause perfect fusion beyond a depth of, say, from 1/8 to 3/16 inch; hence, when material is thicker than about 1/8 inch, the edges are beveled and the V-shaped channel thus formed is filled by using adding material. The edges of steel and iron plate should be beveled to an angle of 45 degrees, so that when the plates are placed together, the included angle of the V-shaped channel is about 90 degrees. (See accompanying illustration.)



The angle may be smaller for brass and bronze when the work is done by experienced men. If the plates are quite thick, it is preferable to bevel and weld on both sides, the bevel extending into the center of the plate from each side. When it is necessary to weld thick material from one side only, it is advisable to reduce the included angle to about 60 degrees. Aluminum need not be beveled as much as steel, and if the plates are 1/4 inch thick or less, beveling is not necessary when a welding iron or spud is employed to break up the oxide, although experience is required to work successfully in this manner.

Provision for Expansion and Contraction.—As a general rule, 1 or 2 per cent of the length of the weld is allowed for expansion and contraction when welding two plates of steel together, especially if the weld is long. For example, if the joint is 12 inches long, the pieces should be laid so that they are $\frac{1}{4}$ inch farther apart at one end than at the end where the welding is begun; thus, there is a tapering space between them. After the parts are “tacked” together and as the welding proceeds, the molten metal cools and contracts. This contraction causes the welded section to act like a hinge, and the unwelded ends draw closer together. It is often difficult to provide for expansion and contraction when welding castings.

Welding Rods or Adding Materials.—Mild steel should be welded with a welding rod or wire that is low in carbon. A welding rod having the composition of pure Swedish iron is preferable. The use of commercial steel wire is not recommended. Cast-iron welding rods should be made from a fine grade of cast iron, high in silicon and low in manganese and sulphur. The best rods are cast in metal molds, which insure density of metal and freedom from blow-holes and sand. Cast aluminum welding rods are used on aluminum castings and the drawn rods or wire are preferable for welding rolled aluminum sheets. Brass and bronze are welded with cast welding rods and drawn bronze rods. Brass wire is not suitable as it contains too much zinc which burns out, leaving the welding material defective. The diameter of the rod or wire should be chosen with reference to the thickness of the joint and the size of the tip and flame. A small wire should not be used for welding a heavy plate.

General Procedure when Welding.—To become proficient in the art of autogenous welding requires experience and practice, but a knowledge of some of the fundamental principles will enable the operator to make more rapid progress. It is advisable to begin by welding thin strips of iron or steel not over $\frac{1}{8}$ inch in thickness. Such light metals can be welded without the addition of a filling-in material. The torch should be given a semicircular or zig-zag motion. This movement tends to blend the metal and reduces the liability of overheating. The beveled surfaces of thicker materials are heated by a semicircular movement of the flame, care being taken to melt them to a soft, plastic state without burning the metal. Wherever fusion occurs, new metal should be added from a “welding rod,” the composition of which is suitable for the work in hand. The surface should be thoroughly fused before adding metal from the welding stick, and the latter should be held close to, or in contact with, the puddle of molten metal. The heat is then radiated from the puddle to the welding rod, whereas if the metal were allowed to drop through the flame, it might be burned to an injurious extent.

Pre-heating Castings.—As a general rule, it is necessary to pre-heat all cast-iron parts before welding, although some parts of very simple form may be welded without pre-heating. The source of heat for pre-heating depends upon local conditions and the character of work. Oil burners, charcoal fires, or pre-heating stoves using oil or gas are used. A hardwood charcoal fire is sometimes used in preference to oil blow-torches. All pre-heated parts should be covered with asbestos paper as much as possible during pre-heating and welding, and the welded section should be immediately protected from radiation and rapid cooling after welding.

Welding Cast Iron.—It is highly important to pre-heat all cast iron before welding except possibly very simple parts, as explained in the preceding paragraph. The metal should be covered as soon as the weld is finished and be allowed to cool slowly. If the metal is more than $\frac{1}{4}$ inch thick, the edges should be beveled at an angle of about 45 degrees on each side. For comparatively heavy welds, it is well to leave three small points of contact for aligning the broken parts in their original position. To make the weld, the flame should be passed for some distance around the fracture and then be directed on it until the metal is cherry-red. When this occurs, have an assistant throw on a little scaling powder, and when the metal begins to run, add cast iron from the cast-iron “welding stick,” which should be of specially refined material. Powder should be added only when the metal does not flow well, as little

as possible being used. Never attempt to re-weld pieces that have been previously welded or brazed, without first cutting away all of the old metal.

Welding Steel.—Steel less than $\frac{1}{8}$ inch thick can be welded without the addition of any welding metal. If the thickness exceeds $\frac{1}{8}$ inch, the edges should be beveled or chamfered. It is very important not to add the welding material until the edges are fused or molten at the place where the weld is being made. In no case should the flame be held at one point until a foam is produced, as this is an indication that the metal is being burned. Do not hold the flame steadily in the center of the weld, but give it a semicircular or zig-zag motion with an uplifting movement at each revolution, the object being to drive the molten metal toward the center of the weld. When welding a crack located in the middle of a heavy steel sheet, begin by chamfering the metal on each side of the fracture at an angle of 45 degrees, the slope extending to the bottom; then apply the welding torch to the sheet beyond the end of the crack, until there is sufficient expansion to open the crack perceptibly. The weld should then be made, and, as a rule, it will be found that the expansion will compensate for the contraction when cooling. No flux is required when welding low-carbon steel, because the oxide melts at a lower temperature than the fusing point of the metal. Flux may be used on the higher carbon steels to prevent oxidation.

Aluminum Welding.—The successful welding of aluminum alloy castings by the oxy-acetylene process, depends a great deal upon the success achieved in breaking down the aluminum oxide, the forming of which is intensified as soon as the oxy-acetylene torch flame comes in contact with the metal. It is this oxide film that prevents the proper flow of the metal at the welding temperatures and that has been the cause of many failures in aluminum welds.

Cleaning Surfaces: The surfaces to be joined must be thoroughly cleaned and the material near the surfaces to be welded must also be clean, as otherwise the impurities near the joint will invariably set up auto-corrosion in the weld. Oily machine parts should be allowed to remain for a few seconds in a hot 10 per cent caustic soda solution, after which, the castings should be thoroughly washed and scrubbed in plenty of clean hot water. It is often advisable first to wash the oily castings with gasoline to remove the greater part of the grease and dirt.

Joint Beveling: After the work is cleaned, a V-shaped groove is filed or chipped along the crack or seam to the bottom to permit the metal to be melted the full depth of the work. However, aluminum alloy castings up to $\frac{1}{4}$ inch in thickness can be welded with the torch flame without beveling the joints.

Preheating: In welding aluminum and aluminum alloy castings, it is necessary to preheat and anneal the work in order to prevent too rapid expansion and contraction of the metal. Preheating also conserves gas, increases the rate of welding, and prevents warping. Great care, however, must be exercised to avoid exceeding a temperature of 750 and 840 degrees F., respectively, when preheating and reheating or annealing the work. At higher temperatures a piece of work may be rendered useless by deformation. During the preheating of castings of complex shape or castings that vary greatly in thickness, the casting should be covered with sheet asbestos to keep the temperature as uniform as possible. The asbestos should not be removed during the welding operation, except as it is necessary to effect the weld.

Welding Procedure: A puddling rod, made from a piece of mild steel rod $\frac{3}{16}$ or $\frac{1}{4}$ inch in diameter and flattened on one end like a flat scraper, is used in welding to scrape and agitate the metal at the moment of melting in order to break up the oxide and allow the molten metal to flow together. It is necessary to wipe the puddling rod frequently to prevent it from becoming coated with oxide, and care must be taken not to allow it to reach a red heat, as otherwise oxide of iron will be formed on it which might result in a defective weld. The oxide formed in the course of melting aluminum offers considerable resistance to the weld-

ing flame, and it must be eliminated to effect a homogeneous weld. This is best done by employing an aluminum alloy welding flux which dissolves and deoxidizes the layer of oxide adjacent to the joint to be welded, at the temperature at which the aluminum reaches a molten state.

The welding material, usually a rod or broken aluminum part, should be of as pure aluminum as it is possible to obtain and the end of the rod should be kept in the molten bath while welding. For aluminum alloy castings, the welding material should be of approximately the same composition as the alloy to be welded.

Flame Adjustment: In making a weld, the torch flame should be so adjusted that it will furnish a slight excess of acetylene, and it is essential to avoid contact of the white-hot bulb or cone with the metal that is about to become molten, because the hot temperature in this part of the flame tends to produce holes in the metal which are often difficult to repair. The correct distance varies according to the size of torch tip employed, but in general, the distance should be from $\frac{1}{4}$ to $\frac{3}{4}$ inch. After welding, the casting should be reheated evenly and allowed to cool very slowly. When the casting is cold, it should be thoroughly washed in hot water to remove all traces of the flux, which would otherwise continue to produce a chemical action on the metal that would result in harmful corrosion.

Aluminum Welding Fluxes.—The oxide formed in the course of melting aluminum offers considerable resistance to the welding flame. It does not always rise to the surface, especially if the work is thick, yet it must be eliminated to effect a homogeneous weld. This is done by employing a flux which dissolves and deoxidizes the layer of oxide adjacent to the joint to be welded, at the temperature at which the aluminum reaches a molten state. Another function of a flux is to protect the fused metal from contact with the air.

An example of a good flux for aluminum and aluminum alloys with a melting point of approximately 1110 degrees F. is one containing a mixture of lithium chloride, potassium chloride, potassium bisulphate, and potassium fluoride.

When castings that have sand on their surface are to be welded, a flux that will remove the sand must be used. If the sand is not removed, it is in part reduced, resulting in silicon being passed into the metal — a condition that often reduces the strength of the weld an appreciable amount. A flux that is adapted for use under these conditions is composed of potassium chloride or fluorspar. This flux will prevent silicon from entering the alloy.

The flux may be applied in paste form to the surfaces to be welded, or the parts may be heated and the powdered flux sprinkled over the joint, or the end of the welding rod may be heated and dipped into the flux, which readily adheres to it in the form of a thin varnish; the last method is the safest and best.

Welding Brass.—In many cases it is preferable to braze rather than to weld brass parts. When the oxy-acetylene torch is used for brass, adjust the flame until there is a single cone, as for steel welding. Keep the point of the white flame slightly away from the weld, according to the thickness of the piece, so that the heat will not be sufficient to burn the copper in the brass or volatilize the zinc. If a white smoke appears, remove the flame, as this indicates excessive heat. A little borax should be used as a flux. For brass welding, it is advisable to use a tip about one size larger than for the same thickness of steel. As the weld is really cast brass, it will not have the strength of rolled sheet brass. Do not breathe the fumes while welding brass.

Welding Copper.—The purest copper wire obtainable should be used as a filler when welding copper and great care should be taken to prevent oxidation. Use the same kind of flame as for steel, but a much larger tip for corresponding dimensions, because of the great radiating property of copper. Pre-heating is necessary when a large piece of copper is to be welded, as otherwise so much heat from the torch will be dissipated by radiation that little will be left for fusing the metal. Copper will weld at about 1930 degrees F.; hence, the flame need not have so high a temperature as for steel and it must not be concentrated on so small a surface. On account of the radiation, however, the total quantity of heat must be

greater. Welded copper has the strength of cast copper, but can be rendered more tenacious by hammering. The radiation of heat from copper can be considerably lessened by covering it with asbestos sheets while heating. To weld copper to steel, first raise the steel to a white heat (the welding point); then put the copper into contact with it and the two metals will fuse together. When the copper begins to flow, withdraw the flame slightly to prevent burning. Ordinary borax may be used as a flux for copper welding.

Welding High-speed Steel to Machine Steel.—Compression welding can be employed advantageously for welding small high-speed drills which require carbon steel shanks of special length. A jig made to hold the carbon steel shank and the high-speed steel drill in line should be employed, and the ends set about $\frac{1}{8}$ inch apart. When the ends have been heated by the torch to the welding temperature, or until the ends are in a pasty condition, the drill is given a smart rap with a wooden mallet and driven against the steel shank, thus producing a butt or compression weld. This method is most successful for lengthening small twist drills with the oxy-acetylene torch.

Welding Cast Iron to Steel.—To weld cast iron to steel, cast-iron rods are used as welding material. The steel must be first heated to the melting point, as cast iron melts at a lower temperature. A very little scaling powder should be used. Pre-heating the cast iron and steel is generally recommended when the joint exceeds three or four inches in length, especially if adjacent parts are thin and likely to crack.

Welding Steel Castings.—As steel castings vary in carbon content, no fixed rule can be laid down for welding them; but, in general, they offer no serious difficulty to welding provided approved welding rods are used. This statement applies to castings whose carbon content is not more than 0.25 per cent. Steel castings containing carbon much in excess of 0.25 or 0.30 per cent may require the use of special welding rods such as those containing nickel. Nickel welding rods give good results on certain grades of steel castings, railway track steel, switch points and other steel products having comparatively high carbon content.

Welding Malleable Iron.—Welding of malleable iron with the oxy-acetylene torch is not recommended, the reason being that the welded joint is necessarily weaker than the malleable iron due to the changes in physical structure produced by the high temperature. Brazing with an approved bronze rod is recommended. A brazed joint in malleable iron will generally be nearly, if not quite, as strong as the original material. Brazing can be effected at a temperature that causes little change in the malleable characteristics.

Welding Tool Steel.—Welding tool steel of the higher carbon contents, with the oxy-acetylene torch, is not generally recommended. The carbon content is changed and the weld produced may be valueless for tool purposes. However, a skilled welder can produce welds in high-carbon steel under proper conditions with fair success and if properly heat-treated they may give satisfaction under some conditions of use.

Welding Alloy Steels.—The alloy steels such as vanadium, chrome-nickel, etc., used in motor car construction may be welded successfully with adding material containing vanadium or nickel. The welds should be heat-treated afterwards in order to restore the joint portion to the physical condition of the part before welding.

Hard-Facing

Hard-facing is the process of welding on to parts or surfaces a coating, edge or point of a metal highly capable of resisting abrasion and wear. In other words, a metal surface, which, due to its use, may normally be worn away rapidly is protected by a layer of special alloy. The process can be applied equally well to new parts or to old worn parts. In many instances, if hard-facing is employed, the metal for the part itself can be selected primarily to withstand shock and fatigue without regard to wear resistance. This often effects a considerable saving in the first cost of the part.

Hard-Facing Materials.—Hard-facing materials may be divided into three general classes: The first comprises alloys having an iron base and containing such elements as chromium, tungsten, manganese, silicon and sometimes cobalt and nickel. The second class is composed of non-ferrous alloys, and the third class consists of the so-called diamond substitutes which are essentially tungsten carbide.

Hard-facing materials of the first class are generally used only under conditions of moderate abrasive wear or severe impact. This class is represented by Hascrome, a self-hardening chromium-manganese-iron alloy. Deposits of Hascrome have a tensile strength of 40,000 and a compressive strength of 177,000 pounds per square inch. Deposits made by the oxy-acetylene process have a hardness of 240 to 500 Brinell, depending upon the amount of excess acetylene in the flame and upon the rate of cooling. Slow cooling makes Hascrome harder than does quenching. Arc-welded deposits have a hardness of 240 to 400 Brinell, depending on the rate of cooling. Hascrome has the property of work hardening under impact, a property similar to that of manganese steel.

The second class (non-ferrous alloys) is represented by Haynes Stellite. This cobalt-chromium-tungsten alloy combines excellent welding properties with maximum wear resistance. When cold, Haynes Stellite is almost as hard as hardened steel and it has the unique property of retaining its original hardness practically unimpaired at the high surface heats developed by friction — and even at a red heat. Haynes Stellite welding rod is available in different grades which vary in regard to physical properties such as hardness, abrasion resistance, shock resistance, etc. All possess to a marked degree the quality of red hardness which is so essential in a wear-resistant alloy.

In the third class (diamond substitutes). Haystellite, a cast tungsten carbide, is recommended. It approaches the diamond in hardness but possesses considerable toughness. It cannot be applied, like welding rods, by melting with the oxy-acetylene flame. It is, therefore, used in the form of small castings of uniform size and shape which are held in place by a binding material. Composite rod consists of various screen sizes of sharp, irregular-shaped grains of Haystellite uniformly distributed in a binding material. These rods are applied quickly and easily with the oxy-acetylene flame like ordinary hard-facing materials.

Soldering and Brazing

Solders.—Solders for joining metallic surfaces or edges are almost invariably composed of an alloy of two or more metals. The solder used must have a lower melting point than the metals to be joined by it, but the fusing point should approach, as nearly as possible, that of the metals to be joined so that a more tenacious joint is effected. Solders may be divided into two general classes, hard and soft. The former fuses at a red heat; the latter, at a comparatively low temperature. These solders are also subdivided into a variety of classes such as brass, silver, gold, copper, tin, plumbers' solder and others — the name, in most cases, designating the application.

Soft Solders.—Soft solders consist chiefly of lead and tin, although other metals are occasionally added to lower the melting point. Lead-tin alloys melt at a lower temperature, with an increase in the percentage of tin, up to a certain point, but when the tin exceeds 67 per cent, the melting point rises gradually to the melting point of tin, as shown by the table "Melting Temperatures of Lead-tin Alloys." This table also gives the Brinell hardness test. The results show that the hardest alloy contains 66 per cent of tin and 34 per cent of lead. Soft solders are termed "common," "medium" and "fine," according to the tin content, those containing the most lead being the cheapest and having the highest melting temperatures.

Fine solder is largely used for soldering britannia metal, brass and tin-plate articles. It is also used for soldering cast iron, steel, copper and many alloys. The soft solder called "common" is used by plumbers for ordinary work; this solder contains two parts of lead to one part of tin. The best soft solders are made from pure lead and pure tin. Antimony is an

objectionable impurity as it renders the solder less fluid when melted and tends to prevent perfect adhesion of the surfaces. Zinc also has an injurious effect on soft solder, causing it to flow sluggishly. Aluminum acts in a similar way. A small percentage of phosphorus renders soft solder very “lively”; that is, the solder has a tendency to run freely. Too much phosphorus is injurious, and if added to thin the solder it should be in the form of phosphor-tin. One or two ounces of five per cent phosphor-tin to one hundred pounds of solder is generally sufficient.

Melting Temperatures of Lead-tin Alloys

Percentage		Melting Temp., Deg. F.	Brinell Hardness Test	Percentage		Melting Temp., Deg. F.	Brinell Hardness Test
Tin	Lead			Tin	Lead		
0	100	618.8	3.9	60	40	368.6	14.6
10	90	577.4	10.1	66	34	356.0	16.7
20	80	532.4	12.16	70	30	365.0	15.8
30	70	491.0	14.5	80	20	388.4	15.2
40	60	446.0	15.8	90	10	419.0	13.3
50	50	401.0	15.0	100	0	450.0	4.1

Melting Temperatures of Copper-zinc Alloys

Percentage		Melting Temp., Deg. F.	Percentage		Melting Temp., Deg. F.	Percentage		Melting Temp., Deg. F.
Copper	Zinc		Copper	Zinc		Copper	Zinc	
100	0	1980	71	29	1746	41	59	1544
96	4	1967	66.4	33.6	1684	35	65	1501
86	14	1890	63	37	1666	33	67	1477
80	20	1846	60	40	1634	29	71	1467
76	24	1796	50	50	1616	24	76	1364
72	28	1756	48	52	1598	20	80	1301

Hard Soldering and Brazing.—Hard solder is used for joining such metals as copper, silver and gold, and alloys such as brass, German silver, gun metal, etc., which require a strong joint and often a solder the color of which is near that of the metal to be joined. The hard soldering of copper, iron, brass, etc., is generally known as brazing, and the solder as spelter. The operations of hard soldering and brazing are identical, and the two terms are often used interchangeably. According to common usage, however, there is the following distinction. Brazing is generally understood to mean the joining of metals by a film of brass, whereas hard soldering (which is the term used by jewelers) ordinarily means that “silver solder” is used as the uniting medium. (See *Silver Solders* on page 3259). For hard soldering or brazing, a red heat is necessary, and borax is used as a flux to protect the metal from oxidation, and to dissolve the oxides formed. Heating cannot be done with a soldering iron, but should be effected by a blowpipe, blowtorch, gas forge or a coke or charcoal fire.

As a greater degree of heat is required to melt spelter than soft solder, brazed work will withstand more heat without breaking or weakening than parts which are soldered. The chief advantage of a brazed joint, however, lies in its superior strength. Before work is assembled for brazing, it should be carefully cleaned; the parts are then fastened together in the position they are to occupy when joined. Usually the pieces are secured by pinning, but sometimes wire, bolts or clamps are used for holding the parts together. If practicable, they should be secured in such a way that the work can be turned over during the process of brazing without disturbing the relation of the parts, thus affording a better chance to apply the flux and spelter.

Composition of Brazing Alloys

Percentage				Characteristics	Color
Copper	Zinc	Tin	Lead		
58	42	Very strong	Reddish-yellow
53	47	Strong	Reddish-yellow
48	52	Medium	Reddish-yellow

Percentage				Characteristics	Color
Copper	Zinc	Tin	Lead		
54.5	43.5	1.5	0.5	Medium	Reddish-yellow
34	66	Easily fusible	White
44	50	4	2	Easily fusible	Gray
55	26	15	4	White solder	White

Soft Solders for Various Metals

Metal to be Soldered	Flux	Soft Solder		
		Tin	Lead	Other Constituents ^a
Aluminum	Stearin	70	{ Zn 25 Al 3 P-tin 2
Brass Gun metal Copper	Chloride of zinc, rosin, or chloride of ammonia	66	34	...
		{ 63	37	...
		60	40	...
Lead	Tallow or rosin	33	67	...
Block tin	Chloride of zinc	99	1	...
Tinned steel	Chloride of zinc or rosin	64	36	...
Galvanized steel	Hydrochloric acid	58	42	...
Zinc	Hydrochloric acid	55	45	...
Pewter	Gallipoli oil	25	25	Bi 50
Iron and steel	Chloride of ammonia	50	50	...
Gold	Chloride of zinc	67	33	...
Silver	Chloride of zinc	67	33	...
Bismuth	Chloride of zinc	33	33	Bi 34

^aZn = zinc. Al = aluminum. P-tin = phosphor-tin. Bi = bismuth.

Hard Solders for Various Metals

Metal to be Soldered	Flux	Hard Solder			
		Copper	Zinc	Silver	Gold
Brass, soft	Borax	22	78
Brass, hard	Borax	45	55
Copper	Borax	50	50
Gold	Borax	22	11	67
Silver	Borax	20	10	70
Cast iron	Cuprous oxide	55	45
Iron and steel	Borax	64	36

Fluxes for Soldering.—As two pieces to be soldered must be thoroughly alloyed with the material used as a solder, the temperature must be raised and maintained at such a point that inter-penetration can take place completely. It is necessary that the surfaces to be joined be perfectly clean, and means must be provided to prevent oxidation during soldering, oxides tending to prevent interfusion. This is accomplished by using a coating of some substance that melts at the fusing temperature of the solder, and thus excludes the air. The coating should have a solvent action on the oxide, thus keeping the metal clean and enabling the metal and solder to unite thoroughly. The fluxes generally used are rosin, sal-ammoniac, zinc chloride and borax. The flux is added first and the solder melted by means of a flame or soldering iron, the latter first having been smoothed with a file and then properly tinned. Rosin and chloride of zinc are fluxes commonly used for soft soldering tin (tinned iron)

brass, etc. For hard soldering or brazing, use burnt or calcined borax, or boracic acid in powdered form. In all cases where zinc chloride is used as a flux, the article should be cleaned after soldering to prevent subsequent corrosion of the metal.

Alloys for Brazing Solders.—The alloys or “spelters” used for brazing are composed of copper-zinc alloys. The melting point of these alloys depends upon the percentage of zinc. As the proportion of zinc increases, the melting point is lowered, as shown by the table *Melting Temperatures of Copper-zinc Alloys* on page 3257. The fusing point of the spelter should be as close as possible to that of the article to be brazed, as a more tenacious joint is thereby secured. An easily fusible spelter may be made of two parts zinc to one part copper, but the joint will be weaker than when an alloy more difficult to fuse is employed. A spelter that is readily fused may be made of 44 per cent copper, 50 per cent zinc, 4 per cent tin and 2 per cent lead. Alloys containing much lead should be avoided, since lead does not transfuse with brass and thus decreases the strength of the joint. A hard solder for the richer alloys of copper and zinc may be produced from 53 parts copper and 47 parts zinc. Copper and iron have a much higher melting point than brass, thus allowing the use of a richer copper alloy. Tin is often added as one of the ingredients, but it should be sparingly used, because it increases the brittleness of the solder. The addition of tin to brass lightens the color, giving it a gray tint. A variety of different brazing alloys and their characteristics are given in the table *Composition of Brazing Alloys* on page 3257.

Silver Solders.—Silver solder is a hard solder containing silver, copper and zinc or brass. The composition of silver solders varies considerably according to the nature of the work. A silver solder extensively used by jewelers contains 70 parts silver and 30 parts copper. Silver coins can be used for small work. Silver soldering is employed for uniting comparatively small parts requiring a strong joint. The heating is usually effected by a blowpipe, and borax or powdered boracic acid may be used as a flux. The flux should be applied before heating, if possible.

A hard solder of low fusing point, that is used extensively by one of the largest electrical companies, is composed of 34.36 per cent copper; 49.24 per cent silver; and 16.40 per cent zinc. Borax is used as a flux.

Solders for German silver are generally made of the same materials as those which compose the alloy to be soldered, but in such proportions that the melting point is lower. In some cases, silver solder is used for uniting German silver articles, and German silver solder is also used for soldering articles of iron and steel on account of its high melting point and tenacity. German silver solder is known under different names, as argentan, arguzoid, etc. It is rendered moderately fusible by an addition of zinc to the copper and nickel. If the solder is too brittle, this is an indication of too much zinc, which defect can be remedied by adding the requisite amount of copper and nickel. For soldering alloys composed of from 16 to 22 per cent; nickel, the following proportions may be used as a solder: Copper 47 per cent; nickel 11 per cent; and zinc 42 per cent.

Dip Brazing.—The principal difference between “dip brazing” and ordinary brazing is that with the former method the work is immersed into the molten spelter until the parts are heated sufficiently to be united by it. This method is extensively employed in bicycle manufacture as it is more economical for duplicate work.

Brazing Band-saws.—Band-saws are joined by lap brazing, silver solder being generally used. The lap is formed by beveling the ends to a sharp edge for a length of about $\frac{3}{8}$ inch for saws up to $\frac{3}{4}$ inch wide, and $\frac{1}{2}$ inch for saws from $\frac{3}{4}$ to $1\frac{1}{2}$ inch wide. After a flux (such as borax) has been applied to the joint, the ends are clamped together. The solder is sometimes melted into the joint from the edges, or it may be applied between the two surfaces. A convenient method is as follows: Pound a piece of silver, about the size of a dime, until quite thin; then clamp it between the surfaces to be brazed after applying damp, powdered borax. When the heat is applied and the silver melts, clamp the beveled ends of the saw

tightly together. The heating should be localized as much as possible. For a flux, use lump borax and pulverize it as used.

Cleaning Surfaces to be Brazed.—Before brazing iron or steel, the surfaces should be thoroughly cleaned, either by filing, grinding or by the use of a sand blast. Brass or bronze parts can be cleaned by dipping in a solution of one-third nitric acid and two-thirds sulphuric acid. This same solution can be used to remove the scale after brazing.

Aluminum Solder.—A thoroughly reliable aluminum solder that is used by a large electrical concern is composed of 75.5 parts (by weight) of tin; 18 parts of zinc; and 2.5 parts of aluminum. No flux is needed. It is advisable to slightly heat the parts to be soldered. Another aluminum solder is composed of 80 per cent tin and 20 per cent zinc, stearic acid being used as a flux.

Sweating.—When parts are soldered together by heating them sufficiently to melt the solder, instead of using a soldering iron, the operation is often known as sweating. Brass boxes for engine connecting-rods are usually sweated together prior to machining, in order to hold the two halves in alignment while finishing the sides and boring. The finished surfaces forming the joint between the brasses are first tinned or covered with solder. This is done by heating the brasses enough to melt the solder, then applying a flux (such as sal-ammoniac), and finally the solder. After tinning, the brasses are again heated if the solder has hardened; they are then put together and allowed to cool. The halves are separated after machining by heating them until the solder melts.

Brazing High-speed Steel Tips to Carbon Steel Shanks.—A method which is used in a large manufacturing plant is as follows: A seat is formed in the tool shank to receive the tip. A welding compound or flux is used in welding the tip to the shank. The flux is placed on the seat of the shank and the tip is then put on top of the flux in the desired position. The tool is placed in the preheating chamber of the furnace and heated to 1550 – 1660 degrees F., allowing sufficient time for complete penetration of the heat. The tool is then removed from the preheating chamber and the tip is pressed firmly to the seat of the shank to insure a close contact between the two pieces. Then the tool is placed in the main furnace chamber and heated rapidly to a temperature of approximately 2250 to 2400 degrees F., depending upon the kind of material used for the tip and its hardening requirements. The tool is next removed from the furnace and sufficient pressure applied to the tip to insure perfect cohesion. The press used for this purpose should be equipped with a pivoted pressure shoe and this shoe must be preheated to prevent cracking of the tip.

The hardening is accomplished at the same time as the tipping operation when tools are tipped with low-cobalt high-speed and high-cobalt high-speed steel. Tools that cannot be ground after hardening are often heated in barium chloride or some similar salt bath. After the pressing and welding operation, the tool is cooled to room temperature under an air blast or quenched in oil. It is advisable to maintain the oil quenching bath at a temperature of 150 to 200 degrees F. After the tipping operation, the tool should be reheated uniformly in an open furnace to a temperature of 1050 to 1150 degrees F, and allowed to cool in air. The hardened tools should have a minimum Rockwell C hardness of 63. Tips are cut from bar stock according to dimensions on standard detail drawing. The material generally used for the shanks of tools tipped with the cutting materials regularly employed contains 0.50 to 0.63 per cent carbon; 0.60 to 0.90 per cent manganese; 0.04 per cent phosphorus; and 0.15 per cent silicon.

Brazing Carbide Tips to Steel Shanks.—Sintered carbide tips or blanks are attached to steel shanks by brazing. Shanks usually are made of low-alloy steels having carbon contents ranging from 0.40 to 0.60 per cent.

One Prominent manufacturer of carbide tools recommends the following shank steels in the order listed: 1) High-silicon steel containing approximately 0.55 carbon, 0.85 manganese, 0.30 vanadium, 2.10 silicon, 0.25 chromium, and maximum sulphur and phosphorus contents of 0.025; 2) S.A.E. 2340 steel; and 3) any low-alloy steel having 0.40 to 0.60 carbon.

Shank Preparation: The carbide tip usually is inserted into a milled recess or seat, but some prefer to omit the recess and braze the tip to the top of the shank. When a recess is used, the bottom should be flat to provide a firm even support for the tip. The corner radius of the seat should preferably be somewhat smaller than the radius on the tip to avoid contact and insure support along each side of the recess.

Cleaning: All surfaces to be brazed must be absolutely clean. Surfaces of the tip may be cleaned by grinding lightly or by sand-blasting. Cleaning with carbon tetrachloride is also recommended.

Brazing Materials and Equipment: The brazing metal may be copper, naval brass such as Tobin bronze, or silver solder. A flux such as borax is used to protect the clean surfaces and prevent oxidation. Heating may be done either in a furnace or by means of an oxy-acetylene torch or an oxy-hydrogen torch. Copper brazing usually is done in a furnace, although an oxy-hydrogen torch with excess hydrogen is sometimes used. An oxy-acetylene torch usually is employed for silver brazing or soldering.

Brazing Procedure: One method of brazing with a torch is to first place a thin sheet material, such as copper foil, around and beneath the carbide tip, the top of which is covered with flux. The flame is applied to the under side of the tool shank, and, when the materials melt, the tip is pressed firmly into its seat with tongs or with the end of a rod. If the brazing material is in the form of wire or rod, this may be used to coat or tin the surfaces of the recess after the flux melts and runs freely. The tip is then inserted, flux is applied to the top, and the heating is continued until the coatings melt and run freely. A firm which supplies carbide tips with nickel-coated surfaces ready for silver soldering, suggests the following procedure: The tip, after coating with flux, is placed in the recess and the shank end is heated. Then a small piece of silver solder, having a melting point of 1325 degrees F., is placed on top of the tip. When this solder melts, it runs over the nickel-coated surfaces while the tip is held firmly into its seat. In all carbide tip brazing, the brazed tool should be cooled slowly to avoid cracking due to unequal contraction between the steel and carbide. To insure slow cooling, the tool may be buried in powdered charcoal, graphite, asbestos, mica, or lime.

Braze Hardening.—This copper-brazing method is applicable in tipping lathe, planer or similar tools with molybdenum steel tips. First clean the tip and end of the shank by immersion in carbon tetrachloride. Cover end of shank with commercial powdered copper brazing flux; then insert the tool partly in the muffle of the furnace (electric or gas). When the flux melts, withdraw the tool and place the tip in position with the copper sheet or foil below and also above the tip. Add more flux and preheat the tip to about 1500 degrees F. Then move the tip end in and heat the tool uniformly to the full hardening temperature; then withdraw it from the furnace and force out the excess copper or flux either with tongs or a press. When the copper solidifies, quench the tip end in oil to below 200 degrees F. This operation, which usually requires less than twenty minutes, brazes and hardens the tip. The final step is to temper the tipped tool at 1050 degrees F.

Previously hardened high-speed steel tips may be attached to shanks by silver brazing. It is possible to braze the hardened tip and temper it simultaneously. This braze-tempering method is suitable for tools not subject to heavy roughing cuts. Tools which are braze-hardened, may be used for either roughing or finishing cuts because copper will withstand much higher temperatures than silver solder; moreover, the tool shank is hardened considerably by the braze-hardening method, whereas, in braze tempering, the shank is relatively unhardened.

Coloring Metals

General Requirements in the Coloring of Metal Surfaces.—Copper is more susceptible to coloring processes and materials than any of the other metals, and hence the alloys containing large percentages of copper are readily given various shades of yellow, brown, red, blue, purple, and black. Alloys with smaller percentages of copper (or none at all) can be given various colors, but not as easily as if copper were the principal ingredient, and the higher the copper content, the more readily can the alloy be colored. The shades, and even the colors, can be altered by varying the density of the solution, its temperature and the length of time the object is immersed. They can also be altered by finishing the work in different ways. If a cotton buff is used, one shade will be produced; a scratch brush will produce another, etc. Thus to color work the same shade as that of a former lot, all the data in connection with these operations must be preserved so they can be repeated with exactness.

Cleaning Metals for Coloring.—Metal surfaces to be colored chemically must first be thoroughly cleaned. To remove grease from small parts, dip in benzine, ether or some other solvent for the grease. Boil large pieces in a solution of one part caustic soda and ten parts water. For zinc, tin or britannia metal, do not use caustic soda, but a bath composed of one part carbonate of soda or potash and ten parts water. After boiling, wash in clean water. Do not touch the clean surfaces with the fingers, but handle the objects by the use of tongs or wires.

Pickling Solutions or Dips for Coloring.—The grease removal should be followed by chemical cleansing, which principally serves the purpose of removing the greenish or brownish films which form on copper, brass, bronze, etc. The composition of the bath or mixture for pickling varies for different metals. For copper and its alloys, a mixture of 100 parts concentrated sulphuric acid (66 degrees Baume and 75 parts nitric acid (40 degrees Baume is sometimes used. If the metal is to be given a luster instead of a mat or dull finish, add about 1 part common salt to 100 parts of the pickling solution, by weight. A better dip for a mat surface consists of 90 parts nitric acid (36 degrees Baume 45 parts concentrated sulphuric acid, 1 part salt, and from 1 to 5 parts of sulphate of zinc, by weight. The composition of copper-zinc alloys will produce different color tones in the same dip and will affect the results of chemical coloring. After pickling, washing in water is necessary.

Another good method of removing these films is to soak the work in a pickle composed of spent aquafortis until a black scale is formed, and then dip it for a few minutes into a solution of 64 parts water, 64 parts commercial sulphuric acid, 32 parts aquafortis, and 1 part hydrochloric acid. After that the work should be thoroughly rinsed several times with distilled water.

Coloring Brass.—Polished brass pieces can be given various shades from golden yellow to orange by immersing them for a certain length of time in a solution composed of 5 parts, by weight, of caustic soda, 50 parts water and 10 parts copper carbonate. When the desired shade is reached, the work must be well washed with water and dried in sawdust. Golden yellow may be produced as follows: Dissolve 100 grains lead acetate in 1 pint of water and add a solution of sodium hydrate until the precipitate which first forms is re-dissolved; then add 300 grains red potassium ferro-cyanide. With the solution at ordinary temperatures, the work will assume a golden yellow, but heating the solution darkens the color, until at 125 degrees F. it has changed to a brown.

To Produce a Rich Gold Color.—Brass can be given a rich gold color by boiling it in a solution composed of 2 parts, by weight, of saltpeter, 1 part common salt, 1 part alum, 24 parts water and 1 part hydrochloric acid. Another method is to apply a mixture of 3 parts alum, 6 parts saltpeter, 3 parts sulphate of zinc, and 3 parts common salt. After applying this mixture the work is heated over a hot plate until it becomes black, after which it is washed with water, rubbed with vinegar, and again washed and dried.

White Colors or Coatings.—The white color or coating that is given to such brass articles as pins, hooks and eyes, buttons, etc., can be produced by dipping them in a solution made as follows: Dissolve 2 ounces fine-grain silver in nitric acid, then add 1 gallon distilled water, and put this into a strong solution of sodium chloride. The silver will precipitate in the form of chloride, and must be washed until all traces of the acid are removed. Testing the last rinse water with litmus paper will show when the acid has disappeared; then mix this chloride of silver with an equal amount of potassium bitartrate (cream of tartar), and add enough water to give it the consistency of cream. The work is then immersed in this solution and stirred around until properly coated, after which it is rinsed in hot water and dried in sawdust.

Silvering.—A solution for silvering, that is applicable to such work as gage or clock dials, etc., can be made by grinding together in a mortar 1 ounce of very dry chloride of silver, 2 ounces cream of tartar, and 3 ounces common salt, then add enough water to obtain the desired consistency and rub it onto the work with a soft cloth. This will give brass or bronze surfaces a dead-white thin silver coating, but it will tarnish and wear if not given a coat of lacquer. The ordinary silver lacquers that can be applied cold are the best. Before adding the water, the mixture, as it leaves the mortar, can be kept a long time if put in very dark colored bottles, but if left in the light it will decompose.

To Give Brass a Green Tint.—One solution that will produce the Verde antique, or rust green, is composed of 3 ounces crystallized chloride of iron, 1 pound ammonium chloride, 8 ounces verdigris, 10 ounces common salt, 4 ounces potassium bitartrate and 1 gallon of water. If the objects to be colored are large, the solution can be put on with a brush. Several applications may be required to give the desired depth of color. Small work should be immersed and the length of time it remains in the solution will govern the intensity of the color. After immersion, stippling the surface with a soft round brush, dampened with the solution, will give it the variegated appearance of the naturally aged brass or bronze.

Blackening Brass.—There are many different processes and solutions for blackening brass. Trioxide of arsenic, white arsenic or arsenious acid are different names for the chemical that is most commonly used. It is the cheapest chemical for producing black on brass, copper, nickel, German silver, etc., but has a tendency to fade, especially if not properly applied, although a coat of lacquer will preserve it a long time. A good black can be produced by immersing the work in a solution composed of 2 ounces white arsenic, 5 ounces cyanide of potassium, and 1 gallon of water. This should be boiled in an enamel or agate vessel, and used hot. Another cheap solution is composed of 8 ounces of sugar of lead, 8 ounces hyposulphite of soda and 1 gallon of water. This must also be used hot and the work afterwards lacquered to prevent fading. When immersed, the brass first turns yellow, then blue and then black, the latter being a deposit of sulphide of lead.

Preservation of Color.—After a part has been given the desired color, it is usually washed in water and then dried with clean sawdust. The colored surfaces of alloys are commonly protected and preserved by coating with a colorless lacquer, such as japan lacquer. Small parts are coated by dipping, and large ones by rubbing the lacquer on. The lacquer is hard after drying, and insoluble in most fluids; hence, it can be washed without injury.

Niter Process of Bluing Steel.—The niter process of bluing iron and steel is as follows: The niter or nitrate of potash (often called saltpeter) is melted in an iron pot and heated to about 600 degrees F. The parts to be blued are cleaned and polished and then immersed in the molten niter until a uniform color of the desired shade has been obtained. This requires only a few seconds. The articles are then removed and allowed to cool, after which the adhering niter is washed off in water. Parts which will not warp may be immersed immediately after removing from the niter bath. After cleaning, dry in sawdust, and then apply some suitable oil, such as linseed, to prevent rusting. To secure uniform coloring, a pyrometer should be used to gage the temperature of the niter, because a higher heat than 600 degrees F. will produce a dark color, whereas a lower heat will give a lighter shade.

Bluing Steel by Heat-treatment.—Polished steel parts can be given a blue color by heating in hot sand, wood ashes, or pulverized charcoal. Place the substance in an iron receptacle and stir constantly, while heating, in order to heat uniformly. Heat just hot enough to char a pine stick. The parts to be blued must be absolutely free from grease. They are placed in the heated substance until the desired color is obtained. Further coloring is then checked by immersing in oil. Small parts are sometimes heated by a Bunsen burner or by laying upon a heated plate. For a light blue color, heat in sand or wood ashes, and for a dark blue, use pulverized charcoal. The quality of the color depends largely upon the fineness of the finish. Still another method of coloring by heat is to immerse the parts in a molten bath of potassium nitrate and sodium nitrate. The coloring is then checked by plunging the work into boiling water.

Blue-black Finish.—To obtain a blue-black finish on small steel parts, use a mixture of 16 parts, by weight, of saltpeter and 2 parts of black oxide of manganese. This mixture is heated to a temperature of 750 degrees F. and the objects are immersed in it. The oxide of manganese is deposited on the work and must, therefore, be frequently replenished in the mixture.

Black Finish.—To obtain a black rust-protecting finish on hardened parts, temper, after hardening, in “heavy” cylinder oil; then immediately place the part with the oil on it in an oven having a temperature of from 300 to 350 degrees F. Remove the work in from 5 to 8 minutes, when the black finish is baked onto it.

Gun Metal Finish.—Several different chemical solutions have been used successfully for giving steel a gun metal finish or black color. Among these are the following:

1) Bismuth chloride, one part; copper chloride, one part; mercury chloride, two parts; hydrochloric acid, six parts; and water, fifty parts.

2) Ferric chloride, one part; alcohol, eight parts; and water, eight parts.

3) Copper sulphate, two parts; hydrochloric acid, three parts; nitric acid, seven parts; and perchloride of iron, eighty-eight parts.

Other solutions have been prepared from nitric ether, nitric acid, copper sulphate, iron chloride, alcohol and water and from nitric acid, copper sulphate, iron chloride and water. The method of applying these and finishing the work is practically the same in all cases.

The surface is given a very thin coating with a soft brush or sponge that has been well squeezed, and is then allowed to dry. The work is then put in a closed retort to which steam is admitted and maintained at a temperature of about 100 degrees F., until the parts are covered with a slight rust. They are then boiled in clean water for about fifteen minutes and allowed to dry. A coating of black oxide will cover the surface, and this is scratch brushed. After brushing, the surface will show a grayish black. By repeating the sponging, steaming and brushing operations several times, a shiny black lasting surface will be obtained. For the best finishes, these operations are repeated as many as eight times.

Another process employs a solution of mercury chloride and ammonium chloride which is applied to the work three times and dried each time. A solution of copper sulphate, ferric chloride, nitric acid, alcohol and water is then applied three times and dried as before. A third solution of ferrous chloride, nitric acid and water is applied three times, and the work is boiled in clean water and dried each time. Finally, a solution of potassium chloride is applied and the work boiled and dried three times. The work is then scratch brushed and given a thin coating of oil. Ordnance for the French Government is treated in this way. The above methods are applicable to hardened and tempered steels, as a temperature of 100 degrees F. does not affect the hardness of the steel. For steels that will stand 600 degrees temperature without losing the desired hardness, better and much cheaper methods have been devised.

The American Gas Furnace Co. has developed a process employing a furnace with a revolving retort. The work is charged in this, together with well-burnt bone. A chemical solution that gasifies when it enters the furnace is then injected into this retort while the

work is heated to the proper temperature. This solution has been named "Carbonia." The color does not form a coating on the outside, as with the other processes, but a thin layer of the metal itself is turned to the proper color. By varying the temperature of the furnace, the time the work is in it, and the chemical, different colors can be produced from light straw to brown, blue, purple and black, or gun metal finish. Rough or sand-blasted surfaces will have a frosted appearance, while smooth polished surfaces will have a shiny brilliant appearance.

Browning Iron and Steel.—A good brown color can be obtained as follows: Coat the steel with ammonia and dry it in a warm place; then coat it with muriatic or nitric acid and dry it in a warm place; then place the steel in a solution of tannin or gallic acid and again dry it. The color can be deepened by placing the work near the fire, but it should be withdrawn the minute the desired shade is reached or it will turn black.

To Produce a Bronze Color.—A bronze-like color can be produced by exposing iron or steel parts to the vapors of heated aqua regia, dipping them in melted petroleum jelly, and then heating them until it begins to decompose, when it is wiped off with a soft cloth. Another method of producing this bronze-brown color is to slightly heat the work, evenly cover the surfaces with a paste of antimony chloride (known as "bronzing salt"), and let the object stand until the desired color is obtained. The paste can be made more active by adding a little nitric acid.

To Produce a Gray Color.—A gray color on steel can be obtained by immersing the work in a heated solution of ten grains of antimony chloride, ten grains of gallic acid, 400 grains of ferric chloride and five fluid ounces of water. The first color to appear is pale blue, and this passes through the darker blues to the purple, and, finally, to the gray. If immersed long enough, the metal will assume the gray color, but any of the intermediate colors may be produced. When used cold, this is also one of the bronzing solutions.

Mottled Coloring.—Mottled colors on steel can be produced by heating the objects to a good cherry-red for several minutes in cyanide of potassium, then pouring the cyanide off, and placing the receptacle containing the work back on the fire for five minutes. The contents are then quickly dumped into clean water. To heighten the colors, boil afterward in water and oil.

Coppering Solution.—A coppering solution for coating finished surfaces in order that lay-out lines may be more easily seen, is composed of the following ingredients: To 4 ounces of distilled water (or rain water) add all the copper sulphate (blue vitriol) it will dissolve; then add 10 drops of sulphuric acid. Test by applying to a piece of steel, and, if necessary, add four or five drops of acid. The surface to be coppered should be polished and free from grease. Apply the solution with clean waste, and, if a bright copper coating is not obtained, add a few more drops of the solution; then scour the surface with fine emery cloth, and apply rapidly a small quantity of fresh solution.

White Coatings for Laying Out Lines.—Powdered chalk or whiting mixed with alcohol is commonly used for coating finished metal surfaces preparatory to laying out lines for machining operations. Alcohol is preferable to water, because it will dry quicker and does not tend to rust the surface. This mixture can be applied with a brush and is more convenient than a coppering solution for general work. For many purposes, the surface can be coated satisfactorily by simply rubbing dry chalk over it.

To Produce Gray Colors.—A solution of 1 ounce of arsenic chloride in 1 pint of water will produce a gray color on brass, but if the work is left in this solution too long it will become black. The brass objects are left in the bath until they have assumed the correct shade, and are then washed in clean warm water, dried in sawdust and finally in warm air.

Blue and Violet Shades.—To give brass a blue color, dissolve 1 ounce of antimony chloride in 20 ounces of water, and add 3 ounces hydrochloric acid; then warm the work and immerse it in this solution, until the desired blue is obtained. After that wash in clean water and dry in sawdust. A permanent and beautiful blue-black can be obtained by using just

enough water to dissolve 2 ounces copper sulphate and then adding enough ammonia to neutralize and make it slightly alkaline. The work must be heated before immersion.

To Give Brass a Green Tint.—One solution that will produce the Verde antique, or rust green, is composed of 3 ounces crystallized chloride of iron, 1 pound ammonium chloride, 8 ounces verdigris, 10 ounces common salt, 4 ounces potassium bitartrate and 1 gallon of water. If the objects to be colored are large, the solution can be put on with a brush. Several applications may be required to give the desired depth of color. Small work should be immersed and the length of time it remains in the solution will govern the intensity of the color. After immersion, stippling the surface with a soft round brush, dampened with the solution, will give it the variegated appearance of the naturally aged brass or bronze.

Chromium Plating.—Chromium plating is an electrolytic process of depositing chromium on metals either as a protection against corrosion or to increase the surface wearing qualities. The value of chromium-plating plug and ring gages has probably been more thoroughly demonstrated than any other one application of this treatment. Chromium-plated gages not only wear longer, but when worn, the chromium may be removed and the gage replated and reground to size.

In general, chromium-plated tools have operated well, giving greatly improved performance on nearly all classes of materials, such as brass, bronze, copper, nickel, aluminum, cast iron, steel, plastics, asbestos compositions, and similar materials. Increased cutting life has been obtained with chromium-plated drills, taps, reamers, files, broaches, tool tips, saws, thread chasers, and the like. Dies for stamping, drawing, hot-forging, die-casting, and for molding plastic materials have shown greatly increased life after being plated with hard chromium.

Special care is essential in grinding and lapping tools preparatory to plating the cutting edges, because the chromium deposit is influenced materially by the grain structure and hardness of the base metal. The thickness of the plating may vary from 0.0001 to 0.001 or 0.002 inch, the thicker platings being used to build up undersize tools such as taps and reamers.

Procedure followed by Westinghouse in the hard chromium-plating of tools, as well as parts salvaged by depositing chromium to increase diameters, is as follows: 1) Degrease with solvent; 2) mount the tools on racks; 3) clean in an anodic alkali bath held at a temperature of 82-degrees C. for from three to five minutes; 4) rinse in boiling water; 5) immerse in a 20 per cent hydro-chloric acid solution for two to three seconds; 6) rinse in cold water; 7) rinse in hot water; 8) etch in a reverse-current chromic acid bath for two to five minutes; 9) place work immediately in the chromium-plating bath; and 10) remove hydrogen embrittlement, if necessary, by immersing the plated tools for two hours in an oil bath maintained at 177 degrees C.

Chromium has a very low coefficient of friction. The static coefficient of friction for steel on chromium-plated steel is 0.17, and the sliding coefficient of friction is 0.16. This compares with static coefficient of friction for steel on steel of 0.30 and a sliding coefficient of friction of 0.20. The static coefficient of friction for steel on babbitt is 0.25, and the sliding coefficient of friction 0.20, whereas for chromium-plated steel on babbitt, the static coefficient of friction is 0.15, and the sliding coefficient of friction 0.13. These figures apply to highly polished bearing surfaces. Articles that are to be chromium-plated in order to resist frictional wear should be highly polished before plating so that full advantage can be taken of the low coefficient of friction that is characteristic of chromium. Chromium resists attack by almost all organic and inorganic compounds, except muriatic and sulphuric acids. The melting point of chromium is 29.30 degrees F., and it remains bright up to 1200 degrees F. Above this temperature, it forms a light adherent oxide, which does not readily become detached. For this reason, chromium has been used successfully for protecting articles that must resist high temperatures, even above 2000 degrees F.

Bronzing.—Bronzing is a process by means of which a bronze-colored surface is produced on objects made from other metals or from wood, plaster, or other materials. A bronze-like color can be produced by exposing iron or steel parts to the vapors of heated *aqua regia*, then dipping them in melted vaseline, and finally heating them until the vaseline begins to decompose, when they are wiped off with a soft cloth. Bronze-like colors may also be produced by slightly heating the work, covering the surface with a paste of antimony chloride, also known as “bronzing salt,” and letting the object stand until the desired color is obtained. The paste of bronzing salt may be made more active by adding a small quantity of nitric acid. Bronze colors can also generally be produced on metals by the action of dilute nitric acid and sal-ammoniac. The so-called “antique bronze” appearance is produced by painting over the bright metal with a solution of sal-ammoniac, cream of tartar, silver nitrate, and common salt. Plaster and wood are bronzed by first coating the articles with a sizing and then covering them with a bronze powder produced by powdering brass or bronze.

Etching And Etching Fluids

Etching Fluids for Different Metals.—A common method of etching names or simple designs upon steel is to apply a thin, even coating of beeswax or some similar substance which will resist acid; then mark the required lines or letters in the wax with a sharp-pointed scribe, thus exposing the steel (where the wax has been removed by the scribe point) to the action of an acid, which is finally applied. To apply a very thin coating of beeswax, place the latter in a silk cloth, warm the piece to be etched, and rub the pad over it. Regular coach varnish is also used instead of wax, as a “resist.”

An etching fluid ordinarily used for carbon steel consists of nitric acid, 1 part; water, 4 parts. It may be necessary to vary the amount of water, as the exact proportion depends upon the carbon in the steel and whether it is hard or soft. For hard steel, use nitric acid, 2 parts; acetic acid, 1 part. For high-speed steel, nickel or brass, use nitro-hydrochloric acid (nitric, 1 part; hydrochloric, 4 parts). For high-speed steel it is sometimes better to add a little more nitric acid. For etching bronze, use nitric acid, 100 parts; muriatic acid, parts. For brass, nitric acid, 16 parts; water, 160 parts; dissolve 6 parts potassium chlorate in 100 parts of water; then mix the two solutions and apply.

A fluid which may be used either for producing a frosted effect or for deep etching (depending upon the time it is allowed to act) is composed of 1 ounce sulphate of copper (blue vitriol); $\frac{1}{4}$ ounce alum; $\frac{1}{2}$ teaspoonful of salt; 1 gill of vinegar, and 20 drops of nitric acid. For aluminum, use a solution composed of alcohol, 4 ounces; acetic acid, 6 ounces; antimony chloride, 4 ounces; water, 40 ounces.

The National Twist Drill Co. employs the following method for etching on cutters and other tools: The steel is brushed with asphaltum varnish which is allowed to stand until it thickens and hardens to the right degree; then the desired inscription is pressed through the asphaltum with a rubber stamp and the etching fluid (nitrohydrochloric acid or *aquaregia*) is applied with a medicine dropper. Practice and experience are required to judge just when the varnish has dried to the right consistency. A similar method, which has been successfully used for etching names on cutlery, is to coat the surface with gum guaiacum varnish. A rubber stamp having the name or design is then coated with a thin layer of potash solution. When this stamp is applied to the work, the varnish is “cut” by the potash wherever the coated stamp comes into contact with it; the surface is then brushed lightly with water to remove the loosened varnish and expose the lettering or design, which is then etched by applying dilute nitric acid. The rubber-stamp method is a very cheap and rapid process. One method of applying the potash is to press the stamp against a pad soaked with the solution. The action of etching fluids on steels varies somewhat according to the composition, high-carbon and alloy steels being acted upon more slowly than low-carbon steel or wrought iron.

Etching Brass Nameplates.—Etched brass nameplates having a black background are now often used in preference to cast plates, as they are less expensive. The etched plate is produced by coating a flat and polished sheet of brass with a thin layer of bichromated albumen, and exposing it to the light for a few minutes under a glass negative upon which are a number of the desired nameplate designs. (In order to prepare the bichromated albumen, mix together 10 parts of the white of egg with 30 parts of water. A second mixture is then made consisting of 2 parts of potassium bichromate and 58 parts of water. The first mixture composed of the white of egg and water, and the second mixture containing potassium bichromate and water, are next mixed together in a dark room. The bichromated albumen thus obtained should be kept and used in the dark.) When the brass plate is developed, this removes the albumen not exposed to the light (or that which has been protected by the black portions of the negative), and leaves the brass free to be etched. The etching solution will not attack the parts protected by the albumen or “resist.”

The etching is done by a solution of perchlorate of iron, or by making the plate the anode in an acid-copper solution. When the plate has been etched to the required depth, it is washed. If the etched surface is tarnished, as it usually is after drying, a solution made of 2 parts of water and 1 part of muriatic acid should be spread over the surface to remove the stains and leave it clean and uniform. The plate should then be rinsed, but not dried. Then, without removing the resist, it is treated in some manner to produce a black background. When this has been done, the resist is removed and the sheet is cut up to form the individual nameplates, which are then lacquered.

Producing a Black Background.—The use of a black nickel deposit is the best method of producing a black background on etched brass name-plates. This solution does not affect any of the various kinds of resist used, and a large number of plates can be treated in a tank at one time. The black nickel bath is composed of water, 1 gallon; double-nickel salts, 8 ounces; ammonium sulpho-cyanate, 2 ounces; zinc sulphate, 1 ounce. This solution is used cold, with a weak current of about 1 volt. With a greater voltage, the deposit will be streaked and gray. As soon as the deposit is black, remove the plates, rinse, dry and cut to the desired size; then lacquer immediately in order to prevent the brownish discoloration which will otherwise form on the surface of the deposit. This solution can be used for brass, copper, bronze, etc.

Etching Ornamental Designs in Metal.—When metal plates having an ornamental design are required in small quantities, the etching process is sometimes used. The photographic method which is employed for nearly all intricate designs is as follows: The design is first drawn on white paper to any convenient scale, in black and white. A photographic negative is then made, or this may be procured from photo engravers who make a specialty of such work. The blacks and whites must be, respectively, opaque and transparent. This negative is used to print the design on the work to be etched, the metal, in order to take the design, being coated with a sensitized emulsion of bi-chromated albumen which has the property of remaining insoluble in water after exposure to the light. The portions corresponding to the opaque parts of the negative thus wash out in warm water, leaving the metal bare. Just prior to washing, however, the surface is coated with special lithographic ink, by means of a roller. The design is now on the metal, surrounded by a resist of a bi-chromated albumen base covered with a sticky ink. This resist is further reinforced by sprinkling the surface with dragon’s blood. The latter is melted by heating and adheres to the resist, but forms a powder on the unprotected surface which can readily be blown off. This resist is effective, provided the etching is not done too deeply. For brass and copper, a strong solution of perchloride of iron is generally preferred as an etching fluid, as this does not attack the resist like strong acids, although its action is comparatively slow. Nitric acid may be used with proper resists. While etching is usually employed for cutting into the surface of the metal, the same process can be used for perforating the design in the plate.

Various acid-resisting materials are used for covering the surfaces of steel rules, etc., prior to marking off the lines on a graduating machine. When the graduation lines are fine

and very closely spaced, as on machinists' scales which are divided into hundredths or sixty-fourths, it is very important to use a thin resist that will cling to the metal and prevent any under-cutting of the acid; the resist should also enable fine lines to be drawn without tearing or crumbling as the tool passes through it. One resist that has been extensively used is composed of about 50 per cent of asphaltum, 25 per cent of beeswax, and, in addition, a small percentage of Burgundy pitch, black pitch, and turpentine. A thin covering of this resisting material is applied to the clean polished surface to be graduated and, after it is dry, the work is ready for the graduating machine. For some classes of work, paraffin is used for protecting the surface surrounding the graduation lines which are to be etched. The method of application consists in melting the paraffin and raising its temperature high enough so that it will flow freely; then the work is held at a slight angle and the paraffin is poured on its upper surface. The melted paraffin forms a thin protective coating.

Etching Resists.—Various acid-resisting materials are used for covering the surfaces of steel rules, etc., prior to marking off the lines on a graduating machine. When the graduation lines are fine and very closely spaced, as on machinists' scales which are divided into hundredths or sixty-fourths, it is very important to use a thin resist that will cling to the metal and prevent any under-cutting of the acid; the resist should also enable fine lines to be drawn without tearing or crumbling as the tool passes through it. One resist that has been extensively used is composed of about 50 per cent of asphaltum, 25 per cent of beeswax, and, in addition, a small percentage of Burgundy pitch, black pitch, and turpentine. A thin covering of this resisting material is applied to the clean polished surface to be graduated and, after it is dry, the work is ready for the graduating machine. For some classes of work, paraffin is used for protecting the surface surrounding the graduation lines which are to be etched. The method of application consists in melting the paraffin and raising its temperature high enough so that it will flow freely; the work on which the graduating is to be done is held at a slight angle and the paraffin is poured on its upper edge. As the melted paraffin flows across the work surface, the latter will be covered with a thin protective coating.

Burnishing

The burnishing of metals is a method of securing smooth finished surfaces by compressing the outer layer of the metal, either by the application of highly polished tools, or by the use of steel balls which, by rolling contact, produce smooth surfaces.

Burnishing of Spun or Drawn Shapes: After sheet metal is spun, or drawn in presses, the smooth, even surface which it has when it comes from the mills is changed to a rough, uneven surface having high and low spots which are hardly noticeable to the naked eye, but very easily distinguished under the magnifying glass. The working operations distend or elongate the molecules, and the annealing operation restores them to their original shape. Some shells are annealed several times before the burnishing operation is reached, besides being pickled after each annealing to remove the scale; this leaves the surface of the metal in a matted condition, as well as soft and without temper.

A spun shell can be gone over with a planisher, and hardened, but the scale and dirt is crowded into the grain of the metal and the only way to obtain a smooth surface is to buff or cut it down until this pitted face is removed, thus wasting about 10 per cent of the metal. The spinner can do this in another way, that is by skimming or shaving the uneven surface, but even more metal is wasted than by buffing, and the shell is also weakened by gouging the high places. This same shell could be left without polish, and the chuck transferred to the burnishing lathe, which runs at much greater speed than one used for spinning. After the shell is dipped right to remove all spinning dirt and scale, it can then be polished to an even surface, the uneven face of the metal being amalgamated or smoothed down to a bright surface of the proper temper; it is then colored with a cloth buff to obtain a perfect finish. The gage or thickness remains the same, as there is no dirt or scale to buff out. It is necessary to have a metal chuck in burnishing, and where the shell has been spun on such a chuck, the latter can be used for both operations. Some work can be lacquered without col-

oring on the buff wheel, the only operation after burnishing being to wash in hot water and dry at once in hot sawdust.

Burnishing Tools: Burnishing tools are made extremely hard and no temper is drawn. These tools have to be re-polished when they become coated with metal, the interval between polishings depending upon the texture of the metal worked and its temper, a shell that has been annealed several times coating the tool more than one that has not. The end of a burnisher may be polished quickly. A board of soft wood is used, or a strip of leather fastened to a board and to the bench, in a position convenient to the operator. Grooves are worn into the leather or board, and flour of emery and oil, or flint flour and water, is used to clean the tools, a few passes of a tool being all that is necessary to polish it.

Cleaning Work for Burnishing: The bright dip which is used to clean work before burnishing is composed of oil of vitriol (sulphuric acid), 2 parts; aqua fortis (nitric acid), 1 part. This solution should be kept in a crock set in a tank of running water, and mixed 7 or 8 hours before using, as the acids when combined heat up. It is best to mix the acids the day before using. In dipping brass, copper, and German silver, the parts are strung on a stiff brass or copper wire whenever possible. If there are no holes in the metal that can be used for stringing, they can be put in a metal or crock basket, but they cannot be handled to good advantage as it is very difficult to thoroughly wash and dip them. The work should be washed in boiling potash, and then dipped in cold water to clean the potash off and cool the metal. After cooling in the water, the parts are dipped for a few seconds in the acids, and are kept constantly in motion, so that the surfaces will be all exposed equally; they are then shaken thoroughly above the acid and immediately washed in two separate cold-water baths, then in hot soapy water, and finally in hot water, after which they are dried at once in hot sawdust. This operation will leave a bright, clean surface free from acid.

Lubricants for Burnishing: Common yellow soap, dissolved to thick paste, may be used as a lubricant when burnishing brass. The shells and the finger pads are dipped in clear water, and the tool is dipped in the soap paste before burnishing each shell. A lubricant for copper is made by dissolving about one ounce of ivory or castile soap in a gallon of water. The shells and pads are dipped in this solution, no lubricant being used on the tool. Yellow soap should not be used on copper, as the action of the resin on copper is different from that on brass, the metal being so glazed or greased that the tool works badly. For copper plate on steel, such as copperized steel oilers, etc., about one-half ounce of oil of vitriol to four gallons of water should be used. The burnishing tool should be dipped in a mixture of mutton tallow that has been melted with 5 per cent of beeswax, and the work and the finger pads should be dipped in the acid mixture. The tool is lubricated in the tallow mixture before burnishing each shell.

For German silver, the shell should be dipped in clear water, the finger pads in sour beer, and the tool in yellow soap paste. For white metal or britannia, use ivory or castile soap in the paste form for the tool, and sour beer or ox gall in water (4 ounces to the gallon) for the finger pads. Wash the work in hot alkali water (a spoonful of cream of tartar, saleratus or soda to a pail of water), and dry in hot sawdust. For burnishing work which is to be lacquered, without coloring on the cloth buff, use thin glue for a lubricant, and also on the finger pads. When the part is burnished, put it in saleratus water to keep it from tarnishing; then wash in hot water and dry in hot sawdust.

Burnishing Broach.—This is a broach having teeth or projections which are rounded on the top instead of being provided with a cutting edge, as in the ordinary type of broach. The teeth are highly polished, the tool being used for broaching bearings and for operations on other classes of work where the metal is relatively soft. The tool compresses the metal, thus making the surface hard and smooth. The amount of metal that can be displaced by a smooth-toothed burnishing broach is about the same as that removed by reaming. Such broaches are primarily intended for use on babbitt, white metal, and brass, but may also be satisfactorily used for producing a glazed surface on cast iron. This type of broach is also used when it is only required to accurately size a hole.

Burnishing by Ball Process.—Barrel burnishing is done to finish, polish, or brighten metal parts without cutting away the stock, steel balls acting as individual burnishing tools. Tilting barrels are sometimes used for ball burnishing when the work is small, but the horizontal type is universally recommended. The hardened and polished steel balls roll over the work while under pressure, and rub against the parts evenly. The pressure is caused by the weight of the balls and the work in the barrel. Some manufacturers claim that a horizontal barrel, large in diameter and comparatively small in width, is the best type to use, because a certain quantity of balls will not spread over so large a space, and will therefore create a greater pressure on the work. In this type of barrel, about two pecks of steel balls should be used for one peck of work, and to this should be added a sufficient quantity of soapy water to rise one inch above the contents of the barrel. Soapy water serves as a lubricant. About six ounces of pure soap or soap chips without much alkali should be put in each pail of water. Another manufacturer claims that a barrel of small diameter, and comparatively long, completely filled with work, balls, and soapy water, is more efficient than the type just mentioned. It is said that the work then passes constantly and evenly through the mass of balls without bumping and falling against each other.

Polygon-shaped barrels prevent the work from bunching together and sliding instead of tumbling inside the barrel. Balls from $\frac{1}{16}$ to $\frac{1}{4}$ inch in diameter are generally used, the size depending on the work and dimension of the cavity or corners in the pieces; the balls should be small enough to enter all cavities, and to insure this, a round steel slug with a fin-like edge is sometimes used. Articles to be barrel-burnished must be cleaned and must be free from oil or dirt. Double and triple burnishing barrels permit of burnishing more than one class of work at a time. Burnishing barrels permit the finishing of hundreds and thousands of small pieces at one time quickly and inexpensively.

Burnishing Dies.—When an exceptionally good finish or polish is required, blanks which have been trimmed in a shaving die are pushed through what is known as a *burnishing* die. Such a die has an opening which tapers slightly inward toward the bottom, and it is finished very smooth, so that, when the blank is forced through by the punch, the metal around the edges is compressed and polished. Naturally, the degree of finish on the blanks will depend largely upon the finish of the burnishing surface of the die.

Burnishing Lathes.—A burnishing lathe is smaller than a spinning lathe, and it has only one speed although the speeds of different lathes are varied to suit the work. The counter shaft is fastened to the floor under the lathe; this is necessary on account of the great speed; besides a downward pull of the driving belt causes less vibration than the upward pull of a belt from an overhead countershaft. The burnishing is done by pushing the tool over the work, beginning at the front end and pushing always against the chuck or form over which the work is held. The toolpost is used as a fulcrum and the tool, which is pressed against the work, as a lever. The tool is given a slight rotary motion, and only the thin edge or end is used. While the pressure against the work is not great, the area in contact with the metal is so small, and the speed of the lathe so high, being from 3200 to 5000 revolutions per minute, that the tool leaves a bright surface. The skill of the operator lies in passing the tool over the metal so as to leave a continuous bright surface without any trace of the tool marks; to do this the tool must be fed with regularity and without overlapping or leaving any dull places.

Burnishing Roller.—The roller type of burnishing tool is sometimes used in machine shops, especially railway repair shops, for rolling the cylindrical surface of a journal, crankpin bearing surface, etc., in order to obtain a smooth dense finish. The burnishing tool consists of a hardened roller or disk which is supported by a shank held in the lathe toolpost. The leading edge or side of this disk is rounded and the burnishing is done by feeding the roller over the surface the same as in turning. The roller may be mounted on a plain bearing, but tools of improved design are equipped with roller bearings.

FASTENERS

Distinguishing Bolts From Screws

STEEL SCREWS AND BOLTS are classified in Chapter 73, *Harmonized Tariff Schedule of the United States (HTSUS)* under heading 7318. The tariff has separate provisions for the different types of screws and bolts, and separate provisions for threaded and non-threaded fasteners. The tariff pages covering the various types of steel screws and bolts can be found by checking the latest version of the HTSUS at www.usitc.gov.

U.S. Customs and Border Protection uses fastener industry standards to distinguish bolts from screws. When a fastener is described in a fastener industry dimensional standard as either a screw or a bolt, that standard is followed; otherwise ANSI/ASME B18.2.1-1981, *Specification for Identification of Bolts and Screws*, (the “Specification”) provides a well-recognized, comprehensive basis for the common and commercial meaning of bolt and screw as understood by the fastener industry in the United States.

The Specification includes both primary and supplementary criteria. If a fastener does not meet the primary criteria and does not conform to a fastener industry standard for a bolt, then it probably is a screw. The supplementary criteria help distinguish bolts from screws. These rules are subordinate to Customs rulings and court decisions.

Specification.—The following definitions are based on *Specification for Identification of Bolts and Screws*, ANSI/ASME B18.2.1-1981. The specification establishes a recommended procedure for determining the identity of an externally threaded fastener as a bolt or as a screw.

Bolt: A bolt is an externally threaded fastener designed for insertion through the holes in assembled parts, and is normally intended to be tightened or released by torquing a nut.

Screw: A screw is an externally threaded fastener capable of being inserted into holes in assembled parts, of mating with a preformed internal thread or forming its own thread, and of being tightened or released by torquing the head.

Explanatory Data.—A bolt is designed for assembly with a nut. A screw has features in its design that make it capable of being used in a tapped or preformed hole in the work. It is possible to use certain types of screws in combination with a nut. *Any externally threaded fastener which has a majority of the design characteristics which assist its proper use in a tapped or other preformed hole is a screw*, regardless of how it is used in service .

Procedure.—To identify an externally threaded fastener as a bolt or as a screw, two sets of criteria, *Primary* and *Supplementary*, shall be applied. The primary criteria shall be applied first. Any fastener which satisfies one of the primary criteria shall be identified accordingly, and no further examination need be made. The supplementary criteria shall be applied to a fastener which does not satisfy completely any one of the primary criteria. The supplementary criteria detail the principal features in the design of an externally threaded fastener that contribute to its proper use as a screw. A fastener having a majority of these characteristics shall be identified as a screw.

Primary Criteria.—1) An externally threaded fastener, which because of head design or other feature, is prevented from being turned during assembly, and which can be tightened or released only by torquing a nut, is a bolt. *Example:* Round head bolts, track bolts, plow bolts.

2) An externally threaded fastener, which has a thread form which prohibits assembly with a nut having a straight thread of multiple pitch length, is a screw. *Example:* Wood screws, tapping screws.

3) An externally threaded fastener, which must be assembled with a nut to perform its intended service, is a bolt. *Example:* Heavy hex structural bolt.

4) An externally threaded fastener, that must be torqued by its head into a tapped or preformed hole to perform its intended service is a screw. *Example:* Square head set screw.

Supplementary Criteria.—When applying the supplementary criteria compare the specification drawing to which the fastener was made to the drawing of an industry standard fastener in order to see if a given tolerance is fine like a screw, or coarse like a bolt.

Underhead Fillet: A screw should have a controlled fillet at the junction of the head with the body. Because of the severe combined torsion and tension stresses at this junction when torquing the head, the minimum limits of the fillet radius should be specified. Because the screw must be capable of being turned through a minimum clearance hole and into an immovable tapped hole, the maximum limits of the fillet radius should be specified to assure solid seating of the head, and to prevent interference at the top of the hole with the junction of head to body. *Example:* An underhead fillet is the concave junction at the head and the shank intersection of a headed fastener.

Head Angularity: The angularity (squareness) of the underhead bearing surface with the shank of a screw should be controlled to minimize eccentric loading in the screw or assembled parts, and to assure complete seating and uniform underhead bearing pressure.

Example: Angularity is the angle between the axes of two surfaces of a fastener.

Bearing Surface: The under head bearing surface of a screw should be smooth and flat to minimize frictional resistance during tightening, to prevent scoring of the surface against which the head is turned, and to produce uniform clamping loads. *Example:* The bearing surface is the supporting or locating surface of a fastener with respect to the part which it fastens (mates). The loading of a fastener is usually through the bearing surface.

Body: The body of a screw should be closely controlled in accuracy of size and roundness. To fit effectively through a minimum clearance hole, the body diameter must have close tolerances, preferably unilateral on the minus side. *Example:* The body of a threaded fastener is the unthreaded portion of the shank.

Shank Straightness: The shank of a screw should be particularly straight to permit ready engagement with the internal thread, to prevent eccentric loading in the fastener or assembled parts, and to minimize interference with the walls of a minimum clearance hole.

Example, Bow or Camber: Bow or camber is the amount that a side of a surface of a fastener deviates from being straight.

Thread Concentricity: The threads of a screw should be concentric with the body axis within close limits to permit assembly into a tapped hole (which usually has a length of thread engagement longer than a nut) without binding of the body against the walls of a minimum clearance hole.

Thread length: Length of thread on a screw must be sufficient to develop the full strength of the fastener in tapped holes in various materials. *Length of complete thread* is defined as the axial length of a thread section having full form at both crest and root but also including a maximum of two pitches at the start of the thread which may have a chamfer or incomplete crests.

Point: A screw should have a chamfered, or other specially prepared point at its end to facilitate entry into the hole and easy start with the internal thread, which may be distant from the top of the hole. The point also protects the first thread, which, if damaged, may gall or scar the internal thread throughout its entire length. *Example:* The point of a fastener is the configuration of the end of the shank of a headed fastener or of each end of a headless fastener.

Length: The length of a screw should be closely toleranced with variance preferably unilateral on the minus side to prevent bottoming in a tapped hole. *Example:* The length of a headed fastener is the distance from the intersection of the largest diameter of the head with the bearing surface to the extreme point, measured in a line parallel to the axis of the fastener. Exceptions: The length of a shoulder screw and a socket head shoulder screw is the length of the shoulder. The length of a headless fastener is the distance from one extreme point to the other, measured in a line parallel to the axis of the fastener.

Fasteners

Stove Bolt.— This bolt has been so named because of its use in stove building. It is made in a number of different forms, either with a round button, or flat countersunk head, the head having a slot for a screwdriver and the threaded end being provided with a square or hexagon nut.

Flattening Test.— This term as applied to tubing refers to a method of testing a section of tubing by flattening it until the inside walls are parallel and separated by a given distance—usually equal to three times the wall thickness for seamless tubes and five times the wall thickness for lap-welded tubes. Boiler tubes subjected to this test should show no cracks or flaws. The flattening test applied to rivets, consists in flattening a rivet head while hot to a diameter equal to $2\frac{1}{2}$ times the diameter of the shank or body of the rivet. Good rivet steel must not crack at the edges of the flattened head.

Rivets, Cold Formed.— In permanently assembling various light parts, it is often possible to greatly reduce the cost and yet secure sufficient strength by cold forming in an assembling die, the rivet or rivets as an integral part of one of the assembled sections. Figs. 1a, 1b, and 1c illustrate how a steel spring is cold riveted to the heavier section. Plain round punches descend and form the rivets by forcing metal down through the holes in the spring (see Fig. 1b); the metal at the edge is then turned back by the die as shown in Fig. 1c, thus completing the riveting at one stroke of the press. In this particular case, about sixty assemblies per minute are obtained.

Embossed Dowels and Hubs: When dowel-pins are required to insure the accurate location of parts relative to each other, small projections or bosses may be formed directly on many die-made products, the projection being an integral part of the work and serving as a dowel-pin. Figure 1d illustrates how the dowel is formed. The method may be described as a partial punching operation, as a punch penetrates about one-half the stock thickness and forces the boss into a pocket in the die which controls the diameter and compresses the metal, thus forming a stronger projection than would be obtained otherwise. The height h of the dowel or boss should not exceed one-half of the dowel diameter d and h should not exceed one-half of the stock thickness t . This is a practical rule which may be applied either to steel or non-ferrous metals, such as brass.

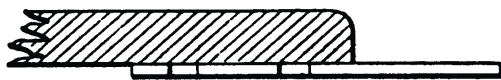


Fig. 1a.

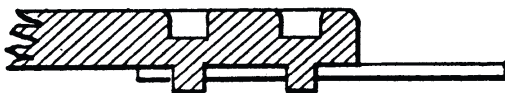


Fig. 1b.



Fig. 1c.

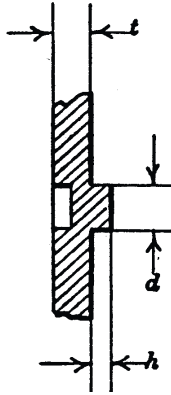


Fig. 1d.

Explosive Rivets.—Explosive rivets are set into metal by means of a special riveting iron which heats the rivet head to about 300 degrees F. and causes detonation of an explosive charge (usually lead azide-tetrazene) in a cavity in the rivet shank. The explosion causes the shank to expand, forming a tight joint between two or more parts.

Expansion Bolt.—When a through bolt cannot be used for attaching a pipe hanger, bracket, or other part, to a wall or ceiling of brick or concrete, what are known as *expansion bolts* are often used. The body of an expansion bolt is divided and the arrangement is such that, when the head of the bolt is turned, the sections forming the body of the bolt are forced outward and against the wall of the hole which has been drilled into the brick, concrete, or stone, as the case may be. Bolts of this type are made in quite a variety of designs. The nominal size represents the diameter of the bolt proper and not the diameter of the casing or expansion member.

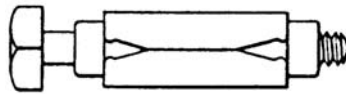


Fig. 2. Expansion Bolt

North Bolt.—A North bolt is one which has a number of longitudinal grooves rolled into its body. This type of bolt is used largely on farming machinery and other agricultural appliances.

Washers.—Plain washers are made in standard sizes to suit standard screw threads, bolts and screws. The manufacturers' regular standard, adopted in 1935, is for bolt sizes ranging from $\frac{1}{4}$ inch up to 3 inches, inclusive. There is also an S.A.E. standard for plain washers. This includes screw and bolt sizes ranging from No. 2 machine screw up to, and including, $1\frac{1}{2}$ -inch bolts. These washers are somewhat smaller than the manufacturers' standard and also have smaller inside diameters or clearance spaces between the bolt and washer.

Nut Standardization.—The former American Standard for Nuts, adopted by the American Standards Association in 1933, includes a Regular Series and a Heavy Series. Regular nuts are for general use and the heavy nuts are for applications requiring a larger bearing surface. In each of these series, there are unfinished, semi-finished, and finished grades.

Regular Nuts, Unfinished: The width across the flats of square and hexagon nuts equals $1\frac{1}{2} \times$ screw thread diameter, excepting $\frac{1}{4}$ - to $\frac{5}{8}$ -inch sizes inclusive, which have widths equal to $1\frac{1}{2} \times$ screw thread diameter + $\frac{1}{16}$ inch, adjusted in all cases to sixteenths. Unfinished nuts are threaded but not machined on any other surface.

Regular Nuts, Semi-Finished: The width across the flats (hexagon nuts only) equals $1\frac{1}{2} \times$ screw thread diameter, excepting sizes $\frac{1}{4}$ - to $\frac{5}{8}$ -inch inclusive, which have widths equal to

$1\frac{1}{2} \times$ screw thread diameter + $\frac{1}{16}$ inch, adjusted in all cases to sixteenths. Semi-finished nuts are threaded and machined on bearing surface only.

Regular Nuts, Finished: The width across the flats equals $1\frac{1}{2} \times$ screw thread diameter, excepting $\frac{1}{4}$ - to $\frac{5}{8}$ -inch sizes inclusive, which have widths equal to $1\frac{1}{2} \times$ screw thread diameter + $\frac{1}{16}$ inch, adjusted in all cases to sixteenths. Finished nuts are threaded and finished on all surfaces. Made in hexagon form only.

Heavy Nuts, Unfinished: The width across the flats of square and hexagon nuts equals $1\frac{1}{2} \times$ screw thread diameter + $\frac{1}{8}$ inch, adjusted to sixteenths excepting sizes below $\frac{1}{2}$ inch.

Heavy Nuts, Semi-Finished: The width across the flats (hexagon nuts only) equals $1\frac{1}{2} \times$ screw thread diameter + $\frac{1}{8}$ inch, adjusted to sixteenths, excepting sizes below $\frac{1}{2}$ inch.

Heavy Nuts, Finished: The width across the flats equals $1\frac{1}{2} \times$ screw thread diameter + $\frac{1}{8}$ inch, adjusted to sixteenths, excepting sizes below $\frac{1}{2}$ inch. Made in hexagon form only.

Wood Screws

The American Standard for wood screws includes both the flat-head and round-head forms. The sizes are indicated by numbers and range from No. 0 to 24. The equivalent diameters range from 0.060 inch to 0.372 inch and are the same as the equivalent diameters for machine screws, although wood screw sizes such as Nos. 11, 14, 16, 18, 20 and 24, are not included in American Standard machine screws. Various forms of wood screws are shown in the illustrations of Tables 1a and 1b. The nominal length of the different forms is indicated by dimensions L . As illustrated in Fig. 1k, the length of the roundhead type is from the bottom of the slot; but the nominal length of an American Standard screw is measured under the head. The range of lengths for each screw size number is included in the American Standard. The number of lengths for each screw size varies. Commonly used sizes, such as No. 6 to No. 18, are made in twelve to fourteen different lengths, whereas small sizes, such as No. 0 to No. 5, are made in two to eight lengths.

Table 1a. Wood-screws of Different Forms

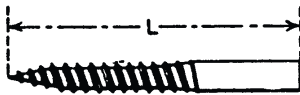


Fig. 1a. Headless

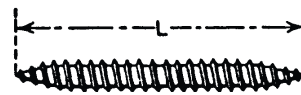


Fig. 1b. Dowel

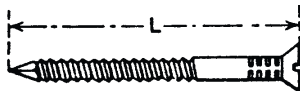


Fig. 1c. Diamond Point Flat Head Drive

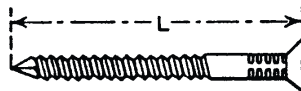


Fig. 1d. Diamond Point Oval Head Drive

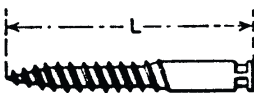


Fig. 1e. Pinched Head

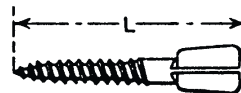


Fig. 1f. Winged

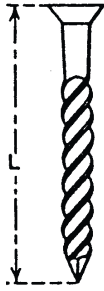
Table 1a. Wood-screws of Different Forms

Fig. 1g. Rogers Flat Head Drive

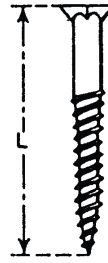


Fig. 1h. Bung Head

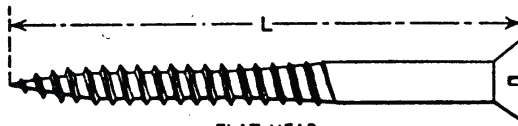
Table 1b. Wood-screws of Different Forms

Fig. 1i. Flat Head

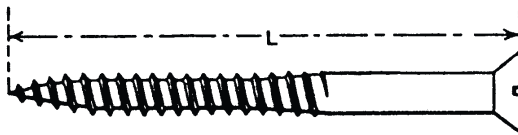


Fig. 1j. Oval Head

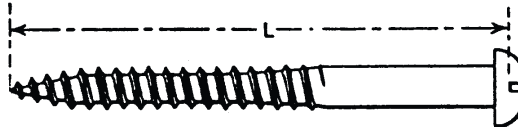


Fig. 1k. Round Head

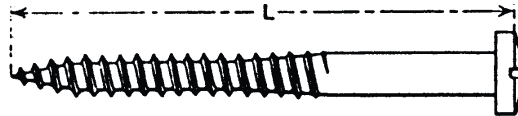


Fig. 1l. Fillister Head

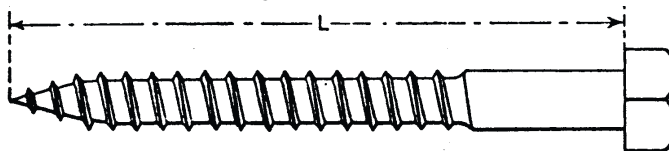


Fig. 1m. Coach or Lag Screw

Wood-Screw Holding Power.—One-half inch diameter wood-screws, driven 4 inches into wood, have a holding power of about 2500 pounds; 1/2-inch lag screws, driven 1½ inches into wood, have a holding power of about 1500 pounds, and, if driven 2½ inches into wood, of 2000 pounds. In all these tests the wood was Norway pine. Five-eighth-inch lag screws, driven 4½ inches into seasoned white oak, show a maximum holding power of 8000 pounds; the same screws driven into yellow pine, 4000 pounds.

THREADS AND THREADING

Threads and Threading

History of Briggs Pipe Thread (NPT).—The USA (American) Standard for Pipe Threads, originally known as the Briggs Standard, was formulated by Mr. Robert Briggs. For several years around 1862 Mr. Briggs was superintendent of the Pascal Iron Works of Morris, Tasker & Company, Philadelphia, Pa., and later engineering editor of the “Journal” of the Franklin Institute. After his death on July 24, 1882, a paper by Mr. Briggs containing detailed information regarding American pipe and pipe thread practice, as developed by him when superintendent of the Pascal Iron Works, was read before the Institution of Civil Engineers of Great Britain. This is recorded in the Excerpt Minutes, Volume LXXI, Session 1882-1883, Part 1, of that Society.

It is of interest to note that the nominal sizes (diameters) of pipe ten (10) inches and under, and the pitches of the thread were for the most part established between 1820 and 1840.

By publishing his data, based on years of practice, Mr. Briggs was the means of establishing definite detail dimensions. The Briggs formula did not provide for the internal threads or gaging requirements for making taper threaded joints. It established only the external thread on pipe, with no tolerance.

In 1886 the large majority of American manufacturers threaded pipe to practically the Briggs Standard, and acting jointly with The American Society of Mechanical Engineers they adopted it as a standard practice that year, and master plug and ring gages were made.

Later at various conferences representatives of the manufacturers and the ASME established additional sizes, certain details of gaging, tolerances, special applications of the standard, and in addition tabulated the formulas and dimensions more completely than was done by Mr. Briggs.

Until the manufacturers adopted the Briggs thread in 1886, it seems that each manufacturer of necessity threaded his pipe and fittings according to his best judgment. After 1886 there was some attempt to work toward better interchangeability. However, the need for a better gaging practice resulted in the adoption of the thin ring gage and the truncation of the plug and ring gages to gage the flanks of the thread. This practice of threading fittings and couplings which provides threads to make up joints with a wrench was standardized about 1913.

In 1913 a Committee on the Standardization of Pipe Threads was organized for the purpose of re-editing and expanding the Briggs Standard. The American Gas Association and The American Society of Mechanical Engineers served as joint sponsors. After six years of work, this committee completed the revised standard for taper pipe thread which was published in the ASME “*Transactions*” of 1919, and was approved as an American Standard by the American Engineering Standards Committee, later named the American Standards Association in December 1919. It was the first standard to receive this designation under the ASA procedure, and was later published in pamphlet form.

In the years which followed, the need for a further revision of this American Standard became evident as well as the necessity of adding to it the recent developments in pipe threading practice. Accordingly, the Sectional Committee on the Standardization of Pipe Threads, B2, was organized in 1927 under the joint sponsorship of the A.G.A. and the ASME.

During the following 15 years, several meetings were held leading to approval by the members of the Sectional Committee, of the April 1941 draft. The revision was approved by the sponsors and ASA and published as an American Standard in October, 1942.

Shortly after publication of the 1942 standard, the Committee undertook preparation of a complete revision. The text and tables were rearranged and expanded to include Dryseal pipe threads, and an extensive appendix was added to provide additional data on the appli-

cation of pipe threads and to record in abbreviated form the several special methods which were established for gaging some of the various applications of pipe threads.

The resulting proposal was approved by letter ballot of the Sectional Committee. Following its acceptance by the sponsor bodies, the draft was submitted to the American Standards Association and designated an American Standard on December 11, 1945.

At a subsequent meeting of the Sectional Committee it was agreed that for the convenience of users, the standards covering Dryseal pipe threads should be published under separate cover. Consequently, the section included in ASA B2.1-1945 on Dryseal pipe threads was deleted from the 1960 revision to that standard and used as a basis for the development of a separate proposal for Dryseal pipe threads. The text and tables were expanded to completely document the various series threads and gages, and appendices covering formulas, drilled hole sizes and special series threads were added. The E_1 internal diameter and the L_1 hand type engagements for the $\frac{1}{8}$ and $\frac{1}{4}$ inch sizes were revised to correct for a disproportionate number of threads for hand tight engagement. This proposal was approved by letter ballot vote of the Sectional Committee and submitted to the A.G.A. and the ASME. Following approval by the sponsor organizations, it was approved by the American Standards Association on April 29, 1960, and designated as ASA B2.1-1960, Pipe Threads (Except Dryseal).

The present revision of this standard constitutes a general updating. In line with their current policy, the A.G.A. has withdrawn sponsorship of this standard, while remaining active in the work of the standards committee. In compliance with the rules of the United States of America Standards Institute (formerly ASA) the previously designated Sectional Committees are now called Standards Committees.

Following approval by the Standards Committee B2 and the sponsor, ASME, the revision was approved by the United States of America Standards Institute on November 29, 1968.

Lock-Nut Pipe Thread.—The lock-nut pipe thread is a straight thread of the largest diameter which can be cut on a pipe. Its form is identical with that of the American or Briggs standard taper pipe thread. In general, “Go” gages only are required. These consist of a straight-threaded plug representing the minimum female lock-nut thread, and a straight-threaded ring representing the maximum male lock-nut thread. This thread is used only to hold parts together, or to retain a collar on the pipe. It is never used where a tight threaded joint is required.

Whitworth Thread Origin.—The work of the earlier generation of English tool builders culminated in that of Sir Joseph Whitworth. He, like most other English mechanics, was a North-country man, who had worked for both Maudslay and Clement. The succession of influence running through these men is singularly illustrated in the development of standard screw threads. Maudslay standardized the screw-thread practice of his own shop, settling upon and adhering to a definite number and size of threads for each size of screw then in use. Clement, who worked for Maudslay, adopted these standards, improved them, began the manufacture of taps and dies, and invented the tap having a small shank to enable it to fall through the tapped hole, thereby avoiding the necessity for backing out the tap. Whitworth took up the work of Clement and Maudslay, and, after making a careful study of all the threads in general use, proposed, in a paper before the Institute of Civil Engineers in 1841, the standard which became general throughout Great Britain and continues today as the Whitworth Standard thread. Most of the general tools had been invented by the time Whitworth began his independent work, but he so improved their design and workmanship that he influenced English tool practice for several generations. He introduced an accuracy in commercial work unknown until that time, which was made possible by his improvements in the methods of measurement.

Helix Angle.—If the base of a right-angle triangle equals the lead of a screw thread and if the altitude equals the pitch circumference of the screw, then the angle between the hypot-

enuse and altitude of the triangle equals the helix angle of that screw thread at the pitch line; hence, the tangent of the helix angle equals the lead of the thread divided by the pitch circumference (circumference at one-half the thread depth). It is evident from the foregoing that the helix angle of a screw thread is measured from a plane perpendicular to the screw axis and it is usually known as the lead angle. This angle ordinarily is based upon the pitch diameter. If the helix angle at the top of a screw thread were required, the circumference at the outside diameter would be taken instead of the pitch circumference. The helix angle of a helical (spiral) gear is measured from the axis. Thus if the lead (axial distance that a tooth would advance if it made one complete turn) of a helical gear equals the base of a right-angle triangle and if the pitch circumference of the gear equals the altitude, then the angle between the hypotenuse and the base equals the helix angle; hence, the tangent of this helix angle equals the pitch circumference of the gear divided by the lead of the helix.

Thread Grinding.—Thread grinding is applied both in the manufacture of duplicate parts and also in connection with precision thread work in the tool-room.

Single-edged Grinding Wheel: In grinding a thread, the general practice in the United States is to use a large grinding wheel (for external threads) having a diameter of possibly 18 to 20 inches. The width may be $5/16$ or $3/8$ inch. The face or edge of this comparatively narrow wheel is accurately formed to the cross-sectional shape of the thread to be ground. The thread is ground to the correct shape and lead by traversing it relative to the grinding wheel. This traversing movement, which is equivalent to the lead of the screw thread for each of its revolutions, is obtained from a lead-screw. On one type of thread grinder, this lead-screw is attached directly to the work-spindle and has the same lead as the screw thread to be ground; hence, there is a separate lead-screw for each different lead of thread to be ground. On another design of machine, the lead-screw arrangement is similar to that on a lathe in that the required lead on the ground thread is obtained by selection of the proper change gears. The grinding wheel may have a surface speed of 7000 feet a minute, whereas the work speed may range from 3 to 10 feet per minute. The grinding wheel is inclined to suit the helix angle of the thread and either right- or left-hand threads may be ground. Provision is also made for grinding multiple threads and for relieving taps and hobs. The wheel shape is accurately maintained by means of diamond truing tools. On one type of machine, this truing is done automatically and the grinding wheel is also adjusted automatically to compensate for whatever slight reduction in wheel size may result from the truing operation.

An internal thread may also be ground with a single-edged wheel. The operation is the same in principle as external thread grinding. The single-edged wheel is used whenever the highest precision is required, grinding the work either from the solid or as a finishing operation.

Grinding "from the Solid": On some classes of work, the entire thread is formed by grinding "from the solid," especially if the time required is less than would be needed for a rough thread-cutting operation followed by finish-grinding after hardening. Grinding threads from the solid is applied to the finer pitches. In some plants, threads with pitches up to about $1/16$ inch are always ground by this method.

Multi-edged Grinding Wheel: An entire screw thread, if not too long, may be ground completely in one revolution by using a multi-edged type of grinding wheel. The face of this wheel is formed of a series of annular thread-shaped ridges so that it is practically a number of wheels combined in one. The principle is the same as that of milling screw threads by the multiple-cutter method. If the length of the thread to be ground is less than the width of the wheel, it is possible to complete the grinding in practically one work revolution as in thread milling. A grinding wheel having a width of, say, $2\frac{1}{2}$ inches, is provided with annual ridges or threads across its entire width. The wheel is fed in to the thread depth, and, while the work makes one single revolution, the wheel moves axially a distance equal

to the thread lead along the face of the work. Most threads which require grinding are not longer than the width of the wheel; hence, the thread is completed by one turn of the work.

If the thread is longer than the wheel width, one method is to grind part of the thread and then shift the wheel axially one or more times for grinding the remaining part. For example, with a wheel $2\frac{1}{2}$ inches in width, a thread approximately 12 inches long might be ground in five successive steps. A second method is that of using a multi-edged tapering wheel which is fed axially along the work. The taper is to distribute the work of grinding over the different edges or ridges as the wheel feeds along.

Hand Chaser.—A hand chaser is a type of threading tool used either for cutting or chasing external or internal threads. The tool is supported upon a rest and is guided by the hand; it is used mainly on brass work, for slightly reducing the size of a thread that has been cut either by a die or threading tool. A hand chaser may also be used for truing up battered threads in repair work and for similar purposes.

Thread-Cutting Methods.—The two general methods of forming screw threads may be defined as the cutting method and the rolling or displacement method. The cutting methods as applied to external threads are briefly as follows:

- 1) By taking a number of successive cuts with a single-point tool that is traversed along the part to be threaded at a rate per revolution of the work depending upon the lead of the thread. (Common method of cutting screw threads in the engine lathe.)
- 2) By taking successive cuts with a multiple-point tool or chaser of the type used to some extent in conjunction with the engine lathe and on lathes of the Fox or monitor types.
- 3) By using a tool of the die class, which usually has four or more multiple-point cutting edges or chasers and generally finishes the thread in one cut or passage of the tool.
- 4) By a single rotating milling cutter, which forms the thread groove as either the cutter or the work is traversed axially at a rate depending upon the thread lead.
- 5) By a multiple rotating milling cutter which completes a thread in approximately one revolution of the work.
- 6) By a multiple rotating cutter which also has a planetary rotating movement about the work which is held stationary. See Planamilling and Planathreading.
- 7) By a grinding wheel having its edge shaped to conform to the groove of the screw thread.
- 8) By a multi-edged grinding wheel which, within certain limits as to thread length, will grind the complete thread in practically one revolution of the work.

Internal screw threads, or those in holes, may or may not be produced by the same general method that is applied to external work. There are three commercial methods of importance, namely:

- 1) By the use of a single-point traversing tool in the engine lathe or a multiple-point chaser in some cases.
- 2) By means of a tap which, in machine tapping, usually finishes the thread in one cut or passage of the tool.
- 3) By a rotating milling cutter of either the single or the multiple type.

Dies operated by hand are frequently used for small and medium-sized parts, especially when accuracy as to the lead of the thread and its relation to the screw axis is not essential and comparatively few parts need to be threaded at a time. When a large number of pieces must be threaded, power-driven machines equipped with dies are commonly employed. If the operation is simply that of threading the ends of bolts, studs, rods, etc., a "bolt cutter" would generally be used, but if cutting the thread were only one of several other operations necessary to complete the work, the thread would probably be cut in the same machine performing the additional operations. For instance, parts are threaded in turret lathes and automatic screw machines by means of dies and in conjunction with other operations. When screws are required which must be accurate as to the pitch or lead of the thread, and be true relative to the axis of the work, a lathe is generally used; lathes are also employed, ordi-

narily, when the threaded part is comparatively long and large in diameter. Many threads which formerly were cut in the lathe are now produced by the milling process in special thread-milling machines. The method often depends upon the equipment at hand and the number of parts to be threaded. Very precise threads may be produced by grinding.

Taper Thread Cutting.—A tool for cutting tapered screw threads should be set as shown in Fig. 1a, or so that the sides of the thread incline equally with reference to a line perpendicular to the axis of the screw. The principal reason why taper threads should be cut with the tool in this position is that taper taps are made in this way or with the threads normal to the axis. If the tool were set in the position shown in Fig. 1b or Fig. 1c or so that the sides of the thread incline equally with reference to the tapering surface, obviously such a thread would be a poor fit in a hole tapped with an ordinary taper tap having threads normal to the axis as in Fig. 1a. If the hole and the tapering part which screws into it were both threaded normal to the surface as in Fig. 1b, the thread would be satisfactory unless there were an unusual amount of taper. In extreme cases, angle α (Fig. 1b) of one side of the thread might be so small that the radial or bursting pressure on the nut would be excessive owing to the wedging action.

Correct and Incorrect Positions of Tool for Taper Thread Cutting

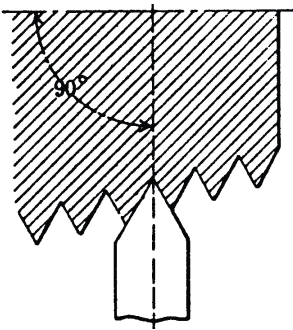


Fig. 1a.

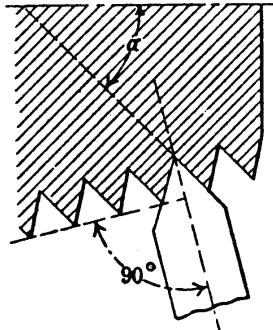


Fig. 1b.

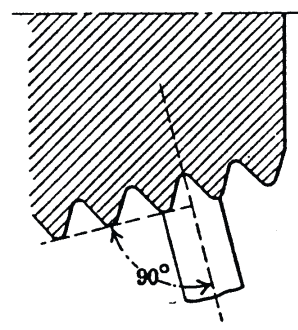


Fig. 1c.

Taps

A tap is an internal thread-cutting tool having teeth which conform to the shape of the thread. Taps may be classified according to the kind of thread with which they are provided, as U. S. Standard thread taps, square thread taps, and Acme thread taps, etc. The most important classification of taps, however, is according to their use.

Hand taps as the name implies, are intended primarily for tapping holes by hand but are often used in machines. All taps used by hand are not termed "hand" taps as there are many special taps used by hand which are known by specific names.

Tapper taps are used for tapping nuts in tapping machines. They are provided with a long chamfered part on the end of the threaded portion, and a long shank.

Machine nut taps are also used for tapping nuts in tapping machines. This type is designed for more severe duty than the tapper tap and is especially adapted for tapping holes in materials of tough structure. Machine nut taps are chamfered and relieved in a different, manner from tapper taps.

Machine screw taps may be either hand taps or machine nut taps, but are known by the name "machine screw tap," because they constitute a class of special taps used for tapping holes for standard machine screw sizes.

Screw machine taps for tapping in the screw machine are provided with shanks fitting either the turret holes of the machine or bushings inserted in these holes. As these taps ordinarily cut threads down to the bottom of the hole, they are provided with a very short chamfer.

Pulley taps are simply a special type of taps used for tapping holes which cannot be reached by ordinary hand taps, as, for instance, the set-screw or oil-cup holes in the hubs of pulleys. They are simply hand taps with a very long shank.

Die taps also known as long taper die taps, are used for cutting the thread in a die in a single operation from the blank, and are intended to be followed by a sizing hob tap. Die taps are similar to machine nut taps.

Hob taps are used for sizing dies. They are intended only for the final finishing of the thread and can only take a slight chip. They are made to the same dimensions as regular hand taps, but fluted differently.

Pipe taps are used for tapping holes for standard pipe sizes. These taps are taper taps. There is also a special form of pipe tap termed *straight* pipe tap, which is simply a hand corresponding in diameter and number of threads per inch to standard pipe sizes.

Pipe hobs are similar to pipe taps, but are intended only for sizing pipe dies after the thread has been cut either by a pipe tap or in a lathe.

Boiler taps are used in steam boiler work where a steam-tight fit is required. They are made either straight or tapered. The straight boiler tap is practically only a hand tap.

Mud or washout taps are used in boiler or locomotive work. They are sometimes also called arch pipe taps. Patch bolt taps are used in boiler and locomotive work. These are taper taps similar to mud or washout taps.

Staybolt taps are used on locomotive boiler work. They are usually provided with a reamer portion preceding the threaded part, and have generally a long threaded portion and a long shank. A special form of staybolt tap is known as a spindle staybolt tap which revolves on a central spindle with a taper guide on the front end.

Stove-bolt taps and *carriage-bolt taps* are taps which have derived their names from the uses to which they were originally put. These taps have special forms of threads.

Bit-brace taps differ in no essential from the hand tap on the threaded portion, but are provided with a special shank for use in a bit brace.

Blacksmiths' taper taps are made for general rough threading and are used especially in repair work, where an accurately fitting thread is not required.

Inserted cutter taps may belong to any of the classes mentioned and constitute a separate type only because they are not solid, but have the cutting teeth on blades inserted and held rigidly in a tap body.

Tapping Lubricants.—Experiments have proved that the power required in tapping—that is, the resistance to the action of the tap when threading a nut—varies considerably with different lubricants. The following lubricants reduce the resistance to the cut when threading forged nuts, as well as those made from hexagon drawn material; the threads in the nut have a good finish and appearance: Stearine oil, lard oil, sperm oil, rape oil, and a mixture of 10 per cent graphite with 90 per cent tallow. A mixture of cutting emulsion with water also reduces the resistance to the threading action fairly well. In tests with emulsion, it was noted that it made very little difference how much water was mixed with the emulsion. A mixture of one part emulsion to 160 parts of water proved practically as good as a mixture of one part emulsion to ten parts of water.

Compound oils, that is, mineral oils mixed with animal or vegetable oils of the type usually employed for cooling lubricants for turning and milling, produce a considerably higher resistance than the animal or vegetable oils and cannot, therefore, be recommended for tapping. Mineral oils not mixed, and ordinary lubricating and machine oils, are wholly unsuitable. The resistance to cutting is very great, the taps break, and the threads in the nuts are badly torn; ordinary water reduces the cutting resistance better than some of the compound oils. Animal and vegetable oils, therefore, ought to be used exclusively for tapping.

Experiments on Lubricants for Tapping: Experiments conducted at Gothenburg, Sweden, on a large scale, indicate that the generalizations made from the earlier experiments, as recorded in the foregoing, are correct. Animal and vegetable oils are the best for tapping mild steel, and of these stearine oil and “Winter-strained” lard oil are preferable. Mineral

oils machine oil were found to be wholly unsuitable. Compound oils containing less than 50 per cent of animal or vegetable oil acted much the same as the mineral oils and cannot be recommended for threading. When the compound oils contained over 50 per cent animal or vegetable oil, they could be used and were then found to be almost as good as the pure animal and vegetable oils.

A few emulsions have given almost as good results as animal and vegetable oils, but the kind of emulsion used plays an important part, and the majority of emulsions do not give good results. In almost all the tests made, a large volume of lubricant gave somewhat better results than a small quantity. This was particularly evident in the case of the thinner oils. Kerosene, turpentine, and graphite proved unsuitable for tapping steel.

With regard to the size of the hole tapped when different lubricants were used, it was found that the lubricant that produced the least resistance to tapping generally tended to produce the largest tapped hole. For example, when a hole was tapped dry, it would be a most accurate reproduction of the tap as far as size was concerned, but the threads were not clean and smooth, and, of course, the length of life of the tap was reduced. Water used as a lubricant produced good looking threads, but rather high resistance. Stearine oil, which reduced the resistance to tapping to the greatest extent, also produced the largest diameter in the hole.

For tapping aluminum, kerosene is recommended. For tapping cast iron use a strong solution of emulsion; oil has a tendency to make cast-iron chips clog in the flutes, thus preventing the lubricant from reaching the cutting teeth of the tap. For tapping copper, milk is a good lubricant.

Tap Drill Diameters.— Tapping troubles are often caused by using tap drills that are too small in diameter. For ordinary manufacturing, not more than 75 or 80 per cent of the standard thread depth is necessary, and for some classes of work not more than 50 per cent is required. Tap drill sizes, especially for machine screws, should be varied according to the material to be tapped and the depth of the tapped hole. The diameters of tap drills can be found by the formula $D = T - (0.75 \ 2 \ d)$, in which D drill diameter; T = diameter of tap or thread; d = depth of thread.

The diameters obtained by this formula allow for a thread having 75 per cent of the standard depth which is sufficient for general work. The full depth of an American Standard thread equals 0.6495 times the pitch of the thread, and the full depth of a British Standard Whitworth thread equals 0.6403 times the pitch.

GEARS, SPLINES, AND CAMS

Geometry Factors For Gear Teeth

Contact and Bending Stresses.—To calculate the contact and bending stresses acting between the teeth of a pair of gears meshing under load, it is necessary to include in the stress formulas a number of factors that account for the geometry of the teeth, the physical properties of the materials used, and the nature of the specific application.

AGMA 908-B89 Information Sheet* gives equations for calculating the pitting resistance geometry factor, I , for external and internal spur and helical gears; and the bending strength geometry factor, J , for external spur and helical gears that are generated by rack-type tools (hobs, rack cutters, or generating grinding wheels) or pinion-type tools (shaper cutters). The document includes 66 tables of geometry factors, I and J , for a range of typical gear sets and tooth forms of $14\frac{1}{2}$ -, 20-, and 25-deg pressure angles and 0-, 10-, 15-, 20-, 25-, and 30-deg helix angles.

The Information sheet was prepared to assist designers making preliminary design studies and to present data useful to those without access to computer programs. Not all tooth forms, pressure angles, and pinion and gear modifications are covered. Neither are these data applicable to all gear designs; however, the data should be helpful to the majority of gear designers. Data from this Information Sheet are used with the rating procedures described in AGMA 2001-B88, *Fundamental Rating Factors and Calculation Methods for Involute Spur and Helical Gear Teeth*, for evaluating various spur and helical gear designs produced by using a generating process (see page 3301).

Geometry Factors for Pitting Resistance and Bending Strength.—The AGMA Information Sheet includes a mathematical procedure to determine the pitting resistance geometry factor, I , for internal and external gear sets of spur, conventional helical, and low-axial-contact-ratio (LACR) helical design. A mathematical procedure is also included to determine the bending strength geometry factor, J , for external gear sets of spur, conventional helical, and low-axial-contact-ratio (LACR) helical designs. The calculation procedure is valid for generated root fillets produced by both rack- and pinion-type tools.

Exceptions to the Information Sheet Data and Procedures.—The formulas in the Information Sheet are not valid when any of the following conditions exist:

- 1) Spur gears with transverse contact ratio less than one, $m_p < 1.0$;
- 2) spur or helical gears with transverse contact ratio equal or greater than two, $m_p \geq 2.0$;
- 3) interference exists between the tips of teeth and root fillets;
- 4) the teeth are pointed;
- 5) backlash is zero;
- 6) undercut exists in an area above the theoretical start of the active profile (the effect of this undercut is to move the highest point of single tooth contact, negating the assumption of this calculation method; however, the reduction in tooth thickness due to protuberance below the active profile is handled correctly by this method);
- 7) the root profiles are stepped or irregular (the J factor calculation uses the stress correction factors developed by Dolan and Broghamer; the factors may not be valid for root forms that are not smooth curves; for root profiles that are stepped or irregular, other stress correction factors may be appropriate);
- 8) where root fillets of the gear teeth are produced by a process other than generating; and
- 9) the helix angle at the standard (reference) diameter is greater than 50 deg.

In addition to these exceptions, it is assumed that 1) the friction effect on the direction of force is neglected; and 2) the fillet radius is smooth (it is actually a series of scallops).

* Extracted from AGMA 908-B89, Information Sheet, *Geometry Factors for Determining the Pitting Resistance and Bending Strength of Spur, Helical, and Herringbone Gear Teeth*, with the permission of the publisher, American Gear Manufacturers Association, 1500 King Street, Suite 201, Alexandria, Virginia 22314.

Basic Gear Geometry of Spur and Helical Gears.—The equations that follow apply to spur and helical gears. Where double signs are used (e.g., \pm), the upper sign applies to external gears and the lower sign to internal gears. The equations given are based on unity normal module ($m_n = 1$) or unity normal diametral pitch ($P_{nd} = 1$) and are valid for any consistent set of units. All angles are in radians unless otherwise specified. *In using the given equations, certain variables must be made dimensionless by dividing by the normal module m_n or multiplying by the normal diametral pitch P_{nd} .* For example, if a face width F 0.5 in. and the normal diametral pitch is 4, then the value of F to be used in the equations is $0.5 \times 4 = 2$. The variables to be so adjusted are $F, R_{o1}, R_{o2}, R_{oc}, R_c, h_{ao}, \delta_{ao}, \rho_{ao}$, and Δ_{sn} .

$$\text{Gear ratio, } m_G = \frac{n_2}{n_1}, \text{ Where } n_1 \text{ and } n_2 \text{ are pinion and gear tooth numbers} \quad (1)$$

$$\text{Standard (reference) pinion pitch radius, } R_1 = \frac{n_1}{2 \cos \psi} \quad (2)$$

Where ψ = standard helix angle.

$$\text{Standard (reference) gear pitch radius, } R_2 = R_1 m_G \quad (3)$$

$$\text{Standard transverse pressure angle, } \phi = \arctan\left(\frac{\tan \phi_n}{\cos \psi}\right) \quad (4)$$

Where ϕ_n = standard normal pressure angle.

$$\text{Pinion base radius, } R_{b1} = R_1 \cos \phi \quad (5)$$

$$\text{Gear base radius, } R_{b2} = R_{b1} m_G \quad (6)$$

$$\text{Operating transverse pressure angle, } \phi_r = \arccos\left(\frac{R_{b2} \pm R_{b1}}{C_r}\right) \quad (7)$$

Where C_r = Operating center distance.

$$\text{Transverse base pitch, } P_b = \frac{2\pi R_{b1}}{n_1} \quad (8)$$

$$\text{Normal base pitch, } P_N = \pi \cos \phi_n \quad (9)$$

$$\text{Base helix angle, } \psi_b = \arccos\left(\frac{P_N}{P_b}\right) \quad (10)$$

Fig. 1 shows a view of the line of action in the transverse plane of two meshing gears. The distances C_1 , through C_6 are derived from this figure taking into account the exceptions noted previously with regard to undercut.

$$C_6 = C_r \sin \phi_r \quad (11)$$

$$C_1 = \pm [C_6 - (R_{o2}^2 - R_{b2}^2)^{0.5}] \quad (12)$$

where R_{o2} = addendum radius of gear, for internal or external gears.

$$C_3 = \frac{C_6}{(m_G \pm 1)} \quad (13)$$

$$C_4 = C_1 + P_b \quad (14)$$

$$C_5 = (R_{o1}^2 - R_{b1}^2)^{0.50} \tag{15}$$

Where R_{o1} = addendum radius of pinion.

$$C_2 = C_5 - P_b \tag{16}$$

$$\text{Active length of line of contact, } Z = C_5 - C_1 \tag{17}$$

Distance C_2 locates the lowest point of single tooth contact (LPSTC); distance C_4 locates the highest point of single tooth contact (HPSTC), where C_r , R_{o1} , and R_{o2} are values for $m_n = 1$ or $P_{nd} = 1$.

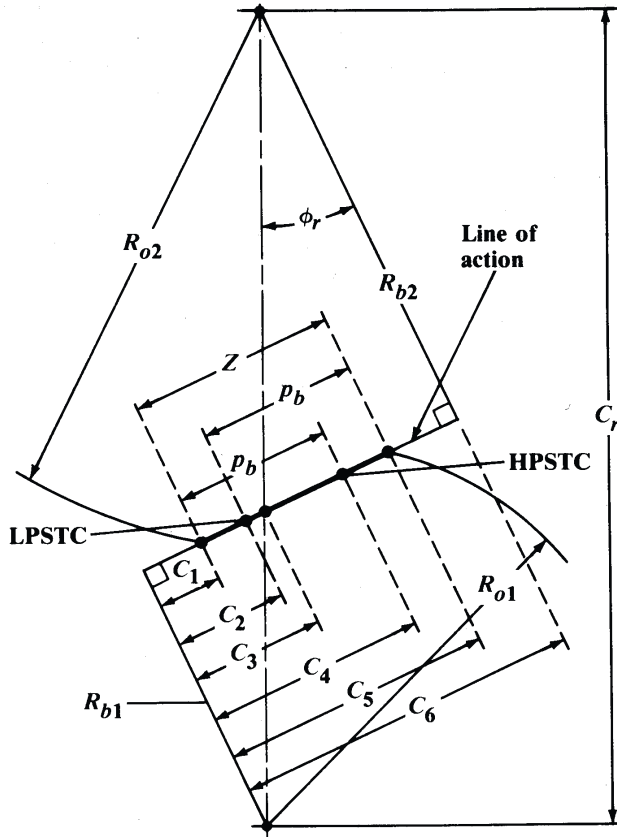


Fig. 1. Transverse Plane View of the Line of Action

Contact Ratios.—The contact ratios are as follows:

$$\text{Transverse Contact ratio, } m_p = \frac{Z}{P_b} \tag{18}$$

$$\text{Axial pitch, } P_x = \frac{\pi}{\sin \psi} \tag{19}$$

$$\text{Axial contact ratio, } m_F = \frac{F}{P_x} \tag{20}$$

where F = effective face width at $m_n = 1$ or $P_{nd} = 1$. For spur gears, $m_F = 0$.

Minimum Lengths of Lines of Contact.—For spur gears with $m_p < 2.0$ the minimum length of contact lines, L_{min} ,

$$L_{min} = F \quad (21)$$

For helical gears, two cases must be considered:

$$\text{Case I: For } n_a \leq 1 - n_r, L_{min} = \frac{(m_p F - n_a n_r p_x)}{\cos \psi_b} \quad (22)$$

$$\text{Case II: For } n_a > 1 - n_r, L_{min} = \frac{[m_p F - (1 - n_a)(1 - n_r)p_x]}{\cos \psi_b} \quad (23)$$

where n_r = fractional part of m_p , and n_a = fractional part of m_F . For example, if $m_p = 1.4$, then $n_r = 0.4$.

Load Sharing Ratio, m_N .—The load sharing ratio m_N , is calculated as follows:

$$\text{For helical gears, } m_N = \frac{F}{L_{min}} \quad (24)$$

$$\text{For spur gears with } m_p \leq 2.0, \text{ Eq. (21) has } L_{min} = F \text{ so that } m_N = 1.0 \quad (25)$$

For low axial contact ratio (LACR) helicals, $m_F \leq 1.0$. Load sharing is accommodated by the helical overlap factor C_ψ [Equation (36)]; therefore,

$$m_N = 1.0 \quad (26)$$

$$\text{Operating helix angle, } \psi_r = \arctan\left(\frac{\tan \psi_b}{\cos \phi_r}\right) \quad (27)$$

$$\text{Operating normal pressure angle, } \phi_{nr} = \arcsin(\cos \psi_b \sin \phi_r) \quad (28)$$

Calculating the Pitting Resistance Geometry Factor, I .—The pitting resistance geometry factor I is a dimensionless number that takes into account the effects of the radii of curvature of the gear tooth surfaces, load sharing, and the normal component of the transmitted load:

$$I = \frac{\cos \phi_r C_\psi^2}{[(1/\rho_1 + 1/\rho_2)(dm_N)]} \quad (29)$$

where

ϕ_r = operating transverse pressure angle [Equation (7)];

C_ψ = helical overlap factor [Equation (36)];

d = pinion operating pitch diameter [Equation (30)];

m_N = load sharing ratio [Equation (24), (25), or (26)]; and

ρ_1 and ρ_2 = radii of curvature of pinion and gear profiles, respectively, at point of stress calculation.

$$\text{Operating pitch diameter of pinion, } d = \frac{2c_r}{(m_G + 1)} \quad (30)$$

Radii of Curvature of Profiles at Contact Stress Calculation Point: For conventional helical gears ($m_F > 1$) the radii of curvature are calculated at the mean radius or middle of the working profile of the pinion where

$$\text{Mean radius of pinion, } R_{m1} = \frac{1}{2}[R_{01} \pm (C_r - R_{02})] \tag{31}$$

where

R_{01} = addendum radius of pinion and;

R_{02} = addendum radius of gear, internal or external.

$$\text{radius of curvature of pinion profile, } \rho_1 = (R_{m1}^2 - R_{b1}^2)^{0.50} \tag{32}$$

Where R_{b1} = base radius of pinion.

$$\text{Radius of curvature of gear profile, } \rho_2 = C_6 \mp \rho_1 \tag{33}$$

For spur and LACR helicals ($m_F \leq 1$), the radii of curvature are calculated at the LPSTC:

$$\rho_1 = C_2 \tag{34}$$

$$\rho_2 = C_6 \mp \rho_1 \tag{35}$$

Helical overlap factor for LACR ($m_F \leq 1$), helical gears,

$$C_\Psi = \left[1 - m_F \left(1 - \frac{\rho_{m1} \rho_{m2} Z}{\rho_1 \rho_2 \rho_N} \right) \right]^{0.50} \tag{36}$$

where Z = Equation (17); p_N = Equation (9); ρ_{m1} = Equation (37) and, ρ_{m2} = Equation (38).
radius of curvature of pinion profile at mean radius of profile,

$$\rho_{m1} = (R_{m1}^2 - R_{b1}^2)^{0.50} \tag{37}$$

Radius of curvature of gear profile at mean radius of gear,

$$\rho_{m2} = C_6 \mp \rho_{m1} \tag{38}$$

$$\text{For spur and conventional helicals, } C_\Psi = 1 \tag{39}$$

Bending Strength Geometry Factor, * J .—The bending strength geometry factor is a dimensionless number that takes into account: 1) shape of the tooth; 2) worst load position; 3) stress concentration; and 4) load sharing between oblique lines of contact in helical gears .

Both tangential (bending) and radial (compressive) components of the tooth load are included. The equations and calculation procedures for the bending stress geometry factor are not given here, but may be found in AGMA 908-B89. The procedures apply only to external gears and must be repeated for both the pinion and the gear using the appropriate dimensions for each.

Generating Tool Geometry: Details of the methods for calculating the geometry of the tools used to generate tooth profiles are provided in the Information Sheet as part of the J -factor calculation procedure.

*Included in the AGMA Information Sheet are the equations needed to write a computer program to calculate values not given in the tables of J factors.

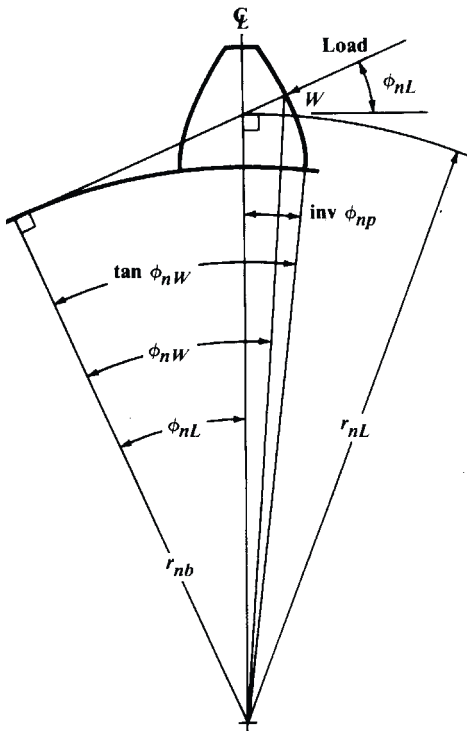


Fig. 2. Load Angle and Load Radius

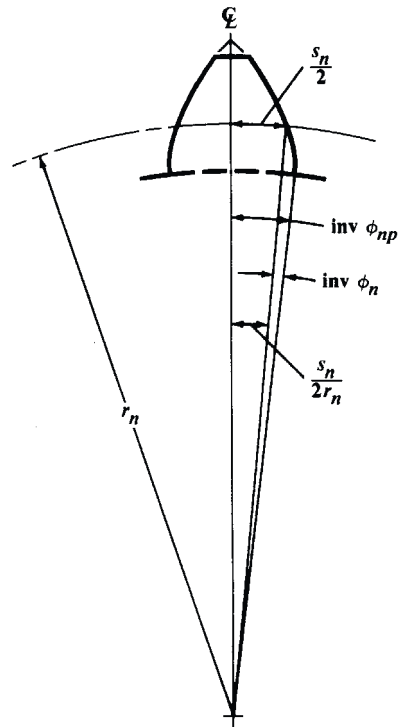


Fig. 3. Pressure Angle Where Tooth Comes to Point

Virtual Spur Gear: Helical gears are considered to be virtual spur gears with the following virtual geometry:

$$\text{Virtual tooth number, } n = \frac{n_1}{\cos^3 \psi} \tag{40}$$

$$\text{Standard (ref) pitch radius of virtual spur gear, } r_n = \frac{n}{2} \tag{41}$$

$$\text{Virtual base radius, } r_{nb} = r_n \cos \phi_n \tag{42}$$

$$\text{Virtual outside radius, } r_{na} = r_n + R_{01} - R_1 \tag{43}$$

For spur gears, the virtual geometry is the same as the actual geometry:

$$n = n_1 \tag{44}$$

$$r_n = R_1 \tag{45}$$

$$r_{nb} = R_{b1} \tag{46}$$

$$r_{na} = R_{01} \tag{47}$$

Pressure Angle at Load Application Point.—The critical bending stress on a spur gear tooth develops when all the applied load is carried at the highest point of single tooth contact on the tooth. Spur gears having variations that prevent two pairs of teeth from sharing the load may be stressed most heavily when the load is applied at the tips of the teeth. **Table 1** has been used in previous standards to establish the variation in base pitch between the

gear and pinion, which determines whether load sharing exists in steel spur gears. Values greater than those in the table require the use of tip loading in determining bending stress geometry factors described in AGMA 908-B89.

Table 1. Maximum Allowable Variation in Action for Steel Spur Gears for Load Sharing (Variation in Base Pitch)

Number of Pinion Teeth	Load Pounds per Inch of Face (Newtons Per Millimeter of Face)				
	500 lb (90N)	1000 lb (175N)	2000 lb (350N)	4000 lb (700N)	8000 lb (1400N)
	Maximum Allowable Variation in Inches and Millimeters when Teeth Share Load				
15	0.0004 in.	0.0007 in.	0.0014 in.	0.0024 in.	0.0042 in.
	0.01 mm	0.02 mm	0.04 mm	0.06 mm	0.11 mm
20	0.0003 in.	0.0006 in.	0.0011 in.	0.0020 in.	0.0036 in.
	0.01 mm	0.02 mm	0.03 mm	0.05 mm	0.09 mm
25	0.0002 in.	0.0005 in.	0.0009 in.	0.0017 in.	0.0030 in.
	0.01 mm	0.01 mm	0.02 mm	0.04 mm	0.08 mm

For helical gears and spur gears that are analyzed with the load applied at the tip of the tooth, the pressure angle at the load application point, ϕ_{nw} , is found from

$$\tan \phi_{nW} = \left[\left(\frac{r_{na}}{r_{nb}} \right)^2 - 1 \right]^{0.50} \tag{48}$$

For spur gears, where the highest bending stress occurs when the load is at the highest point of single tooth contact (HPSTC), the pressure angle is found from

$$\tan \phi_{nW} = \frac{C_4}{r_{nb}} \tag{49}$$

Equation (49) may also be used for LACR helical gears, but distance C_4 must be based on the virtual spur gear. The following equations are from analogy with Equation (3), (6), (11), (12), (14), (44), and (49):

$$\text{Standard (ref) pitch radius of virtual spur gear, } r_{n2} = r_n m_G \tag{50}$$

$$\text{Virtual base radius, } r_{nb2} = r_{nb} m_G \tag{51}$$

$$\text{Virtual outside radius, } r_{na2} = r_{n2} + R_{02} - R_2 \tag{52}$$

$$\text{Sixth distance along line of action of virtual gear, } C_{n6} = (r_{nb2} + r_{nb}) \tan \phi_{nr} \tag{53}$$

$$\text{First distance along line of action of virtual gear, } C_{n1} = [C_{n6} - (r_{na2}^2 - r_{nb2}^2)^{0.50}] \tag{54}$$

$$\text{Fourth distance along line of action of virtual gear, } C_{n4} = C_{n1} + \rho_N \tag{55}$$

The pressure angle at the load application point (tip), ϕ_{nW}

$$\tan \phi_{nW} = \frac{C_{n4}}{r_{nb}} \tag{56}$$

Generating-Rack Shift Coefficient.—The generating-rack shift coefficient, x_g , applies to the completely finished teeth. It includes the rack shift for addendum modification plus the rack shift for thinning the teeth to obtain backlash:

$$x_g = x - \frac{\Delta s_n}{2 \tan \phi_n} \tag{57}$$

where ΔS_n = amount gear tooth is thinned for backlash and x = addendum modification coefficient at zero backlash,

$$x = \frac{\left(S_n + \Delta S_n - \frac{\pi}{2}\right)}{(2 \tan \phi_n)} \quad (58)$$

where S_n = normal circular tooth thickness measured on the standard (ret) pitch cylinder,

$$S_n = \frac{\pi}{2} + 2x_g \tan \phi_n \quad (59)$$

Load Angle and Load Radius: Fig. 2 defines the load angle ϕ_{nl} and the load radius r_{nl} . The applied load is shown at an arbitrary point W such that:

$$\phi_{nl} = \tan \phi_{nw} - \text{INV} \phi_{np} \quad (60)$$

where ϕ_{np} = pressure angle where gear tooth is pointed, Fig. 3.

$$\text{INV} \phi_{np} = \text{INV} \phi_n + \frac{S_n}{2r_n} \quad (61)$$

but,

$$\text{INV} \phi_n = \tan \phi_n - \phi \quad (62)$$

and

$$2r_n = n \quad (63)$$

so that

$$\text{INV} \phi_{np} = \tan \phi_n - \phi_n + \frac{S_n}{n} \quad (64)$$

Then Equation (60) can be expressed as

$$\phi_{nl} = \tan \phi_{nw} - \tan \phi_n + \phi_n - \frac{S_n}{n} \quad (65)$$

Equation (65) gives the load angle ϕ_{nL} for any load position specified by $\tan \phi_{nw}$ found from Equation (48) and (49).

As may be seen from Fig. 3, the virtual radius is

$$r_{nl} = \frac{r_{nb}}{\cos \phi_{nL}} \quad (66)$$

Tables of Geometry Factors, I and J .—Included here are some of the tables of precalculated values of I and J extracted from the Information Sheet. For additional data, tables, and related information for other combinations of gear sets, tooth forms, pressure angles, helix angles, cutting tool dimensions, and addendum coefficients, refer to the Information Sheet. It should be noted that the formulas and data in the Information Sheet are not applicable to bending stresses in internal gears, since no simplified model for calculating bending stresses in internal gears is available.

Using the Tables.—Each of the tables in the Information Sheet and those presented here were generated for a specific tool form (basic rack) defined by whole depth factor, normal pressure (profile) angle, and tool tip radius. Only those tables applicable to spur gears are presented here; those for helical gear sets are available in the Information Sheet.

Whole Depth: Whole depth is expressed in the tables as a “whole depth factor” and is the whole depth of a basic rack for I normal module or I normal diametral pitch. The actual generated depths will be slightly greater due to tooth thinning for backlash

Outside Diameter: The tabulated values are for gears having an outside diameter (for normal module or normal diametral pitch = 1), equal to

$$D_{a1} = \frac{n_1}{\cos \psi} + 2(1 + x_1) \tag{67}$$

$$D_{a2} = \frac{n_2}{\cos \psi} + 2(1 + x_2) \tag{68}$$

where n_1 and n_2 are the pinion and gear tooth numbers, respectively; ψ = standard helix angle, deg.; and D_{a1} and D_{a2} are the pinion and gear addendum, respectively.

Center Distance: The tables apply to gearsets that operate at standard center distance. This center distance is the tight-mesh center distance for gears not yet thinned for backlash:

$$C = \frac{(n_1 + n_2)}{2 \cos \psi} \tag{69}$$

where C = standard center distance. For this center distance the sum of the addendum modification coefficients for pinion and gear is zero:

$$x_1 + x_2 = 0 \tag{70}$$

Tooth Thickness Backlash Allowance: Values in the tables were calculated based on a backlash allowance. The circular tooth thickness for the pinion and gear are each thinned by an amount Δs_n :

$$\Delta s_n = \frac{0.024}{P_{nd}} = 0.024 \text{ for } P_{nd} = 1 \tag{71}$$

If the gears being evaluated have different minimum tooth thicknesses than from Equation (71), the bending strength geometry factor, J , can be approximated by using Equation (72). The pitting resistance geometry factor, I , is unaffected by variations in tooth thickness:

$$J_1 = J_s \left(\frac{s_{n1}}{s_{ns}} \right)^2 \tag{72}$$

where J_1 = adjusted geometry factor; J_s = geometry factor from table; s_{n1} = adjusted circular tooth thickness; and s_{ns} = standard tooth thickness thinned per Equation (71).

As an example, from Table 4, for 20-deg pressure angle spur gears loaded at the highest point of single tooth contact, the J factor for a 21-tooth pinion operating with a 35-tooth gear is found to be 0.31. The table values are based on a circular tooth thickness of $\pi/2 - 0.024 = 3.1416/2 - 0.024 = 1.547$ for diametral pitch.

For a 10 normal diametral pitch pinion or gear, the equivalent circular tooth thickness would be $1.547/10 = 0.155$.

If a J value for a 0.010 in. thinner pinion, having a circular thickness of $0.155 - 0.010 = 0.145$ in. is required, the approximate value is $0.34(0.145/0.155)^2 = 0.30 = J_1$ so that a 6.5 per cent reduction in tooth thickness reduces the J factor by 12 percent.

Undercutting: The tables do not include geometry factors that may be needed if an undercutting condition exists in either of the two gears. Undercutting can be evaluated using Equation (73) and Fig. 4 where the generating-rack shift coefficient, x_g , must be equal to or greater than the expression in Equation (73):

$$x_{gmin} = h_{ao} - \rho_{ao} (1 - \sin \phi_n) - \left(\frac{n}{2} \right) \sin \phi_n^2 \tag{73}$$

where h_{ao} = nominal tool addendum; ρ_{ao} = tool tip radius; and n = pinion or gear tooth number.

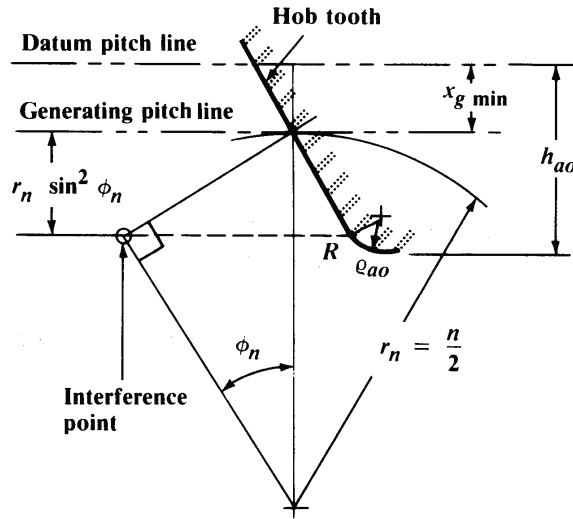


Fig. 4. Undercutting Criteria

Top Land: The tables do not include geometry factors when either the pinion or the gear tooth top land is less than the value expressed in Equation (74) or (74a):

$$s_{namin} \geq \frac{0.3}{P_{nd}} \text{ in.} \tag{74}$$

$$s_{namin} \geq 0.3m_n \text{ mm} \tag{74a}$$

in which s_{na} = tooth thickness at outside diameter.

Cutter Geometry: The hob geometry used in the calculation of I and J is as follows: Tool tooth number, $n_c = 10,000$; reference normal circular tooth thickness of tool, $s_{no} = 1.5708$; addendum modification coefficient of tool, $x_o = 0.0$; amount of protuberance, $\delta_o = 0.0$.

Table 2. Geometry Factors *I* and *J* for Various Number Combinations for Module = 1 or Normal Diametral Pitch = 1

Number of Gear Teeth	14.5 -deg Pressure Angle				2.157 Whole Depth Factor					
	0.0-deg Helix Angle				0.024 Tooth Thinning for Backlash					
	0.0157 Tool Edge Radius				Loaded at Tip of Gears					
	Number of Pinion Teeth									
	21		26		35		55		135	
	Pinion	Gear	Pinion	Gear	Pinion	Gear	Pinion	Gear	Pinion	Gear
Equal Addendum Coefficients ($x_1 = x_2 = 0$)										
35	<i>I</i>				0.061					
	<i>J</i>				0.29	0.29				
55	<i>I</i>				0.074		0.061			
	<i>J</i>				0.30	0.31	0.33	0.33		
135	<i>I</i>				0.096		0.088		0.061	
	<i>J</i>				0.31	0.34	0.35	0.35	0.38	0.38
25 percent Long Addendum Pinion ($x_1 = 0.25$)										
25 percent Short Addendum Gear ($x_2 = -0.25$)										
26	<i>I</i>			0.060						
	<i>J</i>			0.32	0.22					
35	<i>I</i>			0.071		0.059				
	<i>J</i>			0.32	0.24	0.34	0.24			
55	<i>I</i>			0.087		0.077		0.060		
	<i>J</i>			0.33	0.27	0.35	0.27	0.37	0.29	
135	<i>I</i>			0.111		0.106		0.092		0.060
	<i>J</i>			0.35	0.29	0.36	0.30	0.39	0.32	0.41 0.35
50 percent Long Addendum Pinion ($x_1 = 0.50$)										
50 percent Short Addendum Gear ($x_2 = -0.50$)										
21	<i>I</i>	0.056								
	<i>J</i>	0.35	0.15							
26	<i>I</i>	0.067		0.056						
	<i>J</i>	0.36	0.17	0.37	0.17					
35	<i>I</i>	0.081		0.071		0.056				
	<i>J</i>	0.36	0.19	0.37	0.20	0.38	0.20			
55	<i>I</i>	0.100		0.091		0.078		0.057		
	<i>J</i>	0.37	0.22	0.38	0.23	0.39	0.24	0.41	0.25	
135	<i>I</i>	0.127		0.123		0.114		0.096		0.060
	<i>J</i>	0.38	0.26	0.39	0.26	0.40	0.27	0.42	0.29	0.43 0.32

The addendum modification coefficients x_1 and x_2 are for zero backlash gears meshing at standard center distance.

Table 3. Geometry Factors I and J for Various Number Combinations for Module = 1 or Normal Diametral Pitch = 1

Number of Gear Teeth	14.5 -deg Pressure Angle				2.157 Whole Depth Factor						
	0.0-deg Helix Angle				0.024 Tooth Thinning for Backlash						
	0.0157 Tool Edge Radius				Loaded at HPSTC of Gears						
	Number of Pinion Teeth										
	21		26		35		55		135		
	Pinion	Gear	Pinion	Gear	Pinion	Gear	Pinion	Gear	Pinion	Gear	
Equal Addendum Coefficients ($x_1 = x_2 = 0$)											
35	I				0.061						
	J				0.29	0.29					
55	I				0.074		0.061				
	J				0.30	0.31	0.33	0.33			
135	I				0.096		0.088		0.061		
	J				0.31	0.34	0.35	0.35	0.38	0.38	
25 percent Long Addendum Pinion ($x_1 = 0.25$)											
25 percent Short Addendum Gear ($x_2 = -0.25$)											
26	I			0.060							
	J			0.32	0.22						
35	I			0.071		0.059					
	J			0.32	0.24	0.34	0.24				
55	I			0.087		0.077		0.060			
	J			0.33	0.27	0.35	0.27	0.37	0.29		
135	I			0.111		0.106		0.092		0.060	
	J			0.35	0.29	0.36	0.30	0.39	0.32	0.41	0.35
50 percent Long Addendum Pinion ($x_1 = 0.50$)											
50 percent Short Addendum Gear ($x_2 = -0.50$)											
21	I	0.056									
	J	0.35	0.15								
26	I	0.067		0.056							
	J	0.36	0.17	0.37	0.17						
35	I	0.081		0.071		0.056					
	J	0.36	0.19	0.37	0.20	0.38	0.20				
55	I	0.100		0.091		0.078		0.057			
	J	0.37	0.22	0.38	0.23	0.39	0.24	0.41	0.25		
135	I	0.127		0.123		0.114		0.096		0.060	
	J	0.38	0.26	0.39	0.26	0.40	0.27	0.42	0.29	0.43	0.32

The addendum modification coefficients x_1 and x_2 are for zero backlash gears meshing at standard center distance.

Table 4. Geometry Factors *I* and *J* for Various Number Combinations for Module = 1 or Normal Diametral Pitch = 1

Number of Gear Teeth	14.5 -deg Pressure Angle				2.157 Whole Depth Factor				0.0-deg Helix Angle				0.024 Tooth Thinning for Backlash			
	0.0157 Tool Edge Radius				Loaded at Tip of Gears				Number of Pinion Teeth							
	14		17		21		26		35		55		135			
	P	G	P	G	P	G	P	G	P	G	P	G	P	G		
Equal Addendum Coefficients ($x_1 = x_2 = 0$)																
21	<i>I</i>				0.078											
	<i>J</i>				0.24	0.24										
26	<i>I</i>				0.084				0.079							
	<i>J</i>				0.24	0.25	0.25	0.25								
35	<i>I</i>				0.091				0.088		0.080					
	<i>J</i>				0.24	0.26	0.25	0.26	0.26	0.26						
55	<i>I</i>				0.102		0.101		0.095		0.080					
	<i>J</i>				0.24	0.28	0.25	0.28	0.26	0.28	0.28	0.28				
135	<i>I</i>				0.118		0.121		0.120		0.112		0.080			
	<i>J</i>				0.24	0.29	0.25	0.29	0.26	0.29	0.28	0.29	0.29	0.29		
25 percent Long Addendum Pinion ($x_1 = 0.25$)																
25 percent Short Addendum Gear ($x_2 = -0.25$)																
17	<i>I</i>			0.080												
	<i>J</i>			0.27	0.19											
21	<i>I</i>			0.087				0.080								
	<i>J</i>			0.27	0.21	0.27	0.21									
26	<i>I</i>			0.094		0.088		0.080								
	<i>J</i>			0.27	0.22	0.27	0.22	0.27	0.22							
35	<i>I</i>			0.103		0.098		0.092		0.080						
	<i>J</i>			0.27	0.24	0.27	0.24	0.28	0.24	0.28	0.24					
55	<i>I</i>			0.115		0.113		0.108		0.099		0.080				
	<i>J</i>			0.27	0.26	0.27	0.26	0.28	0.26	0.28	0.26	0.29	0.26			
135	<i>I</i>			0.131		0.134		0.133		0.129		0.116		0.080		
	<i>J</i>			0.27	0.28	0.27	0.28	0.28	0.28	0.28	0.28	0.29	0.28	0.30	0.28	
50 percent Long Addendum Pinion ($x_1 = 0.50$)																
50 percent Short Addendum Gear ($x_2 = -0.50$)																
14	<i>I</i>	0.080														
	<i>J</i>	0.30	0.12													
17	<i>I</i>	0.088		0.080												
	<i>J</i>	0.30	0.15	0.30	0.15											
21	<i>I</i>	0.097		0.090		0.080										
	<i>J</i>	0.30	0.17	0.30	0.17	0.31	0.17									
26	<i>I</i>	0.105		0.099		0.090		0.080								
	<i>J</i>	0.30	0.19	0.30	0.19	0.31	0.19	0.31	0.19							
35	<i>I</i>	0.116		0.111		0.103		0.094		0.080						
	<i>J</i>	0.30	0.21	0.30	0.21	0.31	0.21	0.31	0.21	0.30	0.21					
55	<i>I</i>	0.130		0.127		0.122		0.114		0.101		0.080				
	<i>J</i>	0.30	0.24	0.30	0.24	0.31	0.24	0.31	0.24	0.30	0.24	0.30	0.24			
135	<i>I</i>	0.148		0.149		0.148		0.145		0.136		0.120		0.080		
	<i>J</i>	0.30	0.27	0.30	0.27	0.31	0.27	0.31	0.27	0.30	0.27	0.30	0.27	0.30	0.27	

The addendum modification coefficients x_1 and x_2 are for zero backlash gears meshing at standard center distance.

Table 5. Geometry Factors *I* and *J* for Various Number Combinations for Module = 1 or Normal Diametral Pitch = 1

Number of Gear Teeth	14.5 -deg Pressure Angle				2.25 Whole Depth Factor				0.0-deg Helix Angle				0.024 Tooth Thinning for Backlash			
	0.250 Tool Edge Radius				Loaded at HPSTC of Gears				Number of Pinion Teeth							
	14		17		21		26		35		55		135			
	P	G	P	G	P	G	P	G	P	G	P	G	P	G		
Equal Addendum Coefficients ($x_1 = x_2 = 0$)																
21	<i>I</i>				0.078											
	<i>J</i>				0.33	0.33										
26	<i>I</i>				0.084		0.079									
	<i>J</i>				0.33	0.35	0.35	0.35								
35	<i>I</i>				0.091		0.088		0.080							
	<i>J</i>				0.34	0.37	0.36	0.38	0.39	0.39						
55	<i>I</i>				0.102		0.101		0.095		0.080					
	<i>J</i>				0.34	0.40	0.37	0.41	0.40	0.42	0.43	0.43				
135	<i>I</i>				0.118		0.121		0.120		0.112		0.080			
	<i>J</i>				0.35	0.43	0.38	0.44	0.41	0.45	0.45	0.47	0.49	0.49		
25 percent Long Addendum Pinion ($x_1 = 0.25$)																
25 percent Short Addendum Gear ($x_2 = -0.25$)																
17	<i>I</i>			0.080												
	<i>J</i>			0.36	0.24											
21	<i>I</i>			0.087		0.080										
	<i>J</i>			0.37	0.26	0.39	0.27									
26	<i>I</i>			0.094		0.088		0.080								
	<i>J</i>			0.37	0.29	0.39	0.29	0.41	0.30							
35	<i>I</i>			0.103		0.106		0.092		0.080						
	<i>J</i>			0.37	0.32	0.40	0.32	0.41	0.33	0.43	0.34					
55	<i>I</i>			0.115		0.113		0.108		0.099		0.080				
	<i>J</i>			0.38	0.35	0.40	0.36	0.42	0.36	0.44	0.37	0.47	0.39			
135	<i>I</i>			0.131		0.134		0.133		0.129		0.116		0.080		
	<i>J</i>			0.39	0.39	0.41	0.40	0.43	0.41	0.45	0.42	0.48	0.44	0.51	0.46	
50 percent Long Addendum Pinion ($x_1 = 0.50$)																
50 percent Short Addendum Gear ($x_2 = -0.50$)																
14	<i>I</i>	0.080														
	<i>J</i>	0.40	0.14													
17	<i>I</i>	0.088		0.080												
	<i>J</i>	0.41	0.17	0.42	0.18											
21	<i>I</i>	0.097		0.090		0.080										
	<i>J</i>	0.41	0.20	0.43	0.21	0.44	0.21									
26	<i>I</i>	0.105		0.099		0.090		0.080								
	<i>J</i>	0.41	0.23	0.43	0.23	0.45	0.24	0.46	0.24							
35	<i>I</i>	0.116		0.111		0.103		0.094		0.080						
	<i>J</i>	0.42	0.26	0.43	0.27	0.45	0.27	0.46	0.28	0.48	0.29					
55	<i>I</i>	0.130		0.127		0.122		0.114		0.101		0.080				
	<i>J</i>	0.42	0.30	0.44	0.31	0.45	0.31	0.47	0.32	0.48	0.33	0.50	0.34			
135	<i>I</i>	0.148		0.149		0.148		0.145		0.136		0.120		0.080		
	<i>J</i>	0.43	0.34	0.44	0.35	0.46	0.36	0.47	0.37	0.49	0.38	0.50	0.40	0.52	0.43	

The addendum modification coefficients x_1 and x_2 are for zero backlash gears meshing at standard center distance.

Table 6. Geometry Factors *I* and *J* for Various Number Combinations for Module = 1 or Normal Diametral Pitch = 1

Number of Gear Teeth	25 -deg Pressure Angle										2.350 Whole Depth Factor					
	0.0-deg Helix Angle										0.024 Tooth Thinning for Backlash					
	0.027 Tool Edge Radius										Loaded at Tip of Gears					
Number of Pinion Teeth																
12		14		17		21		26		35		55		135		
P	G	P	G	P	G	P	G	P	G	P	G	P	G	P	G	
Equal Addendum Coefficients ($x_1 = x_2 = 0$)																
14	<i>I</i>			0.086												
	<i>J</i>			0.28	0.28											
17	<i>I</i>			0.091		0.090										
	<i>J</i>			0.28	0.30	0.30	0.30									
21	<i>I</i>			0.095		0.096		0.092								
	<i>J</i>			0.28	0.31	0.30	0.31	0.31	0.31							
26	<i>I</i>			0.100		0.101		0.099		0.094						
	<i>J</i>			0.28	0.33	0.30	0.33	0.31	0.33	0.33	0.33					
35	<i>I</i>			0.106		0.109		0.108		0.104		0.095				
	<i>J</i>			0.28	0.34	0.30	0.34	0.31	0.34	0.33	0.34	0.34	0.34			
55	<i>I</i>			0.113		0.119		0.121		0.119		0.112		0.095		
	<i>J</i>			0.28	0.36	0.30	0.36	0.31	0.36	0.33	0.36	0.34	0.36	0.36	0.36	
135	<i>I</i>			0.123		0.132		0.139		0.142		0.141		0.131		
	<i>J</i>			0.28	0.38	0.30	0.38	0.31	0.38	0.33	0.38	0.34	0.38	0.36	0.38	0.49
25 percent Long Addendum Pinion ($x_1 = 0.25$)																
25 percent Short Addendum Gear ($x_2 = -0.25$)																
14	<i>I</i>	0.095		0.093												
	<i>J</i>	0.32	0.22	0.33	0.22											
17	<i>I</i>	0.100		0.099		0.094										
	<i>J</i>	0.32	0.25	0.33	0.25	0.34	0.25									
21	<i>I</i>	0.106		0.106		0.102		0.095								
	<i>J</i>	0.32	0.27	0.33	0.27	0.34	0.27	0.36	0.27							
26	<i>I</i>	0.111		0.112		0.109		0.103		0.095		0.095				
	<i>J</i>	0.32	0.29	0.33	0.29	0.34	0.29	0.36	0.29	0.36	0.29	0.36	0.29			
35	<i>I</i>	0.118		0.120		0.119		0.115		0.108		0.096				
	<i>J</i>	0.32	0.31	0.33	0.31	0.34	0.31	0.36	0.31	0.36	0.31	0.37	0.31			
55	<i>I</i>	0.127		0.131		0.133		0.131		0.126		0.116		0.096		
	<i>J</i>	0.32	0.34	0.33	0.34	0.34	0.34	0.36	0.34	0.36	0.34	0.37	0.34	0.38	0.34	
135	<i>I</i>	0.138		0.145		0.151		0.153		0.153		0.148		0.135		
	<i>J</i>	0.32	0.37	0.33	0.37	0.34	0.27	0.36	0.37	0.36	0.37	0.37	0.37	0.38	0.37	0.39
50 percent Long Addendum Pinion ($x_1 = 0.50$)																
50 percent Short Addendum Gear ($x_2 = -0.50$)																
21	<i>I</i>							0.096								
	<i>J</i>							0.40	0.23							
26	<i>I</i>							0.106		0.096						
	<i>J</i>							0.40	0.25	0.40	0.25					
35	<i>I</i>							0.120		0.110		0.096				
	<i>J</i>							0.40	0.28	0.40	0.28	0.40	0.28			
55	<i>I</i>							0.139		0.131		0.118		0.096		
	<i>J</i>							0.40	0.32	0.40	0.32	0.40	0.32	0.40	0.32	
135	<i>I</i>							0.167		0.163		0.155		0.138		
	<i>J</i>							0.40	0.36	0.40	0.36	0.40	0.36	0.40	0.36	

The addendum modification coefficients x_1 and x_2 are for zero backlash gears meshing at standard center distance.

Table 7. Geometry Factors *I* and *J* for Various Number Combinations for Module = 1 or Normal Diametral Pitch = 1

Number of Gear Teeth	25 -deg Pressure Angle								2.350 Whole Depth Factor							
	0.0-deg Helix Angle								0.024 Tooth Thinning for Backlash							
	0.270 Tool Edge Radius								Loaded at HPSTC of Gears							
Number of Pinion Teeth																
12		14		17		21		26		35		55		135		
P	G	P	G	P	G	P	G	P	G	P	G	P	G	P	G	
Equal Addendum Coefficients ($x_1 = x_2 = 0$)																
14	<i>I</i>	0.086														
	<i>J</i>	0.33	0.33													
17	<i>I</i>	0.091		0.090												
	<i>J</i>	0.33	0.36	0.36	0.36											
21	<i>I</i>	0.095		0.096		0.092										
	<i>J</i>	0.33	0.39	0.36	0.39	0.39	0.39									
26	<i>I</i>	0.100		0.101		0.099		0.094								
	<i>J</i>	0.33	0.41	0.37	0.42	0.40	0.42	0.43	0.43							
35	<i>I</i>	0.106		0.109		0.108		0.104		0.095						
	<i>J</i>	0.34	0.44	0.37	0.45	0.40	0.45	0.43	0.46	0.46	0.46					
55	<i>I</i>	0.113		0.119		0.121		0.119		0.112		0.095				
	<i>J</i>	0.34	0.47	0.38	0.48	0.41	0.49	0.43	0.49	0.47	0.50	0.51	0.51			
135	<i>I</i>	0.123		0.132		0.139		0.142		0.141		0.131		0.096		
	<i>J</i>	0.35	0.51	0.38	0.52	0.42	0.53	0.45	0.53	0.48	0.54	0.53	0.56	0.57	0.57	
25 percent Long Addendum Pinion ($x_1 = 0.25$)																
25 percent Short Addendum Gear ($x_2 = -0.25$)																
14	<i>I</i>	0.095		0.093												
	<i>J</i>	0.38	0.25	0.40	0.25											
17	<i>I</i>	0.100		0.099		0.094										
	<i>J</i>	0.38	0.29	0.40	0.29	0.43	0.29									
21	<i>I</i>	0.106		0.106		0.102		0.095								
	<i>J</i>	0.38	0.32	0.41	0.32	0.43	0.33	0.46	0.33							
26	<i>I</i>	0.111		0.112		0.109		0.103		0.095						
	<i>J</i>	0.39	0.35	0.41	0.35	0.44	0.36	0.46	0.36	0.48	0.37					
35	<i>I</i>	0.118		0.120		0.119		0.115		0.108		0.096				
	<i>J</i>	0.39	0.38	0.41	0.39	0.44	0.39	0.47	0.40	0.49	0.41	0.51	0.41			
55	<i>I</i>	0.127		0.131		0.133		0.131		0.126		0.116		0.096		
	<i>J</i>	0.39	0.42	0.42	0.43	0.44	0.44	0.47	0.44	0.49	0.45	0.52	0.46	0.55	0.47	
135	<i>I</i>	0.138		0.145		0.151		0.153		0.153		0.148		0.096		
	<i>J</i>	0.40	0.47	0.42	0.48	0.45	0.49	0.48	0.49	0.50	0.50	0.53	0.51	0.56	0.53	
50 percent Long Addendum Pinion ($x_1 = 0.50$)																
50 percent Short Addendum Gear ($x_2 = -0.50$)																
21	<i>I</i>							0.096								
	<i>J</i>							0.52	0.27							
26	<i>I</i>							0.106		0.096						
	<i>J</i>							0.52	0.30	0.53	0.31					
35	<i>I</i>							0.120		0.110		0.096				
	<i>J</i>							0.52	0.35	0.53	0.35	0.55	0.36			
55	<i>I</i>							0.139		0.131		0.118		0.096		
	<i>J</i>							0.52	0.40	0.54	0.41	0.56	0.42	0.58	0.43	
135	<i>I</i>							0.167		0.163		0.155		0.096		
	<i>J</i>							0.53	0.46	0.54	0.47	0.56	0.48	0.58	0.50	

The addendum modification coefficients x_1 and x_2 are for zero backlash gears meshing at standard center distance.

Power-Transmitting Capacity of Spur Gears

Modes of Failure.—When sets of spur gears are made, installed, and lubricated properly, they normally may be subject to three primary modes of failure, as discussed below.

Tooth Scoring: Tooth scoring is a scuffing or welding type of tooth failure, caused by high sliding speed combined with high contact stress. Scoring is not a fatigue failure but rather a failure of the lubricant caused by increases in lubricant viscosity with pressure. The lubricant must provide cooling to the gears as well as reducing friction. Well proportioned commercial gears with a pitchline velocity of less than 7000 ft/min will normally not score if they have a reasonably good surface finish and are properly lubricated. If scoring does occur or if it is suspected to be critical in a new high speed design, the scoring temperature index should be determined by the method shown in American Gear Manufacturers Standard AGMA 217.01 or by some similar method.

Pitting: In surface pitting, small cracks first develop on and under the surfaces of gear teeth as a result of metal fatigue. Pieces of the surface then break away, and those that do not fall clear cause further damage or broken teeth. Vacuum melted steels have gone far toward reducing pitting. Failure usually occurs at a point just below the pitch surface on the driving pinion and may be anticipated in the gear design by a determination of the gear set contact compressive stress.

Tooth Breakage: Tooth breakage is usually a tensile fatigue failure at the weakest section of the gear tooth when considered as a cantilever beam. The weakest point is normally the tensile side of the gear tooth fillet, and it may be anticipated in the gear design by determining the stress at this weakest section of the gear tooth.

Strength Calculations for Spur and Helical Gears.—Many standards and procedures for the design, manufacture, inspection, and application of gears have been published for the guidance of both the users and the manufacturers of gears and gear products. Among such publications, those of the American Gear Manufacturers Association (AGMA) represent an authoritative resource for information and standards on all phases of design, inspection, manufacture, application, and other aspects of gear technology.

American Gear Manufacturers Association Standard, AGMA 2001-B88, *Fundamental Rating Factors and Calculation Methods for Involute Spur and Helical Gear Teeth*, is a revision of, and supersedes, AGMA 218.01. The Standard presents general formulas for rating the pitting resistance and the bending strength of spur and helical involute gear teeth and is intended to establish a common base for rating various types of gears for differing applications and to encourage the maximum practical degree of uniformity and consistency between rating practices in the gear industry. Standard 2001-B88 provides the basis from which more detailed AGMA Application Standards are developed and is a means for calculation of approximate ratings in the absence of such standards. Where applicable AGMA standards exist, they should be used in preference to this Standard. Where no applicable standards exist, numerical values may be estimated for the factors used in the general equations presented in the standard. The values of these factors may vary significantly, depending on the application, system effects, gear accuracy, manufacturing practice, and definition of what constitutes gear failure. Proper evaluation of these factors is essential for realistic ratings.

Information on the geometry factors, I and J , used in pitting resistance and bending strength calculations has been amplified, and moved from the old AGMA 218.01 standard to AGMA 908-B89, *Geometry Factors for Determining the Pitting Resistance and Bending Strength of Spur, Helical, and Herringbone Gear Teeth*. AGMA Standard 908-B89 is covered starting on page 3285.

Rating Formulas*.—AGMA 2001-B88 provides a method whereby different gear designs can be compared but it is not intended to ensure the performance of assembled gear drive systems. The formulas are applicable for rating the pitting resistance and bending strength of internal and external spur and helical involute gear teeth operating on parallel axes. Gear tooth capacity is influenced by the major factors that affect gear tooth pitting and gear tooth fracture at the fillet radius can be evaluated with these formulas.

Knowledge and judgment required to evaluate the various rating factors can be gained only from years of accumulated experience in designing, manufacturing, and operating gear units. Empirical factors given in the AGMA 2001-B88 standard are general in nature, and other AGMA application standards may use other empirical factors that are more closely suited to the particular field of application. AGMA 2001-B88 is intended for use by the experienced gear designer capable of selecting suitable values for the factors and not for use by engineers inexperienced in gear design and applications.

Exceptions.—The formulas in this Standard are not applicable to other types of gear tooth deterioration such as plastic yielding, wear, case crushing, and welding and are not applicable when vibratory conditions exceed the limits for the normal operation of the gears (see AGMA 6000-A88, *Specification for Measurement of Lateral Vibration on Gear Units*). The formulas are not applicable when any of the following conditions exist:

5) spur gears with transverse contact ratio less than 1.0; 6) spur or helical gears with transverse contact ratio equal to or greater than 2.0; 7) interference exists between the tips of the teeth and the root fillets; 8) the teeth are pointed; and 9) backlash is zero.

Additional Considerations.—When suitable test results or field data are not available, values for the rating factors should be chosen conservatively. Among other considerations, the following should be taken into account:

Manufacturing Tolerances: Rating factors should be evaluated on the basis of the expected variation of component parts in the production run.

Accuracy: Experimental data from actual gear unit measurements are seldom repeatable within a plus or minus 10 per cent band. Calculated gear ratings are intended to be conservative but the scatter in actual results may exceed 20 per cent.

Misalignment and Deflection of Foundations: Misalignment and deflection of foundations, on which many gear systems depend to maintain alignment of the gear mesh, will adversely affect overall performance.

Deflection due to External Loads: Deflection of supporting housings, shafts, and bearings, due to external overhang, transverse and thrust loads affects tooth contact across the mesh. Deflection varies with load, so it is difficult to obtain good tooth contact at different loads. Generally, deflection due to external loads reduces capacity.

Metallurgy: The allowable stress numbers included in the Standard are a function of melting, casting, forging, and heat treating practices. Hardness, tensile strength, and cleanliness are some of the criteria for determining allowable stress numbers; the allowable values in this Standard are based on 10,000,000 cycles of loading, 99 percent reliability, and unidirectional loading.

Variations in microstructure account for some variation in gear capacity. Higher levels of cleanliness and better metallurgical controls permit use of higher allowable stress values and, conversely, lower quality levels require the use of lower values.

Residual Stress: Any material having a case—core relationship is likely to have residual stresses. Properly managed, these stresses will be compressive at the surface and will enhance the bending strength performance of the gear teeth. Shot peening, case carburiz-

*Extracted from AGMA 2001-B88, Fundamental Rating Factors and Calculation Methods for Involute Spur and Helical Gear Teeth, with the permission of the publisher, American Gear Manufacturers Association, 1500 King Street, Suite 201, Alexandria, Virginia 22314.

ing, nitriding, and induction hardening are common methods of inducing compressive prestress in the surfaces of gear teeth.

Grinding the tooth surfaces after heat treatment reduces residual compressive stresses; and grinding the tooth surfaces and the root fillet areas may introduce tensile stresses and possibly cracks in these areas if done incorrectly. Care is needed to avoid excessive reductions in hardness and changes in microstructure during the grinding process, and shot peening after grinding is often performed to ensure the presence of residual compressive stresses.

Lubrication: The ratings determined by the formulas in the Standard are only valid when a lubricant of proper viscosity for the load, gear-tooth surface finish, temperature, and pitchline velocity is used. Gears with pitchline velocities of less than 100 ft/min require special design considerations to avoid premature failure from inadequate lubrication.

Velocities greater than 100 ft/min but less than 1000 ft/min frequently require special design considerations even when the lubricants used conform to AGMA 250 recommendations.

With velocities in the range of 1000-10,000 ft/min, lubrication problems may be caused by high temperatures, unsuitable additives in the oil, size of the pinion, inadequate oil viscosity, or tooth finish characteristics. Problems in this speed range are not common in industrial gears but sometimes occur in aerospace and in marine gearing.

From a lubrication standpoint, the design of slower gears should be based on application criteria such as hours of life, degree of reliability needed, and acceptable increases in vibration and noise as the gear teeth wear or deform. At pitchline velocities below 100 ft/min, or 20 rpm input speed, the gear designer may allow for acceptable pitting and wear to occur during the gear life when using these rating practices for other than surface-hardened gearing. Rating of gear teeth due to wear is not covered by this Standard.

System Dynamics: The dynamic response of the system results in additional gear tooth loads due to the relative motions of the connected masses of the driver and the driven equipment. Application factors, C_a and K_a , are intended to account for the operating characteristics of the driving and driven equipment. However, if the operating roughness of the driver, gearbox, or driven equipment causes an excitation with a frequency near to one of the system's major natural frequencies, resonant vibrations may cause severe overloads that may be several times higher than the nominal load. For more information, refer to AGMA 427.01, *Information Sheet-Systems Considerations for Critical Service Gear Drives*.

Corrosion: Corrosion of the gear tooth surface can have significant detrimental effects on the bending strength and pitting resistance of the teeth. The extent of these corrosion effects is not included in the Standard.

Cold Temperature Operation: For gears operated at temperatures below 320F, special care must be taken to select materials that will have adequate impact properties at the operating temperature. Consideration should be given to

1) low-temperature Charpy impact specification; 2) fracture appearance transition or nil ductility temperature specification; 3) reduction of carbon content to less than 0.4 per cent; and 4) use of higher nickel alloy steels.

Criteria for Gear Tooth Capacity

Relationship of Pitting Resistance and Bending Strength Ratings.—There are two major differences between the pitting resistance and the bending strength ratings. Pitting is a function of the Hertzian contact (compressive) stresses between two cylinders and is proportional to the square root of the applied load. Bending strength is measured in terms of the bending (tensile) stress in a cantilever plate and is directly proportional to this same load. The difference in the nature of the stresses induced in the tooth surface areas and at

the tooth root is reflected in a corresponding difference in allowable limits of contact and bending stress numbers for identical materials and load intensities.

Analysis of the load and stress modifying factors is similar in each instance, so many of these factors have identical numerical values. The term “gear failure” is itself subjective and a source of considerable disagreement. One observer’s “failure” may be another observer’s “wearing in.” A more complete discussion of “failure” is given in AGMA 110.04, Nomenclature of Gear Tooth Failure Modes.

Pitting Resistance: In most industrial practice, corrective and nonprogressive initial pitting is not deemed serious. Initial pitting is characterized by small pits that do not extend over the entire face width or profile height of the affected teeth. The definition of acceptable pitting varies widely with gear application. Initial pitting occurs in localized, overstressed areas and tends to redistribute the load by progressively removing high contact spots. Generally, when the load has been reduced or redistributed, the pitting stops.

The pitting resistance formula aims to determine a load rating at which destructive pitting of the teeth does not occur during their design life. The ratings for pitting resistance are based on the formulas developed by Hertz for contact pressure between two curved surfaces, modified for the effect of load sharing between adjacent teeth.

Bending Strength: The bending strength of gear teeth is a fatigue phenomenon related to the resistance to cracking at the tooth root fillet in external gears and at the critical section in internal gears. The basic theory employed in this analysis assumes the gear tooth to be rigidly fixed at its base, thus, the critical stress occurs in the fillet. If the rim supporting the gear tooth is thin relative to the size of the tooth and the gear pitch diameter, another critical stress may occur not at the fillet but in the root area. The rim thickness factor, KB, adjusts the calculated bending stress number for thin rimmed gears.

The strength ratings determined by this Standard are based on plate theory that is modified to consider:

- 1) the compressive stress at tooth roots caused by the radial component of tooth loading;
- 2) nonuniform moment distribution resulting from the inclined angle of the load lines on the teeth;
- 3) stress concentrations at the tooth root fillets; and
- 4) the load sharing between adjacent teeth in contact.

The intent of the AGMA strength rating formula is to determine the load that can be transmitted for the design life of the gear drive without causing cracking or failure. Occasionally, wear, surface fatigue, or plastic flow may limit bending strength due to stress concentrations around large, sharp cornered pits or wear steps on the tooth surface.

Fundamental Rating Formulas.—The symbols and definitions used in the pitting resistance and bending strength formulas are shown in Table 1. SI units are shown in parentheses in Table 1 and in the text. Where equations require a different format or constant for use with SI units, a second expression is shown after the first and with M included in the equation number at the right.

Pitting Resistance.—The fundamental formula for pitting resistance of gear teeth is

$$S_c = C_p \sqrt{\frac{W_t \times C_a C_s C_m \times C_f}{C_v d F I}} \quad (1)$$

where the meaning of the symbols is as shown in Table 1 and,

$$d = \frac{2C}{m_G + 1.0} \quad \text{for external gears} \quad (2)$$

$$d = \frac{2C}{m_G - 1.0} \quad \text{for internal gears} \quad (3)$$

Table 1. Symbols Used in Gear Rating Equations

Symbol	Description of Symbols and Units	Symbol	Description of Symbols and Units
C	Operating center distance, in. (mm)	K_R	Reliability factor for bending strength
C_a	Application factor for pitting resistance	K_s	Size factor for bending strength
C_c	Curvature factor at pitchline	K_{SF}	Service factor for bending strength
C_e	Mesh alignment correction factor	K_T	Temperature factor for bending strength
C_f	Surface condition factor for pitting resistance	K_v	Dynamic factor for bending strength
C_G	Gear ratio factor	K_y	Yield strength factor
C_H	Hardness ratio factor for pitting resistance	m	Metric module, nominal in plane of rotation (mm)
C_L	Life factor for pitting resistance	m_B	Back up ratio
C_m	Load distribution factor for pitting resistance	m_G	Gear ratio (never less than 1.0)
C_{ma}	Mesh alignment factor	m_N	Load sharing ratio
C_{mc}	Lead correction factor	m_n	Normal metric module, nominal (mm)
C_{mf}	Face load distribution factor	N	Number of load cycles
C_{mt}	Transverse load distribution factor	N_G	Number of teeth in gear
C_p	Elastic coefficient $[\text{lb/in.}^2]^{0.5}$ $([\text{MPa}]^{0.5})$	N_p	Number of teeth in pinion
C_{pf}	Pinion proportion factor	n_p	Pinion speed rpm
C_{pm}	Pinion proportion modifier	P	Transmitted power, hp (kW)
C_R	Reliability factor for pitting resistance	P_{ac}	Allowable transmitted power for pitting resistance, hp (kW)
C_s	Size factor for pitting resistance	P_{at}	Allowable transmitted power for bending strength, hp (kW)
C_{SF}	Service factor for pitting resistance	P_d	Diametral pitch, nominal, in plane of rotation, in^{-1}
C_T	Temperature factor for pitting resistance	P_{nd}	Normal diametral pitch, nominal, in^{-1}
C_v	Dynamic factor for pitting resistance	P_b	Transverse base pitch, in. (mm)
C_x	Contact height factor	P_x	Axial pitch, in. (mm)
C_ψ	Helical overlap factor	Q_v	Transmission accuracy level number
d	Operating pitch diameter of pinion, in. (mm)	S	Bearing span, in. (mm)
E_G	Modulus of elasticity for gear, lb/in.^2 (MPa)	S_I	Pinion offset, in. (mm)

Table 1. (Continued) Symbols Used in Gear Rating Equations

Symbol	Description of Symbols and Units	Symbol	Description of Symbols and Units
E_p	Modulus of elasticity for pinion, lb/in. ² (MPa)	S_{ac}	Allowable contact stress number, lb/in. ² (MPa)
e_t	Total lead mismatch, in. (mm)	S_{at}	Allowable bending stress number, lb/in. ² (MPa)
f_p	Pinion surface finish, microinches rms	S_{ay}	Allowable yield stress number, lb/in. ² (MPa)
F	Net face width of narrowest member, in. (mm)	S_c	Contact stress number, lb/in. ² (MPa)
G	Tooth stiffness constant, lb/in. ² (MPa)	S_t	Bending stress number, lb/in. ² (MPa)
H_{BG}	Brinell hardness of gear	T	Transmitted pinion torque, lb-in. (N-m)
H_{Bp}	Brinell hardness of pinion	t_R	Gear rim thickness, in. (mm)
h_c	Minimum total case depth for nitrided gears, in. (mm)	t_o	Normal tooth thickness at top land of gear, in. (mm)
h_e	Minimum effective case depth for carburized gears, in. (mm)	U_{at}	Allowable unit load for bending-strength, lb/in. ² (MPa)
$h_{e\ max}$	Maximum effective case depth, in. (mm)	U_c	Core hardness coefficient
h_t	Gear tooth whole depth, in. (mm)	U_H	Hardening process factor
I	Geometry factor for pitting resistance	U_L	Unit load for bending strength, lb/in. ² (MPa)
J	Geometry factor for bending strength	v_t	Pitch line velocity at operating pitch diameter, ft/min (m/s)
K	Contact load factor for pitting resistance, lb/in. ² (MPa)	$v_{t\ max}$	Pitch line velocity maximum at operating pitch diameter, ft/min (m/s)
K_a	Application factor for bending strength	W_d	Incremental dynamic tooth load, lb (N)
K_{ac}	Allowable contact load factor, lb/in. ² (MPa)	W_{max}	Maximum peak tangential load, lb (N)
K_B	Rim thickness factor	W_t	Transmitted tangential load, lb (N)
K_f	Stress correction factor	Y	Tooth form factor
K_L	Life factor for bending strength	Z	Length of action in transverse plane, in. (mm)
K_m	Load distribution factor for bending strength	μ_G	Poisson's ratio for gear
		μ_P	Poisson's ratio for pinion
		ϕ_t	Operating transverse pressure angle
		Ψ_s	Helix angle at standard pitch diameter
		Ψ_b	Base helix angle

Allowable Contact Stress Number: The relation of calculated contact stress number (graphed in Fig. 1) to the allowable contact stress number is

$$S_c \leq S_{ac} \frac{C_L C_H}{C_T C_R} \tag{4}$$

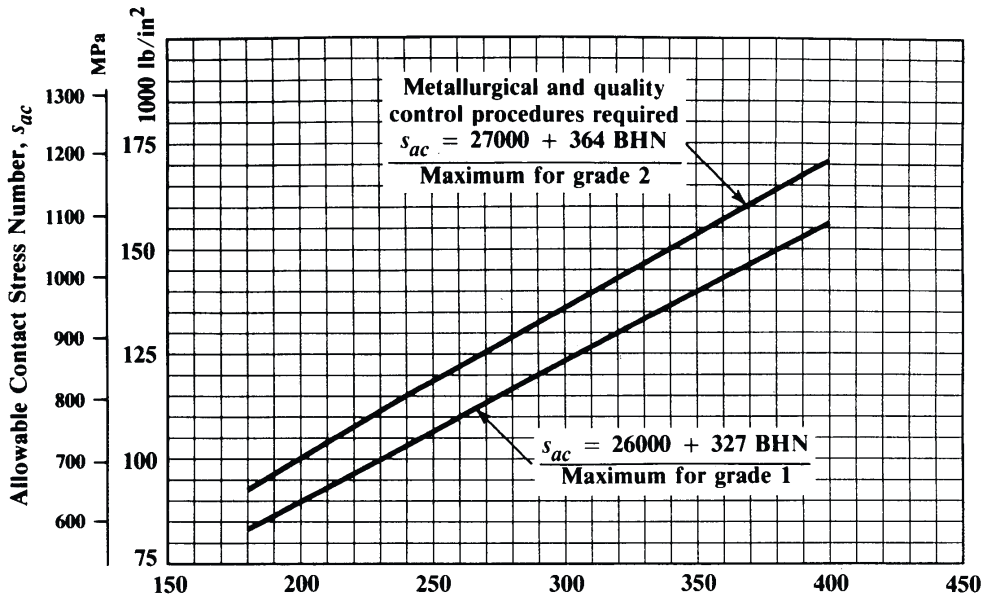


Fig. 1. Allowable Contact Stress Number for Steel Gears, S_{ac}

Pitting Resistance Power Rating.—The pitting resistance power rating is given by

$$P_{ac} = \frac{n_p \times F}{12600 C_s \times C_m \times C_f \times C_a} \frac{I \times C_v}{C_p} \left(\frac{d \times S_{ac} C_L \times C_H}{C_T \times C_R} \right)^2 \tag{5}$$

$$P_{ac} = \frac{n_p \times F}{1.91 \times 10^7 C_s \times C_m \times C_f \times C_a} \frac{I \times C_v}{C_p} \left(\frac{d \times S_{ac} C_L \times C_H}{C_T \times C_R} \right)^2 \tag{5a}$$

In using Formula (5) and (5a), the ratings of both pinion and gear must be calculated to evaluate differences in material properties and the number of cycles under load. The pitting resistance power rating is based on the lowest value of the product $S_{ac} C_L C_H$ for each of the mating gears.

Contact Load Factor, K .—In some industries, pitting resistance is rated in terms of a K factor:

$$K = \frac{W_t}{dF} \times \frac{1}{C_G} \tag{6}$$

for external gears, $C_G = \frac{N_G}{N_G + N_P}$ (7)

for internal gears, $C_G = \frac{N_G}{N_G - N_P}$ (8)

In terms of this Standard, the allowable K factor is defined as

$$K_{ac} = \frac{I}{C_G C_a \times C_s \times C_m \times C_f} \frac{C_v}{\left(\frac{S_{ac} \times C_L \times C_H}{C_p \times C_T \times C_R} \right)^2} \tag{9}$$

The allowable contact load factor, K_{ac} , is the lowest of the ratings calculated using the different values of s_{ac} , C_L , and C_H for pinion and gear.

Bending Strength.—The fundamental formula for bending stress number in a gear tooth is

$$s_t = \frac{W_t \times K_a P_d K_s \times K_m \times K_B}{K_v F J} \tag{10}$$

where $P_d = P_{nd}$ for spur gears. For helical gears, P_d is given by Equation (11),

$$s_t = \frac{W_t \times K_a I K_s \times K_m \times K_B}{K_v F \times m J} \tag{10a}$$

where $m = m_n$ for spur gears. For helical gears m is given by Equation (11a):

$$P_d = \frac{\pi}{p_x \tan \psi_s} = P_{nd} \cos \psi_s \tag{11}$$

$$m = \frac{P_x \times \tan \psi_s}{\pi} = \frac{m_n}{\cos \psi_s} \tag{11a}$$

where ψ_s is given by Equation (12) or (12a)

$$\psi_s = \text{asin} \left(\frac{\pi}{p_x \times P_{nd}} \right) \tag{12}$$

$$\psi_s = \text{asin} \left(\frac{\pi \times m_n}{p_x} \right) \tag{12a}$$

Allowable Bending Stress Number.—The relation of calculated bending stress number to allowable bending stress number is

$$S_t \leq \frac{S_{at} \times K_L}{K_T \times K_R} \tag{13}$$

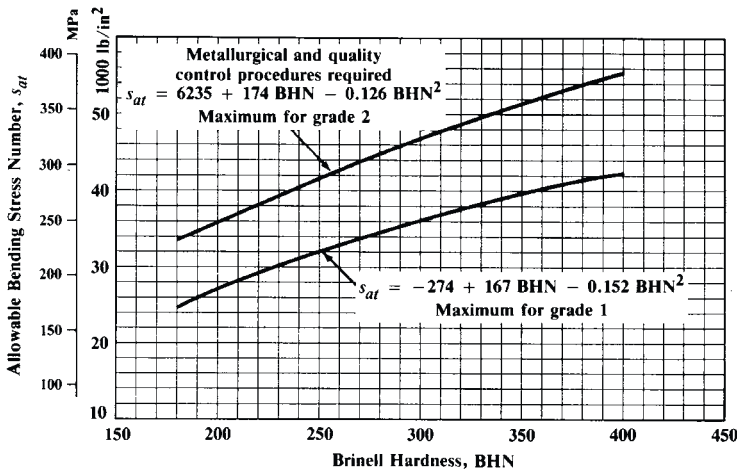


Fig. 2. Allowable Bending Stress Number for Steel Gears s_{at}

Bending Strength Power Rating.—The bending strength power rating is

$$P_{at} = \frac{n_p \times d \times K_v}{126000 \times K_a} \frac{F}{P_d K_s \times K_m \times K_B} \frac{J}{K_R \times K_T} \frac{s_{at} \times K_L}{K_L} \quad (14)$$

$$P_{at} = \frac{n_p \times d \times K_v}{1.91 \times 10^7 \times K_a} \frac{F \times m \times J}{K_s \times K_m \times K_B} \frac{s_{at} \times K_L}{K_R \times K_T} \quad (14a)$$

The ratings of both pinion and gear must be calculated to evaluate differences in geometry factors, number of load cycles, and material properties. The bending strength power rating is based on the lowest value of the term $S_{at}K_LJ/K_B$ for each of the mating gears. In some industries, the bending strength is rated in terms of unit load:

$$U_L = \frac{(W_t \times P_{nd})}{F} \quad (15)$$

$$U_L = \frac{W_t}{(F \times m)} \quad (15a)$$

The allowable unit load, U_{at} , is the lowest of the ratings calculated using the different values of S_{at} , K_B , K_L , and J for pinion and gear in Equation (16):

$$U_{at} = \frac{J}{\cos \psi} \frac{K_v}{K_a \times K_m \times K_s \times K_B} \frac{s_{at} \times K_L}{K_R \times K_T} \quad (16)$$

Values for Factors Applied in Fundamental Equations.—Values for the various factors used in the pitting resistance and bending strength rating equations are discussed and explained in greater detail in the Standard and its appendices than can be provided here. The following paragraphs are intended by the Editors to provide values for some of these factors suitable for making approximations to the ratings of pairs of mating gears without the refinements used by experienced gear designers.

Rim Thickness Factor K_B .—The rim thickness factor, K_B , is used to adjust the calculated bending stress number for thin rimmed gears, the value of the factor depending upon the backup ratio,

$$m_B = \frac{t_R}{h_t} \quad (17)$$

If m_B is equal to or greater than 1.2, then K_B may be taken as 1.0. For values of m_B less than 1.2, see the information in Appendix C following the Standard.

Geometry Factors I and J .—The geometry factors I and J for pitting resistance and bending strength, respectively, are described, along with selected typical values, beginning on page 3285.

Transmitted Tangential Load, W_t .—In most gear applications the torque is not constant, so the transmitted tangential load will vary. To obtain values of the operating transmitted tangential load, W_t , the values of power and speed at which the driven device will operate should be used. If the rating is calculated on the basis of uniform load, then the transmitted tangential load is

$$W_t = \frac{33000 \times P}{v_t} = \frac{2 \times T}{d} = \frac{126000 \times P}{n_p \times d} \quad (18)$$

$$W_t = \frac{1000 \times P}{v_t} = \frac{2000 \times T}{d} = \frac{1.91 \times 10^7 \times P}{n_p \times d} \quad (18a)$$

where,

$$v_t = \frac{(\pi \times n_p \times d)}{12} \quad (19)$$

$$v_t = \frac{(\pi \times n_p \times d)}{60000} \quad (19a)$$

Nonuniform Load: When the transmitted load is not uniform, consideration should be given not only to the peak load and its anticipated number of cycles, but also to intermediate loads and their duration. This type of load is often considered a duty cycle and may be represented by a load spectrum. The cumulative fatigue effect of the duty cycle is then considered in rating the gearset. A method of calculating the effects of the loads under such conditions is given in Appendix B of the Standard.

Dynamic Factors, C_v , and K_d .—Dynamic factors account for internally generated gear tooth loads, which are induced by nonconjugate meshing action of the gear teeth. Even if the input torque and speed are constant, significant vibration of the gear masses, and therefore dynamic tooth forces, can exist. These forces result from the relative displacements between the gears as they vibrate in response to an excitation known as “transmission error.” Ideally, a gearset would have a uniform velocity ratio between the input and output rotation. Transmission error is defined as the departure from uniform relative angular motion of the pair of meshing gears. It is influenced by all the deviations from the ideal gear tooth form.

The dynamic factor relates the total tooth load, including internal dynamic effects, to the transmitted tangential tooth load:

$$C_v = K_v = \frac{W_t}{W_d \times W_t} \quad (20)$$

where W_d = incremental dynamic tooth load due to the dynamic response of the gear pair to the transmission error excitation, excluding the transmitted tangential load W_t .

Excitation: The transmission error contributing to the dynamic factors is influenced by:

- 1) Manufacturing variations such as spacing, profile, lead, and runout.
- 2) Gear mesh stiffness variation as the gear teeth pass through the meshing cycle. This source of excitation is especially pronounced in spur gears without profile modification. Spur gears with properly designed profile modification, and helical gears with axial contact ratios greater than 1.0, have a smaller stiffness variation.
- 3) Transmitted load. Since elastic deflections are load dependent, gear tooth profile modifications can be designed to give a uniform velocity ratio at only one load magnitude.
- 4) Pitchline velocity. The frequencies of the excitation depend on the pitchline velocity.
- 5) Dynamic imbalance of the gears and shafts.
- 6) Excessive wear and plastic deformation of the gear tooth profiles increase the amount of transmission error.
- 7) Shaft alignment. Gear tooth alignment is influenced by load and thermal distortions of the gears, shafts, bearings, and housings, and by manufacturing variations.
- 8) Tooth friction induced excitation.

Dynamic Response: The dynamic tooth forces are influenced by:

- 1) Mass of the gears, shafts, and other major internal components.
- 2) Stiffness of the gear teeth, gear blanks, shafts, bearings, and gear housings.
- 3) Damping. The principal source of coulomb or viscous damping is the shaft bearings. Generally, oil film bearings provide greater damping than rolling element bearings. Other sources of damping include the hysteresis of the gear shafts, and viscous damping at sliding interfaces and shaft couplings.

Resonance: When an excitation frequency coincides with a natural frequency, the resonant response is limited only by the damping, and high dynamic loads may result. The dynamic factors C_v and K_d do not apply to resonance.

Gear Pair Resonance: If a particular frequency of the transmission error excitation is close to the natural frequency of the gear masses, or some multiple of the natural frequency such as $\frac{1}{2}$ or 2, a resonant vibration may cause high dynamic tooth forces due to large relative displacements of the gear masses. The dynamic factors C_v and K_d do not account for gear pair resonance and operation in this regime is to be avoided.

Gear Blank Resonance: Gear blanks may have natural frequencies within the operating speed range. If the gear blank is excited by a frequency that is close to one of its natural frequencies, the resonant deflections may cause high dynamic tooth loads. This phenomenon occurs more frequently in high speed, light weight gear blanks, but can also occur in other thin rimmed or thinwebbed blanks. The dynamic factors C_v and K_d do not account for gear blank resonance. A separate investigation is recommended when these conditions arise.

System Resonance: The gearbox is one component of a system comprised of a power source, gearbox, driven equipment, and interconnecting shafts and couplings. The dynamic response of this system depends on the distribution of the masses, stiffness, and damping. In certain designs, a system may possess a torsional natural frequency close to an excitation frequency associated with an operating speed. Under these resonant conditions the dynamic tooth loads may be high, and operation near such a system resonance is to be avoided. The dynamic factors C_v and K_d do not include considerations of the dynamic loads due to torsional vibration of the gear system. These loads must be included with other externally applied forces in the application factors C_a and K_a . For critical drives, a separate dynamic analysis of the entire system is recommended.

Shaft Critical Speeds: Owing to their high bending stiffness, the natural frequency of lateral vibrations of the gear shafts are usually much higher than the operating speeds. However, for high speed gears it is recommended that the critical speeds be analyzed to ensure that they are well removed from the operating speed range. The dynamic factors C_v and K_d do not account for the dynamic tooth loads due to this mode of vibration.

Nonlinear Resonance: Large cyclical variation in gear mesh stiffness and impact loads may lead to additional regions of resonance and instability. This problem appears primarily with lightly loaded, lightly damped spur gears that do not have profile modifications.

Approximate Dynamic Factors: Fig. 3 shows dynamic factors that can be used in the absence of specific knowledge of the dynamic loads. The curves of Fig. 3 are based on equations in the Standard derived from empirical data and do not account for resonance.

Choice of which of curves 5 through 11 of Fig. 3 to use should be based on transmission error. When transmission error data are unavailable, it is reasonable to use pitch (spacing) and profile accuracy. Q_v is the transmission accuracy level number. It can be the same as the quality number for the lowest quality member in the mesh from AGMA 2000-A88 when manufacturing techniques ensure equivalent transmission accuracy, or when the pitch (spacing) and profile accuracy are the same as AGMA 2000-A88 tolerances.

Owing to the approximate nature of the empirical curves and the lack of measured tolerance values at the design stage, the dynamic factor curve should be selected based on experience with the manufacturing methods and operating considerations of the design.

The curves in Fig. 3 are referenced only by spacing and profile, and actual dynamic load is influenced by many other factors, so slight variations from the selected tolerances are not considered significant to the gearset rating.

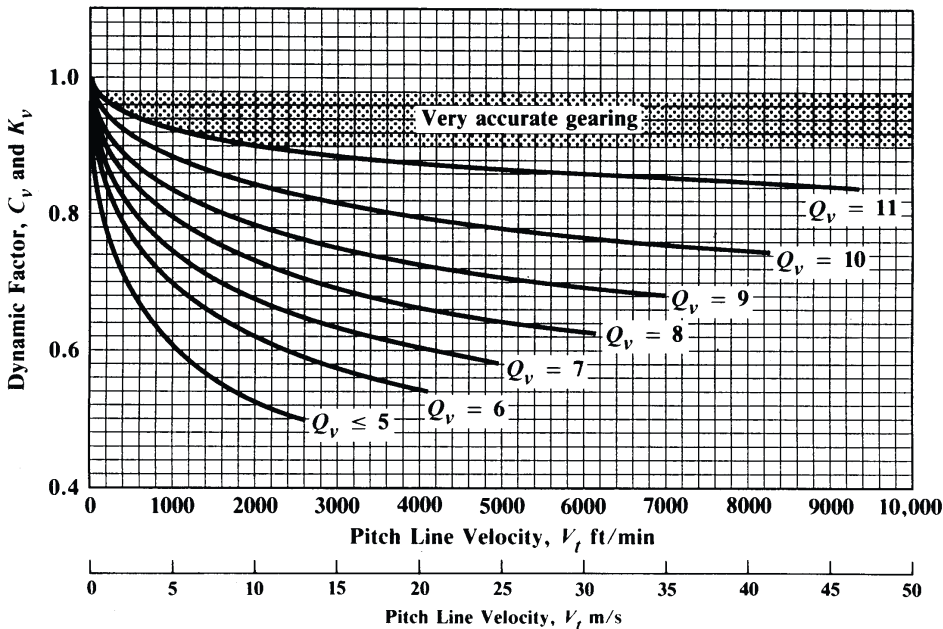


Fig. 3. Dynamic Factors, C_v and K_d

Very Accurate Gearing: Where gearing is manufactured using process controls that correspond to $Q_v \geq 12$ limits, or where the design and manufacturing techniques ensure a low transmission error equivalent to this accuracy, values of C_v and K_d between 0.90 and 0.98 may be used, depending on the specifier's experience with similar applications and the degree of accuracy actually achieved. To use these values, the gearing must be maintained in accurate alignment and adequately lubricated so that its accuracy is maintained under the operating conditions. Spur gears should have properly designed profile modification and helical gears should have an axial contact ratio greater than 1.0.

Curves Numbered 6 through 11 on Fig. 3: These curves are generated by equations in the Standard for values of Q_v such that $6 \leq Q_v \leq 11$.

Unity Dynamic Factor: When the known dynamic loads (from analysis or experience) are added to the nominal transmitted load, then the dynamic factor can be taken to be 1.0.

Application Factors, C_a and K_a .—These application factors make allowance for any externally applied loads in excess of the nominal tangential load W_t . Application factors can only be established after considerable field experience is gained in a particular application.

In determining the application factor, consideration should be given to the fact that many prime movers develop momentary peak torques appreciably greater than those determined by the nominal ratings of either the prime mover or the driven equipment. Many possible sources of overload should be considered. Some of these are system vibrations, acceleration torques, overspeeds, variations in system operation, split path load sharing among multiple prime movers, and changes in process load conditions. When operating near a critical speed of the drive system, a careful analysis of conditions must be made.

Service Factors, C_{SF} and K_{SF} .—These service factors have been used to include the combined effects of C_L , C_R , C_a and K_L , K_R , K_a , respectively, in an empirically determined single factor. The mathematical contribution of each of these factors has not been established, so that, in the absence of more specific load data, a service factor may be used. When a ser-

vice factor is used, the power rating formulas [Equation (5) and (5a)] would be modified as follows:

$$P_{ac} = \frac{n_p \times F}{126000 C_{sf} \times C_s \times C_m \times C_f} \left(\frac{d \times s_{ac} C_H}{C_p C_T} \right) \quad (21)$$

$$P_{ac} = \frac{n_p \times F}{1.91 \times 10^7 C_{sf} \times C_s \times C_m \times C_f} \left(\frac{d \times s_{ac} C_H}{C_p C_T} \right) \quad (21a)$$

$$P_{at} = \frac{n_p \times d \times K_v}{126000 \times K_{SF} P_d K_s \times K_m \times K_B K_T} \frac{F J s_{at}}{K_T} \quad (22)$$

$$P_{at} = \frac{n_p \times d \times K_v}{1.91 \times 10^7 \times K_{SF} K_s \times K_m \times K_B K_T} \frac{F \times m \times J s_{at}}{K_T} \quad (22a)$$

where C_{SF} and K_{SF} are service factors for pitting resistance and bending strength, respectively.

Teeth of both the pinion and the gear must be checked to account for differences in material properties, geometry factors, and the number of cycles under load. The power rating is then based on the lowest values of the following expressions for each of the mating gears:

$$\text{for pitting resistance } \frac{(s_{ac} \times C_H)^2}{C_{SF}}, \text{ and for bending strength } \frac{s_{at} \times J}{K_{SF}}.$$

Elastic Coefficient, C_p .—The elastic coefficient, C_p , is defined by the equation

$$C_p = \sqrt{\frac{1.0}{\pi \left[\left(\frac{1.0 - \mu_P^2}{E_P} \right) \div \left(\frac{1.0 - \mu_G^2}{E_G} \right) \right]}} \quad (23)$$

The value of C_p for a steel gear meshing with a steel pinion is $2300 \text{ [lb/in.}^2\text{]}^{0.5}$, or $191 \text{ (MPa)}^{0.5}$, approximately. Approximate values for other combinations of materials are given in the Standard.

Surface Condition Factor, C_f .—The surface finish factor used only in the pitting resistance formulas has not yet been established for conditions where there is a detrimental surface finish effect. Where such effects are encountered, a surface condition factor greater than unity should be used.

Size Factors, C_s and K_s .—The size factor reflects nonuniformity of material properties and depends primarily on tooth size, diameter of parts, ratio of tooth size to diameter of part, face width, area of stress pattern, ratio of case depth to tooth size, and hardenability and heat treatment of materials. Size factors have not yet been established for conditions where there is a detrimental size effect, but the factor may be taken as unity for most gears provided that a proper choice of steel is made for the size of the part and its heat treatment and hardening processes.

Load Distribution Factors, C_m and K_m .—The load distribution factor modifies the rating equations to reflect the nonuniform distribution of the load along the lines of contact. The amount of nonuniformity of the load distribution is caused by, and is dependent on the following influences:

- 1) The gear tooth manufacturing accuracy: lead, profile, and spacing;
- 2) alignment of the axes of rotation of the pitch cylinders of the mating gear elements;

- 3) elastic deflections of gear unit elements: shafts, bearings, housings, and foundations that support the gear elements;
- 4) bearing clearances;
- 5) Hertzian contact and bending deformations at the tooth surface;
- 6) thermal expansion and distortion due to operating temperature (especially on wide face gearing);
- 7) centrifugal deflections due to operating speed;
- 8) tooth crowning and end relief.

Any of these influences that affect a given application should be evaluated by appropriate analysis when possible.

Values for C_m and K_m : The load distribution factor is defined to be the peak load intensity divided by the average, or uniformly distributed load intensity; i.e., the ratio of peak to mean loading. The magnitude is influenced by two components, namely, C_{mf} = face load distribution factor and C_{mt} = transverse load distribution factor that accounts for nonuniform load sharing among load sharing teeth. The load distribution factor is affected primarily by the correctness of the profiles of mating teeth, i.e., profile modification and profile error. The value of the factor may be taken as 1.0 because the Standard has not yet established procedures to evaluate its influence. If C_{mt} is taken as 1.0, then $C_m = K_m = C_{mf}$.

The face load distribution factor C_{mf} accounts for the nonuniform distribution of load across the gearing face width. The magnitude of C_{mf} is defined as the peak load intensity divided by the average load intensity across the face width. Two methods of determining C_{mf} are given in the Standard, an empirical method and an analytical method. These two methods sometimes yield significantly different results.

Empirical Method: The empirical method requires a minimum amount of information and is recommended for relatively stiff designs that meet the following requirements:

- 1) Ratio of net face width to pinion pitch diameter is less than or equal to 2.0;
- 2) the gear elements are mounted between bearings (not overhung);
- 3) face width up to 40 in. ; and
- 4) contact across full face width of narrowest member when loaded.

Other restrictions apply to the use of this method. For details of these restrictions and how the method is applied, the Standard should be consulted.

Analytical Method: This method is based on theoretical calculation of values of elastic tooth deformation under load and lead mismatch. Knowledge of the design, manufacturing, and mounting are required to evaluate the load distribution factor. Calculated results should be compared with past experience as it may be necessary to reevaluate other rating factors to arrive at a rating consistent with past experience. As explained in the Standard, the analytical method assumes that mismatch between the teeth is a straight line. This approach usually yields load distribution factors larger than those used in the past. Another method, using true deflection between the teeth (which is not straight line deflection), has resulted in calculated values closer to those used in the past, but it has not been demonstrated that either method is more accurate. Further study may produce other, more accurate, methods.

In using the analytical method, if high values of the gear tooth stiffness constant are used ($G = 2,000,000$) or high values of total lead mismatch e_t are assumed, the C_{mf} values calculated will be much more conservative than those obtained by the empirical method. If C_{mf} values calculated are in excess of 2.0, indicating less than full face contact, it may be desirable to revise the design by improving the configuration of bearings, shaft diameters, aspect ratio, and center distance to lower C_{mf} . It may be possible to lower C_{mf} by modifying leads of the parts. The assumed values of e_t and G have a large effect on C_{mf} , so there are times when experimental verification of C_{mf} may be necessary.

The analytical method is valid for any gear design and is recommended for the following conditions:

1) ratio of net face width to pinion pitch diameter, F/D , is equal or greater than 2.0 (for double helical gears the gap is not included in the face width); 2) applications with overhung gear elements; 3) applications with long shafts subject to large deflections or where deflections under load reduce width of contact; and 4) applications where contact does not extend across the full face of narrowest member when loaded.

For designs that have high crowns to centralize tooth contact under deflected conditions, the factors C_m and K_m may be conservatively approximated by this method. For the most commonly encountered condition, contact across the entire face width under normal operating load, the face load distribution factor expressions are

$$\text{for spur gearing: } C_{mf} = 1.0 + \frac{G \times e_t \times F}{2 \times W_t} \quad (24)$$

$$\text{and, for helical gearing: } C_{mf} = 1.0 + \frac{G \times e_t \times Z \times F}{1.8 \times W_t} \quad (25)$$

If the total contact length under normal operating load is less than the face width, the expressions for the load distribution factor are

$$\text{for spur gearing: } C_{mf} = \sqrt{\frac{2.0 \times G \times e_t \times F}{W_t}} \quad (26)$$

$$\text{and, for helical gearing: } C_{mf} = \sqrt{\frac{2.0 \times G \times e_t \times Z \times F}{W_t \times P_b}} \quad (27)$$

where G = tooth stiffness constant, lb/in./in. of face (MPa), the average mesh stiffness of a single pair of teeth in the normal direction. The usual range of this value that is compatible with this analysis is $1.5\text{--}2.0 \times 10^6$ lb/in.² ($1.0\text{--}1.4 \times 10^4$ MPa). The most conservative value is the highest. e_t = total lead mismatch between mating teeth, in loaded condition, in. (mm). Z = length of action in transverse plane, from Equation (17) on page 3309, in. (mm). P_b = transverse base pitch, in. (mm).

The total mismatch, e_t , is a virtual separation between the tooth profiles at the end of the face width which is composed of the static, no load separation plus a component due to the elastic load deformations. This total mismatch is influenced by all the items listed under Load Distribution Factors except the Hertzian contact stress and bending deformations of the gear teeth, which are accounted for by the tooth stiffness constant G . Evaluation of e_t , is difficult but it is critical to the reliability of the analytical method. An iterative computer program may be used, but in critical applications full scale testing may be desirable.

Allowable Stress Numbers, S_{ac} and S_{at} .—The allowable stress numbers depend on

1) material composition and cleanliness; 2) mechanical properties; 3) residual stress; 4) hardness and; and 5) type of heat treatment, surface or through hardened.

An allowable stress number for unity application factor, 10 million cycles of load application, 99 per cent reliability and unidirectional loading, is determined or estimated from laboratory and field experience for each material and condition of that material. This stress number is designated S_{ac} and S_{at} . The allowable stress numbers are adjusted for design life cycles by the use of life factors.

The allowable stress numbers for gear materials vary with material composition, cleanliness, quality, heat treatment, and processing practices. For materials other than steel, a range is shown, and the lower values should be used for general design purposes. Data for materials other than steel are given in the Standard.

Allowable stress numbers for steel gears are established by specific quality control requirements for each material type and grade. All requirements for the quality grade must be met in order to use the stress values for that grade. Details of these quality requirements are given in the Standard.

Reverse Loading: For idler gears and other gears where the teeth are completely reverse loaded on every cycle, 70 per cent of the S_{at} values should be used.

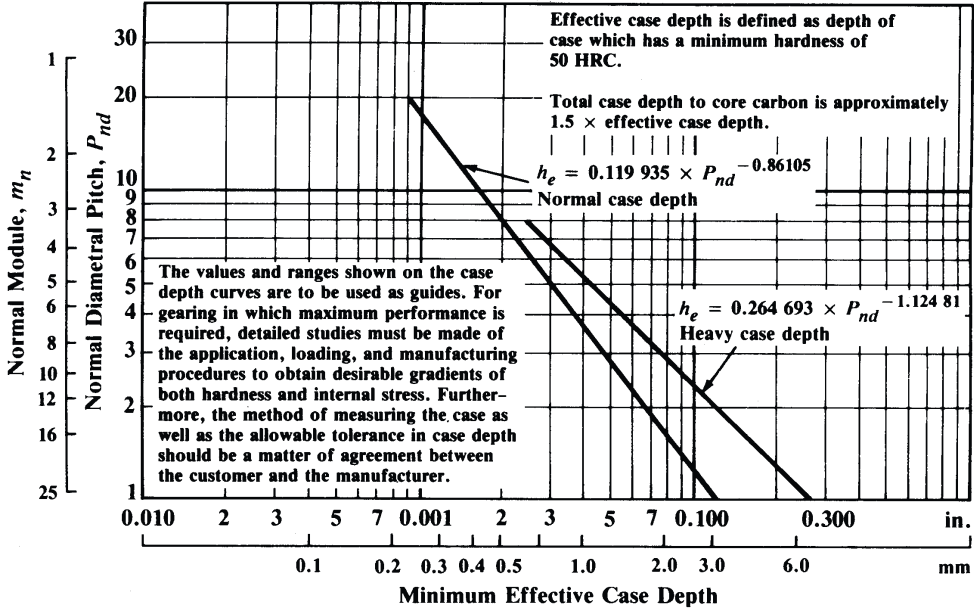


Fig. 4. Effective Case Depth for Carburized Gears, h_e

Case Depth of Surface-Hardened Gears.—The Standard provides formulas to guide the selection of minimum effective case depth at the pitchline for carburized and induction hardened teeth based on the maximum shear from contact loading.

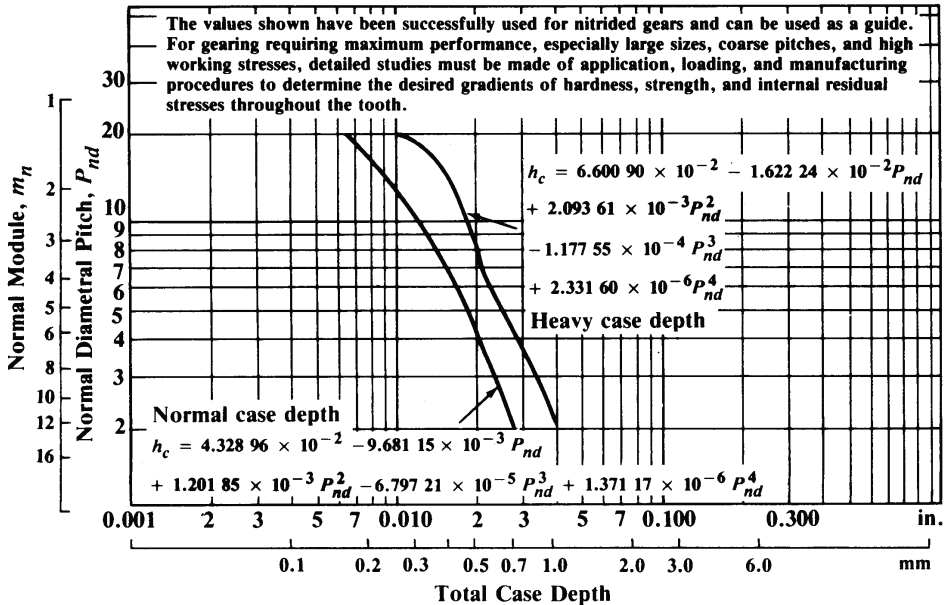


Fig. 5. Minimum Total Case Depth for Nitrided Gears, h_c

Fig. 5 shows values that have a long history of successful use for carburized gears and can be used for such gears.

For nitrided gears, case depth is specified as the total case depth h_c , which is defined as the depth below the surface at which the hardness has dropped to 110 per cent of the core hardness. Minimum total case depths for nitrided gears are shown in Fig. 5.

Momentary Overloads.—When the gear is subjected to less than 100 cycles of momentary overloads, the maximum allowable stress is determined by the allowable yield properties rather than the bending fatigue strength of the material. Fig. 6 shows suggested values of the allowable yield strength S_{ay} for through hardened steel. For case hardened gears, the core hardness should be used in conjunction with the table of metallurgical factors affecting the bending stress number for carburized gears shown in the Standard.

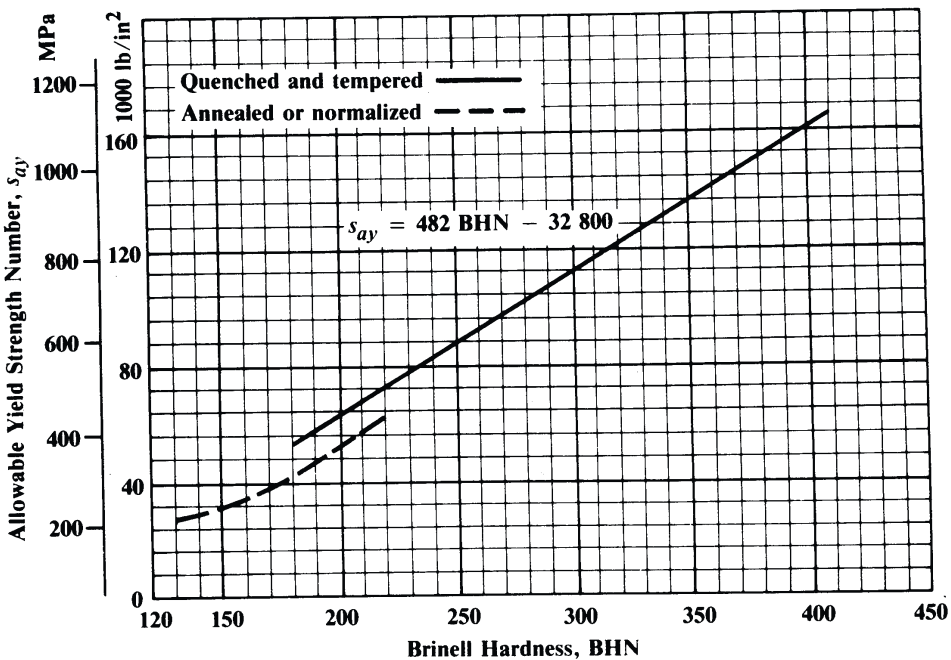


Fig. 6. Allowable Yield Strength Number for Steel Gears, S_{ay}

The design should be checked to make sure that the teeth are not permanently deformed. Also, when yield is the governing stress, the stress correction factor K_f is considered ineffective and therefore taken as unity.

Yield Strength.—For through hardened gears up to 400 BHN, a yield strength factor K_y can be applied to the allowable yield strength taken from Fig. 6. This factor is applied at the maximum peak load to which the gear is subjected:

$$S_{ay} \times K_y \geq \frac{W_{max} \times K_a P_d K_s \times K_m}{K_v F J \times K_f} \tag{28}$$

$$S_{ay} \times K_y \geq \frac{W_{max} \times K_a \times K_s \times K_m}{K_v \times F \times m \times J \times K_f} \tag{28a}$$

For conservative practice, K_y is taken as 0.5 and for industrial practice, K_y is 0.75.

Hardness Ratio Factor C_H .—The hardness ratio factor depends on (1) gear ratio and (2) Brinell hardness numbers of gear and pinion. When the pinion is substantially harder than the gear, the work hardening effect increases the gear capacity. Typical values of the hard-

ness ratio factor, C_H , for through hardened gears are shown in Fig. 7. These values apply to the gear only, not to the pinion.

When surface hardened pinions (48 HRC or harder) are run with through hardened gears (180-400 BHN), a work hardening effect is achieved. The C_H factor varies with the surface finish of the pinion, K_p and the mating gear hardness as shown in Fig. 8.

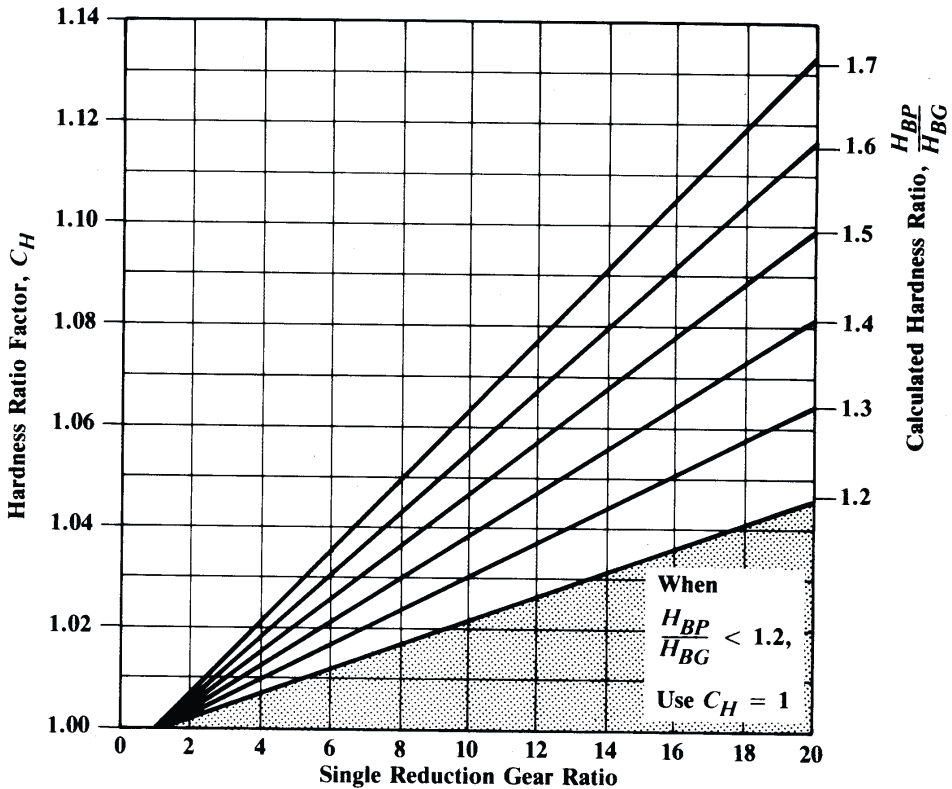


Fig. 7. Hardness Ratio Factor, C_H (Through Hardened)

Life Factors C_L and K_L .— These life factors adjust the allowable stress numbers for the required number of cycles of operation. In the Standard, the number of cycles, N , is defined as the number of mesh contacts under load of the gear tooth being analyzed. Allowable stress numbers are established for 10,000,000 tooth load cycles at 99 per cent reliability. The life cycle factors adjust the allowable stress numbers for design lives other than 10,000,000 cycles.

The life factor accounts for the S/N characteristics of the gear material as well as for the gradually increased tooth stress that may occur from tooth wear, resulting in increased dynamic effects and from shifting load distributions that may occur during the design life of the gearing. A C_L or K_L value of 1.0 may be used beyond 10,000,000 cycles, where justified by experience.

Life Factors for Steel Gears: Insufficient data exist to provide accurate life curves for every gear and gear application. However, experience suggests life curves for pitting and strength of steel gears are as shown in Figs. 9 and 10. These figures do not include data for nitrided gears. The upper portions of the shaded zones are for general commercial applications. The lower portions of the shaded zones are typically used for critical service applications where little pitting and tooth wear are permissible and where smoothness of operation and low vibration levels are required. When gear service ratings are established by the use

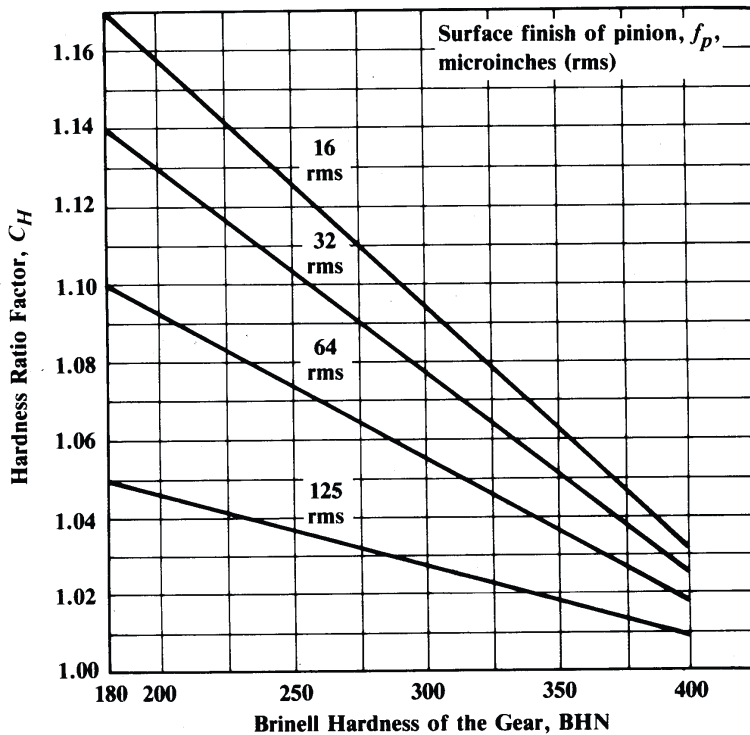


Fig. 8. Hardness Ratio Factor, C_H (Surface Hardened Pinions)

of service factors, life factors C_L and K_L should be set equal to 1.0 for the determination of the gear tooth rating.

Localized Yielding.—If the product of $S_{at} K_L$ exceeds the allowable yield stress S_{ay} of Fig. 6, localized yielding of the teeth may occur. In some applications this yielding is not acceptable. In others, where profile and motion transmission accuracies are not critical, the yielding may be acceptable for limited life.

Reliability Factors, C_R and K_R .—These reliability factors account for the effect of the normal statistical distribution of failures found in materials testing. The allowable stress numbers given in the tables in the Standard are based on a statistical probability of 1 failure in 100 at 10,000,000 cycles. Table 2 contains reliability factors which may be used to modify these allowable stresses to change that probability. These numbers are based on data developed for bending and pitting failure by the U.S. Navy. Other values may be used if specific data are available.

When strength rating is based on yield strength, S_{ay} the values of K_y given in the paragraph, Yield Strength, should be used instead of K_R .

Temperature Factors C_T and K_T .—The temperature factor is generally taken as 1 when gears operate with temperatures of oil or gear blank not over 250°F (120°C). At temperatures above 250°F, the factors are given a value greater than 1.0 to allow for the effect of temperature on oil film and material properties. Consideration must be given to the loss of hardness and strength of some materials due to the tempering effect of temperatures over 350°F (175°C).

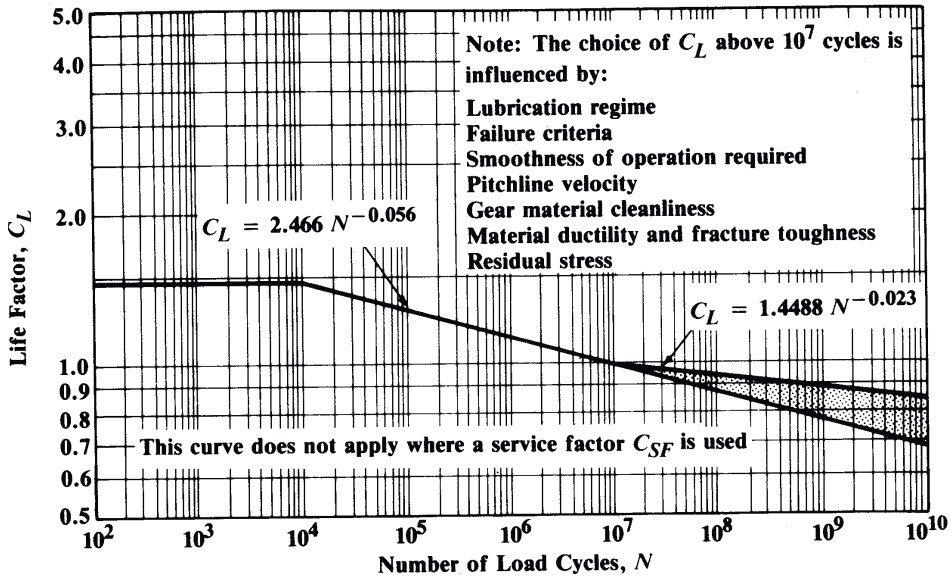


Fig. 9. Pitting Resistance Life Factor, C_L

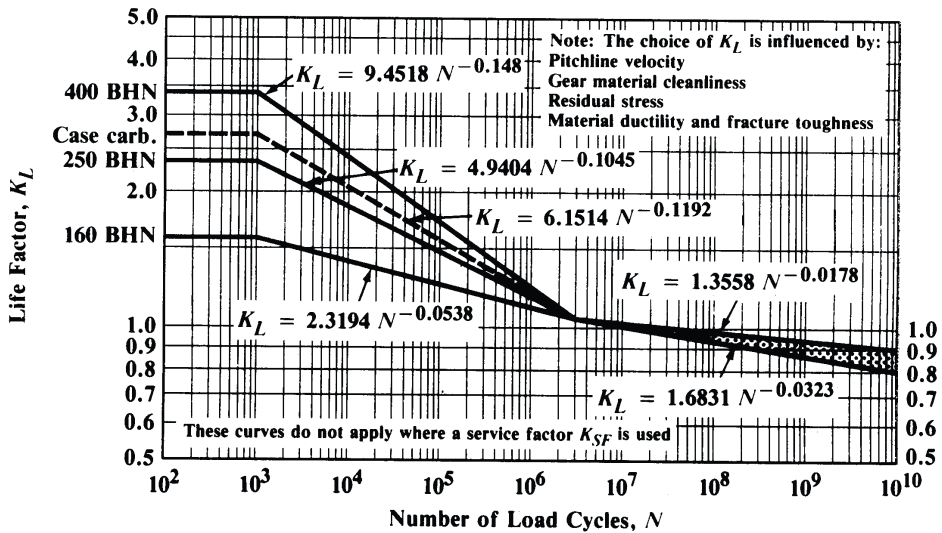


Fig. 10. Bending Strength Life Factor, K_L

Table 2. Reliability Factors, C_R and K_R

Requirement of Application	C_R, K_R^a	Requirement of Application	C_R, K_R
Fewer than 1 failure in 10,000	1.50	Fewer than 1 failure in 100	1.00
Fewer than 1 failure in 1,000	1.25	Fewer than 1 failure in 10	0.85 ^b

^aTooth breakage is sometimes considered a greater hazard than pitting. In such instances a value of K_R greater than C_R is selected.

^bAt this value plastic flow might occur rather than pitting.

Worm Gearing

Worm-Gear Applications.—Worm gearing is employed for transmitting motion between two shafts which are at right angles to each other but which are not in the same plane. Strictly speaking, worm gearing is, therefore, a modified form of spiral or helical gearing, in which one gear takes the form of a screw or worm provided with threads, and the other of a gear with teeth inclined at the same angle as the threads in the worm.

Worm gearing may be employed (1) as an efficient, steady transmitter of power; (2) when a large reduction in velocity is desired; (3) when considerable increase in “mechanical advantage” is required, or, in other words, when a given applied force must overcome a comparatively high resistance to motion. Many worm-gears of the higher ratios are self-locking but very inefficient. Such gears, however, usually are applied to intermittent service, or where the waste of power due to the decreased efficiency of self-locking worm gearing is of little or no importance. The best material for worm gearing is hard phosphor-bronze for the worm-wheel and hardened steel for the worm. The next best materials are cast iron for the worm-wheel and hardened steel or cast iron for the worm. Steel or steel castings for both the worm-wheel and worm are only allowable for slow speeds. The teeth in the worm-wheel and the thread on the worm should always be cut, whenever the gearing is to be used steadily or at a reasonably high speed.

Worm Gearing Classification.—Worm gearing may be divided into two general classes, fine-pitch worm gearing, and coarse-pitch worm gearing. Fine-pitch worm gearing is segregated from coarse-pitch worm gearing for the following reasons:

1) Fine-pitch worms and wormgears are used largely to transmit motion rather than power. Tooth strength except at the coarser end of the fine-pitch range is seldom an important factor; durability and accuracy, as they affect the transmission of uniform angular motion, are of greater importance.

2) Housing constructions and lubricating methods are, in general, quite different for fine-pitch worm gearing.

3) Because fine-pitch worms and wormgears are so small, profile deviations and tooth bearings cannot be measured with the same accuracy as can those of coarse pitches.

4) Equipment generally available for cutting fine-pitch wormgears has restrictions which limit the diameter, the lead range, the degree of accuracy attainable, and the kind of tooth bearing obtainable.

5) Special consideration must be given to top lands in fine-pitch hardened worms and wormgear-cutting tools.

6) Interchangeability and high production are important factors in fine-pitch worm gearing; individual matching of the worm to the gear, as often practiced with coarse-pitch precision worms, is impractical in the case of fine-pitch worm drives.

American Standard Design for Fine-pitch Worm Gearing (ANSI B6.9-1977).—This standard is intended as a design procedure for fine-pitch worms and wormgears having axes at right angles. It covers cylindrical worms with helical threads, and wormgears hobbled for fully conjugate tooth surfaces. It does not cover helical gears used as wormgears.

Hobs: The hob for producing the gear is a duplicate of the mating worm with regard to tooth profile, number of threads, and lead. The hob differs from the worm principally in that the outside diameter of the hob is larger to allow for resharpening and to provide bottom clearance in the wormgear.

Pitches: Eight standard axial pitches have been established to provide adequate coverage of the pitch range normally required: 0.030, 0.040, 0.050, 0.065, 0.080, 0.100, 0.130, and 0.160 inch.

Axial pitch is used as a basis for this design standard because: 1) Axial pitch establishes lead which is a basic dimension in the production and inspection of worms; 2) the axial pitch of the worm is equal to the circular pitch of the gear in the central plane; and 3) only one set of change gears or one master lead cam is required for a given lead, regardless of lead angle, on commonly-used worm-producing equipment.

Lead Angles: Fifteen standard lead angles have been established to provide adequate coverage: 0.5, 1, 1.5, 2, 3, 4, 5, 7, 9, 11, 14, 17, 21, 25, and 30 degrees.

This series of lead angles has been standardized to: 1) Minimize tooling; 2) permit obtaining geometric similarity between worms of different axial pitch by keeping the same lead angle; and 3) take into account the production distribution found in fine-pitch worm gearing applications.

For example, most fine-pitch worms have either one or two threads. This requires smaller increments at the low end of the lead angle series. For the less frequently used thread numbers, proportionately greater increments at the high end of the lead angle series are sufficient.

Table 1. Formulas for Proportions of American Standard Fine-pitch Worms and Wormgears ANSI B6.9-1977

LETTER SYMBOLS			
<p>P = Circular pitch of wormgear P = axial pitch of the worm, P_x, in the central plane P_x = Axial pitch of worm P_n = Normal circular pitch of worm and wormgear = P_x $\cos \lambda = P \cos \psi$ λ = Lead angle of worm ψ = Helix angle of wormgear n = Number of threads in worm N = Number of teeth in wormgear $N = nm_G$ m_G = Ratio of gearing = $N \div n$</p>			
Item	Formula	Item	Formula
WORM DIMENSIONS		WORMGEAR DIMENSIONS ^a	
Lead	$l = nP_x$	Pitch Diameter	$D = NP + \pi = NP_x + \pi$
Pitch Diameter	$d = l \div (\pi \tan \lambda)$	Outside Diameter	$D_o = 2C - d + 2a$
Outside Diameter	$d_o = d + 2a$	Face Width	$F_{Gmin} = 1.125 \times \sqrt{(d_o + 2c)^2 - (d_o - 4a)^2}$
Safe Minimum Length of Threaded Portion of Worm ^b	$F_W = \sqrt{D_o^2 - D^2}$		
DIMENSIONS FOR BOTH WORM AND WORMGEAR			
Addendum	$a = 0.3183P_n$	Tooth thickness	$t_n = 0.5P_n$
Whole Depth	$h_t = 0.7003P_n + 0.002$	Approximate normal pressure angle ^c	$\phi_n = 20$ degrees
Working Depth	$h_k = 0.6366P_n$	Center distance	$C = 0.5 (d + D)$
Clearance	$c = h_t - h_k$		

^a Current practice for fine-pitch worm gearing does not require the use of throated blanks. This results in the much simpler blank shown in the diagram which is quite similar to that for a spur or helical gear. The slight loss in contact resulting from the use of non-throated blanks has little effect on the load-carrying capacity of fine-pitch worm gears. It is sometimes desirable to use topping hobs for producing wormgears in which the size relation between the outside and pitch diameters must be closely controlled. In such cases the blank is made slightly larger than D_o by an amount (usually from 0.010 to 0.020) depending on the pitch. Topped wormgears will appear to have a small throat which is the result of the hobbing operation. For all intents and purposes, the throating is negligible and a blank so made is not to be considered as being a throated blank.

^b This formula allows a sufficient length for fine-pitch worms.

^c As stated in the text on page 3323, the actual pressure angle will be slightly greater due to the manufacturing process.

All dimensions in inches unless otherwise indicated.

Pressure Angle of Worm: A pressure angle of 20 degrees has been selected as standard for cutters and grinding wheels used to produce worms within the scope of this Standard because it avoids objectionable undercutting regardless of lead angle.

Although the pressure angle of the cutter or grinding wheel used to produce the worm is 20 degrees, the normal pressure angle produced in the worm will actually be slightly greater, and will vary with the worm diameter, lead angle, and diameter of cutter or grinding wheel. A method for calculating the pressure angle change is given under the heading *Effect of Production Method on Worm Profile and Pressure Angle*.

Pitch Diameter Range of Worms: The minimum recommended worm pitch diameter is 0.250 inch and the maximum is 2.000 inches. Pitch diameters for all possible combinations of lead and lead angle, together with the number of threads for each lead, are given in **Table 2a** and **2b**.

Tooth Form of Worm and Wormgear: The shape of the worm thread in the normal plane is defined as that which is produced by a symmetrical double-conical cutter or grinding wheel having straight elements and an included angle of 40 degrees.

Because worms and wormgears are closely related to their method of manufacture, it is impossible to specify clearly the tooth form of the wormgear without referring to the mating worm. For this reason, worm specifications should include the method of manufacture and the diameter of cutter or grinding wheel used. Similarly, for determining the shape of the generating tool, information about the method of producing the worm threads must be given to the manufacturer if the tools are to be designed correctly.

The worm profile will be a curve that departs from a straight line by varying amounts, depending on the worm diameter, lead angle, and the cutter or grinding wheel diameter. A method for calculating this deviation is given in the Standard. The tooth form of the wormgear is understood to be made fully conjugate to the mating worm thread.

Proportions of Fine-pitch Worms and Wormgears.—Hardened worms and cutting tools for wormgears should have adequate top lands. To automatically provide sufficient top lands, regardless of lead angle or axial pitch, the addendum and whole depth proportions of fine-pitch worm gearing are based on the normal circular pitch. Tooth proportions based on normal pitch for all combinations of standard axial pitches and lead angles are given in **Table 3**. Formulas for the proportions of worms and worm gears are given in **Table 1**.

Example 1: Determine the design of a worm and wormgear for a center distance of approximately 3 inches if the ratio is to be 10 to 1; axial pitch, 0.1600 inch; and lead angle, 30 degrees.

From **Table 2a** and **2b** it can be determined that there are eight possible worm diameters that will satisfy the given conditions of lead angle and pitch. These worms have from 3 to 10 threads.

To satisfy the 3-inch center distance requirement it is now necessary to determine which of these eight worms, together with its mating wormgear, will come closest to making up this center distance. One way of doing this is as follows:

First use the formula given below to obtain the approximate number of threads necessary. Then from the eight possible worms in **Table 2a** and **2b**, choose the one whose number of threads is nearest this approximate value:

Approximate number of threads needed for required center distance =

$$\frac{2\pi \times \text{required center distance}}{P_x(\cot\lambda + m_G)} = \frac{2 \times 3.1416 \times 3}{0.1600 \times (1.7320 + 10)} = 10.04 \text{ threads}$$

Of the eight possible worms in **Table 2a** and **2b**, the one having a number of threads nearest this value is the 10-thread worm with a pitch diameter of 0.8821 inch. Since the ratio of gearing is given as 10, N may now be computed as follows: $N = 10 \times 10 = 100$ teeth (from **Table 1**)

Other worm and wormgear dimensions may now be calculated using the formulas given in **Table 1** or may be taken from the data presented in **Table 2a**, **2b**, and **3**.

$$l = 1.600 \text{ inches (from Table 2b)}$$

$$d = 0.8821 \text{ inch (from Table 2b)}$$

$$D = 100 \times 0.1600 + 3.1416 = 5.0930 \text{ inches (from Table 1)}$$

$$C = 0.5(0.8821 + 5.0930) = 2.9876 \text{ inches (from Table 1)}$$

$$P_n = 0.1386 \text{ inch (from Table 3)}$$

$$a = 0.0441 \text{ inch (from Table 3)}$$

$$h_t = 0.0990 \text{ inch (from Table 3)}$$

$$h_k = 0.6366 \times 0.1386 = 0.0882 \text{ inch (from Table 1)}$$

$$c = 0.0990 - 0.0882 = 0.0108 \text{ inch (from Table 1)}$$

$$t_n = 0.5 \times 0.1386 = 0.0693 \text{ inch (from Table 1)}$$

$$d_o = 0.8821 + (2 \times 0.0441) = 0.9703 \text{ inch (from Table 1)}$$

$$D_o = (2 \times 2.9876) - 0.8821 + (2 \times 0.0441) = 5.1813 \text{ (from Table 1)}$$

$$F_G = 1.125 \sqrt{(0.9703 + 2 \times 0.0108)^2 - (0.9703 - 4 \times 0.0441)^2} = 0.6689 \text{ inch}$$

$$F_W = \sqrt{5.1813^2 - 5.0930^2} = 0.9525 \text{ inch}$$

Example 2: Determine the design of a worm and wormgear for a center distance of approximately 0.550 inch if the ratio is to be 50 to 1 and the axial pitch is to be 0.050 inch.

Assume that $n = 1$ (since most fine-pitch worms have either one or two threads). The lead of the worm will then be $nP_x = 1 \times 0.050 = 0.050$ inch. From **Table 2a** and **2b** it can be determined that there are six possible lead angles and corresponding worm diameters that will satisfy this lead. The approximate lead angle required to meet the conditions of the example can be computed from the following formula:

$$\text{Cotangent of approx. lead angle} = \frac{2\pi \times \text{approximate center distance required}}{\text{assumed number of threads} \times \text{axial pitch}} - m_G$$

Using letter symbols, this formula becomes:

$$\cot\lambda = \frac{2\pi \times C}{n \times P_x} - m_G = \frac{2 \times 3.1416 \times 0.550}{1 \times 0.050} - 50 = 19.1152$$

$$\lambda = 2^\circ 59'$$

Of the six possible worms in **Table 2a** and **2b**, the one with the 3-degree lead angle is closest to the calculated $2^\circ 59'$ lead angle. This worm, which has a pitch diameter of 0.3037

inch, is therefore selected. The remaining worm and wormgear dimensions may now be determined from the data in Table 2a, 2b, and 3 and by use of the formulas given in Table 1.

$$N = 50 \times 1 = 50 \text{ teeth (from Table 1)}$$

$$d = 0.3037 \text{ inch (from Table 2b)}$$

$$D = 50 \times 0.050 \div 3.1416 = 0.7958 \text{ inch (from Table 1)}$$

$$C = 0.5(0.3037 + 0.7958) = 0.5498 \text{ inch (from Table 1)}$$

$$P_n = 0.0499 \text{ inch (from Table 3)}$$

$$a = 0.0159 \text{ inch (from Table 3)}$$

$$h_t = 0.0370 \text{ inch (from Table 3)}$$

$$h_k = 0.6366 \times 0.0499 = 0.0318 \text{ inch (from Table 1)}$$

$$c = 0.0370 - 0.0318 = 0.0052 \text{ inch (from Table 1)}$$

$$t_n = 0.5 \times 0.0499 = 0.0250 \text{ inch (from Table 1)}$$

$$d_o = 0.3037 + (2 \times 0.0159) = 0.3355 \text{ inch (from Table 1)}$$

$$D_o = (2 \times 0.5498) - 0.3037 + (2 \times 0.0159) = 5.1813 \text{ (from Table 1)}$$

$$F_{Gmin} = 1.125 \sqrt{(0.3355 + 2 \times 0.0052)^2 - (0.3355 - 4 \times 0.0159)^2} = 0.2405 \text{ inch (from Table 1)}$$

$$F_W = \sqrt{0.8277^2 - 0.7958^2} = 0.2276 \text{ inch (from Table 1)}$$

Effect of Production Method on Worm Profile and Pressure Angle.—In worm gearing, tooth bearing is usually used as the means of judging tooth profile accuracy since direct profile measurements on fine-pitch worms or wormgears is not practical. According to AGMA 370.01, Design Manual for Fine-Pitch Gearing, a minimum of 50 per cent initial area of contact is suitable for most fine-pitch worm gearing, but in some cases, such as when the load fluctuates widely, a more restricted initial area of contact may be desirable.

Except where single-pointed lathe tools, end mills, or cutters of special shape are used in the manufacture of worms, the pressure angle and profile produced by the cutter are different from those of the cutter itself. The amounts of these differences depend on several factors, namely, diameter and lead angle of the worm, thickness and depth of the worm thread, and diameter of the cutter or grinding wheel. Fig. 1 shows the curvature and pressure angle effects produced in the worm by cutters and grinding wheels, and how the amount of variation in worm profile and pressure angle is influenced by the diameter of the cutting tool used.

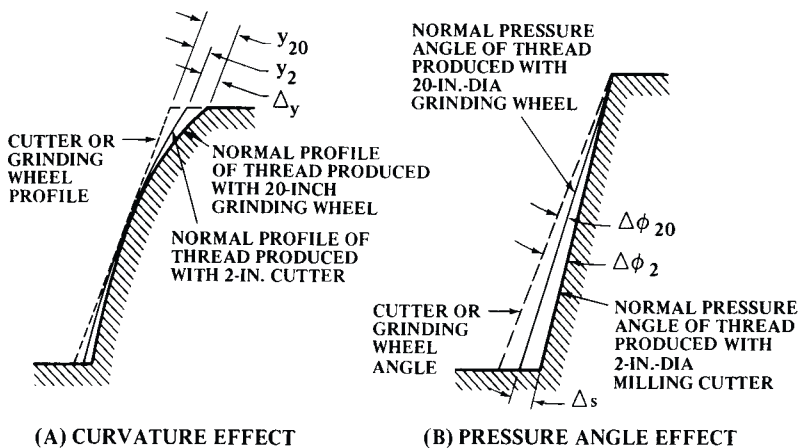


Fig. 1. Effect of Diameter of Cutting on Profile and Pressure Angle of Worms

Table 2b. Pitch Diameters of Fine-pitch Worms for American Standard Combinations of Lead and Lead Angle ANSI B6.9-1977

Lead in Inches, <i>l</i>	Number of Threads <i>n</i>	Lead Angle in Degrees						
		9	11	14	17	21	25	30
		Pitch Diameter <i>d</i> in inches						
0.120	3	0.2412
0.130	1	0.2613
0.150	3	0.3015	0.2456
0.160	1	0.3216	0.2620
0.180	6	0.3618	0.2948
0.195	3	0.3919	0.3193	0.2490
0.200	2	0.4019	0.3275	0.2553
0.210	7	0.4220	0.3439	0.2681	0.2186
0.240	3	0.4823	0.3930	0.3064	0.2499
0.250	5	0.5024	0.4094	0.3192	0.2603
0.260	2	0.5225	0.4258	0.3319	0.2707
0.270	9	0.5426	0.4421	0.3447	0.2811
0.280	7	0.5627	0.4585	0.3575	0.2915
0.300	3	0.6029	0.4913	0.3830	0.3123	0.2488
0.320	2	0.6431	0.5240	0.4085	0.3332	0.2654
0.325	5	0.6532	0.5322	0.4149	0.3384	0.2695
0.350	7	0.7034	0.5731	0.4468	0.3644	0.2902	0.2389	...
0.360	9	0.7235	0.5895	0.4596	0.3748	0.2985	0.2457	...
0.390	3	0.7838	0.6386	0.4979	0.4060	0.3234	0.2662	...
0.400	4	0.8039	0.6550	0.5107	0.4165	0.3317	0.2730	...
0.450	9	0.9044	0.7369	0.5745	0.4685	0.3732	0.3072	0.2481
0.455	7	0.9144	0.7451	0.5809	0.4737	0.3773	0.3106	0.2509
0.480	3	0.9647	0.7860	0.6128	0.4997	0.3980	0.3277	0.2646
0.500	5	1.0049	0.8188	0.6383	0.5206	0.4146	0.3413	0.2757
0.520	4	1.0451	0.8515	0.6639	0.5414	0.4312	0.3550	0.2867
0.560	7	1.1254	0.9170	0.7149	0.5830	0.4644	0.3823	0.3087
0.585	9	1.1757	0.9580	0.7469	0.6091	0.4851	0.3993	0.3225
0.600	6	1.2058	0.9825	0.7660	0.6247	0.4975	0.4096	0.3308
0.640	4	1.2862	1.0480	0.8171	0.6663	0.5307	0.4369	0.3529
0.650	5	1.3063	1.0644	0.8298	0.6767	0.5390	0.4437	0.3584
0.700	7	1.4068	1.1463	0.8937	0.7288	0.5805	0.4778	0.3859
0.720	9	1.4470	1.1790	0.9192	0.7496	0.5970	0.4915	0.3970
0.780	6	1.5676	1.2773	0.9958	0.8121	0.6468	0.5324	0.4300
0.800	5	1.6078	1.3100	1.0213	0.8329	0.6634	0.5461	0.4411
0.900	9	1.8088	1.4738	1.1490	0.9370	0.7463	0.6144	0.4962
0.910	7	1.8289	1.4902	1.1618	0.9474	0.7546	0.6212	0.5017
0.960	6	1.9293	1.5721	1.2256	0.9995	0.7961	0.6553	0.5293
1.000	10	2.0097	1.6376	1.2767	1.0411	0.8292	0.6826	0.5513
1.040	8	...	1.7031	1.3277	1.0828	0.8624	0.7099	0.5734
1.120	7	...	1.8341	1.4299	1.1661	0.9287	0.7645	0.6175
1.170	9	...	1.9159	1.4937	1.2181	0.9702	0.7987	0.6451
1.280	8	...	2.0961	1.6341	1.3327	1.0614	0.8738	0.7057
1.300	10	1.6597	1.3535	1.0780	0.8874	0.7167
1.440	9	1.8384	1.4992	1.1941	0.9830	0.7939
1.600	10	2.0427	1.6658	1.3268	1.0922	0.8821

Table 3. Tooth Proportions of American Standard Fine-Pitch Worms and WormGears ANSI B6.9-1977

Standard Axial Pitch in Inches,	Tooth Parts	Lead angle in λ in degrees														
		0.5	1	1.5	2	3	4	5	7	9	11	14	17	21	25	30
		Dimensions of Tooth Parts in Inches														
0.030	a	0.0095	0.0095	0.0095	0.0095	0.0095	0.0095	0.0095	0.0095	0.0094	0.0094	0.0093	0.0091	0.0089
	h_t	0.0230	0.0230	0.0230	0.0230	0.0230	0.0230	0.0229	0.0229	0.0228	0.0226	0.0224	0.0221	0.0216
	p_n	0.0300	0.0300	0.0300	0.0300	0.0300	0.0299	0.0299	0.0298	0.0296	0.0294	0.0291	0.0287	0.0280
0.040	a	0.0127	0.0127	0.0127	0.0127	0.0127	0.0127	0.0127	0.0126	0.0126	0.0125	0.0124	0.0122	0.0119	0.0115	...
	h_t	0.0300	0.0300	0.0300	0.0300	0.0300	0.0299	0.0299	0.0298	0.0297	0.0295	0.0292	0.0288	0.0282	0.0274	...
	p_n	0.0400	0.0400	0.0400	0.0400	0.0399	0.0399	0.0398	0.0397	0.0395	0.0393	0.0388	0.0383	0.0373	0.0363	...
0.050	a	0.0159	0.0159	0.0159	0.0159	0.0159	0.0159	0.0159	0.0158	0.0157	0.0156	0.0154	0.0152	0.0149	0.0144	0.0138
	h_t	0.0370	0.0370	0.0370	0.0370	0.0370	0.0369	0.0369	0.0368	0.0366	0.0364	0.0360	0.0355	0.0347	0.0337	0.0323
	p_n	0.0500	0.0500	0.0500	0.0500	0.0499	0.0499	0.0498	0.0496	0.0494	0.0491	0.0485	0.0478	0.0467	0.0453	0.0433
0.065	a	0.0207	0.0207	0.0207	0.0207	0.0207	0.0206	0.0206	0.0205	0.0204	0.0203	0.0201	0.0198	0.0193	0.0188	0.0179
	h_t	0.0475	0.0475	0.0475	0.0475	0.0475	0.0474	0.0473	0.0472	0.0470	0.0467	0.0462	0.0455	0.0445	0.0433	0.0414
	p_n	0.0650	0.0650	0.0650	0.0650	0.0649	0.0648	0.0648	0.0645	0.0642	0.0638	0.0631	0.0622	0.0607	0.0589	0.0563
0.080	a	0.0255	0.0255	0.0255	0.0254	0.0254	0.0254	0.0254	0.0253	0.0252	0.0250	0.0247	0.0244	0.0238	0.0231	0.0221
	h_t	0.0580	0.0580	0.0580	0.0580	0.0579	0.0579	0.0578	0.0576	0.0573	0.0570	0.0564	0.0556	0.0543	0.0528	0.0505
	p_n	0.0800	0.0800	0.0800	0.0800	0.0799	0.0798	0.0797	0.0794	0.0790	0.0785	0.0776	0.0765	0.0747	0.0725	0.0693
0.100	a	0.0318	0.0318	0.0318	0.0318	0.0318	0.0318	0.0317	0.0316	0.0314	0.0312	0.0309	0.0304	0.0297	0.0288	0.0276
	h_t	0.0720	0.0720	0.0720	0.0720	0.0719	0.0719	0.0718	0.0715	0.0712	0.0707	0.0699	0.0690	0.0674	0.0655	0.0626
	p_n	0.1000	0.1000	0.1000	0.0999	0.0999	0.0998	0.0996	0.0993	0.0988	0.0982	0.0970	0.0956	0.0934	0.0906	0.0866
0.130	a	0.0414	0.0414	0.0414	0.0414	0.0413	0.0413	0.0412	0.0411	0.0409	0.0406	0.0401	0.0396	0.0386	0.0375	0.0358
	h_t	0.0930	0.0930	0.0930	0.0930	0.0929	0.0928	0.0927	0.0924	0.0919	0.0914	0.0903	0.0891	0.0870	0.0845	0.0808
	p_n	0.1300	0.1300	0.1300	0.1299	0.1298	0.1297	0.1295	0.1290	0.1284	0.1276	0.1261	0.1243	0.1214	0.1178	0.1126
0.160	a	0.0509	0.0509	0.0509	0.0509	0.0509	0.0508	0.0507	0.0505	0.0503	0.0500	0.0494	0.0487	0.0475	0.0462	0.0441
	h_t	0.1140	0.1140	0.1140	0.1140	0.1139	0.1138	0.1136	0.1132	0.1127	0.1120	0.1107	0.1092	0.1066	0.1035	0.0990
	p_n	0.1600	0.1600	0.1599	0.1599	0.1598	0.1596	0.1594	0.1588	0.1580	0.1571	0.1552	0.1530	0.1494	0.1450	0.1386

Calculating Worm Deviations and Pressure Angle Changes.—Included in American Standard ANSI B6.9-1977 is an extensive tabulation of profile deviations and pressure angle changes produced by cutters and grinding wheels of 2-inch and 20-inch diameters. These diameters represent the limits of the range commonly used, and the data given are useful in specifying worm profile tolerances. The data also aid in the selection of the method to be used in producing the worm and in specifying the hobs for wormgears. The formulas used to compute the data in the Standard are given here in slightly modified form, and may be used to calculate the profile deviations and pressure angle changes produced in the worm by cutters or grinding wheels.

$$\rho_{ni} = \frac{r \sin \phi_n}{(\sin \lambda)^2} \text{ inches} \quad (1)$$

$$\rho_n = \rho_{ni} + \frac{r \rho_{ni}}{R(\cos \lambda)^2} \text{ inches} \quad (2)$$

$$\Delta \phi = \frac{5400 r (\sin \lambda)^3}{n(R(\cos \lambda)^2 + r)} \text{ minutes} \quad (3)$$

$$q = a \sec \phi_n \text{ inches} \quad (4)$$

$$y = \frac{q^2}{2\rho_n} \text{ inches} \quad (5)$$

$$s = 0.000582q\Delta\phi \text{ inches} \quad (6)$$

$$\Delta y = y_w - y_c \text{ inches} \quad (7)$$

$$\Delta s = s_c - s_w \text{ inches} \quad (8)$$

In these formulas,

ρ_{ni} = radius of curvature of normal thread profile for involute thread;

r = pitch radius of worm;

Φ_n = normal pressure angle of cutter or grinding wheel;

λ = lead angle of worm;

ρ_n = radius of curvature of normal thread profile;

R = radius of cutter or grinding wheel;

$\Delta\Phi$ = difference between the normal pressure angle of the thread and the normal pressure angle of the cutter or grinding wheel in minutes (see diagram). Subscripts c and w are used to denote the cutter and grinding wheel diameters, respectively;

n = number of threads in worm;

a = addendum of worm;

q = slant height of worm addendum;

y = amount normal worm profile departs from a straight side (see diagram). Subscripts c and w are used to denote the cutter and grinding wheel diameters, respectively;

s = effect along slant height of worm thread caused by change in pressure angle $\Delta\Phi$

Δy = difference in y values of two cutters or grinding wheels of different diameter (see diagram);

Δs = effect of $\Delta\Phi_c - \Delta\Phi_w$ along slant height of thread (see diagram).

Example 3: Assuming the worm dimensions are the same as in **Example 1**, determine the corrections for two worms, one milled by a 2-inch diameter cutter, the other ground by a 20-inch diameter wheel, both to be assembled with identical wormgears.

To make identical worms when using a 2-inch cutter and a 20-inch wheel, the pressure angle of either the cutter or the wheel must be corrected by an amount corresponding to Δs and the profile of the cutter or wheel must be a curve which departs from a straight line by an amount Δy . The calculations are as follows:

For the 2-inch diameter cutter, using **Formula (1) to (6)**,

$$\rho_{ni} = \frac{0.4410 \times 0.3420}{0.5000^2} = 0.6033 \text{ inch} \quad (1)$$

$$\rho_n = 0.6033 + \frac{0.4410 \times 0.6033}{1 \times 0.8660^2} = 0.9581 \text{ inch} \quad (2)$$

$$\Delta\phi_c = \frac{5400 \times 0.4410 \times 0.5000^3}{10(1 \times 0.8660^2 + 0.4410)} = 24.99 \text{ inches} \quad (3)$$

$$q = 0.0441 \times 1.0642 = 0.0469 \text{ inch} \quad (4)$$

$$y_c = \frac{0.0469^2}{2 \times 0.6387} = 0.00172 \text{ inches} \quad (5)$$

$$s_c = 0.000582 \times 0.0469 \times 24.99 = 0.000682 \text{ inch} \quad (6)$$

For the 20-inch diameter wheel, using **Formula (1) to (6)**

$$\rho_{ni} = \frac{0.4410 \times 0.3420}{0.5000^2} = 0.6033 \text{ inch} \quad (1)$$

$$\rho_n = 0.6033 + \frac{0.4410 \times 0.6033}{10 \times 0.8660^2} = 0.6387 \text{ inch} \quad (2)$$

$$\Delta\phi_w = \frac{5400 \times 0.4410 \times 0.5000^3}{10(10 \times 0.8660^2 + 0.4410)} = 3.749 \text{ inches} \quad (3)$$

$$q = 0.0441 \times 1.0642 = 0.0469 \text{ inch} \quad (4)$$

$$y_w = \frac{0.0469^2}{2 \times 0.6387} = 0.00172 \text{ inches} \quad (5)$$

$$s_w = 0.000582 \times 0.0469 \times 3.749 = 0.000102 \text{ inch} \quad (6)$$

Applying **Formula (7) to (8)**:

$$\Delta y = 0.00172 - 0.00115 = 0.00057 \text{ inch} \quad (7)$$

$$\Delta s = 0.000682 - 0.000102 = 0.000580 \text{ inch} \quad (8)$$

Therefore the pressure angle of either the cutter or the wheel must be corrected by an amount corresponding to a Δs of 0.00580 inch and the profile of the cutter or wheel must be a curve which departs from a straight line by 0.00057 inch.

Industrial Worm Gearing.—The primary considerations in industrial worm gearing are usually:

1) To transmit power efficiently; 2) to transmit power at a considerable reduction in velocity; and 3) to provide a considerable “mechanical advantage” when a given applied force must overcome a comparatively high resisting force.

Worm gearing for use in such applications is usually of relatively coarse pitch. The notation in the table that follows is used in the formulas on the following pages.

Notation for Worm Gearing

a	addendum, worm thread	m	module = $0.3183 \times$ axial pitch
A	addendum, wormgear tooth	N	revolutions per minute of wormgear
B	dedendum, wormgear tooth	n	revolutions per minute of worm
b	dedendum, worm thread	P	axial pitch of worm and circular pitch of wormgear
C	center distance (Fig. 2, page 3335)	P_n	normal pitch of worm
c	clearance	Q	arc length of wormgear tooth measured along root
D	pitch diameter of wormgear	R	ratio of worm gearing = No. of wormgear teeth \div No. of worm threads.
d	pitch diameter of worm	S_c	surface stress factor (Table 4)
d_0	outside diameter of worm	S_b	bending stress factors, lbs. per sq. in. (Table 4)
D_0	outside or over-all diameter of wormgear	T	number of teeth on wormgear
D_t	throat diameter of wormgear	t	number of threads or "starts" and on worm-2 for double thread, 3 for triple thread, 4 for quadruple thread, etc.
E	efficiency of worm gearing, per cent	U	radius of wormgear throat (Fig. 2)
F	nominal face width of wormgear rim	V	rubbing speed of worm in feet per minute
F_e	effective face width (Fig. 2, p. 1928)	W	whole tooth depth (worm and-wormgear)
f	coefficient of friction	X_{cp} and X_{cw}	speed factor when load rating is limited by wear (Fig. 2)
G	length of worm threaded section	X_{bp} and X_{bw}	speed factor when load rating is limited by strength (Table 5)
H	horsepower rating	ϕ	angle of friction ($\tan \phi =$ coefficient of friction)
L	lead of worm thread = pitch \times number of threads or "starts"		
L_a	lead angle of worm = helix angle measured from a plane perpendicular to worm axis		
M	torque applied to wormgear, pound inches		

Materials for Worm Gearing.—Worm gearing, especially for power transmission, should have steel worms and phosphor bronze wormgears. This combination is used extensively. The worms should be hardened and ground to obtain accuracy and a smooth finish.

The phosphor bronze wormgears should contain from 10 to 12 per cent of tin. The S.A.E. phosphor gear bronze (No. 65) contains 88-90% copper, 10-12% tin, 0.50% lead, 0.50% zinc (but with a maximum total lead, zinc and nickel content of 1.0 percent), phosphorous 0.10-0.30%, aluminum 0.005%. The S.A.E. nickel phosphor gear bronze (No. 65 + Ni) contains 87% copper, 11% tin, 2% nickel and 0.2% phosphorous.

Single-thread Worms.—The ratio of the worm speed to the wormgear speed may range from 1.5 or even less up to 100 or more. Worm gearing having high ratios are not very effi-

cient as transmitters of power; nevertheless high as well as low ratios often are required. Since the ratio equals the number of wormgear teeth divided by the number of threads or “starts” on the worm, single-thread worms are used to obtain a high ratio. As a general rule, a ratio of 50 is about the maximum recommended for a single worm and wormgear combination, although ratios up to 100 or higher are possible. When a high ratio is required, it may be preferable to use, in combination, two sets of worm gearing of the multi-thread type in preference to one set of the single-thread type in order to obtain the same total reduction and a higher combined efficiency.

Single-thread worms are comparatively inefficient because of the effect of the low lead angle, see *Efficiency of Worm Gearing*, page 3337; consequently, single-thread worms are not used when the primary purpose is to transmit power as efficiently as possible but they may be employed either when a large speed reduction with one set of gearing is necessary, or possibly as a means of adjustment, especially if “mechanical advantage” or self-locking are important factors.

Multi-thread Worms.—When worm gearing is designed primarily for transmitting power efficiently, the lead angle of the worm should be as high as is consistent with other requirements and preferably between, say, 25 or 30 and 45 degrees. This means that the worm must be multi-threaded. To obtain a given ratio, some number of wormgear teeth divided by some number of worm threads must equal the ratio. Thus, if the ratio is 6, combinations such as the following might be used:

$$\frac{24}{4}, \frac{30}{5}, \frac{36}{6}, \frac{42}{7}$$

The numerators represent the number of wormgear teeth and the denominators, the number of worm threads or “starts.” The number of wormgear teeth may not be an exact multiple of the number of threads on a multi-thread worm in order to obtain a “hunting tooth” action.

Number of Threads or “Starts” on Worm. The number of threads on the worm ordinarily varies from one to six or eight, depending upon the ratio of the gearing. As the ratio is increased, the number of worm threads is reduced, as a general rule. In some cases, however, the higher of two ratios may also have a larger number of threads. For example, a ratio of $6\frac{1}{2}$ would have 5 threads whereas a ratio of $6\frac{5}{6}$ would have 6 threads. Whenever the ratio is fractional, the number of threads on the worm equals the denominator of the fractional part of the ratio.

Ratio for Obtaining “Hunting Tooth” Action.—In designing wormgears having multi-thread worms, it is common practice to select a number of wormgear teeth that is not an exact multiple of the number of worm threads. To illustrate, if the desired ratio is about 5 or 6, the actual ratio might be $5\frac{1}{6}$, $5\frac{5}{6}$, $5\frac{2}{3}$, $6\frac{1}{2}$, etc., so that combinations such as $\frac{31}{6}$, $\frac{35}{6}$, $\frac{37}{7}$ or $\frac{31}{5}$ would be obtained. Since the number of wormgear teeth and number of worm threads do not have a common divisor, the threads of the worm will mesh with all of the wormgear teeth in succession, thus obtaining a “hunting tooth” or self-indexing action. This progressive change will also occur during the wormgear hobbing operation, and its primary purpose is to produce more accurate wormgears by uniformly distributing among all of the teeth, any slight errors which might exist in the hob teeth. Another object is to improve the “running-in” action between the hardened and ground worm and the phosphor bronze wormgear, but in order to obtain this advantage, the threads on the worm must be accurately or uniformly spaced by precise indexing. With a “hunting tooth ratio,” if the thread spacing of a multi-thread worm is inaccurate, load distribution on the threads will be unequal and some threads might not even make contact with the wormgear teeth. For this reason, if the indexing is inaccurate, it is preferable to avoid a hunting tooth ratio, but in that case, if the gearing is disassembled, the same worm and wormgear teeth should be mated when reassembled.

Table 4. Rules and Formulas for Worm Gearing

No.	To Find	Rule	Formula
1	Addendum	Addendum may be affected by lead angle. See paragraph, Addendum and Dedendum.	
2	Center Distance	Add pitch diameter of wormgear to pitch diameter of worm, and divide sum by 2	$C = \frac{D+d}{2}$
3		Divide number of worm threads by tangent lead angle, add number of wormgear teeth and multiply sum by quotient obtained by dividing pitch by 6.2832	$C = \frac{P}{6.2832} \left(\frac{t}{\tan L_a} + T \right)$
4	Dedendum	Dedendum may be affected by lead angle. See paragraph, <i>Addendum and Dedendum</i> on page 3335.	
5	Clearance	British Standard-multiply cosine lead angle by 0.2 times module.	$c = 0.2m \cos L_a$
6	Face Width Wormgear	For single and double thread worms, multiply pitch by 2.38 and add 0.25. (shell type worm.)	$F = 2.38P + 0.25$
7		For triple and quadruple thread multiply pitch by 2.15 and add 0.2. (shell type)	$F = 2.15P + 0.20$
8		When worm threads are integral with shaft, face width of wormgear may be equal $C^{0.875}$ divided by 3.	$F = \frac{C^{0.875}}{3}$
9	Lead of Worm Thread	Multiply pitch by number of worm threads or "starts"	$L = lP$
10		Multiply pitch circumference of worm by tangent of lead angle.	$L = \pi d \times \tan L_a$
11		Divide pitch circumference of wormgear by ratio.	$L = \pi D \div R$
12	Lead Angle, Worm	Divide lead by pitch circumference of worm; quotient is tangent of lead angle.	$\tan L_a = \frac{L}{3.1416d}$
13	Outside Diam., Worm	Add to pitch diameter twice the addendum. see paragraph, pitch diameter of worm; also see <i>Addendum and Dedendum</i> on page 3335.	$d_0 = d + 2a$
14	Outside Diam., Wormgear	For outside or over-all diameter of wormgear, see paragraph, outside diameter of wormgear.	
15	Pitch of Worm and Wormgear	Divide lead by number of threads or "starts" on worm = axial pitch of worm and circular pitch of wormgear.	$P = \frac{L}{t}$
16		Subtract the worm pitch diameter from twice the center distance. Multiply by 3.1416 and divide by number of wormgear teeth.	$P = \frac{(2C - d)3.1416}{T}$

Table 4. (Continued) Rules and Formulas for Worm Gearing

No.	To Find	Rule	Formula
17	Pitch of Worm, Normal	Multiply axial pitch by cosine of lead angle to find normal pitch.	$P_n = P \times \cos L_a$
18	Pitch Diameter, Worm	Subtract pitch diameter of worm gear from twice the center distance.	$d = 2C - D$
19		Subtract twice the addendum from outside diameter. See <i>Addendum and Dedendum</i> .	$D = d_0 - 2a$
20		Multiply lead by cotangent lead angle and divide product by 3.1416	$d = \frac{L \times \cot L_a}{3.1416}$
21	Pitch Diameter, Wormgear	Subtract pitch diameter of worm from twice the center distance.	$D = 2C - d$
22		Multiply number of wormgear teeth by axial pitch of worm and divide product by 3.1416.	$D = \frac{TP}{3.1416}$
23	Radius of Rim Corner, Wormgear	Multiply pitch by 0.25	Radius = 0.25P
24		British Standard: Radius = 0.5 × module.	Radius = 0.50m
25	Ratio	Divide number of wormgear teeth by by number of worm threads.	$R = T \div t$
26	Rubbing Speed, Ft. per Minute	Divide wormgear pitch diameter by ratio; square quotient and add to square of worm pitch diameter; multiply square root of this sum by 0.262 × R.P.M. of worm.	$V = 0.262n \sqrt{d^2 + \left(\frac{D}{4}\right)^2}$
27		Multiply 0.262 × Pitch diameter of worm by worm R.P.M. of worm; then multiply product by secant of lead angle.	$V = 0.262dn \times \sec L_a$
28	Throat Diameter Wormgear	Add twice the addendum to pitch diameter. See <i>Addendum and Dedendum</i> on page 3335.	$D_t = D + 2A$
29	Throat Radius Wormgear	Subtract twice the addendum from outside radius of worm.	$U = \frac{d_0}{2} - 2a$
30	Total Depth	Whole depth equals addendum + dedendum. See <i>Addendum and Dedendum</i> on page 3335.	$W = a + b$ or $A + B$
31	Worm Thread Length	Multiply the number of wormgear teeth by 0.02, add 4.5 and multiply sum by pitch.	$G = P(4.5 + 0.02T)$
32		British Standard subtract square of wormgear pitch diameter from square of outside diameter and extract square root of remainder.	$G = \sqrt{D_0^2 - D^2}$

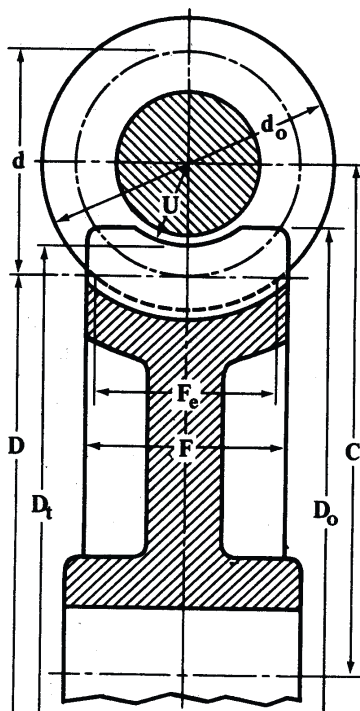


Fig. 2.

Pitch Diameter of Worm.—The worm must be strong enough to transmit its maximum load without excessive deflection but the diameter should be as small as is consistent with the necessary strength in order to minimize the rubbing speed. It is impracticable to give a rule or formula that is generally applicable, but the following empirical rules are based upon actual practice and may prove useful as a general guide. They apply to casehardened alloy steel worms which are integral with the shaft.

For ratios of 5, 6, or 7, the pitch diameter ranges approximately from $0.38 C$ when center distance C is 4 inches to $0.33 C$ when C is 20 inches.

For ratios of 8, 9, 10, the pitch diameter ranges approximately from $0.38 C$ when center distance C is 4 inches to $0.25 C$ when C is 30 inches.

For ratios of 10 to 20, the pitch diameter ranges approximately from $0.37 C$ when center distance C is 4 inches to $0.24 C$ when C is 30 inches.

For ratios of 20 to 40, the pitch diameter ranges approximately from $0.36 C$ when center distance C is 4 inches to $0.23 C$ when C is 30 inches.

According to another empirical formula pitch diameter $d = C^{0.75} + 2.2$.

Addendum and Dedendum.—The following A.G.M.A. formulas are applicable to industrial worm gearing. For single and double thread worms, addendum $a = 0.318 P$ and whole depth $W = 0.686 P$; for triple and quadruple threads, addendum $a = 0.286 P$ and whole depth $W = 0.623 P$.

According to the British standard, $a = \text{module}$; $m = 0.3183 P$; $b = m(2.2 \cos L_a - 1)$; $A = m(2.2 \cos L_a - 1)$; $B = m(1 + 0.2 \cos L_a)$.

Outside Diameter of Wormgear.—Practice varies somewhat in determining the outside or over-all diameter of the wormgear, as indicated by the following formulas. For usual rim shape, see Fig. 2.

- 1) For lead angles up to about 15 or 20 degrees, $D_o = D + (3 \times 0.3183 P)$
- 2) For lead angles over 20 degrees, $D_o = D + (3 \times 0.3183 P \times \cos L_a)$

3) For single and double thread, $D_o = D_t + 0.4775P$

4) For triple and quadruple thread, $D_o = D_t + 0.3183P$

Pressure Angles.—The pressure angle (one-half the included thread angle) ranges from $14\frac{1}{2}$ to 30 degrees. While the practice varies somewhat, the following relationship between lead angle and pressure angle may be used as a general guide.

For lead angles up to about 10 or 12 degrees, pressure angle = $14\frac{1}{2}$ degrees.

For lead angles from 10 or 12 to about 20 or 25 degrees, pressure angle = 20 degrees.

For lead angles from 25 to about 35 degrees, pressure angle = 25 degrees.

For lead angles over 35 degrees, pressure angle = 30 degrees.

In the British Standard specifications, the recommended thread form has a normal pressure angle of 20 degrees.

Designing Worm Gearing Relative to Center Distance and Ratio.—In designing worm gearing, three general cases or types of problems may be encountered in establishing the proportions of the worm and wormgear.

When Center Distance is Fixed and Ratio may be Varied: The ratio in this case is nominal and may be varied somewhat to meet other conditions. Assume that the required center distance is 6 inches, the desired ratio is about 7, and the pitch of the worm and wormgears is to be approximately 1 inch. Combinations of wormgears and worms such as the following might be used in this case:

$$\frac{28}{4}, \frac{35}{5}, \frac{42}{6}, \frac{56}{8}, \text{ etc.}$$

Suppose we select the $\frac{28}{4}$ combination for trial but change the number of worm-gear teeth from 28 to 29 to obtain a self-indexing or “hunting tooth” action. The ratio now equals $\frac{29}{4}$ or 7.25. Then, for trial purposes

$$\text{Pitch diameter } D \text{ of wormgear} = \frac{T \times P}{\pi} = \frac{29 \times 1}{3.1416} = 9.231 \text{ inches}$$

$$\text{Pitch diameter } d \text{ of wormgear} = 2C - D = 2 \times 6 - 9.231 = 2.769 \text{ inches}$$

Assume that experience, tests, or calculations show that a worm of smaller diameter will have the necessary bending and torsional strength and that a pitch of 1.0625 will be satisfactory. Then the pitch diameter of the worm will be decreased to 2.192 inches and the pitch diameter of the wormgear will be increased to 9.808 inches. A check of the lead-angle will show that it equals $31^\circ 41'$ which is conducive to high efficiency.

When Ratio is Fixed and Center Distance may be Varied: Assume that the required ratio is $7\frac{1}{4}$ and that the center distance may be any value consistent with approved designing practice. This ratio may be obtained with a number of different worm and wormgear sizes. For example, in a series of commercial wormgears, the following combinations are employed for gearing having a ratio of $7\frac{1}{4}$ with center distances varying from 4 to 8.25 inches. The number of worm threads is 4 and the number of teeth on the wormgear is 29 in all cases.

$$\text{When } C = 4 \text{ inches, } d = 1.654; D = 6.346; P = 0.6875; L_a = 27^\circ 54'$$

$$\text{When } C = 5 \text{ inches, } d = 1.923; D = 8.077; P = 0.875; L_a = 30^\circ 5'$$

$$\text{When } C = 6 \text{ inches, } d = 2.192; D = 9.808; P = 1.0625; L_a = 31^\circ 41'$$

$$\text{When } C = 7 \text{ inches, } d = 2.461; D = 11.539; P = 1.25; L_a = 32^\circ 53'$$

$$\text{When } C = 8.25 \text{ inches, } d = 2.942; D = 13.558; P = 1.4687; L_a = 32^\circ 27'$$

The horsepower rating increases considerably as the proportions of the worm gearing increase; hence if the gears are intended primarily for power transmission, the general proportions must be selected with reference to the power-transmitting capacity, and, usually the smallest and most compact design that will give satisfactory performance should be selected. The power capacity of the transmission, however, does not depend solely upon the proportions of the worm and wormgear. For example, the quality and viscosity of the lubricant is an important factor. The load transmitting capacity of the lubricant may also be increased decidedly when excessive temperature rises are prevented by special means such as forced air cooling. (See *Water and Forced-Air Cooling*, page 3339)

When Both Ratio and Center Distance are Fixed: When both ratio and center distance are fixed, the problem usually is to obtain the best proportions of worm and wormgear conforming to these fixed values.

Example: The required ratio is 6 (6 to 1) and the center distance is fixed at 3.600 inches. Assume that experience or tests show that an axial pitch of 0.50 inch will meet strength requirements. If normal pitch P_n is given, change to axial pitch ($P = P_n \div \cos L_a$). With a ratio of 6, some of the combinations for trial are: $\frac{30}{5}, \frac{36}{6}, \frac{42}{7}$

Trial calculations will show that the $\frac{36}{6}$ combination gives the best proportions of worm and wheel for the center distance and pitch specified. Thus

$$D = \frac{TP}{\pi} = \frac{36 \times 0.5}{3.1416} = 5.729 \quad d = 2C - D = 2 \times 3.6 - 5.729 = 1.471$$

The lead angle is about 33 degrees. The effect of lead angle on efficiency is dealt with in a following paragraph. The total obtained by adding the number of worm-gear teeth to the number of worm threads, equals $36 + 6 = 42$ (a total of 40 is a desirable minimum). With the $\frac{42}{7}$ combination of the same pitch, the worm would be too small (0.516 inch); and with the $\frac{30}{5}$ combination it would be too large (2.426 inches). The present trend in gear designing practice is to use finer pitches than in the past. In the case of worm gearing, the pitch may, in certain instances, be changed somewhat either to permit cutting with available equipment or to improve the proportions of worm and wheel.

When Ratio, Pitch and Lead Angle are Fixed: Assume that $R = 10$, axial pitch $P = 0.16$ inch, $L_a = 30$ degrees and $C = 3$ inches, approximately.

The first step is to determine for the given ratio, pitch and lead angle, the number of worm threads t which will give a center distance nearest 3 inches.

The whole number nearest 10.04, or 10, is the required number of worm threads; hence number of teeth on wormgear equals $R \times 10 = 100$

$$d = (L \cot L_a) \div \pi = (10 \times 0.16 \times 1.732) \div \pi = 0.8821 \text{ inches}$$

$$D = (TP) \div \pi = (100 \times 0.16) \div \pi = 5.0929 \text{ inches}$$

$$C = (D + d) \div 2 = (5.0929 + 0.8821) \div 2 = 2.9875 \text{ inches}$$

Efficiency of Worm Gearing.—The efficiency at a given speed, depends upon the worm lead angle, the workmanship, the lubrication, and the general design of the transmission. When worm gearing consists of a hardened and ground worm running with an accurately hobbed wormgear properly lubricated, the efficiency depends chiefly upon the lead angle and coefficient of friction between the worm and worm-gear. In the lower range of lead angles, the efficiency increases considerably as the lead angle increases, as shown by [Tables 5 and 6](#). This increase in efficiency remains practically constant for lead angles between 30 and 45 degrees. Several formulas for obtaining efficiency percentage follow:

With worm driving:

$$E = 100 - \frac{R}{2} \text{ (empirical rule); } E = \frac{100 \times \tan L_a}{\tan(L_a + \phi)}; E = \frac{100 \times L}{L + f\pi d}$$

With wormgear driving

$$E = 100 - 2R \text{ (empirical rule); } E = \frac{100 \times \tan(L_a - \phi)}{\tan L_a}$$

The efficiencies obtained by these formulas and other modifications of them differ somewhat and do not take into account bearing and oil-churning losses. The efficiency may be improved somewhat after the "running in" period.

Table 5. Efficiency of Worm Gearing for Different Lead Angles and Frictional Coefficients

Coefficient of Friction	Lead Angle of Worm, Degrees								
	5 Deg.	10 Deg.	15 Deg.	20 Deg.	25 Deg.	30 Deg.	35 Deg.	40 Deg.	45 Deg.
0.01	89.7	94.5	96.1	97.0	97.4	97.7	97.9	98.0	98.0
0.02	81.3	89.5	92.6	94.1	95.0	95.5	95.9	96.0	96.1
0.03	74.3	85.0	89.2	91.4	92.6	93.4	93.9	94.1	94.2
0.04	68.4	80.9	86.1	88.8	90.4	91.4	91.9	92.2	92.3
0.05	63.4	77.2	83.1	86.3	88.2	89.4	90.1	90.4	90.5
0.06	59.0	73.8	80.4	84.0	86.1	87.4	88.2	88.6	88.7
0.07	55.2	70.7	77.8	81.7	84.1	85.6	86.5	86.9	86.9
0.08	51.9	67.8	75.4	79.6	82.2	83.8	84.7	85.2	85.2
0.09	48.9	65.2	73.1	77.5	80.3	82.0	83.0	83.5	83.5
0.1	46.3	62.7	70.9	75.6	78.5	80.3	81.4	81.9	81.8

Table 6. Efficiency of Worm Gearing for Different Lead Angles and Pitch-line Velocities

Velocity at Pitch Line, Feet per Minute	Lead or Helix Angle, Degrees					
	5	10	20	30	40	45
	Efficiency, Per Cent					
5	40	56	69	76	79	80
10	47	62	74	79	82	82
20	52	67	78	83	85	86
30	56	71	81	85	87	87
40	60	74	83	87	88	88
50	63	76	85	88	89	89
75	67	80	87	90	90	90
100	70	82	88	91	91	91
150	74	84	90	92	92	92
200	76	85	91	92	92	92

Table 7. Coefficients of Friction (f) for Worm Gearing^a

Rubbing Speed, Feet per Minute	Coefficients of Friction	Rubbing Speed, Feet per Minute	Coefficients of Friction	Rubbing Speed, Feet per Minute	Coefficients of Friction	Rubbing Speed, Feet per Minute	Coefficients of Friction
30	0.073	180	0.045	550	0.028	1600	0.175
40	0.700	190	0.044	600	0.027	1700	0.170
50	0.066	200	0.043	650	0.026	1800	0.165
60	0.062	225	0.041	700	0.026	1900	0.165
70	0.060	250	0.040	750	0.025	2000	0.160
80	0.058	275	0.038	800	0.024	2100	0.160
90	0.056	300	0.036	850	0.023	2200	0.155
100	0.054	325	0.035	900	0.023	2300	0.150
110	0.052	350	0.034	950	0.022	2400	0.150
120	0.051	375	0.033	1000	0.022	2500	0.150
130	0.050	400	0.033	1100	0.021	2600	0.145
140	0.049	425	0.032	1200	0.020	2700	0.145
150	0.048	450	0.031	1300	0.190	2800	0.140
160	0.047	475	0.030	1400	0.190	2900	0.140
170	0.046	500	0.030	1500	0.180	3000	0.140

^a These values for different rubbing speeds are based upon the use of phosphor bronze wormgears with case-hardened ground and polished steel worms lubricated with mineral oil.

Self-locking or Irreversible Worm Gearing.—Neglecting friction in the bearings, worm gearing is irreversible when the efficiency is zero or negative, the lead angle being equal to or less than the angle ϕ of friction ($\tan \phi =$ coefficient of friction). When worm gearing is self-locking or irreversible, this means that the worm-gear cannot drive the worm. Since the angle of friction changes rapidly with the rubbing speed, and the static angle of friction may be reduced by external vibration, it is usually impracticable to design irreversible worm gearing with any security. If irreversibility is desired, it is recommended that some form of brake be employed.

Worm Gearing Operating Temperatures.—The load capacity of a worm gearing lubricant at operating temperature is an important factor in establishing the continuous power-transmitting capacity of the gearing. If the churning or turbulence of the oil generates excessive heat, the viscosity of the lubricant may be reduced below its load-supporting capacity. The temperature measured in the oil sump should not, as a rule, exceed 180 to 200 degrees F. or rise more than 120 to 140 degrees F. above a surrounding air temperature of 60 degrees F. In rear axle motor vehicle transmissions, the maximum operating temperature may be somewhat higher than the figures given and usually is limited to about 220 degrees F.

Thermal Rating.—In some cases, especially when the worm speed is comparatively high, the horsepower capacity of worm gearing should be based upon its thermal rating instead of the mechanical rating. To illustrate, worm gearing may have a thermal rating of, say, 60 H.P., and mechanical ratings which are considerably higher than 60 for the higher speed ranges. This means that the gearing is capable of transmitting more than 60 H.P. so far as wear and strength are concerned but not without overheating; hence, in this case a rating of 60 should be considered maximum. Of course, if the power to be transmitted is less than the thermal rating for a given ratio, then the thermal rating may be ignored.

Water and Forced-Air Cooling.—One method of increasing the thermal rating of a speed-reducing unit of the worm gearing type, is by installing a water-cooling coil through which water is circulated to prevent an excessive rise of the oil temperature. According to one manufacturer, the thermal rating may be increased as much as 35 per cent in this man-

ner. Much larger increases have been obtained by means of a forced air cooling system incorporated in the design of the speed-reducing unit. A fan which is mounted on the worm shaft draws air through a double walled housing, thus maintaining a comparatively low oil bath temperature. A fan cooling system makes it possible to transmit a given amount of power through a worm-gearing unit that is much smaller than one not equipped with a fan.

Double-enveloping Worm Gearing.—Contact between the worm and wormgear of the conventional type of worm gearing is theoretically a line contact; however, due to deflection of the materials under load, the line is increased to a narrow band or contact zone. In attempting to produce a double-enveloping type of worm gearing (with the worm curved longitudinally to fit the curvature of the gear as shown Fig. 3), the problem primarily was that of generating the worm and worm-gear in such a manner as to obtain area contact between the engaging teeth. A practical method of obtaining such contact was developed by Samuel I. Cone at the Norfolk Navy Yard, and this is known as “Cone-Drive” worm gearing. The Cone generating method makes it possible to cut the worm and wormgear without any interference which would alter the required tooth form. The larger tooth bearing area and multiple tooth contact obtained with this type of worm gearing, increases the load-carrying or horsepower capacity so that as compared with a conventional worm drive a double-enveloping worm drive may be considerably smaller in size. Table 9, which is intended as a general guide, gives input horsepower ratings for Cone-Drive worm gearing for various center distances of from 2 to 12 inches. These ratings are based on AGMA specifications 341, 441, and 641. They allow for starting and momentary peak overloads of up to 300 per cent of the values shown in Table 5 using a service factor of 1. Factors for various types of service are given in Table 8. To obtain the mechanical horsepower rating required, multiply the appropriate rating given in Table 9 by the service factor taken from Table 8.

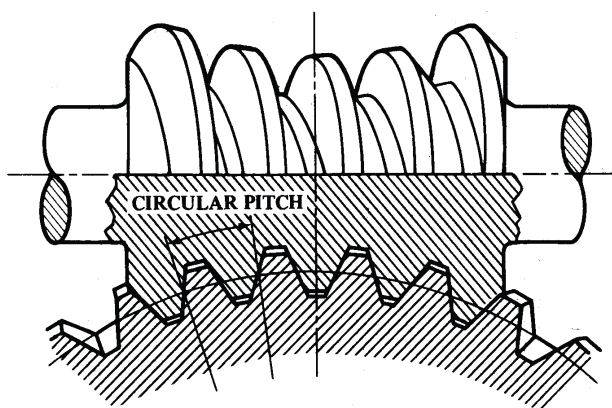


Fig. 3.

Table 8. Service Factors for Cone-Drive Worm Gearing

Hours/Day	Uniform Motion	Moderate Shock	Heavy Shock	Extreme Shock
0.5	0.6	0.8	0.9	1.1
1	0.7	0.9	1	1.2
2	0.9	1	1.2	1.3
10	1	1.2	1.3	1.5
24	1.2	1.3	1.5	1.75

Table 9. AGMA Input Mechanical Horsepower Ratings of Cone-Drive Worm Gearing^a

Ratio	Worm Speed, RPM					
	100	300	720	870	1150	1750
2-Inch Center Distance						
5:1	0.40	1.04	2.18	2.51	3.02	3.81
10:1	0.25	0.66	1.40	1.62	1.98	2.52
15:1	0.18	0.47	0.99	1.15	1.40	1.79
20:1	0.13	0.36	0.76	0.88	1.07	1.38
25:1	0.11	0.29	0.61	0.71	0.87	1.11
30:1	0.09	0.24	0.51	0.59	0.73	0.93
40:1	0.07	0.18	0.38	0.45	0.55	0.70
50:1	0.05	0.15	0.31	0.36	0.44	0.56
2.5-Inch Center Distance						
5:1	0.78	2.04	4.13	4.68	5.48	6.87
10:1	0.49	1.30	2.67	3.05	3.62	4.54
15:1	0.35	0.91	1.89	2.16	2.57	3.22
20:1	0.27	0.70	1.44	1.65	1.97	2.48
25:1	0.21	0.56	1.16	1.33	1.59	2.00
30:1	0.18	0.47	0.98	1.12	1.33	1.68
40:1	0.13	0.35	0.73	0.84	1.00	1.26
50:1	0.11	0.28	0.59	0.68	0.81	1.01
3-Inch Center Distance						
5:1	1.38	3.60	6.99	7.79	9.06	11.30
10:1	0.88	2.31	4.65	5.26	6.16	7.72
15:1	0.62	1.62	3.29	3.74	4.38	5.49
20:1	0.47	1.24	2.52	2.87	3.37	4.22
25:1	0.38	1.00	2.04	2.31	2.72	3.41
30:1	0.32	0.84	1.71	1.94	2.28	2.86
40:1	0.24	0.63	1.28	1.46	1.72	2.15
50:1	0.19	0.51	1.03	1.17	1.38	1.73
60:1	0.16	0.42	0.86	0.98	1.15	1.44
3.5-Inch Center Distance						
5:1	2.55	6.60	12.30	13.70	15.90	19.70
10:1	1.63	4.24	8.27	9.21	10.70	13.40
15:1	1.14	2.99	5.85	6.54	7.62	9.53
20:1	0.88	2.28	4.49	5.03	5.86	7.33
25:1	0.71	1.84	3.62	4.06	4.73	5.92
30:1	0.59	1.54	3.04	3.40	3.96	4.96
40:1	0.44	1.16	2.29	2.56	2.99	3.74
50:1	0.36	0.93	1.83	2.06	2.40	3.00
60:1	0.30	0.78	1.53	1.72	2.00	2.51
4-Inch Center Distance						
5:1	3.66	9.40	16.90	18.70	21.70	26.70
10:1	2.35	6.09	11.50	12.70	14.80	18.40
15:1	1.65	4.29	8.15	9.06	10.50	13.10
20:1	1.26	3.28	6.26	6.96	8.09	10.10
25:1	1.02	2.65	5.05	5.62	6.53	8.13
30:1	0.85	2.22	4.24	4.71	5.48	6.82
40:1	0.64	1.67	3.19	3.55	4.12	5.14
50:1	0.51	1.34	2.56	2.85	3.31	4.12
60:1	0.43	1.12	2.14	2.38	2.76	3.44

Table 9. (Continued) AGMA Input Mechanical Horsepower Ratings of Cone-Drive Worm Gearing^a

Ratio	Worm Speed, RPM					
	100	300	720	870	1150	1750
5-Inch Center Distance						
5:1	7.21	18.20	31.00	34.30	39.60	47.40
10:1	4.63	11.80	21.10	23.40	27.20	33.30
15:1	3.25	8.36	15.00	16.70	19.30	23.80
20:1	2.49	6.40	11.60	12.80	14.90	18.30
25:1	2.01	5.16	9.34	10.30	12.00	14.80
30:1	1.68	4.32	7.83	8.67	10.10	12.40
40:1	1.27	3.25	5.90	6.53	7.58	9.34
50:1	1.02	2.61	4.73	5.24	6.09	7.50
60:1	0.85	2.18	3.95	4.37	5.08	6.26
70:1	0.73	1.87	3.39	3.76	4.36	5.38
6-Inch Center Distance						
5:1	11.10	27.30	45.30	50.10	57.50	66.80
10:1	7.08	17.80	30.40	33.70	38.80	46.40
15:1	4.98	12.60	21.60	23.90	27.60	33.20
20:1	3.81	9.64	16.60	18.40	21.20	25.60
25:1	3.07	7.78	13.40	14.90	17.20	20.70
30:1	2.57	6.52	11.30	12.50	14.40	17.40
40:1	1.94	4.90	8.47	9.38	10.80	13.10
50:1	1.55	3.93	6.80	7.53	8.70	10.50
60:1	1.30	3.28	5.68	6.29	7.26	8.79
70:1	1.11	2.82	4.87	5.40	6.23	7.55
7-Inch Center Distance						
5:1	17.50	41.60	67.30	73.90	83.60	96.40
10:1	11.20	27.70	46.20	51.20	58.70	68.40
15:1	7.88	19.60	32.90	36.50	41.90	49.20
20:1	6.03	15.00	25.30	28.00	32.20	37.90
25:1	4.86	12.20	20.50	22.60	26.00	30.70
30:1	4.07	10.20	17.20	19.00	21.80	25.80
40:1	3.06	7.66	12.90	14.30	16.40	19.40
50:1	2.46	6.15	10.40	11.50	13.20	15.60
60:1	2.05	5.13	8.66	9.58	11.00	13.00
70:1	1.76	4.41	7.43	8.23	9.46	11.20
8-Inch Center Distance						
5:1	25.90	59.60	95.20	104.00	116.00	134.00
10:1	16.70	40.90	67.40	74.40	85.10	98.70
15:1	11.80	29.00	48.20	53.20	61.20	71.00
20:1	9.00	22.20	37.00	40.90	47.00	54.70
25:1	7.26	18.00	29.90	33.10	38.00	44.30
30:1	6.08	15.10	25.10	27.80	31.90	37.20
40:1	4.58	11.30	18.90	20.90	24.00	28.00
50:1	3.67	9.10	15.20	16.80	19.30	22.50
60:1	3.07	7.59	12.70	14.00	16.10	18.80
70:1	2.63	6.52	10.90	12.00	13.80	16.10

Table 9. (Continued) AGMA Input Mechanical Horsepower Ratings of Cone-Drive Worm Gearing^a

Ratio	Worm Speed, RPM					
	100	300	720	870	1150	1750
10-Inch Center Distance						
5:1	48.50	105.00	164.00	178.00	194.00	226.00
10:1	31.40	73.20	117.00	129.00	144.00	166.00
15:1	22.10	52.10	83.70	91.90	104.00	119.00
20:1	16.90	40.00	64.40	70.70	79.80	91.80
25:1	13.60	32.30	52.10	57.20	64.60	74.30
30:1	11.40	27.10	43.70	48.00	54.20	62.40
40:1	8.60	20.40	32.90	36.10	40.90	47.00
50:1	6.90	16.40	26.40	29.00	32.80	37.80
60:1	5.76	13.70	22.10	24.20	27.40	31.60
70:1	4.94	11.70	18.90	20.80	23.50	27.10
12-Inch Center Distance						
5:1	81.30	167.00	257.00	271.00	300.00	...
10:1	53.20	118.00	186.00	202.00	221.00	...
15:1	37.50	83.90	133.00	145.00	159.00	...
20:1	28.70	64.40	102.00	111.00	122.00	...
25:1	23.10	52.10	82.70	90.10	99.10	...
30:1	19.40	43.70	69.40	75.70	83.20	...
40:1	14.60	32.90	52.20	57.00	62.70	...
50:1	11.70	26.40	41.90	45.80	50.40	...
60:1	9.77	22.10	35.00	38.20	42.10	...
70:1	8.39	18.90	30.10	32.80	36.10	...

^aHorsepower ratings are for Class 1 service, using splash lubrication, except for that shown in italics, for which force feed lubrication is required. Other ratios and center distances are available. *Source:* Ex-Cell-O Corp., Cone Drive Operations

Thermal Horsepower Rating: When the operation is to be continuous, consideration must be given to the possibility of overheating. For this possibility, the thermal horsepower rating given in Ex-Cell-O Corporation, Cone Drive Operations catalog must be checked. The thermal rating defines the maximum horsepower which can be transmitted continuously (30 minutes or longer). This is based on an oil sump temperature rise of 100 deg. F above the ambient temperature. This rise must not exceed 200 deg. F. If the thermal rating is lower than the mechanical rating, the unit must be selected on the basis of the thermal rating.

Type of Drive Connection: If either input or output shaft is connected to driver or driven mechanism by other than a direct shaft coupling, the overhead load requirement (chain pull) must be calculated by dividing the torque demand by the pitch radius of the sprocket, sheave, spur gear, or helical gear used. The result is multiplied by the overhung load factor which is: for a chain sprocket, 1.00; for spur or helical gearing, 1.25; for a V-belt sheave, 1.50; and for a flat belt sheave, 2.50. As modified by the applicable overhung load factor, this load may not exceed the overhung load rating given in the company catalog.

Locking Considerations: It is a common misconception that all worm gears are self-locking or non-overhauling. Actually, wormgear ratios up 15 to 1 will overhaul quite freely. Ratios from 20:1 to 40:1 can generally be considered as overhauling with difficulty, particularly from rest. Ratios above 40:1 may or may not overhaul depending on the loading, lubrication, and amount of vibration present. Therefore it is not acceptable to rely on a wormgear to prevent movement in a system. Whenever a load must be stopped or held in

place, a positive mechanical device must be incorporated into the system to prevent rotation of the gearset.

Backdriving or Overhauling: Applications such as wheel drives that require a brake on the motor or input shaft to decelerate a high inertial load require special attention to brake selection. Wherever possible, these applications should utilize freely overhauling ratios (15:1 or less). If higher ratios are used with a brake, the gearset can, under certain conditions, lockup during deceleration and impose severe shock loading on the reducer and driven equipment.

Stairstepping: Self-locking ratios (generally 40:1 and higher) are susceptible to the phenomenon of "stair stepping" when back driving or overhauling. This erratic rotation of the gear set occasionally occurs when the gear set is back driven at worm speeds less than the theoretical lockup speed of the gear set and can be amplified by the rest of the drive train creating a very undesirable operating condition. "Stair stepping" can occur on drives where there is a high inertial load at the output shaft.

Backlash: Defined as the amount of movement at the pitch line of the gear with the worm locked and the gear set on exact center distance, backlash normally ranges from 0.003 to 0.008 inch for a 2-inch center distance set up to 0.012 to 0.020 inch for a 12-inch center distance set. When the gear set is assembled into a machine or reducer, the assembled backlash may fall outside these limits depending upon worm and gear bearing looseness and the actual center distance used.

Lubrication: Lubricating oils for use in double-enveloping worm drive units should be well refined petroleum oils of high quality. They should not be corrosive to gears or bearings and they must be neutral in reaction and free from grit or abrasives. They should have good defoaming properties and good resistance to oxidation. For worm gears, add up to 3 to 10 per cent of acid less tallow or similar animal fat.

The oil bath temperature should not exceed 200 degrees F. Where worm speed exceeds 3600 revolutions per minute, or 2000 feet per minute rubbing speed, a force feed lubrication may be required. Auxiliary cooling by forced air, water coils in sump, or an oil heat exchanger may be provided in a unit where mechanical horsepower rating is in excess of the thermal rating, if full advantage of mechanical capacity is to be realized. The rubbing speed (V), in feet per minute, may be calculated from the formula:

$$V = 0.262 \times \text{worm throat diameter in inches} \times \text{worm RPM} \div \cos \text{lead angle}$$

Worm Thread Cutting.—Worm threads are cut either by using some form of thread-cutting lathe and a single-point tool, by using a thread milling machine and a disk type of cutter, or by using a gear-hobbing machine. Single-thread worms usually have an included angle of 29 degrees. Many worm gears used at the present time, especially for power transmission, have thread angles larger than 29 degrees because multiple-thread worms are used to obtain higher efficiency, and larger thread angles are necessary in order to avoid excessive under-cutting of the worm-wheel teeth. According to the recommended practice of the American Gear Manufacturers' Association, worms having triple and quadruple threads should have a thread angle of 40 degrees, and some manufacturers of worm gearing, especially when the helix or lead angle of the thread is quite large, use a thread angle of 60 degrees.

If the helix or lead angle of the worm thread exceeds 15 or 20 degrees, it is common practice to reduce the depth of the thread by using the normal instead of the axial pitch of the worm in the formulas. Thus, if P_n equals normal pitch, the total depth equals $P_n \times 0.6866$ instead of $P_n = 0.6866$. This normal pitch P_n , equals $P_n \times \cos$ of the helix angle. According to the recommended practice of the American Gear Manufacturers' Association, the whole depth for single- and double-thread worms equals $P_n \times 0.686$, and for triple and quadruple-thread worms equals $P_n \times 0.623$.

Hobs for Gearing

Wormgear Hobs.—An ideal hob would have exactly the same pitch diameter and lead angle as the worm; repeated sharpening, however, would reduce the hob size because of the form-relieved teeth. Hence, the general practice is to make hobs (especially the radial or in-feed type) “over-size” to provide a grinding allowance and increase the hob life. An over-size hob has a larger pitch diameter and smaller lead angle than the worm, but repeated sharpenings gradually reduce these differences. To compensate for the smaller lead angle of an over-size hob, the hob axis may be set 90-degrees relative to the wormgear axis plus the difference between the lead angle of the worm at the pitch line, and the lead angle of the over-size hob at its pitch line. This angular adjustment is in the direction required to increase the inclination of the wormgear teeth so that the axis of the assembled worm will be 90 degrees from the wormgear axis. (“Lead angle” is measured from a plane perpendicular to worm or hob axis.)

Hob Diameter Formulas: If

D = pitch diameter of worm;

D_h = pitch diameter of hob;

A = addendum of worm and wormgear;

C = clearance between worm and worm-gear;

S = increase in hob diameter or “over-size” allowance for sharpening.

Outside diameter O of hob = $D + 2A + 2C + S$

Root diameter of hob = $D - 2A$

Pitch diameter D_h of hob = $O - (2A + 2C)$

Sharpening Allowance: Hobs for ordinary commercial work are given the following sharpening allowance, according to the recommended practice of the AGMA: In this formula, h = helix angle of hob at outside diameter measured from axis; H = helix angle of hob at pitch diameter measured from axis.

$$\text{Sharpening allowance} = 0.075 \times \text{normal pitch} \times \left[\frac{16 - (h - H)}{16} \right] + 0.010$$

Number of Flutes or Gashes in Hobs: For finding the approximate number of flutes in a hob, the following rule may be used: Multiply the diameter of the hob by 3, and divide this product by twice the linear pitch. This rule gives suitable results for hobs for general purposes. Certain modifications, however, are necessary as explained in the following paragraph.

It is important that the number of flutes or gashes in hobs bear a certain relation to the number of threads in the hob and the number of teeth in the wormgear to be hobbled. In the first place, avoid having a common factor between the number of threads in the hob and the number of flutes; that is, if the worm is double-threaded, the number of gashes should be, say, 7 or 9, rather than 8. If it is triple threaded, the number of gashes should be 7 or 11, rather than 6 or 9. The second requirement is to avoid having a common factor between the number of threads in the hob and the number of teeth in the wormgear. For example, if the number of teeth in the wheel is 28, it would be best to have the hob triple-threaded, as 3 is not a factor of 28. Again, if there were to be 36 threads in the wormgear, it would be preferable to have 5 threads in the hob.

The cutter used in gashing hobs should be from $\frac{1}{8}$ to $\frac{1}{4}$ inch thick at the periphery, according to the pitch of the thread of the hob. The width of the gash at the periphery of the hob should be about 0.4 times the pitch of the flutes. The cutter should be sunk into the hob blank so that it reaches from $\frac{3}{16}$ to $\frac{1}{4}$ inch below the root of the thread.

Helical Fluted Hobs.—Hobs are generally fluted parallel with the axis, but it is obvious that the cutting action will be better if they are fluted on a helix at right angles with the

thread helix. The difficulty of relieving the teeth with the ordinary backing-off attachment is the cause for using a flute parallel with the axis. Flutes cut at right angles to the direction of the thread can, however, also be relieved, if the angle of the flutes is slightly modified. In order to relieve hobs with a regular relieving attachment, it is necessary that the number of teeth in one revolution along the thread helix be such that the relieving attachment can be geared to suit it. The following method makes it possible to select an angle of flute that will make the flute come approximately at right angles to the thread, and at the same time the angle is so selected that the relieving attachment can be properly geared for relieving the hob.

Let

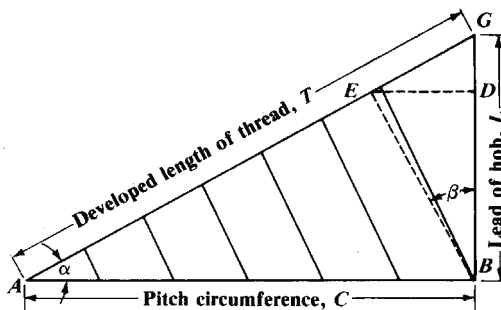
C = pitch circumference

T = developed length of thread in one turn;

N = number of teeth in one turn along thread helix;

F = number of flutes;

α = angle of thread helix.



Then $C \div F$ = length of each small division on pitch circumference;

$(C \div F) \times \cos \alpha$ = length of division on developed thread;

$C \div \cos \alpha = T$

Hence

$$\frac{T}{(C \div F) \cos \alpha} = N = \frac{F}{\cos \alpha^2}$$

Now, if

$$\alpha = 30 \text{ degrees, } N = 1\frac{1}{3}F;$$

$$\alpha = 45 \text{ degrees, } N = 2F;$$

$$\alpha = 60 \text{ degrees, } N = 4F.$$

In most cases, however, such simple relations are not obtained. Suppose for example that $F = 7$, and $\alpha = 35$ degrees. Then $N = 10.432$, and no gears could be selected that would relieve this hob. By a very slight change in the helix angle of the flute, however, we can change N to 10 or $10\frac{1}{2}$; in either case we can find suitable gears for the relieving attachment.

The rule for finding the modified helical lead of the flute is: Multiply the lead of the hob by F , and divide the product by the difference between the desired values of N and F .

Hence, the lead of flute required to make $N = 10$ is:

Lead of hob $\times (7 \div 3)$.

To make $N = 10\frac{1}{2}$, we have:

Lead of flute = lead of hob $\times (7 \div 3.5)$.

From this the angle of the flute can easily be found.

That the rule given is correct will be understood from the following consideration. Change the angle of the flute helix β so that AG contains the required number of parts N desired. Then EG contains $N-F$ parts. But $\cot\beta = BD \div ED$ and by the law of similar triangles,

$$BD = \frac{F}{N} \times BG, \text{ and } ED = \frac{N-F}{N} C$$

The lead of the helix of the flute, however, is $C \times \cot\beta$.

Hence, the required lead of the helix of the flute:

$$C \times \cot\beta = \frac{F}{N-F} L$$

This formula makes it possible always to flute hobs so that they can be conveniently relieved, and at the same time have the flutes at approximately right angles to the thread.

Gear Shaving.—The purpose of gear shaving is to correct errors in indexing, helix angle, tooth profile, and eccentricity by removing small amounts of material from the working surfaces of gear teeth. Special shaving cutters are used and have tooth flanks with sharp-edged grooves that traverse the tooth surfaces of the gear to be corrected as the hardened, driven cutter and the softer (30-35 Rockwell C) free-running gear are rotated in mesh on crossed axes in a special machine. The crossed angle is usually between 10 and 15 degrees, or half the difference between the helix angles of cutter and gear. In conventional shaving, the gear is held between live centers on the machine table, which is moved parallel to the gear axis, and is fed into contact with the cutter at each successive stroke of the table. Cutter speeds of up to 450 surface feet/min are commonly used.

The crossed axes cause the sharp-edged grooves on the cutter to traverse the tooth surfaces on the gear as cutter and gear rotate, resulting in a shearing action that cuts fine slivers from the gear tooth surfaces. At the same time, contact between the meshing sets of teeth has a burnishing action on the gear teeth, improving the surface finish. Shaving can remove 60-80 per cent of errors in a gear, and can produce accuracies of 0.0002 in. on the involute profile, 0.0003 in. on tooth-to-tooth spacing, and 0.0002 in. on lead or parallelism.

Gear-shaving machines have built-in mechanisms that can be used to rock the table as it traverses, producing crowned gear teeth that are slightly thicker at the center than at the ends. In the faster diagonal shaving method, the traversing movement of the table is at an angle to the gear axis, so that the cutter grooves move more rapidly across the gear, increasing the shaving action.

Speeds and Feeds for Gear Cutting

Speeds and Feeds for Gear Cutting.—The variations in speed and feed, owing to limiting conditions, are probably greater for gear cutting than for most other machining operations. The important factors governing the speed and feed, aside from the design and condition of the machine, are the pitch of the gear to be cut, the hardness of the metal, the kind of steel used for making the cutter, the form and condition of the cutter, the rigidity of the gear blank when mounted for cutting, the accuracy and finish required for the gear, and the cutting lubricant used in the case of steel gears. The following speeds are given by Gould & Eberhardt as a fair average for cutting medium grades of cast iron and steel, when using carbon and high-speed steel cutters;

Material	Carbon Steel Cutters			High-speed Steel Cutters		
	Min.	Average	Max.	Min.	Average	Max.
Cast iron, feet per minute	35	45	60	60	70	80
Steel, feet per minute	25	30	40	45	50	55

While these figures are based upon gear-cutting practice, they are merely intended to serve as a guide until the most economical speed for a given case can be determined by actual tests. More specific data on speeds and feeds are given in the table *Speeds and Feeds for Gear Cutting*. This table applies to machines of the rotary cutter type and covers diametral pitches varying from 1 to 20. The feeds and speed listed are for cast iron and steel gears of medium grade, with suitable variation for carbon or high-speed steel cutters. The first column gives the maximum capacity of the machine, in diametral pitch; it will be noted that the values vary somewhat for a gear of given pitch, for machines of different capacity. For example when a cast-iron gear of 6 diametral pitch is cut on a machine having a capacity 3 diametral pitch, the feed per minute is given as 4.5 inches; but when the same pitch is cut on a larger machine of 2 diametral pitch capacity, the feed can be increased to 11.5 inches per minute, high-speed steel cutters being used in each case.

Speeds and Feeds for Gear Cutting^a

Capacity of Machine	Diam. Pitch	Cutter		R.P.M.		Cutting Speed, Feet per Min.		Feed per Min.		No. of cuts	
		Diam.	No. of Teeth	Cast Iron	Steel	Cast Iron	Steel	Cast Iron	Steel	Cast Iron	Steel
1 D.P. for Cast Iron 1¼ D.P. for Steel	1.00	8.00	13	27.5	22.5	58	47.5	3.5	2.8	2	2
	1.25	7.25	14	33.5	22.5	64	43.5	4.5	2.8	2	2
	1.50	7.25	14	33.5	22.5	64	43.5	4.5	2.8	2	2
	1.75	6.25	10	40.5	27.5	67	45.5	4.5	2.8	2	2
	2.00	6.25	11	40.5	27.5	67	45.5	4.5	3.5	2	2
	2.25	6.25	11	40.5	27.5	67	45.5	4.5	3.5	1	2
	2.50	6.25	14	40.5	27.5	67	45.5	5.6	3.5	1	2
	2.75	5.25	12	49.5	33.5	69	46.5	6.9	4.5	1	2
	3.00	5.25	12	49.5	33.5	69	46.5	6.9	4.5	1	2
	4.00	5.25	16	49.5	33.5	69	46.5	8.5	5.6	1	2
5.00	5.25	18	49.5	33.5	69	46.5	11.0	6.9	1	2	
6.00	4.25	16	60.5	40.5	68	45.5	11.0	6.9	1	2	
2 D.P. for Cast Iron 3 D.P. for Steel	2.00	6.25	11	38	26.5	63	44	4	2.7	2	3
	2.25	6.25	11	38	26.5	63	44	4	2.7	2	2
	2.50	6.25	14	38	26.5	63	44	6	4	2	2
	2.75	5.25	12	48	33	67	46	6	4	1	2
	3.00	5.25	12	48	33	67	46	6	4	1	2
	4.00	5.25	16	48	33	67	46	7.3	6	1	2
	5.00	5.25	18	48	33	67	46	9	6	1	2
	6.00	4.25	16	60.5	38	68	43	11.5	7.3	1	2
	7.00	4.25	18	60.5	38	68	43	11.5	7.3	1	2
	8.00	4.25	20	60.5	38	68	43	14.5	9.1	1	2
	10.00	4.25	22	60.5	38	68	43	14.5	9.1	1	1
	12.00	4.25	24	60.5	38	68	43	14.5	9.1	1	1

(Continued) **Speeds and Feeds for Gear Cutting^a**

Capacity of Machine	Diam. Pitch	Cutter		R.P.M.		Cutting Speed, Feet per Min.		Feed per Min.		No. of cuts	
		Diam.	No. of Teeth	Cast Iron	Steel	Cast Iron	Steel	Cast Iron	Steel	Cast Iron	Steel
	High-speed Steel Cutters										
2 D.P. for Cast Iron 3 D.P. for Steel	3.00	4.75	11	46.5	39	59	49	3.5	2.6	1	2
	4.00	4.00	12	55.5	46.5	59	49	4.5	3.5	1	2
	5.00	3.50	12	55.5	46.5	51.5	43	4.5	3.5	1	2
	6.00	3.50	13	55.5	46.5	51.5	43	4.5	3.5	1	2
	7.00	3.50	14	55.5	46.5	51.5	43	5.8	4.5	1	2
	8.00	3.50	16	55.5	46.5	51.5	43	5.8	4.5	1	2
	10.00	3.50	18	55.5	46.5	51.5	43	7.6	5.8	1	1
	12.00	3.50	18	55.5	46.5	51.5	43	7.6	5.8	1	1
	14.00	2.875	16	79	55.5	60	40.5	7.6	5.8	1	1
	16.00	2.875	18	79	55.5	60	40.5	10.0	7.6	1	1
	18.00	2.875	18	79	55.5	60	40.5	10.0	7.6	1	1
20.00	2.875	20	79	55.5	60	40.5	10.0	7.6	1	1	

^aCompiled by Gould & Eberhardt.

Feeds for Hobbing.—The feeds for hobbing usually vary from about 0.020 to 0.200 inch per revolution of the gear. Gould & Eberhardt recommend the following feeds for hobbing spur gears. The figures give the movement of the hob per revolution of the gear.

Material	Feed Inches	Material	Feed Inches	Material	Feed Inches
Tool Steel	0.010	Soft Steel	0.040	Roughing Soft Steel	0.080
Tough Steel	0.020	Average Cast Iron	0.050	Roughing Average Cast Iron	0.100
Average Steel	0.030	Soft Cast Iron	0.060	Roughing Soft Cast Iron	0.150

When hobbing helical gears, the feed depends somewhat upon the angle of the teeth. For angles varying from 0 to 36 degrees the feed should be about the same as for spur gears; for angles from 36 to 48 degrees, the feed should equal $\frac{1}{2}$ of that for spur gears; from 48 to 60 degrees, $\frac{2}{3}$ of the spur gear feed; from 60 to 70 degrees $\frac{1}{2}$ of the spur gear feed; for angles above 70 degrees, $\frac{1}{8}$ of the spur gear feed. The feed is diminished in the case of helical gears, because when the hob is set to conform to the helix angle, the feed of the cutter, per revolution, is increased by the turning movement of the gear blank necessary for generating the helical teeth.

Feeds for Given Pitch and Material.—The table *Feeds for Gear Cutting* contain practical data on the feeds to use for different materials and pitches. The data in the table apply to high-speed steel cutters and are intended as a general guide only. The feeds listed vary according to diametral pitch, kind of material and nature of cut. The shearing-tooth cutter for roughing, referred to in the tables, an ordinary gear cutter having faces of alternate teeth ground at an angle of 11 degrees, so that the teeth have rake and cut similar to a side turning tool. Cast iron gears up to $2\frac{1}{2}$ diametral pitch can usually be finished in one cut with a rotar formed cutter. Cast-iron gears coarser than 2 diametral pitch should, as a rule have the teeth roughened or “blocked out” prior to finishing.

Feeds for Gear Cutting

For High Speed Steel Cutters with a peripheral speed on cast iron of 55 feet per minute and 80 feet per minute on steel.									
Diametral Pitch of Gear	Cast Iron Gears	Soft Steel Gears	High Carbon Steel	Nickel Steel Alloy	Cast Iron Gears	Soft Steel Gears	High Carbon Steel	Nickel Steel Alloy	Shading Indicates Range of Different Sizes of Machines
	Feed, Inches per min., when Finishing in One Cut				Feed, Inches per min., for Roughing Cut, Leaving 0.010 to 0.030 Inch for Finishing				
1		2	1 ⁵ / ₈	1 ⁵ / ₈	1 ¹ / ₄	
1 ¹ / ₄		2 ¹ / ₂	2	2	1 ³ / ₈	
1 ¹ / ₂		3 ³ / ₈	2 ¹ / ₁₆	2 ¹ / ₁₆	2 ¹ / ₁₆	
1 ³ / ₄	2 ¹¹ / ₁₆	2 ¹ / ₁₆	2 ¹ / ₁₆	1 ¹¹ / ₁₆	4 ³ / ₈	3 ³ / ₈	3 ³ / ₈	2 ¹¹ / ₁₆	
2	3 ³ / ₈	2 ¹ / ₂	2 ¹ / ₂	1 ¹⁵ / ₁₆	5 ⁵ / ₈	4	4	3 ³ / ₈	
2 ¹ / ₂	3 ³ / ₈	2 ¹ / ₂	2 ¹ / ₂	1 ¹⁵ / ₁₆	5 ⁵ / ₈	4	4	3 ³ / ₈	
3	3 ⁷ / ₁₆	2 ¹ / ₂	2 ¹ / ₂	2	5 ⁷ / ₁₆	4 ¹ / ₄	4 ¹ / ₄	3 ⁷ / ₁₆	
4	3 ⁷ / ₁₆	2 ¹ / ₂	2 ¹ / ₂	2	5 ⁷ / ₁₆	4 ¹ / ₄	4 ¹ / ₄	3 ⁷ / ₁₆	
5	3 ⁷ / ₁₆	2 ¹ / ₂	2 ¹ / ₂	2	5 ⁷ / ₁₆	4 ¹ / ₄	4 ¹ / ₄	3 ⁷ / ₁₆	
6	4 ¹ / ₄	3 ⁷ / ₁₆	3 ⁷ / ₁₆	2 ¹ / ₂	5 ⁷ / ₁₆	4 ¹ / ₄	4 ¹ / ₄	3 ⁷ / ₁₆	
7	4 ¹ / ₄	3 ⁷ / ₁₆	3 ⁷ / ₁₆	2 ¹ / ₂	5 ⁷ / ₁₆	4 ¹ / ₄	4 ¹ / ₄	3 ⁷ / ₁₆	
8	4 ¹ / ₄	3 ⁷ / ₁₆	3 ⁷ / ₁₆	2 ¹ / ₂	5 ⁷ / ₁₆	4 ¹ / ₄	4 ¹ / ₄	3 ⁷ / ₁₆	
9	5 ⁷ / ₁₆	4 ¹ / ₄	4 ¹ / ₄	3 ⁷ / ₁₆	6 ¹³ / ₁₆	5 ⁷ / ₁₆	5 ⁷ / ₁₆	4 ¹ / ₄	
10	5 ⁷ / ₁₆	4 ¹ / ₄	4 ¹ / ₄	3 ⁷ / ₁₆	6 ¹³ / ₁₆	5 ⁷ / ₁₆	5 ⁷ / ₁₆	4 ¹ / ₄	
	When using Shearing Tooth Cutter for Roughing Cut				Finishing Cut				
1	2 ¹ / ₂	2	2	1 ⁵ / ₈	2 ¹¹ / ₁₆	2 ¹¹ / ₁₆	2 ¹¹ / ₁₆	2 ¹¹ / ₁₆	
1 ¹ / ₄	3 ⁵ / ₁₆	2 ¹ / ₂	2 ¹ / ₂	2	3 ⁵ / ₁₆	3 ⁵ / ₁₆	3 ⁵ / ₁₆	2 ¹¹ / ₁₆	
1 ¹ / ₂	4 ³ / ₈	4 ³ / ₈	3 ³ / ₈	3 ³ / ₈	4 ³ / ₈	4 ³ / ₈	4 ³ / ₈	3 ³ / ₈	
1 ³ / ₄	5 ⁹ / ₁₆	5 ⁹ / ₁₆	4 ³ / ₈	4 ¹ / ₁₆	5 ⁹ / ₁₆	5 ⁹ / ₁₆	5 ⁹ / ₁₆	4 ³ / ₈	
2	6 ⁹ / ₁₆	6 ⁹ / ₁₆	5 ⁵ / ₈	4 ¹ / ₁₆	6 ⁹ / ₁₆	6 ⁹ / ₁₆	6 ⁹ / ₁₆	5 ⁵ / ₈	
2 ¹ / ₂	6 ⁹ / ₁₆	6 ⁹ / ₁₆	5 ⁵ / ₈	4 ¹ / ₁₆	6 ⁹ / ₁₆	6 ⁹ / ₁₆	6 ⁹ / ₁₆	5 ⁵ / ₈	
3	8 ¹ / ₂	8 ¹ / ₂	6 ¹³ / ₁₆	5 ⁵ / ₁₆	6 ¹³ / ₁₆	6 ⁹ / ₁₆	6 ⁹ / ₁₆	5 ⁵ / ₈	
4	8 ¹ / ₂	8 ¹ / ₂	6 ¹³ / ₁₆	5 ⁵ / ₁₆	6 ¹³ / ₁₆	6 ¹³ / ₁₆	6 ¹³ / ₁₆	5 ⁷ / ₁₆	
5	8 ¹ / ₂	8 ¹ / ₂	6 ¹³ / ₁₆	5 ⁵ / ₁₆	6 ¹³ / ₁₆	6 ¹³ / ₁₆	6 ¹³ / ₁₆	6 ¹³ / ₁₆	
6	8 ¹ / ₂	8 ¹ / ₂	6 ¹³ / ₁₆	5 ⁵ / ₁₆	6 ¹³ / ₁₆	6 ¹³ / ₁₆	6 ¹³ / ₁₆	6 ¹³ / ₁₆	
7	8 ¹ / ₂	8 ¹ / ₂	6 ¹³ / ₁₆	5 ⁵ / ₁₆	6 ¹³ / ₁₆	6 ¹³ / ₁₆	6 ¹³ / ₁₆	6 ¹³ / ₁₆	
8	10 ⁵ / ₈	10 ⁵ / ₈	8 ¹ / ₂	8 ¹ / ₂	6 ¹³ / ₁₆	6 ¹³ / ₁₆	6 ¹³ / ₁₆	6 ¹³ / ₁₆	
9	10 ⁵ / ₈	10 ⁵ / ₈	8 ¹ / ₂	8 ¹ / ₂	8 ¹ / ₂	8 ¹ / ₂	8 ¹ / ₂	8 ¹ / ₂	
10	10 ⁵ / ₈	10 ⁵ / ₈	8 ¹ / ₂	8 ¹ / ₂	8 ¹ / ₂	8 ¹ / ₂	8 ¹ / ₂	8 ¹ / ₂	

Compiled by the Cincinnati Gear Cutting Machine Co. The gears are assumed to be of substantial design, and the belts on the machine to be in good condition. For steel gears, a lard oil lubricant is used. For teeth coarser than 1³/₄ diametral pitch, feeds are not given for finishing in one cut, because satisfactory results cannot be obtained with a single cut on the No. 7 machine.

Other Gear Topics

Hunting Tooth Gear Ratios.—When the numbers of teeth in a pair of meshing gears are such that they do not have a common divisor, the ratio of the tooth numbers is said to be a “hunting tooth” or non-factorizing ratio. Each gear in such a pair must make as many revolutions as its mating gear has teeth for a particular tooth on that gear to “hunt” or mesh once with every tooth on the mating gear. For example, with a pair having ⁷³/₂₄ teeth, a particular tooth on the 73-tooth gear will mesh once with every tooth on the 24-tooth gear when the 73-tooth gear has made 24 revolutions. In the same way, a particular tooth on the

24-tooth gear will mesh once with every tooth on the 73-tooth gear in 73 revolutions of the 24-tooth gear.

When several pairs of gears operating at the same center distance are required to have hunting ratios, this can be accomplished by having the sum of the teeth in each pair equal to a prime number. Thus $\frac{77}{20}$, $\frac{76}{21}$, $\frac{75}{19}$, etc., are all hunting ratios and each pair sum is 97, a prime number.

Origin of Hunting Tooth Use: Whenever the number of teeth on a gear is equal to some whole number multiplied by the number of teeth on the mating pinion, then any tooth on the gear meshes with the same tooth on the pinion during each revolution of the gear. For example, with a $\frac{72}{24}$ pair, one tooth on the 24-tooth pinion will always mesh with the same three teeth on the gear. Changing the ratio to $\frac{73}{24}$ produces the hunting tooth condition described previously.

The practice of using "hunting" ratios was common when gears of high accuracy were not available as was the case with the cast iron gears used by millwrights. The theory was that, with a hunting tooth, gear wear would be evenly distributed among all the teeth and they would eventually wear into some indefinite but comparatively true (conjugate) tooth form which operated more quietly and lasted longer than gears of even ratios.

When to Use Hunting Ratios: The following conditions favor hunting tooth ratios:

1. Both gears are hardened or hardened and ground. In this case the gears are too hard to wear in much, but use of the hunting tooth prevents high dynamic tooth loads from being confined to a single pair of teeth thus increasing gear life.
2. The gear pair is subject to high cyclic loads such as in a crankshaft. In this case a hunting ratio distributes the high loads to all the teeth evenly and prevents early breakage of certain teeth resulting when integral ratios are used.

When Not to Use Hunting Ratios: Hunting ratios should not be used in the following situations:

1. For multiple-start worm drives that require long life. If a hunting ratio is used, the hard material of the worm would continually shave particles from the softer worm gear throughout the life of the drive whereas an integral ratio would bed itself in after a short time, and further wear would be small.
2. When gears are repeatedly assembled and disassembled as in the case of change gears; it is of no importance whether they have a common factor or are hunting ratios.
3. If gears are finished by lapping as in the case of automotive bevel gears, even ratios may be used provided the gears are assembled meshed as they were in the lapping process. If this is not practical, then a hunting ratio is more satisfactory.

Maag Gearing.—In the design of the Maag system of gearing, a 15-degree pressure angle is maintained for large gears, but for relatively small gears the angles and also the blank diameters or positions of the teeth relative to the pitch circles, are varied with the idea of obtaining the most satisfactory operation for gearing of a given ratio. This is a departure from standardization and the use of gears which are interchangeable at standard center distances. Those advocating this system, however, believe that what is lost in this respect is more than gained by so forming the teeth of a gear and pinion of given ratio as to obtain more rolling and less sliding action combined with stronger teeth without under-cutting, even when the gears are very small. When necessary or desirable to use gears having possibly not more than five or six teeth, a practical tooth form may be obtained by changing the pressure angle and the relation of the tooth to its pitch circle, to suit the conditions. It has long been the practice to obtain an improvement of tooth shape by the enlargement of small spur and bevel pinions but with the Maag system, the plan is to so modify the relations between addenda, dedenda, and pressure angle as to secure what is considered the best tooth form for each particular ratio.

MACHINE ELEMENTS

Bearings

Percentages of Radial and Thrust Loads.—There are three types of bearing that are combined load carriers: First, the annular ball bearing, which is primarily designed for radial loads and has no angle of contact incorporated in its design, therefore having minimum thrust capacity (approximately 20 per cent of its radial capacity). Second, the one-direction angular contact bearing, which has a thrust capacity depending upon race design and the angle incorporated, which is generally made so that the thrust capacity is 100 per cent of the radial capacity. (This bearing, however, when used for combined loads, can only be used in pairs, and must have a threaded or shim adjustment incorporated in the mounting design to allow for initial adjustment.) Third, the double angular type bearing which is really two of the previously mentioned bearings built as a self-contained unit. The functioning of this bearing is not dependent on any exterior adjustment, and the angle of contact is generally such that it will sustain approximately 150 per cent of its radial capacity as thrust.

Roller Bearing.—The load on roller bearings is supported by cylindrical or conical rollers interposed between two races, one race being mounted on the shaft and one other in the bearing proper. There are three principal designs of roller bearings. One is for straight radial loads, the lines of contact of the rollers with the races being parallel with the shaft axis, as shown by the left-hand diagram; another design is for combined radial and thrust loads (See Fig. 1b.). With this design, the rollers are tapering so that the lines of contact of the rollers with the races, and the axis of the rollers, will intersect, if extended, at the same point on the shaft axis. A third design is intended for thrust or axial loads exclusively. Bearings for radial loads may have solid rollers, or the hollow helically-wound type such as is used in the Hyatt bearing. Although anti-friction bearings have replaced a great many plain or sliding bearings, the trend is toward a much wider application, and evidently will include eventually the heaviest classes of service since modern anti-friction bearings not only greatly reduce friction losses, but lower maintenance and repair costs.

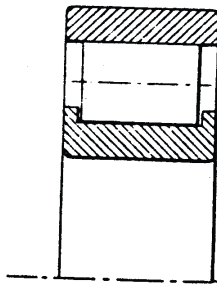


Fig. 1a. Bearing for Radial Load

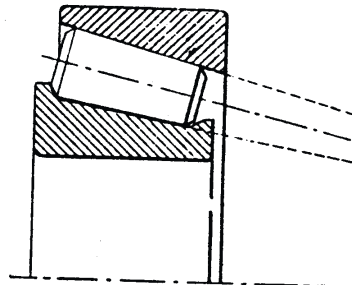


Fig. 1b. Bearing for Radial and Thrust Loads

Ball Bearing Lubrication.—To obtain the full measure of efficiency and service from ball and roller bearing equipment, the kind and quality of the lubricant, as well as the system of applying it, must be adapted to the design of the bearing, the design of the machine, and the operating conditions.

Operating Temperatures: Under ordinary conditions the temperature of a bearing while running will be from 10 to 60 degrees F. above that of the room. If it exceeds 125 degrees F., ordinary greases will frequently prove unsatisfactory. They will tend to soften and flow continuously into the path of the rolling elements, causing a rise in the normal operating temperature due to the increased frictional resistance introduced. This may eventually result in the separation of the oil and soap base, with a complete loss of lubricating qualities. In some cases, greases developed for use at high temperatures may be employed. Care

should be taken, however, to see that they meet all the requirements for adequate lubrication.

Mineral oil of proper physical and chemical properties is an ideal lubricant for ball and roller bearings when the housing is designed to control the quantity entering the bearing and to prevent leakage and protect the bearing from the entrance of foreign matter. A ball or roller bearing should not be subjected to temperature in excess of 300 degrees F., because of the danger of drawing the temper of the hardened steel races and balls.

Quantity of Lubricant Required: In no case does a ball or roller bearing require a large quantity of lubricant. On the contrary, a few drops of oil, or a corresponding amount of grease, properly distributed over the running surfaces of the bearing, will provide satisfactory lubrication for a considerable period of time. A large volume of lubricant within a bearing will usually result in high operating temperatures, due to the working or churning of the lubricant by the rolling elements and retainer. This may seriously impair the useful life of the lubricant through oxidation or sludging of the oil or actual disintegration of greases.

Use of Grease: If grease is used, the housing should not be kept more than one-fourth to one-half full of the lubricant. Unlike oil, there is no way of controlling with any degree of exactness the quantity of grease in a housing, and greater care must therefore be taken to avoid overloading. A bearing that runs at too high a temperature will often return to normal temperature if some of the lubricating grease is removed.

Grease is being used successfully for the lubrication of ball bearings at high speeds, but great care is necessary, both from the standpoint of housing design and selection of the lubricant, in order to obtain satisfactory results. Any system employed must be designed to feed only a limited amount of grease to the bearing. For the average application at operating speeds up to 3600 revolutions per minute, a grease of soft consistency, such as a No. 2 grease, will usually be found satisfactory, provided it is suitable in other respects. Hard greases, such as No. 3, may be used if the grease is to serve as a packing medium around the shaft to prevent the entrance of dirt, water, or other corrosive substances.

Sealed Bearings: Bearings for certain classes of service must operate over long periods without relubrication, as, for example, a motor installation on an airplane beacon; hence the efforts of ball-bearing manufacturers to produce bearings so completely sealed as to enable them to retain their original charge of grease for many months. In appreciation of this requirement, the petroleum industry has developed lubricants that will maintain lubrication for a long period without change in structure, homogeneity, lubricating properties, or leakage.

Oilless Bearings.—Oilless or self-lubricating bearings are especially adapted for applications in places where oiling is undesirable, or where the bearings are difficult of access, or likely to be neglected. They are of particular value in such plants as canneries, textile mills, etc., where the product is liable to harm from dripping oil, and oilless bearings are applied in many other classes of service. A number of different types of oilless bearings have been developed, each of which doubtless has its advantages when applied under suitable conditions. One type consists of wood impregnated with wax, oil or paraffin; another is made of bronze and has graphite inserts; another type is formed of graphite impregnated with some bearing metal such as a white alloy or bronze; and still another consists of hard maple reinforced by babbitt metal, the wood shell of which is impregnated with lubricants and thus serves as an oil reservoir.

Another group of oilless bearings are porous bearings. These are usually of plain or leaded bronze, sometimes of iron, stainless steel and more rarely, aluminum and are made from powdered metal that has been pressed into the desired shape and then sintered, producing a sponge-like structure capable of absorbing fairly large quantities of oil, usually about 25 per cent of the volume of the bearing material. These bearings are used where lubrication supply is difficult, inadequate, or infrequent. This type of bearing should be

flooded from time to time to resaturate the metal. In bearings of these materials the allowable rubbing speed may range up to 2000 fpm with very light loads. The usual operating speed range would be, however, from 75 to 1500 fpm. For porous bearings impregnated with oil the maximum operating temperature is about 150 degrees F. Tests have shown that applied loads should be steady and unidirectional and clearances between shaft and bearing should be between 0.0007 and 0.0012 inches. These materials are generally employed as bushings rather than in split shell bearings.

Thermoil-Granodine.—A coating material developed to prevent wear and rust of machine parts. Applied by immersing the machine parts, after thorough cleaning, in a boiling solution of the coating material. The solution transforms the surface into a layer of iron and manganese phosphates, which becomes an integral part of the metal beneath. Suitable for treating automobile engine parts, such as pistons, valves, and camshafts; gears; and any machine parts having bearing surfaces.

Knife-Edge Bearings.—So-called “knife-edge” bearings are used on weighing and testing machines. When the knife-edge bearing as well as the seat are made of the proper material, the knife-edge will sustain loads up to 10,000 pounds per inch of length; but ordinarily about 5000 pounds is the usual limit of pressure. The knife-edge, as well as the seat bearing upon it, should be made from tool steel having a carbon content of from 0.9 to 1 per cent. The knife-edge should be properly supported underneath its whole length in order to prevent deflection. The angle of the knife-edge should be 90 degrees for heavy loads. It should have a very slight flat at the extreme point, so small, however, that it is barely visible, because a pronounced flat or radius at the edge decreases the accuracy of the device. This flat may be obtained by rubbing with an oilstone. The seat against which the knife-edge bears, if made of an angular form, should be provided with a small round at the vertex of the angle.

Kerosene Lubrication.—Kerosene has proved effective as a lubricant for the plain bearings of grinding wheel spindles. The following information is based upon the experience of the Norton Co. This type of lubrication is recommended only for plain bearings to which an ample flow of lubricant is delivered. It is not recommended for drip-lubricated bearings. The spindle journals of machines intended for kerosene lubrication are finished by methods that give them a highly reflective mirror-like surface. The surfaces thus finished are accurate in size and straightness to 0.0001 inch, and show readings from 1 to 2 micro-inches on the profilometer.

While kerosene has been used for many years as a spindle lubricant in the high-speed internal spindles supplied with Norton tool and cutter grinders, a high-quality oil with a Saybolt viscosity rating of from 60 to 185 at 100 degrees F. has previously been employed for the spindles of external grinders which operate at speeds ranging from about 800 to 1800 R.P.M., depending on the grinding wheel diameter. From 0.001 to 0.002 inch clearance for oil was provided in the bearings, and a bearing temperature of about 140 degrees F. was considered normal. With kerosene lubrication, these clearances can be safely reduced to approximately one-fifth of that formerly provided, and the temperature of the bearing will not rise much, if any, above 100 degrees F. The kerosene temperature does not rise above 100 degrees F. and with kerosene lubrication the fluctuations in temperature are very slight. Consequently, the repetitive expansion and contraction changes of the grinding wheel unit elements are greatly reduced.

Standard Metal Balls

American National Standard ANSI/AFBMA Std 10-1989 provides information for the user of metal balls permitting them to be described readily and accurately. It also covers certain measurable characteristics affecting ball quality.

On the following pages, tables taken from this Standard cover standard balls for bearings and other purposes by type of material, grade, and size range; preferred ball sizes; ball hardness corrections for curvature; various tolerances, marking increments, and maximum surface roughnesses by grades; total hardness ranges for various materials; and minimum case depths for carbon steel balls. The numbers of balls per pound and per kilogram for ferrous and nonferrous metals are also shown.

Definitions and Symbols.—The following definitions and symbols apply to American National Standard metal balls.

Nominal Ball Diameter, D_w : The diameter value that is used for the general identification of a ball size, e.g., $\frac{1}{4}$ inch, 6 mm, etc.

Single Diameter of a Ball, D_{ws} : The distance between two parallel planes tangent to the surface of a ball.

Mean Diameter of a Ball, D_{wm} : The arithmetical mean of the largest and smallest single diameters of a ball.

Ball Diameter Variation, V_{Dws} : The difference between the largest and smallest single diameters of one ball.

Deviation from Spherical Form, ΔR_w : The greatest radial distance in any radial plane between a sphere circumscribed around the ball surface and any point on the ball surface.

Lot: A definite quantity of balls manufactured under conditions that are presumed uniform, considered and identified as an entirety.

Lot Mean Diameter, D_{wmL} : The arithmetical mean of the mean diameter of the largest ball and that of the smallest ball in the lot.

Lot Diameter Variation, V_{DwL} : The difference between the mean diameter of the largest ball and that of the smallest ball in the lot.

Nominal Ball Diameter Tolerance: The maximum allowable deviation of any ball lot mean diameter from the Nominal Ball Diameter.

Container Marking Increment: The Standard unit steps in millionths of an inch or in micrometers used to express the Specific Diameter.

Specific Diameter: The amount by which the lot mean diameter (D_{wmL}) differs from the nominal diameter (D_w), accurate to the container marking increment for that grade; the specific diameter should be marked on the unit container.

Ball Gage Deviation, ΔS : The difference between the lot mean diameter and the sum of the nominal mean diameter and the ball gage.

Surface Roughness, R_a : Surface roughness consists of all those irregularities that form surface relief and are conventionally defined within the area where deviations of form and waviness are eliminated. (See Handbook Surface Texture Section.)

Ordering Specifications.—Unless otherwise agreed between producer and user, orders for metal balls should provide the following information: quantity, material, nominal ball diameter, grade, and ball gage. A *ball grade* embodies a specific combination of dimensional form, and surface roughness tolerances. A *ball gage(s)* is the prescribed small amount, expressed with the proper algebraic sign, by which the lot mean diameter (arithmetical mean of the mean diameters of the largest and smallest balls in the lot) should differ from the nominal diameter, this amount being one of an established series of amounts as shown in the table below. The 0 ball gage is commonly referred to as “OK”.

Preferred Ball Gages for Grades 3 to 200

Grade	Ball Gages (in 0.0001-in. units)			Ball Gages (in 1µm units)		
	Minus	OK	Plus	Minus	OK	Plus
3, 5	- 3 - 2 - 1	0	+ 1 + 2 + 3	- 8 - 7 - 6 - 5 - 4 - 3 - 2 - 1	0	+ 1 + 2 + 3 + 4 + 5 + 6 + 7 + 8
10, 16	- 4 - 3 - 2 - 1	0	+ 1 + 2 + 3 + 4	- 10 - 8 - 6 - 4 - 2	0	+ 2 + 4 + 6 + 8 + 10
24	- 5 - 4 - 3 - 2 - 1	0	+ 1 + 2 + 3 + 4 + 5	- 12 - 10 - 8 - 6 - 4 - 2	0	+ 2 + 4 + 6 + 8 + 10 + 12
48	- 6 - 4 - 2	0	+ 2 + 4 + 6	- 16 - 12 - 8 - 4	0	+ 4 + 8 + 12 + 16
100		0			0	
200		0			0	

Table 1. AFBMA Standard Balls — Tolerances for Individual Balls and for Lots of Balls

Grade	Allowable Ball Diameter Variation	Allowable Deviation from Spherical Form	Maximum Surface Roughness R_a	Allowable Lot Diameter Variation	Nominal Ball Diameter Tolerance (\pm)	Container Marking Increments
	For Individual Balls			For Lots of Balls		
Millionths of an Inch						
3	3	3	0.5	5	a	10
5	5	5	0.8	10	a	10
10	10	10	1	20	a	10
16	16	16	1	32	a	10
24	24	24	2	48	a	10
48	48	48	3	96	a	50
100	100	100	5	200	500	a
200	200	200	8	400	1000	a
500	500	500	a	1000	2000	a
1000	1000	1000	a	2000	5000	a
Micrometers						
3	0.08	0.08	0.012	0.13	a	0.25
5	0.13	0.13	0.02	0.25	a	0.25
10	0.25	0.25	0.025	0.5	a	0.25
16	0.4	0.4	0.025	0.8	a	0.25
24	0.6	0.6	0.05	1.2	a	0.25
48	1.2	1.2	0.08	2.4	a	1.25
100	2.5	2.5	0.125	5	12.5	a
200	5	5	0.2	10	25	a
500	13	13	a	25	50	a
1000	25	25	a	50	125	a

^a Not applicable.

Allowable ball gage (see text) deviation is for Grade 3: +0.000030, -0.000030 inch (+0.75, -0.75 µm); for Grades 5, 10, and 16: +0.000050, -0.000040 inch (+1.25, -1 µm); and for Grade 24: +0.000100, -0.000100 inch (+2.5, -2.5 µm). Other grades not given.

Examples: A typical order, in inch units, might read as follows: 80,000 pieces, chrome alloy steel, ¼-inch Nominal Diameter, Grade 16, and Ball Gage to be -0.0002 inch.

A typical order, in metric units, might read as follows: 80,000 pieces, chrome alloy steel, 6 mm Nominal Diameter, Grade 16, and Ball Gage to be $-4 \mu\text{m}$.

Package Marking: The ball manufacturer or supplier will identify packages containing each lot with information provided on the orders, as given above. In addition, the specific diameter of the contents shall be stated. Container marking increments are listed in [Table 1](#).

Examples: Balls supplied to the order of the first of the previous examples would, if perfect size, be $D_{wmL} = 0.249800$ inch. In Grade 16 these balls would be acceptable with D_{wmL} from 0.249760 to 0.249850 inch. If they actually measured 0.249823 (which would be rounded off to 0.249820), each package would be marked: 5,000 Balls, Chrome Alloy Steel, $\frac{1}{4}$ " Nominal Diameter, Grade 16, -0.0002 inch Ball Gage, and -0.000180 inch Specific Diameter.

Balls supplied to the order of the second of the two previous examples would, if perfect size, be $D_{wmL} = 5.99600$ mm. In Grade 16 these balls would be acceptable with a D_{wmL} from 5.99500 to 5.99725 mm. If they actually measured 5.99627 mm (which would be rounded off to 5.99625 mm), each package would be marked: 5,000 Balls, Chrome Alloy Steel, 6 mm Nominal Diameter, Grade 16, $-4 \mu\text{m}$ Ball Gage, and $-3.75 \mu\text{m}$ Specific Diameter.

For complete details as to material requirements, quality specifications, quality assurance provisions, and methods of hardness testing, reference should be made to the Standard.

Table 2. AFBMA Standard Balls — Typical Nominal Size Ranges by Material and Grade

Steel Balls ^a				Non-Ferrous Balls ^a			
Material	Grade	Size Range ^b		Material Grade	Grade	Size Range ^b	
		Inch	mm			Inch	mm
Chrome Alloy	3	$\frac{1}{32}$ -1	0.8-25	Aluminum	200	$\frac{1}{16}$ -1	1.5-25
	5,10,16,24	$\frac{1}{64}$ -1 $\frac{1}{2}$	0.3-38				
	48, 100, 200, 500	$\frac{1}{32}$ -2 $\frac{7}{8}$	0.8-75	Aluminum Bronze	200	$1\frac{3}{16}$ -4	20-100
	1000	$\frac{3}{8}$ -4 $\frac{1}{2}$	10-115	Brass	100,200,500,1000	$\frac{1}{16}$ - $\frac{3}{4}$	1.5-19
AISI M-50	3	$\frac{1}{32}$ - $\frac{1}{2}$	0.8-12	Bronze	200,500,1000	$\frac{1}{16}$ - $\frac{3}{4}$	1.5-19
	5,10,16,24,48	$\frac{1}{32}$ -1 $\frac{5}{8}$	0.8-40				
Corrosion Resisting-Hardened	3,5,10,16	$\frac{1}{64}$ - $\frac{3}{4}$	0.3-19	Monel Metal 400	100,200,500	$\frac{1}{16}$ - $\frac{3}{4}$	1.5-19
	24	$\frac{1}{32}$ -1	0.8-25				
	48	$\frac{1}{32}$ -2	0.8-50				
	100,200	$\frac{1}{32}$ -4 $\frac{1}{2}$	0.8-115				
Corrosion-Resisting Unhardened	100,200,500	$\frac{1}{16}$ - $\frac{3}{4}$	1.5-19	K-Monel Metal 500	100,200	$\frac{1}{16}$ - $\frac{3}{4}$	1.5-19
Carbon Steel ^c	100,200,500,1000	$\frac{1}{16}$ -1 $\frac{1}{2}$	1.5-38	Tungsten Carbide	5	$\frac{3}{64}$ - $\frac{1}{2}$	1.2-12
					10	$\frac{3}{64}$ - $\frac{3}{4}$	1.2-19
					16	$\frac{3}{64}$ -1	1.2-25
					24	$\frac{3}{64}$ -1 $\frac{1}{4}$	1.2-32
Silicon Molybdenum	200	$\frac{1}{4}$ -1 $\frac{1}{8}$	6.5-28				

^a For hardness ranges see [Table 3](#).

^b For tolerances see [Table 1](#).

^c For minimum case depths refer to the Standard.

Table 3. AFBMA Standard Balls—Typical Hardness Ranges

Material	Common Standard	SAE Unified Number	Rockwell Value ^{a,b}
Steel—			
Alloy tool	AISI/SAE M50	T11350	60-65 “C” ^{c,d}
Carbon ^e	AISI/SAE 1008	G10080	60 Minimum “C” ^b
	AISI/SAE 1013	G10130	60 Minimum “C” ^b
	AISI/SAE 1018	G10180	60 Minimum “C” ^b
	AISI/SAE 1022	G10220	60 Minimum “C” ^b
Chrome alloy	AISI/SAE E52100	G52986	60-67 “C” ^{c,d}
	AISI/SAE E51100	G51986	60-67 “C” ^{c,d}
Corrosion-resisting hardened			
	AISI/SAE 440C	S44004	58-65 “C” ^{f,d}
	AISI/SAE 440B	S44003	55-62 “C” ^{f,d}
	AISI/SAE 420	S42000	52 Minimum “C” ^{f,d}
	AISI/SAE 410	S41000	97 “B”; 41 “C” ^{f,d}
	AISI/SAE 329	S32900	45 Minimum “C” ^{f,d}
Corrosion-resisting unhardened			
	AISI/SAE 3025	S30200	25-39 “C” ^{d,g}
	AISI/SAE 304	S30400	25-39 “C” ^{d,g}
	AISI/SAE 305	S30500	25-39 “C” ^{d,g}
	AISI/SAE 316	S31600	25-39 “C” ^{d,g}
	AISI/SAE 430	S43000	48-63 “A” ^d
Silicon molybdenum	AISI/SAE S2	T41902	52-60 “C” ^c
Aluminum	AA-2017	A92017	54-72 “B”
Aluminium bronze	CDA-624	C62400	94-98 “B”
	CDA-630	C63000	94-98 “B”
Brass	CDA-260	C26000	75-87 “B”
Bronze	CDA-464	C46400	75-98 “B”
Monel 400	AMS-4730	N04400	85-95 “B”
Monel K-500	QA-N-286	N05500	24 Minimum “C”
Tungsten carbide	JIC Carbide Classification	...	84-91.5 “A”

^a Rockwell Hardness Tests shall be conducted on parallel flats in accordance with ASTM Standard E18 unless otherwise specified.

^b Hardness readings taken on spherical surfaces are subject to the corrections shown in Table 5. Hardness readings for carbon steel balls smaller than 5 mm ($\frac{1}{4}$ inch) shall be taken by the microhardness method (detailed in ANSI/AFBMA Std 10-1989) or as agreed between manufacturer and purchaser.

^c Hardness of balls in any one lot shall be within 3 points on Rockwell C scale.

^d When microhardness method (see ANSI/AFBMA Std 10-1989) is used, the Rockwell hardness values given are converted to DPH in accordance with ASTM Standard E 140, “Standard Hardness Conversion Tables for Metals.”

^e Choice of carbon steels shown to be at ball manufacturer's option.

^f Hardness of balls in any one lot shall be within 4 points on Rockwell C scale.

^g Annealed hardness of 75-90 “B” is available when specified.

Table 4. Preferred Ball Sizes

Nominal Ball Sizes Metric	Diameter mm	Diameter Inches	Nominal Ball Sizes Inch	Nominal Ball Sizes Metric	Diameter mmb	Diameter Inches	Nominal Ball Sizes Inch
0.3	0.300 00	0.011 810			0.793 75	0.031 250	$\frac{1}{32}$
	0.396 88	0.015 625	$\frac{1}{64}$	0.8	0.800 00	0.031 496	
0.4	0.400 00	0.015 750		1	1.000 00	0.039 370	
0.5	0.500 00	0.019 680			1.190 63	0.046 875	$\frac{3}{64}$
	0.508 00	0.020 000	0.020	1.2	1.200 00	0.047 240	
0.6	0.600 00	0.023 620		1.5	1.500 00	0.059 060	
	0.635 00	0.025 000	0.025		1.587 50	0.062 500	$\frac{1}{16}$
0.7	0.700 00	0.027 560			1.984 38	0.078 125	$\frac{3}{64}$
2	2.000 00	0.078 740		21	21.000 000	0.826 770	
	2.381 25	0.093 750	$\frac{3}{32}$		21.431 25	0.843 750	$\frac{27}{32}$
2.5	2.500 00	0.098 420		22	22.000 00	0.866 140	
	2.778 00	0.109 375	$\frac{7}{64}$		22.225 00	0.875 000	$\frac{7}{8}$
3	3.000 00	0.118 110		23	23.000 00	0.905 510	
	3.175 00	0.125 000	$\frac{1}{8}$		23.018 75	0.906 250	$\frac{29}{32}$
3.5	3.500 00	0.137 800			23.812 50	0.937 500	$\frac{15}{16}$
	3.571 87	0.140 625	$\frac{9}{64}$	24	24.000 00	0.944 880	
	3.968 75	0.156 250	$\frac{5}{32}$		24.606 25	0.968 750	$\frac{31}{32}$
4	4.000 00	0.157 480		25	25.000 00	0.984 250	
	4.365 63	0.171 875	$\frac{11}{64}$		25.400 00	1.000 000	1
4.5	4.500 00	0.177 160		26	26.000 00	1.023 620	
	4.762 50	0.187 500	$\frac{3}{16}$		26.987 50	1.062 500	$1\frac{1}{16}$
5	5.000 00	0.196 850		28	28.000 00	1.102 360	
5.5	5.500 00	0.216 540			28.575 00	1.125 000	$1\frac{1}{8}$
	5.556 25	0.218 750	$\frac{7}{32}$	30	30.000 00	1.181 100	
	5.953 12	0.234 375	$\frac{15}{64}$		30.162 50	1.187 500	$1\frac{3}{16}$
6	6.000 00	0.236 220			31.750 00	1.250 000	$1\frac{1}{4}$
	6.350 00	0.250 000	$\frac{1}{4}$	32	32.000 00	1.259 840	
6.5	6.500 00	0.255 900			33.337 50	1.312 500	$1\frac{5}{16}$
	6.746 88	0.265 625	$\frac{17}{64}$	34	34.000 00	1.338 580	
7	7.000 00	0.275 590			34.925 00	1.375 000	$1\frac{3}{8}$
	7.143 75	0.281 250	$\frac{9}{32}$	35	35.000 00	1.377 950	
7.5	7.500 00	0.295 280		36	36.000 00	1.417 320	
	7.540 63	0.296 875	$\frac{19}{64}$		36.512 50	1.437 500	$1\frac{7}{16}$
	7.937 50	0.312 500	$\frac{5}{16}$	38	38.000 00	1.496 060	
8	8.000 00	0.314 960			38.100 00	1.500 000	$1\frac{1}{2}$
8.5	8.500 00	0.334 640			39.687 50	1.562 500	$1\frac{9}{16}$
	8.731 25	0.343 750	$\frac{11}{32}$	40	40.000 00	1.574 800	
9	9.000 00	0.354 330			41.275 00	1.625 000	$1\frac{5}{8}$
	9.128 12	0.359 375	$\frac{23}{64}$		42.862 50	1.687 500	$1\frac{11}{16}$
	9.525 00	0.375 000	$\frac{3}{8}$		44.450 00	1.750 000	$1\frac{3}{4}$
	9.921 87	0.390 625	$\frac{25}{64}$	45	45.000 00	1.771 650	
10	10.000 00	0.393 700			46.037 50	1.812 500	$1\frac{13}{16}$
	10.318 75	0.406 250	$\frac{13}{32}$		47.625 00	1.875 000	$1\frac{7}{8}$
11	11.000 00	0.433 070			49.212 50	1.937 500	$1\frac{15}{16}$
	11.112 50	0.437 500	$\frac{7}{16}$	50	50.000 00	1.968 500	
11.5	11.500 00	0.452 756			50.800 00	2.000 000	2
	11.509 38	0.453 125	$\frac{29}{64}$		53.975 00	2.125 000	$2\frac{1}{8}$

Table 4. Preferred Ball Sizes

Nominal Ball Sizes Metric	Diameter mm	Diameter Inches	Nominal Ball Sizes Inch	Nominal Ball Sizes Metric	Diameter mmb	Diameter Inches	Nominal Ball Sizes Inch	
12	11.906 25	0.468 750	$\frac{15}{32}$	55	55.000 00	2.165 354	$2\frac{1}{4}$	
	12.000 00	0.472 440	$\frac{3}{64}$		60	57.150 00		2.250 000
	12.303 12	0.484 375				$\frac{1}{2}$		60.000 00
13	12.700 00	0.500 000	$\frac{17}{32}$	65	60.325 00	2.375 00	$2\frac{3}{8}$	
	13.000 00	0.511 810			63.500 00	2.500 000	$2\frac{1}{2}$	
14	13.493 75	0.531 250	$\frac{9}{16}$	70	65.000 00	2.559 055	$2\frac{5}{8}$	
	14.000 00	0.551 180			66.675 00	2.625 000		$2\frac{3}{4}$
15	14.287 50	0.562 500	$\frac{19}{32}$	75	69.850 00	2.750 000	$2\frac{7}{8}$	
	15.000 00	0.590 550			73.025 00	2.875 000		3
16	15.081 25	0.593 750	$\frac{5}{8}$	80	76.200 00	3.000 000	$3\frac{1}{8}$	
	15.875 00	0.625 000			79.375 00	3.125 000		$3\frac{1}{4}$
17	16.000 00	0.629 920	$2\frac{1}{32}$	85	82.550 00	3.250 000	$3\frac{3}{8}$	
	16.668 75	0.656 250			85.725 00	3.375 00		$3\frac{1}{2}$
18	17.000 00	0.669 290	$1\frac{1}{16}$	90	88.900 00	3.500 000	$3\frac{5}{8}$	
	17.462 50	0.687 500			92.075 00	3.625 000		$3\frac{3}{4}$
19	18.000 00	0.708 660	$2\frac{3}{32}$	95	95.250 00	3.750 000	$3\frac{7}{8}$	
	18.256 25	0.718 750			98.425 00	3.875 000		4
20	19.000 00	0.748 030	$\frac{3}{4}$	100	101.600 00	4.000 000	$4\frac{1}{8}$	
	19.050 00	0.750 000			104.775 00	4.125 000		$4\frac{1}{4}$
20	19.843 75	0.781 250	$2\frac{5}{32}$	105	107.950 00	4.250 000	$4\frac{3}{8}$	
	20.000 00	0.787 400			111.125 00	4.375 000		$4\frac{1}{2}$
	20.637 50	0.812 500	$1\frac{3}{16}$		114.300 00	4.500 000		

Table 5. Ball Hardness Corrections for Curvatures

Hardness Reading, Rockwell C	Ball Diameters, Inch						
	$\frac{1}{4}$	$\frac{5}{16}$	$\frac{3}{8}$	$\frac{1}{2}$	$\frac{5}{8}$	$\frac{3}{4}$	1
	Correction—Rockwell C						
20	12.1	9.3	7.7	6.1	4.9	4.1	3.1
25	11.0	8.4	7.0	5.5	4.4	3.7	2.7
30	9.8	7.5	6.2	4.9	3.9	3.2	2.4
35	8.6	6.6	5.5	4.3	3.4	2.8	2.1
40	7.5	5.7	4.7	3.6	2.9	2.4	1.7
45	6.3	4.9	4.0	3.0	2.4	1.9	1.4
50	5.2	4.0	3.2	2.4	1.9	1.5	1.1
55	4.1	3.1	2.5	1.8	1.4	1.1	0.8
60	2.9	2.2	1.8	1.2	0.9	0.7	0.4
65	1.8	1.3	1.0	0.5	0.3	0.2	0.1
20	12.8	9.3	7.6	6.6	5.2	4.0	3.2
25	11.7	8.4	6.9	5.9	4.6	3.5	2.8
30	10.5	7.5	6.1	5.2	4.1	3.1	2.4
35	9.4	6.6	5.4	4.6	3.6	2.7	2.1
40	8.0	5.7	4.5	3.8	3.0	2.2	1.8
45	6.7	4.9	3.8	3.2	2.5	1.8	1.4
50	5.5	4.0	3.0	2.6	2.0	1.4	1.1
55	4.3	3.1	2.3	1.9	1.5	1.0	0.8
60	3.0	2.2	1.7	1.2	1.0	0.6	0.4
65	1.9	1.3	0.9	0.6	0.4	0.2	0.1

Corrections to be added to Rockwell C readings obtained on spherical surfaces of chrome alloy steel, corrosion resisting hardened and unhardened steel, and carbon steel balls. For other ball sizes and hardness readings, interpolate between correction values shown.

Table 6a. Number of Metal Balls per Pound

Nom. Dia., ^a Inches	Material Density, Pounds per Cubic Inch												
	.101	.274	.277	.279	.283	.284	.286	.288	.301	.304	.306	.319	.540
1/32	620 000	228 000	226 000	224 000	221 000	220 000	219 000	217 000	208 000	206 000	205 000	196 000	116 000
1/16	77 500	28 600	28 200	28 000	27 600	27 500	27 400	27 200	26 000	25 700	25 600	24 500	14 500
3/32	22 900	8 460	8 370	8 310	8 190	8 160	8 100	8 050	7 700	7 620	7 570	7 270	4 290
1/8	9 680	3 570	3 530	3 500	3 500	3 460	3 440	3 420	3 400	3 220	3 200	3 070	1 810
5/32	4 960	1 830	1 810	1 790	1 770	1 760	1 750	1 740	1 660	1 650	1 640	1 570	927
3/16	2 870	1 060	1 050	1 040	1 020	1 020	1 010	1 010	963	953	947	908	537
1/32	1 810	666	659	654	645	642	638	634	606	600	596	572	338
1/4	1 210	446	441	438	432	430	427	424	406	402	399	383	226
9/32	850	313	310	308	303	302	300	298	285	282	281	269	159
5/16	620	228	226	224	221	220	219	217	208	206	205	196	116
11/32	466	172.	170.	169.	166.	166.	164.	163.	156.	155.	154.	147.	87.1
3/8	359	132.	131.	130.	128.	128.	127.	126.	126.	119.	118.	114.	67.1
13/32	282	104.	103.	102.	101.	100.	99.6	98.9	94.6	93.7	93.1	89.3	52.8
7/16	226	83.2	82.3	81.7	80.6	80.3	79.7	79.2	75.8	75.0	74.5	71.5	42.2
15/32	184	67.7	66.9	66.5	65.5	65.3	64.8	64.4	61.6	61.0	60.6	58.1	34.3
1/2	151.	55.8	55.2	54.8	54.0	53.8	53.4	53.1	50.8	50.3	49.9	47.9	28.3
17/32	126.	46.5	46.0	45.7	45.0	44.9	44.5	44.2	42.3	41.9	41.6	39.9	23.6
9/16	106.	39.2	38.7	38.5	37.9	37.8	37.5	37.3	35.7	35.3	35.1	33.6	19.9
19/32	90.3	33.3	32.9	32.7	32.2	32.1	31.9	31.7	30.3	30.0	29.8	28.6	16.9
5/8	77.5	28.6	28.2	28.0	27.6	27.5	27.4	27.2	26.0	25.7	25.6	24.5	14.5
21/32	66.9	24.7	24.4	24.2	23.9	23.8	23.6	23.5	22.5	22.2	22.1	21.2	12.5
11/16	58.2	21.5	21.2	21.1	20.8	20.7	20.6	20.4	19.5	19.3	19.2	18.4	10.9
23/32	50.9	18.8	18.6	18.4	18.2	18.1	18.0	17.9	17.1	16.9	16.8	16.1	9.53
3/4	44.8	16.5	16.3	16.2	16.0	15.9	15.8	15.7	15.0	14.9	14.8	14.2	8.38
25/32	39.7	14.6	14.5	14.4	14.2	14.1	14.0	13.9	13.3	13.2	13.1	12.6	7.42
13/16	35.3	13.0	12.9	12.8	12.6	12.5	12.5	12.4	11.8	11.7	11.6	11.2	6.59
27/32	31.5	11.6	11.5	11.4	11.2	11.2	11.1	11.0	10.6	10.5	10.4	9.97	5.89
7/8	28.2	10.4	10.3	10.2	10.1	10.0	9.97	9.90	9.47	9.38	9.32	8.94	5.28
29/32	25.4	9.37	9.26	9.20	9.07	9.04	8.97	8.91	8.53	8.44	8.39	8.04	4.75
15/16	22.9	8.46	8.37	8.31	8.19	8.16	8.10	8.05	7.70	7.62	7.57	7.27	4.29
31/32	20.8	7.67	7.58	7.53	7.42	7.40	7.35	7.29	6.98	6.91	6.87	6.59	3.89
1	18.9	6.97	6.89	6.85	6.75	6.72	6.68	6.63	6.35	6.28	6.24	5.99	3.54

STANDARD METAL BALLS

3361

^a For sizes above 1 in. diameter, use the following formula: No. balls per pound = 1.91 ÷ [(nom. dia., in.)³ × (material density, lbs. per cubic in.)].

Ball material densities in pounds per cubic inch: aluminum .101; aluminum bronze .274; corrosion resisting hardened steel .277; AISI M-50 and silicon molybdenum steels .279; chrome alloy steel .283; carbon steel .284; AISI 302 corrosion resisting unhardened steel .286; AISI 316 corrosion resisting unhardened steel .288; bronze .304; brass and K-Monel metal .306; Monel metal .319; and tungsten carbide .540.

Table 6b. Number of Metal Balls per Kilogram

Nom.Dia., ^a mm	Material Density, Grams per Cubic Centimeter												
	2.796	7.584	7.667	7.723	7.833	7.861	7.916	7.972	8.332	8.415	8.470	8.830	14.947
0.3	25 300 000	9 330 000	9 230 000	9 160 000	9 030 000	9 000 000	8 940 000	8 870 000	8 490 000	8 410 000	8 350 000	8 010 000	4 730 000
0.4	10 670 000	3 930 000	3 890 000	3 860 000	3 810 000	3 800 000	3 770 000	3 740 000	3 580 000	3 550 000	3 520 000	3 380 000	2 000 000
0.5	5 470 000	2 010 000	1 990 000	1 980 000	1 950 000	1 940 000	1 930 000	1 920 000	1 830 000	1 820 000	1 800 000	1 730 000	1 020 000
0.7	1 990 000	734 000	726 000	721 000	711 000	708 000	703 000	698 000	668 000	662 000	657 000	631 000	373 000
0.8	1 330 000	492 000	487 000	483 000	476 000	475 000	471 000	468 000	448 000	443 000	440 000	422 000	250 000
1.0	683 000	252 000	249 000	247 000	244 000	243 000	241 000	240 000	229 000	227 000	225 000	216 000	128 000
1.2	395 000	146 000	144 000	143 000	141 000	141 000	140 000	139 000	133 000	131 000	130 000	125 000	73 900
1.5	202 000	74 600	73 800	73 300	72 200	72 000	71 500	71 000	67 900	67 200	66 800	64 100	37 900
2.0	85 400	31 500	31 100	30 900	30 500	30 400	30 200	29 900	28 700	28 400	28 200	27 000	16 000
2.5	43 700	16 100	15 900	15 800	15 600	15 500	15 400	15 300	14 700	14 500	14 400	13 800	8 180
3.0	25 300	9 330	9 230	9 160	9 030	9 000	8 940	8 870	8 490	8 410	8 350	8 010	4 730
3.5	15 900	5 870	5 810	5 770	5 690	5 670	5 630	5 590	5 350	5 290	5 260	5 040	2 980
4.0	10 700	3 930	3 890	3 860	3 810	3 800	3 770	3 740	3 580	3 550	3 520	3 380	2 000
4.5	7 500	2 760	2 730	2 710	2 680	2 670	2 650	2 630	2 520	2 490	2 470	2 370	1 400
5.0	5 470	5 010	1 990	1 980	1 950	1 940	1 930	1 920	1 830	1 820	1 800	1 730	1 020
5.5	4 110	1 510	1 500	1 490	1 470	1 460	1 450	1 440	1 380	1 360	1 360	1 300	768
6.0	3 160	1 170	1 150	1 140	1 130	1 120	1 120	1 110	1 060	1 050	1 040	1 000	592
6.5	2 490	917	907	901	888	885	878	872	835	826	821	788	465
7.0	1 990	734	726	721	711	708	703	698	668	662	657	631	373
7.5	1 620	597	590	586	578	576	572	568	543	538	534	513	303
8.0	1 330	492	487	483	476	475	471	468	448	443	440	422	250
8.5	1 110	410	406	403	397	396	393	390	373	370	367	352	208
9.0	937	345	342	339	334	333	331	329	314	311	309	297	175
10.0	683	252	249	247	244	243	241	240	229	227	225	216	128
11.0	513.0	189.0	187.0	186.0	183.0	183.0	181.0	180.0	172.0	171.0	169.0	163.0	96.0
11.5	449.0	166.0	164.0	163.0	160.0	160.0	159.0	158.0	151.0	149.0	148.0	142.0	84.0
12.0	395.0	146.0	144.0	143.0	141.0	141.0	140.0	139.0	133.0	131.0	130.0	125.0	73.9
13.0	311.0	115.0	113.0	113.0	111.0	111.0	110.0	109.0	104.0	103.0	103.0	98.5	58.2
14.0	249.0	91.8	90.8	90.1	88.9	88.5	87.9	87.3	83.5	82.7	82.2	78.8	46.6
15.0	202.0	74.6	73.8	73.3	72.2	72.0	71.5	71.0	67.9	67.2	66.8	64.1	37.9
16.0	167.0	61.5	60.8	60.4	59.5	59.3	58.9	58.5	56.0	55.4	55.1	52.8	31.2
17.0	139.0	51.3	50.7	50.3	49.6	49.5	49.1	48.8	46.7	46.2	45.9	44.0	26.0

^aFor sizes above 17 mm diameter, use the following formula: No. balls per kilogram = 1,910,000 ÷ [(nom. dia., mm)³ × (material density, grams per cu. cm)].

Ball material densities in grams per cubic centimeter: aluminum, 2.796; aluminum bronze, 7.584; corrosion-resisting hardened steel, 7.677; AISI M-50 and silicon molybdenum steel, 7.723; chrome alloy steel, 7.833; carbon steel, 7.861; AISI 302 corrosion-resisting unhardened steel, 7.916; AISI 316 corrosion-resisting unhardened steel, 7.972; bronze, 8.415; brass and K-Monel metal, 8.470; Monel metal, 8.830; tungsten carbide, 14.947.

Cement

The cements used in concrete construction are classified as:

- 1) Portland cements,
- 2) Natural cements,
- 3) Pozzuolanic, pozzuolan, or slag cements.

These different classes are all hydraulic cements as they will set or harden under water. When the powdered cement is mixed with water to a plastic condition, the cement sets or solidifies as the result of chemical action. After the preliminary hardening or initial set, the cement slowly increases in strength, the increase extending over months or years.

In the United States, portland cements are manufactured to comply with ASTM C 150, which defines five main types of portland cement. Type I, which is made in the greatest quantity, is intended for general use when the special properties of the other types are not required. The special properties of the other types when used in concrete are: Type II, moderate sulfate resistance or moderate heat of hydration; Type III, high early strength; Type IV, low heat of hydration; Type V, high sulfate resistance. The chemical and physical differences between the types that produce special properties lie in the proportions of the cement compounds and in the fineness to which the cement is ground (Table 1). A description and applications of various cement types, along with compressive strength achieved versus cure time, is given in Table 2.

Table 1. Approximate Composition and Fineness Ranges for ASTM Standard Types of Portland Cement

Compound/property	Composition, wt%/property value				
	Type I	Type II	Type III	Type IV	Type V
C ₃ S	42-65	35-60	45-70	20-30	40-60
C ₂ S	10-30	15-35	10-30	50-55	15-40
C ₃ A	0-17	0-8	0-15	3-6	0-5
C ₄ AF	6-18	6-18	6-18	8-15	10-18
CH ₂	3-6	3-6	3-6	3-6	3-6
Specific surface area, m ² /kg (ft ² /lb)	300-400 (1465-1955)	280-380 (1365-1855)	450-600 (2195-2930)	280-320 (1365-1560)	290-350 (1415-1710)

Table 2. Compressive Strength Data for Typical Cements vs. Time

Cement type	Description		Applications							
Type I	General use		Pavement, sidewalks, buildings, bridges, other structures, tanks							
Type II	Moderate heat of hydration		Piers, heavy retaining walls							
Type III	High early strength		Structures put into service quickly							
Type IV	Low heat of hydration		Large gravity dams							
Type V	Sulfate-resistant		Structures in areas with high sulfate levels							
White portland	Limited iron content		Architectural applications							
Portland/blast-furnace	Contains blast furnace slag		General construction applications							

Cement type	Strength									
	1-day		3-day		7-day		28-day		91-day	
	MPa	ksi	MPa	ksi	MPa	ksi	MPa	ksi	MPa	ksi
Type I	9.3	1.3	22.5	3.3	32.0	4.6	42.0	6.1	50.5	7.3
Type II	14.0	2.0	27.0	3.9	36.6	5.3	46.3	6.7	52.5	7.6
Type III	21.0	3.0	37.5	5.4	44.2	6.4	52.3	7.6	56.0	8.1
Type IV	9.6	1.4	13.9	2.0	34.3	5.0
Type V	22.1	3.2	29.5	4.3	41.3	6.0
White portland	26.5	3.8	36.2	5.3	46.5	6.7
Portland/blast-furnace	8.6	1.2	13.1	1.9	25.3	3.7	45.0	6.5	53.3	...

Cement Pastes.—Cement and concrete technology have shown important advances in recent years. Two remarkable new products are densified with small particles (DSP) cement and macro-defect-free (MDF) cement. Both DSP and MDF cements are cement

pastes rather than concretes, in that they do not contain aggregates. The DSP cements are pastes with low water-cement ratios that contain portland cement, fly ash, silica fume, water, and a superplasticizer. Low porosity is an important factor in helping them achieve compressive and flexural strengths that are unusually high for cementitious materials. The MDF cements also have low water-cement ratios, but they include a small quantity of polymeric material. They require special processing to avoid the inclusion of macrodefects such as air bubbles, and the best performance appears to be obtained using a calcium aluminate cement rather than a portland cement. Table 3 lists some mechanical properties of these materials.

Table 3. Mechanical Properties of Cements

Material	Strength MPa	Fracture toughness, MPa	Material	Strength MPa	Fracture toughness, MPa
Conventional cement paste	7–10	0.2–0.4	Glass-fiber-reinforced MDF cement	70–124	1.2–2.5
Conventional concrete	2–3	0.2	Polymer-fiber-reinforced MDF cement	54–120	1.7–2.8
Conventional fiber-reinforced concrete	6–13	5–21	Kevlar-fiber-reinforced MDF cement	58–128	2.1–5.3
High-strength concrete	8–11	0.7–1.5	Carbon-fiber-reinforced MDF cement	91–123	2.7–3.2
Densified-with-small-particles (DSP) cement	15–25	0.4–0.5	Aluminum-fiber-reinforced MDF cement	94–127	2.5–2.8
Macro-defect-free (MDF) cement	150–200	3			

Use of Portland Cement.— Portland cement should be used for all structures which must withstand stresses and for masonry that is either under water or heavily exposed to water or the weather. According to the specifications of the American Society for Testing Materials, the specific gravity of Portland cement must be not less than 8:1. If the tested cement is below this requirement. A second test should be made on a sample ignited at a low red heat. The ignited cement should not lose more than four per cent of its weight. A satisfactory Portland cement must not develop initial set in less than 30 minutes; it must not develop hard set in less than 1 hour; but the time required for developing hard set must not exceed 10 hours. The minimum requirements for tensile strength in pounds, for briquettes one square inch in cross-section, should be as follows:

For cement 24 hours old in moist air, 175 pounds.

For cement 7 days old, one day in moist air and six days in water, 500 pounds.

For cement 28 days old, one day in moist air and 27 days in water, 600 pounds.

For one part of cement and three parts of standard Ottawa sand, 7 days old, one day in moist air and six days in water, 200 pounds.

For one part of cement and three parts of standard Ottawa sand, 28 days old, one day in moist air and 27 days in water, 275 pounds.

The cements must under no circumstances show a decrease in strength during the time periods specified.

Natural Cement.— Natural cement is used in mortar for ordinary brick work and stone masonry, street sub-pavements, as a backing or filling for massive concrete or stone masonry, and for similar purposes. Natural cement does not develop its strength as quickly and is not as uniform in composition as Portland cement. It should not be used for columns, beams, floors or any structural members which must withstand considerable stress. Natural cement is also unsuitable for work that is exposed to water. Foundations which are subjected to moderate compressive stresses may be made of natural cement, which is also satisfactory for massive masonry where weight rather than strength is the essential feature.

The American Society for Testing Materials gives the following specifications for natural cement: An initial set must not develop in less than 10 minutes, and the hard set must not develop in less than 30 minutes, but must develop in less than three hours. The minimum requirements for tensile strength in pounds, for briquettes one inch in cross-section, are as follows:

For natural cement 24 hours old in moist air, 75 pounds.

For natural cement 7 days old, one day in moist air and six days in water, 150 pounds.

For natural cement 28 days old, one day in moist air and 27 days in water, 250 pounds.

For one part of cement and three parts of standard Ottawa sand, 7 days old, one day in moist air and six days in water, 50 pounds.

For one part of cement and three parts of standard Ottawa sand, 28 days old, one day in moist air and 27 days in water, 125 pounds.

Pozzuolanic or Slag Cement.—This cement is adapted for structures which are constantly exposed to fresh or salt water and for drains, sewers, foundation work underground, etc. It is not suitable where masonry is exposed to dry air for long periods. Pozzuolanic cement sets slowly but its strength increases considerably with age. While this cement is relatively cheap, it is not as strong, uniform, or reliable as Portland and natural cements, and is not used extensively.

Concrete

Concrete.—The principal ingredients of concrete are the matrix or mortar and the “coarse aggregate.” The matrix consists of cement and sand mixed with water, and the coarse aggregate is usually broken stone or gravel. What is known as *rubble concrete* or cyclo-pean masonry contains large stones which are used for reducing the cost of massive dams and walls. These rubble stones may vary from a few per cent to over one-half the volume. When concrete without much strength but light in weight is required, cinders may be used. This cinder concrete is porous and is used for light floor construction or fire-proofing.

Concrete Mixtures.—In the mixing of concrete, it is desirable to use as little cement as is consistent with the required strength, because the cement is much more expensive than the other ingredients. The proportioning of the ingredients is usually by volume and mixtures are generally designated by giving the amount of each ingredient in a fixed order, as 1 : 2 : 5, the first figure indicating the amount of cement by volume, the second the amount of sand, and the third the amount of broken stone or gravel.

For ordinary machine foundations, retaining walls, bridge abutments, and piers exposed to the air, a 1 : 2½ : 5 concrete is satisfactory; and for ordinary foundations, heavy walls, etc., a lean mixture of 1 : 3 : 6 may be used. For reinforced floors, beams, columns, and arches, as well as for machine foundations which are subjected to vibration, a 1 : 2 : 4 concrete is generally used. This composition is also employed when concrete is used under water. For water tanks and similar structures subjected to considerable pressure and required to be water-tight, mixtures rich in cement and composed of either 1 : 1 : 2 or 1 : 1½ : 3 concrete are used. Portland cement should preferably be used in concrete construction.

Sand, Gravel, and Stone for Concrete.—The sand used must be free from dust, loam, vegetable, or other organic matter; it should pass, when dry, through a screen with holes of ¼-inch mesh. The gravel should consist of clean pebbles free from foreign matter and should be of such coarseness that it will not pass through a screen of ¼-inch mesh. Gravel containing loam or clay should be washed by a hose before mixing. The broken stone should be of a hard and durable kind, such as granite or limestone. This stone should pass through a 2½-inch screen.

Amount of Water for Mixing Concrete.—The amount of water required to combine chemically with cement is about 16 per cent by weight, but in mixing concrete a greater amount than this must be used, because of losses and the difficulty of uniformly distributing the water. In hot weather more water is required than in cool weather because of the loss due to evaporation. The same applies when absorbent sand is used, or when the concrete is not rammed tightly. An excess of water is not desirable, because this excess will flow away and carry some of the cement with it. The water must be free from oils, acids, and impurities that would prevent a proper chemical combination with the cement. It is important to

mix the ingredients thoroughly. Lime cement, sand and stone should be mixed while dry, preferably using a machine. Enough water should then be added to produce a mixture which will flow readily and fill different parts of the form.

Reinforced Concrete.—Concrete reinforced with steel is widely used, especially where the concrete must resist tensile as well as compressive stresses. This reinforcement may be in the form of round bars twisted square bars, corrugated bars, expanded metal, steel mesh, or wire fabric. The proportions for reinforced concrete structures are usually 1 : 2 : 4, or 1 barrel of portland cement, 2 barrels of sand, and 4 barrels of broken stone or gravel. The lateral spacing between reinforcement bars should not be less than three times the bar diameter from center to center, with a clear space between the bars of at least one inch. The distance from the side of a beam to the center of the nearest bar should be not less than two diameters.

Strength of Concrete.—The strength varies greatly depending upon the quality and proportions of the ingredients and the care in mixing and depositing in the forms. The compressive strength of concrete which, after having been mixed and laid, has set 28 days, varies from 1000 to 3300 pounds per square inch, according to the mixture used. If made in the proportion 1 : 3 : 6, using soft limestone and sandstone a compressive strength of only 1000 pounds per square inch may be expected, whereas a mixture of 1 : 1 : 2, made with soft limestone and sandstone, will show a strength of 2200 pounds per square inch. A mixture of 1 : 3 : 6, made from granite or trap rock, will have a compressive strength of 1400 pounds per square inch, while a mixture of 1 : 1 : 2, made from granite or trap rock, will have a strength of 3300 pounds per square inch. Other mixtures will have values between those given. The richer in cement in proportion to sand, gravel, and stone, the stronger will be the concrete. The strongest concretes are also obtained by using granite or trap rock. A medium strength is obtained by using gravel, hard limestone, or hard sandstone, whereas the least strength is obtained by using soft limestone or sandstone. Concrete may also be mixed with cinders, but, in this case, very inferior strength is obtained; the richest mixtures will only give a strength of about 800 pounds per square inch.

Durability of Concrete in Sea Water.—Experiments have been made to determine the durability of different mixtures of concrete when exposed to sea water. It has been found that the mixtures that give the best results are those that are richest in cement. Mixtures of 1 : 1 : 2, for example, will give much better results than mixtures of 1 : 3 : 6. Also, very wet mixtures seem to give better results than those that are comparatively dry when deposited. It has also been found that, in order to insure the permanence of Portland cement concrete in sea water, the cement must contain as little lime and alumina as possible and must also be free from sulfates, and the proportion of sand and stones in the concrete must be such that the structure is practically non-porous. Natural cement should never be used for concrete exposed to sea water.

Waterproofing Concrete.—Several formulas for making concrete waterproof have been successfully used but some of them are too expensive for general application. One of the simplest, cheapest, and most effective is that developed by the U.S. Geological Survey. A heavy residual mineral oil of 0.93 specific gravity, mixed with Portland cement, makes it waterproof and does not weaken when the concrete consists of, say, cement, 1 part, sand, 3 parts, and oil, not more than 10 per cent, by weight, of the cement. Concrete mixed with oil requires about fifty per cent longer time to set hard, and the compressive strength is slightly decreased but not seriously. The bond or grip of oil concrete on steel is much decreased when plain bars are used, but formed bars, wire mesh, or expanded metal act as effectively in it as in ordinary concrete.

Resistance to Acids and Oils.—Concrete of a good quality, that has thoroughly hardened, resists the action of acids and mineral oils as well as other building materials, but vegetable oils containing fatty acids produce injurious effects by combining with the lime in the cement and causing disintegration of the concrete.

Lutes and Cements

Luting and cementing materials for various purposes in the laboratory and shops may be classified as follows: water- and steam-proof; oil-proof; acid-proof; proof to hydrocarbon gases; chlorine-proof; elastic; general purposes; marine glue; gaskets; machinists; leather (belting); crucible; iron; and stone.

Water-proof Compositions.—The asphalt fluid coatings for reservoir wall, concrete foundations, brick, wood, etc., are often of use to engineers. Asphalt only partly dissolves in petroleum naphtha, but when heated in a steam-jacketed kettle and not thinned out too much, a mixture of the two may be obtained in which the part of the asphalt not dissolved is held in suspension. Asphalt is entirely soluble in benzol or toluol, which are about the cheapest solvents for all the constituents of asphalt. Tar and pitch are sometimes used in this connection, but tar contains water, light oils and free carbon, and does not wear as well as good refined asphalt; pitch also contains free carbon, which is sometimes objectionable when it is thinned out with a solvent. Asphalt alone is somewhat pervious to water, but it can be improved in this respect by adding about one-fourth its weight of paraffin; it is also well to add a little boiled linseed oil. For thicker compositions, where body is required, asbestos, stone powder, cement, etc., may be added as fillers. Lutes of linseed oil thickened with clay, asbestos, red or white lead, etc., are waterproof if made thick enough. These are much used for steam joints. Flaxseed meal made into a paste with water is often serviceable, the oil contained serving as a binder as the water evaporates.

Oil-proof Cements.—The well-known “hektograph composition” is the most useful lute for small leaks, etc. It consists of the following ingredients: Good glue or gelatin, 2 parts; glycerin, 1 part; water, 7 parts. This preparation is applied warm and stiffens quickly on cooling. Another very useful composition is a stiff paste of molasses and flour. Another preparation, impervious to oil vapors, is the “flaxseed poultice,” mentioned in *Water-proof Compositions*, which is proof to oil vapors. One of the strongest cements, and one which is really oil-proof, waterproof and acid-proof, is a stiff paste of glycerin and litharge. These form a chemical combination which sets in a few minutes. If a little water is added, it sets more slowly, which is often an advantage. This cement is mixed when required for use. A mixture of plaster-of-paris and water is useful, and it is sometimes advantageous to mix straw or hair with it. A solution of silicate of soda made into a stiff paste with carbonate of lime gets hard in six to eight hours.

Acid-proof Cements.—The asphalt compositions already mentioned, compositions of melted sulphur with fillers of stone powder, cement, sand, etc., may be used, and also the following, which withstands hydrochloric acid vapors: rosin, 1 part; sulphur, 1 part; fire-clay, 2 parts. The lute composed of boiled linseed oil and fireclay acts well with most acid vapors. The composition of glycerin and litharge previously referred to is useful in this connection, especially when made up according to the following formula: Litharge, 80 pounds; red lead, 8 pounds; “flock” asbestos, 10 pounds. It should be fed into a mixer, a little at a time, with small quantities of boiled oil (about six quarts of oil being used). Sockets in 3-inch pipes carrying nitric acid, calked with this preparation, showed no leaks in nine months.

A particularly useful cement for withstanding acid vapors, which is tough and elastic, is composed of crude rubber, cut fine, 1 part; linseed oil, boiled, 4 parts; fireclay, 6 parts. The rubber is dissolved in carbon disulphide to the consistency of molasses and is then mixed with the oil. Other acid-proof cements are as follows: “Black putty” made by carefully mixing equal portions of china-clay, gas-tar and linseed oil. The china-clay must be well dried by placing it over a boiler or by other means. Barytes cement is composed of pure, finely ground sulfate of barium, and is made into a putty with a solution of silicate of soda. This sets very hard when moderately heated, and is then proof against acids. The gravity of the silicate of soda should be between 1.2 and 1.4, 24 degrees to 42 degrees Baume. If too thin, it does not hold; and when thicker than 1.4, it expands and breaks.

Gasket Compositions.—Almost any cementing substance may be used with rings of asbestos, etc., for gaskets, but some are especially adapted for the purpose. Asphalt, tar, petroleum residuum and soft or hard pitch are recommended. Silicate of soda is much used, and is sometimes advantageously mixed with casein, fine sand, clay, carbonate of lime, caustic lime, magnesia, oxides of heavy metals, such as lead, zinc, iron and powdered barytes. A few mixtures that might be selected are: Silicate of soda and asbestos; silicate of soda, asbestos and slaked lime; silicate of soda and fine sand; silicate of soda and fireclay.

Machinists Cements.—These are also known as red and white leads. The red lead is often diluted with an equal bulk of silica or other inert substance to make it less powdery. The best way to do this is to add rubber or gutta-percha to the oil as follows: Linseed oil, 6 parts, by weight; rubber or gutta-percha, 1 part by weight. The rubber or gutta-percha is dissolved in sufficient carbon disulphide to give it the consistency of molasses, mixed with the oil, and left exposed to the air for about twenty-four hours. The red lead is then mixed to a putty. Oxide of iron makes a less brittle cement than red lead.

Leather Cements.—a) Equal parts of good hide glue and American isinglass, softened in water for ten hours and then boiled with pure tannin until the whole mass is sticky. The surface of the joint should be roughened and the cement applied hot.

b) 1 pound of finely shredded gutta-percha digested over a water-bath with 10 pounds of benzol, until dissolved, and 12 pounds of linseed oil varnish stirred in.

c) 7 $\frac{1}{2}$ pounds of finely shredded india-rubber is completely dissolved in 10 pounds of carbon disulphide by treating while hot; 1 pound of shellac and 1 pound of turpentine are added, and the hot solution heated until the two latter ingredients are also dissolved.

d) another leather cement is as follows: gutta-percha, 8 ounces; pitch, 1 ounce; shellac, 1 ounce; sweet oil, 1 ounce. These are melted together.

e) still another is as follows: fish glue is soaked in water twenty-four hours, allowed to drain for a like period, boiled well, and a previously melted mixture of 2 ounces of rosin and $\frac{1}{2}$ ounce of boiled oil is added to every two pounds of glue solution.

Iron and Stone Cements.—When finely divided iron, such as filings or cast iron borings that have been powdered, is mixed with an oxidizing agent, such as manganese dioxide, or a substance electro-negative to iron, such as sulphur, in a good conducting solution like salt or sal-ammoniac, galvanic action sets in very rapidly and the iron swells, by forming iron oxide, and cements the mass together. It is best diluted with Portland cement, the proportions being as follows: iron filings, 40 parts; manganese dioxide or flowers of sulphur, 10 parts; sal-ammoniac, 1 part; Portland cement, 23 to 40 parts; water to form a paste. A hard stone-like composition is made as follows: zinc oxide, 2 parts; zinc chloride, 1 part; water to make a paste. Magnesium oxide and chloride may also be used in like proportions. When used in considerable quantity, this cement is mixed with powdered stone, for reasons of economy, the proportions depending upon the character of the work.

Cement Proof to Hydrocarbon Gases.—Compositions of plaster and cement, the former setting more quickly, are used; also compositions of casein, such as finely powdered casein, 2 parts; fresh slaked lime, 50 parts; fine sand, 50 parts. Water is added, when used, to form a thick mass. Various mixtures of silicate of soda are employed in which the thick silicate is absorbed in some inert material such as clay, sand or asbestos.

Cements Proof to Chlorine.—The best and only reliable compositions are a few made with Portland cement, and the following is used for electrolytic and chemical plants: powdered glass, 1 part; Portland cement, 1 part; silicate of soda, 1 part; a small amount of powdered slate. This lute withstands acids and alkalies, as well as the influences of chlorine. Linseed oil made into a paste with fireclay serves for a time.

Elastic Cements.—The various cements containing rubber are elastic, if the rubber is in a predominating amount; many containing boiled linseed oil and the hektograph composition, see *Oil-proof Cements*, are quite elastic. The rubber and linseed-oil cement, given in *Acid-proof Cements* on page 3367, is very tough and useful for nearly all purposes except

when oil vapors are to be confined. The most useful single rubber lute is probably the so-called Hart's india-rubber cement. Equal parts of raw linseed oil and pure masticated rubber are digested together by heating, and this mixture is made into a stiff putty with fine "paper stock" asbestos. It is more convenient, however, to dissolve the rubber first in carbon disulphide, and, after mixing the oil with it, to let the solvent evaporate spontaneously.

General Purposes.—Plaster-of-paris, especially when mixed with straw, flush trimmings, hair, broken stone, etc., and used according to temperature strain and other conditions, is one of the most useful preparations for general purposes. A putty of flour and molasses is a good composition to keep in a works ready for quick application when needed. It serves, for a time, almost any purpose at moderate temperatures. Casein compositions have great strength. The white of an egg made into a paste with slaked lime is strong and efficient, but must be used promptly on account of its quick setting qualities.

Acid-proof Lining.—A lining for protecting tanks from the influence of acids is made from a mixture consisting of 75 parts (by weight), of pitch; 9 parts plaster-of-paris; 9 parts ochre; 15 parts beeswax; and 3 parts litharge. The tanks are covered on the inside with a thick coat of this mixture.

Cements for Pipe Joints.—A strong cement which is oil-proof, waterproof, and acid-proof, consists of a stiff paste of glycerin and litharge. These form a chemical combination which sets in a few minutes. If a little water is added, it sets more slowly, which is often an advantage. This cement is mixed when required for use.

Mixture for Threaded Pipe Joints: A good material to apply to pipe threads before making up the joints, in order to obtain a tight joint that will resist the action of gases or liquids, is made of red lead mixed with pure boiled linseed oil. This mixture has been widely used and is very satisfactory. It should have a heavy fluid-like consistency, and if applied to a clean, well-cut thread will give an excellent joint.

Shellac for Pipe Connections: Shellac has proved to be a very satisfactory substitute for lead in sealing air and gas pipe connections. It is applied with a brush to the joints and hardens very rapidly, and being brittle, the pipes can be readily disconnected.

Graphic, Litharge, Chalk Cement: A good cement for use in making steam pipe joints is made in the following manner: Grind and wash in clean cold water 15 parts of chalk and 50 parts of graphite; mix the two together thoroughly and allow to dry. When dry regrind to a fine powder, to which add 20 parts of ground litharge and mix to a stiff paste with 15 parts of boiled linseed oil. The preparation may be set aside for future use, as it will remain plastic for a long time if placed in a cool place. It is applied to the joint packing as any ordinary cement.

White and Red Lead Mixture: Mix in ordinary white lead, enough powdered red lead to make a paste the consistency of putty. Spread this mixture on the joint, and when it hardens, the joint will be water tight. This mixture was used on stand-pipe flanges after testing all kinds of rubber gaskets without success. The mixture hardened and made a tight joint, never leaking afterward.

Adhesives and Sealants

Adhesives Bonding.—By strict definition, an adhesive is any substance that fastens or bonds materials to be joined (adherends) by means of surface attachment. However, besides bonding a joint, an adhesive may serve as a seal against attack by or passage of foreign materials. When an adhesive performs both bonding and sealing functions, it is usually called an adhesive sealant.

Where the design of an assembly permits, bonding with adhesives can replace bolting, welding, and riveting. When considering other fastening methods for thin cross-sections, the joint loads might be of such an unacceptable concentration that adhesives bonding may provide the only viable alternative. Properly designed adhesive joints can minimize or

eliminate irregularities and breaks in the contour of an assembly. Adhesives can also serve as dielectric insulation. An adhesive with dielectric properties can act as a barrier against galvanic corrosion when two dissimilar metals such as aluminum and magnesium are joined together. Conversely, adhesive products are available which also conduct electricity.

An adhesive can be classified as structural or non-structural. Agreement is not universal on the exact separation between both classifications. But, in a general way, an adhesive can be considered structural when it is capable of supporting heavy loads; non-structural when it cannot. Most adhesives are found in liquid, paste, or granular form, though film and fabric-backed tape varieties are available. Adhesive formulations are applied by brush, roller, trowel, or spatula. If application surfaces are particularly large or if high rates of production are required, power-fed flow guns, brushes, or sprays can be used.

The hot-melt adhesives are relatively new to the assembly field. In general, they permit fastening speeds that are much greater than water- or solvent-based adhesives. Supplied in solid form, the hot-melts liquefy when heated. After application, they cool quickly, solidifying and forming the adhesive bond. They have been used successfully for a wide variety of adherends, and can greatly reduce the need for clamping and lengths of time for curing storage.

If an adhesive bonding agent is to give the best results, time restrictions recommended by the manufacturer, such as shelf life and working life must be observed. The shelf life is considered as the period of time an adhesive can be stored after its manufacture. Working or "pot" life is the span of time between the mixing or making ready of an adhesive, on the job, and when it is no longer usable.

The actual performance of an adhesive-bonded joint depends on a wide range of factors, many of them quite complex. They include: the size and nature of the applied loads; environmental conditions such as moisture or contact with other fluids or vapors; the nature of prior surface treatment of adherends; temperatures, pressures and curing times in the bonding process.

A great number of adhesives, under various brand names, may be available for a particular bonding task. However, there can be substantial differences in the cost of purchase and difficulties in application. Therefore, it is always best to check with manufacturers' information before making a proper choice. Also, testing under conditions approximating those required of the assembly in service will help assure that joints meet expected performance.

Though not meant to be all-inclusive, the information which follows correlates classes of adherends and some successful adhesive compositions from the many that can be readily purchased.

Bonding Metal: Epoxy resin adhesives perform well in bonding metallic adherends. One type of epoxy formulation is a two-part adhesive which can be applied at room temperature. It takes, however, seven days at room temperature for full curing, achieving shear strengths as high as 2500 psi (17.2 MPa). Curing times for this adhesive can be greatly accelerated by elevating the bonding temperature. For example, curing takes only one hour at 160°F (71°C).

A structural adhesive-filler is available for metals which is composed of aluminum powder and epoxy resin. It is made ready by adding a catalyst to the base components, and can be used to repair structural defects. At a temperature of 140°F (60°C) it cures in approximately one hour. Depending on service temperatures and design of the joint, this adhesive-filler is capable of withstanding flexural stresses above 10,000 psi (69 MPa), tension above 5,000 psi (34 MPa), and compression over 30,000 psi (207 MPa).

Many non-structural adhesives for metal-to-metal bonding are also suitable for fastening combinations of types of materials. Polysulfide, neoprene, or rubber-based adhesives are used to bond metal foils. Ethylene cellulose cements, available in a selection of colors, are used to plug machined recesses in metal surfaces, such as with screw insets. They harden

within 24 hours. Other, stronger adhesive fillers are available for the non-structural patching of defects in metallic parts. One variety, used for iron and steel castings, is a cement that combines powdered iron with water-activated binding agents. The consistency of the prepared mix is such that it can be applied with a trowel and sets within 24 hours at room temperature. The filler comes in types that can be applied to both dry and wet castings, and is able to resist the quick changes of temperature during quenching operations.

Polyester cement can replace lead and other fillers for dents and openings in sheet metal. One type, used successfully on truck and auto bodies, is a two-part cement consisting of a paste resin that can be combined with a paste or powder extender. It is brushed or trowelled on, and is ready for finishing operations in one hour.

Adhesives can be used for both structural and non-structural applications which combine metals with non-metals. Structural polyester-based adhesives can bond reinforced plastic laminates to metal surfaces. One type has produced joints, between glass reinforced epoxy and stainless steel, that have tensile strengths of over 3000 psi (21 MPa). Elevated temperature service is not recommended for this adhesive. However, it is easily brushed on and bonds under slight pressure at room temperature, requiring several days for curing. The curing process accelerates when heat is added in a controlled environment, but there results a moderate reduction in tensile strength.

Low-density epoxy adhesives are successful in structurally adhering light plastics, such as polyurethane foam, to various metals. Applied by brush or spatula, the bonds cure within 24 hours at room temperatures

Metals can be bonded structurally to wood with a liquid adhesive made up of neoprene and synthetic resin. For the best surface coverage, the adhesive should be applied in a minimum of two coats. The joints formed are capable of reaching shear stresses of 125 psi, and can gain an additional 25 percent in shear strength with the passage of time. This adhesive also serves as a strong, general purpose bonding agent for other adherend combinations, including fabrics and ceramics.

For bonding strengths in shear over 500 psi (3.4 MPa) and at service temperatures slightly above 160°F (71°C), one- and two-part powder and jelly forms of metal-to-wood types are available.

Besides epoxy formulations, there are general purpose rubber, cellulose, and vinyl adhesives suitable for the non-structural bonding of metals to other adherends, which include glass and leather. These adhesives, however, are not limited only to applications in which one of the adherends is metal. The vinyl and cellulose types have similar bonding properties, however the vinyls are less flammable and are weaker in resistance to moisture than the comparable cellulose types. Rubber-based adhesives, in turn, have good resistance to moisture and lubricating oil. They can form non-structural bonds between metal and rubber.

One manufacturer has produced an acrylic-based adhesive that is highly suitable for rapidly bonding metal with other adherends at room temperature. For some applications it can be used as a structural adhesive, in the absence of moisture and high temperature. It cures within 24 hours and can be purchased in small bottles with dispenser tips.

A two-part epoxy adhesive is commercially available for non-structural bonding of joints or for patchwork in which one of the adherends is metal. Supplied in small tubes, it performs well even when temperatures vary between -50° to 200°F (-46° to 93°C). However, it is not recommended for use on assemblies that may experience heavy vibrations.

Bonding Plastic: Depending on the type of resin compound used in its manufacture, a plastic material can be classified as one of two types: a thermoplastic or a thermoset.

Thermoplastic materials have the capability of being repeatedly softened by heat and hardened by cooling. Common thermoplastics are nylon, polyethylene, acetal, polycarbonate, polyvinyl chloride, cellulose nitrate and cellulose acetate. Also, solvents can easily dissolve a number of thermoplastic materials. Because of these physical and chemical

characteristics of thermoplastics, heat or solvent welding may in many instances offer a better bonding alternative than adhesives.

Thermoplastics commonly require temperatures between 200° and 400°F (93° and 204°C) for successful heat welding. However, if the maximum temperature limit for a particular thermoplastic formulation is exceeded, the plastic material will experience permanent damage. Heat can be applied directly to thermoplastic adherends, as in hot-air welding. More sophisticated joining techniques employ processes in which the heat generated for fusing thermoplastics is activated by electrical, sonic, or frictional means.

In the solvent welding of thermoplastics, solvent is applied to the adherend surfaces with the bond forming as the solvent dries. Some common solvents for thermoplastics are: a solution of phenol and formic acid for nylon; methylene chloride for polycarbonate; and methyl alcohol for the cellulose.

Many adhesive bonding agents for thermoplastics are “dope” cements. Dope or solvent cements combine solvent with a base material that is the same thermoplastic as the adherend. One type is used successfully on polyvinyl chloride water (PVC) pipe. This liquid adhesive, with a polyvinyl chloride base, is applied in at least two coats. The pipe joint, however, must be closed in less than a minute after the adhesive is applied. Resulting joint bonds can resist hydrostatic pressures over 400 psi (28 MPa), for limited periods, and also have good resistance to impact.

Previously mentioned general purpose adhesives, such as the cellulose, vinyls, rubber cements, and epoxies are also used successfully on thermoplastics.

Thermoset plastics lack the fusibility and solubility of the thermoplastics and are usually joined by adhesive bonding. The phenolics, epoxies, and alkyds are common thermoset plastics. Epoxy-based adhesives can join most thermoset materials, as can neoprene, nitrile rubber, and polyester-based cements. Again, these adhesives are of a general purpose nature, and can bond both thermoplastics and thermosets to other materials which include ceramics, fabric, wood, and metal.

Bonding Rubber: Adhesives are available commercially which can bond natural, butyl, nitrile, neoprene, and silicone rubbers. Natural and synthetic rubber cements will provide flexible joints; some types resist lubricating and other oils. Certain general purpose adhesives, such as the acrylics or epoxies, can bond rubber to almost anything else, though joints will be rigid. Depending on the choice of adhesive as well as adherend types, the bonds can carry loadings that vary from weak non-structural to mild structural in description. One type of natural rubber with a benzene-naphtha solvent can resist shear stresses to 1252.5 psi (83 kPa).

Bonding Wood: Animal glues, available in liquid and powder form, are familiar types of wood-to-wood adhesives, commonly used in building laminated assemblies. Both forms, however, require heavy bonding pressures for joints capable of resisting substantial loadings. Also, animal glues are very sensitive to variations in temperature and moisture.

Casein types of adhesive offer moderate resistance to moisture and high temperature, but also require heavy bonding pressures, as much as 200 psi, for strong joints. Urea resin adhesives also offer moderate weather resistance, but are good for bonding wood to laminated plastics as well as to other wooden adherends. For outdoor service, under severe weather conditions, phenol-resorcinol adhesives are recommended.

Vinyl-acetate emulsions are excellent for bonding wood to other materials that have especially non-porous surfaces, such as metal and certain plastic laminates. These adhesives, too, tend to be sensitive to temperature and moisture, but are recommended for wooden pattern making.

Rubber, acrylic, and epoxy general-purpose adhesives also perform well with wood and other adherend combinations. Specific rubber-based formulations resist attack by oil.

Fabric and Paper Bonding: The general purpose adhesives, which include the rubber cements and epoxies previously mentioned, are capable of bonding fabrics together and

fabrics with other adherend materials. A butadiene-acrylonitrile adhesive, suitable also for fastening metals, glass, plastic, and rubber, forms joints in fabric that are highly resistant to oil and which maintain bonding strength at temperatures up to 160°F (70°C). This adhesive, however, requires a long curing period, the first few hours of which are at an elevated temperature.

Commonly, when coated fabric materials must be joined, the base material forming the suitable adhesive is of the same type as that protecting the fabric. For example, a polyvinyl chloride-based adhesive is acceptable for vinyl-coated fabrics; and neoprene-based cements for neoprene-coated materials.

Rubber cements, gum mucilages, wheat pastes, and wood rosin adhesive can join paper as well as fabric assemblies. Solvent-based rosins can be used on glass and wood also. Rosin adhesives can also be treated as hot-melt adhesives for rapid curing. Generally, the rosins are water resistant, but usually weak against attack by organic solvents.

Sealants.—Normally, the primary role of a sealant composition is the prevention of leakage or access by dust, fluid, and other materials in assembly structures. Nevertheless, many products are currently being manufactured that are capable of performing additional functions. For example, though a sealant is normally not an adhesive, there exists a family of adhesive sealants which in varying degrees can bond structural joints as well. Besides resisting chemical attack, some sealant surface coatings can protect against physical wear. Sealants can also dampen noise and vibration, or restrict the flow of heat or electricity. Many sealant products are available in decorative tints that can help improve the appearance of an assembly.

Most sealants tend to be limited by the operating temperatures and pressures under which they are capable of sustained performance. Also, before a suitable choice of sealant formulation is made, other properties have to be examined; these include: strength of the sealant; its degree of rigidity; ease of repair; curing characteristics; and even shelf and working life.

Dozens of manufacturers supply hundreds of sealant compounds, a number of which may fill the requirements for a particular application. The following information, however, lists common uses for sealants, along with types of compositions that have been employed successfully within each category.

Gasket Materials: Silicone rubber gasket compositions are supplied in tubes in a semi-liquid form ready for manual application. They can also be obtained in larger containers for power-fed applications. Suppliers offer a silicone rubber-based composition that can replace preformed paper, cork, and rubber gaskets for many manufacturing operations. This composition has performed successfully in sealing water pumps, engine filter housings, and oil pans. It can also seal gear housings and other joints that require a flexible gasket material that besides resisting shock can sustain large temperature changes. Silicone rubber compositions can withstand temperatures that vary from -100°F to 450°F (-73°C to 232°C).

Gasket tapes, ropes, and strips can also be readily purchased to fit many assembly applications. One type of sealant tape combines a pressure-sensitive adhesive with a strip of silicone-rubber sponge. This tape has good cushioning properties for vibration damping and can stick to metal, plastic, ceramic, and glass combinations.

TFE-based gasketing strips are also available. This non-stick gasketing material can perform at pressures up to 200 psi (1.4 MPa) and temperatures to 250°F (120°C). Because of the TFE base, the strip does not adhere to or gum joint surfaces.

Sealing Pipe Joints: Phenolic-based sealants can seal threaded joints on high-pressure steam lines. One type, that is available in liquid or paste form, resists pressure up to 1200 psi (8.3 MPa) and temperatures to 950°F (510°C). This compound is brushed on and the joint closed and tightened to a torque of 135 in.-lb. (15.3 N m). The connection is then subjected to a 24-hour cure with superheated steam.

The joining and sealing of plastic pipe is covered under the previous adhesives bonding section.

Sulfur-based compounds, though lacking the durability of caulking lead, can be used on bell and spigot sewer pipe. Available in a formulation that can resist temperatures up to 200°F (93°C), one sulfur-based sealant is applied as a hot-melt and allowed to flow into the bell and spigot connection. It quickly solidifies at room temperature, and can develop a joint tensile strength over 300 psi (2.1 MPa).

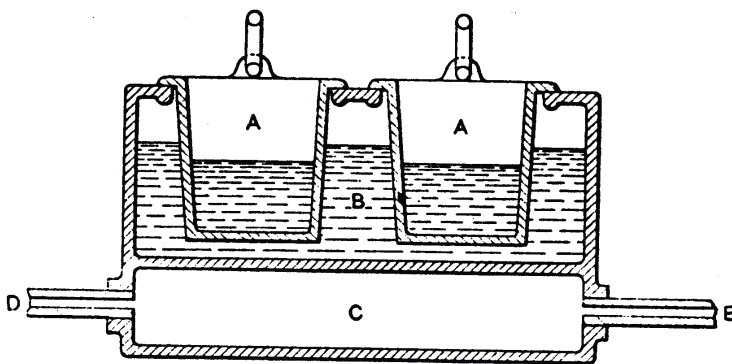
There are asphalt, coal-tar and plastic-based compositions that can be used on both cast-iron and ceramic bell and spigot pipe. Portland cement mortars also seal ceramic piping.

Waterproof Compositions.—The asphalt fluid coatings for reservoir walls, concrete foundations, brick, wood, etc., are often of use to engineers. Asphalt only partly dissolves in petroleum naphtha, but when heated in a steam-jacketed kettle and not thinned out too much, a mixture of the two may be obtained in which the part of the asphalt not dissolved is held in suspension. Asphalt is entirely soluble in benzol or toluol, which are about the cheapest solvents for all the constituents of asphalt. Tar and pitch are sometimes used in this connection, but tar contains water, light oils, and free carbon, and does not wear as well as good refined asphalt; pitch also contains free carbon, which is sometimes objectionable when it is thinned out with a solvent. Asphalt alone is somewhat pervious to water, but it can be improved in this respect by adding about one-fourth its weight of paraffin; it is also well to add a little boiled linseed oil. For thicker compositions, where body is required, asbestos, stone powder, cement, etc., may be added as fillers. Lutes of linseed oil thickened with clay, asbestos, red or white lead, etc., are waterproof if made thick enough. These are much used for steam joints. Flaxseed meal made into a paste with water is often serviceable, the oil contained serving as a binder as the water evaporates.

Marine Glue.—Marine glue, proof against the action of salt water, consists of 1 part of crude rubber, 2 parts of shellac, and 3 parts of pitch. The rubber is first dissolved in carbon disulphide or turpentine, and is then mixed with the heated combination of the two other ingredients.

Glues for Wood.—The glues that are adapted for gluing wood according to a report of the Forest Products Laboratory, U. S. Forest Service, Madison, Wis., may be conveniently divided into five classes as follows:

1. Animal glues, which are made from the hides, hoofs, horns, bones, and fleshings of animals, mostly cattle. These glues come in dry form, and must be mixed with water and melted.
2. Casein glues, which are made from casein, lime, and certain other chemical ingredients. They are commonly sold in prepared form, requiring only the addition of water, but may be mixed by the addition of the separate materials to the water.



Steam Glue Heater

3. Vegetable glues, which are made from starch, usually cassava starch, and sold in powdered form. They may be mixed cold with water and alkali, but heat is commonly used in their preparation.

4. Blood-albumin glues, which are made from soluble blood albumin, a product recovered from the blood of animals. These glues must be mixed just before use, since they deteriorate rapidly on standing.

5. Liquid glues, which are commonly made from the heads, skins, bones, and swimming bladders of fish. Some liquid glues are made from animal glue and from other materials. They come in prepared form ready for immediate use.

Animal Glue: Animal glue, frequently referred to as "hotglue," is familiar to all woodworkers. The principal desirable properties of animal glue are its great strength and reliability in the higher grades, its free-flowing consistency, and the fact that it does not stain wood. So far no glue has been found to be as suitable as animal glue for handspreading on irregular shaped joints. The price of animal glue is the chief factor that limits its use. The fact that it is not highly water-resistant is occasionally a drawback.

Casein Glue: Casein glue has sufficient strength for either veneer or joint work. It is used cold, and when properly mixed it can be spread with a brush. The property most featured is its high water-resistance, which makes it suitable for gluing articles to be used under moist conditions. Not all casein glues are water-resistant, however; there are some on the market which are made to compete with vegetable glue, and for which no great water-resistance is claimed. Among the disadvantages of casein glues are their tendency to stain thin veneer and the relatively short working life of some kinds. It is claimed that this trouble has been overcome to a certain extent in some glues. They are somewhat harder on tools than animal and vegetable glues.

Vegetable Glue: Vegetable glues have found wide use because they are cheap, can be used cold, and remain in good working condition free from decomposition for many days. They are extremely viscous, and it is not practicable to spread them by hand. Their lack of water-resistance and the fact that they usually cause staining in thin fancy veneer are factors limiting their use. They set relatively slowly, and for this reason are not so well adapted for joint work.

Blood-albumin Glue: Blood-albumin glue has shown notably high resistance to moisture, especially in the boiling test. This makes it particularly suitable for gluing plywood which is later to be softened in hot water and molded. The production of molded plywood articles has been very limited, but it offers a good field for future development. In the past the chief drawback to the use of blood glues has been the necessity for hot-pressing, but tests have shown that a highly water-resistant blood glue may be developed which can be cold-pressed successfully.

Liquid Glue: Liquid glues are, in general, similar in properties to animal glue. Some brands are quite equal in strength to good joint glues, but other brands are very weak and unreliable. Their great advantage is that they come in prepared form, ready for immediate use. This makes them particularly suitable for patch work and small gluing jobs. The factors that limit their use are their high price, their lack of water-resistance, and the difficulty in distinguishing between good and poor brands.

Veneer and Joint Glues: Generally speaking, present vegetable and blood-albumin glues are veneer glues, while animal and casein glues are used both as veneer and as joint glues. As between animal and casein glue for joint work, if freedom from staining is important, animal glue is preferable; if water-resistance is of importance, then a casein glue should be selected. Because of the necessity of heat in the preparation and use of animal glue, the casein cold glue will probably be favored if both glues are otherwise equally well adapted.

Rust Prevention.—When the atmosphere, sea water, acids, or similar substances with which iron or steel comes into contact, attack the iron by forming oxides or rust upon its surface, corrosion is said to take place. Iron and steel cannot stand exposure to the atmosphere, particularly when excessive moisture is contained in the air, for any length of time,

without the protection of some covering or coating which excludes the moisture and which, in itself, is not attacked by the influence of the atmosphere. The various preventives which follow have been recommended by different men in the mechanical field.

Resin and Oil: Melt 4 ounces of resin in 1 quart of linseed oil and mix with 2 gallons of kerosene oil. The mixture is readily applied with a cloth or brush, and can be easily removed.

Caoutchouc, Turpentine and Oil: To preserve steel from rust, dissolve 1 part caoutchouc and 16 parts turpentine with a gentle heat, then add 8 parts boiled oil, and mix by bringing them to the heat of boiling water. Apply to the steel with a brush, the same as varnish. It can be removed again with a cloth soaked in turpentine.

Varnish and Turpentine: To make a mixture that will prevent hardware and machinists' tools from rusting, take one-half pint of Demar white varnish and mix it well with one gallon of turpentine. When the polished surfaces are thoroughly covered with a thin coat, the varnish will scarcely show, but will preserve the polish for years, if it is not scraped off with something very hard.

Vaseline and Blue Ointment: In one pound of vaseline melt 2 ounces of blue ointment—what druggists call one-third—and add, to give it a pleasant odor, a few drops of oil of wintergreen, cinnamon, or sassafras. When thoroughly mixed, pour into a tin can.

Alcohol and Sperm Oil: To make a preservative oil, use high test grain alcohol and best grade of sperm oil, equal parts. Keep in a tightly-corked bottle, and shake well before using, as the alcohol and oil separate after standing. Any moisture on a tool or gun at the time of application is quickly absorbed by the alcohol, which in a short time evaporates, leaving a good coat of sperm oil to protect the surface from rust.

Soda Solution: Rust formation takes place on tools within a few hours after they have been hardened in brine or in any of the numerous hardening solutions containing different salts used for this purpose. To counteract this rusting of tools, they should be boiled in a strong solution of soda water for fifteen or twenty minutes after having been hardened. Sal soda (common washing soda) is the kind to use for the solution. A kettle holding about six or eight gallons of water may be used. About five pounds of soda are put in at the start, and after that about one to one and one-half pounds is added every day. In this way the strength of the solution is kept about right.

The addition of soda is necessary on account of the overflow which is required because of the method used for heating, the solution being brought to the boiling point by introducing steam. The work should always be boiled before being put into the tempering furnace and the latter should be at a temperature of about 212 degrees F., when the tools are changed from the soda kettle to the furnace. A basket arrangement with windlass may be used for raising and lowering the work, to prevent scalding the hands. The direction given, if followed, will prove of advantage in hardening and tempering tools, in that the formation of rust will be prevented.

Oil and Graphite: To prevent screws from getting rusty and sticking tight, instead of using ordinary oil only, add some graphite. After years you will be able to unscrew them with ease, and find them as bright as new, even if they have been exposed to very damp air.

Camphor, Lard and Black Lead: A formula for an anti-rust compound is made as follows: Dissolve 1 ounce of camphor in 1 pound of melted lard; take off the scum, and mix in as much fine black lead as will give it color. Clean the machinery, and smear it with the mixture, and after 24 hours rub clean with a soft linen cloth. The machinery will keep clean, under ordinary circumstances, for a long time.

White Lead and Tallow: In order to keep white lead and tallow soft in winter and summer alike, so that it can be applied with a brush to finished parts of machinery before shipping them, and for use in fitting keys, etc., prepare a mixture composed of five pounds of white lead and fifteen pounds of tallow. Heat this in a suitable receptacle, and stir until the ingredients are thoroughly mixed. Then remove the mixture to a cool place, and add two quarts of linseed oil, continuing to stir the composition until it becomes cold, as otherwise the

white lead will settle at the bottom. This mixture will always remain of the same consistency at all temperatures.

Red-lead Paint for Structural Steel: Structural steel is generally protected from rust by painting. A rust-retarding coat of paint may be suitably compounded from red lead mixed with pure linseed oil. The average stock mixture consists of from 25 to 30 pounds of red lead to a gallon of oil. This mixture can be reduced to the proper consistency at the time of application. A small amount of turpentine added to this brush coating will greatly assist in its manipulation, and will also provide for proper penetration. Red lead should be mixed at the time of its application, as it settles quite readily, being an extremely heavy pigment.

Keys and Keyways

British Standard Metric Keys and Keyways.—This British Standard, BS 4235:Part 1:1972 (R1986), covers square and rectangular parallel keys and keyways, and square and rectangular taper keys and keyways. Plain and gib-head taper keys are specified. There are three classes of fit for the square and rectangular parallel keys and keyways, designated free, normal, and close. A *free fit* is applied when the application requires the hub of an assembly to slide over the key; a *normal fit* is employed when the key is to be inserted in the keyway with the minimum amount of fitting, as may be required in mass-production assembly work; and a *close fit* is applied when accurate fitting of the key is required under maximum material conditions, which may involve selection of components.

The Standard does not provide for misalignment or offset greater than can be accommodated within the dimensional tolerances. If an assembly is to be heavily stressed, a check should be made to ensure that the cumulative effect of misalignment or offset, or both, does not prevent satisfactory bearing on the key. Radii and chamfers are not normally provided on keybar and keys as supplied, but they can be produced during manufacture by agreement between the user and supplier.

Unless otherwise specified, keys in compliance with this Standard are manufactured from steel made to BS 970 having a tensile strength of not less than 550 MN/m² in the finished condition. BS 970, Part 1, lists the following steels and maximum section sizes, respectively, that meet this tensile strength requirement: 070M20, 25 × 14 mm; 070M26, 36 × 20 mm; 080M30, 90 × 45 mm; and 080M40, 100 × 50 mm.

At the time of publication of this Standard, the demand for metric keys was not sufficient to enable standard ranges of lengths to be established. The lengths given in the accompanying table are those shown as standard in ISO Recommendations R773: 1969, “Rectangular or Square Parallel Keys and their Corresponding Keyways (Dimensions in Millimeters),” and R 774: 1969, “Taper Keys and their Corresponding Keyways—with or without Gib Head (Dimensions in Millimeters).”

Tables 1 through 4 on the following pages cover the dimensions and tolerances of square and rectangular keys and keyways, and square and rectangular taper keys and keyways. Table 5 on page 3382 provides preferred lengths of metric keys.

Table 1. British Standard Metric Keyways for Square and Rectangular Parallel Keyways BS 4235:Part 1:1972 (1986)

Shaft		Key		Keyway										
Over	Up to and Incl	Size, $b \times h$	Nominal	Width, b					Depth				Radius r	
				Free Fit		Normal Fit		Close Fit	Shaft t_1		Hub t_2		Max.	Min.
				Shaft (H9)	Hub (D10)	Shaft (N9)	Hub (J_s9^a)	Shaft and Hub (P9)	Nominal	Tolerance	Nominal	Tolerance		
Tolerances														
Keyways for Square Parallel Keys														
6	8	2 × 2	2	+0.025	+0.060	-0.004	+0.012	-0.006	1.2	} +0.1 0	1	} +0.1 0	0.16	0.08
8	10	3 × 3	3	0	+0.020	-0.029	-0.012	-0.031	1.8		1.4		0.16	0.08
10	12	4 × 4	4	} +0.030 0	+0.078 +0.030	0 -0.030	+0.015 -0.015	-0.012 -0.042	2.5	} +0.1 0	1.8	} +0.1 0	0.16	0.08
12	17	5 × 5	5						3		2.3		0.25	0.16
17	22	6 × 6	6						3.5		2.8		0.25	0.16
Keyways for Rectangular Parallel Keys														
22	30	8 × 7	8	+0.036	+0.098	0	+0.018	-0.015	4	} +0.2 0	3.3	} +0.2 0	0.25	0.16
30	38	10 × 8	10	0	+0.040	-0.036	-0.018	-0.051	5		3.3		0.40	0.25
38	44	12 × 8	12	} +0.043 0	+0.120 +0.050	0 -0.043	+0.021 -0.021	-0.018 -0.061	5	} +0.2 0	3.3	} +0.2 0	0.40	0.25
44	50	14 × 9	14						5.5		3.8		0.40	0.25
50	58	16 × 10	16	} +0.052 0	+0.149 +0.065	0 -0.052	+0.026 -0.026	-0.022 -0.074	6	} +0.2 0	4.3	} +0.2 0	0.40	0.25
58	65	18 × 11	18						7		4.4		0.40	0.25
65	75	20 × 12	20	} +0.062 0	+0.180 -0.080	0 -0.062	+0.031 -0.031	-0.026 -0.088	7.5	} +0.3 0	4.9	} +0.3 0	0.60	0.40
75	85	22 × 14	22						9		5.4		0.60	0.40
85	95	25 × 14	25	} +0.074 0	+0.220 +0.100	0 -0.074	+0.037 -0.037	-0.032 -0.106	9	} +0.3 0	5.4	} +0.3 0	0.60	0.40
95	110	28 × 16	28						10		6.4		0.60	0.40
110	130	32 × 18	32	} +0.087 0	+0.260 +0.120	0 -0.087	+0.043 -0.043	-0.037 -0.124	11	} +0.3 0	7.4	} +0.3 0	0.60	0.40
130	150	36 × 20	36						12		8.4		1.00	0.70
150	170	40 × 22	40	} +0.087 0	+0.260 +0.120	0 -0.087	+0.043 -0.043	-0.037 -0.124	13	} +0.3 0	9.4	} +0.3 0	1.00	0.70
170	200	45 × 25	45						15		10.4		1.00	0.70
200	230	50 × 28	50	} +0.087 0	+0.260 +0.120	0 -0.087	+0.043 -0.043	-0.037 -0.124	17	} +0.3 0	11.4	} +0.3 0	1.00	0.70
230	260	56 × 32	56						20		12.4		1.60	1.20
260	290	63 × 32	63	} +0.087 0	+0.260 +0.120	0 -0.087	+0.043 -0.043	-0.037 -0.124	20	} +0.3 0	12.4	} +0.3 0	1.60	1.20
290	330	70 × 36	70						22		14.4		1.60	1.20
330	380	80 × 40	80	} +0.087 0	+0.260 +0.120	0 -0.087	+0.043 -0.043	-0.037 -0.124	25	} +0.3 0	15.4	} +0.3 0	2.50	2.00
380	440	90 × 45	90						28		17.4		2.50	2.00
440	500	100 × 50	100						31		19.5		2.50	2.00

^aTolerance limits J_s9 are quoted from BS 4500, "ISO Limits and Fits," to three significant figures. All dimensions in millimeters.

Table 2. British Standard Metric Square and Rectangular Parallel Keys BS 4235:Part 1:1972 (1986)

Width <i>b</i>		Thickness, <i>h</i>		Chamfer, <i>s</i>		Length Range, <i>l</i>	
Nom.	Tol. ^a	Nom.	Tol. ^a	Min.	Max.	From	To
Square Parallel Keys							
2	} 0 -0.025	2	} 0 -0.025	0.16	0.25	6	20
3		3		0.16	0.25	6	36
4	} 0 -0.030	4	} 0 -0.030	0.16	0.25	8	45
5		5		0.25	0.40	10	56
6		6		0.25	0.40	14	70
Rectangular Parallel Keys							
8	} 0 -0.036	7	} 0 -0.090	0.25	0.40	18	90
10		8		0.40	0.60	22	110
12	} 0 -0.043	9	} 0 -0.110	0.40	0.60	28	140
14		10		0.40	0.60	36	160
16		11		0.40	0.60	45	180
18		12		0.60	0.80	50	200
20	} 0 -0.052	14	} 0 -0.130	0.60	0.80	56	220
22		14		0.60	0.80	63	250
25		16		0.60	0.80	70	280
28	} 0 -0.062	18	} 0 -0.160	0.60	0.80	80	320
32		20		0.60	0.80	90	360
36		22		1.00	1.20	100	400
40		25		1.00	1.20
45		28		1.00	1.20
50	} 0 -0.074	32	} 0 -0.160	1.00	1.20
56		32		1.60	2.00
63		36		1.60	2.00
70		40		1.60	2.00
80	} 0 -0.087	45	} 0 -0.160	2.50	3.00
90		50		2.50	3.00
100				2.50	3.00

^a The tolerance on the width and thickness of square taper keys is h9, and on the width and thickness of rectangular keys, h9 and h11, respectively, in accordance with ISO metric limits and fits. All dimensions in millimeters.

Table 3. British Standard Metric Keyways for Square and Rectangular Taper Keyways BS 4235:Part 1:1972 (1986)

Shaft		Key		Keyway									
Nominal Diameter d		Size, $b \times h$	Width b , Shaft and Hub		Depth				Corner Radius of Keyway				
Over	Up to and Incl.		Nom.	Tol. (D10)	Shaft t_1		Hub t_2		Max.	Min.			
Keyways for Square Taper Keys													
6	8	2 × 2	2	}	+0.060	1.2	}	+0.1	0.5	}	+0.1	0.16	0.08
8	10	3 × 3	3		+0.020	1.8		0	0.9		0	0.16	0.08
10	12	4 × 4	4	}	+0.078 +0.030	2.5	}	+0.1	1.2	}	0	0.16	0.08
12	17	5 × 5	5			3			1.7			0.25	0.16
17	22	6 × 6	6			3.5			+0.2 0			2.2	+0.2 0
Keyways for Rectangular Taper Keys													
22	30	8 × 7	8	}	+0.098	4	}	+0.2 0	2.4	}	+0.2 0	0.25	0.16
30	38	10 × 8	10		+0.040	5			2.4			0.40	0.25
38	44	12 × 8	12	}	+0.120 +0.050	5	}	+0.2 0	2.4	}	+0.2 0	0.40	0.25
44	50	14 × 9	14			5.5			2.9			0.40	0.25
50	58	16 × 10	16			6			3.4			0.40	0.25
58	65	18 × 11	18	}	+0.149 +0.065	7	}	+0.2 0	3.4	}	+0.2 0	0.40	0.25
65	75	20 × 12	20			7.5			3.9			0.60	0.40
75	85	22 × 14	22	}	+0.180 +0.080	9	}	+0.3 0	4.4	}	+0.3 0	0.60	0.40
85	95	25 × 14	25			9			4.4			0.60	0.40
95	110	28 × 16	28			10			5.4			0.60	0.40
110	130	32 × 18	32	}	+0.220 +0.120	11	}	+0.3 0	6.4	}	+0.3 0	0.60	0.40
130	150	36 × 20	36			12			7.1			1.00	0.70
150	170	40 × 22	40	}	+0.260 +0.120	13	}	+0.3 0	8.1	}	+0.3 0	1.00	0.70
170	200	45 × 25	45			15			9.1			1.00	0.70
200	230	50 × 28	50			17			10.1			1.00	0.70
230	260	56 × 32	56	}	+0.220 +0.120	20	}	+0.3 0	11.1	}	+0.3 0	1.60	1.20
260	290	63 × 32	63			20			11.1			1.60	1.20
290	330	70 × 36	70	}	+0.260 +0.120	22	}	+0.3 0	13.1	}	+0.3 0	1.60	1.20
330	380	80 × 40	80			25			14.1			2.50	2.00
380	440	90 × 45	90			28			16.1			2.50	2.00
440	500	100 × 50	100	}	+0.260 +0.120	31	}	+0.3 0	18.1	}	+0.3 0	2.50	2.00

All dimensions in millimeters.

Table 4. British Standard Metric Square and Rectangular Taper Keys BS 4235:Part 1:1972 (1986)

Width b		Thickness h		Chamfer s		Length Range l		Gib head h_1	Radius r
Nom.	Tol. ^a	Nom.	Tol. ^a	Min.	Max.	From	To	Nom.	Nom.
Square Taper Keys									
2	0	2	0	0.16	0.25	6	20
3	-0.025	3	-0.025	0.16	0.25	6	36
4	0	4	0	0.16	0.25	8	45	7	0.25
5	-0.030	5	-0.030	0.25	0.40	10	56	8	0.25
6		6		0.25	0.40	14	70	10	0.25
Rectangular Taper Keys									
8	0	7		0.25	0.40	18	90	11	1.5
10	-0.036	8		0.40	0.60	22	110	12	1.5
12		8	0	0.40	0.60	28	140	12	1.5
14		9	-0.090	0.40	0.60	36	160	14	1.5
16	-0.043	10		0.40	0.60	45	180	16	3.2
18		11		0.40	0.60	50	200	18	3.2
20		12		0.60	0.80	56	220	20	3.2
22	0	14	0	0.60	0.80	63	250	22	3.2
25	-0.052	14	-0.110	0.60	0.80	70	280	22	3.2
28		16		0.60	0.80	80	320	25	3.2
32		18		0.60	0.80	90	360	28	6.4
36		20		1.00	1.20	100	400	32	6.4
40	0	22	0	1.00	1.20	36	6.4
45	-0.062	25	-0.130	1.00	1.20	40	6.4
50		28		1.00	1.20	45	6.4
56		32		1.60	2.00	50	9.5
63	0	32		1.60	2.00	50	9.5
70	-0.074	36	0	1.60	2.00	56	9.5
80		40	-0.160	2.50	3.00	63	9.5
90	0	45		2.50	3.00	70	9.5
100	-0.087	50		2.50	3.00	80	9.5

^aThe tolerance on the width and thickness of square taper keys is h9, and on the width and thickness of rectangular taper keys, h9 and h11 respectively, in accordance with ISO metric limits and fits. Does not apply to gib head dimensions.

British Standard Keys and Keyways, Inch.—Tables 6 through 11 from BS 46:Part 1:1958 (1985) (obsolescent) provide data for rectangular parallel keys and keyways, square parallel keys and keyways, plain and gib head rectangular taper keys and keyways, plain and gib head square taper keys and keyways, and Woodruff keys and keyways.

Parallel Keys: These keys are used for transmitting unidirectional torques in transmissions not subject to heavy starting loads and where periodic withdrawal or sliding of the hub member may be required. In many instances, particularly couplings, a gib-head cannot be accommodated, and there is insufficient room to drift out the key from behind. It is then necessary to withdraw the component over the key and a parallel key is essential. Parallel square and rectangular keys are normally side fitting with top clearance and are usually retained in the shaft rather more securely than in the hub. The rectangular key is the gen-

Table 5. Preferred Lengths of Metric Keys BS 4235:Part 1:1972 (1986)

Length	Type of key				Length	Type of key			
	Sq.	Rect.	Sq. Taper	Rect. Taper		Sq.	Rect.	Sq. Taper	Rect. Taper
6	●		●		63	●	●	●	●
8	●		●		70	●		●	
10	●		●		80		●		●
12	●		●		90		●		●
14	●		●		100		●		●
16	●		●		110		●		●
18	●	●	●	●	125		●		●
20	●	●	●	●	140		●		●
22	●	●	●	●	160		●		●
25	●	●	●	●	180		●		●
28	●	●	●	●	200		●		●
32	●	●	●	●	220		●		●
36	●	●	●	●	250		●		●
40	●	●	●	●	280		●		●
45	●	●	●	●	320		●		●
50	●	●	●	●	360		●		●
56	●	●	●	●	400		●		●

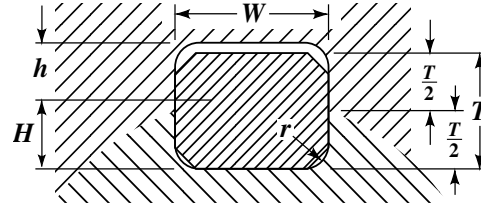
eral-purpose key for shafts greater than 1 inch in diameter; the square key is intended for use with shafts up to and including 1-inch diameter or for shafts up to 6-inch diameter where it is desirable to have a greater key depth than is provided by rectangular keys. In stepped shafts, the larger diameters are usually required by considerations other than torque, e.g., resistance to bending. Where components such as fans, gears, impellers, etc., are attached to the larger shaft diameter, the use of a key smaller than standard for that diameter may be permissible. As this results in unequal disposition of the key in the shaft and its related hub, the dimensions H and h must be recalculated to maintain the $T/2$ relationship.

Taper Keys: These keys are used for transmitting heavy unidirectional, reversing, or vibrating torques and in applications where periodic withdrawal of the key may be necessary. Taper keys are usually top fitting, but may be top and side fitting where required, and the keyway in the hub should then have the same width value as the keyway in the shaft. Taper keys of rectangular section are used for general purposes and are of less depth than square keys; square sections are for use with shafts up to and including 1-inch diameter or for shafts up to 6-inch diameter where it is desirable to have greater key depth.

Dimensions and Tolerances for British Parallel and Taper Keys and Keyways: Dimensions and tolerances for key and keyway widths given in **Tables 6, 7, 8, and 9** are based on the width of key W and provide a fitting allowance. The fitting allowance is designed to permit an interference between the key and the shaft keyway and a slightly easier condition between the key and the hub keyway. In shrink and heavy force fits, it may be found necessary to depart from the width and depth tolerances specified. Any variation in the width of the keyway should be such that the greatest width is at the end from which the key enters and any variation in the depth of the keyway should be such that the greatest depth is at the end from which the key enters.

Keys and keybar normally are not chamfered or radiused as supplied, but this may be done at the time of fitting. Radii and chamfers are given in **Tables 6, 7, 8, and 9**. Corner radii are recommended for keyways to alleviate stress concentration.

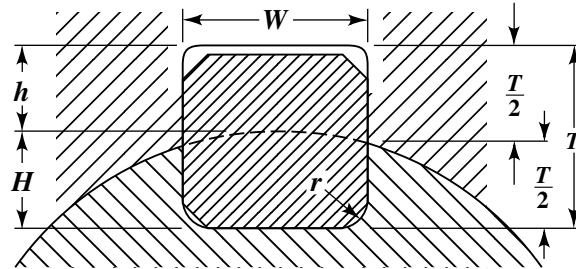
Table 6. British Standard Rectangular Parallel Keys, Keyways, and Keybars B.S. 46: Part I: 1958



Diameter of Shaft		Key				Keyway in Shaft				Keyway in Hub				Nominal Keyway Radius, r^a	Keybar				
Over	Up to and Including	Size $W \times T$	Width, W		Thickness, T		Width W_s		Depth H		Width W_h		Depth h		Width W		Thickness T		
			Max.	Min.	Max.	Min.	Min.	Max.	Min.	Max.	Min.	Max.	Min.	Max.	Max.	Min.	Max.	Max.	Min.
1	1/4	5/16 x 1/4	0.314	0.312	0.253	0.250	0.311	0.312	0.146	0.152	0.312	0.313	0.112	0.118	0.010	0.314	0.312	0.253	0.250
1 1/4	1/2	3/8 x 1/4	0.377	0.375	0.253	0.250	0.374	0.375	0.150	0.156	0.375	0.376	0.108	0.114	0.010	0.377	0.375	0.253	0.250
1 1/2	3/4	7/16 x 5/16	0.440	0.438	0.315	0.312	0.437	0.438	0.186	0.192	0.438	0.439	0.135	0.141	0.020	0.440	0.438	0.315	0.312
1 3/4	2	1/2 x 5/16	0.502	0.500	0.315	0.312	0.499	0.500	0.190	0.196	0.500	0.501	0.131	0.137	0.020	0.502	0.500	0.315	0.312
2	2 1/2	5/8 x 7/16	0.627	0.625	0.441	0.438	0.624	0.625	0.260	0.266	0.625	0.626	0.185	0.191	0.020	0.627	0.625	0.441	0.438
2 1/2	3	3/4 x 1/2	0.752	0.750	0.503	0.500	0.749	0.750	0.299	0.305	0.750	0.751	0.209	0.215	0.020	0.752	0.750	0.503	0.500
3	3 1/2	7/8 x 5/8	0.877	0.875	0.629	0.625	0.874	0.875	0.370	0.376	0.875	0.876	0.264	0.270	0.062	0.877	0.875	0.629	0.625
3 1/2	4	1 x 3/4	1.003	1.000	0.754	0.750	0.999	1.000	0.441	0.447	1.000	1.001	0.318	0.324	0.062	1.003	1.000	0.754	0.750
4	5	1 1/4 x 7/8	1.253	1.250	0.879	0.875	1.248	1.250	0.518	0.524	1.250	1.252	0.366	0.372	0.062	1.253	1.250	0.879	0.875
5	6	1 1/2 x 1	1.504	1.500	1.006	1.000	1.498	1.500	0.599	0.605	1.500	1.502	0.412	0.418	0.062	1.504	1.500	1.006	1.000
6	7	1 3/4 x 1 1/4	1.754	1.750	1.256	1.250	1.748	1.750	0.740	0.746	1.750	1.752	0.526	0.532	0.125				
7	8	2 x 1 3/8	2.005	2.000	1.381	1.375	1.998	2.000	0.818	0.824	2.000	2.002	0.573	0.579	0.125				
8	9	2 1/4 x 1 1/2	2.255	2.250	1.506	1.500	2.248	2.250	0.897	0.905	2.250	2.252	0.619	0.627	0.125				
9	10	2 1/2 x 1 3/8	2.505	2.500	1.631	1.625	2.498	2.500	0.975	0.983	2.500	2.502	0.666	0.674	0.187				
10	11	2 3/4 x 1 3/8	2.755	2.750	1.881	1.875	2.748	2.750	1.114	1.122	2.750	2.752	0.777	0.785	0.187				
11	12	3 x 2	3.006	3.000	2.008	2.000	2.998	3.000	1.195	1.203	3.000	3.002	0.823	0.831	0.187				
12	13	3 1/4 x 2 1/8	3.256	3.250	2.133	2.125	3.248	3.250	1.273	1.281	3.250	3.252	0.870	0.878	0.187				
13	14	3 1/2 x 2 3/8	3.506	3.500	2.383	2.375	3.498	3.500	1.413	1.421	3.500	3.502	0.980	0.988	0.250				
14	15	3 3/4 x 2 1/2	3.756	3.750	2.508	2.500	3.748	3.750	1.492	1.502	3.750	3.752	1.026	1.036	0.250				
15	16	4 x 2 3/8	4.008	4.000	2.633	2.625	3.998	4.000	1.571	1.581	4.000	4.002	1.072	1.082	0.250				
16	17	4 1/4 x 2 3/8	4.258	4.250	2.883	2.875	4.248	4.250	1.711	1.721	4.250	4.252	1.182	1.192	0.312				
17	18	4 1/2 x 3	4.508	4.500	3.010	3.000	4.498	4.500	1.791	1.801	4.500	4.502	1.229	1.239	0.312				
18	19	4 1/4 x 3 1/8	4.758	4.750	3.135	3.125	4.748	4.750	1.868	1.878	4.750	4.752	1.277	1.287	0.312				
19	20	5 x 3 3/8	5.008	5.000	3.385	3.375	4.998	5.000	2.010	2.020	5.000	5.002	1.385	1.395	0.312				

^aThe key chamfer shall be the minimum to clear the keyway radius. Nominal values are given.

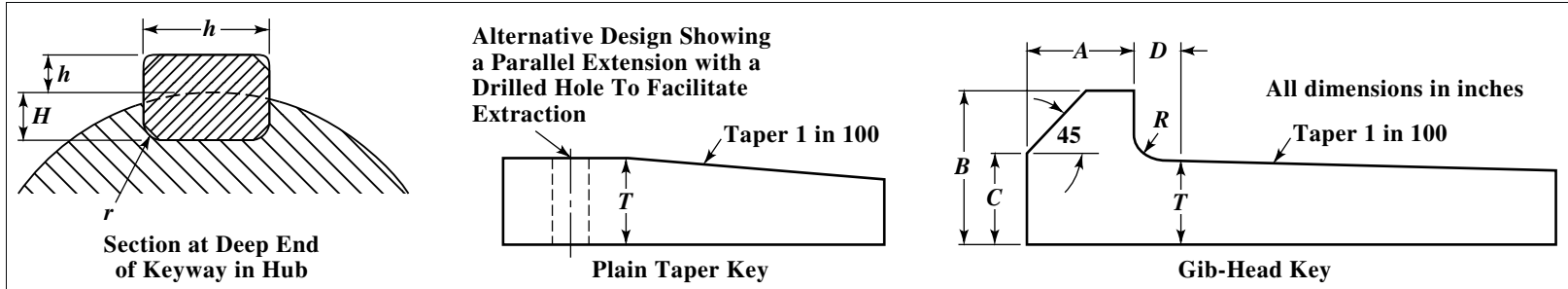
Table 7. British Standard Square Parallel Keys, Keyways, and Keybars B.S. 46: Part I: 1958



Diameter of Shaft		Key Size, $W \times T$	Width, W and Thickness, T		Keyway in Shaft				Keyway in Hub				Nominal Keyway Radius, r^a	Bright Keybar	
Over	Up to and Including		Max.	Min.	Width, W_s		Depth, H		Width, W_h		Depth, h			Width, W and Thickness, T	
					Min.	Max.	Min.	Max.	Min.	Max.	Min.	Max.		Max.	Min.
$\frac{1}{4}$	$\frac{1}{2}$	$\frac{1}{8} \times \frac{1}{8}$	0.127	0.125	0.124	0.125	0.072	0.078	0.125	0.126	0.060	0.066	0.010	0.127	0.125
$\frac{1}{2}$	$\frac{3}{4}$	$\frac{3}{16} \times \frac{3}{16}$	0.190	0.188	0.187	0.188	0.107	0.113	0.188	0.189	0.088	0.094	0.010	0.190	0.188
$\frac{3}{4}$	1	$\frac{1}{4} \times \frac{1}{4}$	0.252	0.250	0.249	0.250	0.142	0.148	0.250	0.251	0.115	0.121	0.010	0.252	0.250
1	$1\frac{1}{4}$	$\frac{5}{16} \times \frac{5}{16}$	0.314	0.312	0.311	0.312	0.177	0.183	0.312	0.313	0.142	0.148	0.010	0.314	0.312
$1\frac{1}{4}$	$1\frac{1}{2}$	$\frac{3}{8} \times \frac{3}{8}$	0.377	0.375	0.374	0.375	0.213	0.219	0.375	0.376	0.169	0.175	0.010	0.377	0.375
$1\frac{1}{2}$	$1\frac{3}{4}$	$\frac{7}{16} \times \frac{7}{16}$	0.440	0.438	0.437	0.438	0.248	0.254	0.438	0.439	0.197	0.203	0.020	0.440	0.438
$1\frac{3}{4}$	2	$\frac{1}{2} \times \frac{1}{2}$	0.502	0.500	0.499	0.500	0.283	0.289	0.500	0.501	0.224	0.230	0.020	0.502	0.500
2	$2\frac{1}{2}$	$\frac{5}{8} \times \frac{5}{8}$	0.627	0.625	0.624	0.625	0.354	0.360	0.625	0.626	0.278	0.284	0.020	0.627	0.625
$2\frac{1}{2}$	3	$\frac{3}{4} \times \frac{3}{4}$	0.752	0.750	0.749	0.750	0.424	0.430	0.750	0.751	0.333	0.339	0.020	0.752	0.750
3	$3\frac{1}{2}$	$\frac{7}{8} \times \frac{7}{8}$	0.877	0.875	0.874	0.875	0.495	0.501	0.875	0.876	0.387	0.393	0.062	0.877	0.875
$3\frac{1}{2}$	4	1×1	1.003	1.000	0.999	1.000	0.566	0.572	1.000	1.001	0.442	0.448	0.062	1.003	1.000
4	5	$1\frac{1}{4} \times 1\frac{1}{4}$	1.253	1.250	1.248	1.250	0.707	0.713	1.250	1.252	0.551	0.557	0.062	1.253	1.250
5	6	$1\frac{1}{2} \times 1\frac{1}{2}$	1.504	1.500	1.498	1.500	0.848	0.854	1.500	1.502	0.661	0.667	0.062	1.504	1.500

^aThe key chamfer shall be the minimum to clear the keyway radius. Nominal values are given. All dimensions in inches.

Table 8. British Standard Rectangular Taper Keys and Keyways, Gib-head and Plain B.S. 46: Part 1: 1958



Diameter of Shaft		Key						Keyway in Shaft and Hub								Nominal Keyway Radius, r^a	Gib-head ^b				Radius, R
Over	Up to and Including	Size, $W \times T$	Width, W		Thickness, T		Keyway in Shaft		Keyway in Hub		Depth in Shaft, H		Depth in Hub at Deep End of Keyway, h		A		B	C	D		
			Max.	Min.	Max.	Min.	Min.	Max.	Min.	Max.	Min.	Max.	Min.	Max.							
1	1/4	5/16 x 1/4	0.314	0.312	0.254	0.249	0.311	0.312	0.312	0.313	0.146	0.152	0.090	0.096	0.010	3/8	7/16	1/4	0.3	1/16	
1 1/4	1 1/2	3/8 x 1/4	0.377	0.375	0.254	0.249	0.374	0.375	0.375	0.376	0.150	0.156	0.086	0.092	0.010	7/16	7/16	9/32	0.3	1/16	
1 1/2	1 3/4	7/16 x 5/16	0.440	0.438	0.316	0.311	0.437	0.438	0.438	0.439	0.186	0.192	0.112	0.118	0.020	1/2	9/16	5/16	0.4	1/16	
1 3/4	2	1/2 x 5/16	0.502	0.500	0.316	0.311	0.499	0.500	0.500	0.501	0.190	0.196	0.108	0.114	0.020	9/16	5/8	3/8	0.4	1/16	
2	2 1/2	5/8 x 7/16	0.627	0.625	0.442	0.437	0.624	0.625	0.625	0.626	0.260	0.266	0.162	0.168	0.020	1 1/16	3/4	7/16	0.5	1/8	
2 1/2	3	3/4 x 1/2	0.752	0.750	0.504	0.499	0.749	0.750	0.750	0.751	0.299	0.305	0.185	0.191	0.020	1 3/16	7/8	17/32	0.5	1/8	
3	3 1/2	7/8 x 5/8	0.877	0.875	0.630	0.624	0.874	0.875	0.875	0.876	0.370	0.376	0.239	0.245	0.062	1 5/16	1	2 1/32	0.6	1/8	
3 1/2	4	1 x 3/4	1.003	1.000	0.755	0.749	0.999	1.000	1.000	1.001	0.441	0.447	0.293	0.299	0.062	1 1/16	1 1/4	2 3/32	0.6	1/8	
4	5	1 1/4 x 7/8	1.253	1.250	0.880	0.874	1.248	1.250	1.250	1.252	0.518	0.524	0.340	0.346	0.062	1 5/16	1 1/2	2 7/32	0.7	1/4	
5	6	1 1/2 x 1	1.504	1.500	1.007	0.999	1.498	1.500	1.500	1.502	0.599	0.605	0.384	0.390	0.062	1 9/16	1 5/8	1 1/32	0.7	1/4	
6	7	1 3/4 x 1 1/4	1.754	1.750	1.257	1.249	1.748	1.750	1.750	1.752	0.740	0.746	0.493	0.499	0.125	1 13/16	2	1 1/32	0.8	1/4	
7	8	2 x 1 3/8	2.005	2.000	1.382	1.374	1.998	2.000	2.000	2.002	0.818	0.824	0.539	0.545	0.125	2 1/16	2 1/4	1 13/32	0.8	1/4	
8	9	2 1/4 x 1 1/2	2.255	2.250	1.509	1.499	2.248	2.250	2.250	2.252	0.897	0.905	0.581	0.589	0.125	2 5/16	2 1/2	1 9/16	0.9	3/8	
9	10	2 1/2 x 1 3/8	2.505	2.500	1.634	1.624	2.498	2.500	2.500	2.502	0.975	0.983	0.628	0.636	0.187	2 9/16	2 3/4	1 11/16	0.9	3/8	
10	11	2 3/4 x 1 7/8	2.755	2.750	1.884	1.874	2.748	2.750	2.750	2.752	1.114	1.122	0.738	0.746	0.187	2 13/16	3	1 15/16	1.0	3/8	
11	12	3 x 2	3.006	3.000	2.014	1.999	2.998	3.000	3.000	3.002	1.195	1.203	0.782	0.790	0.187	3 1/16	3 1/4	2 1/16	1.0	3/8	

^aThe key chamfer shall be the minimum to clear the keyway radius. Nominal values shall be given.

^bDimensions A, B, C, D, and R pertain to gib-head keys only.

All dimensions in inches.

Table 9. British Standard Square Taper Keys and Keyways, Gib-head or Plain B.S. 46: Part I: 1958

Diameter of Shaft		Key		Keyway in Shaft and Hub										Gib-head ^b						
Over	Up to and Including	Size $W \times T$	Width, W		Thickness, T		Keyway in Shaft		Keyway in Hub		Depth in Shaft, H		Depth in Hub at Deep End of Keyway, h		Nominal Keyway Radius, r^a	A	B	C	D	Radius, R
			Max.	Min.	Max.	Min.	Min.	Max.	Min.	Max.	Min.	Max.	Min.	Max.						
1/4	1/2	5/8 x 5/8	0.127	0.125	0.129	0.124	0.124	0.125	0.125	0.126	0.072	0.078	0.039	0.045	0.010	3/16	1/4	5/32	0.1	1/32
1/2	3/4	3/16 x 3/16	0.190	0.188	0.192	0.187	0.187	0.188	0.188	0.189	0.107	0.113	0.067	0.073	0.010	1/4	3/8	7/32	0.2	1/32
3/4	1	1/4 x 1/4	0.252	0.250	0.254	0.249	0.249	0.250	0.250	0.251	0.142	0.148	0.094	0.100	0.010	5/16	7/16	9/32	0.2	1/16
1	1 1/4	5/16 x 5/16	0.314	0.312	0.316	0.311	0.311	0.312	0.312	0.313	0.177	0.183	0.121	0.127	0.010	3/8	9/16	11/32	0.3	1/16
1 1/4	1 1/2	3/8 x 3/8	0.377	0.375	0.379	0.374	0.374	0.375	0.375	0.376	0.213	0.219	0.148	0.154	0.010	7/16	5/8	13/32	0.3	1/16
1 1/2	1 3/4	7/16 x 7/16	0.440	0.438	0.442	0.437	0.437	0.438	0.438	0.439	0.248	0.254	0.175	0.181	0.020	1/2	3/4	15/32	0.4	1/16
1 3/4	2	1/2 x 1/2	0.502	0.500	0.504	0.499	0.499	0.500	0.500	0.501	0.283	0.289	0.202	0.208	0.020	9/16	7/8	17/32	0.4	1/16
2	2 1/2	5/8 x 5/8	0.627	0.625	0.630	0.624	0.624	0.625	0.625	0.626	0.354	0.360	0.256	0.262	0.020	1 1/16	1	2 1/32	0.5	1/8
2 1/2	3	3/7 x 3/4	0.752	0.750	0.755	0.749	0.749	0.750	0.750	0.751	0.424	0.430	0.310	0.316	0.020	1 3/16	1 1/4	2 5/32	0.5	1/8
3	3 1/2	7/8 x 7/8	0.877	0.875	0.880	0.874	0.874	0.875	0.875	0.876	0.495	0.501	0.364	0.370	0.062	1 5/16	1 3/8	2 3/32	0.6	1/8
3 1/2	4	1 x 1	1.003	1.000	1.007	0.999	0.999	1.000	1.000	1.001	0.566	0.572	0.418	0.424	0.062	1 1/16	1 5/8	1 1/32	0.6	1/8
4	5	1 1/4 x 1 1/4	1.253	1.250	1.257	1.249	1.248	1.250	1.250	1.252	0.707	0.713	0.526	0.532	0.062	1 3/16	2	1 7/32	0.7	1/4
5	6	1 1/2 x 1 1/2	1.504	1.500	1.509	1.499	1.498	1.500	1.500	1.502	0.848	0.854	0.635	0.641	0.062	1 9/16	2 1/2	1 17/32	0.7	1/4

^a The key chamfer shall be the minimum to clear the keyway radius. Nominal values shall be given.

^b Dimensions A , B , C , D , and R pertain to gib-head keys only.

All dimensions in inches.

Table 10. British Preferred Lengths of Plain (Parallel or Taper) and Gib-head Keys, Rectangular and Square Section *BS 46:Part 1:1958 (1985) Appendix*

Plain Key Size $W \times T$		Overall Length, L														
		$\frac{3}{4}$	1	$1\frac{1}{4}$	$1\frac{1}{2}$	$1\frac{3}{4}$	2	$2\frac{1}{4}$	$2\frac{1}{2}$	$2\frac{3}{4}$	3	$3\frac{1}{2}$	4	$4\frac{1}{2}$	5	6
$\frac{1}{8} \times \frac{1}{8}$	d	d														
$\frac{3}{16} \times \frac{3}{16}$	d	d	d	d	d	d	d									
$\frac{1}{4} \times \frac{1}{4}$	d	d	d	d	d	d	d	d	d							
$\frac{5}{16} \times \frac{1}{4}$	d	d	d	d	d	d	d	d	d	d						
$\frac{3}{16} \times \frac{3}{16}$	d	d	d	d	d	d	d	d	d	d	d					
$\frac{3}{8} \times \frac{1}{4}$		d	d	d	d	d	d	d	d	d	d	d	d			
$\frac{3}{8} \times \frac{3}{8}$		d	d	d	d	d	d	d	d	d	d	d	d	d		
$\frac{7}{16} \times \frac{3}{16}$					d	d	d	d	d	d	d	d	d			
$\frac{7}{16} \times \frac{7}{16}$						d	d	d	d	d	d	d	d			
$\frac{1}{2} \times \frac{5}{16}$						d	d	d	d	d	d	d	d			
$\frac{1}{2} \times \frac{1}{2}$							d	d	d	d	d	d	d	d	d	
$\frac{5}{8} \times \frac{7}{16}$									d	d	d	d	d	d	d	
$\frac{5}{8} \times \frac{5}{8}$									d	d	d	d	d	d	d	d
$\frac{3}{4} \times \frac{1}{2}$											d	d	d	d	d	d
$\frac{3}{4} \times \frac{3}{4}$												d	d	d	d	d
$\frac{7}{8} \times \frac{5}{8}$												d	d	d	d	d

Gib-head Key Size, $W \times T$		Overall Length, L																
		$1\frac{1}{2}$	$1\frac{3}{4}$	2	$2\frac{1}{4}$	$2\frac{1}{2}$	$2\frac{3}{4}$	3	$3\frac{1}{2}$	4	$4\frac{1}{2}$	5	$5\frac{1}{2}$	6	$6\frac{1}{2}$	7	$7\frac{1}{2}$	8
$\frac{3}{16} \times \frac{3}{16}$	d	d	d	d	d		d											
$\frac{1}{4} \times \frac{1}{4}$	d	d	d	d	d	d	d	d	d	d								
$\frac{5}{16} \times \frac{1}{4}$			d	d	d	d	d	d	d	d								
$\frac{5}{16} \times \frac{5}{16}$			d	d	d	d	d	d	d	d	d							
$\frac{3}{8} \times \frac{1}{4}$			d	d	d	d	d	d	d	d	d	d						
$\frac{3}{8} \times \frac{3}{8}$			d	d	d	d	d	d	d	d	d	d	d	d				
$\frac{7}{16} \times \frac{3}{16}$					d		d	d	d	d	d	d	d	d				
$\frac{7}{16} \times \frac{7}{16}$					d		d	d	d	d	d	d	d	d				
$\frac{1}{2} \times \frac{5}{16}$					d		d	d	d	d	d	d	d	d				
$\frac{1}{2} \times \frac{1}{2}$					d		d	d	d	d	d	d	d	d	d			
$\frac{5}{8} \times \frac{7}{16}$							d			d	d	d	d	d	d	d		
$\frac{5}{8} \times \frac{5}{8}$										d	d	d	d	d	d	d	d	d
$\frac{3}{4} \times \frac{1}{2}$										d	d	d	d	d	d	d	d	d
$\frac{3}{4} \times \frac{3}{4}$										d		d	d	d	d	d	d	d
$\frac{7}{8} \times \frac{3}{8}$												d		d	d	d	d	d
$\frac{7}{8} \times \frac{7}{8}$													d	d	d	d	d	d
$1 \times \frac{3}{4}$														d	d	d	d	d
1×1														d	d	d	d	d

All dimension are in inches

Woodruff Keys.—In the Woodruff key system, half-circular disks of steel are used as keys, the half-circular side of the key being inserted into the keyseat. Part of the key projects and enters into a keyway in the part to be keyed to the shaft in the ordinary way. The advantage of this method of keys is that the keyway is easily milled by simply sinking a milling cutter, of the same diameter as the diameter of the stock from which the keys are made, into the shaft. The keys are also very cheaply made, as they are simply cut off from round bar stock and milled apart in the center. Dimensions of Woodruff keys are given in engineering handbooks.

These keys are used for light applications or the angular location of associated parts on tapered shaft ends. They are not recommended for other applications, but if so used, corner radii in the shaft and hub keyways are advisable to reduce stress concentration.

Dimensions and Tolerances of British Woodruff Keys and Keyways:

Dimensions and tolerances are shown in Table 11. An optional alternative design of the Woodruff key that differs from the normal form in its depth is given in the illustration accompanying the table. The method of designating British Woodruff Keys is the same as the American method explained in the footnote on page 2478.

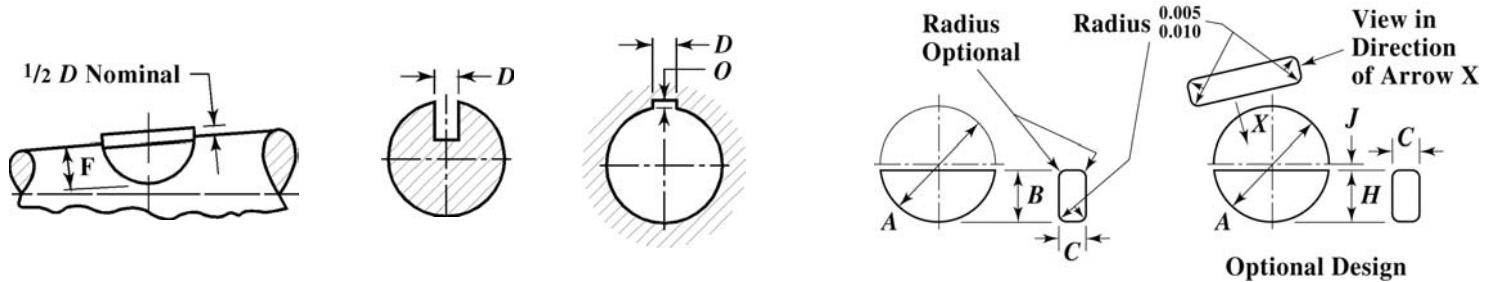


Table 11. British Standard Woodruff Keys and Keyways BS 46: Part 1: 1958

Key and Cutter No.	Key								Keyway								Optional Design		
	Nominal Fractional Size		Diameter A		Depth B		Thickness C		Width in Shaft, D		Width in Hub, E		Depth in Shaft, F		Depth in Hub at Center Line, G		Depth of Key, H		Dimension, J
	Width.	Dia.	Max.	Min.	Max.	Min.	Max.	Min.	Min.	Max.	Min.	Max.	Min.	Max.	Min.	Max.	Max.	Min.	Nom.
203	1/16	3/8	0.375	0.370	0.171	0.166	0.063	0.062	0.061	0.063	0.063	0.065	0.135	0.140	0.042	0.047	0.162	0.156	1/64
303	3/32	3/8	0.375	0.370	0.171	0.166	0.095	0.094	0.093	0.095	0.095	0.097	0.119	0.124	0.057	0.062	0.162	0.156	1/64
403	1/8	3/8	0.375	0.370	0.171	0.166	0.126	0.125	0.124	0.126	0.126	0.128	0.104	0.109	0.073	0.078	0.162	0.156	1/64
204	1/16	1/2	0.500	0.490	0.203	0.198	0.063	0.062	0.061	0.063	0.063	0.065	0.167	0.172	0.042	0.047	0.194	0.188	3/64
304	3/32	1/2	0.500	0.490	0.203	0.198	0.095	0.094	0.093	0.095	0.095	0.097	0.151	0.156	0.057	0.062	0.194	0.188	3/64

Table 11. (Continued) British Standard Woodruff Keys and Keyways BS 46: Part 1: 1958

Key and Cutter No.	Key								Keyway								Optional Design		
	Nominal Fractional Size		Diameter A		Depth B		Thickness C		Width in Shaft, D		Width in Hub, E		Depth in Shaft, F		Depth in Hub at Center Line, G		Depth of Key, H		Dimension, J
	Width.	Dia.	Max.	Min.	Max.	Min.	Max.	Min.	Min.	Max.	Min.	Max.	Min.	Max.	Min.	Max.	Max.	Min.	Nom.
404	1/8	1/2	0.500	0.490	0.203	0.198	0.126	0.125	0.124	0.126	0.126	0.128	0.136	0.141	0.073	0.078	0.194	0.188	3/64
305	3/32	3/8	0.625	0.615	0.250	0.245	0.095	0.094	0.093	0.095	0.095	0.097	0.198	0.203	0.057	0.062	0.240	0.234	1/16
405	1/8	3/8	0.625	0.615	0.250	0.245	0.126	0.125	0.124	0.126	0.126	0.128	0.182	0.187	0.073	0.078	0.240	0.234	1/16
505	3/32	3/8	0.625	0.615	0.250	0.245	0.157	0.156	0.155	0.157	0.157	0.159	0.167	0.172	0.089	0.094	0.240	0.234	1/16
406	1/8	3/4	0.750	0.740	0.313	0.308	0.126	0.125	0.124	0.126	0.126	0.128	0.246	0.251	0.073	0.078	0.303	0.297	1/16
506	3/32	3/4	0.750	0.740	0.313	0.308	0.157	0.156	0.155	0.157	0.157	0.159	0.230	0.235	0.089	0.094	0.303	0.297	1/16
606	3/16	3/4	0.750	0.740	0.313	0.308	0.189	0.188	0.187	0.189	0.189	0.191	0.214	0.219	0.104	0.109	0.303	0.297	1/16
507	3/32	7/8	0.875	0.865	0.375	0.370	0.157	0.156	0.155	0.157	0.157	0.159	0.292	0.297	0.089	0.094	0.365	0.359	1/16
607	3/16	7/8	0.875	0.865	0.375	0.370	0.189	0.188	0.187	0.189	0.189	0.191	0.276	0.281	0.104	0.109	0.365	0.359	1/16
807	1/4	7/8	0.875	0.865	0.375	0.370	0.251	0.250	0.249	0.251	0.251	0.253	0.245	0.250	0.136	0.141	0.365	0.359	1/16
608	3/16	1	1.000	0.990	0.438	0.433	0.189	0.188	0.187	0.189	0.189	0.191	0.339	0.344	0.104	0.109	0.428	0.422	1/16
808	1/4	1	1.000	0.990	0.438	0.433	0.251	0.250	0.249	0.251	0.251	0.253	0.308	0.313	0.136	0.141	0.428	0.422	1/16
1008	5/16	1	1.000	0.990	0.438	0.433	0.313	0.312	0.311	0.313	0.313	0.315	0.277	0.282	0.167	0.172	0.428	0.422	1/16
609	3/16	1 1/8	1.125	1.115	0.484	0.479	0.189	0.188	0.187	0.189	0.189	0.191	0.385	0.390	0.104	0.109	0.475	0.469	3/64
809	1/4	1 1/8	1.125	1.115	0.484	0.479	0.251	0.250	0.249	0.251	0.251	0.253	0.354	0.359	0.136	0.141	0.475	0.469	3/64
1009	5/16	1 1/8	1.125	1.115	0.484	0.479	0.313	0.312	0.311	0.313	0.313	0.315	0.323	0.328	0.167	0.172	0.475	0.469	3/64
810	1/4	1 1/4	1.250	1.240	0.547	0.542	0.251	0.250	0.249	0.251	0.251	0.253	0.417	0.422	0.136	0.141	0.537	0.531	3/64
1010	5/16	1 1/4	1.250	1.240	0.547	0.542	0.313	0.312	0.311	0.313	0.313	0.315	0.386	0.391	0.167	0.172	0.537	0.531	3/64
1210	3/8	1 1/4	1.250	1.240	0.547	0.542	0.376	0.375	0.374	0.376	0.376	0.378	0.354	0.359	0.198	0.203	0.537	0.531	3/64
1011	5/16	1 3/8	1.375	1.365	0.594	0.589	0.313	0.312	0.311	0.313	0.313	0.315	0.433	0.438	0.167	0.172	0.584	0.578	3/32
1211	3/8	1 3/8	1.375	1.365	0.594	0.589	0.376	0.375	0.374	0.376	0.376	0.378	0.402	0.407	0.198	0.203	0.584	0.578	3/32
812	1/4	1 1/2	1.500	1.490	0.641	0.636	0.251	0.250	0.249	0.251	0.251	0.253	0.511	0.516	0.136	0.141	0.631	0.625	7/64
1012	5/16	1 1/2	1.500	1.490	0.641	0.636	0.313	0.312	0.311	0.313	0.313	0.315	0.480	0.485	0.167	0.172	0.631	0.625	7/64
1212	3/8	1 1/2	1.500	1.490	0.641	0.636	0.376	0.375	0.374	0.376	0.376	0.378	0.448	0.453	0.198	0.203	0.631	0.625	7/64

All dimensions are in inches.

Key.—A key of the type commonly used in machine construction consists ordinarily of a piece of steel, either square or rectangular in cross-section, which is inserted into a keyway or keyseat formed partly in a shaft and partly in the hub of a gear, pulley, or other part which, by means of the key, is driven positively and prevented from rotating relative to its shaft. While keys are used primarily to prevent relative rotation between shafts and such parts as pulleys, gears, etc., they also prevent axial movement in many cases, owing to the frictional resistance between the keyed parts. The type of key that may properly be employed in any case naturally depends somewhat upon the class of work for which it is intended.

The draw or *gib key* is a sunk key which has a head by means of which it can be removed. The *round tapered key* is simply a taper pin which is driven into a hole that is partly in the shaft and partly in the hub; this form is used for light work. The name *feather* or *spline* is applied to a key which is fixed to either a shaft or hub, as when a gear must be driven by a shaft, but at the same time be free to slide in a lengthwise direction. The *Woodruff key* is a section of a disk, the part which enters the shaft being circular.

Sunk Key.—A sunk key, as its name implies, is sunk into a shaft. With this type of key, which is the one most commonly used, care should be taken to secure a good bearing on the sides. Ordinarily, the bearing at the top and bottom of a sunk key should be comparatively light, although, in some cases, when it is used to resist endwise movement, as well as a rotary movement, it is given a heavy bearing on all sides. The principal bearing, however, should not be, in any case, at the top and bottom, as it is then more likely to work loose than when fitted tightly at the sides.

The width of an ordinary sunk key ordinarily is equal to about one-fourth of the shaft diameter and the thickness, when a flat key is preferred to the square form, is usually about one-sixth of the shaft diameter; these proportions are varied somewhat by different manufacturers. The taper of American Standard square and flat keys is $\frac{1}{8}$ inch per foot.

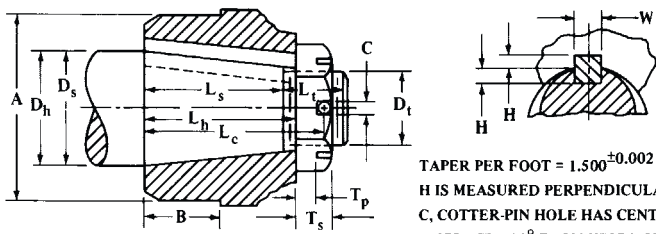
Saddle Key.—The so-called *saddle key* does not enter a slot in the shaft. This form of key has parallel sides and is curved on its under side to fit the shaft. It is slightly tapered on top so that, when it is driven tightly in place, the shaft is held by frictional resistance. This key should be fitted so that it bears lightly on the sides and heavily between the shaft and hub throughout its entire length. As the drive with this type of key is not positive, it is only used where there is little power to transmit. It is an inexpensive method of keying, as the shaft does not need to be machined.

Flat Key.—The *flat key* is a rectangular shape which bears upon a flat surface formed on one side of the shaft. The key is not sunk into the shaft but it gives it a fairly good grip. This type is not adapted to heavy work, however, owing to the excessive strains to which the hub is subjected, as the shaft tends to turn.

Nordberg Key.—This is a taper key of circular cross-section. This type of key may be used for attaching hand wheels to their shafts or for other similar light work requiring an inexpensive type of key. The Nordberg key has a taper of $\frac{1}{16}$ inch per foot. The center of the key hole is located at the joint line between the shaft and hub. A small hole may be drilled first to prevent the larger drill from crowding over into the cast-iron hub. A general rule for determining the size of the key is to make the large key diameter equal to one-fourth the shaft diameter.

Kennedy Key.—The Kennedy or double key system is used in rolling mills and is adapted to the transmission of heavy loads, especially where the torque is intermittent and the direction of rotation periodically reversed. Each key is so located that a diagonal line passing through two corners of the key approximately intersects the shaft axis. The keys have a taper of $\frac{1}{8}$ inch per foot on the hub side and the sides fit closely between the shaft and hub. The keys are driven in from opposite sides of the hub.

Taper Shaft Ends with Slotted Nuts SAE Standard



Nom. Dia.	Dia. of Shaft, D_s		Dia. of Hole, D_h		L_c	L_s	L_h	L_t	T_s	T_p	Nut Width, Flats
	Max.	Min.	Max.	Min.							
1/4	0.250	0.249	0.248	0.247	9/16	5/16	3/8	5/16	7/32	9/64	5/16
3/8	0.375	0.374	0.373	0.372	7/16	7/16	1/2	23/64	17/64	3/16	1/2
1/2	0.500	0.499	0.498	0.497	63/64	11/16	3/4	23/64	17/64	3/16	1/2
5/8	0.625	0.624	0.623	0.622	13/32	11/16	3/4	17/32	7/16	1/4	3/4
3/4	0.750	0.749	0.748	0.747	111/32	15/16	1	17/32	7/16	1/4	3/4
7/8	0.875	0.874	0.873	0.872	111/16	1 1/8	1 1/4	11/16	1/2	5/16	15/16
1	1.001	0.999	0.997	0.995	1 15/16	1 3/8	1 1/2	11/16	1/2	5/16	1 1/4
1 1/8	1.126	1.124	1.122	1.120	1 15/16	1 3/8	1 1/2	11/16	1/2	5/16	1 1/4
1 1/4	1.251	1.249	1.247	1.245	1 15/16	1 3/8	1 1/2	11/16	1/2	5/16	1 1/4
1 3/8	1.376	1.374	1.372	1.370	2 1/16	1 7/8	2	11/16	1/2	5/16	1 1/4
1 1/2	1.501	1.499	1.497	1.495	2 1/16	1 7/8	2	11/16	1/2	5/16	1 1/4
1 5/8	1.626	1.624	1.622	1.620	2 15/16	2 1/8	2 1/4	13/16	5/8	7/16	2 3/16
1 3/4	1.751	1.749	1.747	1.745	2 15/16	2 1/8	2 1/4	13/16	5/8	7/16	2 3/16
1 7/8	1.876	1.874	1.872	1.870	3 1/16	2 3/8	2 1/2	13/16	5/8	7/16	2 3/16
2	2.001	1.999	1.997	1.995	3 1/16	2 3/8	3	13/16	5/8	7/16	2 3/16
2 1/4	2.252	2.248	2.245	2.242	3 1/16	2 7/8	3	13/16	5/8	7/16	2 3/8
2 1/2	2.502	2.498	2.495	2.492	4 9/32	3 3/8	3 1/2	1 1/4	1	5/8	3 3/8
2 3/4	2.752	2.748	2.745	2.742	4 9/32	3 3/8	3 1/2	1 1/4	1	5/8	3 3/8
3	3.002	2.998	2.995	2.992	2 29/32	3 7/8	4	1 1/4	1	5/8	3 3/8
3 1/4	3.252	3.248	3.245	3.242	5 1/32	4 1/8	4 1/4	1 1/4	1	5/8	3 3/8
3 1/2	3.502	3.498	3.495	3.492	5 7/16	4 3/8	4 1/2	1 3/8	1 1/8	3/4	3 7/8
4	4.002	3.998	3.995	3.992	6 1/16	5 3/8	5 1/2	1 3/8	1 1/8	3/4	3 7/8

Nom. Dia.	D_t	Thds. per inch	Keyway				Square Key		A	B	C
			W		H		Max.	Min.			
			Max.	Min.	Max.	Min.					
1/4	#10	40	0.0625	.0615	.037	.033	0.0635	0.0625	1/2	3/16	3/64
3/8	5/16	32	0.0937	.0927	.053	.049	0.0947	0.0937	11/16	1/4	5/64
1/2	5/16	32	0.1250	.1240	.069	.065	0.1260	0.1250	7/8	3/8	5/64
5/8	1/2	28	0.1562	.1552	.084	.080	0.1572	0.1562	1 1/16	3/8	1/8
3/4	1/2	28	0.1875	.1865	.100	.096	0.1885	0.1875	1 1/4	5/8	1/8
7/8	5/8	24	0.2500	.2490	.131	.127	0.2510	0.2500	1 1/2	3/4	5/32
1	3/4	20	0.2500	.2490	.131	.127	0.2510	0.2500	1 3/4	7/8	5/32
1 1/8	7/8	20	0.3125	.3115	.162	.158	0.3135	0.3125	2	7/8	5/32
1 1/4	1	20	0.3125	.3115	.162	.158	0.3135	0.3125	2 1/8	7/8	5/32
1 3/8	1	20	0.3750	.3740	.194	.190	0.3760	0.3750	2 1/4	1	5/32
1 1/2	1	20	0.3750	.3740	.194	.190	0.3760	0.3750	2 1/2	1	5/32
1 5/8	1 1/4	18	0.4375	.4365	.225	.221	0.4385	0.4375	2 3/4	1 1/4	5/32
1 3/4	1 1/4	18	0.4375	.4365	.225	.221	0.4385	0.4375	3	1 1/4	5/32
1 7/8	1 1/4	18	0.4375	.4365	.225	.221	0.4385	0.4375	3 1/8	1 1/4	5/32
2	1 1/4	18	0.5000	.4990	.256	.252	0.5010	0.5000	3 1/4	1 1/2	5/32
2 1/4	1 1/2	18	0.5625	.5610	.287	.283	0.5640	0.5625	3 1/2	1 1/2	5/32
2 1/2	2	16	0.6250	.6235	.319	.315	0.6265	0.6250	4	1 3/4	7/32
2 3/4	2	16	0.6875	.6860	.350	.346	0.6890	0.6875	4 3/8	1 3/4	7/32
3	2	16	0.7500	.7485	.381	.377	0.7515	0.7500	4 3/4	2	7/32
3 1/4	2	16	0.7500	.7485	.381	.377	0.7515	0.7500	5	2 1/8	7/32
3 1/2	2 1/2	16	0.8750	.8735	.444	.440	0.8765	0.8750	5 1/2	2 1/4	9/32
4	2 1/2	16	1.0000	.9985	.506	.502	1.0015	1.0000	6 1/4	2 3/4	9/32

All dimensions in inches except where otherwise noted. © 1990, SAE.

Pipe and Pipe Fittings

Wrought Steel Pipe.—ANSI/ASME B36.10M-1995 covers dimensions of welded and seamless wrought steel pipe, for high or low temperatures or pressures.

The word *pipe* as distinguished from *tube* is used to apply to tubular products of dimensions commonly used for pipelines and piping systems. Pipe dimensions of sizes 12 inches and smaller have outside diameters numerically larger than the corresponding nominal sizes whereas outside diameters of tubes are identical to nominal sizes.

Size: The size of all pipe is identified by the nominal pipe size. The manufacture of pipe in the nominal sizes of $\frac{1}{8}$ inch to 12 inches, inclusive, is based on a standardized outside diameter (OD). This OD was originally selected so that pipe with a standard OD and having a wall thickness which was typical of the period would have an inside diameter (ID) approximately equal to the nominal size. Although there is now no such relation between the existing standard thicknesses, ODs and nominal sizes, these nominal sizes and standard ODs continue in use as “standard.”

The manufacture of pipe in nominal sizes of 14-inch OD and larger proceeds on the basis of an OD corresponding to the nominal size.

Weight: The nominal weights of steel pipe are calculated values and are tabulated in **Table 1**. They are based on the following formula:

$$W_{pe} = 10.68(D - t)t$$

where W_{pe} = nominal plain end weight to the nearest 0.01 lb/ft.

D = outside diameter to the nearest 0.001 inch

t = specified wall thickness rounded to the nearest 0.001 inch

Wall thickness: The nominal wall thicknesses are given in **Table 1** which also indicates the wall thicknesses in API Standard 5L.

The wall thickness designations “Standard,” “Extra-Strong,” and “Double Extra-Strong” have been commercially used designations for many years. The Schedule Numbers were subsequently added as a convenient designation for use in ordering pipe. “Standard” and Schedule 40 are identical for nominal pipe sizes up to 10 inches, inclusive. All larger sizes of “Standard” have $\frac{3}{8}$ -inch wall thickness. “Extra-Strong” and Schedule 80 are identical for nominal pipe sizes up to 8 inch, inclusive. All larger sizes of “Extra-Strong” have $\frac{1}{2}$ -inch-wall thickness.

Wall Thickness Selection: When the selection of wall thickness depends primarily on capacity to resist internal pressure under given conditions, the designer shall compute the exact value of wall thickness suitable for conditions for which the pipe is required as prescribed in the “ASME Boiler and Pressure Vessel Code,” “ANSI B31 Code for Pressure Piping,” or other similar codes, whichever governs the construction. A thickness can then be selected from **Table 1** to suit the value computed to fulfill the conditions for which the pipe is desired.

Metric Weights and Mass: Standard SI metric dimensions in millimeters for outside diameters and wall thicknesses may be found by multiplying the inch dimensions by 25.4. Outside diameters converted from those shown in **Table 1** should be rounded to the nearest 0.1 mm and wall thicknesses to the nearest 0.01 mm.

The following formula may be used to calculate the SI metric plain end mass in kg/m using the converted metric diameters and thicknesses:

$$W_{pe} = 0.02466(D - t)t$$

where W_{pe} = nominal plain end mass rounded to the nearest 0.01 kg/m.

D = outside diameter to the nearest 0.1 mm for sizes shown in **Table 1**.

t = specified wall thickness rounded to the nearest 0.01 mm.

Table 1. American National Standard Weights and Dimensions of Welded and Seamless Wrought Steel Pipe *ANSI/ASME B36.10M-1995*

Nom. Size and (O.D.), inch	Wall Thick., inch	Plain End Wgt., lb/ft	Identification			Nom. Size and (O.D.), inch	Wall Thick., inch	Plain End Wgt., lb/ft	Identification			
			Sch. No.	Other					Sch. No.	Other		
1/8 (0.405)	0.057	0.21	30	3 (3.500)	0.141	5.06	...	5L	...	
	0.068	0.24	40	5L	STD		0.156	5.57	...	5L	...	
	0.095	0.31	80	5L	XS		0.172	6.11	...	5L	...	
1/4 (0.540)	0.073	0.36	30		0.188	6.65	...	5L	...	
	0.088	0.42	40	5L	STD		0.216	7.58	40	5L	STD	
	0.119	0.54	80	5L	XS		0.250	8.68	...	5L	...	
3/8 (0.675)	0.073	0.47	30		0.281	9.66	...	5L	...	
	0.091	0.57	40	5L	STD		0.300	10.25	80	5L	XS	
	0.126	0.74	80	5L	XS		0.438	14.32	160	
1/2 (0.840)	0.095	0.76	30		0.600	18.58	...	5L	XXS	
	0.109	0.85	40	5L	STD		3 1/2 (4.000)	0.083	3.47	...	5L	...
	0.147	1.09	80	5L	XS			0.109	4.53	...	5L	...
0.188	1.31	160	0.125	5.17		...	5L	...		
0.294	1.71	...	5L	XXS	0.141	5.81		...	5L	...		
3/4 (1.050)	0.095	0.97	30	0.156		6.40	...	5L	...	
	0.113	1.13	40	5L	STD	0.172		7.03	...	5L	...	
	0.154	1.47	80	5L	XS	0.188		7.65	...	5L	...	
1 (1.315)	0.179	1.94	160	0.226		9.11	40	5L	STD	
	0.250	2.84	0.250		10.01	...	5L	...	
	0.358	3.66	...	5L	XXS	0.281		11.16	...	5L	...	
1 1/4 (1.660)	0.117	1.93	30	0.318		12.50	80	5L	XS	
	0.140	2.27	40	5L	STD	4 (4.500)		0.083	3.92	...	5L	...
	0.191	3.00	80	5L	XS		0.109	5.11	...	5L	...	
0.250	3.76	160	0.125		5.84	...	5L	...		
0.382	5.21	...	5L	XXS	0.141		6.56	...	5L	...		
1 1/2 (1.900)	0.125	2.37	30		0.156	7.24	...	5L	...	
	0.145	2.72	40	5L	STD		0.172	7.95	...	5L	...	
	0.200	3.63	80	5L	XS		0.188	8.66	...	5L	...	
2 (2.375)	0.281	4.86	160		0.203	9.32	...	5L	...	
	0.400	6.41	...	5L	XXS		0.219	10.01	...	5L	...	
	0.083	2.03	...	5L	...		0.237	10.79	40	5L	STD	
2 1/2 (2.875)	0.109	2.64	...	5L	...		0.250	11.35	...	5L	...	
	0.125	3.00	...	5L	...		0.281	12.66	...	5L	...	
	0.141	3.36	...	5L	...	0.312	13.96	...	5L	...		
3 (3.500)	0.154	3.65	40	5L	STD	0.337	14.98	80	5L	XS		
	0.172	4.05	...	5L	...	0.438	19.00	120	5L	...		
	0.188	4.39	...	5L	...	0.531	22.51	160	5L	...		
3 1/2 (4.000)	0.218	5.02	80	5L	XS	0.674	27.54	...	5L	XXS		
	0.250	5.67	...	5L	...	5 (5.563)	0.083	4.86	...	5L	...	
	0.281	6.28		0.125	7.26	...	5L	...	
0.344	7.46	160	0.156		9.01	...	5L	...		
0.436	9.03	XXS	0.188		10.79	...	5L	...		
4 (4.500)	0.083	2.47	...	5L	...		0.219	12.50	...	5L	...	
	0.109	3.22	...	5L	...		0.258	14.62	40	5L	STD	
	0.125	3.67	...	5L	...		0.281	15.85	...	5L	...	
4 1/2 (4.750)	0.141	4.12	...	5L	...		0.312	17.50	...	5L	...	
	0.156	4.53	...	5L	...		0.344	19.17	...	5L	...	
	0.172	4.97	...	5L	...		0.375	20.78	80	5L	XS	
5 (5.563)	0.188	5.40	...	5L	...		0.500	27.04	120	5L	...	
	0.203	5.79	40	5L	STD		0.625	32.96	160	5L	...	
	0.216	6.13	...	5L	...	0.750	38.55	...	5L	XXS		
5 1/2 (5.813)	0.250	7.01	...	5L	...	6 (6.625)	0.083	5.80	...	5L	...	
	0.276	7.66	80	5L	XS		0.109	7.59	...	5L	...	
	0.375	10.01	160		0.125	8.68	...	5L	...	
6 (6.625)	0.552	13.69	...	5L	XXS		0.141	9.76	...	5L	...	
	0.083	3.03	...	5L	...		0.156	10.78	...	5L	...	
	0.109	3.95	...	5L	...		0.172	11.85	...	5L	...	
6 1/2 (6.875)	0.125	4.51	...	5L	...							

Table 1. (Continued) American National Standard Weights and Dimensions of Welded and Seamless Wrought Steel Pipe ANSI/ASME B36.10M-1995

Nom. Size and (O.D.), inch	Wall Thick., inch	Plain End Wgt., lb/ft	Identification		Nom. Size and (O.D.), inch	Wall Thick., inch	Plain End Wgt., lb/ft	Identification	
			Sch. No.	Other				Sch. No.	Other
6 (6.625)	0.188	12.92	...	5L ...	10 (10.750)	1.125	115.64	160	...
	0.203	13.92	...	5L ...		1.250	126.83	...	5L ...
	0.219	14.98	...	5L ...	12 (12.750)	0.172	23.11	...	5L ...
	0.250	17.02	...	5L ...		0.188	25.22	...	5L ...
	0.280	18.97	40	5L STD		0.203	27.20
	0.312	21.04	...	5L ...		0.219	29.31	...	5L ...
	0.344	23.08	...	5L ...		0.250	33.38	20	5L ...
	0.375	25.03	...	5L ...		0.281	37.42	...	5L ...
	0.432	28.57	80	5L XS		0.312	41.45	...	5L ...
	0.500	32.71	...	5L ...		0.330	43.77	30	5L ...
	0.562	36.39	120	5L ...		0.344	45.58	...	5L ...
	0.625	40.05	...	5L ...		0.375	49.56	...	5L STD
	0.719	45.35	160	5L ...		0.406	53.52	40	5L ...
	0.750	47.06	...	5L ...		0.438	57.59	...	5L ...
	0.864	53.16	...	5L XXS		0.500	65.42	...	5L XS
	0.875	53.73	...	5L ...		0.562	73.15	60	5L ...
	8 (8.625)	0.125	11.35	...		5L ...	0.625	80.93	...
0.156		14.11	...	5L ...		0.688	88.63	80	5L ...
0.188		16.94	...	5L ...		0.750	96.12	...	5L ...
0.203		18.26	...	5L ...	0.812	103.53	...	5L ...	
0.219		19.66	...	5L ...	0.844	107.32	100	...	
0.250		22.36	20	5L ...	0.875	110.97	...	5L ...	
0.277		24.70	30	5L ...	0.938	118.33	...	5L ...	
0.312		27.70	...	5L ...	1.000	125.49	120	5L XXS	
0.322		28.55	40	5L STD	1.062	132.57	...	5L ...	
0.344		30.42	...	5L ...	1.125	139.67	140	5L ...	
0.375		33.04	...	5L ...	1.250	153.53	...	5L ...	
0.406		35.64	60	...	1.312	160.27	160	5L ...	
0.438		38.30	...	5L ...	14 (14.000)	0.188	27.73	...	5L ...
0.500		43.39	80	5L XS		0.203	29.91	...	5L ...
0.562		48.40	...	5L ...		0.210	30.93	...	5L ...
0.594		50.95	100	...		0.219	32.23	...	5L ...
0.625		53.40	...	5L ...		0.250	36.71	10	5L ...
0.719	60.71	120	5L ...	0.281		41.17	...	5L ...	
0.750	63.08	...	5L ...	0.312		45.61	20	5L ...	
0.812	67.76	140	5L ...	0.344		50.17	...	5L ...	
0.875	72.42	...	5L XXS	0.375		54.57	30	5L STD	
0.906	74.69	160	...	0.406		58.94	...	5L ...	
1.000	81.44	...	5L ...	0.438		63.44	40	5L ...	
10 (10.750)	0.156	17.65	...	5L ...		0.469	67.78	...	5L ...
	0.188	21.21	...	5L ...		0.500	72.09	...	5L XS
	0.203	22.87	...	5L ...		0.562	80.66	...	5L ...
	0.219	24.63	...	5L ...		0.594	85.05	60	...
	0.250	28.04	20	5L ...		0.625	89.28	...	5L ...
	0.279	31.20	...	5L ...		0.688	97.81	...	5L ...
	0.307	34.24	30	5L ...	0.750	106.13	80	5L ...	
	0.344	38.23	...	5L ...	0.812	114.37	...	5L ...	
	0.365	40.48	40	5L STD	0.875	122.65	...	5L ...	
	0.438	48.24	...	5L ...	0.938	130.85	100	5L ...	
	0.500	54.74	60	5L XS	1.000	138.84	...	5L ...	
	0.562	61.15	...	5L ...	1.062	146.74	...	5L ...	
	0.594	64.43	80	...	1.094	150.79	120	...	
	0.625	67.58	...	5L ...	1.125	154.69	...	5L ...	
	0.719	77.03	100	5L ...	1.250	170.21	140	5L ...	
	0.812	86.18	...	5L ...	1.406	189.11	160	...	
	0.844	89.29	120	...	2.000	256.32	
0.875	92.28	...	5L ...	2.125	269.50		
0.938	98.30	...	5L ...	2.200	277.25		
1.000	104.13	140	5L XXS	2.500	307.05		

Table 2. Properties of American National Standard Schedule 40 Welded and Seamless Wrought Steel Pipe

Diameter, Inches			Wall Thickness, Inches	Cross-Sectional Area of Metal	Weight per Foot, Pounds		Capacity per Foot of Length		Length of Pipe in Feet to Contain		Properties of Sections		
Nominal	Actual Inside	Actual Outside			Of Pipe	Of Water in Pipe	In Cubic Inches	In Gallons	One Cubic Foot	One Gallon	Moment of Inertia	Radius of Gyration	Section Modulus
1/8	0.269	0.405	0.068	0.072	0.24	0.025	0.682	0.003	2532.	338.7	0.00106	0.122	0.00525
1/4	0.364	0.540	0.088	0.125	0.42	0.045	1.249	0.005	1384.	185.0	0.00331	0.163	0.01227
3/8	0.493	0.675	0.091	0.167	0.57	0.083	2.291	0.010	754.4	100.8	0.00729	0.209	0.02160
1/2	0.622	0.840	0.109	0.250	0.85	0.132	3.646	0.016	473.9	63.35	0.01709	0.261	0.4070
3/4	0.824	1.050	0.113	0.333	1.13	0.231	6.399	0.028	270.0	36.10	0.03704	0.334	0.07055
1	1.049	1.315	0.133	0.494	1.68	0.374	10.37	0.045	166.6	22.27	0.08734	0.421	0.1328
1 1/4	1.380	1.660	0.140	0.669	2.27	0.648	17.95	0.078	96.28	12.87	0.1947	0.539	0.2346
1 1/2	1.610	1.900	0.145	0.799	2.72	0.882	24.43	0.106	70.73	9.456	0.3099	0.623	0.3262
2	2.067	2.375	0.154	1.075	3.65	1.454	40.27	0.174	42.91	5.737	0.6658	0.787	0.5607
2 1/2	2.469	2.875	0.203	1.704	5.79	2.074	57.45	0.249	30.08	4.021	1.530	0.947	1.064
3	3.068	3.500	0.216	2.228	7.58	3.202	88.71	0.384	19.48	2.604	3.017	1.163	1.724
3 1/2	3.548	4.000	0.226	2.680	9.11	4.283	118.6	0.514	14.56	1.947	4.788	1.337	2.394
4	4.026	4.500	0.237	3.174	10.79	5.515	152.8	0.661	11.31	1.512	7.233	1.510	3.215
5	5.047	5.563	0.258	4.300	14.62	8.666	240.1	1.04	7.198	0.9622	15.16	1.878	5.451
6	6.065	6.625	0.280	5.581	18.97	12.52	346.7	1.50	4.984	0.6663	28.14	2.245	8.496
8	7.981	8.625	0.322	8.399	28.55	21.67	600.3	2.60	2.878	0.3848	72.49	2.938	16.81
10	10.020	10.750	0.365	11.91	40.48	34.16	946.3	4.10	1.826	0.2441	160.7	3.674	29.91
12	11.938	12.750	0.406	15.74	53.52	48.49	1343.	5.81	1.286	0.1720	300.2	4.364	47.09
16	15.000	16.000	0.500	24.35	82.77	76.55	2121.	9.18	0.8149	0.1089	732.0	5.484	91.50
18	16.876	18.000	0.562	30.79	104.7	96.90	2684.	11.62	0.6438	0.0861	1172.	6.168	130.2
20	18.812	20.000	0.594	36.21	123.1	120.4	3335.	14.44	0.5181	0.0693	1706.	6.864	170.6
24	22.624	24.000	0.688	50.39	171.3	174.1	4824.	20.88	0.3582	0.0479	3426.	8.246	285.5
32	30.624	32.000	0.688	67.68	230.1	319.1	8839.	38.26	0.1955	0.0261	8299.	11.07	518.7

Note: Torsional section modulus equals twice section modulus.

Table 3. Properties of American National Standard Schedule 80 Welded and Seamless Wrought Steel Pipe

Diameter, Inches			Wall Thickness, Inches	Cross-Sectional Area of Metal	Weight per Foot, Pounds		Capacity per Foot of Length		Length of Pipe in Feet to Contain		Properties of Sections		
Nominal	Actual Inside	Actual Outside			Of Pipe	Of Water in Pipe	In Cubic Inches	In Gallons	One Cubic Foot	One Gallon	Moment of Inertia	Radius of Gyration	Section Modulus
1/8	0.215	0.405	0.095	0.093	0.315	0.016	0.436	0.0019	3966.	530.2	0.00122	0.115	0.00600
1/4	0.302	0.540	0.119	0.157	0.537	0.031	0.860	0.0037	2010.	268.7	0.00377	0.155	0.01395
3/8	0.423	0.675	0.126	0.217	0.739	0.061	1.686	0.0073	1025.	137.0	0.00862	0.199	0.02554
1/2	0.546	0.840	0.147	0.320	1.088	0.101	2.810	0.0122	615.0	82.22	0.02008	0.250	0.04780
3/4	0.742	1.050	0.154	0.433	1.474	0.187	5.189	0.0225	333.0	44.52	0.04479	0.321	0.08531
1	0.957	1.315	0.179	0.639	2.172	0.312	8.632	0.0374	200.2	26.76	0.1056	0.407	0.1606
1 1/4	1.278	1.660	0.191	0.881	2.997	0.556	15.39	0.0667	112.3	15.01	0.2418	0.524	0.2913
1 1/2	1.500	1.900	0.200	1.068	3.631	0.766	21.21	0.0918	81.49	10.89	0.3912	0.605	0.4118
2	1.939	2.375	0.218	1.477	5.022	1.279	35.43	0.1534	48.77	6.519	0.8680	0.766	0.7309
2 1/2	2.323	2.875	0.276	2.254	7.661	1.836	50.86	0.2202	33.98	4.542	1.924	0.924	1.339
3	2.900	3.500	0.300	3.016	10.25	2.861	79.26	0.3431	21.80	2.914	3.895	1.136	2.225
3 1/2	3.364	4.000	0.318	3.678	12.50	3.850	106.7	0.4617	16.20	2.166	6.280	1.307	3.140
4	3.826	4.500	0.337	4.407	14.98	4.980	138.0	0.5972	12.53	1.674	9.611	1.477	4.272
5	4.813	5.563	0.375	6.112	20.78	7.882	218.3	0.9451	7.915	1.058	20.67	1.839	7.432
6	5.761	6.625	0.432	8.405	28.57	11.29	312.8	1.354	5.524	0.738	40.49	2.195	12.22
8	7.625	8.625	0.500	12.76	43.39	19.78	548.0	2.372	3.153	0.422	105.7	2.878	24.52
10	9.562	10.750	0.594	18.95	64.42	31.11	861.7	3.730	2.005	0.268	245.2	3.597	45.62
12	11.374	12.750	0.688	26.07	88.63	44.02	1219.	5.278	1.417	0.189	475.7	4.271	74.62
14	12.500	14.000	0.750	31.22	106.1	53.16	1473.	6.375	1.173	0.157	687.4	4.692	98.19
16	14.312	16.000	0.844	40.19	136.6	69.69	1931.	8.357	0.895	0.120	1158.	5.366	144.7
18	16.124	18.000	0.938	50.28	170.9	88.46	2450.	10.61	0.705	0.094	1835.	6.041	203.9
20	17.938	20.000	1.031	61.44	208.9	109.5	3033.	13.13	0.570	0.076	2772.	6.716	277.2
22	19.750	22.000	1.125	73.78	250.8	132.7	3676.	15.91	0.470	0.063	4031.	7.391	366.4

Note: Torsional section modulus equals twice section modulus.

Table 4. Volume of Flow at 1 Foot Per-Minute Velocity in Pipe and Tube

Nominal Dia., Inches	Schedule 40 Pipe			Schedule 80 Pipe			Type K Copper Tube			Type L Copper Tube		
	Cu. Ft. per Minute	Gallons per Minute	Pounds 60 F Water per Min.	Cu. Ft. per Minute	Gallons per Minute	Pounds 60 F Water per Min.	Cu. Ft. per Minute	Gallons per Minute	Pounds 60 F Water per Min.	Cu. Ft. per Minute	Gallons per Minute	Pounds 60 F Water per Min.
1/8	0.0004	0.003	0.025	0.0003	0.002	0.016	0.0002	0.0014	0.012	0.0002	0.002	0.014
1/4	0.0007	0.005	0.044	0.0005	0.004	0.031	0.0005	0.0039	0.033	0.0005	0.004	0.034
3/8	0.0013	0.010	0.081	0.0010	0.007	0.061	0.0009	0.0066	0.055	0.0010	0.008	0.063
1/2	0.0021	0.016	0.132	0.0016	0.012	0.102	0.0015	0.0113	0.094	0.0016	0.012	0.101
3/4	0.0037	0.028	0.232	0.0030	0.025	0.213	0.0030	0.0267	0.189	0.0034	0.025	0.210
1	0.0062	0.046	0.387	0.0050	0.037	0.312	0.0054	0.0404	0.338	0.0057	0.043	0.358
1 1/4	0.0104	0.078	0.649	0.0088	0.067	0.555	0.0085	0.0632	0.53	0.0087	0.065	0.545
1 1/2	0.0141	0.106	0.882	0.0123	0.092	0.765	0.0196	0.1465	1.22	0.0124	0.093	0.770
2	0.0233	0.174	1.454	0.0206	0.154	1.280	0.0209	0.1565	1.31	0.0215	0.161	1.34
2 1/2	0.0332	0.248	2.073	0.0294	0.220	1.830	0.0323	0.2418	2.02	0.0331	0.248	2.07
3	0.0514	0.383	3.201	0.0460	0.344	2.870	0.0461	0.3446	2.88	0.0473	0.354	2.96
3 1/2	0.0682	0.513	4.287	0.0617	0.458	3.720	0.0625	0.4675	3.91	0.0640	0.479	4.00
4	0.0884	0.660	5.516	0.0800	0.597	4.970	0.0811	0.6068	5.07	0.0841	0.622	5.20
5	0.1390	1.040	8.674	0.1260	0.947	7.940	0.1259	0.9415	7.87	0.1296	0.969	8.10
6	0.2010	1.500	12.52	0.1820	1.355	11.300	0.1797	1.3440	11.2	0.1862	1.393	11.6
8	0.3480	2.600	21.68	0.3180	2.380	19.800	0.3135	2.3446	19.6	0.3253	2.434	20.3
10	0.5476	4.10	34.18	0.5560	4.165	31.130	0.4867	3.4405	30.4	0.5050	3.777	21.6
12	0.7773	5.81	48.52	0.7060	5.280	44.040	0.6978	5.2194	43.6	0.7291	5.454	45.6
14	0.9396	7.03	58.65	0.8520	6.380	53.180
16	1.227	9.18	76.60	1.1170	8.360	69.730
18	1.553	11.62	96.95	1.4180	10.610	88.500
20	1.931	14.44	120.5	1.7550	13.130	109.510

To obtain volume of flow at any other velocity, multiply values in table by velocity in feet per minute.

Plastics Pipe.—Shortly after World War II, plastics pipe became an acceptable substitute, under certain service conditions, for other piping materials. Now, however, plastics pipe is specified on the basis of its own special capabilities and limitations. The largest volume of application has been for water piping systems.

Besides being light in weight, plastics pipe performs well in resisting deterioration from corrosive or caustic fluids. Even if the fluid borne is harmless, the chemical resistance of plastics pipe offers protection against a harmful exterior environment, such as when buried in a corrosive soil.

Generally, plastics pipe is limited by its temperature and pressure capacities. The higher the operating pressure of the pipe system, the less will be its temperature capability. The reverse is true, also. Since it is formed from organic resins, plastics pipe will burn. For various piping compositions, ignition temperatures vary from 700° to 800°F (370° to 430°C).

The following are accepted methods for joining plastics pipe:

Solvent Welding is usually accomplished by brushing a solvent cement on the end of the length of pipe and into the socket end of a fitting or the flange of the next pipe section. A chemical weld then joins and seals the pipe after connection.

Threading is a procedure not recommended for thin-walled plastics pipe or for specific grades of plastics. During connection of thicker-walled pipe, strap wrenches are used to avoid damaging and weakening the plastics.

Heat Fusion involves the use of heated air and plastics filler rods to weld plastics pipe assemblies. A properly welded joint can have a tensile strength equal to 90 percent that of the pipe material.

Elastomeric Sealing is used with bell-end piping. It is a recommended procedure for large diameter piping and for underground installations. The joints are set quickly and have good pressure capabilities.

Table 5. Dimensions and Weights of Thermoplastics Pipe

Nominal Pipe Size		Outside Diameter		Schedule 40				Schedule 80			
				Nom. Wall Thickness		Nominal Weight		Nom. Wall Thickness		Nominal Weight	
in.	cm	in.	cm	in.	cm	lb/100'	kg/m	in.	cm	lb/100'	kg/m
1/8	0.3	0.405	1.03	0.072	0.18	3.27	0.05	0.101	0.256	4.18	0.06
1/4	0.6	0.540	1.37	0.093	0.24	5.66	0.08	0.126	0.320	7.10	0.11
3/8	1.0	0.675	1.71	0.096	0.24	7.57	0.11	0.134	0.340	9.87	0.15
1/2	1.3	0.840	2.13	0.116	0.295	11.4	0.17	0.156	0.396	14.5	0.22
3/4	2.0	1.050	2.67	0.120	0.305	15.2	0.23	0.163	0.414	19.7	0.29
1	2.5	1.315	3.34	0.141	0.358	22.5	0.33	0.190	0.483	29.1	0.43
1 1/4	3.2	1.660	4.22	0.148	0.376	30.5	0.45	0.202	0.513	40.1	0.60
1 1/2	3.8	1.900	4.83	0.154	0.391	36.6	0.54	0.212	0.538	48.7	0.72
2	5.1	2.375	6.03	0.163	0.414	49.1	0.73	0.231	0.587	67.4	1.00
2 1/2	6.4	2.875	7.30	0.215	0.546	77.9	1.16	0.293	0.744	103	1.5
3	7.6	3.500	8.89	0.229	0.582	102	1.5	0.318	0.808	138	2.1
3 1/2	8.9	4.000	10.16	0.240	0.610	123	1.8	0.337	0.856	168	2.5
4	10.2	4.500	11.43	0.251	0.638	145	2.2	0.357	0.907	201	3.0
5	12.7	5.563	14.13	0.273	0.693	197	2.9	0.398	1.011	280	4.2
6	15.2	6.625	16.83	0.297	0.754	256	3.8	0.458	1.163	385	5.7
8	20.3	8.625	21.91	0.341	0.866	385	5.7	0.530	1.346	584	8.7
10	25.4	10.75	27.31	0.387	0.983	546	8.1	0.629	1.598	867	12.9
12	30.5	12.75	32.39	0.430	1.09	722	10.7	0.728	1.849	1192	17.7

The nominal weights of plastics pipe given in this table are based on an empirically chosen material density of 1.00 g/cm³. The nominal unit weight for a specific plastics pipe formulation can be

obtained by multiplying the weight values from the table by the density in g/cm³ or by the specific gravity of the particular plastics composition.

The following are ranges of density factors for various plastics pipe materials: PE, 0.93 to 0.96; PVC, 1.35 to 1.40; CPVC, 1.55; ABS, 1.04 to 1.08; SR, 1.05; PB, 0.91 to 0.92; and PP, 0.91. For meanings of abbreviations see [Table 6](#).

Information supplied by the Plastics Pipe Institute.

Insert Fitting is particularly useful for PE and PB pipe. For joining pipe sections, insert fittings are pushed into the pipe and secured by stainless steel clamps.

Transition Fitting involves specially designed connectors to join plastic pipe with other materials, such as cast iron, steel, copper, clay, and concrete.

Plastic pipe can be specified by means of Schedules 40, 80, and 120, which conform dimensionally to metal pipe, or through a Standard Dimension Ratio (SDR). The SDR is a rounded value obtained by dividing the average outside diameter of the pipe by the wall thickness. Within an individual SDR series of pipe, pressure ratings are uniform, regardless of pipe diameter.

[Table 5](#) provides the weights and dimensions for Schedule 40 and 80 thermoplastic pipe, [Table 6](#) gives properties of plastics pipe, [Table 7](#) gives maximum non-shock operating pressures for several varieties of Schedule 40 and 80 plastics pipe at 73°F, and [Table 8](#) gives correction factors to pressure ratings for elevated temperatures.

Table 6. General Properties and Uses of Plastic Pipe

Plastic Pipe Material	Properties	Common Uses	Operating Temperature ^a		Joining Methods
			With Pressure	Without Pressure	
ABS (Acrylonitrilebutadiene styrene)	Rigid; excellent impact strength at low temperatures; maintains rigidity at higher temperatures.	Water, Drain, Waste, Vent, Sewage.	100°F (38°C)	180°F (82°C)	Solvent cement, Threading, Transition fitting.
PE (Polyethylene)	Flexible; excellent impact strength; good performance at low temperatures.	Water, Gas, Chemical, Irrigation.	100°F (38°C)	180°F (82°C)	Heat fusion, Insert and Transition fitting.
PVC (Polyvinylchloride)	Rigid; fire self-extinguishing; high impact and tensile strength.	Water, Gas, Sewage, Industrial process, Irrigation.	100°F (38°C)	180°F (82°C)	Solvent cement, Elastomeric seal, Mechanical coupling, Transition fitting.
CPVC (Chlorinated polyvinyl chloride)	Rigid; fire self-extinguishing; high impact and tensile strength.	Hot and cold water, Chemical.	180°F (82°C) at 100 psig (690kPa) for SDR-11		Solvent cement, Threading, Mechanical coupling, Transition fitting.
PB (Polybutylene)	Flexible; good performance at elevated temperatures.	Water, Gas, Irrigation.	180°F (82°C)	200°F (93°C)	Insert fitting, Heat fusion, Transition fitting.
PP (Polypropylene)	Rigid; very light; high chemical resistance, particularly to sulfur-bearing compounds.	Chemical waste and processing.	100°F (38°C)	180°F (82°C)	Mechanical coupling, Heat fusion, Threading.
SR (Styrene rubber plastic)	Rigid; moderate chemical resistance; fair impact strength.	Drainage, Septic fields.	150°F (66°C)	...	Solvent cement, Transition fitting, Elastomeric seal.

^aThe operating temperatures shows are general guide points. For specific operating temperature and pressure data for various grades of the types of plastic pipe given, please consult the pipe manufacturer or the Plastics Pipe Institute.

From information supplied by the Plastics Pipe Institute.

**Table 7. Maximum Nonshock Operating Pressure (psi)
for Thermoplastic Piping at 73°F**

Nominal Pipe Size (inch)	Schedule 40		Schedule 80						
	PVC & CPVC (Socket End)	ABS	PVC & CPVC		Polypropylene		PVDF		ABS
			Socket End	Threaded End	Thermo- seal Joint	Threaded End ^a	Thermoseal Joint	Threaded End	
½	600	476	850	420	410	20	580	290	678
¾	480	385	690	340	330	20	470	230	550
1	450	360	630	320	310	20	430	210	504
1¼	370	294	520	260	260	20	416
1½	330	264	470	240	230	20	326	160	376
2	280	222	400	200	200	...	270	140	323
2½	300	243	420	210	...	20	340
3	260	211	370	190	160	20	250	NR	297
4	220	177	320	160	140	NR	220	NR	259
6	180	141	280	NR	190	NR	222
8	160	...	250 ^b	NR
10	140	...	230	NR
12	130	...	230	NR

^a Recommended for intermittent drainage pressure not exceeding 20 psi.

^b 8-inch CPVC Tee, 90° Ell, and 45° Ell are rated at half the pressure shown.

ABS pressures refer to unthreaded pipe only.

For service at higher temperature, multiply the pressure obtained from this table by the correction factor from [Table 6](#).

NR is not recommended.

**Table 8. Temperature-Correction Factors for
Thermoplastic Piping Operating Pressures**

Operating Temperature, °F	Pipe Material			
	PVC	CPVC	Polypropylene	PVDF
70	1	1	1	1
80	0.90	0.96	0.97	0.95
90	0.75	0.92	0.91	0.87
100	0.62	0.85	0.85	0.80
110	0.50	0.77	0.80	0.75
115	0.45	0.74	0.77	0.71
120	0.40	0.70	0.75	0.68
125	0.35	0.66	0.71	0.66
130	0.30	0.62	0.68	0.62
140	0.22	0.55	0.65	0.58
150	NR	0.47	0.57	0.52
160	NR	0.40	0.50	0.49
170	NR	0.32	0.26	0.45
180	NR	0.25	^a	0.42
200	NR	0.18	NR	0.36
210	NR	0.15	NR	0.33
240	NR	NR	NR	0.25
280	NR	NR	NR	0.18

^a Recommended for intermittent drainage pressure not exceeding 20 psi.

NR = not recommended.

For more detailed information concerning the properties of a particular plastic pipe formulation, consult the pipe manufacturer or Plastics Pipe Institute, 1825 Connecticut Ave. NW, Washington, D.C. 2009.

Pipe and Tube Bending.—In bending a pipe or tube, the outer part of the bend is stretched and the inner section compressed, and as the result of opposite and unequal stresses, the pipe or tube tends to flatten or collapse. To prevent such distortion, the common practice is to support the wall of the pipe or tube in some manner during the bending operation. This support may be in the form of a filling material, or, when a bending machine or fixture is used, an internal mandrel or ball-shaped member may support the inner wall when required.

If a filling material is used, it is melted and poured into the pipe or tube. Many filler materials made up from combinations of bismuth, lead, tin, and cadmium, with melting points around 160 degrees F are commercially available. With this material, tubes having very thin walls have been bent to small radii. The metal filler conforms to the inside of the tube so closely that the tube can be bent just as though it were a solid rod. The filler is removed readily by melting.

This method has been applied to the bending of copper, brass, duralumin, plain steel, and stainless steel tubes with uniform success. Tubes plated with chromium or nickel can often be bent without danger of the plate flaking off. Other filling materials such as resin, tar, lead, and dry sand have also been used.

Pipes are often bent to avoid the use of fittings, thus eliminating joints, providing a smooth unobstructed passage for fluids, and resulting in certain other advantages.

Minimum Radius: The safe minimum radius for a given diameter, material, and method of bending depends upon the thickness of the pipe wall, it being possible, for example, to bend extra heavy pipe to a smaller radius than pipe of standard weight. As a general rule, wrought iron or steel pipe of standard weight may readily be bent to a radius equal to five or six times the nominal pipe diameter. The minimum radius for standard weight pipe should, as a rule, be three and one-half to four times the diameter. It will be understood, however, that the minimum radius may vary considerably, depending upon the method of bending. Extra heavy pipe may be bent to radii varying from two and one-half times the diameter for smaller sizes to three and one-half to four times the diameter for larger sizes.

Rules for Finding Lengths of Bends: In determining the required length of a pipe or tube before bending, the lengths of the straight sections are, of course, added to the lengths required for the curved sections in order to make the proper allowance for bends. The following rules are for finding the lengths of the curved sections.

Length of 90-Degree Bend: To find the length of a 90-degree or right-angle bend, multiply the radius of the bend by 1.57. The radius is measured to the center of the pipe, or to a point midway between the inner and outer walls.

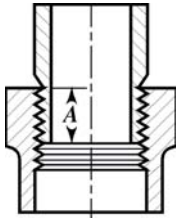
Length of 180-Degree Bend: Multiply the radius of the bend by 3.14.

Length of other than 90- or 180-Degree Bend: Multiply the radius of the bend by the included angle, and then multiply the product by the constant $\pi/180 = 0.01745$. The result is the length of the curved section.

Threading Pipe.—Clean, smooth pipe threads are essential to a good joint and depend largely upon the rake or lip angle and lead of the chasers, and the clearance, chip space and number of chasers in the die-head. The lip angle should vary from 15 to 25 degrees, depending upon the style and condition of the chasers and chaser holders. The chip space in front of the chasers should be large enough to allow room for accumulation of chips and at the same time provide means of lubricating the chasers. This is an important point, as insufficient chip space will cause the chips to clog and tear the threads. The lead of the chaser is the angle which is machined or ground on the leading or front side, to enable the die to start readily on the pipe, and also to distribute the work of cutting over a number of threads. To secure a good thread, the lead should cover the first three threads. As the heaviest cutting is done by this beveled part, it should have a slightly greater clearance angle than the rest of the threads on the chaser. When re-grinding chasers which have become

dull on the lead, care should be taken to give each chaser the same length of lead, as otherwise the work will be unevenly distributed.

Length of Thread on Pipe Required to Make a Tight Joint (Crane Co.)

	Size of Pipe, Inches	Dimension A, Inches	Size of Pipe, Inches	Dimension A, Inches	Size of Pipe, Inches	Dimension A, Inches
	$\frac{1}{8}$	$\frac{1}{4}$	$1\frac{1}{2}$	$\frac{11}{16}$	5	$1\frac{1}{4}$
$\frac{1}{4}$	$\frac{3}{8}$	2	$\frac{3}{4}$	6	$1\frac{5}{16}$	
$\frac{3}{8}$	$\frac{3}{8}$	$2\frac{1}{2}$	$\frac{15}{16}$	7	$1\frac{3}{8}$	
$\frac{1}{2}$	$\frac{1}{2}$	3	1	8	$1\frac{1}{16}$	
$\frac{3}{4}$	$\frac{9}{16}$	$3\frac{1}{2}$	$\frac{11}{16}$	9	$1\frac{1}{2}$	
1	$\frac{11}{16}$	4	$\frac{11}{8}$	10	$1\frac{5}{8}$	
$1\frac{1}{4}$	$\frac{11}{16}$	$4\frac{1}{2}$	$\frac{13}{16}$	12	$1\frac{3}{4}$	

Dimensions do not allow for variation in tapping or threading.

Definitions of Pipe Fittings.—The following definitions for various pipe fittings are given by the National Tube Co.:

Armstrong Joint: A two-bolt, flanged or lugged connection for high pressures. The ends of the pipes are peculiarly formed to properly hold a gutta-percha ring. It was originally made for cast-iron pipe. The two-bolt feature has much to commend it. There are various substitutes for this joint, many of which employ rubber in place of gutta-percha; others use more bolts in order to reduce the cost.

Bell and Spigot Joint: a) The usual term for the joint in cast-iron pipe. Each piece is made with an enlarged diameter or bell at one end into which the plain or spigot end of another piece is inserted when laying. The joint is then made tight by cement, oakum, lead, rubber or other suitable substance, which is driven in or calked into the bell and around the spigot. When a similar joint is made in wrought pipe by means of a cast bell (or hub), it is at times called hub and spigot joint (poor usage). Matheson joint is the name applied to a similar joint in wrought pipe which has the bell formed from the pipe.

b) Applied to fittings or valves, means that one end of the run is a "bell," and the other end is a "spigot," similar to those used on regular cast-iron pipe.

Bonnet: a) A cover used to guide and enclose the tail end of a valve spindle.

b) A cap over the end of a pipe (poor usage).

Branch: The outlet or inlet of a fitting not in line with the run, but which may make any angle.

Branch Ell: a) Used to designate an elbow having a back outlet in line with one of the outlets of the "run." It is also called a heel outlet elbow.

b) Incorrectly used to designate side outlet or back outlet elbow.

Branch Pipe: A very general term used to signify a pipe either cast or wrought, that is equipped with one or more branches. Such pipes are used so frequently that they have acquired common names such as tees, crosses, side or back outlet elbows, manifolds, double-branch elbows, etc. The term branch pipe is generally restricted to such as do not conform to usual dimensions.

Branch Tee or Header: A tee having many side branches. (See *Manifold*.)

Bull Head Tee: A tee the branch of which is larger than the run.

Bushing: A pipe fitting for the purpose of connecting a pipe with a fitting of larger size, being a hollow plug with internal and external threads to suit the different diameters.

Card Weight Pipe: A term used to designate standard or full weight pipe, which is the Briggs' standard thickness of pipe.

Close Nipple: One the length of which is about twice the length of a standard pipe thread and is without any shoulder.

Coupling: A threaded sleeve used to connect two pipes. Commercial couplings are threaded inside to suit the exterior thread of the pipe. The term coupling is occasionally used to mean any jointing device and may be applied to either straight or reducing sizes.

Cross: A pipe fitting with four branches arranged in pairs, each pair on one axis, and the axes at right angles. When the outlets are otherwise arranged the fittings are branch pipes or specials.

Cross-over: A small fitting with a double offset, or shaped like the letter U with the ends turned out. It is only made in small sizes and used to pass the flow of one pipe past another when the pipes are in the same plane.

Cross-over Tee: A fitting made along lines similar to the cross-over, but having at one end two openings in a tee-head the plane of which is at right angles to the plane of the cross-over bend.

Cross Valve: a) A valve fitted on a transverse pipe so as to open communication at will between two parallel lines of piping. Much used in connection with oil and water pumping arrangements, especially on ship board.

b) Usually considered as an angle valve with a back outlet in the same plane as the other two openings.

Crotch: A fitting that has the general shape of the letter Y. Caution should be exercised not to confuse the crotch and wye.

Double-branch Elbow: A fitting that, in a manner, looks like a tee, or as if two elbows had been shaved and then placed together, forming a shape something like the letter Y or a crotch.

Double Sweep Tee: A tee made with easy curves between body and branch, i.e., the center of the curve between run and branch lies outside the body.

Drop Elbow: A small sized ell that is frequently used where gas is put into a building. These fittings have wings cast on each side. The wings have small countersunk holes so that they may be fastened by wood screws to a ceiling or wall or framing timbers.

Drop Tee: One having the same peculiar wings as the drop elbow.

Dry Joint: One made without gasket or packing or smear of any kind, as a ground joint.

Elbow (ELL): A fitting that makes an angle between adjacent pipes. The angle is always 90 degrees, unless another angle is stated. (See *Branch Ell*, *Service Ell*, and *Union Ell*.)

Extra Heavy: When applied to pipe, means pipe thicker than standard pipe; when applied to valves and fittings, indicates goods suitable for a working pressure of 250 pounds per square inch.

Header: A large pipe into which one set of boilers is connected by suitable nozzles or tees, or similar large pipes from which a number of smaller ones lead to consuming points. Headers are often used for other purposes—for heaters or in refrigeration work. Headers are essentially branch pipes with many outlets, which are usually parallel. Largely used for tubes of water-tube boilers.

Hydrostatic Joint: Used in large water mains, in which sheet lead is forced tightly into the bell of a pipe by means of the hydrostatic pressure of a liquid.

Kewanee Union: A patented pipe union having one pipe end of brass and the other of malleable iron, with a ring or nut of malleable iron, in which the arrangement and finish of the several parts is such as to provide a non-corrosive ball-and-socket joint at the junction of the pipe ends, and a non-corrosive connection between the ring and brass pipe end.

Lead Joint: a) Generally used to signify the connection between pipes which is made by pouring molten lead into the annular space between a bell and spigot, and then making the lead tight by calking.

b) Rarely used to mean the joint made by pressing the lead between adjacent pieces, as when a lead gasket is used between flanges.

Lead Wool: A material used in place of molten lead for making pipe joints. It is lead fiber, about as coarse as fine excelsior, and when made in a strand, it can be calked into the joints, making them very solid.

Line Pipe: Special brand of pipe that employs recessed and taper thread couplings, and usually greater length of thread than Briggs' standard. The pipe is also subjected to higher test.

Lip Union: a) A special form of union characterized by the lip that prevents the gasket from being squeezed into the pipe so as to obstruct the flow.

b) A ring union, unless flange is specified.

Manifold: a) A fitting with numerous branches used to convey fluids between a large pipe and several smaller pipes. (See *Branch Tee or Header*.)

b) A header for a coil.

Matheson Joint: A wrought pipe joint made by enlarging one end of the pipe to form a suitable lead recess, similar to the bell end of a cast-iron pipe, and which receives the male or spigot end of the next length. Practically the same style of a joint as used for cast-iron pipe.

Medium Pressure: When applied to valves and fittings, means suitable for a working pressure of from 125 to 175 pounds per square inch.

Needle Valve: A valve provided with a long tapering point in place of the ordinary valve disk. The tapering point permits fine graduation of the opening. At times called a needle point valve.

Nipple: A tubular pipe fitting usually threaded on both ends and under 12 inches in length. Pipe over 12 inches long is regarded as cut pipe. (See *Close Nipple*, *Short Nipple*, *Shoulder Nipple*, and *Space Nipple*.)

Reducer: a) A fitting having a larger size at one end than at the other. Some have tried to establish the term “increaser” — thinking of direction of flow — but this has been due to a misunderstanding of the trade custom of always giving the largest size of run of a fitting first; hence, all fittings having more than one size are reducers. They are always threaded inside, unless specified flanged or for some special joint.

b) Threaded type, made with abrupt reduction.

c) Flanged pattern with taper body.

d) Flanged eccentric pattern with taper body, but flanges at 90 degrees to one side of body.

e) Misapplied at times, to a reducing coupling.

Run: a) A length of pipe that is made of more than one piece of pipe.

b) The portion of any fitting having its ends “in line” or nearly so, in contradistinction to the branch or side opening, as of a tee. The two main openings of an ell also indicate its run, and when there is a third opening on an eli, the fitting is a “side outlet” or “back outlet” elbow, except that when all three openings are in one plane and the back outlet is in line with one of the run openings, the fitting is a “heel outlet elbow” or a “single sweep tee” or sometimes a “branch tee.”

Rust Joint: Employed to secure rigid connection. The joint is made by packing an intervening space tightly with a stiff paste which oxidizes the iron, the whole rusting together and hardening into a solid mass. It generally cannot be separated except by destroying some of the pieces. One recipe is 80 pounds cast-iron borings or filings, 1 pound sal-ammoniac, 2 pounds flowers of sulphur, mixed to a paste with water.

Service Ell: An elbow having an outside thread on one end. Also known as street ell.

Service Pipe: A pipe connecting mains with a dwelling.

Service Tee: A tee having inside thread on one end and on branch, but outside thread on other end of run. Also known as street tee.

Short Nipple: One whose length is a little greater than that of two threaded lengths or somewhat longer than a close nipple. It always has some unthreaded portion between the two threads.

Shoulder Nipple: A nipple of any length, which has a portion of pipe between two pipe threads. As generally used, however, it is a nipple about halfway between the length of a close nipple and a short nipple.

Space Nipple: A nipple with a portion of pipe or shoulder between the two threads. It may be of any length long enough to allow a shoulder.

Standard Pressure: A term applied to valves and fittings suitable for a working steam pressure of 125 pounds per square inch.

Tee: A fitting, either cast or wrought, that has one side outlet at right angles to the run. A single outlet branch pipe. (See *Branch Tee or Header*, *Bull Head Tee*, *Cross-over Tee*, *Double Sweep Tee*, *Drop Tee*, *Service Tee*, and *Union Tee*.)

Union: The usual trade term for a device used to connect pipes. It commonly consists of three pieces which are, first, the thread end fitted with exterior and interior threads; second, the bottom end fitted with interior threads and a small exterior shoulder; and third, the ring which has an inside flange at one end while the other end has an inside thread like that on the exterior of the thread end. A gasket is placed between the thread and bottom ends, which are drawn together by the ring. Unions are very extensively used, because they permit of connections with little disturbance of the pipe positions.

Union Ell: An ell with a male or female union at one end.

Union Joint: A pipe coupling, usually threaded, which permits disconnection without disturbing other sections.

Union Tee: A tee with male or female union at connection on one end of run.

Wiped Joint: A lead joint in which the molten solder is poured upon the desired place, after scraping and fitting the parts together, and the joint is wiped up by hand with a mole-skin or cloth pad while the metal is in a plastic condition.

Wye (Y): A fitting either cast or wrought that has one side outlet at any angle other than 90 degrees. The angle is usually 45 degrees, unless another angle is specified. The fitting is usually indicated by the letter Y.

Clutches

A clutch is a form of coupling which is designed to connect or disconnect a driving or driven member for starting or stopping the driven part. A clutch consists principally of two main sections which are engaged or disengaged either at will by a hand-operated controlling device, or automatically by the action of some power-driven mechanical apparatus, such as a cam connected by suitable means with the shifting clutch member. There are several distinct types of clutches which are made in a great variety of designs. The common types of clutches may be divided into two general classes; namely, (1) those having teeth which interlock, or positive clutches, and (2) those which transmit motion from the driving to the driven part of the clutch by frictional contact.

A third type, the induction clutch, similar in its operation to an induction motor, transmits power without contact between its driving and driven members.

Friction Clutches.—A friction clutch is used for transmitting power from one machine member to another by means of frictional contact between members attached to the driving and driven machine parts. These clutches are made in many different designs, there being, however, four types that predominate; the conical clutch, the radial-expanding friction clutch, the contracting-band clutch, and the friction disk clutch. Friction clutches are used when it is desired to have a smooth and gradual engagement and disengagement of the driving and driven members.

When motion is transmitted from the driving to the driven parts of a clutch simply by frictional contact, the load may be started gradually and without shock, such as often occurs when a positive clutch is engaged. The different types of friction clutches vary in regard to the form of the friction surfaces and with respect to the kinds of material used to obtain sufficient frictional resistance. The frictional surfaces may be either conical or cylindrical, or in the form of one or more flat rings or disks.

Conical Clutches: A conical clutch is so designed that motion is transmitted by the frictional resistance of engaging conical surfaces. The effectiveness of any friction clutch as a transmitter of power varies with the coefficient or degree of friction between the engaged surfaces. The frictional surfaces may both be of metal, but, in many cases, one member has a metal surface and the other is partially or entirely covered with some material such as leather or an asbestos fabric. The cast iron and leather combination is common, and pieces of cork inserted in holes drilled in one member is another common method of increasing

frictional resistance. It is common practice to maintain the driving and driven members of friction clutches in engagement by means of springs which are compressed in order to release the clutch. The angle of the conical surfaces is usually about 12 or 13 degrees. The conical type of friction clutch is simple in construction but rather bulky or large when compared with other types of equal capacity as transmitters of power.

Cone Clutch: A friction clutch in which one friction surface is in the form of a frustum of a cone and which, for engagement, is forced into the other member which is made to fit it on the inside. One friction surface may be covered with leather. If the angle of the conical surface of the cone type of clutch is too small, it may be difficult to release the clutch on account of the wedging effect, whereas, if the angle is too large, excessive pressure will be required to prevent slipping. The minimum angle for a leather-faced cone is about 8 or 9 degrees and the maximum angle about 13 degrees. An angle of 12½ degrees appears to be the most common and is generally considered good practice. These angles are given with relation to the clutch axis and are one-half the included angle.

Disk Clutch: A common design of disk clutch consists of a set of driving disks and a set of driven disks located alternately, so that each driving disk is between two driven disks. The driving disks may have key slots on their outer circumferences which are engaged by a key on the inner side of a driving drum, and the driven disks may be provided with lugs or key slots on the inner circumference for connection with the driven member.

Both the driving and driven disks of many clutches are metallic and run in oil. Steel disks about 1/16 inch thick are often used. One set of disks may be of bronze, or possibly of sheet copper. One multiple-disk clutch which has been extensively used has alternate disks of steel and phosphor-bronze. These disks have V-shaped grooves instead of being flat, frictional contact being between the angular surfaces. In dry-plate clutches, one set of plates may be faced on both sides with asbestos fabric, or cork inserts may be used.

Expanding Type of Friction Clutch: The radially expanding type of clutch is a form that has been widely used, the details of the design being varied more or less. A typical design consists of an outer casing in which there are two expanders or segment-shaped pieces connected by right- and left-hand screws, respectively. These screws are attached to levers, which, in turn, are connected to the sliding sleeve, by links, thus forming toggles between the sleeve and the screws. The two expanders and the toggle mechanism are caused to revolve with the shaft by a central driving hub. The clutch is operated by shifting the sliding sleeve and toggles; this movement turns the screws having right- and left-hand threads far enough to either expand the inner members tightly against the outer casing or to withdraw them from frictional contact. The expanders may be lined with maple grips, to increase the frictional resistance.

Hele-Shaw Clutch: This is a clutch devised by Prof. HeleShaw. Its principal feature is that power is transmitted through the friction between grooved disks. A number of these disks are placed in the clutch, each disk having a V-groove which fits into the V-groove of the next disk. Every other disk is connected to an outside drum, and the alternating disks, to the shaft to which power is to be transmitted. It has been found that V-shaped disks transmit considerably more power and permit of a more even "pick-up" than clutches with flat disks.

Internal Expanding Clutch: This is a friction clutch provided with shoes which are forced outward against an enclosing drum by the action of levers connecting with a collar free to slide along the shaft. The engaging shoes are usually lined with wood.

Magnetic Clutches: Magnetic clutches may be obtained having horsepower ratings varying from one to two horsepower up to several hundred horsepower. Such clutches are adapted particularly for high-speed drives, for heavy duty, and for use when there is difficulty in starting a heavy load with a motor. Magnetic clutches are also useful when machinery must be stopped quickly, a brake being used in such cases in combination with the clutch. One design of magnetic clutch has the field or driving member and the armature or driven member each carried by a flexible spring-steel plate so that when current passes

through the field winding, the armature is attracted to it and friction surfaces come into engagement. The magnetizing winding of the field receives current through two collector rings and graphite brushes, and direct current is used. The clutch driving capacity depends upon the friction surfaces which are held together by the magnetic attraction.

Ring and Disk Clutches: Many clutches of the friction type transmit motion from the driving to the driven side through the frictional resistance of rings, plates, or disks which are pressed together, the resistance being between the flat surfaces of the rings or disks which are thus held in contact. Some clutches of this general type have a few comparatively heavy rings, whereas others are equipped with a larger number of thin rings. By using quite a number of disks or rings instead of one or two, the diameter of the clutch may be reduced without sacrificing the contact area or the amount of frictional surface. Various combinations of materials are used for the disks of multiple-disk clutches. One set, for example, may be of soft steel and the other of phosphor-bronze, and in other types one set of disks is faced with some special friction material such as asbestos wire fabric, as in the case of dry plate clutches, the disks of which are not lubricated like those of a clutch having, for example, the steel and phosphor-bronze combination.

Positive Clutch.—This is a clutch for transmitting power between two machine members, the driving and driven members of which are connected by the engagement of interlocking teeth or projecting lugs, so that there is no slippage, the power being transmitted in a positive manner. This type of clutch is employed when a sudden starting action is not objectionable, and when the inertia of the driven parts is relatively small. The teeth of positive clutches are made in a number of different shapes, according to the service for which they are required.

Spiral-Jaw Clutch: A spiral-jaw clutch is a positive clutch in which the tops of the tooth surfaces are helicoidal, the front of the tooth being flat and in the plane of the axis of the clutch. Clutches of this type can only transmit motion in one direction, and are, therefore, known as right- and left-hand.

Square-Jaw Clutch: This is a positive clutch provided with teeth having perpendicular or square sides, so that, when engaged, the clutch will drive in either direction. Clutches of this type cannot be engaged and disengaged readily unless stationary or revolving slowly.

Clutches that Automatically Disengage.—The clutches used on power presses and some other kinds of machines are designed to automatically disengage after making one or more revolutions. The clutch connects the fly-wheel or driving gear of the press with the driven shaft, whenever it is tripped, by pressing down a foot-treadle. As long as this treadle is held down, the clutch remains in engagement and the press continues to run; if the treadle is released, the clutch is disengaged when the ram or slide of the press is approximately at the top of its stroke. The downward movement of the treadle releases a pin, key, or some other form of locking device which quickly engages the driving member; when the treadle is released, the locking device encounters some form of trip or cam surface which withdraws it and stops the press. There are many designs of clutches of this general type.

Motion Control

The most important factor in the manufacture of accurately machined components is the control of motion, whatever power source is used. For all practical purposes, motion control is accomplished by electrical or electronic circuits, energizing or deenergizing actuators such as electric motors or solenoid valves connected to hydraulic or pneumatic cylinders or motors. The accuracy with which a machine tool slide, for example, may be brought to a required position, time after time, controls the dimensions of the part being machined. This accuracy is governed by the design of the motion control system in use.

There is a large variety of control systems, with power outputs from milliwatts to megawatts, and they are used for many purposes besides motion control. Such a system may control a mechanical positioning unit, which may be linear or rotary, its velocity, acceleration, or combinations of these motion parameters. A control system may also be used to set voltage, tension, and other manufacturing process variables and to actuate various types of solenoid-operated valves. The main factors governing design of control systems are whether they are to be open- or closed-loop; what kinds and amounts of power are available; and the function requirements.

Factors governing selection of control systems are listed in [Table 1](#).

Table 1. Control System Application Factors

Type of System	Nature of required control motion, i.e., position, velocity, acceleration
Accuracy	Controlled output versus input
Mechanical Load	Viscous friction, coulomb friction, starting friction, load inertia
Impact Loads	Hitting mechanical stops and load disturbances
Ratings	Torque or force, and speed
Torque	Peak instantaneous torque
Duty Cycle	Load response, torque level, and duration and effect on thermal response
Ambient Temperature	Relation to duty cycle and internal temperature rise, and to the effect of temperature on the sensor
Speed of Response	Time to reach commanded condition. Usually defined by a response to a stepped command
Frequency Response	Output to input ratio versus frequency, for varying frequency and specified constant input amplitude. Usually expressed in decibels
No-Load Speed	Frequently applies to maximum kinetic energy and to impact on stops; avoiding overspeeding
Backdriving	With power off, can the load drive the motor? Is a fail-safe brake required? Can the load backdrive with power on without damage to the control electronics? (Electric motor acting as a generator)
Power Source	Range of voltage and frequency within which the system must work. Effect of line transients
Environmental Conditions	Range of nonoperating and operating conditions, reliability and serviceability, scheduled maintenance

Open-Loop Systems.—The term open-loop typically describes use of a rheostat or variable resistance to vary the input voltage and thereby adjust the speed of an electric motor, a low-accuracy control method because there is no output sensor to measure the performance. However, use of stepper motors (see [Table 2](#), and page 3414) in open-loop systems can make them very accurate. Shafts of stepper motors are turned through a fixed angle for every electrical pulse transmitted to them. The maximum pulse rate can be high, and the shaft can be coupled with step-down gear drives to form inexpensive, precise drive units with wide speed ranges. Although average speed with stepper motors is exact, speed modulation can occur at low pulse rates and drives can incur serious resonance problems.

Table 2. Control Motor Types

AC Motors	Induction motors, simplest, lowest cost, most rugged, can work directly off the ac line or through an inexpensive, efficient, and compact thyristor controller. Useful in fan and other drives where power increases rapidly with speed as well as in simple speed regulation. Ac motors are larger than comparable permanent-magnet motors
Two-Phase Induction Motors	Often used as control motors in small electromechanical control systems. Power outputs range from a few milliwatts to tens of watts
Split-Field Series Motors	Work on both ac and dc. Feature high starting torque, low cost, uniform power output over a wide speed range, and are easily reversed with a single-pole three-position switch. Very easy to use with electric limit switches for controlling angle of travel
Permanent-Magnet Motors	Operate on dc, with high power output and high efficiency. The most powerful units use rare-earth magnets and are more expensive than conventional types. Lower-cost ferrite magnets are much less expensive and require higher gear-reduction ratios, but at their higher rated speeds are very efficient
Brushless DC Motors	Use electrical commutation and may be applied as simple drive motors or as four-quadrant control motors. The absence of brushes for commutation ensures high reliability and low electromagnetic interference
Stepper Motors	Index through a fixed angle for each input pulse so that speed is in exact proportion to pulse rate and the travel angle increases uniformly with the number of pulses. Proper application in systems with backlash and load inertia requires special care
Wound-Field DC Motors	For subfractional to integral horsepower applications where size is not significant. Cost is moderate because permanent magnets are not required. Depending on the windings, output characteristics can be adjusted for specific applications

Open-loop systems are only as accurate as the input versus output requirement can be calibrated, including the effects of changes in line voltage, temperature, and other operating conditions.

Closed-Loop Systems.—Table 3 shows some parameters and characteristics of closed-loop systems, and a simple example of such a system is shown below. A command may be input by a human operator, it may be derived from another piece of system equipment, or it may be generated by a computer. Generally, the command is in the form of an electrical signal. The system response is converted by the output sensor to a compatible, scaled electrical signal that may be compared with the input command, the difference constituting an error signal. It is usually required that the error be small, so it is amplified and applied to an appropriate driving unit. The driver may take many forms, but for motion control it is usually a motor.

The amplified error voltage drives the motor to correct the error. If the input command is constant, the system is a closed-loop regulator.

Closed-loop systems use feedback sensors that measure system output and give instructions to the power drive components, based on the measured values. A typical closed-loop speed control, for instance, uses a tachometer as a feedback sensor and will correct automatically for differences between the tachometer output and the commanded speed. All motion control systems require careful design to achieve good practical performance. Closed-loop systems generally cost more than open-loop systems because of the extra cost of the tachometer or transducer used for output measurement. Faster response components also increase cost.

Table 3. Closed-Loop System Parameters and Characteristics

Step Response	The response of the system to a step change in the input command. The response to a large step, which can saturate the system amplifier, is different from the response to a small nonsaturating step. Initial overshoots may not be permissible in some types of equipment
Frequency Response	System response to a specified small-amplitude sinusoidal command where frequency is varied over the range of interest. The response is in decibels (dB), where $\text{dB} = 20 \log_{10}(\text{output}/\text{input})$. This characteristic determines whether the system is responsive enough to meet requirements
Bandwidth	The effective range of input frequencies within which the control system responds well. The bandwidth is often described by the point where the frequency response is down by three decibels. Bandwidth is usually defined in Hz (cycles/sec) or $\omega = 2\pi \times \text{Hz}$ (radians/sec)
Loading	The torque required to drive the load and the load inertia. The amplifier must supply enough power to meet acceleration as well as output power requirements. If the load is nonlinear, its effect on error must be within specifications. Behavior may vary considerably, depending on whether the load aids or opposes motor torque, as in a hoist
Output Stiffness	A measure of the system's response to load disturbances. Dynamic stiffness measures the system's response to a rapidly varying load
Resonant Peaks	Can show up in frequency-response testing as sharp (undamped) resonances. These resonances cannot be tolerated in the normal frequency range of the control system because they can lead to oscillation and vibration
No load, or maximum speed and maximum torque	Can be controlled by voltage or current limiting in the electronic amplifier. A slip clutch can also be used for torque limiting, particularly to avoid impact damage

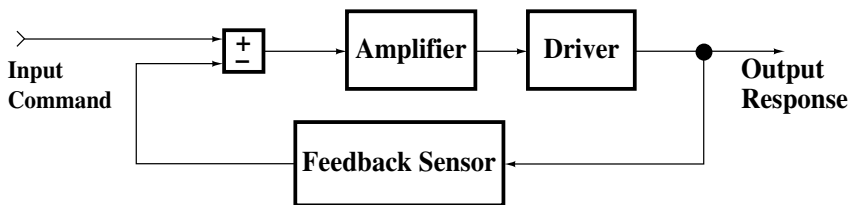


Fig. 1. General Arrangement of a Closed-Loop Control System

Accuracy of closed-loop systems is directly related to the accuracy of the sensor, so that choosing between open-loop and closed-loop controls may mean choosing between low price and consistent, accurate repeatability. In the closed-loop arrangement in Fig. 1, the sensor output is compared with the input command and the difference is amplified and applied to the motor to produce a correction. When the amplifier gain is high (the difference is greatly enlarged), even a small error will generate a correction. However, a high gain can lead to an unstable system due to inherent delays between the electrical inputs and outputs, especially with the motor.

Response accuracy depends not only on the precision of the feedback sensor and the gain of the amplifier, but also on the rate at which the command signal changes. The ability of the control system to follow rapidly changing inputs is naturally limited by the maximum motor speed and acceleration.

Amplified corrections cannot be applied to the motor instantaneously, and the motor does not respond immediately. Overshoots and oscillations can occur and the system must be adjusted or tuned to obtain acceptable performance. This adjustment is called damping

the system response. **Table 4** lists a variety of methods of damping, some of which require specialized knowledge.

Table 4. Means of Damping System Response

Network Damping	Included in the electrical portion of the closed loop. The networks adjust amplitude and phase to minimize control system feedback oscillations. Notch networks are used to reduce gain at specific frequencies to avoid mechanical resonance oscillations
Tachometer Damping	Feedback proportional to output velocity is added to the error signal for system stabilization
Magnetic Damping	Viscous or inertial dampers on the motor rear shaft extension for closed-loop stabilization. Similar dampers use silicone fluid instead of magnetic means to provide damping
Nonlinear Damping	Used for special characteristics. Inverse error damping provides low damping for large errors, permitting fast slewing toward zero and very stable operation at zero. Other nonlinearities meet specific needs, for example, coulomb friction damping works well in canceling backlash oscillations
Damping Algorithms	With information on output position or velocity, or both, sampled data may be used with appropriate algorithms to set motor voltage for an optimum system response

The best damping methods permit high error amplification and accuracy, combined with the desired degree of stability. Whatever form the output takes, it is converted by the output sensor to an electrical signal of compatible form that can be compared with the input command. The error signal thus generated is amplified before being applied to the driving unit.

Drive Power.—Power for the control system often depends on what is available and may vary from single- and three-phase ac 60 or 400 Hz, through dc and other types. Portable or mobile equipment is usually battery-powered dc or an engine-driven electrical generator. Hydraulic and pneumatic power may also be available. Cost is often the deciding factor in the choice.

Table 5. Special Features of Controllers

Linear or Pulse-Width Modulated	Linear is simpler, PWM is more complex and can generate electromagnetic interference, but is more efficient
Current Limiting	Sets limits to maximum line or motor current. Limits the torque output of permanent magnet motors. Can reduce starting transients and current surges
Voltage Limiting	Sets limits to maximum motor speed. Permits more uniform motor performance over a wide range of line voltages
Energy Absorption	Ability of the controller to absorb energy from a dc motor drive, back-driven by the load
EMI Filtering	Especially important when high electrical gain is required, as in thermocouple circuits, for example
Isolation	Of input and output, sometimes using optoisolators, or transformers, when input and output circuits require a high degree of isolation

Control Function.—The function of the control is usually set by the designer of the equipment and needs careful definition because it is the basis for the overall design. For instance, in positioning a machine tool table, such aspects as speed of movement and permissible variations in speed, accuracy of positioning, repeatability, and overshoot are among dozens of factors that must be considered. Some special features of controllers are listed in **Table 5**. Complex electromechanical systems require more knowledge of design and debugging than are needed for strictly mechanical systems.

Electromechanical Control Systems.—Wiring is the simplest way to connect components, so electromechanical controls are more versatile than pure hydraulic or pneumatic controls. The key to this versatility is often in the controller, the fundamental characteristic of which is its power output. The power output must be compatible with motor and load requirements. Changes to computer chips or software can usually change system performance to suit the application.

When driving a dc motor, for instance, the controller must supply sufficient power to match load requirements as well as motor operating losses, at minimum line voltage and maximum ambient temperature. The system's wiring must not be greatly sensitive to transient or steady-state electrical interference, and power lines must be separated from control signal lines, or appropriately shielded and isolated to avoid cross-coupling. Main lines to the controller must often include electrical interference filters so that the control system does not affect the power source, which may influence other equipment connected to the same source. For instance, an abruptly applied step command can be smoothed out so that heavy motor inrush currents are avoided. The penalty is a corresponding delay in response.

Use of current limiting units in a controller will not only set limits to line currents, but will also limit motor torque. Electronic torque limiting can frequently avoid the need for mechanical torque limiting. An example of the latter is using a slip clutch to avoid damage due to overtravel, the impact of which usually includes the kinetic energy of the moving machine elements. In many geared systems, most of the kinetic energy is in the motor. Voltage limiting is less useful than current limiting but may be needed to isolate the motor from voltage transients on the power line, to prevent overspeeding, as well as to protect electronic components.

Mechanical Stiffness.—When output motion must respond to a rapidly changing input command, the control system must have a wide bandwidth. Where the load mass (in linear motion systems) or the polar moment of inertia (in rotary systems) is high, there is a possibility of resonant oscillations. For the most stable and reliable systems, with a defined load, a high system mechanical stiffness is preferred. To attain this stiffness requires strengthening shafts, preloading bearings, and minimizing free play or backlash. In the best-performing systems, motor and load are coupled without intervening compliant members. Even tightly bolted couplings can introduce compliant oscillations resulting from extremely minute slippages caused by the load motions.

Backlash is a factor in the effective compliance of any coupling but has little effect on the resonant frequency because little energy is exchanged as the load is moved through the backlash region. However, even in the absence of significant torsional resonance, a high-gain control system can “buzz” in the backlash region. Friction is often sufficient to eliminate this small-amplitude, high-frequency component.

The difficulty with direct-drive control systems lies in matching motor to load. Most electric motors deliver rated power at higher speeds than are required by the driven load, so that load power must be delivered by the direct-drive motor operating at a slow and relatively inefficient speed. Shaft power at low speed involves a correspondingly high torque, which requires a large motor and a high-power controller. Motor copper loss (heating) is high in delivering the high motor torque. However, direct-drive motors provide maximum load velocity and acceleration, and can position massive loads within seconds of arc (rotational) or tenths of thousandths of an inch (linear) under dynamic conditions.

Where performance requirements are moderate, the required load torque can be traded off against speed by using a speed-changing transmission, typically, a gear train. The transmission effectively matches the best operating region of the motor to the required operating region of the load, and both motor and controller can be much smaller than would be needed for a comparable direct drive.

Torsional Vibration.—Control system instabilities can result from insufficient stiffness between the motor and the inertia of the driven load. The behavior of such a system is sim-

ilar to that of a torsional pendulum, easily excited by commanded motions of the control system. If frictional losses are moderate to low, sustained oscillations will occur. In spite of the complex dynamics of the closed-loop system, the resonant frequency, as for a torsional pendulum, is given to a high degree of accuracy by the formula:

$$f_n = \frac{1}{2\pi} \times \sqrt{\frac{K}{J_L}}$$

where f_n is in hertz, K is torsional stiffness in in.-lb/rad, and J_L is load inertia in in.-lb-sec²/rad. If this resonant frequency falls within the bandwidth of the control system, self-sustained oscillations are likely to occur. These oscillations are often overlooked by control systems analysts because they do not appear in simple control systems, and they are very difficult to correct.

Friction inherently reduces the oscillation by dissipating the energy in the system inertia. If there is backlash between motor and load, coulomb friction (opposing motion but independent of speed) is especially effective in damping out the oscillation. However, the required friction for satisfactory damping can be excessive, introducing positioning error and adding to motor (and controller) power requirements. Friction also varies with operating conditions and time.

The most common method of eliminating torsional oscillation is to introduce a filter in the error channel of the control system to shape the gain characteristic as a function of frequency. If the torsional resonance is within the required system bandwidth, little can be done except stiffening the mechanical system and increasing the resonant frequency. If the filter reduces the gain within the required bandwidth, it will reduce performance. This method will work only if the natural resonance is above the minimum required performance bandwidth.

The simplest shaping network is the notch network (Table 4, network damping), which, in effect, is a band-rejection filter that sharply reduces gain at the notch frequency. By locating the notch frequency so as to balance out the torsional resonance peak, the oscillation can be eliminated. Where there are several modes of oscillation, several filter networks can be connected in series.

Electric Motors.—Electric motors for control systems must suit the application. Motors used in open-loop systems (excluding stepper motors) need not respond quickly to input command changes. Where the command is set by a human, response times of hundreds of milliseconds to several seconds may be acceptable. Slow response does not lead to the instabilities that time delays can introduce into closed-loop systems.

Closed-loop systems need motors with fast response, of which the best are permanent-magnet dc units, used where wide bandwidth, efficient operation, and high power output are required. Table 2 lists some types of control motors and their characteristics. An important feature of high-performance, permanent-magnet motors using high-energy, rare-earth magnets is that their maximum torque output capacity can be 10 to 20 or more times higher than their rated torque. In intermittent or low-duty-cycle applications, very high torque loads can be driven by a given motor. However, when rare-earth magnets (samarium cobalt or neodymium) are not used, peak torque capability may be limited by the possibility of demagnetization. Rare-earth magnets are relatively expensive, so it is important to verify peak torque capabilities for lower-cost motors that may use weaker Alnico or ferrite magnets.

Duty-cycle calculations are an aspect of thermal analysis that are well understood and are not covered here. Motor manufacturers usually supply information on thermal characteristics including thermal time constants and temperature rise per watt of internal power dissipation.

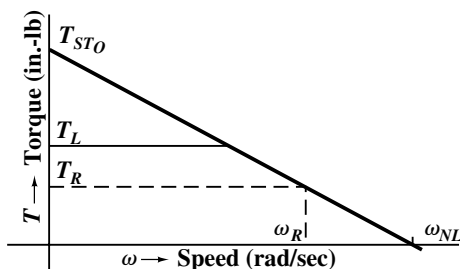


Fig. 2. Idealized Control Motor Characteristics for a Consistent Set of Units

Characteristics of permanent-magnet motors are defined with fair accuracy by relatively few parameters. The most important characteristics are: D_M motor damping in lb-in.-sec/rad; J_M motor inertia in lb-in.-sec²/rad; and R winding resistance in ohms. Fig. 1 shows other control motor characteristics, T_{STO} stall torque with no current limiting; T_L maximum torque with current limiting; ω_{NL} no-load speed; ω_R rated speed. Other derived motor parameters include V rated voltage in volts; $I_{STO} = V/R$ current in amperes at stall with no current limiting; I_L ampere limit, adjusted in amplifier; I_R rated current; $K_T = T_{STO}/I_{STO}$ torque constant in in.-lb/ampere; $K_E = V/\omega_{NL}$ voltage constant in volt/rad/sec; $K_M = K_T/\sqrt{R}$, torque per square root of winding resistance; $D_M = T_{STO}/\omega_{NL}$ motor damping in in.-lb/rad/sec; and $T_M = J_M/D_M$ motor mechanical time constant in seconds.

Stepper Motors.—In a stepper motor, power is applied to a wound stator, causing the brushless rotor to change position to correspond with the internal magnetic field. The rotor maintains its position relative to the internal magnetic field at all times. In its most common mode of operation, the stepper motor is energized by an electronic controller whose current output to the motor windings defines the position of the internally generated magnetic field. Applying a command pulse to the controller will change the motor currents to reposition the rotor. A series of pulses, accompanied by a direction command, will cause rotation in uniformly spaced steps in the specified direction.

If the pulses are applied at a sufficiently high frequency, the rotor will be carried along with the system's inertia and will rotate relatively uniformly but with a modulated velocity. At the other extreme, the response to a single pulse will be a step followed by an overshoot and a decaying oscillation. Where the application cannot permit the oscillation, damping can be included in the controller.

Stepper motors are often preferred because positions of the rotor are known from the number of pulses and the step size. An initial index point is required as an output position reference, and care is required in the electronic circuits to avoid introducing random pulses that will cause false positions. As a minimum, the output index point on an appropriate shaft can verify the step count during operation.

Gearing.—In a closed-loop system, gearing may be used to couple a high-speed, low-torque motor to a lower-speed, higher-torque load. The gearing must meet requirements for accuracy, strength, and reliability to suit the application. In addition, the closed loop requires minimum backlash at the point where the feedback sensor is coupled. In a velocity-controlled system, the feedback sensor is a tachometer that is usually coupled directly to the rotor shaft. Backlash between motor and tachometer, as well as torsional compliance, must be minimized for stable operation of a high-performance system. Units combining motor and tachometer on a single shaft can usually be purchased as an assembly.

By contrast, a positioning system may use a position feedback sensor that is closely coupled to the shaft being positioned. As with the velocity system, backlash between the motor and feedback sensor must be minimized for closed-loop stability. Antibacklash gearing is frequently used between the gearing and the position feedback sensor. When the position

feedback sensor is a limited rotation device, it may be coupled to a gear that turns faster than the output gear to allow use of its full range. Although this step-up gearing enhances it, accuracy is ultimately limited by the errors in the intermediate gearing between the position sensor and the output.

When an appreciable load inertia is being driven, it is important that the mechanical stiffness between the position sensor coupling point and the load be high enough to avoid natural torsional resonances in the passband.

Feedback Transducers.—Controlled variables are measured by feedback transducers and are the key to accuracy in operation of closed-loop systems. When the accuracy of a carefully designed control system approaches the accuracy of the feedback transducer, the need for precision in the other system components is reduced.

Transducers may measure the quantity being controlled in digital or analog form, and are available for many different parameters such as pressure and temperature, as well as distance traveled or degrees of rotation. Machine designers generally need to measure and control linear or rotary motion, velocity, position, and sometimes acceleration. Although some transducers are nonlinear, a linear relationship between the measured variable and the (usually electrical) output is most common.

Output characteristics of an analog linear-position transducer are shown in Fig. 2. By dividing errors into components, accuracy can be increased by external adjustments, and slope error and zero offsets are easily trimmed in. Nonlinearity is controlled by the manufacturer. In Fig. 2 are seen the discrete error components that can be distinguished because of the ease with which they can be canceled out individually by external adjustments. The most common compensation is for zero-position alignment, so that when the machine has been set to the start position for a sequence, the transducer can be positioned to read zero output. Alternatively, with all components in fixed positions, a small voltage can be inserted in series with the transducer output for a very accurate alignment of mechanical and electrical zeros. This method helps in canceling long-term drift, particularly in the mechanical elements.

The second most common adjustment of a position transducer is of its output gradient, that is, transducer output volts per degree. Depending on the type of analog transducer, it is usually possible to add a small adjustment to the electrical input, to introduce a proportional change in output gradient. As with the zero-position adjustment, the gradient may be set very accurately initially and during periodic maintenance. The remaining errors shown in Fig. 2, such as intrinsic nonlinearity or nonconformity, result from limitations in design and manufacture of the transducer.

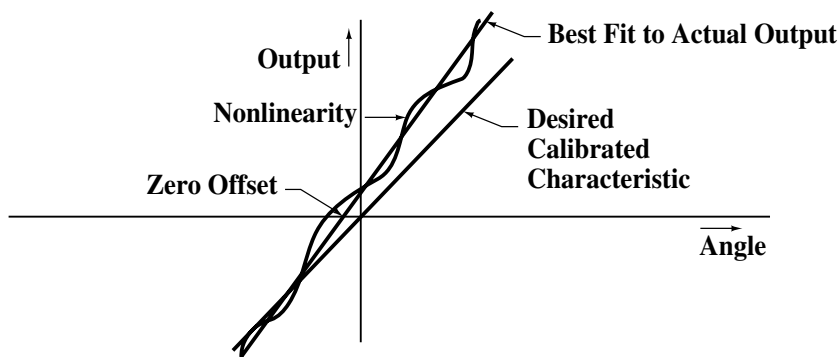


Fig. 3. Output Characteristics of a General Linear Position Transducer

Greater accuracy can be achieved in computer-controlled systems by using the computer to cancel out transducer errors. The system's mechanical values and corresponding transducer values are stored in a lookup table in the computer and referred to as necessary.

Accuracies approaching the inherent repeatability and stability of the system can thus be secured. If necessary, recalibration can be performed at frequent intervals.

Analog Transducers.—The simplest analog position transducer is the resistance potentiometer, the resistance element in which is usually a deposited-film rather than a wire-wound type. Very stable resistance elements based on conductive plastics, with resolution to a few microinches and operating lives in the 100 million rotations, are available, capable of working in severe environments with high vibrations and shock and at temperatures of 150 to 200°C. Accuracies of a few hundredths, and stability of thousandths, of a per cent, can be obtained from these units by trimming the plastics resistance element as a function of angle.

Performance of resistance potentiometers deteriorates when they operate at high speeds, and prolonged operation at speeds above 10 rpm causes excessive wear and increasing output noise. An alternative to the resistance potentiometer is the variable differential transformer, which uses electrical coupling between ac magnetic elements to measure angular or linear motion without sliding contacts. These units have unlimited resolution with accuracy comparable to the best resistance potentiometers but are more expensive and require compatible electronic circuits.

A variable differential transformer needs ac energization, so an ac source is required. A precision demodulator is frequently used to change the ac output to dc. Sometimes the ac output is balanced against an ac command signal whose input is derived from the same ac source. In dealing with ac signals, phase-angle matching and an accurate amplitude-scale factor are required for proper operation. Temperature compensation also may be required, primarily due to changes in resistance of the copper windings. Transducer manufacturers will supply full sets of compatible electronic controls.

Synchros and Resolvers.—Synchros and resolvers are transducers that are widely used for sensing of angles at accuracies down to 10 to 20 arc-seconds. More typically, and at much lower cost, their accuracies are 1 to 2 arc-minutes. Cost is further reduced when accuracies of 0.1 degree or higher are acceptable.

Synchros used as angle-position transducers are made as brush types with slip rings and in brushless types. These units can rotate continuously at high speeds, the operating life of brushless designs being limited only by the bearing life. Synchros have symmetrical three-wire stator windings that facilitate transmission of angle data over long distances (thousands of feet). Such a system is also highly immune to noise and coupled signals. Practically the only trimming required for very long line systems is matching the line-to-line capacitances.

Because synchros can rotate continuously, they can be used in multispeed arrangements, where, for example, full-scale system travel may be represented by 36 or 64 full rotations. When reduced by gearing to a single, full-scale turn, a synchro's electrical inaccuracy is the typical 0.1° error divided by 36 or 64 or whatever gear ratio is used. This error is insignificant compared with the error of the gearing coupling the high-speed synchro and the single speed (1 rotation for full scale) output shaft. The accuracy is dependable and stable, using standard synchros and gearing.

Hydraulic and Pneumatic Systems

In Fig. 1 is shown a schematic of a hydraulic cylinder and the relationships between force and area that govern all hydraulic systems. Hydraulic actuators that drive the load may be cylinders or motors, depending on whether linear or rotary motion is required. The load must be defined by its torque-speed characteristics and inertia, and a suitable hydraulic actuator selected before the remaining system components can be chosen. Fluid under pressure and suitable valves are needed to control motion. Both single- and double-acting hydraulic cylinders are available, and the latter type is seen in Fig. 1.

Pressure can be traded off against velocity, if desired, by placing a different effective area at each side of the piston. The same pressure on a smaller area will move the piston at a higher speed but lower force for a given rate of fluid delivery. The cylinder shown in Fig. 1 can drive loads in either direction. The simple formulas of plane geometry relate cylinder areas, force, fluid flow, and rate of movement. Other configurations can develop equal forces and speeds in both directions.

The rotary equivalent of the cylinder is the hydraulic motor, which is defined by the fluid displacement required to turn the output shaft through one revolution, by the output torque, and by the load requirements of torque and speed. Output torque is proportional to fluid pressure, which can be as high as safety permits. Output speed is defined by the number of gallons per minute supplied to the motor. As an example, if 231 cu. in. = 1 gallon, an input of 6 gallons/min (gpm) with a 5-cu. in. displacement gives a mean speed of $6 \times 231/5 = 277$ rpm. The motor torque must be defined by lb-in. per 100 lb_f/in.² (typically) from which the required pressure can be determined. Various motor types are available.

Hydraulic Pumps.—The most-used hydraulic pump is the positive-displacement type, which delivers a fixed amount of fluid for every cycle. These pumps are also called hydrostatic because they deliver energy by static pressure rather than by the kinetic energy of a moving fluid. Positive-displacement pumps are rated by the gpm delivered at a stated speed and by the maximum pressure, which are the key parameters defining the power capacity of the hydraulic actuator. Delivered gpm are reduced under load due to leakage, and the reduction is described by the volumetric efficiency, which is the ratio of actual to theoretical output.

Hydraulic Fluids.—The hydraulic fluid is the basic means of transmitting power, and it also provides lubrication and cooling when passed through a heat exchanger. The fluid must be minimally compressible to avoid springiness and delay in response. The total system inertia reacts with fluid compliance to generate a resonant frequency, much as inertia and mechanical compliance react in an electromechanical system. Compliance must be low enough that resonances do not occur in the active bandwidth of the servomechanism, and that unacceptable transients do not occur under shock loads. Seal friction and fluid viscosity tend to damp out resonant vibrations. Shock-absorbing limit stops or cushions are usually located at the travel limits to minimize transient impact forces.

$F = \text{force (lb)} = \text{pressure} \times \text{area}$

$P_1 \text{ and } P_2 = \text{line pressure on either side of piston in lb}_f/\text{in.}^2$

$d_1 \text{ and } d_2 = \text{diameters of piston rod and piston in in.}$

$$F_1 = \frac{\pi}{4} (d_2^2 - d_1^2) \times P_1 = 0.7854P_1(d_2^2 - d_1^2)$$

$$F_2 = \frac{\pi}{4} d_2^2 P_2 = 0.7854P_2 d_2^2$$

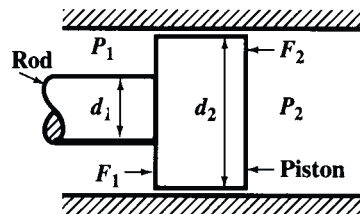


Fig. 1. Elementary Hydraulic Force/Area Formulas

Hydraulic fluids with special additives for lubrication minimize wear between moving parts. An auxiliary function is prevention of corrosion and pitting. Hydraulic fluids must also be compatible with gaskets, seals, and other nonmetallic materials.

Viscosity is another critical parameter of hydraulic fluids as high viscosity means high resistance to fluid flow with a corresponding power loss and heating of the fluid, pressure drop in the hydraulic lines, difficulty in removing bubbles, and sometimes overdamped operation. Unfortunately, viscosity falls very rapidly with increasing temperature, which can lead to reduction of the lubrication properties and excessive wear as well as increasing leakage. For hydraulic actuators operating at very low temperatures, the fluid pour point is important. Below this temperature, the hydraulic fluid will not flow. Design guidelines similar to those used with linear or rotating bearings are applicable in these conditions.

Fire-resistant fluids are available for use in certain conditions such as in die casting, where furnaces containing molten metal are often located near hydraulic systems.

A problem with hydraulic systems that is absent in electromechanical systems is that of dirt, air bubbles, and contaminants in the fluid. Enclosed systems are designed to keep out contaminants, but the main problem is with the reservoir or fluid storage unit. A suitable sealer must be used in the reservoir to prevent corrosion and a filter should be used during filling. Atmospheric pressure is required on the fluid surface in the reservoir except where a pressurized reservoir is used. Additional components include coarse and fine filters to remove contaminants and these filters may be rated to remove micron sized particles (1 micron = 0.00004 in.).

Very fine filters are sometimes used in high-pressure lines, where dirt might interfere with the operation of sensitive valves. Where a high-performance pump is used, a fine filter is a requirement. Usually, only coarse filters are used on fluid inlet lines because fine filters might introduce excessive pressure drop.

Aside from the reservoir used for hydraulic fluid storage, line connections, fittings, and couplings are needed. Expansion of these components under pressure increases the mechanical compliance of the system, reducing the frequencies of any resonances and possibly interfering with the response of wide-band systems.

Formulas relating fluid flow and mechanical power follow. These formulas supplement the general force, torque, speed, and power formulas of mechanical systems.

$$F = P \times A$$

$$A = 0.7854 \times d^2$$

$$hp = 0.000583q \times \text{pressure in lb}_f/\text{in}^2$$

$$1 \text{ gallon of fluid flow/min at } 1 \text{ lb}_f/\text{in}^2 \text{ pressure} = 0.000582 \text{ hp.}$$

For rotary outputs,

$$hp = \text{torque} \times \text{rpm}/63,025$$

where torque is in lb-in. (Theoretical hp output must be multiplied by the efficiency of the hydraulic circuits to determine actual output.)

In the preceding equations,

$$P = \text{pressure in lb}_f/\text{in}^2$$

$$A = \text{piston area in in}^2$$

$$F = \text{force in lb}$$

$$q = \text{fluid flow in gallons/min}$$

$$d = \text{piston diameter in inches}$$

Hydraulic and Pneumatic Control Systems.—Control systems for hydraulic and pneumatic circuits are more mature than those for electromechanical systems because they have been developed over many more years. Hydraulic components are available at moderate prices from many sources. Although their design is complex, application and servicing of these systems are usually more straightforward than with electromechanical systems.

Electromechanical and hydraulic/pneumatic systems may be analyzed by similar means. The mathematical requirements for accuracy and stability are analogous, as are most performance features, although nonlinearities are caused by different physical attributes. Nonlinear friction, backlash, and voltage and current limiting are common to both types of system, but hydraulic/pneumatic systems also have the behavior characteristics of fluid-driven systems such as thermal effects and fluid flow dynamics including turbulence, leakage caused by imperfect seals, and contamination.

Both control types require overhead equipment that does not affect performance but adds to overall cost and complexity. For instance, electromechanical systems require electrical power sources and power control components, voltage regulators, fuses and circuit breakers, relays and switches, connectors, wiring and related devices. Hydraulic/pneumatic sys-

tems require fluid stored under pressure, motor-driven pumps or compressors, valves, pressure regulators/limiters, piping and fasteners, as well as hydraulic/pneumatic motors and cylinders. Frequently, the optimum system is selected on the basis of overhead equipment already available.

Electromechanical systems are generally slower and heavier than hydraulic systems and less suited to controlling heavy loads. The bandwidths of hydraulic control systems can respond to input signals of well over 100 Hz as easily as an electromechanical system can respond to, say, 10 to 20 Hz. Hydraulic systems can drive very high torque loads without intermediate transmissions such as the gear trains often used with electromechanical systems. Also, hydraulic/pneumatic systems using servo valves and piston/cylinder arrangements are inherently suited to linear motion operation, whereas electromechanical controls based on conventional electrical machines are more naturally suited to driving rotational loads.

Until recently, electromechanical systems were limited to system bandwidths of about 10 Hz, with power outputs of a few hundred watts. However, their capabilities have now been sharply extended through the use of rare-earth motor magnets having much higher energies than earlier designs. Similarly, semiconductor power components deliver much higher output power at lower prices than earlier equipment. Electromechanical control systems are now suited to applications of more than 100 hp with bandwidths up to 40 Hz and sometimes up to 100 Hz.

Although much depends on the specific design, the edge in reliability, even for high-power, fast-response needs, is shifting toward electromechanical systems. Basically, there are more things that can go wrong in hydraulic/pneumatic systems, as indicated by the shift to more electrical systems in aircraft.

Hydraulic Control Systems.—Using essentially incompressible fluid, hydraulic systems are suited to a wide range of applications, whereas pneumatic power is generally limited to simpler uses. In Fig. 2 are shown the essential features of a simple linear hydraulic control system and a comparable system for driving a rotating load.

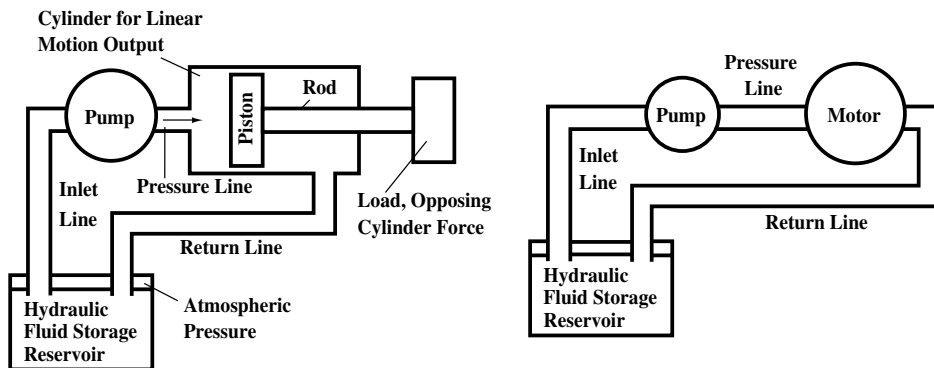


Fig. 2. (left) A Simple Linear Hydraulic Control System in Which the Load Force Returns the Piston and (right) a Comparable System for Driving a Rotating Load

Hydraulic controls of the type shown have fast response and very high load capacities. In a linear actuator, for example, each lb_f/in^2 of system pressure acts against the area of the piston to generate the force applied. Hydraulic pressures of up to $3000 \text{ lb}_f/\text{in}^2$ are readily obtained from hydraulic pumps, so that cylinders can exert forces of hundreds of tons without the need for speed-reducing transmission systems to increase the force. The hydraulic fluid distributes heat, so it helps cool the system.

Systems similar to those in Fig. 2 can be operated in open- or closed-loop modes. Open-loop operation can be controlled by programming units that initiate each step by operating relays, limit switches, solenoid valves, and other components to generate the forces over

the required travel ranges. Auxiliary components are used to ensure safe operation and make such systems flexible and reliable, as shown in Fig. 3.

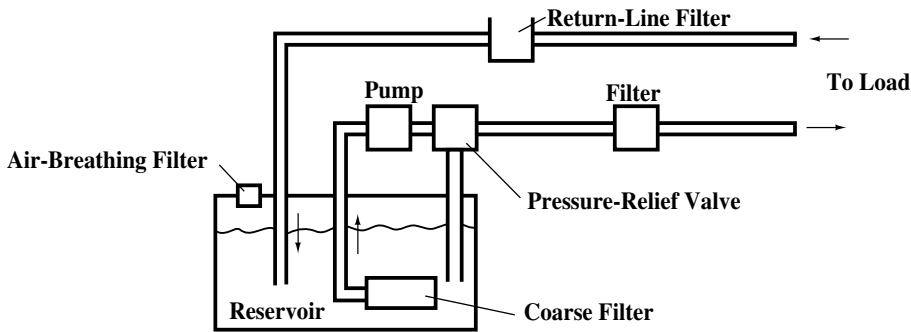


Fig. 3. Some of the Auxiliary Components Used in a Practical Hydraulic System

In the simplest mode, whether open- or closed-loop, hydraulic system operation may be discontinuous or proportional. Discontinuous operation, sometimes called bang-bang, or on-off, works well, is widely used in low- to medium-accuracy systems, and is easy to maintain. In this closed-loop mode, accuracy is limited; if the response to error is set too high, the system will oscillate between on-off modes, with average output at about the desired value. This oscillation, however, can be noisy, introduces system transients, and may cause rapid wear of system components.

Another factor to be considered in on-off systems is the shock caused by sudden opening and closing of high-pressure valves, which introduce transient pulses in the fluid flow and can cause high stresses in components. These problems can be addressed by the use of pressure-limiting relief valves and other units.

Proportional Control Systems.— Where the highest accuracy is required, perhaps in two directions, and with aiding or opposing forces or torques, a more sophisticated proportional control, closed-loop system is preferred. As shown in Fig. 4, the amplifier and electric servomotor used in electromechanical closed-loop systems is replaced in the closed-loop hydraulic system by an electronically controlled servo-valve. In its simplest form, the valve uses a linear motor to position the spool that determines the flow path for the hydraulic fluid. In some designs, the linear motor may be driven by a solenoid against a bias spring on the valve spool. In other arrangements, the motor may be a bidirectional unit that permits a fluid flow depending on the polarity and amplitude of the voltage supplied to the motor.

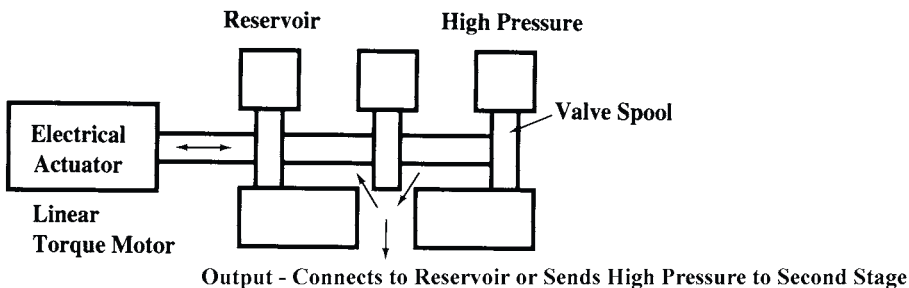


Fig. 4.

Such designs can be used in proportional control systems to achieve smooth operation and minimum nonlinearities, and will give the maximum accuracy required by the best machine tool applications. Where very high power must be controlled, use is often made of a two-stage valve in which the output from the first stage is used to drive the second-stage valve, as shown in Fig. 5.

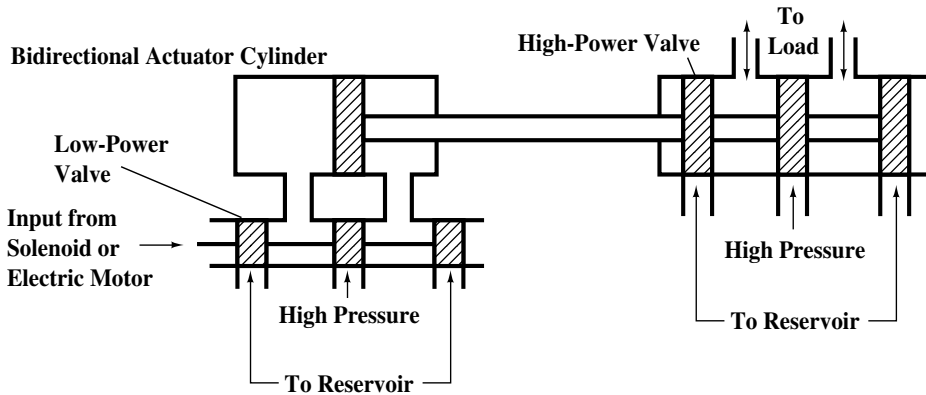


Fig. 5. Two-Stage Valve for Large-Power Control from a Low-Power Input

Electronic Controls.—An error-sensing electronic amplifier drives the solenoid motor of Fig. 5, which provides automatic output correction in a closed-loop system. The input is an ideal place to introduce electrical control features, adding greatly to the versatility of the control system. The electronic amplifier can provide the necessary driving power using pulse-width modulation as required, for minimum heating. The output can respond to signals in the low-microvolt range.

A major decision is whether to use analog or digital control. Although analog units are simple, they are much less versatile than their digital counterparts. Digital systems can be readjusted for total travel, speed, and acceleration by simple reprogramming. Use of appropriate feedback sensors can match accuracy to any production requirement, and a single digital system can be easily adapted to a great variety of similar applications. This adaptability is an important cost-saving feature for moderate-sized production runs. Modern microprocessors can integrate the operation of sets of systems.

Because nonlinearities and small incremental motions are easy to implement, digital systems are capable of very smooth acceleration, which avoids damaging shocks and induced leaks, and enhances reliability so that seals and hose connections last longer. The accuracy of digital control systems depends on transducer availability, and a full range of such devices has been developed and is now available.

Other features of digital controls are their capacity for self-calibration, easy digital read-out, and periodic self-compensation. For example, it is easy to incorporate backlash compensation. Inaccuracies can be corrected by using lookup tables that may themselves be updated as necessary. Digital outputs can be used as part of an inspection plan, to indicate need for tool changing, adjustment or sharpening, or for automatic record keeping. Despite continuing improvements in analog systems, digital control of hydraulic systems is favored in large plants.

Pneumatic Systems.—Hydraulic systems transmit power by means of the flow of an essentially incompressible fluid. Pneumatic systems use a highly compressible gas. For this reason, a pneumatic system is slower in responding to loads, especially sudden output loads, than a hydraulic system. Similarly, torque or force requires time and output motion to build up. Response to sudden output loads shows initial overshoot. Much more complex networks or other damping means are required to develop stable response in closed-loop systems. On the other hand, there are no harmful shock waves analogous to the transients that can occur in hydraulic systems, and pneumatic system components last comparatively longer.

Notwithstanding their performance deficiencies, pneumatic systems have numerous desirable features. Pneumatic systems avoid some fire hazards compared with the most preferred hydraulic fluids. Air can be vented to the atmosphere so a flow line only is needed, reducing the complexity, cost, and weight of the overall system. Pneumatic lines,

couplings, and fittings are lighter than their hydraulic counterparts, often a significant advantage. The gaseous medium also is lighter than hydraulic fluid, and pneumatic systems are usually easier to clean, assemble, and generally maintain. Fluid viscosity and its temperature variations are virtually negligible with pneumatic systems.

Among drawbacks with pneumatics are that lubrication must be carefully designed in, and more power is needed to achieve a desired pressure when the fluid medium is a compressible gas. Gas under high pressure can cause an explosion if its storage tank is damaged, so storage must have substantial safety margins. Gas compressibility makes pneumatic systems 1 or 2 orders of magnitude slower than hydraulic systems.

The low stiffness of pneumatic systems is another indicator of the long response time. Resonances occur between the compressible gas and equivalent system inertias at lower frequencies. Even the relatively low speed of sound in connecting lines contributes to response delay, adding to the difficulty of closed-loop stabilization. Fortunately, it is possible to construct pneumatic analogs to electrical networks to simplify stabilization at the exact point of the delays. Such pneumatic stabilizing means are commercially available and are important elements of closed-loop pneumatic control systems.

In contrast with hydraulic systems, where speed may be controlled by varying pump output, pneumatic system control is almost exclusively by valves, which control the flow from a pneumatic accumulator or pressure source. The pressure is maintained between limits by an intermittently operated pump. Low-pressure outlet ports must be large enough to accommodate the high volume of the expanded gas. In Fig. 6 is shown a simplified system for closed-loop position control applied to an air cylinder, in which static accuracy is controlled by the position sensor. Proper design requires a good theoretical analysis and attention to practical design if good, stable, closed-loop response is to be achieved.

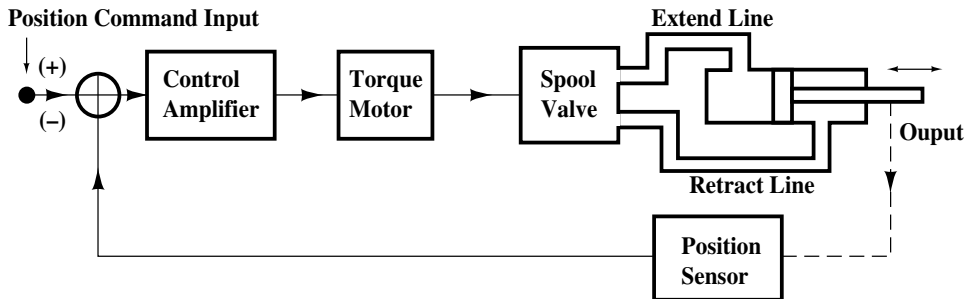


Fig. 6. A Pneumatic Closed-Loop Linear Control System

Strength and Properties of Wire Rope

Wire Rope Construction.—Essentially, a wire rope is made up of a number of strands laid helically about a metallic or non-metallic core. Each strand consists of a number of wires also laid helically about a metallic or non-metallic center. Various types of wire rope have been developed to meet a wide range of uses and operating conditions. These types are distinguished by the kind of core; the number of strands; the number, sizes, and arrangement of the wires in each strand; and the way in which the wires and strands are wound or laid about each other. The following descriptive material is based largely on information supplied by the Bethlehem Steel Co.

Rope Wire Materials: Materials used in the manufacture of rope wire are, in order of increasing strength: iron, phosphor bronze, traction steel, plow steel, improved plow steel, and bridge rope steel. Iron wire rope is largely used for low-strength applications such as elevator ropes not used for hoisting, and for stationary guy ropes.

Phosphor bronze wire rope is used occasionally for elevator governor-cable rope and for certain marine applications as life lines, clearing lines, wheel ropes and rigging.

Traction steel wire rope is used primarily as hoist rope for passenger and freight elevators of the traction drive type, an application for which it was specifically designed.

Ropes made of galvanized wire or wire coated with zinc by the electro-deposition process are used in certain applications where additional protection against rusting is required. As will be noted from the tables of wire-rope sizes and strengths, the breaking strength of galvanized wire rope is 10 per cent less than that of ungalvanized (bright) wire rope. Bethanized (zinc-coated) wire rope can be furnished to bright wire rope strength when so specified.

Galvanized carbon steel, tinned carbon steel, and stainless steel are used for small cords and strands ranging in diameter from $\frac{1}{64}$ to $\frac{3}{8}$ inch and larger.

Marline clad wire rope has each strand wrapped with a layer of tarred marline. The cladding provides hand protection for workers and wear protection for the rope.

Rope Cores: Wire-rope cores are made of fiber, cotton, asbestos, polyvinyl plastic, a small wire rope (independent wire-rope core), a multiple-wire strand (wire-strand core) or a cold-drawn wire-wound spring.

Fiber (manila or sisal) is the type of core most widely used when loads are not too great. It supports the strands in their relative positions and acts as a cushion to prevent nicking of the wires lying next to the core.

Cotton is used for small ropes such as sash cord and aircraft cord.

Asbestos cores can be furnished for certain special operations where the rope is used in oven operations.

Polyvinyl plastics cores are offered for use where exposure to moisture, acids, or caustics is excessive.

Wire-strand core often referred to as WSC, consists of a multiple-wire strand that may be the same as one of the strands of the rope. It is smoother and more solid than the independent wire rope core and provides a better support for the rope strands.

The *independent wire rope core*, often referred to as IWRC, is a small 6×7 wire rope with a wire-strand core and is used to provide greater resistance to crushing and distortion of the wire rope. For certain applications it has the advantage over a wire-strand core in that it stretches at a rate closer to that of the rope itself.

Wire ropes with wire-strand cores are, in general, less flexible than wire ropes with independent wire-rope or non-metallic cores.

Ropes with metallic cores are rated $7\frac{1}{2}$ per cent stronger than those with non-metallic cores.

Wire-Rope Lay: The lay of a wire rope is the direction of the helical path in which the strands are laid and, similarly, the lay of a strand is the direction of the helical path in which the wires are laid. If the wires in the strand or the strands in the rope form a helix similar to the threads of a right-hand screw, i.e., they wind around to the right, the lay is called right hand and, conversely, if they wind around to the left, the lay is called left hand. In the *regular lay*, the wires in the strands are laid in the opposite direction to the lay of the strands in the rope. In right-regular lay, the strands are laid to the right and the wires to the left. In left-regular lay, the strands are laid to the left, the wires to the right. In *Lang lay*, the wires and strands are laid in the same direction, i.e., in right Lang lay, both the wires and strands are laid to the right and in left Lang they are laid to the left.

Alternate lay ropes having alternate right and left laid strands are used to resist distortion and prevent clamp slippage, but because other advantages are missing, have limited use.

The regular lay wire rope is most widely used and right regular lay rope is customarily furnished. Regular lay rope has less tendency to spin or untwist when placed under load and is generally selected where long ropes are employed and the loads handled are frequently removed. Lang lay ropes have greater flexibility than regular lay ropes and are more resistant to abrasion and fatigue.

In preformed wire ropes the wires and strands are preshaped into a helical form so that when laid to form the rope they tend to remain in place. In a non-preformed rope, broken wires tend to “wicker out” or protrude from the rope and strands that are not seized tend to spring apart. Preforming also tends to remove locked-in stresses, lengthen service life, and make the rope easier to handle and to spool.

Strand Construction: Various arrangements of wire are used in the construction of wire rope strands. In the simplest arrangement six wires are grouped around a central wire thus making seven wires, all of the same size. Other types of construction known as “filler-wire,” Warrington, Seale, etc. make use of wires of different sizes. Their respective patterns of arrangement are shown diagrammatically in the table of wire weights and strengths.

Specifying Wire Rope.—In specifying wire rope the following information will be required: length, diameter, number of strands, number of wires in each strand, type of rope construction, grade of steel used in rope, whether preformed or not preformed, type of center, and type of lay. The manufacturer should be consulted in selecting the best type of wire rope for a new application.

Properties of Wire Rope.—Important properties of wire rope are strength, wear resistance, flexibility, and resistance to crushing and distortion.

Strength: The strength of wire rope depends upon its size, kind of material of which the wires are made and their number, the type of core, and whether the wire is galvanized or not. Strengths of various types and sizes of wire ropes are given in the accompanying tables together with appropriate factors to apply for ropes with steel cores and for galvanized wire ropes.

Wear Resistance: When wire rope must pass back and forth over surfaces that subject it to unusual wear or abrasion, it must be specially constructed to give satisfactory service.

Such construction may make use of 1) relatively large outer wires; 2) Lang lay in which wires in each strand are laid in the same direction as the strand; and 3) flattened strands.

The object in each type is to provide a greater outside surface area to take the wear or abrasion. From the standpoint of material, improved plow steel has not only the highest tensile strength but also the greatest resistance to abrasion in regularly stocked wire rope.

Flexibility: Wire rope that undergoes repeated and severe bending, such as in passing around small sheaves and drums, must have a high degree of flexibility to prevent premature breakage and failure due to fatigue. Greater flexibility in wire rope is obtained by

1) using small wires in larger numbers; 2) using Lang lay; and 3) preforming, that is, the wires and strands of the rope are shaped during manufacture to fit the position they will assume in the finished rope.

Resistance to Crushing and Distortion: Where wire rope is to be subjected to transverse loads that may crush or distort it, care should be taken to select a type of construction that will stand up under such treatment.

Wire rope designed for such conditions may have 1) large outer wires to spread the load per wire over a greater area; and 2) an independent wire core or a high-carbon cold-drawn wound spring core.

Standard Classes of Wire Rope.—Wire rope is commonly designated by two figures, the first indicating the number of strands and the second, the number of wires per strand, as: 6×7 , a six-strand rope having seven wires per strand, or 8×19 , an eight-strand rope having 19 wires per strand. When such numbers are used as designations of standard wire rope classes, the second figure in the designation may be purely nominal in that the number of wires per strand for various ropes in the class may be slightly less or slightly more than the nominal as will be seen from the following brief descriptions. (For ropes with a wire strand core, a second group of two numbers may be used to indicate the construction of the wire core, as 1×21 , 1×43 , and so on.)

6×7 Class (Standard Coarse Laid Rope): Wire ropes in this class are for use where resistance to wear, as in dragging over the ground or across rollers, is an important requirement. Heavy hauling, rope transmissions, and well drilling are common applications. These wire ropes are furnished in right regular lay and occasionally in Lang lay. The cores may be of fiber, independent wire rope, or wire strand. Since this class is a relatively stiff type of construction, these ropes should be used with large sheaves and drums. Because of the small number of wires, a larger factor of safety may be called for.

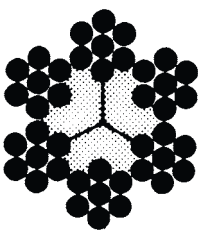


Fig. 1a.
 6×7 with fiber core

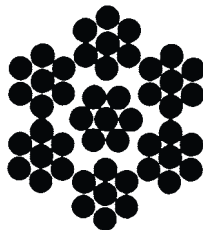


Fig. 1b.
 6×7 with 1×7 WSC

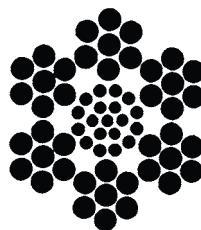


Fig. 1c.
 6×7 with 1×19 WSC

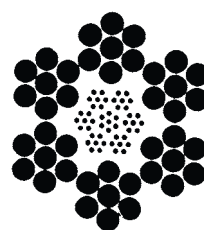


Fig. 1d.
 6×7 with IWRC

As shown in **Figs. 1a** through **Figs. 1d**, this class includes a 6×7 construction with fiber core; a 6×7 construction with 1×7 wire strand core (sometimes called 7×7); a 6×7 construction with 1×19 wire strand core; and a 6×7 construction with independent wire rope core. **Table 1** provides strength and weight data for this class.

Two special types of wire rope in this class are: aircraft cord, a 6×6 or 7×7 Bethanized wire rope of high tensile strength and sash cord, a 6×7 iron rope used for a variety of purposes where strength is not an important factor.

Table 1. Weights and Strengths of 6 × 7 (Standard Coarse Laid) Wire Ropes, Preformed and Not Preformed

Dia., Inches	Approx. Weight per Ft., Pounds	Breaking Strength, Tons of 2000 Lbs.			Dia., Inches	Approx. Weight per Ft., Pounds	Breaking Strength, Tons of 2000 Lbs.		
		Impr. Plow Steel	Plow Steel	Mild Plow Steel			Impr. Plow Steel	Plow Steel	Mild Plow Steel
¼	0.094	2.64	2.30	2.00	¾	0.84	22.7	19.8	17.2
⅕	0.15	4.10	3.56	3.10	⅞	1.15	30.7	26.7	23.2
⅜	0.21	5.86	5.10	4.43	1	1.50	39.7	34.5	30.0
⅙	0.29	7.93	6.90	6.00	1⅛	1.90	49.8	43.3	37.7
½	0.38	10.3	8.96	7.79	1¼	2.34	61.0	53.0	46.1
⅙	0.48	13.0	11.3	9.82	1⅜	2.84	73.1	63.6	55.3
⅝	0.59	15.9	13.9	12.0	1½	3.38	86.2	75.0	65.2

For ropes with steel cores, add 7½ per cent to above strengths.

For galvanized ropes, deduct 10 per cent from above strengths.

Source: Rope diagrams, Bethlehem Steel Co. All data, U.S. Simplified Practice Recommendation 198-50.

6 × 19 Class (Standard Hoisting Rope): This rope is the most popular and widely used class. Ropes in this class are furnished in regular or Lang lay and may be obtained preformed or not preformed. Cores may be of fiber, independent wire rope, or wire strand. As can be seen from Table 2 and Figs. 2a through 2h, there are four common types: 6 × 25 filler wire construction with fiber core (not illustrated), independent wire core, or wire strand core (1 × 25 or 1 × 43); 6 × 19 Warrington construction with fiber core; 6 × 21 filler wire construction with fiber core; and 6 × 19, 6 × 21, and 6 × 17 Seale construction with fiber core.

Table 2. Weights and Strengths of 6 × 19 (Standard Hoisting) Wire Ropes, Preformed and Not Preformed

Dia., Inches	Approx. Weight per Ft., Pounds	Breaking Strength, Tons of 2000 Lbs.			Dia., Inches	Approx. Weight per Ft., Pounds	Breaking Strength, Tons of 2000 Lbs.		
		Impr. Plow Steel	Plow Steel	Mild Plow Steel			Impr. Plow Steel	Plow Steel	Mild Plow Steel
¼	0.10	2.74	2.39	2.07	1¼	2.50	64.6	56.2	48.8
⅕	0.16	4.26	3.71	3.22	1⅝	3.03	77.7	67.5	58.8
⅜	0.23	6.10	5.31	4.62	1½	3.60	92.0	80.0	69.6
⅙	0.31	8.27	7.19	6.25	1⅞	4.23	107	93.4	81.2
½	0.40	10.7	9.35	8.13	1¾	4.90	124	108	93.6
⅙	0.51	13.5	11.8	10.2	1⅞	5.63	141	123	107
⅝	0.63	16.7	14.5	12.6	2	6.40	160	139	121
¾	0.90	23.8	20.7	18.0	2⅞	7.23	179	156	...
⅞	1.23	32.2	28.0	24.3	2¼	8.10	200	174	...
1	1.60	41.8	36.4	31.6	2½	10.00	244	212	...
1⅛	2.03	52.6	45.7	39.8	2¾	12.10	292	254	...

The 6 × 25 filler wire with fiber core not illustrated.

For ropes with steel cores, add 7½ per cent to above strengths.

For galvanized ropes, deduct 10 per cent from above strengths.

Source: Rope diagrams, Bethlehem Steel Co. All data, U.S. Simplified Practice Recommendation 198-50.

6 × 37 Class (Extra Flexible Hoisting Rope): For a given size of rope, the component wires are of smaller diameter than those in the two classes previously described and hence have less resistance to abrasion. Ropes in this class are furnished in regular and Lang lay with fiber core or independent wire rope core, preformed or not preformed.

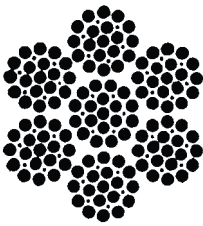


Fig. 2a.
6 × 25 filler wire
with WSC (1 × 25)

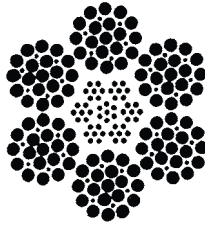


Fig. 2b.
6 × 25 filler wire
with IWRC

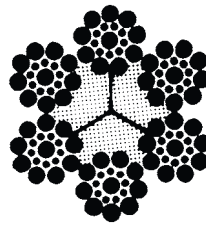


Fig. 2c.
6 × 19 Seale
with fiber core

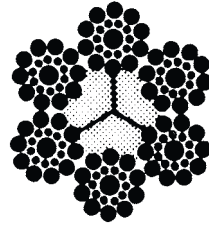


Fig. 2d.
6 × 21 Seale
with fiber core

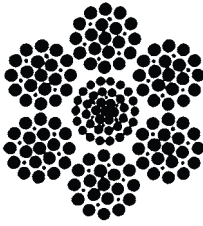


Fig. 2e.
6 × 25 filler wire
with WSC (1 × 43)

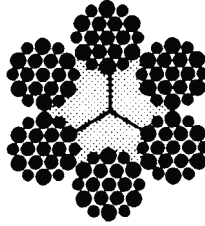


Fig. 2f.
6 × 19 Warrington
with fiber core

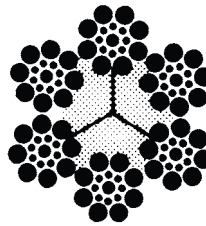


Fig. 2g.
6 × 17 Seale
with fiber core

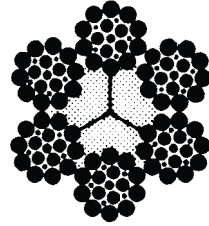


Fig. 2h.
6 × 21 filler wire
with fiber core

Table 3. Weights and Strengths of 6 × 37 (Extra Flexible Hoisting) Wire Ropes, Preformed and Not Preformed

Dia., Inches	Approx. Weight per Ft., Pounds	Breaking Strength, Tons of 2000 Lbs.		Dia., Inches	Approx. Weight per Ft., Pounds	Breaking Strength, Tons of 2000 Lbs.	
		Impr. Plow Steel	Plow Steel			Impr. Plow Steel	Plow Steel
¼	0.10	2.59	2.25	1½	3.49	87.9	76.4
⅕	0.16	4.03	3.50	1⅝	4.09	103	89.3
⅜	0.22	5.77	5.02	1¾	4.75	119	103
7/16	0.30	7.82	6.80	1⅞	5.45	136	118
½	0.39	10.2	8.85	2	6.20	154	134
9/16	0.49	12.9	11.2	2⅝	7.00	173	150
⅝	0.61	15.8	13.7	2¾	7.85	193	168
¾	0.87	22.6	19.6	2½	9.69	236	205
7/8	1.19	30.6	26.6	2¾	11.72	284	247
1	1.55	39.8	34.6	3	14.0	335	291
1⅝	1.96	50.1	43.5	3¼	16.4	390	339
1¼	2.42	61.5	53.5	3½	19.0	449	390
1⅜	2.93	74.1	64.5

For ropes with steel cores, add 7½ per cent to above strengths.

For galvanized ropes, deduct 10 per cent from above strengths.

Source: Rope diagrams, Bethlehem Steel Co. All data, U. S. Simplified Practice Recommendation 198-50.

As shown in Table 3 and Figs. 3a through 3h, there are four common types: 6 × 29 filler wire construction with fiber core and 6 × 36 filler wire construction with independent wire rope core, a special rope for construction equipment; 6 × 35 (two operations) construction with fiber core and 6 × 41 Warrington Seale construction with fiber core, a standard crane rope in this class of rope construction; 6 × 41 filler wire construction with fiber core or independent wire core, a special large shovel rope usually furnished in Lang lay; and 6 × 46

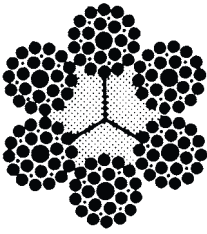


Fig. 3a.
6 × 29 filler wire
with fiber core

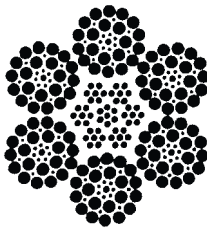


Fig. 3b.
6 × 36 filler wire
with IWRC

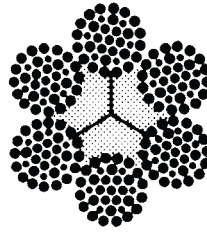


Fig. 3c.
6 × 35 with
fiber core

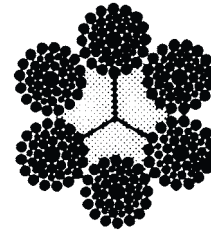


Fig. 3d.
6 × 41 Warrington-Seale
with fiber core

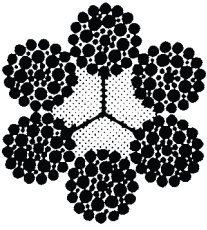


Fig. 3e.
6 × 41 filler wire
with fiber core

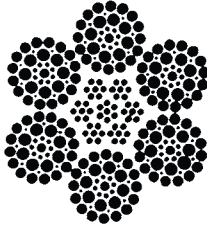


Fig. 3f.
6 × 41 filler wire
with IWRC

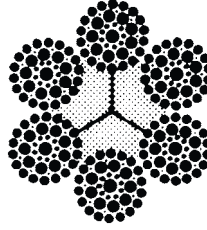


Fig. 3g.
6 × 46 filler wire
with fiber core

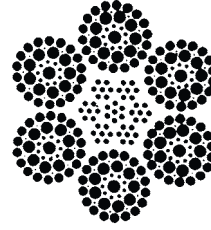


Fig. 3h.
6 × 46 filler wire
with IWRC

filler wire construction with fiber core or independent wire rope core, a special large shovel and dredge rope.

8 × 19 Class (Special Flexible Hoisting Rope): This rope is stable and smooth-running, and is especially suitable, because of its flexibility, for high speed operation with reverse bends. Ropes in this class are available in regular lay with fiber core.

As shown in [Table 4](#) and [Figs. 4a](#) through [4d](#), there are four common types: 8 × 25 filler wire construction, the most flexible but the least wear resistant rope of the four types; Warrington type in 8 × 19 construction, less flexible than the 8 × 25; 8 × 21 filler wire construction, less flexible than the Warrington; and Seale type in 8 × 19 construction, which has the greatest wear resistance of the four types but is also the least flexible.

Table 4. Weights and Strengths of 8 × 19 (Special Flexible Hoisting) Wire Ropes, Preformed and Not Preformed

Dia., Inches	Approx. Weight per Ft., Pounds	Breaking Strength, Tons of 2000 Lbs.		Dia., Inches	Approx. Weight per Ft., Pounds	Breaking Strength, Tons of 2000 Lbs.	
		Impr. Plow Steel	Plow Steel			Impr. Plow Steel	Plow Steel
¼	0.09	2.35	2.04	¾	0.82	20.5	17.8
⅜	0.14	3.65	3.18	⅞	1.11	27.7	24.1
½	0.20	5.24	4.55	1	1.45	36.0	31.3
⅝	0.28	7.09	6.17	1¼	1.84	45.3	39.4
¾	0.36	9.23	8.02	1½	2.27	55.7	48.4
⅞	0.46	11.6	10.1	1¾	2.74	67.1	58.3
1	0.57	14.3	12.4	1½	3.26	79.4	69.1

For ropes with steel cores, add 7½ per cent to above strengths.

For galvanized ropes, deduct 10 per cent from above strengths.

Source: Rope diagrams, Bethlehem Steel Co. All data, U. S. Simplified Practice Recommendation 198-50.

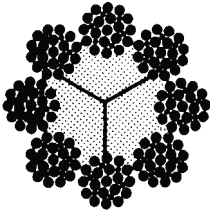


Fig. 4a.
8 x 25 filler wire
with fiber core

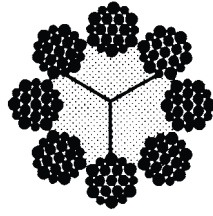


Fig. 4b.
8 x 19 Warrington
with fiber core

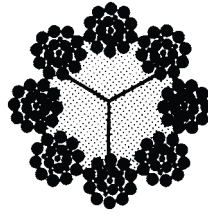


Fig. 4c.
8 x 21 filler wire
with fiber core

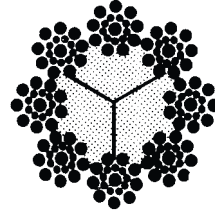
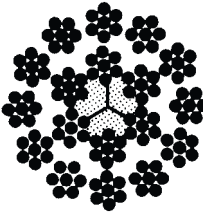


Fig. 4d.
8 x 19 Seale
with fiber core

Also in this class, but not shown in Table 4 are elevator ropes made of traction steel and iron.

18 x 7 Non-rotating Wire Rope: This rope is specially designed for use where a minimum of rotating or spinning is called for, especially in the lifting or lowering of free loads with a single-part line. It has an inner layer composed of 6 strands of 7 wires each laid in left Lang lay over a fiber core and an outer layer of 12 strands of 7 wires each laid in right regular lay. The combination of opposing lays tends to prevent rotation when the rope is stretched. However, to avoid any tendency to rotate or spin, loads should be kept to at least one-eighth and preferably one-tenth of the breaking strength of the rope. Weights and strengths are shown in Table 5.

Table 5. Weights and Strengths of Standard 18 x 7 Nonrotating Wire Rope, Preformed and Not Preformed

 <p>Fig. 5.</p>		Recommended Sheave and Drum Diameters					
		Single layer on drum		36 rope diameters			
		Multiple layers on drum		48 rope diameters			
		Mine service		60 rope diameters			
Dia., Inches	Approx. Weight per Ft., Pounds	Breaking Strength, Tons of 2000 Lbs.		Dia., Inches	Approx. Weight per Ft., Pounds	Breaking Strength, Tons of 2000 Lbs.	
		Impr. Plow Steel	Plow Steel			Impr. Plow Steel	Plow Steel
3/16	0.061	1.42	1.24	7/8	1.32	29.5	25.7
1/4	0.108	2.51	2.18	1	1.73	38.3	33.3
5/16	0.169	3.90	3.39	1 1/8	2.19	48.2	41.9
3/8	0.24	5.59	4.86	1 1/4	2.70	59.2	51.5
7/16	0.33	7.58	6.59	1 3/8	3.27	71.3	62.0
1/2	0.43	9.85	8.57	1 1/2	3.89	84.4	73.4
9/16	0.55	12.4	10.8	1 5/8	4.57	98.4	85.6
5/8	0.68	15.3	13.3	1 3/4	5.30	114	98.8
3/4	0.97	21.8	19.0

For galvanized ropes, deduct 10 per cent from above strengths.

Source: Rope diagrams, sheave and drum diameters, and data for 3/16, 1/4 and 5/16-inch sizes, Bethlehem Steel Co. All other data, U. S. Simplified Practice Recommendation 198-50.

Flattened Strand Wire Rope: The wires forming the strands of this type of rope are wound around triangular centers so that a flattened outer surface is provided with a greater area than in the regular round rope to withstand severe conditions of abrasion. The triangular shape of the strands also provides superior resistance to crushing. Flattened strand wire

rope is usually furnished in Lang lay and may be obtained with fiber core or independent wire rope core. The three types shown in Table 6 and Figs. 6a through 6c are flexible and are designed for hoisting work.

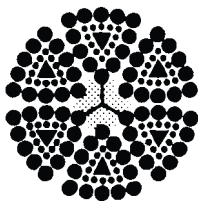


Fig. 6a.
6 × 25 with fiber core

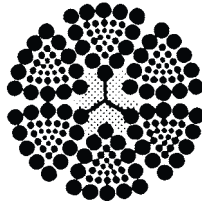


Fig. 6b.
6 × 30 with fiber core

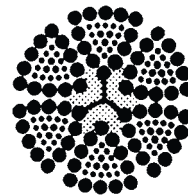


Fig. 6c.
6 × 27 with fiber core

Table 6. Weights and Strengths of Flattened Strand Wire Rope, Preformed and Not Preformed

Dia., Inches	Approx. Weight per Ft., Pounds	Breaking Strength, Tons of 2000 Lbs.		Dia., Inches	Approx. Weight per Ft., Pounds	Breaking Strength, Tons of 2000 Lbs.	
		Impr. Plow Steel	Mild Plow Steel			Impr. Plow Steel	Mild Plow Steel
$\frac{3}{8}$ ^a	0.25	6.71	...	$1\frac{3}{8}$	3.40	85.5	...
$\frac{1}{2}$ ^a	0.45	11.8	8.94	$1\frac{1}{2}$	4.05	101	...
$\frac{9}{16}$ ^a	0.57	14.9	11.2	$1\frac{5}{8}$	4.75	118	...
$\frac{5}{8}$	0.70	18.3	13.9	$1\frac{3}{4}$	5.51	136	...
$\frac{3}{4}$	1.01	26.2	19.8	2	7.20	176	...
$\frac{7}{8}$	1.39	35.4	26.8	$2\frac{1}{4}$	9.10	220	...
1	1.80	46.0	34.8	$2\frac{1}{2}$	11.2	269	...
$1\frac{1}{8}$	2.28	57.9	43.8	$2\frac{3}{4}$	13.6	321	...
$1\frac{1}{4}$	2.81	71.0	53.7

^a These sizes in Type B only.

Type H is not in U.S. Simplified Practice Recommendation.

Source: Rope diagrams, Bethlehem Steel Co. All other data, U.S. Simplified Practice Recommendation 198-50.

Flat Wire Rope: This type of wire rope is made up of a number of four-strand rope units placed side by side and stitched together with soft steel sewing wire. These four-strand units are alternately right and left lay to resist warping, curling, or rotating in service. Weights and strengths are shown in Table 7.

Simplified Practice Recommendations.—Because the total number of wire rope types is large, manufacturers and users have agreed upon and adopted a U.S. Simplified Practice Recommendation to provide a simplified listing of those kinds and sizes of wire rope which are most commonly used and stocked. These, then, are the types and sizes which are most generally available. Other types and sizes for special or limited uses also may be found in individual manufacturer's catalogs.


Sizes and Strengths of Wire Rope.—The data shown in Tables 1 through 7 have been taken from U.S. Simplified Practice Recommendation 198-50 but do not include those wire ropes shown in that Simplified Practice Recommendation which are intended primarily for marine use.

Wire Rope Diameter: The diameter of a wire rope is the diameter of the circle that will just enclose it, hence when measuring the diameter with calipers, care must be taken to obtain the largest outside dimension, taken across the opposite strands, rather than the smallest dimension across opposite "valleys" or "flats." It is standard practice for the nominal diameter to be the minimum with all tolerances taken on the plus side. Limits for diam-

eter as well as for minimum breaking strength and maximum pitch are given in Federal Specification for Wire Rope, RR-R—571a.

Wire Rope Strengths: The strength figures shown in the accompanying tables have been obtained by a mathematical derivation based on actual breakage tests of wire rope and represent from 80 to 95 per cent of the total strengths of the individual wires, depending upon the type of rope construction.

Table 7. Weights and Strengths of Standard Flat Wire Rope, Not Preformed

 Flat Wire Rope					This rope consists of a number of 4-strand rope units placed side by side and stitched together with soft steel sewing wire.				
Width and Thickness, Inches	No. of Ropes	Approx. Weight per Ft., Pounds	Breaking Strength, Tons of 2000 Lbs.		Width and Thickness, Inches	No. of Ropes	Approx. Weight per Ft., Pounds	Breaking Strength, Tons of 2000 Lbs.	
			Plow Steel	Mild Plow-Steel				Plow Steel	Mild Plow Steel
$\frac{1}{4} \times 1\frac{1}{2}$	7	0.69	16.8	14.6	$\frac{1}{2} \times 4$	9	3.16	81.8	71.2
$\frac{1}{4} \times 2$	9	0.88	21.7	18.8	$\frac{1}{2} \times 4\frac{1}{2}$	10	3.82	90.9	79.1
$\frac{1}{4} \times 2\frac{1}{2}$	11	1.15	26.5	23.0	$\frac{1}{2} \times 5$	12	4.16	109	94.9
$\frac{1}{4} \times 3$	13	1.34	31.3	27.2	$\frac{1}{2} \times 5\frac{1}{2}$	13	4.50	118	103
					$\frac{1}{2} \times 6$	14	4.85	127	111
$\frac{5}{16} \times 1\frac{1}{2}$	5	0.77	18.5	16.0	$\frac{1}{2} \times 7$	16	5.85	145	126
$\frac{5}{16} \times 2$	7	1.05	25.8	22.4					
$\frac{5}{16} \times 2\frac{1}{2}$	9	1.33	33.2	28.8	$\frac{5}{8} \times 3\frac{1}{2}$	6	3.40	85.8	74.6
$\frac{5}{16} \times 3$	11	1.61	40.5	35.3	$\frac{5}{8} \times 4$	7	3.95	100	87.1
$\frac{5}{16} \times 3\frac{1}{2}$	13	1.89	47.9	41.7	$\frac{5}{8} \times 4\frac{1}{2}$	8	4.50	114	99.5
$\frac{5}{16} \times 4$	15	2.17	55.3	48.1	$\frac{5}{8} \times 5$	9	5.04	129	112
					$\frac{5}{8} \times 5\frac{1}{2}$	10	5.59	143	124
$\frac{3}{8} \times 2$	6	1.25	31.4	27.3	$\frac{5}{8} \times 6$	11	6.14	157	137
$\frac{3}{8} \times 2\frac{1}{2}$	8	1.64	41.8	36.4	$\frac{5}{8} \times 7$	13	7.23	186	162
$\frac{3}{8} \times 3$	9	1.84	47.1	40.9	$\frac{5}{8} \times 8$	15	8.32	214	186
$\frac{3}{8} \times 3\frac{1}{2}$	11	2.23	57.5	50.0					
$\frac{3}{8} \times 4$	12	2.44	62.7	54.6	$\frac{3}{4} \times 5$	8	6.50	165	143
$\frac{3}{8} \times 4\frac{1}{2}$	14	2.83	73.2	63.7	$\frac{3}{4} \times 6$	9	7.31	185	161
$\frac{3}{8} \times 5$	15	3.03	78.4	68.2	$\frac{3}{4} \times 7$	10	8.13	206	179
$\frac{3}{8} \times 5\frac{1}{2}$	17	3.42	88.9	77.3	$\frac{3}{4} \times 8$	11	9.70	227	197
$\frac{3}{8} \times 6$	18	3.63	94.1	81.9					
					$\frac{7}{8} \times 5$	7	7.50	190	165
$\frac{1}{2} \times 2\frac{1}{2}$	6	2.13	54.5	47.4	$\frac{7}{8} \times 6$	8	8.56	217	188
$\frac{1}{2} \times 3$	7	2.47	63.6	55.4	$\frac{7}{8} \times 7$	9	9.63	244	212
$\frac{1}{2} \times 3\frac{1}{2}$	8	2.82	72.7	63.3	$\frac{7}{8} \times 8$	10	10.7	271	236

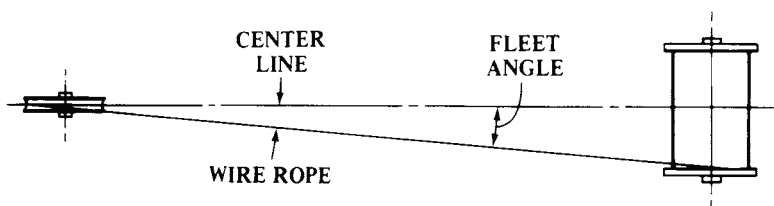
Source: Rope diagram, Bethlehem Steel Co.; all data, U.S. Simplified Practice Recommendation 198-50.

Safe Working Loads and Factors of Safety.—The maximum load for which a wire rope is to be used should take into account such associated factors as friction, load caused by bending around each sheave, acceleration and deceleration, and, if a long length of rope is to be used for hoisting, the weight of the rope at its maximum extension. The condition of the rope — whether new or old, worn or corroded — and type of attachments should also be considered.

Factors of safety for standing rope usually range from 3 to 4; for operating rope, from 5 to 12. Where there is the element of hazard to life or property, higher values are used.

Installing Wire Rope.—The main precaution to be taken in removing and installing wire rope is to avoid kinking which greatly lessens the strength and useful life. Thus, it is preferable when removing wire rope from the reel to have the reel with its axis in a horizontal position and, if possible, mounted so that it will revolve and the wire rope can be taken off straight. If the rope is in a coil, it should be unwound with the coil in a vertical position as by rolling the coil along the ground. Where a drum is to be used, the rope should be run directly onto it from the reel, taking care to see that it is not bent around the drum in a direction opposite to that on the reel, thus causing it to be subject to reverse bending. On flat or smooth-faced drums it is important that the rope be started from the proper end of the drum. A right lay rope that is being overwound on the drum, that is, it passes over the top of the drum as it is wound on, should be started from the right flange of the drum (looking at the drum from the side that the rope is to come) and a left lay rope from the left flange.

When the rope is under wound on the drum, a right lay rope should be started from the left flange and a left lay rope from the right flange, so that the rope will spool evenly and the turns will lie snugly together.



Sheaves and drums should be properly aligned to prevent undue wear. The proper position of the main or lead sheave for the rope as it comes off the drum is governed by what is called the fleet angle or angle between the rope as it stretches from drum to sheave and an imaginary center-line passing through the center of the sheave groove and a point halfway between the ends of the drum. When the rope is at one end of the drum, this angle should not exceed one and a half to two degrees. With the lead sheave mounted with its groove on this center-line, a safe fleet angle is obtained by allowing 30 feet of lead for each two feet of drum width.

Sheave and Drum Dimensions: Sheaves and drums should be as large as possible to obtain maximum rope life. However, factors such as the need for lightweight equipment for easy transport and use at high speeds, may call for relatively small sheaves with consequent sacrifice in rope life in the interest of overall economy. No hard and fast rules can be laid down for any particular rope if the utmost in economical performance is to be obtained. Where maximum rope life is of prime importance, the following recommendations of Federal Specification RR-R-571a for minimum sheave or drum diameters D in terms of rope diameter d will be of interest. For 6×7 rope (six strands of 7 wires each) $D = 72d$; for 6×19 rope, $D = 45d$; for 6×25 rope, $D = 45d$; for 6×29 rope, $D = 30d$; for 6×37 rope, $D = 27d$; and for 8×19 rope, $D = 31d$.

Too small a groove for the rope it is to carry will prevent proper seating of the rope in the bottom of the groove and result in uneven distribution of load on the rope. Too large a groove will not give the rope sufficient side support. Federal Specification RR-R-571a recommends that sheave groove diameters be larger than the nominal rope diameters by the following minimum amounts: For ropes of $\frac{1}{4}$ - to $\frac{5}{16}$ -inch diameters, $\frac{1}{64}$ inch larger; for $\frac{3}{8}$ - to $\frac{3}{4}$ -inch diameter ropes, $\frac{1}{32}$ inch larger; for $\frac{13}{16}$ - to $1\frac{1}{8}$ -inch diameter ropes, $\frac{3}{64}$ inch larger; for $1\frac{3}{16}$ - to $1\frac{1}{2}$ -inch ropes, $\frac{1}{16}$ inch larger; for $1\frac{9}{16}$ - to $2\frac{1}{4}$ -inch ropes, $\frac{3}{32}$ inch larger; and for $2\frac{5}{16}$ and larger diameter ropes, $\frac{1}{8}$ inch larger. For new or regrooved sheaves these values should be doubled; in other words for $\frac{1}{4}$ - to $\frac{5}{16}$ -inch diameter ropes, the groove diameter should be $\frac{1}{32}$ inch larger, and so on.

Drum or Reel Capacity: The length of wire rope, in feet, that can be spooled onto a drum or reel, is computed by the following formula, where

$A = \text{depth of rope space on drum, inches: } A = (H - D - 2Y) \div 2$

$B = \text{width between drum flanges, inches}$

$D = \text{diameter of drum barrel, inches}$

$H = \text{diameter of drum flanges, inches}$

$K = \text{factor from Table 8 for size of line selected}$

$Y = \text{depth not filled on drum or reel where winding is to be less than full capacity}$

$L = \text{length of wire rope on drum or reel, feet: } L = (A + D) \times A \times B \times K$

Table 8. Factors *K* Used in Calculating Wire Rope Drum and Reel Capacities

Rope Dia., In.	Factor <i>K</i>	Rope Dia., In.	Factor <i>K</i>	Rope Dia., In.	Factor <i>K</i>
$\frac{3}{32}$	23.4	$\frac{1}{2}$	0.925	$1\frac{3}{8}$	0.127
$\frac{1}{8}$	13.6	$\frac{9}{16}$	0.741	$1\frac{1}{2}$	0.107
$\frac{9}{64}$	10.8	$\frac{5}{8}$	0.607	$1\frac{5}{8}$	0.0886
$\frac{5}{32}$	8.72	$1\frac{1}{16}$	0.506	$1\frac{3}{4}$	0.0770
$\frac{3}{16}$	6.14	$\frac{3}{4}$	0.428	$1\frac{7}{8}$	0.0675
$\frac{7}{32}$	4.59	$1\frac{3}{16}$	0.354	2	0.0597
$\frac{1}{4}$	3.29	$\frac{7}{8}$	0.308	$2\frac{1}{8}$	0.0532
$\frac{5}{16}$	2.21	1	0.239	$2\frac{1}{4}$	0.0476
$\frac{3}{8}$	1.58	$1\frac{1}{8}$	0.191	$2\frac{3}{8}$	0.0419
$\frac{7}{16}$	1.19	$1\frac{1}{4}$	0.152	$2\frac{1}{2}$	0.0380

Note: The values of “*K*” allow for normal oversize of ropes, and the fact that it is practically impossible to “thread-wind” ropes of small diameter. However, the formula is based on uniform rope winding and will not give correct figures if rope is wound non-uniformly on the reel. The amount of tension applied when spooling the rope will also affect the length. The formula is based on the same number of wraps of rope in each layer, which is not strictly correct, but does not result in appreciable error unless the width (*B*) of the reel is quite small compared with the flange diameter (*H*).

Example: Find the length in feet of $\frac{9}{16}$ -inch diameter rope required to fill a drum having the following dimensions: $B = 24$ inches, $D = 18$ inches, $H = 30$ inches,

$A = (30 - 18 - 0) \div 2 = 6$ inches

$L = (6 + 18) \times 6 \times 24 \times 0.741 = 2560.0$ or 2560 feet

The above formula and factors *K* allow for normal oversize of ropes but will not give correct figures if rope is wound non-uniformly on the reel.

Load Capacity of Sheave or Drum: To avoid excessive wear and groove corrugation, the radial pressure exerted by the wire rope on the sheave or drum must be kept within certain maximum limits. The radial pressure of the rope is a function of rope tension, rope diameter, and tread diameter of the sheave and can be determined by the following equation:

$$P = \frac{2T}{D \times d}$$

where $P = \text{Radial pressure in pounds per square inch (see Table 9)}$

$T = \text{Rope tension in pounds}$

$D = \text{Tread diameter of sheave or drum in inches}$

$d = \text{Rope diameter in inches}$

According to the Bethlehem Steel Co. the radial pressures shown in Table 9 are recommended as maximums according to the material of which the sheave or drum is made.

Table 9. Maximum Radial Pressures for Drums and Sheaves

Type of Wire Rope	Drum or Sheave Material			Type of Wire Rope	Drum or Sheave Material		
	Cast Iron	Cast Steel	Manganese Steel ^a		Cast Iron	Cast Steel	Manganese Steel ^a
	Recommended Maximum Radial Pressures, psi				Recommended Maximum Radial Pressures, psi		
6 × 7	300 ^b	550 ^b	1500 ^b	6 × 8 Flattened Strand	450	850	2200
6 × 19	500 ^b	900 ^b	2500 ^b	6 × 25 Flattened Strand	800	1450	4000
6 × 37	600	1075	3000	6 × 30 Flattened Strand	800	1450	4000

^a 11 to 13 per cent manganese.

^b These values are for regular lay rope. Lang lay rope values may be increased by 15 per cent.

Minimum Sheave- and Drum-Groove Dimensions for Wire Rope Applications

Nominal Rope Diameter	Groove Radius		Nominal Rope Diameter	Groove Radius		Nominal Rope Diameter	Groove Radius	
	New	Worn		New	Worn		New	Worn
1/4	0.135	0.129	1 5/8	0.876	0.833	3 3/8	1.807	1.730
5/16	0.167	0.160	1 3/4	0.939	0.897	3 1/2	1.869	1.794
3/8	0.201	0.190	1 7/8	1.003	0.959	3 3/4	1.997	1.918
7/16	0.234	0.220	2	1.085	1.025	4	2.139	2.050
1/2	0.271	0.256	2 1/8	1.137	1.079	4 1/4	2.264	2.178
9/16	0.303	0.288	2 1/4	1.210	1.153	4 1/2	2.396	2.298
5/8	0.334	0.320	2 3/8	1.271	1.199	4 3/4	2.534	2.434
3/4	0.401	0.380	2 1/2	1.338	1.279	5	2.663	2.557
7/8	0.468	0.440	2 5/8	1.404	1.339	5 1/4	2.804	2.691
1	0.543	0.513	2 3/4	1.481	1.409	5 1/2	2.929	2.817
1 1/8	0.605	0.577	2 7/8	1.544	1.473	5 3/4	3.074	2.947
1 1/4	0.669	0.639	3	1.607	1.538	6	3.198	3.075
1 3/8	0.736	0.699	3 1/8	1.664	1.598			
1 1/2	0.803	0.759	3 1/4	1.731	1.658			

All dimensions in inches. Data taken from *Wire Rope Users Manual*, 2nd ed., American Iron and Steel Institute, Washington, D. C. The values given in this table are applicable to grooves in sheaves and drums but are not generally suitable for pitch design, since other factors may be involved.

Rope Loads due to Bending: When a wire rope is bent around a sheave, the resulting bending stress s_b in the outer wire, and equivalent bending load P_b (amount that direct tension load on rope is increased by bending) may be computed by the following formulas:

$s_b = Ed_w \div D$; $P_b = s_b A$, where $A = d^2 Q$. E is the modulus of elasticity of the wire rope (varies with the type and condition of rope from 10,000,000 to 14,000,000. An average value of 12,000,000 is frequently used), d is the diameter of the wire rope, d_w is the diameter of the component wire (for 6 × 7 rope, $d_w = 0.106d$; for 6 × 19 rope, $0.063d$; for 6 × 37 rope, $0.045d$; and for 8 × 19 rope, $d_w = 0.050d$). D is the pitch diameter of the sheave in inches, A is the metal cross-sectional area of the rope, and Q is a constant, values for which are: 6 × 7 (Fiber Core) rope, 0.380; 6 × 7 (IWRC or WSC), 0.437; 6 × 19 (Fiber Core), 0.405; 6 × 19 (IWRC or WSC), 0.475; 6 × 37 (Fiber Core), 0.400; 6 × 37 (IWRC), 0.470; 8 × 19 (Fiber Core), 0.370; and Flattened Strand Rope, 0.440.

Example: Find the bending stress and equivalent bending load due to the bending of a 6 × 19 (Fiber Core) wire rope of 1/2-inch diameter around a 24-inch pitch diameter sheave.

$$d_w = 0.063 \times 0.5 = 0.0315 \text{ in.} \quad A = 0.5^2 \times 0.405 = 0.101 \text{ sq. in.}$$

$$s_b = 12,000,000 \times 0.0315 \div 24 = 15,750 \text{ lbs. per sq. in.}$$

$$P_b = 15,750 \times 0.101 = 1590 \text{ lbs.}$$

Cutting and Seizing of Wire Rope.—Wire rope can be cut with mechanical wire rope shears, an abrasive wheel, an electric resistance cutter (used for ropes of smaller diameter only), or an acetylene torch. This last method fuses the ends of the wires in the strands. It is important that the rope be seized on either side of where the cut is to be made. Any annealed low carbon steel wire may be used for seizing, the recommended sizes being as follows: For a wire rope of $\frac{1}{4}$ to $\frac{15}{16}$ -inch diameter, use a seizing wire of 0.054-inch (No. 17 Steel Wire Gage); for a rope of 1- to $1\frac{5}{8}$ -inch diameter, use a 0.105-inch wire (No. 12); and for rope of $1\frac{3}{4}$ - to $3\frac{1}{2}$ -inch diameter, use a 0.135-inch wire (No. 10). Except for preformed wire ropes, a minimum of two seizings on either side of a cut is recommended. Four seizings should be used on either side of a cut for Lang lay rope, a rope with a steel core, or a non-spinning type of rope.

The following method of seizing is given in Federal Specification for wire rope, RR-R-571a. Lay one end of the seizing wire in the groove between two strands of wire rope and wrap the other end tightly in a close helix over the portion in the groove. A seizing iron (round bar $\frac{1}{2}$ to $\frac{5}{8}$ inch diameter by 18 inches long) should be used to wrap the seizing tightly. This bar is placed at right angles to the rope next to the first turn or two of the seizing wire. The seizing wire is brought around the back of the seizing iron and wrapped loosely around the wire rope in the opposite direction to that of the seizing coil. As the seizing iron is now rotated around the rope it will carry the seizing wire snugly and tightly into place. When completed, both ends of the seizing should be twisted together tightly.

Maintenance of Wire Rope.—Heavy abrasion, overloading, and bending around sheaves or drums that are too small in diameter are the principal reasons for the rapid deterioration of wire rope. Wire rope in use should be inspected periodically for evidence of wear and damage by corrosion. Such inspections should take place at progressively shorter intervals over the useful life of the rope as wear tends to accelerate with use. Where wear is rapid, the outside of a wire rope will show flattened surfaces in a short time.

If there is any hazard involved in the use of the rope, it may be prudent to estimate the remaining strength and service life. This assessment should be done for the weakest point where the most wear or largest number of broken wires are in evidence. One way to arrive at a conclusion is to set an arbitrary number of broken wires in a given strand as an indication that the rope should be removed from service and an ultimate strength test run on the worn sample. The arbitrary figure can then be revised and rechecked until a practical working formula is arrived at. A piece of waste rubbed along the wire rope will help to reveal broken wires. The effects of corrosion are not easy to detect because the exterior wires may appear to be only slightly rusty, and the damaging effects of corrosion may be confined to the hidden inner wires where it cannot be seen. To prevent damage by corrosion, the rope should be kept well lubricated. Use of zinc coated wire rope may be indicated for some applications.

Periodic cleaning of wire rope by using a stiff brush and kerosene or with compressed air or live steam and relubricating will help to lengthen rope life and reduce abrasion and wear on sheaves and drums. Before storing after use, wire rope should be cleaned and lubricated.

Lubrication of Wire Rope.—Although wire rope is thoroughly lubricated during manufacture to protect it against corrosion and to reduce friction and wear, this lubrication should be supplemented from time to time. Special lubricants are supplied by wire rope manufacturers. These lubricants vary somewhat with the type of rope application and operating condition. Where the preferred lubricant can not be obtained from the wire rope manufacturer, an adhesive type of lubricant similar to that used for open gearing will often be found suitable. At normal temperatures, some wire rope lubricants may be practically solid and will require thinning before application. Thinning may be done by heating to 160 to 200 degrees F. or by diluting with gasoline or some other fluid that will allow the lubricant to penetrate the rope. The lubricant may be painted on the rope or the rope may be passed through a box or tank filled with the lubricant.

Replacement of Wire Rope.—When an old wire rope is to be replaced, all drums and sheaves should be examined for wear. All evidence of scoring or imprinting of grooves from previous use should be removed and sheaves with flat spots, defective bearings, and broken flanges, should be repaired or replaced. It will frequently be found that the area of maximum wear is located relatively near one end of the rope. By cutting off that portion, the remainder of the rope may be salvaged for continued use. Sometimes the life of a rope can be increased by simply changing it end for end at about one-half the estimated normal life. The worn sections will then no longer come at the points that cause the greatest wear.

Wire Rope Slings and Fittings

Slings.—A few of the simpler sling arrangements or hitches as they are called, are shown in the accompanying illustration. Normally 6 × 19 Class wire rope is recommended where a diameter in the $\frac{1}{4}$ -inch to $1\frac{1}{8}$ -inch range is to be used and 6 × 37 Class wire rope where a diameter in the $1\frac{1}{4}$ -inch and larger range is to be used. However, the 6 × 19 Class may be used even in the larger sizes if resistance to abrasion is of primary importance and the 6 × 37 Class in the smaller sizes if greater flexibility is desired.

The *straight lift hitch*, Fig. 7a, is a straight connector between crane hook and load.

The *basket hitch* may be used with two hooks so that the sides are vertical as shown at Fig. 7b or with a single hook with sides at various angles with the vertical as shown at Fig. 7c, Fig. 7d, and Fig. 7e. As the angle with the vertical increases, a greater tension is placed on the rope so that for any given load, a sling of greater lifting capacity must be used.

The *choker hitch*, shown at Fig. 7f, is widely used for lifting bundles of items such as bars, poles, pipe, and similar objects. The choker hitch holds these items firmly, but the load must be balanced so that it rides safely. Since additional stress is imposed on the rope due to the choking action, the capacity of this type of hitch is 25 per cent less than that of the comparable straight lift. If two choker hitches are used at an angle, these angles must also be taken into consideration as with the basket hitches.

Wire Rope Fittings.—Many varieties of swaged fittings are available for use with wire rope and several industrial and aircraft types are shown in the accompanying illustration. Swaged fittings on wire rope have an efficiency (ability to hold the wire rope) of approximately 100 per cent of the catalogue rope strength. These fittings are attached to the end or body of the wire rope by the application of high pressure through special dies that cause the material of the fitting to “flow” around the wires and strands of the rope to form a union that is as strong as the rope itself. The more commonly used types, of swaged fittings range from $\frac{1}{8}$ - to $\frac{5}{8}$ -inch diameter sizes in industrial types and from the $\frac{1}{16}$ - to $\frac{5}{8}$ -inch sizes in aircraft types. These fittings are furnished attached to the wire strand, rope, or cable.

Applying Clips and Attaching Sockets.—In attaching U-bolt clips for fastening the end of a wire rope to form a loop, it is essential that the saddle or base of the clip bears against the longer or “live” end of the rope loop and the U-bolt against the shorter or “dead” end. The “U” of the clips should never bear against the live end of the rope because the rope may be cut or kinked. A wire-rope thimble should be used in the loop eye of the rope to prevent kinking when rope clips are used. The strength of a clip fastening is usually less than 80 percent of the strength of the rope. Table 10 gives the proper size, number, and spacing for each size of wire rope.

In attaching commercial sockets of forged steel to wire rope ends, the following procedure is recommended. The wire rope is seized at the end and another seizing is applied at a distance from the end equal to the length of the basket of the socket. As explained in a previous section, soft iron wire is used and particularly for the larger sizes of wire rope, it is important to use a seizing iron to secure a tight winding. For large ropes, the seizing should be several inches long.

Wire Rope Slings and Fittings

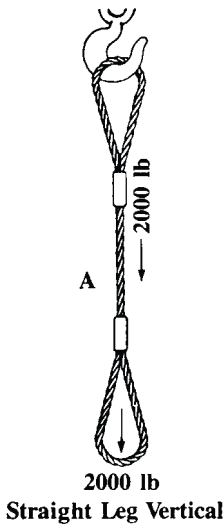


Fig. 7a. Straight Lift
One leg vertical
Load capacity is 100% of a single rope.

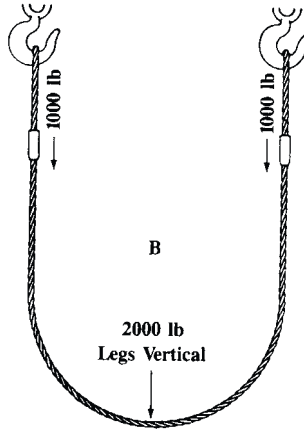


Fig. 7b. Basket Hitch
Two legs vertical
Load capacity is 200% of the single rope in Fig. 7a.

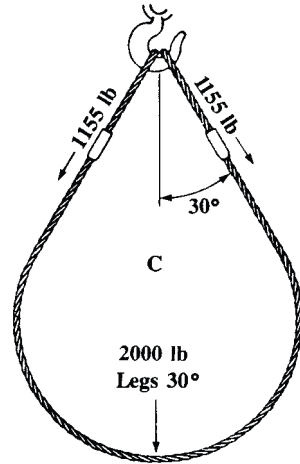


Fig. 7c. Basket Hitch
Two legs at 30° with the vertical
Load capacity is 174% of the single rope in Fig. 7a.

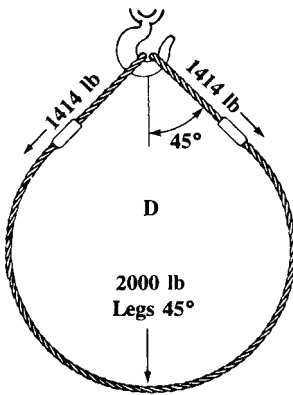


Fig. 7d. Basket Hitch
Two legs at 45° with the vertical
Load capacity is 141% of the single rope in Fig. 7a.

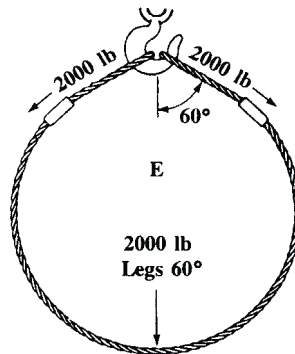


Fig. 7e. Basket Hitch
Two legs at 60° with the vertical
Load capacity is 100% of the single rope in Fig. 7a.



Fig. 7f. Choker Hitch
One leg vertical, with slip-through loop
Rated capacity is 75% of the single rope in Fig. 7a.

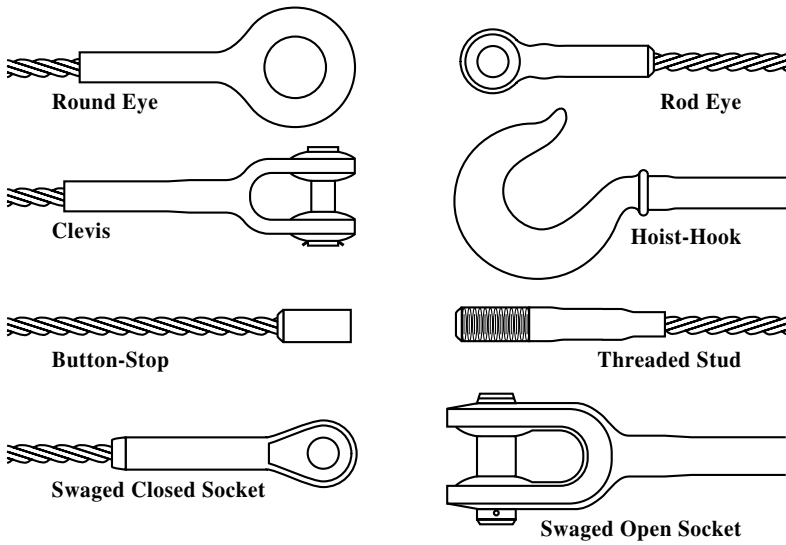
The end seizing is now removed and the strands are separated so that the fiber core can be cut back to the next seizing. The individual wires are then untwisted and “broomed out” and for the distance they are to be inserted in the socket are carefully cleaned with benzine, naphtha, or unleaded gasoline. The wires are then dipped into commercial muriatic (hydrochloric) acid and left (usually one to three minutes) until the wires are bright and clean or, if zinc coated, until the zinc is removed. After cleaning, the wires are dipped into a hot soda solution (1 pound of soda to 4 gallons of water at 175 degrees F. minimum) to neutralize the acid. The rope is now placed in a vise. A temporary seizing is used to hold the wire ends

Rated Capacities for Improved Plow Steel Wire Rope and Wire Rope Slings (in tons of 2,000 lbs)

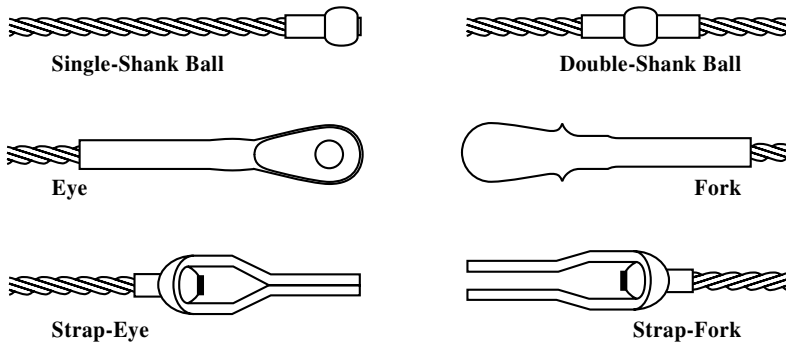
Dia. (in.)	Independent Wire Rope Core												Fiber Core																					
	Vertical			Choker			60° Bridle			45° Bridle			30° Bridle			Vertical			Choker			60° Bridle			45° Bridle			30° Bridle						
	A	B	C	A	B	C	A	B	C	A	B	C	A	B	C	A	B	C	A	B	C	A	B	C	A	B	C	A	B	C	A	B	C	
Single Leg, 6 × 19 Wire Rope																																		
¼	0.59	0.56	0.53	0.44	0.42	0.40	0.55	0.51	0.49	0.41	0.38	0.37	
⅜	1.3	1.2	1.1	0.98	0.93	0.86	1.2	1.1	1.1	0.91	0.85	0.80	
½	2.3	2.2	2.0	1.7	1.6	1.5	2.1	2.0	1.8	1.6	1.5	1.4	
⅝	3.6	3.4	3.0	2.7	2.5	2.2	3.3	3.1	2.8	2.5	2.3	2.1	
¾	5.1	4.9	4.2	3.8	3.6	3.1	4.8	4.4	3.9	3.6	3.3	2.9	
⅞	6.9	6.6	5.5	5.2	4.9	4.1	6.4	5.9	5.1	4.8	4.5	3.9	
1	9.0	8.5	7.2	6.7	6.4	5.4	8.4	7.7	6.7	6.3	5.8	5.0	
1¼	11	10	9.0	8.5	7.8	6.8	10	9.5	8.4	7.9	7.1	6.3	
Single Leg, 6 × 37 Wire Rope																																		
1¼	13	12	10	9.9	9.2	7.9	12	11	9.8	9.2	8.3	7.4	
1⅜	16	15	13	12	11	9.6	15	13	12	11	10	8.9	
1½	19	17	15	14	13	11	17	16	14	13	12	10
1¾	26	24	20	19	18	15	24	21	19	18	16	14
2	33	30	26	25	23	20	31	28	25	23	21	18
2¼	41	38	33	31	29	25
Two-Leg Bridle or Basket Hitch, 6 × 19 Wire Rope Sling																																		
¼	1.2	1.1	1.0	1.0	0.97	0.92	0.83	0.79	0.75	0.59	0.56	0.53	1.1	1.0	0.99	0.95	0.88	0.85	0.77	0.72	0.70	0.55	0.51	0.49		
⅜	2.0	2.5	2.3	2.3	2.1	2.0	1.8	1.8	1.8	1.3	1.2	1.1	2.4	2.2	2.1	2.1	1.9	1.8	1.7	1.6	1.5	1.2	1.1	1.1		
½	4.0	4.4	3.9	4.0	3.6	3.4	3.2	3.1	2.8	2.3	2.2	2.0	4.3	3.9	3.7	3.7	3.4	3.2	3.0	2.8	2.6	2.1	2.0	1.8		
⅝	7.2	6.6	6.0	6.2	5.9	5.2	5.1	4.8	4.2	3.6	3.4	3.0	6.7	6.2	5.6	6.2	5.3	4.8	4.7	4.4	4.0	3.3	3.1	2.8		
¾	10	9.7	8.4	8.9	8.4	7.3	7.2	6.9	5.9	5.1	4.9	4.2	9.5	8.8	7.8	8.2	7.6	6.8	6.7	6.2	5.5	4.8	4.4	3.9		
⅞	14	13	11	12	11	9.6	9.8	9.3	7.8	6.9	6.6	5.5	13	12	10	11	10	8.9	9.1	8.4	7.3	6.4	5.9	5.1		
1	18	17	14	15	15	12	13	12	10	9.0	8.5	7.2	17	15	13	14	13	11	12	11	9.4	8.4	7.7	6.7		
1¼	23	21	18	19	18	16	16	15	13	11	10	9.0	21	19	17	18	16	14	15	13	12	10	9.5	8.4		
Two-Leg Bridle or Basket Hitch, 6 × 37 Wire Rope Sling																																		
1¼	26	24	21	23	21	18	19	17	15	13	12	10	25	22	20	21	19	17	17	16	14	12	11	9.8		
1⅜	32	29	25	28	25	22	22	21	18	16	15	13	30	27	24	26	23	20	21	19	17	15	13	12		
1½	38	35	30	33	30	26	27	25	21	19	17	15	35	32	28	30	27	24	25	22	20	17	16	14		
1¾	51	47	41	44	41	35	36	33	29	26	24	20	46	43	39	41	37	33	34	30	27	24	21	19		
2	66	61	53	57	53	46	47	43	37	33	30	26	62	55	49	53	43	43	43	39	35	31	26	25		
2¼	83	76	66	72	66	67	58	54	47	41	38	33	

A-socket or swaged terminal attachment; B-mechanical sleeve attachment; C-hand-tucked splice attachment. Data from *Longshoring Industry*, OSHA Safety and Health Standards Digest, OSHA 2232, 1985.

Industrial Types



Aircraft Types



Wire Rope Fittings

together until the socket is placed over the rope end. The temporary seizing is then removed and the socket located so that the ends of the wires are about even with the upper end of the basket. The opening around the rope at the bottom of the socket is now sealed with putty.

Table 10. Clips Required for Fastening Wire Rope End

Rope Dia., In.	U-Bolt Dia., In.	Min. No. of Clips	Clip Spacing, In.	Rope Dia., In.	U-Bolt Dia., In.	Min. No. of Clips	Clip Spacing, In.	Rope Dia., In.	U-Bolt Dia., In.	Min. No. of Clips	Clip Spacing, In.
$\frac{3}{16}$	$\frac{11}{32}$	2	3	$\frac{3}{4}$	$\frac{7}{8}$	4	$6\frac{3}{4}$	$1\frac{5}{8}$	$1\frac{3}{4}$	6	$13\frac{1}{4}$
$\frac{1}{4}$	$\frac{7}{16}$	2	$3\frac{1}{4}$	$\frac{7}{8}$	1	4	8	$1\frac{3}{4}$	$1\frac{15}{16}$	7	$14\frac{1}{2}$
$\frac{5}{16}$	$\frac{1}{2}$	2	$3\frac{1}{4}$	1	$1\frac{1}{8}$	4	$8\frac{3}{4}$	2	$2\frac{1}{8}$	8	$16\frac{1}{2}$
$\frac{3}{8}$	$\frac{9}{16}$	2	4	$1\frac{1}{8}$	$1\frac{1}{4}$	5	$9\frac{3}{4}$	$2\frac{1}{4}$	$2\frac{5}{8}$	8	$16\frac{1}{2}$
$\frac{7}{16}$	$\frac{5}{8}$	2	$4\frac{1}{2}$	$1\frac{1}{4}$	$1\frac{7}{16}$	5	$10\frac{3}{4}$	$2\frac{1}{2}$	$2\frac{7}{8}$	8	$17\frac{3}{4}$
$\frac{1}{2}$	$\frac{11}{16}$	3	5	$1\frac{3}{8}$	$1\frac{1}{2}$	6	$11\frac{1}{2}$
$\frac{5}{8}$	$\frac{3}{4}$	3	$5\frac{3}{4}$	$1\frac{1}{2}$	$1\frac{23}{32}$	6	$12\frac{1}{2}$

A special high grade pure zinc is used to fill the socket. Babbit metal should not be used as it will not hold properly. For proper fluidity and penetration, the zinc is heated to a tem-

perature in the 830- to 900-degree F. range. If a pyrometer is not available to measure the temperature of the molten zinc, a dry soft pine stick dipped into the zinc and quickly withdrawn will show only a slight discoloration and no zinc will adhere to it. If the wood chars, the zinc is too hot. The socket is now permitted to cool and the resulting joint is ready for use. When properly prepared, the strength of the joint should be approximately equal to that of the rope itself.

Crane Chain and Hooks

Material for Crane Chains.—The best material for crane and hoisting chains is a good grade of wrought iron, in which the percentage of phosphorus, sulfur, silicon, and other impurities is comparatively low. The tensile strength of the best grades of wrought iron does not exceed 46,000 pounds per square inch, whereas mild steel with about 0.15 per cent carbon has a tensile strength nearly double this amount. The ductility and toughness of wrought iron, however, is greater than that of ordinary commercial steel, and for this reason it is preferable for chains subjected to heavy intermittent strains, because wrought iron will always give warning by bending or stretching, before breaking. Another important reason for using wrought iron in preference to steel is that a perfect weld can be effected more easily. Heat-treated alloy steel is also widely used for chains. This steel contains carbon, 0.30 per cent, max; phosphorus, 0.045 per cent, max; and sulfur, 0.045 per cent, max. The selection and amounts of alloying elements are left to the individual manufacturers.

Strength of Chains.—When calculating the strength of chains it should be observed that the strength of a link subjected to tensile stresses is not equal to twice the strength of an iron bar of the same diameter as the link stock, but is a certain amount less, owing to the bending action caused by the manner in which the load is applied to the link. The strength is also reduced somewhat by the weld. The following empirical formula is commonly used for calculating the breaking load, in pounds, of wrought-iron crane chains: $W = 54,000D^2$ in which W = breaking load in pounds and D = diameter of bar (in inches) from which links are made. The working load for chains should not exceed one-third the value of W , and, it is often one-fourth or one-fifth of the breaking load. When a chain is wound around a casting and severe bending stresses are introduced, a greater factor of safety should be used.

Care of Hoisting and Crane Chains.—Chains used for hoisting heavy loads are subject to deterioration, both apparent and invisible. The links wear, and repeated loading causes localized deformations to form cracks that spread until the links fail. Chain wear can be reduced by occasional lubrication. The life of a wrought-iron chain can be prolonged by frequent annealing or normalizing unless it has been so highly or frequently stressed that small cracks have formed. If this condition is present, annealing or normalizing will not “heal” the material, and the links will eventually fracture. To anneal a wrought-iron chain, heat it to cherry-red and allow it to cool slowly. Annealing should be done every six months, and oftener if the chain is subjected to unusually severe service.

Maximum Allowable Wear at Any Point of Link

Chain Size (in.)	Maximum Allowable Wear (in.)	Chain Size (in.)	Maximum Allowable Wear (in.)	Chain Size (in.)	Maximum Allowable Wear (in.)
$\frac{1}{4}$ ($\frac{5}{32}$)	$\frac{3}{64}$	$\frac{3}{4}$	$\frac{5}{32}$	$1\frac{1}{4}$	$\frac{1}{4}$
$\frac{3}{8}$	$\frac{5}{64}$	$\frac{7}{8}$	$\frac{11}{64}$	$1\frac{3}{8}$	$\frac{3}{32}$
$\frac{1}{2}$	$\frac{7}{64}$	1	$\frac{3}{16}$	$1\frac{1}{2}$	$\frac{5}{16}$
$\frac{5}{8}$	$\frac{9}{64}$	$1\frac{1}{8}$	$\frac{7}{32}$	$1\frac{3}{4}$	$\frac{11}{32}$

Source: *Longshoring Industry*, OSHA 2232, 1985.


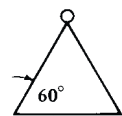
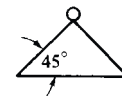
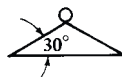
Chains should be examined periodically for twists, as a twisted chain will wear rapidly. Any links that have worn excessively should be replaced with new ones, so that every link will do its full share of work during the life of the chain, without exceeding the limit of safety. Chains for hoisting purposes should be made with short links, so that they will wrap

closely around the sheaves or drums without bending. The diameter of the winding drums should be not less than 25 or 30 times the diameter of the iron used for the links. The accompanying table lists the maximum allowable wear for various sizes of chains.

Safe Loads for Ropes and Chains

Safe loads recommended for wire rope or chain slings depend not only upon the strength of the sling but also upon the method of applying it to the load, as shown by the accompanying table giving safe loads as prepared by OSHA. The loads recommended in this table are more conservative than those usually specified, in order to provide ample allowance for some unobserved weakness in the sling, or the possibility of excessive strains due to misjudgment or accident.

Safe Working Loads in Pounds for Manila Rope and Chains

Diameter of Rope, or Chain Link, Inch	 Rope or Chain Vertical			 Sling at 60°			 Sling at 45°			 Sling at 30°		
	Manila Rope	Crane Chain		Manila Rope	Crane Chain		Manila Rope	Crane Chain		Manila Rope	Crane Chain	
		Wrought Iron	Alloy Steel		Wrought Iron	Alloy Steel		Wrought Iron	Alloy Steel		Wrought Iron	Alloy Steel
1/4 ^a	120	1060	3240	204	1835	5640	170	1500	4540	120	1060	3240
3/16 ^a	200	1655	...	346	2865	...	282	2340	...	200	1655	...
3/8	270	2385	6600	467	4200	11,400	380	3370	9300	270	2385	6600
7/16 ^a	350	3250	...	605	5600	...	493	4600	...	350	3250	...
15/32	450	775	635	450
1/2	530	4200	11,240	915	7400	19,500	798	6000	15,800	530	4200	11,240
9/16 ^a	690	5400	...	1190	9200	...	973	7600	...	690	5400	...
5/8	880	6600	16,500	1520	11,400	28,500	1240	9400	23,300	880	6600	16,500
3/4	1080	9600	23,000	1870	16,600	39,800	1520	13,400	32,400	1080	9600	23,000
13/16	1300	2250	1830	1300
7/8	1540	13,000	28,600	2660	22,400	49,800	2170	18,400	40,600	1540	13,000	28,600
1	1800	17,000	38,600	3120	29,400	67,000	2540	24,000	54,600	1800	17,000	38,600
1 1/16	2000	3400	2800	2000
1 1/8	2400	20,000	44,400	4200	34,600	77,000	3400	28,400	63,000	2400	20,000	44,400
1 1/4	2700	24,800	57,400	4600	42,600	99,400	3800	35,000	81,000	2700	24,800	57,400
1 5/16	3000	5200	4200	3000
1 3/8	...	30,000	67,000	...	51,800	116,000	...	42,200	94,000	...	30,000	67,000
1 1/2	3600	35,600	79,400	6200	61,600	137,000	5000	50,400	112,000	3600	35,600	79,400
1 5/8	4500	41,800	85,000	7800	72,400	147,000	6400	59,000	119,000	4500	41,800	85,000
1 3/4	5200	48,400	95,800	9000	84,000	163,000	7400	68,600	124,000	5200	48,400	95,800
1 7/8	...	55,200	95,800	78,200	55,200	...
2	6200	63,200	...	10,800	109,600	...	8800	89,600	...	6200	63,200	...
2 1/8	7200	12,400	10,200	7200

^a These sizes of wrought chain are no longer manufactured in the United States.








Data from *Longshoring Industry*, OSHA Safety and Health Standards Digest, OSHA 2232, 1985.

The working load limit is defined as the maximum load in pounds that should ever be applied to chain, when the chain is new or in "as new" condition, and when the load is uniformly applied in direct tension to a straight length of chain. This limit is also affected by the number of chains used and their configuration. The accompanying table shows the

working load limit for various configurations of heat-treated alloy steel chain using a 4 to 1 design factor, which conforms to ISO practice.

Protection from Sharp Corners.—When the load to be lifted has sharp corners or edges, as are often encountered with castings, and with structural steel and other similar objects, pads or wooden protective pieces should be applied at the corners, to prevent the slings from being abraded or otherwise damaged where they come in contact with the load. These precautions are especially important when the slings consist of wire cable or fiber rope, although they should also be used even when slings are made of chain. Wooden corner-pieces are often provided for use in hoisting loads with sharp angles. If pads of burlap or other soft material are used, they should be thick and heavy enough to sustain the pressure, and distribute it over a considerable area, instead of allowing it to be concentrated directly at the edges of the part to be lifted.

Working Load Limit for Heat-Treated Alloy Steel Chain, pounds

Chain Size (in.)	Single Leg	Double Leg				Triple and Quad Leg		
	90° 	60° 	45° 	30° 	60° 	45° 	30° 	
¼	3,600	6,200	5,050	3,600	9,300	7,600	5,400	
⅜	6,400	11,000	9,000	6,400	16,550	13,500	9,500	
½	11,400	19,700	16,100	11,400	29,600	24,200	17,100	
⅝	17,800	30,800	25,150	17,800	46,250	37,750	26,700	
¾	25,650	44,400	36,250	25,650	66,650	54,400	38,450	
⅞	34,900	60,400	49,300	34,900	90,650	74,000	52,350	

Source: The Crosby Group.

Strength of Manila Rope

Dia. (in.)	Circumference (in.)	Weight of 100 feet of Rope ^a (lb)	New Rope Tensile Strength ^b (lb)	Working Load ^c (lb)	Dia. (in.)	Circumference (in.)	Weight of 100 feet of Rope ^a (lb)	New Rope Tensile Strength ^b (lb)	Working Load ^c (lb)
⅜	⅝	1.50	406	41	1⅝	4	47.8	13,500	1930
¼	⅜	2.00	540	54	1½	4½	60.0	16,700	2380
⅝	1	2.90	900	90	1⅝	5	74.5	20,200	2880
⅜	1⅝	4.10	1220	122	1¾	5½	89.5	23,800	3400
⅞	1¼	5.25	1580	176	2	6	108	28,000	4000
½	1½	7.50	2380	264	2⅝	6½	125	32,400	4620
⅝	1¾	10.4	3100	388	2¼	7	146	37,000	5300
⅝	2	13.3	3960	496	2½	7½	167	41,800	5950
¾	2¼	16.7	4860	695	2⅝	8	191	46,800	6700
13/16	2½	19.5	5850	835	2⅞	8½	215	52,000	7450
⅞	2¾	22.4	6950	995	3	9	242	57,500	8200
1	3	27.0	8100	1160	3¼	10	298	69,500	9950
1⅞	3¼	31.2	9450	1350	3½	11	366	82,000	11,700
1⅝	3½	36.0	10,800	1540	4	12	434	94,500	13,500
1¼	3¾	41.6	12,200	1740

^a Average value is shown; maximum is 5 per cent higher.

^b Based on tests of new and unused rope of standard construction in accordance with Cordage Institute Standard Test Methods.

^c These values are for rope in good condition with appropriate splices, in noncritical applications, and under normal service conditions. These values should be reduced where life, limb, or valuable property are involved, or for exceptional service conditions such as shock loads or sustained loads.

Data from Cordage Institute Rope Specifications for three-strand laid and eight-strand plaited manila rope (standard construction).

Strength of Nylon and Double Braided Nylon Rope

Dia. (in.)	Circumference (in.)	Weight of 100 feet of Rope ^a (lb)	New Rope Tensile Strength ^b (lb)	Working Load ^c (lb)	Dia. (in.)	Circumference (in.)	Weight of 100 feet of Rope ^a (lb)	New Rope Tensile Strength ^a (lb)	Working Load ^c (lb)
Nylon Rope									
$\frac{3}{16}$	$\frac{5}{8}$	1.00	900	75	$1\frac{5}{16}$	4	45.0	38,800	4,320
$\frac{1}{4}$	$\frac{3}{4}$	1.50	1,490	124	$1\frac{1}{2}$	$4\frac{1}{2}$	55.0	47,800	5,320
$\frac{5}{16}$	1	2.50	2,300	192	$1\frac{3}{8}$	5	66.5	58,500	6,500
$\frac{3}{8}$	$1\frac{1}{8}$	3.50	3,340	278	$1\frac{3}{4}$	$5\frac{1}{2}$	83.0	70,000	7,800
$\frac{7}{16}$	$1\frac{1}{4}$	5.00	4,500	410	2	6	95.0	83,000	9,200
$\frac{1}{2}$	$1\frac{1}{2}$	6.50	5,750	525	$2\frac{1}{8}$	$6\frac{1}{2}$	109	95,500	10,600
$\frac{9}{16}$	$1\frac{3}{4}$	8.15	7,200	720	$2\frac{1}{4}$	7	129	113,000	12,600
$\frac{5}{8}$	2	10.5	9,350	935	$2\frac{1}{2}$	$7\frac{1}{2}$	149	126,000	14,000
$\frac{3}{4}$	$2\frac{1}{4}$	14.5	12,800	1,420	$2\frac{5}{8}$	8	168	146,000	16,200
$1\frac{1}{16}$	$2\frac{1}{2}$	17.0	15,300	1,700	$2\frac{7}{8}$	$8\frac{1}{2}$	189	162,000	18,000
$\frac{7}{8}$	$2\frac{3}{4}$	20.0	18,000	2,000	3	9	210	180,000	20,000
1	3	26.4	22,600	2,520	$3\frac{1}{4}$	10	264	226,000	25,200
$1\frac{1}{16}$	$3\frac{1}{4}$	29.0	26,000	2,880	$3\frac{1}{2}$	11	312	270,000	30,000
$1\frac{1}{8}$	$3\frac{1}{2}$	34.0	29,800	3,320	4	12	380	324,000	36,000
$1\frac{1}{4}$	$3\frac{3}{4}$	40.0	33,800	3,760
Double Braided Nylon Rope (Nylon Cover—Nylon Core)									
$\frac{1}{4}$	$\frac{3}{4}$	1.56	1,650	150	$1\frac{5}{16}$	4	43.1	44,700	5,590
$\frac{5}{16}$	1	2.44	2,570	234	$1\frac{3}{8}$	$4\frac{1}{4}$	47.3	49,000	6,130
$\frac{3}{8}$	$1\frac{1}{8}$	3.52	3,700	336	$1\frac{1}{2}$	$4\frac{1}{2}$	56.3	58,300	7,290
$\frac{7}{16}$	$1\frac{1}{4}$	4.79	5,020	502	$1\frac{5}{8}$	5	66.0	68,300	8,540
$\frac{1}{2}$	$1\frac{1}{2}$	6.25	6,550	655	$1\frac{3}{4}$	$5\frac{1}{2}$	76.6	79,200	9,900
$\frac{9}{16}$	$1\frac{3}{4}$	7.91	8,270	919	2	6	100	103,000	12,900
$\frac{5}{8}$	2	9.77	10,200	1,130	$2\frac{1}{8}$	$6\frac{1}{2}$	113	117,000	14,600
$\frac{3}{4}$	$2\frac{1}{4}$	14.1	14,700	1,840	$2\frac{1}{4}$	7	127	131,000	18,700
$1\frac{1}{16}$	$2\frac{1}{2}$	16.5	17,200	2,150	$2\frac{1}{2}$	$7\frac{1}{2}$	156	161,000	23,000
$\frac{7}{8}$	$2\frac{3}{4}$	19.1	19,900	2,490	$2\frac{3}{8}$	8	172	177,000	25,300
1	3	25.0	26,000	3,250	3	9	225	231,000	33,000
$1\frac{1}{16}$	$3\frac{1}{4}$	28.2	29,300	3,660	$3\frac{1}{4}$	10	264	271,000	38,700
$1\frac{1}{8}$	$3\frac{1}{2}$	31.6	32,800	4,100	$3\frac{1}{2}$	11	329	338,000	48,300
$1\frac{1}{4}$	$3\frac{3}{4}$	39.1	40,600	5,080	4	12	400	410,000	58,600

^a Average value is shown. Maximum for nylon rope is 5 per cent higher; tolerance for double braided nylon rope is ± 5 per cent.

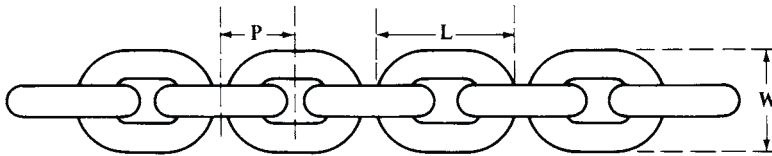
^b Based on tests of new and unused rope of standard construction in accordance with Cordage Institute Standard Test Methods. For double braided nylon rope these values are minimums and are based on a large number of tests by various manufacturers; these values represent results two standard deviations below the mean. The minimum tensile strength is determined by the formula $1057 \times (\text{linear density})^{0.995}$.

^c These values are for rope in good condition with appropriate splices, in noncritical applications, and under normal service conditions. These values should be reduced where life, limb, or valuable property are involved, or for exceptional service conditions such as shock loads or sustained loads.

Data from Cordage Institute Specifications for nylon rope (three-strand laid and eight-strand plaited, standard construction) and double braided nylon rope.

Loads Lifted by Crane Chains.—To find the approximate weight a chain will lift when rove as a tackle, multiply the safe load given in the table *Close-link Hoisting, Sling and Crane Chain* by the number of parts or chains at the movable block, and subtract one-quarter for frictional resistance.

To find the size of chain required for lifting a given weight, divide the weight by the number of chains at the movable block, and add one-third for friction; next find in the column headed “Average Safe Working Load” the corresponding load, and then the corresponding size of chain in the column headed “Size.” With the heavy chain or where the chain is unusually long, the weight of the chain itself should also be considered.



Close-link Hoisting, Sling and Crane Chain

Size	Standard Pitch, P Inches	Average Weight per Foot, Pounds	Outside Length, L Inches	Outside Width, W Inches	Average Safe Working Load, Pounds	Proof Test, Pounds ^a	Approximate Breaking Load, Pounds
1/4	25/32	3/4	1 5/16	7/8	1,200	2,500	5,000
5/16	27/32	1	1 1/2	1 1/16	1,700	3,500	7,000
3/8	3 1/32	1 1/2	1 3/4	1 1/4	2,500	5,000	10,000
7/16	1 5/32	2	2 1/16	1 3/8	3,500	7,000	14,000
1/2	1 11/32	2 1/2	2 3/8	1 11/16	4,500	9,000	18,000
9/16	1 15/32	3 1/4	2 5/8	1 7/8	5,500	11,000	22,000
5/8	1 27/32	4	3	2 1/16	6,700	14,000	27,000
11/16	1 13/16	5	3 1/4	2 1/4	8,100	17,000	32,500
3/4	1 15/16	6 1/4	3 1/2	2 1/2	10,000	20,000	40,000
13/16	2 1/16	7	3 3/4	2 11/16	10,500	23,000	42,000
7/8	2 3/16	8	4	2 7/8	12,000	26,000	48,000
15/16	2 7/16	9	4 3/8	3 1/16	13,500	29,000	54,000
1	2 1/2	10	4 5/8	3 1/4	15,200	32,000	61,000
1 1/16	2 5/8	12	4 7/8	3 5/16	17,200	35,000	69,000
1 1/8	2 3/4	13	5 1/8	3 3/4	19,500	40,000	78,000
1 1/4	3 1/16	14 1/2	5 5/16	3 7/8	22,000	46,000	88,000
1 1/2	3 3/8	16	5 3/4	4 1/8	23,700	51,000	95,000
1 3/4	3 5/8	17 1/2	6 1/8	4 1/4	26,000	54,000	104,000
1 7/8	3 9/16	19	6 7/16	4 9/16	28,500	58,000	114,000
1 15/16	3 11/16	21 1/2	6 11/16	4 3/4	30,500	62,000	122,000
1 1/2	3 7/8	23	7	5	33,500	67,000	134,000
1 9/16	4	25	7 3/8	5 5/16	35,500	70,500	142,000
1 5/8	4 1/4	28	7 3/4	5 1/2	38,500	77,000	154,000
1 11/16	4 1/2	30	8 1/8	5 11/16	39,500	79,000	158,000
1 3/4	4 3/4	31	8 1/2	5 7/8	41,500	83,000	166,000
1 13/16	5	33	8 7/8	6 1/16	44,500	89,000	178,000
1 7/8	5 1/4	35	9 1/4	6 3/8	47,500	95,000	190,000
1 15/16	5 1/2	38	9 5/8	6 9/16	50,500	101,000	202,000
2	5 3/4	40	10	6 3/4	54,000	108,000	216,000
2 1/16	6	43	10 3/8	6 15/16	57,500	115,000	230,000
2 1/8	6 1/4	47	10 3/4	7 1/8	61,000	122,000	244,000
2 1/4	6 1/2	50	11 1/8	7 1/16	64,500	129,000	258,000
2 1/2	6 3/4	53	11 1/2	7 5/8	68,200	136,500	273,000
2 3/8	6 7/8	58 1/2	11 7/8	8	76,000	152,000	304,000
2 1/2	7	65	12 1/4	8 3/8	84,200	168,500	337,000
2 5/8	7 1/8	70	12 5/8	8 3/4	90,500	181,000	362,000
2 3/4	7 1/4	73	13	9 1/8	96,700	193,500	387,000
2 7/8	7 1/2	76	13 1/2	9 1/2	103,000	206,000	412,000
3	7 3/4	86	14	9 7/8	109,000	218,000	436,000

^aChains tested to U.S. Government and American Bureau of Shipping requirements.

Dimensions of Hooks, Eyes, and Drums

Winding Drum Scores for Chain

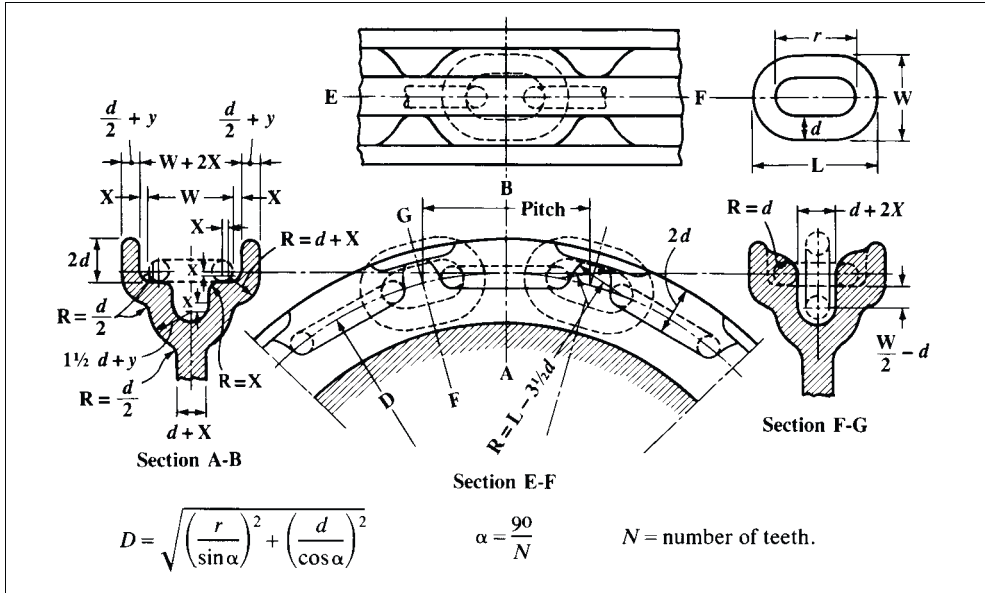
Chain Size	A	B	C	D	Chain Size	A	B	C	D
3/8	1 1/2	3/16	9/16	3/16	3/8	1 1/4	11/32	3/16	1
7/16	1 11/16	7/32	5/8	9/32	7/16	1 7/16	3/8	7/32	1 1/8
1/2	1 7/8	1/4	11/16	5/16	1/2	1 1/16	7/16	1/4	1 1/4
9/16	2 1/16	9/32	3/4	11/32	9/16	1 3/4	15/32	9/32	1 3/8
5/8	2 3/16	5/16	13/16	3/8	5/8	1 7/8	17/32	5/16	1 1/2
11/16	2 1/2	11/32	7/8	13/32	11/16	2 1/16	9/16	11/32	1 5/8
3/4	2 11/16	3/8	15/16	7/16	3/4	2 3/16	5/8	3/8	1 3/4
13/16	2 7/8	13/32	1	15/32	13/16	2 3/8	21/32	13/32	1 7/8
7/8	3 1/8	7/16	1 1/16	1/2	7/8	2 1/2	23/32	7/16	2
15/16	3 5/16	15/32	1 1/8	17/32	15/16	2 11/16	3/4	15/32	2 1/8
1	3 1/2	1/2	1 3/16	9/16	1	2 13/16	13/16	1/2	2 1/4

All dimensions are in inches.

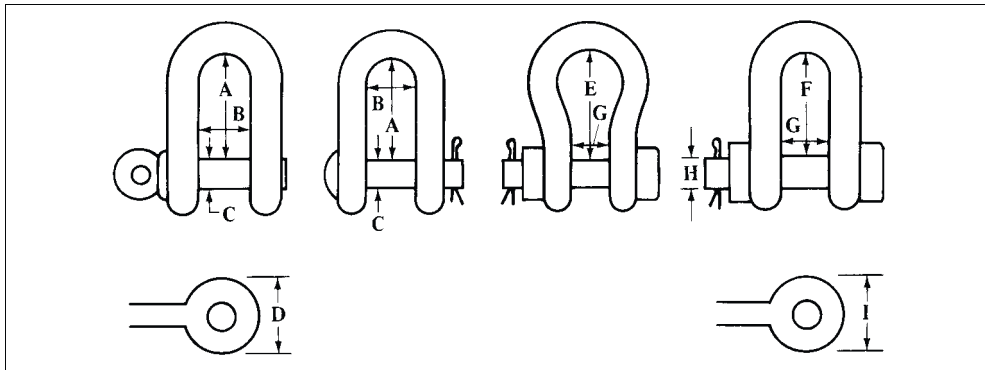
Sprocket Wheels for Ordinary Link Chains

Size of Chain	3/16	1/4	5/16	3/8	7/16	1/2	9/16	5/8	11/16	3/4	13/16	7/8	15/16	1	
Length of Link	1 3/8	1 1/2	1 3/4	2	2 1/4	2 1/2	2 7/8	3 1/4	3 1/2	3 3/4	4	4 1/4	4 1/2	4 3/4	
Width of Link	1 5/16	1	1 3/16	1 3/8	1 1/2	1 3/4	1 15/16	2 1/8	2 1/16	2 1/2	2 11/16	3	3 1/4	3 1/2	
X	1/16	3/32	3/32	3/32	3/32	3/32	1/16	1/16	1/16	1/16	1/16	1/16	1/16	1/16	
y	3/32	3/32	3/32	3/32	3/32	1/16	1/16	1/16	1/16	1/16	1/16	1/16	1/16	...	
No. of Teeth	D = Pitch Diameter in Inches														
7	12°51'	4.50	4.50	5.06	5.63	6.18	6.76	7.88	9.01	9.58	10.14	10.71	11.27	11.84	12.40
8	11°15'	5.13	5.13	5.77	6.42	7.06	7.71	8.97	10.27	10.91	11.56	12.20	12.85	13.50	14.13
9	10°0'	5.76	5.76	6.48	7.21	7.74	8.65	10.08	11.53	12.26	12.98	13.72	14.43	15.15	15.87
10	9°0'	6.40	6.40	7.18	8.00	8.79	9.61	11.19	12.80	13.61	14.40	15.21	16.01	16.81	17.61
11	8°11'	7.03	7.03	7.91	8.79	9.67	10.55	12.30	14.07	14.95	15.83	16.71	17.55	18.47	19.35
12	7°30'	7.66	7.66	8.62	9.59	10.53	11.49	13.41	15.33	16.29	17.26	18.20	19.17	20.13	21.09
13	6°55'	8.29	8.29	9.33	10.38	11.41	12.45	14.52	16.60	17.65	18.68	19.72	20.76	21.80	22.84
14	6°25'	8.93	8.93	10.05	11.17	12.28	13.40	15.63	17.90	18.99	20.06	21.23	22.35	23.46	24.58
15	6°0'	9.57	9.57	10.76	11.96	13.16	14.35	16.74	19.14	20.34	21.54	22.74	23.93	25.13	26.33
16	5°37'	10.20	10.20	11.47	12.76	14.03	15.30	17.85	20.41	21.69	22.97	24.24	25.52	26.80	28.08
17	5°17'	10.84	10.84	12.19	13.56	14.90	16.26	18.97	21.68	23.04	24.40	25.75	27.11	28.47	29.83
18	5°0'	11.47	11.47	12.91	14.36	15.78	17.21	20.08	22.95	24.34	25.83	27.26	28.70	30.14	31.57
19	4°44'	12.11	12.11	13.62	15.16	16.65	18.16	21.19	24.22	25.73	27.26	28.77	30.29	31.80	33.31
20	4°30'	12.75	12.75	14.34	15.96	17.53	19.12	22.30	25.50	27.09	28.69	30.28	31.88	33.46	35.06
21	4°17'	13.38	13.38	15.05	16.74	18.40	20.07	23.42	26.77	28.44	30.12	31.79	33.46	35.13	36.81
22	4°6'	14.02	14.02	15.77	17.53	19.27	21.03	24.53	28.03	29.79	31.55	33.30	35.04	36.83	38.56
23	3°55'	14.66	14.66	16.49	18.32	20.15	21.98	25.64	29.31	31.14	32.97	34.81	36.63	38.48	40.30
24	3°45'	15.29	15.29	17.20	19.11	21.02	22.94	26.76	30.58	32.49	34.41	36.32	38.23	40.15	...
25	3°36'	15.93	15.93	17.92	19.90	21.90	23.89	27.87	31.85	33.84	35.84	37.83	39.82
26	3°28'	16.56	16.56	18.62	20.70	22.77	24.85	28.98	33.13	35.20	37.27	39.34	41.41
27	3°20'	17.20	17.20	19.34	21.50	23.65	25.80	30.10	34.40	36.55	38.70	40.85
28	3°13'	17.84	17.84	20.06	22.29	24.52	26.75	31.21	35.67	37.90	40.04

Sprocket Wheels for Ordinary Link Chains (Continued)



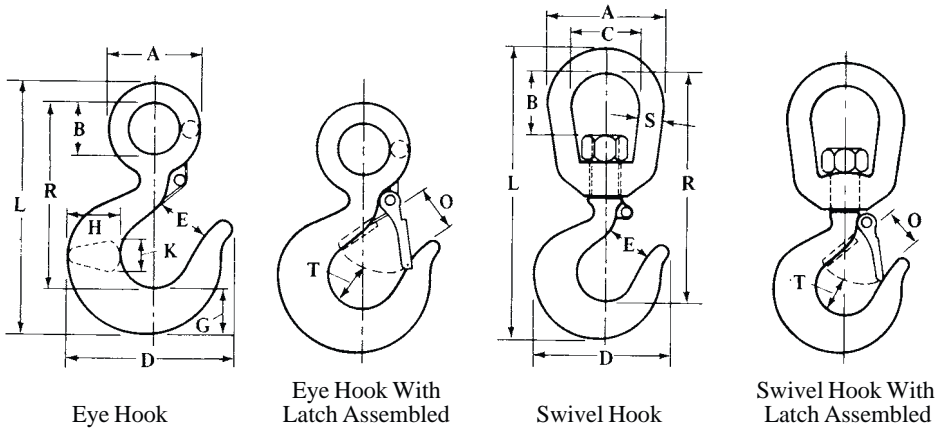
Dimensions of Forged Round Pin, Screw Pin, and Bolt Type Chain Shackles and Bolt Type Anchor Shackles



Working Load Limit (tons)	Nominal Shackle Size	A	B	C	D	E	F	G	H	I
1/2	1/4	7/8	15/32	5/16	11/16
3/4	5/16	1 1/32	17/32	3/8	13/16
1	3/8	1 1/4	2 1/32	7/16	3 1/32
1 1/2	7/16	1 7/16	2 3/32	1/2	1 1/16
2	1/2	1 5/8	1 3/16	5/8	1 3/16	1 7/8	1 3/8	1 3/16	5/8	1 3/16
3 1/4	5/8	2	1 1/16	3/4	1 9/16	2 3/8	2	1 1/16	3/4	1 9/16
4 3/4	3/4	2 3/8	1 1/4	7/8	1 7/8	2 13/16	2 3/8	1 1/4	7/8	1 7/8
6 1/2	7/8	2 13/16	1 1/16	1	2 1/8	3 3/16	2 13/16	1 1/16	1	2 1/8
8 1/2	1	3 3/16	1 11/16	1 1/8	2 3/8	3 3/4	3 3/16	1 11/16	1 1/8	2 3/8
9 1/2	1 1/8	3 9/16	1 13/16	1 1/4	2 5/8	4 1/4	3 9/16	1 13/16	1 1/4	2 5/8
12	1 1/4	3 15/16	2 1/32	1 3/8	3	4 11/16	3 15/16	2 1/32	1 3/8	3
13 1/2	1 3/8	4 3/8	2 1/4	1 1/2	3 5/16	5 3/16	4 3/8	2 1/4	1 1/2	3 5/16
17	1 1/2	4 13/16	2 3/8	1 3/8	3 3/8	5 3/4	4 13/16	2 3/8	1 3/8	3 3/8
25	1 3/4	5 3/4	2 7/8	2	4 7/8	7	5 3/4	2 7/8	2	4 7/8
35	2	6 3/4	3 1/4	2 1/4	5	7 3/4	6 3/4	3 1/4	2 1/4	5

All dimensions are in inches. Load limits are in tons of 2000 pounds.

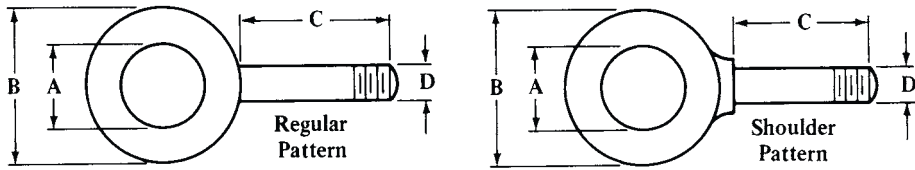
Source: The Crosby Group.



Dimensions of Crane Hooks

Feature	Capacity of Hook in Tons (tons of 2000 lbs)											
	1.1	1.65	2.2	3.3	4.95	7.7	12.1	16.5	24.2	33	40.7	49.5
	Dimensions for Eye Hooks											
A	1.47	1.75	2.03	2.41	2.94	3.81	4.69	5.38	6.62	7.00	8.50	9.31
B	0.75	0.91	1.12	1.25	1.56	2.00	2.44	2.84	3.50	3.50	4.50	4.94
D	2.88	3.19	3.62	4.09	4.94	6.50	7.56	8.69	11.00	13.62	14.06	15.44
E	0.94	1.03	1.06	1.22	1.50	1.88	2.25	2.50	3.38	4.00	4.25	4.75
G	0.75	0.84	1.00	1.12	1.44	1.81	2.25	2.59	3.00	3.66	4.56	5.06
H	0.81	0.94	1.16	1.31	1.62	2.06	2.62	2.94	3.50	4.62	5.00	5.50
K	0.56	0.62	0.75	0.84	1.12	1.38	1.62	1.94	2.38	3.00	3.75	4.12
L	4.34	4.94	5.56	6.40	7.91	10.09	12.44	13.94	17.09	19.47	24.75	27.38
R	3.22	3.66	4.09	4.69	5.75	7.38	9.06	10.06	12.50	14.06	18.19	20.12
T	0.81	0.81	0.84	1.19	1.38	1.78	2.12	2.56	2.88	3.44	3.88	4.75
O	0.88	0.97	1.00	1.12	1.34	1.69	2.06	2.25	3.00	3.62	3.75	4.25
	Dimensions for Swivel Hooks											
A	2	2.50	3	3	3.50	4.50	5	5.63	7	7
B	0.94	1.31	1.63	1.56	1.75	2.31	2.38	2.69	4.19	4.19
C	1.25	1.50	1.75	1.75	2	2.50	2.75	3.13	4	4
D	2.88	3.19	3.63	4.09	4.94	6.5	7.56	8.69	11	13.63
E	0.94	1.03	1.06	1.22	1.5	1.88	2.25	2.5	3.38	4
L	5.56	6.63	7.63	8.13	9.59	12.41	14.50	15.88	21.06	23.22
R	4.47	5.28	6.02	6.38	7.41	9.59	11.13	12.03	16.56	18.06
S	0.38	0.50	0.63	0.63	0.75	1	1.13	1.25	1.5	1.5
T	0.81	0.81	0.84	1.19	1.38	1.78	2.13	2.56	2.88	3.44
O	0.88	0.97	1	1.13	1.34	1.69	2.06	2.25	3	3.63

Source: The Crosby Group. All dimensions are in inches. Hooks are made of alloy steel, quenched and tempered. For swivel hooks, the data are for a bail of carbon steel. The ultimate load is four times the working load limit (capacity). The swivel hook is a positioning device and is not intended to rotate under load; special load swiveling hooks must be used in such applications.

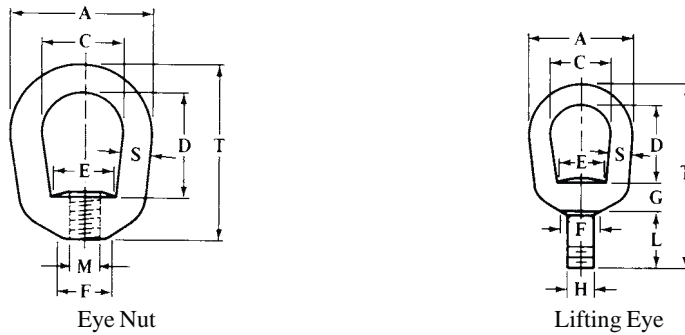


Hot Dip Galvanized, Forged Steel Eye-bolts

Shank		Eye Dia.		Safe Load ^a (tons)	Shank		Eye Dia.		Safe Load ^a (tons)	
D	C	A	B		D	C	A	B		
Regular Pattern										
1/4	2	1/2	1	0.25	3/4	4 1/2	1 1/2	3	2.6	
1/4	4	1/2	1	0.25	3/4	6	1 1/2	3	2.6	
5/16	2 1/4	5/8	1 1/4	0.4	3/4	8	1 1/2	3	2.6	
5/16	4 1/4	5/8	1 1/4	0.4	3/4	10	1 1/2	3	2.6	
3/8	2 1/2	3/4	1 1/2	0.6	3/4	10	1 1/2	3	2.6	
3/8	4 1/2	3/4	1 1/2	0.6	3/4	10	1 1/2	3	2.6	
3/8	6	3/4	1 1/2	0.6	7/8	5	1 3/4	3 1/2	3.6	
1/2	3 3/4	1	2	1.1	7/8	8	1 3/4	3 1/2	3.6	
1/2	6	1	2	1.1	7/8	10	1 3/4	3 1/2	3.6	
1/2	8	1	2	1.1	1	6	2	4	5	
1/2	10	1	2	1.1	1	9	2	4	5	
1/2	12	1	2	1.1	1	10	2	4	5	
5/8	4	1 1/4	2 1/2	1.75	1	10	2	4	5	
5/8	6	1 1/4	2 1/2	1.75	1 1/4	8	2 1/2	5	7.6	
5/8	8	1 1/4	2 1/2	1.75	1 1/4	10	2 1/2	5	7.6	
5/8	10	1 1/4	2 1/2	1.75	1 1/4	10	2 1/2	5	7.6	
5/8	12	1 1/4	2 1/2	1.75	
Shoulder Pattern										
1/4	2	1/2	7/8	0.25	5/8	6	1 1/4	2 1/4	1.75	
1/4	4	1/2	7/8	0.25	3/4	4 1/2	1 1/2	2 3/4	2.6	
5/16	2 1/4	5/8	1 1/8	0.4	3/4	6	1 1/2	2 3/4	2.6	
5/16	4 1/4	5/8	1 1/8	0.4	7/8	5	1 3/4	3 1/4	3.6	
3/8	2 1/2	3/4	1 3/8	0.6	1	6	2	3 3/4	5	
3/8	4 1/2	3/4	1 3/8	0.6	1	9	2	3 3/4	5	
1/2	3 3/4	1	1 3/4	1.1	1 1/4	8	2 1/2	4 1/2	7.6	
1/2	6	1	1 3/4	1.1	1 1/4	12	2 1/2	4 1/2	7.6	
5/8	4	1 1/4	2 1/4	1.75	1 1/2	15	3	5 1/2	10.7	

^a The ultimate or breaking load is 5 times the safe working load.
 All dimensions are in inches. Safe loads are in tons of 2000 pounds.
 Source: The Crosby Group.

Eye Nuts and Lift Eyes



Eye Nuts

The general function of eye nuts is similar to that of eye-bolts. Eye nuts are utilized for a variety of applications in either the swivel or tapped design.

M	A	C	D	E	F	S	T	Working Load Limit (lbs) ^a
1/4	1 1/4	3/4	1 1/16	2 1/32	1/2	1/4	1 1/16	520
5/16	1 1/4	3/4	1 1/16	2 1/32	1/2	1/4	1 1/16	850
3/8	1 5/8	1	1 1/4	3/4	9/16	5/16	2 1/16	1,250
7/16	2	1 1/4	1 1/2	1	13/16	3/8	2 1/2	1,700
1/2	2	1 1/4	1 1/2	1	13/16	3/8	2 1/2	2,250
5/8	2 1/2	1 1/2	2	1 3/16	1	1/2	3 3/16	3,600
3/4	3	1 3/4	2 3/8	1 3/8	1 1/8	5/8	3 3/8	5,200
7/8	3 1/2	2	2 5/8	1 5/8	1 5/16	3/4	4 5/16	7,200
1	4	2 1/4	3 1/16	1 7/8	1 1/16	7/8	5	10,000
1 1/8	4	2 1/4	3 1/16	1 7/8	1 1/16	7/8	5	12,300
1 1/4	4 1/2	2 1/2	3 1/2	1 15/16	1 7/8	1	5 3/4	15,500
1 3/8	5	2 3/4	3 3/4	2	2	1 1/8	6 1/4	18,500
1 1/2	5 5/8	3 3/8	4	2 3/8	2 1/4	1 1/4	6 3/4	22,500
2	7	4	6 1/4	4	3 3/8	1 1/2	10	40,000

^aData for eye nuts are for hot dip galvanized, quenched, and tempered forged steel.

Lifting Eyes

A	C	D	E	F	G	H	L	S	T	Working Load Limit Threaded (lbs) ^a
1 1/4	3/4	1 1/16	19/32	1/2	3/8	5/16	1 1/16	1/4	2 3/8	850
1 5/8	1	1 1/4	3/4	9/16	1/2	3/8	1 5/16	5/16	3	1,250
2	1 1/4	1 1/2	1	13/16	5/8	1/2	1 1/4	3/8	3 3/4	2,250
2 1/2	1 1/2	2	1 3/16	1	11/16	5/8	1 1/2	1/2	4 1/16	3,600
3	1 3/4	2 3/8	1 3/8	1 1/8	7/8	3/4	1 3/4	5/8	5 5/8	5,200
3 1/2	2	2 5/8	1 5/8	1 5/16	1 5/16	7/8	2	3/4	6 5/16	7,200
4	2 1/4	3 1/16	1 7/8	1 1/16	1 1/16	1	2 1/16	7/8	7 1/16	10,000
4 1/2	2 1/2	3 1/2	1 15/16	1 7/8	1 1/4	1 1/8	2 1/2	1	8 1/4	12,500
5 5/8	3 3/8	4	2 3/8	2 3/8	1 1/2	1 3/8	2 15/16	1 1/4	9 1/16	18,000

^aData for lifting eyes are for quenched and tempered forged steel.

All dimensions are in inches. Source: The Crosby Group.

Specifying Eyebolt Capacities

Rigger's Capacity.—The rigger's capacity refers to the actual load a single eyebolt can lift. The allowable load varies with the angle between the leg of the lifting rig and the shank of the eyebolt. In general, it also assumes that the load to be lifted acts along the axis through the shank. (The primary exception is where the eyebolts are mounted on the sides of the load.) Rigger's capacities are most easily used when the eyebolts are mounted on the top of a uniformly distributed load. In such cases, the total load is divided by the number of eyebolts to be used for the lift in order to determine the required capacity, taking into account the angle of the legs of the rig. Fig. 1 shows such an application.

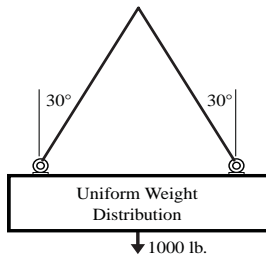


Fig. 1. Uniformly Distributed Load, Equal Tension in Legs of the Lifting Rig

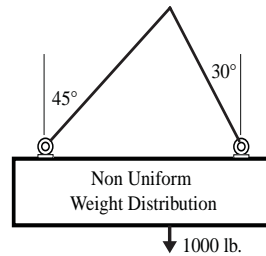


Fig. 2. Nonuniform Weight Distribution, Unequal Tension in Legs of the Lifting Rig

Example: By symmetry in Fig. 1, if the load is 1000 pounds, each eyebolt carries one-half of the 1000 pound total load, i.e., 500 lb. in a vertical direction. Therefore, each eyebolt must have a rigger's capacity of at least 500 lb. for a sling angle of 30°.

Engineering Capacity.—The engineering capacity, on the other hand, refers to the allowable tension in the leg of the lifting rig as it is applied to the eyebolt. This type of capacity is particularly useful when the load distribution is nonuniform, requiring nonsymmetrical slings, or when the eyebolts are not placed on the top surface of the load. In such cases, the load to be lifted does not act through the shank of the eyebolt. It is necessary to determine the tension in each leg of the rig before sizing the eyebolts. *Caution: Dividing the total load by the number of eyebolts may give erroneous and unsafe results.* Fig. 2 shows such an application.

Example: In Fig. 2, the tension in the left and right cables are T_1 and T_2 , respectively, the horizontal tension components acting on the eyebolts are equal, as follows:

$$T_1 \sin 45 = T_2 \sin 30$$

$$T_1 = T_2 \frac{\sin 30}{\sin 45} \quad (1)$$

From Fig. 2, the vertical force components supporting the weight are

$$T_1 \cos 45 + T_2 \cos 30 = 1000 \quad (2)$$

Substituting T_1 from Equation (1) into (2), then solving yields $T_2 = 732.1$ and $T_1 = 517.6$.

Step 1:

$$T_2 \frac{\sin 30}{\sin 45} \cos 45 + T_2 \cos 30 = T_2 \left(\frac{\sin 30}{\tan 45} + \cos 30 \right) = 1000$$

$$T_2 = \left(\frac{1000}{1.366} \right) = 732.1$$

Step 2:

$$T_1 = \frac{1000 - T_2 \cos 30}{\cos 45}$$

$$T_1 = 517.6$$

The left eyebolt requires an engineering capacity of at least 518 lb for an angle of 45°, while the right eyebolt requires a capacity of at least 732 lb for an angle of 30°.

Rope Splicing

Splicing is the operation when two pieces of rope are joined by unlaying the strands and weaving or intertwining the strands of one end with those of the other.

Short Splice.—The first step in making a short splice is to unlay or untwist the strands at the end of each rope. After the ropes are placed together, as shown at *A*, Fig. 1*a*, the strands on one side, as shown at *d*, *e*, and *f*, are either held together by the left hand or are fastened together with twine, in case the rope is too large to be held by the hand. The splicing operation is started by taking one of the strands as at *a*, and passing it across or over the adjacent strand *d* and then under the next strand *e*, after having made an opening beneath strand *e*. The strands *b* and *c* are next treated in the same manner, first one and then the other being passed over its adjoining strand and then under the next successive one. These same operations are then repeated for the strands *d*, *e* and *f* of the other rope. The splice will now appear as shown at *B*, Fig. 1*b*. In order to make it stronger and more secure, the projecting strands of each rope are again passed diagonally over the adjoining strands and under the next successive ones. The splice should then be subjected to a strong pull, in order to tighten the strands and make them more compact. The projecting ends of the strands should then be cut off, thus completing the splice as shown at *C*. For making the openings beneath the strands on the rope, what is known as a marlin spike is generally used. This is merely a tapering, pointed pin made of wood or iron.

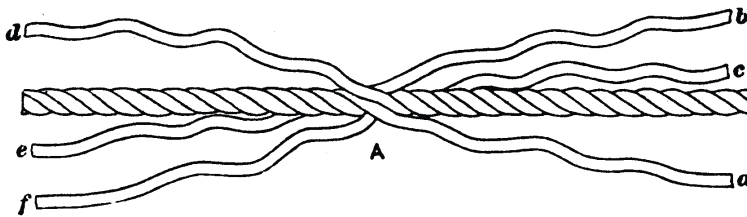


Fig. 1a. Method of Making a Short Splice

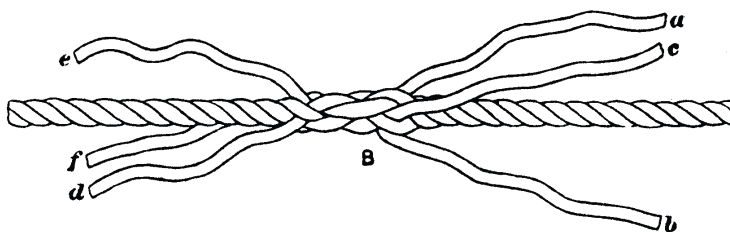


Fig. 1b. Method of Making a Short Splice



Fig. 1c. Method of Making a Short Splice

Long Splice.—When a rope has to pass through pulley blocks, or in case any increase in the size of the rope would be objectionable, the short splice is not suitable and the long splice should be employed. The diameter of a long splice is the same as that of the rope and, if the work is done carefully, the place where the ends are joined can scarcely be distinguished from the rest of the rope. The ends of each rope are first unlayed or untwisted the same as when making a short splice, but for a distance about three times as long. These ends are then placed together so that each strand lies between two strands of the other rope, the same as for a short splice. One of the strands is next unlayed and then a strand from the other rope is curled around into the groove thus made, as indicated at *A* Fig. 2*a*, strand *a* having been unlayed and strand *b* from the other rope end, put into its place. Care should be taken to twist strand *b* so that it will lie in its natural position into the groove previously occupied by strand *a*, as the neatness of the splice will depend partly upon the care with

which this part of the work is done. This operation is then repeated in connection with strands *c* and *d*, strand *c* being unlaid and strand *d* twisted around to occupy the groove thus made. The splice will now be as shown at *B*, Fig. 2*b*, and the next step is that of disposing of the protruding ends of the strands. After these strands have been cut to about the length shown at *B*, two of the strands, as at *a* and *b*, are first reduced in size by removing about one-third of the fiber; these ends are then tied by an overhand knot as shown at *e*. After tightening this knot, the protruding ends may be disposed of the same as when making a short splice, or by passing them over the adjoining strand and through the rope, under the next one. By gradually removing the fiber each time the end is passed across an adjoining strand, the enlargement of the rope at this point may be made very slight and scarcely noticeable. The strands *f* and *g* which remain in their original positions in the center of the splice, and the strands *c* and *d* are disposed of in a similar manner, thus completing the splice as shown at Fig. 2*c*.

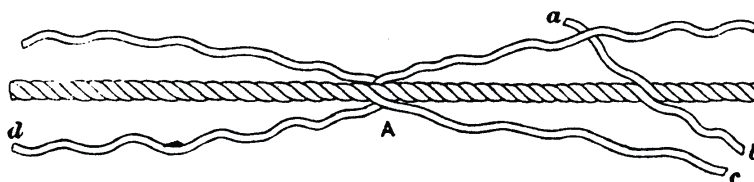


Fig. 2a. How a Long Splice is Made

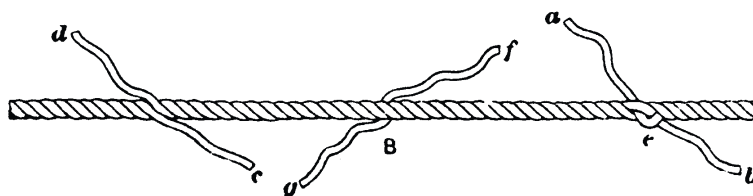


Fig. 2b. How a Long Splice is Made

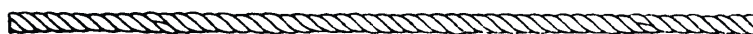


Fig. 2c. How a Long Splice is Made

Eye-Splice.—When a loop is formed at the end of a rope by splicing the free end to the main or standing part of the rope, this is known as an *eye-splice*. The end of the rope is first unlaid about as far as it would be for making a short splice. After bending the end around to form a loop of the required size, the middle strand *a*, Fig. 3*a*, is tucked under a strand on the main part of the rope. The strand *b* is next inserted from the rear side under the strand on the main part which is just above the strand under which *a* was inserted. Since strand *b* is pushed under the strand on the main part from the rear side, it will come out at the point where strand *a* went in, as Fig. 3*b*. The third strand *c* is now passed over the strand under which strand *a* was inserted, and then under the next successive one, as Fig. 3*c*. These three strands are next pulled taut and then about one-third of the fiber should be cut from them; they are next tucked away by passing a strand over its adjoining one and under the next successive strand. Cutting away part of the fiber or yarns is to reduce the size of the splice and give it a neater appearance. By gradually thinning out the fiber, the over-lapping strands may be given a gradual taper, as Fig. 3*d* which shows the completed eye-splice.

Method of Making an Eye-splice.—: When a loop is formed at the end of a rope by splicing the free end to the main or standing part of the rope, this is known as an *eye-splice*. The end of the rope is first unlaid about as far as it would be for making a short splice. After bending the end around to form a loop of the required size, the middle strand *a*, Fig. 3*a*, is tucked under a strand on the main part of the rope. The strand *b* is next inserted from the rear side under the strand on the main part which is just above the strand under which *a* was inserted. Since strand *b* is pushed under the strand on the main part from the rear side, it will come out at the point where strand *a* went in, as Fig. 3*b*. The third strand *c* is now passed

over the strand under which strand *a* was inserted, and then under the next successive one, as Fig. 3c. These three strands are next pulled taut and then about one-third of the fiber should be cut from them; they are next tucked away by passing a strand over its adjoining one and under the next successive strand. The reason for cutting away part of the fiber or yarns is to reduce the size of the splice and give it a neater appearance. By gradually thinning out the fiber, the over-lapping strands may be given a gradual taper, as Fig. 3d which shows the completed eye-splice.

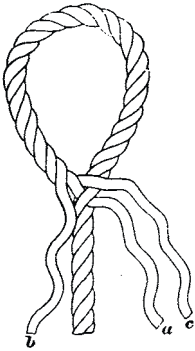


Fig. 3a. Eye -Splice

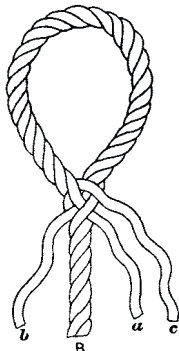


Fig. 3b. Eye -Splice



Fig. 3c. Eye -Splice



Fig. 3d. Eye -Splice

Governors

Engine Governors.—Governors may be of a purely centrifugal type such as the fly-ball or pendulum design previously referred to, or the principle of inertia may be introduced to secure better speed regulation. Thus, there are two general classes of governors known as centrifugal and inertia governors. The method of utilizing the motion of the governing element for regulating the speed varies; as applied to steam engines, there is the general type of governor which controls the speed by operating a throttling valve which increases or diminishes the amount of steam admitted to the steam-chest, and another general type which regulates the speed by changing the point of cut-off and consequently the amount of expansion in the cylinders.

In the design of governors, the sensitiveness, effort, and stability of the governor are important factors. The sensitiveness of a fly-ball governor is indicated by the amount that the governing sleeve is displaced for a given change in speed, the displacement being relatively large for a given speed change if the governor is sensitive.

The term “effort” as applied to a governor relates to the energy it is capable of exerting upon the governing mechanism. Thus, in the case of a fly-ball governor, the effort indicates the energy exerted on the sleeve while the governor speed is increasing or diminishing. If the energy stored in a revolving governor is small, its sensitiveness will be reduced, because a larger speed change is necessary to obtain the power for operating the governing mechanism than would be required with a governor which exerts greater energy for a given speed change.

When a governor occupies a definite position of equilibrium for any speed within the range of speeds controlled by the governor, it is said to be “stable.” If the load on an engine having a fly-ball governor is diminished, the balls of a stable governor will move outward to a new position as the speed increases, although there will usually be a temporary oscillating movement on each side of this new position, the oscillations gradually diminishing. If the governor were unstable (and therefore useless) the oscillations would increase until the limiting points were reached.

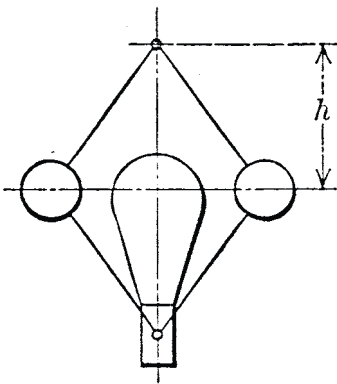


Fig. 1.

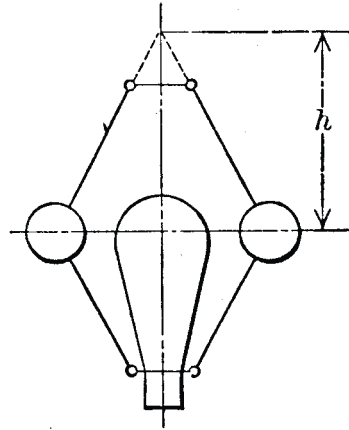


Fig. 2.

Loaded or Weighted Fly-ball Governors.—As the arms of a governor of the conical pendulum type swing outward toward the horizontal position as the result of increasing speed, the change in height h (see Fig. 1) is small for given changes in speed. For instance, if the speed is changed from 50 to 70 revolutions per minute, the difference between the values of h is nearly 7 inches, whereas if the speed changes from 200 to 300 revolutions per minute, the difference in height h for the two speeds is only about $\frac{1}{2}$ inch. Hence, the simple pendulum governor is not suitable for the higher speeds, because then the movement which accompanies the speed changes is too small to secure proper regulation through the governing mechanism. Fly-ball governors are adapted for much higher speeds by loading them. The load may be in the form of a weight which surrounds the spindle, as illustrated by Fig. 1. This is known as a Porter governor.

In the following formula, w = the weight of one governor ball in pounds; c = the weight of the additional load; h = the height in feet indicated by the diagram, Fig. 1; n = speed of governor in revolutions per minute:

$$h = \frac{2933}{n^2} \times \frac{e + w}{w}$$

If the governor is constructed as indicated by the diagram Fig. 2, the height h is not measured from the points at which the arms or rods are suspended, but from the point where the axes of the rods intersect with the vertical center line. The outward movement of the balls may be resisted by a spring instead of a weight, as in the case of the Hartnell governor, which is known as a spring-loaded type.

Sensitiveness and Stability of Governors.—The sensitiveness of one governor may be compared with that of another by determining the *coefficient of speed variations*. If C = the coefficient of speed variations, M = maximum speed within limits of the governor action; M_1 = minimum speed within limits of governor action; m = mean speed within these limits; then,

$$C = \frac{M - M_1}{m}$$

The minimum value of coefficient C necessary to obtain stability in a pendulum type of governor is given by the following formula in which y = distance the fly-balls move horizontally in feet; F = mean centrifugal force of fly-balls in pounds; H = indicated horsepower of engine; W = the weight of engine flywheel in pounds; S = revolutions per minute of main shaft; R = the flywheel radius in feet.

$$C = 4000 \sqrt[3]{\frac{xy}{F}} \times \sqrt[8]{\frac{H^2}{S^4 R^4 W^2}}$$

The factor x in this formula represents that weight which would be equivalent to the weights of the various moving parts, if it were centered at a point corresponding to the center of gravity of the fly-balls. To determine the value of x , first determine the weights of the different moving parts of the governor, such as the balls, the central weight or load (in the case of a Porter governor), the sleeve, etc.; multiply the weight of each part by the square of the distance it moves from one position to the other; add the various products thus obtained, and divide the total sum by the square of the corresponding movement of the fly-balls at right angles to the governor spindle.

Shaft Governors.—Shaft governors are so named because the governing mechanism is carried by the main shaft and is commonly attached in some way to the flywheel. One type is so arranged that, in the case of a steam engine, the action of centrifugal force on a pivoted and weighted lever, to which a spring is attached, changes the position of the eccentric which operates the slide valve, thus increasing or decreasing the valve travel and changing the point of cut-off. Another type is so designed that the inertia of a pivoted “weight arm” accelerates the governing action by acting in conjunction with the effect of centrifugal force, thus increasing the sensitiveness of the governor. With the inertia governor, the effort or force needed to actuate the governing mechanism increases as the rate of velocity change increases; hence this type is adapted to engines liable to sudden load changes. When the load remains practically constant, the centrifugal type of shaft governor is often employed in preference to the inertia type. The design of these governors depends upon the arrangement of the governing mechanism and upon varying factors.

Machinery Noise

Noise from machinery or mechanical systems can be controlled to some degree in the design or development stage if quantified noise criteria are provided the designer. Manufacturers and consumers may also use the same information in deciding whether the noise generated by a machine will be acceptable for a specific purpose.

Noise criteria for may be classified as follows: 1) relating to the degree of interference with speech communications; 2) relating to physiological damage to humans, especially hearing; and 3) those relating to psychological disturbances in people exposed to noise.

Sound Level Specifications.—Noise criteria generally are specified in some system of units representing sound levels. One commonly used system specifies sound levels in units called decibels on the “A” scale, written dBA. The dBA scale designates a sound level system weighted to match human hearing responses to various frequencies and loudness. For example, to permit effective speech communication, typical criteria for indoor maximum noise levels are: meeting and conference rooms, 42 dBA; private offices and small meeting rooms, 38 to 47 dBA; supervisors' offices and reception rooms, 38 to 52 dBA; large offices and cafeterias, 42 to 52 dBA; laboratories, drafting rooms, and general office areas, 47 to 56 dBA; maintenance shops, computer rooms, and washrooms, 52 to 61 dBA; control and electrical equipment rooms, 56 to 66 dBA; and manufacturing areas and foremen's offices, 66 dBA. Similarly, there are standards and recommendations for daily permissible times of exposure at various steady sound levels to avoid hearing damage. For a working shift of 8 hours, a steady sound level of 90 dBA is the maximum generally permitted, with marked reduction in allowable exposure times for higher sound levels.*

Measuring Machinery Noise.—The noise level produced by a single machine can be measured by using a standard sound level meter of the handheld type set to the dBA scale.

* After April 1983, if employee noise exposures equal or exceed an 8-hour, time-weighted average sound level of 85 dB, OSHA requires employers to administer an effective hearing conservation program.

However, when other machines are running at the same time, or when there are other background noises, the noise of the machine cannot be measured directly. In such cases, two measurements, taken as follows, can be used to calculate the noise level of the individual machine. The meter should be held at arm's length and well away from any bystanders to avoid possible significant error up to 5 dBA.

Step 1. At the point of interest, measure the total noise, T , in decibels; that is, measure the noise of the shop and the machine in question when all machines are running; Step 2. Turn off the machine in question and measure B , the remaining background noise level; Step 3. Calculate M , the noise of the machine alone.

$$M = 10\log\left(10^{\frac{T}{10}} - 10^{\frac{B}{10}}\right)$$

Example 1: With a machine running, the sound level meter reads 51 decibels as the total shop noise T ; and with the machine shut off the meter reads 49 decibels as the remaining background noise B . What is the noise level M of the machine alone?

$$M = 10\log\left(10^{\frac{51}{10}} - 10^{\frac{49}{10}}\right) = 46.7 \text{ decibels dBA}$$

Example 2: If in **Example 1** the remaining background noise level B was 41 decibels instead of 49, what is the noise level of the machine alone?

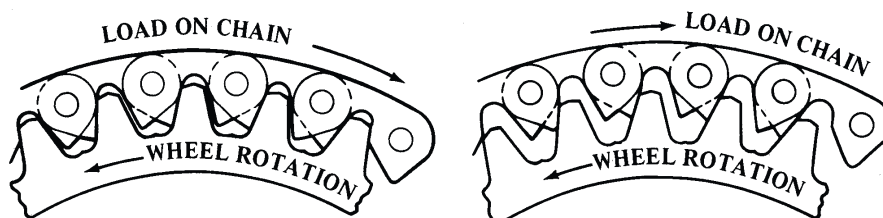
$$M = 10\log\left(10^{\frac{51}{10}} - 10^{\frac{41}{10}}\right) = 50.5 \text{ decibels dBA}$$

Note: From this example it is evident that when the background noise level B is approximately 10 or more decibels lower than the total noise level T measured at the machine in question, then the background noise does not contribute significantly to the sound level at the machine and, for practical purposes, $M = T$ and no calculation is required.

Silent or Inverted Tooth Chain

Silent or inverted tooth chain consists of a series of toothed links alternately assembled either with pins or with a combination of joint components in such a way that the joints articulate between adjoining pitches. Side Guide chain has guide links which straddle the sprocket sides to control the chain laterally. Center Guide chain has guide links that run within a circumferential groove or grooves for lateral control.

Characteristics of Silent Chain Drives.—The silent or “inverted-tooth” driving chain has the following characteristics: The chain passes over the face of the wheel like a belt and the wheel teeth do not project through it; the chain engages the wheel by means of teeth extending across the full width of the under side, with the exception of those chains having a central guide link; the chain teeth and wheel teeth are of such a shape that as the chain pitch increases through wear at the joints, the chain shifts outward upon the teeth, thus engaging the wheel on a pitch circle of increasing diameter; the result of this action is that the pitch of the wheel teeth increases at the same rate as the chain pitch. The accompanying illustration shows an unworn chain to the left, and a worn chain to the right, which has moved outward as the result of wear. Another distinguishing feature of the silent chain is that the power is transmitted by and to all the teeth in the arc of contact, irrespective of the increasing pitch due to elongation. The links have no sliding action either on or off the teeth, which results in a smooth and practically noiseless action, the chain being originally designed for the transmission of power at higher speeds than are suitable for roller chains. The efficiency of the silent chain itself may be as high as 99 per cent, and for the complete drive, from 96 to 97 per cent, under favorable conditions; from 94 to 96 per cent can be secured with well-designed drives under average conditions.



The life and upkeep of silent chains depend largely upon the design of the entire drive, including the provision for adjustment. If there is much slack, the whipping of the chain will greatly increase the wear, and means of adjustment may double the life of the chain. A slight amount of play is necessary for satisfactory operation. The minimum amount of sag should be about $\frac{1}{8}$ inch. Although the silent chain shifts outward from the teeth and adjusts itself for an increase of pitch, it cannot take up the increased pitch in that portion of the chain between the wheels; therefore, the wheel must lag to the extent of the increased pitch in the straight portion of the chain.

Standard Silent Chain Designation.—The standard chain number or designation for $\frac{3}{8}$ -inch pitch or larger consists of:

1) a two letter symbol SC; 2) one or two numerical digits indicating the pitch in eighths of an inch; and 3) two or three numerical digits indicating the chain width in quarter-inches.

Thus, SC302 designates a silent chain of $\frac{3}{8}$ -inch pitch and $\frac{1}{2}$ -inch width, while SC1012 designates a silent chain of $1\frac{1}{4}$ -inch pitch and 3-inch width.

The standard chain number or designation for $\frac{3}{16}$ -inch pitch consists of:

a) a two letter symbol SC; b) a zero followed by a numerical digit indicating pitch in sixteenths of an inch; and c) two numerical digits indicating the chain width in thirty-seconds of an inch. Thus, SC0309 designates a silent chain of $\frac{3}{16}$ -inch pitch and $\frac{9}{32}$ -inch width.

Silent Chain Links.—The joint components and link contours vary with each manufacturer’s design. As shown in [Table 1](#) minimum crotch height and pitch have been standard-

ized for interchangeability. Chain link designations for $\frac{3}{8}$ -inch and larger pitch are given in [Table 1](#)

Table 1. American National Standard Silent Chain Links*

Chain Number	Chain Pitch		Stamp	Crotch Height, Min.	
	inch	mm		inch	mm
SC3 (Width in $\frac{1}{4}$ in.)	0.375	9.52	SC3 or 3	0.0232	0.589
SC4 (Width in $\frac{1}{4}$ in.)	0.500	12.70	SC4 or 4	0.0310	0.787
SC5 (Width in $\frac{1}{4}$ in.)	0.625	15.88	SC5 or 5	0.0388	0.985
SC6 (Width in $\frac{1}{4}$ in.)	0.750	19.05	SC6 or 6	0.0465	1.181
SC8 (Width in $\frac{1}{4}$ in.)	1.000	25.40	SC8 or 8	0.0620	1.574
SC10 (Width in $\frac{1}{4}$ in.)	1.250	31.76	SC10 or 10	0.0775	1.968
SC12 (Width in $\frac{1}{4}$ in.)	1.500	38.10	SC12 or 12	0.0930	2.302
SC16 (Width in $\frac{1}{4}$ in.)	2.000	50.80	SC16 or 16	0.1240	3.149

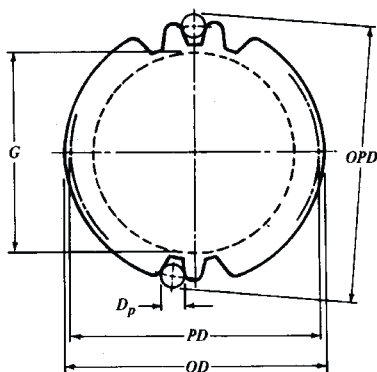
Silent Chain Sprocket Diameters.—The important sprocket diameters are:

- 1) outside diameter; 2) pitch diameter; 3) maximum guide groove diameter; and
- 4) over-pin diameter.

These are shown in the diagram in [Table 2](#) and the symbols and formulas for each are also given in this table. [Table 3a](#) gives values of outside diameters for sprockets with rounded teeth and with square teeth, pitch diameters, and over-pin diameters for chains of 1-inch pitch and sprockets of various tooth numbers. Values for chains of other pitches ($\frac{3}{8}$ inch and larger) are found by multiplying the values shown by the pitch. [Table 3b](#) gives this information for $\frac{3}{16}$ -in. pitch chains. Note that the over-pin diameter is measured over gage pins having a diameter $D_p=0.625P$ in. for $\frac{3}{8}$ -in. and larger pitch and $D_p=0.667P$ in. for $\frac{3}{16}$ -in. pitch chains. Over-pin diameter tolerances are given in [Table 4a](#) and [4b](#).

Silent Chain Sprocket Profiles and Chain Widths.—Sprocket tooth face profiles for side guide chain, center guide chain and double guide chain are shown in [Table 4c](#) and [4d](#) together with important dimensions for chains of various pitches and widths. Maximum over-all width M of the three types of chain are also given in this table for various pitches and widths. It should be noted that the sprocket tooth width W for the side guide chain is given in [Table 5](#) for one-half-inch wide chains of $\frac{3}{8}$ -inch and $\frac{1}{2}$ -inch pitches. No values of W for other chain sizes are specified in American National Standard B29.2M-1982 (1987).

* For $\frac{3}{8}$ -inch and larger pitch chains.

Table 2. ANSI Silent Chain Sprocket Diameters (ANSI B29.2M-1982, R1987)

P = Chain Pitch
 PD = Pitch Diameter
 OD = Outside Diameter
 D_p = Gage Pin Diameter
 N = Number of Teeth
 E = Diameter to center of Topping Curve
 OPD = Over Pin Diameter
 G = Max. Guide Groove Diameter

$$PD = \frac{P}{\sin \frac{180^\circ}{N}}$$

$D_p = 0.625P$, for $\frac{3}{8}$ in. and larger pitch chain

[= $0.667P$ for $\frac{3}{16}$ in. pitch chain]

$$OPD \text{ (For Even No. of Teeth)} = PD - 0.125P \csc \left(30 - \frac{180^\circ}{N} \right) + 0.625P$$

$$\left[= PD - 0.160P \csc \left(30 - \frac{180^\circ}{N} \right) + 0.667P \right]$$

$$OPD \text{ (For Odd No. of Teeth)} = \cos \frac{90^\circ}{N} \left[PD - 0.125P \csc \left(30 - \frac{180^\circ}{N} \right) \right] + 0.625P$$

$$\left[= \cos \frac{90^\circ}{N} \left[PD - 0.160P \csc \left(30 - \frac{180^\circ}{N} \right) \right] + 0.625P \right]$$

$$OD \text{ (For Round Teeth)} = P \left(\cot \frac{180^\circ}{N} + 0.08 \right)$$

$$\left[OD \text{ (For Nominal Round Teeth)} = P \left(\cot \frac{180^\circ}{N} - 0.032 \right) \right]$$

$$OD \text{ (For Square Teeth)} = 2\sqrt{X^2 + L^2} - 2XL \cos \alpha$$

Where

$$X = Y \cos \alpha - \sqrt{(0.15P)^2 - (Y \sin \alpha)^2}$$

$$Y = P(0.500 - 0.375 \sec \alpha) \cot \alpha + 0.11P$$

$$L = Y + \frac{E}{2} \text{ (See Table 8A for } E \text{);}$$

$$\alpha = \left(30 - \frac{360^\circ}{N} \right)^\circ$$

$$G(\text{max.}) = P \left(\cot \frac{180^\circ}{N} - 1.16 \right)$$

$$\left[G(\text{max.}) = P \left(\cot \frac{180^\circ}{N} - 1.20 \right) \right]$$

Tolerance = +0, -0.030 in. (0.76 mm)

[Tolerance = +0, -0.015 in. (0.38 mm)]^a

^a All inside [] bracket applies to $\frac{3}{16}$ inch pitch main. All other equations apply to $\frac{3}{8}$ inch and larger pitch chains.

**Table 3a. American National Standard Silent Chain
Sprocket Diameters ANSI B29.2M-1982, R1987**

These diameters apply only to chain of 1-inch pitch. For any other pitch ($\frac{3}{8}$ -inch and larger) multiply the values given below by the pitch.									
No. Teeth	Pitch Diameter	Outside Diameter		Over Pin Diameter ^a	No. Teeth	Pitch Diameter	Outside Diameter		Over Pin Diameter
		Rounded Teeth ^b	Square Teeth ^c				Rounded Teeth	Square Teeth	
17	5.442	5.430	5.302	5.669	56	17.835	17.887	17.835	18.182
18	5.759	5.751	5.627	6.018	57	18.153	18.205	18.154	18.494
19	6.076	6.073	5.951	6.324	58	18.471	18.524	18.473	18.820
20	6.392	6.394	6.275	6.669	59	18.789	18.843	18.793	19.132
21	6.710	6.715	6.599	6.975	60	19.107	19.161	19.112	19.457
22	7.027	7.035	6.923	7.315	61	19.425	19.480	19.431	19.769
23	7.344	7.356	7.247	7.621	62	19.744	19.798	19.750	20.094
24	7.661	7.676	7.570	7.960	63	20.062	20.117	20.070	20.407
25	7.979	7.996	7.894	8.266	64	20.380	20.435	20.389	20.731
26	8.296	8.316	8.217	8.602	65	20.698	20.754	20.708	21.044
27	8.614	8.636	8.539	8.909	66	21.016	21.073	21.027	21.369
28	8.931	8.955	8.862	9.244	67	21.335	21.391	21.346	21.681
29	9.249	9.275	9.184	9.551	68	21.653	21.710	21.665	22.006
30	9.567	9.594	9.506	9.884	69	21.971	22.028	21.984	22.319
31	9.885	9.914	9.828	10.192	70	22.289	22.347	22.303	22.643
32	10.202	10.233	10.150	10.524	71	22.607	22.665	22.622	22.956
33	10.520	10.552	10.471	10.833	72	22.926	22.984	22.941	23.280
34	10.838	10.872	10.793	11.164	73	23.244	23.302	23.260	23.593
35	11.156	11.191	11.114	11.473	74	23.562	23.621	23.579	23.917
36	11.474	11.510	11.435	11.803	75	23.880	23.939	23.898	24.230
37	11.792	11.829	11.756	12.112	76	24.198	24.258	24.217	24.554
38	12.110	12.148	12.076	12.442	77	24.517	24.576	24.535	24.867
39	12.428	12.467	12.397	12.751	78	24.835	24.895	24.854	25.191
40	12.745	12.786	12.717	13.080	79	25.153	25.213	25.173	25.504
41	13.063	13.105	13.038	13.390	80	25.471	25.532	25.492	25.828
42	13.381	13.424	13.358	13.718	81	25.790	25.850	25.811	26.142
43	13.700	13.743	13.678	14.028	82	26.108	26.169	26.129	26.465
44	14.018	14.062	13.998	14.356	83	26.426	26.487	26.448	26.779
45	14.336	14.381	14.319	14.667	84	26.744	26.806	26.767	27.102
46	14.654	14.699	14.638	14.994	85	27.063	27.124	27.086	27.416
47	14.972	15.018	14.958	15.305	86	27.381	27.442	27.405	27.739
48	15.290	15.337	15.278	15.632	87	27.699	27.761	27.723	28.053
49	15.608	15.656	15.598	15.943	88	28.017	28.079	28.042	28.376
50	15.926	15.975	15.918	16.270	89	28.335	28.398	28.361	28.690
51	16.244	16.293	16.237	16.581	90	28.654	28.716	28.679	29.012
52	16.562	16.612	16.557	16.907	91	28.972	29.035	28.998	29.327
53	16.880	16.931	16.876	17.219	92	29.290	29.353	29.317	29.649
54	17.198	17.249	17.196	17.545	93	29.608	29.672	29.635	29.964
55	17.517	17.568	17.515	17.857	94	29.927	29.990	29.954	30.286
56	17.835	17.887	17.835	18.182	95	30.245	30.308	30.273	30.600

**Table 3a. (Continued) American National Standard Silent Chain
Sprocket Diameters ANSI B29.2M-1982, R1987**

These diameters apply only to chain of 1-inch pitch. For any other pitch ($\frac{3}{8}$ -inch and larger) multiply the values given below by the pitch.									
No. Teeth	Pitch Diameter	Outside Diameter		Over Pin Diameter ^a	No. Teeth	Pitch Diameter	Outside Diameter		Over Pin Diameter
		Rounded Teeth ^b	Square Teeth ^c				Rounded Teeth	Square Teeth	
96	30.563	30.627	30.591	30.923	125	39.793	39.860	39.830	40.153
97	30.881	30.945	30.910	31.237	126	40.111	40.179	40.148	40.475
98	31.200	31.264	31.229	31.560	127	40.429	40.497	40.467	40.790
99	31.518	31.582	31.547	31.874	128	40.748	40.815	40.785	41.112
100	31.836	31.901	31.866	32.197	129	41.066	41.134	41.104	41.427
103	32.791	32.856	32.822	33.148	130	41.384	41.452	41.422	41.748
104	33.109	33.174	33.140	33.470	131	41.703	41.771	41.741	42.064
105	33.428	33.493	33.459	33.785	132	42.021	42.089	42.059	42.385
106	33.746	33.811	33.778	34.107	133	42.339	42.407	42.378	42.700
107	34.064	34.129	34.096	34.422	134	42.657	42.726	42.696	43.022
108	34.382	34.448	34.415	34.744	135	42.976	43.044	43.015	43.337
109	34.701	34.766	34.733	35.059	136	43.294	43.362	43.333	43.658
110	35.019	35.085	35.052	35.381	137	43.612	43.681	43.652	43.974
111	35.337	35.403	35.371	35.696	138	43.931	43.999	43.970	44.295
112	35.655	35.721	35.689	36.017	139	44.249	44.318	44.289	44.611
113	35.974	36.040	36.008	36.332	140	44.567	44.636	44.607	44.932
114	36.292	36.358	36.326	36.654	141	44.885	44.954	44.926	45.248
115	36.610	36.677	36.645	36.969	142	45.204	45.273	45.244	45.569
116	36.928	36.995	36.963	37.291	143	45.522	45.591	45.563	45.884
117	37.247	37.313	37.282	37.606	144	45.840	45.909	45.881	46.205
118	37.565	37.632	37.600	37.928	145	46.159	46.228	46.199	46.521
119	37.883	37.950	37.919	38.243	146	46.477	46.546	46.518	46.842
120	38.202	38.268	38.237	38.565	147	46.795	46.864	46.836	47.158
121	38.520	38.587	38.556	38.880	148	47.113	47.183	47.155	47.479
122	38.838	38.905	38.874	39.201	149	47.432	47.501	47.473	47.795
123	39.156	39.224	39.193	39.517	150	47.750	47.820	47.792	48.115
124	39.475	39.542	39.511	39.838

^a For tolerances on over-pin diameters, see table 4.

^b Blank diameters are 0.020 inch larger and maximum guide groove diameters G are 1.240 inches smaller than these outside diameters.

^c These diameters are maximum; tolerance is +0, -0.50×pitch, inches.

Tolerance for maximum eccentricity (total indicator reading) of pitch diameter with respect to bore is 0.001 × PD, but not less than 0.006 nor more than 0.032 inch.

**Table 3b. American National Standard Silent Chain Sprocket Diameters
for $\frac{3}{16}$ -in. Pitch Chain ANSI B29.2M-1982, R1987**

No. Teeth	Pitch Diameter	Outside Diameter		Over Pin Diameter ^a	No. Teeth	Pitch Diameter	Outside Diameter		Over Pin Diameter ^a
		Rounded Teeth ^b	Square Teeth ^c				Rounded Teeth ^b	Square Teeth ^c	
11	0.666	0.633	0.691	0.414	53	3.165	3.153	3.232	2.934
12	0.724	0.694	0.762	0.475	54	3.225	3.213	3.293	2.994
13	0.783	0.755	0.820	0.536	55	3.284	3.273	3.351	3.054
14	0.843	0.815	0.888	0.596	56	3.344	3.333	3.412	3.114
15	0.902	0.876	0.946	0.657	57	3.404	3.392	3.471	3.173
16	0.961	0.937	1.012	0.718	58	3.463	3.452	3.532	3.233
17	1.020	0.997	1.069	0.778	59	3.523	3.512	3.590	3.293
18	1.080	1.057	1.134	0.838	60	3.583	3.572	3.651	3.353
19	1.139	1.118	1.191	0.899	61	3.642	3.631	3.710	3.412
20	1.199	1.178	1.255	0.959	62	3.702	3.691	3.771	3.472
21	1.258	1.238	1.312	1.019	63	3.762	3.751	3.829	3.532
22	1.318	1.298	1.376	1.079	64	3.821	3.811	3.890	3.592
23	1.377	1.358	1.433	1.139	65	3.881	3.870	3.949	3.651
24	1.436	1.418	1.497	1.199	66	3.941	3.930	4.009	3.711
25	1.496	1.478	1.554	1.259	67	4.000	3.990	4.068	3.771
26	1.556	1.538	1.617	1.319	68	4.060	4.050	4.129	3.831
27	1.615	1.598	1.674	1.379	69	4.120	4.109	4.188	3.890
28	1.675	1.658	1.737	1.439	70	4.179	4.169	4.248	3.950
29	1.734	1.718	1.795	1.499	71	4.239	4.229	4.307	4.010
30	1.794	1.778	1.857	1.559	72	4.299	4.288	4.368	4.069
31	1.853	1.838	1.915	1.619	73	4.358	4.348	4.426	4.129
32	1.913	1.898	1.977	1.679	74	4.418	4.408	4.487	4.189
33	1.973	1.958	2.035	1.739	75	4.478	4.468	4.546	4.249
34	2.032	2.017	2.097	1.798	76	4.537	4.527	4.607	4.308
35	2.092	2.077	2.154	1.858	77	4.597	4.587	4.665	4.368
36	2.151	2.137	2.216	1.918	78	4.657	4.647	4.726	4.428
37	2.211	2.197	2.274	1.978	79	4.716	4.706	4.785	4.487
38	2.271	2.257	2.336	2.038	80	4.776	4.766	4.845	4.547
39	2.330	2.317	2.394	2.098	81	4.836	4.826	4.904	4.607
40	2.390	2.376	2.456	2.157	82	4.895	4.886	4.965	4.667
41	2.449	2.436	2.514	2.217	83	4.955	4.945	5.024	4.726
42	2.509	2.496	2.575	2.277	84	5.015	5.005	5.084	4.786
43	2.569	2.556	2.633	2.337	85	5.074	5.065	5.143	4.846
44	2.628	2.616	2.695	2.397	86	5.134	5.124	5.204	4.905
45	2.688	2.675	2.753	2.456	87	5.194	5.184	5.263	4.965
46	2.748	2.735	2.815	2.516	88	5.253	5.244	5.323	5.025
47	2.807	2.795	2.873	2.576	89	5.313	5.304	5.382	5.085
48	2.867	2.855	2.934	2.636	90	5.373	5.363	5.443	5.144
49	2.926	2.914	2.992	2.695	91	5.432	5.423	5.501	5.204
50	2.986	2.974	3.054	2.755	92	5.492	5.483	5.562	5.264
51	3.046	3.034	3.112	2.815	93	5.552	5.542	5.621	5.323
52	3.105	3.094	3.173	2.875	94	5.611	5.602	5.681	5.383

Table 3b. (Continued) American National Standard Silent Chain Sprocket Diameters for $\frac{3}{16}$ -in. Pitch Chain ANSI B29.2M-1982, R1987

No. Teeth	Pitch Diameter	Outside Diameter		Over Pin Diameter ^a	No. Teeth	Pitch Diameter	Outside Diameter		Over Pin Diameter ^a
		Rounded Teeth ^b	Square Teeth ^c				Rounded Teeth ^b	Square Teeth ^c	
95	5.671	5.662	5.740	5.443	108	6.447	6.438	6.517	6.219
96	5.731	5.722	5.801	5.503	109	6.506	6.498	6.576	6.279
97	5.790	5.781	5.860	5.562	110	6.566	6.557	6.637	6.338
98	5.850	5.841	5.920	5.622	111	6.626	6.617	6.696	6.398
99	5.910	5.901	5.979	5.682	112	6.685	6.677	6.756	6.458
100	5.969	5.960	6.040	5.741	113	6.745	6.736	6.815	6.517
101	6.029	6.020	6.099	5.801	114	6.805	6.796	6.875	6.577
102	6.089	6.080	6.159	5.861	115	6.864	6.856	6.934	6.637
103	6.148	6.139	6.218	5.920	116	6.924	6.916	6.995	6.697
104	6.208	6.199	6.278	5.980	117	6.984	6.975	7.054	6.756
105	6.268	6.259	6.337	6.040	118	7.043	7.035	7.114	6.816
106	6.327	6.319	6.398	6.100	119	7.103	7.095	7.173	6.876
107	6.387	6.378	6.457	6.159	120	7.163	7.154	7.233	6.935

^a For tolerances on over-pin diameters, see table 4.

^b Blank diameters are 0.020 inch larger and maximum guide groove diameters G are 1.240 inches smaller than these outside diameters.

^c These diameters are maximum; tolerance is +0, -0.50 × pitch, inches.

Tolerance for maximum eccentricity (total indicator reading) of pitch diameter with respect to bore is 0.004 in. up to and including 4 in. diameter; and 0.008 in., over 4 in. diameter.

Table 4a. Over-Pin Diameter Tolerances for American National Standard $\frac{3}{8}$ -in. Pitch and Larger Silent Chain Sprocket Measurement ANSI B29.2M-1982, 1987

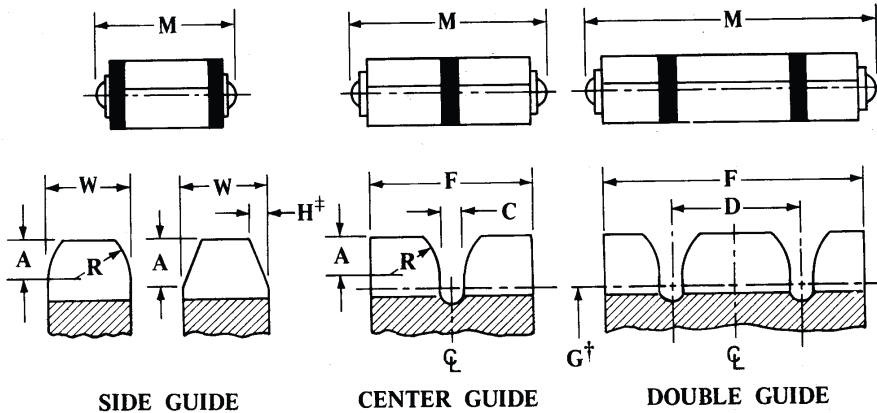
Pitch	Number of Teeth									
	Up to 15	16-24	25-35	36-48	49-63	64-80	81-99	100-120	121-143	144 up
Tolerance, ^a Inches										
0.375	0.005	0.006	0.006	0.006	0.007	0.007	0.008	0.008	0.008	0.009
0.500	0.006	0.006	0.007	0.007	0.008	0.008	0.009	0.009	0.010	0.010
0.625	0.006	0.007	0.007	0.008	0.009	0.009	0.010	0.011	0.011	0.012
0.750	0.006	0.007	0.008	0.009	0.010	0.010	0.011	0.012	0.013	0.013
1.000	0.008	0.009	0.010	0.011	0.012	0.013	0.014	0.015	0.016	0.016
1.250	0.008	0.009	0.010	0.012	0.013	0.015	0.016	0.017	0.018	0.019
1.500	0.009	0.010	0.012	0.014	0.015	0.017	0.018	0.020	0.021	0.022
2.000	0.012	0.014	0.017	0.019	0.021	0.023	0.025	0.027	0.028	0.028
Tolerances, Millimeters										
9.52	0.13	0.13	0.13	0.15	0.15	0.18	0.18	0.18	0.20	0.20
2.70	0.13	0.15	0.15	0.18	0.18	0.20	0.20	0.23	0.23	0.25
15.88	0.15	0.15	0.18	0.20	0.23	0.25	0.25	0.25	0.28	0.30
19.05	0.15	0.18	0.20	0.23	0.25	0.28	0.28	0.30	0.33	0.36
25.40	0.18	0.20	0.23	0.25	0.28	0.30	0.33	0.36	0.38	0.40
31.75	0.20	0.23	0.25	0.28	0.33	0.36	0.38	0.43	0.46	0.48
38.10	0.20	0.25	0.28	0.33	0.36	0.40	0.43	0.48	0.51	0.56
50.80	0.25	0.30	0.36	0.40	0.46	0.51	0.56	0.61	0.66	0.71

^a All tolerances are negative. Tolerances = $(0.004 + 0.001P\sqrt{N})$, where P = chain pitch, N = number of teeth. See 3A for over pin diameters.

Table 4b. Over-Pin Diameter Tolerances for ANSI $\frac{3}{16}$ -in. Pitch and Larger Silent Chain Sprocket Measurement (ANSI B29.2M-1982, R1987)

Pitch	Number of Teeth									
	Up to 15	16 - 24	25 - 35	36 - 48	49 - 63	64 - 80	81 - 99	100 - 120	121 - 143	144 up
Tolerances, ^a Inches										
0.1875	0.004	0.004	0.004	0.004	0.004	0.005	0.005	0.005	0.005	0.005
Tolerances, ^a Millimeterers										
4.76	0.10	0.10	0.10	0.10	0.10	0.13	0.13	0.13	0.13	0.13

^a All tolerances are negative.



Grooving tool may be either square or round end but groove must be full width down to diameter of *G*. For values of *G* (max.) see footnote to [Table 3a](#)

Values of *H* (± 0.003 in.) = 0.051 in. are given only for chain numbers SC302 and SC402. *M* = Max. overall width of chain. The maximum radius over a new chain engaged on a sprocket will not exceed the sprocket pitch radius plus 75 per cent of the chain pitch. To obtain the chain widths and sprocket face dimensions in millimeters, multiply each entry by 25.4.

Table 4c. ANSI $\frac{3}{8}$ -in. Pitch and Larger Silent Chain Widths and Sprocket Face Dimensions (ANSI B29.2M-1982, R1987)

Chain No	Chain Pitch	Type	M ^a Max.	A	C ±0.005	D ±0.010	F +0.125 -0.000	R ±0.003	W +0.010 -0.000	
SC302	0.375	Side Guide ^b	0.594	0.133	0.200	0.410	
SC303		Center Guide	0.844		0.100	...	0.750			...
SC304			1.094		...	1.000	...			
SC305			1.344		...	1.250	...			
SC306			1.594		...	1.500	...			
SC307			1.844		...	1.750	...			
SC308			2.094		...	2.000	...			
SC309			2.344		...	2.250	...			
SC310			2.594		...	2.500	...			
SC312			Double-Guide		3.094	1.000	3.000			...
SC316					4.094	4.000	...			
SC320		5.094			5.000	...				
SC324		6.094			6.000	...				
SC402		0.500	Side Guide ^b		0.750	0.133
SC403	Center Guide		0.875	0.100	...		0.750	...		
SC404			1.125	...	1.000		...			
SC405			1.375	...	1.250		...			
SC406			1.625	...	1.500		...			
SC407			1.875	...	1.750		...			
SC408			2.125	...	2.000		...			
SC409			2.375	...	2.250		...			
SC410			2.625	...	2.500		...			
SC411			2.875	...	2.750		...			
SC412			3.125	...	3.000		...			
SC414			3.625	...	3.500		...			
SC416			Double-Guide	4.125	1.000		4.000	...		
SC420	5.125			5.000	...					
SC424	6.125			6.000	...					
SC432	8.125			8.000	...					
SC504	0.625	Center-Guide	1.156	0.177	0.125	...	1.000	0.250	...	
SC505			1.406			...	1.250			...
SC506			1.656			...	1.500			...
SC507			1.906			...	1.750			...
SC508			2.156			...	2.000			...
SC510			2.656			...	2.500			...
SC512			3.156			...	3.000			...
SC516			4.156			...	4.000			...
SC520		Double-Guide	5.156			2.000	5.000			...
SC524			6.156			6.000	...			
SC528			7.156			7.000	...			
SC532			8.156			8.000	...			
SC540			10.156			10.000	...			

Table 4c. (Continued) ANSI $\frac{3}{8}$ -in. Pitch and Larger Silent Chain Widths and Sprocket Face Dimensions (ANSI B29.2M-1982, R1987)

Chain No	Chain Pitch	Type	M ^a Max.	A	C ±0.005	D ±0.010	F +0.125 -0.000	R ±0.003	W +0.010 -0.000	
SC604	0.750	Center-Guide	1.187	0.274	0.180	...	1.000	0.360	...	
SC605			1.437			...	1.250		...	
SC606			1.687			...	1.500		...	
SC608			2.187			...	2.000		...	
SC610			2.687			...	2.500		...	
SC612			3.187			...	3.000		...	
SC614			3.687			...	3.500		...	
SC616			4.187			...	4.000		...	
SC620			5.187			...	5.000		...	
SC624			6.187			...	6.000		...	
SC628			Double guide			7.187	4.000		7.000	...
SC632						8.187	8.000		...	
SC636		9.187				9.000	...			
SC640		10.187				10.000	...			
SC648		12.187				12.000	...			
SC808	1.000	Center Guide	2.250	0.274	0.180	...	2.000	0.360	...	
SC810			2.750			...	2.500		...	
SC812			3.250			...	3.000		...	
SC816			4.250			...	4.000		...	
SC820			5.250			...	5.000		...	
SC824			6.250			...	6.000		...	
SC828		Double guide	7.250			4.000	7.000		...	
SC832			8.250			8.000	...			
SC836			9.250			9.000	...			
SC840			10.250			10.000	...			
SC848			12.250			12.000	...			
SC856			14.250			14.000	...			
SC864			16.250			16.000	...			
SC1010	1.25	Center Guide	2.812	0.274	0.180	...	2.500	0.360	...	
SC1012			3.312			...	3.000		...	
SC1016			4.312			...	4.000		...	
SC1020			5.312			...	5.000		...	
SC1024			6.312			...	6.000		...	
SC1028			7.312			...	7.000		...	
SC1032			Double guide			8.312	4.000		8.000	...
SC1036		9.312				9.000	...			
SC1040		10.312				10.000	...			
SC1048		12.312				12.000	...			
SC1056		14.312				14.000	...			
SC1064		16.312				16.000	...			
SC1072		18.312				18.000	...			
SC1080		20.312				20.000	...			

Table 4c. (Continued) ANSI $\frac{3}{8}$ -in. Pitch and Larger Silent Chain Widths and Sprocket Face Dimensions (ANSI B29.2M-1982, R1987)

Chain No	Chain Pitch	Type	M ^a Max.	A	C ±0.005	D ±0.010	F +0.125 -0.000	R ±0.003	W +0.010 -0.000
SC1212	1.500	Center Guide	3.375	0.274	0.180	...	3.000	0.360	...
SC1216			4.375			...	4.000		...
SC1220			5.375			...	5.000		...
SC1224			6.375			...	6.000		...
SC1228			7.375			...	7.000		...
SC1232		Double guide	8.375			4.000	8.000		...
SC1236			9.375				9.000		...
SC1240			10.375				10.000		...
SC1248			12.375				12.000		...
SC1256			14.375				14.000		...
SC1264			16.375				16.000		...
SC1272			18.375				18.000		...
SC1280			20.375				20.000		...
SC1288			22.375				22.000		...
SC1296			24.375				24.000		...
SC1616	2.000	Center Guide	4.500	0.274	0.218	...	4.000	0.360	...
SC1620			5.500			...	5.000		...
SC1624			6.500			...	6.000		...
SC1628			7.500			...	7.000		...
SC1632			Double guide			8.500	4.000		8.000
SC1640		10.500				10.000			...
SC1648		12.500				12.000			...
SC1656		14.500				14.000			...
SC1664		16.500				16.000			...
SC1672		18.500				18.000			...
SC1680		20.500				20.000			...
SC1688		22.500				22.000			...
SC1696		24.500				24.000			...
SC16120		30.500				30.000			...

^aSpecify side guide or center guide type.

^bSide Guide chains have single outside guides of same thickness as toothed links.

All dimensions in inches. M Max. overall width of chain.

Table 4d. American National Standard $\frac{3}{16}$ -in. Pitch and Larger Silent Chain Widths and Sprocket Face Dimensions ANSI B29.2M-1982,1987

Chain No	Chain Pitch	Type	M Max.	A	C Max.	F Min.	R	W ± 0.003
SC0305	0.1875	Side Guide	0.216	0.06	0.09	0.075
SC0307			0.278			0.138
SC0309			0.341			0.201
SC0311		Side Guide/ Center Guide	0.403		0.050	0.334		0.264
SC0313			0.466		0.396	0.327		
SC0315			0.528		0.459	0.390		
SC0317		Center Guide	0.591		0.521	...		
SC0319			0.653		0.584	...		
SC0321			0.716		0.646	...		
SC0323			0.778		0.709	...		
SC0325			0.850		0.771	...		
SC0327			0.903		0.834	...		
SC0329			0.966		0.896	...		
SC0331		1.028	0.959		...			

All dimensions in inches. M = Max. overall width of chain.

To obtain chain width and sprocket face dimensions in millimeters, multiply each entry by 25.4.

Sprocket Hub Dimensions.—The important hub dimensions are the outside diameter, the bore, and the length. The maximum hub diameter is limited by the need to clear the chain guides and is of particular importance for sprockets with low numbers of teeth. The American National Standard for inverted tooth chains and sprocket teeth ANSI B29.2M-1982 (R1987) provides the following formulas for calculating maximum hub diameters, *MHD*.

$$MHD(\text{for hobbed teeth}) = P \left[\cot \left(\frac{180^\circ}{N} \right) - 1.33 \right]$$

$$MHD(\text{for straddle cut teeth}) = P \left[\cot \left(\frac{180^\circ}{N} \right) - 1.25 \right]$$

Maximum hub diameters for sprockets with from 17 to 31 teeth are given in **Table 5**. Maximum hub diameters for other methods of cutting teeth may differ from these values. Recommended maximum bores are given in **Table 6**.

Table 5. American National Standard Minimum Hub Diameters for Silent chain Sprockets (17 to 31 Teeth) ANSI B29.2M-1982, 1987

No. Teeth	Hob Cut	Straddle Cut	No. Teeth	Hob Cut	Straddle Cut	No. Teeth	Hob Cut	Straddle Cut
	Min. Hub Diam.			Min. Hub Diam.			Min. Hub Diam.	
17	4.019	4.099	22	5.626	5.706	27	7.226	7.306
18	4.341	4.421	23	5.946	6.026	28	7.546	7.626
19	4.662	4.742	24	6.265	6.345	29	7.865	7.945
20	4.983	5.063	25	6.586	6.666	30	8.185	8.265
21	5.304	5.384	26	6.905	6.985	31	8.503	8.583

All dimensions in inches.

Values shown are 1-inch pitch chain. For other pitches ($\frac{3}{8}$ -inch and larger) multiply the values given by the pitch.

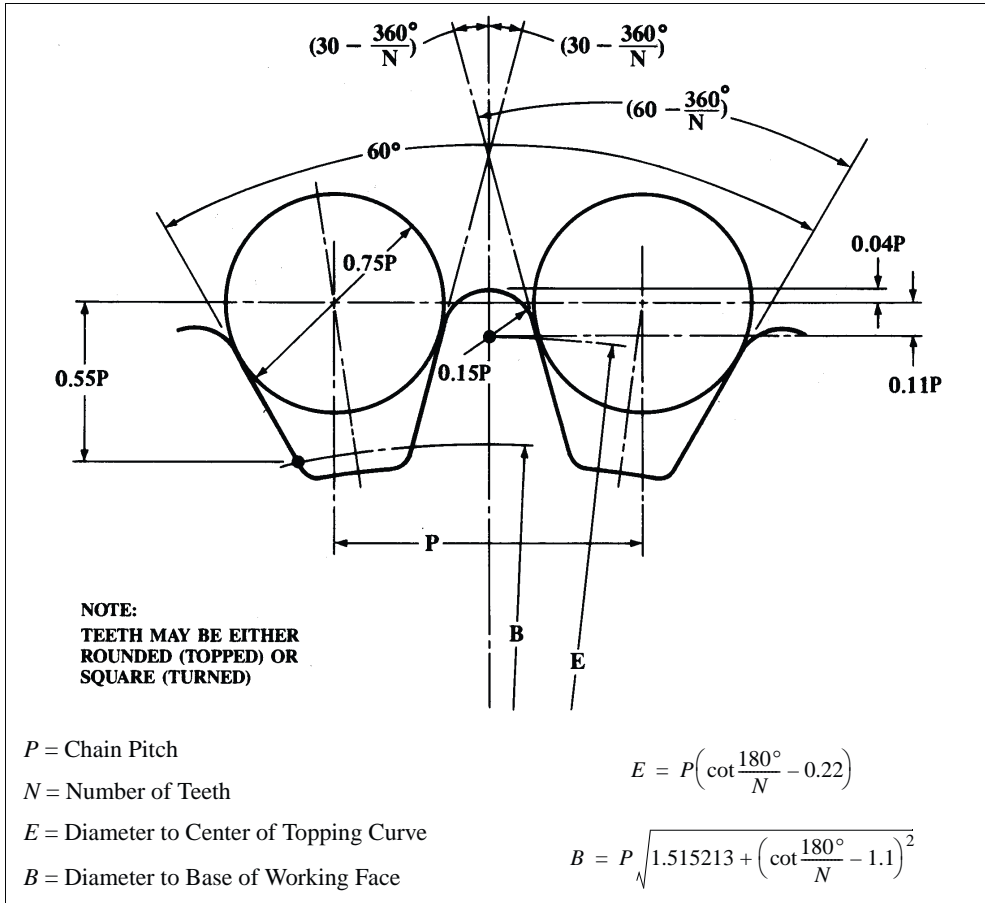
Good practice indicates that teeth of sprockets up to and including 31 teeth should have a Rockwell hardness of C50 min.

Table 6. Recommended Maximum Sprocket Bores for Silent Chains

Number of Teeth	Chain Pitch, Inches							
	$\frac{3}{8}$	$\frac{1}{2}$	$\frac{5}{8}$	$\frac{3}{4}$	1	$1\frac{1}{4}$	$1\frac{1}{2}$	2
Maximum Sprocket Bore, Inches								
17	1	$1\frac{3}{8}$	$1\frac{3}{4}$	2	$2\frac{3}{4}$	$3\frac{3}{8}$	$4\frac{1}{8}$	$5\frac{1}{4}$
19	$1\frac{1}{4}$	$1\frac{5}{8}$	2	$2\frac{3}{8}$	$3\frac{1}{4}$	4	$4\frac{7}{8}$	$6\frac{3}{4}$
21	$1\frac{3}{8}$	$1\frac{7}{8}$	$2\frac{1}{4}$	$2\frac{3}{4}$	$3\frac{3}{4}$	$4\frac{1}{2}$	$5\frac{1}{2}$	$7\frac{3}{4}$
23	$1\frac{5}{8}$	$2\frac{1}{8}$	$2\frac{5}{8}$	$3\frac{1}{4}$	$4\frac{3}{8}$	$5\frac{1}{2}$	$6\frac{1}{2}$	9
25	$1\frac{3}{4}$	$2\frac{3}{8}$	3	$3\frac{5}{8}$	$4\frac{3}{4}$	6	$7\frac{1}{4}$	10
27	2	$2\frac{5}{8}$	$3\frac{3}{8}$	$3\frac{7}{8}$	$5\frac{3}{8}$	$6\frac{3}{4}$	$8\frac{1}{8}$	$11\frac{1}{4}$
29	$2\frac{1}{8}$	$2\frac{13}{16}$	$3\frac{5}{8}$	$4\frac{3}{8}$	$5\frac{3}{4}$	$7\frac{3}{8}$	$9\frac{1}{8}$	$12\frac{1}{4}$
31	$2\frac{5}{16}$	$3\frac{1}{16}$	$3\frac{7}{8}$	$4\frac{5}{8}$	$6\frac{3}{8}$	8	$9\frac{7}{8}$	$13\frac{1}{4}$

American Chain Association.

**Table 7a. Tooth Form for ANSI $\frac{3}{8}$ -inch and larger Silent Tooth Sprocket
ANSI B29.2M-1982, R1987**



**Table 7b. Tooth Form for ANSI $\frac{3}{16}$ -inch and larger Silent Tooth Sprocket
ANSI B29.2M-1982, R1987**

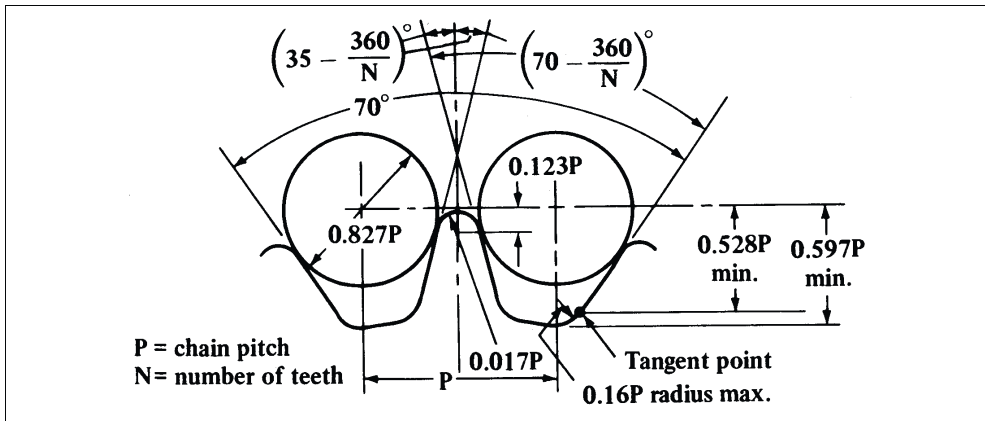
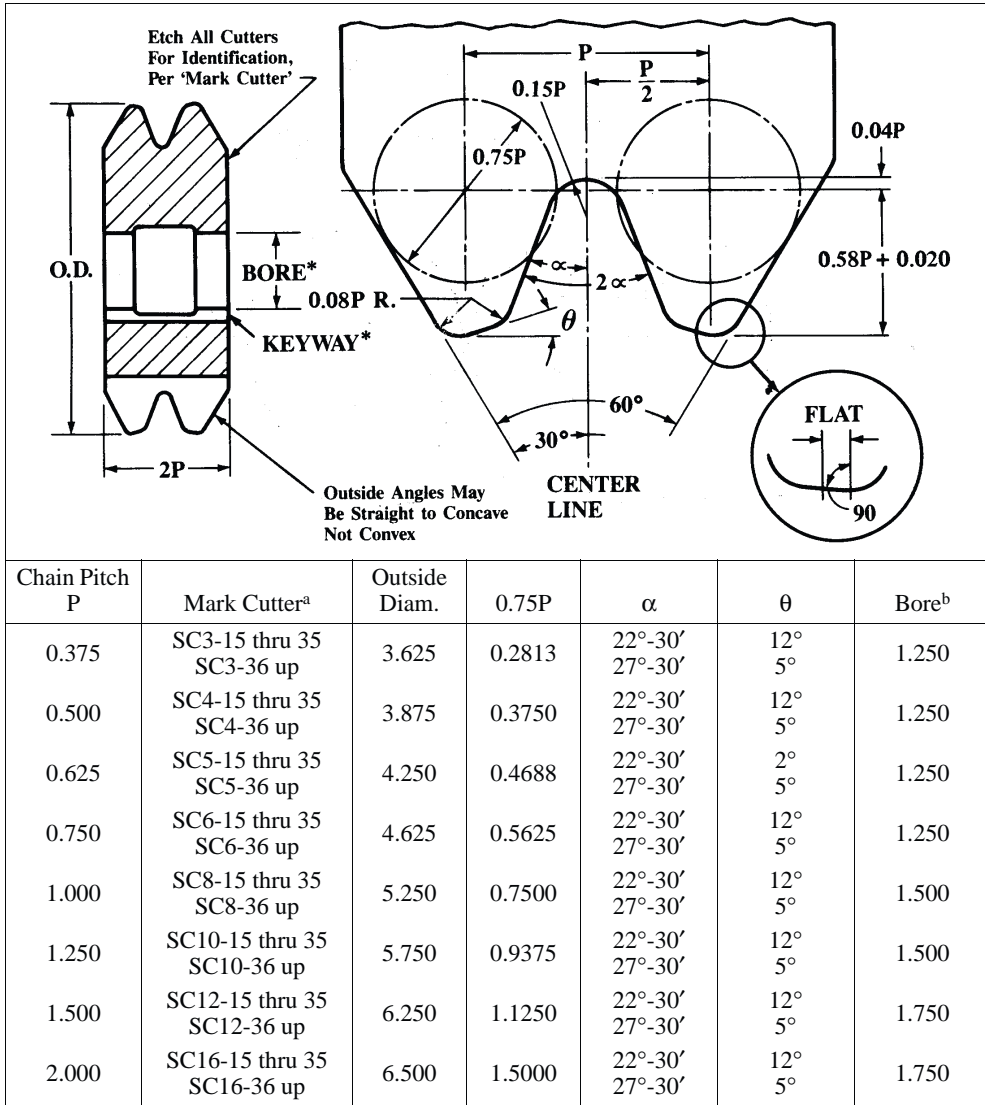


Table 8. Straddle Cutters for American National Standard $\frac{3}{8}$ -in. Pitch and Larger Silent Chain Sprocket Teeth



^a Range of teeth is indicated in the cutter marking.

^b Suggested standard. Bores other than standard must be specified.

All dimensions in inches. To obtain values in millimeters, multiply inch values by 25.4.

These data are given as supplementary information in ANSI B29.2M-1982, R1987 and are made available by the American Chain Association.

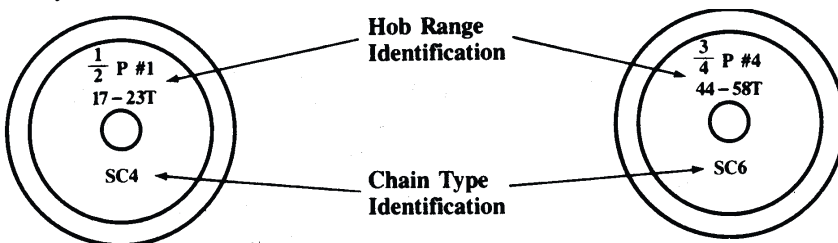
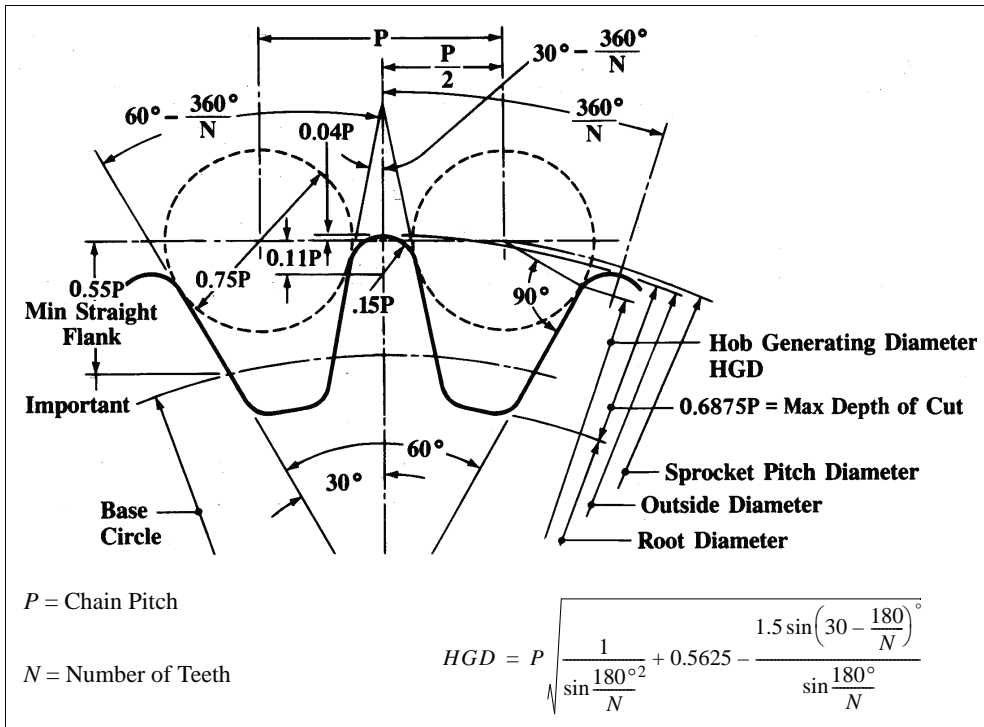


Fig. 1. Identification of Inverted Tooth Chain Hobs.

Table 9. Hobs for ANSI $\frac{3}{8}$ -inch and larger Silent Tooth Sprocket*

Sprocket Design and Tooth Form.—Except for tooth form, silent chain sprocket design parallels the general design practice of roller chain sprockets as covered in the previous section.

As shown in Tables 7a and 7b, sprockets for American National Standard silent chains have teeth with straight-line working faces. The tops of teeth for $\frac{3}{8}$ -in. and larger pitch chains may be rounded or square. Bottom clearance below the working face is not specified but must be sufficient to clear the chain teeth. The standard tooth form for $\frac{3}{8}$ -in. and larger pitch chains is designed to mesh with link plate contours having an included angle of 60 degrees as shown in the diagram of Table 7a. The standard tooth form for $\frac{3}{16}$ -in. pitch chains has an included angle of 70 degrees as shown in Table 7b. It will be seen from these tables that the angle between the faces of a given tooth [$60^\circ - 720^\circ/N$ for $\frac{3}{8}$ -in. pitch and larger; $70^\circ - 720^\circ/N$ for $\frac{3}{16}$ -in. pitch] becomes smaller as the number of teeth decreases. Therefore, for a $\frac{3}{8}$ -in. pitch or larger 12-tooth sprocket it will be zero. In other words the tooth faces will be parallel.

For smaller tooth numbers the teeth would be undercut. For best results, 21 or more teeth are recommended; less than 17 should not be used.

Cutting Silent Chain Sprocket Teeth.—Sprocket teeth may be cut by either a straddle cutter or a hob. Essential dimensions for straddle cutters are given in Table 8 and for hobs in Table 9 and 10. American National Standard silent chain hobs are stamped for identification as shown in Fig. 1 on page 3471.

* Source: American Chain Association.

**Table 10. Hobs for American National Standard $\frac{3}{8}$ -in. Pitch and Larger
Silent Chain Sprocket Teeth***

Chain Pitch	Hob Number	Basic Number of Teeth	Tooth Range of Hob	Generating Diameter	
				Inches	Millimeters
SC3 = 0.375 in. = 9.52 mm	1	20	17 - 23	2.311	58.70
	2	28	24 - 32	3.247	82.47
	3	38	33 - 43	4.428	112.47
	4	51	44 - 58	5.971	151.66
	5	69	29 - 79	8.114	206.10
	6	95	80 - 110	11.212	284.78
	7	130	111 - 150	15.385	390.78
SC4 = 0.500 in. = 12.70 mm	1	20	17 - 23	3.082	78.28
	2	28	24 - 32	4.329	109.96
	3	38	33 - 43	5.904	149.96
	4	51	44 - 58	7.962	202.23
	5	69	29 - 79	10.818	274.78
	6	95	80 - 110	14.950	379.73
	7	130	111 - 150	20.513	521.03
SC5 = 0.625 in. = 15.88 mm	1	20	17 - 23	3.852	97.84
	2	28	24 - 32	5.412	137.46
	3	38	33 - 43	7.381	187.48
	4	51	44 - 58	9.952	252.78
	5	69	29 - 79	13.522	343.46
	6	95	80 - 110	18.687	474.65
	7	130	111 - 150	25.641	651.28
SC6 = 0.750 in. = 19.05 mm	1	20	17 - 23	4.623	117.42
	2	28	24 - 32	6.494	164.95
	3	38	33 - 43	8.857	224.97
	4	51	44 - 58	11.943	303.35
	5	69	29 - 79	16.227	412.17
	6	95	80 - 110	22.424	569.57
	7	130	111 - 150	30.770	781.56
SC8 = 1.000 in. = 25.40 mm	1	20	17 - 23	6.163	156.54
	2	28	24 - 32	8.659	219.94
	3	38	33 - 43	11.809	299.95
	4	51	44 - 58	15.924	404.47
	5	69	29 - 79	21.636	549.55
	6	95	80 - 110	29.899	759.43
	7	130	111 - 150	41.026	1042.06
SC10 = 1.250 in. = 31.75 mm	1	20	17 - 23	7.704	195.68
	2	28	24 - 32	10.823	274.90
	3	38	33 - 43	14.761	374.93
	4	51	44 - 58	19.905	505.59
	5	69	29 - 79	27.045	686.94
	6	95	80 - 110	37.374	949.30
	7	130	111 - 150	51.283	1302.59
SC12 = 1.500 in. = 38.10 mm	1	20	17-23	9.245	234.82
	2	28	24 - 32	12.988	329.90
	3	38	33 - 43	17.713	449.91
	4	51	44 - 58	23.886	606.70
	5	69	29 - 79	32.454	824.33
	6	95	80 - 110	44.849	1139.16
	7	130	111 - 150	61.539	1563.09
SC16 = 2.000 in. = 50.80 mm	1	20	17 - 23	12.327	313.11
	2	28	24 - 32	17.317	439.85
	3	38	33 - 43	23.618	599.90
	4	51	44 - 58	31.848	808.94
	5	69	29 - 79	43.272	1099.11
	6	95	80 - 110	59.798	1518.87
	7	130	111 - 150	82.052	2.84.12

* Source: American Chain Association.

Design of Silent Chain Drives.—The design of silent chain transmissions must be based not only upon the power to be transmitted and the ratio between driving and driven shafts, but also upon such factors as the speed of the faster running shaft, the available space, assuming that it affects the sprocket diameters, the character of the load and certain other factors. Determining the pitch of the chain and the number of teeth on the smallest sprocket are the important initial steps. Usually any one of several combinations of pitches and sprocket sizes may be employed for a given installation. In attempting to select the best combination, it is advisable to consult with the manufacturer of the chain to be used. Some of the more important fundamental points governing the design of silent chain transmissions will be summarized.

The design of a silent chain drive consists, primarily, of the selection of the chain size, sprockets, determination of chain length, center distance, lubrication method, and arrangement of casings.

Pitch of Silent Chain.—The pitch is selected with reference to the speed of the faster running shaft which ordinarily is the driver and holds the smaller sprocket. The following pitches are recommended: for a faster running shaft of 2000 to 5000 rpm, $\frac{3}{8}$ -inch pitch; for 1500 to 2000 rpm, $\frac{1}{2}$ -inch pitch; for 1200 to 1500 rpm, $\frac{5}{8}$ -inch pitch, for 1000 to 1200 rpm, $\frac{3}{4}$ -inch pitch; for 800 to 1000 rpm, 1-inch pitch; for 650 to 800 rpm, $1\frac{1}{4}$ -inch pitch; for 300 to 600 rpm, $1\frac{1}{2}$ -inch pitch; for 300 to 500 rpm, 2-inch pitch; and for below 300 rpm, $2\frac{1}{2}$ -inch pitch. As the normal operating speeds increase, the allowable pitch decreases. Recommendations relating to the relationship between pitch and operating speed are intended for normal or average conditions. Speeds for a given pitch may be exceeded under favorable conditions and may have to be reduced when conditions are unfavorable. In general, smoother or quieter operation will result from using the smallest pitch suitable for a given speed and load. However, a larger pitch which might be applicable under the same conditions, will result in a narrower chain and a less expensive transmission. This relationship usually is true when there is a small speed reduction and comparatively long center distance. If there is a large speed reduction and short center distance, drives having the smaller pitches may be less expensive.

Maximum Ratios for Silent Chain Drives.—The maximum permissible ratios between driving and driven sprockets vary somewhat for different conditions and usually range from 6- or 7-to-1 up to 10-to-1. Some drives have even higher ratios, especially when the operating conditions are exceptionally favorable. When a large speed reduction is necessary, it is preferable as a general rule to use a double reduction or compound type of transmission instead of obtaining the entire reduction with two sprockets. Drives should be so proportioned that the angle between the two strands of a tight chain does not exceed 45 degrees. When the angle is larger, the chain does not have sufficient contact with the driving sprocket.

Sprocket Size and Chain Speed: A driving sprocket with not less than 17 teeth is generally recommended. For the driven sprocket, one manufacturer recommends 127 teeth as a maximum limit and less than 100 as preferable. If practicable, the sprocket sizes should be small enough to limit the chain speed to from 1200 to 1400 feet per minute. If the chain speed exceeds these figures, this may indicate that the pitch is too large or that a smaller pitch, and, consequently, a reduction in sprocket diameters (and chain speed) will result in better operating conditions. Both sprockets should preferably have a "hunting tooth ratio" relative to the number of chain links for uniform wear. See *Hunting Tooth Gear Ratios*, page 3350.

If there is a small reduction in speed between the driving and driven shafts, both sprockets may be made as small as is consistent with satisfactory operation, either to obtain a compact drive or possibly to avoid excessive chain speed in cases where the rotative speed is high for a given horsepower. Under such conditions, one manufacturer recommends driving sprockets ranging from 17 to 30 teeth, and driven sprockets ranging from 19 to 33

teeth. If the number of revolutions per minute is low for a given horsepower and the center distance comparatively long, then the recommended range for driving sprockets is from 23 to 111 teeth, and driven sprockets from 27 to 129 teeth. The preferable range is from 17 to 75 teeth for the driving sprockets, and 19 to 102 teeth for the driven sprockets.

Center Distance for Silent Chain Drives.—If the ratio of the drive is small, it is possible to locate the sprockets so close—that the teeth just clear; however, as a general rule, the minimum center-to-center distance should equal the sum of the diameters of both sprockets. According to the Whitney Chain & Mfg. Co., if the speed ratio is not over $2\frac{1}{2}$ -to-1, the center distance may be equal to one-half the sum of the sprocket diameters plus tooth clearance, providing this distance is not less than the minimum given in [Table 11](#). If the speed ratio is greater than $2\frac{1}{2}$ -to-1, the center distance should not be less than the sum of the sprocket diameters.

Table 11. Minimum Center Distances for Various Pitches

Pitch, inches	$\frac{3}{8}$	$\frac{1}{2}$	$\frac{5}{8}$	$\frac{3}{4}$	1	$1\frac{1}{4}$	$1\frac{1}{2}$
Minimum Center Distances, inches	6	9	12	15	21	27	33

When the chain length in pitches is known, the equivalent center distance for a tight chain may be determined by the formula for roller chain found on page [2553](#).

In selecting chain length, factors determining length should be adjusted so that the use of offset links may be avoided wherever possible. Chain lengths of an uneven number of pitches are also to be avoided.

Silent Tooth Chain Horsepower Capacity.—The horsepower ratings given in [Tables 12a, 12b, and 12c](#) have been established on a life expectancy of approximately 15,000 hours under optimum drive conditions, i.e. for a uniform rate of work where there is relatively little shock or load variation throughout a single revolution of a driven sprocket. Using these horsepower ratings as a basis, engineering judgment should be exercised as to the severity of the operating conditions for the intended installation, taking into consideration the source of power, the nature of the load, and the resulting effects of inertia, strain, and shock. Thus, for other than optimum drive conditions, the specified horsepower must be multiplied by the applicable service factor to obtain a “design” horsepower value. This is the value used to enter [Table 13](#) to obtain the required size of chain.

Service Factors: For a uniform type of load, a service factor of 1.0 for a 10-hour day and 1.3 for a 24-hour day are recommended. For a moderate shock load, service factors of 1.4 for a 10-hour day and 1.7 for a 24-hour day are recommended. For heavy shock loads, service factors of 1.7 for a 10-hour day and 2.0 for a 24-hour day are recommended. For extensive table of service factor applications, see supplementary information in ANSI B29.2M-1982.

Installation of Silent Chain Drives.—In installing chain transmissions of any kind, horizontal drives are those having driving and driven shafts in a horizontal plane. These are always preferable to vertical drives, which have a vertical center line intersecting the driving and driven shafts. If one sprocket must be higher than the other, avoid a vertical drive if possible by so locating the two sprockets that the common center line inclines from the vertical as far as is permitted by other conditions which might govern the installation. If practicable, an adjustment should be provided for the center distance between the driving and driven shafts.

Slack Side of Chain: As a general rule, the slack strand of a chain should be on the lower side of a horizontal drive. If the drive is not horizontal but angular or at some angle less than 90 degrees from the vertical, the slack should preferably be on that side which causes the strand to curve outward or away from the center line of the driving and driven shafts. Whenever the slack strand is on the upper side of either a horizontal or inclined drive,

adjustment for the center distance is especially important to compensate for possible chain elongation.

Lubrication: The life of a silent chain subjected to conditions such as are common to automobile drives, depends largely upon the wear of the joints. On account of the high speed and whipping action, it is important to have the chains well oiled. When splash lubrication is employed, the supply pipe should be placed so that the oil will be directed against the inside of the chain. It is preferable that silent chains be operated in an oil-retaining casing with provisions for lubrication. Avoid using greases of any kind. The viscosity of the oil depends on temperature, as follows:

Ambient Temp. °F	Chain Pitch		Ambient Temp. °F	Chain Pitch	
	$\frac{3}{16}$ & $\frac{3}{8}$ inch	$\frac{1}{2}$ inch & larger		$\frac{3}{16}$ & $\frac{3}{8}$ inch	$\frac{1}{2}$ inch & larger
	Recommended Lubricant			Recommended Lubricant	
20-40	SAE 10	SAE 20	100-120	SAE 30	SAE 40
40-100	SAE 20	SAE 30	120-140	SAE 40	SAE 50

Double-Flexure Silent Chain.—In double-flexure chain, the teeth of the link plates project on both sides of the chain and the chain flexes in both directions. This chain is used where the drive arrangements require that sprockets contact both sides of the chain. Neither double-flexure chain nor sprockets are covered in American National Standard ANSI 29.2M-1982 (R1987).

Horsepower Ratings Per Inch of Chain Width for Silent Chain Drives — 1982.—

The following industrial standard horsepower ratings for silent chain drives have been supplied by the American Chain Association. These ratings are for American National Standard silent chain as covered by ANSI B29.2M-1982 (R1987). These values may require modification by using the appropriate service factors (see *Service Factors*, page 3475). These factors, which apply to typical drives, are intended as a general guide only, and engineering judgment and experience may indicate different modifications to suit the nature of the load.

$$\text{Horsepower capacity of chain per inch of width} = \frac{\text{Rating in Table 13a, 13b, 13c}}{\text{Service Factor}}$$

$$\text{Chain width for given total hp capacity} = \frac{\text{hp} \times \text{Service factor}}{\text{Rating per inch, Table 13a, 13b, 13c}}$$

Lubrication: The horsepower established from the sprocket and speed combinations of the drive under consideration will indicate a method of lubrication. This method or a better one must be used to obtain optimum chain life. The types of lubrication as indicated on the tables are: Type I, manual, brush, or oil cup; Type II, bath or disk; Type III, circulating pump.

Table 12a. Horse Power Ratings per Inch of Chain Width for Silent Chain Drives—1982

No. of Teeth Small Sprkt.	$\frac{3}{16}$ Inch Pitch Chain												
	Revolutions per Minute—Small Sprocket												
	500	600	700	800	900	1200	1800	2000	3500	5000	7000	9000	
15	0.28	0.33	0.38	0.43	0.47	0.60	0.80	0.90	1.33	1.66	1.94	1.96	
17	0.33	0.39	0.44	0.50	0.55	0.70	0.96	1.05	1.60	2.00	2.40	2.52	
19	0.37	0.43	0.50	0.55	0.61	0.80	1.10	1.20	1.80	2.30	2.76	2.92	
21	0.41	0.48	0.55	0.62	0.68	0.87	1.22	1.33	2.03	2.58	3.12	3.35	
23	0.45	0.53	0.60	0.68	0.75	0.96	1.35	1.47	2.25	2.88	3.50	3.78	
25	0.49	0.58	0.66	0.74	0.82	1.05	1.47	1.60	2.45	3.13	3.80	4.10	
27	0.53	0.62	0.71	0.80	0.88	1.15	1.58	1.72	2.63	3.35	4.06	4.37	
29	0.57	0.67	0.76	0.86	0.95	1.21	1.70	1.85	2.83	3.61	4.40	4.72	
31	0.60	0.72	0.81	0.91	1.01	1.30	1.81	1.97	3.02	3.84	4.66	5.00	
33	0.64	0.75	0.86	0.97	1.07	1.37	1.90	2.08	3.17	4.02	4.85	...	
35	0.68	0.80	0.92	1.03	1.14	1.45	2.03	2.21	3.41	4.27	5.16	...	
37	0.71	0.84	0.96	1.08	1.19	1.52	2.11	2.30	3.48	4.39	5.24	...	
40	0.77	0.91	1.04	1.16	1.29	1.64	2.28	2.50	3.77	4.76	
45	0.86	1.02	1.15	1.30	1.43	1.83	2.53	2.75	4.15	5.21	
50	0.95	1.12	1.27	1.37	1.58	2.00	2.78	3.02	4.52	5.65	
Type I							Type II			Type III			

No. of Teeth Small Sprkt.	$\frac{3}{8}$ Inch Pitch Chain												
	Revolutions per Minute—Small Sprocket												
	100	500	1000	1200	1500	1800	2000	2500	3000	3500	4000	5000	6000
^a 17	0.46	2.1	4.6	4.9	5.3	6.5	6.9	7.9	8.5	8.8	8.8
^a 19	0.53	2.5	4.8	5.4	6.5	7.4	7.9	9.1	9.9	10	11	9.8	...
21	0.58	2.8	5.1	6.0	7.3	8.3	9.0	10	11	12	12	12	10
23	0.63	3.0	5.6	6.6	8.0	9.3	10	12	13	14	14	14	12
25	0.69	3.3	6.1	7.3	8.8	10	11	13	14	15	15	15	14
27	0.74	3.5	6.8	7.9	9.5	11	12	14	15	16	18	18	16
29	0.80	3.8	7.3	8.5	10	12	13	15	16	18	19	19	18
31	0.85	4.1	7.8	9.1	11	13	14	16	18	19	20	20	19
33	0.90	4.4	8.3	9.8	12	14	15	18	19	21	21	21	20
35	0.96	4.6	8.8	10	13	15	16	19	20	23	23	23	21
37	1.0	4.9	9.1	11	14	15	16	20	21	24	24	24	...
40	1.1	5.3	10	12	15	16	18	21	24	25	26	26	...
45	1.3	6.0	11	13	16	19	20	24	26	28	29
50	1.4	6.6	13	15	18	20	23	26	29	30
Type I				Type II				Type III					

No. of Teeth Small Sprkt.	$\frac{1}{2}$ Inch Pitch Chain										
	Revolutions per Minute—Small Sprocket										
	100	500	700	1000	1200	1800	2000	2500	3000	3500	4000
^a 17	0.83	3.8	5.0	6.3	7.5	10	11	11	11	11	...
^a 19	0.93	3.8	5.0	7.5	8.8	11	13	14	14	14	...
21	1.0	5.0	6.3	8.8	10	14	14	15	16	16	...
23	1.1	5.0	7.5	10	11	15	16	18	19	19	18
25	1.2	5.0	7.5	10	13	16	18	20	21	21	20
27	1.3	6.3	8.8	11	13	18	19	21	24	24	23
29	1.4	6.3	8.8	13	14	19	21	24	25	25	25
31	1.5	7.5	10	13	15	21	23	25	28	28	28
33	1.6	7.5	10	14	16	23	24	28	29	30	29
35	1.8	7.5	11	15	18	24	25	29	31	31	30
37	1.9	8.8	11	16	19	25	26	30	33	33	...
40	2.0	8.8	13	18	20	28	29	33	35	35	...
45	2.5	10	14	19	23	30	30	36	39
50	2.5	11	15	21	25	34	36	40
Type I			Type II				Type III				

^a For best results, smaller sprocket should have at least 21 teeth.

Table 12b. Horse Power Ratings per Inch of Chain Width for Silent Chain Drives—1982

No. of Teeth Small Sprkt.	$\frac{3}{8}$ - Inch Pitch Chain									
	Revolutions per Minute—Small Sprocket									
	100	500	700	1000	1200	1800	2000	2500	3000	3500
^a 17	1.3	6.3	7.5	10	11	14	15	14
^a 19	1.4	6.3	8.8	13	14	16	18	18
21	1.6	7.5	10	13	15	19	20	20	20	...
23	1.8	7.5	11	15	16	21	23	24	23	...
25	1.9	8.8	11	16	19	24	25	26	26	24
27	2.0	10	13	18	20	26	28	29	29	26
29	2.1	10	14	19	21	28	30	31	31	29
31	2.4	11	15	20	23	30	31	34	34	31
33	2.5	11	16	21	25	33	34	36	36	34
35	2.6	13	16	23	26	34	36	39	39	35
37	2.8	13	18	24	28	36	39	43	41	...
40	3.0	14	19	26	30	39	41	44
45	3.4	16	21	29	34	44	46
50	3.8	18	24	33	38	48	50
	Type I			Type II			Type III			

No. of Teeth Small Sprkt.	$\frac{1}{2}$ - Inch Pitch Chain								
	Revolutions per Minute- Small Sprocket								
	100	500	700	1000	1200	1500	1800	2000	2500
^a 17	1.9	8.1	11	14	15	16	18	18	...
^a 19	2.0	9.3	13	15	18	20	21	21	...
21	2.3	10	14	18	20	23	24	25	24
23	2.5	11	15	20	23	25	28	28	28
25	2.8	13	16	21	25	29	31	31	30
27	2.9	14	18	24	28	31	34	35	35
29	3.1	15	20	26	30	34	36	38	38
31	3.4	15	21	28	31	36	40	41	41
33	3.6	16	23	30	34	39	43	44	44
35	3.8	18	24	31	36	41	45	46	46
37	4.0	19	25	34	39	44	48	49	49
40	4.4	20	28	36	41	48	51	53	53
45	4.9	23	30	40	46	53	56	58	...
50	5.4	25	34	45	51	58	61
	Type I			Type II			Type III		

No. of Teeth Small Sprkt.	1- Inch Pitch Chain										
	Revolutions per Minute- Small Sprocket										
	100	200	300	400	500	700	1000	1200	1500	1800	2000
^a 17	3.8	6.3	8.8	11	14	18	21	23
^a 19	3.8	7.5	10	13	15	20	25	26	28
21	3.8	7.5	11	15	18	23	29	31	33	33	...
23	3.8	8.8	13	16	19	25	31	35	38	38	...
25	5.0	8.8	14	18	21	28	35	39	41	41	41
27	5.0	10	15	19	24	30	39	43	46	46	45
29	5.0	11	16	20	25	33	41	46	50	51	50
31	6.3	11	16	23	28	35	45	50	54	55	54
33	6.3	13	18	24	29	38	49	54	59	59	58
35	6.3	13	19	25	30	40	51	56	61	63	61
37	6.8	14	20	26	33	43	54	60	65	66	...
40	7.5	15	23	29	35	45	59	65	70
45	8.8	16	25	31	39	51	65	71	76
50	10	19	28	35	43	56	71	78
	Type I			Type II				Type III			

^a For best results, smaller sprocket should have at least 21 teeth.

Table 12c. Horse Power Ratings per Inch of Chain Width for Silent Chain Drives –1982

No. of Teeth Small Sprkt.	1/4 Inch Pitch Chain										
	Revolutions per Minute- Small Sprocket										
	100	200	300	400	500	600	700	800	1000	1200	1500
^a 19	5.6	10	15	20	24	26	29	31	34	35	...
21	6.3	11	18	23	26	30	33	36	40	41	...
23	6.9	13	19	24	29	34	36	40	45	46	46
25	7.5	14	20	26	31	36	40	44	50	53	53
27	8.0	15	23	29	35	40	44	49	54	58	58
29	8.6	16	24	31	38	43	48	53	59	63	64
31	9.3	18	26	34	40	46	51	56	64	68	69
33	9.9	19	28	35	43	49	55	60	69	73	74
35	11	20	29	38	45	53	59	64	73	78	78
37	11	21	30	40	48	55	63	68	76	81	...
40	12	24	34	44	53	60	68	74	83	88	...
45	13	26	38	49	59	68	75	81	91
50	15	29	43	54	65	74	83	90	100
	Type I			Type II			Type III				

No. of Teeth Small Sprkt.	1/2 Inch Pitch Chain										
	Revolutions per Minute- Small Sprocket										
	100	200	300	400	500	600	700	800	900	1000	1200
^a 19	8.0	15	21	28	31	35	39	40	41	43	...
21	8.8	16	24	30	36	40	44	46	49	49	...
23	10	19	26	34	40	45	49	53	55	56	55
25	10	20	29	38	44	50	55	59	61	65	64
27	11	23	31	40	48	54	60	64	68	70	70
29	13	24	34	44	51	59	65	70	74	75	76
31	14	25	36	46	55	64	70	75	79	81	83
33	14	28	39	50	59	68	75	80	85	88	89
35	15	29	41	53	63	71	79	85	90	93	94
37	16	30	44	59	66	76	84	90	96	99	...
40	18	33	48	66	73	83	90	98	105
45	19	38	54	68	81	93	101	108	113
50	21	41	59	75	89	101	111	118
	Type I			Type II			Type III				

No. of Teeth Small Sprkt.	2- Inch Pitch Chain								
	Revolutions per Minute- Small Sprocket								
	100	200	300	400	500	600	700	800	900
^a 19	14	26	36	44	50	54	56
21	16	29	40	50	53	63	65
23	17	33	45	55	64	70	74	75	...
25	18	35	49	61	70	78	83	85	85
27	20	38	54	66	78	85	91	94	94
29	21	41	58	73	84	93	99	103	103
31	23	44	63	78	90	100	106	110	110
33	25	46	66	83	96	106	114	118	118
35	26	50	71	88	103	114	121	125	125
37	28	53	75	93	110	124	128	131	...
40	30	58	81	101	118	129	138	141	...
45	34	64	90	113	131	144	151
50	38	71	100	125	144	156
	Type I		Type II			Type III			

^a For best results, smaller sprocket should have at least 21 teeth.

ADDITIONAL

Miscellaneous Topics

Locomotive Development.—The first steam locomotive which ever ran on rails was built in 1804 by Richard Trevithick, an Englishman, and the first one to be used on a commercial basis was built by Matthew Murray, another Englishman. In 1811, Blenkinsop of Leeds, had several locomotives built by Murray in order to operate a railway extending from Middletown Colliers to Leeds, a distance of three and one-half miles. Trevithick's impracticable design had a single cylinder only, but Murray used two cylinders which were utilized in driving the same shaft on which cranks were set at right angles an important arrangement common to all modern locomotives. A cog-wheel, or gear, meshing with a continuous rack laid along the road-bed was employed. These locomotives were used daily for years and were examined by George Stephenson when he began his work on locomotive development. Several years after the construction of Murray's locomotives Hedley and Stephenson demonstrated that the gear and rack method of propulsion was unnecessary, and that the frictional resistance of smooth drivers would supply adequate tractive power. Stephenson's name will always be associated with locomotive development owing to his accomplishments in perfecting the locomotive and in establishing it on a commercial basis. His first locomotive was tried on the Killing worth Railway in 1814. The first locomotive to be used in the United States was imported from England in 1829.

Wheatstone Bridge.—The most generally used method for the measurement of the ohmic resistance of conductors is by the use of the *Wheatstone bridge*. In a simple form (See Fig. 1.) it comprises two resistance coils the ratio of the resistances of which is known, and a third, generally adjustable, resistance of known value. These are connected in circuit with the unknown resistance to be measured, a galvanometer, and a source of current, as in the diagram.

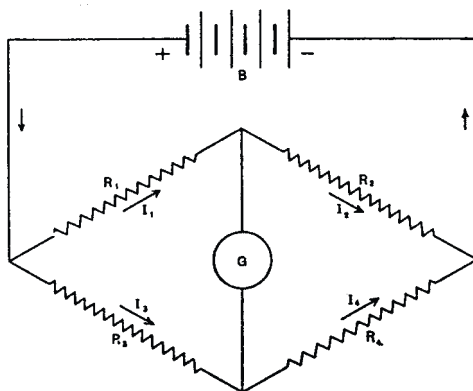


Fig. 1. Wheatstone Bridge

The adjustable resistance and the "bridge arms," if necessary, are adjusted until the galvanometer indicates no flow of current. The value of the unknown resistance is thus measured in terms of the known resistance and the known ratio of the bridge arms. In the diagram, R_1 , R_2 , R_3 , and R_4 are resistances, B a source of electromotive force and I_1 , I_2 , I_3 and I_4 currents through the resistances; G is a galvanometer. If the relation of the various resistances is such that no current flows through G , then I_1 equals I_2 , and I_3 equals I_4 ; also $I_1 R_1$ equals $I_3 R_3$, and $I_2 R_2$ equals $I_4 R_4$, there being no electromotive forces in the triangles $R_1 R_3 G$ and $R_2 R_4 G$. It follows, therefore, that

$$\frac{I_1}{I_3} = \frac{R_3}{R_1}, \quad \text{and} \quad \frac{I_2}{I_4} = \frac{R_4}{R_2}$$

and hence, as

$$\frac{I_1}{I_3} = \frac{I_2}{I_4}, \quad \text{it follows that} \quad \frac{R_3}{R_1} = \frac{R_4}{R_2}$$

If one of these resistances, R_1 for instance, is unknown, it may then be found through the equation:

$$R_1 = \frac{R_2 R_3}{R_4}$$

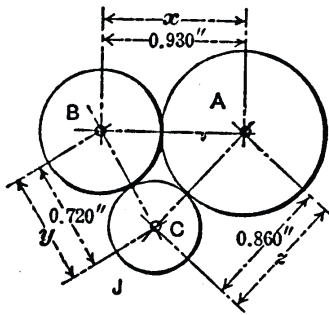
Wheatstone bridges are made in many forms. The three known resistances are made adjustable and are usually made of many spools of special resistance wire. The resistances are usually varied by short-circuiting a greater or smaller number of these spools.

Wax Impressions.—A wax impression of a sample or model is sometimes required in the manufacture of articles made from metal. To make a wax impression, proceed as follows: Oil the surface, of which the impression is to be made, very slightly with a few drops of oil applied to a little waste. Then take common bees wax and melt it slowly, without boiling. Mix it with one or two tablespoonfuls of lamp black to half a tumbler of beeswax, and stir the mixture. In order to make the wax impression show up clearly, take a fine hair brush and brush a small amount of powdered graphite or rouge over the object of which the impression is to be made.

Winchester Bushel.—A measure of capacity or volume, legal in the United States, and equal to 2150.42 cubic inches. This measure has not been legal in Great Britain since 1825, when it was superseded by the Imperial bushel which is equal to 2218.19 cubic inches.

Miner's Inch.—The term "miner's inch," used in western United States for measuring the flow of a stream of water, is more or less indefinite, because different values have been assigned to it; thus, the amount of water corresponding to a miner's inch varies from 1.36 to 1.73 cubic feet per minute, according to the method used for the measurement. The California Legislature, by an Act of 1901, prescribed that the miner's inch should be equivalent to 1.5 cubic feet of water per minute, measured through any aperture or orifice. The most common measurement is through an aperture 2 inches high and through a plank $1\frac{1}{4}$ inches thick, the width of the aperture being whatever length is required. The lower edge of the aperture is placed 2 inches above the bottom of the measuring box and the plank is 5 inches high above the aperture, so that the head will be 6 inches above the center of the stream through the orifice. Each square inch of the opening represents a miner's inch, and the amount of water that will flow through it equals about $1\frac{1}{2}$ cubic feet per minute.

Locating Holes by the Disk Method.—When machining holes in comparatively small precision work, three carefully centered disks are sometimes used to align the respective holes with the lathe spindle. These disks are made to such diameters that when their peripheries are in contact, each disk center will coincide with the position of the hole to be machined; the centers are then used for locating the work. The diameters of the disks can be found as follows: Subtract dimension y from x , thus obtaining the difference between the radii of disks C and A ; add this difference to dimension z to obtain the diameter of disk A ; subtract the radius of disk A from the center distance x to obtain the radius of B ; subtract the radius of B from dimension y to obtain the radius of C .



Example: $0.930 - 0.720 = 0.210$, or the difference between the radii of disks *C* and *A*. The diameter of *A* equals $0.210 + 0.860 = 1.070$ inch, and the radius equals $1.070 \div 2 = 0.535$ inch. The radius of *B* = $0.930 - 0.535 = 0.395$ inch. The radius of *C* = $0.720 - 0.395 = 0.325$ inch.

Electrical Cord Gage Rating.—The following tables shows the correct minimum recommended electrical cord size to use depending on supply voltage, cord length, and nameplate ampere rating of connected load. A smaller gage number is a larger cord.

Minimum Gage for Cord Sets by Voltage, Length, and Load

Voltage	Length of Cord, Feet			
	120V	0 - 25	26 - 50	51 - 100
240V	0 - 50	51 - 100	101 - 200	201 - 300
Nameplate Ampere Rating	American Wire Gage (AWG) Minimum Gage for Cord Sets			
0 - 6	18	16	16	14
6 - 10	18	16	14	12
10 - 12	16	16	14	12
12 - 16	14	12	Not Recommended	

Wire Gauge Selection for 12 Volt Circuits

Load Rating, Amps	Wire Distance (feet)						
	3'	5'	7'	10'	15'	20'	25'
	Minimum Wire Gage Required						
< 5	18	18	18	18	18	18	18
6	18	18	18	18	18	18	18
7	18	18	18	18	18	18	18
8	18	18	18	18	18	16	16
10	18	18	18	18	16	16	16
11	18	18	18	18	16	16	14
12	18	18	18	18	16	16	14
15	18	18	18	18	14	14	12
18	18	18	16	16	14	14	12
20	18	18	16	16	14	12	10
22	18	18	16	16	12	12	10
24	18	18	16	16	12	12	10
30	18	16	16	14	10	10	10
40	18	16	14	12	10	10	8
50	16	14	12	12	10	10	8
100	12	12	10	10	6	6	4
150	10	10	8	8	4	4	2

The Slide-rule

By means of the slide-rule, various calculations may be made mechanically with greater ease and rapidity than by ordinary arithmetical methods, and usually with sufficient accuracy for all practical requirements. Slide-rules are used principally for performing multiplication and division, but they may also be used for finding powers, roots, logarithms, and trigonometrical functions, and for various other purposes. The slide-rule in its most common form consists of three main parts. There is a main body or rule, a slide, and a runner or "cursor." Scales *A* and *D* (see Fig. 1) are on the rule, and scales *B* and *C* on the slide. Fig. 1 shows the right-hand half of the rule and the left-hand half of the slide, this sectional view being shown in order to secure a larger reproduction. The runner, which is in the form of a light metal frame that is free to slide endwise along the rule, is also shown in Fig. 1. Scales *A* and *B* are alike, as are scales *C* and *D*. All four scales are of the same length, but the graduations on scales *A* and *B* are different from those on scales *C* and *D*. The graduation 1 (seen at the extreme left in Fig. 1) is in the center of the rule, and scale *A* has two parts on opposite sides of this middle point 1 that are graduated exactly alike. The left-hand half from 1 to 1 is called the *left-hand A scale*, and the right-hand half from 1 to 1, the *right-hand A scale*. As scale *B* is exactly like scale *A*, its sections are designated as the *left-hand B scale* and the *right-hand B scale*. Each end of each scale is marked by the figure 1 which is known as the *index*. Thus, the figure 1 at the left-hand end of a scale is called the *left-hand index*, and figure 1 at the right-hand end is called the *right-hand index*.

As will be seen, the divisions on a slide-rule are not uniform. For example, that part of the left-hand *D* scale between divisions 1 and 2 (see enlarged detailed view, Fig. 2) is divided into ten main parts, no two of which are equal. Nevertheless, each of these main spaces represents 0.1. Each main space is subdivided into ten unequal parts, each of which represents one-tenth of 0.1, or 0.01. On the scales *A* and *B*, each of the ten main spaces between 1 and 2 is divided into only five parts; therefore, each subdivision represents 0.02. It is not possible to divide the spaces between graduations 4 and 5, 6 and 7, 8 and 9, etc., into as many parts as between 1 and 2, or 2 and 3, because the graduation lines would be too close together; therefore, the subdivisions near the right-hand end of any of the scales represent greater values than those near the left-hand end. This fact must be kept in mind or errors will result in the use of the slide-rule.

Reading the Slide-rule Graduations.—The method of reading the graduations is indicated in Fig. 2. A small figure 1 to the right of the left-hand index 1, represents the value 1.1, the small figure 2 marks the line that represents 1.2, and so on, to the small figure 9, which denotes 1.9. The second line to the right of the left-hand index denotes 1.02, as it is the second of the ten marks between 1 and 1.1. Several other lines at different points of the scale have the values indicated. It will be noticed that in each case the reading is accurate to at least three figures, and in some cases to four. The divisions on all four of the scales on the slide-rule are such that values can be read correctly to three figures; but beyond this it is not possible to proceed accurately, although the fourth figure may be obtained by estimating with the eye the fractional part of the subdivision. For instance, the fourth figure of the reading 1.535 is possible because the point is halfway between 1.53 and 1.54.

The values of these readings are based on the assumption that the left-hand index represents 1. The value of the left-hand index of any scale may be taken as any power of 0.1 or of 10; that is, it may be taken to represent 0.1, 0.01, 0.001, etc., or 10, 100, 1000, etc. If the left-hand index of the *D* scale represents 0.01, the readings in Fig. 2 must be multiplied by 0.01, so that they become 0.0102, 0.0111, 0.0136, 0.01535, 0.01683, and 0.0229. If the left-hand index represents 1000, the readings must be multiplied by 1000. When a value has been assigned to the index, the same ratio must be maintained throughout the remainder of the scale, a line on any scale always representing the same sequence of figures, but not always the same value. The scales *C* and *D* have a greater number of subdivisions between two consecutive numbers than have the scales *A* and *B* between the same num-

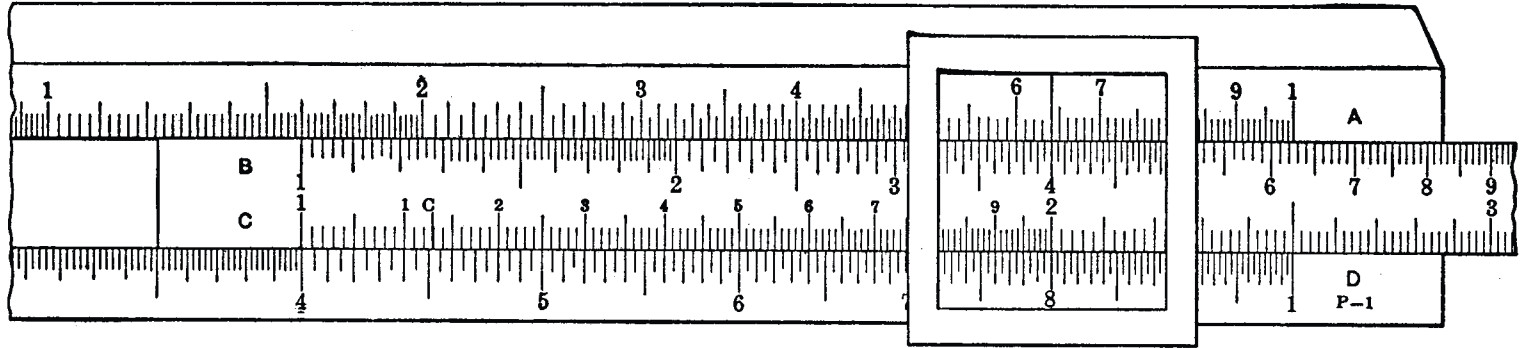


Fig. 1.

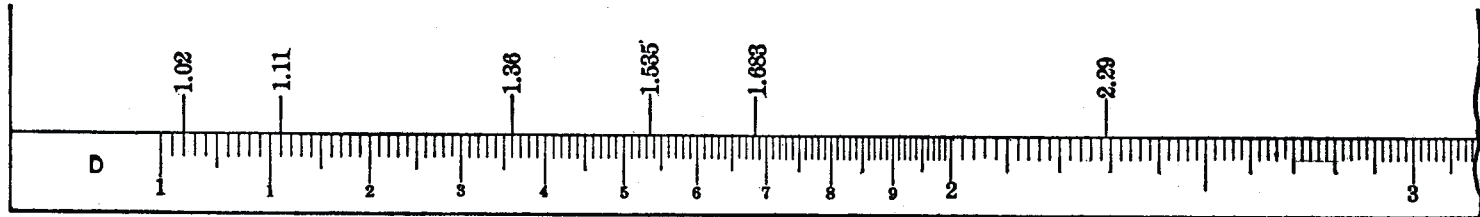


Fig. 2.

bers; therefore, it is customary to use the *C* and *D* scales for multiplications and divisions, as they can be read with greater ease and accuracy.

Multiplication of Whole Numbers.—In multiplying two numbers with the slide-rule, one index of the *C* scale is set opposite one of the numbers on the *D* scale, and the product is read on the *D* scale directly in line with the other number on the *C* scale.

Example: Find the product of 4×2 . Move the slide to the right, as shown in Fig. 1, until the left-hand index of the *C* scale is exactly in line with 4 on the *D* scale; then, directly opposite 2 on the *C* scale, read the product, 8, on the *D* scale. The hair-line on the glass plate of the runner should be used, as shown, to determine what reading on the *D* scale is opposite 2 on the *C* scale.

Example: Find the product of 7×2 . If the left-hand index of the *C* scale is set to 7 on the *D* scale, the 2 on the *C* scale will be far to the right of the end of the *D* scale, and no result can be read. In such a case as this, move the slide to the left until the right-hand index of the *C* scale is opposite 2 on the *D* scale; then, opposite 7 on the *C* scale will be found the small Fig. 4 on the *D* scale, which is the point corresponding to 1.4; but 1.4 is not the product of 7 and 2, as $7 \times 2 = 14$. However, neglecting the decimal point, the figures of the result are correct. It becomes evident, therefore, that while the slide-rule will correctly show the first two, three, or four figures of the result, it will not always indicate the correct number of figures preceding the decimal point. The following simple rule may be used to find the number of figures in the product of two whole numbers:

Rule: If the result is obtained with the slide projecting to the left, the number of figures in the product is equal to the sum of the numbers of figures in the two numbers; but, if the slide projects to the right, the number of figures in the product is one less than the sum of the numbers of figures in the two numbers.

For instance, apply this rule to the example illustrated by Fig. 1. In this case, each number contains one figure, and the slide projects to the right; therefore, the number of figures in the result must be $(1 + 1) - 1 = 1$.

Example: Let the product of 223×7285 be required. Set the right-hand index of the *C* scale to 223 on the *D* scale, as shown in Fig. 3. It is not possible to determine the exact point on the *C* scale corresponding to 7285, as that scale, between 7 and 8, can be read accurately to only two figures, while the third must be approximated. So the runner is set with its hair-line at the position corresponding to 729 on the *C* scale, as nearly as can be judged. Below, on the *D* scale, the hair-line points to 1625, as nearly as can be read; hence, 1625 forms the first four figures of the result. As the slide projects to the left, the product must contain $3 + 4 = 7$ figures, according to the rule. Therefore the first four figures 1625 must be increased to seven by the addition of ciphers at the right, giving 1,625,000. The actual product, worked out in the usual way, is 1,624,555, which shows that the slide-rule gives the correct result to the third figure.

Multiplication of Decimals.—If the numbers to be multiplied are decimals or mixed numbers, disregard the decimal points for the time being and treat each as a whole number. Find the product of the whole numbers as already explained, and then point off as many decimal places as there are in both original numbers.

Example: Let the product of 335.75×0.00264 be required. Neglecting the decimal points, these numbers become 33,575 and 264. As the scales cannot be read accurately to more than three places, the first of the numbers may be written 33,600. Set the left-hand index of the *C* scale to 336 on the *D* scale, and opposite 264 on the *C* scale, as indicated by the hair-line, read 886 on the *D* scale. As the slide projects to the right, the number of figures in the product is $5 + 3 - 1 = 7$; that is, four ciphers must be added to the three figures read on the *D* scale, giving 8,860,000 as the product of 33,600 and 264 on the rule. But the original numbers, 335.75 and 0.00264, have two decimal places and five decimal places,

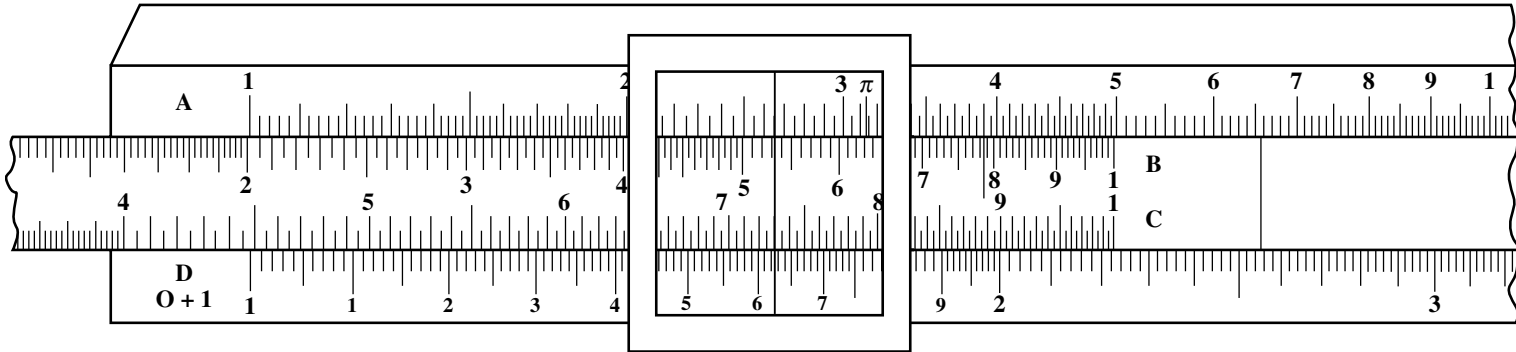


Fig. 3.

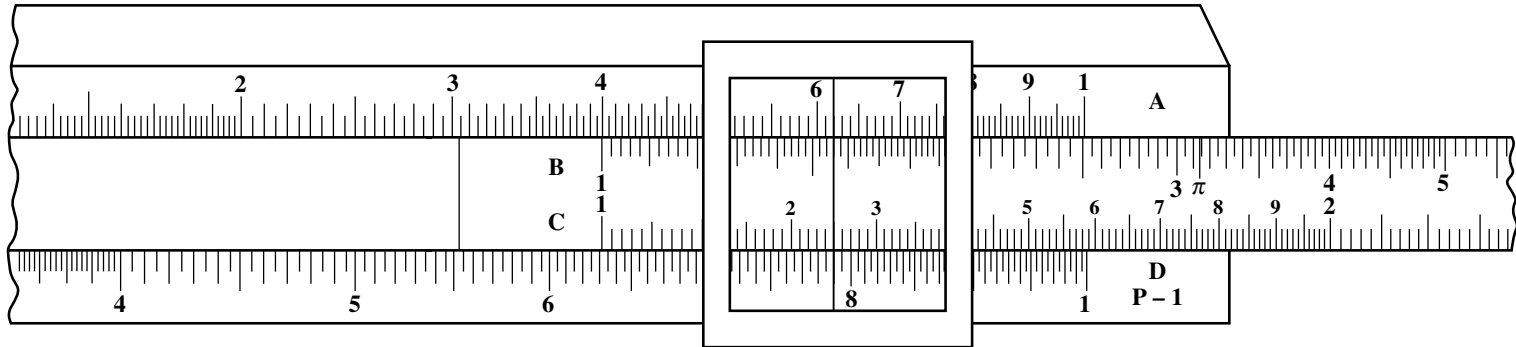


Fig. 4.

respectively, or seven decimal places in all; hence, seven places must be pointed off in the product of the whole numbers, giving 0.8860000, or simply 0.886, as the required result.

Continued Multiplication.—Continued multiplication can be performed very quickly by the use of the slide-rule. For example, suppose that the result of $6.3 \times 1.25 \times 965.5 \times 0.47$ is required. Neglecting decimal points for the time being, and writing all the numbers as whole numbers, the problem becomes $63 \times 125 \times 9655 \times 47$. Set the left-hand index of the *C* scale to 63 on the *D* scale and move the runner until the hair-line is over 125 on the *C* scale, as shown in Fig. 4. Now, without disturbing the runner, move the slide to the left until the right-hand index of the *C* scale is under the hair-line, and then, leaving the slide stationary, move the runner until the hair-line is over 9655 on the *C* scale. Finally without moving the runner set the slide with the right-hand index of the *C* scale under the hair-line. Then, without moving the slide, set the hair-line over 47 on the *C* scale. The result, read on the *D* scale under the hair-line, is 357. In obtaining this result, however, the slide projected once to the right and twice to the left; so taking the sum of the numbers of figures in all the factors, treated as whole numbers, and subtracting 1 for the time that the slide projected to the right, the number of figures in the product is found to be $(2 + 3 + 4 + 2) - 1 = 10$; that is, the product of the whole numbers is 3,570,000,000. But, the original factors contain $1 + 2 + 1 + 2 = 6$ decimal places, which must be pointed off in the final result; hence, the required product is 3570.000000, or simply 3570.

In this example there are three settings of the slide, each representing one process of multiplication. The first gives the product of 63 and 125; the second gives the product of (63×125) and 9655; and the third gives the product of $(63 \times 125 \times 9655)$ and 47. The hair-line on the runner serves to designate the product obtained at each setting.

Division of Whole Numbers.—Division is simply a reversal of multiplication. The number to be divided, or the dividend, is found on the *D* scale, and the hair-line of the runner is set over it. The divisor is found on the *C* scale and is set directly under the hair-line, also. The quotient is then read from the *D* scale at a point opposite the index of the *C* scale. In performing the division of whole numbers by the aid of the slide-rule, two cases may arise: The dividend may exceed the divisor or the divisor may exceed the dividend. If the dividend is the greater, the quotient will be a whole number or a mixed number. To find the number of figures in the whole-number part of the quotient, the following simple rule may be used:

Rule: If the slide projects to the left, the number of figures in the whole number part of the quotient is equal to the difference between the number of figures in the dividend and the number of figures in the divisor; but, if the slide projects to the right, the number of figures in the whole-number part of the quotient is 1 plus this difference.

Example: To illustrate the application of this rule, suppose that the quotient of $1325 \div 592$ is required. Set the runner so that the hair-line is directly over 1325 on the *D* scale, as in Fig. 5. Next, without moving the runner, set the slide so that 592 on the *C* scale is directly under the hair-line. Then, opposite the right-hand index of the *C* scale will be found 224 on the *D* scale. As there are four figures in the dividend and three in the divisor, and the slide projects to the left, the number of figures in the whole-number part of the quotient, according to the rule, is $4 - 3 = 1$; therefore, the result is 2.24.

When Divisor is Greater than Dividend.—If the divisor is greater than the dividend, a different rule must be used, because the result will then be wholly a decimal. The slide and the runner are set in the same way as previously described, but the decimal point is located according to the following rule:

Rule: If the slide projects to the left, the number of ciphers between the decimal point and the first figure of the quotient is equal to the difference between the number of figures in the divisor and the number of figures in the dividend; but, if the slide projects to the right, the number of ciphers is 1 less than this difference.

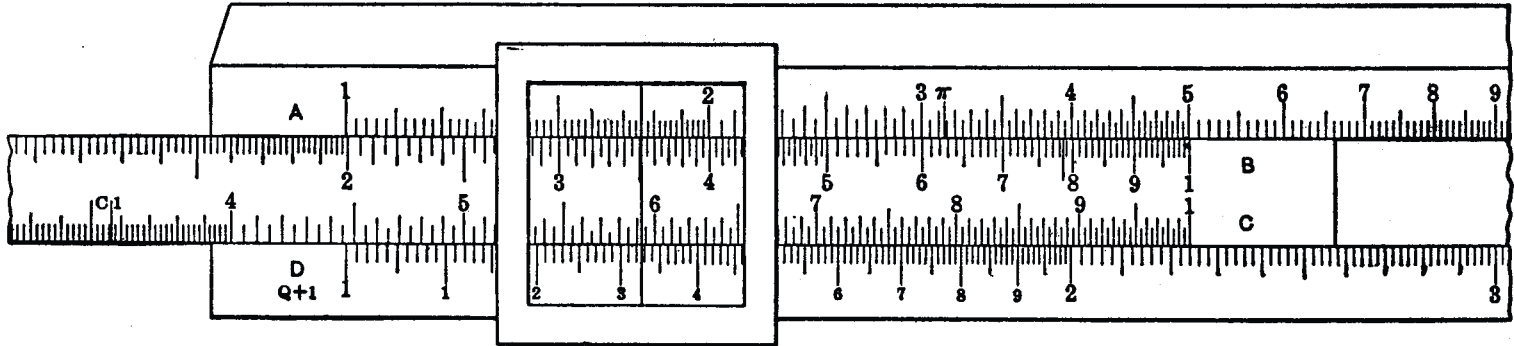


Fig. 5.

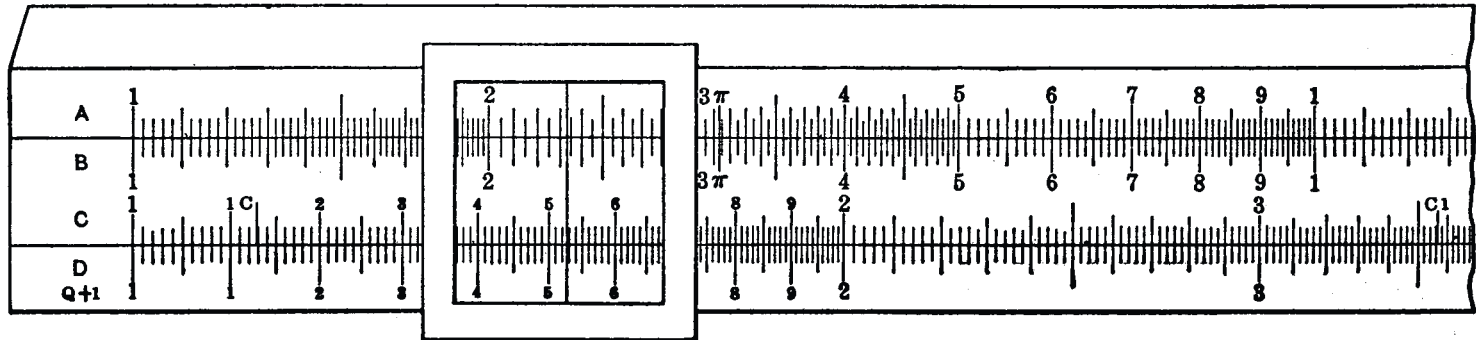


Fig. 6.

Example: Let the quotient of $176 \div 625$ be required. Setting the runner and the slide as already explained, the result is found to be 282, with the slide projecting to the left. Then, the number of ciphers between the decimal point and the first figure must be $3 - 3 = 0$, since the divisor and the dividend each three figures; that is, the first figure immediately follows the decimal point, and the result is 0.282.

Division of Decimals.—The division of decimals and mixed numbers by means of the slide-rule does not differ in principle from the division of whole numbers. The only difficulty that arises is that of locating the decimal point in the quotient. As the adding of ciphers to the right of a decimal number does not affect its value — that is, $0.2 = 0.20 = 0.200$, and so on — the following rule may be formulated:

Rule: If the problem requires the division of decimals, add ciphers to either the dividend or the divisor until both have the same number of decimal places. Then ignore the decimal points in the new numbers thus obtained, converting them into whole numbers, perform the division as already explained, and locate the decimal point by the proper rule as given in connection with the division of whole numbers.

Example: As an illustration of the method to be followed, let the quotient of $0.236 \div 926$ be required. The divisor, 926, may be written 926.000 without changing its value, and the problem then becomes $0.236 \div 926,000$; or, dropping the decimal points, and treating both as whole numbers, the problem is $236 \div 926,000$. The runner and slide are set as explained for whole numbers. The slide projects to the left and the quotient on the *D* scale is 255. There are six figures in the divisor and three in the dividend; hence, the number of ciphers intervening between the decimal point and the first figure is $6 - 3 = 3$. The result, therefore, must be 0.000255.

Squares of Numbers.—The squares and square roots of numbers can readily be found by using the slide-rule. The *A* and *D* scales only are used in finding the square of a number. Set the runner so that the hair-line stands over the number on the *D* scale and the square of that number will be found on the *A* scale under the hair-line.

Example: Find the square of 152.7. Set the runner, as shown in Fig. 6, so that the hair-line is over 1527 on the *D* scale, and under the hair-line on the *A* scale will be found 233. The number of whole-number places and decimal places in the square can easily be found. If the result is read from the left-hand *A* scale, the square contains one less than twice as many figures as there are in the original number; whereas, if it is read from the right-hand *A* scale, the square contains twice as many figures as the original number; and if there is a decimal, there will be twice as many places as in the original number. In the above problem, the original number contains four figures and the result is found on the left-hand *A* scale; hence, the number of figures in the square is $(2 \times 4) - 1 = 7$. There must also be $2 \times 1 = 2$ decimal places in the final result. Therefore, adding ciphers to 233 to make seven figures and then pointing off two decimal places, the required square is found to be 23,300.00, or 23,300.

Square Root.—The square root of a number is found by reversing the process of finding the square; that is, the number is located on the *A* scale and the root is found directly below, on the *D* scale, the hair-line being used to make the readings accurately. If the number is a whole number or a mixed number and contains an *odd* number of figures in the whole-number part, or if it is wholly a decimal and has an *odd* number of ciphers directly following the decimal point, the left-hand *A* scale must be used; in all other cases, the right-hand *A* scale is used. Let N represent the number of figures in the whole-number part, N' the number of ciphers directly following the decimal point, in the root, and n the same numbers in the original number.

Then, if the left-hand *A* scale is used, $N = \frac{n+1}{2}$ and $N' = \frac{n-1}{2}$

If the right-hand *A* scale is used, $N = N' = \frac{n}{2}$

The finding of a square root is illustrated in Fig. 6.

Example: Let the square root of 2.33 be required. As there is an odd number of figures in the whole-number part, the left-hand *A* scale is used, and below, on the *D* scale, 1527 is read. With the left-hand *A* scale in use,

$$N = \frac{n+1}{2} = \frac{1+1}{2} = 1$$

Hence, the square root is 1.527.

It is very probable that the number of figures preceding the decimal point, or the number of ciphers following the decimal point, in a square root can be determined more easily and quickly by inspection than by the foregoing rules, because by pointing off the given number into periods of two figures each, as taught in arithmetic, the desired information as to the location of the decimal point in the root can be seen at a glance. It is absolutely necessary, however, to use some form of rule, such as that given, to determine whether the left-hand or the right-hand *A* scale is to be used.

Cubes of Numbers.—Finding the cube of a number requires the use of all four scales. The index of the *C* scale is set to the given number on the *D* scale and, opposite the same number on the *left-hand B* scale, the cube is read from the *A* scale. Three cases may arise, as follows:

Case I: The slide may project to the left and the cube be found on the left-hand *A* scale.

Case II: The slide may project to the right and the cube be found on the right-hand *A* scale.

Case III: The slide may project to the right and the cube be found on the left-hand *A* scale.

If the number contains a decimal, ignore the decimal point for the time being and treat it as a whole number. Let N represent the number of figures in the cube and n the number of figures in the given number. Then:

$N = 3n$, for *Case I*;

$N = 3n - 1$, for *Case II*;

$N = 3n - 2$, for *Case III*.

After the total number of figures has been found by one of these rules, point off three times as many places as there are decimal places in the given number, and the result will be the required cube of the given number:

Example: To illustrate, suppose that 36.8^3 is to be found. Treat it as a whole number, 368, and set the left-hand index of the *C* scale to 368 on the *D* scale, as in Fig. 7. Then, opposite 368 on the left-hand *B* scale will be found 5 on the *A* scale. As this setting falls under *Case II*, $N = (3 \times 3) - 1 = 8$; hence, the reading is 50,000,000. There is one decimal place in the given number, so that three places must be pointed off in the result, giving 50,000.000, or simply 50,000, as the required cube.

The cube can be found quite as readily by multiplying the number together three times; that is, $36.8^3 = 36.8 \times 36.8 \times 36.8$. This continued multiplication can be performed as previously described, and the position of the decimal point be determined by the rules given in that connection. This method will doubtless be found easier to remember than the one outlined above, involving three cases with as many different rules.

Cube Root.—The operation of finding the cube root is the reverse of finding the cube, and the method of determining the number of figures in the root, preceding or following the decimal point, is the same as that used in arithmetic; that is, the number is pointed off into periods of three figures each, beginning at the decimal point, and the root then contains one figure for each period or part of a period. If the number contains a decimal, add ciphers to the right of it, if necessary, so that the number of figures in the decimal part will be exactly divisible by 3, without a remainder. The scales and indexes to be used in finding the cube

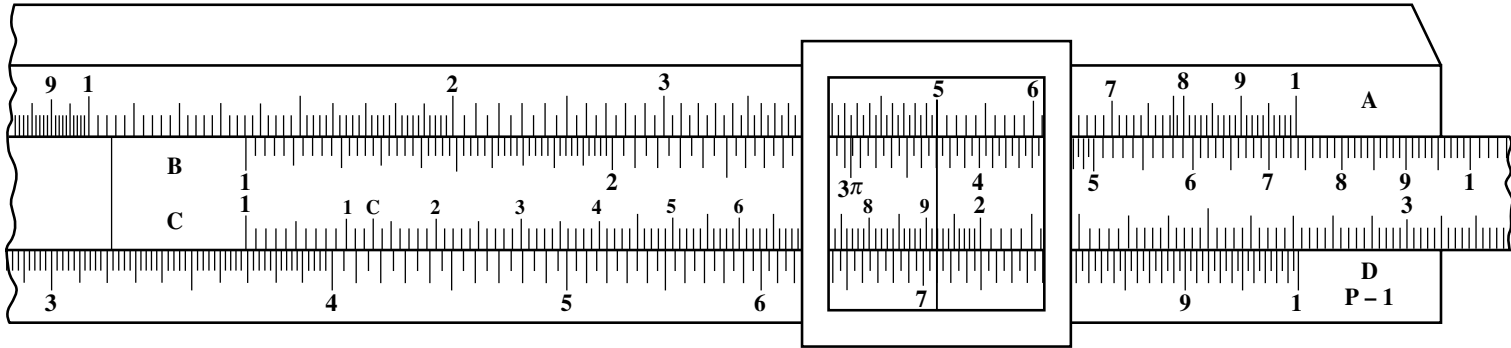


Fig. 7.

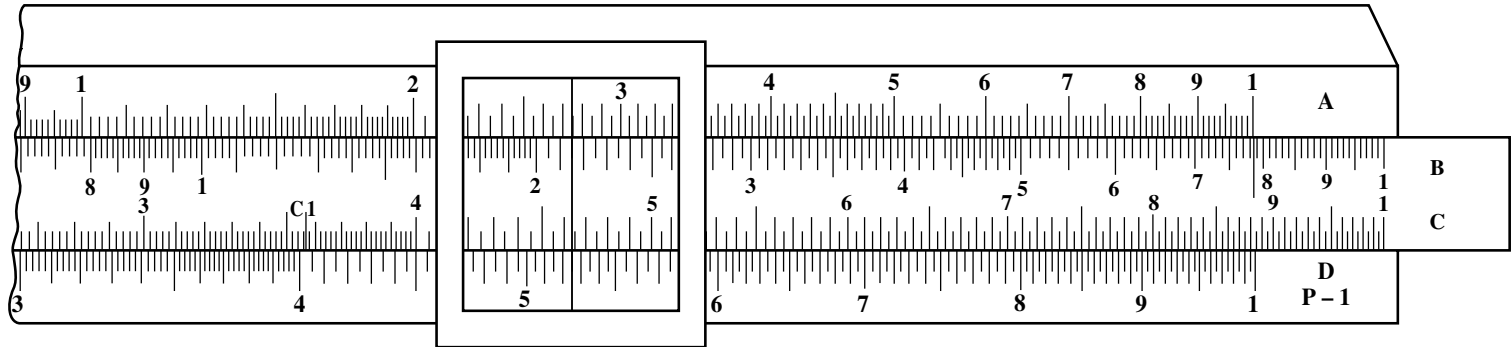


Fig. 8.

root depend upon the number of figures in the first period at the left, not counting ciphers when they *immediately* follow the decimal point. The rules to be followed are:

Case I: If there are three figures in the first period, use the left-hand *A* scale, left-hand *B* scale, and the right-hand index of the *C* scale.

Case II: If there are two figures in the first period, use the right-hand *A* scale, left-hand *B* scale, and the left-hand index of the *C* scale.

Case III: If there is one figure in the first period, use the left-hand *A* scale, left-hand *B* scale and the left-hand index of the *C* scale.

Example: Find the cube root of 0.05. Add ciphers to make three figures, giving 0.050, thus forming one period of three figures. This indicates that the first figure of the root immediately follows the decimal point. As there are two figures, 50, in the first period, "050," the right-hand *A* scale and the left-hand index of the *C* scale are used. Set the runner so that the hair-line is across 5 on the right-hand *A* scale, as in Fig. 7. Then move the slide until the reading on the left-hand *B* scale under the hair-line is exactly equal to that on the *D* scale opposite the left-hand index of the *C* scale. This reading on the *D* scale, 368, is the result required. The first figure of the root must follow the decimal point; therefore, the root is 0.368.

Use of K Scale for Cubes and Cube Roots: Some slide rules are equipped with a *K* scale for finding cubes and cube roots in one setting. To find the cube of a number, set the runner so that the hair-line stands over the number on the *D* scale; read the cube on the *K* scale.

To find the cube root of a number the reverse procedure is used, that is, the hair-line is set over the number on the proper section of the *K* scale and the cube root is read on the *D* scale. To determine which of the three sections of the *K* scale to use, point off the number into periods of three figures, starting at the decimal point; the number of digits in the extreme left-hand period will indicate the section of the *K* scale to use. For example, 4'567.89 has one digit in the extreme left-hand period; therefore, use the left section of the *K* scale. The number 45'678.9 has two digits; use the center section of the *K* scale. The number 456'789 has three digits; use the right section of the *K* scale.

For the Cube Root of a Decimal Fraction: Count the number of zeros between the decimal point and the first significant figure; divide the number of zeros by 3; if the remainder is 2, use the left section of the *K* scale; if the remainder is 1, use the center section; and if the remainder is 0, use the right section. For example, the number 0.000000082 has 7 zeros before the 8 so that $7 \div 3 = 2$ and 1 left over, therefore, use the center section of the *K* scale.

Diameters and Circumferences of Circles.—The ratio of the circumference of a circle to the diameter is $3.1416 = \pi$, and this value is marked by an extra line on the *A* and *B* scales, on many rules. It is used in finding the circumference from the diameter by multiplication, or the diameter from the circumference by division. In either instance, the *A* and *B* scales are used. The left-hand index of the *B* scale is set to π on the *A* scale, and opposite the given diameter on the *B* scale is read the circumference on the *A* scale; or, the value π on the *B* scale is set to the given circumference on the *A* scale, and opposite the index of the *B* scale the required diameter is read from the *A* scale. This multiplication or division is performed exactly as in using the *C* and *D* scales for the same kind of operation.